

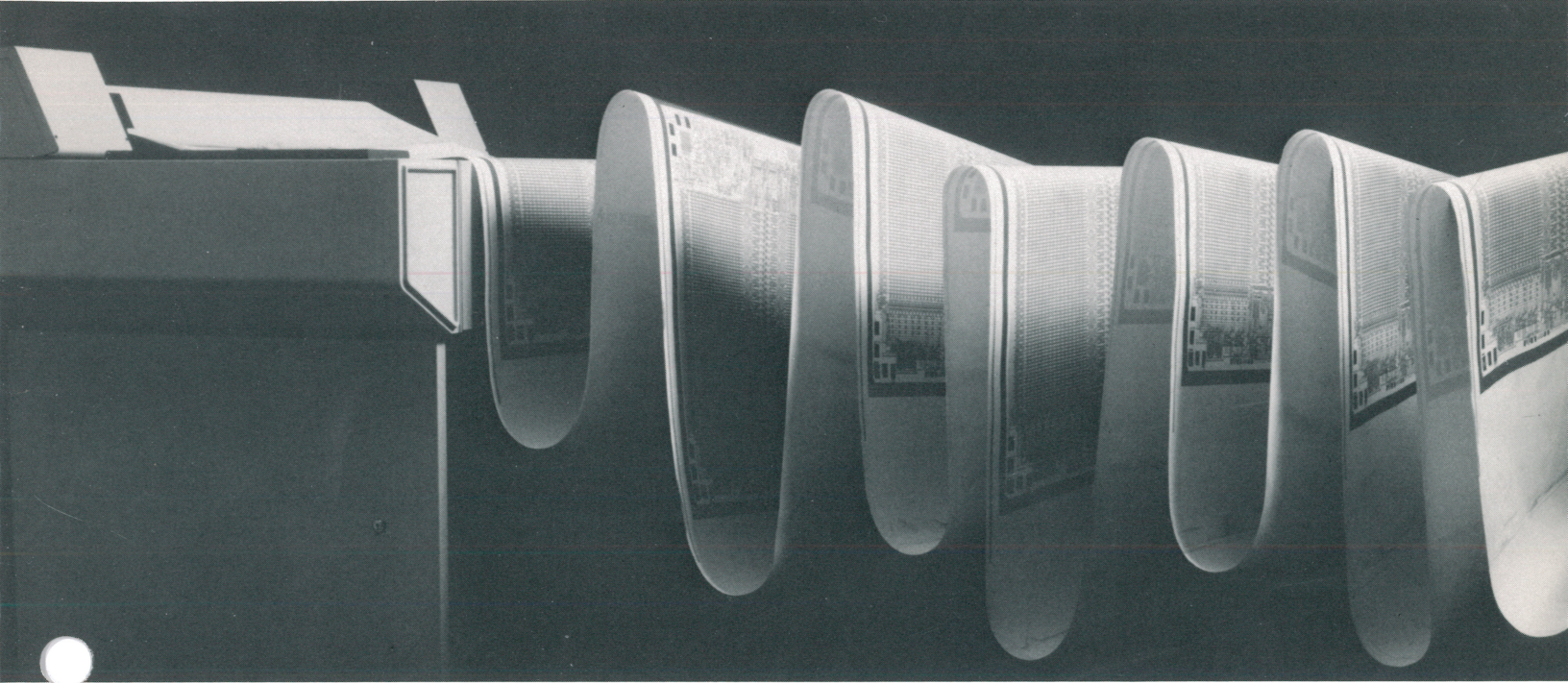

**Electrographic supplies.
The critical difference.**

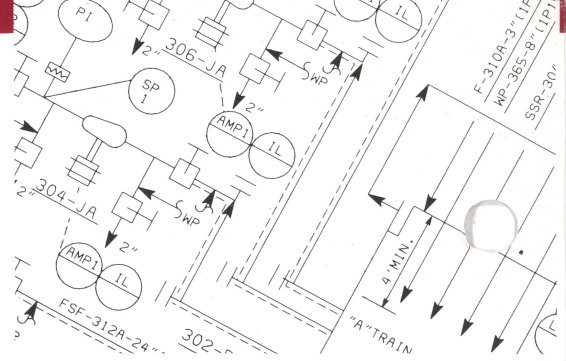

Are you getting the plot quality you deserve?



Each one of us who has worked with electrostatic plotters has shared the same experience. The plotter is producing excellent output, but when you change paper or film, quality changes. The wrong paper. A different brand of film. Improperly stored supplies. An unknown toner. All can reduce the quality of hard copy output.

Media may play a relatively unimportant role in some hard copy technologies, but it is a critical component of the electrostatic plotting technique. If the paper or film does not hold the appropriate electrical charge, there is no image. Any deviation from standard reduces image quality.

Your electrographic supplies do make a difference. The paper or film must maintain consistent, correct dielectric surface resistivity and conductive substrate. Precise location and proper density of sensor marks assure correct form feed, top-of-form (fan-fold), and sensing of "low" and "out" supply conditions. Protective packaging is necessary to shield paper from humidity, an especially critical factor in color and high resolution plotting.

Versatec does more to assure that electrographic supplies deliver the plot quality you deserve. It can make the critical difference in your satisfaction.

Improving quality.

Versatec established its own materials research group in 1977. Responsible for more than fifty patents, this group includes chem-

ists, chemical engineers, physicists, electrical engineers, and materials scientists. They have improved coating formulations, processes, yields, and testing methodology.

Materials research is dedicated primarily to improving paper, film, and toner. Versatec researchers evaluate existing products, develop new materials, and help customers solve specific application problems. They continue to improve materials and coatings,



study environmental issues, and enhance electrostatic plotting price/performance.

Versatec researchers have developed papers with lower background and higher contrast images, films with improved dielectric coating, blacker, smudge-resistant toners and new exclusive color toners. They have tested materials for chemical resistance, wear resistance, electrical conductance, and temperature stability.

VERSATEC'S SCANNING ELECTRON MICROGRAPHS REVEAL THE MICRO-TOPOGRAPHY OF THE PAPER SURFACE.

200X

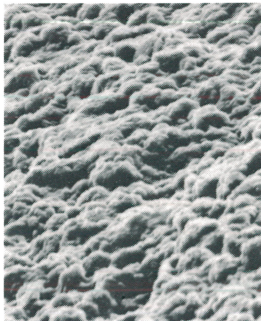

500X

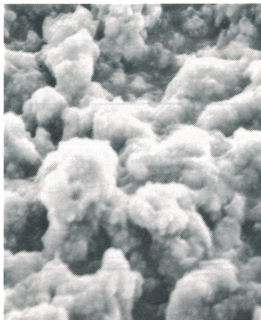

500X

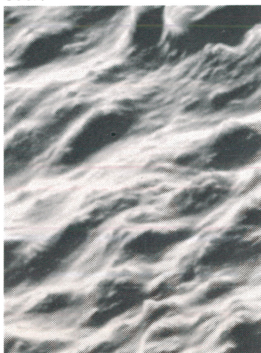

TESTS OF MEDIA AND TONER WITH VARIOUS VERSATEC PLOTTERS OFFER REAL-WORLD PERFORMANCE EVALUATION.



PROCESS DIAGRAM

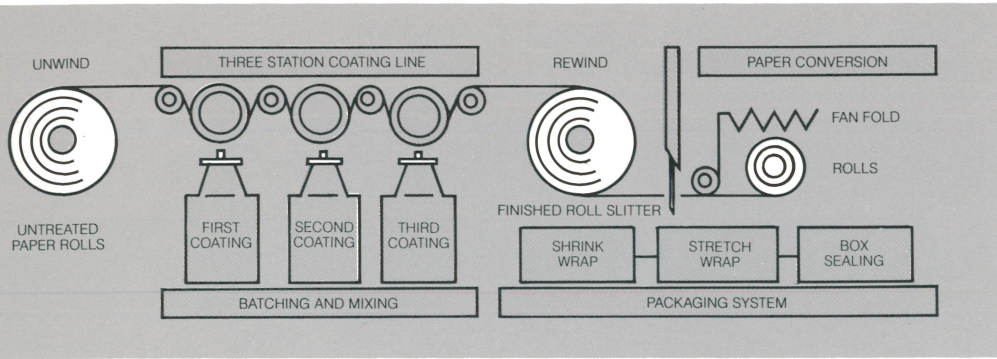

At quality control laboratories in Santa Clara, California and Oklahoma City, Oklahoma, Versatec media undergoes over 35 analytical and performance tests. Brightness. Coating thickness. Charge acceptance. Surface roughness. Curl. And more.

But Versatec does more than test supplies. Versatec is the only manufacturer to warranty the compatibility of hardware with supplies. We test the complete output system—plotter, media, and toner—in actual plotting applications. Does the image maintain the appropriate density. Is contrast sufficient? Does this plot represent the best in Versatec quality?

Research and quality control assure ever improving appearance, utility, and continuity of your plotting images.

Building in quality.

Our own specialized paper coating plant in Oklahoma City gives Versatec better control of quality and cost. Devoted exclusively to production of electrographic media for our plotters, the plant is optimized to meet Versatec's special electrical, chemical, and physical requirements. The plant further improves plotter output quality, reduces supplies cost, and improves customer service.

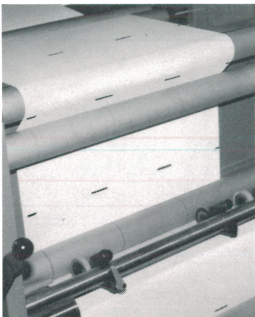

The plant uses three process control computers to monitor and control the production of more than 1.8 million square feet of paper per shift. Base web stock is coated with one dielectric and two conductive coats, cut to proper width and length, and packaged for

shipment. The 50,000 square foot facility also includes a fully equipped quality control laboratory.

The most modern automated facility of its kind in the United States, the plant is one of only four such facilities capable of precision coating across a 79-inch web. Direct Versatec process control and on-site acceptance testing assure fast reaction feedback and process correction.

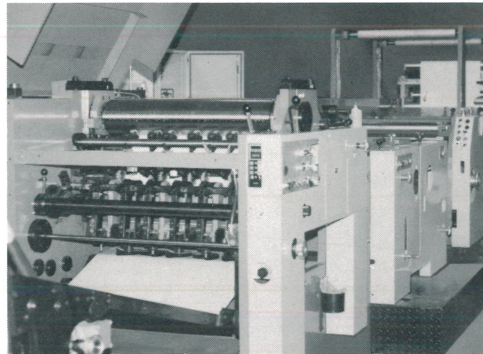

Quality through service.

The best research, manufacturing, and quality control have no value until their benefits are delivered to your plotting application. Your direct link with Versatec is your own supplies sales specialist.

The supplies sales specialist has direct responsibility for your account. Dedicated to



helping you obtain quality output, this specialist can help you determine the supplies that best meet your needs. What's new, what's improved, what's best for your special requirements? What order quantities and frequency will provide a smooth flow of supplies while avoiding excessive inventories or critical shortages? Your supplies sales specialist has the answers.

Call toll free at (800) 538-6468, in California (800) 672-3307, in Canada (800) 268-3335, or direct at (408) 748-3080.

But what if a phone call doesn't solve your problem? Then a regional Versatec supplies technical supplies representative will come to your facility and investigate the problem. Versatec is the only plotter manufacturer that offers service and support people for both hardware and supplies.

Instead of finger-pointing, you get an answer that considers the entire plotting system. And if on-site service can't resolve the problem, we call in headquarters equipment and materials research support.

Research. Manufacturing. Quality control. Direct sales and service support. You get it all with Versatec supplies—the critical difference in plotting. So get the plot quality you deserve. Specify Versatec supplies.

Related Versatec products.

Versatec offers a complete line of hard copy output equipment including: monochrome and color electrostatic plotters in narrow and wide formats; thermal transfer color plotters; high speed rasterizers; interfaces; controllers; software and supplies.

The Supplies Division of Versatec offers both electrographic and thermal transfer supplies. Toners, papers and film are available for Versatec electrostatic plotters. Thermal transfer supplies include ink donor rolls, cut sheet paper and film transparencies. Versatec supplies you with the complete plotting solution!

VERSATEC LABORATORIES TEST THE CHEMICAL PURITY OF VERSATEC SUPPLIES.

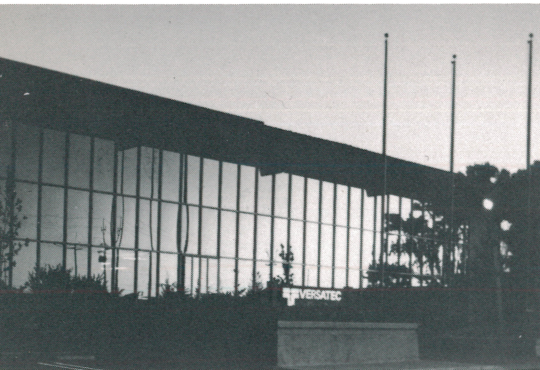

Versatec, a Xerox company, is the world's leading manufacturer of electrostatic printers, plotters and output systems. Versatec has sold more electrostatic output devices than all other competitors combined. We offer more electrostatic models (both color and monochrome), thermal transfer color plotters, interfaces, rasterizers, controllers, software packages, supplies and accessories.



Versatec Headquarters
2710 Walsh Avenue
Santa Clara, California 95051
Telephone (408) 988-2800
Telex 334421

Versatec Canada
251 Consumers Road, Ste. 802
Willowdale, Ontario M2J 4T5
Telephone: 416-494-8204
Telex: 06-0986616

Technical Supplies Representative locations:

Boston: (617) 229-6740
Detroit: (313) 348-5100
Dallas: (214) 620-7620
Santa Clara: (408) 988-2800

Versatec (SA)
Rue de College Saint Michel 9
1150 Brussels
Belgium
Telephone: 32-2-771 9907
Telex: 61286 VSCBRU B

Versatec, Inc. (UK)
Versatec Electronics Ltd. (VEL)
5 Oxford Road
Newbury, Berkshire RG13 1QD
England
Telephone: 44-635-30778
Telex: 847259 VTECUK G

Versatec France
Immeuble Le Baltique
Avenue De Le Baltique
ZA De Courtaboeuf
91940 Les Ulis
France
Telephone: 33-1-6446-1414
Telex: 692235 VERSAT F

Versatec GmbH
Kolpingring 18A
D-8024 Oberhaching
West Germany
Telephone: 49-89-61003-1
Telex: 897407 VETEC D

Versatec (BV)
Strijkviertel 35
3454 PJ De Meern
Netherlands
Telephone: 31-3406-64504
Telex: 70880 VETEC NL

Fuji-Xerox Co. Ltd.
2-11, Nishi-Shinjuku 3 Chome
Shinjuku-ku
Tokyo 160
Telephone: 81-3-342-7481
Telex: 78124988
Cable: FUJIXEROX TOKYO