

ATTN: CHARLIE GIBBS

00657
CAV208M45541 UP 8250 R 3

SPERRY UNIVAC UAS
SUITE 906
1177 WEST HASTINGS ST
VANCOUVER BC V6E 2K3 CAV
##

General
0776 Printer Subsystem
Operator Reference
UP-8250 Rev. 3

This Library Memo announces the release and availability of "SPERRY UNIVAC® 0776 Printer Subsystem Operator Reference", UP-8250 Rev. 3.

This revision provides additional information on operating controls for the printer.

References that are no longer applicable have been deleted.

Destruction Notice: This revision supersedes and replaces "SPERRY UNIVAC 0776 Printer Subsystem Operator Reference", UP-8250 Rev. 2, released on Library Memo dated June, 1981. Please destroy all copies of UP-8250 Rev. 2 and/or its Library Memo.

Additional copies may be ordered by your local Sperry Univac representative.

LIBRARY MEMO ONLY	LIBRARY MEMO AND ATTACHMENTS	THIS SHEET IS
Mailing Lists BZ, CZ (less DE, GZ, HA) MZ, 10, 11, 20, 21, 75, 76, 77 and 78	Mailing Lists DE, GZ, HA, 28U and 29U (Covers and 57 pages)	Library Memo for UP-8250 Rev. 3
		RELEASE DATE: March, 1982

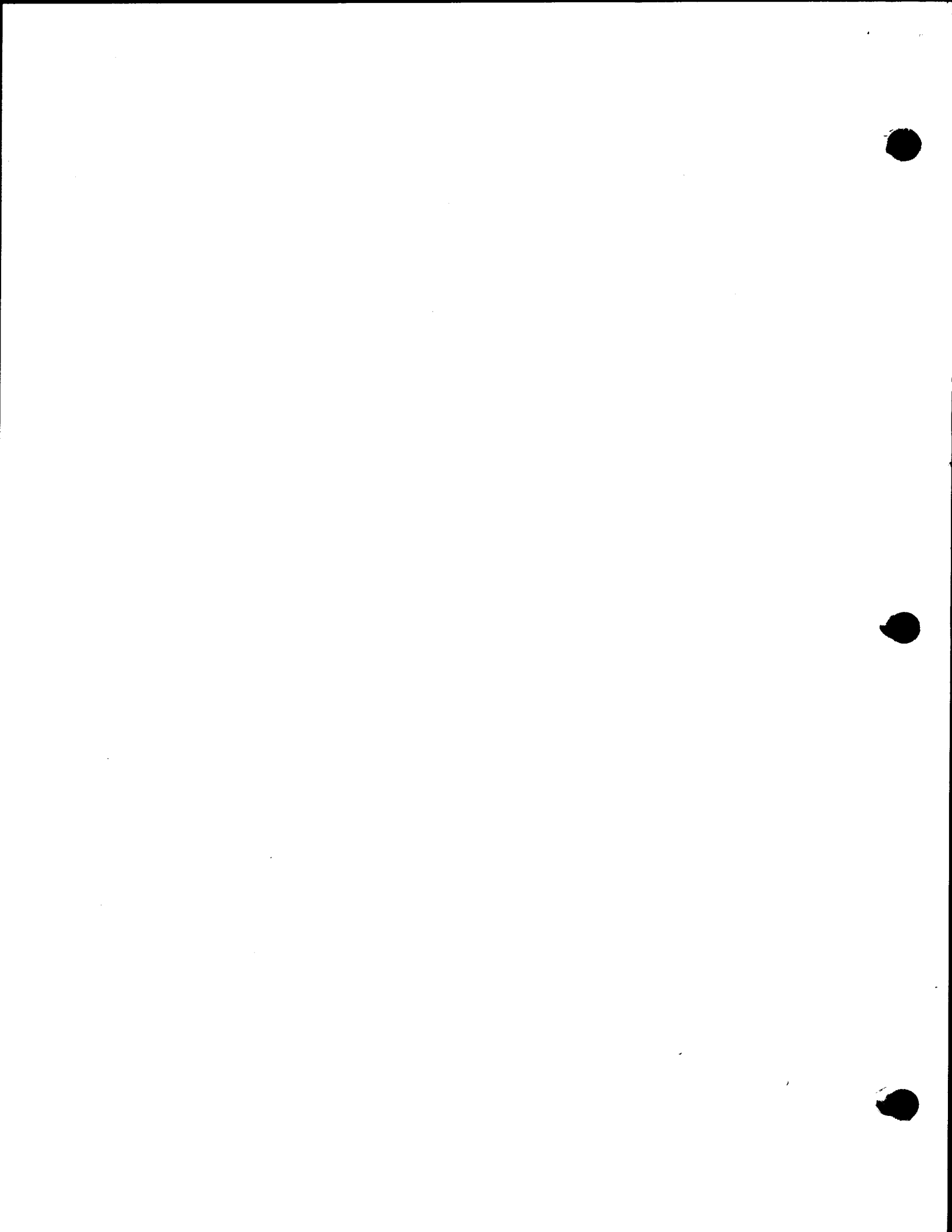

0776 Printer Subsystem

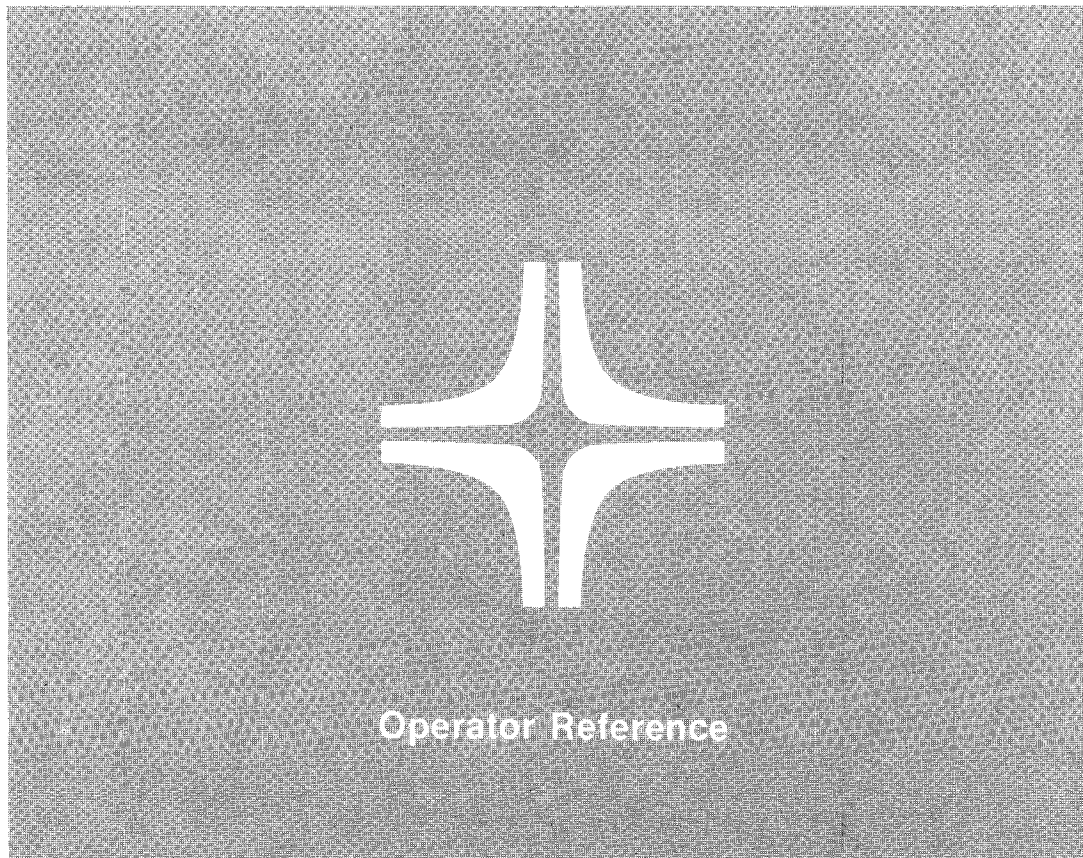

This document contains the latest information available at the time of preparation. Therefore, it may contain descriptions of functions not implemented at manual distribution time. To ensure that you have the latest information regarding levels of implementation and functional availability, please consult the appropriate release documentation or contact your local Sperry Univac representative.

Sperry Univac reserves the right to modify or revise the content of this document. No contractual obligation by Sperry Univac regarding level, scope, or timing of functional implementation is either expressed or implied in this document. It is further understood that in consideration of the receipt or purchase of this document, the recipient or purchaser agrees not to reproduce or copy it by any means whatsoever, nor to permit such action by others, for any purpose without prior written permission from Sperry Univac.

Sperry Univac is a division of the Sperry Corporation.

FASTRAND, SPERRY UNIVAC, UNISCOPE, UNISERVO, and UNIVAC are registered trademarks of the Sperry Corporation. ESCORT, MAPPER, PAGEWRITER, PIXIE, and UNIS are additional trademarks of the Sperry Corporation.

This document was prepared by Systems Publications using the SPERRY UNIVAC UTS 400 Text Editor. It was printed and distributed by the Customer Information Distribution Center (CIDC), 555 Henderson Rd., King of Prussia, Pa., 19406.

PAGE STATUS SUMMARY

ISSUE: UP-8250 Rev. 3

Part/Section	Page Number	Update Level	Part/Section	Page Number	Update Level	Part/Section	Page Number	Update Level
Cover/Disclaimer								
PSS	1							
Contents	1 thru 3							
1	1							
2	1 thru 7							
3	1 thru 14							
4	1 thru 25							
5	1 thru 4							
User Comment Sheet								

All the technical changes are denoted by an arrow (→) in the margin. A downward pointing arrow (↓) next to a line indicates that technical changes begin at this line and continue until an upward pointing arrow (↑) is found. A horizontal arrow (→) pointing to a line indicates a technical change in only that line. A horizontal arrow located between two consecutive lines indicates technical changes in both lines or deletions.



Contents

PAGE STATUS SUMMARY

CONTENTS

1. INTRODUCTION

2. SUBSYSTEM DESCRIPTION

2.1.	GENERAL	2-1
2.2.	HARDWARE ELEMENTS	2-3
2.2.1.	Print Mechanism	2-3
2.2.1.1.	Print Hammer/Actuator Assembly	2-3
2.2.1.2.	Print Carriage	2-4
2.2.2.	Ribbon Feed Mechanism	2-4
2.2.3.	Forms Handling Mechanism	2-4
2.2.4.	Control Electronics	2-5
2.2.4.1.	Character Control	2-5
2.2.4.2.	Vertical Format Control	2-5
2.3.	PRINTER CONTROL	2-5
2.3.1.	Print Line Buffer	2-6
2.3.2.	Vertical Format Buffer	2-6
2.3.3.	Load Code Buffer	2-6
2.3.4.	Operating Modes	2-6

3. CONTROLS AND INDICATORS

3.1.	GENERAL	3-1
3.2.	OPERATOR CONTROL PANEL	3-2
3.3.	POWER SUPPLY	3-5
3.4.	LOWER TRAY SWITCH	3-6
3.5.	POWER CONTROL PANEL	3-6
3.6.	INTERNAL ADJUSTMENT CONTROLS	3-8

4. OPERATION

4.1.	GENERAL	4-1
4.2.	TURN-ON PROCEDURE	4-1
4.3.	TURN-OFF PROCEDURE	4-2
4.4.	FORMS LOADING	4-2
4.4.1.	Forms Loading, Condition 1	4-3
4.4.2.	Forms Loading, Condition 2	4-11
4.4.3.	Forms Loading, Condition 3	4-13
4.5.	RIBBON REPLACEMENT	4-16
4.6.	PRINT BAND CARTRIDGE REPLACEMENT	4-20
4.7.	PRINT PHASING ADJUSTMENT	4-21
4.8.	PRINT GAP ADJUSTMENT	4-22
→ 4.9.	UNLOADING FORMS STACKER (1200-LPM PRINTER ONLY)	4-22
4.10.	PAPER ADVANCE	4-23
4.10.1.	Manual Paper Advance	4-23
4.10.2.	Program Controlled Paper Advance	4-23
4.11.	RECOVERY PROCEDURES	4-24

5. OPERATOR-PERFORMED MAINTENANCE

5.1.	GENERAL	5-1
5.2.	CLEANING REQUIREMENTS	5-1
5.2.1.	Cabinet	5-1
5.2.2.	Print Band Cartridge	5-1
→ 5.2.3.	Forms Stacker (1200-Lpm Printer Only)	5-2
5.3.	INDICATOR LAMP REPLACEMENT	5-2

USER COMMENT SHEET**FIGURES**

1-1.	SPERRY UNIVAC 0776 Printer Subsystem	1-1
2-1.	Impact Printing Technique	2-2
2-2.	Print Cartridge Assembly	2-2
2-3.	Major 0776 Printer Hardware Elements	2-3
3-1.	0776 Printer, Front and Rear Views	3-1
3-2.	Operator Control Panel	3-2
3-3.	Power Supply	3-5
3-4.	Power Control Panel	3-6
3-5.	Location of Internal Adjustment Controls	3-8
4-1.	Preliminary Adjustments for Forms Loading	4-3
4-2.	Print Carriage Assembly, Closed	4-4
4-3.	Printer, Opened to Receive Forms (Carriage Assembly Fully Open)	4-5
4-4.	Form Alignment Tick Placement	4-6
4-5.	Form Alignment	4-7
4-6.	Form Feed Configuration	4-10
4-7.	Forms Stacker (1200-Lpm Printer)	4-10
4-8.	Print Carriage Assembly Open and Removable Roller in Place	4-16
4-9.	Ribbon Shield Open	4-17
4-10.	Removing Upper Takeup Spool	4-18
4-11.	Removing Upper and Lower Takeup Spools	4-19
4-12.	Printer Ribbon Threading Path	4-19
4-13.	Alignment of Print Cartridge Assembly	4-21
4-14.	Example of Correct Print Phasing	4-22
5-1.	Removing Lens from Lamp	5-2
5-2.	Removing Lamp from Socket	5-3
5-3.	Inserting New Lamp into Switch/Indicator Socket	5-3
5-4.	Pressing Lamp into Socket	5-4
5-5.	Replacing Lens of Switch/Indicator	5-4

TABLES

3-1.	Operator Control Panel, Controls and Indicators	3-3
3-2.	Power Supply Circuit Breakers	3-7
3-3.	Power Control Panel, Controls and Indicators	3-7
3-4.	Internal Adjustment Controls	3-9
4-1.	Operator Recovery Procedures	4-24



1. Introduction

This manual contains subsystem descriptions and procedures for operating the SPERRY UNIVAC 0776 Printer Subsystem (Figure 1-1). The 0776 printer is a freestanding, impact type, cartridge (print band) printer.

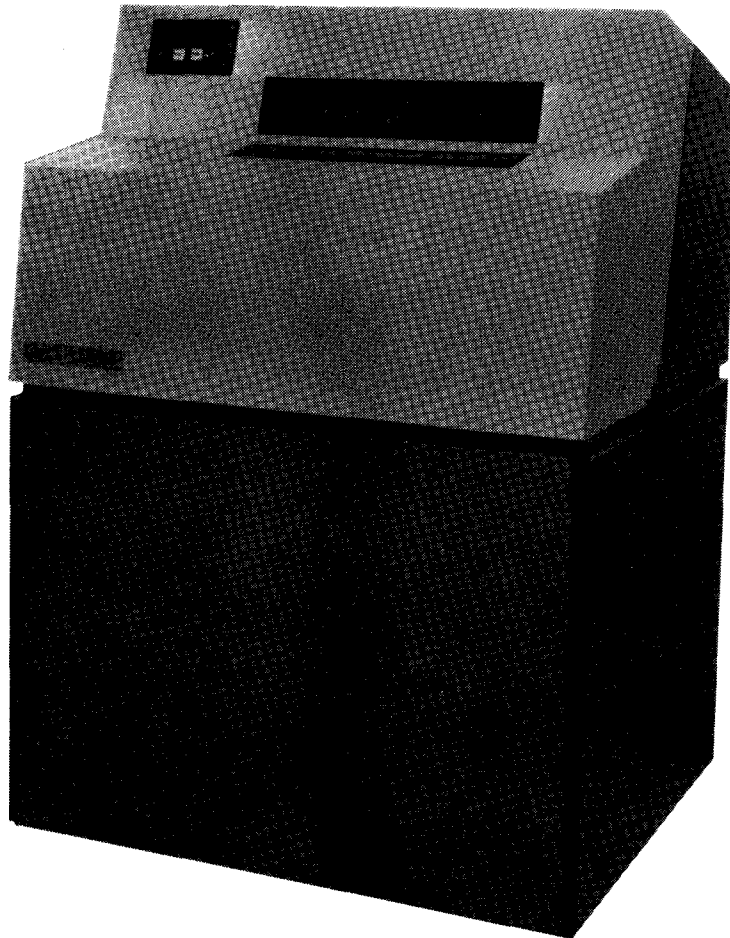

Figure 1—1. SPERRY UNIVAC 0776 Printer Subsystem

The 0776 printer provides excellent print quality from print font characters etched on a metal band that travels in a continuous direction across the front of a printed form. This results in excellent horizontal alignment of the printed characters at extremely high speed.



2. Subsystem Description

2.1. GENERAL

The 0776 printer operates at a throughput rate of 760, 940/900, or 1200 lines/minute (lpm) with a 48-character array, depending on the printer selected. The printer is the impact type in which the print hammers (136) strike the rear of a form pack, forcing the pack into contact with an inked ribbon and the etched characters on the moving print band (Figure 2-1). Printing occurs asynchronously (not dependent on initial position of characters on moving print band) when a selected character aligns with a selected column position. The print band is a flexible horizontal-moving metallic band with etched characters mounted in an interchangeable print cartridge assembly (Figure 2-2). The assembly is mounted on a swing-out carriage for accessibility.

WARNING

The casework of the 0776 printer is designed to reduce the noise level. To protect personnel from high noise levels, do not operate the printer with covers or doors open (except when forms exceeding 17 inches necessitate leaving the paper well door open).

The 0776 printer contains the following major components:

- Print band
- Print mechanism (hammers)
- Actuator drive electronics
- Actuator drive
- Power supply
- Paper forms feed control
- Interface electronics
- Power-up control
- Operator control panel
- Frame and casework

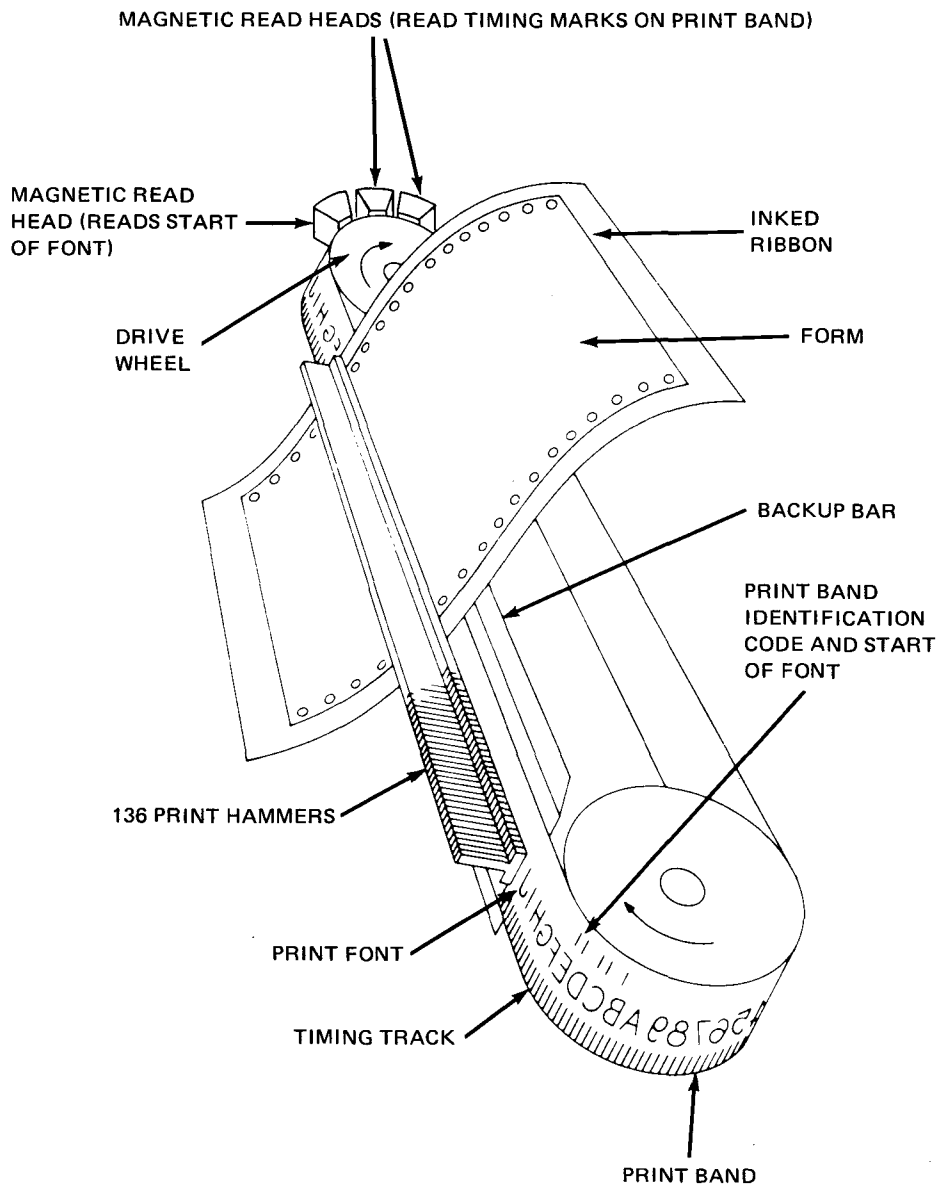

Figure 2-1. Impact Printing Technique

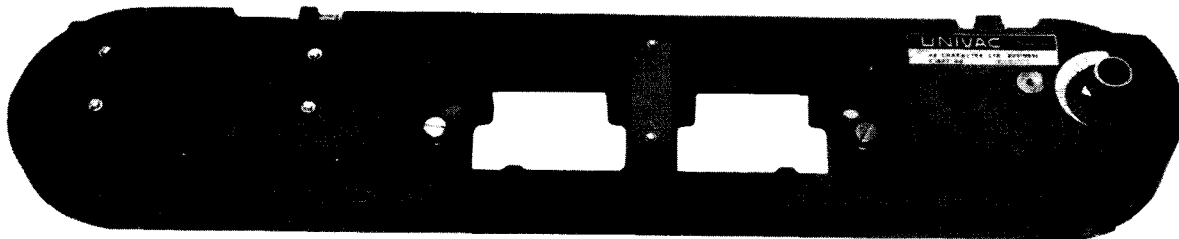

Figure 2-2. Print Cartridge Assembly

2.2. HARDWARE ELEMENTS

The major hardware elements of the 0776 printer are:

- Print mechanism
- Ribbon feed mechanism
- Forms handling mechanism
- Control electronics

2.2.1. Print Mechanism

The printing mechanism consists of the print hammer/actuator assembly and the print carriage assembly (Figures 2-1 and 2-3).

2.2.1.1. Print Hammer/Actuator Assembly

The print hammer/actuator assembly is located behind the paper forms and contains the electromechanical actuators and hammers; one hammer/actuator for each column. These hammers strike the rear face of the paper form forcing the form against the inked ribbon and printing the print band character. The assembly contains 136 hammers/actuators. The print cartridge and carriage assemblies swing out as a unit for easy access (see Figure 3-5).

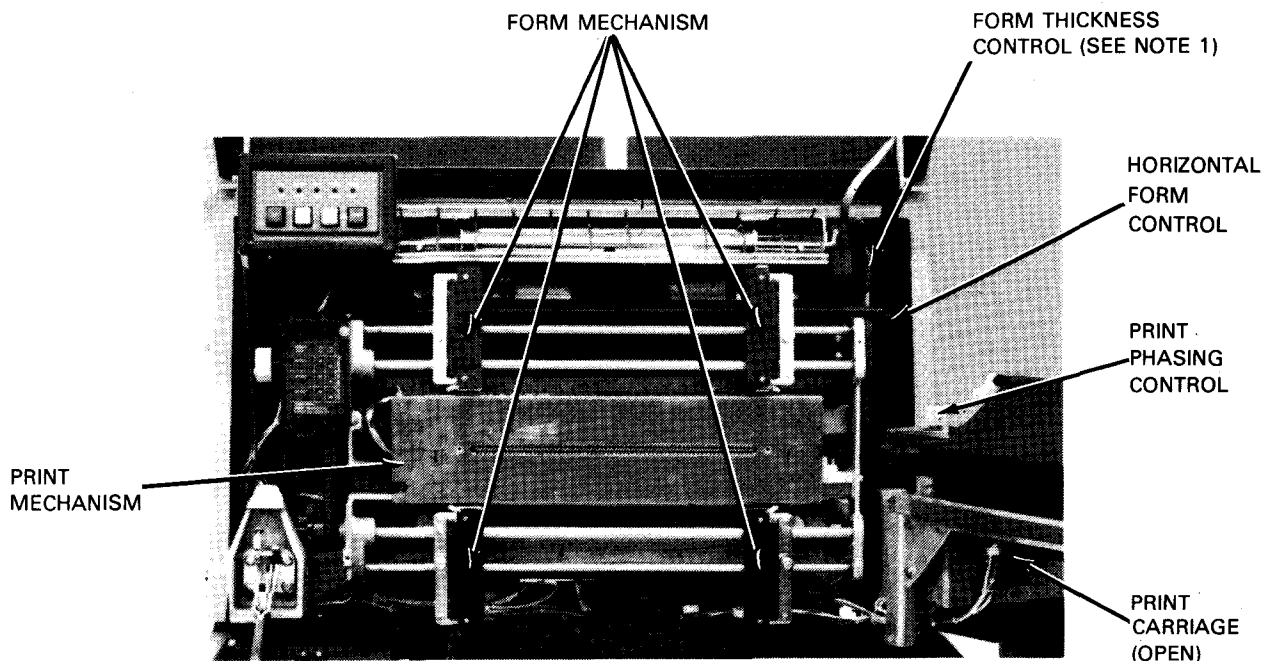

NOTES:

1. Earlier versions of the printer have a knob instead of a lever for form thickness adjustment.
2. Control electronics, located in lower bay, are accessed from rear.

Figure 2-3. Major 0776 Printer Hardware Elements

2.2.1.2. Print Carriage

The print carriage is located at the front of the printer, immediately forward of the paper forms. The print carriage contains both the interchangeable cartridge (with print band) and the print band drive mechanism. The print carriage is mounted so that it can be moved outward by the operator to permit access for changing forms and ribbon.

2.2.2. Ribbon Feed Mechanism

The ribbon feed mechanism is located within the print carriage and provides the mounting and driving of the printer ink ribbon. Automatic control is provided to ensure an even winding of the ink ribbon onto the spools. Automatic reversal of the ink ribbon direction is provided when the ribbon is depleted from a spool.

2.2.3. Forms Handling Mechanism

The print carriage assembly swings outward for access to the forms area. The forms are supported and driven by four pin-feed tractors; two above and two below the print line. The tractors are manually adjusted to accommodate forms ranging from 4 inches (10.16 cm) to 18.75 inches (47.62 cm) in width. The tractors may be positioned anywhere within the print area of a form 17.2 inches (43.69 cm) wide to print a full line (136 characters). This requires a line width of 13.6 inches (34.54 cm).

The column 1 position is fixed, for the 136-column printer, at a position approximately 7.2 inches (18.29 cm) left of center of the total print line. Manual control is provided to move the tractors up and down to align the form with the first line of printing. A forms alignment guide is provided on the ribbon shield assembly. This guide permits easy alignment of the forms for printing in the proper column and line position. A horizontal line on the print head baffle plate aids the operator in adjusting the tractor location.

Forms with a maximum width of 18.75 inches (47.62 cm) and a length of 17 inches (43.18 cm) can be contained within the subsystem casework. Forms with a maximum length of 24 inches (60.96 cm) for the 760- and 940/900-lpm printers and 18 inches (45.72 cm) for the 1200-lpm printer can be used; however, in these cases, the printer must be operated with the casework lower door open.

During printing, forms are advanced by the forms tractors and a driving motor. Print commands either contain line spacing instructions or may indicate a skip to a specific line position on the form. The vertical format control causes skipping to program-selected line positions. An end-of-paper detection device generates the FORMS OUT indicator signal when approximately 8 inches (20.32 cm) of paper remains below the print line.

Forms controls (see Figure 3-5) are:

- Forms thickness gap adjustment control
- Line positioning (forms position)
- Tractor adjustment
- Form tension

A powered forms pull out roller assembly is provided for the 760- and 940/900-lpm printers, to aid in the movement of forms through the printer. For the 1200-lpm printer, a powered forms stacker is provided to facilitate stacking of forms at the rear of the printer. The top of the forms is maintained at a constant height under the stacker power rollers, to ensure uniform stacking. The stacker accommodates a maximum form length of 18 inches.

2.2.4. Control Electronics

Control and interface electronic circuits are contained in the lower area of the printer (access from rear) on pluggable printed circuit boards located in the control electronics card module. The control electronics consist of the following major circuits:

- Intimate electronics include internal power driver and sense amplifier electronics.
- Mechanism control logic provides sequence, control, and fault detection logic.
- Interface logic handles channel operation requirements and staticizing interface logic.

2.2.4.1. Character Control

Character control, part of the mechanism for the control logic, controls the timing of the print hammers. The hammers are actuated at the correct time to print the character in the proper location. The print band contains raised timing marks. The timing signals generated provide the information to determine the position of the band at any given time. This section of logic contains a load code buffer where the character codes are program-loaded in the sequence that appears on the print band. The load code permits any 6-, 7-, or 8-bit code to be assigned to the graphic characters.

A print line buffer, into which is loaded character codes for the line to be printed, also is part of this section. The load code buffer codes, representing the characters to be printed, are compared to the character codes in the print line buffer to determine when a print hammer is to be actuated. When positive comparisons have been completed for all 136 positions of the print line buffer that contain printable character codes or spaces, printing of the line is terminated. To increase character print band life, band movement automatically stops approximately 7 minutes after the last print-advance command.

2.2.4.2. Vertical Format Control

Advancement of a form is controlled by the vertical format control. A form can be advanced up to 15 lines or can be skipped to line positions specified by the program-loaded vertical format buffer. Selected codes are loaded into the buffer positions corresponding to the stop position desired. The vertical format buffer accommodates 192 stop positions, which is equivalent to 8 lpi on a 24-inch (60.96 cm) form. An end-of-forms code is entered in one of the stop positions to indicate the length of the forms being run. When a command is received containing a skip code, the form is advanced until the first line position containing that code is reached. The vertical format buffer is incremented synchronously with the movement of the form. The initial position in the buffer (home position) corresponds to the setup line on the form.

2.3. PRINTER CONTROL

Printer control provides storage buffers for printing and forms control, and transfers data to and from the buffers on command. The channel sends command codes and data to the control. The control sends status and sense information, and data from the buffers to the channel. The three main storage buffer areas are:

- Printer buffer (136 locations)
- Vertical format buffer (192 locations)
- Load code buffer (64 locations expandable to 384 locations)

2.3.1. Print Line Buffer

The print line buffer is loaded by way of the print-advance or the diagnostic-write command with the appropriate data to be printed. An entire print line is loaded before printing. Each buffer location contains 10 bits: a print bit, a parity bit, and an 8-bit character code. Print line buffer codes are compared to the load code buffer codes for match condition. When a match occurs, a print operation is performed.

2.3.2. Vertical Format Buffer

Printer forms can be advanced up to 15 lines or moved to line positions specified in the program-loaded vertical format by way of the advance or print advance commands. Selected codes are loaded into the vertical format buffer locations corresponding to the stop positions desired on the form. Print form information in the vertical format buffer consists of the home-paper and end-of-forms codes and may also consist of forms overflow and stop/skip codes. If a command is received specifying a print advance or advance command and the vertical forms buffer is not loaded, the command is rejected with a unit check and the vertical format request sense bit is set.

2.3.3. Load Code Buffer

The load code buffer defines character codes in sequence corresponding to the character set (array) on the installed character print band. The load code buffer permits any code to be assigned to the character set on the print band corresponding to the code in the print line buffer. When a comparison takes place, the selected character is printed.

Various character sets can be accommodated. Character sets (or arrays) may consist of any number of characters ranging from 24 to 384, provided the number is equally divisible into 384. The print band can contain repeated arrays, groups of different print characters, or high usage characters can be repeated within an array. The load code buffer is loaded with character codes in the proper sequence required for the array before any printing is initiated.

2.3.4. Operating Modes

The printer operates in one of two modes: the run mode and the stop mode. The run mode (state) is the normal operating mode when the printer is controlled by commands from the system processor by way of its control electronics. The stop mode (state) is an offline mode at which time all programmed paper motion and printing are inhibited so the operator can change the print cartridge assembly, forms, ribbon, or make adjustments to the paper feed and printing mechanisms. Selection of the run mode is operator initiated. While in the run mode, any of these conditions will place the machine in the stop mode:

- Open carriage
- Lack of air flow
- Damaged paper form
- ■ Forms stacker full (1200-lpm printer only)
- Out-of-forms
- ■ Print actuator error
- Print band timing error (i.e., slowed or broken band)

The operator can manually initiate the stop mode by:

- Pressing the STOP switch
- Activating the single cycle mode switch



3. Controls and Indicators

3.1. GENERAL

The operating controls and indicators for the 0776 printer are located on the control panel at the top of the front hood and in the paper well area of the printer (Figure 3-1). Additional adjustment controls are located within the printer under the hinged front cover and behind the casework panel doors. Control panels are:

- Operator control panel
- Power control panel

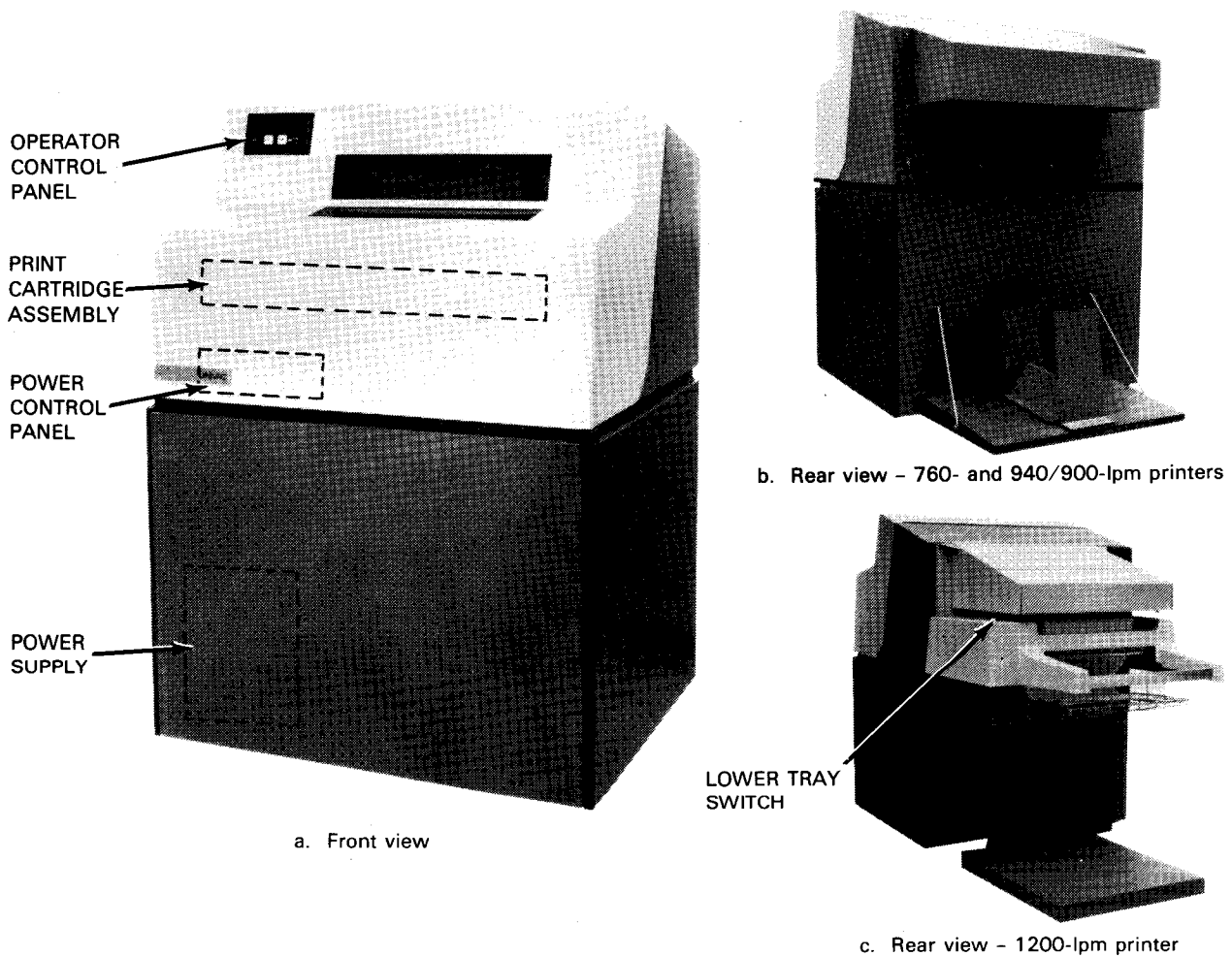
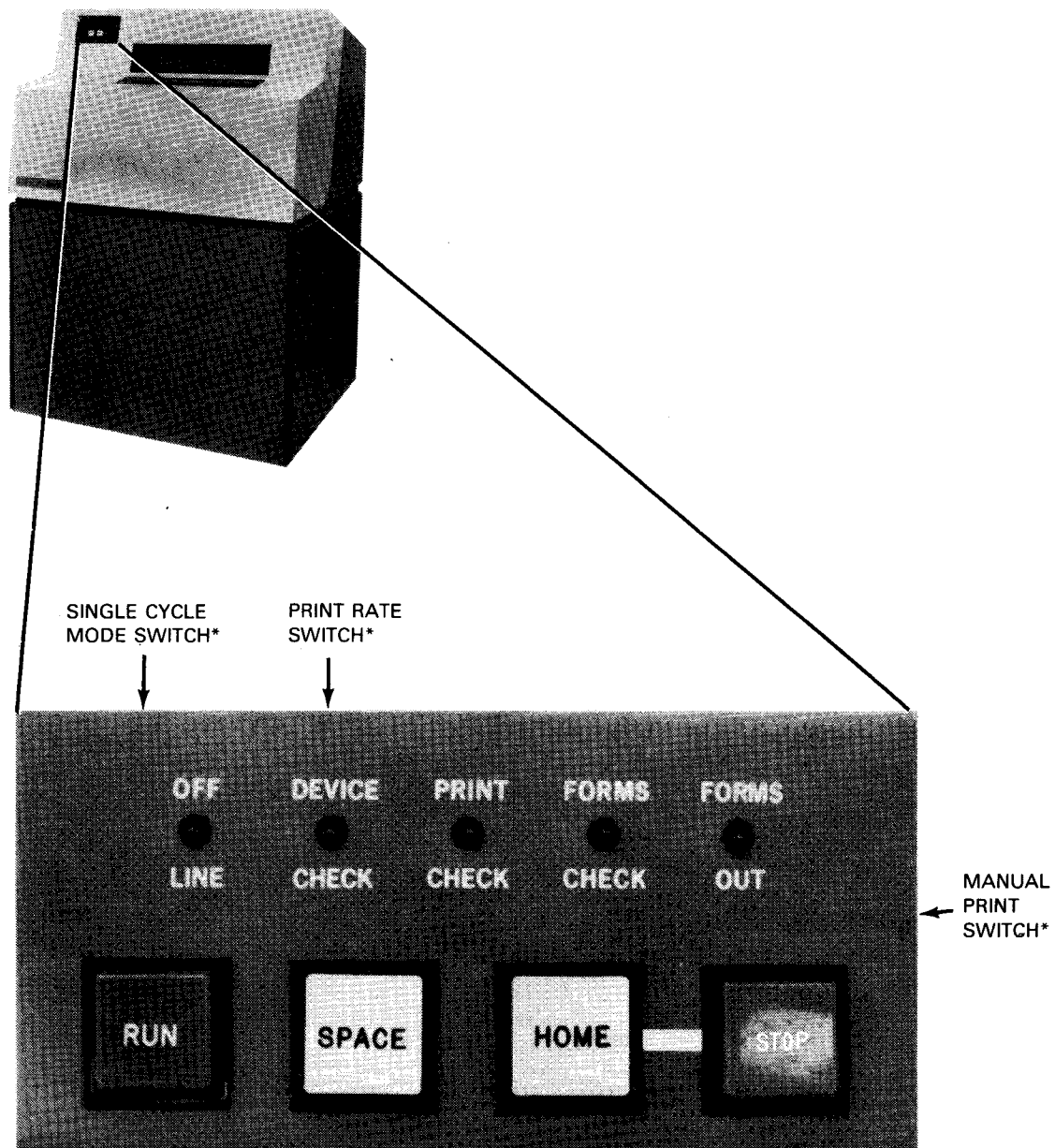

Figure 3-1. 0776 Printer, Front and Rear Views

3.2. OPERATOR CONTROL PANEL

The operator control panel (Figure 3—2) is located at the upper front of the printer. Table 3—1 lists each control/indicator with its function.



*Behind Panel

Figure 3—2. Operator Control Panel

Table 3—1. Operator Control Panel, Controls and Indicators (Part 1 of 2)

Control/Indicator	Description
OFF LINE indicator	Indicates ON LINE/OFF LINE switch located on maintenance panel in electronics module in OFF LINE position. Printer does not respond to any commands addressed to it. Commands addressed to it are propagated down the signal bus.
DEVICE CHECK indicator	Indicates one or both of the following conditions: <ul style="list-style-type: none"> ■ Print carriage assembly open ■ Air flow through module blower or forms advance motor blower slowed below adequate volume required for proper cooling (may indicate a dirty filter or blower malfunction)
PRINT CHECK indicator	Indicates one or more of the following conditions: <ul style="list-style-type: none"> ■ Actuator circuit malfunction ■ Broken or slowed print band ■ Print line or load code buffer parity error
FORMS CHECK indicator	Indicates one or more of the following conditions: <ul style="list-style-type: none"> ■ Continuously fed forms for over 1.2 seconds with no intervening stop ■ Forms feeding mechanism required too much time to accelerate to running speed (may indicate a paper jam) ■ Forms feeding mechanism required too much time to decelerate to stop ■ Form jam or torn paper. The forms LED sensor, located at the top of the upper right-band tractor plate, did not detect either the presence of forms (torn paper) or paper motion (jam) for the equivalent of 8 print lines at 6 lines per inch (11 print lines at 8 lines per inch). ■ Vertical format buffer parity error
FORMS OUT indicator	Indicates 8 inches (20.32 cm) or less of forms remain below print line
RUN switch/indicator	Momentary pushbutton switch. When operated during stop state (STOP indicator lit) and control not active, initiates the following sequence: <ol style="list-style-type: none"> 1. When pressed, clears all check conditions except those activated by an interlock switch or forms low condition which require operator intervention. 2. When released, if all check conditions clear, RUN indicator lights and STOP indicator extinguishes. 3. Attention status generated. Program notified by way of its status that control is ready to accept all commands. Pressing and releasing this switch with printer in RUN state results in no action. Pressing and releasing this switch with printer in stop state, and all check conditions fail to clear, results in: <ol style="list-style-type: none"> 1. No attention status generated. 2. Partial clearing of check condition. 3. Printer remains in stop state.

Table 3-1. Operator Control Panel, Controls and Indicators (Part 2 of 2)

Control/Indicator	Description
Audible alarm	Forms stacker full; alarm remains on until forms are removed and stacker tray is raised (applies to the 1200-lpm printer only).
SPACE switch	Momentary pushbutton switch for operator use only during stop state. Form advances one line each time this switch is momentarily pressed. Holding switch pressed advances form until switch is released.
HOME switch/indicator	<p>Momentary pushbutton switch for operator use only during stop state. Form advances under control of vertical format buffer (VFB) to next home (or setup) position in VFB. If VFB and load code buffer are not loaded, form does not advance. The switch/indicator is lit when the VFB is in home position.</p> <p>Pressing this switch while STOP switch is pressed initializes VFB to home paper position without advancing form. VFB address register is cleared to initial position.</p>
STOP switch/indicator	<p>Momentary pushbutton switch. Pressing this switch when printer is in run state stops printer. A control executing a command, or holding pending status, delays entry to stop state until completion of command and transfer of status to channel.</p> <p>Printer can be placed in stop state by any of the following conditions:</p> <ul style="list-style-type: none"> ■ Forms out ■ Forms check ■ Carriage open ■ Actuator check ■ Loss of cooling air (1200 LPM printer has a separate air vane switch, which monitors air flow to the paper feed motor) ■ Type speed check ■ Stacker full (1200-lpm printer only) ■ Single cycle mode (advance complete) <p>Lamp test performed by pressing STOP switch with printer in stop state. All indicator lamps on operator control panel illuminate.</p>
Print rate switch	An interlock switch that slows print rate to one-half speed when printer front top hood raised to reduce acoustic noise level.
Manual print switch	<p>Three-position switch effective only with printer in stop state to check print actuators and print alignment prior to a print run.</p> <p>Center Position: Normal position to permit printer to operate with top hood closed.</p> <p>In Position (momentary switch): When pressed and released printer prints image of band once and advances form one line. If held in, printer continues printing until switch is released, provided backboard jumper is installed (contact Sperry Univac customer engineer).</p> <p>Out Position (manually pulled out): Switch remains out and printer prints image of band for each line and advances forms until switch set to normal (center) position.</p>
Single cycle print switch	In the up position, subsequent commands are executed until the next paper feed advance completes, at which time the machine assumes the stop mode. Each time the RUN switch is pressed, the printer executes the next command and then, following any paper advance, returns to stop the mode. The top cover must be raised and must remain open to access and continue single cycle operation. When the cover is closed, single cycle mode is disabled, and normal operation is restored.

3.3. POWER SUPPLY

The power supply (Figure 3-3) is located in a lower corner behind the panel door at the rear of the printer cabinet. Table 3-2 lists the circuit breakers mounted on the power supply.

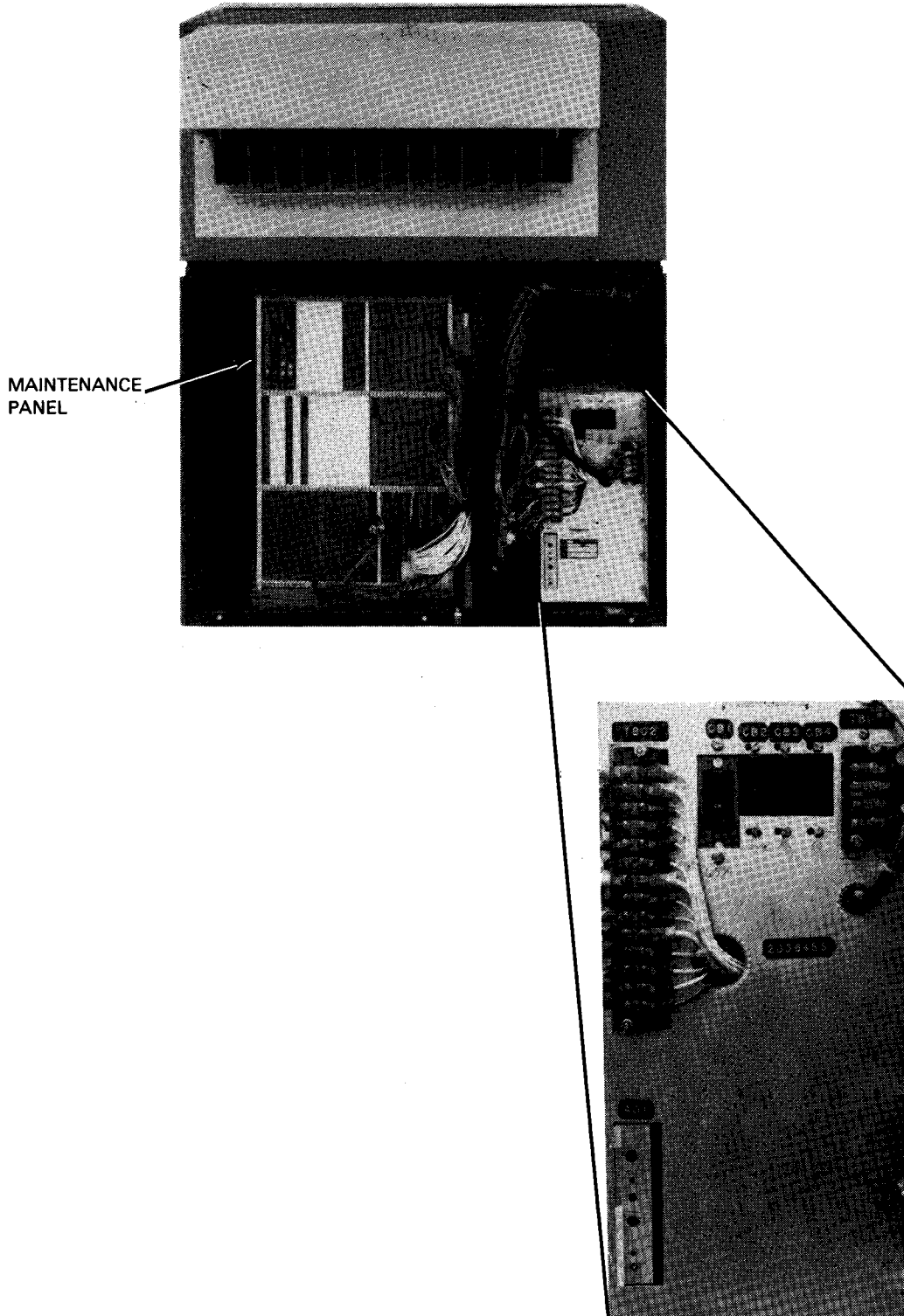

Figure 3-3. Power Supply

3.4. LOWER TRAY SWITCH

The LOWER TRAY switch (1200-lpm printer only) is located on the forms stacker hood at the rear of the printer (Figure 3-1). Pressing (and holding) this toggle switch lowers the stacker tray for ease in removing forms. The tray is easily raised manually by the operator.

CAUTION

Do not attempt to push tray down. To do so may damage the equipment.

3.5. POWER CONTROL PANEL

The power control panel (Figure 3-4) is located in the front portion of the printer cabinet, under the top hood and behind the paper well door. Table 3-3 lists each control/indicator with its function.

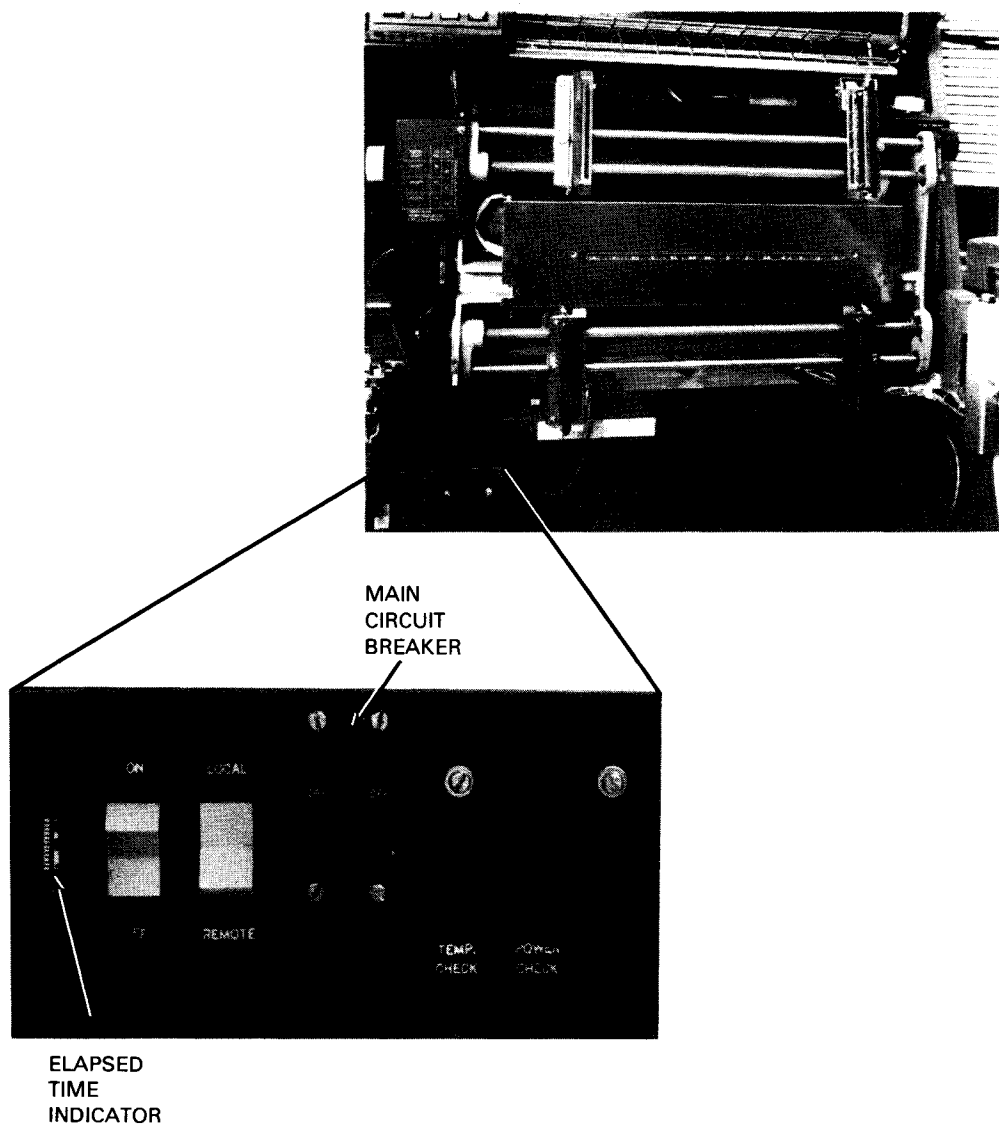

Figure 3-4. Power Control Panel

Table 3—2. Power Supply Circuit Breakers

Circuit Breaker	Function
CB1	Provides circuit protection for 65 Vdc power supply.
CB2	Provides circuit protection for 26 Vdc power supply.
CB3	Provides circuit protection for 25 Vac power control circuits and ribbon drive motors.
CB4	Provides circuit protection for 5 Vdc power supply.

Table 3—3. Power Control Panel, Controls and Indicators

Control/Indicator	Function
ON/OFF rocker switch	When pressed to ON position, initiates printer power-up sequence (if TEMP CHECK or POWER CHECK indicators not lit). When power is fully up, either RUN or STOP indicators light. When pressed to OFF position, printer powers-down and is placed in "not ready" status.
LOCAL/REMOTE rocker switch	When set to LOCAL, power is controlled by ON/OFF switch. When set to REMOTE, power turn on/turn off is controlled by system processor. When set to LOCAL and power off, momentarily pressing ON/OFF switch to ON position (provided no temperature or power check conditions exist) cycles power-up sequence and places printer online (provided ON-LINE/OFF-LINE switch located on maintenance panel is set to ON-LINE).
CB1 main power circuit breaker switch	Provides ac input power circuit protection for printer.
TEMP. CHECK indicator	Indicates above normal temperature exists in electronics module or surge resistor. The +26 Vdc supply is not energized.
POWER CHECK indicator	Indicates dc power failure. Indicator may flash on and off briefly during power-up sequence.
Elapsed time indicator	Indicates time (in hours) that power has been applied to printer.

3.6. INTERNAL ADJUSTMENT CONTROLS

The printer contains internal adjustment controls requiring operator use. Access to these controls is gained by raising the front top hood of the printer cabinet. Locations of these controls are shown in Figure 3-5. Table 3-4 lists the controls and their descriptions.

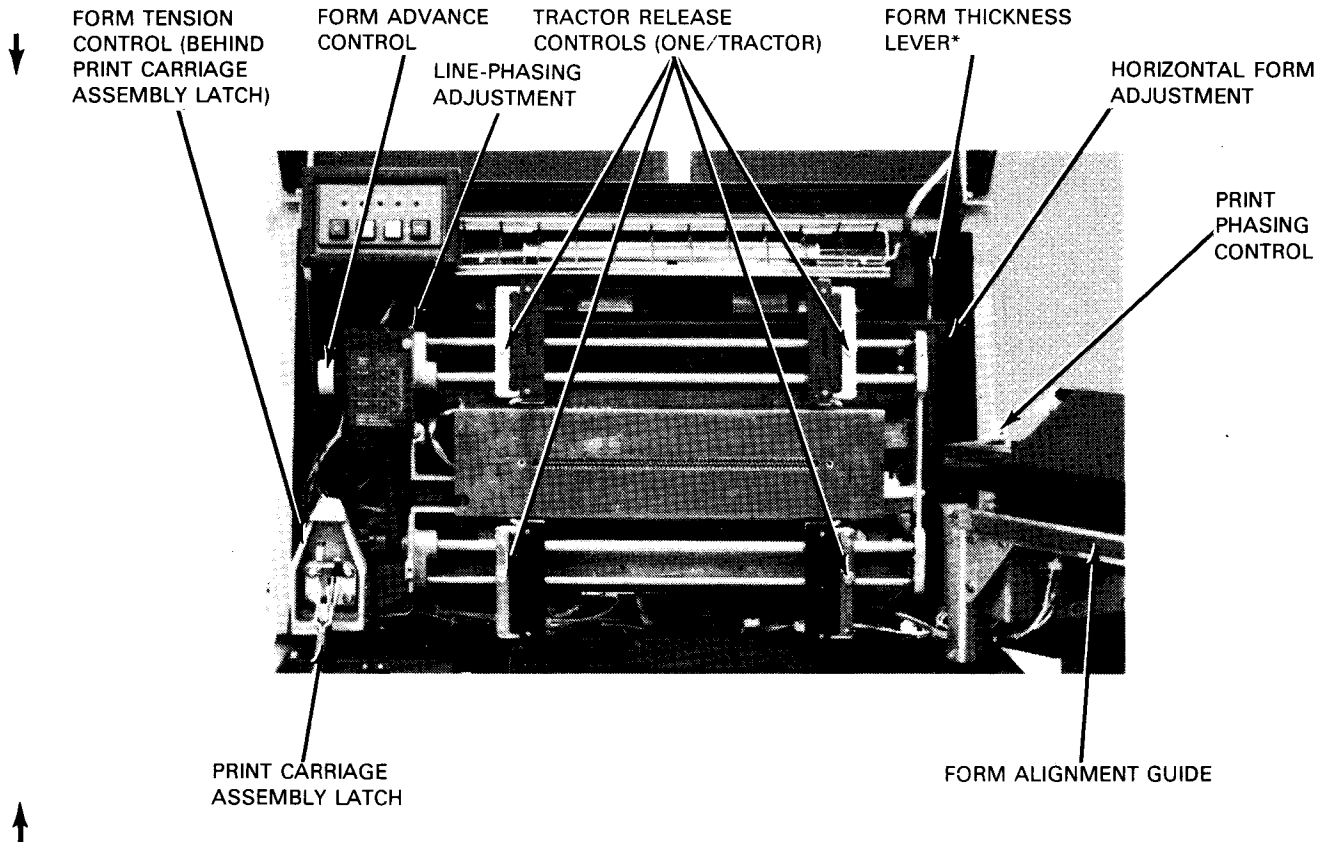

*Earlier versions of the printer have a form thickness control knob instead of a lever.

Figure 3-5. Location of Internal Adjustment Controls

Table 3-4. Internal Adjustment Controls (Part 1 of 6)

Control/Switch	Function
<p>Line-phasing control</p> <p>Form advance control</p> <p>Form tension control</p>	<div data-bbox="763 399 1380 1144" style="text-align: center;"> </div> <p>Location: Upper left front</p> <p>Allows line position adjustment ($\pm \frac{1}{2}$ line) to assist in setup. Can be adjusted in stop mode or while printing during the initial setup procedure.</p> <p>Disengages tractor shaft from tractor drive so that proper line position can be selected by adjusting tractors and form.</p> <p>Permits adjustment of form tension between upper and lower set of tractors. Push in lightly to disengage from paper feed mechanism.</p>



Table 3-4. Internal Adjustment Controls (Part 2 of 6)

Control/Switch	Function
<p>Form thickness lever</p>	<div style="text-align: right;">  </div> <p>Location: Upper right-front of paper handling assembly</p> <p>Permits adjustment for various form thicknesses by varying gap at print head. Print phasing control should be adjusted, if necessary, after adjusting form thickness lever. (Earlier versions of the printer have a form thickness control knob instead of a lever.)</p>
<p>Horizontal form adjustment</p>	<div style="text-align: center; border: 1px solid black; padding: 5px; margin-bottom: 10px;"> <p>CAUTION</p> </div> <p><i>The numbers on the control lever bracket/knob do not pertain to parts of multipart forms. They are intended only as an aid to help operators repeat settings for previously positioned forms. For example, 6 does NOT mean a 6-part forms position.</i></p> <p>Permits vernier horizontal adjustment ($\pm \frac{1}{4}$ inch or 6.35 mm) of tractors for final column positioning of form. (Tractors move in unison.)</p>



Table 3-4. Internal Adjustment Controls (Part 3 of 6)

Control/Switch	Function
Print phasing control	 <p data-bbox="516 1171 1073 1199">Location: Print cartridge assembly, right front, top view</p> <p data-bbox="516 1226 1230 1276">Permits vernier horizontal adjustment of printer character in a column so that character is centered on hammer when printing.</p>

Table 3-4. Internal Adjustment Controls (Part 4 of 6)

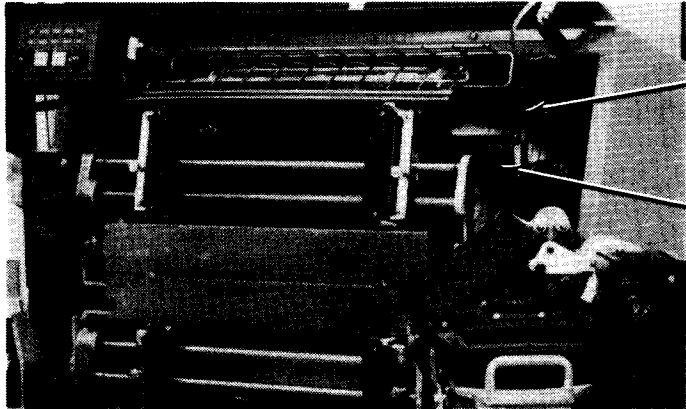
Control/Switch	Function
<p>Tractor release controls (four knurled wheel controls, one for each tractor)</p> <p>Print band speed control (1200-lpm printer only)</p>	<div style="text-align: center;"> <p>UPPER TRACTOR RELEASE CONTROLS</p>  <p>LOWER TRACTOR RELEASE CONTROLS (NOT SHOWN)</p> <p>PRINT BAND SPEED CONTROL (FOR 1200-LPM PRINTER ONLY)</p>  </div> <p>Location: Front of paper handling assembly</p> <p>Controls on each of four tractors provide coarse adjustment of form with respect to print line by allowing each tractor to be individually positioned horizontally on tractor shaft.</p> <p>Permits selection of a lower print band speed for optimum print quality.</p>

Table 3-4. Internal Adjustment Controls (Part 5 of 6)

Control/Switch	Function
<p>Print carriage assembly latch</p> <p>Print carriage assembly interlock switch</p>	<div style="display: flex; align-items: center;"> <div style="margin-right: 20px;"> <p>PRINT CARRIAGE ASSEMBLY INTERLOCK SWITCH</p> <p>PRINT CARRIAGE ASSEMBLY LATCH</p> </div>  </div> <p>Location: Upper left-front of paper handling assembly</p> <p>Allows print carriage assembly to be securely held in operating position.</p> <p>When print carriage assembly is open, prevents operation of printer by notifying printer controller logic in processor of condition. Printer automatically placed in stop mode and DEVICE CHECK indicator on processor operator/maintenance panel lights.</p> <p>NOTE:</p> <p>Other interlock switches are included in printer (such as thermal interlocks, no-air-flow-in-plenum interlock, paper feed motor air vane switch (1200-lpm printer only), etc.), but not described since they are primarily maintenance-type interlocks.</p>

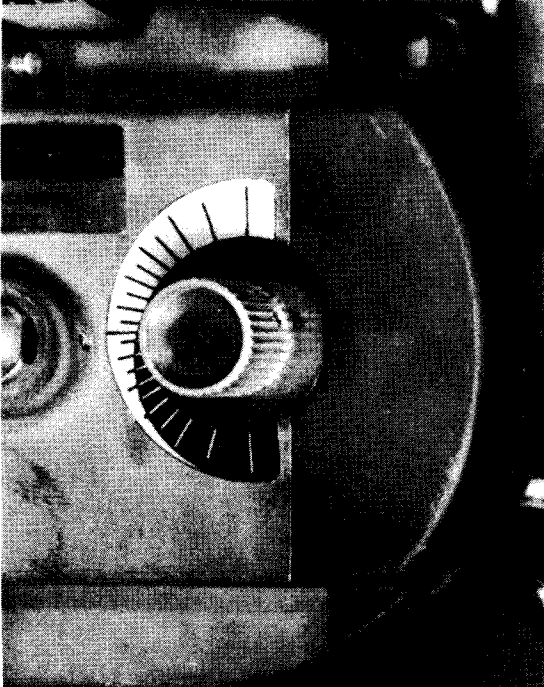

Table 3—4. Internal Adjustment Controls (Part 6 of 6)

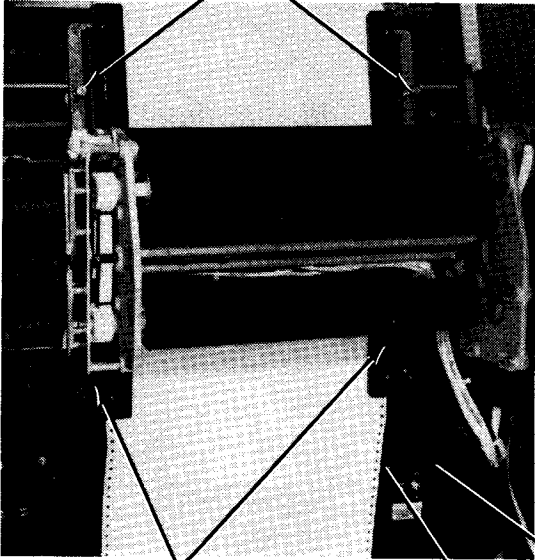
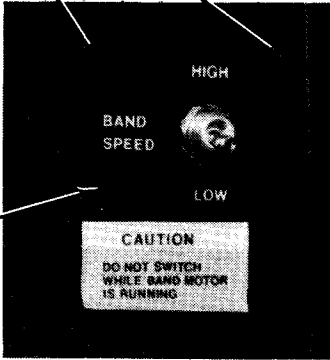
Control/Switch	Function
<p>Form alignment guide</p>	<div data-bbox="451 386 1036 789" data-label="Image"> </div> <p data-bbox="443 831 803 856">Location: Paper handling assembly</p> <p data-bbox="443 884 1174 1010">Allows alignment of form for printing in proper columns and line positions. Forms alignment guide is magnetically latched to printer carriage assembly and placed against print head before form alignment. After use, guide is manually returned to latched position on print carriage assembly.</p>

4. Operation

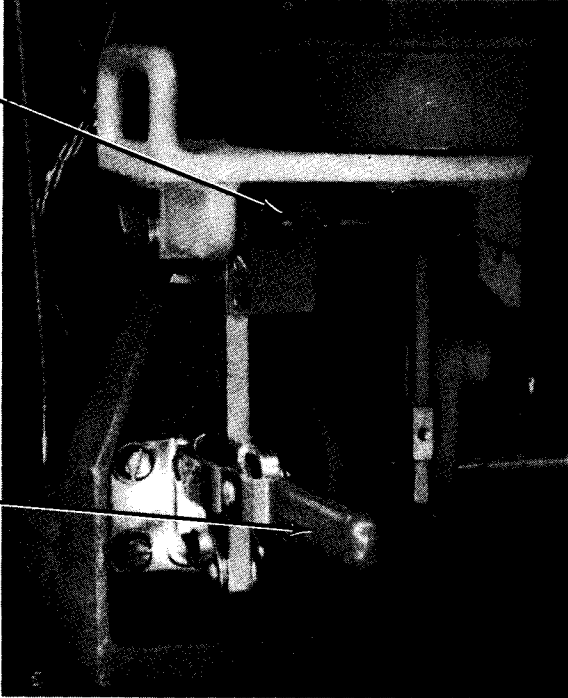
4.1. GENERAL

Operating procedures for the 0776 printer described in this section cover the following conditions:

- Turn on
- Turn off
- Forms loading
- Ribbon replacement
- Print band cartridge replacement
- Print phasing adjustment
- Print gap adjustment
- Paper advance
- Recovery procedures

4.2. TURN-ON PROCEDURE

WARNING

The casework of the 0776 printer is designed to reduce the noise level. To protect personnel from high noise levels, do not operate the printer with covers or doors open (except when forms exceeding 17 inches necessitate leaving the paper well door open).

To apply power initially to the printer, or to reapply power if a circuit breaker switch has been tripped, perform the following procedure:

1. Open rear panel door at rear of printer cabinet.
2. At power supply control panel, set circuit breakers CB1 (65 Vdc), CB2 (26 Vdc), CB3 (25 Vac), and CB4 (5 Vdc) to ON (up) position. Close panel door.

3. Raise top hood at front of printer.
4. At power control panel:
 - a. Set main power circuit breaker to UP (on) position.
 - b. Set power ON/OFF switch to ON position.

CAUTION

If any circuit breaker continually trips to OFF position after being set to ON, contact Sperry Univac customer engineer.

- c. Set LOCAL/REMOTE switch to LOCAL for local turn on. Set to REMOTE if power sequencing is to be system controlled.
- d. Close top hood.
- e. Set ON-LINE/OFF-LINE switch to ON-LINE. (Switch is located behind rear panel door in upper left portion of the printer control electronics module.)

4.3. TURN-OFF PROCEDURE

NOTE:

Power to the printer is turned off by the operator only during an emergency condition.

Remove power from printer as follows:

1. Raise top hood at front of printer.
2. At power control panel, set power circuit breaker to OFF (down) position.
3. Close top hood.
4. If printer is turned off due to emergency condition, contact Sperry Univac customer engineer.

4.4. FORMS LOADING

Three procedures are provided for forms loading. The procedure to be used is determined by one of the following conditions existing at the printer:

■ Condition 1:

Loading new form into the printer with no form previously installed (4.4.1).

■ Condition 2:

Loading form when existing form supply runs out and requires replenishing (4.4.2).

■ Condition 3:

Loading new type of form different from the form already installed in the printer (4.4.3).

NOTE:

Optimum performance is produced on single-part, 20-pound bond stock. Satisfactory performance can also be realized on 18-pound bond, provided the relative humidity does not drop below 40 percent and the roller adjustment lever (in the stacker, Figure 4-7) has been properly set. Forms handling problems may increase when forms are made of less than 18-pound paper or if recycled paper is used. These problems can be minimized by avoiding multiline skips or paper advances whenever possible.

4.4.1. Forms Loading, Condition 1

Condition 1 requires a new form to be loaded into the printer when no form was previously installed.

1. Raise top hood of printer.
2. Set maximum form adjustment by setting HORIZ FORM ADJ control so that retaining rings on tractor supports are equally spaced with respect to the side castings. (Figure 4-1).
3. Open front paper well door in bottom of printer cabinet.
4. Press down on latch lever to release carriage assembly (Figure 4-2). Swing carriage assembly fully open (assembly hinged at right side).
5. Unclamp four tractors by loosening knurled locking screw on each tractor and turning counterclockwise (Figure 4-3).
6. Open four tractor pressure plates and swing up hinged portion of paper rack.
7. Place supply of forms to be loaded into paper well compartment so that form print surface faces operator.

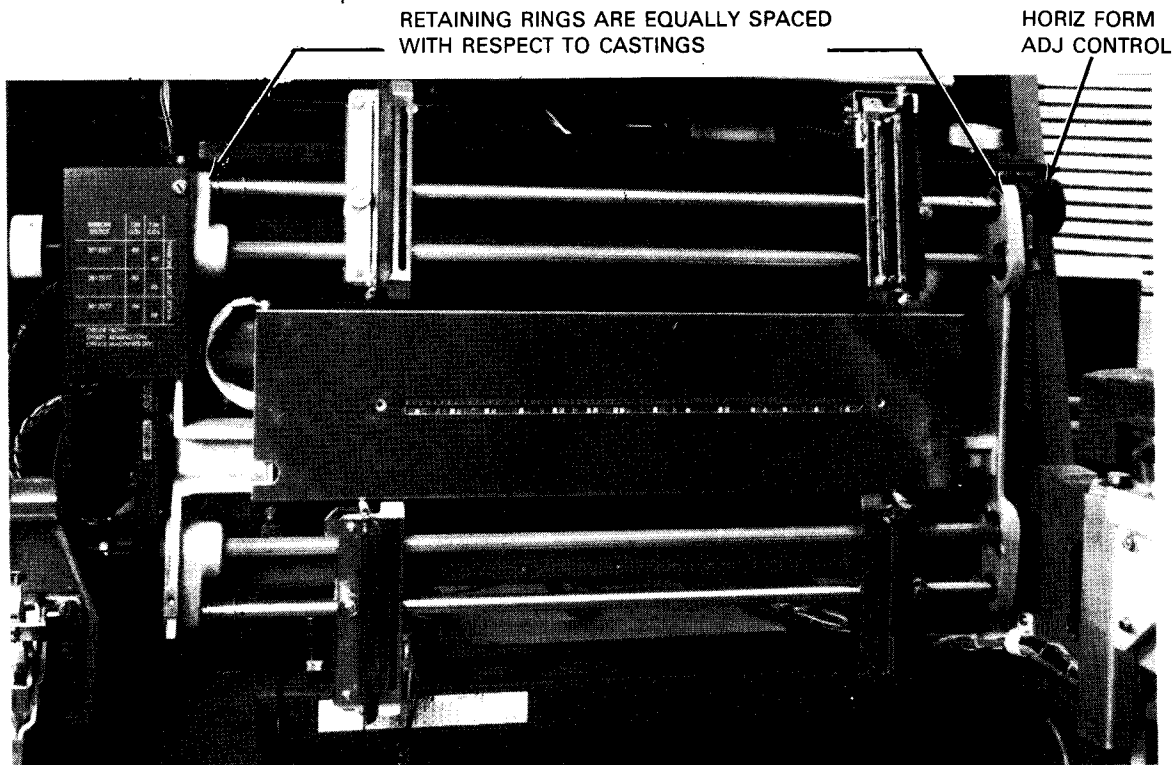

Figure 4-1. Preliminary Adjustments for Forms Loading

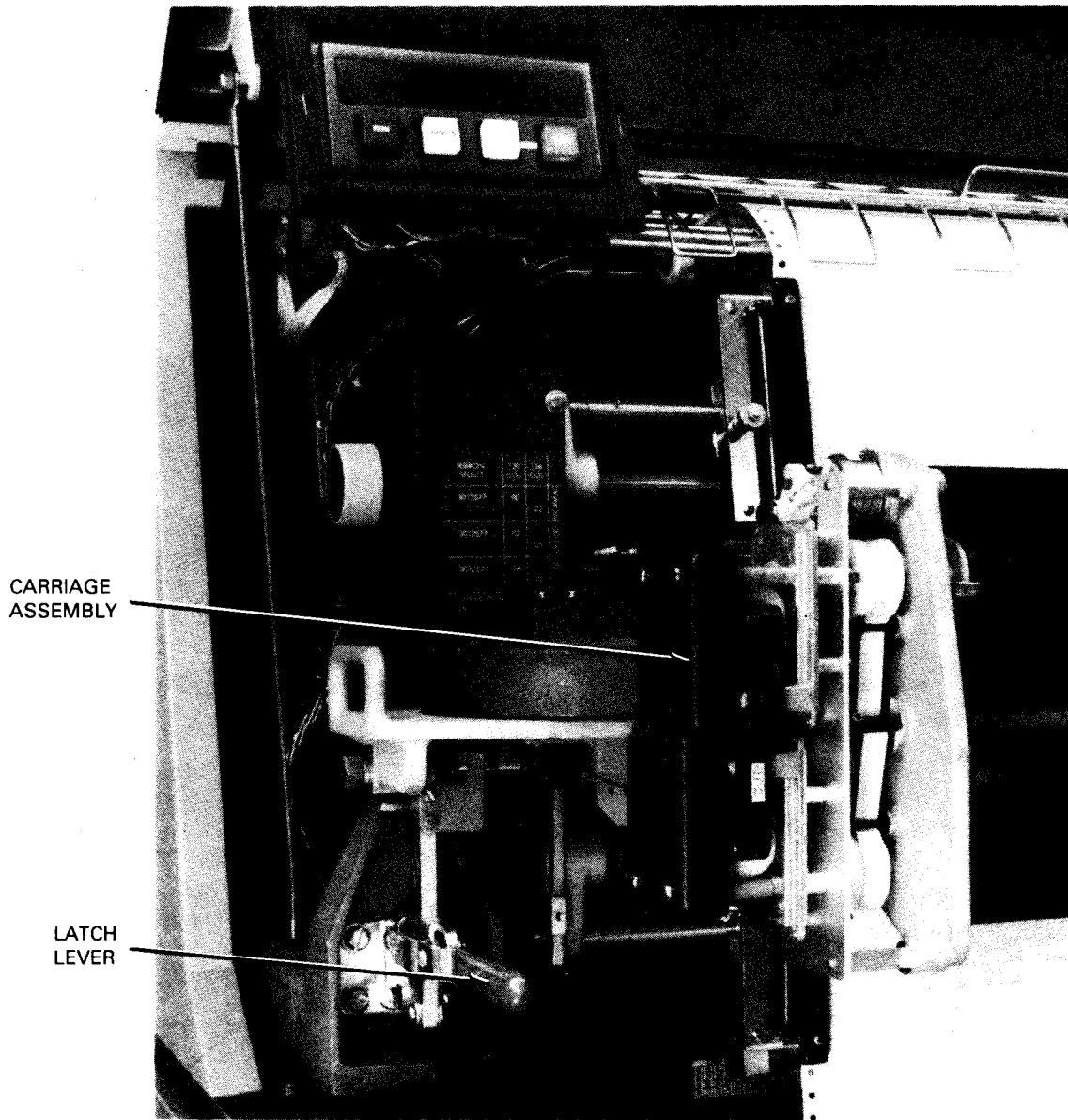

Figure 4—2. Print Carriage Assembly, Closed

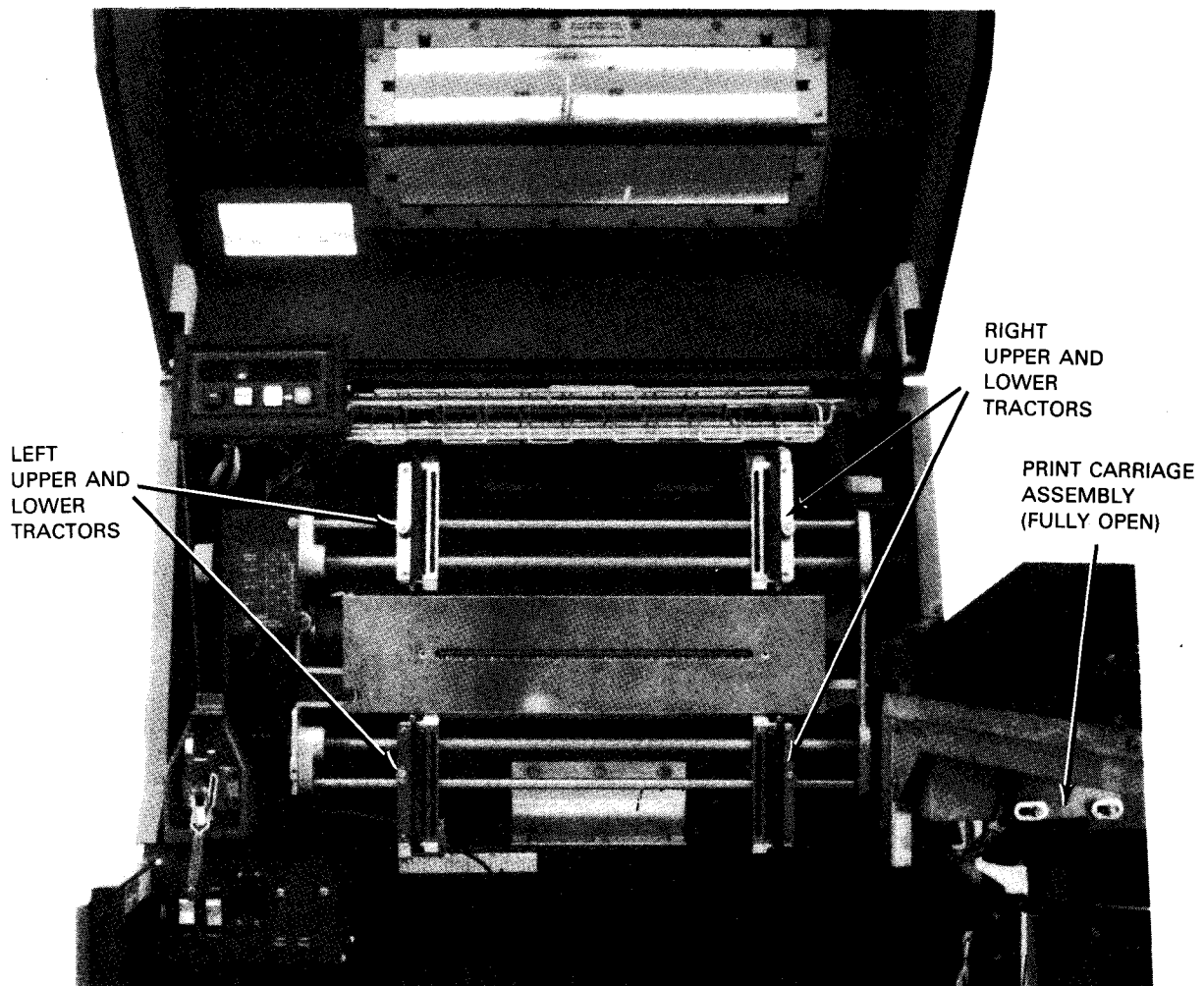

Figure 4—3. Printer, Opened to Receive Forms (Carriage Assembly Fully Open)

8. Place form on upper left tractor pins.
9. Close pressure plate on upper left tractor.

NOTE:

If form being loaded contains alignment ticks, perform step 10, otherwise go directly to step 11.

10. To load form provided with alignment ticks:
 - a. Unlatch form alignment guide from print carriage assembly and place across print head.

- b. Adjust upper left tractor until vertical tick on form corresponds to proper column on column indicator (Figure 4-4).
- c. Lock upper left tractor by turning tractor knurled locking screw clockwise.
- d. Adjust upper right tractor until form mates with tractor pins.
- e. Close upper right tractor pressure plate.
- f. Proceed to step 12.

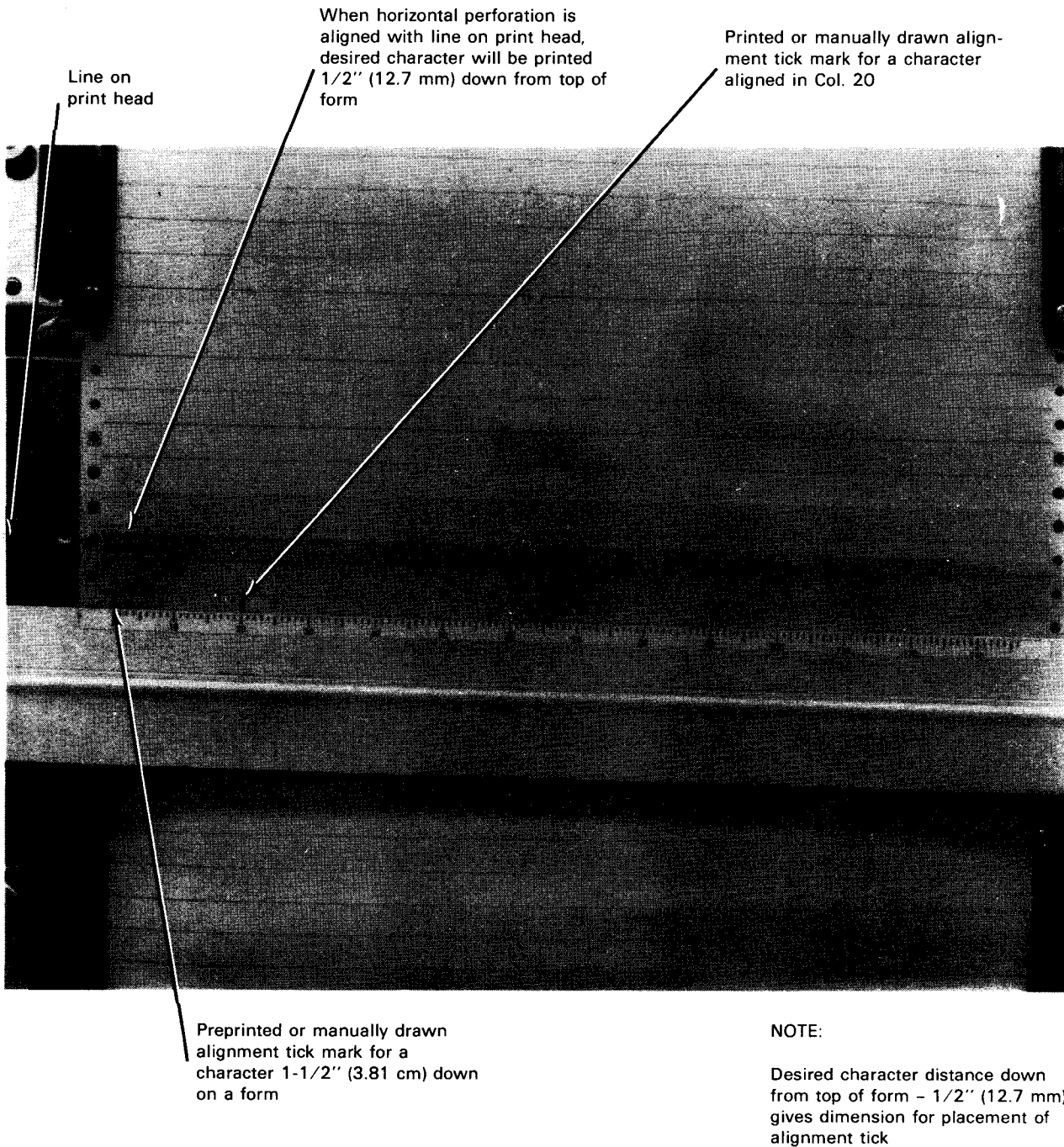
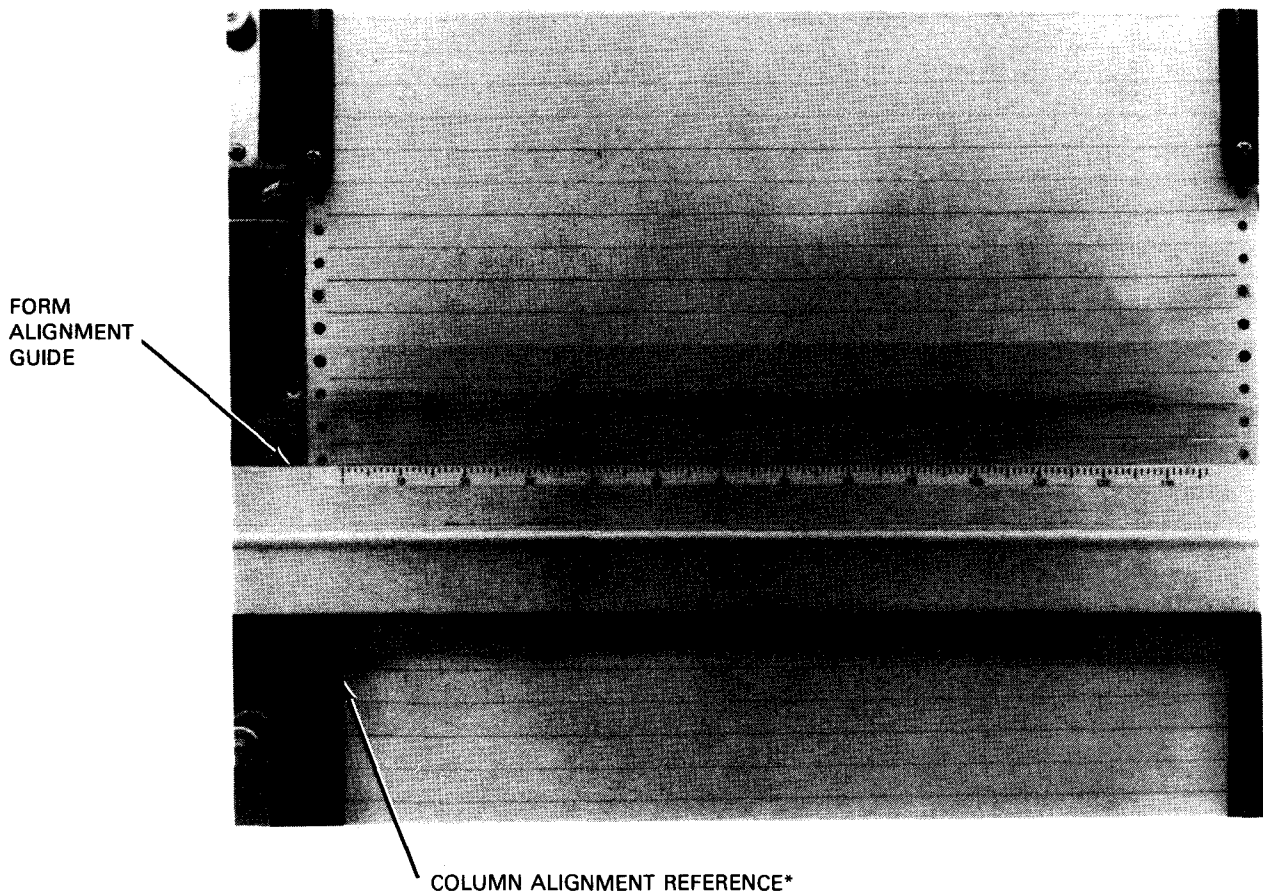

Figure 4-4. Form Alignment Tick Placement

11. To load form not provided with alignment ticks:
 - a. Adjust upper right tractor until form engages tractor pins.
 - b. Close upper right tractor pressure plate.
 - c. Unlatch form alignment guide from print carriage and place across print head.
 - d. Press and turn form advance knob until bottom edge of form guide aligns with intended bottom of line to be printed (Figure 4-5).
 - e. Adjust two upper tractors to shift form horizontally until correct column indication block is centered on intended position in first column.
 - f. Remove all horizontal slack from form by adjusting two upper tractors.
 - g. Secure both tractors by turning knurled locking screw on each tractor clockwise.
 - h. Proceed to step 12.



*Repeatable tractor position - the inner edge of the lower left-hand tractor can be used as reference mark to point to column indicator on form alignment guide. This is used to pre-position tractors to known location for same type of form. The first time a common form is used and set in proper position, a notation should be made at lower left-hand tractor location so that in future usages of this form the tractors can be pre-positioned.

Figure 4-5. Form Alignment

12. Adjust and secure two lower tractors so that form is held in correct vertical position.
13. Press and turn form tension knob until slight tension is felt over curvature of print head.

NOTE:

Make certain sprocket holes in form are not deformed.

14. If form alignment guide was used for aligning form, retract and latch guide (magnetically) to print carriage assembly.
15. On form provided with horizontal tick, press and turn form advance knob until horizontal alignment tick at edge of form is aligned with line on print head (Figure 4-4). Make certain form extends beyond paper LED sensor on upper tractor.
16. Move form thickness control lever to proper location for form used.
17. If operating a 760- or 940/900-lpm printer, close and lock the print carriage assembly. If operating a 1200-lpm printer, leave the print carriage assembly open.
18. Feed form through internal guide assembly (Figure 4-6). On the 760- or 940/900-lpm printer, pass form through rear exit slot in hood and fold between rear and front paper guides to paper shelf (Figure 4-6). On the 1200-lpm printer, perform the following steps:
 - a. Manually raise forms stacker output tray (Figure 4-7) by pulling up evenly at front center of tray. Be certain that tray is fully raised against its upper stop position. Pull finger assemblies to their extreme open position.
 - b. Pull roller adjustment handle as far toward front of forms stacker as possible, to open roller gap to its widest position.
 - c. Fold forms along natural fold line (line along which paper was originally folded in its carton), and feed forms through throat of forms stacker until forms rest on output tray and paper contacts rear finger assembly.
 - d. Push front finger assembly toward rear of forms stacker until front fingers contact edge of paper.

NOTE:

Output tray may lower slightly during this operation.

Forms should now be evenly aligned between front and rear finger assemblies. View forms from side of forms stacker to check alignment.

- e. Accumulate at least a forms length of paper on top of forms stacker, then push roller adjustment handle toward rear of forms stacker, increasing pull force just enough so that forms are fed into forms stacker. Then push roller adjustment handle an additional 1/4 inch, so that pull force is slightly increased. This adjustment should be made with care, as too much or too little tension can cause improper folding and stacking. Single-part forms generally require greater movement of the roller adjustment handle than heavier forms.
- f. Check throat of forms stacker to ensure that the fold line of the forms is parallel to the edge of the forms stacker casework. If not parallel, rotate the forms stacker to the right or left until the condition is corrected.
- g. Proceed to step 19.

19. Close paper well door at front of printer cabinet. If form exceeds 17 inches (43.18 cm) in length, leave door open.
20. If operating a 760- or 940/900-lpm printer, proceed directly to step 21. If operating a 1200-lpm printer, close and lock print carriage assembly, then proceed to step 21.
21. Press and hold the STOP switch, and then press the HOME switch. Release the HOME switch first, and then the STOP switch. The HOME indicator lights, but no forms motion is initiated (operator home procedure).
22. Press and release RUN switch. RUN indicator lights.
23. If further minor adjustment is required, adjust HORIZ FORM ADJ knob for side-to-side character placement.

CAUTION

Do not adjust form advance or tension controls while form is in motion (to prevent possible tearing of form).

24. Ensure LOCAL/REMOTE switch is set to REMOTE position if control is from system processor.
25. Close top hood.

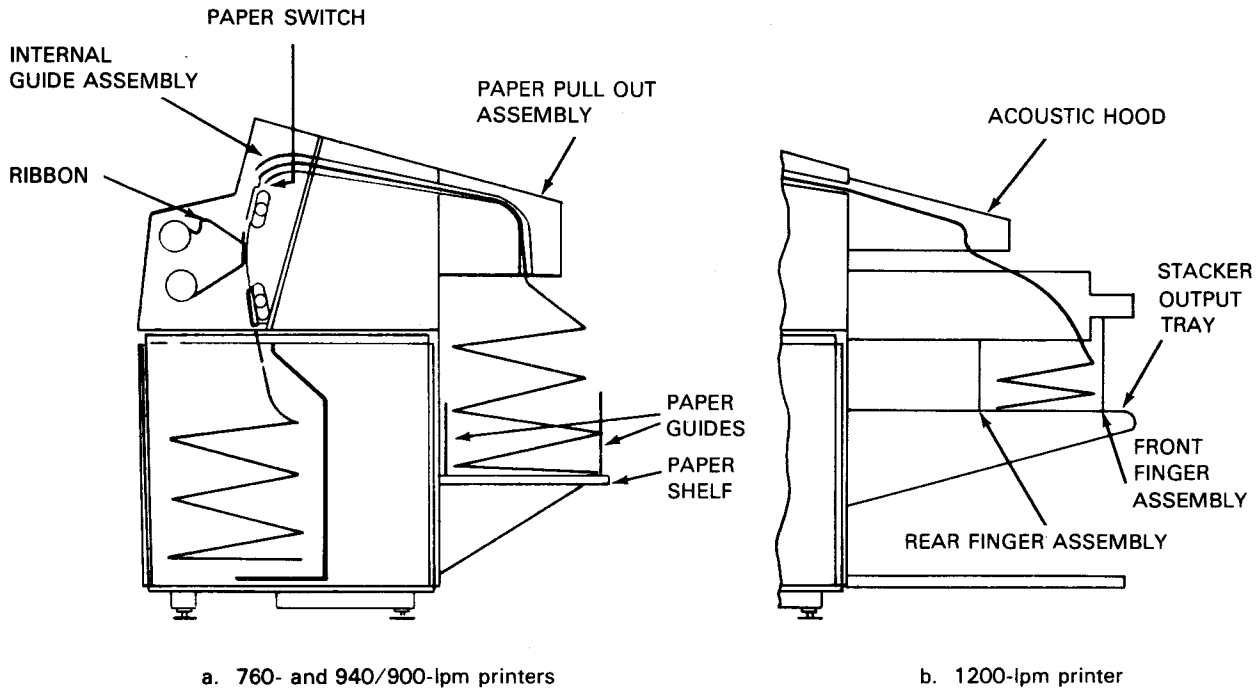

Figure 4-6. Form Feed Configuration

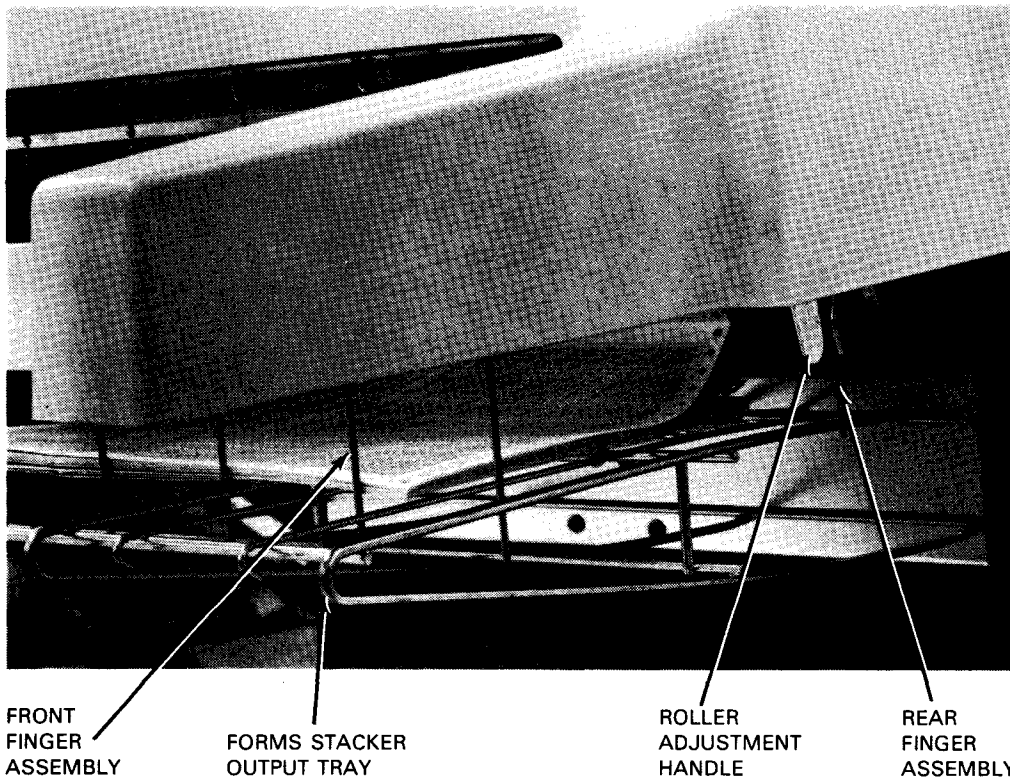

Figure 4-7. Forms Stacker (1200-Lpm Printer)

4.4.2. Forms Loading, Condition 2

Condition 2 requires forms loading when the existing form has been depleted, and more of the same form is required.

1. Observe STOP indicator. If not lit, press STOP switch/indicator.
2. Raise top hood of printer.
3. Open front paper well door in bottom of printer cabinet and remove any empty form container from paper well compartment.
4. If necessary, remove form already printed from rear paper shelf (on 1200-lpm printer, from stacker output tray). ←
5. Press down on latch lever to release carriage assembly (Figure 4-2) and swing carriage assembly fully open.
6. Open four tractor pressure plates and swing up hinged portion of paper rack (Figure 4-3).
7. Place form to be loaded into paper well compartment so that form print surface faces operator.
8. Place form on upper tractor pins and close upper tractor pressure plates.
9. Place form on lower tractor pins and close lower tractor pressure plates.
10. If form provided with alignment ticks, observe form alignment and use form advance and HORIZ FORM ADJ knobs for minor adjustment.
11. Ensure form thickness control lever is set for proper thickness and adjust if necessary.
12. If operating a 760- or 940/900-lpm printer, close and lock the print carriage assembly. If operating a 1200-lpm printer, leave the print carriage assembly open. ←
13. Feed form through internal guide assembly (Figure 4-6). On the 760- or 940/900-lpm printer, pass form through rear exit slot in hood and fold between rear and front paper guides to paper shelf (Figure 4-6). On the 1200-lpm printer, perform the following steps: ←
 - a. Manually raise forms stacker output tray (Figure 4-7) by pulling up evenly at front center of tray. Be certain that tray is fully raised against its upper stop position. Pull finger assemblies to their extreme open position.
 - b. Pull roller adjustment handle as far toward front of forms stacker as possible, to open roller gap to its widest position.
 - c. Fold forms along natural fold line (line along which paper was originally folded in its carton), and feed forms through throat of forms stacker until forms rest on output tray and paper contacts rear finger assembly.

- d. Push front finger assembly toward rear of forms stacker until front fingers contact edge of paper.

NOTE:

Output tray may lower slightly during this operation.

Forms should now be evenly aligned between front and rear finger assemblies. View forms from side of forms stacker to check alignment.

- e. Accumulate at least a forms length of paper on top of forms stacker, then push roller adjustment handle toward rear of forms stacker, increasing pull force just enough so that forms are fed into forms stacker. Then push roller adjustment handle an additional 1/4 inch, so that pull force is slightly increased. This adjustment should be made with care, as too much or too little tension can cause improper folding and stacking. Single-part forms generally require greater movement of the roller adjustment handle than heavier forms.
- f. Check throat of forms stacker to ensure that the fold line of the forms is parallel to the edge of the forms stacker casework. If not parallel, rotate the forms stacker to the right or left until the condition is corrected.
- g. Proceed to step 19.

14. Close paper well door at front of printer cabinet. If form exceeds 17 inches (43.18 cm) in length, leave door open.

- 15. If operating a 760- or 940/900-lpm printer, proceed directly to step 21. If operating a 1200-lpm printer, close and lock print carriage assembly, then proceed to step 21.

16. Press and hold the STOP switch, and then press the HOME switch. Release the HOME switch first, and then the STOP switch. The HOME indicator lights, but no forms motion is initiated (operator home procedure).

17. Press and release RUN switch. RUN indicator lights.

18. Check form tension to ensure sprocket holes are not distorted. Adjust tension control, if necessary.

19. Close top hood.

It may be desirable to merely attach the old forms to the new forms, instead of following the entire preceding procedure. To attach the forms, perform the following steps:

1. Perform steps 1-7 of the preceding procedure.
2. Line up top edge of new forms against bottom edge of old forms, and tape securely.
3. Close tractor pressure plates.
4. Close and lock print carriage assembly.
5. Close paper well door of printer cabinet.
6. Press and release RUN switch. RUN indicator lights.
7. Close top hood.

4.4.3. Forms Loading, Condition 3

Condition 3 requires the loading of a new type of form into the printer that is different from the form already in the printer.

1. Observe STOP indicator. If not lit, press STOP switch/indicator.
2. Raise top hood of printer.
3. Open front paper well door in bottom of printer cabinet.
4. Press down on latch lever to release carriage assembly (Figure 4-2) and swing carriage assembly fully open (Figure 4-3).
5. Tear form off at first line of perforations just below lower tractors.
6. Remove form from paper well compartment and set aside.
7. Open four tractor pressure plates and swing up hinged portion of paper rack (Figure 4-3).
8. At rear of printer, pull form through exit slot and, for 760- and 940/900-lpm printers, fold on top of existing form on paper shelf. For the 1200-lpm printer, fold on top of existing form on stacker output tray.
9. Remove existing form from paper shelf or, for the 1200-lpm printer, from stacker output tray, and set aside.
10. At front of printer, set maximum form adjustment by setting HORIZ FORM ADJ control so that retaining rings on tractor supports are equally spaced with respect to side castings (Figure 4-1).
11. Place form to be loaded into paper well compartment so that form print surface faces operator.
12. Place form on upper left tractor pins.
13. Close pressure plate on upper left tractor.

NOTE:

If form being loaded contains alignment ticks, perform step 14, otherwise go directly to step 15.

14. To load form provided with alignment ticks:
 - a. Unlatch form alignment guide from print carriage assembly and place across print head.
 - b. Adjust upper left tractor until vertical tick mark on form corresponds to proper column on column indicator (Figure 4-4).
 - c. Lock upper left tractor by turning tractor knurled locking screw clockwise.
 - d. Adjust upper right tractor until form mates with tractor pins.
 - e. Close upper right tractor pressure plate.
 - f. Proceed to step 16.

15. To load form not provided with alignment ticks:
 - a. Adjust upper right tractor until form engages tractor pins.
 - b. Close upper right tractor pressure plate.
 - c. Unlatch forms alignment guide from print carriage and place across print head.
 - d. Press and turn form advance knob until bottom edge of form guide aligns with intended bottom line to be printed (Figure 4-5).
 - e. Adjust two upper tractors to shift form horizontally until correct column indication block is centered on intended position in first column.
 - f. Remove all horizontal slack from form by adjusting two upper tractors.
 - g. Secure both tractors by turning knurled locking screw on each tractor clockwise.
 - h. Proceed to step 16.
16. Adjust and secure two lower tractors so that form is held in correct vertical position.
17. Press and turn form tension knob until slight tension is felt over curvature of print head.

NOTE:

Make certain sprocket holes in form are not deformed.

18. If form alignment guide is used for aligning form, retract and latch guide (magnetically) to print carriage assembly.
19. On form provided with horizontal tick, press and turn form advance knob until horizontal alignment tick at edge of form is aligned with line on print head (Figure 4-4). Make certain form extends beyond paper switch on upper tractor.
20. Move form thickness control lever to proper location for form used.
- 21. If operating a 760- or 940/900-lpm printer, close and lock the print carriage assembly. If operating a 1200-lpm printer, leave the print carriage assembly open.
- 22. Feed form through internal guide assembly (Figure 4-6). On the 760- or 940/900-lpm printer, pass form through rear exit slot in hood and fold between rear and front paper guides to paper shelf (Figure 4-6). Perform the following steps on the 1200-lpm printer:
 - a. Manually raise forms stacker output tray (Figure 4-7) by pulling up evenly at front center of tray. Be certain that tray is fully raised against its upper stop position. Pull finger assemblies to their extreme open position.
 - b. Pull roller adjustment handle as far toward front of forms stacker as possible, to open roller gap to its widest position.
 - c. Fold forms along natural fold line (line along which paper was originally folded in its carton), and feed forms through throat of forms stacker until forms rest on output tray and paper contacts rear finger assembly.

- d. Push front finger assembly toward rear of forms stacker until front fingers contact edge of paper.

NOTE:

Output tray may lower slightly during this operation.

Forms should now be evenly aligned between front and rear finger assemblies. View forms from side of forms stacker to check alignment.

- e. Accumulate at least a forms length of paper on top of forms stacker, then push roller adjustment handle toward rear of forms stacker, increasing pull force just enough so that forms are fed into forms stacker. Then push roller adjustment handle an additional 1/4 inch, so that pull force is slightly increased. This adjustment should be made with care, as too much or too little tension can cause improper folding and stacking. Single-part forms generally require greater movement of the roller adjustment handle than heavier forms.
 - f. Check throat of forms stacker to ensure that the fold line of the forms is parallel to the edge of the forms stacker casework. If not parallel, rotate the forms stacker to the right or left until the condition is corrected.
 - g. Proceed to step 23.
23. Close paper well door at front of printer cabinet. If form exceeds 17 inches (43.18 cm) in length, leave door open.
 24. If operating a 760- or 940/900-lpm printer, proceed directly to step 25. If operating a 1200-lpm printer, close and lock print carriage assembly, then proceed to step 25. ←
 25. Press and hold the STOP switch, and then press the HOME switch. Release the HOME switch first, and then the STOP switch. The HOME indicator lights, but no forms motion is initiated (operator home procedure).
 26. Press and release RUN switch. RUN indicator lights.
 27. If further minor adjustment is required, adjust HORIZ FORM ADJ knob for side-to-side character placement.

CAUTION

Do not adjust form advance or tension controls while form is in motion (to prevent possible tearing of form).

28. Close top hood.

4.5. RIBBON REPLACEMENT

Ribbon replacement on the print carriage assembly is required when printing appears light or faded. The printer must be offline and turned off, and the front hood open before attempting to replace the inked ribbon. Also, the operator should wear a pair of plastic gloves for protection against the ink in the ribbon (gloves are provided with each new ink ribbon).

Replace ink ribbon as follows:

1. Push downward on latch lever, locking print carriage assembly. Swing print carriage assembly to fully open position (Figure 4-8).
2. Open ribbon shield by pulling right-hand side of shield from magnetic latch. Swing shield back (Figure 4-9).

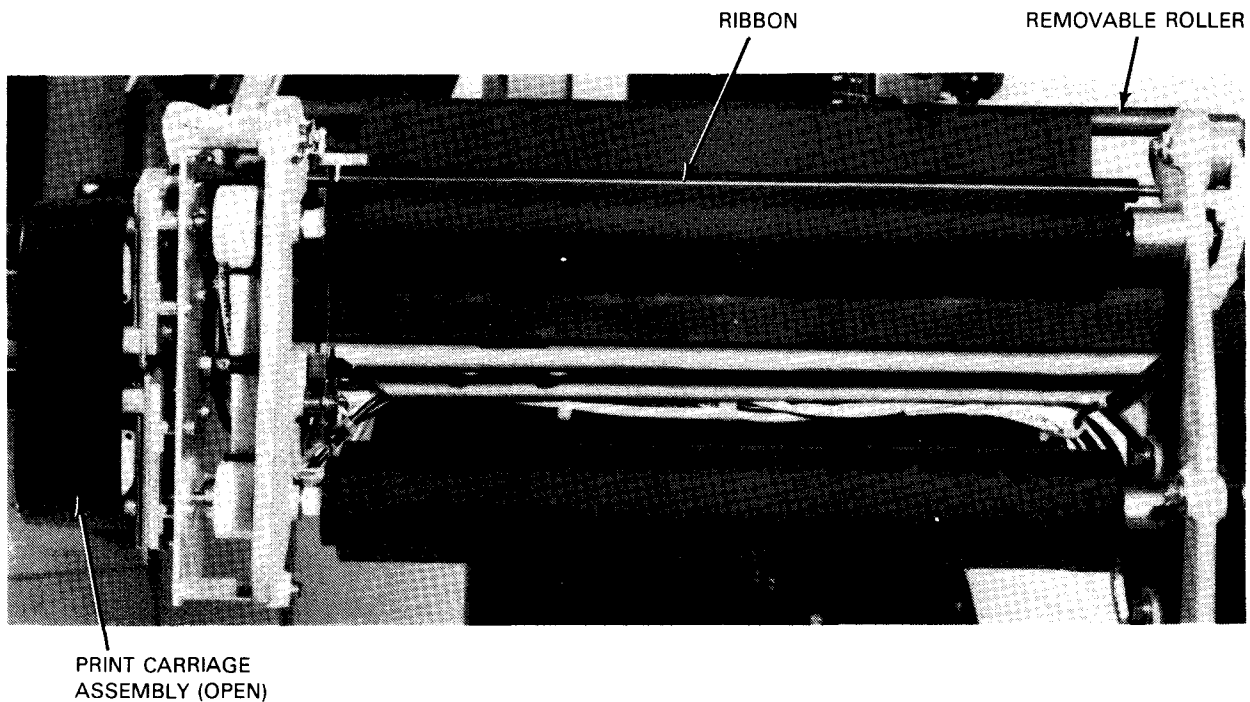

Figure 4-8. Print Carriage Assembly Open and Removable Roller in Place

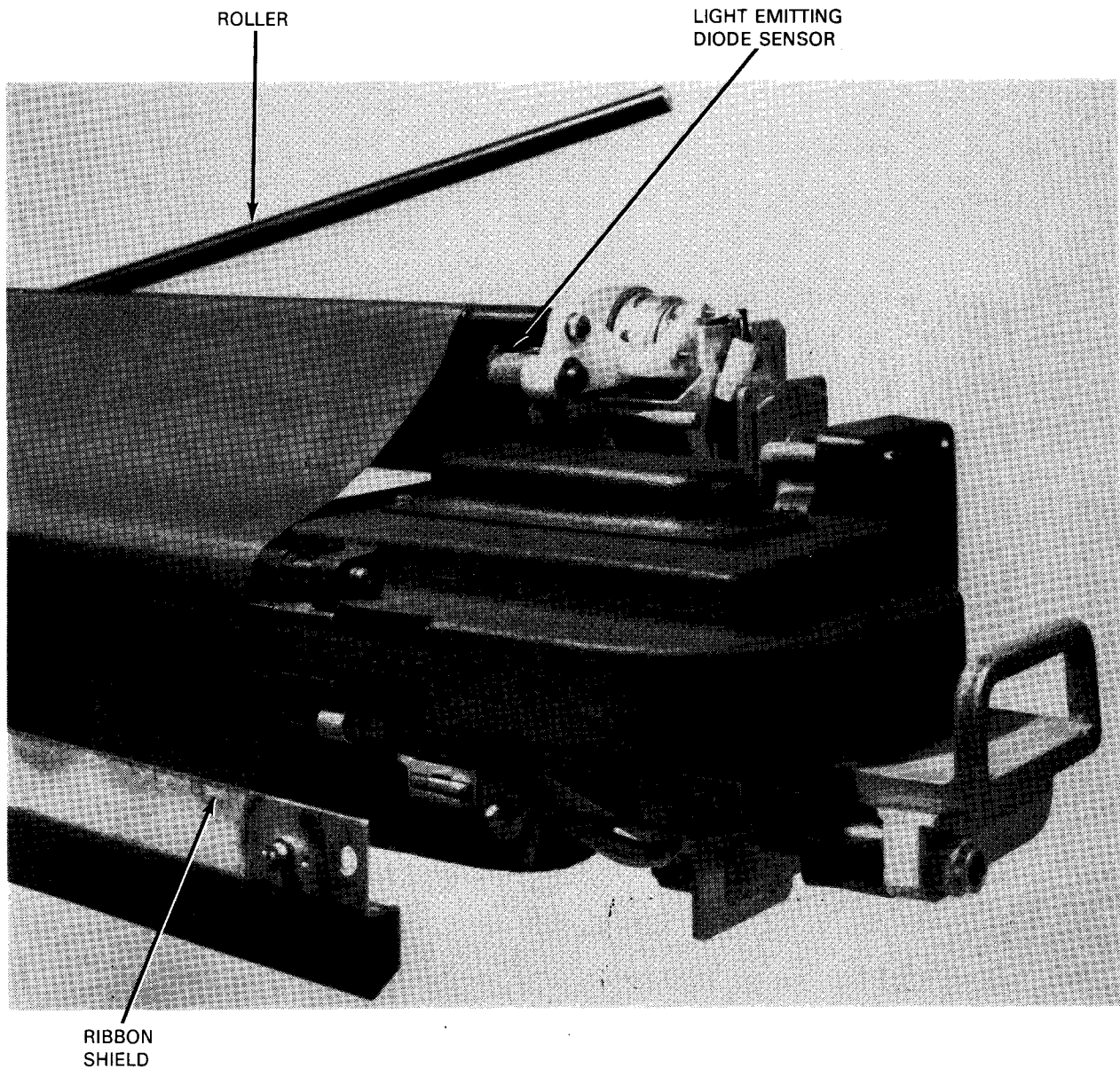

Figure 4-9. Ribbon Shield Open

3. Remove spring-loaded roller from support by grasping roller and pushing it against support to release spring.
4. Wearing plastic gloves provided with new ribbon, remove upper takeup spool from upper spool holder (Figure 4-10).
5. Remove lower spool from lower takeup spool holder (Figure 4-11) by pushing spool toward spring-loaded spool holder.
6. With both takeup spools disengaged, remove ribbon from around print carriage assembly and discard ribbon (Figure 4-11).
7. Install new ribbon on lower and upper takeup spools in the reverse manner that old ribbon was removed. Follow ribbon threading path shown in Figure 4-12.

8. Replace roller over ribbon.
9. Take up slack in ribbon by turning ribbon rolls. Make certain ribbon edge passes inside ribbon light emitting diode (LED) (Figure 4-9).
10. Close ribbon shield.
11. Close print carriage assembly and lock print carriage assembly latch.

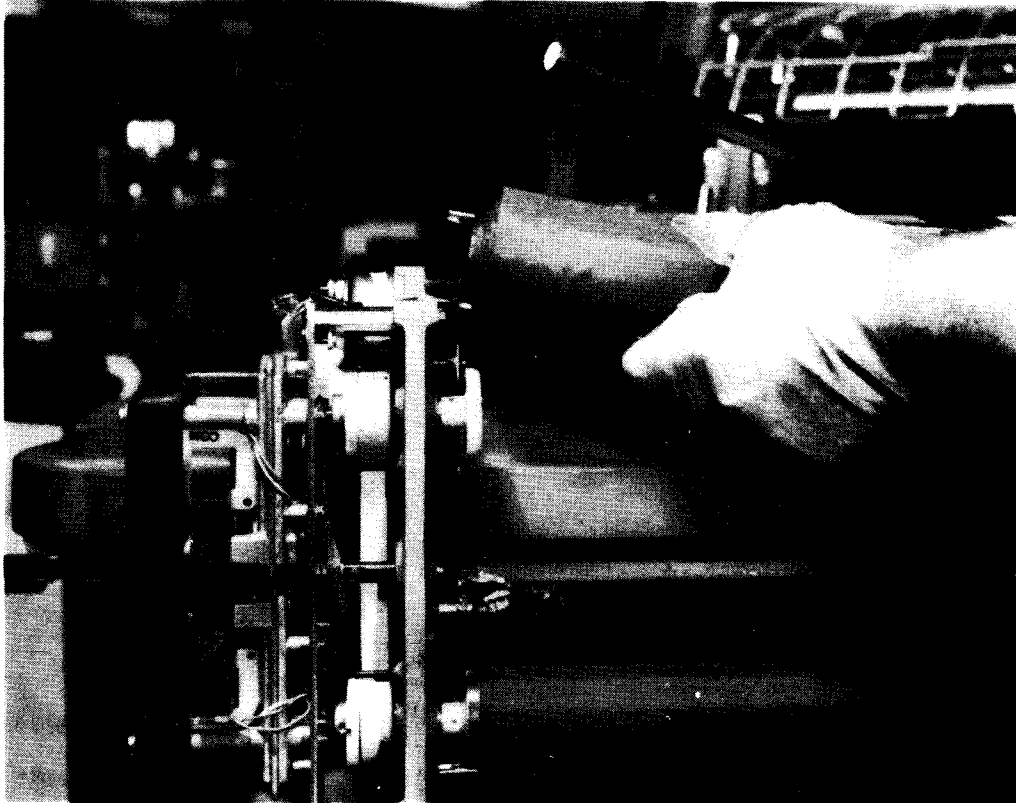

Figure 4-10. Removing Upper Takeup Spool

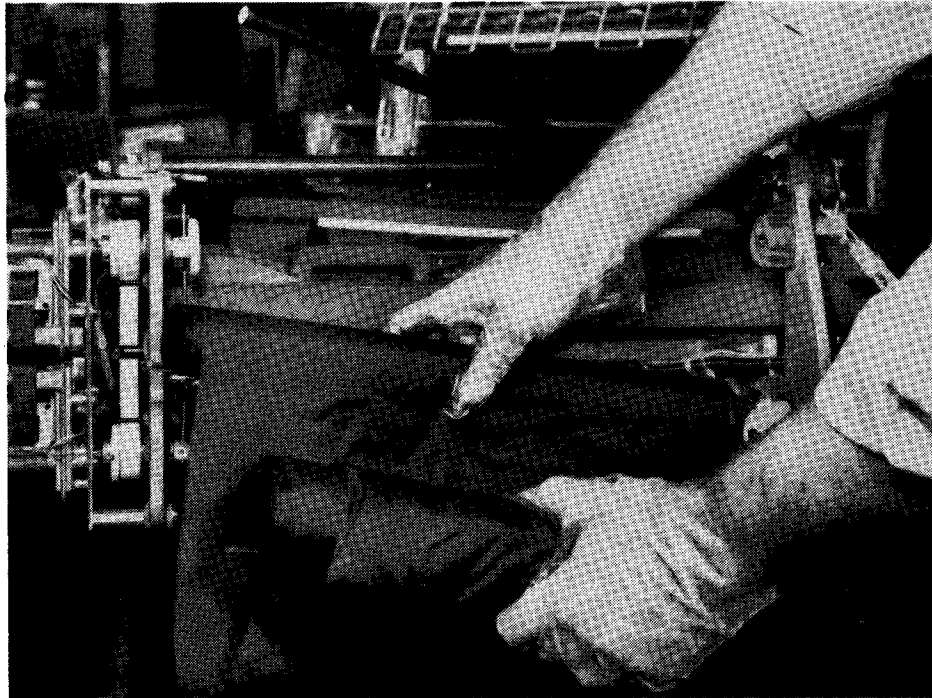

Figure 4-11. Removing Upper and Lower Takeup Spools

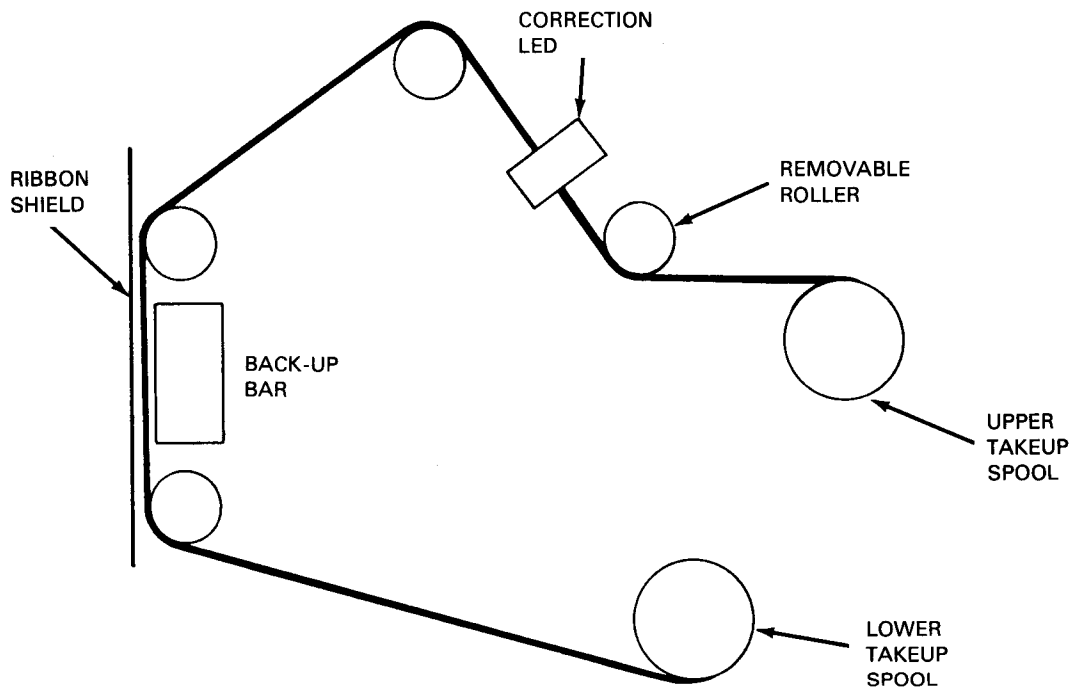

Figure 4-12. Printer Ribbon Threading Path

4.6. PRINT BAND CARTRIDGE REPLACEMENT

Replacement of a print band cartridge is necessary when a different band (type font) is required or a print band becomes damaged or worn. Before performing this task, make certain power to the printer is off and top hood is raised. Replace the print band cartridge as follows:

1. Remove ribbon from upper takeup spool holder as specified in steps 1 through 4 of 4.5.
2. Remove bottom ribbon roll and cradle between upper ribbon roll and spring-loaded roller (see Figure 4-8).
3. Loosen two thumbscrews holding print cartridge assembly to print carriage assembly.
4. Grasp two handles of print band cartridge and remove from print carriage assembly by lifting straight up (Figure 4-13).
5. To install print band cartridge, align two holes on print band cartridge with two alignment pins on print carriage assembly. Lower print band cartridge onto print carriage assembly (Figure 4-13).
6. Fasten print band cartridge by hand-tightening two thumbscrews.
7. Visually check cartridge to ensure that it is fully seated.
8. Replace ribbon removed in steps 1 and 2.
9. Close ribbon shield.
10. Close print cartridge assembly and secure by raising print carriage assembly latch.

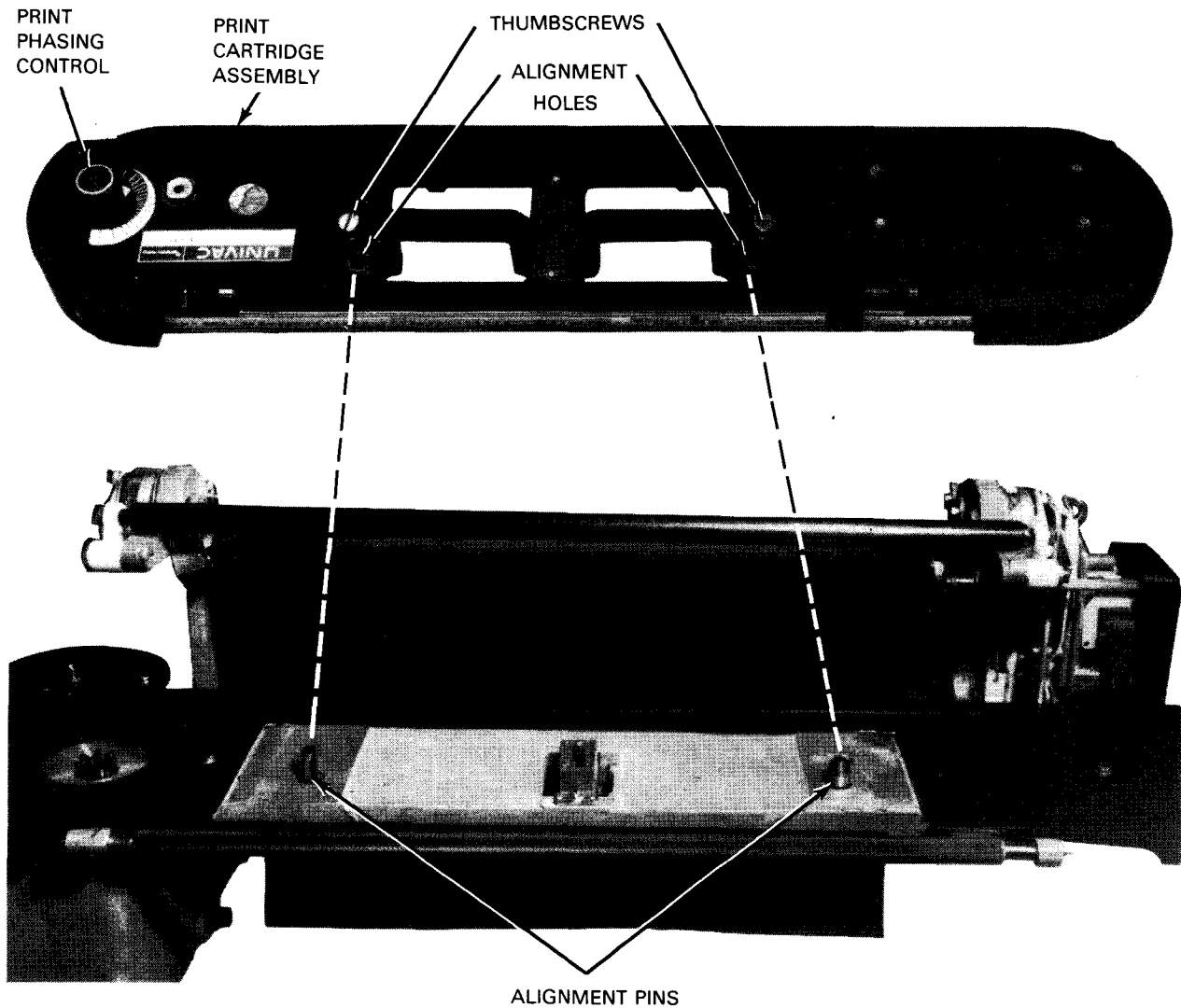

Figure 4-13. Alignment of Print Cartridge Assembly

4.7. PRINT PHASING ADJUSTMENT

The print phasing control on the print cartridge assembly permits the operator to eliminate clipping printed characters. Clipping is indicated when either side of the printed character is faded or missing. Evidence of incorrect setting of the print phasing control can best be seen on the last part of a multipart form.

If clipping occurs, print phasing can be adjusted during printing by turning the control in either direction until the characters are printed uniformly over the entire surface. Figure 4-14 illustrates evenly printed characters, indicating a properly adjusted phasing control.

Changing the thickness of the form and print band speed requires an adjustment of the print phasing control. If the correct phasing setting can not be obtained by setting the control near either limit of its rotation range, the operator should notify the Sperry Univac customer engineer.

```

6E #X#XEE --22 Z2TT AA 77@@VVPP, 3388 RRL L 88 XX W W N N H H 4 4 $ $ S S J J 0 0 0 0 X X
6E #X#XEE --22 Z2TT AA 77@@VVPP, 3388 RRL L 88 XX W W N N H H 4 4 $ $ S S J J 0 0 0 0 X X
6E #X#XEE --22 Z2TT AA 77@@VVPP, 3388 RRL L 88 XX W W N N H H 4 4 $ $ S S J J 0 0 0 0 X X
6E #X#XEE --22 Z2TT AA 77@@VVPP, 3388 RRL L 88 XX W W N N H H 4 4 $ $ S S J J 0 0 0 0 X X

```

Figure 4-14. Example of Correct Print Phasing

4.8. PRINT GAP ADJUSTMENT

The print gap (i.e., distance between hammer face and type face) is adjusted using the form thickness control to compensate for use of forms with various thicknesses. The range of the control is such that a 6-part form with a maximum pack thickness of 0.018 inch (0.457 mm) can be printed without any degradation in quality. At the operator's discretion, other forms which exceed the maximum pack thickness can be made workable by manipulation of the form thickness control in conjunction with the print phasing control on the print cartridge assembly. However, this is not recommended, and if this option is taken by the operator, reduced print quality may result. For assistance in determining the correct settings for special forms, the operator should contact the Sperry Univac customer engineer.

→ 4.9. UNLOADING FORMS STACKER (1200-LPM PRINTER ONLY)

When the printer has ceased operating, the printed and stacked forms may be removed from the stacker output tray (Figure 4-7).

To remove forms, perform the following steps:

1. Detach the last printed form from the unprinted forms.
2. Allow the forms stacker to stack the remaining printed forms.
3. Press the LOWER TRAY switch (3.4 and Figure 3-1), lowering the stacker output tray until the top of the forms is beneath the lower tip of the finger assemblies.

CAUTION

Do not attempt to push tray down. To do so may damage the equipment.

4. Release the LOWER TRAY switch to stop the tray motion.
5. Lift the right and left edges of the stack of printed forms, slide the stack to the front of the forms stacker, and remove the forms.

4.10. PAPER ADVANCE

Form advance is by means of the form tractors and a driving motor. Form advance is initiated manually during the stop state or by program control.

4.10.1. Manual Paper Advance

Pressing the STOP switch while the printer is in the run state places the printer in the stop state. A control which is executing a command, or holding pending status, is delayed entry to the stop state until completion of the command and the transfer of status to the channel.

To advance a form to the home position manually:

1. Momentarily press STOP switch. If in run state, printer stops printing and STOP indicator lights.
2. Momentarily press HOME switch. Form advances to next home or setup position. HOME indicator lights when home position is obtained.

To initialize the printer to home paper position without advancing form:

1. Momentarily press STOP switch. STOP indicator lights if not already lit.
2. Press and hold STOP switch and then momentarily press HOME switch. Release STOP switch. The vertical form buffer is now initialized to home paper position without advancing form. HOME indicator lights to indicate vertical format buffer is in home position.

4.10.2. Program Controlled Paper Advance

To initiate paper advance under program control, the form must be synchronized with the vertical format buffer while in the stop state as follows:

1. Load paper form as specified in 4.4.
2. Press and hold SPACE switch until form reaches home position. Release switch.
3. Press and hold STOP switch, then press HOME switch. This initializes vertical format buffer with no advance of form.
4. Press RUN switch. Printer enters run state if no error conditions exist. Program and form are now synchronized; HOME and RUN indicators light.

4.11. RECOVERY PROCEDURES

Abnormal conditions that may occur in the 0776 printer are noted by the operator according to the indications presented on the operator control panel (see Figure 3-2). Table 4-1 lists each possible fault that can occur and the recovery procedures to return the printer to full operation.

Table 4-1. Operator Recovery Procedures (Part 1 of 2)

Indication	Probable Cause	Recovery Procedures
No indicator lit, no motors or blowers operating	No power to printer.	Check main power circuit breaker (power control panel) under top hood. If switch is tripped, reset. If not tripped, check main power source.
DEVICE CHECK indicator lit, STOP switch/indicator lit	<ol style="list-style-type: none"> Print carriage assembly not closed or installed properly. No air or reduced air flow through module (or, if a 1200-lpm printer, through paper feed motor). 	<p>Check installation of print carriage assembly.</p> <p>Check module fans. On a 1200-lpm printer, check belt on paper feed cooling motor and determine if hose is off.</p>
TEMP CHECK indicator lit, DEVICE CHECK indicator lit, STOP switch/indicator lit	<ol style="list-style-type: none"> Air flow within printer restricted. Temperature within printer exceeds 134.6° F (57° C). 	<p>Determine if blower operating or if air circulating within printer.</p> <p>Determine that ambient temperature not excessive and that printer floor-level fresh air intakes not obstructed.</p> <p>Press and release RUN switch/indicator. Observe that DEVICE CHECK indicator and STOP switch/indicator are extinguished.</p> <p>Restart program.</p> <p>If error condition persists or reoccurs, notify Sperry Univac customer engineer.</p>
PRINT CHECK indicator lit, STOP switch/indicator lit	Failure in print head actuator circuits or print band.	<p>Faulty actuator circuit or incorrect print band timing.</p> <p>Restart program, or if desirable to continue printing from this line, press and release RUN switch/indicator (the line will be overprinted).</p> <p>If error persists, notify Sperry Univac customer engineer.</p>

Table 4-1. Operator Recovery Procedures (Part 2 of 2)

Indication	Probable Cause	Recovery Procedures
FORM CHECK indicator lit, STOP switch/indicator lit	Form jammed or ripped.	<p>Remove torn or jammed form from printer. Note location of torn or jammed form with respect to printed data so that convenient restart point can be established.</p> <p>Reload forms as described in 4.4.</p> <p>Press and release RUN switch/indicator. Observe that FORM CHECK indicator and STOP switch/indicator extinguished.</p> <p>Reenter program at proper point.</p> <p>If error persists, notify Sperry Univac customer engineer.</p>
FORMS OUT indicator lit, STOP switch/indicator lit	Paper form required in printer.	<p>Reload forms as described in 4.4.</p> <p>Press and release RUN switch/indicator. Observe that FORMS OUT indicator and STOP switch/indicator extinguished.</p> <p>Reenter program at proper point.</p>
POWER CHECK indicator (power control panel) lit, DEVICE CHECK indicator lit, STOP switch/indicator lit	<ol style="list-style-type: none"> 1. Power supply output voltage low. 2. One or more power supplies not operating. 	<p>Notify Sperry Univac customer engineer.</p> <p>Check circuit breakers (power supply control panel) behind rear panel door of printer. Reset any tripped circuit breaker. If breaker trips again, notify Sperry Univac customer engineer.</p>



5. Operator-Performed Maintenance

5.1. GENERAL

Operator-performed maintenance on the 0776 printer is limited to cleaning requirements for:

- the cabinet;
- the print band cartridge; and
- the forms stacker (1200-lpm printer only).

Replacement of indicator lights is also an operator-performed maintenance task.

5.2. CLEANING REQUIREMENTS

5.2.1. Cabinet

Cleaning requirements necessitate keeping the external surfaces of the 0776 printer clean and dust free using a damp cloth and thorough drying. Keep the paper well area and paper shelf clean and free of paper lint.

5.2.2. Print Band Cartridge

The print band cartridge should be cleaned after each ribbon change.

1. Press STOP switch/indicator on operator control panel (Figure 3-2). (STOP indicator should light.)
2. Raise front top hood of printer. Open paper well door at lower front of printer cabinet.
3. Remove ink ribbon from around print cartridge assembly by performing steps 1 through 4 of 4.5 and step 2 of 4.6.
4. Carefully remove ribbon lint and paper debris from print band cartridge and the surrounding area using cleaning kit 5027856-00 materials (brush, cloth, solvent). Then vacuum area around print head assembly.
5. Loosen two thumbscrews securing print cartridge assembly and remove assembly.
6. Using the cleaning brush or a standard typewriter brush, manually rotate the print band and carefully brush the print band and cartridge area that is beneath the print cartridge assembly. Be sure to remove ribbon lint from the vicinity of the reluctance pick-up heads.
7. Reinstall print cartridge assembly on print carriage assembly as specified in 4.6.

→ 5.2.3. Forms Stacker (1200-Lpm Printer Only)

Dust should be removed from the forms stacker (Figure 4-7) periodically. The use of a blower to remove paper dust is recommended.

5.3. INDICATOR LAMP REPLACEMENT

Three switch/indicators (RUN, STOP, and HOME) located on the operator control panel are the indicators containing lamps that require replacement by the operator.

Replace switch/indicator lamps as follows:

1. Remove switch/indicator lens by lifting up lens (Figure 5-1).
2. Remove lamp from socket by pressing side of lamp with eraser end of a pencil. Tilt and release lamp from snap-type socket (Figure 5-2).
3. Install new lamp by inserting lamp into socket (Figure 5-3) (Sperry Univac part no. 4914177-01).
4. Press lamp into socket until fully seated (Figure 5-4). (A slight snap action of the lamp seating is felt when pressing in on lamp.)
5. Replace switch/indicator lens into socket. (Note lens lettering to insert in correct position.)
6. Press lens into socket assembly firmly (Figure 5-5).

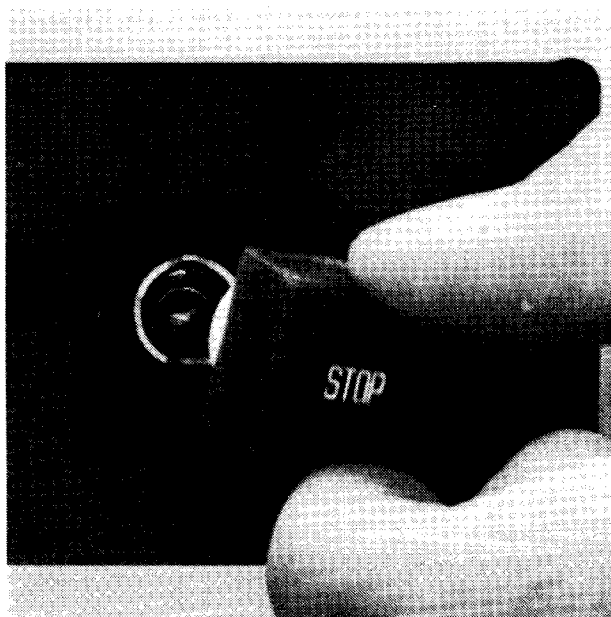

Figure 5-1. Removing Lens from Lamp

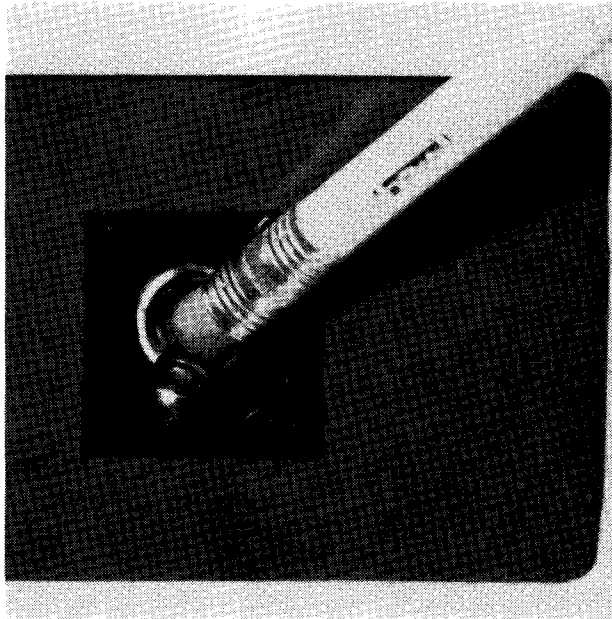

Figure 5—2. Removing Lamp from Socket

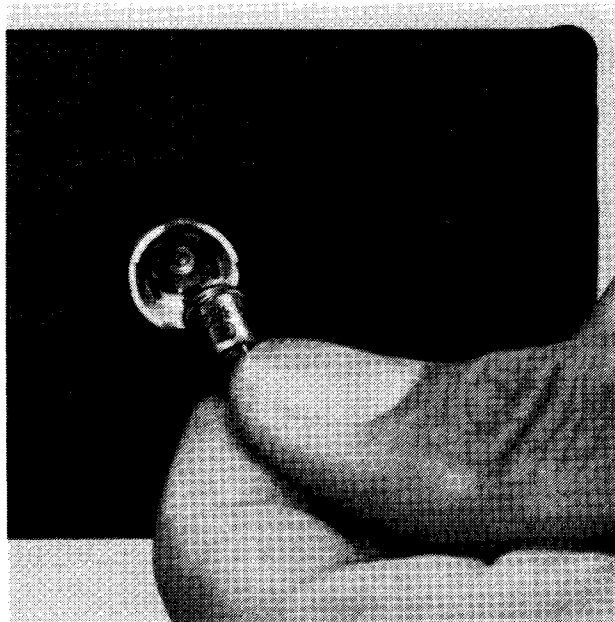

Figure 5—3. Inserting New Lamp into Switch/Indicator Socket

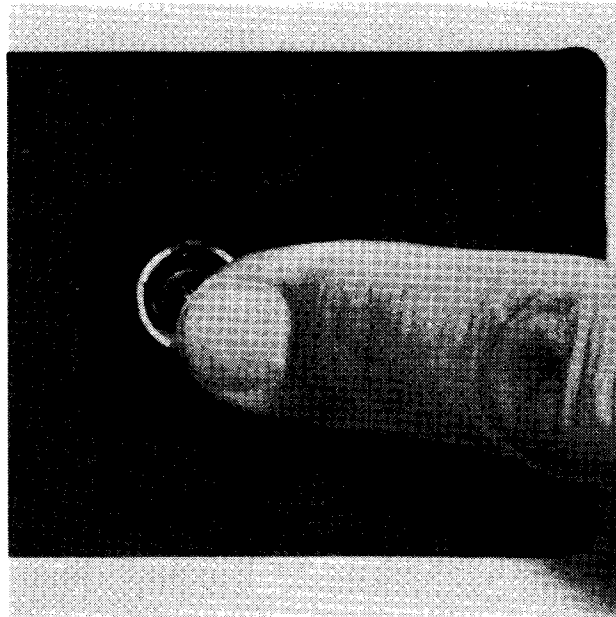

Figure 5—4. Pressing Lamp into Socket

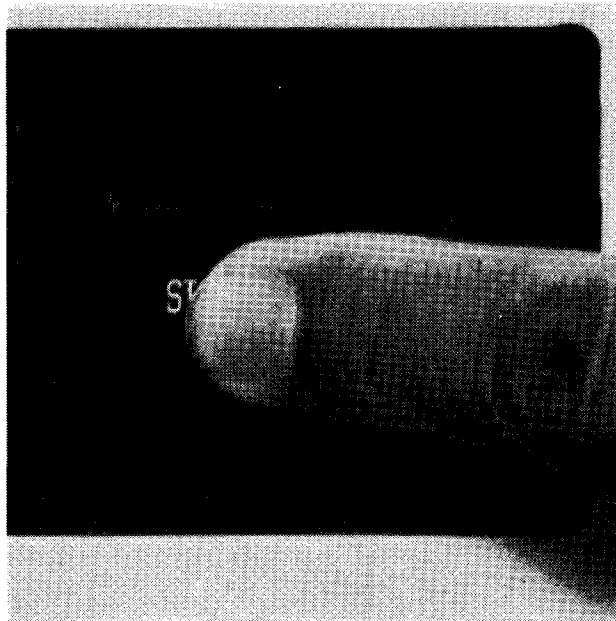

Figure 5—5. Replacing Lens of Switch/Indicator

USER COMMENT SHEET

Your comments concerning this document will be welcomed by Sperry Univac for use in improving subsequent editions.

Please note: This form is not intended to be used as an order blank.

(Document Title)

(Document No.)

(Revision No.)

(Update No.)

Comments:

Cut along line.

From:

(Name of User)

(Business Address)

Fold on dotted lines, and mail. (No postage stamp is necessary if mailed in the U.S.A.)
Thank you for your cooperation

FOLD



NO POSTAGE
NECESSARY
IF MAILED
IN THE
UNITED STATES

BUSINESS REPLY MAIL

FIRST CLASS PERMIT NO. 21 BLUE BELL, PA.

POSTAGE WILL BE PAID BY ADDRESSEE

SPERRY UNIVAC

ATTN.: SYSTEMS PUBLICATIONS

P.O. BOX 500
BLUE BELL, PENNSYLVANIA 19424

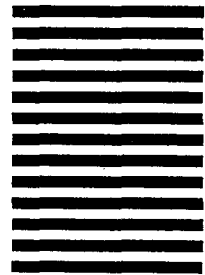

CUT

FOLD