

ULT

Operations and Maintenance

1400 Series Systems

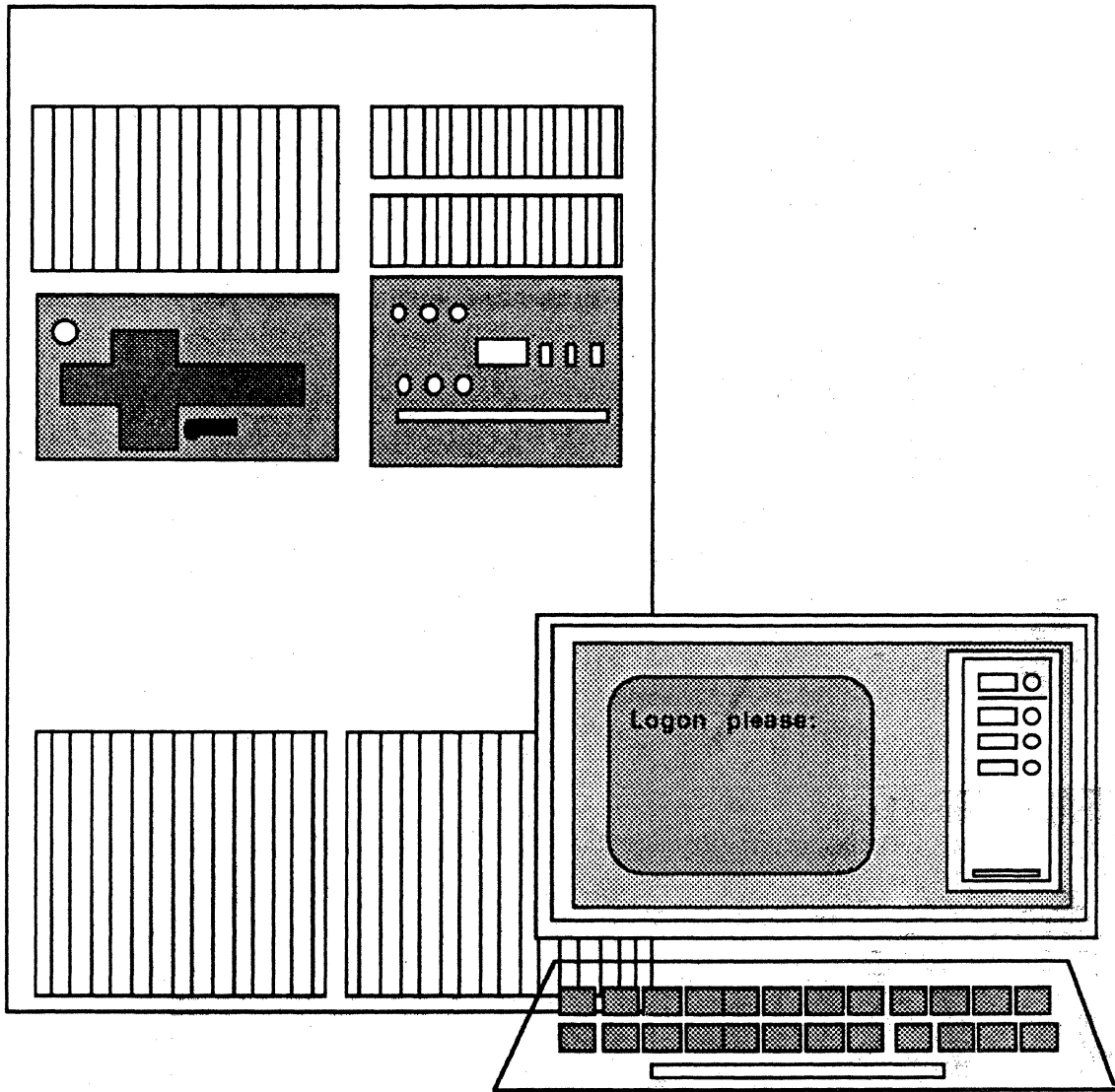

THE ULTIMATE CORP.

FOR INTERNAL USE

This document contains information that is the property of The Ultimate Corp. and is intended for internal use only. It is not to be distributed outside the company without the express written approval of The Ultimate Corp. This document is the property of The Ultimate Corp. and is not to be reproduced, copied, used, disclosed, transferred, adopted, or modified without the express written approval of The Ultimate Corp.

PROPRIETARY INFORMATION

Copyright (c) 1988, The Ultimate Corp. All Rights Reserved. This work is the property of and embodies trade secrets and confidential information proprietary to Ultimate, and may not be reproduced, copied, used, disclosed, transferred, adopted, or modified without the express written approval of Ultimate.

Copyright March 1988, THE ULTIMATE CORP.
Document No. BOM-01

PROPRIETARY INFORMATION

This document contains information that is the property of The Ultimate Corp. and is intended for internal use only. It is not to be distributed outside the company without the express written approval of The Ultimate Corp. This document is the property of The Ultimate Corp. and is not to be reproduced, copied, used, disclosed, transferred, adopted, or modified without the express written approval of The Ultimate Corp.

FCC WARNING

This equipment generates, uses, and can radiate radio frequency energy and, if not installed and used in accordance with the instruction manuals, may cause interference to radio communications. It has been tested and found to comply with the limits for a Class A computing device pursuant to Subpart J of Part 15 of FCC Rules, which are designed to provide reasonable protection against such interference when operated in a commercial environment. Operation of this equipment in a residential area is likely to cause interference, in which case the user, at his or her own expense, will be required to take whatever measures necessary to correct the interference.

PROPRIETARY INFORMATION

Copyright © 1990 by the Copyright Clearance Center, Inc. All rights reserved. This work is published by the Copyright Clearance Center, Inc., 222 Rosewood Drive, Danvers, MA 01923. This work is published by the Copyright Clearance Center, Inc., 222 Rosewood Drive, Danvers, MA 01923.

PROPERTY OF THE COPYRIGHT CLEARANCE CENTER, INC.

ACKNOWLEDGEMENT

The illustrations in Section 4.2 are courtesy of Cipher Data Products, Inc.

TABLE OF CONTENTS

	Page
FCC WARNING.....	P-1
How to Use This Manual.....	P-6
1. GETTING STARTED.....	1-1
1.1 Power On.....	1-1
1.2 Boot the System.....	1-1
1.3 Format Disk(s).....	1-1
1.4 Check Equipment.....	1-1
1.4.1 Terminals.....	1-1
1.4.2 Printers.....	1-3
1.5 Check ACC and DICT ACC Files.....	1-4
1.6 Load UltiWord.....	1-4
1.7 Getting Started Checklist.....	1-12
2. POWERING ON.....	2-1
3. POWERING OFF.....	3-1
4. TAPE DRIVE PROCEDURES.....	4-1
4.1 One Quarter Inch (1/4") Cartridge Tapes.....	4-1
4.2 One Half Inch (1/2") Reel Tapes.....	4-3
5. BOOTING THE SYSTEM.....	5-1
6. SYSTEM STARTUP OPTIONS.....	6-1
6.1 Coldstart.....	6-3
6.2 Diagnostics Monitor.....	6-10
6.2.1 Formatting a Disk For 1410 Systems.....	6-10
6.2.2 Formatting a Disk For 1420 and 1430 Systems.....	6-15
6.3 File-Restore.....	6-19
6.4 Warmstart.....	6-19
6.4.1 From Menu.....	6-19
6.4.2 From TCL.....	6-20
7. BACKING UP THE SYSTEM.....	7-1
7.1 Organizing Backup Tapes.....	7-1
7.1.1 Labeling.....	7-1
7.1.2 Rotating.....	7-2
7.2 File-Save.....	7-3
7.3 Account-Save.....	7-7
7.4 T-DUMP.....	7-10
7.5 Update-Saves and Transaction Logger.....	7-12
7.5.1 ALL-UPDATE-SAVE.....	7-12
7.5.2 PART-UPDATE-SAVE.....	7-15

Table of Contents

7.5.3 Transaction Logger..... 7-18

7.5.4 Using Update-Saves and Transaction Logger Together.....7-23

8. RESTORING DATA..... 8-1

8.1 File-Restore..... 8-1

8.2 Account-Restore..... 8-11

8.2.1 From File-Save or Account-Save Tape..... 8-11

8.2.2 From Update-Save Tape..... 8-13

8.3 T-LOAD.....8-20

8.4 Selective-Restore..... 8-22

8.5 Restore From Update-Saves and Transaction Logger..... 8-25

9. MAINTENANCE..... 9-1

9.1 Daily..... 9-1

9.1.1 Back Up Your Data..... 9-1

9.1.2 Check File Statistics Report..... 9-1

9.1.3 Verify-System..... 9-2

9.1.4 List-System-Errors..... 9-3

9.1.5 Check Print Overflow Table..... 9-5

9.2 Weekly..... 9-6

9.2.1 File-Save..... 9-6

9.2.2 Clean Tape Heads..... 9-6

9.3 Monthly..... 9-6

9.3.1 File-Restore..... 9-6

9.3.2 Clear ACC File..... 9-6

10. ADDING EQUIPMENT..... 10-1

10.1 Adding Ports..... 10-1

10.2 Adding Disk Drives..... 10-1

10.3 Adding Tape Drives and Parallel Printers..... 10-1

10.4 Adding Communications Boards..... 10-1

11. TROUBLESHOOTING..... 11-1

11.1 General Procedures..... 11-1

11.2 Calling Ultimate Technical Support 11-2

11.3 Group Format Errors (GFEs)..... 11-2

11.4 Aborts..... 11-4

11.5 System Hangs..... 11-6

11.5.1 System..... 11-6

11.5.2 Terminals..... 11-6

11.5.3 Hangs During a File-Save..... 11-7

11.5.3.1 Disk Errors..... 11-7

11.5.3.2 Tape Errors..... 11-19

11.5.3.3 Checking for Parity Errors..... 11-19

11.5.3.4 Lock Errors..... 11-20

11.6 Printer Problems..... 11-20

11.7 System Errors..... 11-21

11.8 Mismatches..... 11-22

11.9 Power Failures..... 11-23

11.9.1 Power Failure Recoveries..... 11-24

11.10 Creating a Memory Dump..... 11-25

Ultimate Site Log..... 11-27

APPENDIX A: GLOSSARY..... A-1

APPENDIX B: PANEL LAYOUTS..... B-1

Figure B.1 - 1400 Series System CPU..... B-2

Figure B.2 - 1400 Series System Panel..... B-3

Figure B.3 - Back of the 1400 Series System..... B-4

APPENDIX C: CRT CONFIGURATIONS..... C-1

ADDS 2020 Terminal..... C-1

Viewpoint/60 Terminal..... C-3

Viewpoint/60+ Terminal..... C-6

Viewpoint Plus Terminal..... C-9

Viewpoint 1010 Terminal..... C-10

Wyse WY-50 Terminal..... C-11

Wyse 60 Terminal..... C-17

Wyse 85 Terminal..... C-20

APPENDIX D: PRINTER CONFIGURATIONS..... D-1

Data Comm Board..... D-1

DEC Letterprinter 210..... D-4

IGP-10 Board (Revisions 1 through 4)..... D-6

IGP-10 Board (Revision 6)..... D-9

NEC 3500 Letter Quality Printer..... D-12

NEC 5500 SpinWriter..... D-14

Printronix A and B Logic Boards..... D-16

Printronix MVP..... D-18

Printronix Compress Print Mode..... D-22

APPENDIX E: CABLE SPECIFICATIONS..... E-1

CRT to CPU (System) Cable..... E-1

Parallel Printer Cable..... E-3

Using Existing Ultimate Cabling..... E-5

APPENDIX F: MODEM SPECIFICATIONS..... F-1

Racal-Vadic VA212LC..... F-1

Hayes Smartmodem 1200..... F-2

INDEX..... I-1

Table of Contents

Summaries

Coldstart Procedure.....6-9

Formatting Disks For 1410 Systems.....6-14

Formatting Disks For 1420 and 1430 Systems.....6-18

Warmstart From the Options Menu.....6-22

Warmstart From TCL.....6-22

File-Save Procedure.....7-6

Account-Save Procedure.....7-9

T-Dump Procedure.....7-11

All-Update-Save Procedure.....7-14

Part-Update-Save Procedure.....7-17

Transaction Logger Procedures.....7-22

File-Restore Procedure.....8-10

Account-Restore From File-Save or Account-Save.....8-18

Account-Restore From Update-Save.....8-19

T-Load Procedure.....8-21

Selective-Restore Procedure.....8-24

File-Restore With Update/Transaction Tapes.....8-36

Maintenance Items.....9-8

Procedures When Adding Equipment.....10-2

HOW TO USE THIS MANUAL

The 1400 Systems Operations and Maintenance Guide is designed to guide you through normal operating procedures and scheduled maintenance of your Ultimate 1400 Series computer system.

You should have read and followed the instructions in the Site Preparation Guide before attempting any steps in this manual.

You should read and become familiar with all of the steps in this manual, and refer to specific sections as they are required.

- Section 1 defines the steps necessary in **GETTING STARTED** with your Ultimate system. This section explains what you'll need to do before you can use your system, and it provides a checklist so you may check your progress and ensure you've completed all the steps necessary in getting started.
- Section 2 explains the procedures for **POWERING ON** your Ultimate system.
- Section 3 explains the procedures for **POWERING OFF** your Ultimate system. Normally, your Ultimate system can be left on, so you won't need to power off very often.
- Section 4 explains **TAPE DRIVE PROCEDURES**, such as loading and unloading tapes, and cleaning tape drives. Although these procedures are included in the instructions on powering on and off, they are separated in this section in case they need to be performed separately.
- Section 5 explains **BOOTING THE SYSTEM**, which is the procedure for restarting your computer without powering it off.
- Section 6 explains the **SYSTEM STARTUP OPTIONS** available for your system. These options are displayed when you boot your system, as explained in Section 5. Section 6 explains when and why each option should be used.
- Section 7 explains various procedures for **BACKING UP THE SYSTEM**. These instructions are vital in preventing data losses.
- Section 8 explains **RESTORING DATA**. If your data is lost or corrupted, it can be recovered if you've used one of the backup methods explained in Section 7.
- Section 9 explains **MAINTENANCE**. Ultimate recommends that you periodically perform certain maintenance functions to keep your system running smoothly. Procedures are given for daily, weekly, and monthly maintenance.
- Section 10 explains the steps necessary for **ADDING EQUIPMENT**. Whenever you add a piece of equipment, you need to make sure that your system recognizes it.
- Section 11 explains **TROUBLESHOOTING** procedures. If you experience a problem with your system, follow the steps in this section to try to determine the problem. Of course, whenever you need help with your system, you may contact Ultimate Technical Support.

How To Use This Manual

Appendix A is a **GLOSSARY** of terms used throughout the manual.

Appendix B illustrates **PANEL LAYOUTS**, which may be helpful in locating components of your control panel and tape drives.

Appendix C provides **CRT CONFIGURATIONS**, to aid you in setting up your CRTs.

Appendix D provides **PRINTER CONFIGURATIONS**, to aid you in setting up your printers.

Appendix E provides **CABLE SPECIFICATIONS**, to help you install your CRTs and printers.

Appendix F provides **MODEM SPECIFICATIONS**, to aid you in setting up your modems.

The end of this document contains a Reader Comment Form and a Bug Report Form. If you find a problem or error in this guide, or with the system software, please complete the appropriate form. Then fold and tape the form so that Ultimate's address appears on the outside, and send it to The Ultimate Corp.

1 GETTING STARTED

Now that your Ultimate system has been installed, you'll need to follow a few steps before you can begin working. Use this section as a guide to make sure you complete each step.

1.1 POWER ON

The first thing you'll need to do is power on your system. If you haven't already done this, do it now. Power-on instructions are explained in Section 2 of this manual.

1.2 BOOT THE SYSTEM

Once your system has been powered on, it must be initialized, or booted. Refer to Section 5 for instructions on booting your equipment. See Appendix B for illustrations of the control panel.

1.3 FORMAT DISK(S)

Once you have booted the system, you'll see a screen of boot options. Choose option D. You'll use this option to format your disk(s). Refer to Section 6.2 for instructions on formatting your disk(s).

1.4 CHECK EQUIPMENT

Follow the instructions in this section to locate your terminals (CRTs) and printers. You'll need to know what numbers are assigned to each terminal and printer, and where each terminal and printer is physically located. You'll also need to know at what baud rate your terminals and printers are running.

To start, you'll need a description or list of the physical layout of your system. You should have obtained this list when your system was installed.

1.4.1 TERMINALS

All CRT terminals attach to the system via asynchronous RS-232 ports. The base system contains 8 ports. These are available in 6-port or 8-port increments. The baud rate for each port may be set independently, from 110 baud to 9600 baud. Note that port zero (the console) must be set at 9600 at all times.

NOTE: *If your terminals have not yet been installed, refer to Appendix C for options and switch settings for each terminal supported by Ultimate.*

Getting Started

Location

Each terminal (or CRT) is identified by a line number. To list the line number of a particular terminal, at the TCL prompt type:

WHO and press RETURN.

The line number and the account that's logged on will be displayed. To list all line numbers and the accounts logged onto those lines, type:

WHO * and press RETURN.

(For more information on the WHO verb, refer to your System Commands Guide.)

Baud Rate

In addition to the line numbers, you should know the baud rates of each of your CRTs. To check the baud rate of a particular port, type:

LOGTO SYSPROG and press RETURN.

Then press RETURN to go to TCL. At the TCL prompt, type:

SET-BAUD and press RETURN.

The port (line number) and line speed (baud rate) are displayed, along with other information about the port. (For more information about the SET-BAUD verb, refer to your System Commands Guide.)

1.4.2 PRINTERS

Printers may be attached to your system via the standard asynchronous ports for serial printers, or via a parallel printer adapter for parallel printers. All printers are required to have the XON/XOFF protocol for proper operation.

NOTE: *If your printers have not been installed, refer to Appendix D for options and switch settings of printers supported by Ultimate.*

Location

Each printer is identified by a line number, logical printer number, and a job queue number. To list the line, logical, and job queue numbers of each printer, at TCL, type:

SP-LISTLPTR and press RETURN.

Information about each of your printers is displayed. A sample screen is shown below.

```

>SP-LISTLPTR

Printer assignments
Printer      Output queues  Page   Dev or   time
Type  Number          skip   line #   Status
-----
Parallel    0          3      0      0      Active
Serial      1          0  15    0      1      Inactive
Serial      2          16     0      2      Inactive
Serial      3          60     0      3      Inactive
Serial      4          56     1      4      Inactive

```

In this example, the parallel printer has a logical number of 0, and a job queue number of 3. (Note that serial printer #1 has two job queue numbers: 0 and 15).

NOTE: *If your printer numbers have not yet been assigned, refer to the System Commands Guide for instructions on assigning them (use the SP-STARTLPTR verb).*

Baud Rate

To check the baud rate of all ports on your system, type:

LOGTO SYSPROG and press RETURN.

Getting Started

Then press RETURN to go to TCL. At the TCL prompt, type:

SET-BAUD Z and press RETURN.

The ports (line numbers) and line speeds (baud rates) are displayed, along with other information about each port. (For more information about the SET-BAUD verb, refer to your System Commands Guide.)

1.5 CHECK ACC AND DICT ACC FILES

Your Ultimate system should already contain an Accounting History (ACC) File. This file contains information on your system usage, and on each user. Information includes the dates and times that your users log on and off, and the amount of time spent on the computer (called "connect time"). This file also keeps track of "charge-units," which are numbers representing the computer usage, and "line-printer pages," which is the amount of pages printed during each logon session.

This file is only updated if the Accounting option is in effect (refer to the System Management and Support Guide for details). Entries may be created in the dictionary portion of the ACC file to set baud rates and term types automatically when several devices are logged on.

1.6 LOAD ULTIWORD

If UltiWord (the word processing account, also referred to as WP) has not already been installed on your system, you may install it now, or you may refer to these instructions whenever you are ready to begin using UltiWord.

NOTE: *Follow this procedure only if UltiWord has never been installed on your system. If UltiWord has already been installed and you want to load a new version of the WP account, then refer to your Upgrade Procedures document.*

1. Make sure your system has been powered on and initialized. Mount the SYS-GEN tape and bring it to load point (see Section 4 for instructions).
2. At TCL, type:

LOGTO SYSPROG and press RETURN.

The following screen is displayed.

SYS-PROG MAIN MENU
(Honeywell 68000-Based Systems)

1. File-Save with automatic GFE fixer
- 1A. File-Save without automatic GFE fixer
2. ALL-UPDATE-SAVE
3. PART-UPDATE-SAVE
4. Documentation Menu
5. Spooler Menu
6. Automatic Async setup
7. Automatic File Reallocation Menu
8. Load WP account from SYS-GEN tape
9. Create Boot tape
10. Load UTILINK account from SYS-GEN tape
11. Load ATP account from SYS-GEN tape
12. Load ULTIMATION account from SYS-GEN tape

88. Logoff
99. Go to TCL

ENTER SELECTION _

Type **8** and press RETURN.

This will select "Load WP account from SYS-GEN tape." The system will search for and load the WP account.

3. When the WP account has been loaded, remove the SYS-GEN tape.
4. Set up the accounts in which you want to enable UtiWord. At the TCL prompt, type:

LOGTO WP and press RETURN.

You are now in the WP account. The WP Main Menu should be displayed.

```
***** The Ultimate Corp. *****
***** WORD PROCESSING *****
***** Document Manager *****
          Main Menu
```

YOUR USER NAME:
DOCUMENT NAME:

- (C)opy documents
- (D)elete user
- (E)dit/Enter
- (L)ist
- (N)ew
- (P)rint
- (S)et up user account
- (U)tility
- (V)iew
- e(X)it

Enter option wanted:

Type S

This selects the program to set up user accounts. The following screen is displayed.

```
***** The Ultimate Corp.      *****  
***** WORD PROCESSING        *****  
***** Document Manager        *****  
          Main Menu
```

YOUR USER NAME:
DOCUMENT NAME:

Enter name of account to set up or <EDIT>

Enter the name of an account you want to set up for UltiWord, and press RETURN.

The following screen is displayed.

```
***** The Ultimate Corp.      *****  
***** WORD PROCESSING        *****  
***** Document Manager        *****  
          Main Menu
```

YOUR USER NAME:
DOCUMENT NAME:

Enter name of account to set up or <EDIT>
The master dictionary of XXXX contains the following

These will be overwritten if Y is answered. (Y)es or <EDIT>

Enter Y

You will now be able to use WP from this account. Repeat this step for all accounts for which you want to enable WP.

Getting Started

5. Enter user names for each account in which you'll use WP. One or more user names may be established within the same user account.

If you set up an account for WP, logto that account. Then type **WP** and press RETURN. The WP Main Menu is displayed, as shown following.

```
***** The Ultimate Corp.      *****
***** WORD PROCESSING        *****
***** Document Manager       *****
          Main Menu
```

```
YOUR USER NAME:
DOCUMENT NAME:
```

```
(C)opy documents
(D)elete user
(E)dit/Enter
(L)ist
(N)ew
(P)rint
(S)et up user account
(U)tility
(V)iew
e(X)it
```

```
Enter option wanted:
```

Type N

The following screen is displayed.

```
***** The Ultimate Corp.      *****
***** WORD PROCESSING        *****
***** Document Manager        *****
      Main Menu
```

```
YOUR USER NAME: _ <CR> for current User Name or
DOCUMENT NAME:    <EDIT> to exit
```

```
(C)opy documents
(D)elete user
(E)dit/Enter
(L)ist
(N)ew
(P)rint
(S)et up user account
(U)tility
(V)iew
e(X)it
```

```
Enter option wanted: N
```

Enter a user name that you will use with WP. The name may consist of one to 20 characters.

The following screen is displayed.

Getting Started

```
***** The Ultimate Corp.      *****
***** WORD PROCESSING        *****
***** Document Manager        *****
      Main Menu
```

```
YOUR USER NAME: _  USER NAME NOT ON FILE! ADD IT (Y/CR)?
DOCUMENT NAME:
```

```
(C)opy documents
(D)elete user
(E)dit/Enter
(L)ist
(N)ew
(P)rint
(S)et up user account
(U)tility
(V)iew
e(X)it
```

```
Enter option wanted: N
```

Type Y

to create this user name. The following screen is displayed.

```
***** The Ultimate Corp. *****
***** WORD PROCESSING *****
***** Document Manager *****
Main Menu
```

```
YOUR USER NAME: _
DOCUMENT NAME:
```

```
(C)opy documents      The USER file will be created as follows
(D)elete user          CREATE-FILE DATA WP-DOCUMENTS,USER 41,1
(E)dit/Enter          Enter <CR>, New Modulo or <EDIT> to exit
(L)ist
(N)ew
(P)rint
(S)et up user account
(U)tility
(V)iew
e(X)it
```

```
Enter option wanted: N
```

Press RETURN to create the user name.

The cursor will then prompt you to enter a DOCUMENT NAME. If you are ready to begin creating documents, enter a name for your first document. This document will be stored in the user name and user account you specified.

6. Refer to the UltiWord Training Manual and UltiWord Reference Manual for instructions on using UltiWord.

1.7 GETTING STARTED CHECKLIST

Make sure you have completed each item on the checklist below before you begin creating and using files on your Ultimate system.

- 1. The system has been powered up successfully.
- 2. You have booted the system, following the instructions for your hardware configuration.
- 3. You have formatted your disk(s).
- 4. You have checked the location and baud rate of each terminal on your system.
- 5. You have checked the location and baud rate of each printer on your system.
- 6. You have checked the ACC and DICT ACC files.
- 7. If you will be using UltiWord, you have loaded the WP account and set up user accounts and user names.

Congratulations on getting your system ready to work for you! Refer to the instructions in the remainder of this manual as they are required.

2 POWERING ON

Now that your Ultimate system has been installed, follow the instructions below to power on the system.

1. Locate the main POWER switch on the back and turn to the ON position. If you have a dual-cabinet system, be sure to turn on both POWER switches.
2. Make sure the AC PRESENT light is lit.
3. If your system includes a 1/2" reel tape drive, turn the POWER switch on. See the diagram in Appendix B.
4. Boot the system. Refer to Section 5 for booting instructions.

3 POWERING OFF

Generally, your Ultimate system may be left powered on. You may want to power off, however, during a long weekend or vacation, or if you are having power problems. Follow the instructions below if you want to power off your system.

1. Make sure all users are logged off the system. To do so, go to the TCL prompt, and type:

LISTUSERS and press RETURN.

The console (line 0) should be the only terminal logged on. If other users are logged on, make sure they log off before you continue.

2. After all users have logged off, go to port 0 (the console terminal). Type:

LOGTO SYSPROG and press RETURN.

Then press RETURN again to go to TCL. Type:

:WARMSTOP and press RETURN.

A message similar to the following is displayed.



Memory Flushed!

This message means that the system has halted all processing and flushed memory.

3. Press the **STANDBY** button on the computer to bring the system down.
4. After the **:WARMSTOP** is complete, locate the **POWER** switch on the back of the computer and turn it to the **OFF** position.

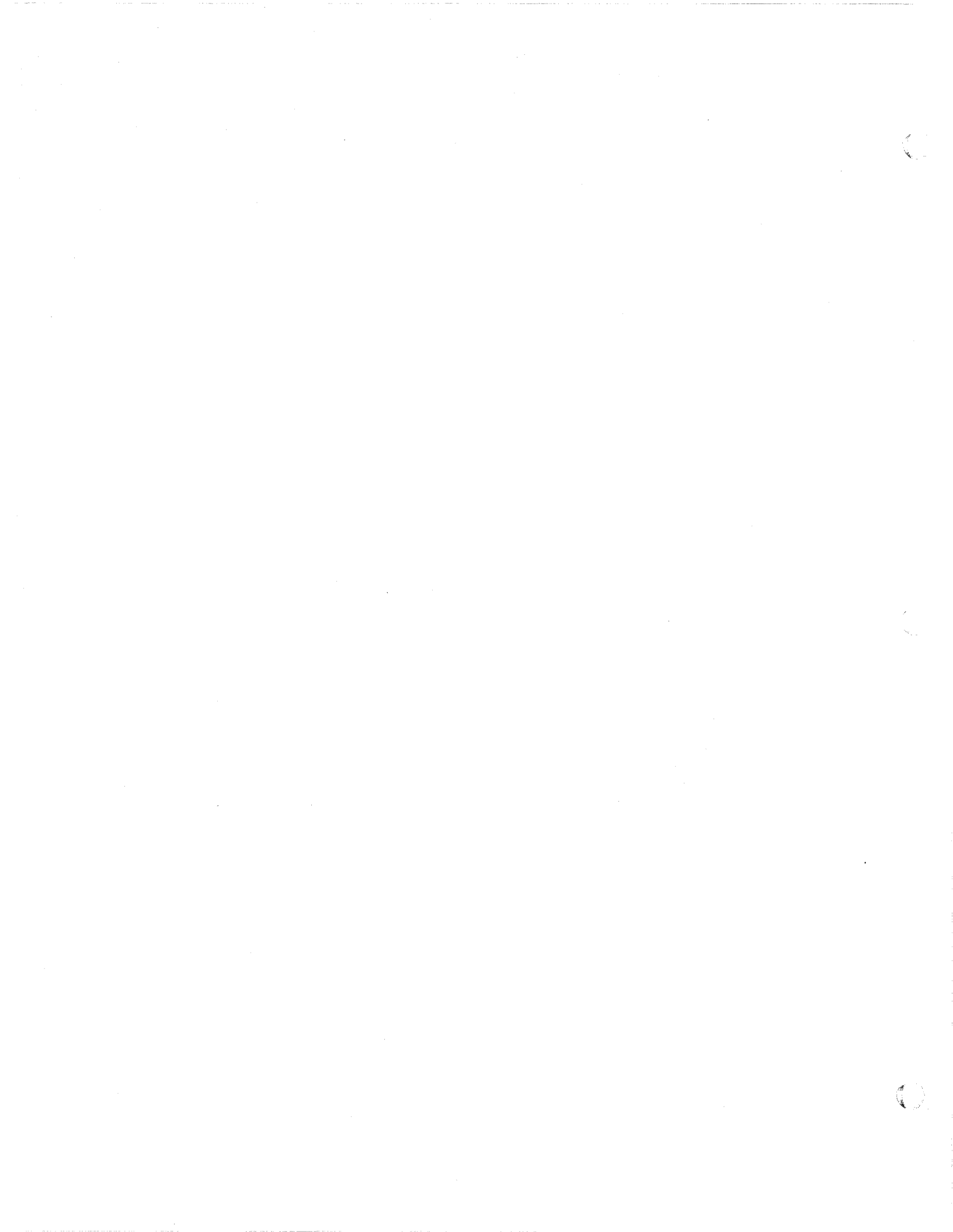

4 TAPE DRIVE PROCEDURES

4.1 ONE QUARTER INCH (1/4") CARTRIDGE TAPES

Loading

1. Lower the tape lever to the horizontal position (see Figure 4.1.)
2. Slide the tape tray toward you.
3. Insert the cartridge tape with the plastic side up and the tape opening to the right.
4. Slide the tape tray back into the tape drive.
5. Lock the tape in drive by raising the tape lever to the vertical position.

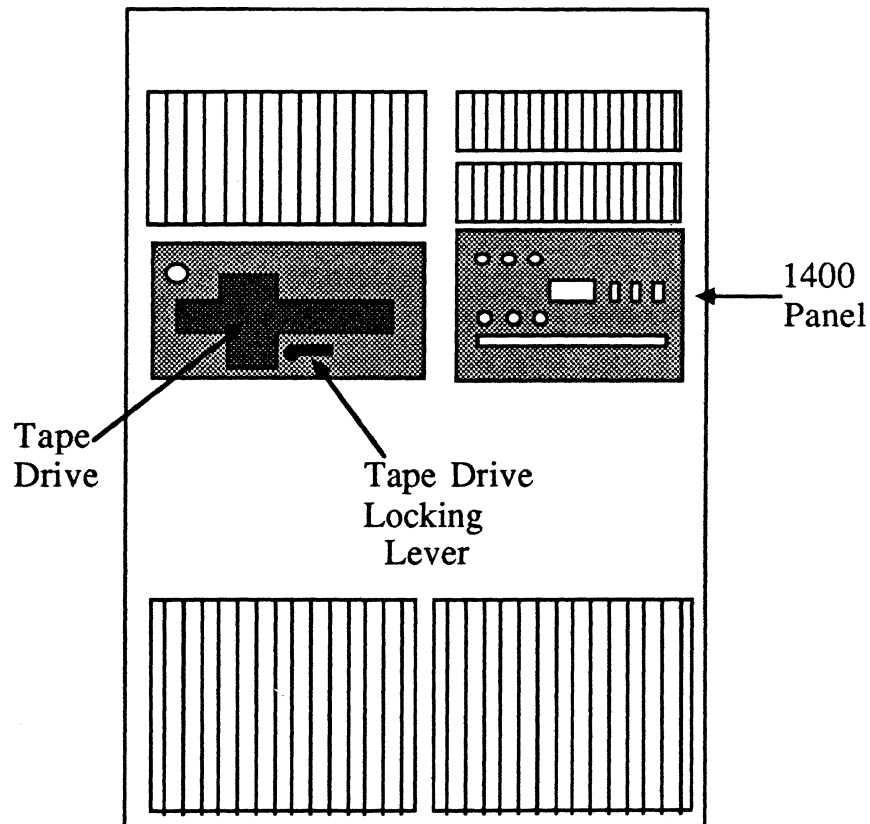

Figure 4.1 1400 Series System CPU

Tape Drive Procedures

6. If you are using a new tape, the tape should be retentioned. To retention a tape, at TCL type:

T-ATT 0 and press RETURN.

Make sure you type a zero, not the letter O. The message "Tape attached block size xxxx" appears. At TCL, type:

T-RET and press RETURN.

You will see the message "Retentioning...", and then you will return to TCL. (For more information on the T-ATT and T-RET commands, refer to the System Commands Guide.)

Unloading

1. Lower the tape lever to the horizontal position.
2. Slide the tape tray toward you.
3. Remove the cartridge from the tape drive.

Tape Handling Procedures

1. Never touch the tape.
2. Do not use contaminated or dirty cartridges.
3. Store the tape inside its container.
4. Do not smoke near the tape drive or tape storage area.

Cleaning the Tape Drive

Follow the instructions enclosed in a 1/4" cartridge tape cleaning kit. The kits are available from the Ultimate Computer Supplies catalog.

4.2 ONE HALF INCH (1/2") REEL TAPES

Loading

1. Turn the power switch on, and make sure the UNLOAD indicator is lit.
2. Make sure the tape is wound completely onto the reel.
3. Open the tape access door. Insert the tape, with the write-enable ring side down. Then close the tape access door.
4. Press the LOAD switch. The access door is now locked. The LOAD indicator will pulse.
5. When the LOAD indicator is on, the load sequence is complete. Press the ON-LINE switch to put the drive on-line. The ON-LINE LED will go on.

Unloading

1. Press the ON-LINE switch to take the tape drive off-line. The ON-LINE LED will go out.
2. Press the UNLOAD switch. The UNLOAD indicator will pulse.
3. When the unload sequence is complete, the UNLOAD indicator will remain on and the access door will unlock.
4. Open the access door and remove the tape.

Tape Handling Procedures

1. Always inspect the tape leader to make sure it's not damaged. If the tape leader is wrinkled, the unit may not load properly. If this happens, either try another tape reel, or squarely cut the damaged portion of the tape leader.
2. Handle the tape reel by the hub hole.
3. Never touch the portion of the tape between BOT (beginning of tape) and EOT (end of tape).
4. Do not use contaminated or dirty reels.
5. Store the tape inside its container.
6. Do not smoke near the tape drive or tape storage area.
7. Clean the tape path frequently.

Tape Drive Procedures

Cleaning the Tape Drive

1. Make sure you have a tape cleaning kit that consists of:
 - a. cotton swabs
 - b. tape drive cleaner (Freon TF--Trichlorotrifluoroethane)
 - c. felt pads

NOTE: *Rough or abrasive materials can scratch sensitive surfaces of the tape head, resulting in permanent damage. Alcohol-based cleaners may cause read/write errors or load failures. Be sure to use only FREON TF to clean the tape head.*

2. Unload the tape.
3. Turn off the tape drive POWER switch.
4. Lift the plastic casing on top of the tape drive.
5. Grasp the lower edges of the top cover and lift. While holding the top cover in the raised position, place the retainer bar in its slot (see illustration).

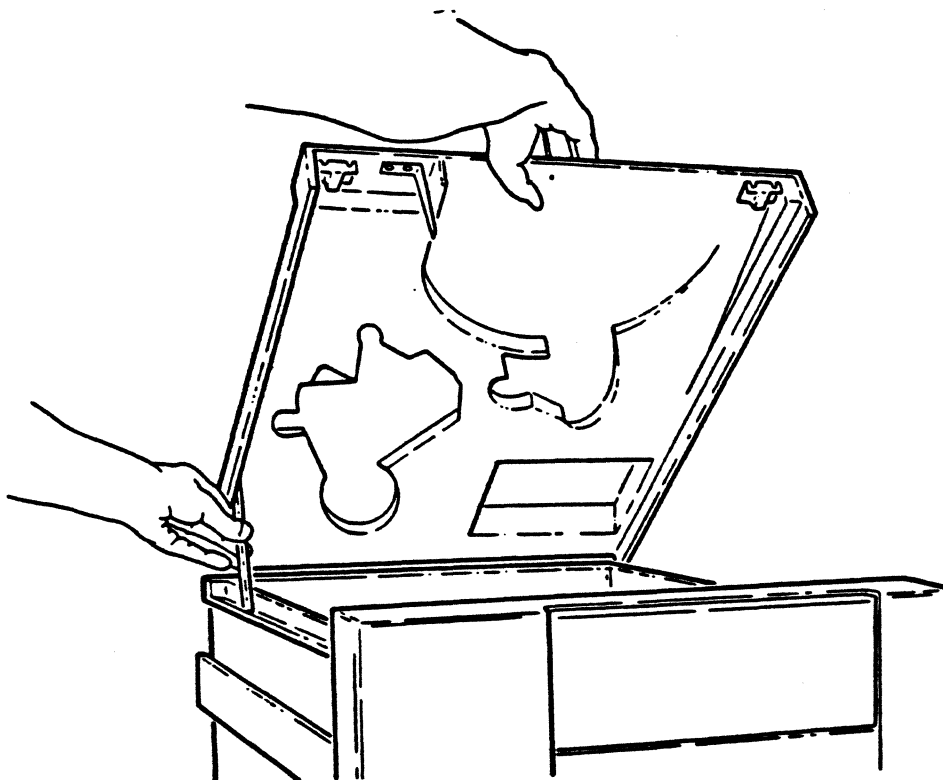

6. Moisten a cotton swab with tape drive cleaner. Carefully swab the surface of the read/write head (see illustration).

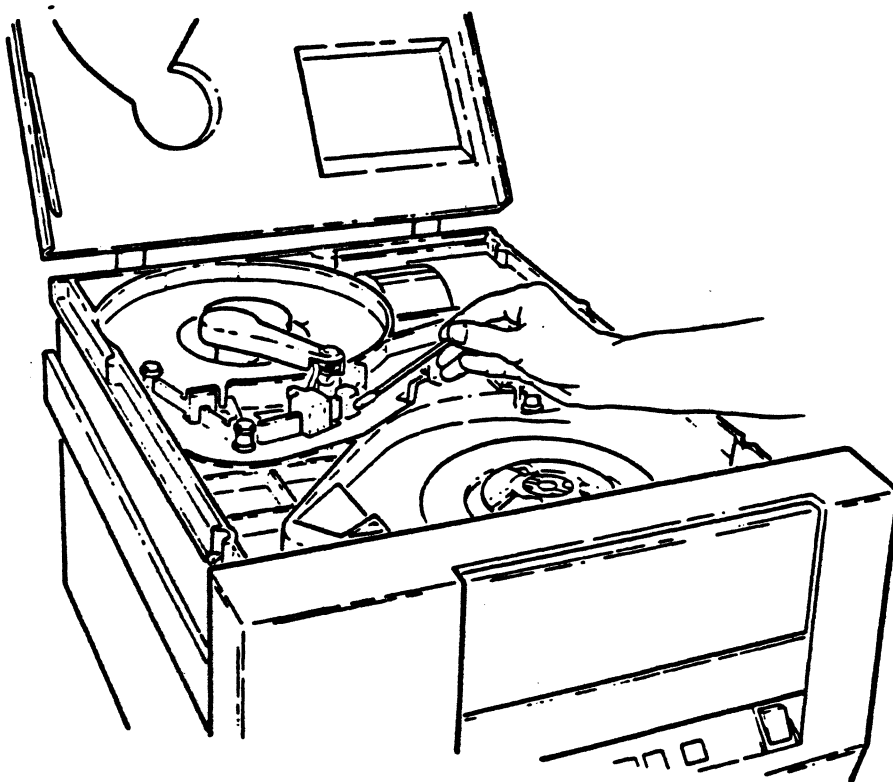

Tape Drive Procedures

7. Moisten a cotton swab with tape drive cleaner and clean the tachometer roller (see illustration).

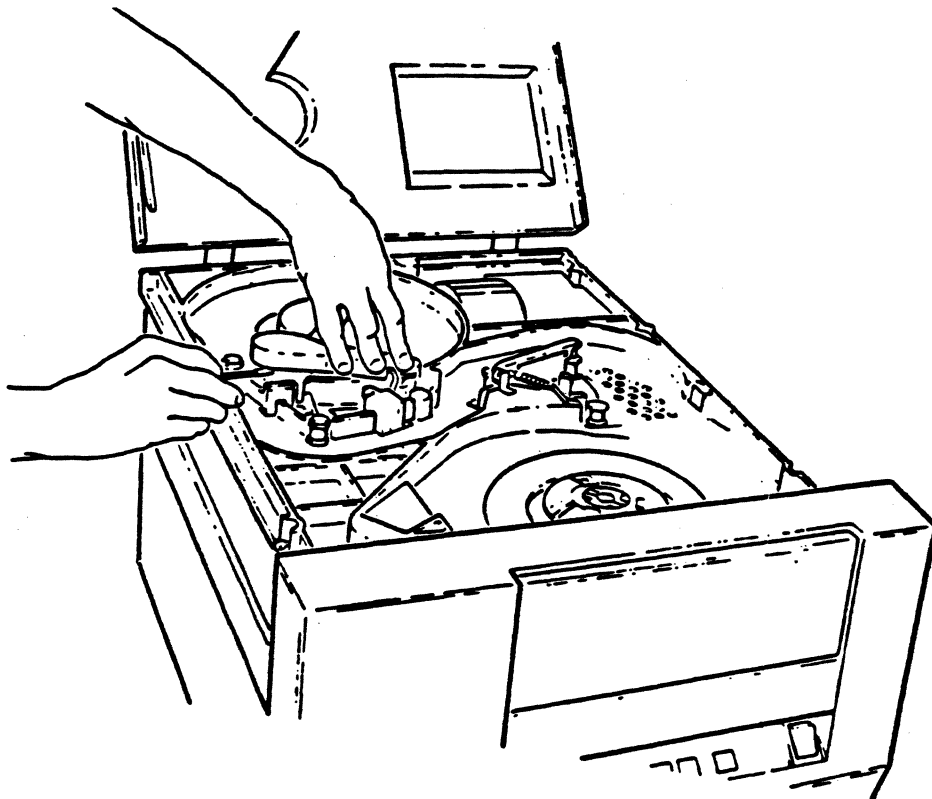

CAUTION: *If the tape drive cleaner seeps into the tachometer housing, it could damage the tachometer. Do not release the tachometer while holding it away from the take-up hub. It will become damaged if it strikes sharply against the hub.*

8. Use the felt pads to clean the hub pads, take-up hub, and roller guides.

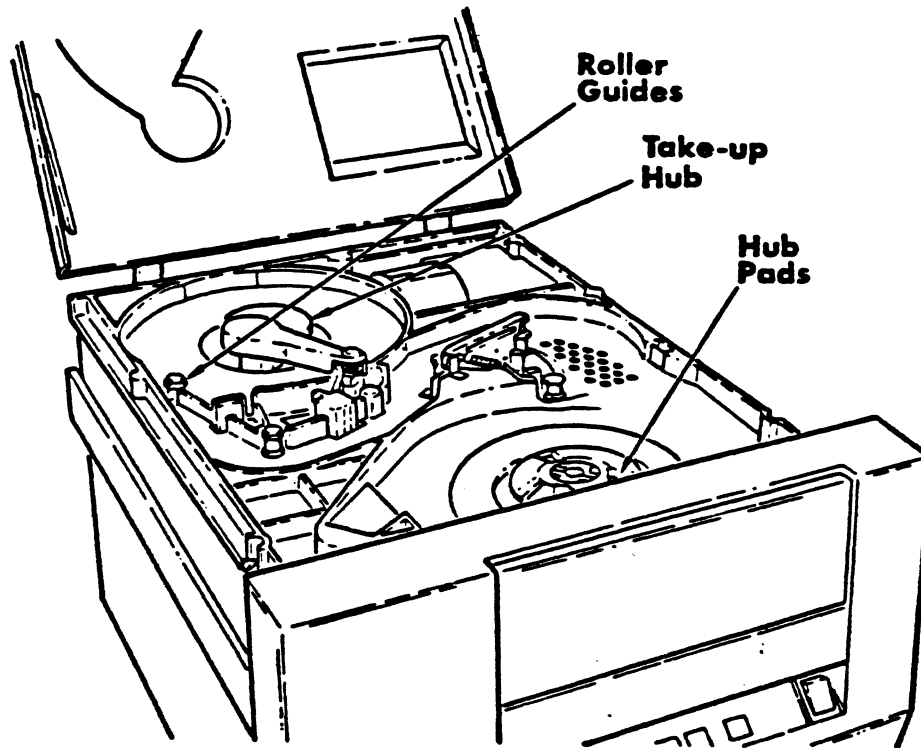

9. Lift the top cover until the retainer bar is clear of its slot. Push the retainer bar back and up so that it lies flat against the underside of the top cover. Then close the top cover.

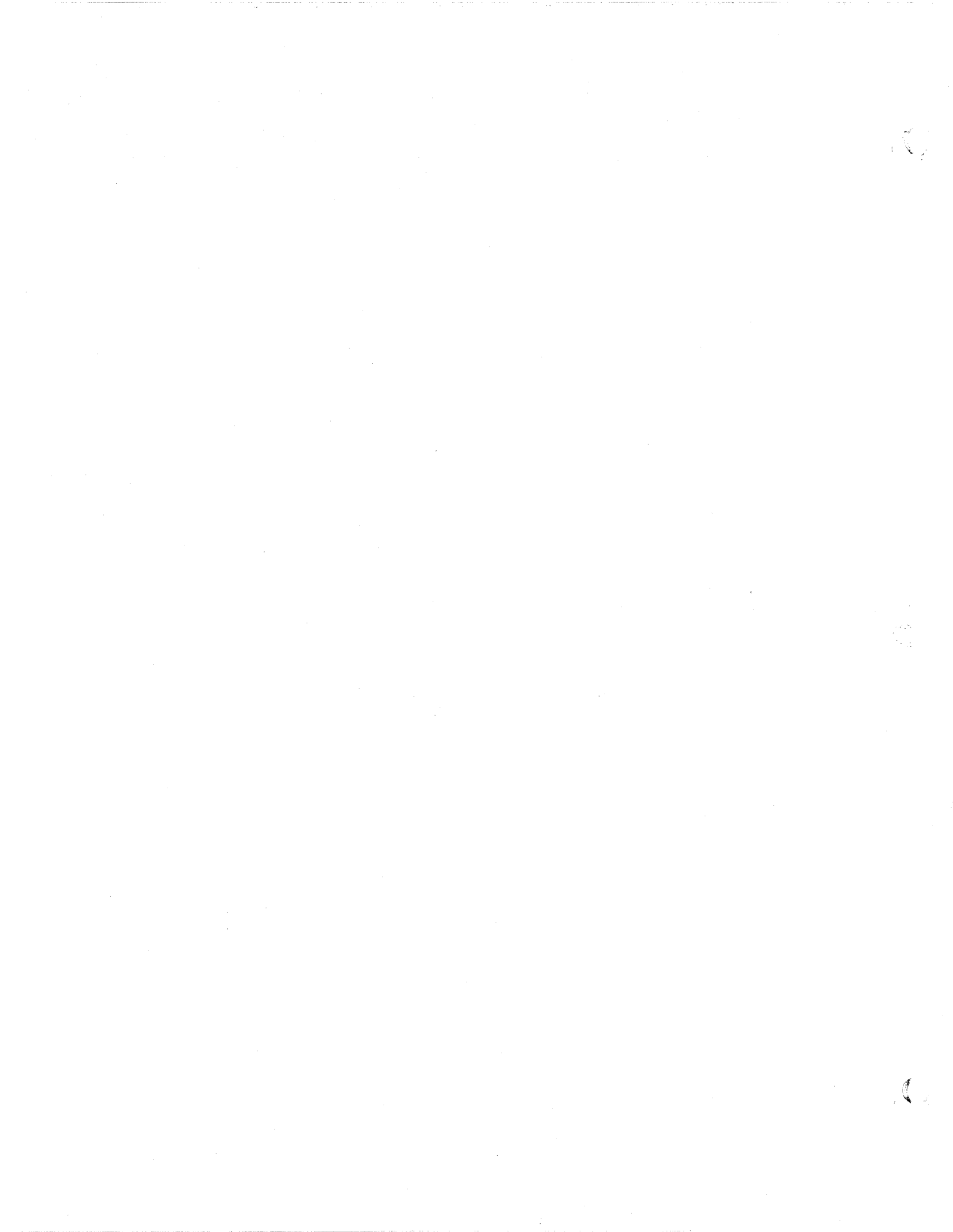

5 BOOTING THE SYSTEM

Follow the instructions in this section to boot or initialize your 1400 Series systems.

Refer to Figure B.1 in Appendix B for an illustration of the 1400 system.

Before attempting to boot the system, you should have followed all steps in Section 2, Powering On. If you are rebooting a system that is up and running, you must first do a :WARMSTOP from the SYSPROG account.

1. Make sure all users are off the system.
2. Make sure the AC PRESENT light is ON. (Refer to the POWERING ON instructions in Section 2.)
3. Load the Ultimate SYS-GEN tape. (Refer to the tape-loading instructions in Section 4.)
4. If both the AC PRESENT and DC ON lights are on, press the RESET button. If only the AC PRESENT light is on, press the POWER ON button. The following screen is displayed.

```
This is the Ultimate Operating System

System Startup Options:

(C)oldstart
(D)iagnostic Monitor
(F)ile Restore
(W)armstart

Enter Option:
```

5. Refer to Section 6 for information on each of the System Startup Options.

NOTE: *If the system was :WARMSTOPPED prior to being powered off, refer to Section 6.4 to WARMSTART the system. If the system was not :WARMSTOPPED prior to being powered off, then refer to Section 6.1 to COLDSTART the system.*

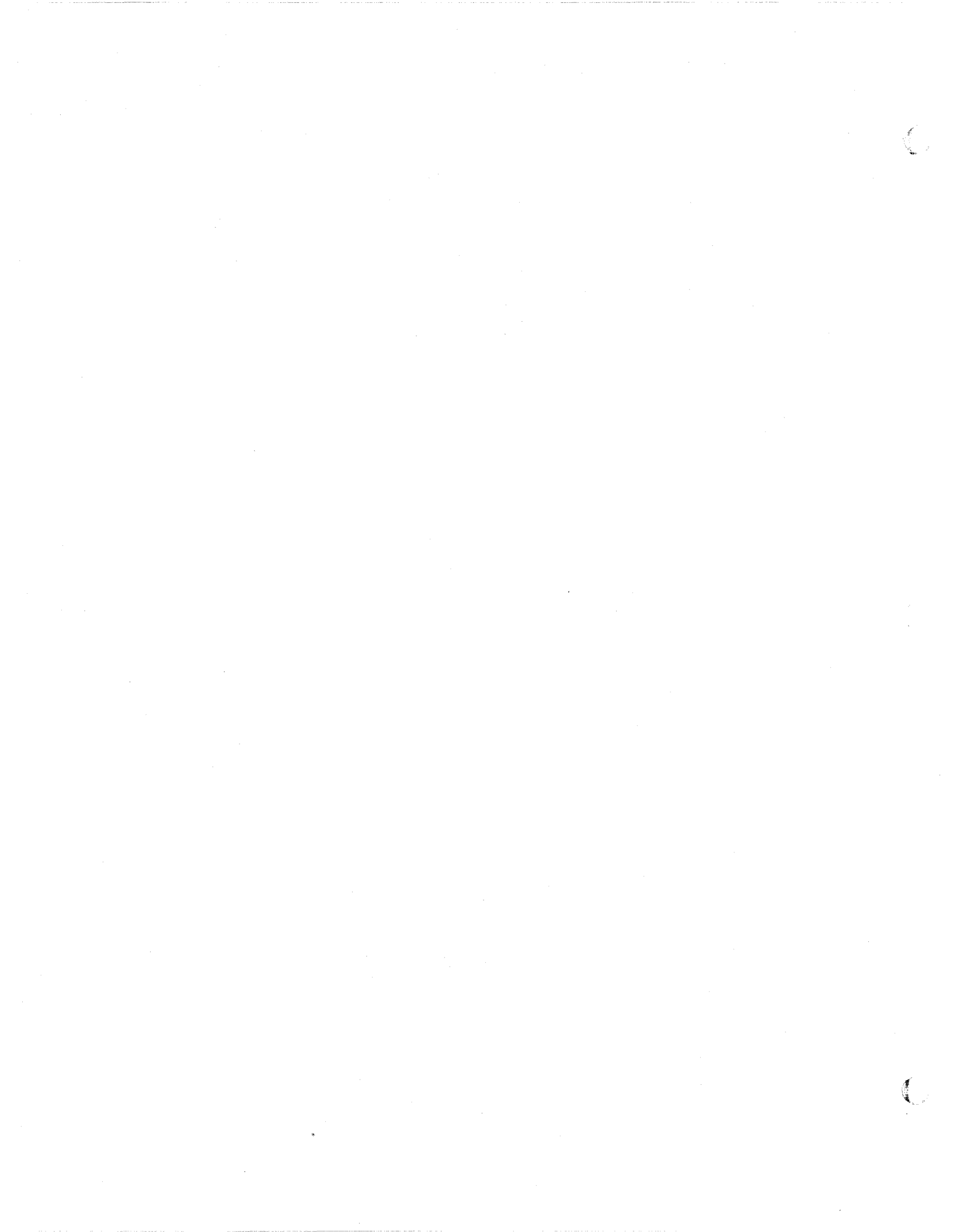

6 SYSTEM STARTUP (BOOT) OPTIONS

Whenever you boot or initialize your system, you are presented with a menu of System Startup Options, shown below.

```
This is the Ultimate Operating System

System Startup Options:
(C)oldstart
(D)iagnostics Monitor
(F)ile Restore
(W)armstart

Enter Option(s) or ? for help:
```

A brief explanation of the purpose of each option is explained below. Refer to Sections 6.1 through 6.4 for instructions on performing each of these options.

Coldstart

The Coldstart procedure is used to load the Monitor code into memory, and all virtual system software from the SYS-GEN tape onto your system. The procedure ensures that all system software has been properly loaded. This procedure will not load your files.

A Coldstart is normally required if your system fails.

Diagnostics Monitor

The Diagnostics Monitor is primarily used to format disks. It may also be used to check your system configuration, boot other channels, and perform other diagnostic utilities. Normally, you should not try to perform diagnostics unless instructed by Ultimate Technical Support.

The Diagnostics Monitor is run off-line. This means that you are not able to run your system in the normal mode. The Diagnostics Monitor will be activated on line zero (the console) only.

System Startup (Boot) Options

File-Restore

The File-Restore procedure is used to load the Monitor, the program frames (ABS), and all the files, both dictionary and data, from tape. Unlike the Coldstart procedure, this option is used to restore your entire system from your File-Save tapes. The File-Restore will overwrite data previously written on your system.

Warmstart

The Warmstart procedure is used to reload the Monitor after a system failure. This procedure allows you to recover from a :WARMSTOP and then resume working where you left off, without losing your data. This option should only be attempted if your system was brought down with a :WARMSTOP.

NOTE: *If you Warmstart a system that was not :WARMSTOPPED, you will cause Group Format Errors (GFEs).*

6.1 COLDSTART

The Coldstart procedure is used to load the Monitor code into memory, and all virtual system software from the SYS-GEN tape onto your system. The procedure ensures that all system software has been properly loaded. This procedure will not load your files.

A Coldstart is normally required if your system fails.

1. Make sure you've followed the power-on instructions in Section 2. Also make sure your Ultimate SYS-GEN tape is mounted.
2. At the System Startup Options menu, type C. Information about your disc configuration will be displayed. A sample screen is shown below.

Disc Configuration

```
chan set name # of
FF20 Ultimate 1400 1 1
L 2000# time date ABS ULT REL XX
```

Tape 0 attached Block size: 16384

In the next screen, you will be asked for your system serial number.

Tape 0 attached Block size: 16384

System serial # is presently BVxxxx

Enter system serial # or <CR> to accept

System Startup (Boot) Options

Enter your System Serial Number

For example, enter BV0000. If the correct serial number is shown, press RETURN to accept it. You may reenter the correct number if you made a mistake. Press RETURN after you enter the correct number.

The following screen is displayed.

Tape 0 attached Block size: 16384

System serial # is presently

Enter system serial # or <CR> to accept

Mount ABS tape and enter number of files to skip, if any

Press RETURN.

(Your SYS-GEN tape should already be mounted.) The following screen is displayed.

Mount ABS tape and enter number of files to skip, if any:

XX-XXX
XXXX-XXX
XXXX-XXX
XXXX-XXXX

Spooler started

Linking workspace for line 0

date time Logon please:

<<< Welcome to the Ultimate Computer System >>>
<<< Copyright date The Ultimate Corp. >>>
<<< time Release XX Rev XXX date >>>

This is the Cold-Start Procedure
Enter <CR> to continue

Press RETURN.

The following screen is displayed.

System Startup (Boot) Options

date time Logon Please:

```
<<< Welcome to the Ultimate Computer System >>>
<<< Copyright date The Ultimate Corp. >>>
<<< time Release XX Rev XXX date >>>
```

This is the Cold-Start Procedure
Enter <CR> to continue

Linking secondary TCL workspaces

X additional task workspaces initialized

time date

Time =

Enter the time in military format (HH:MM:SS) and press RETURN.

For example, enter 5pm as 17:00:00. The following screen is displayed.

This is the Cold-Start Procedure
Enter <CR> to continue

Linking secondary TCL workspaces

X additional task workspaces initialized

time date

Time = 17:00:00

17:00:00 date

Date =

Enter the date in the following format: MM/DD/YY and press RETURN.

For example, enter February 3, 1986 as 02/03/86. The following screen is displayed.

```
This is the Cold-Start Procedure
Enter <CR> to continue

Linking secondary TCL workspaces

X additional task workspaces initialized

time    date

Time = 17:00:00
17:00:00 date
Date = 02/03/86
17:00:00 03 FEB 1986
```

NOTE: *If you included other commands in the COLDSTART PROC in SYSPROG's Master Dictionary (MD), those commands will be executed at this point.*

The system will display several messages. If there are any error messages (i.e.: System does not verify), call Ultimate Technical Support immediately .

The following screen is displayed.

<<<Verifying software>>>
System software verified

Do You Wish to Start Parallel Printer 0 (<CR>=NO, Y=YES) ?

If you have a parallel printer, type **Y**. If you do not have a parallel printer, just press RETURN. The following screen is displayed.

SP-STARTLPTR 0,0,1,PO

[1118]

The printer control block has been initialized. The correct paper and LPI settings must have been previously set to insure proper printing.

date time Logon please:

You may now log on to the system. If you did not start a parallel printer, the following screen is displayed.

date time Logon please:

3. You may now log on.

SUMMARY OF COLDSTART PROCEDURE

1. Power up the system, and load the SYS-GEN tape.
2. Enter C at the System Startup Options menu.
3. Enter your system serial number.
4. Verify that the SYS-GEN is loaded, and press RETURN.
5. Press RETURN at "This is the Cold-Start Procedure."
6. Enter the time and date in military format and press RETURN after each.
7. Check for error messages.
8. If you want to start a parallel printer, type Y.

6.2 DIAGNOSTICS MONITOR

The Diagnostics Monitor is used to perform many functions. The most-commonly used function, formatting disks, is described here.

The Diagnostics Monitor is run off-line. This means that you are not able to run your system in the normal mode. Only line zero (the console) is activated.

6.2.1 FORMATTING A DISK DRIVE FOR 1410 SYSTEMS

Follow the instructions in this section if you are formatting a disk drive for 1410 systems. If you want to format a disk drive for a 1420 or 1430 system, refer to Section 6.2.2.

WARNING: *If you format a disk, you will destroy all data on that disk. If you wish to save the data, perform a File-Save first (see Section 7.2). If you upgrade to Revision 185S or later, you must format your disk drives.*

1. Make sure you've followed the booting instructions in Section 5.
2. At the System Startup Options menu, type **D**.

This will load the Diagnostics Monitor. The following screen is displayed.

```
ST506 disc sub-system
Format and disc diagnostic utility
```

```
(F)ormat a drive
(B)ad sector map read
(R)ead disc parameters (vtoc)
(W)rite disc parameters (vtoc)
(D)rive diagnostics menu
(S)ystem debugger module
(E)xit to options menu
```

```
Select option:
```

Type **F** to select "Format a drive."

The following screen is displayed.

ST506 disc sub-system
Format and disc diagnostic utility

- (F)ormat a drive
- (B)ad sector map read
- (R)ead disc parameters (vtoc)
- (W)rite disc parameters (vtoc)
- (D)rive diagnostics menu
- (S)ystem debugger module
- (E)xit to options menu

Select option: F

Enter drive number (0-2)

Enter the number of the drive (0, 1, or 2) that you want to format.

The following screen is displayed.

ST506 disc sub-system
Format and disc diagnostic utility

- (F)ormat a drive
- (B)ad sector map read
- (R)ead disc parameters (vtoc)
- (W)rite disc parameters (vtoc)
- (D)rive diagnostics menu
- (S)ystem debugger module
- (E)xit to options menu

Select option: F

Enter drive number (0-2).. 0
Enter (Y)es to continue

Type Y to continue the formatting process. This will destroy all previous data on the disc.

System Startup (Boot) Options

The following screen is displayed.

```
ST506 disc sub-system
Format and disc diagnostic utility

(F)ormat a drive
(B)ad sector map read
(R)ead disc parameters (vtoc)
(W)rite disc parameters (vtoc)
(D)rive diagnostics menu
(S)ystem debugger module
(E)xit to options menu

Select option: F

Enter drive number (0-2).. 0
Enter (Y)es to continue... Y
Use bad sector map (Y/N)
```

CAUTION: *If you are formatting a new drive, you must type N at the "bad sector map" prompt. Then, at any time in the future when formatting the drive, you should type Y.*

Type:

Y to make sure previous bad tracks are marked defective
N if you don't want to save previously marked bad tracks

The following screen is displayed.

ST506 disc sub-system
Format and disc diagnostic utility

- (F)ormat a drive
- (B)ad sector map read
- (R)ead disc parameters (vtoc)
- (W)rite disc parameters (vtoc)
- (D)rive diagnostics menu
- (S)ystem debugger module
- (E)xit to options menu

Select option: **F**

Enter drive number (0-2).. **0**
Enter (Y)es to continue... **Y**
Use bad sector map (Y/N).. **N**

Verifying
cyl:xxxx trk:xx
Writing map
Writing VTOC

Once these messages have been displayed, then the formatting process is complete. Make sure you format all drives on your system.

NOTE: *Several error messages may occur during the formatting process. This is to be expected. Most errors that appear will be relocated automatically. However, if the message "Unrecoverable disk error" appears, call Ultimate Technical Support.*

SUMMARY--FORMATTING A DISK DRIVE FOR 1410 SYSTEMS

1. Power on the system. Make sure the SYS-GEN tape is mounted.
2. Boot the system.
3. Type **D** at the System Startup Options menu.
4. Type **F** to format the drive.
5. Enter **0**, **1** or **2** to select the drive to format.
6. Type **Y** to continue.
7. Enter **Y** or **N** at "Use Bad Sector Map."
8. The formatting process will begin. When completed, check the console for an "Unrecoverable disk error" message. If this message appears, call Ultimate Technical Support.
9. Boot your system.

6.2.2 FORMATTING A DISK DRIVE FOR 1420 AND 1430 SYSTEMS

Follow the instructions in this section to format a disk drive for 1420 and 1430 systems.

WARNING: *If you format a disk, you will destroy all data on that disk. If you wish to save the data, perform a File-Save first (see Section 7.2). If you upgrade to Revision 185S or later, you must format your disk drives.*

1. Make sure you have followed the booting instructions in Section 5.
2. At the System Startup Options menu, type D.

This will load the Diagnostics Monitor. The following screen is displayed.

Diagnostic monitor menu

(F)ormat utility menu
(D)isc diagnostics menu
(H)ardware configuration
(B)inary save and restore
(S)ystem debugger utility
e(X)it to options menu

Select option:

Type **F** to select "Format utility menu."

The following screen is displayed.

Format utility menu (rev 3)

(F)ormat disc (data erased)
(S)how manufacturers defect log
(E)nter manufacturers defect log
(D)isplay defective sector log
(R)elocate a defective sector
e(X)it to diagnostic monitor

Select option:

System Startup (Boot) Options

Type **F** to select "Format disc."

The following screen is displayed.

```
Format utility menu (rev 3)

(F)ormat disc (data erased)
(S)how manufacturers defect log
(E)nter manufacturers defect log
(D)isplay defective sector log
(R)elocate defective sector
e(X)it to diagnostic monitor

Select option: F

Enter drive number (0-5)
```

Enter the number of the drive (**0, 1, 2, 3, 4, or 5**) that you want to format.

The following screen is displayed.

```
Format utility menu (rev 3)

(F)ormat disc (data erased)
(S)how manufacturers defect log
(E)nter manufacturers defect log
(D)isplay defective sector log
(R)elocate defective sector
e(X)it to diagnostic monitor

Select option: F

Enter drive number (0-5) 0

Enter (Y)es to continue
```

Type **Y** to continue the formatting process. This will destroy all previous data on the disc.

The following screen is displayed.

```
Format utility menu (rev 3)

(F)ormat disc (data erased)
(S)how manufacturers defect log
(E)nter manufacturers defect log
(D)isplay defective sector log
(R)elocate defective sector
e(X)it to diagnostic monitor
```

```
Select option: F
```

```
Enter drive number (0-5) 0
```

```
Enter (Y)es to continue Y
```

```
Formatting...
cyl:xxx trk:xxx
Verifying
cyl:xxx trk:xxx sec:xxx
```

Once these messages have been displayed, then the formatting process is complete. Make sure you format all drives on your system.

NOTE: *Several error messages may occur during the formatting process. This is to be expected. Most errors that appear will be relocated automatically. However, if the message "Unrecoverable disk error" appears, call Ultimate Technical Support.*

**SUMMARY -
FORMATTING A DISK DRIVE FOR 1420 AND 1430 SYSTEMS**

1. Power on the system. Make sure the SYS-GEN tape is mounted.
2. Boot the system.
3. Type **D** at the System Startup Options menu.
4. Type **F** to select the Format utility menu.
5. Type **F** to format the disk.
6. Enter **0, 1, 2, 3, 4, or 5** to select the drive to format.
7. Type **Y** to continue.
8. The formatting process will begin. When completed, check the console for an "Unrecoverable disk error" message. If you get this message, call Ultimate Technical Support.
9. Boot your system.

6.3 FILE-RESTORE

Use this procedure whenever you need to restore your entire system from your File-Save tape(s). This procedure should also be performed approximately once a month, to improve system performance. The File-Restore will reorganize your files into contiguous frames.

A File-Restore should also be done whenever you add communications boards to your system. The system will not recognize the boards until the File-Restore is performed.

NOTE: *A File-Restore will overwrite your existing data, so you should do a File-Save first, then use that File-Save to do the File-Restore. File-Restores may only be done with File-Save tapes.*

Refer to Section 8.1 for instructions on performing a File Restore.

6.4 WARMSTART

The Warmstart procedure reloads the monitor/firmware and all controller software. It then resumes execution of the process that was running previously. The Warmstart procedure is normally executed after a :WARMSTOP.

NOTE: *Do not attempt a Warmstart unless your system was :WARMSTOPPED.*

6.4.1 WARMSTART FROM OPTIONS MENU

1. Make sure all users are logged off the system. To do so, go to the TCL prompt and type:

LISTUSERS and press RETURN.

The console should be the only terminal logged on. If other users are logged on, make sure they log off before you continue.

2. If the system has not already been booted, do so now (see instructions in Section 4).
3. At the System Startup Options menu, type **W**.

The following screen is displayed.

THE DATE AND TIME MUST BE RE-SET!!!

4. To reset the date, type:

SET-DATE DD/MM/YY and press RETURN.

DD is the day, MM is the month, and YY is the year.

5. To reset the time, type:

SET-TIME HH:MM:SS and press RETURN.

HH is the hour, MM is the minutes, and SS is the seconds, in military format.

6. You may now log on to the system.

6.4.2 WARMSTART FROM TCL

1. Make sure all users are logged off the system. To do so, go to the TCL prompt, and type:

LISTUSERS and press RETURN.

The console should be the only terminal logged on. If other users are logged on, make sure they log off before you continue.

2. After all users have logged off, go to port 0 (the console terminal). Type:

LOGTO SYSPROG and press RETURN.

Then press RETURN again to go to TCL. Type:

:WARMSTART and press RETURN.

This verb first flushes memory and then enters an automatic Warmstart.

The following screen is displayed.



THE DATE AND TIME MUST BE RE-SET!!!

3. To reset the date, type:

SET-DATE DD/MM/YY and press RETURN.

DD is the day, MM is the month, and YY is the year.

4. To reset the time, type:

SET-TIME HH:MM:SS and press RETURN.

HH is the hour, MM is the minutes, and SS is the seconds. in military format.

5. You may now log on to the system.

SUMMARY OF WARMSTART FROM THE OPTIONS MENU

1. Make sure all users have logged off.
2. If the system has not been booted, do that now.
3. Type **W** at the System Startup Options menu.
4. If necessary, reset the date and time.
5. You may now log on.

SUMMARY OF WARMSTART FROM TCL

1. Make sure all users have logged off the system.
2. Logto SYSPROG, then go to TCL.
3. Type **:WARMSTART** and press RETURN.
4. If necessary, reset the date and time.
5. You may now log on.

7 BACKING UP THE SYSTEM

Ultimate strongly recommends that you back up your system files at least once a day to ensure that you always have a method of recovery, in the event of data loss.

There are various backup procedures you may use to make an off-line copy of your data base files. If ever you need to recover your files, you can use the off-line copy to restore them.

Once you have made backup copies of your files, you must organize and store them so that they may be easily located and identified. Section 7.1 explains how to organize your backups. Various backup methods are explained in Sections 7.2 through 7.5.

7.1 ORGANIZING BACKUP TAPES

Making backup tapes is very important in ensuring that you are able to restore your system in the event of data loss. It is equally important that you store your backups in an orderly manner, so that they may be quickly and easily identified when they are needed. When you need to restore from a backup tape, it's important that you use the most recent backup available. Otherwise, you may have to spend time recreating some of your data.

Ultimate recommends that you have separate daily backup tapes for one week's time, and a monthly backup for each month in the previous year. Some situations may also require a weekly backup cycle for the past month. That is, use a separate tape set for each day of the week, one for each week of the month, and one for each month of the year. The longer cycle tape sets should be stored off premises to provide protection in the event of physical damage, such as a fire or flood.

There are two steps in organizing your backup tapes: labeling and rotating.

7.1.1 LABELING

Be sure to label every one of your backup tapes so that you may easily locate and identify them when they are needed. Make sure you label the tape itself, as well as the casing or cover, so that tapes separated from their covers won't be confused. The label should include:

1. The type of backup (FILE-SAVE, ACCOUNT-SAVE, T-DUMP, ALL-UPDATE-SAVE, PART-UPDATE-SAVE, or TRANSACTION LOG). This is very important, as this will dictate the type of restore method that may be used. For example, T-DUMPs may only be restored via T-LOADs.
2. The sequence number of the tape (Tape 1 of 2, Tape 2 of 2, etc.). If your backup includes more than one tape, you must preserve the sequence. When you restore from a multiple-tape save, the tapes must be restored in the exact order in which they were saved. Otherwise, you won't be able to fully restore your data.
3. The date the backup was made. It is very important to date every backup tape so that you'll be able to identify the most recent backups when they are needed. The date should be in the format DD/MM/YY, where DD is the day, MM is the month, and YY is the year.

7.1.2 ROTATING

It is important to rotate the sets of tapes you use for backups, so that you don't always use the same set, and so that you don't take the chance of losing your most recent backup while you are creating another.

For example, if you use the same daily backup tape every day, it is possible that something could happen to that tape while you are creating a new File-Save with it. In this case, you may have lost your most recent daily backup.

Ultimate recommends that you keep a tape set for each day of the work week--one for Monday, one for Tuesday, etc. This set should only be used for daily backups, and only on the day of the week specified (Monday's tape should only be used for each Monday's daily backup).

If you choose to maintain a weekly backup cycle in addition to the daily and monthly cycles, then you should maintain at least two sets of tapes for this cycle. Set 1 may be used for the first week's backup, and Set 2 may be used for the second week's backup. On the third week, you may use Set 1, and on the fourth week, use Set 2. This way, you'll always have a current weekly backup tape.

Your monthly backup tapes should include one tape for each month of the year. You should never reuse a monthly tape until a full year has passed. This way, you'll be able to recreate your data from the previous year, if necessary.

7.2 FILE-SAVE

The File-Save method is the most common backup method. This method allows you to easily back up your entire system files in one operation. Ultimate recommends you perform a File-Save at the end of each work day. You must also perform a File-Save immediately prior to performing a full File-Restore (see Section 8.1).

1. Select the tape you want to use for the File-Save. Mount a write-ring on the tape. Make sure the tape doesn't contain data that you need to save, because the File-Save process will overwrite any data that already exists on the tape.
2. Load the tape. See instructions in Section 4.
3. Make sure all users are logged off the system. To do so, go to the TCL prompt, and type:

LISTUSERS and press RETURN.

The console should be the only terminal logged on. If other users are logged on, make sure they log off before you continue.

If users remain logged on during the File-Save, the process will take longer to complete, and any work updated while the File-Save is in process will not be backed up.

4. After all users have logged off, go to port 0 (the console terminal). Type:

LOGTO SYSPROG and press RETURN.

The following screen is displayed.

SYSPROG MAIN MENU
(Honeywell 68000-Based Systems)

1. File-Save with automatic GFE fixer
- 1A. File-Save without automatic GFE fixer
2. ALL-UPDATE-SAVE
3. PART-UPDATE-SAVE
4. Documentation Menu
5. Spooler Menu
6. Automatic Async setup
7. Automatic File Reallocation Menu
8. Load WP account from SYS-GEN tape
9. Create Boot tape
10. Load UTILINK account from SYS-GEN tape
11. Load ATP account from SYS-GEN tape
12. Load ULTIMATION account from SYS-GEN tape

88. Logoff
99. Go to TCL

ENTER SELECTION _

(Your menu may be different, according to your system configuration.)

Type **1** and press RETURN

to select "File-Save with automatic GFE fixer," or

Type **1A** and press RETURN

to select "File-Save without automatic GFE fixer."

The automatic GFE fixer will automatically truncate data that contains Group Format Errors (GFEs). For more information on GFEs, see Section 11.3.

The following questions will appear on your screen, and they will be automatically answered by the File-Save PROC, as shown below.

NOTE: *If you want to change the answers to any of the questions below, do not select File-Save from the SYSPROG menu. Instead, go to TCL and type:*

FILE-SAVE and press RETURN.

You will be asked each question below individually, and you may enter your own answers.

```
Now beginning File-Save Write/Read Test
File-Save now beginning at XXXX
Do you want the Console Listing to go to the Printer?(Y/N) N
Enter tape block size (512 - 16384) 16384
Do you want to generate File Statistics? (Y/N) Y
Do you want to fix GFEs? (Y/N) Y
Enter Tape label: FILE-SAVE
```

The File-Save will begin. At "Do you want to fix GFEs?", the answer will automatically be Y if you entered menu selection 1, and N if you entered menu selection 1A.

CAUTION: Do not open the door of the tape drive while the File-Save is in process!

The following information will appear on your terminal when the File-Save is complete.

NOTE: If your File-Save requires more than one tape, you will be prompted to "Mount the next reel".

```
# RECORDS WRITTEN
END OF FILE-SAVE - (date)
DUMPING STAT FILE
# ITEMS DUMPED
PREPARING FILE STATISTICS REPORT
FILE SAVE COMPLETED
```

Backing Up the System

The File Statistics report should now be printing.

5. Before unloading the File-Save tape, check the tape for parity errors. Follow the instructions in Section 11.5.3.3.
6. Unload the File-Save tape. See instructions in Section 4.
7. Store the File-Save tape(s) in a safe place, along with the file statistics report. For more information on storing and organizing File-Saves, see Section 7.1.

SUMMARY OF FILE-SAVE PROCEDURE

1. Select the tape or disk to be used.
2. Load the tape or disk.
3. Make sure all users have logged off.
4. Log to SYSPROG from the console, and select **1** or **1A** from the menu.
5. Check the tape for parity errors. Refer to Section 11.5.3.3.
6. Unload the tape or disk.
7. Store the File-Save tape or disk in a safe place, along with the corresponding file-stats report.

7.3 ACCOUNT-SAVE

The Account-Save method allows you to back up all files for a particular account. (By contrast, the File-Save allows you to back up all accounts on your system.) You may want to perform an Account-Save if only one account has been updated since the last backup procedure.

1. Select the tape you want to use for the Account-Save. Mount a write-ring on the tape. Make sure the tape doesn't contain data that you need to save, because the Account-Save process will overwrite any data that already exists on the tape.
2. Load the tape. See instructions in Section 4.
3. It is not necessary for all users to log off the system during the Account-Save, however, no work should be performed on the account that is being saved.
4. Go to port 0 (the console terminal). Type:

LOGTO SYSPROG and press RETURN.

Then press RETURN again to go to TCL. Type:

ACCOUNT-SAVE and press RETURN.

The following screen is displayed.

NOTE: *If you want to generate a File-Statistics report for the account at the end of the Account-Save, do not type ACCOUNT-SAVE. Instead, type:*

SAVE (D,F,I,T,S) and press RETURN.

```
>ACCOUNT-SAVE
```

```
Tape Label if desired
```

Enter a tape label and press RETURN.

For easy reference, Ultimate suggests you label your tapes in the following format: ACCOUNT-SAVE (MM-DD-YY). MM is the month, DD is the day, and YY is the year in which the Account-Save was performed.

Backing Up the System

The following screen is displayed.

```
>ACCOUNT-SAVE  
Tape Label if desired  
Account name?
```

Enter the account name you wish to save, and press RETURN.

The account name must be of a valid account in the system dictionary. The Account-Save will begin.

CAUTION: *Do not open the door of the tape drive while the Account-Save is in process!*

The following information will appear on your terminal when the Account-Save is complete.

NOTE: *If your Account-Save requires more than one tape, you will be prompted to "Mount the next reel".*

```
ACCOUNT SAVE COMPLETED
```

5. If you entered the SAVE verb with the (D,F,I,T,S) options to generate File-Statistics, you may now print those statistics. To do so, at TCL type:

LIST-FILE-STATS and press RETURN.

The File Statistics report will be printed.

6. Before unloading the Account-Save tape, check the tape for parity errors. Follow the instructions in Section 11.5.3.3.
7. Unload the Account-Save tape. See instructions in Section 4.
8. Store the Account-Save tape(s) in a safe place, along with the file statistics report. For more information on storing and organizing backup tapes, see Section 7.1.

SUMMARY OF ACCOUNT-SAVE PROCEDURE

1. Select the tape to be used.
2. Load the tape.
3. Make sure no work is being done on the account to be saved.
4. Logto SYSPROG from the console, and type **ACCOUNT-SAVE** and press RETURN, or type **SAVE (D,F,I,T,S)** and press RETURN.
5. Enter the tape label.
6. Enter the account name to be saved.
7. If you entered **SAVE (D,F,I,T,S)**, then type **LIST-FILE-STATS** and press RETURN to print the File Statistics report.
8. Check the tape for parity errors. Refer to Section 11.5.3.3.
9. Unload the tape.
10. Store the File-Save tape in a safe place.

7.4 T-DUMP

The T-DUMP verb allows you to copy a single file or individual items from disk to tape.

1. Load the tape to which you want to dump your file(s). See instructions in Section 4.
2. Use the T-DUMP verb to dump your file(s): T-DUMP is a RECALL verb, and its general form is as follows:

T-DUMP {DICT} filename {item-list} {selection-criteria} {HEADER "name"} {(options)}

The filename may be preceded by the DICT modifier to dump dictionary data. File definition items (such as D/CODE=D) will not be dumped.

The filename is the name of the source file to be dumped or copied onto the tape.

As explained in the Recall manual, the item-list and selection criteria select a sub-set of the items in the specified file which are to be written to tape. If the item-list and selection-criteria are omitted, then all items in the file will be written to tape. As in other Recall statements, each item-id must be enclosed in double quotes (").

The HEADER allows a "name" to be included in the tape label at the start of the file.

Options:

- (I) Inhibits listing to the terminal of items dumped.
- (O) Enables overwrite of items in the file with item IDs corresponding to the item IDs of items in the tape file.

An EOF mark is written to the tape at the completion of the T-DUMP.

3. Before unloading the tape, check the tape for parity errors. Follow the instructions in Section 11.5.3.3.
4. Unload the tape and store it in a safe place. See instructions in Section 4.

SUMMARY OF T-DUMP PROCEDURE

1. Load the tape to which you will dump your files.
2. Type T-DUMP {DICT} filename {item-list} {selection-criteria} {HEADER "name"} {(options)}
3. Check the tape for parity errors. Refer to Section 11.5.3.3.
4. Unload the tape and store it in a safe place.

7.5 UPDATE-SAVES AND TRANSACTION LOGGER

The Update-Save, also called Incremental File-Save, allows you to save only those file groups that have been changed since the last File-Save. Associated with each group of each disk file is a flag indicating whether any item in the group has been updated. To allow you to do Update-Saves, two PROCs have been set up in your SYSPROG account. They are ALL-UPDATE SAVE and PART-UPDATE-SAVE.

WARNING: *Following a full File-Restore, you must do a full File-Save before you can use the Update-Save methods. It is by this full File-Save that the Update-Saves are referenced.*

7.5.1 ALL-UPDATE-SAVE

The ALL-UPDATE-SAVE allows you to do an Update-Save, but it does not reset the "group-updated" flags. Therefore, each Update-Save tape will contain all the changes since the last full File-Save. To restore the system from this backup method, only the most recent full File-Save tape and the most recent ALL-UPDATE-SAVE tape are required.

If using this method, Ultimate recommends that you do an ALL-UPDATE-SAVE every day, and a full File-Save once a week.

1. Select the tape you want to use for the ALL-UPDATE-SAVE. Mount a write-ring on the tape. Make sure the tape doesn't contain data that you need to save, because the ALL-UPDATE-SAVE process will overwrite any data that already exists on the tape.
2. Load the tape. See instructions in Section 4.
3. Make sure all users are logged off the system. To do so, go to the TCL prompt, and type:

LISTUSERS and press RETURN.

The console should be the only terminal logged on. If other users are logged on, make sure they log off before you continue.

If users remain logged on during the ALL-UPDATE-SAVE, the process will take longer to complete, and any work updated while the ALL-UPDATE-SAVE is in process will not be backed up.

4. After all users have logged off, go to port 0 (the console terminal). Type:

LOGTO SYSPROG and press RETURN.

The following screen is displayed.

SYSPROG MAIN MENU
(Honeywell 68000-Based Systems)

1. File-Save with automatic GFE fixer
- 1A. File-Save without automatic GFE fixer
2. ALL-UPDATE-SAVE
3. PART-UPDATE-SAVE
4. Documentation Menu
5. Spooler Menu
6. Automatic Async setup
7. Automatic File Reallocation Menu
8. Load WP account from SYSGEN tape
9. Create Boot tape
10. Load UTILINK account from SYS-GEN tape
11. Load ATP account from SYS-GEN tape
12. Load ULTIMATION account from SYS-GEN tape

88. Logoff
99. Go to TCL

ENTER SELECTION _

(Your menu may be different, according to system configuration.)

Type **2** and press RETURN

to select ALL-UPDATE-SAVE. The ALL-UPDATE-SAVE will begin.

CAUTION: *Do not open the door of the tape drive while the ALL-UPDATE-SAVE is in process!*

NOTE: *If your ALL-UPDATE-SAVE requires more than one tape, you will be prompted to "Mount the next reel".*

5. Before unloading the ALL-UPDATE-SAVE tape, check the tape for parity errors. Follow the instructions in Section 11.5.3.3.
6. Unload the ALL-UPDATE-SAVE tape. See instructions in Section 4.
7. Store the tape(s) in a safe place. For more information on storing and organizing backup tapes, see Section 7.1.

SUMMARY OF ALL-UPDATE-SAVE PROCEDURE

1. Select the tape to be used.
2. Load the tape.
3. Make sure all users have logged off.
4. Log to SYSPROG from the console, and select 2 ,
ALL-UPDATE SAVE, from the menu.
5. Check the tape for parity errors. Refer to Section 11.5.3.3.
6. Unload the ALL-UPDATE-SAVE tape.
7. Store the tape in a safe place.

NOTE: *For more information on the ALL-UPDATE-SAVE method, refer to the System Management and Support Guide.*

7.5.2 PART-UPDATE-SAVE

The PART-UPDATE-SAVE allows you to do an Incremental File-Save, and it resets the "group-updated" flags. Therefore, each Update-Save tape will contain only those changes since the last Update-Save or File-Save. To restore the system from this backup method, the most recent full File-Save tape and every subsequent PART-UPDATE-SAVE tape are required.

If using this method, Ultimate recommends that you do a PART-UPDATE-SAVE every day, and a full File-Save once a week.

NOTE: If, for any reason, a PART-UPDATE-SAVE is aborted, the next save you attempt will automatically be a full File-Save.

1. Select the tape you want to use for the PART-UPDATE-SAVE. Mount a write-ring on the tape. Make sure the tape doesn't contain data that you need to save, because the PART-UPDATE-SAVE process will overwrite any data that already exists on the tape.
2. Load the tape. See instructions in Section 4.
3. Make sure all users are logged off the system. To do so, go to the TCL prompt, and type:

LISTUSERS and press RETURN.

The console should be the only terminal logged on. If other users are logged on, make sure they log off before you continue.

If users remain logged on during the PART-UPDATE-SAVE, the process will take longer to complete, and any work updated while the PART-UPDATE-SAVE is in process will not be backed up.

4. After all users have logged off, go to port 0 (the console terminal). Type:

LOGTO SYSPROG and press RETURN.

The following screen is displayed.

SYSPROG MAIN MENU
(Honeywell 68000-Based Systems)

1. File-Save with automatic GFE fixer
- 1A. File-Save without automatic GFE fixer
2. ALL-UPDATE-SAVE
3. PART-UPDATE-SAVE
4. Documentation Menu
5. Spooler Menu
6. Automatic Async setup
7. Automatic File Reallocation Menu
8. Load WP account from SYSGEN tape
9. Create Boot tape
10. Load UTILINK account from SYS-GEN tape
11. Load ATP account from SYS-GEN tape
12. Load ULTIMATION account from SYS-GEN tape

88. Logoff
99. Go to TCL

ENTER SELECTION _

(Your menu may be different, according to system configuration.)

Type **3** and press RETURN

to select PART-UPDATE-SAVE. The PART-UPDATE-SAVE will begin.

CAUTION: *Do not open the door of the tape drive while the PART-UPDATE-SAVE is in process!*

NOTE: *If your PART-UPDATE-SAVE requires more than one tape, you will be prompted to "Mount the next reel".*

5. Before you unload the PART-UPDATE-SAVE tape, check the tape for parity errors. Follow the instructions in Section 11.5.3.3.
6. Unload the PART-UPDATE-SAVE tape. See instructions in Section 4.
7. Store the tape(s) in a safe place. For more information on storing and organizing backup tapes, see Section 7.1.

SUMMARY OF PART-UPDATE-SAVE PROCEDURE

1. Select the tape to be used.
2. Load the tape.
3. Make sure all users have logged off.
4. Log to SYSPROG from the console, and select 3, PART-UPDATE-SAVE, from the menu.
5. Check the tape for parity errors. Refer to Section 11.5.3.3.
6. Unload the tape.
7. Store the tape in a safe place.

NOTE: *For more information on the PART-UPDATE-SAVE method, refer to the System Management and Support Guide.*

7.5.3 TRANSACTION LOGGER

NOTE: *Before using the Transaction Logger, you should refer to the System Management and Support Guide.*

The Transaction Logger records disk file updates on magnetic tape as the updates are made. In the event of a system failure, the tape can be used in conjunction with a File-Save tape to restore all files to their state at the time of the failure.

A transaction is considered any one of the following: item update, item deletion, file creation, file deletion, and file clearing for any disk file on the system. The Transaction Logger records all transactions on tape. It runs as an independent, transparent process.

Note that writing the same copy of an item back to the file is considered an "item update." For example, filing an item by the FI command of the Editor is considered an item update, even if no change was made to the item.

NOTE: *Do not update items in DX files or a DX pointer while the transaction logger is activated. If you do, you will experience problems when you attempt to restore the data.*

A transaction logging session starts when the logger is activated or restarted, and ends when the logger is deactivated or the tape operation is suspended.

During a transaction logging session, more than one tape may be needed to log all transactions. The system will display the message "MOUNT REEL #" to prompt you to mount a new tape. All tapes made in the same session are collectively called a transaction session tape set.

A new tape should be mounted before each new transaction logging session. The tape should be at the BOT (beginning of tape) mark. When you deactivate the logger or suspend the tape operation, the logger writes an EOF (end of file) mark to the tape to signify the end of the transaction logging session.

1. Select the tape you want to use for the Transaction Logger. Mount a write-ring on the tape. Make sure the tape doesn't contain data that you need to save, because the Transaction Logger will overwrite any data that already exists on the tape.
2. Load the tape. See instructions in Section 4.
3. If you are using a tape, type:

T-ATT 0 and press RETURN.

Be sure to type the number zero, not the letter O.
4. Select the terminal that will be dedicated to transaction logging. This should be any terminal other than port zero. At the selected terminal, type:

LOGTO SYSPROG and press RETURN.

The following screen is displayed.

SYSPROG MAIN MENU
(Honeywell 68000-Based Systems)

1. File-Save with automatic GFE fixer
- 1A. File-Save without automatic GFE fixer
2. ALL-UPDATE-SAVE
3. PART-UPDATE-SAVE
4. Documentation Menu
5. Spooler Menu
6. Automatic Async setup
7. Automatic File Reallocation Menu
8. Load WP account from SYSGEN tape
9. Create Boot tape
10. Load UTILINK account from SYS-GEN tape
11. Load ATP account from SYS-GEN tape
12. Load ULTIMATION account from SYS-GEN tape

88. Logoff
99. Go to TCL

ENTER SELECTION _

(Your menu may be different, according to system configuration.)

Press RETURN

to go to TCL. Then type:

LOG and press RETURN.

The following screen is displayed.

Logger status: Inactive

Transaction logger options:

1. Activate logger; start tape
2. Deactivate logger; exit menu
3. Suspend tape
4. Restart tape
5. Change tape attachment parameters

Enter option or <cr> to display status:

The logger status may be INACTIVE, ACTIVE AND STARTED, or ACTIVE AND SUSPENDED. INACTIVE indicates that the logger is invoked on a terminal but is not recording updates. ACTIVE AND STARTED means that updates are being recorded onto tape. ACTIVE AND SUSPENDED means that the logger is recording updates but that the tape operation is suspended. You may suspend a tape operation to use the tape drive temporarily for other purposes by another port (for example, a File-Save or T-DUMP). During suspension, transactions are recorded on disk. When tape operation is restarted for the transaction logger, these transactions are recorded onto tape.

Activate Logger

At the Transaction Logger menu, type 1 and press RETURN to select "Activate logger; start tape." A transaction tape must already be mounted on the tape drive and loaded at the BOT (beginning of tape) mark. All transactions will be recorded onto tape, until you deactivate the logger or suspend the tape.

NOTE: While the logger is active, be sure to check the tape drive frequently and mount a new tape as needed.

Deactivate Logger

At the Transaction Logger menu, type 2 and press RETURN to select "Deactivate logger; exit menu." If any transactions were queued to disk (if the tape was suspended), those transactions will be flushed to tape, and then an EOF mark is written to tape to signify the end of the transaction logging session. You will be returned to TCL.

Suspend Tape

At the Transaction Logger menu, type **3** and press RETURN to select "Suspend Tape." This option puts the transaction logger into the Active and Suspended state and ends the current transaction logging session. Transactions queued to disk are flushed to tape, and an EOF mark is written to tape. The tape drive is detached from the transaction logger. Remove the tape from the tape drive. The drive may now be used for other purposes (for example, a File-Save, T-DUMP, or T-LOAD). During the time the tape is suspended, transactions are queued to disk.

When the tape drive is ready to resume transaction logging, mount a new tape (see Section 4), and then select option **4** (Restart tape) from the Transaction Logger menu.

Restart Tape

Mount a new tape before selecting this option. Then, at the Transaction Logger menu, type **4** and press RETURN to select "Restart tape." This option starts a new transaction logging session. All transactions queued to disk will be flushed to tape.

Change Tape Attachment Parameters

Use this option to change the block size and tape drive number. At the Transaction Logger menu, type **5** and press RETURN to select "Change tape attachment parameters." (You may only select this option if the logger is in the INACTIVE or ACTIVE AND SUSPENDED state.) You will be prompted for the new block size and tape drive numbers. Enter the new numbers, or press RETURN to keep the default values. The defaults are block size 8192 and tape drive 0.

SUMMARY OF TRANSACTION LOGGER PROCEDURES

1. Select the tape you'll use to record the transactions.
2. Load the tape.
3. Type **T-ATT 0** and press RETURN if you are using a tape.
4. Select the terminal (any one other than port zero) that will be dedicated to transaction logging.
5. Log to **SYSPROG**, and press RETURN to go to TCL. Type **LOG** and press RETURN.
6. At the Transaction Logger menu, type **1** and press RETURN to activate the logger.

NOTE: *For more information on the Transaction Logger, refer to the System Management and Support Guide.*

7.5.4 USING UPDATE-SAVES AND TRANSACTION LOGGER TOGETHER

You may use Update-Saves along with the Transaction Logger. By using the transaction logger, system updates can be kept up-to-the-minute, and, by using Update-Saves regularly, fewer tapes are needed for transaction logging and less time is required for a full File-Restore.

1. Activate the transaction logger immediately after a full File-Save (see Section 7.5.3 for instructions).
2. Do an ALL-UPDATE-SAVE or PART-UPDATE-SAVE every day (see Sections 7.5.1 and 7.5.2 for instructions).
3. Do a full File-Save regularly, at least once a week (see Section 7.2 for instructions).
4. Make sure each transaction tape is associated with the latest "save" tape (either Update-Save or File-Save). For example, if the latest "save" is a full File-Save, then the transaction tapes made after the save are associated with this File-Save tape. But if an Update-Save (ALL-UPDATE-SAVE or PART-UPDATE-SAVE) was done, then the transaction tapes made after the Update-Save are associated with the Update-Save tape.



8 RESTORING DATA

There are basically three reasons to restore your files:

- 1) to recover lost data,
- 2) to improve system performance when disk space becomes fragmented, and
- 3) to allow the system to recognize the addition of communications boards to your system.

Just as there are various methods to save your files, there are various methods to recover them. Each is discussed below.

8.1 FILE-RESTORE

The File-Restore is the most common recovery method. This method allows you to recover lost data, improve system performance, and to recognize added communications boards.

Ultimate recommends you do a full File-Restore every 4 to 6 weeks to improve system performance, which is affected when disk space becomes fragmented. By fully restoring your files, you decrease the amount of fragmented disk space.

***NOTE:** A File-Restore will overwrite your existing data, so you should do a File-Save first, then use that File-Save to do the File-Restore. File-Restores may only be done with File-Save tapes. Make sure you check your File-Save tape for parity errors before doing the File-Restore. Follow the instructions in Section 11.5.3.3.*

1. Make sure all users are logged off the system. To do so, go to the TCL prompt and type:

LISTUSERS and press RETURN.

The console (line 0) should be the only terminal logged on. If other users are logged on, make sure they log off before you continue.

2. After all users have logged off, go to port 0 (the console terminal). Type:

LOGTO SYSPROG and press RETURN.

Then press RETURN again to go to TCL. Type:

:WARMSTOP and press RETURN.

A message similar to the following will be displayed.

Memory Flushed!

This message means that the system has halted all processing and flushed memory.

3. Use the instructions in Section 5 to boot your system. Be sure your SYS-GEN tape is mounted.
4. Locate the File-Save tape with which you will be restoring the system.
5. At the System Startup Options menu, type F.

This initiates a complete File-Restore.

Information about your disc configuration will be displayed. A sample screen is shown below.

Disc Configuration

chan	set name	# of
FF20	Ultimate 1400	1 1

L 2000# time date ABS ULT REL XX*185 COLD LOAD FRAMES ~01

In the next screen, you will be asked for your system serial number.

Tape 0 attached Block size: 16384

System serial # is presently BVxxxx

Enter system serial # or <CR> to accept

Enter your System Serial Number

For example, enter BV0000. If the correct serial number is shown, press RETURN to accept it. You may reenter the correct number if you made a mistake. Press RETURN after you enter the correct number.

The following screen is displayed.

Tape 0 attached Block size: 16384

System serial # is presently

Enter system serial # or <CR> to accept

Mount ABS tape and enter number of files to skip, if any

Press RETURN.

(Your SYS-GEN tape should already be mounted.) The following screen is displayed.

System serial # is presently BVxxxx

Enter system serial # or <CR> to accept

Mount ABS tape and enter number of files to skip, if any

XX-XXX
XXXX-XXX
XXXX-XXX
XXXX-XXXX

Spooler started

Mount DATA tape and press RETURN

Type U

You will see the message "Rewinding..." on your screen. When the SYS-GEN tape is finished rewinding, the green light on the tape drive will go out, and you will be prompted to "Mount DATA tape and press RETURN" again.

6. Unload the SYS-GEN tape. See instructions in Section 4.
7. Mount the first File-Save tape and bring it to load point. See instructions in Section 4.

NOTE: *If you specified new reallocation modulo and separation values via the UPDATE-ACCOUNT or UPDATE-FILE commands, those values will take affect when the File-Restore is complete. If you want to ignore the new reallocation modulo and separation for this File-Restore, type I and press RETURN after the File-Save tape is on-line. If you want any new reallocation values to take affect, then just press RETURN when the File-Save tape is on-line.*

Press RETURN

once the File-Save tape is on-line.

The following screen is displayed.

```
Mount DATA tape and press RETURN
L 2000# time  date  DATA File-Save
Seq# of this data tape: 0 0 0 0
Is this the right tape (Y/N)?
```

Check the tape label displayed to verify that this is your most recent File-Save tape.

NOTE: *If you are not sure how to check the tape label, refer to the topic System Sequencing Information under the heading "Update Save Procedures" in the System Management and Support Guide.*

Type **Y** and press RETURN.

The File-Restore will begin. Each filename on the tape will be listed on your screen. If this is a multiple tape File-Save, you will be prompted to "Mount the next reel". After you mount the tape, type **C** to Continue at the "(C)ontinue/(Q)uit?" prompt. When all the files on all the tapes have been restored, the following screen is displayed.

```
Update/transaction tapes (Y/N)?
```

At "Update/transaction tapes," type **N** if there are no update or transaction tapes from which to restore. If the file-save does include update or transaction tapes, then unload the last tape of the file-save, and load the first update or transaction tape. When the tape is on-line, type **Y**.

Restoring Data

NOTE: *If you are restoring from both update and transaction tapes, load the update tapes first. When all update tapes have been restored, you will see the prompt "Update/transaction tapes?" Type Y, then load the first transaction tape.*

At the end of each tape, you will be prompted to mount the next tape. When the next tape is loaded and on-line, then type C to continue.

When all of the update and transaction tapes have been restored, you will see the prompt "Update/transaction tapes?" Type N. Then the file-restore will continue.

The following screen is displayed.

```
Update/transaction tapes (Y/N)? N
Saving Monitor
Linking workspace for line 0

    date    time    Logon please:

<<< Welcome to the Ultimate Computer System >>>
<<< Copyright  date  The Ultimate Corp.    >>>
<<< time  Release XX Rev XX  date        >>>

This is the Cold-Start Procedure
Enter <CR> to continue
```

Press RETURN

The following screen is displayed.

date time Logon please:

```
<<< Welcome to the Ultimate Computer System >>>
<<< Copyright date The Ultimate Corp. >>>
<<< time Release XX Rev XX date >>>
```

This is the Cold-Start Procedure
Enter <CR> to continue

Linking secondary TCL workspaces

X additional task workspaces initialized

time date

Time =

Enter the time in military format (HH:MM:SS) and press RETURN.

For example, enter 5pm as 17:00:00. The following screen is displayed.

This is the Cold-Start Procedure
Enter <CR> to continue

Linking secondary TCL workspaces

X additional task workspaces initialized

time date

Time = 17:00:00

17:00:00 date

Date =

Restoring Data

Enter the date in the following format: MM/DD/YY and press RETURN.

For example, enter February 3, 1986 as 02/03/86. The following screen is displayed.

```
This is the Cold-Start Procedure
Enter <CR> to continue

Linking secondary TCL workspaces

X additional task workspaces initialized

time    date
Time = 17:00:00
17:00:00 date
Date = 02/03/86
17:00:00 03 FEB 1986
```

The system will display several messages. If there are any error messages (i.e. "Ultimate system software does not verify"), call Ultimate Technical Support immediately.

The following screen will be displayed.

```
<<< Verifying software >>>
System software verified

Do You Wish to Start Parallel Printer 0 (<CR>=NO, Y=YES) ?
```

If you have a parallel printer, type **Y**. If you do not have a parallel printer, just press RETURN. If you type **Y**, the following screen is displayed.

SP-STARTLPTR 0,0,1,PO

[1118]

The printer control block has been initialized. The correct paper and LPI settings must have been previously set to insure proper printing.

date time Logon please:

You may now log on to the system. If you did not start a parallel printer, the following screen is displayed.

date time Logon please:

8. You may now log on.

SUMMARY OF THE FILE-RESTORE PROCEDURE

1. :WARMSTOP the system.
2. Make sure the system has been booted, and that the SYS-GEN tape is mounted.
3. Locate your File-Save tape. Make sure you check the tape for parity errors. Refer to Section 11.5.3.3.
4. Type F at the System Startup Options menu.
5. Enter your system serial number.
6. Press RETURN at "Mount ABS tape."
7. At the "Mount data tape" prompt, type U to rewind the SYS-GEN tape. Then unload the SYS-GEN tape.
8. Mount the first tape of the File-Save, and bring it to load point.
9. Press RETURN (or type I and press RETURN to ignore reallocation values).
10. Verify the tape label, and type Y and press RETURN. If you are using a multiple-tape File-Save, mount the tapes as prompted, and then enter C at the "(C)ontinue/(Q)uit?" prompt.
11. Type N and press RETURN at "Update/transaction tapes?" if you do not have update or transaction tapes. Type Y and press RETURN if you have update or transaction tapes. Then unload the File-Save tape, mount the update or transaction tape, and bring it to load point.
12. Press RETURN at "This is the Cold-Start Procedure."
13. Enter the time and date in military format and press RETURN after each.
14. Check error messages.
15. Type Y if you want to start a parallel printer, or press RETURN if you do not want to start a parallel printer.
16. Log onto the system.

8.2 ACCOUNT-RESTORE

An Account-Restore may be done to restore files from a single account, rather than restoring the entire system. An Account-Restore may be done from a File-Save tape, an Update-Save tape, or an Account-Save tape. Make sure you check the File-Save, Update-Save, or Account-Save tape for parity errors before doing the Account-Restore. Follow the instructions in Section 11.5.3.3.

You cannot restore an account if it already exists on the system. If the account does exist, you may either delete it before performing the restore, or you may restore it under a different account name.

If you are restoring the account from a File-Save or Account-Save tape, an Account-Restore may be started from any multiple tape on which the account resides. If you are restoring from an Update-Save tape, you must begin from File-Save tape #1. If the account is located on a different tape, you cannot skip to that tape. You must load each tape in sequence until you reach the tape with the account you want to restore. If you don't know which tape the account is on, refer to the File Statistics report. Locate the account name on the report, and then look in the column labeled R# (reel number) to determine the tape on which the account is located.

8.2.1 ACCOUNT-RESTORE FROM FILE-SAVE OR ACCOUNT-SAVE TAPE

To begin the restore, mount the tape containing the account, or mount the first tape of the Account-Save. (The system will prompt you for successive tapes until the desired account is found.)

1. Log on to the SYSPROG account, and press RETURN to go to TCL.
2. Load the save tape. See instructions in Section 4.
3. Type:

ACCOUNT-RESTORE ACCOUNTNAME and press RETURN.

Enter the account name you wish to restore. If you wish, you can change the name of the account to a different account name. For more information, see your System Commands Guide .

The following screen will be displayed.

>ACCOUNT-RESTORE ACCOUNTNAME

Account name on tape:

Enter the name of the account from which you are restoring, and press RETURN.

NOTE: You must enter the exact name under which the account was originally saved.

The following screen will be displayed.

>ACCOUNT-RESTORE ACCOUNTNAME

Account name on tape:

Password(s) (Y/N)?

If you want to assign one or more passwords to the account when it is restored, type **Y** and press RETURN. If you don't want to use passwords, type **N** and press RETURN.

If you entered **Y**, you will be prompted:

Password(s) or <CR> (use password(s) from tape)

Either type the new password and press RETURN, or just press RETURN to use the password(s) that were stored on the tape along with the account. If you type a new password, it will not be displayed on the screen. You will be prompted to enter the password again:

Re-enter password(s) to confirm:

Type the password again. Multiple passwords must be separated with spaces.

4. The system will begin looking for the specified account, and it will list on the screen each account it finds. When the account you specified is found, the restore will begin, one file at a time. The filenames will appear on the screen as they are loaded. Once the account has been restored, the TCL prompt will be displayed.
5. Unload the save tape and store it in a safe place. See instructions in Section 4.

8.2.2 ACCOUNT-RESTORE FROM UPDATE-SAVE TAPE

To restore an account from an Update-Save, you must first restore the account from the latest File-Save. Then you will be prompted to mount the Update-Save.

NOTE: An account cannot be restored from a transaction logger tape.

If you have a multiple tape File-Save, you must start the restore with tape #1. If your account is located on another tape, you cannot skip to that tape. You must load each tape in sequence.

WARNING: If, at any point in the Account-Restore from Update-Save procedure, the Update-Save tape label cannot be read, unload the tape and do not try to continue. Otherwise, your account may be deleted!

1. To begin the restore, mount tape #1 of the File-Save tape that accompanies the Update-Save (each Update-Save must be accompanied by the latest full File-Save).
2. Log on to the SYSPROG account, and go to TCL.
3. Type:

ACCOUNT-RESTORE ACCOUNTNAME (U and press RETURN.

Enter the account name you wish to restore. (Do not enter an account name that already exists on the system.) The (U option indicates that you are restoring from an Update-Save. The following screen will be displayed.

>ACCOUNT-RESTORE ACCOUNTNAME (U

Account name on tape:

Enter the name of the account from which you are restoring, and press RETURN.

The following screen will be displayed.

>ACCOUNT-RESTORE ACCOUNTNAME (U

Account name on tape:

Password(s) (Y/N)?

If you want to assign one or more passwords to the account when it is restored, type Y and press RETURN. If you don't want to use passwords, type N and press RETURN.

If you entered Y, you will be prompted:

Password(s) or <CR> (use password(s) from tape)

Either type the new password and press RETURN, or just press RETURN to use the password(s) that were stored on the tape along with the account. If you type a new password, it will not be displayed on the screen. You will be prompted to enter the password again:

Re-enter password(s) to confirm:

Type the password again. Multiple passwords must be separated with spaces.

4. The system will display the sequence number on the File-Save tape, as displayed in the following screen.

```
L 2000# time  date  DATA FILE-SAVE
Seq# of this data tape: 0 0 0 0
Is this the right tape (Y/N)?
```

Check the tape label displayed to verify that this is your most recent File-Save tape. Then type **Y** and press RETURN.

WARNING: *If the sequence number of the tape is not displayed, you will be prompted to Continue or Quit. Do not continue! If you continue, your account will be deleted.*

NOTE: *If you are not sure how to check the tape label, refer to the topic "System Sequencing Information" under the heading "Update Save Procedures" in the System Management and Support Guide.*

5. The system will begin looking for the specified account, and it will list on the screen each account it finds.

When the account you specified is found, the account will be restored from the File-Save tape. Then you will be prompted to load the Update-Save tape. The following screen will be displayed.

```
Update/transaction tapes (Y/N)?
```

Restoring Data

Remove the File-Save tape. If you are restoring from an ALL-UPDATE-SAVE, mount the latest Update-Save tape. If you are restoring from a PART-UPDATE-SAVE, you will have to load every Update-Save tape since the last full File-Save, in the same sequence in which the tapes were made. Mount the Update-Save tape. Then enter Y and press RETURN. The following screen will be displayed.

Update/transaction tapes (Y/N)? Y

Account name on tape:

Enter the account name from which you are restoring, and press RETURN.

WARNING: *Be sure to type the account name correctly. If you enter the wrong account name, the account will be deleted!*

Once you have entered the account name, the following screen is displayed.

Mount DATA tape and press RETURN

Make sure the update-save tape is on-line and at load point. Then press RETURN. The following screen is displayed.

Mount DATA tape and press RETURN
L 2000# time date DATA ALL-UPDATE SAVE
Seq# of this data tape:
Seq# of last data tape:
Is this the right tape (Y/N)?

Check the label displayed to verify that this is the correct Update-Save tape. Then enter Y and press RETURN.

WARNING: *If an incorrect sequence number of the tape is displayed, type Q to Quit at the "(C)ontinue/(Q)uit?" prompt. If you continue, your account will be deleted.*

NOTE: *If you are not sure how to check the tape label, refer to the topic "System Sequencing Information" under the heading "Update Save Procedures" in the System Management and Support Guide.*

Once the tape has been loaded, you will again be prompted to "Mount the next reel". When ready, type C at the "(C)ontinue/(Q)uit?" prompt. Repeat this step until all of the Update-Save tapes have been loaded. When all Update-Save tapes have been loaded, type N and press RETURN at the "Update/transaction tapes (Y/N)?" prompt.

6. The TCL prompt will be displayed. Unload the update-save tape and store it in a safe place. See the instructions in Section 4.

SUMMARY OF ACCOUNT-RESTORE FROM FILE-SAVE OR ACCOUNT-SAVE

1. Log to SYSPROG, and go to TCL.
2. Load the save tape. Make sure you check the tape for parity errors. Refer to Section 11.5.3.3.
3. Type **ACCOUNT-RESTORE ACCOUNTNAME** and press RETURN.
4. Enter the account name from which you are restoring.
5. At "Passwords?", type **Y** to restore the account with a password, or type **N** for no password.
6. When the restore is complete, unload the tape, and store it in a safe place.

SUMMARY OF ACCOUNT-RESTORE FROM UPDATE-SAVE

1. Log to SYSPROG, and go to TCL.
2. Load tape #1 of the File-Save tape. Make sure you check the tape for parity errors. Refer to Section 11.5.3.3.
3. Type **ACCOUNT-RESTORE ACCOUNTNAME (U** and press **RETURN**.
4. Enter the account name from which you are restoring.
5. At "Passwords?", type **Y** to restore the account with a password, or enter **N** for no password.
6. At "Is this the right tape?" verify the tape label and type **Y**.
7. If restoring from a multi-tape File-Save, load each tape in sequence until you reach the tape with the account you want to restore.
8. When the account has been restored from the File-Save, mount the Update-Save, and type **Y** at "Update/transaction tapes?"
9. Enter the account name from which you are restoring and press **RETURN**.
10. At "Mount DATA tape," make sure the update-save tape is on-line and press **RETURN**.
11. At "Is this the right tape?", verify the tape label and type **Y**.
12. If you have a multi-tape Update-Save, you will be prompted to "Mount the next reel". Then type **C** at the "(C)ontinue/(Q)uit?" prompt. When there are no more tapes, type **N** and press **RETURN** at the "Update/transaction tapes (Y/N)?" prompt.
13. When the restore is complete and the TCL prompt is displayed, unload the tape, and store it in a safe place.

8.3 T-LOAD

The T-LOAD verb may be used to restore files that have been T-DUMPed.

1. Load the tape from which you want to load your file(s). See instructions in Section 4. Make sure you check the tape for parity errors before loading your file(s). Follow the instructions in Section 11.5.3.3.
2. Use the T-LOAD verb to load your file(s): T-LOAD is a RECALL verb, and its general form is as follows:

T-LOAD {DICT} filename {item-list} {selection-criteria} {HEADER "name"} {(options)}

The filename may be preceded by the DICT modifier to load dictionary data. File definition items (such as D/CODE=D) will not be loaded.

The filename is the name of the source file to be loaded, or copied, onto the disk.

As explained in the Recall manual, the item-list and selection criteria select a sub-set of the items in the specified file which are to be written to disk. If the item-list and selection-criteria are omitted, then all items in the file will be written to disk. As in other Recall statements, each item ID must be enclosed in double quotes (").

The HEADER allows a "name" to be included in the label at the start of the file.

Options:

- (I) Inhibits listing to the terminal of items loaded.
- (O) Enables overwrite of items in the file with item IDs corresponding to the item IDs of items in the disk file.

3. Unload the tape. See instructions in Section 4.

SUMMARY OF T-LOAD PROCEDURE

1. Load the tape from which you will load your files. Make sure you check the tape for parity errors. Refer to Section 11.5.3.3.
2. Type T-LOAD {DICT} filename {item-list}
{selection-criteria} {HEADER "name"}{(options)}
3. Unload the tape, and store it in a safe place.

8.4 SELECTIVE-RESTORE

The Selective-Restore allows you to restore data into individual files or items from a File-Save or Account-Save tape.

NOTE: *Selective-Restores may be started from any tape of a multi-tape File-Save, ALL-UPDATE-SAVE, OR PART-UPDATE-SAVE. To save time in searching the tape, check the File-Stats listing to determine on which tape the file's data starts. Then mount that tape. A Selective-Restore may be started at any place on any File-Save tape.*

1. Log on to the account that contains the file to be restored.
2. Load the save tape. See instructions in Section 4. Make sure you check the tape for parity errors. Follow the instructions in Section 11.5.3.3.
3. Type:

SEL-RESTORE {DICT} FILENAME {ITEM-LIST} {(OPTIONS)}

and press RETURN.

The filename may be preceded by the DICT modifier to restore dictionary data. File definition items (such as D/CODE=D) will not be restored.

The filename is the name of the file in which the restored items will be placed. This filename must exist on the account from which the restore is run.

The item-list selects a sub-set of the items within the specified file which are to be restored. You may enter an asterisk (*), instead of an item-list, to specify that all items within the file be restored.

Options

- (A) Indicates that the tape is already positioned at the desired account. The prompt "Account name on tape" will not appear. This option may not be used if you specify that the account MD is to be restored.
- (B) Used to selectively restore BASIC object code files, and save-lists in a pointer file.
- (C) This option has effect when the N option is used. It causes every item before the next end-of-file to be a candidate for restore. This ensures that data can be restored even if a D-pointer is damaged on the tape.
- (I) The item IDs of the restored items will not be printed.
- (N) The file is to be identified on tape by its file number, instead of filename. The file number may be obtained from a listing of the STAT-FILE when the tape was created. If this option is used, the prompt "File name" will be replaced with the prompt "File #."
- (O) Overlay items already on the file.

- (S) Skips forward spacing of the tape. This option is used when at the beginning of the second or later reels of a File-Save tape.

The following screen will be displayed.

Account name on tape?

Enter the name of the account under which the file was saved on tape.

The following screen is displayed.

Account name on tape?
File name?

Enter the name of the file as it appears on the tape, or press RETURN to indicate that the account Master Dictionary (MD) should be restored. The filename may be of the form filename, DICT filename, or filename, dataname.

As the tape is searched, the filenames on it are printed, along with the file numbers.

- 4. Unload the tape. See instructions in Section 4.

SUMMARY OF SELECTIVE-RESTORE PROCEDURE

1. Log on to the account that contains the file to be restored.
2. Load the save tape. Make sure you check the tape for parity errors.
Refer to Section 11.5.3.3.
3. Type **SEL-RESTORE {DICT} FILENAME {ITEM-LIST} {(OPTIONS)}** and press RETURN.
4. Enter the account name on tape.
5. Enter the filename (or file number, if using the N option), on tape.
The Selective-Restore will begin.
6. When the restore is complete, unload the tape.

8.5 RESTORE FROM UPDATE-SAVES AND TRANSACTION LOGGER

Use this procedure to restore your data from ALL-UPDATE-SAVES, PART-UPDATE-SAVES, and transaction loggings. You will start by restoring your data from the File-Save. Then you will be prompted to mount the Update-Save or transaction tapes.

NOTE: For instructions on restoring an account (via the *ACCOUNT-RESTORE* command) from an Update-Save tape, see Section 8.2.2.

1. Make sure all users are logged off the system. To do so, go to the TCL prompt and type:

LISTUSERS and press RETURN.

The console (line 0) should be the only terminal logged on. If other users are logged on, make sure they log off before you continue.

2. After all users have logged off, go to port 0 (the console terminal). Type:

LOGTO SYSPROG and press RETURN.

Then press RETURN again to go to TCL. Type:

:WARMSTOP and press RETURN.

A message similar to the following will be displayed.

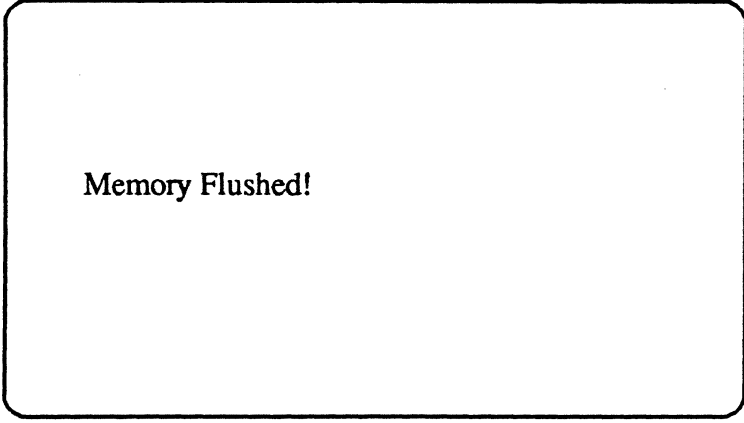

Memory Flushed!

This message means that the system has halted all processing and flushed memory.

3. Use the instructions in Section 5 to boot your system. Be sure your SYS-GEN tape is mounted.
4. Locate the latest full File-Save tape, and the update-save and/or transaction logger tapes with which you will be restoring the system. Make sure you check the tapes for parity errors before restoring the system. Follow the instructions in Section 11.5.3.3.

Restoring Data

5. At the System Startup Options menu, type F.

This initiates a complete File-Restore.

Information about your disc configuration will be displayed. A sample screen is shown below.

```
Disc Configuration

chan      set name    # of
FF20 Ultimate 1400 1 1
L 2000# time date ABS ULT REL XX *185 COLD LOAD FRAMES ~01
```

In the next screen, you will be asked for your system serial number.

```
Tape 0 attached Block size: 16384

System serial # is presently BVxxxx

Enter system serial # or <CR> to accept
```

Enter your System Serial Number.

For example, enter BV0000. If the correct serial number is shown, press RETURN to accept it. You may reenter the correct number if you made a mistake. Press RETURN after you enter the correct number.

The following screen is displayed.

Tape 0 attached Block size: 16384

System serial # is presently BVxxxx

Enter system serial # or <CR> to accept

Mount ABS tape and enter number of files to skip, if any

Press RETURN.

(Your SYSGEN tape should already be mounted.) The following screen is displayed.

System serial # is presently

Enter system serial # or <CR> to accept

Mount ABS tape and enter number of files to skip, if any

XX-XXX

XXXX-XXX

XXXX-XXX

XXXX-XXXX

Spooler started

Mount DATA tape and press RETURN

Restoring Data

Type U

You will see the message "Rewinding..." on your screen. When the SYS-GEN tape is finished rewinding, the green light on the tape drive will go out, and you will be prompted to "Mount DATA tape and press RETURN" again.

6. Unload the SYS-GEN tape. See instructions in Section 4.
7. Mount the first tape of the latest File-Save and bring it to load point. See instructions in Section 4.

Press RETURN.

The following screen is displayed.

```
Mount DATA tape and press RETURN
L 2000# time   date   DATA File-Save
Seq# of this data tape: 0 0 0 0
Is this the right tape (Y/N)?
```

Check the tape label displayed to verify that this is your most recent File-Save tape.

NOTE: *If you are not sure how to check the tape label, refer to the topic "System Sequencing Information" under the heading "Update Save Procedures" in the System Management and Support Guide.*

Enter **Y** and press RETURN.

The File-Restore will begin. Each filename on the tape will be listed on your screen. If this is a multi-tape File-Save, you will be prompted to "Mount the next tape". After you have loaded the tape, type **C** to Continue at the "(C)ontinue/(Q)uit?" prompt. When all files on all the tapes have been restored, the following screen is displayed.

Update/transaction tapes (Y/N)?

NOTE: *If you are restoring from both Update-Saves and transaction tapes, follow the procedures for restoring the ALL-UPDATE-SAVE or PART-UPDATE-SAVE tapes. Once the Update-Saves have been loaded, begin loading the transaction tapes.*

If Restoring From ALL-UPDATE-SAVE

If you are restoring from an ALL-UPDATE-SAVE, mount the latest Update-Save tape. Then type Y and press RETURN. The following screen is displayed.

Mount DATA tape and press RETURN
L 2000# time date DATA All-Update-Save
Seq# of this data tape:
Seq# of last data tape:
Is this the right tape (Y/N)?

Check the label displayed to verify that this is the correct tape. Then type Y and press RETURN.

If this is a multiple-tape Update-Save, the following screen is displayed.

Mount reel #2
(C)ontinue/(Q)uit?

Mount the next tape. When ready, type C. Continue mounting the tapes as prompted. When all of the Update-Save tapes have been loaded, type N and press RETURN at the "Update/transaction tapes (Y/N)?" prompt.

If Restoring From a PART-UPDATE-SAVE

If you are restoring from a PART-UPDATE-SAVE, you will have to load every Update-Save tape since the last full File-Save, in the same sequence in which the tapes were made. Mount the first Update-Save tape made after the last full File-Save. Then type Y and press RETURN. The following screen will be displayed.

Mount DATA tape and press RETURN
L 2000# time date DATA Part-Update-Save
Seq# of this data tape:
Seq# of last data tape:
Is this the right tape (Y/N)?

Check the label displayed to verify that this is the correct tape. Then type Y and press RETURN.

If this is a multiple-tape Update-Save, the following screen will be displayed.

Mount reel #2
(C)ontinue/(Q)uit?

Mount the next tape. When ready, type C. Continue mounting the tapes as prompted. When all of the Update-Save tapes have been loaded, type N and press RETURN at the "Update/transaction tapes (Y/N)?" prompt.

If Restoring From a Transaction Tape

If you are restoring from a transaction tape, you will have to load every transaction tape since the last full File-Save, ALL-UPDATE-SAVE, or PART-UPDATE-SAVE in the same sequence in which the tapes were made. Mount tape #1 of the first transaction session tape set made after the last full File-Save or Update-Save. Then type Y and press RETURN. The following screen will be displayed.

Mount DATA tape and press RETURN
L 2000# time date DATA Transaction
Seq# of this data tape:
continued from tape:
Seq# of last data tape:
Is this the right tape (Y/N)?

Check the label displayed to verify that this is the correct tape. Then type Y and press RETURN.

At the end of tape #1, the system will automatically unload the tape.

The following screen is displayed.

Restoring Data

Mount reel #2
(C)ontinue/(Q)uit?

NOTE: *If you are restoring from both Update-Saves and transaction tapes, follow the procedures for restoring the ALL-UPDATE-SAVE or PART-UPDATE-SAVE tapes. Once the Update-Saves have been loaded, begin loading the transaction tapes.*

Mount the next tape in the same transaction session set. Then type **C** to continue. After all tapes of the transaction session set have been loaded, you will be prompted with "Update/transaction tapes (Y/N)?" If there is another transaction tape set, mount tape #1 of that set. Then type **Y** and press RETURN. You will be prompted to "Mount the next reel". Then type **C** to Continue at the "(C)ontinue/(Q)uit?" prompt. When all of the transaction tapes have been loaded, type **N** and press RETURN at the "Update/transaction tapes (Y/N)?" prompt.

When All Tapes Have Been Restored

Once all update/transaction tapes have been loaded, the following screen will be displayed.

```
Update/transaction tapes (Y/N)? N
Saving Monitor
Linking workspace for line 0

    date    time  Logon Please:

<<< Welcome to the Ultimate Computer System >>>
<<< Copyright date  The Ultimate Corp.    >>>
<<< time  Release XX Rev XX   date      >>>

This is the Cold-Start Procedure
Enter <CR> to continue
```

Press RETURN.

The following screen is displayed.

```
date  time  Logon please:

<<< Welcome to the Ultimate Computer System >>>
<<< Copyright  date  The Ultimate Corp.  >>>
<<< time Release XX Rev XX  date  >>>

This is the Cold-Start Procedure
Enter <CR> to continue

Linking secondary TCL workspaces

X additional task workspaces initialized

time  date

Time =
```

Enter the time in military format (HH:MM:SS) and press RETURN.

For example, enter 5pm as 17:00:00. The following screen is displayed.

```
This is the Cold-Start Procedure  
Enter <CR> to continue
```

```
Linking secondary TCL workspaces
```

```
X additional task workspaces initialized
```

```
time    date
```

```
Time = 17:00:00
```

```
17:00:00  date
```

```
Date =
```

Enter the date in the following format: MM/DD/YY and press RETURN.

For example, enter February 3, 1986 as 02/03/86. The following screen is displayed.

```
This is the Cold-Start Procedure  
Enter <CR> to continue
```

```
Linking secondary TCL workspaces
```

```
X additional task workspaces initialized
```

```
time    date
```

```
Time = 17:00:00
```

```
17:00:00  date
```

```
Date = 02/03/86
```

```
17:00:00 03 FEB 1986
```

The system will display several messages. If there are any error messages (i.e. "Ultimate system software does not verify"), call Ultimate Technical Support immediately.

The following screen is displayed.

```
<<< Verifying software >>>
System software verified

Do You Wish to Start Parallel Printer 0 (<CR>=NO, Y=YES) ?
```

If you have a parallel printer, type Y. If you do not have a parallel printer, just press RETURN. If you typed Y, the following screen is displayed.

```
SP-STARTLPTR 0,0,1,PO

[1118]
  The printer control block has been initialized. The correct
  paper and LPI settings must have been previously set to
  insure proper printing.

date  time  Logon please:
```

You may now log on to the system. If you did not start a parallel printer, the following screen is displayed.

```
date  time  Logon please:
```

8. You may now log on.

SUMMARY OF THE FILE-RESTORE WITH UPDATE/TRANSACTION TAPES

1. At TCL on the SYSPROG account, type :WARMSTOP to warmstop your system.
2. Boot your system and make sure that the SYS-GEN tape is mounted.
3. Locate your File-Save tape. Make sure you check the tape for parity errors. Refer to Section 11.5.3.3.
4. Type F at the System Startup Options menu.
5. Enter your system serial number.
6. Press RETURN at "Mount ABS tape."
7. At "Mount data tape," type U to rewind the SYS-GEN tape.
8. When the tape is fished rewinding, unload the SYS-GEN tape.
9. Mount the first tape of the File-Save, and bring it to load point.
10. Press RETURN.
11. Verify the tape label, and type Y and press RETURN.
12. At "Update/transaction tapes?" mount the first tape of the update or transaction tapes. Then type Y and press RETURN. If you are using a multi-tape set, you will be prompted to "Mount the next reel". Then type C at the "(C)ontinue/(Q)uit?" prompt. When all of the tapes have been loaded, type N and press RETURN at "Update/transaction tapes (Y/N)?".
13. Press RETURN at "This is the Cold-Start Procedure."
14. Enter the time and date in military format and press RETURN after each.
15. Check error messages.
16. If you want to start a parallel printer, type Y. If not, just press RETURN.
17. Log onto the system.

9 MAINTENANCE

The steps in this section should be performed routinely to ensure that your Ultimate system runs smoothly and efficiently. Ultimate strongly advises that you follow all daily, weekly, and monthly procedures.

9.1 DAILY

9.1.1 BACK UP YOUR DATA

Ultimate strongly recommends that you back up your data at the end of each work day. Failure to do so could result in considerable data loss if a system failure occurs. Such a failure (without a backup) would require the reentry of all data, which may be difficult to retrace.

Note that full File-Saves should be done at least once each week.

For more information on backup methods, see Section 7.

9.1.2 CHECK FILE STATISTICS REPORT

Each time you perform a File-Save, you should also generate a file statistics report. This report may also be generated at any time by typing **LIST-FILE-STATS** and pressing RETURN at TCL.

The file stats report lists one item for each D-pointer saved on the File-Save tape. The report also adds security data by providing a list of file Base, Modulo, and Separation parameters, and by recording the order of the files on a File-Save tape. The information on the file stats report is only updated when a File-Save is performed. If you want a current file stat report, you will have to do it immediately after a File-Save.

The report is broken down by account, with a line of information generated for each file in the account, that includes:

1. total and average item size
2. total and average number of items per group
3. use of file space
4. actual data stored, and "pad" space used in the file

A total line is generated for each account, showing the total:

1. items
2. bytes (characters)
3. frames (includes linked)
4. Group Format Errors (GFEs)

The file stats report is cleared after every File-Restore, because the data is no longer applicable. The report is regenerated with every File-Save.

Maintenance

Check the file stats report at the end of every File-Save. Pay particular attention to the total line for each account, which shows the total number of Group Format Errors (GFEs).

CAUTION: *If any GFEs are indicated on the file stats report, they must be corrected immediately! Refer to Section 11.3 of this manual, and call Ultimate Technical Support. Do not do any further processing until the GFEs have been corrected.*

9.1.3 VERIFY-SYSTEM

The verify-system procedure ensures that the system software is correct.

The verify-system generates a checksum for every frame of software, from 1 to 399 and from 600 to 1023. These check-sums are compared with those in the ERRMSG file, in an item named "CHECK-SUM." This item contains the correct check-sum for all the system software frames. Each line in the item contains a check-sum for one frame of code, optionally followed by one or more hexadecimal limits. If the limits are present, the check-sum is generated only for bytes within the limits. If no limits are present, the check-sum is generated for bytes 0--X'1FF.' This is done because some frames contain tables that change from time to time, such as the system overflow table. Table entries are not check-summed, only assembly code is check summed.

1. Log to the SYSPROG account, and go to TCL.
2. Type:

VERIFY-SYSTEM and press RETURN.

If all the program frames verify, the following message is displayed:

[341] Ultimate System Software Verified

If a frame generates a check-sum that does not match the check-sum for that frame in the "CHECK-SUM" item, then the FID of the frame, the generated check-sum, and the stored check-sum from the item are printed, and the following message is displayed:

[342] Ultimate system software does not verify!

If this message is displayed, your system has mismatches. See Section 11.8 for causes and possible solutions for mismatches.

9.1.4 LIST-SYSTEM-ERRORS

The List-System-Errors procedure lists disk errors.

1. Log on to the SYSPROG account, and go to TCL.
2. Type:

LIST-SYSTEM-ERRORS and press RETURN.

The following screen is displayed.

```
>LIST-SYSTEM-ERRORS  
To the Printer (Y=<CR>/N)?
```

Type **Y** and press RETURN (or press RETURN only)

for a printout of the errors, or type **N** and press RETURN to display the errors on the terminal.

The following screen is displayed.

```
>LIST-SYSTEM-ERRORS  
To the Printer (Y=<CR>/N)?  
System Error listing explanation (Y/N=<CR>)?
```

Maintenance

Type **N** and press RETURN (or press RETURN only)

if you don't want a printout explaining all possible system errors, or type **Y** and press RETURN to print the document.

If you have never printed this document before, Ultimate suggests you type **Y** to print it now. If you already have a copy of this document, you may type **N** to bypass it.

The following screen is displayed.

```
>LIST-SYSTEM-ERRORS
To the Printer (Y=<CR>/N)?
System Error listing explanation (Y/N=<CR>)?
Would you like the list sorted (Y/N)?
```

Type **Y** and press RETURN

to sort the list by date and time, or type **N** and press RETURN if you don't want the list sorted.

The system errors will be listed. If there are no errors, the following message will be displayed:

```
[401] No items present.
```

If errors are listed, refer to the "System Error Listing Explanation" in the System Management and Support Guide. Recurring errors should be reported to Ultimate Technical Support.

9.1.5 CHECK PRINT OVERFLOW TABLE

The POVf verb is used to check the system overflow table, which displays the amount of disk space available on the system.

1. From TCL, type:

POVF and press RETURN.

You may also specify the (P) option to print the overflow table on the printer.

The overflow table will be displayed. The following is an example of an overflow table.

```

>POVF
          3936          ( 823)
5549- 5551 : 3 6746- 6746 : 1
6748- 7160 : 431 7254- 7258 : 2
23054- 23289 : 236 26000- 148159 : 122159

Total number of contiguous frames : 123655
>

```

The first line of output is the FID of the first frame in linked overflow, followed by the number of frames in the linked chain. The next lines describe blocks of contiguous overflow, and have the following format:

$$m - n : p \quad m - n : p$$

m = the first frame of a contiguous block

n = the last frame of the block

p = the number of frames in the block

The total number of frames contained in all the contiguous overflow is then displayed:

Total number of contiguous frames :

If you have a 1400 WREN II Disk Drive, this number should be greater than 19,000 frames. If it is not, call Ultimate Technical Support.

If you have a 1400 WREN III Disk Drive, this number should be greater than 38,000 frames. If it is not, call Ultimate Technical Support.

9.2 WEEKLY

9.2.1 FILE-SAVE

If your daily back-up method is one other than the File-Save, then you should perform a full File-Save at least once each week. Note that if your daily method is the Update-Save, each Update-Save tape should be associated with a full File-Save tape.

Refer to Section 7.2 for instructions.

9.2.2 CLEAN TAPE HEADS

If your system is equipped with a tape drive, you should clean the tape heads once a week.

Follow the procedures in Section 4 to clean the tape drive.

9.3 MONTHLY

9.3.1 FILE-RESTORE

You should perform a full File-Restore approximately once every 4 to 6 weeks, or as needed, to repair any fragmented disk space. See Section 8.1 for instructions and more information.

9.3.2 CLEAR ACC FILE

You should check and clear, if necessary, the accounting history items in the accounting history file for specific users to avoid overflowing them.

The point of overflow is determined by the amount of activity of each user (approximately 1000 logon/logoffs are allowed). If you do not clear the ACC file before it overflows, you may experience abort errors when attempting to log on.

1. From TCL, type:

LOGTO SYSPROG and press RETURN.

Then press RETURN again to go to TCL.

2. Type:

SORT ACC WITH NAME LPTR and press RETURN.

This will produce a list of users that are logged on.

3. Type:

SELECT ACC WITH NO NAME and press RETURN.

This selects updated items only.

WARNING: *If you accidentally pressed an extra RETURN, do not continue to step 4. If you do, all your accounting records will be deleted. Instead, you should repeat step 3 before you go to step 4.*

4. Type:

DELETE ACC and press RETURN.

The ACC file will be cleared. Refer to the System Management and Support Guide for more information on the ACC file.

SUMMARY OF MAINTENANCE ITEMS

Daily

1. Back up your data.
2. Create and check the File Stats Report for GFEs. If GFEs appear, correct them or call Ultimate immediately.
3. From SYSPROG, run **VERIFY-SYSTEM**. If the system does not verify, see Section 11.8.
4. From SYSPROG, run **LIST-SYSTEM-ERRORS**. If errors are present, check the System Error Listing Explanation, or call Ultimate.
5. Check the Print Overflow Table (POVF).

Weekly

1. If you have a tape drive system, clean the tape heads.
2. If your daily backup method is one other than a File-Save, then perform a full File-Save.

Monthly

1. Perform a full File-Restore.
2. Clear the ACC file.

10 ADDING EQUIPMENT

10.1 ADDING PORTS

Whenever you add ports to your system, you must perform a full File-Restore so that the system will recognize the ports. Perform the File-Restore from the latest File-Save. If you do not have the latest File-Save, you must do a File-Save first.

Refer to Section 7.2 for instructions on performing a File-Save, and Section 8.1 for instructions on performing a full File-Restore.

NOTE: If you are adding CRTs, refer to Appendix C for configurations of CRTs supported by Ultimate. If you are adding printers, refer to Appendix D for configurations of printers supported by Ultimate. If adding parallel printers, see Section 10.3.

10.2 ADDING DISK DRIVES

Whenever you add disk drives to your system, you must perform a full File-Restore so that the system will recognize the drives. Perform the File-Restore from the latest File-Save. If you do not have the latest File-Save, you must do a File-Save first.

Refer to Section 7.2 for instructions on performing a File-Save, and Section 8.1 for instructions on performing a full File-Restore.

10.3 ADDING TAPE DRIVES AND PARALLEL PRINTERS

Whenever you add tape drives or parallel (not serial) printers to your system, you must perform a Coldstart so that the system will recognize them.

Refer to Section 6.1 for instructions on performing a Coldstart.

10.4 ADDING COMMUNICATIONS BOARDS

Whenever you add communications boards to your system, you must perform a full File-Restore so that the system will recognize them. Perform the File-Restore from the latest File-Save. If you do not have the latest File-Save, you must do a File-Save first.

Refer to Section 7.2 for instructions on performing a File-Save, and Section 8.1 for instructions on performing a full File-Restore.

SUMMARY OF PROCEDURES WHEN ADDING EQUIPMENT

Adding Ports, Disk Drives, Communications Boards

1. Perform a File-Save.
2. Perform a full File-Restore.

Adding Tape Drives and Parallel Printers

1. Perform a Coldstart.

11 TROUBLESHOOTING

11.1 GENERAL PROCEDURES

These procedures apply to all types of problems:

1. Whenever you encounter any type of error or problem, always write down all messages and prompts that appear on your screen and on line 0 (the console). Troubleshooting will be very difficult without this information.
2. Whenever possible, leave your system in its failed state until the service organization responds to your call. Otherwise, valuable diagnostic information may be lost.
3. Whenever you encounter an error or problem, do not try to continue processing until the problem has been corrected. In many cases, processing under error conditions may create more errors.
4. Keep a log of all problems on your system so that recurring problems may be tracked. Make copies of the log sheet at the end of this section, and use them to track the history of your system.
5. If you have a problem or question about your hardware or operating system that you can't solve, call Ultimate Technical Support for assistance.
6. If you have a problem with your application software, call your application software dealer.
7. Before calling Ultimate Technical Support, be prepared to answer the following questions:
 - a. What is your system number (the BV number)?
 - b. What is the nature of your problem?
 - c. What software release are you on?
 - d. When did you notice the problem? Has this been a recurring problem?
 - e. Have you recently made any hardware replacements or upgrades?
 - f. Are you upgrading to a new release?
 - g. Is this a new installation?
8. Before a Honeywell engineer works on your system, make sure you :WARMSTOP the system! See Section 3 for instructions.
9. When sending correspondence to the Ultimate Corp., be sure to include your system number (the BV number).

11.2 CALLING ULTIMATE TECHNICAL SUPPORT

The telephone number for Ultimate Technical Support is (201) 887-2721. This number should be used for technical questions and problems only. Calls cannot be transferred to other departments.

Questions regarding shipments or billings should be directed to the Administration department, at (201) 887-9222.

Ultimate Technical Support works on a call-back system, meaning that when you place a call, the call is entered into Ultimate's on-line support system, and the next available support technician will call you.

Ultimate's software support is available in the continental U.S. from 8am to 8pm, your local time. Tutorial or question-type calls after 5pm will be deferred until the next working day. All service calls received after 8pm (your local time) will be deferred until the next working day, unless your system is covered by an extended maintenance contract.

Technical support is available outside the normal hours on a contract basis only. Extended maintenance is available for second and third shifts, Saturdays and/or Sundays, or 24 hours per day, seven days per week.

For information on pricing and arrangements for extended maintenance, contact the Administration department at (201) 887-9222.

11.3 GROUP FORMAT ERRORS (GFES)

A Group Format Error (GFE) may occur when either reading or writing an item to or from disk. The GFE indicates that the group in which the item is located has been incorrectly or incompletely updated. Some or all of the data in that group may be destroyed or erroneous. The frames in that group must be corrected to restore database integrity.

When a GFE message is displayed, always write down all data in the message. This data is vital to correcting the GFE. Then call Ultimate Technical Support.

Group Format Errors (GFES) should always be corrected as soon as they are discovered. If a file containing GFES has records written against it, you will cause more GFES. Eventually, they may cross into other files and even into other accounts.

WARNING: *Unattended GFES can eventually cause loss of data!*

The following are types of GFES and some possible causes:

1. The most common type of GFE is a bad forward or backward frame link. It can be caused by:
 - a. having to do a Warmstart because of a system hang while users were logged on
 - b. power losses
 - c. system hangs

- d. the system going down without being :WARMSTOPped first
 - e. problems with the spooler when using the SP-KILL command
 - f. starting the spooler while the spooler is still active
 - g. memory problems or other hardware problems.
2. Another type of GFE is one with a bad count field. Each item in a group is made up of a count field, a key, and the data. The count field is used as a pointer to the end of the item. The end of the item must be an attribute mark followed by a segment mark. If the count field does not point to this pattern, then a Group Format Error is generated. (For more information on groups and count fields, see the System Management and Support Guide.) This can be caused by:
- a. the system going down during processing
 - b. a hardware failure.

All GFEs may cause a loss of data. The amount of data lost will depend on the type and number of GFEs.

Ultimate recommends that when you do a File-Save, you select 1 on the SYSPROG Main Menu. This selects File-Save with automatic GFE fixer. The automatic GFE fixer has the ability to correct 80% of the types of GFEs. If you are still having GFE problems, type:

FIX-FILE-ERRORS FILENAME and press RETURN.

This loads the data removed to the TSYM file. After fixing GFEs, you should type:

COUNT FILENAME and press RETURN.

Any existing GFEs will be displayed. If you are still having problems, call Ultimate.

When a GFE is corrected, some of the data in the affected file may be lost. So after the GFE is corrected, you should selectively restore the file from a previous File-Save. (See Section 8.4 for instructions on doing a SEL-RESTORE.)

Once your GFEs have been corrected, it is highly recommended that you do a File-Save immediately to determine if there are more GFEs. In any case, if there were many GFEs or several files affected, you must do a File-Restore to ensure that your system is back to a clean base.

CAUTION: *Never use the DELETE-FILE or CLEAR-FILE commands on a file that contains a GFE. If you do, you will not be able to determine the cause of the GFE, and you will probably still have GFEs.*

11.4 ABORTS

When an abort message is displayed, always write down all data in the message. This data is vital to correcting your problem.

The following are possible causes and solutions for aborts. If you need assistance, call Ultimate Technical Support.

1. The data that the system is trying to manipulate may be corrupted. Try to determine which item was being accessed when the abort occurred, and then check that item for errors.
2. The abort may have been caused because the workspace for the line was blown, especially if the process being run works on another line. Simply run the LINK-WS verb, as instructed below.

Workspace links should be particularly suspect if a program or process aborts on one channel, but works correctly on others. The workspace may be (re)linked on a live system using the LINK-WS verb on the SYSPROG account. But first, be sure the affected line is logged off.

Log on to SYSPROG, then press RETURN to go to TCL. At TCL, type:

LINK-WS {(n{-m})} and press RETURN.

If the (n) or (n-m) is omitted, the workspace of all lines will be relinked, except those of lines logged on and that of the spooler process. The "(n)" or "(n-m)" may be used to limit the relinking process to lines "n", or "n" through "m" only. (The affected lines are given in the abort message.)

As the linkage proceeds, the line number of the process whose workspace is currently being linked is displayed on the terminal. If the line is logged on, the messages "ON!" and "THE WORK-SPACE IS NOT RELINKED!" are displayed.

The spooler's workspace can be linked via a Coldstart. However, internally the spooler's workspace is not used in a manner that can cause problems if its links are not correct. Therefore, this is not necessary.

3. Your system software may not verify. Use the VERIFY-SYSTEM verb to determine if there are any mismatches. It is possible that a mismatch caused the abort. If there are mismatches, call Ultimate Technical Support.
4. Have there been any recent hardware problems or hardware upgrades to the system? The hardware replacement may not have corrected the problem for which it was intended, or the upgrade may not have been installed properly.
5. If the message "!ERR" is displayed, then the abort may be caused by a bad board. Call Ultimate Technical Support.

6. The process currently active sometimes cannot be ENDED from the System Debugger prompt (!). When this happens on a 1400 Series system, type:

G4.2 and press RETURN.

Log on and then log off again. This will ensure that all registers will be properly set, and that any overflow frames the prior process may have been using will be released back to overflow.

7. If you abort with an asterisk (*) prompt, you have an application program problem. Call your application software dealer for assistance.

11.5 SYSTEM HANGS

System hangs can occur on a single line, on several lines, or on a total system. There are many different causes of system hangs, so they are difficult to troubleshoot. You should always call Ultimate Technical Support for all system hangs. However, there are some things you can check first.

11.5.1 SYSTEM

1. Check for error messages on all of your CRTs. If there are any messages, write them down.
2. Are there ampersands (&) on any of your screens? If so, you may have a disk error.
3. Are all of your terminals hung? Check each terminal, not just those in the computer room.
4. Check your disk drives and system panel to see if any CHECK lights are on.
5. Call Ultimate Technical Support before attempting to boot your system.

11.5.2 TERMINALS

1. Check your communications cables. Make sure there are no loose connections. If you have a CRT cable connected to the system but not connected to a CRT, this is known as an "unterminated" cable. The cable should be connected to the modem or EIA port on the CRT.
2. Are ampersands (&) being displayed on your terminal? If so, you may have disk errors.
3. The LOCK table is full, or the File-Save process has a lock on a file that you are also trying to access from the hung line. Refer to the BASIC manual, the System Commands Guide, and the System Management and Support Guide for information on group and item locks. Call Ultimate Technical Support for further assistance.
4. If you are working on a modem line and you can't get a connection, press CTRL BREAK. If you still cannot get a connection, or if you are getting "garbage" on your screen, then check the baud rate for your port from another port. (Refer to the TERMINAL command in the System Commands Guide.)
5. If your terminal has recently been installed, check the cables, switch settings, and configuration options to make sure it was installed correctly. Make sure all cables from the CRT are plugged into the EIA or modem port. Only a slave printer should be plugged into an auxiliary port.
6. Try powering on and off the CRT.

11.5.3 HANGS DURING A FILE-SAVE

If you experience a hang during the File-Save process, it may be caused by hardware, software, or media. In most cases, only the File-Save process is in a halted state, and not the entire system. If this is the case, do not end the File-Save process. Write down the name of the last account and file displayed, and call Ultimate Technical Support.

11.5.3.1 DISK ERRORS

The File-Save process can halt if it encounters a "hard disk error." This means that a portion of the disk cannot have data written to or read from. This is usually indicated by ampersands (&) displayed on your terminal.

To determine if there are any errors, from another terminal, log to the SYSPROG account and go to TCL. Type:

LIST-SYSTEM-ERRORS and press RETURN

for a complete error report, or type:

SYSTEM-ERROR-SUMMARY and press RETURN

for a summary of errors.

List the errors to the printer, then check the listing to determine if there are any disk errors present. (Disk errors are indicated by the presence of cylinder, head, and sector numbers.)

If you must continue the File-Save before attempting to correct the disk errors, then delete (FD) the file (or the pointer to the file) causing the error before doing the File-Save. If you do not know how to delete the pointer to the file, call Ultimate Technical Support.

There are two methods of recovering from a disk error:

1. Reformat your disk. You should reformat your disk only if you have a recent File-Save from which to restore your data after the reformat.

If you deleted the file causing the error prior to the File-Save, then you must do a File-Restore. Then create the file you deleted, and SEL-RESTORE it from a previous File-Save tape.

For information on formatting your disk, refer to Section 6.3 of this manual.

2. Relocate the defective sector. Each disk has an Alternate Sector Table that is a record of sectors that have been assigned alternates because of excessive errors. Each entry in the table has the cylinder number, head number, sector number, and the alternate cylinder that contains the sector's relocated data. The following instructions explain the procedure for relocating the defective sector.

Troubleshooting

If you want to check for any disk errors in addition to the disk error that occurred during your File-Save, follow the instructions in Step 1 and then proceed to Step 2. If you just want to correct the disk error that occurred during your File-Save, proceed directly to Step 2.

Step 1: Verifying Additional Errors

1410 Systems

Boot your system. At the System Startup Options menu, type **D**.

This will load the Diagnostics Monitor. The following screen is displayed.

```
ST506 disc sub-system
Format and disc diagnostic utility

(F)ormat a drive
(B)ad sector map read
(R)ead disc parameters (vtoc)
(W)rite disc parameters (vtoc)
(D)rive diagnostics menu
(S)ystem debugger module
(E)xit to options menu

Select option:
```

Type **D** to select the "Drive diagnostics menu."

The following screen is displayed.

```
Ultimate 1400 Diagnostics Menu

C - Verify cylinder media
D - Verify disc surface media (data safe)
R - Reassign sector with data
X - Exit

Enter option:
```

Type **D** to select "Verify disc surface media."

The following screen is displayed.

```
Ultimate 1400 Diagnostics Menu

C - Verify cylinder media
D - Verify disc surface media (data safe)
R - Reassign sector with data
X - Exit

Enter option: D

Enter drive number (0-2)
```

Enter the drive (**0**, **1**, or **2**) that had the disk error.

The following screen is displayed.

```
Ultimate 1400 Diagnostics Menu

C - Verify cylinder media
D - Verify disc surface media (data safe)
R - Reassign sector with data
X - Exit

Enter option: D

Enter drive number (0-2) 0
Enter (Y)es to continue
```

Type **Y** to continue the verifying process.

The following screen is displayed.

Ultimate 1400 Diagnostics Menu

- C - Verify cylinder media
- D - Verify disc surface media (data safe)
- R - Reassign sector with data
- X - Exit

Enter option: **D**

Enter drive number (0-2) **0**

Enter (Y)es to continue **Y**

Verifying

cyl:xxx trk:xx sec: xx

If an additional error is found, an error message will appear next to the defective cylinder, track, and sector numbers. Then the verifying process will skip a line on your screen and continue. Write down the defective cylinder, track, and sector numbers, and the error message.

The verifying process will usually end at cylinder 001, track 00, and sector 00, or cylinder 000, track 00, and sector 00. Press RETURN to go to the Drive diagnostics menu, then type X to exit. Then go to Step 2.

NOTE: *If an "Unrecoverable disk error" message is displayed, or if an error occurs immediately and the verifying process does not begin, a serious disk error has occurred. Call Ultimate Technical Support.*

1420 and 1430 Systems

Boot the system. At the System Startup Options menu, type **D**.

This will load the Diagnostics Monitor. The following screen is displayed.

Diagnostic monitor menu

- (F)ormat utility menu
- (D)isc diagnostics menu
- (H)ardware configuration
- (B)inary save and restore
- (S)ystem debugger utility
- e(X)it to options menu

Select option:

Type **D** to select "Disc diagnostics menu."

The following screen is displayed.

Disc diagnostics menu (rev3)

- (V)erify disc (data safe)
- (C)ylinder verify (data safe)
- (D)isplay disc parameters (vtoc)
- (W)rite disc parameters (vtoc)
- (S)eek diagnostic (data safe)
- e(X)it to diagnostic monitor

Select option:

Type **V** to select "Verify disc."

The following screen is displayed.

Disc diagnostics menu (rev3)

(V)erify disc (data safe)
(C)ylinder verify (data safe)
(D)isplay disc parameters (vtoc)
(W)rite disc parameters (vtoc)
(S)eek diagnostic (data safe)
e(X)it to diagnostic monitor

Select option: V

Enter drive number (0-5)

Enter the drive (0, 1, 2, 3, 4, or 5) that had the disk error.

The following screen is displayed.

Disc diagnostics menu (rev3)

(V)erify disc (data safe)
(C)ylinder verify (data safe)
(D)isplay disc parameters (vtoc)
(W)rite disc parameters (vtoc)
(S)eek diagnostic (data safe)
e(X)it to diagnostic monitor

Select option: V

Enter drive number (0-5) 0
Enter (Y)es to continue

Enter Y to continue the verifying process.

The following screen is displayed.

Disc diagnostics menu (rev3)

(V)erify disc (data safe)
(C)ylinder verify (data safe)
(D)isplay disc parameters (vtoc)
(W)rite disc parameters (vtoc)
(S)eek diagnostic (data safe)
e(X)it to diagnostic monitor

Select option: V

Enter drive number (0-5) 0

Enter (Y)es to continue Y

Verifying...

cyl:xxx trk:xx sec: xx

If an additional error is found, an error message will appear next to the defective cylinder, track, and sector numbers. Then the verifying process will skip a line on your screen and continue. Write down the defective cylinder, track, and sector numbers, and the error message.

The verifying process will usually end at cylinder 001, track 00, and sector 00, or cylinder 000, track 00, and sector 00. Press RETURN to go to the Disc diagnostics menu. Then go to Step 2.

NOTE: *If an "Unrecoverable disk error" message is displayed, or if an error occurs immediately and the verifying process does not begin, a serious disk error has occurred. Call Ultimate Technical Support.*

STEP 2: Relocating Defective Sectors

1410 Systems

If the System Startup Options menu is not displayed, then boot the system. At the System Startup Options menu, type **D**.

This will load the Diagnostics Monitor. The following screen is displayed.

```
ST506 disc sub-system
Format and disc diagnostic utility

(F)ormat a drive
(B)ad sector map read
(R)ead disc parameters (vtoc)
(W)rite disc parameters (vtoc)
(D)rive diagnostics menu
(S)ystem debugger module
(E)xit to options menu

Select option:
```

Type **D** to select "Drive diagnostics menu."

The following screen is displayed.

```
Ultimate 1400 Diagnostics Menu

C - Verify cylinder media
D - Verify disc surface media (data safe)
R - Reassign sector with data
X - Exit

Enter option:
```

Type **R** to select "Reassign sector with data."

The following screen is displayed.

Ultimate 1400 Diagnostics Menu

- C - Verify cylinder media
- D - Verify disc surface media (data safe)
- R - Reassign sector with data
- X - Exit

Enter option: **R**

Enter drive number (0-2)

Enter the drive (0, 1, or 2) with the disk error.

You will be prompted to "Input cylinder in hex." Enter the cylinder number of the defective sector, and press RETURN.

You will then be prompted to "Input head no.". Enter the head number of the defective sector, and press RETURN.

You will then be prompted to "Input sector in hex." Enter the sector number of the defective sector, and press RETURN.

The following screen is displayed.

Reading map
Writing map
Writing VTOC

Sector reassigned successfully
Press <CR> to continue

Press RETURN to go to the Diagnostics Menu, then type X to exit.

Troubleshooting

1420 and 1430 Systems

If the System Startup Options menu is not displayed, boot the system. At the System Startup Options Menu, type **D**.

This will load the Diagnostics Monitor. The following screen is displayed.

```
Diagnostic monitor menu

(F)ormat utility menu
(D)isc diagnostics menu
(H)ardware configuration
(B)inary save and restore
(S)ystem debugger utility
e(X)it to options menu

Select option:
```

Type **F** to select the "Format utility menu."

The following screen is displayed.

```
Format utility menu (rev3)

(F)ormat disc (data erased)
(S)how manufacturers defect log
(E)nter manufacturers defect log
(D)isplay defective sector log
(R)elocate a defective sector
e(X)it to options menu

Select option:
```

Type **R** to select "Relocate a defective sector."

The following screen is displayed.

Format utility menu (rev3)

- (F)ormat disc (data erased)
- (S)how manufacturers defect log
- (E)nter manufacturers defect log
- (D)isplay defective sector log
- (R)elocate a defective sector
- e(X)it to options menu

Select option: **R**

Enter drive number (0-5)

Enter the drive (**0, 1, 2, 3, 4, or 5**) with the disk error.

The following screen is displayed.

Format utility menu (rev3)

- (F)ormat disc (data erased)
- (S)how manufacturers defect log
- (E)nter manufacturers defect log
- (D)isplay defective sector log
- (R)elocate a defective sector
- e(X)it to options menu

Select option: **R**

Enter drive number (0-5) **0**

Bad sectors..
cyl: trk: sec:

-

Troubleshooting

At the flashing cursor, enter the cylinder number of the defective sector and press RETURN. The cursor will move under the prompt "trk." Now enter the track number of the defective sector and press RETURN. The cursor will move under the prompt "sec." Now enter the sector number of the defective sector and press RETURN. The cursor will go to the next line, and prompt you for the cylinder number of the next defective sector. If you have any more defective sectors, enter the cylinder, track, and sector numbers at this time. When you have entered all the defective sectors, press RETURN again.

The following screen is displayed.

```
Format utility menu (rev3)

(F)ormat disc (data erased)
(S)how manufacturers defect log
(E)nter manufacturers defect log
(D)isplay defective sector log
(R)elocate a defective sector
e(X)it to options menu

Select option: R

Enter drive number (0-5) 0

Bad sectors..
cyl: trk: sec:
xxx xx  xx

Data entry correct (Y/N)
```

Type **Y** to verify that the information you entered is correct. You will then return to the Format utility menu.

11.5.3.2 TAPE ERRORS

If percent signs (%) have been displayed and the File-Save process does not continue after you respond to the "(C)ontinue or (Q)uit" message, you may have a bad spot on the tape. Clean the heads on your tape drive. If this does not work, mount another tape, and try the File-Save again.

11.5.3.3 CHECKING A TAPE FOR PARITY ERRORS

You may use the following procedure to determine if a tape has parity errors before using it to back up or restore your data (see Sections 7 and 8 for backup and restore methods).

This procedure involves doing a selective restore on an account and file that does not exist. This forces the system to read all of the tape(s), thereby checking the tape(s) for parity errors. Parity errors are signaled by percent (%) signs on your terminal.

1. Mount tape #1 of your File-Save (or the tape you will use to back up or restore). Make sure the tape is on-line.
2. At TCL, type:

LOGTO SYSPROG and press RETURN.

Then press RETURN again to go to TCL. At TCL, type:

T-ATT n and press RETURN.

Replace "n" with the number of the tape drive on which the tape is mounted. Then, at TCL, type:

SEL-RESTORE SYSPROG-PL * and press RETURN.

You will be prompted:

Account name on tape?

Type a name that you know does not exist on the tape. For example, type TEST-ACCOUNT and press RETURN. Next, you will see the following prompt:

Filename on tape?

Again, type a name that does not exist on the tape. For example, type TEST-FILE and press RETURN.

3. The system will begin reading the tape for the account and filenames you entered. Watch the terminal for % signs. If the tape is one of a multiple tape set, then you will be prompted to enter tape #2, then tape #3, etc., until all tapes have been mounted. Of course, the system will not find the account and file names so, when all tapes have been mounted, you will see the message:

0 items restored

If you see percent (%) signs on the terminal at any point during this procedure, then your tape(s) contains parity errors, and should not be used. Use another set of tapes to back up or restore your data. Then try this test again. If the entire procedure runs without displaying percent (%) signs, then your tape(s) does not contain parity errors, and may be used to back up or restore your data.

11.5.3.4 LOCK ERRORS

1. If the total system is not hung, and if there are no tape errors, then the hang was probably caused by locks. Use the WHAT, WHERE, or LIST-LOCKS verbs to determine if you have a lock problem. If you press CTRL BREAK and the address is 667.xxx, then you have a lock problem.

The File-Save process LOCKS a group while it is being saved. If a BASIC program leaves a lock on that group set, or if the LOCK table is full, then the File-Save process will definitely hang. End out of the BASIC program, and call Ultimate.

NOTE: If you try to clear the locks, subsequent updates may contain errors.

If the LOCK table continually becomes full, have your application software vendor check your programs to make sure each process is releasing the locks being set.

11.6 PRINTER PROBLEMS

The following are possible causes and solutions for printer problems. If you need assistance, call Ultimate Technical Support.

1. Is the printer on-line? Make sure the ON-LINE button is lit.
2. Are you using a parallel printer? Make sure that the printer is in parallel port 0, and assigned to queue 0.
3. Is the printer loaded with paper?
4. Are you assigned to the correct printer? At TCL, type SP-ASSIGN ? and press RETURN to determine to which printer you are assigned. Type SP-LISTLPTR and press RETURN for a listing of printers installed on your system. Ultimate recommends that you keep a list of the printer assignments for quick reference.
5. Is the printer connected to the CPU or to a port?
6. Has this printer ever worked before? If not, it may not have been installed correctly. Check the printer's cabling and switch settings. Refer to Appendix D for options and switch settings of printers supported by Ultimate.
7. Was this printer recently added to your system? If yes, see Section 10 on Adding Equipment.

8. Is there sufficient voltage for the printer? Insufficient voltage can cause the printer to stop in the middle of a job or not print at all. If all the lights on the printer remain solid and the printer cannot be taken off-line, then the printer's power cord should be put on another circuit.

9. At TCL, type:

SP-STATUS and press RETURN.

If the message "Needs to start printers" appears, then the spooler has been corrupted. Have everyone log off the system. Log on to the SYSPROG account, and at TCL, type:

:STARTSPOOLER C and press RETURN.

Then type:

:WARMSTOP and press RETURN.

Now Warmstart the system. (Refer to Section 6.4 for instructions.) Once your system is back up, you must restart your printers. (Refer to the SP-STARTLPTR command in the System Commands Guide.)

11.7 SYSTEM ERRORS

Follow the instructions in Section 9.1.4 to LIST-SYSTEM-ERRORS. If you don't have a copy of the System Errors Listing Explanation, type **Y** at the prompt to print a copy. If system errors are listed, refer to that document for information on the errors.

11.8 MISMATCHES

A mismatch occurs when the check-sum of the actual frame on the disk doesn't match the predetermined check-sum item in the ERRMSG file.

Use the following steps to get a list of your system's mismatches.

1. Log to SYSPROG, then press RETURN to go to TCL.
2. At the TCL prompt, type:

VERIFY-SYSTEM and press RETURN.

The following screen is a sample of what might be displayed.

```
>VERIFY-SYSTEM
034 F7BE F89E
103 0D49 0D39
308 0200 E491
[342] ***Ultimate system software does not verify!***
      There are 3 frames with mismatches.
```

The following are possible causes and solutions for mismatch problems.

1. Are you booting the system with the wrong release tape? If you are, reboot with the correct tape, or upgrade to the new release.
2. Was your operating system properly upgraded? If the mismatches accompanied an upgrade, you should go over your upgrade instructions to see if you followed them correctly. If you find a mistake, all or part of the upgrade procedure may need to be repeated.
3. Did you add or delete any ABS frames? Either the frames or their checksum(s) may need to be reloaded in the ERRMSG file.
4. Do you have a hardware failure? Mismatches that occur consistently and cannot be attributed to software are probably hardware related.

If your mismatch was not caused by booting the system with the wrong release tape, or by problems during the upgrade procedure, you should :WARMSTOP the system. Then follow the procedure in Section 6.1 to Coldstart the system. Run the VERIFY-SYSTEM procedure again. If the system still does not verify, call Ultimate.

11.9 POWER FAILURES

There are many different causes of power failures. The following are possible causes and solutions. If you need assistance, call Ultimate Technical Support.

Occasional power fluctuations may cause your system to hang. Constant system hangs caused by power fluctuations can cause extreme damage to both hardware (for example, boards going bad) and software (for example, data corruption and GFEs).

If power is a constant problem in your business environment, identify the types of power problems you are having, and install an appropriate device to correct the problem. Available devices include power conditioners and uninterruptable power supplies. Ultimate also suggests that you plug an inexpensive digital clock into the same outlet as your computer. If the power fluctuates, the clock's readout will blink. This helps determine if you are having a power problem or a problem with your computer.

11.9.1 POWER FAILURE RECOVERIES

The most critical step in recovering from a power failure is to make sure memory is flushed to disk. Perform a Coldstart after the power failure, to flush memory (see Section 6.1). If you do not perform a Coldstart, you will have a greater probability of Group Format Errors.

Power Conditioners

Power conditioners are designed to prevent the most common forms of electrical disturbances (noise and surges) from reaching your computer. These disturbances account for 95 percent of the electrical problems affecting computers.

Although a power conditioner does not regulate, it will provide a degree of "ride-through." That is, in the case of momentary power dips that cause the lights to flicker, the power conditioner will maintain voltage to the system and prevent a power failure.

See your Site Preparation Guide for more information on power conditioners.

Uninterruptable Power Supply (UPS)

The primary purpose of the UPS is to maintain power to the system if the main power source fails. Its batteries, from which the system draws power, can keep a system up from 10 minutes to over an hour. If power is restarted within that time, the system should execute an auto-warmstart, meaning that it will bring itself back up.

Although the UPS does provide isolation from certain types of power disturbances, it does not provide total protection. The UPS is primarily for systems in areas subject to frequent or prolonged power losses.

If you have a power failure and you do not have a UPS, or if the UPS did not auto-warmstart, then perform a Coldstart to reduce the possibility of data corruption. See Section 6.1 for instructions on the Coldstart procedure.

11.10 CREATING A MEMORY DUMP

1. Insert a 1/4" tape (with a write ring attached) into the tape drive. Raise the tape lever to the vertical position to put the tape on line.
2. Make sure you are in the 1400 system facility panel. If you are not, press the STANDBY button to enter into the panel.
3. Enter **FD** to flush the memory to the disk.

The following screen will be displayed.



ULT1400 Virtual Memory Flushed

4. Enter **FT** to flush the memory to the tape.

The following screen will be displayed.

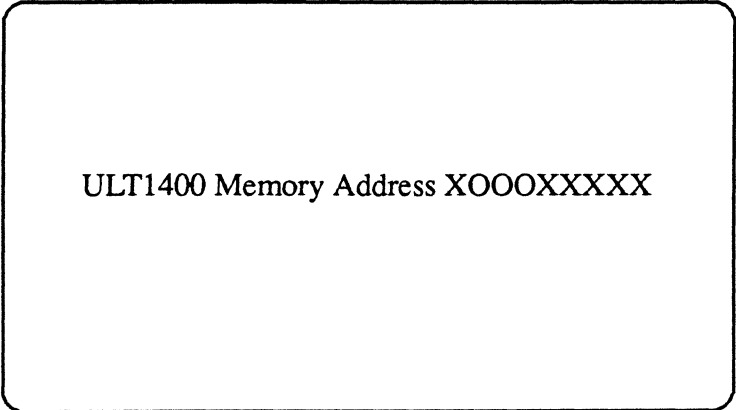

ULT1400 Memory Address XOOOXXXXX

5. Once the memory has been flushed, lower the tape lever to the horizontal position and remove the cartridge from the tape drive. Press the RESET button, and follow the instructions in Section 6.1 to Coldstart your system.

Troubleshooting

6. Write down the following information:
 - a. the system number (include the number in your letter and on the tape)
 - b. the current date
 - c. a brief explanation of the last system activity
 - d. a copy of all the information that appears on port zero.
7. Send the tape and all the information to the following address (please do not send a memory dump until you have spoken with someone from Ultimate Technical Support):

The Ultimate Corp.
717 Ridgedale Avenue
East Hanover, NJ 07936
Attn: 1400 Memory Dumps

ULTIMATE SITE LOG

SYSTEM NUMBER :

Date	Reported by	Repaired by	Time Reported	Start Time	Stop Time
------	-------------	-------------	---------------	------------	-----------

Symptom/Problem

Solution

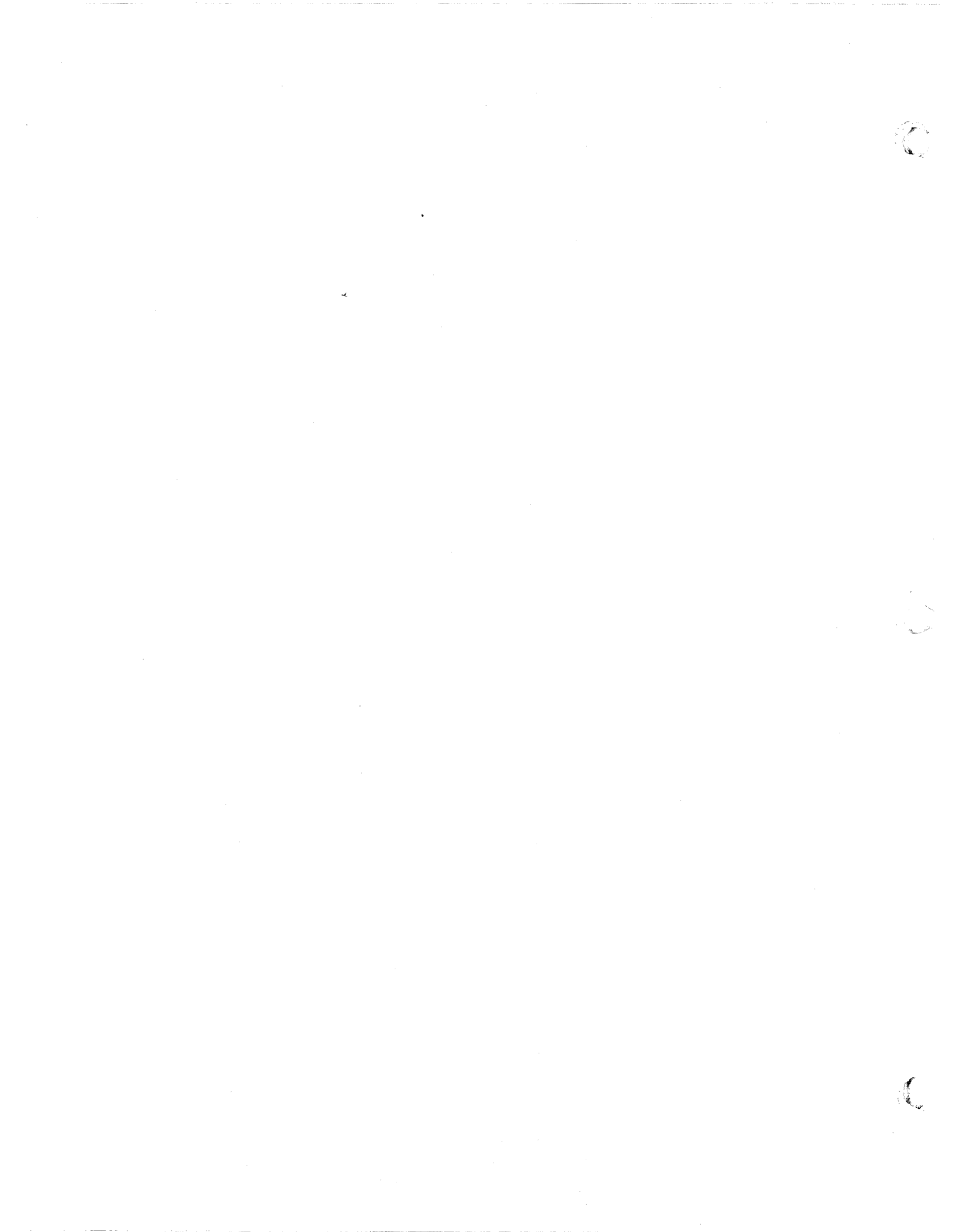

APPENDIX A: GLOSSARY

68000 Debugger Utility	A troubleshooting aid designed to help diagnose problems. The debugger utility is invoked under certain error conditions.
Abort	A system error identified by an abort error message.
ACC File	An accounting history file that keeps track of the time and date of each logon, and the location of each terminal. This file should be cleared periodically.
Account-Restore	A method of restoring files from a single account, rather than restoring the entire system. An account-restore may be done from a file-save or account-save tape.
Account-Save	A method of backing up files from a particular account, rather than backing up the entire system.
ALL-UPDATE-SAVE	A backup method that allows you to save only those file groups that have been changed since the last File-Save. To restore the system from this backup method, only the most recent full File-Save tape and the most recent ALL-UPDATE-SAVE tape are required.
Alternate Sector Table	A record of sectors that have been assigned alternates because of excessive errors.
Backups	Tapes containing copies of your files. Backups are used to restore your files in case they become lost or destroyed.
Boot	To initialize or start up a system after it has been powered up.
Boot Options	A series of choices for different types of booting. See System Startup Options.
Baud Rate	Speed of transmission.
Charge Units	Numbers that represent computer usage.
Coldstart	A procedure used to load the Monitor code into memory, and all virtual system software from the SYS-GEN onto your system. This method does not load your files. A Coldstart is normally required if your system fails, or if any maintenance has been performed on your system.
Connect Time	Amount of time spent on the computer.
Diagnostics Monitor	Used primarily to format disks, and may also be used by experienced or support personnel to diagnose problems.

Glossary

File-Restore	Used to perform a complete restore of system files and customer files. The restore is done from the most recent file-save.
File-Save	Used to back up your entire system. This procedure is recommended daily.
File-Stats	Statistics about your files, generated after each file-save. This report will indicate any Group Format Errors (GFEs) present in your system.
Group Format Errors (GFEs)	An error condition that indicates errors in the format of a virtual storage frame of a file. If your system contains GFEs, call Ultimate immediately.
Hang	An error condition caused by various reasons, usually characterized by one or more lines (or the total system) appearing to "freeze."
Line-Printer Pages	The number of pages printed during each logon session.
PART-UPDATE-SAVE	A backup method that allows you to save only those file groups that have been changed since the last Update-Save or File-Save. To restore the system from this backup method, the most recent full File-Save tape and every subsequent PART-UPDATE-SAVE tape are required.
Power Conditioner	A unit designed to prevent common electrical disturbances from reaching your computer.
Print Overflow Table (POVF)	A pool of available space that contains portions of the file area not allocated to the files.
Selective Restore	A method of restoring individual files or items from a file-save or account-save tape.
System Startup Options	A series of choices for different types of booting. See Boot Options.
T-DUMP	A method of copying single files or individual items from disk to tape.
T-LOAD	A method of restoring files or items that have been T-DUMPed.
Transaction Logger	A backup method that records disk file updates on magnetic tape as the updates are made. In the event of a system failure, the tape can be used in conjunction with a File-Save tape to restore all files to their state at the time of the failure.
Uninterruptable Power Supply (UPS)	A unit that can maintain power to your system for 10 minutes to an hour in the event of a power failure. If power is restarted within that time, the system will bring itself back up.
Update-Save	A backup method that allows you to save only those file groups that have been changed since the last File-Save.

Warmstart

Used to restart a system that was brought down in a controlled manner, and resumes program execution. Is normally used on a system that was Warmstopped.

Warmstop

Used to bring the system down in a controlled manner, insuring data integrity. A system that was Warmstopped may be Warmstarted.

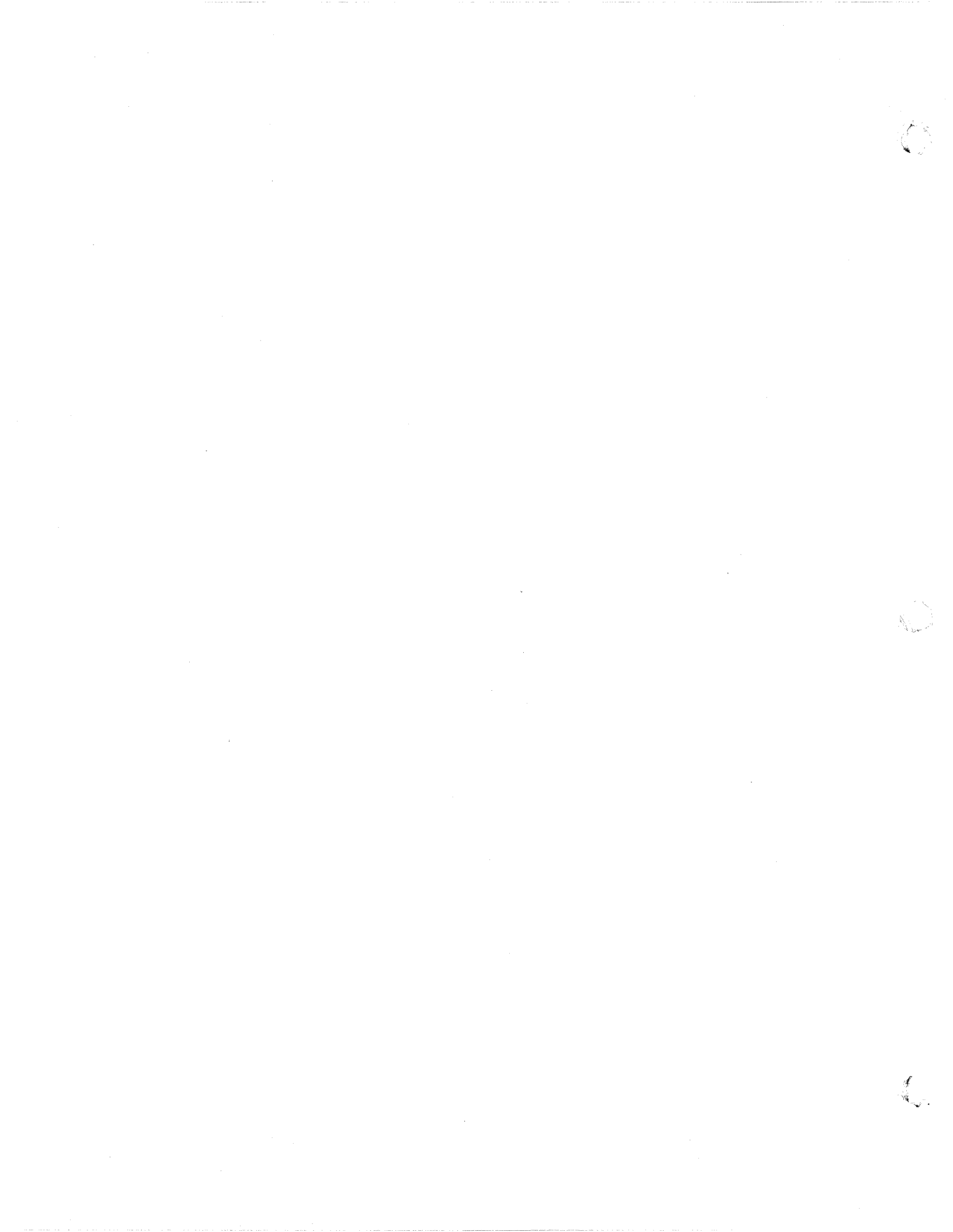

APPENDIX B: PANEL LAYOUTS

The next two pages contain illustrations of your hardware.

Figure B.1 1400 Series System CPU

Figure B.2 1400 Series System Panel

Figure B.3 Back of the 1400 Series System

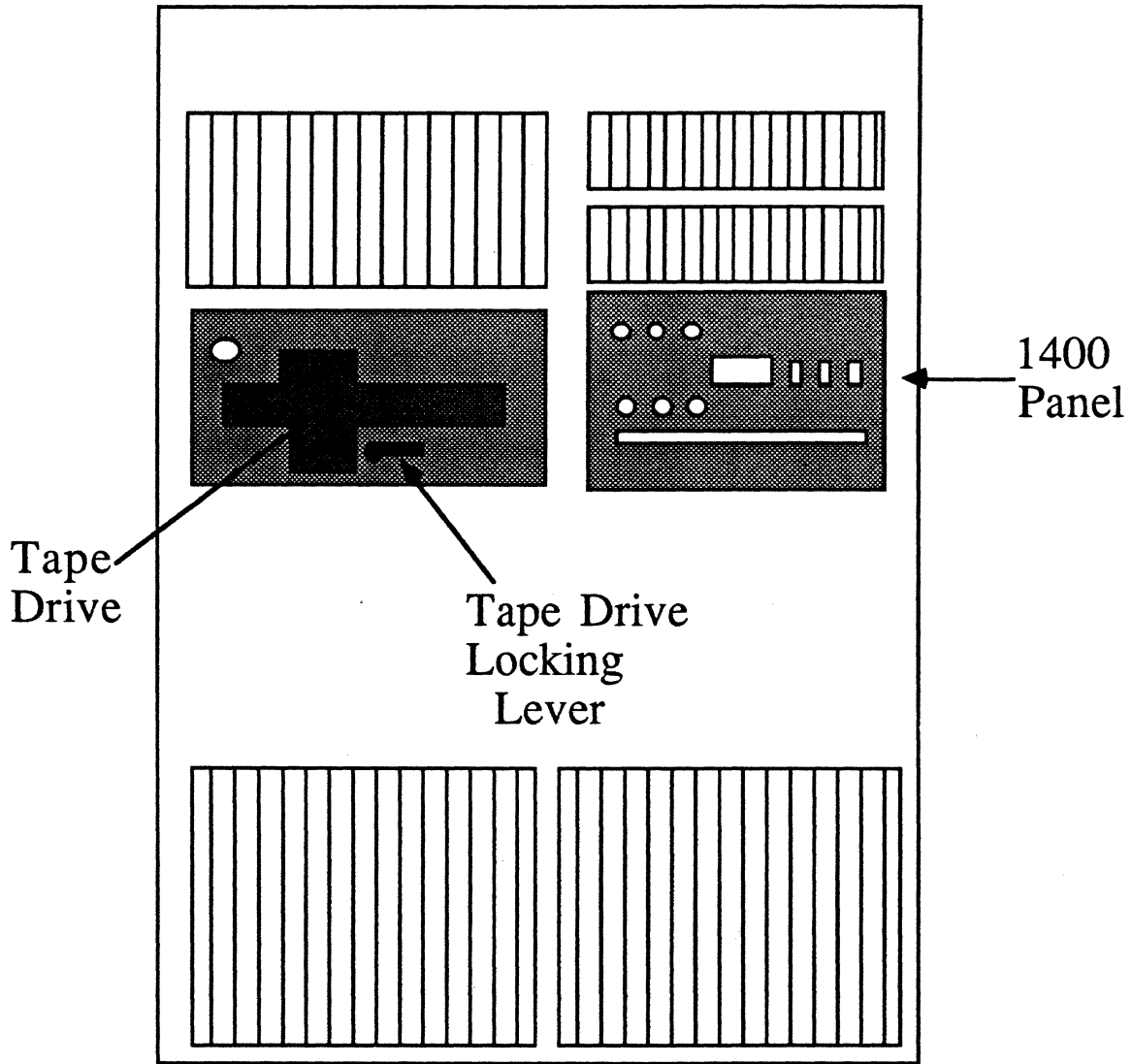

Figure B.1 1400 Series System CPU

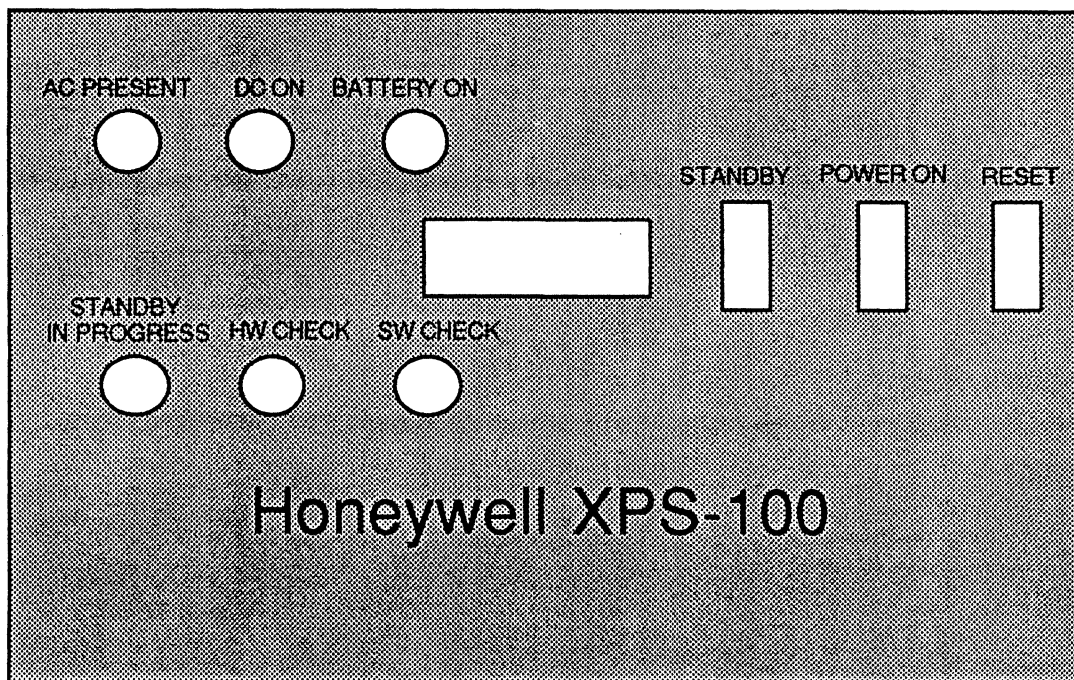
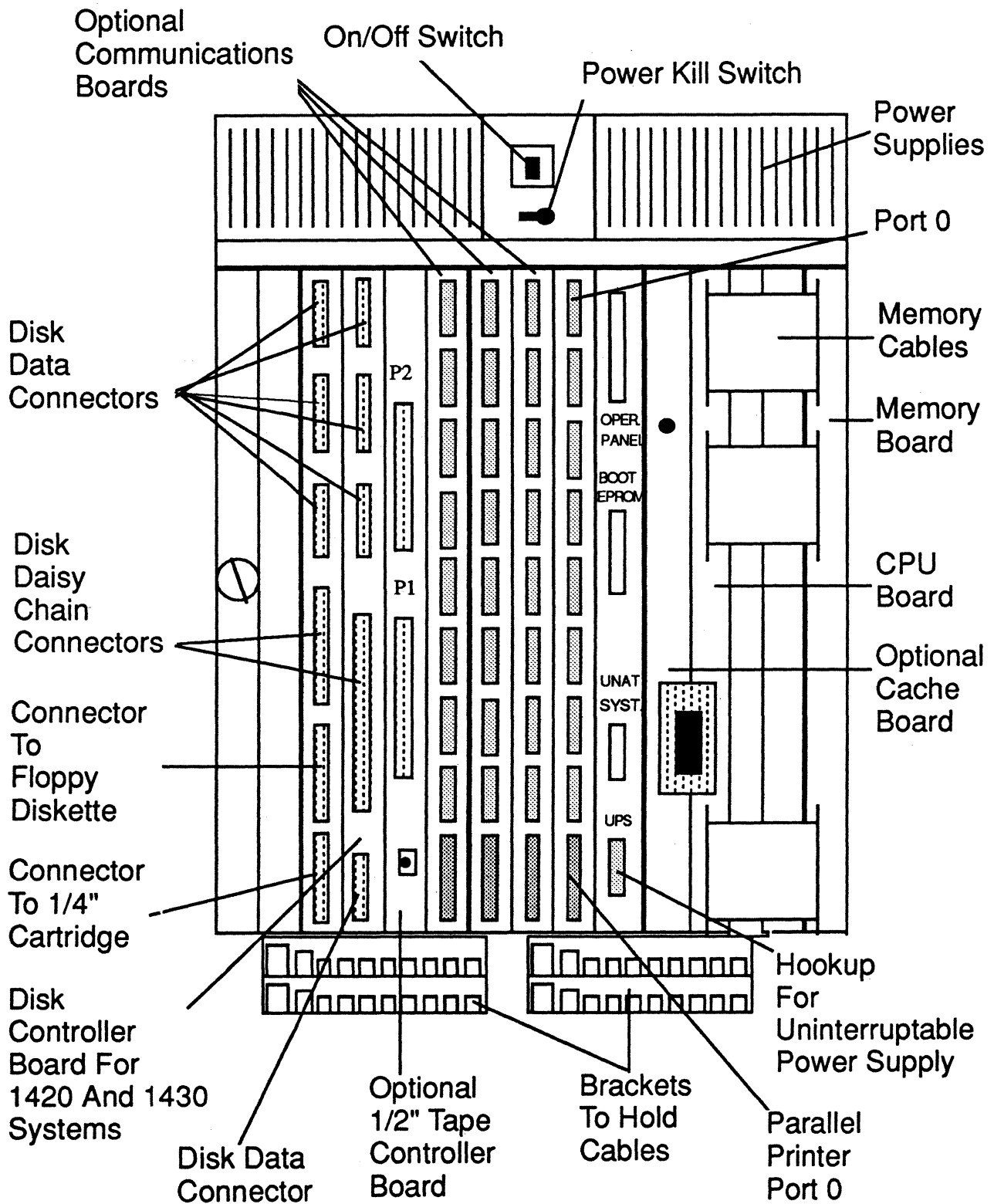

Figure B.2 1400 Series System Panel



APPENDIX C: CRT CONFIGURATIONS

NOTE: Refer to Appendix E for information on Interface Cable Specifications.

ADDS 2020 TERMINAL

The ADDS 2020 terminal has the following general features:

1. 80 or 132 column mode
2. Programmable function keys
3. Bi-directional aux port

This terminal can operate under terminal type V or W.

SETUP MODE

To enter the setup mode, press and hold the SHIFT key and press the SETUP key. A menu of options will be displayed. Use the arrow keys and the ENTER key to get to the option you wish to change.

NOTE: The following settings are recommended by Ultimate. Other options may be set later via software. Refer to your ADDS 2020 manual for the correct escape sequences.

COMM

MODE	FDX	BAUD RATE	9600
PARITY	NONE	PARITY CHECK	NO
DATA BITS	8	STOP BITS	1
X-ON/X-OFF	DC1/DC3	PACE	00
TERMINATOR	US/CR		

AUX

PRINTER	SERIAL	BAUD RATE	9600
PARITY	SPACE	PARITY CHECK	NO
STOP BITS	1	X-ON/X-OFF	DC1/DC3
AUX ECHO	NO	PACE	00

KEYBOARD

CASE SELECT	UPPER/LOWER	SPACE CHAR	NON DESTRUCTIVE
KEY CLICK	NO	MARGIN BELL	NO
MENUS	U.S.	KEYBOARD	U.S.

CRT Configurations

SCREEN

SCREEN TIMEOUT	YES	AUTO WRAP	YES
AUTO SCROLL	YES	SCROLL	JUMP
CURSOR HOME	UPPER LEFT	COLUMNS	80
CURSOR	BLOCK	CURSOR BLINK	YES
FORE/BACK	WHT/BLK	PROTECT	HLFINT
DISPLAY TEST	YES		

MODE

TERMINAL	VIEWPOINT	MODE	ENHANCED
PROGRAM KEYS	USER DEPENDENT*		

TABS

User defined for applications. No Ultimate setting.

FUNCTION

Function keys 1-6 and shifted 1-6 are not to be changed. All other function keys are user-definable.

BELL

User defined. No Ultimate setting.

OPTIONS

Not changeable. Hardware set.

NOTE: *In the MODE setup, the program keys option may be changed to Terminal Dependent if you wish to have the function keys revert to the default codes at power up. If the program keys are not to be changed, the User Dependent option should be used.*

ADDED PRINT @(-n) FUNCTIONS

The following PRINT @(-n) have been added for the ADDS 2020.

@(-70) = 80 column screen display
@(-71) = 132 column screen display

VIEWPOINT/60 TERMINAL

SWITCH SETTINGS

To set up the Viewpoint/60 terminal, you must first enter its setup mode by pressing the SHIFT-HOME keys. The STATUS line will then be displayed on the bottom of the terminal.

Example of status line:

	Bank 1	Bank 2	Bank 3	Bank 4	
SETUP	1=01110111	2=11010001	3=00000000	4=00000000	VP/60

The cursor will be set to bank 1. To move the cursor, use the cursor control arrows. The UP ARROW changes the status to 1. The LINE-FEED (DOWN ARROW) changes the status to 0. After you make a selection, move the cursor to the right or left with the cursor control arrows.

To leave the SET-UP mode, press the HOME key to save your new options. Press the (ESC)ape key to exit from the SET-UP mode without saving new options.

The settings for each switch bank appear on the next two pages.

NOTE: *Settings with an asterisk (*) next to them are the recommended settings.*

NOTE: 0 = OFF
1 = ON

CRT Configurations

Bank number 1

Switch positions 1 through 4 are for the EIA PORT
Switch positions 5 through 8 are for the AUX PORT

Baud Rates	Bit Settings
110	0000
150	0001
300	0010
1200	0011
1800	0100
2400	0101
4800	0110
9600*	0111*
19200	1000

Bank number 2

Position	Function	Selection			
		Choice 1	Setting	Choice 2	Setting
1	Duplex	Half	0	Full	1*
2	Video Presentation	Drk Lht	0	Lht Drk	1*
3	Video Highlight	Half	0*	Full	1
4	Auto Scroll	Disable	0	Enable	1*
5	Auto Line Feed	Disable	0*	Enable	1
6	Display Parity err.	Disable	0*	Enable	1
7	Parity High Bit	Odd	00	Mark	10
8	Parity Low Bit	Even	01**	Space	11

** If you have an LSI 1000/2000 system and are on Rev 110 or later, the terminals should be set for SPACE parity.

Bank number 3

Position	Function	Selection			
		Choice 1	Setting	Choice 2	Setting
1	Screen Refresh Rate	60Hz	0*	50Hz	1
2	Cursor Suppress	Visual	0*	Suppressed	1
3	Cursor Format 1	Block	0*	Underline	1
4	Cursor Format 2	Blink	0*	Steady	1
5,6	Character Case	Upper	00*	Up Only	10
		Lower	01	---	11
7,8	Line Terminator	Cr	00*	Cr EOT	10
		Cr ETX	01	No Term.	11

Bank number 4

Leave at all zeroes.

The Viewpoint/60 controls the communication flow to the AUX-PORT by using XON-XOFF and data terminal ready (DTR, pin 20) from the printer. When the terminal's AUX-PORT detects DTR dropped by the printer, it will then send an XOFF character to the system. This will stop data from going to the printer and overflowing its buffer. When DTR is raised, then the terminal sends an X/ON signal to the computer and then the computer continues sending data.

VIEWPOINT/60+ TERMINAL

The Viewpoint/60+ terminal gives you split-screen capabilities. Terminal features and operating parameters are selected via the keyboard, and are stored in a non-volatile memory. This feature allows you to turn the terminal off and on while still retaining the options you selected.

SETUP MODE

To enter the setup mode, press and hold the SHIFT and HOME keys, then release both keys. The following menu will appear.

MAIN SETUP MENU

==== PLEASE SELECT ONE OF THE FOLLOWING ====

- "C" - adjust contrast
- "F" - program function keys
- "T" - set tab stops
- "P" - select parameters
- "D" - install default values
- "I" - install power up values
- "E" - exit setup menu

Enter **C** to adjust the contrast of the screen. The following menu will appear:

CONTRAST

ARROW UP	- increase contrast
ARROW DOWN	- decrease contrast
HOME	- save contrast
RESET	- abort

NORMAL HALF INTENSITY NORMAL REVERSE REVERSE HALF
INTENSITY

Press the UP ARROW to increase intensity. Press the DOWN ARROW to decrease intensity, and press HOME to save it and return to the MAIN SETUP MENU. Press RESET to return to the MAIN SETUP MENU.

To program the function keys, enter F at the MAIN SETUP MENU. The following screen will appear:

<u>FUNCTION KEYS</u>		
<u>OPERATING KEYS</u>	<u>DESTINATION</u>	
ARROWS	- cursor movement	0 = AUX
Fn	- function key to edit	1 = LOCAL
RESET	- abort	2 = EIA
ENTER	- exit & update	3 = LOCAL & EIA
HOME	- exit, update & save for power up	

<u>EDITING Fx</u>		
<u>DESTINATION</u>	<u>LINK</u>	<u>LINK KEY</u>
X	X	Fx

Enter the key you want to edit. It should appear in the heading EDITING Fx. Then enter the characters that you want the function key to represent. Use the ARROWS to move from editing line to DESTINATION, to LINK, or LINK KEY. DESTINATION is the port to which the terminal is going to send the function key values (ex. 0=AUX , 2=EIA, EIA is to the system). LINK allows you to link one function key to another.

Tab stops are not recognized by the system and it is recommended that you do not use them.

To change parameters, enter P. The following menu will appear:

VIEWPOINT PLUS TERMINALS

Terminal features and operating parameters are selected via the keyboard and are stored in a non-volatile memory. This feature allows you to turn the terminal off and on while retaining the options you selected.

SETUP MODE

To enter the setup mode press and hold the CTRL and TAB keys, then release both keys. The following menu will appear.

<u>SETUP MENU</u>		
1 Terminal mode	<u>MODES</u>	<u>PARITY</u>
8 Baud rate	0 = A1	0 = Odd
1 Parity	1 = A2	1 = Even
N Display parity error	2 = 3A	2 = Marking
Y Full duplex	3 = 3A+	3 = Spacing
Y Auto scroll		
N Auto line feed		<u>LANGUAGE SELECTION</u>
N Light background	<u>BAUD RATES</u>	0 = United States
N Underline cursor	0 = 110	1 = France
N Blinking cursor	1 = 150	2 = Germany/Switz.
N Keyclick	2 = 300	3 = Sweden/Finland
N Bell on 73rd column	3 = 600	4 = Denmark/Norway
N 50 Hz operation	4 = 1200	5 = Spain/Portugal
O Language	5 = 1800	6 = United Kingdom
N Keycap option	6 = 2400	
N Disable CTRL-Z (3A/3A+)	7 = 4800	
N Space advance (3A only)	8 = 9600	
N Programmable funct. keys	9 = 19200	

Cursor up/dn select
Enter param. change
HOME saves/exit
ESC exit without
saving changes
CTRL-UP & DOWN to
change contrast

To change a parameter, move the cursor up or down to the parameter and enter your option. If you want the changes to take effect for the duration of one session, press the ENTER key. The options will only be used until you power off the terminal. To save the options, press the HOME key. The ESC key is for exiting the setup menu without resetting the options. The CTRL-UP & DOWN keys are used to adjust the contrast of the terminal.

VIEWPOINT 1010 TERMINAL

This terminal operates in the Viewpoint mode with a term type of V.

INTERFACE CABLE

Refer to the specifications in the Site Preparation Guide. The aux port is configured as an IBM PC compatible parallel printer port.

SETUP MODE

To enter the setup mode, press and hold the CTRL and F1 keys, then release both. The following menu will appear on the screen. The settings below are recommended by Ultimate.

<u>SETUP MENU</u>			
	<u>MODES</u>	<u>PARITY</u>	<u>PRINT LOCAL</u>
1 Term mode	0=A1	0=ODD	0=INHIBIT
8 Baud	1 A2	1 EVEN	1 CR/LF
3 Parity	2 3A	2 MRK	2 CR
N Display parity	3 3A+	3 SPC	3 NONE
Y Full dup			
Y Auto scroll		<u>SCRN FORMAT</u>	<u>LANGUAGE</u>
N Auto line feed		0=Normal	0=US
N Light background *		1 SS/24 LINES	1 FR
Y Line cursor *		2 JS/25 LINES	2 GEP/SWS
N Blink cursor *			3 SWE/FIN
N Keyclick *		<u>BAUD</u>	4 DEN/NOR
Y CRT saver *		0 110	5 SPN/POR
N 50 Hz		1 150	6 UK
0 Language		2 300	
N Disable CTRL-Z(3A/+ONLY)		3 600	
N Space advance(3A ONLY)		4 1200	
0 Screen format		5 1800	
N XON/XOFF		6 2400	
0 Print local		7 4800	
		8 9600	
		9 19200	

UP/DOWN TO SELECT
HOME - EXITS & SAVES
ESC - EXITS NO SAVE

* Set to User preference.

WYSE WY-50 TERMINAL

The WYSE terminal has a screen width of 80 or 132 columns and split-screen capabilities. Terminal features and operating parameters are selected via the keyboard, and are stored in a non-volatile memory. This feature allows you to turn the terminal off and on, while retaining the options you selected.

SETUP MODE

To enter the setup mode, press and hold the SHIFT and SETUP keys, then release both keys. A status line should appear at the top and bottom of the screen. For example:

Top of screen:

Cursor-keys: select fields SPACE: changes FUNCT: F-Keys ESC: Default

Bottom of screen:

HANDSHAKE=XONXOFF SCREEN=80 CURSOR=BLOCK BLINK?=ON MODE=FDX

This is level one of five levels. All parameter fields are dim except the far left field in the bottom row, which is normal intensity. Normal intensity indicates the active field (meaning that you can change that field).

Press the SPACEBAR to change the parameter in the active field. Press the RIGHT ARROW key to activate the next field to the right, and press the LEFT ARROW key to activate the next field to the left. Press the UP ARROW key to move the fields up one level, and press the DOWN ARROW key to move the fields down one level.

NOTE: *Where there is an asterisk (*), use this setting. Where there is no asterisk, set the parameter at your preference.*

Field level 1

HANDSHAKE=XONXOFF SCREEN=80 CURSOR=BLOCK
BLINK?=ON MODE=FDX

PARAMETER

SELECTIONS

Handshake
(protocol)

None (default)
* XonXoff
DTR
Both (Xon/off and DTR)

Screen
(column/color)

* 80 (default)
132
80 Rev
132 Rev

Cursor

Block (default)
Line

Blink?

On (default)
Off

Mode

* FDX (default)
Block
HDX
H-BLK

Field level 2

DATA BIT=8 STOP BIT=1 PARITY BIT=NONE MODEM PORT BAUD RATE=9600

<u>PARAMETER</u>	<u>SELECTIONS</u>
DATA BIT	* 8 (DEFAULT) 7
STOP BIT	* 1 (DEFAULT) 2
PARITY BIT	* None (default) Odd Even Mark
Modem Port Baud Rate	* 9600 (default)

Field Level 3

BLK END = US/CR AUTO NL = ON CR = CR AUTO SCRL = ON
AUX BAUD R = 9600

<u>PARAMETER</u>	<u>SELECTION</u>
BLK END	* US/CR (default) CR,LF/ETX
AUTO NL	* ON (default) OFF
CR	* CR (default) CR,LF
AUTO SCRL	* On (default) OFF
AUX BAUD R	9600

CRT Configurations

Field Level 4

SCRL = JUMP STATUS = ON S.SAVER = OFF PROT = DIM TEST = OFF

<u>PARAMETER</u>	<u>SELECTION</u>
SCRL (scrolling type)	* Jump (default) SM-1 SM-2 SM-3 SM-4 SM-8
STATUS	* On (default) Off
S.SAVER (shuts off screen)	Off (default) On
PROT (display protect attribute)	Dim (default) Rev Norm
TEST	* Off (default) (self test) On

Field Level 5

KEYS? = US/UK RET/ENTER = CR/CR COMPATIBLE MODE = WY50 ENHANCE = OFF	
<u>PARAMETER</u>	<u>SELECTION</u>
KEYS? (require special ROMs)	* US/UK (default) German French Spanish Danish
RET/ENTER	* CR/CR (default) CR,LF/TAB
COMPATIBLE MODE	WY50 (default) TVI910 TVI920 TVI925 * ADDSVP HZ1500
ENHANCE (ADDS-VP, HZ1500 CODE)	Off (default) * On

NOTE: *The KEY CLICK status is also saved with the setup. To turn the KEY CLICK on or off, press and hold the SHIFT and ENTER keys, then release both.*

Saving Setup Changes

Press and hold the SHIFT and SETUP keys, then release both. The top row should look like the example below, with "Save changes for power-on?" flashing on and off.

Save changes for power-on? Y:yes (no F-keys) A:F-keys also others: no

If you press **Y**, all changes except those made to the function keys are saved for the next power-on. If you press **A**, all changes are saved. If you press any key other than **Y** or **A**, the terminal will operate with the current parameter changes, but will not save them when power is turned off.

After you make your selection, the screen will go blank for a second and then return to its operating mode.

CRT Configurations

PRINT @(-n) COMMANDS FOR THE WYSE 50

The following PRINT @(-n) values have been added for the Wyse-50:

<u>Function</u>	<u>Before Rev. 180</u>	<u>After Rev. 180</u>
80 column	@(-70)	@(-33)
132 column	@(-71)	@(-34)

WYSE-60 TERMINAL

The WYSE-60 terminal has the following general features:

1. 80 or 132 column mode
2. 24 or 42 lines per screen
3. Programmable function keys
4. Bi-directional auxiliary port that can be used as a modem port to another system

This terminal operates in a WYSE-60 mode, instead of a compatible mode. This may cause a problem with programs that have hard-coded screen functions. To eliminate this problem, use the Ultimate @ Function Negative Values for these features (i.e. PRINT @(-1) TO CLEAR SCREEN). Refer to the "BASIC Statements and Functions" section of your BASIC manual, and on the next page, for a list of @ functions.

SETUP MODE

To enter the setup mode, press and hold the SHIFT and SETUP keys. A menu of screen options is displayed. Select the option you wish to change by using the function keys across the top of the keyboard.

NOTE: *The following settings are recommended by Ultimate. Other options may be set later via software. See your WYSE-60 manual for escape sequences.*

F1 DISPLAY

COLUMNS = 80	STATUS LINE = STANDARD	BACKGROUND = DARK
LINES = 24	SCRL = JUMP	SCRN SAVER = ON
PAGE LENGTH=1xLINES	CURSOR = BLINK BLOCK	MONITOR = OFF
ATTRIBUTE = CHAR	TVI955 = NO SPACE	

F2 GENERAL

PERSONALITY = WY60	ENHANCE = ON	FONT LOAD = ON
COMM MODE=FULL		
DUPLEX	END OF LINE WRAP = ON	SEND ACK = ON
DATA/PRINTER=		
MODEM/AUX	TEST = OFF	PAGE EDIT = OFF
MARGIN BELL = OFF	LABELS = ON	SAVE LABELS = ON

CRT Configurations

F3 KEYBOARD

KEY CLICK = ON
RETURN = CR
XMT LIMIT = NONE
WYSEWORD = OFF

KEY LOCK = REV
ENTER = CR
FKEY LIMIT = NONE
LANGUAGE = US

KEY REPEAT = ON
CORNER KEY = HOLD
BREAK = 250ms

F4 MODEM

BAUD RATE = 9600
PARITY = NONE

DATA BIT = 8
STOP BIT = 1

RCV HANDSHAKE=X-ON/X-OFF
XMT HANDSHAKE=X-ON/X-OFF
XPC HANDSHAKE=ON

F5 AUX

BAUD RATE = 9600
PARITY = NONE

DATA BIT = 8
STOP BIT = 1

RCV HANDSHAKE=X-ON/X-OFF
XMT HANDSHAKE=X-ON/X-OFF
XPC HANDSHAKE=ON

F6 IBM

NULL = ON

SEND PAGE = LINE

F7 ASCII

BLOCK END = US/CR
VP60 BLK END = NONE
RCVD CR = CR

AUTO SCRL = ON
AUTO PAGE = OFF

WPRT INTENSITY = DIM
WPRT REVERSE = OFF
WPRT UNDERLINE = OFF

F8 (FUNCTION KEYS) and F9 (FUNCTION KEY LABELS) are user-defined. The settings above are recommended by Ultimate. Your software house or dealer may suggest other settings, depending on your application.

ADDED PRINT @(-N) FUNCTIONS

The following PRINT @(-n) have been added for the WYSE-60:

Before Revision 180:

@(-70) = 80 column screen display
@(-71) = 132 column screen display
@(-72) = 24 line mode
@(-73) = 42 line mode

After Revision 180:

@(-33) = 80 column screen display
@(-34) = 132 column screen display
@(-35) = 24 line mode
@(-36) = 42 line mode

CHIRON SYSTEMS

The following information is for Chiron systems with the SCF PORT 0. These systems include the 6200 and 6400. The 6000 systems will run with the Wyse terminals if the CPU has a part number greater than BXCSS11A-009 (this information should be available from Honeywell). All 6000 systems shipped recently will have the correct CPU.

HANDSHAKE = NONE
DATA BIT = 7
STOP BIT = 1
PARITY = EVEN

WYSE-85 TERMINAL

SETUP

The set-up mode is entered by pressing the SET-UP key, located in the upper left hand corner of the keyboard.

Upon entering the setup mode, a status line should appear both at the top and bottom of the screen. The status line at the top left corner of the screen displays the name of the set-up level currently being monitored. The rest of this status line displays the valid keyboard responses, followed by the action taken when that key is entered. In all levels, the keyboard responses are single key commands.

For example:

The status line for the DIRECTORY level (1st level) is:

LEVEL NAME SETUP-Exit ENTER-Select < > New field ^ v New level

Press the SETUP key to exit the set-up mode.

Press the ENTER key to select the next parameter in the active field. The active field is displayed in reverse video on the bottom status line.

Press the LEFT-ARROW or the RIGHT-ARROW keys to change the active field.

Press the UP-ARROW and DOWN-ARROW keys to select the next and previous levels, respectively.

The status line at the bottom of the screen displays the parameters that can be monitored in this level.

NOTE: *This terminal will not send a control underscore to the system because the terminal that it emulates does not send that character.*

SETTING UP THE WYSE-85 ON REV 150 AND ABOVE

If you are on Rev 150 or above, the Wyse-85 terminal may be set up by entering **TERM-INIT** from **TCL** on **SYS-PROG**. You will be prompted for the terminal type, which is **Y** for this terminal. After using this utility, three parameters must be set up from the keyboard set-up mode. They are Handshake, Xmt limit and Fkey limit. Follow the steps below to set up these parameters.

1. Press the SET-UP key to enter the set-up mode.
2. Press the DOWN-ARROW key until you reach the Communications-2 level.
3. The active field will be the HANDSHAKE field.
4. Press the ENTER key until this field changes to <Both>.
5. Press the LEFT-ARROW to change the active field to XMT LIMIT.
6. Press the ENTER key until this field changes to <150 cps>.
7. Press the DOWN-ARROW until you reach the Send level.
8. Press the RIGHT-ARROW to change the active field to Fkey XMT.
9. Press the ENTER key until this field changes to <150 cps>.
10. Press the SET-UP key to return to the Directory level.
11. Press the RIGHT-ARROW to select the SAVE field.
12. Press the ENTER key to save all changes into memory.

CRT Configurations

SETTING UP THE WYSE-85 MANUALLY FOR ALL RELEASES

Below is a list of the proper setups for each of the setup levels.

LEVEL NAME: DISPLAY-1

Columns: 80 Controls: Interpret Autowrap: ON Scroll: Jump Screen: Dark Rows: 24

LEVEL NAME: DISPLAY-2

Cursor: Blinking Block CRT Saver: ON Width Change Clear: OFF Status Line: ON

LEVEL NAME: GENERAL-1

Mode: VT200 7 bit Pound: # Fkey Lock: OFF Feature Lock: OFF Newline: OFF Local: OFF

LEVEL NAME: GENERAL-2

Keypad: Numeric Cursor Keys: Normal Transfer Term: Cursor Test: OFF

LEVEL NAME: COMMUNICATIONS-1

Transmit: 9600 Receive: 9600 Data Bits: 8 Parity: None Parity Check: OFF Echo: OFF

LEVEL NAME: COMMUNICATIONS-2

Handshake: Both Stop Bits: 1 Port: EIA data Disconnect: 2 sec Xmt Limit: 150 cps

LEVEL NAME: PRINTER-1

Speed: 9600 Data Bits: 8 Parity: None Stop Bits: 1 Handshake: Both Terminator: None

LEVEL NAME: PRINTER-2

Print: Full Screen Print: ASCII Print Mode: Normal PR Receive: OFF

LEVEL NAME: KEYBOARD-1

Lock: Caps Keyrepeat: ON Keyclick: OFF Margin bell: OFF Warning Bell: ON Break: ON

LEVEL NAME: KEYBOARD-2

Answerback: OFF Compose: ON X: BS/DEL Keyboard: N. American Keys: Typewriter

LEVEL NAME: SEND

Fkeys: Remote Fkey Xmt: 150 cps Send: All Send Area: Full Screen Send Term: None

APPENDIX D: PRINTER CONFIGURATIONS

NOTE: Refer to Appendix E for information on Interface Cable Specifications.

DATA COMM BOARD

JUMPERS

The following jumpers are required on the Data Comm board of a Printronix printer with a serial interface. This jumper scheme supports XON/XOFF protocol.

Location A-10 HYBRID CURRENT LOOP DISABLE jumpered

Location B-3 BIT 8 (P1 to GND) and (DATA to E2) jumpered

Location C-9 REQ TO SEND - BSY jumpered
DTR - BSY jumpered
DTR - NBSY jumpered (for 9370s only)
DATA TRANSMIT - TOB jumpered
REVERSE CHANNEL - NBSY jumpered

Location C-11 BAUD RATE SELECT - (9.6k jumpered) or appropriate baud rate

Location F-4 PARITY ENABLE - jumpered (remove for LSI systems)
128 - jumpered
256 - jumpered
512 - jumpered

Location H-10 BAFL HYS - jumpered

Location K-4 PROGRAM X-MIT CHARACTER

ON-ACK	OFF-NACK
8 - jumpered	8 - jumpered
1 - open	1 - open
7 - jumpered	7 - jumpered
2 - jumpered	2 - open
6 - jumpered	6 - jumpered
3 - jumpered	3 - jumpered
5 - open	5 - open
4 - jumpered	4 - jumpered

Printer Configurations

A-10	HYBRID CURRENT LOOP DISABLE	E5 .--.
B-3	BIT 8	E1 . . P1 \ (connect) / GND . GND . . DATA \ (connect) / E2 .
C-9	REQ TO SEND - BSY	. . IONL BSY .--.
	DTR - BSY	. . NBSY BSY .--.
	DTR - NBSY (for 9370s)	. . NBSY NTO . .
	DATA TRANSMIT - TOB	. . TOB TOB .--.
	REVERSE CHANNEL - NBSY	. . NTO NBSY .--. . . BSY
C-11	BAUD RATE SELECT - 9.6K	EXT 75 150 300 600 1.2k 2.4k 4.8k 9.6k .--. . . 19.2k
F-4	PARITY	PARITY .--.ENABLE(remove . . 64 for LSI) .--. 128 8 . . BITS .--. 256 .--. 512 . . ODD PARITY

H-10 BAFL - HYS

HYS .
 \
 (connect)
 /
 .
 NO HYS

K-4 PROGRAM X-MIT
CHARACTER

ON-ACK	OFF-NACK
8 .--.	8 .--.
1 . .	1 . .
7 .--.	7 .--.
2 .--.	2 . .
6 .--.	6 .--.
3 .--.	3 .--.
5 . .	5 . .
4 .--.	4 .--.

DEC LETTERPRINTER 210

The Letterprinter 210 is a dot-matrix serial printer with logic-seeking, bidirectional print. It can print at a maximum speed of 240 characters per second in Draft Quality Mode, and at 40 characters per second in Letter Quality Mode. The Letterprinter 210 can be used on the entire Ultimate product line.

SWITCH SETTINGS

Switch banks are located at the back of the printer, along the bottom. There are two banks of switches. They must be set before you power on the printer. The following are the standard switch settings for Ultimate systems.

NOTE: ON = UP, and OFF = DOWN.

ULTIMATE PC

<u>Switch Bank A</u>	<u>Switch Bank B</u>
1 OFF	1 ON
2 OFF	2 OFF
3 OFF	3 ON
4 OFF	4 ON
5 ON	5 OFF
6 ON	6 OFF
7 ON	7 ON
8 ON	8 OFF

LSI AND HONEYWELL SYSTEMS

<u>Switch Bank A</u>	<u>Switch Bank B</u>
1 OFF	1 ON
2 OFF	2 OFF
3 OFF	3 ON
4 OFF	4 ON
5 ON	5 OFF
6 ON	6 OFF
7 ON	7 ON
8 OFF	8 OFF

Switch Bank A

1 Speed Control Line	OFF Restraint mode ON Speed Control mode
2 Modem Control	OFF No Modem Control ON Modem Control
3/4 Paper Fault	OFF/OFF XOFF Sent ON/OFF Break Sent OFF/ON Drop DTR ON/ON Do Not Connect
5 End of Transmission	OFF Disconnect on EOT ON Ignore EOT
6 XON/XOFF	OFF Disable XON/XOFF ON Enable XON/XOFF
7 Error Processing	OFF Print Substitute Char. ON Print as Received
8 Store Features	Move off, then on, to store settings in memory.

Switch Bank B

BAUD RATE	1	2	3	4	5
50	OFF	OFF	OFF	OFF	OFF
75	ON	OFF	OFF	OFF	OFF
110	OFF	ON	OFF	OFF	OFF
134.5	ON	ON	OFF	OFF	OFF
150	OFF	OFF	ON	OFF	OFF
200	ON	OFF	ON	OFF	OFF
300	OFF	ON	ON	OFF	OFF
600	ON	ON	ON	OFF	OFF
1200	OFF	OFF	OFF	ON	OFF
1800	ON	OFF	OFF	ON	OFF
2400	OFF	ON	OFF	ON	OFF
4800	ON	ON	OFF	ON	OFF
7200	OFF	OFF	ON	ON	OFF
9600	ON	OFF	ON	ON	OFF

IGP-10 BOARD
(Revisions 1 through 4)

The Intelligent Graphics Processor, or IGP-10, is an optional board that is used with the P-Series Printronix printers. This board can be used in a serial printer, where it takes the place of the data communications board, or in a parallel printer, where it occupies the empty slot.

The IGP board allows an operator to design and print forms, logos, seven types of bar codes, and alphanumeric data. The IGP board also allows compressed print of 10, 13, 15, and 17 characters per inch and expanded print of 1 to 99 times the standard size. The IGP board has vertical line spacing of 6, 8, 9, or 10 lines per inch. The reverse print command causes the printer to print white on black, and works with standard and expanded characters, logos, and forms. However, the reverse print command does not work with bar codes or compressed print.

The jumpers on the A and B logic boards must be changed before the IGP board is installed. Refer to "Printronix A and B Logic Boards" in this appendix for the correct jumpering. The following is a list of the switch settings for the IGP-10 board.

SERIAL SWITCH SETTINGS

Switch B2

<u>Sw #</u>	<u>Open/Closed</u>	<u>Function</u>
1	Closed	Enable DTR
2	Closed	Enable RTS
3	Open	Control Character Selection (CNTL C)
4	Open	Control Character Selection (CNTL C)
5	Open	N/A
6	Open	Select P-Series Control Codes
7	Open	N/A
8	Open	Forms Length Selector Option

Switch B3

<u>Sw #</u>	<u>Open/Closed</u>	<u>Function</u>
1	Open/Closed	Serial Interface/Parallel Interface
2	Closed	Select Internal Baud Rate Clock
3	Open	External Clock (Ignored, Internal Clock Used)
4	Open	External Timing (Ignored, Internal Clock Used)
5	Open	N/A
6	Open	N/A
7	Open	N/A
8	Open	N/A

Switch D1

<u>Sw #</u>	<u>Open/Closed</u>	<u>Function</u>
1	Closed	Baud Rate * 9600
2	Open	Baud Rate * 9600
3	Closed	Baud Rate * 9600
4	Closed	Baud Rate * 9600
5	Open/Closed	Select 8 Bit Interface (Open for LSI, Closed for Honeywell)
6	Open	Even Parity
7	Open/Closed	Enable/Disable Parity (Open for LSI, Closed for Honeywell)
8	Closed	2 Stop Bits

Switch D2

<u>Sw #</u>	<u>Open/Closed</u>	<u>Function</u>
1	Open	High True Logic (DTR/RTS)
2	Open	Enable Sense of Data Bit 8
3	Open	High True (data strobe)
4	Open	Enable Sense of PI Line
5	Open	CR will not cause Paper Advance
6	Open	Auto-Line Feed Disable
7	Open	Test
8	Open	N/A

PARALLEL SWITCH SETTINGS

Switch B2	1-8 Open
Switch B3	1 Closed, 2-8 Open
Switch D1	1-7 Open, 8 Closed
Switch D2	1-8 Closed

SERIAL/PARALLEL INTERFACE JUMPERS

Jumper location A9 for Serial Interface.
Jumper location A10 for Parallel Interface.

Printer Configurations

ALTERNATE BAUD RATES

<u>Baud Rate</u>	<u>Sw 1</u>	<u>Sw 2</u>	<u>Sw 3</u>	<u>Sw 4</u>
50	Closed	Open	Open	Open
75	Open	Closed	Open	Open
110	Closed	Closed	Open	Open
134.5	Open	Open	Closed	Open
150	Closed	Open	Closed	Open
300	Open	Closed	Closed	Open
600	Closed	Closed	Closed	Open
1200	Open	Open	Open	Closed
1800	Closed	Open	Open	Closed
2000	Open	Closed	Open	Closed
2400	Closed	Closed	Open	Closed
4800	Open	Open	Closed	Closed
9600	Closed	Open	Closed	Closed
19.2K	Open	Closed	Closed	Closed
38.4K	Closed	Closed	Closed	Closed

IGP-10 BOARD (Revision 6)

The Intelligent Graphics Processor series 10 (IGP-10) is an optional board that is used with the P-Series Printronix printers. This board can be used as a serial or parallel device. As a serial device, it takes the place of the Data Communications board. As a parallel device, it uses the empty slot.

The jumpers on the A and B logic boards must be changed at the same time that the IGP board is installed. Refer to "Printronix A and B Logic Boards" in this appendix for correct settings.

The Revision 6 IGP-10 board has an address wheel located at the front of the board. The address wheel is labeled ADDR, and is switch S4. Ultimate uses 9 address options to configure this board. The only dip switch (labeled DATA or S5) sets the address indicated by the ADDR wheel. After you set and enter each address, reset the DATA switches to OFF before you begin the next address. To lock in a DATA setting, press and hold the CONFIG ENABLE (or S7), and press and release the CONFIG (or S3) switch.

NOTE: *The SELF TEST switch was mislabeled. The SELF TEST switch (or S2) must cover the words "SELF TEST" to run in normal mode. Also, the EXP ADDR (or S6) switch is not used at this time.*

REQUIRED JUMPERS

The jumper located at position E-1 should be jumpered from E-1 to E-2.

SERIAL INTERFACE SETUP OPTIONS

The jumper located at position A-9 should be jumpered. Position A-10 should not be jumpered.

The following is the setup for the serial interface options:

Address 0

	8	7	6	5	4	3	2	1
Honeywell	OFF	OFF	ON	OFF	OFF	OFF	OFF	OFF
LSI	OFF	ON	ON	OFF	ON	OFF	OFF	OFF

Address 1

	8	7	6	5	4	3	2	1
ALL	ON	OFF	OFF	ON	ON	OFF	OFF	OFF

Address 2 *

	8	7	6	5	4	3	2	1
ALL	OFF	OFF	OFF	OFF	ON	ON	OFF	ON

Printer Configurations

Address 3

	<u>8</u>	<u>7</u>	<u>6</u>	<u>5</u>	<u>4</u>	<u>3</u>	<u>2</u>	<u>1</u>
ALL	OFF	OFF	OFF	OFF	OFF	OFF	OFF	OFF

Address 4

	<u>8</u>	<u>7</u>	<u>6</u>	<u>5</u>	<u>4</u>	<u>3</u>	<u>2</u>	<u>1</u>
ALL	OFF	OFF	OFF	ON	OFF	OFF	OFF	OFF

Address 5

	<u>8</u>	<u>7</u>	<u>6</u>	<u>5</u>	<u>4</u>	<u>3</u>	<u>2</u>	<u>1</u>
ALL	OFF	OFF	OFF	OFF	OFF	OFF	OFF	OFF

Address 6

	<u>8</u>	<u>7</u>	<u>6</u>	<u>5</u>	<u>4</u>	<u>3</u>	<u>2</u>	<u>1</u>
ALL	OFF	OFF	OFF	OFF	OFF	OFF	ON	ON

Address 7

	<u>8</u>	<u>7</u>	<u>6</u>	<u>5</u>	<u>4</u>	<u>3</u>	<u>2</u>	<u>1</u>
ALL	ON	OFF	OFF	OFF	OFF	OFF	OFF	OFF

Address 8 *

	<u>8</u>	<u>7</u>	<u>6</u>	<u>5</u>	<u>4</u>	<u>3</u>	<u>2</u>	<u>1</u>
ALL	ON	OFF	OFF	OFF	OFF	OFF	OFF	OFF

Address 9

	<u>8</u>	<u>7</u>	<u>6</u>	<u>5</u>	<u>4</u>	<u>3</u>	<u>2</u>	<u>1</u>
ALL	OFF	OFF	OFF	OFF	OFF	OFF	OFF	OFF

NOTE: Please refer to your printer manual for different baud rates and different printer types (for example, P6000).

PARALLEL INTERFACE SETUP OPTIONS

The jumper located at position A-10 should be jumpered. Position A-9 should not be jumpered.

Except for the address listed below, the parallel addresses are the same as the serial addresses.

Address 3

	8	7	6	5	4	3	2	1
Honeywell/ LSI	ON	ON	OFF	OFF	OFF	OFF	OFF	OFF

NEC 3500 LETTER QUALITY PRINTER

SWITCH SETTINGS

Use the following switch settings for the NEC 3500 35cps printer. The switch settings are located on the logic board inside the rear of the printer. There are three sets of 8 dip switches each. The diagram below shows the order of these switches.

SW3

00001000

SW1

11010110

SW2

00000011

NOTE: 0 = OFF 1 = ON

The following is a description of each switch setting.

SW1

1 SPEED	ON (1200 BAUD)
2 SPEED	ON
3 LOCAL LF	OFF
4 AUTO CR	ON
5 PARITY ENABLE/DISABLE	OFF for LSI systems, ON for HONEYWELL
6 PARITY EVEN/ODD	ON
7 X/ON	ON
8 CUT SHEET GUIDE	OFF

SW2

1 10/12/15 CPI DEFAULT	OFF
2	OFF
3 LF/FF	OFF (FF)
4 PAPER OUT DETECT	OFF
5 8/6 LPI DEFAULT	OFF
6 PS/STD DEFAULT	OFF
7 TEST	ON
8 REMOTE/LOCAL DEFAULT	ON

SW3

1	NOT USED	OFF
2	" "	OFF
3	" "	OFF
4	" "	OFF
5	DATA SET READY	ON
6	DTR=RVC	ON
7	RVC=-12	OFF
8	HAMMER DISABLE	OFF

Printer Configurations

NEC 5500 SPINWRITER

SWITCH SETTINGS

NOTE: ON is the UP position and OFF is the DOWN position. The "*" indicates the normal switch settings for use with ULTIMATE systems.

Printer Interface Logic Board

The printer cover must be removed. The switches are located on the board in the rear of the printer. Only the first 4 switches are set:

<u>SW.</u>	<u>ON</u>	<u>OFF</u>
1	Keyboard Enabled (KSR)	* Keyboard Disabled (RD)
2	* Driver Lock Normal	Driver Lock
3	Carrier Detect Enabled	* Carrier Detect Disabled
4	Hammer Driver Enabled	* Hammer Driver Disabled

Printer Control Panel Board

To locate the switch, lift the printer lid, and look behind the Front Panel Cover on the top left side.

<u>SW.</u>	<u>ON</u>	<u>OFF</u>
1	Auto Carriage Return	* Auto Carriage Return Disabled
2	* Clear Individual Tab Stops	Clear All Tab Stops
3	Break Enabled	* Console Interrupt Enabled
4	* XON/XOFF Protocol	ETX/ACK Protocol
5	Reverse Channel High	* Reverse Channel Low
6	RESERVED...MUST BE OFF	* RESERVED...MUST BE OFF
7	* ON Baud Rate See Table 1	
8	* ON Baud Rate See Table 1	

Front Panel Rocker Switch Settings

TEST	Down	SPEED	High
DUPLEX	Full	PARITY	Even - Honeywell Systems Mark - LSI Systems

The rest of the rocker switches are set according to individual specifications.

TABLE 1

<u>7</u>	<u>8</u>	<u>L</u>	<u>M</u>	<u>H</u>
OFF	OFF	110	150	300
OFF	ON	110	200	300
ON	OFF	110	300	600
ON	ON	110	300	1200

Switches 7 and 8 on the Panel Control Board set the baud rates that can be selected by the Panel Rocker Switch, labeled L M H.

PRINTRONIX A AND B LOGIC BOARDS

JUMPERS

The following jumpers are required on the Printronix printer to properly interface with the Ultimate systems.

CAUTION

On the "A" logic board of all model printers, chip location "3A" must contain a 1K ohm resistor pack, and location "2A" must be left empty.

<u>Printer Speed</u>	<u>Logic Bd.</u>	<u>Chip Loc.</u>	<u>Jumper Pins</u>	<u>Comments</u>	
P-150	A-2	8K	4-11	Note 1	
		8K	5-10	Note 1	
		9K	7-8		
		9K	2-13	Note 2	
	A-4	See A-2			
	A-6	See A-2			
	B-5	8K	4-11	Note 2	
			9K	4-11	
	B-7	8K	6-9		
			8K	4-11	Note 2
9K			3-12		
9K			7-8		
B-9	See B-7				
P-300	A-1	8K	4-11	Note 1	
		8K	5-10	Notes 1 & 3	
		9K	2-13	Note 2	
	A-2	See A-1			
	A-4	8K	4-11	Note 1	
			8K	5-10	Notes 1 & 3
			9K	2-13	Note 2
			9K	4-11	
A-6	See A-4				

Printer Configurations

<u>Printer Speed</u>	<u>Logic Bd.</u>	<u>Chip Loc.</u>	<u>Jumper Pins</u>	<u>Comments</u>
P-300	B-4	8K	6-9	Note 2
		8K	4-11	
	B-5	8K	6-9	Note 2
		8K	4-11	
		9K	6-9	
	B-7	8K	6-9	Note 2
		8K	4-11	
		9K	4-11	
		9K	6-9	
		9K	7-8	
	B-9	8K	6-9	Note 2
		8K	4-11	
		9K	4-11	
		9K	6-9	
		9K	7-8	
P-600	A-4	8K	4-11	Note 1
		8K	5-10	Notes 1 & 3
		8K	1-14	Note 5
		9K	2-13	Note 2
	A-6	See A-4		
	B-7	8K	4-11	Note 2
		8K	5-10	
		8K	6-9	
		9K	4-11	
		9K	6-9	
B-9	See B-7			

Note 1 Remove if using IGP board

Note 2 Install if using IGP board

Note 3 Release 10 only

Note 4 Install if using A-1 through A-5 logics

Note 5 Phase Fire printer only

Printer Configurations

PRINTRONIX MVP

The MVP printer is a dot matrix line printer with 5 printing modes. The printing modes are Correspondence Print at 10 characters/inch, Data Processing Print at 10 characters/inch, Compressed Print at 12.5 characters/inch, Condensed Print at 16.7 characters/inch, and Plot Mode.

CONFIGURATION OPTIONS

The following are the standard internal settings for the MVP Printronix printer on Ultimate systems. For a description of each switch setting, consult the MVP Printer manual. You can select the printer configuration options shown below with the ADDR and DATA panel switches located directly on the right front of the printer. You must raise the front cover to see these switches. Also note the digital display to the left of the panel.

Standard Internal Settings

20.1	21.0	22.0	23.0	24.0	25.0	26.0	27.0	28.0	29.0
30.0	31.0	32.0	33.0	34.0	35.0	36.0	37.0	38.0	39.0
40.0	41.0	42.0	43.0	44.0	45.0	46.0	47.0	48.0	49.0
50.1	51.0	52.0	53.0	54.0	55.0	56.0	57.0	58.0	59.0
60.1	61.0	62.0	63.1	64.0	65.0	66.0	67.0	68.0	69.0
70.1	71.0	72.9	73.0	74.0	75.0	76.1	77.0	78.2	79.1
80.0	81.0	82.17	83.19	84.11	85.0	87.2 *	87.8	88.1	89.0
90.0	91.0	92.0	93.0	94.0	95.0	96.0	97.0	98.0	99.0

* This setting appears as 86.C on the printed configuration sheet.

NOTE: For parallel printers on 1400 systems, change the following configurations.

<u>Change</u>	<u>To</u>
63.1	63.0
74.0	74.1
76.1	76.0

Changing the Internal Settings

Follow the instructions below to change the internal settings.

1. Ensure that the RDY light is blinking. (If not, press the RDY switch).
2. Press the second Function key.
3. Press the ADDR switch to increment the left side of the digital display (the left counter will increment rapidly). Stop at the desired selection.
4. When the desired configuration parameter is reached, place the printer into configuration mode by holding the DATA key and quickly pressing and releasing the MODE key.
5. Press the DATA key to increment the rightmost digit on the digital counter. When you reach the correct selection, press the second Function key.

Brief Description of the Major Switch Settings.

<u>Feature</u>	<u>Options</u>	<u>Comments</u>
Programming standard	20.1	P-Series
Perforation skip	50.1	Disable perf. skip
Forms length (power on)	52.0	Enable 11 inches
Interface type	70.1	RS232 with XON/XOFF
Baud rate	71.0	9600 baud (see NOTE)
Word length	72.1	7 bits even parity
	72.9	(LSI and 1400 only) 7 bits no parity
Xmit polarity	73.0	Normal
Request to send	74.0	On if buffer not full
Clear to send	75.0	Disable
Data set ready	76.1	On to receive
Reverse channel	77.0	Disable
Data terminal ready	78.2	Always on
XON level	79.1	25% of buffer
XOFF level	80.0	75% of buffer

NOTE: See the MVP Printer Operator's Guide for the options available for baud rates.

Printer Configurations

Printing a Configuration Sheet

Follow the instructions below to print a configuration sheet. The configuration sheet shows all the internal settings for the MVP.

1. Ensure that the RDY light is blinking.
2. Press the second Function key.
3. Press the ADDR key until the first two digits are zeros.
4. Press the DATA key until the last digit is a one. The display should now show 00.1
5. Press the second Function key. The printer should now start printing a configuration sheet.

Error Codes

When the MVP printer detects a fault, an error code is displayed on the inside control panel. These error codes fall into two categories: "soft errors" and errors requiring service. Soft errors can usually be bypassed by the operator; however, soft errors sometimes require service.

Below is a list of the error codes, their meaning, and corrective action. If the corrective action does not solve the problem, you may have a hardware problem.

<u>CHK INDICATOR</u>	<u>FAULT CODE</u>	<u>DESCRIPTION</u>	<u>CORRECTIVE ACTION</u>
Flashing	001	paper out	check for paper
Flashing	012	platen open shuttle cover removed	check platen adjustment reseat shuttle cover
Flashing	013	no paper motion	check paper
Flashing	014	shuttle jammed	check paper/ribbon
Flashing	015	shuttle not up to speed	check paper/ribbon
Flashing	072	buffer is full and is overflowing	check options (XON/XOFF, dtr), check baud rate, check port on system.
Flashing	073	framing error, cannot read incoming bits.	check baud rate, check port on system, check parity.

To bypass the following errors, press and hold the CHK switch, press and release the RDY switch, then release the CHK switch. If the problem recurs, call for service.

<u>CHK INDICATOR</u>	<u>FAULT CODE</u>	<u>DESCRIPTION</u>
Steady	030	CPU program ROM check sum
Steady	031	DCU data RAM pattern check
Steady	032	DCU configuration memory check sum
Steady	033	control and status interface timeout
Steady	040	primary font ROM check sum
Steady	041	alternative font ROM check sum
Steady	050	MCU program ROM check sum
Steady	051	MCU data RAM pattern check

If you get one of the following fault codes, call for service. (There is no corrective action for these fault codes.)

<u>CHK INDICATOR</u>	<u>FAULT CODE</u>	<u>DESCRIPTION</u>
Steady	060	+30/+12 volt power supply failure
Steady	061	-16/-12 volt power supply failure
Steady	070	I/O port failure
Steady	081	UART error
Steady	082	UART error
Steady	083	UART error

PRINTRONIX COMPRESS PRINT MODE

There are two methods of achieving compressed print on the Printronix printers.

1. Install an A7-B10 logic board combination.
2. Install an IGP board.

A7-B10 LOGIC BOARDS

The A7-B10 logic board combination has printing of 10, 13.3, or 16.7 characters per inch. The character size is software-selectable, with a switch for default setup. For example, if the switch is set at 10 and you software-select 16.7 characters per inch, the printer will return to 10 characters per inch when done with your job. The A7-B10 combination also has a Draft Mode. This will allow the 300 to print at 400 lines per minute, and the 600 at 800 lines per minute, although the print quality is not as good.

IGP-10 BOARD

The use of an IGP-10 board is another way of achieving compressed print. This board will work on a parallel or serial printer. In a parallel printer, it goes in the empty card slot. In the serial printer, it replaces the data comm board. This board features 10, 13.3, 15, or 17 characters per inch, bar code, reverse printing, and enlarged print from a maximum of 9.9 inches, decreasing in 1/10 inch increments. This is totally software-selectable, with no default switch settings.

APPENDIX E: CABLE SPECIFICATIONS

The cabling specifications are divided into three parts:

1. CRT to CPU (System) Cable
2. Parallel Printer Cable
3. Using Existing Ultimate Cabling

1. CRT TO CPU (SYSTEM) CABLE

Note that improper cabling may cause interference with other equipment that would be required to be corrected by the user at the user's expense.

The following specifications apply to the 8-way Station Processor Board. Devices used on the 8-way must use X-ON/X-OFF protocol.

Cable Specifications

The cable (Belden 9502 or equivalent) consists of 2 twisted pairs of #22 or #24 gauge stranded wire. Around these 2 pairs is a foil shield, which has a bare wire wrapped around it. The bare wire is used for the ground connection to pin 1 on both ends of the cable.

If using a Belden equivalent, only #22 or #24 gauge stranded wire should be used. Smaller wire is too thin, and larger wire will not fit into the pin sockets in the connector. Stranded wire is preferred over solid because of its lower capacitance, which is a major factor in determining acceptable line length.

Connector Specifications

FCC regulations require grounded connector covers. They are made of metallized plastic and must be grounded to the cable shield. This is done by connecting a second "bare" wire to pin 1 at both ends. This wire should be brought back along the cable to the point where the clamshell will engage the cable. At this point, the bare ground wire should be wrapped around the cable sheath 3 or 4 times. The cover is grounded by its pressure on the bare wire.

The cable has a 9-pin connector (AMP 205204-4) with an EMI/RFI connector cover (amp 745854-3) at one end, and a 25-pin connector (AMP 207464-2) with an EMI/RFI connector cover (AMP 745833-9) at the other end.

Modem Cable

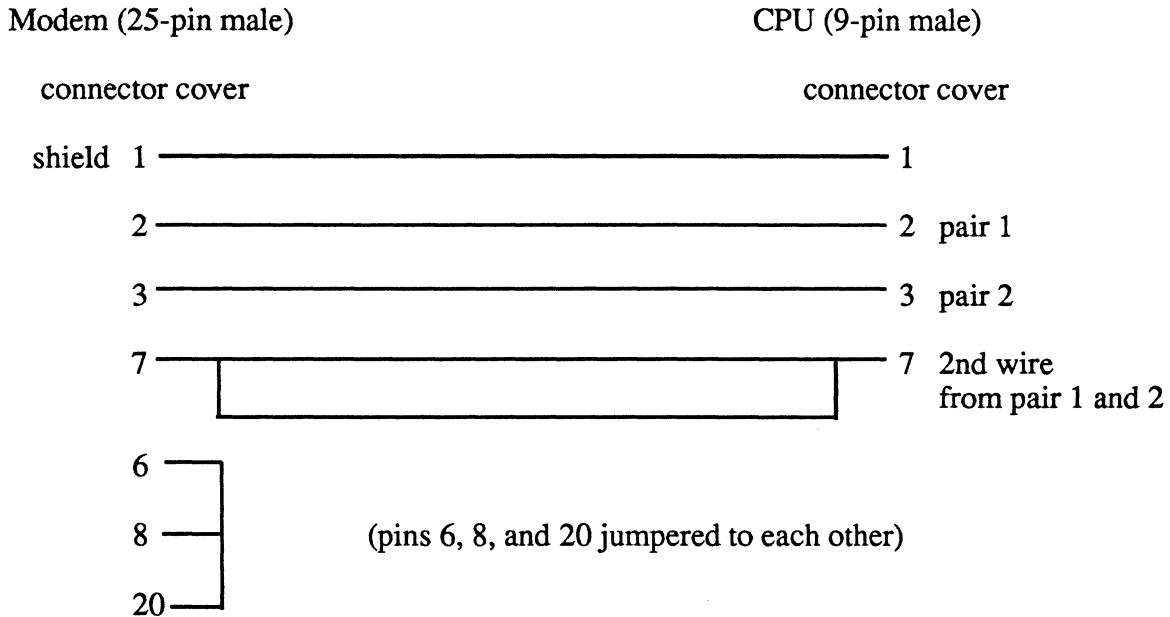

2. PARALLEL PRINTER CABLE

Note that improper cabling may cause interference with other equipment that would be required to be corrected by the user at the user's expense.

The 1400 system uses a Centronics parallel interface. The cable should not exceed 50 feet in length.

Cable Specifications

The cable is a Belden 9519 or equivalent. The male 37-pin connector (amp part number 205210-3) connects to the communications board. The male 36 pin Centronics connector connects to the printer (Amphonol, part number 77-30360).

On the following page is a diagram of the pinning scheme.

Cable Specifications

1400 Parallel Printer Cable (Centronics Interface)

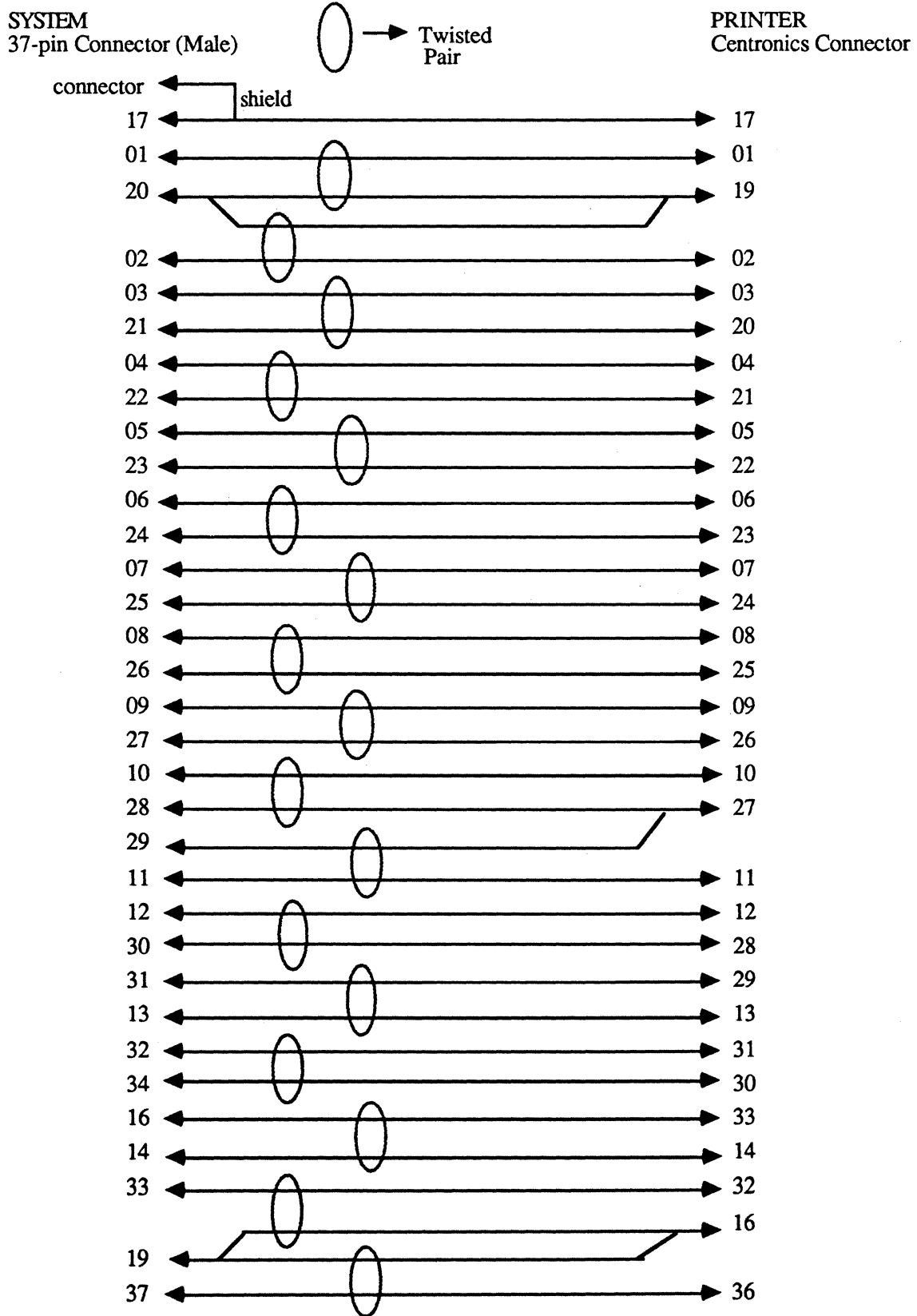

3. USING EXISTING ULTIMATE CABLING

If Ultimate cabling is already installed according to Ultimate's specifications, then that cabling can be modified for the 1400 system by one of the following two methods.

1. Remove existing cable connectors, and re-pin them to match the cable specifications described in the section titled "CRT to CPU (System) Cable."
2. Use special adapters for the 1400 system (see the following section titled "Special Adapters for 1400 Systems.")

SPECIAL ADAPTERS FOR 1400 SYSTEMS

Note that improper cabling may cause interference with other equipment that would be required to be corrected by the user at the user's expense.

Cable and Connector Specifications

For cable and connector specifications, refer to the section titled "CRT to CPU (System) Cable."

Cable Specifications

Adapter for Standard Ultimate CRT to CPU Cables to 1400 System

The adapter consists of a 25-pin (female) connector to a 9-pin (male) connector. The 9-pin connector connects to the 1400 system. The 25-pin connector connects to the CPU end of the Standard Ultimate CRT to CPU cable.

NOTE: *The adapter cables must be at least 36 inches long, to avoid crowding the connectors inside the computer cabinet.*

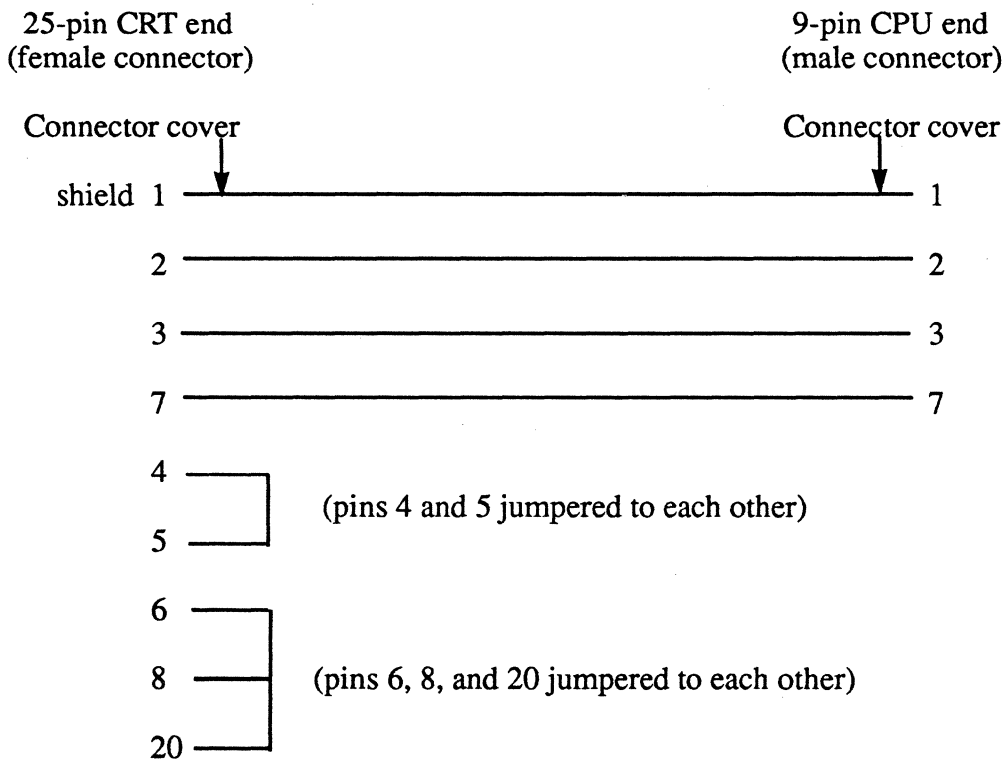

Adapter For 1525 CRT to CPU Cables to 1400 System

This adapter consists of a 25-pin connector (male) to a 25-pin connector (female). The male end of the adapter connects to the CRT, and the female side connects to the CRT end of the 1525 CRT to CPU cable.

NOTE: *The adapter cables must be at least 36 inches long, to avoid crowding the connectors inside the computer cabinet.*

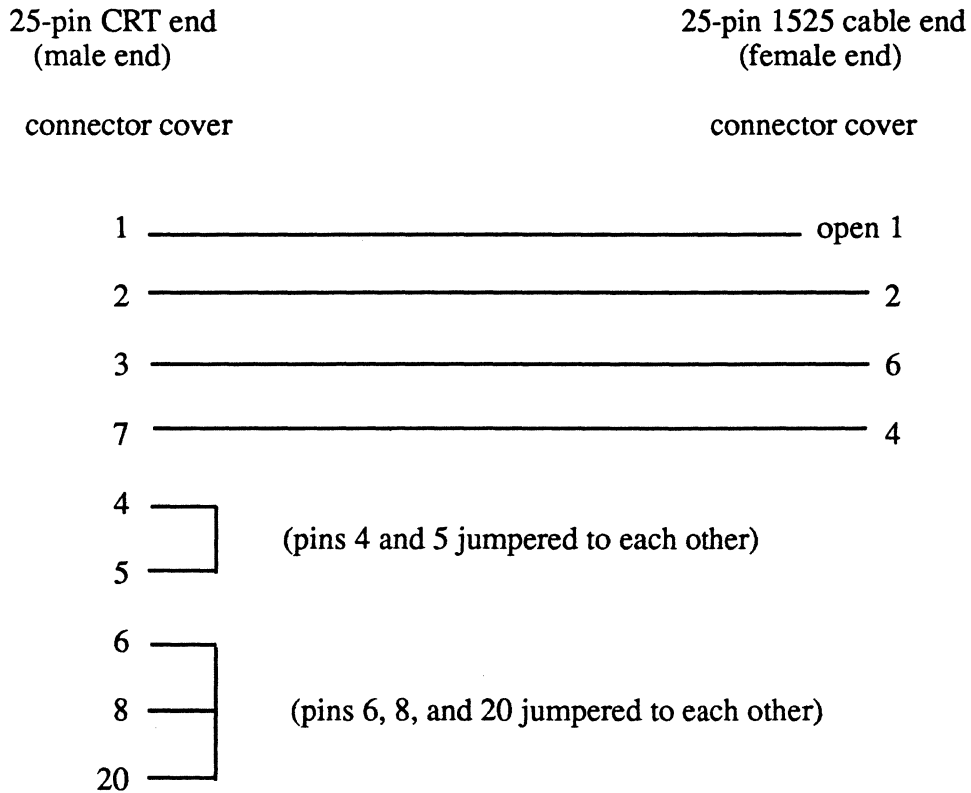



APPENDIX F: MODEM SPECIFICATIONS

RACAL-VADIC VA212LC

CABLING

Two Racal Vadic modems, the VA212LC and the VA3451, require special cabling in order to be used on 1400 systems. If you do not use the special cabling specifications for these modems, the modems will not answer an incoming call.

This problem occurs because these modems require the DTR signal to be present at all times, and in this case, the 1400 SP0 (8-way communications board) cannot provide the signal. So, to provide the DTR signal, you must jumper pin 9 to pin 20 on the modem side of the cable.

HAYES SMARTMODEM 1200

The Hayes Smartmodem 1200 is an auto-dial modem that can be used to auto-dial either from the keyboard of a CRT or through software on a computer system. It is capable of detecting the baud rate being used, and thus does not require a modem baud rate setting. However, it is capable only of 300 and 1200 baud.

SWITCH SETTINGS

To use the Hayes Smartmodem 1200, the following switch settings are required. The switches can be accessed by removing the front cover of the modem, where the red indicator lights are located. Note that the older style Hayes Smartmodems have only 8 switches. On those modems, only the first 8 switches apply:

NOTE: UP=ON
 DOWN=OFF

1	2	3	4	5	6	7	8	9	10
DOWN	DOWN	UP	DOWN	UP	DOWN	UP	DOWN	UP	UP

<u>Switch</u>	<u>Direction</u>	<u>Function</u>
1	down	Forces DTR high
2	down	Does not send out command results
3	up	Results will not be sent to computer
4	down	Does not echo commands to computer
5	up	Automatically answers incoming calls
6	down	Forces carrier detect true
7	up	Setting for connection to RJ1 jack
8	down	Enables command recognition
9	up	Compatible with Bell 103/212a modems
10	up	Modem reset when turned on

When hooking up this modem directly to a Honeywell-based Ultimate system, Switch 1 should be UP, to allow DTR to be raised and lowered to insure disconnection when using UltiLink communications. Also, the modem will only read switches optioned upon power on. Once the modem is optioned, it must be powered off and then on.

CABLING

When using a Hayes Smartmodem 1200 on a CRT , you must use the following cabling specification:

CRT	MODEM
1	1
2	2
3	3
4	
5	
6	6
7	7
8	8
13	13
15	15
17	17
20	20

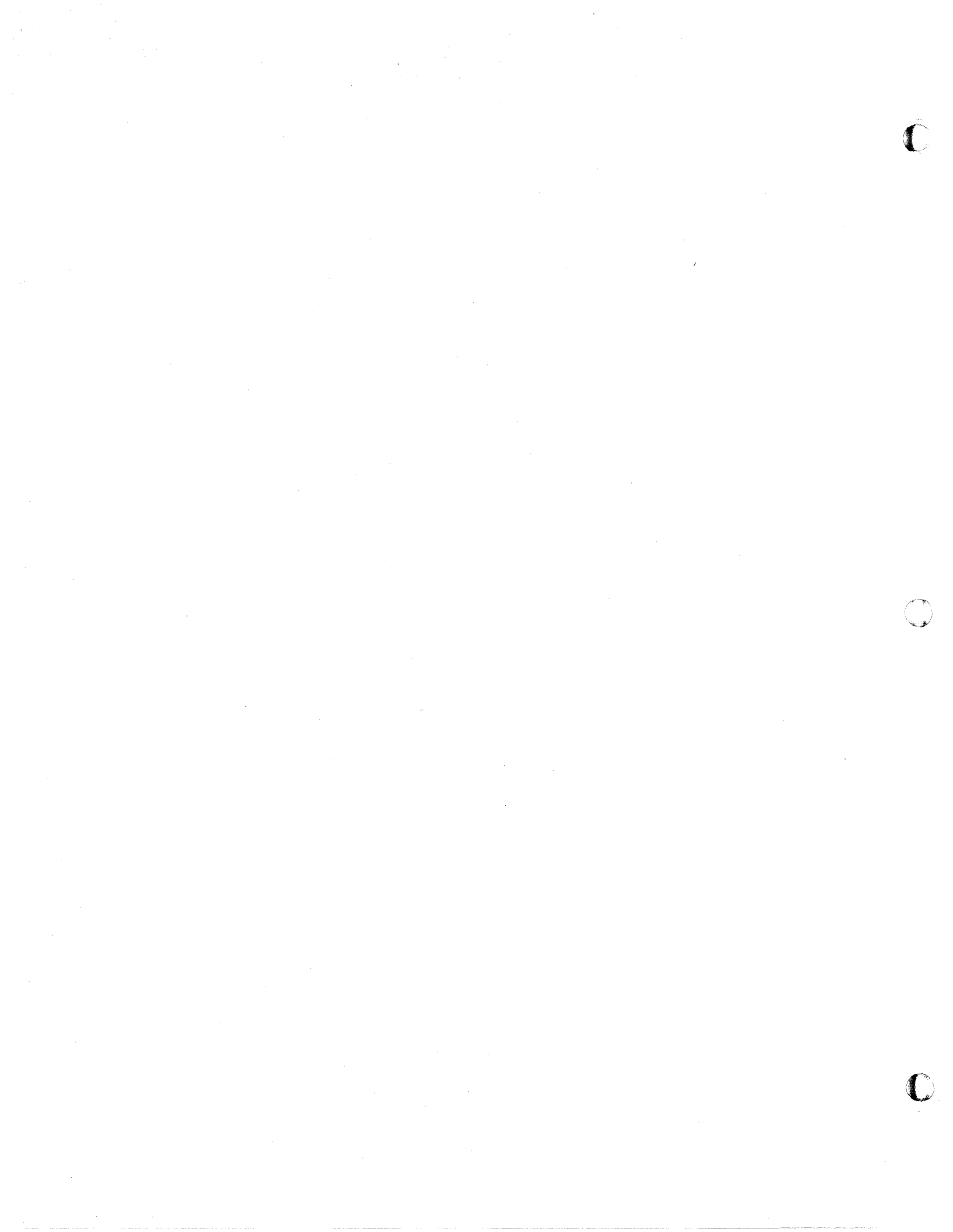

INDEX

1/2" Reel tapes	4-3
1/2" Reel tapes, cleaning tape drives	4-4
1/2" Reel tapes, handling procedures	4-3
1/2" Reel tapes, loading	4-3
1/2" Reel tapes, unloading	4-3
1/4" Cartridge tapes	4-1
1/4" Cartridge tapes, cleaning tape drives	4-2
1/4" Cartridge tapes, handling procedures	4-2
1/4" Cartridge tapes, loading	4-1
1/4" Cartridge tapes, unloading	4-2
68000 Debugger Utility	A-1
Aborts	11-4, A-1
ACC File	1-4, A-1
ACC File, clearing	9-6
Account-Restore	8-11, A-1
Account-Restore, from File-Save or Account-Save tapes	8-11
Account-Restore, from File-Save or Account-Save tapes, summary	8-18
Account-Restore, from Update-Save tapes	8-13
Account-Restore, from Update-Save tapes, summary	8-19
Account-Save	7-7, A-1
Account-Save, summary	7-9
Adding communications boards	10-1
Adding disk drives	10-1
Adding equipment	10-1
Adding equipment, summary	10-2
Adding parallel printers	10-1
Adding ports	10-1
Adding tape drives	10-1
ADDS 2020 terminal	C-1
ALL-UPDATE-SAVE	7-12, A-1
ALL-UPDATE-SAVE, restoring from	8-25, 8-29
ALL-UPDATE-SAVE, summary	7-14
Alternate sector table	A-1
Ampersands	11-6
Backing up data	7-1, 9-1, A-1
Backup tapes, labeling	7-1
Backup tapes, organizing	7-1
Backup tapes, rotating	7-2
Booting	5-1, A-1
Boot options	A-1
Cable specifications	E-1
Cable specifications, CRT to CPU	E-1
Cable specifications, parallel printer	E-3
Cable specifications, using existing Ultimate cabling	E-5
Calling Ultimate Technical Support	11-2
Cartridge tapes, 1/4"	4-1
Cartridge tapes, cleaning tape drives	4-2

Index

Cartridge tapes, handling procedures	4-2
Cartridge tapes, loading	4-1
Cartridge tapes, unloading	4-2
Charge units	A-1
Check File-Stats Report	9-1
Checklist, getting started	1-12
Check print overflow table	9-5
Clear ACC file	9-6
Cleaning tape heads	9-6
Coldstart	6-1, 6-3, A-1
Coldstart, summary	6-9
Communications boards, adding	10-1
Connect time	A-1
CRT configurations	C-1
CRTs, ADDS 2020	C-1
CRTs, Viewpoint 1010	C-10
CRTs, Viewpoint/60	C-3
CRTs, Viewpoint/60+	C-6
CRTs, Viewpoint Plus	C-9
CRTs, Wyse-60	C-17
CRTs, Wyse-85	C-20
CRTs, Wyse WY-50	C-11
Data Comm Board	D-1
Data, restoring	8-1
DEC Letterprinter 210	D-4
Diagnostics monitor	6-1, 6-10, A-1
Disk drives, adding	10-1
Disk drives, formatting for 1410 systems	6-10
Disk drives, formatting for 1410 systems, summary	6-14
Disk drives, formatting for 1420 and 1430 systems	6-15
Disk drives, formatting for 1420 and 1430 systems, summary	6-18
Disk error	11-7
Disk error recovery, reformatting your disks	11-7
Disk error recovery, relocating the defective sector	11-7
Disk error recovery, relocating the defective sector for 1410 systems	11-14
Disk error recovery, relocating the defective sector for 1420 and 1430 systems	11-16
Disk error recovery, verifying additional errors for 1410 systems	11-8
Disk error recovery, verifying additional errors for 1420 and 1430 systems	11-11
Equipment, adding	10-1
Equipment, adding, summary	10-2
FCC warning	P-1
File-Restore	6-2, 6-19, 8-1, 9-6, A-2
File-Restore, maintenance	9-6
File-Restore, with Update/Transaction tapes	8-25
File-Restore, with Update/Transaction tapes, summary	8-36
File-Restore, summary	8-10
File-Save	7-3, 9-6, A-2
File-Save, incremental	7-12
File-Save, hangs	11-7

File-Save, summary	7-6
File-Save, weekly	9-6
File-Stats	A-2
File-Stats, checking	9-1
Formatting disk drives for 1410 systems.....	6-10
Formatting disk drives for 1410 systems, summary.....	6-14
Formatting disk drives for 1420 and 1430 systems.....	6-15
Formatting disk drives for 1420 and 1430 systems, summary.....	6-18
Getting Started Checklist.....	1-12
Glossary	A-1
Group Format Errors.....	A-2
Group Format Errors, troubleshooting	11-2
Hangs	A-2
Hangs, during File-Save	11-7
Hangs, system.....	11-6
Hangs, terminal.....	11-6
Hayes Smartmodem 1200	F-2
IGP-10 Board (Revisions 1 through 4).....	D-6
IGP-10 Board (Revision 6).....	D-9
Incremental File-Saves	7-12
Labeling backup tapes	7-1
Line-Printer pages.....	A-2
LIST-SYSTEM-ERRORS	9-3
Loading cartridge tapes	4-1
Loading reel tapes.....	4-3
Loading UltraWord.....	1-4
Loading WP	1-4
Lock errors.....	11-20
Maintenance.....	9-1
Maintenance, daily.....	9-1
Maintenance, monthly	9-6
Maintenance, summary.....	9-8
Maintenance, weekly	9-6
Memory dumps.....	11-25
Mismatches, troubleshooting.....	11-22
Modem specifications.....	F-1
Modem specifications, Hayes Smartmodem 1200.....	F-2
Modem specifications, Racal-Vadic VA212LC.....	F-1
NEC 3500 Letter Quality.....	D-12
NEC 5500 Spinwriter	D-14
Organizing backup tapes	7-1
Panel layouts	B-1
Parallel printers, adding.....	10-1
Parity errors, checking.....	11-19
PART-UPDATE-SAVE.....	7-15, A-2
PART-UPDATE-SAVE, restoring from.....	8-25, 8-30
PART-UPDATE-SAVE, summary	7-17
Percent signs	11-19
Ports, adding	10-1

Index

POVF.....9-5, A-2
Power conditioners11-24, A-2
Power failures11-23
Power failure recoveries11-24
Powering off3-1
Powering on2-1
Print overflow table9-5, A-2
Printer configurationsD-1
Printer problems.....11-20
Printers.....1-3
Printers, baud rate.....1-3, A-1
Printers, Data Comm Board.....D-1
Printers, DEC Letterprinter 210.....D-4
Printers, IGP-10 Board (Revisions 1 through 4)D-6
Printers, IGP-10 Board (Revision 6)D-9
Printers, location.....1-3
Printers, NEC 3500 Letter QualityD-12
Printers, NEC 5500 Spinwriter.....D-14
Printers, Printronix A and B Logic Boards.....D-16
Printers, Printronix Compress Print Mode.....D-22
Printers, Printronix MVPD-18
Printronix A and B Logic BoardsD-16
Printronix Compress Print ModeD-22
Printronix MVPD-18
Racal-Vadic VA212LC modemF-1
Reel tapes, 1/2"4-3
Reel tapes, cleaning tape drives.....4-4
Reel tapes, handling procedures4-3
Reel tapes, loading.....4-3
Reel tapes, unloading.....4-3
Reformatting disks.....11-7
Relocating the defective sector.....11-7
Relocating the defective sector for 1410 systems.....11-14
Relocating the defective sector for 1420 and 1430 systems.....11-16
Restoring data8-1
Restoring from transaction logger.....8-25, 8-31
Restoring from Update-Saves8-25, 8-29, 8-30
Rotating backup tapes.....7-2
Sel-Restore8-22, A-2
Selective-Restore.....8-22, A-2
Selective-Restore, summary8-24
SET-BAUD verb.....1-2
Site log11-27
SP-ASSIGN11-20
SP-LISTLPTR11-20
System.....11-6
System errors11-21
System hangs11-6
System Startup Options.....6-1, A-2

SYSTEM-ERROR-SUMMARY	11-7
Tape drives.....	4-1
Tape drives, 1/4"	4-1
Tape drives, 1/2"	4-3
Tape drives, adding.....	10-1
Tape errors	11-19
Tape handling	4-2, 4-3
Tape heads, cleaning.....	9-6
Tape parity errors, checking.....	11-19
T-DUMP	7-10, A-2
T-DUMP, summary	7-11
Terminal hangs.....	11-6
Terminals, baud rate	1-2
Terminals, location	1-2
Terminals, troubleshooting	1-1
T-LOAD	8-20, A-2
T-LOAD, summary.....	8-21
Transaction logger	7-18, A-2
Transaction logger, activate.....	7-20
Transaction logger, change tape attachment parameter.....	7-21
Transaction logger, deactivate	7-20
Transaction logger, restart tape.....	7-21
Transaction logger, suspend tape.....	7-21
Transaction logger, restoring from	8-25, 8-31
Transaction logger, summary	7-22
Transaction logger, with update-saves.....	7-23
Troubleshooting	11-1
Troubleshooting, general	11-1
Ultimate Technical Support, calling	11-2
UltiWord, loading	1-4
Uninterruptable Power Supply (UPS)	11-24, A-2
Unloading cartridge tapes.....	4-2
Unloading reel tapes	4-3
Update-Saves.....	7-23, A-2
Update-Saves, restoring from.....	8-25
Update-Saves, with transaction logger	7-23
Verifying additional disk errors for 1410 systems.....	11-8
Verifying additional disk errors for 1420 and 1430 systems	11-11
VERIFY-SYSTEM.....	9-2, 11-22
Viewpoint 1010 terminal.....	C-10
Viewpoint/60 terminal	C-3
Viewpoint/60+ terminal	C-6
Viewpoint Plus terminal.....	C-9
Warmstart	6-2, 6-19, A-3
Warmstart from options menu	6-19
Warmstart from options menu, summary	6-22
Warmstart from TCL	6-20
Warmstart from TCL, summary	6-22
Warmstop.....	5-1, A-3

Index

WP, loading.....1-4
Wyse-60 terminal.....C-17
Wyse-85 terminal.....C-20
Wyse WY-50 terminal.....C-11

Ultimate Technical Support Bug/Suggestion Form

Bug Key _____ Priority _____ Date Received _____

For Ultimate Use Only

Category Affected: Systems, Applications, Other _____

Release Affected _____ Date Submitted _____

Your System No. _____ Contact Name _____

Detailed Description

System Configuration (memory size, number of ports, types of terminals and printers, etc.)

Response/Status

Date _____

FROM:

Name: _____ Title: _____

Company: _____

Address: _____

City: _____ State: _____ Zip: _____

Fold and tape. Please do not staple.

Place
Stamp
Here

**THE ULTIMATE CORP.
717 Ridgedale Avenue
East Hanover, NJ 07936
Attn: Quality Assurance**

Fold and tape. Please do not staple.

100

100

100

100

100

100

100

100

100

100

100	100
100	100
100	100
100	100

100

100

ULT

THE ULTIMATE CORP.

717 RIDGEDALE AVENUE,
EAST HANOVER, NEW JERSEY 07936

(201) 887-9222 TWX 710-996-5862 Telecopier (201) 887-6139
