

Field Engineer Handbook

Technical Volume I



Sun Microsystems, Inc.

Customer Service Division

2550 Garcia Avenue

Mountain View, CA 94043

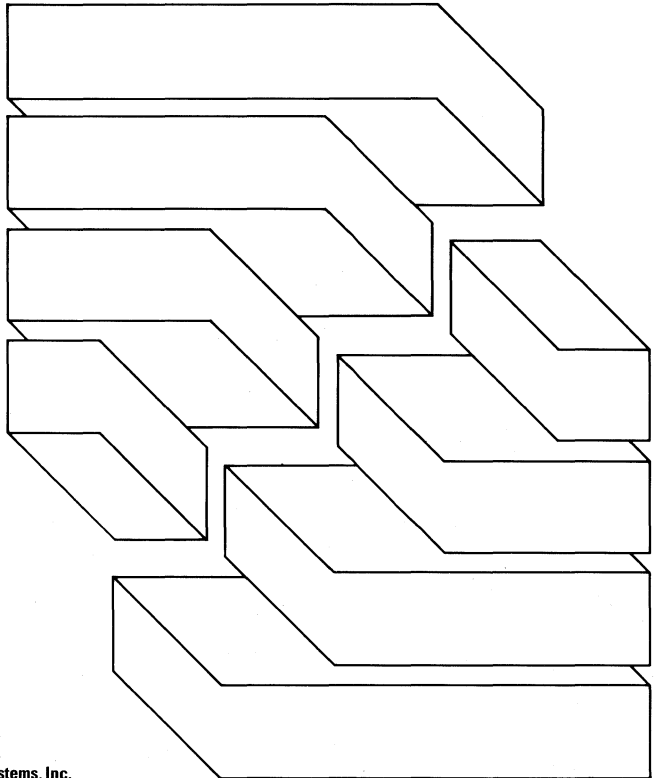

Written and published by Mike Persichetty and Gerri Roe.

The Sun logo, Sun Microsystems, Sun Workstation, are registered trademarks of Sun Microsystems.

Sun, Sun-2, Sun-3, Sun-4, Sun386i, SPARCstation, SPARCserver, SunView, SunLink, SunIPC, PC-NFS, NFS, SunOS, NeWS, SunGKS, Sun CGI, SunSimplify, SunPro, NSE, TAAC-1, SunTrac, ONC, DOS Windows, SPE, and ALM are registered trademarks of Sun Microsystems, Inc.

UNIX is a registered trademark of AT&T; OPEN LOOK is a trademark of AT&T.

All other products or services mentioned in this document are identified by trademarks or service marks of their respective companies or organizations.

Copyright © 1990 by Sun Microsystems, Inc.

This publication is protected by Federal Copyright Law, with all rights reserved. No part of this publication may be reproduced, stored in a retrieval system, translated, transcribed, or transmitted, in any form, or by any means, manual, electric, electronic, electro-magnetic, mechanical, chemical, optical, or otherwise without prior explicit written permission from Sun Microsystems, Incorporated.

Printed in USA

Preface

The *Field Engineer (FE) Handbook – Technical Volumes I and II*, describes and illustrates specific Sun Microsystems, Inc. products. While Sun publishes extensive hardware documents, this handbook is a portable reference manual for Field Engineers, support personnel, and customers. Sun Field Engineers and customers equipped with the FE Handbook may perform service calls accurately and efficiently, thus reflecting Sun's commitment to quality customer service.

This handbook complements other Sun technical publications and education courses. We assume that Sun Field Engineers, support personnel, and customers who service and repair Sun products have access to these resources.

Handbook Organization

The technical information contained in the Field Engineer Handbook is organized into two volumes.

Volume I contains the following sections.

- **Configurations.** Contains illustrations identifying jumper and switch locations, and configuration tables for field replaceable boards.
- **Power Supplies.** Contains illustrations of power supplies and power distribution units with power supply specifications.

Volume II contains the following sections.

- **Parts Breakdown.** This section contains part numbers and descriptions for Sun systems, racks, options, boards, monitors, keyboard/mouse, and provides miscellaneous hardware information.
- **Troubleshooting.** This section contains error code charts for CPUs, disks, tapes, and communications.
- **Operating Systems.** Contains selected software charts.
- **Diagnostics.** Describes diagnostics tools.

Revision History

DATE	DESCRIPTION		PART NO.
6/87	First Edition		800-1819-01
11/87	Second Edition	Entire contents	800-1819-01
4/88	Third Edition	Entire contents	800-4006-01
9/88	Fourth Edition	Entire contents	800-4006-02
5/89	Fifth Edition	Entire contents	800-4006-03
10/89	Supplement	Change pages New Products	800-4704-01
5/90	Supplement	Change pages New Products	800-5140-01
12/90	Sixth Edition	Entire contents Vol-I Vol-II	800-4006-04 800-4247-02

READER COMMENT CARD

Dear Reader:

Sun Microsystems wishes to provide the best possible documentation for our products and service. Your input is critical to the quality and accuracy of the Field Engineer Handbook.

Please use the Reader Comment Card to send us your suggestions on the following:

Content Please indicate information you think should be added or deleted. Comment on any material that is missing.

Layout/Style Is the organization of this handbook useful? If not, how would you rearrange things? What would you like to see different?

Technical Errors Note any errors in technical accuracy by page.

Typographical Errors Note typographical errors by page number.

Thank you! Your feedback is appreciated.

Customer Service Division
Sun Microsystems, Incorporated

CONFIGURATIONS

Configurations

Handling Static Sensitive Devices

Electronic components on printed circuit boards can be damaged by static electricity. Always wear a grounding strap and use an antistatic mat when handling boards or components.

Overview

This section illustrates boards and peripherals. EEPROM and NVRAM programming, switch settings, and configuration notes are included. Titles include the part name, part number, and systems the part is supported in. The Option number is listed for boards and peripherals that are not installed in the system logic enclosure.

The Backplane section contains connector signals and backplane illustrations.

The Slot Assignment section contains board installation notes and cardcage slot assignment charts.

Reference Documentation

Standard Configurations and Standard Options supported by Sun Microsystems are documented in Configuration Guides, Technical Reports, Product Brochures, Price Lists, and Hardware Installation Manuals.

ID PROMs and NVRAM

Transfer the ID PROM or NVRAM when a CPU board is replaced. This component contains the hostid, ethernet address, and machine type.

DIP Switches

Rocker and Slide type DIP Switches are used in Sun products. Turn on a Rocker-type switch by pressing down the end of the switch furthest from the OPEN lettering on the switch. Turn on a Slide-type switch by sliding the switch in the direction of the arrow on the switch. Switches 1 and 2 are shown in the ON position in the illustrations below.

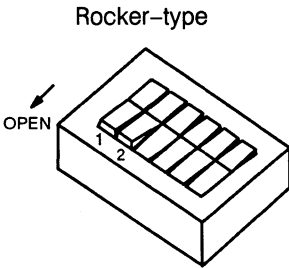

SWITCH TYPE A

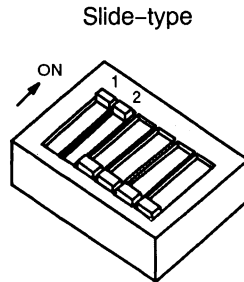

SWITCH TYPE C

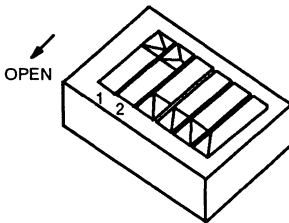

SWITCH TYPE B

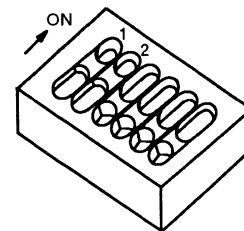

SWITCH TYPE D

CONFIGURATIONS

CPU

CPU

FIRMWARE

EEPROM and NVRAM Programming	3
ID PROM and NVRAM Information	12
Disk Controller Base Addresses	14
Booting SCSI Peripherals	15
Sun-2 Multibus	20
Sun-2 Multibus Prime	22
Sun 2050 CPU	24
Sun-3/50	28
Sun-3/60	30
Sun-3/60LE	32
Sun-3/80	34
Sun 3004 CPU	36
Sun-3/110	40
Sun 3200 CPU	42
Sun 3400 CPU	44
Sun386i/150	46
Sun386i/250	48
Sun-3/E	50
Sun-4/20	52
Sun-4/40	54
Sun-4/60	56
Sun-4/65	58
Sun-4/75	60
Sun 4100 CPU	62
Sun 4200 CPU	66
Sun 4300 CPU	70
Sun 4400 CPU	74
Sun-4E	78

This page intentionally left blank.

EEPROM and NVRAM Programming Using the Sun PROM Monitor

To program the EEPROM or NVRAM using the PROM monitor, enter **q** followed by the hexadecimal address in the EEPROM or NVRAM to open and display the contents. Change the contents by typing in the new value followed by a carriage return. To exit, type a space and <CR>, or a "." and <CR>.

Common EEPROM or NVRAM Parameters

Location 0x14 [Installed Memory]

Amount of installed Memory (in hexadecimal)

Location 0x15 [Tested Memory]

Amount of memory to test during Power On Self-Test

Location 0x16 [Monitor screen size]

00 = 1152x900 (standard resolution)

12 = 1024x1024 (1Kx1K)

13 = 1600x1280 (high resolution) (see 0x50 & 0x51)

14 = 1440x1440

15 = 1024x768 (low resolution)

Location 0x17 [Watchdog Reset Action]

00 = Watchdog Reset will fall into PROM monitor

12 = Watchdog Reset will cause a Power On Reset (default)

Location 0x18 [Operating System Boot Device]

00 = poll devices (default)

12 = use EEPROM/NVRAM specified boot device

Common EEPROM or NVRAM Parameters

Location 0x19 – 0x1a [OS Boot Device in ASCII]

xy 78	79	id	69	64
xd 78	64	gn	67	6e
sd 73	64	le	6c	65
ie 69	65			

Location 0x1b 0x1c 0x1d [Controller,Unit,Partition]

default 00 00 00 (default)

Location 0x1f [Primary Terminal]

00 = Monochrome Monitor

10 = Serial Port A

11 = Serial Port B

12 = Color Monitor and 3/60 plug-in Color Frame Buffer

20 = P4 Color Frame Buffer (Sun-3 and Sun-4)

Location 0x20 [Power-Up Banner]

00 = Sun

12 = Custom

Location 0x21 [Keyboard Click]

00 = turn click off

12 = turn click on (default)

Location 0x22 – 0x23 [Diagnostic Boot Device in ASCII]

xy 78	79	id	69	64
xd 78	64	gn	67	6e
sd 73	64	le	6c	65
ie 69	65			

Location 0x24 0x25 0x26 [Controller,Unit,Partition]

default 00 00 00 (normal setting)

Location 0x28 – 0x4f [Diagnostic Boot Path]

These 40 bytes represent the ASCII values for the desired diagnostic boot path.

Location 0x50 [Hi Res # Columns]

50 = 80 columns (standard resolution display) (default)

78 = 120 columns (full screen display)

Common EEPROM or NVRAM Parameters

Location 0x51 [Hi Res # Rows]

22 = 34 rows (standard resolution display) (default)

30 = 48 rows (full screen display)

Location 0x58 [Port A Default Baud Rate]

00 = use default 9600 baud (default)

12 = use EEPROM/NVRAM defined baud rate

Location 0x59 – 0x5a [Port A Baud Rate]

1200 baud 04 b0

4800 baud 12 c0

9600 baud 25 80

Location 0x5b [Port A DTR/RTS]

00 = assert DTR and RTS signals

12 = do NOT assert DTR and RTS signals

Location 0x60 [Port B Default Baud Rate]

00 = use default 9600 baud (default)

12 = use EEPROM/NVRAM defined baud rate

Note: In the diag position, port B is set to output at 1200 baud. The setting of location 0x60 – 0x62 is ignored.

Location 0x61 – 0x62 [Port B Baud Rate]

1200 baud 04 b0

4800 baud 12 c0

9600 baud 25 80

Location 0x63 [Port B DTR/RTS]

00 = assert DTR and RTS signals

02 = do NOT assert DTR and RTS signals

Location 0x111 [CPU Board Artwork Rev. Level] Sun386i only

0x01 = P1.5 CPU (Should not be in the field)

0x02 = 501-1241-xx and 501-1324-xx CPU Boards

0x03 = 501-1413-xx and 501-1414-xx CPU Boards

Common EEPROM or NVRAM Parameters

Location 0x112 [CPU Board Revision Level] Sun386i only

0x00 = P1.5 CPU (Should not be in the field)

0x00 = \leq 501-1241-02, Rev.15

= \leq 501-1324-02, Rev.15

0x02 = \geq 501-1241-02, Rev.16

= \geq 501-1324-02, Rev.16

0x00 = 501-1413-xx and 501-1414-xx

Location 0x154 [SCSI Spin Up Delay] Sun386i only

Boot PROM \geq 4.5

00 = no delay (default)

xx = delay in seconds

Location 0x162 [Password Mode Select] Sun386i only

Boot PROM \geq 4.5

5E = fully secure mode

01 = command secure mode

All else = non-secure mode

Location 0x163 - 0x16A [Password] Sun386i only

Boot PROM \geq 4.5

8 bytes of password in ASCII

Location 0x18f [LogoType]

00 = Sun

06 = 3D for CG6

12 = Custom

Location 0x492 [Power-On Mode] Sun386i only

07 = normal boot

06 = diagnostic boot

02 = bypass mode

Location 0x494 [Auto Config Message Flag] Sun386i only

00 = no messages

01 = Sun-3 (UNIX expert type messages)

02 = verbose messages

Common EEPROM or NVRAM Parameters

Location 0x492 [Password Mode Select]

Boot PROM $\geq 2.7.1$ (Sun-3 & Sun-4)

- 5E = fully secure mode
- 01 = command secure mode
- All else = non-secure mode

Location 0x493-0x49A [Password Bytes]

Boot PROM $\geq 2.7.1$ (Sun-3 & Sun-4)

8 bytes of password in ASCII

If the PROM Rev level is 2.8, enter a @ character before each letter of the password. Enter one letter per location, followed by <Return>. If the password is less than 8 letters, enter 00 in the remaining locations.

The hexadecimal equivalent of the letters can also be used to enter the password.

Location 0x70B [Power-On Mode] (Sun-3/80 only)

Boot PROM ≥ 2.3

- 06 = normal boot
- 12 = diagnostic mode
- All else = full diagnostic boot

References

1. *Sun Bootstrap PROM Security Features User's Guide for the Sun Workstation*, 800-8836.
2. *Sun Workstation Bootstrap PROM Security Features User's Guide*, 800-8843.
3. *Sun-3/80 Self-Tests and Monitor Commands*, 800-5027.
4. *SPARCsystem 300 Series Self-Tests and Monitor Commands*, 800-4950.
5. *SPARCsystem 400 Series Self-Tests and Monitor Commands*, 800-4833.
6. *PROM User's Manual*, 800-1736.
7. *EEPROM Users Guide for Sun-3, Sun-4, and SPARCsystems 300/400*, 800-3512.
8. *Boot PROM User's Guide*, 800-4852.

NVRAM Programming Using the Open PROM Toolkit

Parameters are set by name and may vary between system types. Examples in this section are from the Sun-4/40 Boot EPROM 1.6 Version 151, part number 525-1085-03.

The old command mode options are:

b (boot), **c** (continue), or **n** (new command mode)

To enter the new command mode, type **n** at the system prompt:

```
> n
```

The system prompt in the new command mode changes from ">" to "ok" and the help banner is displayed.

Type **help** for more information.

```
ok help
```

Enter 'help command-name' or 'help category-name' for more help.
(Use ONLY the first word of a category-name or category description)

Examples: help select -or- help line

Main categories are:

File download and boot

Resume execution

Diag (diagnostic routines)

Select I/O devices

System and boot configuration parameters

Line editor

Tools:(memory,numbers,new commands,loops)

Assembly debugging:(breakpoints,registers,disassembly,symbolic)

>-prompt

Power on reset

Floppy eject

Sync (synchronize disk data)

ok

NVRAM Programming Using the Open PROM Toolkit

The **printenv** command displays NVRAM parameter names, current values, and default values.

ok printenv

PARAMETER NAME	VALUE	DEFAULT VALUE
selftest-#megs	1	1
oem-logo		
oem-logo?	false	false
oem-banner		
oem-banner?	false	false
ttyb-mode	9600,8,n,1,-	9600,8,n,1,-
ttya-mode	9600,8,n,1,-	9600,8,n,1,-
sbus-probe-list	0123	0123
fcode-debug?	false	false
screen-#columns	80	80
screen-#rows	34	34
use-nvramrc?	false	false
nvramrc		
boot-from-diag	le()vmunix	le()vmunix
boot-from	vmunix	vmunix
auto-boot?	true	true
watchdog-reboot?	false	false
input-device	keyboard	keyboard
output-device	screen	screen
keyboard-click?	false	false
sunmon-compat?	true	true
security-mode	none	none
security-password		
security-#badlogins	0	0
sd-targets	31204567	31204567
st-targets	45670123	45670123
scsi-initiator-id	7	7
ttyb-rts-dtr-off	false	false
ttyb-ignore-cd	true	true
ttya-rts-dtr-off	false	false
ttya-ignore-cd	true	true
hardware-revision		
last-hardware-update		
testarea	0	0
mfg-switch?	false	false
diag-switch?	false	false

NVRAM Programming Using the Open PROM Toolkit

To show a specific parameter, enter **show** and the parameter name. For example:

```
ok show selftest-#megs
1
ok
```

To change a parameter, use the **setenv** command. For example, to change the number of megabytes tested at power on:

```
ok setenv selftest-#megs 8
```

The **set-defaults** command restores the default setting of all parameters.

Other commonly used commands are shown below.

OPTION	DESCRIPTION
banner	Displays the selftest banner message.
.version	Displays the version and date of boot PROM.
.enet-addr	Displays the Ethernet address.
.idprom	Displays the ID PROM contents.
input [source]	Selects source for input (ttya, ttyb, or keyboard).
output [source]	Selects source for output (ttya, ttyb, or keyboard).
reset	Resets entire system, similar to old k2.
soft-reset	Soft reset, similar to old k1.
eject-floppy	Ejects floppy diskette from the drive.
security-mode	Allows user to select security mode.
	non-secure mode enter none
	command secure mode enter command
	full secure mode enter full
security-password	Allows user to enter a security password.
	Enter up to 8 bytes of password in ASCII.
probe-scsi	Displays addresses and types of SCSI devices.

NVRAM Programming Using the Open PROM Toolkit

The `use-nvramrc?` Parameter

For normal operation, set the `use-nvramrc?` parameter to false. The system will not complete selftest if `use-nvramrc?` is true and there are no entries in `nvramrc`. The `nvramrc` parameter is a series of Forth commands used for system initialization. The `nvramrc` parameter is normally empty. There is no documentation available on how to use this feature.

OpenBoot PROM Power On Commands

The following commands are initialized by depressing multiple keys on the keyboard during a power on reset.

L1-D forces a diagnostic power on. The NVRAM parameter `diag-switch?` is set to true.

L1-F forces input and output to `ttya`. Input from the keyboard is disabled except for L1-A.

L1-N forces a `set-defaults` of the NVRAM.

ID PROM and NVRAM Information

The ID PROM or NVRAM on Sun CPU boards contains identification information including a machine-type code, serial number, and hardware ethernet address.

The machine-type code and serial number are combined to create the `hostid` number that allows use of restricted software on authorized machines.

ID PROMs and NVRAMs are not interchangeable between different CPU board types. For example, if a machine is upgraded from a Sun-3/260 to a Sun-4/260, the upgraded machine requires a new ID PROM.

The `hostid` command under SunOS displays the serial number in hexadecimal. The printed label on the ID PROM and the power-on Self Test banner serial number are in decimal. Do not rely on the printed label on the ID PROM to verify the ID PROM or NVRAM device for a system. Follow the steps in the example below to verify the ID PROM or NVRAM.

The printed label on the ID PROM in a 3/160C workstation is **3 1774**. The system power-on Self Test serial number is **#1774**.

1. Convert the 1774 decimal number to a hexadecimal value of 006EE.
2. Add this number to the `hostid` machine-type code for a `hostid` of 110006ee.
3. Use the `hostid` command under SunOS to display the system `hostid` of **11006ee**.

IDPROM and NVRAM Information

The chart below contains the System Type, HostID, label legend, device type, Sun part number, and socket location for IDPROMS and NVRAMS used on Sun CPU boards.

SYSTEM TYPE	HOSTID	PRINTED LABEL	DEVICE TYPE	SUN PART NUMBER	LOCATION
100U/150U	100xxxx	xxxx	IDPROM	520-1042-01	U411
120/170	100xxxx	xxxx	IDPROM	520-1042-01	U411
2/50/130/160	200xxxx	xxxx	IDPROM	520-1039-01	U510
3/75/140/150	1100xxxx	3 xxxx	IDPROM	520-1221-01	U1409
3/160/180	1100xxxx	3 xxxx	IDPROM	520-1221-01	U1409
3/50	1200xxxx	4 xxxx	IDPROM	520-1295-01	U0204
3/260/280	1300xxxx	5 xxxx	IDPROM	520-1322-01	U1907
3/110	1400xxxx	6 xxxx	IDPROM	520-1412-01	U1409
3/60	1700xxxx	0 xxxx	IDPROM	520-1559-01	U224
3E	1800xxxx	9 xxxx	IDPROM	520-8049-01	U224
3/460/470/480	4100xxxx	D xxxx	IDPROM	523-2127-01	U1701
3/80	4200xxxx		NVRAM	525-1031-01	U0205
4/260/280	2100xxxx	A xxxx	IDPROM	520-1532-01	U1901
4/110/150	2200xxxx	B xxxx	IDPROM	520-1638-01	U805
4/3xx	2300xxxx	C xxxx	IDPROM	523-2136-01	U2202
4/3xx	None	None	NVRAM	100-1628-01	U2200
4/470/490	2400xxxx		IDPROM	525-1100-01	U1404
4/470/490	None	None	NVRAM	100-1628-01	U3505
4/60	5100xxxx	None	NVRAM	525-1032-01	U089
4/40	5200xxxx	None	NVRAM	525-1084-01	U0901
4/65	5300xxxx	None	NVRAM	525-1109-01	U089
4/20	5400xxxx	None	NVRAM	520-2749-01	U1011
4/75	5800xxxx	None	NVRAM	525-1107-01	U0512
4E	6100xxxx	None	NVRAM	523-8151-01	U1101
Sun386i	3100xxxx	xxxx	IDPROM	520-1811-01	U601
Sun386i	None	None	NVRAM	100-1628-01	U603
 Serial # in hexadecimal					
Machine-type					

Disk Controller Base Addresses

Sun-2

Host Adapter	UNIX Device	Multibus 1st	Address 2nd	VMEbus Address 1st
Sun2 SCSI	sc	80000	84000	200000*

Host Adapter	UNIX Device	Multibus 1st	Address 2nd	VMEbus Address 1st	VMEbus Address 2nd
Xylogics 450	xy	ee40	ee48	ee40	ee48
Xylogics 451	xy	n/a	n/a	ee40	ee48

* SunOS revisions below 3.x use ee2800 as the SCSI base address.

Sun-3 & Sun-4

Host Adapter	UNIX Device	VMEbus Address
Sun2 SCSI	sc	200000
Sun3 SCSI	si	200000
3/50 SCSI	si	140000
3/60 SCSI	si	140000
3/E SCSI	se	310000
4/110 SCSI	sw	a000000

Controller	UNIX Device	VMEbus Address			
		1st	2nd	3rd	4th
Xylogics 450/451	xy	ee40	ee48	n/a	n/a
Xylogics 7053	xd	ee80	ee90	eea0	eeb0
ISP-80	id	00FF	01FF	02FF	03FF

SMD & ESMD Disk Drive Default Drive Type Parameters

Default Drive Type	DISK DRIVE MODEL		
	0	M2351	
1	CDC-9720-368	Hitachi-DK815-10	M2312
2	M2322/M2284	NEC 02363	
3	M2333	M2361	

The "drive type" parameter used by the Xylogics 450/451 identifies a drive by the number of cylinders, heads, and sectors. Disk drives which use the same "drive type" parameter, but have a different number of cylinders, heads, or sectors, may not be mixed on the same controller (eg. an M2333 and a M2361). This parameter is not used by the Xylogics 7053.

Booting SCSI Peripherals from the Sun PROM Monitor

Legend

DBP = Desktop Backup Pack (Lunchbox)

DDP = Desktop Disc Pack (Lunchbox)

ESM = External Storage Module (P-Box)

EEM = External Expansion Module (P-Box)

Sun-3/80

SCSI DEVICE	TARGET ID	UNIX ID	BOOT ID
1st Internal Disk	3	sd6	sd(0,18,0)
2nd Internal Disk	1	sd2	sd(0,8,0)
1st Internal Tape	4	st0	st(0,0,0)
1st DDP Disk	0	sd0	sd(0,0,0)
2nd DDP Disk	2	sd4	sd(0,10,0)
3rd DDP Disk	1	sd2	sd(0,8,0)
4th DDP Disk	3	sd6	sd(0,18,0)
1st DBP Tape	4	st0	st(0,0,0)
2nd DBP Tape	5	st1	st(0,28,0)
1st ESM Disk	0	sd0	sd(0,0,0)
2nd ESM Disk	2	sd4	sd(0,10,0)
1st ESM Tape	4	st0	st(0,0,0)
1st EEM Disk	1	sd2	sd(0,8,0)

Sun-4/20

SCSI DEVICE	TARGET ID	UNIX ID	BOOT ID
1st DDP Disk	0	sd3	sd(0,3,0)
2nd DDP Disk	2	sd2	sd(0,2,0)
3rd DDP Disk	1	sd1	sd(0,1,0)
4th DDP Disk	3	sd0	sd(0,0,0)
1st DBP Tape	4	st0	st(0,0,0)
2nd DBP Tape	5	st1	st(0,1,0)
1st ESM Disk	0	sd3	sd(0,3,0)
2nd ESM Disk	2	sd2	sd(0,2,0)
1st ESM Tape	4	st0	st(0,0,0)
1st EEM Disk	1	sd1	sd(0,1,0)
CD-ROM	6	sr0	sd(0,6,2)

Booting SCSI Peripherals from the Sun PROM Monitor

Sun-4/40

SCSI DEVICE	TARGET ID	UNIX ID	BOOT ID
1st Internal Disk	3	sd0	sd(0,0,0)
1st DDP Disk	0	sd3	sd(0,3,0)
2nd DDP Disk	2	sd2	sd(0,2,0)
3rd DDP Disk	1	sd1	sd(0,1,0)
4th DDP Disk	3	sd0	sd(0,0,0)
1st DBP Tape	4	st0	st(0,0,0)
2nd DBP Tape	5	st1	st(0,1,0)
1st ESM Disk	0	sd3	sd(0,3,0)
2nd ESM Disk	2	sd2	sd(0,2,0)
1st ESM Tape	4	st0	st(0,0,0)
1st EEM Disk	1	sd1	sd(0,1,0)
CD-ROM	6	sr0	sd(0,6,2)

Sun-4/60

SCSI DEVICE	TARGET ID	UNIX ID	BOOT ID
1st Internal Disk	3	sd0	sd(0,0,0)
2nd Internal Disk	1	sd1	sd(0,1,0)
1st Internal Tape	4	st0	st(0,0,0)
1st DDP Disk	0	sd3	sd(0,3,0)
2nd DDP Disk	2	sd2	sd(0,2,0)
3rd DDP Disk	1	sd1	sd(0,1,0)
4th DDP Disk	3	sd0	sd(0,0,0)
1st DBP Tape	4	st0	st(0,0,0)
2nd DBP Tape	5	st1	st(0,1,0)
1st ESM Disk	0	sd3	sd(0,3,0)
2nd ESM Disk	2	sd2	sd(0,2,0)
1st ESM Tape	4	st0	st(0,0,0)
1st EEM Disk	1	sd1	sd(0,1,0)
CD-ROM	6	sro	sd(0,6,2)

Sun-4/330

SCSI DEVICE	TARGET ID	UNIX ID	BOOT ID
1st Internal Disk	3	sd6	sd(0,18,0)
2nd Internal Disk	1	sd2	sd(0,8,0)
1st Internal Tape	4	st0	st(0,0,0)
1st DBP Tape	4	st0	st(0,0,0)
2nd DBP Tape	5	st1	st(0,28,0)
1st ESM Disk	0	sd0	sd(0,0,0)
2nd ESM Disk	2	sd4	sd(0,10,0)
1st ESM Tape	4	st0	st(0,0,0)
1st EEM Disk	1	sd2	sd(0,8,0)
CD-ROM	6	sr0	sd(0,30,1)

Booting SCSI Peripherals from the Sun PROM Monitor

Sun-4/370/470 & Sun-3/470

SCSI DEVICE	TARGET ID	UNIX ID	BOOT ID
1st Internal Disk	0	sd0	sd(0,0,0)
2nd Internal Disk	1	sd2	sd(0,8,0)
3rd Internal Disk	2	sd4	sd(0,10,0)
4th Internal Disk	3	sd6	sd(0,18,0)
1st Internal Tape	4	st0	st(0,0,0)
2nd Internal Tape	5	st1	st(0,28,0)
CD-ROM	6	sr0*	sr(0,30,1)

Sun-4/390/490 on SunOS 4.0.3

SCSI DEVICE	HOST ADAPTER	TARGET ID	UNIX ID	BOOT ID
1st Tape	1st SCSI	4	st0	st(0,0,0)
2nd Tape	1st SCSI	5	st1	st(0,28,0)
CD-ROM	1st SCSI	6	sr0*	sr(0,30,1)
1st Tape	2nd SCSI	4	st2	st(1,0,0)
2nd Tape	2nd SCSI	5	st3	st(1,28,0)

Sun-4/390/490 on SunOS 4.1 PSR A

SCSI DEVICE	HOST ADAPTER	TARGET ID	UNIX ID	BOOT ID
1st Tape	1st SCSI	4	st0	st(0,0,0)
2nd Tape	1st SCSI	5	st1	st(0,28,0)
3rd Tape	1st SCSI	3	st2	st(0,18,0)
4th Tape	1st SCSI	2	st3	st(0,10,0)
CD-ROM	1st SCSI	6	sr0*	sr(0,30,1)
1st Tape	2nd SCSI	4	st2	st(1,0,0)
2nd Tape	2nd SCSI	5	st3	st(1,28,0)
3rd Tape	2nd SCSI	3	st6	st(0,18,0)
4th Tape	2nd SCSI	2	st7	st(1,10,0)

* The Sun 4300 CPU requires EPROM 3.0.2 to boot from CD-ROM.
The Sun 4400 CPU requires EPROM 3.0 to boot from CD-ROM.

Booting SCSI Peripherals from the Open Boot PROM

Sun-4/75

SCSI DEVICE	COMMAND	BOOT PATH	TARGET ID	UNIX ID
Internal Disk	boot disk	/sbus/esp/sd@3,0	3	sd0
Internal Disk	boot disk0	/sbus/esp/sd@3,0	3	sd0
Internal Disk	boot disk1	/sbus/esp/sd@1,0	1	sd1
External Disk	boot disk2	/sbus/esp/sd@2,0	2	sd2
External Disk	boot disk3	/sbus/esp/sd@0,0	0	sd3
1st Tape	boot tape	/sbus/esp/st@4,0	4	st0
1st Tape	boot tape0	/sbus/esp/st@4,0	4	st0
2nd Tape	boot tape1	/sbus/esp/st@5,0	5	st1
CD-ROM	boot cdrom	/sbus/esp/sd@6,0:c	6	sr0
Floppy	boot floppy	/fd	---	fd0

This page intentionally left blank.

Sun-2 Multibus

Sun-2/100U/120/150U/170

501-1007

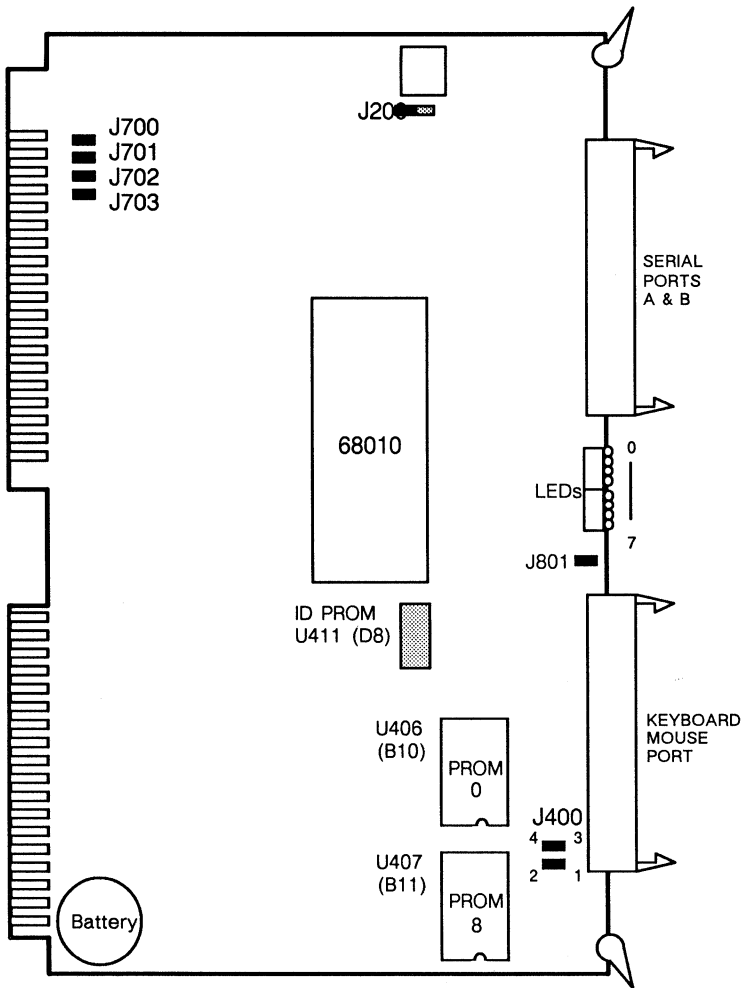

Power: 6.0 Amps @ +5Vdc
30.0 Watts

501-1007 Jumper Settings

JUMPER	PINS	SETTING	DESCRIPTION
J200	1-2	In	Crystal Shunt
J400/ J401	1-2 3-4	In Out	Select 27128 EPROMs Select 27256 EPROMs
J700	1-2	Out * In	Priority on serial arbiter For Sun-2/100U BPRO
J701	1-2	Out * In	Common bus request arbiter BPRN For Sun-2/100U CBRQ
J702	1-2	In	CPU drives P1.CCLK
J703	1-2	In	CPU drives P1.BCLK
J801	1-2	In	100U/150U only, remainder not used (Mouse) VCC

*May cause problems with Tapemaster Controller settings.

Notes

1. SunOS 2.0 and above requires Revision N or greater EPROMs.
2. CPU boards with EPROM Revision N or below may require the addition of shunts at J1600 on the 501-1052-01/02 video board to operate properly with SunOS 3.0 and greater.
3. The 501-1007 CPU has a RasterOP function. The 501-1051 CPU does not have a RasterOp function.
4. Change J400, Pins 1-2, Out and Pins 3-4, In, for 1.1.2 Boot EPROM for Sun-2/120 or Sun-2/170.
5. J701 must be installed for SunOS 4.0, unless the kernel has been patched.
6. The Sun-2/100U/150U CPU requires Boot EPROM Rev Q, part numbers 520-1103-02 and 520-1104-02, for the VT100 keyboard.
7. The last software release for 68010 systems is SunOS 4.0.3.

References

1. *Hardware Installation Manual for the Sun-2/120*, 800-1170.
2. *Hardware Installation Manual for the Sun-2/170*, 800-1171.

Sun-2 Multibus Prime

Sun-2/120/170

501-1051

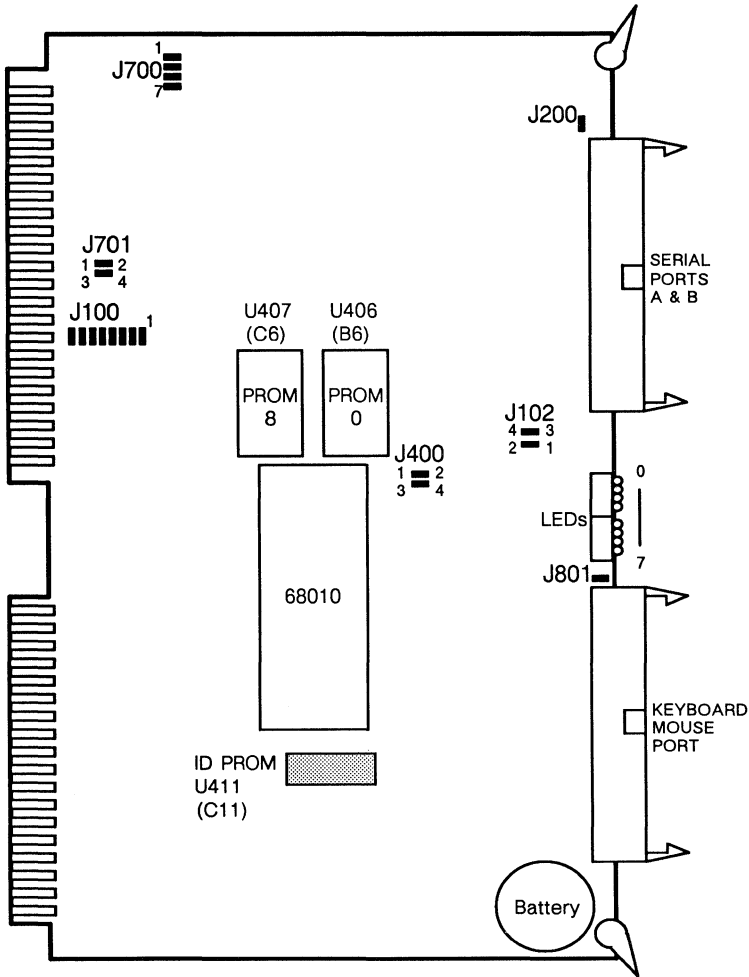

Notes

1. CPU boards with EPROM revision N or below may require the addition of shunts at J1600, Pins 1-8, on the 501-1052-01/02 video board to operate properly with SunOS 3.0 or greater.
2. Change J400, Pins 1-2, OUT, and Pins 3-4, IN, for 1.1.2 EPROM.

501-1051 Jumper Settings

JUMPER	PINS	SETTING	DESCRIPTION
J100	1-2	*	P1.INT0
	3-4	*	P1.INT1
	5-6	*	P1.INT2
	7-8	*	P1.INT3
	9-10	*	P1.INT4
	11-12	*	P1.INT5
	13-14	*	P1.INT6
	15-16	*	P1.INT7
J102	1-2	*	Connection to P1--5V
	3-4	Out	Connection to P1--5Reg.
J200	1-2	In	Crystal shunt
J400	1-2	In	Select 27128 EPROMs
	3-4	Out	Select 27256 EPROMs
J700	1-2	In	CPU drives P1 reset
	3-4	Out	P1.INT drives CPU reset
	5-6	Out	Serial arbiter enable
	7-8	Out	Arbiter bus configuration select
J701	1-2	In	CPU drives P1.BCLK
	3-4	In	CPU drives P1.CCKL
J801	1-2	Out	Not used

* Hardwired

Notes

1. The 501-1007 CPU has a RasterOP function. The 501-1051 CPU does not have a RasterOP function.
2. The last software release for 68010 systems is SunOS 4.0.3.

References

1. *Hardware Installation Manual for the Sun-2/120*, 800-1170.
2. *Hardware Installation Manual for the Sun-2/170*, 800-1171.

Sun 2050 CPU

Sun-2/50

501-1141 501-1142 501-1143
 1MB 2MB 4MB

Sun-2/130/160

501-1144 501-1145 501-1146
 1MB 2MB 4MB

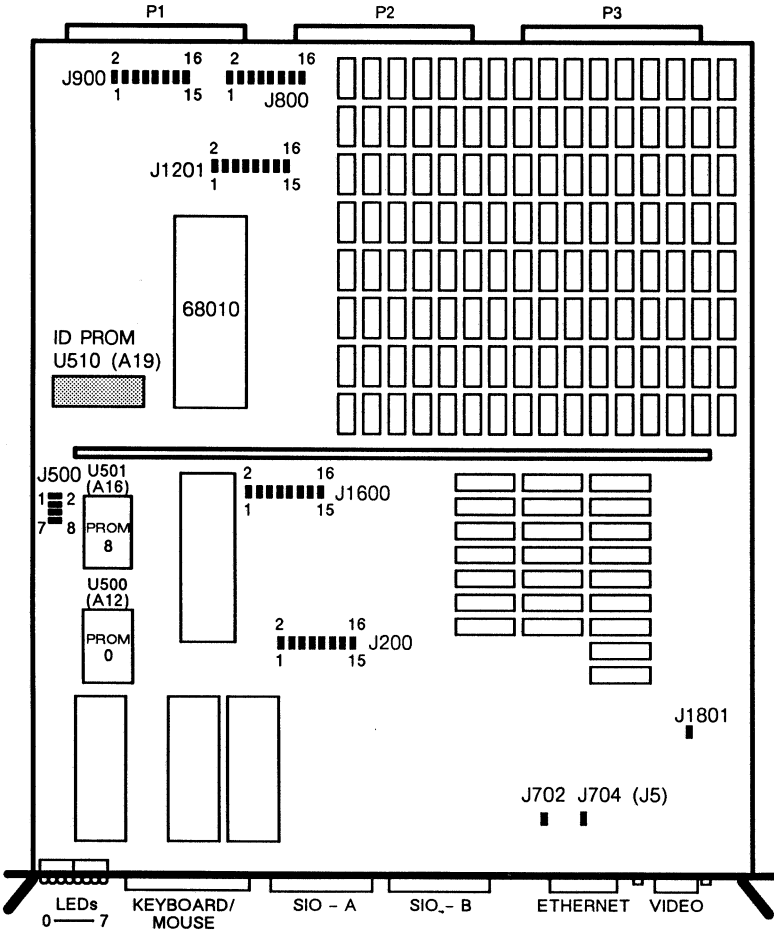

Power: 12.0 Amps @ +5Vdc
 1.0 Amps @ +12Vdc
 0.5 Amps @ -12Vdc
 78.0 Watts

501-1141 501-1142 501-1143
 501-1144 501-1145 501-1146

Jumper Settings

JUMPER	PINS	SETTING	DESCRIPTION
J200	1-2	In	UART clock
	3-4	In	10/12 MHz CPU operation
	5-6	Out	12/10 MHz CPU operation
	7-8	Out	Reserved
	9-10	Out	Reserved
	11-12	In	Ethernet clock
	13-14	In	Memory refresh
	15-16	In	Time outs
J500 *	1-2	In	PROM type=27128
	3-4	Out	PROM type=27256 or 27512
	5-6	In	PROM type=27128 or 27256
	7-8	Out	PROM type=27512
J702	1-2	Out	5V to Ethernet, Pin 7
J704	1-2	In	Level 1 Ethernet transceiver
		Out	Level 2 Ethernet transceiver
J800	1-2	In	VME interrupt level 1
	3-4	In	VME interrupt level 2
	5-6	In	VME interrupt level 3
	7-8	In	VME interrupt level 4
	9-10	In	VME interrupt level 5
	11-12	In	VME interrupt level 6
	13-14	In	VME interrupt level 7
	15-16	Out	Not used

*Change J500, Pins 3-4, 7-8, In, and Pins 1-2, 5-6, Out, for 1.1.2 EPROM.

Note: The last software release for 68010 systems is SunOS 4.0.3.

References

1. *Hardware Installation Manual for the Sun-2/50*, 800-1143.
2. *Hardware Installation Manual for the Sun-2/130 and Sun-2/160*, 800-1144.

501-1141 501-1142 501-1143
 501-1144 501-1145 501-1146

Jumper Settings – Continued

JUMPER	PINS	SETTING	DESCRIPTION	
J900	1-2	In	DVMA address comparator A20=0/1	
	3-4	In	DVMA address comparator A21=0/1	
	5-6	In	DVMA address comparator A22=0/1	
	7-8	In	DVMA address comparator A23=0/1	
	9-10	In	VME arbiter	
	11-12	In	VME reset master	
	13-14	Out	Reset slave	
	15-16	In	VME system clock	
J1201	1MB (64K Rams)		3MB (256K Rams)	
	5-6	In	1-2	In
	9-10	In	3-4	In
	13-14	In	7-8	In
			11-12	In
			15-16	In
	2MB (256K Rams)		4MB (256K Rams)	
	1-2	In	1-2	In
	7-8	In	3-4	In
	11-12	In	7-8	In
	15-16	In	11-12	In
			15-16	In
J1600	1-2	In	Video register sense bit 0	
	3-4	In	Video register sense bit 1 *	
	5-6	In	Video register sense bit 2	
	7-8	In	Video register sense bit 3	
	9-10	Out	Reserved	
	11-12	Out	Reserved	
	13-14	In	10/12 MHz CPU operation	
	15-16	Out	12/10 MHz CPU operation	
J1801	1-2	In	Enable/disable 100MHz video CLK	

*J1600, Pins 3-4, must be OUT if a color PCB is installed.

This page intentionally left blank.

Sun-3/50

501-1075 501-1133 501-1162 501-1207

w/o FPP
w FPP

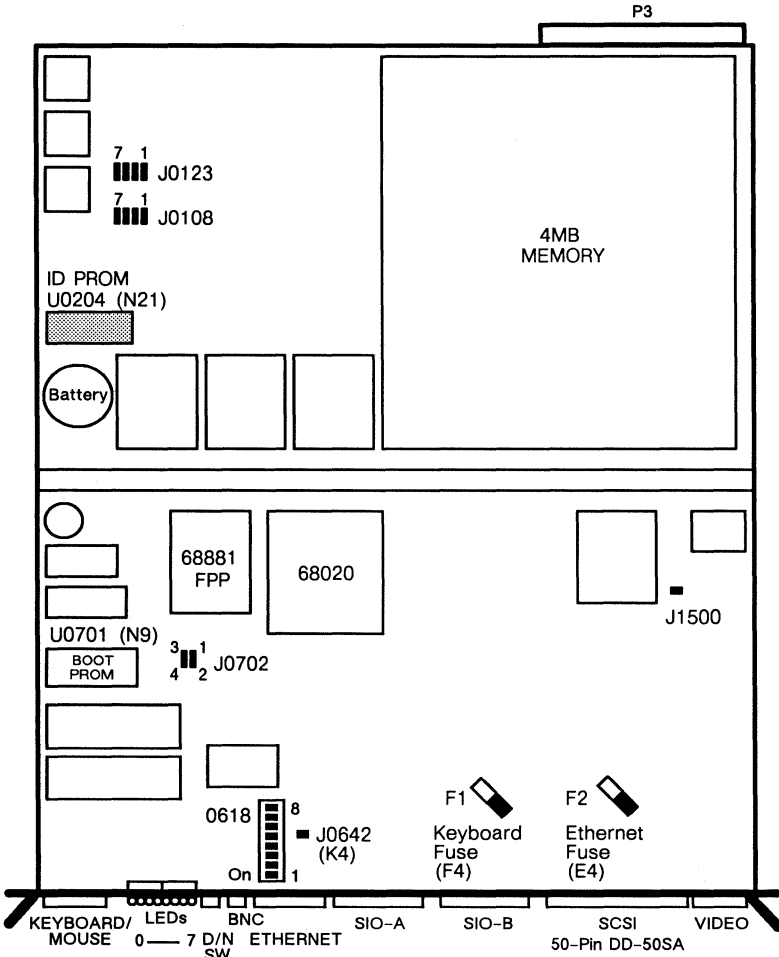

Power: 13.5 Amps @ +5Vdc
 0.8 Amps @ -5Vdc
 0.5 Amps @ +12Vdc
 100.0 Watts

Notes

1. CPU EPROM 1.8 or greater is required to load SunOS 1/4" distribution tapes in QIC-24 format.
2. CPU EPROM 2.5 or greater is required to load SunOS 1/4" distribution tapes in QIC-24 format from a Sun-2 Shoebox.

501-1075 501-1133 501-1162 501-1207 Jumper & Switch Settings

JUMPER	PINS	SETTING	DESCRIPTION
J0108	1-2	In	Diag test 4 MB main memory ETH SIA CAL. test SCSI on (on is active high) DCP on (on is active high)
	3-4	Out	
	5-6	Out	
	7-8	In	
J0123	1-2	In	68020 CLK 15MHz 68020 CLK 12.5MHz 68881 CLK 12.5MHz 68881 CLK 15MHz
	3-4	Out	
	5-6	Out	
	7-8	In	
J0642	1-2	In	Level 1 Ethernet transceiver Level 2 Ethernet transceiver
		Out	
J0702	1-2	Out	27256 K BOOT PROM 27512 K BOOT PROM
	3-4	In	
J1500	1-2	In	100 MHz video CLK

DIP SWITCH	SWITCH	SETTING	DESCRIPTION
0618	1-8	Off	Set for Ethernet Set for Thin Ethernet
	1-8	On*	

*Factory Setting

Notes

1. For SunOS 3.3 and greater, this CPU may fail with revisions lower than 501-1075-10, 501-1162-08, and 501-1133-10.
2. For SunOS 3.3, the Sysgen 1/4" tape controller, 370-1011, will not work with this board.
3. A bus error may occur when large executables are run during a prefetch across the page boundary with board revisions lower than 501-1162-11 or 501-1207-04.

Reference

Hardware Installation Manual for the Sun 3/50M, 800-1355.

Sun-3/60

501-1205

4MB w Mono

501-1322

4MB w/o Mono

501-1334

0MB w Mono

501-1345

0MB w/o Mono

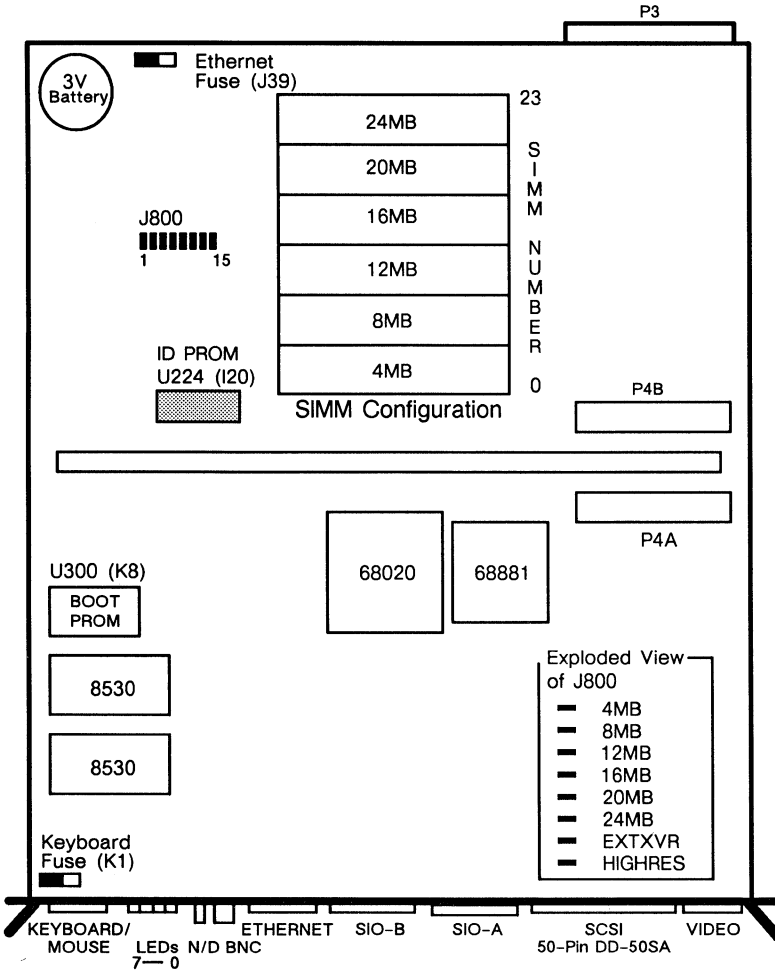

Note: CPU EPROM 1.6 or greater is required to load SunOS 1/4" distribution tapes in QIC-24 format.

501-1205 501-1322 501-1334 501-1345 Jumper Settings

JUMPER	PINS	SETTINGS	DESCRIPTION
J800	1-2	*	Select 4MB
	3-4	*	Select 8MB
	5-6	*	Select 12MB
	7-8	*	Select 16MB
	9-10	*	Select 20MB
	11-12	*	Select 24MB
	13-14	Out	Ethernet auto select †
	13-14	In	Select Ethernet
	13-14	Out	Select Thin Ethernet
	15-16	Out	Monitor auto select †§£
	15-16	Out	Select 1152 x 900 resolution
	15-16	In	Select 1600 x 1280 resolution

* Jumper installation depends on memory configuration.

† Factory setting

§ Must be used with mono video cable 530-1359 or 530-1336 for auto select to operate.

£ Hi Resolution Monitor, 540-1427, must be Motorola revision T or greater for auto select to operate.

Power

501-1205 10.1 Amps @ +5Vdc
0.7 Amps @ -5Vdc
44.1 Watts

501-1322 8.9 Amps @ +5Vdc
0.3 Amps @ -5Vdc
48.1 Watts

Notes

1. This board uses 1MB SIMM module, 501-1239.
2. On CPU boards with part numbers ≤501-1205-09, 501-1322-01, 501-1334-01, and 501-1345-01, SCSI Bus Pin 26 (TERMPWR) is connected to ground.

Reference

Hardware Installation Manual for the Sun-3/60 Workstation, 800-1987.

Sun-3/60LE

501-1378

4MB w/o Mono

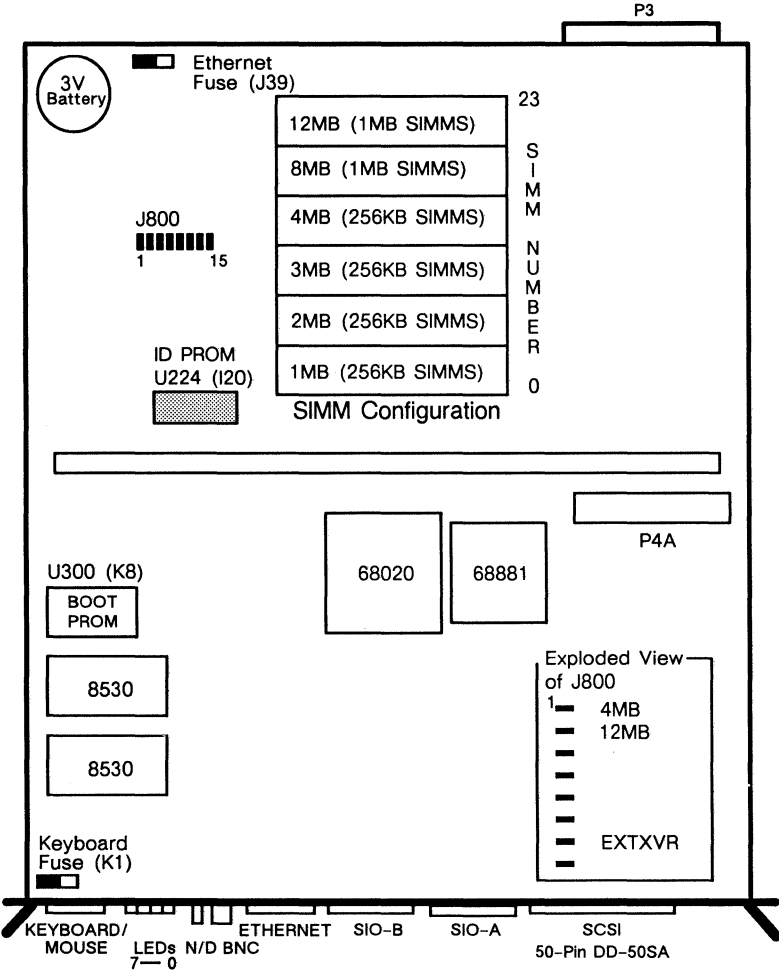

501-1378 Jumper Settings

JUMPER	PINS	SETTINGS	DESCRIPTION
J800	1-2	In	Select 8MB
	3-4	In	Select more than 8MB
	5-6	In/Out	Not connected
	7-8	In/Out	Not connected
	9-10	In/Out	Not connected
	11-12	In/Out	Not connected
	13-14	Out	Ethernet auto select
	13-14	In	Select Ethernet
	13-14	Out	Select Thin Ethernet
	15-16	In/Out	Not connected

Notes

1. Memory slots 0 to 15 use 256KB SIMM module, 501-1349.
2. Memory slots 16 to 23 use 1MB SIMM module, 501-1346.
3. The maximum amount of memory is 12MB.

Reference

Hardware READ ME FIRST for the Sun-3/60 and Sun-3/60LE Systems, 800-3065.

Sun-3/80

≥501-1401-10

501-1401

501-1650

4MB
FCC-A/VCCI-1

4MB

4MB
FCC-A/VCCI-1

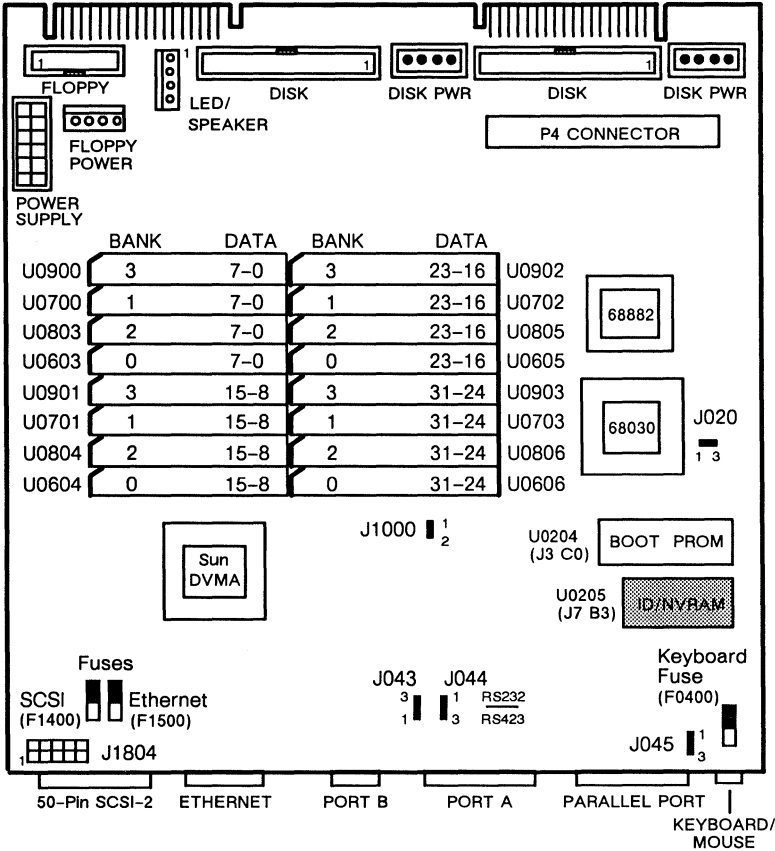

Power: 4.6 Amps @ +5Vdc
23.0 Watts

Notes

1. This board uses 1MB SIMM module, 501-1408.
2. SIMM modules must be installed in 1 bank increments.
3. SCSI port, Pin 38, is fused (F1400) with 1.5A Fuse, 150-1383.
4. F0400 and F1500 use 2A Fuses, 150-1174.
5. CPU boards ≤501-1401-07 do not meet the P4 Bus specifications.
6. This board uses SCSI terminator assembly, 150-1537.

501-1401 501-1650 Jumper Settings

JUMPER	PINS	SETTING	DESCRIPTION
J1000	1-2	Out	Watchdog reset (test only)
J020	1-2	In*	20 MHz 68882 clock
J020	2-3	Out	40 MHz 68882 clock
J043	2-3	In*	RS-232, Ports A and B
J044	1-2	In*	RS-232, Ports A and B
J043	1-2	In	RS-423, Ports A and B
J044	2-3	In	RS-423, Ports A and B
J045	1-2	Out	Enable transmit data to mouse
J045	2-3	In*	GND transmit data to mouse

*Factory Setting

Sun 3004 CPU

Sun-3/75/140/150/160/180

501-1074 501-1094 501-1163 501-1164

2MB

4MB

2MB

4MB

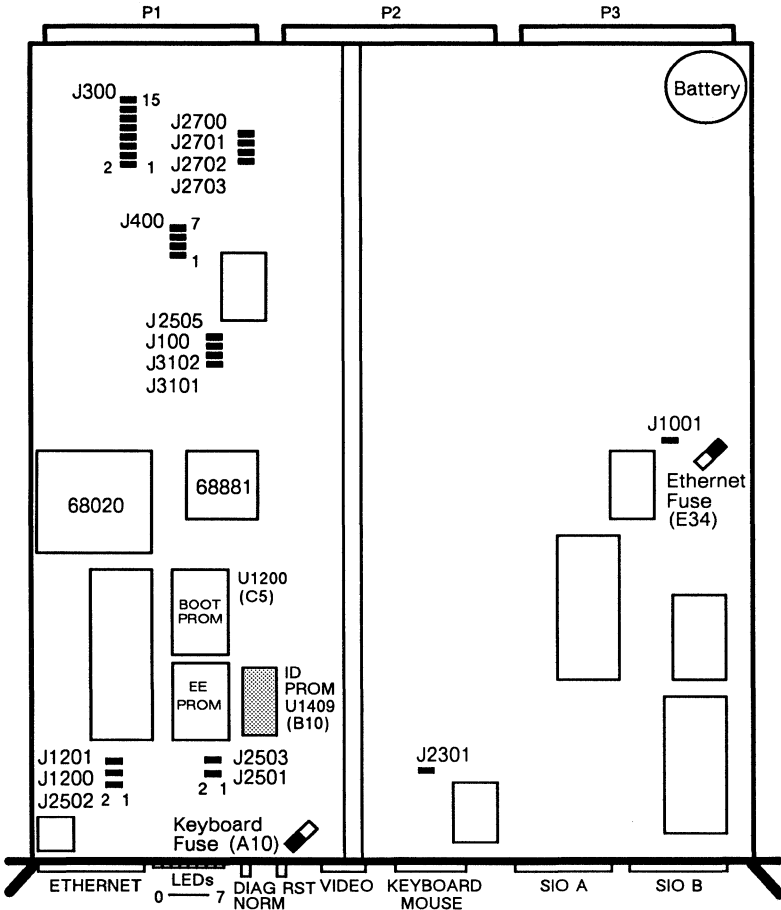

Notes

1. CPU EPROM 1.8 or greater is required to load SunO 1/4" distribution tapes in QIC-24 format.
2. CPU EPROM 2.6 or greater is required to load SunO 1/4" distribution tapes in QIC-24 format from a Sun-2 Shoebox.
3. CPU EPROM 2.6 or greater is required for the Xylogics 7053 disk controller.
4. To install with a VME 32-bit data device (MCP, ALM-2, SCA, HSI, Xylogics 7053, SCSI-3, or TAAC-1), the CPU revision must be 501-1094-22, 501-1074-22, 501-1163-09, 501-1164-09, or greater.

501-1074 501-1094 501-1163 501-1164 Jumper Settings

JUMPER	PINS	SETTING	DESCRIPTION
J300	1-2	Not used	Not used
	3-4	In	VME interrupt level 1
	5-6	In	VME interrupt level 2
	7-8	In	VME interrupt level 3
	9-10	In	VME interrupt level 4
	11-12	In	VME interrupt level 5
	13-14	In	VME interrupt level 6
	15-16	In	VME interrupt level 7
J400	1-2	In	Enable 16.67MHz CPU clock
	3-4	Out	Enable 12.5MHz CPU clock
	5-6	Out	Enable 12.5MHz FFP clock
	7-8	In	Enable 16.67MHz FFP clock
J1001	1-2	In	Enable SCC clock
J1201	5-6	In	If 27512 Boot PROM
J1200	3-4	Out	If 27256 Boot PROM
J2502	1-2	In	Enable VME clock
J2301	1-2	In	Enable Video clock
J2503	1-2	Out	VCC - Pin 7 on Ethernet
J2501	1-2	In	Enable Ethernet CLK
J2700	7-8	Out	Enable VME request only
J2701	5-6	In	Enable VME request/arbiter
J2702	3-4	Out	Enable VME reset slave
J2703	1-2	In	Enable VME reset master
J3101	1-2	In	2MB CPU
J3102	3-4	In	4MB CPU
J100	5-6	Out	Cache disable
J2505	7-8	In	Level 1 Ethernet transceiver
		Out	Level 2 Ethernet transceiver

Power

2MB	14.6 Amps @ +5Vdc
	0.8 Amps @ -5Vdc
	77.2 Watts
4MB	15.2 Amps @ +5Vdc
	0.8 Amps @ -5Vdc
	80.2 Watts

Reference: *Sun 3004 CPU Board Configuration Procedures*, 813-2047.

Sun 3004 CPU

Sun-3/140/150/160/180

501-1208

4MB

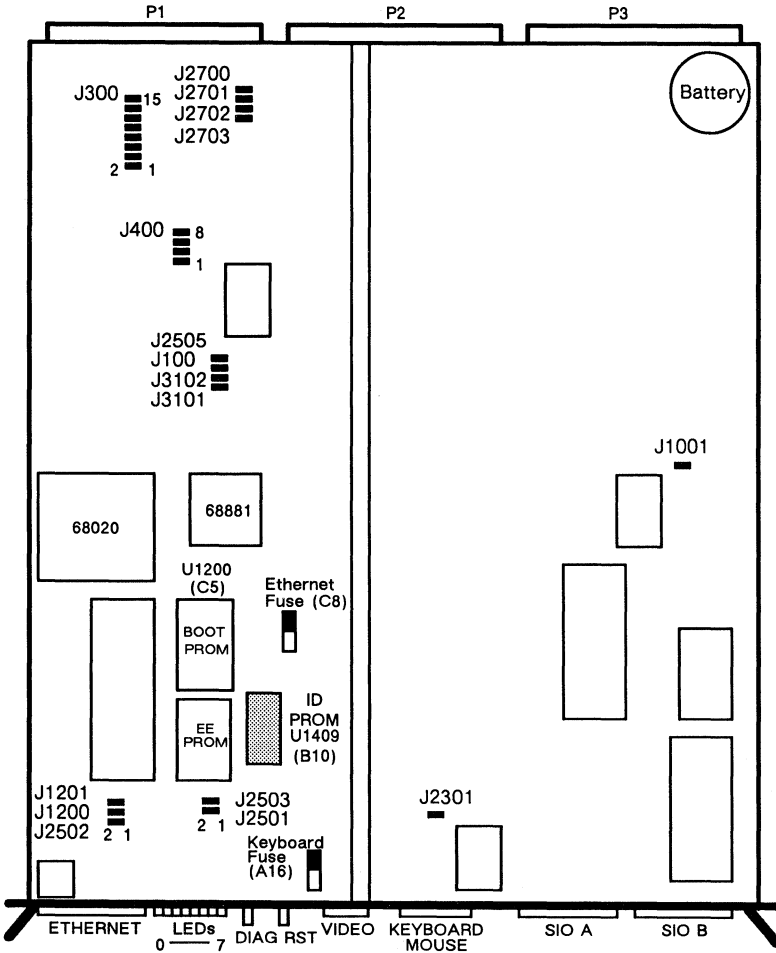

Notes

1. CPU EPROM 1.8 or greater is required to load SunO 1/4" distribution tapes in QIC-24 format.
2. CPU EPROM 2.6 or greater is required to load SunO 1/4" distribution tapes in QIC-24 format from a Sun-2 Shoebox.
3. CPU EPROM 2.6 or greater is required for the Xylogics 7053 disk controller.

501-1208 Jumper Settings

JUMPER	PINS	SETTING	DESCRIPTION
J300	1-2	In/Out	Not used
	3-4	In	VME interrupt level 1
	5-6	In	VME interrupt level 2
	7-8	In	VME interrupt level 3
	9-10	In	VME interrupt level 4
	11-12	In	VME interrupt level 5
	13-14	In	VME interrupt level 5
	15-16	In	VME interrupt level 6
J400	1-2	In	Enable 16.67MHz CPU clock
	3-4	Out	Enable 12.5MHz CPU clock
	5-6	Out	Enable 12.5MHz FFP clock
	7-8	In	Enable 16.67MHz FFP clock
J1001	1-2	In	Enable SCC clock
J1201	1-2	In	If 27512 Boot PROM
J1200	1-2	Out	If 27256 Boot PROM
J2502	1-2	In	Enable VME clock
J2301	1-2	In	Enable Video clock
J2503	1-2	Out	Level 1/2
J2501	1-2	In	Enable Ethernet clock
J2700	1-2	Out	Enable VME request only
J2701	1-2	In	Enable VME request/arbitrator
J2702	1-2	Out	Enable VME reset slave
J2703	1-2	In	Enable VME reset master
J3101	1-2	In	2MB CPU
J3102	1-2	In	4MB CPU
J100	1-2	Out	Cache disable
J2505	1-2	In/Out	Not Used

Power: 15.2 Amps @ +5Vdc
 0.8 Amps @ -5Vdc
 80.2 Watts

Note: This board may fail with non-Sun supplied boards. Use
 501-1208-05 or greater

Reference: Sun 3004 CPU Board Configuration Procedures, 813-2047.

Sun-3/110

501-1134 501-1209

└────────── 4MB ─────────┘

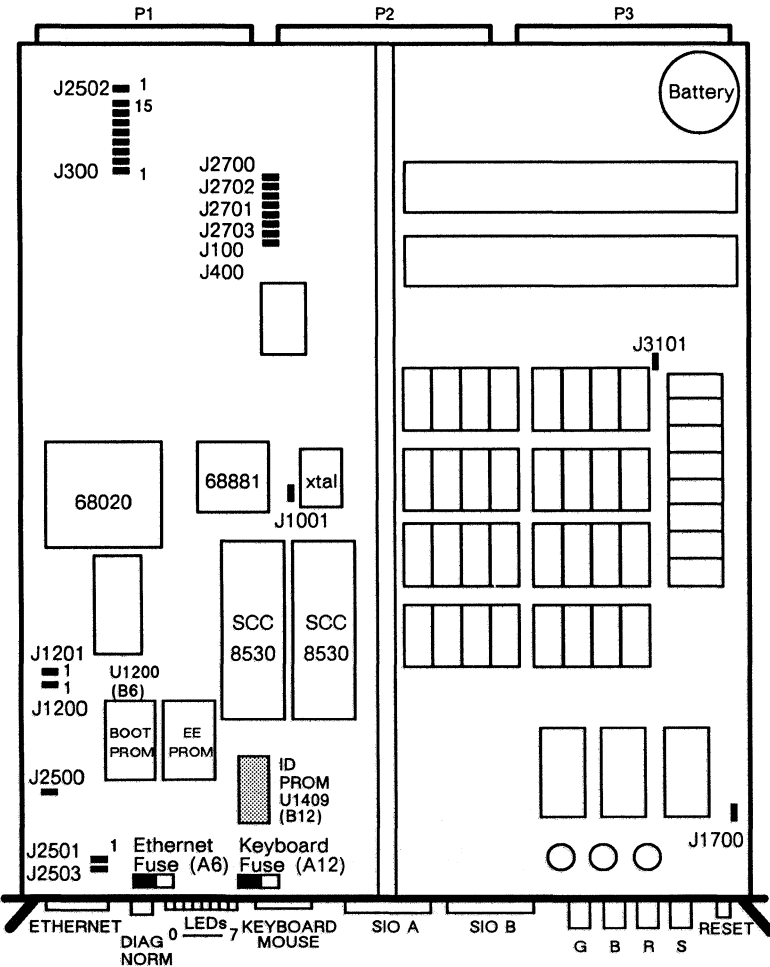

Power: 14.7 Amps @ +5Vdc
 4.1 Amps @ -5Vdc
 0.15 Amps @ +12Vdc
 96.6 Watts

501-1134 501-1209 Jumper Settings

JUMPER	PINS	SETTING	DESCRIPTION
J100	1-2	Out	Cache disable
J300	1-2	In/Out	Not Used
	3-4	In	P1 interrupt request 1
	5-6	In	P1 interrupt request 2
	7-8	In	P1 interrupt request 3
	9-10	In	P1 interrupt request 4
	11-12	In	P1 interrupt request 5
	13-14	In	P1 interrupt request 6
	15-16	In	P1 interrupt request 7
J400	1-2	In	Enable main clock
J1001	1-2	In	Enable SCC clock
J1200	1-2	Out	Sel 256KB PROM
J1201	1-2	In	Sel 512KB PROM
J1700	1-2	In	Video CLK 92.94MHz
J2500 J2501 J2502 J2503	1-2	In	Level 1 Ethernet
		Out	Level 2 Ethernet
	1-2	In	Enable Ethernet clock
	1-2	In	P1 system clock
	1-2	No Pins	+ 5 VDC to pin 7 on Ethernet connector
J2700 J2701 J2702 J2703	1-2	Out	P1 BG3 in
		In	Bus arbiter/requester
	1-2	Out	VME cntrl buff RST In
	1-2	In	System reset
J3100	1-2	Out	Disable onboard mem.

Notes

- When this board is installed with a VME 32-bit data device (MCP, HSI, ALM-2, SCA, or SCSI 3), use 501-1134-06 or greater.
- CPU revisions lower than 501-1134-07, Rev. 50, may fail vid3.diag or video3.exec.

Reference

Sun 501-1134 CPU Board Configuration Procedures, 812-2013.

Sun 3200 CPU

Sun-3/260/280

501-1100 501-1206

└────────── OMB ─────────┘

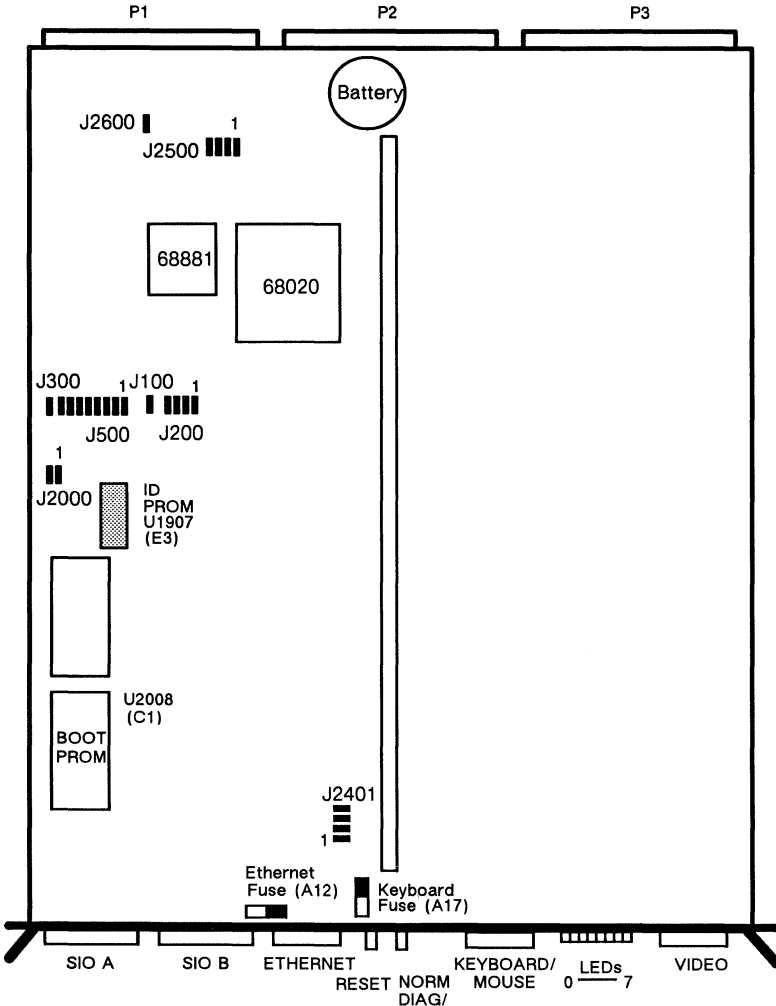

Power: 22.5 Amps @ +5Vdc
 0.6 Amps @ -5Vdc
 115.6 Watts

Note: CPU EPROM 2.6 or greater is required for the Xylogics 7053 disk controller.

501-1100 501-1206 Jumper Settings

JUMPER	PINS	SETTING	DESCRIPTION
J100	1-2	Out	Cache Disable for the 68020
J200	1-2 3-4 5-6 7-8	In/Out In Out In	Not used CPU CLK at 25.00MHz FPP CLK at 25.00MHz FPP CLK at 20.00MHz
J300	1-2	In	P2 Bus enable (501-1100 only)
J500	1-2 3-4 5-6 7-8 9-10 11-12 13-14 15-16	In In In In In In In Out	VME IRQ1 VME IRQ2 VME IRQ3 VME IRQ4 VME IRQ5 VME IRQ6 VME IRQ7 Not used
J2000	1-2 3-4	In Out	Selects 27512 Boot PROM Selects 27256 Boot PROM
J2401	1-2 3-4 5-6 7-8	In Out Out In	ETH CLK +5 VDC to pin 7 ETH conn Level 2 (In for Level 1) SCC CLK (1206 only) *
J2500	1-2 3-4 5-6 7-8	In Out Out In	CPU is VME arbiter/requester CPU is VME requester only CPU is VME reset slave CPU is VME reset master
J2600	1-2	In	VME CLK at 16.00MHz

*Null on 501-1100

Notes

- Two control-Gs ring the keyboard bell with EPROM 2.1. The bell stays ON until the system is reset.
- When this board is installed with an IPC, use 501-1100-08, 501-1206-06, or greater.

Reference

Sun 501-1206 CPU Board Configuration Procedures, 813-2017.

Sun 3400 CPU
Sun-3/460/470/480
501-1299 501-1550
OMB

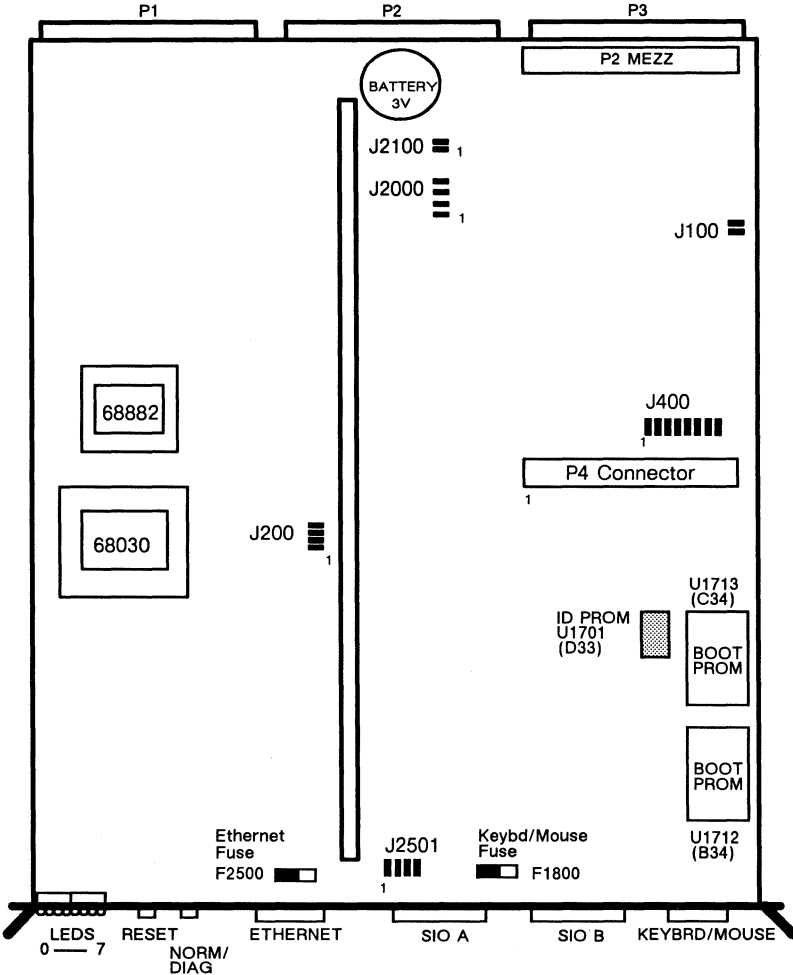

Notes

1. To use with the 8MB Memory board and the FPA board, or the FPA+ board, the memory board revision must be \geq 501-1102-11.
2. This CPU is not compatible with the 501-1254 32MB Memory board.
3. The CPU must be \geq 501-1550-10 to use with the SunLink Channel Adapter.

501-1299 501-1550 Jumper Settings

JUMPER	PINS	SETTING	DESCRIPTION
J100	1-2	Out	Enable 68030 cache
J100	3-4	Out	Enable 68030 MMU
J200	1-2	In	Enable 68030 clock
J200	3-4	In/Out	Not Used
J200	5-6	In/Out	Not Used
J200	7-8	In	Enable 50ns clock
J400	1-2	In	Enable VME interrupt level 1
J400	3-4	In	Enable VME interrupt level 2
J400	5-6	In	Enable VME interrupt level 3
J400	7-8	In	Enable VME interrupt level 4
J400	9-10	In	Enable VME interrupt level 5
J400	11-12	In	Enable VME interrupt level 6
J400	13-14	In	Enable VME interrupt level 7
J400	15-16	In/Out	Not Used
J2000	1-2	Out	IN=Enable VME requester
J2000	3-4	In	Enable VME arbiter
J2000	5-6	Out	IN=VME-generated VME reset
J2000	7-8	In	CPU-generated VME reset
J2100	1-2	In	Enable VME system clock
J2100	3-4	In	Enable Round Robin arbiter
J2501	1-2	In	Enable Ethernet clock
J2501	3-4	In/Out	Not Used
J2501	5-6	Out*	Select level 2 Ethernet
J2501	5-6	In	Select level 1 Ethernet
J2501	7-8	In/Out	Not Used

* Factory setting

Power: 24.5 Amps @ +5Vdc
 0.3 Amps @ +12Vdc
 126.0 Watts

Reference: *Sun 3400 CPU Board Configuration Manual*, 813-2055.

Sun386i/150

501-1241 501-1414

VOLTAGE TEST POINTS

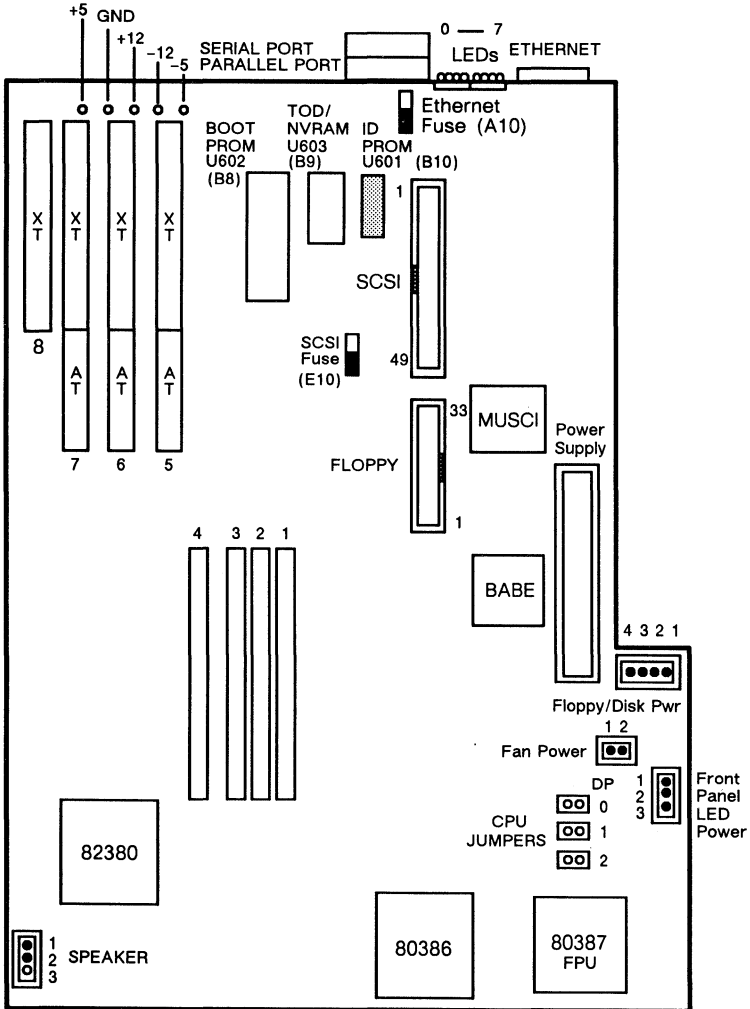

Note: CPU EPROM 4.4 or greater is required for use with the 501-1433 Low-Res Mono Frame Buffer board.

501-1241 501-1414 Jumper Settings

JUMPER			FUNCTION
0	1	2	
Out	Out	Out	Normal Mode
In	Out	Out	Diagnostic Mode
Out	Out	In	Manufacturing Mode
In	Out	In	Bypass Mode

FUNCTION	DESCRIPTION
Normal Mode	Self-Test is executed. Memory tested is determined by NVRAM setting.
Diagnostic Mode	Self-Test is executed. All memory is tested. Status information is directed to the serial port until all video hardware is successfully tested.
Manufacturing Mode	Diagnostic mode runs in a continuous loop.
Bypass Mode	Bypasses most of the Self-Test.

Power: 5.8 Amps @ +5Vdc
28.0 Watts

Notes

1. The serial port uses a male connector.
2. The Ethernet and SCSI fuses are 1 Amp subminiature fuses, Sun part number, 140-1027-01.
3. CPU, 501-1241-04 Rev. 01, 501-1414-01 Rev. A, or greater is required for use with Dynamic Memory boards, 501-1394, 501-1441, and 501-1423.
4. The board is set for Ethernet Level 2. Level 1 is NOT selectable.

Reference: *Sun386i Field Service Manual*, 814-0002.

Sun386i/250

501-1324 501-1413

VOLTAGE TEST POINTS

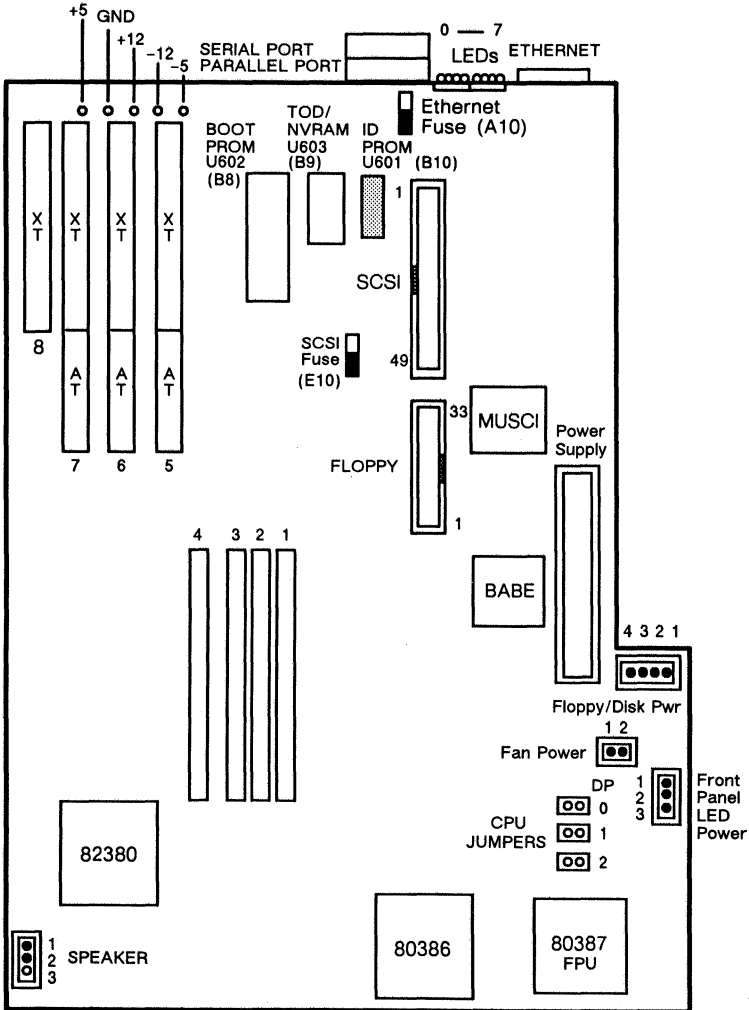

Note: CPU EPROM 4.4 or greater is required for use with the 501-1433 Low-Res Mono Frame Buffer board.

501-1324 501-1413 Jumper Settings

JUMPER			FUNCTION
0	1	2	
Out	Out	Out	Normal Mode
In	Out	Out	Diagnostic Mode
Out	Out	In	Manufacturing Mode
In	Out	In	Bypass Mode

FUNCTION	DESCRIPTION
Normal Mode	Self-Test is executed. Memory tested is determined by NVRAM setting.
Diagnostic Mode	Self-Test is executed. All memory is tested. Status information is directed to the serial port until all video hardware is successfully tested.
Manufacturing Mode	Diagnostic mode runs in a continuous loop.
Bypass Mode	Bypasses most of the Self-Test.

Power: 5.8 Amps @ +5Vdc
29.0 Watts

Notes

1. The serial port uses a male connector.
2. The Ethernet and SCSI fuses are 1 Amp subminiature fuses, Sun part number, 140-1027-01.
3. The board is set for Ethernet Level 2. Level 1 is NOT selectable.

Reference: *Sun386i Field Service Manual*, 814-0002.

Sun-3/E

501-8028
4MB

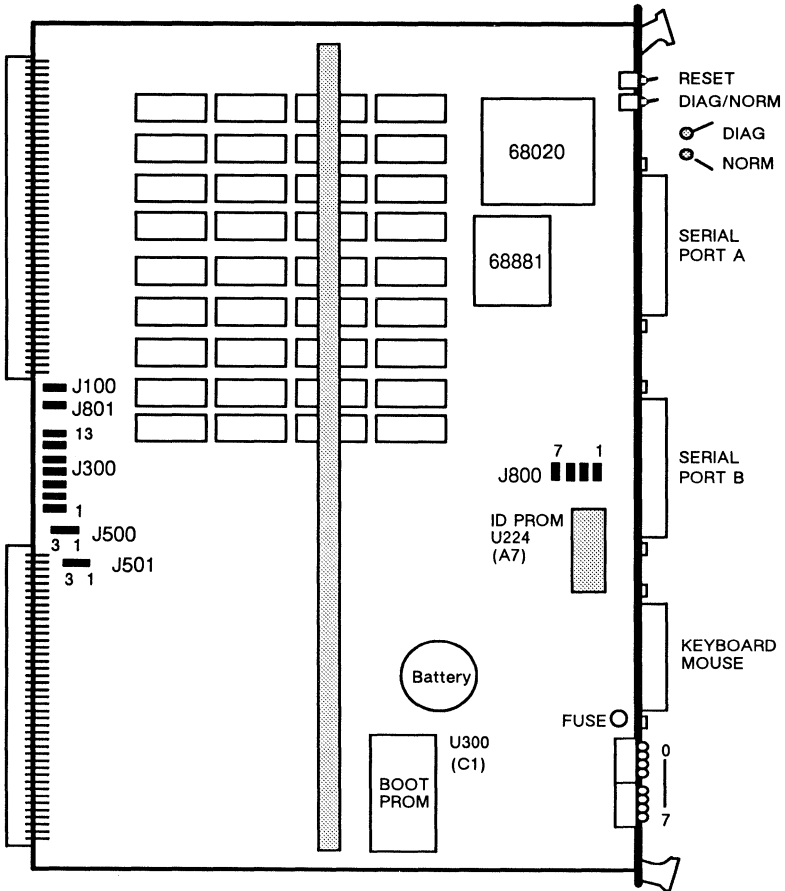

Power: 8.1 Amps @ +5 Vdc
0.25 Amps @ +12 Vdc
0.12 Amps @ -12 Vdc
45.0 Watts

Note: The fuse is not field replaceable.

501-8028 Jumper Settings

JUMPER	PINS	SETTING	DESCRIPTION
J100	1-2	In/Out	Not used
J801	1-2	In	VME system clock driver
J300	1-2	In	Enable VME interrupt level 1
J300	3-4	In	Enable VME interrupt level 2
J300	5-6	In	Enable VME interrupt level 3
J300	7-8	In	Enable VME interrupt level 4
J300	9-10	In	Enable VME interrupt level 5
J300	11-12	In	Enable VME interrupt level 6
J300	13-14	In	Enable VME interrupt level 7
J500	1-2	In	CPU can reset other VME boards
J500	2-3	Out	Other VME boards can reset CPU
J501	1-2	In	CPU is the daisy chain driver
J501	2-3	Out	CPU is not the daisy chain driver
J800	1-2	In/Out	Not used
J800	3-4	In	VMEbus arbiter
J800	5-6	In	Enable video board interrupt
J800	7-8	In	Respond as a VMEbus slave

Sun-4/20

501-1627 8MB 501-1680 0MB 501-1720 8MB
 501-1748 0MB 501-1776 8MB 501-1777 0MB

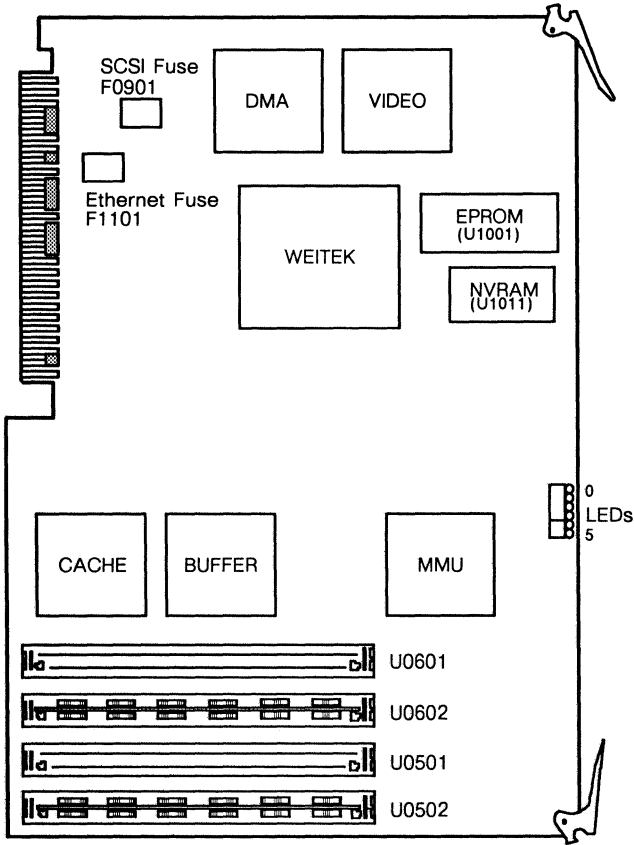

I/O Board Connectors

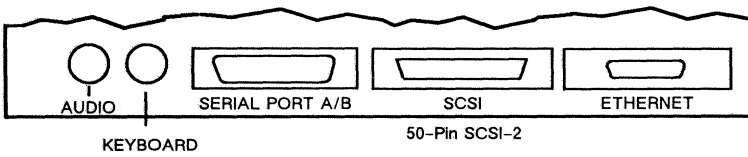

501-1627 501-1680 501-1720
501-1748 501-1776 501-1777

Notes

1. This board uses 4MB SIMM, 501-1676 or 501-1698.
2. Install the first 4MB SIMM in U0502.
3. Fuses F0901 and F1101 are non-replaceable PTC devices.
4. The minimum operating system is SunOS 4.0.3c.
5. CPU boards with the 53C90A SCSI Controller require a patch to operate under SunOS 4.0.3c.

Reference: *SPARCstation SLC Installation & Repair Guide*, 814-5039.

Sun-4/40

501-1689 501-1690 501-1835
 8MB 0MB 8MB
 FCC-B/VCCI-2

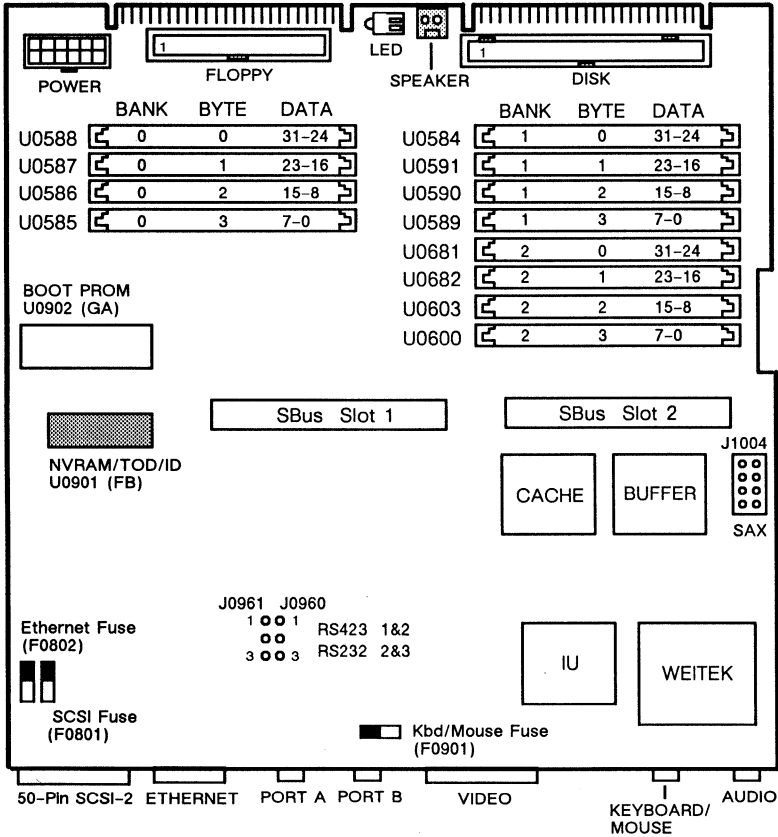

501-1689 501-1690 501-1835

Notes

1. The Sun-4/40 uses 1MB SIMM module, 501-1697.
2. The Sun-4/40 uses 4MB SIMM module, 501-1625.
3. All fuses are 2A part number 150-1174.
4. The minimum operating system is SunOS 4.0.3c.
5. SCSI bus errors may occur when multiple SCSI devices are used with CPU boards below 501-1689-06.
6. CPU boards below 501-1689-07 fail SunDiag Floppy Drive testing.
7. CPU boards with the 53C90A SCSI Controller require a patch to operate under SunOS 4.0.3c.

Reference: *SPARCstation IPC Field Service Manual*, 800-5038.

501-1382 501-1629

Notes

1. The Sun-4/60 uses 1MB SIMM module, 501-1408.
2. The Sun-4/60 uses 4MB SIMM module, 501-1625.
3. All fuses are 2A part number, 150-1174.
4. The minimum operating system is SunOS 4.0.3c.
5. CPU 501-1382-08 or greater or 501-1629-10 or greater is required for use with Sun Common LISP, AutoCAD, Cobol, and SunOS 4.1.
6. SPARC IU 100-1808-02 or greater is required for use with Sun Common LISP, AutoCAD, Cobol, and SunOS 4.1.
7. Power on systems with CPU boards 501-1382-10 or lower, or 501-1629-10, before turning on external disk drive units.
8. A Load Board, 501-1667, must be installed in systems without a disk drive and SBus cards.

Reference: *SPARCstation 1 Installation Guide*, 800-4036.

Sun-4/65

501-1632

8MB w FPU

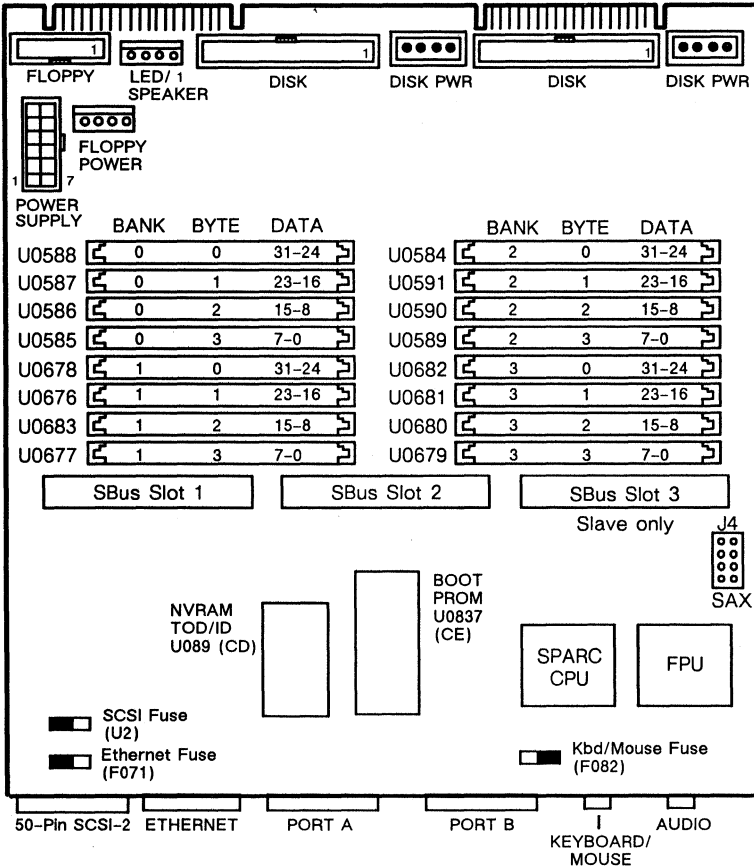

Power: 8MB Board with 1MB SIMMs
 2.4 Amps @ +5Vdc
 16.1 Watts

501-1632

Notes

1. The Sun-4/65 uses 1MB SIMM, 501-1408.
2. The Sun-4/65 uses 4MB SIMM, 501-1625.
3. The minimum operating system is SunOS 4.0.3c.
4. All fuses are 2A part number, 150-1174.
5. Load Board, 501-1667, must be installed in systems without a disk drive and SBus cards.

Reference: *SPARCstation 1+ Installation Guide*, 800-4784.

Sun-4/75

501-1638 501-1744

16MB 0MB

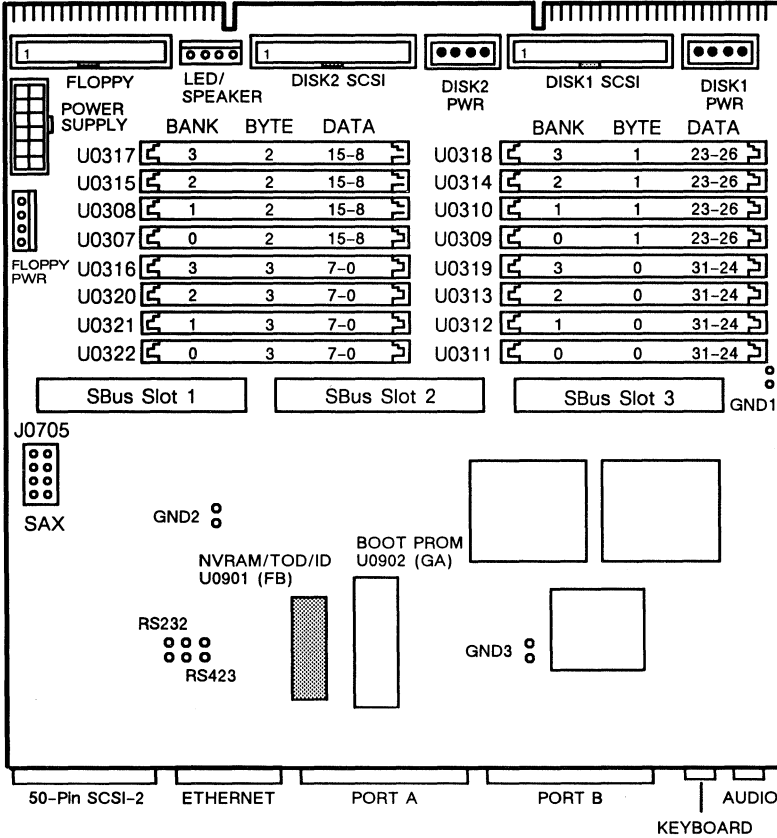

Notes

1. The Sun 4/75 CPU uses 4MB SIMM, 501-1739.
2. The minimum operating system is SunOS 4.1.1.

Reference: *SPARCstation 2 Installation Guide*, 800-5035.

Sun 4100 CPU

Sun 4/110/150

501-1199
501-1512
8MB w/o FPC

501-1237
501-1513
8MB w FPC

501-1462
501-1514
16MB w/o FPC

501-1463
501-1515
16MB w FPC

501-1464
501-1516
32MB w/o FPC

501-1465
501-1517
32MB w FPC

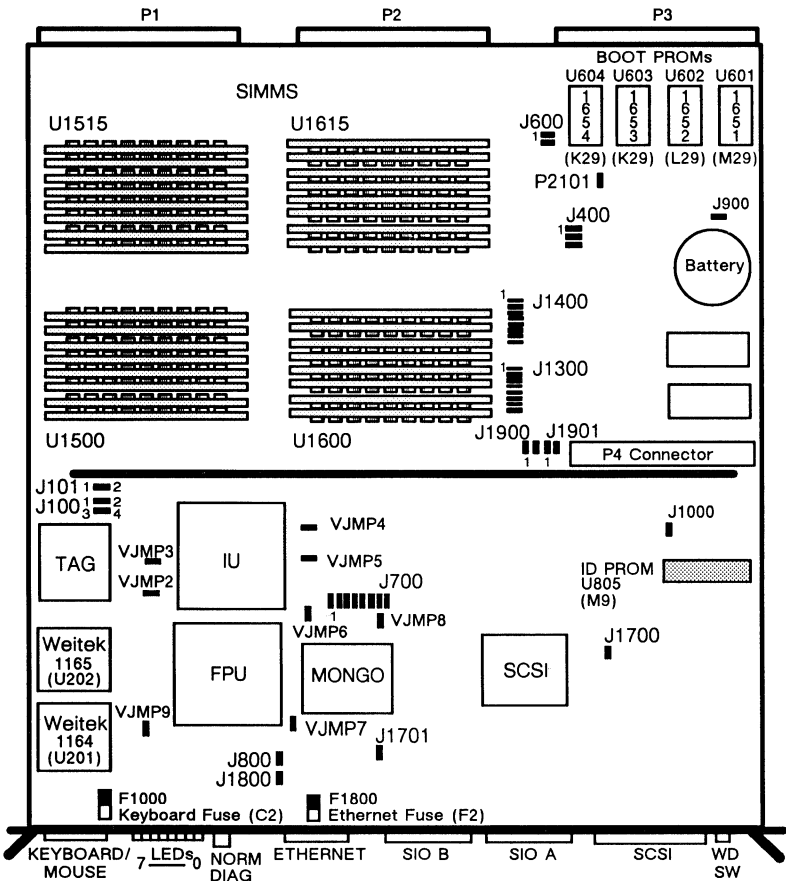

Power: with FPU
 13.8 Amps @ +5Vdc
 0.1 Amps @ -5Vdc
 69.5 Watts

Sun 4100 CPU

Sun-4/110/150

501-1656
8MB w/o FPC

501-1657
8MB w FPC

501-1658
16MB w/o FPC

501-1659
16MB w FPC

501-1660
32MB w/o FPC

501-1661
32MB w FPC

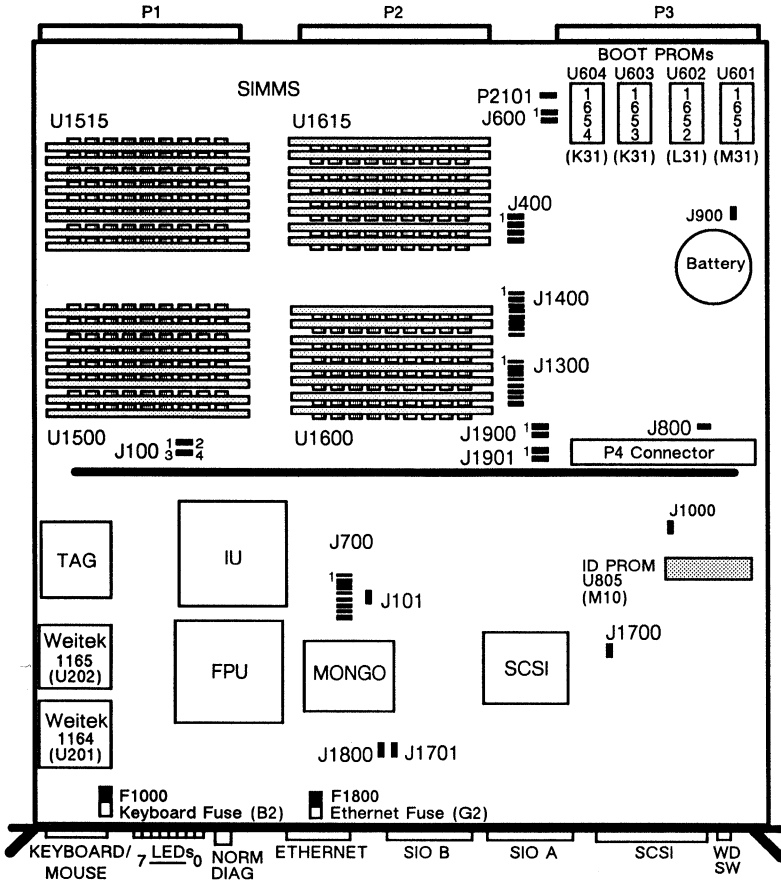

Power: with FPU
 13.8 Amps @ +5Vdc
 0.1 Amps @ -5Vdc
 69.5 Watts

501-1199	501-1237	501-1462	501-1463
501-1465	501-1465	501-1512	501-1513
501-1514	501-1515	501-1516	501-1517
501-1656	501-1657	501-1658	501-1659
	501-1660	501-1661	

Jumper Settings

JUMPER	PINS	SETTING	DESCRIPTION
J101	1-2	In	Enable 57.1 MHz clock
J600	1-2	In	27512 Boot PROM
J600	3-4	Out	27256 Boot PROM
J700	1-2	In	VME interrupt level 1
J700	3-4	In	VME interrupt level 2
J700	5-6	In	VME interrupt level 3
J700	7-8	In	VME interrupt level 4
J700	9-10	In	VME interrupt level 5
J700	11-12	In	VME interrupt level 6
J700	13-14	In	VME interrupt level 7
J700	15-16	In	Not used
J800	1-2	Out	Force reset
J900	1-2	Out	In=Shorts 3V battery
J1000	1-2	In	Enable UART clock
J1700	1-2	In	Enable Ethernet Clock
J1701	1-2	Out	Ethernet level 2 (In = level 1)
J1800	1-2	Out	Auto sense Ethernet*
J1800	1-2	Out	Force Thin Ethernet
J1800	1-2	In	Force Thick Ethernet
J1900	1-2	Out	CPU is VME requester only
J1900	3-4	In	CPU is VME requester
J1901	1-2	Out	CPU is VME reset slave
J1901	3-4	In	CPU is VME reset master
P2101	1-2	In	Enable VME system clock

*Factory setting. Requires greater than 30 milliamps on +12V return for auto sense feature to operate, (example, DEC DELNI).

Notes

- 501-1199 must be \geq 501-1199-11 and 501-1237 must be \geq 501-1237-11 to use with the Type-4 keyboard.
- The 501-1384 FPU2 is supported only on CPU boards 501-1512, 501-1514, 501-1516, 501-1656, 501-1658, and 501-1660.

Reference: *Sun 4100 Board Set Configuration Procedures*, 813-2049.

501-1199 501-1237 501-1462 501-1463
 501-1465 501-1465 501-1512 501-1513
 501-1514 501-1515 501-1516 501-1517
 501-1656 501-1657 501-1658 501-1659
 501-1660 501-1661

Jumper Settings – Continued

Cache Line, J100

MEMORY SIZE	8MB	16MB	20MB	32MB
SIMM SIZE	256K	1MB	1MB/256K	1MB
Pin 1-2	In	Out	In	Out
Pin 3-4	Out	In	Out	In

Memory Strobe Configuration, J400

MEMORY SIZE	8MB	16MB	20MB	32MB
Pin 1-2	Out	In	Out	In
Pin 3-4	In	Out	Out	In
Pin 5-6	In	In	In	Out

SIMM Addressing Mode, J1300

SIMM TYPE	MEMORY SIZE	8MB	16MB	20MB	32MB
		256K	1MB	1MB/256K	1MB
Same*	Pin 1-2	In	Out	Out	In
Different*	Pin 3-4	Out	In	In	Out
256K	Pin 5-6	In	Out	In	Out
1 M	Pin 7-8	Out	In	Out	In
2 M	Pin 9-10	Out	Out	Out	Out
<32M	Pin 11-12	In	In	In	Out
32M	Pin 13-14	Out	Out	Out	In
Unused	Pin 15-16	Out	Out	Out	Out

SIMM Addressing Mode, J1400

SIMM TYPE	MEMORY SIZE	8MB	16MB	20MB	32MB
		256K	1MB	1MB/256K	1MB
Same*	Pin 1-2	In	Out	Out	In
Different*	Pin 3-4	Out	In	In	Out
256K	Pin 5-6	In	Out	Out	Out
1 M	Pin 7-8	Out	In	In	In
2 M	Pin 9-10	Out	Out	Out	Out
<32M	Pin 11-12	In	In	In	Out
32M	Pin 13-14	Out	Out	Out	In
Unused	Pin 15-16	Out	Out	Out	Out

* Same/Different corresponds to sets of 256KB/1MB DRAMS.

Sun 4100 CPU

SIMM Memory Configurations

501-1314
256KB SIMMs

501-1466
1MB SIMMs

8MB

16MB

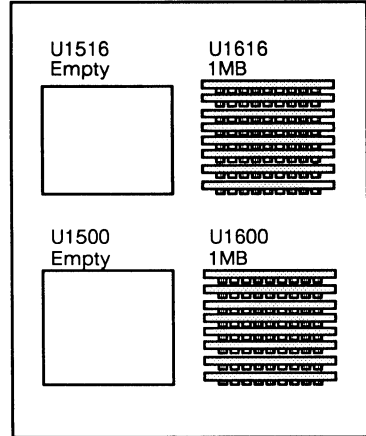
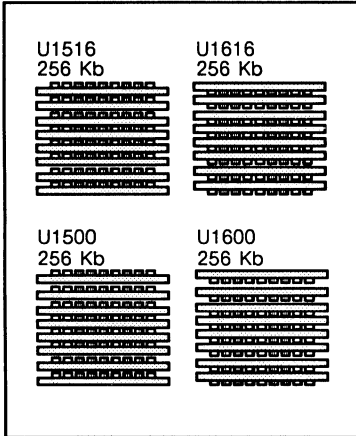

20MB

32MB

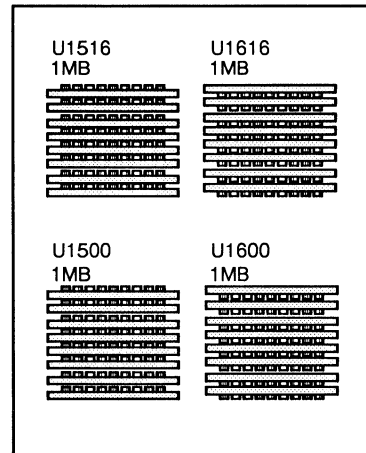
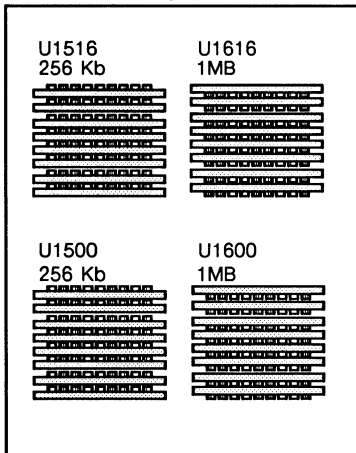

Notes

1. The Sun 4100 CPU uses 256KB SIMM, 501-1314.
2. The Sun 4100 CPU uses 1MB SIMM, 501-1466.

Sun 4200 CPU

Sun-4/260/280

501-1129*

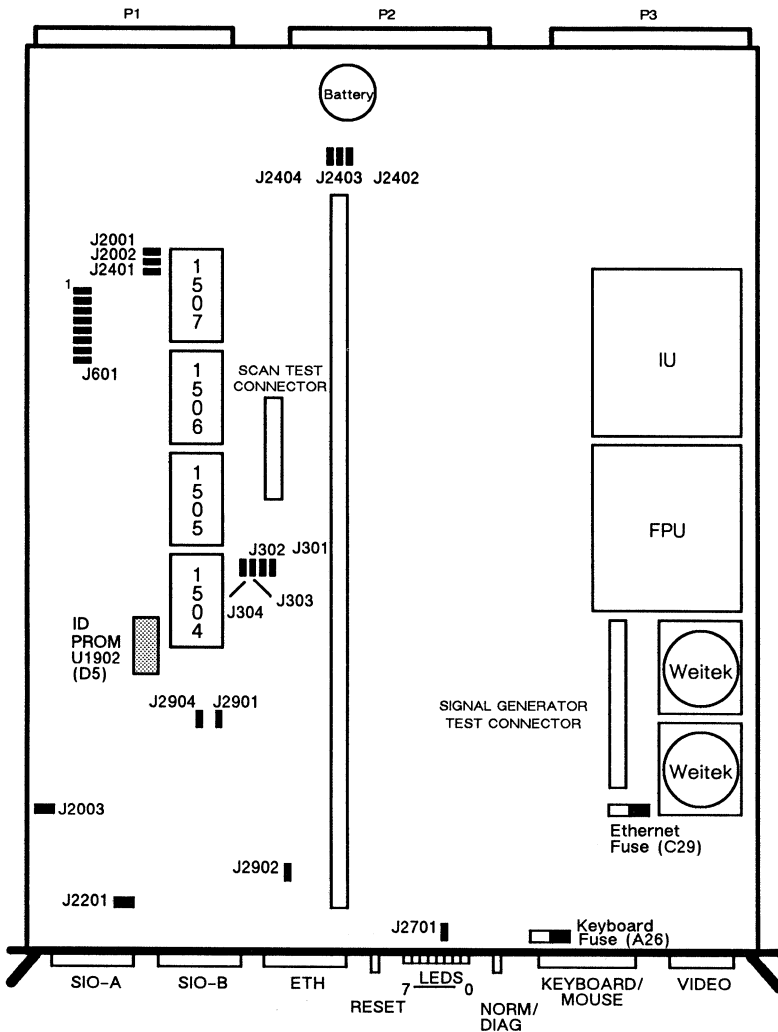

* Replaced with 501-1274. **Do NOT use this board.**

501-1129 Jumper Settings

JUMPER	PINS	SETTING	DESCRIPTION
J2701	1-2	Out	Debug jumper
J2003	1-2	In	Connect 3V battery
J2201	1-2	In	UART clock enable
J2901	1-2	In	Enable Ethernet clock
J2902	1-2	Out	+5V to Ethernet tap
J2904	1-2	Out	Null
J304	1-2	In	Enable VME clock
J303	1-2	In	Enable 16Mhz clock
J302	1-2	In	Enable 46Mhz clock
J301	1-2	Out	Enable External clock
J601	1-2	In	Null
	3-4	In	VME interrupt level 1
	5-6	In	VME interrupt level 2
	7-8	In	VME interrupt level 3
	9-10	In	VME interrupt level 4
	11-12	In	VME interrupt level 5
	13-14	In	VME interrupt level 6
	15-16	In	VME interrupt level 7
J2001	1-2	In	Select 27512 PROM
J2002	1-2	Out	Select 27256 PROM
J2401	1-2	Out	CPU is VME requestor only
J2402	1-2	In	CPU is VME arb/req
J2403	1-2	Out	CPU is reset slave
J2404	1-2	In	CPU is reset master

Reference: *Sun 4200 Board Configuration Procedures*, 813-2031.

Sun 4200 CPU

Sun-4/260/280

501-1274
w FPC-6/4

501-1491
w FPU-2
2-hi Backpanel

501-1522
w FPC-6/4
2-hi Backpanel

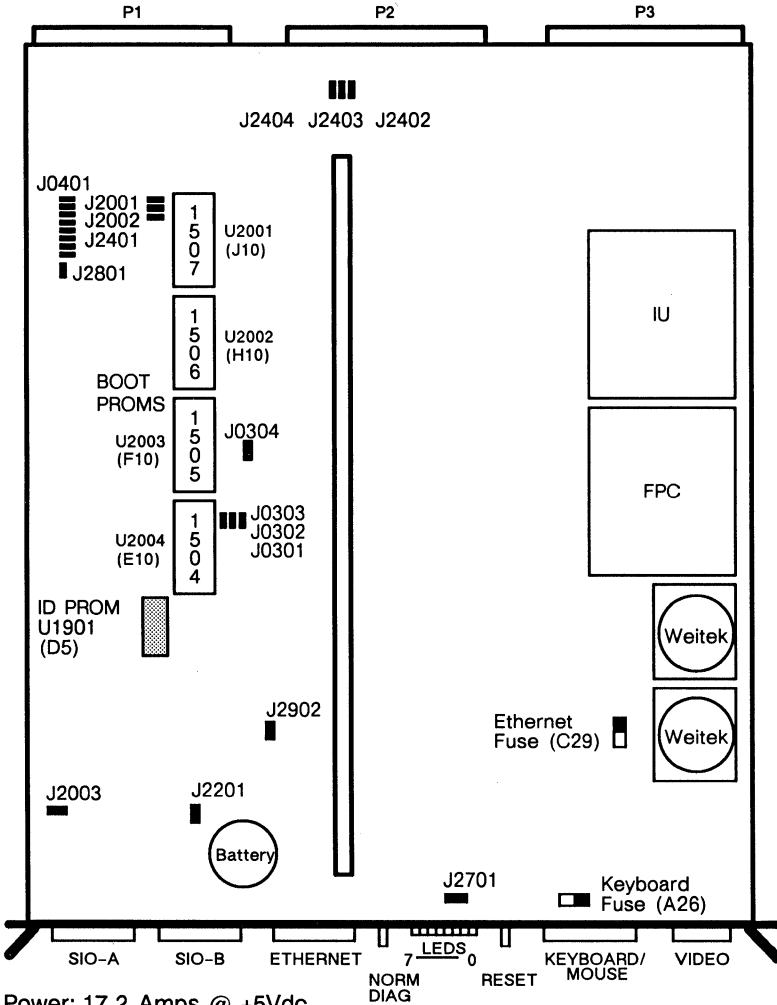

Power: 17.2 Amps @ +5Vdc
 1.3 Amps @ -5Vdc
 0.4 Amps @ +12Vdc
 98.0 Watts

Note: CPU EPROM 1.7 or greater is required for proper operation with the Xylogics 7053 disk controller.

501-1274 501-1491 501-1522

Jumper Settings

JUMPER	PINS	SETTING	DESCRIPTION
J2701	1-2	Out	Debug jumper
J2003	1-2	In	Connect 3V battery
J2201	1-2	In	SCC (UART) clock enable
J2902	1-2	Out	Enet Level 2 (IN for level 1)
J2904	1-2	Out	Null
J0304	1-2	In	Enable VME clock
J0303	1-2	In	16 MHz clock enable
J0302	1-2	In	46.153 MHz clock enable
J0301	1-2	Out	External clock clock
J2801	1-2	In	Enable system DVMA
J0401	1-2	In/Out	Null
J0401	3-4	In	VME interrupt level 1
J0401	5-6	In	VME interrupt level 2
J0401	7-8	In	VME interrupt level 3
J0401	9-10	In	VME interrupt level 4
J0401	11-12	In	VME interrupt level 5
J0401	13-14	In	VME interrupt level 6
J0401	15-16	In	VME interrupt level 7
J2001	1-2	In	Select 27512 PROM
J2002	1-2	Out	Select 27256 PROM
J2401	1-2	Out	CPU is VME requester only
J2402	1-2	In	CPU is arbiter/requester
J2403	1-2	Out	CPU is reset slave
J2404	1-2	In	CPU is reset master

Notes

1. 501-1274 must be \geq 501-1274-12 to use with the Type-4 Keyboard.
2. 501-1274 must be \geq 501-1274-13 to use with the Xylogics 7053.
3. CPU EPROM 3.0 or greater is required when more than two 16MB memory boards are used.

Reference: Sun-4200 CPU Board Configuration Procedures, 813-2031.

Sun 4300 CPU

Sun-4/310/330/350/360/370/380/390

501-1316

501-1742

8MB
w 1MB SIMMS

32MB
w 4MB SIMMS

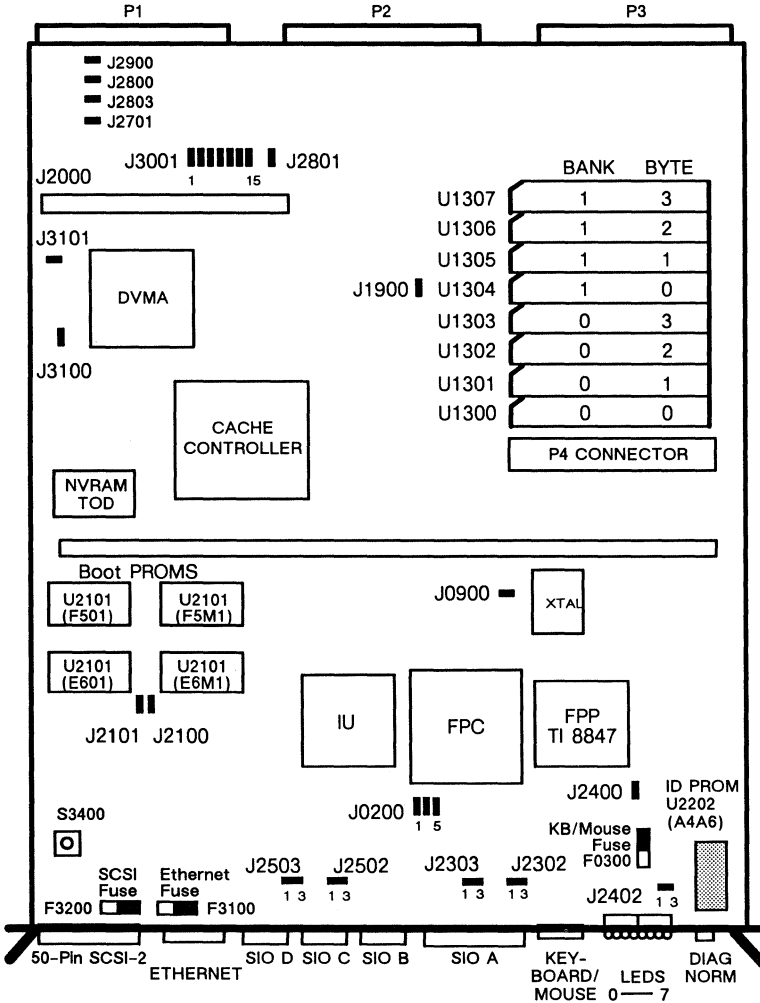

Power: 17.5 Amps @ +5vdc
 0.2 Amps @ +12vdc
 0.2 Amps @ -12vdc
 45.0 Watts

501-1316 501-1742 Jumper Settings

JUMPER	PINS	SETTING	DESCRIPTION
J0200	1-2	In	FPC normally low
J0200	3-4	In	FPC normally low
J0200	5-6	Out	FPC normally high
J0900	1-2	In	Enable Sysclock
J1900	1-2	In	CPU has 4MB SIMMs
J1900	1-2	Out	CPU has 1MB SIMMs
J2100	1-2	In	Enable 27512 EPROM
J2101	1-2	Out	Enable 27256 EEPROM
J2302	1-2	In*	Set Ports A,B for RS-232C, +/- 12V
J2303	1-2	In*	Set Ports A,B for RS-232C, +/- 12V
J2302	2-3	In	Set Ports A,B for RS-423, +/- 5V
J2303	2-3	In	Set Ports A,B for RS-423, +/- 5V
J2400	1-2	In	Enable serial port clock
J2402	1-2	Out	Keyboard set on transmit mouse
J2402	2-3	In	Keyboard set on ground
J2502	1-2	In*	Set Ports C,D for RS-232C, +/- 12V
J2503	1-2	In*	Set Ports C,D for RS-232C, +/- 12V
J2502	2-3	In	Set Ports C,D for RS-423, +/- 5V
J2503	2-3	In	Set Ports C,D for RS-423, +/- 5V
J2701	1-2	Out	Disable VME loopback
J2800	1-2	In	Enable VME reset Out
J2801	1-2	In	Enable VME arbiter
J2803	1-2	Out	Enable VME reset IN
J2900	1-2	In	Enable 16 Mhz clock to backplane
J3001	1-2	Out	Not used
J3001	3-4	In	Enable VME interrupt level 1
J3001	5-6	In	Enable VME interrupt level 2
J3001	7-8	In	Enable VME interrupt level 3
J3001	9-10	In	Enable VME interrupt level 4
J3001	11-12	In	Enable VME interrupt level 5
J3001	13-14	In	Enable VME interrupt level 6
J3001	15-16	In	Enable VME interrupt level 7
J3100	1-2	In	Enable 32 Mhz clock
J3101	1-2	In	Enable 48 Mhz clock

501-1316 501-1742
Sun 4300 CPU
Notes

1. The Sun 4300 CPU uses 1MB SIMM, 501-1544, or 501-1565.
2. The Sun 4300 CPU uses 4MB SIMM, 501-1682.
3. The Sun 4100 1MB SIMM, 501-1466, may be used in the Sun-4/310 and Sun-4/350 system upgrades.
4. F0300, F3100, and F3200 use 2 Amp Fuses, 150-1174.
5. CPU board is Set for Ethernet Level 2. Level 1 is not selectable.
6. CPU \geq 501-1316-04 is required for use with the ISP-80 and FDDI controllers and with LISP software.
7. CPU \geq 501-1316-03 is required for use with CG5.
8. CPU EPROM 3.0 or greater is required to boot from the 60MB 1/4" tape drive in the Mass Storage Subsystem.
9. CPU EPROM 3.0.1 or greater is required to boot from a tape drive on a second SCSI Host Adapter.
10. CPU EPROM 3.0.3 or greater is required with 4MB SIMM modules.
11. Install Fused Shunt, 150-1669-01, at locations J2302, J2303, J2502, and J2503 to provide circuit protection to the M+ (+12Vdc) and M- (-12Vdc) inputs to the UC5170 Serial Port Line Driver.

Reference: *Sun 4300 CPU Board Installation Notes*, 800-3119.

This page intentionally left blank.

Sun 4400 CPU

Sun-4/470/490

501-1381

OMB

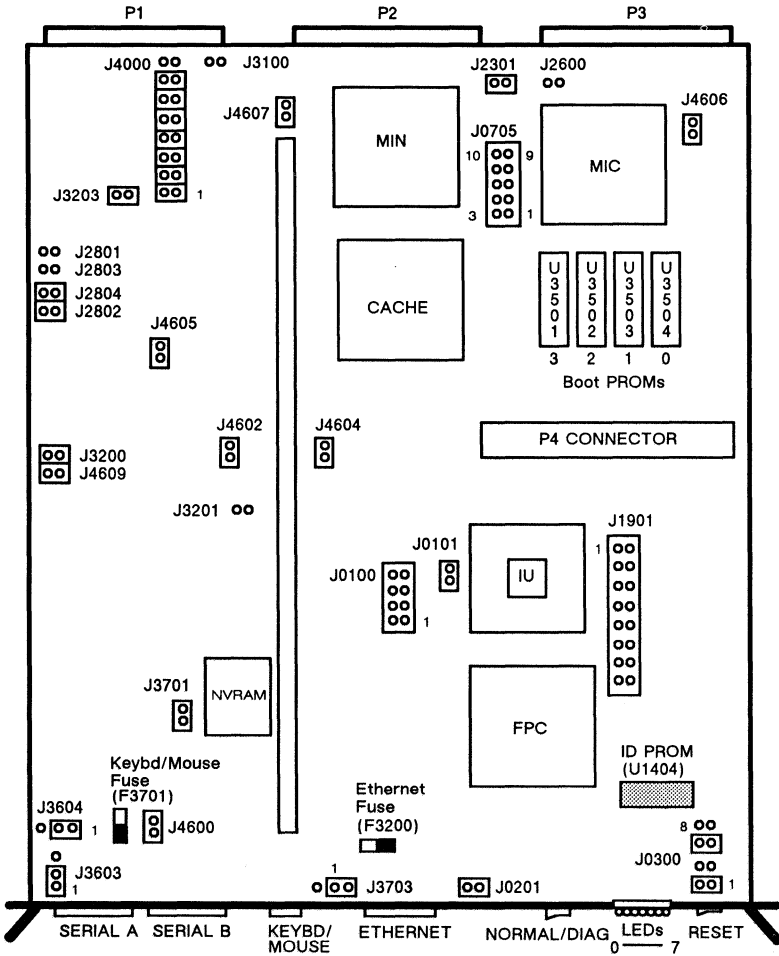

501-1381 Jumper Settings

JUMPER	PINS	SETTING	DESCRIPTION
J0100	1-10	Out	Used for debug
J0101	1-2	In	Used for ATE
J0201	1-2	In	Used for ATE
J0300	1-2	In	If FPC is present
J0300	3-4	Out	If FPC is present
J0300	5-6	In	Avoid a trap when I-Flush instruction is executed
J0300	7-8	Out	FPC Chaining (only if FPC is present)
J0705	1-10	Out	Used for debug
J1901	1-36	Out	Used for debug
J2301	1-2	In	Enable system clock (33 MHz)
J2600	1-2	Out	Used for debug
J2801	1-2	Out	Disable VME arbiter
J2802	1-2	In	Enable VME arbiter
J2803	1-2	Out	Connect P1.SYSRST* to VME.RST.IN*
J2804	1-2	In	Connect VME.RST.OUT* to P1.SYSRST*
J3100	1-2	Out	VME loopback mode enabled
J3200	1-2	In	Provide 16 MHz Ethernet clock
J3201	1-2	Out	Enet Level 2 (IN for level 1)
J3203	1-2	In	Provide P1.SYSCLCK
J3603	1-2	In	Select RS-423
J3603	2-3	In	Select RS-232 (+12V)
J3604	1-2	In	Select RS-423
J3604	2-3	In	Select RS-232 (+12V)
J3701	1-2	In	Provide 4.9152 MHz SCC clock
J3703	1-2	Out	Keyboard set on transmit mouse
J3703	2-3	In	Pin 7 of keyboard/mouse to GND (default)

501-1381

Jumper Settings – Continued

JUMPER	PINS	SETTING	DESCRIPTION
J4000	1-2	In	VME IRQ1
J4000	3-4	In	
J4000	5-6	In	
J4000	7-8	In	
J4000	9-10	In	
J4000	11-12	In	
J4000	13-14	In	VME IRQ7
J4000	15-16	In/Out	Not connected
J4600	1-2	In	Used for ATE
J4602	1-2	In	
J4604	1-2	In	
J4605	1-2	In	
J4606	1-2	In	
J4607	1-2	In	
J4609	1-2	In	

Note: Install Fused Shunt, 150-1669-01, at locations J3603 and J3604, to provide circuit protection to the M+ (+12Vdc) and M- (-12Vdc) inputs to the UC5170 Serial Port Line Driver.

Reference

Sun 4400 Board Set Installation and Configuration Manual, 800-3269.

This page intentionally left blank.

Sun-4/E

SPARCengine 1E

501-8058 501-8035

4MB 4MB
w/o Weitek w Weitek

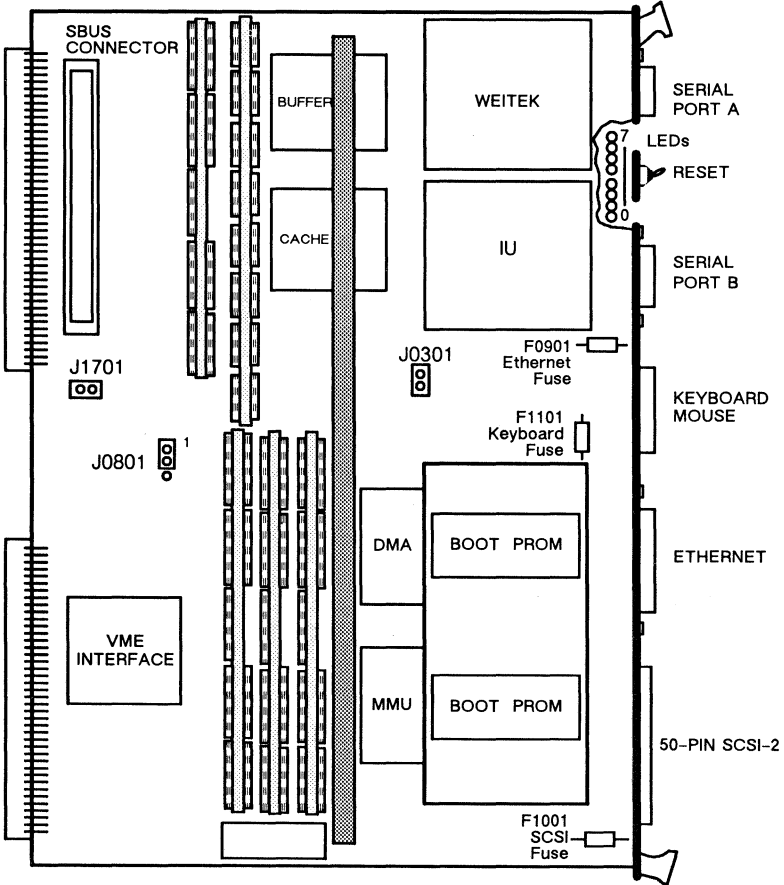

Power: 5.0 Amps @ +5vdc
 0.1 Amps @ +12vdc.
 0.1 Amps @ -12vdc.
 27.4 Watts

Note: The fuses are not field replaceable.

501-8058 501-8035 Jumper Settings

JUMPER	PINS	SETTING	DESCRIPTION
J0301	1-2	In	20MHz clock enable
J0801	1-2	In	Use 4MB parity memory (default)
J0801	2-3	In	Disable 4MB parity memory
J1701	1-2	In	CPU is installed in VME slot 1

Notes

1. CPU EPROM 1.4 does not support SunOS 4.1e.
2. CPU EPROM 1.5 does not support SunOS 4.0.3e.

Reference

The SPARCengine 1E CPU Card User's Manual, 800-8137.

CONFIGURATIONS

MEMORY

Memory

SIMM Modules	2
Sun-2 Multibus (1MB)	3
Sun-2 Multibus Prime (1MB)	4
Sun-2 Multibus Prime (4MB)	6
Sun 2051 Memory	8
Sun-3/75 & Sun-3/110/140/150/160/180	10
Sun-3/260/280 & Sun-4/260/280 (8MB)	12
Sun-3/460/470/480 & Sun-4/260/280 (32MB)	12
Sun386i Dynamic Memory	14
Sun386i XP Cache	16
Sun-3/E (4MB)	18
Sun-3/E (12MB)	19
Sun-4/330	20
Sun 4300	22
Sun 4400	26
Sun-4/E	28
Sun-4/E Combo Memory	30

SIMM Modules

In the chart below, an X indicates the Sun system(s) that use the SIMM modules described by size and part number.

SIZE	SIMM P/N	SYSTEMS												
		Sun-3			Sun386i		Sun-4							
		60	60 LE	80	150	250	20	40	60	65	75	110 150	330 370 390	
256KB	501-1314												x	
256KB	501-1349		x											
1MB	501-1239	x												
1MB	501-1346		x											
1MB	501-1375					x								
1MB	501-1408			x					x	x				
1MB	501-1424				x	x								
1MB	501-1466											x	x*	
1MB	501-1510					x								
1MB	501-1544													x
1MB	501-1565													x
1MB	501-1697							x						
4MB	501-1625							x	x	x				
4MB	501-1676						x							
4MB	501-1682													x†
4MB	501-1698						x							
4MB	501-1739										x			

* The 1MB SIMM, 501-1466, can be used in systems upgraded from Sun-4/110 to Sun-4/310 and Sun-4/150 to Sun-4/350.

† The 4MB SIMM, 501-1682, is NOT supported on the Sun-4/330 CPU board.

Sun-2 Multibus

Sun-2/100U/120/150U/170

501-1013

1MB

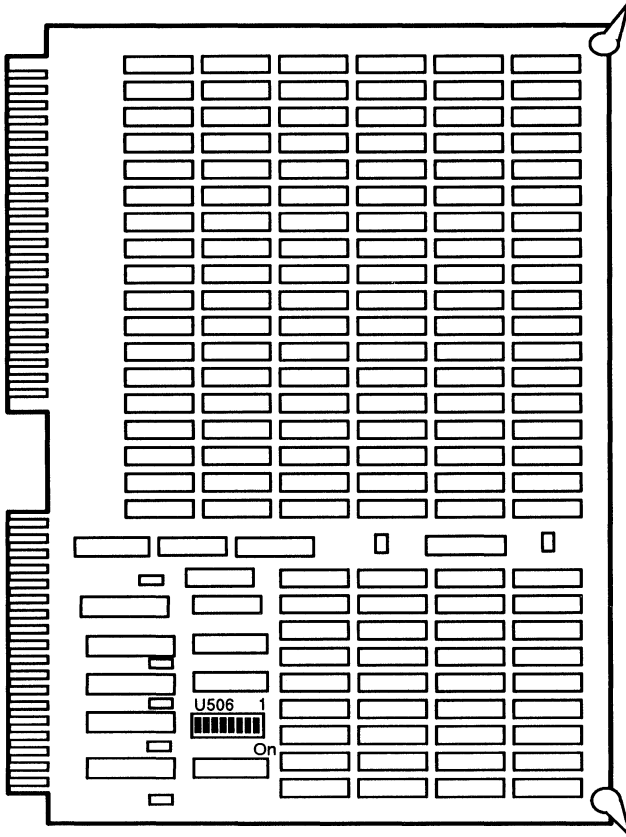

MEMORY SIZE	DIP SWITCH U506							
	1	2	3	4	5	6	7	8
1st MB	On	Off	Off	Off	Off	Off	Off	Off
2nd MB	Off	On	Off	Off	Off	Off	Off	Off
3rd MB	Off	Off	On	Off	Off	Off	Off	Off
4th MB	Off	Off	Off	On	Off	Off	Off	Off
5th MB	Off	Off	Off	Off	On	Off	Off	Off
6th MB	Off	Off	Off	Off	Off	On	Off	Off

References

1. *Hardware Installation Manual for the Sun-2/120, 800-1170.*
2. *Hardware Installation Manual for the Sun-2/170, 800-1171.*

Sun-2 Multibus Prime

Sun-2/120/170

501-1048

1MB

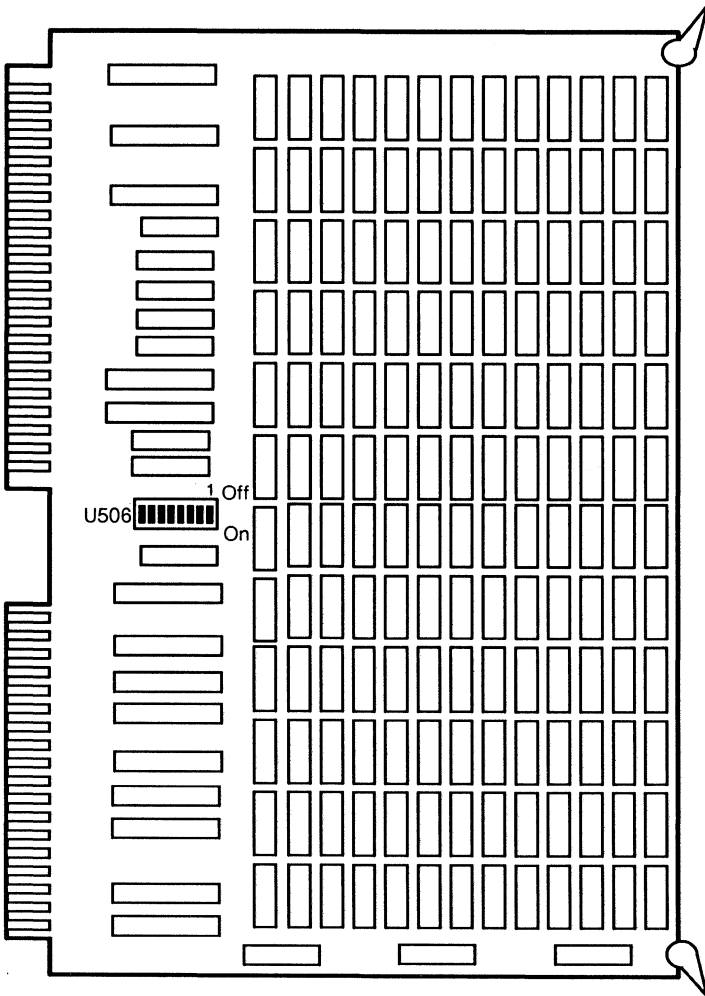

Power: 3.0 Amps @ +5Vdc
15.0 Watts.

501-1048 Switch Settings

MEMORY SIZE	DIP SWITCH U506							
	1	2	3	4	5	6	7	8
1st MB	On	Off	Off	Off	Off	Off	Off	Off
2nd MB	Off	On	Off	Off	Off	Off	Off	Off
3rd MB	Off	Off	On	Off	Off	Off	Off	Off
4th MB	Off	Off	Off	On	Off	Off	Off	Off
5th MB	Off	Off	Off	Off	On	Off	Off	Off
6th MB	Off	Off	Off	Off	Off	On	Off	Off

References

1. *Hardware Installation Manual for the Sun-2/120, 800-1170.*
2. *Hardware Installation Manual for the Sun-2/170, 800-1171.*

Sun-2 Multibus Prime

Sun-2/100U/120/150U/170

501-1232

4MB

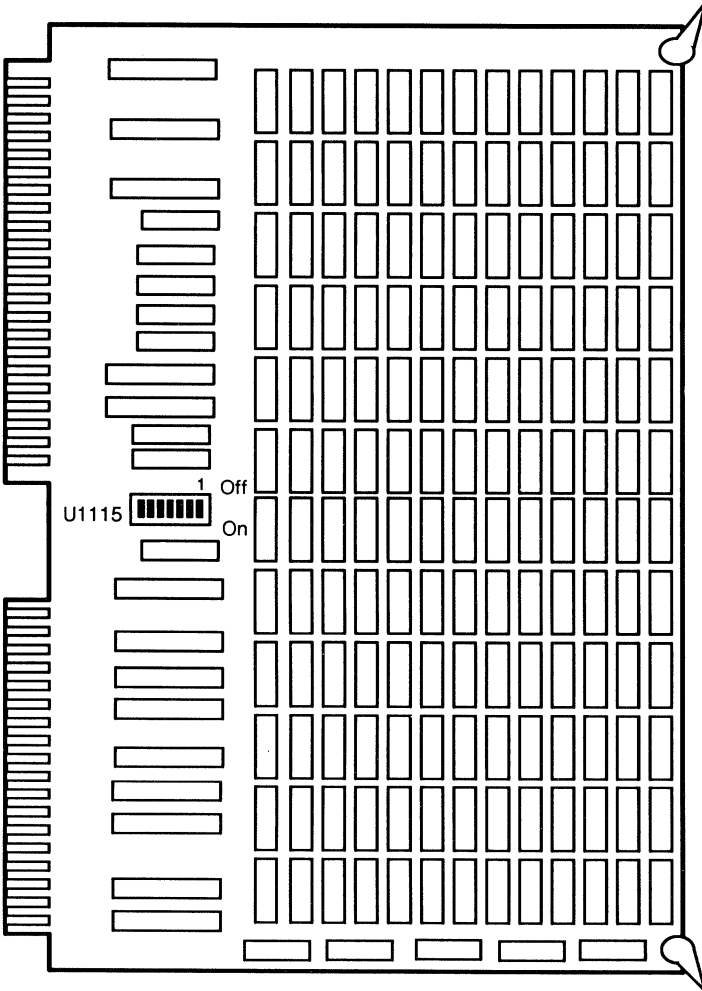

References

1. *Hardware Installation Manual for the Sun-2/120*, 800-1170.
2. *Hardware Installation Manual for the Sun-2/170*, 800-1171.

501-1232

Switch or Jumper Settings

MEMORY SIZE	SWITCH U1115						
	1	2	3	4	5	6	7
1-4MB	On	On	On	On	Off	Off	Off
5-7MB	Off	Off	Off	Off	On	On	On

MEMORY SIZE	JUMPER U1115						
	1	2	3	4	5	6	7
1-4MB	In	In	In	In	Out	Out	Out
5-7MB	Out	Out	Out	Out	In	In	In

Notes

1. Two boards may be used. The maximum supported configuration is 6MB.
2. The Sun-2 Multibus Prime board uses either a dip switch or a set of jumpers to configure the board. Configuration is the same in either case. Each jumper or switch selects a one megabyte range.

Sun 2051 Memory

Sun-2/50

501-1029 501-1046 501-1047

1MB 2MB 4MB

501-1047 501-1079

3MB 0MB

Sun-2/130/160

501-1070 501-1071 501-1096 501-1097

1MB 3MB 2MB 4MB

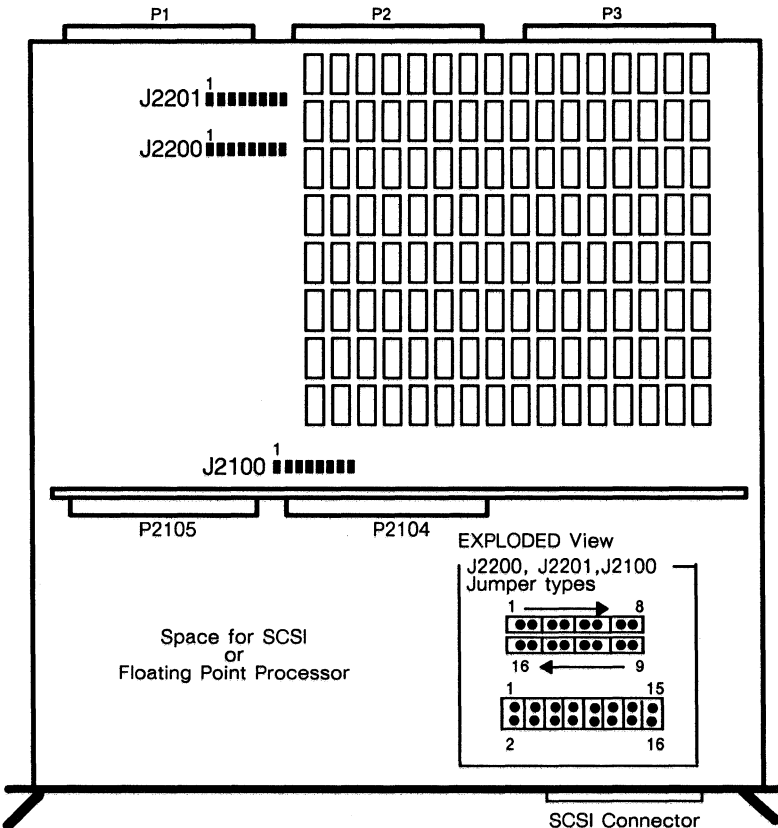

Space for SCSI
or
Floating Point Processor

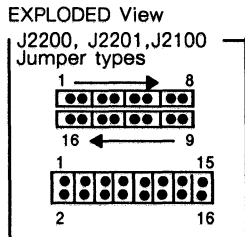

SCSI Connector
50-Pin DD-50SA

Power: 4.0 Amps @ +5Vdc
20.0 Watts.

Note: The P2105 and P2104 connectors on the board, the space for the SCSI, and the SCSI connector are on 501-1020, 1046, 1047, 1067, and 1079.

References

1. *Hardware Installation Manual for the Sun-2/50*, 800-1143.
2. *Hardware Installation Manual for the Sun-2/130 and Sun-2/160*, 800-1144.

501-1029 501-1046 501-1047 501-1047
 501-1079 501-1070 501-1071 501-1096
 501-1097

Jumper Settings

JUMPER	PINS	SETTING	DESCRIPTION
J2100	1-2	Out	Bus Grant 0
J2100	3-4	Out	Bus Grant 1
J2100	5-6	Out	Bus Grant 2
J2100	7-8	Out	Bus Grant 3
J2100	15-16	Out	IACK Chain

	SIZE	JUMPER	SETTING	PINS
1MB CPU Board	1MB	J2200	In	3-4
	1MB	J2201	In	5-6,9-10,13-14
	2MB	J2200	In	3-4,5-6
	2MB	J2201	In	3-4,7-8,11-12
	3MB	J2200	In	3-4,5-6,7-8,9-10
	3MB	J2201	In	7-8,11-12,15-16
	4MB	J2200	In	3-4,5-6,7-8,9-10
	4MB	J2201	In	7-8,11-12,15-16
2MB CPU Board	1MB	J2200	In	5-6
	1MB	J2201	In	5-6,9-10,13-14
	2MB	J2200	In	5-6,7-8
	2MB	J2201	In	3-4,7-8,11-12
	3MB	J2200	In	5-6,7-8,9-10
	3MB	J2201	In	7-8,11-12,15-16
	4MB	J2200	In	5-6,7-8,9-10,11-12
	4MB	J2201	In	7-8,11-12,15-16
4MB CPU Board	1MB	J2200	In	9-10
	1MB	J2201	In	5-6,9-10,13-14
	2MB	J2200	In	9-10,11-12
	2MB	J2201	In	3-4,7-8,11-12
	3MB	J2200	In	9-10,11-12,13-14
	3MB	J2201	In	7-8,11-12,15-16
	4MB	J2200	In	9-10,11-12,13-14,15-16
	4MB	J2201	In	7-8,11-12,15-16

Note: Not all CPU and Memory board combinations function.

Sun-3/75

501-1111 501-1121 501-1122
 2MB 0MB 4MB

Sun-3/110/140/150/160/180

501-1131 501-1132
 2MB 4MB

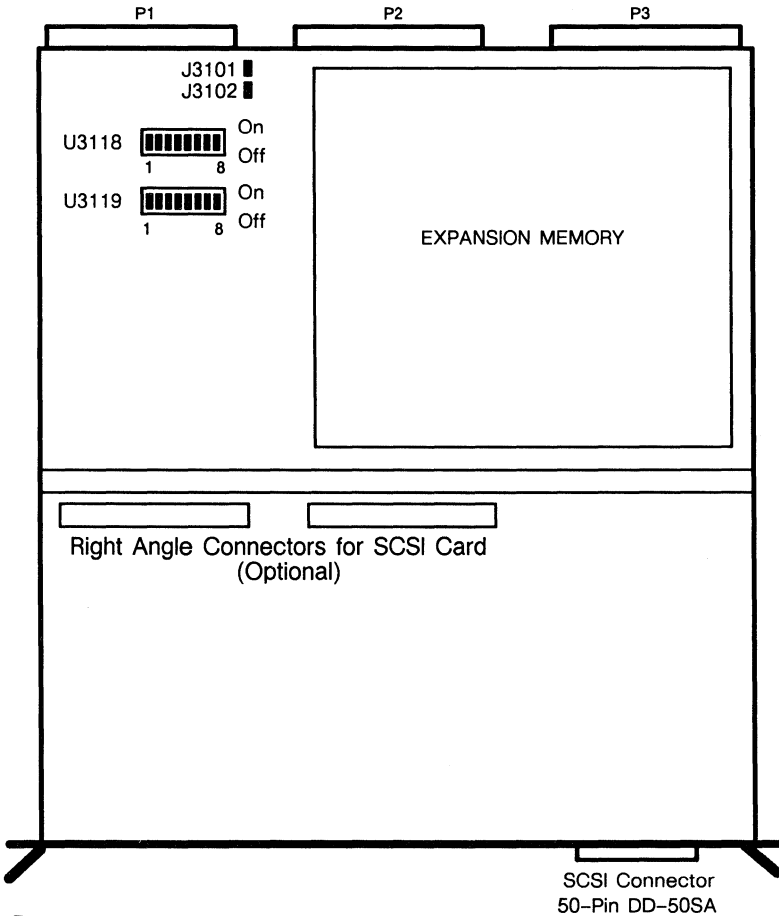

Power

2MB 1.8 Amps @ +5Vdc
 8.5 Watts
 4MB 2.3 Amps @ +5Vdc
 11.5 Watts

Note: The SCSI connector is used on the Sun-3/75 memory boards.

501-1111 501-1121 501-1122
501-1131 501-1132

Jumper Settings

2MB CPU with 2MB Expansion Memory Boards

ADDRESS RANGE	J3101	U3118	U3119
3rd-4th MB	In	SW-2 On	SW-2 On
5th-6th MB	In	SW-3 On	SW-3 On
7th-8th MB	In	SW-4 On	SW-4 On
9th-10th MB	In	SW-5 On	SW-5 On
11th-12th MB	In	SW-6 On	SW-6 On

2MB CPU with 4MB Expansion Memory Boards

ADDRESS RANGE	J3102	U3118	U3119
3rd-6th MB	In	SW-2 On	SW-3 On
7th-10th MB	In	SW-4 On	SW-5 On
11th-12th MB	In	SW-6 On	SW-7 On

4MB CPU with 2MB Expansion Memory Boards

ADDRESS RANGE	J3101	U3118	U3119
5th-6th MB	In	SW-3 On	SW-3 On
7th-8th MB	In	SW-4 On	SW-4 On
9th-10th MB	In	SW-5 On	SW-5 On
11th-12th MB	In	SW-6 On	SW-6 On
13th-14th MB	In	SW-7 On	SW-7 On
15th-16th MB	In	SW-8 On	SW-8 On

4MB CPU with 4MB Expansion Memory Boards

ADDRESS RANGE	J3102	U3118	U3119
5th-8th MB	In	SW-3 On	SW-4 On
9th-12th MB	In	SW-5 On	SW-6 On
13th-16th MB	In	SW-7 On	SW-8 On

Note: Balance of pins not specified are OUT.

Reference

Sun 501-1131 and 501-1132 Memory Board Configuration Procedures,
813-2016.

Sun-3/260/280 & Sun-4/260/280

501-1102

8MB

Sun-4/260/280

501-1254 501-1576

32MB

16MB

Sun-3/460/470/480 & Sun-4/260/280

501-1451 501-1576

32MB

16MB

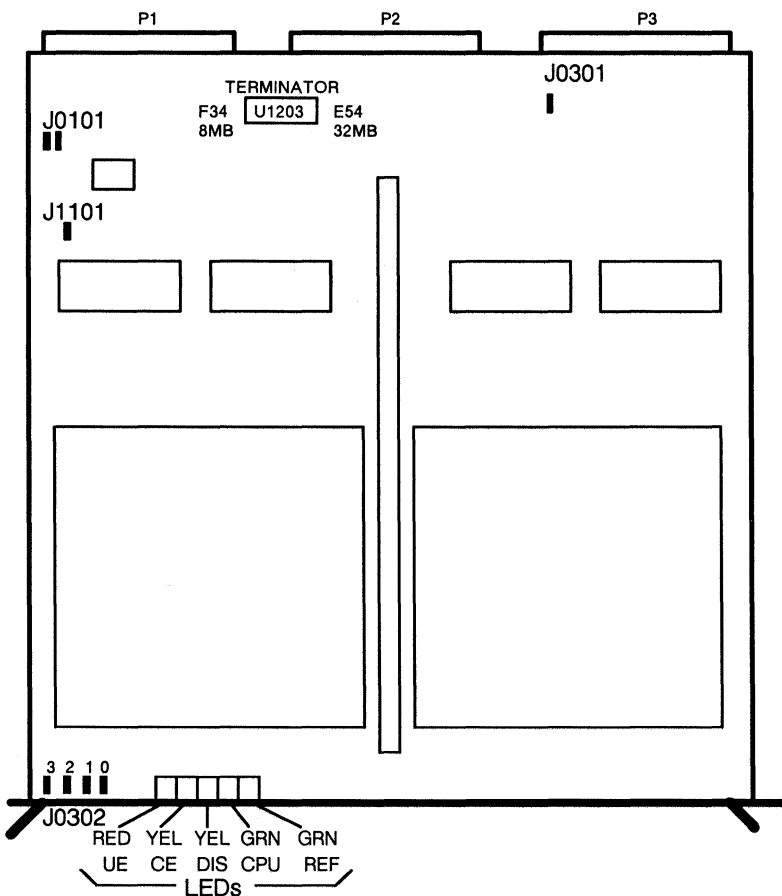

Note: The Sun 4200 CPU requires EPROM 3.0 or greater when more than two 16 MB ECC Memory boards are used.

501-1102 501-1254 501-1451 501-1576

Memory Board LEDs

		STATUS		
LED	COLOR	INTERPRET ON	INTERPRET OFF	
Top Bottom	UE	Red	Uncorrectable error	No UE reported
	CE	Yel	Correctable error	No CE reported
	DIS	Yel	CPU access disabled	CPU access enabled
	CPU	Grn	CPU accessing memory	No CPU accesses
	REF	Grn	Refresh enabled	Refresh failure

Jumper Settings

JUMPER	PINS	SETTING	DESCRIPTION
J0101	1-2	Out	External clock
	3-4	Out	
J1101	1-2	Out	Disable refresh
J0301	1-2	Out	32MB configuration 16MB configuration
		In	
J0302	1	In	1st memory board
	2	In	2nd memory board
	3	In	3rd memory board
	4	In	4th memory board

Notes

- 501-1092 or 501-1117 Backplanes.** Install a single memory board in slot 6 with a 220/270 Terminator, 120-1613-01, installed at location U1203. Remove the terminator when expansion memory boards are installed in slots 2, 3, 4, and 5.
- 501-1439 or 501-1498 Backplanes.** Install a 220/270 Terminator, 120-1613-01, at location U1203 on the memory board installed in slot 1. If placement results in memory boards on both sides of the CPU, remove the Terminator at location U1411 on the Sun 3400 CPU. Install a terminator on memory boards in slot 1 and slot 7.
- When used with the Sun 3400 CPU, the FPA, and the FPA+, the 8MB Memory board must be \geq 501-1102-11.
- The 501-1451 32MB board must be \geq 501-1451-03 when used with the 501-1576 16MB memory board.
- Remove jumpers P10, P11, P12, and P13 from the 501-1598 and 501-1832 Backplanes when the Sun 3400 board set is installed.

References

- Sun 501-1102 Memory Board Configuration Procedures*, 813-2018.
- Installation Notes for the 32MB Memory Board*, 800-2123.
- 16MB ECC Memory Board Installation and Configuration Manual*, 813-1066.

Sun386i Dynamic Memory

386i/150

501-1394
4MB

501-1441
8MB

555-1423
0MB

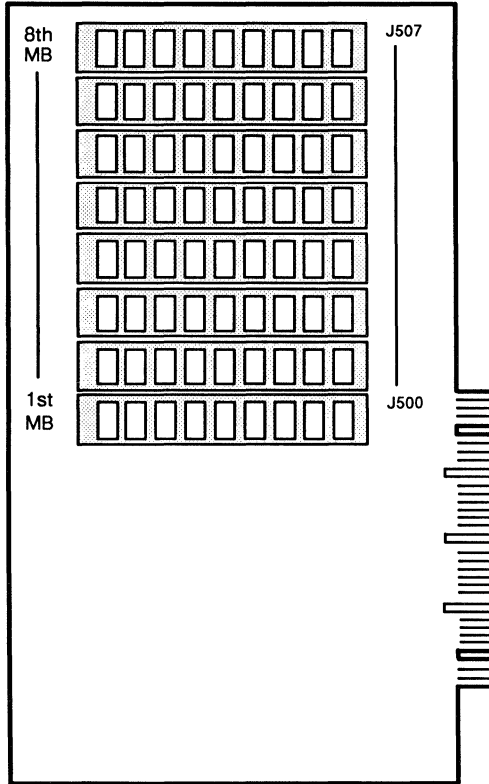

Notes

1. The Dynamic Memory board can be used with any revision of the 501-1414 CPU.
2. CPU revision 501-1241-02, Rev. 03, or greater is required for use with the Dynamic Memory board.
3. CPU revision 501-1241-04, Rev. 01, or greater is required for use with multiple Dynamic Memory boards.
4. The Dynamic Memory board uses the 1MB SIMM module 501-1424.

Reference: Sun386i Installing SIMM Memory Modules, 814-5017.

This page intentionally left blank.

Sun386i XP Cache Memory

386i/150/250

501-1298 501-1325 501-1482 501-1054

8MB

4MB

0MB

0MB

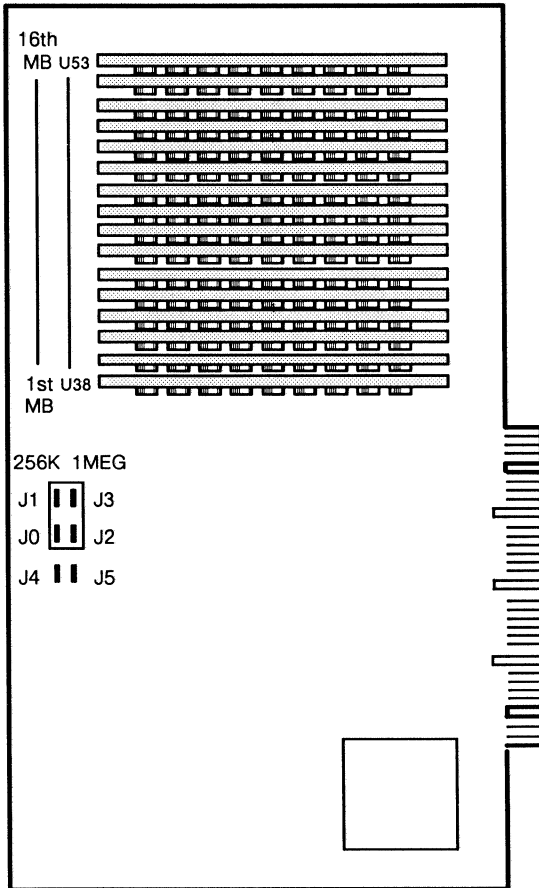

501-1298 501-1325 501-1482 555-1054 Jumper Settings

SIMM Size Jumpers*

JUMPER	256K SIMM	1MB SIMM
J0	In	Out
J1	In	Out
J2	Out	In
J3	Out	In

Memory Size Jumpers*

JUMPER	4MB	8MB	12MB	16MB
J4	In	In	Out	Out
J5	In	Out	In	Out

*The system is software configured. These jumpers are present only on FAB 270-1298-01. Jumper settings do not affect system operation.

Notes

1. 555-1054 uses 1MB SIMM module, 501-1424 or 501-1375.
2. 501-1482 uses 1MB SIMM module, 501-1424, 501-1510, or 501-1375.

Reference: *386i Field Service Manual*, 814-0002.

Sun-3/E

501-8031

4MB

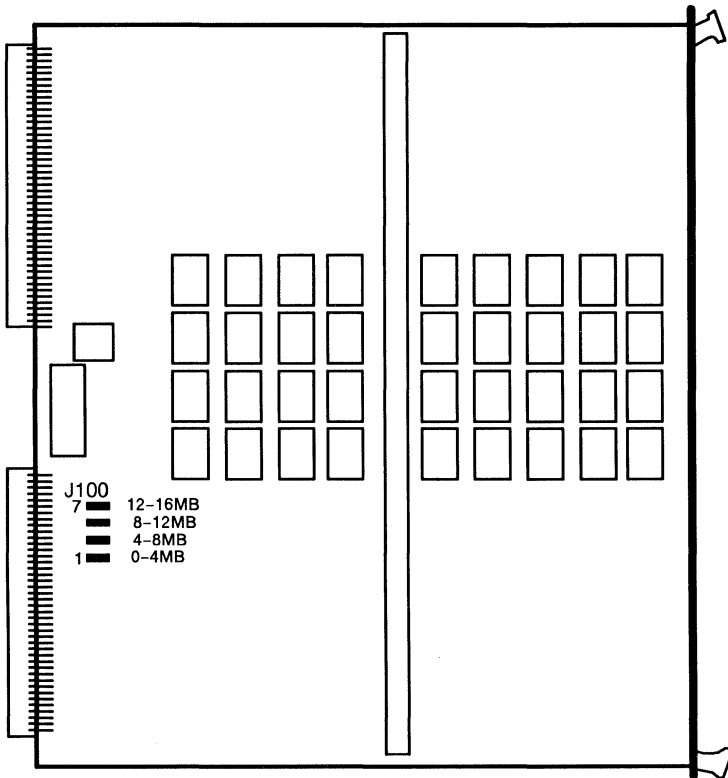

JUMPER	PINS	SETTING	DESCRIPTION
J100	0-4MB	N/A	No pins
J100	4-8MB	*	Selects 1st 4MB board
J100	8-12MB	*	Selects 2nd 4MB board
J100	12-16MB	*	Selects 3rd 4MB board

*Only one location is jumpered, depending on the expansion board address range.

Power: 1.1 Amps @ +5Vdc
5.5 Watts

Note: The Sun 3/E CPU board onboard memory occupies the first 4MB of the addressing range. The 4MB memory board can only be jumpered for 4MB increments in the 5 to 16MB address range.

Sun-3/E
501-8030
12MB

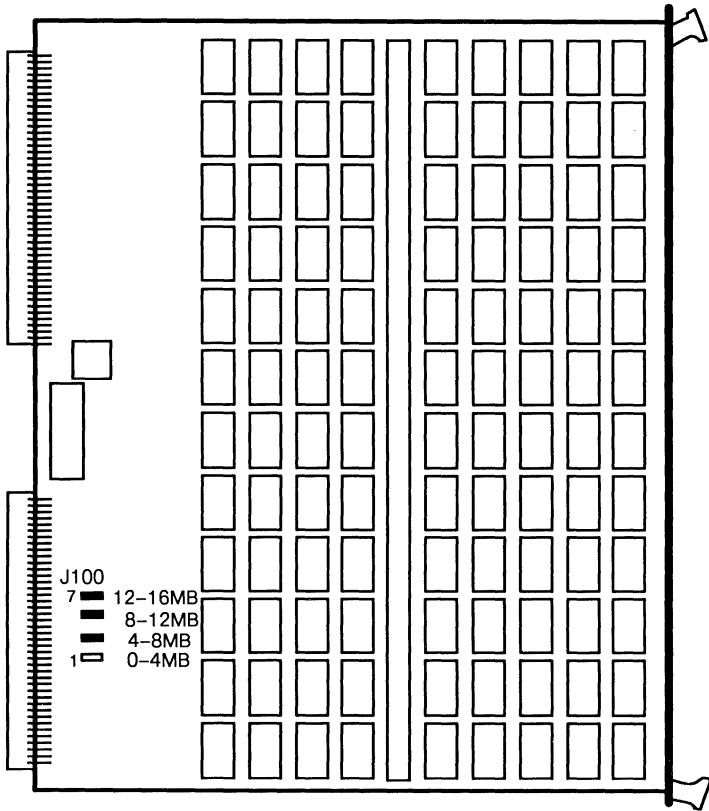

JUMPER	PINS	SETTING	DESCRIPTION
J100	0-4MB	N/A	No pins
J100	4-8MB	*	Selects 1st 4MB bank
J100	8-12MB	*	Selects 2nd 4MB bank
J100	12-16MB	*	Selects 3rd 4MB bank

* Normally installed to configure full 12MB of memory.

Power: 2.0 Amps @ +5Vdc
10.0 Watts

Note: The Sun 3/E CPU board onboard memory occupies the first 4MB of the addressing range. The 12MB memory board can be jumpered in 4MB increments in the 5 to 16MB range.

Sun-4/330

501-1723	501-1711	501-1755
501-1436	501-1317	501-1704
8MB w 1MB SIMMS	16MB w 1MB SIMMS	32MB w 4MB SIMMS

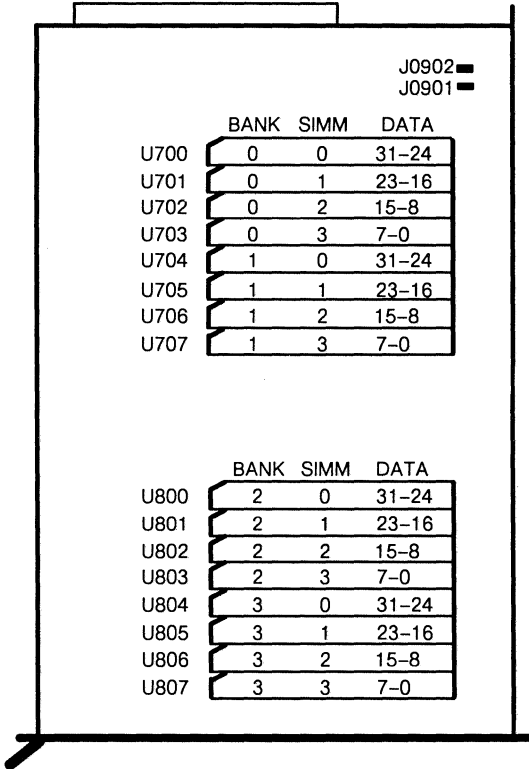

JUMPER	PINS	SETTING	DESCRIPTION
J0901	1-2	In	8 SIMMS installed
		Out	16 SIMMS installed
J902	1-2	In	1MB SIMM
		Out	4MB SIMM

Power: 1.1 Amps @ +5Vdc
5.5 Watts.

Note: The Sun-4/330 memory uses 1MB SIMM, 501-1544 or 501-1565, or 4MB SIMM module, 501-1682.

Reference
Sun 4300 CPU and Memory Board Configuration Procedure, 813-2064.

This page intentionally left blank.

Sun 4300 Memory

Sun-4/310/350/360/370/380/390

501-1563 501-1564 501-1495 501-1703

24MB
w 1MB SIMMS

8MB
w 1MB SIMMS

48MB
w 1MB SIMMS

32MB
w 4MB SIMMS

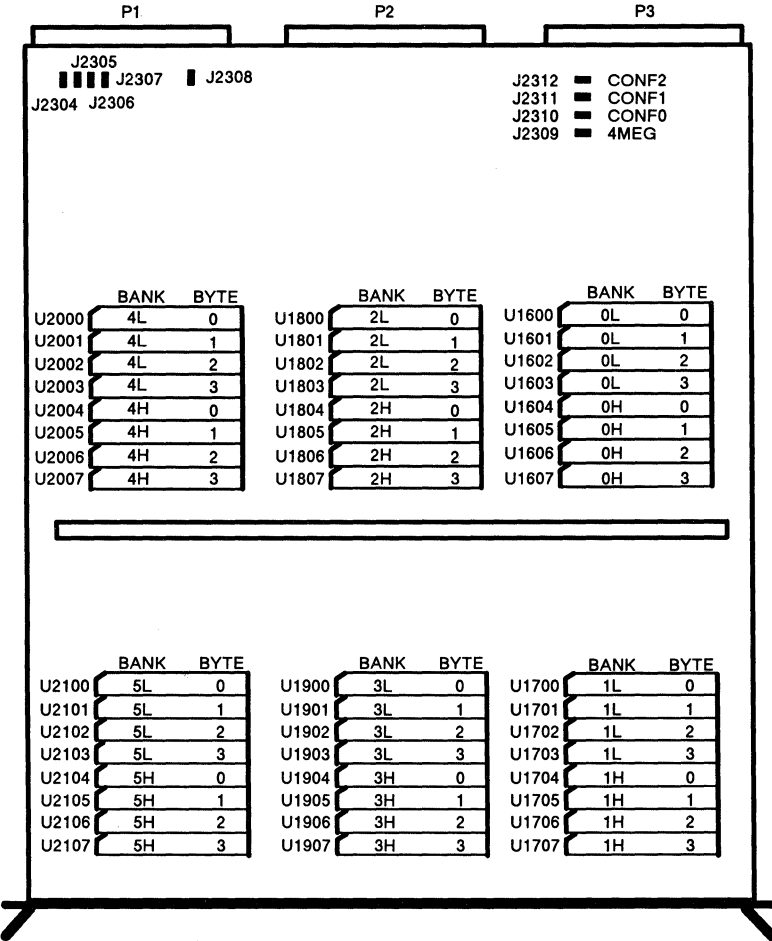

Note: Socket locations are silkscreened on the solder side of this board.

Reference

8 Mbyte, 24 Mbyte, and 48 Mbyte Parity Memory Board Installation and Configuration Manual, 800-3403.

501-1563 501-1564 501-1495 501-1703 Jumper Settings & Memory Configurations

JUMPER	SETTING	DESCRIPTION
J2304	In	BGR0
J2305	In	BGR1
J2306	In	BGR2
J2307	In	BGR3
J2308	In	IACK

JUMPER	SETTING	SIMM MODULE	PART NUMBER
J2309/4MEG	Out	1MB SIMM	501-1565/501-1544/501-1466
J2309/4MEG	In	4MB SIMM	501-1682

8MB J2312 CONF2
 32MB J2311 CONF1
 J2310 CONF0

24MB J2312 CONF2
 96MB J2311 CONF1
 J2310 CONF0

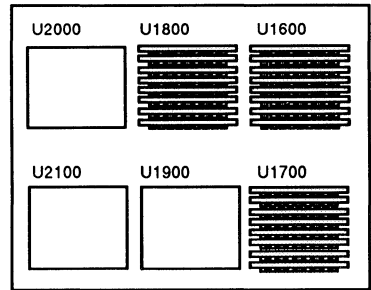
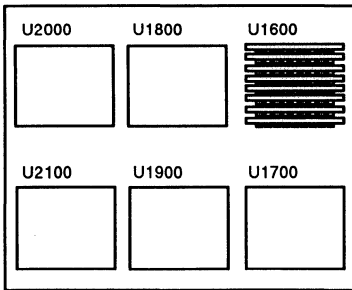

48MB J2312 CONF2
 192MB J2311 CONF1
 J2310 CONF0

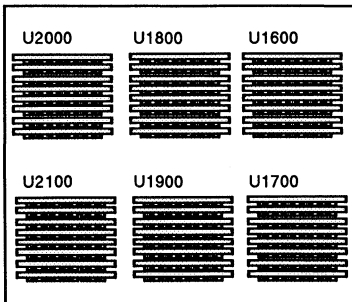

Power
 24MB 4.3 Amps @ +5vdc
 21.5 Watts
 48MB 5.3 Amps @ +5vdc
 26.5 Watts

Sun 4400 Memory

Sun-4/470/490

501-1333

501-1721

32MB

128MB

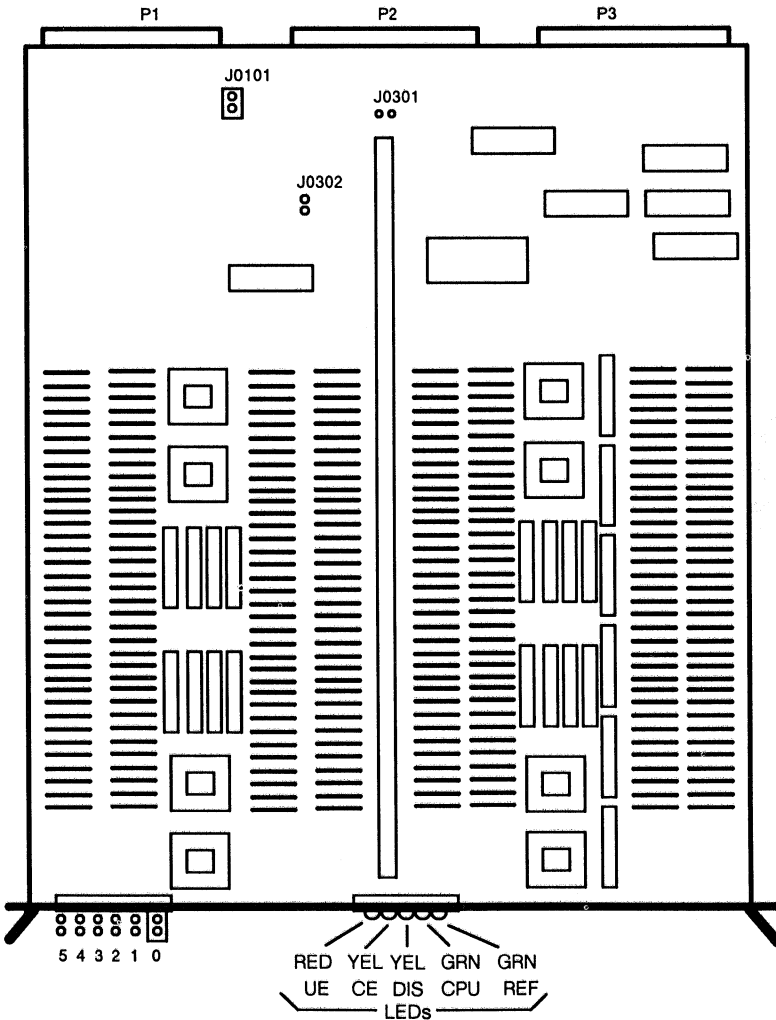

Power

32MB 15.6 Amps @ +5Vdc
78.0 Watts

128MB 13.7 Amps @ +5Vdc
68.5 Watts

501-1333 501-1721 LED Status & Jumper Settings

Memory Board LEDs

		STATUS		
LED	COLOR	INTERPRET ON	INTERPRET OFF	
Top Bottom	UE	Red	Uncorrectable error	Normal condition
	CE	Yel	Correctable error	Normal condition
	DIS	Yel	CPU access disabled	CPU access enabled
	CPU	Grn	CPU accesses (flickering) memory	No CPU access occurring
	REF	Grn	Refresh is working properly	Refresh failure. Board needs attention.

Jumper Settings

JUMPER	PINS	SETTING	DESCRIPTION
J0101	1-2	In	Enable SET.RDY
J0301	1-2	In	Set for 32MB board
J0302	1-2	Out	Set for 32MB board
J0301	1-2	Out	Set for 128MB board
J0302	1-2	In	Set for 128MB board
J0310	1-2	In	1st memory board
J0311	1-2	In	2nd memory board
J0312	1-2	In	3rd memory board
J0313	1-2	In	4th memory board
J0314	1-2	In	5th memory board
J0315	1-2	In	6th memory board

Notes

1. The Sun 4400 CPU requires EPROM 3.0 or greater to support the 128MB Memory Board.
2. SunOS 4.0.3 supports up to 256MB of memory.
3. SunOS 4.1 PSR A requires *4.1 PSR A Sun-4 PMEG Patch* to enable over 256MB of memory.
4. A Correctable Error on the sixth 128MB board turns on the CE LED and turns off error logging. Reset power to clear this condition.

Reference

32- and 128-Mbyte Memory Board Installation and Configuration Procedures, 800-3518.

Sun-4/E

501-8042

4MB

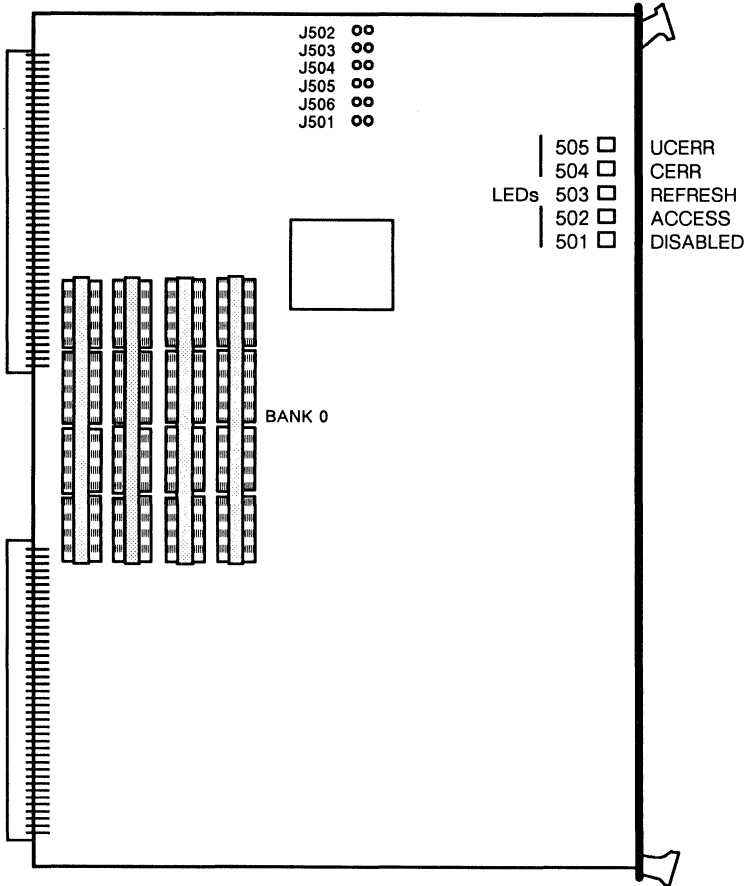

501–8042

Jumper Descriptions

- BOARD SIZE** Sets the memory size of the board.
- BOARD ID** Determines where a memory board is mapped into the 256MByte space allocated for memory expansion.
- HI/LOW MEM** IN maps the memory board into the lowest 256MBytes of CPU type 0 space. OUT maps the memory board in the address range between 256MBytes and 512MBytes.
- BD ID** **LOW MEMORY** **HIGH MEMORY**
 0 = 0x00000000 – 0x003fffff or 0x10000000 – 0x103fffff
 1 = 0x01000000 – 0x013fffff or 0x11000000 – 0x113fffff
 2 = 0x02000000 – 0x023fffff or 0x12000000 – 0x123fffff
 3 = 0x03000000 – 0x033fffff or 0x13000000 – 0x133fffff
- 1M/4M DRAM** Specifies 1MByte or 4Mbyte DRAM modules.

Jumper Settings

Memory Mapped into the Upper 256MBytes of Type 0 Address Space

BOARD SIZE	BOARD ID	HI/LOW MEM	1/4MB DRAM	ADDRESS RANGE		
J0502	J0503	J0504	J0505	J0506	J0501	PHYSICAL ADDR RANGE
Out	Out	Out	Out	Out	Out	0x10000000 – 0x103fffff
Out	Out	Out	In	Out	Out	0x11000000 – 0x113fffff
Out	Out	In	Out	Out	Out	0x12000000 – 0x123fffff
Out	Out	In	In	Out	Out	0x13000000 – 0x133fffff

Memory Mapped into the Lower 256MBytes of Type 0 Address Space

BOARD SIZE	BOARD ID	HI/LOW MEM	1/4MB DRAM	ADDRESS RANGE		
J0502	J0503	J0504	J0505	J0506	J0501	PHYSICAL ADDR RANGE
Out	Out	Out	Out	In	Out	0x00000000 – 0x003fffff
Out	Out	Out	In	In	Out	0x01000000 – 0x013fffff
Out	Out	In	Out	In	Out	0x02000000 – 0x023fffff
Out	Out	In	In	In	Out	0x03000000 – 0x033fffff

Notes

- For specific application dependent memory configurations refer to the SPARCengine 1E ECC Memory Card User's Manual, 800–8138.
- The default configuration for Hi Mem/Low Mem is J0506 OUT.

Reference

SPARCengine 1E ECC Memory Card User's Manual, 800–8138.

Sun-4/E

501-8036

16MB

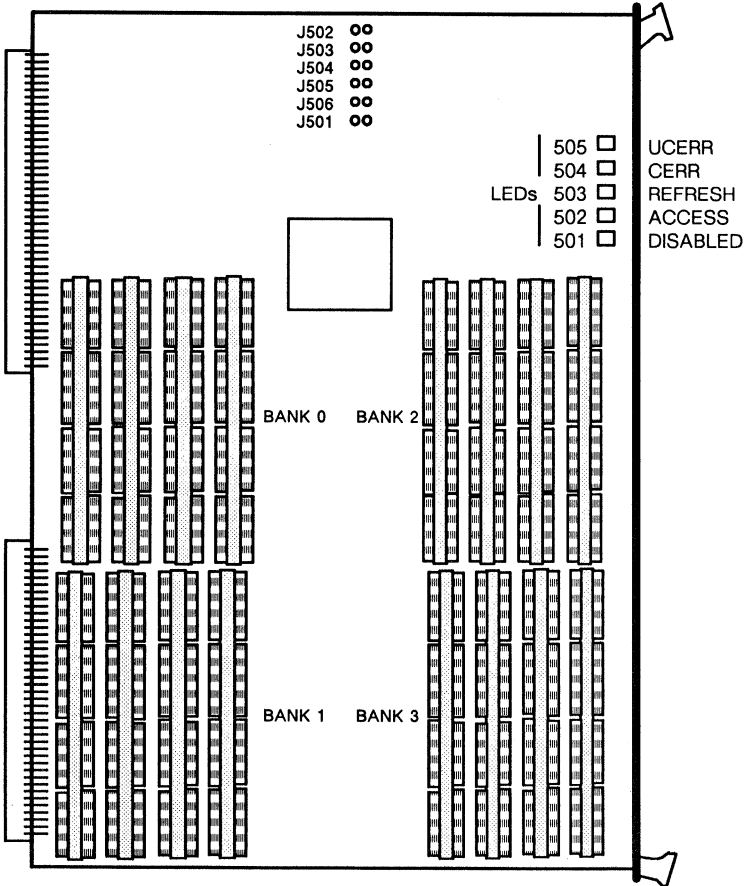

501–8036

Jumper Descriptions

- BOARD SIZE** Sets the memory size of the board.
- BOARD ID** Determines where a memory board is mapped into the 256MByte space allocated for memory expansion.
- HI/LOW MEM** IN maps the memory board into the lowest 256MBytes of CPU type 0 space. OUT maps the memory board in the address range between 256MBytes and 512MBytes.
- BD ID** **LOW MEMORY** **HIGH MEMORY**
- 0 = 0x00000000 – 0x00ffffff or 0x10000000 – 0x10ffffff
- 1 = 0x01000000 – 0x01ffffff or 0x11000000 – 0x11ffffff
- 2 = 0x02000000 – 0x02ffffff or 0x12000000 – 0x12ffffff
- 3 = 0x03000000 – 0x03ffffff or 0x13000000 – 0x13ffffff
- 1M/4M DRAM** Specifies 1MByte or 4MByte DRAM modules.

Jumper Settings

Memory Mapped into the Upper 256MBytes of Type 0 Address Space

BOARD SIZE	BOARD ID	HI/LOW MEM	1/4MB DRAM	ADDRESS RANGE		PHYSICAL ADDR RANGE
				J0506	J0501	
J0502	J0503	J0504	J0505	J0506	J0501	PHYSICAL ADDR RANGE
In	In	Out	Out	Out	Out	0x10000000 – 0x10ffffff
In	In	Out	In	Out	Out	0x11000000 – 0x11ffffff
In	In	In	Out	Out	Out	0x12000000 – 0x12ffffff
In	In	In	In	Out	Out	0x13000000 – 0x13ffffff

Memory Mapped into the Lower 256MBytes of Type 0 Address Space

BOARD SIZE	BOARD ID	HI/LOW MEM	1/4MB DRAM	ADDRESS RANGE		PHYSICAL ADDR RANGE
				J0506	J0501	
J0502	J0503	J0504	J0505	J0506	J0501	PHYSICAL ADDR RANGE
In	In	Out	Out	In	Out	0x00000000 – 0x00ffffff
In	In	Out	In	In	Out	0x01000000 – 0x01ffffff
In	In	In	Out	In	Out	0x02000000 – 0x02ffffff
In	In	In	In	In	Out	0x03000000 – 0x03ffffff

Notes

- For specific application dependent memory configurations refer to the SPARCengine 1E ECC Memory Card User's Manual, 800–8138.
- The default configuration for Hi Mem/Low Mem is J0506, OUT.

Reference

SPARCengine 1E ECC Memory Card User's Manual, 800–8138.

Sun-4/E Combo Memory

501-8060

OMB

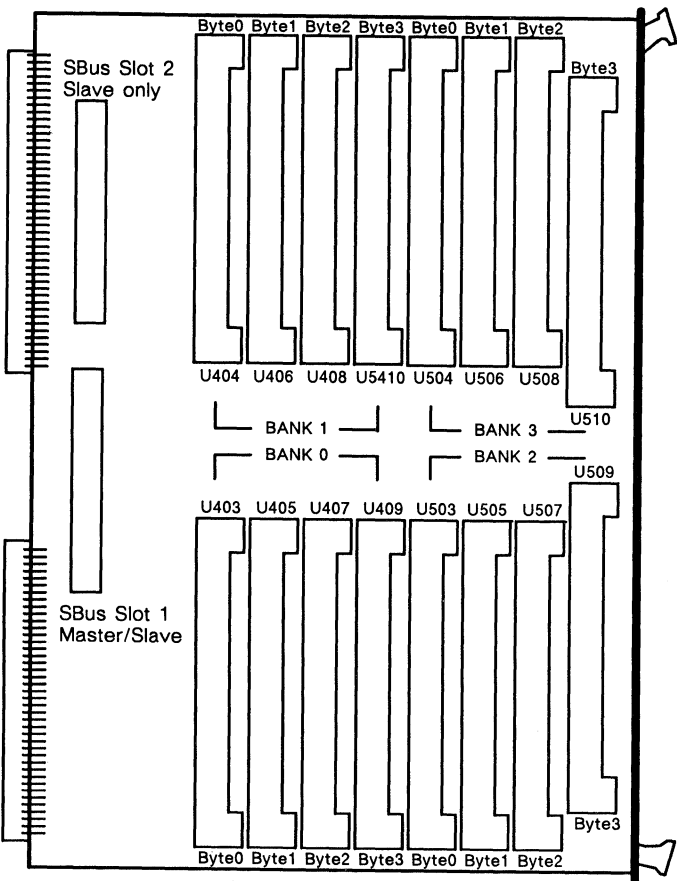

Note: SunOS 4.0.3e requires the 4.0.3e SRX Feature Tape to support the Combo Memory Card.

Reference
SPARCengine 1E Combo Memory Card User's Manual, 800-8152.

CONFIGURATIONS

VIDEO/GRAPHIC

Video/Graphic

MULTIBUS

Sun 1024 Monochrome Frame Buffer	3
Color Frame Buffer	4
TTL Monochrome Frame Buffer	6
TTL/ECL Monochrome Frame Buffer	8

VMEbus

Sun 2160 Color Frame Buffer	10
GP Graphics Processor	12
GP+ Graphics Processor Plus	14
GB Graphics Buffer	16
CG3 Sun 3160 Color Frame Buffer	18
CG5 Color Frame Buffer	20
GP2 Graphics Processor	24
CG9 24-Bit Color Frame Buffer	26
TAAC-1 Application Accelerator	28
Sun-3/E Monochrome Frame Buffer	31
Sun-3/E Color Frame Buffer	32

P4 Bus

Sun-3/60 CG4 Color Frame Buffer	33
MG3 ECL Monochrome Frame Buffer	34
CG4 Color Frame Buffer	35
CG6 Color Frame Buffer	36
CG8 24-Bit Color Frame Buffer	38
MG4 Analog/ECL Frame Buffer	39
DC to DC Converter	40

Sun386i

Color Frame Buffer (High-Resolution)	41
Color Frame Buffer (Low-Resolution)	42
Monochrome Frame Buffer (Low-Resolution)	43
Monochrome Frame Buffer (High-Resolution)	44
SunVGA/EGA	45
GXi Frame Buffer	46

Video/Graphic – Continued

SBus

MG1 ECL Monochrome Frame Buffer	47
MG2 Analog Frame Buffer	48
CG3 Color Frame Buffer	50
CG6 Color Frame Buffer	52
CG12 24-bit Color Frame Buffer	55
VideoPics	56

Sun 1024 Monochrome Frame Buffer

800 x 1024 30KHz 77Hz
Sun-1/100 & Sun-2/100U/150U
501-0059

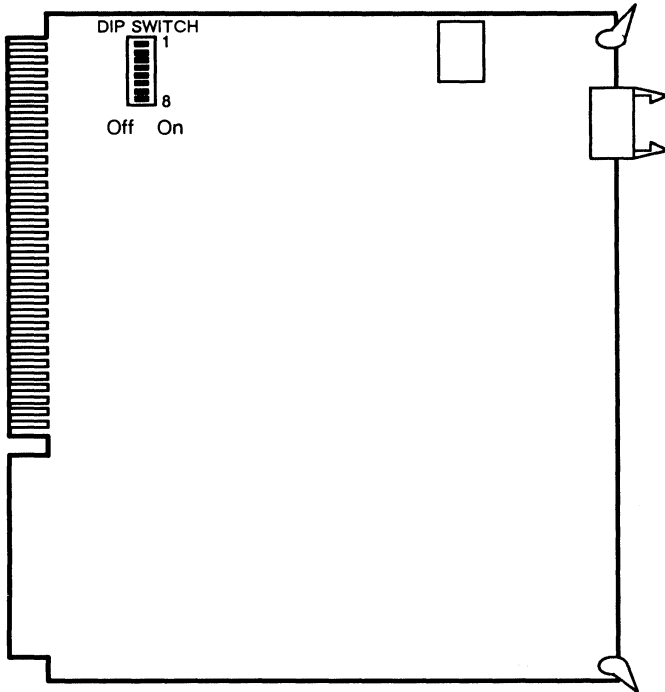

DIP SWITCH	SETTING	DESCRIPTION
1	Off	Address 0x00000
2	On	Address 0x20000
3	Off	Address 0x40000
4	Off	Address 0x60000
5	Off	Address 0x80000
6	Off	Address 0xA0000
7	Off	Address 0xC0000
8	Off	Address 0xE0000

UNIX ID: /dev/bwone0

Power: 5.0 Amps @ +5Vdc
25.0 Watts

Color Frame Buffer

475 x 640 15.75KHz 60Hz
Sun-2/100U/120/150U/170
501-0461

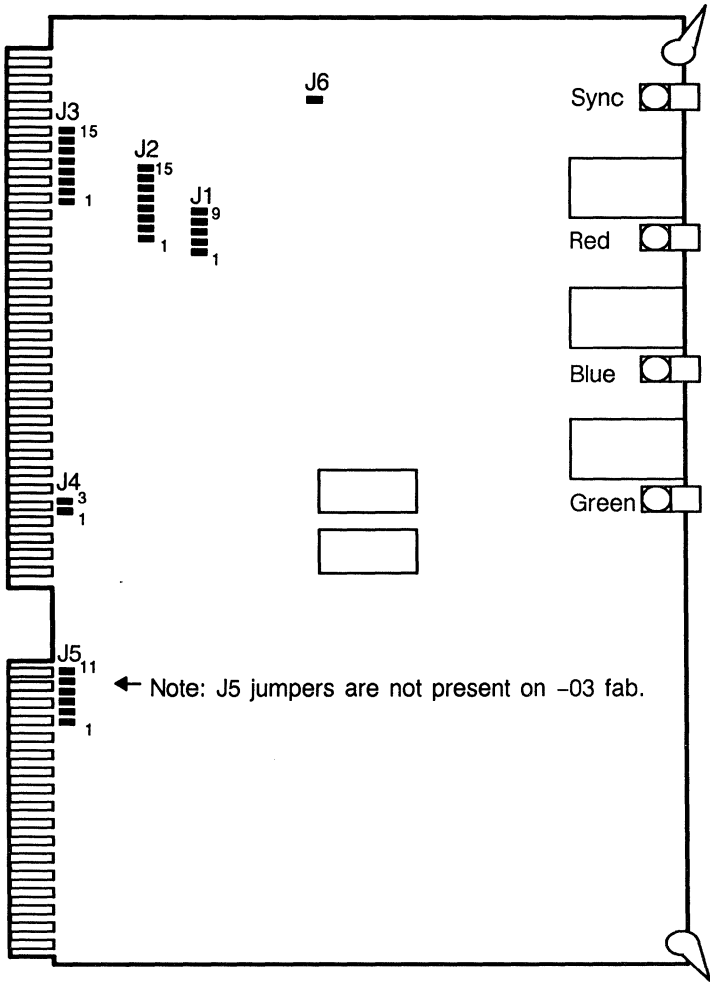

UNIX ID: /dev/cgtwo0

Power: 6.0 Amps @ +5Vdc
1.2 Amps @ -5Vdc
36.0 Watts

501-0461 Jumper Settings

JUMPER	PINS	SETTINGS	DESCRIPTION	
J1	1-2	In	VODD	
	3-4	In	VRESET	
	5-6	In	SYSCP1	
	7-8	In	HRESET	
	9-10	In	STATE 11	
J2 *	1-2	In	Address bit A19	
	3-4	In	Address bit A18	
	5-6	In	Address bit A17	
	7-8	Out	Address bit A16	
	9-10	In	Address bit A15	
	11-12	In	Address bit A14	
J3	13-14	N/A	Not connected	
	15-16	N/A	Not connected	
	1-2	Out	Interrupt level 0	
	3-4	Out	Interrupt level 1	
	5-6	In	Interrupt level 2	
	7-8	Out	Interrupt level 3	
J4	9-10	Out	Interrupt level 4	
	11-12	Out	Interrupt level 5	
	13-14	Out	Interrupt level 6	
	15-16	Out	Interrupt level 7	
	J5	1-2	In	Inverts BBUS.A0
		3-4	Out	
J6	5-6	In †	Grounds the P2 bus	
	7-8	In †		
	9-10	In †		
	11-12	In †		
	1-2	In		Enable clock

* The default base address is 0x1EC00.

† Must be Out if board is in P2 slot shared by the CPU.

References

1. *Hardware Installation Manual for the Sun-2/120*, 800-1170.
2. *Hardware Installation Manual for the Sun-2/170*, 800-1171.

TTL Monochrome Frame Buffer

1152 x 900 62KHz 66Hz

Sun-2/120/170

501-1003

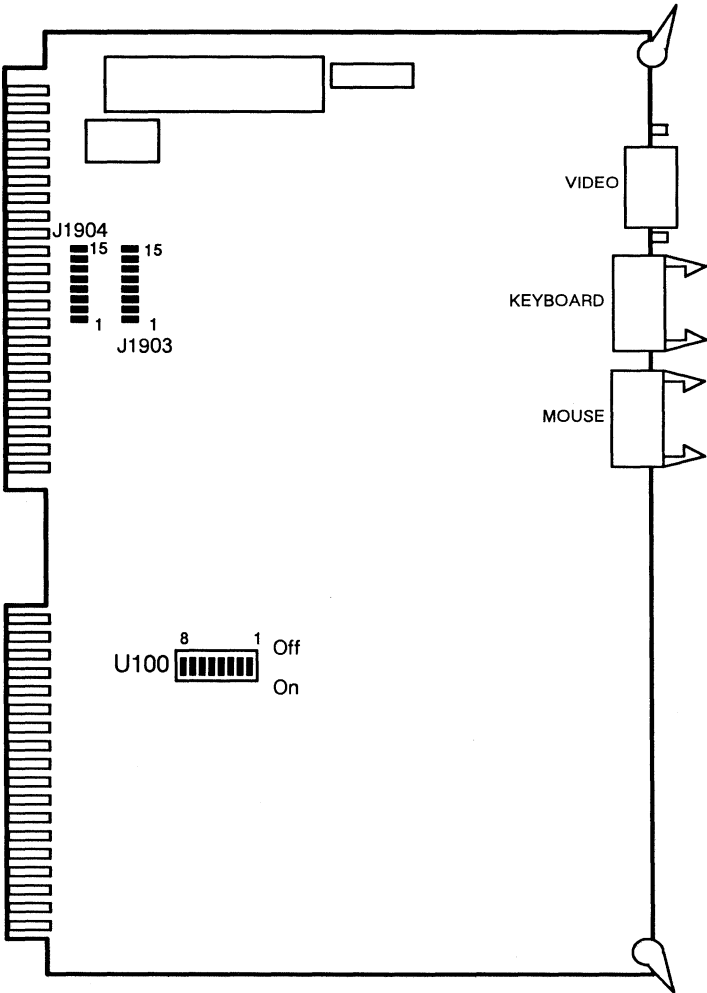

UNIX ID: /dev/bwone0

Power: 4.0 Amps @ +5Vdc
20.0 Watts

501-1003 Jumper & Switch Settings

JUMPER	PINS	SETTING	DESCRIPTION
J1903	1-2	Out	Serial interrupt level select
	3-4	Out	
	5-6	Out	
	7-8	Out	
	9-10	Out	
	11-12	Out	
	13-14	In	
	15-16	Out	
J1904	1-2	Out	Video interrupt level select Used for diagnostics*
	3-4	Out	
	5-6	Out	
	7-8	Out	
	9-10	In	
	11-12	Out	
	13-14	Out	
	15-16	Out	

*Must be installed to run video tests under the Diagnostic Executive.

DIP SWITCH	SWITCH	SETTING	DESCRIPTION
U100	1-7	Off	Base address=0x700000
	8	On	

References

1. *Hardware Installation Manual for the Sun-2/120*, 800-1170.
2. *Hardware Installation Manual for the Sun-2/170*, 800-1171.

TTL/ECL Monochrome Frame Buffer

1152 x 900 62KHz 66Hz
Sun-2/120/170
501-1052

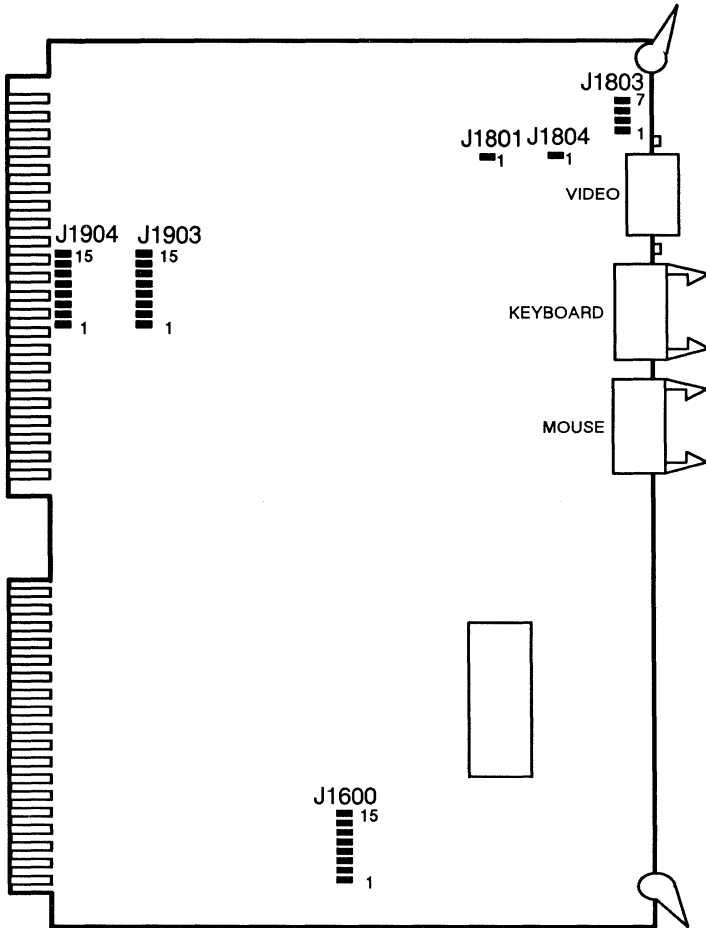

UNIX ID: /dev/bwone0

Power: 4.0 Amps @ +5Vdc
20.0 Watts

References

1. *Hardware Installation Manual for the Sun-2/120, 800-1170.*
2. *Hardware Installation Manual for the Sun-2/170, 800-1171.*

501-1052 Jumper Settings

JUMPER	PINS	SETTING	DESCRIPTION
J1600	1-2	In	Sun standard video screen Not used
	3-4	In	
	5-6	In	
	7-8	In	
	9-10	Out	
	11-12	Out	
	13-14	Out	
15-16	Out		
J1801	1-2	In	Crystal shunt
J1803	1-2	In for ECL or Out for TTL	In for ECL or Out for TTL In for TTL or Out for ECL In for ECL or Out for TTL In for TTL or Out for ECL
	3-4	In for TTL or Out for ECL	
	5-6	In for ECL or Out for TTL	
	7-8	In for TTL or Out for ECL	
J1804	1-2	Out	
J1903	1-2	Out	Serial interrupt level select
	3-4	Out	
	5-6	Out	
	7-8	Out	
	9-10	Out	
	11-12	Out	
	13-14	In	
15-16	Out		
J1904	1-2	Out	Video interrupt level select Used for diagnostics*
	3-4	Out	
	5-6	Out	
	7-8	Out	
	9-10	In	
	11-12	Out	
	13-14	Out	
15-16	Out		

*Must be installed to run video tests under the Diagnostic Executive.

Note: CPU boards with EPROM Revision N or below may require the addition of shunts at J1600 to operate properly with SunOS 3.0 and greater.

Sun 2160 Color Frame Buffer

1152 x 900 62KHz 66Hz

Sun-2/160 & 3/160/180/260/280/460/470/480

501-1014

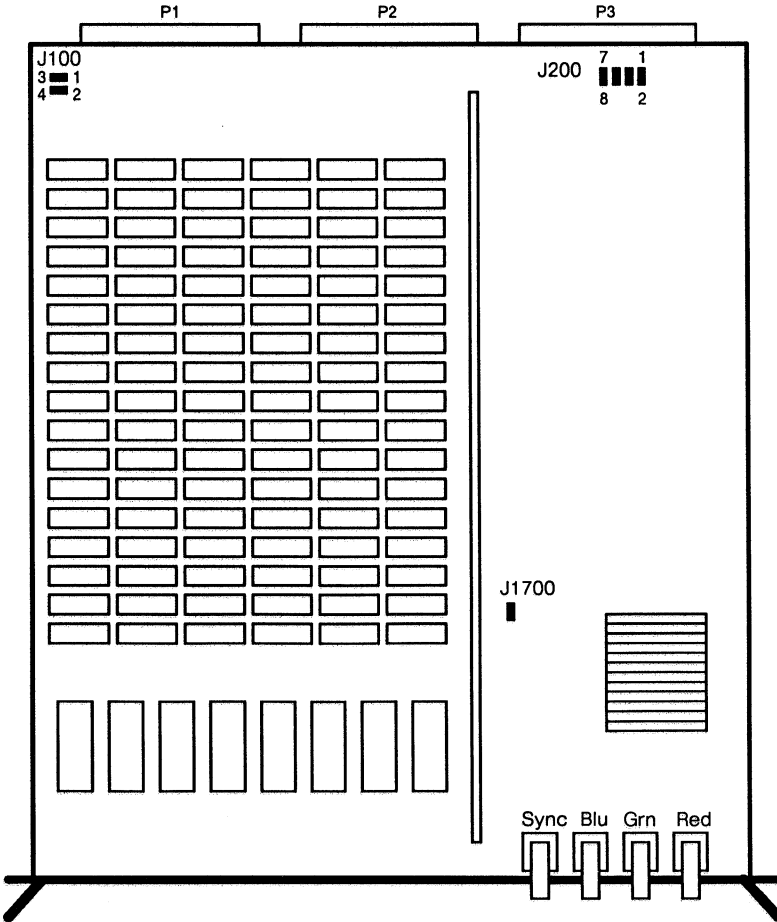

UNIX ID: /dev/cgtwo0

Power: 15.0 Amps @ +5Vdc
 5.7 Amps @ -5Vdc
 0.2 Amps @ -12Vdc
 107.0 Watts

501-1014 Jumper Settings

JUMPER	PINS	SETTING	DESCRIPTION
J100*	1-3 3-4	In Hardwired	Sets base address to 400000
J200	1-2 3-4 5-6 7-8	Out Out Out Out	Sense Bit 0 Sense Bit 1 Sense Bit 2 Sense Bit 3
J1700	1-2	In	Enable clock

* Pins 1-3 are hardwired on Fab 270-1014-02/03.
Pins 1-3 are not hardwired on Fab 270-1014-05/06.

GP Graphics Processor

Sun-2/160

Sun-3/160/180/260/280/460/470/480

Sun-4/150/260/280/330/350/360/370/380

501-1055

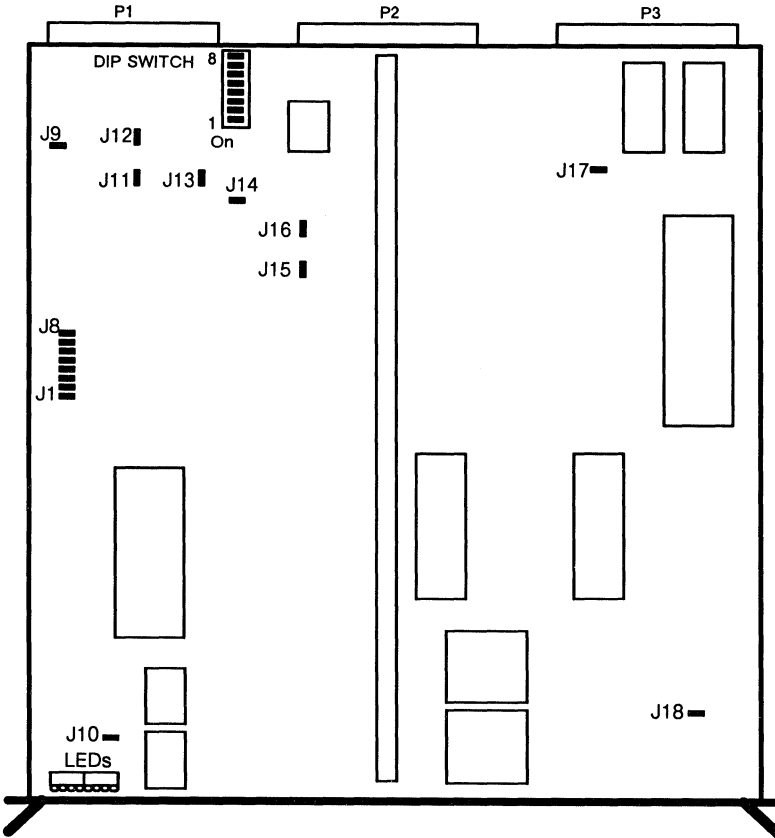

UNIX ID: /dev/gpone0a-d

Power

GP 16.4 Amps @ +5Vdc
82.0 Watts

501-1055

Jumper & Switch Settings

JUMPER	SETTING	DESCRIPTION
J1	Out	GP board ID bit 3
J2	In	GP board ID bit 4
J3	In	GP board ID bit 2
J4	Out	GP board ID bit 5
J5	Out	GP board ID bit 1
J6	Out	GP board ID bit 6
J7	In, if GB present	GP board ID bit 0
J8	Out	GP board ID bit 7
J9	Out*	GND test point
J10	Out*	GND test point
J11	Out*	PP halt test point
J12	Out*	VP halt test point
J13	Out*	Manual reset test point
J14	In	Main clock connect
J15	Out	VP free-running CLK test point
J16	Out	PP free-running CLK test point
J17	Out*	GND test point
J18	Out	GND test point

*Hardwired

DIP SWITCH	ON/OFF	DESCRIPTION
1	On	VME address bit 17
2	Off	VME address bit 16
3	On	VME address bit 23
4	On	VME address bit 22
5	Off	VME address bit 21
6	On	VME address bit 20
7	On	VME address bit 19
8	On	VME address bit 18

Notes

1. J7 must be IN when a Graphics Buffer is installed.
2. The Sun-2/160 Power Supply requires RC Network 540-1300-01.
3. The default base address is 0x210000.

Reference

Hardware Installation Manual for the Sun-2/130 and Sun-2/160, 800-1144.

GP+ Graphics Processor Plus Sun-2/160

Sun-3/160/180/260/280/460/470/480

Sun-4/150/260/280/330/350/360/370/380

501-1139

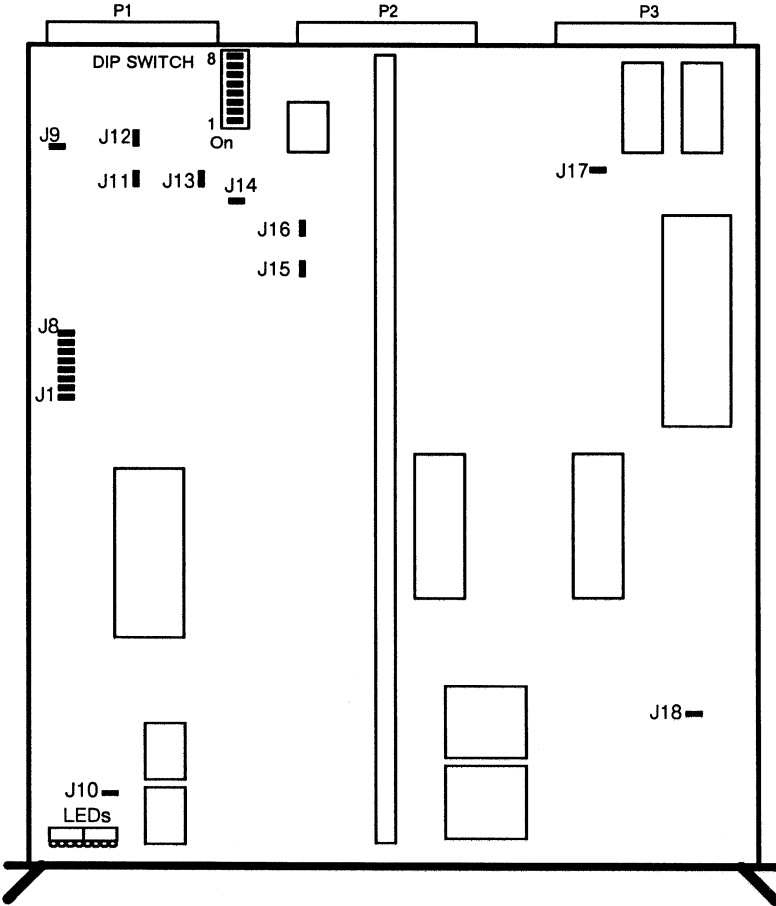

UNIX ID: /dev/gpone0a-d

Power

GP+ 14.6 Amps @ +5Vdc
73.0 Watts

501-1139

Jumper & Switch Settings

JUMPER	SETTING	DESCRIPTION
J1	Out	GP board ID bit 3
J2	In	GP board ID bit 4
J3	In	GP board ID bit 2
J4	Out	GP board ID bit 5
J5	Out	GP board ID bit 1
J6	Out	GP board ID bit 6
J7	In, if GB present	GP board ID bit 0
J8	Out	GP board ID bit 7
J9	Out*	GND test point
J10	Out*	GND test point
J11	Out*	PP halt test point
J12	Out*	VP halt test point
J13	Out*	Manual reset test point
J14	In	Main clock connect
J15	Out	VP free-running CLK test point
J16	Out	PP free-running CLK test point
J17	Out*	GND test point
J18	Out	GND test point

*Hardwired

DIP SWITCH	ON/OFF	DESCRIPTION
1	On	VME address bit 17
2	Off	VME address bit 16
3	On	VME address bit 23
4	On	VME address bit 22
5	Off	VME address bit 21
6	On	VME address bit 20
7	On	VME address bit 19
8	On	VME address bit 18

Notes

1. The Sun-2/160 Power Supply requires RC Network 540-1300-01 (FCO 160-0002, Doc 807-0029).
2. The default base address is 0x210000.

Reference

Graphics Processor Plus Configuration Procedures, 813-2023.

GB Graphics Buffer

Sun-2/160
Sun-3/160/180/260/280/460/470/480
Sun-4/150/260/280/360/370/380
501-1058

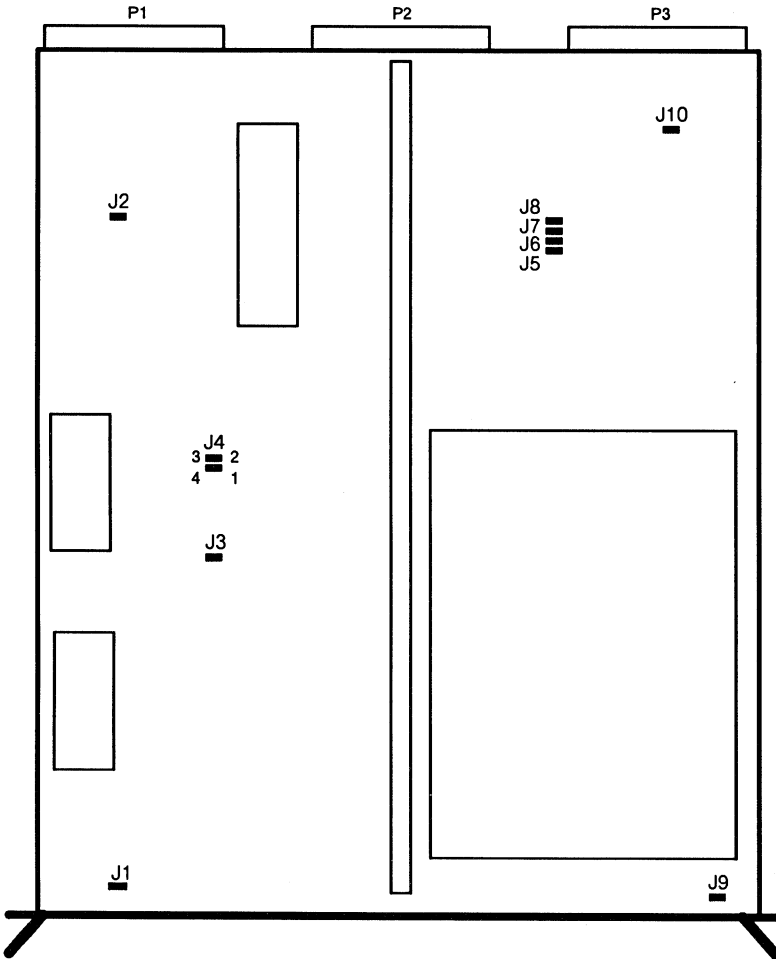

Power: 2.1 Amps @ +5Vdc
10.5 Watts

501–1058 Jumper Settings

JUMPER	SETTING	DESCRIPTION
J1	Out	GND test point
J2	Out	GND test point
J3	Out	Manual reset test point
J4 (2–3)	In	Graphics buffer = 2MB
J5	Out *	Refresh interval test point bit 0
J6	Out *	Refresh interval test point bit 1
J7	Out *	Refresh interval test point bit 2
J8	Out *	Refresh interval test point bit 3
J9	Out	GND test point
J10	Out	GND test point

* Hardwired

Note: The Sun-2/160 Power Supply requires RC Network, 540-1300-01, (FCO 160-0002, Doc 807-0029).

Reference
Hardware Installation Manual for the Sun-2/130 and Sun-2/160, 800-1144.

CG3 Sun 3160 Color Frame Buffer

1152 x 900 62KHz 66Hz

Sun-3/150/160/180/260/280/460/470/480

Sun-4/110/150/260/280/310/330/350/360/370/380

501-1116
Single Buffered

501-1089
Double Buffered*

501-1319
1Kx1K

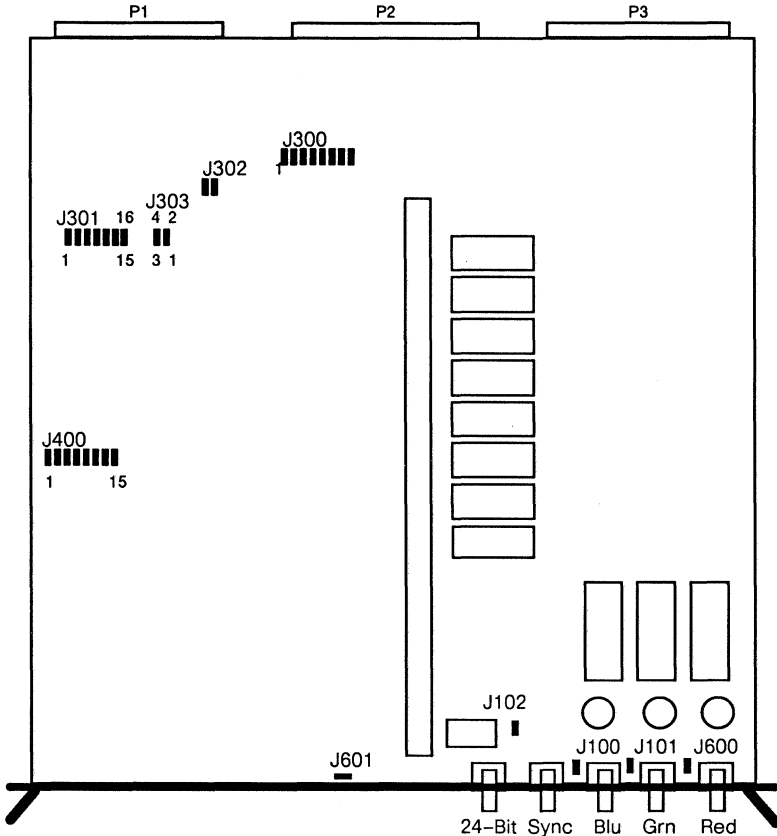

*Double buffering requires SunOS 3.5 (Sun-3) or SunOS 4.0 (Sun-4).

UNIX ID: /dev/cgtwo0

Power: 501-1116
 8.2 Amps @ +5Vdc
 2.9 Amps @ -5Vdc
 0.1 Amps @ +12Vdc
 0.2 Amps @ -12Vdc
 59.0 Watts

501-1319 and 501-1089
 8.3 Amps @ +5Vdc
 3.1 Amps @ -5Vdc
 0.1 Amps @ +12 Vdc
 0.2 Amps @ -12Vdc
 61.2 Watts

501-1116 501-1089 501-1319
Jumper Settings

JUMPER	PINS	SETTING	DESCRIPTION	
J100	All	Factory Set		
J101	All	Factory Set		
J102	1-2	In		
J300	1-2	Out		
	3-4	Out		
	5-6	Out		
	7-8	Out		
	9-10	Out		
	11-12	Out		
	13-14	Out		
J301	1-2	Out	Default Address = 0x400000	
	3-4	Hardwired		
	5-6	Out		
	7-8	Out		
	9-10	Hardwired		
	11-12	Out		
	13-14	Hardwired		
J302	1-2	Out		
	3-4	Hardwired		
J303	1-2	Hardwired		
	3-4	Out		
J400	1-2/J8	Out †	1152x900 Resolution	
	3-4/J9	Out		
	5-6/J10	Out		
	7-8/J11	Out		
	9-10/J12	Out		VME port and GP port
	11-12/J13	In*		VME port fast read
	13-14/J14	Out		Reserved
J600	All	Factory Set		
	All	Factory Set		

* For revisions below 501-1116-06, J400, Pins 11-12/J13 are Out.

† Jumper J400, Pins 1-2/J8, are jumpered for 1024x1024 resolution.

References

1. *Installation Notes for the GP2 and CG5 Boards*, 800-2330.
2. *Sun-3 Color Board Configuration Procedures*, 813-2030.

CG5 Color Frame Buffer

1152 x 900 62KHz 66Hz

Sun-3/150/160/180/260/280/460/470/480

Sun-4/110/150/260/280/310/330/350/360

Sun-4/370/380/380/470/490

501-1267

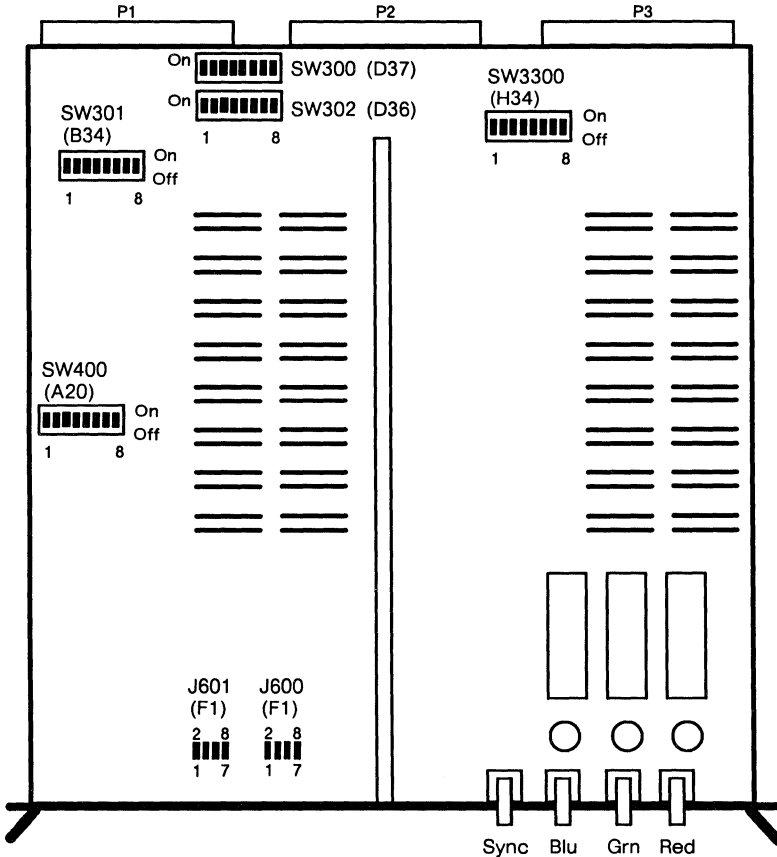

UNIX ID: /dev/cgtwo0

Power: 8.8 Amps @ +5Vdc
 3.2 Amps @ -5Vdc.
 0.2 Amps @ +12Vdc
 0.1 Amps @ -12Vdc
 64.2 Watts

501-1267 Switch Settings

SWITCH	SETTING	DESCRIPTION
SW300-1	Off	A24 address decode
SW300-2	Off	A25 address decode
SW300-3	Off	A26 address decode
SW300-4	Off	A27 address decode
SW300-5	Off	A28 address decode
SW300-6	Off	A29 address decode
SW300-7	Off	A30 address decode
SW300-8	Off	A31 address decode
SW301-1	Off	A22 address decode
SW301-2	On	A23 address decode
SW301-3	Off	AM4 decode
SW301-4	Off	AM5 decode
SW301-5	On	2MB H/L decode
SW301-6	Off	2/4MB, A21 decode
SW301-7	On	2/4MB, X.A21 decode
SW301-8	On	2/4MB, X.A21
SW302-1	On	Control space 2/4MB decode
SW302-2	Off	Control space 2/4MB decode
SW302-3	Off	24/32 bit address decode (24 bit)
SW302-4	On	24/32 bit address decode (24 bit)
SW302-5	n/c	Not used
SW302-6	n/c	Not used
SW302-7	n/c	Not used
SW302-8	n/c	Not used
SW400-1	Off	Status bit 08 (resolution)
SW400-2	Off	Status bit 09 (resolution)
SW400-3	Off	Status bit 10 (resolution)
SW400-4	Off	Status bit 11 (resolution)
SW400-5	On	Status bit 12 (extra registers)
SW400-6	On	Status bit 13 (fast RD)
SW400-7	Off	Status bit 14 (RFU)
SW400-8	Off	Status bit 15 (RFU)

501-1267

Switch Settings – Continued

SWITCH	SETTING	DESCRIPTION
SW3300-1	On	Selects board 0
SW3300-2	Off	Selects board 1
SW3300-3	Off	Selects board 2
SW3300-4	Off	Selects board 3
SW3300-5	*	P2 Bus enable
SW3300-6	Off	No connection
SW3300-7	Off	No connection
SW3300-8	Off	No connection

* SW3300-5 is ON when the CG5 is used with the GP2 and OFF when when it is not used with the GP2.

Jumper Settings

J600

PINS	SETTING	DESCRIPTION
1 to 2	In	V reset
3 to 4	Out	Ext vertical blank output to ground
5 to 6	Out	Ext display buffer A output to ground
7 to 8	Out	No connection

J601

PINS	SETTING	DESCRIPTION
1 to 2	In	Green sync
3 to 4	Out	Green sync
5 to 6	Out	Sync
7 to 8	In	Sync

Notes

1. The Sun 4300 CPU must be \geq 501-1316-03 for use with CG5.
2. The CG5 must be \geq 501-1267-05 for use with the 501-1539 ISP-80 Disk Controller.

References

1. *Installation Notes for the GP2 and CG5 Boards*, 800-2330.
2. *Configuration Procedures for the GP2 and CG5 Boards*, 813-2059.

This page intentionally left blank.

GP2 Graphics Processor

Sun-3/150/160/180/260/280/460/470/480

Sun-4/150/260/280/330/350/360/370/380

Sun-4/390/470/490

501-1268

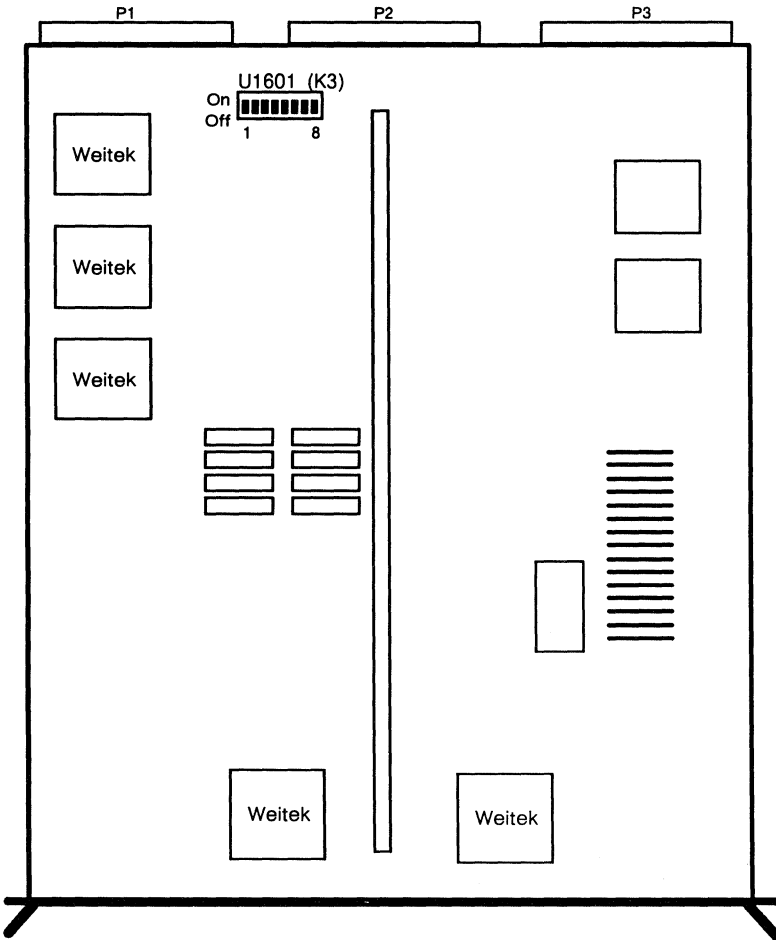

UNIX ID: /dev/gpone0a-d

Power: 12.1 Amps @ +5Vdc
60.5 Watts

501-1268 Switch Settings

U1601 – Enable P2 Connection

DIP SWITCH	SWITCH	SETTING	DESCRIPTION
U1601	1	Off	A18 address decode
	2	On	A19 address decode
	3	On	A20 address decode
	4	Off	A21 address decode
	5	On	A22 address decode
	6	On	A23 address decode
	7	On	Not used
	8	On	Not used

Notes

1. The GP2 is used with the CG5 or CG9. Unbundled software is required for SunOS 3.5, 3.5.1, 3.5.2, Sys4-3.2, and Sys4-3.2.1. Unbundled software is not required for SunOS 4.0.
2. The GP2 must be \geq 501-1268-07 for use with CG9.
3. The CG9 is not supported under OpenWindows Version 2.

References

1. *Installation Notes for the GP2 and CG5 Boards*, 800-2330.
2. *Configuration Procedures for the GP2 and CG5 Boards*, 813-2059.

CG9 24-bit Color Frame Buffer

1152 x 900 62KHz 66Hz
 Sun-3/260/460/470/480
 Sun-4/150/260/280/330/350/360/370/380
 Sun-4/390/470/490
 501-1434

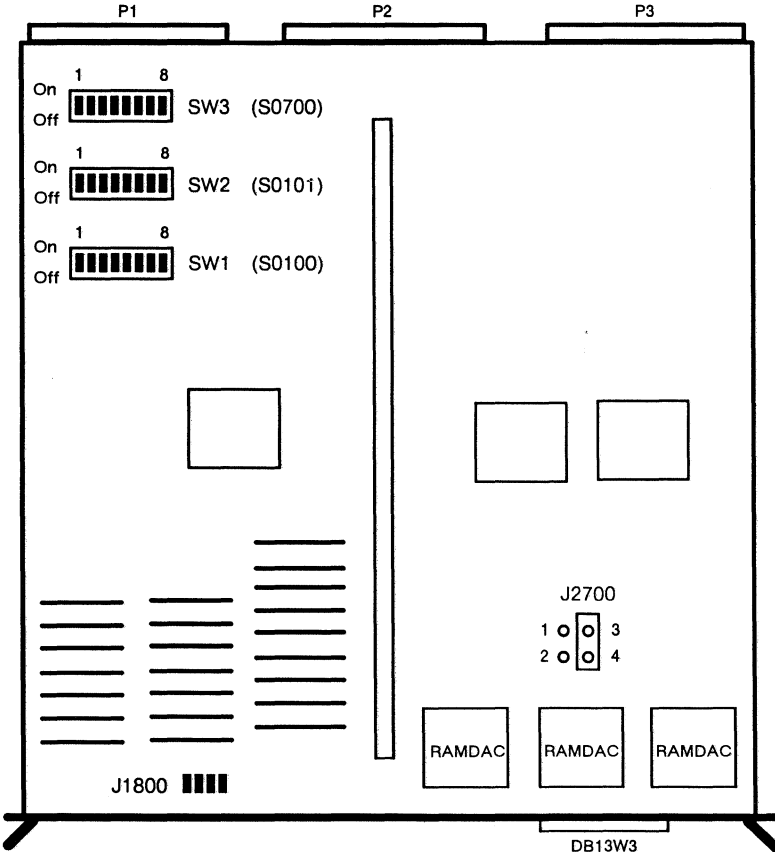

UNIX ID: /dev/cg9ine0

Power: 14.6 Amps @ +5Vdc
 73.0 Watts

Notes

1. The GP2 must be \geq 501-1268-07 when used with CG9.
2. The CG9 is not supported with the GP or GP+.
3. CG9 must be \geq 501-1434-04 for use with the Xylogics 7053.
4. The CG9 is not supported under OpenWindows Version 2.

501-1434

Jumper & Switch Settings

JUMPER	PINS	SETTING	DESCRIPTION
J1800	1-2	Out	Display
	3-4	Out	Video blank
	5-6	Out	N/C
	7-8	Out	N/C
J2700	1-2	Out	Sync or Green
	3-4	In	Normal operation sync

SW1 S0100

DIP	SETTING	DESCRIPTION
1	On	A24
2	On	A25
3	On	A26
4	Off	A27
5	On	A28
6	On	A29
7	On	A30
8	On	A31

SW2 S0101

DIP	SETTING	DESCRIPTION
1	On/Off	N/C
2	On/Off	N/C
3	On	Flag
4	On/Off	N/C
5	Off	A32 mode
6	On	AM4 switch
7	On	AM5 switch
8	On	A23 mode

SW3 S0700

DIP	SETTING	DESCRIPTION
1	Off	P2 Bus enable
2	Off	Selects board 3
3	Off	Selects board 2
4	Off	Selects board 1
5	On	Selects board 0
6	On	N/C
7	Off	N/C
8	On	N/C

Reference
Installation and Configuration Guide for the CG9 Color Frame Buffer,
 800-3627.

TAAC-1 Application Accelerator

Sun-3/160/180/260/280/460/470/480

Sun-4/260/280/360/370/380/390/470/490

501-1383 501-1447

POP Board

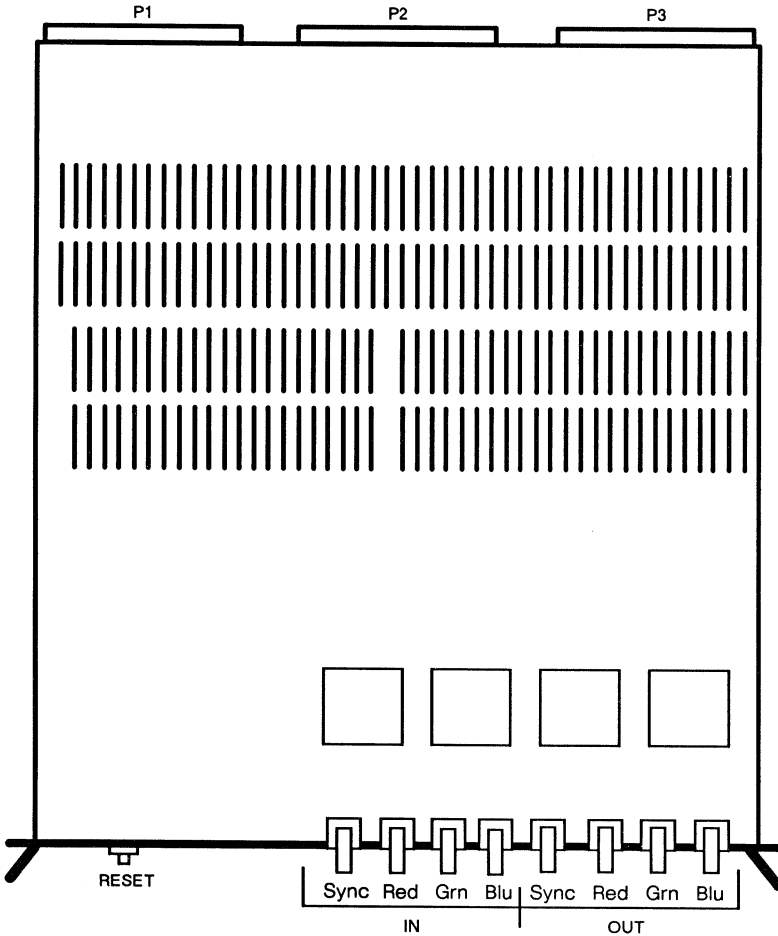

UNIX ID: /dev/taac0

Power: 23.9 Amps @ +5Vdc
 0.4 Amps @ -5Vdc
 0.2 Amps @ +12Vdc
 123.9 Watts

TAAC-1 Application Accelerator

501-1383 501-1447

DFB Board

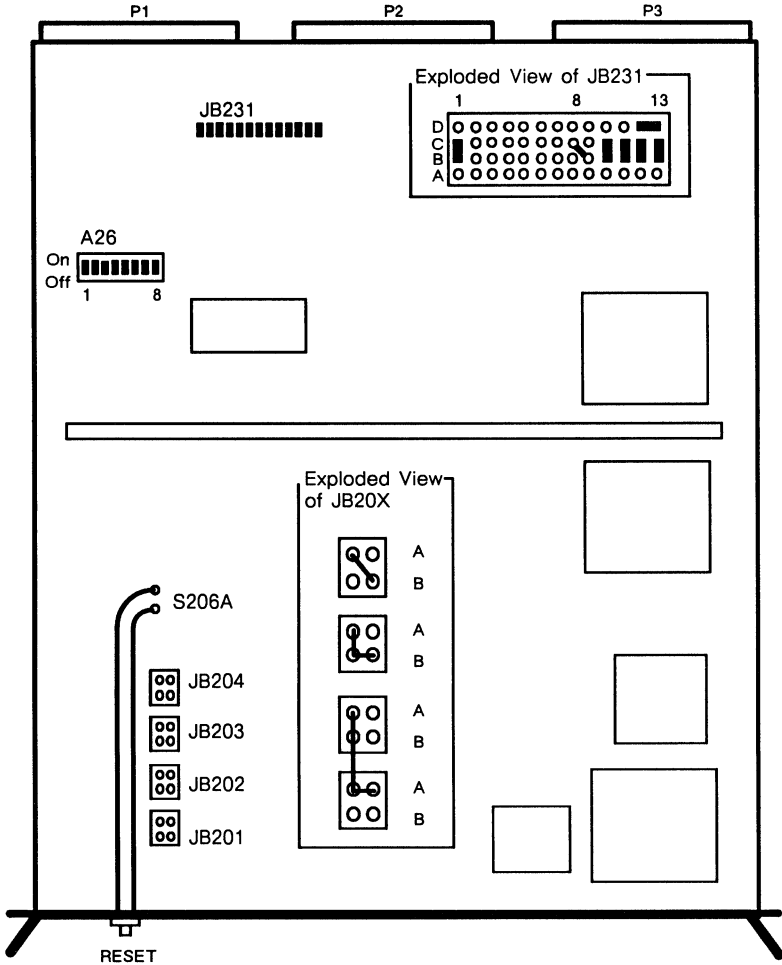

501-1383 501-1447
DFB Board
Jumper and Switch Settings

Jumper JB231

ROW	SHUNTS	DESCRIPTION
1	B - C	
2-7*	Not Used	Base addressing
8	8C - 9B	BGIN
9	Empty	
10	B - C	VMBG IN/OUT 0
11	B - C	VMBG IN/OUT 1
12	B - C	VMBG IN/OUT 2
12	12D - 13D	Enable 50MHz CLK
13	B - C	VMBG IN/OUT 3

*Jumpers 2-7 are hardwired on board revisions without Switch A26. These boards are Not marked with a Sun Part Number. Jumpers 2-7 are empty on board revisions that have Switch A26, .

Switch A26

SWITCH NUMBER	DEFAULT SETTING*	Sun 4/150 †	VME ADDRESS
1 †	On	On	Bit 25
2	On	On	Bit 26
3	Off	Off	Bit 27
4	On	Off	Bit 28
5	Off	Off	Bit 29
6	On	Off	Bit 30
7	On	Off	Bit 31

* Base address = 0x28000000

† Base address = 0xF8000000

Notes

1. Do not disassemble the matched two-board assembly.
2. The TAAC-1 is not supported with the Sun-2 Color Frame Buffer.
3. The TAAC-1 is not supported with the CG9 Color Frame Buffer.
4. Jumpers JB201-JB204 are hardwired for 16K x 4K RAM.
5. Reference the *Configuration Procedures for the TAAC-1 Application Accelerator Board Set*, 813-2057.

Sun-3/E Monochrome Frame Buffer

1152 x 900 62KHz 66Hz
501-8020

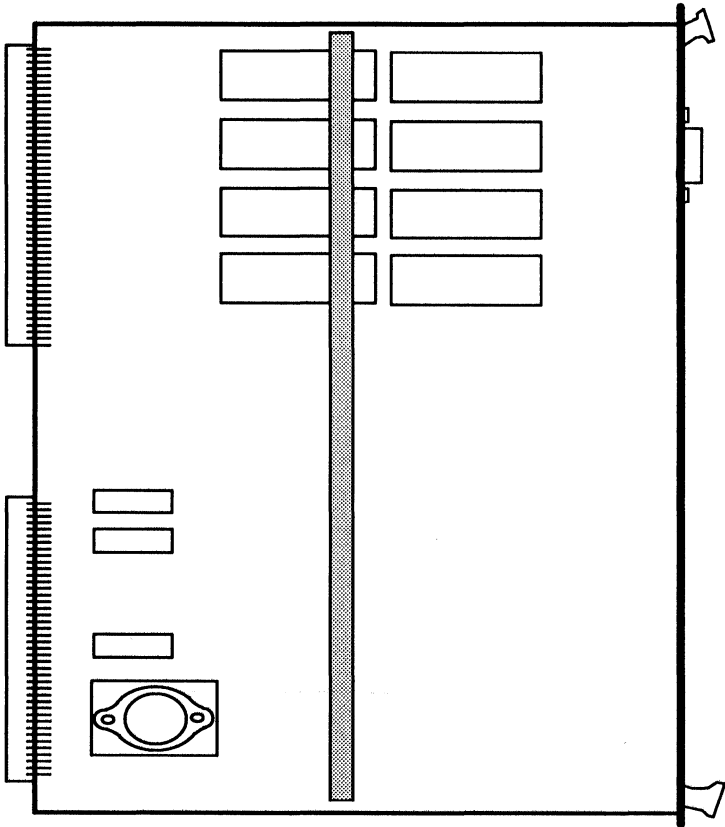

UNIX ID: /dev/bwtwo0

Power: 3.0 Amps @ +5Vdc
15.0 Watts

Note: There are NO jumpers or switches on the 3/E Monochrome Frame Buffer.

Sun-3/E Color Frame Buffer

1152 x 900 62KHz 66Hz

501-8029

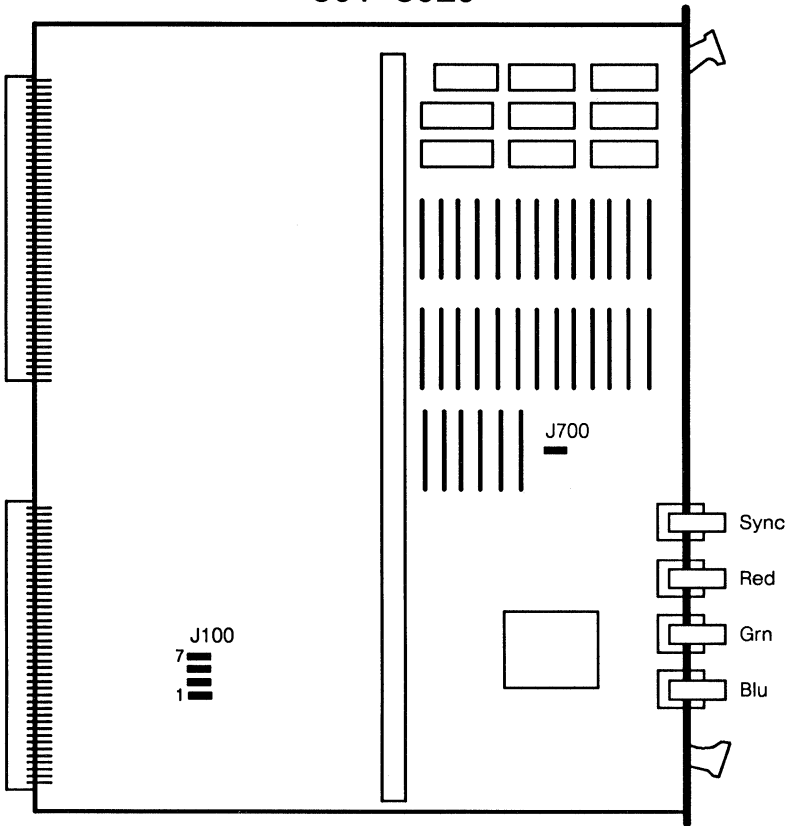

JUMPER	PINS	SETTING	DESCRIPTION
J100	1-2	In	Base address =FF400000
J100	3-4	Out	
J100	5-6	In	
J100	7-8	Out	
J700	1-2	In	Clock enable

UNIX ID: /dev/cgtwo0

Power: 4.0 Amps @ +5Vdc
20.0 Watts

Notes:

1. The Sun-3/E Color Frame Buffer requires a 3/E CPU, 501-8028-07, or greater.
2. This board requires SunOS 3.5 or greater.

Sun-3/60 CG4 Color Frame Buffer

1152 x 900 62KHz 66Hz

Sun-3/60

501-1210

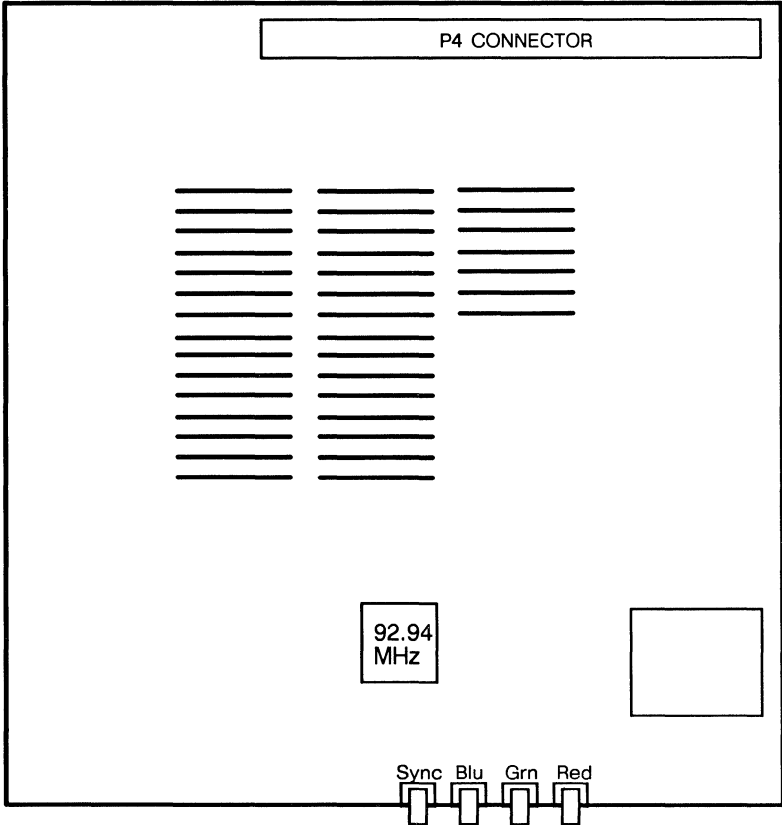

UNIX ID: /dev/cgfour0 and /dev/bwtwo1

Power: 2.6 Amps @ +5Vdc
13.0 Watts

Notes

1. There are NO jumpers on the Sun-3/60 CG4 Color Frame Buffer.
2. Set EEPROM location 0x1F to 0x12.

MG3 ECL Monochrome Frame Buffer

1152 x 900 62KHz 66Hz

Sun-3/60/80/460/470/480

Sun-4/110/150/310/350/370/390/470/490

501-1247 501-1637

w 3/80 Backpanel

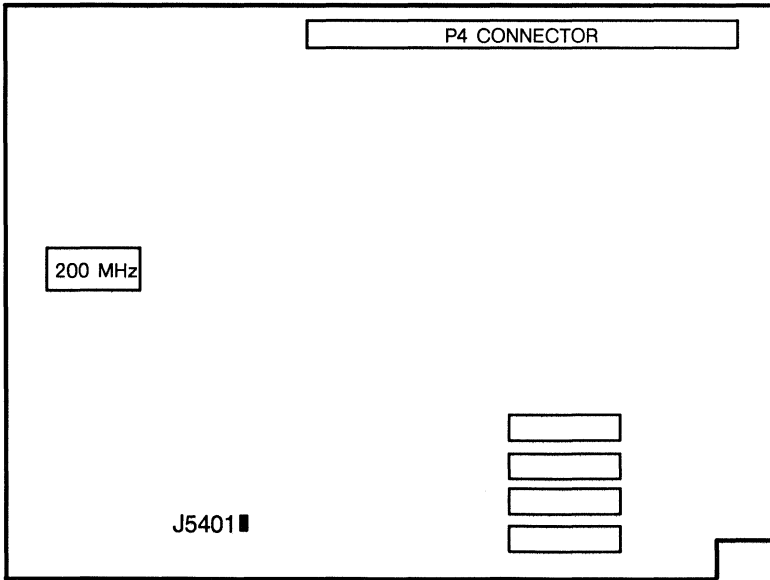

Jumper J5401 Settings

JUMPER	PINS	SETTING	DESCRIPTION
J5401	1-2	Out	Monitor auto select
J5401	1-2	In	Select 1600 x 1280 resolution
J5401	1-2	Out	Select 1152 x 900 resolution

*Factory setting

UNIX ID: /dev/bwtwo0

Power: 0.8 Amps @ +5Vdc
 1.2 Amps @ -5Vdc
 10.0 Watts

Notes

1. Set EEPROM location 0x1f to 20.
2. The auto-select feature requires cable 530-1336 or 530-1359.
3. Hi resolution Monitor 540-1427 must be Motorola revision T or greater for the auto-select feature to operate.

CG4 Color Frame Buffer

1152 x 900 62KHz 66Hz

Sun-3/60/80/460/470/480

Sun-4/110/150/310/350/370/390/470/490

501-1248 501-1443

BNC

DB13W3

w 3/80 Backpanel

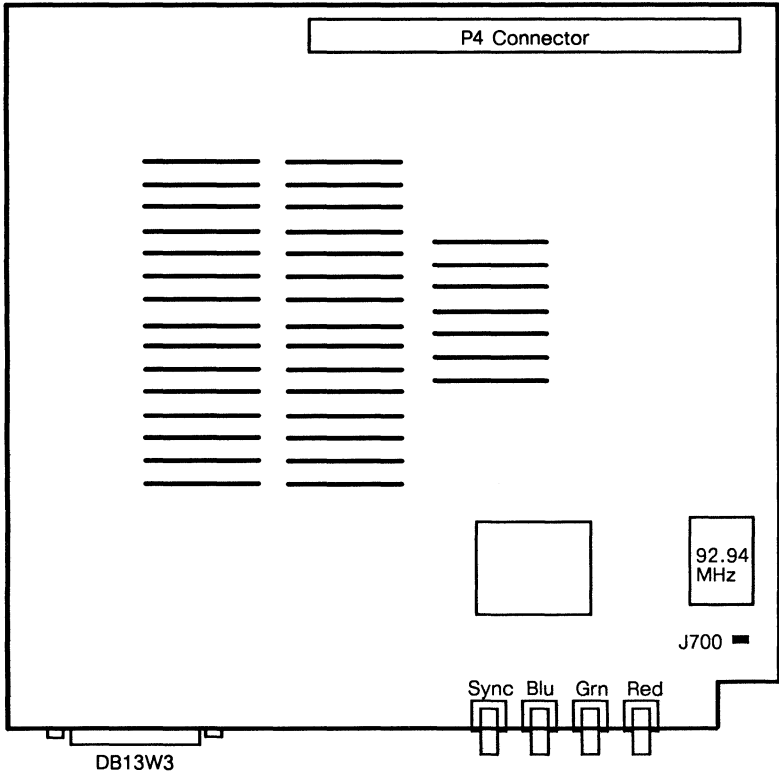

J700 Setting

PINS	SETTING	DESCRIPTION
1-2	In	Enable clock

UNIX ID: /dev/cgfour0 and /dev/bwtwo1

Power: 3.8 Amps @ +5Vdc
19.0 Watts

Note: Set EEPROM location 0x1F to 0x20.

CG6 Color Frame Buffer

1152 x 900 62KHz 66Hz

Sun-3/60/80/460/470/480

Sun-4/110/150/310/350/370/390/470/490

501-1374 501-1505 501-1532

3/80 w Panel

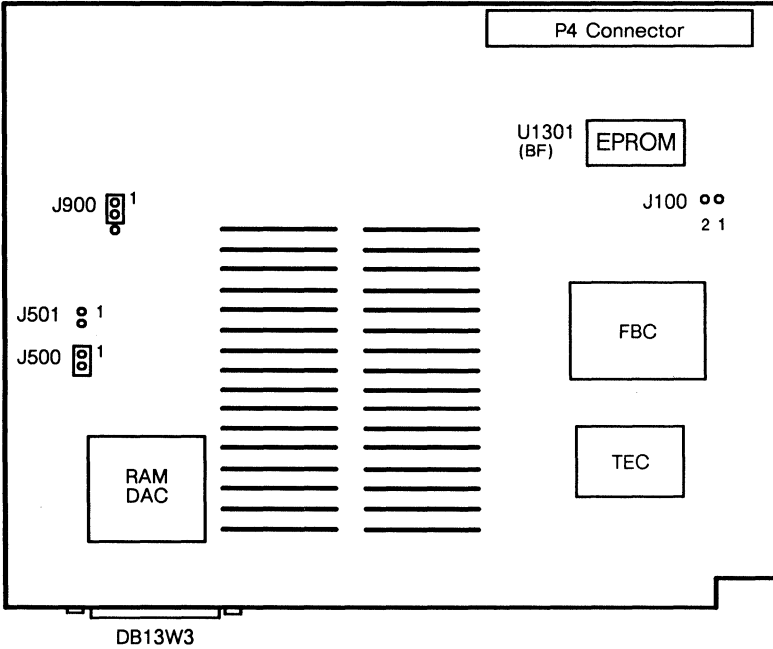

UNIX ID: /dev/cgsix0

Power

501-1374 3.5 Amps @ +5Vdc
 17.5 Watts

501-1505 and 501-1532
 4.6 Amps @ +5Vdc
 23.0 Watts

501-1374 501-1505 501-1532

Jumper Settings

JUMPER	PINS	SETTING	DESCRIPTION
J100	1-2	Out	Monitor I.D.
J500	1-2	In	V.Y. CLK memory control
J501	1-2	Out	OSC 2 CLK
J900	2-3	In	1152 x 900 (on 270-1532 Fab)

Notes

1. Sun-3/60, Sun-4100, and Sun-4300 CPU boards require EPROM revision 3.0 or greater.
2. Set CPU EEPROM location 0x1F to 0x20.
3. The minimum operating system is SunOS 4.0.3.

CG8 24-bit Color Frame Buffer

1152 x 900 62KHz 66Hz

Sun-4/110/150

501-1374
BNC

501-1505
DB13W3

501-1532
w 3/80 rear panel
DB13W3

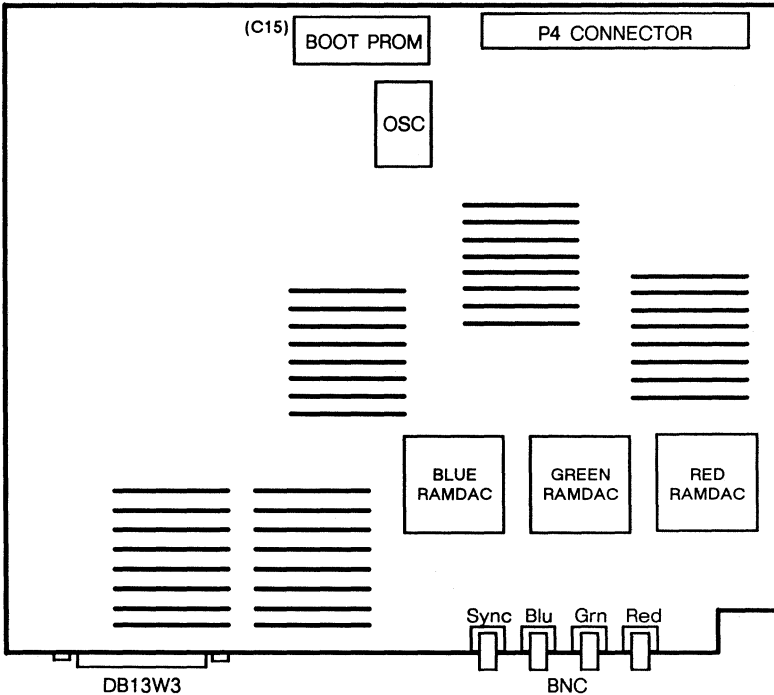

UNIX ID: /dev/cgeight0

Power

501-1371 and 501-1518
5.5 Amps @ +5Vdc
27.5 Watts

501-1577 4.8 Amps @ +5Vdc
24.0 Watts

Notes

1. There are NO jumpers or switches on this board.
2. Set CPU EEPROM location 0x1F to 0x20.
3. Requires SunOS 4.0 CG8 or 4.0.3 or greater.
4. SunOS 4.0 CG8 is not upgradeable to 4.0.1.
5. CG8 must be 501-1374-04 or greater for use with Sun 3400 and Sun 4300 CPU boards.
6. The CG8 is not supported under OpenWindows Version 2.

MG4 Analog/ECL Frame Buffer

1152 x 900 62KHz 66Hz

Sun-3/80/460/470/480

Sun-4/310/350/370/390/470/490

501-1402

w 3/80 Backpanel

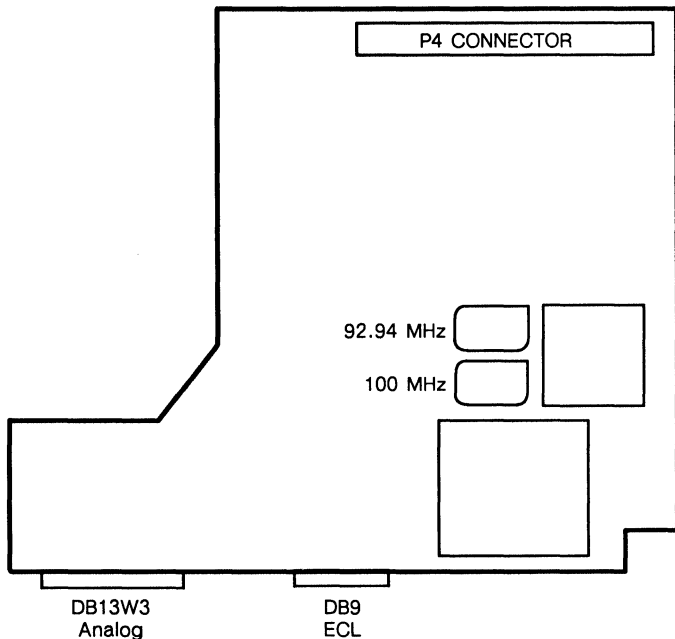

UNIX ID: /dev/bwtwo0

Power: 3.3 Amps @ +5Vdc
16.5 Watts

Notes

1. There are NO jumpers or switches on the MG4 Frame Buffer.
2. The MG4 Frame Buffer produces a 1-bit Analog output and a 1-bit ECL output.

DC to DC Converter

Sun-3/80

501-1483

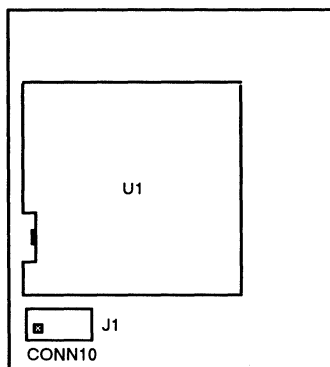

Exploded View of Connector J1

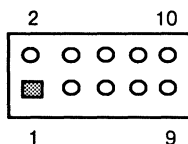

Power

Total Power for 501-1483 and 501-1637 is 2.7 Amps @ +5Vdc

Notes

1. The DC to DC Converter used with the MG3 Frame Buffer allows the Sun-3/80 to operate a 1600 x 1280 High Resolution monitor.
2. The -5 volt DC output of the DC to DC Converter can be measured on Pins 1 and 10 of connector J1 and on Pins 31 and 63 of the CPU P4 connector.

Color Frame Buffer

1152 x 900 62KHz 66Hz
Sun386i/150/250
501-1243

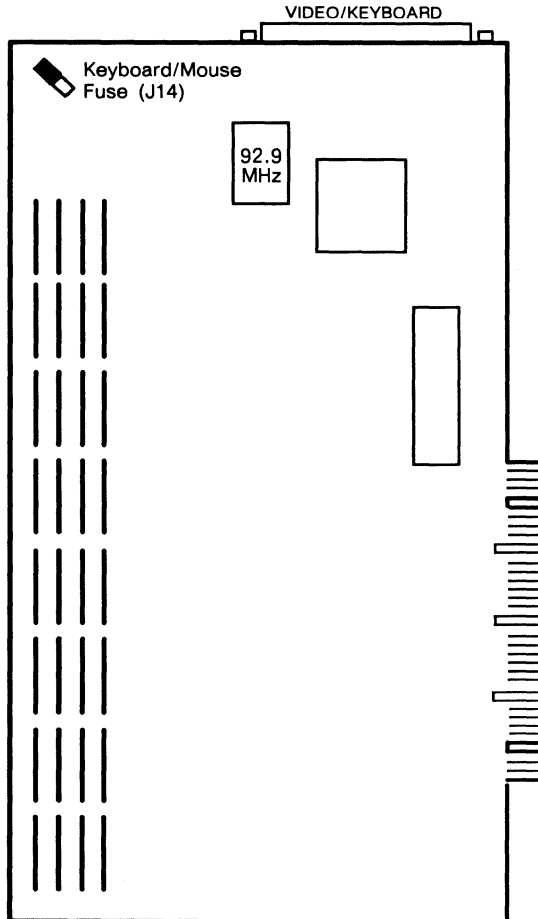

UNIX ID: /dev/cgthree0

Notes

1. There are NO jumpers on the Sun386i Color Frame Buffer.
2. The Keyboard/Mouse fuse is a 1 Amp subminiature fuse, Sun part number, 140-1027-01.

Color Frame Buffer
 1024 x 768 53KHz 66Hz
 Sun386i/150/250
 501-1286

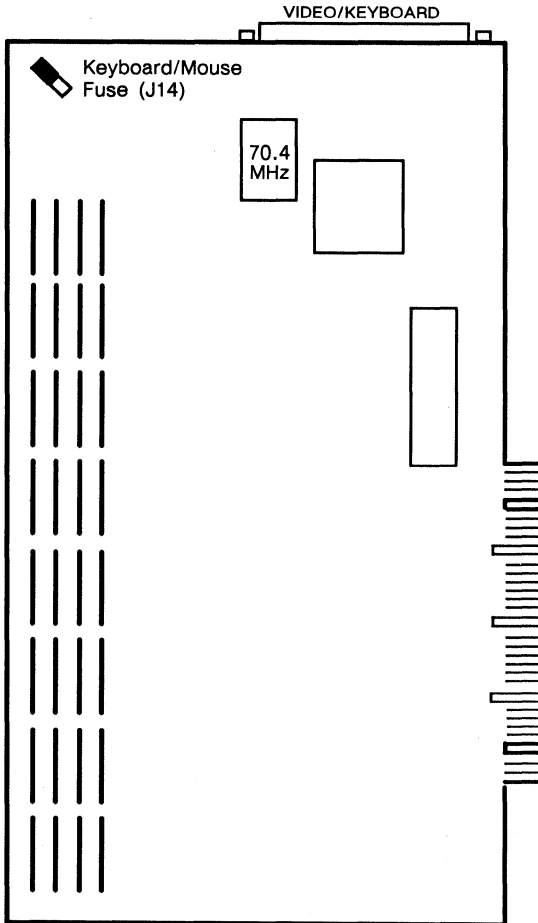

UNIX ID: /dev/cgthree0

Notes

1. There are NO jumpers on the Sun386i Color Frame Buffer.
2. The Keyboard/Mouse fuse is a 1 Amp subminiature fuse, Sun part number, 140-1027-01.

Monochrome Frame Buffer

1024 x 768 64KHz 66Hz

Sun386i/150/250

501-1433 501-1568

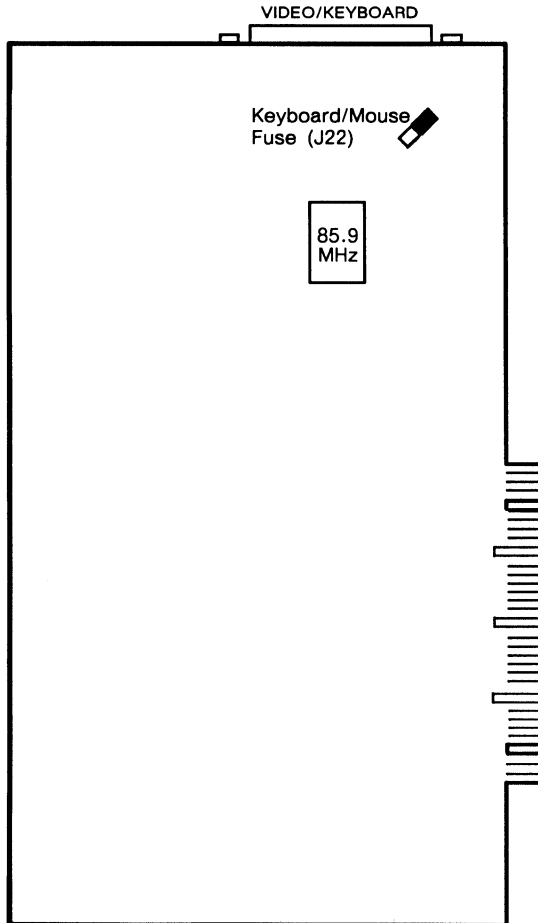

UNIX ID: /dev/bwtwo0

Notes

1. There are NO jumpers on this board.
2. The Keyboard/Mouse fuse is a 1 Amp subminiature fuse part number 140-1027-01.
3. The CPU requires EPROM revision 4.4 or greater.

Monochrome Frame Buffer

1152 x 900 62KHz 66Hz

Sun386i/150/250

501-1244 501-1567

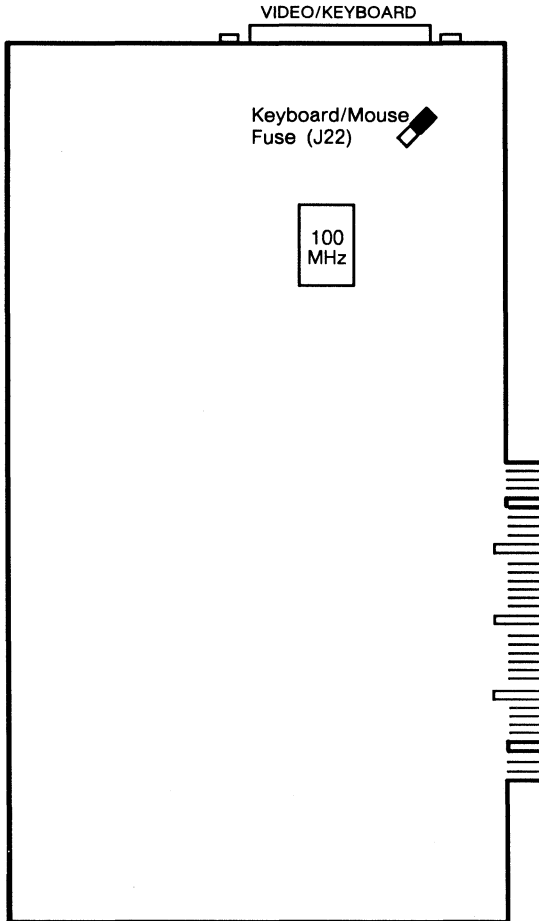

UNIX ID: /dev/bwtwo0

Notes

- 1. There are NO jumpers on this board.
- 2. The Keyboard/Mouse fuse is a 1 Amp subminiature fuse part number, 140-1027-01.

SunVGA/EGA

Sun386i/150/250

501-1397

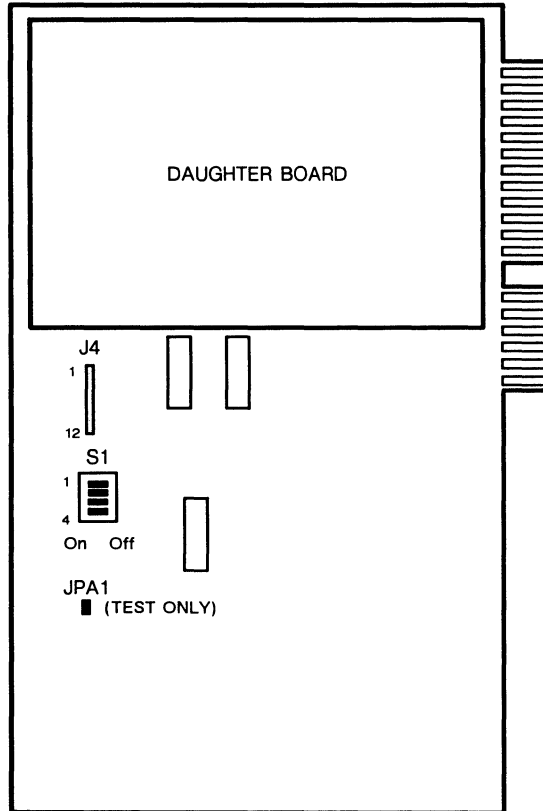

S1 Switch Settings

SWITCH	SETTING	DESCRIPTION
1	On	Set Base Address = A000
2	Off	
3	On	
4	Off	

Notes

1. The SunVGA requires a color frame buffer.
2. The SunVGA requires SunOS 4.0.1.

GXi Color Frame Buffer

1152 x 900 62KHz 66Hz

Sun386i/150/250

501-1352

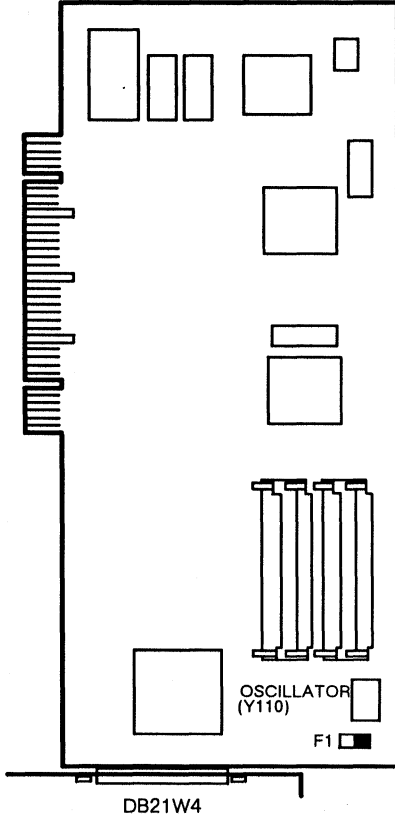

UNIX ID: /dev/cgfive0

Notes

1. The Sun386i CPU requires EPROM revision 4.3 or greater.
2. 1MB SIMM modules are not installed at locations J1000, J1001, J1002, and J1003 on the 2D GXI board.
3. F1 uses a 1 Amp fuse, 140-1027-01.
4. OpenWindows is not supported on the GXi.

Reference: *Sun386i GX Installation and Upgrade Guide*, 814-5024.

MG1 ECL Monochrome Frame Buffer

1152 x 900 62KHz 66Hz

Sun-4/60/65 Sun 4/E

501-1419 501-8043

w 4/E Backpanel

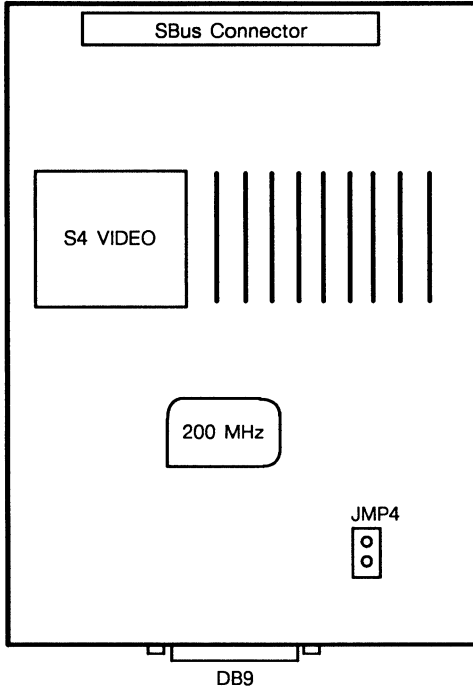

Jumper JMP4

PINS	SETTING	DESCRIPTION
1-2	In	Select 1600 x 1280 resolution
1-2	Out	Select 1152 x 900 resolution
1-2	Out	Monitor auto select

UNIX ID: /dev/bwtwo0

Power: 1.3 Amps @ +5Vdc
6.5 Watts

MG2 Analog Frame Buffer

1152 x 900 62KHz 66Hz

Sun-4/60/65

501-1455

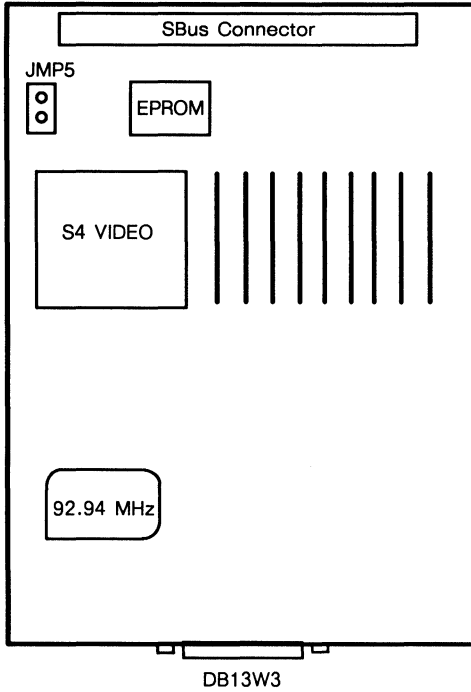

Jumper JMP5

PINS	SETTING	DESCRIPTION
1-2	In	Select 27C256 EPROM
1-2	Out	Select 27C64 EPROM

UNIX ID: /devbwtwo0

Power: 0.4 Amps @ +5Vdc
2.0 Watts

Note: The MG2 Frame Buffer produces a 1-bit Analog output.

MG2 Analog Frame Buffer

1152 x 900 62KHz 66/76Hz

Sun-4/40/75

501-1561

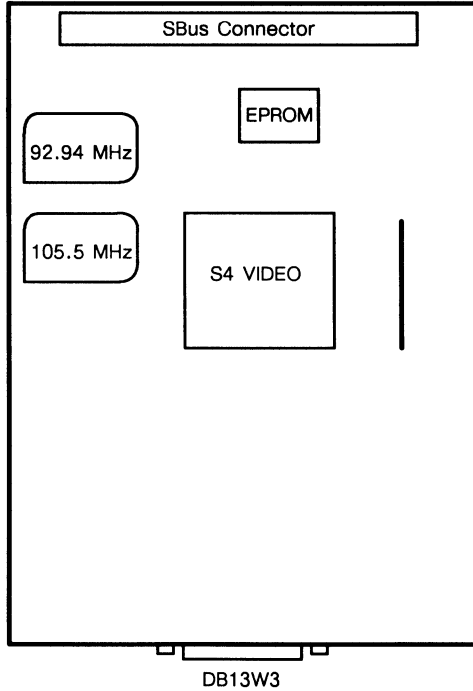

Power: 0.4 Amps @ +5Vdc
2.0 Watts

Note: The MG2 Frame Buffer produces a 1-bit Analog output.

CG3 Color Frame Buffer

1152 x 900 62KHz 66Hz

Sun-4/60/65 Sun-4/E

501-1415 501-8044

w 4/E Backpanel

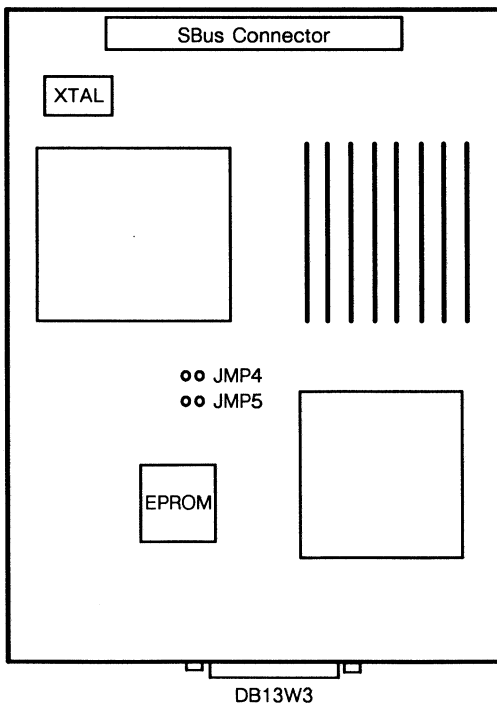

UNIX ID: /dev/cgthree0

Power: 0.7 Amps @ +5Vdc
3.5 Watts

Note: The jumpers on this board are not used.

CG3 Color Frame Buffer

1152x900 62KHz 66/76Hz

Sun-4/40/75

501-1718

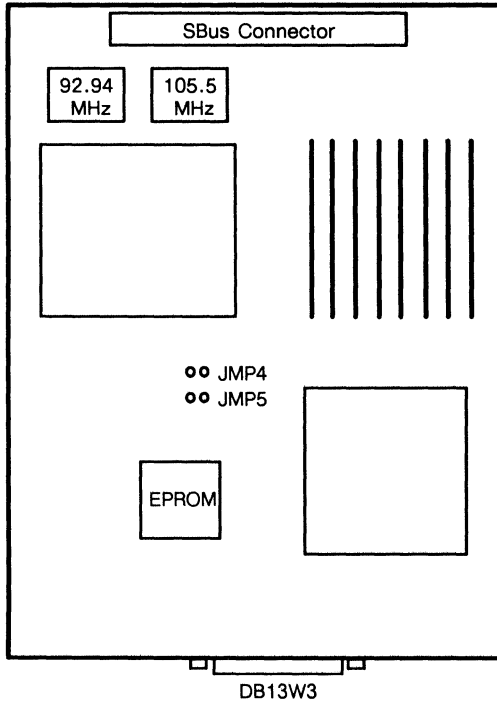

UNIX ID: /dev/cgthree0

Power: 0.7 Amps @ +5Vdc
3.5 Watts.

Note: The jumpers on this board are not used.

CG6 Color Frame Buffer

1152 x 900 62KHz 66Hz
Sun-4/60
501-1481

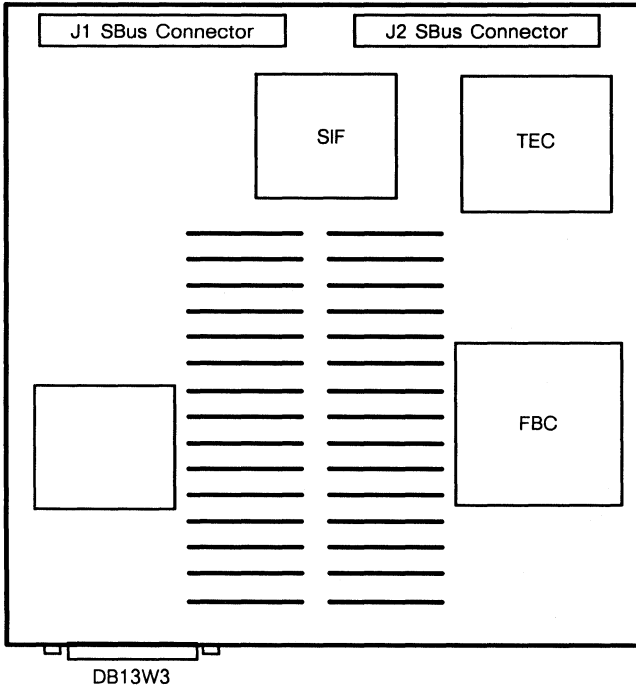

UNIX ID: /dev/cgsix0

Power: 1.4 Amps @ +5Vdc
7.0 Watts

Note: The 501-1481 board is only supported in the Sun-4/60.

CG6 Color Frame Buffer

1152 x 900 62KHz 66Hz

Sun-4/60/65/75

501-1645

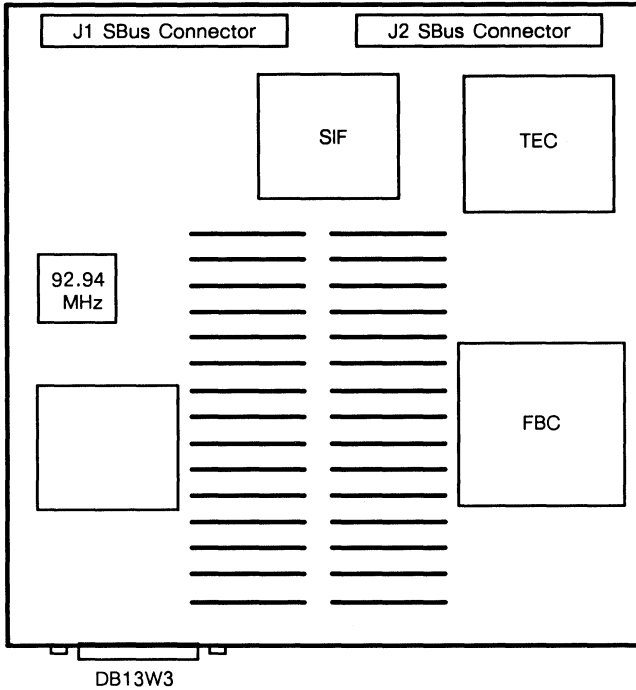

UNIX ID: /devcgsix0

Power: 1.4 Amps @ +5Vdc
7.0 Watts

CG6 Color Frame Buffer

1152x900 62KHz 66/76Hz
Sun-4/40/75
501-1672

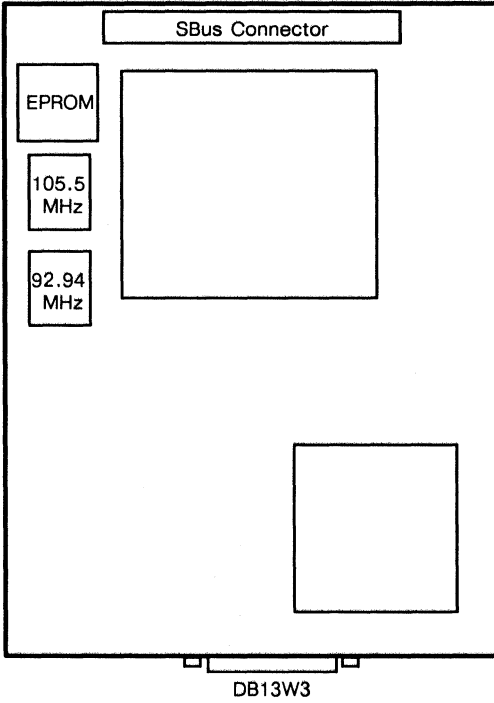

UNIX ID: /dev/cgsix0

CG12 24-bit Color Frame Buffer

1152 x 900 62KHz 76Hz

Sun-4/75

370-1329

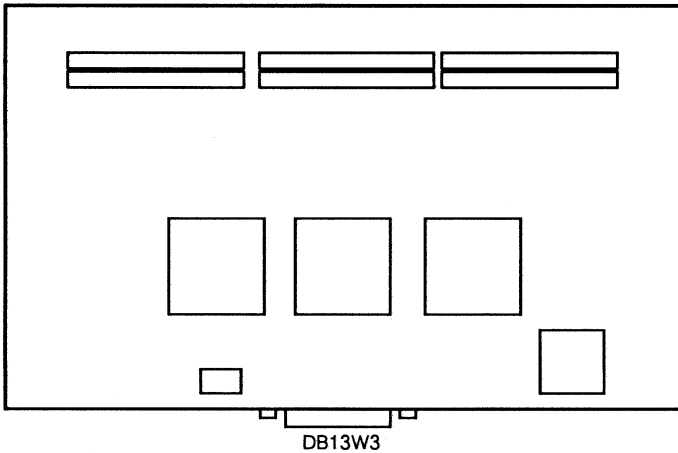
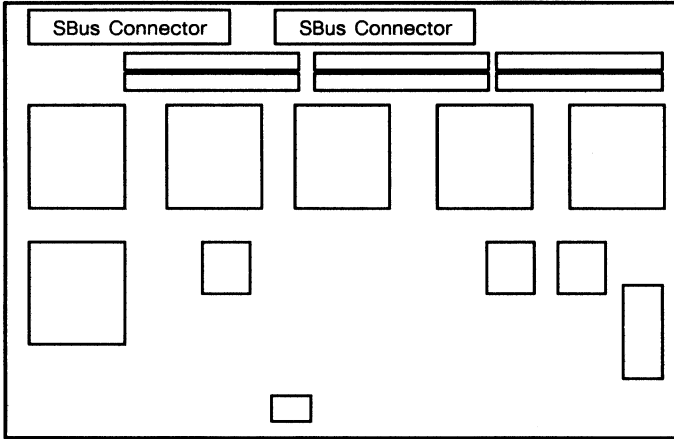

UNIX ID: /dev/cgtwelve0

Note: Do not disassemble this two-board set.

VideoPics

Sun-4/40/60/65/75
501-1706

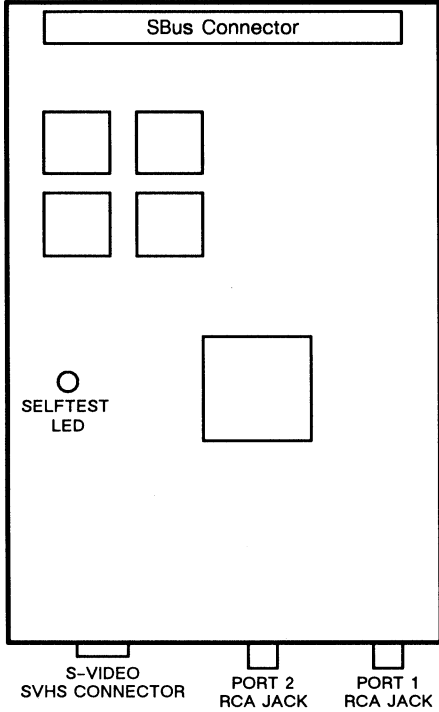

Reference: *Using VideoPics*, 800-5099.

CONFIGURATIONS

DISK

Disk

DISK DRIVES

SCSI

ST506

Micropolis 1304 (42MB)	4
Fujitsu M2243AS (71MB)	6
Micropolis 1325 (71MB)	8

ESDI

Micropolis 1355 (141MB)	10
Toshiba MK156 (141MB)	12
Micropolis 1558-15 (327MB)	14

Embedded SCSI

CDC 94211-91 (91MB)	15
Quantum 105S (104MB)	16
CDC 94161-155 (155MB)	17
Quantum 210S (207MB)	18
Maxtor LXT-213SY (207MB)	19
Quantum 210S (207MB)	20
CDC 94171-344 (327MB)	21
Micropolis 1588-15 (699MB)	24
Maxtor XT-8760S (669MB)	26

SMD

Fujitsu M2312 (65MB)	30
Fujitsu M2322 (130MB)	32
Fujitsu M2284 VOFM PCB (130MB)	34
Fujitsu M2284 CQFM PCB(130MB)	36
Fujitsu M2351 Logic PCB (380MB)	38

ESMD

Fujitsu M2333 (280MB)	40
CDC 9720 (280MB)	42
Fujitsu M2361 (575MB)	44

Disk – Continued

ESMD – Continued

CDC 9720–850 (688MB)	46
Fujitsu M2372 (688MB)	48
Hitachi DK815–10 (892MB)	50
NEC D2363 (892MB)	52

IPI

Seagate 97209–12G (1.2GB)	54
Seagate 97229–11G (911MB)	58

DISK CONTROLLERS

SCSI

ST506

Adaptec ACB4000 ST506	62
-----------------------------	----

ESDI

Emulex MD21	64
-------------------	----

SMD

Xylogics 450	66
VME–Multibus Adapter with Xylogics 450	73

ESMD

Xylogics 451	75
VME–Multibus Adapter with Xylogics 451	78
Xylogics 7053	80

IPI

ISP–80 Disk Controller (IPI–2)	84
--------------------------------------	----

NFS ACCELERATOR

Prestoserve	86
-------------------	----

CD ROM

Sony CDU–8012 CD–ROM	88
----------------------------	----

This page intentionally left blank

Micropolis 1304 (42MB)
 5-1/4" ST506
 Sun-2/120
 370-1015

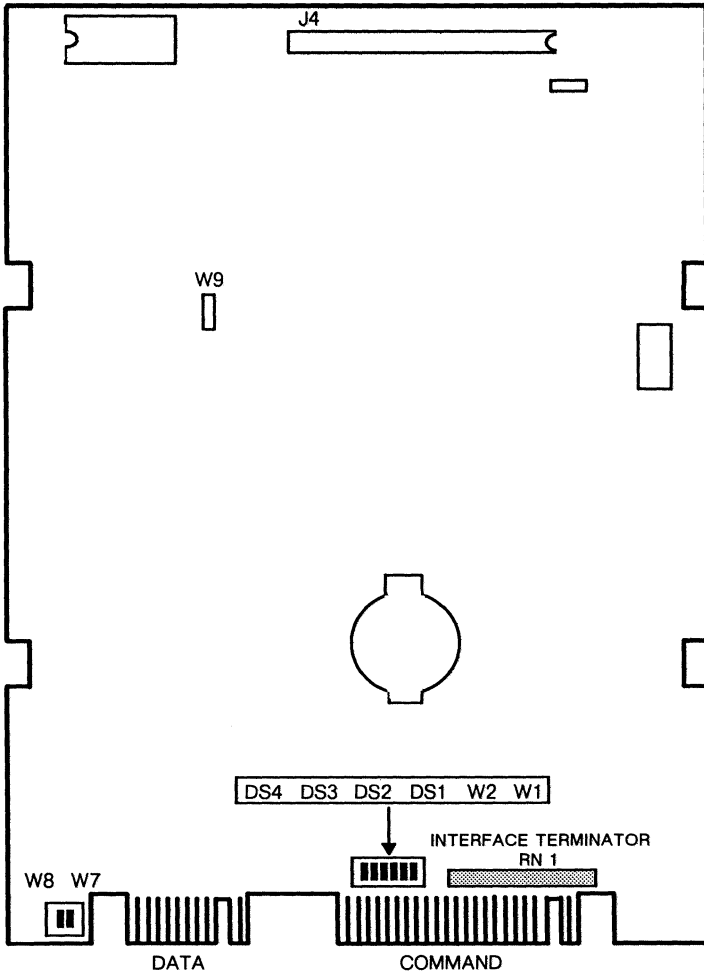

Power: 1.5 Amps @ +5 Vdc
 3.5 Amps @ +12 Vdc
 49.5 Watts

370-1015 Jumper Settings

W1	W2	DS1*	DS2*	DS3	DS4	W7	W8	W9
In	In	In	Out	Out	Out	Out	In	Out

*DS1 is Out and DS2 is In for Drive unit 1

Note: Refer to the chart below to jumper the disk drive.

Drive Serial Number	Action
41210001 and greater	Jumper the Adaptec for NO precompensation (PU-R)
411559999 or lower	Check the drive PCB
Drive PCB Serial Number	Action
101242-xx-x	Jumper the Adaptec for precompensation (R-S)
101362-xx-x	Jumper the Adaptec for NO precompensation (PU-R)

Reference

71 MByte Disk Drive Configuration Procedures, 813-2026.

Fujitsu M2243AS (71MB)

5-1/4" ST506

Sun-2/120/130/160 & Sun-3/160

Options 55 55EX 56 501 503 511

370-1034

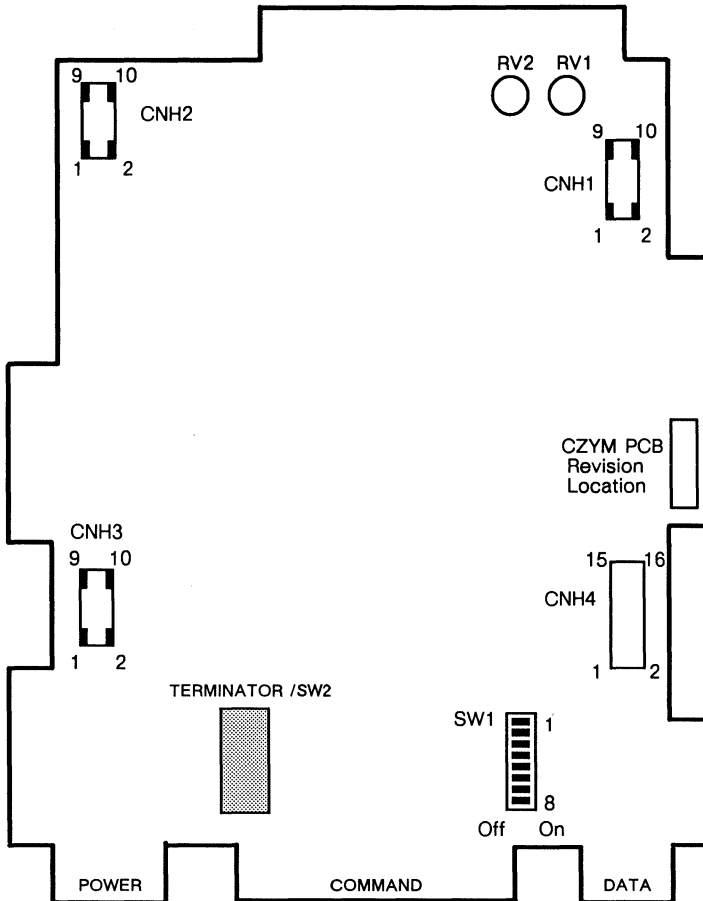

Power: 2.0 Amps @ +5 Vdc
3.1 Amps @ +12 Vdc
47.2 Watts

370-1034 Switch Settings

DIP	SWITCH	SETTING
SW1	1	On; Off for drive unit 1
	2	Off; On for drive unit 1
	3	Off
	4	Off
	5	Off
	6	On; Off for CZYM boards below revision 46L
	7	Off
	8	Off
SW2*	1-8	On for termination enabled Off for termination disabled

* Present only on drives revision C0 and above; drives below C0 use a resistor pack for termination.

Note: The Adaptec controller must be jumpered for no precompensation (PU-R).

Reference

71 MByte Disk Drive Configuration Procedures, 813-2026.

Micropolis 1325 (71MB)

5-1/4" ST506

Sun-2/120/130/160 & Sun-3/160

Options 55 55EX 56 501 503 511

370-1034

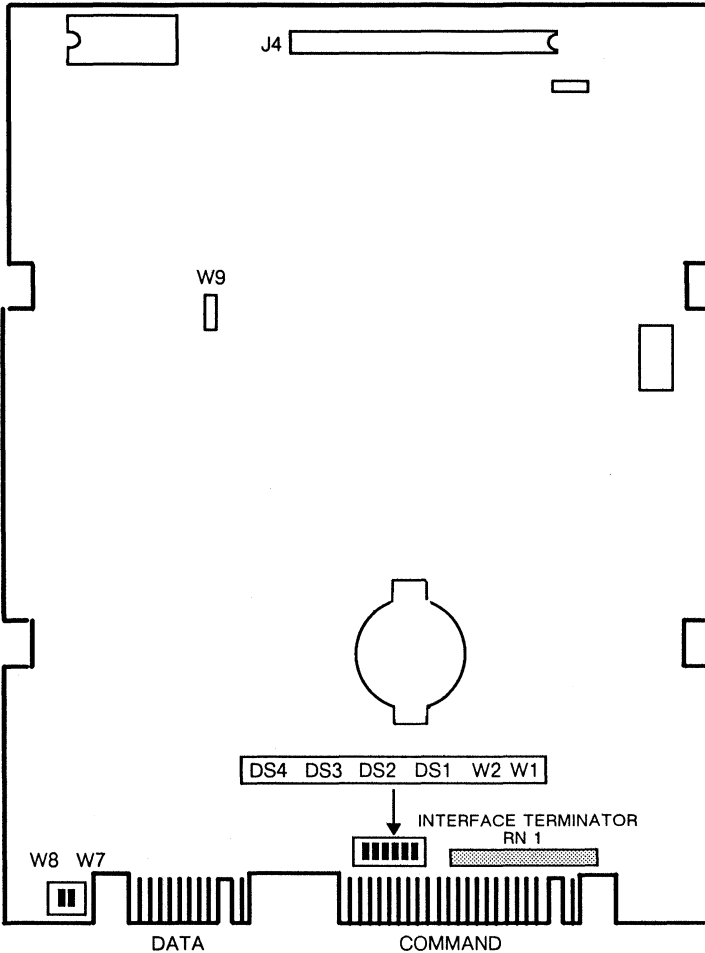

Power: 2.0 Amps @ +5 Vdc
3.1 Amps @ +12 Vdc
47.2 Watts

370-1034 Jumper Settings

W1	W2	DS1 *	DS2 *	DS3	DS4	W7	W8	W9
In	In	In	Out	Out	Out	Out	In	Out

*DS1 is Out and DS2 is In for drive unit 1.

Note: The Adaptec controller must be jumpered for no precompensation (PU-R).

Reference

71 MByte Disk Drive Configuration Procedures, 813-2026.

Micropolis 1355 (141MB)

5-1/4" EDSI

Sun-3/160/260 & Sun-4/260

Options 504 505 514

370-0551

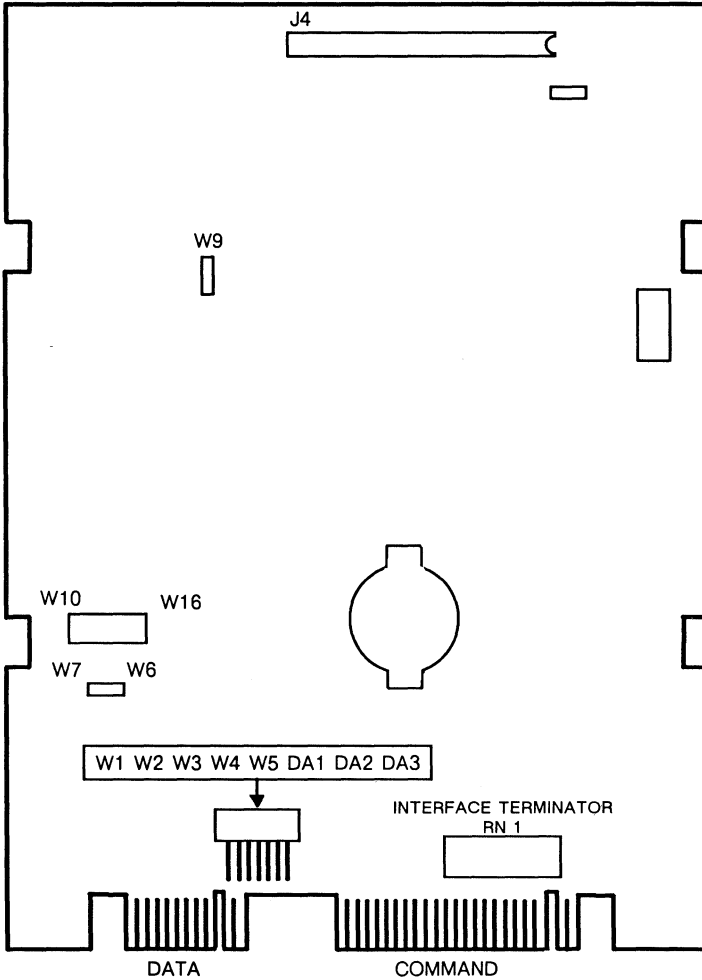

Power: 1.4 Amps @ +5 Vdc
2.4 Amps @ +12 Vdc
35.8 Watts

370-0551 Jumper Settings

JUMPER*	SETTING
W1	Out
W2	Out
W3	Out
W4	Out
W5	Out
DA1 [†]	In
DA2 [†]	Out
DA3	Out

* Jumpers not described here are factory set and must not be disturbed.

[†] DA1 is Out and DA2 is In for drive unit 1.

Reference
141 MByte Disk Drive Configuration Procedures, 813-2021.

Toshiba MK156 (141MB)

5-1/4" ESDI

Sun-3/160/260 & Sun-4/260

Options 504 505 514

370-0551

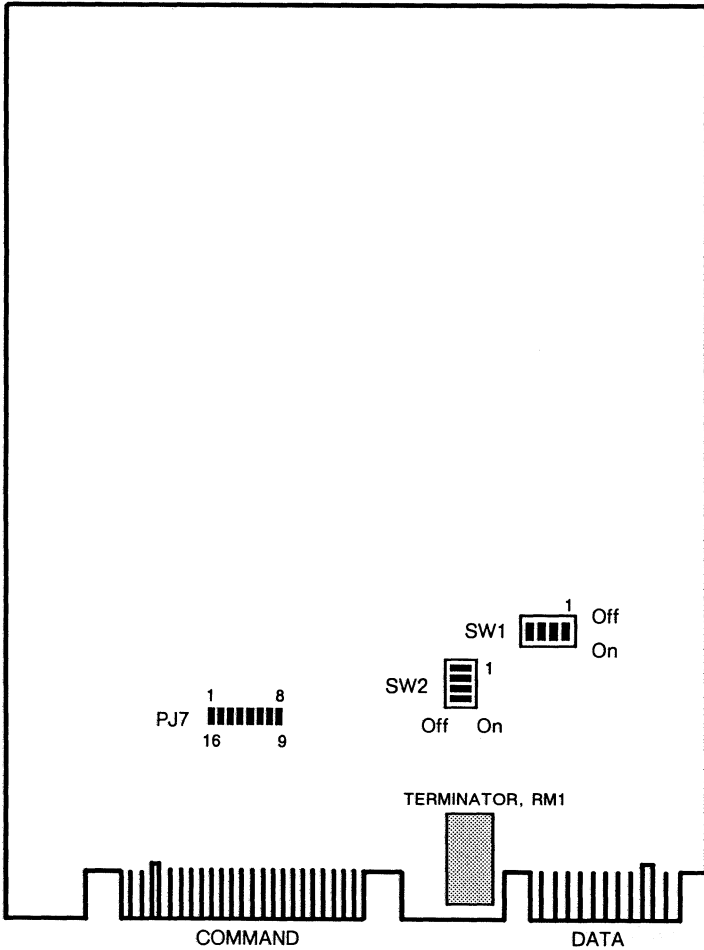

Power: 1.4 Amps @ +5Vdc
2.4 Amps @ +12Vdc
35.8 Watts

370-0551

Switch & Jumper Settings

DIP	SWITCH	SETTING
SW1	1	On
	2	Off
	3	Off
	4	Off
SW2	1	Off
	2	Off; On for drive unit 1
	3	On; Off for drive unit 1
	4	On

JUMPER*	PINS	SETTING
PJ7	1-16	Out
	2-15	In
	3-14	Out
	4-13	Out
	5-12	Out
	6-11	In
	7-10	Out
	8-9	Out

*Jumpers not described are factory set and must not be disturbed.

Reference
141 MByte Disk Drive Configuration Procedures, 813-2021.

Micropolis 1558-15 (327MB) 5-1/4" ESDI

Sun-3/160/260 & Sun-4/260

Options 506 507 509 510 516
370-1133

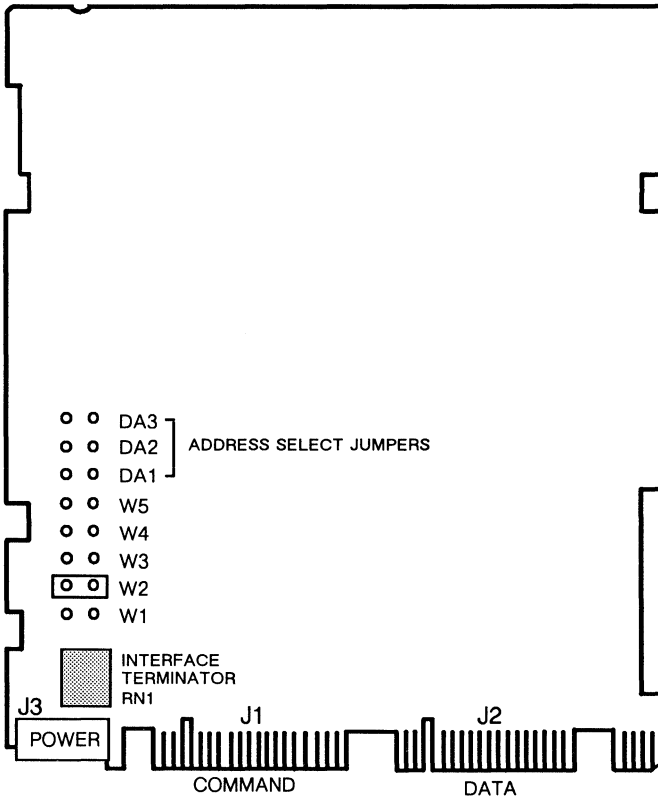

Jumper Settings

W1	W2	W3	W4	W5	DA1*	DA2*	DA3	*DA1 is Out & DA2 is In for drive unit 1
Out	In	Out	Out	Out	In	Out	Out	

Power: 1.3 Amps @ +5Vdc
1.9 Amps @ +12Vdc
29.3 Watts

Reference
327 MByte Disk Drive Configuration Procedures, 813-2101.

CDC 94211-91 (91MB)

5-1/4" Embedded SCSI

Sun386i/150/250

Option RR133

555-1004 370-1148

End View

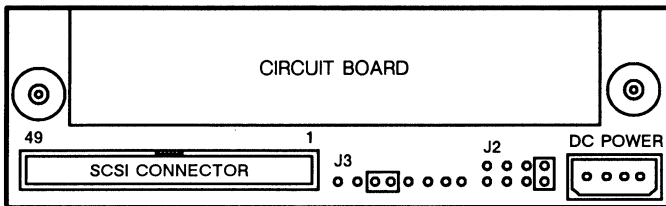

TERMINATORS ON UNIT BOTTOM

Terminator Power Source Select and Test Seek Jumper J3

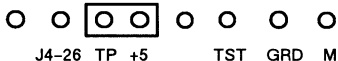

TP - +5V	In	Terminator power is from DC connector
----------	----	---------------------------------------

Drive Select and Parity Check Jumper J2

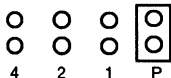

JUMPER	SETTING	DESCRIPTION	USAGE
P	In	Parity check	All drives
2	In	Drive select	Target 2*
1,2,4	Out	Drive select	Target 0†

* Target 2, drive sd2, is located in the CPU chassis.

† Target 0, drive sd0, is located in the peripheral box.

Power: 1.3 Amps @ +5Vdc
 1.7 Amps @ +12Vdc
 26.9 Watts

Note: Remove the drive terminators. Use terminator part number 530-1381 to terminate the SCSI bus.

Reference

- 386i Field Service Manual, 814-0002.
- 91MB Embedded SCSI Configuration Procedures, 814-1017.

Quantum 105S (104MB)
3 1/2" Embedded SCSI
Sun-3/80 & Sun-4/60/65
Option 550
370-1200

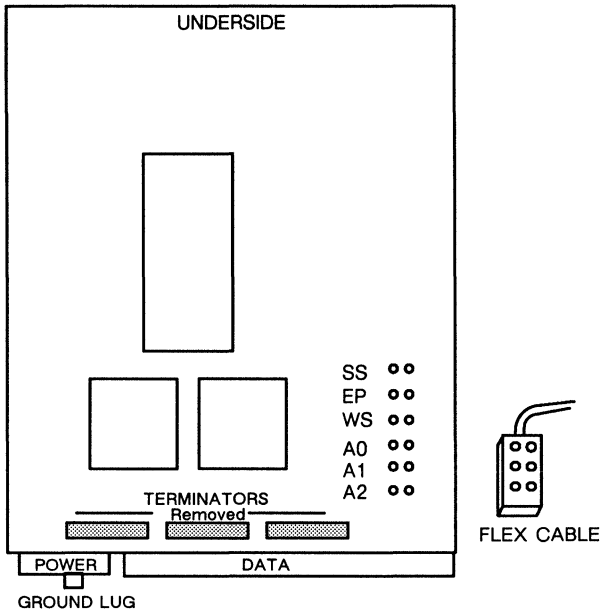

In the Desktop Storage Pack, orient flex cable, 530-1454, as shown above and plug it into jumper block A0, A1, A2.

JUMPER	SETTING	DESCRIPTION	USAGE
SS	Out	Spindle Sync	Not used
EP	Out	Parity	Not Used
WS	Out	Wait Spin	Not Used
A0,A1,A2	Out	Drive ID	Target 0
A0	In	Drive ID	Target 1
A1	In	Drive ID	Target 2
A0,A1	In	Drive ID	Target 3

Power: 0.7 Amps @ +5Vdc
 0.5 Amps @ +12Vdc
 9.5 Watts

Reference: *Sun-3/80 Internal Disk Drive Installation Manual*, 813-1064.

CDC 94161-155 (155MB)

5 1/4" Embedded SCSI

Sun386i/150/250

Option RR131

555-1059 370-1191
 w Bracket w/o Bracket

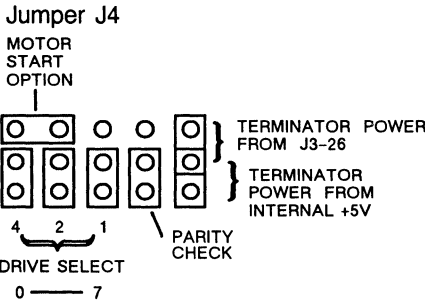
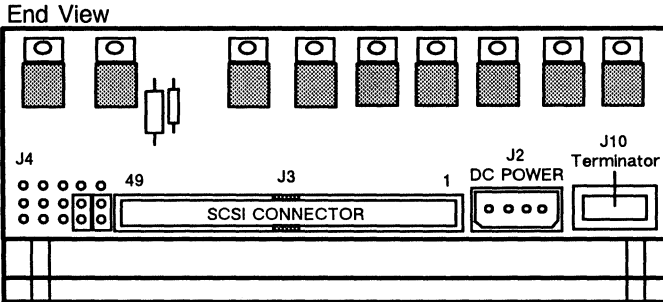

JUMPER	SETTING	DESCRIPTION	USAGE
Motor Start	Out	Motor start	Not used
T P (J3-26)	Out	Term pwr from J3-26	Not used
T P (+5V)	In	Term pwr from +5V	Enable
Parity Check	In	Parity check	Enable
4,2,1	All Out	Drive select	Target 0*
4	In	Drive select	Target 1
2	In	Drive select	Target 2†
4,2	In	Drive select	Target 3

* Target 0, drive sd0, is located in the peripheral box (Sun386i).
 † Target 2, drive sd2, is located in the CPU chassis (Sun386i).

Note: Remove terminator J10 on the end of the drive for normal operation.

Reference

155MB Embedded SCSI Disk Drive Configuration Procedures, 813-2070 and 814-1018.

Quantum 210S (207MB)

3 1/2" Embedded SCSI

Sun-4/40/75
370-1327

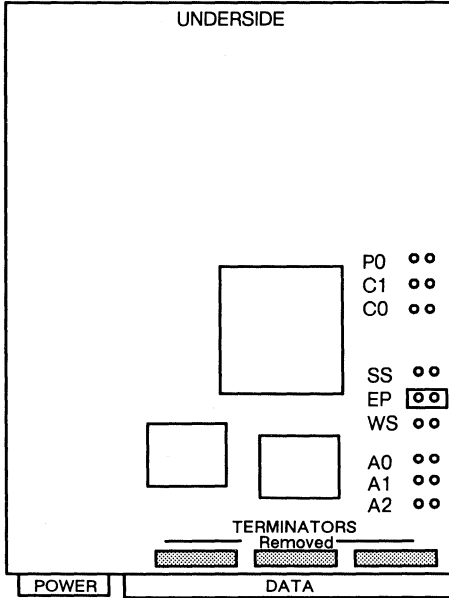

JUMPER	SETTING	DESCRIPTION	USAGE
SS	Out	Spindle Sync	Not used
EP	In	Parity	Enable Parity
WS	Out	Wait Spin	Not Used
A0,A1,A2	Out	Drive ID	Target 0
A0	In	Drive ID	Target 1
A1	In	Drive ID	Target 2
A0,A1	In	Drive ID	Target 3

Note: This drive is not supported inside the Sun-4/60 or Sun-4/65.
The chassis does not provide adequate cooling.

References

1. Sun-4/40 Installation Guide, 800-5037.
2. Installing SPARCstation 2 Internal Disk Drives, 800-5661.

Maxtor LXT-213SY (207MB)

3 1/2" Embedded SCSI

Sun-4/40/75

370-1327

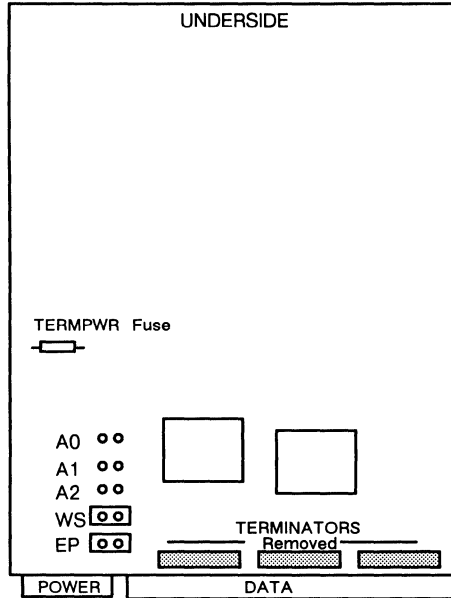

JUMPER	SETTING	DESCRIPTION	USAGE
A0,A1,A2	Out	Drive ID	Target 0
A0	In	Drive ID	Target 1
A1	In	Drive ID	Target 2
A0,A1	In	Drive ID	Target 3
WS	In	Wait Spin	Spin with power
EP	In	Parity	Enable parity

Notes

1. Installation of this drive inside the Sun-4/60 and Sun-4/65 is not supported. The chassis does not provide adequate cooling.
2. This drive is currently not supported inside the Desktop Storage Pack due to the orientation of the address jumpers.

References

1. *Sun-4/40 Installation Guide*, 800-5037.
2. *Installing SPARCstation 2 Internal Disk Drives*, 800-5661.

Quantum 210S (207MB)
3 1/2" Embedded SCSI
Option 552
370-1376
 Desktop Storage Pack

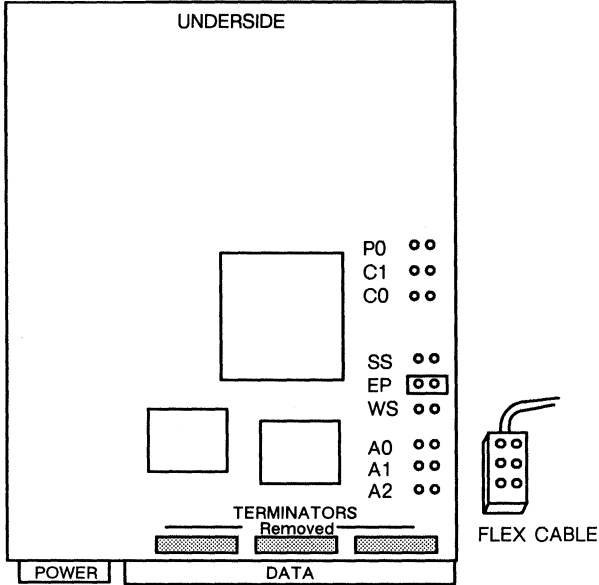

In the Desktop Storage Pack, orient flex cable, 530-1454, as shown above and plug it into jumper block A0, A1, A2.

JUMPER	SETTING	DESCRIPTION	USAGE
SS	Out	Spindle Sync	Not used
EP	In	Parity	Enable Parity
WS	Out	Wait Spin	Not Used
A0,A1,A2	Out	Drive ID	Target 0
A0	In	Drive ID	Target 1
A1	In	Drive ID	Target 2
A0,A1	In	Drive ID	Target 3

Note: This drive is not supported inside the Sun-4/40, Sun-4/60, Sun-4/65, or Sun-4/75.

References for Drive Configuration

1. *Sun-4/40 Installation Guide*, 800-5037.
2. *Installing SPARCstation 2 Internal Disk Drives*, 800-5661.

CDC 94171-327/344 (327MB)

5 1/4" Embedded SCSI

Sun386i/150/250

Sun-3/470 & Sun-4/330/370/470

Options RREXP-P7 RR129 RR134

Options 526 527 530 539

555-1005 370-1153 370-1230

w Bracket
w/o Bezel
77777107

w/o Bracket
w/o Bezel
77777107

w/o Bracket
w Bezel
77777126

End View

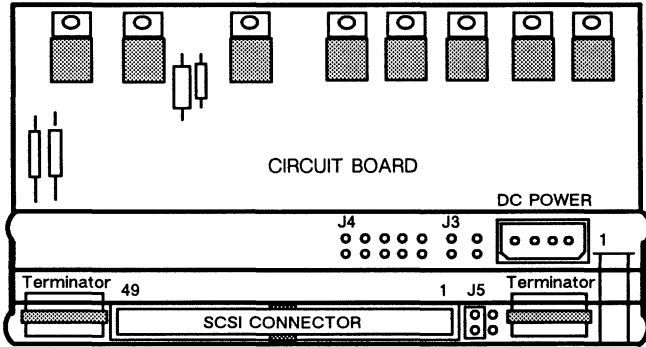

Ground Select Jumper J3

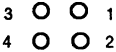

Drive Select and Option Select Jumper J4

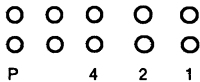

In the External Storage Module orient Pin-1 of the Address Select Switch Cable, 530-1659, with ID4 of Jumper J4.



Terminator Power Source Select Jumper J5

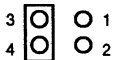

Power: 1.5 Amps @ +5Vdc
1.4 Amps @ +12Vdc.
24.3 Watts

555–1005 & 370–1153 Only

Jumper Settings

Jumper J3

PIN	SETTING	DESCRIPTION
1–2	In	AC + DC ground connected to signal ground
3–4	In	AC + DC ground connected to chassis ground

Jumper J4

PIN	SETTING	DESCRIPTION
P	In	Parity enabled

Jumper J5

PIN	SETTING	DESCRIPTION
3–4	In	Terminator power from DC connector

370–1230 only

Jumper J3

PIN	SETTING	DESCRIPTION
1–2	Out	AC + DC ground not connected to signal ground
3–4	Out	AC + DC ground not connected to chassis ground

Jumper J4

PIN	SETTING	DESCRIPTION
P	Out	Parity enabled

Jumper J5

PIN	SETTING	DESCRIPTION
3–4	In	Terminator power from DC connector

Address Jumper Settings

Jumper J4

PIN	SETTING	DESCRIPTION	USAGE
1,2,4	Out	Drive select	Target 0
1	In	Drive select	Target 1
2	In	Drive select	Target 2
1,2	In	Drive select	Target 3

555-1005 370-1153

Notes

Note: Remove the drive terminators. Use terminator part number 530-1381 to terminate the SCSI bus.

References

1. *386i Field Service Manual*, 814-0002.
2. *327MB Embedded SCSI Configuration Procedures*, 814-1015.

370-1230

1. Remove the terminators from the underside of the drive.
2. Sun-3/470, Sun-4/370, and Sun-4/470 systems with dual option trays are terminated internally on the 501-1493 Interface PCB. The right side tray must be installed to terminate the SCSI bus.
3. Sun-4/370, and Sun-4/470 systems with a single option tray are terminated externally with terminator part number 150-1346.
4. Terminate the External Storage Module externally with terminator part number 530-1381.
5. Terminate the Sun-4/330 on the SCSI Out PCB with three 220/330 terminators part number 120-1608-01.

References

1. *5 1/4-Inch Disk Drive Installation in the 12-Slot Office Pedestal Manual*, 813-1055.
2. *Sun 327 Mbyte SCSI Disk Configuration Manual*, 813-2048.

Micropolis 1588-15 (669MB)

5 1/4" Embedded SCSI

Sun-4/330/370/470

Options 561 563 565 566

370-1319 370-1326 555-1151

FS0013-03-5
Black Bezel
Green LED

FS0019-01-6
No Bezel
No LED

FS0019-01-6
No Bezel
No LED
w Bracket

Bottom View

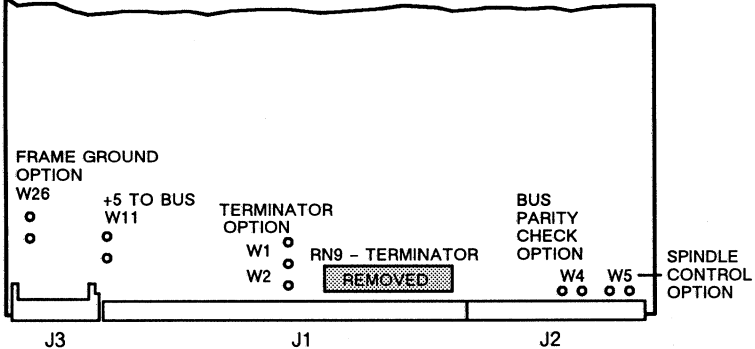

Note: All other jumpers on this board are set by the manufacturer. Do NOT change these settings.

End View

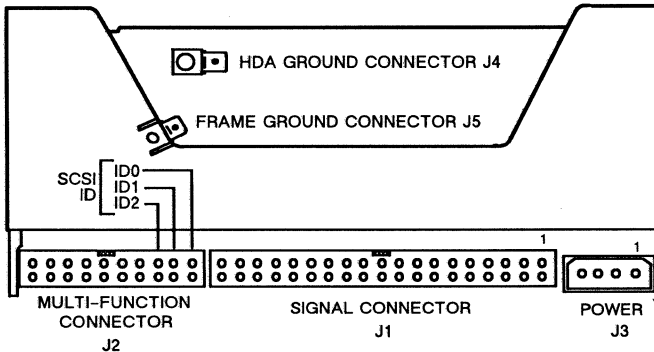

In the External Storage Module orient Pin-1 of the Address Select Switch Cable, 530-1659, with ID2 of Connector J2.

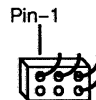

370-1319 370-1326 555-1151 Option Jumper Settings

JUMPER	SETTING	DESCRIPTION
W5	Out	Spindle starts at power on
W4	Out	Enable parity detection
W1	In	Drive provides internal terminator power
W2	Out	
W11	Out	
W28	Out	Frame ground not connected to logic ground

External Storage & External Expansion Modules

JUMPER	SETTING	DESCRIPTION
W5	Out	Spindle starts at power on
W4	Out	Enable parity detection
W1	In	Drive provides internal terminator power
W2	Out	
W11	Out	
W28	In	Frame ground connected to logic ground

Address Jumper Settings

J2 Multi-function Connector

PIN	SETTING	DESCRIPTION
0,1,2	Out	Target 0
0	In	Target 1
1	In	Target 2
0,1	In	Target 3

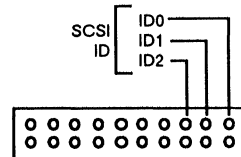

References

1. *5-1/4" SCSI Disk Drive Installation and Configuration for Sun Office Pedestals*, 813-2048.
2. *Revised Removal/Replacement Procedures for Sun ESM and EEM Storage Units*, 814-3044.

Maxtor XT-8760S (669MB)

5 1/4" Embedded SCSI

Sun-4/330/370/470

Options 561 563 565 566

370-1319

1098618-B
Black Bezel
Green LED

370-1326

1098778-B
No Bezel
No LED

555-1151

FS0019-01-6
No Bezel
No LED
w Bracket

Bottom View

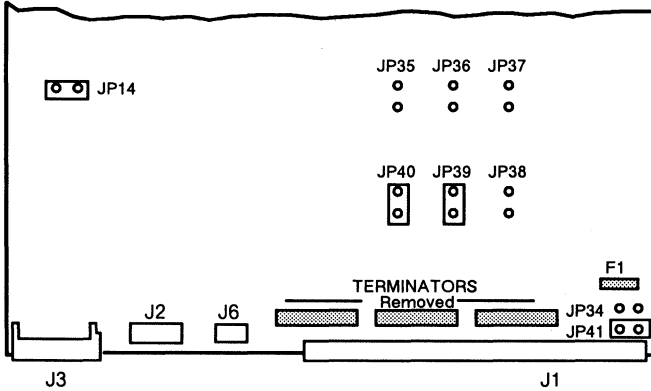

Note: All other jumpers on this board are set by the manufacturer. Do not change these settings.

End View

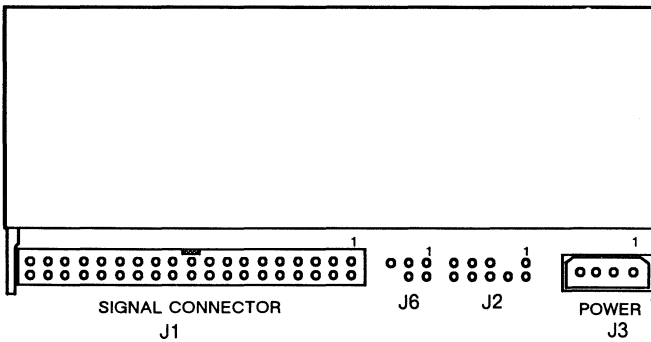

In the External Storage Module, orient Pin-1 of the Address Select Switch Cable, 530-1659, with ID4 on the J2 Adapter Plug.



370-1319 370-1326 555-1151 Option Jumper Settings

JUMPER	SETTING	DESCRIPTION
JP14	In	Spindle starts at power on
JP38	Out	No motor delay at power on
JP40	In	Enable parity detection
JP41	In	Drive provides internal terminator power
JP34	Out	Terminator power option

Address Jumper Settings

Drive address selection is set either on the J2 Adapter or on jumpers JP35, JP36, and JP37. Because these circuits are in parallel, install jumpers at only one location.

J2 Auxiliary Connector with Adapter Plug

JUMPER	SETTING	DESCRIPTION
1,2,4	Out	Target 0
1	In	Target 1
2	In	Target 2
1,2	In	Target 3

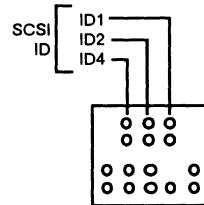

JP35, JP36, and JP37

JUMPER	SETTING	DESCRIPTION
JP35, JP36, JP37	Out	Target 0
JP35	In	Target 1
JP36	In	Target 2
JP35, JP36	In	Target 3

370-1319 370-1326 555-1151

Maxtor XT-8760S

Notes

1. The J2 Adapter Plug must be installed in order for the ID Select Switch on the External Storage Module to function.
2. Drive address selection cannot be set on Auxiliary Connector J2 unless the Adapter Plug is installed.
3. The Maxtor drive does not fit into the lower drive position of External Storage Modules manufactured prior to October 1990. Remove the vertical stop block with 10-Inch End Cutter, 250-1074-01.

References

1. *5-1/4" SCSI Disk Drive Installation and Configuration for Sun Office Pedestals*, 813-2048.
2. *Revised Removal/Replacement Procedures for Sun ESM and EEM Storage Units*, 814-3044.

This page intentionally left blank.

Fujitsu M2312 (65MB)

8" SMD

Options 60 61 62

Options D84 D84EX D84TC D84TR

370-0567

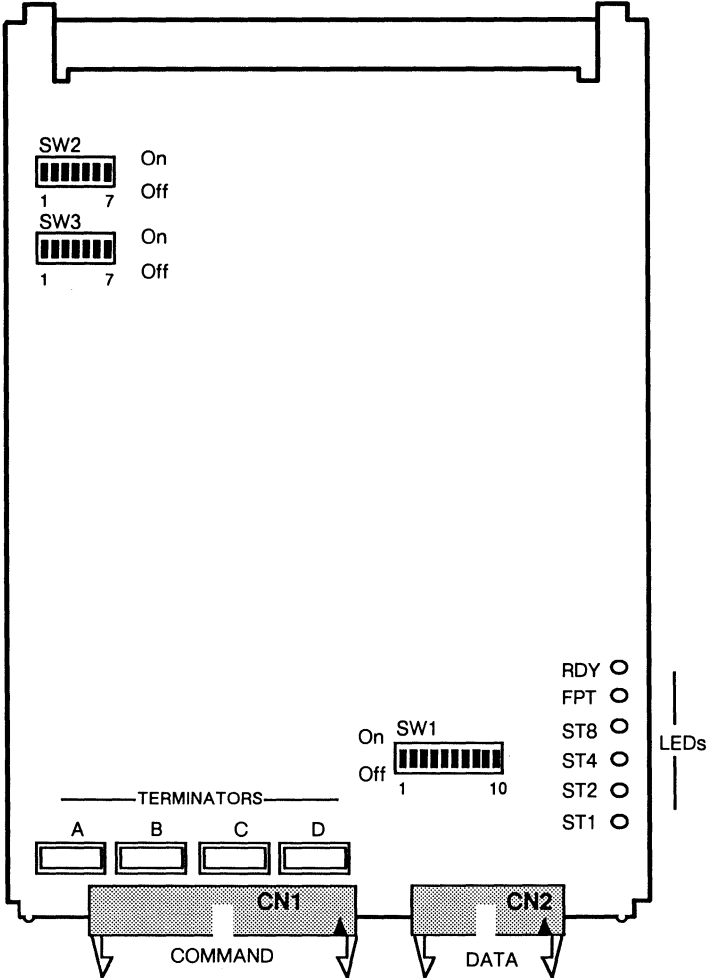

Power: 3.5 Amps @ +5Vdc
 3.0 Amps @ -12Vdc
 3.0 Amps @ +24Vdc
 125.5 Watts

370-0567

Jumper Settings

Non-slip sector format
32 Sectors / Track †

DIP	SWITCH	SETTING
SW1	1	Off*
	2	Off
	3	Off
	4	On
	5	Off
	6	Off
	7	Off*
SW2	1	On
	2	On
	3	On
	4	On
	5	On
	6	On
	7	On
SW3	1	Off
	2	Off
	3	On
	4	Off
	5	Off
	6	Off
	7	Off

Slip sector format
33 Sectors / Track

DIP	SWITCH	SETTING
SW1	1	Off*
	2	Off
	3	Off
	4	On
	5	Off
	6	Off
	7	Off*
SW2	1	Off
	2	Off
	3	On
	4	On
	5	Off
	6	On
	7	On
SW3	1	Off
	2	Off
	3	On
	4	Off
	5	Off
	6	Off
	7	Off

*SW1 Switch Settings

Switch-1, Off, for drive 0, On, for drive 1

Switch-7, On, enables write protect

† Non-slip sector format used on OS3.0 and below.

Fujitsu M2322 (130MB)

8" SMD

Options 63 64 65 601 602 603

370-1014

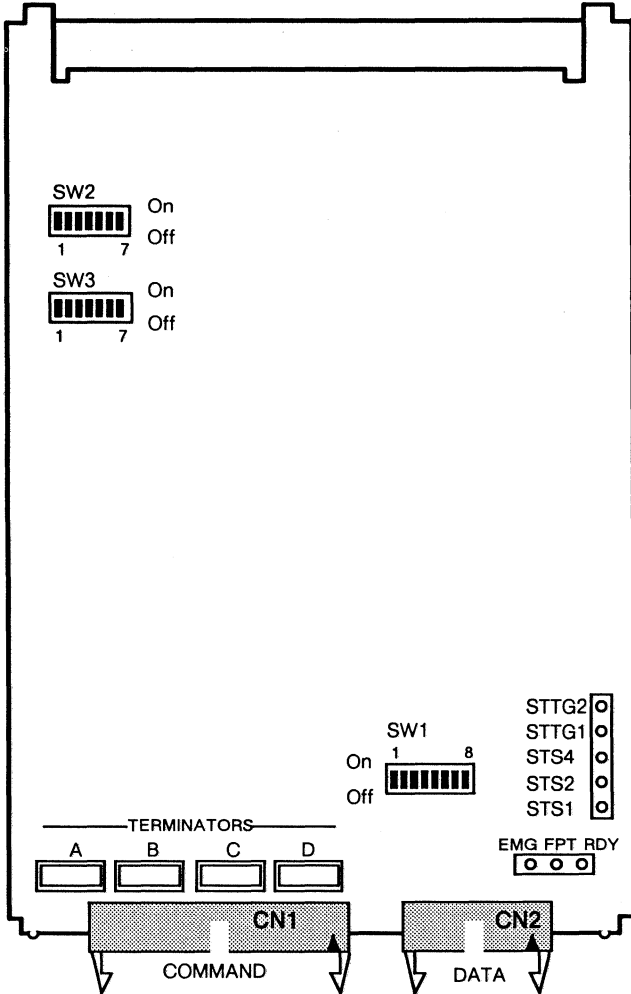

370-1014 Switch Settings

Non-slip sector format
32 Sectors/Track

Slip sector format
33 Sectors/Track

DIP	SWITCH	SETTING
SW1	1	Off*
	2	Off
	3	Off
	4	On
	5	Off
	6	Off
	7	Off*
	8	Off*
SW2	1	On
	2	On
	3	On
	4	On
	5	On
	6	On
	7	On
SW3	1	Off
	2	Off
	3	On
	4	Off
	5	Off
	6	Off
	7	Off

DIP	SWITCH	SETTING
SW1	1	Off*
	2	Off
	3	Off
	4	On
	5	Off
	6	Off
	7	Off*
	8	Off*
SW2	1	Off
	2	Off
	3	On
	4	On
	5	Off
	6	On
	7	On
SW3	1	Off
	2	Off
	3	On
	4	Off
	5	Off
	6	Off
	7	Off

*SW1 Switch Settings

- Switch-1, On, for drive 1, Off, for drive 0
- Switch-7, On, enables write protect
- Switch-8, On, when drive is mounted on-end

Notes

1. Remove the TVQM cover plate for normal operation.
2. Attach the TVQM cover plate to the drive to prevent damage to C15 and C16 during shipping.

Fujitsu M2284 (130MB)

14" SMD

Options D169 D169EX D169TC D169TR

Options 66 67

370-1005

VOFM PCB

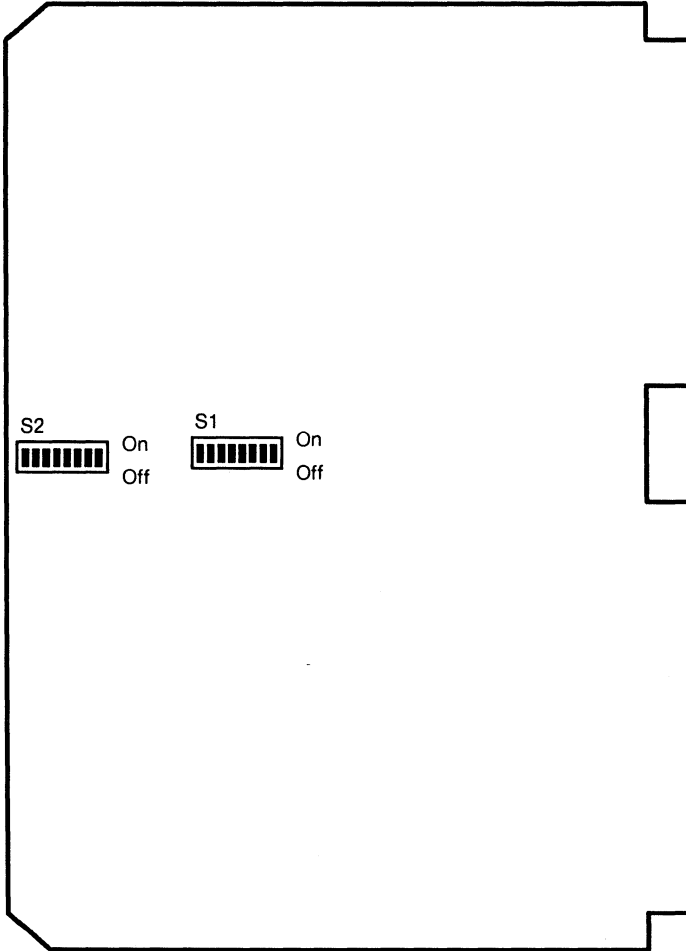

Power: 3.0 @ 115VAC
2.0 @ 240VAC

370-1005 Switch Settings

VOFM PCB
Non-slip sector format
for Xylogics 450/451
32 Sectors / Track †

DIP	SWITCH	SETTING
S1	1	On
	2	On
	3	On
	4	On
	5	On
	6	On
	7	On
S2	1	Off
	2	Off
	3	On
	4	Off
	5	Off
	6	Off
	7	Off

VOFM PCB
Slip sector format
for Xylogics 450/451
33 Sectors / Track

DIP	SWITCH	SETTING
S1	1	Off
	2	Off
	3	On
	4	On
	5	Off
	6	On
	7	On
S2	1	Off
	2	Off
	3	On
	4	Off
	5	Off
	6	Off
	7	Off

† Non-slip sector format used on SunOS 3.0 and below.

Fujitsu M2284 (130MB)

14" SMD

Options D169 D169EX D169TC D169TR

Options 66 67

370-1005

CQFM PCB

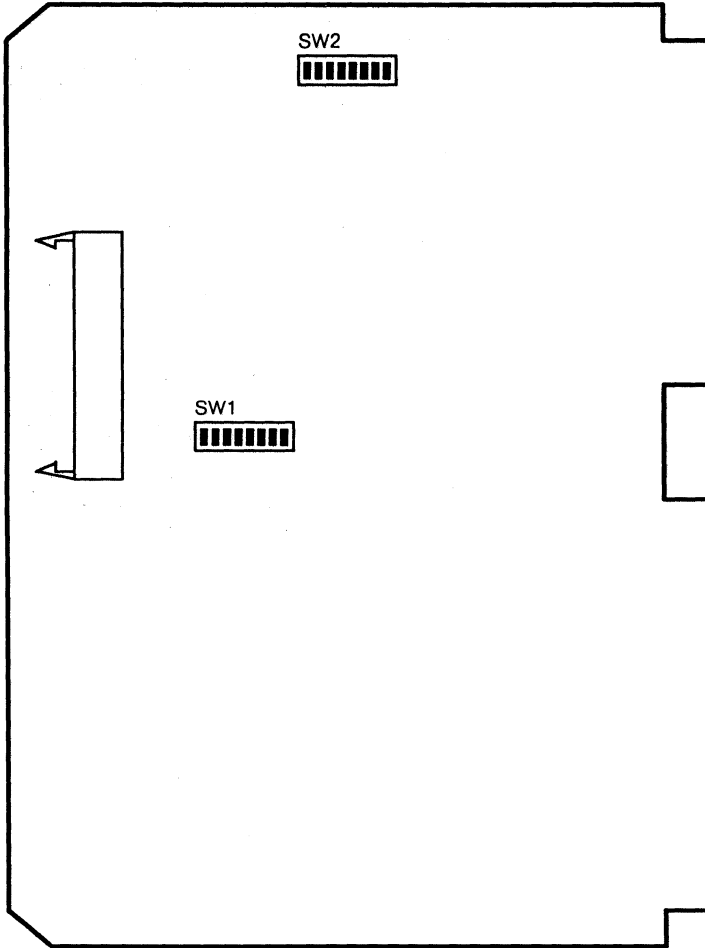

370-1005 Switch Settings

DIP	SWITCH	SETTING	DIP	SWITCH	SETTING
SW1	1	Off*	SW2	1	Off
	2	Off		2	Off
	3	Off		3	Off
	4	Off		4	Off
	5	Off		5	Off
	6	Off		6	Off
	7	Off		7	Off
	8	Off		8	Off

*SW1, Switch -1, Off, for drive 0, On, for drive 1

Notes

1. Xylogics 450 firmware revisions greater than 952C do not function with the Fujitsu M2284. Firmware revisions lower than 952C do not operate with the Fujitsu M2284 and SunOS 3.2 and greater.
2. Termination is required in a single drive configuration and on the last drive of a multiple drive configuration. Install the terminator at location OM1. Install the Ground Wire at location TRM1-2.

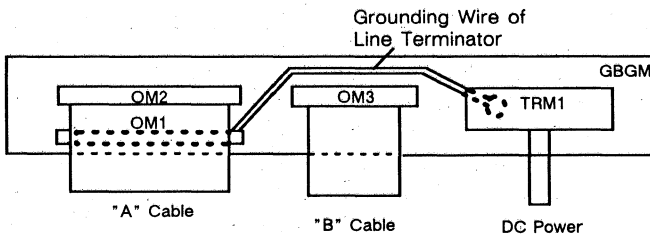

Fujitsu M2351 (380MB)
 10" SMD
 Options 68 69 620 621
 Options D474 D474EX D474TR
 370-1003
 Logic PCB

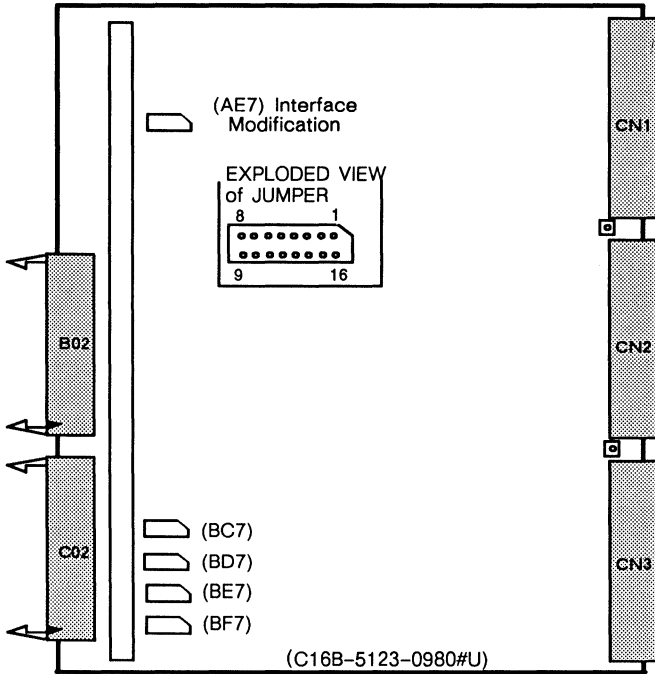

Non-slip sector format for Xylogics 450/451 46 Sectors/Track

Jumper	2-3	3-4	5-6	6-7	9-10	10-11	12-13	13-14
BF7	Out	In	Out	In	Out	In	Out	Out
BE7	Out	In	In	Out	Out	In	Out	In
BD7	In	Out	Out	In	In	Out	Out	In
BC7	In	Out	In	Out	In	Out	Out	In
AE7	Out	In	Out	In	Out	In	Out	Out

Slip Sector format for Xylogics 450/451 47 Sectors/Track

Jumper	2-3	3-4	5-6	6-7	9-10	10-11	12-13	13-14
BF7	Out	In	Out	In	Out	In	Out	Out
BE7	Out	In	In	Out	Out	In	Out	In
BD7	In	Out	Out	In	In	Out	Out	In
BC7	Out	In	In	Out	Out	In	Out	In
AE7	Out	In	Out	In	Out	In	Out	Out

370-1003 Setting of Sector Count on Logic PCB (Slip Sector Format)

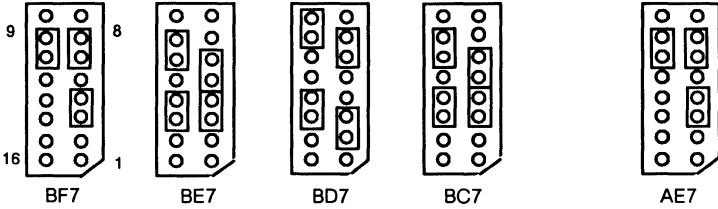

Interface PCB

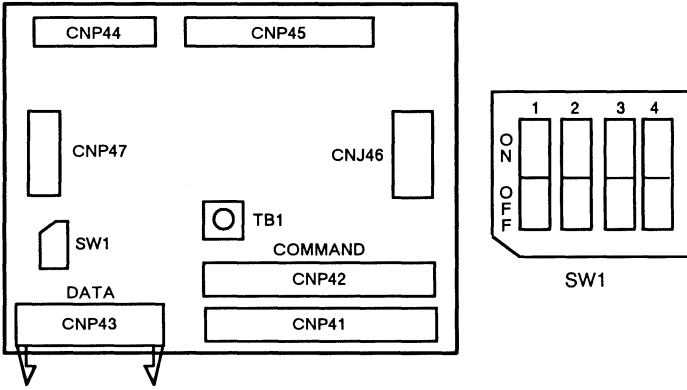

Note: Terminator plugs into CNP42 and grounds at location TB1.

SW1 Drive Addressing

DRIVE ADDRESS	SWITCH POSITION			
	1	2	3	4
0	Off	Off	Off	
1	On	Off	Off	Not Used
2	Off	On	Off	Used
3	On	On	Off	

Fujitsu M2333 (280MB)

8" ESMD

Options 605 606

540-1635 370-1068

w Bracket

w/o Bracket

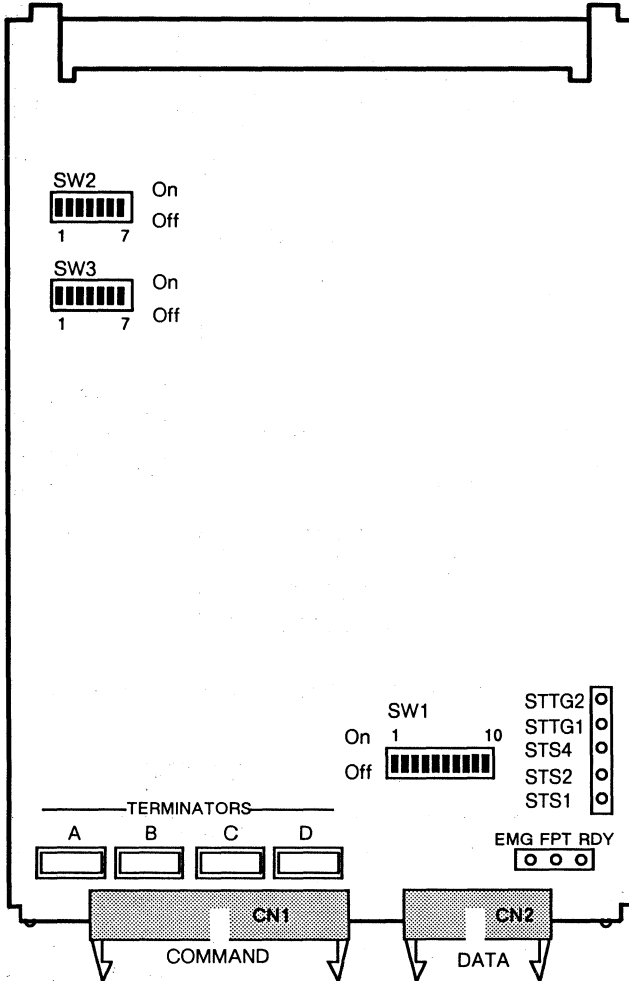

Power: 4.5 Amps @ +5Vdc
3.5 Amps @ -12Vdc
4.0 Amps @ +24Vdc
165.5 Watts

540-1635 370-1068 Switch Settings

DIP	SWITCH	SETTING
SW1	1	Off*
	2	Off
	3	Off
	4	Off
	5	On
	6	On
	7	On
	8	Off
	9	Off*
	10	Off*
SW2	1	On
	2	On
	3	Off
	4	On
	5	Off
	6	On
	7	Off
SW3	1	Off
	2	On
	3	Off
	4	Off
	5	Off
	6	Off
	7	Off

*SW1 Switch Settings

Switch-1, On, for drive 1, Off, for drive 0

Switch-9, On, enables write protect

Switch-10, On, when drive is mounted on-end

Notes

1. Remove the TVQM cover plate for normal operation.
2. Attach the TVQM cover plate to the drive to prevent damage to C15 and C16 during shipping.

Reference

280 MByte Disk Drive Configuration Procedures, 813-2006.

CDC 9720-368 (280MB)

8" ESMD

Options 605 606

540-1635 370-1068

w Bracket

w/o Bracket

Control Board

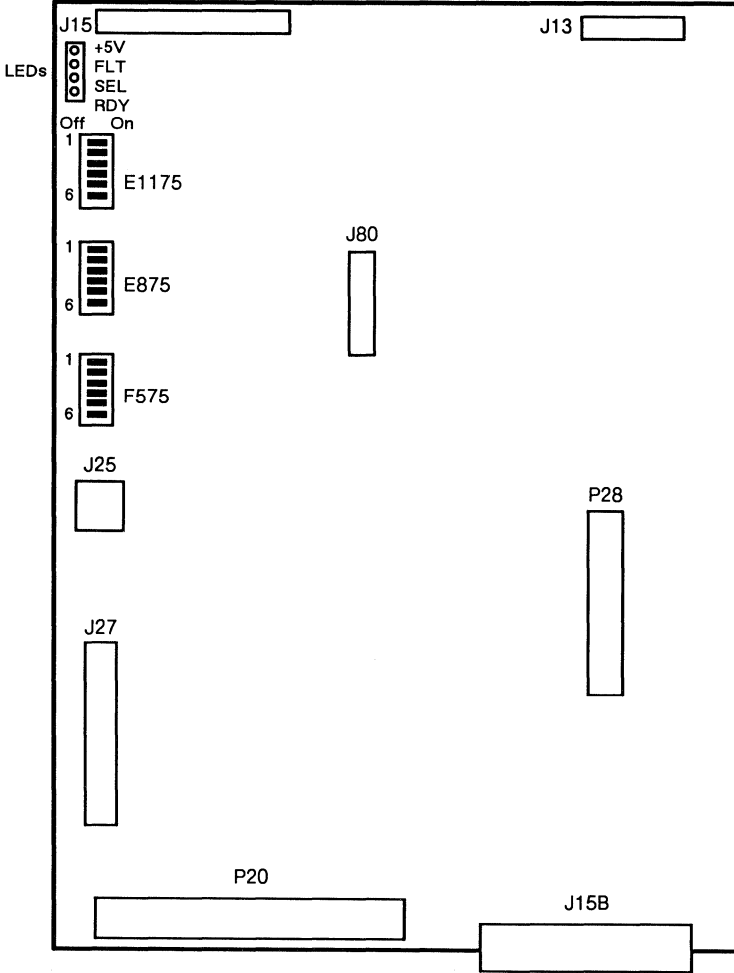

540-1635 370-1068

Switch Settings

Control Board

Slip sector format
49 Sectors/Track

DIP	SWITCH	SETTING
E1175	1	On*
	2	On
	3	On
	4	On
	5	On
	6	On
E875	1	On
	2	Off
	3	Off
	4	Off
	5	Off
	6	On
E575	1	Off
	2	Off
	3	Off
	4	On
	5	Off
	6	Off

I/O Board

DIP	SWITCH	SETTING
A213	1	Off
	2	Off
	3	On
	4	On
	5	Off
	6	On
	7	On
	8	Off
	9	Off
	10	On
A224	1	On
	2	On
	3	On
	4	On
	5	On
	6	On
	7	On
	8	On

*E1175, Switch-1, On, for drive 0, Off, for drive 1

I/O Board

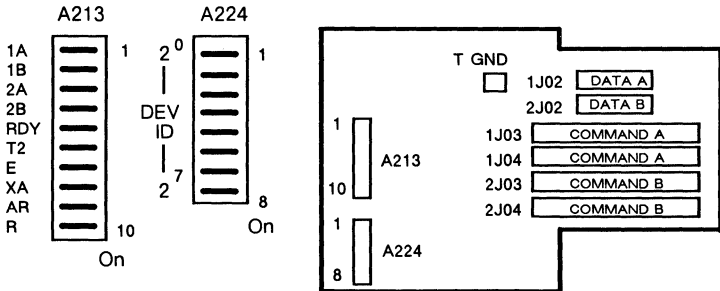

Notes

1. Install the terminator at location 1J03.
2. Install the ground wire at T GND.

Reference: 280 MByte Disk Drive Configuration Procedures, 813-2006.

Fujitsu M2361 (575MB)
 10" ESMD
 Options 625 626
 370-1069

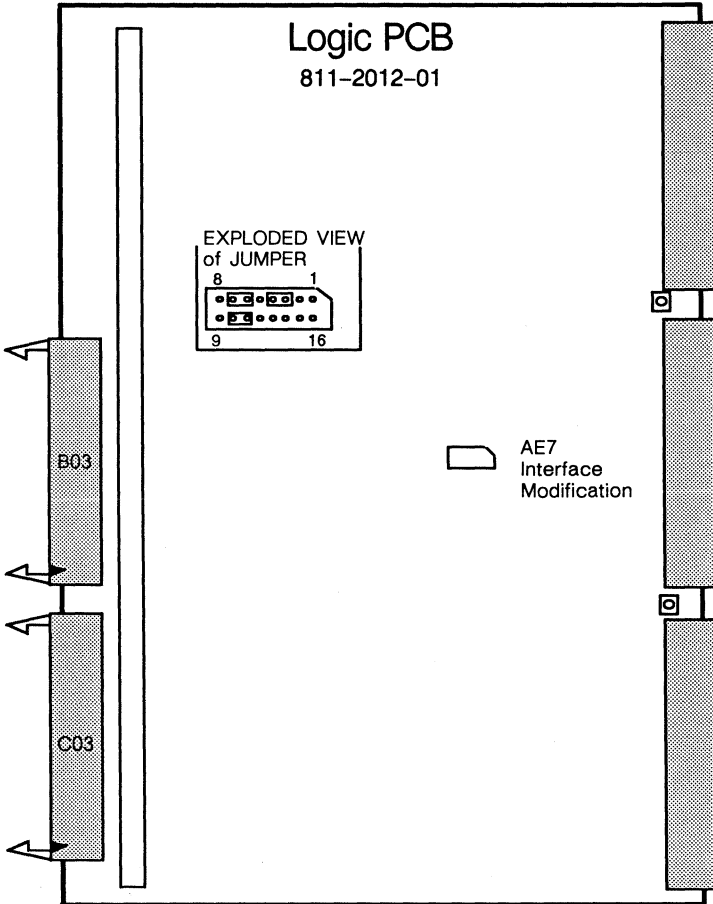

JUMPER	2-3	3-4	5-6	6-7	9-10	10-11	12,13,14,15,16
AE7	Out	In	Out	In	Out	In	Out

370-1069 Switch Settings

Slip Sector format for Xylogics 451, 68 Sectors/Track

SWITCH	1	2	3	4	5	6	7	8
A	Off	Off	Off	Off	Off	Off	On	Off
B	Off	On	Off	On	Off	On	On	On

STATE SWITCHES	SETTING	DRIVE	ADDRESS SWITCH			
Remote/Local	Local		1	2	3	4
Enable A/Disable A	Enable A	Drive0	Off	Off	Off	Off
Enable B/Disable B	Disable B	Drive1	Off	Off	Off	On
RLTM/ABSL	Either position					
MRTZ	Off					
ST0/ST1/ST2	Either position					

Operator Panel

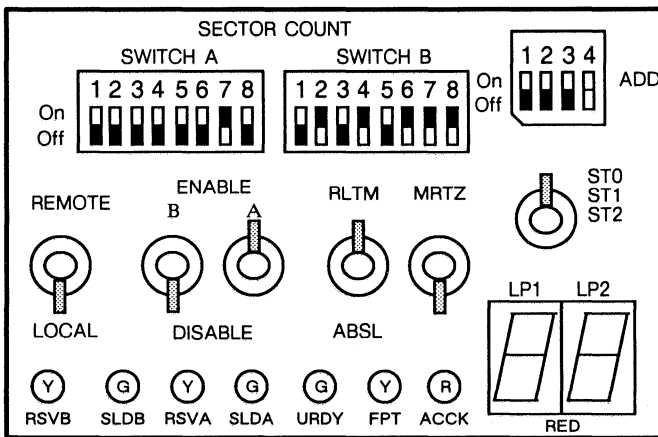

Reference
Fujitsu 2361A Disk Drive Configuration Procedures, 813-2005.

CDC 9720-850 (688MB)

8" ESMD

Options 615 616 731 732 733 734

370-1197 540-1768 (FRU) 540-1813 (FRU)

w/o Bracket

w Mass Storage
Pedestal Bracket

w Sun Expansion
Pedestal Bracket

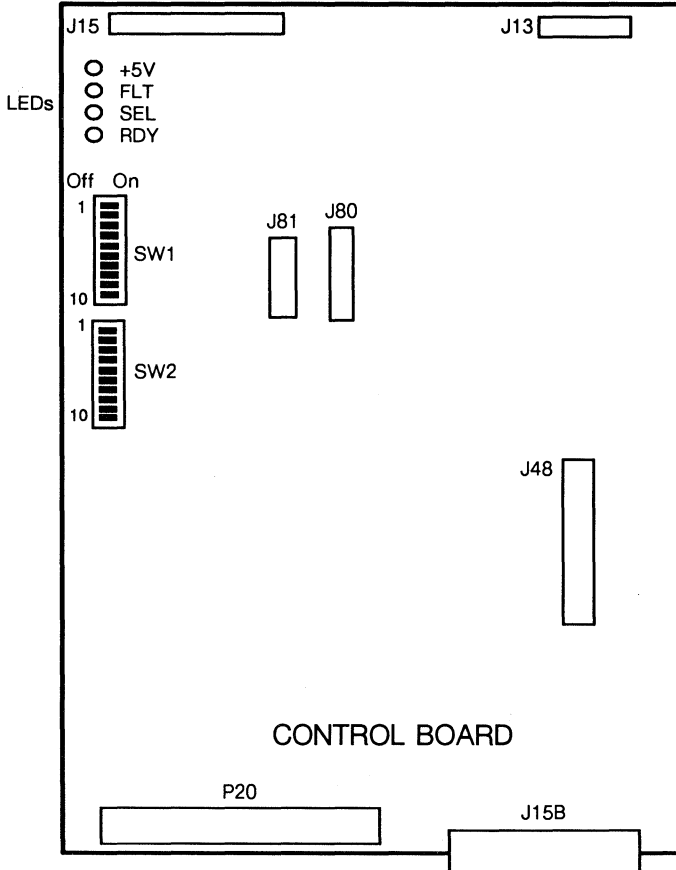

Notes

1. Power Supply 300-1014 must be Boschert, Rev F or greater.
2. The upper fans in the Mass Storage Pedestal MUST intake air. The lower fans MUST exhaust air.
3. The 688MB drive is only supported on the Xylogics 7053.
4. Power Supply 300-1075 does NOT support the 688MB Disk Drive.

540-1768 370-1197 540-1813 Switch Settings

Controller Board

DIP	SWITCH	SETTING
SW1	1	On*
	2	On
	3	On
	4	On
	5	On
	6	On
	7	Off
	8	On
	9	On
	10	On
SW2	1	On
	2	Off
	3	Off
	4	On
	5	On
	6	Off
	7	On
	8	On
	9	On
	10	On

I/O Board

DIP	SWITCH	SETTING
A213	1	Off
	2	Off
	3	On
	4	On
	5	Off
	6	On
	7	Off
	8	Off
	9	Off
	10	On
A224	1	On
	2	On
	3	On
	4	On
	5	On
	6	On
	7	On
	8	On

* SW1, Switch-1, ON for drive 0, OFF for drive 1

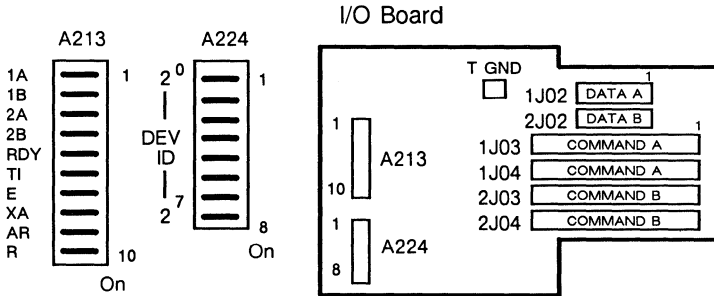

Notes

1. Install the terminator at location 1J03.
2. Install the ground wire from the terminator board to T GND.
3. Jumpers not described are factory set and are not user configurable.

Reference: 688 MByte Disk Drive Configuration Procedures, 813-2062.

Fujitsu M2372 (688MB) 8" ESMD

Options 615 616 731 732 733 734

370-1197 540-1768 540-1813

w/o Bracket

w Mass Storage
Pedestal Bracket

w Sun Expansion
Pedestal Bracket

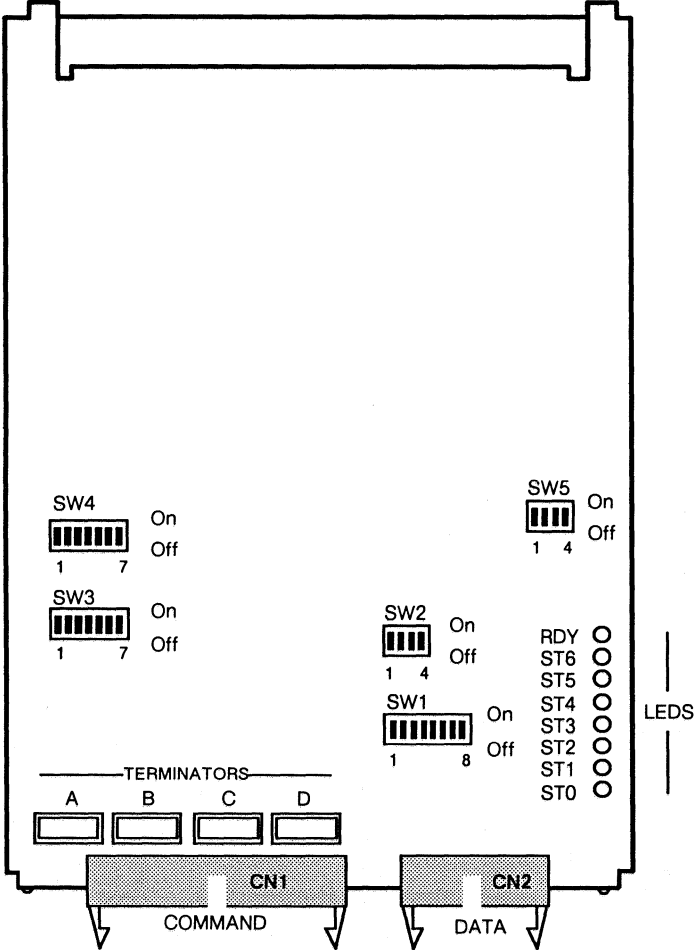

Power: 3.5 Amps @ +5Vdc
 3.5 Amps @ -12Vdc.
 4.5 Amps @ +12Vdc.
 164.5 Watts

540-1768 370-1197 540-1813 Switch Settings

DIP	SWITCH	SETTING
SW1	1	Off*
	2	Off
	3	Off
	4	Off
	5	Off
	6	Off
	7	Off
	8	Off
SW2	1	Off
	2	Off
	3 [†]	Off
	4	Off
SW3	1	On
	2	On
	3	Off
	4	On
	5	Off
	6	On
	7	Off

DIP	SWITCH	SETTING
SW4	1	Off
	2	On
	3	Off
	4	Off
	5	Off
	6	Off
	7	Off
SW5	1	Off
	2	Off
	3	Off
	4	Off

* SW1 Switch Settings

Switch-1, OFF, for drive 0, ON, for drive 1

Switch-5, ON, enables write protect

† SW2, Switch-3, ON, for Sun Expansion Pedestal side-mount

Notes

1. Power Supply 300-1014 must be Boschert, Rev F or greater.
2. The upper fans in the Mass Storage Pedestal MUST intake air. The lower fans MUST exhaust air.
3. The 688MB Disk Drive is only supported on the Xylogics 7053.
4. Drives manufactured prior to 5/8/89 may require the Fujitsu M2372 noise insulator kit, Sun part number 370-1300-01.
5. Power Supplies 300-1052-03, 300-1052-04, 300-1056-03, and 300-1056-04 do NOT support the Fujitsu M2372 Disk Drive. Use 300-1052-05 or 300-1056-05.
6. Power Supply 300-1075 does NOT support the 688MB Disk Drive.

Reference: *688 MByte Disk Drive Configuration Procedures*, 813-2062.

Hitachi DK815-10 (892MB)

9" ESMD

Options 629 630 631

Options 641 642 643 644 645 646

555-1008 370-1141

w Mounting Hardware

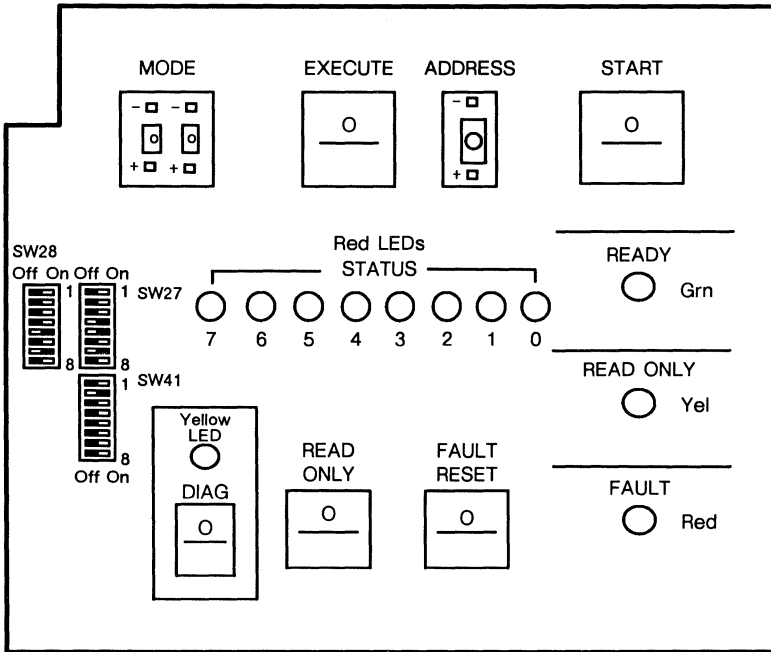

555-1008 370-1141 Switch Settings

Sector Count Switches – 68 sectors per track

SWITCH	1	2	3	4	5	6	7	8
SW-27	Off	Off	Off	On	On	Off	On	Off
SW-41	Off	On	Off	Off	Off	Off	Off	Off

Drive Mode Switch

SWITCH	1	2	3	4	5	6	7	8
SW-28	Off	Off	Off	Off	On	Off	On	Off

Operator Panel

SWITCH	SETTING
Mode	00
Execute	N/A*
Address	0,1,2, or 3
Start	On
Fault Reset	N/A*
Diag	Off
Read Only	Off

*Indicates a momentary switch

Notes

1. A maximum of 2 drives may be installed in a system rack using the 115V power sequencer.
2. A maximum of 4 drives may be installed in a system rack using the 230V or 240V, 20 sec delay power sequencer.
3. The six and eight drive expansion racks are only available as factory installed configurations. Sun does not support installation in the field of more than four 892MB drives in ANY expansion rack.
4. The minimum software level is Sys4-3.2 or 3.5.
5. Different drive types cannot be connected to the same Xylogics 451 Disk Controller when an 892MB Disk Drive is used.
6. The Xylogics 450 is not supported with the 892MB Disk Drive, and cannot be mixed with the Xylogics 451 in any 892MB configuration.

Reference

Sun 900 MByte Disk Drive Configuration Procedures, 813-2046.

NEC D2363 (892MB) (9" ESMD)

Options 629 630 631

Options 641 642 643 644 645 646

555-1008 370-1140 370-1141

w Mounting Hardware

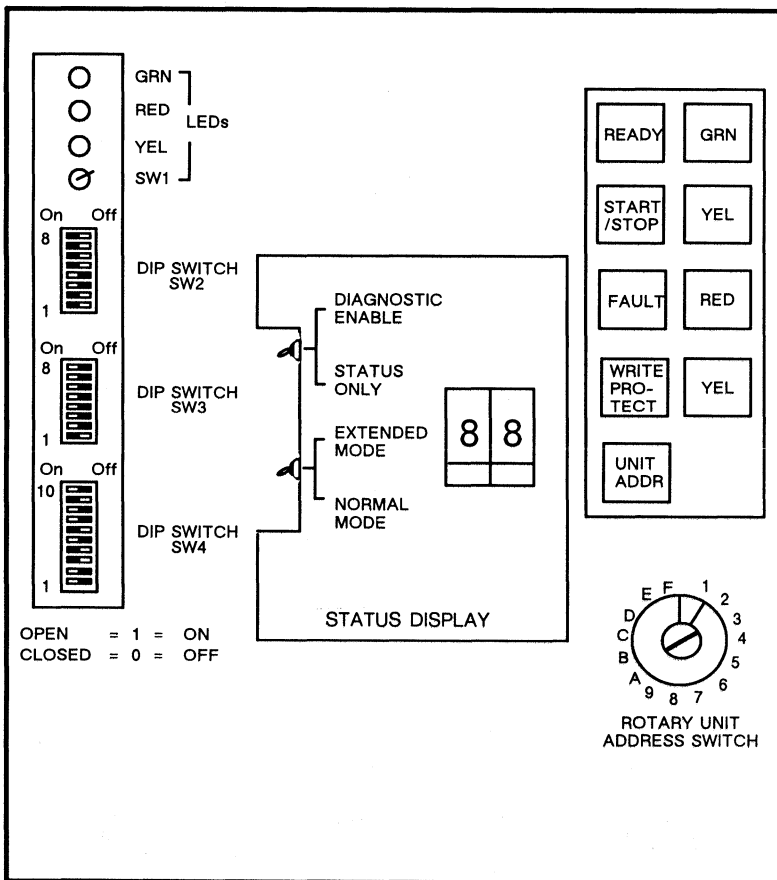

555-1008 370-1140 370-1141 Switch Settings

Operator Panel

SWITCH	SETTING
Ready	Indicator lamp
Start/Stop	In
Fault	Momentary switch
Write Protect	Out

Status Display Panel

SWITCH	SETTING
Diagnostic Enable/Status Only	Status only
Extended Mode/Normal Mode	Normal Mode
CE Reset/Reset Drive Status	N/A*

*Momentary switch only

Parameter Selection Switches

SWITCH	1	2	3	4	5	6	7	8
SW-2	On	On	Off	Off	On	On	On	On
SW-3	On	Off	Off	Off	Off	Off	Off	Off

Sector Count Switch – 68 Sectors Per Track

SWITCH	1	2	3	4	5	6	7	8	9	10
SW-4	Off	Off	On	On	Off	On	Off	Off	On	Off

Notes

1. The Rotary Unit Address Switch is selectable from unit 1 to unit F. It is enabled when SW2 switches 5,6,7, 8 are ON.
2. The six and eight drive expansion racks are only available as factory installed configurations. Sun does not support installation in the field of more than four 892MB drives in ANY expansion rack.

Reference

Sun 900 MByte Disk Drive Configuration Procedures, 813-2046.

Seagate 97209-12G (1.2GB)

8" IPI-2 3MB/Sec
Options 706 707 709 710
Options 741A 742A 743A 744A 745A

Operator Panel 370-1221

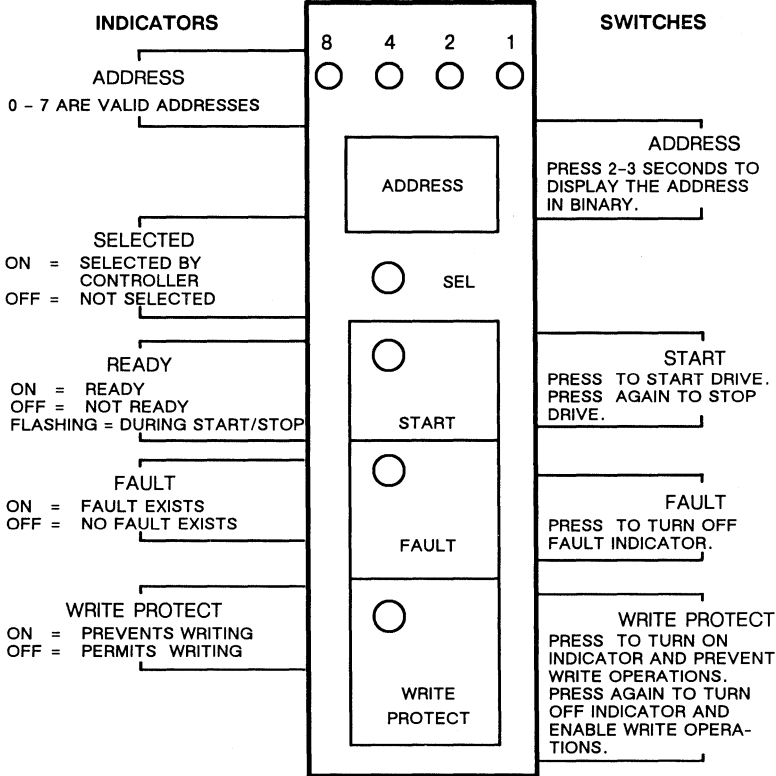

Note: Each drive power on sequence is delayed for a time equal to five seconds times its address. For example, if the address is 3, the drive starts after a 15 second delay.

Disk Enclosure

370-1187

Rackmount Disk
w/o Power Supply
w/o Tray

370-1314

Pedestal Disk
w/o Bracket

540-1770

Rackmount Disk
w Power Supply
w Tray

540-1926

Pedestal Disk
w Tray

Control Board Dip Switch Settings

Dip Switch 1, Switches 1,2,3,4

DRIVE	SWITCH 4	SWITCH 3	SWITCH 2	SWITCH 1
0	Closed	Closed	Closed	Closed
1	Closed	Closed	Closed	Open
2	Closed	Closed	Open	Closed
3	Closed	Closed	Open	Open
4	Closed	Open	Closed	Closed
5	Closed	Open	Closed	Open
6	Closed	Open	Open	Closed
7	Closed	Open	Open	Open

Dip Switch 1, Switches 5 and 6

DIP	SWITCH	DESCRIPTION
2	5	Not Used
	6	Open = Write protected Closed = Write enabled

Control Board Types

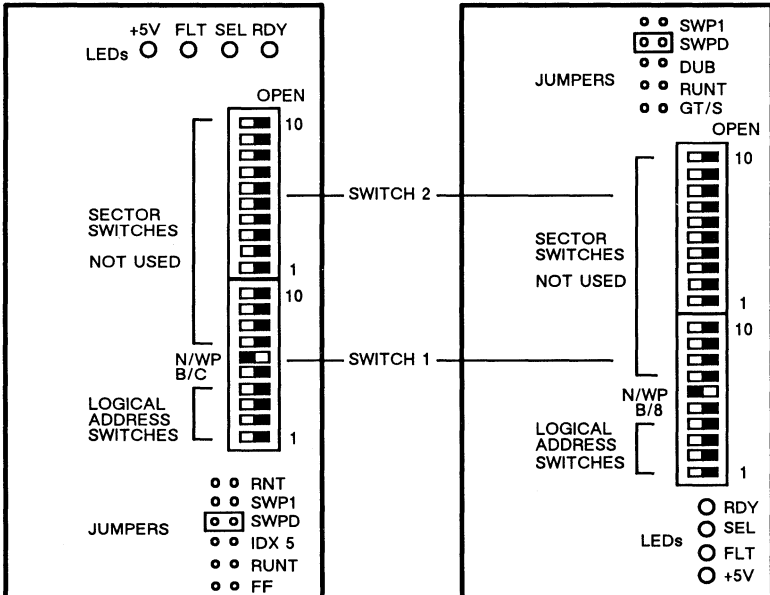

Disk Enclosure

370-1187 370-1314 540-1770 540-1926

I/O Board Rear View

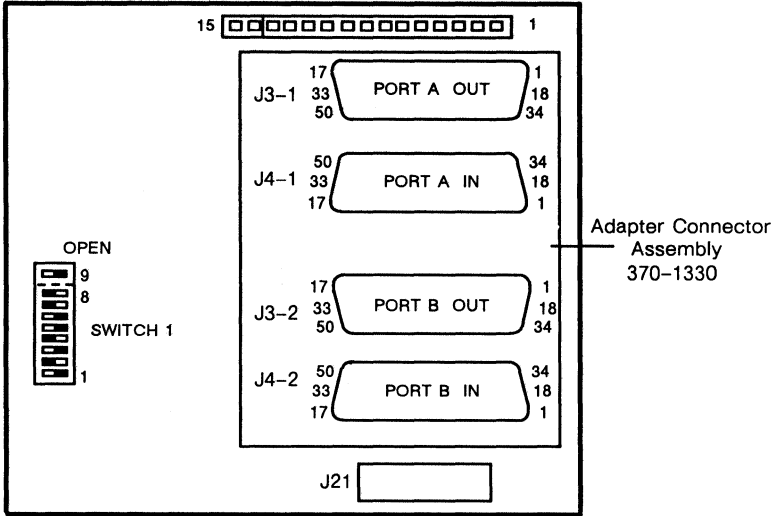

Power Connector

15	14	13	12	11	10	9	8	7	6	5	4	3	2	1
+24 RTN	+24	+24	+24	+24 RTN	+24 RTN	N/C	PWR OK	-12	-5	-5	GND	GND	+5	+5

Dip Switch 1 Settings

SWITCH	SETTING	DESCRIPTION
1	Open	Drive starts when DC Power is applied
2	Closed	Disable Port B
3	Open	Enable Port A
4	Closed	Disable internal diagnostics
5	Open	ID Microcode. Do Not Change.
6	Open	
7	Closed	
8	Closed	
9	Open	Slave/Master spindle sync-slave

370-1187 370-1314 540-1770 540-1926
Seagate 97209-12G
Notes

1. Use terminator 370-1220-01 on the Port A/B Out connector.
2. Disable an unused port with the Port Enable/Disable switch.
3. Do not install a terminator on an unused port.
4. Switch 9 is on I/O board LYBX. It is not on I/O board BXDX.
5. There may be cooling vents on the top cover of 1.2GB Disk Drive 370-1187. Do NOT install this drive in the Sun Expansion Pedestal.
7. Power Supply 300-1052-02 does NOT support 1.2GB Disk Drives.
8. Power Supply 300-1052-03 supports two 1.2GB Disk Drives. Power must be distributed between the two 410 Watt modules.
9. Power Supply 300-1052-04 supports four 1.2GB Disk Drives.
10. Power Supply 300-1052-05 does NOT support 1.2GB Disk Drives.
11. Use Power Supply 300-1075 in the Sun Expansion Pedestal.

References

1. *IPI8-1000/2HP Disk Drive Configuration and Installation Procedures for the Sun Expansion Pedestal, 813-5377.*
2. *IPI8-1000 and IPI8-1000/2HP Disk Drive Configuration and Installation Procedures for the Sun 56-inch Cabinets, 813-1109.*

Seagate 97229-11G (911MB)

8" IPI-2 6MB/Sec
Options 716 717 719 720
Options 741L 742L 743L 744L 745L

Operator Panel 370-1355

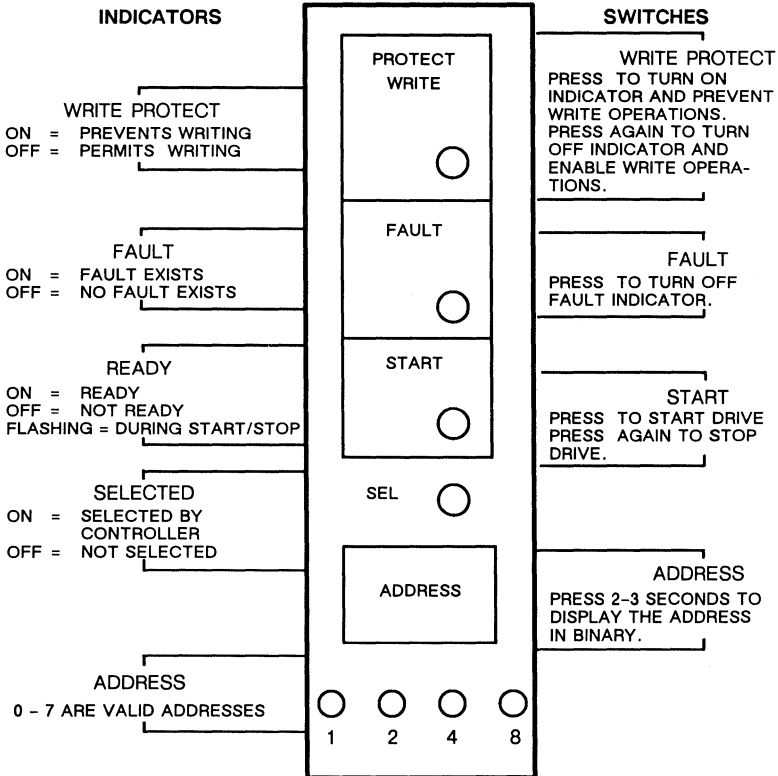

Note: Each drive power on sequence is delayed for a time equal to five seconds times its address. For example, if the address is 3, the drive starts after a 15 second delay.

Disk Enclosure

370-1351
Rackmount Disk
w/o Tray
w/o Power Supply

370-1352
Pedestal Disk
w/o Bracket

540-2005
Rackmount Disk
w Tray
w Power Supply

540-2008
Pedestal Disk
w Bracket

Control Board Dip Switch Settings

Dip Switch 1, Switches 1,2,3,4

DRIVE	SWITCH 4	SWITCH 3	SWITCH 2	SWITCH 1
0	Closed	Closed	Closed	Closed
1	Closed	Closed	Closed	Open
2	Closed	Closed	Open	Closed
3	Closed	Closed	Open	Open
4	Closed	Open	Closed	Closed
5	Closed	Open	Closed	Open
6	Closed	Open	Open	Closed
7	Closed	Open	Open	Open

Dip Switch 1, Switches 5 and 6

DIP	SWITCH	DESCRIPTION
1	5	Not Used
	6	Open = Write Protected Closed = Write enabled

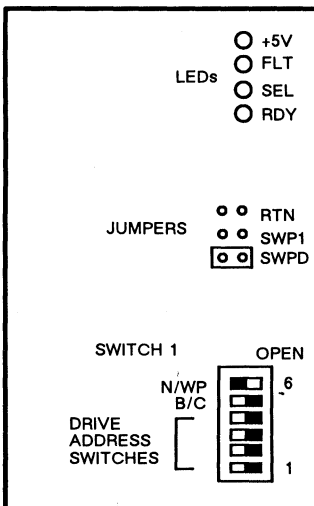

Disk Enclosure

370-1351 370-1352 540-2005 540-2008

I/O Board Rear View

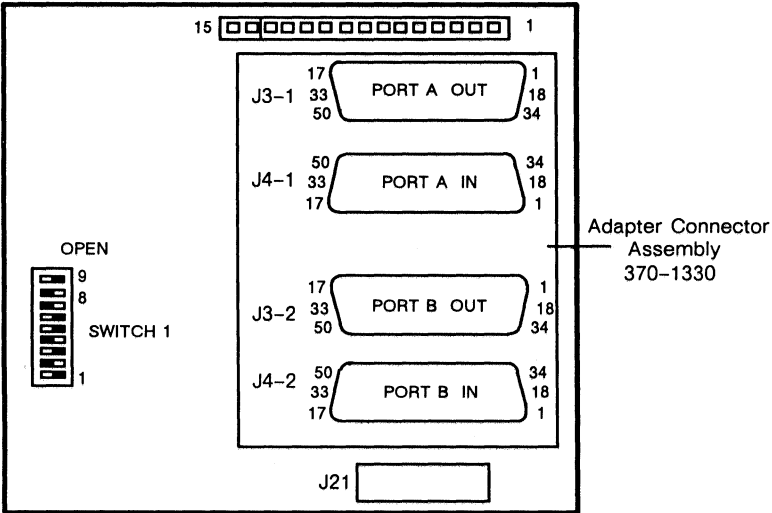

Power Connector

15	14	13	12	11	10	9	8	7	6	5	4	3	2	1
+24 RTN	+24	+24	+24	+24 RTN	+24 RTN	N/C	PWR OK	-12	-5	-5	GND	GND	+5	+5

Dip Switch 1 Settings

SWITCH	SETTING	DESCRIPTION	
1	Open	Drive starts when DC Power is applied	
2	Closed	Disable Port B	
3	Open	Enable Port A	
4	Closed	Disable internal diagnostics	
5	Open	ID Microcode. Do Not Change.	
6	Closed		1D 3
7	Open		1D 2
8	Closed		1D 1
8	Closed	1D 0	Slave/Master spindle sync-slave
9	Open		

370-1351 370-1352 540-2005 540-2008
Seagate 97229-11G
Notes

1. The ISP-80 IPI-2 Disk Controller must be 501-1539-05 or greater.
2. Use terminator 370-1220-01 on the Port A/B Out connector.
3. Disable an unused port with the Port Enable/Disable switch.
4. Do not install a terminator on an unused port.
5. There are cooling vents on the cover of 911MB Disk Drive 370-1351. Do NOT install this drive in the Sun Expansion Pedestal.
6. There are no cooling vents on the cover of 911MB Disk Drive 370-1352. Do NOT install this drive in the Sun 56" Rack.
7. Power Supply 300-1052 does NOT support 911MB Disk Drives.
8. Use Power Supply 300-1075 in the Sun Expansion Pedestal.

References

1. *IPI8-1000/2HP Disk Drive Configuration and Installation Procedures for the Sun Expansion Pedestal, 813-5377.*
2. *IPI8-1000 and IPI8-1000/2HP Disk Drive Configuration and Installation Procedures for the Sun 56-inch Cabinets, 813-1109.*

Adaptec ACB4000

Sun-2/120/130/160 & Sun-3/160

Options 55 55EX 56 501 503 511
370-1010

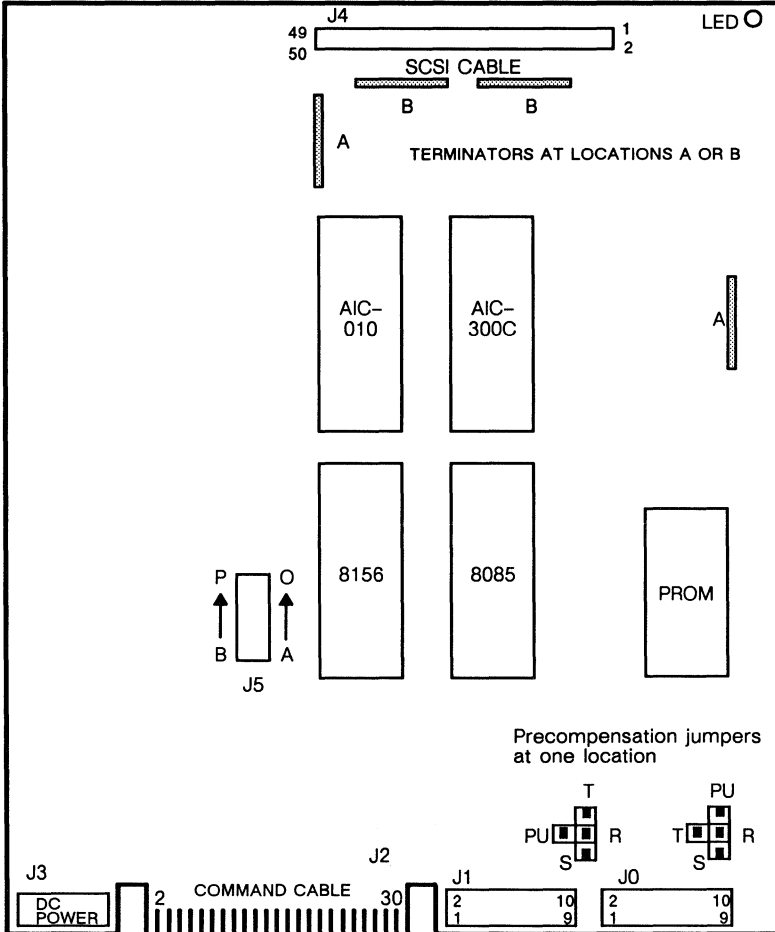

Power: 1.5 Amps @ +5Vdc
 0.1 Amps @ +12Vdc.
 8.7 Watts

Note: On individual board layouts, the terminators are either at the A or B location, and the precompensation jumpers are oriented as shown in one of the examples above.

370-1010 Jumper Settings

JUMPER	PINS	SETTING	DESCRIPTION
S, R T&PU	R-S	Out	Selects Precomp at Cyl 400*
	R-T	Out	Selects Precomp all tracks
	R-PU	In	De-selects Precomp all tracks
J5	A-B [†]	Out	SCSI bus address
	C-D	Out	SCSI bus address
	E-F	Out	SCSI bus address
	G-H	Out	Halves the transfer rate
	I-J	Out	Not used
	K-L	Out	Not used
	M-L	Out	Selects a seek complete status
	O-P	Out	Not used

*Refer to the charts below for Micropolis 1304 disk drive.

DRIVE SERIAL NUMBER	ACTION
41210001 and greater	Jumper the Adaptec for NO precompensation (PU-R)
411559999 or lower	Check the drive PCB

DRIVE PCB SERIAL NUMBER	ACTION
101242-xx-x	Jumper the Adaptec for precompensation (R-S).
101362-xx-x	Jumper the Adaptec for NO precompensation (PU-R).

[†] A-B, In, for second Adaptec controller

Reference
71 MByte Disk Controller Configuration Procedures, 813-2027.

Emulex MD21

Sun-3/160/260 & Sun-4/260

Options 504 505 507 509 510 514 516

370-0552 370-1236

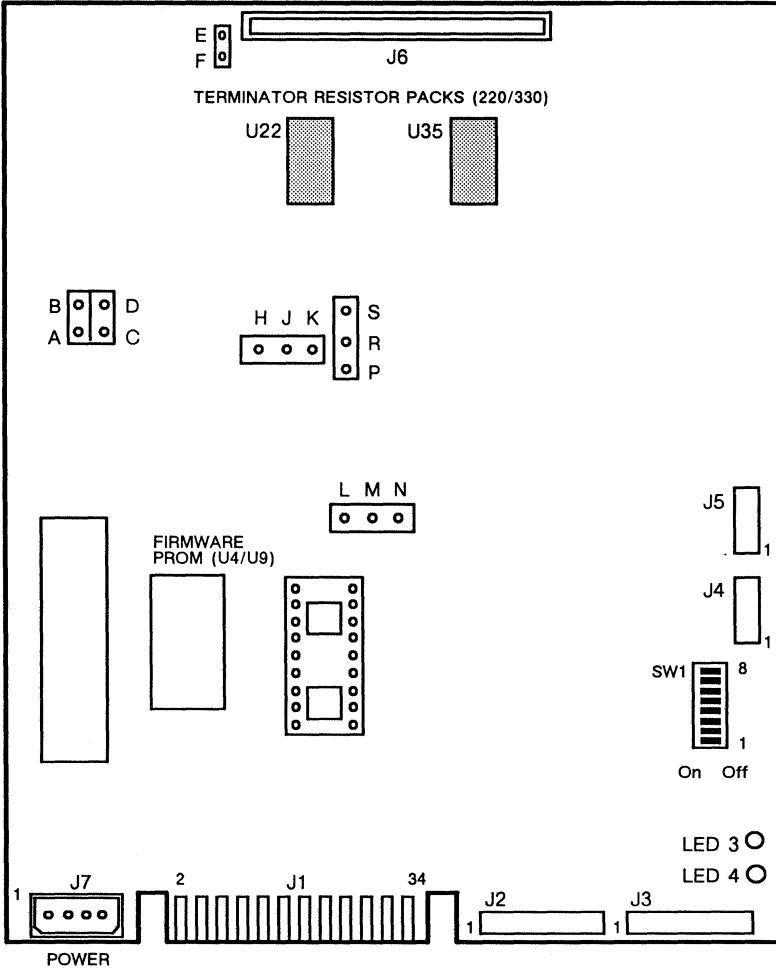

Power: 1.6 Amps @ +5Vdc
8.0 Watts

370-0552 370-1236 Switch & Jumper Settings

DIP SWITCH	SETTING	DESCRIPTION
1	Off *	SCSI BUS ADDRESS/TARGET Bit 0-7
2	Off	
3	Off	
4	Off	Not used
5	Off	512 byte/sector
6	Off	Power on spin-up
7	Off	Soft errors reported
8	Off	Parity disabled

* For DeskTop Expansion Shoebox, Dip Switch 1 is ON for Target 1.

JUMPER	SETTING	DESCRIPTION
E,F *	Out	SCSI bus termination power option

* E and F jumpers are not on the Emulex Rev MD2110103 board.

Note: Install termination resistor packs on the last Tape/Disk Controller on the SCSI bus.

Reference: *ESDI Disk Controller Configuration Procedures*, 813-2022.

Xylogics 450

Sun-2/100U/120/130/150U/160/170
Sun-3/160/180/260/280/460/470/480
Sun-4/260/280

370-1012 (Fab C, Revs C thru K)

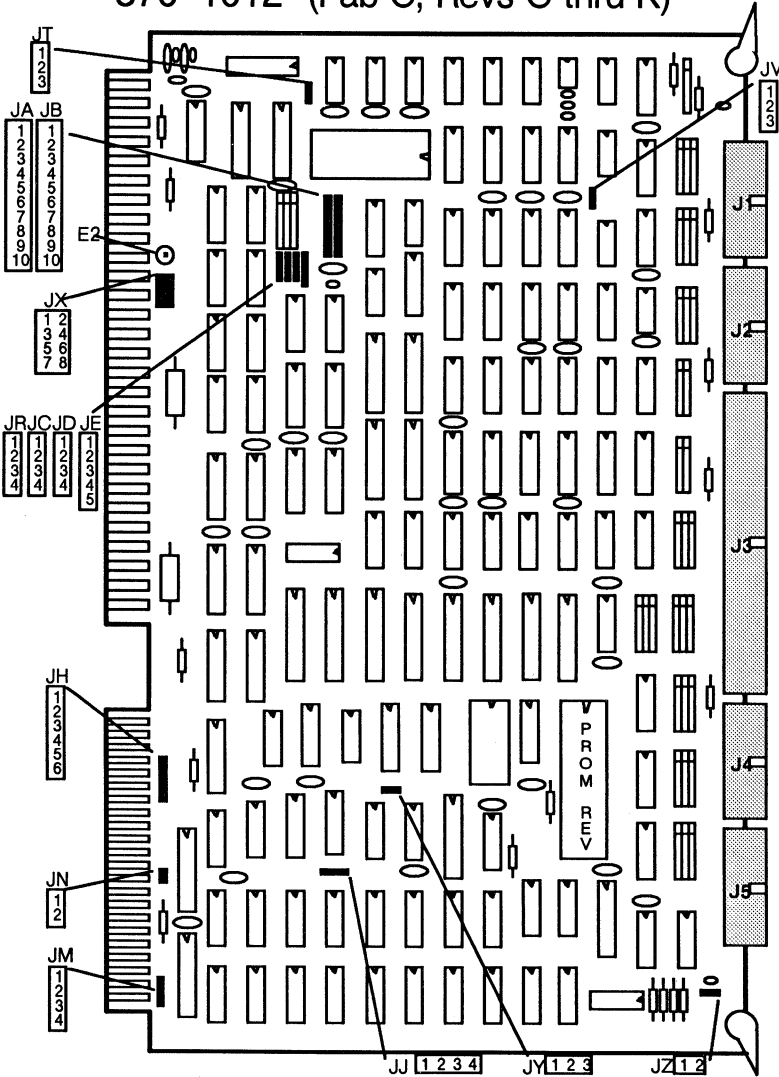

Xylogics 450

370-1012 (Fab D, Revs K, L & M)

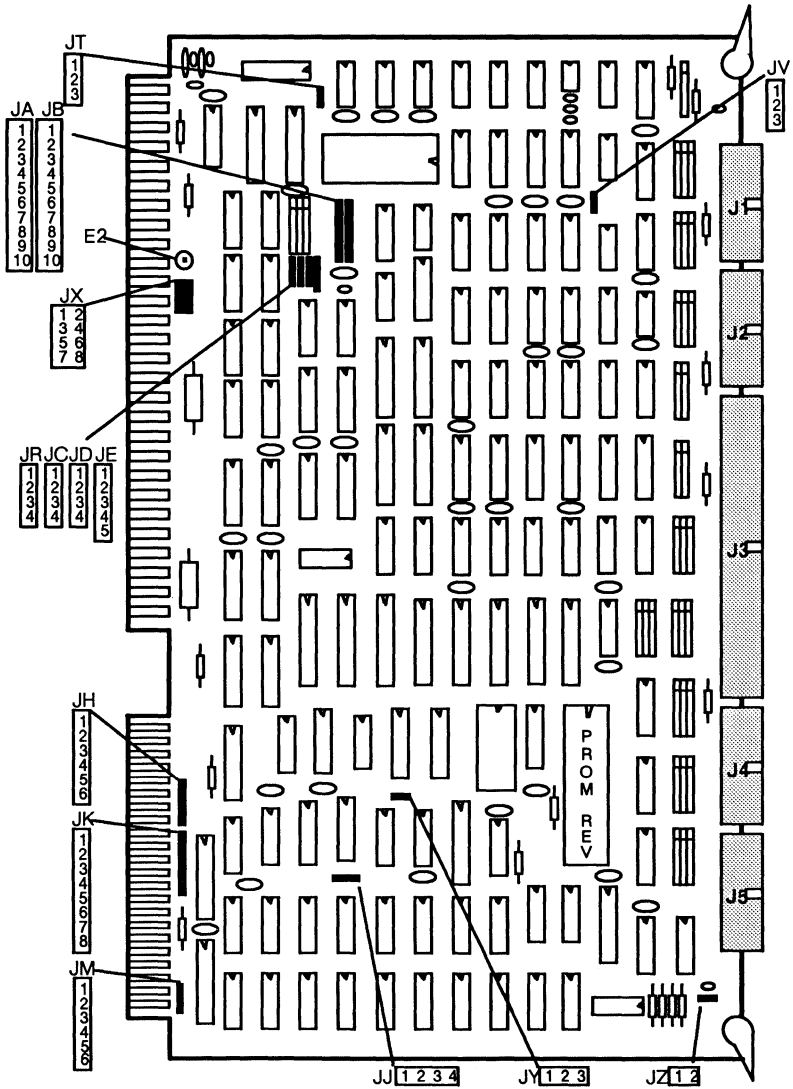

Xylogics 450

370-1012 (Fab E, Rev N)

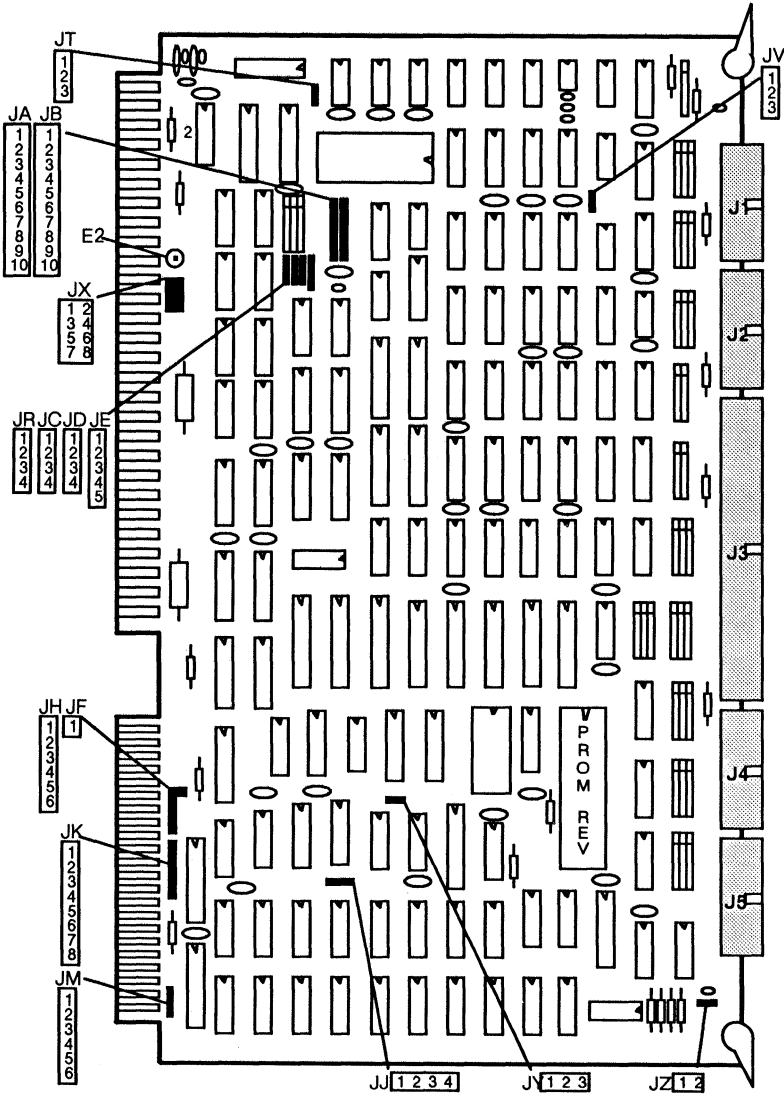

370-1012 (Fab C, Revs C thru K)
 370-1012 (Fab D, Revs K, L & M)
 370-1012 (Fab E, Rev N)
 Common Jumper Settings

JUMPER	PINS	SETTING	DESCRIPTION
JV	1-2 3	In N/A	Optional 8KB
JT	1-2 3	In N/A	Optional 8KB
JJ	1-2 3-4	Out In	Disk Sequencer Clock
JY	1 2-3	N/A In	Close ECC Feedback
E2 & JX	E2 JX E2 to 2 E2 to 7 E2 to 4 E2 to 5 E2 to 8 E2 to 3 E2 to 6 E2 to 1	N/A N/A In N/A N/A N/A N/A N/A	Interrupt Request Level Selections: Level - 0 Level - 1 Level - 2 Level - 3 Level - 4 Level - 5 Level - 6 Level - 7
JA & JB	JA JB 1 to 1 2 to 2 3 to 3 4 to 4 5 to 5 6 to 6 7 to 7 8 to 8 9 to 9 10 to 10	Out Out In Out Out Out Out In Out Out	16 or 8 Bit Address Control Address Bit F Address Bit 8 Address Bit E Address Bit 9 Address Bit D Address Bit A Address Bit C Address Bit B Ground
JE	1 to 2 1 to 2 3 4 to 5	In Out N/A In	Selects Serial Arbitration (Sun-100's Only) Selects Parallel Arbitration (All other products) Address Bit 7 (Hex)

370-1012 (Fab C, Revs C thru K)
 370-1012 (Fab D, Revs K, L & M)
 370-1012 (Fab E, Rev N)
Common Jumper Settings – Continued

JUMPER	PINS	SETTING	DESCRIPTION
JR, JC & JD	JR JC 1 to 1	In	Address Bit 6 (Hex) } Address Bit 5 (Hex) } Address Bit 4 (Hex) } Address Bit 3 (Hex) } Sets Address of device for xy0, EE40
	JD JC 2 to 2	In	
	3 to 3	In	
	4 to 4	In	
	JR JC 1 to 1	In	Address Bit 6 (Hex) } Address Bit 3 (Hex) } Address Bit 5 (Hex) } Address Bit 4 (Hex) } Sets Address of device for xy1, EE48
	4 to 4	In	
	JD JC 2 to 2	In	
	3 to 3	In	
JZ	1 to 2	In	Crystal Shunt

Notes

1. Firmware revisions greater than 952C do not work with the Fujitsu M2284 disk drive.
2. Firmware revisions lower than 952C do not work with the Fujitsu M2284 disk drive and SunOS 3.2 or greater.

Reference

Xylogics 450/451 SMD Controller Board Configuration Procedures, 813-2002.

Jumper Settings

370-1012 (Fab C, Revs C thru K)

JUMPER	PINS	SETTING	DESCRIPTION
JH	1-2	Out In=N/A	Automatically Selects DC Power Fail Detection AC Power Fail Detection (Not for Sun systems)
	3-4	Out	Inhibit DMA Sequencer Clock
	5-6	In	Select DMA Sequencer Clock
JM	1-2	Out	20-Bit Address Selected
	3-4	In	20-Bit Address Selected
	1-2	In	24-Bit Address Selected
	3-4	Out	24-Bit Address Selected
JN	1 to 2	Out	Disable Remote Act Indicator

370-1012 (Fab D, Revs K, L & M)

JUMPER	PINS	SETTING	DESCRIPTION
JH	1 to 2	Out In =N/A	Automatically selects DC power fail detection AC Power Fail Detection-not in Sun systems
	3 to 4	Out	Inhibit DMA Sequencer Clock
	5 to 6	In	Select DMA Sequencer Clock
20-Bit Addressing - For Multibus			
JM	1 to 2	Out	24-Bit Address Selected
	3 to 4	In	20-Bit Address Selected
	5 to 6	Out	Connect ADR0x14
JK	1 to 2	Out	Connect ADR0x16
	3 to 4	Out	Connect ADR0x17
	5 to 6	Out	Connect ADR0x15
	7 to 8	Out	Disable ACT Indicator
24-Bit Addressing - For VMEbus			
JM	1 to 2	In	24-Bit Address Selected
	3 to 4	Out	20-Bit Address Selected
	5 to 6	In	Connect ADR0x14
JK	1 to 2	In	Connect ADR0x16
	3 to 4	In	Connect ADR0x17
	5 to 6	In	Connect ADR0x15
	7 to 8	Out	Disable ACT Indicator

370-1012 (Fab E, Rev N) Jumper Settings

JUMPER	PINS	SETTING	DESCRIPTION
JF & JH	JF JH 1 to 1	In	DC Power Fail Detection Selected
JH ONLY	1 to 2	Out	AC Power Fail Detection-not in Sun systems
	3 to 4	Out	Inhibit DMA Sequencer Clock
	5 to 6	In	Select DMA Sequencer Clock
20-Bit Addressing - For Multibus			
JM	1 to 2	Out	24-Bit Address Selected
	3 to 4	In	20-Bit Address Selected
	5 to 6	Out	Connect ADR0x14
JK	1 to 2	Out	Connect ADR0x16
	3 to 4	Out	Connect ADR0x17
	5 to 6	Out	Connect ADR0x15
	7 to 8	Out	Disable ACT Indicator
24-Bit Addressing - For VMEbus			
JM	1 to 2	In	24-Bit Address Selected
	3 to 4	Out	20-Bit Address Selected
	5 to 6	In	Connect ADR0x14
JK	1 to 2	In	Connect ADR0x16
	3 to 4	In	Connect ADR0x17
	5 to 6	In	Connect ADR0x15
	7 to 8	Out	Disable ACT Indicator

VMEbus to Multibus Adapter with Xylogics 450

Sun-2/130/160
Sun-3/160/180/260/280/460/470/480
Sun-4/260/280
501-1154

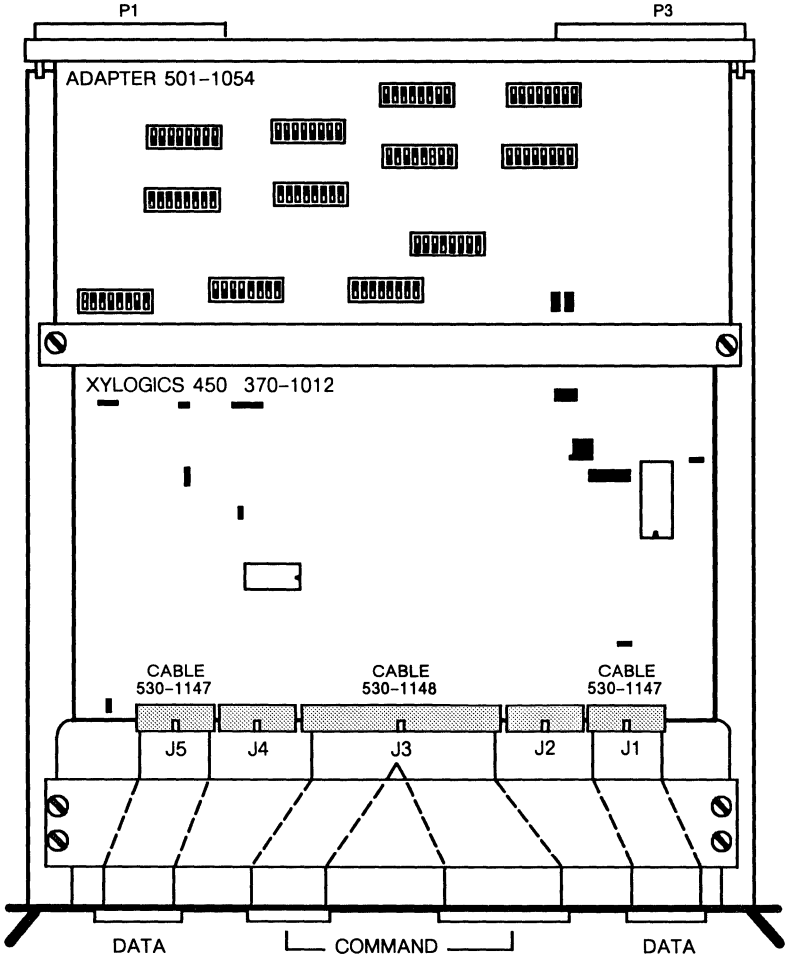

VMEbus to Multibus Adapter with Xylogics 450 501-1154

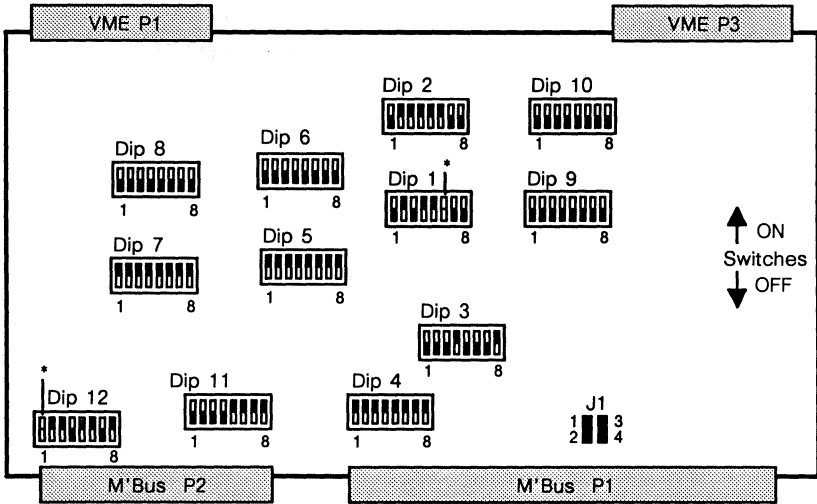

VME TO MULTIBUS ADAPTER BOARD SWITCH SETTINGS									
Switch	1	2	3	4	5	6	7	8	Description
U1	N/C	ON	OFF	ON	ON	*	OFF	OFF	I-O Address
U2	N/C	ON	ON	ON	ON	ON	OFF	OFF	I-O Space = 8
U3	OFF	OFF	OFF	ON	OFF	OFF	OFF	ON	I-O Address = 0xEE
U4	ON	ON	ON	ON	ON	ON	ON	ON	VME I-O Space
U5	ON	ON	ON	ON	ON	ON	ON	ON	24-Bit Memory Address Space
U6	OFF	OFF	OFF	OFF	OFF	OFF	OFF	OFF	24-Bit Memory Block Size
U7	ON	ON	ON	ON	ON	ON	ON	ON	24-Bit Memory Address Space
U8	OFF	OFF	OFF	OFF	OFF	OFF	OFF	OFF	24-Bit Memory Block Size
U9	OFF	OFF	OFF	OFF	OFF	OFF	OFF	OFF	No connection
U10	OFF	OFF	OFF	OFF	OFF	OFF	OFF	OFF	No connection
U11	OFF	OFF	OFF	OFF	ON	ON	ON	ON	Sets Address Bits A23 Thru A20
U12	*	ON	ON	OFF	ON	ON	OFF	ON	Interrupt Vector
J1	PINS 1-2	IN	If BCLK is desired						
	PINS 3-4	IN	If CCLK is desired						

* xyc0= ON (I-O Address = 0xee40, Interrupt Vector = 0x48)
 xyc1= OFF (I-O Address = 0xee48, Interrupt Vector = 0x49)

Power: 8.0 Amps @ +5Vdc
 0.6 Amps @ -5Vdc
 43.1 Watts

Xylogics 451

Sun-3/160/180/260/280/460/470/480

Sun-4/260/280/360/370/380

370-1082

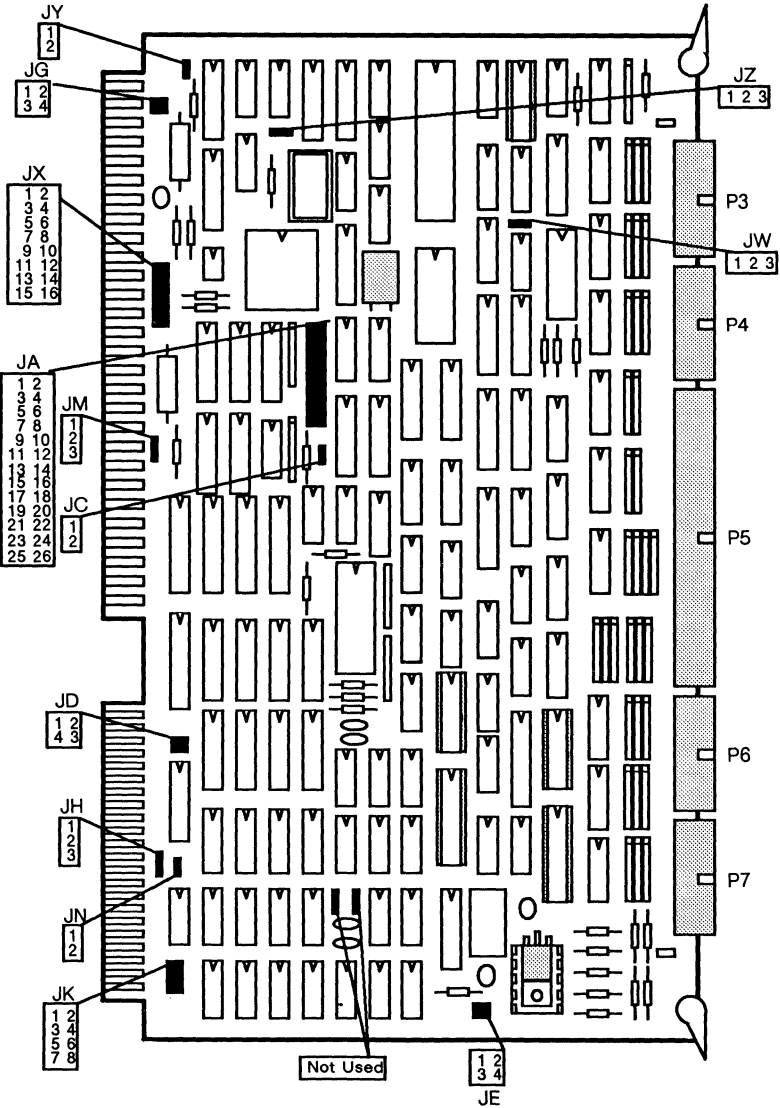

370-1082

Jumper Settings

JUMPER	PINS	SETTING	DESCRIPTION
JC	1 to 2	Out	Enables 16-bit addressing mode
JA	1-2	In	Base address setting (ee40)
	3-4	In	Address Bit F
	5-6	In	Address Bit E
	7-8	In	Address Bit D
	9-10	Out	Address Bit C
	11-12	In	Address Bit B
	13-14	In	Address Bit A
	15-16	In	Address Bit 9
	17-18	Out	Address Bit 8
	19-20	Out	Address Bit 7
	21-22	In	Address Bit 6
	23-24	Out	Address Bit 5
	25-26	Out	Address Bit 4
			Address Bit 3*
JM	1-2	In	16-24 Mode for VME-bus
JK	1-8	In for VMEbus	24-bit address jumpers ADROx17-ADROx14
JX	1-2	Out	INT0 Interrupt Request level
	3-4	Out	INT1
	5-6	In	INT2
	7-8	Out	INT3
	9-10	Out	INT4
	11-12	Out	INT5
	13-14	Out	INT6
	15-16	Out	INT7
JY	1-2	Out	Bus arbitration (BPRO)
JH	1-2	In	AC Power-down protection
JZ	2-3	In	Common bus request disabled
JN	1-2	Out	Activity indicator
JD	1-2-3-4	Out	-5 VDC from backplane
JE	1-2-3-4	Out	-5 VDC from backplane
JG	1-2-3-4	In	-5 VDC from backplane
JW	1-2	In	Busy not synchronized to bus clock

*In for address ee48(xy1), Out for address ee40(xy0)

370-1082

Xylogics 451

Notes

1. The Xylogics 451 SMD Controller may exhibit random "no return status seek errors" due to intermittent contact between the gate array and its socket. Replace with 370-1082-05 or 501-1166-05 or higher.
2. 370-1082-05 or lower may exhibit "cylinder head header" or "seek error header 1" when used with the Fujitsu M2351. Replace with 370-1082-06 or greater.
3. The Xylogics 450 cannot be mixed with the Xylogics 451 for any 892MB disk drive configuration.
4. Systems using Sun-2 SCSI, 501-1138, or Sun-3 SCSI, 501-1217, may mix a maximum of one Xylogics 451 and two Xylogics 7053 disk controllers.
5. Systems using Sun-2 SCSI, 501-1167, may mix a maximum of one Xylogics 451 and two Xylogics 7053 disk controllers.
6. Systems using Sun-2 SCSI, 501-1149, or Sun-3 SCSI, 501-1170, may mix a maximum of one Xylogics 451 and one Xylogics 7053.

Reference

Xylogics 450/451 SMD Controller Board Configuration Procedures, 813-2002.

VMEbus to Multibus Adapter with Xylogics 451

Sun-3/160/180/260/280/460/470/480

Sun-4/260/280/360/370/380

501-1166

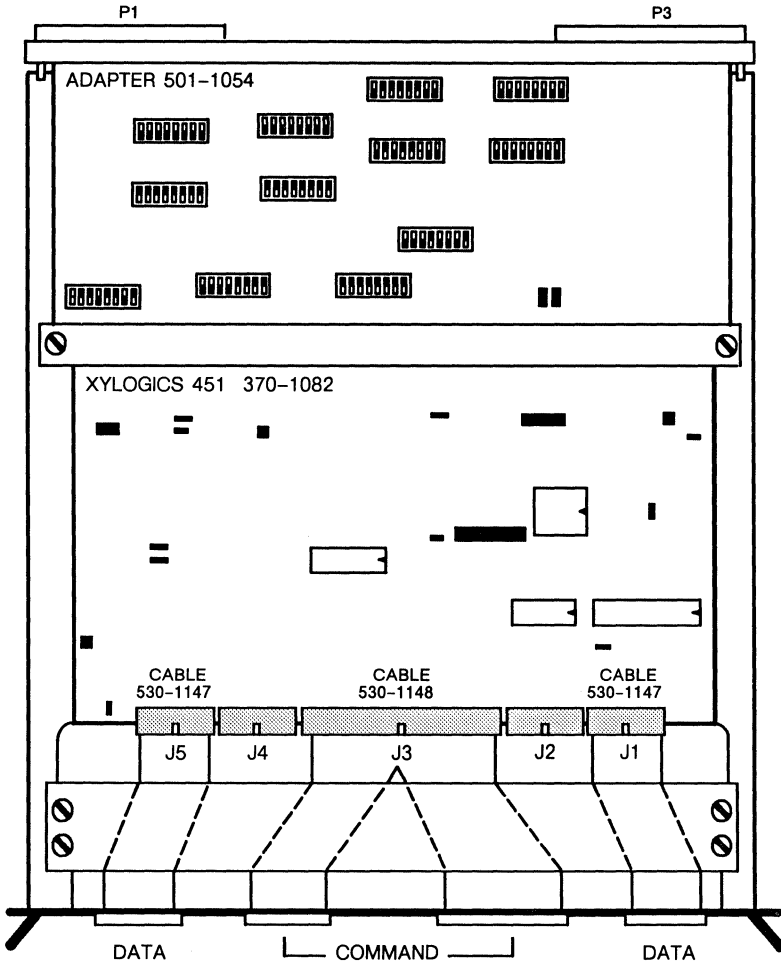

VMEbus to Multibus Adapter with Xylogics 451

501-1166

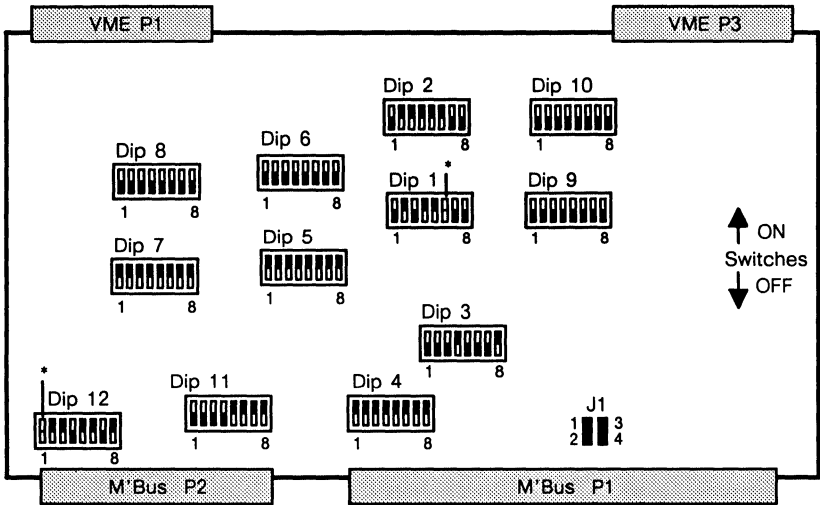

VME TO MULTIBUS ADAPTER BOARD SWITCH SETTINGS									
Switch	1	2	3	4	5	6	7	8	Description
U1	N/C	ON	OFF	ON	ON	*	OFF	OFF	I-O Address
U2	N/C	ON	ON	ON	ON	ON	OFF	OFF	I-O Space = 8
U3	OFF	OFF	OFF	ON	OFF	OFF	OFF	ON	I-O Address = 0xEE
U4	ON	ON	ON	ON	ON	ON	ON	ON	VME I-O Space
U5	ON	ON	ON	ON	ON	ON	ON	ON	24-Bit Memory Address Space
U6	OFF	OFF	OFF	OFF	OFF	OFF	OFF	OFF	24-Bit Memory Block Size
U7	ON	ON	ON	ON	ON	ON	ON	ON	24-Bit Memory Address Space
U8	OFF	OFF	OFF	OFF	OFF	OFF	OFF	OFF	24-Bit Memory Block Size
U9	OFF	OFF	OFF	OFF	OFF	OFF	OFF	OFF	No connection
U10	OFF	OFF	OFF	OFF	OFF	OFF	OFF	OFF	No connection
U11	OFF	OFF	OFF	OFF	ON	ON	ON	ON	Sets Address Bits A23 Thru A20
U12	*	ON	ON	OFF	ON	ON	OFF	ON	Interrupt Vector
J1	PINS 1-2		IN		If BCLK is desired				
	PINS 3-4		IN		If CCLK is desired				

* xyc0= ON (I-O Address = 0xEE40, Interrupt Vector = 0x48)
 xyc1= OFF (I-O Address = 0xEE48, Interrupt Vector = 0x49)

Power: 6.3 Amps @ +5Vdc
 0.6 Amps @ -5Vdc
 34.6 Watts

Xylogics 7053

Sun-3/160/180/260/280/460/470/480
 Sun-4/260/280/370/390/470/490
 501-1249

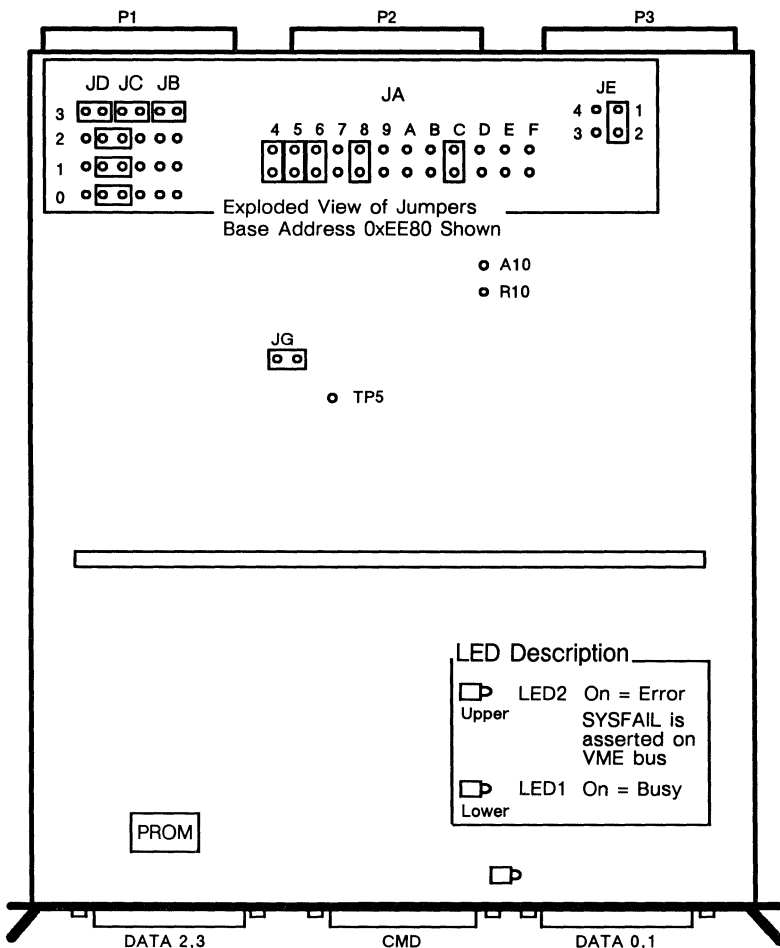

Power: 4.8 Amps @ +5Vdc
 0.6 Amps @ -12Vdc
 31.2 Watts

501-1249 Jumper Settings

Jumper Block JA – Controller Address

4	5	6	7	8	9	A	B	C	D	E	F	BOARD BASE ADDRESS
<input type="checkbox"/>	<input type="checkbox"/>	<input type="checkbox"/>	<input type="checkbox"/>	<input type="checkbox"/>	<input type="checkbox"/>	<input type="checkbox"/>	<input type="checkbox"/>	<input type="checkbox"/>	<input type="checkbox"/>	<input type="checkbox"/>	<input type="checkbox"/>	ee80 = xdc0
<input type="checkbox"/>	<input type="checkbox"/>	<input type="checkbox"/>	<input type="checkbox"/>	<input type="checkbox"/>	<input type="checkbox"/>	<input type="checkbox"/>	<input type="checkbox"/>	<input type="checkbox"/>	<input type="checkbox"/>	<input type="checkbox"/>	<input type="checkbox"/>	ee90 = xdc1
<input type="checkbox"/>	<input type="checkbox"/>	<input type="checkbox"/>	<input type="checkbox"/>	<input type="checkbox"/>	<input type="checkbox"/>	<input type="checkbox"/>	<input type="checkbox"/>	<input type="checkbox"/>	<input type="checkbox"/>	<input type="checkbox"/>	<input type="checkbox"/>	eea0 = xdc2
<input type="checkbox"/>	<input type="checkbox"/>	<input type="checkbox"/>	<input type="checkbox"/>	<input type="checkbox"/>	<input type="checkbox"/>	<input type="checkbox"/>	<input type="checkbox"/>	<input type="checkbox"/>	<input type="checkbox"/>	<input type="checkbox"/>	<input type="checkbox"/>	eeb0 = xdc3

Jumper Block JB, JC, JD

PINS	SETTING	DESCRIPTION
JB3	In	Bus request level 3
JC3	In	Bus request level 3
JD3	In	Bus request level 3
JD2-JC2	In	BG2In -BG2Out
JD1-JC1	In	BG1In -BG1Out
JD0-JC0	In	BG0In -BG0Out

Jumper Block JE

PINS	SETTING	DESCRIPTION
1-2	In*	Unrestricted maintenance mode (In=disables self test mode)
3-4	Out†	

* JE, 1-2, Out, enables only diagnostic maintenance mode.

† JE, 3-4, In, disables diagnostic maintenance mode testing.

Jumper Block JG

PINS	SETTING	DESCRIPTION
1-2	In	Enables bus release if data is not available

501-1249

Xylogics 7053

Notes

1. Do not install a shunt at locations R10 and A10 (test points).
2. When the Xylogics 7053 is installed in a Sun-4/2xx, the CPU be revision 501-1274-13, 501-1491-01, 501-1522-01, or greater.
3. When the Xylogics 7053 is installed in a Sun-3/160/180, use only the 501-1208 CPU board.
4. When the Xylogics 7053 is installed in a Sun-3/1xx or Sun-3/2xx, the CPU requires EPROM 2.6 or greater.
5. Systems using Sun-2 SCSI, 501-1138, or Sun-3 SCSI, 501-1217, may mix a maximum of one Xylogics 451 and two Xylogics 7053 disk controllers.
6. Systems using Sun-2 SCSI, 501-1167, may mix a maximum of one Xylogics 451 and two Xylogics 7053 disk controllers.
7. Systems using Sun-2 SCSI, 501-1149, or Sun-3 SCSI, 501-1170, may mix a maximum of one 451 and one 7053.
8. Requires SunOS 4.0.1 or greater. Minimum 4.0.1 requirements are the MB and SCSI fixes.
9. Requires 1.0 SunFeatures tape for SunOS 4.0.1.
10. Systems using more than two Fujitsu M2372 disk drives on a single controller require 501-1249-05 or greater.
11. CG9 must be \geq 501-1434-04 for use with the Xylogics 7053 Disk Controller.
12. The Sun 4400 CPU must be \geq 501-1381-12 when used with the Xylogics 7053.
13. The Xylogics 7053 must be \geq 501-1249-04 when used with the Sun 4400 CPU.
14. SunOS 4.1.1 is required when the Xylogics 7053 is used with the Sun 4400 CPU.

Reference

VME/SMD Disk Controller Configuration Procedures, 813-2033.

This page intentionally left blank.

ISP-80 IPI-2 Sun-4/370/390/470/490 501-1539 501-1855

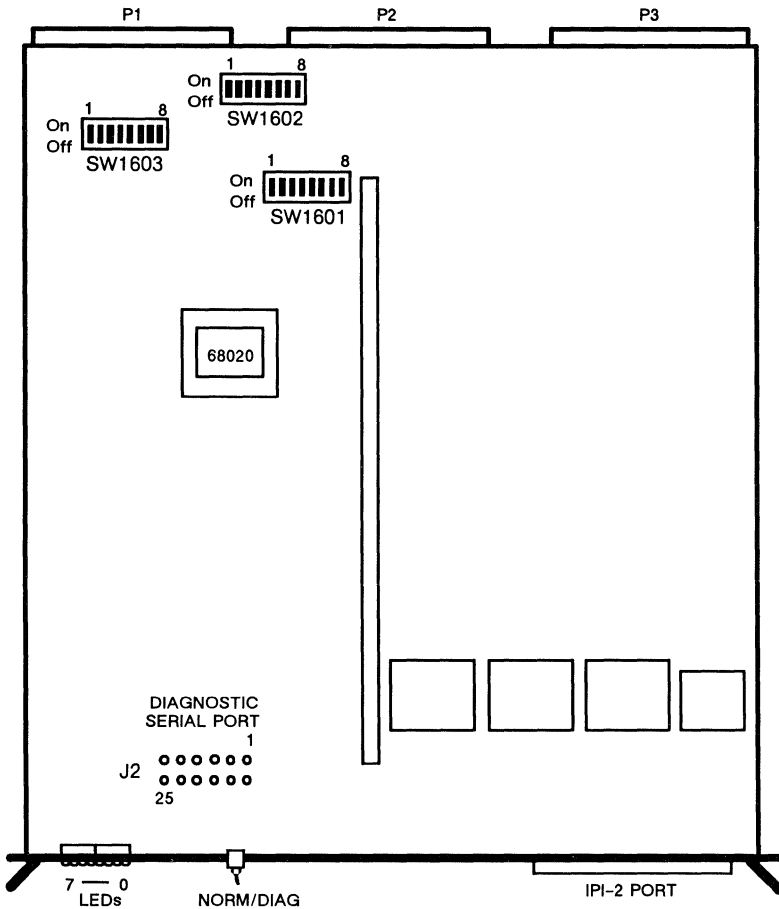

Power: 11.8 Amps @ +5Vdc
59.0 Watts

Notes

1. This board must be \geq 501-1539-04 for use with the Sun-4400 CPU.
2. This board must be \geq 501-1539-05 for use with 6MB/sec disk drives.
3. Board revisions lower than 501-1539-08 or 501-1855-02 may hang under SunDiag when the ISP-80 is used with the Prestoserve and 32MB of system memory.

Reference

ISP-80 Disk Controller Configuration Procedures, 813-2065.

501-1539 501-1855 Switch & Jumper Settings

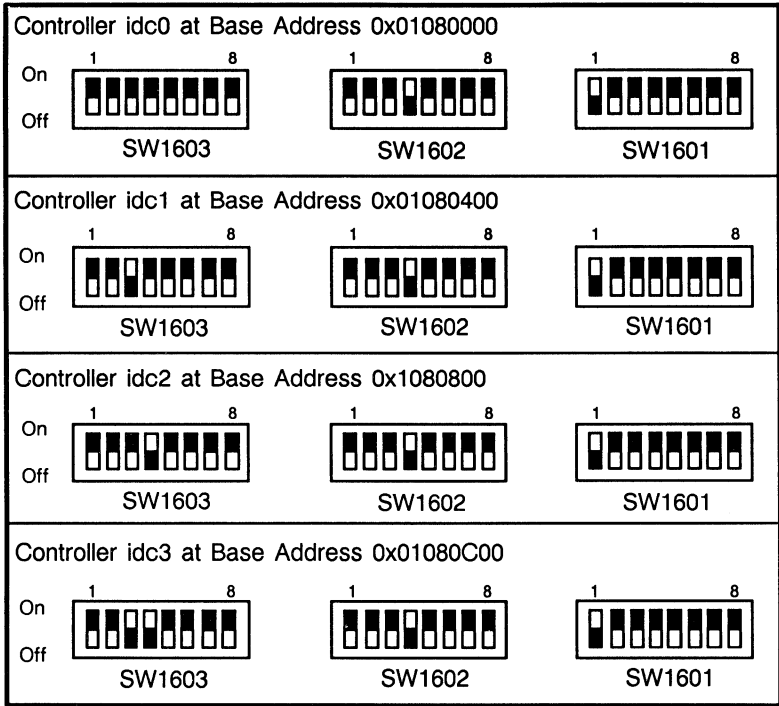

Note: Dip Switches 3 and 4, SW1603, select bits A10 and A11 of the controller base address. These are the only switches changed when setting up a system with multiple controllers.

Jumper JM2

PINS	SETTING	DESCRIPTION
1-2	In	Enable UART clock

Base Address Select Switches

DIP SWITCH	1	2	3	4	5	6	7	8
SW1603	AM0	AM1	A10	A11	A12	A13	A14	A15
SW1602	A16	A17	A18	A19	A20	A21	A22	A23
SW1601	A24	A25	A26	A27	A28	A29	A30	A31

Prestoserve Sun-4/470/490 501-1847

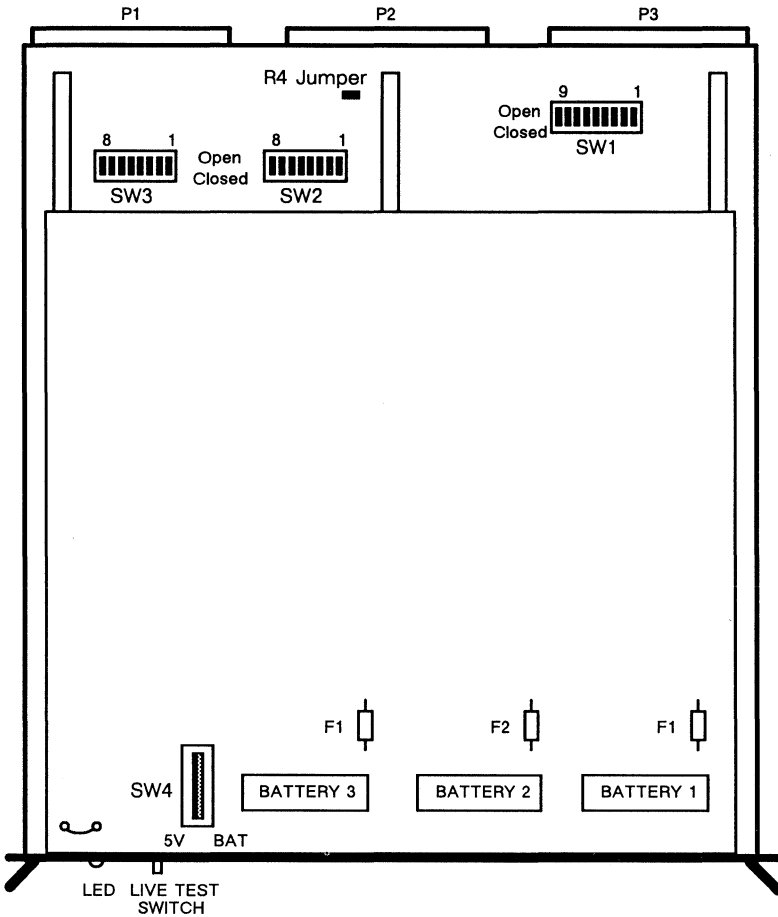

Switch SW1, SW2, and SW3

DIP	SWITCH	DESCRIPTION
SW1	1	Enable vme24d32 (closed)
SW1	1	Enable vme32d32 (open)
SW1	2-9	A24-A31
SW2	1-8	A16-A23 starting address
SW3	1-8	A16-A23 ending address

501-1847 Switch & Jumper Settings

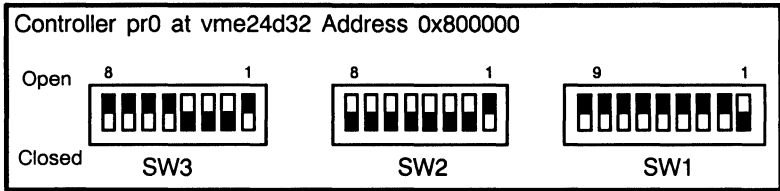

Switch SW4

SETTING	DESCRIPTION
BAT	Enables battery backup mode
5V	Disables battery backup mode

Jumper at Resistor R4

PINS	SETTING	DESCRIPTION
1-2	Out	Not used

Live Test LED

Press the Live Test Switch to determine the cache data state.

LED On	Cached data in memory
LED Off	No cached data in memory

Notes

1. Set SW4 to BAT when the board is installed. Software will not initialize Prestoserve unless battery backup is enabled.
2. Set SW4 to 5V when the board is removed and cached data does not need to be preserved.
3. Cached data is cleared from memory when SW4 is set to 5V for more than five minutes.
4. IPI-2 Disk Controller board revisions lower than 501-1539-08 or 501-1855-02 may hang under SunDiag when used with the Prestoserve and 32MB of system memory.
5. The batteries are not field replaceable.
6. The minimum operating system is SunOS 4.1 PSR A.

Reference

Sun Prestoserve Installation Manual, 813-1112.

Sony CDU-8012

Sun-4/370/390/470/490

Option 558

370-1312 370-1347

White Bezel

Black Bezel

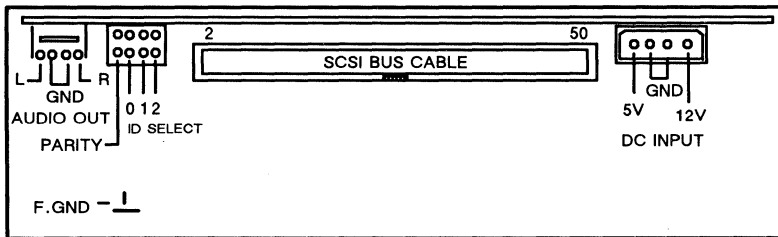
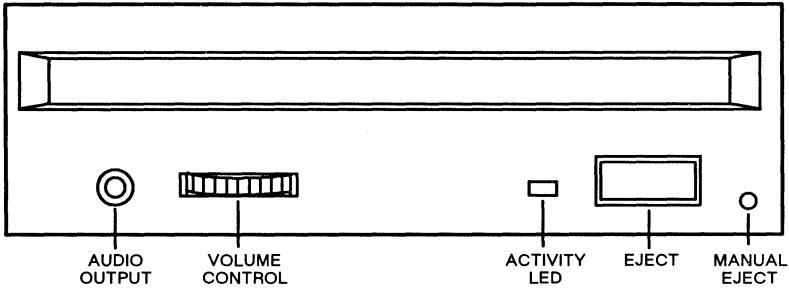

Flex Cable

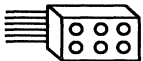

To install the 370-1312 CD-ROM drive in the Desktop SunCD Pack, orient the flex cable, 530-1454, as shown and plug it into the ID Select jumper block. Set the ID switch on the back of the SunCD Pack to 6.

JUMPER	SETTING	DESCRIPTION
1	In	ID6 (SR0)
2	In	Enable Parity
Parity	In	Enable Parity

Power: 0.5 Amps @ +5Vdc
 0.5 Amps @ +12Vdc.
 8.5 Watts

Note: The Sun CD-ROM requires 1.0 SunCD for SunOS 4.0.3c.

CONFIGURATIONS

TAPE

Tape

TAPE DRIVES

60MB 1/4" Tape	3
150MB 1/4" Tape	6
Fujitsu M244AC 1/2" Tape (6250 bpi)	8
EXABYTE EXB-8200 8mm Tape Drive	21
HP 88780 Front Load Tape Drive	22

CONTROLLERS

1/4" Tape

Sun 1/4" Tape	24
Sysgen SC4000	26
Archive Standalone Controller (SAC)	28
Emulex MT02	30

1/2" Tape

Ciprico Tapemaster (1600 bpi)	32
VMEbus to Multibus Adapter with Tapemaster .	35
Xylogics 472 (1600/6250 bpi)	37
VMEbus to Multibus Adapter with Xylogics 472 .	40

FLOPPY DRIVES

Sony 1.4MB Floppy Diskette (3 1/2")	42
---	----

This page intentionally left blank.

60MB 1/4" Tape Drive with Formatter

Sun-2/130/160 & Sun-3/160

Option 56

370-1037

Wangtech
5099EG11

370-1104

Wangtech
5099EG11

370-1112

Wangtech
5099EG11
Archive
5945L-2

End View

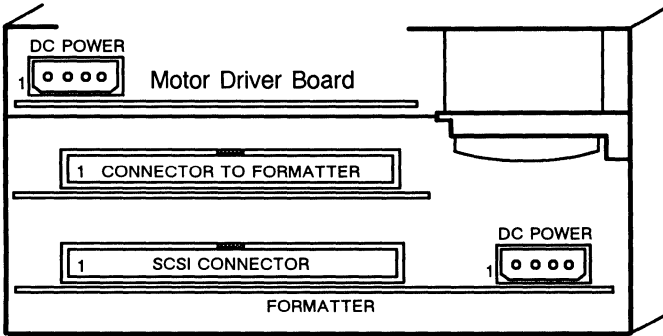

Wangtech Model 5099EG11

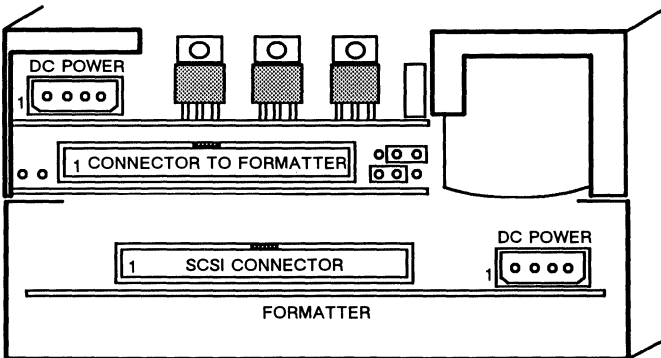

Archive Model 5945L-2

Note: This Tape Drive is used with the Sysgen SC4000 QIC-02
Tape Controller.

60MB 1/4" Tape Drive
 Sun-3/160/180/260/280/460/480
 Sun-4/260/280/360/380
 Options 511 514 516
 370-1076 370-1103

Wangtech
5099EN24

Wangtech
5099EN24

Archive
5945C

End View

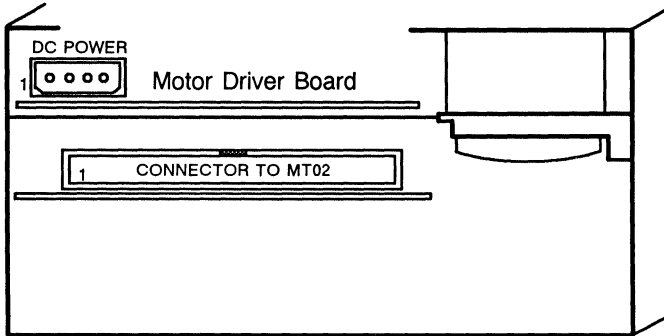

Wangtech Model 5099EN24

End View

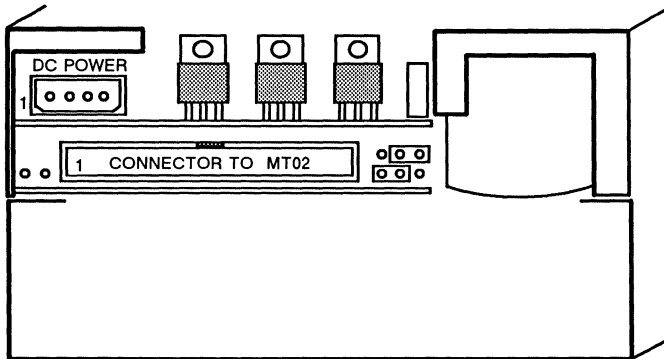

Archive Model 5945C

Note: This Tape Drive is used with the Emulex MT02 QIC-36 Tape Controller.

60MB 1/4" Tape Drive
with Emulex MT02 Tape Controller
 Sun-386i/150/250 Sun-3/470 Sun-4/370
 Option RR128 RR129 RREXP RREXP-P7
 370-1247 370-1179
 Archive 5945S Archive 5945S
 Full-Height Full-Height
 Black Bezel Lt. Grey Bezel

End View

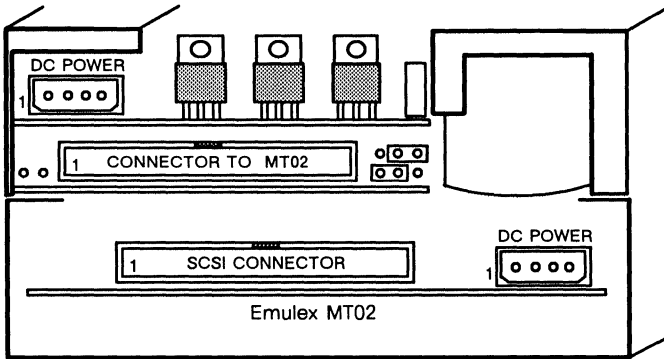

Emulex MT02 Tape Controller Switch Settings

DIP SWITCH	SWITCH	SETTING	DESCRIPTION
SW1	1 & 2	Off	SCSI Target 4
	3	On	SCSI Target 4
	1 & 3	On	SCSI Target 5
	2	Off	SCSI Target 5
	4	Off	Not used
	5	On	Archive Tape Drive
	6	Off	Archive Tape Drive
	7	Off	Drive type
	8	On	Parity Check On for 370-1179
	8	Off	Parity Check Off for 370-1247

Reference

60MB Streaming Tape Drive with SCSI Controller Configuration Procedures, 814-1019.

150MB 1/4" Tape Drive

Sun-3/470 & Sun-4/330/370/390/470/490

Options 539 565 660

370-1205	370-1206	370-1218	370-1246	370-1293
Archive 2150S Half-Height Black Bexel	Archive 2150S Full-Height Black Bexel	Archive 2150S Full-Height Custom Bexel	Archive 2150S Full-Height Lt. Grey Bexel	Archive 2150S Full-Height Lt. Grey Bexel

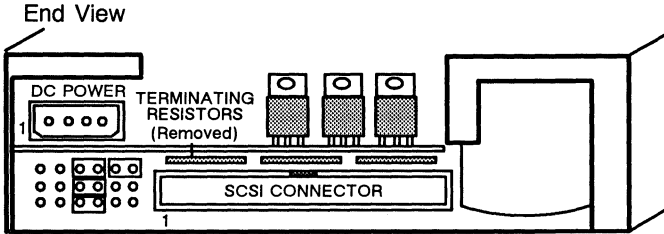

SERIAL PORT	DISCONNECT SIZE	SCSI ID
RXD TXD		
○ ○	○ CF2 ○	○ ID2 ○
○ DIAG ○	○ CF1 ○	○ ID1 ○
○ PARITY ○	○ CF0 ○	○ ID0 ○

Flex Cable

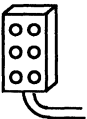

To install Tape Drive 370-1218 in the Desktop Tape Pack, remove the SCSI ID jumper. Orient Flex Cable, 530-1454, as shown and plug it into the SCSI ID jumper block on the Tape Drive.

Address Select Switch Cable

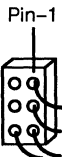

In the External Storage Module, orient Pin-1 of the Address Select Switch Cable, 530-1659, with ID2 of the SCSI ID jumper block.

Power: 0.7 Amps @ +5vdc
 1.5 Amps @ +12vdc
 21.5 Watts

370-1205 370-1206 370-1218 370-1246
370-1293

JUMPER	SETTING	DESCRIPTION	USAGE
RXD/TXD	Out	Serial Port	Not used
DIAG Parity	Out Out*	Normal/Diag Parity check	Not used Not used
CF2,CF1,CF0	In	Disconnect Transfer Size	Size = 32K

JUMPER	TARGET 2	TARGET 3	TARGET 4	TARGET 5
ID2	Out	Out	In	In
ID1	In	In	Out	Out
ID0	Out	In	Out	In
1st SCSI	st3	st2	st0	st1
2nd SCSI	st7	st6	st2, st4	st3, st5

*IN for 370-1246 and 370-1293 drives.

Reference

150MB 1/4-Inch Cartridge Tape Drive Configuration Manual for the 56-Inch Data Center Cabinet, 813-2076.

Fujitsu M2444AC 1/2" Tape Drive

Servo Amplifier (SVA)

811-1050

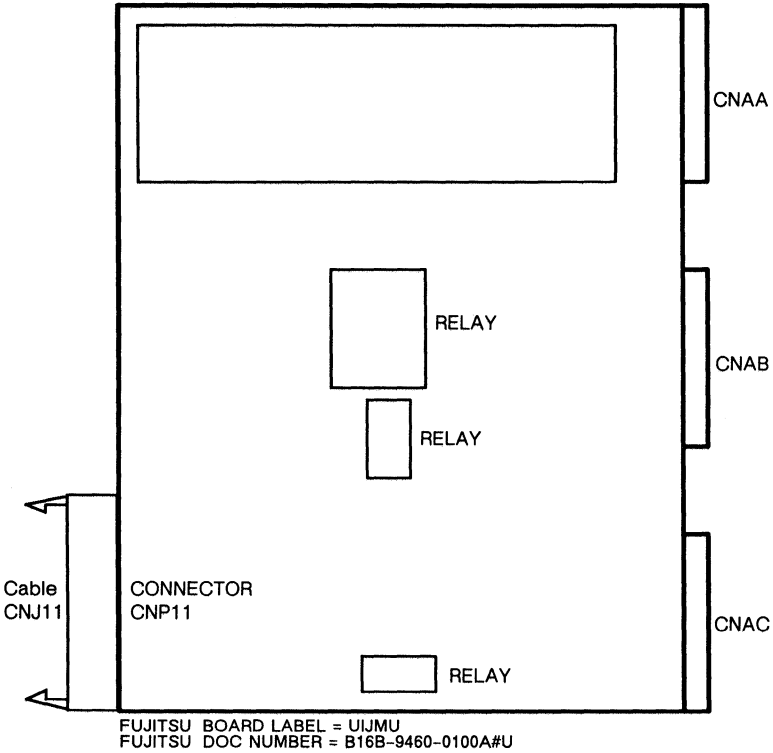

Slots 1 & 2

Note: The SVA requires adjustment upon replacement (Test 90). See REP 1150 and 2310 in the *Fujitsu M244X CE Manual*, 800-1409-01.

Fujitsu M2444AC 1/2" Tape Drive

Buffer Option (BUF)

811-1051

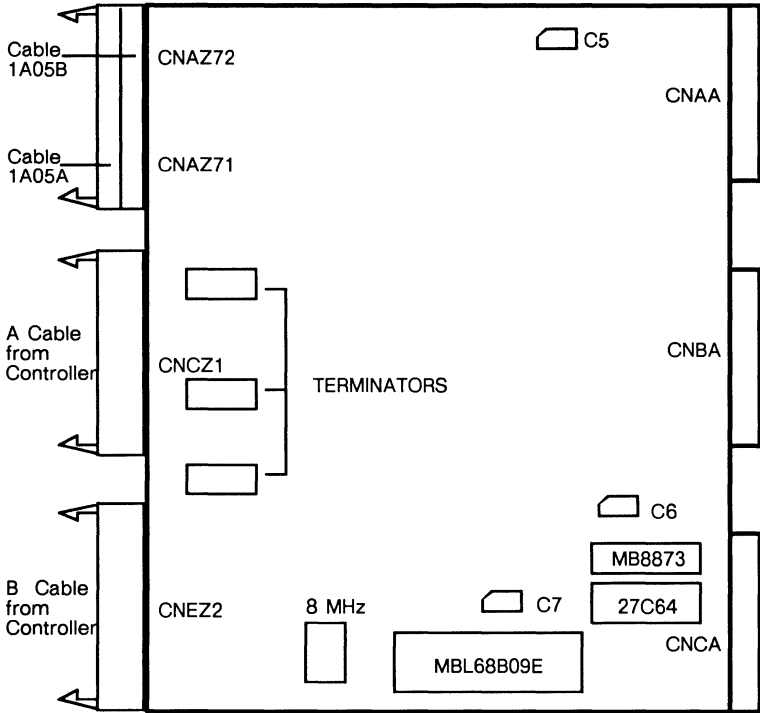

FUJITSU BOARD LABEL = B17B-0160-0010A 10F
 FUJITSU DOC NUMBER = B17B-0160-0010A#U

Slot 4 & 5

Notes

1. The BUF requires NO adjustment upon replacement.
2. Premature failure of the BUF may occur if capacitors C5, C6, and C7 are not installed correctly. This may occur on board revisions below Rev. L.

Fujitsu M2444AC 1/2" Tape Drive Microprocessor Unit (MPU) 811-1054

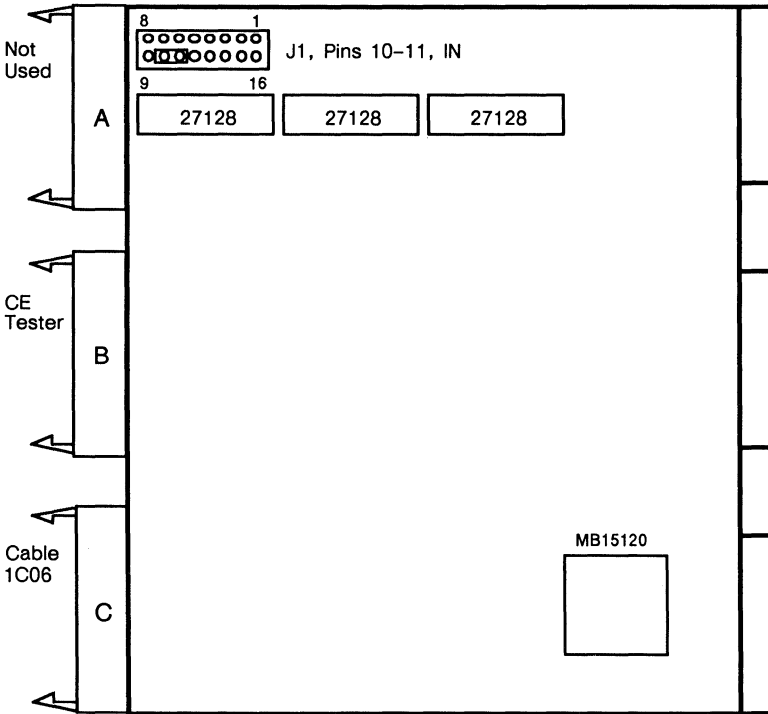

FUJITSU BOARD LABEL = 532705U
FUJITSU DOC NUMBER = C16B-5327-0050#U

Slot 6

Note: The MPU requires adjustment upon replacement (Test 92).
See REP 2330 in the *Fujitsu M244X CE Manual*, 800-1409-01.

Fujitsu M2444AC 1/2" Tape Drive Interface Controller (IFC) 811-1055

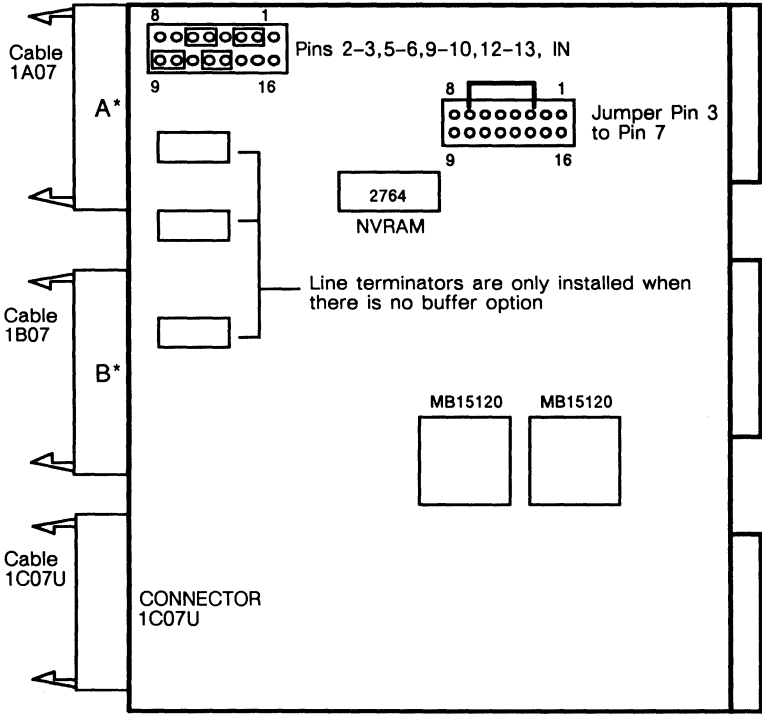

FUJITSU BOARD LABEL = 532706U
FUJITSU DOC NUMBER = C16B-5327-0060#U

Slot 7

Note: The IFC requires adjustment upon replacement (Tests 90, 92, 93, and 97). See REP 1130, 2310, 2320, and 2330 in the *Fujitsu M244X CE Manual*, 800-1409-01.

Fujitsu M2444AC 1/2" Tape Drive

IFC NVRAM Configuration Procedures

Test 93 – Drive Parameters

1. Press and hold TEST.
2. Press START.
3. Release TEST.
4. 00 is displayed.
5. Press START until 93 is displayed.
6. Press and hold TEST.
7. Press DENSITY SELECT.
8. Release TEST.
9. DT is displayed.
10. Press RESET to display parameter of Device Type.
11. Press START or UNLOAD to change the Device Type.
12. Press TEST.
13. EL is displayed.
14. Press RESET to display parameter of EC Level.
15. Press START or UNLOAD to change the EC Level.
16. Press TEST.
17. BG is displayed.
18. Press RESET to display parameter of BOT Gain.
19. Press START or UNLOAD to change the BOT Gain.
20. Press TEST.
21. EG is displayed.
22. Press TEST to display P5 in the LED.
23. Press RESET to display parameter of EOT Gain.
24. Press TEST.
25. Press RESET to exit the test mode.
26. Use test 94 to store the new value.

Drives Shipped Prior to September 1987

Device Type = 80

EC Level = 13

BOT Gain = Use test 90 to set value between 0xb0 and 0xcf

EOT Gain = Use test 90 to set value between 0xb0 and 0xcf

Drives Shipped After September 1987

Device Type = C0

EC Level = 13

BOT Gain = Use test 90 to set value between 0xb0 and 0xcf

EOT Gain = Use test 90 to set value between 0xb0 and 0xcf

Drives Shipped After September 1987

The High Speed Bit is set to ON. Refer to REP 2320-1 in the Fujitsu M244X CE Manual, 800-1409-01.

Fujitsu M244AC 1/2" Tape Drive

IFC NVRAM Configuration Procedures

Test 97 – Buffer Parameters

1. Press and hold TEST.
2. Press START.
3. Release TEST.
4. Press UNLOAD to decrement the LED display to 97.
5. Press and hold TEST.
6. Press DENSITY SELECT to display P0 in the LED.
7. Release TEST.
8. Press RESET button to display the contents of P0.
9. Press START or UNLOAD to change P0 to 04
10. Press TEST to display P1 in the LED.
11. Press RESET to display the contents of P1.
12. Press START or UNLOAD to change P1 to 00.
13. Press TEST to display P2 in the LED.
14. Press START or UNLOAD to change P2 to 02.
15. Press RESET to display the contents of P2.
16. Press TEST to display P3 in the LED.
17. Press RESET to display the contents of P3.
18. Press START or UNLOAD to change P3 to 02.
19. Press TEST to display P4 in the LED
20. Press RESET to display the contents of P4.
21. Press START or UNLOAD to change P4 to 00.
22. Press TEST to display P5 in the LED.
23. Press RESET to display the contents of P5
24. Press START or UNLOAD button to change P5 to 00.
25. Press TEST to display P6 in the LED.
26. Press RESET to display the contents of P6.
27. Press START or UNLOAD to change P6 to 00.
28. Press TEST to display P7 in the LED.
29. Press RESET to display the contents of P7.
30. Press START or UNLOAD to change P7 to 00.
31. Press TEST to exit test 97.
32. Press RESET to exit the test mode.

Test 94 – Set New Parameters into NVRAM

1. Press and hold TEST.
2. Press START.
3. Release TEST.
4. Press UNLOAD to decrement the LED display to 94.
5. Press and hold TEST.
6. Press DENSITY SELECT and release TEST.
7. Press RESET to exit the test mode.

Fujitsu M2444AC 1/2" Tape Drive Write Formatter (WFM) 811-1052

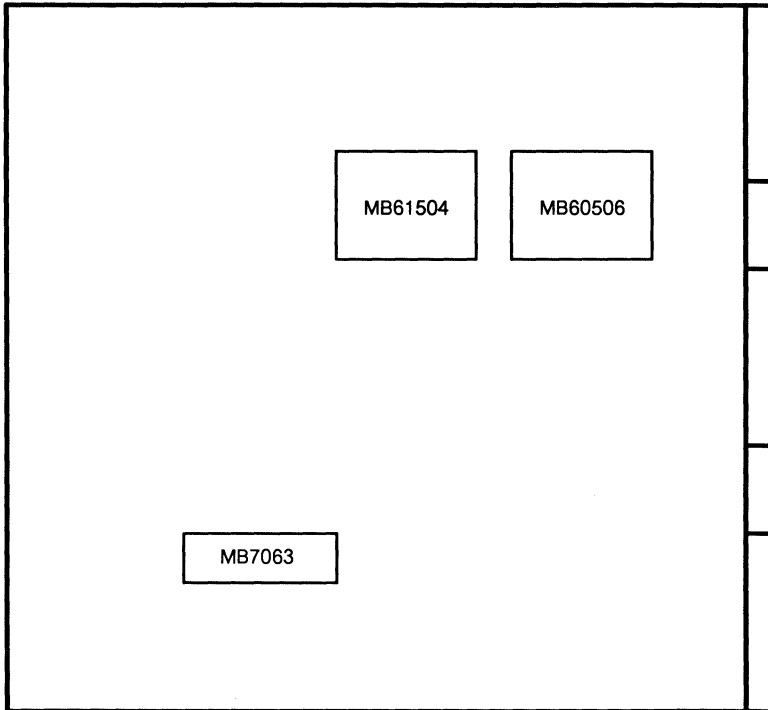

FUJITSU BOARD LABEL = 512186U
FUJITSU DOC NUMBER = C16B-5121-0860#U

Slot 8

Note: The WFM requires NO adjustment upon replacement.

Fujitsu M2444AC 1/2" Tape Drive Read Formatter (RFM) 811-1053

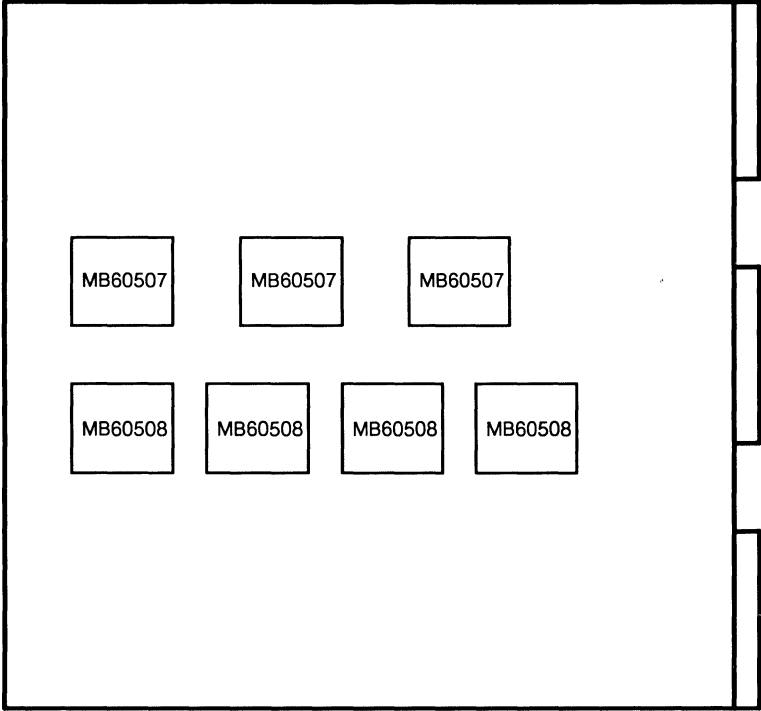

FUJITSU BOARD LABEL = 512188U
FUJITSU DOC NUMBER = C16B-5121-0880-#U

Slot 9

Note: The RFM requires NO adjustment upon replacement.

Fujitsu M2444AC 1/2" Tape Drive

Variable Frequency Oscillator (VFO)

811-1057

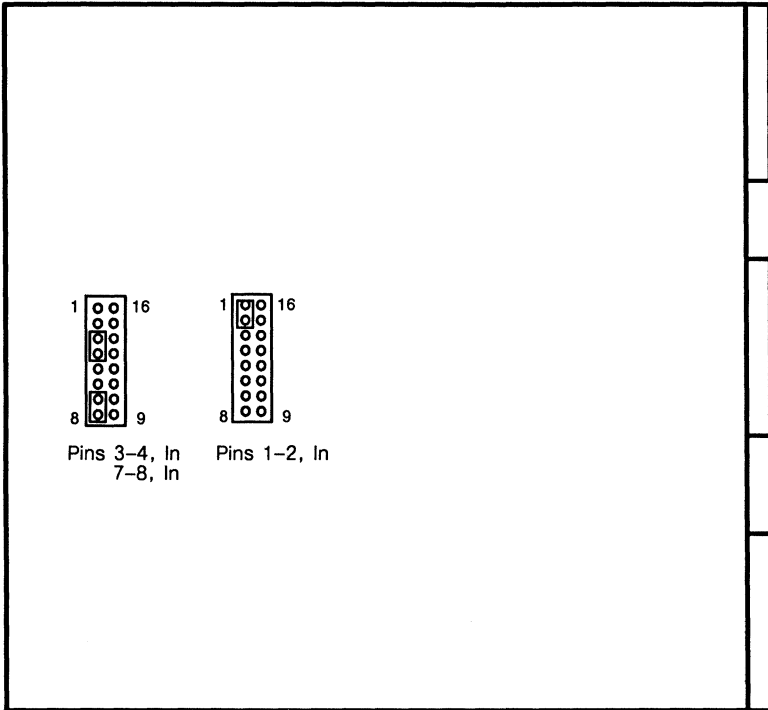

FUJITSU BOARD LABEL = 550194U C320-5501-T274/03 FJ-A
FUJITSU DOC NUMBER = C16B-54501-0940#U

Slot 10

Note: The VFO requires NO adjustment upon replacement.

Fujitsu M2444AC 1/2" Tape Drive Read Amplifier Card (RDA) 811-1056

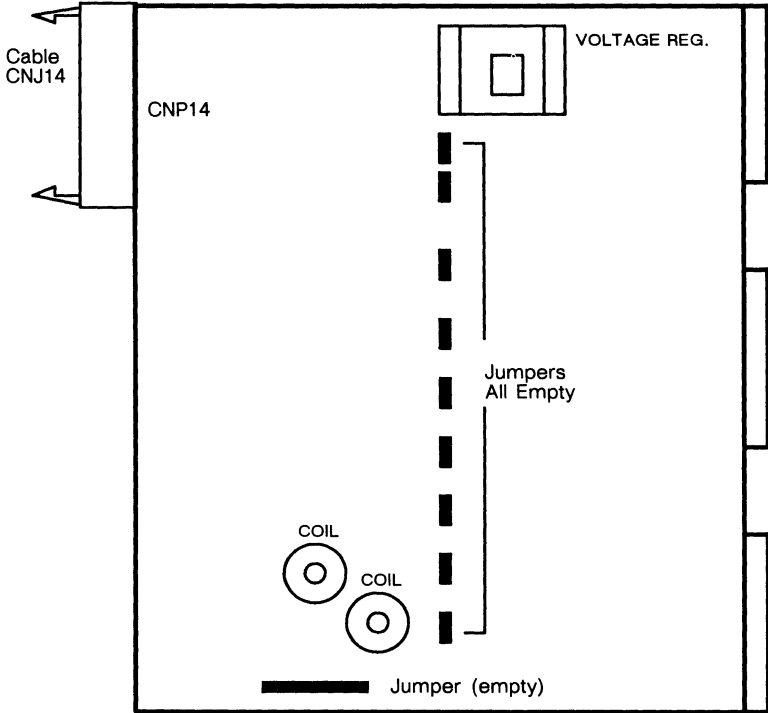

FUJITSU BOARD LABEL = RKEMU B350-8930-T016A02 FJ-A
FUJITSU DOC NUMBER = B16B-9920-0010A#U

Slots 11 & 12

Note: The RDA requires adjustment upon replacement (Test 92). See REP 1140 and 2330 in the *Fujitsu M244X CE Manual*, 800-1400-01.

Fujitsu 1/2" Tape Drive

Write Amplifier (WTA) 811-1049

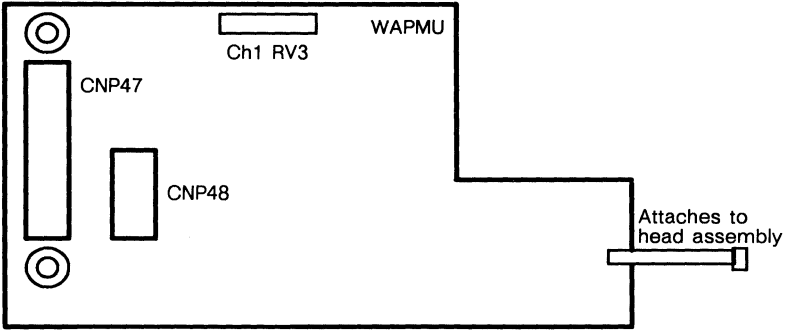

FUJITSU BOARD LABEL = WAPMU
 FUJITSU DOC NUMBER = B16B-9470-0100A#U(WAPMU)

Note: The WTA requires adjustment upon replacement (Tests 91, 92, and skew tape). See REP 1120, 2110, and 2330 in the Fujitsu M244X CE Manual, 800-1409-01.

Read/Write Head 811-1042

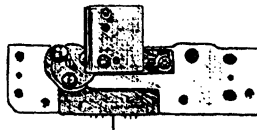

Note: The Read/Write Head requires adjustment upon replacement (skew tape). See REP 1240, 2110, and 2330 in the Fujitsu M244X CE Manual, 800-1409-01.

Fujitsu M244AC 1/2" Tape Drive

555-1055

The RPA, Tension Sensor, and Idler Tachometer are kitted as FRU 555-1055.

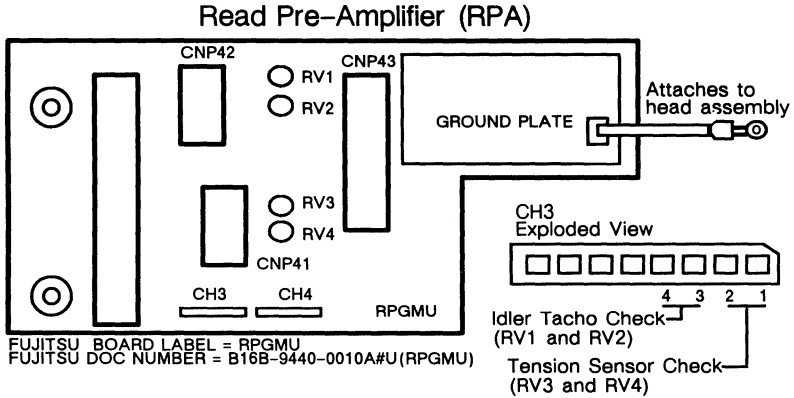

Tension Sensor

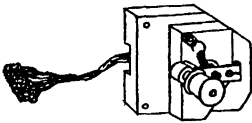

Idler Tachometer *

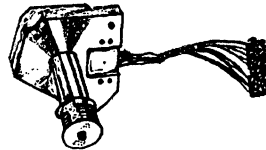

* Idler Tachometer, part number B90L-1650f-0001A, does NOT require adjustment. Variable Resistor RV1 and RV2 do not effect the signal output at CH3, pins 3 and 4.

Note: Assembly 555-1055 requires adjustment upon replacement (tests 91, 92, skew tape). See REP 1110, 1410, 1420, 2110, and 2330 in the *Fujitsu M244X CE Manual*, 800-1409-01. Adjustments under REP 2210 and 2220 have been performed at the repair depot to create the matched set.

Fujitsu M2444AC 1/2" Tape Drive Rear Door Harness and Assembly

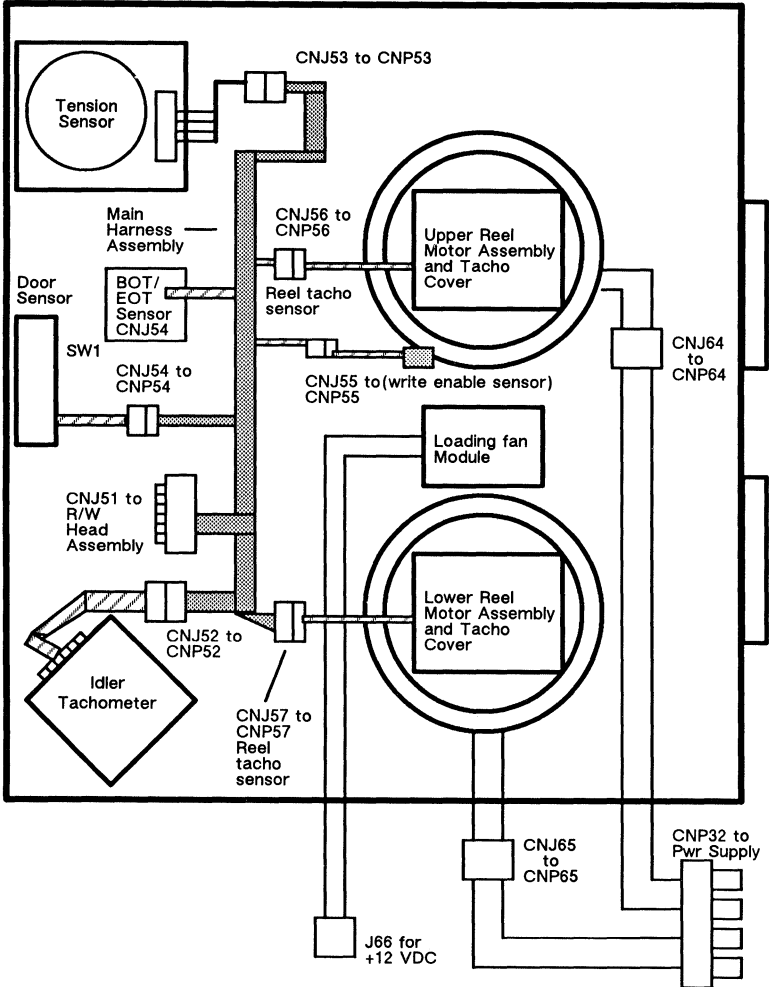

EXABYTE EXB-8200 8mm 2.3GB

Sun-4/370/390/470/490
Option 566
370-1297

End View

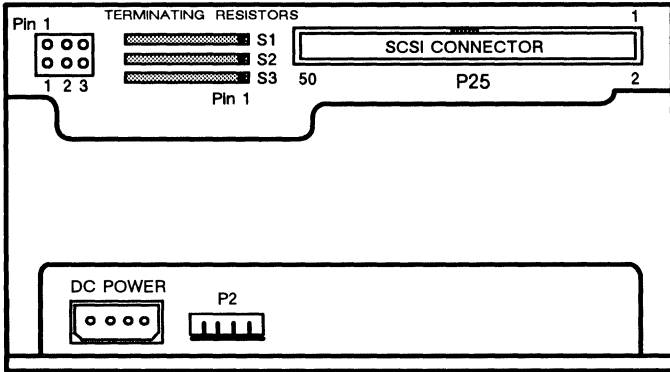

Address Select Switch Cable



In the External Storage Module, orient Pin-1 of the Address Select Switch Cable, 530-1659, with Pin 1 of jumper block U15.

Jumper U15

SCSI ID	UNIX ID	(MSB) 1	2	(LSB) 3
4	st0, st2, st4	In	Out	Out
5	st1, st3, st5	In	Out	In
3	st2, st6	Out	In	In
2	st3, st7	Out	In	Out

Power: 4.0 Amps @ +5Vdc
1.2 Amps @ +12Vdc.
36.4 Watts

Notes

1. Sun 8mm Cartridge Tape is part number 370-1298-01.
2. The Terminating Resistor part number is 120-1206-01.
3. The Cleaning Kit part number is 370-1318-01.

Reference

Sun 2.3-Gbyte 8mm Tape Drive Configuration Procedures for 56-Inch Data Center Cabinets, 813-2081.

HP 88780 Front Load Tape Drive

Options 680 682 683 684
Read/Write/Format Board

370-1276

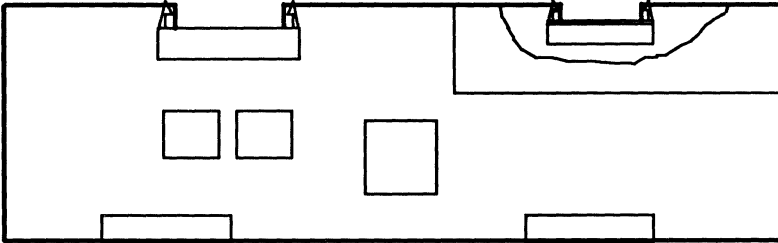

HP BOARD LABEL = 07980-66531

Drive Controller Board
370-1277

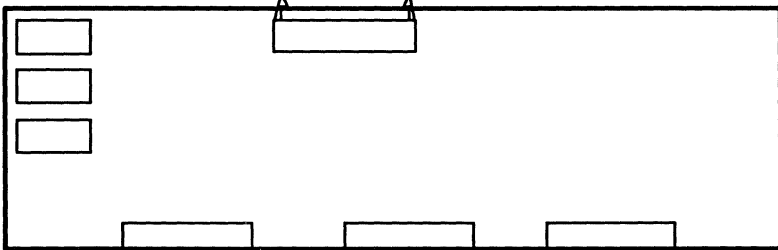

HP BOARD LABEL = 07980-66503

Single Ended I/O Board
811-1241

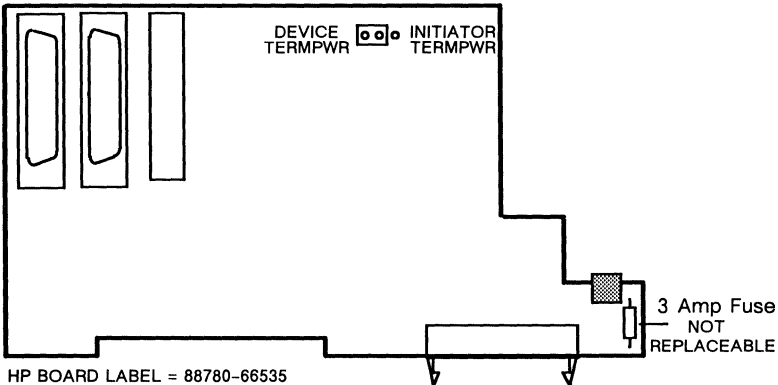

HP BOARD LABEL = 88780-66535

HP 88780 Front Load Tape Drive Data Buffer Board 370-1279

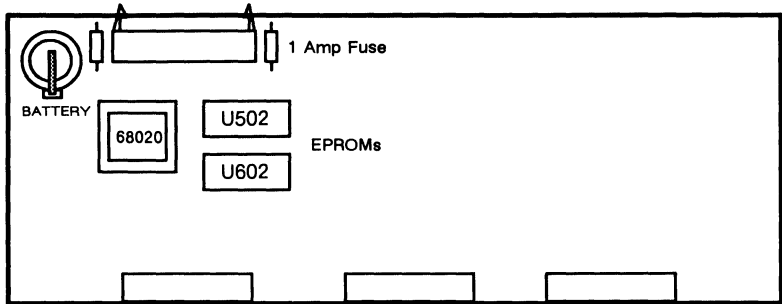

HP BOARD LABEL = 07980-66514

Reset the NVRAM when the Data Buffer Board is replaced or if the EPROMs are upgraded.

1. Load a scratch tape.
2. Run TEST 150 to write a GCR ID to the scratch tape.
3. Run TEST 128 to store the NVRAM contents to the scratch tape.
4. Remove Power.
5. Install the new Data Buffer Board or new EPROMs.
6. Connect a jumper between locations GND and CLRNV.

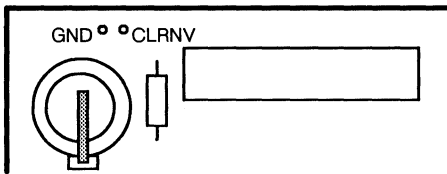

7. Apply power. FAIL--0 is displayed when selftest is complete.
8. Remove Power.
9. Remove the jumper.
10. Apply Power.
11. Load the scratch tape.
12. Run TEST 129 to load NVRAM with the contents stored on tape.
13. Run TEST 99 to calibrate the read channel gain values.

Note: The battery part number is 150-1204-01 or 811-1232-01.

Reference

Sun Front-Load 1/2-Inch Tape Drive Field Service Manual, 800-3447.

Sun 1/4" Tape Controller

Sun-2/100U/150U
501-0526

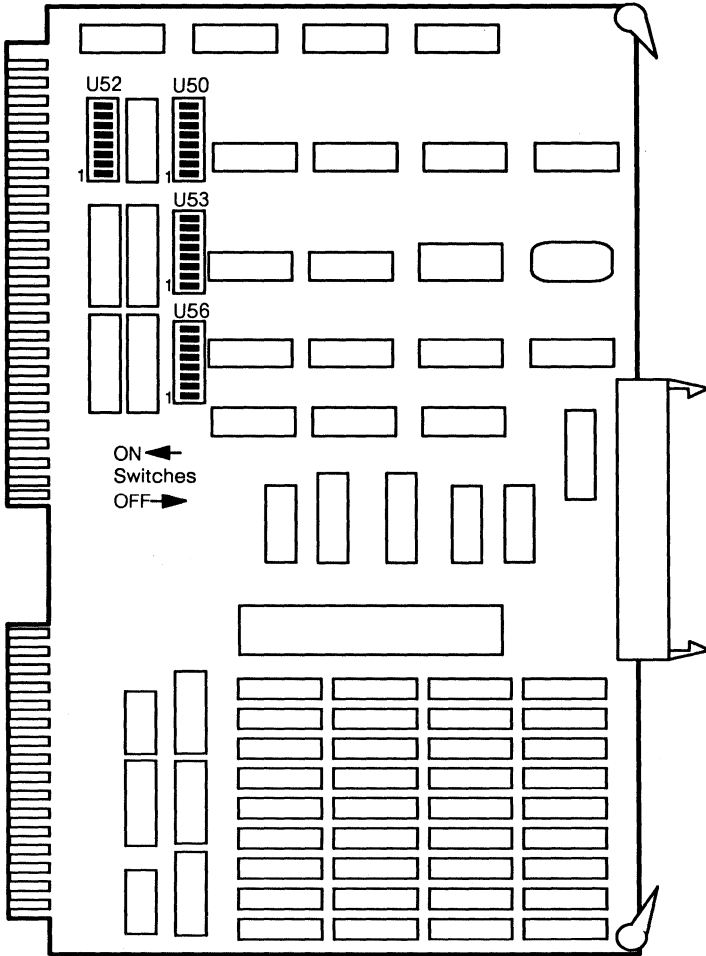

501-0526 Switch Settings

DIP SWITCH	SWITCH	SETTING	DESCRIPTION
U50	1-8	Off	Selects base address
U52	1	Off	Selects interrupt level 0
	2	Off	Selects interrupt level 1
	3	Off	Selects interrupt level 2
	4	On	Selects interrupt level 3
	5	Off	Selects interrupt level 4
	6	Off	Selects interrupt level 5
	7	Off	Selects interrupt level 6
	8	Off	Selects interrupt level 7
U53*	1	Off	} Decode address lines
	2	On	
	3-8	Off	
U56*	1-8	Off	

* Selects the base address of I/O registers in Multibus

Sysgen SC4000

Sun-2/120/130/160 & Sun-3/160

Options 56 511 370-1011

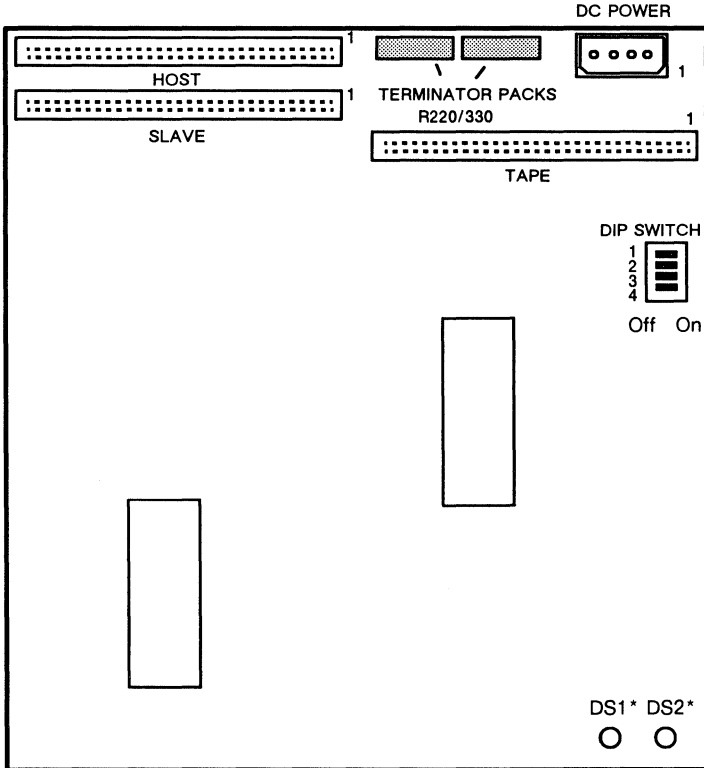

*DS1, On, indicates an error
 DS2, On, indicates Sysgen is busy

Dip Switch Settings

DIP	SETTING	DESCRIPTION
1	Off	Base address select (bit 0)
2	Off	Base address select (bit 1)
3	On	Base address select (bit 2)
4	Off	Base address select (bit 3)

Power: 2.0 Amps @ +5Vdc
 10.0 Watts

This page intentionally left blank.

Archive SAC Standalone Controller

Sun-2/120
Options 61 73
370-1026

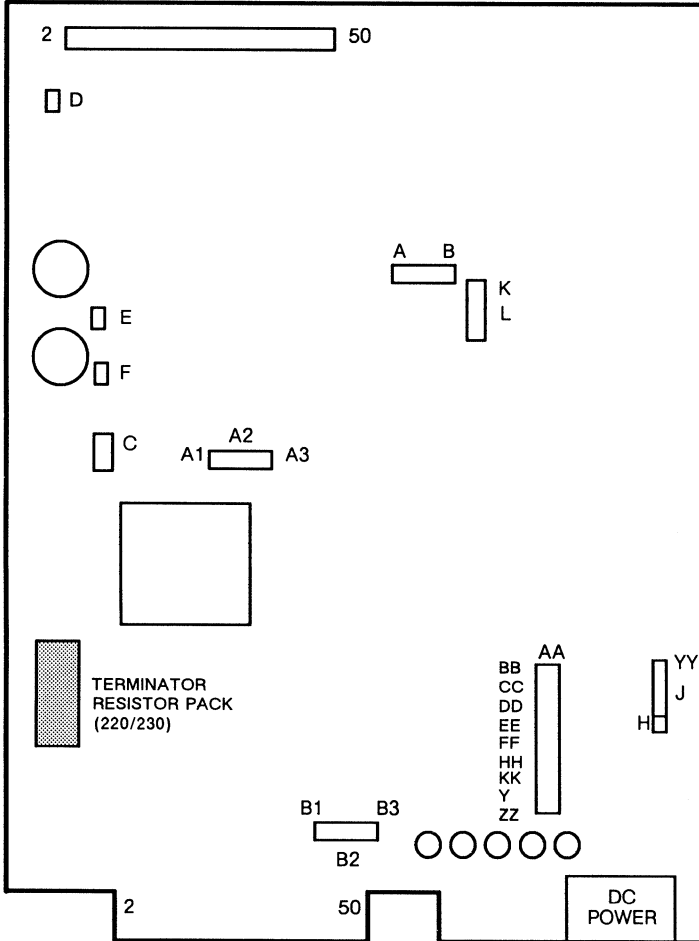

370-1026 Jumper Settings

JUMPER	SETTING	DESCRIPTION
AA BB CC* DD EE FF HH	Off Off Off/On Off Off Off Off	Format Selection QIC-11/24
KK	Off	Power on clear
Y	Off	Sun-2/120/170
	On	Sun-2 Shoebox
ZZ	On	
A B A1 A2 A3 B1 B2 B3 YY J K L	B On A1-A2 On B1-B2 On Off L On	
C D E F	Off Off Off Off	

*Add a jumper at CC for SunOS distribution tapes in QIC-24 format.

Note: This board is used with the Archive Basic Drive part numbers 370-1024 and 370-1043.

Emulex MT02

Sun-3/160/180/260/280/460/480

Sun-4/260/280/360/380

Options 511 514 516

370-1061 370-1235

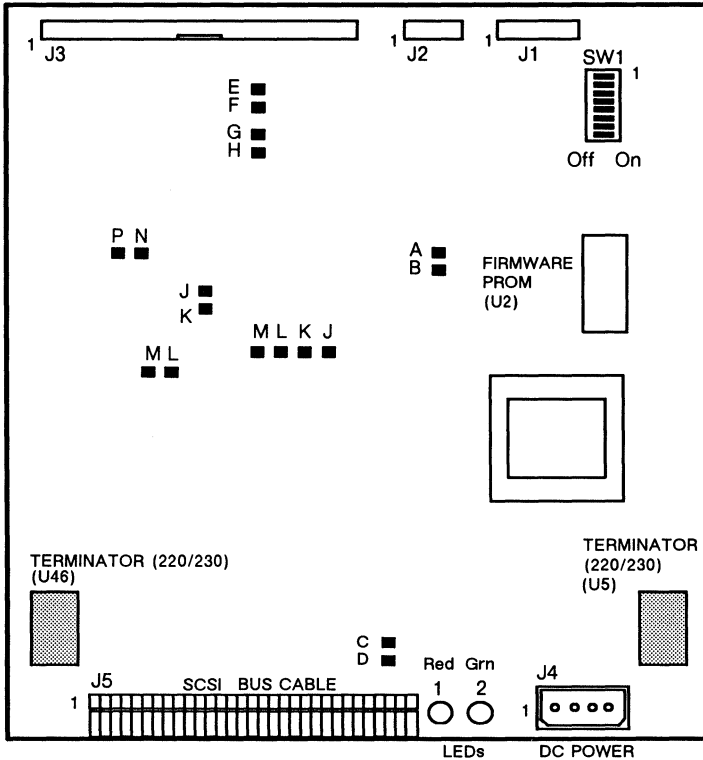

KEY	LED 1 (Green)	LED 2 (Red)	STATE
0 = Off	0	0	Power up reset clear
1 = On	1	1	Power up self-test passed

LED 1. Blinking, MT02 operating normally.
 LED 2, On, Do not remove cartridge.

Power: 1.5 Amps @ +5Vdc
 0.04 Amps @ +12Vdc.
 8.0 Watts

370-1061 370-1235 Switch and Jumper Settings

DIP SWITCH	SWITCH	SETTING	DESCRIPTION
SW1	1	Off	Bit 0
	2	Off	Bit 1
	3	On	Bit 2-SCSI device address 04
	4	Off	Not Used
	5	On	Archive Drive (Scorpion)
	6	Off	Wangtek Drive (5000E)
	5	On	Wangtek Drive (5000E)
	6	On	Wangtek Drive (5000E)
7	Off	Drive type	
8*	Off	SCSI bus parity check	

* The Sun386i Tape assembly, 370-1179, includes the MT02 Controller and the Tape Drive. SW1, Switch 8, is ON for this application.

JUMPER	SETTING	DESCRIPTION
A-B *	In	EPROM Memory size select
C-D *	Out	
E-F *	In	Hi/Lo write current (Archive Drive)
	Out	Hi/Lo write current (Wangtek Drive)
G-H	Out	
J-K †	Out	
L-M †	Out	

* Jumpers A-B, C-D, and E-F are on the Emulex Rev. MW0210402 board. They are not on Rev. MT0210403 and MT0210103 boards. SW1, Switch 5 and Switch 6, control drive selection on the MT0210403 and MT0210203 boards.

† Jumpers J-K and L-M are in one of the locations shown on the board layout drawing.

Note: Terminators U5 and U46 must always be installed for Sun-3/160 and Sun-3/180 plus configurations. Remove these terminators when the board is used with all other Sun-3 and Sun-4 Mass Storage Subsystems.

References

1. *Sun-3 Emulex MT02 Controller Configuration Procedures*, 813-2011.
2. *60 Mbyte Streaming Tape Drive with SCSI Controller Configuration Procedures*, 814-1019.

Ciprico Tapemaster

Sun-2/100U/120/130/150U/160/170
Sun-3/160/180/260/280/460/470/480
370-0502

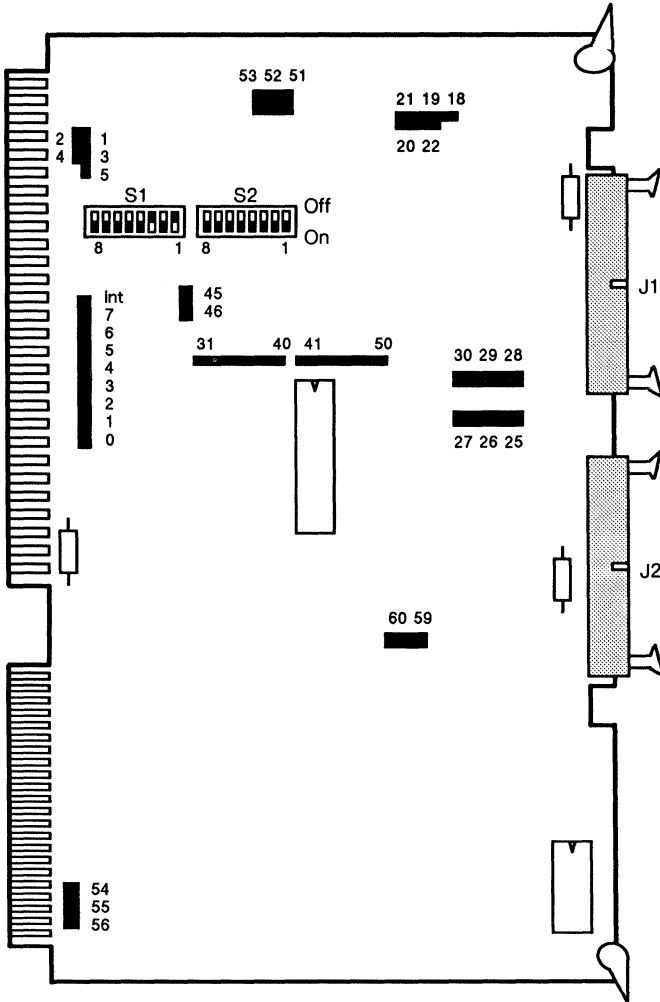

Power: 5.0 Amps @ +5Vdc
25.0 Watts

370-0502 Switch Settings

DIP SWITCH	SWITCH	SETTING	DESCRIPTION
S1			Addressing Mode and Address Line select
	1	Off	Addr A7
	2	On	Addr A6
	3	Off	Addr A5
	4	On	Addr A4
	5	On	Addr A3
	6	On	Addr A2
	7	*	Addr A1 Channel Attn addr
	8	On	Data Bus selection (16Bit/8Bit)
S2			Channel Attention Selection
	1	On	Addr AF
	2	On	Addr AE
	3	On	Addr AD
	4	On	Addr AC
	5	On	Addr AB
	6	On	Addr AA
	7	On	Addr A9
	8	On	Addr A8

*tm0=On (Channel Attention Address LSB=0xA0)

tm1=Off (Channel Attention Address LSB=0xA2)

Note: Support for the Tapemaster Controller was removed from the Sun 3200 CPU EPROM 3.0 in July 1989. The 1600 BPI Tape Drive can only be used as a backup device.

370-0502 Jumper Settings

PINS	SETTING	DESCRIPTION	
1,2	Out	Parallel arbitration (BPRO)	
3-4	In	Enable CBRQ	
5	Out		
15-16	Hardwired	Select 16-bit address mode	
18-19	Hardwired	Non-maintenance mode	
20-21	Hardwired	(Normal mode)	
22	Out		
25-26	Hardwired	Check odd parity	
27	Out		
28-29	Hardwired	Generate odd parity	
30	Out		
31 to 32,33,34,35	Hardwired	A4-A7 (Low)	
36-40	Hardwired	A8 (High)	Address (A4-A19) 0x01106
31 to 37,38,39	Hardwired	A9-A11 (Low)	
42-50	Hardwired	A12 (High)	
41 to 43,44,45	Hardwired	A13-A15 (Low)	
41 to 46,47,48,49	Hardwired	A16-A15 (Low)	
51-52	Hardwired	Enable ANYQRST high	
53	Out		
54-55	Hardwired	Select 2732-based firmware	
56	Out		
57-58	Hardwired	Enable system bus time-out	
59,60	Out	(Normal mode) Disable Diagnostics	
INT-3	Hardwired	Level 3 interrupt	

Sun-2/100U

PINS	SETTING	DESCRIPTION
1,2	In	Serial arbitration
3-5	In	CBRQ low
4	Out	
51-52	Hardwired	ANYQRST high
53	Out	

VMEbus to Multibus Adapter with Ciprico Tapemaster

Sun-2/130/160
Sun-3/160/180/260/280/460/470/480
501-1156

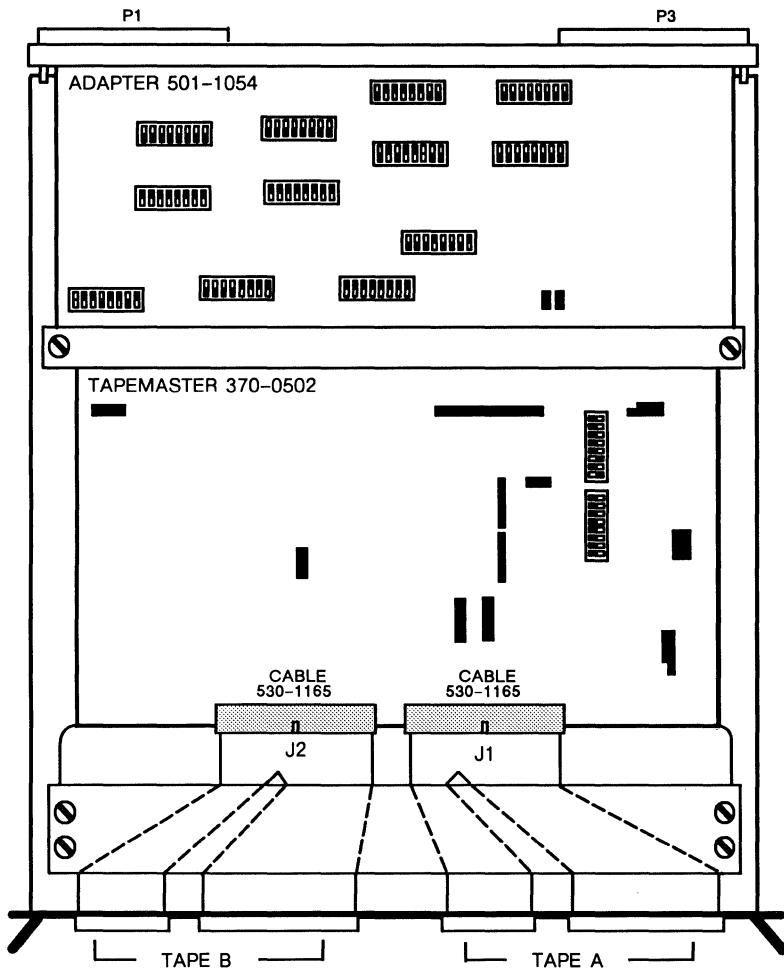

VMEbus to Multibus Adapter with Ciprico Tapemaster

501-1156

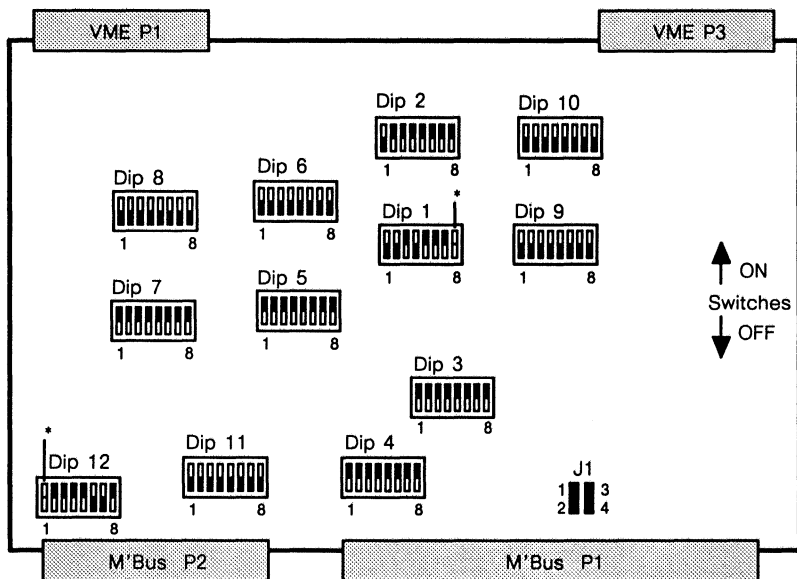

SWITCH	1	2	3	4	5	6	7	8	DESCRIPTION
U1	N/C	OFF	ON	OFF	ON	ON	ON	*	I-O Address
U2	N/C	ON	ON	ON	ON	ON	ON	ON	I-O Space = 2
U3	ON	ON	ON	ON	ON	ON	ON	ON	I-O Address = 0x00
U4	ON	ON	ON	ON	ON	ON	ON	ON	VME I-O Space
U5	ON	ON	ON	ON	ON	ON	ON	ON	24-Bit Memory Address Space
U6	OFF	OFF	OFF	OFF	OFF	OFF	OFF	OFF	24-Bit Memory Block Size
U7	ON	ON	ON	ON	ON	ON	ON	ON	24-Bit Memory Address Space
U8	OFF	OFF	OFF	OFF	OFF	OFF	OFF	OFF	24-Bit Memory Block Size
U9	OFF	OFF	OFF	OFF	OFF	OFF	OFF	OFF	No Connection
U10	OFF	OFF	OFF	OFF	OFF	OFF	OFF	OFF	No Connection
U11	OFF	OFF	OFF	OFF	OFF	OFF	OFF	OFF	Sets Address Bits A23 Thru A20
U12	*	ON	ON	ON	ON	OFF	OFF	ON	Interrupt Vector
J1	PINS 1-2	IN	If BCLK is desired						
	PINS 3-4	IN	If CCLK is desired						

* tm0 = ON (I-O Address = 0x00A0, Interrupt Vector = 0x60)
 tm1 = OFF (I-O Address = 0x00A2, Interrupt Vector = 0x61)

Power: 5.1 Amps @ +5Vdc
 25.5 Watts

Xylogics 472

Sun-2/120/130/160/170

Sun-3/160/180/260/280/460/470/480

Sun-4/260/280/360/380

370-1067

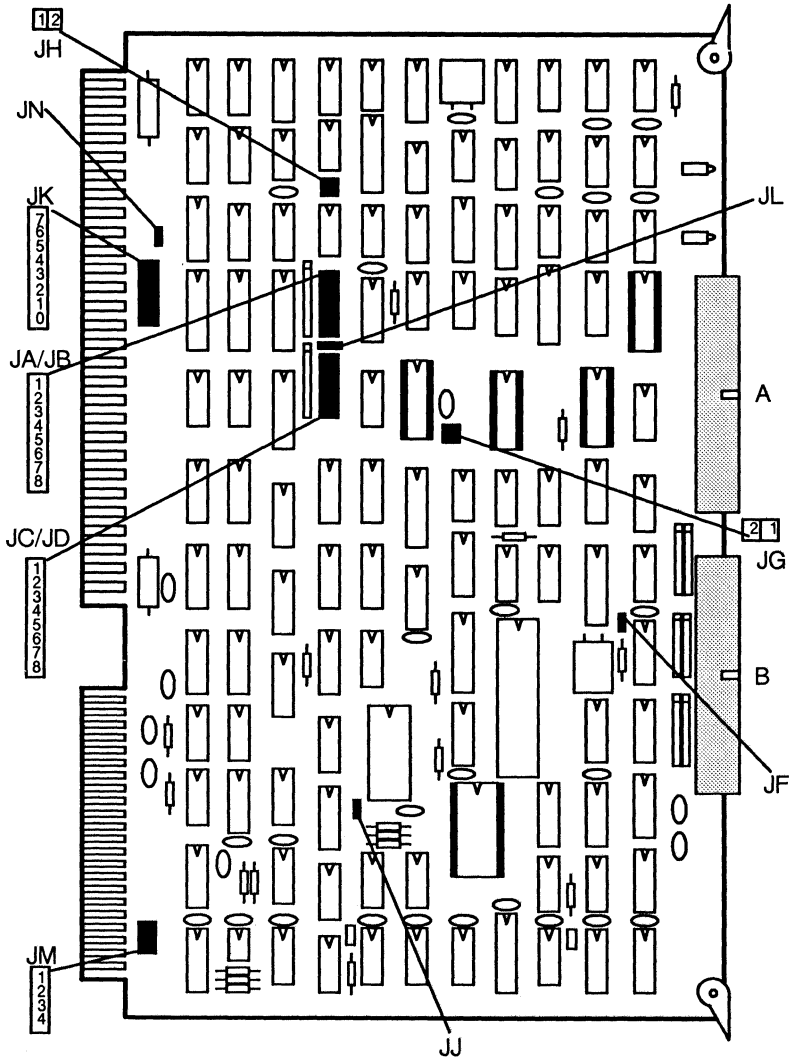

370-1067 Jumper Settings

JUMPER	PINS	SETTING	DESCRIPTION
JF	N/A	Out In	All Sun-2 Multibus Systems (20-bit address) All Sun-2,3,4 VME Systems (24-bit address)
JM	1 2 3 4	* * * *	Select ADR0x17 Select ADR0x16 Select ADR0x15 Select ADR0x14 } All IN for 24-bit addressing and all OUT for 20-bit addressing
JG	1 2	Out In	8KB FIFO Buffer On-Board (Selected)
JJ	N/A	In	8KB FIFO Buffer On-Board (Selected)
JH	1 2	Out In	Select 10MHz On-Board Sequencer Clock
JK	0 1 2 3 4 5 6 7	Out Out Out In Out Out Out Out	Interrupt Level Selection Select Interrupt Level-0 Select Interrupt Level-1 Select Interrupt Level-2 Select Interrupt Level-3 ← Factory Setting Select Interrupt Level-4 Select Interrupt Level-5 Select Interrupt Level-6 Select Interrupt Level-7
JL	N/A	Out	Select 16-Bit I-O Address
JN	N/A	Out	Select Parallel DMA Priority
JA to JB	JA JB 1 to 1 2 to 2 3 to 3 4 to 4 5 to 5 6 to 6 7 to 7 8 to 8	Out Out Out In Out Out Out In	Selects the "high-order" byte of I-O Address ADR0xF } ADR0xE } ADR0xD } ADR0xC } Selects High-Order ADR0xB } Byte = 0xEE ADR0xA } ADR0x9 } ADR0x8 }

370-1067

Jumper Settings – Continued

JUMPER	PINS	SETTING	DESCRIPTION
JC to JD	JC JD		
	1 to 1	In	} Set as "First Controller" device (xtc0). I-O Address = 0x60
	2 to 2	Out	
	3 to 3	Out	
	4 to 4	In	
	5 to 5	In	
	6 to 6	In	
	7 to 7	In	
	8 to 8	In	
	1 to 1	In	} Set as "Second Controller" device (xtc1). I-O Address = 0x68
	2 to 2	Out	
	3 to 3	Out	
	4 to 4	In	
	5 to 5	Out	
	6 to 6	In	
	7 to 7	In	
8 to 8	In		

VMEbus to Multibus Adapter with Xylogics 472

Sun-2/120/130/160/170
Sun-3/160/180/260/280/460/470/480
Sun-4/260/280/360/380
501-1155

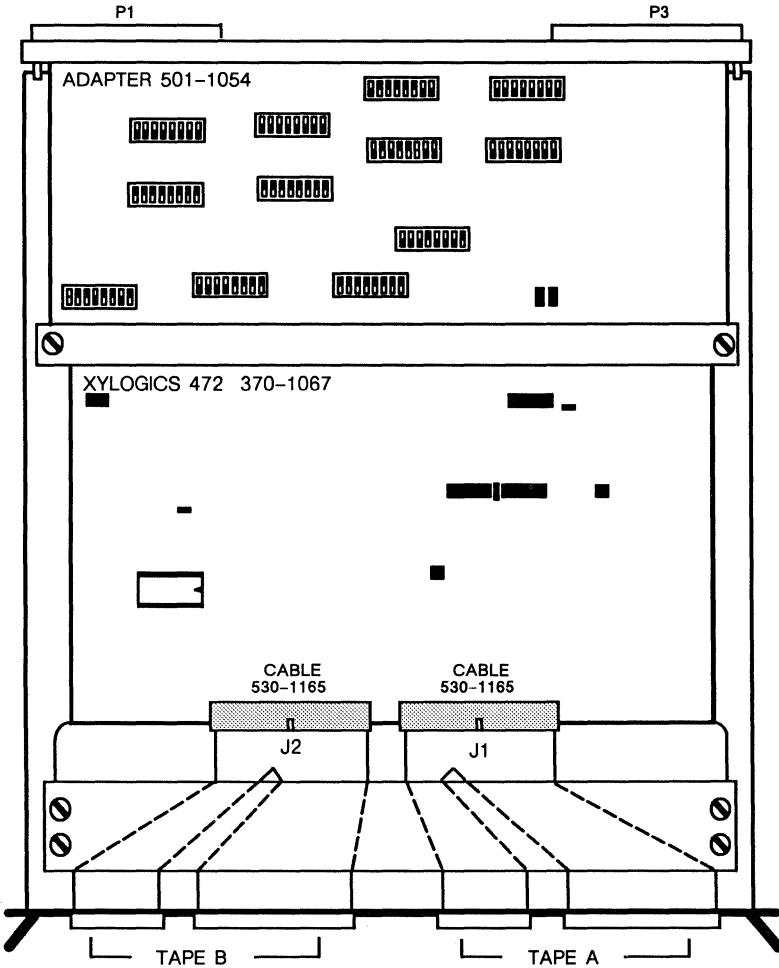

VMEbus to Multibus Adapter with Xylogics 472 501-1155

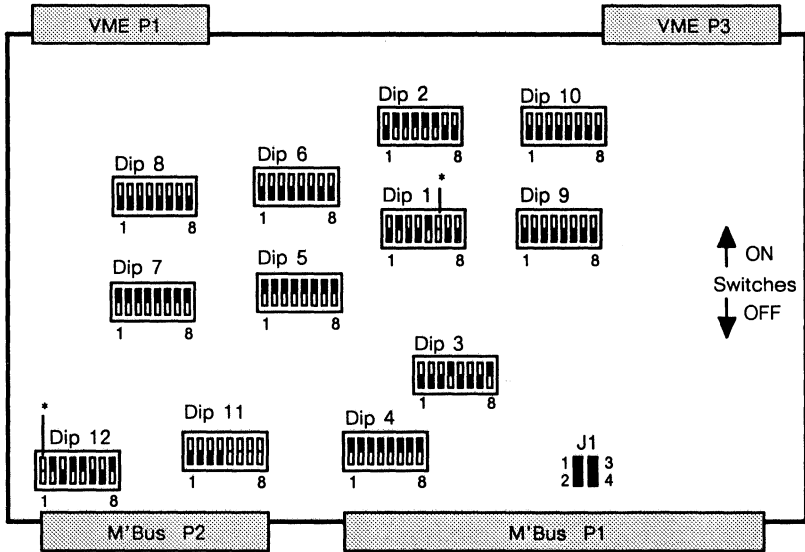

SWITCH	1	2	3	4	5	6	7	8	DESCRIPTION
U1	N/C	ON	OFF	OFF	ON	*	OFF	OFF	I-O Address
U2	N/C	ON	ON	ON	ON	ON	OFF	OFF	I-O Space = 8
U3	OFF	OFF	OFF	ON	OFF	OFF	OFF	ON	I-O Address = 0xEE
U4	ON	ON	ON	ON	ON	ON	ON	ON	VME I-O Space
U5	ON	ON	ON	ON	ON	ON	ON	ON	24-Bit Memory Address Space
U6	OFF	OFF	OFF	OFF	OFF	OFF	OFF	OFF	24-Bit Memory Block Size
U7	ON	ON	ON	ON	ON	ON	ON	ON	24-Bit Memory Address Space
U8	OFF	OFF	OFF	OFF	OFF	OFF	OFF	OFF	24-Bit Memory Block Size
U9	OFF	OFF	OFF	OFF	OFF	OFF	OFF	OFF	No connection
U10	OFF	OFF	OFF	OFF	OFF	OFF	OFF	OFF	No connection
U11	OFF	OFF	OFF	OFF	ON	ON	ON	ON	Sets Address Bits A23 - A20
U12	*	ON	OFF	ON	ON	OFF	OFF	ON	Interrupt Vector
J1	PINS 1-2	IN	If BCLK is desired						
	PINS 3-4	IN	If CCLK is desired						

*xtc0 = ON (I-O Address = 0xEE60, Interrupt Vector = 0x64)
 xtc1 = OFF (I-O Address = 0xEE68, Interrupt Vector = 0x65)

Note: Sun-3/160/180/260/280 and Sun-4/260/280 CPU boards with EPROM revisions below 3.0 fail to boot from tape and fail the boot path diagnostic [b*xt()] if the Xylogics 472 or the VME-Multibus Adapter is set to 24-bit.

Sony 1.4MB Floppy Diskette

Sun386i
370-1150
 White Bezel
 MP-F73W-34D

Sun-3/80
Sun-4/60/65/75
370-1207
 4 mm Black Bezel
 MP-17W-5PF
 MP-17W-FP

Sun-4/40
370-1354
 8 mm Black Bezel
 MP-17W-2PF
 MP-17W-F1

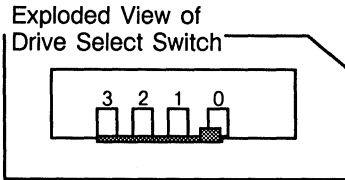
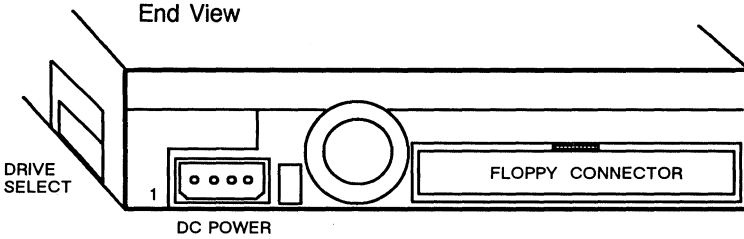

Power: 0.3 Amps @ +5Vdc
 1.5 Watts

Notes

1. Set the Drive Select Switch to 1 for the Sun386i.
2. Set the Drive Select Switch to 0 for all other systems.

References

1. Sun-3/80 Internal Diskette Drive Installation Manual, 813-1065.
2. Installing SPARCstation 1 Internal Drives, 800-4902.

CONFIGURATIONS

COMMUNICATION

Communication

MULTIBUS

3Com 3C400 Ethernet Controller	4
Sun-2 Ethernet Controller	6
VMEbus to Multibus Adapter with Sun-2 Ethernet	8
Sun-3/E Ethernet Assembly	10
System DCP-8804	12
VMEbus to Multibus Adapter with DCP-8804	16
System MTI-800/1600 (ALM-1) (370-1047)	18
System MTI-850/1650 (ALM-1) (370-1099)	20
VMEbus to Multibus Adapter with MTI-1600	23
VMEbus to Multibus Adapter with MTI-1650	24
VMEbus to Multibus Adapter with MTI-1650A ...	25

VMEbus

MAPKIT	28
Asynchronous Line Multiplexor-2 (ALM-2)	30
Multiprotocol Communication Processor (MCP) ..	32
SunLink Channel Adapter-IBD	34
SunLink Channel Adapter-CIO	36
SunLink Channel Adapter-LCP	38
High-Speed Serial Interface (HSI)	42
Fibercom Ethernet Controller	44
FDDI	48

AT, XT, and MICROCHANNEL

Etherlink I	50
Etherlink II	51
Etherlink/MC	52

SBus

Ethernet Controller	53
SBus Printer	54
Serial Parallel Interface Controller	55
High Speed Serial Interface	56

This page intentionally left blank.

3Com 3C400 Ethernet Controller

Sun-2/100U/120/150U/170

370-0288

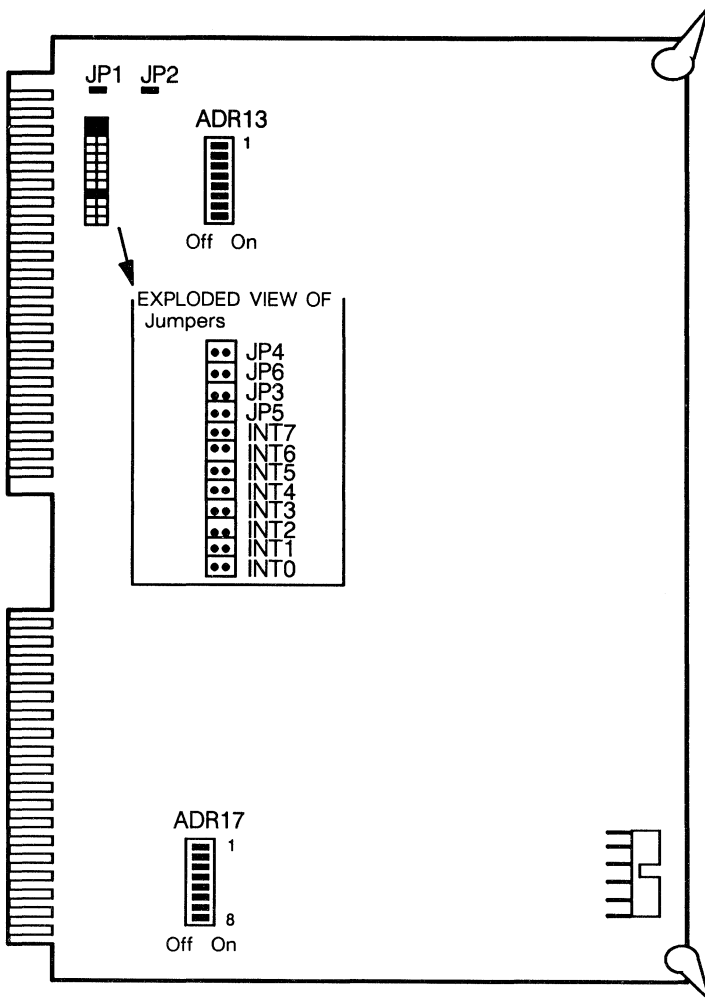

Power: 5.0 Amps @ +5Vdc
0.5 Amps @ +12VdcVdc
31.0 Watts

Note: This board only works with an Ethernet Level 1 Transceiver.

370-0288 Jumper & Switch Settings

JUMPER	SETTING	DESCRIPTION
JP1	Out	24 bit address
JP2	In	20 bit address
JP3	Out	Memory
JP4	In	Memory
JP5	Out	Memory
JP6	In	Memory
INT7	Out	Int7
INT6	Out	Int6
INT5	Out	Int5
INT4	Out	Int4
INT3	In	Int3
INT2	Out	Int2
INT1	Out	Int1
INT0	Out	Int0

First Board (ec0)

Base address is 0xE 0000

DIP SWITCH ADR 13

	1	2	3	4	5	6	7	8
ON	X	X	X					
OFF				X	X	X	X	X

Second Board (ec1)

Base address is 0xE 2000

DIP SWITCH ADR 13

	1	2	3	4	5	6	7	8
ON	X	X	X				X	
OFF				X	X	X		X

DIP SWITCH ADR 17

	1	2	3	4	5	6	7	8
ON								
OFF	X	X	X	X	X	X	X	X

DIP SWITCH ADR 17

	1	2	3	4	5	6	7	8
ON								
OFF	X	X	X	X	X	X	X	X

Sun-2 Ethernet Controller

Sun-2/120/130/160/170 & Sun-3/110/140

Sun-3/150/160/180/260/280/460/470/480

Sun-4/110/150/260/280/310/330/350/360

Sun-4/370/390

501-1004

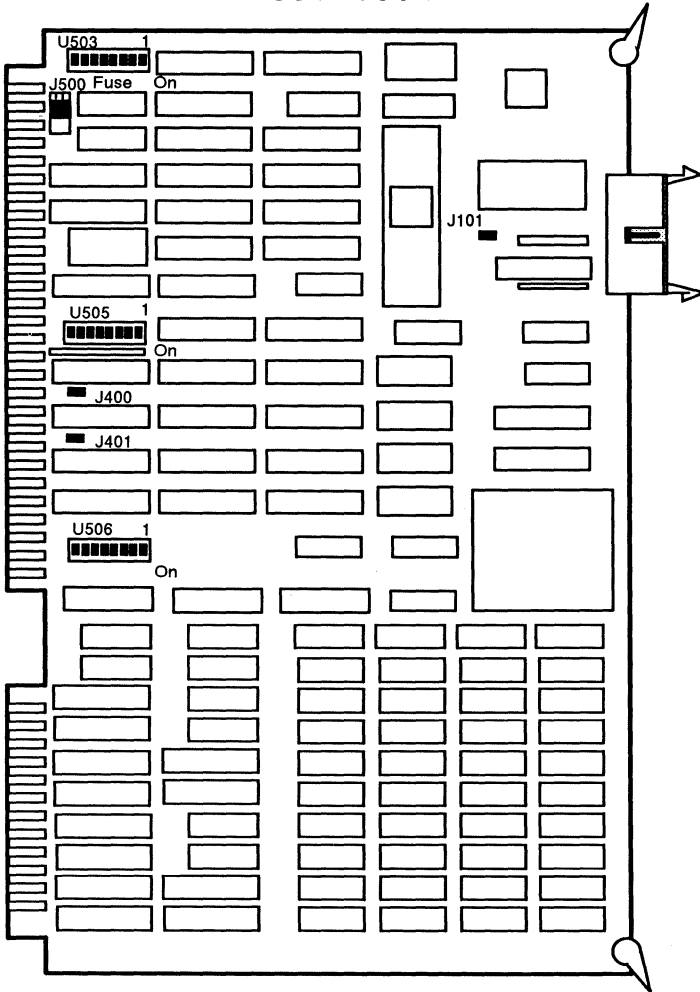

Power: 6.0 Amps @ +5Vdc
0.5 Amps @ +12VdcVdc
36.0 Watts

501-1004

Jumper & Switch Settings

JUMPER	PINS	SETTING	DESCRIPTION
J101	1-2	In	Level 1 Ethernet
	1-2	Out	Level 2 Ethernet
J400	1-2	Out	M.BIG select
J401	1-2	Out	M.EXP select
J500	1-2	Out	Ethernet interrupt level 0
	3-4	Out	Ethernet interrupt level 1
	5-6	Out	Ethernet interrupt level 2
	7-8	Hardwired	Ethernet interrupt level 3
	9-10	Out	Ethernet interrupt level 4
	11-12	Out	Ethernet interrupt level 5
	13-14	Out	Ethernet interrupt level 6
	15-16	Out	Ethernet interrupt level 7

Note: The 2Amp 125V subminiature fuse is located on top of J500

First controller in a Multibus system,
second in a VME system.

U503

	1	2	3	4	5	6	7	8
ON				X				X
OFF	X	X	X		X	X	X	

U505

	1	2	3	4	5	6	7	8
ON			X					
OFF	X	X		X	X	X	X	X

U506

	1	2	3	4	5	6	7	8
ON		X	X			X	X	
OFF	X			X	X			X

Second controller in a Multibus system.

U503

	1	2	3	4	5	6	7	8
ON			X	X				X
OFF	X	X			X	X	X	

U505

	1	2	3	4	5	6	7	8
ON		X		X				
OFF	X		X		X	X	X	X

U506

	1	2	3	4	5	6	7	8
ON	X			X	X			X
OFF		X	X			X	X	

VMEbus to Multibus Adapter with Sun-2 Ethernet

Sun-2/130/160 & Sun-3/110/140/150/160

Sun-3/180/260/280/460/470/480

Sun-4/110/150/260/280/310/330/350/360

Sun-4/370/390

501-1153

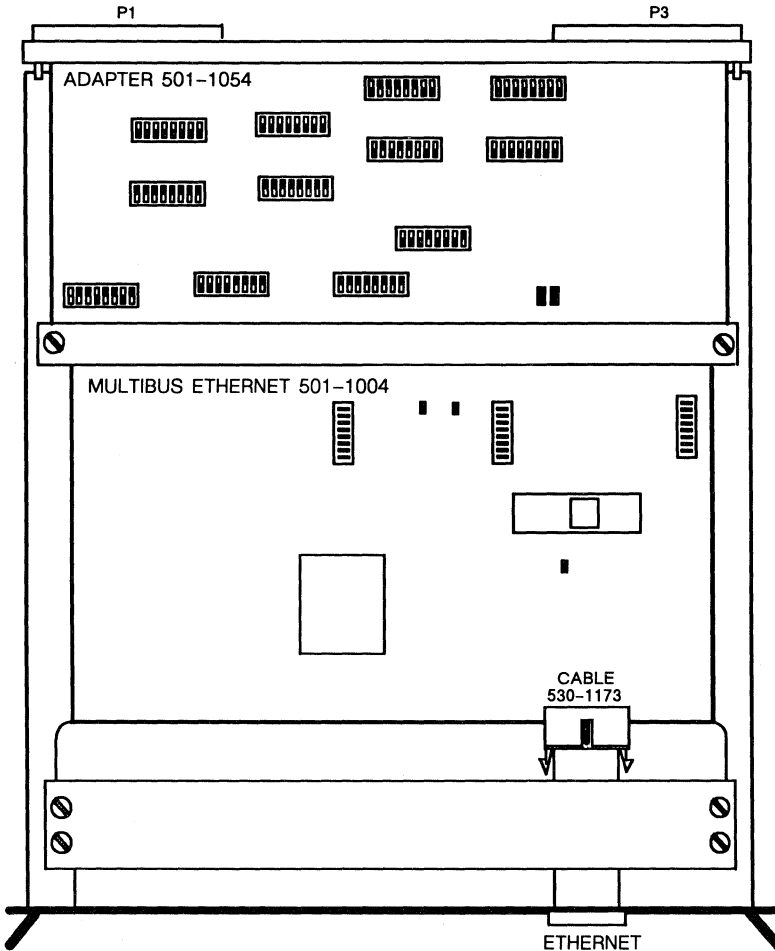

VMEbus to Multibus Adapter with Sun-2 Ethernet

Sun-2/130/160

Sun-3/110/140/150/160/180/260/280/460/470/480
Sun-4/110/150/260/280/310/330/350/360/370/380/390
501-1153

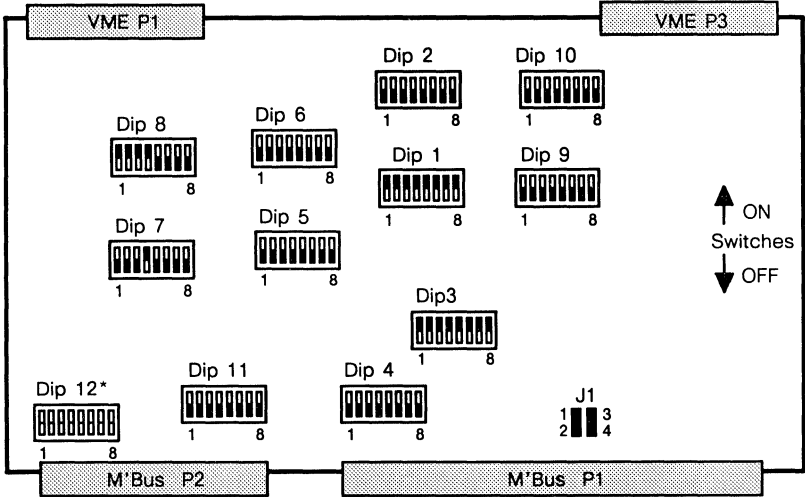

VME TO MULTIBUS ADAPTER BOARD SWITCH SETTINGS									
SWITCH	1	2	3	4	5	6	7	8	DESCRIPTION
U1	N/C	ON	ON	ON	ON	ON	ON	ON	I-O Address = 0x00
U2	N/C	OFF	OFF	OFF	OFF	OFF	OFF	OFF	I-O Space = No response
U3	ON	ON	ON	ON	ON	ON	ON	ON	I-O Address = 0x00
U4	OFF	OFF	OFF	OFF	OFF	OFF	OFF	OFF	VME I-O Space = No response
U5	OFF	OFF	OFF	OFF	OFF	OFF	OFF	OFF	24-Bit Memory Address Space
U6	OFF	OFF	OFF	OFF	OFF	OFF	OFF	OFF	24-Bit Memory Block Size
U7	OFF	OFF	OFF	ON	OFF	OFF	OFF	OFF	24-Bit Memory Address Space
U8	ON	ON	ON	ON	OFF	OFF	OFF	OFF	24-Bit Memory Block Size
U9	OFF	OFF	OFF	OFF	OFF	OFF	OFF	OFF	No connection
U10	OFF	OFF	OFF	OFF	OFF	OFF	OFF	OFF	No connection
U11	OFF	OFF	OFF	OFF	OFF	OFF	OFF	OFF	Sets Address Bits A23 - A20
U12*	OFF	ON	OFF	ON	OFF	OFF	OFF	ON	Interrupt Vector = 0x75
	OFF	OFF	ON	OFF	OFF	ON	ON	ON	Interrupt Vector = 0x1B
J1	PINS 1-2	IN	If BCLK is desired						
	PINS 3-4	IN	If CCLK is desired						

* For SunOS 3.0 and above, use 0x75. For SunOS below 3.0, use 0x1B.

Power: 5.8 Amps @ +5Vdc
29.0 Watts

Sun-3/E Ethernet Assembly

Sun-4/390/470/490

501-1584

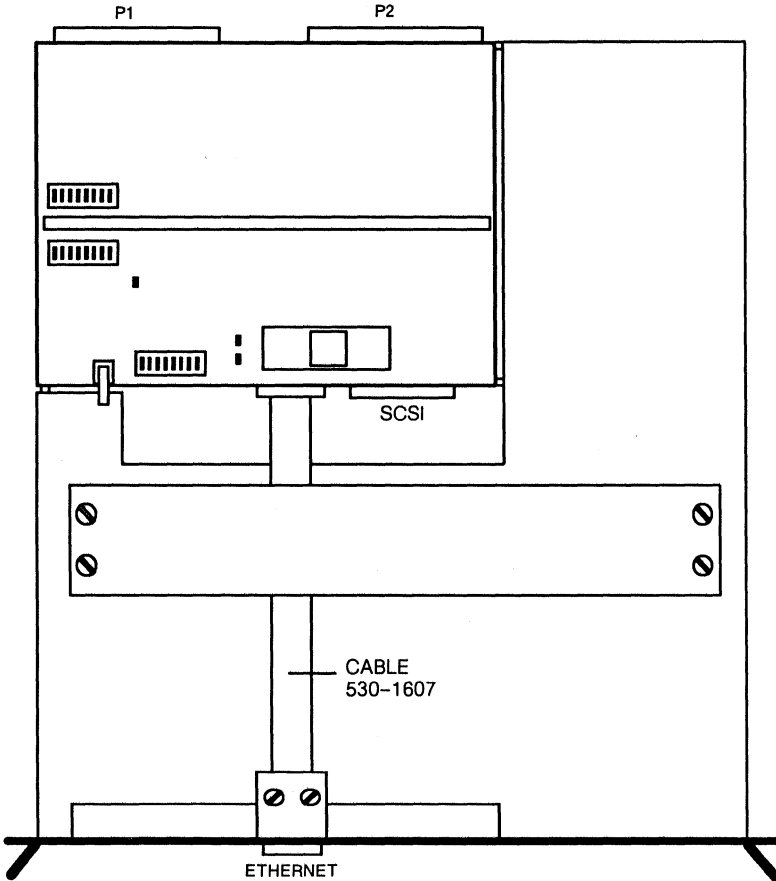

Notes

1. Board revision 501-8027-06 or 501-1584-01 is required for use in any SPARC CPU based system.
2. The fuse is not replaceable.
3. When used with the Sun-4400 CPU, 501-1381, the board revision must be \geq 501-8027-07 or the assembly must be \geq 501-1584-02.
4. SCSI TERMPWR is provided on boards \geq 501-8027-07 or \geq 501-1584-02.

Reference

Sun SunNet Ethernet/VME Controller Installation Manual for 56-Inch Data Center Cabinets, 813-1068.

501-1584

Switch & Jumper Settings

DIP SWITCH	SWITCH	SETTING	DESCRIPTION
SW0601	1-7	On	Not Supported
SW0601	1-7	Off	Enable Ethernet*

DIP SWITCH	SWITCH	SETTING	DESCRIPTION
SW0201	1	Off	24/32-bit addressing
SW0201	2	Off/On	N/C
SW0201	3	*	A18 address decode
SW0201	4	*	A19 address decode
SW0201	5	*	A20 address decode
SW0201	6	Off	A21 address decode
SW0201	7	On	A22 address decode
SW0201	8	On	A23 address decode

*DIP Switch SW0201 settings for ie2, ie3, and ie4

SW0201	SWITCH 3	SWITCH 4	SWITCH 5	ADDRESS
1st Board	On	On	Off	31ff02
2nd Board	Off	On	Off	35ff02
3rd Board	Off	Off	On	2dff02

DIP SWITCH	SWITCH	SETTING	DESCRIPTION
SW0202	1	On	A24 address decode
SW0202	2	On	A25 address decode
SW0202	3	On	A26 address decode
SW0202	4	On	A27 address decode
SW0202	5	On	A28 address decode
SW0202	6	On	A29 address decode
SW0202	7	On	A30 address decode
SW0202	8	On	A31 address decode

JUMPER	PINS	SETTING	DESCRIPTION
J0201	1-2	In	Clock enable

Note: This board is designed for use with Level 2 transceivers only.

Systemch DCP-8804

SunLink Communications Processor (SCP)

Sun-2/120/130/160/170 & Sun-3/110/140/150

Sun-3/160/180/260/280/460/470/480

370-1049

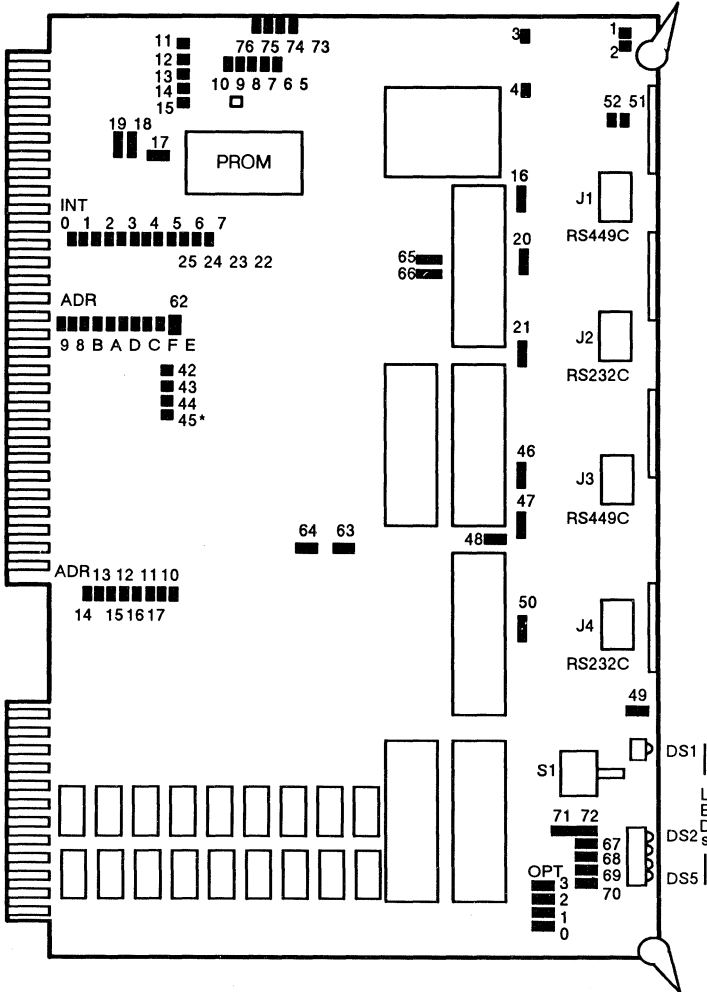

Power: 5.6 Amps @ +5Vdc
 0.2 Amps @ +12VdcVdc
 0.1 Amps @ -12
 31.6 Watts

370-1049 Jumper Settings

JUMPER	SETTING	DESCRIPTION
1	Out	Serial I/F ground, channel A
2	Out	Serial I/F multifunction, channel A
3	Out	RS-232 ground, channel A
4	In	RS-449 ground, channel A
5	Out	EPROM size select
6	In	EPROM size select
7	In	RAM size select
8	In	Bus timeout enable
9	Out	Byte swapping
10	In	Disable Multibus memory address
11	In/Out	ADR-F bit compare
12	In/Out	ADR-E bit compare
13	In	Byte swapping
14	In	BPRO enable
15	In	Byte swapping
16	In	RS-232 ground, channel B
17	In	Enable BPRN in
18	Out	BPRN in disable
19	Out	8289 Any request
20	Out	RS-449 ground, channel B
21	Out	RS-232 ground, channel C
22	Out	EPROM size select
23	In	EPROM size select
24	Out	8289 CBRQ ground
25	In	Enable CBRQ out

Note: LED DS5 is the least significant bit (bit 0). LED DS2 is the most significant bit (bit 3).

Reference

SunLink Communication Processor Installation and Configuration Guide, 800-1398.

370-1049 Jumper Settings – Continued

JUMPER	SETTING	DESCRIPTION
42	Out	I/O A-7 compare
43	Out	I/O A-6 compare
44	Out	I/O A-5 compare
45	Out*	I/O A-4 compare
46	In	RS-449 ground, channel C
47	In	RS-232 ground, channel D
48	Out	Serial I/F ground, channel D
49	Out	Serial I/F ground, channel C
50	Out	Serial I/F ground, channel D
51	Out	Serial I/F ground, channel B
52	Out	Serial I/F ground, channel B
62	Out	Enables I/O space addressing
63	Out	RS-449 tri-state, channel C
64	Out	RS-449 tri-state, channel D
65	Out	RS-449 tri-state, channel A
66	Out	RS-449 tri-state, channel B
67	Out	TX clock from DCE, channel A
68	In	TX clock from DCE, channel B
69	In	TX clock from DCE, channel C
70	Out	TX clock from DCE, channel D
71	In	64K DMA range
72	Out	64K DMA range
73	Out	64K DMA range
74	In	64K DMA range
75	Out	64K DMA range
76	In	64K DMA range

*Jumper 45 is OUT for the DCP0 board at address 800 and IN for the DCP1 board at address 810.

370-1049

Jumper Settings – Continued

JUMPER	SETTING	DESCRIPTION
ADR10	In/Out	Address compare
11	In/Out	Address compare
12	In/Out	Address compare
13	In/Out	Address compare
14	In/Out	Address compare
15	In/Out	Address compare
16	In/Out	Address compare
17	In/Out	Address compare
I/OADR8	Out	I/O address compare
9	Out	I/O address compare
A	Out	I/O address compare
B	In	I/O address compare
C	Out	I/O address compare
D	Out	I/O address compare
E	Out	I/O address compare
F	Out	I/O address compare
INT0	Out	Interrupt level 0
1	Out	Interrupt level 1
2	Out	Interrupt level 2
3	In	Interrupt level 3
4	Out	Interrupt level 4
5	Out	Interrupt level 5
6	Out	Interrupt level 6
7	Out	Interrupt level 7
OPT0	In	Short self-test
1	Out	Reserved
2	Out	Reserved
3	Out	Reserved

VMEbus to Multibus Adapter with Systech DCP-8804

Sun-2/130/160 & Sun-3/110/140/150
Sun-3/160/180/260/280/460/470/480
501-1158

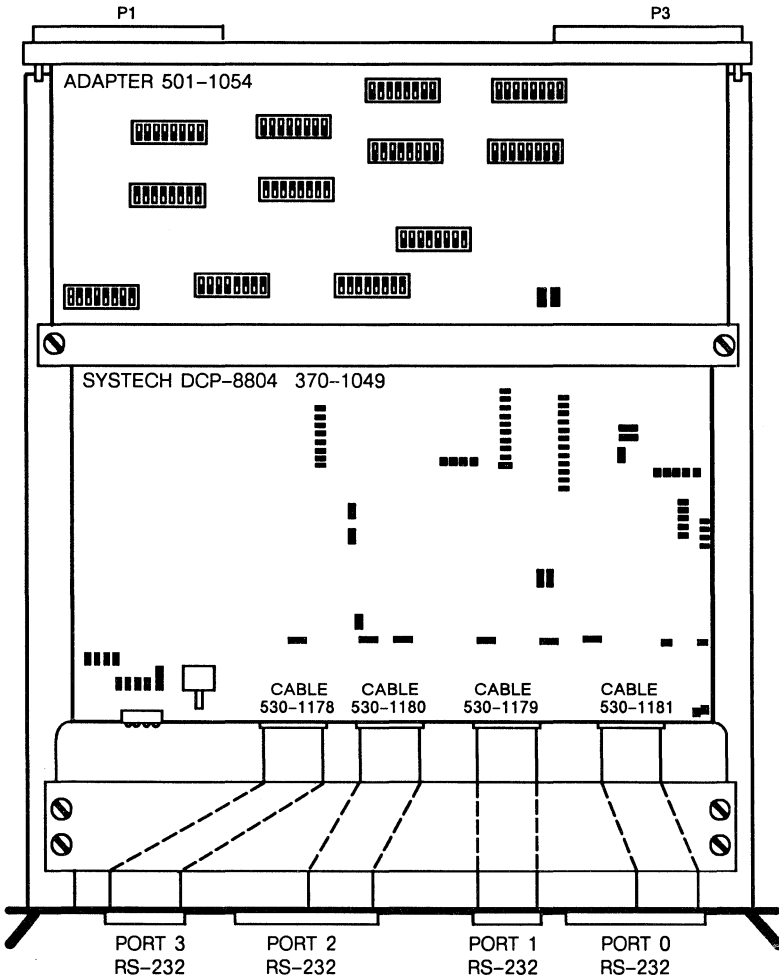

VMEbus to Multibus Adapter with Systech DCP-8804 501-1158

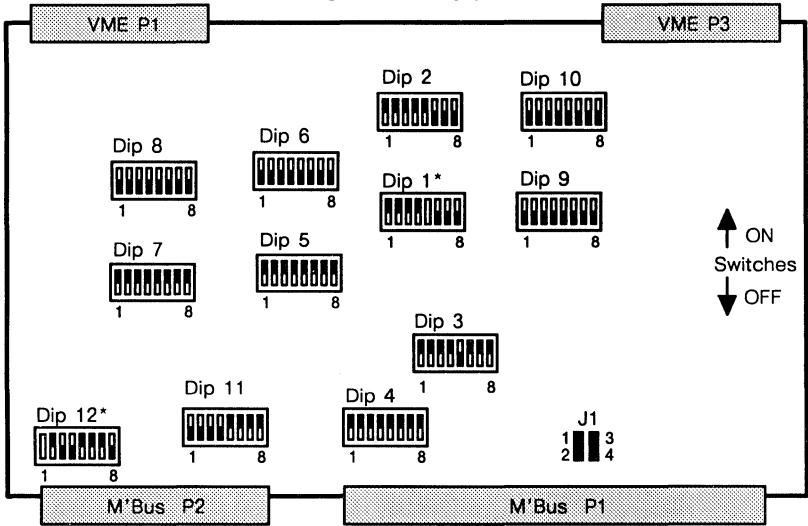

VME TO MULTIBUS ADAPTER BOARD SWITCH SETTINGS									
SWITCH	1	2	3	4	5	6	7	8	Description
U1	N/C	ON	ON	ON	*	OFF	OFF	OFF	I-O Address = 0x800
U2	N/C	ON	ON	ON	ON	OFF	OFF	OFF	I-O Space = 16
U3	ON	ON	ON	ON	OFF	ON	ON	ON	I-O Address = 0x0800
U4	ON	ON	ON	ON	ON	ON	ON	ON	VME I-O Space
U5	ON	ON	ON	ON	ON	ON	ON	ON	24-Bit Memory Address Space
U6	OFF	OFF	OFF	OFF	OFF	OFF	OFF	OFF	24-Bit Memory Block Size
U7	ON	ON	ON	ON	ON	ON	ON	ON	24-Bit Memory Address Space
U8	OFF	OFF	OFF	OFF	OFF	OFF	OFF	OFF	24-Bit Memory Block Size
U9	OFF	OFF	OFF	OFF	OFF	OFF	OFF	OFF	No connection
U10	OFF	OFF	OFF	OFF	OFF	OFF	OFF	OFF	No connection
U11	OFF	OFF	OFF	OFF	ON	ON	ON	ON	Sets Address Bits A23 Thru A20
U12	*	ON	OFF	OFF	ON	ON	ON	OFF	Interrupt Vector = 0x8C
J1	PINS 1-2	IN If BCLK is desired							
	PINS 3-4	IN If CCLK is desired							

* DCP0, U1, 5, ON and U12, 1, ON.
DCP1, U1, 5 OFF and U12, 1, OFF

Power: 5.6 Amps @ +5Vdc
 0.2 Amps @ +12Vdc
 0.1 Amps @ -12Vdc
 31.6 Watts

Systech MTI-800/1600 Controller

Asynchronous Line Multiplexer 1 (ALM-1)

Sun-2/120/130/160/170 & Sun-3/150/160
Sun-3/180/260/280/460/470/480
Sun-4/260/280
370-1047

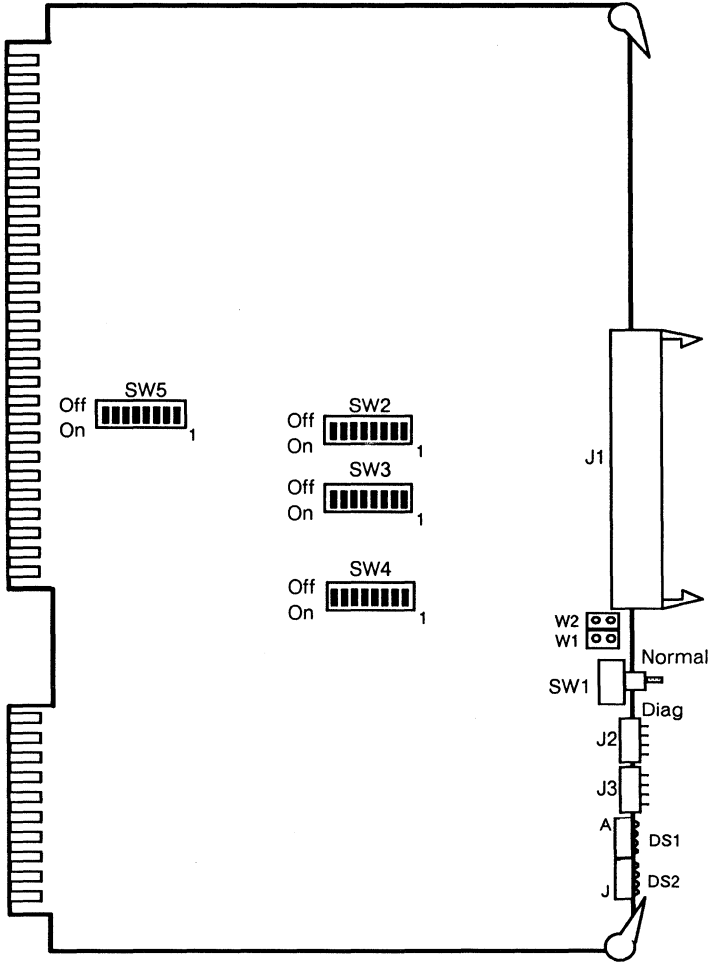

Systech Part Number 65-200004-7

370-1047 Switch Settings

mti0 Defaults

DIP	SWITCH	SETTING	DESCRIPTION
SW2	1	Off	Address Select (0 x 620)
	2	Off	Address Select (0 x 620)
	3	Off	Address Select (0 x 620)
	4	Off	Address Select (0 x 620)
	5	Off	Address Select (0 x 620)
	6	On	Address Select (0 x 620)
	7	On	Address Select (0 x 620)
	8	Off	Address Select (0 x 620)
SW3	1	Off	Address Select (0 x 620)
	2*	Off	Address Select (0 x 620)
	3*	On	Address Select (0 x 620)
	4	Off	Address Select (0 x 620)
	5	Off	Address Select (0 x 620)
	6	Off	16-bit Address
	7	Off	One Stop Bit
	8	On	One Stop Bit
SW4	1	Off	Odd Parity
	2	Off	No Parity
	3	On	8-bit Characters
	4	On	8-bit Characters
	5	On	9600 Baud
	6	On	9600 Baud
	7	On	9600 Baud
	8	Off	9600 Baud
SW5	1	Off	Interrupt Level 4
	2	Off	Interrupt Level 4
	3	Off	Interrupt Level 4
	4	Off	Interrupt Level 4
	5	On	Interrupt Level 4
	6	Off	Interrupt Level 4
	7	Off	Interrupt Level 4
	8	Off	Interrupt Level 4

*For mti1, Dip SW3, Switch-2, On, and Switch-3, Off
For mti2, Dip SW3, Switch-2, On, and Switch-3, On

Systech MTI-850/1650 Controller

Asynchronous Line Multiplexer 1 (ALM-1)

Sun-2/120/130/160/170 & Sun-3/150/160
Sun-3/180/260/280/460/470/480
Sun-4/260/280
370-1099

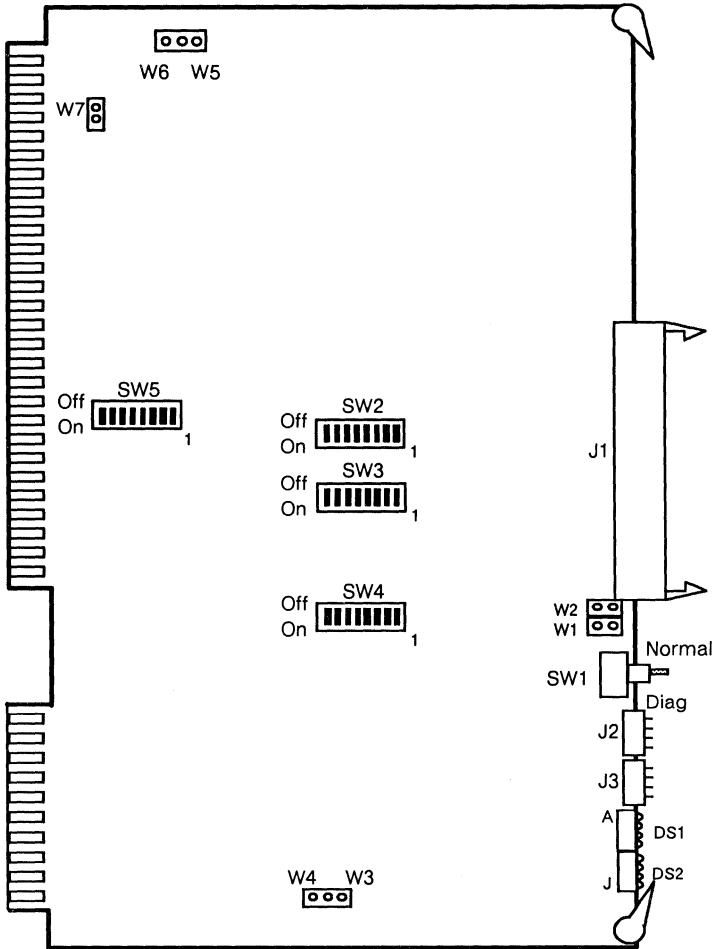

370-1099 Switch Settings

mti0 Defaults

DIP	SWITCH	SETTING	DESCRIPTION
SW2	1	Off	Address Select (0 x 620)
	2	Off	Address Select (0 x 620)
	3	Off	Address Select (0 x 620)
	4	Off	Address Select (0 x 620)
	5	Off	Address Select (0 x 620)
	6	On	Address Select (0 x 620)
	7	On	Address Select (0 x 620)
	8	Off	Address Select (0 x 620)
SW3	1	Off	Address Select (0 x 620)
	2*	Off	Address Select (0 x 620)
	3*	On	Address Select (0 x 620)
	4	Off	Address Select (0 x 620)
	5	Off	Address Select (0 x 620)
	6	Off	16-bit Address
	7	Off	One Stop Bit
	8	On	One Stop Bit
SW4	1	Off	Odd Parity
	2	Off	No Parity
	3	On	8-bit Characters
	4	On	8-bit Characters
	5	On	9600 Baud
	6	On	9600 Baud
	7	On	9600 Baud
	8	Off	9600 Baud
SW5	1	Off	Interrupt level 0
	2	Off	Interrupt level 1
	3	Off	Interrupt level 2
	4	Off	Interrupt level 3
	5	On	Interrupt level 4
	6	Off	Interrupt level 5
	7	Off	Interrupt level 6
	8	Off	Interrupt level 7

* For mti1, Dip SW3, Switch-2, On and Switch-3, Off
 For mti2, Dip SW3, Switch-2, On, and Switch-3, On

370-1099

Switch Settings – Continued

SHUNTS	SETTINGS	DESCRIPTION
W1	Out	+12Vdc routing to data cable disabled
W2	Out	-12Vdc routing to data cable disabled
W3	In	Normal transfer acknowledge delay
W4	Out	Extra 100 nsec delay during transfer acknowledge
W5	Out	Byte swap enable
W6	In	Byte swap disable
W7	In	Enable BPRO

References

1. *Sun-3/180 16-Channel Asynchronous Line Multiplexer Configuration Procedures*, 813-2008
2. *Asynchronous Line Multiplexer Configuration Procedures*, 813-2003.

VMEbus to Multibus Adapter with Systech MTI-1600

Sun-2/130/160 & Sun-3/150/160/260/460/470

Sun-4/260/360

501-1157-01

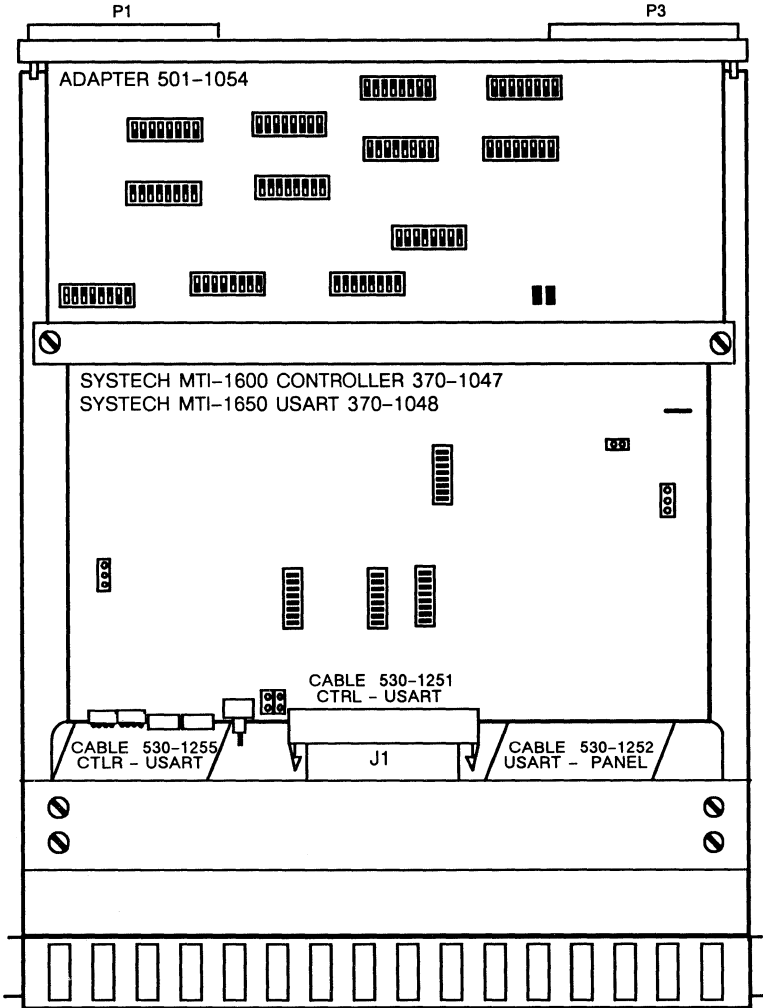

VMEbus to Multibus Adapter with Systech MTI-1650

Sun-2/130/160 & Sun-3/150/160/260/460/470

Sun-4/260/360

501-1157-02

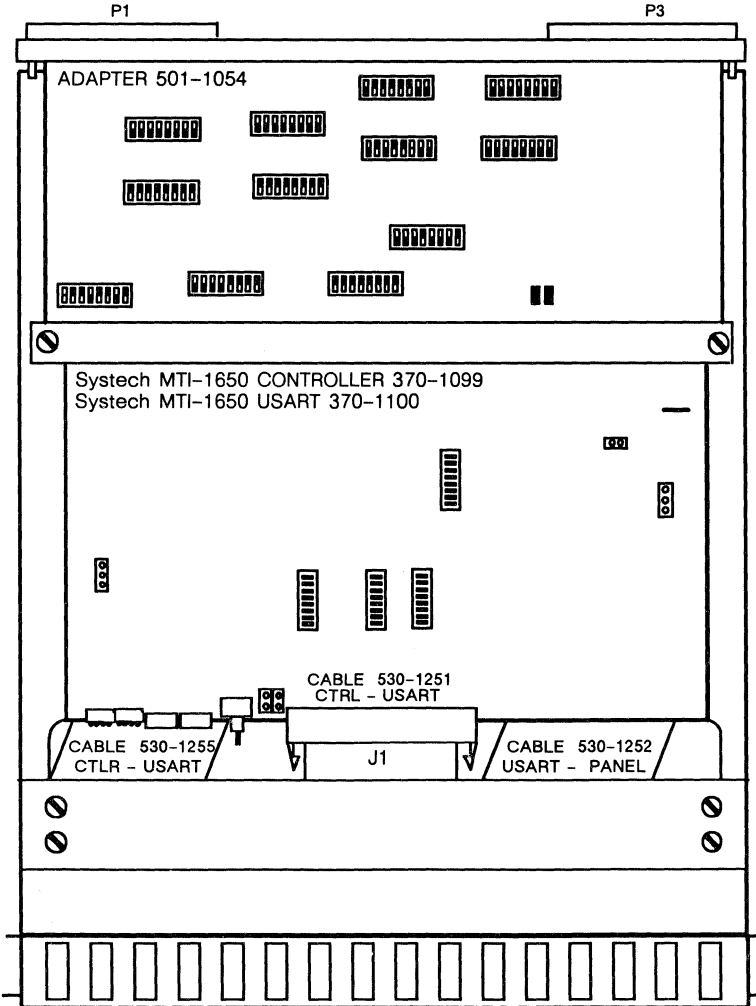

VMEbus to Multibus Adapter with Systech MTI-1650A

Sun-3/160/180/260/280/460/470/480

Sun-4/260/280/360/380

501-1165

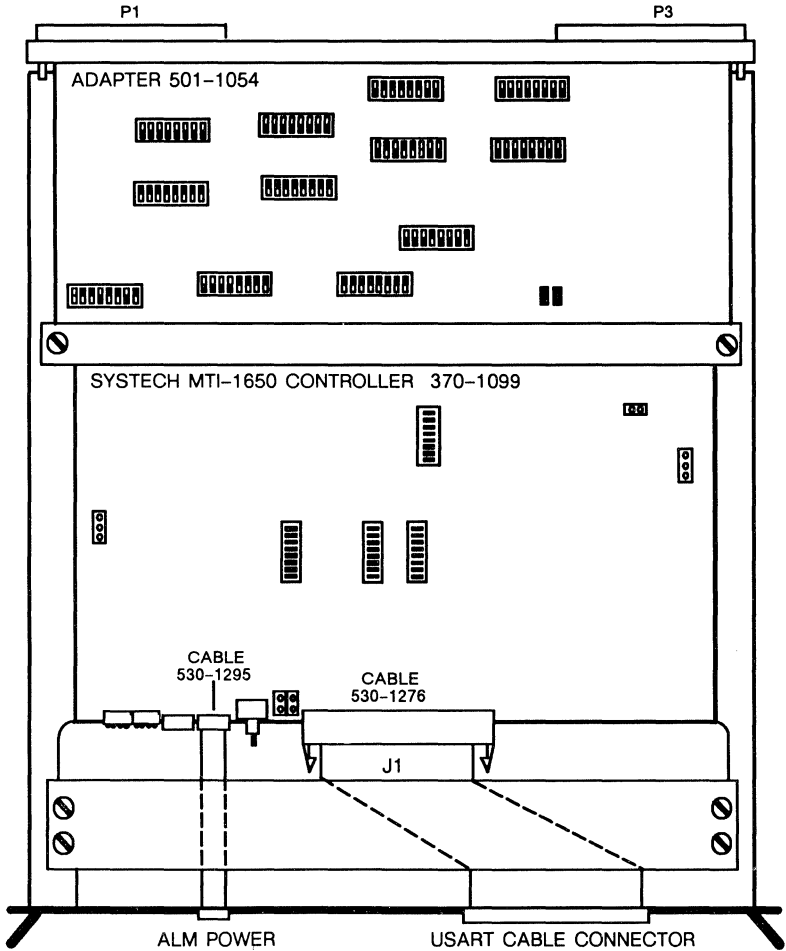

VMEbus to Multibus Adapter with Systech MTI-1650A

501-1157 501-1165

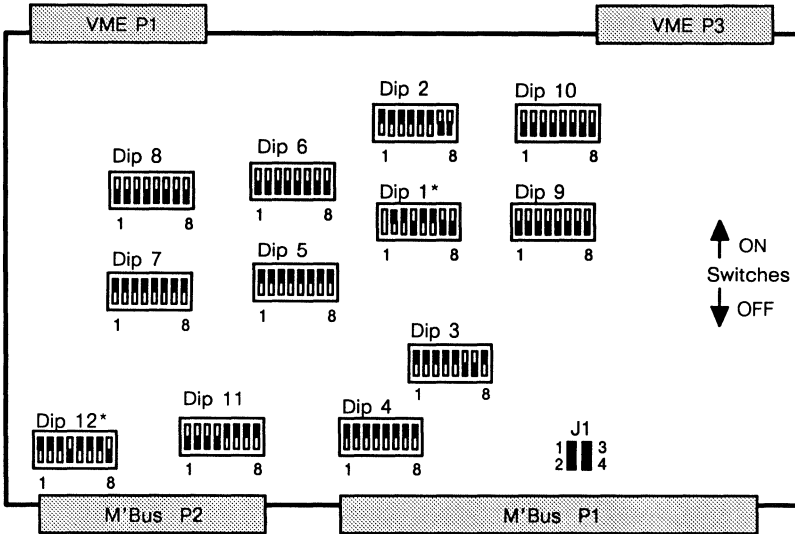

VME TO MULTIBUS ADAPTER BOARD SWITCH SETTINGS									
SWITCH	1	2	3	4	5	6	7	8	DESCRIPTION
U1*	N/C	ON	ON	OFF	ON	ON	OFF	OFF	I-O Address
U2	N/C	ON	ON	ON	ON	ON	OFF	OFF	I-O Space = 2
U3	ON	ON	ON	ON	ON	OFF	OFF	ON	I-O Address = 0xEE
U4	ON	ON	ON	ON	ON	OFF	OFF	ON	VME I-O Space
U5	ON	ON	ON	ON	ON	ON	ON	ON	24-Bit Memory Address Space
U6	OFF	OFF	OFF	OFF	OFF	OFF	OFF	OFF	24-Bit Memory Block Size
U7	ON	ON	ON	ON	ON	ON	ON	ON	24-Bit Memory Address Space
U8	OFF	OFF	OFF	OFF	OFF	OFF	OFF	OFF	24-Bit Memory Block Size
U9	OFF	OFF	OFF	OFF	OFF	OFF	OFF	OFF	No connection
U10	OFF	OFF	OFF	OFF	OFF	OFF	OFF	OFF	No connection
U11	OFF	OFF	OFF	OFF	ON	ON	ON	ON	Sets Address Bits A23 Thru A20
U12*	ON	ON	ON	OFF	ON	ON	ON	OFF	Interrupt Vector
J1	PINS 1-2			IN					If BCLK is desired
	PINS 3-4			IN					If CCLK is desired

* For mti1 (second board): U1, 2,4,5,& 6 are ON; U12, 2,3,5,6 & 7 are ON.
 For mti2 (third board): U1, 2,5, & 6 are ON; U12 1,3,5,6, & 7 are ON.

Power: 7.1 Amps @ +5Vdc
 0.6 Amps @ +12Vdc
 0.4 Amps @ -12Vdc
 47.5 Watts

This page intentionally left blank.

MAPKIT

Sun-2/130/160

Sun-3/110/140/150/160/180/260/280/460/470/480

Sun-4/260/280/390

501-1202*

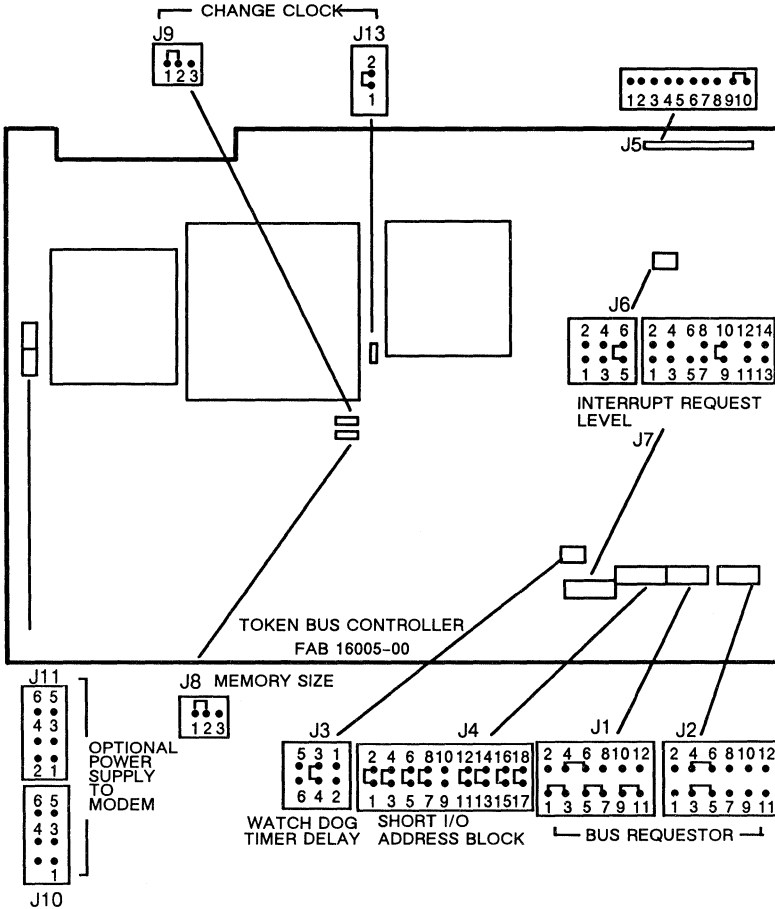

*Sun supplies the adapter board, 501-1202, required for MAPKIT installation. The INI Token Bus Controller and Modem boards are not supplied by Sun.

Note: Install the INI Token Bus Controller in the left slot of the adapter board. Install the INI Token Bus Modem in the right slot of the adapter board.

501-1202 Jumper Settings

JUMPER	PINS	VALUE	DESCRIPTION
J1	1-3 4-6 5-7 9-11	3	Bus request level
J2	3-5 4-6	3	Bus request level
J3	3-4	16 sec	Watchdog timer
J4	1-2 3-4 5-6 7-8 11-12 13-14	0X900	Short I/O address
J5	9-10	Bus Boot	Boot configuration
J6	5-6	3	VME host interrupt
J7	9-10	3	VME host interrupt
J8	1-2	512K	Memory size
J9	2-1	Normal	Clock parameters
J13	1-2	Normal	Clock parameters

Power: 4.9 Amps @ +5Vdc
 0.3 Amps @ +12Vdc
 0.1 Amps @ -12Vdc
 29.3 Watts

Reference
Sun MAPkit Board Configuration Procedures, 813-2029.

Asynchronous Line Multiplexor-2 (ALM-2)

Sun-3/110/140/150/160/180/260/280/460/470/480

Sun-4/110/150/260/280/310/330/350/360/370/380

Sun-4/390/470/490

501-1203

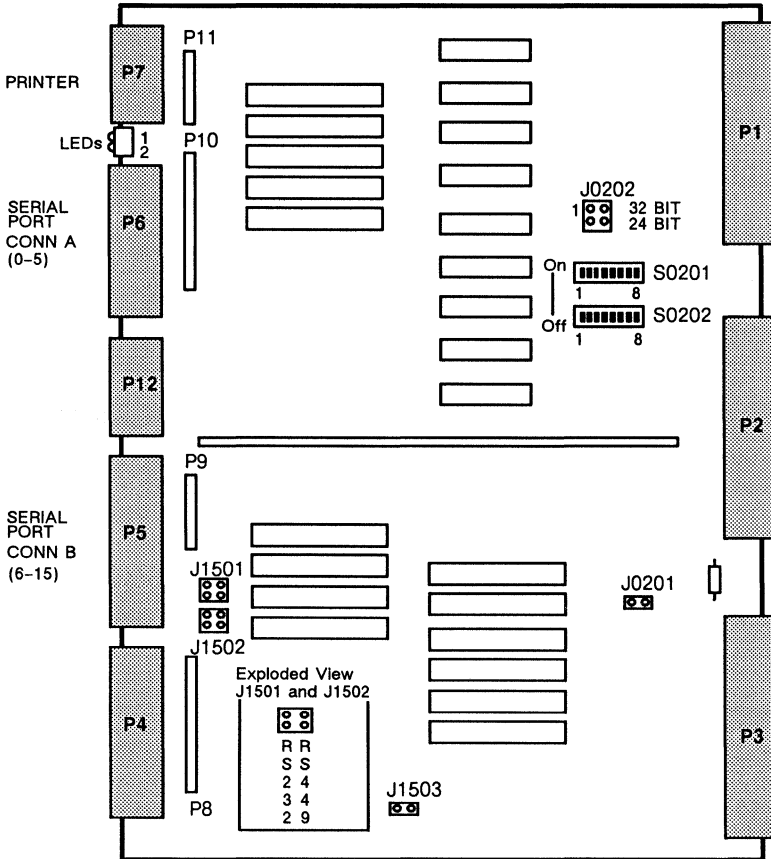

Power: 7.0 Amps @ +5Vdc
 0.2 Amps @ -5Vdc
 36.0Watts

Note: An addressing conflict can occur between the ALM-2 and the MCP and ALM-1. Refer to the VME Installation Notes in the Backplane Section.

501-1203

Jumper & Switch Settings

JUMPER	PINS	SETTING	DESCRIPTION
J0201	1-2	In	Test jumper for oscillator
J0202	32 Bit 24 Bit	In Out	VME address bus size
J1501	RS-232 RS-449	In Out	Enables RS-232 for ALM-2 Not used for ALM-2
J1502	RS-232 RS-449	In Out	Enables RS-232 for ALM-2 Not used for ALM-2
J1503	1-2	In	Test jumper for oscillator

DIP SWITCH	SWITCH	SETTING	ADDRESS BIT	DESCRIPTION
S0201	3-8	On	A18-A23	mcp0-mcp7
S0202	3-8	On	A26-A31	mcp0-mcp7
S0202	1	Off	A24	mcp0-mcp3
S0202	2	On	A25	mcp0-mcp3
S0202	1	On	A24	mcp4-mcp7
S0202	2	Off	A25	mcp4-mcp7
S0201	1	On	A16	mcp0(0x01000000) & mcp4 (0x02000000)
S0201	2	On	A17	mcp0(0x01000000) & mcp4 (0x02000000)
S0201	1	Off	A16	mcp1(0x01010000) & mcp5 (0x02010000)
S0201	2	On	A17	mcp1(0x01010000) & mcp5 (0x02010000)
S0201	1	On	A16	mcp2(0x01020000) & mcp6 (0x02020000)
S0201	2	Off	A17	mcp2(0x01020000) & mcp6 (0x02020000)
S0201	1	Off	A16	mcp3(0x01030000) & mcp7 (0x02030000)
S0201	2	Off	A17	mcp3(0x01030000) & mcp7 (0x02030000)

Notes

1. The Sun-3/110 and Sun 3004 CPU must be 501-1134-06, 501-1163-09, 501-1164-09, or greater. All 501-1208 and 501-1209 revisions are useable.
2. When four or more ALM-2 boards are installed in a system, the part number must be \geq 501-1203-05 because of the mechanical fit of the data cables.

Reference

16-Channel Asynchronous Line Multiplexor-2 Configuration Procedures, 813-2042.

Multiprotocol Communication Processor (MCP)

Sun-3/110/140/150/160/180/260/280/460/470/480

Sun-4/110/150/260/280/310/330/350/360/370/380

Sun-4/390/470/490

501-1221

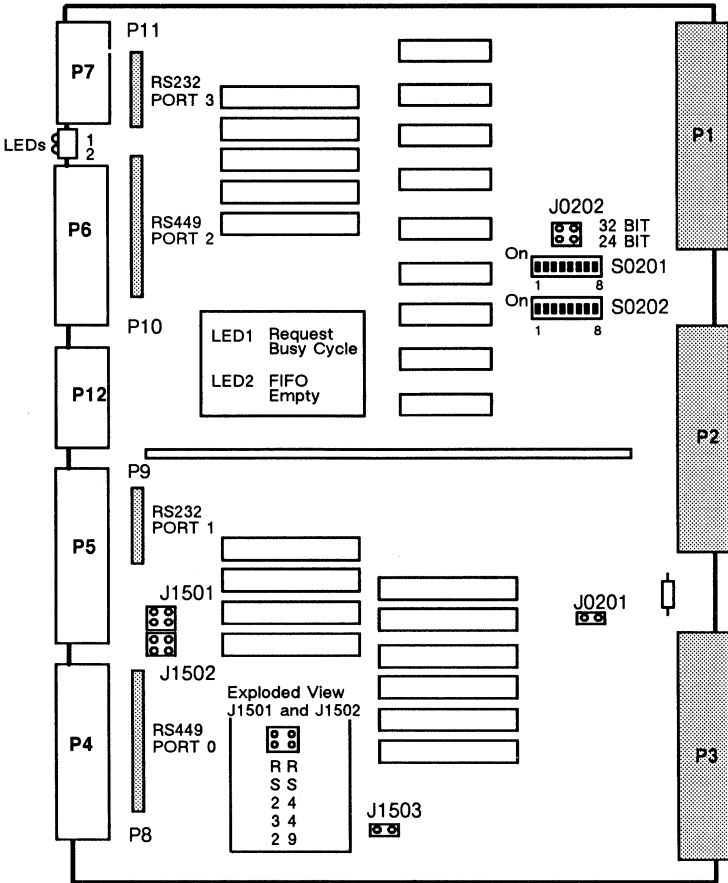

Power: 7.3 Amps @ +5Vdc
 0.1 Amps @ -5Vdc
 37.0 Watts

Note: An addressing conflict can occur between the MCP and the ALM-1 and ALM-2. Refer to the VME Installation Notes in the Backplane Section.

501-1221

Jumper & Switch Settings

JUMPER	PINS	SETTING	DESCRIPTION
J0201	1-2	In	Test jumper for oscillator
J0202	32 Bit 24 Bit	In Out	VME address bus size
J1501	RS-232 RS-449	Out In	Enables RS-449 for MCP
J1502	RS-232 RS-449	Out In	Enables RS-449 for MCP
J1503	1-2	In	Test jumper for oscillator

Address Select Switches

DIP SWITCH	SWITCH	SETTING	DESCRIPTION
S0202	1 2-8	Off On	VME address A24-A31
S0201 S0201	1 2	On On	Board 0 VME address A16-A17 (0x1000000)
S0201 S0201	1 2	Off On	Board 1 VME address A16-A17 (0x1010000)
S0201 S0201	1 2	On Off	Board 2 VME address A16-A17 (0x1020000)
S0201 S0201	1 2	Off Off	Board 3 VME address A16-A17 (0x1030000)
S0201	3-8	On	VME address A18-A23

Note: The Sun-3/110 and Sun 3004 CPU must be 501-1134-06, 501-1163-09, 501-1164-09, or greater. All 501-1208 and 501-1209 revisions are usable.

Reference

SunLink Multiprotocol Communication Processor Configuration Procedures, 813-2032.

SunLink Channel Adapter

Sun-3/150/160/180/260/280/460/470/480
 Sun-4/260/280/350/360/370/380/390/470/470
 370-1128 501-1460

IBD Board

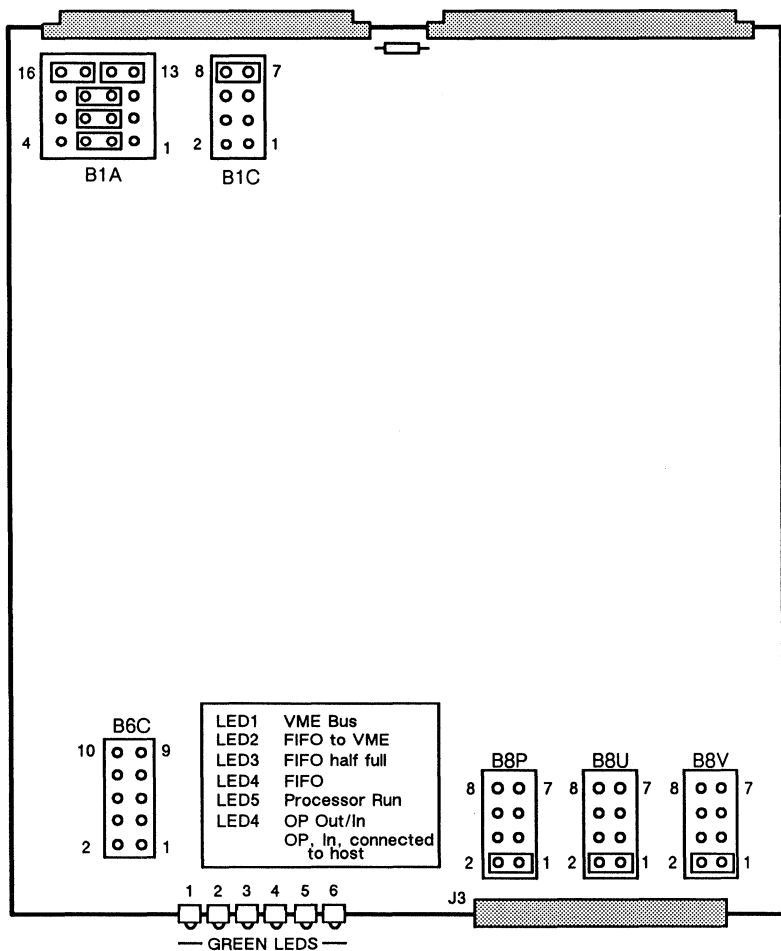

Note: The jumpers on this board are not accessible or visible without disassembling the board set. Do not disassemble the set.

370-1128 501-1460 Jumper Settings

JUMPER	PINS	SETTINGS	DESCRIPTION
B1C	7-8 Others	In Out	VME bus request level BR gives level 3
B1A	2-3 6-7 10-11 13-14 15-16	In In In In In	Bus grant In/Out BG0/BG3 gives level 3
B6C	All	Out	VME bus data transfer timeout
B8P	1-2 3-4 5-6 7-8	In Out Out Out	Local processor external bus page selection BS gives page 0
B8U	1-2 3-4 5-6 7-8	In Out Out Out	Interrupt acknowledge page selection IACK gives page 0
B8V	1-2 3-4 5-6 7-8	In Out Out Out	Interrupt request page selection IREQ gives page 0 and must be the same as IACK

SunLink Channel Adapter

370-1128 501-1460

CIO Board

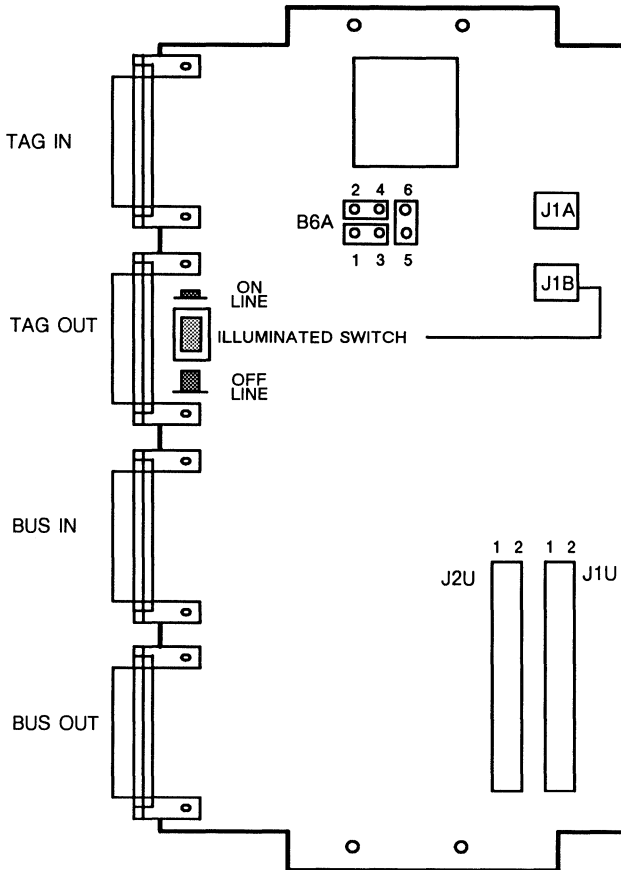

Note: The jumpers on this board are not accessible or visible without disassembling the board set. Upon request, remove the cable retainer bars to change the select signal jumpers.

370-1128 501-1460 Jumper Settings

JUMPER	PINS	SETTINGS	DESCRIPTION
B6A	1-3 2-4 5-6	<p style="text-align: center;"> 2 4 6 1 3 5 </p>	Channel to mainframe priority select Out/In (gives Select-Out) Factory setting
B6A	1-2 3-5 4-6	<p style="text-align: center;"> 2 4 6 1 3 5 </p>	Channel to mainframe priority select (gives Select-In)

SunLink Channel Adapter

370-1128 501-1460

LCP Board

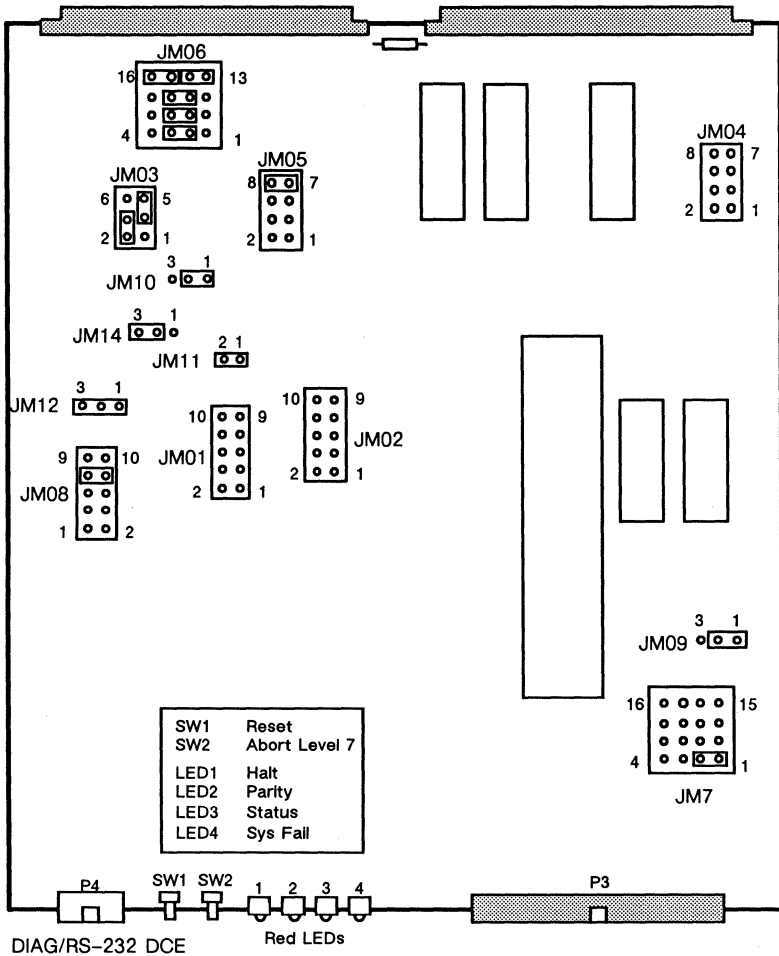

Note: Assemblies 370-1128 and 501-1460 are three board sets: the LCP, IBD, and CIO. Do not disassemble the board set.

370-1128 501-1460 Jumper Settings

JUMPER	PINS	SETTING	DESCRIPTION
JM01	1-2 3-4 5-6 7-8 9-10	Out Out Out Out Out	VME data transfer bus timeout (gives 67.1 sec.)
JM02	1-2 3-4 5-6 7-8 9-10	Out Out Out Out Out	Local data transfer timeout (gives 107.4 sec.)
JM03	2-4 3-5 Others	In In Out	SYSRESET In-Enabled SYSTRESET Out-Disabled
JM04	1-2* 3-4 5-6 7-8	Out* Out Out Out	1-2, Out, for 1st board (chat0) 1-2, In, for 2nd board (chat1)
JM05	1-2 3-4 5-6 7-8	Out Out Out In	Bus request level 0 Bus request level 1 Bus request level 2 Bus request level 3
JM06	2-3 6-7 10-11 13-14 15-16 Others	In In In In In Out	VME bus grant In/Out (gives level 3)
JM07	1-2 Others	In Out	Local PROM DRACK delay (gives 100ns)

370-1128 501-1460
Jumper Settings – Continued

JUMPER	PINS	SETTING	DESCRIPTION
JM08	1-2 3-4 5-6 7-8 9-10	Out Out Out In Out	Unclaimed grant timeout (gives 262ms)
JM09	1-2 2-3	In Out	EPROM size (uses 27128 EPROMs)
JM10	1-2 2-3	In Out	VME bus release option (Release when done)
JM11	1-2	Out	System controller function (gives Disabled)
JM12	1-2	Out	Arbitration style priority (gives Don't Care)
JM14	1-2 2-3	Out In	Minimum address strobe hold time (gives 60ns)

Channel Adapter Parts

DESCRIPTION	OBSOLETE#	CURRENT#
Loopback Test Plug Set	370-1134-02	370-1134-03
Bus Terminator Plug	370-1135-01	370-1135-02
Tag Terminator Plug	370-1136-01	370-1136-02
8 ft Cable, Bus Out/Tag Out	370-1130-03	370-1130-04
8 ft Cable, Bus In/Tag In	370-1129-03	370-1129-04
5 ft Cable, Bus Out/Tag Out	370-1131	None
5 ft Cable, Bus In/Tag In	370-1132	None
RS232 Cable (20 ft)	None	530-1364
SunLink Channel Adapter Bd.	370-1128	501-1460

Do NOT use the cables or loopback connector listed below.

Cables

370-1129-01,-02,-03
370-1130-01,-02,-03
370-1131-01,-02
370-1132-01,-02

Loopback Connector

370-1134-01 and -02

Power: 8.6 Amps @ +5Vdc
43.0 Watts

Notes

1. The Sun-3/110 and Sun 3004 CPU must be 501-1134-06, 501-1163-09, 501-1164-09, or greater. All 501-1208 and 501-1209 revisions are usable.
2. In Sun-3/2XX systems with multiple SCA boards, the CPU must be 501-1100-08, 501-1206-06, or greater.
3. The SunLink Channel Adapter must be \geq 501-1460-02 for use with the Sun 3400 CPU.
4. The Sun FDDI Board must be \geq 501-1276-02 for use with the SunLink Channel Adapter.
5. SunLink Release 7.0 Channel Gateway is required for use with the Sun 3400 CPU.
6. The Sun 3400 CPU must be \geq 501-1550-10 for use with the SunLink Channel Adapter.
7. The Sun 4200 CPU, 501-1274 must be \geq 501-1274-13 for use with the SunLink Channel Adapter.

Reference

SunLink Channel Adapter Configuration Procedures, 813-2040.

High-speed Serial Interface (HSI)

Sun-3/110/140/150/180/260/280/460/470/480

Sun-4/110/150/260/280/330/350/390/470/490

501-1338

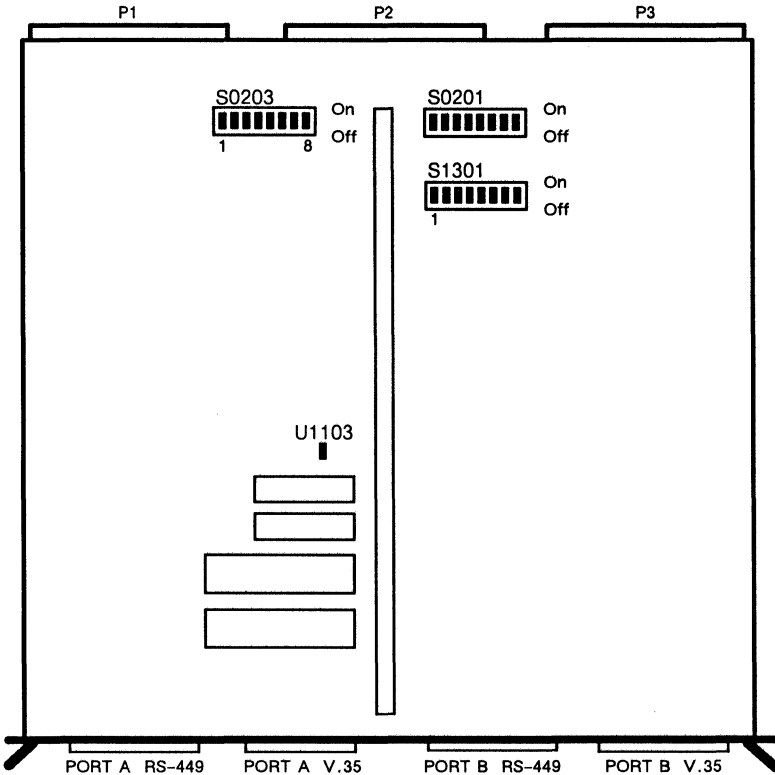

Power: 5.3 Amps @ +5Vdc
 0.3 Amps @ -5Vdc
 28.1 Watts

Notes

1. SCSI-3 Host Adapter must be ≥501-1120-07, ≥501-1170-07, ≥501-1217-04, or ≥501-1236-03.
2. Sun-3/110 CPU must be ≥501-1134-06.
3. Sun-3/140/150/160/180 CPU must be ≥501-1074-22, ≥501-1094-22, ≥501-1163-09, ≥501-1164-09, or any revision of 501-1208.
4. The HSI board requires SunOS 4.0 or greater.

Reference

SunLink High-speed Serial Interface Board Installation/Service Manual, 813-1046-10.

501–1338

Switch & Jumper Settings

DIP SWITCH	SWITCH	SETTING	DESCRIPTION
SW020*	1	Off	Base address select A24
	2	On	Base address select A25
	3	On	Base address select A26
	4	On	Base address select A27
	5	On	Base address select A28
	6	On	Base address select A29
	7	On	Base address select A30
	8	On	Base address select A31
SW0203*	1	On	Base address select A16
	2	On	Base address select A17
	3	On	Base address select A18
	4	On	Base address select A19
	5	On	Base address select A20
	6	Off	Base address select A21 [†]
	7	On	Base address select A22 [†]
	8	On	Base address select A23
SW1301	1	On	Interrupt level 1
	2	On	Interrupt level 2
	3	Off	Interrupt level 3
	4	On	Interrupt level 4
	5	On	Interrupt level 5
	6	On	Interrupt level 6
	7	On	Interrupt level 7
	8	On	Not used

* The first HSI address is 0x01200000.

* The second HSI address is 0x01400000.

† SW-6 is On and SW-7 is Off for a second HSI.

Jumper U1103

PINS	SETTING	DESCRIPTION
1-2	In	Clock enable

Fiberoptic Ethernet Controller

Fibercom 027-100G6

Sun-3/160T

370-8012-01 370-8012-02

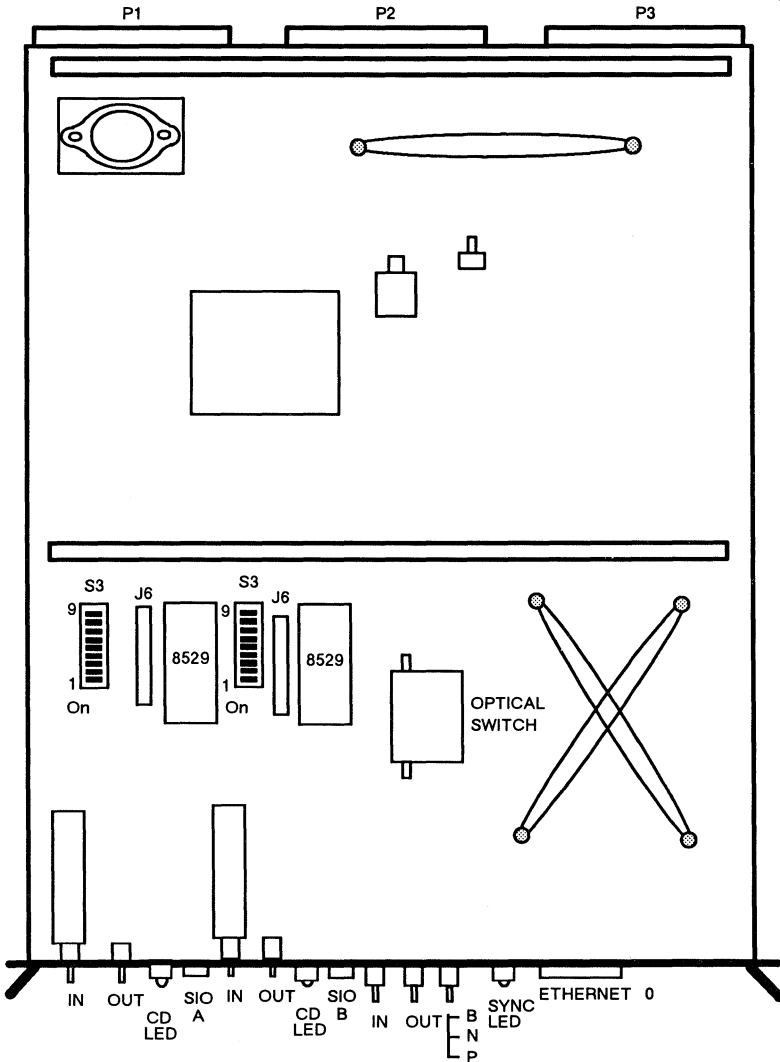

Reference

Fiber Optic Ethernet Transceiver Installation Guide for the Sun-3/160T Workstation, 800-8006.

370-8012 Switch Settings

Dip Switch 3

RTS Setting

DIP SWITCH	SETTING	DESCRIPTION
1	On* Off	RTS continuous RTS switched

Transmit Carrier Control

DIP SWITCH	SETTING	DESCRIPTION
2 3	Off* Off*	Continuous carrier
2 3	On On	Switched by RTS & DTR
2 3	Off Off	Switched by DTR
2 3	Off On	Switched by RTS

Clear To Send Delay

DIP SWITCH	SETTING	DESCRIPTION
4 5	Off* Off*	0 msec
4 5	Off On	8 msec
4 5	On Off	50 msec
4 5	On On	150 msec

* Factory Setting

370-8012 Switch Settings

Transmit Timing Source

DIP	SETTING	DESCRIPTION
6	On*	Async
7	Off*	
8	Off*	
9	Off*	
6	On	External
7	Off	
8	Off	
9	On	
6	Off	Received
7	Off	
8	Off	
9	Off	
6	Off	300 Hz
7	Off	
8	Off	
9	Off	
6	Off	600 Hz
7	On	
8	Off	
9	Off	

DIP	SETTING	DESCRIPTION
6	Off	1200 Hz
7	Off	
8	On	
9	Off	
6	Off	2400 Hz
7	Off	
8	On	
9	On	
6	Off	4800 Hz
7	On	
8	Off	
9	Off	
6	Off	9600 Hz
7	On	
8	Off	
9	On	
6	Off	19200 Hz
7	On	
8	On	
9	Off	

* Factory Setting

Fiberoptic Ethernet Controller

Fibercom 7501-01

Sun-3/160T

370-8012-03

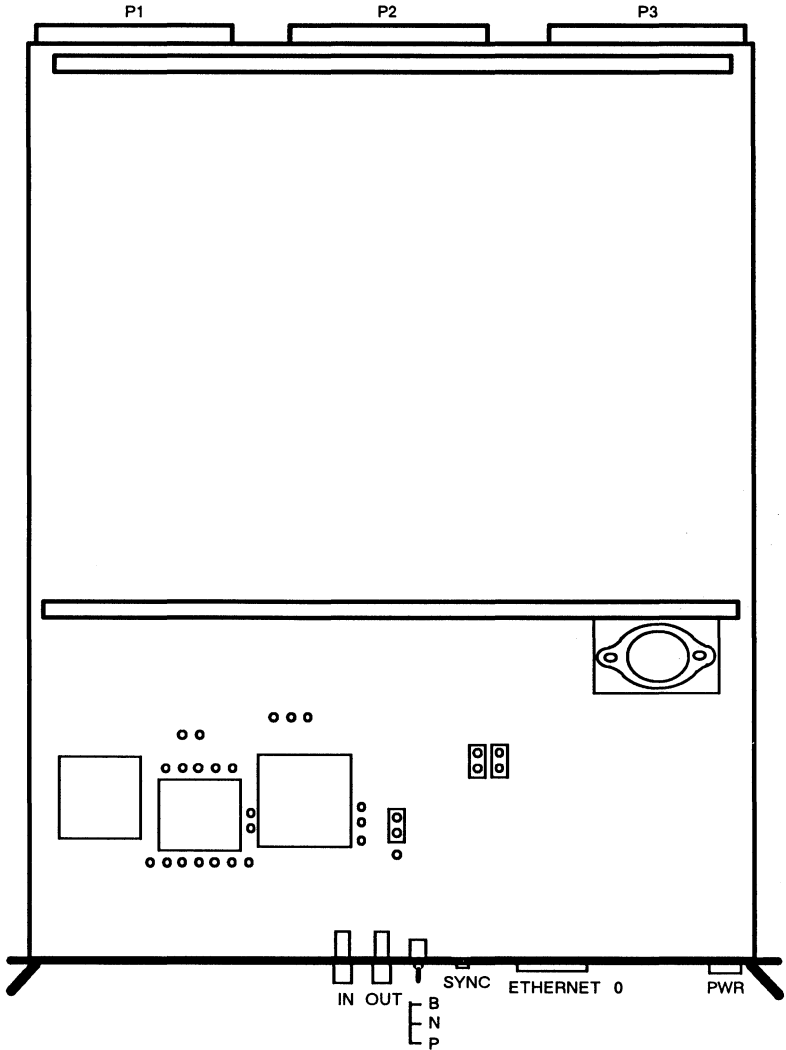

FDDI

Sun-3/150/180/260/280/460/470/480

Sun-4/110/150/260/280/350/390/470/490

501-1276

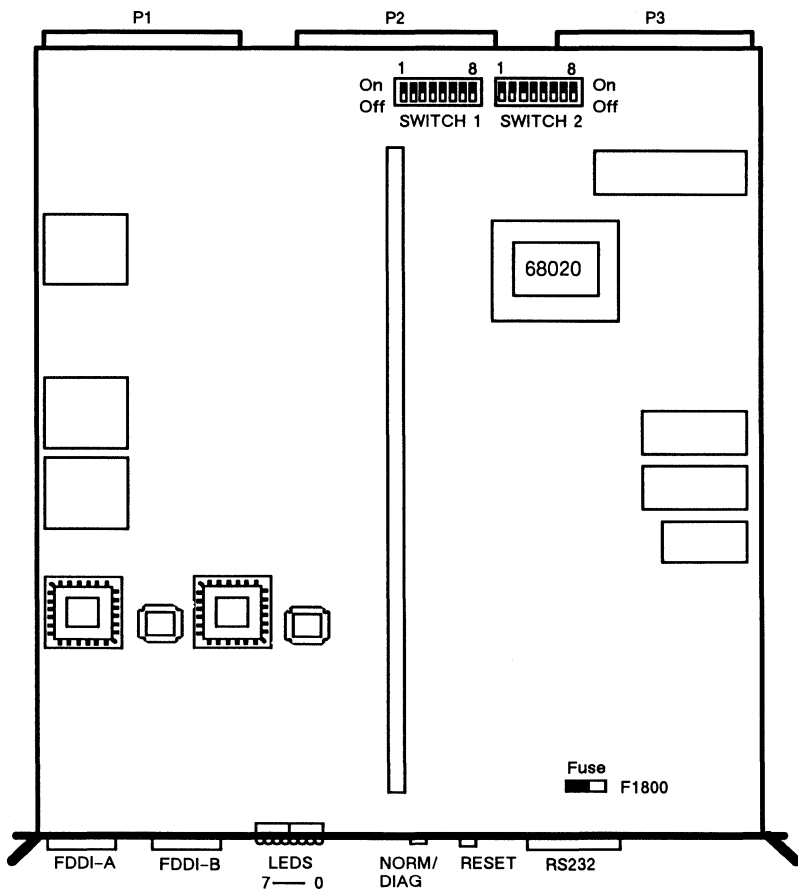

501-1276 Switch Settings

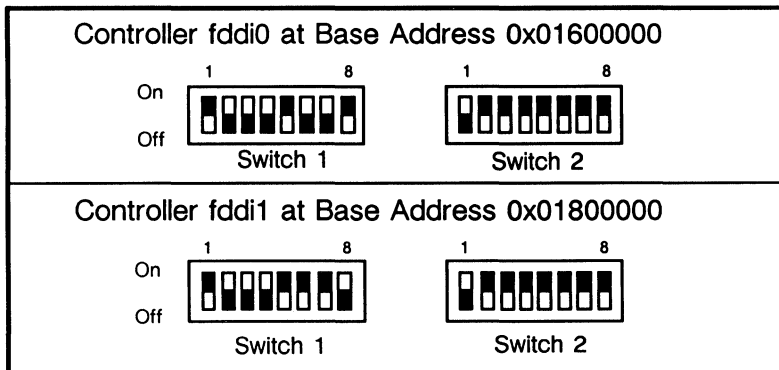

Notes

1. Diskless booting requires CPU EPROM 3.0 or greater.
2. Requires SunOS 4.0.3 or greater.
3. The FDDI uses a 2A subminiature fuse, 150-1174.
4. The Sun 3004 CPU must be 501-1163-09, 501-1164-09 or greater. All 501-1208 revisions are useable.
5. 501-1276-02 or greater is required for use with the SunLink Channel Adapter board.
6. The Sun-4/330 requires Power Supply 300-1072.
7. Set the FDDI controller Switch 1, Dip 1, to ON if the DMA uses 32-bit addresses. All Sun systems use 32-bit DMA.
8. Set the FDDI controller Switch 1, Dip 1, to OFF if the DMA uses 24-bit addresses.
9. Remove the BG3 and IACK jumpers from the backplane.

Reference

SunLight FDDI Dual-Attach Controller Card Configuration and Installation Manual, 813-1053.

Etherlink I

3COM 3C501

370-1111

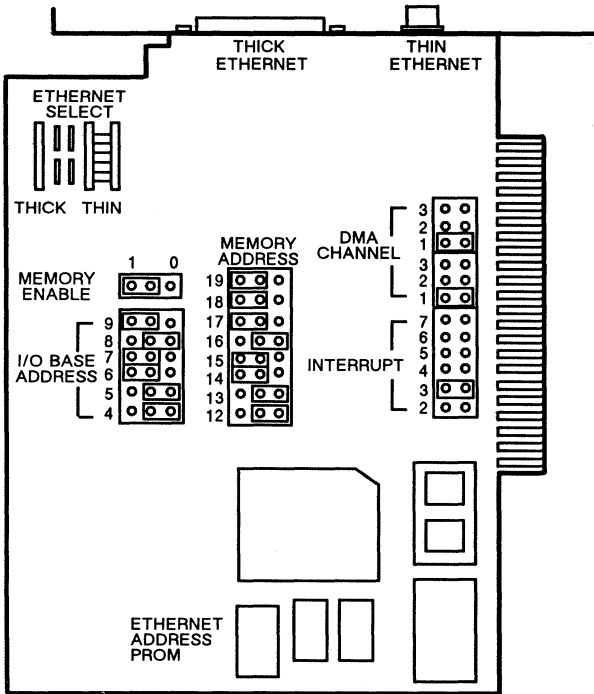

JUMPER	SETTING	DESCRIPTION
Memory Enable	1	EtherStart ROM installed
I/O Base Address	4-9	I/O base address (000H-3F0H) Address bits 4-9
Memory Address	12-19	Memory base address (00000H - FF000H) Address bits 12-19
DMA	1-3	DMA channel select
Channel Interrupt	2-7	Interrupt channel

Reference: *Etherlink I Installation Guide*, 814-5000.

Etherlink II

3COM 3C503

370-1180

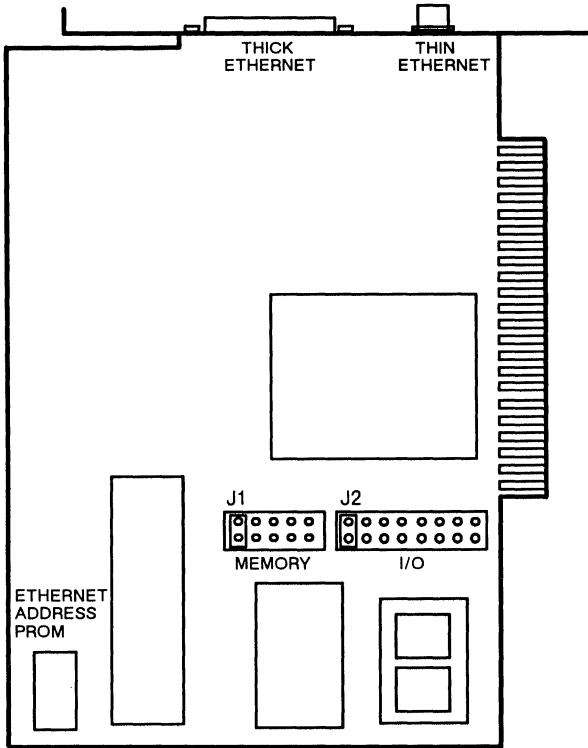

JUMPER	SETTING	DESCRIPTION
J1	DC000H	Memory select/ Base address
	D8000H	
	CC000H	
	C8000H	
J2	300H	I/O base address
	310H	
	330H	
	350H	
	280H	
	2A0H	
	2E0H	

Reference: *Etherlink II Installation Guide*, 814-5005.

Etherlink/MC
 3COM 3C523
 370-1181

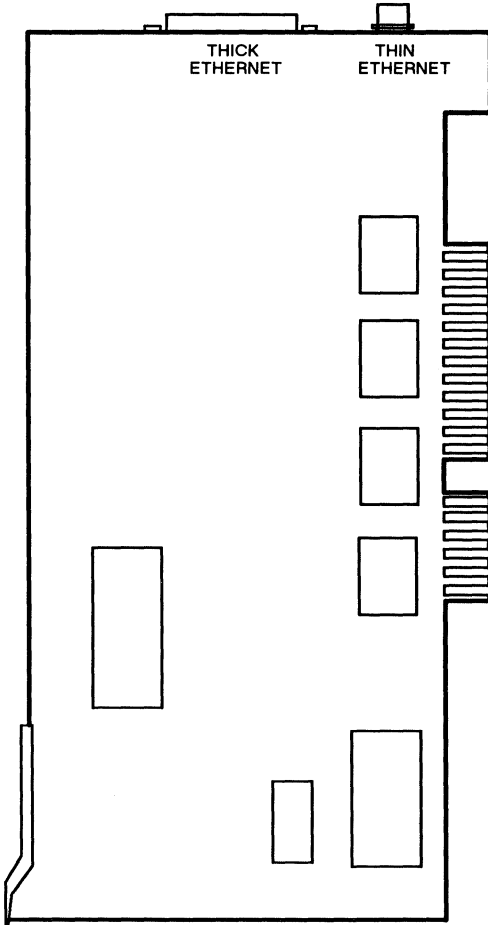

Note: There are NO user selectable switches/jumpers on this board.
 Configuration parameters are set in the software file ETH523SYS.

Reference: *Etherlink/MC Installation Guide*, 814-5006.

Ethernet Controller

Sun-4/40/60/65/75
501-1450

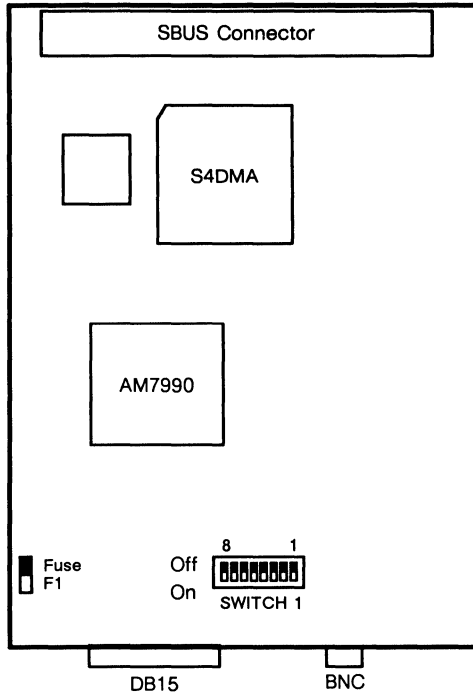

Dip Switch 1

SWITCH	SETTING	DESCRIPTION
1-8	Off	Ethernet
1-8	On	Thin Ethernet

Power: 1.0 Amps @ +5Vdc
5.0 Watts

Note: Fuse F1 is a 2A subminiature fuse, part number 150-1174.

SBus Printer

Sun-4/40/60/65/75
501-1540

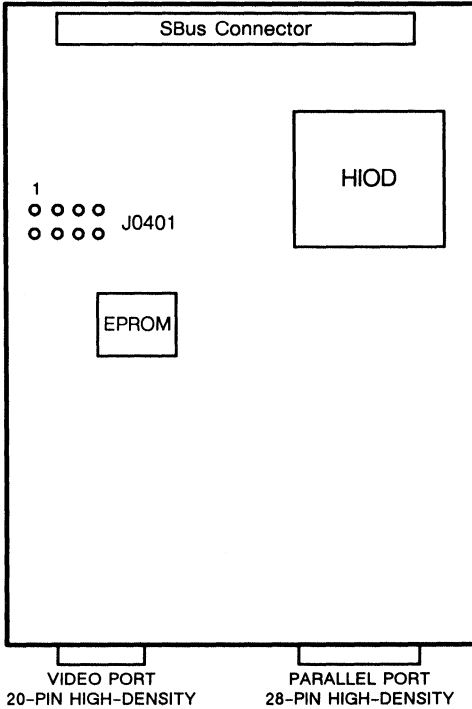

Notes

- 1. The Sun-4/60 CPU requires EPROM 1.3 Version 3.
- 2. All J0401 pins are ground points.

Reference: *SBus Printer Board Installation Guide*, 800-4486.

Serial Parallel Controller

Sun-4/40/60/65/75

501-1511

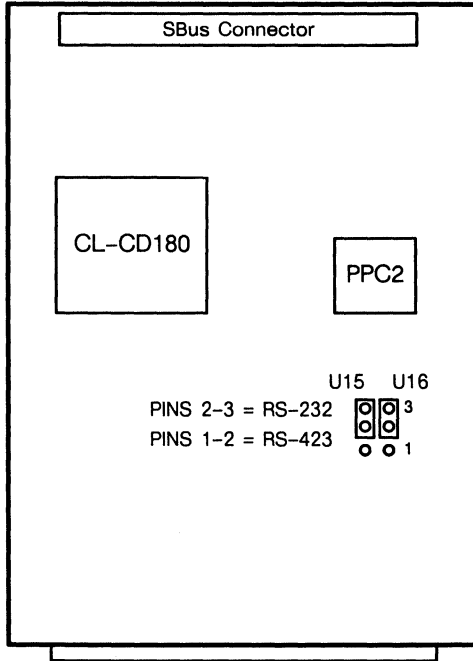

U15 and U16 Jumper Settings

PINS	SETTING	DESCRIPTION
1-2	In	Select RS-423 (5Vdc)
2-3	In	Select RS-232 (12Vdc)

Power: 2.0 Amps @ +5Vdc
10.0 Watts

High Speed Serial Interface

Sun-4/40/60/65/75
501-1725

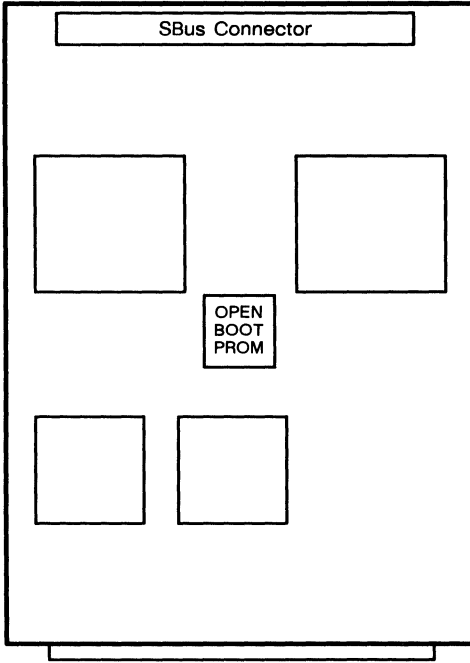

Notes

- 1. The minimum operating system requirement is SunOS 4.1.
- 2. RS-530 and RS-232 signal levels are not compatible. Install an RS-232 to RS-530 or an RS-422 to RS-530 Converter on each port.

Reference

High Speed Interface/SBus (HSI/S) Installation and Administration Guide, 800-5332.

CONFIGURATIONS

SCSI

SCSI

SCSI HOST ADAPTERS

Sun-2 Multibus SCSI	2
Sun-2 SCSI Host Adapter	4
Sun-2 SCSI Host Adapter Assembly	6
Sun-3 SCSI Host Adapter	10
Sun-3 SCSI Host Adapter Assembly	12
Sun-3/E SCSI/Ethernet	14
Sun-4/330 Terminator Board	16
SCSI Adapter Assembly	17
SCSI Host Adapter	18

Sun-2 Multibus SCSI

Sun-2/120/170
501-1006

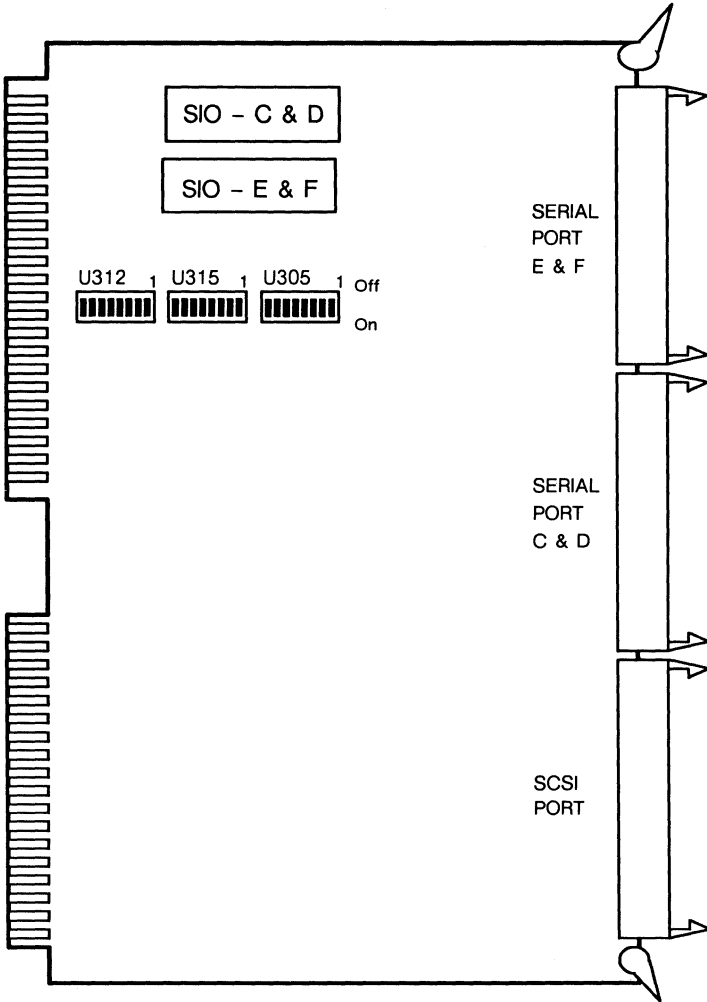

Power: 5.0 Amps @ +5 Vdc
25.0 Watts

501-1006 Switch Settings

DIP SWITCH	SWITCH	SETTING	DESCRIPTION
U305	1-5 6 7-8	Off On Off	Sets base address 80000
U315	1 2 3-8	Off On Off	Selects interrupt level on P1
U312	1-5 6 7-8	Off On Off	Selects interrupt level on P1

Sun-2 SCSI Host Adapter

Sun-2/50/130/160
Sun-3/75/140/150/160/180/260/280
Sun-4/260/280
501-1045

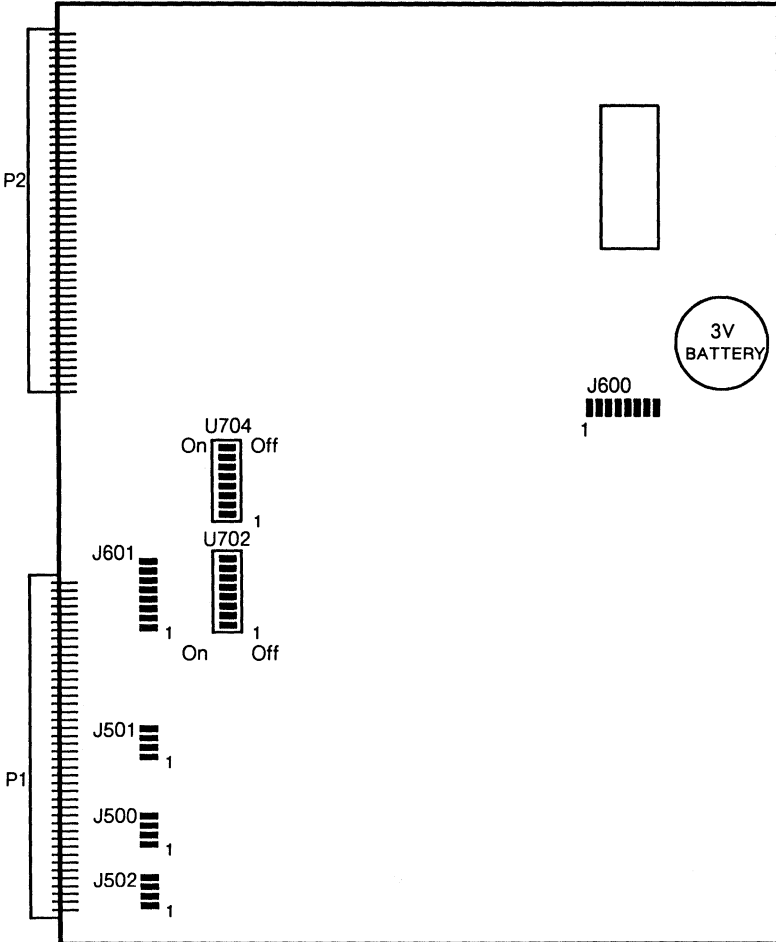

Power: 2.8 Amps @ +5 Vdc
14.0 Watts

501-1045

Jumper & Switch Settings

JUMPER	PINS	SETTING	DESCRIPTION
J500	1-2	Out	P1 Bus Grant 0 in
	3-4	Out	P1 Bus Grant 1 in
	5-6	Out	P1 Bus Grant 2 in
	7-8	In	P1 Bus Grant 3 in
J501	1-2	Out	P1 Bus Request 0
	3-4	Out	P1 Bus Request 1
	5-6	Out	P1 Bus Request 2
	7-8	In	P1 Bus Request 3
J502	1-2	Out	P1 Bus Grant 0 Out
	3-4	Out	P1 Bus Grant 1 Out
	5-6	Out	P1 Bus Grant 2 Out
	7-8	In	P1 Bus Grant 3 Out
J600	1-2	Out	Respond Priority 0
	3-4	Out	Respond Priority 1
	5-6	In	Respond Priority 2
	7-8	Out	Respond Priority 3
	9-10	Out	Respond Priority 4
	11-12	Out	Respond Priority 5
	13-14	Out	Respond Priority 6
	15-16	Out	Respond Priority 7
J601	1-2	Out	P1 Int Req 0
	3-4	Out	P1 Int Req 1
	5-6	In	P1 Int Req 2
	7-8	Out	P1 Int Req 3
	9-10	Out	P1 Int Req 4
	11-12	Out	P1 Int Req 5
	13-14	Out	P1 Int Req 6
	15-16	Out	P1 Int Req 7

DIP SWITCH	SWITCH	SETTING	DESCRIPTION
U702*	1-4	On/Off	Not Connected
	5-8	On	Address A12-A15
U704*	1-5	On	Address A16-A23
	6	Off	
	7-8	On	

*U702 and U704 set the base address to 0x200000 for the first SCSI.

Sun-2 SCSI Host Adapter Assembly

Sun-3/110/140/150/180/280/470/480

Sun-4/280

501-1138

without P2A & P2C

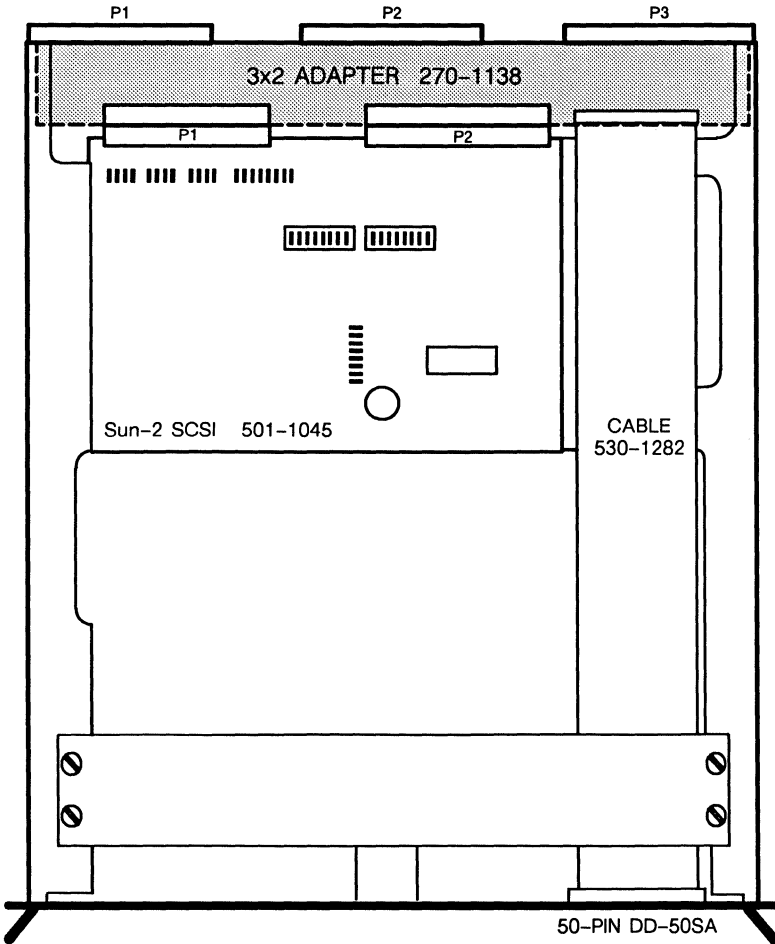

Sun-2 SCSI Host Adapter Assembly

Sun-2/130/160

Sun-3/160/260/460 & Sun-4/260

501-1149

with P2A & P2C

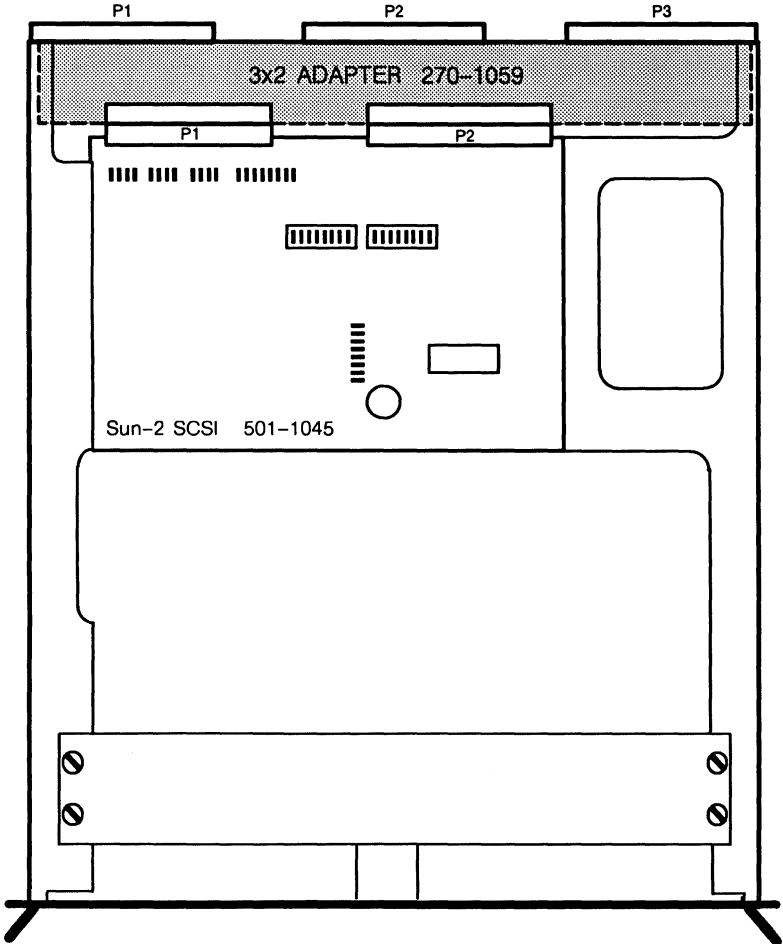

Sun-2 SCSI Host Adapter Assembly

Sun-3/180/280 & Sun-4/280

501-1167

with P2A & P2C

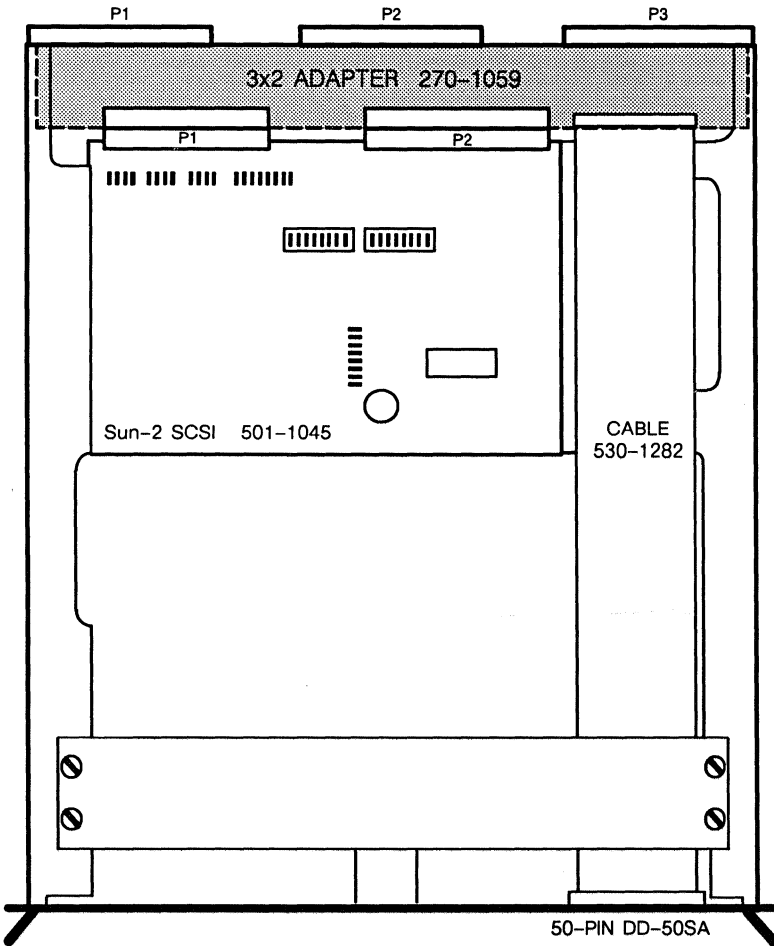

This page intentionally left blank.

Sun-3 SCSI Host Adapter

Sun-3/110/140/150/160/180/260/280/460/470/480

Sun-4/260/280/330/370/380/390/490

501-1236

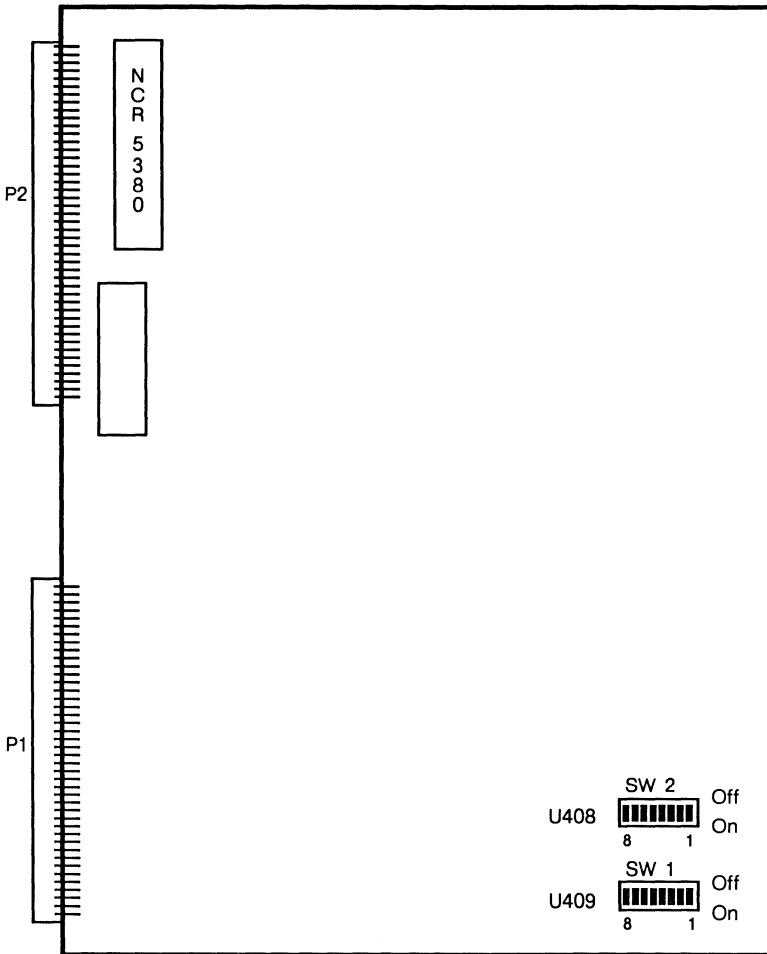

Power: 4.8 Amps @ +5 Vdc
24.0 Watts

501-1236 Switch Settings

DIP SWITCH	SWITCH	SETTING	DESCRIPTION
SW1 * U409	1	On	Address A23
	2	On	A22
	3	Off	A21
	4	On	A20
	5	On	A19
	6	On	A18
	7	On	A17
	8	On	A16
SW2 * U408	1	On	Address A15
	2	On †	A14
	3	On	A13
	4	On	A12
	5	On	A11
	6	On/Off	Not connected
	7	On/Off	Not connected
	8	On/Off	Not connected

* SW1 and SW2 set the address to 0X200000 for the first SCSI.

† SW2, Switch 2, OFF, sets the address to 0x204000 for the second SCSI.

1. Do not use the original release of this board, 501-1120-xx.
2. The Sun-3/1xx CPU must be 501-1074-22, 501-1094-22, 501-1134-06, 501-1163-09, 501-1164-09, or greater.
3. The Sun-3 SCSI must be \geq 501-1236-02, \geq 501-1170-06, or \geq 501-1217-03 when used with a SunLink Channel Adapter.
4. Set the base address as a 2nd SCSI in Sun-4300 systems. The first SCSI Host Adapter is on the Sun 4300 CPU.
5. The Sun-3 SCSI must be \geq 501-1236-08 or \geq 501-1217-09 when used with the Sun-4400 CPU.
6. SCSI TERMPWR is provided on boards \geq 501-1236-08 and \geq 501-1217-09.

Reference

Sun-3 Small Computer Systems Interface Configuration Procedures, 813-2007.

Sun-3 SCSI Host Adapter Assembly

Sun-3/160/260/460 & Sun-4/260

501-1170
with P2A & P2C

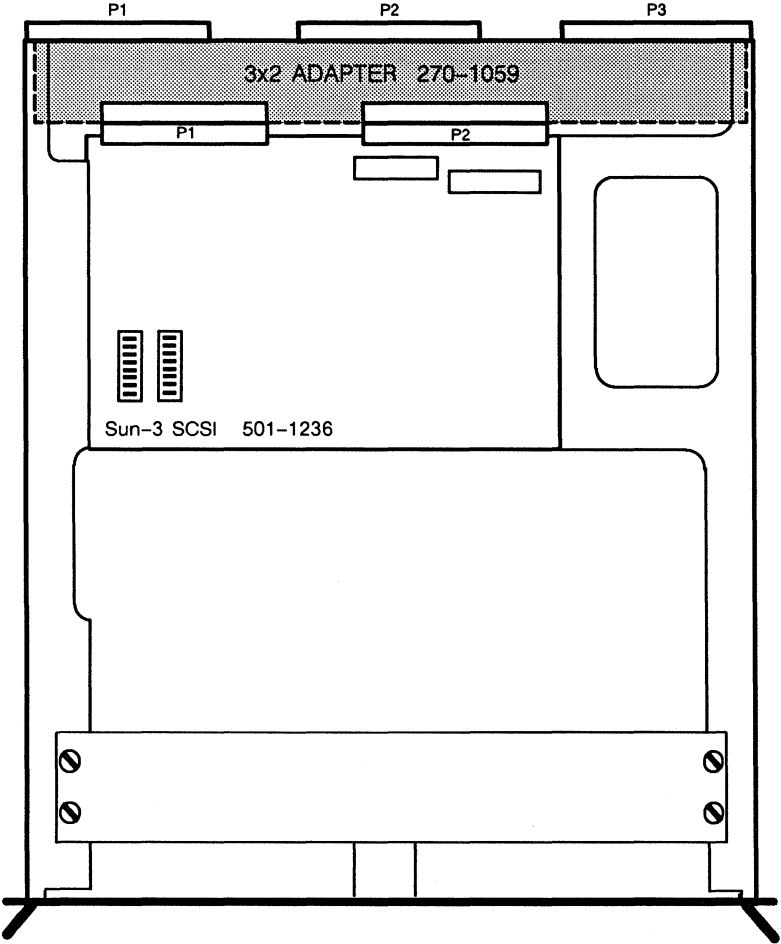

Sun-3 SCSI Host Adapter Assembly

Sun-3/110/140/150/160/180/260/280/470/480

Sun-4/280/330/370/390/470/490

501-1217
without P2A & P2C

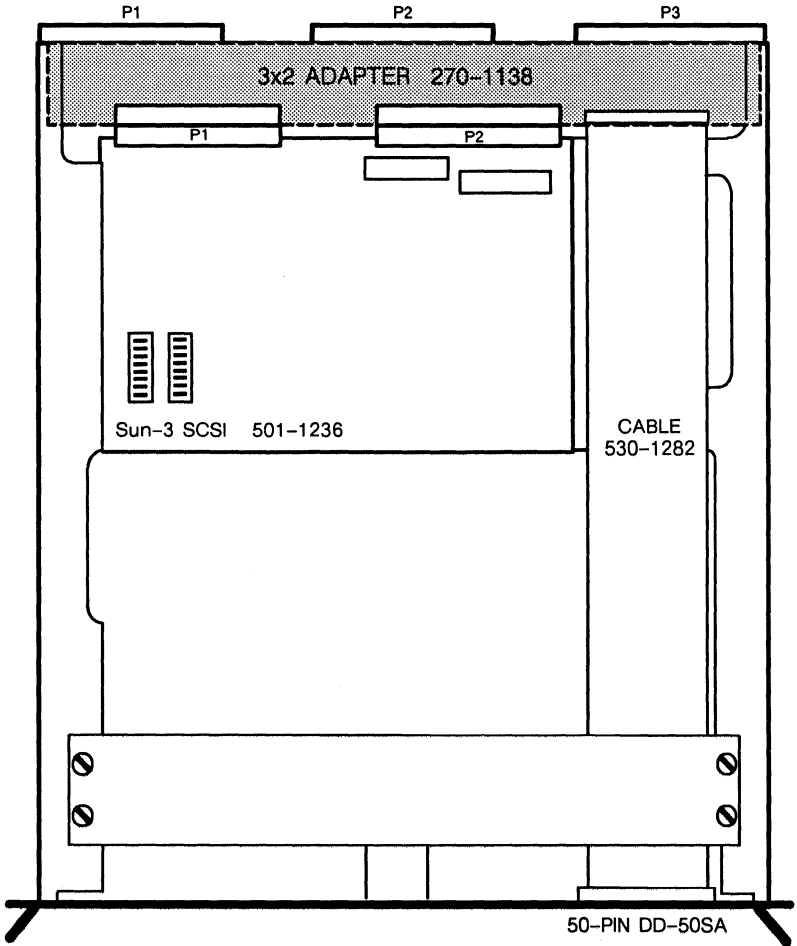

Sun-3/E SCSI/Ethernet

501-8027 501-1584

9U Assembly

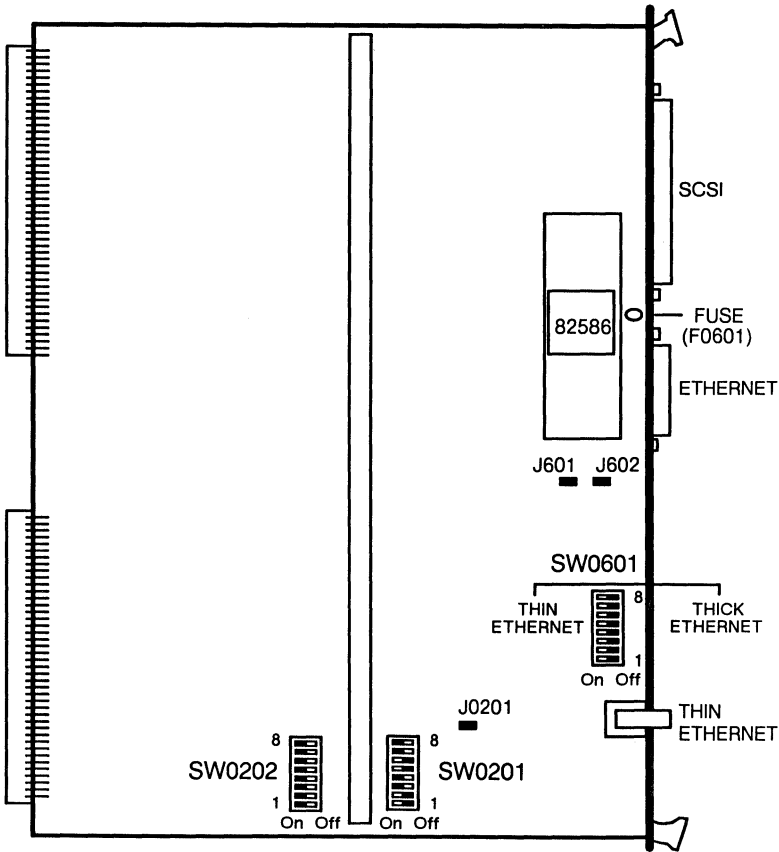

Power: 4.1 Amps @ +5 Vdc
20.5 Watts

Notes

1. Board revision 501-8027-06 or 501-1584-01 is required for use in any SPARC CPU based system.
2. The fuse is not replaceable.
3. When used with the Sun-4400 CPU, 501-1381, the board revision must be \geq 501-8027-07 or the assembly must be \geq 501-1584-02.
4. SCSI TERMPWR is provided on boards \geq 501-8027-07.

Reference

Sun SunNet Ethernet/VME Controller Installation Manual for 56-Inch Data Center Cabinets, 813-1068.

501-8027

Switch & Jumper Settings

DIP SWITCH	SWITCH	SETTING	DESCRIPTION
SW0601	1-7	On	Enable thin Ethernet
SW0601	1-7	Off	Enable Ethernet*

DIP SWITCH	SWITCH	SETTING	DESCRIPTION
SW0201	1	Off	24/32-bit addressing
SW0201	2	Off/On	N/C
SW0201	3	*	A18 address decode
SW0201	4	*	A19 address decode
SW0201	5	*	A20 address decode
SW0201	6	Off	A21 address decode
SW0201	7	On	A22 address decode
SW0201	8	On	A23 address decode

*DIP Switch SW0201 settings for ie2, ie3, and ie4

SW0201	SWITCH 3	SWITCH 4	SWITCH 5	ADDRESS
1st Board	On	On	Off	31ff02
2nd Board	Off	On	Off	35ff02
3rd Board	Off	Off	On	2dff02

DIP SWITCH	SWITCH	SETTING	DESCRIPTION
SW0202	1	On	A24 address decode
SW0202	2	On	A25 address decode
SW0202	3	On	A26 address decode
SW0202	4	On	A27 address decode
SW0202	5	On	A28 address decode
SW0202	6	On	A29 address decode
SW0202	7	On	A30 address decode
SW0202	8	On	A31 address decode

JUMPER	PINS	SETTING	DESCRIPTION
J0201	1-2	In	Clock enable

Notes

1. This board is designed for use with Level 2 transceivers only.
2. Use 31000 as the SCSI base address under SunOS 3.5 diag.

Sun-4/330 Terminator Boards

Sun-4/330

SCSI-OUT Terminator Board
501-1416

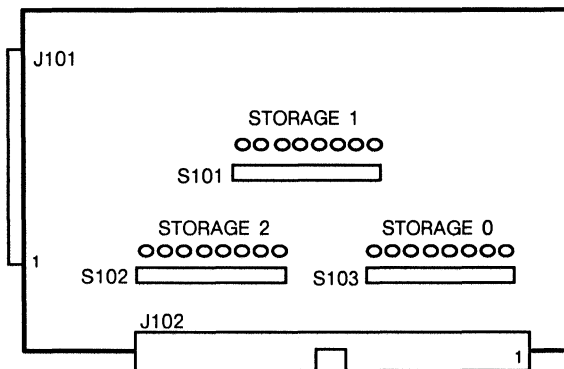

SCSI-IN Terminator Board
501-1432

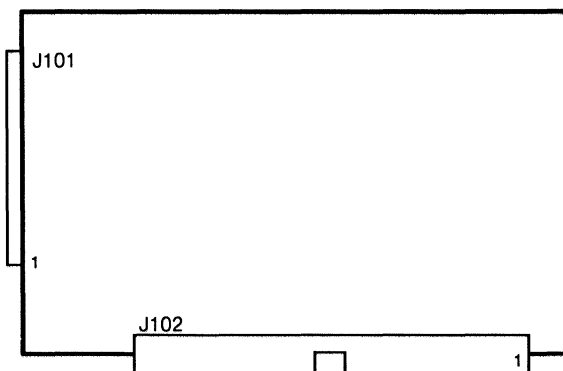

Notes

1. The 4/330 Terminator Board uses three 221/331 terminators, 120-1608.
2. Move Terminators to the Storage position to connect an external peripheral subsystem.
3. There are NO components on the SCSI-IN Terminator board, 501-1432.

SCSI Adapter Assembly

Sun-4/360

501-1666

with P2A & P2C

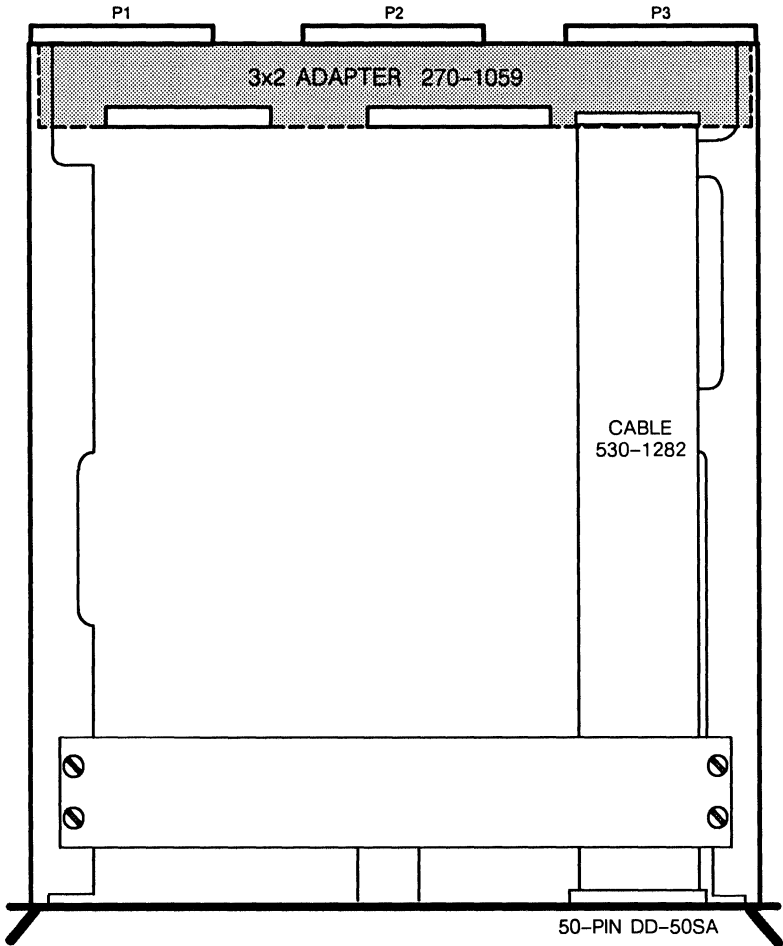

SCSI Host Adapter

Sun-4/40/60/65/75

501-1759 501-1850
 FCC-A/VCCI-1 FCC-B/VCCI-2

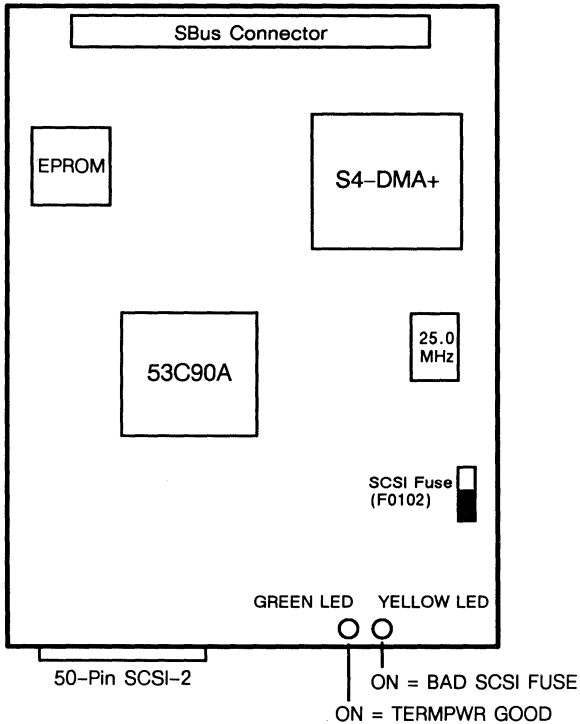

Power: 0.2 Amps @ +5vdc
 1.0 Watt Average

Notes

1. The Sun-4/60 CPU requires Boot EPROM 1.3 Version 3.
2. SCSI port, Pin 38, is fused with 2A Fuse, 150-1174.
3. The component layout is slightly different on the 501-1759 and the 501-1850 boards. The 501-1850 is illustrated on this page.
4. Reference the *SBus SCSI Host Adapter Installation Guide for SPARCstations*, 800-5385-10.

CONFIGURATIONS

BACKPLANE

Backplane

Backplane Information	2
Sun-2/120	8
Sun-2/170	9
Sun-2/130/160	10
Sun-2/50, Sun-3/50, Sun-3/75	11
Sun 3/50 & 3/60	12
Sun-3/110/140 & Sun 4/110/310	12
Sun-3/150 & Sun-4/150/350	13
Sun-3/160/180/260/280 & Sun-4/260/280/360/380	14
Sun-3/470 & Sun-4/370	15
Sun-3/470 & Sun-4/370/470	16
Sun-4/330	18
Sun-4/390/490	19

Backplane Information

This section contains bus signal charts and backplane layout illustrations.

VMEbus Backplane

Cardcage slot numbers are stamped, printed, or labeled on the sheet metal near the card ejectors. VMEbus backplane jumpers are silk-screened on the cardcage as Px00, Px01, Px02, Px03, and Px04 or Jx00, Jx01, Jx02, Jx03, and Jx04; where x represents the card slot number.

These jumpers control VMEbus signals BUS GRANT 0-3 IN (BG0-3IN) to BUS GRANT 0-3 OUT (BG0-3 OUT), and INTERRUPT ACKNOWLEDGE IN (IACKIN) to INTERRUPT ACKNOWLEDGE OUT (IACKOUT). The VMEbus signals are referred to as BG0, BG1, BG2, BG3, and IACK in this section.

SILKSCREEN LABEL	SIGNAL NAME	VMEBUS MNEMONIC
Jxx0 Pxx0	BUS GRANT 0	BG0
Jxx1 Pxx1	BUS GRANT 1	BG1
Jxx2 Pxx2	BUS GRANT 2	BG2
Jxx3 Pxx3	BUS GRANT 3	BG3
Jxx4 Pxx4	INTERRUPT ACKNOWLEDGE	IACK

VMEbus

The VMEbus connector name, the common Sun name for the connector, and the corresponding pins are shown in the chart below.

CONNECTOR		PINS
VME	SUN	
J1/P1 Row A	P1 Row A	1-32
J1/P1 Row B	P1 Row B	33-64
J1/P1 Row C	P1 Row C	65-96
J2/P2 Row B	P2 Row B	33-64

P2 Bus

The VMEbus connector name, the common Sun name for signals on the Sun P2 or private bus, and the corresponding pins are shown below.

CONNECTOR		PINS
VME	SUN	
J2/P2 Row A	P2 Row A	1-32
J2/P2 Row C	P2 Row C	65-96
N/A	P3 Row B	33-64

Power and Ground

The power and ground connectors and pins are shown below.

CONNECTOR		PINS
VME	SUN	
N/A	P3 Row A	1-32
N/A	P3 Row C	65-96

501-1354 5-Slot Backplane

Memory board options plug into connector J3, Slots 4 and 5, on the 501-1354 backplane. The Sun P2 bus connects slots 1, 4, and 5 as shown below.

J102 Row A	Connects to J403 Row A and J503 Row A
J102 Row C	Connects to J403 Row C and J503 Row C
J103 Row B	Connects to J403 Row B and J503 Row B

Cardcage slots 4 and 5 share a private bus that connects signals between J2/P2, Row A and J2/P2, Row C. These slots are used with 6U VMEbus boards.

The function of the 501-1354 backplane jumpers is shown below.

JUMPER	CONNECTS
J2xx	BG0-3IN to BG0-3Out and IACKIN to IACKOUT on slot 2
J3xx	BG0-3IN to BG0-3Out and IACKIN to IACKOUT on slot 3
J4xx	BG0-3IN to BG0-3Out and IACKIN to IACKOUT on slot 4

501-1439, 501-1598, and 501-1832 12-Slot Backplanes

The Sun P2 bus connects cardcage slots 1 through 7 to each other, and cardcage slots 10, 11, and 12 to each other.

In addition to the Sun P2 bus and the VMEbus, the 12-slot backplane has a private Internal bus that connects slots 1, 2, and 3 as shown below.

J101 Row A	Connects to J201 Row A and J301 Row A
J101 Row B	Connects to J201 Row B and J301 Row B
J101 Row C	Connects to J201 Row C and J301 Row C
J102 Row B	Connects to J202 Row B and J302 Row B

J1/P1, Rows A, B, and C, on slots 1, 2, and 3 are not connected to the VMEbus. Boards that use the VMEbus cannot be used in slots 1, 2, or 3. J2/P2, Row B is connected between slots 1 through 7.

The Sun 4400 CPU is not supported in the 501-1439 backplane.

The function of the backplane jumpers is shown below.

JUMPER	CONNECTS
J4xx	BG0-3IN to BG0-3Out and IACKIN to IACKOUT on slot 4
J5xx	BG0-3IN to BG0-3Out and IACKIN to IACKOUT on slot 5
J6xx	BG0-3IN to BG0-3Out and IACKIN to IACKOUT on slot 6
J7xx	BG0-3IN to BG0-3Out and IACKIN to IACKOUT on slot 7
J8xx	BG0-3IN to BG0-3Out and IACKIN to IACKOUT on slot 8
J9xx	BG0-3IN to BG0-3Out and IACKIN to IACKOUT on slot 9
J10xx	BG0-3IN to BG0-3Out and IACKIN to IACKOUT on slot 10
J11xx	BG0-3IN to BG0-3Out and IACKIN to IACKOUT on slot 11
J12xx	BG0-3IN to BG0-3Out and IACKIN to IACKOUT on slot 12

501-1498 and 501-1597 16-Slot Backplanes

The Sun P2 bus connects cardcage slots 1 through 7 to each other, cardcage slots 11, and 12 to each other, and cardcage slots 13, 14, and 15 to each other.

In addition to the Sun P2 bus and the VMEbus, the 16-slot backplane private internal bus connects slots 1, 2, and 3 as shown below.

J101 Row A	Connects to J201 Row A and J301 Row A
J101 Row B	Connects to J201 Row B and J301 Row B
J101 Row C	Connects to J201 Row C and J301 Row C
J102 Row B	Connects to J202 Row B and J302 Row B

J1/P1 Rows A, B, and C on slots 1, 2, and 3 are not connected to the VMEbus. Boards that use the VMEbus cannot be used in slots 1, 2, or 3. J2/P2, Row B is connected between slots 1 through 7.

The 501-1498 backplane must be 501-1498-02 or greater when used with the Sun 4400 CPU.

The function of the backplane jumpers is shown below.

JUMPER	CONNECTS
J2xx	BG0-3IN to BG0-3Out and IACKIN to IACKOUT on slot 2
J3xx	BG0-3IN to BG0-3Out and IACKIN to IACKOUT on slot 3
J4xx	BG0-3IN to BG0-3Out and IACKIN to IACKOUT on slot 4
J5xx	BG0-3IN to BG0-3Out and IACKIN to IACKOUT on slot 5
J6xx	BG0-3IN to BG0-3Out and IACKIN to IACKOUT on slot 6
J7xx	BG0-3IN to BG0-3Out and IACKIN to IACKOUT on slot 7
J8xx	BG0-3IN to BG0-3Out and IACKIN to IACKOUT on slot 8
J9xx	BG0-3IN to BG0-3Out and IACKIN to IACKOUT on slot 9
J10xx	BG0-3IN to BG0-3Out and IACKIN to IACKOUT on slot 10
J11xx	BG0-3IN to BG0-3Out and IACKIN to IACKOUT on slot 11
J12xx	BG0-3IN to BG0-3Out and IACKIN to IACKOUT on slot 12
J13xx	BG0-3IN to BG0-3Out and IACKIN to IACKOUT on slot 13
J14xx	BG0-3IN to BG0-3Out and IACKIN to IACKOUT on slot 14
J15xx	BG0-3IN to BG0-3Out and IACKIN to IACKOUT on slot 15
J16xx	BG0-3IN to BG0-3Out and IACKIN to IACKOUT on slot 16

Backplane Sun P2 or Private Bus Connections

Backplane slot that share an adjacent P2 bus are marked with the same letter in the charts below .

3-Slot VMEbus Backplane, 501-1127

Slot	1	2	3
P2 Bus	A	A	A

5-Slot VMEbus Backplane, 501-1354

Slot	1	2	3	4	5	6	7
P2 Bus	A	B	B	C	D	A	A

6-Slot VMEbus Backplane, 501-1128

Slot	1	2	3	4	5	6
P2 Bus	A	A	A	A	B	B

7-Slot Multibus Backplane, 340-0332

Slot	1	2	3	4	5	6	7
P2 Bus	-	A	A	A	-	-	-

9-Slot Multibus Backplane, 501-1049 & 501-1090

Slot	1	2	3	4	5	6	7	8	9
P2 Bus	A	A	A	A	A	A	B	B	C

12-Slot VMEbus Backplane, 501-1053 & 501-1085

Slot	1	2	3	4	5	6	7	8	9	10	11	12
P2 Bus	A	A	B	B	C	D	E	F	G	H	I	J

12-Slot VMEbus Backplane, 501-1092 & 501-1117

Slot	1	2	3	4	5	6	7	8	9	10	11	12
P2 Bus	A	A	A	A	A	A	B	C	D	E	E	E

12-Slot VMEbus Backplane, 501-1439, 501-1598, & 501-1832

Slot	1	2	3	4	5	6	7	8	9	10	11	12
P2 Bus	A	A	A	A	A	A	A	B	C	D	D	D

15-Slot Multibus Backplane, 340-0644

Slot	1	2	3	4	5	6	7	8	9	10	11	12	13	14	15
P2 Bus	A	A	A	A	A	A	A	B	B	B	B	B	C	C	C

15-Slot Multibus Backplane, 501-1050 & 501-1150

Slot	1	2	3	4	5	6	7	8	9	10	11	12	13	14	15
P2 Bus	A	A	A	A	A	A	B	B	B	B	C	C	C	D	E

16-Slot VMEbus Backplane, 501-1498 & 501-1597

Slot	1	2	3	4	5	6	7	8	9	10	11	12	13	14	15	16
P2 Bus	A	A	A	A	A	A	A	B	C	D	E	E	F	F	F	G

Sun-2/120

501-1090 501-1049
Non-Prime Prime

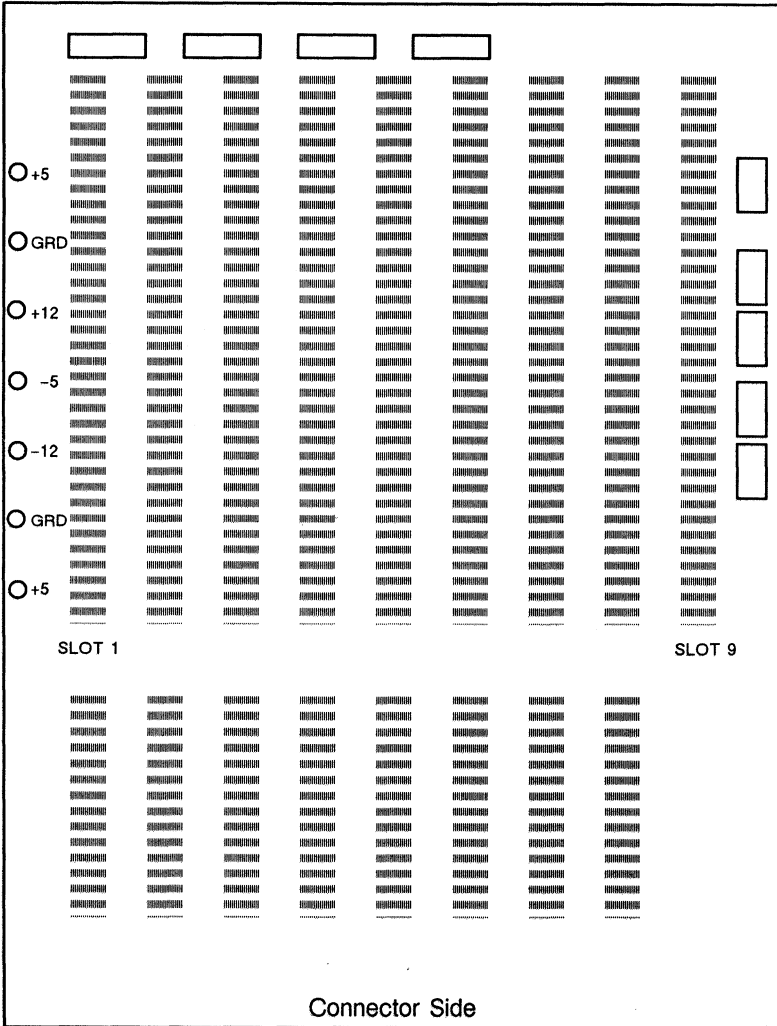

Sun-2/170

501-1050
Prime

501-1150
Non-Prime

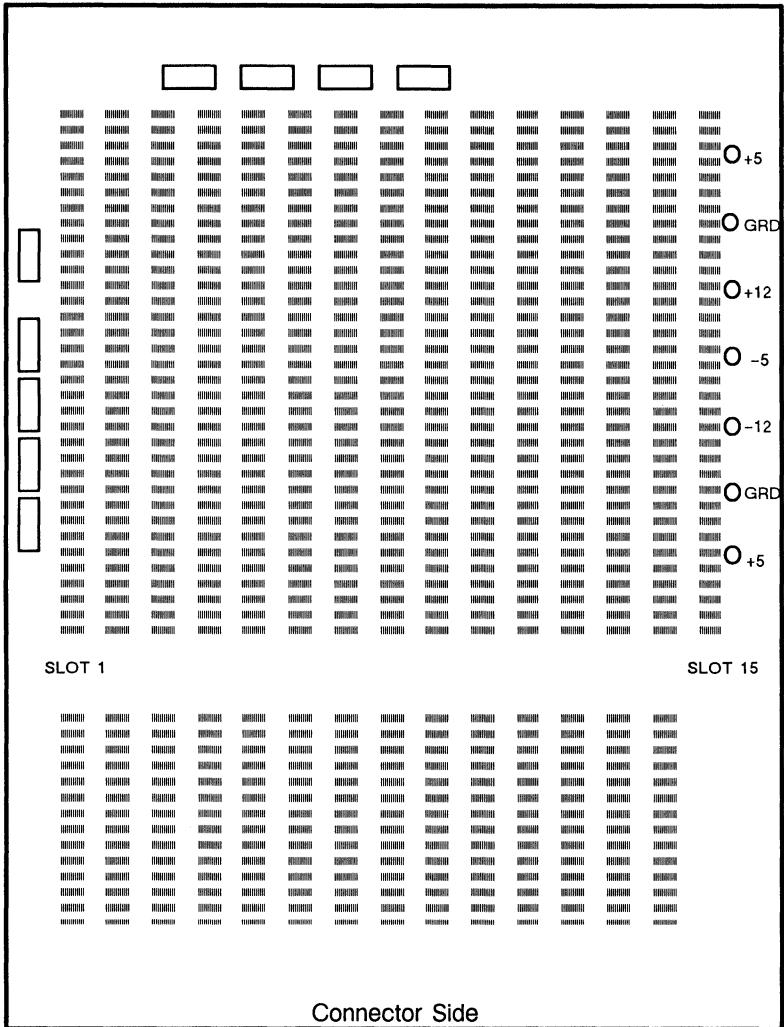

Sun-2/130/160

501-1053 501-1085

Pressfit

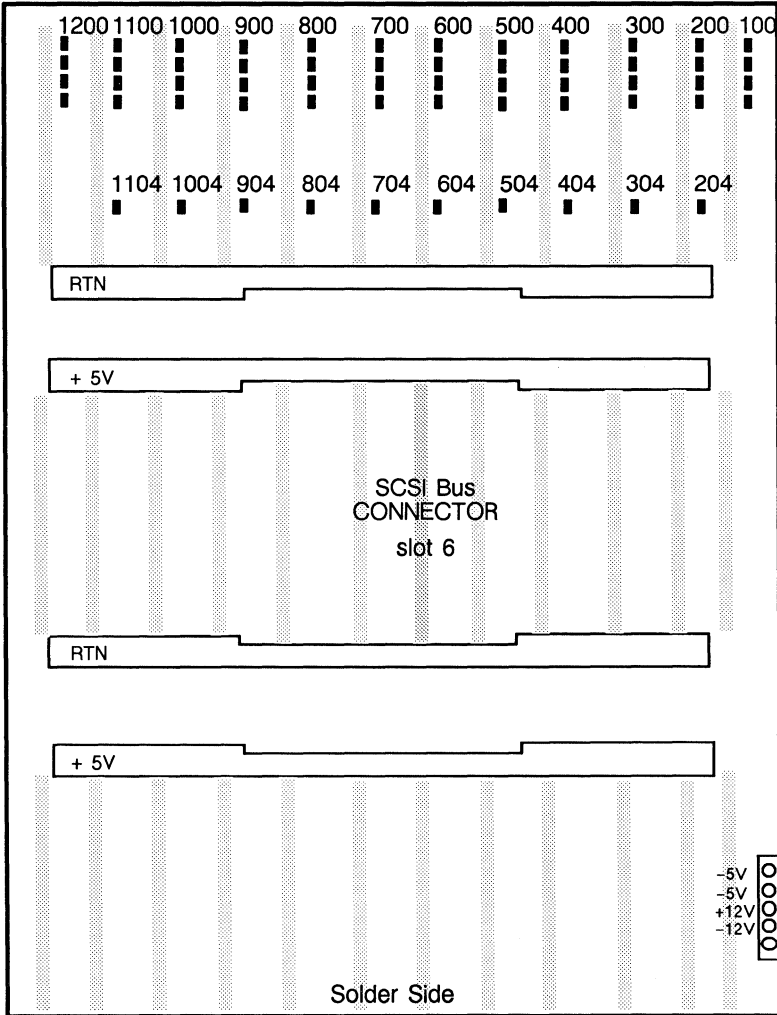

Sun-2/50 501-1042

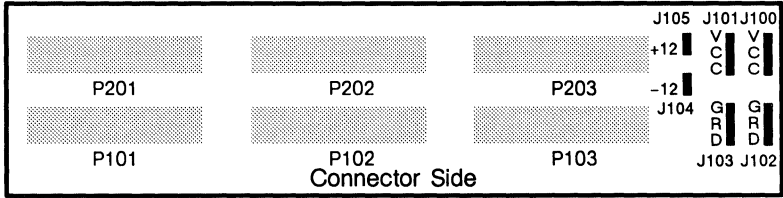

Power: 0.5 Amps @ +5Vdc
2.5 Watts

Sun-3/50 501-1109

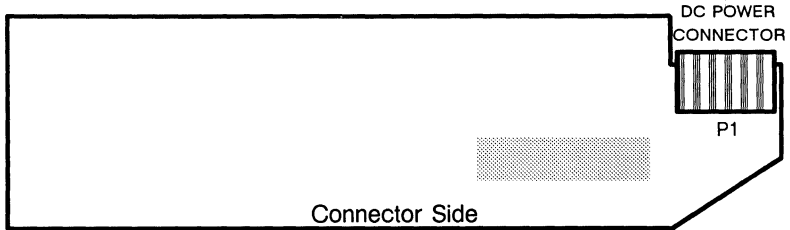

Power: 0.5 Amps @ -5Vdc
2.7 Watts

P1 Power Pinouts

1	2	3	4-8	9-12
-5	-12	+12	GND	+5

Sun-3/75 501-1093

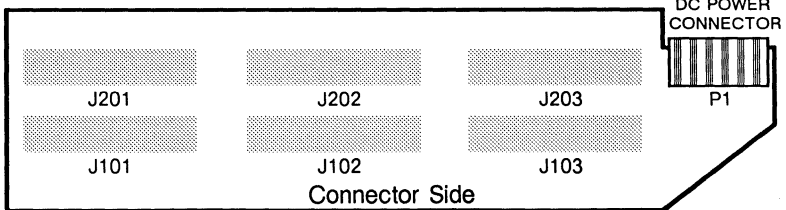

Power: 1.4 Amps @ +5Vdc
7.0 Watts

P1 Power Pinouts

1	2	3	4-8	9-12
-5	PFail	+12	GND	+5

Sun-3/50 & 3/60

501-1277

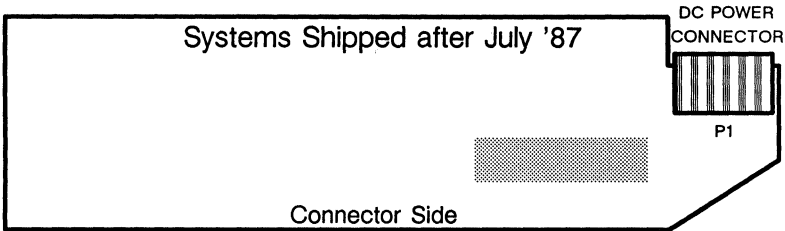

Power: 0.5 Amps @ -5Vdc
2.4 Watts

P1 Power Pinouts

1	2	3	4-8	9-12
-5	-12	+12	GND	+5

Sun-3/110/140 & Sun 4/110/310

501-1127

Pressfit

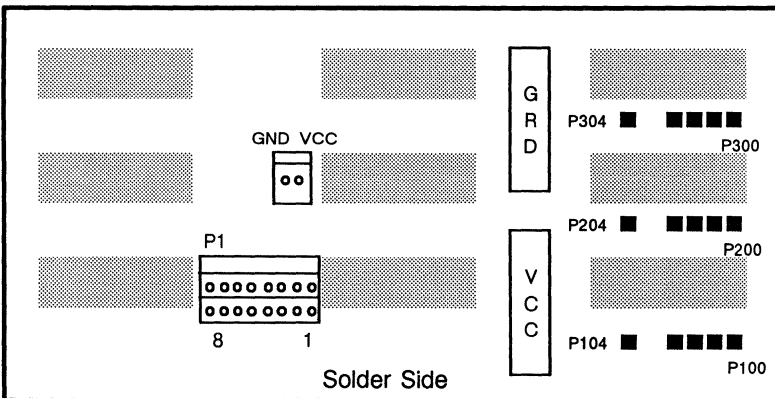

Power: 1.3 Amps @ +5Vdc
6.5 Watts

P1 Power Pinouts

1-2	3-4	5	6	7	8
-5	GND	+12	GND	-12	GND

Sun-3/150 & 4/150/350

501-1128

Pressfit

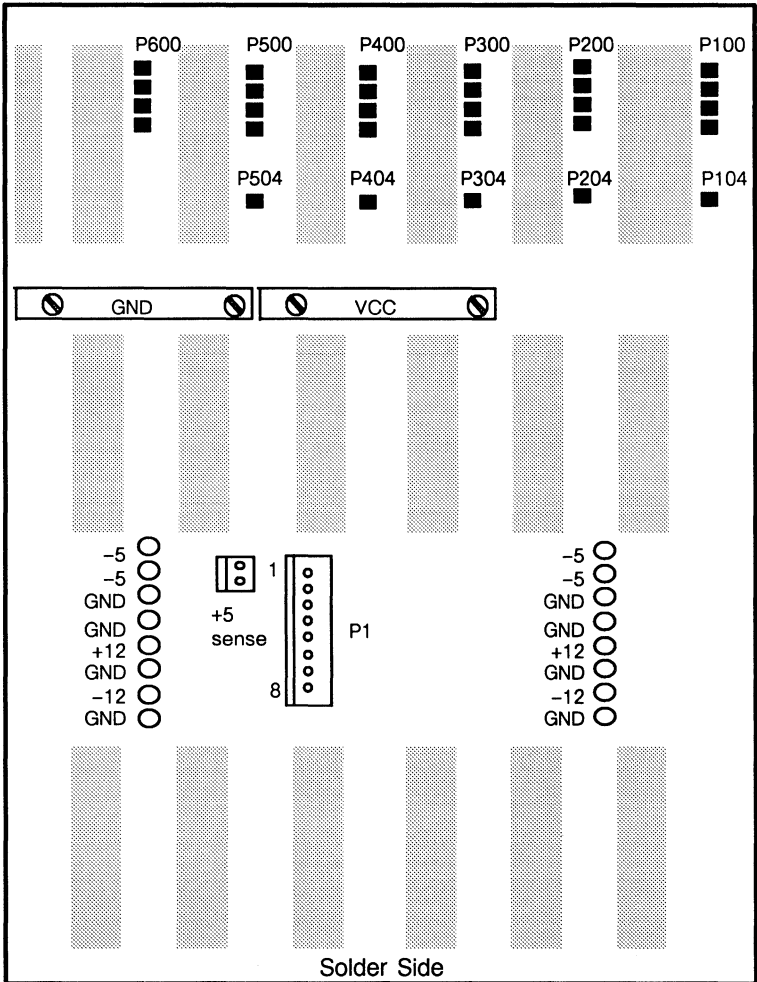

Power: 1.3 Amps @ +5Vdc
6.5 Watts

P1 Power Pinouts

1-2	3-4	5	6	7	8
-5	GND	+12	GND	-12	GND

Sun-3/160/180/260/280/460/480

Sun-4/260/280/360/380

501-1092 501-1117

Pressfit

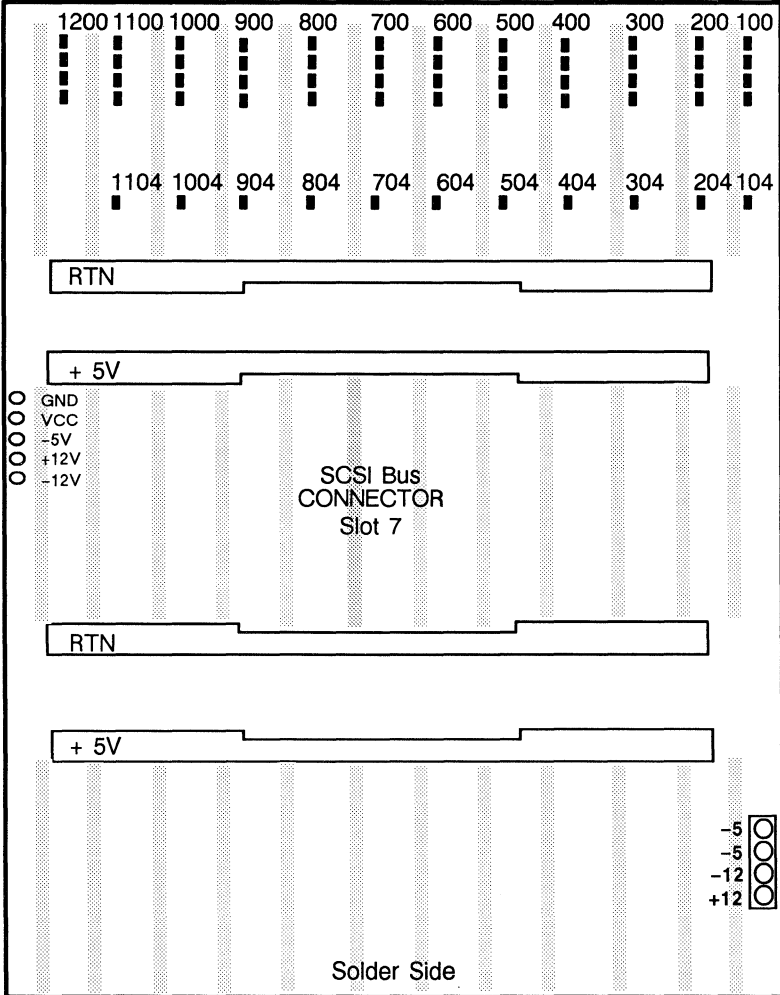

Power: 1.3 Amps @ +5Vdc
6.5 Watts

Sun-3/470 & Sun-4/370

501-1439

Pressfit

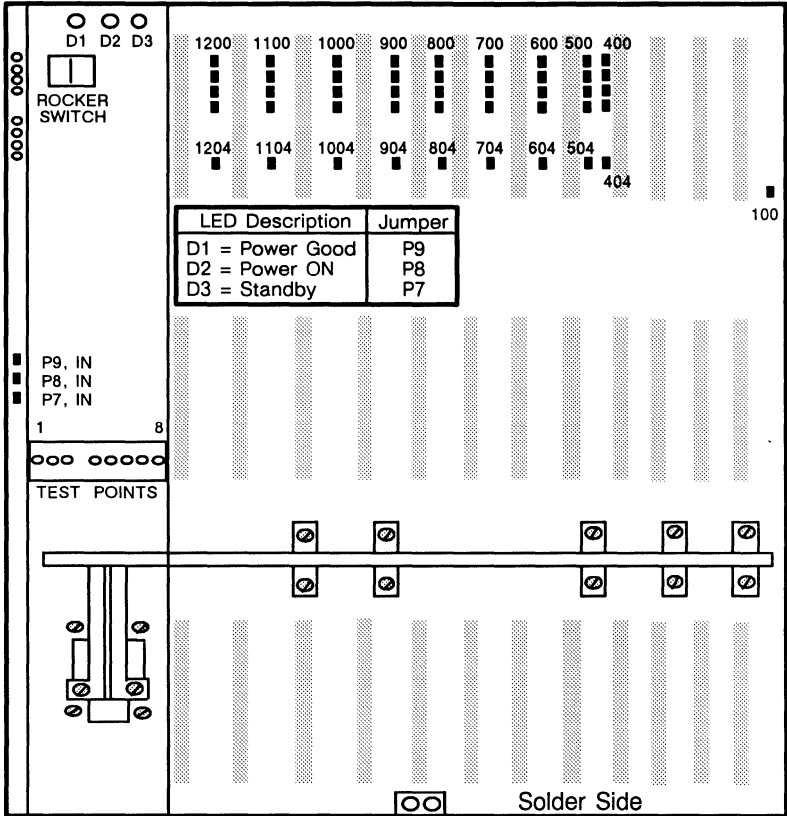

Test Points Description

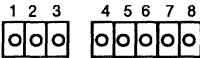

TEST POINT	DESCRIPTION	TEST POINT	DESCRIPTION
1	+5	5	+12
2	GND	6	-5.2
3	+12 Motor	7	Chassis ground
4	-12	8	Ground

Power: 2.1 Amps @ +5Vdc
10.5 Watts

Note: The LED positions on the backplane and the descriptions molded into the front cover do not match.

Sun-3/470 & Sun-4/370/470

501-1598

Pressfit

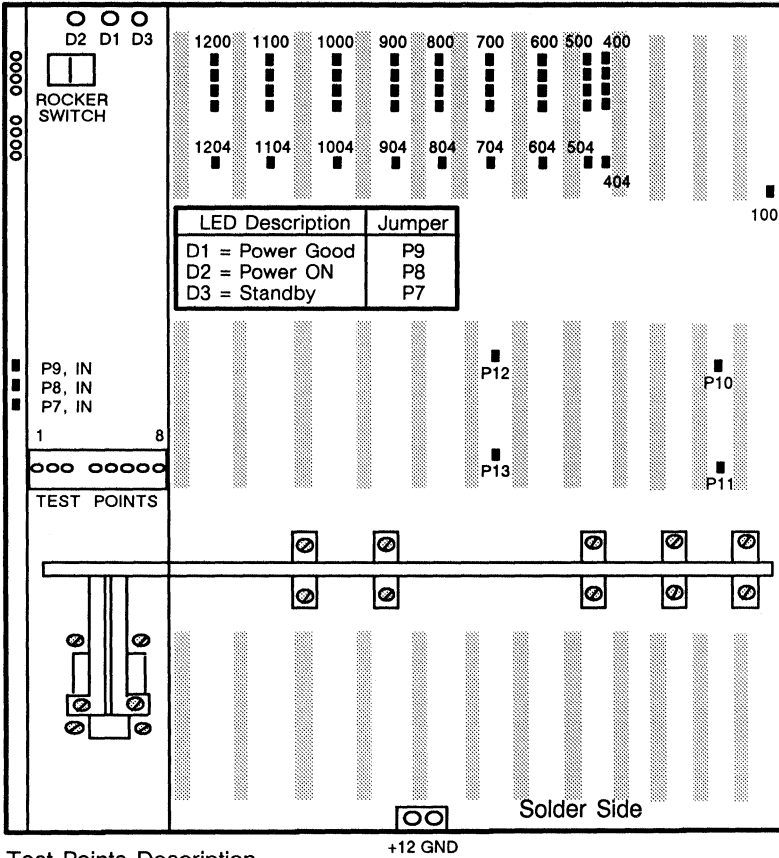

Test Points Description

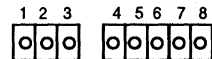

TEST POINT	DESCRIPTION	TEST POINT	DESCRIPTION
1	+5	5	+12
2	GND	6	-5.2
3	+12 Motor	7	Chassis ground
4	-12	8	Ground

Power: 2.1 Amps @ +5Vdc
10.5 Watts

Sun-3/470 & Sun-4/370/470

501-1832

Pressfit

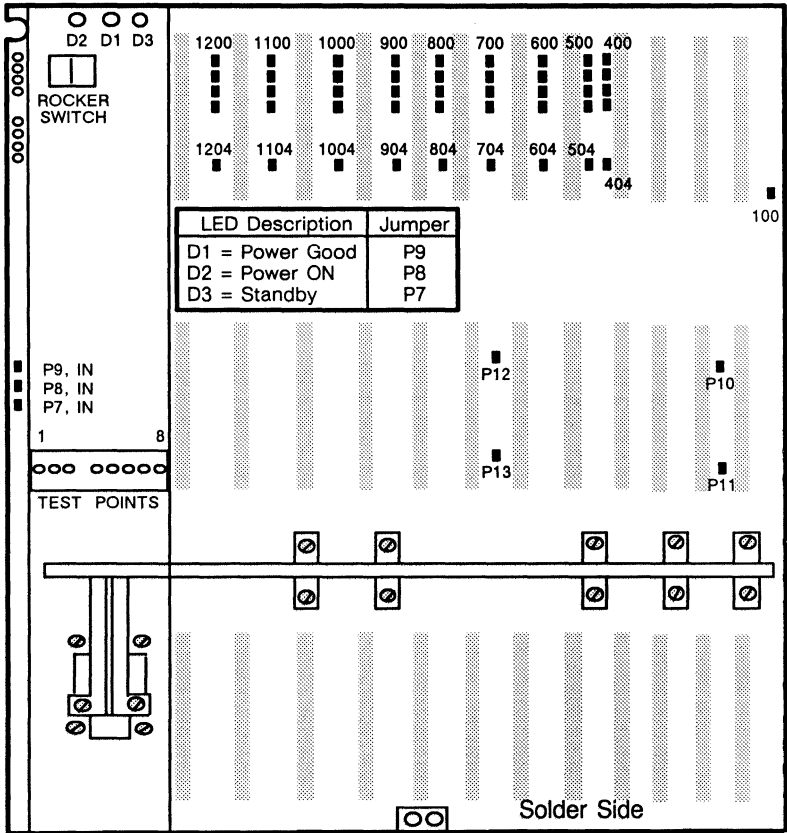

Test Points Description

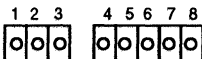

TEST POINT	DESCRIPTION	TEST POINT	DESCRIPTION
1	+5	5	+12
2	GND	6	-5.2
3	+12 Motor	7	Chassis ground
4	-12	8	Ground

Power: 2.1 Amps @ +5Vdc
10.5 Watts

Sun-4/330

501-1354

Pressfit

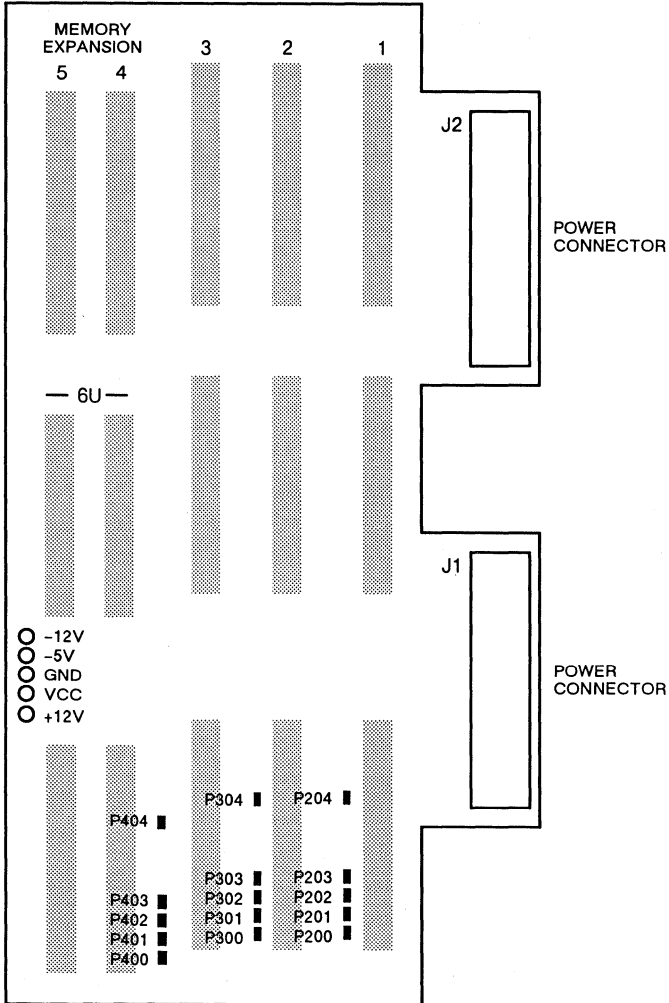

Power: 2.0 Amps @ +5Vdc
10.0 Watts

Sun-4/390/490

501-1498

Pressfit

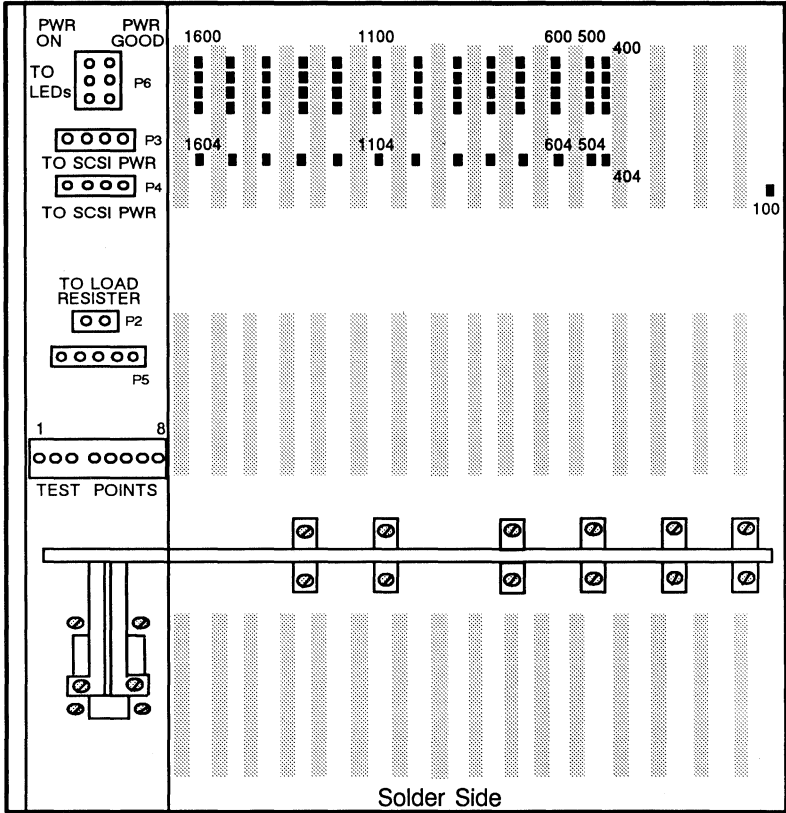

Test Points Description

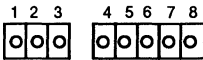

TEST POINT	DESCRIPTION	TEST POINT	DESCRIPTION
1	+5	5	+12
2	GND	6	-5.2
3	+12 Motor	7	Chassis ground
4	-12	8	Ground

Power: 2.1 Amps @ +5Vdc
10.5 Watts

Sun-4/390/490

501-1597

Pressfit

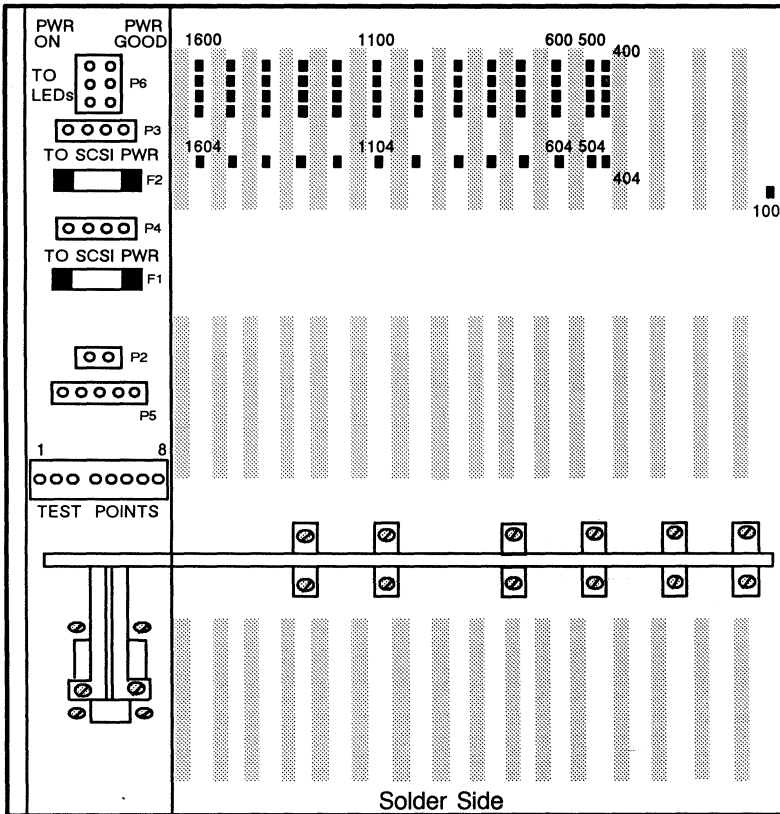

Test Points Description

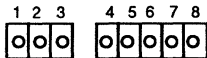

Fuses: F1 and F2
 15 Amp @ 250V
 P/N 140-1019
 140-1019

TEST POINT	DESCRIPTION	TEST POINT	DESCRIPTION
1	+5	5	+12
2	GND	6	-5.2
3	+12 Motor	7	Chassis ground
4	-12	8	Ground

Power: 2.1 Amps @ +5Vdc
 10.5 Watts

Note: The Load Resistor Assembly is only used with the 925W power supply.

CONFIGURATIONS

SLOT ASSIGNMENT

Slot Assignment

Board Installation Notes	3
SCSI Host Adapter Assemblies	16
Sun-2/50	18
Sun-2/130/160	19
Sun-2/120	21
Sun-2/170	22
Sun-3/50 & Sun-3/60	24
Sun-3/75 & Sun-3/80	25
Sun386i/150/250	26
Sun-3/110	27
Sun-3/140	28
Sun-3/150	29
Sun-3/160	30
Sun-3/180	32
Sun-3/260	40
Sun-3/280	42
Sun-3/460	50
Sun-3/470	52
Sun-3/480	54
Sun-4/20	59
Sun-4/40	60
Sun-4/60	61
Sun-4/65	62
Sun-4/75	63
Sun-4/110	64
Sun-4/150	65
Sun-4/260	66
Sun-4/280	70
Sun-4/310	84
Sun-4/330	85
Sun-4/350	86
Sun-4/360	87

Slot Assignment – Continued

Sun-4/370	88
Sun-4/380	89
Sun-4/390	90
Sun-4/470	94
Sun-4/490	96

Board Installation Notes

Backplane Slot Assignment Charts

Each system chart lists the PCB slot assignments in order of descending priority. In the charts **A,B,C...** indicates the preferred location for a specific board. An **A** is the most preferred location. An **a** indicates that a board requires more than one slot if Memory, Frame Buffer, or other options are installed. Multiple capital letters (**AA, BBB...**) indicate a board requires more than one slot. Boards with multiple part numbers are shown with a footnote (Sun 3004 CPU 1) and are listed in tables after each grouping of slot assignment charts.

Installing VMEbus Boards

1. Refer to the Backplane Slot Assignment Charts to determine where to install additional boards.
2. Move boards in the cardcage as required.
3. Configure backplane jumpers for BG3 and IACK. The IACK jumper for the last slot is not present on some backplanes. It is not needed.

Removing VMEbus Boards

1. Refer to the Backplane Slot Assignment Charts to determine if other boards in the cardcage require repositioning.
2. Configure backplane jumpers for BG3 and IACK.
3. Install an air restrictor and the external filler panel in any unused slot.

Sun-2/130 and Sun-2/160

Do not install a Tape Controller or a Disk Controller in an unused slot to the left of the SCSI Host Adapter. Throughput of the SCSI subsystem may be affected.

Sun-3/160

1. Sun-3/160 systems using the Pioneer or ETA Power Supply require FCO 807-0068 to upgrade to a Sun-3/260, Sun-3/460, Sun-4/260, or Sun-4/360.
2. Sun-3/160 systems manufactured prior to July 1987 (serial number 724E2223) require FCO 808-0067 to upgrade to a Sun-3/260, Sun-3/460, Sun-4/260, or Sun-4/360.

Sun-3/180, Sun-3/280, and Sun-4/280

Sun-3/180, Sun-3/280, and Sun-4/280 systems manufactured prior to November 1988 require FCO 807-0073 to upgrade to a Sun-3/480 or a Sun-4/380.

Sun-3/260 and Sun-4/260

1. Do not install an air restrictor in slot 2.
2. Do not install non-memory board options in slots 2 through 5 using the standard left to right sequence. If possible, leave Slot 2 empty for system cooling.

Sun-3/470

1. Remove jumpers P10, P11, P12, and P13 from the 501-1598 Backplane when the Sun 3400 board set is installed.
2. Remove jumpers P10, P11, P12, and P13 from the 501-1832 Backplane when the Sun 3400 board set is installed.

Sun 4/40 CPU

SBus Slots 1 and 2 are DVMA masters. SBus cards can be installed in any SBus Slot.

Sun 4/60 and Sun-4/65 CPUs

SBus Slots 1 and 2 are DVMA masters. SBus Slot 3 is Slave only. SBus cards capable of becoming DVMA masters (Printer Card, Serial Parallel Interface, SCSI Host Adapter, ...) cannot be installed in SBus Slot 3. SBus cards not capable of becoming DVMA masters can be installed in any SBus Slot.

Sun-4/75 CPU

SBus Slots 1, 2, and 3 are DVMA masters. SBus cards can be installed in any SBus Slot.

Sun 4100 CPU

1. The Sun 4100 CPU does not have a VMEbus slave interface. VMEbus boards requiring a slave interface on the processor do not function with the Sun 4100 CPU (eg. Xylogics 451, Xylogics 472, Xylogics 7053).
2. The Sun 4100 CPU has 28 bits of physical address space. Bit 27 is replicated out to bit 31 in A32D32 space.

Sun 4400 CPU

1. The Sun 4400 CPU requires 12-slot Backplane 501-1598 or 501-1382. The Sun 4400 CPU is not supported in the 501-1439 12-slot Backplane.
2. The Sun 4400 CPU requires 16-slot Backplane 501-1498-02 or 501-1597.

Sun-4/40/60/65/75 SBus Slot Priority

The default NVRAM setting for the *sbus-probe-list* parameter is Slot 0, Slot 1, Slot 2, and Slot 3. SBus Slot 0 is reserved for CPU space and must be the first entry. SBus slot placement affects the UNIX major and minor device numbers.

SBus Slot Priority – Example 1

When a Serial Parallel Controller is installed in Slot 3, it is recognized as card 0. If a second SPC is installed in Slots 1 or 2, the second SPC becomes card 0 and the SPC in Slot 3 becomes card 1. Peripheral devices attached to the SPC in Slot 3 must be redefined in the software or in the NVRAM *sbus-probe-list* parameter.

One SPC installed with *sbus-probe-list* = 0123

Slot 1	Slot 2	Slot 3
Empty	Empty	tty0 - 7
Empty	Empty	ttyz0 - 7

Second SPC installed with *sbus-probe-list* = 0123

Slot 1	Slot 2	Slot 3
Empty	tty0 - 7	tty8 - f
Empty	ttyz0 - 7	ttyz8 - f
tty0 - 7	Empty	tty8 - f
ttyz0 - 7	Empty	ttyz8 - f

Second SPC installed with *sbus-probe-list* = 0312

Slot 1	Slot 2	Slot 3
Empty	tty8 - f	tty0 - 7
Empty	ttyz8 - f	ttyz0 - 7
tty8 - f	Empty	tty0 - 7
ttyz8 - f	Empty	ttyz0 - 7

SBus Slot Priority – Example 2

When two Printer Cards are installed and one is removed, the remaining card becomes card 0. Peripheral devices attached to the remaining card must be redefined in the software. A single card is always recognized as card 0 and cannot be changed in the NVRAM *sbus-probe-list* parameter.

Two Printer cards installed with *sbus-probe-list* = 0123

Slot 1	Slot 2	Slot 3
stc0	stc1	Empty
stclp0	stclp1	Empty

One Printer card removed with *sbus-probe-list* = 0123

Slot 1	Slot 2	Slot 3
stc0	Removed	Empty
stclp0	Removed	Empty
Removed	stc0	Empty
Removed	stclp0	Empty

SBus Slot Priority – Example 3

When three SPC Cards are installed and one card is removed, the remaining cards become cards 0 and 1. Peripheral devices attached to the remaining cards must be redefined in the software.

Three SPCs installed with *sbus-probe-list* = 0123

Slot 1	Slot 2	Slot 3
ttyy0 - 7	ttyy8 - f	ttyy10 - 17
ttyz0 - 7	ttyz8 - f	ttyz10 - 17

One SPC removed with *sbus-probe-list* = 0123

Slot 1	Slot 2	Slot 3
Removed	ttyy0 - 7	ttyy8 - f
Removed	ttyz0 - 7	ttyz8 - f
ttyy0 - 7	Removed	ttyy8 - f
ttyz0 - 7	Removed	ttyz8 - f
ttyy0 - 7	ttyy8 - f	Removed
ttyz0 - 7	ttyz8 - f	Removed

Sun 3200, 3400, and 4200 ECC Memory

1. **501-1092 or 501-1117 Backplanes.** Install the first Memory board in slot 6. Install 220/270 Terminating Resistor part number 120-1613-01, at location F-34 or F-54 on the Memory board.

Remove the Terminating Resistor from location F-34 or F-54 on Memory boards installed in slots 2, 3, 4, and 5.

2. **501-1439, 501-1598, or 501-1832 Backplanes.** Install the first Memory board in slot 1. Install 220/270 Terminating Resistor part number 120-1613-01 at location F-34 or F-54 on the Memory board.

If placement results in Memory boards on both sides of the Sun 3400 CPU, remove the Terminating Resistor at location O-23 (U1411) on the CPU. Install Terminating Resistors on Memory boards in slot 1 and slot 7.

3. Remove jumpers P10, P11, P12, and P13 from the 501-1598 Backplane when the Sun 3400 board set is installed.
4. Remove jumpers P10, P11, P12, and P13 from the 501-1832 Backplane when the Sun 3400 board set is installed.

GP2

The GP2 does not function with the Sun-2 Color Board, Sun-3 Color Board, or the Graphics Buffer.

CG5 with GP+ or GP

1. The CG5 P2 bus must be disabled (SW3300-5, OFF).
2. The CG5 must be installed in slots that do not share the P2 bus with the GP or GP+. Signals provided by the CG5, but not used by the GP or GP+, may cause contention.

CG5 with GP2

1. The CG5 P2 bus must be enabled (SW3300-5, ON).
2. The CG5 must be installed in cardcage slots that share the P2 bus with the GP2.

CG5 without GP2

The CG5 P2 bus must be disabled (SW3300-5, OFF).

CG9 with GP2

1. The CG9 P2 bus must be enabled (SW3-1, OFF).
2. The CG9 must be installed in cardcage slots that share the P2 bus with the GP2.
3. This configuration is not supported with the TAAC-1.
4. The CG9 is not supported without the GP2.

TAAC-1

1. The TAAC-1 requires 3 slots. Install backplane jumpers BG3 and IACK in all three slots.
2. Sun-3/160 systems require FCO 807-0071 if the TAAC-1 is installed.
3. The TAAC-1 is not supported with the CG9 and GP2GXP System Option.

ALM-1, ALM-2, and MCP

1. The ALM-2 and MCP share the same base address and interrupt vector.
2. The ALM-1 shares the same interrupt vector as the ALM-2 and MCP.
3. Because of the conflict with the interrupt vector, no more than four ALM-1, ALM-2, or MCP boards can be installed at the same time.
4. The ALM-1, ALM-2, or MCP boards must be installed in sequential address order or a conflict with the interrupt vector may result.
5. The maximum combination of ALM-2 and MCP boards allowed is eight. When mixing ALM-2 and MCP, the MCP must be addressed as boards 1, 2, 3, and 4.
6. The maximum number of MCP boards is four.
7. The maximum number of ALM-2 boards is eight.

BOARD	ALM-1 VECTOR	ALM-2 & MCP VECTOR
1	0x88	0x8b
2	0x89	0x8a
3	0x8a	0x89
4	0x8b	0x88
5	-	0xa0
6	-	0xa1
7	-	0xa2
8	-	0xa3

ALM-1, 501-1157 (Pedestal Systems)

The ALM-1 must be installed in slots 11 and 12. Install backplane jumpers BG3 and IACK in slot 11. Remove backplane jumper BG3 from slot 12.

MAPkit

1. The MAPkit requires two slots. Remove backplane jumpers BG3 and IACK from the slot that contains the MAPkit board nearest to slot 1. Install backplane jumpers BG3 and IACK in the second slot.
2. The MAPkit data throughput rate may be affected if a Tape Controller or a Disk Controller is installed in an unused slot between the CPU and the MAPkit .

SunLink Channel Adapter

1. The SCA requires 2 slots. Remove backplane jumpers BG3 and IACK from both slots.
2. Installing a 1/2" Tape Controller or an SMD Controller in an unused slot between the CPU and the SCA option may affect the SCA data throughput rate.

Systech MTI-800, MTI-850, MTI-1600, and MTI-1650

Tables A and B provide reference information for Systech boards packaged in kits.

Table A identifies the ALM boards in a Sun PCB kit. Columns 2, 3, and 4 provide the Sun PCB part number, a board description, and the Systech part number for individual boards within each set.

Table A

SUN PCB KIT P/N	SUN PCB P/N	DESCRIPTION	SYSTECH P/N
370-1039	370-1046	MTI-800 : 8-Channel USART PCB	65-201616-7
	370-1047	MTI-800/1600 Multiplex Controller PCB	65-200004-7
370-1040	370-1048	MTI-1600 : 16-Channel USART PCB	65-201516-6
	370-1047	MTI-800/1600 Multiplex Controller PCB	65-200004-7
370-1098	370-1102	MTI-850B : 8-Channel USART PCB	65-201606-6
	370-1099	MTI-850/1650 Multiple Controller PCB	65-201004-8
370-1097	370-1100	MTI-1650B : 16-Channel USART PCB	65-201506-5
	370-1099	MTI-850/1650 Multiple Controller PCB	65-201004-8
370-1096	811-1100	MTI-1650A : 16-Channel USART Rack-Mount Box	65-701005-4
	370-1099	MTI-850/1650 Multiple Controller PCB	65-201004-8

Table B describes the boards in a Sun VME assembly kit. This assembly contains an ALM board set, a VME-Multibus Adapter PCB, and frame. Column 1 lists the Sun VME assembly part number. Columns 2 and 3 provide the part numbers and a description of the ALM channel and the VME-Multibus Adapter PCB in the Sun VME assembly kit. Only three of the PCB kits from Chart A are used as VME options. Systech discontinued the 800/1600 series when the 850-1650 series was introduced. Replace the entire VME assembly upon failure of any component in these VME options.

Table B

SUN VME KIT P/N	SUN PCB KIT P/N	DESCRIPTION
501-1157-01	370-1040	MTI-1600 : 16-Channel ALM for VME systems (replaced by 370-1097)
	501-1054	VME-Multibus Adapter PCB
501-1157-02	370-1097	MTI-1650B : 16-Channel ALM for Desk-side systems
	501-1054	VME-Multibus Adapter PCB
501-1165	370-1096	MTI-1650A Controller
	501-1054	VME-Multibus Adapter PCB

Xylogics 450 Disk Controller

1. Do not mix the Xylogics 450 with the Xylogics 7053.
2. Xylogics 450 is not supported with the 900MB Disk Drive, and cannot be mixed with the Xylogics 451 in any 900MB Disk Drive configuration.

Xylogics 7053 Disk Controller

1. Do not mix the Xylogics 7053 with the Xylogics 450.
2. Systems with Sun-2 SCSI, 501-1138, or Sun-3 SCSI, 501-1217 may mix a maximum of one Xylogics 451 and two Xylogics 7053s.
3. Systems with Sun-2 SCSI, 501-1167, may mix a maximum of one 451 and two 7053s.
4. Systems with Sun-2 SCSI, 501-1149, or Sun-3 SCSI, 501-1170 may mix a maximum of one Xylogics 451 and one Xylogics 7053.
5. The Sun-4/470 and Sun-4/490 may mix a maximum of one Xylogics 7053 and one ISP-80 IPI-2 controller.

Tapemaster Tape Controller

1. The Tapemaster controller is not supported in any Sun-3x or Sun-4 system.
2. Support for the Tapemaster controller was removed from the Sun 3200 CPU Boot EPROM revision 3.0.

VME to Multibus Adapter Board

Use adapter board subassembly 501-1054-04 Rev. A or greater to avoid signal contention on the "P2" bus. This change was effective in September 1985 (ECO 1850).

VME to Multibus Adapter Board

Use adapter board subassembly 501-1054-04 Rev. A or greater to avoid signal contention on the "P2" bus. This change was effective in September 1985 (ECO 1850).

12-Slot Office Pedestal Backplane 501-1382

A cutout in the upper left corner of the 501-1382 Backplane allows the DC Wire Harness to be routed from the rear of the Backplane to the front of the Peripheral Tray.

SCSI Host Adapter Assemblies

1. Use the slot assignment charts for systems with the 501-1138 or 501-1217 SCSI Assembly if there is no SCSI Host Adapter installed in a Sun-3/180, Sun-3/280, or Sun-4/280.
2. Sun 3x2 Adapter 501-1269, Option 160A, is connected to J2 Rows A and C. There is no external connector.
3. Sun 3x2 Adapter 501-1191, Option 160B, is not connected to J2 Rows A and C. There is no external connector.
4. Sun 3x2 Adapter 501-1220 has no connection to J2 Rows A and C and has an external 50-pin connector.
5. Sun 3x2 Adapter 501-1666 is connected to J2 Rows A and C and has an external 50-pin connector. This adapter is used to to connect the Sun 4300 CPU to the internal SCSI subsystem of the Sun-4/360.
6. Sun-2 SCSI Host Adapter 501-1167 has P2 bus connections and an external cable assembly. Do not substitute a 501-1236 Sun-3 SCSI for a 501-1045 Sun-2 SCSI in this adapter assembly.
7. Sun-3 SCSI Host Adapter 501-1217 SCSI does not function with the SCSI subsystem in the Sun-3/160, Sun-3/260, or Sun-4/260. The SCSI subsystem interfaces through J2 Rows A and B of the VMEbus connector. These signals are not connected on the 501-1217 assembly.

Sun VME 3x2 SCSI Host Adapter Assemblies

ASSY # w SCSI	INCLUDES SCSI #	INCLUDES BLANK ASSY #	P2 ROWS A + C	SCSI CONNECTION
501-1138	501-1045	500-1220	No	External
501-1149	501-1045	500-1269	Yes	Internal
501-1167	501-1045	500-1059	Yes	External
501-1170	501-1236	500-1269	Yes	Internal
501-1217	501-1236	500-1220	No	External

Sun 3x2 Adapter Assemblies

OPTION #	TESTED ASSY #	ADAPTER FAB #	P2 ROWS A + C	EXTERNAL CONNECTION
160A	501-1269	270-1059	Yes	No
160B	501-1191	270-1138	No	No
None	501-1220	270-1138	No	Yes
None	501-1666	270-1059	Yes	Yes

Memory Boards With SCSI

ASSY #	MEMORY BD #	DESCRIPTION	SCSI HOST
501-1147	501-1079	2/50 0MB	501-1045
501-1172	501-1121	3/75 0MB	501-1045

Memory Boards That Can Use A 501-1045 SCSI

MEMORY BD #	DESCRIPTION
501-1020	2/50 1MB
501-1046	2/50 2MB
501-1047	2/50 4MB
501-1067	2/50 3MB
501-1079	2/50 0MB
501-1111	3/75 2MB
501-1121	3/75 0MB
501-1122	3/75 4MB

Sun-2/50

PART #	DESCRIPTION
501-1141	1MB CPU
501-1142	2MB CPU
501-1143	4MB CPU
501-1020	1MB Memory
501-1046	2MB Memory
501-1067	3MB Memory
501-1047	4MB Memory
501-1079	0MB Memory
501-1147	0MB Memory with Sun-2 VME SCSI
501-1148	0MB Memory with Sky FPP

Reference

Hardware Installation Manual for the Sun-2/50, 800-1143-02.

Sun-2/130/160

SHUNTS		BOARD	SLOT POSITION														
			1	2	3	4	5	6	7	8	9	10	11	12			
BG3	IACK																
Out	Out	CPU 1	A														
In	In	Memory 2		A													
Out	Out	GP 3			A												
In	In	GB				A											
In	Out	Color 4					A										
Out	N/A	ALM-1 5														A	A
Out	Out	SCSI 6							A								
Out	Out	1st SCP			A	B	C	D	E								
Out	Out	2nd SCP				A	B	C	D	E							
Out	Out	1st MAPkit			A	A	C	C	E	E	G	G					
-	-				B	B	D	D	F	F							
Out	Out	2nd MAPkit					A	A	C	C	E	E	G	G			
-	-						B	B	D	D	F	F					
Out	Out	1st Tape Ctlr 7			A	B	C	D	E	F	G	H	I	J			
Out	Out	2nd Tape Ctlr 7				A	B	C	D	E	F	G	H	I			
Out	Out	1st SMD Ctlr 8			A	B	C	D	E	F	G	H	I	J			
Out	Out	2nd SMD Ctlr 8				A	B	C	D	E	F	G	H	I			
In	In	Sky FPP					A	B	C	D	E	F	G	H			
Out	Out	2nd Ethernet			A	B	C	D	E	F	G	H	I	J			
In	Out	1st IPC 9										B		A			
In	Out	2nd IPC 9										B		A			
In	Out	3rd IPC 9									B		A				
In	Out	4th IPC 9								B		A					

References

1. *Hardware Installation Manual for the Sun-2/130 and Sun-2/160*, 800-1144-02.
2. *Sun Systems Cardcage Slot Assignments and Backplane Configuration Procedures*, 813-2004-16.

Sun-2/130/160

NOTE #	PART#	BOARD
1	501-1144 501-1145 501-1146	1MB CPU 2MB CPU 4MB CPU
2	501-1070 501-1071 501-1096 501-1097	1MB Memory 2MB Memory 3MB Mem 4MB Memory
3	501-1055 501-1139	Graphics Processor Graphics Processor + RC Network 540-1300-01 must be installed on the power supply. (FCO 160-0002 DOC 807-0029)
4	501-1014 501-1116	Sun-2 Color Sun-3 Color
5	501-1157 370-1040 370-1047 370-1048	ALM-1 Assy (501-1157-01) MTI-1600 Board Set MTI-1600 Controller MTI-1600 USART
	501-1157 370-1097 370-1099 370-1100	ALM-1 Assy (501-1157-02) MTI-1650B Board Set MTI-1650B Controller MTI-1650B USART
6	501-1049	Sun-2 VME SCSI Assy
7	501-1155 501-1156	1/2" Xylogics 472 Assy 1/2" CPC Tapemaster Assy
8	501-1154 501-1166	Xylogics 450 SMD Ctr Assy Xylogics 451 SMD Ctr Assy
9	501-1125 501-1214	SunIPC w/o 80287 SunIPC w 80287

Sun-2/120

BOARD	SLOT POSITION								
	1	2	3	4	5	6	7	8	9
CPU 1	A								
1st Memory 2		A							
2nd Memory 2			A						
3rd Memory 2				A					
4th Memory 2					A				
ALM-8 Ctr 3							A		
ALM-8 USART						A			
Video 4					B	A			
1st SCP							A	B	
2nd SCP								A	B
SCSI				B	A		C	D	E
1st Ethernet 5			A	B	C		D	E	F
2nd Ethernet 5				A	B		C	D	E
1st Tape Ctr 6							A	B	C
2nd Tape Ctr 6								A	B
1st Disk Ctr 7							A	B	C
2nd Disk Ctr 7								A	B
Sky FPP							A		C
Color			F	E	D		C	B	A

References

1. *Hardware Installation Manual for the Sun-2/170*, 800-1171-01.
2. *Sun Systems Cardcage Slot Assignments and Backplane Configuration Procedures*, 813-2004-16.

Sun-2/170

BOARD	SLOT POSITION														
	1	2	3	4	5	6	7	8	9	10	11	12	13	14	15
CPU 1	A														
1st Memory 2		A													
2nd Memory 2			A												
3rd Memory 2				A											
4th Memory 2					A										
Video 4						A									
1st SCP							A								
2nd SCP								A							
SCSI				A	B		C	D	E	F	G				
1st Ethernet 5			A	B	C		D	E	F	G					
2nd Ethernet 5				A	B		C	D	E	F	G				
1st Tape Ctlr 6							A	B	C	D	E	F			
2nd Tape Ctlr 6								A	B	C	D	E	F		
1st Disk Ctlr 7							A	B	C	D	E	F	G		
2nd Disk Ctlr 7								A	B	C	D	E	F	G	H
Sky FPP							A	B	C	D	E	F	G	H	I
Color															A
ALM-14 Ctlr 8							A	B	C	D	E	F	G	H	I
ALM-14 USART								A	B	C	D	E	F	G	H

References

1. *Hardware Installation Manual for the Sun-2/120*, 800-1170-01.
2. *Sun Systems Cardcage Slot Assignments and Backplane Configuration Procedures*, 813-2004-16.

Sun-2/120/170

NOTE #	PART#	BOARD
1	501-1007 501-1051	68010 CPU 68010 CPU Avoid using the 501-1051 CPU with the 501-1013 Memory
2	501-1013 501-1051 501-1232	1MB Memory 1MB Memory 4MB Memory Avoid using the 501-1013 Memory board with the 501-1051 CPU
3	370-1039 370-1047 370-1046 370-1098 370-1099 370-1102	MTI-800 Board Set MTI-800 Controller MTI-800 USART MTI-850B Board Set MTI-850B Controller MTI-850B USART
4	501-1003 501-1052	Monochrome Frame Buffer Monochrome Frame Buffer
5	501-0288 501-1004	3Com 3C400 Ethernet Sun-2 Ethernet
6	370-0502 370-1067	Tapemaster Tape Controller Xylogics 472 Tape Controller
7	370-1012	Xylogics 450 Disk Controller The Xylogics 451, 370-1082, is NOT supported.
8	370-1040 370-1047 370-1048 370-1097 370-1099 370-1100	MTI-1600 Board Set MTI-1600 Controller MTI-1600 USART MTI-1650B Board Set MTI-1650B Controller MTI-1650B USART

Sun-3/50

PART#	DESCRIPTION
501-1074	2MB CPU w/o 68881
501-1075	4MB CPU w/o 68881
501-1133	4MB CPU w/o 68881
501-1162	4MB CPU w/o 68881
501-1207	4MB CPU w/68881

Sun-3/60

PART#	DESCRIPTION
501-1205	4MB CPU Monochrome
501-1322	4MB CPU Monoless
501-1334	0MB CPU Monochrome
501-1345	0MB CPU Monoless
501-1210	CG4 Frame Buffer
501-1239	1MB SIMM Module
501-1247	MG3 Mono Frame Buffer
501-1248	CG4 Color Frame Buffer
501-1210	CG4 Color Frame Buffer
501-1443	CG4 Color Frame Buffer
501-1374	CG6 Color Frame Buffer
501-1532	CG6 Color Frame Buffer
501-1505	CG6 Color Frame Buffer

Sun-3/75

PART#	DESCRIPTION
501-1074	2MB Sun 3100 CPU
501-1094	4MB Sun 3100 CPU
501-1163	2MB Sun 3100 CPU
501-1164	4MB Sun 3100 CPU
501-1121	0MB Memory
501-1111	2MB Memory
501-1122	4MB Memory
501-1172	0MB Memory with Sun-2 VME SCSI
501-1045	Sun-2 VME SCSI

Note: The 501-1236 SCSI, is not supported in the Sun-3/75.

Sun-3/80

PART#	DESCRIPTION
501-1401	Sun-3/80 CPU
501-1650	Sun-3/80 CPU
501-1408	1MB SIMM
501-1443	CG4 Color Frame Buffer
501-1374	CG6 Color Frame Buffer
501-1532	CG6 Color Frame Buffer
501-1505	CG6 Color Frame Buffer
501-1402	MG3 Mono Frame Buffer
501-1518	CG8 Color Frame Buffer
501-1577	CG8 Color Frame Buffer
150-1424	CPU SCSI Terminator
150-1537	CPU SCSI Terminator, Keyed

Sun386i/150/250

PART #	DESCRIPTION	P2Bus Slot			
		1	2	3	4
501-1241	Sun386i/150 20Mhz CPU	-	-	-	-
501-1414	Sun386i/150 20Mhz CPU	-	-	-	-
501-1324	Sun386i/250 25Mhz CPU	-	-	-	-
501-1413	Sun386i/250 25Mhz CPU	-	-	-	-
501-1298	8MB XP Cache Memory		B	A	-
501-1325	4MB XP Cache Memory		B	A	-
501-1482	0MB XP Cache Memory		B	A	-
501-1375	●1MB SIMM	-	-	-	-
501-1424	●1MB SIMM	-	-	-	-
501-1510	●1MB SIMM	-	-	-	-
555-1054	0MB XP Cache Memory		B	A	-
501-1375	●1MB SIMM	-	-	-	-
501-1424	●1MB SIMM	-	-	-	-
501-1394	4MB Dynamic Memory		B	A	-
501-1441	8MB Dynamic Memory		B	A	-
501-1423	0MB Dynamic Memory		B	A	-
501-1424	●1MB SIMM	-	-	-	-
501-1243	1152x900 Color FB	-	-	-	A
501-1286	1024x768 Color FB	-	-	-	A
501-1433	1024x768 Mono FB	-	-	-	A
501-1568	1024x768 Mono FB	-	-	-	A
501-1244	1152x900 Mono FB	-	-	-	A
501-1567	1152x900 Mono FB	-	-	-	A

Sun-3/110

SHUNTS		BOARD	SLOT POSITION		
BG3	IACK		1	2	3
Out	Out	Sun 3100 CPU 1	A		
In	In	1st Memory 2		A	
In	In	2nd Memory 2			A
In	In	FPA	A	B	
Out	Out	1st SCP		A	B
Out	Out	2nd SCP			A
Out	Out	1st MCP		A	B
Out	Out	2nd MCP			A
Out	Out	1st ALM-2		A	B
Out	Out	2nd ALM-2			A
Out	Out	MAPkit		A	A
Out	Out	SCSI 3		B	A
In	Out	HSI		A	B
Out	Out	Ethernet		B	A
In	Out	1st IPC 4		B	A
In	Out	2nd IPC 4		A	

Reference

Sun Systems Cardcage Slot Assignments and Backplane Configuration Procedures, 813-2004-16.

Sun-3/140

SHUNTS		BOARD	SLOT POSITION		
BG3	IACK		1	2	3
Out	Out	Sun 3100 CPU 5	A		
In	In	1st Memory 2		A	
In	In	2nd Memory 2			A
In	In	FPA		A	B
Out	Out	1st SCP		A	B
Out	Out	2nd SCP			A
Out	Out	1st MCP		A	B
Out	Out	2nd MCP			A
Out	Out	1st ALM-2		A	B
Out	Out	2nd ALM-2			A
Out	Out	MAPkit		A	A
Out	Out	SCSI 3		B	A
In	Out	HSI		A	B
Out	Out	Ethernet		B	A
In	Out	1st IPC 4		B	A
In	Out	2nd IPC 4		A	

References

1. *Sun Systems Cardcage Slot Assignments and Backplane Configuration Procedures*, 813-2004-16.
2. *Cardcage Slot Assignments and Backplane Configuration Procedures for the Sun 3/140*, 813-2025-05.

Sun-3/150

SHUNTS		BOARD	SLOT POSITION					
BG3	IACK		1	2	3	4	5	6
Out	Out	Sun 3004 CPU 5	A					
In	In	1st Memory 2		A				
In	In	FPA				A		
In	In	2nd Memory 2			A			
In	In	3rd Memory 2				A		
Out	Out	GP 6					A	
In	In	GB						A
Out	N/A	ALM-1					A	A
Out	Out	1st SCP		A	B	C	D	E
Out	Out	2nd SCP			A	B	C	D
In	Out	1st MCP		A	B	C	D	E
In	Out	2nd MCP			A	B	C	D
In	Out	3rd MCP				A	B	C
In	Out	4th MCP					A	B
In	Out	1st ALM-2		A	B	C	D	E
In	Out	2nd ALM-2			A	B	C	D
In	Out	3rd ALM-2				A	B	C
In	Out	4th ALM-2					A	B
Out	Out	SunLink Channel Adapter		A	A	C	C	
-	-				B	B	D	D
Out	Out	1st MAPkit		A	A	C	C	
-	-				B	B	D	D
Out	Out	2nd MAPkit				A	A	
-	-						B	B
Out	Out	SCSI 3		A	B	C	D	E
In	Out	Color 7		A	B	C	D	E
In	Out	CG5 with GP/GP+		A	B	C		
In	Out	CG5 with GP2						A
In	Out	HSI		A	B	C	D	E
Out	Out	Ethernet		A	B	C	D	E
Out	Out	FDDI		A	B	C	D	E
In	Out	1st IPC 4		A	B	C	D	E
In	Out	2nd IPC 4			A	B	C	D

References

1. *Sun Systems Cardcage Slot Assignments and Backplane Configuration Procedures*, 813-2004-16.
2. *Cardcage Slot Assignments and Backplane Configuration Procedures for the Sun 3/150*, 813-2038-05.

Sun-3/160

SHUNTS		BOARD	SLOT POSITION													
			1	2	3	4	5	6	7	8	9	10	11	12		
BG3	IACK															
Out	Out	Sun 3004 CPU 5	A													
In	In	1st Memory 2					A									
In	In	2nd Memory 2				A										
In	In	3rd Memory 2			A											
In	In	FPA						A								
Out	Out	GP 6											A			
In	In	GB												A		
In	In	TAAC-1 8		C	C	C			B	B	B	A	A	A		
-	-				D	D	D									
Out	N/A	ALM-1												A	A	
Out	Out	SCSI 9						A								
Out	Out	1st SCP		E	A	B	C	D								
Out	Out	2nd SCP		D		A	B	C	E	F						
Out	Out	1st MCP		E	A	B	C	D	F	G	H					
Out	Out	2nd MCP		D		A	B	C	E	F	G	H	I	J		
Out	Out	3rd MCP		C			A	B	C	E	F	G	H	I		
Out	Out	4th MCP		B				A	B	C	E	F	G	H		
Out	Out	1st ALM-2		E	A	B	C	D	F	G	H	I	J	K		
Out	Out	2nd ALM-2		D		A	B	C	E	F	G	H	I	J		
Out	Out	3rd ALM-2		C			A	B	C	E	F	G	H	I		
Out	Out	4th ALM-2		B				A	B	C	E	F	G	H		
Out	Out	1st SunLink Channel Adapter		A	A	C	C	E	E	G	G	I	I			
-	-				B	B	D	D	F	F	H	H	J	J		
Out	Out	2nd SunLink Channel Adapter				A	A	C	C	E	E	G	G			
-	-					B	B	D	D	F	F	H	H			
Out	Out	1st MAPkit		A	A	C	C	E	E	G	G	I	I	J	J	
-	-				B	B	D	D	F	F	H	H	J	J		
Out	Out	2nd MAPkit				A	A	C	C	E	E	G	G			
-	-					B	B	D	D	F	F	H	H			
In	Out	HSI		E	A	B	C	D	F	G	H	I	J	K		
Out	Out	Ethernet		E	A	B	C	D	F	G	H	I	J	K		

Sun-3/160 – Continued

SHUNTS		BOARD	SLOT POSITION													
			1	2	3	4	5	6	7	8	9	10	11	12		
BG3	IACK															
In	Out	1st IPC 4		E	A	B	C	D	F	G	H	I	J	K		
In	Out	2nd IPC 4		D		A	B	C	E	F	G	H	I	J		
In	Out	3rd IPC 4		C			A	B	D	E	F	G	H	I		
In	Out	4th IPC 4		B				A	C	D	E	F	G	H		
Out	Out	1st Tape Ctlr 10							A	B	C	D	E	F		
Out	Out	2nd Tape Ctlr 10								A	B	C	D	E		
Out	Out	1st Disk Ctlr 11							A	B	C	D	E	F		
Out	Out	2nd Disk Ctlr 11								A	B	C	D	E		
In	Out	Color 12		K	A	B	C	D	E	F	G	H	I	J		
In	Out	CG5 with GP/GP+		H	A	B	C	D	E	F	G					
In	Out	CG5 with GP2												A	B	
Out	Out	1st Ext SCSI 13							A	B	C	D	E	F		
Out	Out	2nd Ext SCSI 13								A	B	C	D	E		

Note: For systems without a SCSI Host Adapter, use charts for the Sun-3/180 with 501-1138 or 501-1217 SCSI Host Adapter.

Reference
Sun Systems Cardcage Slot Assignments and Backplane Configuration Procedures, 813-2004-16.

Sun-3/180

with 501-1167 SCSI Host Adapter

SHUNTS		BOARD	SLOT POSITION											
			1	2	3	4	5	6	7	8	9	10	11	12
BG3	IACK													
Out	Out	Sun 3004 CPU 5	A											
In	In	1st Memory 2		A										
In	In	2nd Memory 2			A									
In	In	3rd Memory 2				A								
In	In	FPA						A						
Out	Out	GP 6										A		
In	In	GB											A	
In	In	TAAC-1 8		C	C	C			B	B	B	A	A	
-	-			D	D	D								
-	-			E	E	E								
Out	N/A	1st ALM-1											A	
Out	N/A	2nd ALM-1											A	
Out	N/A	3rd ALM-1										A		
Out	Out	SCSI 3						A						
Out	Out	1st SCP		A	B	C	D							
Out	Out	2nd SCP			A	B	C	D	E					
Out	Out	1st MCP		A	B	C	D	E	F	G				
Out	Out	2nd MCP			A	B	C	D	E	F	G	H	I	
Out	Out	3rd MCP				A	B	C	D	E	F	G	H	
Out	Out	4th MCP					A	B	C	D	E	F	G	
Out	Out	1st ALM-2		A	B	C	D	E	F	G				
Out	Out	2nd ALM-2			A	B	C	D	E	F	G	H	I	
Out	Out	3rd ALM-2				A	B	C	D	E	F	G	H	
Out	Out	4th ALM-2					A	B	C	D	E	F	G	
Out	Out	1st SunLink Channel Adapter		A	A	C	C		E	E	G	G		
-	-			B	B	D	D			F	F	H	H	
Out	Out	2nd SunLink Channel Adapter				A	A		C	C	E	E		
-	-					B	B			D	D	F	F	
Out	Out	1st MAPkit		A	A	C	C		E	E	G	G		
-	-			B	B	D	D			F	F	H	H	
Out	Out	2nd MAPkit				A	A		C	C	E	E		
-	-					B	B			D	D	F	F	

Sun-3/180 – Continued

with 501-1167 SCSI Host Adapter

SHUNTS		BOARD	SLOT POSITION														
			1	2	3	4	5	6	7	8	9	10	11	12			
BG3	IACK																
In	Out	Color 12		A	B	C	D	E		F	G	H	I	J			
In	Out	CG5 with GP/GP+		A	B	C	D	E		F	G						
In	Out	CG5 with GP2												A	B		
In	Out	HSI		A	B	C	D	E		F	G	H	I	J			
Out	Out	FDDI		A	B	C	D	E		F	G	H	I	J			
In	Out	1st IPC 4		A	B	C	D	E		F	G	H	I	J			
In	Out	2nd IPC 4			A	B	C	D		E	F	G	H	I			
In	Out	3rd IPC 4				A	B	C		D	E	F	G	H			
In	Out	4th IPC 4					A	B		C	D	E	F	G			
Out	Out	1st Tape Ctr 10								A	B	C	D	E			
Out	Out	2nd Tape Ctr 10									A	B	C	D			
Out	Out	1st SMD Ctr 11								A	B	C	D	E			
Out	Out	2nd SMD Ctr 11									A	B	C	D			
Out	Out	3rd SMD Ctr 14										A	B	C			
Out	Out	4th SMD Ctr 14											A	B			

Note: For systems without a SCSI Host Adapter, use charts for the Sun-3/180 with 501-1138 or 501-1217 SCSI Host Adapter.

Reference

Sun Systems Cardcage Slot Assignments and Backplane Configuration Procedures, 813-2004-16.

Sun-3/180

with 501-1138 or 501-1217 SCSI Host Adapter

SHUNTS		BOARD	SLOT POSITION													
			1	2	3	4	5	6	7	8	9	10	11	12		
Out	Out	Sun 3004 CPU 5	A													
In	In	1st Memory 2		A												
In	In	2nd Memory 2			A											
In	In	3rd Memory 2				A										
In	In	FPA						A								
Out	Out	GP 6											A			
In	In	GB												A		
In	In	TAAC-1 8		C	C	C			B	B	B	A	A	A		
---	---			D	D	D										
---	---			E	E	E										
Out	N/A	1st ALM-1														A
Out	N/A	2nd ALM-1													A	
Out	N/A	3rd ALM-1											A			
Out	Out	1st SCP		A	B	C	D									
Out	Out	2nd SCP			A	B	C	D	E							
Out	Out	1st MCP		A	B	C	D	E	F	G						
Out	Out	2nd MCP			A	B	C	D	E	F	G					
Out	Out	3rd MCP				A	B	C	D	E	F	G	H	I		
Out	Out	4th MCP					A	B	C	D	E	F	G	H		
Out	Out	1st ALM-2		A	B	C	D	E	F	G	H	I	J	K		
Out	Out	2nd ALM-2			A	B	C	D	E	F	G	H	I	J		
Out	Out	3rd ALM-2				A	B	C	D	E	F	G	H	I		
Out	Out	4th ALM-2					A	B	C	D	E	F	G	H		
Out	Out	1st SunLink Channel Adapter		A	A	C	C	E	E	G	G	I	I			
-	-			B	B	D	D	F	F	H	H	J	J			
Out	Out	2nd SunLink Channel Adapter				A	A	C	C	E	E	G	G			
-	-					B	B	D	D	F	F	H	H			
Out	Out	1st MAPkit		A	A	C	C	E	E	G	G	I	I			
-	-			B	B	D	D	F	F	H	H	J	J			
Out	Out	2nd MAPkit				A	A	C	C	E	E	G	G			
-	-					B	B	D	D	F	F	H	H			

Sun-3/180 – Continued

with 501-1138 or 501-1217 SCSI

SHUNTS		BOARD	SLOT POSITION														
			1	2	3	4	5	6	7	8	9	10	11	12			
BG3	IACK																
Out	Out	SCSI		A	B	C	D	E	F	G	H	I	J	K			
In	Out	Color 12		A	B	C	D	E	F	G	H	I	J	K			
In	Out	CG5 with GP/GP+		A	B	C	D	E	F	G	H						
In	Out	CG5 with GP2													A	B	
In	Out	HSI		A	B	C	D	E	F	G	H	I	J	K			
Out	Out	Ethernet		A	B	C	D	E	F	G	H	I	J	K			
Out	Out	FDDI		A	B	C	D	E	F	G	H	I	J	K			
In	Out	1st IPC 4		A	B	C	D	E	F	G	H	I	J	K			
In	Out	2nd IPC 4			A	B	C	D	E	F	G	H	I	J			
In	Out	3rd IPC 4				A	B	C	D	E	F	G	H	I			
In	Out	4th IPC 4					A	B	C	D	E	F	G	H			
In	Out	1st Tape Ctlr 10		A	B	C	D	E	F	G	H	I	J	K			
In	Out	2nd Tape Ctlr 10			A	B	C	D	E	F	G	H	I	J			
Out	Out	1st SMD Ctlr 11		A	B	C	D	E	F	G	H	I	J	K			
Out	Out	2nd SMD Ctlr 11			A	B	C	D	E	F	G	H	I	J			
Out	Out	3rd SMD Ctlr 14				A	B	C	D	E	F	G	H	I			
Out	Out	4th SMD Ctlr 14					A	B	C	D	E	F	G	H			

Reference

Sun Systems Cardcage Slot Assignments and Backplane Configuration Procedures, 813-2004-16.

Sun-3/180

with 501-1138 or 501-1217 SCSI Host Adapter
Slots 7,8,9 reserved for non-Sun boards that use P2

SHUNTS		BOARD	SLOT POSITION											
BG3	IACK		1	2	3	4	5	6	7	8	9	10	11	12
Out	Out	Sun 3004 CPU 5	A											
In	In	1st Memory 2	A											
In	In	2nd Memory 2		A										
In	In	3rd Memory 2			A									
In	In	FPA					A							
Out	Out	GP 6									A			
In	In	GB										A		
In	In	TAAC-1 8		B	B	B					A	A	A	
-	-			C	C	C								
-	-			D	D	D								
Out	N/A	1st ALM-1												A
Out	N/A	2nd ALM-1											A	
Out	N/A	3rd ALM-1									A			
Out	Out	1st SCP		A	B	C	D							
Out	Out	2nd SCP			A	B	C	D			E	F	G	
Out	Out	1st MCP		A	B	C	D	E			F	G	H	
Out	Out	2nd MCP			A	B	C	D			E	F	G	
Out	Out	3rd MCP				A	B	C			D	E	F	
Out	Out	4th MCP					A	B			C	D	E	
Out	Out	1st ALM-2		A	B	C	D	E			F	G	H	
Out	Out	2nd ALM-2			A	B	C	D			E	F	G	
Out	Out	3rd ALM-2				A	B	C			D	E	F	
Out	Out	4th ALM-2					A	B					C	D
Out	Out	1st SunLink Channel Adapter		A	A	C	C				E	E		
-	-			B	B	D	D				F	F		
Out	Out	2nd SunLink Channel Adapter				A	A				C	C		
-	-					B	B				D	D		
Out	Out	1st MAPkit		A	A	C	C				E	E		
-	-			B	B	D	D				F	F		
Out	Out	2nd MAPkit				A	A				C	C		
-	-					B	B				D	D		

Sun-3/180 – Continued
with 501-1138 or 501-1217 SCSI Host Adapter
 Slots 7,8,9 reserved for non-Sun boards that use P2

SHUNTS		BOARD	SLOT POSITION												
			1	2	3	4	5	6	7	8	9	10	11	12	
Out	Out	SCSI 3		A	B	C	D	E					F	G	H
In	Out	Color 12		A	B	C	D	E					F	G	H
In	Out	CG5 with GP/GP+		A	B	C	D	E							
In	Out	CG5 with GP2												A	B
In	Out	HSI		A	B	C	D	E					F	G	H
Out	Out	Ethernet		A	B	C	D	E					F	G	H
Out	Out	FDDI		A	B	C	D	E					F	G	H
In	Out	1st IPC 4		A	B	C	D	E					F	G	H
In	Out	2nd IPC 4			A	B	C	D					E	F	G
In	Out	3rd IPC 4				A	B	C					D	E	F
In	Out	4th IPC 4					A	B					C	D	E
In	Out	1st Tape Ctlr 10		A	B	C	D	E					F	G	H
In	Out	2nd Tape Ctlr 10			A	B	C	D					E	F	G
Out	Out	1st Disk Ctlr 11		A	B	C	D	E					F	G	H
Out	Out	2nd Disk Ctlr 11			A	B	C	D					E	F	G
Out	Out	3rd Disk Ctlr 14				A	B	C					D	E	F
Out	Out	4th Disk Ctlr 14					A	B					C	D	E

Reference

Sun Systems Cardcage Slot Assignments and Backplane Configuration Procedures, 813-2004-16.

Sun-3/110/140/150/160/180

NOTE #	PART#	BOARD
1	501-1134 501-1209	Sun-3/110 CPU Sun-3/110 CPU
2	501-1131 501-1132	2MB Memory 4MB Memory The 501-1131 is NOT supported in the Sun-3/110 or the Sun-3/150.
3	501-1138 501-1217	Sun-2 SCSI Host Adapter Assembly Sun-3 SCSI Host Adapter Assembly
4	501-1125 501-1214	SunIPC without 80287 SunIPC with 80287
5	501-1074 501-1094 501-1163 501-1164 501-1208	2MB Sun 3004 CPU 4MB Sun 3004 CPU 2MB Sun 3004 CPU 4MB Sun 3004 CPU 4MB Sun 3004 CPU
6	501-1055 501-1139 501-1268	Graphics Processor Graphics Processor + Graphics Processor 2
7	501-1116 501-1267	Sun-3 Color Frame Buffer CG5 Color Frame Buffer
8	501-1383 501-1447	TAAC-1 Application Accelerator TAAC-1 Application Accelerator
9	501-1149 501-1170	Sun-2 SCSI Host Adapter Assembly Sun-3 SCSI Host Adapter Assembly
10	501-1155 501-1156	Xylogics 472 Tape Controller Assembly Tapemaster Tape Controller Assembly
11	501-1154 501-1166 501-1249	Xylogics 450 Disk Controller Assembly Xylogics 451 Disk Controller Assembly Xylogics 7053 Disk Controller

Sun-3/110/140/150/160/180

Continued

NOTE #	PART#	BOARD
12	501-1014 501-1116 501-1267	Sun-2 Color Frame Buffer Sun-3 Color Frame Buffer CG5 Color Frame Buffer
13	501-1217	Sun-3 SCSI Host Adapter Assy
14	501-1249	Xylogics 7053 Disk Controller

Sun-3/260

SHUNTS		BOARD	SLOT POSITION											
			1	2	3	4	5	6	7	8	9	10	11	12
BG3	IACK													
Out	Out	Sun 3200 CPU 1	A											
In	In	1st Memory 2						A						
In	In	2nd Memory 2				A								
In	In	3rd Memory 2			A									
In	In	4th Memory 2		A										
In	In	FPA						A						
Out	Out	GP 3										A		
In	In	GB											A	
In	In	TAAC-1 4		C	C	C			B	B	B	A	A	A
-	-			D	D	D								
-	-			E	E	E								
Out	N/A	ALM-1											A	A
Out	Out	SCSI 5						A						
Out	Out	1st SCP		D	A	B	C		E	F				
Out	Out	2nd SCP		C		A	B		D	E	F			
Out	Out	1st MCP		D	A	B	C		E	F	G	H	I	J
Out	Out	2nd MCP		C		A	B		D	E	F	G	H	I
Out	Out	3rd MCP		B			A		C	D	E	F	G	H
Out	Out	4th MCP		A					B	C	D	E	F	G
Out	Out	1st ALM-2		D	A	B	C		E	F	G	H	I	J
Out	Out	2nd ALM-2		C		A	B		D	E	F	G	H	I
Out	Out	3rd ALM-2		B			A		C	D	E	F	G	H
Out	Out	4th ALM-2		A					B	C	D	E	F	G
Out	Out	1st SunLink		A	A	C	C		D	D	F	F	H	H
-	-	Channel Adapter			B	B				E	E	G	G	
Out	Out	2nd SunLink				A	A		B	B	D	D	F	F
-	-	Channel Adapter								C	C	E	E	
Out	Out	1st MAPkit		A	A	C	C		D	D	F	F	H	H
-	-				B	B				E	E	G	G	
Out	Out	2nd MAPkit				A	A		B	B	D	D	F	F
-	-									C	C	E	E	
In	Out	HSI		D	A	B	C		E	F	G	H	I	J
Out	Out	Ethernet		D	A	B	C		E	F	G	H	I	J

Sun-3/260 – Continued

SHUNTS		BOARD	SLOT POSITION													
			1	2	3	4	5	6	7	8	9	10	11	12		
BG3	IACK															
Out	Out	1st FDDI		D	A	B	C		E	F	G	H	I	J		
Out	Out	2nd FDDI		C		A	B		D	E	F	G	H	I		
In	Out	1st IPC 6		D	A	B	C		E	F	G	H	I	J		
In	Out	2nd IPC 6		C		A	B		D	E	F	G	H	I		
In	Out	3rd IPC 6		B			A		C	D	E	F	G	H		
In	Out	4th IPC 6		A					B	C	D	E	F	G		
Out	Out	1st Tape Ctlr 7							A	B	C	D	E	F		
Out	Out	2nd Tape Ctlr 7								A	B	C	D	E		
Out	Out	1st SMD Ctlr 8							A	B	C	D	E	F		
Out	Out	2nd SMD Ctlr 8								A	B	C	D	E		
In	Out	Color 9		J	A	B	C		D	E	F	G	H	I		
In	Out	CG5 with GP/GP+		G	A	B	C		D	E	F					
In	Out	CG5 with GP2													A	B
In	Out	CG9													A	B
Out	Out	1st Ext SCSI 10							A	B	C	D	E	F		
Out	Out	2nd Ext SCSI 10								A	B	C	D	E		

Note: For systems without a SCSI Host Adapter, use charts for the Sun-3/280 with 501-1138 or 501-1217 SCSI Host Adapter.

Reference

Sun Systems Cardcage Slot Assignments and Backplane Configuration Procedures, 813-2004-16.

Sun-3/280

with 501-1167 SCSI Host Adapter

SHUNTS		BOARD	SLOT POSITION											
			1	2	3	4	5	6	7	8	9	10	11	12
BG3	IAck													
Out	Out	Sun 3200 CPU 1	A											
In	In	1st Memory 2						A						
In	In	2nd Memory 2		A										
In	In	3rd Memory 2			A									
In	In	4th Memory 2				A								
In	In	FPA					A							
Out	Out	GP 3										A		
In	In	GB											A	
In	In	TAAC-1 4		C	C	C			B	B	B	A	A	A
-	-				D	D	D							
-	-					E	E	E						
Out	N/A	1st ALM-1												A
Out	Out	2nd ALM-1											A	
Out	Out	3rd ALM-1										A		
Out	Out	SCSI 11						A						
Out	Out	1st SCP		A	B	C	D			E				
Out	Out	2nd SCP			A	B	C			D	E			
Out	Out	1st MCP		A	B	C	D			E	F	G	H	I
Out	Out	2nd MCP			A	B	C			D	E	F	G	H
Out	Out	3rd MCP				A	B			C	D	E	F	G
Out	Out	4th MCP					A			B	C	D	E	F
Out	Out	1st ALM-2		A	B	C	D			E	F	G	H	I
Out	Out	2nd ALM-2			A	B	C			D	E	F	G	H
Out	Out	3rd ALM-2				A	B			C	D	E	F	G
Out	Out	4th ALM-2					A			B	C	D	E	F
Out	Out	1st SunLink Channel Adapter		A	A	C	C			D	D	F	F	
-	-				B	B				E	E	G	G	
Out	Out	2nd SunLink Channel Adapter				A	A			B	B	D	D	
-	-									C	C	E	E	
Out	Out	1st MAPkit		A	A	C	C			D	D	F	F	
-	-				B	B			E	E	D	D		
Out	Out	2nd MAPkit				A	A			B	B	D	D	
-	-									C	C	E	E	

Sun-3/280 – Continued

with 501-1167 SCSI Host Adapter

SHUNTS		BOARD	SLOT POSITION														
			1	2	3	4	5	6	7	8	9	10	11	12			
BG3	IACK																
In	Out	Color 9		A	B	C	D				E	F	G	H	I		
In	Out	CG5 with GP/GP+		A	B	C	D				E	F					
In	Out	CG5 with GP2													A	B	
In	Out	1st HSI		A	B	C	D				E	F	G	H	I		
In	Out	2nd HSI			A	B	C				D	E	F	G	H		
Out	Out	1st FDDI		A	B	C	D				E	F	G	H	I		
Out	Out	2nd FDDI			A	B	C				D	E	F	G	H		
Out	Out	Ethernet		A	B	C	D				E	F	G	H	I		
In	Out	1st IPC 6		A	B	C	D				E	F	G	H	I		
In	Out	2nd IPC 6			A	B	C				D	E	F	G	H		
In	Out	3rd IPC 6				A	B				C	D	E	F	G		
In	Out	4th IPC 6					A				B	C	D	E	F		
Out	Out	1st Tape Ctlr 7									A	B	C	D	E		
Out	Out	2nd Tape Ctlr 7										A	B	C	D		
Out	Out	1st Disk Ctlr 8									A	B	C	D	E		
Out	Out	2nd Disk Ctlr 8										A	B	C	D		
Out	Out	3rd Disk Ctlr 12											A	B	C		
Out	Out	4th Disk Ctlr 12													A	B	

Reference

Sun Systems Cardcage Slot Assignments and Backplane Configuration Procedures, 813-2004-16.

Sun-3/280

with 501-1138 or 501-1217 SCSI Host Adapter

SHUNTS		BOARD	SLOT POSITION											
			1	2	3	4	5	6	7	8	9	10	11	12
BG3	IACK													
Out	Out	Sun 3200 CPU 1	A											
In	In	1st Memory 2						A						
In	In	2nd Memory 2		A										
In	In	3rd Memory 2			A									
In	In	4th Memory 2				A								
In	In	FPA					A							
Out	Out	GP 3										A		
In	In	GB											A	
In	In	TAAC-1 4		C	C	C			B	B	B	A	A	A
-	-			D	D	D								
-	-			E	E	E								
Out	N/A	1st ALM-1												A
Out	Out	2nd ALM-1											A	
Out	Out	3rd ALM-1										A		
Out	Out	SCSI 10						A						
Out	Out	1st SCP		A	B	C	D			E				
Out	Out	2nd SCP			A	B	C			D	E			
Out	Out	1st MCP		A	B	C	D		E	F	G			
Out	Out	2nd MCP			A	B	C		D	E	F	G	H	I
Out	Out	3rd MCP				A	B		C	D	E	F	G	H
Out	Out	4th MCP					A		B	C	D	E	F	G
Out	Out	1st ALM-2		A	B	C	D		E	F	G	H	I	J
Out	Out	2nd ALM-2			A	B	C		D	E	F	G	H	I
Out	Out	3rd ALM-2				A	B		C	D	E	F	G	H
Out	Out	4th ALM-2					A		B	C	D	E	F	G
Out	Out	1st SunLink		A	A	C	C		D	D	F	F	H	H
	--	Channel Adapter			B	B				E	E	G	G	
Out	Out	2nd SunLink				A	A		B	B	D	D	F	F
-	-	Channel Adapter								C	C	E	E	
Out	Out	1st MAPkit		A	A	C	C		D	D	F	F	G	G
-	-				B	B				E	E			
Out	Out	2nd MAPkit				A	A		B	B	D	D	F	F
-	-									C	C	E	E	

Sun-3/280 – Continued

with 501-1138 or 501-1217 SCSI Host Adapter

SHUNTS		BOARD	SLOT POSITION											
			1	2	3	4	5	6	7	8	9	10	11	12
BG3	IACK													
Out	Out	SCSI 10		A	B	C	D		E	F	G	H	I	J
In	Out	Color 9		A	B	C	D		E	F	G	H	I	J
In	Out	CG5 with GP/GP+		A	B	C	D		E	F	G			
In	Out	CG5 with GP2											A	B
In	Out	1st HSI		A	B	C	D		E	F	G	H	I	J
In	Out	2nd HSI			A	B	C		D	E	F	G	H	I
Out	Out	Ethernet		A	B	C	D		E	F	G	H	I	J
Out	Out	1st FDDI		A	B	C	D		E	F	G	H	I	J
Out	Out	2nd FDDI			A	B	C		D	E	F	G	H	I
In	Out	1st IPC 6		A	B	C	D		E	F	G	H	I	J
In	Out	2nd IPC 6			A	B	C		D	E	F	G	H	I
In	Out	3rd IPC 6				A	B		C	D	E	F	G	H
In	Out	4th IPC 6					A		B	C	D	E	F	G
Out	Out	1st Tape Ctr 7		A	B	C	D		E	F	G	H	I	J
Out	Out	2nd Tape Ctr 7			A	B	C		D	E	F	G	H	I
Out	Out	1st Disk Ctr 8		A	B	C	D		E	F	G	H	I	J
Out	Out	2nd Disk Ctr 8			A	B	C		D	D	F	G	H	I
Out	Out	3rd Disk Ctr 12				A	B		C	D	E	F	G	H
Out	Out	4th Disk Ctr 12					A		B	C	D	E	F	G

Reference

Sun Systems Cardcage Slot Assignments and Backplane Configuration Procedures, 813-2004-16.

Sun-3/280

with 501-1138 or 501-1217 SCSI Host Adapter
 Slots 7,8,9 reserved for non-Sun boards that use P2

SHUNTS		BOARD	SLOT POSITION											
			1	2	3	4	5	6	7	8	9	10	11	12
BG3	IACK		1	2	3	4	5	6	7	8	9	10	11	12
Out	Out	Sun 3200 CPU 1	A											
In	In	1st Memory 2						A						
In	In	2nd Memory 2		A										
In	In	3rd Memory 2				A								
In	In	4th Memory 2					A							
In	In	FPA						A						
Out	Out	GP 3										A		
In	In	GB											A	
In	In	TAAC-1 4		B	B	B						A	A	A
-	-			C	C	C								
-	-				D	D	D							
Out	N/A	1st ALM-1												A
Out	Out	2nd ALM-1											A	
Out	Out	3rd ALM-1										A		
Out	Out	1st SCP		A	B	C	D					E	F	G
Out	Out	2nd SCP			A	B	C					D	E	F
Out	Out	1st MCP		A	B	C	D					E	F	G
Out	Out	2nd MCP			A	B	C					D	E	F
Out	Out	3rd MCP				A	B					C	D	E
Out	Out	4th MCP					A					B	C	D
Out	Out	1st ALM-2		A	B	C	D					E	F	G
Out	Out	2nd ALM-2			A	B	C					D	E	F
Out	Out	3rd ALM-2				A	B					C	D	E
Out	Out	4th ALM-2					A					B	C	D
Out	Out	1st SunLink		A	A	C	C					E	E	
-	-	Channel Adapter			B	B	D	D					F	F
Out	Out	2nd SunLink				A	A					C	C	
-	-	Channel Adapter					B	B					D	D
Out	Out	1st MAPkit		A	A	C	C					E	E	
-	-				B	B	D	D					F	F
Out	Out	2nd MAPkit				A	A					C	C	
-	-						B	B					D	D

Sun-3/280 – Continued
with 501-1138 or 501-1217 SCSI
 Slots 7,8,9 reserved for non-Sun boards that use P2

SHUNTS		BOARD	SLOT POSITION												
			1	2	3	4	5	6	7	8	9	10	11	12	
BG3	IACK														
Out	Out	SCSI 10		A	B	C	D						E	F	G
In	Out	Color 9		A	B	C	D						E	F	G
In	Out	CG5 with GP/GP+		A	B	C	D								
In	Out	CG5 with GP2												A	B
In	Out	1st HSI		A	B	C	D						E	F	G
In	Out	2nd HSI			A	B	C						D	E	F
Out	Out	Ethernet		A	B	C	D						E	F	G
Out	Out	1st FDDI		A	B	C	D						E	F	G
Out	Out	2nd FDDI			A	B	C						D	E	F
In	Out	1st IPC 6		A	B	C	D						E	F	G
In	Out	2nd IPC 6			A	B	C						D	E	F
In	Out	3rd IPC 6				A	B						C	D	E
In	Out	4th IPC 6					A						B	C	D
Out	Out	1st Tape Ctlr 7		A	B	C	D						E	F	G
Out	Out	2nd Tape Ctlr 7			A	B	C						D	E	F
Out	Out	1st Disk Ctlr 8		A	B	C	D						E	F	G
Out	Out	2nd Disk Ctlr 8			A	B	C						D	E	F
Out	Out	3rd Disk Ctlr 12				A	B						C	D	E
Out	Out	4th Disk Ctlr 12					A						B	C	D

Reference

Sun Systems Cardcage Slot Assignments and Backplane Configuration Procedures, 813-2004-16.

Sun-3/260/280

NOTE #	PART#	BOARD
1	501-1100 501-1206	Sun 3200 CPU Sun 3200 CPU
2	501-1102 501-1576	8MB Memory 16MB Memory
3	501-1055 501-1139 501-1268	Graphics Processor Graphics Processor + Graphics Processor 2
4	501-1383 501-1447	TAAC-1 Application Accelerator TAAC-1 Application Accelerator
5	501-1149 501-1170	Sun-2 SCSI Host Adapter Assembly Sun-3 SCSI Host Adapter Assembly
6	501-1125 501-1214	SunIPC without 80287 SunIPC with 80287
7	501-1155 501-1156	Xylogics 472 Tape Controller Assy Tapemaster Tape Controller Assy
8	501-1154 501-1166	Xylogics 450 Disk Controller Assy Xylogics 451 Disk Controller Assy
9	501-1014 501-1116 501-1267	Sun-2 Color Frame Buffer Sun-3 Color Frame Buffer CG5 Color Frame Buffer
10	501-1138 501-1217	Sun-2 SCSI Host Adapter Assembly Sun-3 SCSI Host Adapter Assembly
11	501-1167	Sun-2 SCSI Host Adapter Assembly
12	501-1249	Xylogics 7053 Disk Controller

This page intentionally left blank.

Sun-3/460

SHUNTS		BOARD	SLOT POSITION											
			1	2	3	4	5	6	7	8	9	10	11	12
BG3	IACK													
Out	Out	Sun 3400 CPU	A	A										
In	In	1st Memory 1						A						
In	In	2nd Memory 1				B	A							
In	In	3rd Memory 1			B	A								
In	In	4th Memory 1			A									
In	In	FPA					A							
Out	Out	GP 2										A		
In	In	GB											A	
In	In	TAAC-1 3		C	C	C			B	B	B	A	A	A
-	-			D	D	D								
-	-				E	E	E							
Out	N/A	ALM-1											A	A
Out	Out	SCSI 4						A						
Out	Out	1st SCP			A	B	C		D	E	F	G	H	I
Out	Out	2nd SCP				A	B		C	D	E	F	G	H
Out	Out	1st MCP			A	B	C		D	E	F	G	H	I
Out	Out	2nd MCP				A	B		C	D	E	F	G	H
Out	Out	3rd MCP					A		B	C	D	E	F	G
Out	Out	4th MCP							A	B	C	D	E	F
Out	Out	1st ALM-2			A	B	C		E	F	G	H	I	J
Out	Out	2nd ALM-2				A	B		D	E	F	G	H	I
Out	Out	3rd ALM-2					A		C	D	E	F	G	H
Out	Out	4th ALM-2							B	C	D	E	F	G
Out	Out	1st SunLink			A	A			C	C	E	E	G	G
-	-	Channel Adapter				B	B			F	F	D	D	
Out	Out	2nd SunLink							A	A	C	C	E	E
-	-	Channel Adapter								B	B	D	D	
Out	Out	1st MAPkit			A	A			C	C	E	E	G	G
-	-					B	B			F	F	D	D	
Out	Out	2nd MAPkit							A	A	C	C	E	E
-	-									B	B	D	D	

Sun-3/460 – Continued

SHUNTS		BOARD	SLOT POSITION												
			1	2	3	4	5	6	7	8	9	10	11	12	
BG3	IACK														
In	Out	Color 5			A	B	C		D	E	F	G	H	I	
In	Out	CG5 with GP/GP+			A	B	C		D	E	F				
In	Out	CG5 with GP2												A	B
In	Out	CG9 Color												A	B
In	Out	1st HSI			A	B	C		D	E	F	G	H	I	
In	Out	2nd HSI				A	B		C	D	E	F	G	H	
Out	Out	Ethernet			A	B	C		D	E	F	G	H	I	
Out	Out	1st FDDI			A	B	C		D	E	F	G	H	I	
Out	Out	2nd FDDI				A	B		C	D	E	F	G	H	
In	Out	1st IPC 6			A	B	C		D	E	F	G	H	I	
In	Out	2nd IPC 6				A	B		C	D	E	F	G	H	
In	Out	3rd IPC 6					A		B	C	D	E	F	G	
In	Out	4th IPC 6							A	B	C	D	E	F	
Out	Out	1st Tape Ctr 7							A	B	C	D	E	F	
Out	Out	2nd Tape Ctr 7								A	B	C	D	E	
Out	Out	1st Disk Ctr 8							A	B	C	D	E	F	
Out	Out	2nd Disk Ctr 8								A	B	C	D	E	

References

1. *Sun Systems Cardcage Slot Assignments and Backplane Configuration Procedures*, 813-2004-16.
2. *Sun-3/460 and 3/480 Cardcage Slot Assignments and Backplane Configuration Procedures*, 813-2056-11.

Sun-3/470

SHUNTS		BOARD	SLOT POSITION											
			1	2	3	4	5	6	7	8	9	10	11	12
BG3	IACK													
Out	Out	Sun 3400 CPU				A	A							
In	In	1st Memory 1	A											
In	In	2nd Memory 1		A										
In	In	3rd Memory 1			A									
In	In	FPA						A						
In	In	4th Memory 1							A					
Out	Out	GP 2										A		
In	In	GB											A	
In	In	TAAC-1 3		C	C	C			B	B	B	A	A	A
Out	In	ALM-1										A	A	A
Out	Out	1st SCP						A	B	C	D	E	F	G
Out	Out	2nd SCP							A	B	C	D	E	F
Out	Out	1st MCP						A	B	C	D	E	F	G
Out	Out	2nd MCP							A	B	C	D	E	F
Out	Out	3rd MCP								A	B	C	D	E
Out	Out	4th MCP									A	B	C	D
Out	Out	1st ALM-2						A	B	C	D	E	F	G
Out	Out	2nd ALM-2							A	B	C	D	E	F
Out	Out	3rd ALM-2								A	B	C	D	E
Out	Out	4th ALM-2									A	B	C	D
Out	Out	1st SunLink Channel Adapter						A	A	C	C	E	E	
									B	B	D	D	F	F
Out	Out	2nd SunLink Channel Adapter								A	A	C	C	
-	-										B	B	D	D
Out	Out	1st MAPkit						A	A	C	C	E	E	
-	-								B	B	D	D	F	F
Out	Out	2nd MAPkit								A	A	C	C	
-	-										B	B	D	D
Out	Out	SCSI 9						A	B	C	D	E	F	G
In	Out	Color 5						A	B	C	D	E	F	G
In	Out	CG5 with GP/GP+						A	B	C	D			
In	Out	CG5 with GP2											A	B
In	Out	CG9 Color											A	B

Sun-3/470 – Continued

SHUNTS		BOARD	SLOT POSITION													
			1	2	3	4	5	6	7	8	9	10	11	12		
BG3	IACK															
In	Out	1st HSI						A	B	C	D	E	F	G		
In	Out	2nd HSI							A	B	C	D	E	F		
Out	Out	Ethernet						A	B	C	D	E	F	G		
Out	Out	1st FDDI						A	B	C	D	E	F	G		
Out	Out	2nd FDDI							A	B	C	D	E	F		
In	Out	1st IPC 6						A	B	C	D	E	F	G		
In	Out	2nd IPC 6							A	B	C	D	E	F		
In	Out	3rd IPC 6								A	B	C	D	E		
In	Out	4th IPC 6									A	B	C	D		
Out	Out	1st Tape Ctlr 7						A	B	C	D	E	F	G		
Out	Out	2nd Tape Ctlr 7							A	B	C	D	E	F		
Out	Out	1st Disk Ctlr 8						A	B	C	D	E	F	G		
Out	Out	2nd Disk Ctlr 8							A	B	C	D	E	F		
Out	Out	3rd Disk Ctlr 10								A	B	C	D	E		
Out	Out	4th Disk Ctlr 10									A	B	C	D		

Notes

1. Remove jumpers P10, P11, P12, and P13 from the 501-1598 Backplane when the Sun 3400 board set is installed.
2. Remove jumpers P10, P11, P12, and P13 from the 501-1832 Backplane when the Sun 3400 board set is installed.

References

1. *Sun Systems Cardcage Slot Assignments and Backplane Configuration Procedures*, 813-2004-16.
2. *Sun-3/470 Deskside Workstation Cardcage Slot Assignments and Backplane Configuration Procedures*, 813-2073-11.

Sun-3/480

SHUNTS		BOARD	SLOT POSITION											
			1	2	3	4	5	6	7	8	9	10	11	12
BG3	JACK													
Out	Out	Sun 3400 CPU	A	A										
In	In	1st Memory 1						A						
In	In	FPA					A							
In	In	2nd Memory 1		A										
In	In	3rd Memory 1			A									
In	In	4th Memory 1				A								
Out	Out	GP 2										A		
In	In	GB											A	
In	In	TAAC-1 3			C	C	C		B	B	B	A	A	A
-	-					D	D	D						
Out	In	1st ALM-1												A
Out	Out	2nd ALM-1											A	
Out	Out	3rd ALM-1										A		
Out	Out	1st SCP			A	B	C		D	E	F	G	H	I
Out	Out	2nd SCP				A	B		C	D	E	F	G	H
Out	Out	1st MCP			A	B	C		D	E	F	G	H	I
Out	Out	2nd MCP				A	B		C	D	E	F	G	H
Out	Out	3rd MCP					A		B	C	D	E	F	G
Out	Out	4th MCP							A	B	C	D	E	F
Out	Out	1st ALM-2			A	B	C		D	E	F	G	H	I
Out	Out	2nd ALM-2				A	B		C	D	E	F	G	H
Out	Out	3rd ALM-2					A		B	C	D	E	F	G
Out	Out	4th ALM-2							A	B	C	D	E	F
Out	Out	1st SunLink			A	A			C	C	E	E	G	G
-	-	Channel Adapter				B	B			D	D	F	F	
Out	Out	2nd SunLink							A	A	C	C	E	E
-	-	Channel Adapter								B	B	D	D	
Out	Out	1st MAPkit			A	A			C	C	E	E	G	G
-	-					B	B			D	D	F	F	
Out	Out	2nd MAPkit							A	A	C	C	E	E
-	-									B	B	D	D	
Out	Out	SCSI 9			A	B	C		D	E	F	G	H	I

Sun-3/480 - Continued

SHUNTS		BOARD	SLOT POSITION											
			1	2	3	4	5	6	7	8	9	10	11	12
BG3	IACK													
In	Out	Color 5			A	B	C		D	E	F	G	H	I
In	Out	CG5 with GP/GP+			A	B	C		D	E	F			
In	Out	CG5 with GP2											A	B
In	Out	CG9 Color											A	B
In	Out	1st HSI			A	B	C		D	E	F	G	H	I
In	Out	2nd HSI				A	B		C	D	E	F	G	H
Out	Out	Ethernet			A	B	C		D	E	F	G	H	I
Out	Out	1st FDDI			A	B	C		D	E	F	G	H	I
Out	Out	2nd FDDI				A	B		C	D	E	F	G	H
In	Out	1st IPC 6			A	B	C		D	E	F	G	H	I
In	Out	2nd IPC 6				A	B		C	D	E	F	G	H
In	Out	3rd IPC 6					A		B	C	D	E	F	G
In	Out	4th IPC 6							A	B	C	D	E	F
Out	Out	1st Tape Ctlr 7			A	B	C		D	E	F	G	H	I
Out	Out	2nd Tape Ctlr 7				A	B		C	D	E	F	G	H
Out	Out	1st Disk Ctlr 8			A	B	C		D	E	F	G	H	I
Out	Out	2nd Disk Ctlr 8				A	B		C	D	D	F	G	H
Out	Out	3rd Disk Ctlr 10					A		B	C	D	E	F	G
Out	Out	4th Disk Ctlr 10							A	B	C	D	E	F

References

1. *Sun Systems Cardcage Slot Assignments and Backplane Configuration Procedures*, 813-2004-16.
2. *Sun-3/460 and 3/480 Cardcage Slot Assignments and Backplane Configuration Procedures*, 813-2056-11.

Sun-3/480

Slots 7,8,9 reserved for non-Sun boards that use P2

SHUNTS		BOARD	SLOT POSITION												
			1	2	3	4	5	6	7	8	9	10	11	12	
BG3	IACK														
Out	Out	Sun 3400 CPU	A	A											
In	In	1st Memory 1						A							
In	In	FPA					A								
In	In	2nd Memory 1			A										
In	In	3rd Memory 1				A									
In	In	4th Memory 1					A								
Out	Out	GP 2										A			
In	In	GB											A		
In	In	TAAC-1 3			B	B	B					A	A	A	
-	-				C	C	C								
Out	Out	1st ALM-1												A	
Out	Out	2nd ALM-1											A		
Out	Out	3rd ALM-1										A			
Out	Out	1st SCP			A	B	C					D	E	F	
Out	Out	2nd SCP				A	B					C	D	E	
Out	Out	1st MCP			A	B	C					D	E	F	
Out	Out	2nd MCP				A	B					C	D	E	
Out	Out	3rd MCP					A					B	C	D	
Out	Out	4th MCP										A	B	C	
Out	Out	1st ALM-2			A	B	C					D	E	F	
Out	Out	2nd ALM-2				A	B					C	D	E	
Out	Out	3rd ALM-2					A					B	C	D	
Out	Out	4th ALM-2						A				A	B	C	
Out	Out	1st SunLink			A	A						C	C		
-	-	Channel Adapter				B	B						D	D	
Out	Out	2nd SunLink										A	A		
-	-	Channel Adapter											B	B	
Out	Out	1st MAPkit			A	A						C	C		
-	-					B	B						D	D	
Out	Out	2nd MAPkit										A	A		
-	-												B	B	

Sun-3/480 – Continued

Slots 7,8,9 reserved for non-Sun boards that use P2

SHUNTS		BOARD	SLOT POSITION											
BG3	IACK		1	2	3	4	5	6	7	8	9	10	11	12
Out	Out	SCSI 9			A	B	C					D	E	F
In	Out	Color 5			A	B	C					D	E	F
In	Out	CG5 with GP/GP+			A	B	C							
In	Out	CG5 with GP2											A	B
In	Out	CG9 Color											A	B
In	Out	1st HSI			A	B	C					D	E	F
In	Out	2nd HSI				A	B					C	D	E
Out	Out	Ethernet			A	B	C					D	E	F
Out	Out	1st FDDI			A	B	C					D	E	F
Out	Out	2nd FDDI				A	B					C	D	E
In	Out	1st IPC 6			A	B	C					D	E	F
In	Out	2nd IPC 6				A	B					C	D	E
In	Out	3rd IPC 6					A					B	C	D
In	Out	4th IPC 6										A	B	C
Out	Out	1st Tape Ctlr 7			A	B	C					D	E	F
Out	Out	2nd Tape Ctlr 7				A	B					C	D	E
Out	Out	1st Disk Ctlr 8			A	B	C					D	E	F
Out	Out	2nd Disk Ctlr 8				A	B					C	D	D
Out	Out	3rd Disk Ctlr 10					A					B	C	D
Out	Out	4th Disk Ctlr 10										A	B	C

References

1. *Sun Systems Cardcage Slot Assignments and Backplane Configuration Procedures*, 813-2004-16.
2. *Sun-3/460 and 3/480 Cardcage Slot Assignments and Backplane Configuration Procedures*, 813-2056-11.

Sun-3/460/470/480

NOTE #	PART#	BOARD
	501-1532 501-1518 501-1371 501-1374 501-1248 501-1402 501-1446	CG6 Color Frame Buffer CG8 24-bit Color Frame Buffer CG8 24-bit Color Frame Buffer CG6 Color Frame Buffer CG4 Color Frame Buffer MG4 Mono Frame Buffer FPA+
1	501-1102 501-1451 501-1576	8MB Memory 32MB Memory 16MB Memory
2	501-1055 501-1139 501-1268	Graphics Processor (GP) Graphics Processor Plus (GP+) Graphics Processor 2 (GP2)
3	501-1383 501-1447	TAAC-1 Application Accelerator TAAC-1 Application Accelerator
4	501-1149 501-1170	Sun-2 VME SCSI Assembly Sun-3 VME SCSI Assembly
5	501-1014 501-1116 501-1267	Sun-2 Color Frame Buffer Sun-3 Color Frame Buffer CG5 Color Frame Buffer
6	501-1125 501-1214	SunIPC without 80287 SunIPC with 80287
7	501-1155 501-1156	Xylogics 472 Tape Controller Assy Tapemaster Tape Controller Assembly
8	501-1154 501-1166 501-1249	Xylogics 450 Disk Controller Assembly Xylogics 451 Disk Controller Assembly Xylogics 7053 Disk Controller
9	501-1138 501-1217	Sun-2 SCSI Host Adapter Assembly Sun-3 SCSI Host Adapter Assembly
10	501-1249	Xylogics 7053 Disk Controller

Sun-4/20

PART #	DESCRIPTION
501-1627	8MB Sun-4/20 CPU
501-1720	8MB Sun-4/20 CPU
501-1776	8MB Sun-4/20 CPU
501-1748	0MB Sun-4/20 CPU
501-1680	0MB Sun-4/20 CPU
501-1777	0MB Sun-4/20 CPU
501-1676	4MB SIMM
501-1698	4MB SIMM

Sun-4/40

PART #	DESCRIPTION	SBus Slot	
		1	2
501-1689	8MB Sun-4/40 CPU	-	-
501-1690	0MB Sun-4/40 CPU	-	-
501-1408	1MB SIMM	-	-
501-1625	4MB SIMM	-	-
501-1415	CG3 66hz Color	A	B
501-1718	CG3 66/76hz Color	A	B
501-1481	CG6 66hz Color	A	B
501-1645	CG6 66hz Color	A	A
501-1672	CG6 66/76hz Color	A	B
501-1419	MG1 66hz ECL	A	B
501-1455	MG2 66hz Analog	A	B
501-1561	MG2 66/76hz Analog	A	B
501-1706	VideoPics	A	B
501-1450	Ethernet	A	B
501-2140	SBus Printer	A	B
501-1511	Serial Parallel Controller	A	B
501-1557	FDDI	A	B
501-1725	HSI	A	B
501-1759	SCSI Host Adapter	A	B
501-1850	SCSI Host Adapter	A	B

Sun-4/60

PART #	DESCRIPTION	SBus Slot		
		1	2	3
501-1382	Sun-4/60 CPU	-	-	-
501-1629	Sun-4/60 CPU	-	-	-
501-1408	1MB SIMM	-	-	-
501-1625	4MB SIMM	-	-	-
501-1415	CG3 66hz Color	C	B	A
501-1481	CG6 66Hz Color	B	A	A
501-1645	CG6 66Hz Color	B	A	A
370-1329	CG12 76Hz 24-bit Color	A	A	A
501-1693	GT SBus Adapter	A	B	*
501-1419	MG1 66hz ECL	C	B	A
501-1455	MG2 66hz Analog	C	B	A
501-1450	Ethernet	A	B	*
501-1454	TI FPU	-	-	-
501-1667	DC Load Board	-	-	-
501-1706	VideoPics	C	B	A
501-2140	SBus Printer	A	B	*
501-1511	Serial Parallel Controller	A	B	C
501-1557	FDDI	A	B	*
501-1725	HSI	A	B	C
501-1759	SCSI Host Adapter	A	B	*
501-1850	SCSI Host Adapter	A	B	*

* These cards can NOT be installed in SBus Slot 3.

Sun-4/65

PART #	DESCRIPTION	SBus Slot		
		1	2	3
501-1632	Sun-4/65 CPU	-	-	-
501-1408	1MB SIMM	-	-	-
501-1625	4MB SIMM	-	-	-
501-1415	CG3 66Hz Color	C	B	A
501-1645	CG6 66Hz Color	B	A	A
370-1329	CG12 76Hz 24-bit Color	A	A	A
501-1693	GT SBus Adapter	A	B	*
501-1419	MG1 66Hz ECL	C	B	A
501-1455	MG2 66Hz Analog	C	B	A
501-1450	Ethernet	A	B	*
501-1454	TI FPU	-	-	-
501-1667	DC Load Board	-	-	-
501-1706	VideoPics	C	B	A
501-2140	SBus Printer	A	B	*
501-1511	Serial Parallel Controller	A	B	C
501-1557	FDDI	A	B	C
501-1725	HSI	A	B	C
501-1759	SCSI Host Adapter	A	B	C
501-1850	SCSI Host Adapter	A	B	C

* These cards can NOT be installed in SBus Slot 3.

Sun-4/75

PART #	DESCRIPTION	SBus Slot		
		1	2	3
501-1638	16MB Sun-4/75 CPU	-	-	-
501-1744	0MB Sun-4/75 CPU	-	-	-
501-1739	4MB SIMM	-	-	-
501-1823	32MB Memory Primary	A	-	-
501-1824	32MB Memory Secondary	-	-	-
501-1415	CG3 66Hz Color	A	B	C
501-1718	CG3 66/76hz 8-bit Color	A	B	C
501-1645	CG6 66Hz Color	B	A	A
501-1672	CG6 66/76hz Color	A	B	C
370-1329	CG12 76Hz 24-bit Color	A	A	A
501-1693	GT SBus Adapter	A	B	C
501-1419	MG1 66Hz ECL	A	B	C
501-1455	MG2 66Hz Analog	A	B	C
501-1561	MG2 66/76hz Analog	A	B	C
501-1450	Ethernet	A	B	C
501-1706	VideoPics	A	B	C
501-2140	SBus Printer	A	B	C
501-1511	Serial Parallel Controller	A	B	C
501-1557	FDDI	A	B	C
501-1725	HSI	A	B	C
501-1667	DC Load Board	-	-	-
501-1759	SCSI Host Adapter	A	B	C
501-1850	SCSI Host Adapter	A	B	C

Sun-4/110

SHUNTS		BOARD	SLOT POSITION		
BG3	IACK		1	2	3
Out	Out	Sun 4100 CPU 1	A	A	
Out	Out	MCP			A
Out	Out	ALM-2			A
In	Out	Color 2			A
In	Out	HSI			A
Out	Out	Ethernet			A
Out	Out	FDDI			A
In	Out	IPC 3			A

References

1. *Sun Systems Cardcage Slot Assignments and Backplane Configuration Procedures*, 813-2004-16.
2. *Cardcage Slot Assignments and Backplane Configuration Procedures for the Sun 4/110*, 813-2053-05.

Sun-4/150

SHUNTS		BOARD	SLOT POSITION					
BG3	IACK		1	2	3	4	5	6
Out	Out	Sun 4100 CPU 1	A	A				
Out	Out	GP 4					A	
In	In	GB						A
In	In	TAAC-1 5			A	A	A	B
-	-				B	B	B	B
Out	Out	1st MCP		A	B	C	D	E
Out	Out	2nd MCP			A	B	C	D
Out	Out	1st ALM-2		A	B	C	D	E
Out	Out	2nd ALM-2			A	B	C	D
In	Out	Color 2			A	B	C	D
In	Out	CG5 with GP/GP+			A	B		
In	Out	CG5 with GP2						A
In	Out	CG9 Color						A
In	Out	1st HSI			A	B		C
In	Out	2nd HSI				A		B
Out	Out	Ethernet			A	B		C
Out	Out	FDDI			A	B		C
In	Out	1st IPC 3			A	B		C
In	Out	2nd IPC 3				A		

References

1. *Sun Systems Cardcage Slot Assignments and Backplane Configuration Procedures*, 813-2004-16.
2. *Cardcage Slot Assignments and Backplane Configuration Procedures for the Sun 4/150 Systems*, 813-2054-01.

Sun-4/260

SHUNTS		BOARD	SLOT POSITION											
			1	2	3	4	5	6	7	8	9	10	11	12
BG3	IACK													
Out	Out	Sun 4200 CPU	A											
In	In	1st Memory 6						A						
In	In	2nd Memory 6					A							
In	In	3rd Memory 6				A								
In	In	4th Memory 6			A									
Out	Out	GP 4										A		
In	In	GB											A	
In	In	TAAC-1 5		C	C	C			B	B	B	A	A	A
-	-			D	D	D								
Out	Out	ALM-1											A	A
Out	Out	SCSI 7						A						
Out	Out	1st MCP		A	B	C	D	E	F	G	H	I	J	
Out	Out	2nd MCP			A	B	C	D	E	F	G	H	I	
Out	Out	3rd MCP				A	B	C	D	E	F	G	H	
Out	Out	4th MCP					A	B	C	D	E	F	G	
Out	Out	1st ALM-2		A	B	C	D	E	F	G	H	I	J	
Out	Out	2nd ALM-2			A	B	C	D	E	F	G	H	I	
Out	Out	3rd ALM-2				A	B	C	D	E	F	G	H	
Out	Out	4th ALM-2					A	B	C	D	E	F	G	
Out	Out	1st SunLink		A	A	C	C	D	D	F	F	H	H	
-	-	Channel Adapter						E	E	G	G			
Out	Out	2nd SunLink				A	A	B	B	D	D	F	F	
-	-	Channel Adapter						C	C	E	E			
Out	Out	1st MAPkit		A	A	C	C	D	D	F	F	H	H	
-	-							E	E	G	G			
Out	Out	2nd MAPkit				A	A	B	B	D	D	F	F	
-	-							C	C	E	E			
In	Out	1st HSI		D	A	B	C	E	F	G	H	I	J	
In	Out	2nd HSI		C		A	B	D	E	F	G	H	I	
Out	Out	Ethernet		D	A	B	C	E	F	G	H	I	J	

Sun-4/260 – Continued

SHUNTS		BOARD	SLOT POSITION														
			1	2	3	4	5	6	7	8	9	10	11	12			
BG3	IACK																
Out	Out	1st FDDI		D	A	B	C		E	F	G	H	I	J			
Out	Out	2nd FDDI		C		A	B		D	E	F	G	H	I			
In	Out	1st IPC 3		A	B	C	D		E	F	G	H	I	J			
In	Out	2nd IPC 3			A	B	C		D	E	F	G	H	I			
In	Out	3rd IPC 3				A	B		C	D	E	F	G	H			
In	Out	4th IPC 3					A		B	C	D	E	F	G			
Out	Out	1st Tape Ctr 8							A	B	C	D	E	F			
Out	Out	2nd Tape Ctr 8								A	B	C	D	E			
Out	Out	1st Disk Ctr 9							A	B	C	D	E	F			
Out	Out	2nd Disk Ctr 9								A	B	C	D	E			
In	Out	Color 2		J	A	B	C		D	E	F	G	H	I			
In	Out	CG5 with GP/GP+		G	A	B	C		D	E	F						
In	Out	CG5 with GP2													A	B	
In	Out	CG9 Color													A	B	

References

1. *Sun Systems Cardcage Slot Assignments and Backplane Configuration Procedures*, 813-2004-16.
2. *Sun-4/200 Cardcage Slot Assignments and Backplane Configuration Procedures*, 813-2037-05.

Sun-4/260

with Double-Height Backpanel

SHUNTS		BOARD	SLOT POSITION											
			1	2	3	4	5	6	7	8	9	10	11	12
BG3	IACK		1	2	3	4	5	6	7	8	9	10	11	12
Out	Out	Sun 4200 CPU	A	A										
In	In	1st Memory 6						A						
In	In	2nd Memory 6					A							
In	In	3rd Memory 6				A								
In	In	4th Memory 6			A									
Out	Out	GP 4										A		
In	In	GB											A	
In	In	TAAC-1 5							B	B	B	A	A	A
-	-				C	C	C							
Out	Out	ALM-1											A	A
Out	Out	SCSI 7							A					
Out	Out	1st MCP			A	B	C		D	E	F	G	H	I
Out	Out	2nd MCP				A	B		C	D	E	F	G	H
Out	Out	3rd MCP					A		B	C	D	E	F	G
Out	Out	4th MCP							A	B	C	D	E	F
Out	Out	1st ALM-2			A	B	C		D	E	F	G	H	I
Out	Out	2nd ALM-2				A	B		C	D	E	F	G	H
Out	Out	3rd ALM-2					A		B	C	D	E	F	G
Out	Out	4th ALM-2							A	B	C	D	E	F
Out	Out	1st SunLink			A	A			C	C	E	E	G	G
-	-	Channel Adapter				B	B			D	D	F	F	
Out	Out	2nd SunLink							A	A	C	C	E	E
-	-	Channel Adapter								B	B	D	D	
Out	Out	1st MAPkit			A	A			C	C	E	E	G	G
-	-					B	B			D	D	F	F	
Out	Out	2nd MAPkit							A	A	C	C	E	E
-	-									B	B	D	D	
In	Out	1st HSI			A	B	C		D	E	F	G	H	I
In	Out	2nd HSI				A	B		C	D	E	F	G	H
Out	Out	Ethernet			A	B	C		D	E	F	G	H	I

Sun-4/260 – Continued

with Double-Height Backpanel

SHUNTS		BOARD	SLOT POSITION																
			1	2	3	4	5	6	7	8	9	10	11	12					
BG3	IACK																		
Out	Out	1st FDDI			A	B	C		D	E	F	G	H	I					
Out	Out	2nd FDDI				A	B		C	D	E	F	G	H					
In	Out	1st IPC 3			A	B	C		D	E	F	G	H	I					
In	Out	2nd IPC 3				A	B		C	D	E	F	G	H					
In	Out	3rd IPC 3					A		B	C	D	E	F	G					
In	Out	4th IPC 3							A	B	C	D	E	F					
Out	Out	1st Tape Ctr 8							A	B	C	D	E	F					
Out	Out	2nd Tape Ctr 8								A	B	C	D	E					
Out	Out	1st Disk Ctr 9							A	B	C	D	E	F					
Out	Out	2nd Disk Ctr 9								A	B	C	D	E					
In	Out	Color 2			A	B	C		D	E	F	G	H	I					
In	Out	CG5 with GP/GP+			A	B	C		D	E	F								
In	Out	CG5 with GP2															A	B	
In	Out	CG9 Color															A	B	

References

1. *Sun Systems Cardcage Slot Assignments and Backplane Configuration Procedures*, 813-2004-16.
2. *Cardcage Slot Assignments and Backplane Configuration Procedures for Sun 4/200 Systems with Double-Height Backpanels*, 813-2071-05.

Sun-4/280

with 501-1167 SCSI Host Adapter

SHUNTS		BOARD	SLOT POSITION														
			1	2	3	4	5	6	7	8	9	10	11	12			
Out	Out	Sun 4200 CPU	A														
In	In	1st Memory 6							A								
In	In	2nd Memory 6		A													
In	In	3rd Memory 6			A												
In	In	4th Memory 6				A											
Out	Out	GP 4											A				
In	In	GB													A		
In	In	TAAC-1 5		C	C	C			B	B	B	A	A	A			
-	-				D	D	D										
Out	Out	1st ALM-1															A
Out	Out	2nd ALM-1													A		
Out	Out	3rd ALM-1											A				
Out	Out	SCSI 11							A								
Out	Out	1st MCP		A	B	C	D										
Out	Out	2nd MCP			A	B	C			D							
Out	Out	3rd MCP				A	B			C	D						
Out	Out	4th MCP					A			B	C	D	E	F			
Out	Out	1st ALM-2		A	B	C	D			E	F	G	H	I			
Out	Out	2nd ALM-2			A	B	C			D	E	F	G	H			
Out	Out	3rd ALM-2				A	B			C	D	E	F	G			
Out	Out	4th ALM-2					A			B	C	D	E	F			
Out	Out	1st SunLink		A	A	C	C			D	D	F	F				
-	-	Channel Adapter			B	B					E	E	G	G			
Out	Out	2nd SunLink				A	A			B	B	C	C				
-	-	Channel Adapter										D	D				
Out	Out	1st MAPkit		A	A	C	C			D	D	F	F				
-	-			B	B					E	E	G	G				
Out	Out	2nd MAPkit				A	A			B	B	C	C				
-	-											D	D				

Sun-4/280 – Continued

with 501-1167 SCSI Host Adapter

SHUNTS		BOARD	SLOT POSITION											
			1	2	3	4	5	6	7	8	9	10	11	12
BG3	IACK													
In	Out	Color 2		A	B	C	D			E	F	G	H	I
In	Out	CG5 with GP/GP+		A	B	C	D			E	F			
In	Out	CG5 with GP2											A	B
In	Out	CG9 Color											A	B
In	Out	1st HSI		A	B	C	D			E	F	G	H	I
In	Out	2nd HSI			A	B	C			D	E	F	G	H
Out	Out	Ethernet		A	B	C	D			E	F	G	H	I
Out	Out	1st FDDI		A	B	C	D			E	F	G	H	I
Out	Out	2nd FDDI			A	B	C			D	E	F	G	H
In	Out	1st IPC 3		A	B	C	D			E	F	G	H	I
In	Out	2nd IPC 3			A	B	C			D	E	F	G	H
In	Out	3rd IPC 3				A	B			C	D	E	F	G
In	Out	4th IPC 3					A			B	C	D	E	F
Out	Out	1st Tape Ctr 8								A	B	C	D	E
Out	Out	2nd Tape Ctr 8								A	B	C	D	
Out	Out	1st Disk Ctr 9								A	B	C	D	E
Out	Out	2nd Disk Ctr 9								A	B	C	D	
Out	Out	3rd Disk Ctr 10									A	B	C	
Out	Out	4th Disk Ctr 10										A	B	

References

1. *Sun Systems Cardcage Slot Assignments and Backplane Configuration Procedures*, 813-2004-16.
2. *Sun-4/200 Cardcage Slot Assignments and Backplane Configuration Procedures*, 813-2037-05.

Sun-4/280

with Double-Height Backpanel
with 501-1167 SCSI Host Adapter

SHUNTS		BOARD	SLOT POSITION													
			1	2	3	4	5	6	7	8	9	10	11	12		
BG3	IACK															
Out	Out	Sun 4200 CPU	A	A												
In	In	1st Memory 6						A								
In	In	2nd Memory 6		A												
In	In	3rd Memory 6			A											
In	In	4th Memory 6				A										
Out	Out	GP 4											A			
In	In	GB												A		
In	In	TAAC-1 5			C	C	C		B	B	B	A	A	A		
Out	Out	1st ALM-1														A
Out	Out	2nd ALM-1												A		
Out	Out	3rd ALM-1										A				
Out	Out	SCSI 11							A							
Out	Out	1st MCP		A	B	C	D									
Out	Out	2nd MCP			A	B	C			D						
Out	Out	3rd MCP				A	B			C	D					
Out	Out	4th MCP					A			B	C	D	E	F		
Out	Out	1st ALM-2		A	B	C	D			E	F	G	H	I		
Out	Out	2nd ALM-2			A	B	C			D	E	F	G	H		
Out	Out	3rd ALM-2				A	B			C	D	E	F	G		
Out	Out	4th ALM-2					A			B	C	D	E	F		
Out	Out	1st SunLink		A	A	C	C			D	D	F	F	F		
-	-	Channel Adapter			B	B					E	E	G	G	G	
Out	Out	2nd SunLink				A	A			B	B	C	C			
-	-	Channel Adapter											D	D		
Out	Out	1st MAPkit		A	A	C	C			D	D	F	F			
-	-			B	B					E	E	G	G			
Out	Out	2nd MAPkit				A	A			B	B	C	C			
-	-												D	D		

Sun-4/280 – Continued

with Double-Height Backpanel
with 501-1167 SCSI Host Adapter

SHUNTS		BOARD	SLOT POSITION												
			1	2	3	4	5	6	7	8	9	10	11	12	
BG3	IACK														
In	Out	Color 2			A	B	C		D	E	F	G	H	I	
In	Out	CG5 with GP/GP+			A	B	C		D	E	F				
In	Out	CG5 with GP2												A	B
In	Out	CG9 Color												A	B
In	Out	1st HSI			A	B	C			D	E	F	G	H	
In	Out	2nd HSI				A	B			C	D	E	F	G	
Out	Out	Ethernet			A	B	C		D	E	F	G	H	I	
Out	Out	1st FDDI			A	B	C			D	E	F	G	H	
Out	Out	2nd FDDI				A	B			C	D	E	F	G	
In	Out	1st IPC 3			A	B	C		D	E	F	G	H	I	
In	Out	2nd IPC 3				A	B		C	D	E	F	G	H	
In	Out	3rd IPC 3					A		B	C	D	E	F	G	
In	Out	4th IPC 3							A	B	C	D	E	F	
Out	Out	1st Tape Ctr 8							A	B	C	D	E	F	
Out	Out	2nd Tape Ctr 8								A	B	C	D	E	
Out	Out	1st Disk Ctr 9							A	B	C	D	E	F	
Out	Out	2nd Disk Ctr 9								A	B	C	D	E	
Out	Out	3rd Disk Ctr 10									A	B	C	D	
Out	Out	4th Disk Ctr 10										A	B	C	

References

1. *Sun Systems Cardcage Slot Assignments and Backplane Configuration Procedures*, 813-2004-16.
2. *Cardcage Slot Assignments and Backplane Configuration Procedures for Sun 4/200 Systems with Double-Height Backpanels*, 813-2071-05.

Sun-4/280

with 501-1138 or 501-1217 SCSI

SHUNTS		BOARD	SLOT POSITION											
			1	2	3	4	5	6	7	8	9	10	11	12
BG3	IACK													
Out	Out	Sun 4200 CPU	A											
In	In	1st Memory 6						A						
In	In	2nd Memory 6		A										
In	In	3rd Memory 6			A									
In	In	4th Memory 6				A								
Out	Out	GP 4										A		
In	In	GB											A	
In	In	TAAC-1 5		C	C	C			B	B	B	A	A	A
-	-				D	D	D							
Out	Out	1st ALM-1												A
Out	Out	2nd ALM-1											A	
Out	Out	3rd ALM-1										A		
Out	Out	1st MCP		A	B	C	D							
Out	Out	2nd MCP			A	B	C		D					
Out	Out	3rd MCP				A	B		C	D				
Out	Out	4th MCP					A		B	C	D			
Out	Out	1st ALM-2		A	B	C	D		E	F	G	H	I	J
Out	Out	2nd ALM-2			A	B	C		D	E	F	G	H	I
Out	Out	3rd ALM-2				A	B		C	D	E	F	G	H
Out	Out	4th ALM-2					A		B	C	D	E	F	G
Out	Out	1st SunLink Channel Adapter		A	A	C	C		D	D	F	F	G	G
-	-				B	B				E	E			
Out	Out	2nd SunLink Channel Adapter				A	A		B	B	D	D	F	F
-	-									C	C	E	E	
Out	Out	1st MAPkit		A	A	C	C		D	D	F	F	H	H
-	-									E	E			
Out	Out	2nd MAPkit				A	A		B	B	D	D	F	F
-	-									C	C	E	E	
In	Out	1st HSI		D	A	B	C		E	F	G	H	I	J
In	Out	2nd HSI		C		A	B		D	E	F	G	H	I
Out	Out	Ethernet		D	A	B	C		E	F	G	H	I	J
Out	Out	SCSI 12		A	B	C	D		E	F	G	H	I	J

Sun-4/280 – Continued

with 501-1138 or 501-1217 SCSI

SHUNTS		BOARD	SLOT POSITION											
			1	2	3	4	5	6	7	8	9	10	11	12
BG3	IACK													
In	Out	Color 2		A	B	C	D		E	F	G	H	I	J
In	Out	CG5 with GP/GP+		A	B	C	D		E	F	G			
In	Out	CG5 with GP2											A	B
In	Out	CG9 Color											A	B
In	Out	1st HSI		A	B	C	D		E	F	G	H	I	J
In	Out	2nd HSI			A	B	C		D	E	F	G	H	I
Out	Out	Ethernet		A	B	C	D		E	F	G	H	I	J
Out	Out	1st FDDI		A	B	C	D		E	F	G	H	I	J
Out	Out	2nd FDDI			A	B	C		D	E	F	G	H	I
In	Out	1st IPC 3		A	B	C	D		E	F	G	H	I	J
In	Out	2nd IPC 3			A	B	C		D	E	F	G	H	I
In	Out	3rd IPC 3				A	B		C	D	E	F	G	H
In	Out	4th IPC 3					A		B	C	D	E	F	G
Out	Out	1st Tape Ctlr 8		A	B	C	D		E	F	G	H	I	J
Out	Out	2nd Tape Ctlr 8			A	B	C		D	E	F	G	H	I
Out	Out	1st Disk Ctlr 9		A	B	C	D		E	F	G	H	I	J
Out	Out	2nd Disk Ctlr 9			A	B	C		D	E	F	G	H	I
Out	Out	3rd Disk Ctlr 10				A	B		C	D	E	F	G	H
Out	Out	4th Disk Ctlr 10					A		B	C	D	E	F	G

References

1. *Sun Systems Cardcage Slot Assignments and Backplane Configuration Procedures*, 813-2004-16.
2. *Sun-4/200 Cardcage Slot Assignments and Backplane Configuration Procedures*, 813-2037-05.

Sun-4/280
with Double-Height Backpanel
with 501-1138 or 501-1217 SCSI

SHUNTS		BOARD	SLOT POSITION											
			1	2	3	4	5	6	7	8	9	10	11	12
BG3	IACK													
Out	Out	Sun 4200 CPU	A	A										
In	In	1st Memory 6					A							
In	In	2nd Memory 6		A										
In	In	3rd Memory 6			A									
In	In	4th Memory 6				A								
Out	Out	GP 4									A			
In	In	GB										A		
In	In	TAAC-1 5			C	C	C		B	B	B	A	A	A
Out	Out	1st ALM-1												A
Out	Out	2nd ALM-1											A	
Out	Out	3rd ALM-1										A		
Out	Out	1st MCP			A	B	C		D					
Out	Out	2nd MCP				A	B		C	D				
Out	Out	3rd MCP					A		B	C	D			
Out	Out	4th MCP							A	B	C	D	E	F
Out	Out	1st ALM-2			A	B	C		D	E	F	G	H	I
Out	Out	2nd ALM-2				A	B		C	D	E	F	G	H
Out	Out	3rd ALM-2					A		B	C	D	E	F	G
Out	Out	4th ALM-2							A	B	C	D	E	F
Out	Out	1st SunLink			A	A			C	C	E	E	G	G
-	-	Channel Adapter				B	B			D	D	F	F	
Out	Out	2nd SunLink							A	A	C	C	E	E
-	-	Channel Adapter								B	B	D	D	
Out	Out	1st MAPkit			A	A			C	C	E	E	G	G
-	-					B	B			D	D	F	F	
Out	Out	2nd MAPkit							A	A	C	C	E	E
-	-									B	B	D	D	
Out	Out	SCSI 12			A	B	C		D	E	F	G	H	I
In	Out	Color 2			A	B	C		D	E	F	G	H	I
In	Out	CG5 with GP/GP+			A	B	C		D	E	F			
In	Out	CG5 with GP2											A	B
In	Out	CG9 Color											A	B

Sun-4/280 – Continued
with Double-Height Backpanel
with 501-1138 or 501-1217 SCSI

SHUNTS		BOARD	SLOT POSITION											
			1	2	3	4	5	6	7	8	9	10	11	12
BG3	IACK													
In	Out	1st HSI			A	B	C		D	E	F	G	H	I
In	Out	2nd HSI				A	B		C	D	E	F	G	H
Out	Out	Ethernet			A	B	C		D	E	F	G	H	I
Out	Out	1st FDDI			A	B	C		D	E	F	G	H	I
Out	Out	2nd FDDI				A	B		C	D	E	F	G	H
In	Out	1st IPC 3			A	B	C		D	E	F	G	H	I
In	Out	2nd IPC 3				A	B		C	D	E	F	G	H
In	Out	3rd IPC 3					A		B	C	D	E	F	G
In	Out	4th IPC 3							A	B	C	D	E	F
Out	Out	1st Tape Ctlr 8			A	B	C		D	E	F	G	H	I
Out	Out	2nd Tape Ctlr 8				A	B		C	D	E	F	G	H
Out	Out	1st Disk Ctlr 9			A	B	C		D	E	F	G	H	I
Out	Out	2nd Disk Ctlr 9				A	B		C	D	E	F	G	H
Out	Out	3rd Disk Ctlr 10					A		B	C	D	E	F	G
Out	Out	4th Disk Ctlr 10							A	B	C	D	E	F

References

1. *Sun Systems Cardcage Slot Assignments and Backplane Configuration Procedures*, 813-2004-16.
2. *Cardcage Slot Assignments and Backplane Configuration Procedures for Sun 4/200 Systems with Double-Height Backpanels*, 813-2071-05.

Sun-4/280

with 501-1138 or 501-1217 SCSI

Slots 7,8,9 reserved for non-Sun boards that use P2

SHUNTS		BOARD	SLOT POSITION													
			1	2	3	4	5	6	7	8	9	10	11	12		
BG3	IACK															
Out	Out	Sun 4200 CPU	A													
In	In	1st Memory 6						A								
In	In	2nd Memory 6		A												
In	In	3rd Memory 6			A											
In	In	4th Memory 6				A										
Out	Out	GP 4											A			
In	In	GB												A		
In	In	TAAC-1 5		B	B	B							A	A	A	
-	-			C	C	C										
Out	Out	1st ALM-1													A	
Out	Out	2nd ALM-1													A	
Out	Out	3rd ALM-1											A			
Out	Out	1st MCP		A	B	C	D									
Out	Out	2nd MCP			A	B	C						D	E	F	
Out	Out	3rd MCP				A	B						C	D	E	
Out	Out	4th MCP					A						B	C	D	
Out	Out	1st ALM-2		A	B	C	D						E	F	G	
Out	Out	2nd ALM-2			A	B	C						D	E	F	
Out	Out	3rd ALM-2				A	B						C	D	E	
Out	Out	4th ALM-2					A						B	C	D	
Out	Out	1st SunLink Channel Adapter		A	A	C	C						D	D		
-	-			B	B								E	E		
Out	Out	2nd SunLink Channel Adapter				A	A						B	B		
-	-												C	C		
Out	Out	1st MAPkit		A	A	C	C						D	D		
-	-			B	B								E	E		
Out	Out	2nd MAPkit				A	A						B	B		
-	-												C	C		
Out	Out	SCSI 12		A	B	C	D						E	F	G	

Sun-4/280 – Continued
with 501-1138 or 501-1217 SCSI
 Slots 7,8,9 reserved for non-Sun boards that use P2

SHUNTS		BOARD	SLOT POSITION													
			1	2	3	4	5	6	7	8	9	10	11	12		
BG3	IACK															
In	Out	Color 2		A	B	C	D						E	F	G	
In	Out	CG5 with GP/GP+		A	B	C	D									
In	Out	CG5 with GP2												A	B	
In	Out	CG9 Color												A	B	
In	Out	1st HSI		A	B	C	D						E	F	G	
In	Out	2nd HSI			A	B	C						D	E	F	
Out	Out	Ethernet		A	B	C	D						E	F	G	
Out	Out	1st FDDI		A	B	C	D						E	F	G	
Out	Out	2nd FDDI			A	B	C						D	E	F	
In	Out	1st IPC 3		A	B	C	D						E	F	G	
In	Out	2nd IPC 3			A	B	C						D	E	F	
In	Out	3rd IPC 3				A							C	D	E	
In	Out	4th IPC 3					A						B	C	D	
Out	Out	1st Tape Ctlr 8		A	B	C	D						E	F	G	
Out	Out	2nd Tape Ctlr 8			A	B	C						D	E	F	
Out	Out	1st Disk Ctlr 9		A	B	C	D						E	F	G	
Out	Out	2nd Disk Ctlr 9			A	B	C						D	E	F	
Out	Out	3rd Disk Ctlr 10				A	B						C	D	E	
Out	Out	4th Disk Ctlr 10					A						B	C	D	

References

1. *Sun Systems Cardcage Slot Assignments and Backplane Configuration Procedures*, 813-2004-16.
2. *Sun-4/200 Cardcage Slot Assignments and Backplane Configuration Procedures*, 813-2037-05.

Sun-4/280
 with Double-Height Backpanel
 with 501-1138 or 501-1217 SCSI
 Slots 7,8,9 reserved for non-Sun boards that use P2

SHUNTS		BOARD	SLOT POSITION														
			1	2	3	4	5	6	7	8	9	10	11	12			
BG3	IACK																
Out	Out	Sun 4200 CPU	A	A													
In	In	1st Memory 6						A									
In	In	2nd Memory 6			A												
In	In	3rd Memory 6				A											
In	In	4th Memory 6					A										
Out	Out	GP 2											A				
In	In	GB												A			
In	In	TAAC-1 5		B	B	B							A	A	A		
Out	Out	1st ALM-1															A
Out	Out	2nd ALM-1												A			
Out	Out	3rd ALM-1											A				
Out	Out	1st MCP			A	B	C						D	E	F		
Out	Out	2nd MCP				A	B						C	D	E		
Out	Out	3rd MCP					A						B	C	D		
Out	Out	4th MCP											A	B	C		
Out	Out	1st ALM-2			A	B	C						D	E	F		
Out	Out	2nd ALM-2				A	B						C	D	E		
Out	Out	3rd ALM-2					A						B	C	D		
Out	Out	4th ALM-2											A	B	C		
Out	Out	1st SunLink Channel Adapter		A	A	B	C						D	D			
-	-	2nd SunLink Channel Adapter				A	A						B	B			
Out	Out	1st MAPkit			A	A	B						C	C	C		
-	-	2nd MAPkit				B	B							D	D		
Out	Out	SCSI 12											A	A			
In	Out	Color 2			A	B	C						D	E	F		
In	Out	CG5 with GP/GP+			A	B	C										
In	Out	CG5 with GP2													A	B	
In	Out	CG9 Color													A	B	

Sun-4/280 – Continued with Double-Height Backpanel with 501-1138 or 501-1217 SCSI

Slots 7,8,9 reserved for non-Sun boards that use P2

SHUNTS		BOARD	SLOT POSITION													
			1	2	3	4	5	6	7	8	9	10	11	12		
BG3	IACK															
In	Out	1st HSI			A	B	C							D	E	F
In	Out	2nd HSI				A	B							C	D	E
Out	Out	Ethernet			A	B	C							D	E	F
Out	Out	1st FDDI			A	B	C							D	E	F
Out	Out	2nd FDDI				A	B							C	D	E
In	Out	1st IPC 3			A	B	C							D	E	F
In	Out	2nd IPC 3				A	B							C	D	E
In	Out	3rd IPC 3					A							B	C	D
In	Out	4th IPC 3												A	B	C
Out	Out	1st Tape Ctlr 8			A	B	C							D	E	F
Out	Out	2nd Tape Ctlr 8				A	B							C	D	E
Out	Out	1st Disk Ctlr 9			A	B	C							D	E	F
Out	Out	2nd Disk Ctlr 9				A	B							C	D	E
Out	Out	3rd Disk Ctlr 10					A							B	C	D
Out	Out	4th Disk Ctlr 10												A	B	C

References

1. *Sun Systems Cardcage Slot Assignments and Backplane Configuration Procedures*, 813-2004-16.
2. *Cardcage Slot Assignments and Backplane Configuration Procedures for Sun 4/200 Systems with Double-Height Backpanels*, 813-2071-05.

Sun-4/110/150/260/280

NOTE #	PART#	BOARD
1	501-1199	Sun 4100 CPU (-03 FAB) 8MB w/o FPU
	501-1237	Sun 4100 CPU (-03 FAB) 8MB w FPU
	501-1462	Sun 4100 CPU (-03 FAB) 16MB w/o FPU
	501-1463	Sun 4100 CPU (-03 FAB) 16MB w FPU
	501-1464	Sun 4100 CPU (-03 FAB) 32MB w/o FPU
	501-1465	Sun 4100 CPU (-03 FAB) 32MB w FPU
	501-1512	Sun 4100 CPU (-04 FAB) 8MB w/o FPU
	501-1513	Sun 4100 CPU (-04 FAB) 8MB w FPU
	501-1514	Sun 4100 CPU (-04 FAB) 16MB w/o FPU
	501-1515	Sun 4100 CPU (-04 FAB) 16MB w FPU
	501-1516	Sun 4100 CPU (-04 FAB) 32MB w/o FPU
	501-1517	Sun 4100 CPU (-04 FAB) 32MB w FPU
	501-1656	Sun 4100 CPU (-07 FAB) 8MB w/o FPU
	501-1657	Sun 4100 CPU (-07 FAB) 8MB w FPU
	501-1658	Sun 4100 CPU (-07 FAB) 16MB w/o FPU
	501-1659	Sun 4100 CPU (-07 FAB) 16MB w FPU
	501-1660	Sun 4100 CPU (-07 FAB) 32MB w/o FPU
	501-1661	Sun 4100 CPU (-07 FAB) 32MB w FPU
	501-1247	MG3 P4 Mono Frame Buffer
	501-1248	CG4 P4 Color Frame Buffer
	501-1371	CG8 P4 24-Bit Color Frame Buffer
501-1374	CG6 P4 Color Frame Buffer	
501-1518	CG8 P4 24-Bit Color Frame Buffer	
501-1532	CG6 P4 Color Frame Buffer	
501-1314	256KB SIMM Module	
501-1466	1MB SIMM Module	
2	501-1116	Sun-3 Color Frame Buffer
	501-1267	CG5 Color Frame Buffer The Sun-2 Color Board is not supported.
3	501-1125	SunIPC without 80287
	501-1214	SunIPC with 80287
4	501-1055	Graphics Processor
	501-1139	Graphics Processor +
	501-1268	Graphics Processor 2

Sun-4/110/150/260/280 – Continued

NOTE #	PART#	BOARD
5	501-1383 501-1447	TAAC-1 Application Accelerator TAAC-1 Application Accelerator
6	501-1102 501-1451 501-1254 501-1576	8MB Memory 32MB Memory 32MB Memory 16MB Memory
7	501-1149 501-1170	Sun-2 SCSI Host Adapter Assembly Sun-3 SCSI Host Adapter Assembly
8	501-1155	Xylogics 472 Tape Controller Assy The 501-1156, CPC Tapemaster Tape Ctrl Assembly is not supported.
9	501-1154 501-1166 501-1249	Xylogics 450 Disk Controller Assembly Xylogics 451 Disk Controller Assembly Xylogics 7053 Disk Controller
10	501-1249	Xylogics 7053 Disk Controller
11	501-1167	Sun-2 SCSI Host Adapter Assembly
12	501-1138 501-1217	Sun-2 SCSI Host Adapter Assembly Sun-3 SCSI Host Adapter Assembly

Sun-4/310

SHUNTS		BOARD	SLOT POSITION		
BG3	IACK		1	2	3
Out	Out	Sun 4300 CPU 1	A	A	
In	In	Memory 2		A	B
In	Out	Color 3		A	B
Out	Out	1st MCP		A	B
Out	Out	2nd MCP			A
Out	Out	1st ALM-2		A	B
Out	Out	2nd ALM-2			A
Out	Out	Ethernet 4		B	A
In	Out	1st IPC 5		B	A
In	Out	2nd IPC 5		A	

Reference

SPARCsystem 350 and 310 Cardcage Slot Assignments and Backplane Configuration Procedures, 800-5722-10.

Sun-4/330

SHUNTS		BOARD	SLOT POSITION						
			9U			6U		3U	
BG3	IACK		1	2	3	4A	5A	4B	5B
Out	Out	Sun 4300 CPU 8	A	a					
Out	Out	1st MCP		B	A				
Out	Out	2nd MCP		B	A				
Out	Out	1st ALM-2		B	A				
Out	Out	2nd ALM-2		B	A				
Out	Out	GP 6		A					
In	Out	Color 3		B	A				
In	Out	1st HSI		B	A				
In	Out	2nd HSI			A				
Out	Out	Ethernet 4		B	A				
In	Out	IPC		B	A				
Out	Out	SCSI 9		B	A				
-	-	1st Memory 10						A	B
-	-	2nd Memory 11							A

References

1. *Sun-5 Slot Office Pedestal Cardcage Slot Assignments and Backplane Configuration Procedures*, 813-2068-11.
2. *Sun-3 SCSI Host Adapter Installation Manual*, 813-1015-11.

Sun-4/350

SHUNTS		BOARD	SLOT POSITION					
BG3	IACK		1	2	3	4	5	6
Out	Out	Sun 4300 CPU 1	A	A				
In	In	Memory 2			A			
Out	Out	GP 6					A	
Out	Out	CG9						A
In	In	TAAC-1 7			A	A	A	
-	-					B	B	B
In	Out	1st MCP		E	A	B	C	D
In	Out	2nd MCP		D		A	B	C
In	Out	1st ALM-2		E	A	B	C	D
In	Out	2nd ALM-2		D		A	B	C
Out	Out	SunLink Channel Adapter			A	A		
-	-					B	B	
-	-						C	C
-	-			D	D			
Out	Out	1st Mapkit			A	A		
-	-					B	B	
-	-						C	C
-	-			D	D			
Out	Out	2nd Mapkit				A	A	
-	-						B	B
-	-			C	C			
In	Out	Color 3		E	A	B	C	D
In	Out	CG5 with GP+		C	A	B		
In	Out	CG5 with GP2						A
Out	Out	Ethernet 4		E	A	B	C	D
Out	Out	FDDI		E	A	B	C	D
In	Out	HSI		E	A	B	C	D
In	Out	1st IPC 5		E	A	B	C	D
In	Out	2nd IPC 5		D		A	B	C

Reference

SPARCsystem 350 and 310 Cardcage Slot Assignments and Backplane Configuration Procedures, 800-5722-10.

Sun-4/360

SHUNTS		BOARD	SLOT POSITION														
			1	2	3	4	5	6	7	8	9	10	11	12			
BG3	IACK																
Out	Out	Sun 4300 CPU 1	A	A													
In	In	Memory 2			A	A											
Out	Out	GP 6											A				
In	Out	CG9													A	A	
In	In	GB													A		
In	In	TAAC-1 7											A	A	A		
Out	Out	ALM-1												A	A		
Out	Out	SCSI Adapter 12							A								
Out	Out	1st MCP		K	A	B	C	D	E	F	G	H	I	J			
Out	Out	2nd MCP		J		A	B	C	D	E	F	G	H	I			
Out	Out	3rd MCP		I			A	B	C	D	E	F	G	H			
Out	Out	4th MCP		H				A	B	C	D	E	F	G			
Out	Out	1st ALM-2		K	A	B	C	D	E	F	G	H	I	J			
Out	Out	2nd ALM-2		J		A	B	C	D	E	F	G	H	I			
Out	Out	3rd ALM-2		I			A	B	C	D	E	F	G	H			
Out	Out	4th ALM-2		H				A	B	C	D	E	F	G			
Out	Out	1st SunLink				A	A	C	C	E	E	G	G	J			
-	-	Channel Adapter					B	B	D	D	F	F	J	J			
Out	Out	2nd SunLink						A	A	C	C	E	E	J			
-	-	Channel Adapter							B	B	D	D	F	F			
Out	Out	Ethernet 4		E	A	B	C	D	F	G	H	I	J	K			
Out	Out	1st Tape Ctlr 13							A	B	C	D	E	F			
Out	Out	2nd Tape Ctlr 13								A	B	C	D	E			
Out	Out	1st Disk Ctlr 14							A	B	C	D	E	F			
Out	Out	2nd Disk Ctlr 14								A	B	C	D	E			
In	Out	Color 3		K	A	B	C	D	E	F	G	H	I	J			
In	Out	CG5 with GP/GP+		H	A	B	C	D	E	F	G						
In	Out	CG5 with GP2													A	B	

Reference

SPARCsystem 360 & SPARCserver 380 Cardcage Slot Assignments and Backplane Configuration Procedures, 813-2088-11.

Sun-4/370

SHUNTS		BOARD	SLOT POSITION													
			1	2	3	4	5	6	7	8	9	10	11	12		
Out	Out	Sun 4300 CPU 1				A	a									
In	In	Memory 2		A												
In	Out	CG9													A	B
Out	Out	GP 6											A			
In	In	GB													A	
In	In	TAAC-1 7					A	A	A	D	D	D				
-	-							B	B	B	E	E	E	E		
-	-								C	C	C	F	F	F	F	
Out	Out	1st MCP					A	B	C	D	E	F	G	H		
Out	Out	2nd MCP						A	B	C	D	E	F	G		
Out	Out	3rd MCP							A	B	C	D	E	F		
Out	Out	4th MCP								A	B	C	D	E		
Out	Out	1st ALM-2					A	B	C	D	E	F	G	H		
Out	Out	2nd ALM-2						A	B	C	D	E	F	G		
Out	Out	3rd ALM-2							A	B	C	D	E	F		
Out	Out	4th ALM-2								A	B	C	D	E		
Out	Out	1st SunLink					A	A	C	C	E	E	G	G		
-	-	Channel Adapter						B	B	D	D	F	F			
Out	Out	2nd SunLink							A	A	C	C	E	E		
-	-	Channel Adapter								B	B	D	D			
Out	Out	SCSI 9					A	B	C	D	E	F	G	H		
Out	Out	Ethernet 8					A	B	C	D	E	F	G	H		
Out	Out	1st Disk Ctlr 14					A	B	C	D	E	F	G	H		
Out	Out	2nd Disk Ctlr 14						A	B	C	D	E	F	G		
Out	Out	3rd Disk Ctlr 15							A	B	C	D	E	F		
Out	Out	4th Disk Ctlr 15								A	B	C	D	E		
In	Out	Color 3					A	B	C	D	E	F	G	H		
In	Out	CG5 with GP2												A	B	
In	Out	CG5 with GP/GP+					A	B	C	D	E					

References

1. SPARCsystem 370 Cardcage Slot Assignments and Backplane Configuration Procedures, 813-2079-11.
2. Sun-3 SCSI Hosts Adapter Installation Manual, 813-1015-11.

Sun-4/380

SHUNTS		BOARD	SLOT POSITION														
			1	2	3	4	5	6	7	8	9	10	11	12			
BG3	IACK																
Out	Out	Sun 4300 CPU 1	A	a													
In	In	Memory 2		A	a												
Out	Out	GP 6										A					
In	Out	CG9												A		B	
In	In	GB													A		
In	In	TAAC-1 7											A	A	A		
Out	Out	1st ALM-1															A
Out	Out	2nd ALM-1														A	
Out	Out	3rd ALM-1											A				
Out	Out	1st MCP		K	A	B	C	D	E	F	G	H	I	J			
Out	Out	2nd MCP		J		A	B	C	D	E	F	G	H	I			
Out	Out	3rd MCP		I			A	B	C	D	E	F	G	H			
Out	Out	4th MCP		H				A	B	C	D	E	F	G			
Out	Out	1st ALM-2		K	A	B	C	D	E	F	G	H	I	J			
Out	Out	2nd ALM-2		J		A	B	C	D	E	F	G	H	I			
Out	Out	3rd ALM-2		I			A	B	C	D	E	F	G	H			
Out	Out	4th ALM-2		H				A	B	C	D	E	F	G			
Out	Out	1st SunLink				A	A	C	C	E	E	G	G				
-	-	Channel Adapter					B	B	D	D	F	F	J	J			
Out	Out	2nd SunLink						A	A	C	C	E	E				
-	-	Channel Adapter							B	B	D	D	F	F			
In	Out	Color 3		K	A	B	C	D	E	F	G	H	I	J			
In	Out	CG5 with GP2													A	B	
In	Out	CG5 with GP/GP+		H	A	B	C	D	E	F	G						
Out	Out	Ethernet 4		E	A	B	C	D	F	G	H	I	J	K			
Out	Out	1st Tape Ctlr 13								A	B	C	D	E	F		
Out	Out	2nd Tape Ctlr 13									A	B	C	D	E		
Out	Out	1st Disk Ctlr 14									A	B	C	D	E	F	
Out	Out	2nd Disk Ctlr 14										A	B	C	D	E	
Out	Out	3rd Disk Ctlr 15											A	B	C	D	
Out	Out	4th Disk Ctlr 15												A	B	C	

Reference
 SPARCsystem 360 & SPARCserver 380 Cardcage Slot Assignments
 and Backplane Configuration Procedures, 813-2088-11.

Sun-4/390

SHUNTS		BOARD	SLOT POSITION															
			1	2	3	4	5	6	7	8	9	10	11	12	13	14	15	16
BG3	IACK																	
Out	Out	4300 CPU 1				A	a											
In	In	Memory 2	A															
Out	Out	GP2											B					
In	In	TAAC-1 7													A	A	A	
Out	Out	1st MCP						A	B	C	D	E	F	G	H	I	J	K
Out	Out	2nd MCP							A	B	C	D	E	F	G	H	I	J
Out	Out	3rd MCP								A	B	C	D	E	F	G	H	I
Out	Out	4th MCP									A	B	C	D	E	F	G	H
Out	Out	1st ALM-2						A	B	C	D	E	F	G	H	I	J	K
Out	Out	2nd ALM-2							A	B	C	D	E	F	G	H	I	J
Out	Out	3rd ALM-2								A	B	C	D	E	F	G	H	I
Out	Out	4th ALM-2									A	B	C	D	E	F	G	H
Out	Out	5th ALM-2										A	B	C	D	E	F	G
Out	Out	6th ALM-2											A	B	C	D	E	F
Out	Out	7th ALM-2												A	B	C	D	E
Out	Out	8th ALM-2													A	B	C	D
Out	Out	1st Channel						A	A	C	C	E	E	G	G	I	I	
-	-	Adapter							B	B	D	D	F	F	H	H	J	J
Out	Out	2nd Channel								A	A	C	C	E	E	G	G	
-	-	Adapter									B	B	D	D	F	F	H	H
Out	Out	SCSI 9						A	B	C	D	E	F	G	H	I	J	K
In	Out	1st HSI						A	B	C	D	E	F	G	H	I	J	K
In	Out	2nd HSI							A	B	C	D	E	F	G	H	I	J
Out	Out	Ethernet 4						A	B	C	D	E	F	G	H	I	J	K
Out	Out	1st FDDI						A	B	C	D	E	F	G	H	I	J	K
Out	Out	2nd FDDI							A	B	C	D	E	F	G	H	I	J
In	Out	1st IPC 5						A	B	C	D	E	F	G	H	I	J	K
In	Out	2nd IPC 5							A	B	C	D	E	F	G	H	I	J
In	Out	3rd IPC 5								A	B	C	D	E	F	G	H	I
In	Out	4th IPC 5									A	B	C	D	E	F	G	H

Sun-4/390 – Continued

SHUNTS		BOARD	SLOT POSITION															
			1	2	3	4	5	6	7	8	9	10	11	12	13	14	15	16
BG3	JACK																	
Out	Out	1st IPI Ctlr						A	B	C	D	E	F	G	H	I	J	K
Out	Out	2nd IPI Ctlr							A	B	C	D	E	F	G	H	I	J
Out	Out	3rd IPI Ctlr								A	B	C	D	E	F	G	H	I
Out	Out	4th IPI Ctlr									A	B	C	D	E	F	G	H
In	Out	CG5						A	B	C	D	E	F	G	H	I	J	K
In	Out	CG5 w GP2													A	B		
In	Out	CG9													A	B		

Reference

Sun SPARCserver 390 Card Cage Slot Assignments and Backplane Configuration Procedure, 813-2067-10.

Sun-4/310/330/350/360/370/380/390

NOTE #	PART#	BOARD
	501-1247 501-1374 501-1402 501-1443 501-1532	MG3 P4 Mono Frame Buffer CG6 P4 Color Frame Buffer MG4 P4 Mono Frame Buffer CG4 P4 Color Frame Buffer CG6 P4 Color Frame Buffer
1	501-1316 501-1466 501-1544 501-1565	8MB Sun 4300 CPU 1MB SIMM Module 1MB SIMM Module 1MB SIMM Module
	501-1742 501-1682	32MB Sun 4300 CPU 4MB SIMM Module
2	501-1495 501-1563 501-1564 501-1466 501-1544 501-1565	48MB Memory Board 24MB Memory Board 8MB Memory Board 1MB SIMM Module 1MB SIMM Module 1MB SIMM Module
	501-1703 501-1682	32MB Memory Board 4MB SIMM Module
3	501-1116 501-1267	Sun-3 Color Frame Buffer CG5 Color Frame Buffer
4	501-1153	Multibus Ethernet Controller Assembly
5	501-1125 501-1214	SunIPC w/o 80287 SunIPC w 80287
6	501-1268 501-1139	GP2 GP+
7	501-1381 501-1447	TAAC-1 Application Accelerator TAAC-1 Application Accelerator

Sun-4/310/330/350/360/370/380/390

NOTE #	PART#	BOARD
8	501-1316 501-1466 501-1544 501-1565	8MB Sun 4300 CPU 1MB SIMM Module 1MB SIMM Module 1MB SIMM Module 4MB SIMMs are not supported on the Sun-4/330 CPU board.
9	501-1217	Sun-3 SCSI Host Adapter Assembly
10	501-1436 501-1723 501-1317 501-1711 501-1466 501-1544 501-1565	8MB Memory Board 8MB Memory Board 16MB Memory Board 16MB Memory Board 1MB SIMM Module 1MB SIMM Module 1MB SIMM Module
	501-1704 501-1755 501-1682	32MB Memory Board 32MB Memory Board 4MB SIMM Module
11	501-1436 501-1723 501-1317 501-1711 501-1466 501-1544 501-1565	8MB Memory Board 8MB Memory Board 16MB Memory Board 16MB Memory Board 1MB SIMM Module 1MB SIMM Module 1MB SIMM Module
12	501-1666	Blank SCSI Adapter Assembly
13	501-1155	Xylogics 472 Tape Controller Assembly
14	501-1166 501-1249	Xylogics 451 Disk Controller Assembly Xylogics 7053 Disk Controller
	501-1249	Xylogics 7053 Disk Controller

Sun-4/470

SHUNTS		BOARD	SLOT POSITION											
			1	2	3	4	5	6	7	8	9	10	11	12
BG3	IACK													
Out	Out	Sun 4400 CPU				A	a							
In	In	1st Memory 1	A											
In	In	2nd Memory 1							A					
In	In	3rd Memory 1		A										
In	In	4th Memory 1						A						
In	In	5th Memory 1			A									
In	In	6th Memory 1					A							
Out	Out	GP2										A	B	
In	In	TAAC-1 2										A	A	A
Out	Out	1st MCP						A	B	C	D	E	F	G
Out	Out	2nd MCP							A	B	C	D	E	F
Out	Out	3rd MCP								A	B	C	D	E
Out	Out	4th MCP									A	B	C	D
Out	Out	1st ALM-2						A	B	C	D	E	F	G
Out	Out	2nd ALM-2							A	B	C	D	E	F
Out	Out	3rd ALM-2								A	B	C	D	E
Out	Out	4th ALM-2									A	B	C	D
Out	Out	5th ALM-2										A	B	C
Out	Out	6th ALM-2											A	B
Out	Out	1st SunLink Channel Adapter						A	A	C	C	E	E	
-	-							B	B	B	D	D	F	F
Out	Out	2nd SunLink Channel Adapter							A	A	C	C	E	E
-	-								B	B	B	D	D	
Out	Out	1st SCSI 3						A	B	C	D	E	F	G
Out	Out	2nd SCSI 3							A	B	C	D	E	F
In	Out	1st HSI						A	B	C	D	E	F	G
In	Out	2nd HSI							A	B	C	D	E	F
Out	Out	1st Ethernet 4						A	B	C	D	E	F	G
Out	Out	2nd Ethernet 4							A	B	C	D	E	F
Out	Out	3rd Ethernet 4								A	B	C	D	E
Out	Out	1st FDDI						A	B	C	D	E	F	G
Out	Out	2nd FDDI							A	B	C	D	E	F

Sun-4/470 - Continued

SHUNTS		BOARD	SLOT POSITION														
			1	2	3	4	5	6	7	8	9	10	11	12			
BG3	IACK																
Out	Out	1st SMD Ctlr 5										A	B	C	D		
Out	Out	2nd SMD Ctlr 5											A	B	C		
Out	Out	1st IPI Ctlr										A	B	C	D		
Out	Out	2nd IPI Ctlr											A	B	C		
Out	Out	3rd IPI Ctlr													A	B	
Out	Out	4th IPI Ctlr															A
In	Out	CG5										A	B	C	D		
In	Out	CG5 with GP2													A	B	
In	Out	CG9													A	B	

Reference

Sun SPARCsystem 470 Cardcage Slot Assignments and Backplane Configuration Procedures, 813-2102-12.

Sun-4/490

SHUNTS		BOARD	SLOT POSITION															
			1	2	3	4	5	6	7	8	9	10	11	12	13	14	15	16
BG3	IACK																	
Out	Out	Sun 4400 CPU				A	a											
In	In	1st Memory 1	A															
In	In	2nd Memory 1							A									
In	In	3rd Memory 1		A														
In	In	4th Memory 1						A										
In	In	5th Memory 1			A													
In	In	6th Memory 1						A										
Out	Out	GP2													A	B		
In	In	TAAC-1 2														A	A	A
Out	Out	1st MCP						A	B	C	D	E	F	G	H	I	J	K
Out	Out	2nd MCP							A	B	C	D	E	F	G	H	I	J
Out	Out	3rd MCP								A	B	C	D	E	F	G	H	I
Out	Out	4th MCP									A	B	C	D	E	F	G	H
Out	Out	1st ALM-2						A	B	C	D	E	F	G	H	I	J	K
Out	Out	2nd ALM-2							A	B	C	D	E	F	G	H	I	J
Out	Out	3rd ALM-2								A	B	C	D	E	F	G	H	I
Out	Out	4th ALM-2									A	B	C	D	E	F	G	H
Out	Out	5th ALM-2										A	B	C	D	E	F	G
Out	Out	6th ALM-2											A	B	C	D	E	F
Out	Out	7th ALM-2												A	B	C	D	E
Out	Out	8th ALM-2													A	B	C	D
Out	Out	1st Channel Adapter						A	A	C	C	E	E	G	G	I	I	
									B	B	D	D	F	F	H	H	J	J
Out	Out	2nd Channel Adapter							A	A	C	C	E	E	G	G	I	I
										B	B	D	D	F	F	H	H	
Out	Out	1st SCSI 3						A	B	C	D	E	F	G	H	I	J	K
Out	Out	2nd SCSI 3							A	B	C	D	E	F	G	H	I	J
Out	Out	Tape Ctr 6						A	B	C	D	E	F	G	H	I	J	K
In	Out	1st HSI						A	B	C	D	E	F	G	H	I	J	K
In	Out	2nd HSI							A	B	C	D	E	F	G	H	I	J
Out	Out	1st Ethernet 4						A	B	C	D	E	F	G	H	I	J	K
Out	Out	2nd Ethernet 4							A	B	C	D	E	F	G	H	I	J
Out	Out	3rd Ethernet 4								A	B	C	D	E	F	G	H	I

Sun-4/490 - Continued

SHUNTS		BOARD	SLOT POSITION																	
			1	2	3	4	5	6	7	8	9	10	11	12	13	14	15	16		
BG3	IACK																			
Out	Out	1st FDDI						A	B	C	D	E	F	G	H	I	J	K		
Out	Out	2nd FDDI							A	B	C	D	E	F	G	H	I	J		
Out	Out	1st IPI Ctlr									A	B	C	D	E	F	G	H		
Out	Out	2nd IPI Ctlr										A	B	C	D	E	F	G		
Out	Out	3rd IPI Ctlr											A	B	C	D	E	F		
Out	Out	4th IPI Ctlr												A	B	C	D	E		
In	Out	CG5									A	B	C	D	E	F	G	H		
In	Out	CG5 with GP2													A	B				
In	Out	CG9													A	B				
Out	Out	1st SMD Ctlr 5																A		
Out	Out	2nd SMD Ctlr 5															B	A		
Out	Out	3rd SMD Ctlr 5														C	B	A		
Out	Out	4th SMD Ctlr 5													D	C	B	A		
In	In	Prestoserve								A	B	C	D	E	F	G	H	I		

Reference
Sun SPARCserver 490 Cardcage Slot Assignments and Backplane Configuration Procedures, 813-2087-14.

Sun-4/470/490

NOTE #	PART#	BOARD
	501-1402 501-1374 501-1532	MG4 P4 Mono Frame Buffer CG6 P4 Color Frame Buffer CG6 P4 Color Frame Buffer
1	501-1333 501-1721	32MB ECC Memory 128MB ECC Memory
2	501-1381 501-1447	TAAC-1 Application Accelerator TAAC-1 Application Accelerator
3	501-1217	Sun-3 SCSI Host Adapter Assembly
4	501-1584	Sun 3E Ethernet Controller Assembly
5	501-1249	Xylogics 7053
6	501-1155	Xylogics 472 Tape Controller Assembly

CONFIGURATIONS

MISCELLANEOUS

Miscellaneous

Sky Floating Point Processor (Multibus)	2
Sky Floating Point Processor (VMEbus)	4
Floating Point Accelerator (FPA)	6
Floating Point Accelerator Plus (FPA+)	8
FPU2	9
SBus FPU	10
Type-4 Keyboard	11
SunIPC	12
6U to 9U VMEbus Adapter	14

Sky Floating Point Processor (Multibus) Sun-2/120/170 370-1021

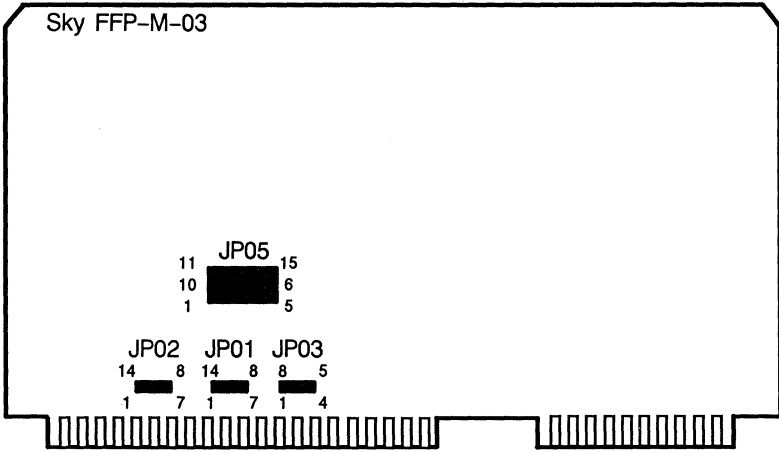
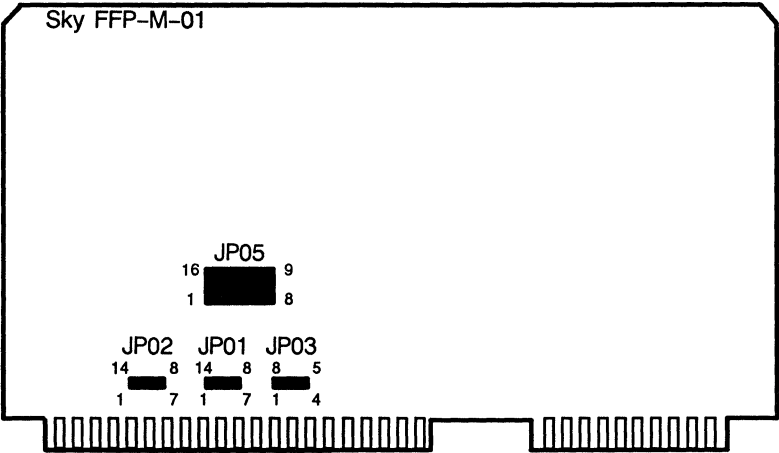

370-1021 Jumper Settings

Jumpers JP01, JP02, and JP03

JUMPER	PINS	SETTING	DESCRIPTION
JP01	1-11	Wirewrap	Sets base address at 8000
JP02	1-3-6 4-5	Wirewrap Wirewrap	
JP03	2-3 4-5 6-7	In In In	Set for no interrupts*

Sky FFP M-01, Jumper JP05

BOARD	PINS	SETTING
M-01	1-16	In
	2-15	In
	3-14	In
	4-13	In
	5-12	In
	6-11	In
	7-10	In
	8-9	In

Sky FFP-M-03, Jumper JP05

BOARD	PINS	SETTING	
M-03	10-11	In	
	9-12	In	
	8-13	In	
	7-14	In	
	6-15		In

Reference

Sky Board Configuration Procedures for the Sun-2/120/170, 813-2014.

Sky Floating Point Processor (VMEbus)

Sun-2/50/130/160
370-1029

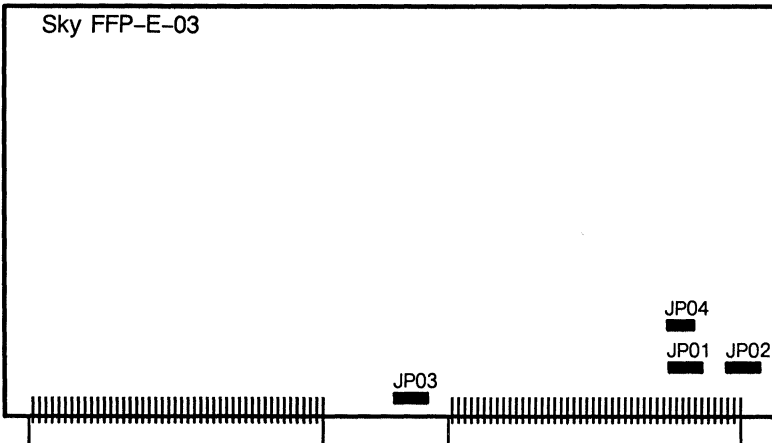
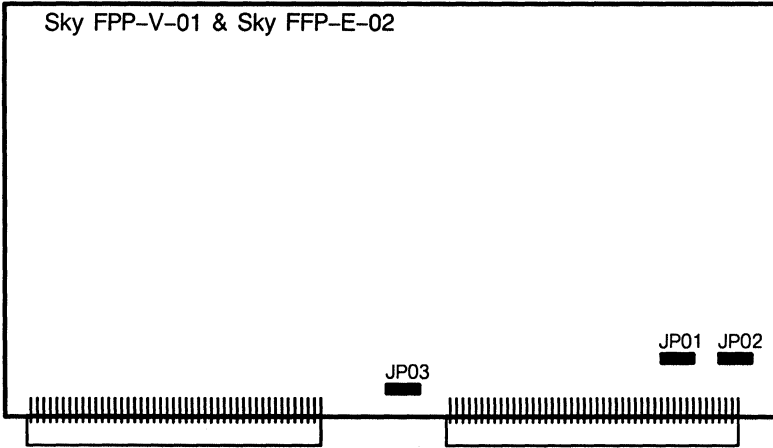

Reference

Sky Board Configuration Procedures for the Sun-2/130/160, 813-2015.

370-1029

Jumper Settings

Sky FPP-V-01 & Sky FPP-E-02

JUMPER	PINS	SETTING
JP01	1-2-3-4-5 6-7-8-9-10	Wirewrapped Wirewrapped
JP02	1-16 2-15 3-14 5-6 7-8 10-11 12-13	In In In In In In In
JP03	1-6 2-5 3-4	In In In

Sky FPP-E-03

JUMPER	PINS	SETTING
JP01	1-16 2-15 3-14 4-13 5-12 6-11 7-10	In In In In In In In
JP02	1-16 2-15 3-14 5-6 7-8 10-11 12-13	Soldered Soldered Soldered Soldered Soldered Soldered Soldered
JP03	1-6 2-5	In In
JP04	1-2 4-5	In In

Floating Point Accelerator (FPA)

Sun-3/110/140/150/160/180/260/280/460/470/480
501-1105

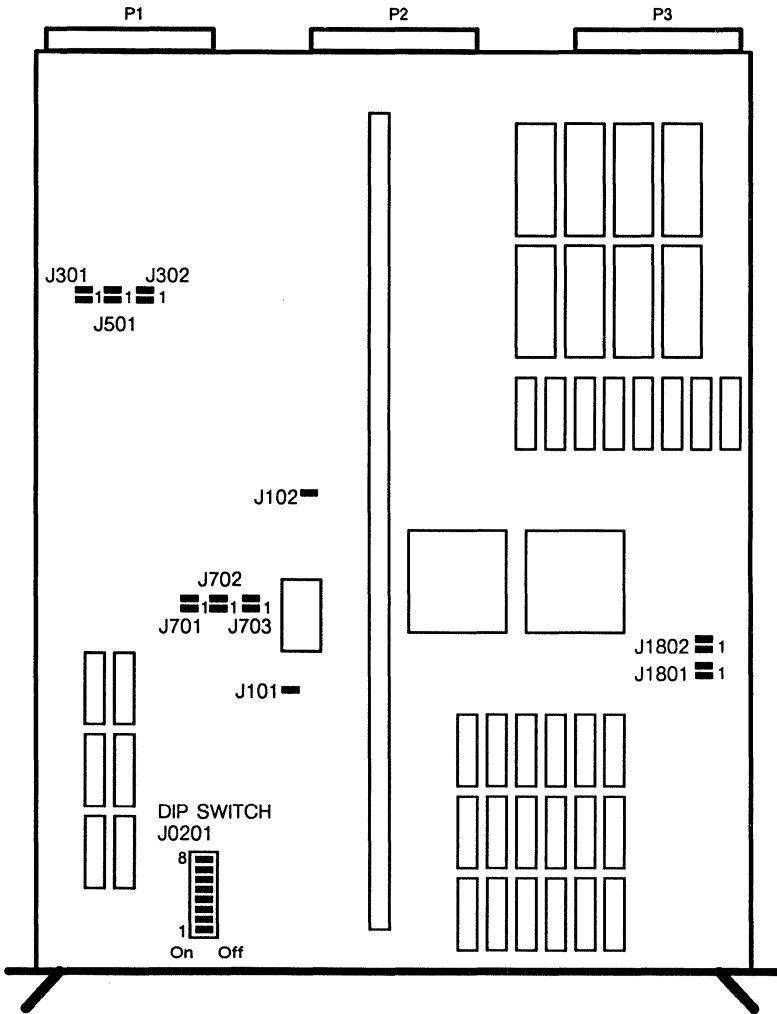

501-1105 Jumper & Switch Settings

JUMPER	PINS	SETTING	DESCRIPTION
J0101	1-2	In	50 MHz clock
J0102	1-2	Out	Clock enable (hardwired)
J0301	1-2 3-4	In* Out*	Shadow read ack/nack
J0302	1-2 3-4	In* Out*	FPA access pending
J0501	1-2 3-4	In* Out*	Asynch cntrl for 1st pipe stage
J0701	1-2 3-4	In Out	Version level 0
J0702	1-2 3-4	In Out	Version level 0
J0703	1-2 3-4	In Out	Version level 0
J1801	1-2 3-4	Out In	4 VDC for WTL1164 (Multiplier) 5 VDC for WTL1164 (Multiplier)
J1802	1-2 3-4	Out In	4 VDC for WTL1165 (ALU) 5 VDC for WTL1165 (ALU)

*Remove Pins 1-2 and jumper Pins 3-4, In, when used in a Sun-3/2XX. Jumper Pins 1-2 and remove Pins 3-4 when used in a Sun-3/1XX.

DIP SWITCH J0201 – Bus Time Out

1	2	3	4	5	6	7	8
ON	ON	OFF	ON	OFF	ON	ON	ON

Note: Board revisions lower than 501-1105-07 may fail the stand-alone diagnostics Fpa3,diag or the Fpa3.exec.

Reference
Sun Floating Point Accelerator Board Configuration Procedures,
813-2012.

Floating Point Accelerator Plus (FPA+)

Sun-3/460/470/480
501-1446

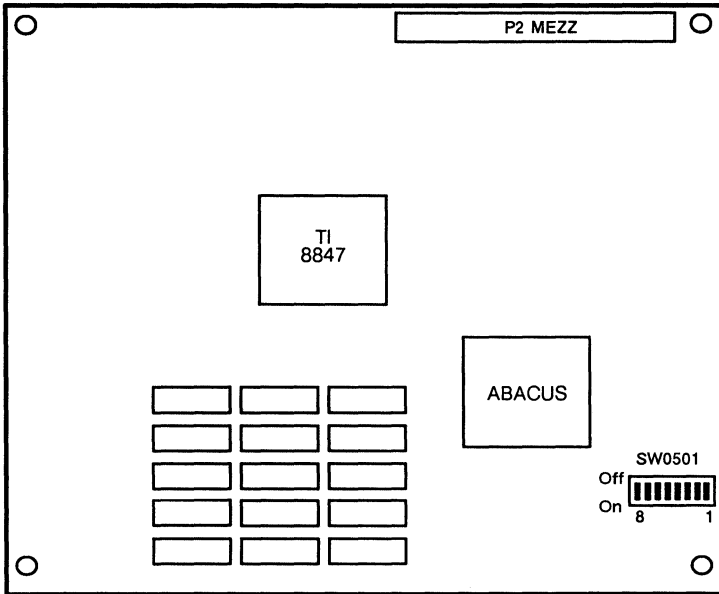

SWITCH	SETTING	DESCRIPTION
1	On	Timeout Internal = 4.8 MS
2	Off	
3	On	
4	On	
5	Off	Retry = 256
6	Off	
7	Off	
8	Off	

Power: 2.3 Amps @ +5Vdc
11.5 Watts

Note: A 1/4" Patch Tape Assy, 790-4004, or 1/2" Patch Tape Assy, 790-4005 is required for SunOS 4.0.3.

Reference
Sun FPA+ Board Installation and Configuration Manual, 800-3258.

FPU2

501-1387
Sun-4/260/280

501-1384
Sun-4/110/150

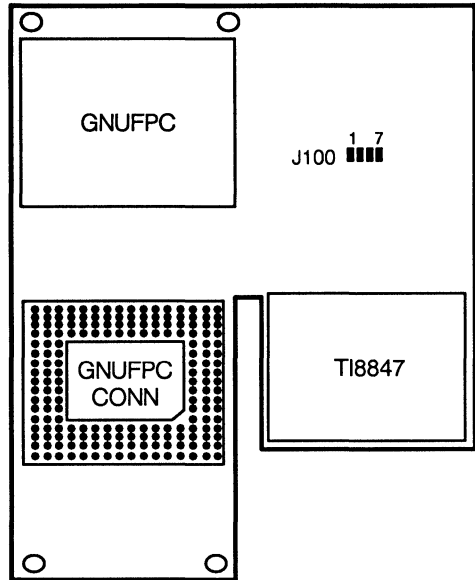
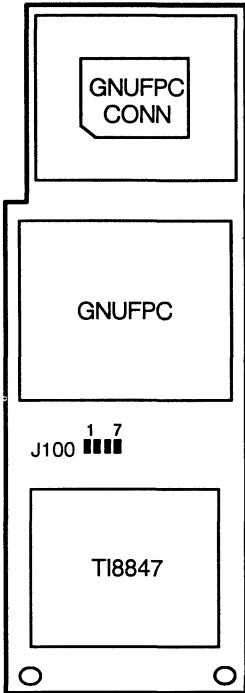

4/110/150 Option Parts

Front Bracket	340-1743
Rear Bracket	340-2163
4-40 Screw	240-1196

J100 Jumper Settings

PINS	SETTING	DESCRIPTION
1-2	In	TI chip on board
3-4	In	No Tristate on all output
5-6	In	TI8847/TI8837
7-8	Out	Enable chaining mode

Notes

1. The 501-1384 FPU2 is supported only on CPU boards 501-1512, 501-1513, 501-1514, 501-1515, 501-1516, and 501-1517.
2. Remove the Weitek ALU (U202) and Multiplier (U201) from the 4/110/150 CPU to install the FPU2.
3. Diagnostics fpurel and fputest for SunOS 4.0 and 4.0.1 are on the 1.0 FPU2 Patch Tape.

Reference

FPU-2 Daughter Board Installation Manual for Sun-4/100 Systems, 800-3067.

SBus FPU

Sun-4/60
501-1454

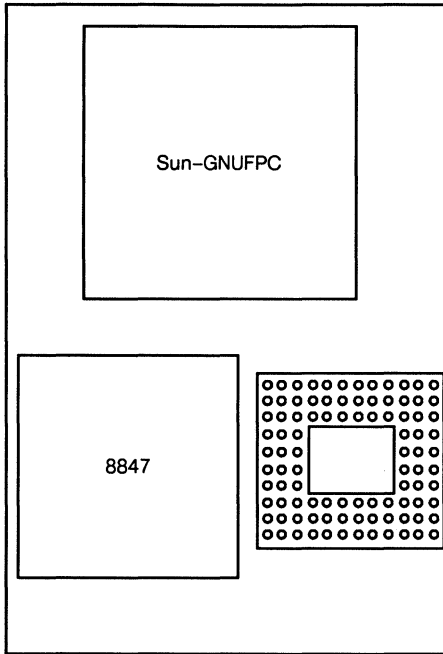

Type-4 Keyboard

320-1005 United States	320-1006 German	320-1007 Swiss German	320-1008 Belgium French
320-1009 United Kingdom	320-1010 Swiss French	320-1011 Netherlands	320-1012 Sweden Denmark
320-1013 Denmark	320-1014 Norway	320-1015 Italy	320-1016 Spanish
320-1017 Portugal	320-1018 French Canadian		

UNDERSIDE OF KEYBOARD

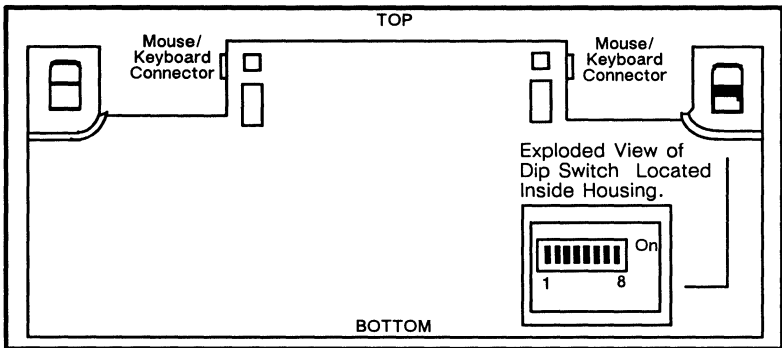

DESCRIPTION	DIP SWITCH								CODE
	1	2	3	4	5	6	7	8	
Sun-3/4 w > 4.0 or 386i	Off	-	-	-	-	-	-	-	-
Sun-3 w < 3.5	On	-	-	-	-	-	-	-	-
United States	-	-	-	-	-	-	-	-	00
Belgium/French	-	-	-	-	-	-	On	-	02
Canadian French	-	-	-	-	-	-	On	On	03
Danish	-	-	-	-	-	On	-	-	04
German	-	-	-	-	-	On	-	On	05
Italian	-	-	-	-	-	On	On	-	06
Netherlands (Dutch)	-	-	-	-	-	On	On	On	07
Norwegian	-	-	-	-	On	-	-	-	08
Portuguese	-	-	-	-	On	-	-	On	09
Spanish	-	-	-	-	On	-	On	-	0A
Swedish/Finnish	-	-	-	-	On	-	On	On	0B
Swiss French	-	-	-	-	On	On	-	-	0C
Swiss German	-	-	-	-	On	On	-	On	0D
United Kingdom	-	-	-	-	On	On	On	-	0E

Power: 0.2 Amps @ +5Vdc
11.5 Watts.

SunIPC

Sun-2/130/160

Sun-3/110/140/150/160/180/260/280/460/470/480

Sun-4/260/280/330/360/370/380/390

501-1125

501-1214

w/o 80287

w 80287

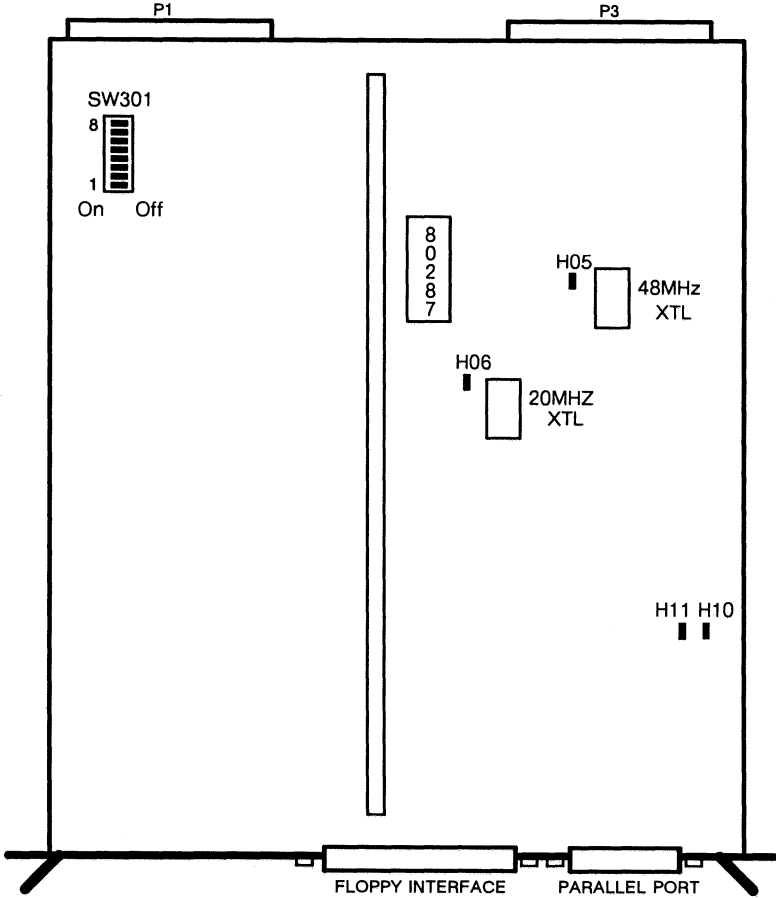

Power: 5.6 Amps @ +5Vdc
28.0 Watts

501-1125 & 501-1214 Jumper & Switch Settings

JUMPER	SETTING	DESCRIPTION
H05 1-2	In	Enable 48MHz XTAL
H06 1-2	In	Enable 20 MHz XTAL
H10 1-2	Out	For 501-1214 with 80287
	In	For 501-1125 without 80287
H11 1-2	Out	Enable XTAL1

VME Address 380000; device pc0

SWITCH	SETTING	DESCRIPTION
SW3-1	On	A23
SW3-2	On	A22
SW3-3	Off	A21
SW3-4	Off	A20
SW3-5	Off	A19
SW3-6	On	A18
SW3-7	On	A17
SW3-8	On	A16

VME Address 3C0000; device pc2

SWITCH	SETTING	DESCRIPTION
SW3-1	On	A23
SW3-2	On	A22
SW3-3	Off	A21
SW3-4	Off	A20
SW3-5	Off	A19
SW3-6	Off	A18
SW3-7	On	A17
SW3-8	On	A16

VME Address 3A0000; device pc1

SWITCH	SETTING	DESCRIPTION
SW3-1	On	A23
SW3-2	On	A22
SW3-3	Off	A21
SW3-4	Off	A20
SW3-5	Off	A19
SW3-6	On	A18
SW3-7	Off	A17
SW3-8	On	A16

VME Address 3E0000; device pc3

SWITCH	SETTING	DESCRIPTION
SW3-1	On	A23
SW3-2	On	A22
SW3-3	Off	A21
SW3-4	Off	A20
SW3-5	Off	A19
SW3-6	Off	A18
SW3-7	Off	A17
SW3-8	On	A16

Notes

1. The Sun 3200 CPU must be $\geq 501-1100-08$ or $\geq 501-1206-06$.
2. Boards with Aeroscientific FAB date code 8639 may randomly exhibit "interrupt level 2" errors.

6U to 9U VMEbus Adapter

Option 160A
501-1269
with P2A & P2C

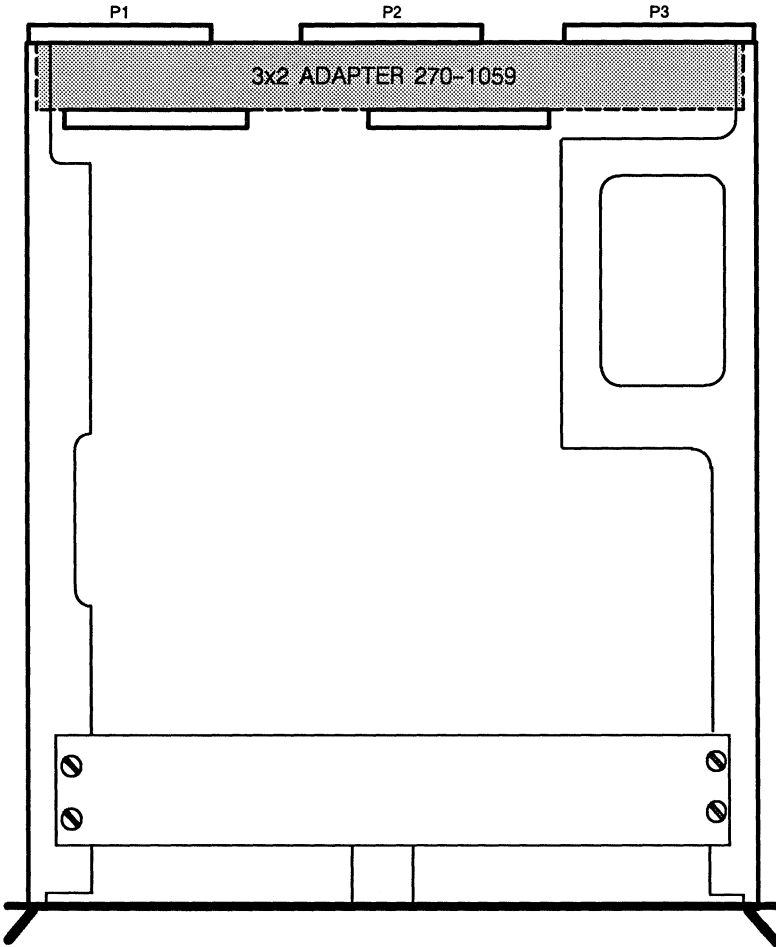

6U to 9U VMEbus Adapter

Option 160B

501-1191
without P2A & P2C

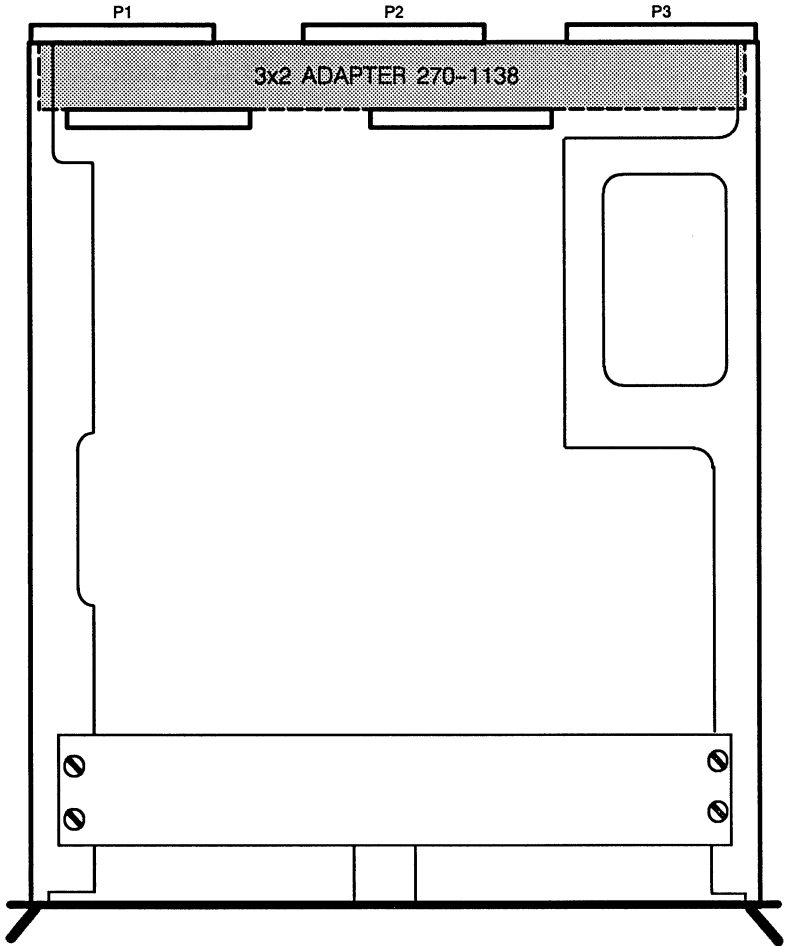

POWER

Power

This section contains information on power supplies, power power distribution units. Illustrations of power supplies and power distribution unit appear in order by Sun part number. The illustration titles include the Sun Microsystems part number, the manufacturer name and model number, the power rating, and the Sun product in which the power supply or distribution unit is used.

Fuses

The Fuse chart in the Parts Breakdown, Miscellaneous section, contains Sun and vendor part number information.

Wire Harness Color Coding

Typical Sun wire harness color coding is defined below.

DC Wire Harnesses

COLOR	DESCRIPTION
White (Wht)	-5 vdc (2/100/150/120/170 only)
Yellow (Yel)	-5.2 vdc
Blue (Blu)	+24 vdc (Fatbox only)
Blue (Blu)	+12 vdc (except Fatbox)
Brown (Brn)	-12 vdc
Red (Red)	+5 vdc
Orange (Org)	+24 vdc
Orange (Org)	+12 vdc (4/330)
Green (Grn)	GND (1/100, 2/100 ONLY)

AC Wire Harnesses

COLOR	DESCRIPTION
Green (Grn)	AC Ground
White (Wht)	AC Neutral
Black (Blk)	AC Line (Hot)
Green/Yellow (Grn/Yel)	AC Ground
Blue (Blu)	AC Neutral
Brown (Brn)	AC Line (Hot)

Adapter Harness

Adapter Harness, 811-9015-01, connects non-TUV approved fastons on AC and DC wire harnesses to the TUV approved fastons cut into production in February 1987. One end of the adapter harness has TUV approved female fastons. The other end of the adapter harness has non-TUV male fastons. The adapter harness is illustrated below.

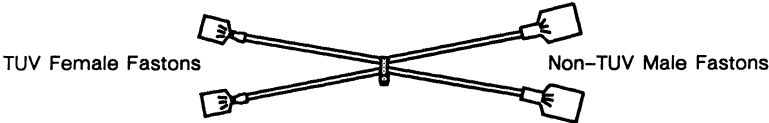

A TUV female faston attaches to a non-TUV male faston.

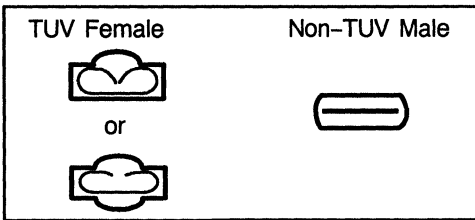

A non-TUV female faston does NOT attach to a TUV male faston. Use adapter harness 811-9015-01.

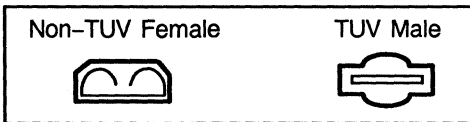

Fuseholder and Fusecarrier

Follow these instructions to avoid electrical hazard when wiring the type of fuseholder illustrated below.

1. Connect the AC Input to the Terminal on the end of the Fuseholder.
2. Connect the Terminal on the side of the Fuseholder to the AC Line Filter or AC Switch

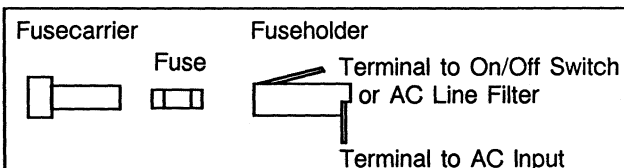

Power

POWER SUPPLIES

300-0135	Power Tec	5
300-0135-03	Power One	6
300-0566	Power Tec	7
300-0645	LH Research	8
300-0645	Power Tec	9
300-1000	LH Research	10
300-1001	Fujitsu	11
300-1002	Power Systems	12
300-1003	Fujitsu	13
300-1004	Boschert	14
300-1014	Boschert	15
300-1015	Matsushita	16
300-1016	Fuji	17
300-1016	Pioneer	18
300-1016	ETA	19
300-1017	Power Systems	20
300-1020	Brown	21
300-1020	Fuji	22
300-1022	Summit	23
300-1022	Brown	24
300-1024	Fuji	25
300-1025	Power General	26
300-1028	Cal DC	27
300-1028	Todd Products	28
300-1031	Delta	29
300-1034	Boschert	30
300-1037	Sony	31
300-1038	Sony	32
300-1040	Boschert	33
300-1041	Seagate	34

Power – Continued

POWER SUPPLIES

300-1043	Fuji	36
300-1045	Boschert	37
300-1047	Zytec	38
300-1052	Fuji	39
300-1055	Mitsubishi	40
300-1056	Fuji	41
300-1065	Zytec	43
300-1072	Boschert	44
300-7074	Seagate	45
300-1075	Fuji	46
300-1089	Fuji	47
300-1090	Sony	48
555-1006	SPS	49
300-1032	SPS	49
300-1046	SPS	49
811-1027	Fujitsu	50
811-1242	HP	52

POWER SEQUENCERS

300-1011	Pulizzi Engineering	53
370-1155	Pulizzi Engineering	54
370-1156	Pulizzi Engineering	55

Power Tec 19C-A01-ABC 150 Watts
 Sun-1/100U
 300-0135

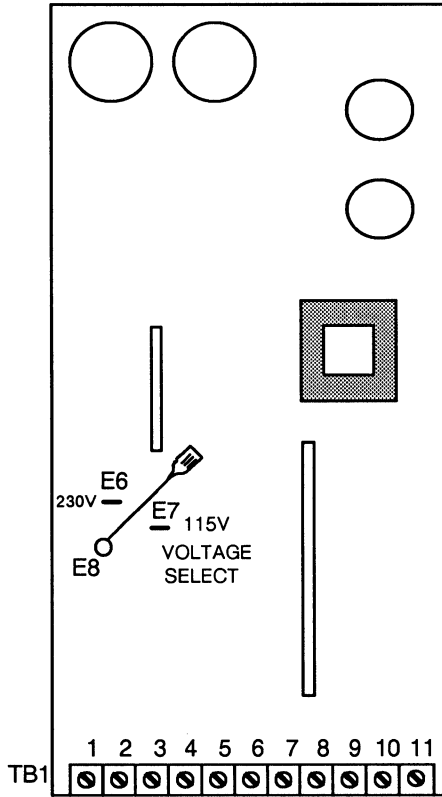

TB1

1	2	3	4	5	6	7	8	9	10	11
Grn	Wht	Blk	Blu	Wht	Brn				Red	Red
GND	NEUT	LINE	+12 V	-5 V	-12 V	COM	COM	COM	+5 V	+5 V

DC Current Output

+5V	-5.2V	+12V	-12V
25A	4.0A	4.0A	4.0A

Note: Connect wire E8 to E7 for 115 voltage or to E6 for 230 voltage.

Power One SPL200-4100P 200 Watts
Sun-2/100U

300-0135-03

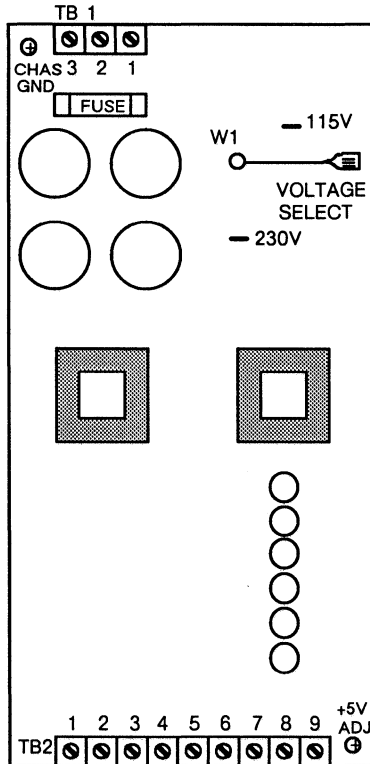

TB1

1	2	3
Wht	Blk	Grn
NEUT	LINE	GND

TB2

1	2	3	4	5	6	7	8	9
Wht	Blu	Brn	--	Grn	Grn	Grn	Red	Red
-5 V	+12 V	-12 V	NC	GND	GND	GND	+5 V	+5 V

DC Current Output

+5V	-5.2V	+12V	-12V
35A	1.5A	4.0A	1.5A

Fuse: 8 Amps @ 250 Volts

Note: Connect wire W1 to 115V for 115 voltage or to 230V for 230 voltage.

Power Tec 19C-B00-BS1286 170 Watts
 Options D84 D84EX D84TC D84TR TC
 Options 60 61 62 63 64 65 73
 300-0566

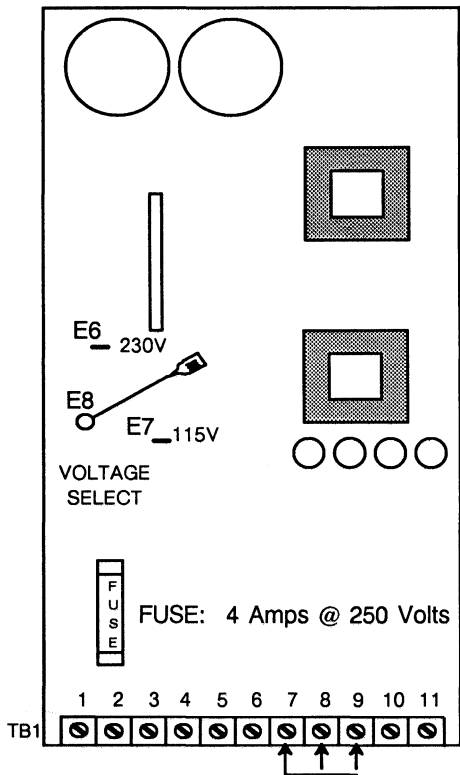

TB1

1	2	3	4	5	6	7	8	9	10	11
Grn	Wht	Blk	--	Blu	Brn	Blk	Blk	Blk	Red	Red
CHAS GND	NEUT	LINE	+12 V	+24 V	-12 V	COM	COM	COM	+5 V	+5 V

DC Current Output

+5V	+12V	-12V	+24V
20A	4.0A	4.0A	4.0A

Notes

1. Connect wire E8 to E7 for 115 voltage or to E6 for 230 voltage.
2. When used with the Fujitsu M2322, upon failure replace with 300-1014. See FCO 120-0014 and 170-0015.

LH Research SM24-12Y2Y1Y 1000 Watts
Sun-1/150U & Sun-2/150U

300-0645

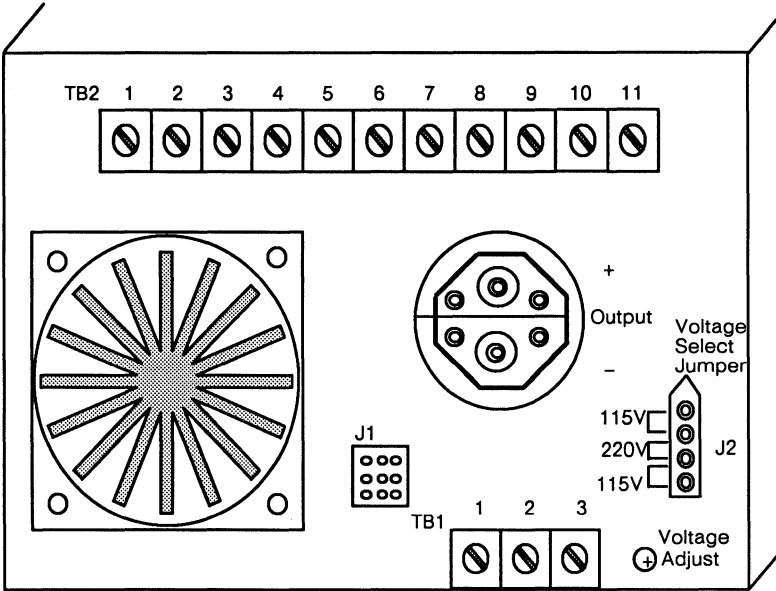

TB1

1	2	3
Blk	Wht	Grn
LINE	NEUT	GND

TB2

1	2	3	4	5	6	7	8	9	10	11
+S2	+V2	-V2	-S2	+S3	+V3	-V3	+S4	+V4	-V4	-S4

JUMPER FOR VOLTAGE SELECT (J2)

LH PART NUMBER	USED FOR
46867	115V
46868	230V

DC Current Output

+5V	-5V	+12V	-12V
150A	5.0A	10.0A	10.0A

Power Tec 6M5-BBA-17 1000 Watts
Sun-1/150U & Sun-2/150U

300-0645

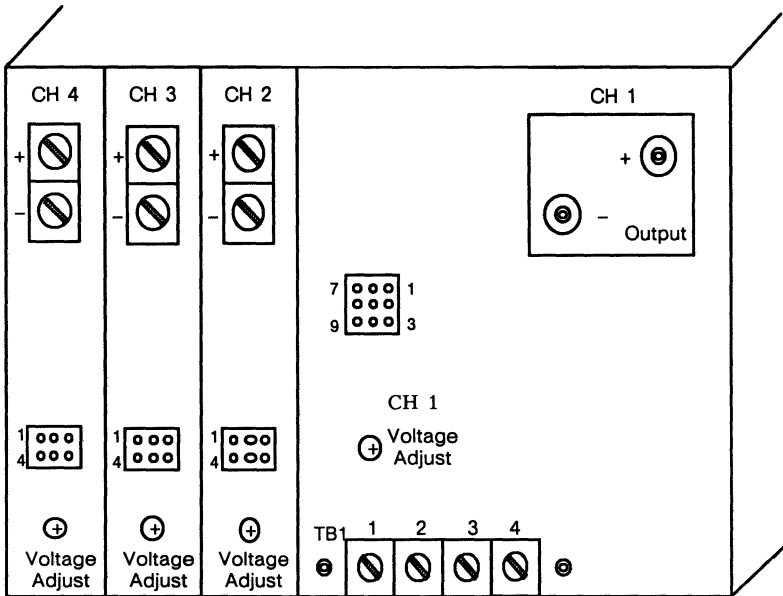

TB1

1	2	3	4
Blk	Grn	Wht	Blk
LINE 115V	GND	NEUT	LINE 230V

DC Current Output

CH 1	CH 2	CH 3	CH 4
+5V	+12V	-12V	-5V
150A	10.0A	10.0A	10.0A

LH Research MML45-E1246 600 Watts
 Sun-2/120
 300-1000

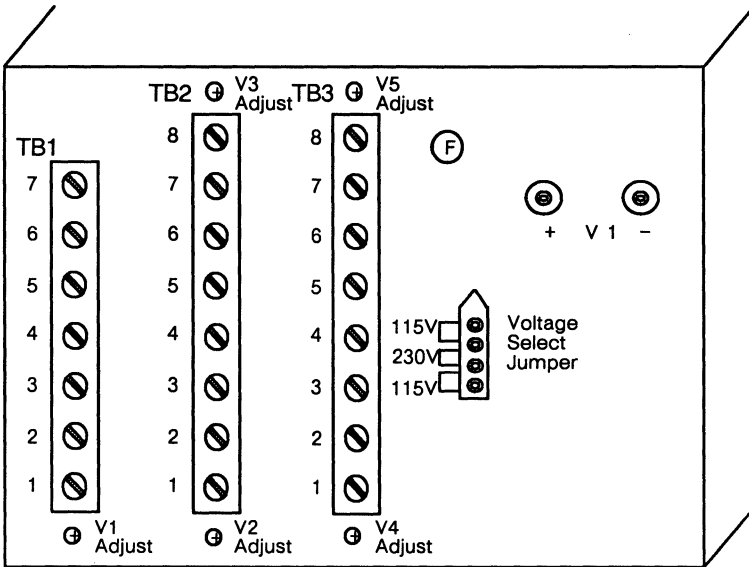

TB1

1	2	3	4	5	6	7
				Grn	Wht	Blk
+S1	-S1	ON OFF	PF	GND	NEUT	LINE

JUMPER FOR VOLTAGE SELECT

LH PART NUMBER	USED FOR
46867	115V
46868	230V

TB2

1	2	3	4	5	6	7	8
+S2	+V2	-V2	-S2	+S3	+V3	-V3	-S3

DC Current Output

TB3

1	2	3	4	5	6	7	8
+S4	+V4	-V4	-S4	+S5	+V5	-V5	-S5

V1	V2	V3	V4	V5
+5V	+12V	-12V	-5V	+24V
60A	10.0A	5.0A	2.0A	8.0A

Fuses

20 Amp @ 250 Volts for 115 Volts

10 Amp @ 250 Volts for 230 Volts

Note: This supply was only used on early production units.

Fujitsu B14L-0300-00118A .351KVA 115V
 Options 66 67 D169 D169EX D169TC
 Option 169TR
 300-1001

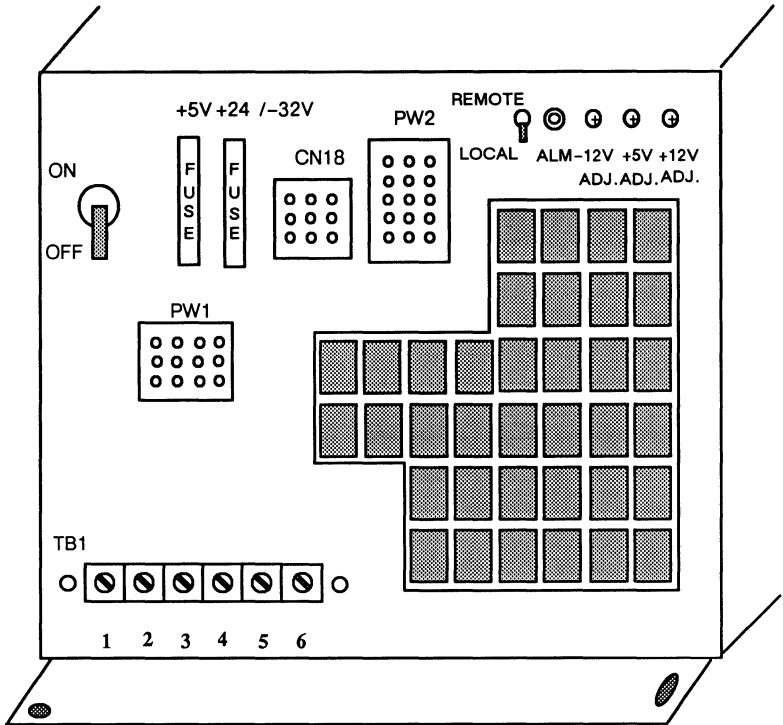

TB1

1	2	3	4	5	6
Blk	Wht				
LINE	NEUT	FG	SG	ALM	ALM

DC Current Output

+5V	+12V	-12V	+24V
7.0A	1.0A	2.5A	4.0A

Fuses

+5V Fuse = 15 Amps @ 250 Volts

+24/32V Fuse = 15 Amps @ 250 Volts

Power Systems PS 1557
 Sun-2/50
 300-1002

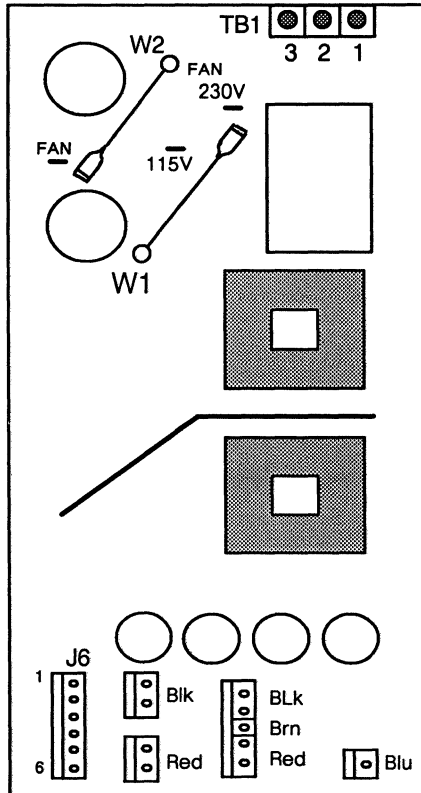

TB1

1	2	3
Blk	Grn	Wht
LINE	GND	NEUT

J6 Test Points

1 & 2	3	4 & 5	6
RTN	-12V	+5V	+12V

DC Current Output

+5V	+12V	-12V
22A	1.5A	0.5A

Note: Connect wire W1 to 115V for 115 voltage or to 230V for 230 voltage.

Fujitsu B141-5-1-0030A .391KVA 220V/240V
 Options 66 67 D169 D169EX D169TC
 Option D169TR
 300-1003

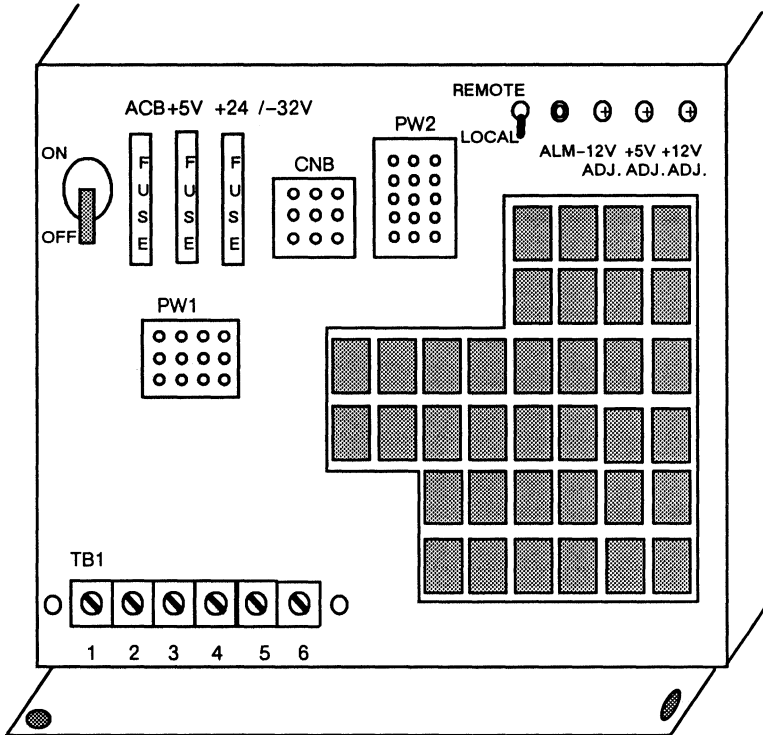

TB1

1	2	3	4	5	6
Blk	Wht				
LINE	NEUT	FG	SG	ALM	ALM

DC Current Output

+5V	+12V	-12V	+24V
7.0A	1.0A	2.5A	4.0A

ACB Fuse = 1.3 Amps @ 250 Volts
 +5V Fuse = 15 Amps @ 250 Volts
 +24/32V Fuse = 15 Amps @ 250 Volts

Boschert XL 750 750 Watts
Sun-2/120/130/160/170

300-1004

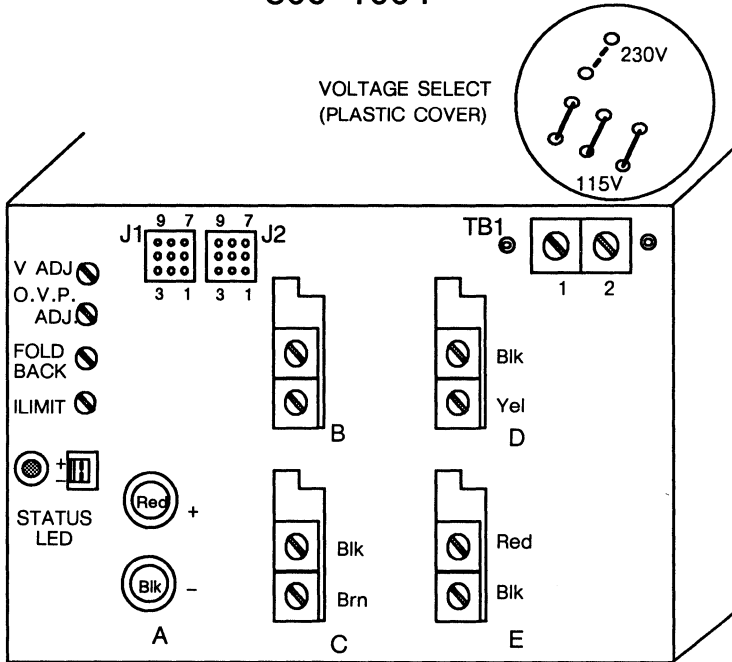

OUTPUT B, C, D & E

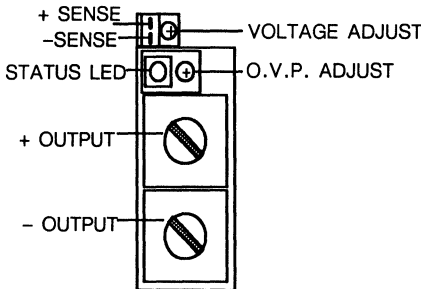

TB1

1	2
Blk	Wht
LINE	NEUT

DC Current Output

+5V	-5V	+12V	-12V	+24V
100A	5.0A	6.0A	3.0A	3.0A

Notes

1. Change voltage select by removing plastic cover and adding wire to terminal 230V.
2. When used in a Sun2/160 and configured with a GP/GB, RC Network, 540-1300-01, must be installed on J1/J2. Reference Installation Note, 800-1400-01 and FCO 160-0002.

Boschert XL250-3602 250 Watts
 Options D84 D84EX D84TC D84TR TC
 Options 60 61 62 63 64 65 73
 Options 601 602 603 605 606 615 616
 300-1014

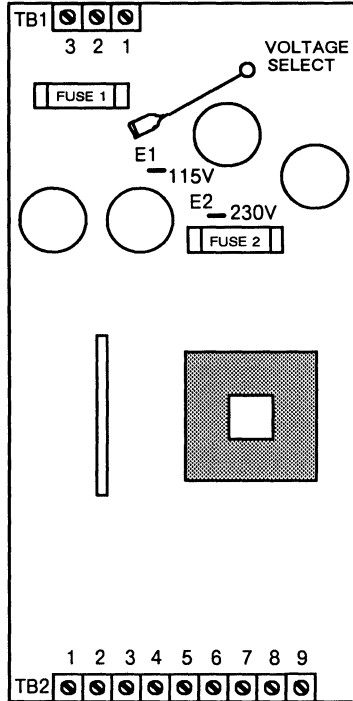

TB1

1	2	3
Blk	Wht	Grn
LINE	NEUT	GND

TB2

1	2	3	4	5	6	7	8	9
	Brn	Red	Blu	Blk	Blk	Blk	Red	Red
PF	-12 V	+12 V	+24	RTN	RTN	RTN	+5 V	+5 V

Fuses

Fuse 1 = 8 Amps @ 250 Volts
 Fuse 2 = 3 Amps @ 250 Volts

DC Current Output

+5V	+12V	-12V	+24V
30A	7.0A	4.0A	7.0A

Notes

1. Connect wire to E1 for 115 voltage or to E2 for 230 voltage.
2. The 688MB SMD Disk Drive requires XL250 Rev. F or greater.

Matsushita ETX-593C101M 100 Watts

Sun-3/50/60

300-1015

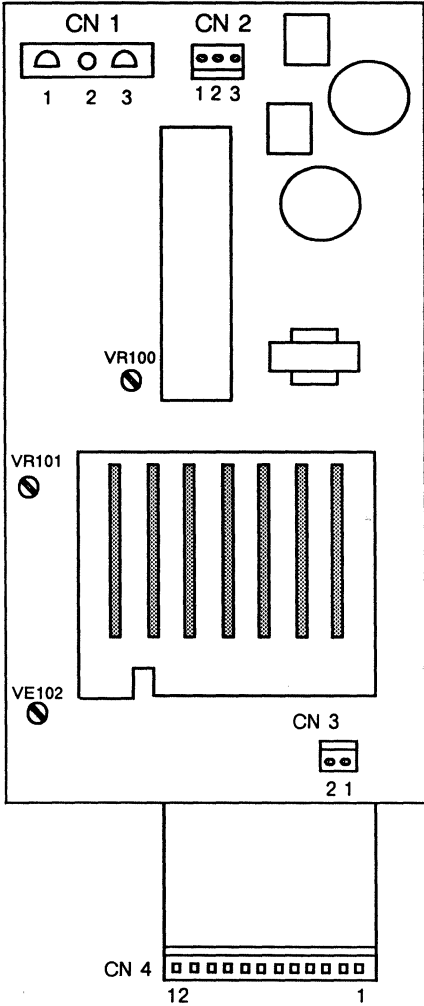

CN 1

1	2	3
Blk	Grn	Wht
LINE	GND	NEUT

CN 2

1	2	3
Blk	--	Blk
COM	N/C	VOLT SEL

CN 3

1	2
Red	Blk
+12	GND

CN 4

1	2	3	4	5	6
Wht	Brn	Blu	Blk	Blk	Blk
-5.2 V	PWR OK	+12 V	GND	GND	GND

CN 4

7	8	9	10	11	12
Blk	Blk	Red	Red	Red	Red
GND	GND	+5V	+5V	+5V	+5V

DC Current Output

+5V	-5V	+12V
15.0A	2.0A	1.3A

Fuji PEX391 850 Watts

Sun-3/160/180

300-1016

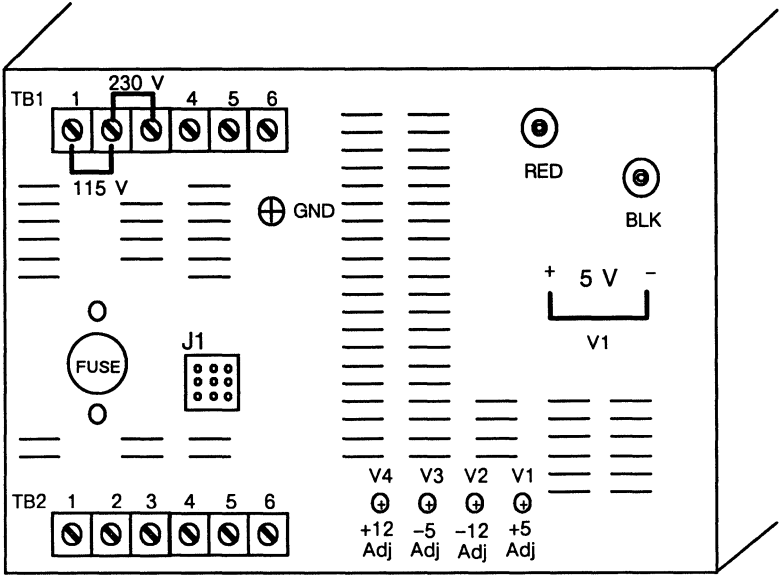

TB1

1	2	3	4	5	6
			Wht	Blk	
115 V STRAP		220 V STRAP		NEUT	LINE
					NOT USED

TB2

1	2	3	4	5	6
Blu	Blk	Blk	Yel	Blk	Brn
+12 (+)	+12 (-)	-5 (+)	-5 (-)	-12 (+)	-12 (-)
V4		V3		V2	

DC Current Output

+5V	-5V	+12V	-12V
120A	10.0A	15.0A	5.0A

Fuse: 30 Amps @ 250 Volts

Note: This vendor's power supply is the same as 300-1024.

Pioneer PM2975A-3-4 850 Watts
 Sun-3/160/180
 300-1016

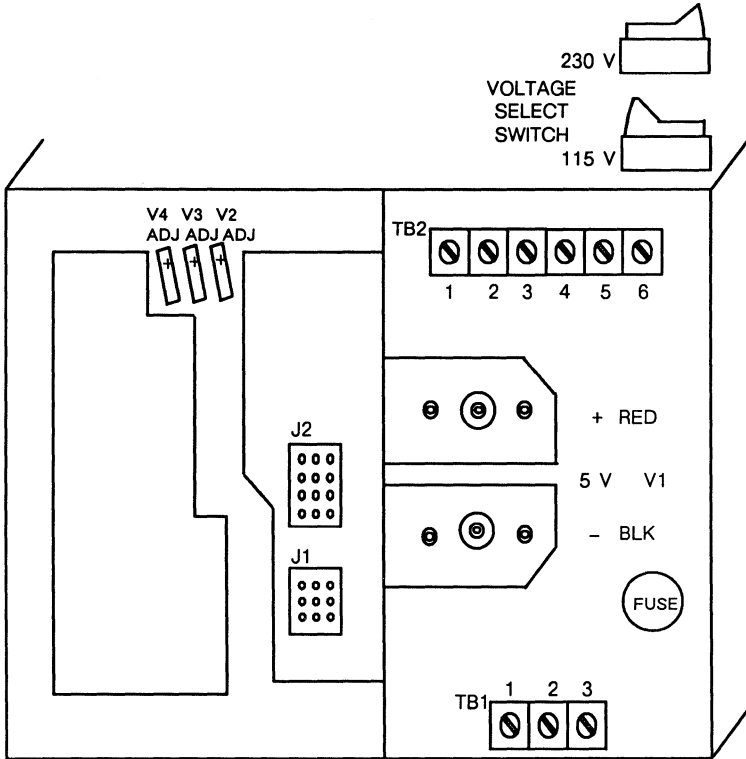

TB1

1	2	3
Wht	Blk	Grn
NEUT	LINE	GND

TB2

1	2	3	4	5	6
Blk	Yel	Blk	Brn	Blu	Blk
-5V (+)	-5V (-)	-12V (+)	-12V (-)	+12V (+)	+12V (-)
V4		V3		V2	

DC Current Output

CH 1	CH 2	CH 3	CH 4
+5V	+12V	-12V	-5V
120A	15.0A	5.0A	10.0A

Fuse: 20 Amps @ 250 Volts

Note: The PM2975A cannot be used with wire harness 530-1207-03 Rev 53 or greater (systems manufactured after 3/1/87).

ETA 804-1212AE 850 Watts
Sun-3/160/180

300-1016

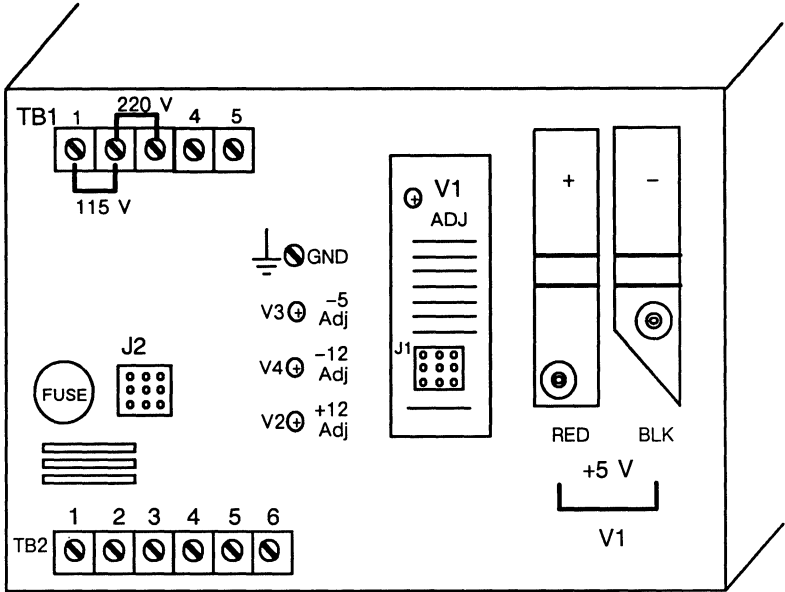

TB1

1	2	3	4	5
			Wht	Blk
115 V STRAP	230 V STRAP	NEUT	LINE	

TB2

1	2	3	4	5	6
Blu	Blk	Blk	Yel	Blk	Brn
+12 (+)	+12 (-)	-5 (+)	-5 (-)	-12 (+)	-12 (-)
V4		V3		V2	

DC Current Output

+5V	-5V	+12V	-12V
120A	10.0A	15.0A	5.0A

Fuse: 30 Amps @ 250 Volts

Note: This power supply cannot be used in 180/280 12-slot rackmount systems manufactured after 11/1/88.

Power Systems PS1559 150 Watts
 Sun-3/75
 300-1017

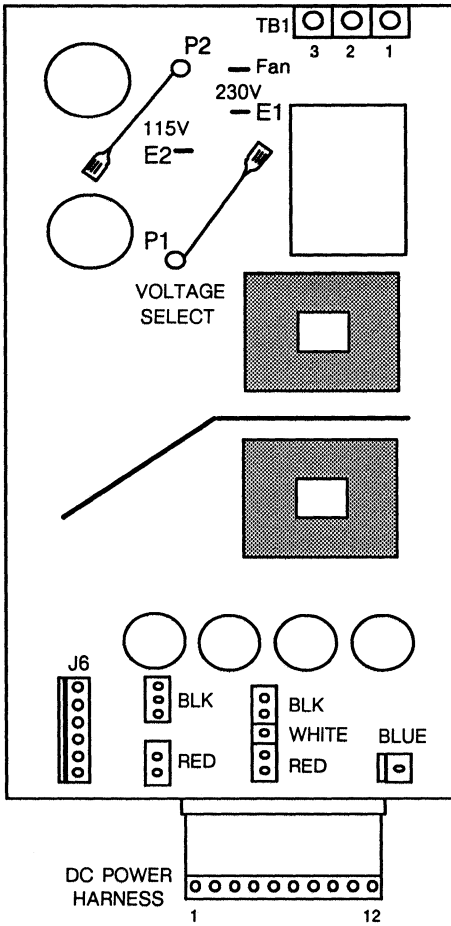

TB1

1	2	3
Blk	Grn	Wht
LINE	GND	NEUT

J6 Test Points

1 & 2	3	4 & 5	6
RTN	-12V	+5V	+12V

DC Current Output

+5V	-5V	+12V
25A	1.5A	1.5A
Red	White	Blue

Note: Connect wire P1 to E2 for 115 voltage or to E1 for 230 voltage.

Brown 300-1020 575 Watts
 Sun-3/150 & Sun-4/150/350
 300-1020

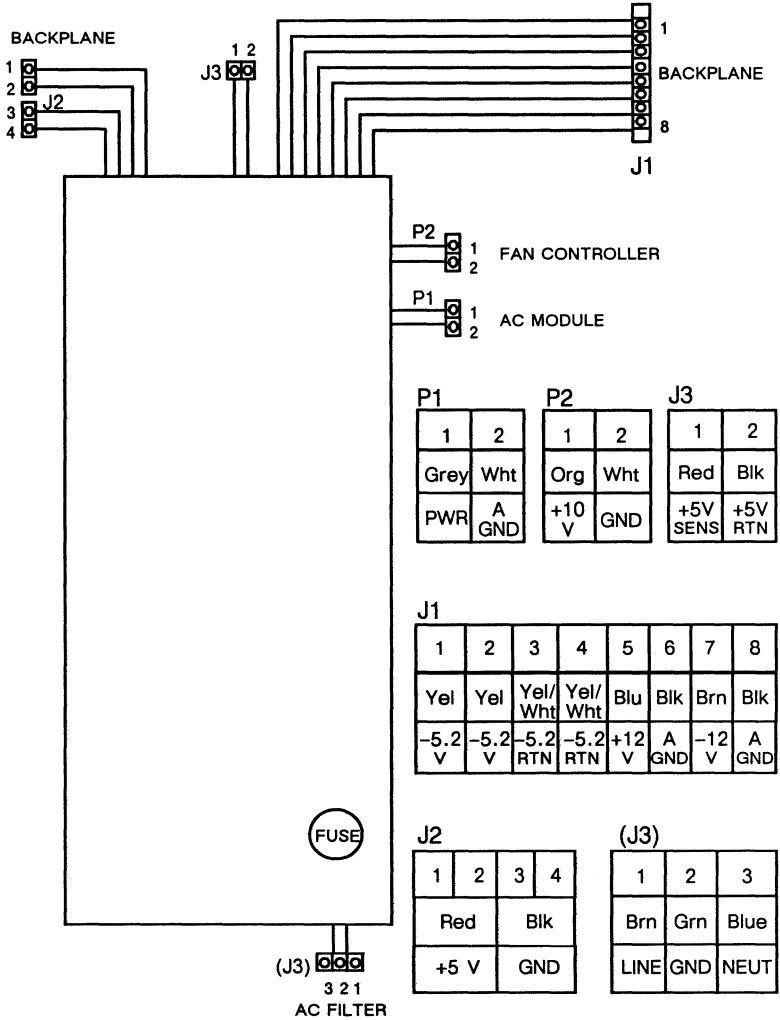

DC Current Output

+5V	-5V	+12V	-12V	+24V
100A	8.0A	3.0A	1.5A	1.5A

Fuse: 10 Amps @ 250 Volts

Fuji PE X445-30 575 Watts
Sun-3/150 & Sun-4/150/350

300-1020

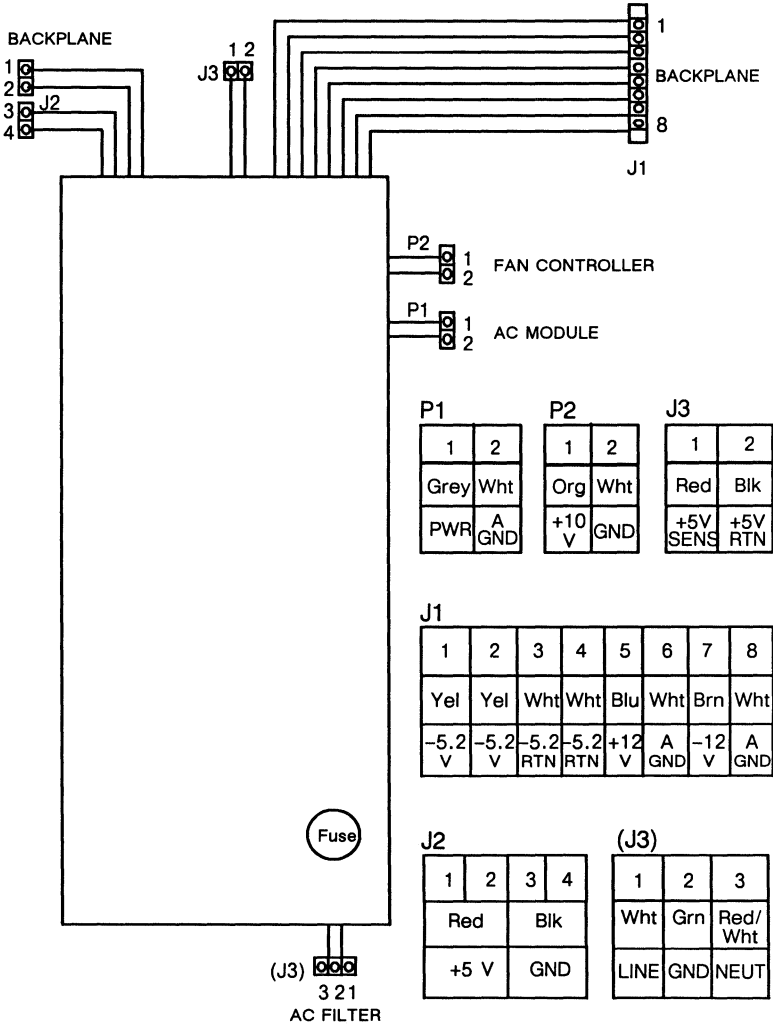

DC Current Output

+5V	-5V	+12V	-12V	+24V
100A	8.0A	3.0A	1.5A	1.5A

Fuse: 15 Amps @ 250 Volts

Summit CS0325-9001 325 Watts
Sun-3/110/140 & 4/110/310

300-1022

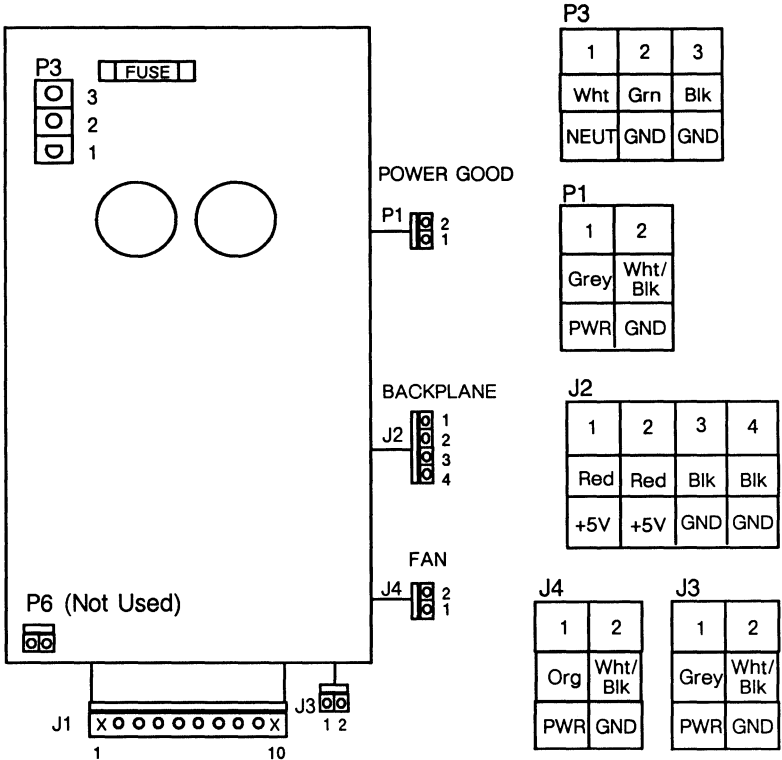

P3

1	2	3
Wht	Grn	Blk
NEUT	GND	GND

P1

1	2
Grey	Wht/Blk
PWR	GND

J2

1	2	3	4
Red	Red	Blk	Blk
+5V	+5V	GND	GND

J4

1	2
Org	Wht/Blk
PWR	GND

J3

1	2
Grey	Wht/Blk
PWR	GND

DC Current Output

+5V	-5V	+12V	-12V
60A	8.0A	3.0A	1.5A

J1

1	2	3	4	5	6	7	8	9	10
--	Yel	Yel	Wht/Yel	Wht/Yel	Blu	Wht/Blk	Brn	Wht/Blk	--
N/A	-5.2 V	-5.2 V	-5.2 RTN	-5.2 RTN	+12 V	GND	-12 V	GND	N/A

Fuse: 7 Amps @ 250 Volts

Note: Wait at least two minutes after power down or power outage before turning power ON to allow the unit to reset.

Brown PS41 325 Watts
Sun-3/110/140 & 4/110/310

300-1022

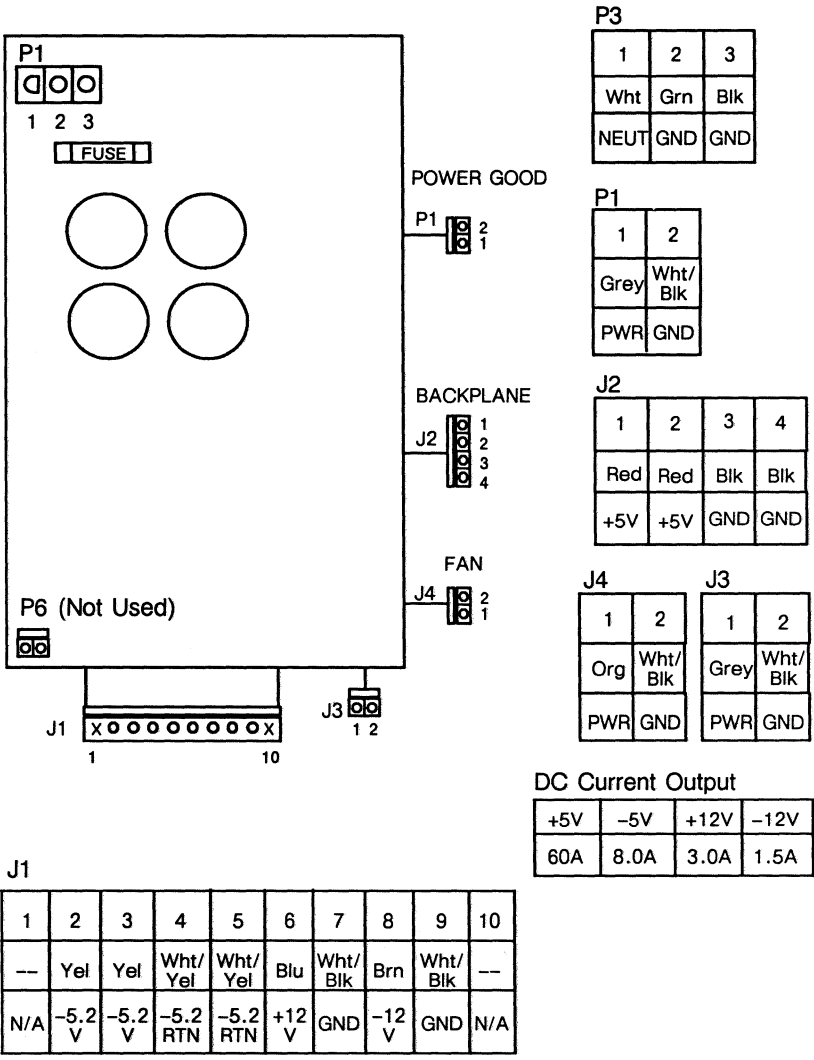

Fuse: 7 Amps @ 250 Volts

Note: Wait at least two minutes after power down or power outage before turning power ON to allow the unit to reset.

Fuji PEX391 850 Watts
Sun-3/160/180/260/280/460/480
Sun-4/260/280/360/380
300-1024

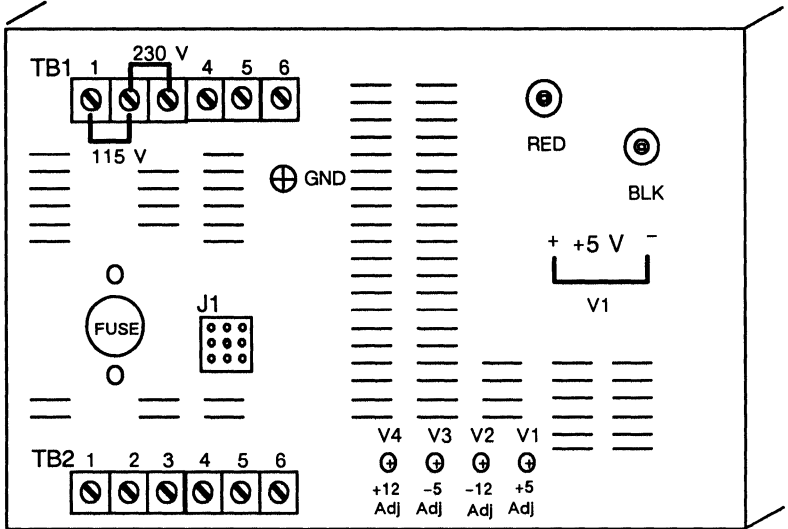

TB1

1	2	3	4	5	6
			Wht	Blk	
115 V STRAP	220 V STRAP		NEUT	LINE	NOT USED

TB2

1	2	3	4	5	6
Blu	Blk	Blk	Yel	Blk	Brn
+12 (+)	+12 (-)	-5 (+)	-5 (-)	-12 (+)	-12 (-)
V4		V3		V2	

DC Current Output

+5V	-5V	+12V	-12V
120A	10A	15A	0.5A

Fuse: 30 Amps @ 250 Volts

Power General 4110-2-8968 100 Watts
Options 55 55EX 56

300-1025

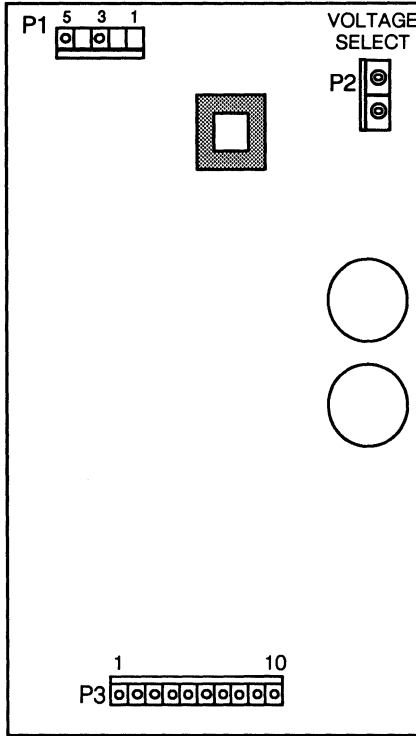

P1

1	3	5
Blu	Brn	--
NEUT	LINE	

P3

1	2	3	4	5	6	7	8	9	10
Blu	Blu	Blu	Grn	Grn	Org	Grn	Red	Grn	Wht
+5 V	+5 V	+5 V	+5 RTN	+5 RTN	-V	V RTN	+V	ISO RTN	ISO

Cal DC LR150-19 170 Watts
 Options 501 503 504 505 506 507 509
 Options 510 511 514 516
 300-1028

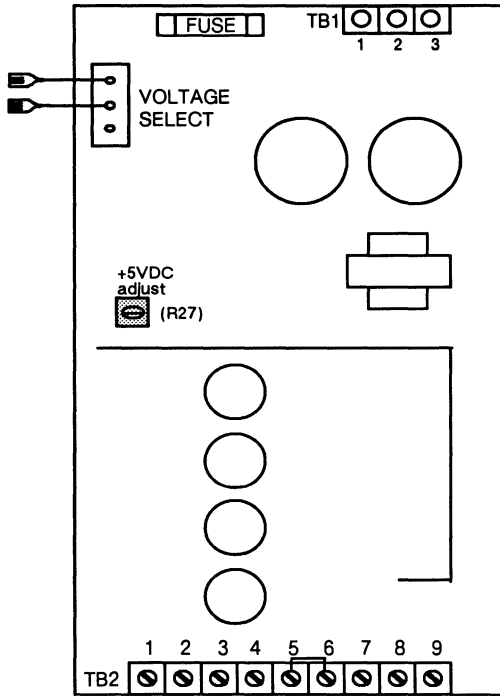

TB1

1	2	3
Blk	Wht	Grn
LINE	NEUT	GND

TB2

1	2	3	4	5	6	7	8	9
Blk	Blk	Blu	Blu	Blk	Blk	Blk	Red	Red
RTN	RTN	+12 V	+12 V	SENS RTN	+5 V RTN	GND	+5 V	+5V SENS

DC Current Output

+5V	+12V
10A	10.5A

Fuse: 5 Amps @ 250 Volts

Note: TB1 may be hardwired on some revisions of this power supply.

Todd Products MDT23-8945 170 Watts
 Options 501 503 504 505 506 507 509
 Options 510 511 514 516
 300-1028

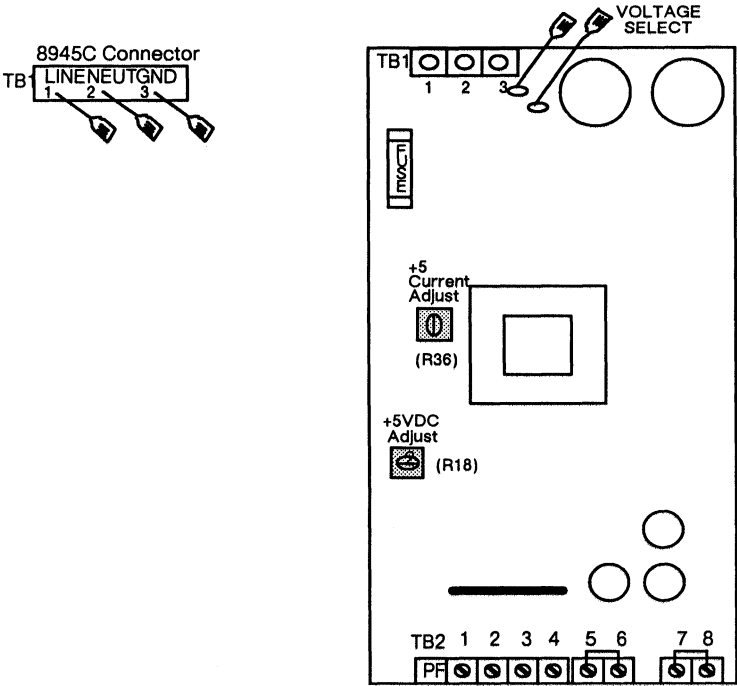

TB1

1	2	3
Blk	Wht	Grn
LINE	NEUT	GND

TB2

1	2	3	4	5	6	7	8
N/C	N/C	Blu	N/C	Blk	Blk	Red	Red
RTN	RTN	+12 V	+12 V	SENS RTN	+5V RTN	+5V	+5V SENS

Fuses
 7 Amps @ 250 Volts for 115 Volts
 4 Amps @ 250 Volts for 230 Volts

DC Current Output

+5V	+12V
10A	10.5A

Note: AC harness, 530-1325-01, is required for this power supply.

Delta DPS-118AB 120 Watts
 Options 526 527 530 539 561 563 565
 Options 566 RR126 RR128 RR129 RREXP
 300-1031

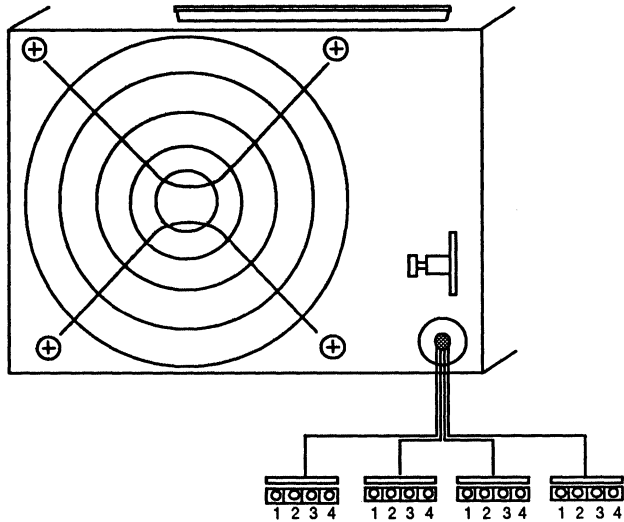

Connector Pinout

1	2	3	4
+12V	GND	GND	+5V

AC Current Input

100-120V	200-240V
3.0A	1.5A

DC Current Output

+5V	+12V
8A	6.5A

Fuses

4 Amps @ 250 Volts

3 Amps @ 250 Volts

Boschert XL520-3625 520 Watts
 Sun-4/330
 300-1034

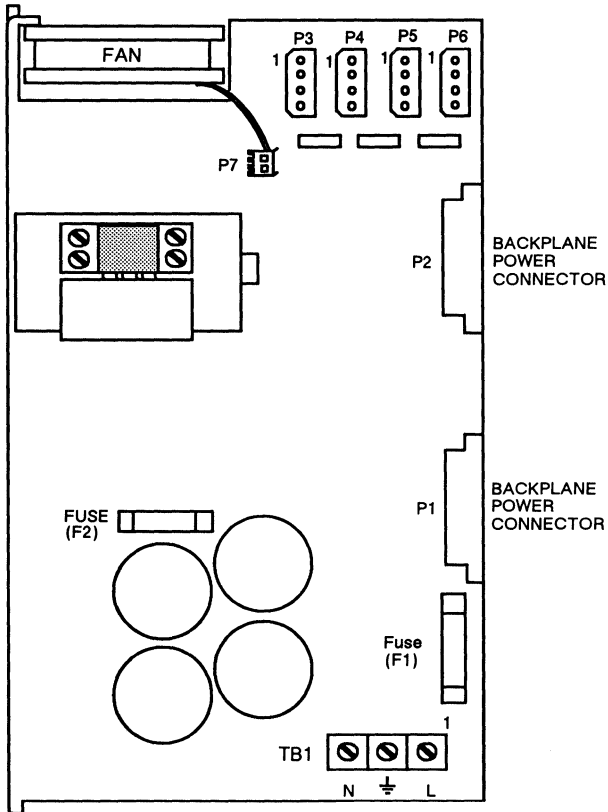

TB1

1	2	3
Brn	Grn	Wht
LINE	GND	NEUT

P3,P4,P5,P6

1	2	3	4
Red	Blk	Blk	Org
+5V	GND	GND	12V

DC Current Output

+5	-5.2	+12 Analog	-12	+12 Motor
70	4	1.5	0.5	10.5

Fuses
 F1 = 20 Amps @ 250 Volts
 F2 = 10 Amps @ 250 Volts

Sony 062-0412 35 Watts
 Options 550 552 558 660
 300-1037

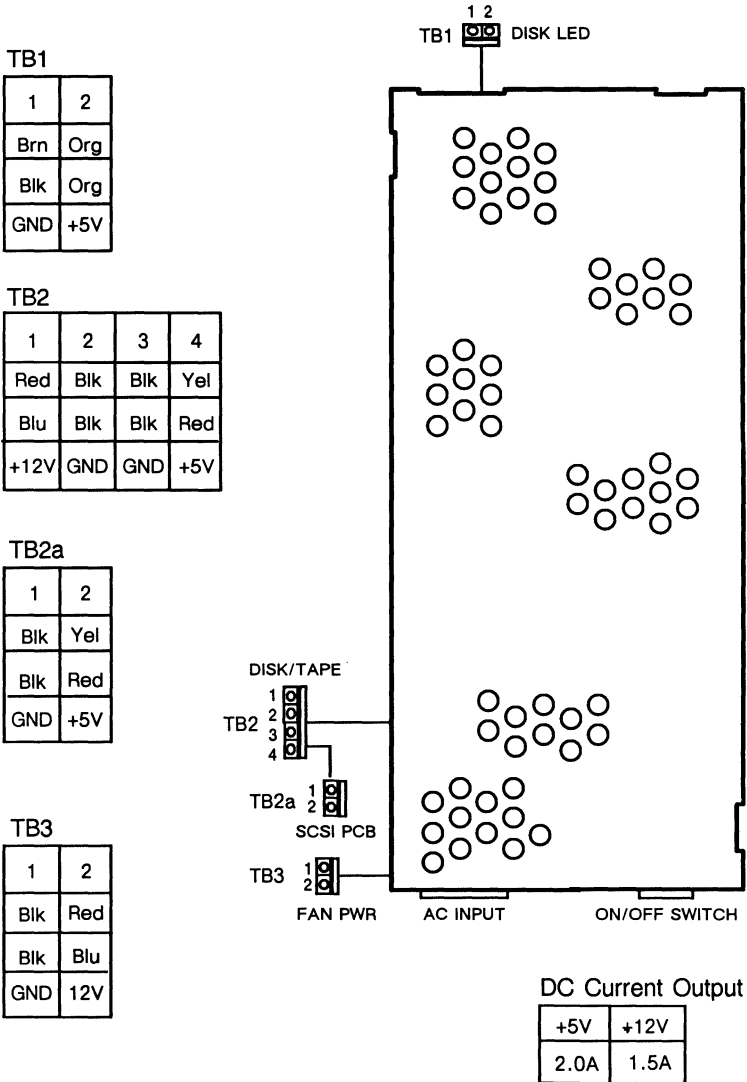

Note: The Disk Drive LED harness is 530-1522.

Sony CR-81 85 Watts
Sun-3/80 & Sun-4/60/65/75

300-1038

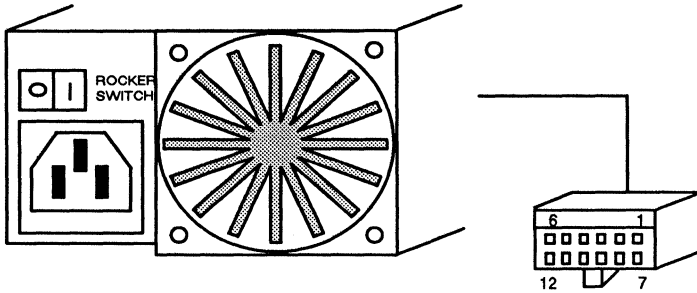

J1

SERIAL #	1	2	3	4	5	6	7	8	9	10	11	12
≤4000	Red	Red	Blk	Blk	Yel	Org	Red	Red	Blk	Blk	Yel	Blu
≥4001	Red	Red	Blk	Blk	Blu	Gry	Red	Red	Blk	Blk	Blu	Brn
	+5 V	+5 V	GND	GND	+12 V	+5 (POR) V	+5 V	+5 V	GND	GND	+12 V	-12 V

DC Current Output

+5V	+12V
12A	2.0A

Note: This power supply has automatic input voltage ranging.

Boschert NFS116-7630 116 Watts
 Sun-3/50/60
 300-1040

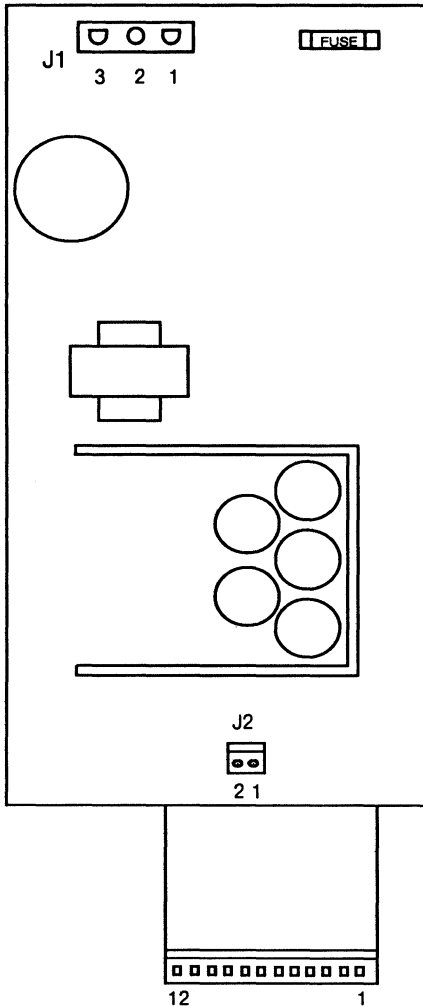

J1

1	2	3
Blu	Grn	Wht
LINE	GND	NEUT

J2

1	2
Blu	Red

J3

1	2	3	4	5	6
Wht	--	Blu	Blk	Blk	Blk
-5.2 V	N/C	+12 V	GND	GND	GND

J3

7	8	9	10	11	12
Blk	Blk	Red	Red	Red	Red
GND	GND	+5.1 V	+5.1 V	+5.1 V	+5.1 V

DC Current Output

+5V	-5V	-12V
20A	1.0A	0.5A

Fuse: 5 Amps @ 250Volts

Seagate 45070622 205 Watts
 Seagate 97209-12G Disk Drive
 Options 706 707 709 710
 300-1041

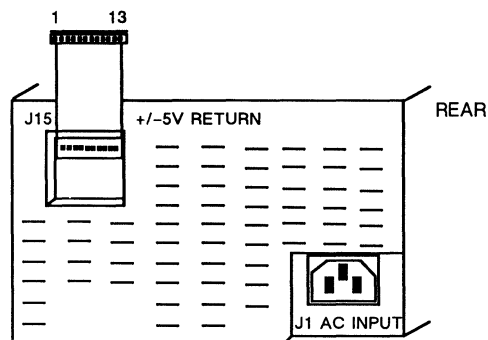
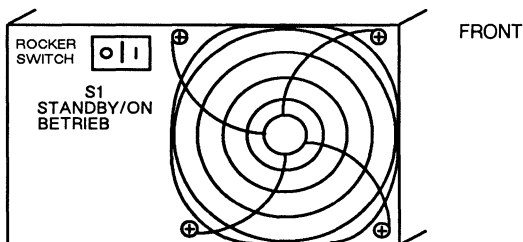
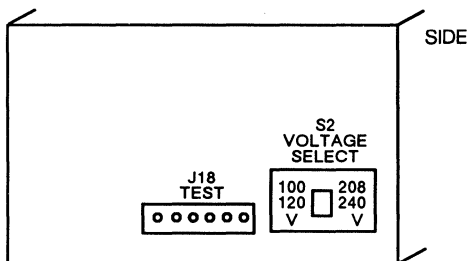

DC Current Output

+5V	-5.1V	-12V	+24V
7.0A	4.25A	0.35A	6.0A

J15

1	2	3	4	5	6	7	8	9	10	11	12	13
+5V	+5V	GND	GND	-5V	-5V	-12V	+PWR OK	NC	+24V RTN	+24V RTN	+24V	+24V

Fuse: Soldered at F100, 8 Amps @ 250 Volts

300-1041 300-1074**Notes****205 Watt Power Supply 300-1041**

Supports one Seagate 97209-12G 3mb/Sec IPI Disk Drive.

Does NOT Support the Seagate 97229-11G 6mb/Sec IPI Disk Drive.

215 Watt Power Supply 300-1074

Supports one Seagate 97209-12G 3mb/Sec IPI Disk Drives.

Supports one Seagate 97229-11G 6mb/Sec IPI Disk Drives.

Fuji PEX479-30 925 Watts
Sun-3/160/180/260/280/460/480
Sun-4/260/280/360/380
300-1043

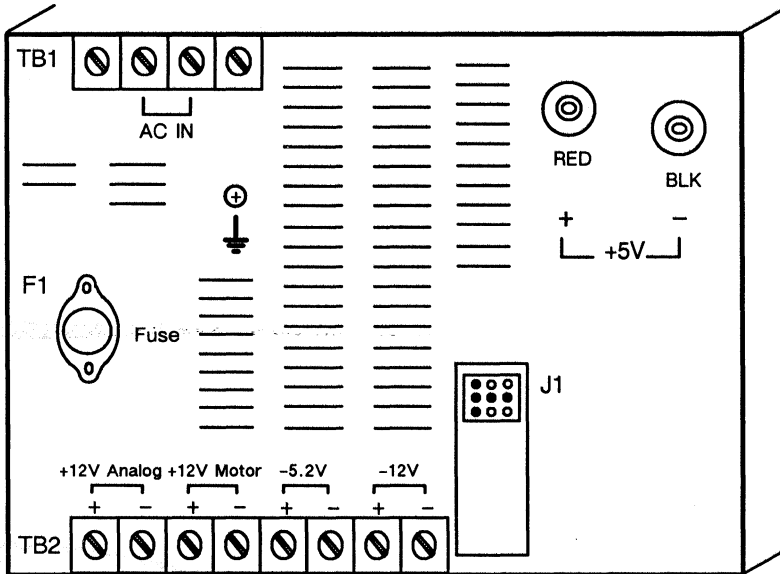

TB1

AC IN	
Blk	Wht
LINE	NEUT

TB2

+12 ANALOG		+12 MOTOR						WIRE HARNESS
+12V (+)	+12V (-)	+12V (+)	+12V (-)	-5.2 (+)	-5.2 (-)	-12V (+)	-12V (-)	Use 530-1578 and the wire harness listed below
Blu	Blk	Blu	Blk	Blk	Wht	Blk	Brn	
P8	P10	P9 P19	P11	P17	P7	P16 P20	P6	530-1581 160 Chassis
P9 P4	P5 P3	P16	P17 P7	P12	P10	P13	P8	530-1580 180 Chassis

Terminal Lugs

+5V (+)	+5V (-)
Red	Blk

DC Current Output

+5	-5.2	+12 Analog	-12	+12 Motor
150A	15A	15A	10A	10A

Fuse: Littelfuse 30A 250V BLN 30

Note: Use wire harnesses 530-1578 and 530-1580 for the 180/280/380/480 chassis. Use wire harnesses 530-1578 and 530-1581 for the 160/260/360/460 chassis.

Boschert XL 121-3630 130 Watts
 Options 501 503 504 505 506 507 509
 Options 510 511 514 516
 300-1045

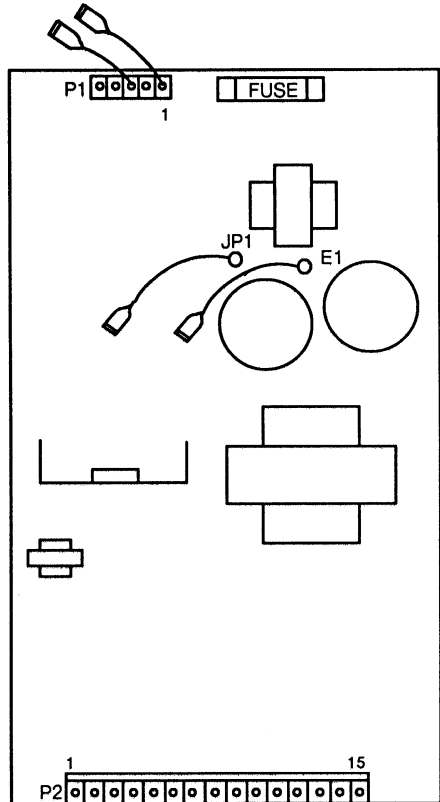

DC Current Output

+5V	+12V
4.0	5.2A

P1

1	2	3	4	5
Brn	---	Blu	---	---
LINE	NEUT	GND		

P2

1	2	3	4	5	6	7	8	9	10	11	12	13	14	15
Blk	Blu	Blu	Blu	Blu	Blk	Blk	Blk	Blk	Blk	Blk	---	Red	Red	Red
RTN	+12 V	+12 V	+12 V	+12 V	RTN	RTN	RTN	RTN	RTN	RTN	N/C	+5V	+5V	5V

Fuse: 5 Amps @ 250 Volts

Note: Use Power Harness, 530-1432-01, for this power supply.

Zytec 22903110 925 Watts
 Sun-3/470 & Sun-4/370/470

300-1047

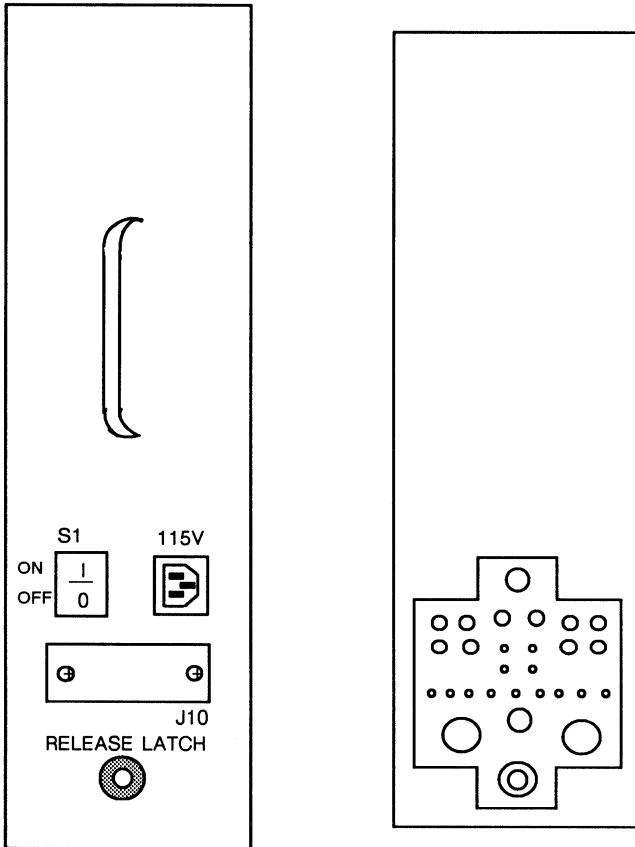

DC OUTPUT	REGULATION	FULL LOAD
+5	150 Amps	145.0 Amps
-5.2	15 Amps	10.0 Amps
+12 analog	15 Amps	2.0 Amps
+12 motor	15 Amps	6.3 Amps
-12	10 Amps	4.0 Amps

Fuji PEX527-30 820 Watts
Options 733 734
300-1052

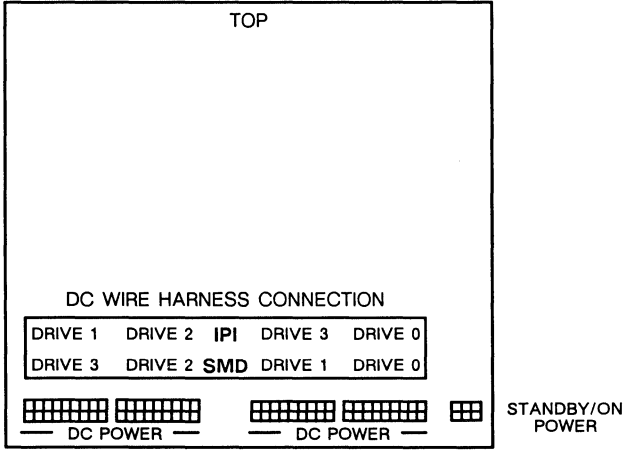

+5V	GND	GND	-5V		-12V	GND		
Red	Blk	Blk	Yel	NC	Brn	Blk	NC	NC
1	2	3	4	5	6	7	8	9
10	11	12	13	14	15	16	17	18
Red	NC	NC	Yel	NC		Blk	Org	Org
+12V			-5V			GND	+24	+24

Gry	Wht/ Brn	Wht/ Red
1	2	3
4	5	6
Wht/ Org	Blk	Blk

DC Current Output

+5Vdc	-5.1Vdc	-12Vdc	+24Vdc
7.0A x 2	7.0A x 2	7.0A x-2	7.0A x 2

Fuse: 20 Amps @ 250 Volts

Mitsubishi MMF-06012DS 65 Watts
 Sun-4/40
 300-1055

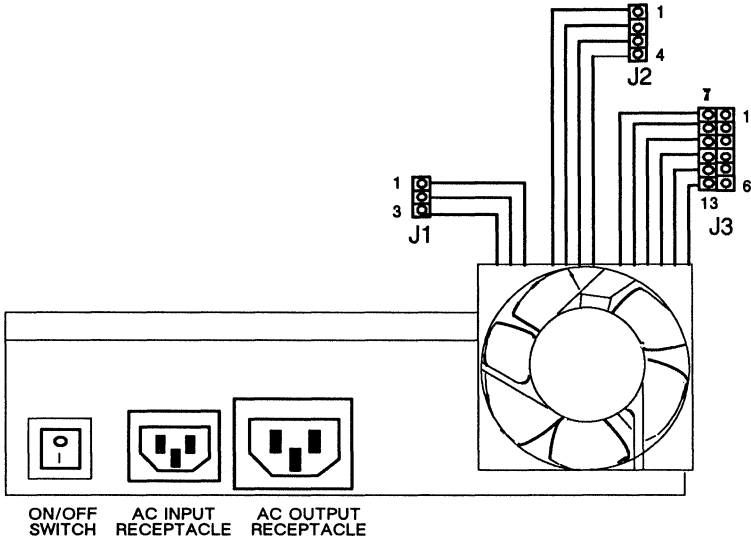

J1

1	2	3
Red	Blk	Blk
+5	GND	GND

J2

1	2	3	4
Blu	Blk	Blk	Red
+12	GND	GND	+5

J1

1	2	3	4	5	6	7	8	9	10	11	12
Red	Red	Blk	Blk	Blu	Gry	Red	Red	Blk	Blk	Blu	Brn
+5	+5	GND	GND	+12	SENS	+5	+5	GND	GND	+12	-12

DC Current Output

+5V	+12V	-12V
9.0A	1.5A	0.1A

Fuji PEX527-40 410 Watts
Options 731 732

300-1056

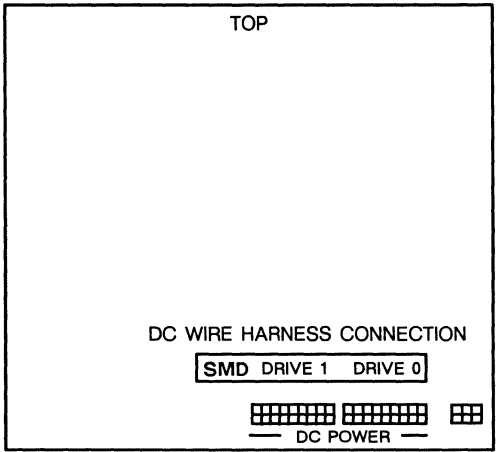

+5V	GND	GND	-5V		-12V	GND		
Red	Blk	Blk	Yel	NC	Brn	Blk	NC	NC
1	2	3	4	5	6	7	8	9
10	11	12	13	14	15	16	17	18
Red	NC	NC	Yel	NC		Blk	Org	Org
+12V			-5V			GND	+24	+24

Gry	Wht/Brn	Wht/Red
1	2	3
4	5	6
Wht/Org	Blk	Blk

DC Current Output

+5Vdc	-5.1Vdc	-12Vdc	+24Vdc
7.0A	7.0A	7.0A	7.0A

Fuse: 20 Amps @ 250 Volts

300-1052 300-1056 300-1075

Notes

410 Watt Power Supply 300-1056-02

Supports two CDC 9720-688 Disk Drives.
Supports two Fujitsu M2372K Disk Drives.

410 Watt Power Supply 300-1056-03

Supports two CDC 9720-688 Disk Drives.
Does not support the Fujitsu M2372K Disk Drive.

410 Watt Power Supply 300-1056-04

Supports two CDC 9720-688 Disk Drives.
Does not support the Fujitsu M2372K Disk Drive.

410 Watt Power Supply 300-1056-05

Supports two CDC 9720-688 Disk Drives.
Supports two Fujitsu M2372K Disk Drives.

820 Watt Power Supply 300-1052-02

Supports four CDC 9720-688 Disk Drives.
Supports four Fujitsu M2372K Disk Drives.

820 Watt Power Supply 300-1052-03

Supports four CDC 9720-688 Disk Drives.
Does not support the Fujitsu M2372K Disk Drive.
Supports two Seagate 97209-12G 3mb/Sec IPI Disk Drives.
Does not Support Seagate 97229-11G 6mb/Sec IPI Disk Drives.

820 Watt Power Supply 300-1052-04

Supports four CDC 9720-688 Disk Drives.
Does not support the Fujitsu M2372K Disk Drive.
Supports four Seagate 97209-12G 3mb/Sec IPI Disk Drives.
Does not Support Seagate 97229-11G 6mb/Sec IPI Disk Drives.

820 Watt Power Supply 300-1052-05

Supports four CDC 9720-688 Disk Drives.
Supports four Fujitsu M2372K Disk Drives.
Does not Support Seagate 97209-12G 3mb/Sec IPI Disk Drives.
Does not Support Seagate 97229-11G 6mb/Sec IPI Disk Drives.

840 Watt Power Supply 300-1075

Supports four Seagate 97209-12G 3mb/Sec IPI Disk Drives.
Supports four Seagate 97229-11G 6mb/Sec IPI Disk Drives.
Does not support Fujitsu M2372K Disk Drives.
Does not support CDC 9720-688 Disk Drives.

Zytec 22907400 1200 Watts
Sun-4/390/490

300-1065

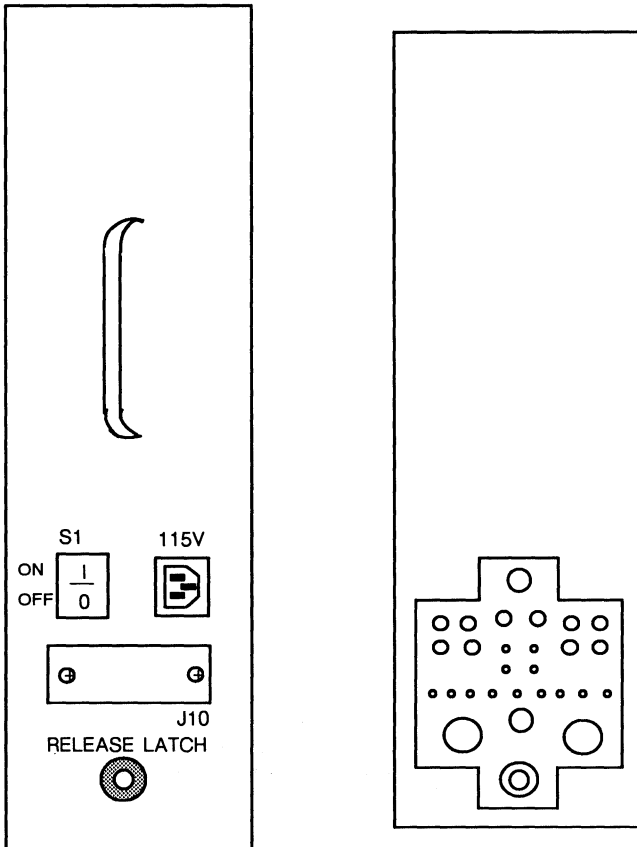

DC OUTPUT	REGULATION	FULL LOAD
+5	10-200 Amps	200.0 Amps
-5.2	0.4-15 Amps	10.0 Amps
+12 analog	0-10 Amps	2.0 Amps
+12 motor	4-15 Amps	6.3 Amps
-12	0-5 Amps	4.0 Amps

Boschert XL520-3625 520 Watts
 Sun-4/330
 300-1072

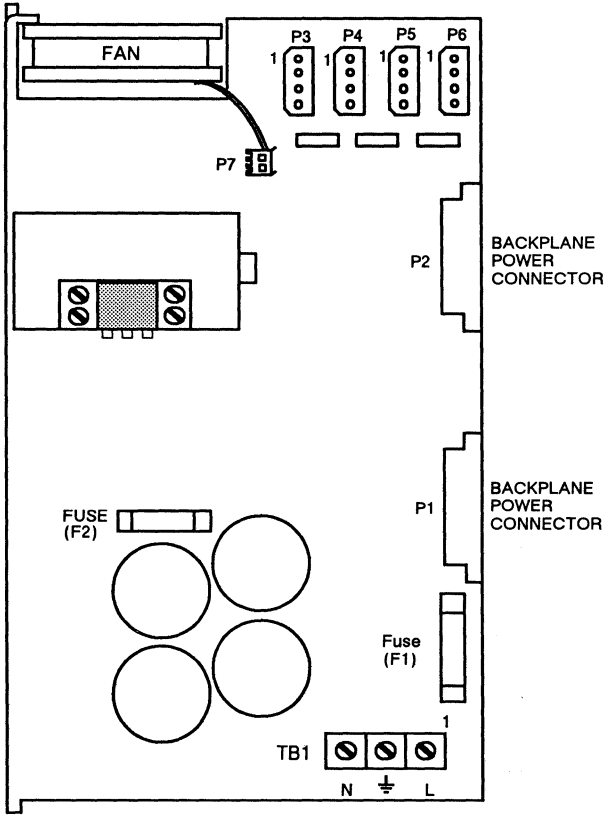

TB1

1	2	3
Brn	Grn	Wht
LINE	GND	NEUT

P3,P4,P5,P6

1	2	3	4
Red	Blk	Blk	Org
+5V	GND	GND	12V

Fuses

F1 = 20 Amps @ 250 Volts

F2 = 10 Amps @ 250 Volts

DC Current Output

+5	-5.2	+12 Analog	-12	+12 Motor
62	4.5	3.0	2.0	10.5

Seagate 45070625 215 Watts
 Seagate 97209-12G & 97229-11G
 Options 706 707 709 710 716 717 719 720
 300-1074

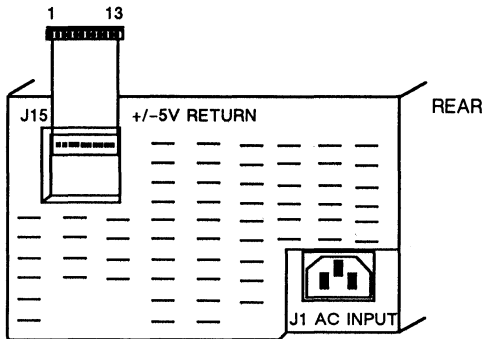
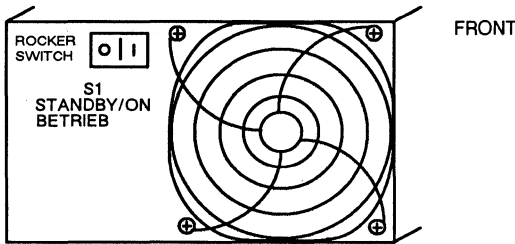
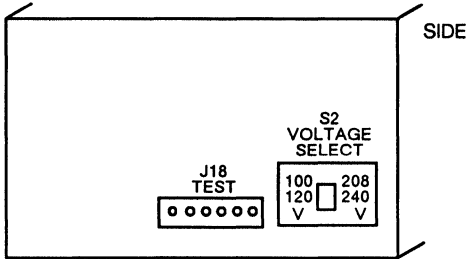

DC Current Output

+5V	-5.1V	-12V	+24V
7.0A	6.25A	0.35A	6.0A

J15

1	2	3	4	5	6	7	8	9	10	11	12	13
+5V	+5V	GND	GND	-5V	-5V	-12V	+PWR OK	NC	+24V RTN	+24V RTN	+24V	+24V

Fuse: at F100, 8 Amps, 250 Volts, LittleFuse, 312-008

Fuji PEX527-31 840 Watts
 Options 741A 742A 743A 744A
 Options 741L 742L 743L 744L
 300-1075

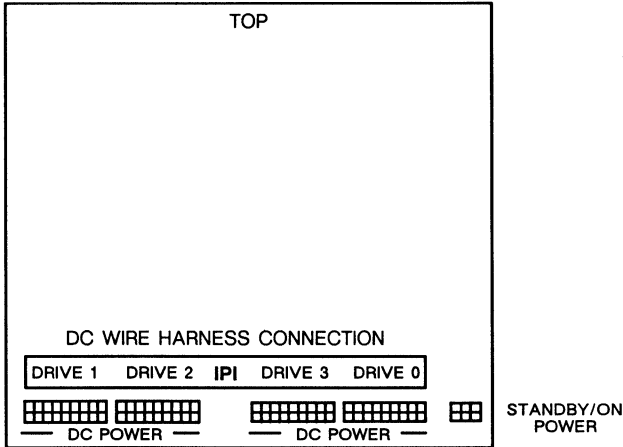

+5V	GND	GND	-5V		-12V	GND		
Red	Blk	Blk	Yel	NC	Brn	Blk	NC	NC
1	2	3	4	5	6	7	8	9
10	11	12	13	14	15	16	17	18
Red	NC	NC	Yel	NC		Blk	Org	Org
+12V			-5V			GND	+24	+24

Gry	Wht/ Brn	Wht/ Red
1	2	3
4	5	6
Wht/ Org	Blk	Blk

Current Output

+5V	-5.1V	-12V	+24V
28A	25A	1.4A	28A

Fuse: 20 Amps @ 250 Volts

Fuji PEX526-30 925 Watts
Sun-3/470 & Sun-4/370/470

300-1089

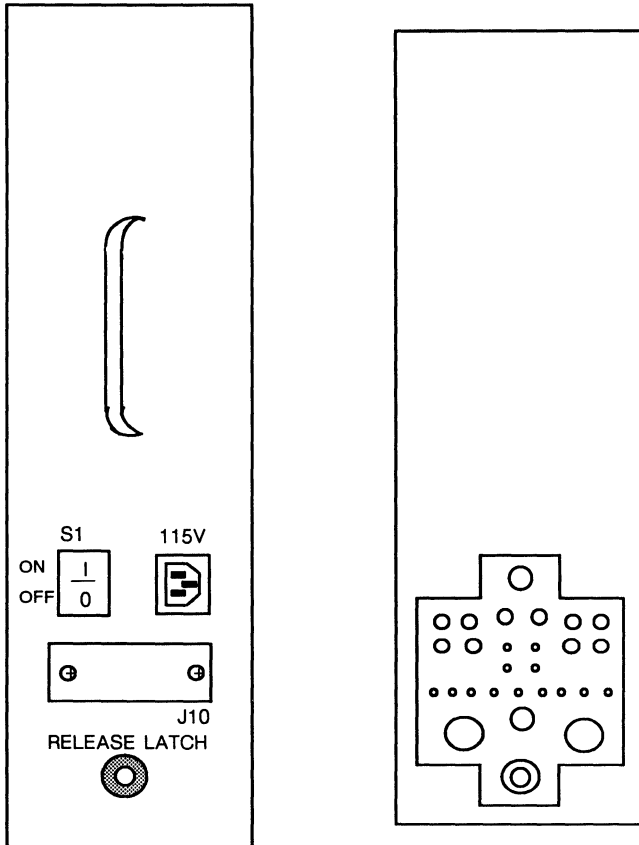

DC OUTPUT	REGULATION	FULL LOAD
+5	150 Amps	145.0 Amps
-5.2	15 Amps	10.0 Amps
+12 analog	15 Amps	2.0 Amps
+12 motor	15 Amps	6.3 Amps
-12	10 Amps	4.0 Amps

Sony 062-0412 35 Watts
 Options 550 552 558 660
 300-1090

TB1

1	2
Blk	Org
GND	+5V

TB2

1	2	3	4
Blu	Blk	Blk	Red
+12V	GND	GND	+5V

TB2a

1	2
Blk	Red
GND	+5V

TB3

1	2
Blk	Blu
GND	12V

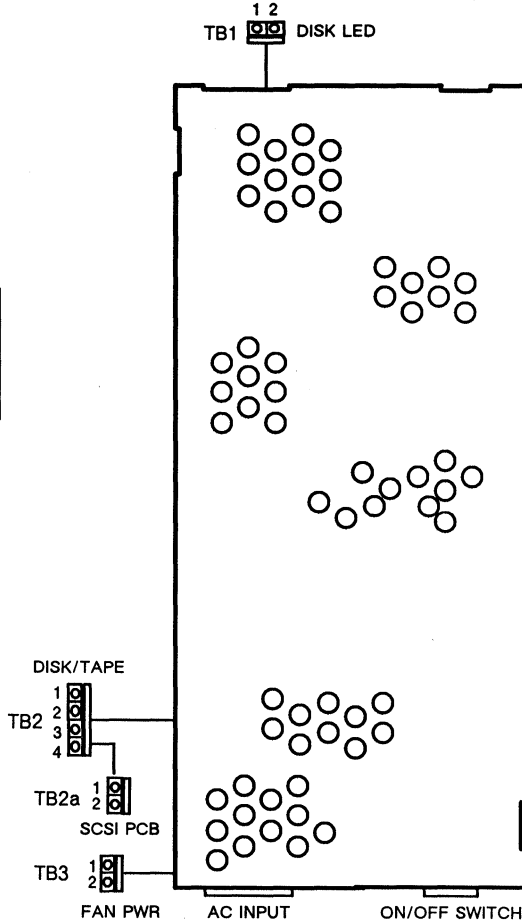

DC Current Output

+5V	+12V
2.0A	1.5A

Notes

1. The Disk Drive LED harness is 530-1522.
2. This Power Supply cannot be installed in Desktop Storage Packs manufactured prior to March 1991.

SPS265 265 Watts
Sun386i/150/250

555-1006
w Bracket
w/o DC Output

300-1032
w/o Bracket
w DC Output

300-1046
w/o Bracket
w/o DC Output

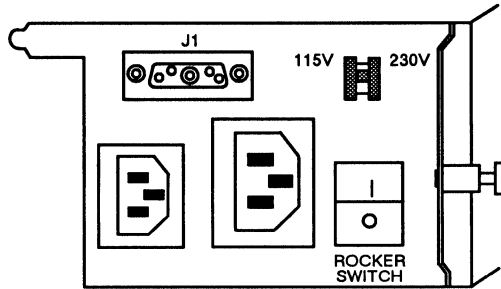

Current Input

100-120V	200-240V
10A	5A

DC Current Output

+5V	-5.2V	+12V	-12V
38A	1.9A	5.6A	.05A

Fuse: 15 Amps @ 250 Volts

Note: Power Supply 300-1032 was discontinued in March 1989.

Fujitsu M2444AC Power Supply Module A-1

Options 78 675

811-1027

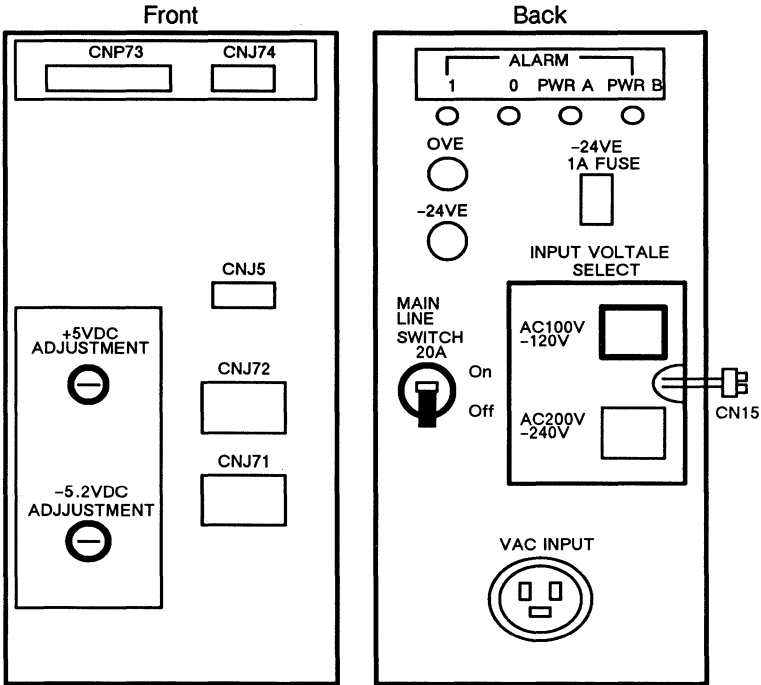

The abnormal conditions indicated by the main alarm panel are described in the chart below.

ALARM LEADS				INDICATES
1	0	PWR	PWR	
*				Abnormal temp due to failing Fan 1 (away from PSU)
*	*			High temp in power amplifier of servo circuits
	*			Abnormal temp due to failing Fan 2 (near to PSU)
		*		Over-power/over current in +5, -6, +12 VDC circuit
			*	Over-power/over current in -5.2, +24, -24 VDC circuit

Fujitsu M2444AC Power Supply Module A-2

Options 78 675

811-1027

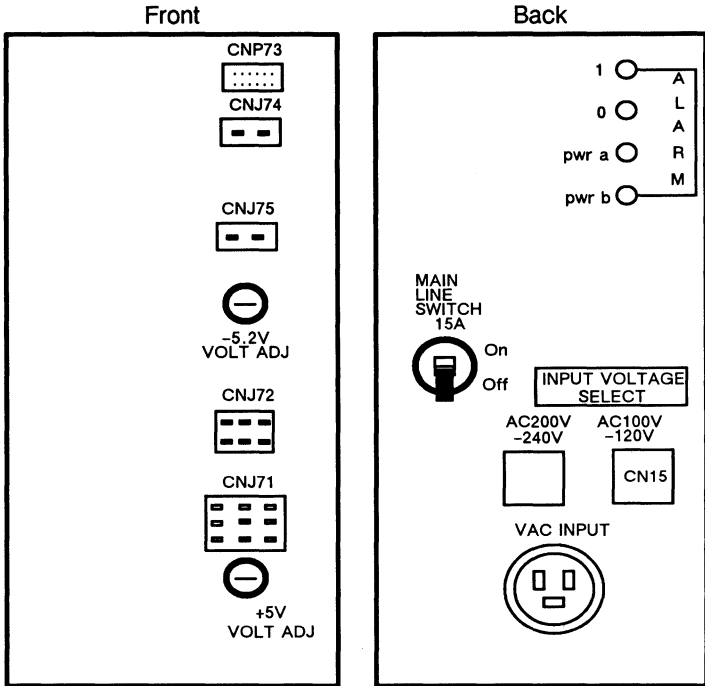

The abnormal conditions indicated by the alarm panel are described in the chart below.

ALARM LEDS				INDICATES
1	0	PWR	PWR	
*				Abnormal temp due to failing Fan 1 (away from PSU)
*	*			High temp in power amplifier of servo circuits
	*			Abnormal temp due to failing Fan 2 (near to PSU)
		*		Over-power/over current in +5, -6, +12 VDC circuit.
			*	Over-power/over current in -5.2, +24, -24 VDC circuit

HP 88780 Power/Motor Drive Board

Options 680 682 683 684

811-1242

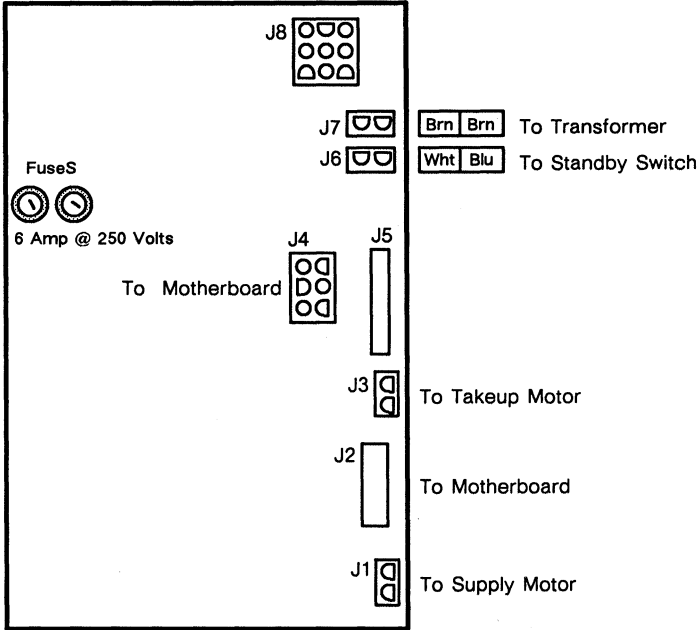

HP BOARD LABEL = 07980-66535

Note: The Sun part number for the 6 Amp fuse is 140-1021-01.

Pulizzi Engineering PC874D-472 115 Volt 300-1011

Outlet Side

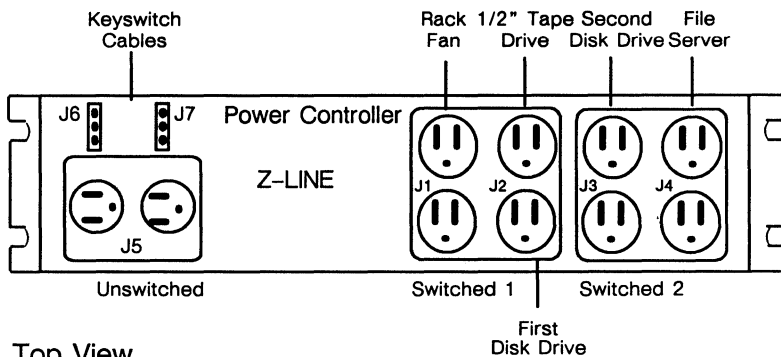

Top View

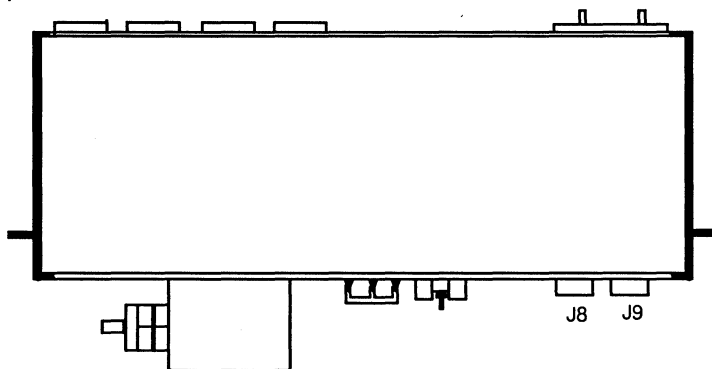

Control Side

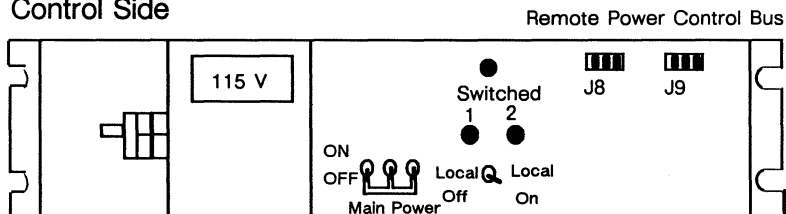

Note: Requires AC outlet NEMA L5-30R.

Pulizzi Engineering PC874E-583 230 Volt
 370-1155 370-1127
 Obsolete

Outlet Side

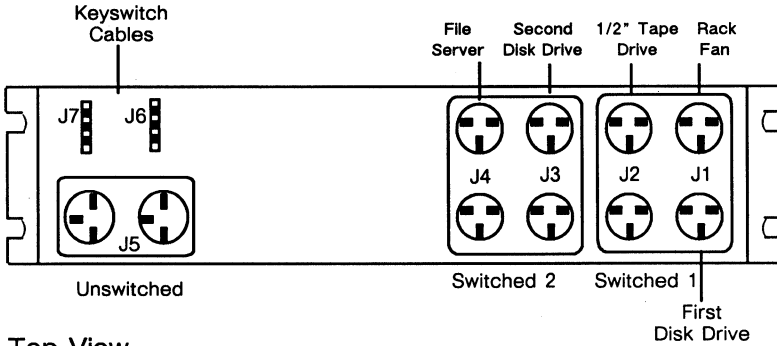

Top View

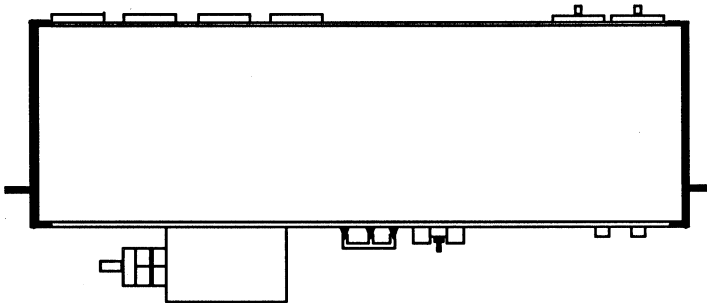

Control Side

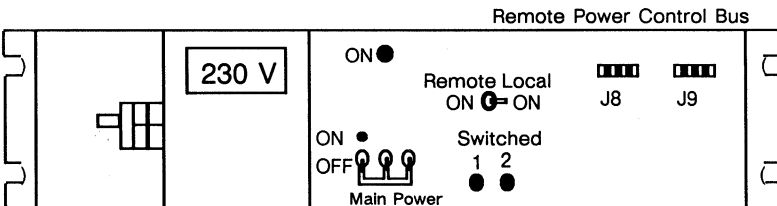

Notes

1. Requires AC outlet NEMA L6-30R.
2. When more than two disk drives are installed, distribute the power between the Switched 1 and Switched 2 outlets.

Pulizzi Engineering PC500 240 Volt
 370-1156 370-1126
 Obsolete

Outlet Side

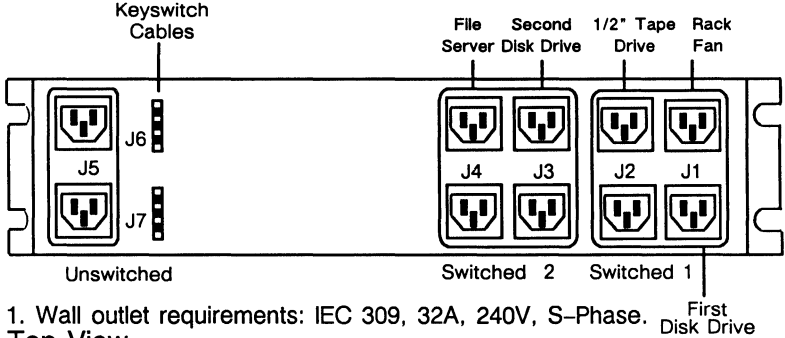

1. Wall outlet requirements: IEC 309, 32A, 240V, S-Phase.

Top View

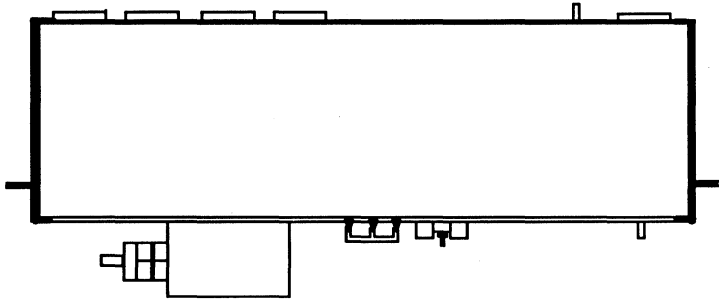

Control Side

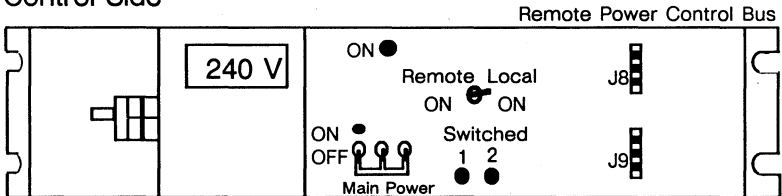

Notes

1. Requires AC outlet IEC 309, 32A, 240V.
2. When more than two disk drives are installed, distribute the power between the Switched 1 and Switched 2 outlets.