

IDEMA[®]
**“Magnetic Recording
Horizons Are
Perpendicular”**

**Perpendicular Recording Symposium
February 26, 2004
Network Meeting Center-Techmart
Santa Clara, California**

**Conference Chairmen:
David Wachenschwanz, KOMAG and Dr. Chris Bajorek, KOMAG**

Perpendicular recording, or the technology for storing magnetic bits of information vertically with respect to the disk media surface, has been studied for many years. Recent limitations in conventional longitudinal recording technology for disk drives, specifically in data stability at very high areal densities, exceeding 100 Gbits/in², have prompted renewed interest in perpendicular recording. A weathervane for this progress has been that recent demonstrations performed in several laboratories at the highest areal densities have been accomplished principally with perpendicular heads and media. This IDEMA symposium will address progress made since our last February 2002 event and emphasize such mature subjects as standardization of structures for heads and disk media, component integration, as well as such industry impacts as timing and costs, from the migration to perpendicular recording. How this technology could be applied to HDD products will constitute a summary for the symposium.

8:00-9:00am Registration and Coffee

9:00-9:10am Welcome and Introduction: Ed Grochowski, Hitachi GST

Session I:
Theory and Mechanisms

9:10-9:40am

Mason Williams, Hitachi GST

“Introduction to Perpendicular Recording”

An overview of perpendicular recording, its early history, potential advantages, timeliness and challenges. Why perpendicular recording hasn't dominated in the past, why perpendicular recording is of interest now, some of the significant differences and the key technical challenges for perpendicular recording progress.

9:40-10:10am

Dr. Neal H. Bertram, Professor and CMRR Endowed Chair, UCSD

“Critical Aspects of Perpendicular Recording: 200 Gbits/in² and Beyond”

Perpendicular recording appears to be the major candidate for the growth of information storage beyond areal densities of 200 Gbit/in². Reasonable raw error rates are achieved with transition jitter (the dominant medium noise) variance about 10% of the bit cell. This requirement places stringent demands on allowable medium grain diameters. Record data stability limits the minimum medium coercivity. These two conditions are difficult to maintain due to write pole saturation. In this talk these aspects will be explained in some detail. It will be argued that novel head design (the “shielded pole”) and/or novel media (“tilted perpendicular media”) are required to achieve densities beyond 200Gbit/in². In addition, effects of edge track erasure and DC noise will be discussed.

Introduction to Perpendicular Recording

**Potential advantages, difficulties
and a little history**

M. Williams

IDEMA Symposium 2/26/2004

Brief abstract

- **An overview of perpendicular recording, its early history, potential advantages, timeliness and challenges.**

Outline

- **Definition of perpendicular recording**
- **A little history**
- **Comparing the write head geometries**
- **Why perpendicular recording hasn't dominated in the past**
- **Why perpendicular recording is of interest now**
- **What are some of the significant differences**
- **What are the key technical challenges for perpendicular recording progress?**

Definition of perpendicular recording

- Recording in which the predominant direction of the recorded magnetization in the medium (disk) is perpendicular to the plane of the medium, as contrasted to longitudinal recording in which the recorded magnetization is mostly in the plane of the medium.
- Today we will focus on geometries in which the disk has a magnetically soft under-layer below the storage layer to help orient the write field and increase the efficiency of the write head by providing a low reluctance closure path.
- (What Prof. Iwasaki calls REAL perpendicular recording.)

Perpendicular/Longitudinal recording geometry

Longitudinal Recording

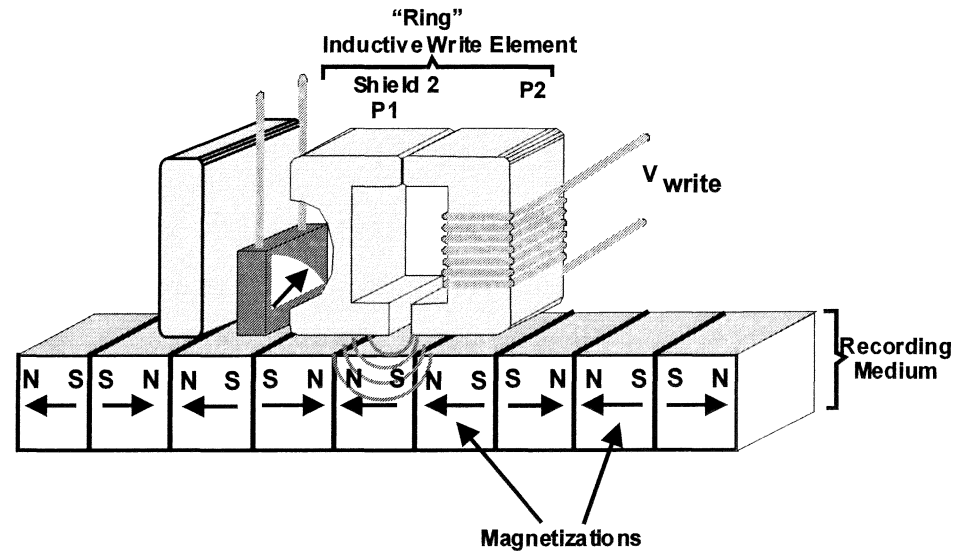

Perpendicular Recording

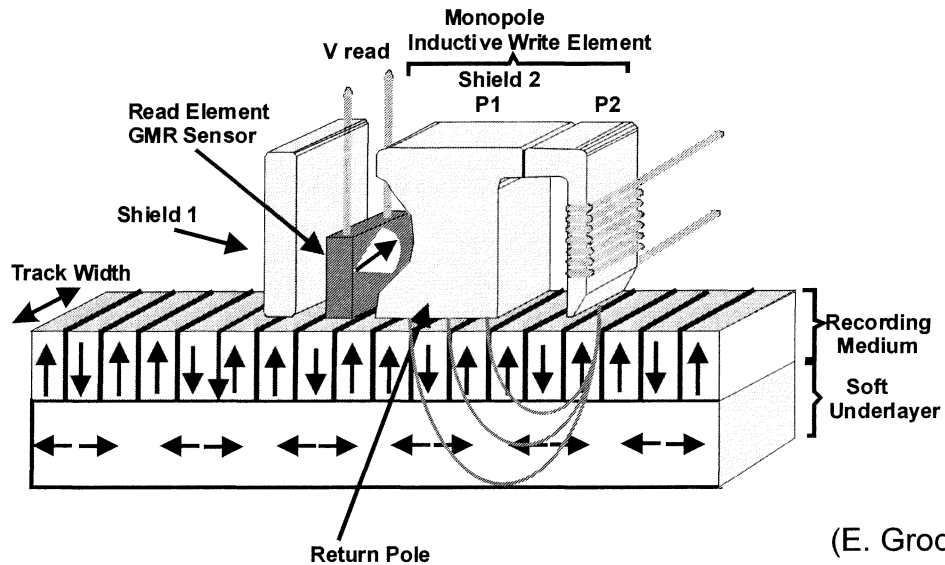

(E. Grochowski)

A little history

- **1898, V. Poulsen initially thought his steel wire audio recorder utilized perpendicular recording because he arranged two poles on opposite sides of the wire, but eventually found that a slight misalignment was necessary for good results- the medium was longitudinal.**
- **1958, A. Hoagland publishes shielded pole head design as IBM almost follows Ramac with a perpendicular recording design using a soft under-layer, but drops it due to media defect difficulties.**
- **1977, S. Iwasaki introduces CoCr perpendicular media in a tape configuration with simple pole and auxiliary pole.**
- **1978 Iwasaki adds a soft under-layer to his CoCr medium.**
- **2000 H. Takano, *et. al.*, of Hitachi report over 50Gb/sq.in demo at Intermag Conference.**

From A. Hoagland's 1958 paper in IBM Journal of R. and D.

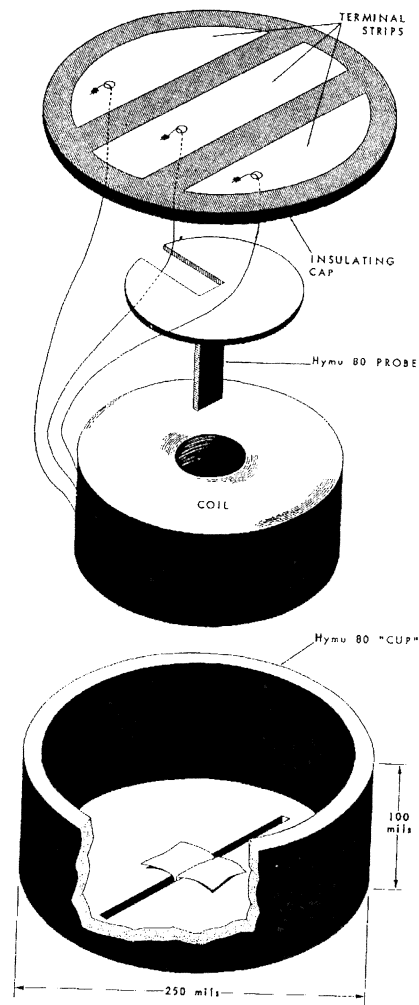
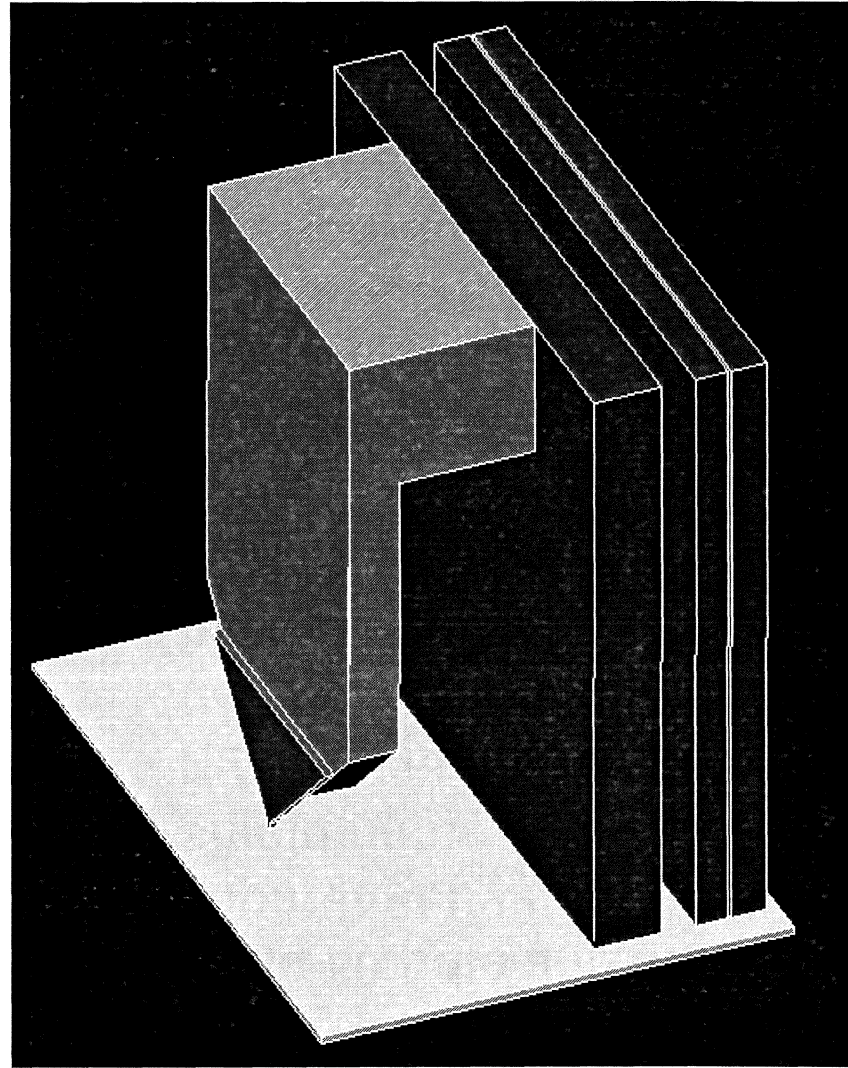
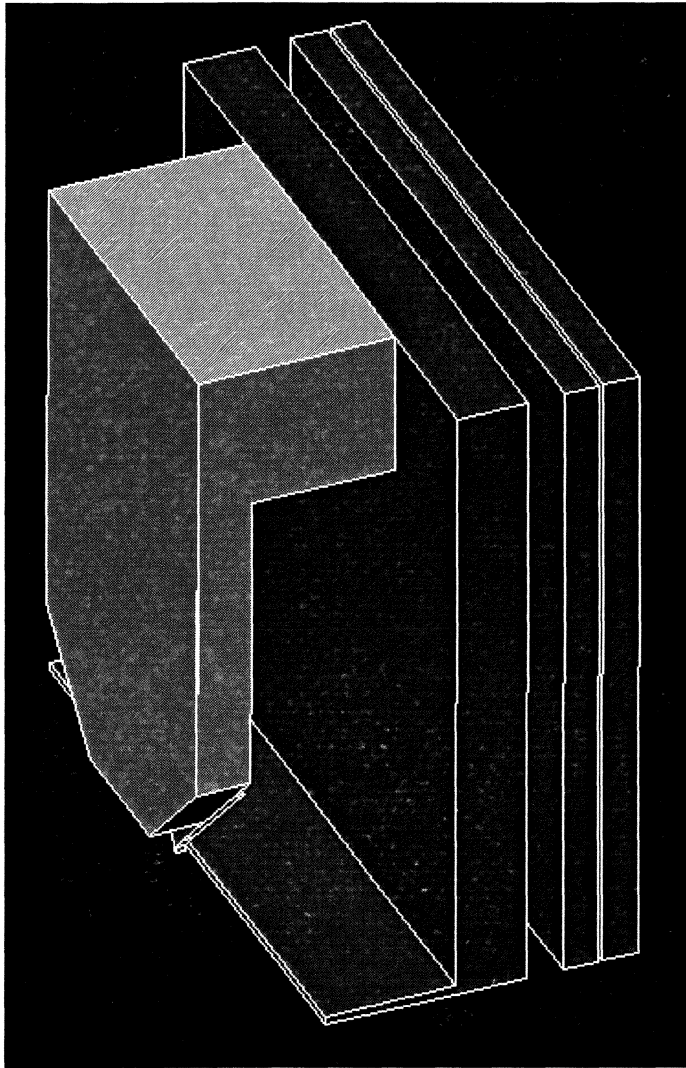

Figure 12 Design of probe-type recording head.

- HiMu 80 pole and shield were separated by copper shim shield gap.
- Paper explains sharper field derivative with shielded pole head design.
- Medium was a magnetically soft steel substrate which worked as a soft under-layer covered with an oxide film which was the data-storage layer produced by the "steam-homo" process.
- Motivation was density and low cost for simple head design.

Recording head geometry overview



Longitudinal (medium moves left) Perpendicular

Recording geometry detail

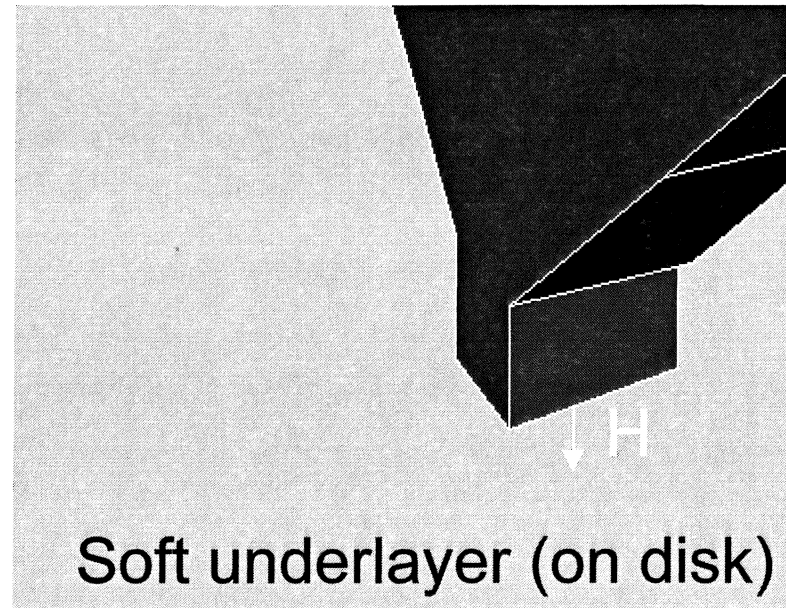
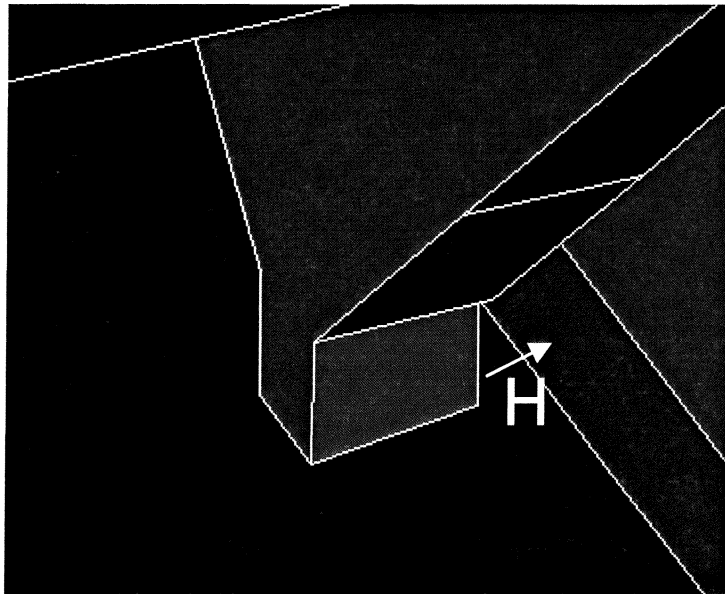

Magnetization, longitudinal and perpendicular signals

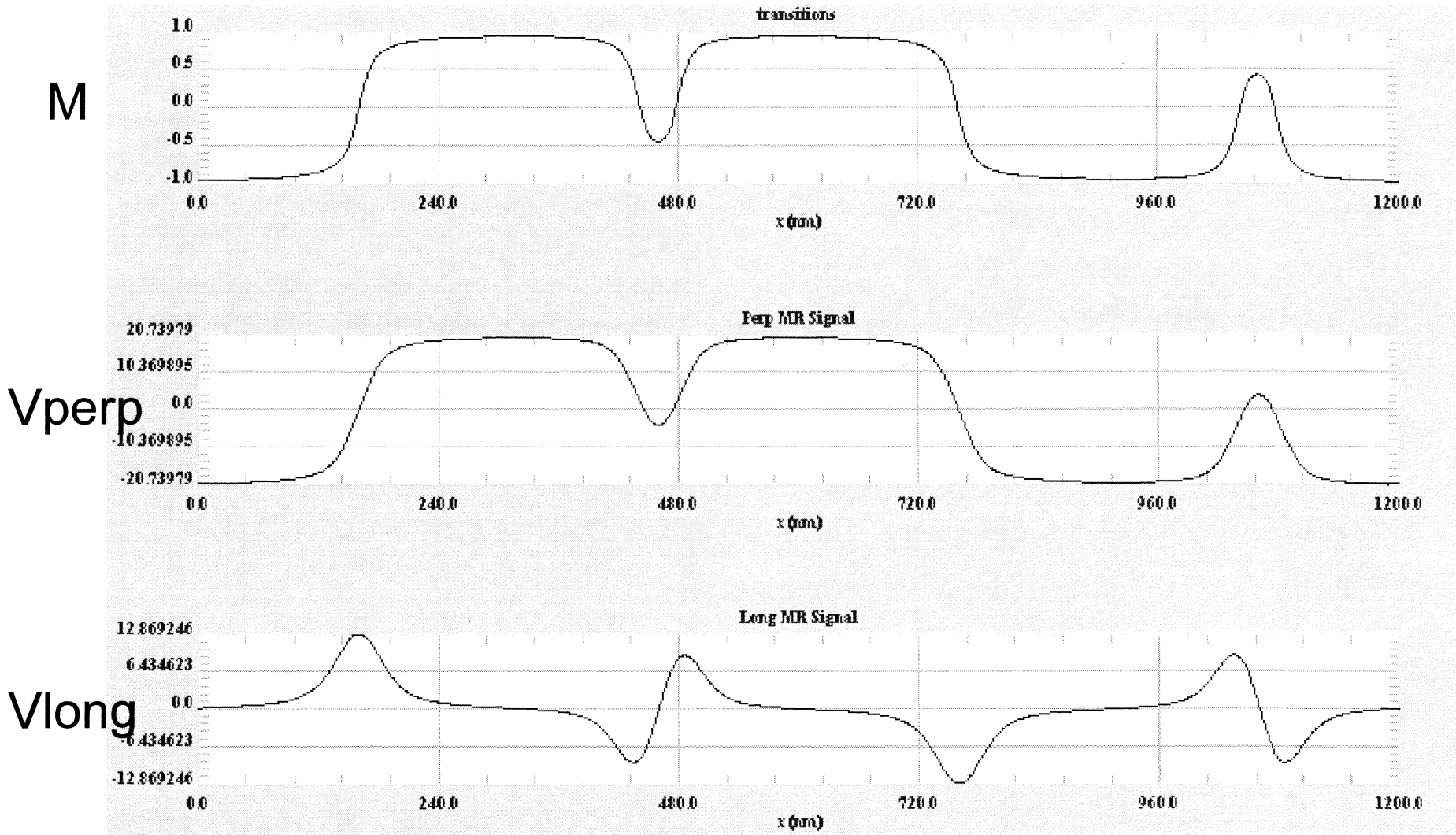

Readback signal differences

- The perpendicular signal looks like the magnetization; the longitudinal signal looks like the derivative.
- That's because the poles detected by the read head are on the top of the recorded magnets for perpendicular and are between the magnets through the depth of the medium for longitudinal.
- The perpendicular head has response down to dc.
- The peak to peak signal for the same M and t can be larger for perpendicular and there is slightly better high frequency response due the poles being at the top surface.
- Often a channel may be adapted to perpendicular recording simply by changing tap-weights.

Why perpendicular recording hasn't dominated in the past

- **(Disclaimer: this is just my speculation)**
- **When areal density was primarily limited by resolution (flying height and head dimensions), the relative advantage of perpendicular was small.**
- **With longitudinal recording progressing at a rapid rate, 60% or more per year, the entrenched technology was a moving target.**
- **Any advantage to perpendicular was eliminated by the additional time required to solve problems with its complexity, e.g., defect and noise free soft underlayers, sensitivity to stray fields, media s/n.**

Areal density history – E. Grochowski's chart

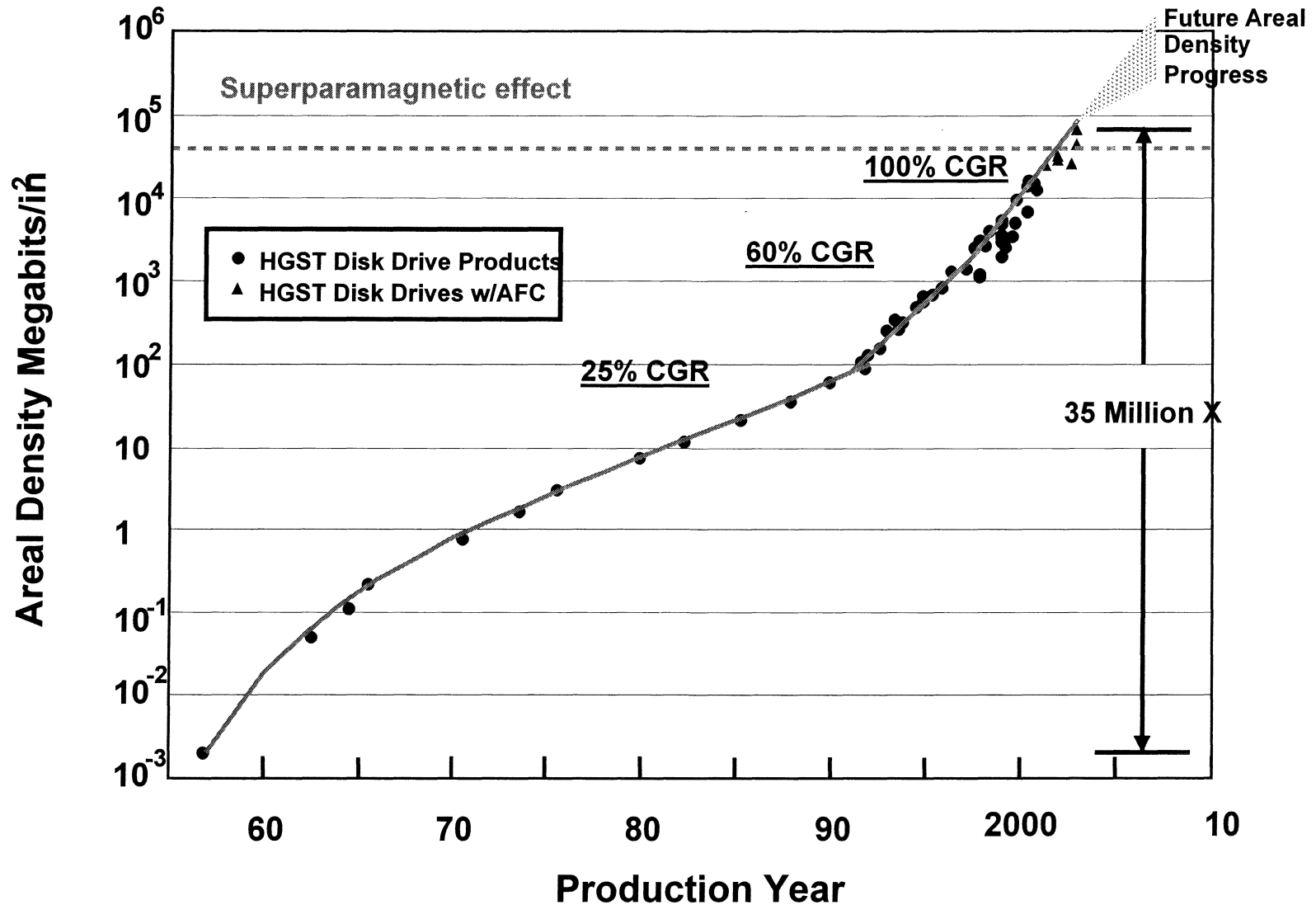

Why perpendicular is of interest now

- **We are getting to areal densities where longitudinal recording is starting to see limitations in the rate of progress due to the need to keep grain magnetization reversal energy barriers above 40kT to ensure stability.**
- **This means we can no longer simply scale down the thickness of the medium along with the gap, flying heights, track widths etc.**
- **While we could scale, the areal density increased inversely with the square of flying height.**
- **Now it is much more difficult to advance longitudinal recording.**
- **The same read head appears to provide a narrower read-profile with perpendicular recording.**

Comparing read track profiles

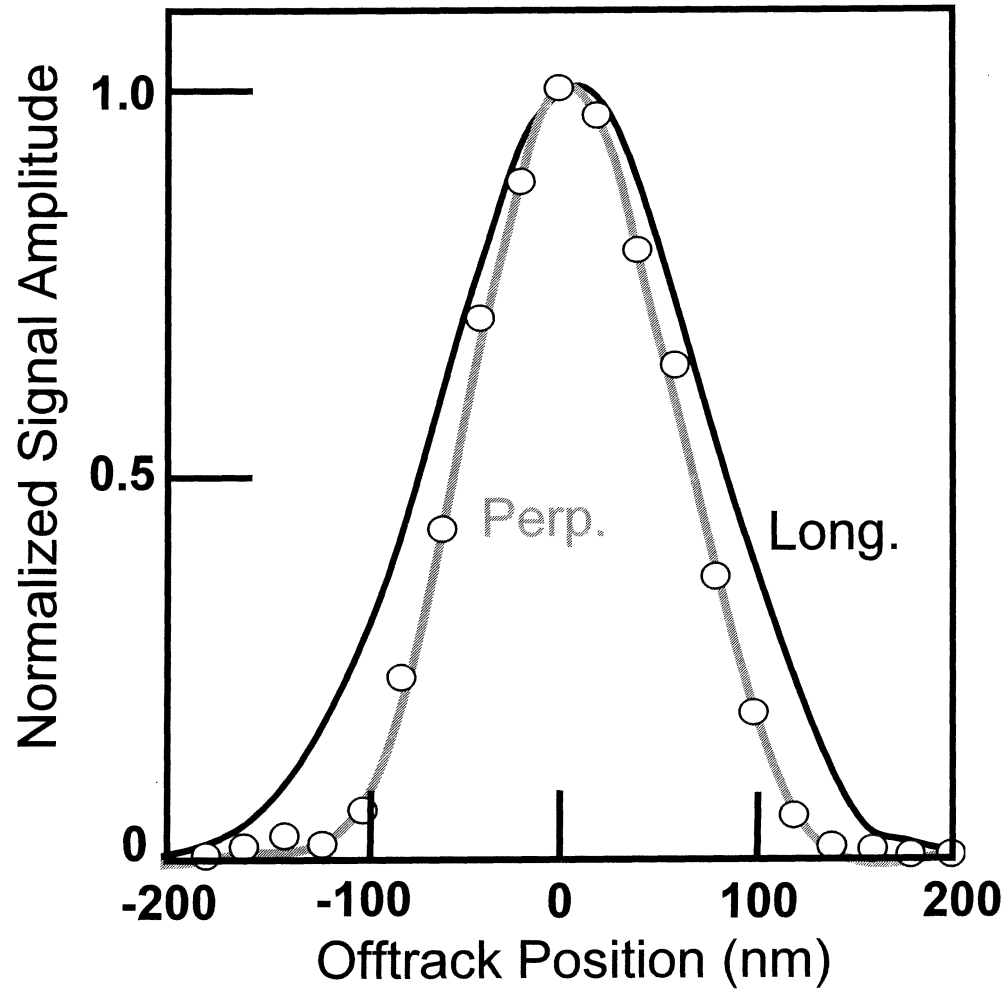

← very significant @ 10% side reading impact.

Approximating longitudinal limits from 3 criteria

- **Percolation: Bitcell length B**
 $B \geq 3 * a$ (using wc a)

$$B = 3a \quad a = \sqrt{\frac{4Mty}{QH}}$$

- **Jitter media noise: B** $\geq 10 * j$
 rms transition jitter for 10^{-5} on-track error rate

$$B = 10j = 14.2a\sqrt{g/w}$$

- **Thermal Stability: grain energy barrier** ≥ 60 kT.

$$60kT = HMtg^2$$

- **Grain size g, read width w.**

$$D = 1/(2Bw)$$

- **Eliminate Mt, solve, get approximate areal density limit:**

$$D = \frac{164Gb / sq.in.}{\sqrt{(y/10nm)}} \bullet \left(\frac{H}{10KOe} \right)$$

was 1/2 when could scale media from w/ FH.

Y is magnetic spacing to center of medium;
 H is H0 that can be written.

AFC media can improve on this somewhat by reducing MHV for stability.

Comments

- **Limits on perpendicular appear to be somewhat higher and increase if we can increase head field derivative for a given flying height.**
- **Unfortunately, they are not as easy to express in 3 equations. INSIC work indicates 700 Gb/sq.in. may be conceivable, and perhaps beyond 1 Tb/sq.in..**
- **If the areal density goes linearly with H_0 , perhaps a larger H can be written with the perpendicular geometry where the medium is essentially in the gap rather than near it.**
- **For these reasons, it appears to be worthwhile to look at how far perpendicular recording can be pushed.**
- **Note that a perpendicular system must be developed and optimized to be superior- no one should expect all perpendicular systems to beat all longitudinal systems.**

Significant differences

- Perpendicular recording linear resolution is even more sensitive to the narrowness of switching field distributions than is longitudinal recording.
- A perpendicular pole writes everywhere under the magnetic material in contact with the medium. If the system must work at sizable skew (say 15 degrees), this limits the down track length of the pole that can be used to carry flux down to the abs. This in turn means very short throat heights are required in skew tolerant writers.
- The signal of a perpendicular system at low density is proportional to MrT but also inversely proportional to the head-underlayer spacing. This means sensor thickness may have to be designed to match specific media.

- writes under whole pole not just ~~head~~ trailing head pole

Advantage of short-gap trailing shield head

- Increased dHy/dx .
- Increased dHy/dz with wrap-around shields.
- Increased angle between write field and average easy axis direction.
- The increased angle helps with writing and improves media jitter due to scatter in easy axis direction.

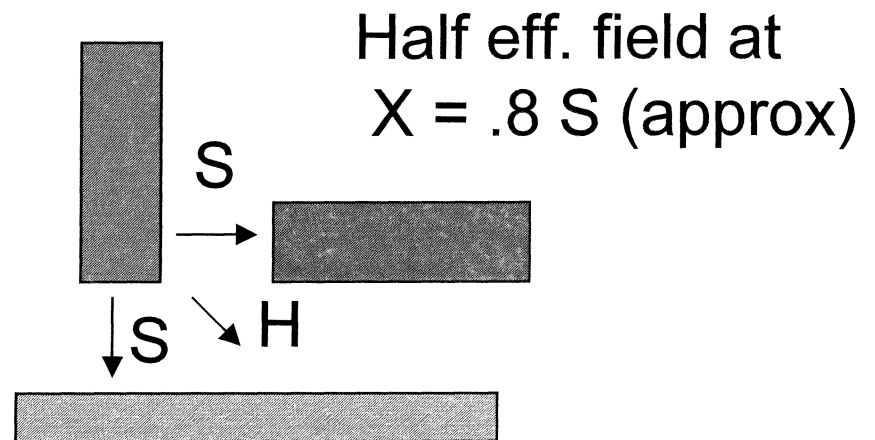
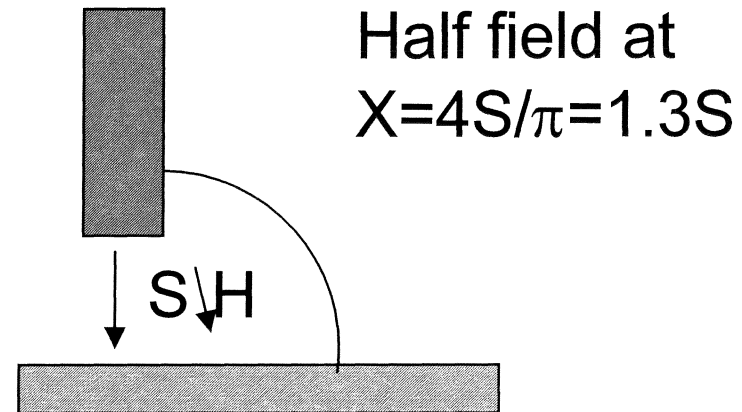

Stoner-Wohlfarth H_{sw} vs angle

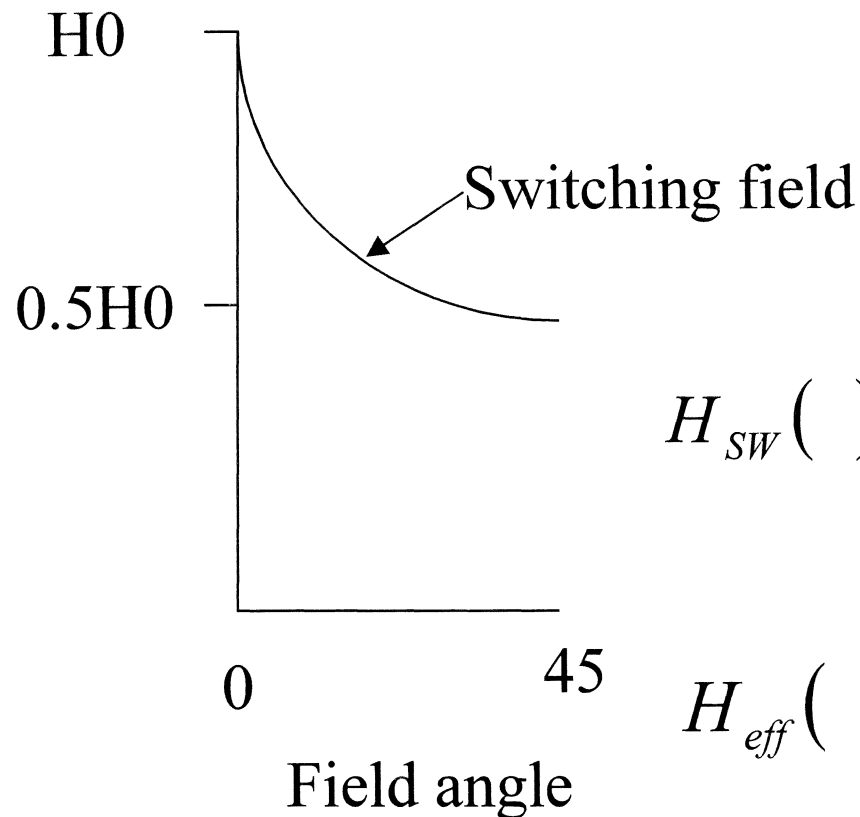

$$H_{sw}(\theta) = H_0 \left[\sin^2 \theta + \cos^2 \theta \right]^{3/2}$$

$$H_{eff}(\theta) = H_0 \left[\sin^2 \theta + \cos^2 \theta \right]^{3/2}$$

Jitter due to variation in Hsw

$$\Delta H(\theta_H) = H_{SW}(\theta_H - 10^\circ) - H_{SW}(\theta_H + 10^\circ)$$

$$j \approx 0.5 \times \frac{\Delta H(\theta_H)}{\frac{dH}{dx}} \times \sqrt{\frac{s}{W}}$$

Experiment: 4-5dB
Gain in media s/n

Rel jitter (-dB)

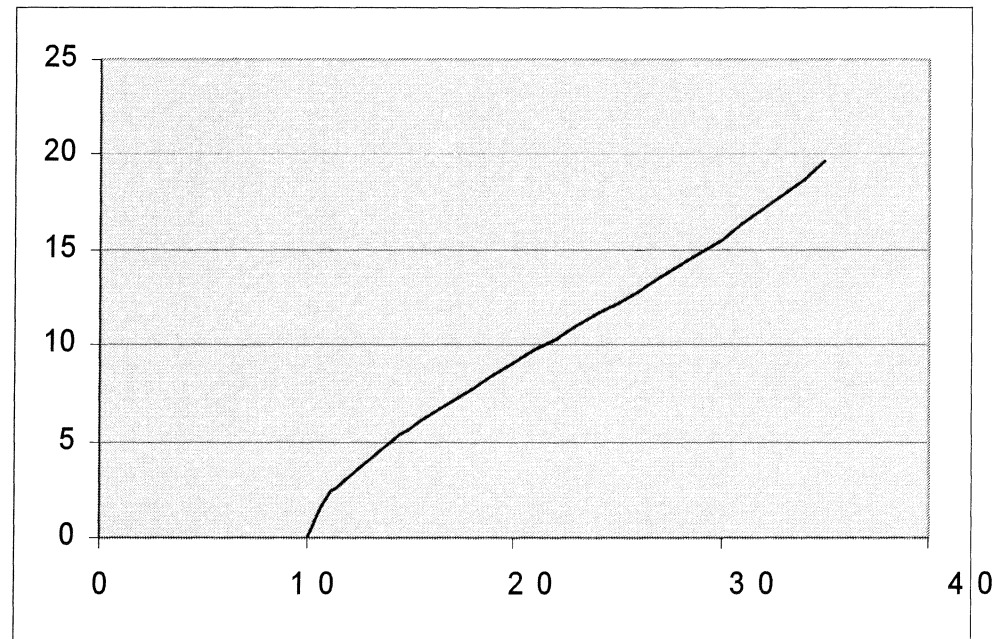

Field angle

INSIC 1 Tb/sq in geometry – Mallery design

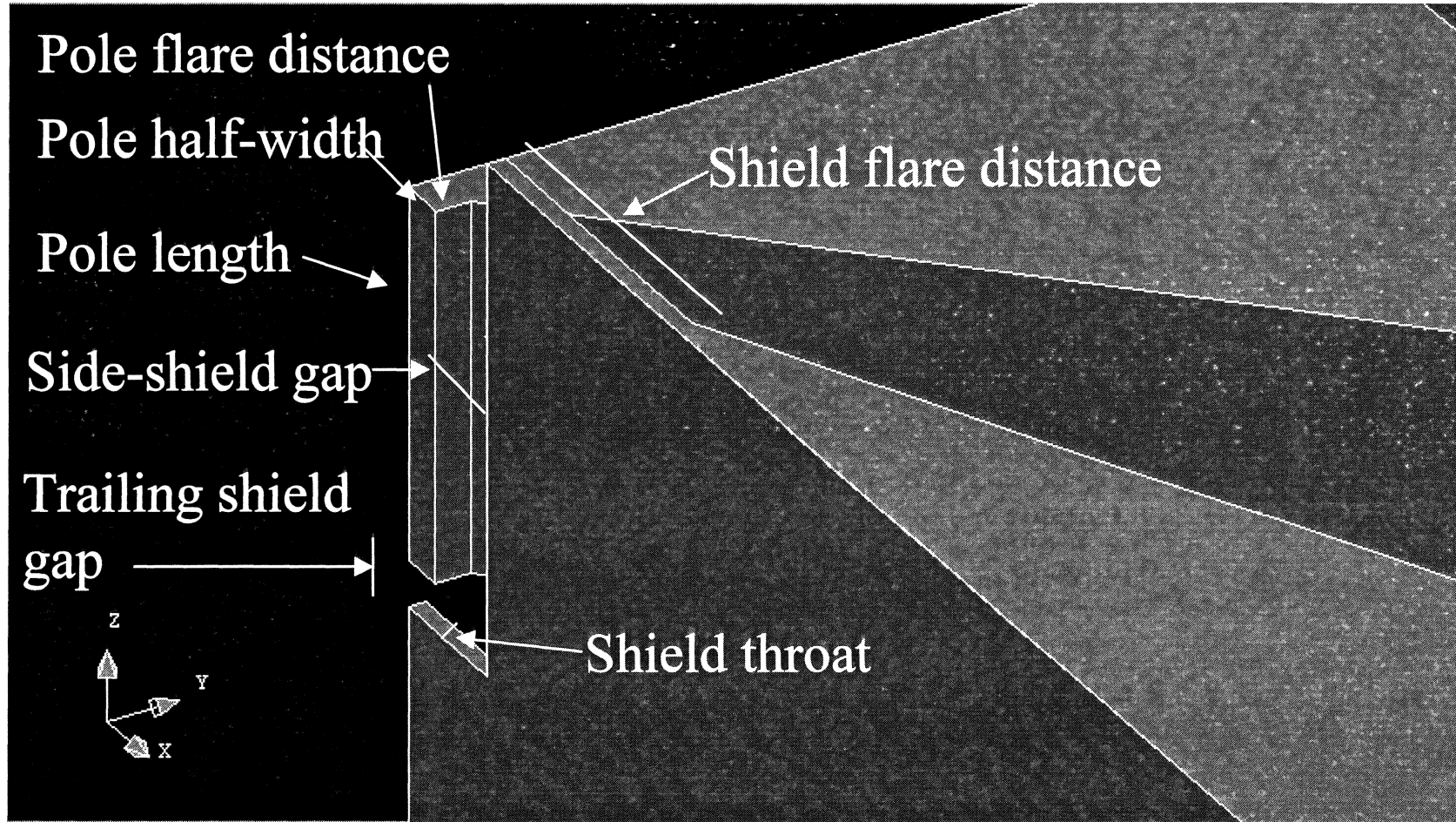

(y-z plane is symmetric centerplane, $x > 0$ only shown here)

INSIC 1TB model parameters

- Shield throat (thickness) 20 nm
- Shield flare distance 20 nm
- HUS 25 nm
- Gap to side shields (1.5) * hus
- Gap to trailing shield 1 * hus
- Current 54 milli-amp-turns

Max H_y 15 KOe
Max H_{eff} 20 KOe

Without side shields



With side shields

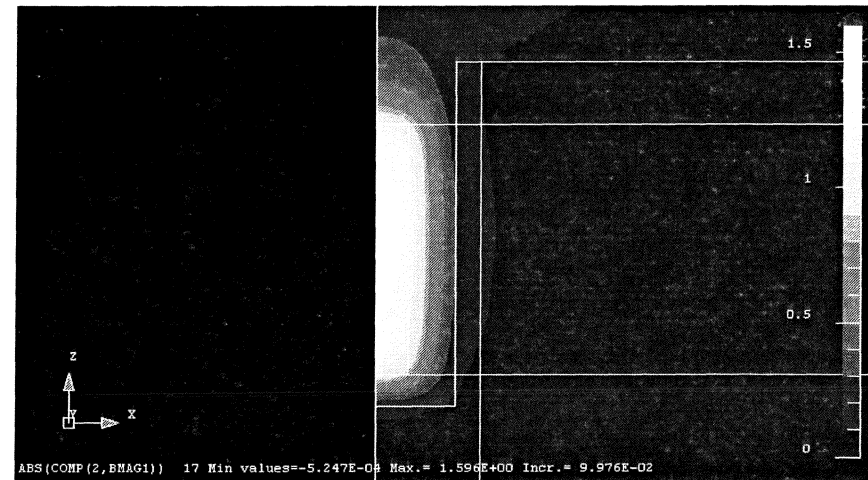

The write field problem

- Because the entire bottom of the pole writes, we need a pole not much longer than a track-width to avoid writing on the adjacent track at large skew, or, at best, a trapezoidal pole about two track-widths long.
- Flux leaks from the sides of the pole to the soft underlayer. If the pole cross section must remain constant up to a “flare point”, the flux density at the pole-tip will be significantly less than that at the flare point:

$$\frac{B_{p0}}{B_s} \approx \frac{A}{A + \frac{2}{\pi} PS \ln\left(1 + \frac{F}{S}\right)}$$

Here, A is pole-tip area, S the head-underlayer spacing, F the distance to flare and P is the perimeter of the pole. Trailing or side-shields steal even more flux, requiring short shield throats.

Key challenges

- **To get the most linear density, it will be desirable ultimately to use heads with trailing shields (as proposed by A. Hoagland and, more recently, by M. Mallary. These designs will require write heads with throats controlled as well as reader stripe heights are presently controlled. This is a challenging alignment or process issue.**
- **Uniformity of media parameters including easy-axis angle distributions, Hk distributions, inter-granular exchange distributions and grain size distributions is key to obtaining the best performance.**

Critical Aspects of Perpendicular Recording

200Gbit/in² and Beyond

H. N. Bertram

***CMRR, UCSD, La Jolla, CA
92093-0401***

Email: nbertram@ucsd.edu



Record/Replay Geometry of Kepered GMR Head(200Gbit/in²)

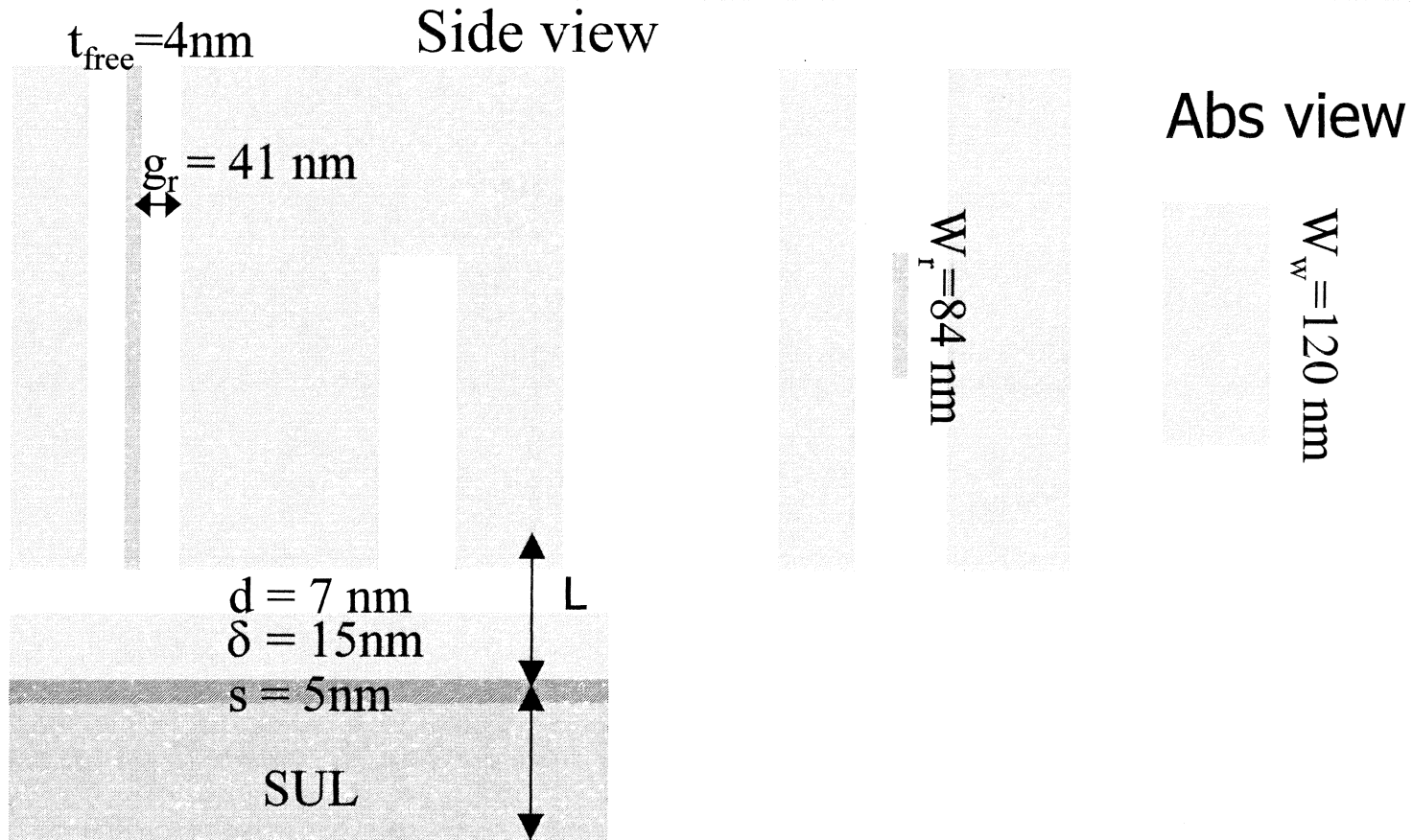

Replay Pulse with GMR Head

Perpendicular

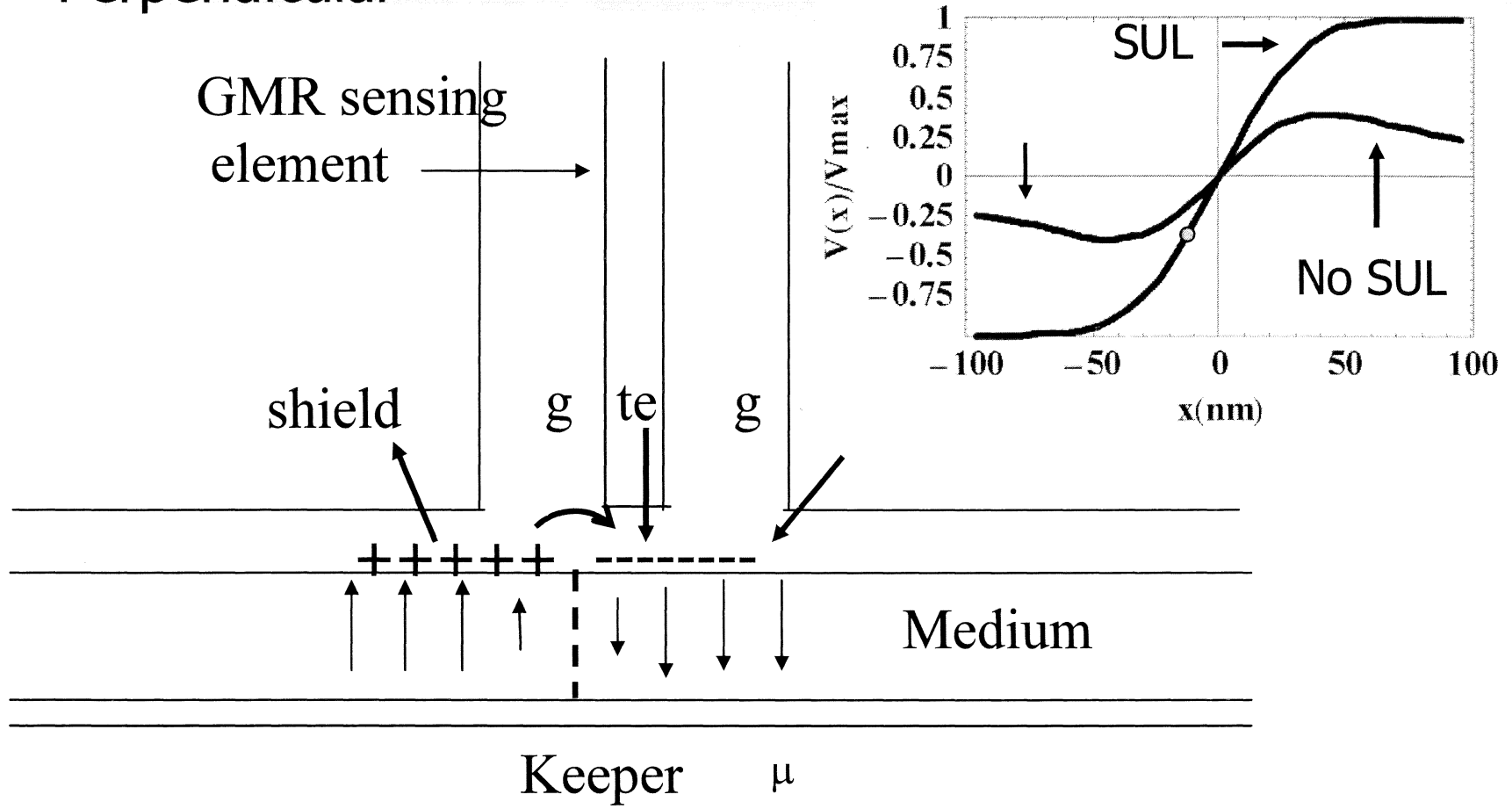

Perpendicular Isolated Pulse Approximation

(Infinite μ_{sul})

$$V(t) \approx V_{\max} \operatorname{Erf}\left[\frac{0.95vt}{T_{50}}\right]$$

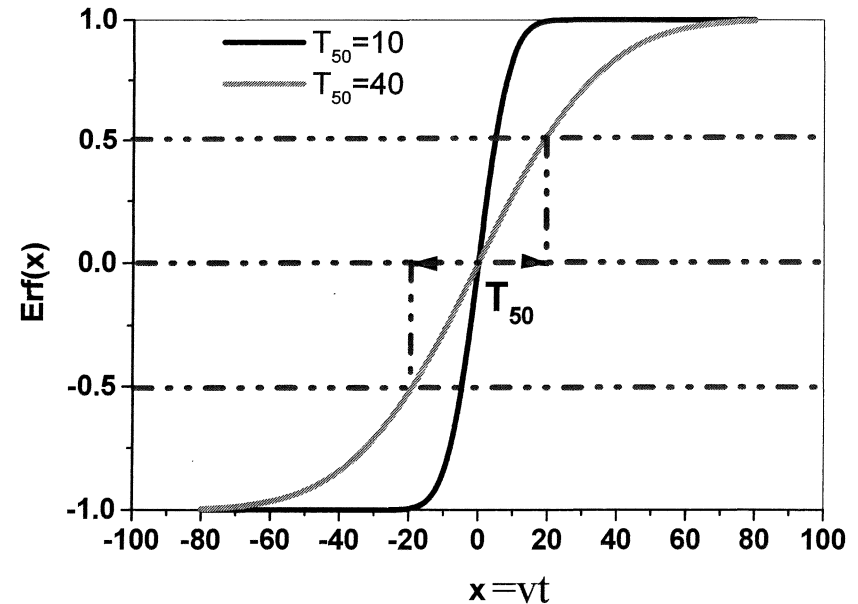

$$T_{50} \approx \frac{0.77}{v} \sqrt{\frac{1}{6} [d^2 + 2d(s+t_e) - s(2s+t_e)] + \frac{g^2}{4} + \frac{(g+t_e)^2}{4} + \frac{\pi^4 a^2}{16}}$$



Center for Magnetic Recording Research

Model of Simulated Media

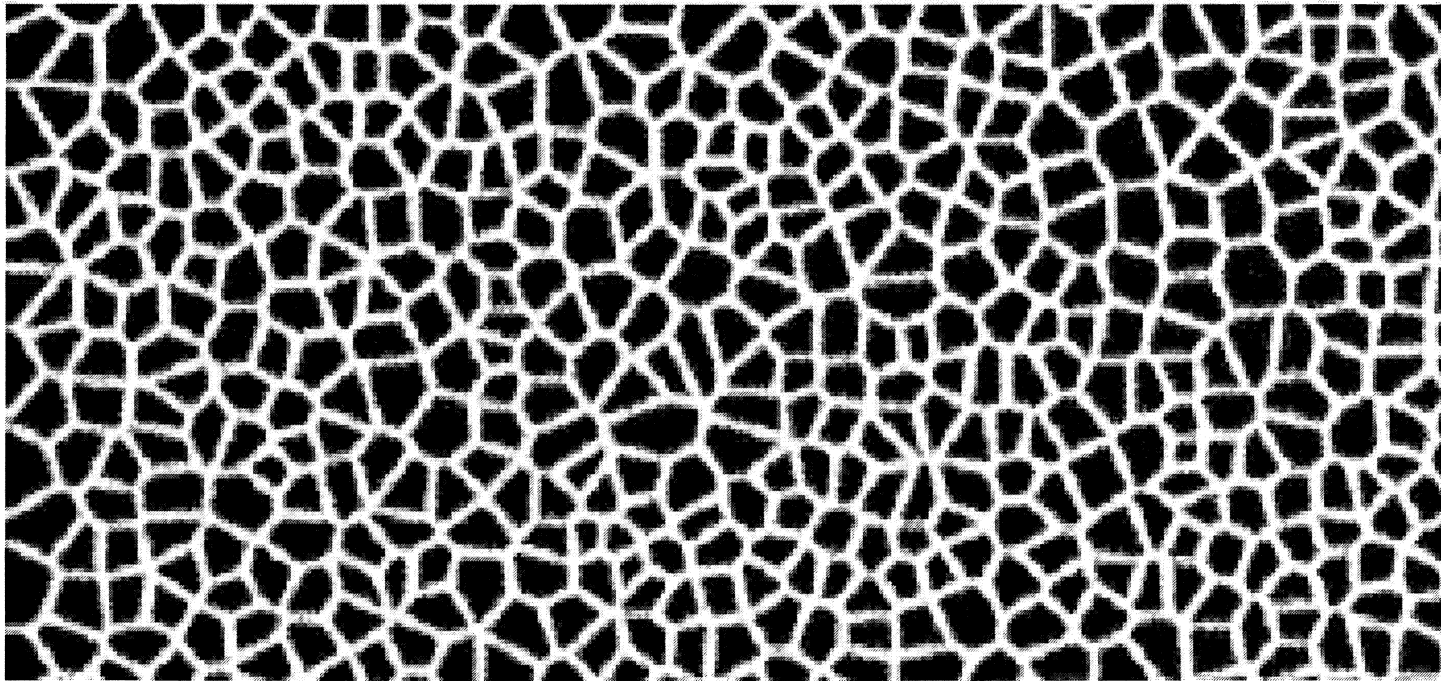

- "Grown" by random seeds with fixed boundary separation.
- Utilized Cellular Automaton with algorithm to give approximately octagonal (isolated) grains.
- Small pixel size to make quantization error negligible

Illustration of a Recorded Magnetization Transition

Up Magnetization

Down Magnetization

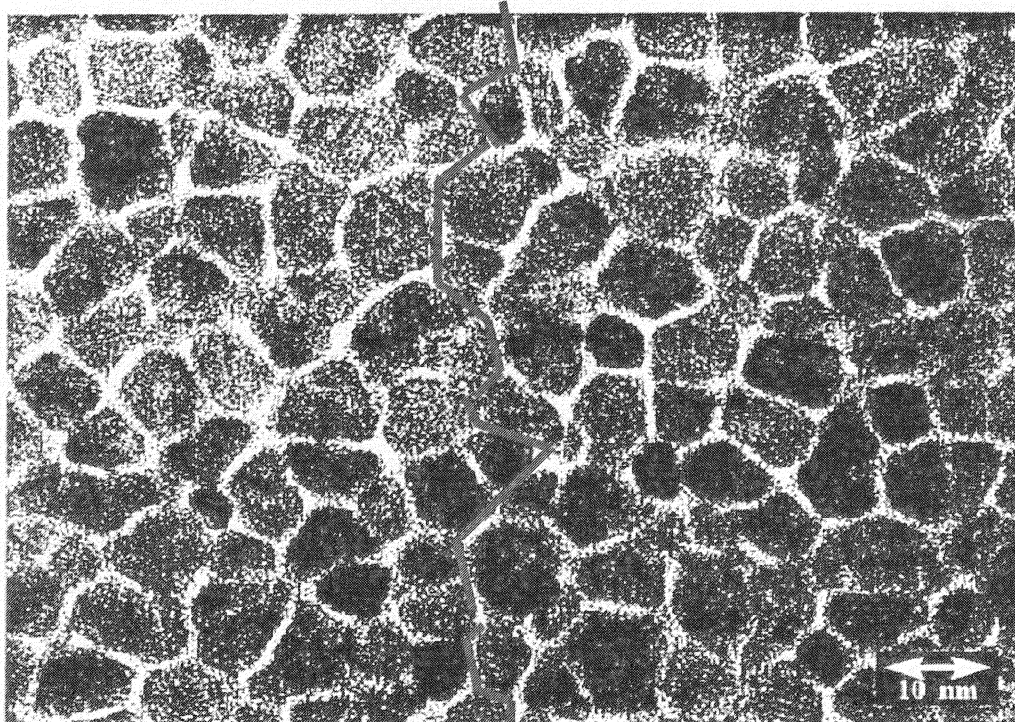

**Cross Track
Correlation Width**

s_c

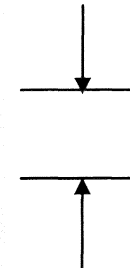

Minimum:

$$a \sim \langle D \rangle / 3$$

$$s_c \sim \langle D \rangle$$

Is this due to position of gran variation? If so control on gran positions could reduce.

Transition Width πa



Center for Magnetic Recording Research

2/26/04

Bertram/IDEMA6

Basic Medium Noise Mechanism

Random grain growth causes transition center to vary "jitter" from bit cell to bit cell:

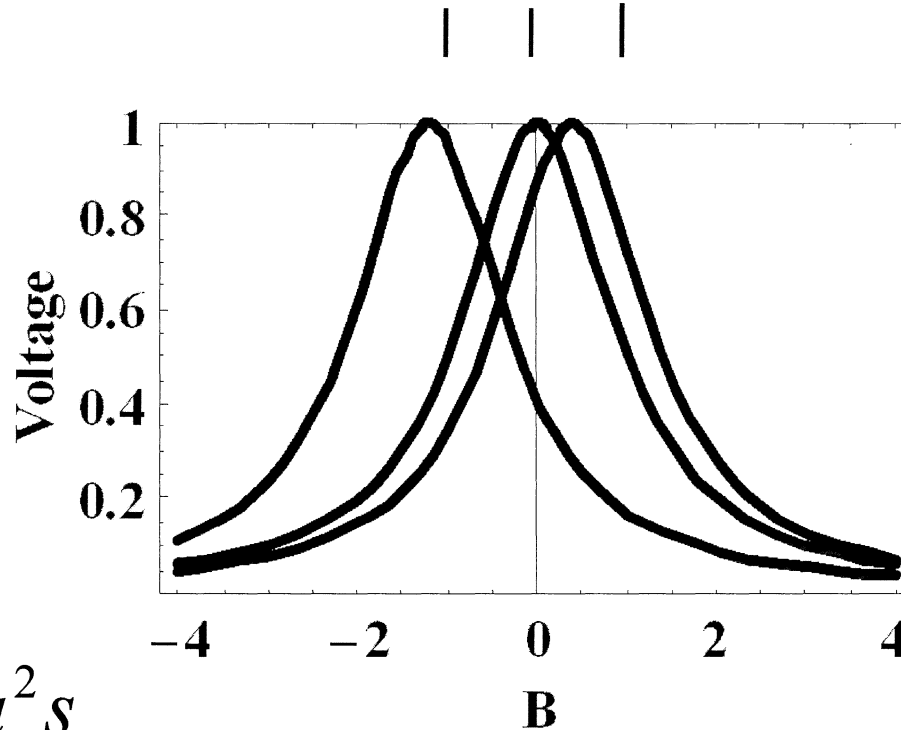

PW₅₀ = 2B

bit spacing

$$\sigma_J^2 \approx \frac{2a^2 s_c}{W_r}$$

2/26/04

Jitter Error Rate

- If we assume Gaussian jitter noise with variance σ_J :

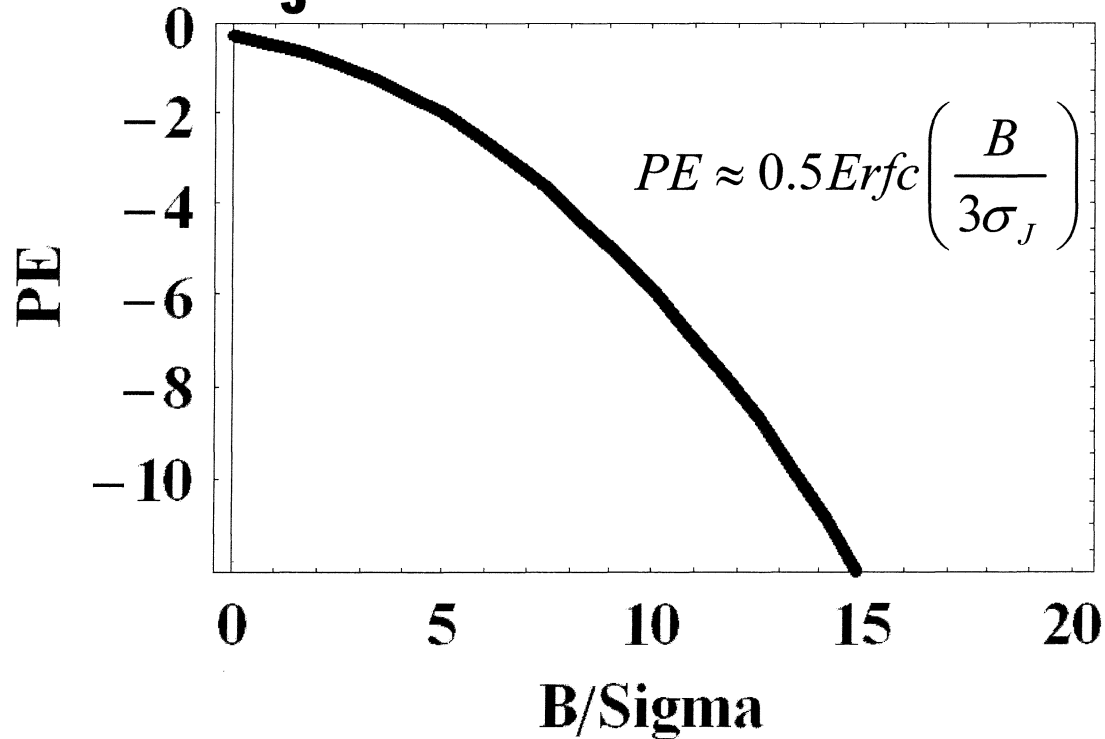

- **10% jitter yields about 10^{-6} BER!!**



Center for Magnetic Recording Research

Design Criteria

For a system with 10% jitter (SNR \sim 18dB, BAR=6, $W_r=3B$)

$$\frac{B}{\sigma_J} = 10 = \sqrt{\frac{B^2 W_r}{2a^2 s_c}} \quad \text{or} \quad a^2 s_c = \frac{B^2 W_r}{200}$$

Density	B	$a^2 s_c$ ($W_r/B=3$)	s_c ($1.2\langle D \rangle$)	a	$\langle D \rangle$ (thermal stability)	a/ $\langle D \rangle$
200 Gbit /in ²	22.4nm: 1134kfc	170nm ³	9nm	4.34nm	7.5nm	0.6 Difficult
1 Tbit /in ²	10nm: 2540kfc	15 nm ³	6nm	1.6nm	5nm	0.32 Very very Difficult!



Magnetization Decay versus Time

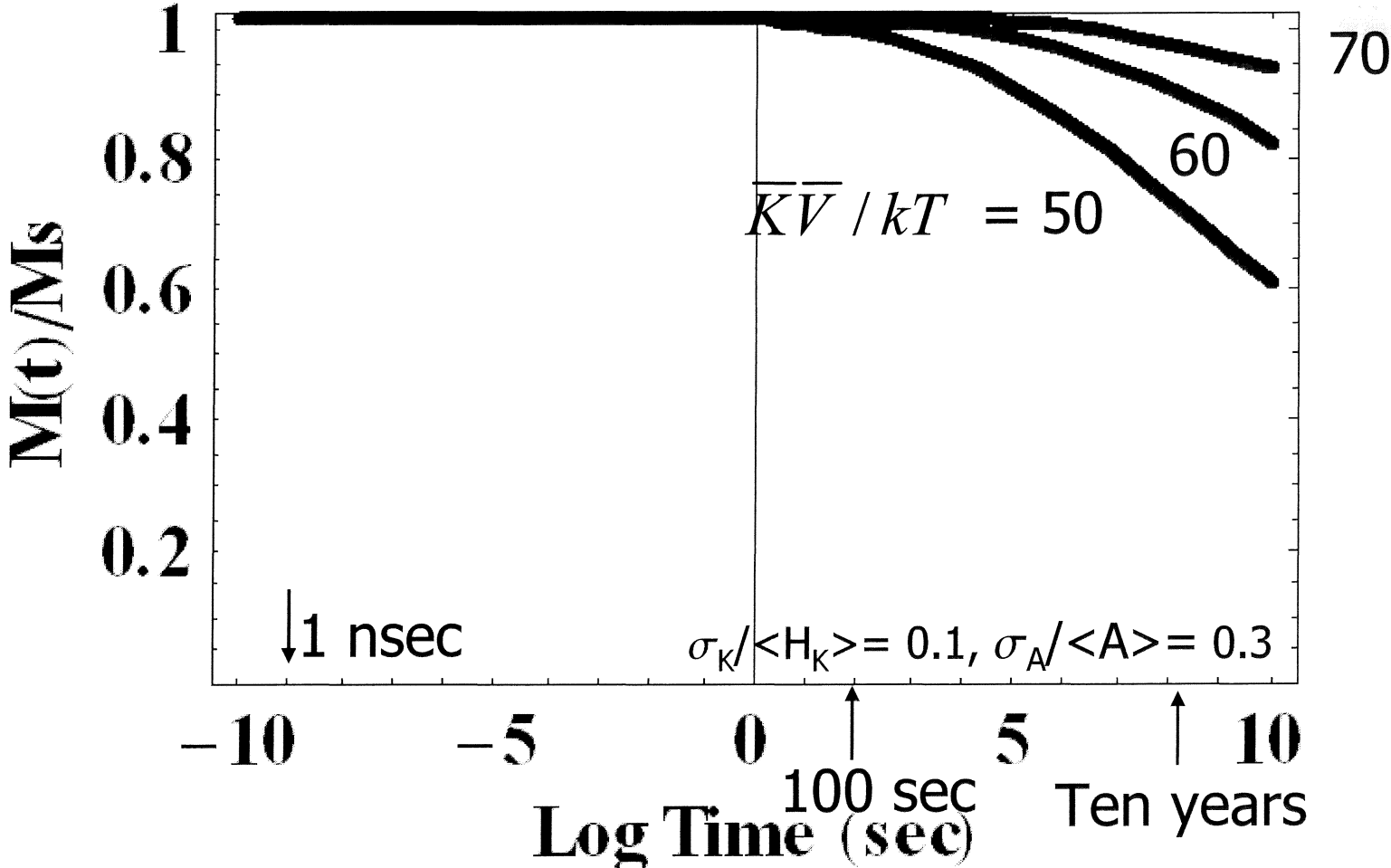

$\sigma_D / \langle D \rangle = 0.5 \sigma_A / \langle A \rangle$



Center for Magnetic Recording Research

Minimum Anisotropy Versus Average Grain Diameter

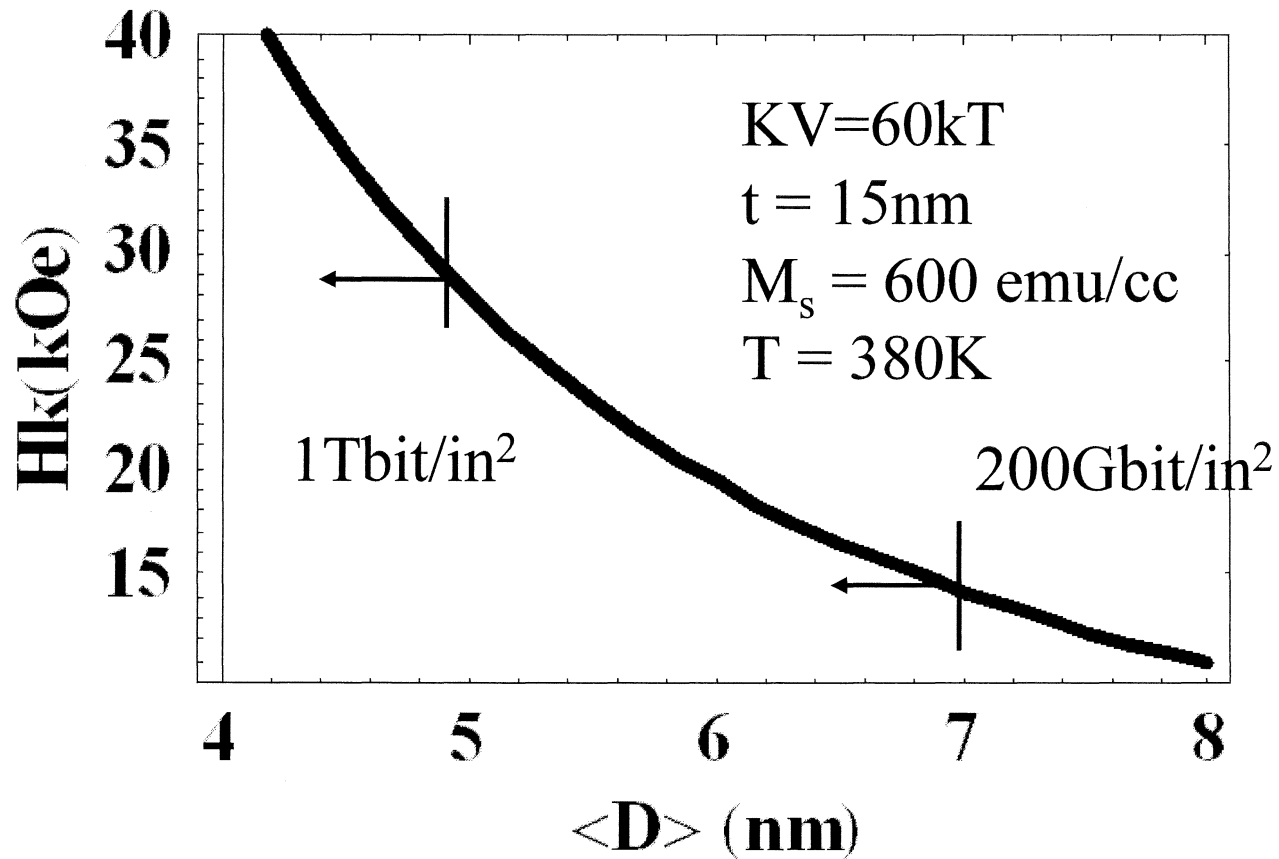

Maximum Medium Anisotropy

- **Overwrite condition requires loop to close:**

$$H_{dg} \approx H_c + 2\pi M_s^{media}$$

- **For ideal head ($4\pi M_s^{head} \sim 2.4kOe$ with tapered pole):**

$$H_{dg}^{max} \approx 0.71 \times 4\pi M_s^{head} \approx 17kOe$$

- **For medium $M_s = 600$ emu/cc: $H_c^{max} \approx 13kOe$**

- **For well oriented media with good dispersion control: $H_c \sim 0.82H_K \Rightarrow$**

$$H_K^{max} \approx 15,800Oe$$

Density Limit

- **Anisotropy Limit of about 15.8kOe limits grain diameter to about 7nm.**
- **Thus 200GBit/in² might be achievable if the transition parameter could be made sufficiently small a ~ 4nm.**
- **We need to examine transition parameter analysis.**
- **Can we use configurations that lead to higher usable H_K ?**

Basic Reversal Process

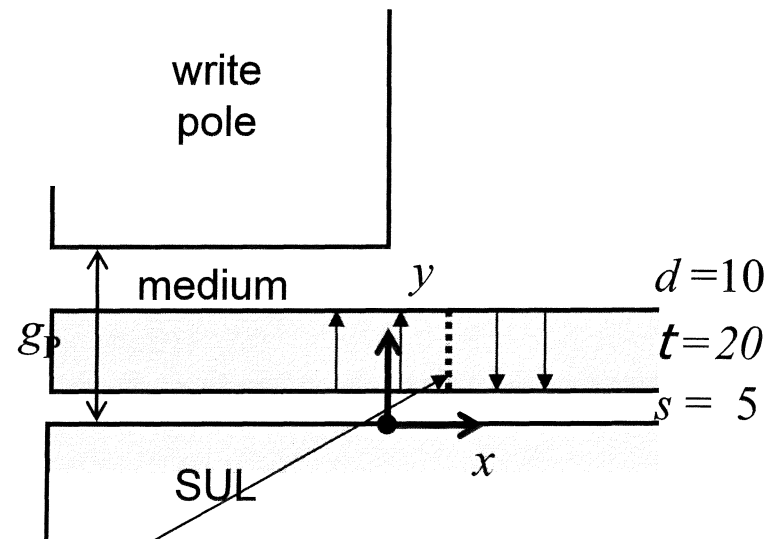
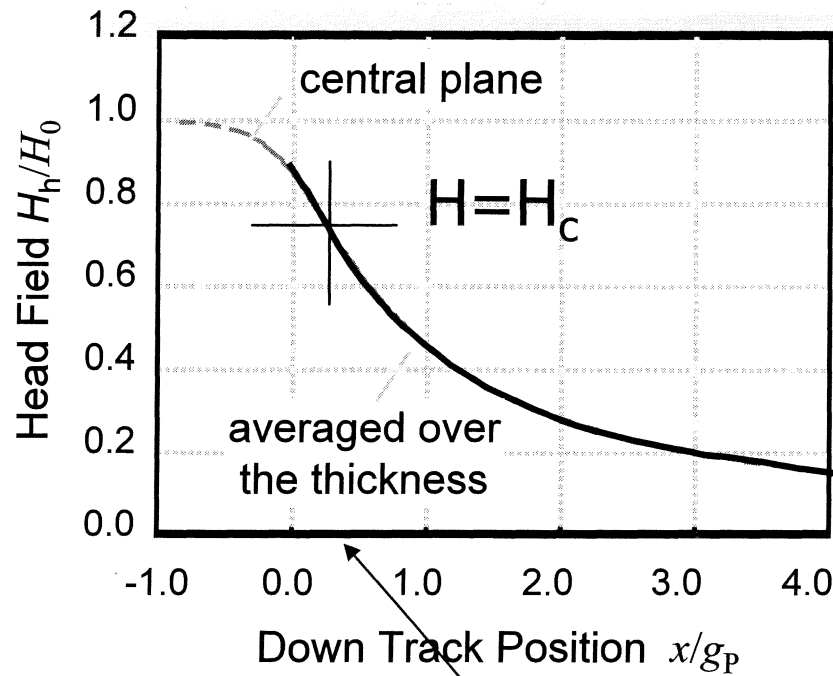

Recording location

Transition Parameter versus Head Field Gradient-Various Exchange (modified Williams-Comstock)

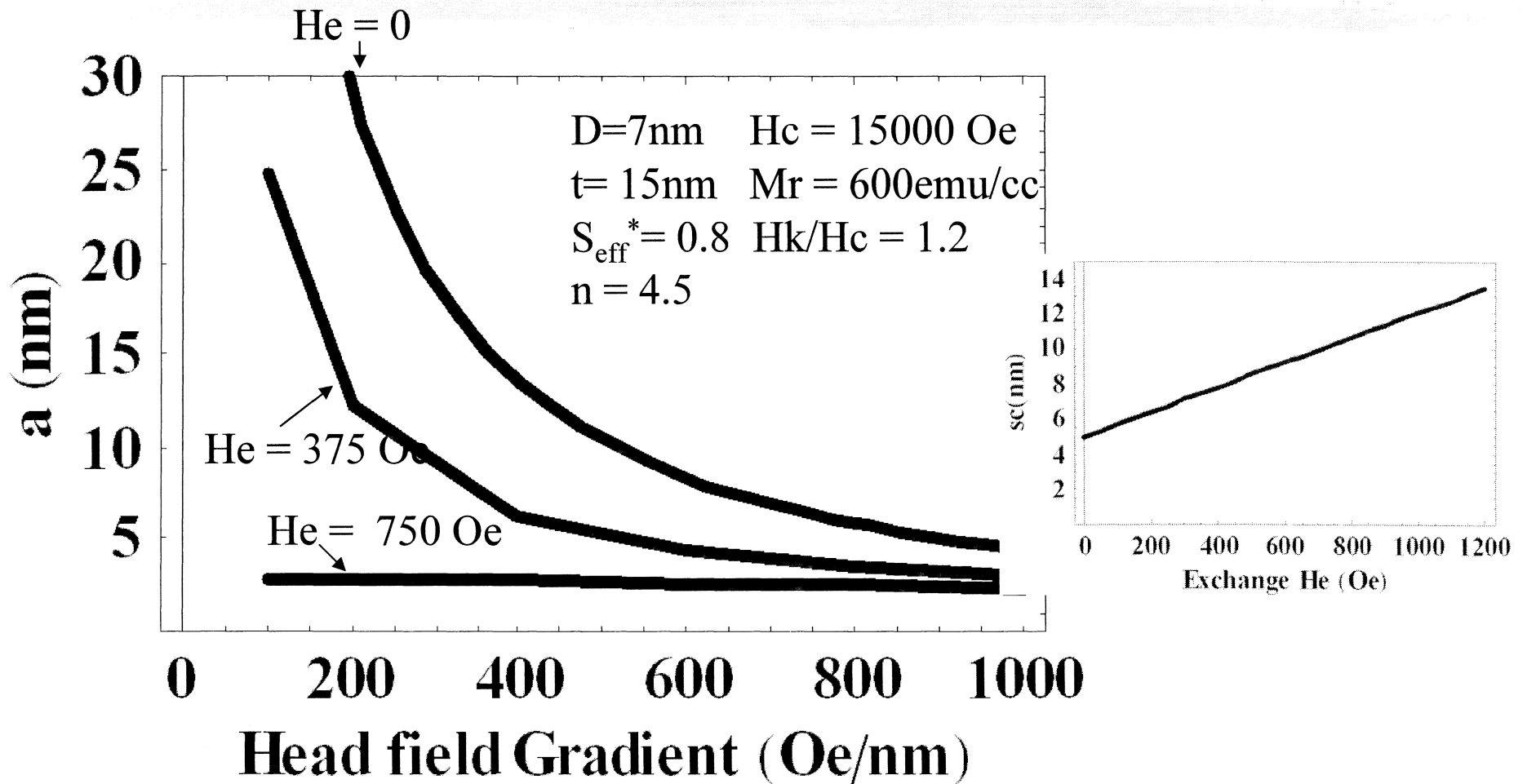

Tilted Perpendicular Recording (TPR) [1-2]

3 side tapered pole with small throat height ($TH < TW < PT$) [3]

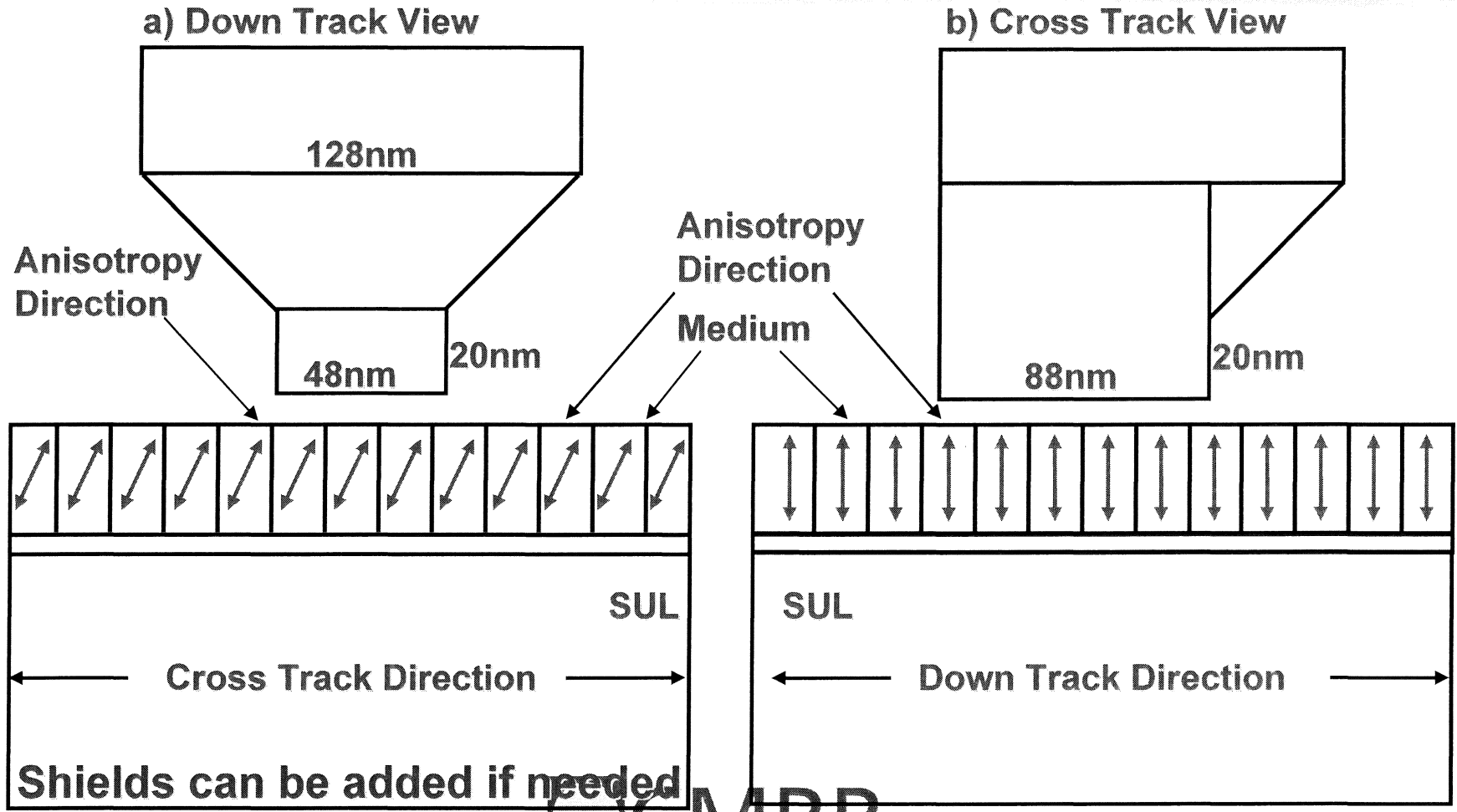

(Shielded) Perpendicular Recording [3-6]

By Mike Mallary

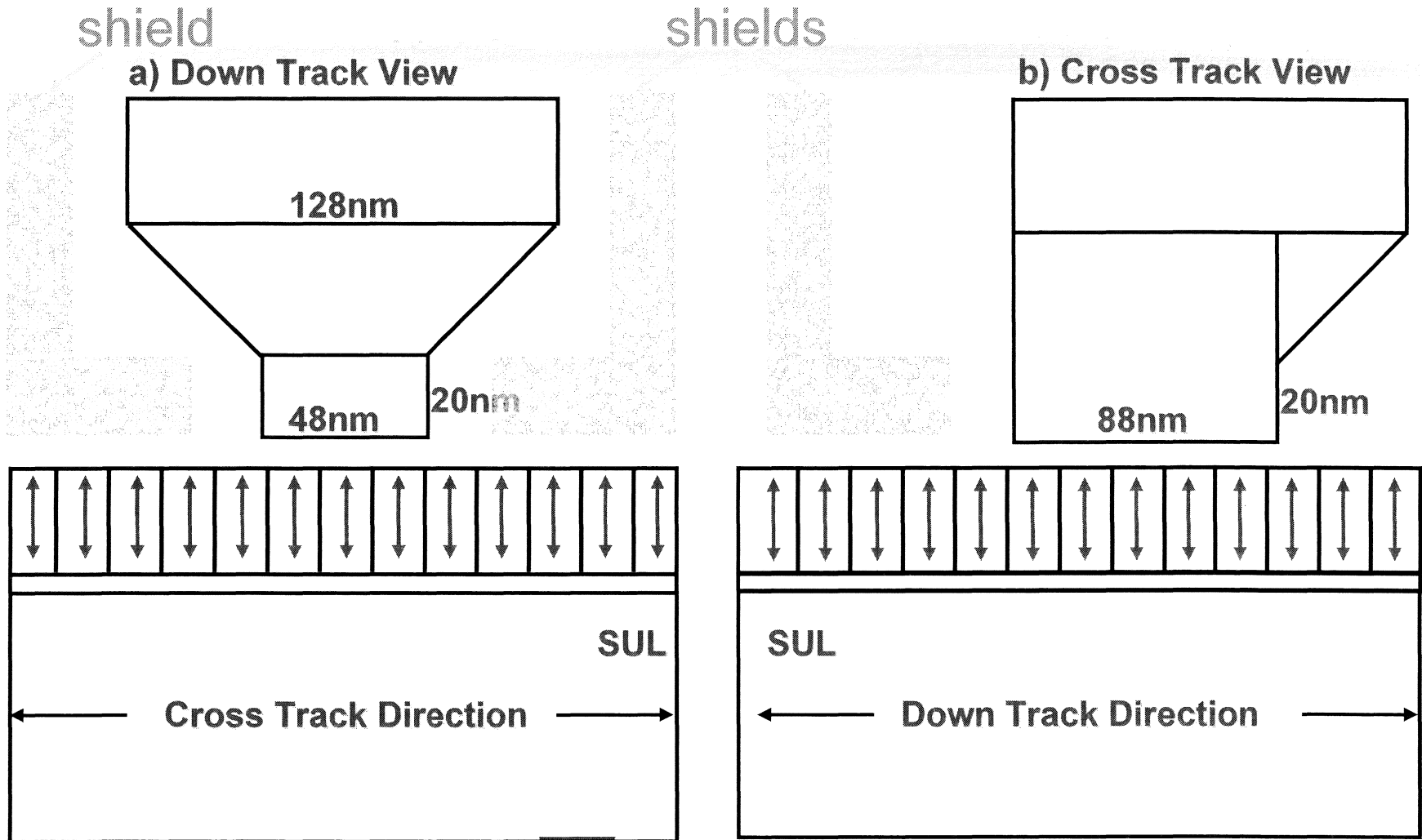

Switching Field and Overwrite Field

A Comparison Between CPR and TPR

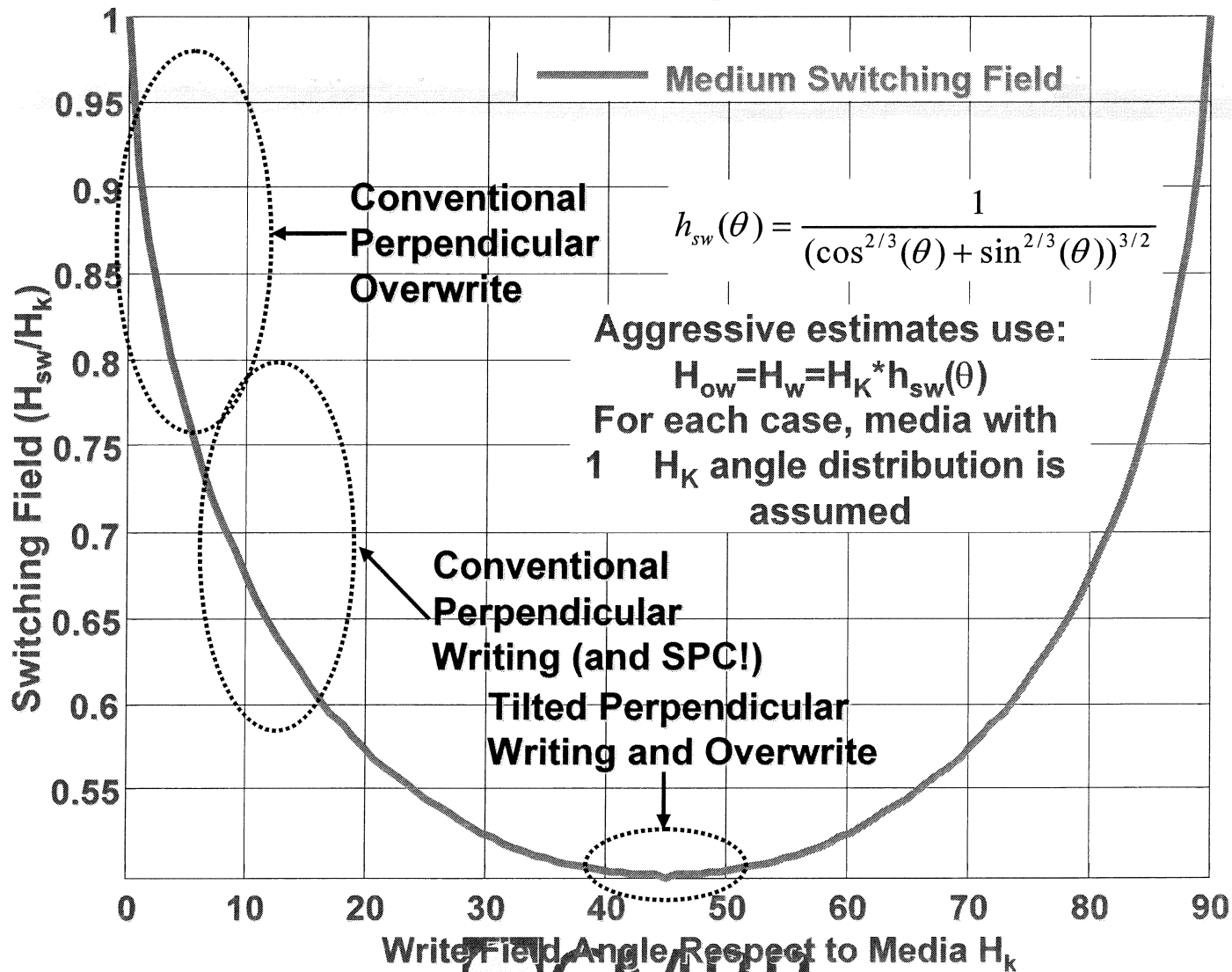

Tilted / Shielded pole

Track Edge Effect in TPR & SPR

— Single Pole Head Field — Field angle in TPR
- - Shielded Pole Head Field - - Field angle in SPR

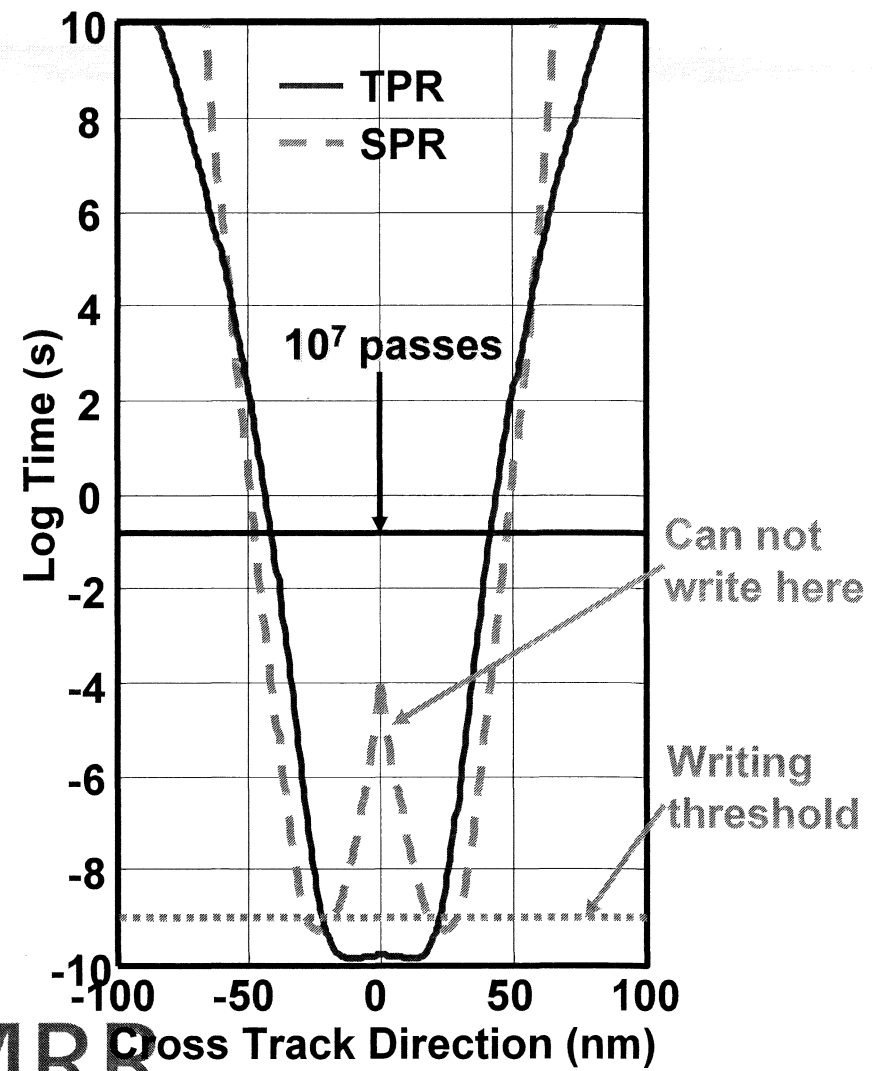
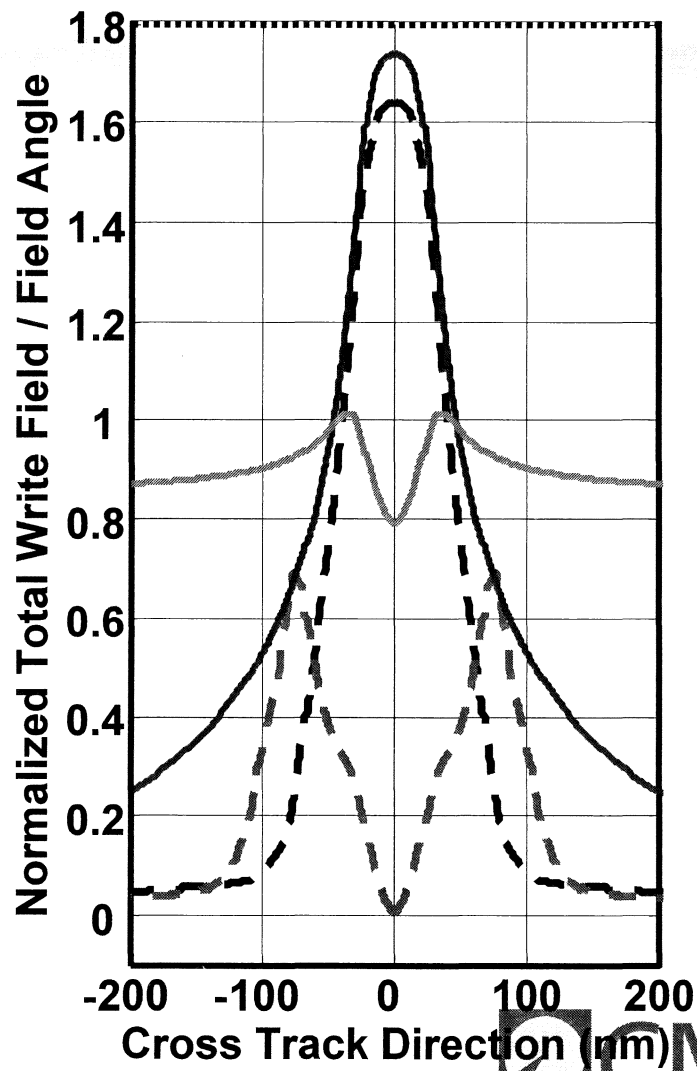

Guard Band vs. Medium $K_U V/k_B T$ [2,10]

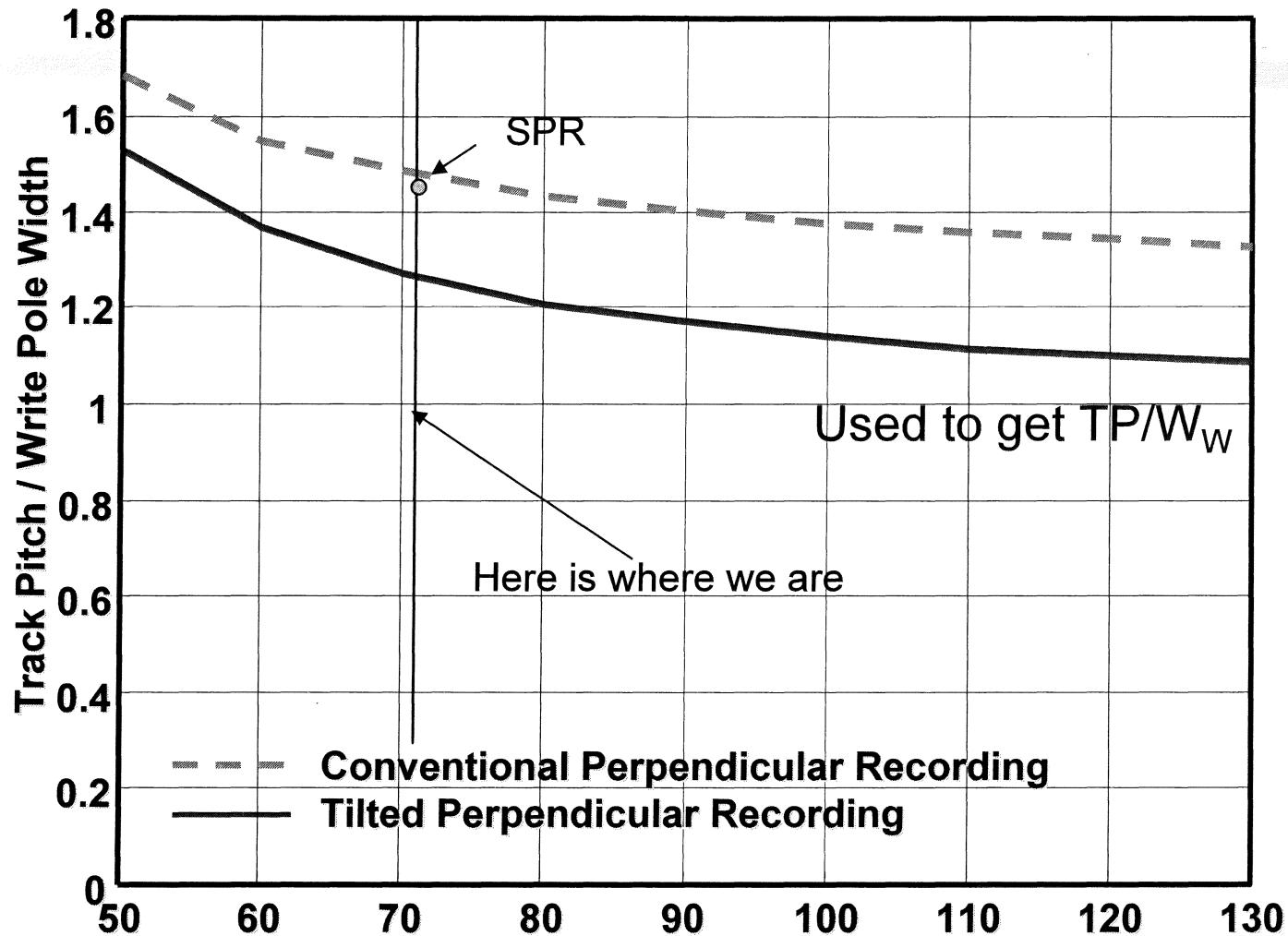

Ratio of DC to Transition Noise Power

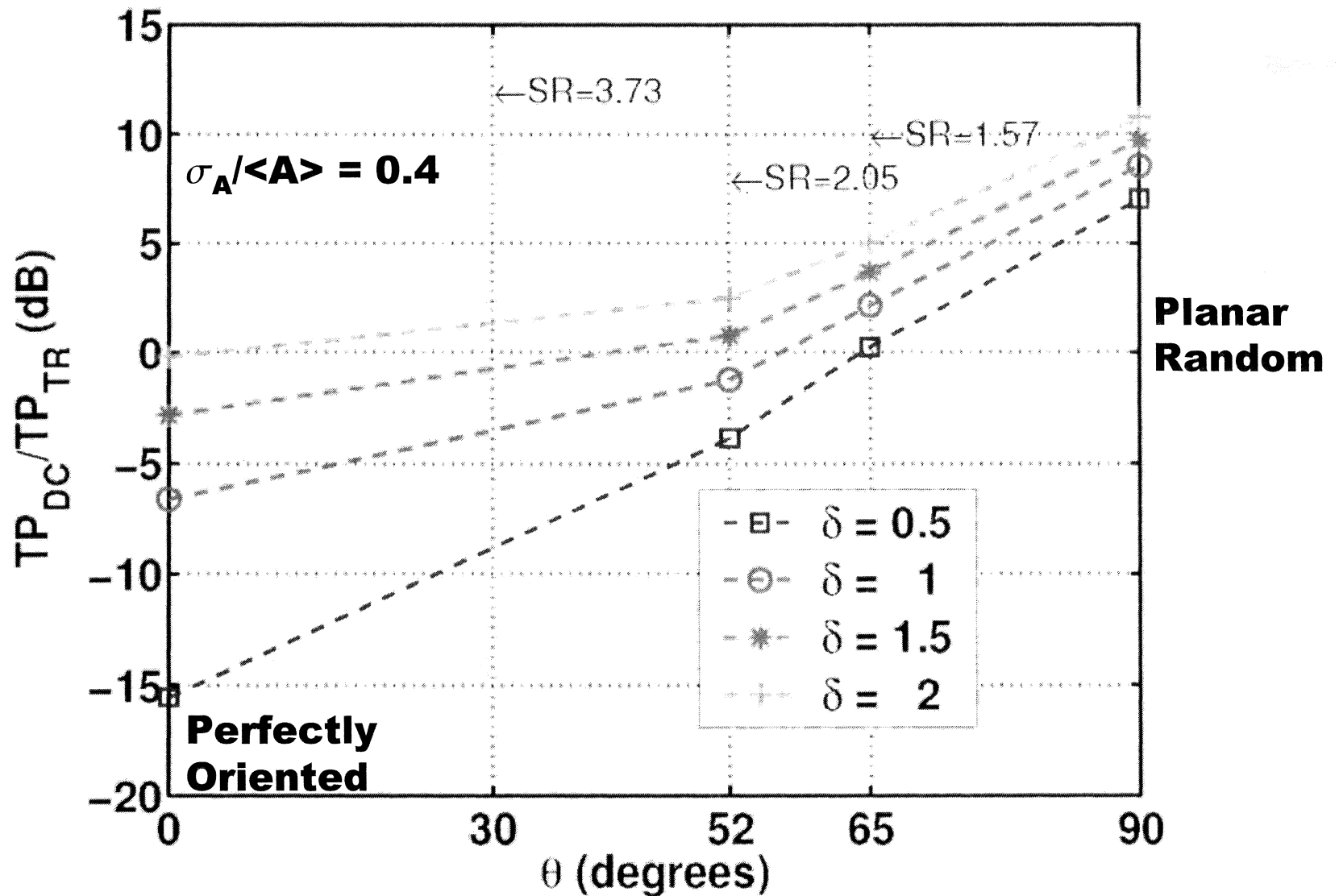

Percentage Jitter vs. Density for CPR, SPR and TPR

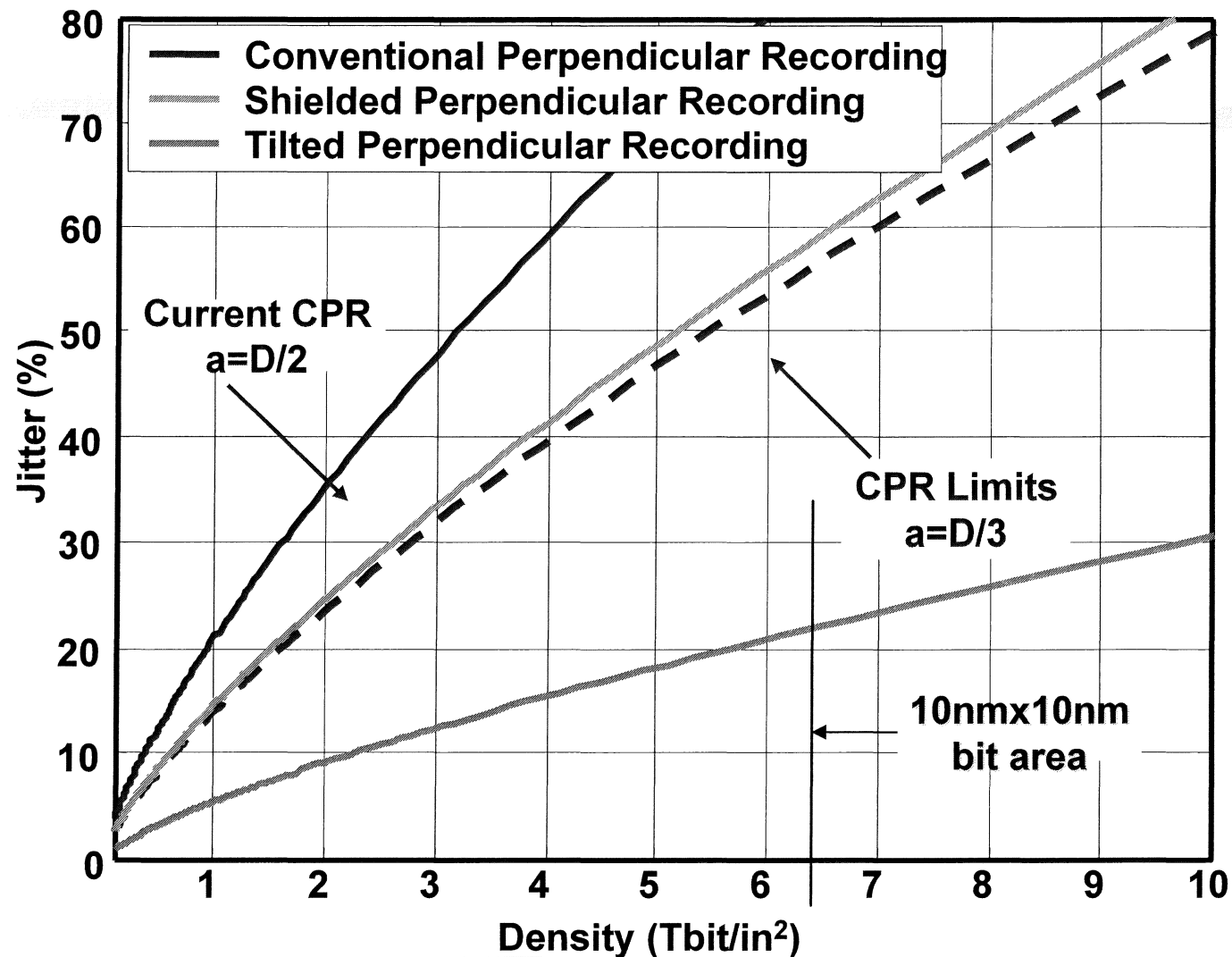

Effect of Distributions

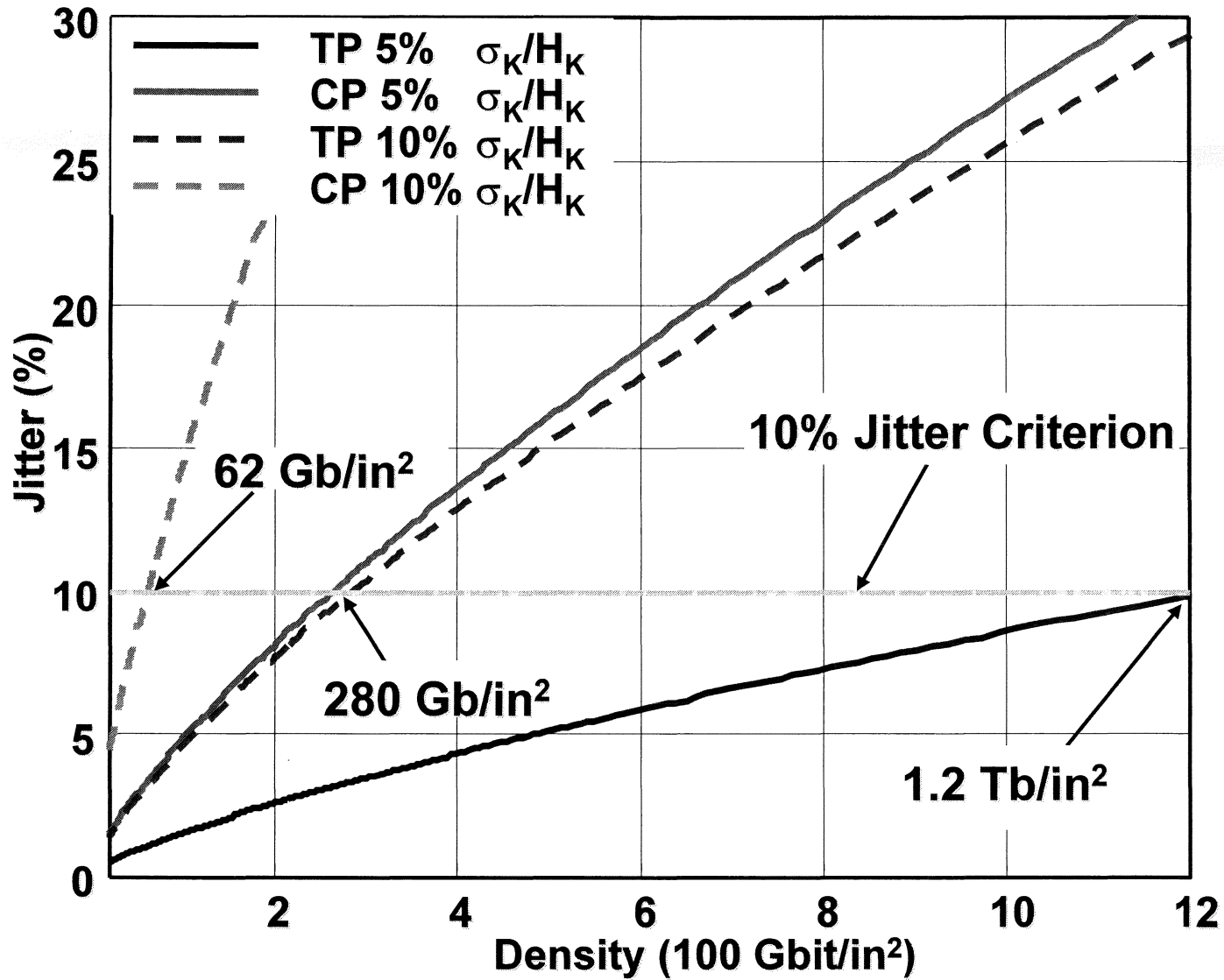

Conclusions and Future Work

- **To achieve 1000kfcu “a” parameter must be reduced to about 3-4nm (with minimal exchange ($s_{cr} = \langle D \rangle$)).**
- **Besides scaling geometry and keeping tight medium parameter distributions, reducing grain size is important. H_k should be increased as much as possible**
- **Ultra fast switching in small fields should be explored**

Selected References

- "Measurements and analysis of transition noise in perpendicular media." C. Fu, Z. Jin, H. N. Bertram, Y. Wu and D. Guarisco. *IEEE Trans. Magn.*, **39**(5), pp. 2606-2608, Sept. 2003.
- "Simple transition parameter expression including grain size and intergranular exchange." X. Wang and H. N. Bertram. *Journal of Applied Physics*, vol. **93**, no. 10, pp. 7005-7007, May 2003.
- "Write field analysis and write pole design in perpendicular recording." K. Gao and H. N. Bertram. *IEEE Trans. Magn.*, **38**(5), pp. 3521-3527, Sept. 2002.
- "Pulse shape, resolution and signal-to-noise ratio in perpendicular recording." B. Valcu, T. Roscamp and H. N. Bertram. *IEEE Trans. Magn.*, **38**(1), p. 288-294, January 2002.
- "Effect of crystallographic orientation on grain size distribution." B. Valcu, Y. Takahashi, H. N. Bertram. *Journal of Applied Physics*, vol. **92**, no. 10, pp. 6094-6098. November 1002.
- "SNR and density limit estimates: A comparison of longitudinal and perpendicular recording." H. N. Bertram and M. Williams. *IEEE Trans. Magn.*, **36**(1), p. 4, (2000).
- "Magnetic recording configuration for densities beyond 1 Tb/in² and data rates beyond 1 Gb/s." K. Gao and H. N. Bertram. *IEEE Trans. Magn.* **38**(6), pp. 3675-3683, Nov. 2002.

Session II:
Perpendicular Media Technology

10:10-10:40am

Gerardo Bertero, Komag

“Granular Oxide Perpendicular Magnetic Recording Media”

Perpendicular recording drives are finally at the verge of being commercialized. Much progress has been made in all aspects of the technology. In particular, perpendicular media has improved significantly over the last two years with marked gains in SNR and thermal decay performance. Much of this progress has been possible thanks to the introduction of granular, oxide segregated magnetic layers providing high squareness, exchange decoupled grains, large negative nucleation fields and good thermal decay properties. Similarly, much progress has been made at the soft magnetic underlayer level with alloys and structures that minimize the effects of magnetic domain transitions present in the soft magnetic film. However, much remains to be done both at the media level itself and also in optimizing particular head and media combinations. In this talk, we will review the major characteristics of granular oxide perpendicular media focusing on structural and magnetic properties. We will also, highlight the progress made and will discuss the major obstacles that limit our ability to achieve much higher performance.

10:40-11:10am

Dr. Gunn Choe, MMC Technology

“Perpendicular Recording Media: Technical and Manufacturing Challenges”

Perpendicular magnetic recording (PMR) is considered the most likely candidate to replace longitudinal recording to sustain the continuous growth in data storage capacity. In order to achieve good recording performance, PMR media require very stringent structural and magnetic properties such as reduced magnetic grain size and distribution, low inter-granular exchange coupling, good crystallography of Co c-axis, narrow anisotropy distribution and domain-free soft magnetic underlayer (SUL). An oxygen doped magnetic alloy, CoPtCrO has been considered as a recording layer for PMR media and has been extensively explored in terms of recording performance and manufacturable process. CoPtCrO media exhibit excellent recording performance and show great potential for high-density perpendicular recording. A high-throughput PMR disk manufacturing process is vital to make cost effective PMR media equivalent to current longitudinal disks. Optimum SUL design is necessary to accommodate a SUL thickness as low as 100 nm, which is critical in making low cost PMR media with existing sputtering equipment. First or second generation PMR media can be fabricated by current longitudinal media production system without significantly affecting throughput.

11:10-11:40am

Hiroyuki Uwazumi, Fuji Electric

“The Perpendicular Recording Media with an Electroless-Plated Ni-P Soft Magnetic Underlayer”

An electroless-plated ferromagnetic Ni-P layer, which is suitable for mass production, was employed as a soft magnetic underlayer(SUL) for a double-layered perpendicular recording media. A Ni-P SUL with the thickness range from 1.5 to 3.0 micro-meter was plated on the Al substrate then the surface of the Ni-P SUL was polished about 1 micro-meter to obtain a smooth surface with a roughness Ra of less than 0.3 nm. The saturation flux density B_s and the in-plane coercivity H_c for the Ni-P SUL were about 0.5 T and 15 ~ 20 Oe, respectively. Media with a Ni-P SUL at the thickness of more than 0.5 micro-meter showed almost same magnetic properties and recording performances as a medium with a 200 nm-thick sputtered CoZrNb SUL. Furthermore, the spike noise commonly observed from an SUL was not found for the media with the Ni-P SUL in this study, indicating great potential of the electroless-plated ferromagnetic Ni-P layer as the SUL of the perpendicular recording media.

11:40-12:10am

Bob Weiss, Intevac

“Equipment Technology for Perpendicular Recording”

12:10-1:10pm

Lunch

*IDEMA – Perpendicular Recording Symposium -
- February 26, 2004*

Granular Oxide Perpendicular Magnetic Recording Media

Gerardo Bertero, David Wachenschwanz,
Wen Jiang, Sudhir Malhotra, Sam Velu

Komag, Inc.

1710 Automation Parkway, San Jose, CA

KOMAG

Initial Remarks

- ***Most drive companies have official perpendicular recording drive programs.***
- ***Performance on par or exceeding LMR.***
Targeted generally for ~160 Gb/in² and higher.
- ***PMR technology is just as hard (or harder) compared to LMR.***
- ***SNR gain is still badly needed for first generation programs.***

***How many more generations will use “conventional”
PMR ??***

Outline

- ┌ **Main structural features of state-of-the-art granular, oxide segregated media.**
- ┌ **Hard layer features.**
- ┌ **Soft magnetic underlayer.**
- **SNR Progress.**
- **Main Challenges.**
- **Summary.**

Why Granular PMR Media?

■ *Media Noise*

- ◆ **Of all the candidates, granular media offers the easiest way to achieve low noise while maintaining other desirable properties.**

Familiarity

The manufacturing methods are extensions of current (or recent) technologies.

Manufacturability

- ◆ **Moderate heating or room-temperature processes, possible to make using current equipment. Higher throughput potential.**

CoCrPt-Oxide Perpendicular Media Structure⁵

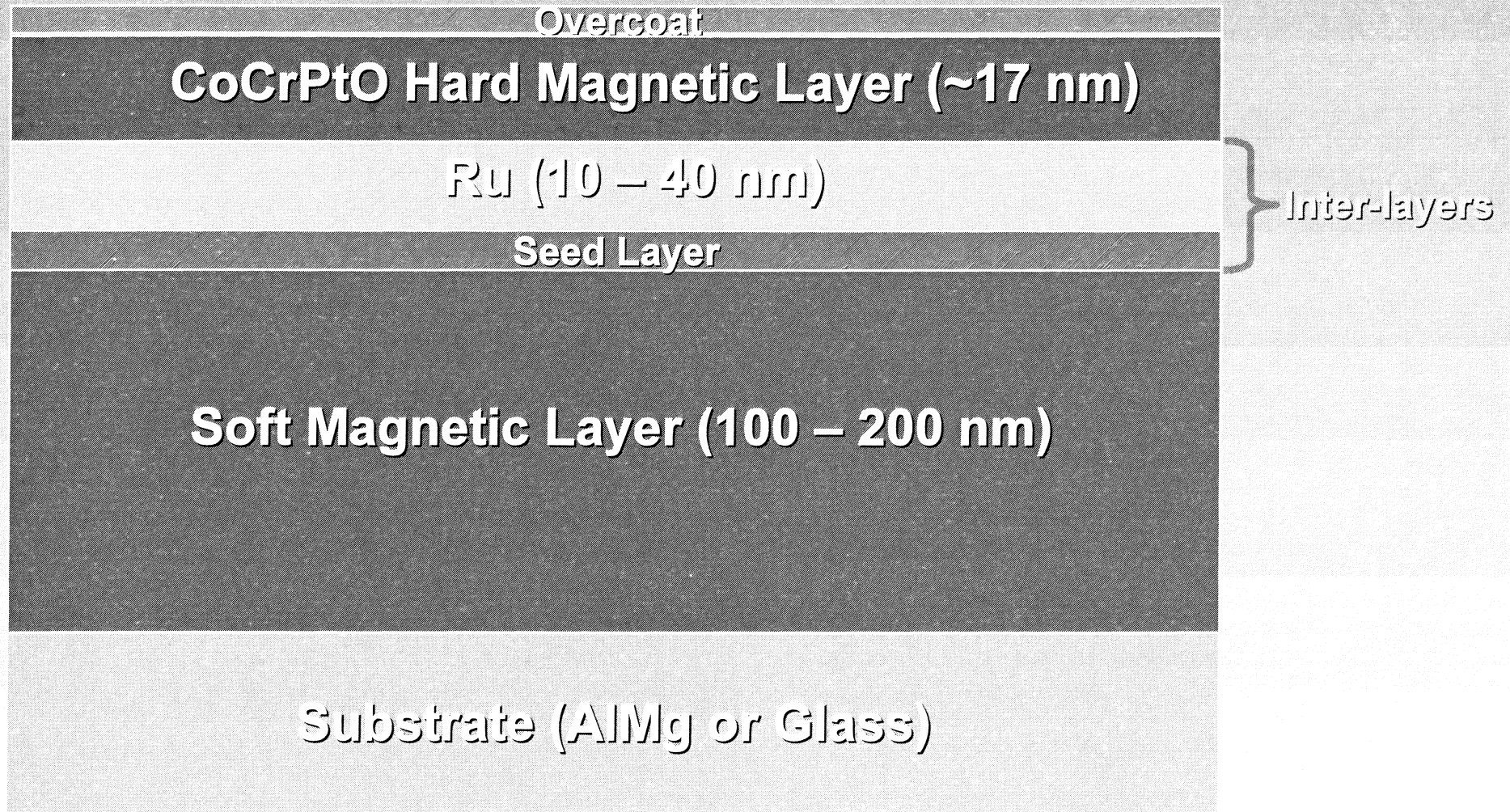

TEM micrograph of CoCrPt-Oxide Media

6

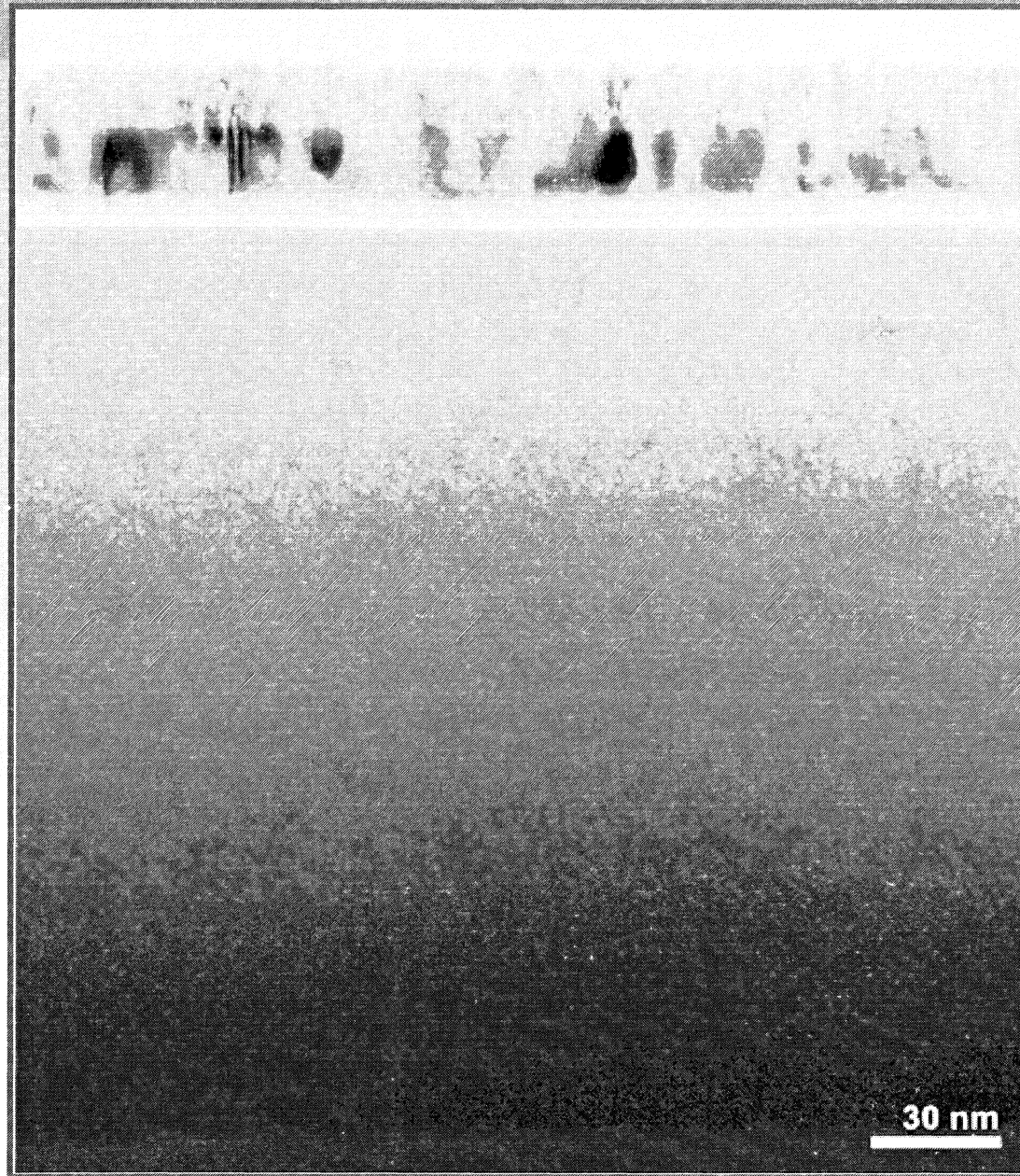

CoCrPtO

Ru

← Seed Layer

SUL

30 nm

KOMAG

CoCrPtO Kerr Magnetometer Loop and Amplitude Decay Results

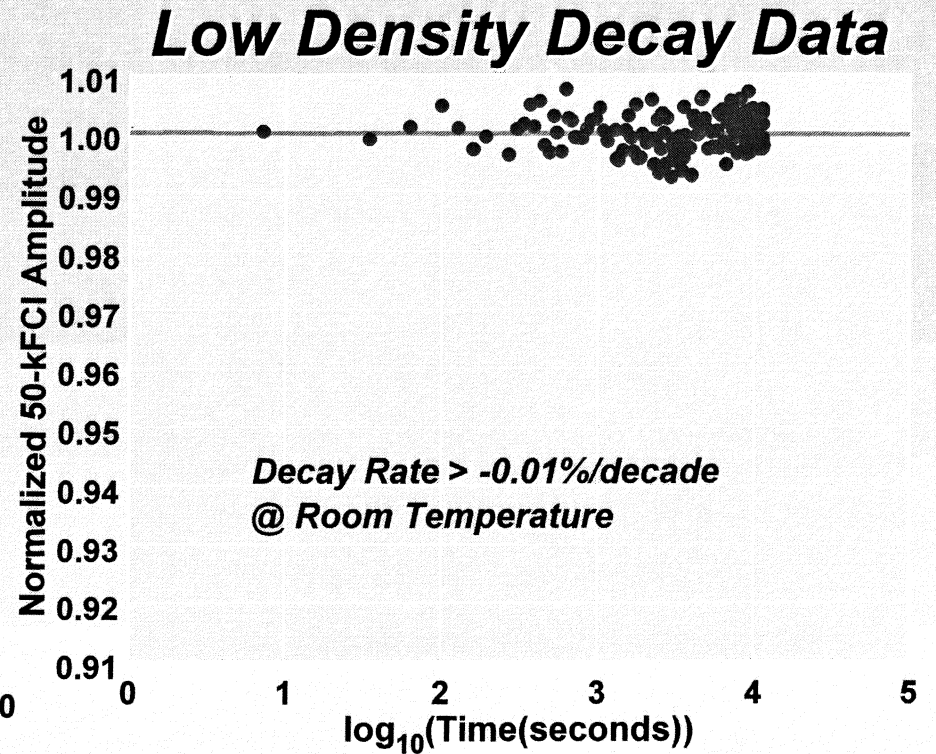
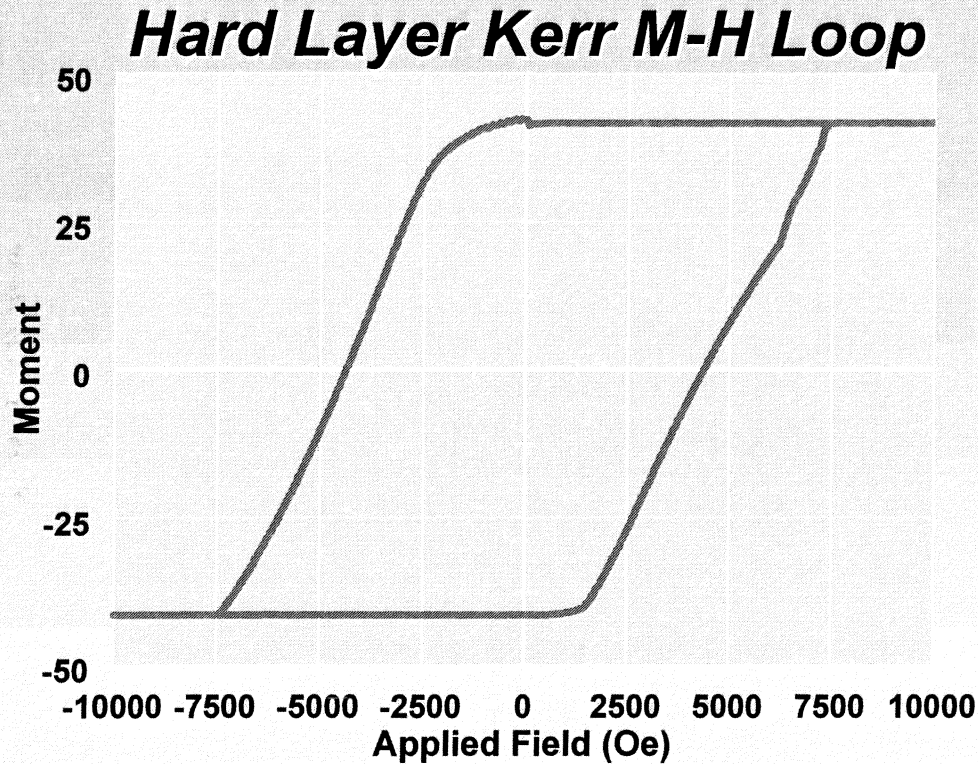

$$|H_{nucleation}| \geq 2 \text{ kOe}$$

Plan-view Bright Field TEM Image & SADP

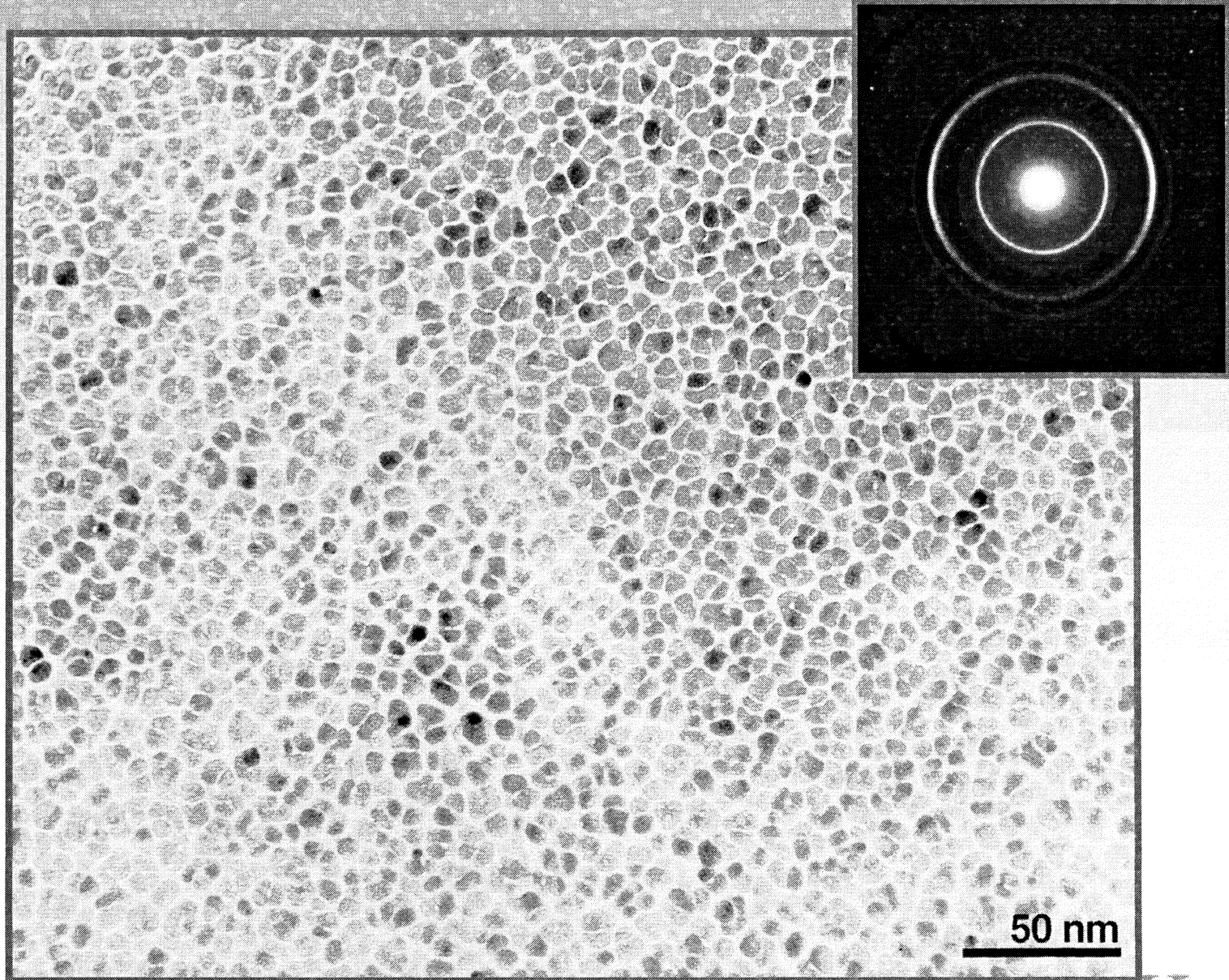

Grain Size Data

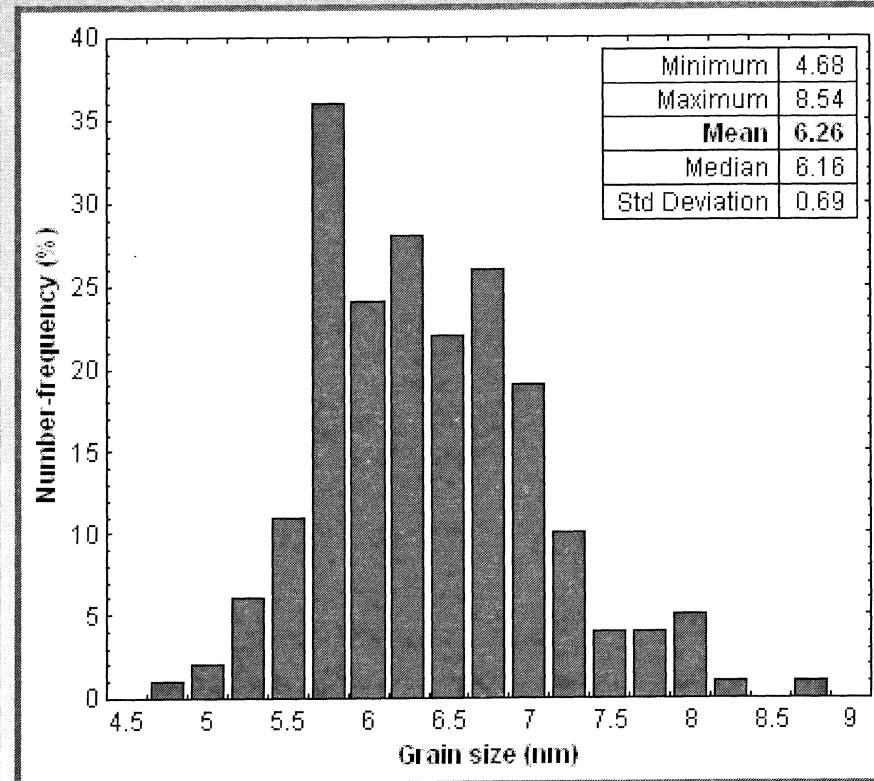
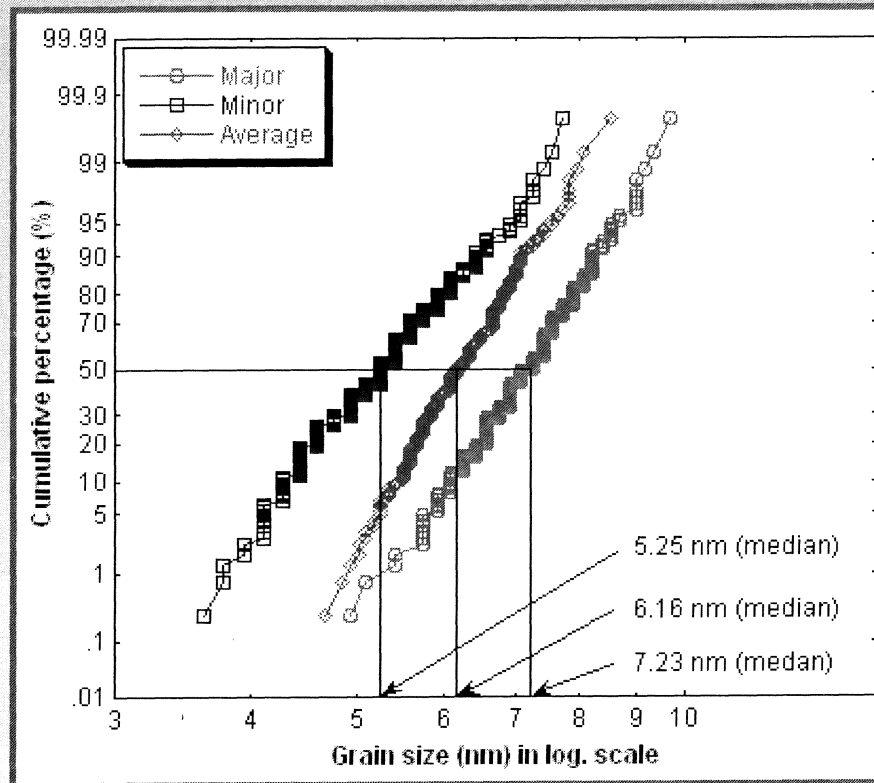

Grain size and standard deviation

Major axes

$7.19 \pm 0.86 \text{ nm}$

Minor axes

$5.33 \pm 0.83 \text{ nm}$

Average grain size

$6.26 \pm 0.69 \text{ nm}$

Magnetic Cluster Size

*This is what matters to recording
~100nm here (many grains)
not real!*

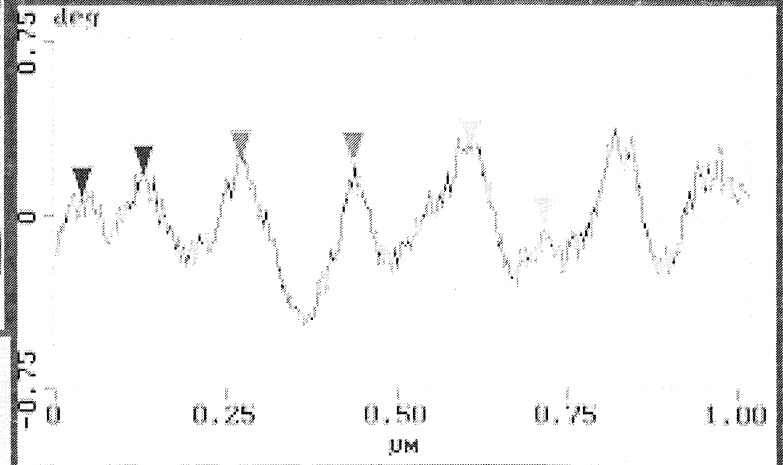
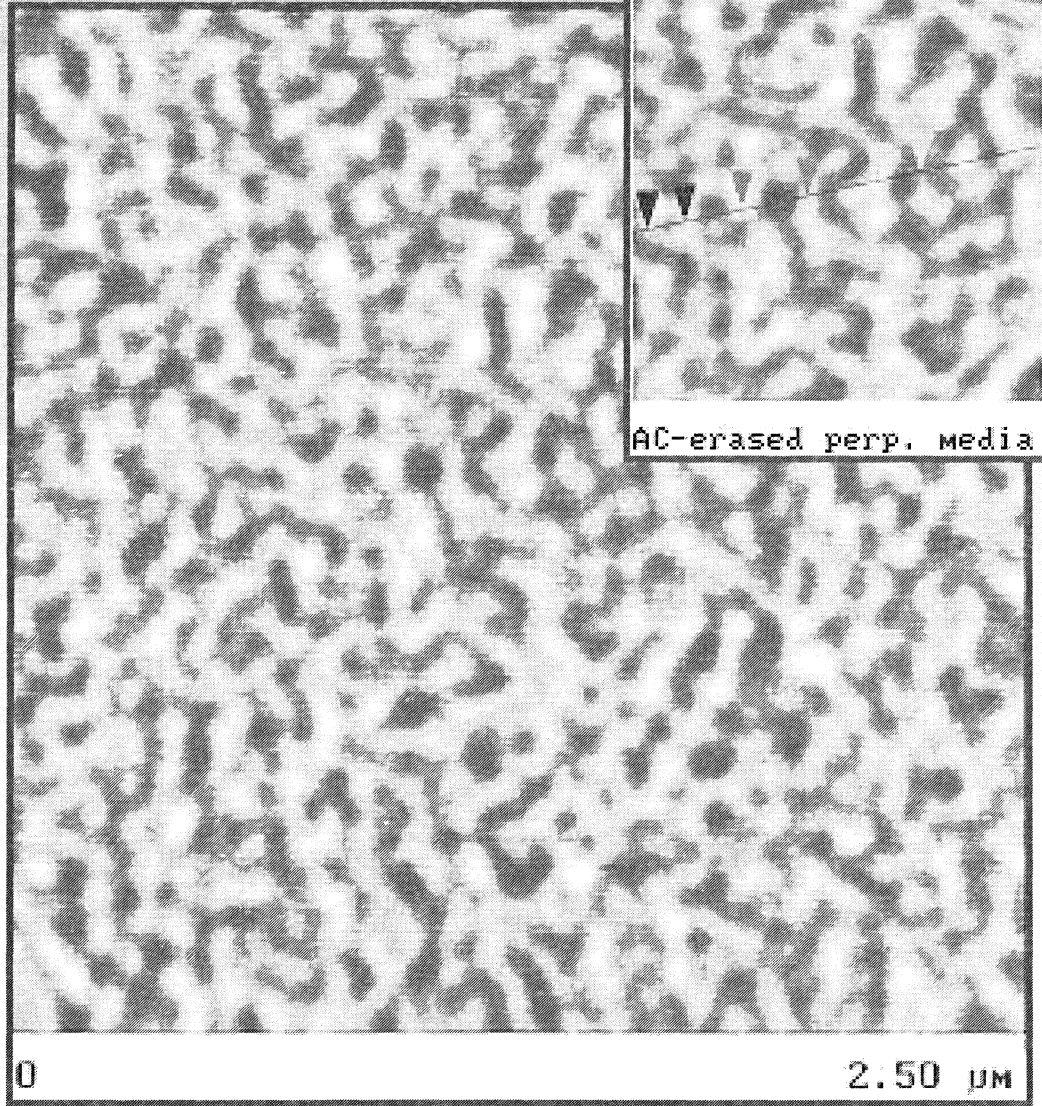

Horiz distance	89.844 nm
Horiz distance(1)	161.06 nm
Horiz distance	109.333 nm

Cross-section High Resolution TEM Image

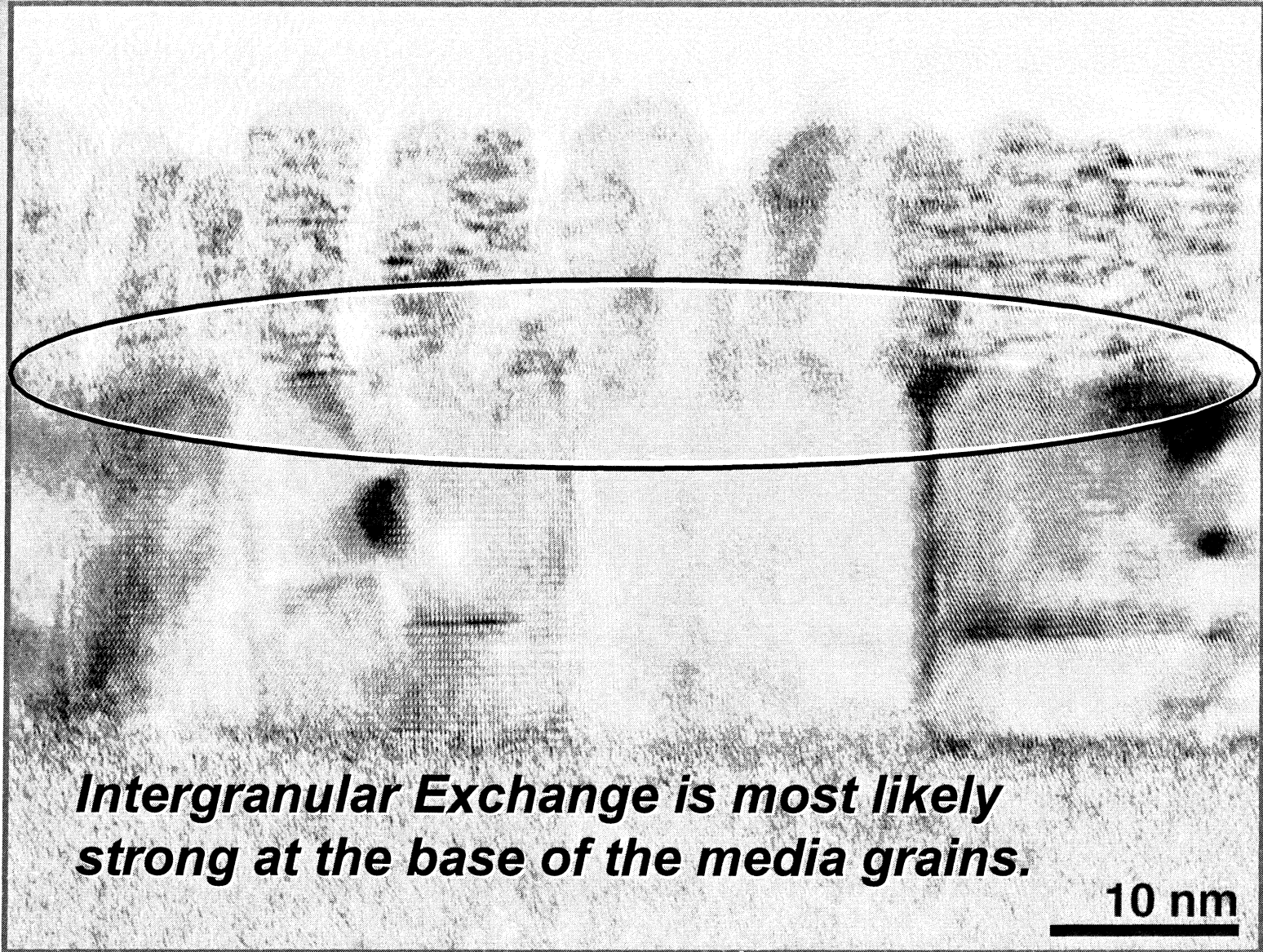

- problems w/ nucleation layer

Intergranular Exchange is most likely strong at the base of the media grains.

10 nm

Ru Interlayer Grain Size and Morphology

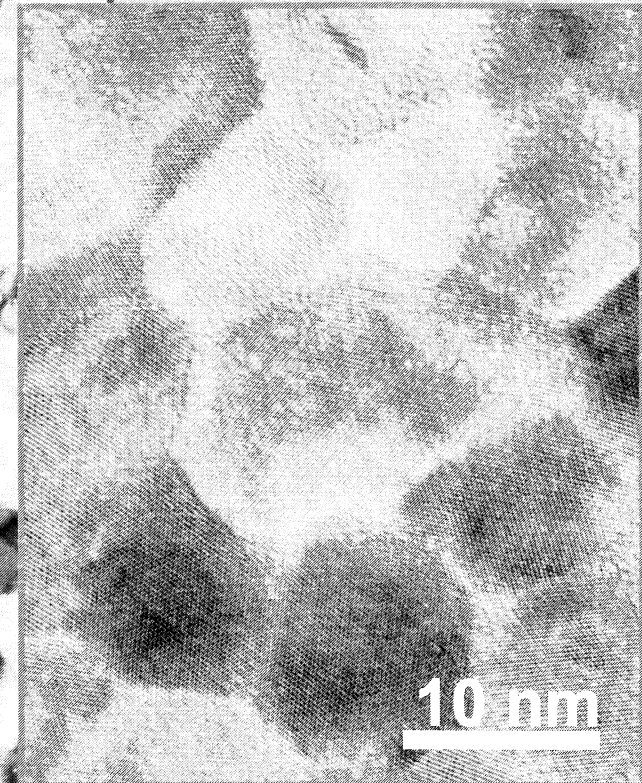
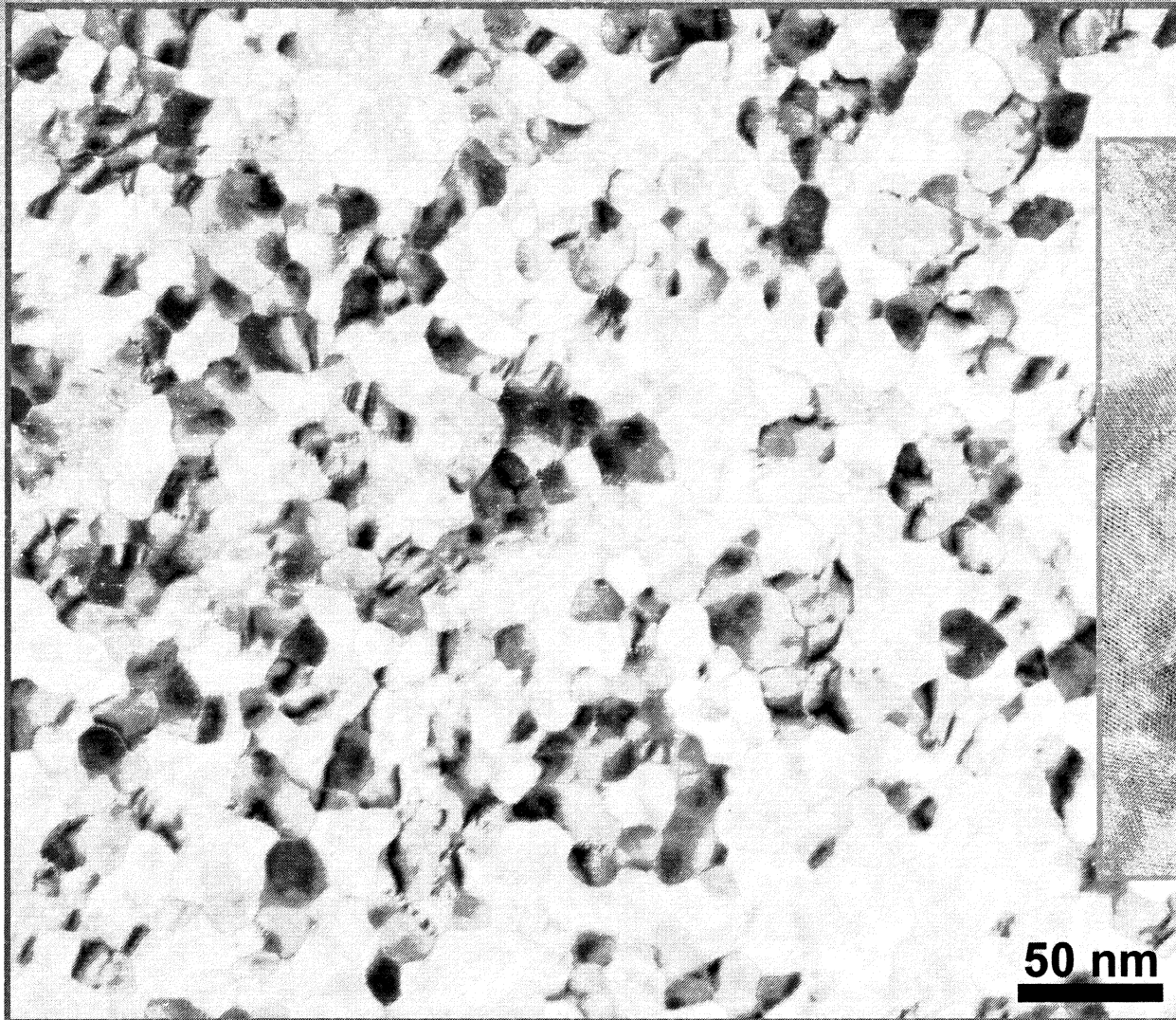

*- likely grain coalescence
when similar orientation*

Ru Grain Size and uniformity need to improve

KOMAG

Hysteresis Loops & Domain Images of SUL

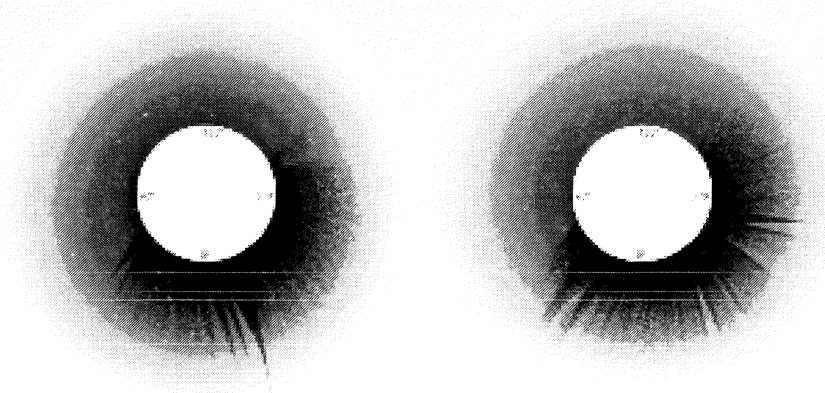
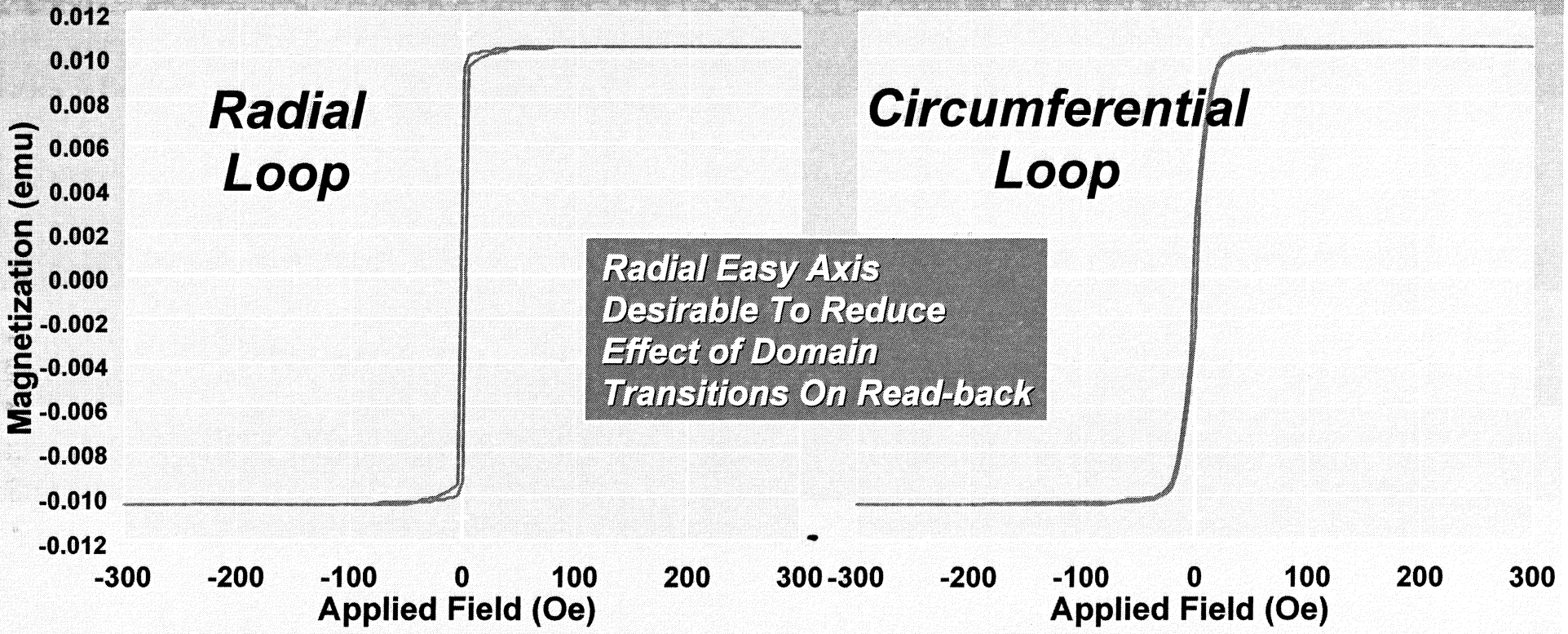

- came naturally w/ sputter magneton fields

AF (Anti-Ferromagnetically) Coupled SUL

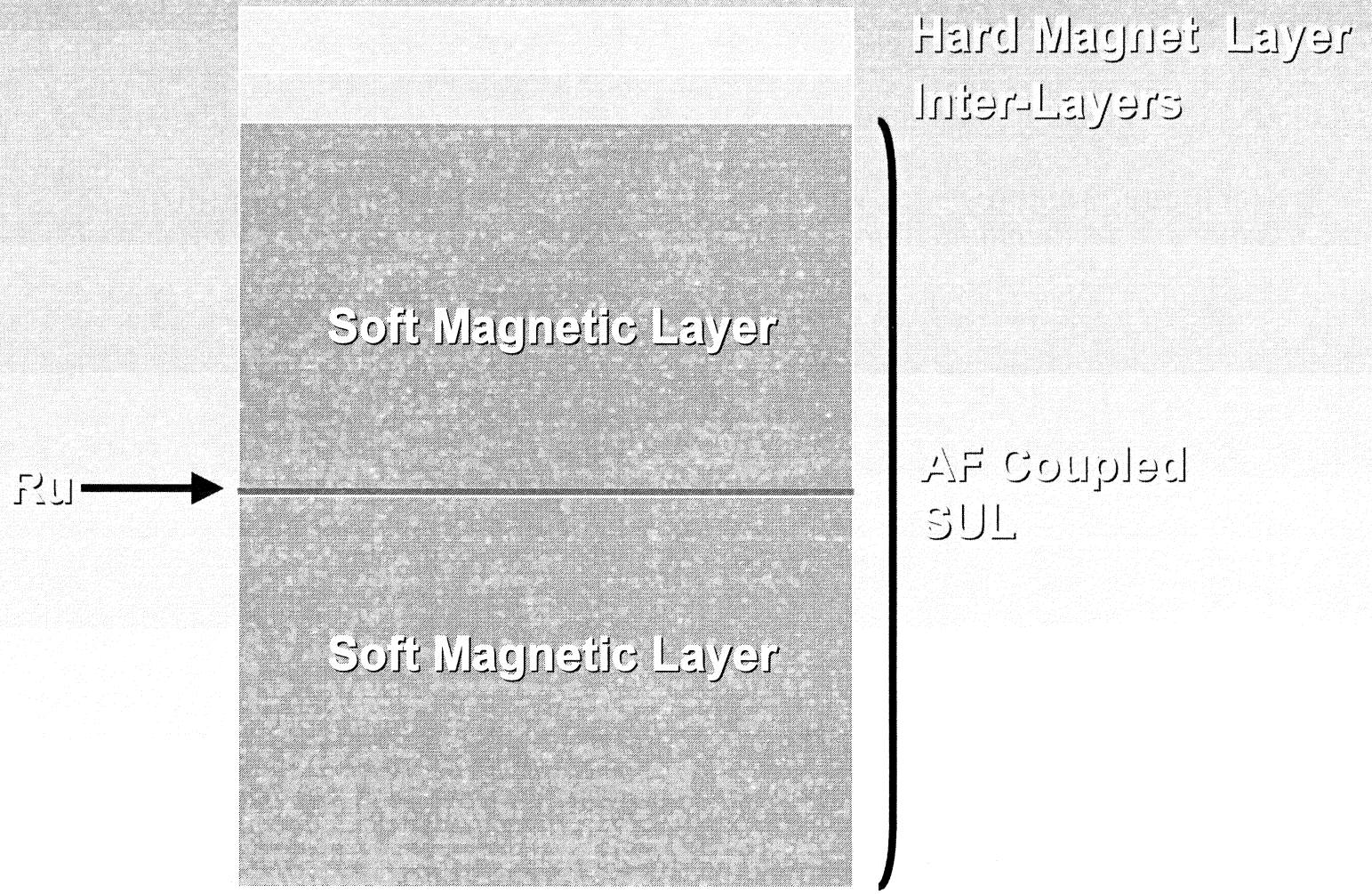

Layer Thickness

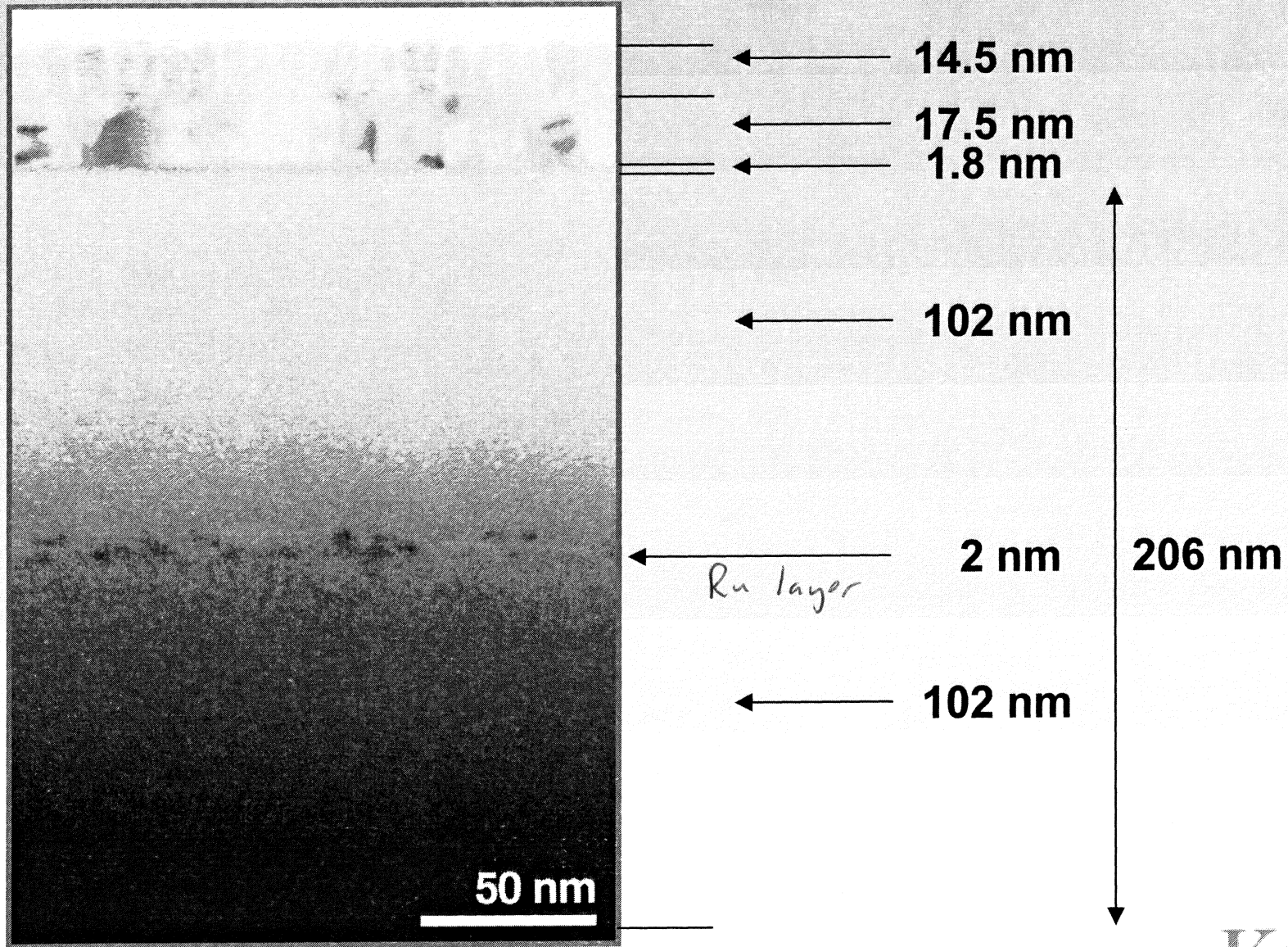

Hysteresis Loops & Domain Images of AF-Coupled SUL

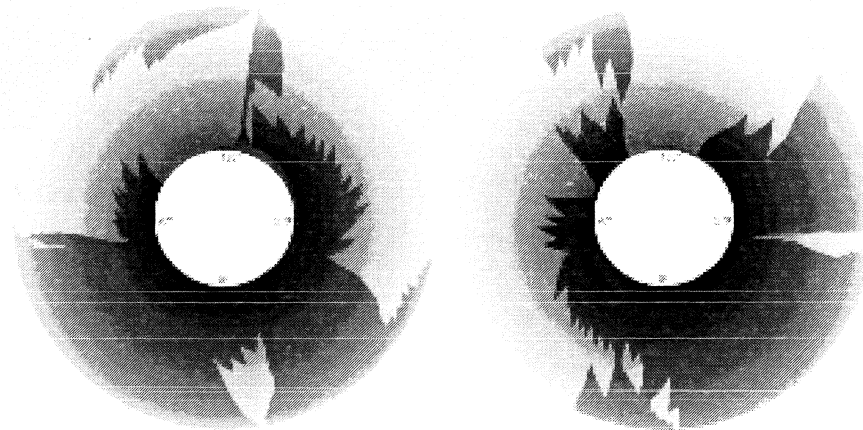
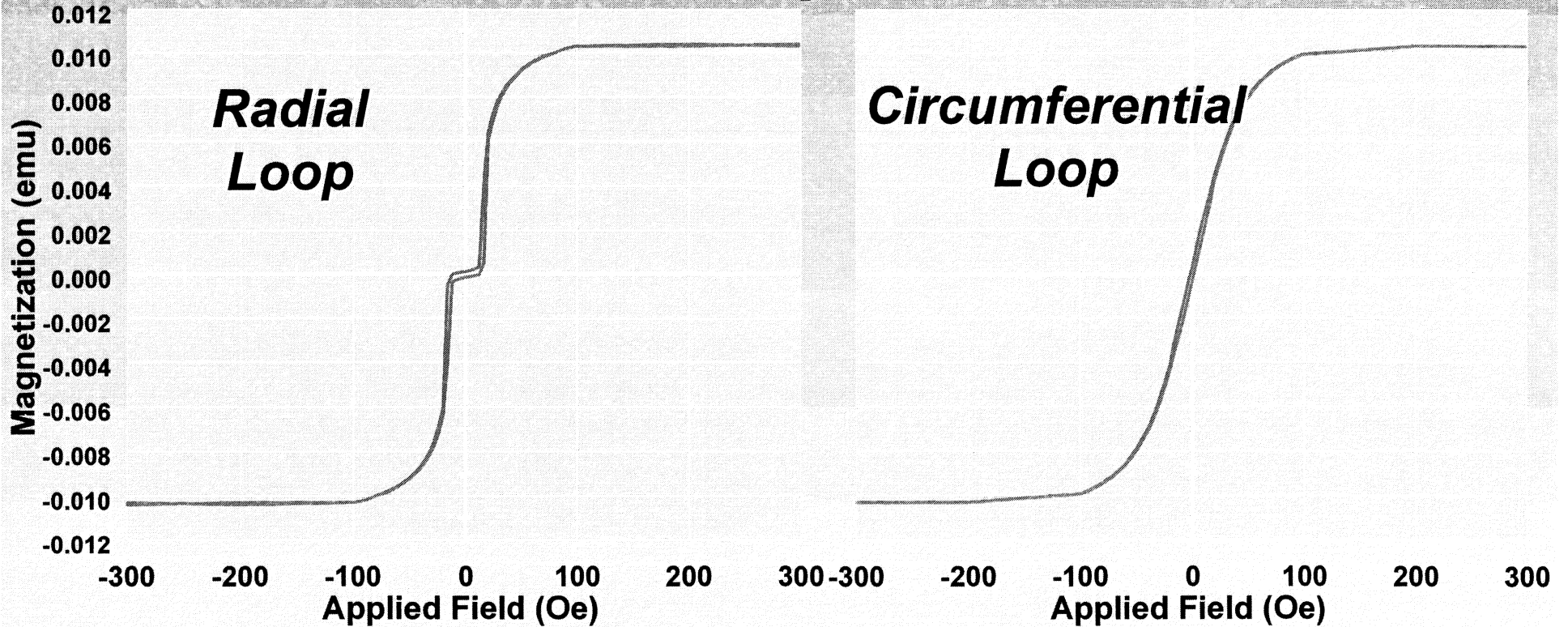

- lower frequency domains

Multi-Layered AF-Coupled SUL

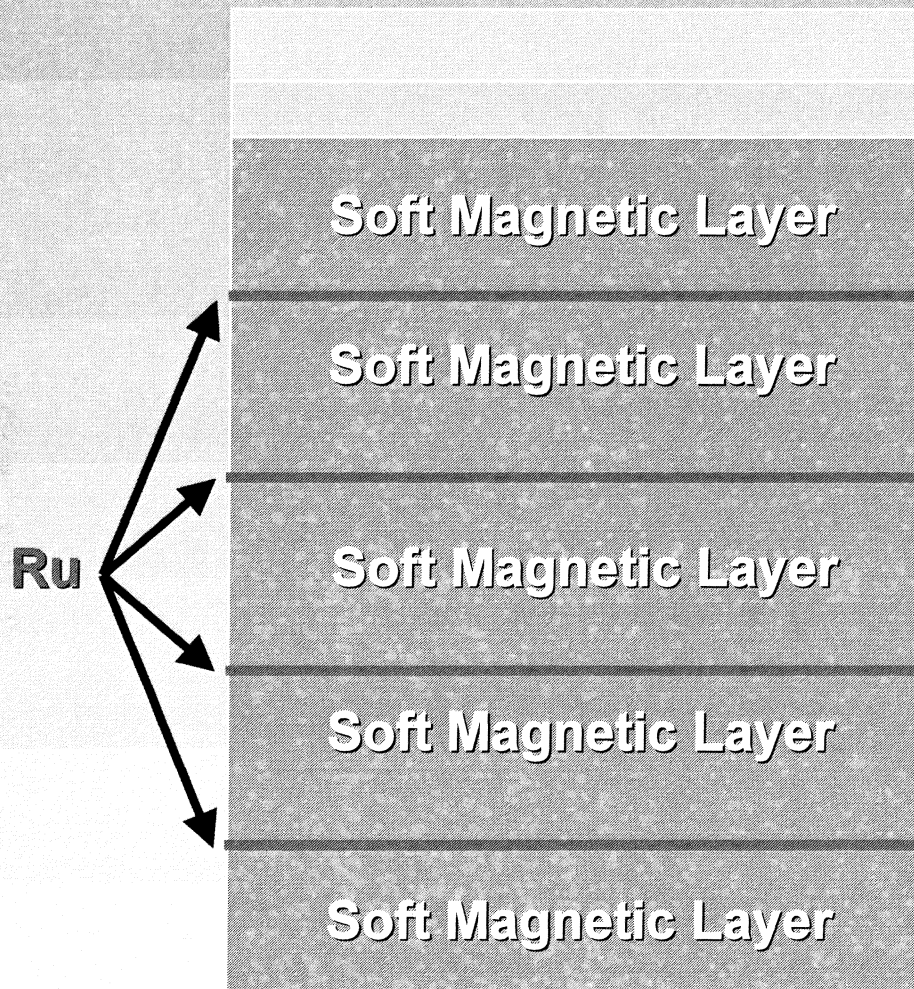

Hard Magnet Layer
Inter-Layers

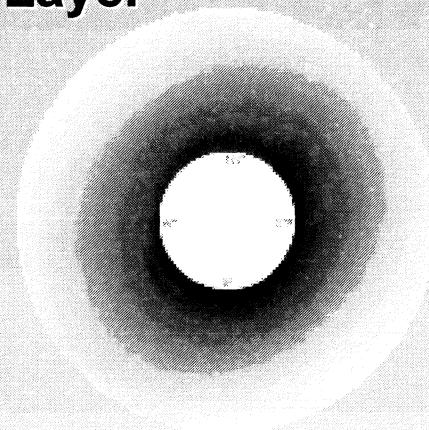

AF Coupled
SUL

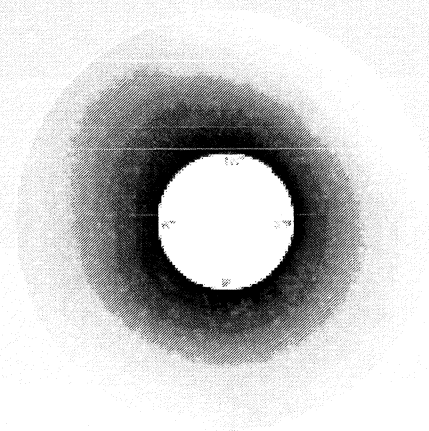

- limited by # chambers in systems.

SNR Progress In Perpendicular Media

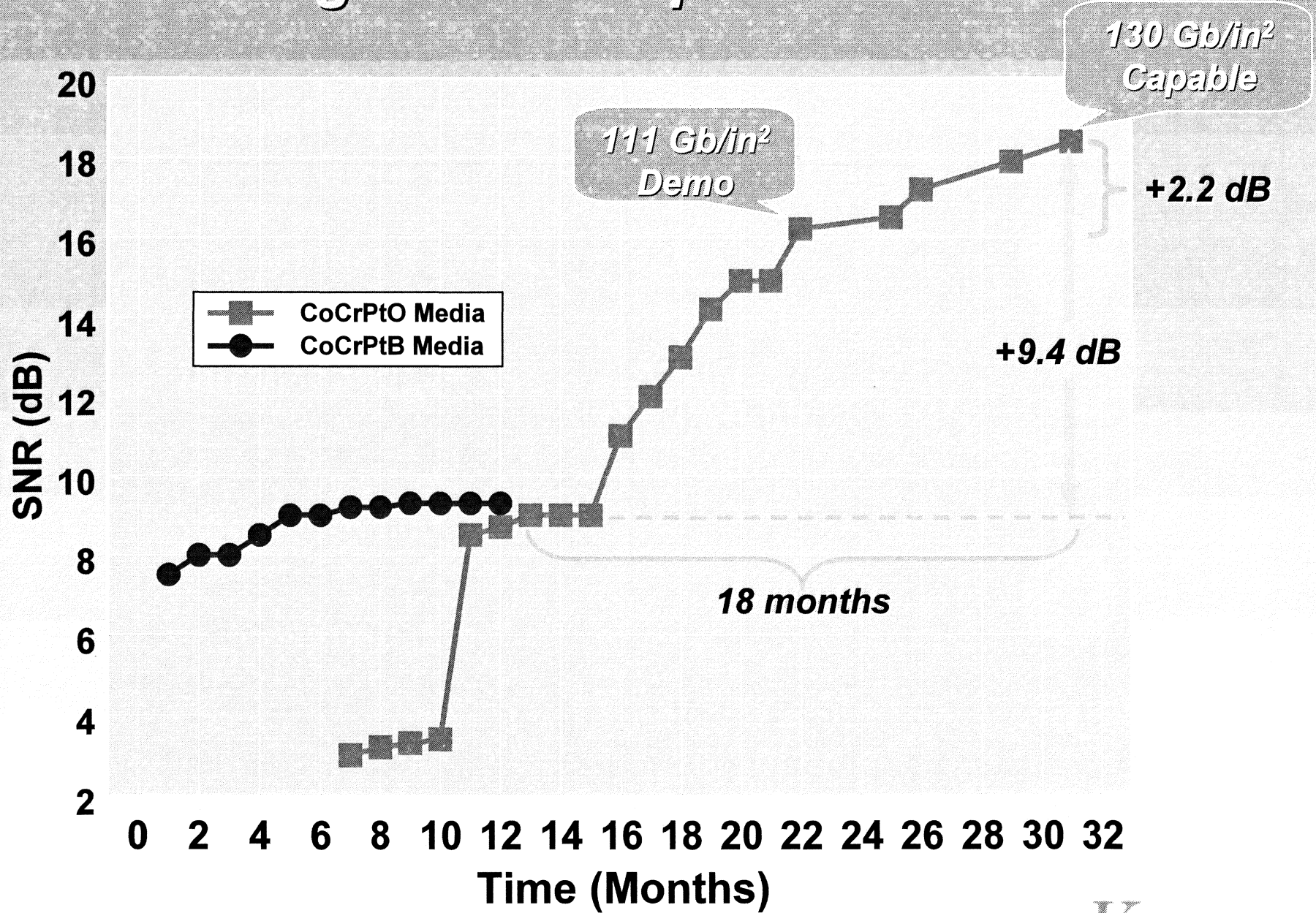

Shielded Pole Writer vs. Single Pole Writer¹⁹

Recording Performance Strongly Dependent on Head

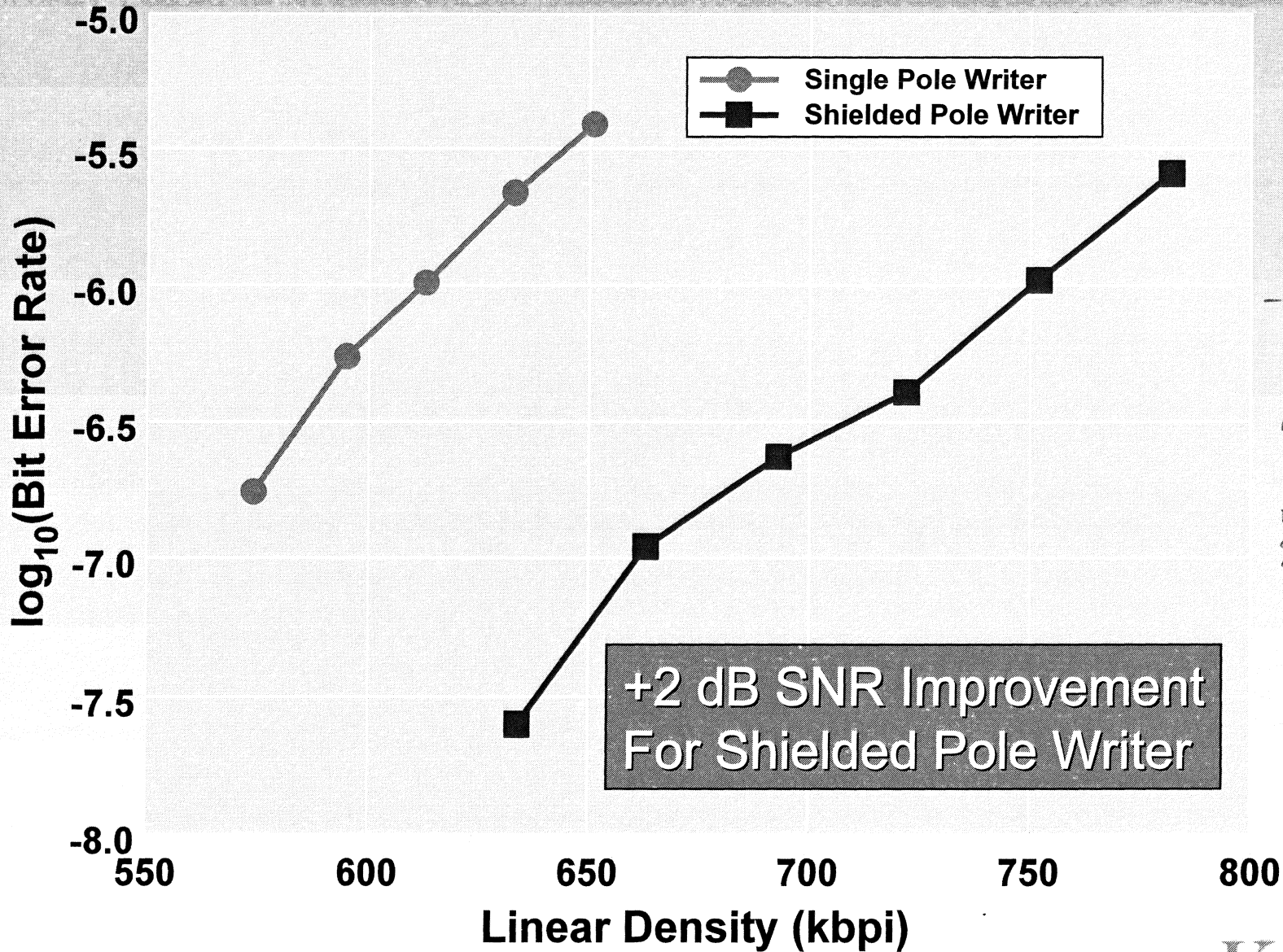

Different media optimization differences reduce Mason Williams 4dB improvement reduced to 2dB improvements

+2 dB SNR Improvement For Shielded Pole Writer

1000 kbpi Linear Density Using PMR Media

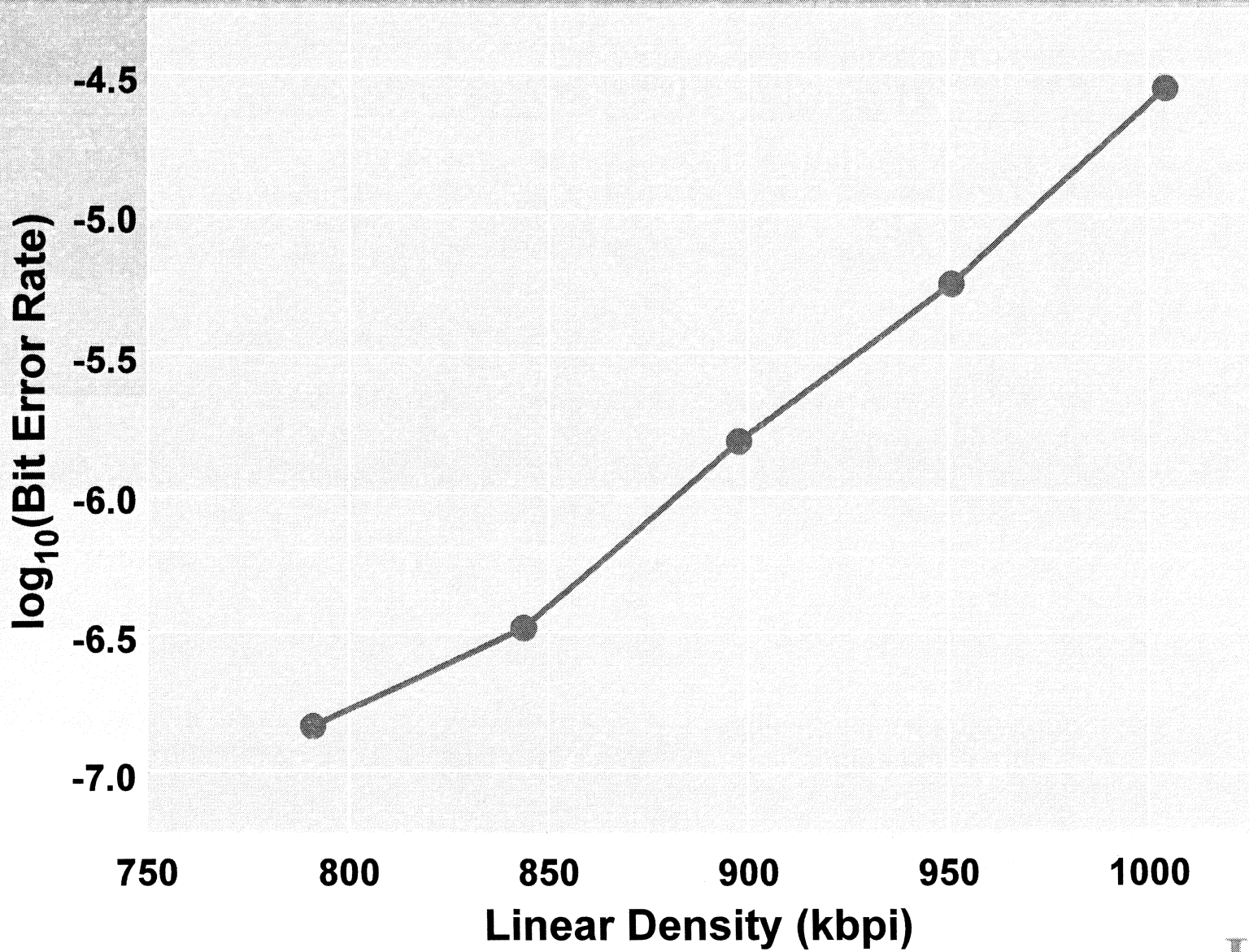

MFM Image of CoCrPtO PMR Medium

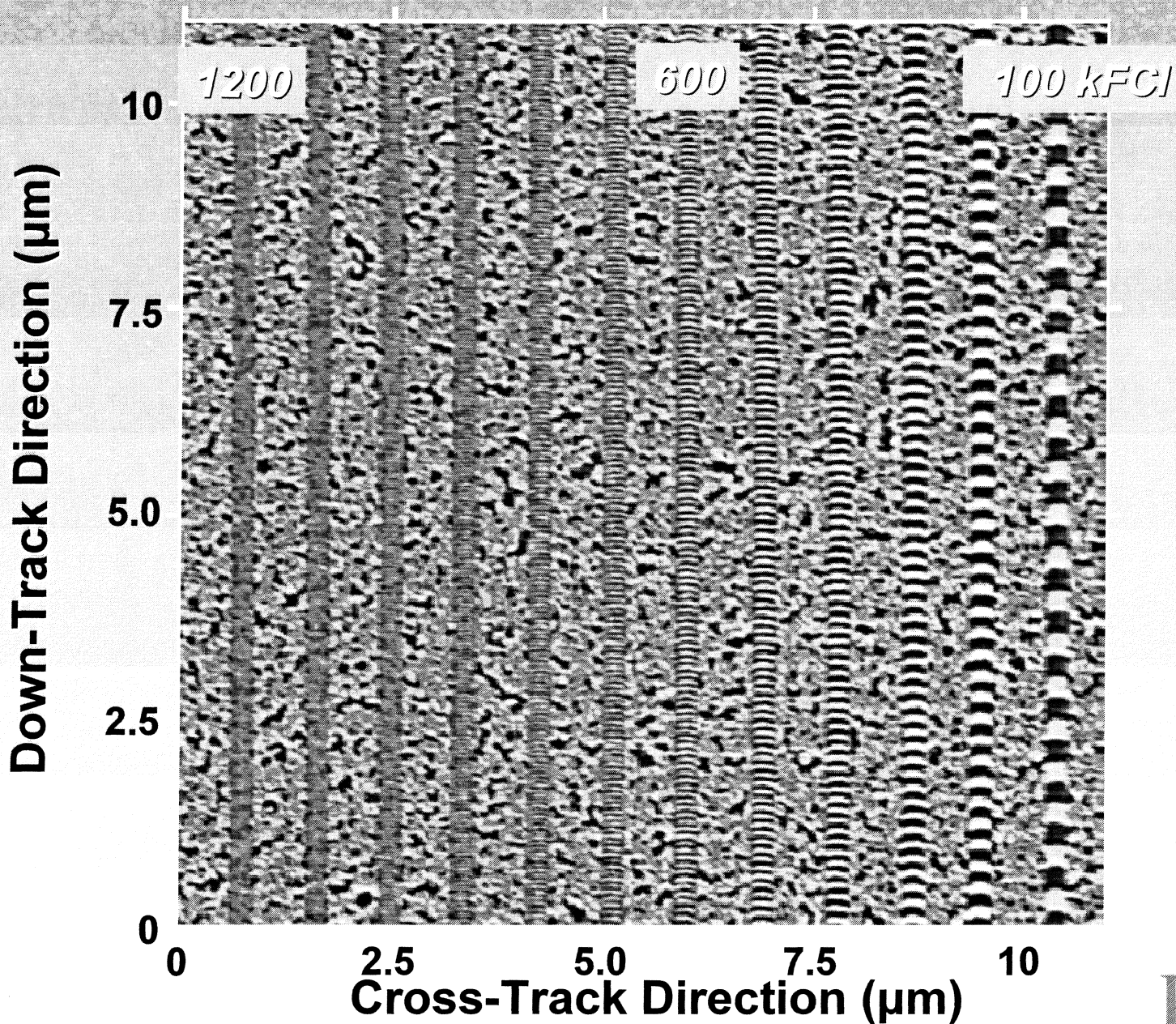

MFM Image of CoCrPtO PMR Medium

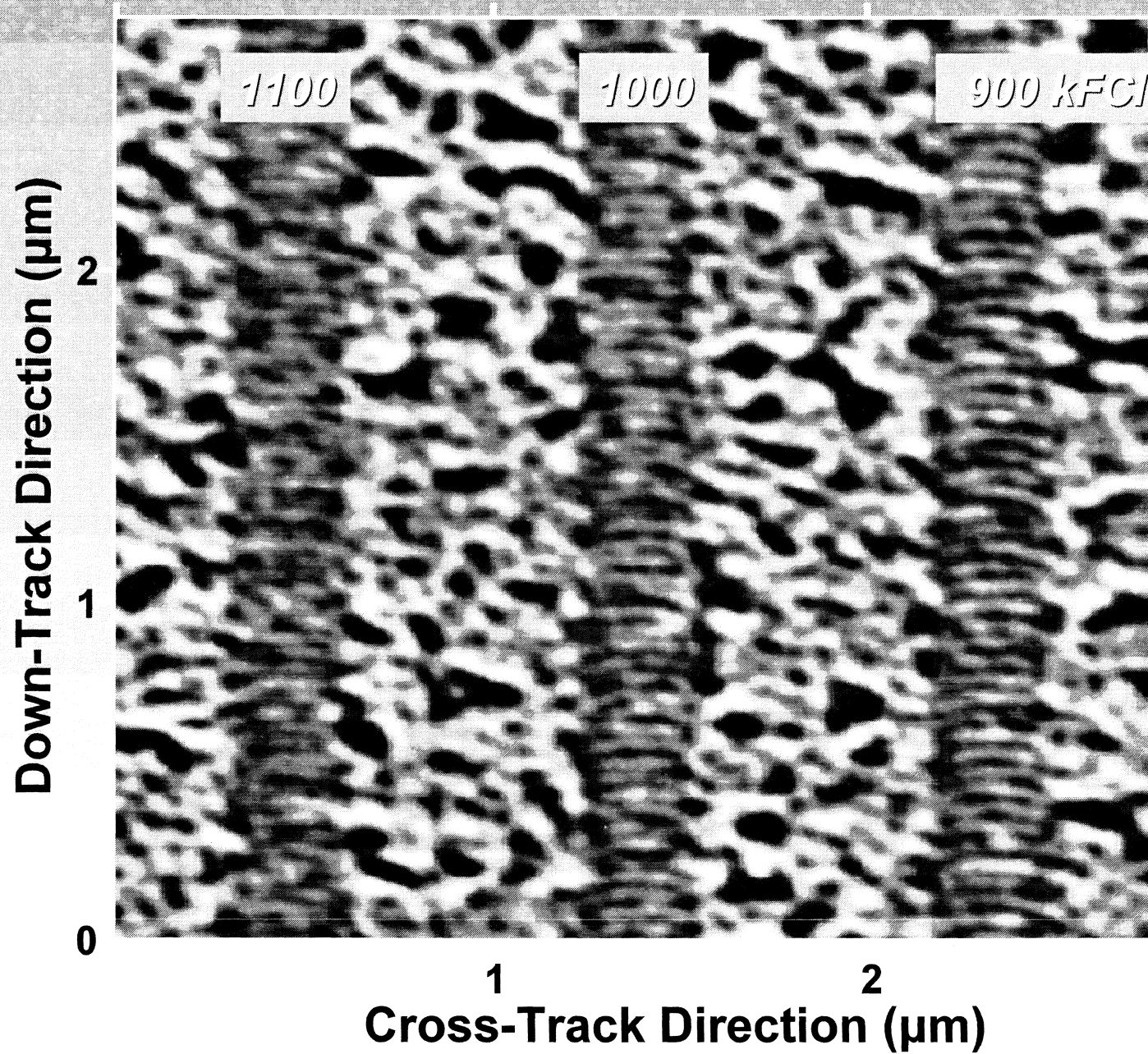

MFM Image of Shielded Pole Head Erased media: 100 - 1200 kfci ²³

Down-Track Direction (μm)

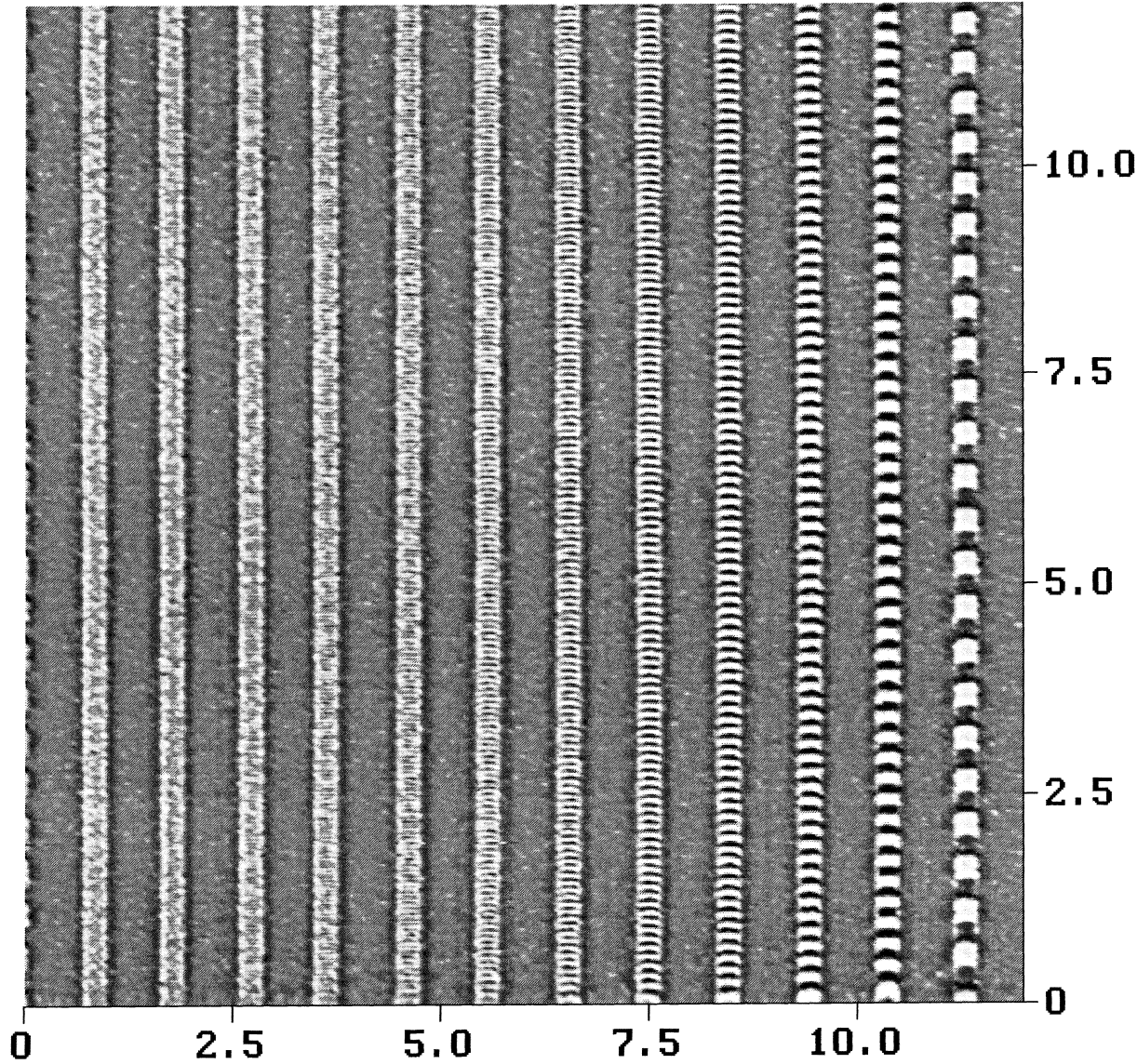

- Had to lower
H_c

Cross-Track Direction (μm)

μm

KOMAG

-10 μ m magnetic head width

Shielded Pole
Write

24

Bit Curvature at 900 KFCI

B=28 nm

B

Camber

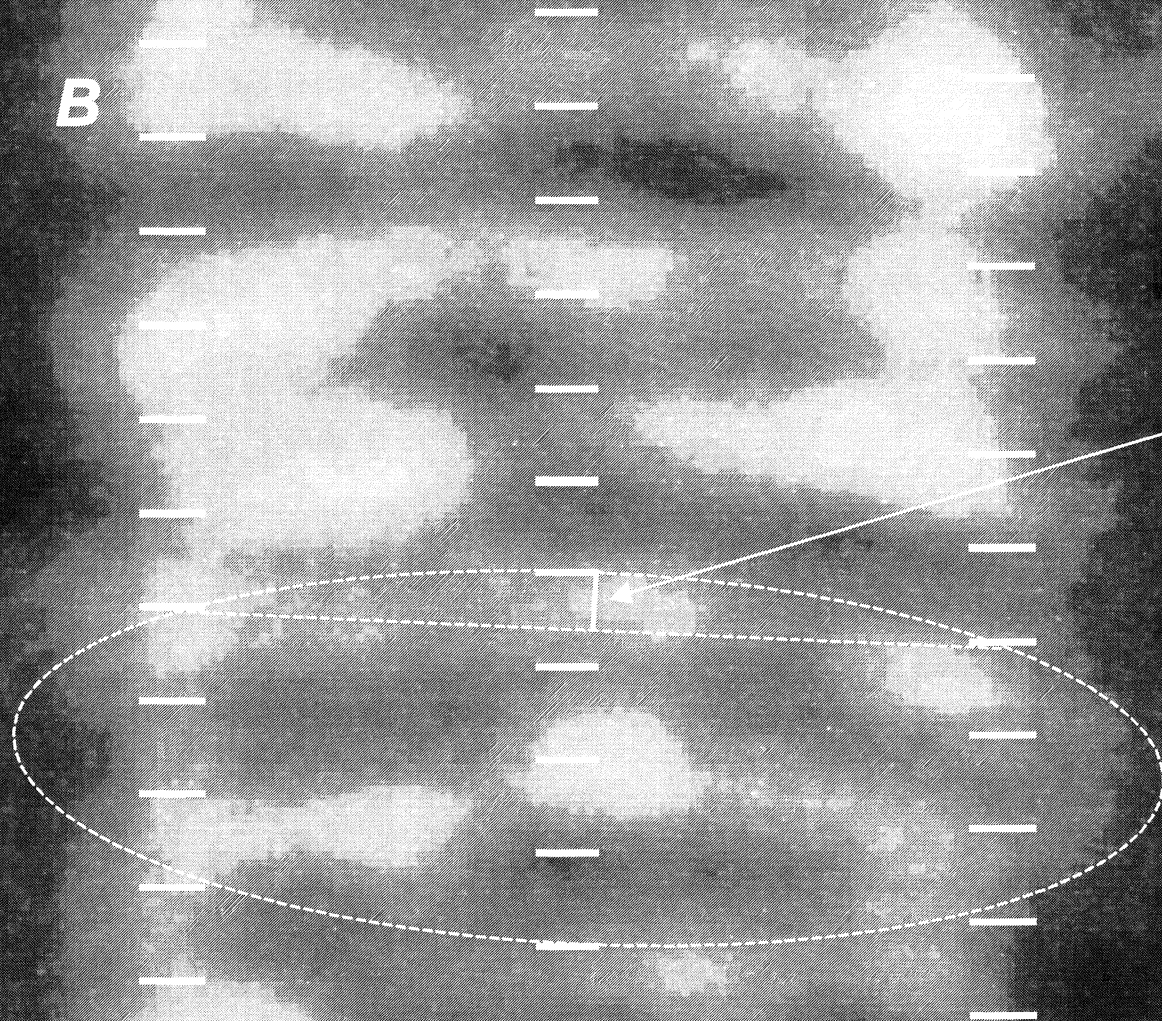

Bit curvature results in cambers as large as half of bit spacing at 900 KFCI.

KOMAG

Bit Curvature at 400 KFCI

25

B=63 nm

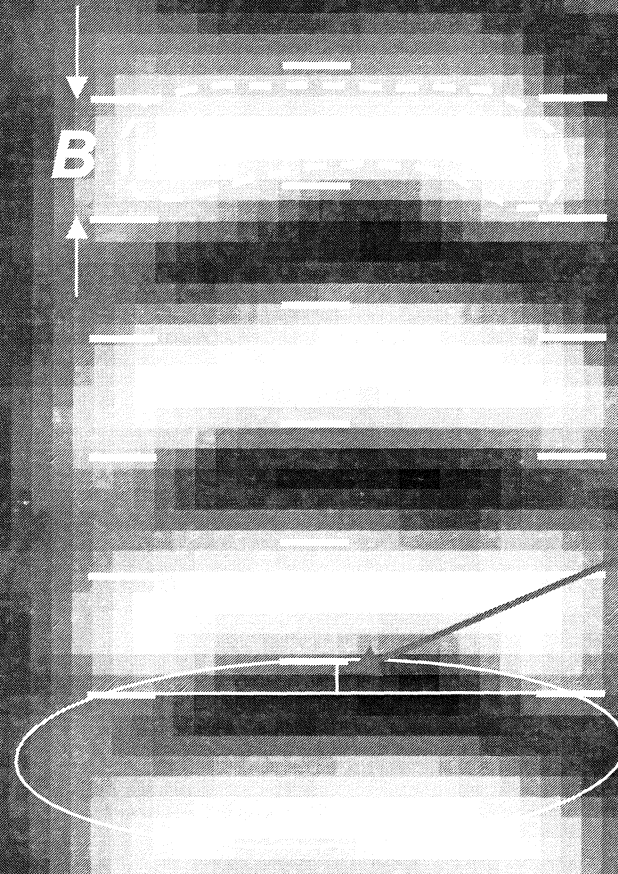

Camber at 400 KFCI is ~1/4 of bit length (~17 nm)

KOMAG

Challenges

■ *Media Noise*

- ◆ **Magnetic cluster size appears to be large (>100 nm) pointing to excessive intergranular exchange coupling.**

└ *Bit Curvature*

Place blame mostly on heads.

Hard layer to SUL spacing needs to be reduced for future programs.

└ *Thermal stability*

- ◆ **PMR media requires better thermal stability performance than LMR media.**
- ◆ **Grain size already approaching 6-7 nm, size distribution can still be improved.**

Conclusions

- ┌ **PMR media performance on par with LMR media.**

- ┌ **Need more SNR_{me}**
 - ┆ Intergranular exchange decoupling
 - ┆ Minimization of SUL to recording layer spacing
 - ┆ SUL domain noise minimization
 - ┆ Need to minimize bit curvature

- **PMR media, heads and channels will need to continue to improve performance to maintain areal density growth.**



MMC Technology[®]
A Maxtor Company

Perpendicular Recording Media: Technical and Manufacturing Challenges

**MMC Technology
2001 Fortune Drive, San Jose CA 95131**

**Gunn Choe, B.R. Acharya, E.N. Abarra, M. Zheng,
J.N. Zhou, B.G. Demczyk and K.E. Johnson**

Areal density growth trend

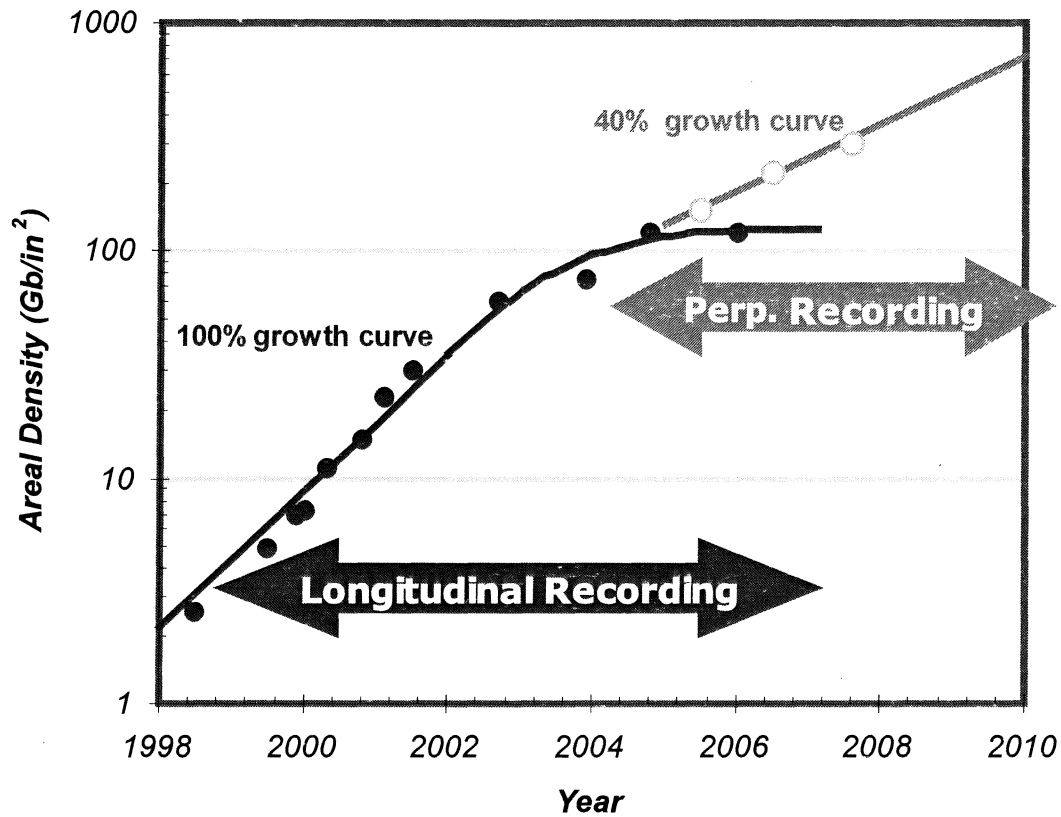

Areal density growth slows down in longitudinal recording.

Future Technology Directions

MMC Technology
A Maxtor Company

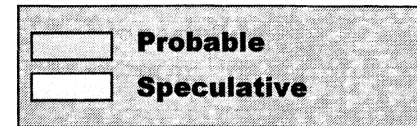
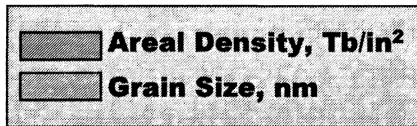

TECHNOLOGY 2003 2005 2007 2009 2011 2013

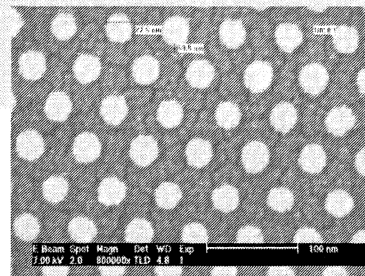
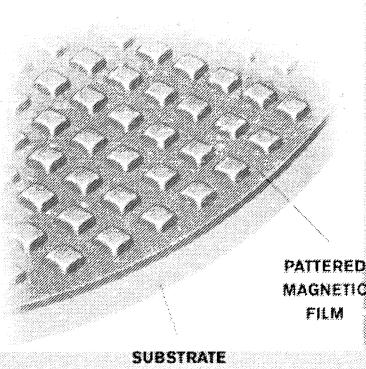
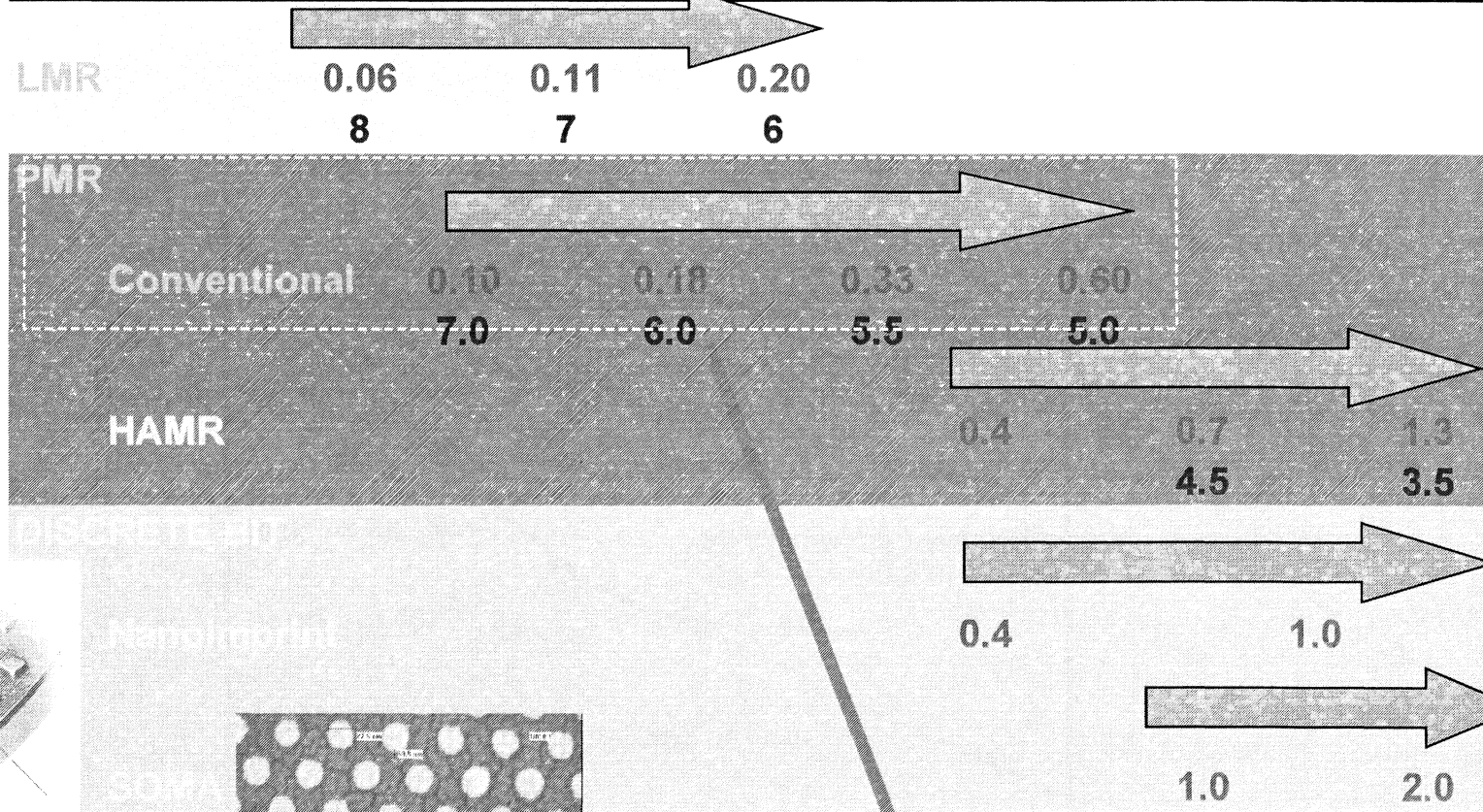

Manufacturable thin film technology

- PMR disk: **SUL(100 nm)/CoPtCrO (15nm)**
- Fabricated by current LMR media sputter system with **similar throughput**
- Head: Shielded pole

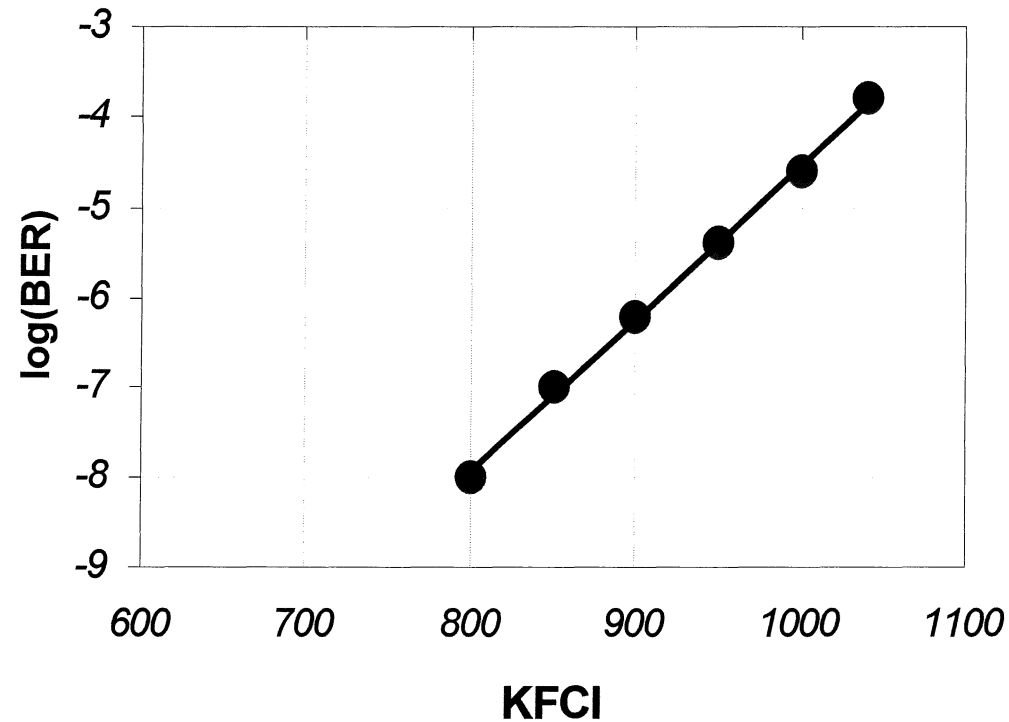

Longitudinal

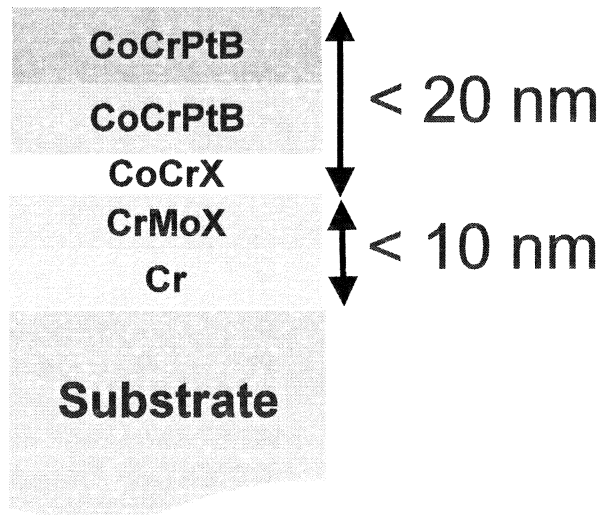

Perpendicular

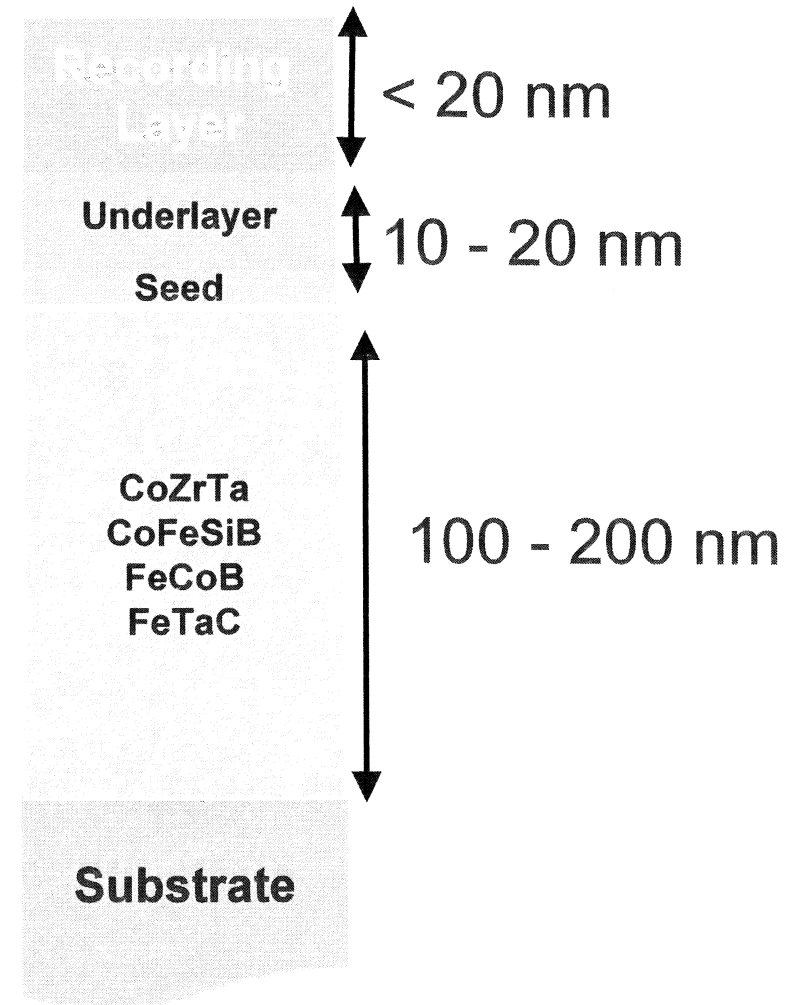

Technical Challenges

Magnetic Recording layer

- High SNR – reduced grain size and exchange coupling
- Good thermal stability
- High H_c , squareness, high negative nucleation field

Soft Magnetic Underlayer

- Domain noise
- High permeability – radial anisotropy
- Optimum design to reduce adjacent track erasure

PMR recording layer materials

MMC Technology
A Maxtor Company

- CoCrPtB alloy
 - Low H_c , $S < 1$
 - High stacking fault, poor H_k distribution
 - Poor thermal stability

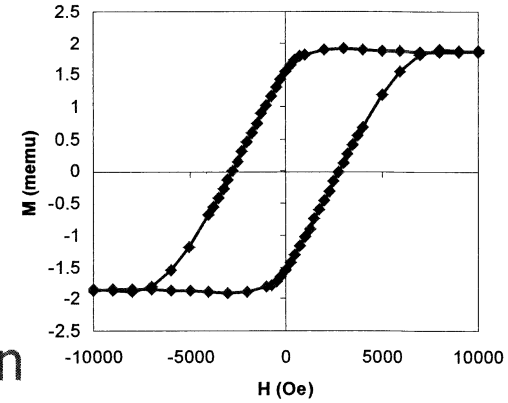
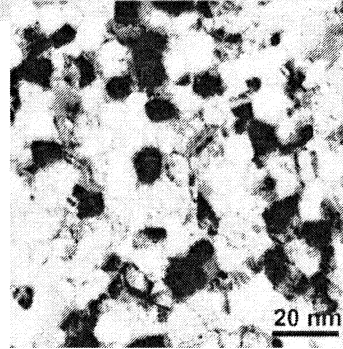

- Co/Pd(Pt) multilayer, Tb-Fe based alloy
 - High H_c , $S = 1$
 - High grain-to-grain exchange coupling
 - Low SNR

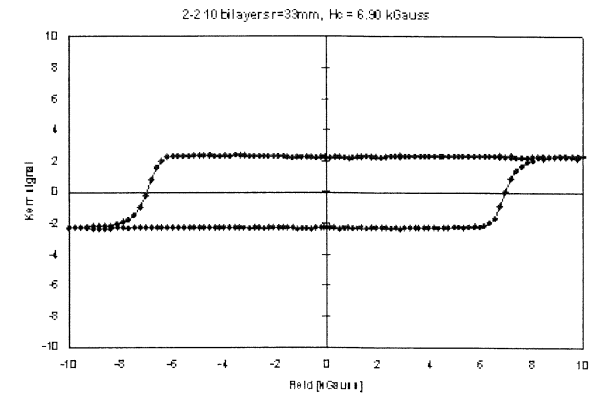

- CoCrPtO alloy
 - High H_c , $S = 1$
 - Excellent crystallography
 - Reduced grain size, distribution
 - High SNR

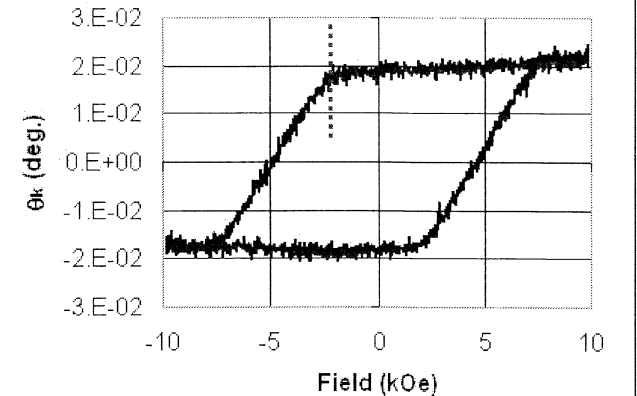
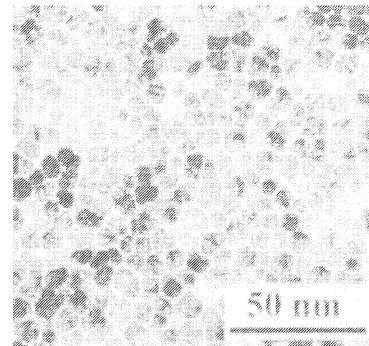

- Very promising alloy for products

Media Parameters	Effects
High anisotropy, K_u	Thermal stability, Can reduce grain
High squareness, $S=1$	Resolution, dc noise
High negative nucleation field	Thermal stability, ATE
Reduced anisotropy dispersion	Resolution, dc noise
Co grain size and distribution	Transition noise
Inter-granular exchange coupling	Noise (jitter)
Reduced SUL-to-ML spacing	Head write field gradient, OW, resolution

Ru/CoPtCrO Crystallography

MMC Technology
A Maxtor Company

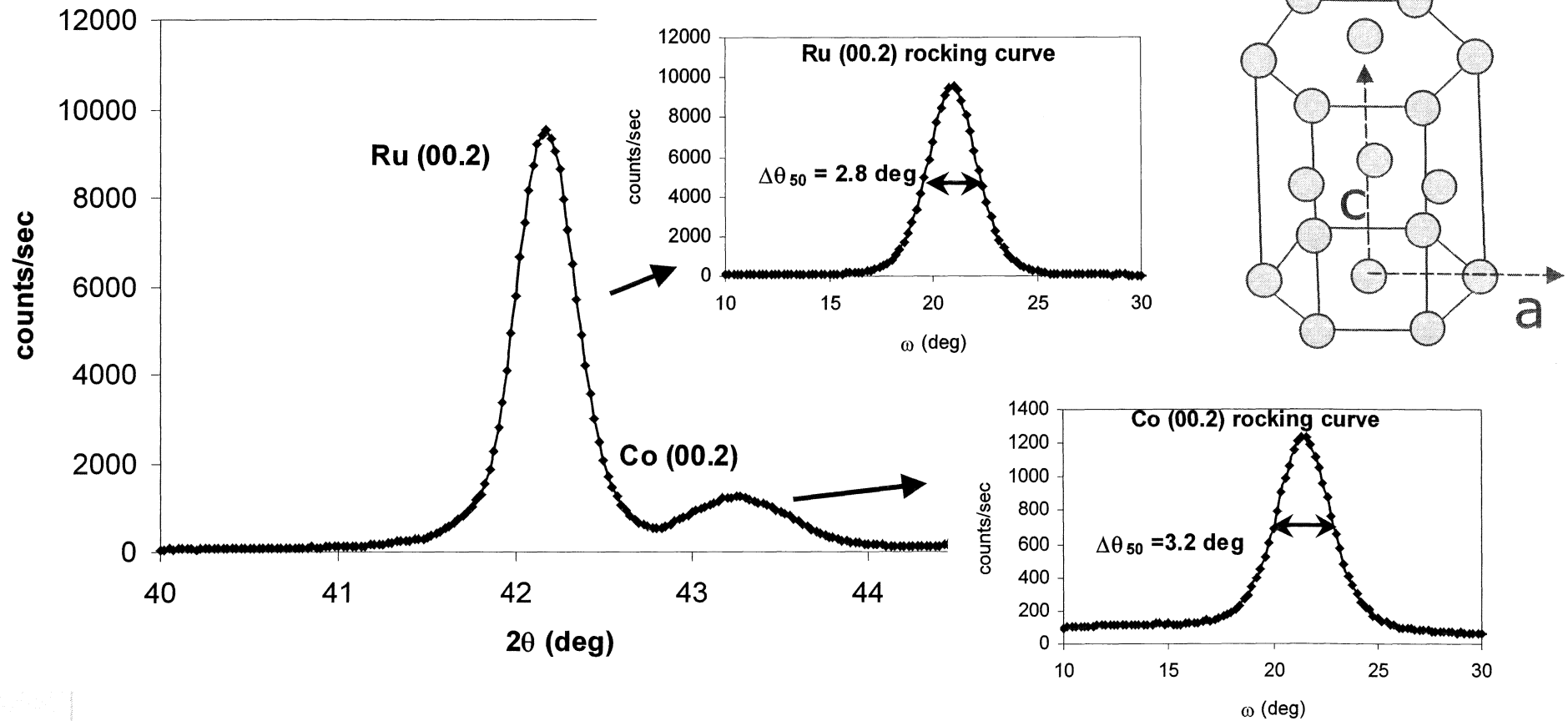

Excellent (00.2) orientation of Ru and Co is achieved.

Co epitaxial growth onto Ru

MMC Technology
A Maxtor Company

Cr-O rich amorphous boundary

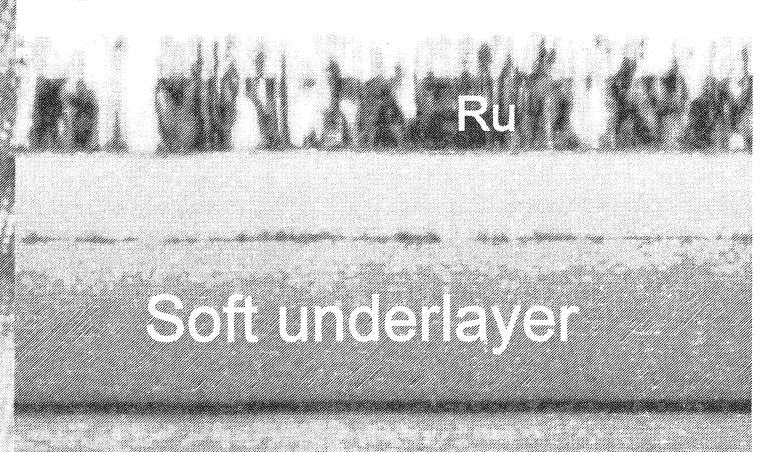
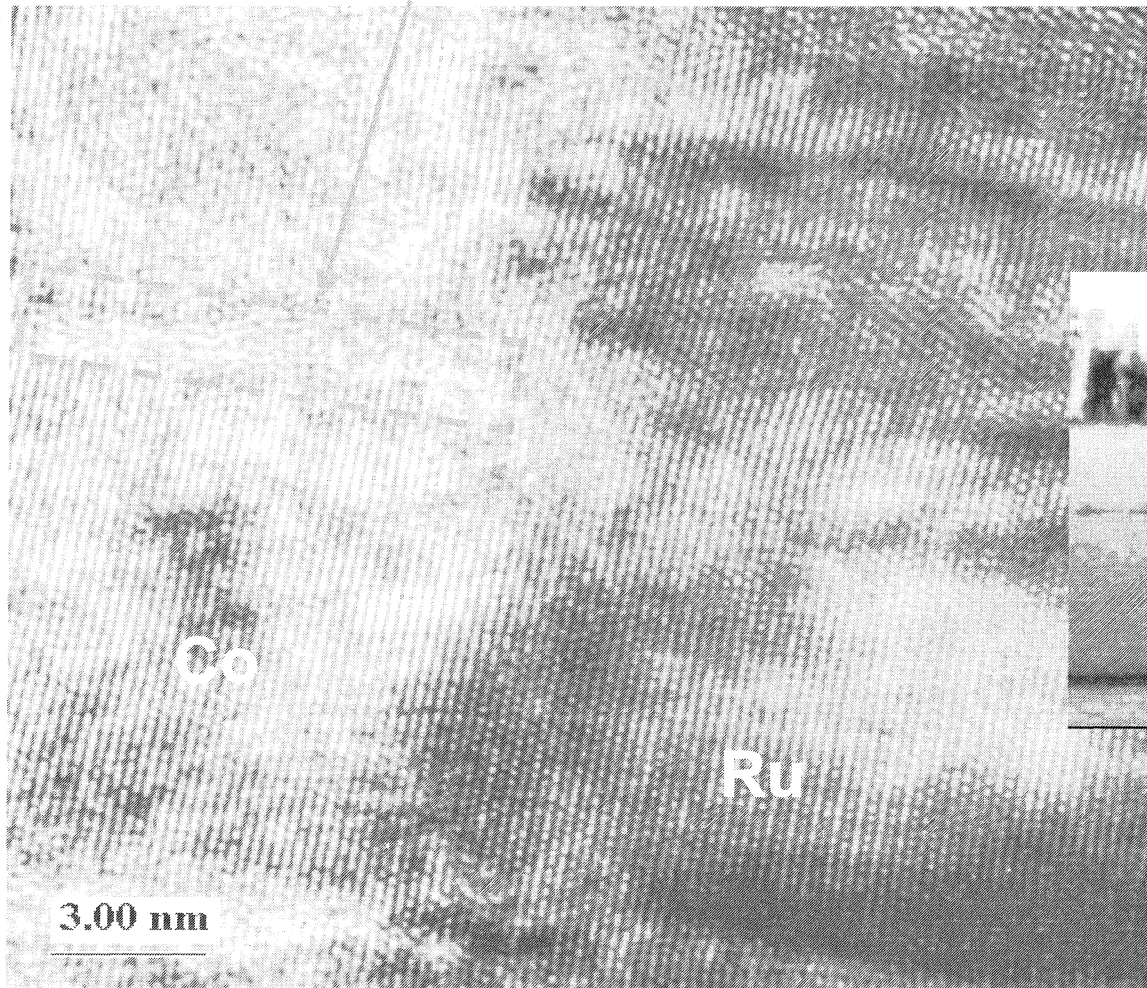

Defect free Co epitaxially grown onto Ru

Well oriented Co c-axis

MMC Technology
A Maxtor Company

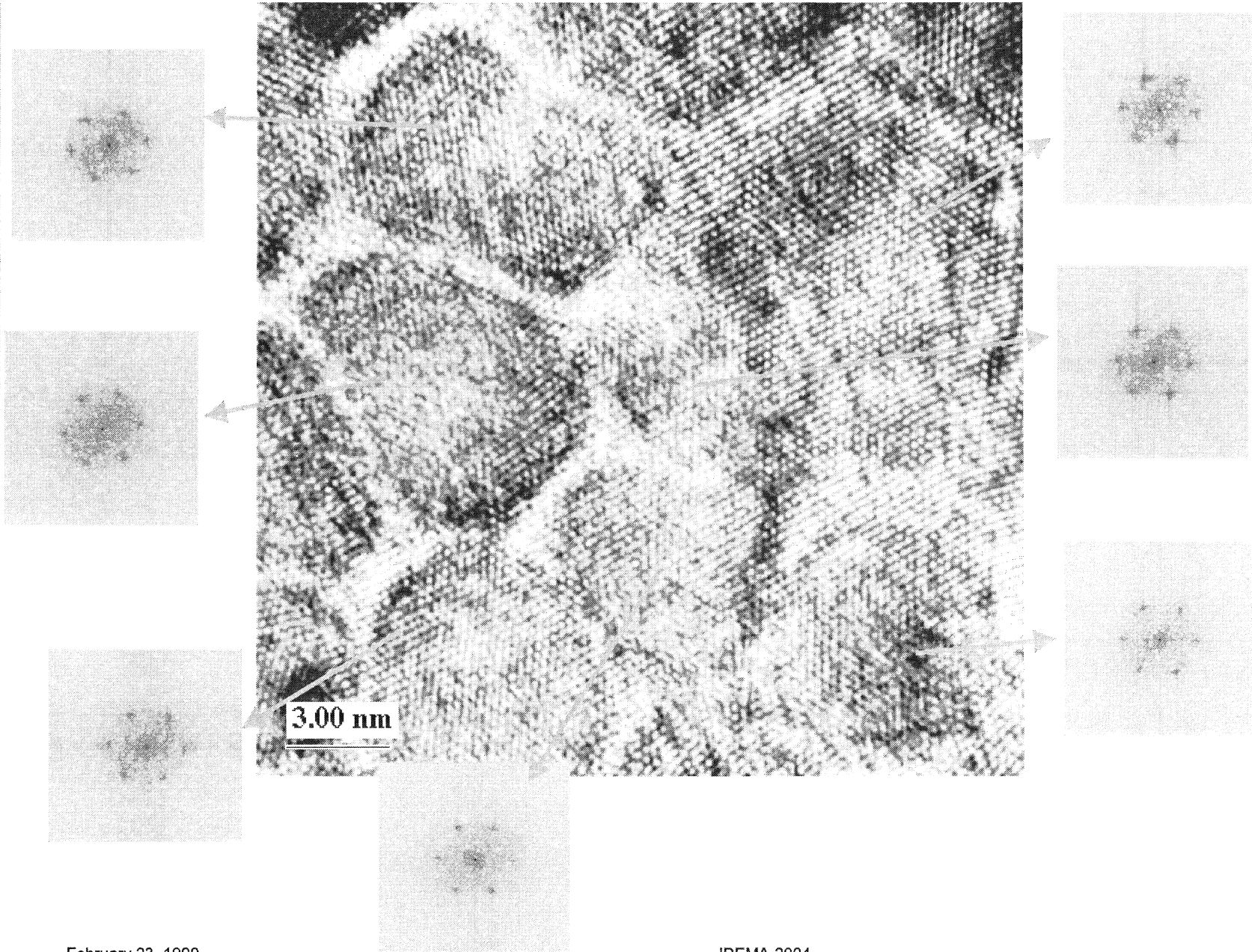

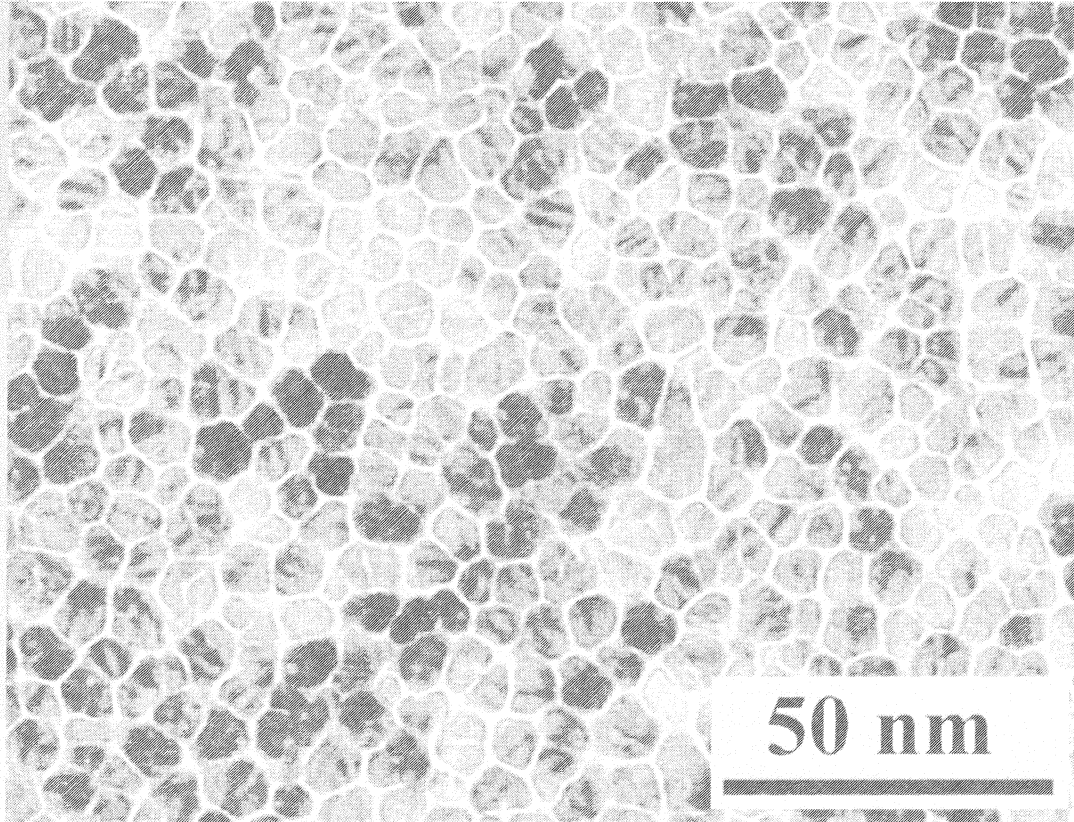

Grain size distribution

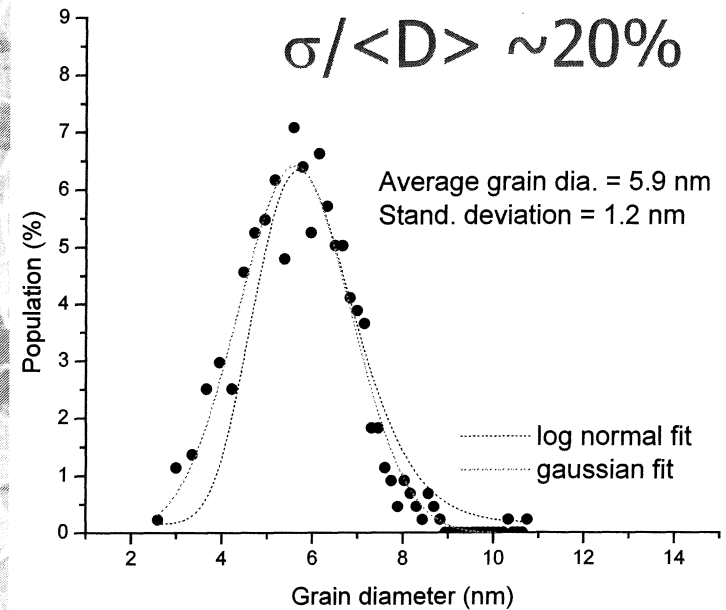

Reduced grain size and distribution achieved on CoCrPtO PMR media.

Reduction of inter-granular coupling through Cr-O grain boundary segregation

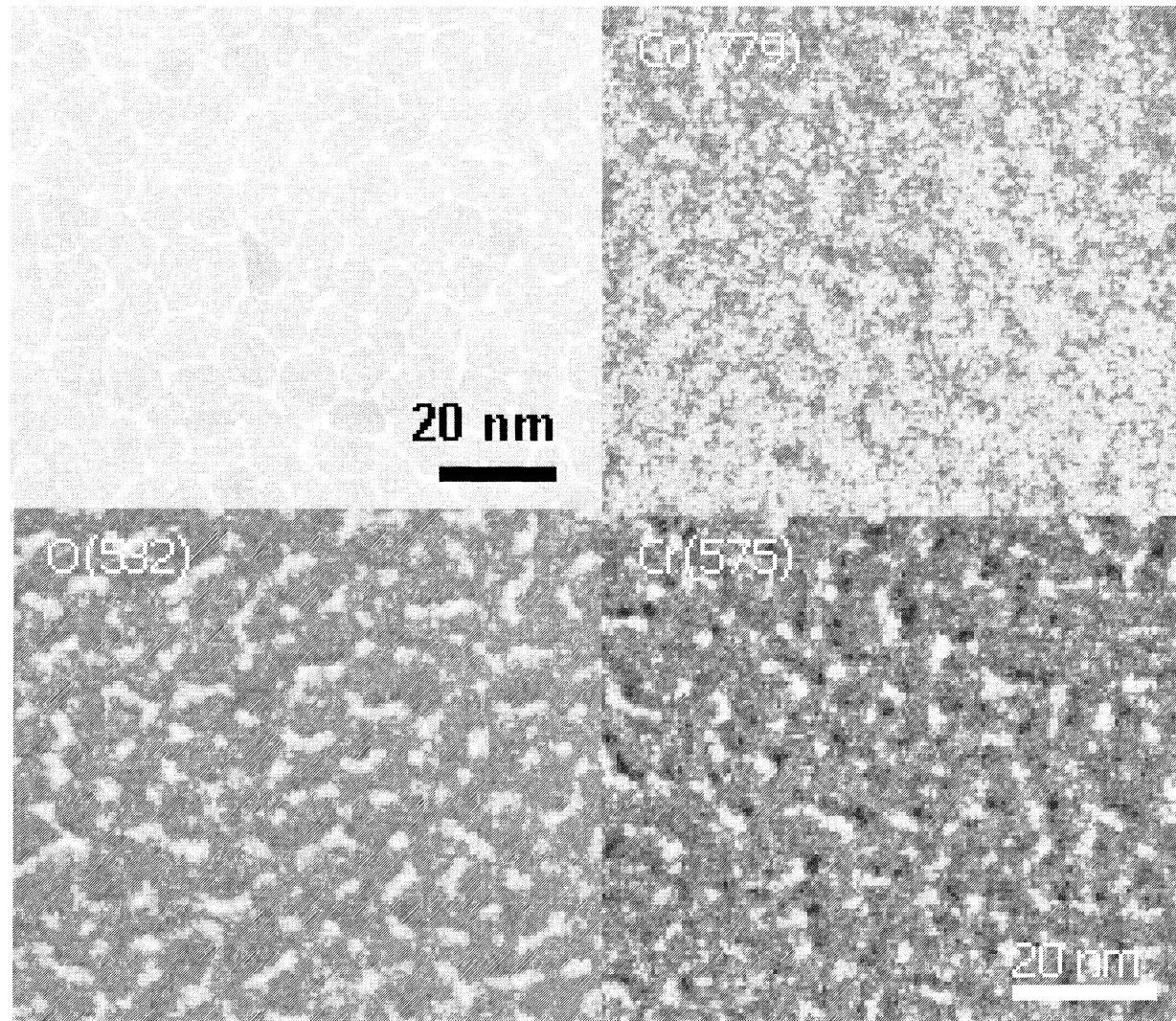

Strong evidence of Cr and O segregation at grain boundaries.

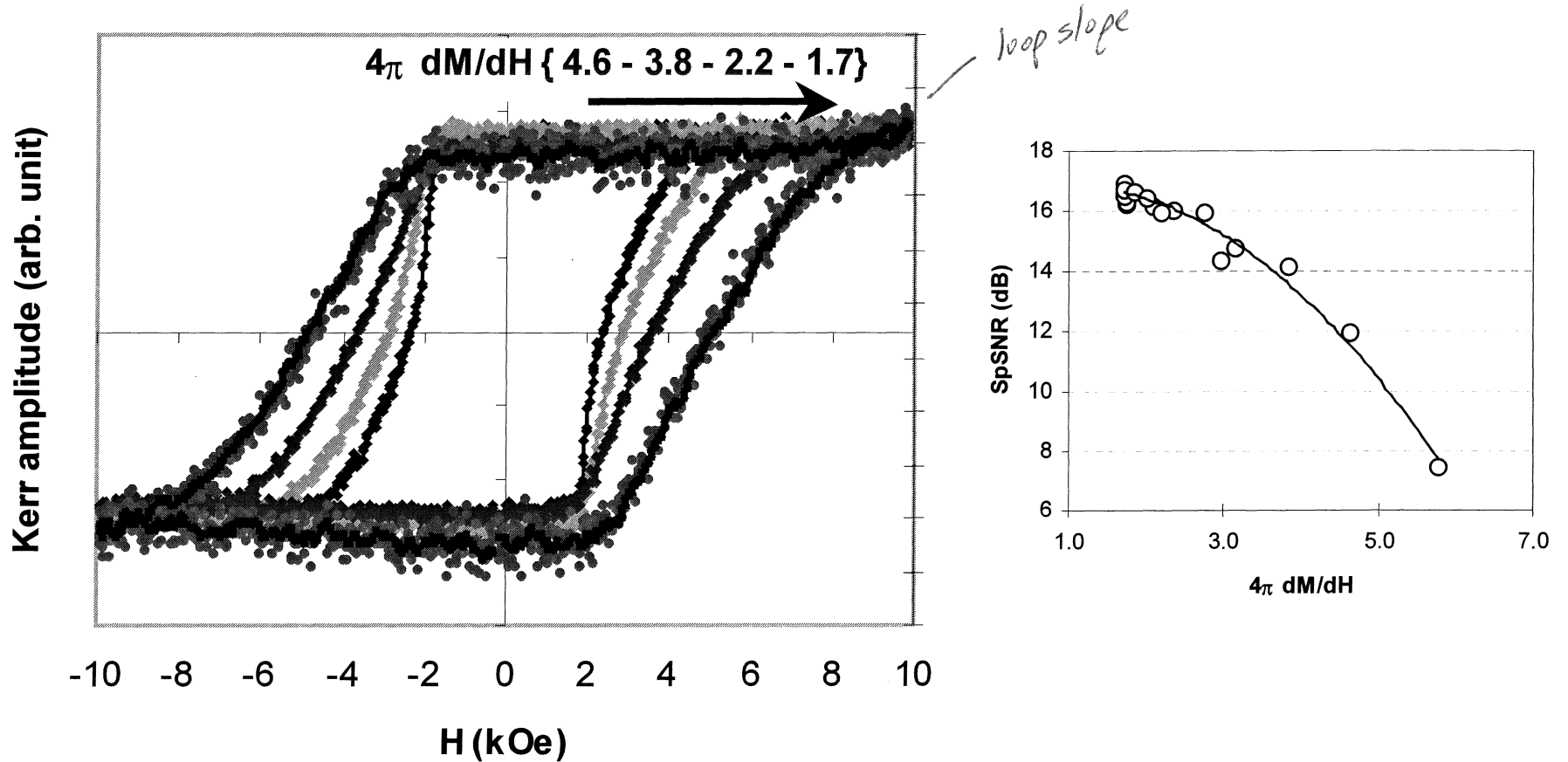

As inter-granular exchange coupling decreases, the loop slope decreases and H_c increases.

OSA image

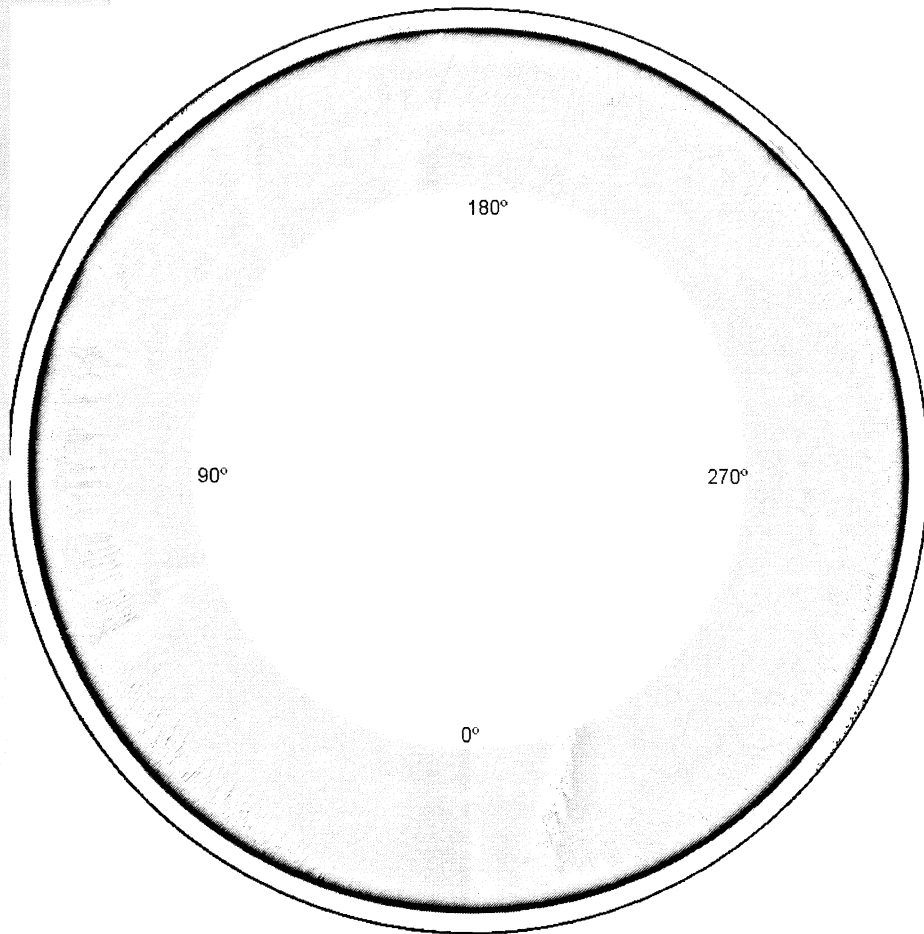

GMR head TAA Envelope:

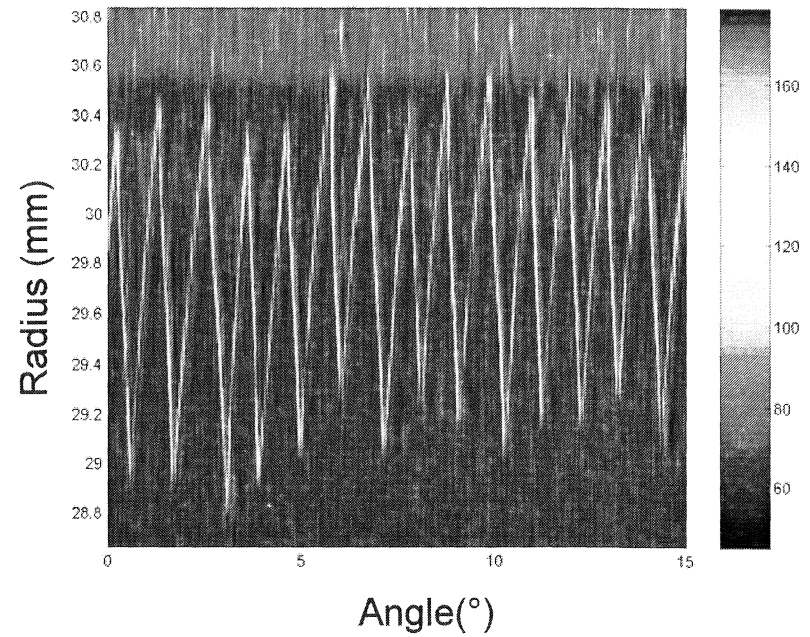

- **AFM pinning method**

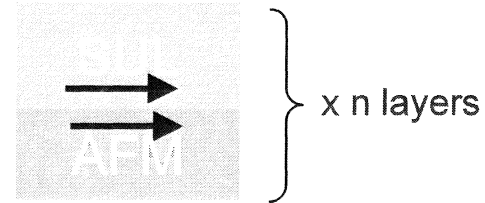

- **Anti-parallel coupled SUL with AFM pinning layer**

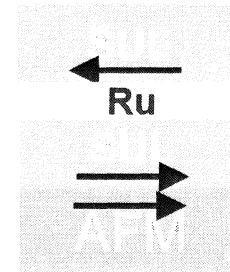

- **High Hc layer/SUL exchange coupling**

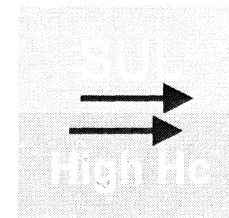

- **External bias field in the drive**

AFM Pinned SUL

MMC Technology
A Maxtor Company

NiFeNb
C
NiFeNb
C
NiFeNb
C
NiFeNb
C
NiFeNb



NiFeNb
FeMn
NiFeNb
FeMn
NiFeNb
FeMn
SL

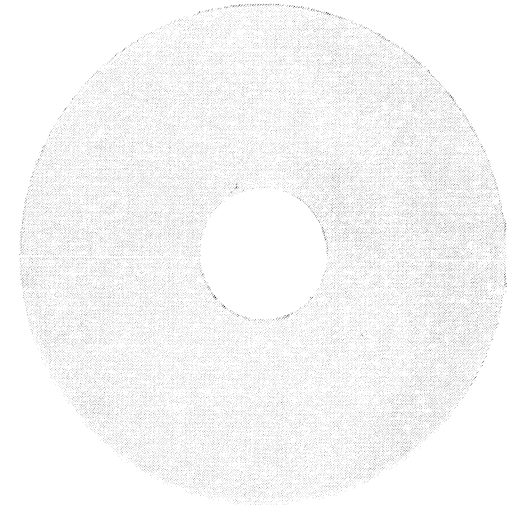

$dc \mu \sim 1600$

$H_{ex} \sim 20 \text{ Oe}$

Spike Noise

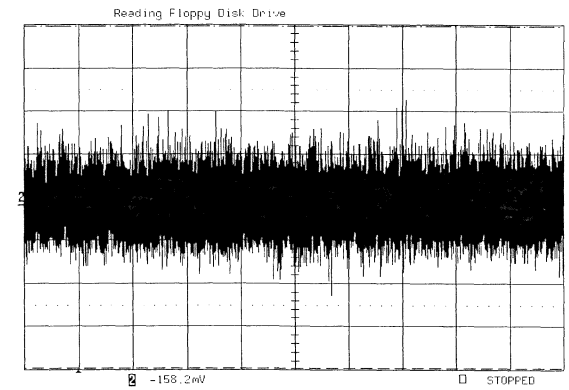
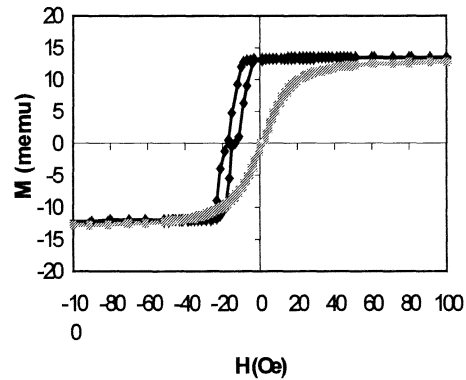
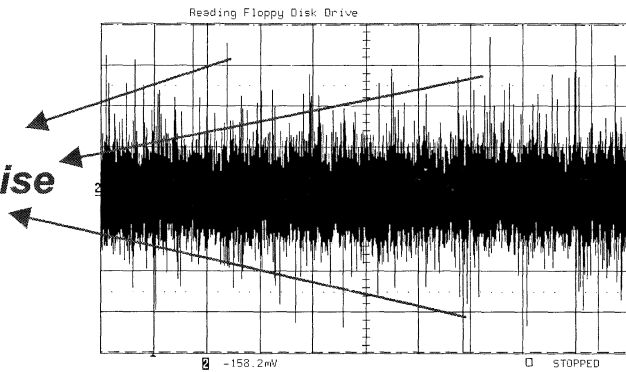

SUL domains can be eliminated through AFM pinning method.

As-deposited

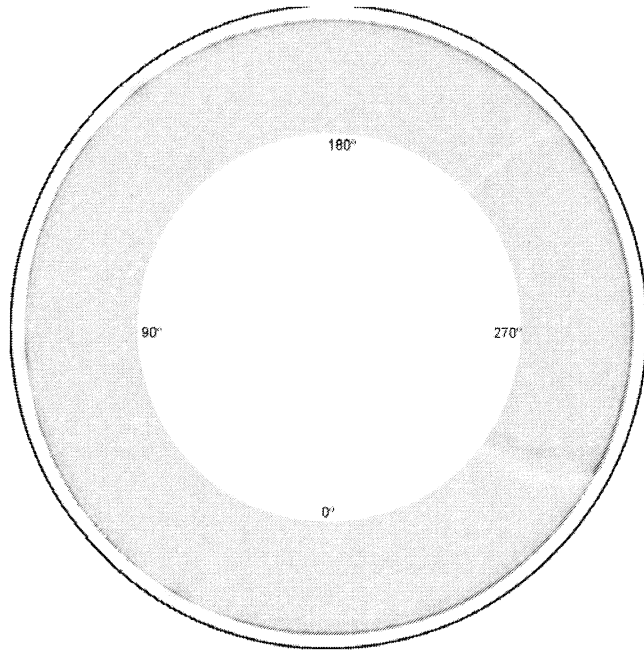

Bulk-erased

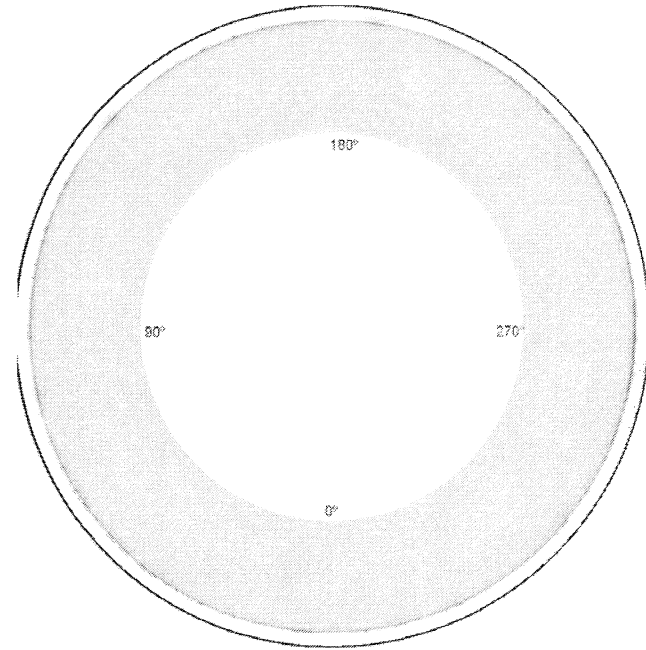

Finger-like domains already absent from as-dep state.
Bulk erasure is effective in making single domain state.

Wide Area Track Erasure in PMR

MMC Technology
A Maxtor Company

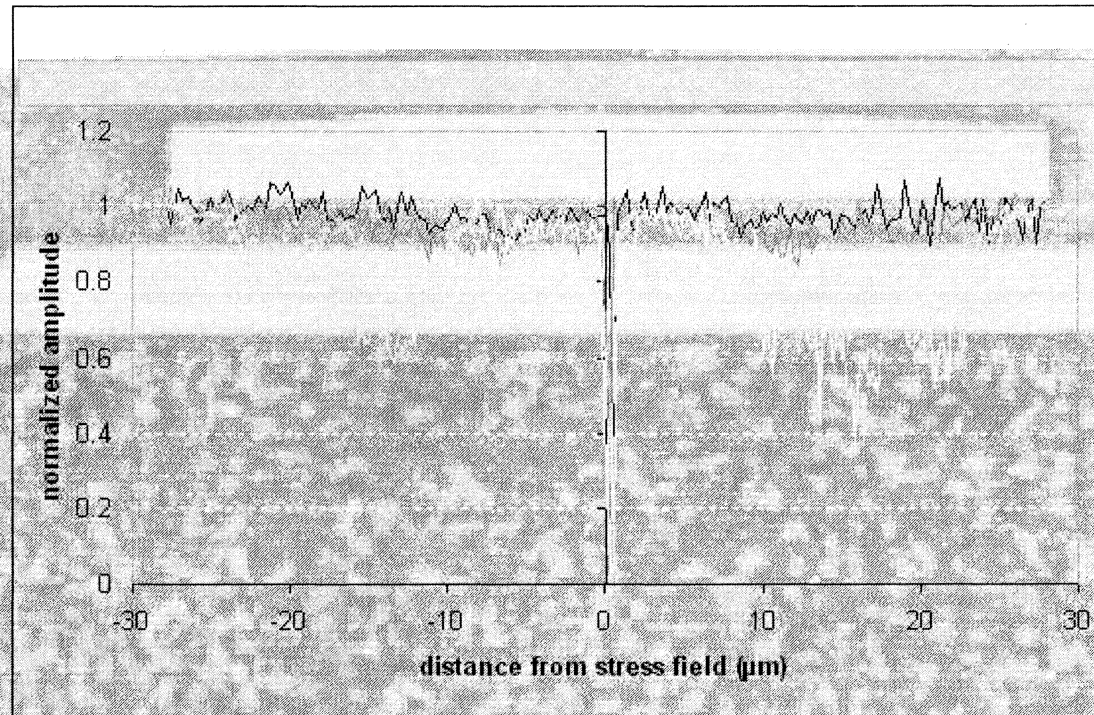

xtor

LOWER 3.0W X1,000 10µm WD 14.3mm

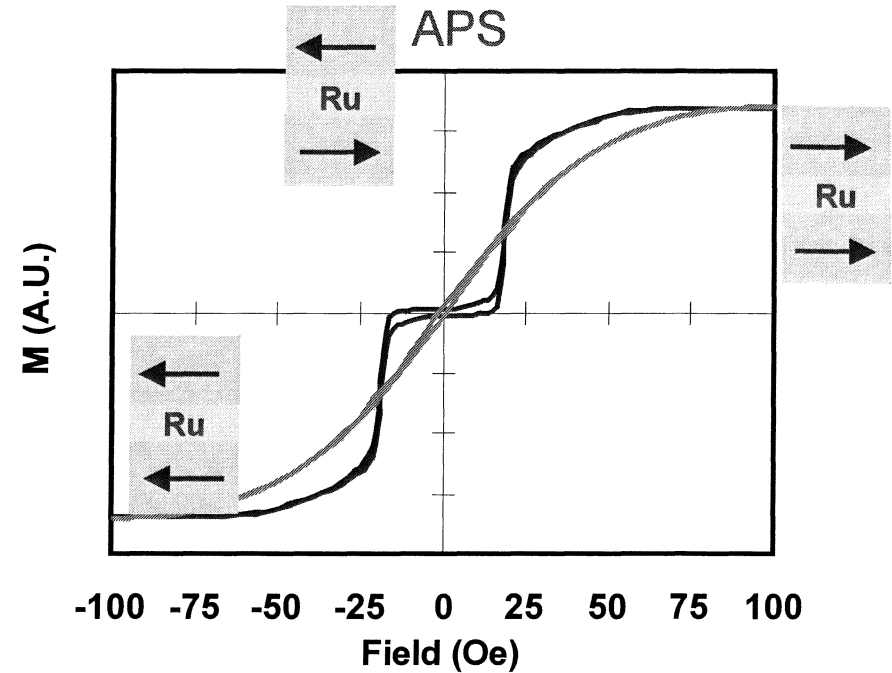
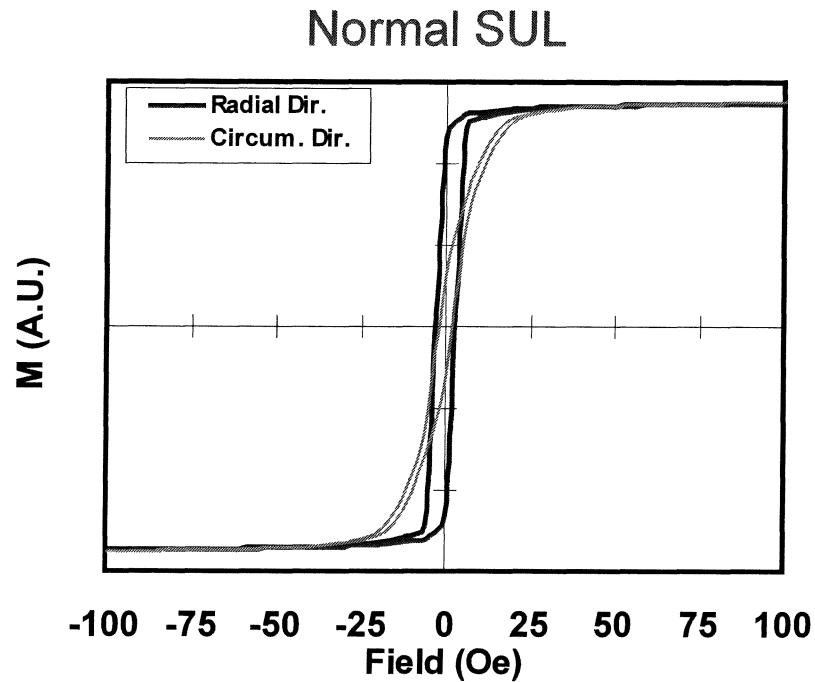

The maximum permeability ($4\pi M_S/H_k$) of APS can be controlled by adjusting SUL thickness.

Wide area track erasure in PMR recording

MMC Technology
A Maxtor Company

Normal SUL

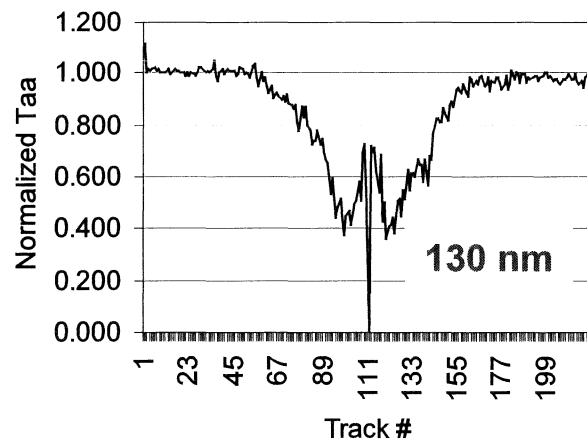

APS I

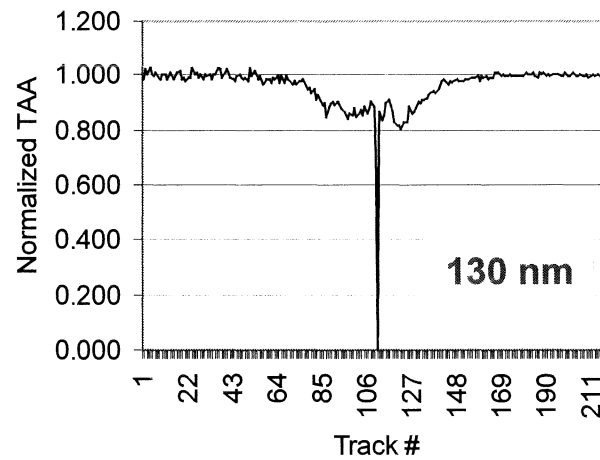

APS II

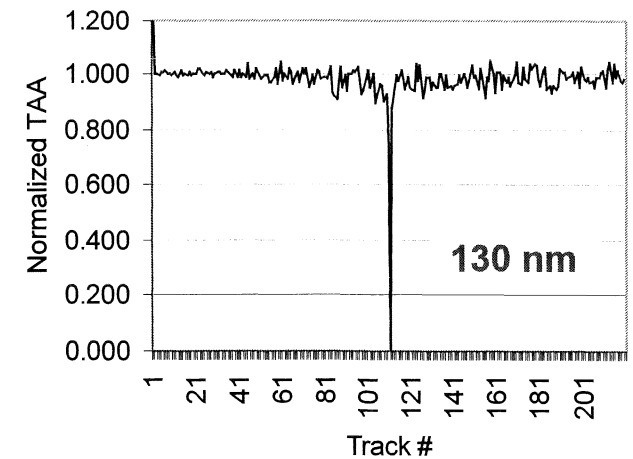

Improved SUL design can eliminate ATE!

SUL thickness for PMR media

$$t_{SUL-Minimum} \approx \frac{1}{2} \frac{M_{S-PoleTip}}{M_{S-SUL}} W_{PoleTip}$$

(D. Litvinov et al, J. Magn. Magn. Mater., 232, 84-90, 2001)

For write width of $0.2 \mu\text{m}$ & SUL $B_{sat} = 1.2 \text{ T}$, SUL-thickness $\sim 180 \text{ nm}$.

Mono-pole writer, $t_W = 0.25 \mu\text{m}$

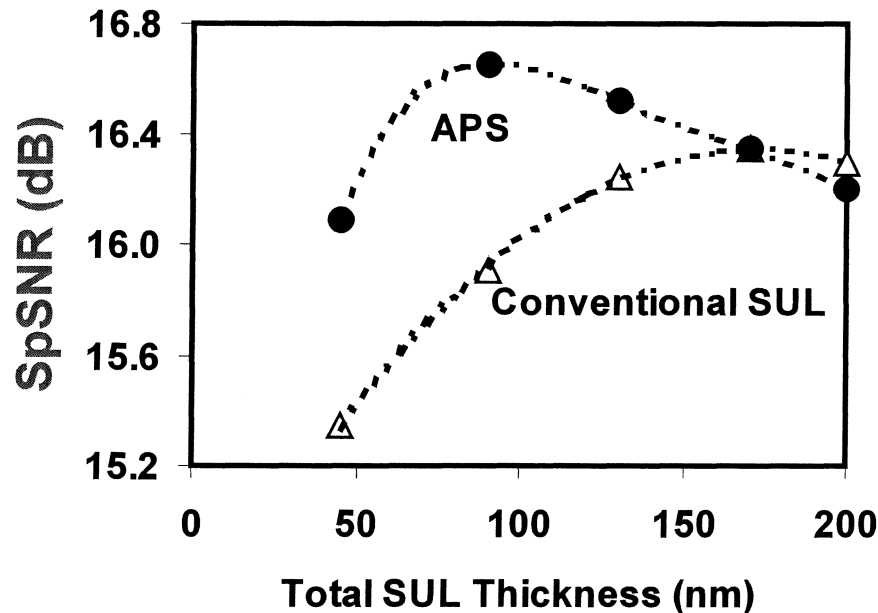

Shielded-pole writer, $t_W = 0.2 \mu\text{m}$

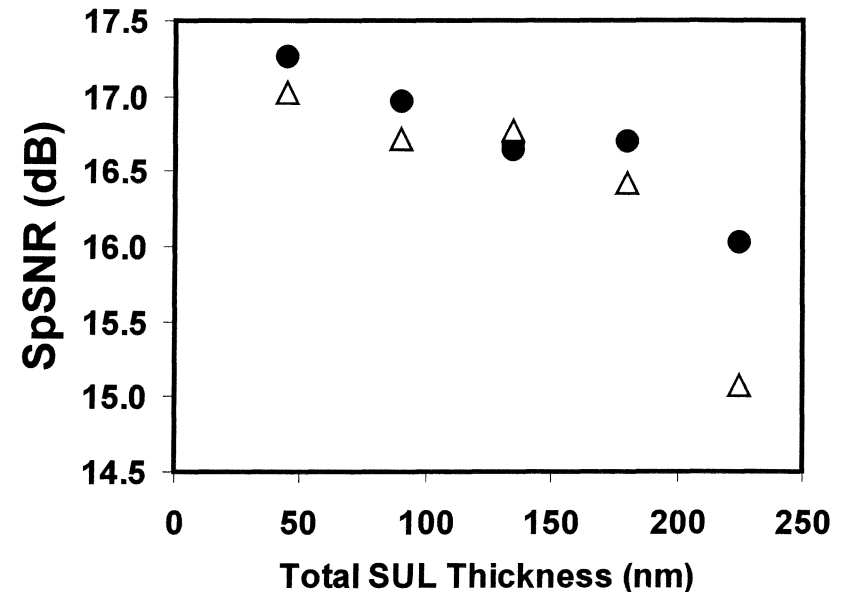

- APS is effective down to 80 nm for mono-pole writer.
- SUL thickness $\sim 50 \text{ nm}$ can be used for shielded pole writer.

Media Parameters	Current Achievement
High anisotropy, K_u	$\sim 3.0 \times 10^6 \text{ erg/cm}^3$ $H_c > 5 \text{ kOe}$
High squareness	$S=1$
High negative nucleation field	$H_n < -2 \text{ kOe}$
Reduced anisotropy dispersion	Co (00.2) $\Delta\theta_{50} \sim 3^\circ$
Co grain size and distribution	$D = 6 \text{ nm}$, $\sigma / \langle d \rangle \sim 20\%$
Inter-granular exchange coupling	$4\pi dM/dH \sim 1.7$
Reduced SUL-to-ML spacing	7 nm
SUL domains	Eliminated
High permeability of SUL	100 - 600

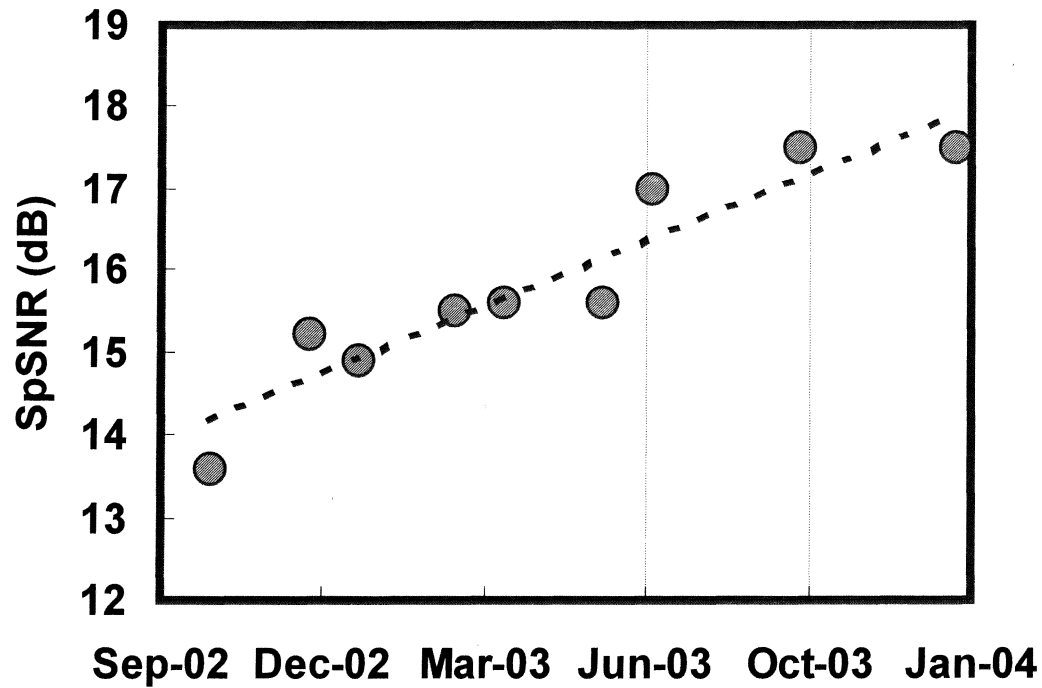

Significant improvement of media SNR achieved.

Manufacturing Challenges

- CoPtCrO uniformity
- Process repeatability
- Surface roughness
- PMR media generation I, II, III
- Material cost – SUL thickness

Dynamic Hc mapping @ 95mm \varnothing

Earlier

Now

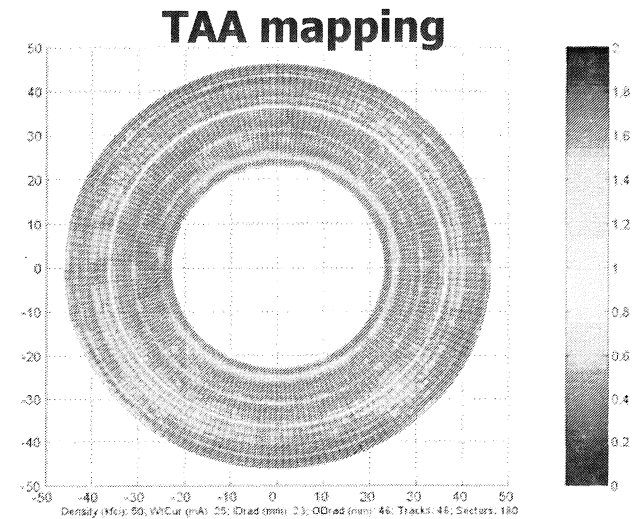
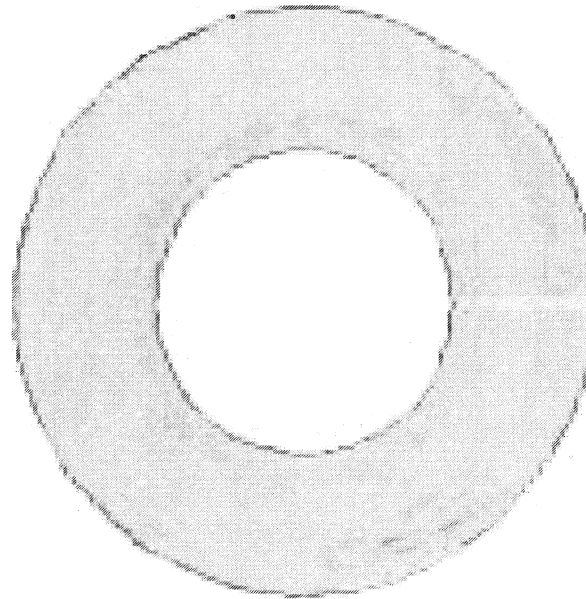
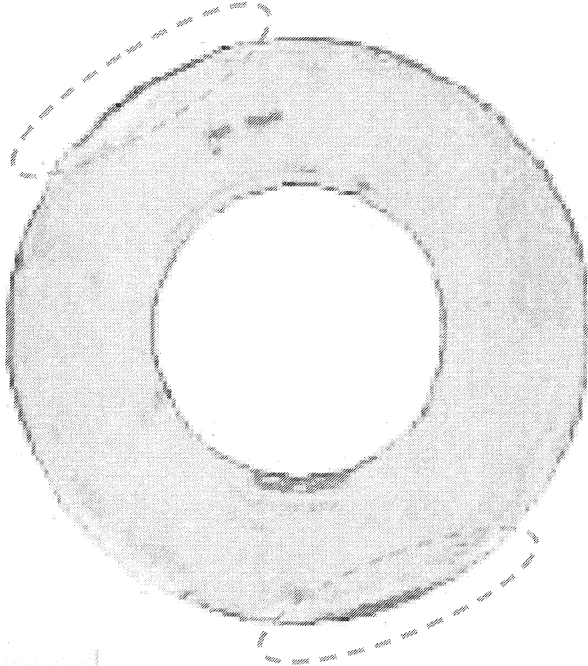

Lighter rings are artifacts.

+/- 26 %

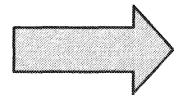

+/- 7 %

Hc uniformity is improved by optimizing process and gas distribution.

CoPtCrO Hc run-to-run repeatability (SUL/CoPtCrO media with throughput similar to LMR product)

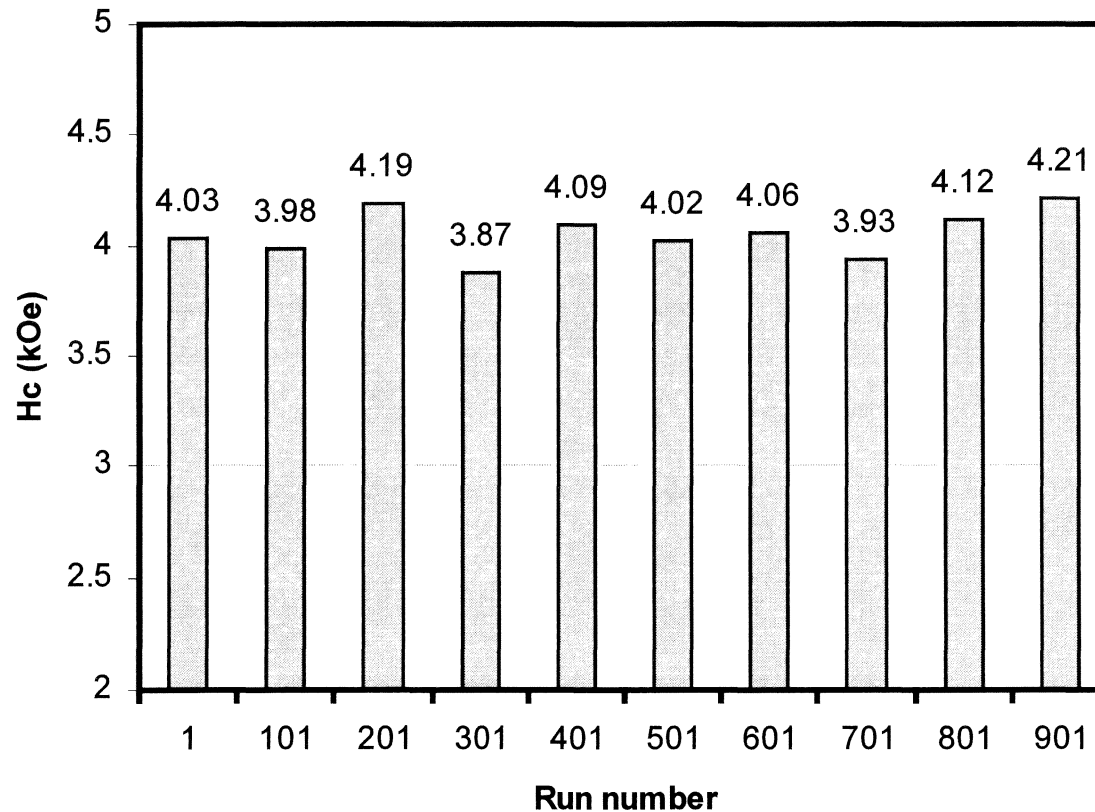

Average Hc: 4.05 kOe
STD: 0.108 kOe
Max-Min: 0.34 kOe

PMR Media (200nm SUL/RL)

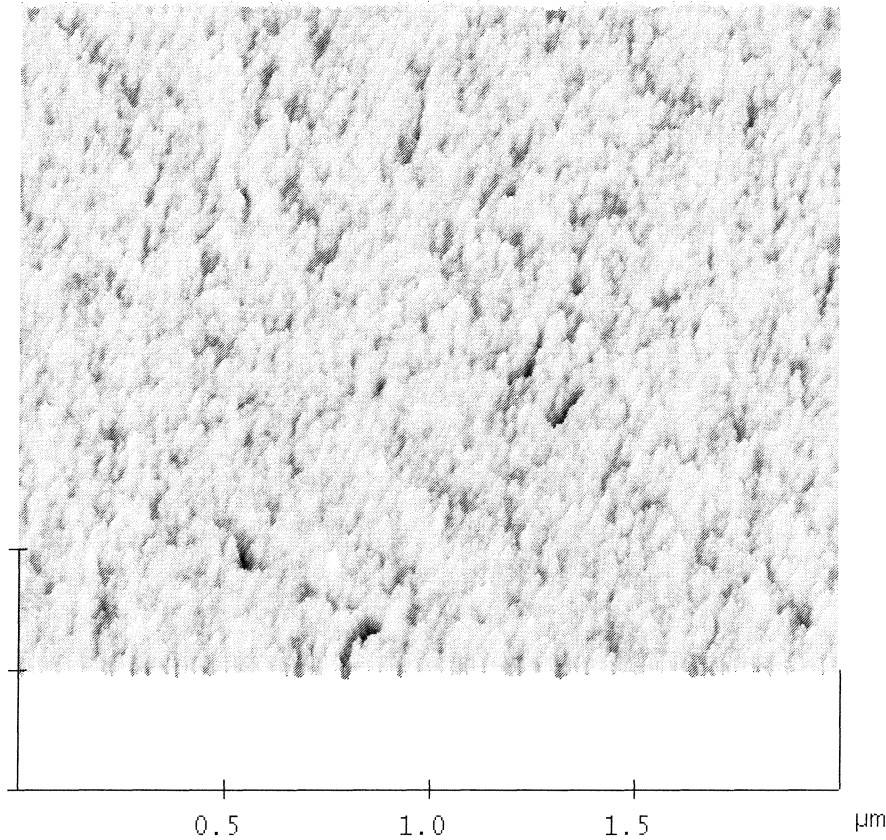

$R_a = 0.36 \text{ nm}$

Longitudinal media

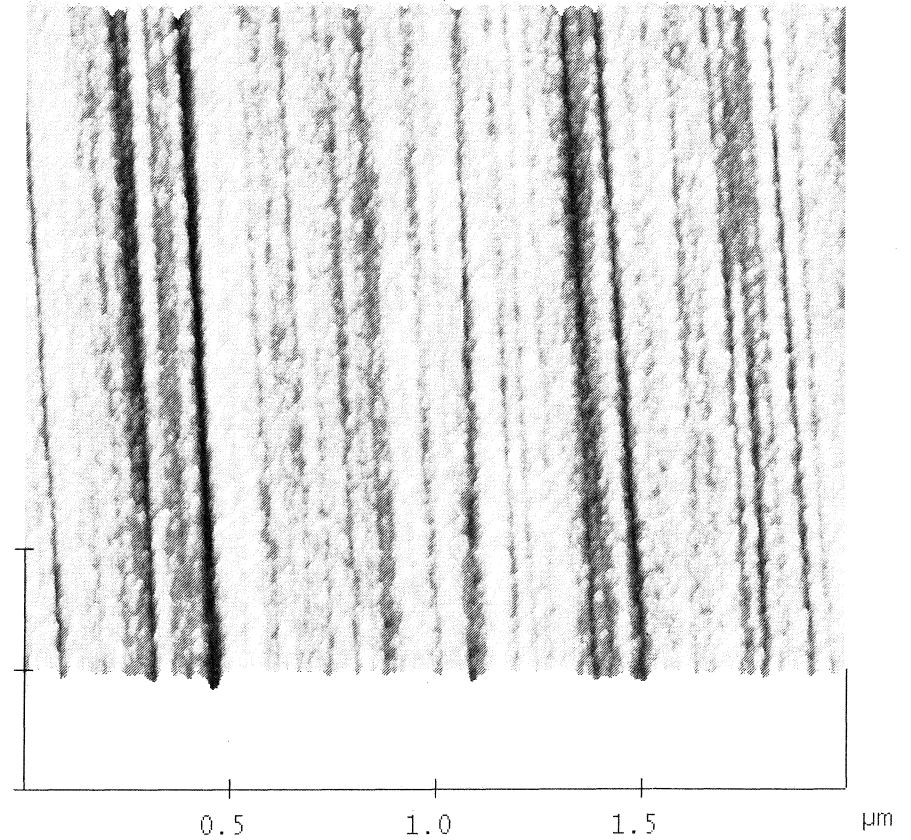

$R_a = 0.52 \text{ nm}$

LZT for LMR

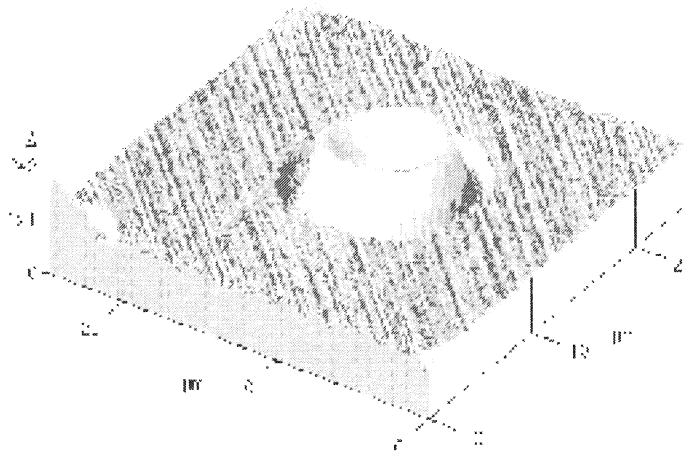

LZT for PMR

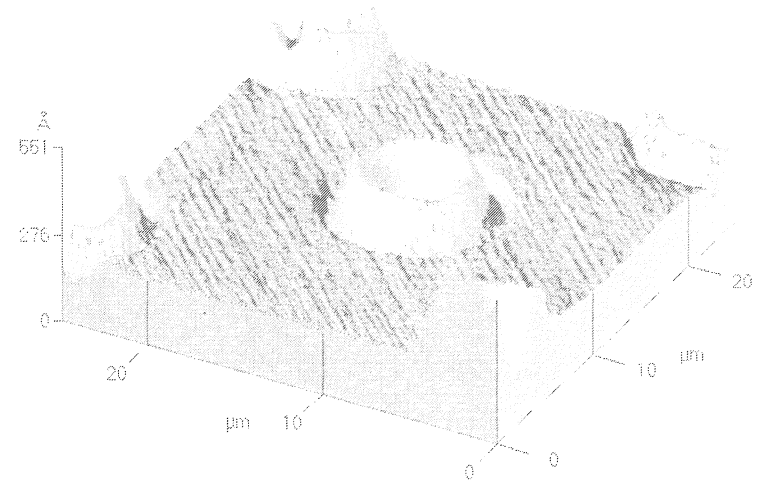

No difference in bump shape and shrinkage between LMR and PMR disks with SUL.

PMR Media Layered Structure

2 more layers

3 more layers

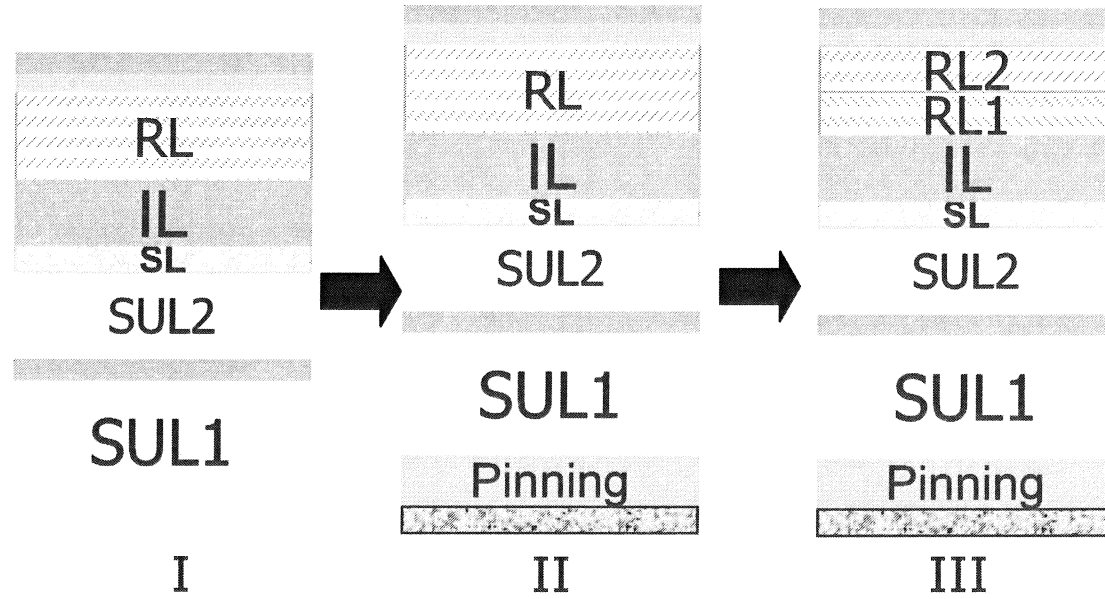

	Number of Layers / Stations		
	Generation I	Generation II	Generation III
SUL	3 / 5	5 / 6	5 / 7
ML	3	3	4
Carbon	2	2	2
Process	1	1	2
Total	9 / 11	11 / 12	13 / 15

- 1st 2 generations made w/ existing sputtering systems
IDEMA-2004
need new sputtering system.

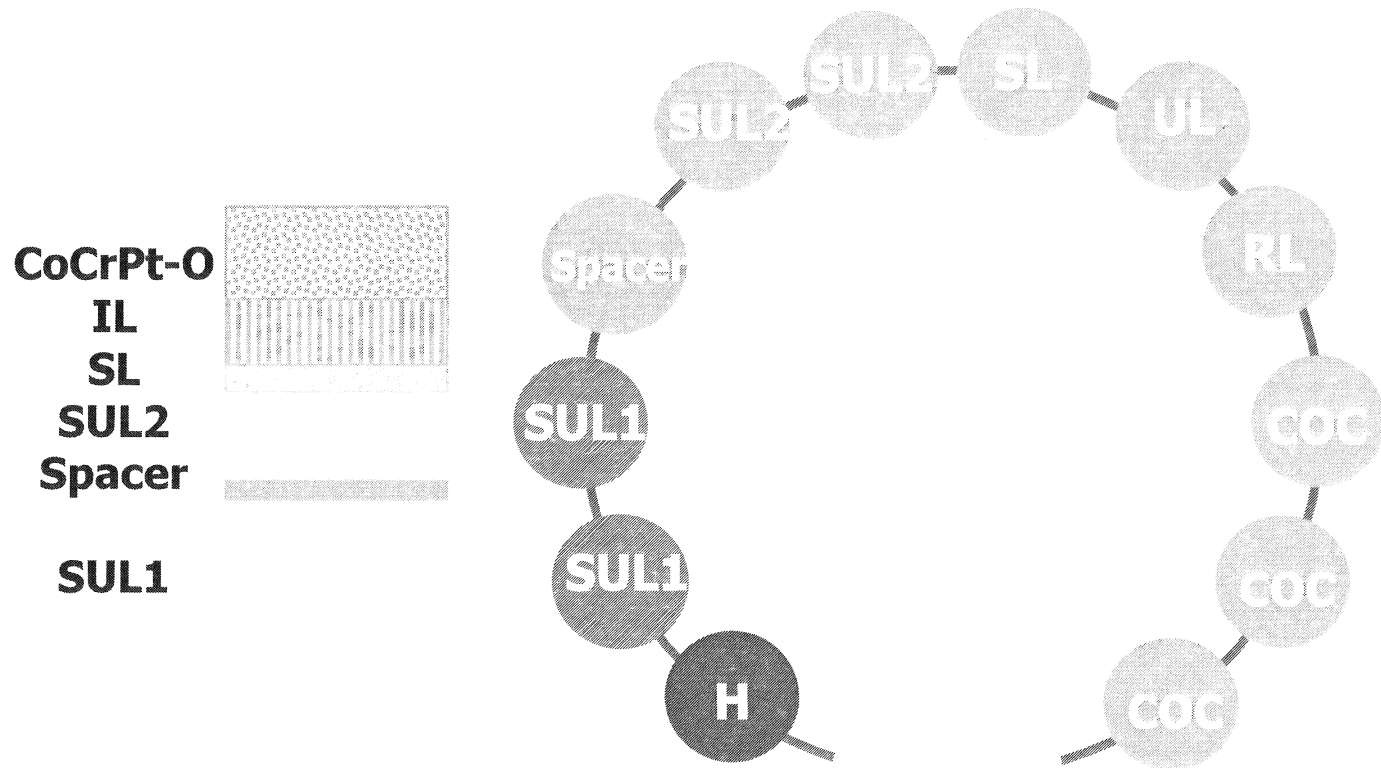

Integrated process demonstration configuration

Disks were successfully made with throughput similar to current longitudinal products.

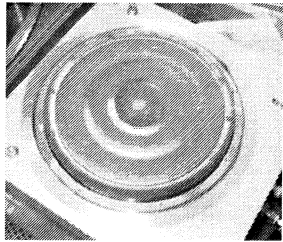

- Sputter uptime

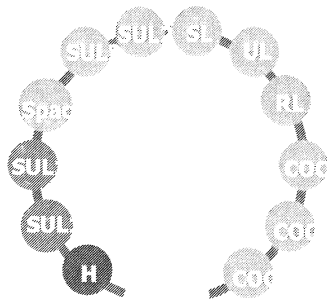

- Throughput

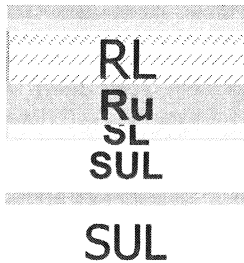

- Materials

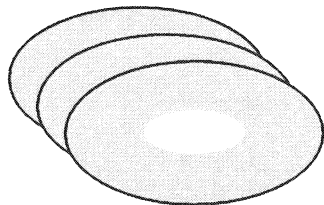

- Yield



- **Successful fabrication of CoPtCrO media: $H_c > 5$ kOe, $S=1$, $H_n < -2$ kOe, Co c-axis $\Delta\theta_{50} = 3.3^\circ$ and grain size ~ 6 nm.**
- **Excellent recording performance and great potential for high-density perpendicular recording.**
- **Soft underlayer thickness as low as 100 nm, performs well.**
- **Optimizing SUL design effective in ATE suppression.**

- **1st and 2nd generation of PMR media fabricated by current LMR media production system with similar throughput.**
- **Incrementally higher cost than LMR media due to additional SUL material and lower uptime of sputter system.**
- **Minimizing SUL thickness and number of media layers will enable use of existing equipment.**

The Perpendicular Recording Media with an Electroless-plated Ni-P Soft Magnetic Underlayer

Hiroyuki Uwazumi

Fuji Electric Storage Device Co., Ltd

OUTLINE

Introduction

SUL in the PMR media

Plated SUL

Experimental

Substrates and media preparation

Measurements

Results and Discussions

Characteristics of plated Ni-P SUL

Spike noise observation

Characteristics of media with Ni-P SUL

Conclusions

Introduction (1)

Double Layered perpendicular media with soft magnetic underlayer (SUL)

S. Iwasaki, Y.

⇒ promising candidates to achieve high recording density

Requirements for SUL

> 100 nm-thick SUL by sputtering method

Particles / Target Life / Maintenance cycle

Need many sputtering chambers

Introduction of new cathode system ?

Suppression of the domain wall

Complex multilayer system

Need many sputtering chambers



Decrease in throughput / Increase of manufacturing cost

Introduction (2)

SUL deposition without any impact on the throughput

⇒ Electroless-plated SUL : CoNiFeB[1], NiFeP[2]

- Large $B_s > 1$ T, good soft magnetic properties
- Difficult to control the process & composition
- May need to add the *gest of* domain control layer

[1]T. Yokoshima, et al., *Di*

, 18pE-8, p. 378, 2003.

[2]S. Saito, et al., *Digest of 27th Conf. of*

, 18pE-11, p. 381, 2003.

Electroless-plated Ni-P layer

- ~20at%P [non magnetic] : Widely used for Al substrates
Well established plating & polishing process
- **Low P content [ferromagnetic] : today's topic**

Is it available to use as SUL ?

- { Surface roughness
- { Magnetic properties
- { Recording characteristics
- { Spike noise

Media Preparation

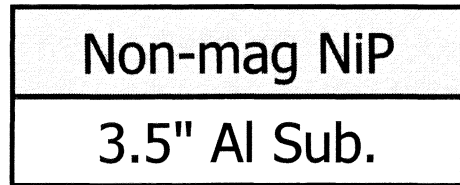

Polished substrate

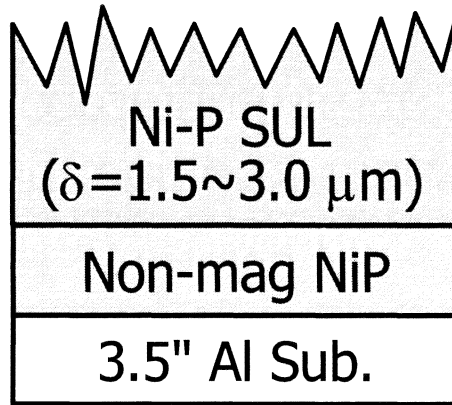

Electroless-plating
(use similar facilities & processes to non-mag NiP)



IEEE

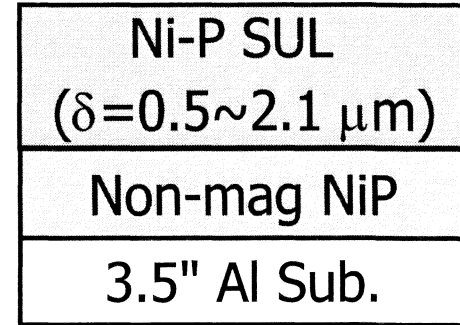

Polishing (remove $\sim 1\ \mu\text{m}$ -thick)

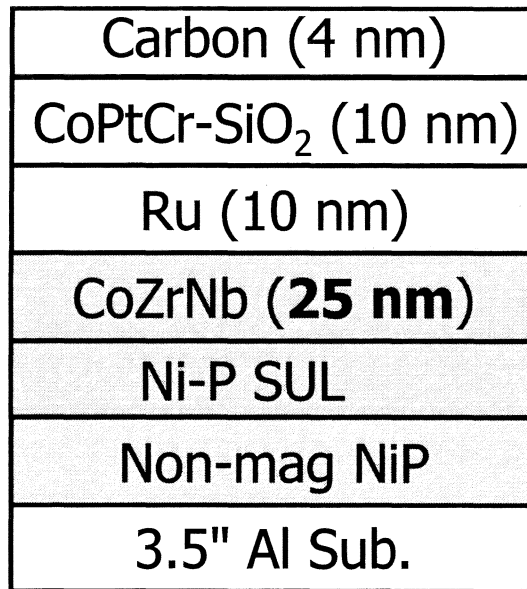

Sputtering

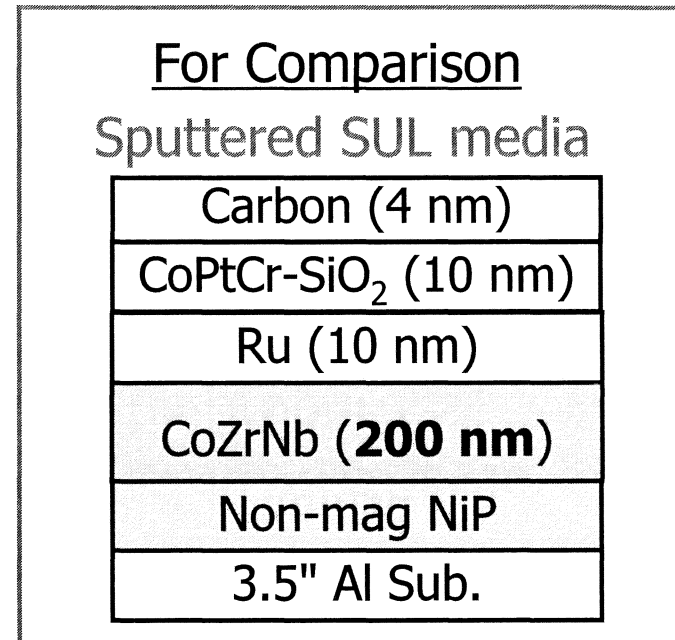

T. Oikawa, et

Measurement Methods

for the Ni-P SUL

Surface roughness, Ra

Magnetic properties (B_s , H_c)

Atomic Force Microscope

VSM

for the media with a Ni-P SUL

Magnetic properties

Recording performance

Kerr magnetometer

Spin stand tester

with SPT/GMR head

<u>Head specification</u>	
Write Track width	0.3 μm
B_s of main pole	1.8 T
Read Track width	0.2 μm
Shield gap length	80 nm
Flying Height	12 nm

Results and Discussions

- Characteristics of plated Ni-P SUL
- Spike noise observation
- Characteristics of Media with Ni-P SUL

Surface Roughness of Ni-P SUL

Ra of the polished Ni-P SUL used in this study : $\sim 0.3 \text{ nm}$
 almost same roughness compared to that of the non-mag. Ni-P layer

⇒ More precious polishing process has been developing

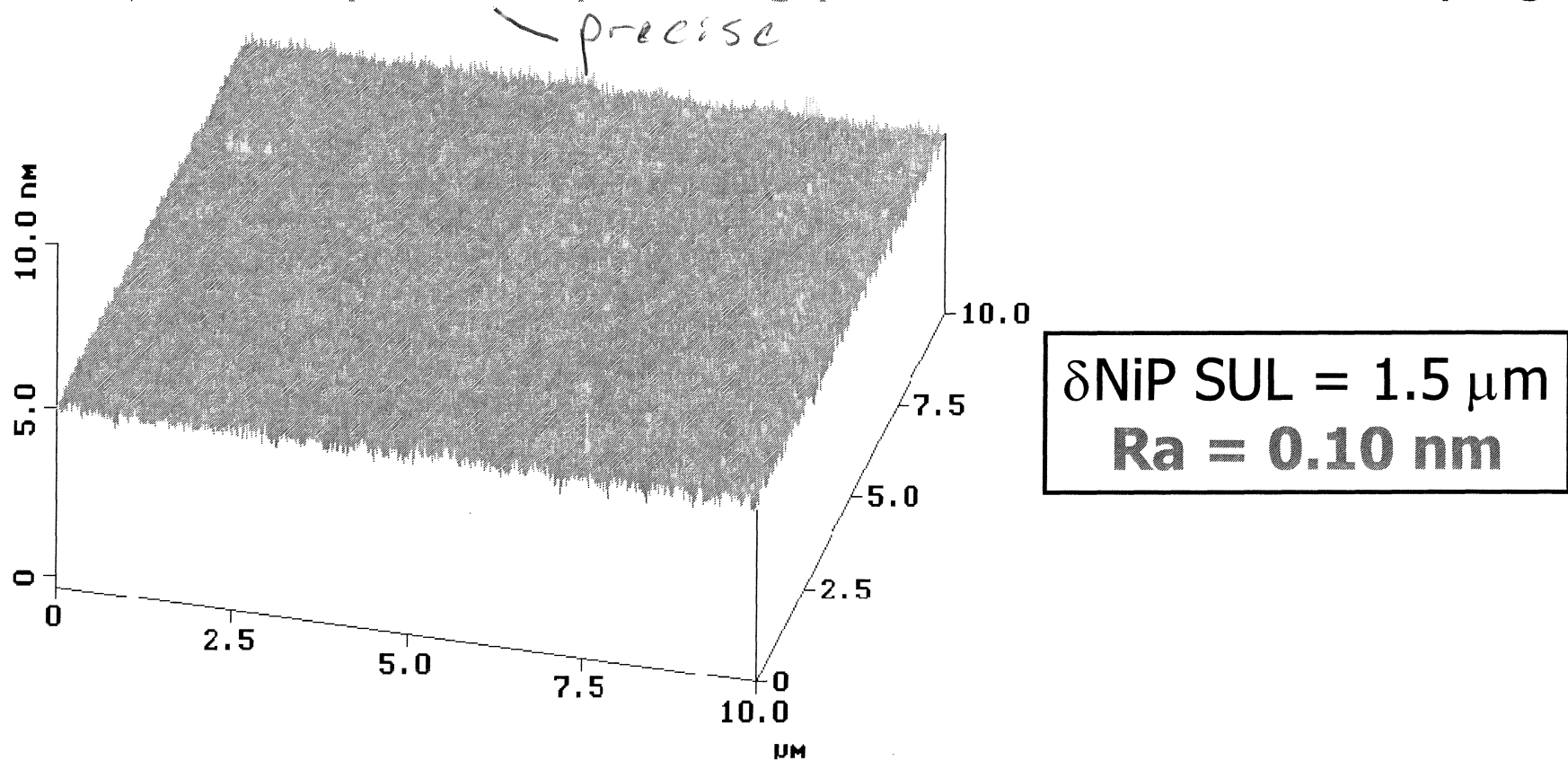

✓ **Capability for future high-density recording media**

Magnetic Properties of Ni-P SUL

Typical in-plane magnetization curve

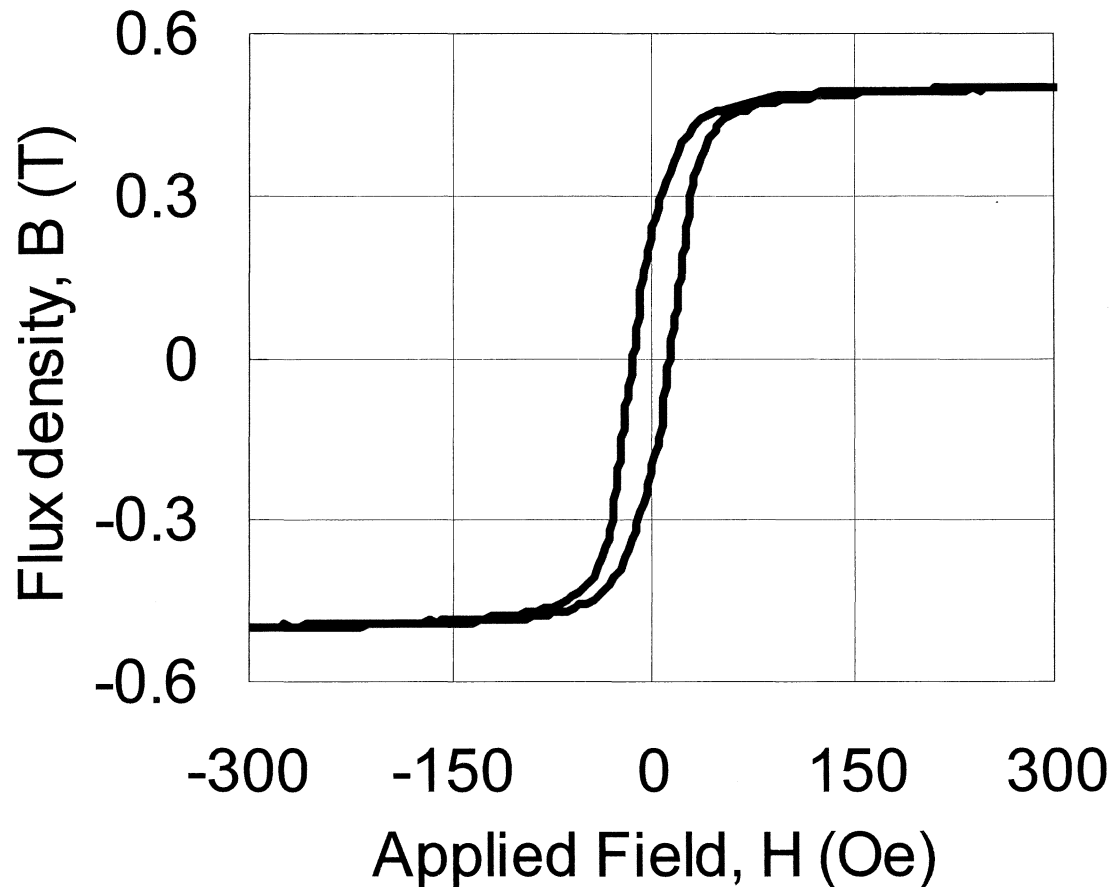

$\delta\text{NiP SUL} = 2.1 \mu\text{m}$
 $B_s = 0.5 \text{ T}$
 $H_c = 15 \sim 20 \text{ Oe}$

- ✓ **Almost independent of Ni-P thickness**
- ✓ **Isotropic in-plane magnetic properties**

Results and Discussions

- Characteristics of plated Ni-P SUL
- Spike noise observation
- Characteristics of Media with Ni-P SUL

Spike Noise observed from SUL

Spike noise map : for the media with d.c. erased state

Bright color represents **large signal** output

Media with
2.1 μm -thick Ni-P SUL

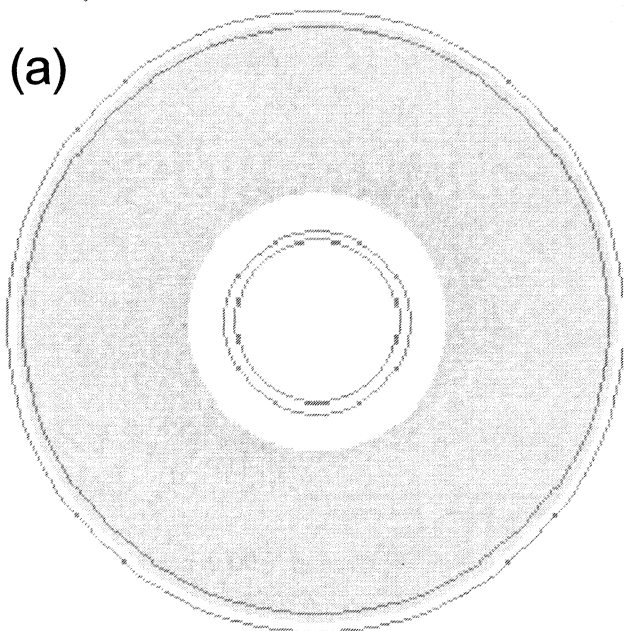

Almost **no** spike noise

Media with
200 nm-thick sputtered SUL

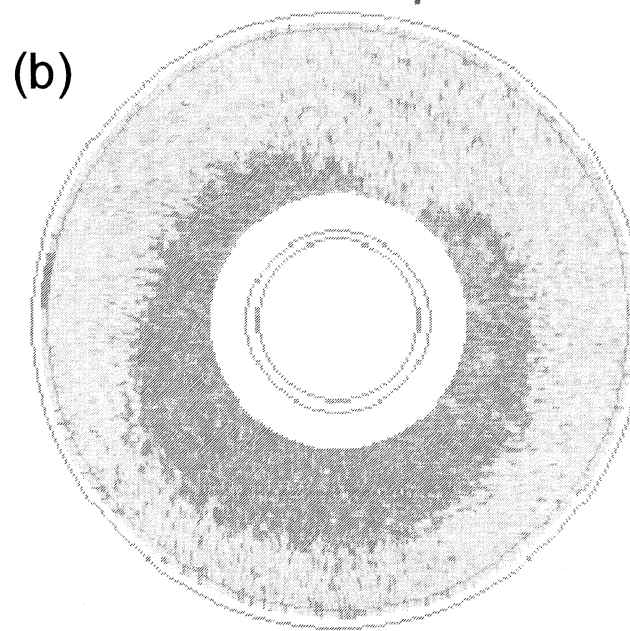

A **large amount** of spike noise

✓ **The Ni-P SUL's studied here are
likely to be free from the spike noise**

Results and Discussions

- Characteristics of plated Ni-P SUL
- Spike noise observation
- Characteristics of Media with Ni-P SUL

Magnetic Properties of Media with Ni-P SUL

H_c of the granular recording layer vs Thickness of the Ni-P SUL

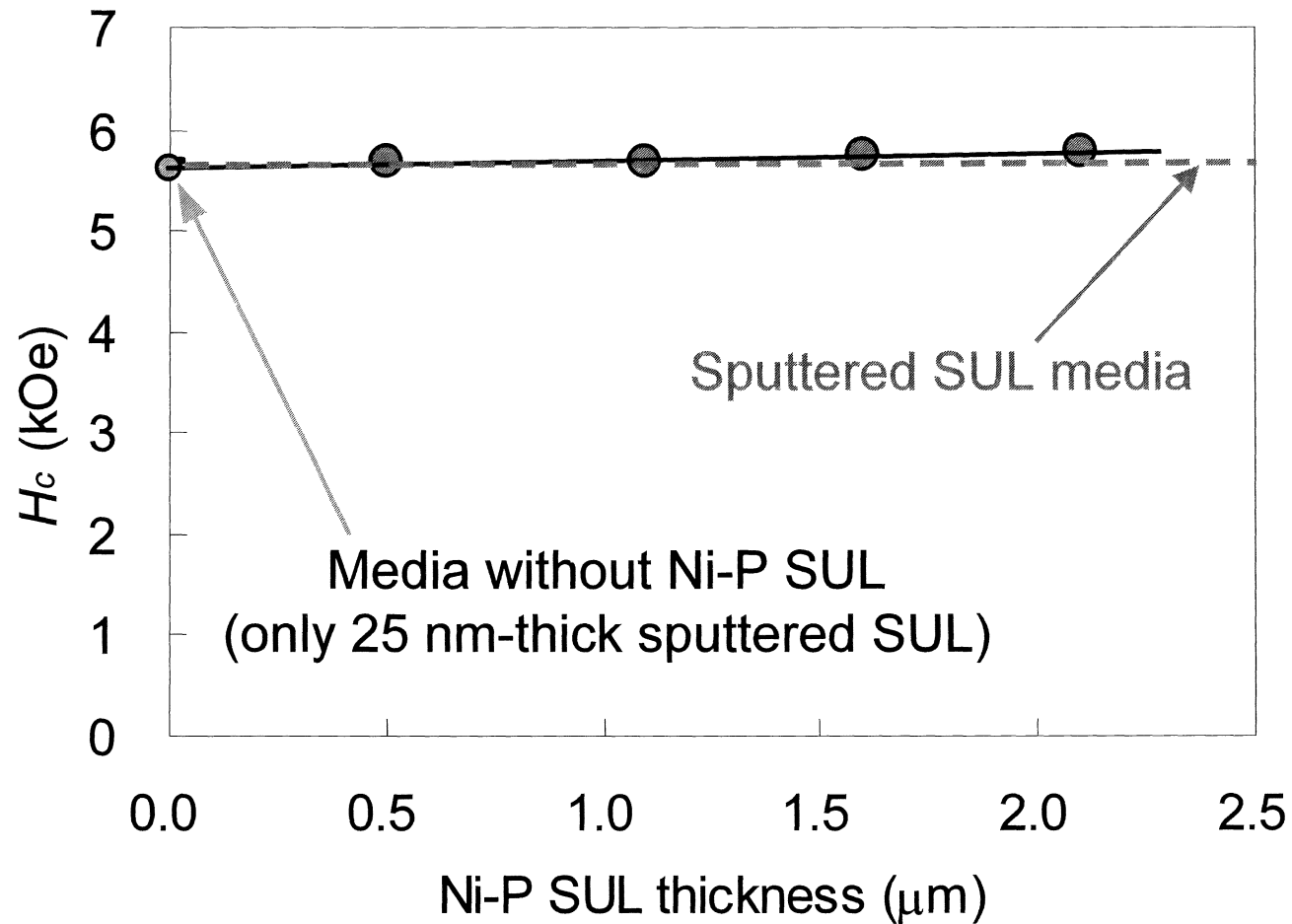

✓ **Same sputtering process
can be applied for the Ni-P SUL media**

Recording performance : Overwrite Saturation

A 61 kFCI signal was overwritten by a 735 kFCI signal

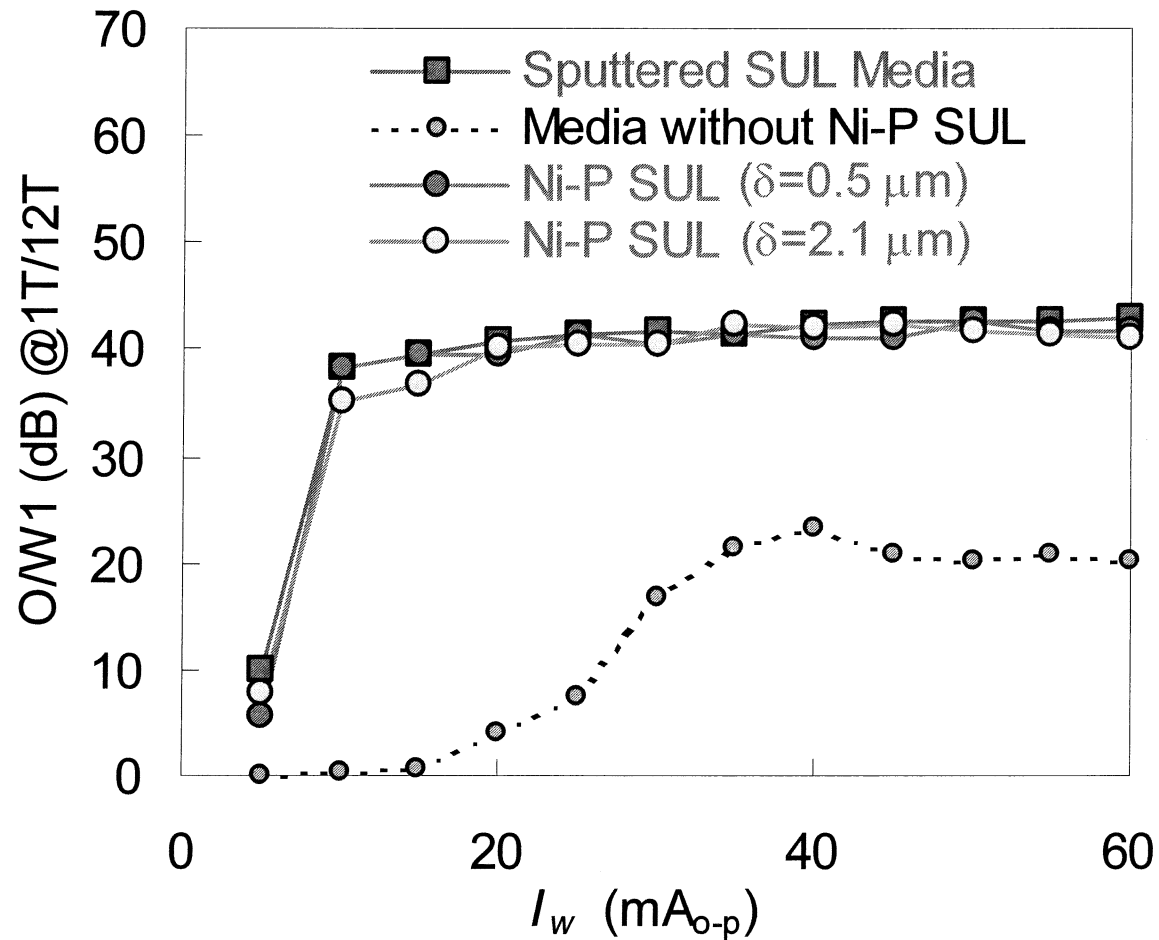

✓ **>0.5 μm -thick plated Ni-P layer together with 25 nm-thick sputtered CoZrNb layer are sufficient to act as an SUL**

Recording performance : SNR

SNR performance @ 367 kFCI vs Thickness of the Ni-P SUL

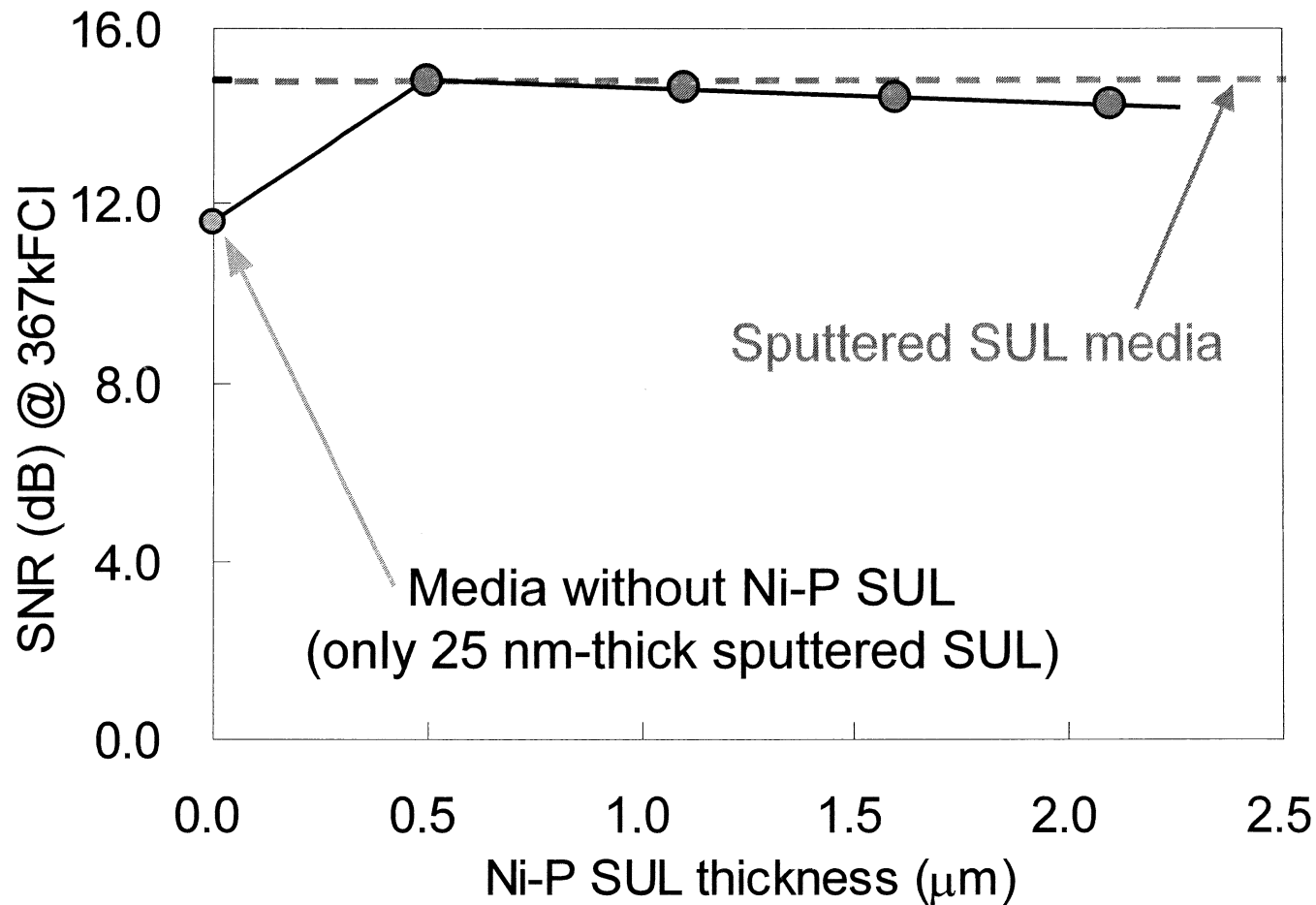

✓ **SNR of the media with a 0.5 μm -thick Ni-P SUL is $\sim 15\text{dB}$**
 (as good as that of the media with a sputtered SUL)

Signal waveform at a d.c. erased state

Media with
2.1 μm -thick Ni-P SUL

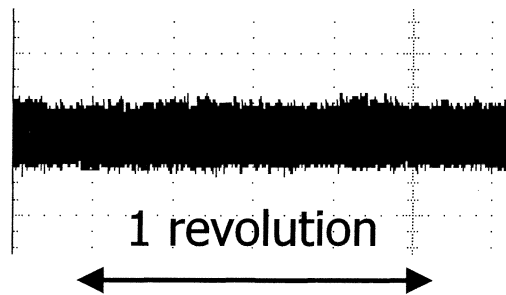

Media with
200 nm-thick sputtered SUL

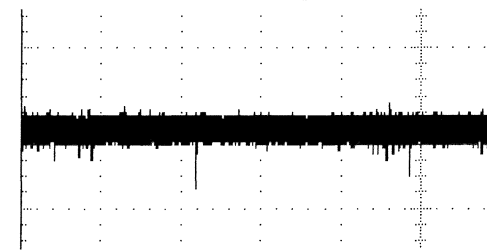

Noise Spectra @ 122 kFCI (13.0m/s, 10MHz=0.65 μm bit length)

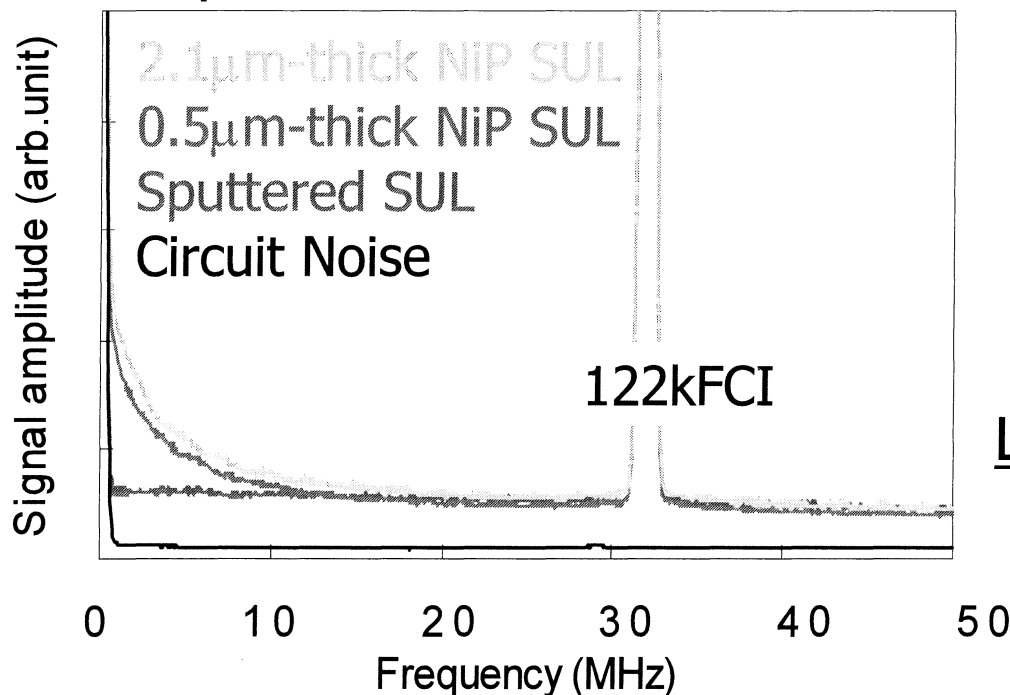

Ni-P SUL media
Large noise is observed
in low frequency region



**Long-wavelength fluctuation of
the magnetization must exist.**

Reduction of the SUL noise

Noise Spectra @ d.c. erased state

(13.0m/s, 10MHz=0.65 μ m bit length)

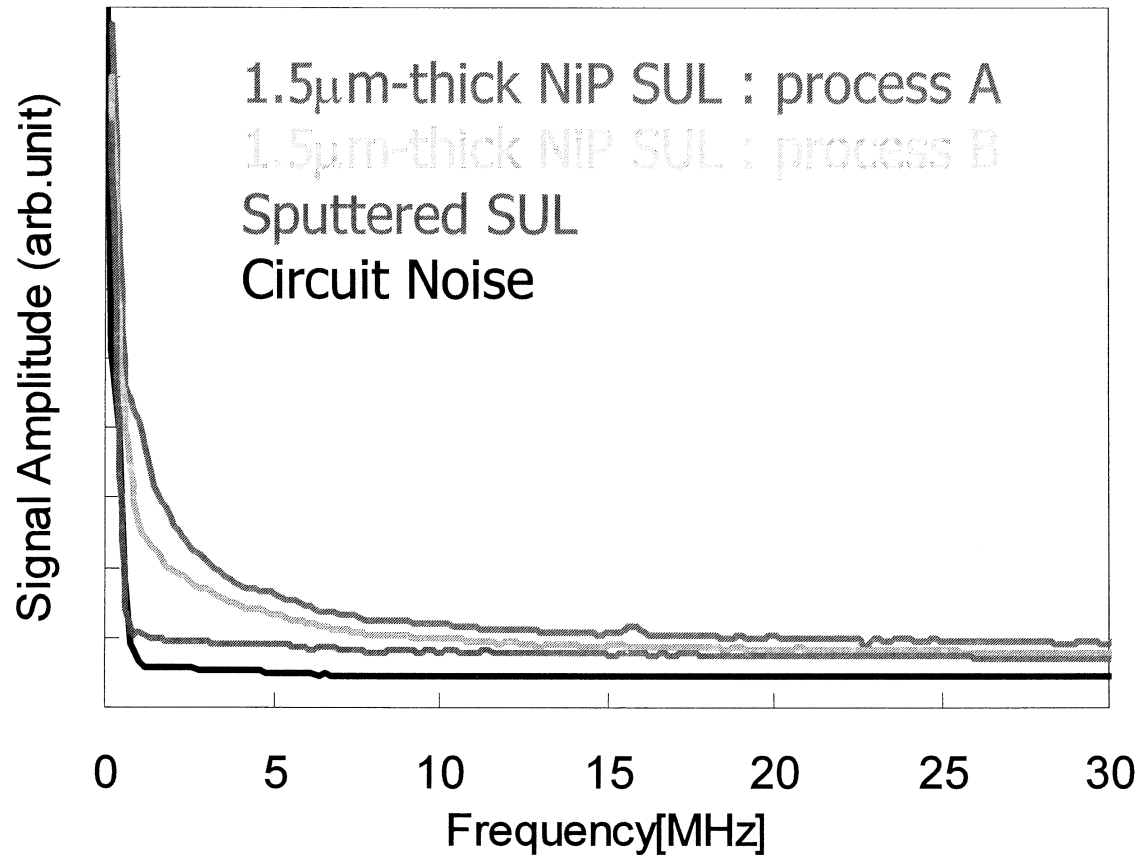

Is this normal to anything?

✓ **SUL noise can be reduced**

due to the control of the plating process

Conclusions

A plated ferromagnetic Ni-P layer was employed as an SUL

Characteristics of the Ni-P SUL :

- ✓ Excellent manufacturing throughput, using conventional facilities
- ✓ A super-smooth surface of $Ra \sim 0.1$ nm was achieved after polishing
- ✓ $B_s = 0.5$ T, $H_c = 15 \sim 20$ Oe, in-plane isotropic properties

Compared to the sputtered SUL media :

- ✓ Almost no spike noise was observed from the Ni-P SUL
- ✓ Same sputtering process can be applied to realize same magnetics
- ✓ 0.5 μ m-thick Ni-P with a 25 nm-thick sputtered CoZrNb is sufficient
- ✓ Almost same SNR of the media with a 0.5 μ m-thick Ni-P SUL
- ✓ Large noise in low frequency region must be reduced

Great potential of using a plated Ni-P layer as an SUL
in the manufacturing of perpendicular recording media

Session III:
Perpendicular Head Technology and Design, and Component Integration

1:10-1:40pm

Moris Dovek, Headway

“Advances and Challenges of Perpendicular Recording Heads”

Perpendicular Magnetic Recording (PMR) Heads have been demonstrated to extend the areal density capabilities of magnetic recording systems. The addition of a shield has allowed improved field gradients and writeability at higher linear densities. PMR systems have also extended the capabilities of the GMR reader by narrowing down the trackwidth and generating higher readback amplitude both of which had been limiting the GMR read head extendibility until now. However, many challenges still remain in PMR designs especially at narrow trackwidths and high track pitch. As the critical dimensions are pushed to lower values for narrow trackwidths, process tolerances need to get tighter to deliver good OW and Magnetic Write Width (MWW) distributions. Narrow trackwidths impose a similar challenge for OW as it does in longitudinal recording systems (LMR). In addition, PMR side fringing is typically higher than what is measured in an LMR system which also forces narrower physical dimensions and introduces concerns about transition quality at track edges. Finally, an additional track pitch penalty may also be paid due to the skew range of the disk drive.

1:40-2:10pm

Lamar Nix, Hitachi GST

“Perpendicular Heads for Tomorrow’s HDD”

In this study we explore heads for perpendicular recording. We show some of the significant challenges for operation at 100-200 gigabits/in.² and discuss some practical solutions. We compare the three principal write head designs for perpendicular-single pole, trailing shield, and trailing and side shield-showing the advantages of each and the challenges involved. Finally we discuss processing methods involved in making perpendicular heads.

2:10-2:40pm

Yan Wu, Maxtor

“Progress and Challenges in Perpendicular Drive Integration”

The potential of perpendicular recording technology has been well advertised since its first proposal in 1977[1]. The persistent development effort uncovered many challenges in this technology [2]. Because of this, no products have been introduced with this technology up to date. With the increased difficulty seen in longitudinal recording becoming more and more difficult to develop the future products, perpendicular recording now have received more attention than ever before.

In this presentation, we will review the recent progress in the perpendicular drive integration effort and discuss some of the challenges that are particular to the technology. Most of the challenges discussed here have been known for a number of years. Some of the difficulties have been mostly solved with recent progress, such as thermal decay. Others still remain to be challenging today, such as head induced media erasure and stray field sensitivity. Some of the challenges are not believed to be intrinsic to the technology, but certainly non-trivial for the process side such as media uniformity.

With the increased efforts in recent years and significant progress it resulted, it is most likely we will be able to overcome the challenges and introduce products based on perpendicular recording technology in the near future.

- [1] S. Iwasaki and Y. Nakamura, "An analysis for the magnetization mode for high density magnetic recording", *IEEE trans. Magn.*, vol. 13, p.1272,1977.
- [2] W. Cain et al., "Challenges in the Practical Implementation of Perpendicular Magnetic Recording", *IEEE trans. Magn.*, vol. 32, p.97,1996.

2:40-3:10pm

Francis Liu, Western Digital

"Advanced Perpendicular Magnetic Recording Head Technologies"

3:10-3:40pm

Coffee Break



Advances and Challenges of Perpendicular Recording Heads

M.M. Dovek, L. Guan, Y. Tang, Y. Sasaki, K. Takano
Headway Technologies
February 2004





Outline

- **Today's PMR Write Head**
- **Why PMR?**
 - Read Head
 - Trackwidth, amplitude
 - Write Head
 - Ability to deliver flux at a smaller physical dimension
- **TPI Extendibility Challenges**
 - Manufacturing Tolerances
 - Overwrite at narrow trackwidth
 - Fringing: Magnetic to Physical Difference
 - Bevel Angle and Skew



Outline

- **Today's PMR Write Head**
- **Why PMR?**
 - Read Head
 - Trackwidth, amplitude
 - Write Head
 - Ability to deliver flux at a smaller physical dimension
- **TPI Extendibility Challenges**
 - Manufacturing Tolerances
 - Overwrite at narrow trackwidth
 - Fringing: Magnetic to Physical Difference
 - Bevel Angle and Skew



Today's typical PMR Write Head

Shielded Pole with Two Layer Coil

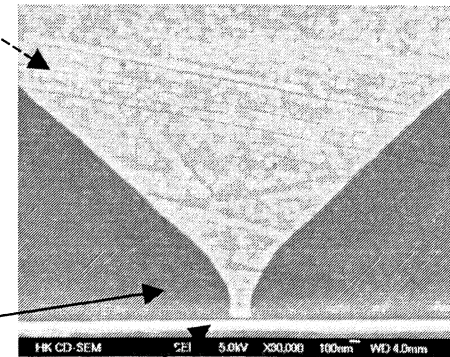
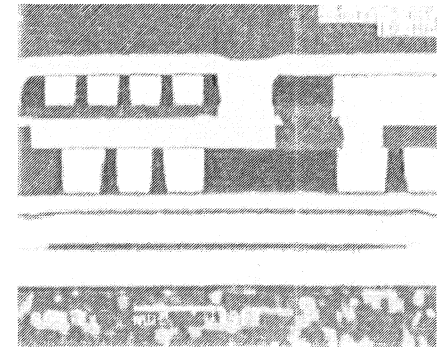
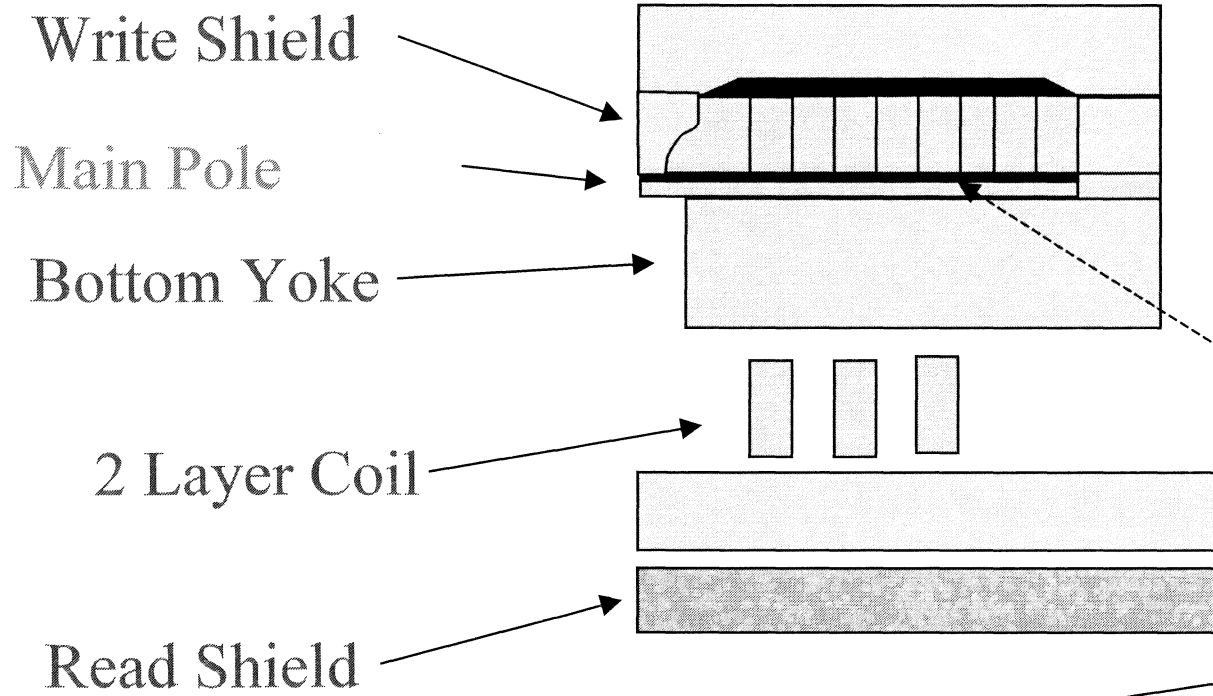

Neck Point

Beveled Pole

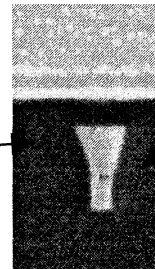



Why Shielded Pole?: BPI improvement

960 kfc

No shield

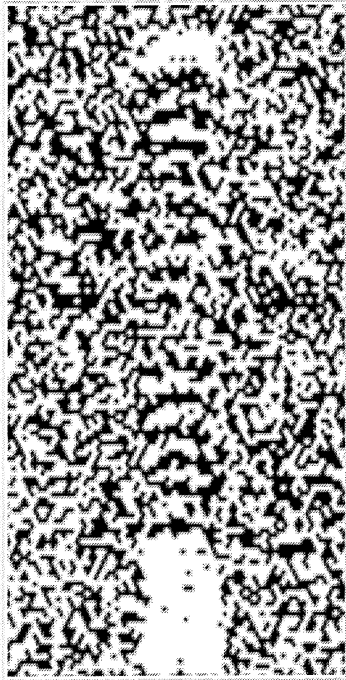

WG = 100 nm

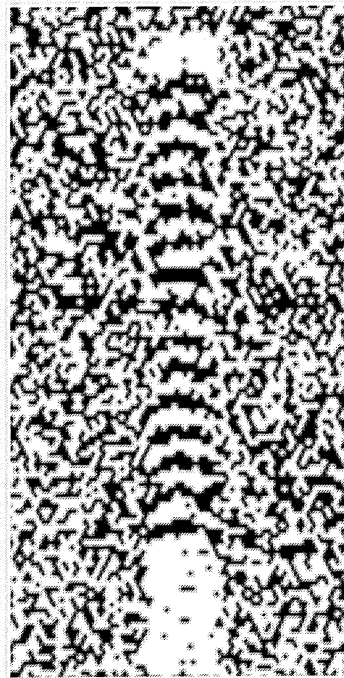

WG = 50 nm

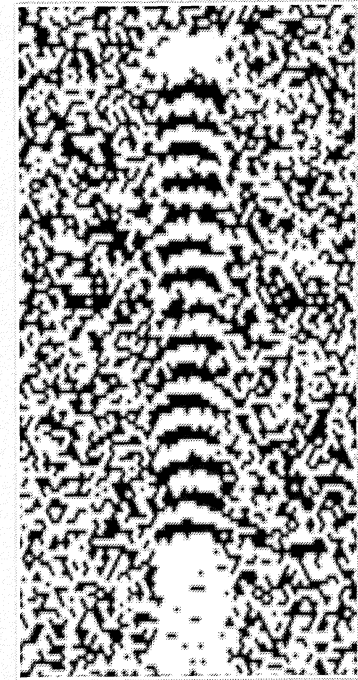

- **BPI significantly improved with trailing shield**
- **PMR High BPI capability demonstrated**

1. Francis Liu, et al, TMRC 2003, " Design and Characterization of Advanced Perpendicular Magnetic Recording Head"
2. Davide Guarisco et al, joint [NA] PMRC 2003, "High Linear Density In Perpendicular Recording".

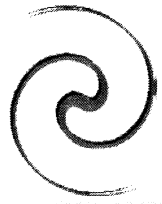

Write Field Components

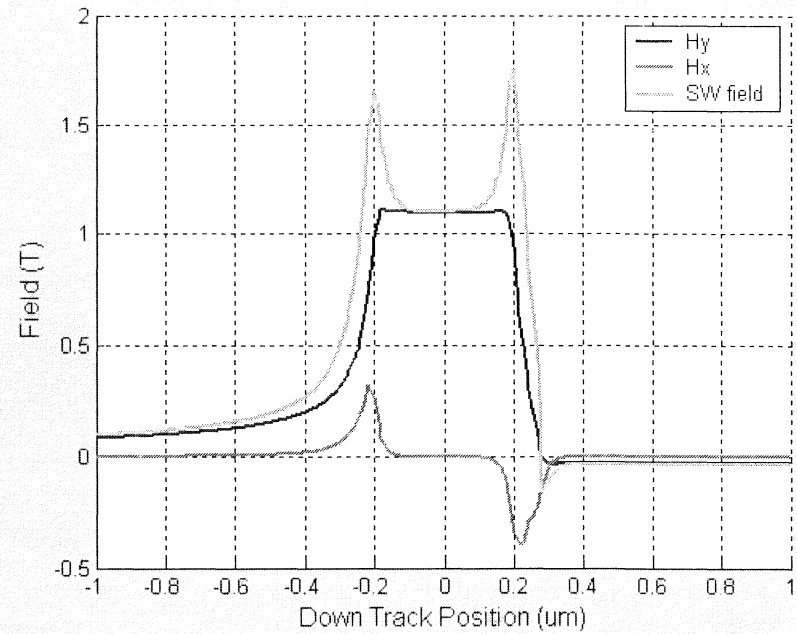
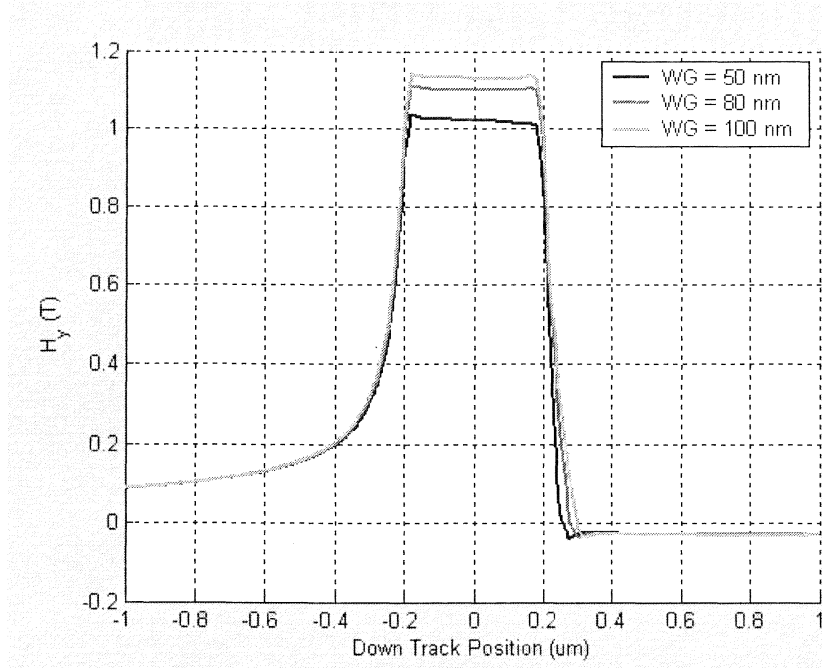

- **Narrower gap loses field in return for gradient**
- **Longitudinal Field helps SW switching field**



Critical Design Parameter: Neck Height

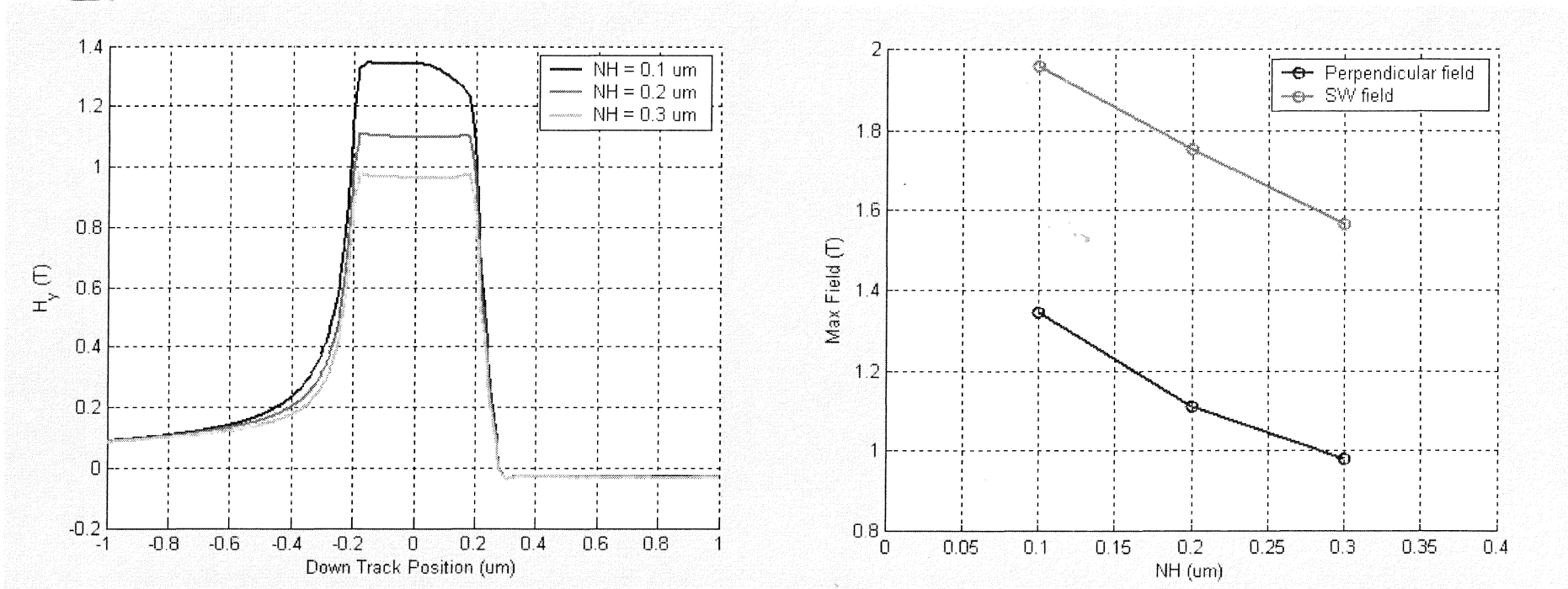

- **Neck Height most sensitive design parameter for field**
 - Often used to compensate the decreasing field at narrow trackwidths



Outline

- Today's PMR Write Head
- **Why PMR?**
 - Read Head
 - Trackwidth, amplitude
 - Write Head
 - Ability to deliver flux at a smaller physical dimension
- TPI Extendibility Challenges
 - Manufacturing Tolerances
 - Overwrite at narrow trackwidth
 - Fringing: Magnetic to Physical Difference
 - Bevel Angle and Skew

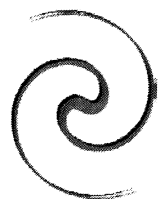

Readback Modeling: Simulation parameters

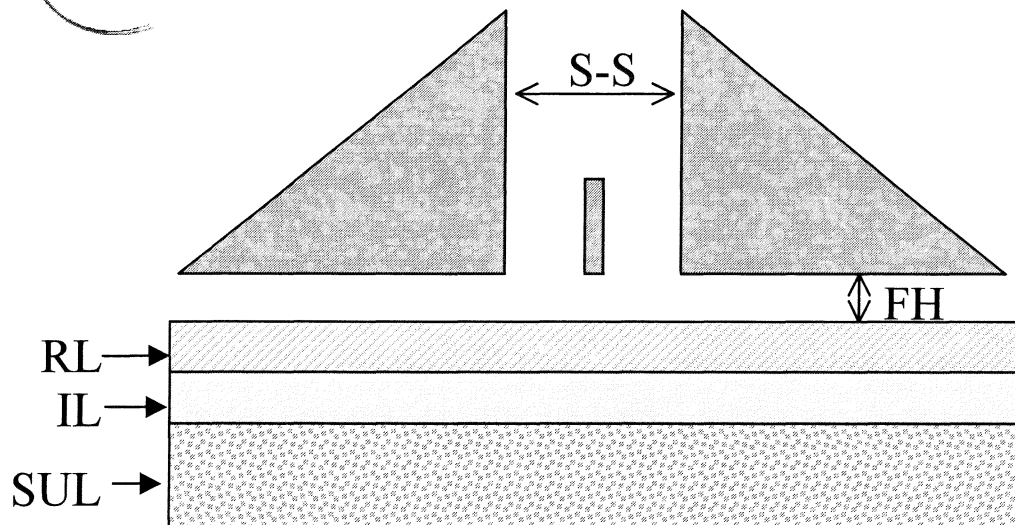

Generic CIP: S-S spacing = 60 nm

PMR media:

$M_s = 400 \text{ emu/cc}$, RL thickness = 15 nm

IL = 15 nm, FH = 15 nm

LMR media:

$M_s = 350 \text{ emu/cc}$, RL thickness = 10 nm

FH = 15 nm

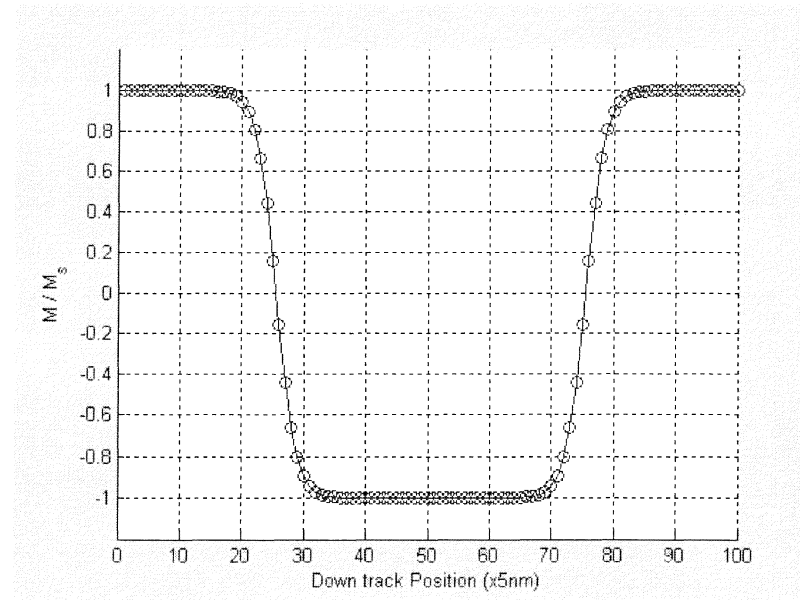

Transition shape:

$$m(x) = \tanh \frac{2(x - x_0)}{\pi a}$$

where transition parameter $a = 10 \text{ nm}$



Waveforms for PMR and LMR

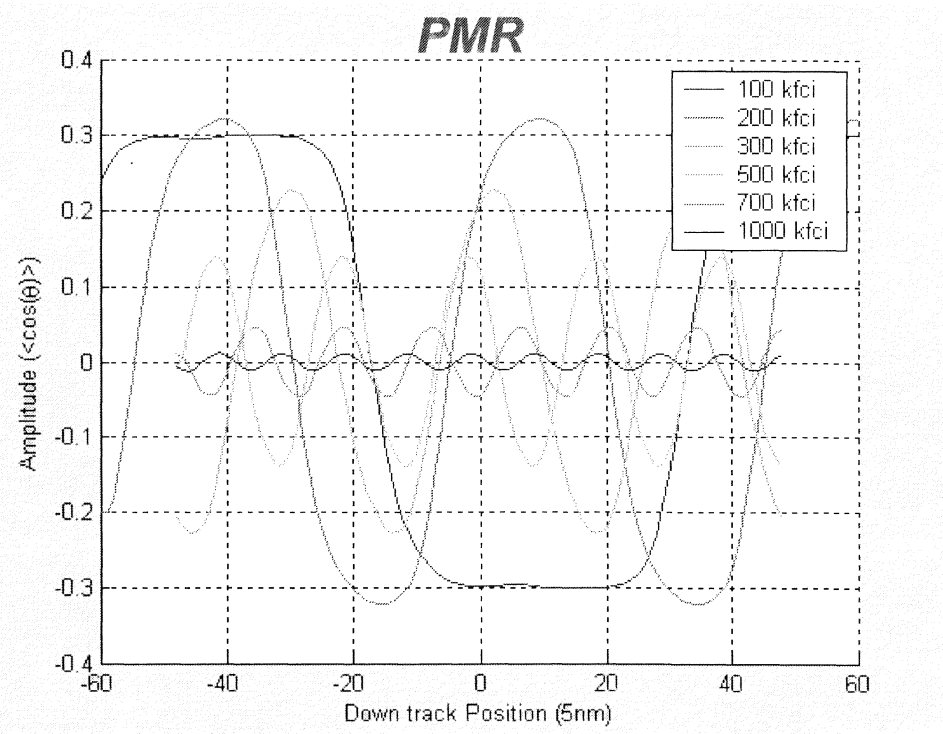
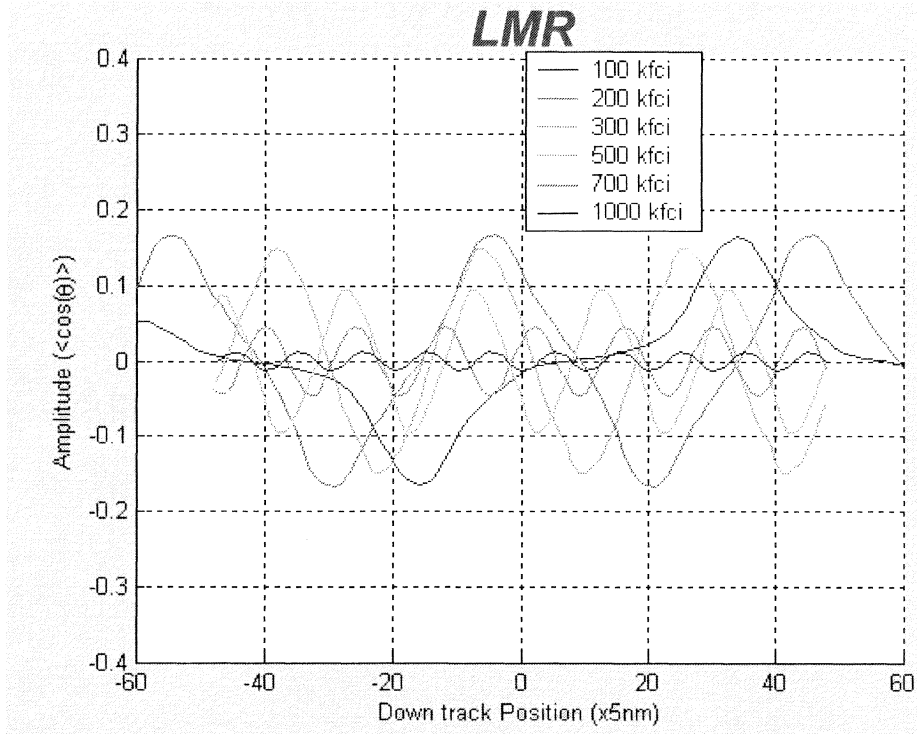



TAA roll-off: PMR vs. LMR

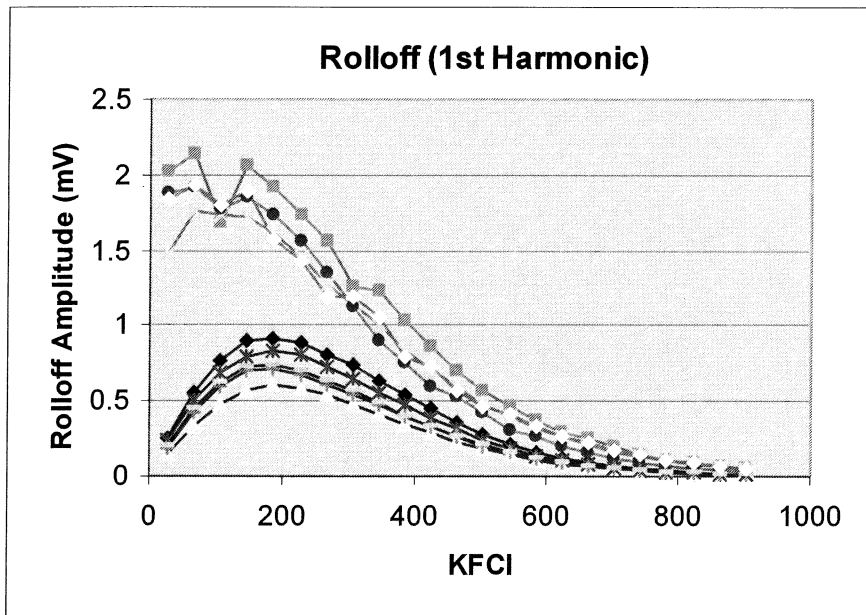
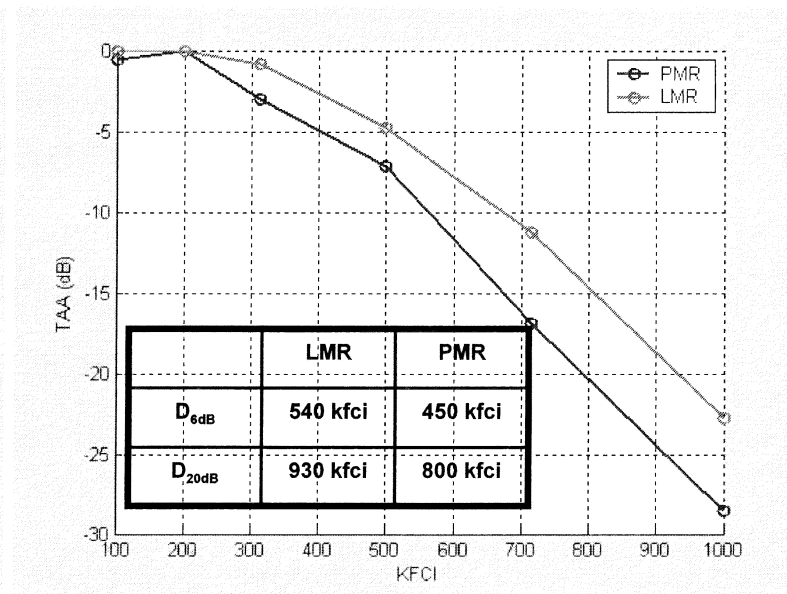
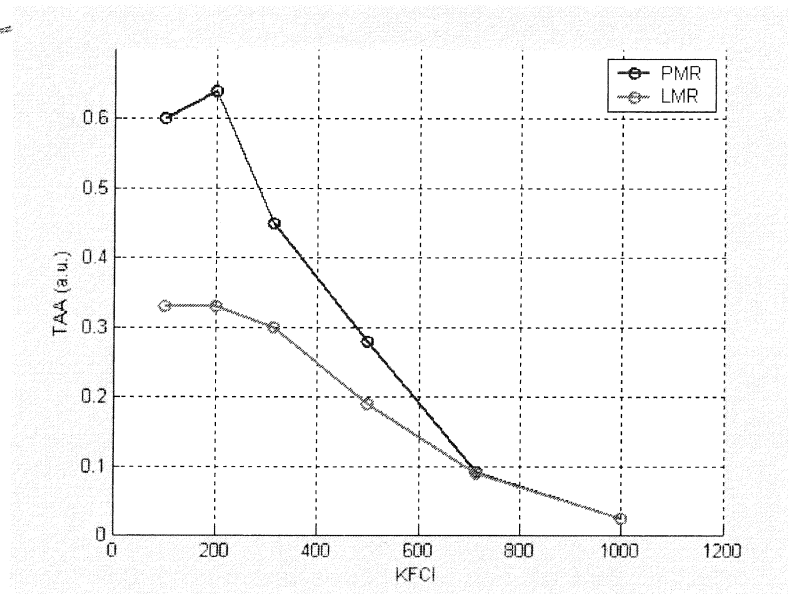

- **Much higher LF amplitude**
- **Amplitude rolls off faster for PMR compared to LMR**
 - Narrower S-S required to boost high frequency
- **Measured PMR rolloff better than modeled one**
 - Sharper “a”?

MRW_μ advantage for PMR

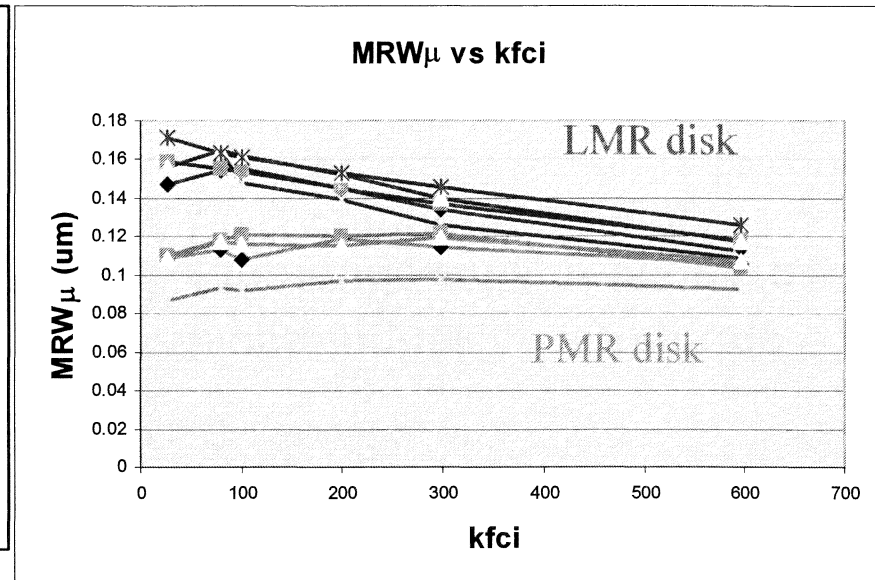
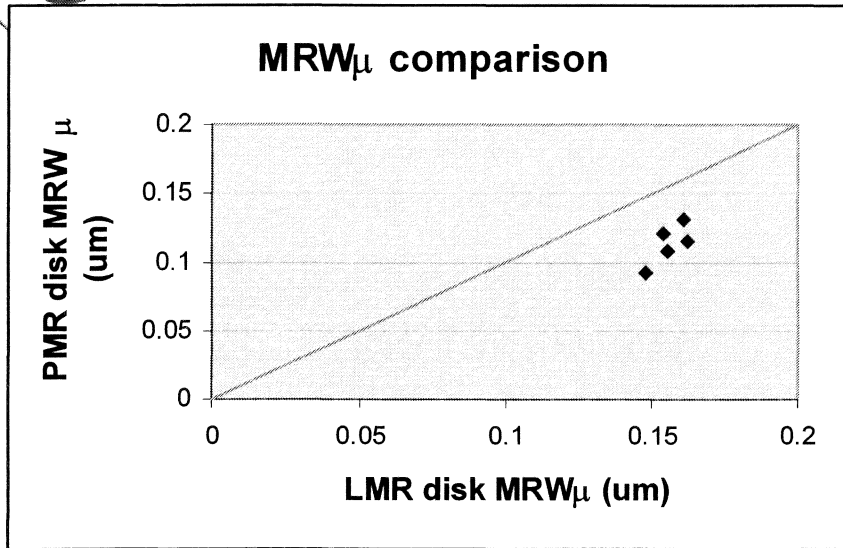

- **PMR shows clear advantage for MRW_μ**
 - Same heads measured on PMR and LMR disk
 - ⇒ 0.03-0.04 μm advantage
 - LMR MRW_μ more sensitive to kfc
 - ⇒ Side flux propagation depends on kfc
 - For OTRC, worst case matters → PMR is better!



Outline

- Today's PMR Write Head
- Why PMR?
 - Read Head
 - Trackwidth, amplitude
 - **Write Head**
 - **Ability to deliver flux at a smaller physical dimension**
- TPI Extendibility Challenges
 - Manufacturing Tolerances
 - Overwrite at narrow trackwidth
 - Fringing: Magnetic to Physical Difference
 - Bevel Angle and Skew



Maintaining Field Strength at narrow PW

	LMR	PMR
Spacing	20 nm	20 nm
Pole	2.4 T	2.4 T
WG/P2t	0.1 μ m	1.5*P2W
Coil	6 turns	4 turns

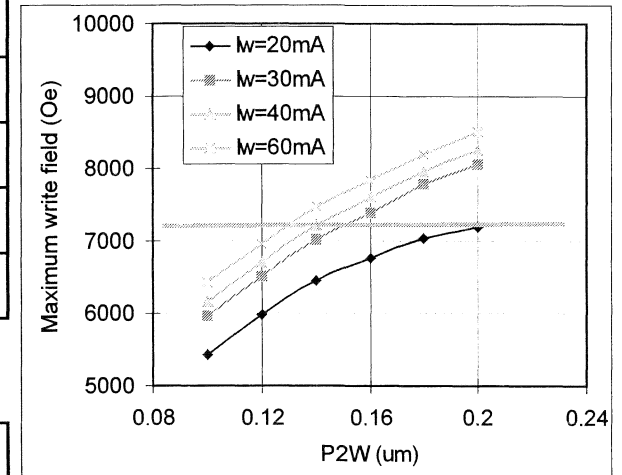

	LMR	PMR
Media Hc	5 kOe	6 kOe
Minimum P2W	0.14 μ m (lw=40~60mA)	0.10 μ m (lw=60mA)
Head field	7.2 ~ 7.5 kOe	8.1 kOe
Minimum MWW	0.120 ~ 0.132 μ m	0.09 μ m

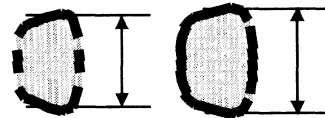

unshielded PMR

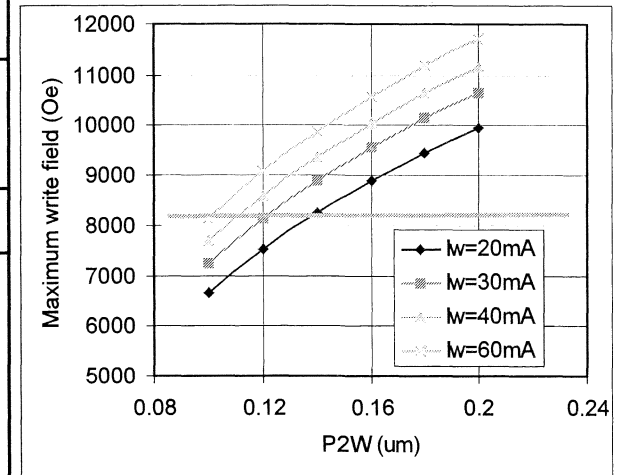



Maintaining Field Strength at narrow PW

- **LMR uses fringing field to write**
 - wgap used to scale down as pole B_s increased
 - wgap very difficult to scale as B_s is kept at 24 kG
- **PMR uses gap field to write**
 - Shielded PMR a bit closer to “fringing field” case
- **PMR and LMR writer both suffer similar limitations**
 - Material B_s
 - wgap
 - Flyheight
 - Flarepoint/Neck-Height



Outline

- Today's PMR Write Head
- Why PMR?
 - Read Head
 - Trackwidth, amplitude
 - Write Head
 - Ability to deliver flux at a smaller physical dimension
- **TPI Extendibility Challenges**
 - Manufacturing Tolerances
 - Overwrite at narrow trackwidth
 - Fringing: Magnetic to Physical Difference
 - Bevel Angle and Skew



TPI Challenge for PMR

- **PMR has been pushed to higher kbpi than LMR (~by around 20%)**
 - already gives density advantage
- **Track Pitch advantage of PMR may not be as large as initially thought**
 - Extendibility somewhat similar to LMR
 - Skew and Pole Bevel also affect track pitch
 - Side Fringing dominates MWW at given physical
- **Players for track pitch extendibility are similar to those for LMR**
 - Disk
 - Spacing



Outline

- Today's PMR Write Head
- Why PMR?
 - Read Head
 - Trackwidth, amplitude
 - Write Head
 - Ability to deliver flux at a smaller physical dimension
- TPI Extendibility Challenges
 - **Manufacturing Tolerances**
 - Overwrite at narrow trackwidth
 - Fringing: Magnetic to Physical Difference
 - Bevel Angle and Skew



Write Field Sensitivity LMR – PMR Comparison

Longitudinal				Perpendicular					
Hx_max 8713 (Oe)	σ (μm)	Sensitivity [Oe/ μm]	Sens * σ	Hy_max 11100 (Oe)	σ (μm)	Sensitivity [Oe/ μm]	Sens * σ		
TH	0.100	-341	-34.090	TH	0.066	3600	237.600		
P2T	0.100	976	97.572	P2T	0.050	12600	630.000		
FP	0.100	-2144	-214.385	NH	0.040	18300	732.000		
P2W	0.012	16416	196.989	P2W	0.012	15000	180.000		
			overall σ	308.947				overall σ	1010.731
			% sigma	3.546				% sigma	9.106

- **Much tighter process tolerance requirements forecasted for PMR**
 - However, Field Magnitude- σ more than doubled for PMR

P2T: Pole Thickness
FP: Flarepoint
NH: Neck Height
P2W: Pole Width
TH: Throat Height



MWW Sensitivity- Definition

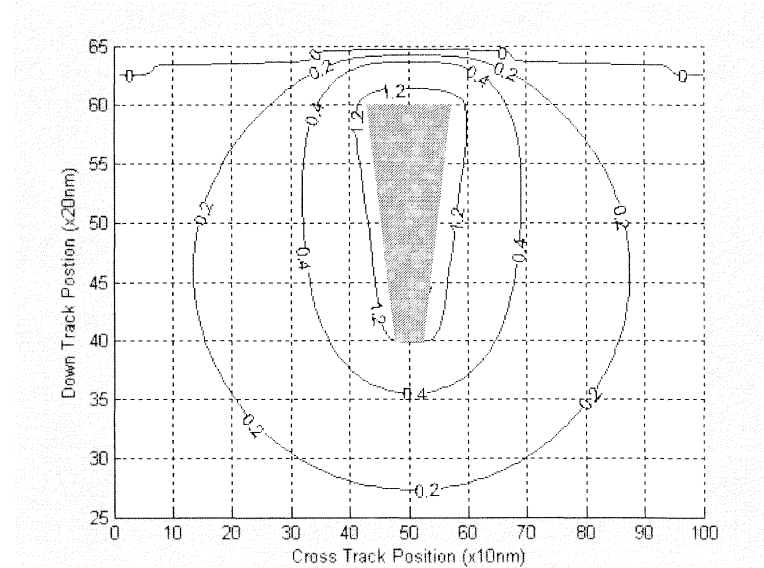
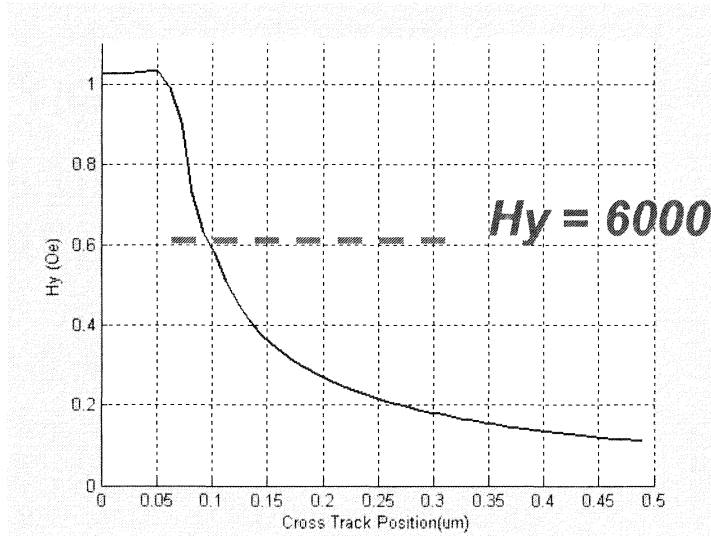

- **Downtrack maximum field plotted as a function of cross track position**
 - $H_c \sim 6000 \text{ Oe}$ chosen for EW/MWW definition



MWW Sensitivity

	Longitudinal				Perpendicular		
MWW_6k 0.218 (μm)	σ (μm)	Sensitivity [$\mu\text{m}/\mu\text{m}$]	Sens * σ	MWW_6k 0.2 (μm)	σ (μm)	Sensitivity [$\mu\text{m}/\mu\text{m}$]	Sens * σ
TH	0.100	-0.0101	-0.001	TH	0.066	0.04	0.003
P2T	0.100	0.0340	0.003	P2T	0.050	0.12	0.006
FP	0.100	-0.0969	-0.010	NH	0.040	0.28	0.011
P2W	0.012	1.4419	0.017	P2W	0.012	1.15	0.014
		overall σ	0.020			overall σ	0.019
		% sigma	9.242			% sigma	9.472

- **Percent σ comparable with much tighter process tolerances**

⇒ Significant process improvement needed to deliver similar % TW control



Outline

- Today's PMR Write Head
- Why PMR?
 - Read Head
 - Trackwidth, amplitude
 - Write Head
 - Ability to deliver flux at a smaller physical dimension
- TPI Extendibility Challenges
 - Manufacturing Tolerances
 - **Overwrite at narrow trackwidth**
 - Fringing: Magnetic to Physical Difference
 - Bevel Angle and Skew



OW vs Magnetic Write Width LMR and PMR

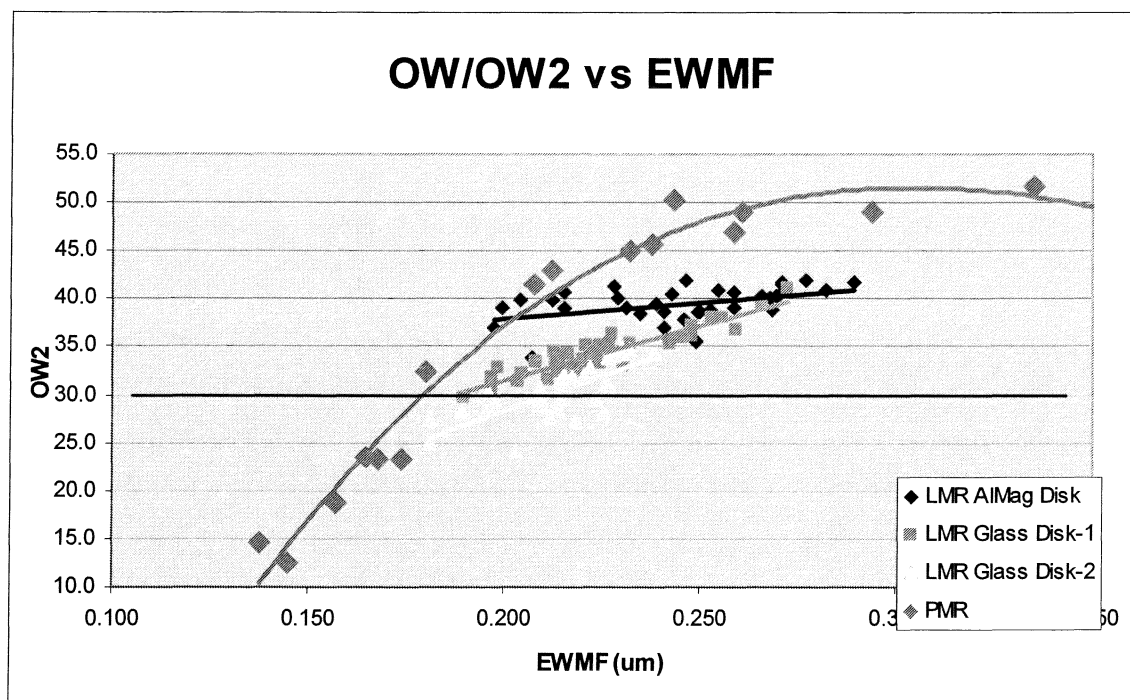

*Data shown
aggregate of
various pole
thickness,
flare points
and throat
heights*

- **EWMF follows a general trend for both LMR and PMR**
 - ⇒ OW drops with smaller EWMF
- **Key players are:**
 - Disk
 - Spacing



Disk Effect for PMR

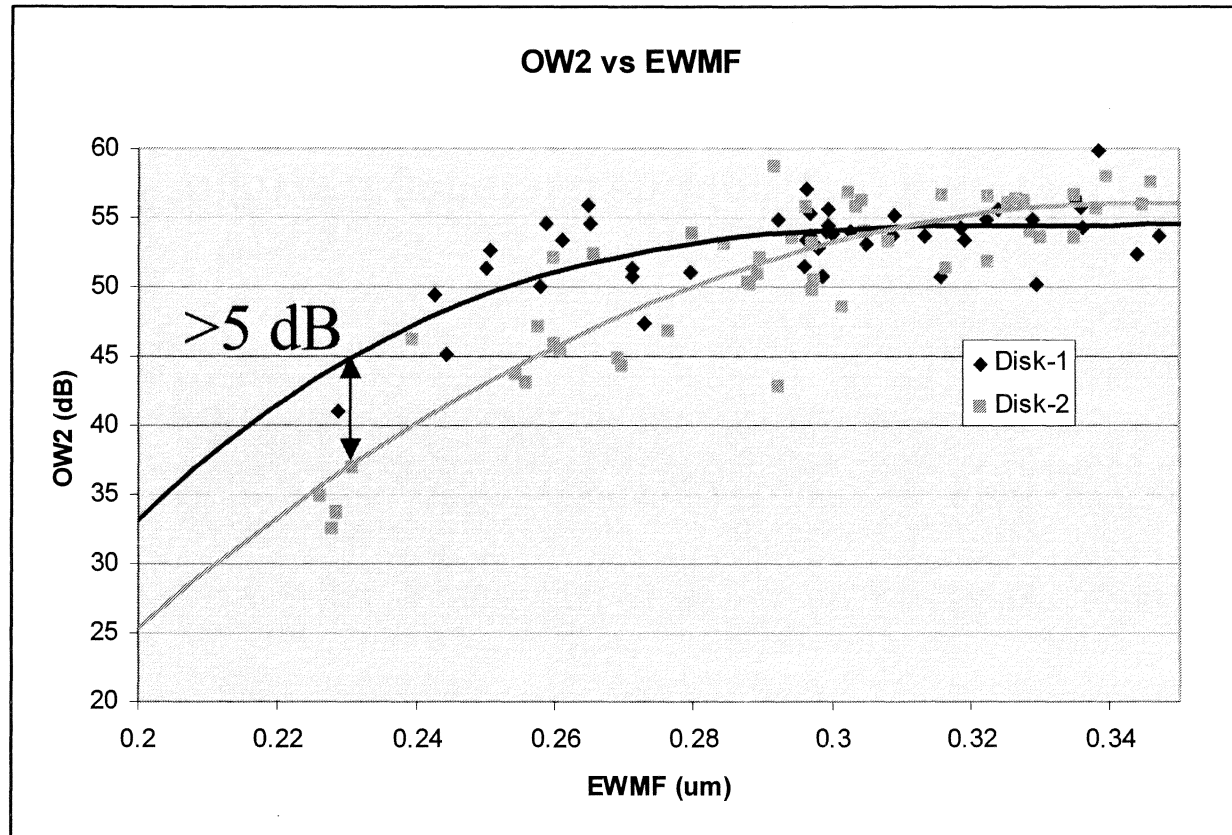

Data shown
for same
heads
measured on
two disks

- **Disk is a key player for OW2 vs MWW tradeoff**
 - Between two disks MWW constant, OW2 is better for Disk-1
- **Sp-SNR and OW2 may not always have the same tradeoff**



Spacing Effect for PMR

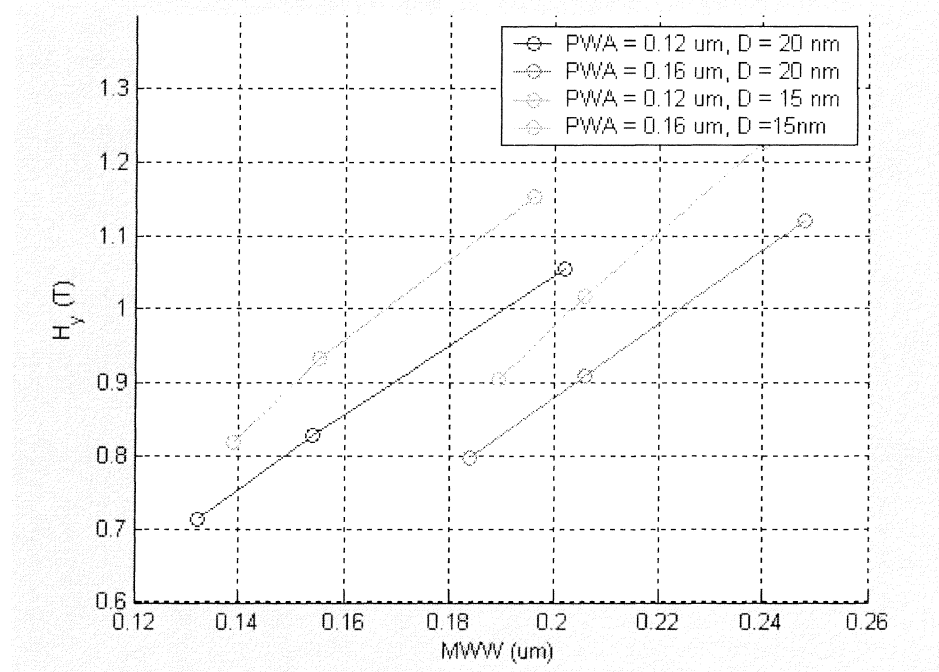

- **Lower spacing helps PMR similar to LMR**
 - Two different pole widths and spacings shown
- **Each 5 nm results in >10% increase in field**



Outline

- Today's PMR Write Head
- Why PMR?
 - Read Head
 - Trackwidth, amplitude
 - Write Head
 - Ability to deliver flux at a smaller physical dimension
- TPI Extendibility Challenges
 - Manufacturing Tolerances
 - Overwrite at narrow trackwidth
 - **Fringing: Magnetic to Physical Difference**
 - Bevel Angle and Skew

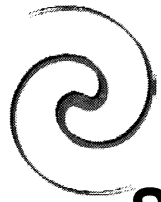

Fringing: PMR vs LMR

- **Side Fringing (defined as magnetic to physical Δ)**
 - LMR: ~ 0.02 μm PMR: ~ 0.04 - 0.05
- **Cross track field profiles similar between LMR and PMR**
 - Disk squareness (ratio of H_n/H_s) very different

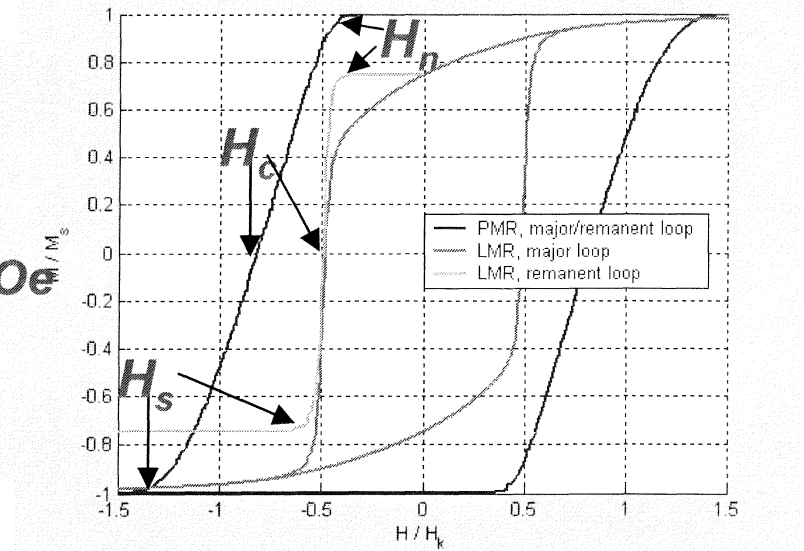
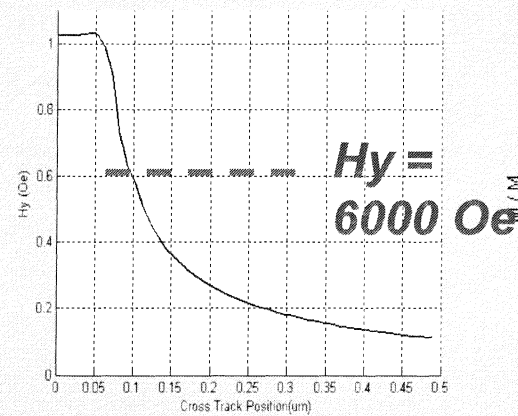
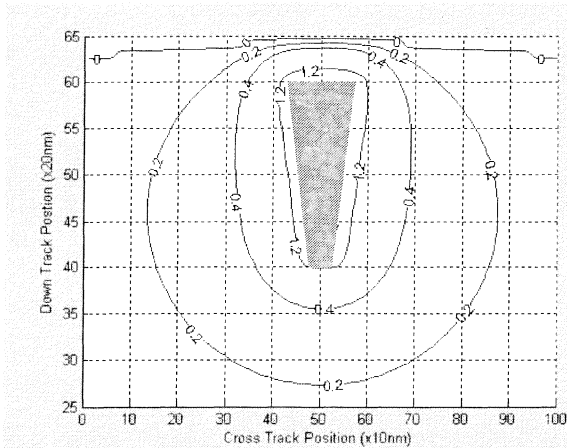



Outline

- Today's PMR Write Head
- Why PMR?
 - Read Head
 - Trackwidth, amplitude
 - Write Head
 - Ability to deliver flux at a smaller physical dimension
- TPI Extendibility Challenges
 - Manufacturing Tolerances
 - Overwrite at narrow trackwidth
 - Fringing: Magnetic to Physical Difference
 - **Bevel Angle and Skew**



Higher KTPI Design: Pole Thickness and Bevel

- Three designs at fixed adjacent track overhang considered for a drive skew ~14-deg

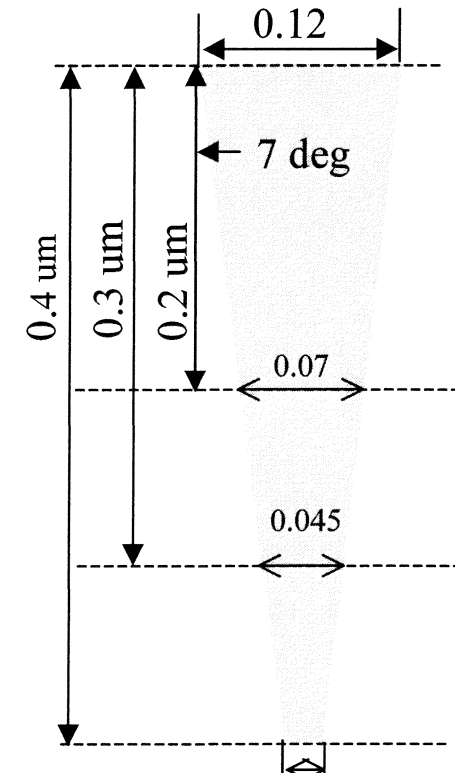
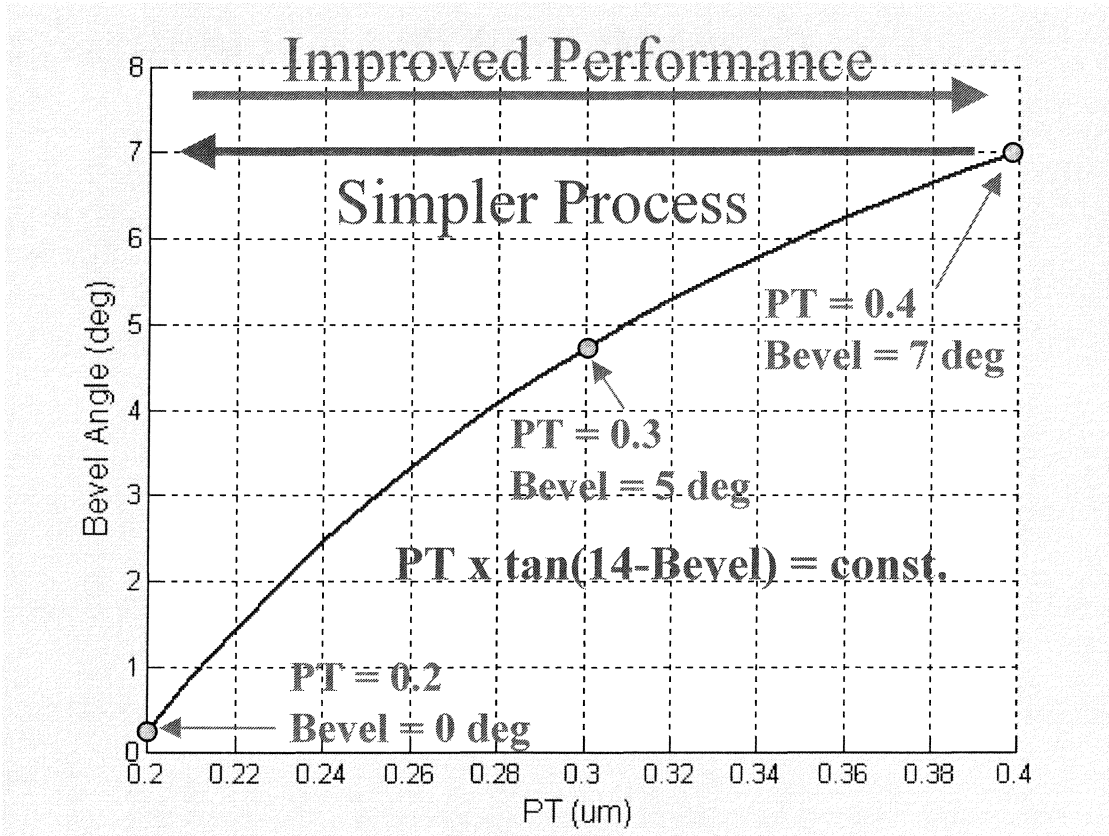
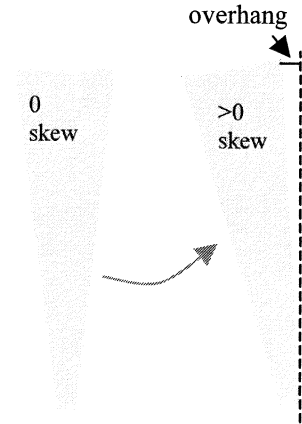



PW = 0.12 Optimization for Bevel and PT

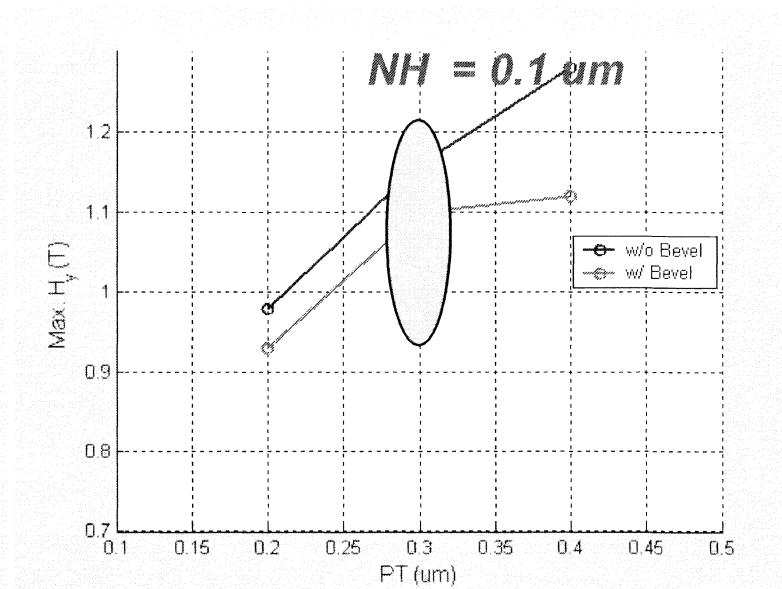
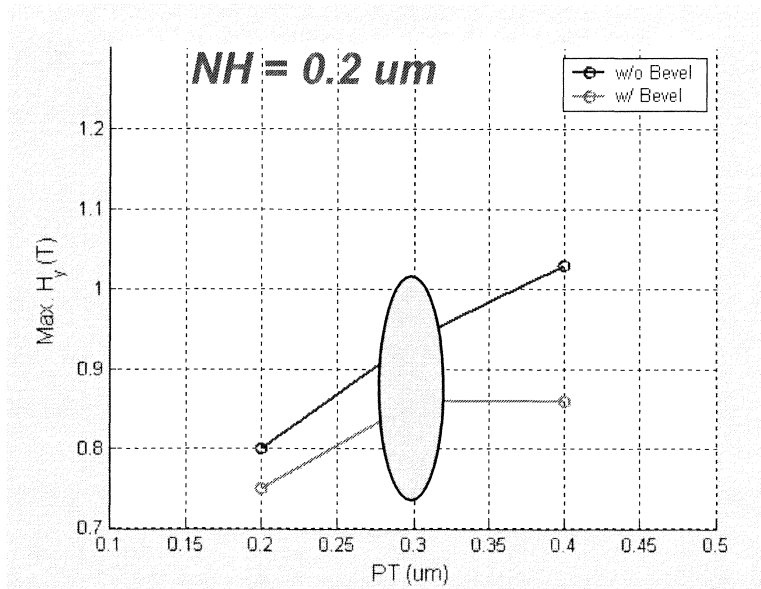

- Optimum is $PT=0.3\mu\text{m}$, bevel = 5°
- Higher thickness and higher resulting bevel doesn't gain any increase in field

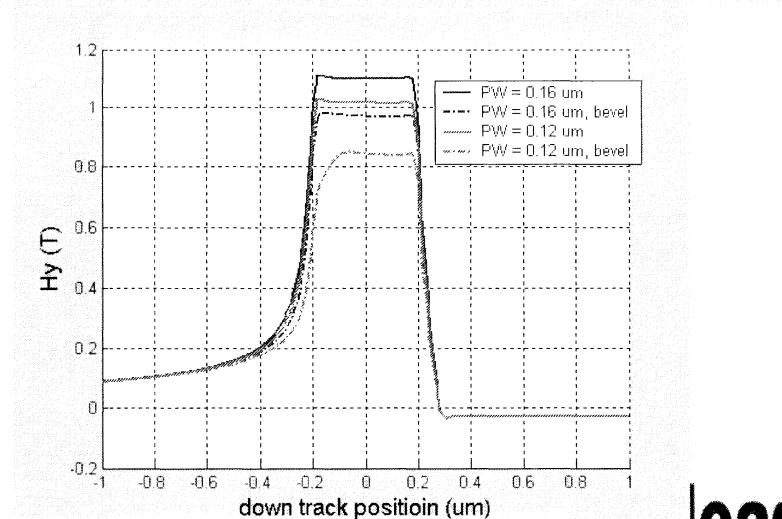



Summary

- **PMR offers an areal density advantage**
 - Primarily from linear density
 - Extends trackwidth limitations of GMR read head technology
 - TAALF and MRWu
- **TPI extendibility, however, imposes challenges**
 - Manufacturing tolerances
 - Must maintain small neck height and good pole thickness control
 - Much higher (2x) field strength sigma \rightarrow OW sigma
 - Track Pitch further impacted by
 - Skew, bevel, and pole thickness interdependence
 - Keeping fringing down without affecting OW at narrow MWW

- 1st product probably use existing tool set, ~ same cost
- next generations?

PERPENDICULAR HEADS FOR TOMORROW'S HDD

Lamar Nix

Hitachi Global Storage Technologies, Inc.

San Jose Research Center

ABSTRACT

PERPENDICULAR HEADS FOR TOMORROW'S HDD

Lamar Nix

In this study we explore heads for perpendicular recording. We show some of the significant challenges for operation at 100-200 gigabits/in.² and discuss some practical solutions. We compare the three principal write head designs for perpendicular-single pole, trailing shield, and trailing and side shield - showing the advantages of each and the challenges involved. Finally we discuss processing methods involved in making perpendicular heads.

The Author

Lamar Nix is with Hitachi Global Storage Technologies, Inc. , San Jose Research Laboratory where he is the manager of the recording head design and characterization group.

ACKNOWLEDGEMENTS

It is a pleasure to acknowledge

Aron Pentek

Quang Le

Mason Williams

Kaz Nakamoto

Tomohiro Okada

Yimin Hsu

Walt Weresin

Prakash Kasiraj

Jay Li

Michael Feldbaum

PERPENDICULAR HEADS FOR TOMORROW'S HDD

- ✓ PERPENDICULAR HEADLINERS
- ✓ SINGLE POLE DESIGN
 - ✓ WRITE FIELD
 - ✓ TRACK DENSITY LIMITATIONS
- ✓ TRAILING SHIELD DESIGN
- ✓ TRAILING AND SIDE SHIELD DESIGN
- ✓ PROCESSING CHALLENGES

PERPENDICULAR HEADS FOR TOMORROW'S HDD

PERPENDICULAR HEADLINERS

PERPENDICULAR RECORDING : GOOD NEWS !

WRITEABILITY : PERPENDICULAR MEDIA EASIER TO WRITE !

Conventional , Thick Pole
Write Head : Write pole
0.25 um

Longitudinal AFC media 80
gigabytes/disk , Hc: 4 kOe.

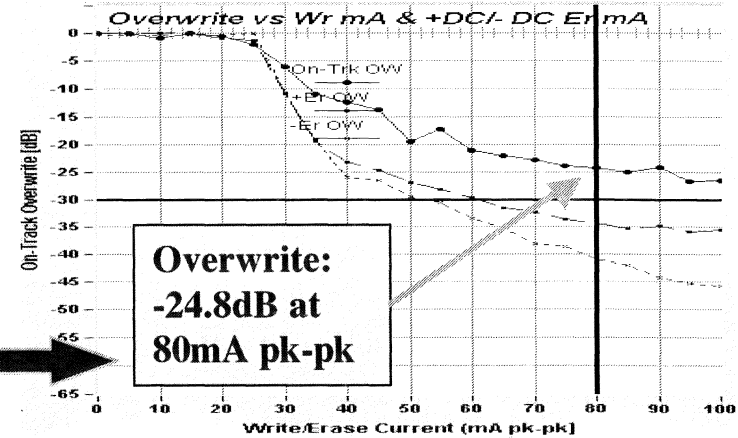

- Same Head -

Perpendicular media Hc :
5 kOe.

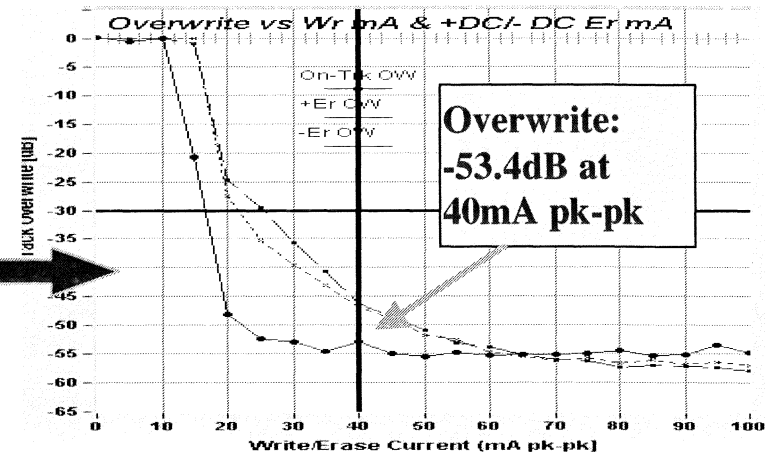

PERPENDICULAR RECORDING : GOOD NEWS !

✓MRW PHYSICAL-MAGNETIC BIAS FAVORABLE

✓AMPLITUDE SENSITIVITY FAVORABLE

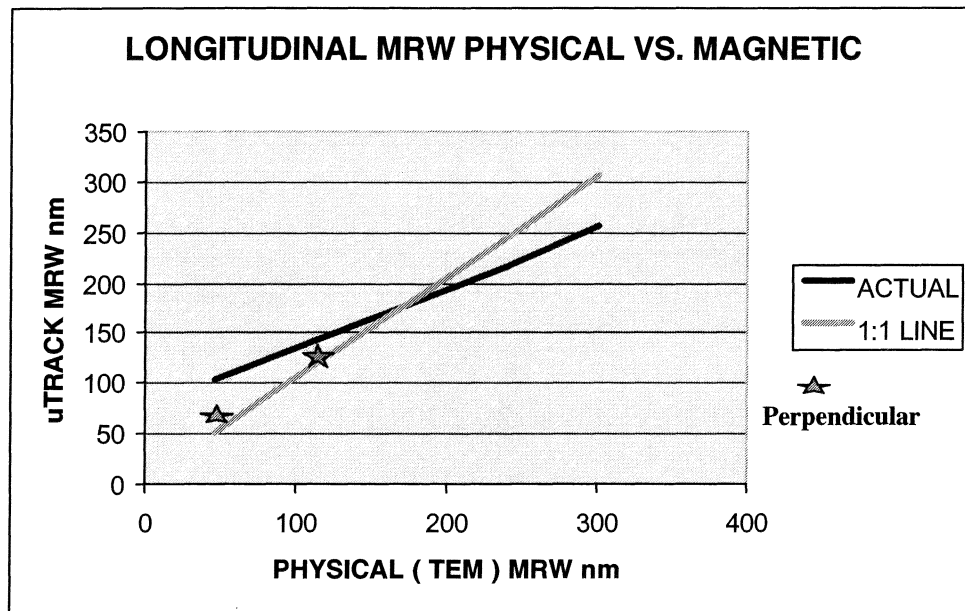

Same Read Head mTW Comparison

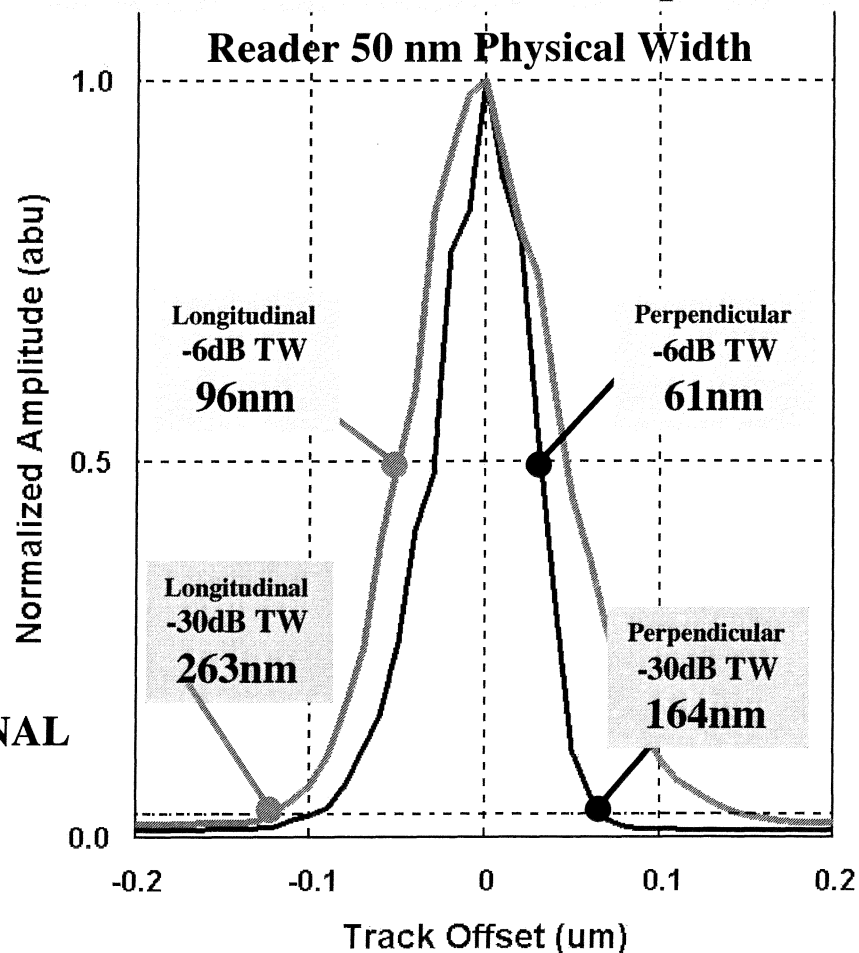

Same Read Head Comparison

	PERPENDICULAR	LONGITUDINAL
AMPLITUDE SENSITIVITY	16.7 mV/um	2.5 mV/um

HITACHI
Inspire the Next

Longitudinal & Perpendicular Writing Fundamentals

Longitudinal Recording

Perpendicular Recording

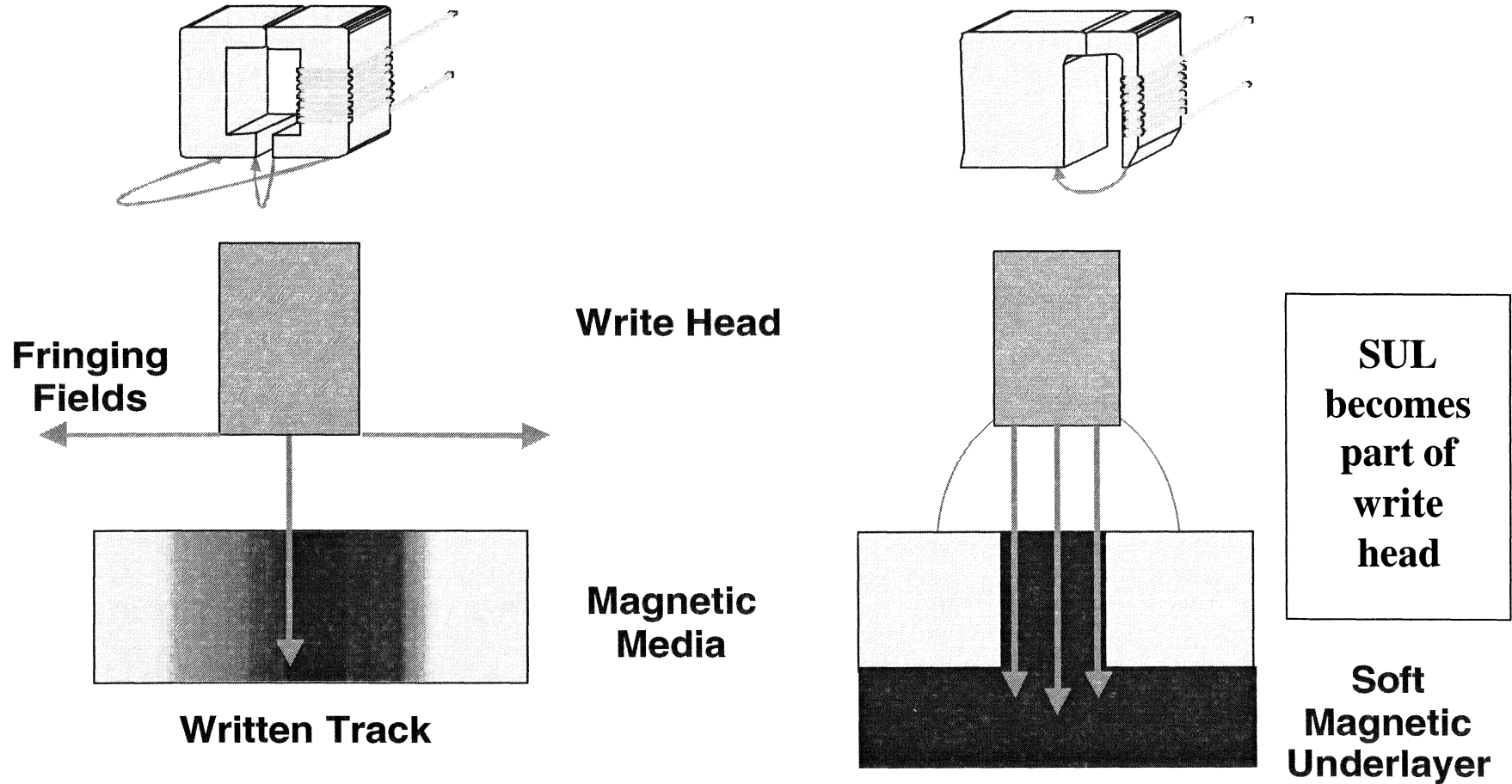
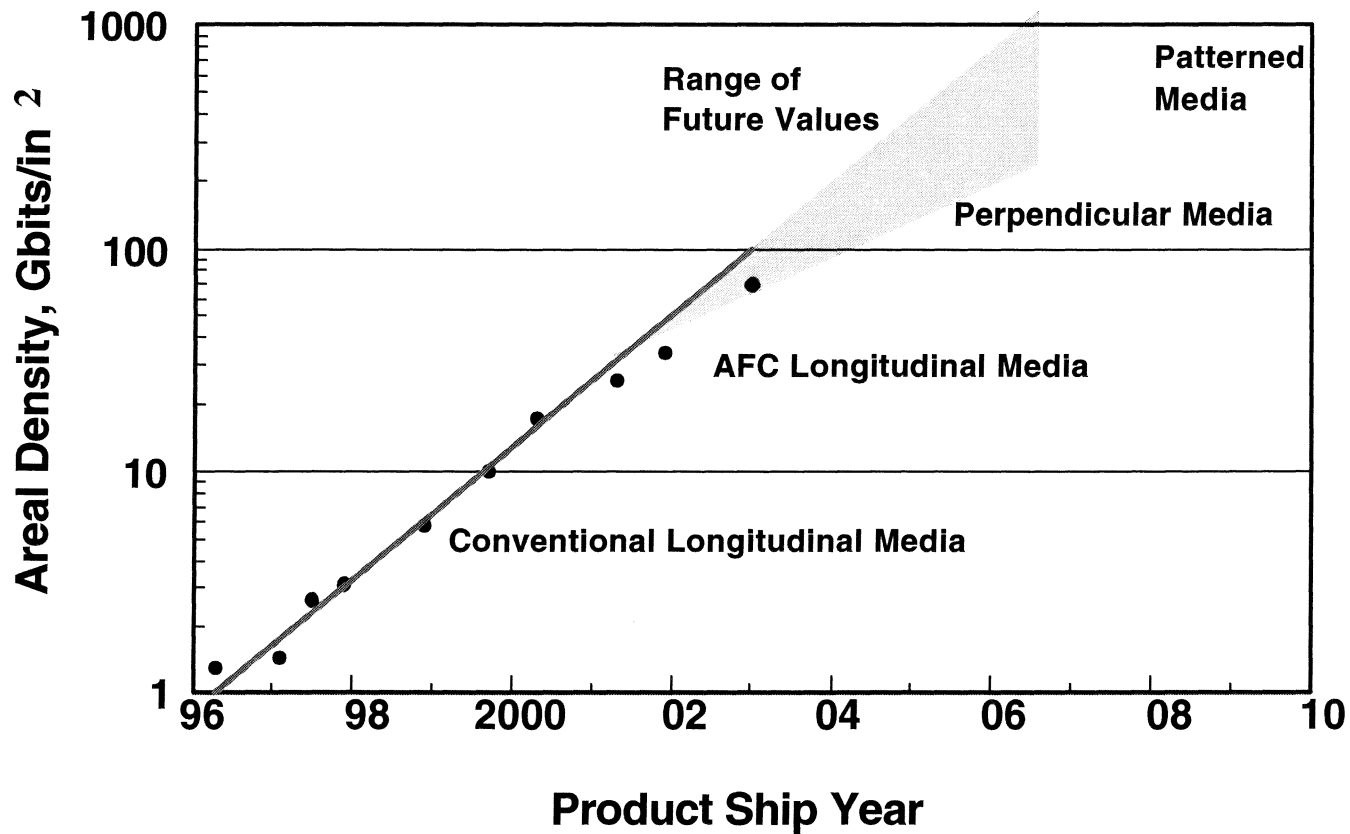

Figure 6. Field Distribution During Writing

Magnetic Media Roadmap



PROSPEROUS FUTURE PROJECTED FOR PERPENDICULAR RECORDING ABOVE 100 gBits/in.²

PERPENDICULAR HEADS FOR TOMORROW'S HDD

SINGLE POLE DESIGN

PERPENDICULAR INTEGRATED HEAD

Single Pole Write Head

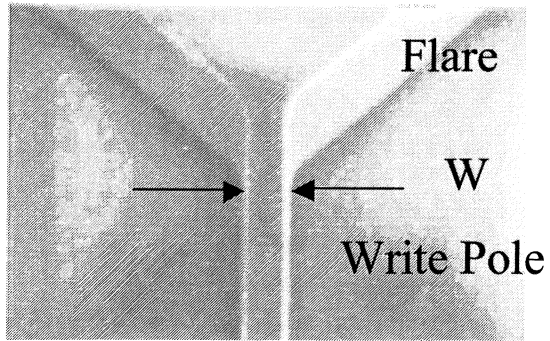

Write Pole ABS
Perspective View

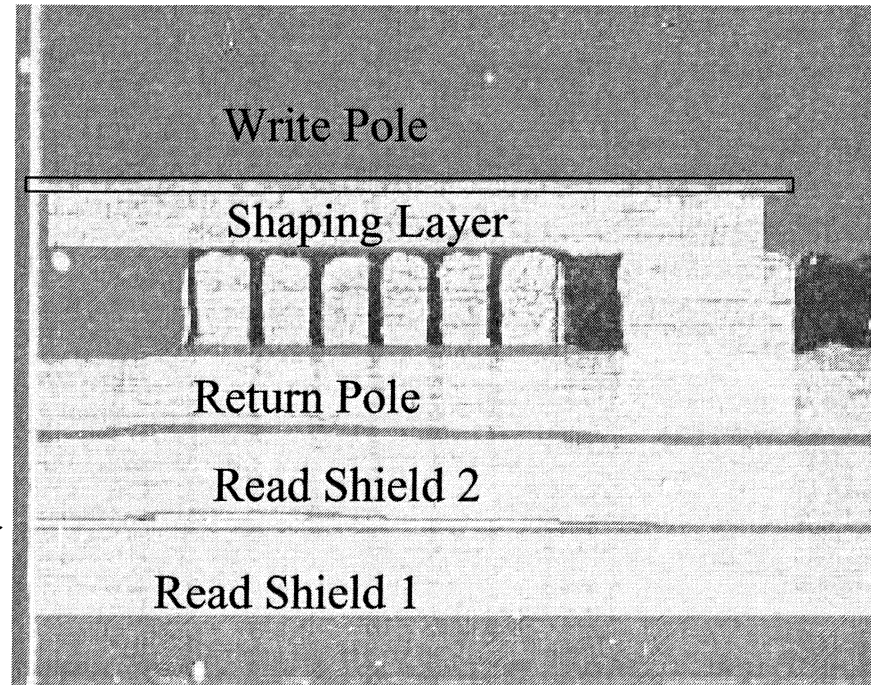

GMR
Read
Sensor

Cross Sectional View

PERPENDICULAR RECORDING : HEAD REALITY !

Need for ever increasing write fields
driven by:

- ✓ SNR : reducing media grain volume V
- ✓ Thermal Stability : increase $K_u V$
- ✓ Switching field of media

$$H_0 = 2 K_u / M_s - N_{\text{eff}} M_s$$

$$H_{\text{WRITE}} > H_0$$

✓ Media for 100-200 gbits/in.² requires 9-12 kOe H_{write} , going to 15 kOe at 1 Tb/in.²

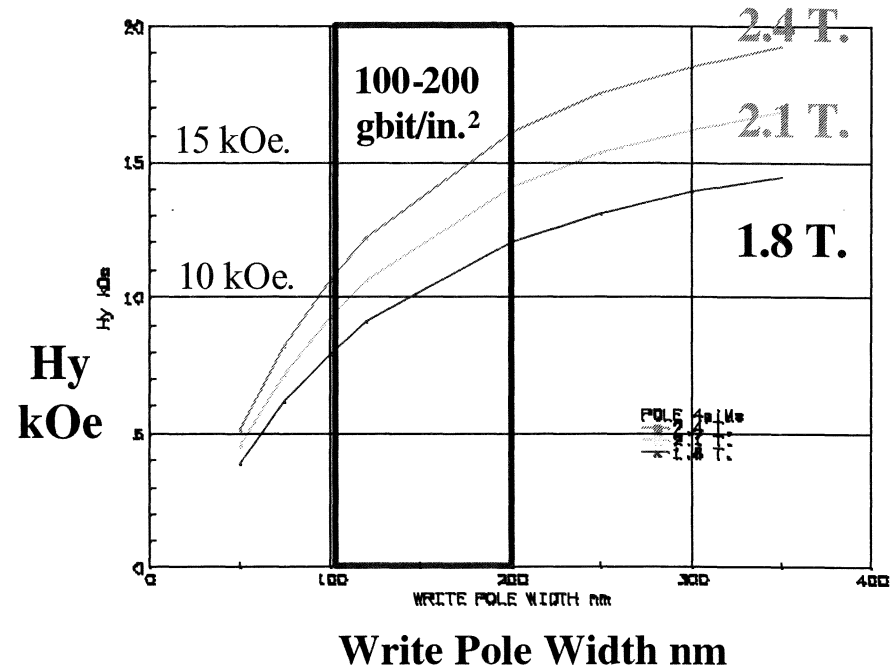

H_{WRITE} dependent on $4P M_s$ of write pole

- ✓ 2.4 Tesla pole materials in use today
- ✓ Gains beyond 2.4 Tesla hard to come by

PERPENDICULAR RECORDING : HEAD REALITY !

Actuator Skew Range Constraint on Head

At skew ,
rectangular pole
tip writes in
guard band or
adjacent track

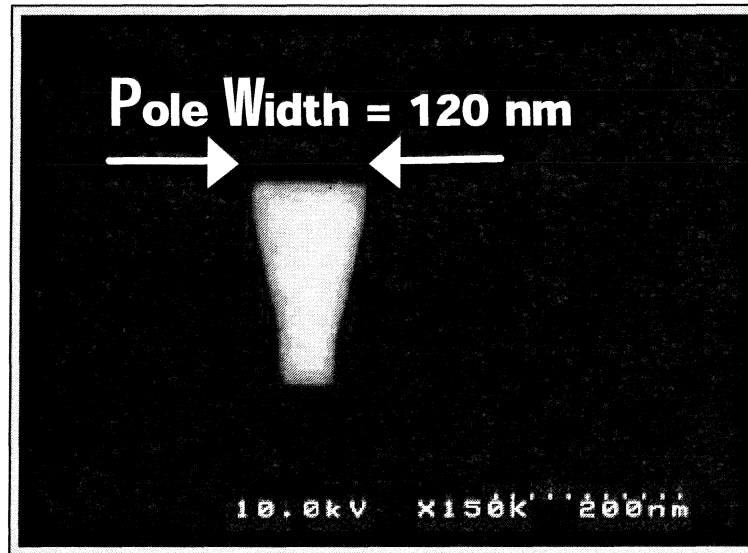

T.Okada, H.
Kimura, I.
Nunokawa,N.
Yoshida,K. Etoh,M.
Fuyama,

STRC, Hitachi Ltd.
IEEE Trans. Magn,
vol.40,
p.290, 2004

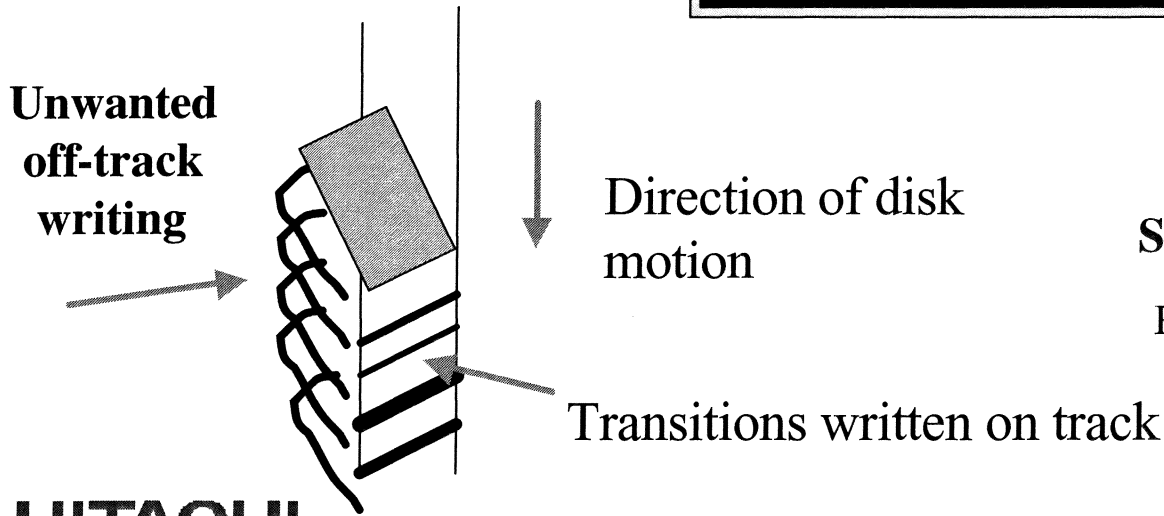

Solved by Trapezoidal Pole

Pole Bevel Angle matched to
actuator skew range

HITACHI
Inspire the Next

Copyright © 2004 Hitachi Global Storage Technologies

PERPENDICULAR RECORDING : HEAD REALITY !

- ✓ H_Y falls rapidly with shrinking Pole width dimensions
- ✓ Increasing pole thickness helps but HDD skew range of ± 14 degrees effectively limits thickness/width to **2:1 or less**.

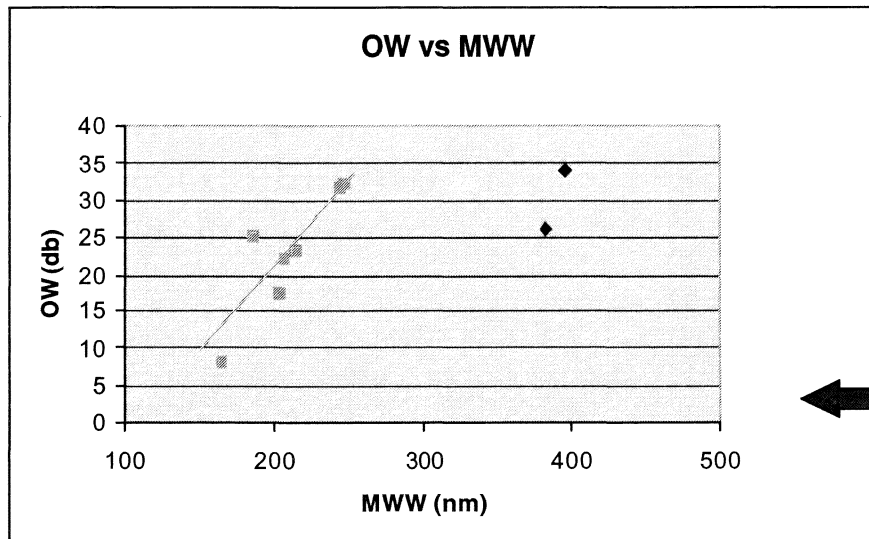
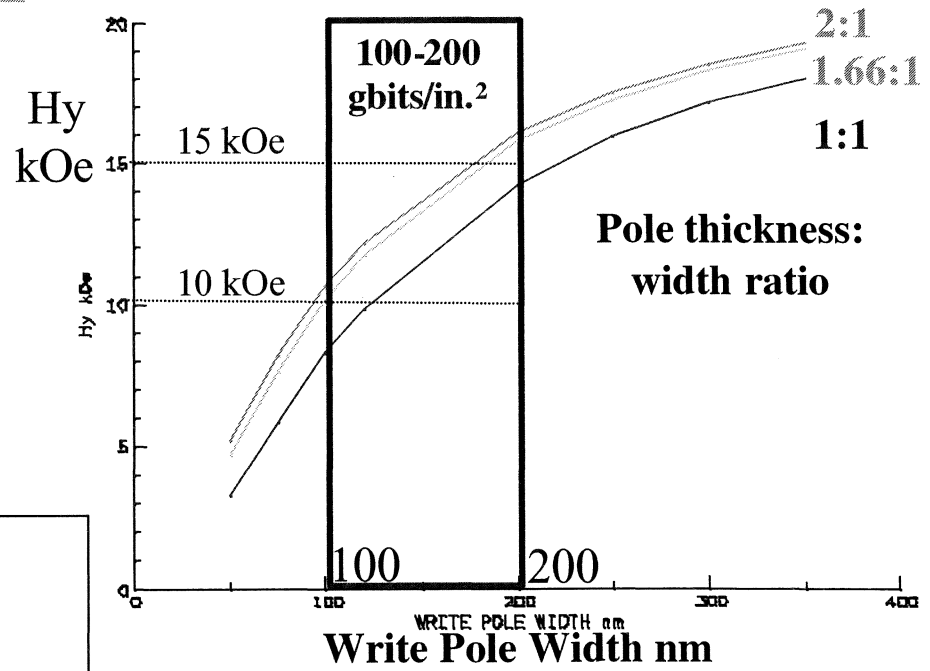

Trapezoidal (7°) pole heads with 2:1 thickness/width ratio exhibit declining overwrite as track width falls below 240 nm.

INFLUENCE OF POLE GEOMETRY ON WRITE FIELD

Optimizing Head Geometry for Maximum Field

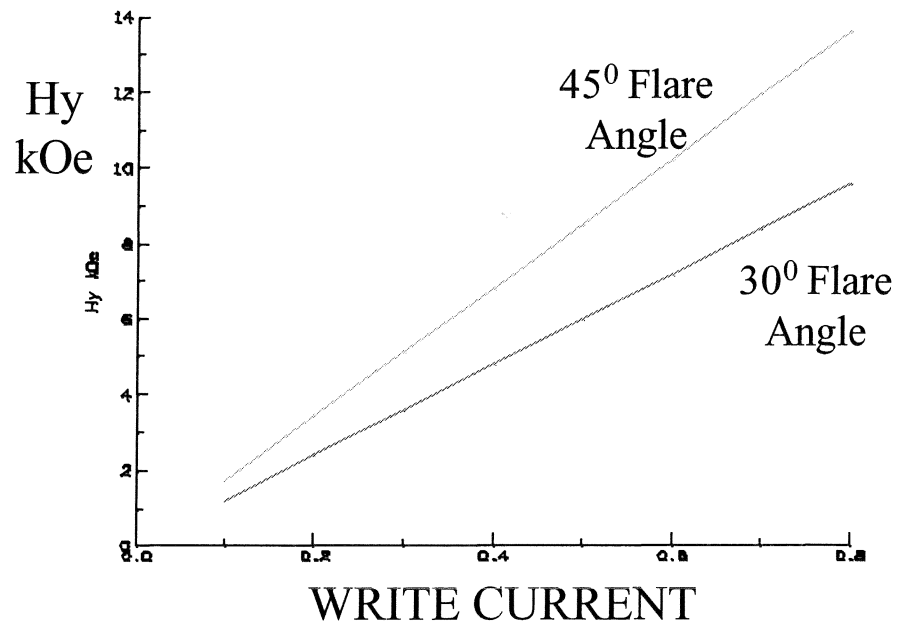
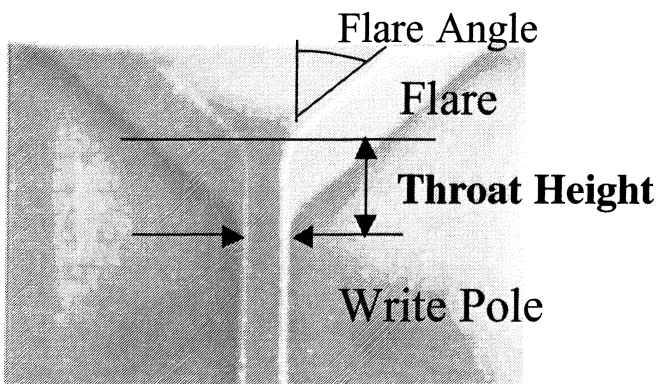

Write Pole ABS
Perspective View

INFLUENCE OF POLE GEOMETRY ON WRITE FIELD

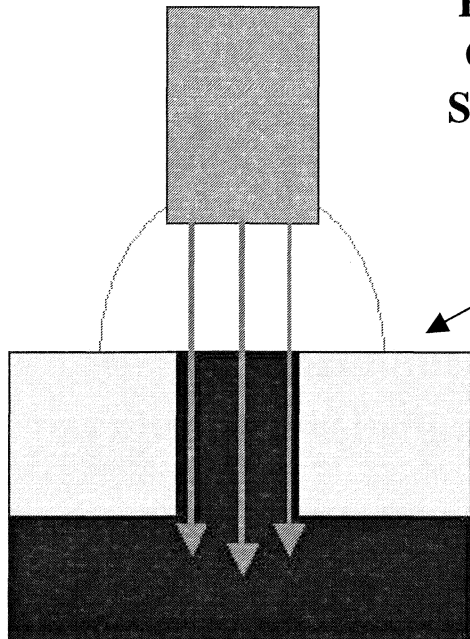
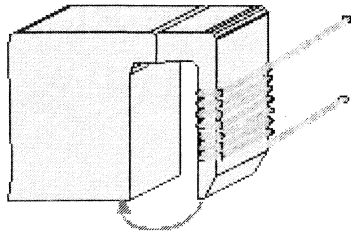

Fringe Fields
Can Become
Significant for
Single Pole
Design

Relative Cross Track Field vs.
Throat Height

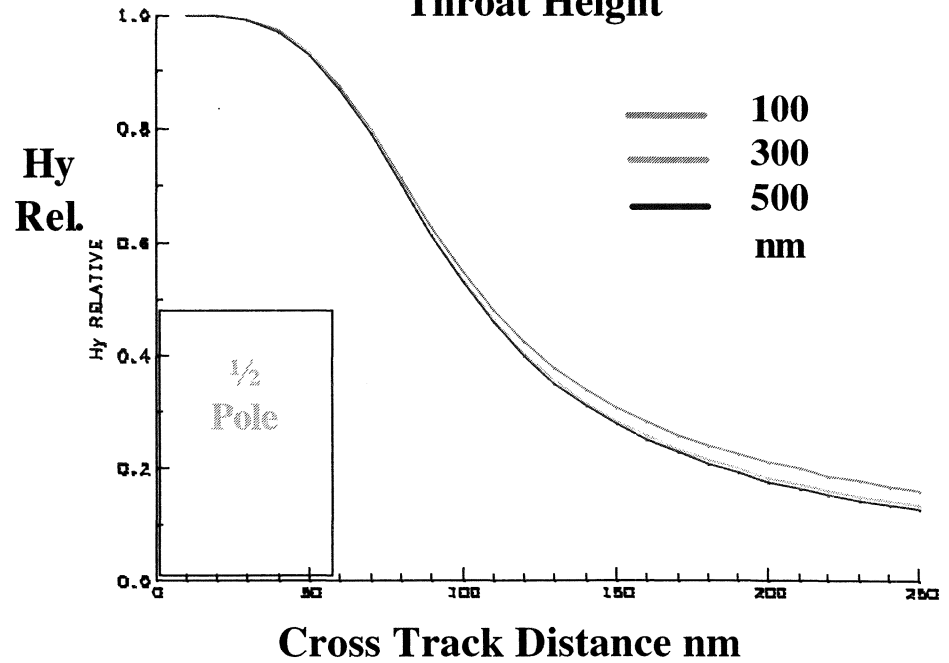

INFLUENCE OF POLE GEOMETRY ON WRITE FIELD

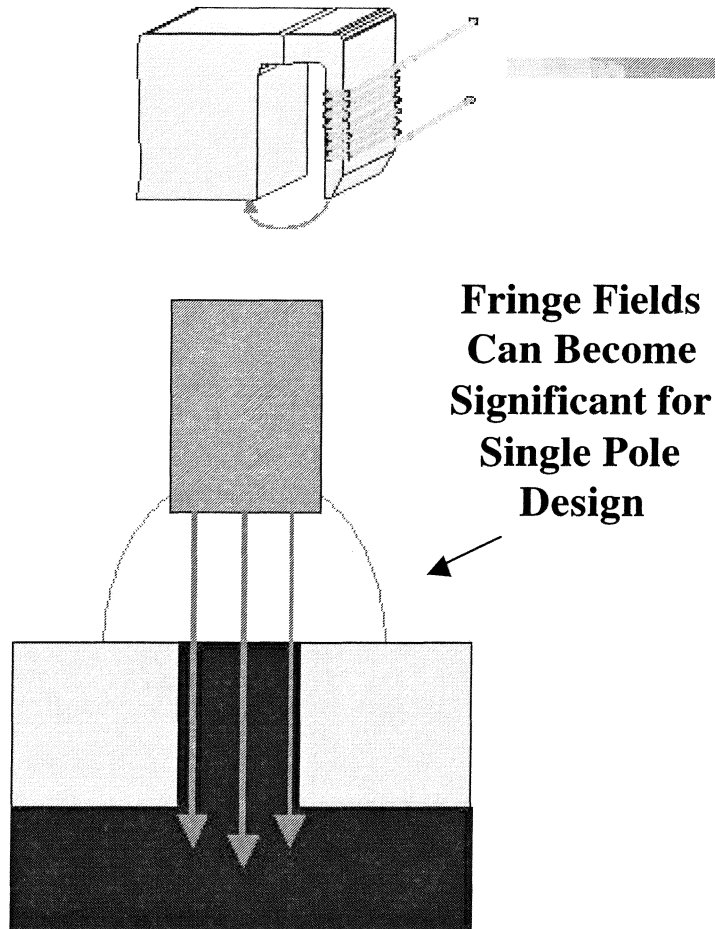

Relative Cross Track Field vs. Throat Height

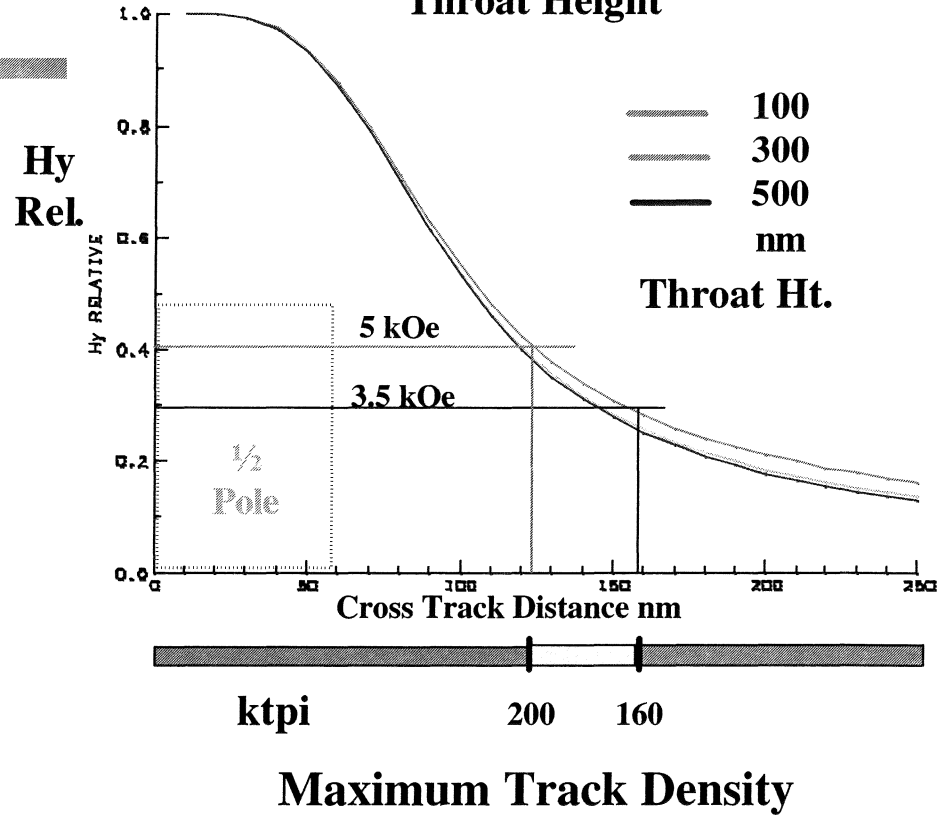

✓ Destructive level of ATI field limits track density (3.5 and 5 kOe levels for comparison)

✓ Assuming 12 kOe write field @ 50 nm HUS

Write Instability vs. Write Width

Medium Coercivity = 3.7 kOe

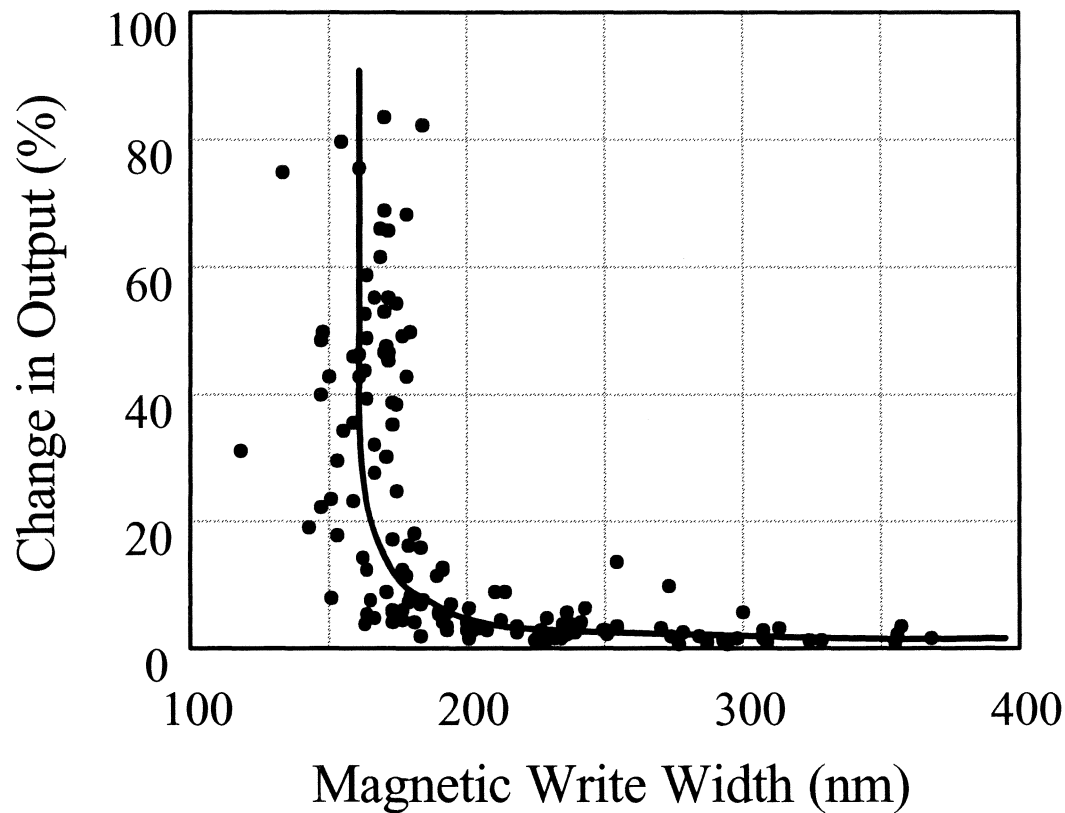

Change =

$$\frac{\text{Max} - \text{Min}}{\text{Max}}$$

K.Nakamoto, Y.Kawato, N.
Yoshida, Y. Okada, M.
Hatatani, M. Mochizuki, K.
Watanabe, M. Fuyama,
STRC, Hitachi Ltd. J. Magn.
Soc. Jpn, vol.27, p.124,
2003

Instability vs. Throat Height

Pole Width = 150 nm

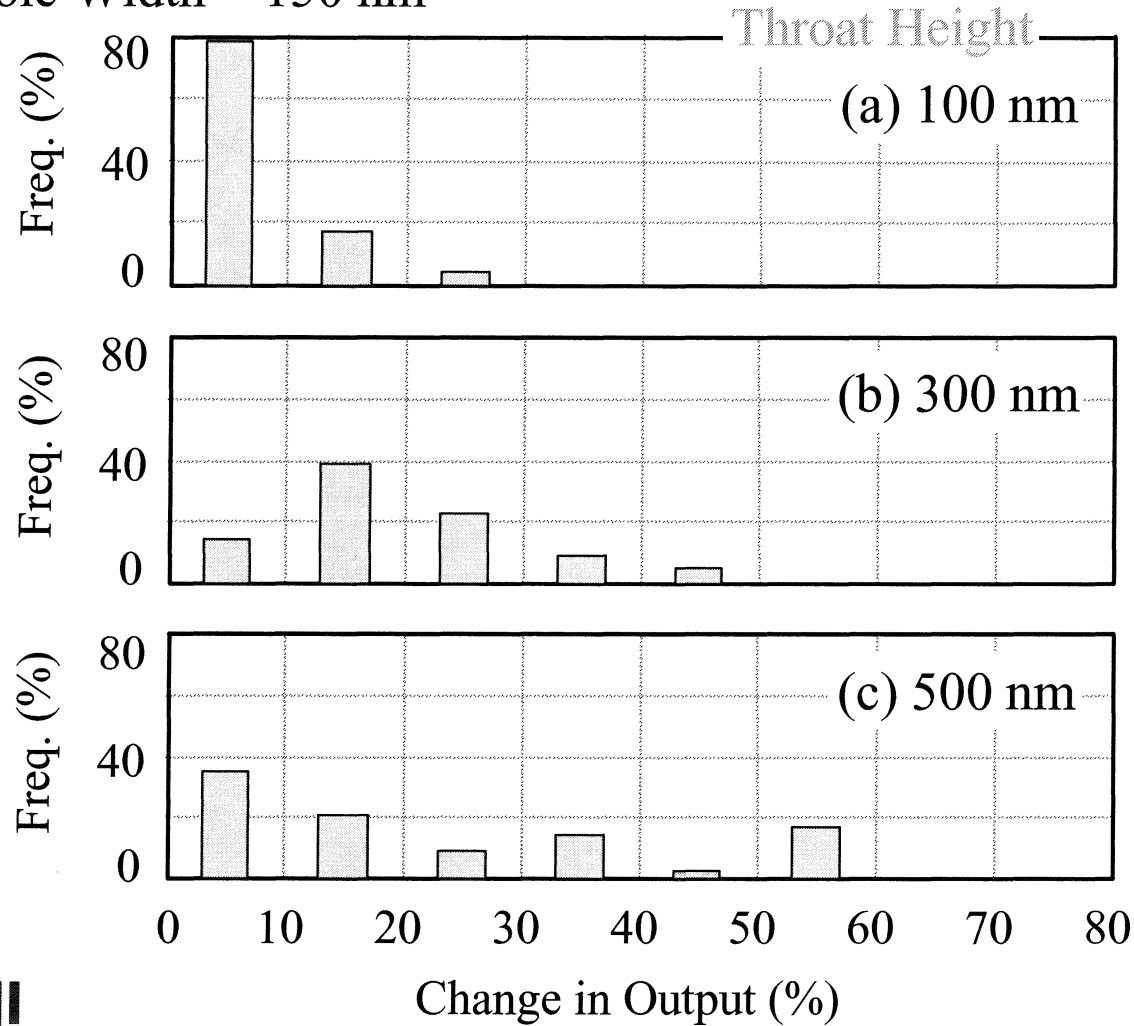

K.Nakamoto,
 Y.Kawato, N.
 Yoshida, Y. Okada,
 M. Hatatani, M.
 Mochizuki, K.
 Watanabe, M.
 Fuyama,
 STRC, Hitachi Ltd. J.
 Magn. Soc. Jpn,
 vol.27, p.124,
 2003

Multi-layered Pole

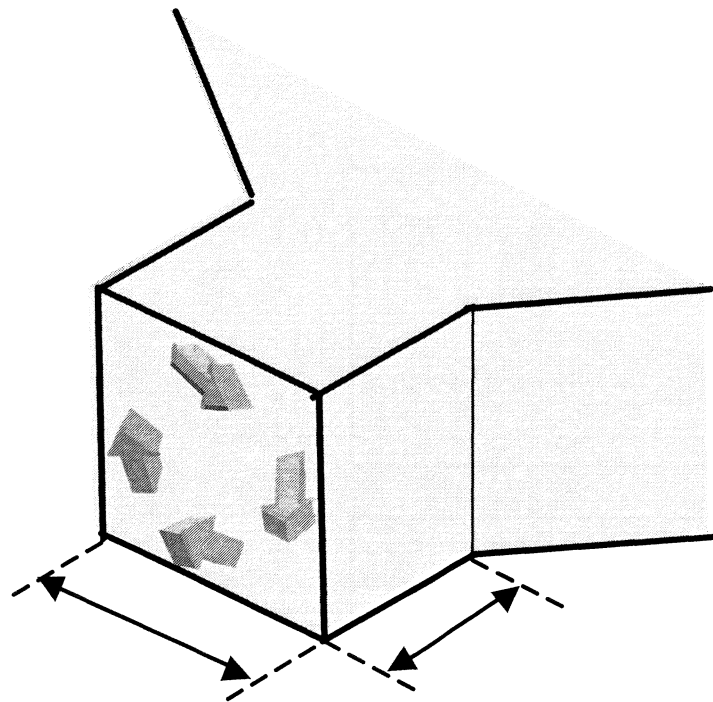

Pole Width
= 60 nm

Throat Height
= 60 nm

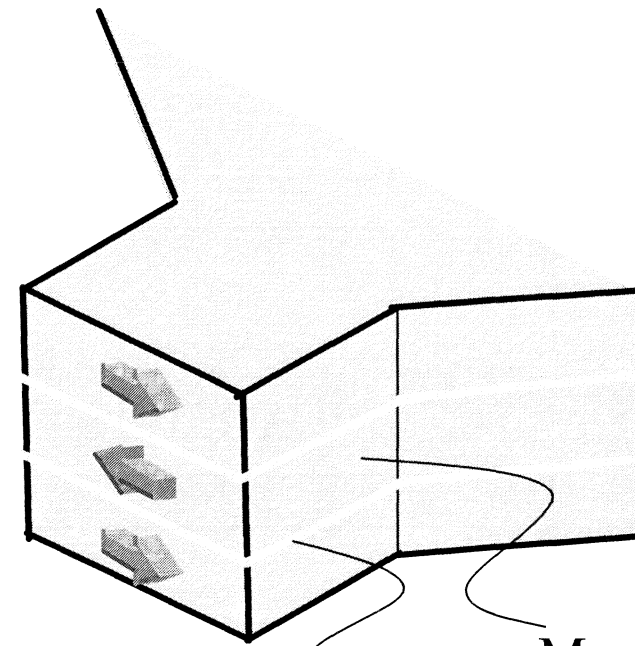

Non-mag. Layer
Remanent Field = 200 Oe

Mag. Layer

Remanent Field (Calc.) = 1700 Oe

K. Nakamoto, T. T. Okada, K. Watanabe, H. Hoshiya, N. Yoshida,
Y. Kawato, M. Hatatani, K. Meguro, Y. Okada, H. Kimura,
M. Mochizuki, K. Kusakawa, C. Ishikawa, M. Fuyama, Hitachi, Ltd.
IEEE Trans. Magn, vol.40, p.290, 2004

HITACHI
Inspire the Next

Copyright © 2004 Hitachi Global Storage Technologies

Instability vs. Multi-layered Main Pole

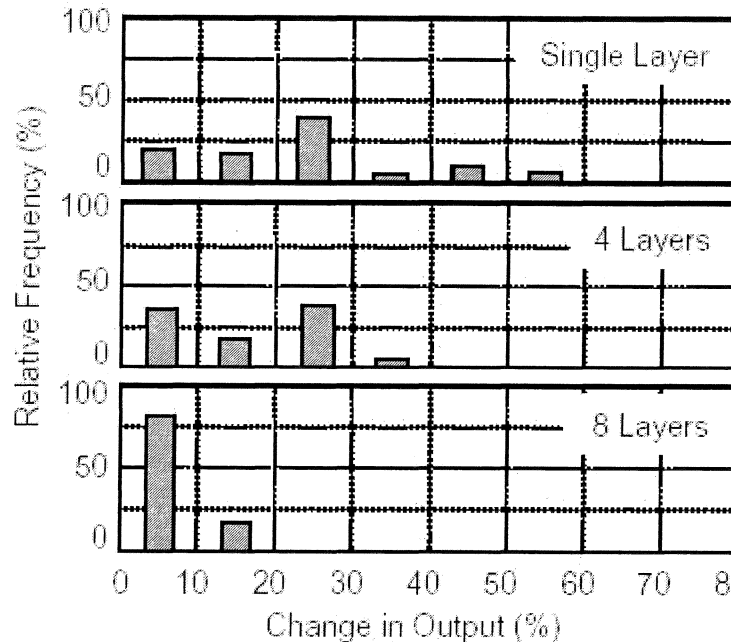

Change in output vs. number of magnetic layers in main pole (throat ht. 300 nm)

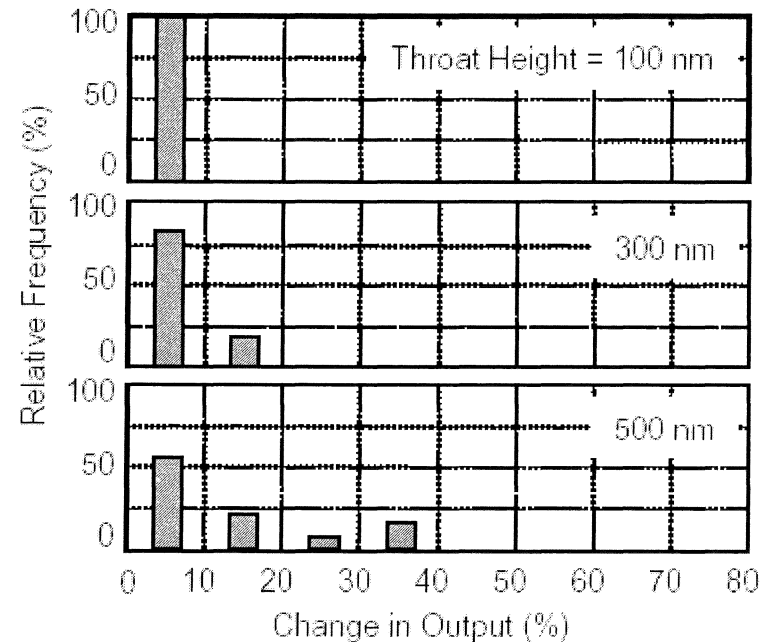

Change in output vs. throat height for 8 layered main pole.

K. Nakamoto, T. T. Okada, K. Watanabe, H. Hoshiya, N. Yoshida, Y. Kawato, M. Hatatani, K. Meguro, Y. Okada, H. Kimura, M. Mochizuki, K. Kusakawa, C. Ishikawa, M. Fuyama, Hitachi, Ltd., IEEE Trans. Magn, vol.40, p.290, 2004

Improved Write Instability with AFC Multi-Layers in Main Pole

Pole Width = 120 nm, Throat Height = 150 nm,
Magneto-motive Force = 0.2 AT

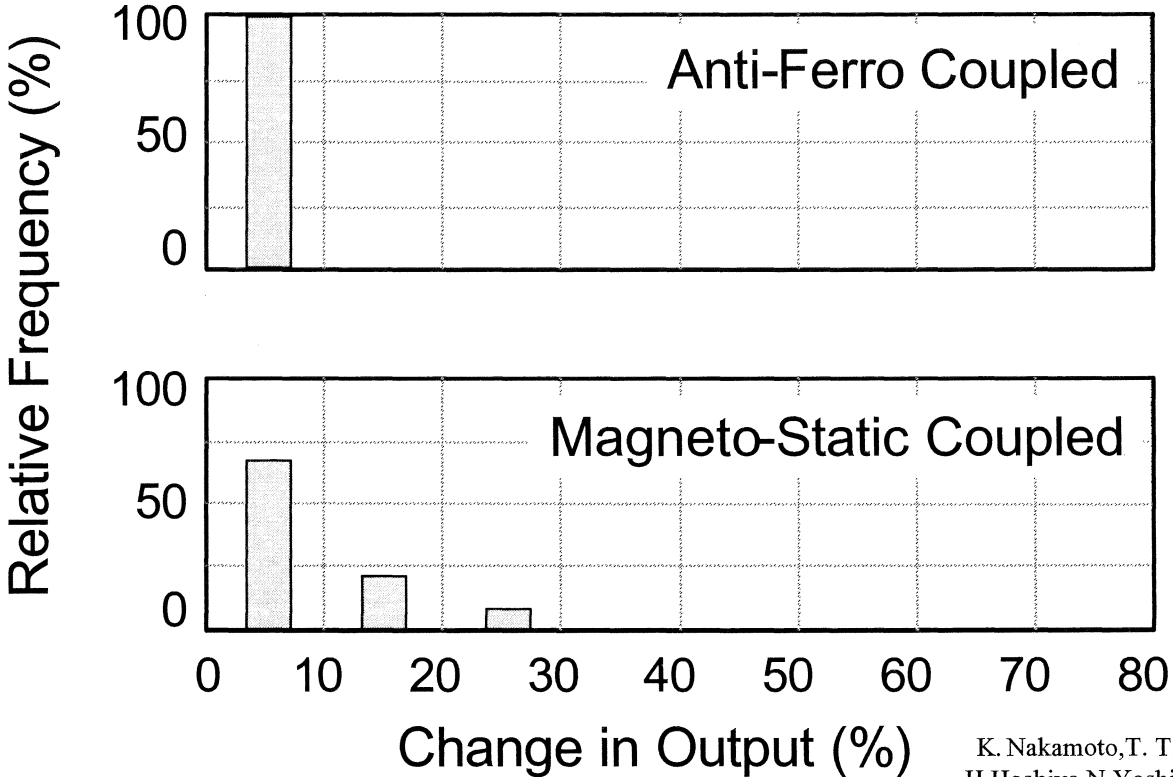

K. Nakamoto, T. T. Okada, K. Watanabe,
H. Hoshiya, N. Yoshida, Y. Kawato, M. Hatatani,
K. Meguro, Y. Okada, H. Kimura, M. Mochizuki,
K. Kusakawa, C. Ishikawa, M. Fuyama, Hitachi,
Ltd., IEEE Trans. Magn, vol.40, p.290, 2004

Single Pole Write Head Field Diagram

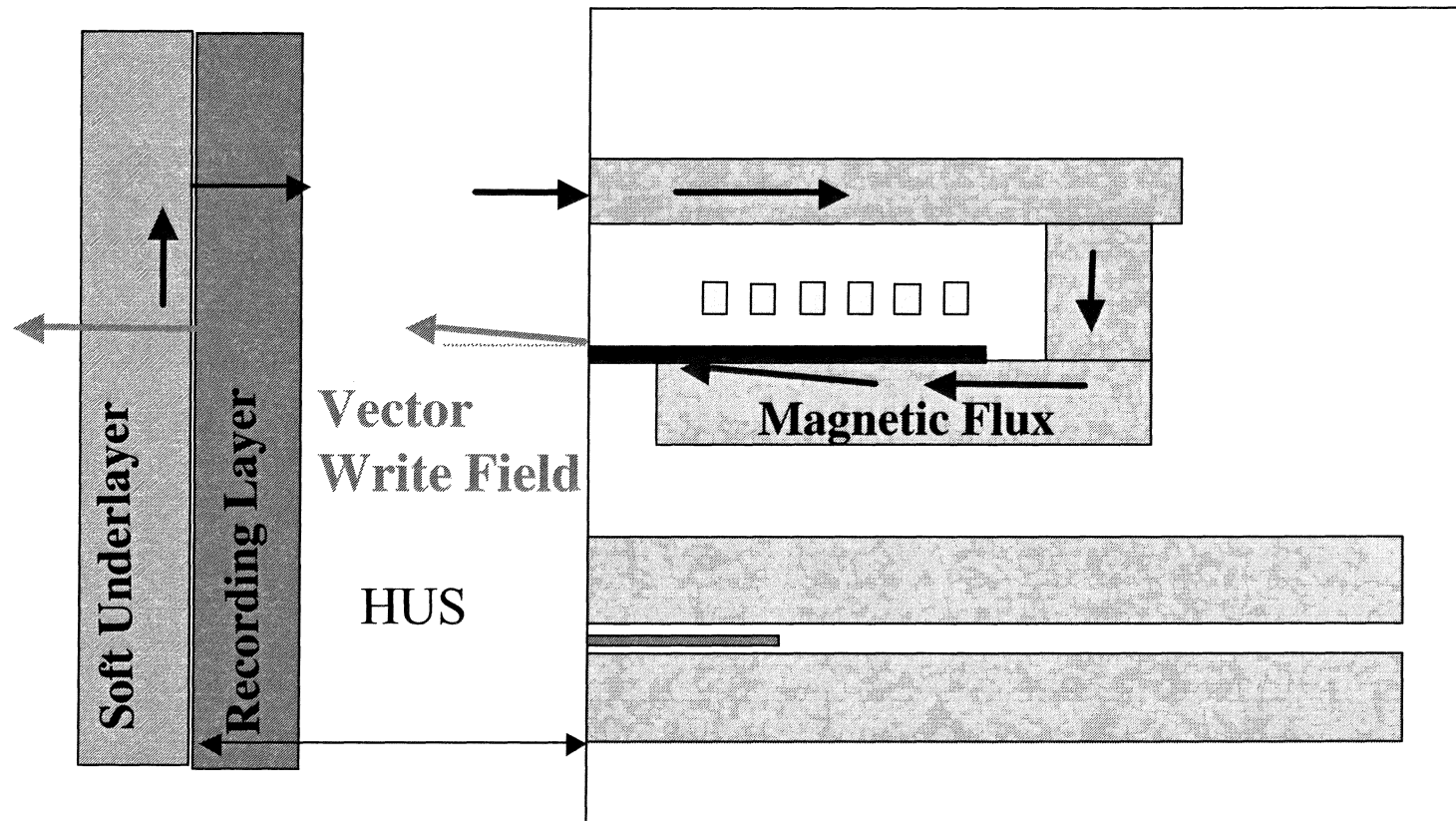

STONER WOHLFARTH SWITCHING FIELD

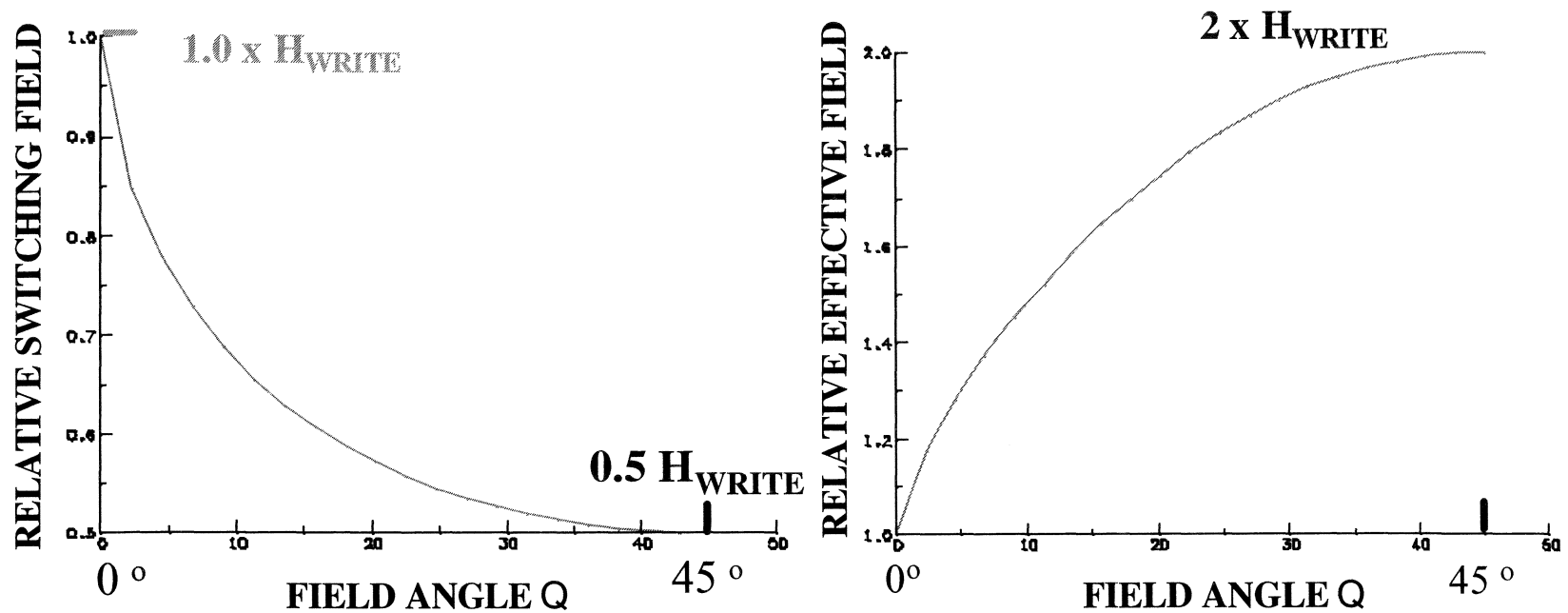

$$H_{SW}(Q) = H_{WRITE} \times (\sin Q^{2/3} + \cos Q^{2/3})^{-3/2}$$

Prescription for achieving higher effective write fields

PERPENDICULAR HEADS FOR TOMORROW'S HDD

TRAILING SHIELD DESIGN

Trailing Shield Field Diagram

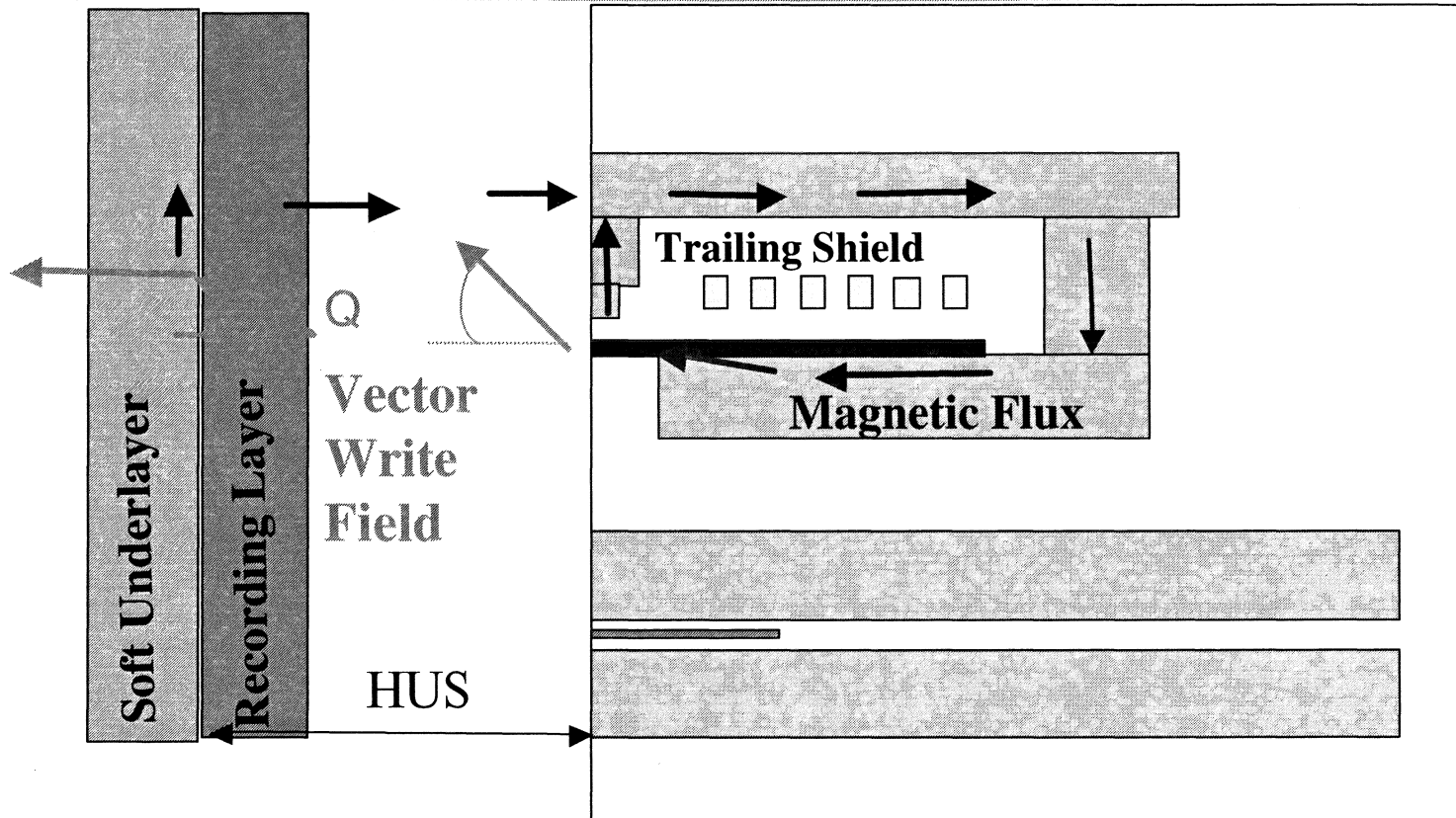

**Significant Improvement in Effective Writing
Field as Function of Field angle Q**

(With respect to medium anisotropy direction)

Jitter due to variation in H_{SW}

$$\Delta H(q_H) = H_{SW}(q_H - 10^\circ) - H_{SW}(q_H + 10^\circ)$$

$$j \approx 0.5 \times \frac{\Delta H(q_H)}{\frac{dH}{dx}}$$

Experiment: 4-5dB
Gain in media s/n

Per Mason
Williams

Rel jitter (dB)

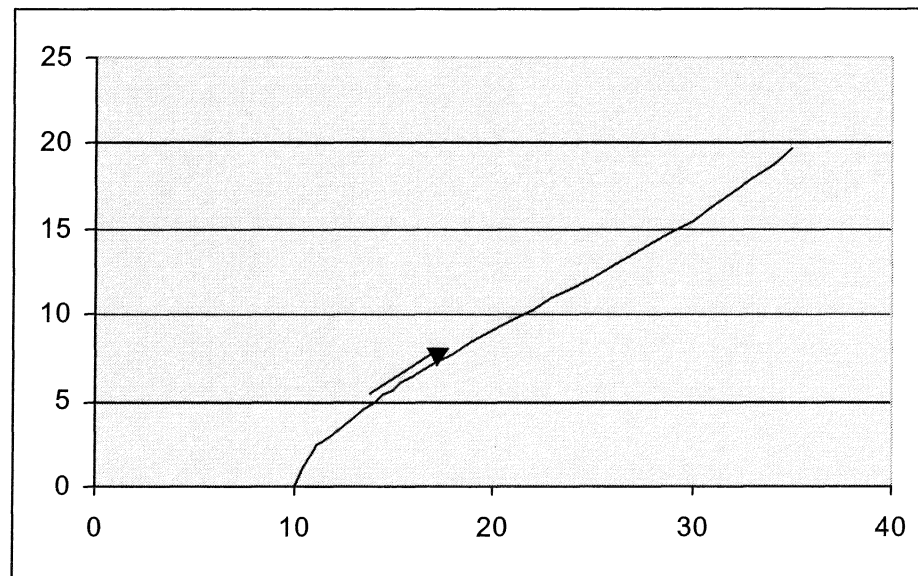

Field angle

Trailing Shield Perpendicular Recording Head

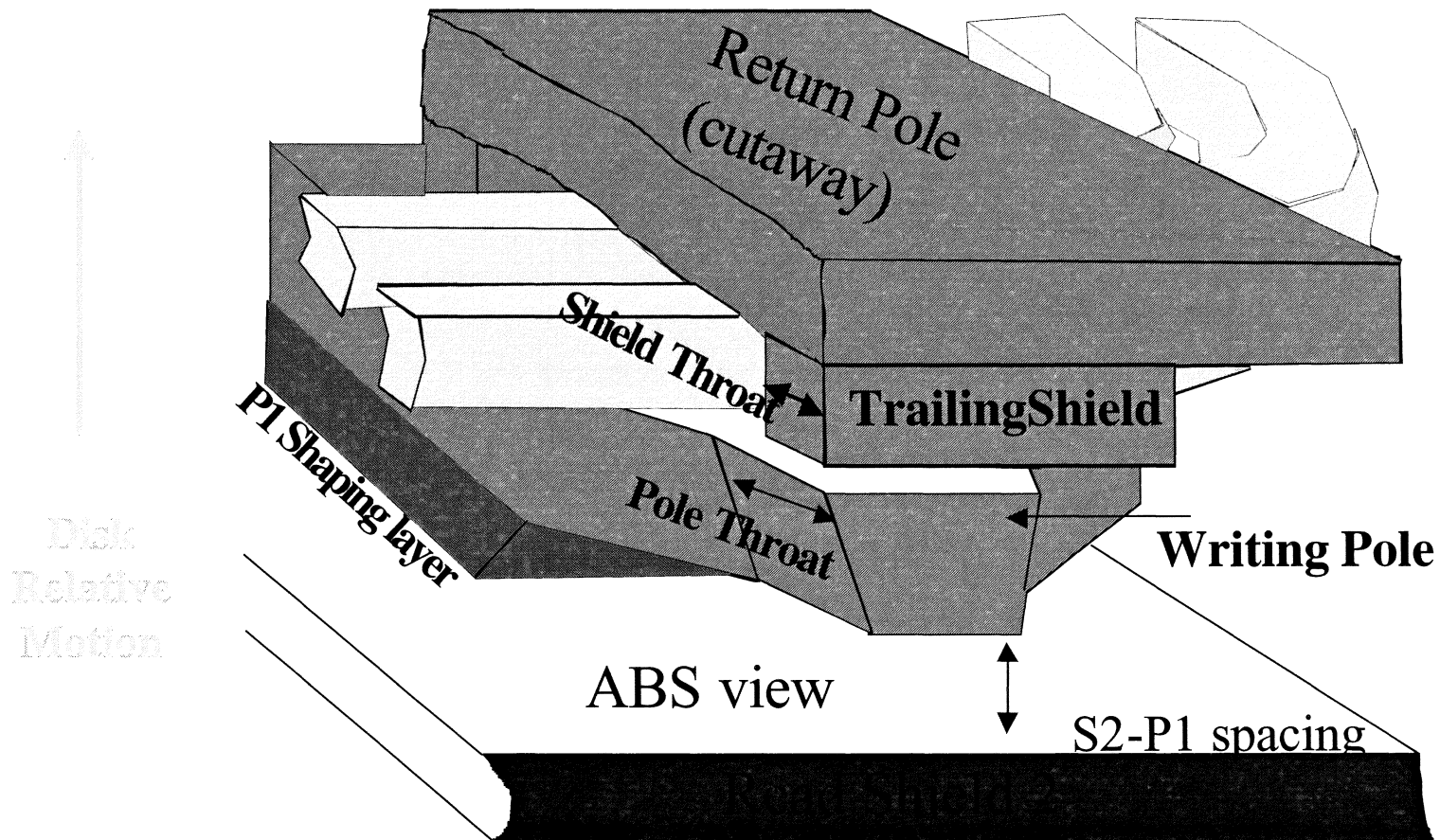

DESIGN CONSIDERATIONS OF TRAILING SHIELD HEAD

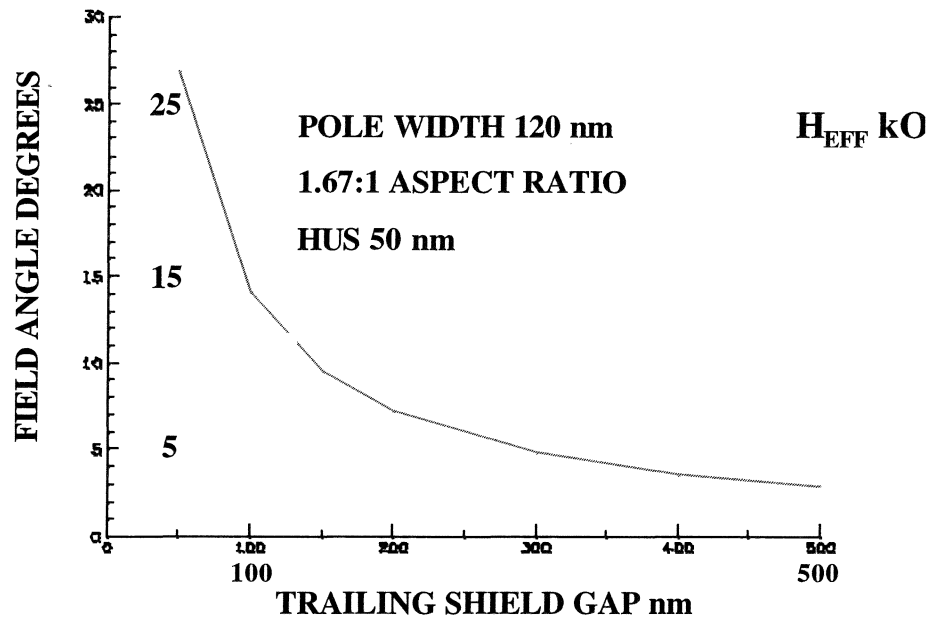

✓ Modeling shows that field angles of ~20° are achievable at recording layer surface

✓ At Trailing Shield Gap ~ HUS

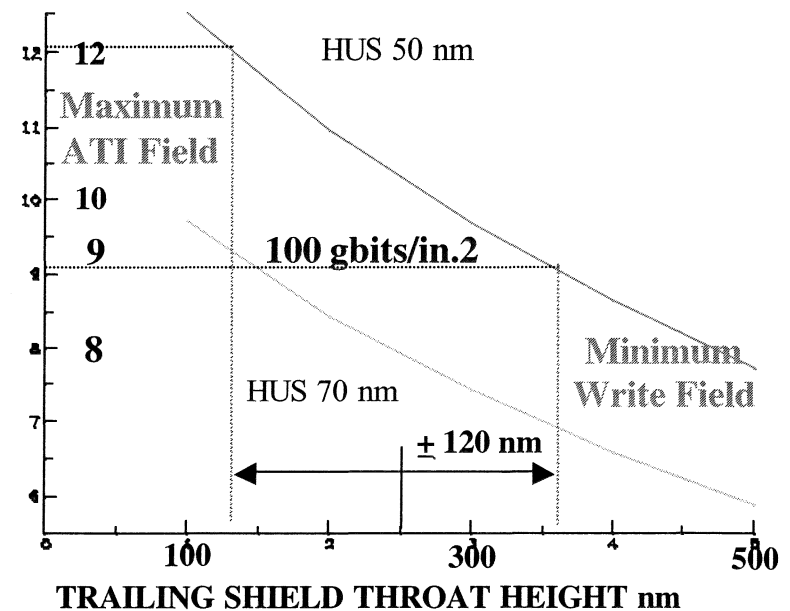

✓ For Trailing Shield maintaining sufficient H_{EFF} becomes very challenging

✓ Here we see small HUS and tight control of Trailing Shield Throat are very important

DESIGN CONSIDERATIONS FOR TRAILING SHIELD HEAD

**For Trailing Shield
Heads dominant
parameter on writing
continues to be pole
width at 100-200
gbit/in.² dimensions**

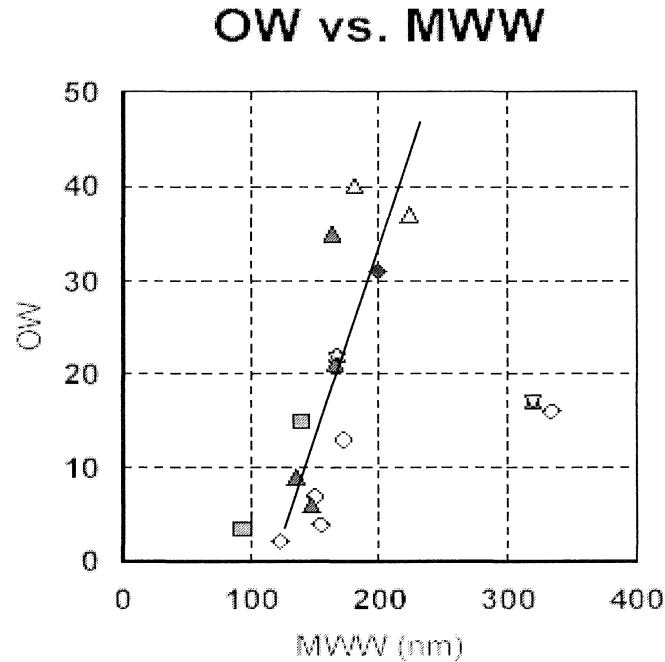

**Various Flare
and Shield
Throat
Combinations**

Due to division of writing flux between Trailing Shield and SUL strict control of key head parameters becomes imperative

PERPENDICULAR HEADS FOR TOMORROW'S HDD

TRAILING AND SIDE SHIELD DESIGN

Trailing & Side Shielded Perpendicular Recording Head

Full Side Shielded Version

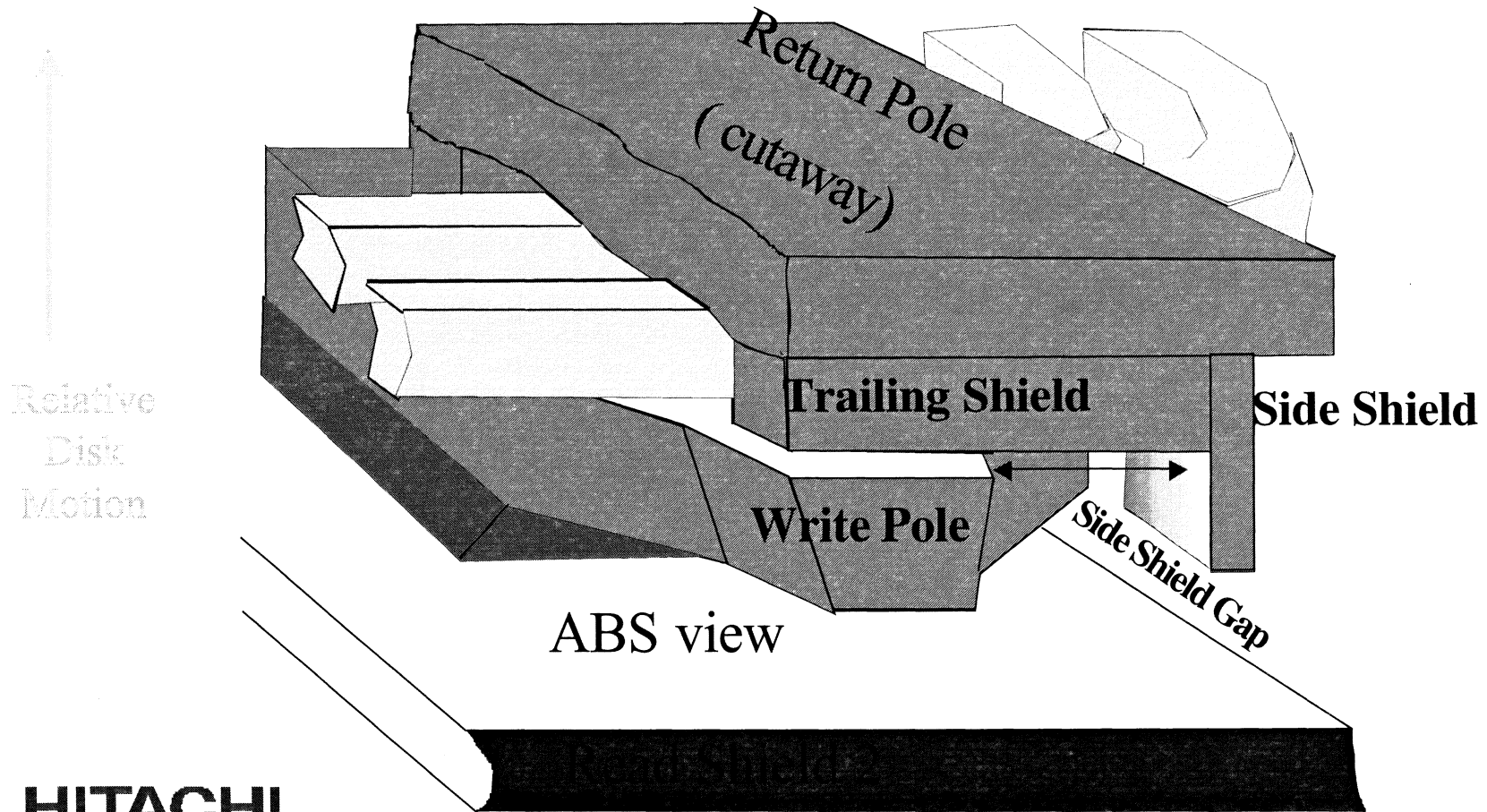

TRAILING AND SIDE SHIELD HEAD (TSS) DESIGN

- ✓ Addition of Side Shield offers significant benefit in track density increases
- ✓ Processing becomes very complex
- ✓ Burden on maintaining sufficient write fields becomes significant

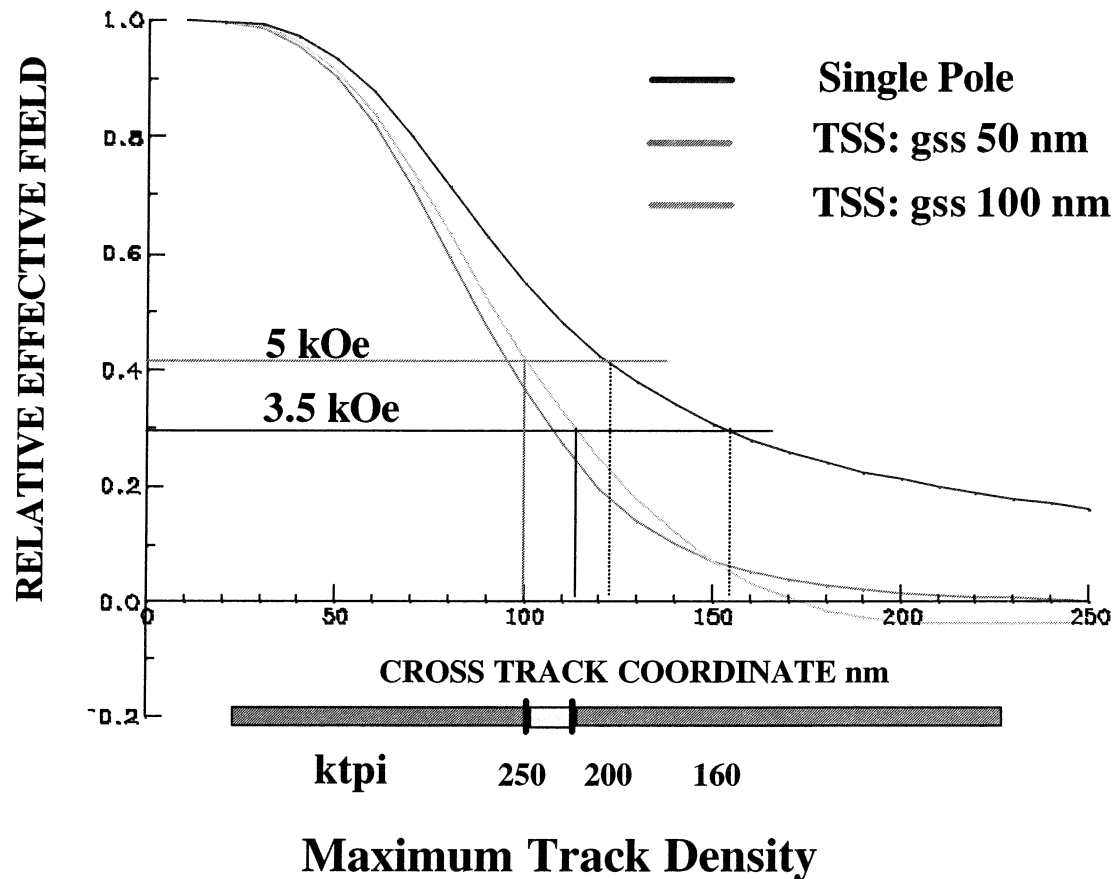

PERPENDICULAR HEADS FOR TOMORROW'S HDD

PROCESS CHALLENGES

WRITE POLE FORMATION

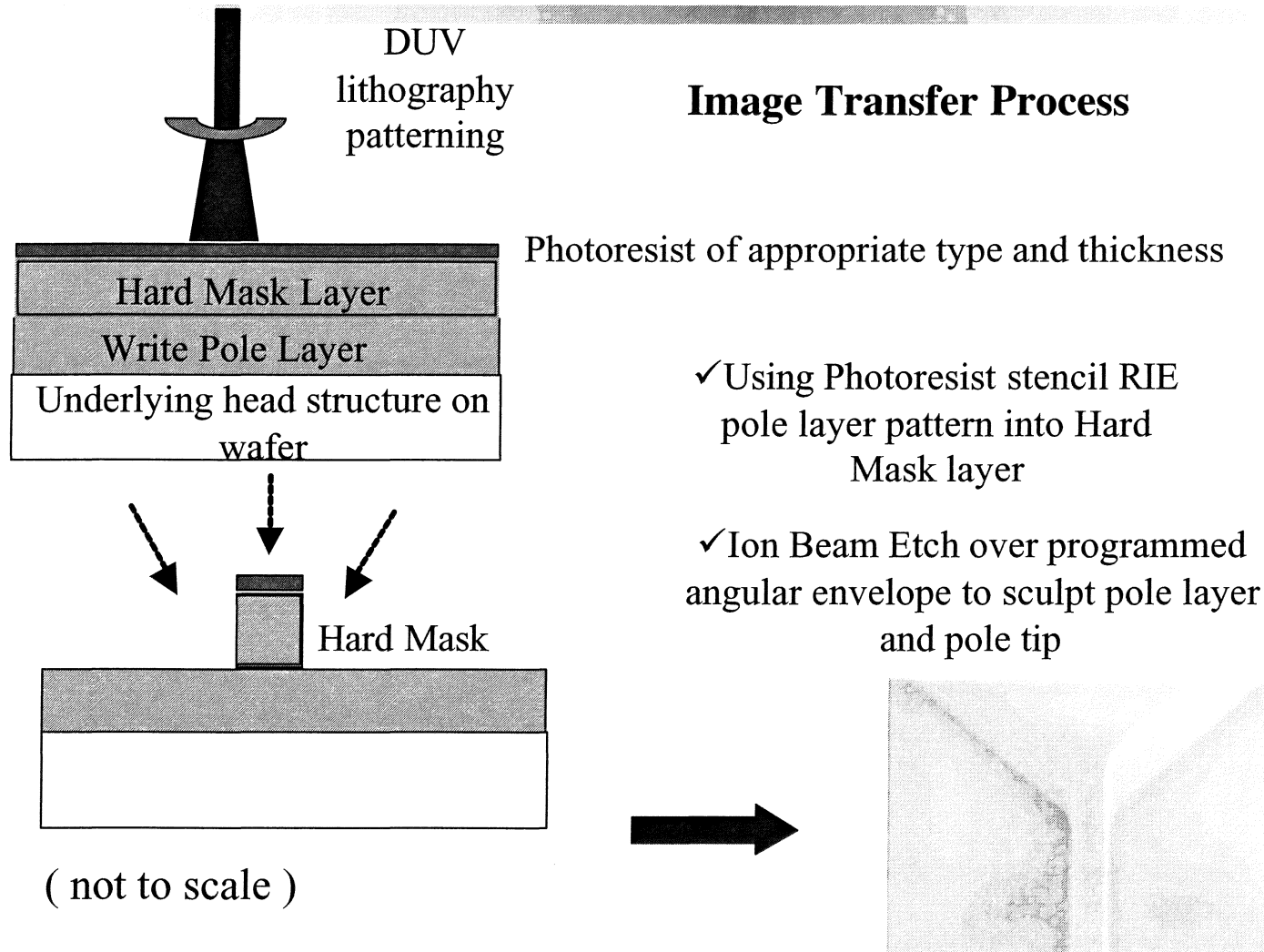

WRITE POLE WIDTH CONTROL

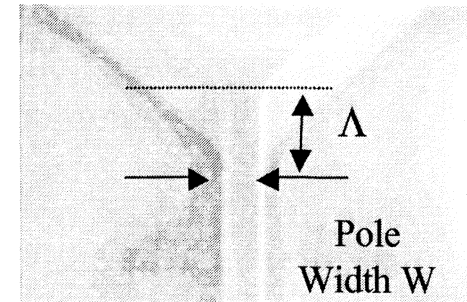
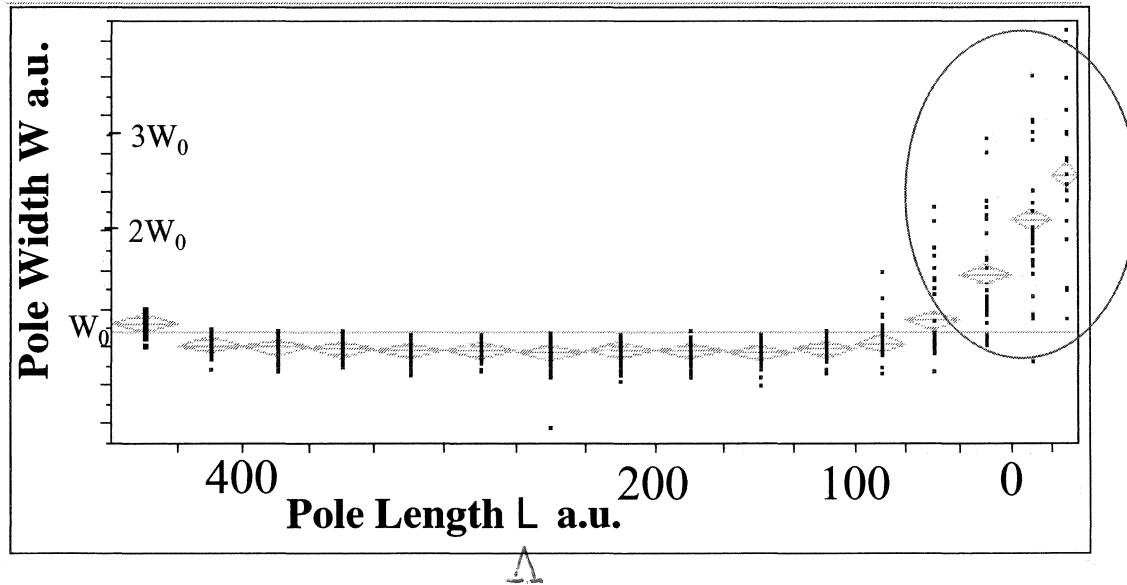

Pole Width Data shows ability to control W diminishes the closer we get to the flare point $L=0$



RECONCILING CRITICAL DIMENSIONS

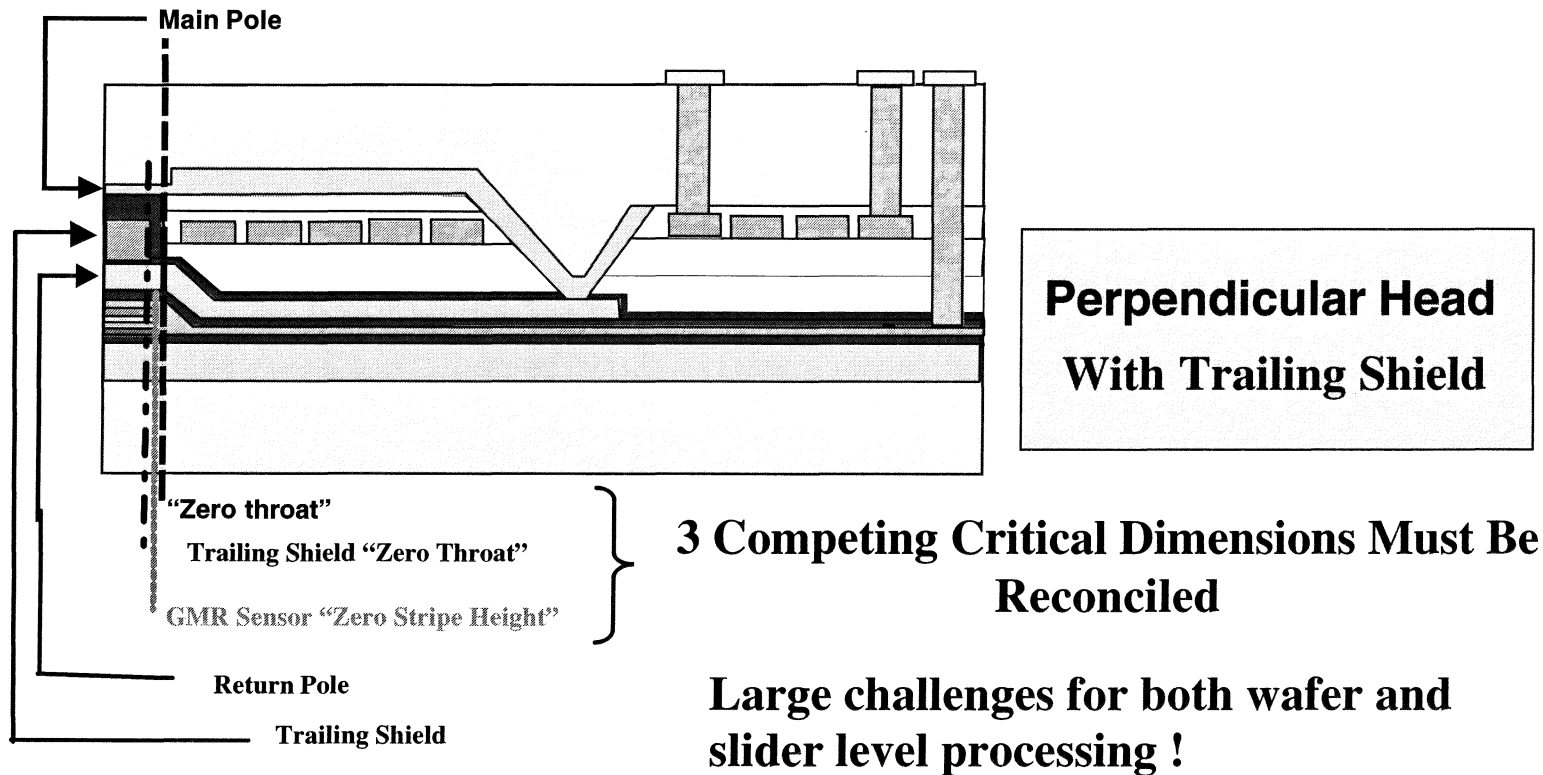

PERPENDICULAR HEADS FOR TOMORROW'S HDD

CONCLUSIONS

- ✓ SINGLE POLE WRITE HEAD LIMITED IN TRACK DENSITY
 - ✓ Tension between sufficient write field and ATI
- ✓ TRAILING SHIELD DESIGN IMPROVES EFFECTIVE WRITE FIELD
 - ✓ Improves gradient and jitter
 - ✓ Improves effective write field
- ✓ TRAILING AND SIDE SHIELD DESIGN
 - ✓ Significantly extends track density
 - ✓ At expense of processing requirements and precision

Progress and Challenges in Perpendicular Drive Integration

IDEMA

Perpendicular Recording Symposium

February 26, 2004

Yan Wu

Maxtor Corporation

Milpitas, CA

Acknowledgement

- Heads/Media Evaluations and Drive-building team
 - Davide Guarisco, Peng Luo, Ton Huang, Teresa Baisa, Truc Do
- Support from other functional teams
 - Heads/Media teams at all Maxtor sites
 - STW team for Maxtor desktop products
 - Channel and RW team for Maxtor desktop products
 - Firmware team for Maxtor desktop products
 - Mechanical, head/disk interface teams
- Heads and Media Vendors
 - They have contributed enormously to our efforts, without their close collaboration, none of the progress would be possible

Maxtor[®] Outline

- **Introduction**
- **Drive integration**
 - Drive configurations
 - Drive performance
- **Major issues**
 - Thermal stability
 - Media uniformity
 - Shield induced wide reading
 - On track erasure (domain lock-up in the pole)
 - ATE (adjacent track erasure upon multiple writes)
 - External fields
- **Conclusions and summary**

Why Perpendicular?

- **Potential advantages compared to longitudinal recording**
 - Highest de-mag field at low density
 - Higher areal density capability
 - Higher effective writing field due to soft underlayer
 - Sharper transitions (lower noise) due to higher head field gradient
 - Could use Higher Hc media due to soft underlayer to improve thermal stability and transition length
 - Improved written track edge definition
- **Most importantly, what if longitudinal recording reaches its limit in terms of areal density?**
 - **We need to be prepared!**

- Start from current longitudinal drives, develop perpendicular recording technology from the finished drive point of view
 - Same or better data rates
 - As high areal density as possible
 - Finding solution to known issues and uncover new issues
 - What do we have to change and what we can live with?
- With limited resources, change as little as possible on the drive platform for now

- Start with mature longitudinal recording drives
 - Replace with perpendicular heads and media
 - Change as little as possible on everything else
 - Mechanical, Preamp, Channel, PCB, firmware, etc...
- In reality
 - Add a differentiator to transform the step response waveform for isolated transitions in perpendicular recording to pulse response waveforms
 - Make necessary process and firmware changes to make the drive to work
- Focus on heads/media designs to improve the performance and areal density over time

- **Differentiation used to shape waveform**
 - External passive differentiator (high pass filter) with fixed corner frequency added to PCB board for most of the drives built so far
 - Internal filter (such as FIR) also works, but required more work on the tuning side
- **After differentiation**
 - Channel optimization routine worked without much adjustments
 - Of course, new defaults is needed
 - Parametric measurements ran easily



Waveforms with and without Differentiation

21-Feb-02
18:37:48

Average(1)
.1 μ s
39.0 MV/s
==1000 sups

2
.1 μ s
132mV

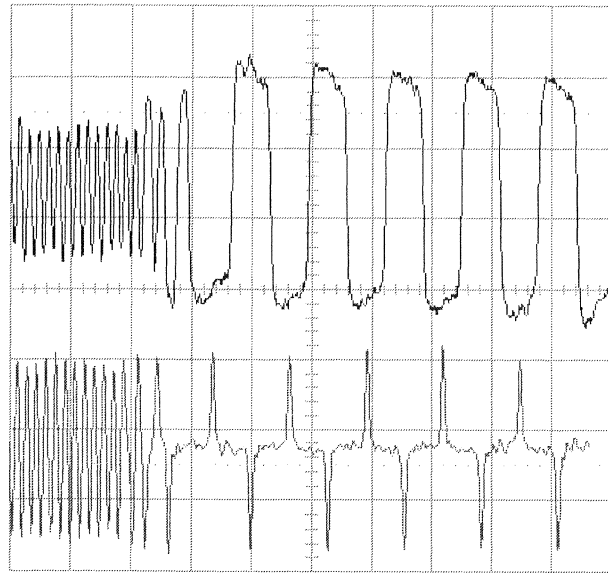

.1 μ s BWL
1 .2 V DC \times
2 132mV 50 Ω
3 .5 V DC
4 .2 V DC \times

← 2.13 μ s



1 DC 1.92 V
4 DC 0.64 V

21-Feb-02
18:43:10

Average(1)
.1 μ s
39.0 MV/s
==1000 sups

2
.1 μ s
132mV

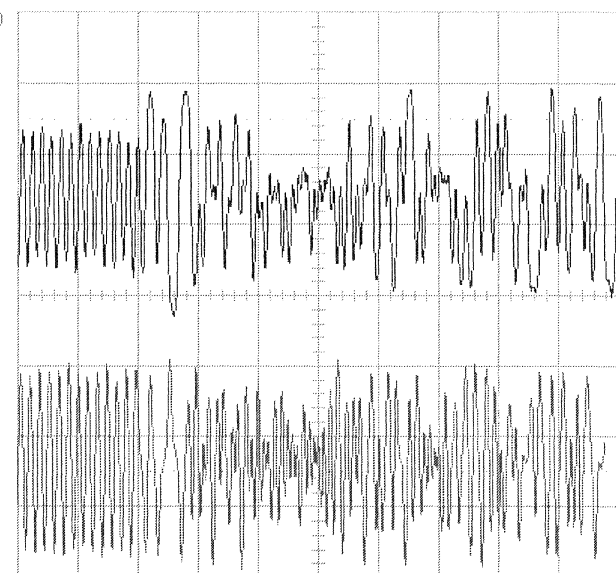

.1 μ s BWL
1 .2 V DC \times
2 132mV 50 Ω
3 .5 V DC
4 .2 V DC \times

← 2.13 μ s



1 DC 1.92 V
4 DC 0.64 V

2 GS/s

AUTO

Single frequency

Random data

Drive level waveform:

Raw signal on the top. Differentiated on the bottom.

Servo Pattern on Longitudinal vs. Perpendicular Media

Longitudinal media

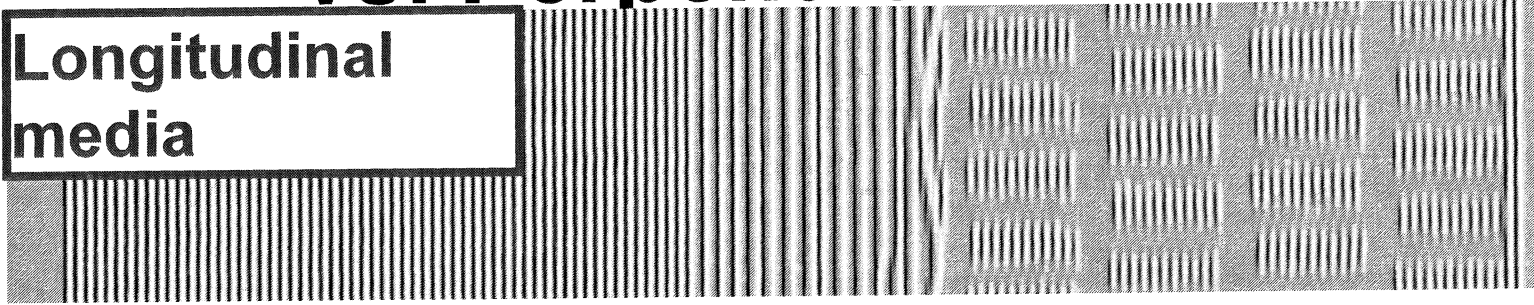

**Perpendicular media:
undifferentiated signal**



**Perpendicular media:
differentiated signal**

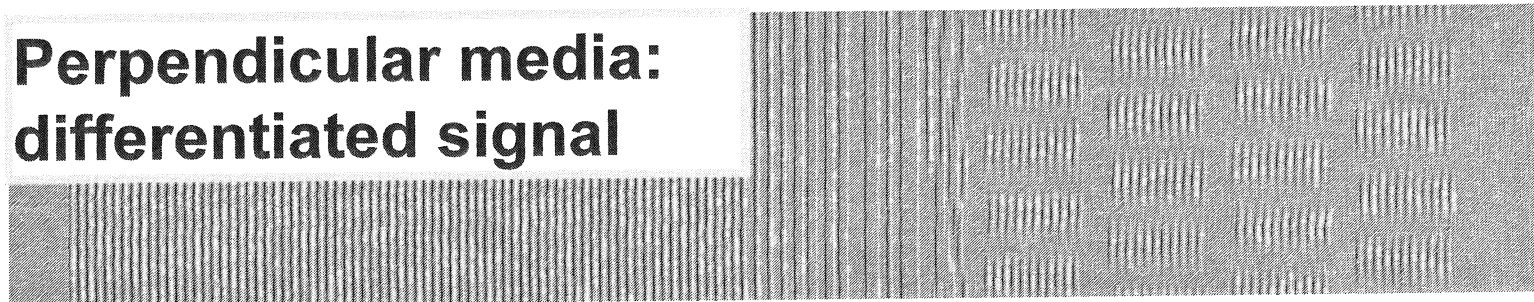

Standard servo write, servo functions over entire stroke

PES Samples- Histogram from Drive

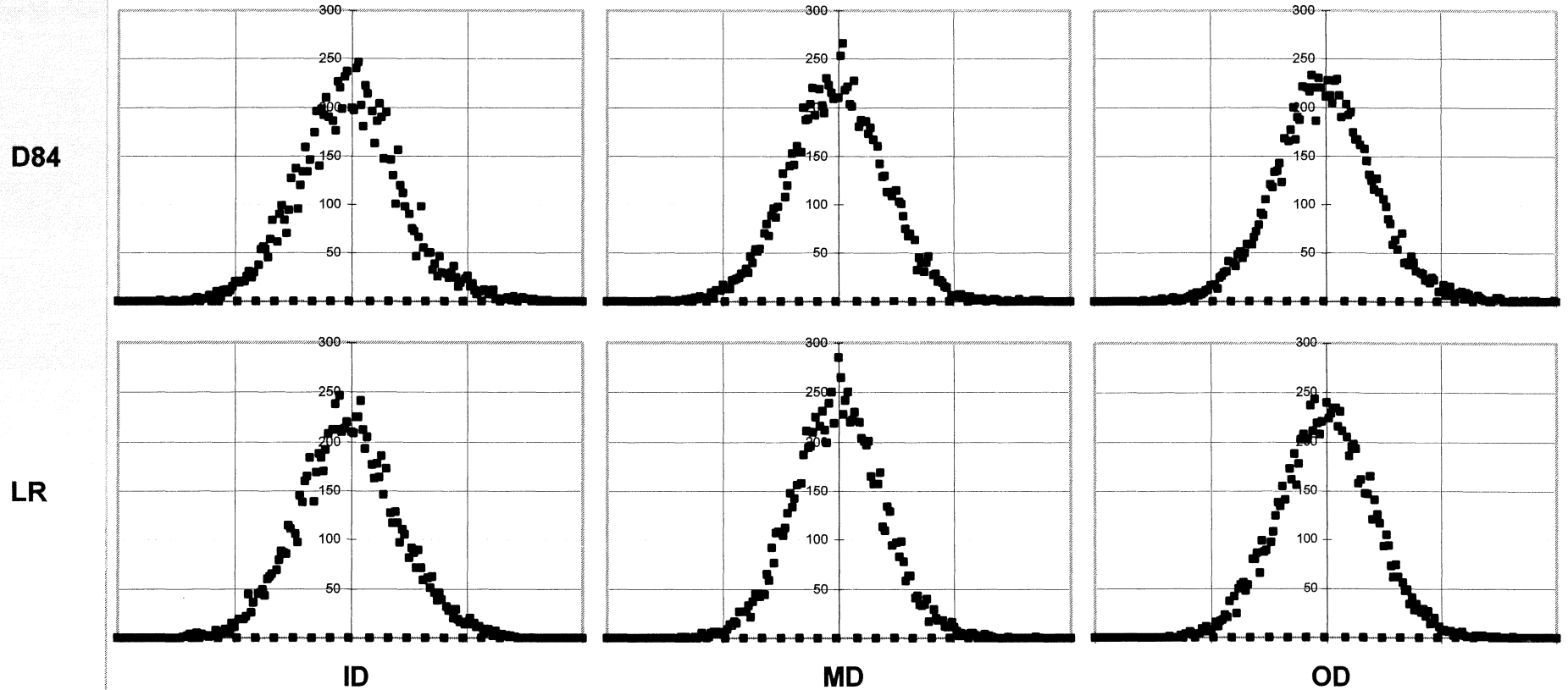

X axis range is +/- 10% of track pitch (89KTPI)

- **Standard read/write channels were used on waveform after differentiation**
- **Several generation of channel chips used in longitudinal drives worked fine**
- **Existing channel optimization routine for longitudinal recording worked pretty well**

- **In the future**
 - **Channels optimized for perpendicular waveforms should provide better performance**

Drive Level BER Across Full Stroke at 30GB/surface

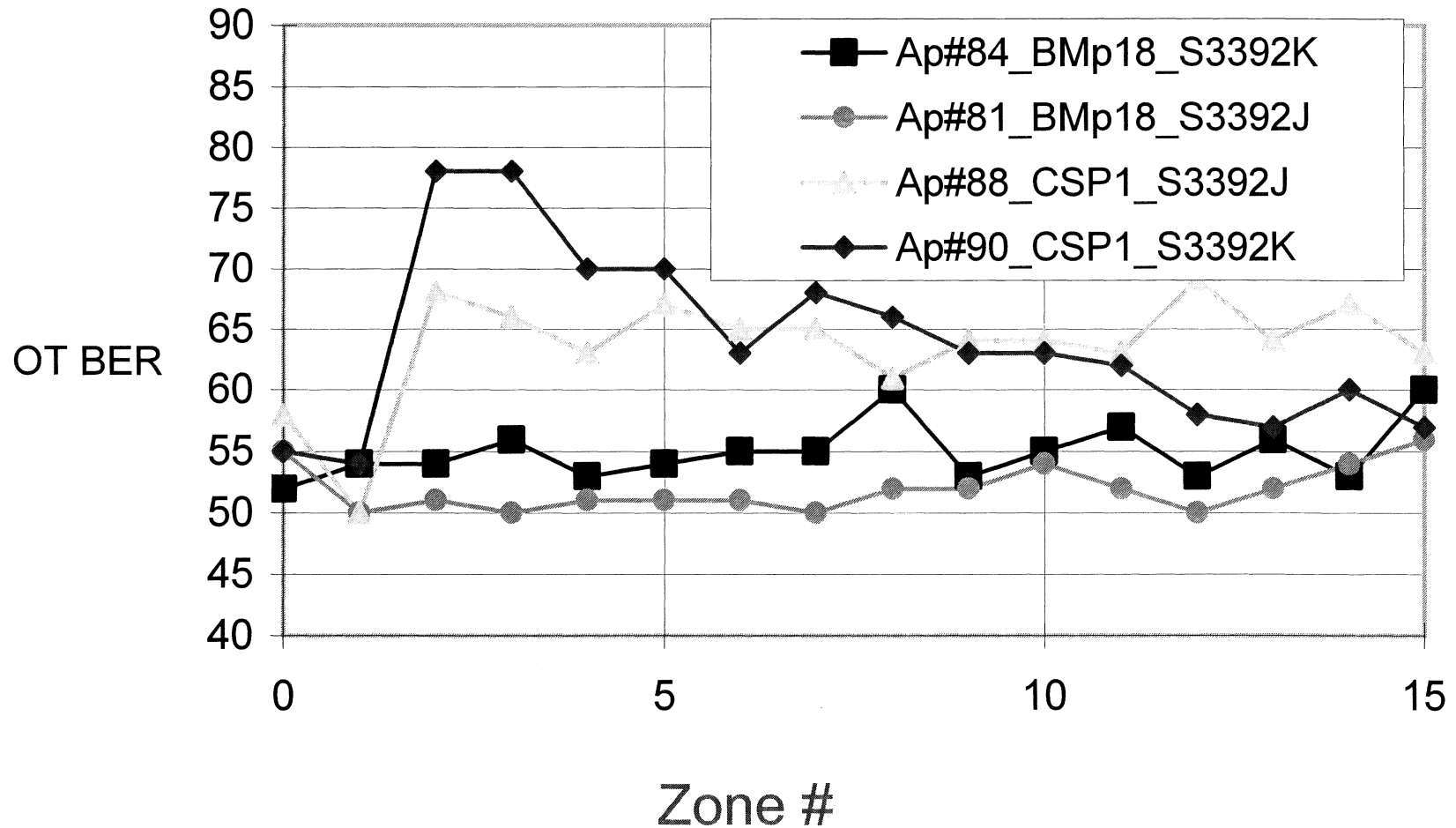



Drive Level 747 Curves

ID

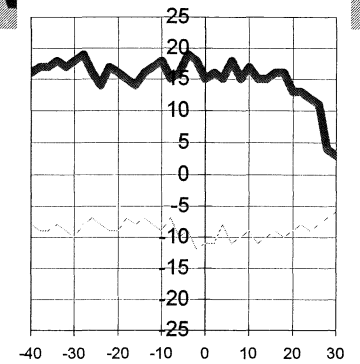
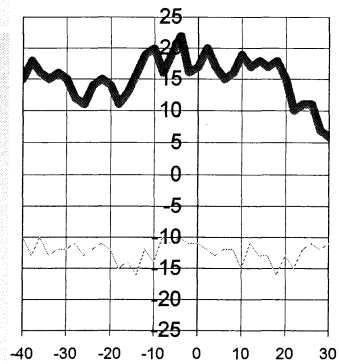

MD

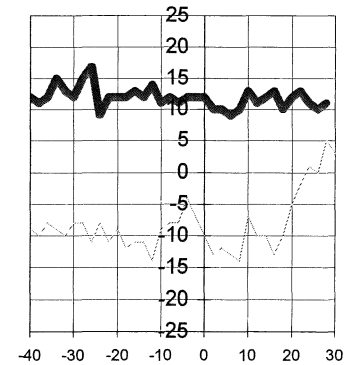
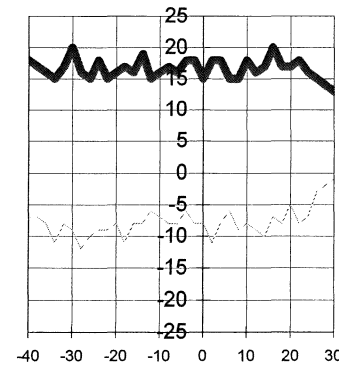
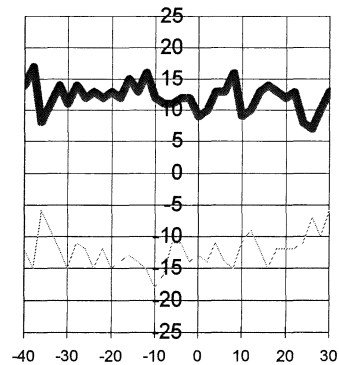
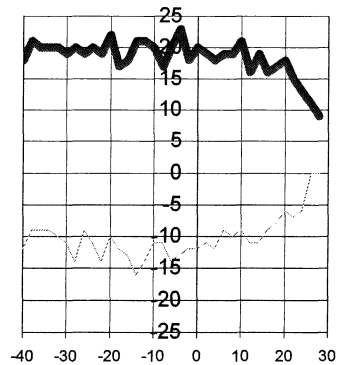
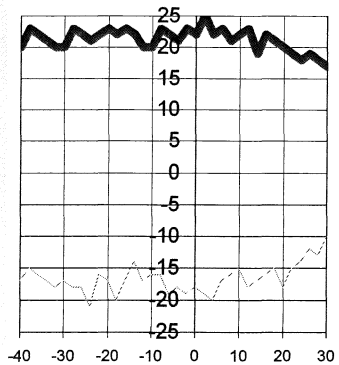

OD

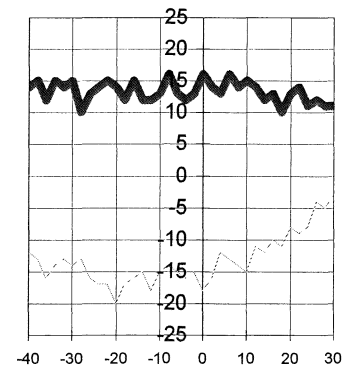
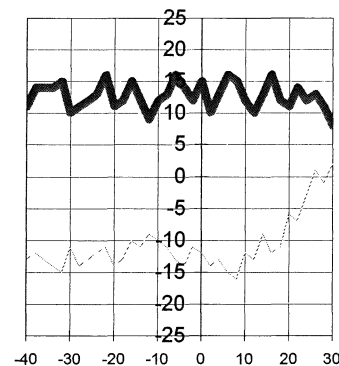
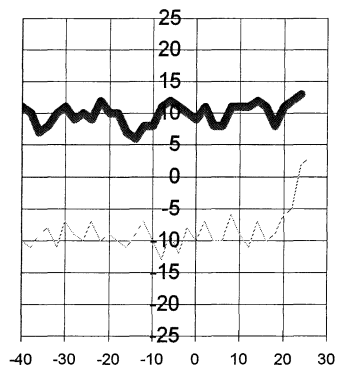
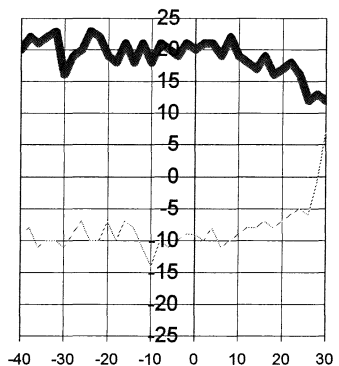
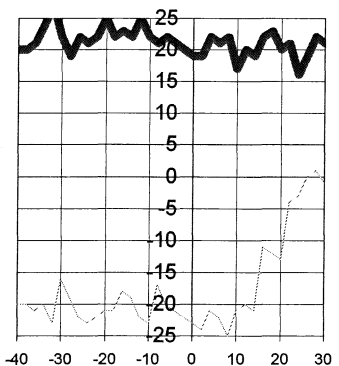

Drive-->

e11pfexe

e15y110e_LR

e1238LBE_A

E1Y01MLE

e1238LBE

Challenges in the Practical Implementation of Perpendicular Magnetic Recording

William Cain, Alexander Payne, Michael Baldwinson and Robert Hempstead
Censtor Corporation, 530 Race Street, San Jose, CA 95126

Abstract- The storing of recorded bits in a perpendicular orientation holds great promise for high linear density recording systems. However, the most common embodiment of perpendicular recording (the probe head/double layer media) has several unresolved issues complicating its integration into commercial disk drives. The major issues include media relaxation, head induced media erasure, resolution limitations due to head-to-underlayer spacing constraints, and extreme sensitivity to stray magnetic fields, which are complex and highly interrelated. It is concluded that the realization of perpendicular recording in commercial disk drives will require new transducer and media designs that solve these problems.

- Paper published 8 years ago, listed major issues:
 - Media relaxation, i.e. Thermal decay
 - Head induced media erasure
 - Resolution limitations due to head-to-underlayer spacing constraints
 - Extreme sensitivity to stray magnetic fields

Ref: IEEE Trans. Magn. Vol. 32, p97

Early Drive Level Thermal Decay Data

Old data taken on a 15G/Surface PR Drive

Comparison of a Perpendicular Drive with Longitudinal Drives

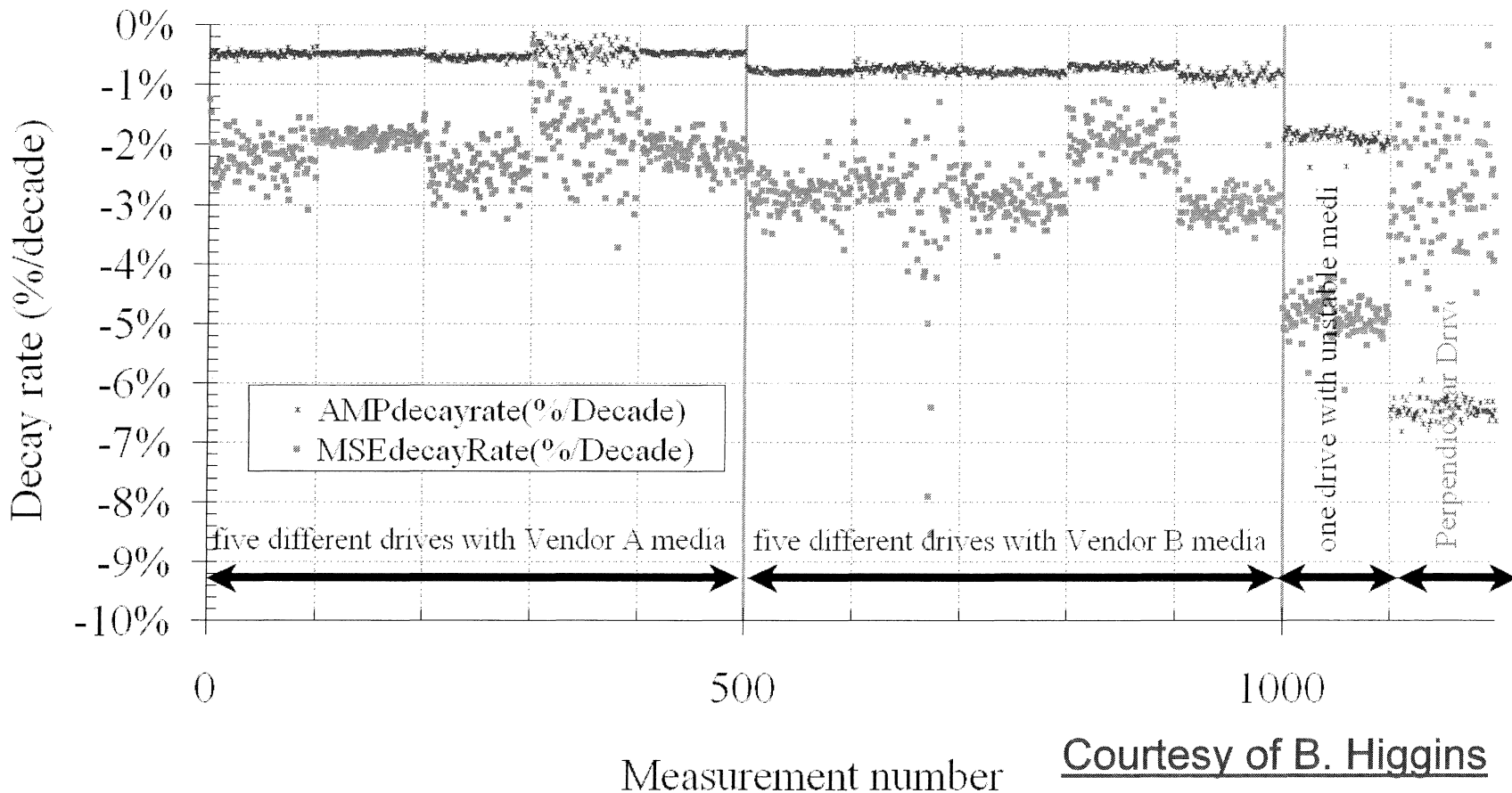

Courtesy of B. Higgins

Drive with perpendicular drive have very low amplitude decay rate

Comparison of Drive level amplitude decay rate:

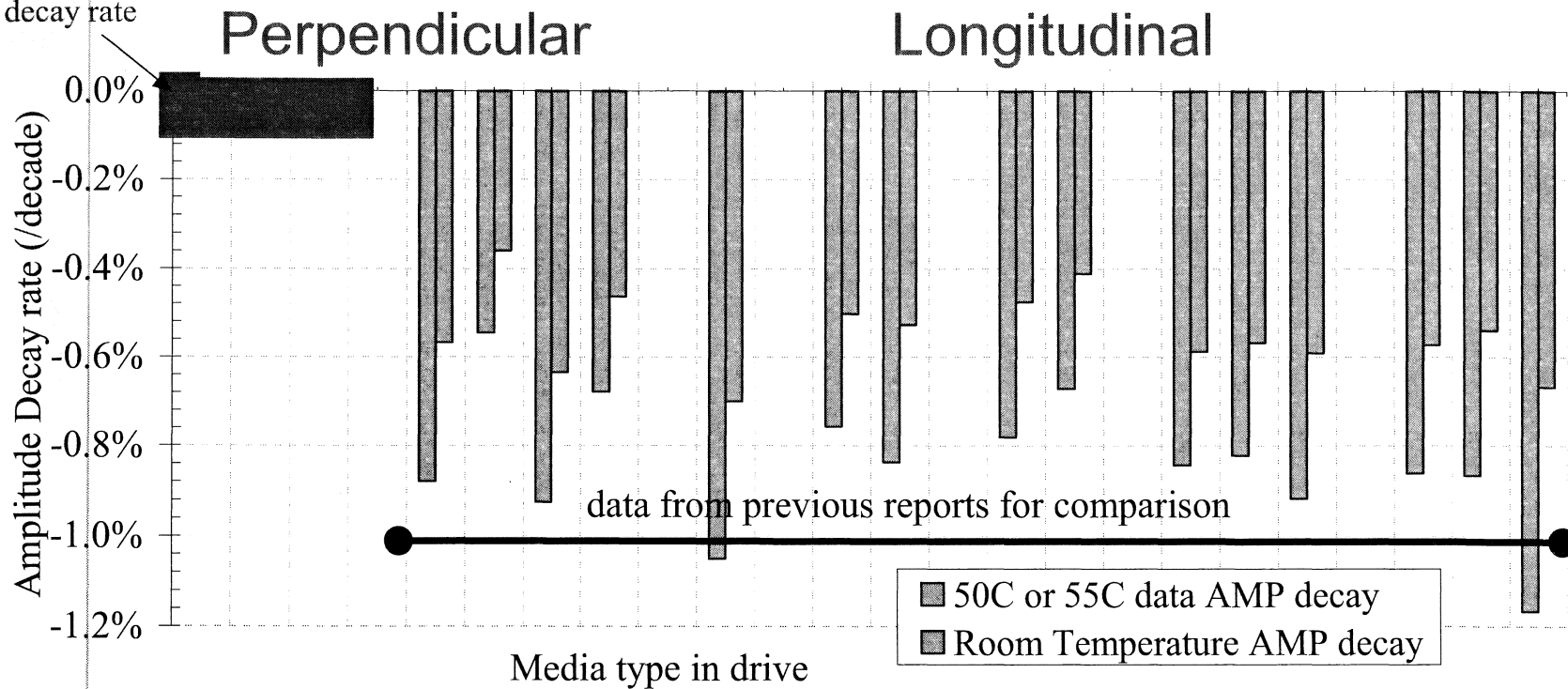

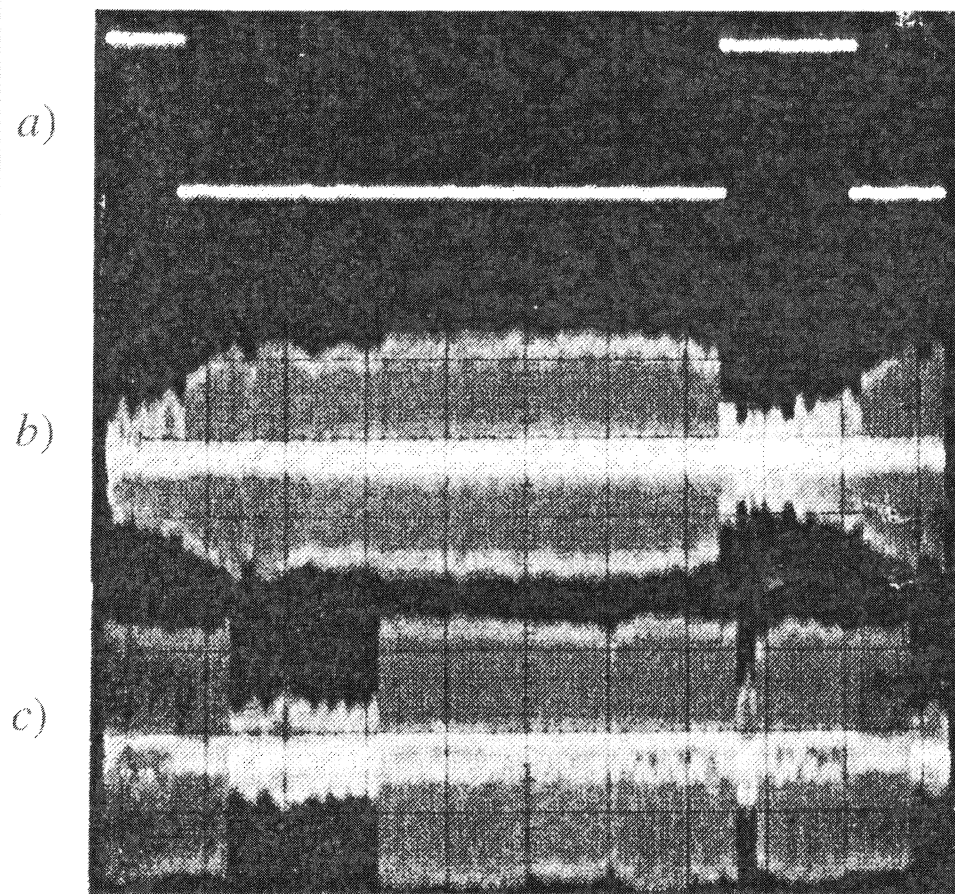
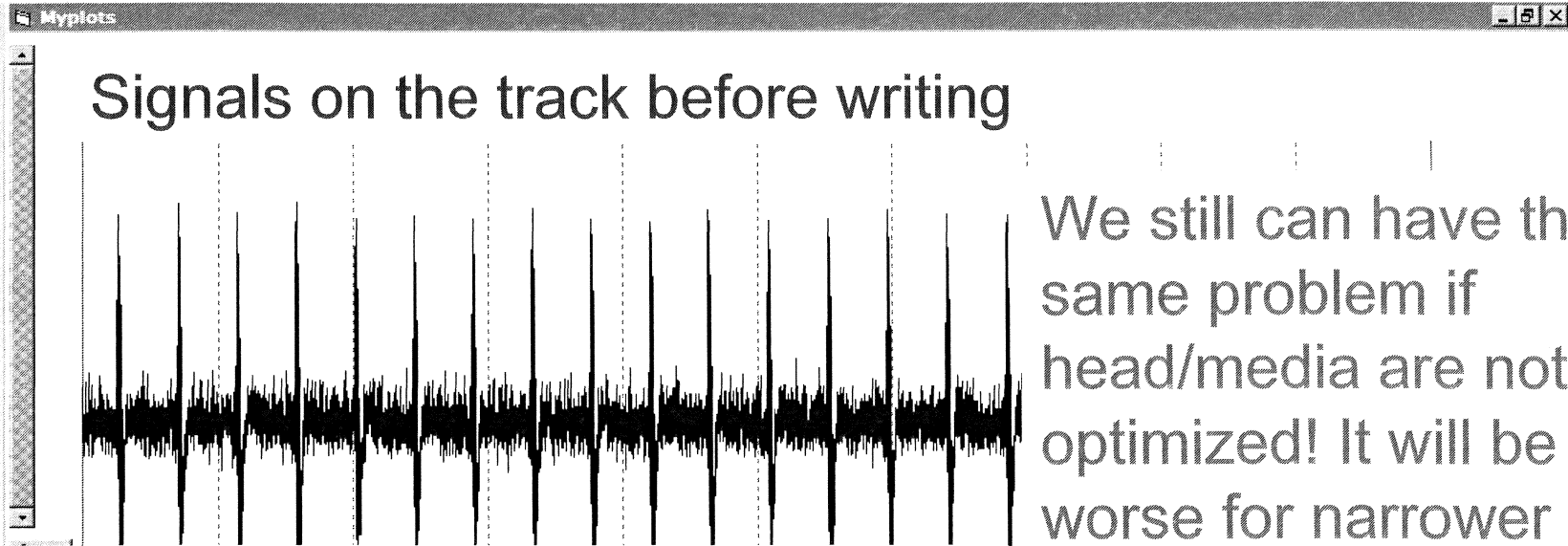
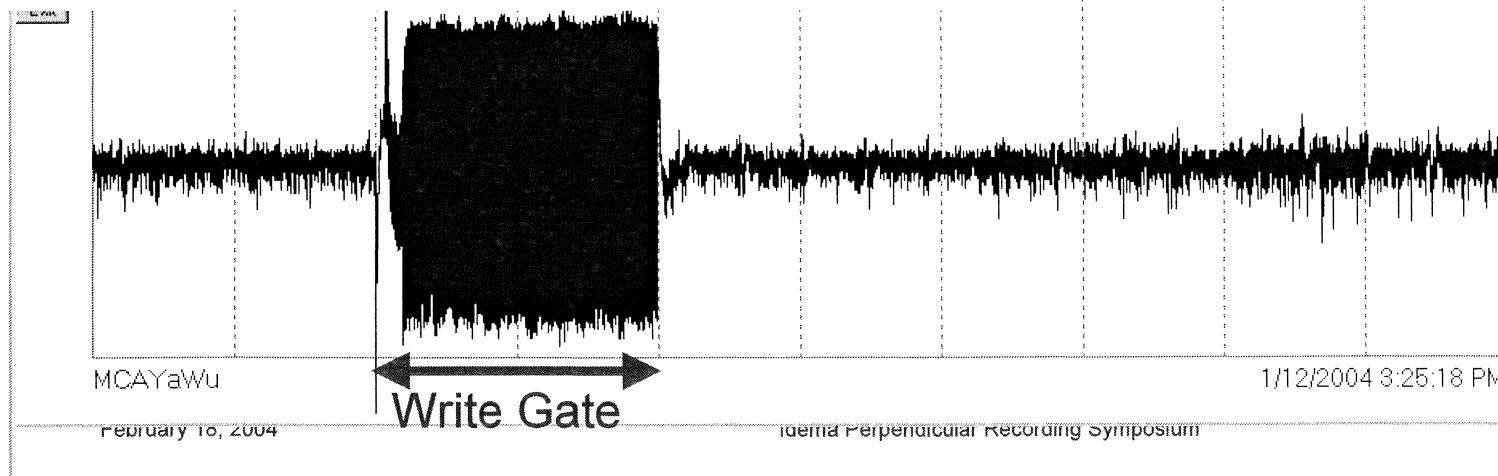

Fig. 10. Oscilloscope photos showing (a) the clock pulse for Guzik readgate (portion of track not rewritten and used for error counts), once around envelope photo showing (b) erase after write, and (c) write rattiness.

- From the above reference paper
- Note:
 - Not complete erasure
 - Erasing field appears to slowly decrease with time even within the revolution



Complete erasure was observed after writing a smaller portion of the track continuously for ~1min with 20MF/s



Maxtor[®] Influence of Vertical Magnetic Field

(spinstand, note different scale on x axis)

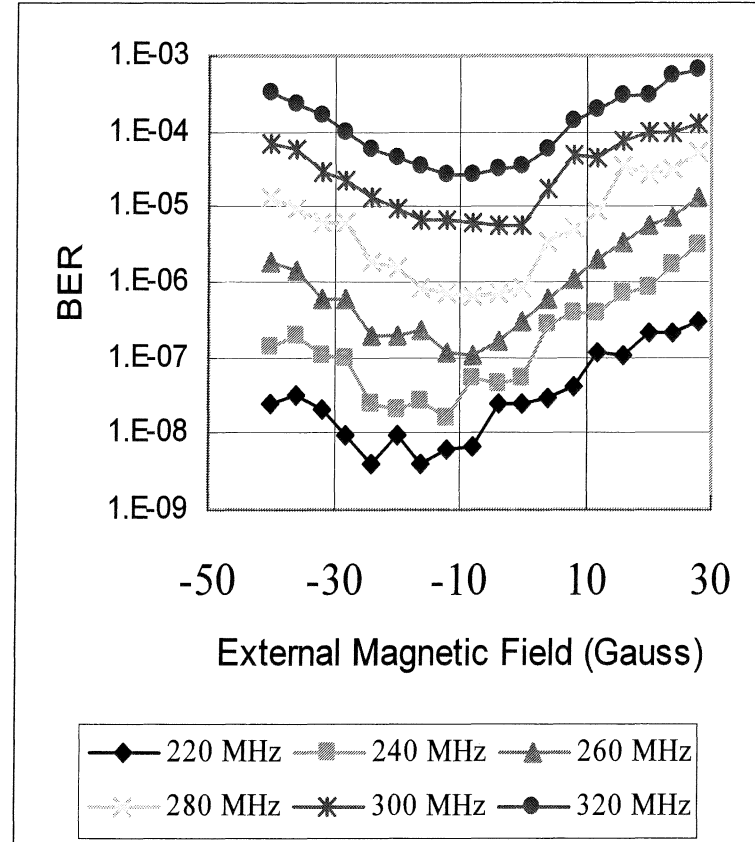
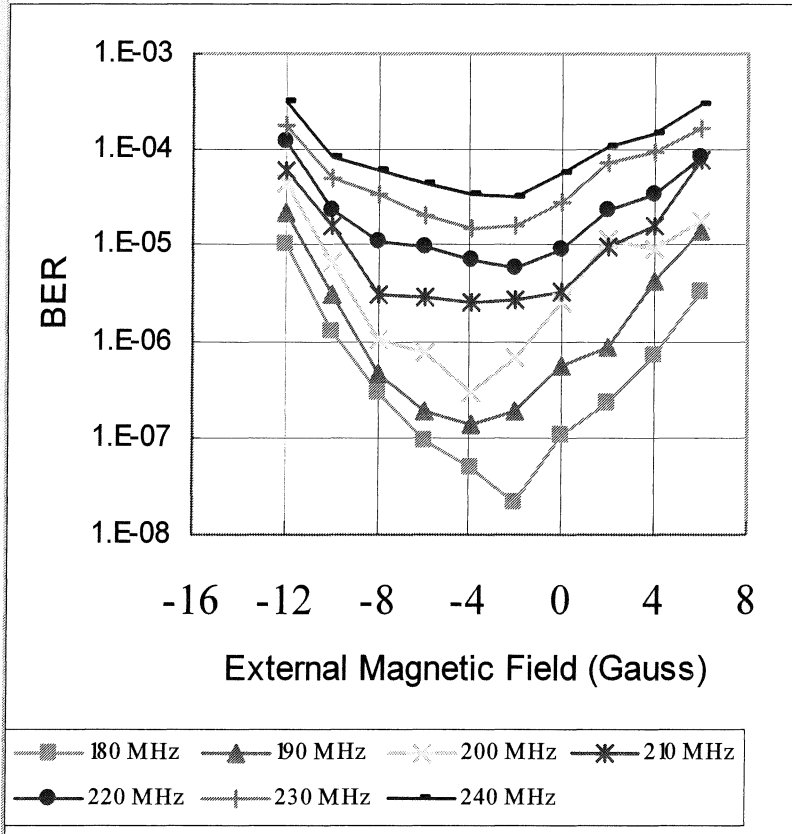

Courtesy of H. Nguy

Influence of Vertical Field on BER (Spinstand Data)

- Perpendicular about 7x more sensitive to external field:
 - 1 order change in BER:
 - Perpendicular 2.5 gauss
 - Longitudinal 18 gauss
- Tested vertical, radial, and circumferential fields
 - Strongest effect with vertical field for both perpendicular and longitudinal
- No special precautions taken in lab or drives to shield magnetic fields at present

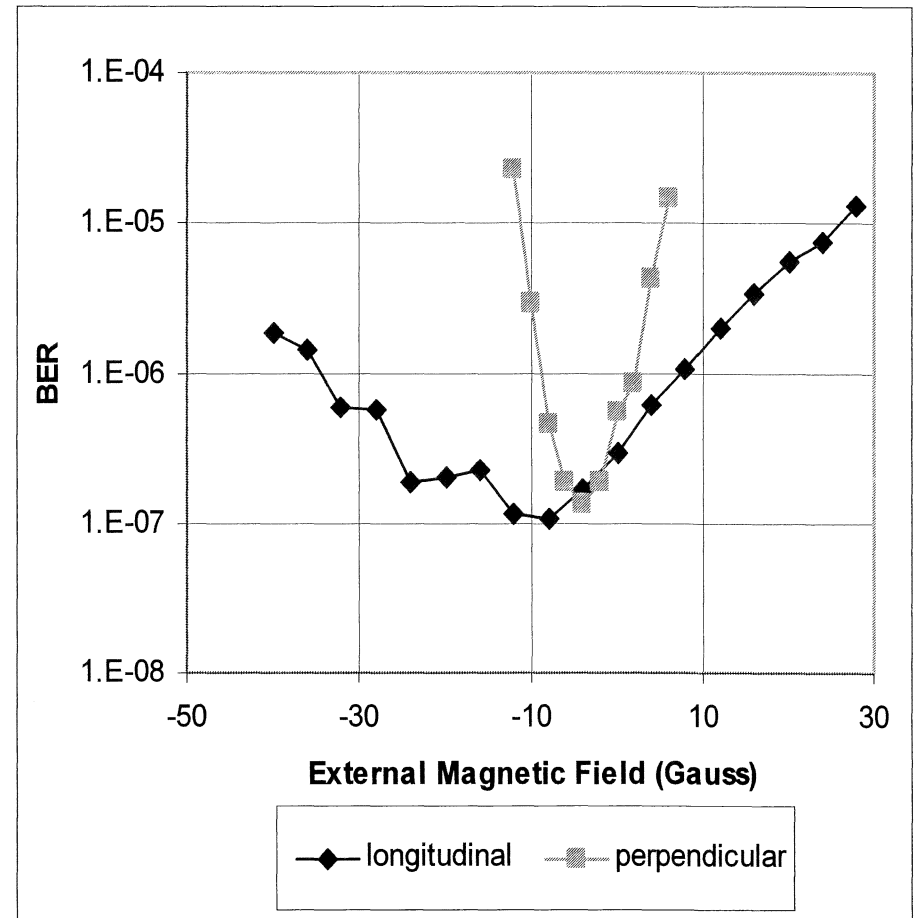

Courtesy of H. Nguy



Drive Level Vertical Field Sensitivity

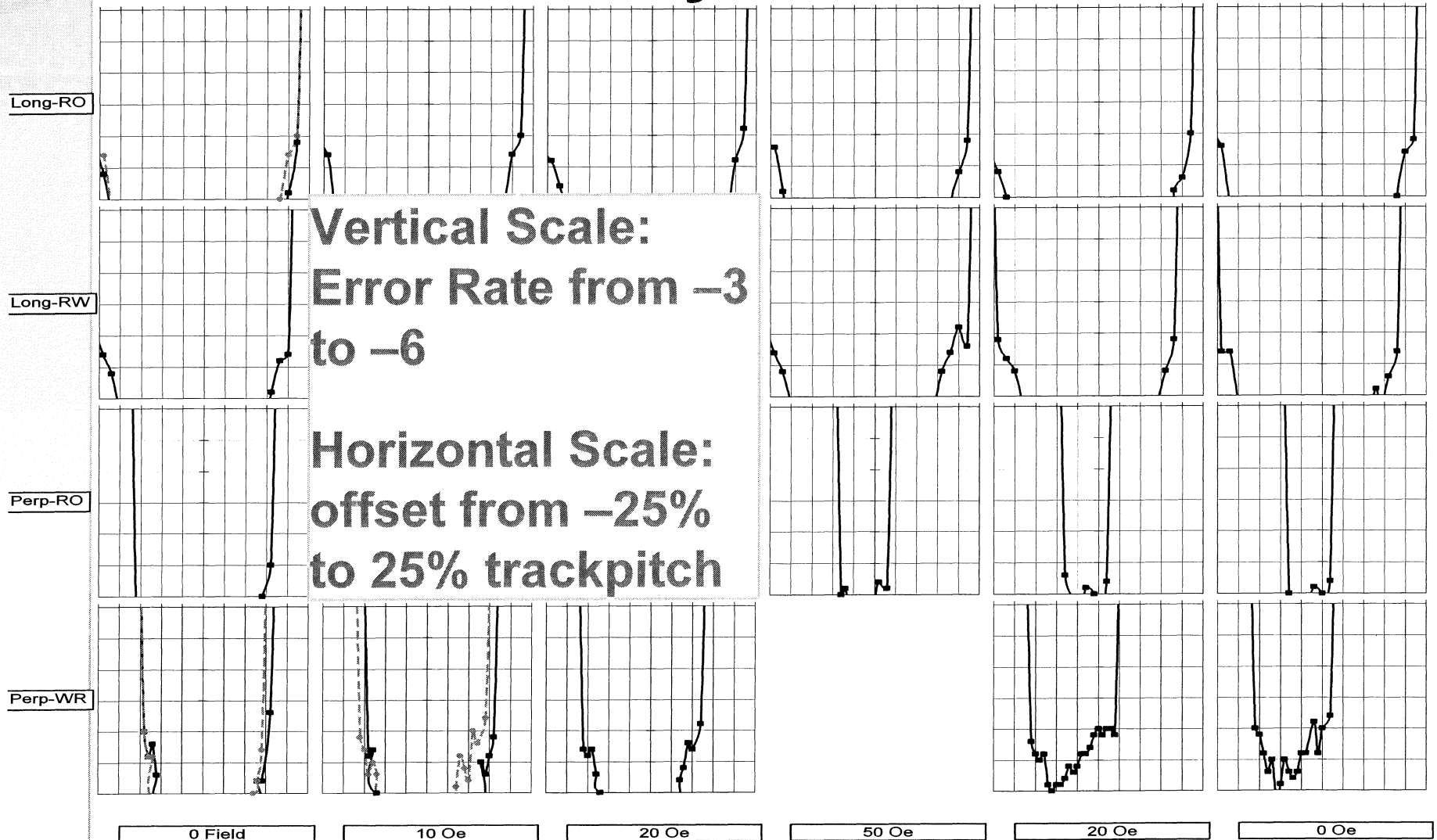

Old data taken on a 15G/Surface PR Drive

Challenges and Issues Identified more Recently

- Side writing occurs at high skew angles unless writing pole is properly shaped
- Side reading through the reader shield
- Wide area erasure
- Some issues are not fundamental, but still need engineering work
 - Media performance uniformity, both around the track and from ID to OD

Side Reading Effect due to Shield

- See for example:
 - P. Dhagat, D. Palmer and B. Xu, paper ES-01 at MMM 2002
- Our evaluation technique
 - Prepare wide tracks with very low density transitions
 - Go to the middle of the track, write relatively high density transitions for a shortened duration
 - Then look at the readback signal

Side Reading Evaluations

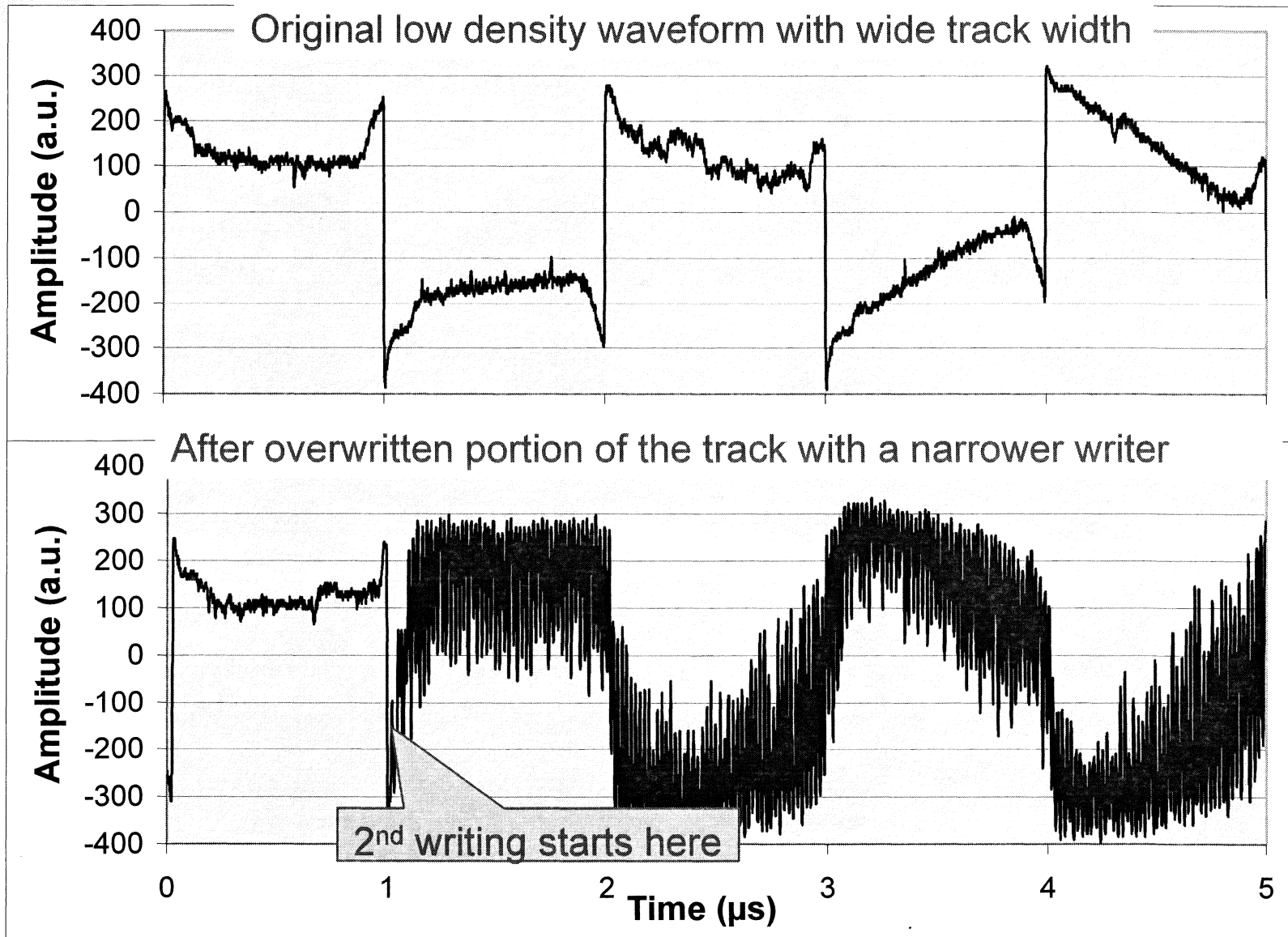

Imaging the Side Reading

Cross track direction
(50 μ in range)

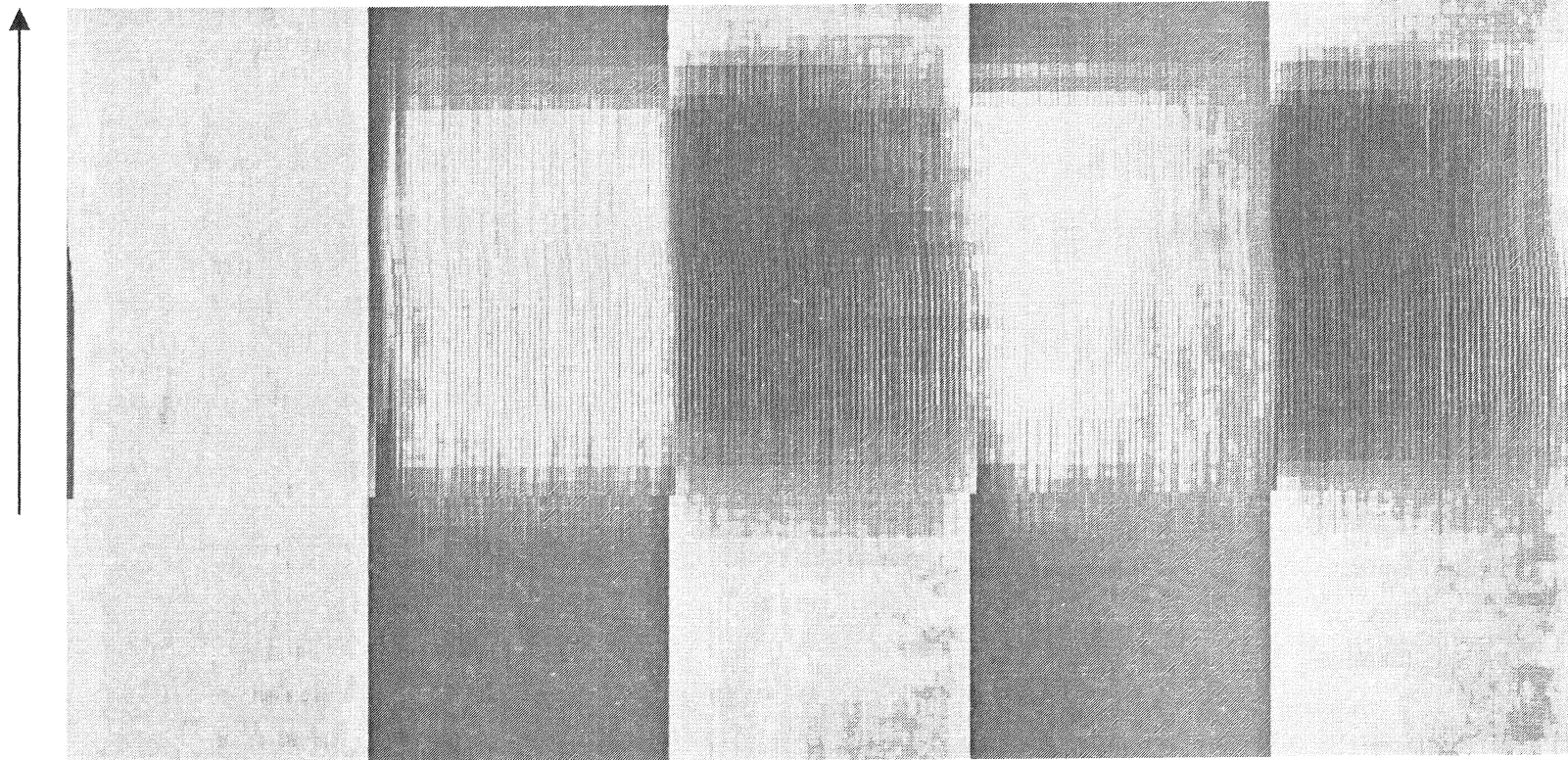

Down track direction (~5 mil)

Fix for Side Reading due to Shield

- Never leave too big a DC erased region on the disk
- Start with AC erased disk
- Write AC pattern during servo writing

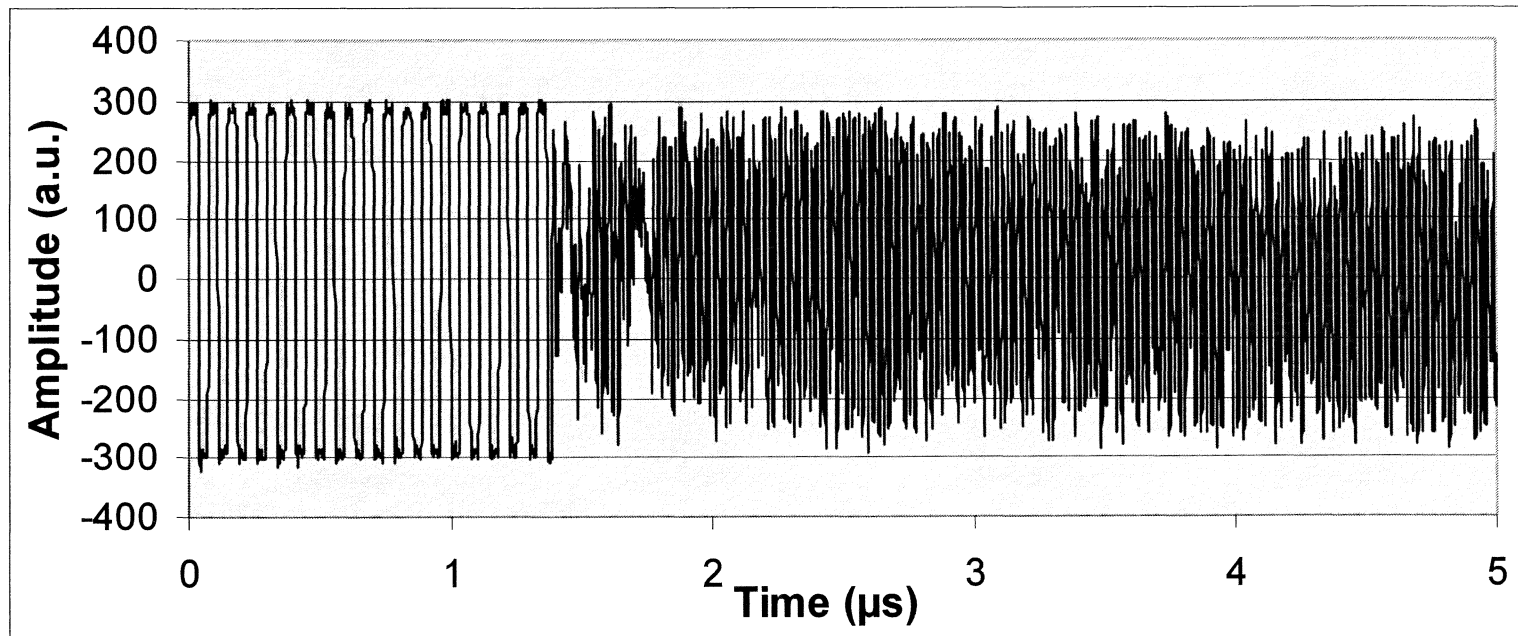

- DC erase the media in opposite directions on alternating tracks

- Some published papers
 - C. Brucker et al. Paper C3 at TMRC 2002
 - W. Jiang et al. Paper BA06 at MMM 2002
- We encountered the problem during drive integration effort
 - Data loss during multiple writes on the same track
- Experimental verification
 - Write a band of tracks, measure track profiles
 - Write center track a number of times, re-measure the track profiles

MSE vs Track Number with the center track written different number of times

B1DX20LE
Track=2000

Preamp is T11710 AAA
WC = 14
WCB = 0
M1 = 77
N1 = 3
Turbo is Off
squeeze is = 0
longtest_flg is = 0
QMDIV = 6

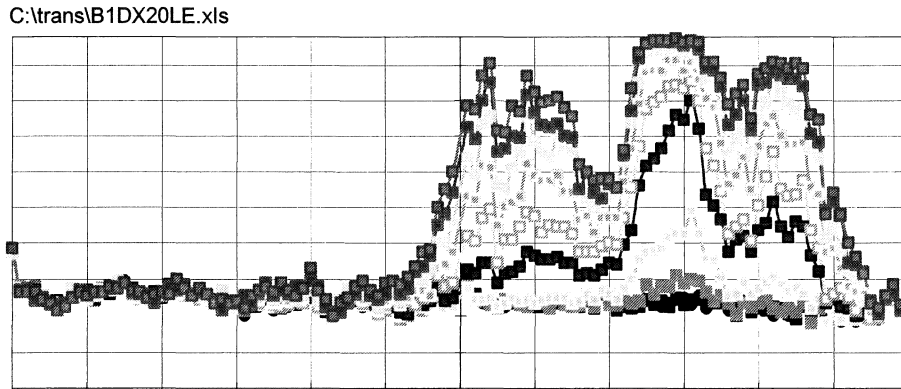

B1DX20LE
Track=30000

Preamp is T11710 AAA
WC = 14
WCB = 0
M1 = 73
N1 = 4
Turbo is Off
squeeze is = 0
longtest_flg is = 0
QMDIV = 6

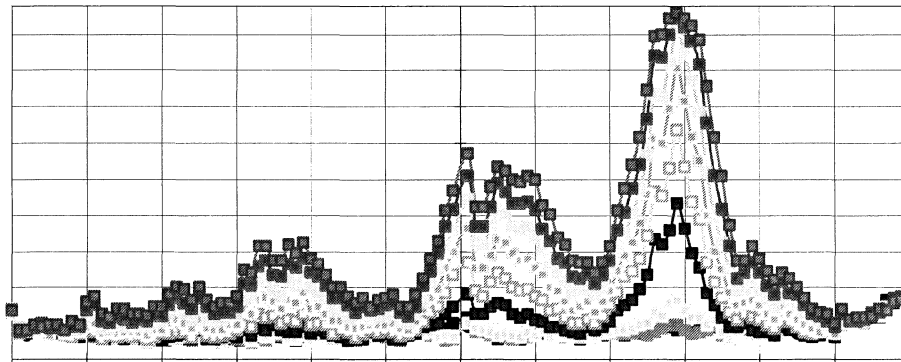

B1DX20LE
Track=49000

Preamp is T11710 AAA
WC = 9
WCB = 0
M1 = 106
N1 = 9
Turbo is Off
squeeze is = 0
longtest_flg is = 0
QMDIV = 6

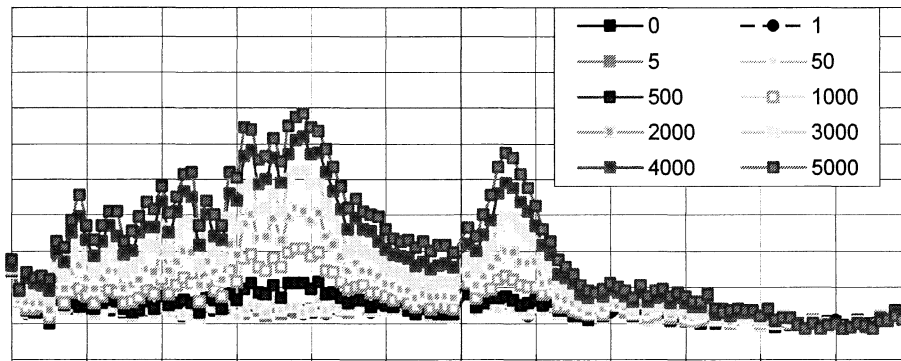

Erasures spans over many tracks and its location changes at different skew angles

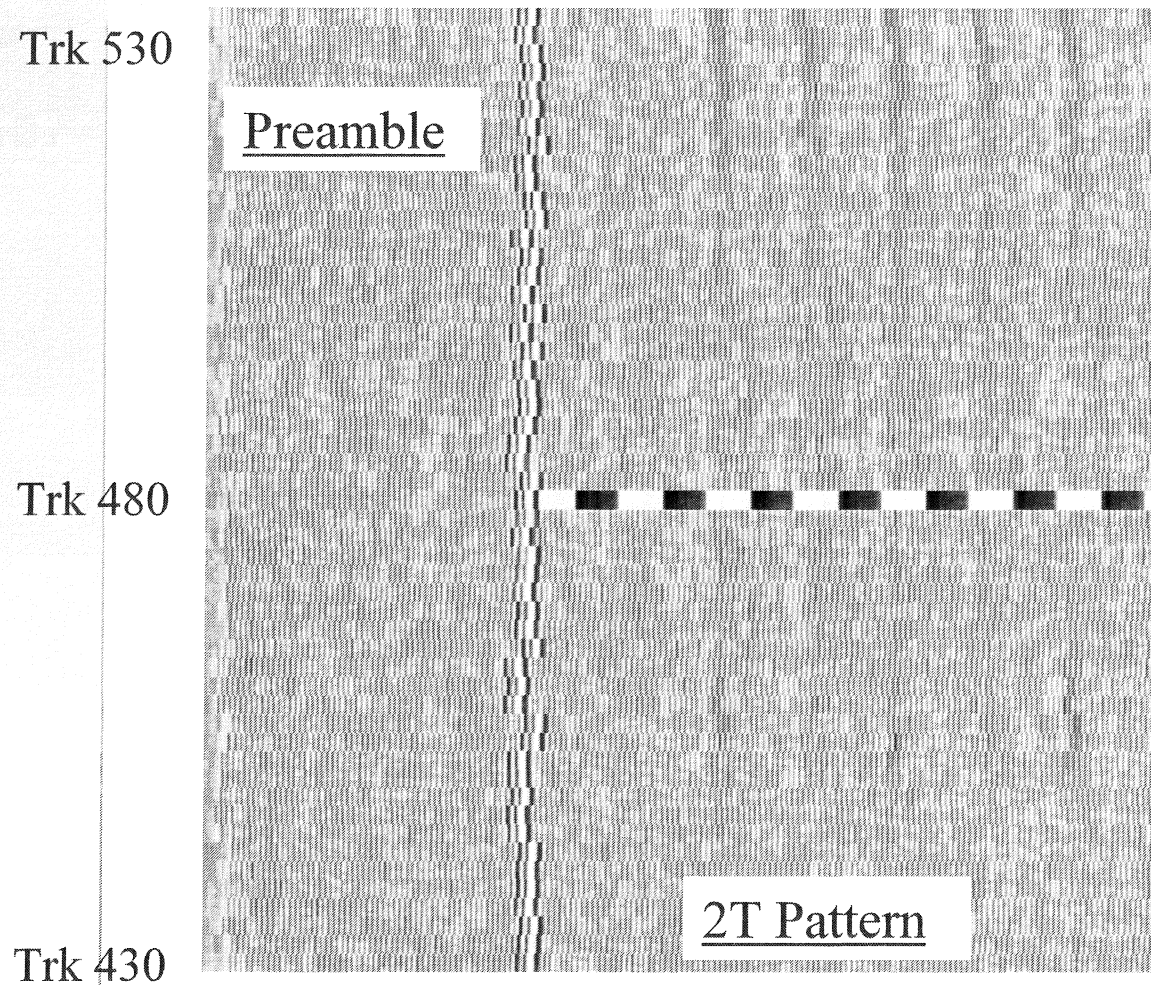

Along Track direction →

- Write “2T” on every track from 430 to 530

- then write “32T” on trk 480 500 times

- capture the readback of every track afterwards

U:\YW32\ntpd\5k_clvs_Rev.ntp

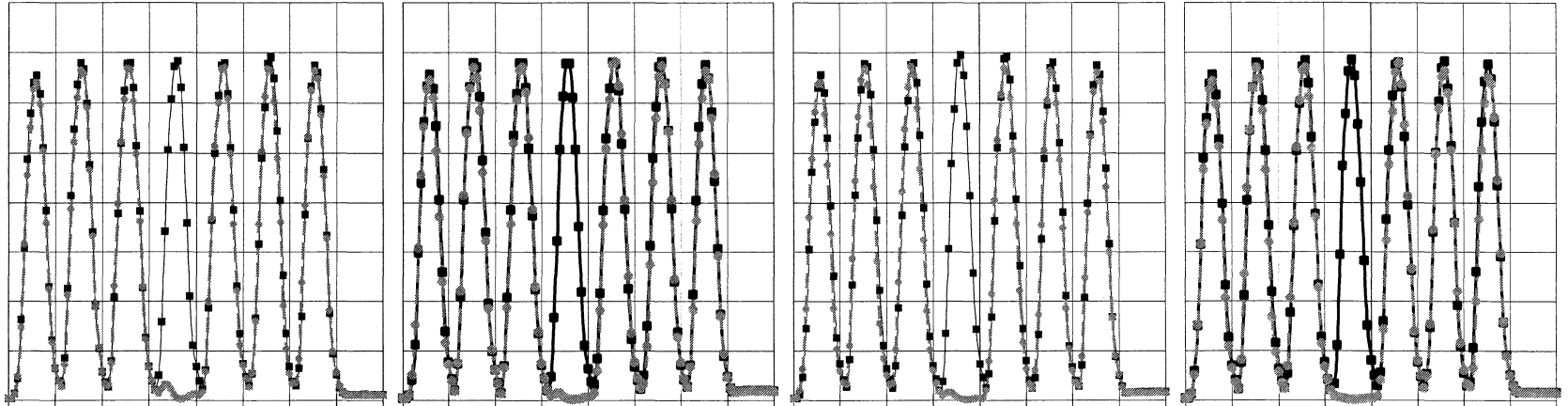

Revolutions

2

4

8

16

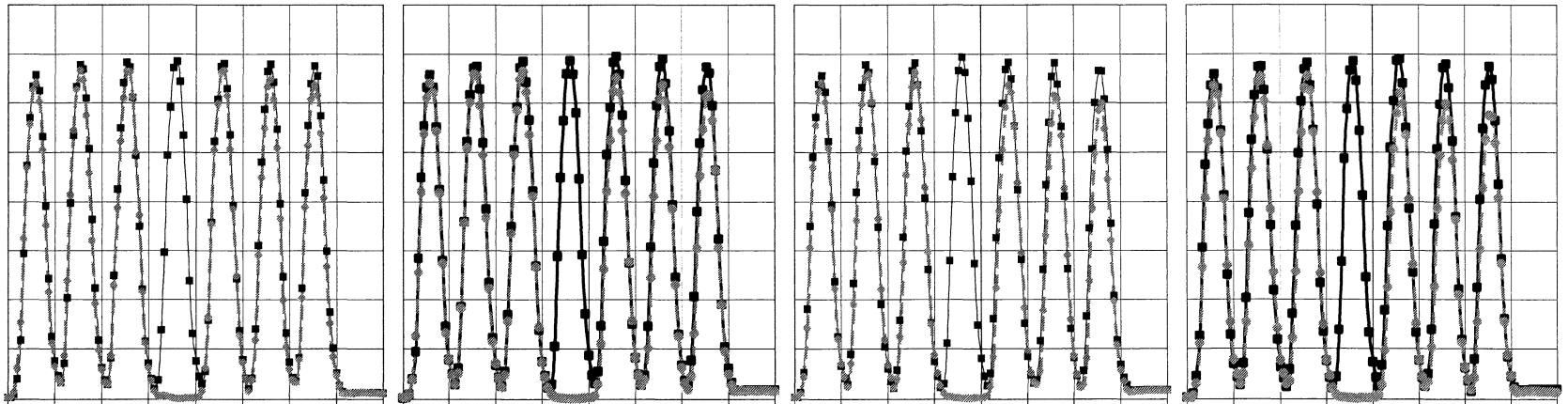

Revoluti

32

64

128

256

- The extent and severity of side writing are sensitive to media coercivity, nucleation field, squareness and soft underlayer properties
- Head design also have large effect
- Write current choice may be very limited
- Preamps also have big contribution as the write current boost and rise time play important roles
- This may limit the competitiveness of perpendicular recording because of the sheared hysteresis loops for perpendicular media

Longitudinal
Media

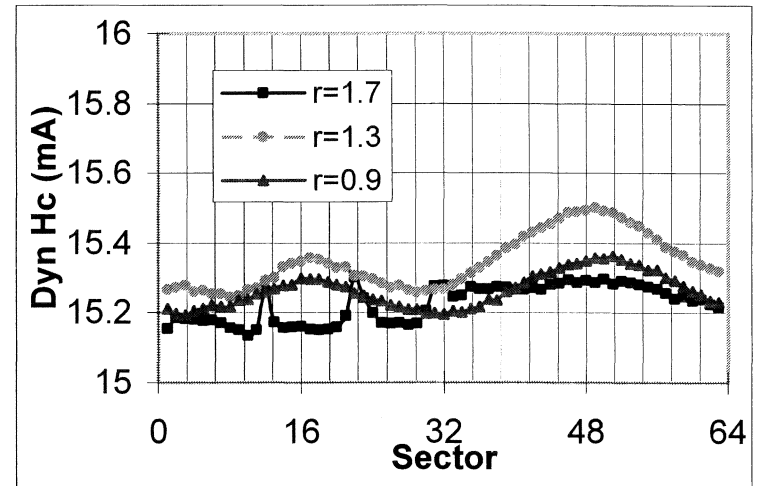
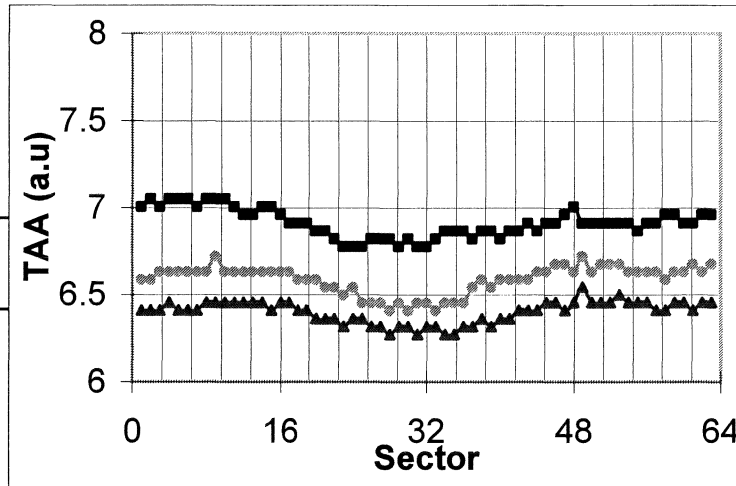

Perpendicular
Media

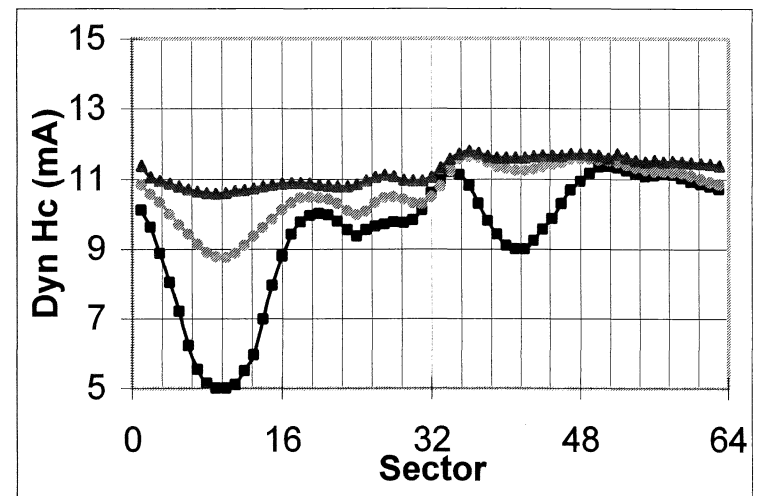
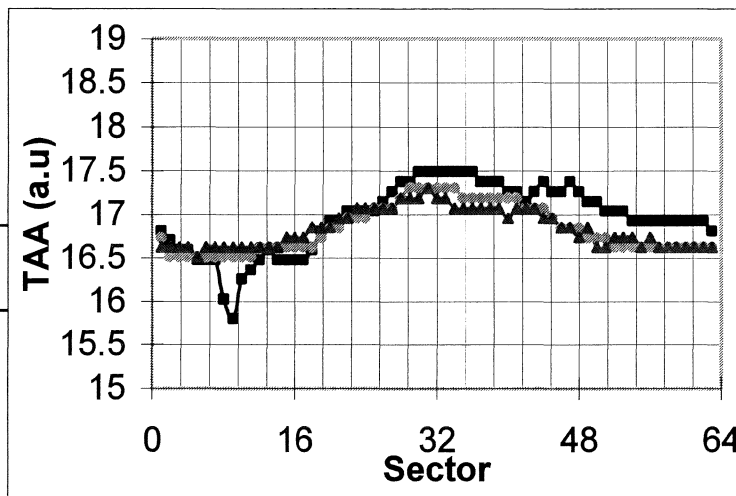

There still is a long way to get comparable performance to longitudinal recording

Maxtor[®] Summary

- Drives built with dual layer perpendicular disks and pole heads
 - Fully functional, can boot windows operating system and lasted more than two years now
- Differentiation effective in shaping waveform
 - Standard partial response channels performed well
- Servo functions well- PES spectrum indistinguishable from that of longitudinal
- Stray field sensitivity is a concern, but not a limiting factor in laboratory --- need further study
- **Key challenges ahead**
- Improving head/media performance to achieve consistent high BPI and TPI
- Controlling the read wide and wide write problem
- Reduce stray field sensitivity
- Confirm capability of perpendicular ready channels

Advanced Perpendicular Magnetic Recording Head Technologies

February 26, 2004

**Francis Liu
Western Digital**

Outline

- **Areal Density Trend**
- **Introduction**
- **Recent Advancement in PMR**
- **Key Technology Challenges for PMR**
- **Migration from Single Pole to Shielded Pole**
- **Shielded Pole Feasibility**
- **80 GB/P Drive Integration**
- **Conclusions**

Areal Density Growth Curves

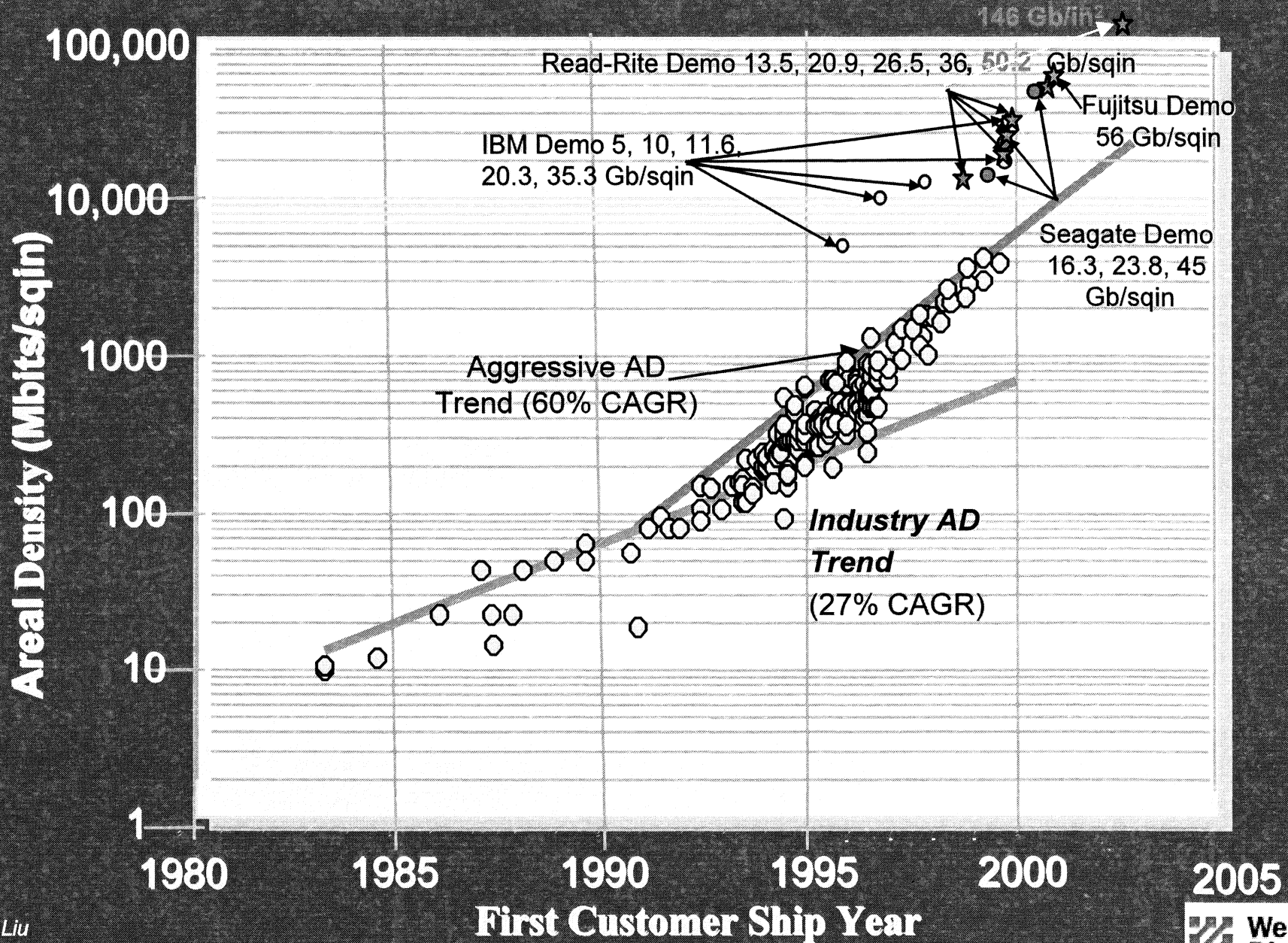

Areal Density Growth Curves

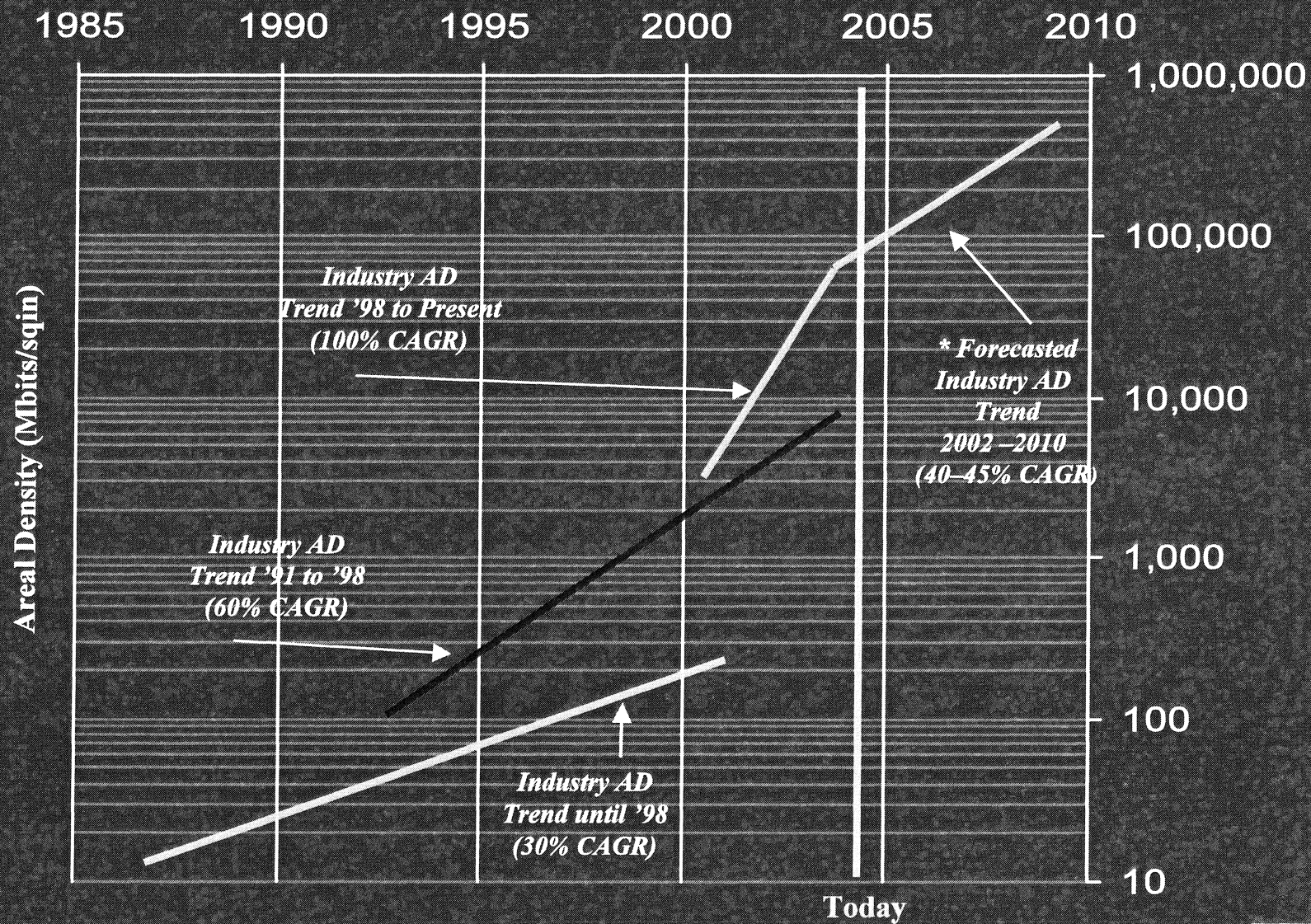

Scaling Challenges

- **Media thermal stability tradeoff with writability**
 - **Media coercivity increase for thermal stability at higher linear density**
 - **Write pole material will reach physical limit (2.45T)**
 - **Write track width is decreasing, thus limiting available write field**
 - **Magnetic spacing reduction is limited by reliability concerns**
- **Continued bit-aspect-ratio (BAR) reduction challenges**
 - **Track-Mis-Registration scaling challenges**
 - **Physical head width tolerances require state-of-art lithography**

Technology Enabler for Density Scaling

- **Industry will transition to perpendicular recording, because it offers:**
 - **A solution path for high linear density and high data rate recording**
 - **Overcoming the near term magnetic moment limitation**
 - **A solution path for high track density recording**
 - **Narrower magnetic read width due to SUL and sharper written tracks**
 - **Sharper off-track field gradients and erase bands**
 - **A solution path for higher read-back amplitudes**
 - **Thicker recording layer, higher Ms material and soft-underlayer**
 - **Extending CIP-GMR to higher densities**
 - **A solution path for thermally stable recording at high linear densities**
 - **Thermal stability at low linear densities and media SNR have been improved lately**

Technology Migration

Perpendicular is the key for technology migration

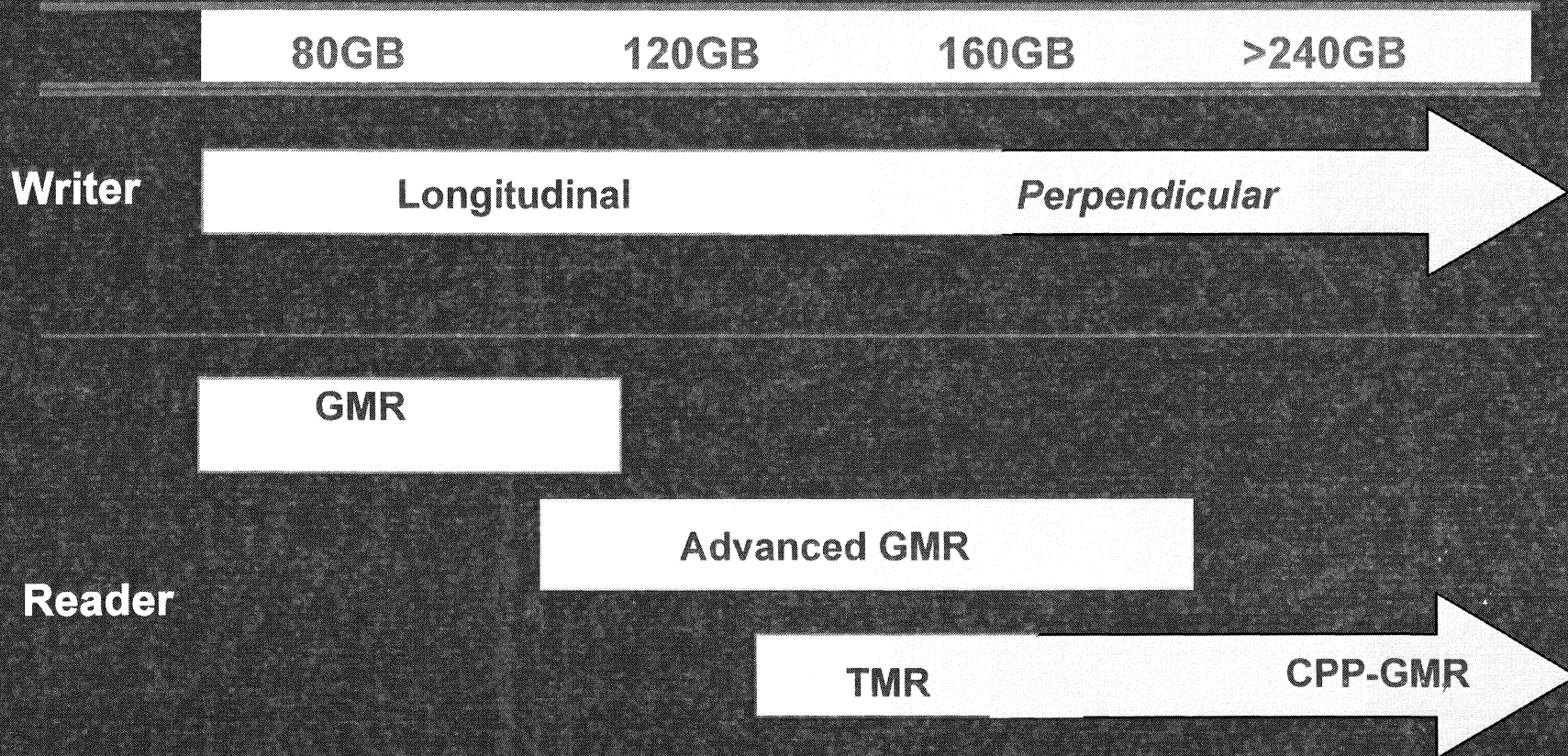

Recent Advancement in PMR

■ Probe (Single-Pole) Head:

- Electrical performance and areal density capability
- Side writing at large skew angles
- Track density advantages
- Ramanence erasure robustness
- 80 GB/P Drive Integration

Advanced Probe Head Design

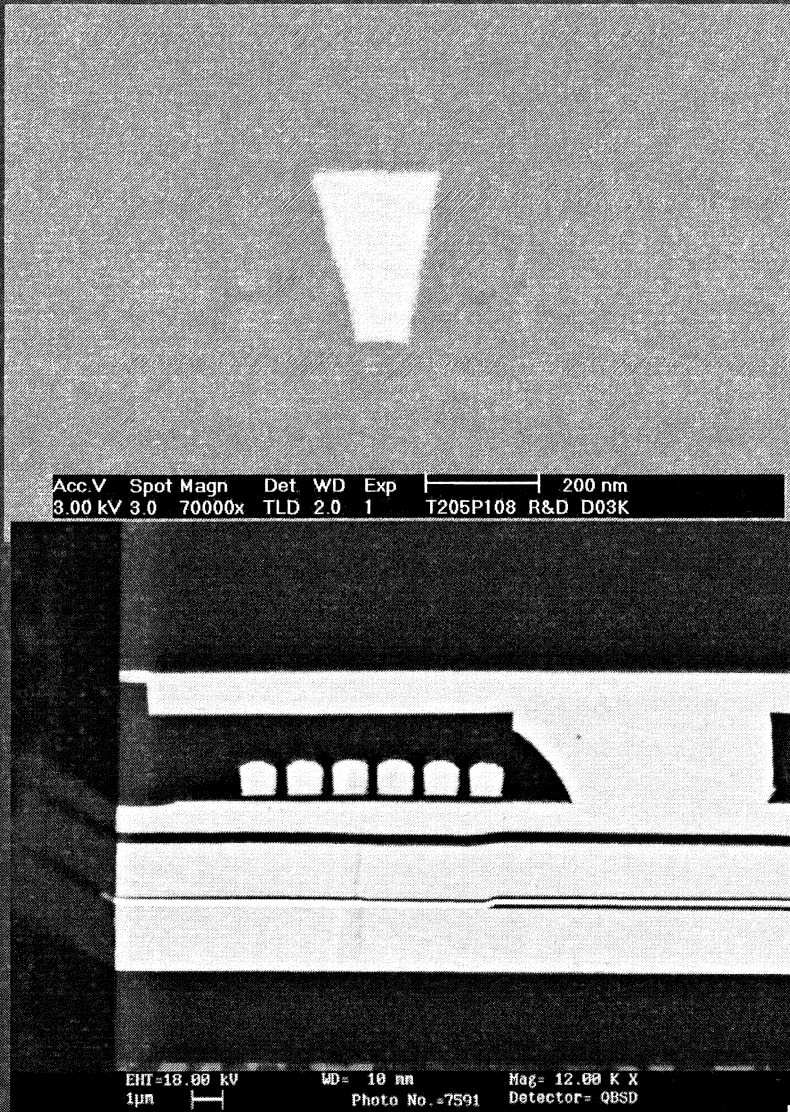

Design Feature:

- 6 coil-turn
- 15 μm yoke length
- P3 Bsat @ 2.35 T
- P2 Bsat @ 1.6 T @ 1 μm
- Trapezoidal poles
- Thin film deposition and processing (No CMP for P3)
- Conventional GMR reader
- ~ 640 A of shield-to-shield spacing

Parametrics Summary

<i>AsymCOV</i>	<i>COVR</i>	<i>OW(dB)</i>	<i>PW50 (ulnch)</i>	<i>D50 (KFCI)</i>	<i>SpSNR (dB)</i>	<i>TAAA(%)</i>	<i>LF TAA (mV)</i>
-0.02	0.99	-45	2.3	647.3	16.9	1.28	2.69

<i>800 KFCI</i>					
<i>NLTS (dB) @ 0%</i>	<i>Min NLTS (dB)</i>	<i>Precom(%)</i>	<i>MRw(uln)</i>	<i>MWw(uln)</i>	<i>SkirtRatio</i>
-25	-32	7.2	4.4	7.16	1.81

145.7 Gb/in² Areal Density Demonstration

747 Curve @ 772 KBPI

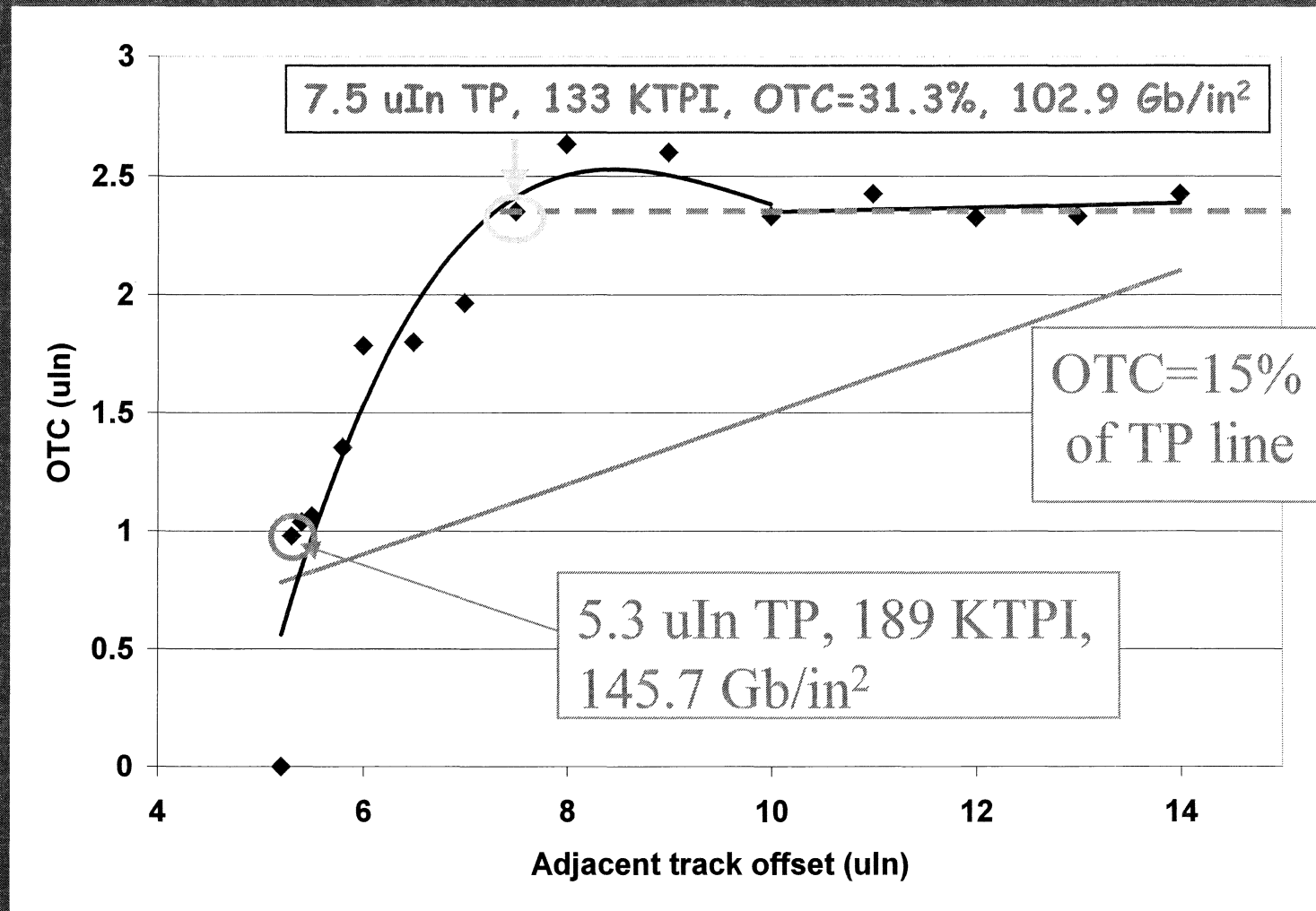

Track Profiles vs. Skew Angles

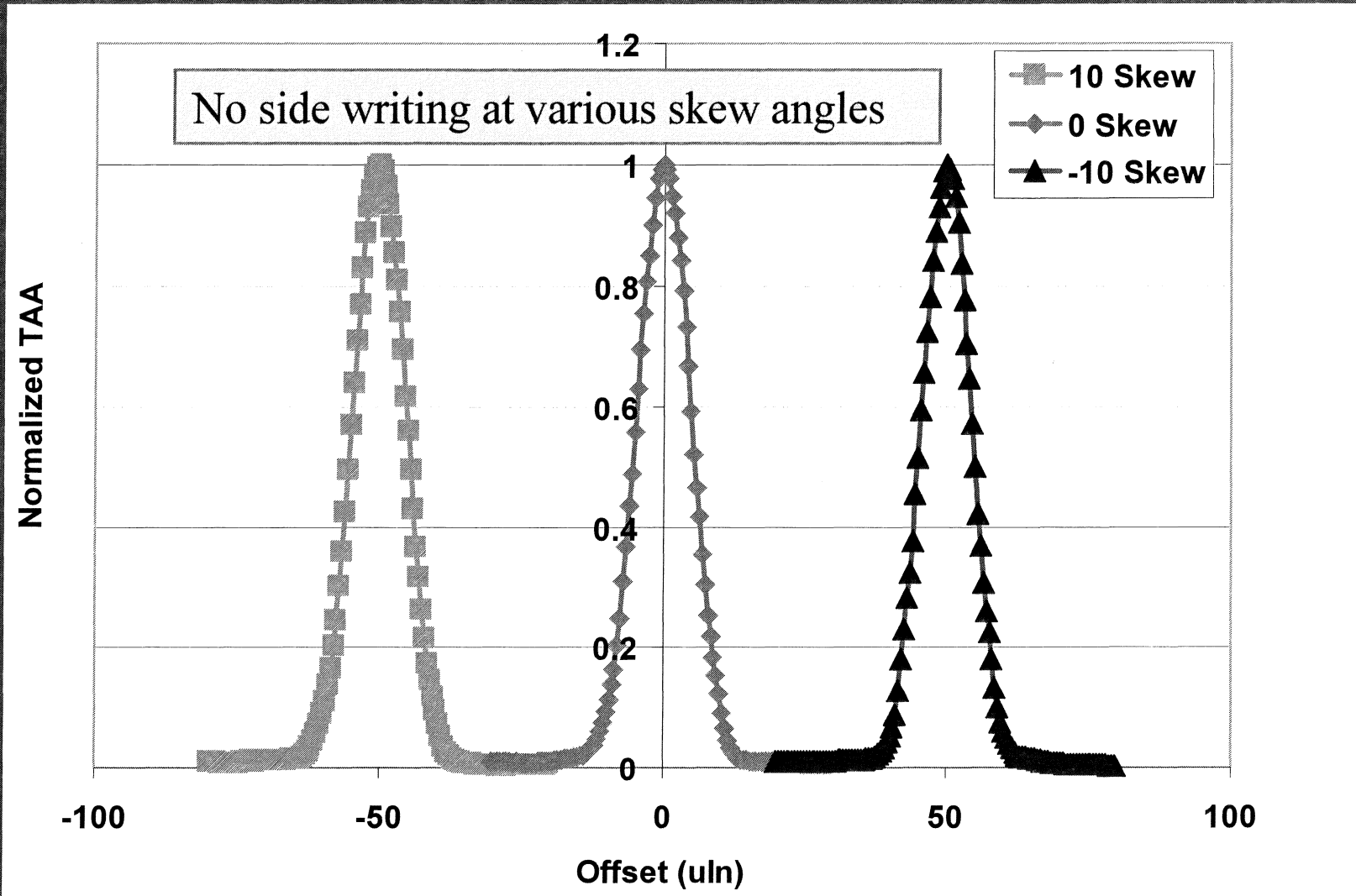

Track Density Advantages of PMR

> 10 % improvement in TPI

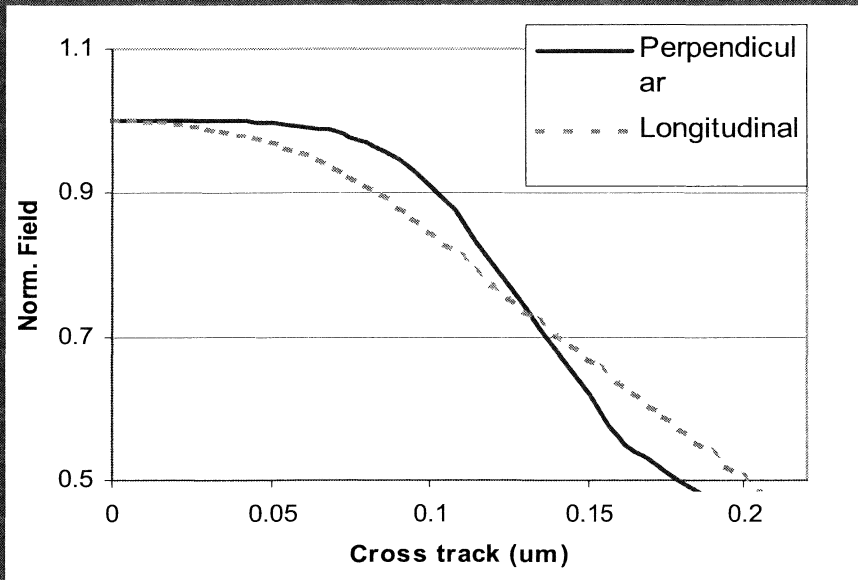

Skirt Ratio=MRW at -6/-20 dB

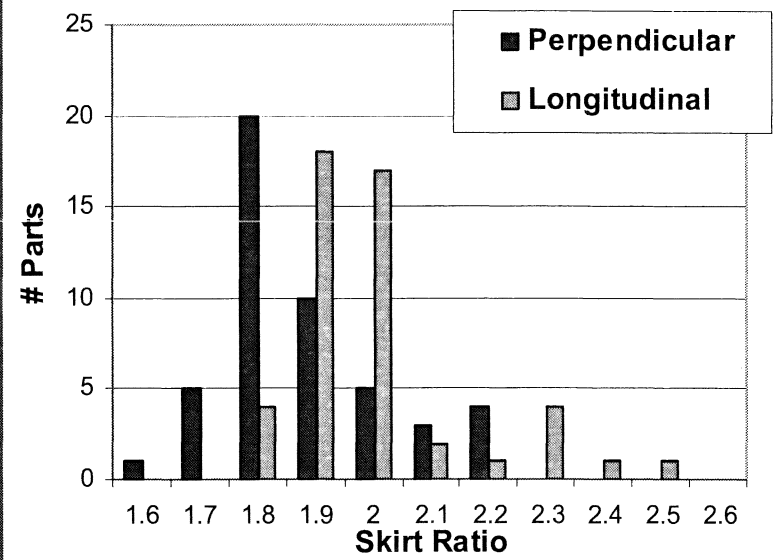
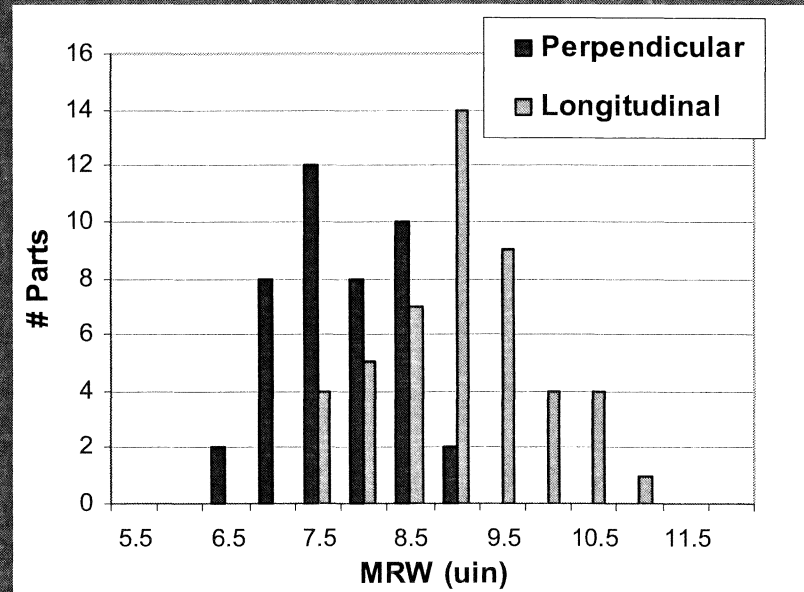

High Bsats Material Properties

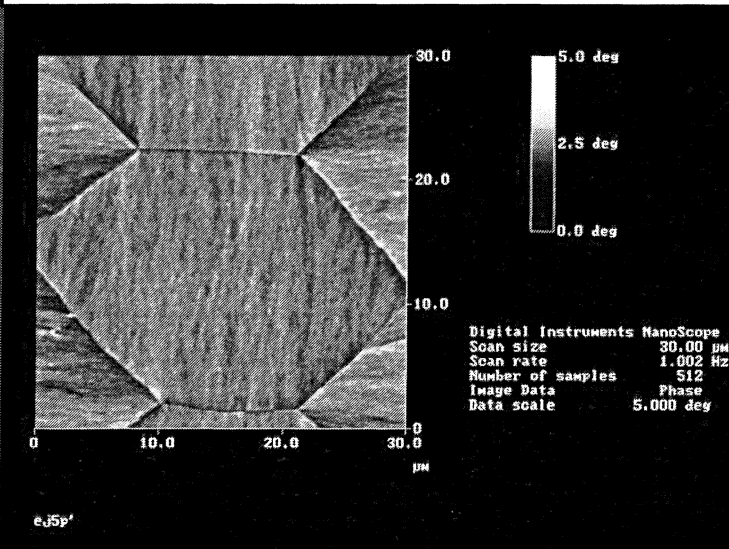
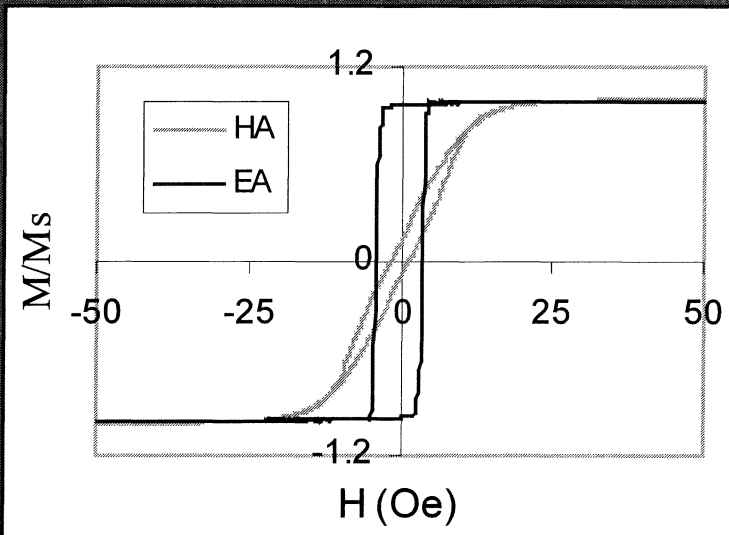

Soft film properties:

- $B_s = 23.5 \text{ kG}$

- $H_{ch} = 1.6 \text{ Oe}$

- $H_{ce} = 4.0 \text{ Oe}$

- $H_k = 15.11 \text{ Oe}$

- $M_r/M_s < 10\%$

- $\text{Skew} = 1.26^\circ$

- $R = 29.5 \mu\Omega\text{cm}$

• Corrosion resistance (0.01 M NaCl):
 $23.5 \text{ KG} > \text{Ni}_{55}\text{Fe}_{45} > \text{Ni}_{42}\text{Fe}_{58} > \text{CoNiFe}$

Stability with Multiple Write/Read Cycles

Stable Domain Structures: No Remanence Erasure

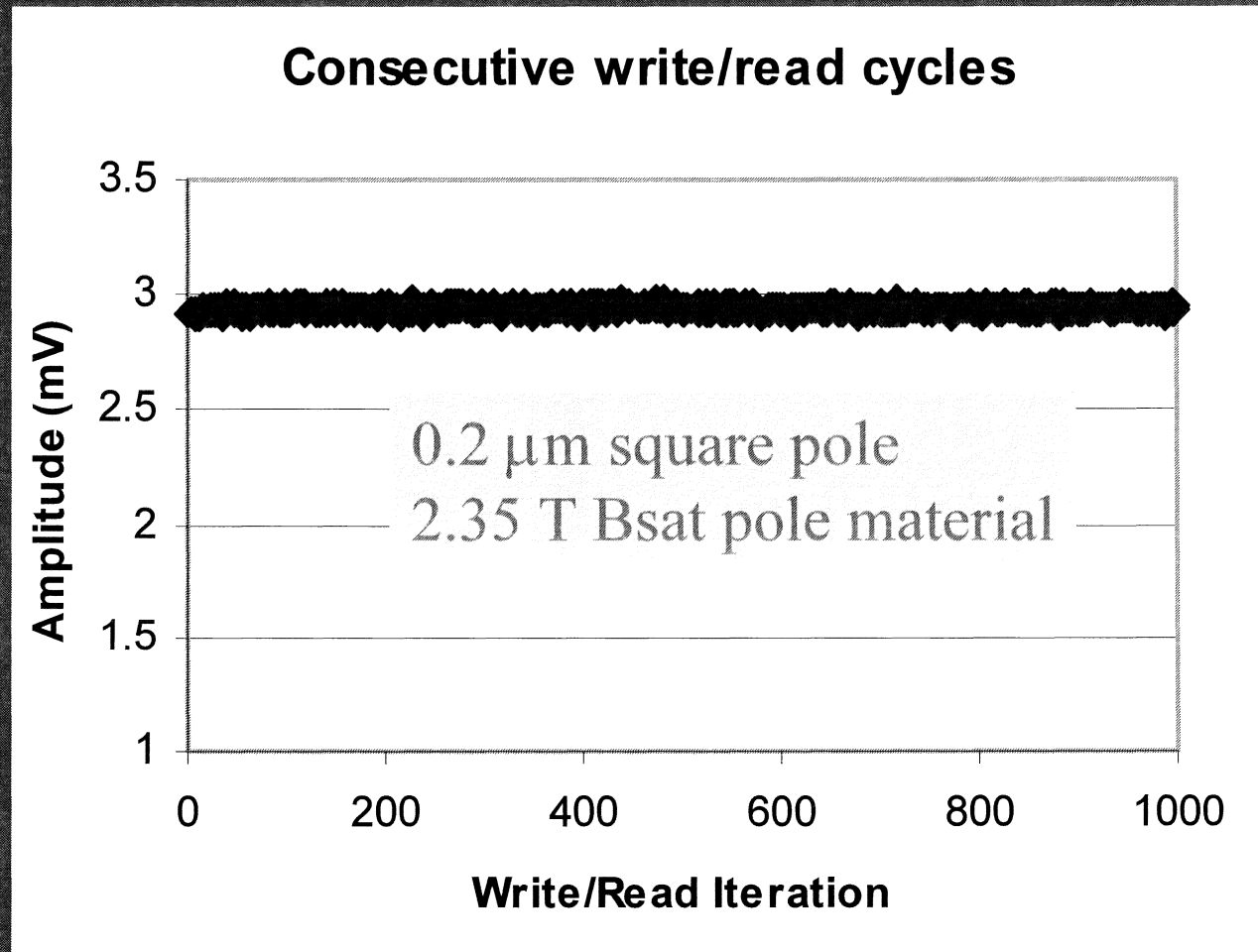

Key Technology Challenges for PMR

- **Linear density still needs to be improved**
 - **Media noise**
 - **Anisotropy field dispersion**
 - **Head field gradients for single pole head/double layer media**
- **Shielded pole perpendicular recording head has been proposed to improve write field gradients and insensitivity to anisotropy field dispersion***

***M. Mallery, A Tobabi and M. Benalkli, "One terabit per square inch perpendicular recording conceptual design", IEEE Trans. Magn., vol-38, p. 1719 (2002)**

Shielded Pole Cross-sectional View

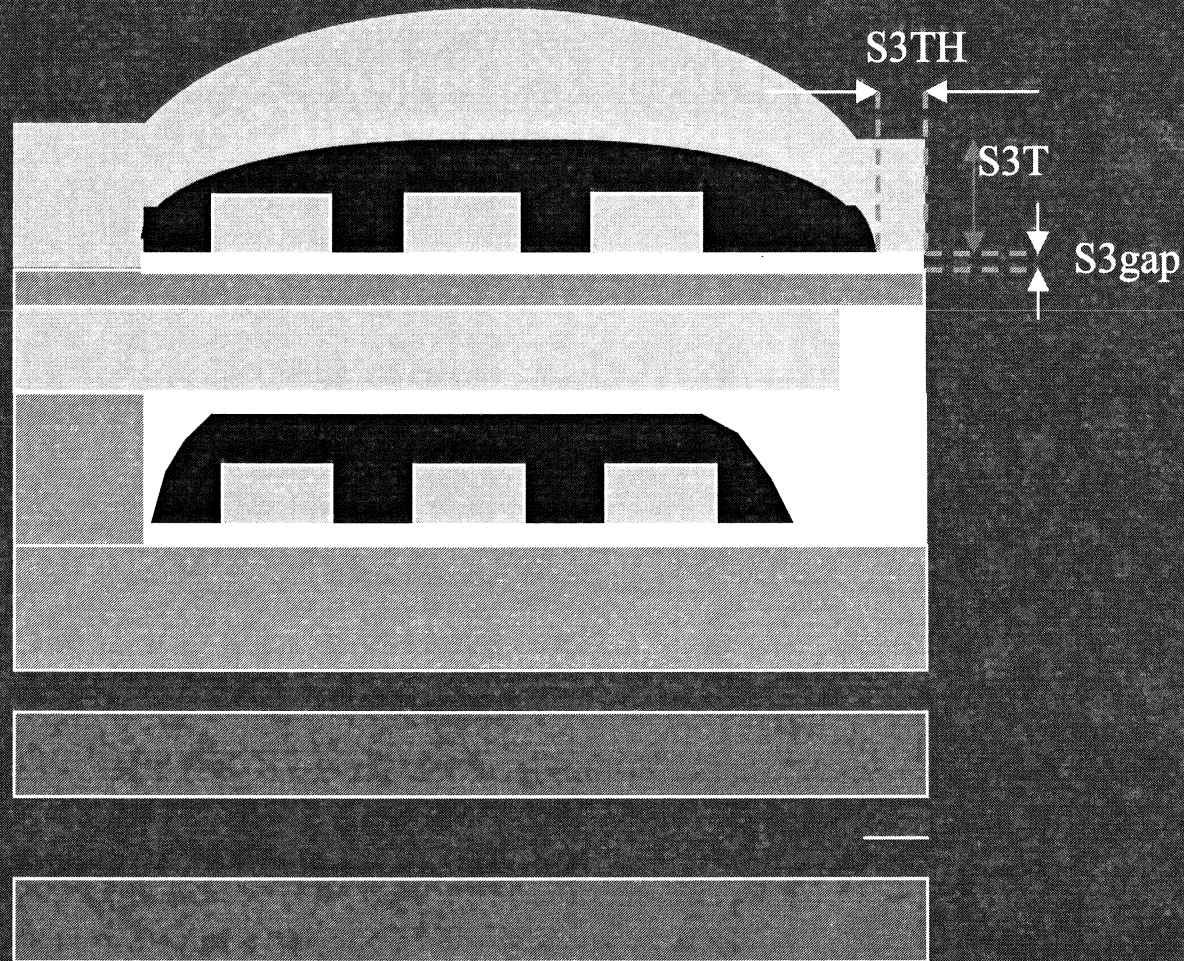

Shielded Pole ABS View

Side Shield Design

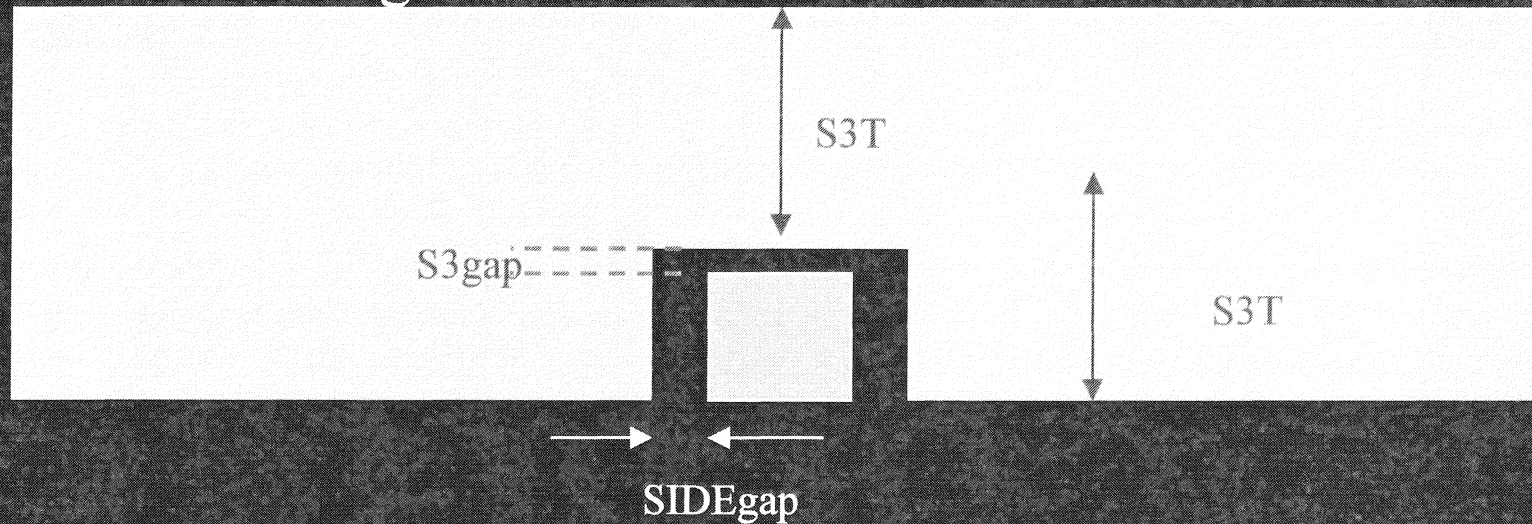

No Side Shield Design

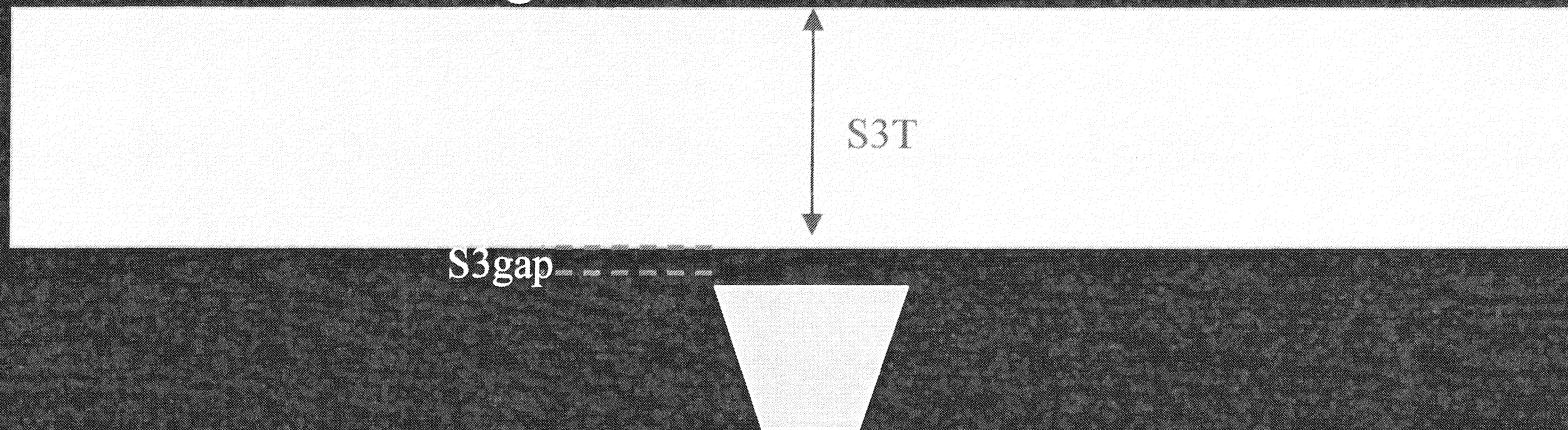

Field Profile of Shielded Pole

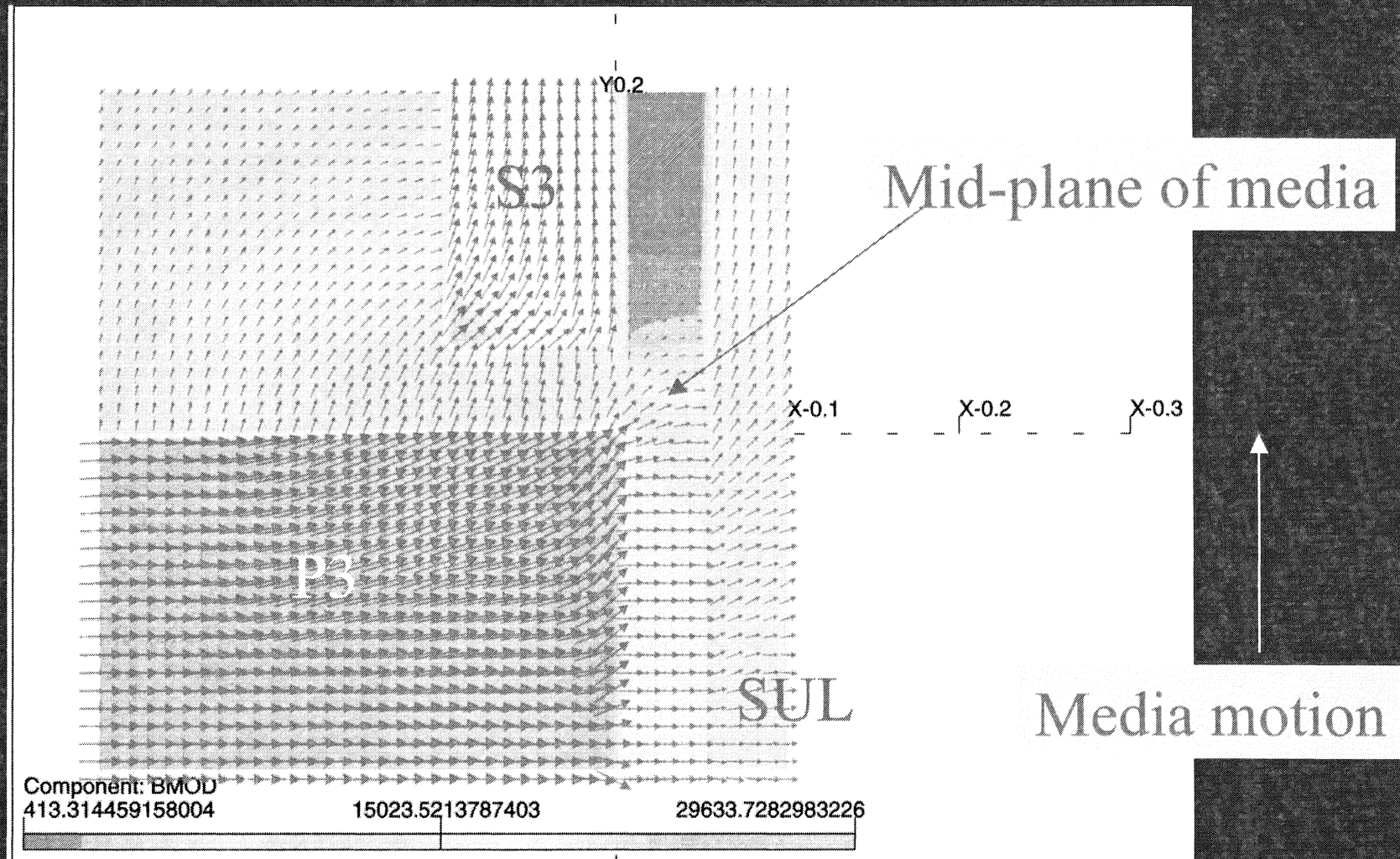

Cross Sectional SEM of Shielded Pole

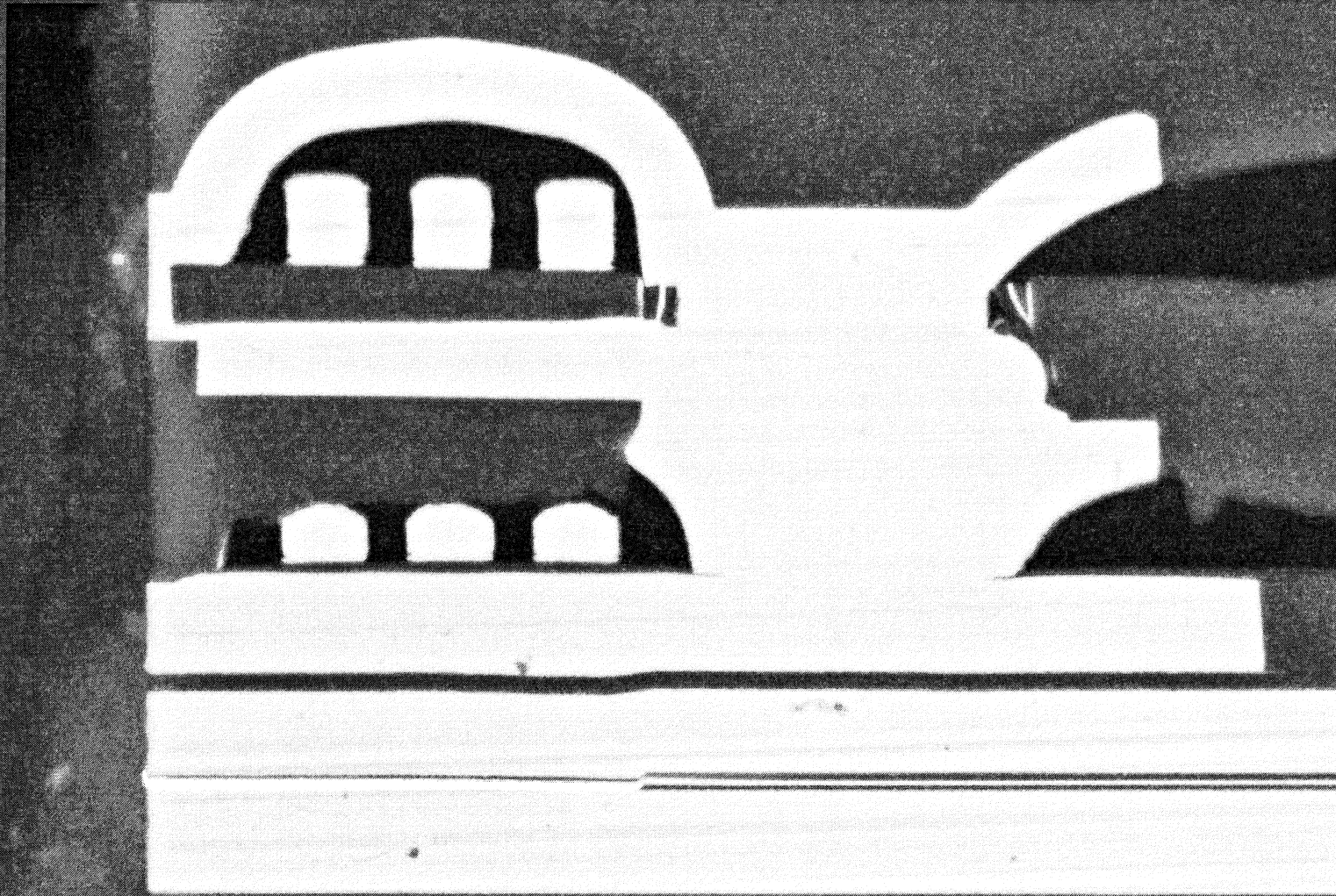

EHT=18.00 kV
1 μ m

WD= 10 mm
Photo No.=585

Mag= 12.00 K X
Detector= QBSD

ABS SEM of Shielded Pole

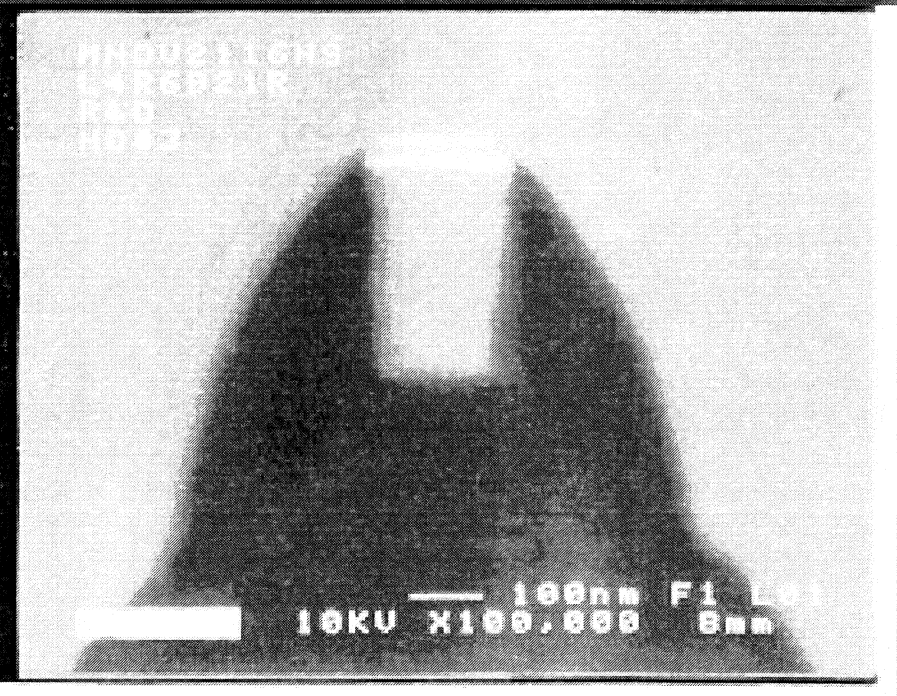
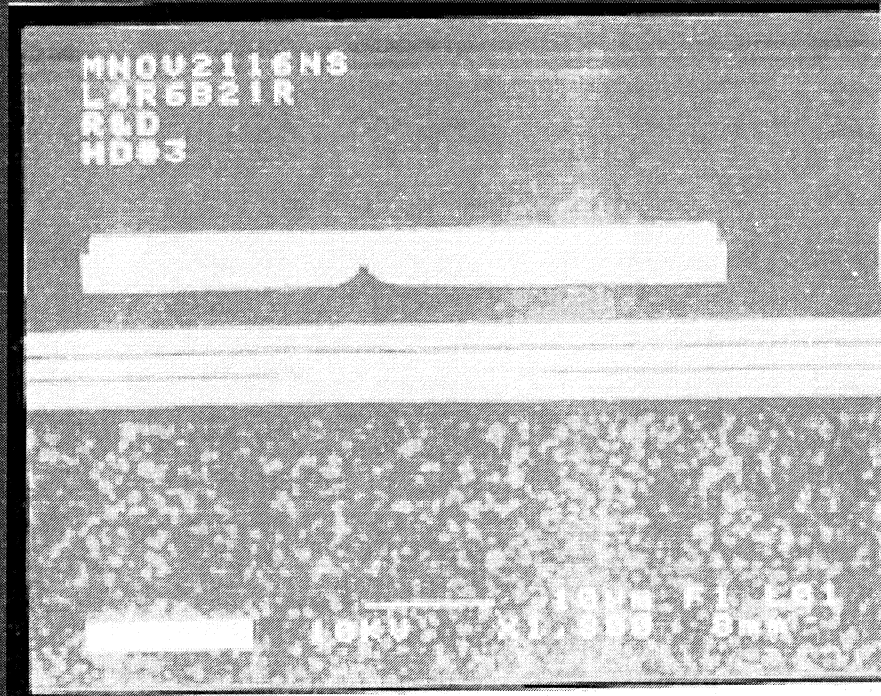

PW50 vs. Write Current

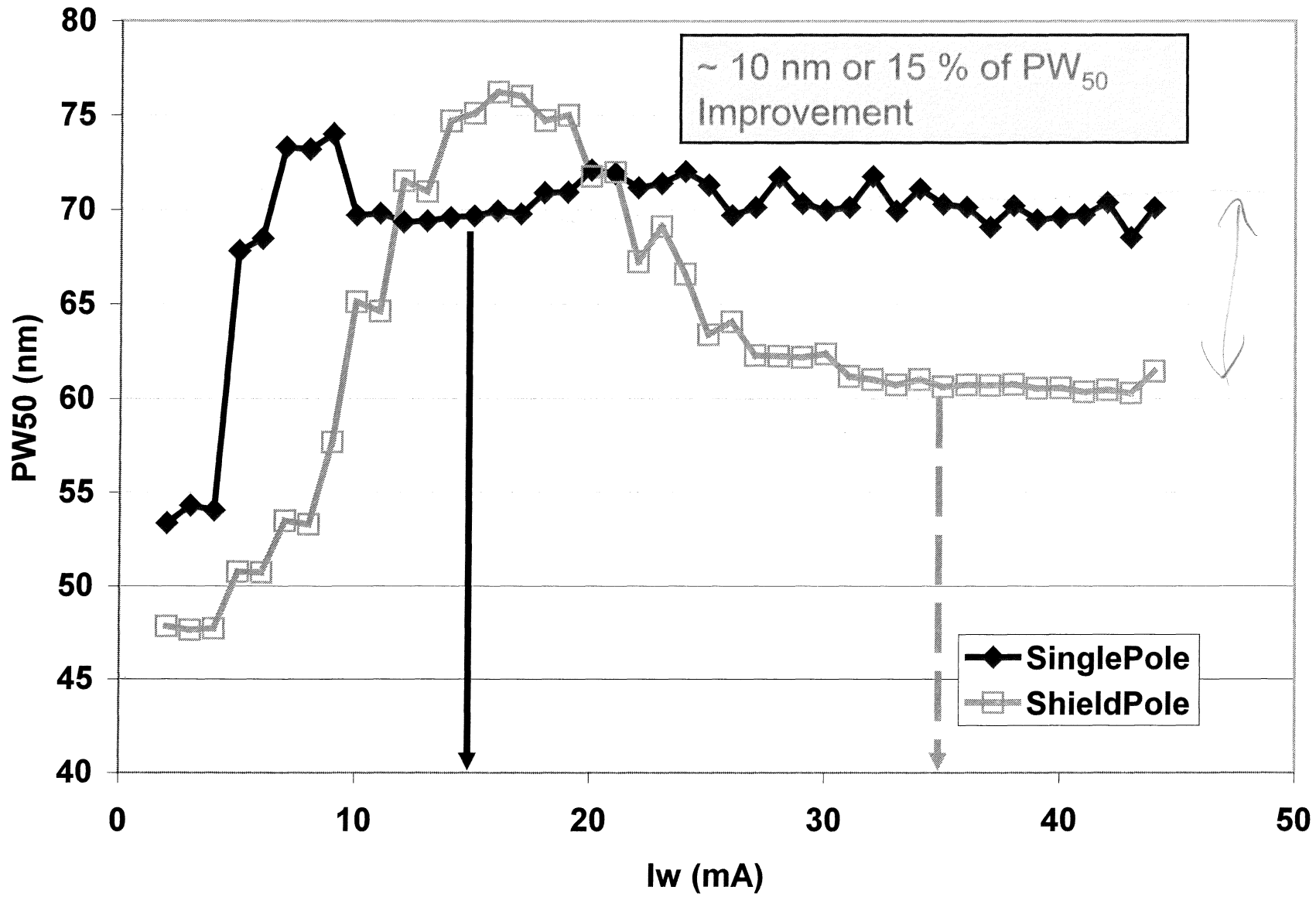

Resolution vs. Linear Density

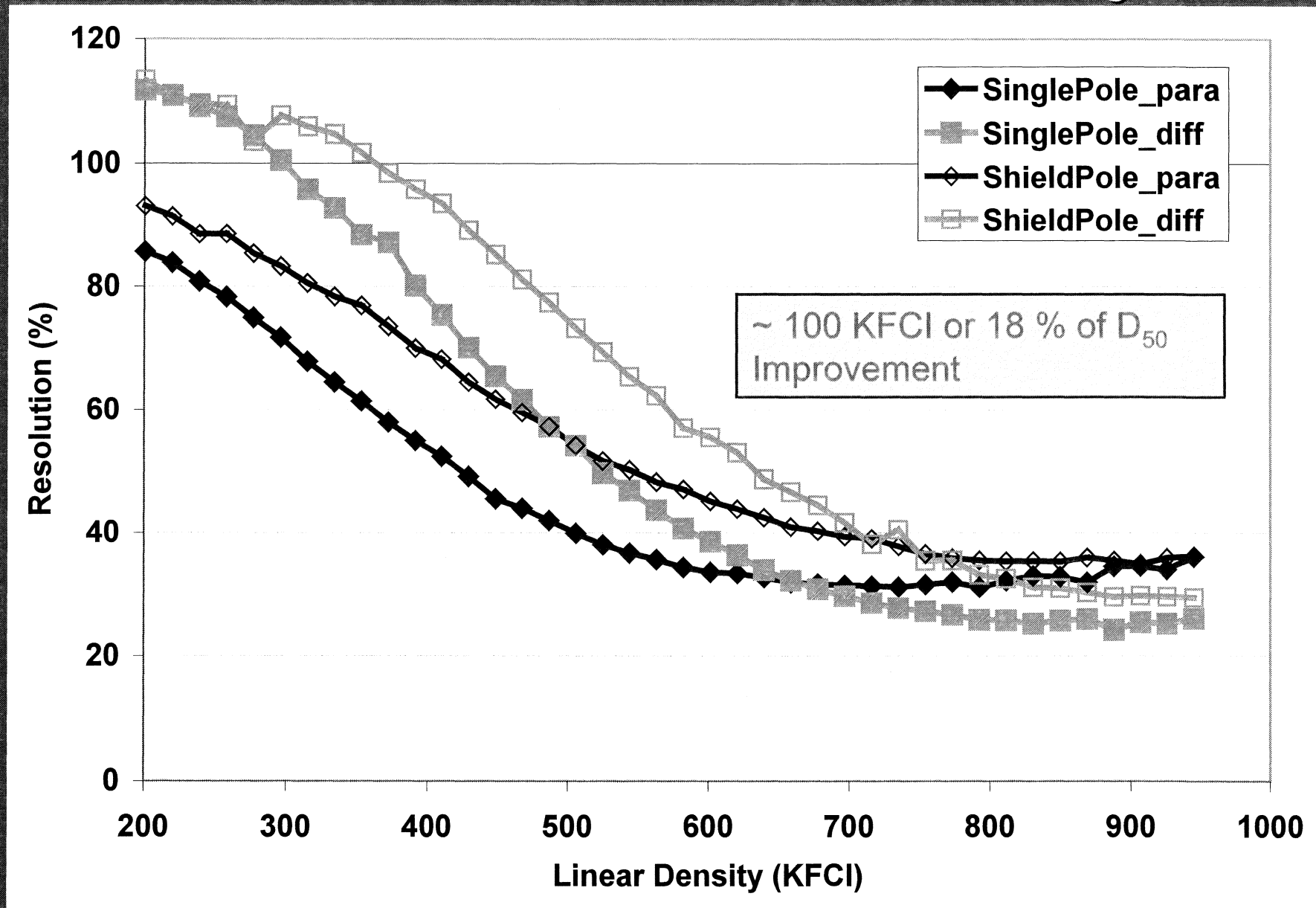

OW (1:6 ratio) vs. Write Current

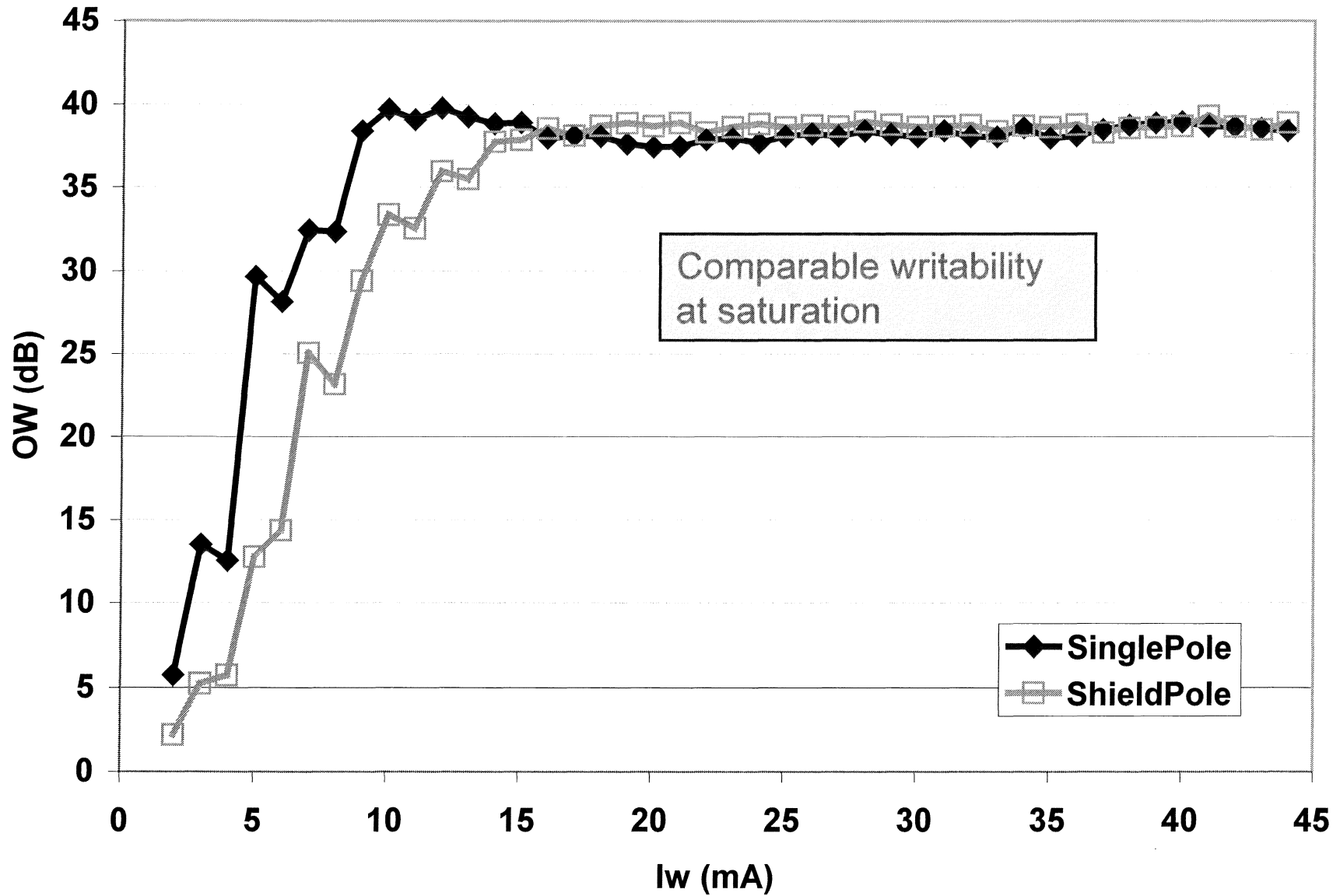

NLTS vs. Write Current

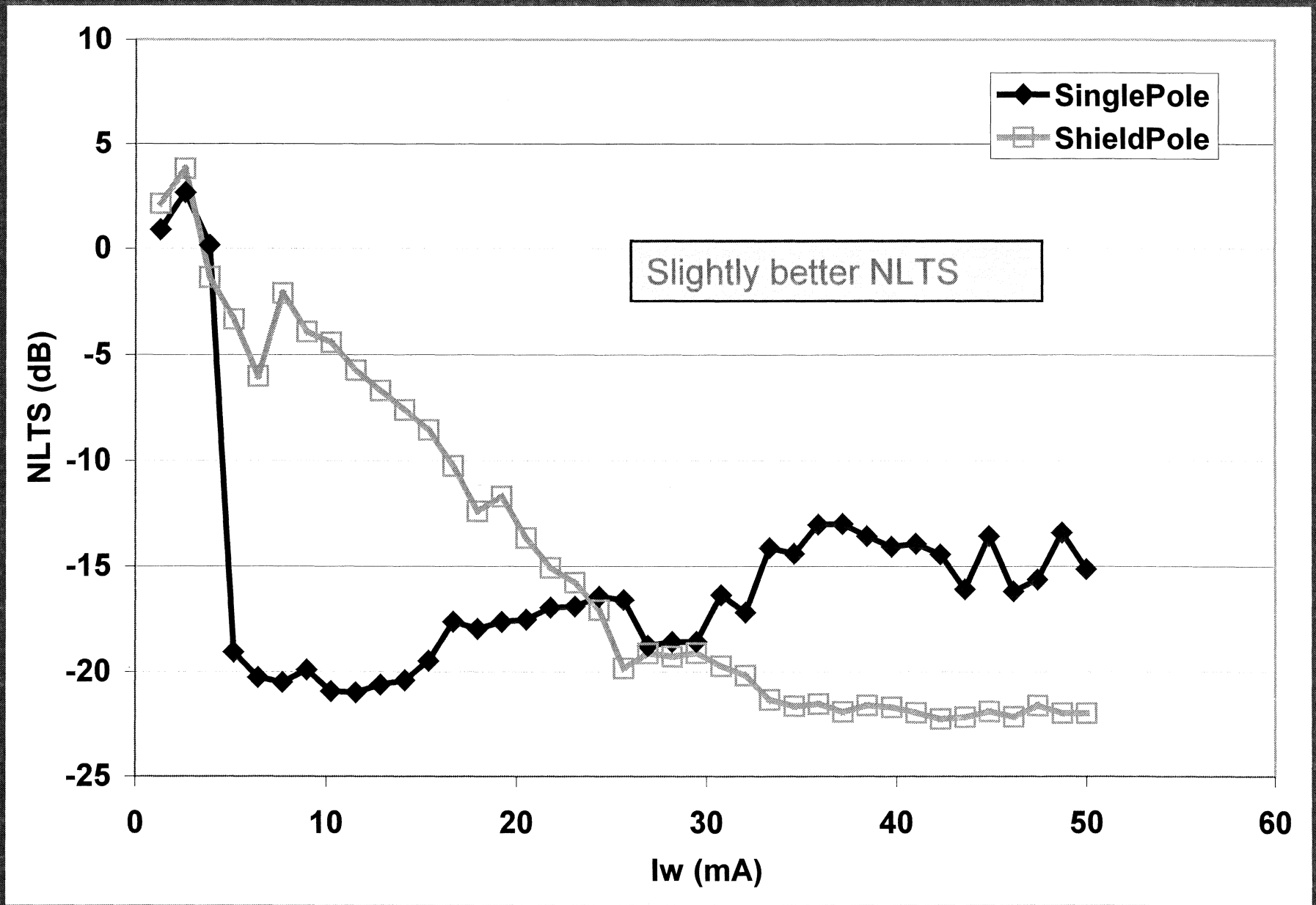

Linear Density Capability

~ 2-3 order of BER and
~ 200 KFCI improvement

10,000 RPM, Radius=0.9 inch, Diamondback Channel

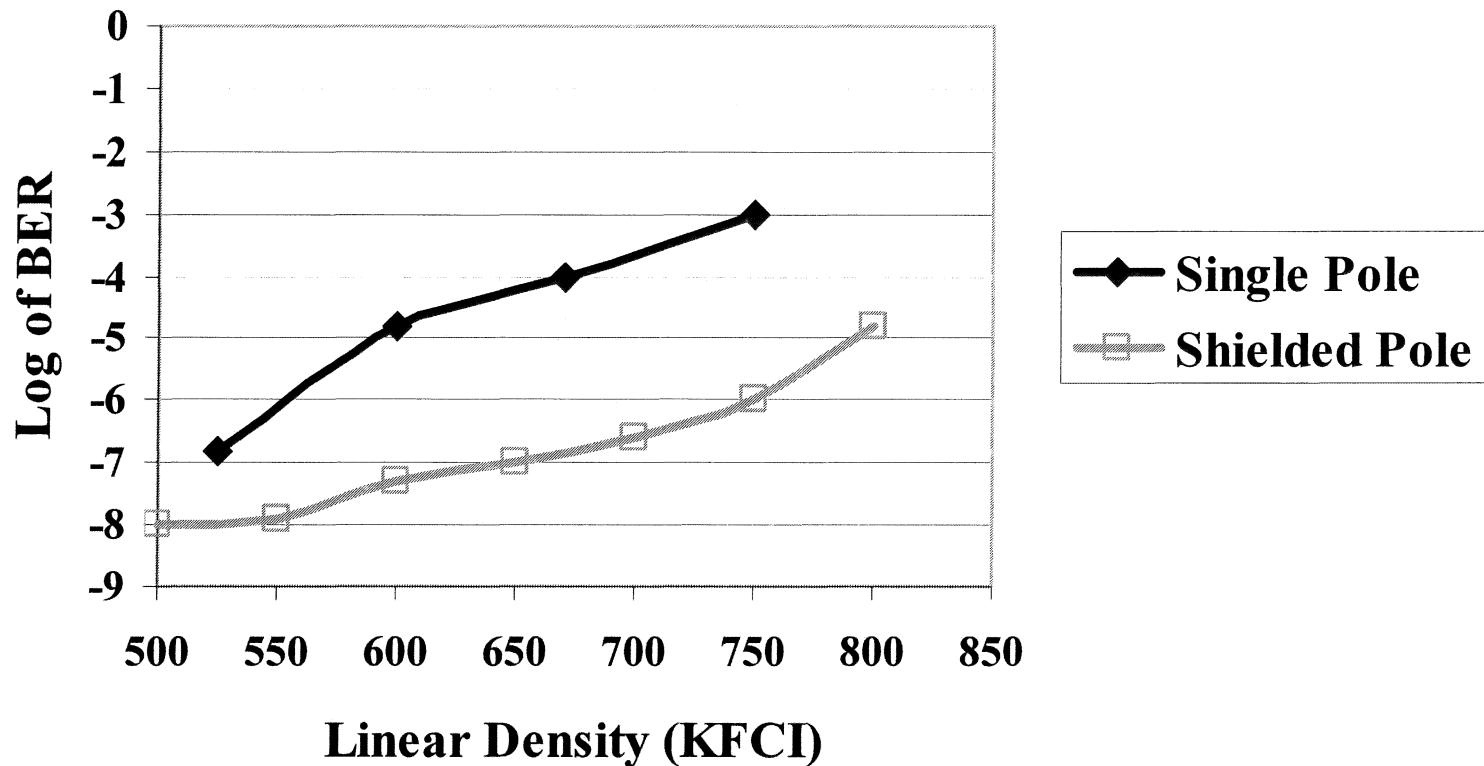

80 GB/P Perpendicular Drive Integration

Content	Previous Results*	Current Results
Test base	Samsung 3.5 " HDD	Samsung 3.5 " HDD
Capacity	80 GB	80 GB
Areal density	60.8 Gb/in ²	63.8 Gb/in ²
Track density	93 KTPI	88 KTPI
Linear density	653 KBPI	725 KBPI
Rotation speed	7200	7200
Head	Single pole tip	Shielded pole
MWW	0.24 um	0.25 um
MRW	0.18 um	0.17 um
Media	Double layered media	Double layered media
Channel	PRML (Marvell)	PRML (Marvell)
BER	Less than 10E-4.9	Less than 10E-8

* Published @ NAPMRC
2003, Monterey

■ Courtesy of Sooyoul Hong in Samsung

Bath Tub Curves at Increasing Linear density

Bath tub curves at different linear density

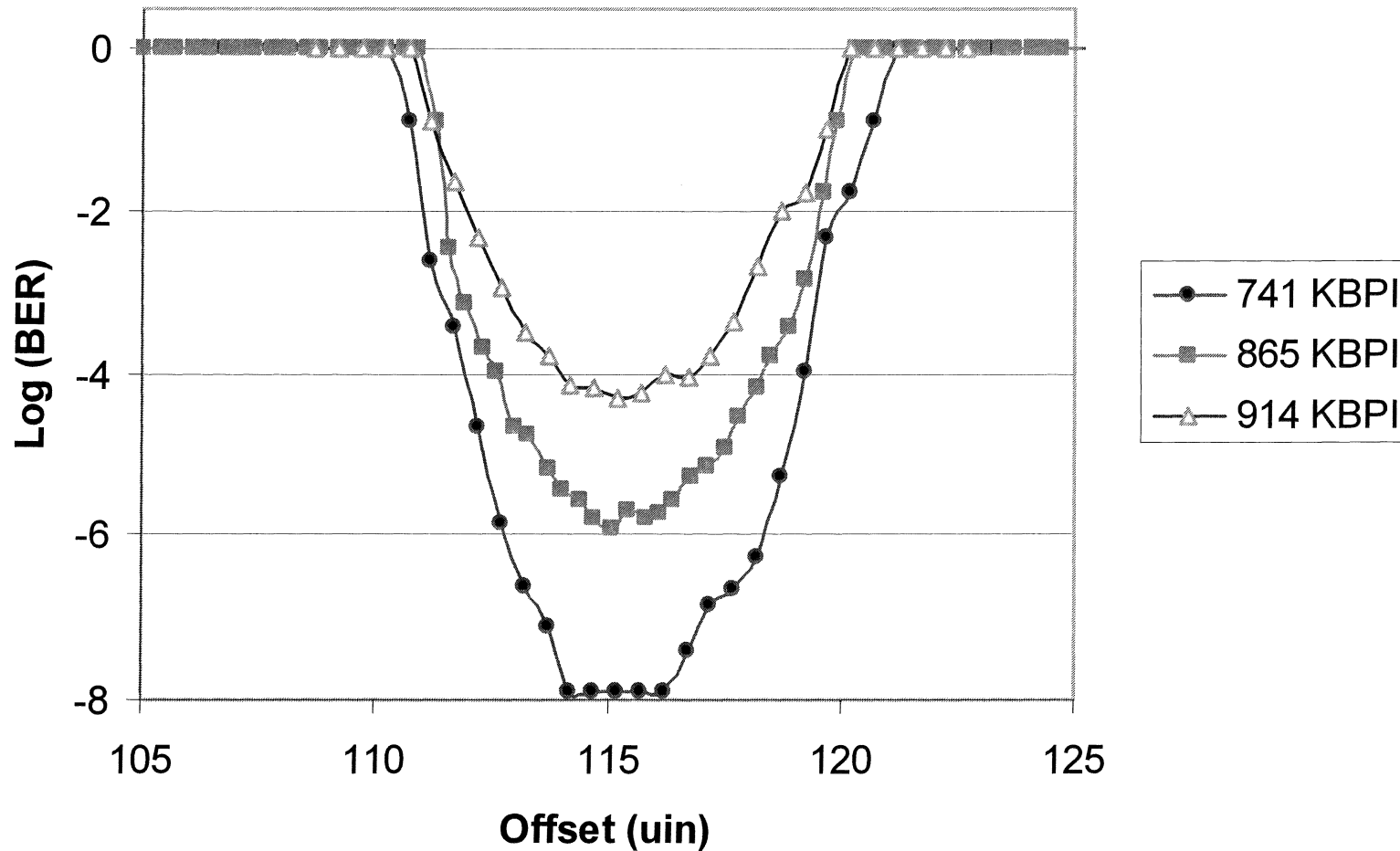

OW~37dB; NLTS (1000 KFCI) ~ -21dB; D_{50} ~ 750 KFCI.

ATE Performance after 10,000 Writes

ATE BER Performance for a PMR Shielded Pole Head

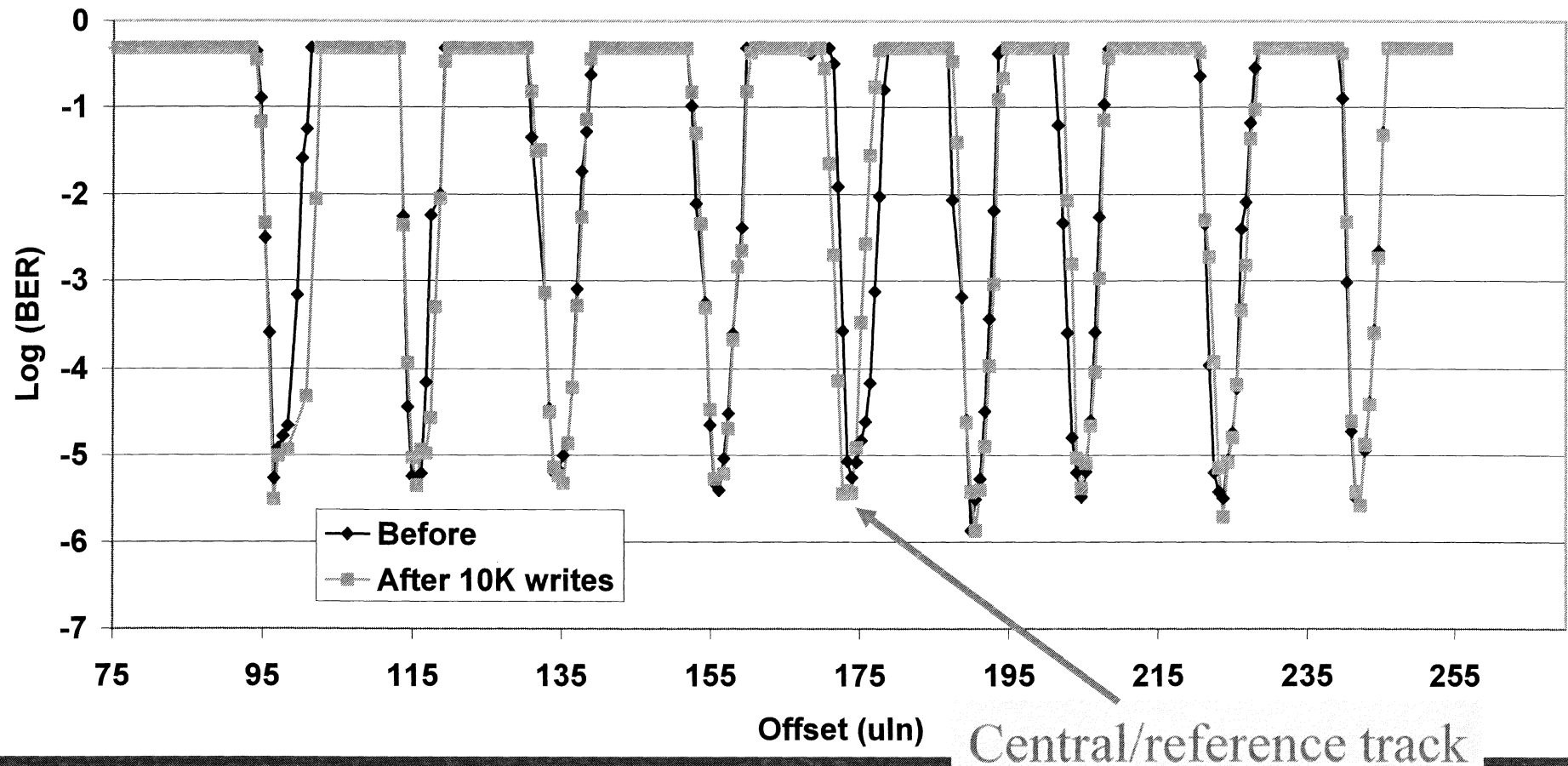

Conclusions and Summary

Perpendicular Recording:

- Allows larger bit aspect ratios – works better at high linear densities and extendable to high track densities
- Tremendous advancement due to recent media and head improvements
- Likely to be the technology of choice transitions around 120 Gb/in² and beyond

Handwritten notes:
~60
56 Gb/in² ⇒ 80 GB 95m
~ 120 Gb/in² ⇒ 160 GB "
#2

Handwritten notes:
1st products

Session IV:
Electronics Design for Perpendicular Recording

3:40-4:10pm

Mike Madden, Marvell

“Read Channel for Perpendicular Recording”

This talk will discuss the design and performance of a working perpendicular recording read-channel. The talk will describe the most important channel components for perpendicular recording: a Viterbi with programmable DC-attenuated targets, a baseline correction loop, and lowered preamplifier and read-channel AC-coupling cutoff frequencies. Also discussed will be coding for perpendicular recording and a non-linear detector suited to the media-noise-dominant nature of perpendicular recording. Laboratory measurements from a working silicon read-channel on real perpendicular heads and media will be presented.

4:10-4:40pm

Zak Keirn, Agere

“Baseline Wander Compensation for Long Latency Detectors”

This study explores a potential solution to the problem of baseline or DC wander caused by the high pass pole of the preamp in perpendicular recording. Perpendicular recording achieves highest SNR when matched with a channel target that contains energy at DC. The preamplifier used with magnetic recording heads introduces a dominant high pass pole that causes the impulse response of the channel to have a long slowly decaying tail. This tail will degrade performance of the detector unless it is compensated for. Decisions from the detector may be used to help cancel this tail but the delay involved degrades performance.

The approach shown here introduces a feed forward path which effectively shortens this delay and thus improves performance.

Session V:

Panel Discussion of Perpendicular Recording and Status of Technology

4:40-5:40pm

All speakers and Dr. Dave Thompson, IBM Fellow (retired)

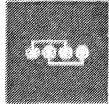

SWITCHING

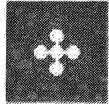

TRANSCIVERS

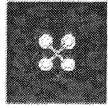

WIRELESS

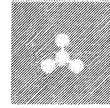

PC CONNECTIVITY

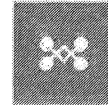

GATEWAYS

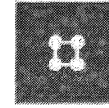

COMMUNICATIONS
CONTROLLERS

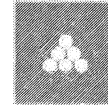

STORAGE



Read Channel for Perpendicular Recording

Michael Madden

Feb. 26, 2004

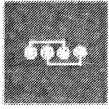

SWITCHING

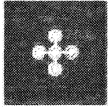

TRANSCIVERS

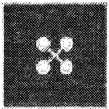

WIRELESS



PC CONNECTIVITY

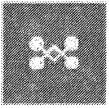

GATEWAYS

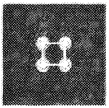

COMMUNICATIONS
CONTROLLERS

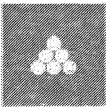

STORAGE

Outline

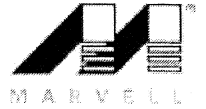

- **Analytical performance evaluation**
- **Most important components for PMR channel**
 - DC target programming
 - Baseline correction loop
 - Lowered preamp and input AC-coupling frequencies
- **Coding**
- **Non-linear detector**
- **Servo**
- **Silicon PMR channel measurements**
- **Conclusions**

Perpendicular vs. Longitudinal

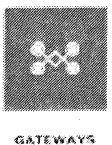
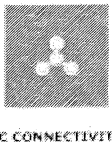
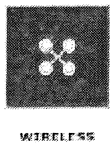
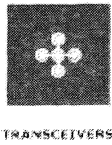
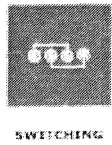

Longitudinal recording

Disk surface

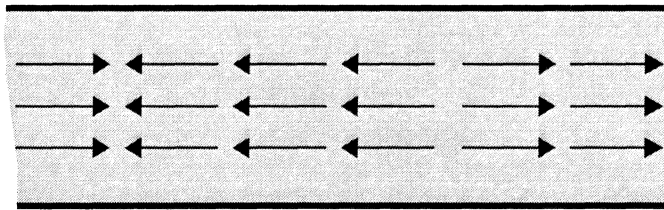

Perpendicular recording

Disk surface

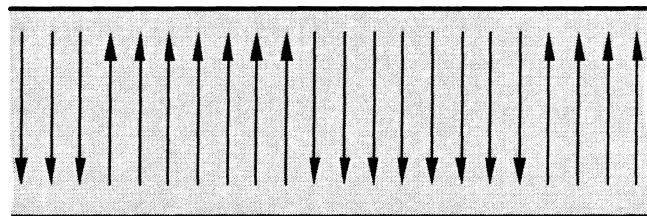

Longitudinal Readback Signal

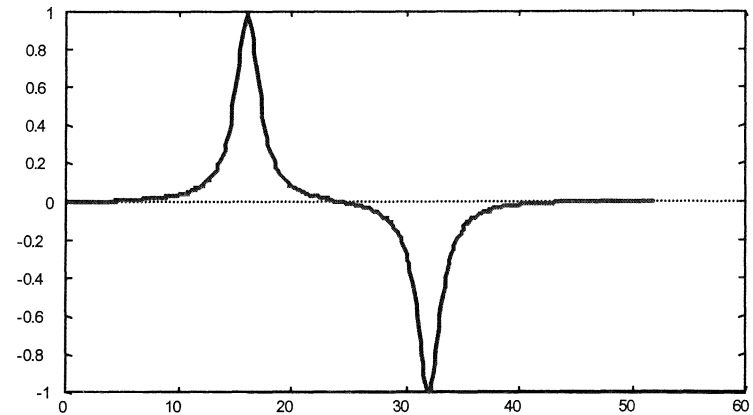

Perpendicular Readback Signal

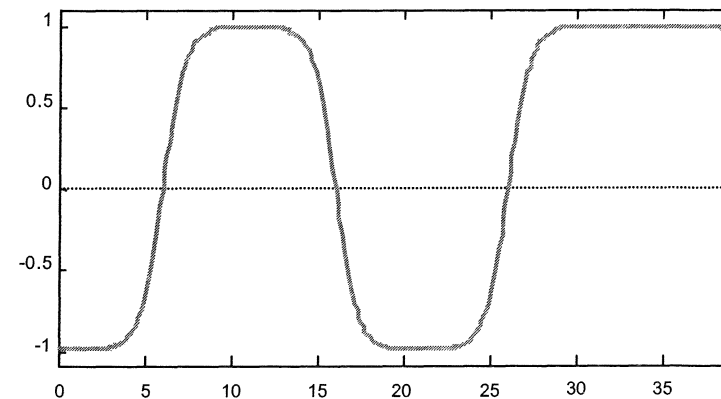

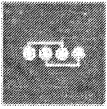

SWITCHING

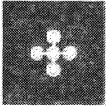

TRANSCIVERS

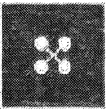

WIRELESS

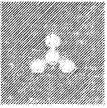

PC CONNECTIVITY



GATEWAYS

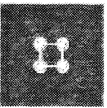

COMMUNICATIONS CONTROLLERS

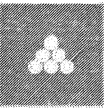

STORAGE

Perpendicular vs. Longitudinal

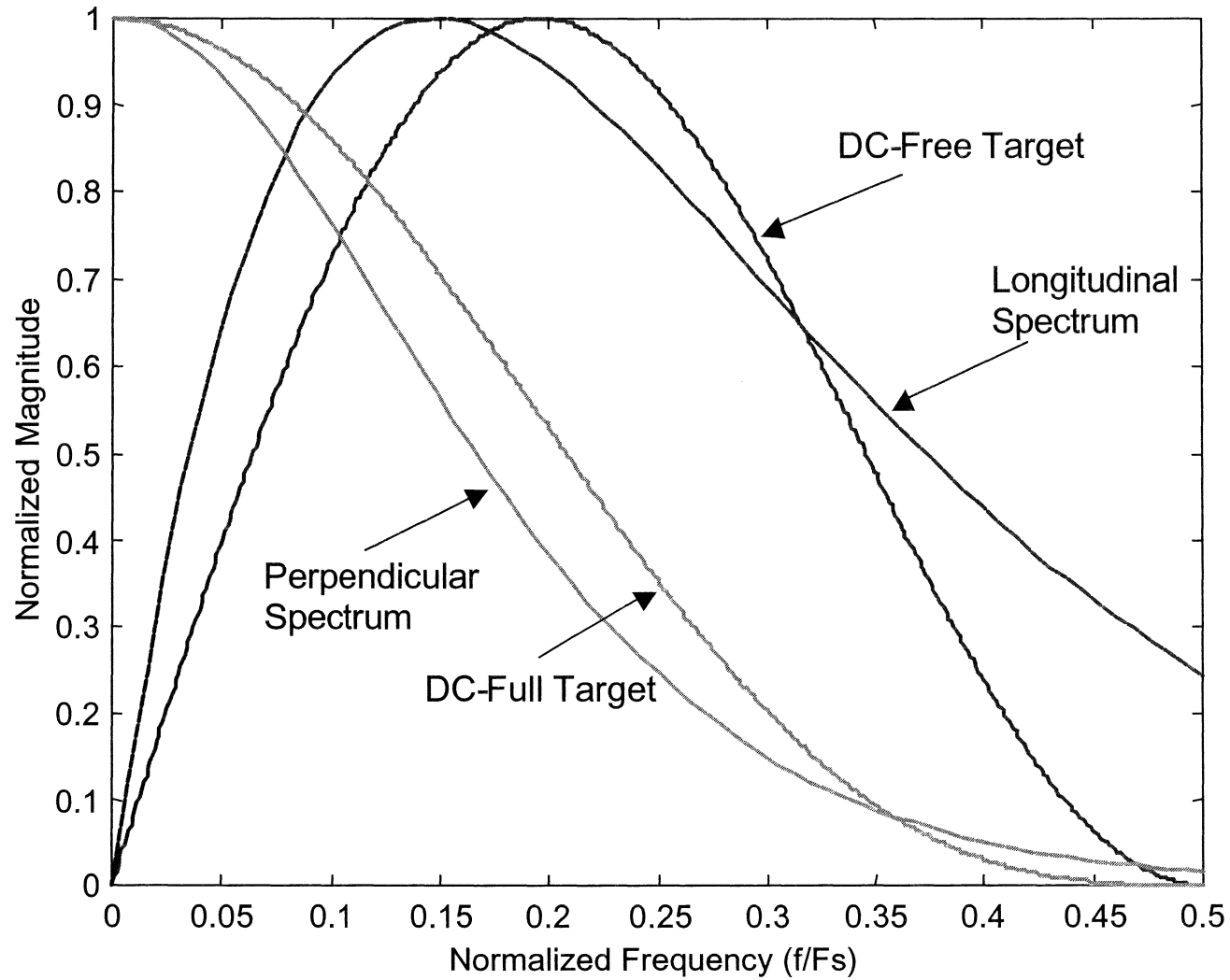
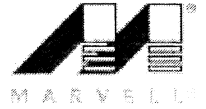

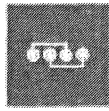

SWITCHING

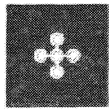

TRANSCIVERS

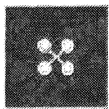

WIRELESS

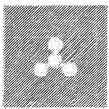

PC CONNECTIVITY

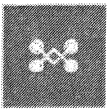

GATEWAYS

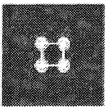

COMMUNICATIONS CONTROLLERS

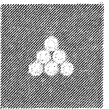

STORAGE

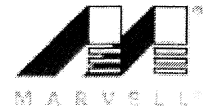

Perpendicular Channel Model

- Generalized PMR channel model for performance analysis

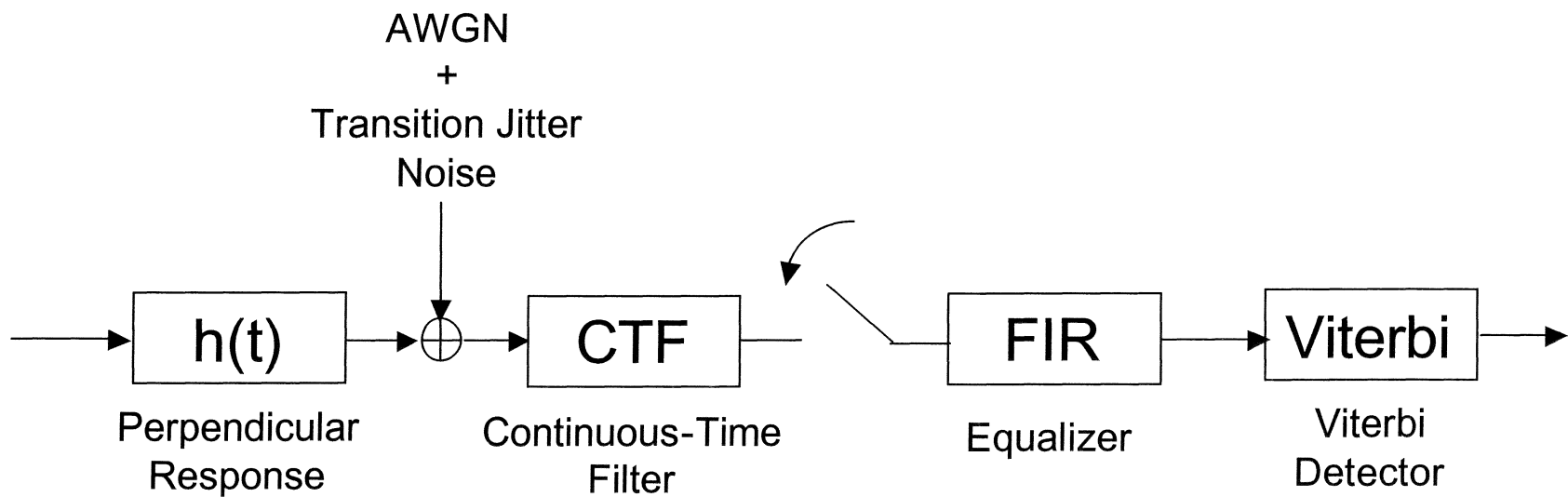

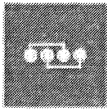

SWITCHING

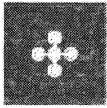

TRANSCIVERS

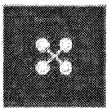

WIRELESS

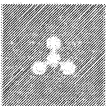

PC CONNECTIVITY

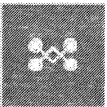

GATEWAYS

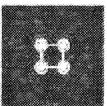

COMMUNICATIONS CONTROLLERS

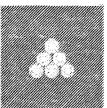

STORAGE

Performance Analysis

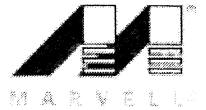

50% AWGN, 50% TJN

- noise power

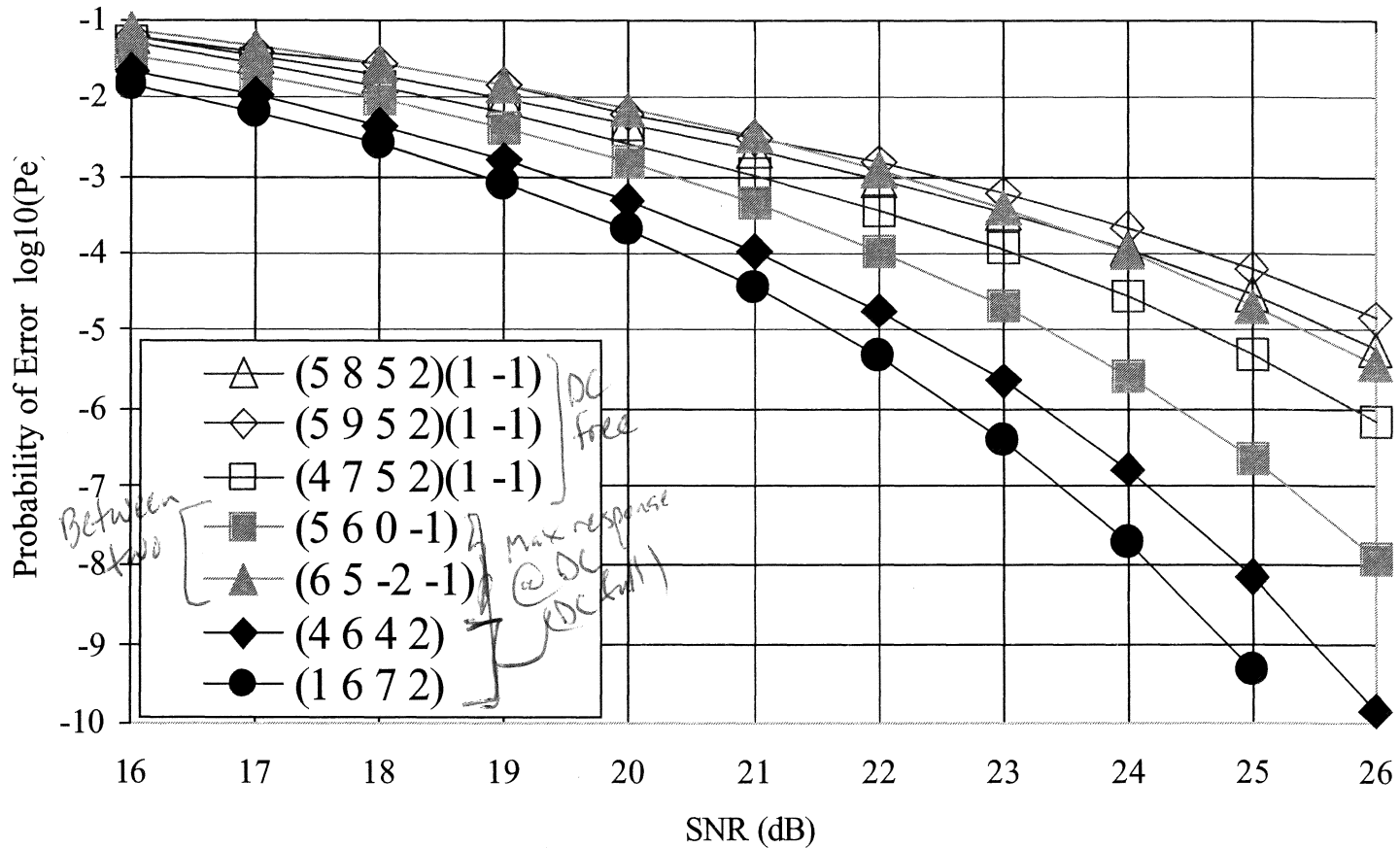

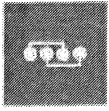

SWITCHING

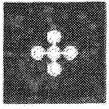

TRANSCIVERS



WIRELESS

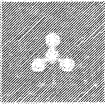

PC CONNECTIVITY

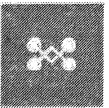

GATEWAYS



COMMUNICATIONS CONTROLLERS

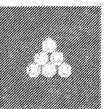

STORAGE

Performance Analysis

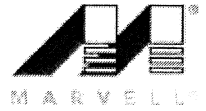

MARVELL

10% AWGN, 90% TJN

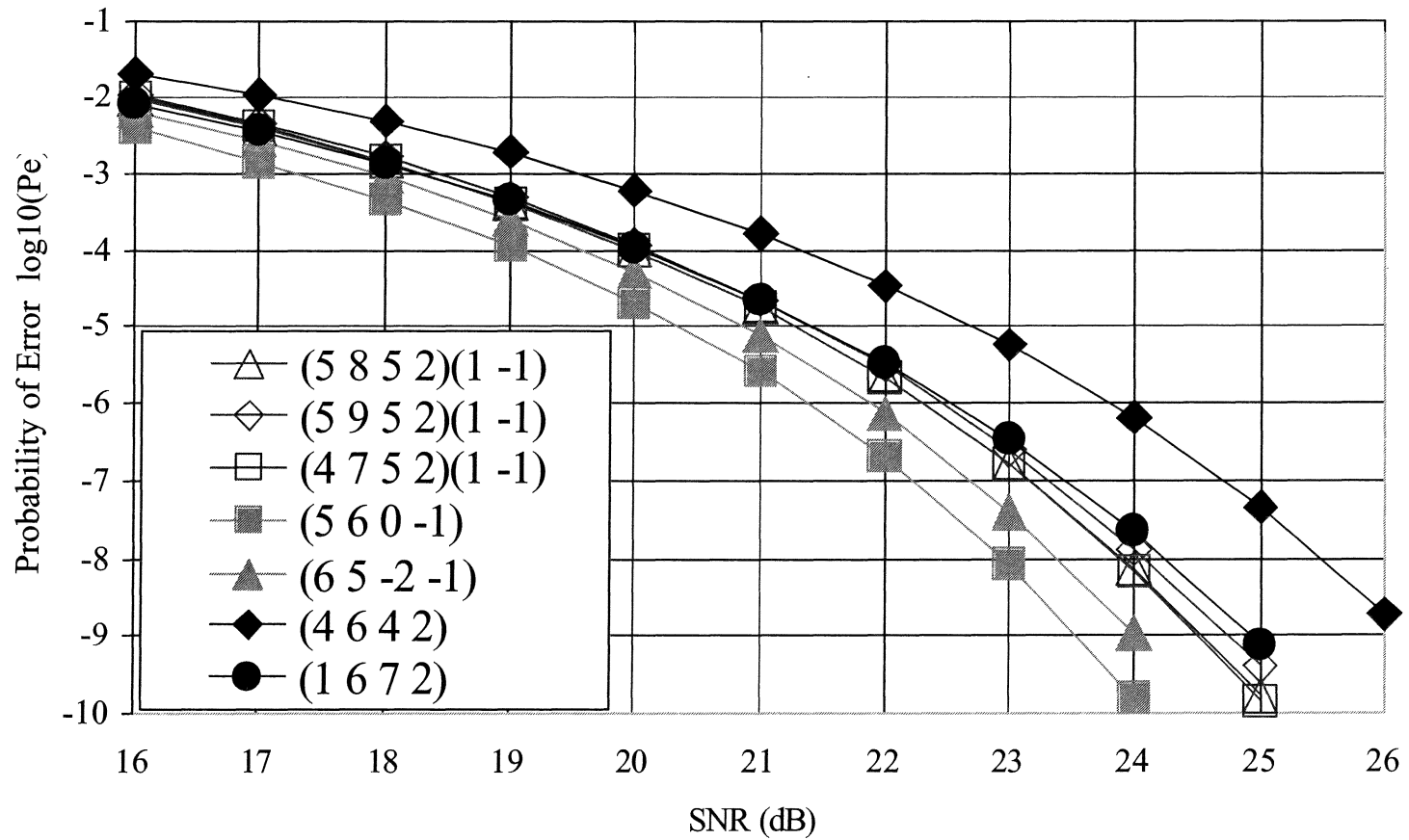

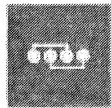

SWITCHING

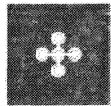

TRANSCIVERS

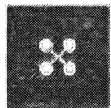

WIRELESS



PC CONNECTIVITY

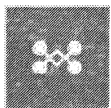

GATEWAYS

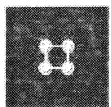

COMMUNICATIONS CONTROLLERS

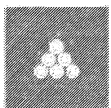

STORAGE

Differentiation – Sub-Opt Solution

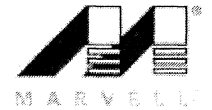

Longitudinal recording

Disk surface

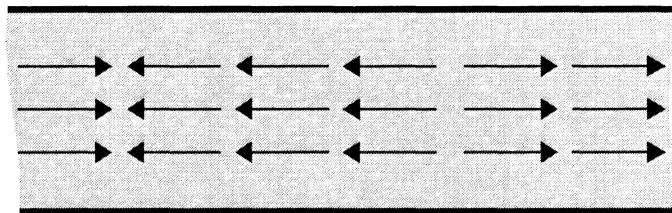

Perpendicular recording

Disk surface

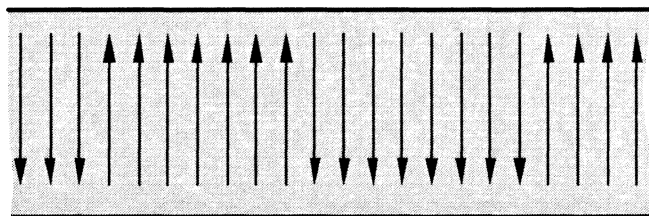

Longitudinal Readback Signal

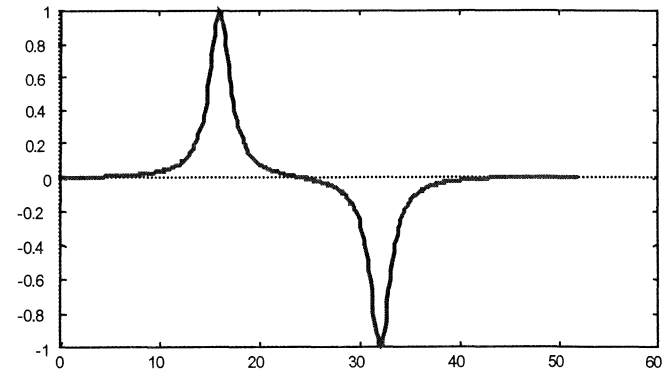

Perpendicular Readback Signal

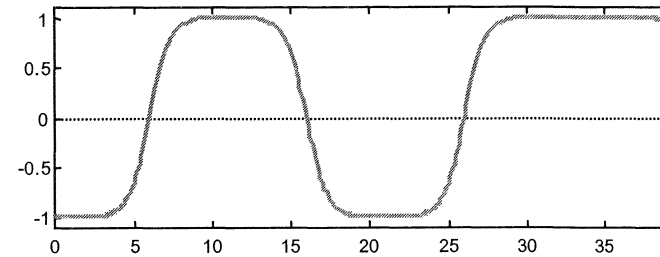

Differentiated Perpendicular Signal

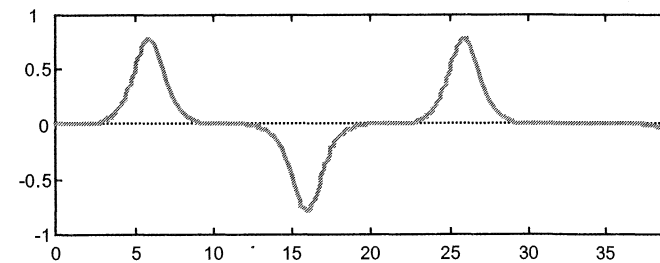

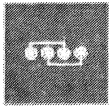

SWITCHING

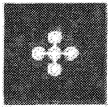

TRANSCIVERS

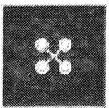

WIRELESS

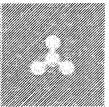

PC CONNECTIVITY

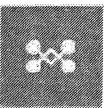

GATEWAYS

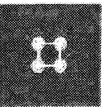

COMMUNICATIONS
CONTROLLERS

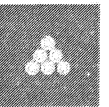

STORAGE

Differentiation – Sub-Opt Solution

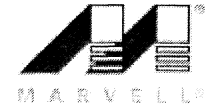

- **Advantages**

- Uses existing longitudinal read channel
- Insensitive to DC offsets, other low-frequency disturbances
- Since media noise is concentrated in low frequencies, much media noise is attenuated by differentiating

- **Disadvantages**

- Since most of useful perpendicular signal is concentrated in low frequencies, signal power is reduced by differentiating
- High-frequency noise components are enhanced
- SNR loss

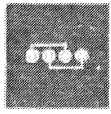

SWITCHING

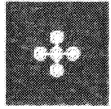

TRANSCIVERS

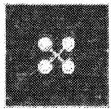

WIRELESS



PC CONNECTIVITY

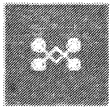

GATEWAYS

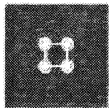

COMMUNICATIONS CONTROLLERS



STORAGE

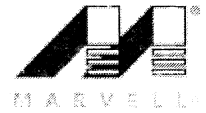

Baseline Wander

- Viterbi input with and without baseline wander

No HPF (DC-coupled)

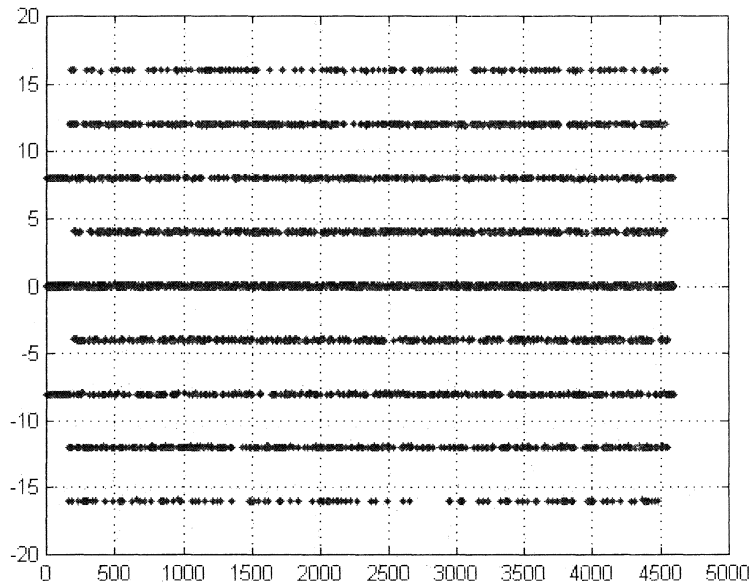

Sample Index

HPF with $F_c/F_s = 0.1\%$

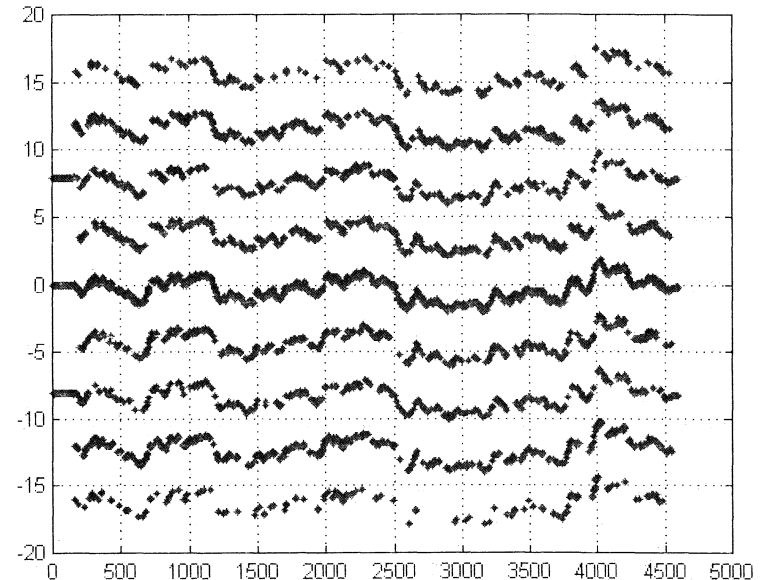

Sample Index

Effects of Baseline Wander

BER vs. HPF F_c/F_s
No Baseline Correction

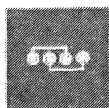
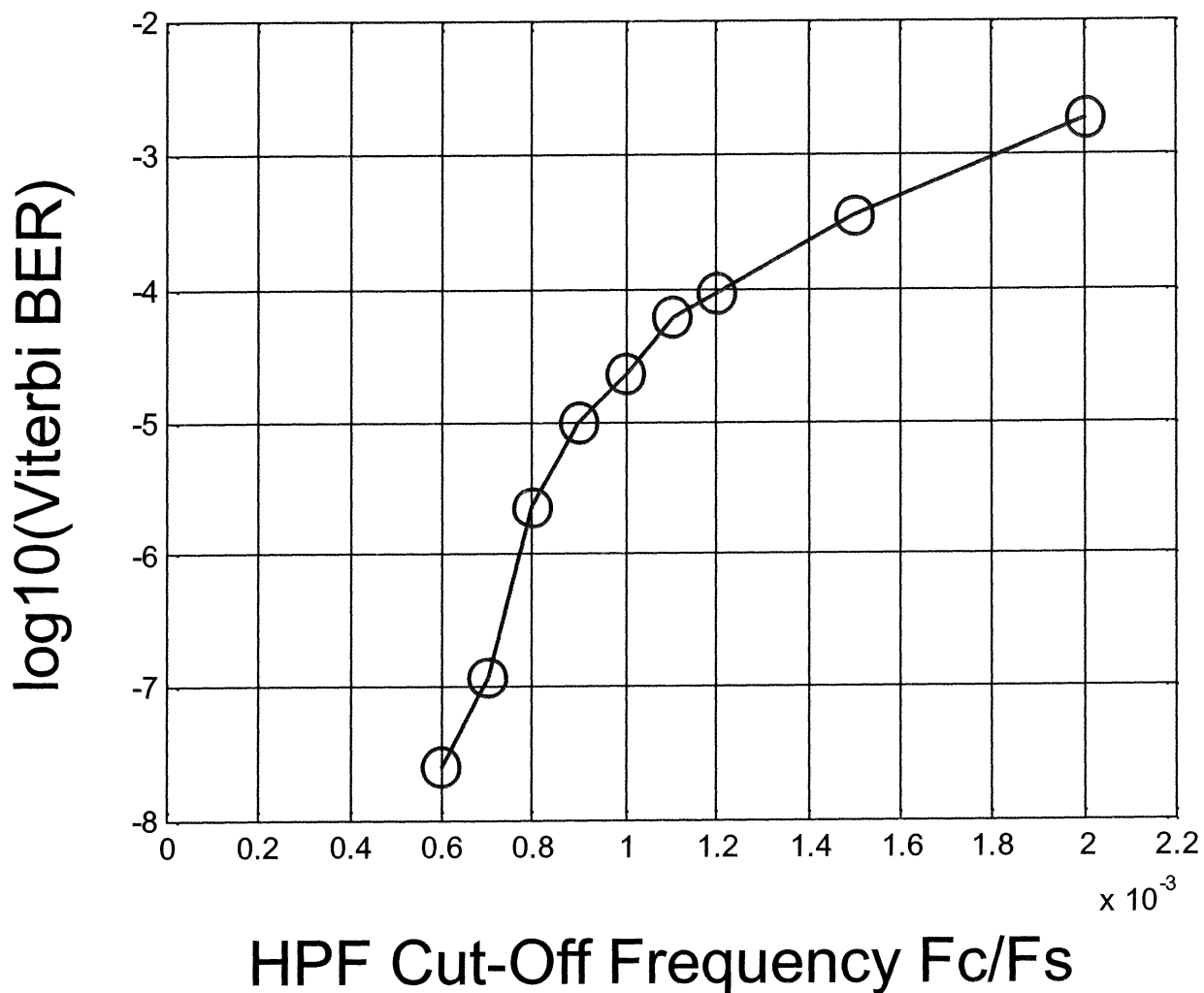

SWITCHING



TRANSCIVERS

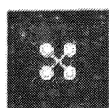

WIRELESS

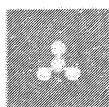

PC CONNECTIVITY

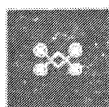

GATEWAYS

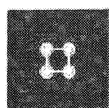

COMMUNICATIONS CONTROLLERS



STORAGE

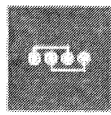

SWITCHING

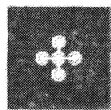

TRANSCIVERS

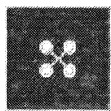

WIRELESS

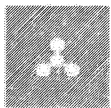

PC CONNECTIVITY

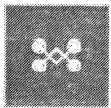

GATEWAYS

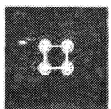

COMMUNICATIONS
CONTROLLERS

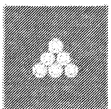

STORAGE



MARVELL

General Baseline Correction Loop

- A loop can be designed to follow and substantially reduce the baseline wander

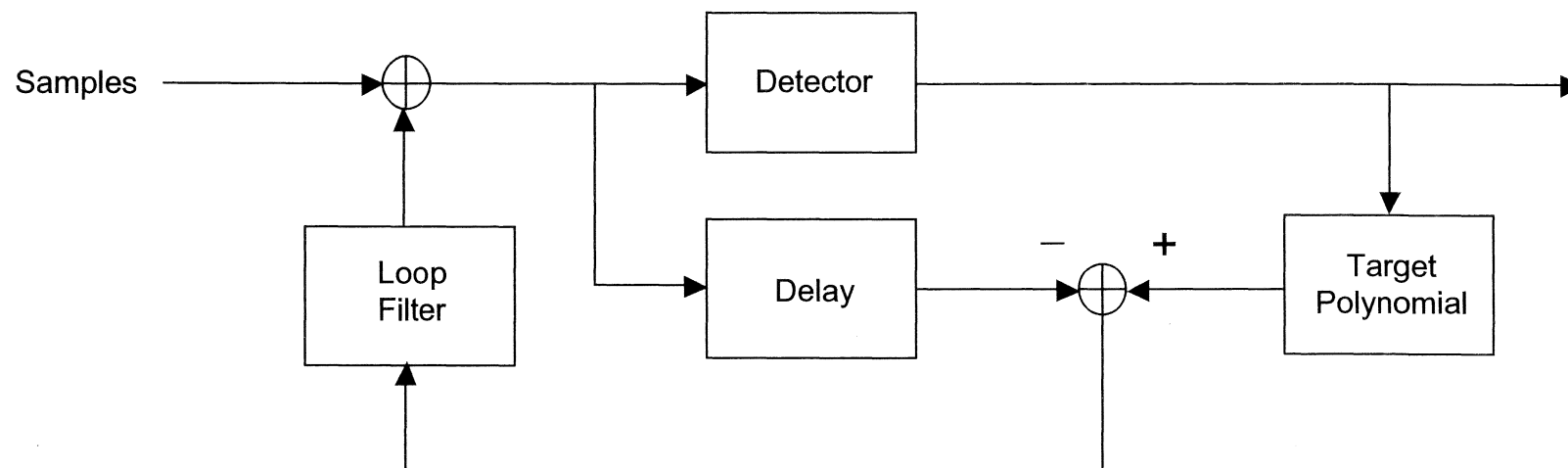

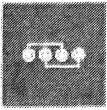

SWITCHING

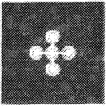

TRANSCIVERS

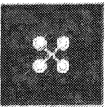

WIRELESS

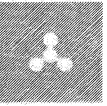

PC CONNECTIVITY

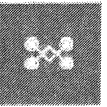

GATEWAYS



COMMUNICATIONS CONTROLLERS



STORAGE

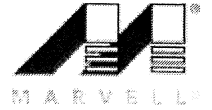

Baseline Correction

Baseline Loop Off

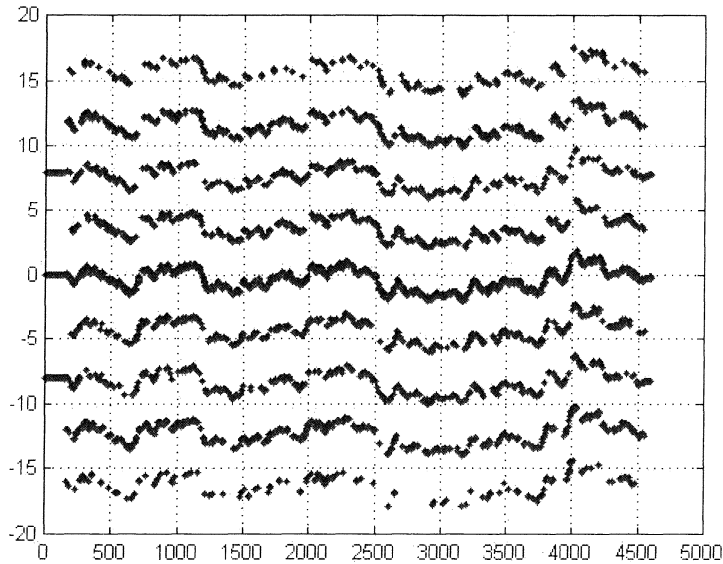

Sample Index

Baseline Loop On

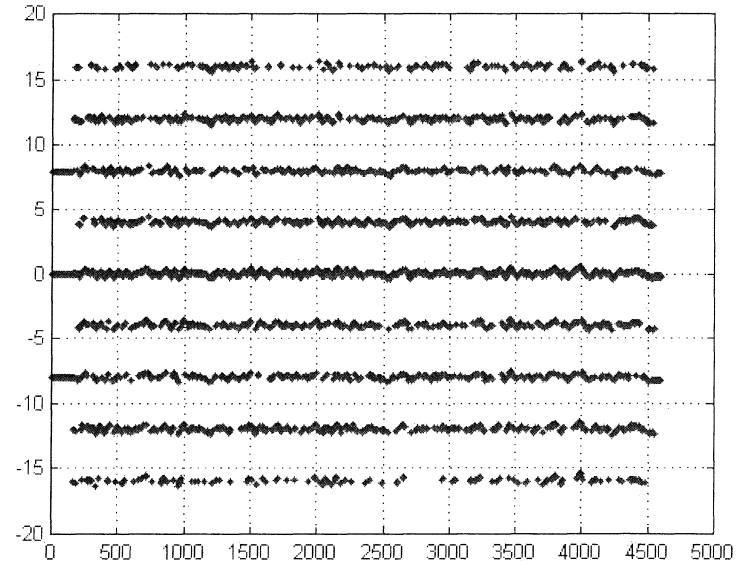

Sample Index

- still some ripple

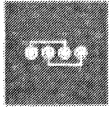

SWITCHING

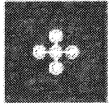

TRANSCIVERS



WIRELESS

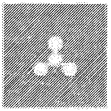

PC CONNECTIVITY

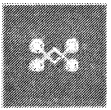

GATEWAYS

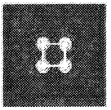

COMMUNICATIONS CONTROLLERS

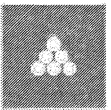

STORAGE



Baseline Correction Performance

BER vs. SNR

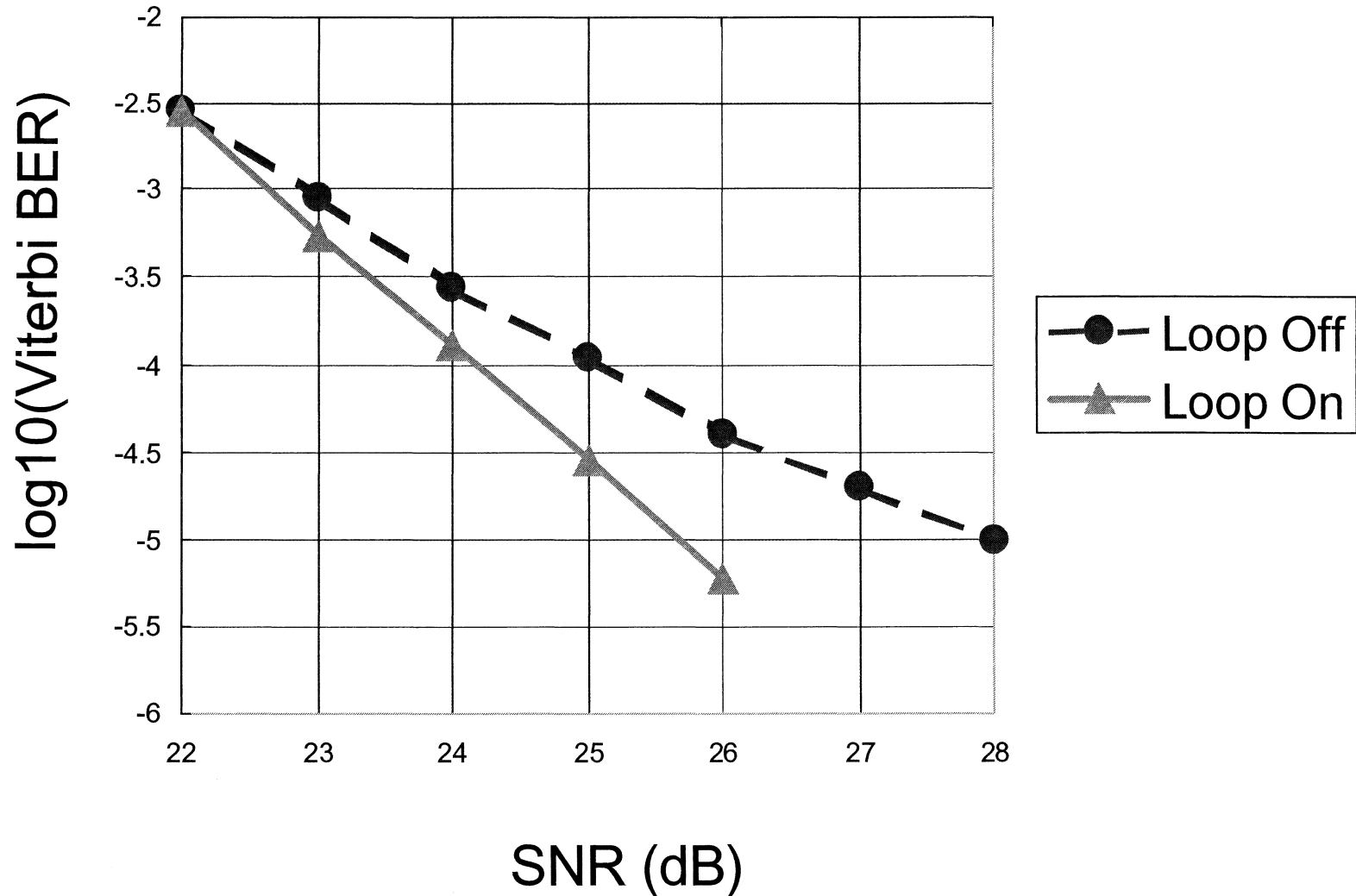

Preamp Requirements



SWITCHING



TRANSCIVERS

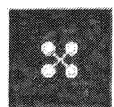

WIRELESS

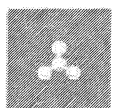

PC CONNECTIVITY

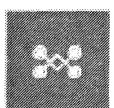

GATEWAYS



COMMUNICATIONS CONTROLLERS

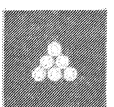

STORAGE

- Channel input AC-coupling HPF cutoff is lowered
- Preamp cutoff must also be lowered
- Effective cutoff from preamp + HPF is greater than the higher of the two cutoffs
- Traditional preamps will not work well with DC-attenuated targets

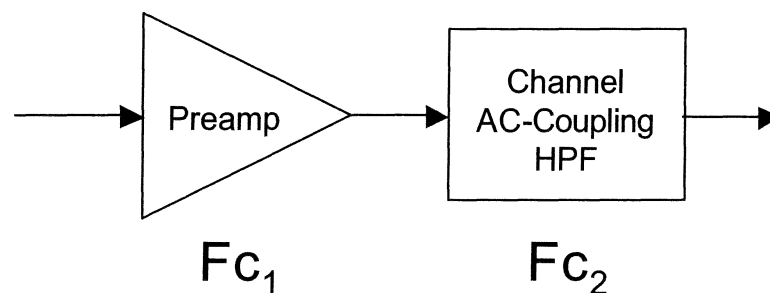

$$F_{c_{effective}} > \max(F_{c1}, F_{c2})$$

Preamp cutoff
 $\sim 200\text{kHz}$

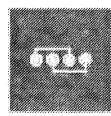

SWITCHING

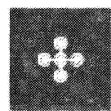

TRANSCIVERS

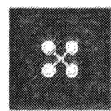

WIRELESS

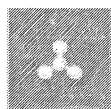

PC CONNECTIVITY

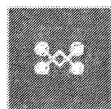

GATEWAYS



COMMUNICATIONS
CONTROLLERS

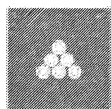

STORAGE

Bit Error Events in PMR

- Signals captured from real PMR heads and media
- Dominant error event is single bit error

DC-Free Target

Error Event Percentage

+	93.30
+--+	3.92
+--++	0.90
<hr/>	
	98.12

DC-Attenuated Target

Error Event Percentage

+	91.54
+--+	3.35
+--++	0.59
<hr/>	
	95.47

Parity Codes

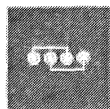

SWITCHING



TRANSCEIVERS

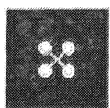

WIRELESS

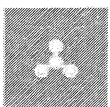

PC CONNECTIVITY

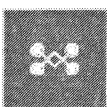

GATEWAYS

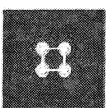
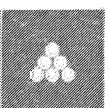
COMMUNICATIONS
CONTROLLERS

STORAGE

- **Bit error events are dominated by singletons and other odd-weight events**
- **These events can be detected by a single bit of parity**
 - Multiple parity prone to miscorrection, post-ECC performance suffers
- **Additional bits of parity lower the code rate**
- **These additional bits can be better used to strengthen ECC**
- **Example: 60/61 (1 parity bit) vs. 100/104 (4 parity bits)**
 - Sector size 420 10-bit symbols
 - 60/61 code yields 70 bits of redundancy for parity
 - 100/104 code yields 168 bits of redundancy for parity
 - With 60/61 code, these extra bits can be used to increase ECC correction power to 5 symbols without increasing UBD

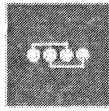

SWITCHING

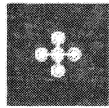

TRANSCIVERS

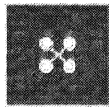

WIRELESS

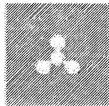

PC CONNECTIVITY

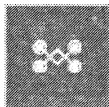

GATEWAYS

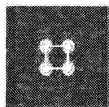

COMMUNICATIONS
CONTROLLERS



STORAGE

DC-Limited Codes

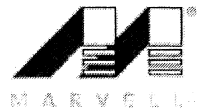

- **RLL codes can be designed to limit the DC content of the bits**
- **This can limit the extent of baseline wander for random data**
- **However, a DC-limited code will always have a lower code rate than a traditional RLL code**
- **Even DC-limited codes have “worst-case” patterns in which DC levels can cause problems**

- **A well-designed baseline loop can track DC wander such that the rate penalty of DC-limited codes is unnecessary**

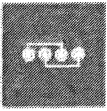

SWITCHING

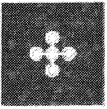

TRANSCIVERS

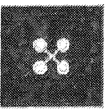

WIRELESS

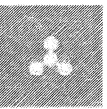

PC CONNECTIVITY

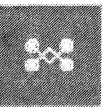

GATEWAYS

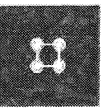

COMMUNICATIONS CONTROLLERS

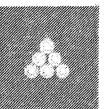

STORAGE

Silicon PMR Channel Measurements

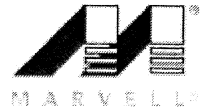

- Code rates are equal for DC-limited code and standard code
- Viterbi performance after baseline loop is nearly identical

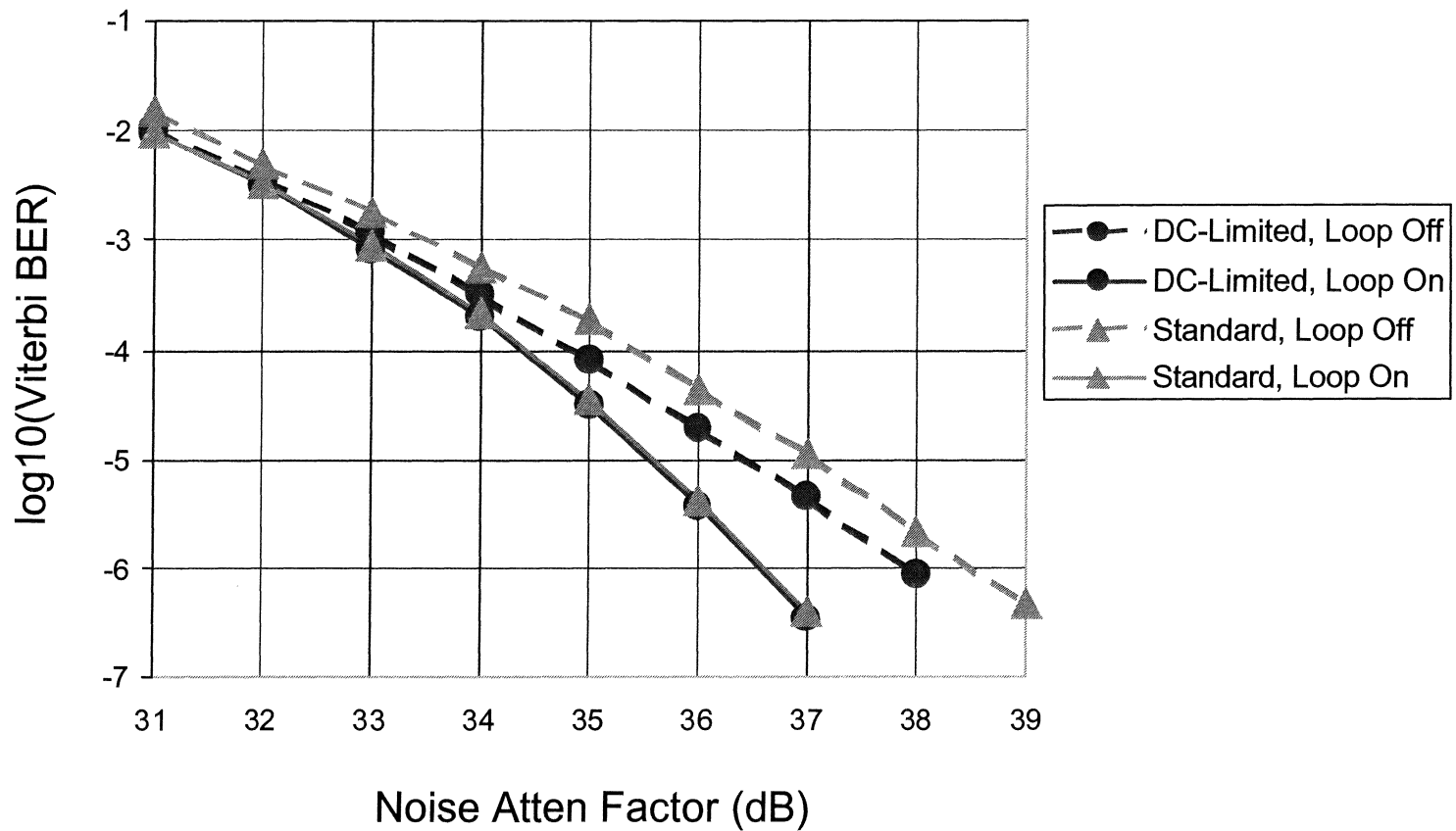

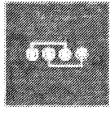

SWITCHING

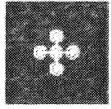

TRANSCIVERS

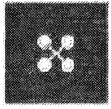

WIRELESS

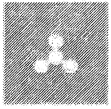

PC CONNECTIVITY

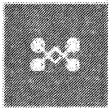

GATEWAYS

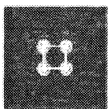

COMMUNICATIONS
CONTROLLERS

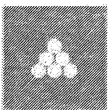

STORAGE

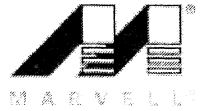

Non-Linear Detector

- **Noise in PMR is dominated by transition-jitter**
- **Sequences that contain many transitions will be noisier than sequences with few transitions**
 - (10101) has four transitions to be jittered
 - (11100) has only one transition to be jittered
- **Transition-jitter noise is highly correlated to the data pattern**
- **A non-linear detector can de-correlate this data-dependent noise and improve BER over a linear detector**

Servo for Perpendicular Recording

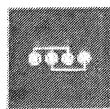

SWITCHING



TRANSCIVERS

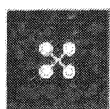

WIRELESS

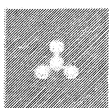

PC CONNECTIVITY

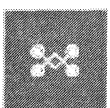

GATEWAYS

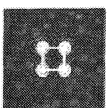

COMMUNICATIONS CONTROLLERS

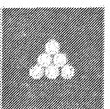

STORAGE

- **Servo burst is differentiated by analog front end**
- **Minimal performance loss from differentiating servo burst**
 - Most energy is away from DC in servo burst
 - SNR much higher than in data sectors
 - Can use DC-free codes without significant penalty

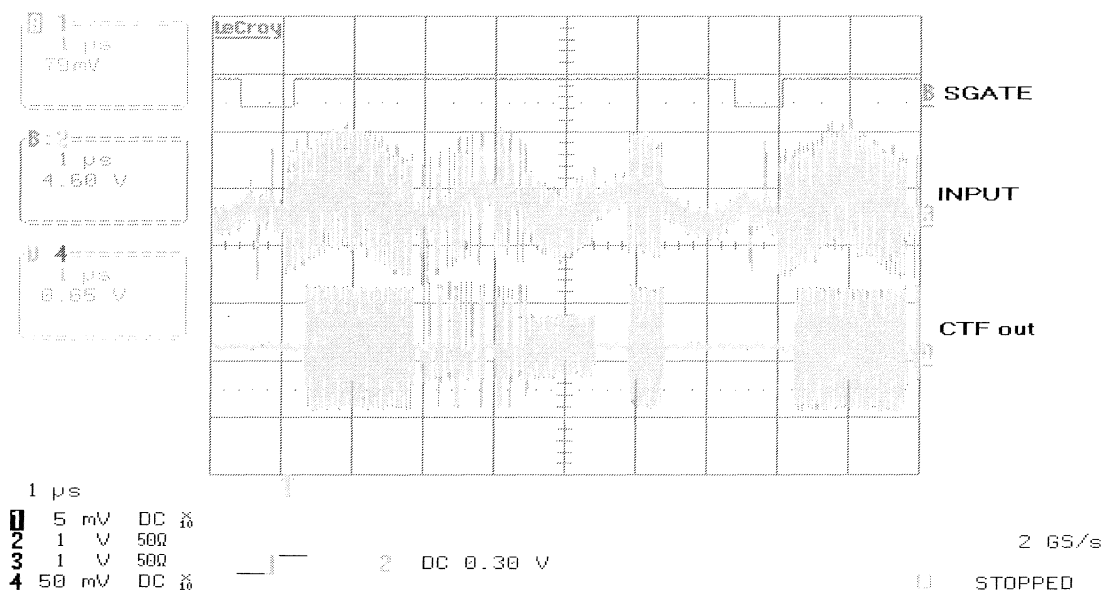

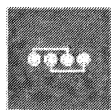

SWITCHING

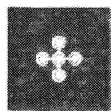

TRANSCIVERS

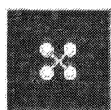

WIRELESS

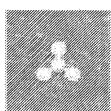

PC CONNECTIVITY

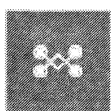

GATEWAYS



COMMUNICATIONS CONTROLLERS

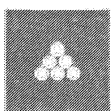

STORAGE

Silicon PMR Channel on Spinstand



BER vs. Data Rate for Different Targets

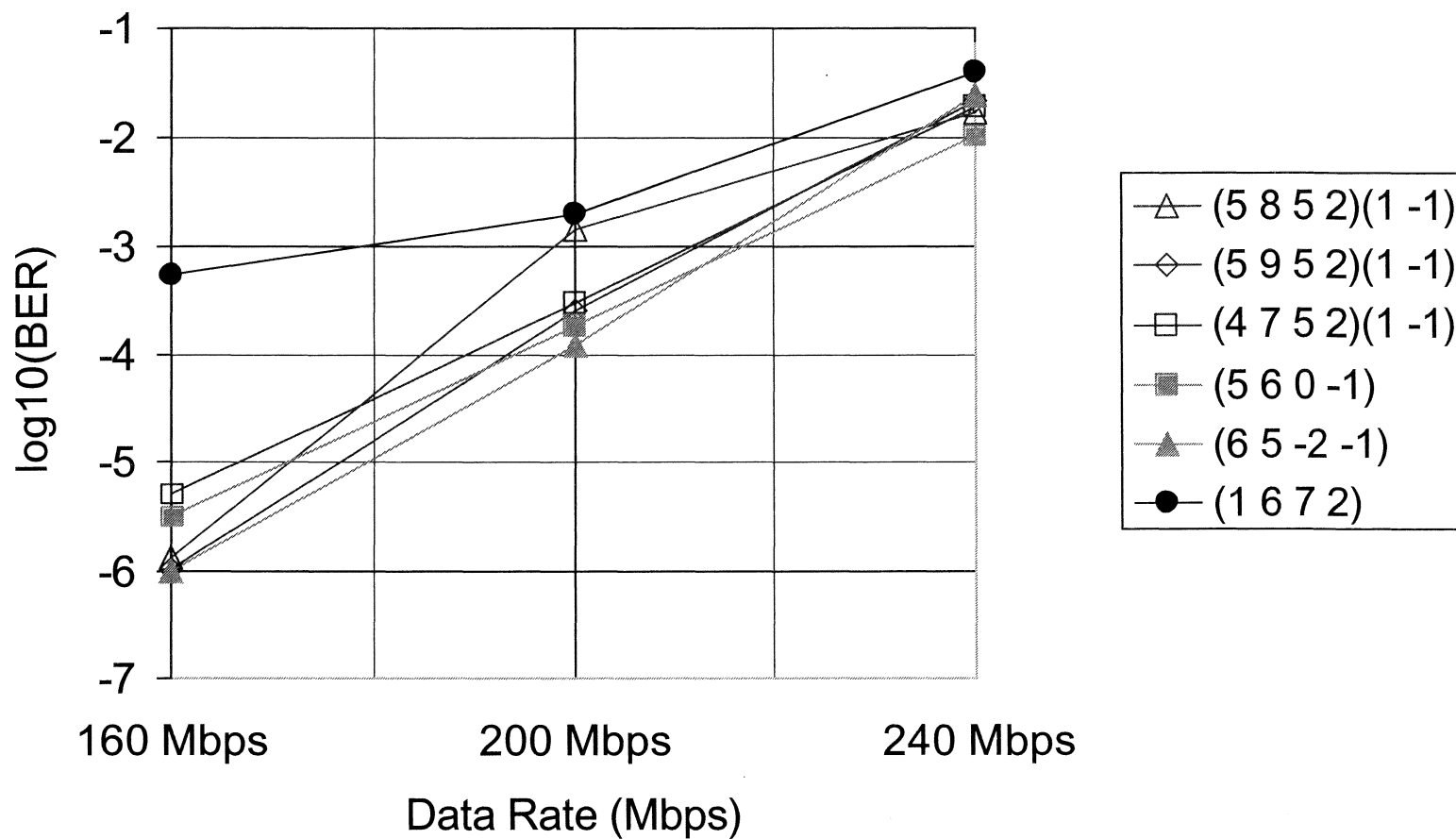

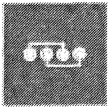

SWITCHING

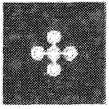

TRANSCEIVERS

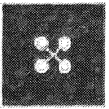

WIRELESS

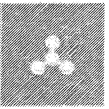

PC CONNECTIVITY

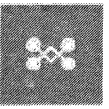

GATEWAYS

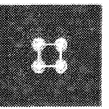

COMMUNICATIONS CONTROLLERS

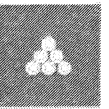

STORAGE

Silicon PMR Channel on Spinstand

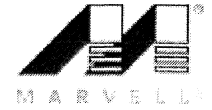

BER vs. Data Rate with and without Baseline Loop

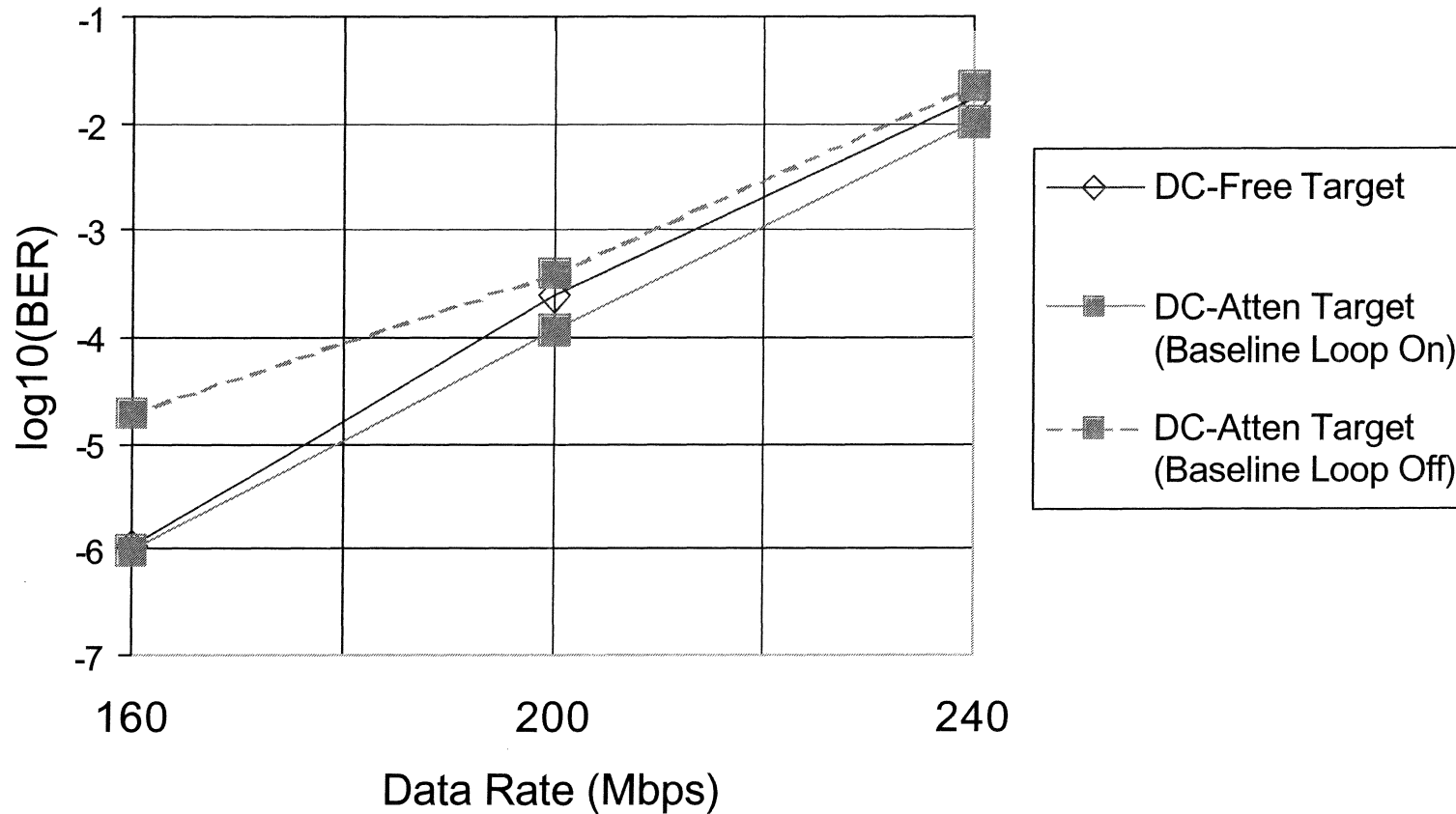

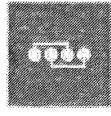

SWITCHING

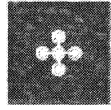

TRANSCIVERS

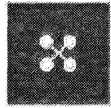

WIRELESS

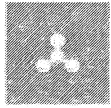

PC CONNECTIVITY

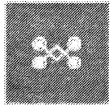

GATEWAYS



COMMUNICATIONS
CONTROLLERS

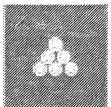

STORAGE

Conclusions

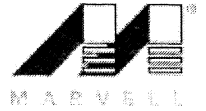

- **Most important components for PMR channel**
 - DC target programming
 - DC-attenuated targets make use of low-frequency signal energy while providing some attenuation of low-frequency-dominant media noise
 - Baseline loop
 - Lowered preamp and input AC-coupling frequencies
- **Multiple-parity codes not necessary for PMR**
 - PMR dominated by singletons and odd-weight events
 - Extra parity bits lower code rate
 - Better use of redundancy is to strengthen ECC
 - DC-limited code rate penalty not necessary to take because of baseline loop
- **Non-linear detector offers improvement over linear detector in PMR**
 - Noise is dominated by data-dependent transition-jitter

Baseline Wander Compensation for Long Latency Detectors

IDEMA

German Feyh, Victor Krachkovsky

Zak Keirn – Agere Systems

Perpendicular Recording

- Full DC channel
- Preamp has a high pass filter for fast write to read recovery
- If the data sequence has DC content, then the baseline is shifted, since the DC is filtered by the Preamp high pass filter
- DC-free targets do not need baseline compensation
- Baseline compensation grows in importance for higher cbds

Baseline Wander Compensation

- Combination of CTF and FIR cannot provide the equalization need for the high pass pole
- Linear filtering only leads to unacceptable high noise enhancement
- Viterbi has too many states if the target includes the long tail of the preamp pole
- Decision feedback scheme:
 - Local feedback
 - Global feedback

Baseline Wander Compensation Local vs. Global Feedback

- Local vs. global: difference lies in the generation of the feedback signals
- Local feedback
 - The path memory of each state is fed back to this state
 - Baseline wander compensation implemented for each state
- Global feedback
 - The path memory of the state with the best metric is fed back to all the states
 - Baseline wander compensation implemented once
- Error events for perpendicular are mostly Nyquist error events (+, +-, +--+, +--+-, +--+--+, ...)
- Local and global feedback have the same BER performance

HPFM Code for Baseline Wander

- DC content can be coded out
- Rate loss of channel modulation
- Limit error propagation
- Match coding to expected high pass
- Rate high pass filtered matched coding
- Permits worst-case code patterns that could shift the baseline by 29% of zero to peak

HPFM Code: Supported Baseline Wander

HPFM code, worst case sustained bit pattern

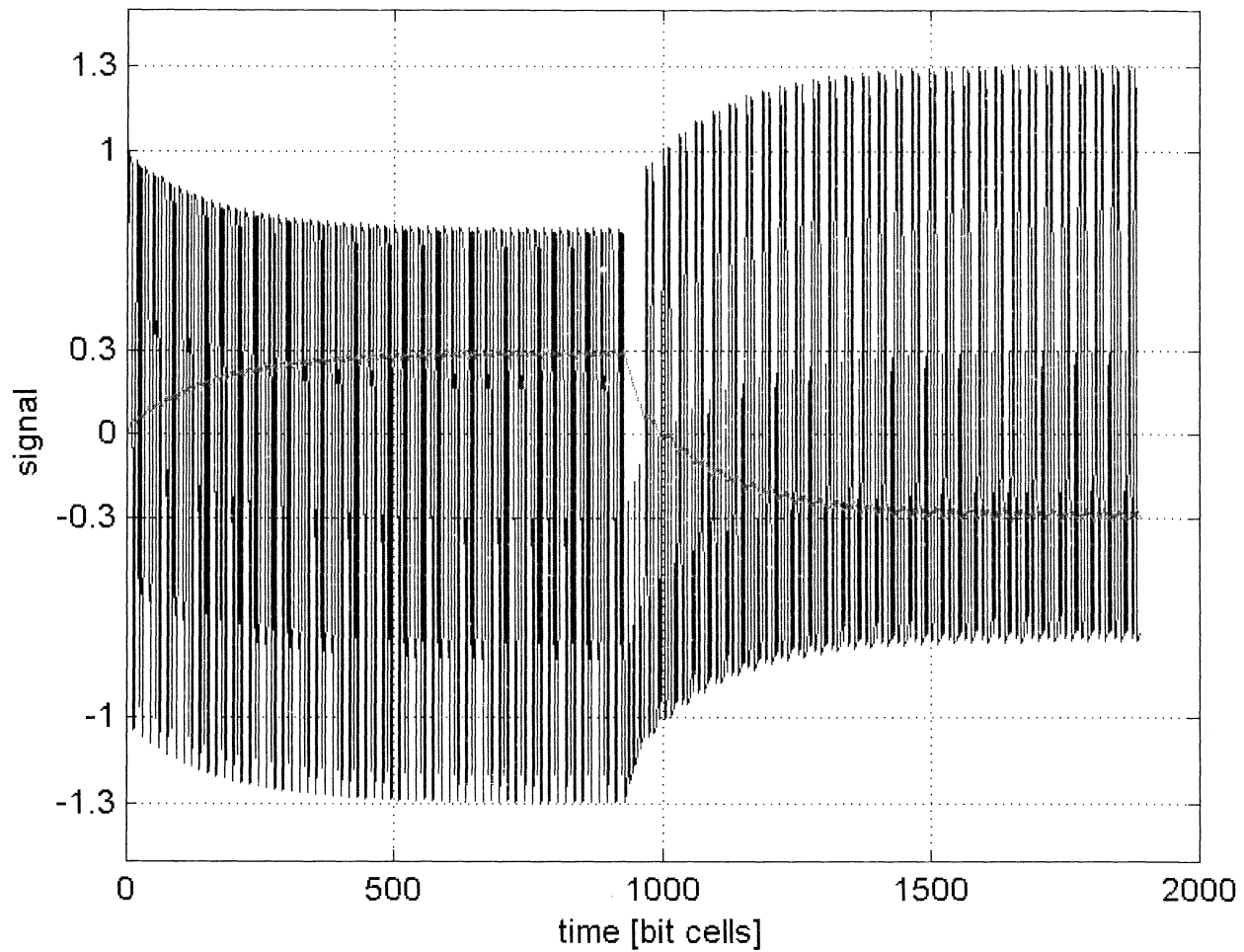

Long Latency Detectors

- Modern magnetic detectors have a high latency
- Use of short latency detectors in loops decreases detection reliability
 - Loops will adapt to a non optimum setting due to detector errors
 - Hang ups might occur in the decision feedback baseline compensation
- Feedback baseline compensation degrades with increasing latency of the detector [S. Gopaldaswamy and P. McEwen, 2001]
- Signal processing to overcome latency of detection

Baseline Compensation Architecture

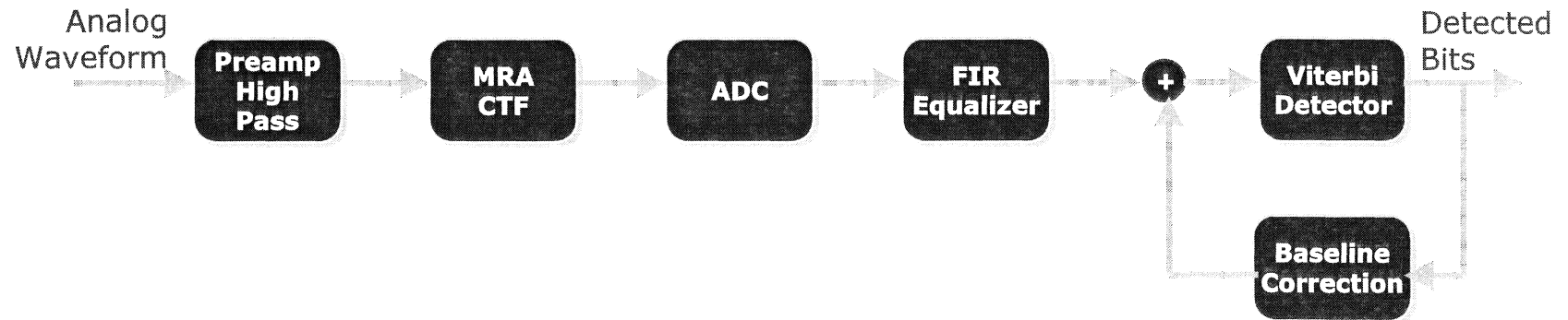

- Preamp high pass results in long tail
- Influence length of CTF or FIR equalizer too short to undo Preamp high pass
- Linear equalizer only would lead to noise enhancement
- Decision feedback to cancel the long tail

Long Detector Delay Baseline Compensation

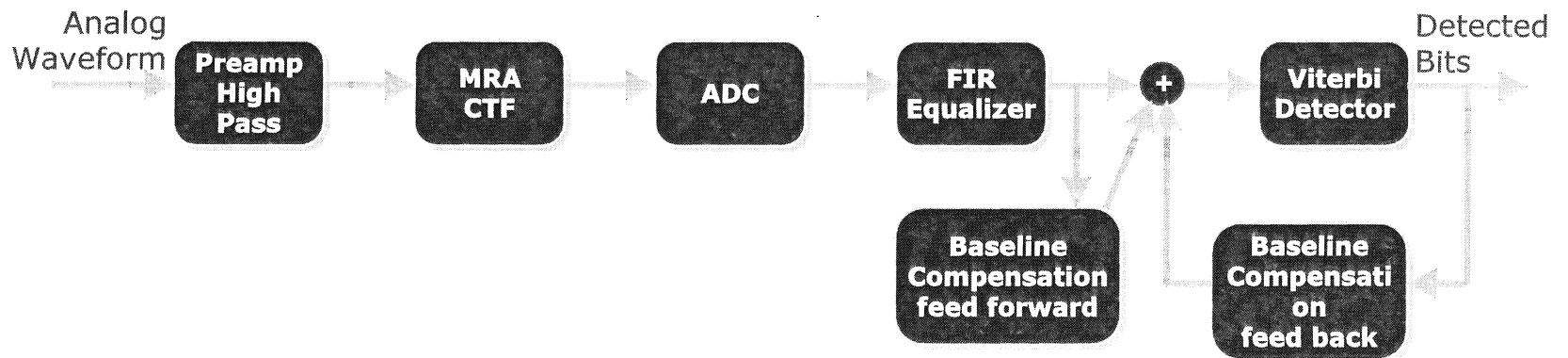

- Compensating feedback in the feedback path only after the detector delay
- Feed forward baseline compensation spans the time until feedback compensation
- Simple expressions for a single pole

Expressions for inversion of a single high pass filter pole

- Preamp high pass:

$$\frac{1-z^{-1}}{1-qz^{-1}}$$

- Inverse preamp high pass as a feedback:

$$\frac{1-qz^{-1}}{1-z^{-1}} = \frac{1}{1-\frac{(1-q)z^{-1}}{1-qz^{-1}}}$$

- Inverse preamp high pass can be written as a low pass filter in the feedback path

$$H(f) = 1 - L(f) \Leftrightarrow \frac{1}{H(f)} = \frac{1}{1-L(f)}$$

- Low pass in feedback path:

$$L(f) = \frac{(1-q)z^{-1}}{1-qz^{-1}}$$

Expressions for inversion of a single high pass filter pole

- Inverse Preamp high pass as a linear filter:

$$\frac{1-qz^{-1}}{1-z^{-1}} = (1-qz^{-1})(1+z^{-1}+z^{-2}+z^{-3}+\dots)$$

$$= 1 + (1-q)(z^{-1} + z^{-2} + z^{-3} + \dots)$$

- Suggest form of a direct path plus a boxcar filter for the time the feedback path for N samples till the feedback path is valid
- Linear feed forward boxcar filter:

$$(1-q) \frac{1-z^{-N-1}}{1-z^{-1}}$$

Long Detector Delay Baseline Compensation

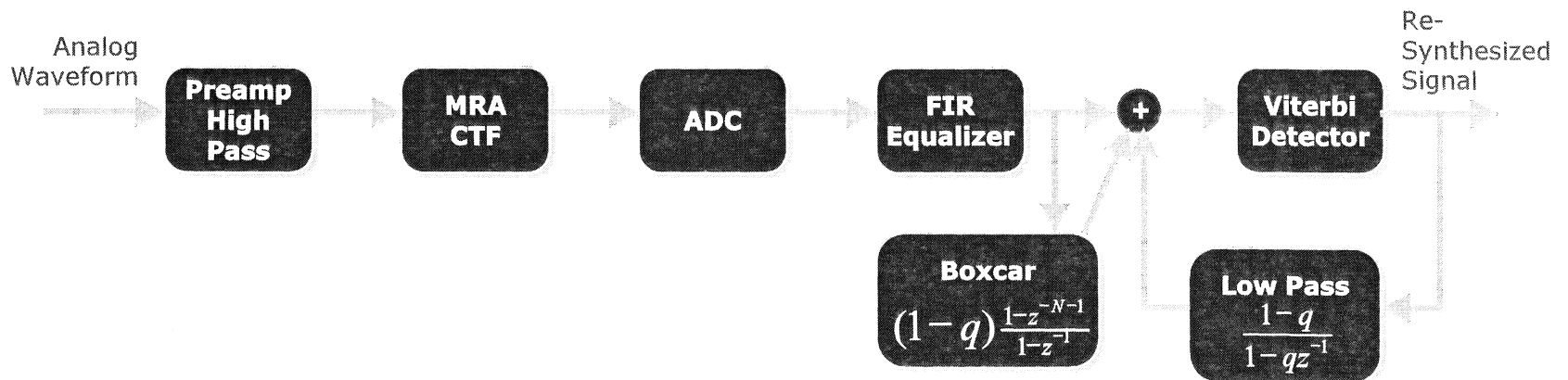

- Boxcar and low pass filter are both parameterized by q , q is the high pass pole location, e.g., $1/1000$ is $q=0.999$
- Feed back low pass filters re-synthesized signal from Viterbi decisions
- Three multiplies for implementation: one in the feed forward path, two multiplications in the feed back path

Smith Predictor for MRA, ADC range

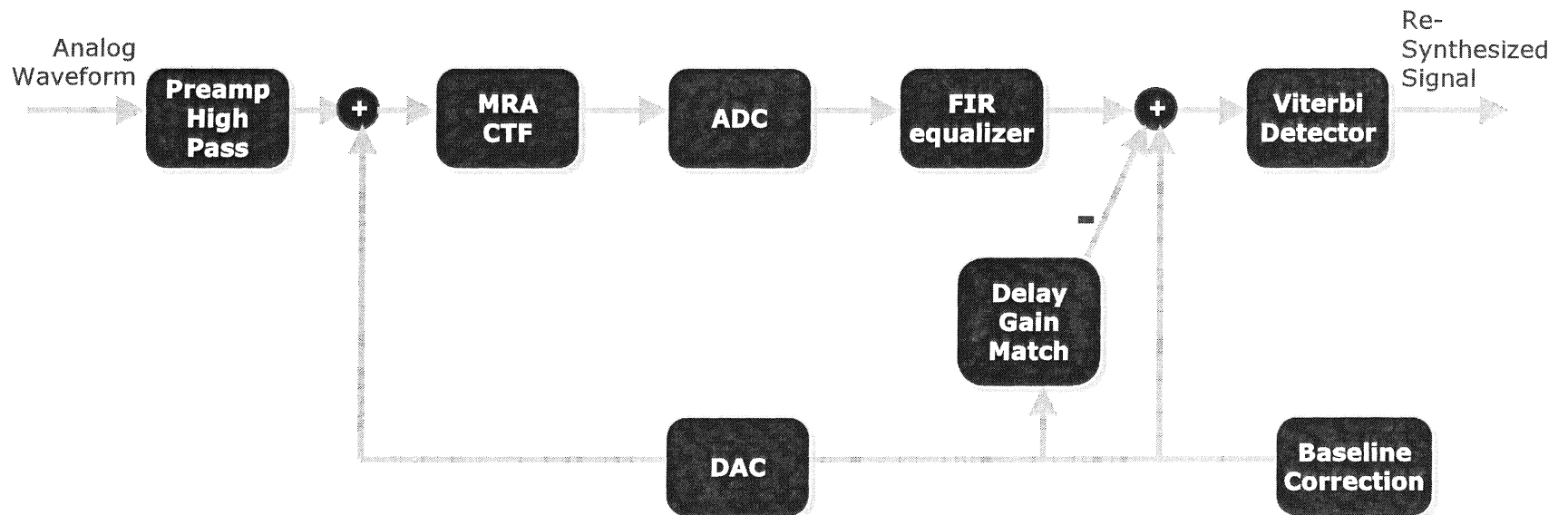

- Smith predictor removes delay of front end from cancellation loop
- Smith predictor is a basic control technique to overcome delay
- Benefit of baseline compensation for analog front end
 - Reduced ADC range
 - MR Asymmetry cancellation

Simulation Environment

- High pass preamp modeled by dominant and parasitic pole
- Timing variations
- Fix point code matching hardware latencies
- Channel bit density: 2.3, pw50 measurement on impulse response

Baseline Compensation and Detector Setup

- All loops (timing, gain, offset, MRA) active
- Baseline compensation matches preamp high pass pole within implementation accuracy
- NPML detector with 1bit parity code
- FIR and NPML FIR adapted to signal
- HPFM code

Results for Worst-Case Pattern

Test pattern with worst-case baseline shift that is allowed by the code in the data

- Highly regular pattern
- SNR loss grows with lower data rate over preamp high pass frequency ratio
- Filters adapted over random data

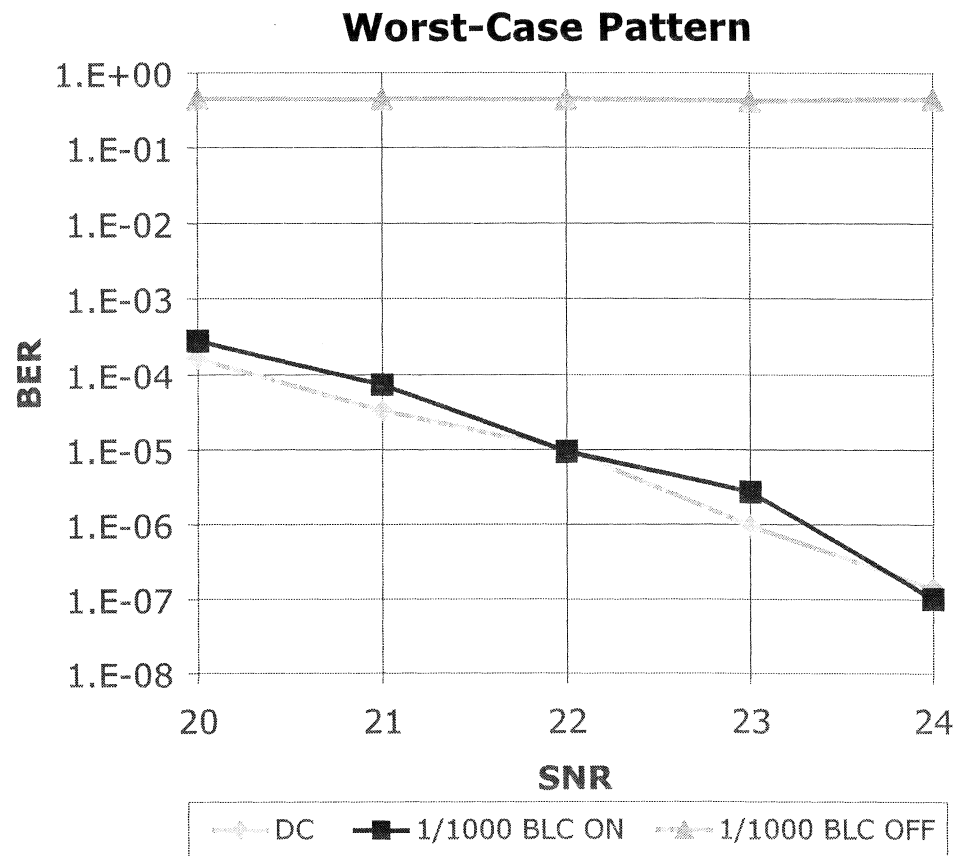

Conclusion

- Decision directed baseline compensation
- Matches long delay detector
- Smith predictor reduces delay in loop
- Enables MR asymmetry cancellation
- High ADC utilization
- Worst-case data is readable with baseline compensation
- Minimizes SNR loss from preamp high pass filter

Biographies:

Dr. Chris Bajorek, KOMAG

Dr. Christopher Bajorek was appointed Executive Vice President, Advanced Technology, in October 2000. Prior to his current position, Dr. Bajorek had been named Executive Vice President, Chief Technical Officer and Senior Vice President, Chief Technical Officer, in 2000 and 1996 respectively. Dr. Bajorek is regarded as an expert in managing applied research, product and process development, customer support and manufacturing functions, with special emphasis on data storage devices, products, and software. In his career Dr. Bajorek has played a significant role in the development and high-volume manufacturing of thin film magnetoresistive (MR) recording heads in the storage industry. In his current position, Dr. Bajorek is responsible for Komag's advanced disk designs and processes with focus on developing media more than two generations in the future.

Before joining Komag, Dr. Bajorek was Vice President, Technology Development and Manufacturing, for IBM's Storage Systems Division. In this capacity he was responsible for research, development, and manufacturing for both IBM's magnetic recording heads and disks.

Prior to his tenure with the Storage Systems Division, Dr. Bajorek worked for ten years at IBM's Thomas J. Watson Research Center in Research where he managed the applied research efforts in several areas of data storage and semiconductor technologies. In this role, he was an integral part of the team that invented and prototyped the world's first MR heads for consumer-transaction readers, the world's first MR heads for tape drives, and the world's first MR head for disk drives. He also initiated IBM's second and third interdivisional laboratories: the Advanced Packaging Technology Laboratory, for research and development of packages for high-speed semiconductor chips; and the Magnetic Recording Institute, for research and development of advanced disk drive technology.

Dr. Bajorek received his B.S., Electrical Engineering; M.S., Electrical Engineering; and Ph.D., Electrical Engineering and Business Economics, from the California Institute of Technology.

Dr. Bajorek is a Fellow of the Institute of Electrical and Electronics Engineers (IEEE). He is the recipient of the prestigious 2002 IEEE Reynold B. Johnson Information Storage Award for leadership in the development and manufacturing of magnetoresistive recording heads for data storage devices, and the Third Millennium Medal Award for outstanding contributions by the IEEE Magnetics Society. From 1997 to 2000, he was a Director of the International Disk Drive Equipment & Materials Association (IDEMA). Dr. Bajorek has contributed to more than 20 patents and 50 publications in the fields of semiconductors, electronic packaging, and data recording.

Ed Grochowski, Hitachi GST

Ed Grochowski began his career with IBM in New York helping to develop IBM's microelectronic silicon activity, and later joined the Almaden Research Center, San Jose, California where he was Program Manager of Storage Devices. His interests include disk drive component design as well as drive form factor development which have contributed to IBM's latest storage products. Dr. Grochowski holds nine patents. He has a Ph.D. from New York University (1971), held the position of Adjunct Professor of Chemical Engineering at the University and was also associated with the University of Michigan Semiconductor Research Lab. In addition to being a member of the board of directors of IDEMA, Ed serves as chairman of the technical program committee for DISKCON AP and DISKCON USA, leading storage conferences in the industry. He is also a member of the IEEE. In 2003, following 41 years with IBM, Dr. Grochowski joined Hitachi Global Storage Technologies at the San Jose Research Center where he serves as storage consultant.

David Wachenschwanz, KOMAG

David Wachenschwanz has been involved in the magnetic recording industry for over 20 years with a focus on magnetic recording physics and how it affects the recording performance of heads and media. Since 1990, he has been with Komag, Inc. in San Jose, the largest independent supplier of thin film recording media to the hard disk drive industry. At Komag, he is the head of the Advanced Magnetic Recording Group and has the responsibility for developing, designing and characterizing recording media for future generation disk drive products. Previously, he worked for Kodak Research Laboratories in San Diego on heads and recording tape development. He has numerous technical publications regarding recording heads, media and recording physics and has given many talks on these topics for conferences, seminars and short courses. He has an M.S. in applied physics from the University of California at San Diego, where he did his thesis work at the Center for Magnetic Recording Research. He is a senior member of the IEEE.

Session I: Theory and Mechanisms

Mason Williams, Hitachi GST: “Introduction to Perpendicular Recording”

Mason L. Williams is a Research Staff Member in the Hitachi GST San Jose Research Center, San Jose, California. Mason Williams was born in San Mateo, California on January 20, 1943. He received his B.S. in Engineering from the California Institute of Technology in 1964, M.S. in Electrical Engineering and PhD in Electrical Engineering in 1966 and 1970 respectively from the University of Southern California, where he studied Magnetic Materials under Professor Jan Smit. Dr. Williams joined IBM in San Jose, California in 1970. His work on thin film media recording with R. L. Comstock led to the Williams/Comstock recording model in 1971. From 1974 to 1982 he was involved in magnetic bubble materials characterization, bubble chip design and bubble card design management. In 1982 he joined the IBM Magnetic Recording Institute and worked in it and its successor, the IBM Advanced Magnetic Recording Laboratory, with interests in recording head design. From 1992 through 2002 he also represented IBM in the Advanced Recording Head projects of the National Storage Industry Consortium, now INSIC. Dr. Williams is a Fellow of the I.E.E.E.

Dr. Neal H. Bertram, Professor and CMRR Endowed Chair, UCSD: “Critical Aspects of Perpendicular Recording: 200 Gbits/in² and Beyond”

Dr. Bertram received his B.A. from Reed College in Portland, OR in 1963 and his Ph.D. at Harvard University in Cambridge, MA in 1968. From 1968 to 1985 he was employed by the Ampex Corporation in Redwood City, CA where he worked on fundamental problems in magnetic tape recording. In 1985 he joined the University of California at San Diego as an Endowed Chair Professor in the Electrical Engineering and Computer Sciences Department associated with the (then) newly created Center for Magnetic Recording Research. At UCSD, Dr. Bertram directs a research program in the physics of magnetic recording, including studies of polycrystalline thin film media, magnetoresistive heads, and fine particle tape systems. In these areas, his Ph.D.

students engage in both experimental and theoretical studies of basic issues in high density magnetic recording, such as noise phenomena, nonlinearities, dynamic processes, and thermally induced relaxation. Dr. Bertram has created graduate courses in magnetic recording theory, analysis of recording materials, and magnetic recording measurements.

In 1986, Dr. Bertram was an IEEE Distinguished Lecturer, and in 1987 he was named an IEEE Fellow. He has published a book entitled "Theory of Magnetic Recording" (Cambridge University Press, March 1994). In 1999 he received the annual technical achievement award from INSIC (International Storage Industry Consortium). Dr. Bertram won the 2003 IEEE Reynold B. Johnson Information Storage Award. The prize is awarded each year for outstanding achievement in the field of information storage, mainly computer storage. Dr. Bertram was cited for "fundamental and pioneering contributions to magnetic recording physics research."

Professor Bertram frequently gives courses on magnetic recording; limits and high density design to the Storage Industry, both for specialists as well as non-specialists who would like to better understand this technology.

Professor and CMRR Endowed Chair II (PhD, Harvard): experimental and theoretical studies of magnetic recording, dynamic processes and thermal fluctuations in magnetic materials.

Session II: Perpendicular Media Technology

Gerardo Bertero, Komag

“Granular Oxide Perpendicular Magnetic Recording Media”

Gerardo Bertero has over 10 years experience in the magnetic recording industry. He received his Engineering degree in Metallurgical Engineering from the Catholic University of Cordoba, a M.S. degree in Materials Science from Vanderbilt University and a Ph.D. degree in Materials Science from Stanford University. Since 1994 he has been with Komag, Inc. where he holds the position of Executive Director in the R&D Department working on research projects and process development for next and future generations media.

Dr. Gunn Choe, MMC Technology

“Perpendicular Recording Media: Technical and Manufacturing Challenges”

Dr. Gunn Choe, is currently with MMC Technology (a Maxtor company) as a Director of Magnetics R&D. His research focuses on the development of longitudinal and perpendicular recording media for high-density data storage. He has been with magnetic recording industries for 14 years. He was formerly employed by MRC (Orangeburg NY), Quantum (Shrewsbury MA), IBM (San Jose CA) before he joined MMC technology in 2000. In 1989, he received the Ph.D degree in materials science from the University of Texas at Austin. He has presented several invited papers at magnetic conferences and has published more than 30 papers on magnetic recording area in professional journals.

Hiroyuki Uwazumi, Fuji Electric: "The Perpendicular Recording Media with an Electroless-Plated Ni-P Soft Magnetic Underlayer"

Hiroyuki Uwazumi received his B.S. and M.S. degrees from Tohoku University in 1989 and 1991, respectively. In 1991, he joined Fuji Electric Co., Ltd. and worked on R&D of the high-density longitudinal recording media, especially in the area of magnetism and sputtering process.

From 1995 to 1997, he was a visiting researcher of the University of Minnesota. He worked on the thermal stability of the longitudinal recording media, under Prof. J. Judy. Since 1999, his research concentrated on the high-density perpendicular recording media.

He obtained Ph.D. of Information Science from Tohoku University in 2002, worked on a study of recording performance and thermal stability for perpendicular magnetic recording media. Currently he is an assistant manager of the Advanced Technology Department of the Fuji Electric Storage Device Co., Ltd.

Bob Weiss, Intevac: "Equipment Technology for Perpendicular Recording"

Session III: Perpendicular Head Technology and Design, and Component Integration

Moris Dovek, Headway: “Advances and Challenges of Perpendicular Recording Heads”

Moris Dovek got his Ph.D. in Electrical Engineering from Stanford University in 1990. He then joined IBM where he worked on AMR heads, near contact recording technology, and GMR heads in its Storage and Research Divisions in San Jose. Since 1998 he has been with Headway Technologies where he is presently Senior Director of Product Development responsible for GMR, PMR, and other advanced device design and characterization.

Lamar Nix, Hitachi GST: “Perpendicular Heads for Tomorrow’s HDD”

Lamar Nix is with Hitachi Global Storage Technologies, Inc., San Jose Research Laboratory where he is the manager of the recording head design and characterization group.

Yan Wu, Maxtor: “Integration of Heads/Media”

Yan Wu has a Ph.D in Physics from UC Berkeley. He started working in the drive industry when he joined IBM Almaden Research Center as a visiting scientist to work on magnetic materials and interactions. After that, he worked at HOYA Corporation (USA) on recording media development and characterization on glass substrates. He then joined Komag Inc. where he worked in a number of roles including media performance characterization and program management, as well as advanced technology development. He is currently with Maxtor Corporation and responsible for advanced heads/media and magnetic integrations in Milpitas, California.

Francis Liu, Western Digital: "Advanced Perpendicular Magnetic Recording Head Technologies"

Dr. Francis Liu is Senior Director of Head Design and Characterization at Western Digital Corporation. He has the overall responsibility of current product and developmental head design. Dr Liu's has been involved in demonstrating the feasibility of future generations of head technology used for longitudinal, perpendicular and high data rate recording applications. His recent contribution includes Read-Rite's areal density demonstrations from 13.5, to 146 Gb/in² and the data rate demonstration of 1 Gb/sec on both longitudinal and perpendicular recording media. Francis Liu received his Ph.D. in Electrical Engineering from Carnegie Mellon University in 1994 and is a holder of eleven U.S. patents.

Session IV: Electronics Design for Perpendicular Recording

Mike Madden, Marvell: "Channel Electronics-Key to Perpendicular Recording Success"

Michael Madden has been with Marvell Semiconductor in the signal processing department since 2000. His focus has been on signal processing design and testing for magnetic recording channels, in particular for perpendicular recording. Michael is a graduate of Princeton University and the University of California at Los Angeles. He was previously at the Institute for Integrated Signal Processing Systems at the Aachen University of Technology in Aachen, Germany as a DAAD scholar.

Zak Keirn, Read Channel Architecture Manager, Storage Div.,Agere: "Baseline Wander Compensation for Long Latency Detectors"

Zak Keirn is a read channel architecture manager for the Storage division of Agere Systems. Agere is a premier provider of advanced integrated circuit solutions for wireless data, high-density storage and multiservice networking applications.

In this capacity, Dr. Keirn is responsible for inventing, developing and implementing new read channel architectures for disk drives. Prior to joining Agere, he held similar positions in the read channel architecture area for both Texas Instruments and Maxtor. He has also worked for the IBM storage division and Corning Glassworks fiber optic division.

He has authored several trade journal articles and holds patents in magnetic recording.

He earned a Ph.D. in electrical engineering from Colorado State University in 1992, and Master's and Bachelor's degrees in electrical engineering from Purdue University in 1984 and 1988 respectively.

Session V: Panel Discussion of Perpendicular Recording and Status of Technology

All Speakers and Dr. Dave Thompson, IBM Fellow (retired)