

DISPLAED Ltr. 000
mid 87 - 8988

H-82-0176

VistagraphicTM 3000/ Graphic 8TM Series 8000

COMPUTER GRAPHICS DISPLAY SYSTEM

OPERATION AND MAINTENANCE MANUAL

CALCOMP

A Sanders Graphics Company



SANDERS

DANIEL WEBSTER HIGHWAY, SOUTH-NASHUA, NEW HAMPSHIRE 03061

The terms Vistagraphic 3000 and GRAPHIC 8 are interchangeable; they describe the same equipment. The term GRAPHIC 8 is used throughout this manual.

CalComp/Sanders Associates, Inc., reserves the right to modify the products described in this manual and to make corrections or alterations to this manual at any time without notice.

First Edition - September 1982

Reprint - February 1983

RECORD OF CHANGES

CHANGE NO.	DATE	TITLE OR BRIEF DESCRIPTION	ENTERED BY
1	Oct 82	Correct errors in original issue	
2	Nov 82	Add card cage definitions	
3	Feb 83	Add timing module II	

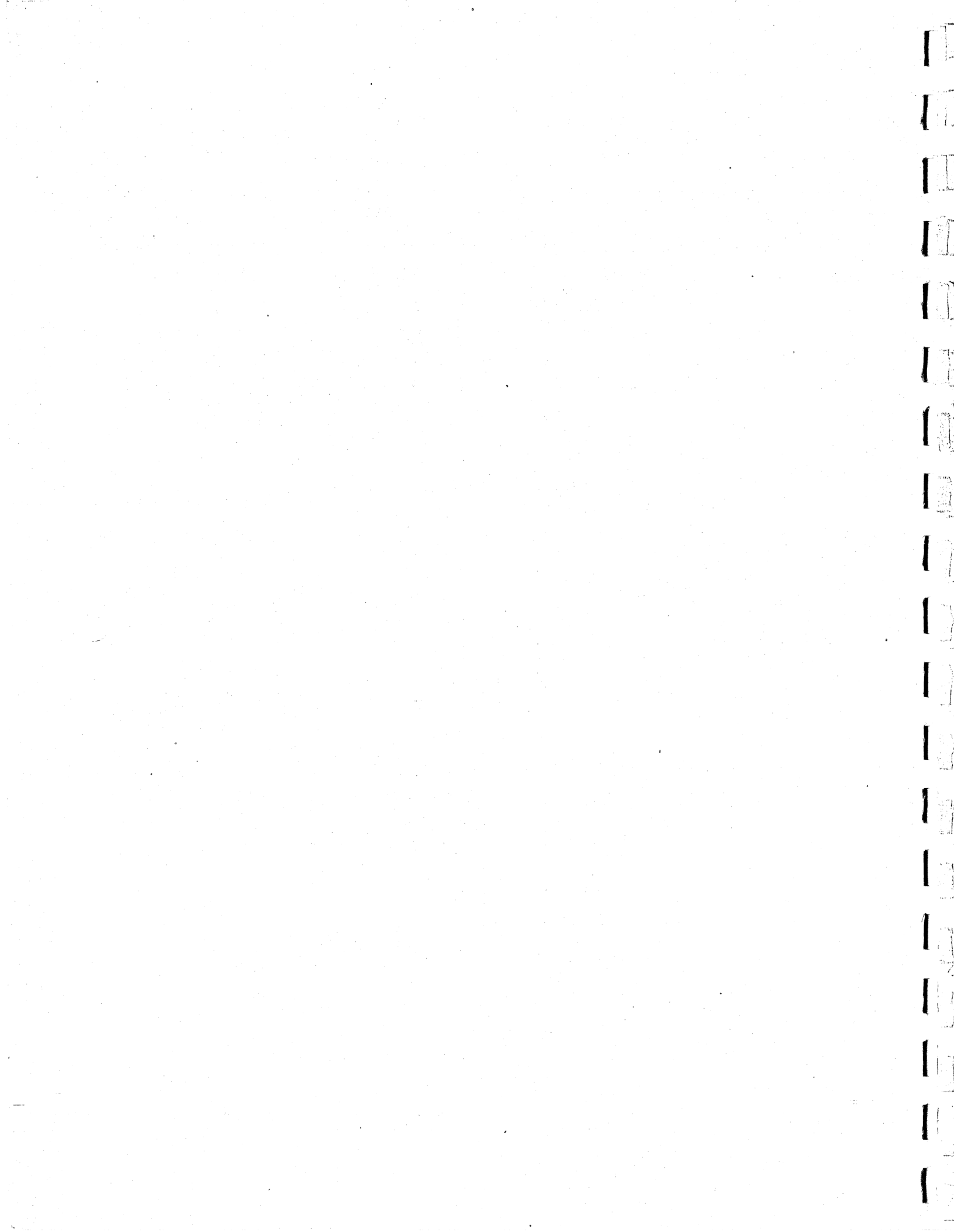

TABLE OF CONTENTS

Section		Page
1	GENERAL INFORMATION	1-1
1.1	Introduction	1-1
1.2	Component Description	1-1
1.2.1	Terminal Controller	1-1
1.2.1.1	Display Processor	1-5
1.2.1.2	Read/Write Memory	1-5
1.2.1.3	ROM and Status Logic	1-6
1.2.1.4	Multiport Serial Interface	1-6
1.2.1.5	High Speed Serial Interface	1-6
1.2.1.6	Parallel Interface	1-10
1.2.1.7	Digital Graphic Controller	1-10
1.2.1.8	Mapping Memory	1-11
1.2.1.9	Video Controller	1-11
1.2.1.10	Timing Module	1-13
1.2.1.11	2D Coordinate Converter	1-13
1.2.1.12	3D Coordinate Converter	1-13
1.2.1.13	EPROM Expansion Module	1-14
1.2.2	Input Devices	1-14
1.2.2.1	Keyboards	1-14
1.2.2.2	Trackball, Forcestick, and Data Tablet	1-14
1.2.2.3	PHOTOPEN	1-15
1.2.2.4	Maintenance Data Input Devices	1-15
1.2.3	Output Devices	1-15
1.2.3.1	Display Monitors	1-15
1.2.3.2	Hardcopy	1-15
1.3	Terminal Controller Physical Description	1-16
1.3.1	Standard Card Cage	1-16
1.3.2	Extended Card Cage	1-17
1.4	Input Devices Physical Description	1-19
1.4.1	Keyboard Physical Description	1-19
1.4.1.1	Model 5783/5784 Keyboards	1-19
1.4.1.2	Model 5789 Keyboard	1-22
1.4.2	Model 5786 Trackball and Model 5787 Forcestick Physical Description	1-29
1.4.3	Model 5788 Data Tablet Physical Description	1-32
1.4.4	Model 5781 Photopen Physical Description	1-34
1.5	Output Devices Physical Description	1-36
1.5.1	Color Monitor Physical Description	1-36
1.5.2	Monochrome Monitor Physical Description	1-40
1.5.3	Hard Copy Unit Physical Description	1-44
1.5.3.1	Monochrome Hard Copy Unit	1-44
1.5.3.2	Color Hard Copy Unit	1-47

TABLE OF CONTENTS (Cont)

Section		Page
1.6	Power and Environmental Requirements	1-50
1.7	Performance Specifications	1-50
1.8	Equipment Identification	1-53
1.9	Test Equipment Requirement	1-53
1.10	Related Publications	1-53
1.11	Mnemonics Conventions	1-54
2	OPERATION	2-1
2.1	General	2-1
2.2	Controls and Indicators	2-1
2.2.1	Terminal Controller Controls and Indicators	2-1
2.2.2	Color Monitor Controls and Indicators	2-3
2.2.3	Monochrome Monitor Controls and Indicators	2-3
2.2.4	Monochrome Hard Copy Unit Controls and Indicators	2-3
2.2.5	Color Hard Copy Unit Controls and Indicators	2-8
2.3	Turn-On Procedures	2-11
2.3.1	Terminal Controller	2-11
2.3.2	Color Monitor	2-11
2.3.3	Monochrome Monitor	2-12
2.3.4	Monochrome Hard Copy Unit	2-12
2.3.5	Color Hard Copy Unit	2-14
2.4	Operating Procedures	2-17
2.4.1	System Mode Operation	2-17
2.4.2	Local Mode Operation	2-19
2.4.2.1	Verification Test Pattern and Diagnostics	2-19
2.4.2.2	Local Mode Commands	2-22
2.4.3	Operator Performance Checks	2-27
2.4.4	Hard Copy Usage	2-29
2.4.4.1	Monochrome Hard Copy Unit	2-29
2.4.4.2	Color Hard Copy Unit	2-29
2.4.5	PHOTOPEN Usage	2-31
2.4.6	Trackball/Forcestick Usage	2-31
2.4.7	Data Tablet Usage	2-32
2.4.8	Turn-Off Procedures	2-32
3	INSTALLATION	3-1
3.1	Environmental Considerations	3-1
3.2	Equipment Cabinet	3-1
3.3	Power Panel Assembly	3-2
3.3.1	Standard Power Panel Assembly	3-2
3.3.2	Alternative Power Panel Assembly	3-4
3.4	System Interconnect Panel Assembly	3-4
3.5	Connections To Be Made At Installation	3-9
3.5.1	Terminal Controller Mounted In Equipment Cabinet	3-9

TABLE OF CONTENTS (Cont)

Section		Page
3.5.2	Terminal Controller Without Equipment Cabinet	3-10
3.5.3	Monitor Connections	3-14
3.5.3.1	Color Monitor	3-14
3.5.3.2	Monochrome Monitor	3-15
3.5.4	Input Device Connections	3-15
3.5.4.1	Keyboards	3-15
3.5.4.2	Trackball and Forcestick	3-16
3.5.4.3	Data Tablet	3-17
3.5.4.4	PHOTOPEN	3-18
3.5.5	Hard Copy Unit Connections	3-19
3.5.5.1	Monochrome Hard Copy Unit	3-19
3.5.5.2	Color Hard Copy Unit	3-20
3.6	Switch and Jumper Selections	3-20
3.6.1	Display Processor II	3-22
3.6.2	Read/Write Memory	3-24
3.6.3	ROM and Status Card	3-27
3.6.4	Multiport Serial Interface	3-30
3.6.5	Parallel Interface	3-34
3.6.6	Digital Graphic Controller	3-38
3.6.7	Video Controller	3-39
3.6.8	Mapping Memory	3-40
3.6.9	Timing Module	3-44
3.6.10	Timing Module II	3-46
4	MAINTENANCE	4-1
4.1	General	4-1
4.2	Maintenance Philosophy	4-1
4.3	Test Equipment Required	4-1
4.4	Troubleshooting Instructions	4-1
4.4.1	Built-In Diagnostics	4-2
4.4.2	Verification Test Pattern	4-3
4.4.2.1	Character Verification	4-3
4.4.2.2	PED Manipulation	4-3
4.4.2.3	Polygon Fill	4-3
4.4.2.4	Point Plot	4-3
4.4.2.5	Overflow Indicators	4-3
4.4.3	Using the Troubleshooting Flow Diagram	4-3
4.4.4	Card Cage Circuit Card Installation	4-3
4.5	Adjustments	4-14
4.5.1	Timing Module (Part Number 5977168) Adjustments	4-14
4.5.2	Timing Module (Part Number 5809960) Adjustments	4-18
4.5.3	Timing Module II (Part Number 5810009G1)	4-18
4.5.3.1	Internal Frequency Load Adjustment	4-18
4.5.3.2	External Synchronization Adjustment	4-18
4.6	Repair	4-21
4.6.1	Circuit Card Replacement	4-21

TABLE OF CONTENTS (Cont)

Section	Page
4.6.2	Chassis-Mounted Components 4-21
4.6.3	Special Handling for MOS Devices 4-22
4.7	Preventive Maintenance 4-22
4.7.1	Inspections 4-22
4.7.2	Cleaning 4-22
 APPENDIX A	 RELATED PUBLICATIONS A-1

LIST OF ILLUSTRATIONS

Number	Page
1-1	Typical GRAPHIC 8 System Configurations 1-2
1-2	GRAPHIC 8 Terminal Controller and Monitor 1-3
1-3	GRAPHIC 8 Terminal Controller Organization 1-4
1-4	GRAPHIC 8 System Memory Map 1-7
1-5	Addressable Vs. Displayable Areas for Four Screen Resolutions 1-12
1-6	Standard Card Cage, Card Locations 1-16A
1-7	Extended Card Cage, Card Locations (Typical) Function Keyboard 1-18
1-8	Typical Model 5783/5784 Keyboard 1-20
1-9	Model 5789 Keyboard 1-22
1-10	Model 5786 Trackball and Model 5787 Forcestick 1-30
1-11	Data Tablet 1-32
1-12	PHOTOPEN 1-34
1-13	Color Monitor, 19-inch (Typical) 1-37
1-14	Monochrome Monitor, 19-inch (Typical) 1-41
1-15	Monochrome Hard Copy Unit 1-44
1-16	Color Hard Copy Unit 1-48
2-1	Terminal Controller Controls and Indicators 2-2
2-2	Color Monitor Controls and Indicators 2-4
2-3	Monochrome Monitor Controls and Indicators 2-6
2-4	Monochrome Hard Copy Unit Controls and Indicators 2-7
2-5	Color Hard Copy Unit Controls and Indicators 2-10
2-6	Verification Test Pattern 2-13
3-1	Interconnection Diagram 3-7
3-2	Terminal Controller Configuration Guide 3-21
3-3	Display Processor II Switch and Jumper Locations 3-22
3-4	Large Read/Write Memory Switch Location 3-24
3-5	Large Refresh Memory Switch and Jumper Locations 3-25
3-6	ROM and Status Card Jumper Locations 3-29
3-7	Multiport Serial Interface Switch and Jumper Locations 3-30
3-8	Multiport Serial Interface, Normal Switch Locations 3-30
3-9	Digital Graphic Controller Switch Locations 3-38
3-10	Video Controller Switches 3-39
3-11	Mapping Memory Switches 3-42

LIST OF ILLUSTRATIONS (Cont)

Number		Page
3-12	Timing Module Switches	3-44
3-13	Timing Module II Switches	3-46
4-1	Verification Test Pattern, Normal Indications	4-4
4-2	Verification Test Pattern, Error Indications	4-5
4-3	Troubleshooting Flow Diagram	4-6
4-4	Timing Module (Part No. 5977168G1) Adjustment Locations	4-15
4-5	Timing Module (Part No. 5977168G2) Adjustment Locations	4-19
4-6	Timing Modules (part Nos. 5810009G1, 5810010G1) Component Locations	4-20
4-7	Timing Module Waveforms	4-20

LIST OF TABLES

Number		Page
1-1	Standard Card Cages	1-16
1-1A	Standard Card Cage Physical Characteristics	1-17
1-2	Extended Card Cage Physical Characteristics	1-19
1-3	Principal Differences Between Keyboards	1-20
1-4	Model 5783/5784 Keyboard Specifications	1-21
1-5	Model 5789 Key Codes	1-23
1-6	Model 5789 Keyboard Specifications	1-28
1-7	PED Specifications	1-31
1-8	Data Tablet Specifications	1-33
1-9	PHOTOPEN Specifications	1-35
1-10	Color Monitor Model Numbers	1-38
1-11	Color Monitor Specifications	1-38
1-12	Monochrome Monitor Model Numbers	1-40
1-13	Monochrome Monitor Specifications	1-42
1-14	Principal Differences Between Monochrome Hard Copy Units	1-45
1-15	Monochrome Hard Copy Unit Specifications	1-46
1-16	Color Hard Copy Unit Specifications	1-47
1-17	GRAPHIC 8 Terminal Controller Specifications	1-50
2-1	Terminal Controller Controls and Indicators	2-1
2-2	Color Monitor Controls and Indicators	2-3
2-3	Monochrome Monitor Controls and Indicators	2-5
2-4	Monochrome Hard Copy Unit Controls and Indicators	2-5
2-5	Color Hard Copy Unit Controls and Indicators	2-8
2-6	Serial Interface Port Codes	2-20
2-7	Local Mode Command Summary	2-23
3-1	Connector P3 Configurations	3-3
3-2	Parallel Interface I/O Connectors, Pin Assignments	3-11
3-3	Multipoint Serial Interface I/O Connectors, Pin Assignments	3-13
3-4	Keyboard Cable Connector, Pin Assignments	3-16

LIST OF TABLES (Cont)

Number		Page
3-5	Trackball or Forcestick Cable Connector, Pin Assignments	3-16
3-6	Data Tablet Connector, Pin Assignments	3-17
3-7	PHOTOPEN Cable Connector, Pin Assignments	3-19
3-8	Display Processor II Switch Settings	3-23
3-9	Read/Write Memory Switches and Jumpers, Part No. 1089724	3-24A
3-10	Large Refresh Memory Switches and Jumpers, Part Number 5809944	3-25
3-11	Large Refresh Memory Bank Swap and Page Size Switch Settings, Part No. 5809944	3-26
3-12	ROM and Status Card Jumper Configurations	3-27
3-12A	Serial Interface Port Device Assignments	3-30A
3-13	Multiport Serial Interface Parameter Selections	3-31
3-14	Parallel Interface Parameter Selections	3-35
3-15	Mapping Memory Configurations	3-40
4-1	Timing Module Pin Assignments	4-16

SAFETY PRECAUTIONS

The following are general safety precautions not related to any specific procedure and therefore do not appear elsewhere in this manual. These are recommended precautions that must be understood and applied during installation or maintenance of the terminal controller.

AVOID LIVE CIRCUITS

Observe all safety regulations at all times. Do not replace components in the terminal controller power panel assembly with power applied.

RESUSCITATION

When working with or near high voltages, be familiar with modern resuscitation methods.

WARNING

Primary power (100 Vac to 240 Vac) is present at the power panel assembly. Line voltage of 115 Vac is present at the power supply. Always turn off terminal controller and pull power plug before moving any cabinet- or chassis-mounted component.

TERMINAL CONTROLLER PROTECTION

Circuit card assemblies in the terminal controller can be damaged by transient surges.

CAUTION

Always turn off terminal controller before removing or installing any circuit card.

SPECIAL HANDLING FOR MOS DEVICES

MOS devices are subject to damage caused by static charges. Assemblies that contain MOS devices are mapping memories and timing module. When not installed in the card cage, these assemblies should be stored in black Velostat bags with the MOS warning statement printed on the outside of the bag.

CAUTION

Always handle these cards only by the card extractors or by the edges of the connector. Avoid touching the card components or the printed circuit.

SPECIAL HANDLING FOR UV EPROMS

UV EPROMs are subject to damage by ultra violet radiation (including sunlight and some fluorescent lamps). Do not remove the paper cover from the sensitive area of the device. When not installed in the card cage, store the card assemblies in light-proof bags. Card assemblies that contain UV EPROMs are the digital graphic controller and expansion module.

WARNING

This equipment generates, uses, and can radiate radio frequency energy; and if not installed and used in accordance with the instructions manual, may cause interference to radio communications. It has been tested and found to comply with the limits for a Class A computing device pursuant to Subpart J of Part 15 of FCC Rules, which are designed to provide reasonable protection against such interference when operated in a commercial environment. Operation of this equipment in a residential area is likely to cause interference, in which case the user at his own expense will be required to take whatever measures may be required to correct the interference.

NOTE

The GRAPHIC 8 was tested and found to comply with the limits for a Class A computing device with the terminal controller installed in a model 7895 equipment cabinet. If the user does not procure the model 7895 equipment cabinet, the user is responsible for providing an installation with comparable shielding qualities.

SECTION 1

GENERAL INFORMATION

1.1 INTRODUCTION

The Sanders Associates, Inc. GRAPHIC 8™ is a high-performance, intelligent computer graphics terminal system incorporating refreshed raster display technology. It is designed to interface a host computer and to support operator CRT display monitor stations configured with interactive devices such as keyboards, trackballs, forcesticks, and data tablets. It can also produce permanent hard copy records of displayed data.

The GRAPHIC 8 features a dynamic display update via a double refresh buffer memory technique, and supports up to four CRT display monitors. Resolutions of 512 x 512, 640 x 480, 1024 x 768 (interlaced) or 1024 x 1024 (interlaced) are available. Both color and monochrome versions are offered with up to 8 bits per pixel to provide as many as 256 simultaneous colors or monochrome intensities (or 128 plus blink).

The GRAPHIC 8 display processor is a general purpose digital computer with a set of over 400 instructions that controls a variety of functions to reduce the loading on the host computer. In combination with the host computer, the GRAPHIC 8 system permits the user to display digital data in a visual format on the CRT display monitor and to interact with the displayed image by means of keyboards, forcesticks, trackballs, data tablets, and PHOTOPENS®. Its high performance and intelligence make it well suited to a variety of applications, such as CAD/CAM, simulation and training, command and control, cartography, and many others.

1.2 COMPONENT DESCRIPTION

The basic GRAPHIC 8 system (figure 1-1) consists of a terminal controller (figure 1-2) and a monitor. The basic system can be expanded to include a wide variety of options and enhancements.

1.2.1 TERMINAL CONTROLLER. The GRAPHIC 8 terminal controller consists of a rack mountable card cage and a power supply. As shown in figure 1-3, the cards are interconnected by a processor bus and a graphic bus. The size of controller selected is based on the four following major considerations:

™GRAPHIC 8 is a trademark of Sanders Associates, Inc.

®PHOTOPEN is a registered trademark of Sanders Associates, Inc.

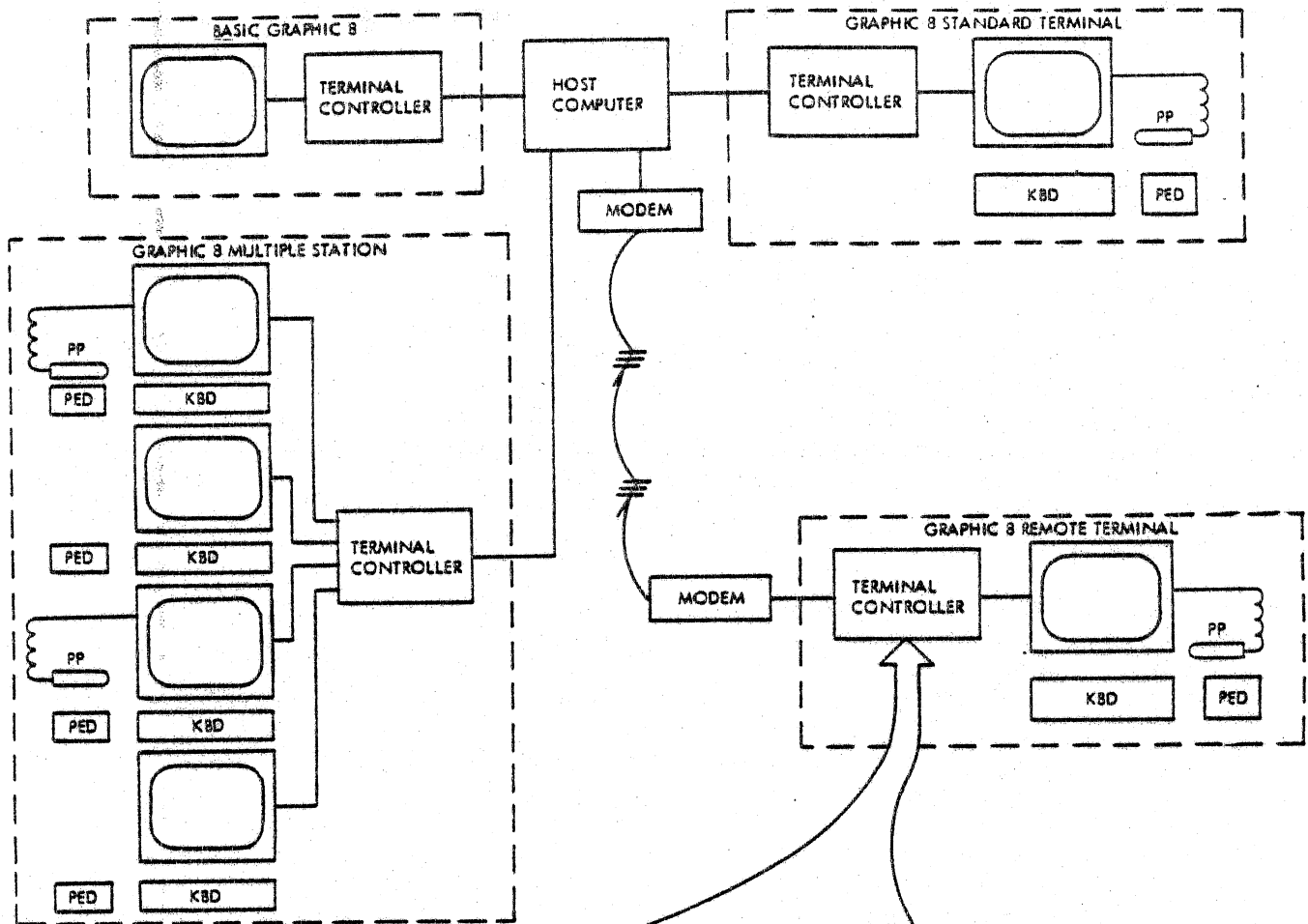

KBD - KEYBOARD
 PED - TRACKBALL, FORCESTICK,
 DATA TABLET
 PP - PHOTOPEN

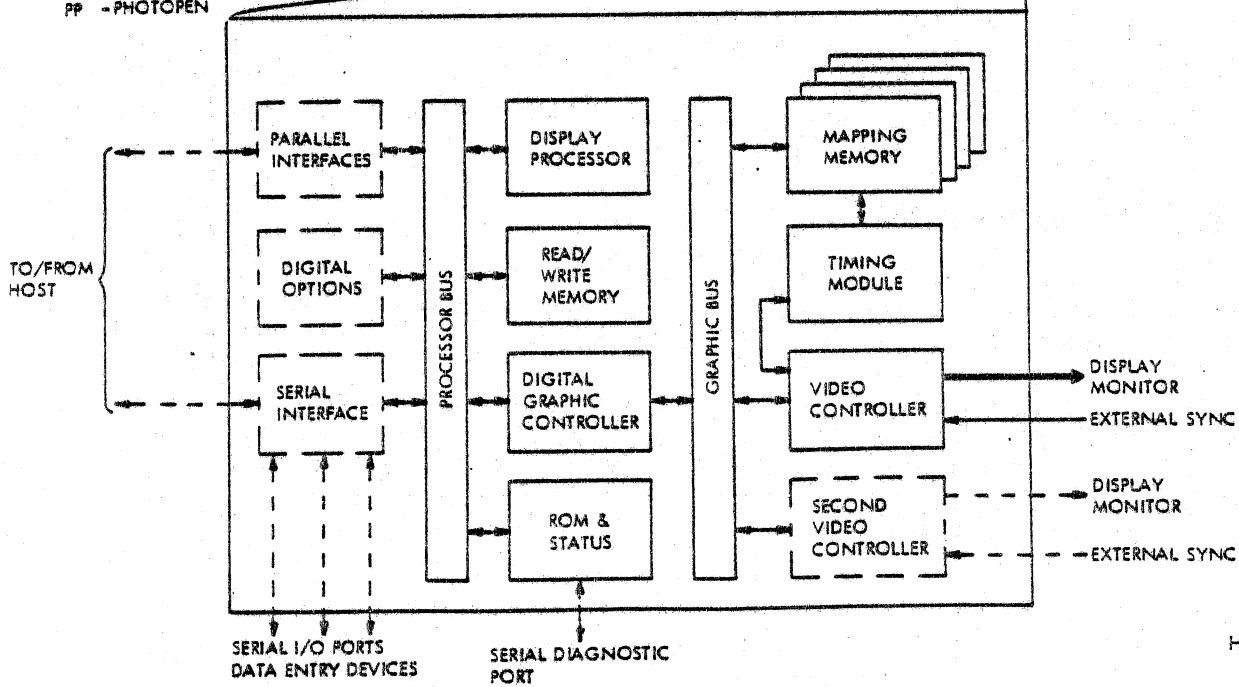

H-82-0176-001

Figure 1-1. Typical GRAPHIC 8 System Configurations

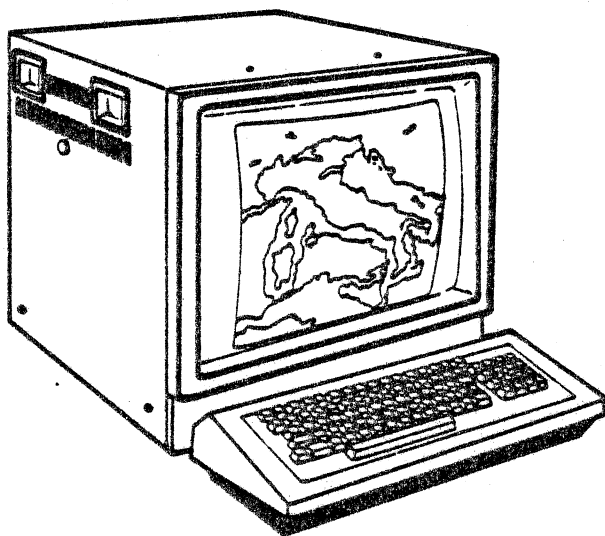

COLOR DISPLAY MONITOR
AND KEYBOARD

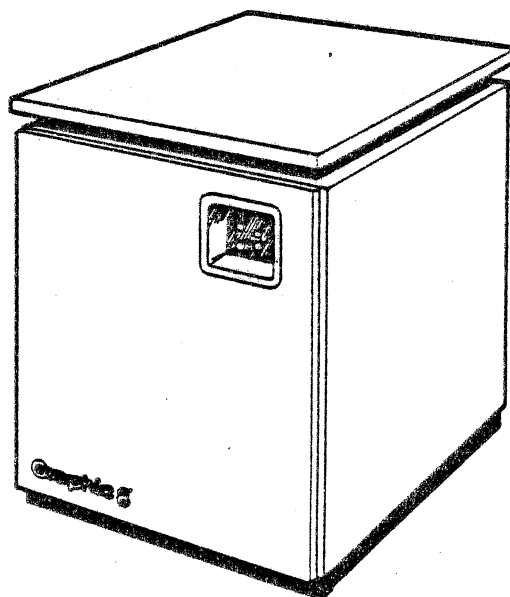

TERMINAL CONTROLLER

H-82-0176-002

Figure 1-2. GRAPHIC 8 Terminal Controller and Monitor

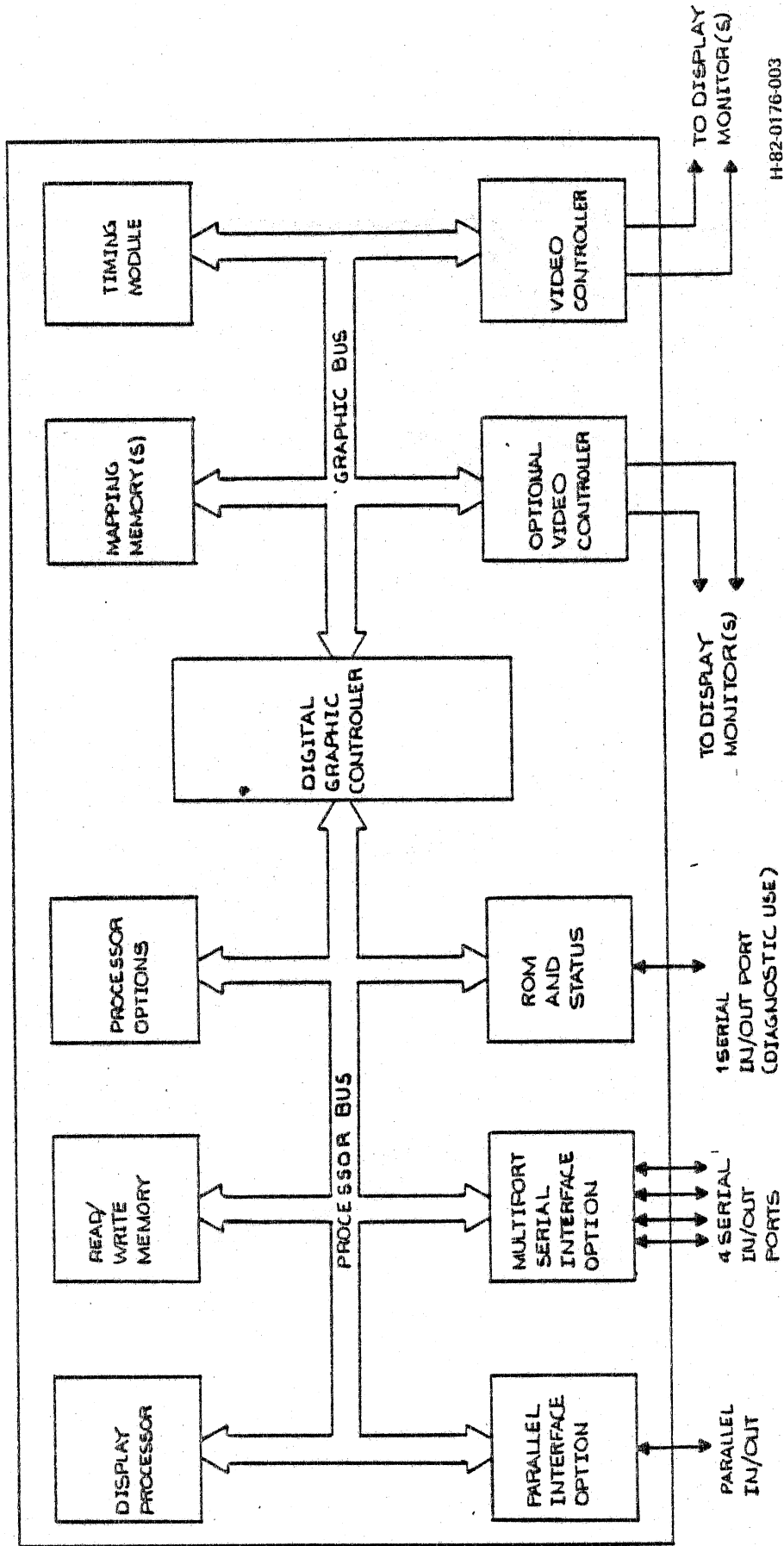

H-82-0176-003

Figure 1-3. GRAPHIC 8 Terminal Controller Organization

1. Color or monochrome
2. Number of simultaneous colors or intensities
3. Resolution of the display image
4. Number of display stations per controller

The basic GRAPHIC 8 terminal controller consists of a 17-slot card cage with integral power supply. Six of the slots are for the processor cards, one slot is for the digital graphics controller, one slot is for the timing module, and the remaining nine slots are for mapping memory and video controller cards.

An optional, 25-slot card cage with separate power supply and control panel is also available. Twelve of the slots are for the processor cards, one slot is for the digital graphic controller card, one slot is for the timing module, and the remaining eleven slots are for mapping memory and video controller cards.

The following paragraphs give a brief description of each type of circuit card available for use with the GRAPHIC 8 terminal controller.

1.2.1.1 Display Processor. The display processor card is a general purpose digital computer that runs the control program and acts as master control for all devices connected to the processor bus. It contains multiple high-speed general-purpose registers that can be used as accumulators, pointers, index registers, or auto-indexing pointers in auto-increment and auto-decrement modes. Functions performed by the display processor card include system initialization, interface handling, local data editing, and local generation of simple display images.

Instructions used for the display processor emulate the instruction set for the PDP-11/34[®] manufactured by Digital Equipment Corporation (DEC[®]). They are fetched either from the control program in read-only memory on the ROM and status logic card or from the read/write memory.

An 8-bit configuration switch register on the display processor is program readable from octal location 177774. The switches may be set to an octal value and read like any other memory location. The four least significant bit switches are usually set to represent port assignments for keyboard and position entry devices. A second switch on the display processor allows the circuit to operate at either a 400-nanosecond or a 300-nanosecond cycle time.

1.2.1.2 Read/Write Memory. The GRAPHIC 8 system can accommodate up to 256K words (512K bytes) of read/write memory. Two card configurations are available: 64K words and 256K words. Also available are

[®]PDP and DEC are registered trademarks of Digital Equipment Corporation

depopulated versions of these two configurations. The GRAPHIC 8 can thus be fitted with one or two of the 64K word cards, or one 256K word card.

Those devices in the card cage that have 18-bit address lines (such as the digital graphic controller) can directly access addresses up to 128K, less certain addresses which are reserved for other functions. For example, 0 to 4K is reserved for interrupts and vector trap addresses, while 24K to 32K is reserved for the operating program and device addresses.

The display processor also has an 18-bit address line, giving direct access to 128K words, less the reserved locations. In addition, the display processor can use the page registers on the read/write memory cards to access addresses above 128K and to access memory locations with the same addresses as the reserved locations.

Figure 1-4 shows how the GRAPHIC 8 system memory may be mapped into 4K, 8K, or 16K word blocks.

1.2.1.3 ROM and Status Logic. The ROM and status logic card contains the read-only memory in which the program used to control the display processor is stored. Also contained on the card are display status and interrupt logic circuits plus a serial interface port to which a teletypewriter may be connected for diagnostic purposes. Like read/write memory, read-only memory may be accessed to retrieve either 16-bit words or individual 8-bit bytes.

The standard read-only memory provided on the ROM and status logic card contains the Graphics Control Program (GCP+) in firmware. GCP+ occupies approximately 7.5K words of read-only memory. GCP+ handles communications with the host computer, controls data entry devices, and performs built-in test routines. These functions reduce the software requirements for the host computer. Optionally available firmware further reduces the software requirements for the host computer. However, these programs are substantially different from GCP+.

1.2.1.4 Multipoint Serial Interface. The multipoint serial interface card contains four serial interface ports that operate in a serial asynchronous mode using RS-232C or TTL voltage levels with standard transmission rates up to 9600 baud. Additionally, the first port can be operated as a full RS-232C asynchronous interface at transmission rates greater than 9600 baud. For GCP applications, the maximum transmission rate supported is 9600 baud. Normally, the host computer is connected to the first port, which is compatible with the standard communication and terminal interfaces supplied by most computer manufacturers. The remaining three ports on the card are used for peripheral devices.

1.2.1.5 High-Speed Serial Interface. An optional, high-speed serial interface, designed for bit stream-oriented packet switching networks, is also available for the GRAPHIC 8. The high-speed serial interface supports the Consultative Committee for International Telephony and

OCTAL PAGE #		EFFECTIVE ADDRESSES
MEMORY BANK 1A		
0	RESERVED	000000:017776
1	MAP AREA 1	020000:037776
2	MAP AREA 2	040000:057776
3	MAP AREA 3	060000:077776
4		100000:117776
5		120000:137776
6	GCP (ROM)	140000:157776
7	DEVICE ADDRESSES	160000:177776
10		200000:217776
11		220000:237776
12		240000:257776
13		260000:277776
14		300000:317776
15		320000:337776
16		340000:357776
17		360000:377776
MEMORY BANK 2B		
20		400000:417776
21		420000:437776
22		440000:457776
23		460000:477776
24		500000:517776
25		520000:537776
26		540000:557776
27		560000:577776
30		600000:617776
31		620000:637776
32		640000:657776
33		660000:677776
34		700000:717776
35		720000:737776
36		740000:757776
37		760000:777776
MEMORY BANK 3C		
40		000000:017776
41		020000:037776
42		040000:057776
43		060000:077776
44		100000:117776
45		120000:137776
46		140000:157776
47		160000:177776
50		200000:217776
51		220000:237776
52		240000:257776
53		260000:277776
54		300000:317776
55		320000:337776
56		340000:357776
57		360000:377776
MEMORY BANK 4D		
60		400000:417776
61		420000:437776
62		440000:457776
63		460000:477776
64		500000:517776
65		520000:537776
66		540000:557776
67		560000:577776
70		600000:617776
71		620000:637776
72		640000:657776
73		660000:677776
74		700000:717776
75		720000:737776
76		740000:757776
77		760000:777776

4K WORD MAPPING

Page Registers:

A - address 172342₈
(Area 1)

B - address 172344₈
(Area 2)

C - address 172346₈
(Area 3)

32K WORDS

64K WORDS

Page Register Format:

(4K Word Octal Page Number)

D ₅	D ₄	D ₃	D ₂	D ₁	D ₀
----------------	----------------	----------------	----------------	----------------	----------------

NOTE

4K word mapping is supported by Sanders Graphics Control Program (GCP).

128K WORDS

192K WORDS

256K WORDS

H-82-0176-004A

Figure 1-4. GRAPHIC 8 System Memory Map (Sheet 1 of 3)

OCTAL PAGE #	EFFECTIVE ADDRESSES
MEMORY BANK 1	
0	RESERVED { 000000:017776 MAP AREA 1 { 020000:037776
1	MAP AREA 2 { 040000:057776 060000:077776
2	100000:117776 120000:137776
3	GCP (ROM) 140000:157776 DEVICE ADDRESSES 160000:177776
4	200000:217776 220000:237776
5	240000:257776 260000:277776
6	300000:317776 320000:337776
7	340000:357776 360000:377776
MEMORY BANK 2	
10	400000:417776 420000:437776 440000:457776
11	460000:477776 500000:517776
12	520000:537776 540000:557776
13	560000:577776 600000:617776
14	620000:637776 640000:657776
15	660000:677776 700000:717776
16	720000:737776 740000:757776
17	760000:777776
MEMORY BANK 3	
20	000000:017776 020000:037776 040000:057776
21	060000:077776 100000:117776
22	120000:137776 140000:157776
23	160000:177776 200000:217776
24	220000:237776 240000:257776
25	260000:277776 300000:317776
26	320000:337776 340000:357776
27	360000:377776
MEMORY BANK 4	
30	400000:417776 420000:437776 440000:457776
31	460000:477776 500000:517776
32	520000:537776 540000:557776
33	560000:577776 600000:617776
34	620000:637776 640000:657776
35	660000:677776 700000:717776
36	720000:737776 740000:757776
37	760000:777776

8K WORD MAPPING

Page Registers:

A - address 172342₈
(Area 1)

B - Not used

C - address 172346₈
(Area 2)

Page Register Format:

(8K Word Octal Page No.) X

D₅ D₄ D₃ D₂ D₁ D₀

X = Don't Care

NOTE

128K WORDS 8K word mapping is NOT supported by Sanders Graphics Control Program (GCP).

192K WORDS

256K WORDS

H-82-0176-0048

Figure 1-4. GRAPHIC 8 System Memory Map (Sheet 2 of 3)

OCTAL PAGE #	EFFECTIVE ADDRESSES
MEMORY BANK 1	
0	RESERVED MAP AREA { 000000:017776 020000:037776 040000:057776 060000:077776
	100000:117776
	120000:137776
	140000:157776
1	GCP (ROM) 160000:177776
	DEVICE ADDRESSES 200000:217776
2	220000:237776
	240000:257776
	260000:277776
	300000:317776
3	320000:337776
	340000:357776
	360000:377776
	MEMORY BANK 2
4	400000:417776
	420000:437776
	440000:457776
	460000:477776
5	500000:517776
	520000:537776
	540000:557776
	560000:577776
6	600000:617776
	620000:637776
	640000:657776
	660000:677776
7	700000:717776
	720000:737776
	740000:757776
	760000:777776
MEMORY BANK 3	
10	000000:017776
	020000:037776
	040000:057776
	060000:077776
11	100000:117776
	120000:137776
	140000:157776
	160000:177776
12	200000:217776
	220000:237776
	240000:257776
	260000:277776
13	300000:317776
	320000:337776
	340000:357776
	360000:377776
MEMORY BANK 4	
14	400000:417776
	420000:437776
	440000:457776
	460000:477776
15	500000:517776
	520000:537776
	540000:557776
	560000:577776
16	600000:617776
	620000:637776
	640000:657776
	660000:677776
17	700000:717776
	720000:737776
	740000:757776
	760000:777776

32K WORDS

64K WORDS

128K WORDS

192K WORDS

256K WORDS

16K WORDS MAPPING

Page Registers:

- A - Not used
- B - Not used
- C - address 172346₈

Page Register Format:

(16K Word Octal Page Number)

				X	X
D ₅	D ₄	D ₃	D ₂	D ₁	D ₀

X = Don't Care

NOTE

16K word mapping is NOT supported by Sanders Graphics Control Program (GCP).

H-82-0176-004C

Figure 1-4. GRAPHIC 8 System Memory Map (Sheet 3 of 3)

Telegraphy (CCITT) X.25 protocol and operates in full duplex at up to 56 kilobaud.

The high-speed serial interface uses two cascaded, 4-bit micro-processor slices. In addition, a large scale integrated circuit (LSI) data link controller on the interface performs full cyclic redundancy checking (CRC) and zero insertion and deletion. Microprogram control storage for the interface is provided by on-board ROM. However, the high-speed serial interface also requires the use of the EPROM expansion module described in paragraph 1.2.1.13. The EPROM expansion module stores the additional software needed for the GRAPHIC 8 to handle input/output via the high-speed serial interface.

The electrical characteristics of the high-speed interface conform to EIA standard RS449.

1.2.1.6 Parallel Interface. Use of an optional GRAPHIC 8 parallel interface allows high-speed host-to-GRAPHIC 8 communications, with handshaking. The various parallel interface cards available are intended for applications where the GRAPHIC 8 is located in proximity to the host. All parallel interface signals are TTL-compatible. Under program control, the interface operates in either an interrupt driven or a DMA mode. In the latter mode, the interface operates at speeds up to 500,000 16-bit words/second. If a parallel interface card is installed in the terminal controller, GCP+ assumes that it is connected to the host computer. Therefore, if serial communication with the host computer is desired, a parallel interface card cannot be connected to the processor bus.

NOTE

Normally, if a parallel interface port is used, a single parallel interface card (for the host computer) is installed in the terminal controller. For special applications, however, two parallel interface cards may be installed, but are not supported by the standard Graphics Control Program.

1.2.1.7 Digital Graphic Controller. The digital graphic controller is a microprocessor with more than 50 instructions committed to ROM. It retrieves display update instructions from read/write memory, generates vectors, characters, conics, point plots, and fills, and stores these in mapping memory in raster-scan format. The complete series of sequential instructions that defines any particular display image is referred to as a refresh file.

The digital graphic controller may be considered as a device on the processor bus of the terminal controller. It contains its own set of registers that maintain instruction address, control fetch operations, and perform any branching that may be specified by non-graphic instructions. It also calculates relative data when required, loads data into appropriate registers, and initiates execution of refresh file instructions.

Status bits of the digital graphic controller are maintained by circuits on the ROM and status logic card. These bits plus the graphic controller registers are accessible to the display processor which maintains control over the entire terminal controller.

The digital graphic controller also performs character generation. The basic set of characters supplied is a standard set of 96 ASCII characters. When the ASCII code corresponding to the desired character is applied to the read-only memory, the character is drawn at the position specified by the current position for X and Y.

As determined by instructions from the digital controller, characters of three different sizes can be generated. Typically, the digital graphic controller generates a 7 x 9 pixel character set or a 5 x 7 pixel character set. Characters may also be rotated 90 degrees counterclockwise to accommodate vertical writing requirements. Both normal and rotated characters can be made to blink.

Read-only memory for six groups of 16 characters can be added to provide a total of 192 standard and special characters that can be produced by the GRAPHIC 8.

1.2.1.8 Mapping Memory. The mapping memory contains pixel data in a format which allows display refresh in a raster scan mode. The mapping memory may be configured for various resolutions up to 1024 x 1024 (see figure 1-5) and for interlace or non-interlace refresh. A single memory board can be supplied with a capacity of over four million bits. Up to eight bits can be combined per pixel to provide 256 possible colors or intensity levels.

A dual mapping memory configuration provides high-speed dynamic update of data. The dual memory concept allows the hardware to clear and update one memory while the second memory is refreshing the display. When the next update occurs, the roles of the two memories are reversed so that the previously updated memory now becomes the refresh memory.

Additional mapping memory cards may be connected in parallel, as needed, to provide the required resolution or number of bits per pixel.

1.2.1.9 Video Controller. The video controller obtains data from the mapping memory and formats it for presentation on the display monitor(s). Outputs are provided as either RGB color or monochrome and as composite video.

External video may be accepted by the video controller and logically ORed with internally-generated video. A single video controller can accommodate up to eight bits per pixel.

The video controller generates one non-destructive, full screen, crosshair cursor and contains the cursor address registers which are accessible to the user. It controls the split screen function which

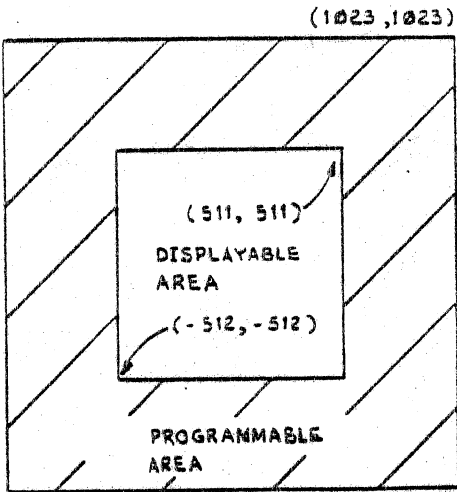

(-1024, -1024)
1024 X 1024

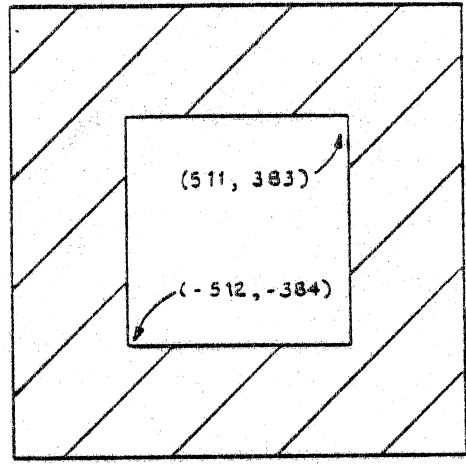

1024 X 768

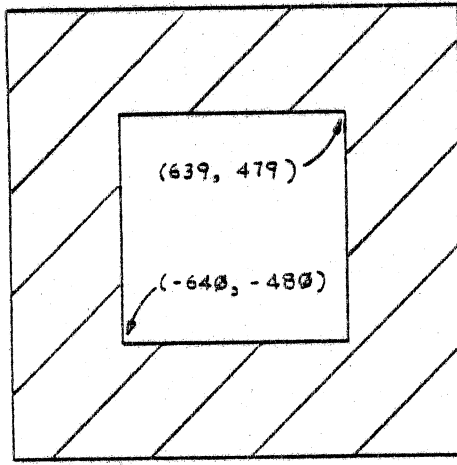

640 X 480

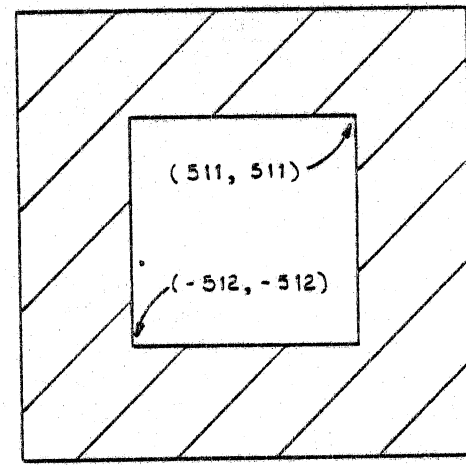

512 X 512

H-82-0176-005

Figure 1-5. Addressable Vs. Displayable Areas for Four Screen Resolutions

allows the user to divide the display face into two or three variable-height horizontal bands and fill these bands with data from anywhere in addressable mapping memory. This feature allows the user to simultaneously view up to three separate areas of mapping memory which are not necessarily contiguous.

The video controller contains a 256 x 8-bit word RAM look-up-table (LUT) which allows pseudo-color or pseudo-gray level transformation to be made.

1.2.1.10 Timing Module. The timing module generates all display-related timing signals as well as the necessary synchronization signals for the monitors. On-board switches allow selection for compatible operation with the possible resolutions and refresh frequencies.

1.2.1.11 2D Coordinate Converter. The optional 2D coordinate converter permits programmed rotation and translation of the image on the CRT display. Rotation commands cause 0 degrees to 360 degrees rotation about any point in the display area. Rotation may be either clockwise or counterclockwise. Translation commands cause the image to move anywhere in the display area. Rotation and translation can be used independently, or translation can follow rotation. Rotation and translation affect only the selected elements of the display presentation, independent of the rest of the display.

1.2.1.12 3D Coordinate Converter. The optional 3D coordinate converter converts a Sanders graphic display into a three dimensional display capable of independent dynamic manipulation of objects in apparent space. Among the functions provided by the 3D coordinate converter are translation, scaling, rotation, windowing, independent display coordinate mapping, perspective, and zooming with perspective.

The perspective feature is especially useful for realistic viewing of an object. Utilizing perspective, the location of the viewer is defined relative to the image space, and all lines and objects within the image space are then viewed at the proper perspective for that location. The view may be completely orthographic if the viewer does not wish to use the perspective feature.

Objects can be defined within a 64K (X), 64K (Y), by 32K (Z) image space and presented on a 1K by 1K screen or any portion thereof. Translations can be made within the limits of the image space and scaling range is 64 to 1. Rotation can be provided about any axis.

3D windowing, in conjunction with independent screen coordinate mapping, allows the presentation of any data within a software definable X, Y, Z image space to be presented on the full screen or any portion of the screen. Zooming is accommodated by scaling and changing the user's apparent perspective viewpoint.

Alphanumeric data can be moved about the screen with vector defined data without scaling and rotation.

The 3D coordinate converter provides for both homogeneous and non-homogeneous matrix operation. Also, transformations of 2D images can be accomplished including translation, rotation, scaling, and windowing.

1.2.1.13 EPROM Expansion Module. As options are added to the GRAPHIC 8, the additional software required to handle the options is stored on the EPROM expansion module.

The expansion module may contain up to 32K 16-bit words of non-volatile read-only memory (EPROMs). The data may be loaded from the expansion module automatically by pressing the SYSTEM button or when so instructed by the host, depending on the options stored.

1.2.2 INPUT DEVICES. Optional data input devices for the GRAPHIC 8 give the operator two-way interaction with the display and processing system. Input devices available include various keyboards, a trackball, a forcestick, a data tablet, and a PHOTOPEN. The standard control program in firmware can support up to eight keyboards, eight position entry devices (trackball, forcestick, or data tablet), or two PHOTOPENS. In addition, a teletypewriter or paper tape reader can be connected to the GRAPHIC 8 for the input of maintenance data.

1.2.2.1 Keyboards. Standard keyboards available for the GRAPHIC 8 are the Model 5783 and Model 5784 keyboards. The keyboards contain a main block of alphanumeric keys plus a matrix and a row of function keys.

The Model 5783 keyboard offers an alphanumeric block of 58 keys. These keys generate standard seven-bit ASCII codes with an eighth (MSB) bit always set to 1. The alphabetic keys generate both upper and lower case codes. A four-by-four matrix of function keys is located to the right of the alphanumeric block and a row of 16 function keys is located immediately above the alphanumeric block. Each function key generates a single eight-bit octal code from 000 to 037.

An added feature of the Model 5784 keyboard is that each function key contains an LED that can be lighted or turned off as required under program control. The Model 5784 also has provisions for additional keys to the basic board. These keys are for future expansion and are located on both sides of the space bar.

The keyboards operate at a rate of 9600 baud and interface to the terminal controller via ports on the multiport serial interface card.

1.2.2.2 Trackball, Forcestick, and Data Tablet. The trackball, forcestick, and data tablet are referred to as PEDs (position entry devices). These devices are used as determined by program control to move a cursor and/or data displayed on the CRT screen. Movement initiated by the trackball is proportional to the speed and direction in which the trackball is rolled. Movement initiated by the forcestick is proportional to the direction and force with which the forcestick is deflected. Movement initiated by a data tablet is

proportional to the speed and direction in which the data tablet pen is moved along the data tablet surface. PEDs are connected to the system via ports on the multiport serial interface card(s) in the terminal controller.

1.2.2.3 PHOTOPEN. The PHOTOPEN is a small hand-held device that detects light from data displayed on the CRT of a display monitor. Detected light is converted into an electrical impulse to identify the specific data at which the PHOTOPEN is pointed. The excellent resolving capability of the PHOTOPEN enables individual characters and even displayed points of light to be distinguished.

A switch in the PHOTOPEN is actuated when the PHOTOPEN is pressed against the CRT screen. Actuation of this switch causes the data sensed by the PHOTOPEN to be processed as determined by program control.

1.2.2.4 Maintenance Data Input Devices. A teletypewriter and/or a paper tape reader can be connected to the GRAPHIC 8 to input data for maintenance purposes. The teletypewriter is normally connected to a port on the ROM and status card in the terminal controller while the paper tape reader is connected to one of the ports on a multiport serial interface card. The teletypewriter serves basically as a troubleshooting aid. The paper tape reader is used to load special user or diagnostic programs into the GRAPHIC 8.

1.2.3 OUTPUT DEVICES. The standard output device for the GRAPHIC 8 is the CRT display monitor. A hardcopy unit is available as an optional device. Using the same signals that go to a standard display monitor, the hardcopy unit can produce a duplicate on paper of any static image displayed on the CRT of the display monitor. Operation of the hardcopy unit is controlled manually.

An optional hardcopy multiplex switch is available. The multiplex switch is capable of interfacing up to four GRAPHIC 8 terminal controllers to a single hardcopy unit.

1.2.3.1 Display Monitors. The GRAPHIC 8 offers the user a choice of configuration of various CRT monitors (both monochrome and color) to provide the right monitor for the intended application.

Positions on the screen are specified in terms of a matrix containing 2048 coordinates in the X dimension and 2048 coordinates in the Y dimension. Two's complement notation is used to designate the coordinates with location 0, 0 being defined as the center of the screen. Of the 2048 by 2048 addressable locations, the displayable area comprises the field of coordinates centered about the middle of the screen. Refer to figure 1-5 for different screen resolutions.

1.2.3.2 Hardcopy. Both monochrome and color hardcopy devices are available for use with the GRAPHIC 8.

1.3 TERMINAL CONTROLLER PHYSICAL DESCRIPTION

The terminal controller comprises a card cage, a power supply, two fans, a control panel, and a protective cover mounted on the back.

The terminal controller may be mounted either in a standard 19-inch equipment rack, an optional cabinet, or an optional desk assembly.

The circuit cards are inserted into the card cage from the front of the terminal controller, and plug into a wire-wrapped backplane. The blower fans, located beneath the card cage, draw air from the bottom of the unit and discharge the air through the top.

The terminal controller can operate with 100V - 120V or 220V - 240V ac input power. An input power control panel (located in a lower front of the equipment cabinet) contains a fuse, a power receptacle, and a removable configuration plug. The configuration plug must be wired for the proper voltages. The power panel contains two outlets. One outlet is live when the circuit breaker is ON. The other outlet is live when the circuit breaker is on and a control signal is applied through a connector (P2) on the power panel.

Both a standard, 17-slot card cage and an optional, 25-slot card cage are available. The following paragraphs describe each of these terminal controller configurations in more detail.

1.3.1 STANDARD CARD CAGE. The card cage supplied for a particular installation is selected as a function of the number of monitors to be driven and the number of cards on the processor bus. See figure 1-6 and table 1-1.

Table 1-1. Standard Card Cages

CARD CAGE PART NO.	CHARACTERISTICS	SEE FIGURE	BACKPLANE DGM
5977184G1	Single monitor, 4 slots available for read/write memory and processor bus options	A, figure 1-6	5977185 in H-81-0097 Rev A
5977184G2	Three monitors, 4 slots available for read/write memory and processor bus options	B, figure 1-6	5977296
5977184G3	Four monitors, 4 slots available for read/write memory and processor bus options	C, figure 1-6	5802978
5809900G1	Two monitors, 7 slots available for read/write memory and processor bus options	D, figure 1-6	5809899

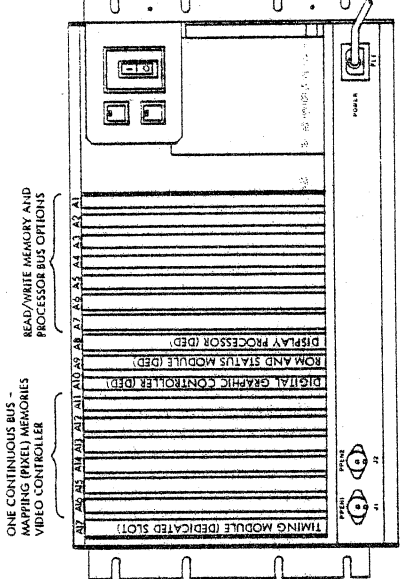

E. PART NO. 580900G2

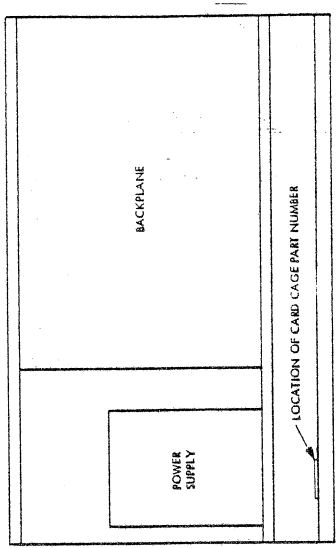

F. CARD CAGE, REAR VIEW

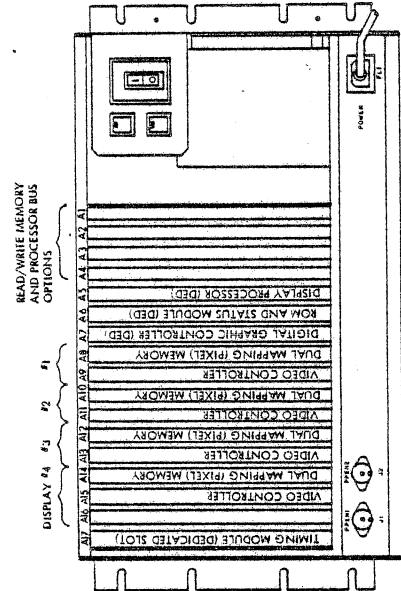

C. PART NO. 597784G3

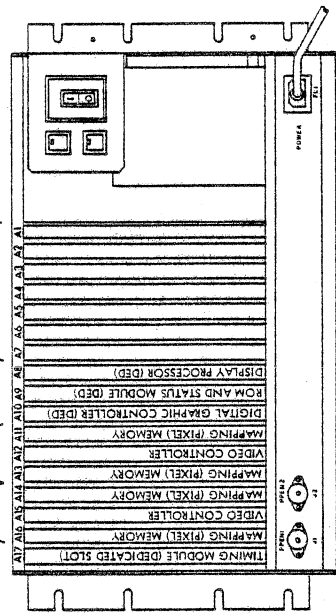

D. PART NO. 580900G1

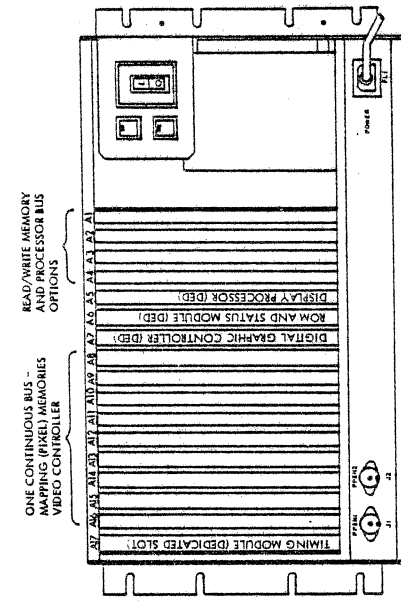

A. PART NO. 597784G1

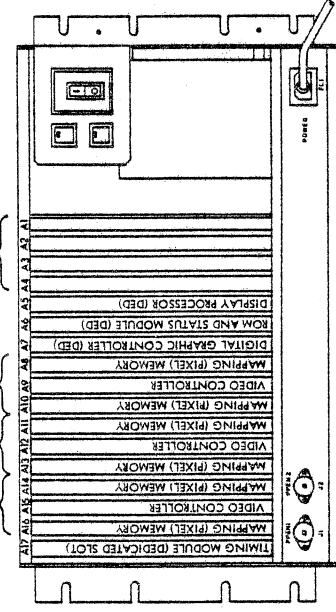

B. PART NO. 597784G2

NOTE: (DED) = DEDICATED

Figure 1-6. Standard Card Cage, Card Locations

Change 2 1-16A/(1-16B blank)

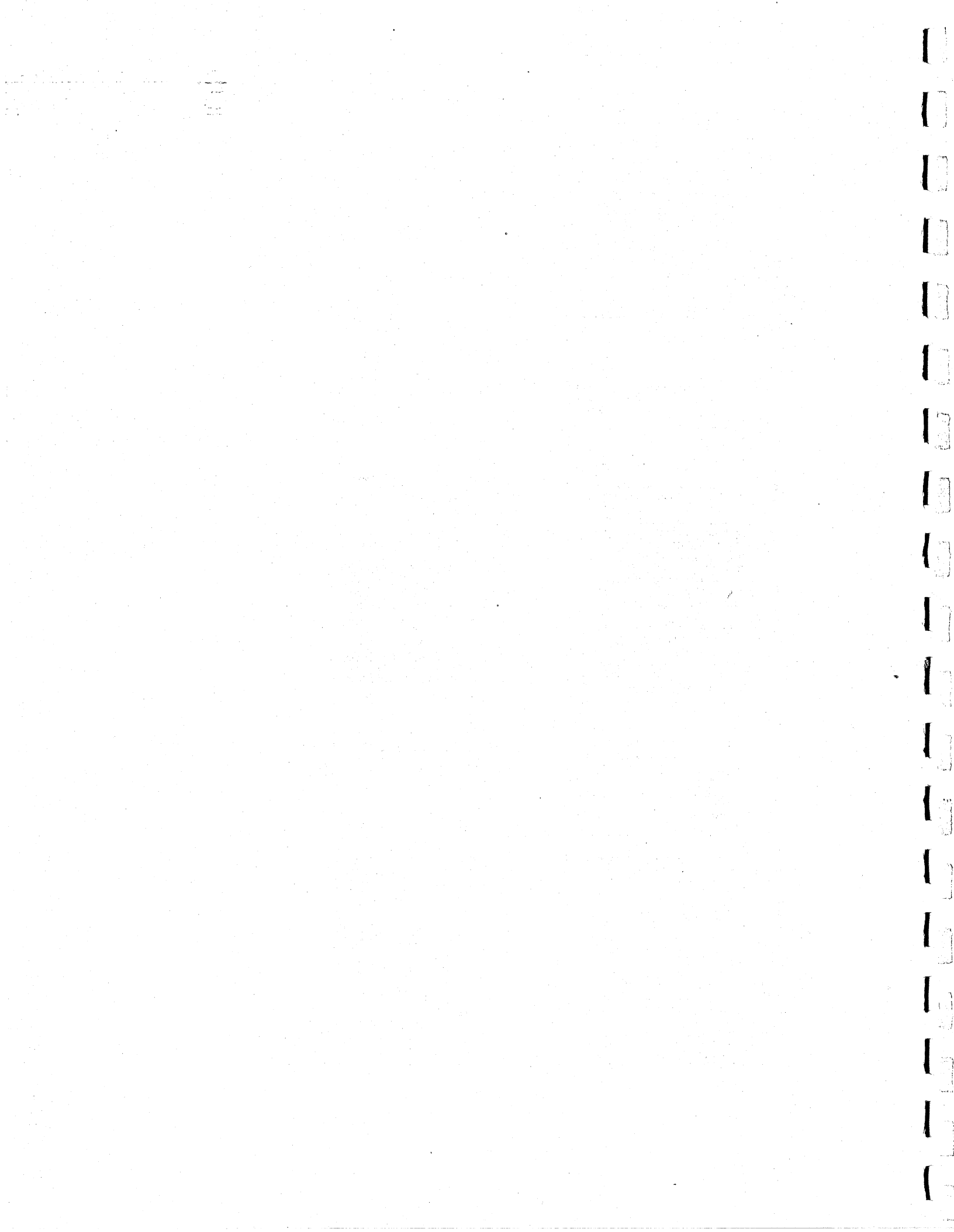

Table 1-1. Standard Card Cages (Cont)

CARD CAGE PART NO.	CHARACTERISTICS	SEE FIGURE	BACKPLANE DGM
5809900G2	Single monitor, 7 slots available for read/write memory and processor bus options	E, figure 1-6	5809850

The card cage assembly number appears at the rear of the card cage, below the power supply (see F, figure 1-6).

On the standard card cage, the terminal controller control panel covers the front of the unit and must be removed for access.

Table 1-1A lists the physical characteristics of the standard card cage and circuit cards.

1.3.2 EXTENDED CARD CAGE. The extended card cage typically contains a minimum of eleven circuit cards. Additional cards may be inserted as required.

The low voltage power supply and controls and indicators for the extended card cage are mounted on a separate panel. This allows unobstructed access to the circuit cards, as needed for adjustment or troubleshooting.

Table 1-1A. Standard Card Cage Physical Characteristics

TERMINAL CONTROLLER	
Height	10.5 inches (26.8 cm)
Width	19.0 inches (48.2 cm) including mounting flanges
Depth	16.0 inches (40.6 cm)
Weight	55 pounds (25 kg) including circuit cards
CIRCUIT CARDS	
Height	12-3/8 inches (31.4 cm)
Width	7-3/4 inches (19.7 cm)

Figure 1-7 shows the circuit card order assumed for a full complement of circuit cards.

Table 1-2 lists the physical characteristics of the extended card cage and circuit cards.

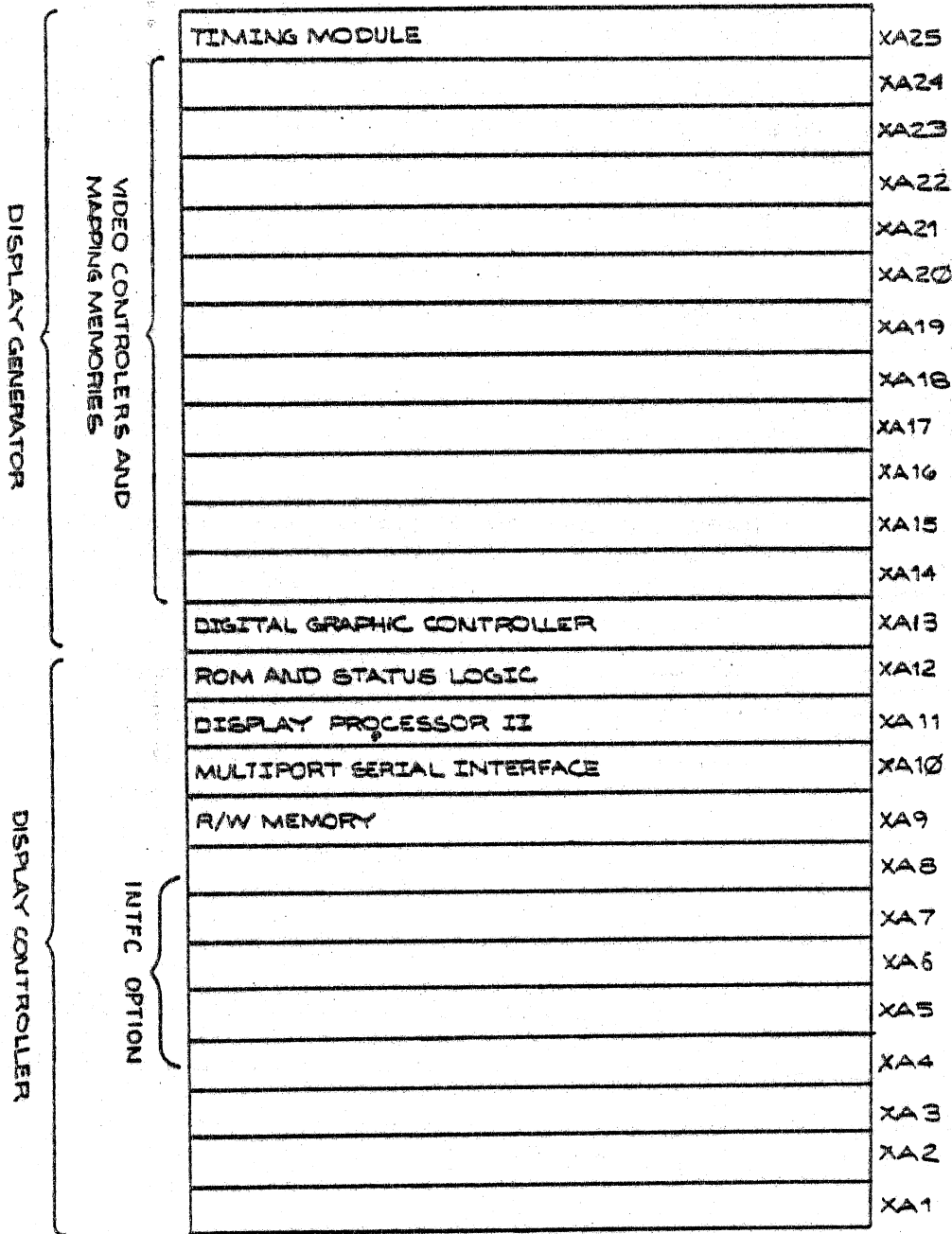

H-82-0176-007

Figure 1-7. Extended Card Cage, Card Locations (Typical) Function Keyboard

Table 1-2. Extended Card Cage Physical Characteristics

TERMINAL CONTROLLER	
Height	10.5 inches (26.8 cm)
Width	19.0 inches (48.2 cm) including mounting flanges
Depth	14.25 inches (40.6 cm)
Weight	55 pounds (25 kg) including circuit cards
CIRCUIT CARDS	
Height	12.375 inches (31.4 cm)
Width	7.75 inches (19.7 cm)
LVPS AND CONTROL PANEL	
Height	8.72 inches (22.25 cm)
Width	19.0 inches (48.2 cm) including mounting flanges
Depth	5.25 inches (13.35 cm)
Weight	20 pounds (9.9 kg), maximum

1.4 INPUT DEVICES PHYSICAL DESCRIPTION

A variety of input devices are available for use with GRAPHIC 8 systems. These include several keyboards, a trackball, a forcestick, a data tablet, and a PHOTOPEN. The following paragraphs describe each of these input devices in more detail.

1.4.1 KEYBOARD PHYSICAL DESCRIPTION. Three keyboard models are currently available for use with GRAPHIC 8 systems: models 5783, 5784, and 5789.

1.4.1.1 Model 5783/5784 Keyboards. Each model 5783 or 5784 keyboard is self contained in a cast aluminum housing, designed for desk top or similar use. Figure 1-8 shows a typical keyboard.

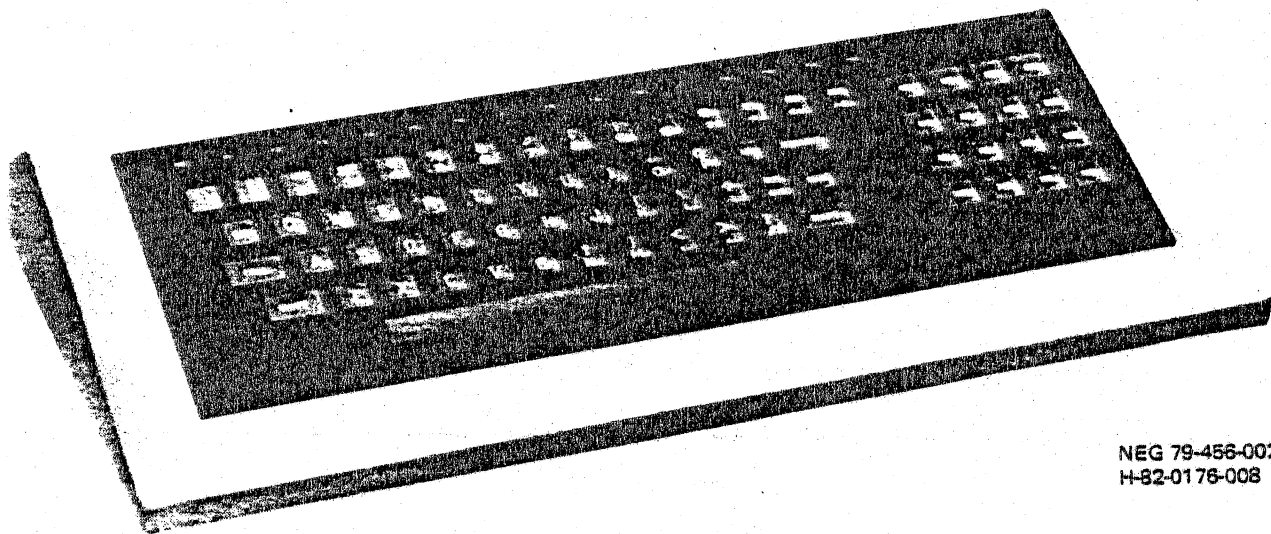

NEG 79-456-002
H-82-0176-008

Figure 1-8. Typical Model 5783/5784 Keyboard

The keyboard contains three separate key sets: a main block of 55 ASCII alphanumeric, symbol, and special purpose keys; a four-by-four matrix of 16 function keys to the right (the matrix keyboard); and a row of 16 function keys across the top (the function keyboard).

Both the model 5783 and the model 5784 keyboard have a lamp in the CAPS LOCK key. In addition, the model 5784 keyboard contains a lamp in each matrix key and each function key. Table 1-3 lists the principal differences between different versions of the model 5783 and model 5784 keyboards.

Table 1-3. Principal Differences Between Keyboards

MODEL	LOGIC TYPE	KEYBOARD	LOCAL MODE CONTROL	AUDIBLE ALARM	TTY EMULATOR
5783	Discrete RAM/ROM	Flat	No	No	No
5783A	Microprocessor	Flat	Yes	No	Yes
5783B	Microprocessor	Stepped	Yes	Yes	Yes
5784	Discrete RAM/ROM	Flat	No	No	No
5784A	Microprocessor	Flat	Yes	No	Yes
5784B	Microprocessor	Stepped	Yes	Yes	Yes

The keyboard interfaces with the terminal controller through one of the terminal controller's serial interface ports. An adapter cable is required between the keyboard cable and the serial interface port connector. No adapter is required when the keyboard cable goes to the system interconnect panel. Refer to Section 3 for details. All power required to operate the keyboard is supplied by the terminal controller.

Table 1-4 lists the keyboard specifications. The model 5783 and model 5784 keyboards are commercial units built to Sanders' specifications. The units are supplied under manufacturer's warranty to Sanders and are not considered field maintainable.

Table 1-4. Model 5783/5784 Keyboard Specifications

PARAMETER	CHARACTERISTIC
Alphanumeric keys	55, momentary action, of which 50 are upper and lower case
Matrix keys	16, momentary action
Function keys	16, momentary action
Power	+5V, $\pm 1\%$, 750 mA max +15V, $\pm 1\%$, 50 mA max -15V, $\pm 1\%$, 50 mA max
Output levels	Logic low is 0.0 to +0.45V Logic high is +2.45 to +5.25V
Output signal characteristics	Serial, RS-232 compatible, negative true <ul style="list-style-type: none"> ● Rest = low ● Logic 1 = low ● Code = 10 bit (one start bit, eight data bits, one stop bit)
Maximum cable length (keyboard to terminal controller)	Model 5783 - 50 feet Model 5784 - 100 feet with external +5V power supply
Operating temperature range	+4°C to +49°C (40°F to 120°F)
Storage temperature range	-40°C to +60°C (-40°F to 140°F)
Humidity	5% to 95%, non-condensing
Storage pressure range	483 mm Hg to 813 mm Hg (19 to 32 inches Hg)

Table 1-4. Model 5783/5784 Keyboard Specifications (Cont)

PARAMETER	CHARACTERISTIC
Dimensions	475 mm wide by 206 mm deep by 94 mm high (18.75 by 8.1 by 3.7 inches)
Weight	3.2 kg (7 lbs.)

1.4.1.2. Model 5789 Keyboard. The model 5789 alphanumeric, fixed function, programmable function keyboard (AN/FF/PFK) is self contained in an aluminum housing, designed for desk top or similar use. Figure 1-9 shows the AN/FF/PFK keyboard.

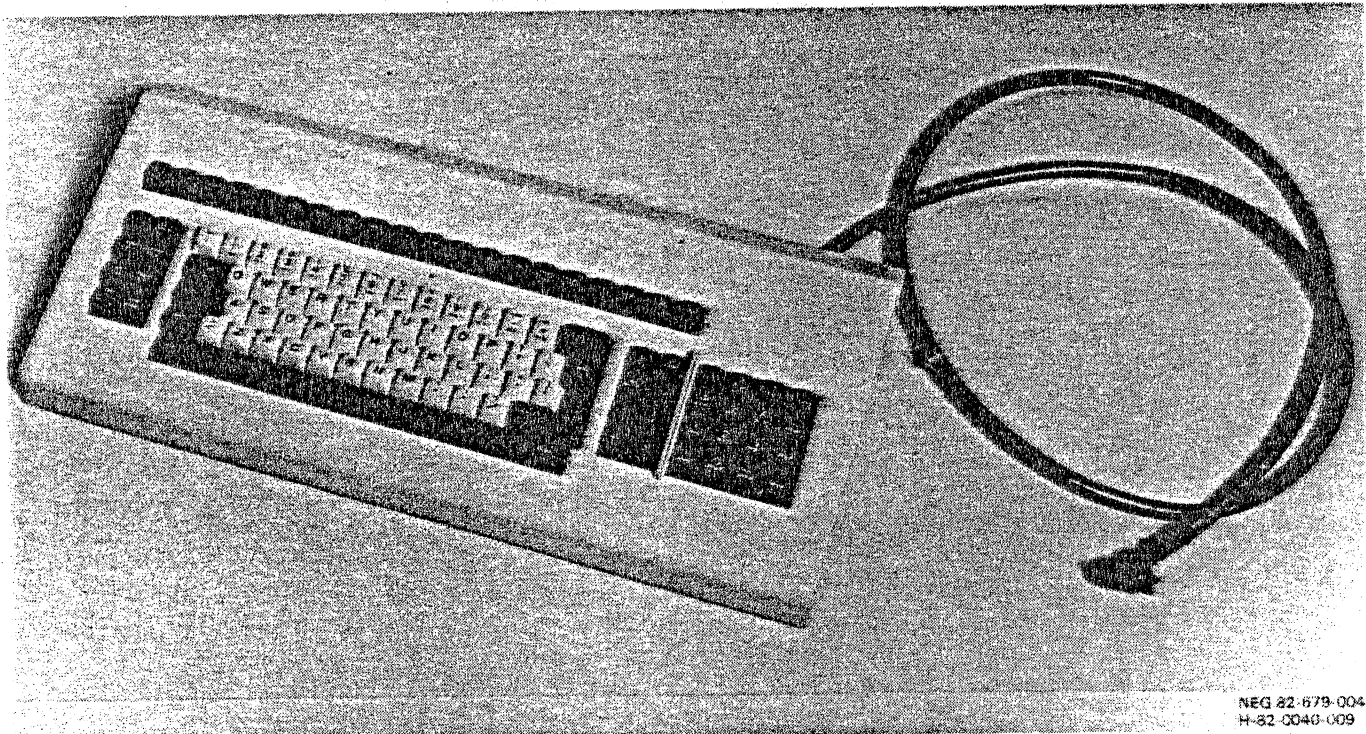

Figure 1-9. Model 5789 Keyboard

The keyboard contains three separate key sets: a main block of 75 ASCII alphanumeric, symbol, and fixed function keys; a four-by-four matrix of 16 programmable function keys to the right (the matrix keyboard); and a row of 20 programmable function keys across the top (the function keyboard). In addition, 12 of the keys in the top row of the main block are also programmable, making 48 programmable function keys in all.

Each key (except the SHIFT, ALT, and LOCK keys), when pressed, causes a 10-bit code to be generated and sent to the multiport serial interface in the terminal controller. The 10-bit code consists of a start bit, eight data bits, and a stop bit. The least significant bit of the eight data bits is sent first, the most significant bit last. The serial data has the following characteristics:

Logic 1 = low (negative true)

Rest = low

Data rate = 9600 baud

The SHIFT, ALT, and LOCK keys modify the codes of the other keys. The ALT key must be held down while the other key is pressed to achieve the ALT function. The SHIFT keys may either be held down while the desired key is pressed, or the LOCK key may be pressed to lock the shift function. The LOCK key is an alternate action switch; pressing it once locks the function, pressing it again releases the function.

Table 1-5 lists the key codes.

Table 1-5. Model 5789 Key Codes

KEY NO.	UNSHIFTED		SHIFTED		ALTERNATE	
	SYMBOL	CODE	SYMBOL	CODE	SYMBOL	CODE
1	PF25	031	PF25	031		
2	PF26	032	PF26	032		
3	PF27	033	PF27	033		
4	PF28	034	PF28	034		
5	PF29	035	PF29	035		
6	PF30	036	PF30	036		
7	PF31	037	PF31	037		
8	PF32	040	PF31	040		
9	PF33	041	PF33	041		
10	PF34	042	PF34	042		
11	PF35	043	PF35	043		
12	PF36	044	PF36	044		
13	PF37	045	PF37	045		
14	PF38	046	PF38	046		
15	PF39	047	PF39	047		
16	PF40	050	PF40	050		
17	PF41	051	PF41	051		

Table 1-5. Model 5789 Key Codes (Cont)

KEY NO.	UNSHIFTED		SHIFTED		ALTERNATE	
	SYMBOL	CODE	SYMBOL	CODE	SYMBOL	CODE
18	PF42	052	PF42	052		
19	PF43	053	PF43	053		
20	PF44	054	PF44	054		
21	SCRN SEL (SCREEN SELECT)	206	SCRN SEL	206	(SPARE)	217
22	RESHOW	221	RESHOW	221	CLEAR	201
23*	(ACCENT GRAVE)	340	~ (TILDE)	376	(SPARE)	177
24*	1	261		335	PF1	001
25*	2	262	@	300	PF2	002
26*	3	263	#	243	PF3	003
27*	4	264	\$	244	PF4	004
28*	5	265	%	245	PF5	005
29*	6	266	—	336	PF6	006
30*	7	267	&	246	PF7	007
31*	8	270	*	252	PF8	010
32*	9	271	(250	PF9	011
33*	0	260)	251	PF10	012
34*	- (HYPHEN)	255	_ (UNDERLINE)	337	PF11	013
35*	=	275	+	253	PF12	014
36*	— (BACK SPACE)	210	—	210	(SPARE)	071
37	DUP	222	DUP	222	PA1	202
38	FIELD MARK	223	FIELD MARK	223	PA2	203

Table 1-5. Model 5789 Key Codes (Cont)

KEY NO.	UNSHIFTED		SHIFTED		ALTERNATE	
	SYMBOL	CODE	SYMBOL	CODE	SYMBOL	CODE
39	ALARM ACK	220	ALARM ACK	220	ENBL DSBL (ENABLE/ DISABLE ALARM)	200
40	GRAPH PICK	224	GRAPH PICK	224	ERASE INPUT	204
41*	→ (TAB)	211	→	211		
42*	q	361	Q	321		
43*	w	367	W	327		
44*	e	345	E	305		
45*	r	362	R	322		
46*	t	364	T	324		
47*	y	371	Y	331		
48*	u	365	U	325		
49*	i	351	I	311		
50*	o	357	O	317		
51*	p	360	P	320		
52*	ç	333	!	241		
53*	/	334		374		
54*	← (BACK TAB)	225	←	225	HOME	205
55	INS MODE (INSERT CHARACTER)	237	INS MODE	237	(SPARE)	171
56	DEL (DELETE CHARACTER)	377	DEL	377	(SPARE)	172
57	ANK ZONE	232	ANK ZONE	232	MOVE	212
58	ERASE EOF	234	ERASE EOF	234	SWITCH OVER	214
59	LOCK	NONE	LOCK	NONE		

Table 1-5. Model 5789 Key Codes (Cont)

KEY NO.	UNSHIFTED		SHIFTED		ALTERNATE	
	SYMBOL	CODE	SYMBOL	CODE	SYMBOL	CODE
60*	a	341	A	301		
61*	s	363	S	323		
62*	d	344	D	304		
63*	f	346	F	306		
64*	g	347	G	307		
65*	h	350	H	310		
66*	j	352	J	312		
67*	k	353	K	313		
68*	l	354	L	314		
69*	;	273	:	272		
70*	,	247	"	242		
71*	{	373	}	375		
72*	← (NEW LINE)	215	←	215		
73*	↑ (CURSOR UP)	236	↑	236	(SPARE)	173
74*	↓ (CURSOR DOWN)	231	↓	231	(SPARE)	174
75	PRINT	233	COPY	216	LEFT FREZE	213
76	PFK ZONE	227	PFK ZONE	227	TEST	207
77	SHIFT	NONE	SHIFT	NONE		
78*	<	274	>	276		
79*	z	372	Z	332		
80*	x	370	X	330		
81*	c	343	C	303		
82*	v	366	V	326		
83*	b	342	B	302		

Table 1-5. Model 5789 Key Codes (Cont)

KEY NO.	UNSHIFTED		SHIFTED		ALTERNATE	
	SYMBOL	CODE	SYMBOL	CODE	SYMBOL	CODE
84*	n	356	N	316		
85*	m	355	M	315		
86*	,	254	,	254		
87*	.	256	.	256		
88*	/	257	?	277		
89	SHIFT	NONE	SHIFT	NONE		
90*	— (CURSOR LEFT)	210	—	210	(SPARE)	175
91*	— (CURSOR RIGHT)	226	—	226	RIGHT FREEZE	176
92	RESET	230	RESET	230		
93*	SPACE BAR	240	SPACE BAR	240		
94	ALT	NONE	ALT	NONE		
95	ENTER	235	ENTER	235		
96	PF13	015	7	267		
97	PF14	016	8	270		
98	PF15	017	9	271		
99	PF45	055	(SPARE)	170		
100	PF16	020	4	264		
101	PF17	021	5	265		
102	PF18	022	6	266		
103	PF46	056	(SPARE)	167		
104	PF19	023	1	261		
105	PF20	024	2	262		
106	PF21	025	3	263		
107	PF47	057	(SPARE)	166		

Table 1-5. Model 5789 Key Codes (Cont)

KEY NO.	UNSHIFTED		SHIFTED		ALTERNATE	
	SYMBOL	CODE	SYMBOL	CODE	SYMBOL	CODE
108	PF22	026	.	256		
109	PF23	027	0	260		
110	PF24	030	- (MINUS)	255		
111	PF48	060	(SPARE)	165		

Certain keys (indicated by an asterisk in the KEY NO. column of table 1-5 have a feature called Typamatic. This is an automatic repeat function. When you hold any one of these keys down, it automatically repeats at a rate of 10 times per second, after an initial half-second delay.

The Typamatic function is effective in both shifted and unshifted modes. It is not effective when you press the ALT key.

The keyboard also provides two audible tones. The alarm tone is activated by a code received from the terminal controller. The alarm tone is automatically shut off after 20 seconds. The alarm tone may also be shut off before 20 seconds elapses, by a shut-off code received from the terminal controller. The second audible tone corresponds to the TTY bell function, and is activated by a code received from the terminal controller. The TTY bell tone lasts about one-half second. The two audible tone frequencies are sufficiently different to allow immediate recognition of one from the other.

All power required to operate the model 5789 keyboard is supplied by the terminal controller.

Table 1-6 lists the keyboard specifications. The model 5789 keyboard is a commercial unit built to Sanders specifications. The keyboard is supplied under manufacturer's warranty to Sanders and is not considered field maintainable.

Table 1-6. Model 5789 Keyboard Specifications

PARAMETER	CHARACTERISTIC
Alphanumeric/fixed function keys	One alternate action and 71 momentary action, of which 50 are SHIFT key affected and 30 are ALT key affected
Programmable function keys	36 momentary action, of which 16 are SHIFT key affected

Table 1-6. Model 5789 Keyboard Specifications (Cont)

PARAMETER	CHARACTERISTIC
Power	+5V, $\pm 1\%$, 850 mA maximum +15V, $\pm 1\%$, 50 mA maximum -15V, $\pm 1\%$, 50 mA maximum
Output levels	Logic low is 0.0V to +0.45V Logic high is +2.45V to +5.25V
Output signal characteristics	Serial, RS-232 compatible, negative true <ul style="list-style-type: none"> ● Rest = low ● Logic 1 = low ● Code = 10 bits (one start bit, eight data bits, one stop bit)
Maximum cable length (keyboard to terminal controller)	(To be determined)
Operating temperature range	+40°F to +120°F
Storage temperature range	-40°F to 140°F
Relative humidity	10% to 90%, noncondensing
Storage pressure range	19 inches to 32 inches, Hg
Dimensions	Length 20.5 inches (52.1 cm) Width 10.0 inches (25.4 cm) Height 3.25 inches (8.3 cm)
Weight	(To be determined)

1.4.2 MODEL 5786 TRACKBALL AND MODEL 5787 FORCESTICK PHYSICAL DESCRIPTION. The trackball and forcestick are position entry devices (PEDs). A PED provides position input data to the terminal controller and controls the position of a cursor on the screen of a display monitor. The model 5786 trackball and the model 5787 forcestick are shown in figure 1-10.

Each PED is self contained in a black plastic case designed for desk top or similar use. Except for the means by which they are controlled, the two units are physically identical.

The trackball is controlled by means of a phenolic composition ball that can be rotated continuously in any direction. Interfacing with the internal electronics is accomplished by two digital shaft encoders that are turned by the ball as it is rotated.

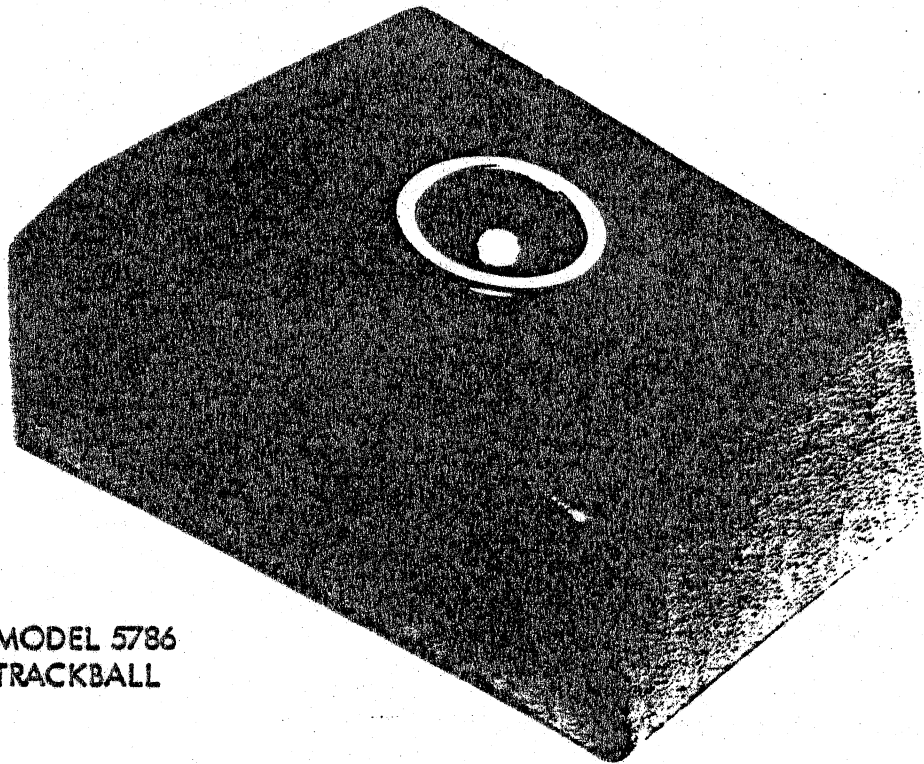

MODEL 5786
TRACKBALL

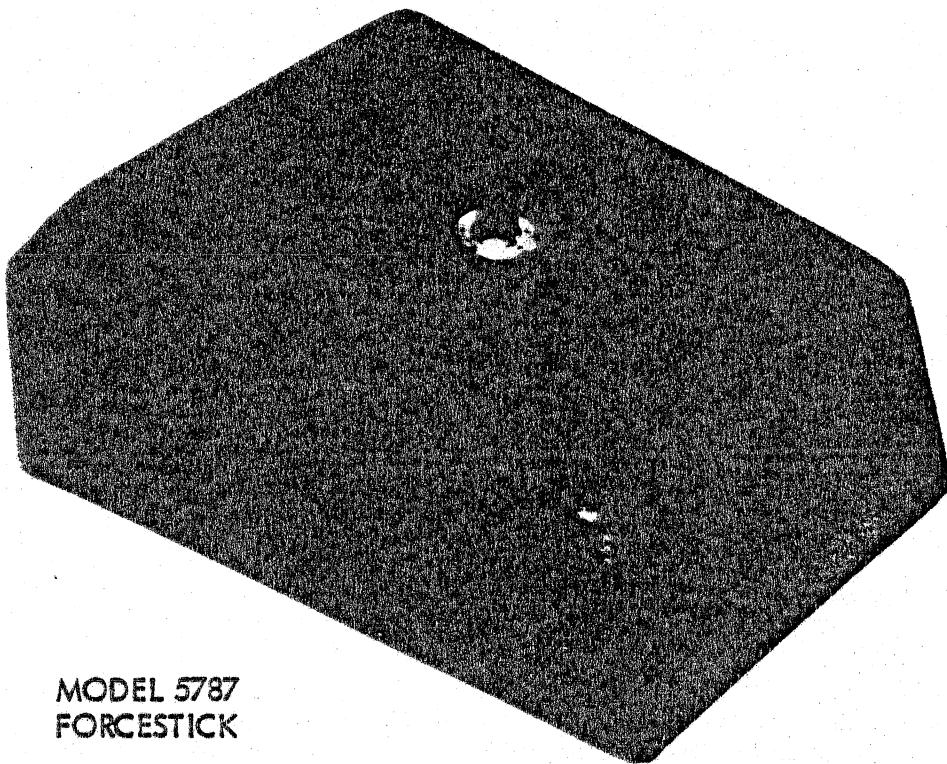

MODEL 5787
FORCESTICK

NEG 79-456-007
H-82-0176-009

Figure 1-10. Model 5786 Trackball and Model 5787 Forcestick

The forcestick is controlled by means of spring-loaded rod approximately one inch long that can be deflected in any direction. Interfacing with the internal electronics is accomplished by strain gauges that are actuated when the rod is deflected.

Table 1-7 lists the specifications for both the trackball and the forcestick. Both the trackball and forcestick are commercial units built to Sanders' specifications. Each is supplied with a six-foot, permanently attached cable. A 15-pin connector on the cable plugs into one of the jacks on the system interconnect panel used with the GRAPHIC 8 terminal controller. The units are supplied to Sanders under manufacturer's warranty and are not field repairable or adjustable.

Table 1-7. PED Specifications

	TRACKBALL	FORCESTICK
Electrical Interface (to Terminal Controller)		
Code Signal Levels	256-bit binary words, 9600 baud, asynchronous RS-232C	
Word Repetition Rate	37.5 Hz	
Cursor Movement	300 display elements per revolution of ball	1280 display elements per second maximum
Resolution	Within one display element in 1024	
Force to Move Cursor	15 grams (typical)	37 grams, minimum cursor movement 909 grams, maximum cursor movement
Power Requirements	+5V, 410 mA ±15V, 20 mA	+5V, 450 mA ±15V, 20 mA
Operating Temperature	15°C to 40°C (59°F to 104°F)	
Humidity	10% to 90%	
Connector	Cannon DA-15P	
Cable	6 feet supplied, 50 feet maximum length	
Size	Height - 3.3 inches Width - 5.0 inches Depth - 7.5 inches	

Table 1-7. PED Specifications (Cont)

	TRACKBALL	FORCESTICK
Weight	3.0 pounds (1.36 kg)	2.5 pounds (1.14 kg)
Mechanical Action	Friction drive, spring loaded	Spring return to center

1.4.3 MODEL 5788 DATA TABLET PHYSICAL DESCRIPTION. The data tablet is a position entry device used to move a cursor and/or data displayed on a display monitor. The data tablet is shown in figure 1-11.

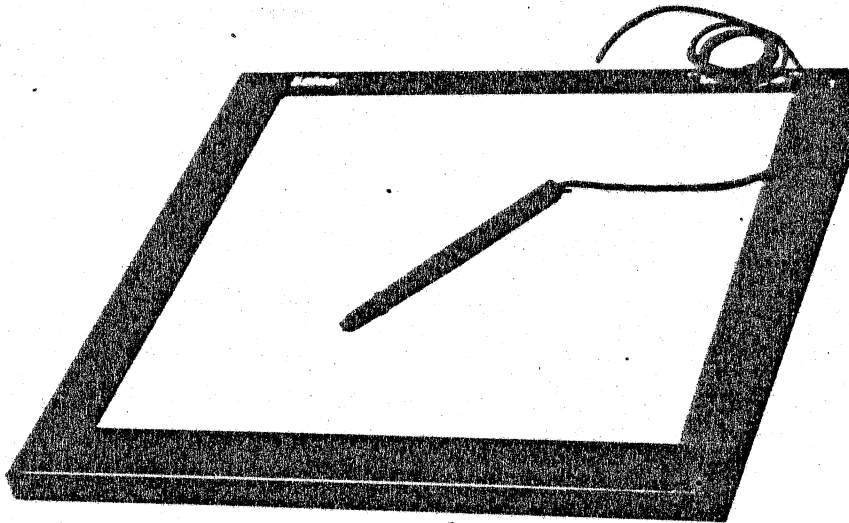

NEG 81-108-001
H-82-0176-010

Figure 1-11. Data Tablet

The model 5788 data tablet has a formica surface that is housed in a steel and aluminum frame designed for desk top or similar use. The data tablet is a digitizer that uses a system of magnetic coupling between an electronic pen stylus transducer and an active surface to resolve positional coordinates. Movement initiated by the data tablet is proportional to the speed and direction in which the pen stylus is moved along the active surface. The data tablet may also be used to plot individual X, Y coordinate pairs.

Switch selection of the output and operation modes is provided on the data tablet rear panel. Two connectors are also provided on the rear panel: one for the output circuits and one for the pen stylus. All power required to operate the data tablet is supplied from the terminal controller and is applied to the data tablet via the rear panel output circuit connector.

Table 1-8 lists the specifications for the data tablet. The data tablet is a commercial unit built to Sanders' specifications. The data tablet is supplied under manufacturer's warranty to Sanders and is not field repairable or adjustable.

Table 1-8. Data Tablet Specifications

PARAMETER	CHARACTERISTIC
<u>Electrical</u> Active surface area (in.) Total surface area (in.) Resolution (lines/in.) Accuracy (in.) Coordinate refresh rate (pr/sec) Operating modes Transducer Output configurations Nominal Power Requirements Operational temperature range	11 x 11 12.8 x 12.8 400 (200 full parallel) ± 0.025 120 (standard) 240 (optional) Point, run Pen stylus <u>Option 1</u> 8-bit parallel, binary and BCD <u>Option 2</u> Serial, TTL, and RS232 <u>Option 3</u> Full parallel, binary 15 Vdc at 0.15A 15° to 40°C
<u>Mechanical</u> Tablet: Weight (lb) Enclosure Size (in.)	7.25 Steel and aluminum 15.66 x 15.24 x (0.76 front; 2.14 rear)

Table 1-8. Data Tablet Specifications (Cont)

PARAMETER	CHARACTERISTIC
Pen stylus assembly:	
Length (in.)	5.5
Width (in.)	0.5
Cable (in.)	40

1.4.4 MODEL 5781 PHOTOPEN PHYSICAL DESCRIPTION. The model 5781 PHOTOPEN is a lightweight, hand-held data entry device that uses a light detecting circuit to produce a TTL pulse output. The PHOTOPEN is shown in figure 1-12.

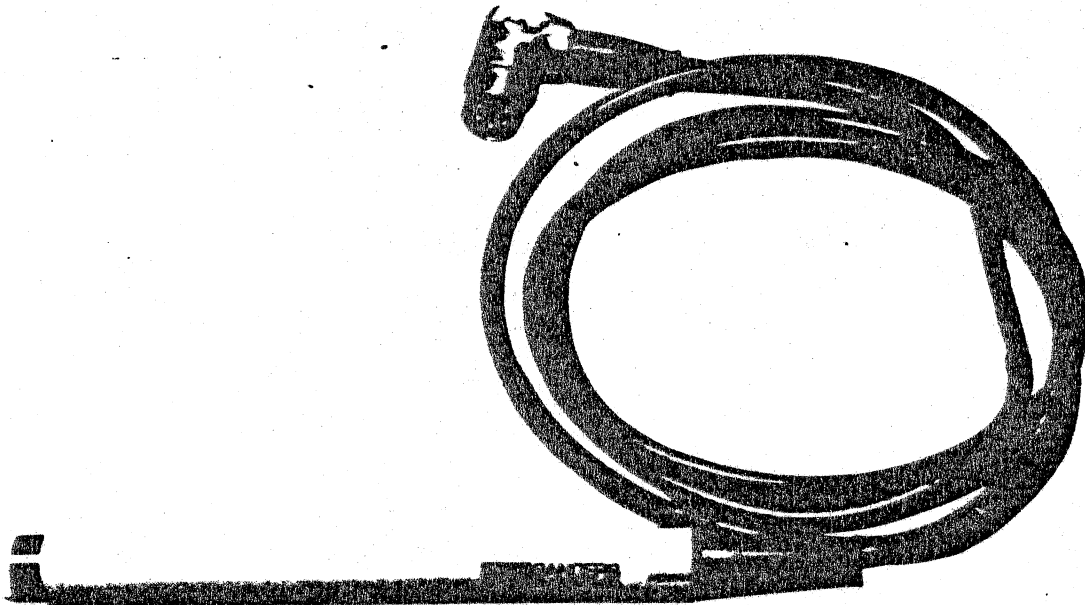

NEG 81-1284-001
H-82-0176-011

Figure 1-12. PHOTOPEN

The housing of the PHOTOPEN unit is made from two concentric metal cylinders, mechanically connected so that the outer shell is pushed back from the tapered front end of the inner cylinder. When the operator holds the unit by its outer shell and pushes the unit against the display monitor CRT screen hard enough, a switch circuit inside the unit produces a steady-state logic level output.

The tapered end of the inner cylinder houses a lens assembly that focuses light from the target area of the display monitor CRT screen onto a photosensitive circuit. The light causes the circuit to produce a low-going logic pulse that confirms the PHOTOPEN strike.

All electronic components of the PHOTOPEN are mounted on a 0.4 x 5.0 inch circuit card contained within the hand-held unit. An end cap at the rear of the hand-held unit provides structural rigidity and forms a grommet for the electrical cable that connects the PHOTOPEN unit to the terminal controller. Color-coded conductors within the cable carry the power required to operate the PHOTOPEN and provide for output signal interfacing. The conductors are soldered to terminal pins on the PHOTOPEN circuit card at one end; the other end of the cable has a 5-pin connector that mates with one of two PPNn connectors on the terminal controller or system interconnect panel.

Table 1-9 lists the specifications for the PHOTOPEN unit.

Table 1-9. PHOTOPEN Specifications

PARAMETER	CHARACTERISTIC
Response time	500 ns, maximum (measured with 40 ft-L with 150 ns pulse on P31 @ 60 Hz)
Sensitivity	10 ft-L with 150 ns pulse on P31 @ 60 Hz, typical
Immunity	No false triggering caused by normal fluorescent or incandescent lamps producing 100 ft-L at display level
EMI	Immune to normal computer and display system EMI
Focal length	Optimized for 3/4-inch length from lens to display screen phosphor plane
Spectral response	Approximately 4,000A to 11,000A
Power input	PHOTOPEN only: +5V @ 25 mA With intensifier/driver assembly: +5V @ 75 mA
Pulse output	TTL signal compatible, as follows: Logic high level with no detected light-pulse input Logic low pulse of approximately, 1.0-us duration when struck by CRT light beam, repeated at CRT refresh intervals if held within target area

Table 1-9. PHOTOPEN Specifications (Cont)

PARAMETER	CHARACTERISTIC
Manual switch	Solid-state switch activated by pressing PHOTOPEN tip against CRT face to push inner assembly back into outer shell
Switch output	TTL signal compatible, as follows (fanout 2, maximum load): Logic high level with outer shell in relaxed state Logic low level while outer shell is pushed forward
Size	Diameter: 0.6 inch; length: 6.0 inches
Weight (incl. cable)	4.0 ounces
Temperature (operating)	+15°C to +40°C
Relative humidity	30% to 90%

1.5 OUTPUT DEVICES PHYSICAL DESCRIPTION

A variety of output devices is available for use with GRAPHIC 8 systems. These include color display monitors, monochrome display monitors, a monochrome hard copy unit, and a color hard copy unit. The following paragraphs describe each of these output devices in more detail.

1.5.1 COLOR MONITOR PHYSICAL DESCRIPTION. All the color display monitors available for use with GRAPHIC 8 systems use a 19-inch (diagonally measured) picture tube and provide raster scan displays. Both standard and long persistence phosphor, and in-line and delta gun tube models are available. A typical color monitor is shown in figure 1-13.

All the color monitors available accept standard red, green, and blue (RGB) video inputs; all inputs are typically terminated into 75 ohms. Each color monitor includes a sync stripper circuit to separate the sync signal from the green (G) signal; however, external sync may also be used. All the color monitors available will operate at various horizontal scan frequencies to support the various resolutions required.

The color monitors are usually supplied in cabinet enclosures for desk top or similar use. However, the color monitors may also be

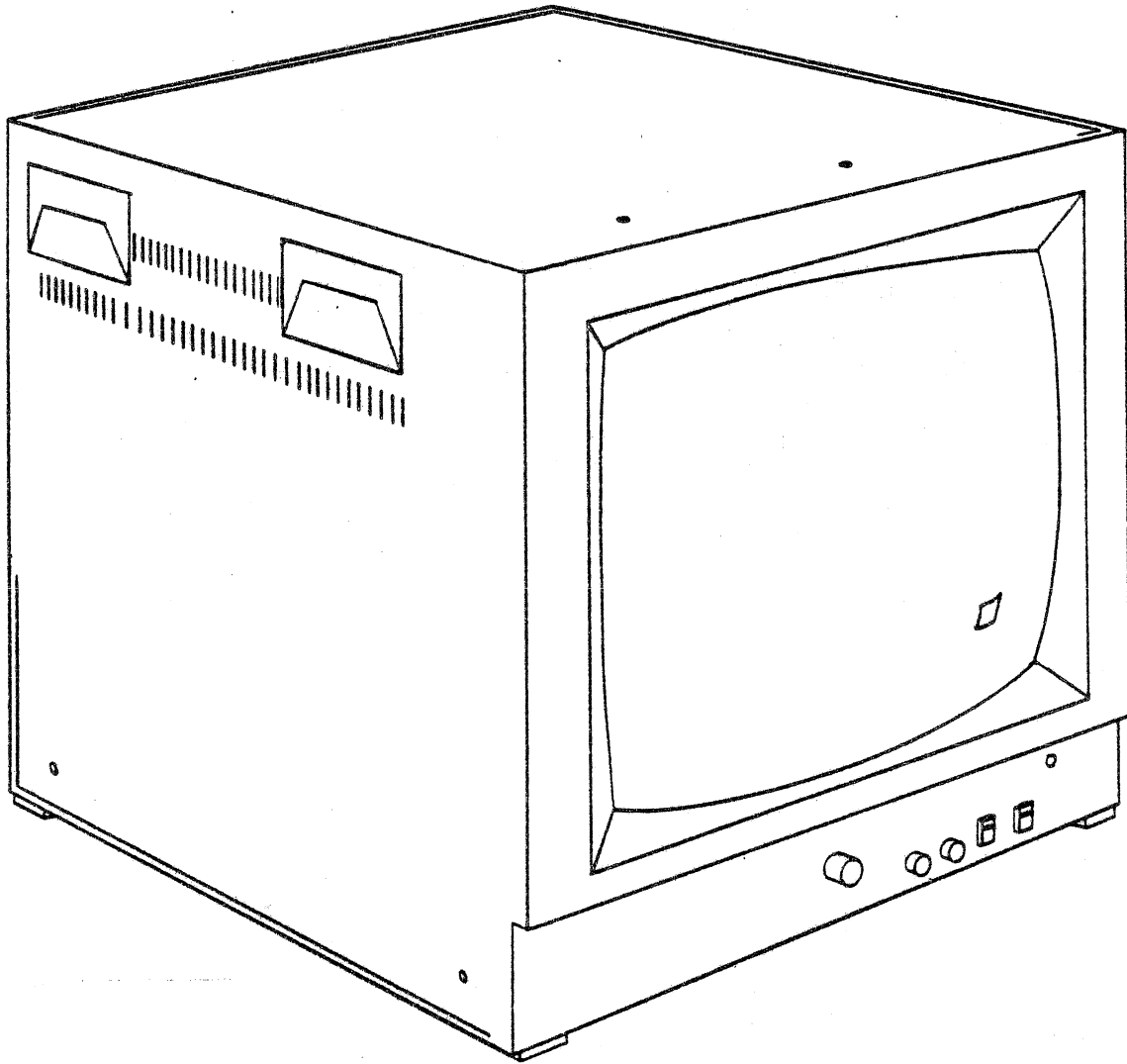

H-82-0176-012

Figure 1-13. Color Monitor, 19-inch (Typical)

supplied without enclosures, with sliders and other mounting hardware as needed for installation in EIA standard 19-inch equipment racks.

Table 1-10 identifies the different models of color monitors. Table 1-11 lists general performance specifications that apply to all models. The color monitors are commercial units built to Sanders' specifications and are supplied to Sanders under manufacturer's warranty.

Table 1-10. Color Monitor Model Numbers

MODEL NUMBER				
RESOLUTION (SEE NOTE)	DELTA GUN, DESK TOP	DELTA GUN, RACK MOUNT	IN-LINE GUN, DESK TOP	IN-LINE GUN, RACK MOUNT
NOTE: All interlaced resolutions require long persistence phosphor. Noninterlaced resolutions use standard phosphor.				
512 x 512 interlaced	8315	8415	8515	8615
512 x 512 noninterlace	8316	8416	8516	8616
640 x 480 interlaced	8325	8425	8525	8625
640 x 480 noninterlaced	8326	8426	8526	8626
1024 x 768 interlaced	8335	8435	8535	8635
1024 x 1024 interlaced	8345	8445	8545	8645

Table 1-11. Color Monitor Specifications

PARAMETER	CHARACTERISTIC
Input power voltage	100 Vac, 110 Vac, 120 Vac, 220 Vac, or 240 Vac, selectable, depending on model Typically 105 Vac to 125 Vac
Input power frequency	50 Hz or 60 Hz Typically 47 Hz to 63 Hz
Power consumption	280 VA, maximum

Table 1-11. Color Monitor Specifications (Cont)

PARAMETER	CHARACTERISTIC
Input signals	R, G, B video Typically 1.0V peak-to-peak
Input connectors	BNC Terminated into 75 ohms or high impedance (switch selectable)
Scanning frequency	Horizontal: 15 kHz to 35 kHz, depending on model Vertical: Typically 60 Hz
Maximum screen size	400 mm x 300 mm
Video bandwidth	20 MHz or 40 MHz, depending on model
Pulse response, rise and fall time	Typically better than 20 nano-seconds for 20 MHz bandwidth Typically better than 11 nano-seconds for 40 MHz bandwidth
Black level stability	Typically $\pm 1\%$ over 10% to 90% average picture level (APL)
Convergence	Typically better than 1.0 mm over the entire screen
Raster size distortion	Typically less than 1% of raster height
Linearity	Typically better than 7%
Warm-up time	Typically 20 minutes to 30 minutes for stable display
Ambient operating temperature	Typically 0°C to 40°C
Storage temperature	Typically -10°C to 60°C
Relative humidity	Typically 10% to 80%, non-condensing
Height	366 mm to 443 mm, depending on model

Table 1-11. Color Monitor Specifications (Cont)

PARAMETER	CHARACTERISTIC
Width	470 mm to 485 mm, depending on model
Depth	480 mm to 545 mm, depending on model
Weight	22 kg to 25 kg, depending on model

1.5.2 MONOCHROME MONITOR PHYSICAL DESCRIPTION. The optional monochrome monitors available for use with GRAPHIC 8 systems provide high resolution, raster scan displays of both interlaced and non-interlaced formats. All the monochrome monitors use a 19-inch (diagonally measured) picture tube; both standard and long persistence phosphor models are available. A typical monochrome monitor is shown in figure 1-14.

All the monochrome monitors accept either EIA standard RS170 or EIA standard RS343 composite video inputs. Preset contrast and brightness controls are included on all configurations.

The monochrome monitors are available with or without a cabinet enclosure, and may be equipped with sliders for rack mounting, if desired. Table 1-12 identifies the different models of monochrome monitors. Table 1-13 lists the performance specifications for the monochrome monitors. The monochrome monitors are commercial units built to Sanders' specifications and are supplied to Sanders under manufacturer's warranty.

Table 1-12. Monochrome Monitor Model Numbers

TYPES	RESOLUTIONS					
	512 x 512	512 x 512	640 x 480	640 x 480	1024 x 768	1024 x 1024
	INTERLACE	NON- INTERLACE	INTERLACE	NON- INTERLACE	INTERLACE	NON- INTERLACE
DESK TOP 19-inch (48 cm) Display Monitor	8310	8311	8320	8321	8330	8340
RACK MOUNT 19-inch (48 cm) Display Monitor	8410	8411	8420	8421	8430	8440

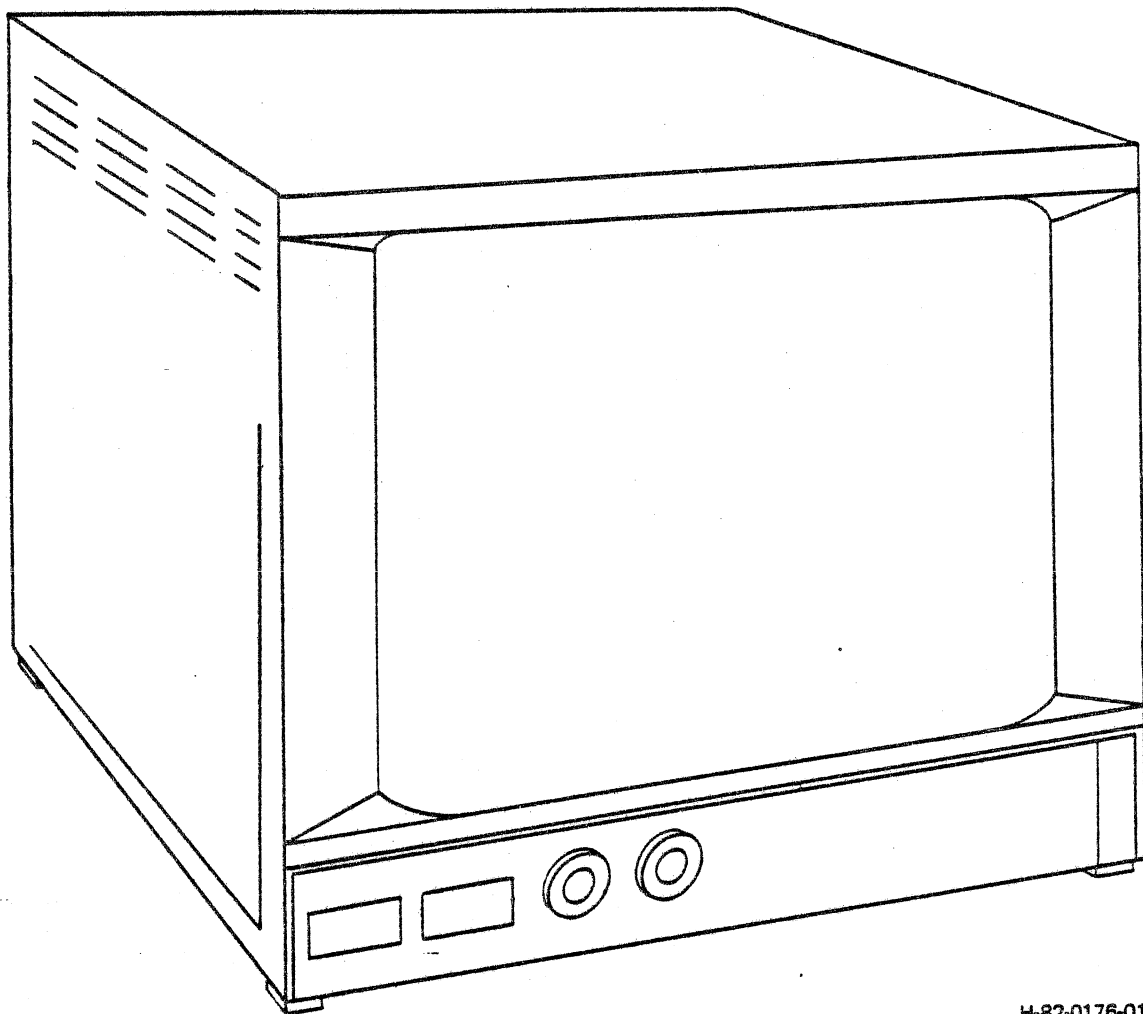

H-82-0176-013

Figure 1-14. Monochrome Monitor, 19-inch (Typical)

Table 1-13. Monochrome Monitor Specifications

PARAMETER	CHARACTERISTIC
Controls	Contrast with preset. Brightness with preset. Power On/Off
Inputs	BNC type input connectors are provided with switchable high Z or 75 ohm termination.
Signal input	<p>Composite video input 1.0V p-p nominal (0.35 to 2.0 acceptable) Sync negative.</p> <p>Input standards are RS170 compatible for 15.75 kHz operation or RS343 for 37 kHz operation.</p> <p>Return loss: greater than 40 dB.</p> <p>Common mode rejection: greater than 50 dB for 50/60 Hz power frequency.</p>
Deflection characteristics	<p>Scan rates: 15.750 kHz through 36.75 kHz interlaced or non-interlaced. Scanning rates are determined by adjustment on scan module.</p> <p>Horizontal retrace: 5 usec nominal Vertical retrace: 600 usec nominal</p> <p>Interlace performance: better than 90%.</p> <p>Raster size regulation: less than 1% change from 0% to 100% APL at 50 FL.</p> <p>Scan failure protection: High voltage is switched off in the event of horizontal or vertical scan failure.</p>
Video characteristics	<p>Video bandwidth: -3 dB at 35 MHz</p> <p>Pulse performance: TR = 10 nsec, TF = 13 nsec</p> <p>Line distortion: less than 1% Field distortion: less than 1%</p>

Table 1-13. Monochrome Monitor Specifications (Cont)

PARAMETER	CHARACTERISTIC
Display performance	<p>Black level stability: black level shift less than 1% change of peak luminance from 10% to 90% APL</p> <p>Picture tube 19V type 90° deflection</p> <p>Geometric distortion: $\pm 1\%$ of raster height</p> <p>Scanning linearity: $\pm 1\%$ of raster height</p>
Actual display size	<p>1176.1 sq. cm. (180.0 sq. in.) 29.7 cm high (11.6 in.) 39.6 cm wide (15.5 in.)</p> <p>Aspect ratio adjusted at factory 4 to 3 underscan. Other aspect ratios available on special order.</p>
Brightness	<p>Maximum usable brightness 150 FL Calibration 50 FL</p> <p>Calibration is achieved with brightness at visual raster cutoff and contrast adjusted with a flat field signal.</p>
Typical display resolution 1225 line scan	1280 horizontal by 960 vertical
Power requirements	<p>100 VAC $\pm 10\%$ 117 VAC $\pm 10\%$ 200 VAC $\pm 10\%$ 220 VAC $\pm 10\%$ 234 VAC $\pm 10\%$</p>
Frequency	50-60 Hz $\pm 10\%$
Power consumption	240 Watts nominal
Environmental	<p>Temperature</p> <p>0° to 50°</p> <p>Humidity</p> <p>5% to 90% non-condensing</p> <p>Altitude</p> <p>Normal operation to 10,000 feet</p>

Table 1-13. Monochrome Monitor Specifications (Cont)

PARAMETER	CHARACTERISTIC
Safety	Per applicable DHHS, UL, CSA as date of manufacture
Physical characteristics	
Weight	86 pounds
Dimensions	Rackmount 19 inches wide, 15.70 high, 22.3 deep Cabinet 19 inches wide, 15.70 high, 22.3 deep

1.5.3 HARD COPY UNIT PHYSICAL DESCRIPTION. Both monochrome and color hard copy units are available. The paragraphs that follow describe each of these units in more detail.

1.5.3.1 Monochrome Hard Copy Unit. A monochrome hard copy unit produces paper copies from standard, raster scan video signals of refreshed graphic terminals. The unit produces high contrast black and white or gray scale copies within seconds, using a clean, dry process. The unit is completely self contained, has a built-in stacking tray, and is mounted on casters for portability. A typical monochrome hard copy unit is shown in figure 1-15.

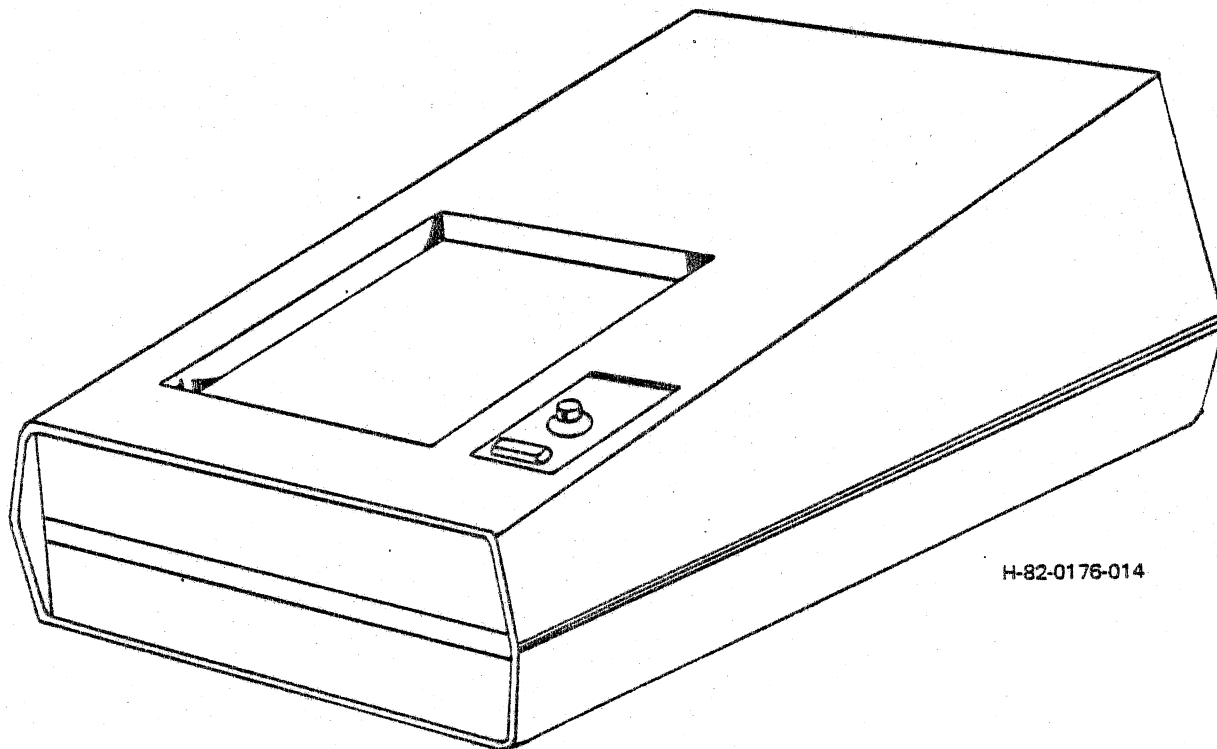

H-82-0176-014

Figure 1-15. Monochrome Hard Copy Unit

The monochrome hard copy is easily interfaced to a graphic system or refreshed terminal by one coaxial cable and one control cable. Operation is as simple as pushing a button. Remote operation is provided for, allowing control from a simple remote switch or from a complex computer system, under program control.

The monochrome hard copy unit developing uses 3M brand, type 777 dry-silver paper. The process is dry and stable and allows clean, conventional paper handling.

Maintainability is built in. All electrical and mechanical assemblies are easily accessible. Circuit boards and modules can be easily removed or placed on an extender board for maintenance. The transport mechanism is virtually jam-free.

Table 1-14 lists the principal differences between the different models of monochrome hard copy units. Table 1-15 lists the performance specifications for the monochrome hard copy unit. The monochrome hard copy unit is a commercial equipment built to Sanders' specifications and is supplied to Sanders under manufacturer's warranty.

Table 1-14. Principal Differences Between Monochrome Hard Copy Units

MODEL	RESOLUTION SUPPORTED
8570	512 x 512, interlaced
8571	512 x 512, non-interlaced
8572	640 x 480, interlaced
8573	640 x 480, non-interlaced
8574	1024 x 768, interlaced
8575	1024 x 1024, interlaced

Table 1-15. Monochrome Hard Copy Unit Specifications

PARAMETER	CHARACTERISTIC
Paper size (nominal)	8-1/2 x 11 inches (21.6 x 27.9 cm)
Image size	
Rectangular format	6-3/8 x 8-1/2 inches (16.2 x 21.6 cm)
Square format	7-1/2 x 7-1/2 inches (19.1 x 19.1 cm)
Image characteristics	
Gray scales	5 distinguishable levels (minimum)
Resolution	100 lines per inch
Copy time (approximate)	
First copy	18 seconds (7 second exposure, 11 second process)
Additional copies	8 second intervals
Warmup time	10 minutes

Table 1-15. Monochrome Hard Copy Unit Specifications (Cont)

PARAMETER	CHARACTERISTIC
Input signal requirements	
Video	0.3 to 5V p-p at 75 ohms
Sync	0.3 to 8V p-p at 20K ohms
Remote copy	A logic low (ground closure > 200 us) initiates a copy command
Output signal characteristics	
End of copy	Open collector; 10 to 20 us low after end of copy exposure time
Power	105 to 125 Vac 50/60 Hz 1000 watts maximum, 500 watts standby
Dimensions	
Height	42 inches (106.7 cm)
Width	23 inches (58.4 cm)
Depth	30 inches (76.2 cm)
Weight	275 pounds (124.7 kg)
Environmental	
Temperature, operating	+15°C to +35°C
Temperature, non-operating	-15°C to +55°C
Humidity	To 90%, non-condensing
Paper life (typical)	Approximately 6 months at 20°C Approximately 15 days at 30°C
Multiple input switching	Optional
Motor and temperature control	
Temperature adjustment range	120°C to 150°C
Stability	±2°C of set point at sensor location
Thermal cut-out	168°C
Motor control	Speed adjustable to 2 inches/second; maintains speed at ±3% of set speed under all conditions

Table 1-15. Monochrome Hard Copy Unit Specifications (Cont)

PARAMETER	CHARACTERISTIC
Idle speed	Approx 1/2 set speed
Fuses	
Line	8A fast
Electronics	1A slow
High voltage	0.6A slow
+400V (2 ea)	1/16A fast
Deflection ampl	1.5A fast

1.5.3.2 Color Hard Copy Unit. A color hard copy unit is a stand-alone recording device for making 8 x 10 inch color or black and white prints and 35 mm slides of any data presented on a high resolution, raster scan CRT. A typical color hard copy unit is shown in figure 1-16.

The color hard copy unit features exceptional image resolutions with accurate rendition of color hue, saturation, and lightness; high throughput; separation mode for automatic three-color separation exposures; and switchable raster blending for high color saturation prints. The color hard copy unit is microprocessor controlled to assure consistent exposure and reliable operation. Fully automated 35 mm slide capabilities are also provided for, with remote control.

Two models are currently available: model 8580 and model 8581. Model 8580 supports non-interlaced resolution formats and model 8581 supports interlaced resolution formats. Table 1-16 lists the performance specifications for the color hard copy unit.

The color hard copy unit is a commercial equipment built to Sanders specifications and is supplied to Sanders under manufacturer's warranty.

Table 1-16. Color Hard Copy Unit Specifications

PARAMETER	CHARACTERISTIC
Video monitor	Nominal resolution of 1400 lines center screen at 100 cd/m ² (30 FL) on flat-face CRT. Pixel position error is <0.5% within a 9 cm circle, <1% at corners.
Speed of operation	8" by 10" Polaroid - less than 60 seconds per exposure 8" by 10" transparency - less than 40 seconds per exposure 35 mm - 6 seconds per exposure

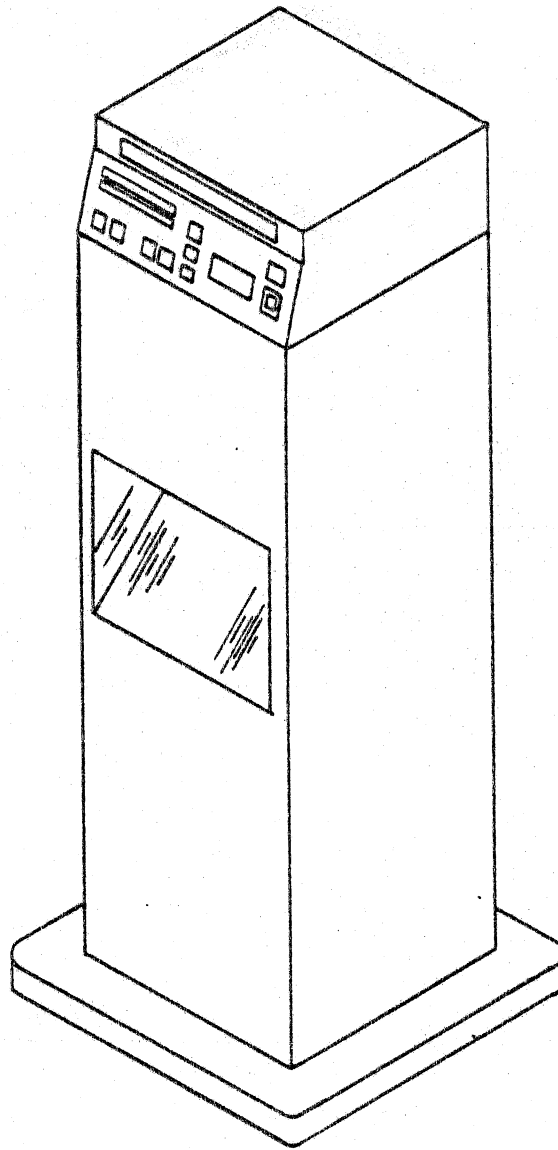

H-82-0176-015

Figure 1-16. Color Hard Copy Unit

Table 1-16. Color Hard Copy Unit Specifications (Cont)

PARAMETER	CHARACTERISTIC
Film type	<p>8" x 10" (20.32 cm x 25.40 cm) - color or black and white. Must be loadable in cassette format.</p> <p>With optional auxiliary camera, 35 mm sprocket feed film, color only, in cartridge.</p>
Film speed	15 DIN (ASA25) to 24 DIN (ASA200)
Physical specifications	<p>Width 38.7 cm (15.25 in.)</p> <p>Depth 38.7 cm (15.25 in.)</p> <p>Height 113.2 cm (44.75 in.)</p> <p>Base 50.4 cm x 50.4 cm (20 in. x 20 in.)</p> <p>Weight 40 kg (88 lbs.)</p>
Power requirements (all units single phase, line to neutral)	<p>Standard 120 VAC \pm 10%, 50/60 Hz, 0.8 amps, 110 watts (max)</p> <p>Optional 100 VAC \pm 10%, 50/60 Hz, 1.0 amps, 220 or 240 VAC \pm 10%, 50/60 Hz, 0.5 amps</p>
Video inputs	<p>Separate red, green, blue, and sync video signals of 0.35 to 2.0 peak to peak voltage required.</p> <p>Standard - Handles horizontal line rate of 500 to 650.</p> <p>Optional-High Line - Handles horizontal line rate of 800 to 1100 at 60 Hz or 1300 at 50 Hz.</p>
Operating environment	<p>Temperature - 20°C \pm 10°C</p> <p>Relative Humidity - 15% to 90% non-condensing</p> <p>Altitude - Sea level to 4500 meters</p> <p>Operating Noise - Negligible</p>
Cables	Power: 3 meter power cord.

Table 1-16. Color Hard Copy Unit Specifications (Cont)

PARAMETER	CHARACTERISTIC
	Interface: Four 74 Ohm, RG-59 coaxial cables of 3 meters each. BNC plug on each end mates to BNC bulkhead receptacle.

1.6 POWER AND ENVIRONMENTAL REQUIREMENTS

The terminal controller requires 300W of single-phase primary power. The power source must be within six cable-feet of the terminal controller.

The terminal controller fits a 10.5-inch vertical space in a standard 19-inch equipment rack, either directly or on slides. The controller can also be supplied as a stand-alone cabinet unit.

The operating environment temperature range is +15°C (59°F) through +40°C (104°F). The relative humidity should not exceed 90%.

1.7 PERFORMANCE SPECIFICATIONS

Table 1-17 lists the performance specifications for the overall terminal controller and its assemblies where applicable.

Table 1-17. GRAPHIC 8 Terminal Controller Specifications

PARAMETER	CHARACTERISTIC
GENERAL	
Power source	115 + 10 Vac, 47 to 63 Hz
Power	300 Watts
Temperature: Storage	0° to 50°C
Operating	15° to 40°C
Relative humidity	10 to 90%
Dimensions:	
Rack mount configuration	
Height	10.5 in (26.8 cm)
Width	19.0 in (48.2 cm)
Depth	16.0 in (40.6 cm)

Table 1-17. GRAPHIC 8 Terminal Controller Specifications (Cont)

PARAMETER	CHARACTERISTIC
GENERAL (Cont)	
Weight Equipment cabinet configuration Height Width Depth Weight	55 lbs (25 kg) including cards 30 in (76.2 cm) 23 in (58.4 cm) 30 in (76.2 cm) 155 lbs (70.3 kg) on four casters
DISPLAY PROCESSOR	
General purpose microprocessor Word length Byte mode Instructions Registers Hardware stacks Automatic priority interrupt Memory ROM RAM	Yes 16 bits 8 bits 400 plus 8 Yes Yes 16 bit words 8192 words to 262,144 words
INTERFACE OPTIONS (DIGITAL)	
Parallel Serial Parallel microprocessor Display instructions Synchronized linkage to display processor	16 bits 32 bits (optional) RS-232C, RS449 16 bits 50 plus Yes

Table 1-17. GRAPHIC 8 Terminal Controller Specifications (Cont)

PARAMETER	CHARACTERISTIC
INTERFACE OPTIONS (DIGITAL) (Cont)	
Subroutine stack	Yes
Display registers	64 plus
Registers (GP)	4
VECTORS/CONICS	
Line texture	4
Ellipse	any angle
CHARACTERS	
Font size	5 x 7 7 x 9
Character set (standard)	96
User defined (optional)	96
Rotation	90° clockwise
Sizes	3
Tabular characters	Auto text spacing
Positioning	Random
MAPPING MEMORY	
Addressable locations	2048 x 2048
Bits/pixel	1, 2, 4, 8
VIDEO CONTROLLER	
Blink	Yes
Color or gray level	256
Screen splits	3
Cursor	non-destructive
Terminations	75 ohm

Table 1-17. GRAPHIC 8 Terminal Controller Specifications (Cont)

PARAMETER	CHARACTERISTIC
VIDEO CONTROLLER (Cont)	
Video	Composite
Displays max	6

1.8 EQUIPMENT IDENTIFICATION

The part number of the terminal controller is a function of its card complement and thus varies from installation to installation. The Sanders identification plate at the rear of the terminal controller carries the part number, voltage rating, current rating, and UL, CSA, and VDE identification.

Nomenclatures and part numbers for the circuit cards are etched on the component side of the cards. Serial numbers are stenciled next to part numbers.

All correspondence and documentation concerning the terminal controller or its assemblies should include full identification data.

1.9 TEST EQUIPMENT REQUIRED

The following equipment (or equivalent) is recommended for maintenance of the terminal controller:

Oscilloscope	Tektronix type 465 with 10X probe
Digital voltmeter	Fluke model 8000A
Card extender	Sanders part no. 4171110

1.10 RELATED PUBLICATIONS

Publications relating to the GRAPHIC 8 system are as follows:

<u>PUBLICATION NO.*</u>	<u>TITLE</u>
H-80-0483	GRAPHIC 8 Technical Description
H-80-0444	GRAPHIC 8 Programmer's Reference Manual
H-81-0021	GRAPHIC 8 Fortran Support Package Reference Manual
H-81-0027	GRAPHIC 8 Terminal Controller Maintenance Manual
H-81-0097	GRAPHIC 8 Terminal Controller Maintenance Diagrams Manual

*This column lists the manual's basic number. Revisions are indicated on the cover of the manual by a letter following this basic number.

PUBLICATION NO.*

TITLE

H-81-0162	GRAPHIC 8 19-Inch Color Display Manual
H-81-0129	GRAPHIC 8 Installation Planning Guide
H-80-0087	Terminal Controller Power Supply Model MM23-E0647/115

1.11 MNEMONICS CONVENTIONS

The convention established for naming mnemonics throughout this manual is as follows. In general, terminal controller mnemonics consist of six characters. The first four are an alphanumeric abbreviation of the signal name. The fifth is a sign (+ or -) that indicates the active state of the signal (high or low). The sixth character is an alphabetic code that identifies the source of the signal as follows:

<u>SOURCE CODE</u>	<u>SOURCE</u>
B	Processor bus signal
D	Display processor
F	ROM and status
H	Digital graphic controller
I	Parallel interface
M	Read/write memory
N	Mapping memory
V	Video controller
X	Multiple source
S	Multiport serial interface
U	Timing module

Register and bus mnemonics use the lowest numeric to designate the least significant bit and the highest numeric to designate the most significant bit. For example, in the terminal controller data bus:

DA00-B = LSB
DA15-B = MSB

Power supply mnemonics are as follows:

<u>MNEMONIC</u>	<u>DESCRIPTION</u>
P05V+	+5 Vdc
P15V+	+15 Vdc
N15V-	-15 Vdc
ARET-	Analog ground
DRET-	Digital ground
CGND	Chassis ground

*This column lists the manual's basic number. Revisions are indicated on the cover of the manual by a letter following this basic number.

SECTION 2

OPERATION

2.1 GENERAL

This section contains information for operating the GRAPHIC 8 system. Topics discussed include: controls and indicators, turn-on procedure, and operation in the SYSTEM and LOCAL modes, and peripherals usage.

2.2 CONTROLS AND INDICATORS

The following paragraphs describe the location and function of the controls and indicators on the various components of a typical GRAPHIC 8 system.

2.2.1 TERMINAL CONTROLLER CONTROLS AND INDICATORS. Table 2-1 lists the terminal controller controls and indicators, their locations and functions. Figure 2-1 shows their location on the equipment. Circuit connections for the controls and indicators are shown on the applicable terminal controller diagrams in the Terminal Controller Diagrams Manual (H-81-0097).

Table 2-1. Terminal Controller Controls and Indicators

NOMENCLATURE	LOCATION	FUNCTION
POWER ON/OFF circuit breaker	Control panel	Energizes/deenergizes terminal controller
RUN/SYS pushbutton	Control panel	Initiates SYSTEM mode (host computer control)
RUN/SYS lamp	In RUN/SYS pushbutton	Indicates display processor card operating
DIS/LOC pushbutton	Control panel	Initiates LOCAL mode (GCP/operator commands)
DIS/LOC lamp	In DIS/LOC pushbutton	Indicates digital graphic controller card operating

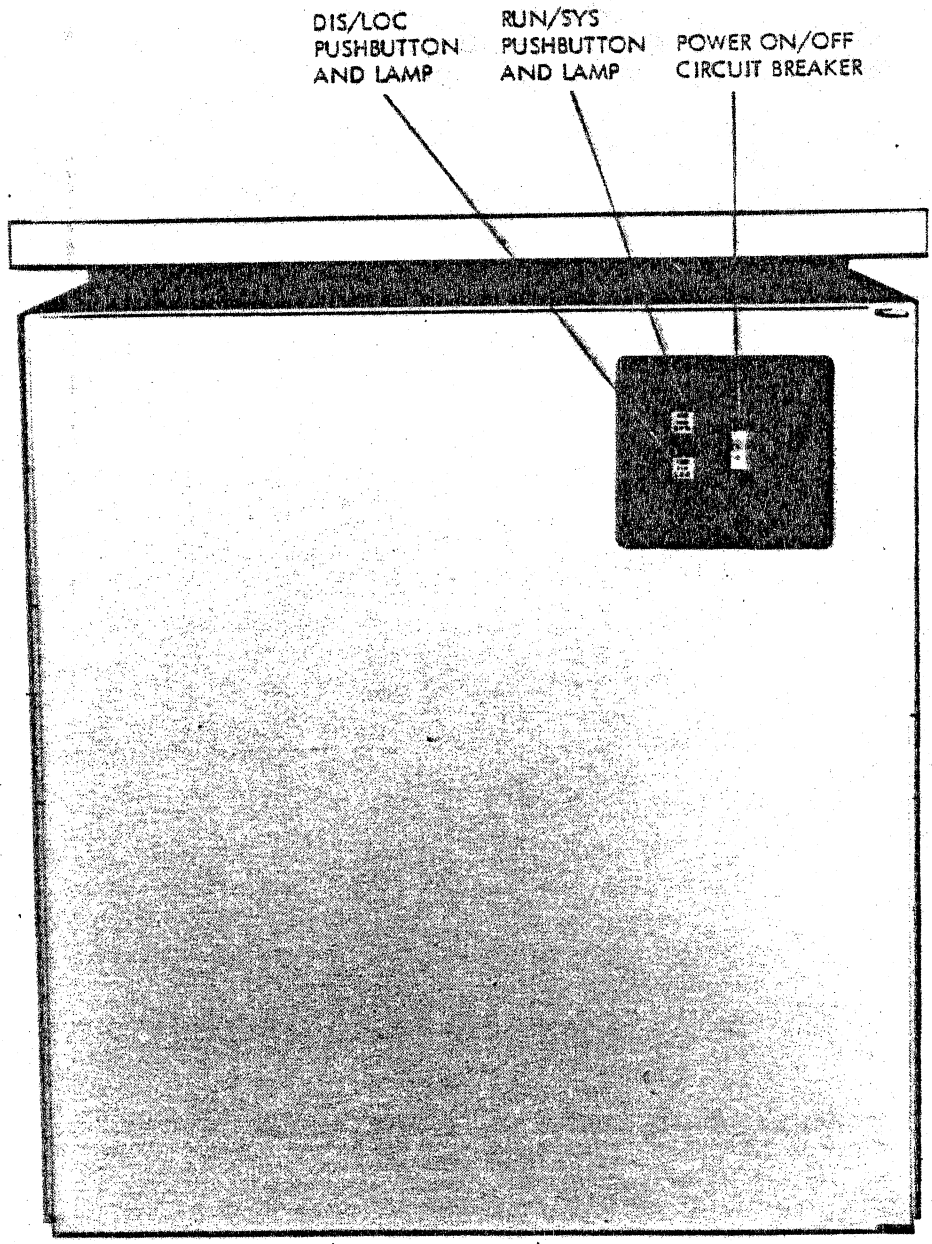

NEG 80 346-015
+82-0040-017

Figure 2-1. Terminal Controller Controls and Indicators

2.2.2 COLOR MONITOR CONTROLS AND INDICATORS. Table 2-2 lists the controls and indicators for a typical color monitor, by their locations and functions. Figure 2-2 shows their locations on the equipment. Circuit connections for the controls and indicators are shown in the applicable technical manual for the color monitor used in your GRAPHIC 8 system.

Table 2-2. Color Monitor Controls and Indicators

NOMENCLATURE	LOCATION	FUNCTION
POWER ON/OFF switch	Bottom right of control panel	Energizes/deenergizes the color monitor
DEGAUSS switch	Bottom right of control panel	Demagnetizes picture tube
BRIGHTNESS control	Bottom right of control panel	Adjusts brightness of display presentation
MONO/COLOR switch	Bottom right of control panel	Selects color or monochrome operation
HEALTH lamp	Top right of control panel	Lights to indicate proper operation of the power supply circuits
TERMINATION switches	Center of rear panel	Selects 75 ohms or high impedance for video inputs

2.2.3 MONOCHROME MONITOR CONTROLS AND INDICATORS. Table 2-3 lists the controls and indicators for a typical monochrome monitor, by their locations and functions. Figure 2-3 shows their locations on the equipment. Circuit connections for the controls and indicators are shown in the applicable technical manual when a monochrome monitor is used in your GRAPHIC 8 system.

2.2.4 MONOCHROME HARD COPY UNIT CONTROLS AND INDICATORS. Table 2-4 lists the controls and indicators for a typical monochrome hard copy unit, by their locations and functions. Figure 2-4 shows their locations on the equipment. Circuit connections for the controls and indicators are shown in the hard copy unit technical manual when a monochrome hard copy unit is used in your GRAPHIC 8 system.

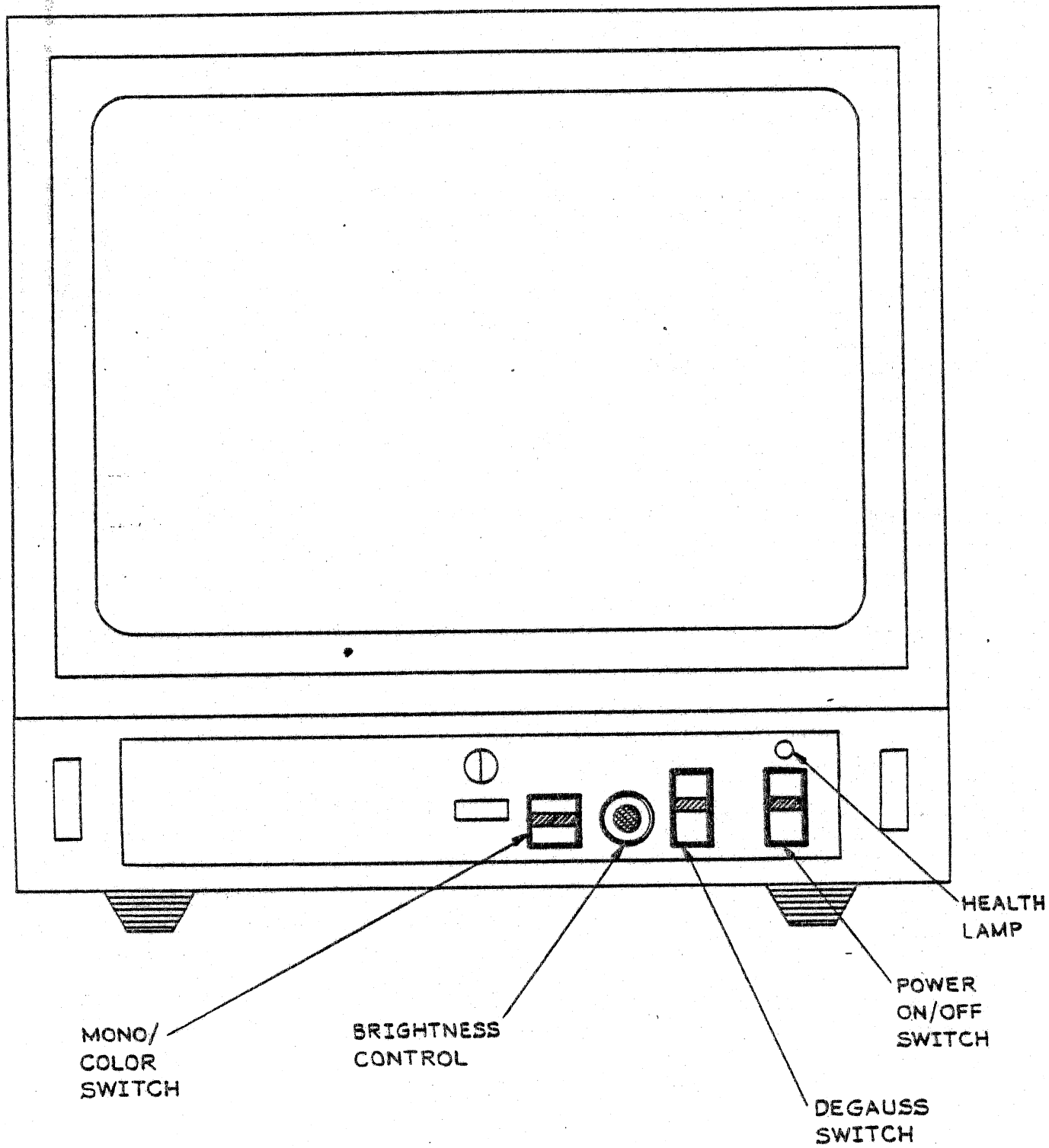

Figure 2-2. Color Monitor Controls and Indicators

Table 2-3. Monochrome Monitor Controls and Indicators

NOMENCLATURE	LOCATION	FUNCTION
POWER switch	Bottom left of control panel	Energizes/deenergizes the monochrome monitor
BRIGHT control with PRESET OFF/ON switch	Bottom center of front panel	Adjusts brightness of display presentation; allows brightness level to be preset
CONT control with PRESET OFF/ON switch	Bottom right of front panel	Adjusts contrast of display presentation; allows contrast level to be preset
Termination switches	Center of rear panel	Selects 75 ohms or high impedance termination for video inputs

Table 2-4. Monochrome Hard Copy Unit Controls and Indicators

NOMENCLATURE	LOCATION	FUNCTION
POWER OFF/ON switch	Top of control panel (on top of unit)	Energizes/deenergizes the monochrome hard copy unit
LIGHT/DARK control	Center of control panel (on top of unit)	Varies the darkness of the delivered copy
COPY pushbutton	Bottom of control panel	Initiates production of a paper copy
SYNC EXT/INT switch	Top center of rear panel	Selects external or internal sync for operating the monochrome hard copy unit
VIDEO BACKGROUND INVERT/NORM switch	Bottom center of rear panel	Selects inverted (black) or normal (white) background for copies produced

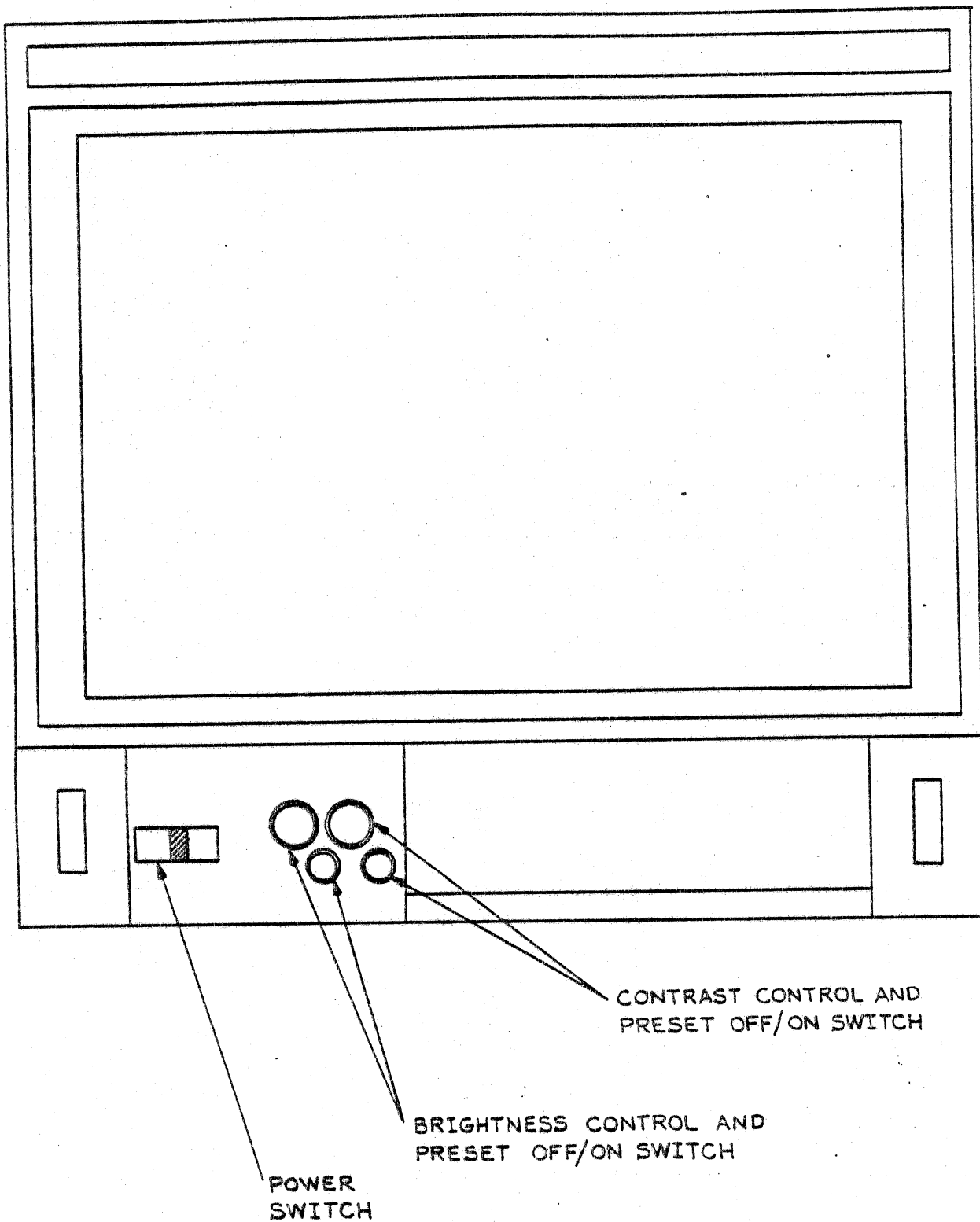

H-82-0176-018

Figure 2-3. Monochrome Monitor Controls and Indicators

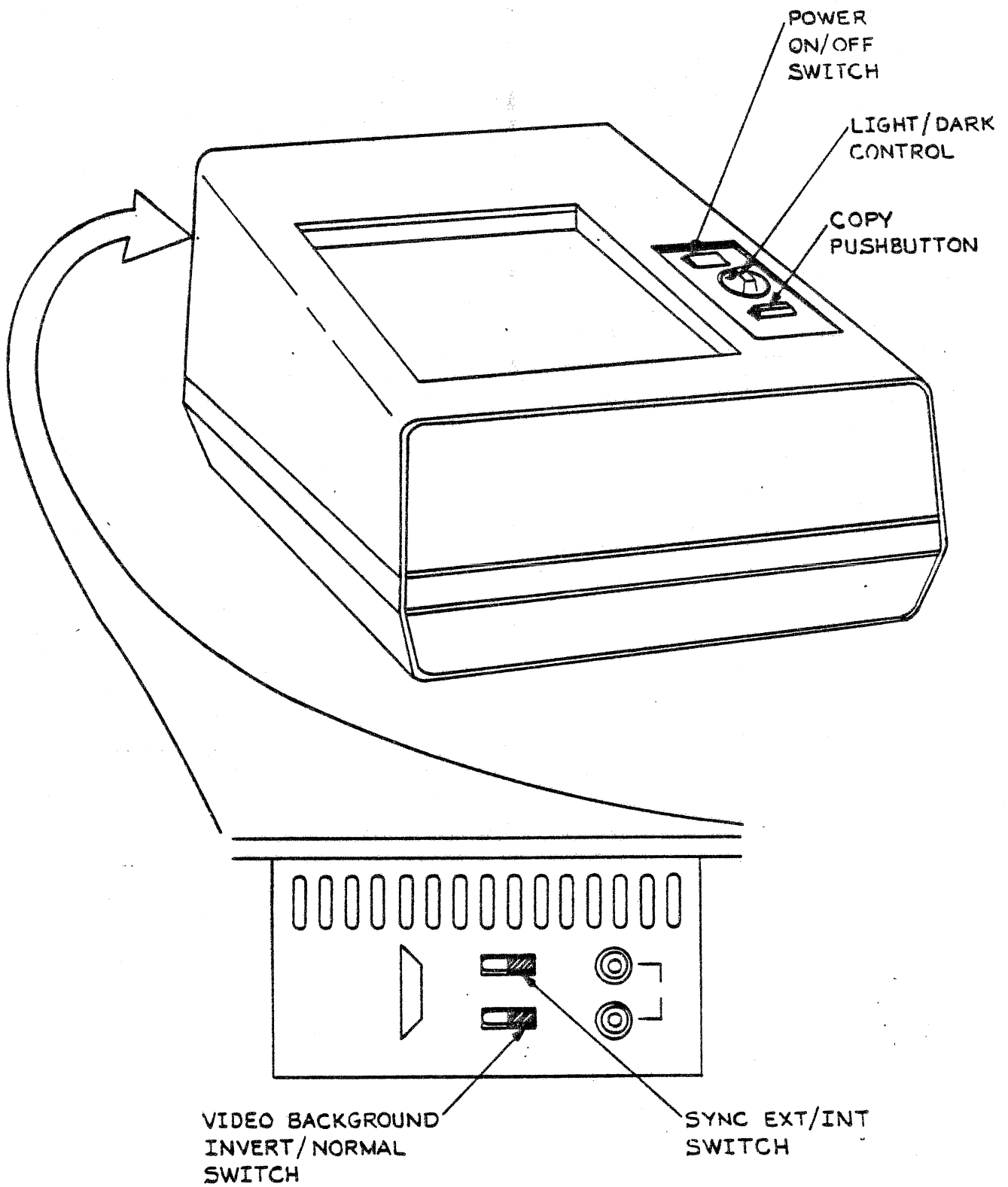

H-82-0176-019

Figure 2-4. Monochrome Hard Copy Unit Controls and Indicators

2.2.5 COLOR HARD COPY UNIT CONTROLS AND INDICATORS. Table 2-5 lists the color hard copy unit controls and indicators, by their locations and functions. Figure 2-5 shows their locations on the equipment. Circuit connections for the controls and indicators are shown in the applicable technical manual when a color hard copy unit is used with your GRAPHIC 8 system.

Table 2-5. Color Hard Copy Unit Controls and Indicators

NOMENCLATURE	LOCATION	FUNCTION
POWER on/off switch	Bottom left of control panel	Energizes/deenergizes the color hard copy unit
POWER on indicator (green)	Integral with POWER on/off	Lights to indicate power on
RESET pushbutton (red)	Bottom left of control panel	Terminates all camera operations, causes filter wheels to seek and return to home, and enters data from internal program switches
RESET indicator	Integral with RESET pushbutton	Lights during reset cycle
COLOR/FOCUS switch	Bottom left of center on control panel	In COLOR position, exposures are made on film when EXPOSE pushbutton is pressed. In FOCUS position, allows auxiliary cameras to be focused.
FOCUS indicator	Integral with NORMAL/FOCUS switch	Lights to indicate FOCUS mode
SEPARATE/NORMAL switch	Bottom left of center on control panel	In NORMAL position, complete RGB exposure is made when EXPOSE pushbutton is pressed. In SEPARATE position, one color is exposed at a time. EXPOSE pushbutton must be pressed once for each color.

Table 2-5. Color Hard Copy Unit Controls and Indicators (Cont)

NOMENCLATURE	LOCATION	FUNCTION
SEPARATE indicator (yellow)	Integral with SEPARATE/NORMAL switch	Lights to indicate SEPARATE mode
EXPOSE pushbutton	Bottom right of control panel	Starts the exposure cycle
EXPOSE indicator (green)	Integral with EXPOSE pushbutton	Lights to indicate that camera is able to take a picture
SEQUENCE indicator (red, green, blue)	Right of control panel	Displays the color of the video signal being photographed
AUX position indicator (yellow)	Bottom center of control panel	Lights when auxiliary port mirror is in position for auxiliary exposure mode.
8x10 position indicator (yellow)	Middle center of control panel	Lights when auxiliary port mirror is in position for 8x10 exposure mode
OUT OF FILM indicator (red)	Top center of control panel	Lights when an expose command is sent to the 35 mm camera and no corresponding X sync pulse is received from the camera
Film counter (EXPOSURE)	Bottom right of center on control panel	Five-digit electro-mechanical counter logs each auxiliary port exposure. Includes manual reset pushbutton.

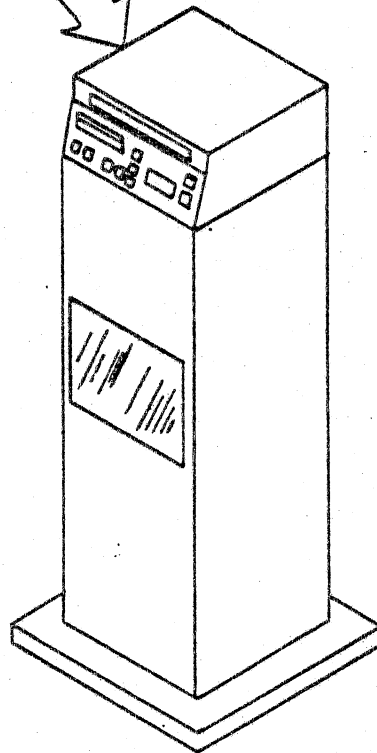
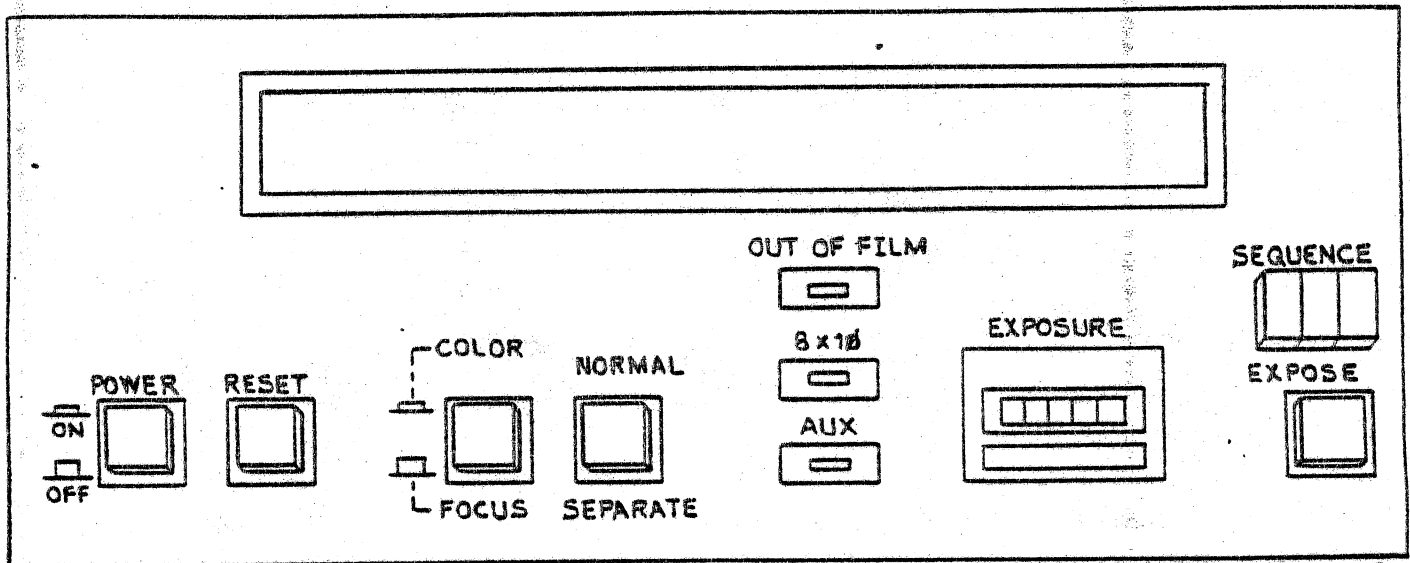

H-82-0176-020

Figure 2-5. Color Hard Copy Unit Controls and Indicators

2.3 TURN-ON PROCEDURES

Only the terminal controller, the display monitor, and the hard copy unit require turn-on. The remaining GRAPHIC 8 system components are all initialized when the terminal controller is turned on. The following paragraphs describe the steps required to set up and turn on the terminal controller, the display monitor, and the hard copy unit. These procedures assume that the GRAPHIC 8 system has been installed and that the system components have been properly interconnected, as described in Section 3 of this manual.

2.3.1 TERMINAL CONTROLLER. To turn the terminal controller on, press the 1 side of the POWER ON/OFF circuit breaker. This action lights the RUN/SYS lamp and applies power to the circuit cards.

Delay timers in the circuit cards allow initial power surges to settle, then initialize the terminal controller in the SYSTEM mode. All peripheral devices are reset, and the control program performs automatic diagnostic tests to verify operation of the basic terminal controller functions.

If the terminal controller is connected to a host computer that is already operating, the controller automatically transmits a performance status report to the computer. If the host computer is not operating, the computer can receive this status report only by initializing the terminal controller as part of its own turn-on procedure. In either case, the host computer's response to the status report is a function of the host computer application software.

NOTE

Refer to Section 4 for maintenance information if (a) RUN/SYS lamp does not light following power turn-on; (b) host computer subsequently reports terminal controller defective; or (c) terminal controller operation is suspect for any reason.

2.3.2 COLOR MONITOR. To turn on a typical color monitor, proceed as follows:

1. Ensure that the MONO/COLOR switch is set to COLOR.
2. Set the POWER ON/OFF switch to ON. With the terminal controller in LOCAL mode, the verification test pattern (figure 2-6) should appear after approximately 30 seconds delay.
3. Ensure that the HEALTH indicator lamp lights, indicating a proper and safe high voltage level.
4. Adjust the BRIGHTNESS control for the desired viewing level.

NOTE

If the color purity or the convergence appears to be slightly out of adjustment, press and hold the DEGAUSS switch for several seconds, then release. The display image should improve noticeably. If the monitor does not display an image, or if the displayed image is out of adjustment and cannot be corrected by pressing the DEGAUSS switch, refer to the maintenance and alignment procedures given in the applicable technical manual.

2.3.3 MONOCHROME MONITOR. To turn on a typical monochrome monitor, proceed as follows:

1. Press the POWER switch. With the terminal controller in LOCAL mode, the verification test pattern (figure 2-6) should appear after a brief delay.
2. Adjust the BRIGHT and CONT controls for the desired viewing level. Specific brightness and contrast levels may be preset by using the associated PRESET OFF/ON switches, if desired.

NOTE

If the monitor does not display an image, or if the image is out of adjustment, refer to the maintenance and alignment procedures given in the applicable technical manual.

2.3.4 MONOCHROME HARD COPY UNIT. To set up and turn on a typical monochrome hard copy unit, proceed as follows:

1. Ensure that the POWER OFF/ON switch (on top of the unit) is set to OFF.
2. Lift the cover of the unit from the front and push it back until it latches in an upright position.
3. Pull the paper carriage down and out so that the hard copy unit CRT screen is visible.
4. Pull up on the cover interlock button (at the upper right rear corner) to bypass the safety cut-off.
5. Set the POWER OFF/ON switch to ON.

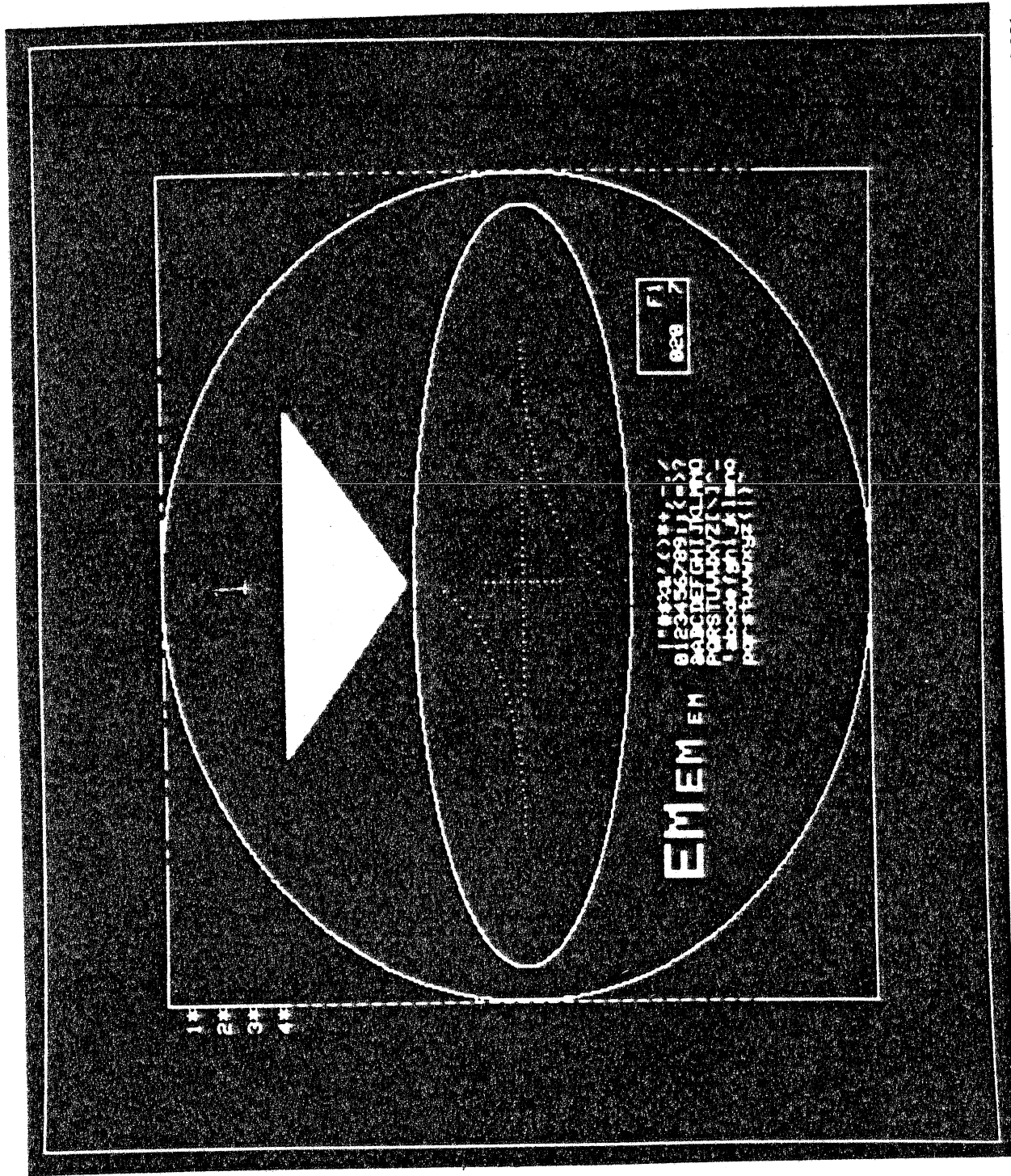

H-82-0176-021

Figure 2-6. Verification Test Pattern

6. Adjust the LIGHT/DARK control (on top of the unit) to mid-scale.
7. Press the COPY pushbutton (on top of the unit). With the terminal controller in LOCAL mode, the verification test pattern should move across the face of the CRT in the hard copy unit.
8. Ensure that the paper drive mechanism and cutter bar are operating properly.
9. Set the POWER OFF/ON switch to OFF.
10. Load the paper cassette, following the instructions printed on the upper inside surface of the hard copy unit cover.
11. Set the POWER OFF/ON switch to ON.
12. Press the cover interlock button and hold for two seconds, to reset the safety cut-off.
13. Lift the cover latch and close the cover.
14. Allow the unit to warm up for 10 minutes.
15. Press the COPY pushbutton.

NOTE

The first copy will be black, due to exposure to light while loading.

16. Make several more copies and observe the results. Adjust the LIGHT/DARK control as required for best copy density.

NOTE

If the hard copy unit does not produce a reliable copy of the display image, or the LIGHT/DARK control has no effect, refer to the maintenance and alignment procedures given in the hard copy unit technical manual.

2.3.5 COLOR HARD COPY UNIT. To turn on and set up a typical color hard copy unit, proceed as follows:

1. Press the front control panel POWER pushbutton and allow the color hard copy unit to warm up for 20 minutes.
2. Open the color hard copy unit operator door (on the right-hand side of the unit). Make sure that you override the door interlock switch by pulling it all the way out.

3. Insert a properly loaded 8 x 10 film cassette into the cassette door at the top of the unit. Make sure the dark slide in the cassette is not pulled out. (Refer to the instruction sheet supplied with the box of film for details.)
4. Set the mode select lever to the 8 x 10 position.
5. Set the front control panel COLOR/FOCUS switch to COLOR.
6. Select an image that represents the maximum output of the graphics terminal red video signal. Since the color white is composed of the maximum values of red, green, and blue video, this can be accomplished by creating a white image on the graphics terminal. The image should be large enough for the "eye" of the color hard copy unit photometer probe to cover it.
7. Set all the calibration control panel BRIGHTNESS and CONTRAST potentiometers to 0.
8. Set the calibration control panel photometer (FOOTLAMBERTS) switch to 2.
9. Press the front control panel RESET pushbutton.
10. Set the calibration control panel VIDEO PREVIEW switch to RED.
11. Place the photometer probe over the selected image area on the video monitor inside the color hard copy unit.
12. Adjust the calibration control panel RED BRIGHTNESS potentiometer until the dc meter on the panel reads 0.1. The phosphor should just be visible on the video monitor inside the unit.
13. Set the calibration control panel FOOTLAMBERTS switch to 50 and adjust the RED CONTRAST potentiometer until the dc meter on the panel reads 0.6.
14. Write the setting of the RED CONTRAST potentiometer on a piece of paper. This corresponds to the red video contrast setting.
15. Disconnect the red video input cable from the connector marked RED on the color hard copy unit back panel.
16. Connect the green video input cable to the RED connector.
17. Press the front control panel EXPOSE pushbutton.

18. Adjust the calibration control panel RED CONTRAST potentiometer until the dc meter on the panel reads 0.6.
19. Write the setting of the RED CONTRAST potentiometer on a piece of paper. This corresponds to the green video contrast setting.
20. Disconnect the green video input cable from the RED connector and reconnect it to the connector marked GREEN on the color hard copy unit back panel.
21. Connect the blue video input cable to the RED connector.
22. Repeat steps 18 and 19 for the blue video signal.
23. Disconnect the blue video input cable from the RED connector. Reconnect both the red video input cable and the blue video input cable to their respective connectors on the color hard copy unit back panel.
24. Set the calibration control panel RED, GREEN, and BLUE CONTRAST potentiometers to the settings recorded in steps 14, 19, and 22. Lock the potentiometers.
25. Press the front control RESET pushbutton.
26. Set the calibration control panel VIDEO PREVIEW switch to NORM.
27. Return the photometer probe to its stowage position and secure it in place.
28. Close and secure the operator door.
29. Press the front control panel RESET pushbutton.
30. Set the auxiliary (35 mm) camera shutter control dial to B.
31. Set the auxiliary camera motor drive switch to S.
32. Set the auxiliary camera lens to $f/4$.
33. Pull out the auxiliary camera film rewind knob and open the back cover.
34. Place a roll of film in the camera and push the film rewind knob back to its original position. Use standard 35 mm film (12, 20, or 36 exposures).
35. Clip the end of the film tip onto the take-up spool.

36. Press the auxiliary camera magnetic release button and advance the film until the sprocket teeth catch properly in the perforations along both edges of the film. Close the back cover and press until it locks in place.
37. Press the magnetic release button and advance the film again. The white line on the film rewind knob should rotate when the film is advanced.
38. Press the front control panel EXPOSE pushbutton several times to skip past the leader on the film.
39. Set the front control panel exposure counter to zero to ensure an accurate count of the 35 mm exposures made.
40. Set the model select lever to AUX.
41. Set the front control panel COLOR/FOCUS switch to FOCUS.
42. Press the front control panel EXPOSE pushbutton. This unblanks the monitor for approximately 60 seconds.
43. Focus the auxiliary camera, using the through-the-lens viewer.
44. Return the front control panel COLOR/FOCUS switch to COLOR.

The color hard copy unit is now turned on, calibrated, and set up. Use the mode select lever to control whether 8 x 10 instant color prints or 35 mm slides will be produced.

2.4 OPERATING PROCEDURES

The GRAPHIC 8 system normally operates in either the SYSTEM mode or the LOCAL mode. Typically, in the SYSTEM mode the GRAPHIC 8 is under host computer control; in the LOCAL mode the GRAPHIC 8 functions as a stand-alone device. Operator performance checks and various other diagnostics may be performed in the LOCAL mode.

The following paragraphs describe operation in the SYSTEM mode and the LOCAL mode in more detail.

2.4.1 SYSTEM MODE OPERATION. This mode is established when one of the following occurs:

1. When primary ac power is applied to the terminal controller.
2. When you press the RUN/SYS pushbutton.
3. When the terminal controller is in LOCAL mode and you type S on the keyboard.
4. When the terminal controller is in LOCAL mode and you type 157760G RETURN on the keyboard.

5. When an initialize signal comes from the host computer via the parallel interface or the multiport serial interface (series 8000 only).
6. When the terminal controller is in the teletypewriter emulation mode (see paragraph 2.4.2.2.e) and you press function key F13 on the keyboard or the host computer sends octal code 035 (ASCII control character GS Group Separator).

If the terminal controller is already in SYSTEM mode, it can be initialized again by either of the following:

1. A discrete initialize signal from the host computer via the parallel interface or the multiport serial interface (series 8000 only).
2. An IZ (initialize) message from the host computer.

Initialization in the SYSTEM mode automatically causes the built-in diagnostic routines to be performed and the results sent in an error status message to the host computer. The diagnostic routines include GO/NO-GO checks of the graphic controller; display processor; read/write memory; 2D or 3D coordinate converter (if installed); and either the parallel interface or the multiport serial interface, whichever is used for communications with the host computer. The error status message also includes a checksum of the control program stored in read-only memory.

In the SYSTEM mode, responses to all operator actions are determined by the application program of the host computer. Control is exercised and data is transferred by means of messages sent between the host computer and the terminal controller. See the GRAPHIC 8 Programmer's Reference Manual, Sanders document H-80-0444.

The host computer application program accesses all display registers and parameters for organization of display images. The initialization sequence enables the associated keyboards so you can enter commands without special action by the host computer.

The control program handles all internal display interrupts and operator inputs. The control program performs all housekeeping required for these events, and sends the host computer a message containing all information needed for operational decisions. However, the host computer can preset the terminal controller to transmit only specified signals under specified conditions.

The control program processes trackball, forcestick, data tablet, or PHOTOPEN inputs without host computer intervention. The control program detects all PED (position entry device) inputs and either transmits them to the host computer, or uses them to update the position of a predefined PED identifier symbol on the display. Control program processing of PED symbols is controlled by the host computer application program.

The control program also inserts alphanumeric data from the keyboard into the refresh pattern; you can enter and edit a message without host computer intervention. You complete your entry by pressing the RETURN key, and the control program informs the computer that a new message is ready. The application program indicates how alphanumeric inputs are handled by issuing special commands.

2.4.2 LOCAL MODE OPERATION. After primary power has been applied to the terminal controller, you can initialize the terminal controller in LOCAL mode by pressing the DIS/LOC pushbutton. When you press this pushbutton, the verification test pattern appears on each of the associated display indicators, the terminal controller performs its built-in diagnostic routines, and LOCAL mode commands can be executed.

NOTE

When you press the DIS/LOC pushbutton, the built-in diagnostic exercises the complete memory system. For systems containing more than 32K of memory, it may take several seconds before the terminal verification pattern appears. As part of the memory diagnostic, the memory configuration installed in the terminal controller is saved and can be examined if desired.

2.4.2.1 Verification Test Pattern and Diagnostics. Figure 2-6 shows the verification test pattern that is displayed on each display indicator when the terminal controller is initialized in the LOCAL mode. The pattern remains displayed until terminated by the proper command or until approximately 45 minutes have elapsed since that last performed operation that affected the pattern.

When the system is first initialized in the LOCAL mode, 'XX' appears in the small box in the lower right portion of the pattern. The 'XX' indicates that the code appearing in the same box contains the results of the built-in diagnostic routines that were automatically performed. The diagnostic code is a three-digit octal representation of an eight bit binary code that indicates the results of each diagnostic routine. Bits in the binary code are assigned as follows:

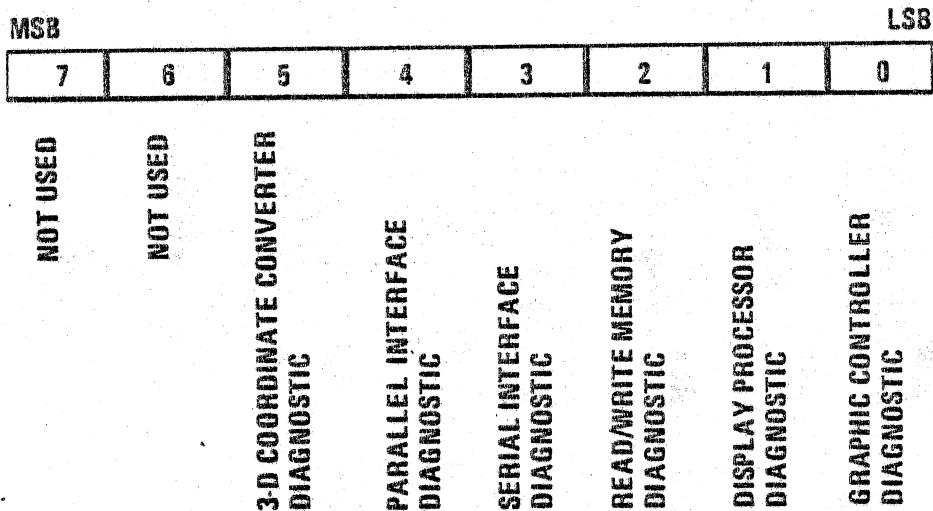

When a diagnostic routine detects a malfunction, the corresponding bit in the error code is set to a 1; if no malfunction is detected, the bit is set to a 0. The octal code displayed in the verification test pattern then tells you the results of all the diagnostic tests. For example, 000 indicates all tests passed, 002 indicates the display processor diagnostic test failed, 030 indicates the serial and the parallel interface diagnostic tests failed, and 077 indicates that all diagnostic tests failed.

As soon as the terminal controller receives any input via a serial interface port, the "XX" in the small box is replaced by a code that indicates the port to which the input device is connected. Codes associated with each serial interface port are shown in table 2-6.

Table 2-6. Serial Interface Port Codes

CODE	SERIAL INTERFACE PORT	DEVICE	ASSOCIATED CONNECTOR
F1	3	Keyboard (with function keys)	J5 on multiport serial interface card no. 1
F2	7	Keyboard (with function keys)	J5 on multiport serial interface card no. 2
TT	TTY	Teletypewriter	J2 on ROM and status card
S1, S5	1 or 5	Any	J2 or J3 on multiport serial interface card no. 1 or no. 2
HC	5	Hardcopy	J3 on multiport serial interface card no. 2

NOTE

No indicator code is provided for ports 4 or 8. These ports are normally used for PEDs which have separate indicators on the test pattern.

When the serial interface port designation is displayed in the small box, the three digit octal code in the box indicates the code last transmitted to the terminal controller. Also, if the code represents a displayable character, the character appears in the upper left corner of the box. If the code does not represent a displayable character, the upper left corner of the box is blank. In systems using SI (shift-in) and SO (shift-out) codes to identify characters in an extended set, the SI character is displayed over the left hand digit of the code and the SO character is displayed over the right hand digit.

The test results box also contains a single-digit real-time clock counter readout in the lower right corner. This counter increments from 0 through 7 continuously at a 1-Hz rate to confirm operation of the real-time clock timing function.

The numeral in the upper center of the verification test pattern indicates the video controller card to which the display indicator is connected.

Trackball (or forcestick) indicators appear in the upper left corner of the verification test pattern. The "1*" indicator is associated with the device normally connected to serial interface port 4 (J6 on multiport serial interface card no. 1) while the "2*" is associated with the device normally connected to serial interface port 8 (J6 on multiport serial interface card no. 2). These indicators are always displayed on the test pattern regardless of whether or not a trackball or forcestick is connected to the system. If a trackball or forcestick is connected to port 4 or 8, it can be manipulated to move its associated indicator about the screen of the CRT as desired.

PHOTOPEN indicators are displayed in the upper right corner of the verification test pattern. The "*1S" with an arrow is associated with a PHOTOPEN connected to the PPN1 connector on the front of the terminal controller. the "*2S" with an arrow is associated with a PHOTOPEN connected to the PPN2 connector. Like the trackball/forcestick indicators, the PHOTOPEN indicators appear on the verification test pattern whether or not PHOTOPENS are connected to the system.

If a PHOTOPEN is connected to the system, its associated indicator responds as light from various data items is sensed by the PHOTOPEN. Whenever an item of data is sensed, the sensed point is intensified and the indicator moves so that the arrow points to the location at which the data item ends. Alphanumeric data is normally stored with two characters per data item. Therefore, the arrow always

points to the end of the second character in a pair. If the PHOTOPEN is also pointed at the character, an asterisk is added to the indicator. When the PHOTOPEN is pointed at the first character in a pair or at a non-character data item, the asterisk is removed from the indicator.

The "S" in each indicator provides an indication of PHOTOPEN switch operation. When you actuate the switch by pressing the PHOTOPEN against the CRT screen, the "S" is removed from the indicator. Pressing the switch a second time causes the "S" to reappear with the indicator.

NOTE

The complete character set is displayed at the bottom center of the terminal verification pattern. In this area all characters are insensitive to PHOTOPEN strikes.

You can test the data tablet by pressing function key F1. This causes the 1* and 2* trackball/forcestick indicators to change to 1# and 2#. The 1# and 2# symbols indicate that all messages received via ports 4 and 8 are in data tablet format. (Data tablet messages consist of 10-character messages, whereas the trackball and forcestick generate 2-character messages.) When you press the data tablet pen switch and move the pen along the active area of the data tablet surface, the appropriate cursor symbol (1# or 2#) moves at a rate proportional to the movement of the pen. The 1# symbol is associated with the data tablet connected to port 4 and the 2# symbol is associated with the data tablet connected to port 8.

NOTE

Successively pressing function key F1 causes the terminal verification pattern to switch from processing data tablet messages to trackball/forcestick messages and vice versa.

2.4.2.2 Local Mode Commands. After the GRAPHIC 8 has been initialized in the LOCAL mode and the verification test pattern is no longer required, you can terminate the pattern by pressing the RETURN key on the keyboard. The pattern then disappears and the letters "BQ M" are displayed in the center of the CRT screen as an indication that the system is in the LOCAL MONITOR mode. At this point, you can perform any of several operations that let you monitor or debug a program, transfer control, or communicate with the host computer.

The following paragraphs discuss commands that can be executed when the system is in the LOCAL MONITOR mode in more detail. Table 2-7 is a summary of the commands.

NOTE

Commands are executed when you press the RETURN key on the standard keyboard.

a. Memory Commands. You can display the content of a memory location by typing the octal address (typing of leading zeros is not required) followed by a slash (/). As soon as you type the slash, the content of the memory location is displayed immediately to the right of the address. You can examine successive memory locations by simply pressing the slash key. Each time you press the slash key, the memory address is incremented by two and its content displayed immediately to the right of the slash.

Table 2-7. Local Mode Command Summary

KEYBOARD ENTRY	OPERATION
RETURN	Executes LOCAL mode command or returns system to LOCAL MONITOR level.
nnnnnn/	Displays contents of memory address nnnnnn (octal).
/	Increments memory address counter by two and displays address contents.
^ or ↑	Decrements memory address counter by two and displays address contents.
Bn	Select different memory bank. (B0 0-32K; B1 32-64K; B2 64-96K; B3 96-128K; and B4 16-32K RAM).
S	Transfers GRAPHIC 8 to SYSTEM mode operation
T RETURN	Transfers to the verification test pattern.
L RETURN	Loads memory from paper tape reader.
nnnnL RETURN	Loads selected option from expansion module
U RETURN	Unload all options
O RETURN	Display status of all options loaded
Q	Decrements contents of display processor Q register by two and displays result. Used with diagnostics to indicate address at which display processor halted.
nnnnnnD RETURN	Directs graphic controller to display refresh file beginning at address nnnnnn (octal).

Table 2-7. Local Mode Command Summary (Cont)

KEYBOARD ENTRY	OPERATION
nnnnnnG RETURN	Transfers control of display processor to program beginning at memory address nnnnnn (octal).
Y RETURN	Calls teletypewriter emulation program. After entering emulation program, function key F0 clears CRT screen. Function key 1 selects full or half duplex operation; receipt of octal code 035 from the host computer or pressing function key F13 transfers GRAPHIC 8 to SYSTEM operating mode.
RUB OUT	Deletes last octal entry from keyboard.

After you have used the slash key to examine the content of a memory location, you can use the up arrow (^ or ↑) key in a similar manner to examine preceding memory locations. Each time you press the up arrow key, the memory address is decremented by two and its content displayed immediately to the right of the slash.

You can change the content of a memory location after you have examined it by typing the new data (typing of leading zeros is not required) before pressing the slash or up arrow key. The new data is displayed to the right of the old data and is automatically substituted when the slash or up arrow key is pressed.

You can examine or change memory locations in other banks via the bank (B) select command. Typing B0, B1, B2, B3, or B4 changes the memory bank selection to bank 0, bank 1, bank 2, bank 3, or bank 4 respectively. Below is a table representing the associated virtual and physical addresses for each bank.

<u>Bank Number</u>	<u>Virtual Address</u>	<u>Physical Address</u>	<u>Pages</u>
0*	000000-177777	000000-177777	00-07
1	000000-177777	200000-377777	10-17
2	000000-177777	400000-577777	20-27
3	000000-177777	600000-777777	30-37
4*	100000-177777	100000-177777	04-07

NOTE

*Addresses in the range of 100000-177777 (pages 4, 5, 6, and 7) for bank 0 correspond to ROM and I/O device registers. Addresses in the range of 100000-177777 for bank 4 correspond to RAM.

You can return to the LOCAL MONITOR level by pressing the RETURN key. When you press this key, any specified memory content change is completed and the system returns to LOCAL MONITOR level as indicated by letters "B0 M" displayed at the center of the CRT screen.

b. Displaying a Refresh File. When the system is at the LOCAL MONITOR level, you can display the contents of a refresh file by typing the starting address of the file (in octal notation) followed by a "D" and then pressing the RETURN key. This command instructs the digital graphic controller to display the entire refresh file that begins at the specified address. Display of the refresh file continues until you press RETURN key again, at which time the system returns to the LOCAL MONITOR level. This command is subject to the bank argument presently displayed.

c. Transfer of Program Control. You can transfer program control from LOCAL MONITOR level to any desired address location in bank 0 by typing the address location in octal notation followed by a "G" and then pressing the RETURN key. The display processor then executes instructions beginning with the instruction at the specified address. Any further operations depend on the program in which control is transferred.

d. Transfer to System Mode. To transfer to the SYSTEM mode of operation from the LOCAL MONITOR level, type "S". This command has the same effect as pressing the RUN/SYS pushbutton on the terminal controller. After transferring to the SYSTEM mode, operation in the LOCAL mode can be reestablished only by a message from the host computer, or by pressing the DIS/LOC pushbutton on the terminal controller, or by pressing CONTROL and SHIFT and RETURN on the keyboard.

e. Teletypewriter Emulation. For purposes of communicating with a host computer, the GRAPHIC 8 can be made to emulate the functions of a teletypewriter. In this mode, the keyboard operates like the keyboard of a teletypewriter and the display indicator serves as the printout device. Scrolling of data on the display indicator is handled on a half-page basis. That is, when the CRT screen is full, the top half of the data is deleted from the display and the bottom half of the data moves up to take its place.

If a parallel interface card is installed in the terminal controller, the graphic control program assumes that communications with the host computer are to be handled over the parallel interface. In this case, teletypewriter emulation signals are transmitted in parallel using only the low order byte (bits 0-7) of the 16-bit interface. If a parallel interface card is not installed, a standard 8-bit serial interface via serial interface port 1 is assumed. In either case, bit 7 is always equal to zero.

You enter the emulation program from the LOCAL MONITOR level by typing the letter "Y" followed by RETURN. Full-duplex or half-duplex emulation may then be selected by pressing function key F1, which

changes the selection each time it is pressed. The type of emulation selected is indicated by the "TTY F" (full duplex) or "TTY H" (half duplex) that is displayed at the top of the CRT screen at all times during emulation. You can switch between full and half duplex operation at any time during emulation by pressing function key F1. Pressing function key F0 during teletypewriter emulation clears the CRT screen.

Exit from the teletypewriter emulation program occurs when octal code 035 (ASCII control character GS Group Separator) is received from the host computer. This code, which can also be generated by pressing function key F13, immediately causes the GRAPHIC 8 to transfer to the SYSTEM mode of operation. On basic series 8000 systems, return to the LOCAL MONITOR level can be achieved only by a command from the host computer, or by pressing the DIS/LOC pushbutton on the terminal controller, or by pressing CONTROL and SHIFT and RETURN on the keyboard.

f. Additional Local Mode Commands. Additional commands that you can use when the GRAPHIC 8 is in the LOCAL mode at the MONITOR level are the L, U, O, T, Q, H, and RUB OUT commands. The L command enables the memory to be loaded from a paper tape reader connected to the terminal controller. After the tape has been placed in the reader, loading is initiated by typing the letter "L" followed by RETURN.

NOTE

A paper tape reader may be connected to multiport serial interface card ports 1, 2, or 3 or to the serial interface port on the ROM and status logic card.

You also use the L command to load in options from the expansion module. The option command format is as follows:

```
nnnnL RETURN
```

where nnnn is the option number. Valid option numbers are in the ranges of 1 to 3777 and 4001 to 7777.

NOTE

The optional expansion module can store a variety of option types.

The U command is used to unload all options. Typing "U" followed by RETURN unloads all options.

The O command is used to detect the presence and status of all loaded options. Typing O followed by RETURN causes the display of the first option loaded. Successively pressing the RETURN key causes the display of all other options loaded. The option status is displayed in the following format.

```
nnnn ss
```

where nnnn is the option number and ss is the option status code.

The option status code is as follows:

00	Detected but unloaded
01	Unloaded, checksum error (local)
11	Unloaded, checksum error (system)
02	Unloaded, checksum OK, hardware not present (LOCAL)
12	Unloaded, checksum OK, hardware not present (SYSTEM)
03	Unloaded, checksum OK, self-test = NO GO (LOCAL)
13	Unloaded, checksum OK, self-test = NO GO (SYSTEM)
04	Loaded, checksum OK, self-test = GO (LOCAL)
14	Loaded, checksum OK, self-test = GO (SYSTEM)

You use the T command to recall the verification test pattern when the system is at the LOCAL MONITOR level. This command is executed by typing the letter "T" followed by RETURN. The effect is the same as pressing the DIS/LOC pushbutton on the terminal controller. Pressing RETURN a second time causes the system to return to the LOCAL MONITOR level.

The Q command is a special command used for diagnostic and debugging purposes. Whenever a HALT instruction is executed by the display processor, the content of the program counter is stored in the Q register of the display processor. After you have reinitialized the system by pressing the DIS/LOC pushbutton on the terminal controller, you can use the Q command to display the address at which the display processor halted. The Q command is executed by typing the letter "Q". This causes the content of the Q register to be decremented by two and the result displayed to indicate the address of the HALT instruction. Note that the Q command always decrements the content of the Q register by two and displays the result. The result, however, is only meaningful immediately following initialization in the LOCAL mode after a HALT instruction has been executed. After using a Q command, pressing RETURN returns the system to the LOCAL MONITOR level.

The RUB OUT command provides a means of correcting erroneous entries from the keyboard. At any time before a command is executed, pressing RUB OUT causes the last keystroke entry to be deleted. An additional entry is deleted each time the RUB OUT key is pressed.

2.4.3 OPERATOR PERFORMANCE CHECKS. If you suspect a malfunction in the terminal controller or any of its peripherals (or if the host computer reports the terminal controller to be defective), you can perform the following procedure to verify basic system operation. If you do not get the described results, refer to Section 4.

1. Press the DIS/LOC pushbutton to initialize LOCAL mode. Confirm that the verification test pattern (figure 2-6) is present on the display indicator.
2. Confirm that the test results box shows a 000 value (code for all tests passed), with the "XX" error word code displayed in the upper right corner of the box.

3. Confirm that the seconds counter at the lower right corner of the test results box runs continuously through an 8-count cycle (0-7).
4. Confirm that the letter "T" appears in the upper left corner of the test results box.
5. Press one or more alphanumeric keys on the keyboard. Confirm that:
 - a. The alphanumeric symbol replaces the letter "T" in the upper left corner of the test results box.
 - b. The applicable ASCII value in octal format replaces the test results value below that symbol.
 - c. The appropriate source code (table 2-6) replaces the "XX" code.
6. Confirm that a full library of alphanumeric and special symbols is displayed at the lower center of the verification test pattern.
7. Confirm that three different sized sets of "EM" letter pairs are displayed in the lower left quadrant of the verification test pattern.
8. Confirm that the line structure of the overall test pattern conforms with the pattern shown in figure 2-6 with respect to the following:
 - a. The corners of the displayed squares are clearly defined right angles, with uniform intensity through the points of congruence in all four corners.
 - b. The central portions of the sides of the inner square represent different line structure patterns: solid (bottom), dotted (right), dashed (left), and centerline (top).
 - c. The circle and ellipse patterns are smooth and unbroken; the dotted cross and arc segments are as shown in figure 2-6.
 - d. The triangle is smooth and complete, as shown in figure 2-6.
9. Confirm that the number of the video controller card associated with a specific display indicator appears in the upper center of the pattern, continuously blinking on and off.

10. Confirm that the trackball/forcestick/data tablet identifier symbols are initially presented in the upper left corner of the pattern, with the applicable symbol moving as appropriate for any PED displacement inputs.
11. Confirm that the PHOTOPEN identifier signals are initially presented in the upper right corner of the test pattern with the applicable symbol moving as appropriate for any strike inputs, and responding appropriate ("S" character disappearing or reappearing) each time you press the PHOTOPEN switch.
12. In the case of a four-color display, confirm that the proper colors are displayed.

2.4.4 HARD COPY USAGE. Both the monochrome hard copy unit and the color hard copy unit produce high contrast paper copies from standard, raster scan signals of refreshed graphics terminals. The following paragraphs describe how to make a hard copy of any displayed pattern using each of these units.

2.4.4.1 Monochrome Hard Copy Unit. To make a black-and-white or gray-scale hard copy of a displayed pattern using a monochrome hard copy unit, proceed as follows:

1. Press function key F0 on the keyboard; this action freezes the display.
2. Press the COPY pushbutton on the hard copy unit once for each copy required. Adjust the LIGHT/DARK control as needed for best copy quality.
3. Press function key F0 on the keyboard again to allow the display to update.

2.4.4.2 Color Hard Copy Unit. To make an 8 x 10 instant color print of a displayed pattern, proceed as follows:

1. Press function key F0 on the keyboard; this action freezes the display.
2. Set the color hard copy unit mode select lever to the 8 x 10 position.
3. Set the front control panel NORMAL/SEPARATE switch to NORMAL.
4. Set the front control panel COLOR/FOCUS switch to COLOR.
5. Press the front control panel RESET pushbutton; wait for the green indicator lamp in the EXPOSE pushbutton to light.
6. Grasp the blue handles on the dark slide in the film cassette and pull the slide out as far as it will go.

7. Press the front control panel EXPOSE pushbutton. Each of the SEQUENCE indicator lamps should light in turn as the three exposures are made: the red exposure should last approximately 40 seconds, the green exposure seven seconds, and the blue exposure three seconds. At the end of the exposure sequence, the color hard copy unit speaker should beep.
8. Push the dark slide on the film cassette all the way in.
9. Process the film. Refer to the instruction sheet supplied with the box of film and the instruction book supplied with the film processor for details.

To make additional 8 x 10 instant color prints, you must first reload the film cassette and reinsert it in the color hard copy unit. (Refer to the instruction sheet supplied with the box of film for loading procedure.) However, you do not need to press the front control panel RESET pushbutton before making each additional print. Simply repeat steps 6 through 9 above. Use function key FO on the keyboard to update and freeze the display, as desired, before making each new exposure.

To make a 35 mm slide of a displayed pattern, proceed as follows:

1. Press function key FO on the keyboard to freeze the display.
2. Set the color hard copy unit mode select lever to the AUX position.
3. Set the front control panel NORMAL/SEPARATE switch to NORMAL.
4. Set the front control panel COLOR/FOCUS switch to COLOR.
5. Press the front control panel RESET pushbutton; wait for the green indicator lamp in the EXPOSE pushbutton to light.
6. Press the front control panel EXPOSE pushbutton. Each of the SEQUENCE indicator lamps should light in turn as the three exposures are made; the red exposure should last approximately 40 seconds, the green exposure seven seconds, and the blue exposure three seconds. At the end of the exposure sequence, the color hard copy unit speaker should beep.

You may continue making 35 mm exposures simply by pressing the front control panel EXPOSE pushbutton. You do not need to press the RESET pushbutton before making each additional exposure. Use function key FO on the keyboard to update and freeze the display, as desired, before each exposure. When you reach the end of the roll of film, the color hard copy unit will:

- Go into the red exposure cycle (the red SEQUENCE indicator lamp should light and remain lit)
- Terminate the 35 mm shutter
- Beep three times
- Light the front control panel OUT OF FILM indicator lamp

To remove the exposed roll of film, proceed as follows:

1. Move the lever marked R on the real-time winder toward the camera.
2. Fold out the film rewind crank handle and turn it clockwise. Keep turning until the crank handle rotates freely.
3. Open the auxiliary camera back cover and take out the roll of film.

Process the roll according to the directions given on the instruction sheet supplied with the film.

2.4.5 PHOTOPEN USAGE. To operate the model 5781 PHOTOPEN, proceed as follows:

1. Locate the desired target (character, symbol, line, or other display element) on the display screen. The display target area must be lighted.
2. Place the tapered front end of the PHOTOPEN against the display screen, pointed directly at the target location.
3. Press downward on the PHOTOPEN, sliding the outer shell forward. This action activates the PHOTOPEN ON switch. The terminal controller responds according to the software instructions supplied with the GRAPHIC 8 system. Hold the outer shell forward as long as necessary.
4. To turn the PHOTOPEN off, release the downward pressure on the outer shell and allow it to return to its normal position.

2.4.6 TRACKBALL/FORCESTICK USAGE. To operate the model 5786 trackball, rotate the trackball in the direction in which the cursor or other displayed data is to move on the display screen. Rotate the trackball faster to increase the speed at which the data moves across the screen, or slower to decrease the speed.

To operate the model 5787 forcestick, push the control rod in the direction in which the cursor or other displayed data is to move across the display screen. Increase the pressure on the control rod to increase the speed at which the data moves across the screen. Release the control rod to stop the movement.

2.4.7 DATA TABLET USAGE. The model 5788 data tablet may be operated in either the POINT mode or the RUN mode. To select the POINT mode, set the operation mode select switch, located on the data tablet rear panel, to position A. To select the RUN mode, set the operation mode select switch to position B.

The POINT mode is used for entering charts and graphs or for making point-to-point plots and measurements. To operate the data tablet in the POINT mode, proceed as follows:

1. Place the material to be digitized on the active surface of the data tablet.
2. Place the point of the pen stylus over the place on the material where the first coordinate to be plotted appears.
3. Lift the pen stylus from the active surface of the data tablet and place it over the place where the next coordinate appears.
4. Lift the pen stylus from the active surface of the data tablet again before entering each additional coordinate. For best results, hold the pen stylus perpendicular to the active surface of the data tablet.

The RUN mode is used for creating graphics such as maps, stylized line drawings, and special symbols. To operate the data tablet in the RUN mode, proceed as follows:

1. Place the material to be digitized on the active surface of the data tablet.
2. Hold the pen stylus within one-half inch above the active surface of the data tablet.
3. Move the pen stylus over the material to be digitized, using a continuous motion. The data tablet will transmit a continuous stream of data identifying the immediate location of the pen stylus to the terminal controller for display.

2.4.8 TURN-OFF PROCEDURES. To turn off the terminal controller, press the 0 side of the POWER ON/OFF circuit breaker.

To turn off the color monitor, set the POWER ON/OFF switch to OFF.

To turn off the monochrome monitor, press the POWER switch.

To turn off the monochrome hard copy unit, set the POWER OFF/ON switch (on top of the unit) to OFF.

SECTION 3

INSTALLATION

3.1 ENVIRONMENTAL CONSIDERATIONS

A typical GRAPHIC 8 system is designed to operate in an ambient temperature range of +15°C to +40°C (+59°F to +104°F), with a relative humidity not exceeding 90 percent, and at altitudes not exceeding 3048 meters (10,000 feet). However, the use of optional equipment components (such as a color hard-copy unit) may restrict these ranges. Refer to the appropriate table in Section 1 for the environmental considerations that apply to any optional component included as part of your GRAPHIC 8 system.

The GRAPHIC 8 terminal controller, color monitor, and monochrome monitor can be mounted in EIA standard 19-inch equipment racks, either directly or on optional slide assemblies. The terminal controller card cage (standard or extended) occupies 10.5 inches of rack height. The low voltage power supply (LVPS) and control panel used with the optional, extended card cage occupies an additional 8.72 inches of rack height. A GRAPHIC 8 color monitor typically occupies 14.4 to 17.4 inches of rack height, depending on the model. A GRAPHIC 8 monochrome monitor occupies 15.7 inches of rack height.

The terminal controller can also be mounted in an equipment cabinet (Sanders part number 5976104). The equipment cabinet also accommodates a system interconnect panel and a power panel assembly. The system interconnect panel occupies a 9.25-inch vertical space; the power panel assembly occupies a 10.48-inch vertical space. Both the system interconnect panel and the power panel assembly may also be rack mounted.

3.2 EQUIPMENT CABINET

The equipment cabinet is a four-wheeled, semi-portable equipment rack with the following approximate dimensions:

<u>Height</u>	<u>Width</u>	<u>Depth</u>
30 inches (76.3 cm)	23 inches (58.4 cm)	30 inches (76.2 cm)

The cabinet has doors on both front and back. The front door is hinged on its right side, and is held shut by a magnetic latch. The front door has a cut-out to give access to the terminal controller controls and indicators. The rear door is hinged on its left side, and is held shut by a magnetic latch.

When the equipment cabinet contains the standard terminal controller, system interconnect panel, and power panel assembly, they are arranged as follows:

1. The terminal controller is accessible from the front of the cabinet, and is installed in the upper half of the cabinet.
2. The power panel assembly is accessible from the front of the cabinet, and is installed in the lower half of the cabinet.
3. The system interconnect panel is accessible from the rear of the cabinet, and is installed in the lower half of the cabinet.

When the equipment cabinet contains the extended terminal controller, LVPS and control panel, system interconnect panel, and power panel assembly, they are arranged as follows:

1. The LVPS and control panel is accessible from the front of the cabinet, and is installed in the upper half of the cabinet.
2. The terminal controller is accessible from the front of the cabinet, and is installed in the lower half of the cabinet.
3. The system interconnect panel is accessible from the rear of the cabinet, and is installed in the upper half of the cabinet.
4. The power panel assembly is accessible from the rear of the cabinet, and is installed in the lower half of the cabinet.

A cut-out in the bottom of the cabinet, below the system interconnect panel, is the entryway for power and signal cables. There is also an air filter in the bottom of the cabinet. Refer to Section 4 for access and maintenance instructions.

3.3 POWER PANEL ASSEMBLY

3.3.1 STANDARD POWER PANEL ASSEMBLY. The standard power panel assembly is Sanders part number 5976122. This power panel assembly is usable with prime power voltages of 100 Vac, 120 Vac, 220 Vac, and 240 Vac.

The power panel assembly contains a circuit breaker (CB1) in the prime power lines; a programmable power transformer; a line filter assembly; a 15-pin connector (J3) for voltage configuration; a power contactor (K1); and a duplex 110 Vac power outlet (J1, J2).

Outlet J1 is live when the circuit breaker on the power panel assembly is ON. Outlet J2 is live when the circuit breaker is ON and relay K1 is energized. Relay K1 is energized by a control signal at connector P2 on the power panel.

The power cord is Belden type 17612 (length 6 feet 7 inches, or 2 meters). If the primary power source is not 120V, 60 Hz, the first step in installation is to connect an appropriate power connector to this power cord. The three lines in the power cord are color-coded as follows:

Light blue for the neutral line
 Brown for the high line
 Green/yellow for safety ground

The power cord is soldered to terminals on the line filter. The line filter suppresses transients that may appear on the primary power line. The output of the line filter goes to the circuit breaker.

The circuit breaker opens if the current at 115V exceeds 10A or if the current at 220V exceeds 5A.

The high line output of the circuit breaker goes to pin 1 of connector J3 (brown wire) and to pin 3 of connector J3 (light blue wire). The neutral line output of the circuit breaker goes to pin 2 of connector J3 (tan wire) and to pin 4 of connector J3 (dark blue wire).

The mating connector P3 contains jumper connections that set up the primary windings of the power transformer to match the input voltage. Connector P3 is wired as shown in table 3-1.

Table 3-1. Connector P3 Configurations

G-CONDITION INPUT VOLTAGE	JUMPERS INSTALLED
G1 100 Vac	1 to 6; 3 to 7; 10 to 13 to 15; 11 to 12 to 14
G2 120 Vac	1 to 5 to 8; 3 to 7 to 9; 10 to 13 to 15; 11 to 12 to 14
G3 220 Vac	2 to 6; 4 to 9; 7 to 8; 10 to 13 to 15; 11 to 12 to 14
G4 240 Vac	2 to 5; 4 to 9; 7 to 8; 10 to 13 to 15; 11 to 12 to 14

Connections from J3 to the transformer primary winding are as follows:

From J3-5 to T1-C (white)
 From J3-6 to T1-A (white)
 From J3-7 to T1-E (white)
 From J3-8 to T1-D (white)
 From J3-9 to T1-F (white)

The output from the transformer secondary winding (110 Vac) goes back to connector J3 as follows:

From T1-1 to J3-10 (light blue)
From T1-2 to J3-11 (brown)

The 110 Vac lines go from connector J3 to the duplex output box connector J1 as follows:

From J3-13 to J1-N (light blue)
From J3-12 to J1-L (brown)

The ground pin of the duplex output box is connected to the outlet box mounting stud.

The 110 Vac lines go from connector J3 to the power contactor K1 as follows:

From J3-15 to K1-8 (light blue)
From J3-14 to K1-7 (brown)

The 110 Vac lines go from power contactor K1 to duplex output box connector J2 as follows:

From K1-4 to J2-N (light blue)
From K1-3 to J2-L (brown)

The power contactor control signal goes from connector P2 to power contactor K1 as follows:

From P2-1 to K1-5 (red)
From P2-3 to K1-6 (black)
From P2-2 to K1 mounting stud (shield)

3.3.2 ALTERNATIVE POWER PANEL ASSEMBLY. The alternative power panel assembly (Sanders part number 5976121) is usable if the prime power is 110 Vac. The alternative power panel contains a filter, a circuit breaker, a relay, and a duplex outlet box. The power cord is Belden type 17612 with the original power connector left on.

Outlet J1 is live when the circuit breaker on the power panel assembly is ON. Outlet J2 is live when the circuit breaker is ON and power contactor K1 is energized. The power contactor is energized by a control signal at connector P2 on the power panel.

3.4 SYSTEM INTERCONNECT PANEL ASSEMBLY

The system interconnect panel (Sanders part number 5976105) provides a convenient means of connecting the terminal controller to the host computer, to the displays, and to other peripheral devices (keyboards, position entry devices, PHOTOPENS).

The panel assembly consists of a panel with cutouts and a number of cable assemblies with connectors; the connectors are secured to the panel at their respective cutouts.

Figure 3-1 shows typical wiring between the terminal controller and the system interconnect panel and lists the part numbers of the cable assemblies. Note that the figure shows the back side of the interconnect panel assembly. The figure shows specifically the standard card cage terminal controller. The slot numbers of the individual circuit cards differ from the standard card cage to the extended card cage; refer to figure 1-7 for extended card cage card locations.

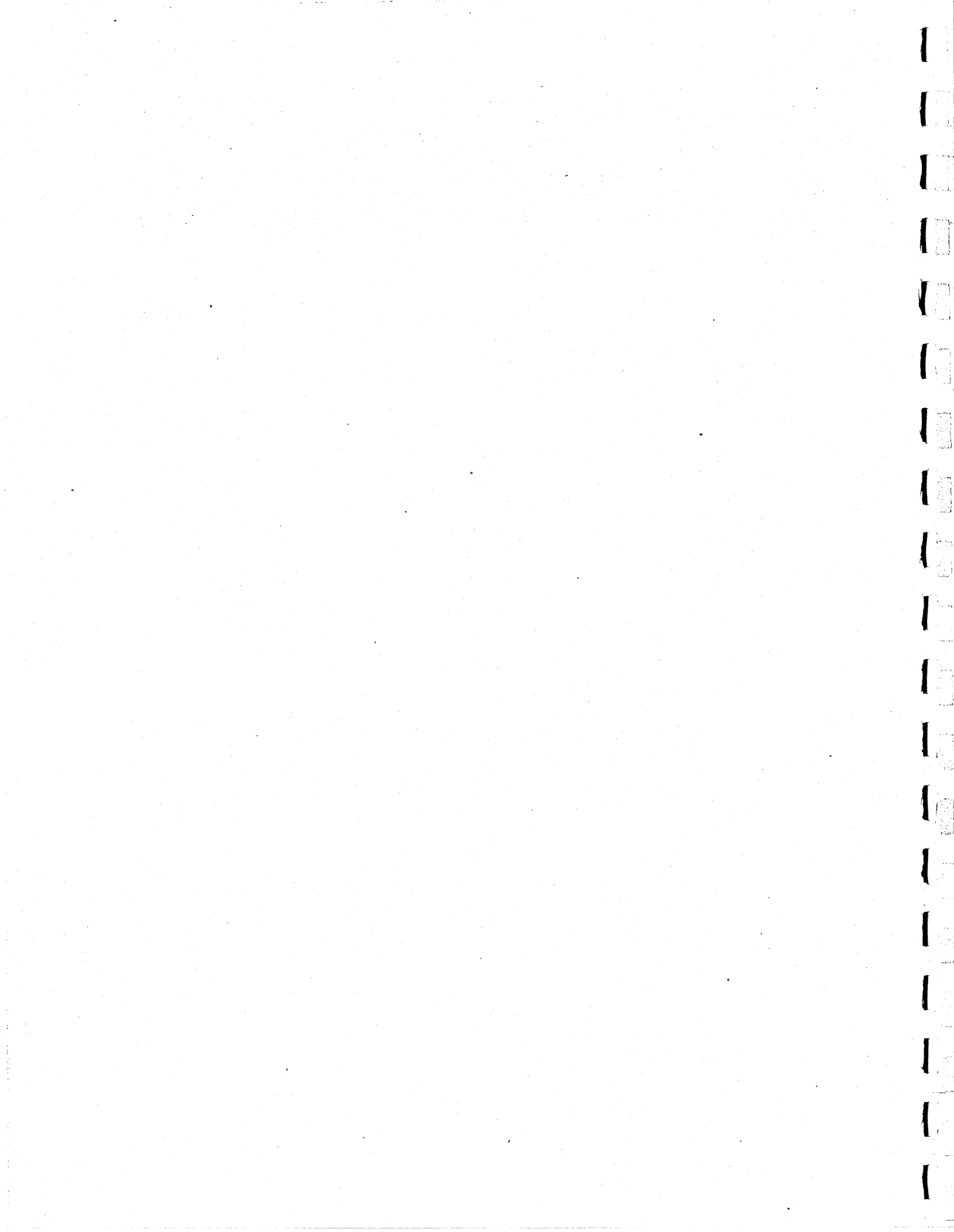

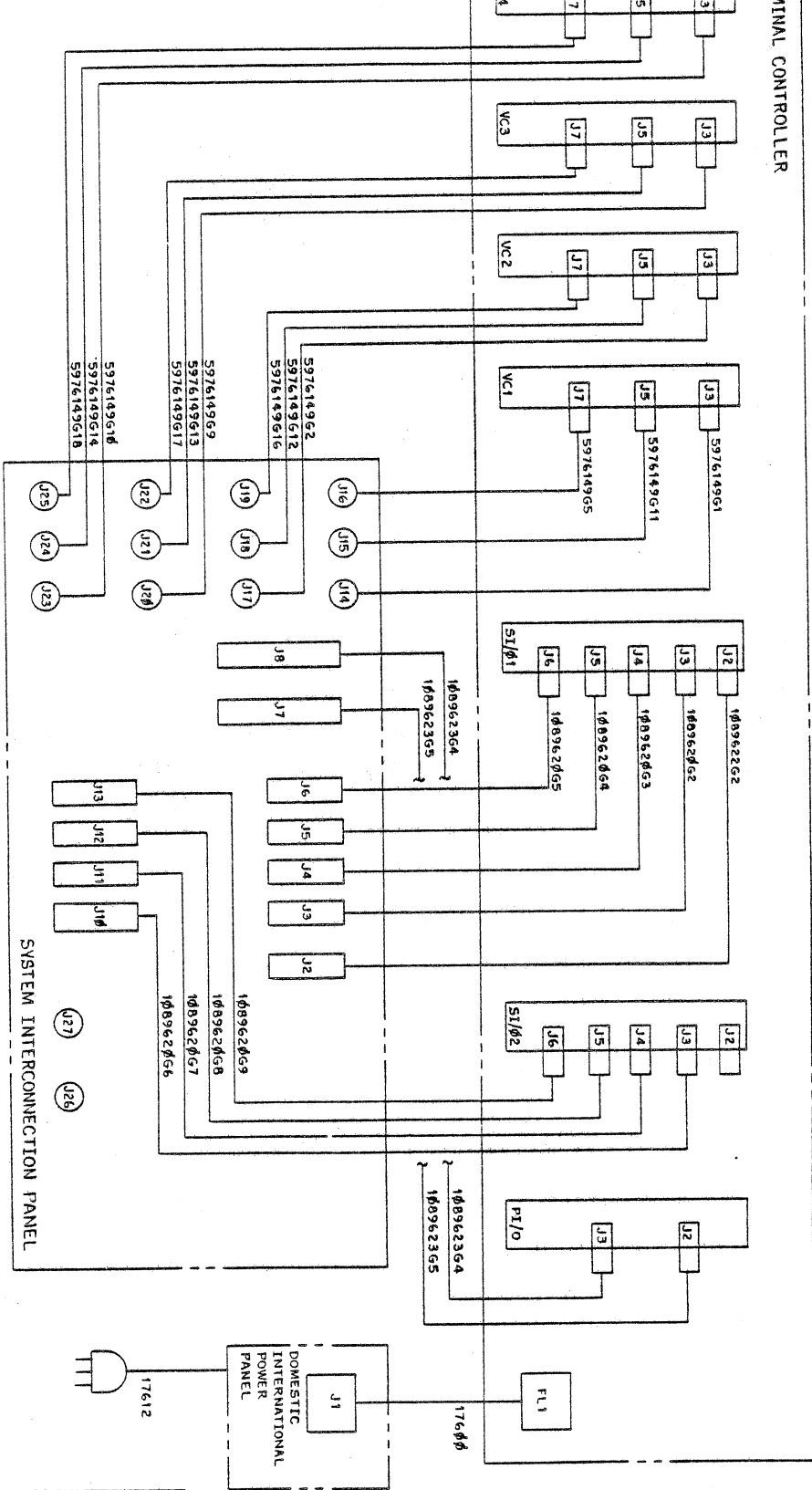

TIMING MODULE	A17	A16	A15	A14	A13	A12	A11	A10	A9	A8	A7	A6	A5
MAPPING MEMORY													
VIDEO CONTROLLER # 2													
MAPPING MEMORY													
VIDEO CONTROLLER # 1													
MAPPING MEMORY													
DIGITAL GRAPHIC CONTROLLER													
ROM AND STATUS MODULE													
DISPLAY PROCESSOR													

"TYPICAL" GRAPHIC 8 CONFIGURATION

- NOTES:
1. THE MULTIPORT SERIAL INTERFERENCE MAY BE PLACED IN ANY SLOT FROM A1 THROUGH A17, WITH THE LEFT MODULE DESIGNATED SI/81 AND THE RIGHT MODULE TO THE RIGHT DESIGNATED SI/82.
 2. THE VIDEO CONTROLLER MODULES MAY BE PLACED IN ANY SLOT FROM A8 THROUGH A17, WITH THE RIGHT MOST MODULE DESIGNATED VC2, AND THE LEFT MOST MODULE DESIGNATED VC1, AND SO ON TO VC3 AND VC4.

SEE ALSO FIGURE 1-6.

Figure 3-1. In Diagram

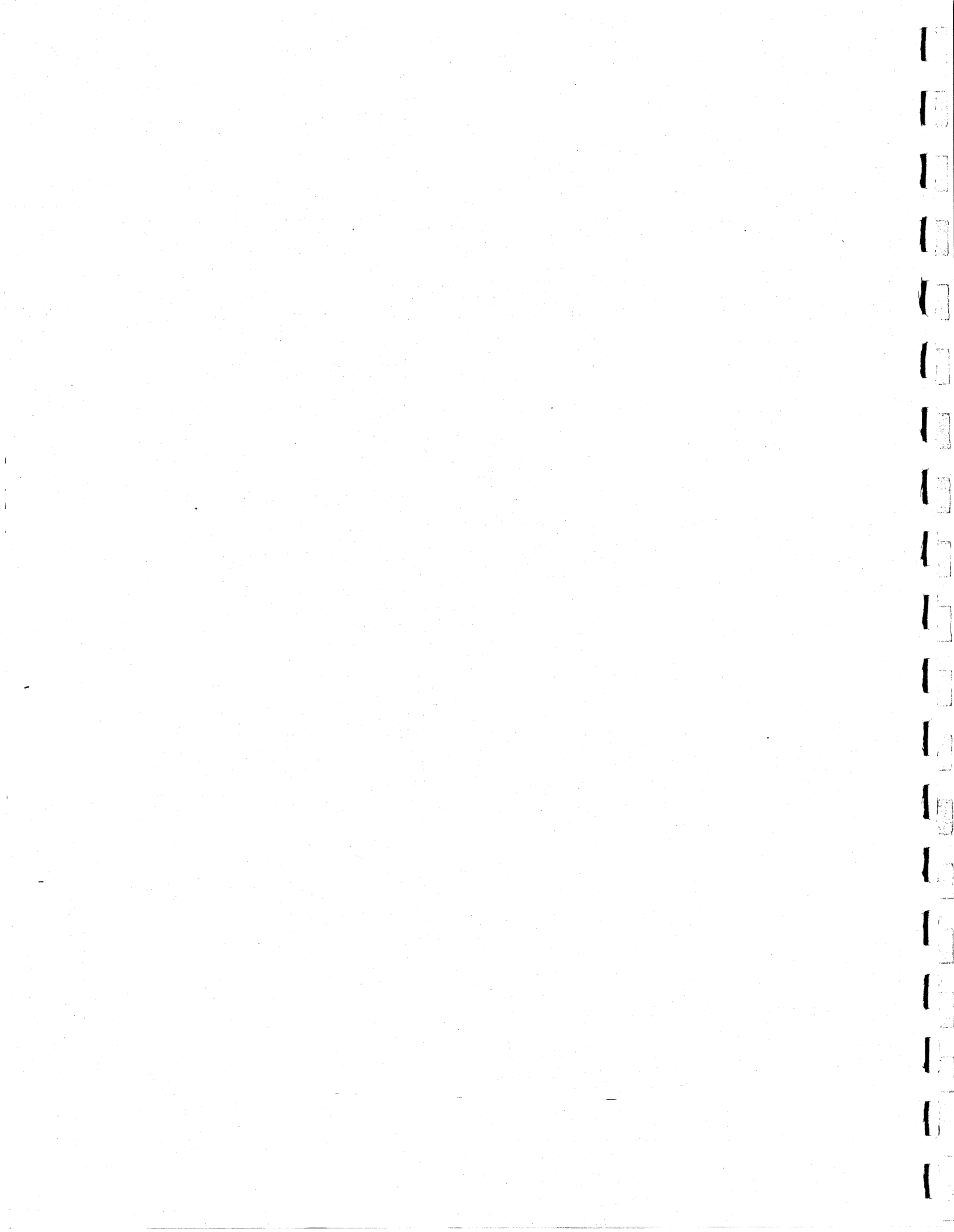

3.5 CONNECTIONS TO BE MADE AT INSTALLATION

3.5.1 TERMINAL CONTROLLER MOUNTED IN EQUIPMENT CABINET. If the terminal controller and equipment cabinet are ordered at the same time, the terminal controller is shipped from the factory installed in the equipment cabinet, and all connections between the terminal controller and the system interconnect panel are already made.

For other situations, refer to figure 3-1.

Connections between the system interconnect panel and other devices are a function of the individual installation. Refer to the top assembly drawing for your installation. In general:

1. Connections to the host computer are made by cables from J1 and J8 of the system interconnect panel to the appropriate point in the host computer. If the parallel interface is not Sanders model no. 5712 (part number 1086802), then the cables needed to connect between the system interconnect panel and the host computer may be supplied with the parallel interface. If the parallel interface is Sanders model no. 5712, then the interconnecting cables are the customer's responsibility.
2. If the GRAPHIC 8 system does not contain a parallel interface, and communications with the host computer are through the multiport serial interface, then the cable needed to connect between the system interconnect panel and the host computer is the customer's responsibility. The cable would normally be connected to the J2 connector on the system interconnect panel, but in some cases could be connected to J3.
3. If the GRAPHIC 8 system includes one alphanumeric keyboard, the keyboard connects to J5 on the system interconnect panel. However, if the associated display indicator pedestal contains an accessory panel, the keyboard may plug into that accessory panel. Another cable leads from the accessory panel to J5 on the system interconnect panel.
4. If the GRAPHIC 8 system includes two alphanumeric keyboards and two serial interface cards, the second keyboard connects (either directly or through an accessory panel) to J12 on the system interconnect panel.
5. If the GRAPHIC 8 system includes two alphanumeric keyboards and only one serial interface card, the second keyboard connects (either directly or through an accessory panel) to J4 on the system interconnect panel; the serial interface card must be modified to make its port 2 appear to be port 7.

6. If the GRAPHIC 8 system includes one position entry device (trackball, forcestick, or data tablet), the PED connects to J6 on the system interconnect panel. However, if the associated display indicator pedestal contains an accessory panel, the PED may plug into that accessory panel. Another cable leads from the accessory panel to J6 on the system interconnect panel.
7. If the GRAPHIC 8 system includes two PEDs and two serial interface cards, the second PED connects (either directly or through an accessory panel) to J13 on the system interconnect panel.
8. If the GRAPHIC 8 system includes two PEDs and only one serial interface card, the second PED connects (either directly or through an accessory panel) to J4 on the system interconnect panel; the serial interface card must be modified to make its port 2 appear to be port 8.
9. If the GRAPHIC 8 system includes one PHOTOPEN, it connects to J26 on the system interconnect panel. However, if the associated display indicator pedestal contains an accessory panel, the PHOTOPEN may plug into that accessory panel. Another cable leads from the accessory panel to J26 on the system interconnect panel.
10. If the GRAPHIC 8 system includes two PHOTOPENS, the second one connects (either directly or through an accessory panel) to J27 on the system interconnect panel. In this case the customer must specify an additional cable, part number 5976150G1, to connect from the system interconnect panel to the PHOTOPEN 2 connector on the terminal controller.
11. For all color systems, connectors J14 through J16 on the system interconnect panel are exact replicas of connectors J3, J5, J7 of the video controller card #1. Similarly J17 through J19 on the system interconnect panel correspond to J3, J5, J7 of video controller card #2; J20 through J22 pertain to video controller card #3, and J23 through J25 pertain to video controller card #4. For systems with monochrome applications, connector J2 on the respective video controller card connects to J16, J19, J22, or J25 on the system interconnect panel.
12. Connector J2 on the ROM and status card (usable with a teletypewriter, paper tape reader, keyboard, PED, or even the host computer) does not have a comparable connector on the system interconnect panel. Any connection must be made directly to the connector on the edge of the ROM and status card, using a cable with suitable connectors.

3.5.2 TERMINAL CONTROLLER WITHOUT EQUIPMENT CABINET. If the terminal controller is purchased without the equipment cabinet (as for rack mounting or installation in a display console), and if the system

interconnect panel is not procured, then connections between the terminal controller, the host computer, and the peripheral devices must be made directly to connectors on the terminal controller.

If the GRAPHIC 8 system includes a parallel interface, the cables from the host computer go to connectors J2 and J3 on the edge of the parallel interface card. J2 accepts output data and control signals from the host computer. J3 carries input data and control signals to the host computer. Table 3-2 lists and identifies the pins in parallel interface connectors J2 and J3 for the model 5712 parallel interface.

Table 3-2. Parallel Interface I/O Connectors, Pin Assignments

JACK/PIN	SIGNAL	JACK/PIN	SIGNAL	JACK/PIN	SIGNAL
J2-1	OD00(+)	J2-20	DRET-	J3-39	OMR(+)
J2-2	DRET-	J2-21	OD10(+)	J3-40	DRET-
J2-3	OD01(+)	J2-22	DRET-	J3-41	OCTL(+)
J2-4	DRET-	J2-23	OD11(+)	J3-42	DRET-
J2-5	OD02(+)	J2-24	DRET-	J3-43	ODR(+)
J2-6	DRET-	J2-25	OD12(+)	J3-44	DRET-
J2-7	OD03(+)	J2-26	DRET-	J3-45	SPARE
J2-8	DRET-	J2-27	OD13(+)	J3-46	SPARE
J2-9	OD04(+)	J2-28	DRET-	J3-47	INIT
J2-10	DRET-	J2-29	OD14(+)	J3-48	DRET-
J2-11	OD05(+)	J2-30	DRET-	J3-49	*IMR(+)
J2-12	DRET-	J2-31	OD15(+)	J3-50	SPARE
J2-13	OD06(+)	J2-32	DRET-		
J2-14	DRET-	J2-33	*SPR1-	J3-1	ID00(+)
J2-15	OD07(+)	J2-34	SPARE	J3-2	DRET-
J2-16	DRET-	J2-35	ATN1(+)	J3-3	ID01(+)
J2-17	OD08(+)	J2-36	DRET-	J3-4	DRET-

*Signals used only in test operation using input to output (J3 to J2) loop cable.

Table 3-2. Parallel Interface I/O Connectors,
Pin Assignments (Cont)

JACK/PIN	SIGNAL	JACK/PIN	SIGNAL	JACK/PIN	SIGNAL
J2-18	DRET-	J2-37	OWR(+)	J3-5	ID02(+)
J2-19	OD09(+)	J2-38	DRET-	J3-6	DRET-
J3-7	ID03(+)	J3-22	DRET-	J3-37	ICTL(+)
J3-8	DRET-	J3-23	ID11(+)	J3-38	DRET-
J3-9	ID04(+)	J3-24	DRET-	J3-39	ATN2(+)
J3-10	DRET-	J3-25	ID12(+)	J3-40	DRET-
J3-11	ID05(+)	J3-26	DRET-	J3-41	IWR(+)
J3-12	DRET-	J3-27	ID13(+)	J3-42	DRET-
J3-13	ID06(+)	J3-28	DRET-	J3-43	SPARE
J3-14	DRET-	J3-29	ID14(+)	J3-44	DRET-
J3-15	ID07(+)	J3-30	DRET-	J3-45	NDRY(+)
J3-16	DRET-	J3-31	ID15(+)	J3-46	SPARE
J3-17	ID08(+)	J3-32	DRET-	J3-47	SPARE
J3-18	DRET-	J3-33	*SPR1-	J3-48	SPARE
J3-19	ID09(+)	J3-34	SPARE	J3-49	*SPR2-
J3-20	DRET-	J3-35	IMR(+)	J3-50	SPARE
J3-21	ID10(+)	J3-36	DRET-		

*Signals used only in test operation using input to output (J3 to J2) loop cable.

If the GRAPHIC 8 system does not include a parallel interface, the cable from the host computer goes to connectors J2 or J3 on the edge of the serial interface card, or (in some cases) to connector J2 on the ROM and status card. In addition, peripheral devices (keyboard, PED) connect directly to the appropriate connector on the edge of the serial interface card. It is imperative that the serial interface card be configured to match each port to the type of device connected to it. Table 3-3 lists and identifies the pins in serial interface connectors J2 through J6.

Table 3-3. Multiport Serial Interface I/O Connectors,
Pin Assignments

JACK/PIN	SIGNAL	JACK/PIN	SIGNAL
J2-1	CGND PORT 1	J2-25	SPARE
J2-2	SPARE	J2-26	SPARE
J2-3	X232-		
J2-4	TSCK+	J3-1	XMT1- PORT 1
J2-5	RDAL-	J3-2	P15V+
J2-6	SPARE	J3-3	DRET-
J2-7	RQTS+	J3-4	DRET-
J2-8	RSCK+	J3-5	RDAL-
J2-9	CLTS+	J3-6	P05V+
J2-10	SPARE	J3-7	DRET-
J2-11	DSRY+	J3-8	DRET-
J2-12	SPARE	J3-9	REN1- PORT 1
J2-13	SPARE	J3-10	N15V
J2-14	DGND		
J2-15	DTRY+	J4-1	XMT2- PORT 2
J2-16	CARR+	J4-2	P15V+
J2-17	SPARE	J4-3	DRET-
J2-18	SPARE	J4-4	DRET-
J2-19	RING+	J4-5	RDA2-
J2-20	SPARE	J4-6	P05V+
J2-21	SPARE	J4-7	DRET-
J2-22	SPARE	J4-8	DRET-
J2-23	TXCO+	J4-9	REN2-
J2-24	SPARE	J4-10	N15V-

Table 3-3. Multiport Serial Interface I/O Connectors,
Pin Assignments (Cont)

JACK/PIN	SIGNAL	JACK/PIN	SIGNAL
J5-1	XMT3E PORT 3	J6-1	XMT4- PORT 4
J5-2	P15V+	J6-2	P15V+
J5-3	DRET-	J6-3	DRET-
J5-4	DRET-	J6-4	DRET-
J5-5	RDA3-	J6-5	RDA4-
J5-6	P05V-	J6-6	P05V+
J5-7	DRET-	J6-7	DRET-
J5-8	DRET-	J6-8	DRET-
J5-9	REN3-	J6-9	REN4-
J5-10	N15V-	J6-10	N15V-

The J2 connector on the ROM and status card is identical to connectors J3 through J6 of the serial interface.

Display indicators connect to J3, J5, J7 on the edge of the video controller card. Refer to the technical manual for your display indicator for the method of making connections.

PHOTOPENS connect directly to PHOTOPEN connector J1 and J2 on the terminal controller card cage.

3.5.3 MONITOR CONNECTIONS. The monitor power cables may be connected to primary power via convenience outlets furnished at the installation site, or via convenience outlets on the GRAPHIC 8 system power panel (if installed). For proper operation, the monitors must be connected to the same phase of primary power as the terminal controller. The following paragraphs describe the signal connections for the color and monochrome display monitors.

3.5.3.1 Color Monitor. Each color display monitor in a GRAPHIC 8 system requires three video inputs for proper operation: R=red, G=green, and B=blue. Typically, a dual coaxial cable carries the monitor R and G inputs and a single coaxial cable carries the monitor B input. The dual coaxial cable connects to connectors J3 and J5 on the corresponding video controller card in the terminal controller. The single coaxial cable connects to connector J7 on the video controller card. If the GRAPHIC 8 system includes a system interconnect panel, the R and G video signals may be brought out via

connectors J14 and J15, J17 and J18, J20 and J21, or J23 and J24 on the panel. Similarly, the B video signal may be brought out via connector J16, J19, J22, or J25. If the GRAPHIC 8 system includes slave displays, the same dual coaxial/single coaxial cabling scheme may be used. The cables then connect the R,G,B inputs on a slave display to the R,G,B loop-through connectors on a display monitor driven by the terminal controller.

3.5.3.2 Monochrome Monitor. Each monochrome display monitor in a GRAPHIC 8 system requires only one video input for proper operation: B/M=blue/monochrome. Typically, a single coaxial cable connects the monitor input to connector J2 on the corresponding video controller card in the terminal controller. If a GRAPHIC 8 system includes a system interconnect panel, the video signal may be brought out via connector J16, J19, J22, or J25 on the panel.

3.5.4 INPUT DEVICE CONNECTIONS. The following paragraphs describe the cabling and connections required to interface keyboards, trackballs, forcesticks, data tablets, and PHOTOPENS with the GRAPHIC 8 terminal controller.

3.5.4.1 Keyboards. The model 5783 keyboard may be operated on any convenient flat surface within 50 cable feet (15.24 meters) of the terminal controller. The cable supplied with the keyboard is 72 ± 2 inches (183 ± 5 cm) long. The connector on the mating end of the keyboard cable is a type DAC-15P with hood. You need an adapter cable to accommodate this connector. The adapter cable (part number 1089765) connects between the keyboard cable and port 3 or port 7 (J4) on the multiport serial interface card in the terminal controller. If the GRAPHIC 8 system includes a system interconnect panel, the adapter cable (part number 1088738) connects between the keyboard cable and connector J5 or J12 on the panel.

The model 5784 keyboard may be operated up to 100 feet (30.48 meters) from the terminal controller if a separate +5V power supply (Acopian 5EB200 or equivalent) is provided.* The power supply mounts on the accessory panel (data entry device panel) of the associated display monitor. The power supply +15V input comes from the terminal controller. Its +5V output goes to the keyboard through the keyboard connector on the data entry device panel. As with the model 5783 keyboard, you need an adapter cable to connect between the cable supplied with the keyboard and either the multiport serial interface card or the system interconnect panel (if installed).

Table 3-4 lists the signals present at the pins of the keyboard cable connector.

*Separate power supply not required for runs up to 50 feet.

Table 3-4. Keyboard Cable Connector, Pin Assignments

PIN NUMBER	FUNCTION
1	Serial data from keyboard
9	Return
11	Serial data to keyboard
4	Return
13, 14	+5V power
10	+15V power
2	-15V power
6, 7	Power return
8	Chassis (safety) ground
15	LOCAL MODE signal (on 5783/5784 A and B models only)

3.5.4.2 Trackball and Forcestick. The model 5786 trackball and model 5787 forcestick may be operated on any convenient flat surface within 50 cable feet (15.24 meters) of the terminal controller. The cable supplied with a trackball or forcestick is 72 + 2 inches (183 + 5 cm) long. The connector on the mating end of the trackball or forcestick cable is a type DA-15P. The trackball or forcestick cable connects to connector J4 on the system interconnect panel. If a second trackball or forcestick is used, it should be connected to connector J13 on the panel. The position entry device (PED) connected to J6 is called PED1 by the software and the PED connected to J13 is called PED2.

Table 3-5 lists the signals present at the pins of the trackball or forcestick cable connector.

Table 3-5. Trackball or Forcestick Cable Connector, Pin Assignments

PIN NUMBER	FUNCTION
1	Signal out
2	-15 VDC
3	Not Used
4	Ground
5	Test Input

Table 3-5. Trackball or Forcestick Cable Connector, Pin Assignments (Cont)

PIN NUMBER	FUNCTION
6	Ground
8	Chassis ground
9	Ground
10	+15 VDC
11	Not Used
12	Not Used
13	+5 VDC
14, 15	Not Used

3.5.4.3 Data Tablet. The model 5788 data tablet may be operated on any convenient flat surface within 50 cable feet (15.24 meters) of the terminal controller. Like the model 5786 trackball and model 5787 forcestick, the data tablet is a position entry device (PED) and connects to either J6 or J13 on the system interconnect panel. An adapter cable connects between the 25-pin connector (J1) on the data tablet and the 15-pin connector on the system interconnect panel.

Table 3-6 lists the signals present at the pins of the data tablet connector.

Table 3-6. Data Tablet Connector, Pin Assignments

PIN NUMBER	FUNCTION
1	Not Used
2	RS232C Output
3	Clear to Send (A logic 0 stops data transmission)
4	<u>Point/Run</u> mode (logic 1 = Run, logic 0 = Point)
5	<u>TTL Output</u>
6	TTL Output
7	Signal Ground
8	Baud Rate Address Input D
9	Baud Rate Address Input C

Table 3-6. Data Tablet Connector, Pin Assignments (Cont)

PIN NUMBER	FUNCTION
10	Baud Rate Address Input B
11	Baud Rate Address Input A
12	Not Used
13	Not Used
14	Not Used
15	Not Used
16	Not Used
17	Not Used
18	Not Used
19	Not Used
20	Not Used
21	Not Used
22	Not Used
23	Not Used
24	+15 Vdc Input
25	Power Ground Return

3.5.4.4 PHOTOPEN. The model 5781 PHOTOPEN is supplied with a connector cable up to 74 inches (188 cm) long and either a five- or six-pin connector, depending on G-condition. The PHOTOPEN cable connects to connector J26 on the system interconnect panel, or directly to the PHOTOPEN number 1 (PP1) connector on the terminal controller. If a second PHOTOPEN is used, it should be connected to connector J27 on the system interconnect panel, or directly to the PHOTOPEN number 2 (PP2) connector on the terminal controller.

Table 3-7 lists the signals present at the pins of the PHOTOPEN cable connector.

Table 3-7. PHOTOPEN Cable Connector, Pin Assignments

PIN NUMBER	FUNCTION
1 (A)	+5 Vdc input
2 (B)	Pulse output
3 (C)	Not used
4 (D)	Switch output
5 (E)	Ground
(F)	Not used

NOTE: Pin designations in parentheses apply to the six-pin connector used on G-conditions 2, 4, 5, and 7. The five-pin connector is used on G-conditions 1, 3, and 6.

3.5.5 HARD COPY UNIT CONNECTIONS. The following paragraphs describe the cabling and connections required to interface monochrome and color hard copy units with the GRAPHIC 8 terminal controller.

3.5.5.1 Monochrome Hard Copy Unit. The power cable supplied with the monochrome hard copy unit varies, depending on the model number. Typically, for 120V operation, the power cable comes with a 3-wire molded plug. For operation from other source voltages, the power cable comes without a connector plug. You must then add a suitable connector that fits your source of ac power. Detailed instructions for making power connections are contained in the hard copy unit technical manual. For proper operation, the hard copy unit must be connected to the same phase of primary power as the terminal controller.

The monochrome hard copy unit requires only one composite video input. The video controller card in the terminal controller produces six composite video outputs. Thus, any of the three (R,G,B) video signals in a GRAPHIC 8 system may be used to drive the monochrome hard copy unit. However, for true gray scale rendition, an RGB mixer (part number 5809873) must be used. The RGB mixer accepts three color video signals from the video controller card and produces a single, composite video output. The output of the RGB mixer is then used to drive the hard copy unit.

Typically, a single coaxial cable connects J2 on the video controller card to connector J701 on the hard copy unit. If an RGB mixer is used, a dual coaxial cable connects J3 and J5 on the video controller card to the R and G inputs on the mixer. A single coaxial cable connects J7 on the video controller card to the B input on the mixer. If the GRAPHIC 8 system includes a system interconnect panel,

these signals may also be brought out via connectors J14 through J25 on the panel. A single coaxial cable connects the output of the mixer to J701 on the hard copy unit.

When remote control of the hard copy unit is required, a control cable (part number 5810506) connects the appropriate port on the multiport serial interface card in the terminal controller to connector J790 on the hard copy unit. (The multiport serial interface port must be reconfigured to represent port 5. Refer to Sanders manual H-81-0027 for information on the multiport serial interface. Refer to Sanders manual H-80-0444 for hard copy unit programming instructions.) If the GRAPHIC 8 system includes a system interconnect panel, the control signals may be brought out via connector J10 on the panel.

3.5.5.2 Color Hard Copy Unit. The power supplied with the color hard copy unit varies, depending on the source voltage. Typically, for 120V operation, the power cable comes with a 3-wire molded plug. To avoid ground loop problems, the color hard copy unit should share a common ground with the terminal controller. For proper operation, the color hard copy unit must be connected to the same phase of primary power as the terminal controller.

The color hard copy unit requires three video inputs. Typically, a dual coaxial cable connects J3 and J5 on the video controller card to the RED and GREEN video input connectors on the color hard copy unit back panel. A single coaxial cable connects J7 on the video controller card to the BLUE video input connector on the color hard copy unit back panel. If the GRAPHIC 8 system includes a system interconnect panel, the red and green video signals may be brought out via connectors J14 and J15, J17 and J18, J20 and J21, or J23 and J24 on the panel. Similarly, the blue video signal may be brought via connector J16, J19, J22, or J25.

3.6 SWITCH AND JUMPER SELECTIONS

Some of the circuit cards in the terminal controller contain jumper terminals and/or switches to allow selection of operating characteristics that differ from those normally preselected at the factory.

Determines the model number of your terminal controller (printed on the identification label attached to the bottom front panel of the terminal controller). Use figure 3-2 to determine the terminal controller configuration, number of displays per terminal controller, and the number of memory bits per pixel. You need this information to set the DIP switches on the circuit card assemblies. Figure 3-2 also relates the mapping memories and video controllers to their respective displays.

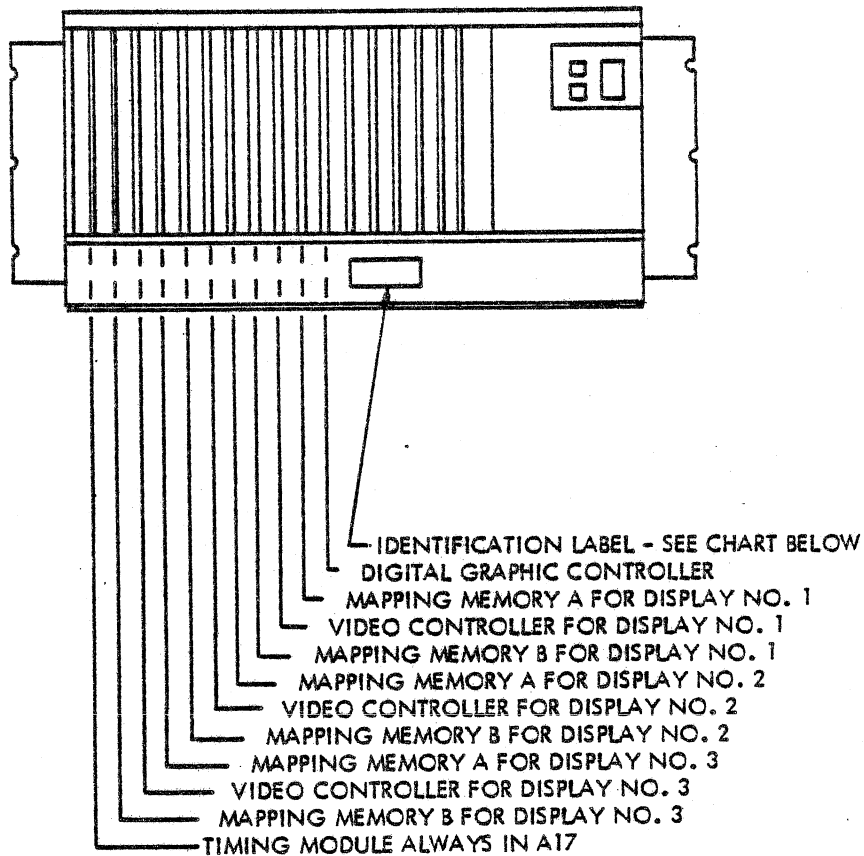

REFERENCE CHART

MODEL NO.	CONFIGURATION
8215-NB	512 x 512 I
8216-NB	512 x 512 NI
8225-NB	640 x 480 I
8226-NB	640 x 480 NI
8235-NB	1024 x 768 I
8245-NB	1024 x 1024 I
N = NUMBER OF DISPLAYS B = BITS PER PIXEL I = INTERLACED NI = NONINTERLACED	

SEE ALSO FIGURE I-6.

EXAMPLE:
 8215-34 = 512 x 512, INTERLACED,
 3 DISPLAYS, 4 BITS PER PIXEL

H-82-0176-030

Figure 3-2. Typical Terminal Controller Configuration

3.6.1 DISPLAY PROCESSOR II. The display processor II circuit card assembly contains two switches and one set of jumper points (see figure 3-3).

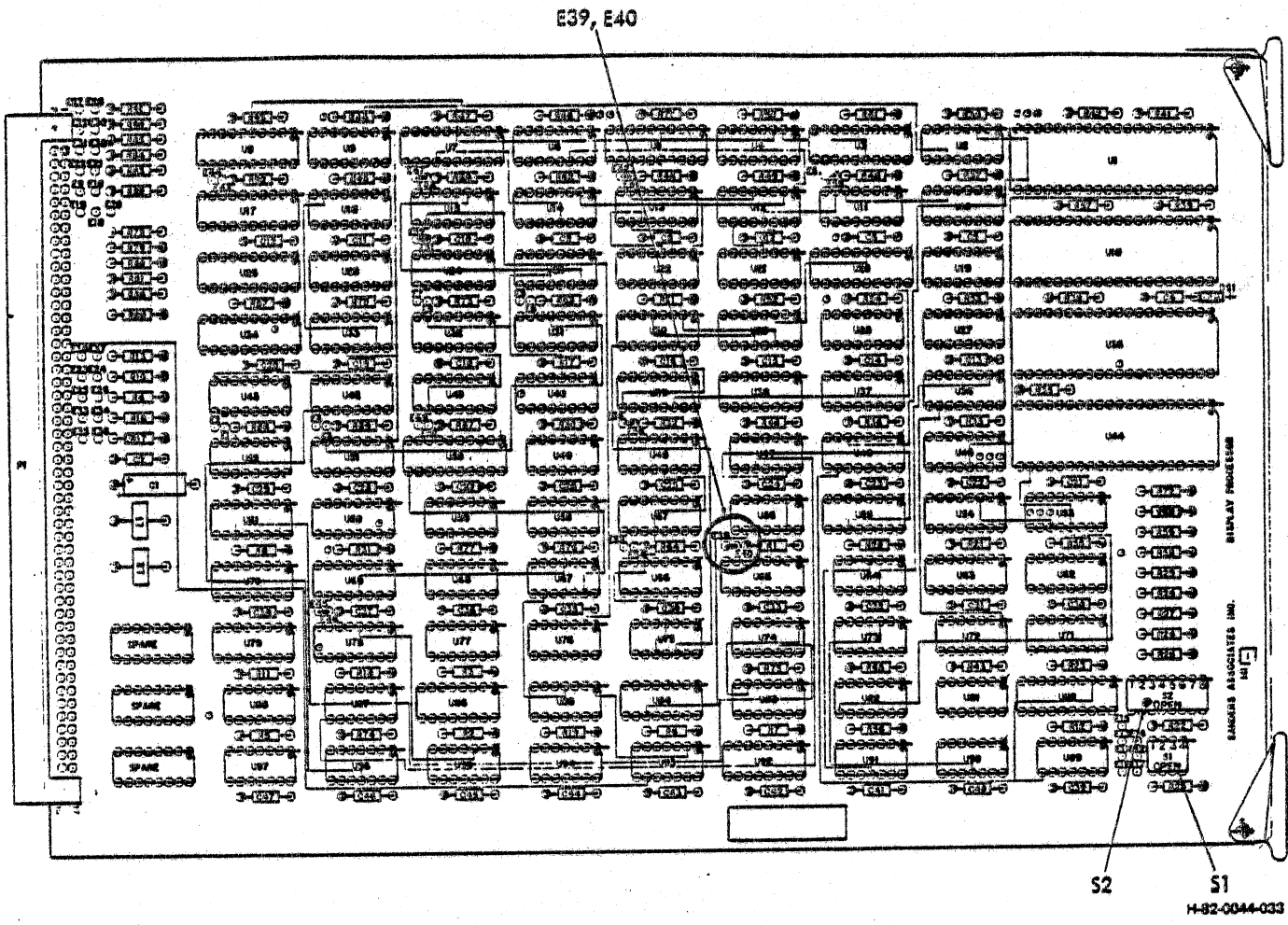

Figure 3-3. Display Processor II Switch and Jumper Locations

When E39 is connected to E40 (the standard configuration), the display processor II recognizes instruction 0 as a halt instruction. When E39 and E40 are open, instruction 0 is an illegal instruction.

Table 3-8 defines the switch settings.

Table 3-8. Display Processor II Switch Settings

SWITCH	FUNCTION																				
S1-1	Not used																				
S1-2	Open sets the number of address bits at 16; closed = 18. Standard configuration is open.																				
S1-3	Open sets the device number at 8 ₁₀ ; closed = 12 ₁₀ . Standard configuration is open.																				
S1-4	Open sets the cycle time for 400 ns operation; closed = 300 ns. Standard configuration is open.																				
S2-1 through S2-8	<p>Contribute the last three digits of a 6-digit configuration register (the first three digits are understood to be zeros). Switches 7 and 8 make up the first digit (bit 8 is MSB); maximum value is 3. Switches 4-6 make up the second digit, and switches 1-3 make up the third digit. Switch closed = logic 1. Maximum value is 000377.</p> <table border="1" data-bbox="521 905 1317 1304"> <thead> <tr> <th data-bbox="521 905 911 957">S2 SWITCH</th> <th data-bbox="911 905 1317 957">CONFIGURATION</th> </tr> <tr> <th data-bbox="521 957 911 999">1 2 3 4 5 6 7 8</th> <th data-bbox="911 957 1317 999"></th> </tr> </thead> <tbody> <tr> <td data-bbox="521 999 911 1052">O O O C C C C C</td> <td data-bbox="911 999 1317 1052">7 keyboards, 1 PED</td> </tr> <tr> <td data-bbox="521 1052 911 1094">C O O C C C C C</td> <td data-bbox="911 1052 1317 1094">6 keyboards, 2 PEDs</td> </tr> <tr> <td data-bbox="521 1094 911 1136">O C O C C C C C</td> <td data-bbox="911 1094 1317 1136">5 keyboards, 3 PEDs</td> </tr> <tr> <td data-bbox="521 1136 911 1178">C C O C C C C C</td> <td data-bbox="911 1136 1317 1178">4 keyboards, 4 PEDs</td> </tr> <tr> <td data-bbox="521 1178 911 1220">O O C C C C C C</td> <td data-bbox="911 1178 1317 1220">3 keyboards, 5 PEDs</td> </tr> <tr> <td data-bbox="521 1220 911 1262">C O C C C C C C</td> <td data-bbox="911 1220 1317 1262">2 keyboards, 6 PEDs</td> </tr> <tr> <td data-bbox="521 1262 911 1304">O C C C C C C C</td> <td data-bbox="911 1262 1317 1304">1 keyboard, 7 PEDs</td> </tr> <tr> <td data-bbox="521 1304 911 1346">C C C C C C C C</td> <td data-bbox="911 1304 1317 1346">8 PEDs</td> </tr> </tbody> </table> <p data-bbox="521 1346 1317 1388">C = closed = + O = open</p> <p data-bbox="521 1388 1317 1514">Register address 177774 is used to determine the number of keyboards defined in the system.</p>	S2 SWITCH	CONFIGURATION	1 2 3 4 5 6 7 8		O O O C C C C C	7 keyboards, 1 PED	C O O C C C C C	6 keyboards, 2 PEDs	O C O C C C C C	5 keyboards, 3 PEDs	C C O C C C C C	4 keyboards, 4 PEDs	O O C C C C C C	3 keyboards, 5 PEDs	C O C C C C C C	2 keyboards, 6 PEDs	O C C C C C C C	1 keyboard, 7 PEDs	C C C C C C C C	8 PEDs
S2 SWITCH	CONFIGURATION																				
1 2 3 4 5 6 7 8																					
O O O C C C C C	7 keyboards, 1 PED																				
C O O C C C C C	6 keyboards, 2 PEDs																				
O C O C C C C C	5 keyboards, 3 PEDs																				
C C O C C C C C	4 keyboards, 4 PEDs																				
O O C C C C C C	3 keyboards, 5 PEDs																				
C O C C C C C C	2 keyboards, 6 PEDs																				
O C C C C C C C	1 keyboard, 7 PEDs																				
C C C C C C C C	8 PEDs																				

3.6.2 READ/WRITE MEMORY. For part number 1089724 (figure 3-4), confirm that switches are set and jumpers installed as shown in table 3-9.

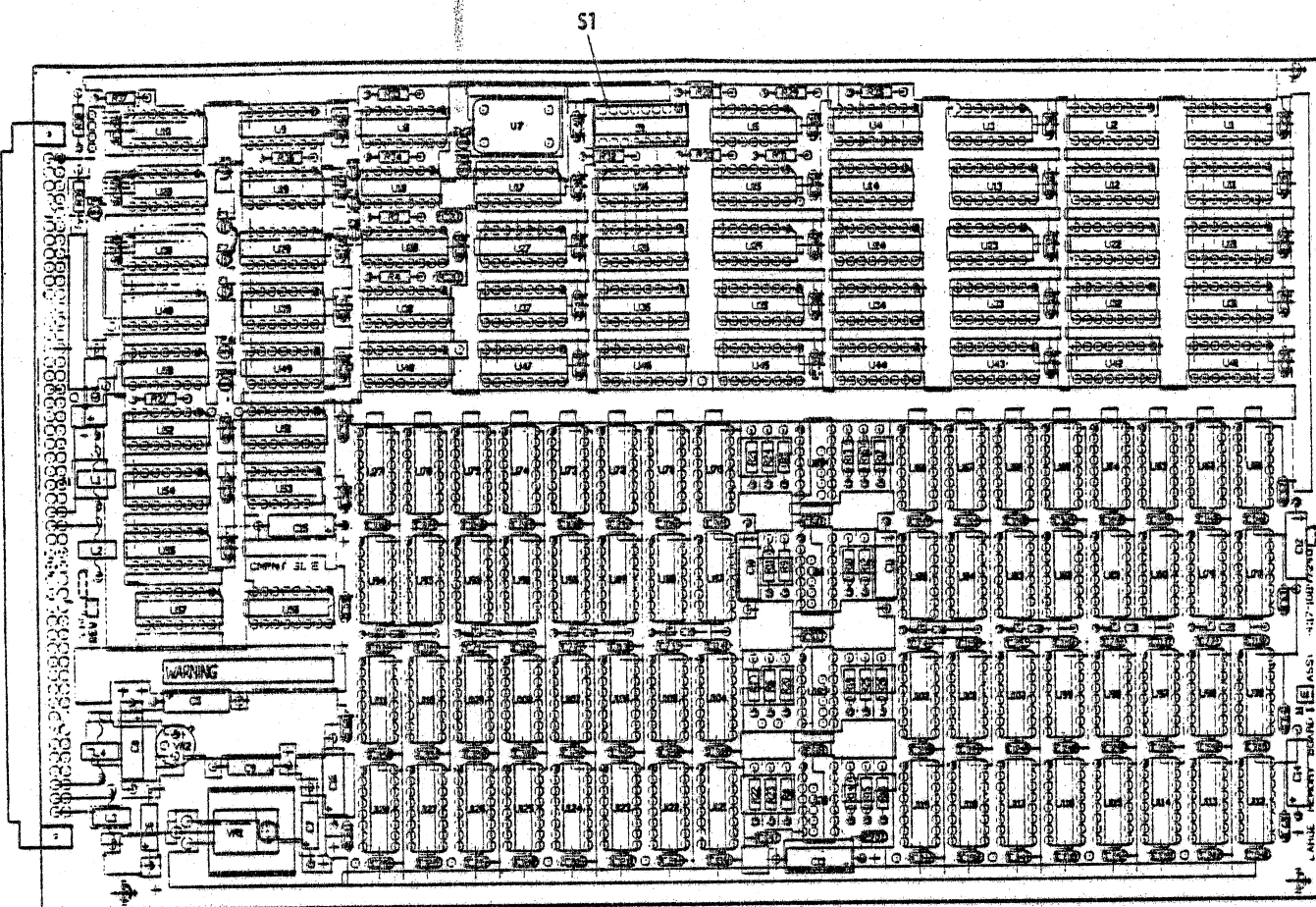

H-82-0044-034

Figure 3-4. Large Read/Write Memory Switch Location

Table 3-9. Read/Write Memory Switches and Jumpers,
Part No. 1089724

MEMORY CONFIGURATION	S1 SWITCH POSITIONS		JUMPER CONNECTIONS	
	CARD #1	CARD #2	CARD #1	CARD #2
16K	S1-1 thru S1-5 ON	N/A	E2-E3	N/A
32K	S1-1 ON S1-2 thru S1-5 OFF*	N/A	E2-E3	N/A
64K	S1-1 ON S1-2 thru S1-5 OFF*	N/A	E2-E3	N/A
96K	S1-1 ON S1-2 thru S1-5 OFF*	S1-1 OFF S1-2 thru S1-5 OFF*	E2-E3	E2-E3
128K	S1-1 ON S1-2 thru S1-5 OFF*	S1-1 OFF S1-2 thru S1-5 OFF*	E2-E3	E1-E2

*These switch positions allow access to all available memory. To mask out undesired memory blocks, set corresponding switch to ON.

For the G2 and G4 conditions of part number 1089724, lift U16-2. Add jumper from U13-12 to U16-12.

For part number 5809944 (figure 3-5), confirm that jumpers are installed and that memory boundary switches S1-1 through S1-8 are set as shown in table 3-10 for all memory configurations. Confirm that bank swap switches S2-1 through S2-4, page size switches S3-1 through S3-4, and mask area switches S4-1 through S4-8 are set as shown in table 3-11.

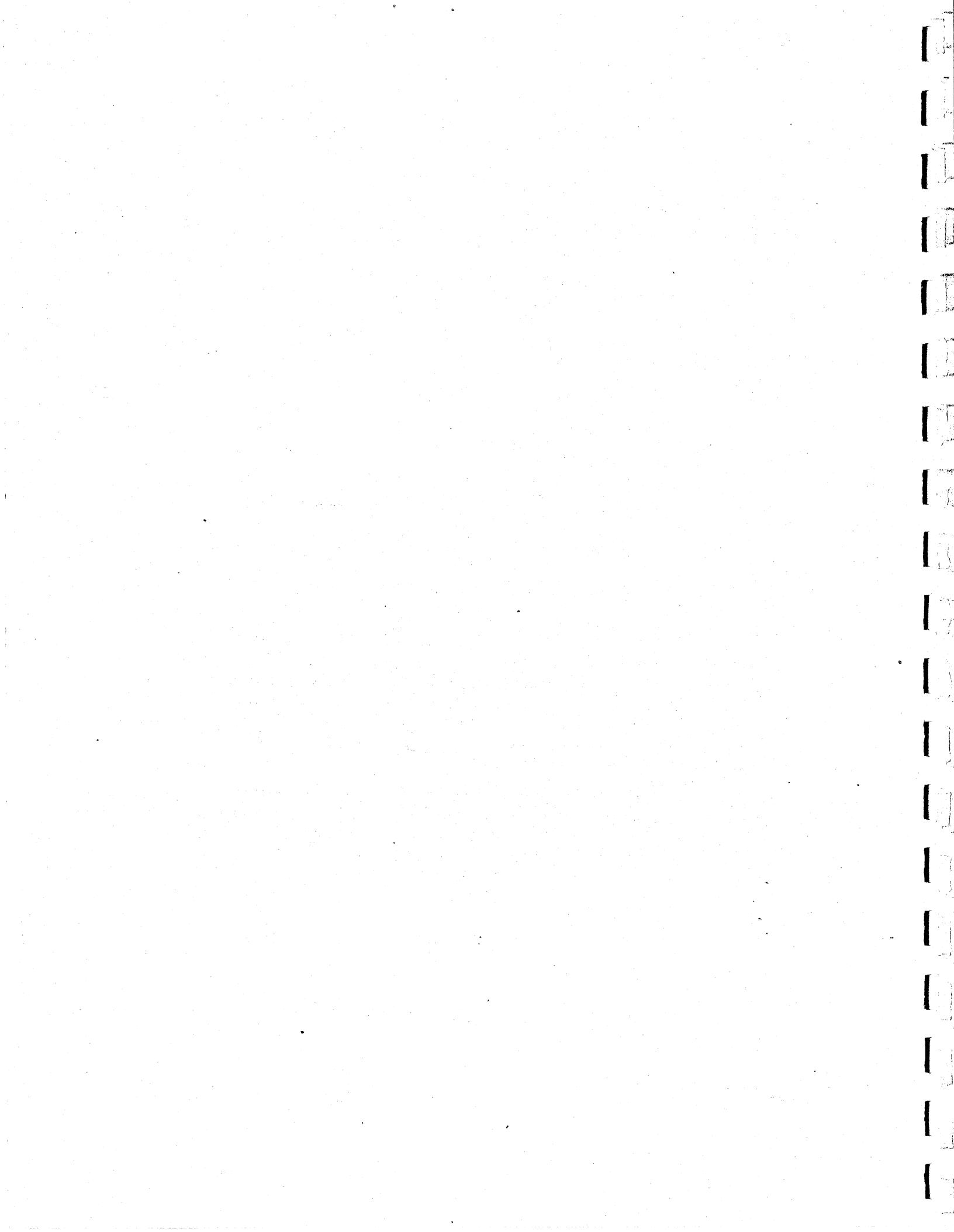

Table 3-10. Large Refresh Memory Switches and Jumpers, Part Number 5809944

MEMORY CONFIGURATION	SWITCH SETTINGS	JUMPER CONNECTIONS
All (64K, 128K, 192K, 256K)	S1-1	OPEN
	S1-2	CLOSED
	S1-3	CLOSED
	S1-4	CLOSED
	S1-5	OPEN
	S1-6	CLOSED
	S1-7	CLOSED
	S1-8	OPEN

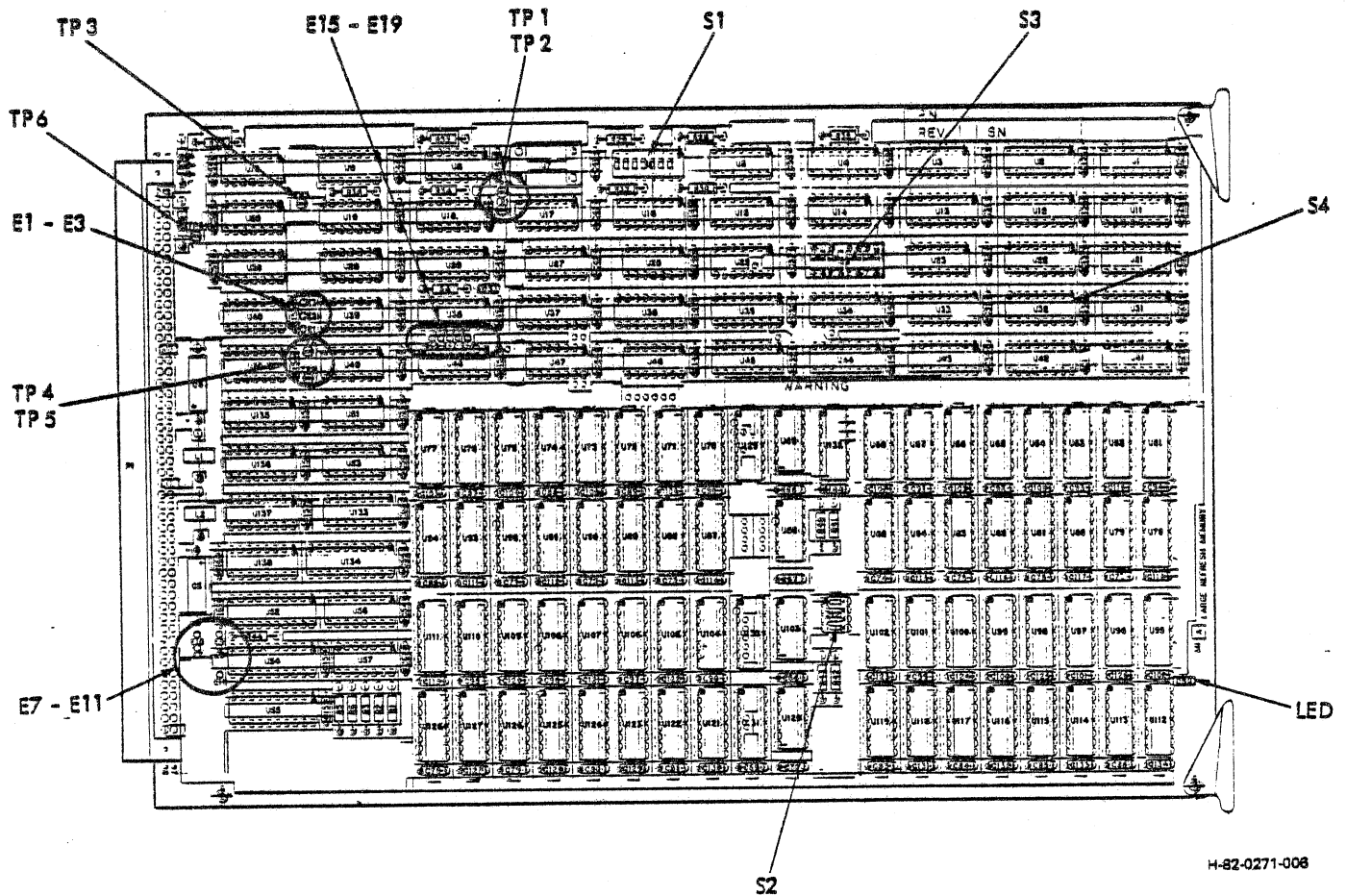

Figure 3-5. Large Refresh Memory Switch and Jumper Locations

Table 3-11. Large Refresh Memory Bank Swap, Page Size, and Mask Area Switch Settings, Part No. 5809944

BANK SWAP (SWITCH S2)									
SWAP DESCRIPTION	S2-1	S2-2	S2-3	S2-4					
No swap (normal configuration)	Open	Open	Open	Open					
Swap A and B, swap C and D	Closed	Closed	Closed	Open					
Swap C and D	Open	Closed	Closed	Open					
Swap A and D	Closed	Open	Closed	Open					
Swap A and C	Open	Open	Closed	Open					
Swap A and C, swap B and D	Closed	Closed	Open	Open					
Swap B and C	Open	Closed	Open	Open					
Swap A and B	Closed	Open	Open	Open					
PAGE SIZE (SWITCH S3)									
PAGE SIZE	S3-1	S3-2	S3-3	S3-4					
4K words (normal)	Closed	Closed	Closed	Closed					
8K words	Open	Closed	Closed	Open					
16K words	Open	Open	Open	Open					
MASK AREAS (SWITCH S4)									
MEMORY SIZE	S4-1	S4-2	S4-3	S4-4	S4-5	S4-6	S4-7	S4-8	
64K words (128K bytes)	Closed	Closed	Closed	Closed	Open	Open	Open	Open	Open
128K words (256K bytes)	Closed	Closed	Closed	Open	Closed	Open	Open	Open	Open
192K words (384K bytes)	Open	Closed	Closed	Open	Closed	Closed	Open	Open	Open
256K words (512K bytes)	Open	Open	Open	Open	Closed	Closed	Closed	Closed	Closed

3.6.3 ROM AND STATUS CARD. This card (see figure 3-6) contains jumper terminals that allow reconfiguration of 15 different parameters, as described in table 3-12.

Table 3-12. ROM and Status Card Jumper Configurations

FEATURE	JUMPER CONFIGURATION
Sync link interrupt level Level 7 Level 6 Level 5	E1 to E4 (normal configuration) E2 to E4 E3 to E4
Display status interrupt level Level 5 Level 6 Level 7	E3 to E5 (normal configuration) E2 to E5 E1 to E5
Transmit data select TTY, RS-232C, or 20 mA current loop TTL	E7 to E8 (normal configuration) E7 to E6
Receive data termination TTY TTL 20 mA current loop RS-232C	E35 to E36 (normal configuration) E9 to E10; E35 to E36 open E9 to E11; E35 to E36 open No jumper at E35, E36, E9
Receive/transmit data TTY TTL or RS-232C	E12 to E13 open (normal configuration) E12 to E13
Word length select 5 bits 6 bits 7 bits 8 bits	E14 to E17 to E19 E14 to E19 E17 to E19 E14 and E17 open (normal configuration)

Table 3-12. ROM and Status Card Jumper Configurations (Cont)

FEATURE	JUMPER CONFIGURATION
Receive/transmit parity Checked and generated Disabled	E16 to E19 E16 open (normal configuration)
Parity select Odd Even	E18 to E19 E18 open (normal configuration)
Number of stop bits 2 stop bits 1 stop bit	E15 to E19 E15 open (normal configuration)
Receive/transmit frequency select 110 baud 300 baud 1200 baud 2400 baud 4800 baud 9600 baud 50K baud	E20 to E22; E23 to E25 to E26 to E27 (normal configuration) E20 to E22; E24 to E26 to E27 E20 to E22; E26 to E27 E20 to E22; E23 to E25 to E27 E20 to E22; E23 to E24 to E27 E20 to E22; E23 to E27 E20 to E21
System clock mode Internal clock External clock	E28 to E29 (normal configuration) E29 open
Address selection 16K to 24K 20K to 28K 24K to 32K	E44 to E32 E30 to E32 E31 to E32
Status logic enable Enabled Disabled	E33 to E34 (normal configuration) E33 open

Table 3-12. ROM and Status Card Jumper Configurations (Cont)

FEATURE	JUMPER CONFIGURATION
Trap address memory locations	
0 - 8K	E37, E38, E39, E40 open (normal configuration)
8K - 16K	E39 to E40
16K - 24K	E37 to E38
24K - 32K	E37 to E38; E39 to E40
50K/800K baud select	
50 kHz	E42 to E43 (normal configuration)
800 kHz	E41 to E43

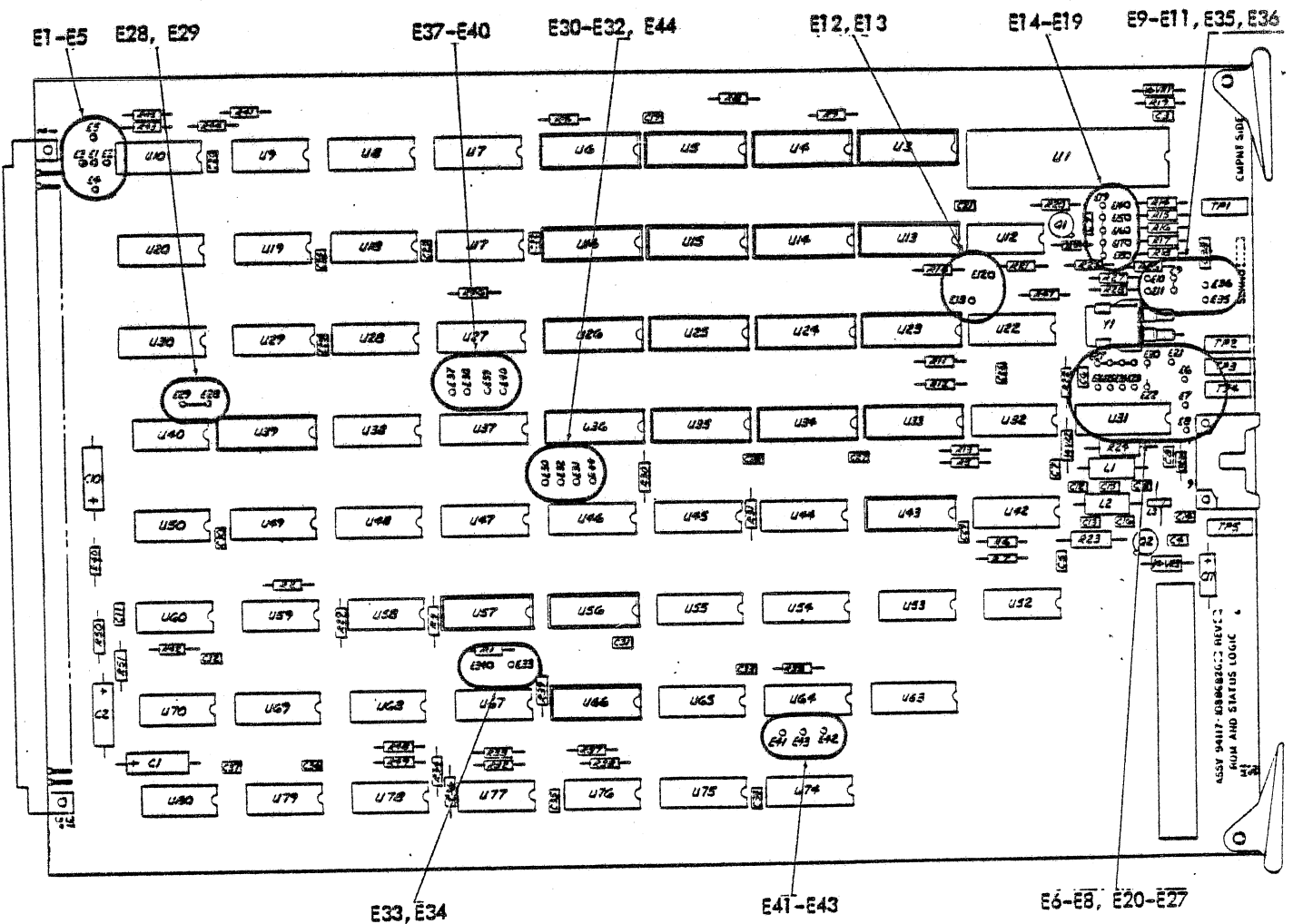

Figure 3-6. ROM and Status Card Jumper Locations

H-82-0044-038

3.6.4 MULTIPOINT SERIAL INTERFACE. This card (figure 3-7) contains both jumper terminals and DIP switches that allow reconfiguration of 14 different parameters, as described in table 3-13.

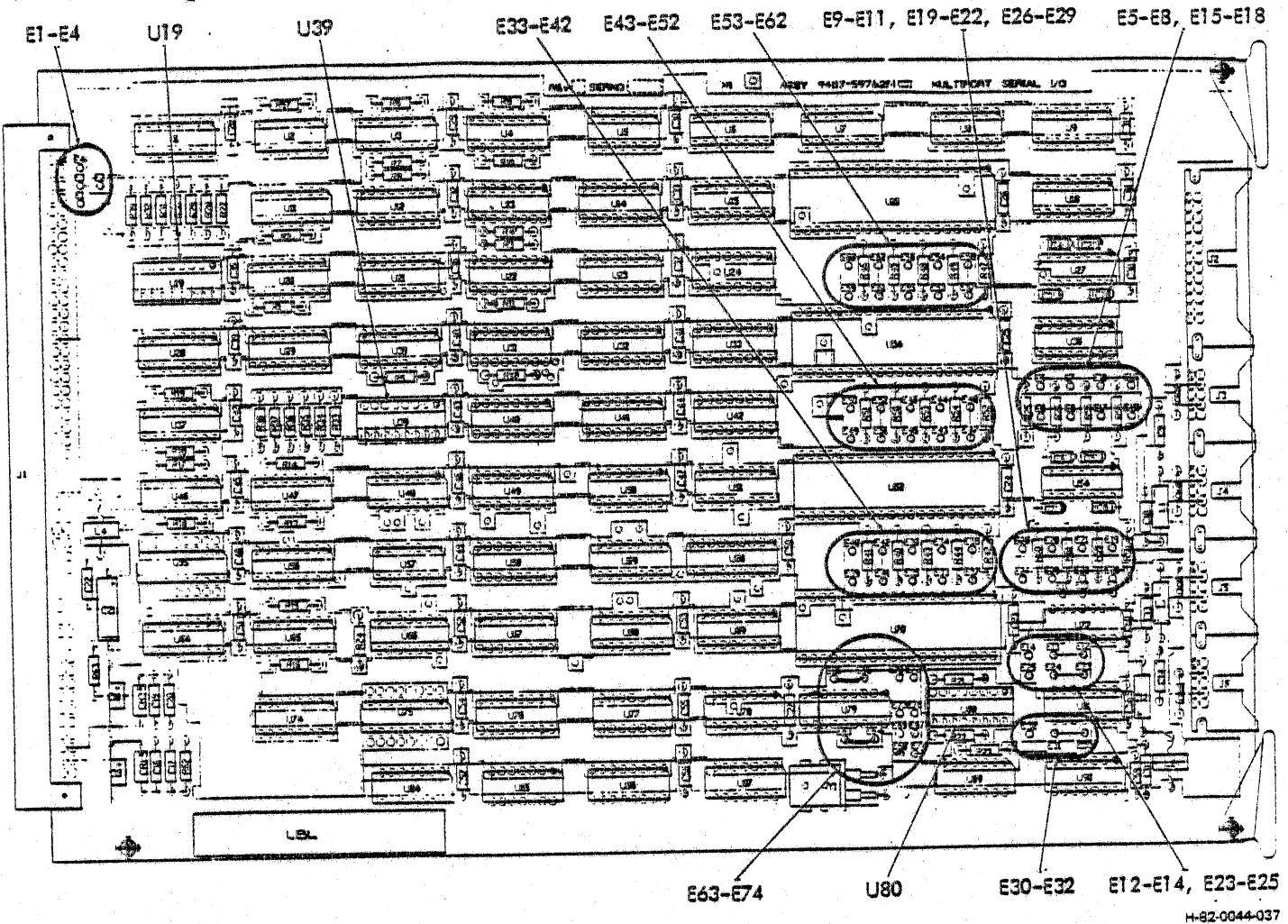
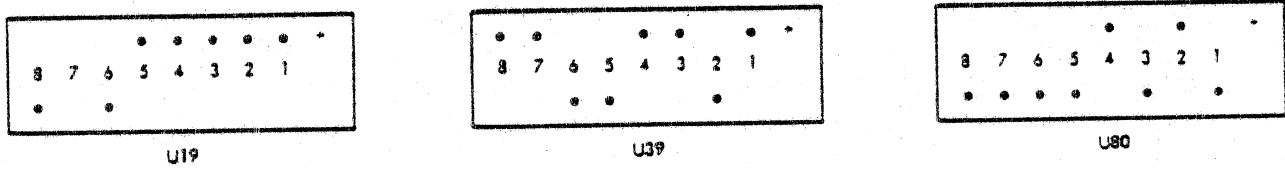

Figure 3-7. Multiport Serial Interface Switch and Jumper Locations

Figure 3-8 shows the normal switch positions for the standard port configuration. The + mark on the switch indicates the ON side. The dots in the figure indicate the side of the switch that is pushed down. Table 3-12A shows other possible arrangements.



H-82-0176-023

Figure 3-8. Multiport Serial Interface, Normal Switch Positions.

When setting up these assignments, do not use the same switch settings for more than one port; only the lowest numbered port will respond to the device. If two serial interface cards are used, ports 5 through 8 are programmed in the same manner as ports 1 through 4. Do not duplicate any card #1 switch settings on card #2; if there is a duplication, neither port will work.

Table 3-12A. Serial Interface Port Device Assignments

DEVICE	PORT 1 (U19)			PORT 2 (U19)			PORT 3 (U39)			PORT 4 (U39)			
	S1	S2	S3	S4	S5	S6	S1	S2	S3	S4	S5	S6	
Communicator (RS-232-C)	<u>On</u>	<u>On</u>	<u>On</u>	-	-	-	-	-	-	-	-	-	
Keyboard #1	Off	Off	On	On	Off	On	<u>On</u>	<u>Off</u>	<u>On</u>	On	Off	On	
PED #1	On	Off	Off	On	Off	Off	On	Off	Off	<u>On</u>	<u>Off</u>	<u>Off</u>	
Hardcopy Unit	Off	On	On	Off	On	On	Off	On	On	Off	On	On	
Keyboard #2	Off	Off	On	Off	Off	On	Off	Off	On	Off	Off	On	
PED #2	Off	Off	Off	Off	Off	Off	Off	Off	Off	Off	Off	Off	
Spare #1	On	On	Off	<u>On</u>	<u>On</u>	<u>Off</u>	On	On	Off	On	On	Off	
Spare #2	Off	On	Off	Off	On	Off	Off	On	Off	Off	On	Off	

Underlined switch settings are the normal configuration. Unless otherwise specified by the customer, switches are set to these positions at the factory.

Table 3-13. Multiport Serial Interface Parameter Selections

FEATURE	CONFIGURATION			
Device address select				
Standard address (1765XX)	U19-S8 OFF (normal configuration)			
Expanded address (1766XX)	U19-S8 ON			
Word length select	Port 2	Port 3	Port 4	
5 bits	E43 to E44, E45 to E46	E33 to E34, E35 to E36	E53 to E54 E55 to E56	
6 bits	E45 to E46	E35 to E36	E55 to E56	
7 bits	E43 to E44	E33 to E34	E53 to E54	
8 bits (normal configuration)	E44, E46 open	E34, E36 open	E54, E56 open	
Parity select	Port 2	Port 3	Port 4	
Parity enabled (normal configuration)	E49 to E50	E39 to E40	E59 to E60	
Parity disabled	E50 open	E40 open	E60 open	
Odd parity	E47 to E48	E37 to E38	E57 to E58	
Even parity	E48 open	E38 open	E58 open	
Stop bit select	Port 2	Port 3	Port 4	
1 stop bit (normal configuration)	E51 to E52	E41 to E42	E61 to E62	
2 stop bits	E52 open	E42 open	E62 open	
Transmit levels	Port 1	Port 2	Port 3	Port 4
RS-232 (normal configuration)	E9 to E10	E12 to E13	E30 to E31	E23 to E24
TTL	E10 to E11	E13 to E14	E31 to E32	E24 to E25

Table 3-13. Multiport Serial Interface Parameter Selections (Cont)

FEATURE	CONFIGURATION			
Receive levels	Port 1	Port 2	Port 3	Port 4
TTL	E5 to E6	E15 to E16	E19 to E20	E26 to E27
RS-232	E5 open	E15 open	E19 open	E26 open
F _t baud rate (all ports asynchronous)	NOTE			
	E63 to E64 and E65 to E66 are connected for all baud rates.			
9600 baud (normal configuration)	E68 to E67; E69, E71, E73 open			
50 baud	E68 to E67 to E69 to E71 to E73			
75 baud	E68 to E69 to E71 to E73			
110 baud	E68 to E67 to E71 to E73			
134.5 baud	E68 to E71 to E73			
150 baud	E68 to E67 to E69 to E73			
300 baud	E68 to E69 to E73			
600 baud	E68 to E67 to E73			
1200 baud	E68 to E73			
1800 baud	E68 to E67 to E69 to E71			
2000 baud	E68 to E69 to E71			
2400 baud	E68 to E67 to E71			
3600 baud	E68 to E71			
4800 baud	E68 to E67 to E69			
7200 baud	E68 to E69			
19200 baud	E68 to E67			

Table 3-13. Multiport Serial Interface Parameter Selections (Cont)

FEATURE	CONFIGURATION			
	U80-S4	U80-S5	U80-S6	U80-S7
F_r baud rate (port 1 only)				
50	On	On	On	On
75	Off	On	On	On
110	On	Off	On	On
134.5	Off	Off	On	On
150	On	On	Off	On
300	Off	On	Off	On
600	On	Off	Off	On
1200	Off	Off	Off	On
1800	On	On	On	Off
2000	Off	On	On	Off
2400	On	Off	On	Off
3600	Off	Off	On	Off
4800	On	On	Off	Off
7200	Off	On	Off	Off
9600 (normal configuration)	On	Off	Off	Off
19200	Off	Off	Off	Off
Number of stop bits (port 1)				
1 stop bit	U80-S3 on			
2 stop bits	U80-S3 off			

Table 3-13. Multiport Serial Interface Parameter Selections (Cont)

FEATURE	CONFIGURATION
Parity (port 1 only) Parity disabled Parity enabled Odd parity Even parity	U80-S1 off U80-S1 on U80-S2 on U80-S2 off NOTE If parity is disabled, there are eight data bits. If parity is enabled, there are seven data bits.
Data terminal ready (port 1 only) Circuit enabled Circuit disabled Interrupt level select Level 5 Level 6 (normal configuration) Level 7	U39-S7 on U39-S7 off E1 to E3 E2 to E3 E4 to E3

3.6.5 PARALLEL INTERFACE. The model 5712 parallel interface card contains 105 terminals that allow you to customize the card for special installations. Most of the terminals (E1 through E43 and E49 through E66) plus a 2.35 by 6.5 inch (6 by 16.5 cm) unused area are for use with additional integrated circuit elements, which can interface with devices that have unique signal definitions, signal polarities, handshaking requirements, and/or driver/receiver and line matching requirements.

The remaining terminals let you change certain operating parameters, as described in table 3-14.

Table 3-14. Parallel Interface Parameter Selections

FEATURE	CONFIGURATION
Register address select	
First card, address 17241X (normal configuration)	E96 to E99
Second card, address 17243X	E98 to E99
Third card, address 17245X	E97 to E99
Fourth card, address 17247X	E95 to E99
Interrupt trap address select	
First card (normal configuration)	E87, E88 open; E47, E45 open
Second card	E87 to E88, E46 to E47; E45 open
Third card	E87 to E88, E44 to E45; E47 open
Fourth card	E87 to E88, E44 to E45, E46 to E47
Word vs byte mode	
Word mode (normal configuration)	E90 open
Byte mode	E89 to E90
Polarity of INIT signal from host	
Low (INIT-) produces SYST-B	E93 to E94
High (INIT+) produces SYST-B	E92 to E94
SYST-B inhibited	E91 to E94
Interrupt priority level	
Level 6 (normal configuration)	E83 to E85
Level 5	E84 to E85
Level 7	E86 to E85

Table 3-14. Parallel Interface Parameter Selections (Cont)

FEATURE	CONFIGURATION
<p>Clock speed</p> <p>CLOK-F (10 MHz) (normal configuration)</p> <p>Clock rate divided (for long distance interface)</p>	<p>E100 to E101</p> <p>Open E100 to E101. Connect E100 to input of a suitable divider. Connect divider output to E101. (Divider may be added to the parallel interface card or located externally with connections made through unused back-plane connections).</p>
<p>Output data enable ODEN- signal from host</p> <p>ODEN- enabled</p> <p>ODEN- disabled</p>	<p>E102 to E103</p> <p>E102, E103 open</p>
<p>Input data enable function</p> <p>Ground enable to input drivers</p> <p>Ground enable not required</p>	<p>E104 to E105</p> <p>E104, E105 open</p>
<p>Additional integrated circuit connections</p>	
<p>NOTE</p>	
<p>These connections allow additional integrated circuits to be added to the card.</p>	
<p>Connect attention interrupt enable to IC</p>	<p>E48</p>
<p>Accept interrupt requests from IC</p>	<p>E67</p>
<p>Connect resets to IC</p>	<p>E68</p>

Table 3-14. Parallel Interface Parameter Selections (Cont)

FEATURE	CONFIGURATION
Additional integrated circuit connections (Cont)	
Connect fixed logic high to IC	E69
Connect +5V to IC	E70 through E78
Connect -15V to IC	E79
Connect ARET- to IC	E80
Connect +15V to IC	E81
Accept reset from IC	E82
Card device select	
Normal configuration is:	
DEV0-B high	E112, E113 open
DEV1-B low	E114 to E115
DEV2-B high	E116, E117 open
DEV3-B active	E110 to E111
Device codes for second, third, and fourth cards can be created by connecting E112 to E113, E116 to E117, or both.	

3.6.6 DIGITAL GRAPHIC CONTROLLER. This card contains two DIP switches to accommodate three types of PROM devices and two screen configurations. See figure 3-9.

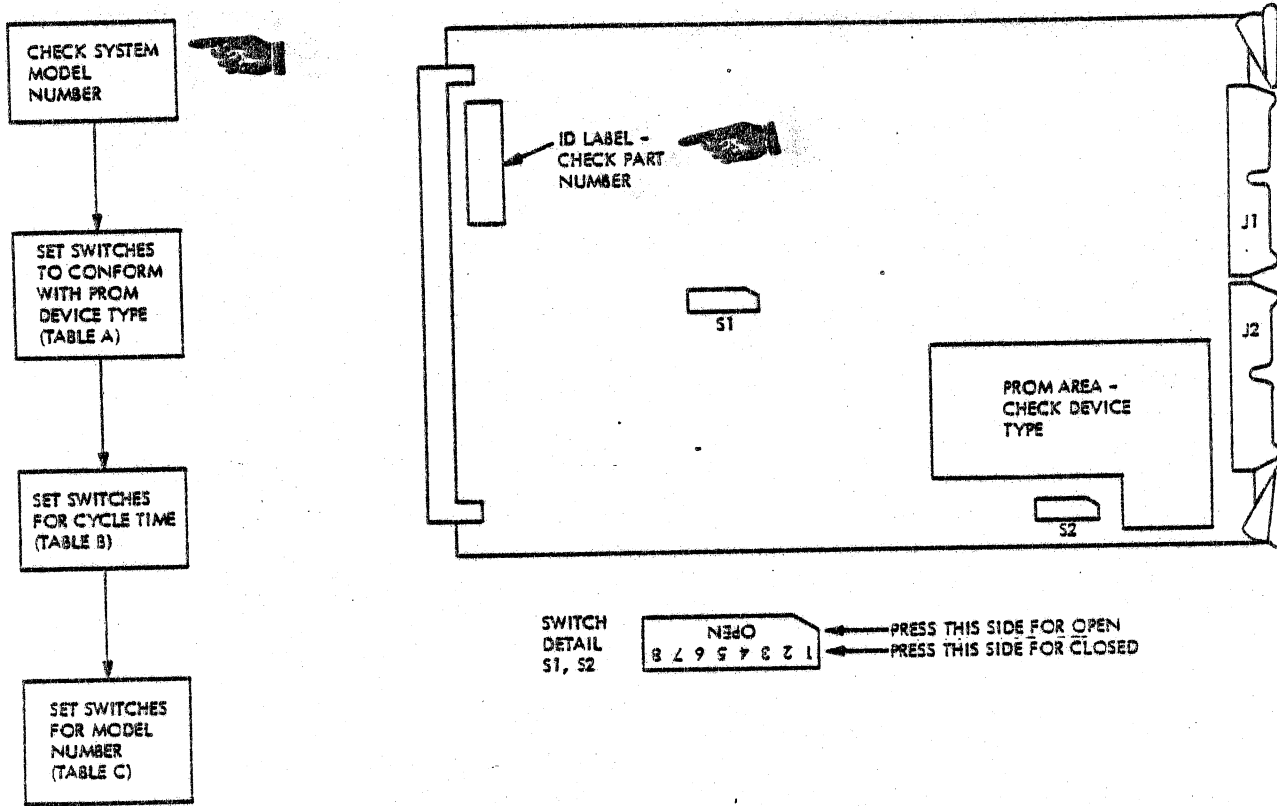

TABLE A

SWITCH	DEVICE TYPE		
	D3636	MK2716	2732
S2-1	O	O	O
S2-2	O	C	O
S2-3	O	O	O
S2-4	O	O	O
S2-5	C	O	O
S2-6	C	O	O
S2-7	C	O	O
S2-8	C	O	O
S1-6	C	C	C
S1-8	C	C	C

C = CLOSED
O = OPEN

TABLE B

DEVICE TYPE	S1-1	S1-2	S1-3
D3636	C	O	O
MK2716, 2732	C	O	C

TABLE C

MODEL NUMBER	S1-4	S1-5	S1-7
8215, 8216, 8225, 8226	O	C	C
8235, 8245	O	C	O

M-82-0178-031

Figure 3-9. Digital Graphic Controller Switches

3.6.7 VIDEO CONTROLLER. This card contains three DIP switches to select the video blink, display number, and shift register configuration. See figure 3-10.

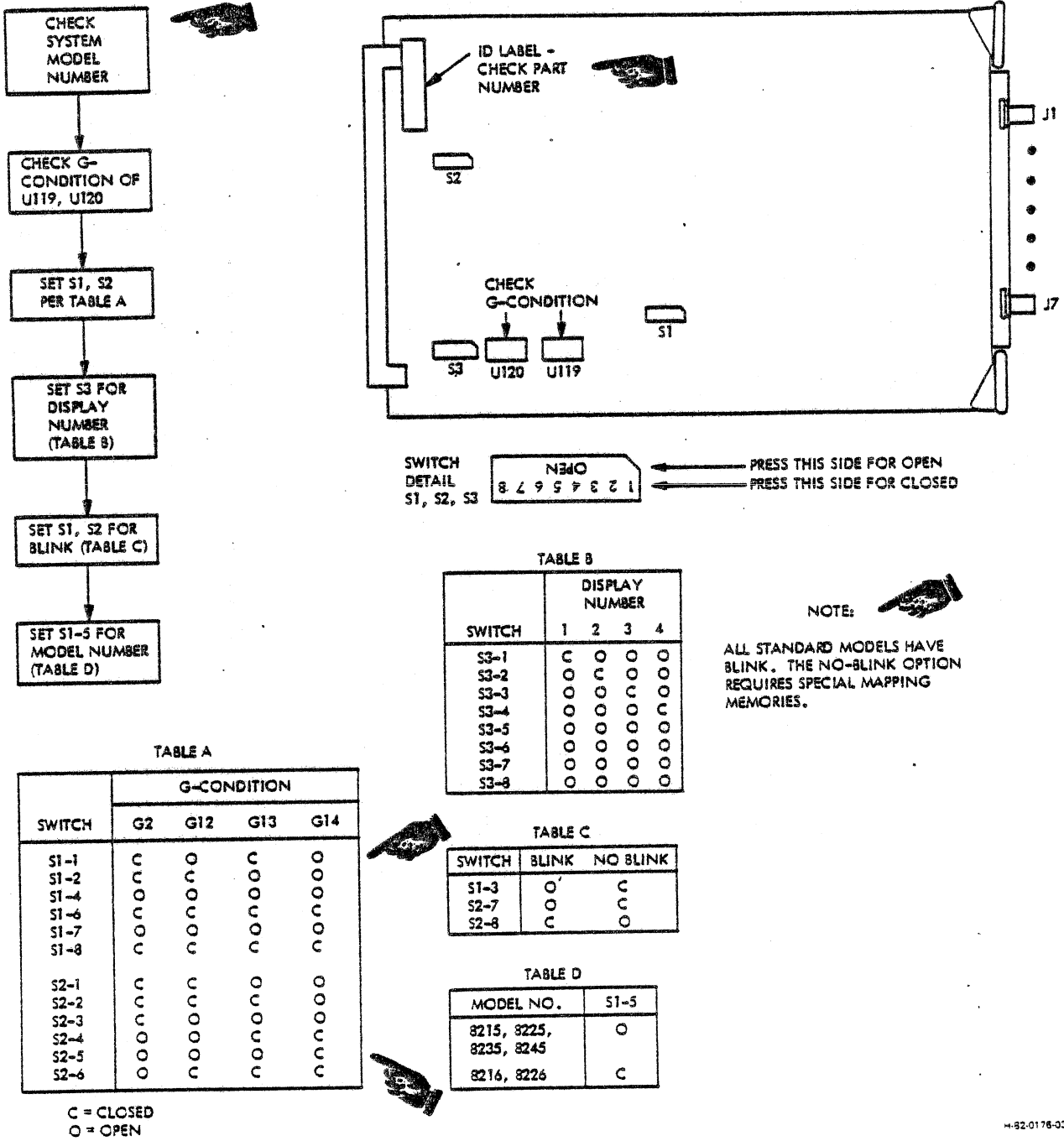

Figure 3-10. Video Controller Switches

3.6.8 MAPPING MEMORY. There are many configurations of mapping memory (see table 3-15). They are all similar in layout; the differences are in the components used. All the mapping memories listed in table 3-15 are altered items, made from one of the following basic boards:

- 5802554 - basic 64K board
- 5809875 - high speed 64K board
- 5977176 - basic 16K board

Table 3-15. Mapping Memory Configurations

PART NO.	TYPE	RESOLUTION X BITS/PIXEL/BLINK	INPUT BITS	PIXEL BITS
5802966	64K	1024 x 1024 x 4, blink	0-3	0-2, 7
5802967	64K	1024 x 1024 x 4	0-3	0-3
5802968	64K	1024 x 1024 x 4, blink	4-7	4-7
5809855	16K	512 x 512 x 4 (2 displays), blink	0-3	0-2, 7
5809970	64K	1024 x 1024 x 4 (high speed), blink	0-3	0-2, 7
5809971	64K	1024 x 1024 x 4 (high speed), blink	4-7	4-7
5809972	64K	1024 x 1024 x 4 (high speed)	0-3	0-3
5809973	64K	512 x 512 x 8 (high speed), blink	0-7	0-7
5810013	64K	1024 x 512 x 4 (dual, high speed), blink	0-3	0-2, 7
5977268	16K	512 x 512 x 4, blink	0-3	0-2, 7
5977269	16K	512 x 512 x 4	0-3	0-3
5977270	16K	512 x 512 x 4, blink	4-7	4-7
5977271	16K	1024 x 512 x 2	0-1	0-1
5977272	16K	1024 x 512 x 2	2-3	2-3
5977273	16K	1024 x 512 x 2	4-5	4-5
5977274	16K	1024 x 512 x 2, blink	6-7	6-7
5977275	16K	1024 x 512 x 2, blink	2-3	2-7
5977276	64K	1024 x 512 x 4, blink	0-3	0-2, 7
5977277	64K	1024 x 512 x 4	0-3	0-3

Table 3-15. Mapping Memory Configurations (Cont)

PART NO.	TYPE	RESOLUTION X BITS/PIXEL/BLINK	INPUT BITS	PIXEL BITS
5977278	64K	1024 x 512 x 4, blink	4-7	4-7
5977279	64K	1024 x 512 (or 512 ²) x 8, blink	0-7	0-7
5977280	16K	1024 x 1024 x 1	0	0
5977281	16K	1024 x 1024 x 1	1	1
5977282	16K	1024 x 1024 x 1	2	2
5977283	16K	1024 x 1024 x 1	3	3
5977284	16K	1024 x 1024 x 1	4	4
5977285	16K	1024 x 1024 x 1	5	5
5977286	16K	1024 x 1024 x 1	6	6
5977287	16K	1024 x 1024 x 1, blink	7	7
5977288	16K	1024 x 1024 x 1, blink	3	7
5977289	64K	1024 x 1024 x 2	0-1	0-1
5977290	64K	1024 x 1024 x 2	2-3	2-3
5977291	64K	1024 x 1024 x 2	4-5	4-5
5977292	64K	1024 x 1024 x 2, blink	6-7	6-7
5977293	64K	1024 x 1024 x 2, blink	2-3	2-7
5977305	64K	1024 x 512 x 4 (dual), blink	0-3	0-2, 7

See figure 3-11 for mapping memory switch settings.

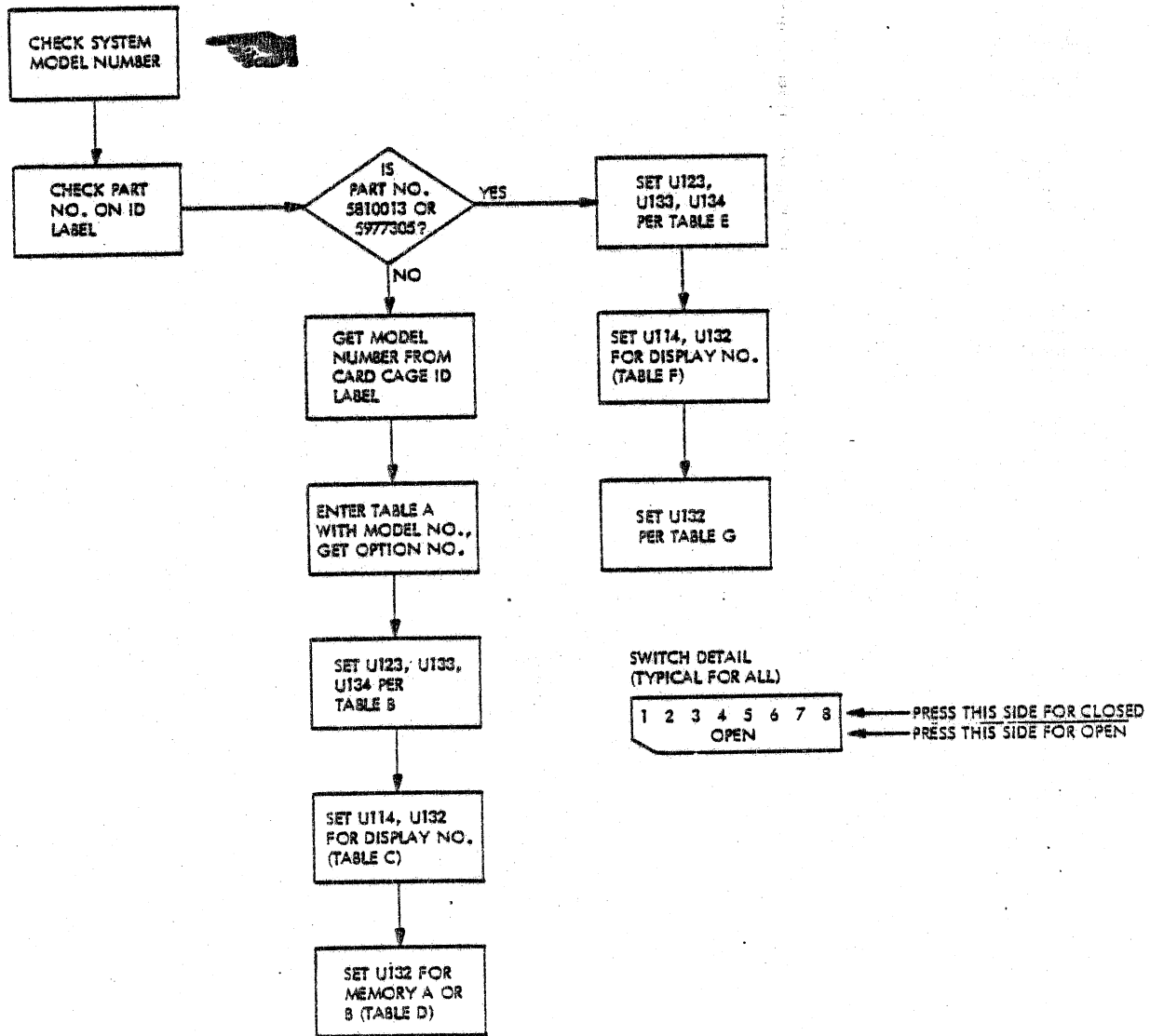
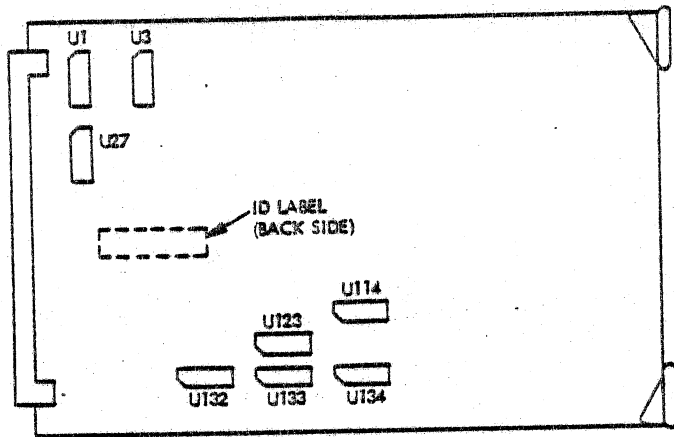

M-82-0175-033A

Figure 3-11. Mapping Memory Switches (Sheet 1 of 2)

TABLE A

MODEL NO.	OPTION
8215-X4	3
8215-X8	4
8216-X4	3
8216-X8	4
8225-X4	1
8225-X8	2
8226-X4	1
8226-X8	1
8235-X4	1
8235-X8	1
8245-X4	1
8245-X8	1

TABLE C

SWITCH	DISPLAY NO.			
	1	2	3	4
U114-1	O	O	O	C
U114-2	O	O	C	O
U114-3	O	C	O	O
U114-4	C	O	O	O
U114-5	C	C	O	C
U114-6	C	O	O	O
U114-7	O	O	O	O
U114-8	O	O	O	O
U132-1	O	O	O	C
U132-2	O	C	O	O
U132-3	C	O	C	O
U132-4	C	O	O	O

TABLE F

SWITCH	DISPLAY NO.			
	1	2	3	4
U114-1	O	O	O	C
U114-2	O	O	C	O
U114-3	O	C	O	O
U114-4	C	O	O	O
U114-5	C	C	O	C
U114-6	C	O	O	O
U114-7	O	O	O	O
U114-8	O	O	O	O
U132-1	O	O	O	O
U132-2	O	O	O	O
U132-3	O	O	O	O
U132-4	O	O	O	O

TABLE B

SWITCH	OPTION			
	1	2	3	4
U123-1	O	O	C	O
U123-2	O	O	O	O
U123-3	C	C	O	O
U123-4	O	O	C	O
U123-5	O	O	O	O
U123-6	C	C	O	O
U123-7	O	O	O	O
U123-8	O	O	O	O
U133-1	O	O	C	O
U133-2	C	C	O	O
U133-3	O	O	O	O
U133-4	C	O	O	O
U133-5	O	C	O	O
U133-6	O	O	C	O
U133-7	C	O	C	O
U133-8	O	O	O	O
U134-1	O	O	O	O
U134-2	C	C	C	C
U134-3	C	O	C	C
U134-4	O	C	C	O
U134-5	O	C	C	O
U134-6	C	C	C	O
U134-7	C	C	O	O
U134-8	O	O	C	C

TABLE D

MEMORY SELECT	U132			
	5	6	7	8
A	C	O	O	C
B	O	C	C	O

TABLE G

U132			
5	6	7	8
O	O	O	O

TABLE E

SW	U123	U133	U134
1	O	O	O
2	O	C	C
3	C	O	O
4	O	O	O
5	O	O	O
6	C	O	C
7	O	C	C
8	O	O	O

O = OPEN
C = CLOSED

H-82-0176-0338

Figure 3-11. Mapping Memory Switches (Sheet 2 of 2)

3.6.9 TIMING MODULE. This card contains five DIP switches to select the number of bits per pixel, the number of bits per memory board, and the number of displays per terminal. See figure 3-12.

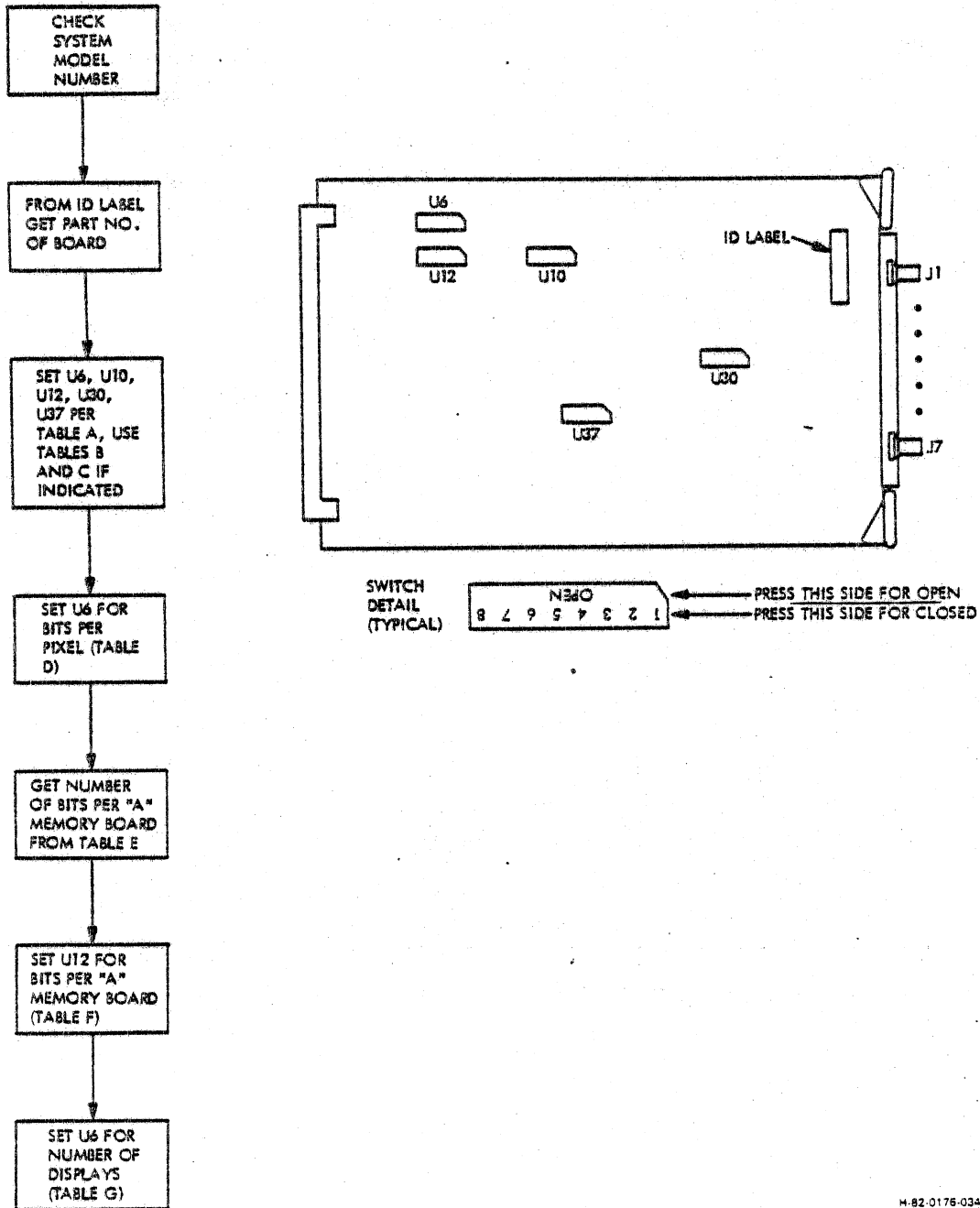

M-82-0176-034A

Figure 3-12. Timing Module Switches (Sheet 1 of 2)

TABLE A

SWITCH	MODEL NUMBER					
	8215	8216	8225	8226	8235	8245
U6-1	O	O	O	O	O	O
U6-4	O	O	C	C	C	C
U6-5	O	O	O	O	O	O
U6-6	O	O	O	O	O	O
U10-1	C		O		C	O
U10-2	C		C		C	O
U10-3	C		C		C	O
U10-4	C	SEE NOTE 1	C	SEE NOTE 1	C	O
U10-5	O		O		O	O
U10-6	O		O		O	O
U10-7	C		C		C	O
U10-8	O		O		O	O
U12-1	C	C	C	C	C	C
U12-2	C	C	C	C	C	C
U12-3	O	O	O	O	O	O
U12-4	O	O	O	O	O	O
U12-5	C	C	C	C	C	C
U12-6	C	C	C	C	C	C
U30-1	O	O	O	O	O	O
U30-2	C	C	C	C	C	C
U30-3	C	C	C	C	C	C
U30-4	O	O	O	O	O	O
U30-5	O	O	O	O	O	O
U30-6	O	O	O	O	O	O
U30-7	O	O	O	O	O	O
U30-8	O	O	O	O	O	O
U37-1	C		O		O	O
U37-2	C		C		C	O
U37-3	O		O		O	O
U37-4	O	SEE NOTE 1	O	SEE NOTE 1	O	O
U37-5	O		O		O	O
U37-6	O		O		O	O
U37-7	O		O		O	O
U37-8	O		O		O	O

NOTE 1: DETERMINE OPTION NUMBER FROM TABLE B, THEN SET U10 AND U37 PER TABLE C.

TABLE G

SWITCH	NUMBER OF DISPLAYS			
	1	2	3	4
U6-7	C	O	C	O
U6-8	C	C	O	O

O = OPEN
C = CLOSED



TABLE B

PART NUMBER	MODEL NUMBER	
	8216	8226
5977168G1	OPTION 1	OPTION 3
5977168G2	OPTION 2	OPTION 4
5809995G1	OPTION 2	OPTION 4

TABLE C

SWITCH	OPTION			
	1	2	3	4
U10-1	C	C	C	O
U10-2	O	C	O	C
U10-3	C	O	O	C
U10-4	O	C	C	C
U10-5	C	C	C	C
U10-6	O	C	O	C
U10-7	C	O	C	O
U10-8	O	O	O	O
U37-1	C	O	O	C
U37-2	O	C	C	C
U37-3	O	O	O	C
U37-4	C	O	C	C
U37-5	O	C	O	O
U37-6	O	O	O	O
U37-7	O	O	O	O
U37-8	C	O	C	O

TABLE D

SWITCH	BITS/PIXEL		
	2	4	8
U6-2	O	C	O
U6-3	C	O	O

TABLE E

NUMBER OF "A" MEMORY CARDS PER DISPLAY	4 BITS PER PIXEL	8 BITS PER PIXEL
	1	4 BPB
2	2 BPB	4 BPB
4	1 BPB	2 BPB

TABLE F

SWITCH	BPB			
	1	2	4	8
U12-7	C	O	C	O
U12-8	C	C	O	O

M-82-0178-0348

Figure 3-12. Timing Module Switches (Sheet 2 of 2)

3.6.10 TIMING MODULE II. This card contains 8 DIP switches to select the number of bits per pixel, the number of bits per memory board, and the number of displays per terminal. See figure 3-13.

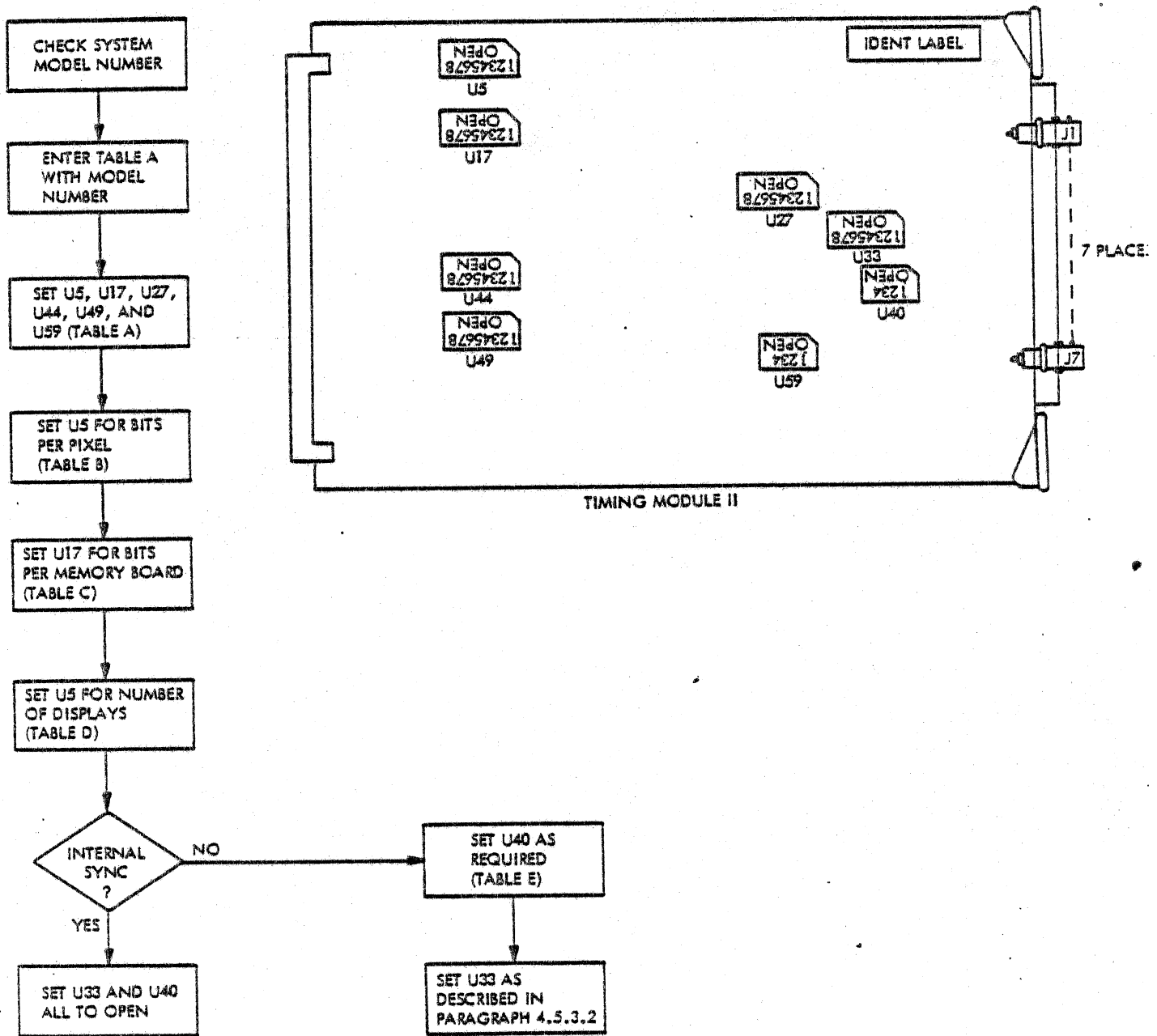

Figure 3-13. Timing Module II Switches (Sheet 1 of 2)

TABLE A

SWITCH	MODEL NUMBER						
	8215	8216	8225	8226	8235	8245	8256
U5-2	O	O	O	O	C	C	C
U5-4	O	O	O	O	O	O	C
U5-6	O	O	C	C	C	C	C
U5-7	O	O	O	O	O	O	O
U17-1	O	O	O	O	O	O	O
U17-2	O	O	O	O	O	O	O
U17-3	O	O	O	O	O	O	O
U17-4	O	O	O	O	O	O	O
U17-7	C	C	C	C	C	O	O
U17-8	C	C	O	O	C	O	O
U27-1	C	C	O	O	C	O	C
U27-2	C	C	C	C	C	O	O
U27-3	C	C	C	C	C	O	O
U27-4	C	C	C	C	C	O	O
U27-5	C	C	C	C	C	O	O
U27-6	C	C	C	C	C	O	O
U27-7	C	C	C	C	C	O	O
U27-8	O	O	O	O	O	O	O
U44-1	C	C	C	O	C	C	C
U44-2	O	O	O	C	O	O	O
U44-3	O	O	O	O	O	O	O
U44-4	O	O	O	C	C	O	O
U44-5	O	O	O	C	C	O	O
U44-6	O	C	C	O	O	O	O
U44-7	O	O	O	O	O	O	O
U44-8	O	O	O	O	O	O	O
U49-1	O	O	O	O	O	O	O
U49-2	O	O	O	O	O	O	O
U49-3	O	O	O	O	O	O	O
U49-4	O	O	O	O	O	O	O
U49-5	O	O	O	O	O	O	O
U49-6	C	C	C	O	C	O	O
U49-7	O	O	O	O	O	O	O
U49-8	O	O	O	O	O	O	O
U59-1	C	C	C	C	C	C	O
U59-2	O	O	O	O	O	O	O
U59-3	C	C	C	C	C	C	C
U59-4	O	O	O	O	O	O	O

TABLE B

SWITCH	BITS PER PIXEL		
	2	4	8
U5-3	C	O	O
U5-5	O	C	O

TABLE C

SWITCH	BITS PER MAPPING MEMORY			
	1	2	4	8
U17-5	C	C	O	O
U17-6	C	O	C	O

TABLE D

SWITCH	NUMBER OF DISPLAYS			
	1	2	3	4
U5-1	C	O	C	O
U5-8	C	C	O	O

TABLE E
OUTPUT SYNC LOGIC SELECT

C SYNC J5 U40-3		H SYNC J6 U40-1		V SYNC J7 U40-2	
POS	NEG	POS	NEG	POS	NEG
C	O	C	O	C	O

H-82-0178-0408

Figure 3-13. Timing Module II Switches (Sheet 2 of 2)

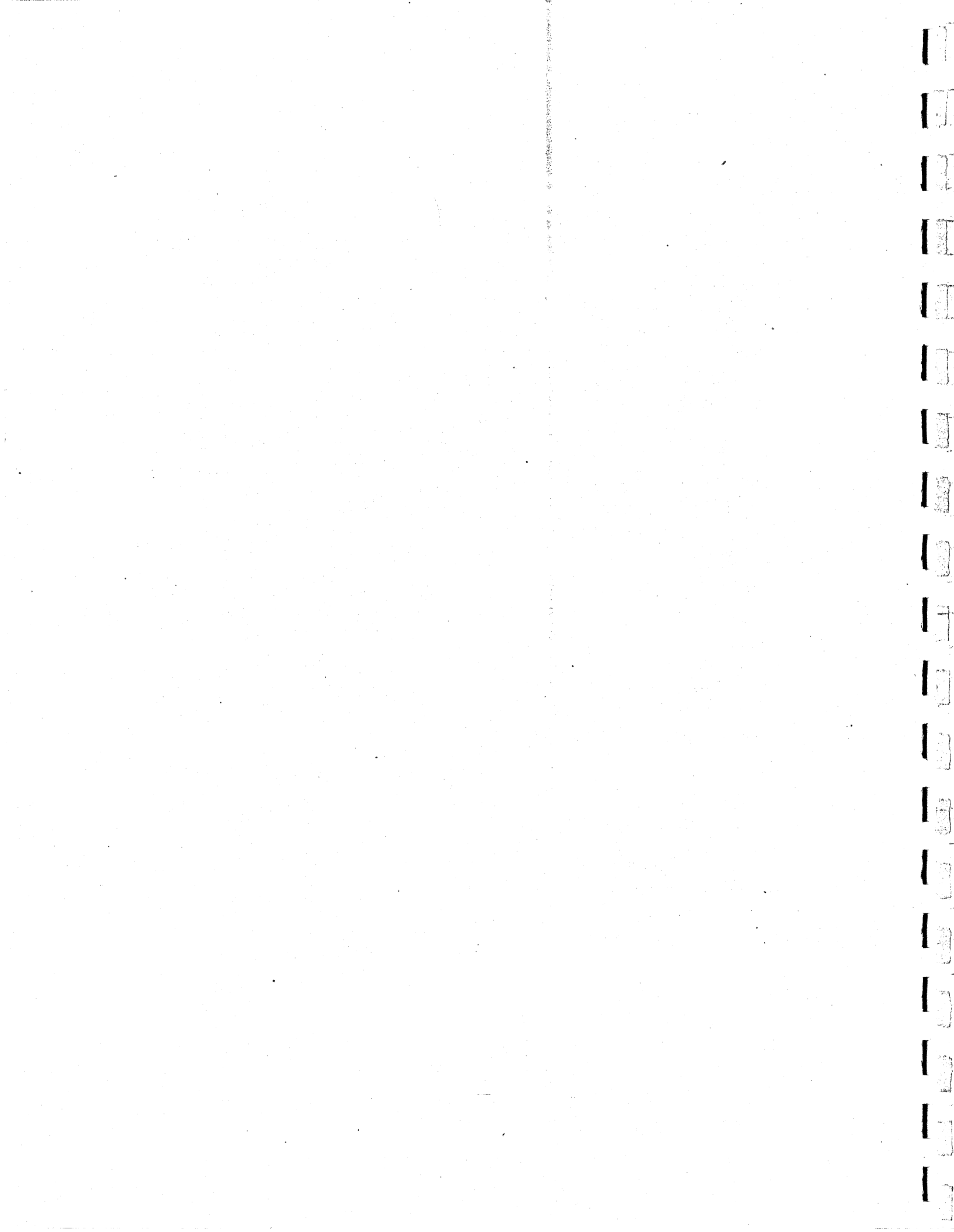

SECTION 4
MAINTENANCE

4.1 GENERAL

This section contains the maintenance philosophy, test equipment required, troubleshooting instructions, adjustments, and repair information.

4.2 MAINTENANCE PHILOSOPHY

The maintenance philosophy for a typical GRAPHIC 8 system is to isolate faults to the equipment unit or system component causing the fault. You can then make the appropriate adjustment, alignment or repair by following the instructions given in the applicable technical manual for that unit. In particular, the maintenance philosophy for the terminal controller is to limit repairs to replacement of plug-in circuit cards and chassis-mounted components. This approach reduces system down-time if a failure occurs. Field repair of circuit cards is not recommended because of their complexity. Testing them requires special factory-level test equipment.

If you encounter a failure, try to isolate the failure to a specific circuit card, then replace that card and make any required adjustments. If the system resumes normal operation, the card that you took out is defective. Return that card to Sanders for repair. Send us also a description of the symptoms that led you to the failed card.

4.3 TEST EQUIPMENT REQUIRED

The following equipment (or equivalent) is recommended for maintenance of the terminal controller:

Oscilloscope	Tektronix type 465 with 10X probe
Digital voltmeter	Fluke model 8000A
Card extender	Sanders part no. 4171110

4.4 TROUBLESHOOTING INSTRUCTIONS

Troubleshooting the GRAPHIC 8 system involves checking the results of the terminal controller built-in diagnostics, observing the terminal controller verification test pattern, and following the steps shown on the troubleshooting flow diagram. The following paragraphs give the instructions needed to use these techniques, along with some additional hints that may be used when isolating faults to individual plug-in circuit cards.

4.4.1 BUILT-IN DIAGNOSTICS. When the terminal controller is initialized in the SYSTEM mode, it executes a set of diagnostic routines that test the GO/NO GO status of certain circuit cards. If a NO GO is detected, the terminal controller sets a bit in the diagnostic error word, and an error message containing the error word is sent to the host computer. The message indicates the diagnostic routine that failed, but does not specifically state how the routine failed.

When you initialize the terminal controller in the LOCAL mode, it executes the same set of diagnostic routines, then executes the terminal verification pattern. The results of the diagnostic routines are displayed in the left field of the readout box as an octal number with the letter T above it (the letter T means that the 3-digit code is the result of the diagnostic routines).

If all tests pass, the 3-digit number is 000, assuming all cards are installed. If any card is not installed, the bit for that card is set, producing an error indication.

If more than one test fails, and sequencing through the remaining tests does not stop, the readout is the sum of all the failed tests. For example, if the terminal controller does not contain a 3D coordinate converter, and both the memory and the graphic controller diagnostics fail, the readout is 045.

The following paragraphs describe the diagnostic routines.

Serial Interface Diagnostic. This test verifies initialization of the status registers.

Parallel Interface Diagnostic. This test verifies initialization of the handshaking circuits and status registers.

Display Processor Diagnostic. This test verifies execution of a branch instruction, an interrupt sequence, and single-word, double-word, and triple-word instructions from the instruction set.

Memory Diagnostic. This test verifies the ability to write and read at each memory location. (During this test, any data already contained in a memory location is temporarily stored in a general purpose register, then restored to its location.)

Graphic Controller Diagnostic. This test verifies that:

1. Each display register is initialized.
2. The graphic controller is in its proper state.
3. The display processor can start a refresh sequence.
4. The graphic controller can start, run, access memory, perform refresh functions, and stop.

3D Coordinate Converter Diagnostic. This test verifies the 3D coordinate converter's ability to write and execute a simple instruction.

4.4.2 VERIFICATION TEST PATTERN. The terminal controller verification test pattern can be used with up to two display indicators and a full complement of peripherals. The pattern verifies proper operation of the terminal controller and display indicators. Each area of the verification test pattern has a specific function: either executing a system parameter or providing a visual indication for fault isolation. Figure 4-1 shows the normal indications expected when using the verification test pattern; figure 4-2 shows some common error indications.

4.4.2.1 Character Verification. The character area of the test pattern displays the character repertoire, including alphanumeric and special symbols. In addition, the letters EM are displayed in three different sizes.

4.4.2.2 PED Manipulation. A set of numerals and asterisks should appear at the upper left corner of the screen. The numerals indicate the PED assigned to the symbol. There may be up to eight symbols present, depending on the input device configuration as set on the display processor.

4.4.2.3 Polygon Fill. The triangle directly below the monitor number will cycle through all available colors in the particular configuration.

4.4.2.4 Point Plot. All point plot instructions are used to build the geometric plot in the center of the screen.

4.4.2.5 Overflow Indicators. Various full-screen vectors will appear in the test pattern if X or Y overflow interrupts occur unexpectedly or if they fail to occur when they are expected. See figures 4-1 and 4-2.

4.4.3 USING THE TROUBLESHOOTING FLOW DIAGRAM. Follow the steps indicated in figure 4-3 to isolate a trouble to a circuit card or equipment unit. Pay particular attention to the cautions of sheet 1 of the figure. Figure 4-3 applies specifically to the standard card cage and circuit card complement; however, the same general procedure applies when troubleshooting the extended card cage. The slot numbers of the individual circuit cards differ from the standard card cage to the extended card cage; refer to figure 1-7 for extended card cage card locations.

4.4.4 CARD CAGE CIRCUIT CARD INSTALLATION. The circuit cards that connect to the processor bus (cards in slots XA1 through XA7 in the standard card cage, cards in slots XA4 through XA11 in the extended card cage) can be installed in other arrangements than that shown in figure 4-3. However, the following rules must be followed:

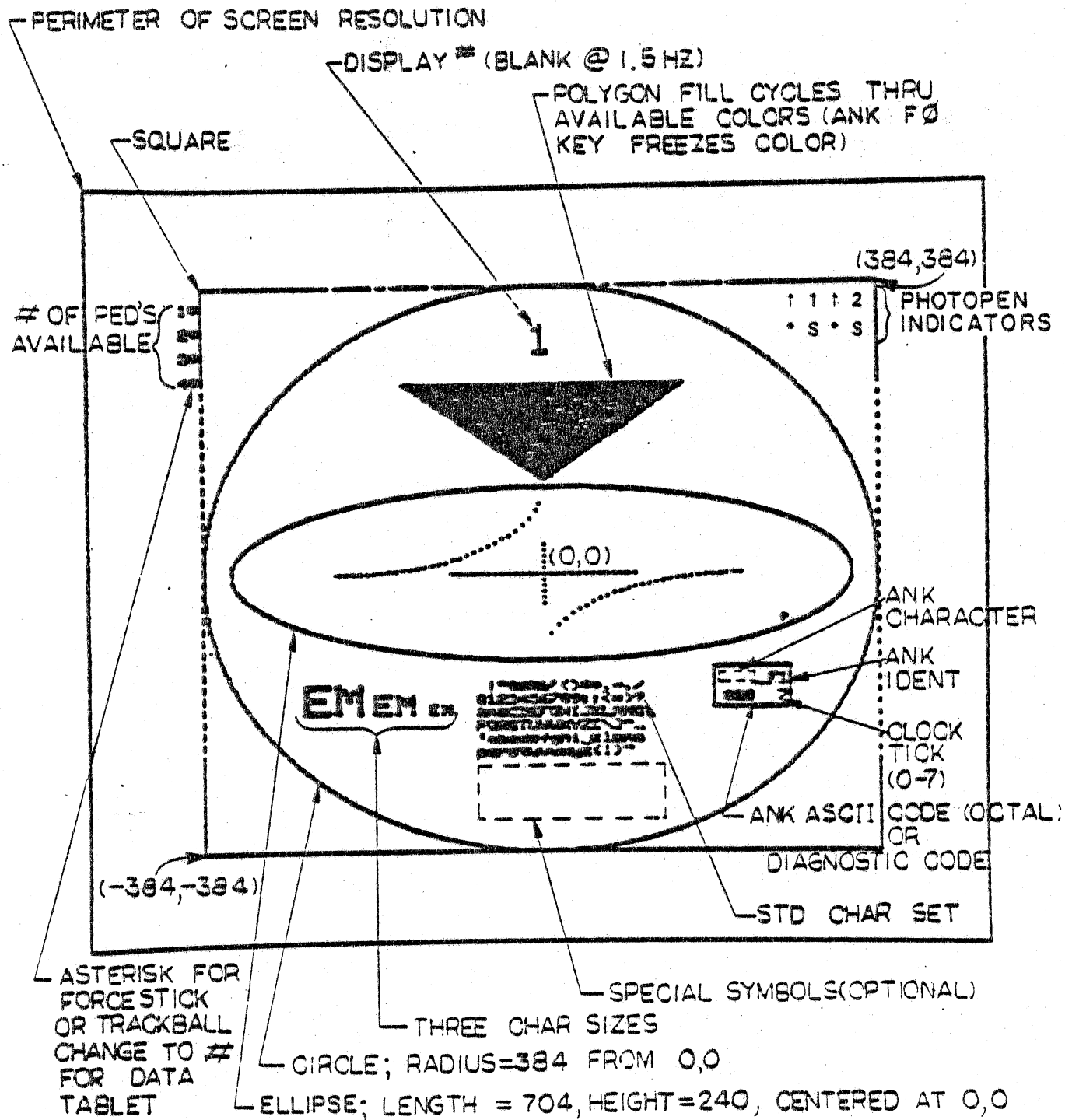

H-82-0176-024

Figure 4-1. Verification Test Pattern, Normal Indications

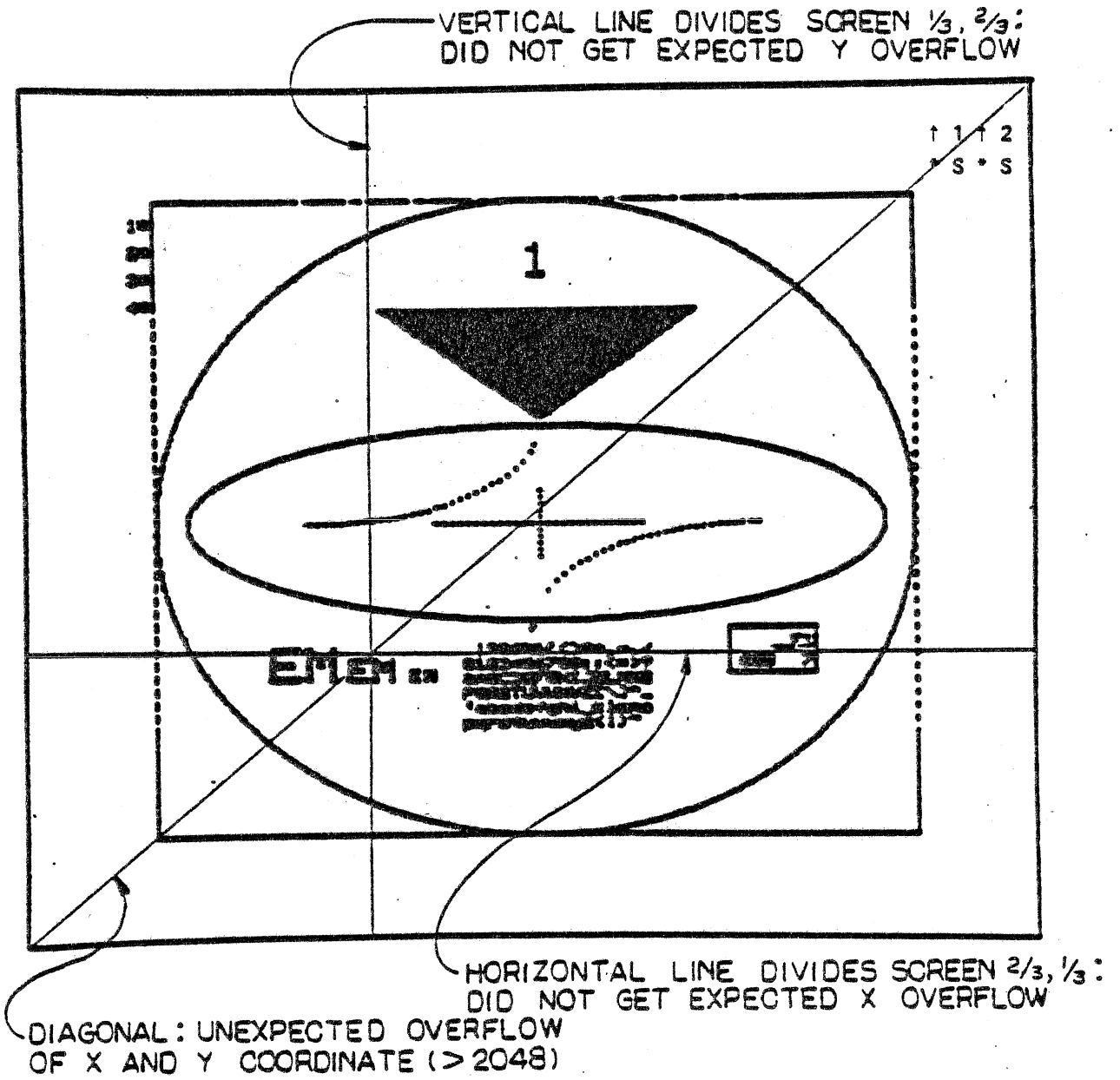

H-82-0176-025

Figure 4-2. Verification Test Pattern, Error Indications

WARNING

TERMINAL CONTROLLER OPERATES ON 110 VAC POWER. ASSOCIATED POWER CONTROL PANEL MAY HAVE 220 TO 240 VAC INPUT.

CAUTION

ALWAYS TURN TERMINAL CONTROLLER OFF BEFORE REMOVING OR INSERTING CIRCUIT CARDS.

MAPPING MEMORY, LARGE MEMORY, AND TIMING MODULE CONTAIN MOS DEVICES. WHEN NOT IN USE, STORE THESE CARDS IN STATICPROOF CONTAINERS.

NOTES

1. TECHNICAL MANUAL FOR DISPLAY MONITORS: TBD
2. TECHNICAL MANUAL FOR MODEL 5783/5784 KEYBOARDS: H-79-0363.
3. TECHNICAL MANUAL FOR MODEL 5781 PHOTOPEN: H-78-0042.
4. TECHNICAL MANUAL FOR MODEL 5786 TRACKBALL/5787 FORCESTICK: H-78-0044.
FOR MODEL 5788 DATA TABLET: H-81-0159.
5. TECHNICAL MANUAL FOR COLOR HARDCOPY UNIT: DUNN MODEL 631.
6. TECHNICAL MANUAL FOR MONOCHROME HARDCOPY UNIT: TEKTRONIX MODEL 4632.
7. FOR SOFTWARE INSTRUCTIONS, SEE GRAPHIC 8 PROGRAMMER'S REFERENCE MANUAL. H-80-0444.
8. ALIGNMENT PROCEDURES:
TIMING MODULE, PARAGRAPH 4-5.
9. TECHNICAL MANUAL FOR POWER SUPPLIES:
MODEL MM23-50647/115
H-90-0087
10. IF OTHER MODELS ARE USED, APPROPRIATE MANUALS WILL BE PROVIDED.
11. BEFORE REPLACING A BOARD, CHECK SWITCH SETTINGS AGAINST THE CONFIGURATION DOCUMENT.
12. THE BACKPLANE WIRING FOR THE STANDARD CARD CAGE IS IDENTICAL FOR CARD SLOTS 1A1XA1 THROUGH 1A1XA5, MAKING THE DESIGNATED CARD PLACEMENT FOR THOSE SLOTS ARBITRARY. EXCEPT FOR THE READ/WRITE MEMORY CARDS; THE CARDS IN THESE EIGHT SLOTS CAN BE INTERCHANGED TO REASSIGN PROCESSOR BUS CONTROL PRIORITIES AS DESIRED, WITH THE BUS CONTROL PRIORITY GRANT FUNCTION BEING PASSED IN CARD SLOT SEQUENCE FROM THE HIGHEST-PRIORITY SLOT (1A1XA1) TOWARD THE LOWEST-PRIORITY CARD (GRAPHIC CONTROLLER 1A1XA7). RELOCATABLE CARDS MUST BE PLACED IN ADJACENT SLOTS (1A1XA5, 1A1XA4, 1A1XA3, ETC, IN THAT ORDER); LEAVING ANY ONE OF THESE SLOTS VACANT WOULD BREAK THE PRIORITY CHAIN, WHICH COULD RESULT IN UNIT MALFUNCTION. THE READ/WRITE MEMORY CARDS ARE PASSIVE CIRCUITS THAT ARE ACCESSED BY THE PROCESSOR BUS BUT DO NOT SEIZE BUS CONTROL. THE GRANT SIGNAL IS PASSED DIRECTLY THROUGH A READ/WRITE MEMORY CARD.

Figure 4-3. Troubleshooting Flow Diagram (Sheet 1 of 4)

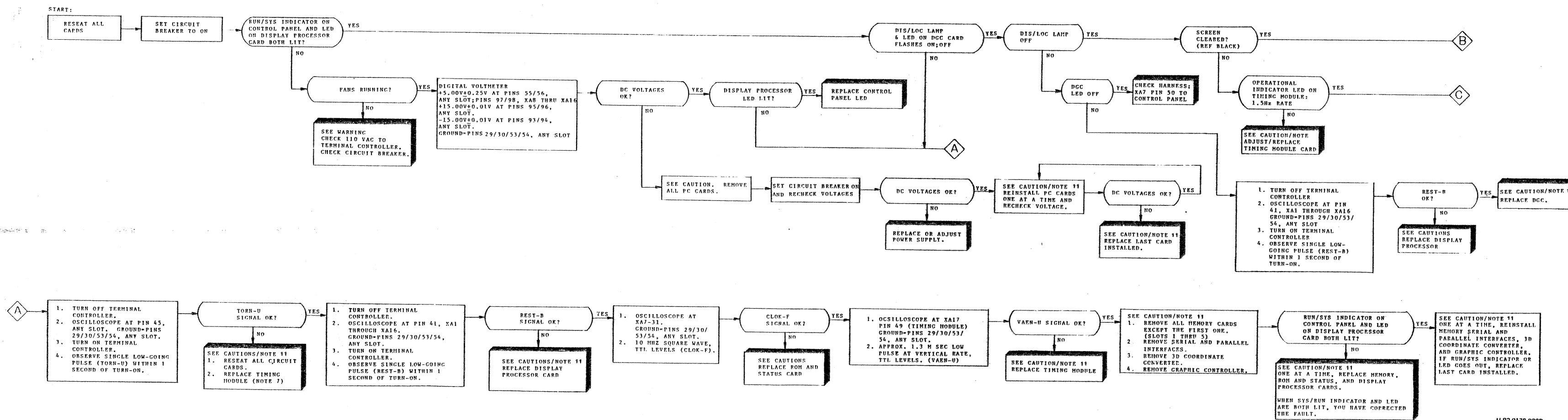

H-82-0176-0268

Figure 4-3. Troubleshooting Flow Diagram (Sheet 2 of 4)

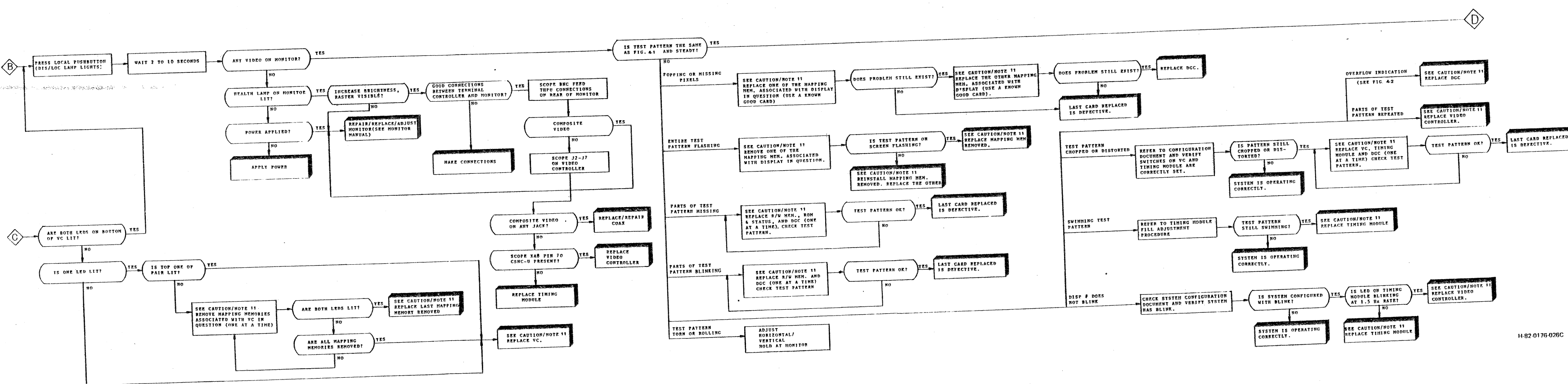

Figure 4-3. Troubleshooting Flow Diagram (Sheet 3 of 4)

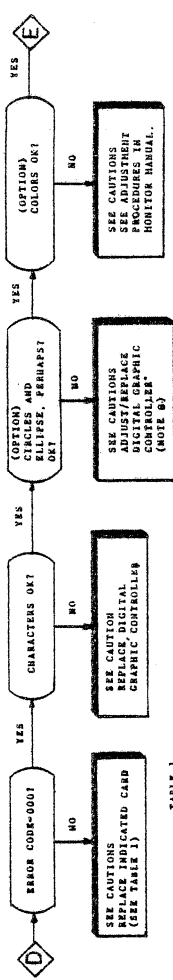

TABLE 1
ERROR CODE IS 3-DIGIT CODE THAT REPRESENTS THE FOLLOWING 8-BIT BINARY CODE.

FIRST DIGIT	SECOND DIGIT	THIRD DIGIT	USE				
7	6	5	4	3	2	1	0

- NOT USED
- 3D COORDINATOR
- PARALLEL INTERFACE
- DIAGNOSTIC
- SERIAL INTERFACE
- DIAGNOSTIC
- READ/WRITE
- MEMORY DIAGNOSTIC
- DISPLAY PROCESSOR
- DIAGNOSTIC
- GRAPHIC CONTROLLER
- DIAGNOSTIC
- GRAPHIC CONTROLLER

WHEN A DIAGNOSTIC ROUTINE DETECTS AN ERROR, THE BIT CORRESPONDING TO THE ERROR IS SET TO A 1. IF NO ERROR OCCURS, IT IS SET TO 0.

IF SYSTEM DOES NOT CONTAIN ONE OF THESE CARDS, CORRESPONDING BIT SHOULD BE SET TO 0. IF 3-D COORDINATE CONVERTER IS NOT USED, THEN SECOND DIGIT OF ERROR CODE IS 4 OR LARGER.

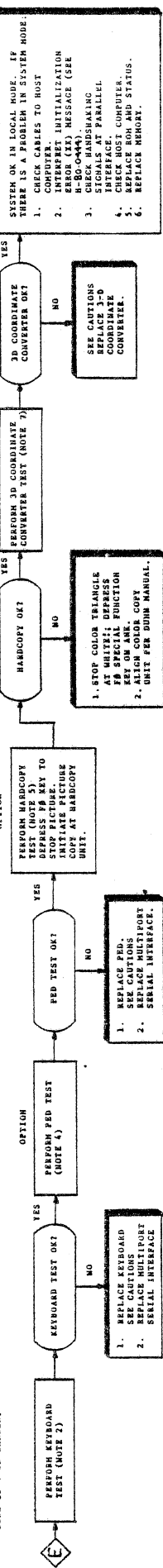

H82-0176-026D

Figure 4-3. Troubleshooting Flow Diagram (Sheet 4 of 4)

4-11/ (4-12 blank)

1. All read/write memory cards should be installed in consecutive slots.
2. Those cards that can seize the processor bus should be installed in consecutive slots, to maintain the integrity of the grant bus. If there is a gap between such cards, you effectively get two grant buses in parallel, with subsequent interference when two cards want the bus at the same time. If it is necessary to separate such cards, you must connect the grant out connection (pin 35) of the higher priority card (lower numbered slot) across the gap to the grant in connection (pin 36) of the next lower priority card (higher numbered slot). For this type of connection, use Sanders part number 47067, daisy-chain jumper.

4.5 ADJUSTMENTS

The timing module is the only card in the terminal controller requiring adjustment. The timing module is basically a phase-locked loop that locks to the line frequency or an external input. The line frequency may be 50 Hz or 60 Hz.

Any of several different timing modules may be used in a GRAPHIC 8 system, as follows:

<u>Non-interlaced</u>	<u>Interlaced</u>	<u>Description</u>
5977168G1	5977168G2	Version 1
	5809995G1	Version 1.5
5810009G1	5810010G1	Version 2

The following paragraphs give the instructions for adjusting the timing modules.

4.5.1 TIMING MODULE (PART NUMBER 5977168) ADJUSTMENTS. The timing module VCO frequency is approximately 45 MHz. Binary dividers reduce this frequency to VSYNC, which is phase-locked to the line frequency.

A light-emitting diode on the edge of the timing module blinks at a rate of 1.5 Hz, indicating that VSYNC is present and functioning correctly. If this indicator is either off or steady on, there is a problem with the phase-locked loop. Blinking at a rate slower than 1.5 Hz indicates improper lock, or that the line frequency is lower than 60 Hz.

Before adjusting the timing module, check that the configuration switches are properly set (refer to drawing 5977170 in H-81-0097).

Adjust the timing module as follows (see figure 4-4):

1. Set gain potentiometer R43 fully counterclockwise (maximum gain).
2. Open switch U30-S2.
3. Adjust offset potentiometer R42 for -8V at TP6.
4. Using oscilloscope, observe waveform VSYNC at J7. Sync internally and observe pulse output. The signal on the oscilloscope should have a pulse duration of 90 us at the line frequency. Adjust C24 for the most stable display. (Pulse period is 16.6 ms for 60 Hz line, 20 ms for 50 Hz line.)
5. Change oscilloscope sync to line. Adjust C24 to minimize movement of the signal on the oscilloscope.

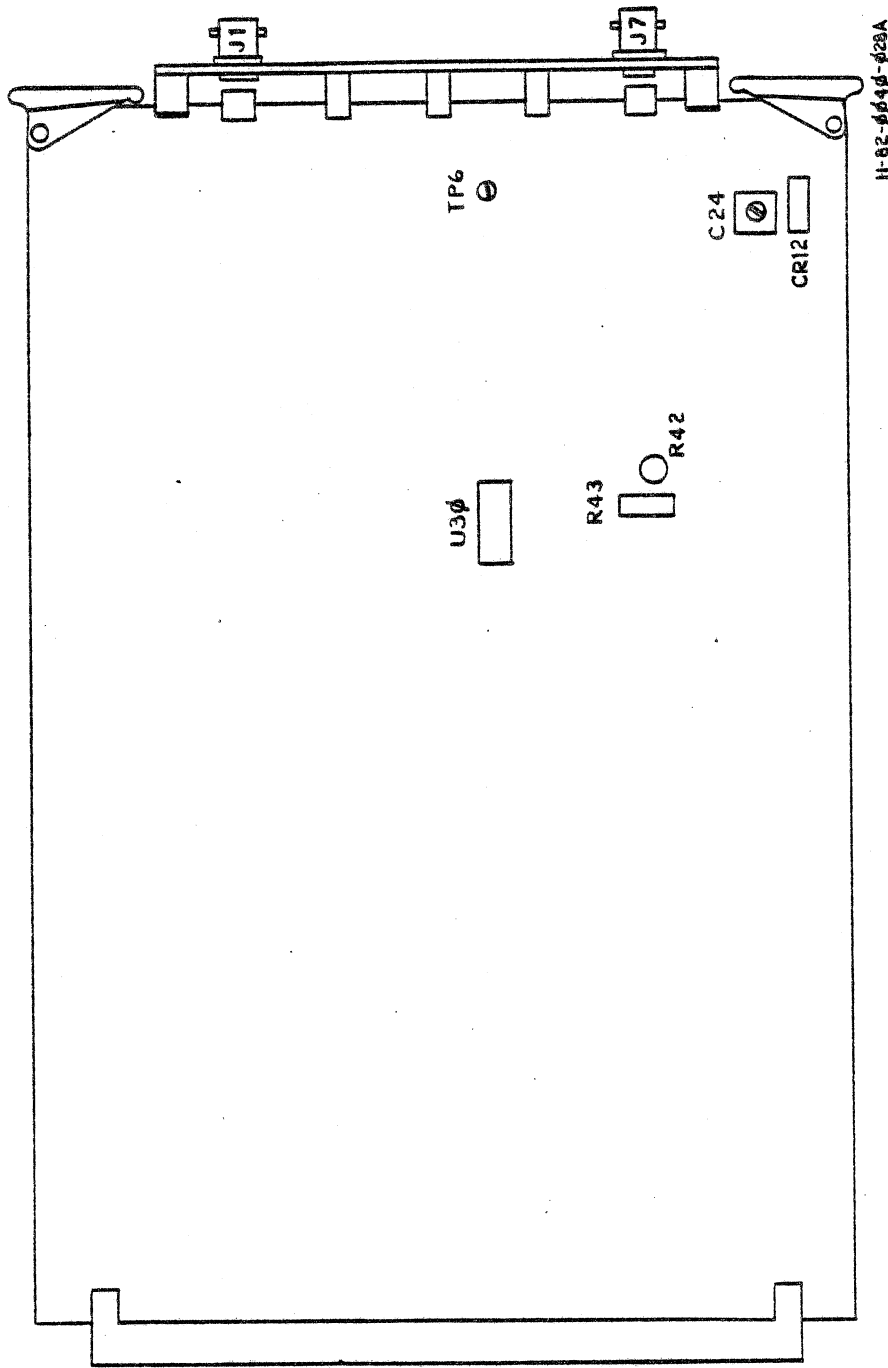

Figure 4-4. Timing Module (Part No. 5977168G1) Adjustment Location

6. Close switch U30-S2. The signal displayed on the oscilloscope should lock and be stable.
7. On second trace of oscillocope, observe signal at TP6. This signal should be a triangular-shaped wave, centered around -8V, with a peak-to-peak amplitude of approximately 1V. The VSYNC waveform should track about midway on the rising edge of the triangle.
8. Adjust R42 as necessary to center VSYNC on the rising edge of the triangle. Leave R43 set for maximum gain.
9. Verify operation of all I/O signals against table 4-1.

Table 4-1. Timing Module Pin Assignments

PIN/ TERM.	SIGNAL NAME	DESCRIPTION
P1-1 P1-2 P1-3 P1-4 P1-5	DB00+H DB01+H DB02+H DB03+H DB04+H	Bidirectional data line, exclusively raster bus, TTL levels, timing module output configuration switch settings to these lines for a short period after TORN goes high.
P1-6	DB05+H	
P1-7 P1-8 P1-9 P1-10 P1-11	DB06+H DB07+H DB08+H DB09+H DB10+H	Bidirectional data line, exclusively raster bus, TTL levels, timing module output configuration switch settings to these lines for a short period after TORN goes high.
P1-12	DB11+H	
P1-43 P1-44 P1-46 P1-48	GCMK+H GRAS-H GCAS-H GRMK+H	Timing module provides only a pull up to these bus signals.
P1-37	EXTR-	TTL level input. When this signal is low, TORN-U will be low and a system reset will result.
P1-33	6.3 VAC	6.3 volt RMS sine wave derived from the AC power source.
J1	VIDEO 2 IN	Video input to a wideband variable gain amplifier.
J3	VIDEO 1 IN	Video input to a wideband variable gain amplifier.

Table 4-1. Timing Module Pin Assignments (Cont)

PIN/ TERM.	SIGNAL NAME	DESCRIPTION
P1-31	20CK+U	TTL square wave 50% duty cycle $\pm 5\%$ at 20 MHz.
P1-52	RTCK-U	TTL square wave 50% duty cycle $\pm 5\%$ at AC line rate.
P1-45	TORN-U	TTL pulse which is low for approximately 500 ms after power turn on. Signal then goes high and remains so until system power down or EXTR- active low input.
P1-27 P1-28	SCLK-U SCLK+U	ECL square wave 50% duty cycle at pixel rate (balanced output).
P1-25 P1-26	SHLD SHLD	Grounding point for SCLK-U and SCLK-U bus strip shield.
P1-36	CCLK-U	TTL square wave 50% duty cycle at approximately 3.5 Hz.
P1-40	BLNK-U	TTL square wave 50% duty cycle at 1.5 Hz.
P1-15	ODDF+U	TTL square wave 50% duty cycle at one half the vertical rate.
P1-47	VAEE-U	TTL pulses active low for approximately 1250 usec at the vertical rate.
P1-49	VAEN-U	TTL pulses active low for approximately 1250 us at the vertical rate.
P1-69	VBLK-U	TTL pulses active low for approximately 1250 usec at the vertical rate.
P1-73	HBLK-U	TTL pulses active low for 7 us at the horizontal rate.
P1-70	CSNC-U	TTL pulses derived from H SYNC, V-DRIVE, SERRATION, and VSYNC signals.
J5 J6	CSYNC HSYNC	AC coupled TTL line driver output, polarity is determined by a switch setting.

Table 4-1. Timing Module Pin Assignments (Cont)

PIN/ TERM.	SIGNAL NAME	DESCRIPTION
J7	VSYNC	AC coupled TTL Line driver output, polarity is determined by a switch setting. Alternately VDRIVE can be routed to this output by a switch setting.
J2	VIDEO 2 OUT	Amplified video output.
J4	VIDEO 1 OUT	Amplified video output.

4.5.2 TIMING MODULE (PART NUMBER 5977168G2) ADJUSTMENTS. Proceed as for part no. 5977168G1, plus the following additional steps:

1. Connect the digital voltmeter between E8 and ground (see figure 4-5). Adjust R73 for a voltmeter indication of zero volts.
2. While observing the display, adjust R73 for the clearest, most stable picture. There should be no break-up, roll-over, horizontal movement, or fuzzy edges.

4.5.3 TIMING MODULE (PART NUMBERS 5810009G1, 5810010G1) ADJUSTMENTS. Timing modules 5810009G1 and 5810010G1 have two adjustment procedures: one for the internal frequency loop, the other for external synchronization.

4.5.3.1 Internal Frequency Loop Adjustment

1. Open switch U59-S1 and close U59-S2 (see figure 4-6). Check that U59-S3 is closed.
2. Connect one channel of the oscilloscope to TP6, the other channel to TP5. Trigger on TP6. Adjust C31 (accessible through the right side of the can) until the two waveforms are stable at the proper period (16.6 ms for 60 Hz line, 20.0 ms for 50 Hz line). Adjust C31 to minimize drift of the sawtooth waveform at TP5. See figure 4-7.
3. Now close U59-S1 and open U59-S2. While observing the signals at TP5 and TP6, carefully adjust C31 to align the pulse at TP6 with the zero crossing of the waveform at TP5.

4.5.3.2 External Synchronization Adjustment

1. Connect source signals to J1 and J3. Set termination switches U33-S1 and U33-S2 as needed (closed = 75 ohms, open = high impedance).

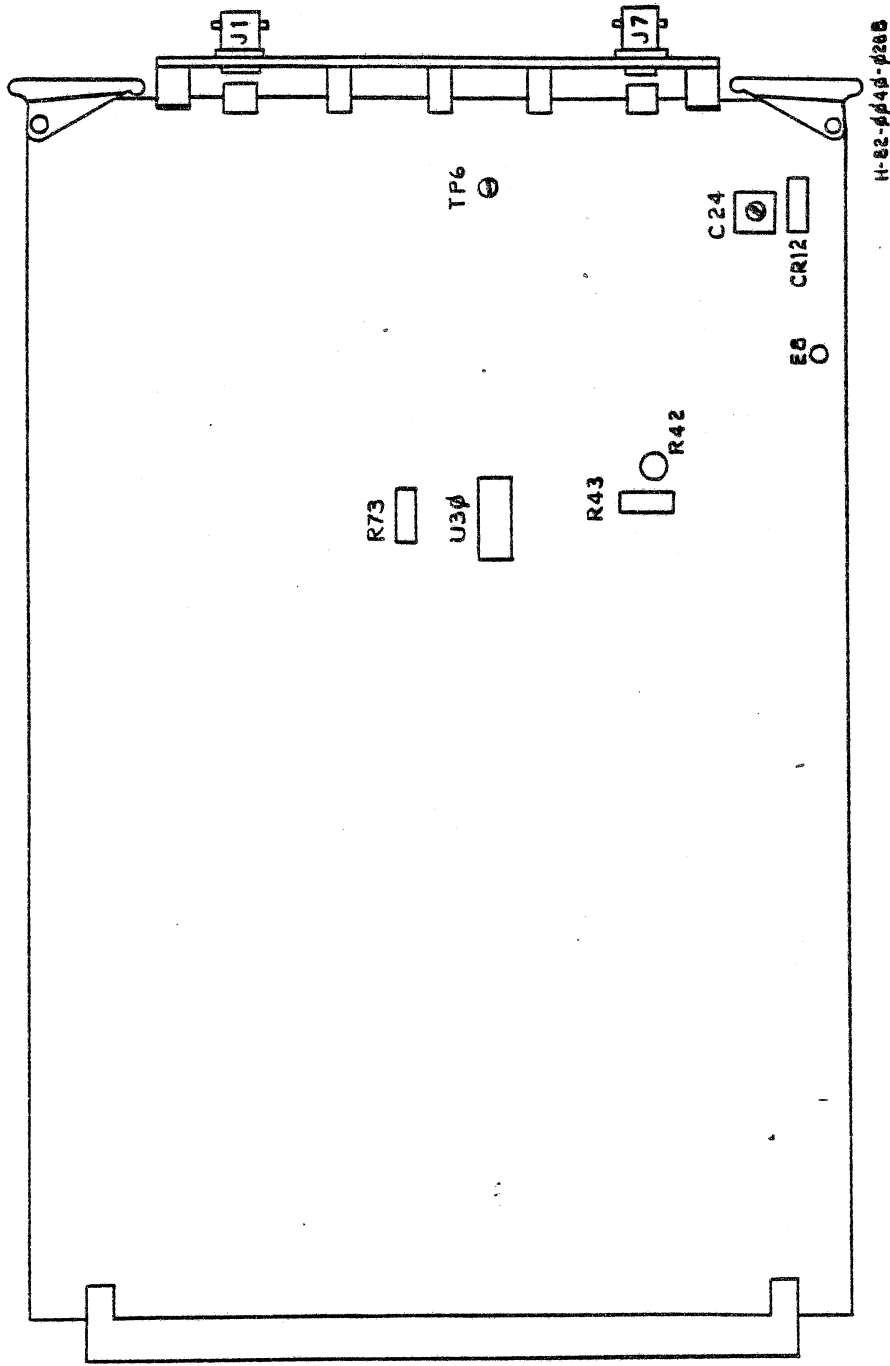

Figure 4-5. Timing Module (Part No. 5977168G2) Adjustment Locations

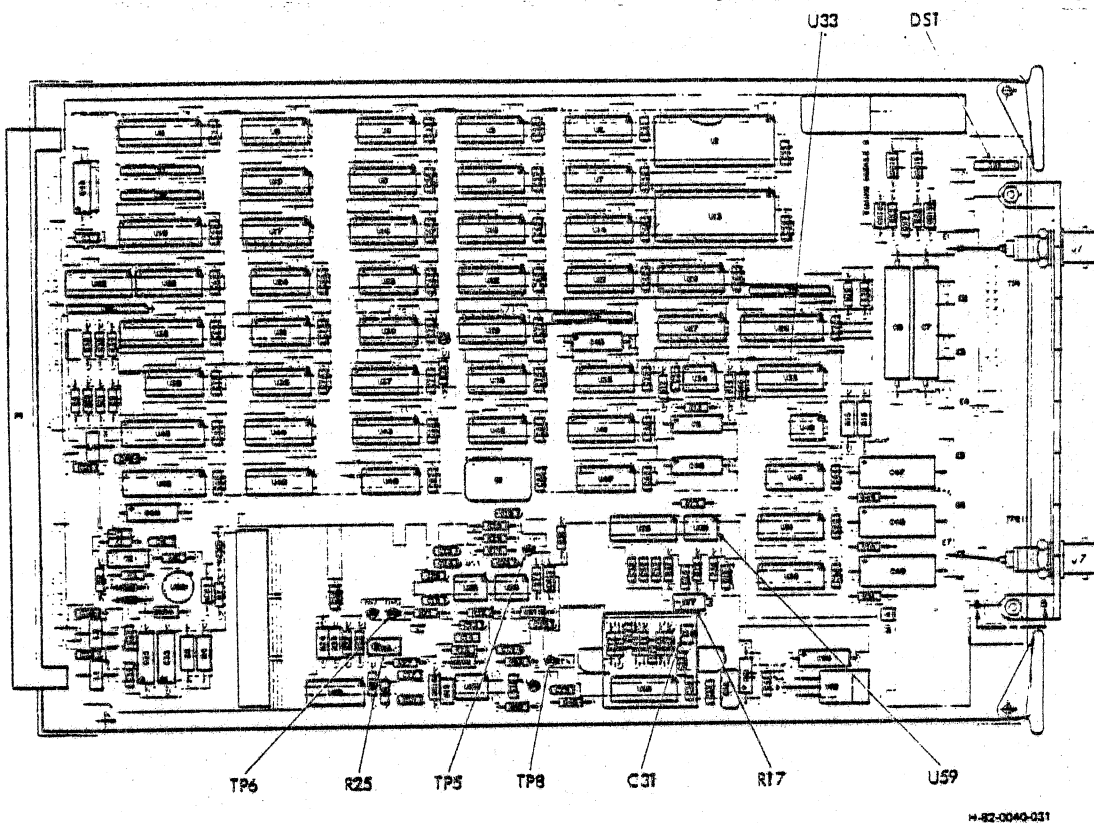

Figure 4-6. Timing Module (Parts Nos. 5810009G1, 5810010G1)
Component Locations

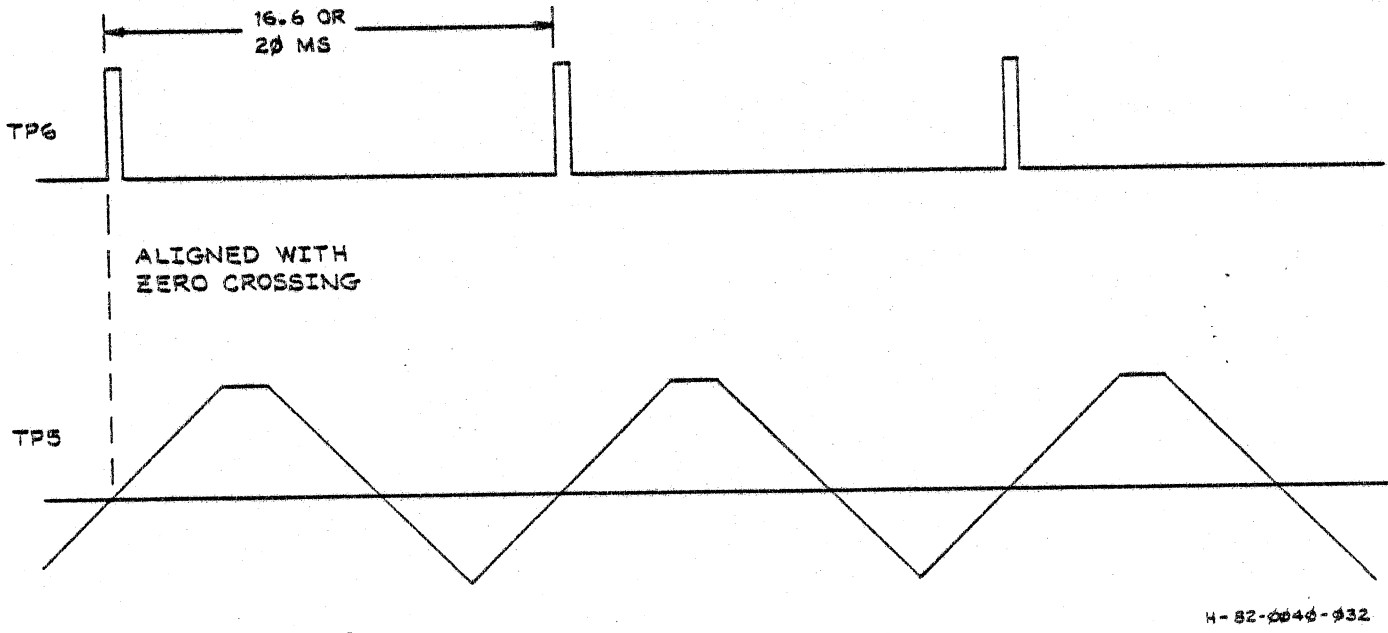

Figure 4-7. Timing Module Waveforms

2. Device U52 requires a positive input. Set U33-S3 and U33-S4 as required (when U33-S3 is closed and U33-S4 is open, an inverter is connected in the input line). Do not set both U33-S3 and U33-S4 closed at the same time.
3. Similarly set U33-S5 and U33-S6 as required to produce a positive external vertical drive signal. (When U33-S5 is closed and U33-S6 is open, an inverter is connected in the input line. Do not set both U33-S5 and U33-S6 closed at the same time.)
4. Open switch U59-S3. When you open this switch, the screen goes blank. Press the DIS/LOC pushbutton on the terminal controller front panel and wait for the verification test pattern to come up. If the pattern comes up garbled, adjust R25 throughout its range until the pattern becomes clear.
5. Connect the digital voltmeter to TP8 and adjust R17 for a voltmeter reading of +1.5V, then adjust R17 as required to center the image horizontally.
6. Retouch R25 as required for the best picture quality: no break-up, no roll-over, no fuzzy edges, and no horizontal movement.

4.6 REPAIR

Repair consists of replacing circuit cards or chassis-mounted electrical assemblies suspected of being faulty, based on the trouble-shooting analysis (figure 4-3).

CAUTION

Always turn off terminal controller before removing or installing any circuit card.

Always turn off terminal controller and pull power plug before removing any chassis-mounted component.

4.6.1 **CIRCUIT CARD REPLACEMENT.** To remove a circuit card assembly, grasp the two card extractor handles, exert outward pressure to disengage the card from its connector, and pull straight out of card cage.

Before installing a circuit card assembly, verify the part number of the card. Insert the card (component side to the left) into its slot in the card cage. Engage it with its connector by exerting firm inward pressure.

4.6.2 **CHASSIS-MOUNTED COMPONENTS.** Chassis-mounted assemblies are secured with standard mounting hardware, and can be removed and replaced using common hand tools.

Refer to the appropriate separate manual for maintenance of the terminal controller power supply.

4.6.3 SPECIAL HANDLING FOR MOS DEVICES. MOS devices are subject to damage caused by static charges. Assemblies that contain MOS devices are the read/write memory, mapping memories, and timing module. When not installed in the card cage, these assemblies should be stored in black Velostat bags with the MOS warning statement printed on the outside of the bag.

CAUTION

Always handle these cards only by the card extractors or by the connector. Avoid touching the card components or the printed circuit.

4.7 PREVENTIVE MAINTENANCE

Preventive maintenance consists of visual and mechanical inspections and cleaning.

4.7.1 INSPECTIONS. Check that all power cords are in good condition, clean, and firmly plugged into their power outlets.

Check that signal cables are in good condition, clean, and that all connectors are tight.

Check that equipment control knobs are tight on their shafts.

Check that fans are operating in the card cage and power supply.

4.7.2 CLEANING. Clean equipment exteriors with a cloth dipped in warm soapy water and wrung out. Rinse with a cloth dipped in clear water and wrung out. Do not allow water to get inside any piece of equipment.

Clean monitor display surfaces with soft cloth and a commercial liquid glass cleaner. Never use an abrasive glass cleaner on the monitor display surfaces.

Inspect and clean air filter in the bottom of the equipment cabinet as follows:

1. Open rear cabinet door.
2. Loosen two screws on the air filter retainer (adjacent to the cable entryway). Move the filter retainer toward the cable entryway, then pull the air filter toward you one inch and lift out.
3. Clean the air filter by agitating it in warm soapy water; rinse it in clear water and dry it thoroughly with forced air before reinstalling in the equipment cabinet. Installation is the reverse of removal.

APPENDIX A

RELATED PUBLICATIONS

The following listed publications apply to options that may be added to a GRAPHIC 8 system. The manual number listed is the manual's basic number. Revisions are indicated on the cover of the manual by a letter following this basic number.

<u>MANUAL NO.</u>	<u>TITLE</u>
H-78-0042	Model 5781 PHOTOPEN® Unit Technical Manual
H-78-0044	Model 5786 Trackball/Model 5787 Forcestick Entry Devices Technical Manual
H-78-0408	Large Read/Write Memory Circuit Card Assembly Technical Manual
H-82-0271	Large Refresh Memory Part No. 5809944 Technical Manual
H-78-0435	Model 575 Hard Copy Multiplex Switch Technical Manual
H-79-0363	Model 5783 Alphanumeric Function Keyboard/Model 5784 Lighted Alphanumeric Function Keyboard
H-79-0450	Model 7750 Expansion Module Technical Manual
H-81-0159	Talos "Wedge" Data Tablet Operator's Manual (Talos Manual 50156-1 REV B)

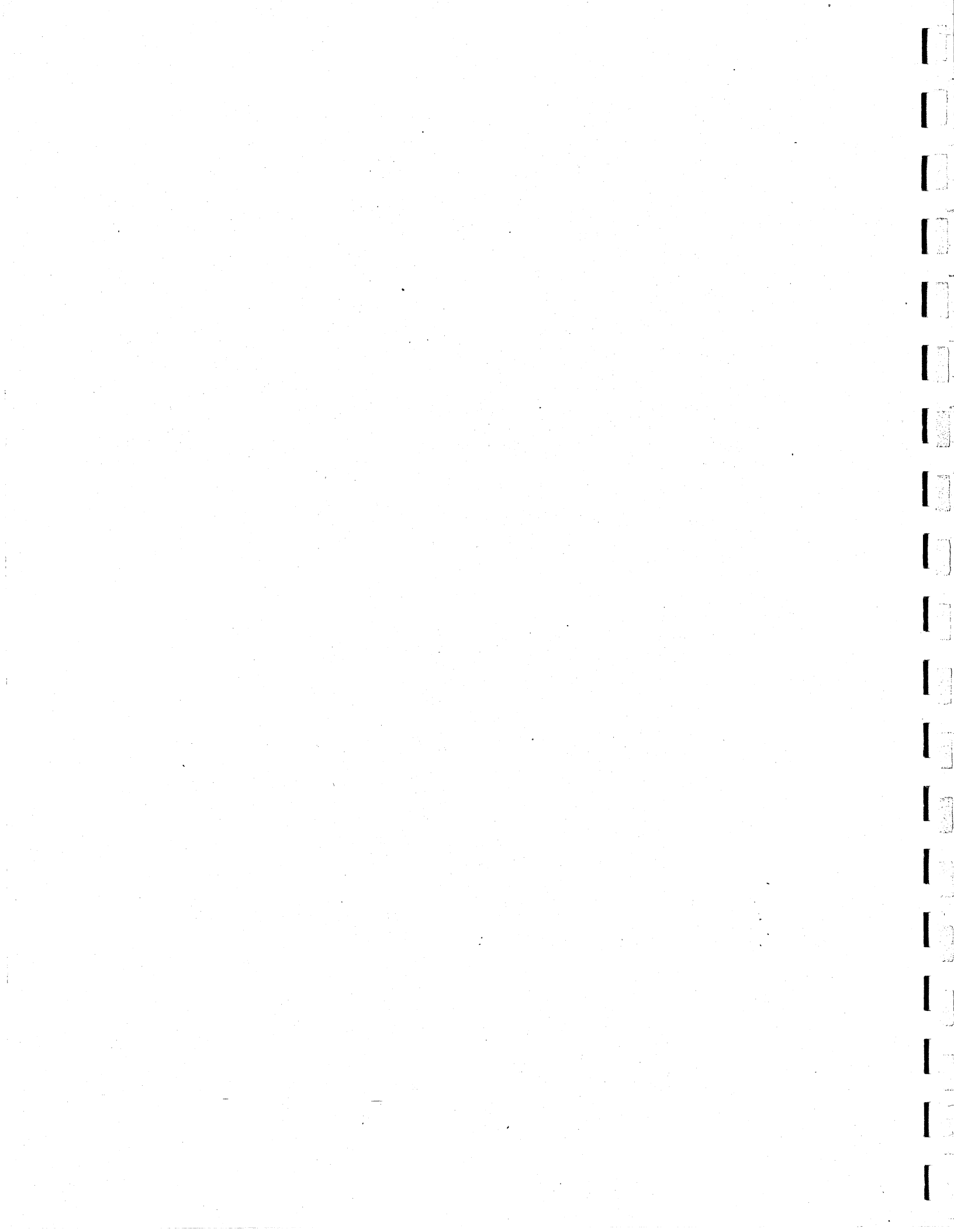

THE INTENT AND PURPOSE OF THIS PUBLICATION IS TO PROVIDE ACCURATE AND MEANINGFUL INFORMATION TO SUPPORT EQUIPMENT MANUFACTURED BY CALCOMP/SANDERS. YOUR COMMENTS AND SUGGESTIONS ARE REQUESTED.

PLEASE USE THE FORM ON THE REVERSE SIDE TO REPORT ANY PROBLEMS YOU HAVE HAD WITH THIS PUBLICATION OR THE EQUIPMENT IT DESCRIBES.

FOLD

FOLD



BUSINESS REPLY MAIL
NO POSTAGE STAMP NECESSARY IF MAILED IN THE UNITED STATES

FIRST CLASS
PERMIT NO. 568
NASHUA, N.H.



Postage will be paid by

CalComp
Display Products Division
Daniel Webster Highway, South
P.O. Box 868
Nashua, NH 03061

FOLD

FOLD

CALCOMP
A Sanders Graphics Company
 **SANDERS**