

ELECTRONICS DIVISION

The National Cash Register Company

Magnetic Rod

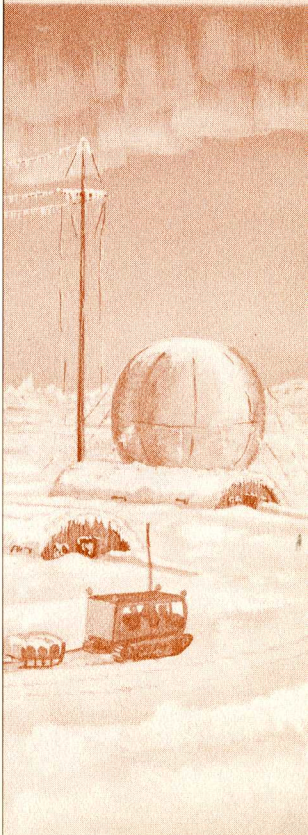
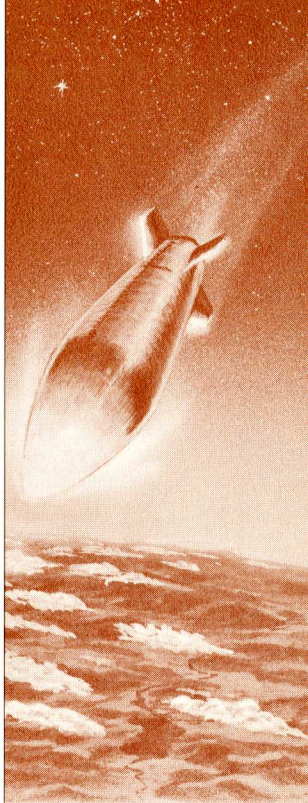
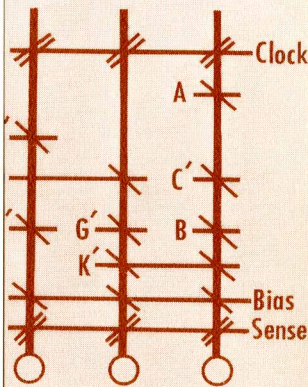
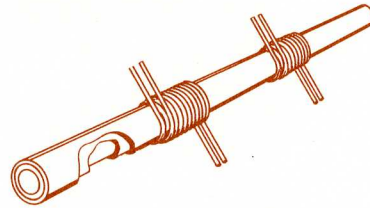

MAGNETIC ROD

A HIGH-SPEED DIGITAL LOGIC AND STORAGE ELEMENT
SUITABLE FOR EXTREME MILITARY ENVIRONMENTS.

The first practical embodiment of electrodeposited magnetic films for computer applications is found in National's magnetic Rod. It consists of a supporting glass rod with a thin film of Fe-Ni alloy over a silver undercoating. Typical dimensions are a 0.010-inch diameter rod with a 3000\AA magnetic film. Windings are placed around the rod in solenoid fashion for the drive, sense, enable or inhibit currents.

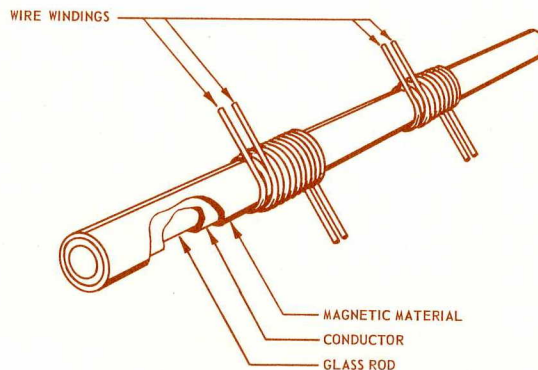

The Rod is functionally the equivalent of a magnetic core, with all the advantages of a reliable magnetic threshold device. However, the Rod's properties are outstandingly superior. It switches in 50 millimicroseconds in the coincident-current mode with normal currents. Only 20 thousandths of a watt are required

for storage of a bit. The Rod has been switched continuously at 5 megacycles at room temperature without adverse heating effects, and it can operate in either the word-ordered or the coincident-current mode from -100C to $+200\text{C}$.

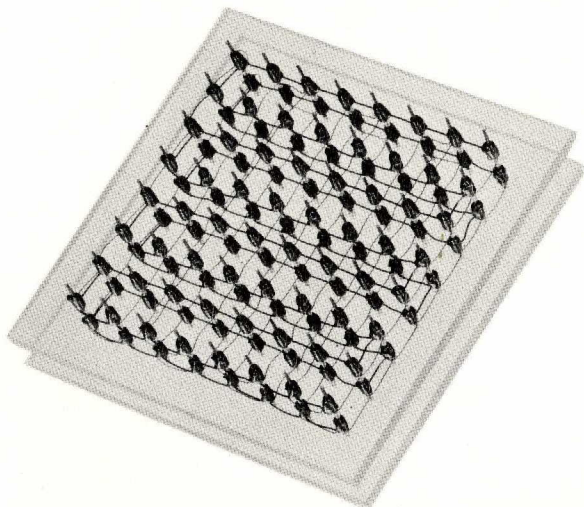

For memory applications, the tiny coils are arranged in planes, like the two at the left, by being wound about mandrels by semiautomatic machines. Typically, each bit position employs four concentric windings of ten turns each. The planes are potted before the mandrels are removed and are then stacked and interconnected. Insertion of the Rod is the last step in assembly. For the word-ordered mode, the drive winding is placed directly upon the Rod to switch all the bit positions along it. This winding slips smoothly within the others. A 1024-bit memory of this type with a one-half-microsecond cycle time is shown at the right.

Applications of the Rod to logic offer striking examples of speed and flexibility. With National's concept of *Inhibit Rod Logic*, the *NOR* function of many propositions is formed within

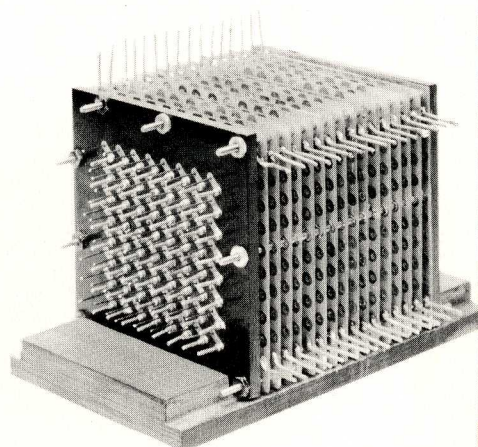

a single group of windings and sums result from a series connection of the sense windings of several such groups. Substitution of these passive elements for active devices such as semiconductors greatly increases the system reliability while the inhibit technique reduces power requirements. The clock current switches the Rod only when no current flows in the proposition windings. The technique can be utilized for the mechanization of all the logic and storage in any digital system.

Descriptions of the Rod and its switching and storage applications have appeared in the Journal of Applied Physics, Vol 30, No.1, pp 122-123, Jan 1959 and Vol. 30, No.4, pp 45S-46S, April 1959. Its use for logic is discussed in the 1959 WESCON Convention Record.

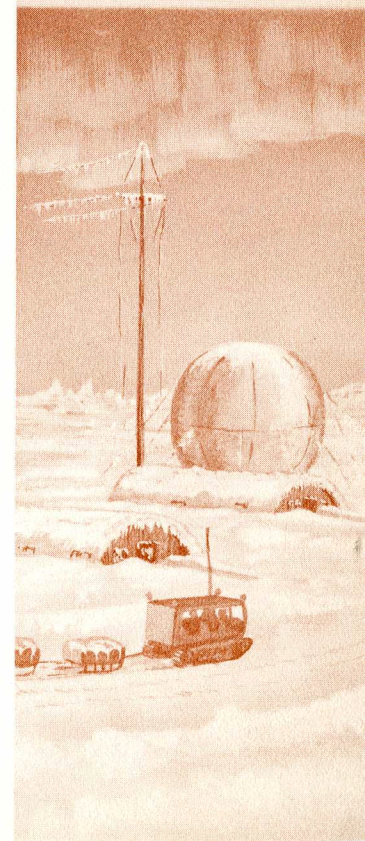
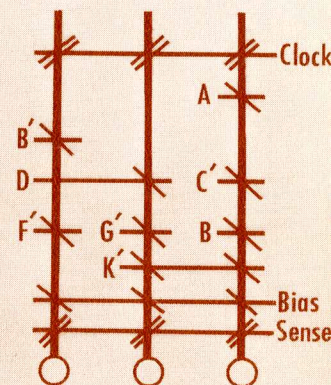
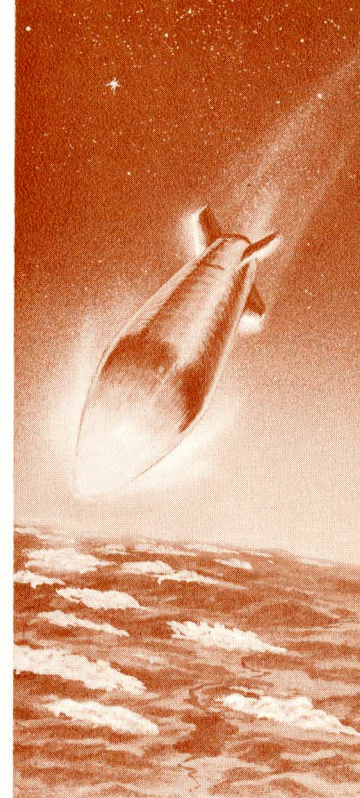

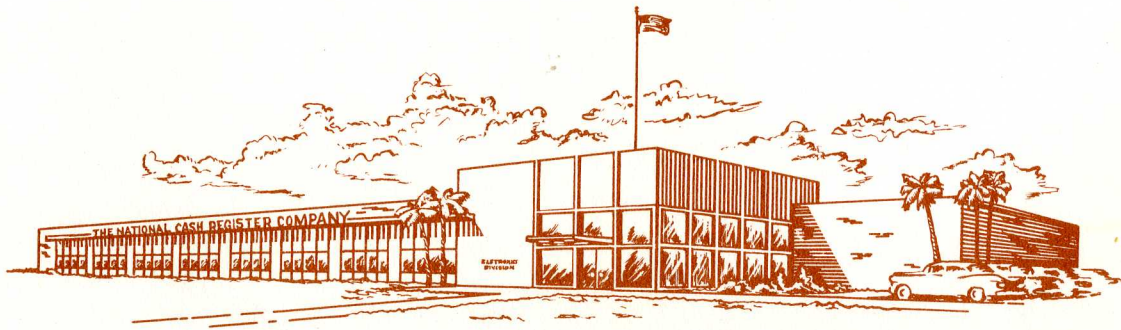

National

Reg. U. S. Pat. Off.

THE NATIONAL CASH REGISTER COMPANY

1401 EAST EL SEGUNDO BOULEVARD

HAWTHORNE, CALIFORNIA