

Handbook  
by  
Elizabeth M. Lamey

# Keying Magnetic Tape for Computers

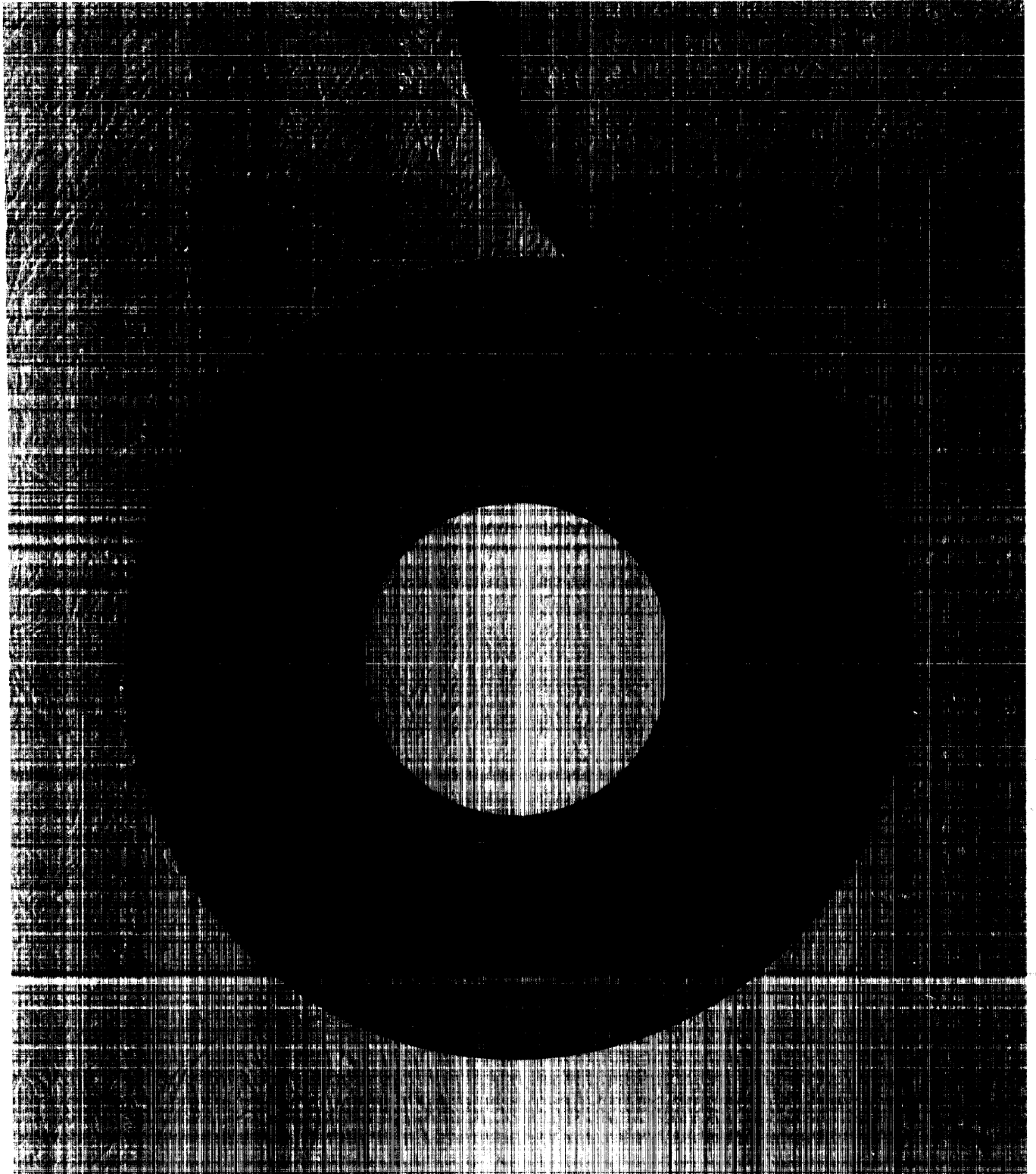

HAASE PUBLISHING, INC., Los Angeles, California

# Keying Magnetic Tape for Computers

Handbook  
by  
Elizabeth M. Lamey

# CONTENTS

	<u>PAGES</u>
1101 MOHAWK/735 NCR DATA RECORDER - MODEL A .....	1-61
Description.....	1-2
Magnetic Core Memory.....	3-5
Program Planning Card.....	6
Program Code.....	7-8
Making a Program Tape.....	9
Magnetic Tape.....	10
Interrecord Gap.....	10
Modes of Operation.....	11-12
Tape Movement During Entry.....	13
Tape Movement During Verification .....	14
Tape Movement During a Correction in Verification .....	15-17
Control Panel .....	18-21
Power Switch .....	18
Rewind Switch .....	18
Status Indicators .....	19-20
Memory Position Indicators .....	20
Function Switches .....	21
Tape Transport .....	22
Verify Interlock Switch .....	22
Special Function Switches - Keyboard .....	23
Keyboard .....	24-30
Record Counter.....	29
Memory Display Indicators .....	30
To Clear Memories .....	31
To Load One Program Through The Keyboard .....	32
To Load Two Programs Through The Keyboard .....	33-34
Changing a Character in Program Memory .....	35
Positioning a Program Tape .....	36
Writing a Program Tape - One Program .....	37
Writing a Program Tape - Two Programs .....	38
Loading Programs From a Program Tape .....	39
Threading a Program Tape .....	40
Cleaning .....	41
Mounting a Tape Supply Reel .....	42
Threading Tape .....	43
Tape Rewind .....	44
Data Entry .....	45-48
Header and Trailer Labels - Tape Marks .....	49
Data Verification .....	50
Reading a Data Block From Data Memory .....	51
Verifying The Last Record Written .....	51
Replacing Damaged Data Blocks During Verification .....	52
Performing A Search .....	53-54
Error Recovery During Entry .....	55-56
Error Recovery During Verification .....	57-58
Error Recovery During Search .....	59
Parity Error .....	60
Deleting a Data Block From Tape .....	61
Features .....	62-68

# CONTENTS

## PAGES

1101 MOHAWK/735 NCR DATA RECORDER - MODEL C .....	69-133
Description .....	69-70
Magnetic Core Memory .....	71-73
Program Planning Card .....	74
Program Code .....	75-77
Making a Program Tape .....	77
Magnetic Tape .....	78
Modes of Operation .....	79-80
Tape Movement During Entry .....	81-82
Tape Movement During Verification .....	83-84
Tape Movement During Correction .....	85-88
Building the Data Recorder .....	89
Control Panel .....	90-93
Power Switch .....	90
Rewind Switch .....	90
Memory Position Display .....	91
Status Indicators .....	91-92
Function Switches .....	93
Tape Transport .....	94
Verify Interlock Switch .....	94
Special Function Switches - Keyboard .....	95
Keyboard .....	96-102
Memory Display Indicators .....	102
To Clear Memories .....	103
To Load One Program Through The Keyboard .....	104
To Load Two Programs Through The Keyboard .....	105-106
Changing a Character In Program Memory .....	107
Positioning a Program Tape .....	108
Writing a Program Tape - One Program .....	109
Writing a Program Tape - Two Programs .....	110
Loading Program From a Program Tape .....	111
Threading Program Tape .....	112
Cleaning .....	113
Mounting The Tape Supply Reel .....	114
Threading Tape .....	115
Tape Rewind .....	116
Data Entry .....	117-120
Header and Trailer Labels - Tape Marks .....	121
Data Verification .....	122
Reading a Data Block From Data Memory .....	123
Verifying The Last Record Written .....	123
Replacing Damaged Data Blocks During Verification .....	124
Performing A Search .....	125-126
Error Recovery During Entry .....	127-128
Error Recovery During Verification .....	129-130
Error Recovery During Search .....	131
Parity Error .....	132
Deleting a Data Block From Tape .....	133
Illustration Mohawk Family of Data Recorders .....	134
1102 Multi-Tape Pooler .....	135
1103 For Long Distance Communication of Data .....	135
1104 Data Recorder With Adding Machine Control .....	135
1105 Recorder With Punched Paper Tape Reader .....	136
1106 With Punched Card Reader .....	136
1118 Recorder With Printed Output .....	136



# CONTENTS

	<u>PAGES</u>
6401 MOHAWK/736 NCR DATA RECORDER .....	137-189
Illustration 6401 Mohawk/736 NCR Data Recorder .....	137
Features .....	138
Modes of Operation .....	139-141
Extended Binary Coded Decimal Interchange Code .....	142
Magnetic Memory .....	143-144
Program Codes .....	145-146
Data Codes .....	146
Program Planning Card Illustration .....	147
Program Planning Card .....	148
Tape Deck .....	149
Tape Feed .....	150
Illustration of Tape Records .....	151
Operator Console .....	152
Control Switches .....	153-155
Status Indicators .....	156
Memory Position Display .....	157
Data and Program Display .....	157
Keyboard .....	158
Special Function Keys .....	159-162
Tape Movement During Entry .....	163
Tape Movement During Verification .....	164
Tape Movement During Correction in Verification .....	165-166
Program Entry - Loading a Single Program Through the Keyboard .....	167
Program Entry - Loading Two Programs Through the Keyboard .....	168
Program Tape .....	169
Illustration of Loading a Program Tape .....	170
Writing a Program Tape .....	171
Loading a Program From a Program Tape .....	172
Changing a Character In Program Memory .....	173
Cleaning .....	174
Illustration of Tape Feed Mechanism .....	175
Tape Feed Operation .....	176
Tape Rewind .....	176
Data Entry .....	177
Data Verification .....	178
Performing a Search .....	179-180
Error Recovery During Entry .....	181-182
Error Recovery During Verification .....	183-184
Error Recovery During Search .....	185
Parity Error .....	186
Reading a Data Block From Data Memory .....	187
To Code a Record For Computer Deletion .....	188
The NCR 736 With Data Phone For Transmission .....	189

# CONTENTS

	<u>PAGES</u>
<b>K-700 BASIC KEYS TAPE DEVICE .....</b>	<b>190-245</b>
Major Components of the Keypaper Device .....	191
Keyboard Console Control Panel .....	192
Keypaper Specifications .....	193
Data Formatting .....	194
Checking Capabilities .....	194
Memory .....	195
Memory Unit .....	196
Memory Parity Check .....	196
Central Control Unit .....	196
Modes of Operation .....	197-198
Program Codes .....	198
Single Program Control .....	199
Dual Program Control .....	199
Movement of Data Records On Tape .....	200
Mode Selector Switch .....	201
Function Control Switches .....	202
Time Shared Numeric Display Panel .....	203
Conversion Chart .....	204
Status Panel .....	205-206
Status Indicators.....	207
Keyboard.....	208
Control Keys .....	209-212
Control Key Chart .....	213
Abbreviation Chart.....	214
Tape Handler .....	215
Tape Recording System .....	215
Tape Maintenance .....	216
Tape Unit Control Panel .....	216
Tape Loading Procedure .....	217-218
Tape Unloading Procedure .....	218
Program Entry .....	219
Program Verify Procedure .....	220
Data Entry Procedure .....	221-223
Data Verification of the First Record .....	222
Data Verification Procedure .....	224
Search Procedure .....	225-226
Unprogrammed Left Zero Fill Capability .....	227
Programmed Left Zero Fill Capability .....	228
Error Recovery Procedures .....	229-234
Illustration of Keypaper Devices .....	235
Multi-Purposes Keypaper Devices .....	236
Keypaper Communicators .....	237-240
Keypaper Card Readers .....	241-243
Keypaper Poolers .....	244-245

# CONTENTS

	<u>PAGES</u>
<b>IBM 50 MAGNETIC DATA INSCRIBER .....</b>	<b>246-268</b>
Description .....	247-248
Keyboard .....	249-254
Code Set .....	255
EBCDIC Code Structure .....	256
Program Control Unit .....	257
Program Card .....	257
Duplicating and Skipping .....	257
Controls and Indicators on the Console .....	258-260
Inserting a Tape Cartridge Into The Loading Station .....	261
Tape Cartridge .....	262
Tape Station .....	262
Tape Station Controls .....	263
Initialization .....	264
Modes of Operation .....	264-266
Program Start .....	266
Program End .....	267
Program Level or Field Size .....	267
Field Functions .....	268
Field Modifiers .....	268
<b>IBM 2495 TAPE CARTRIDGE READER .....</b>	<b>269-277</b>
Description .....	270
Components .....	270
Controls and Indicators .....	271-272
Addressing .....	273
Code Sets .....	273
Commands and Command Operation .....	273-274
Sense and Status Bytes .....	275-277

## ACKNOWLEDGEMENTS

*My debts of gratitude are many.*

*My first thanks go to the staff of Haase Publishing, Inc., especially to Harold Haase for his faith in my ability, and to John Haase for his advice and direction.*

*Many people from the Mohawk Data Sciences Corporation have been of great help to me. John Symons deserves special mention for "above and beyond" assistance. I also want to thank Jim Lupo, Don Sturt, Jim Meehan, and Steve Markeson of the Mohawk Data Sciences Corporation. Pat Smith and Al Hoge of the Mohawk Data Sciences Corporation were very helpful in providing photographs for the section on the Mohawk Device.*

*I want to thank Mark Connolly and Yolanda Wheeler of NCR. Mr. Connolly generously provided photographs and information for the book. Yolanda Wheeler answered hundreds of questions about the NCR 735 Data Encoder.*

*Sincere thanks go to Donald McAlister of Honeywell, Inc. He gave me marvelous assistance on the chapter about the Keytape Device.*

*I want to acknowledge the help of Andrew Burgoyne of IBM in providing material for the chapter on the IBM 50 Magnetic Data Inscrber.*

*I want to thank Dave Palmer and Duke Robles for their assistance in the initial stages of preparation.*

*I want to acknowledge the help of Joanne Becker; her ruthless blue pencil has immeasurably improved the presentation.*

*My very warm appreciation goes to my secretary, Virgie Petti; her untiring efforts and her constant encouragement was of inestimable value.*

*Finally, I wish to thank my family. Without their cooperation not a word would have been written.*

E.M.L.

Hollywood, California  
November, 1968

# 1101 MOHAWK/735 NCR DATA RECORDER - MODEL A

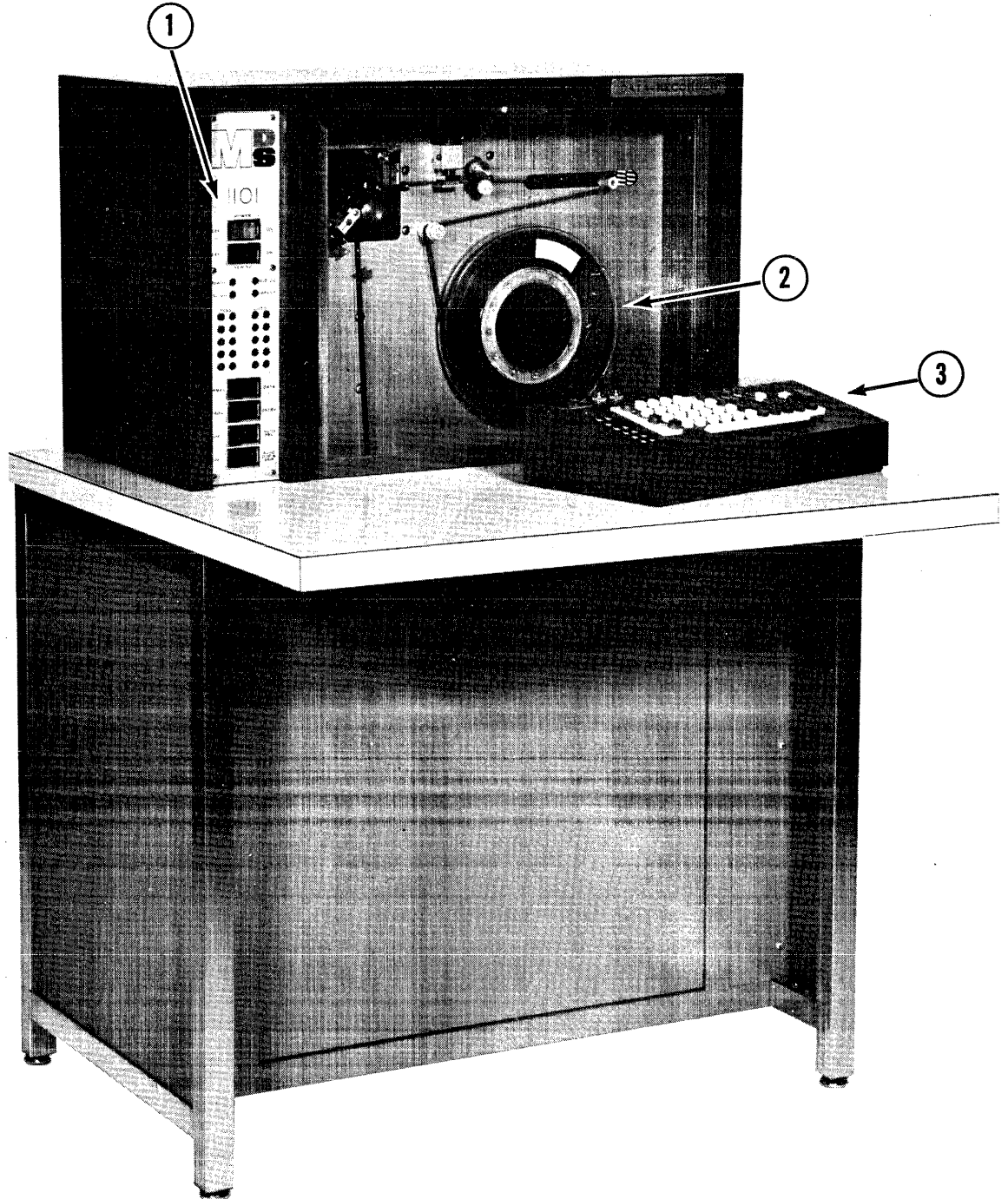

## MOHAWK 1101/NCR 735 KEYED DATA RECORDER

This is the basic unit in the Data Recorder line, designed for greater accuracy and efficiency in the preparation of magnetic tape computer input. It permits transcribing of data from source documents direct to standard  $\frac{1}{2}$ " computer magnetic tape . . . with no intermediate media . . . and verifying the transcription. This machine replaces the functions ordinarily performed by a Card Punch, Key Verifier and Card-to-Magnetic Tape conversion runs.

# 1101 MOHAWK/735 NCR DATA RECORDER - MODEL A

## DESCRIPTION

### CONTROL PANEL<sup>1</sup>

The control panel is made up of switches that control operational modes of the Data Recorder. Status and memory position indicator lights are also on this panel.

### TAPE DECK<sup>2</sup>

The Tape Transport and the Verify Interlock switch are on the Tape Deck. Two arrows on the back panel of the Tape Deck assist the operator when she is positioning the tape for different operational modes. The bottom arrow is used to position the BOT reflective marker during the entry mode. The top arrow is used to position the BOT reflective marker for verify and search modes.

### KEYBOARD<sup>3</sup>

The standard keyboard consists of 34 character keys, 14 special function keys, a space bar, and two special function switches. The 47 character keyboard is standard. A 64 character option is available. Program and data memory display indicators are also on the keyboard. The memory display indicators are used for reading the BCD code.

CHARACTER	BCD	CHARACTER	BCD	CHARACTER	BCD
A	B A 1	Q	B 8	6	4 2
B	B A 2	R	B 8 1	7	4 2 1
C	B A 2 1	S	A 2	8	8
D	B A 4	T	A 2 1	9	8 1
E	B A 4 1	U	A 4	&	B A
F	B A 4 2	V	A 4 1	.	B A 8 2 1
G	B A 4 2 1	W	A 4 2	<	B A 8 4
H	B A 8	X	A 4 2 1	-	B
I	B A 8 1	Y	A 8	\$	B 8 2 1
J	B 1	Z	A 8 1	*	B 8 4
K	B 2	0	8 2	,	A 8 2 1
L	B 2 1	1	1	%	A 8 4
M	B 4	2	2	/	A 1
N	B 4 1	3	2 1	#	8 2 1
O	B 4 2	4	4	@	8 4
P	B 4 2 1	5	4 1	Space	A

BCD CODE (EVEN PARITY) FOR 47 CHARACTER IBM COMPATIBLE KEYBOARD

# 1101 MOHAWK/735 NCR DATA RECORDER - MODEL A

## MAGNETIC CORE MEMORY

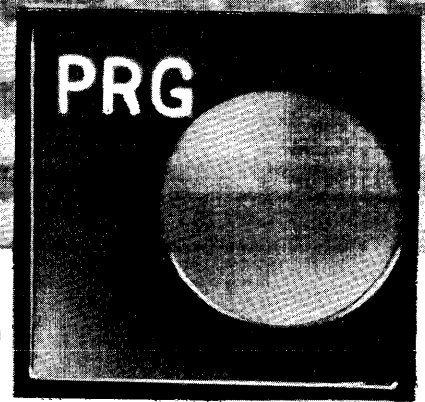
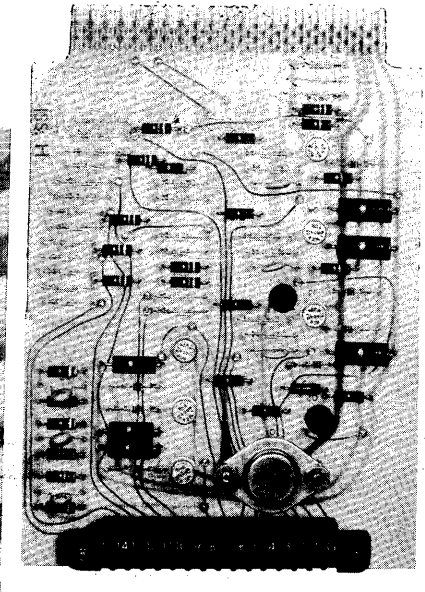
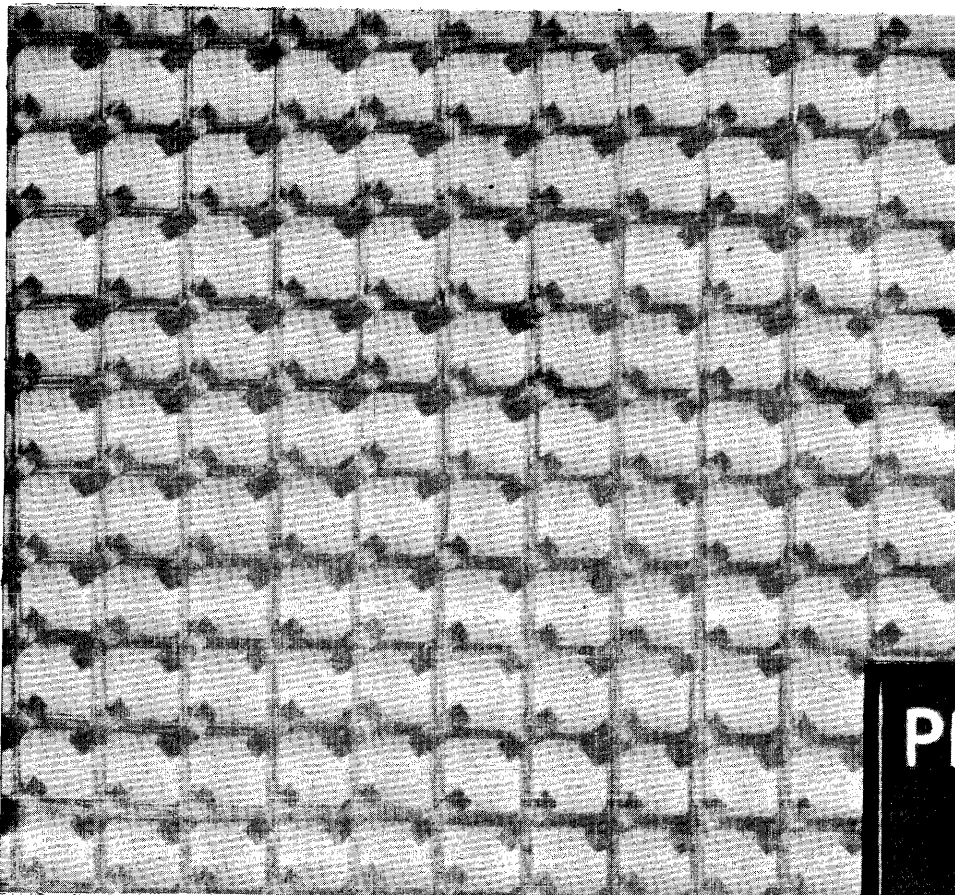

Solid-state circuitry and a "computer type" magnetic core memory permit high speed machine operations with a high degree of reliability and electronic tape encoding control. The magnetic core memory stores a regular and alternate program format. It also stores key entered data. The data patterns in data memory will change with each different data block because data is stored in memory before it is released to tape and operator need only to backspace to memory and key enter a new character if an error was made during a data entry run.

Each position of core memory has a section for program memory and a section for data memory. Six magnetic cores in each position of data memory enables the equipment to accept any 6 bit alpha-numeric code structure. Four core positions are assigned the decimal equivalents 8, 4, 2 and 1; above them are the A and B zone positions. There are four combinations for the zone bits, 00, 01, 10 and 11. With the 6 bit data memory section, the Data Recorder can recognize 64 total characters, alphabetic, numeric and symbols. There is also a parity check bit.

There are two sections of program memory, main program and alternate program memory. Both main and alternate program have their own core positions for the 4, 2, and 1 bits and they share the 8 bit position. The program key controls program selection. Codes in program memory remain unaltered during entry of records.

M  
A  
I  
N  
  
P  
R  
O  
G  
R  
A  
M  
  
C  
O  
R  
E  
S

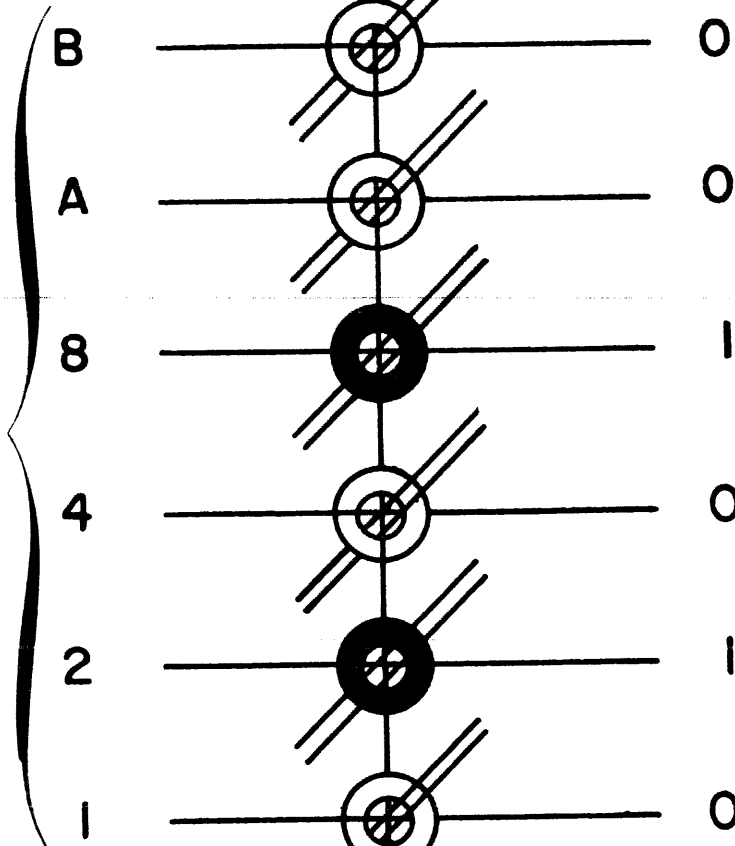
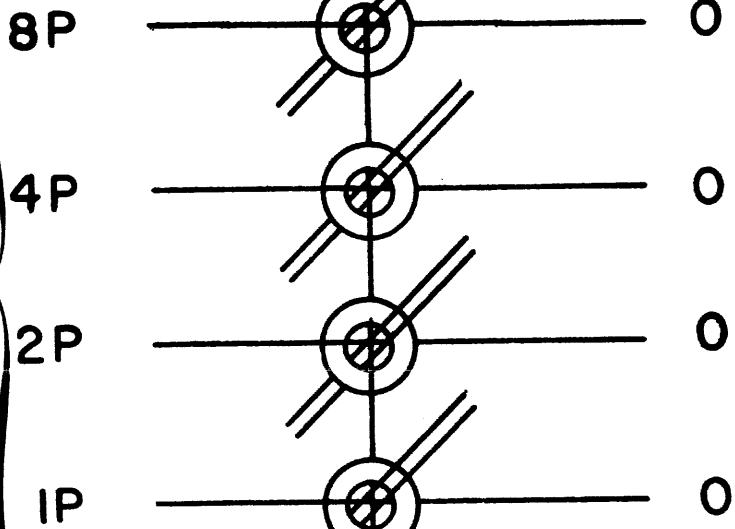

**MEMORY CORE POSITION**

This stylized illustration of magnetic cores in one memory position shows the name of each core to the left and the core condition for an 1101 "zero" on the right.

A magnetic core is defined as being either in an "on" or "off" condition. To designate the condition of a core, it is accepted practice to show a core in the "on" condition with the "1" and a core in the "off" condition with a "0." Thus, an era of six cores that store an 1101 "Zero" are conditioned **off, off, on, off, on, off**, and this is written 001010.

D  
A  
T  
A  
  
C  
O  
R  
E  
S



# 1101 MOHAWK/735 NCR DATA RECORDER - MODEL A

## MAGNETIC CORE MEMORY (CONT.)

Think of the magnetic core memory as the *heart* of the Data Recorder. It is the storage, or holding place, for the data being recorded or verified. The data patterns in data memory will change with each different data block because data is stored in memory before it is released to tape.

The program codes in program memory remain unchanged during entry of a given set of records. They are the program instructions that direct basic machine functions.

A magnetic core is defined in either an "on" or an "off" condition. The condition of a core in an "on" condition is designated with a "1" and a core in the "off" condition with an "0."

The combination of the program bits in any particular memory position is the program code that will control the machine functions for that position. These program codes are effective in both the entry and verify modes.

Notice in the illustration below that regular and alternate programs have their own core positions for the 4, 2 and 1 bits. Notice also that the 8 bit position is *shared* by both regular and alternate program.

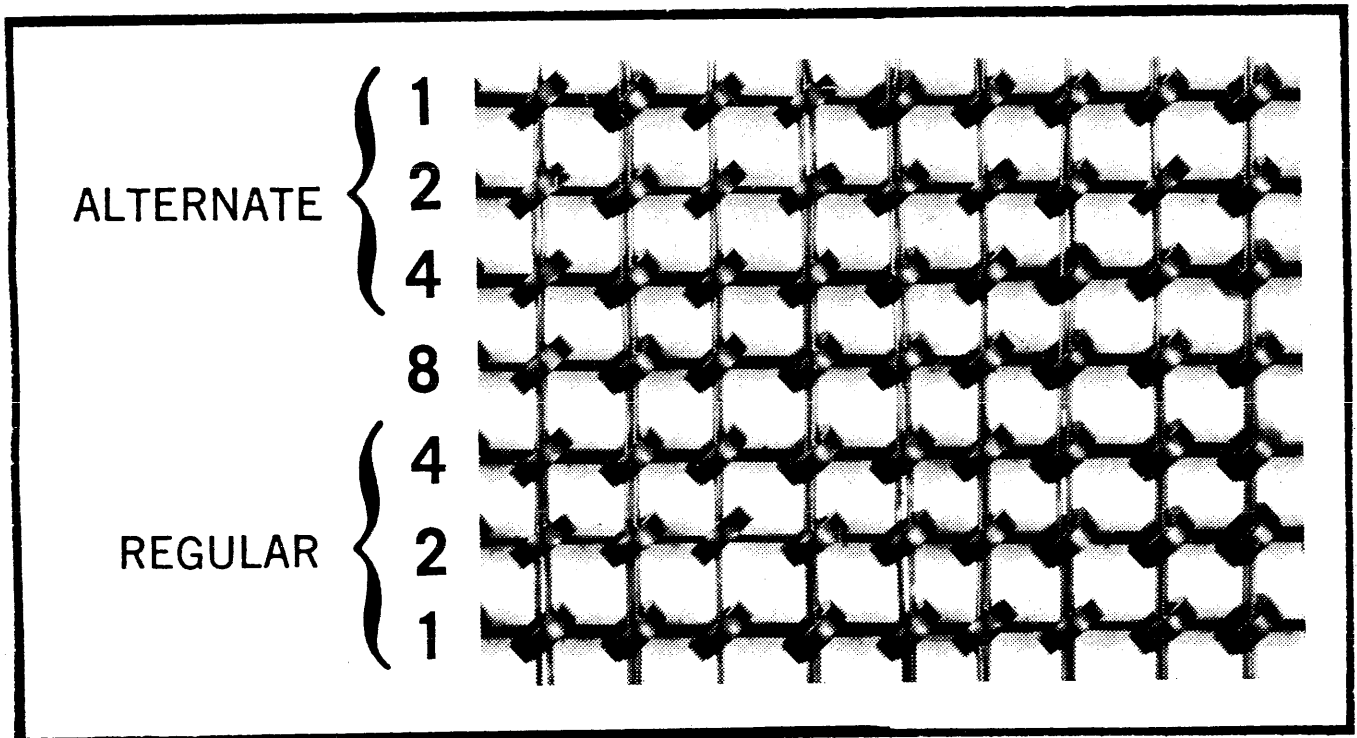

### PROGRAM KEY

The Program Key is in the upper righthand corner of the keyboard and is labeled PRG. It works in conjunction with a small light in the display at the left of the keyboard. The lens over the light has an "ALT" etched on it. If the light is "on," this means that the Data Recorder is ready to accept data in the Alternate program format. A depression of this Program Key will extinguish the light and condition the equipment to accept data in the Regular program format.



# 1101 MOHAWK/735 NCR DATA RECORDER - MODEL A

## PROGRAM CODES

To operate under program control, the first position of each field should be indicated by the program code that defines the MSP of that type of field. Program codes 2 through 7, 12 and 13, indicate the MSP of a field. Program codes 12 and 13 are composite codes made up of bits 8 and 4, and bits 8 and 5 respectively. The MC key must be used when keying program codes 12 and 13.

### "SP" (0000)

Program code SP (*Space*) identifies the memory position that is to contain a numeric data character. To enter an alpha or alpha shift character in a position programmed with 0000, the letter shift (LTR) key *must* be held depressed while entry is being made. To enter a numeric shift special character, the numeric shift (NUM) key *must* be held depressed while the entry is being made.

This code will not stop skipping, duplication, or left zero action and, therefore, should not be used in the first position of a field (MSP).

### "1" (0001)

Program code 1 identifies a memory position that is to contain an *alpha* character. To enter a numeric or a numeric shift special character in a position programmed with a 0001, the numeric shift (NUM) key *must* be held depressed while entry is being made.

This code will not stop skipping, duplication, or left zero action and, therefore, should not be used in the first position of a field (MSP).

### "2" (0010)

Program code 2 is used to stop skip, dup and left zero action and is commonly used to identify the first position of a *numeric* field.

### "3" (0011)

Program code 3 is used to stop skip, dup and left zero action and is commonly used to identify the first position of an *alpha* field.

### "4" (0100)

Program code 4 is used to start an *automatic duplicate* operation. This code is commonly used to identify the first position of a field that is to contain *semi-constant* information; information that is usually repeated for more than one data block but that periodically changes during the run. Program code 4 is effective for automatic duplication *only* when the DUP/SKIP 1 switch is "on." An automatic Dup 1 operation ends only when a program code 2, 3, 5, 12 or 13 is encountered. With DUP/SKIP 1 switch "off," a code 4 in memory stops a manual Dup or Skip or an automatic Dup 2 or Skip 2 operation. Program code 4 also *stops left zero fill* and conditions the 1101 for numeric entry. The program code 4 is also used during verification to start a duplicate verify action for *constant* data fields that are to be *machine verified*.

# 1101 MOHAWK/735 NCR DATA RECORDER - MODEL A

## PROGRAM CODES (CONT.)

### "5" (0101)

Program code 5 is used to start an *automatic skip* action. Positions that are going to be skipped frequently in successive records, *but not for the entire run*, are programmed with program code 5. Program code 5 is effective for automatic skip *only* when DUP/SKIP 1 switch is "on." An automatic Skip 1 operation ends only when a program code 2, 3, 4, 12 and 13 is encountered. With DUP/SKIP 1 switch "off," a code 5 in memory stops manual Dup or Skip or an automatic Dup 2 or Skip 2 operation. The program code 5 also stops *left zero fill* and conditions the 1101 for numeric entry.

Program code 5 is used during verification to start a skip action. Positions skipped during verification are *not verified*.

### "12" (1100)

Program code 12 is used to start an *automatic duplicate* operation. This code is commonly used to identify the first position of a field that will contain *constant* information; information that remains *unchanged* during the run. Program Code 12 is effective for automatic duplication *only* if DUP/SKIP 2 switch is "on." An automatic Dup 2 operation ends only when a program code 2 through 5 or 13 is encountered. With DUP/SKIP 2 switch "off," a code 12 stops a manual Dup or Skip or an automatic Dup 1 or Skip 1 operation. Program code 12 also stops left zero fill and conditions the 1101 for numeric entry.

Program code 12 is *not used* during verification. Constant data fields that are to be machine verified are programmed with code 4.

### "13" (1101)

Program code 13 is used to start an *automatic skip* action for a field that is to be skipped *throughout* the entire run. Program code 13 is effective for automatic skipping *only* if DUP/SKIP 2 switch is "on." An automatic Skip 2 operation ends only when a program code 2 through 5 or 12 is encountered. With DUP/SKIP 2 switch "off," a code 13 stops manual Dup or Skip or automatic Dup 1 or Skip 1 operations. Program code 13 also stops *left zero fill* and conditions the 1101 for numeric entry.

Program code 13 *is not used* during verification. Fields to be skipped during verification are programmed with code 5.

CODE NUMBER	CODE BITS				FUNCTION
	8P	4P	2P	1P	
SP	0	0	0	0	NUMERIC SHIFT
1	0	0	0	1	LETTERS SHIFT
2	0	0	1	0	NUMERIC SHIFT – STOP SKIP AND DUP
3	0	0	1	1	LETTERS SHIFT – STOP SKIP AND DUP
4	0	1	0	0	START AUTOMATIC DUPLICATION
5	0	1	0	1	START AUTOMATIC SKIP
12	1	1	0	0	START AUTOMATIC DUPLICATION
13	1	1	0	1	START AUTOMATIC SKIP

## 1101 MOHAWK/735 NCR DATA RECORDER - MODEL A

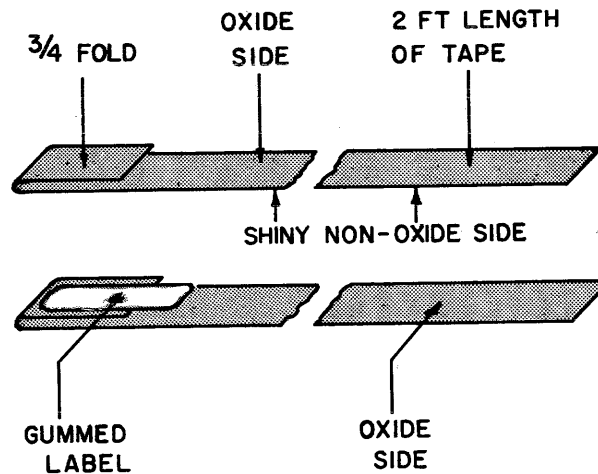

### MAKING A PROGRAM TAPE

To make a program tape, use a piece of magnetic tape approximately two feet in length - Fold one end of the tape back approximately  $\frac{3}{4}$  of an inch with the shiny non-oxide side on the outside of the fold. Seal the fold with a one inch gummed label.

The small loop formed at the end of the tape is used for positioning the tape on the Data Recorder. The loop may also be used to hold the program tape on a special program tape holding rack.

### PROGRAM TAPE

A program tape is a length of magnetic tape on which *permanent* programs can be stored. Program tapes can be used when more than one 1101 is to be programmed with identical programs or when a program is subject to occasional recall. The program tape gummed label must carry the *same* program tape number entered on the program card.

Additional data blocks may be stored on a program tape, if desired. For example, a block containing constant information, or data for a label block could be written on the program tape following the program block. The constant block can be read into memory following the program loading by merely changing the memory selection switch to the DATA position and depressing the release key a *second time*.

More than one program may also be stored on a single program tape. The proper program is then selected by utilizing the Search function.

# 1101 MAGNETIC/735 NCR DATA RECORDER - MODEL A

## MAGNETIC TAPE

The 1101 uses a standard one half inch wide computer magnetic tape. The Data Recorder tape handler will accommodate any IBM compatible tape reel, up to 10.5 inches in diameter. Recording is done in odd or even parity at a density of 200 bpi with fixed length blocks of 80 data characters.

Magnetic tapes are extremely durable under normal handling but misuse could cause the tape to be scratched or stretched. Usual care should be exercised whenever handling the tape.

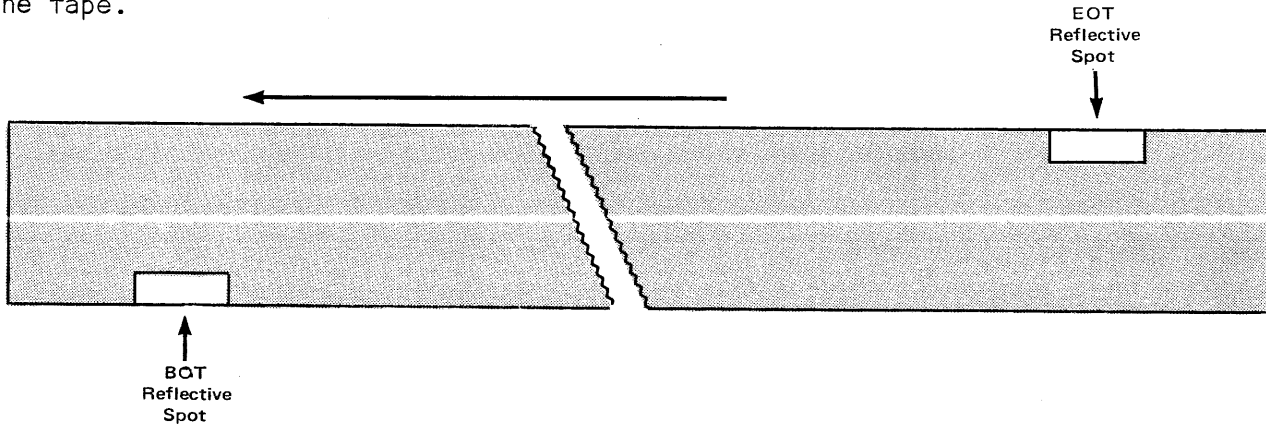

For an entry run, the beginning of tape reflective marker is positioned at the lower arrow on the tape deck. In the verify and search mode, the beginning of tape reflective marker is positioned at the upper arrow.

Tape should be stored under controlled environmental conditions. It is desirable to maintain the temperature between 40°F and 90°F and the relative humidity between 20% and 80%. Further, large or rapid changes in environment should be avoided.

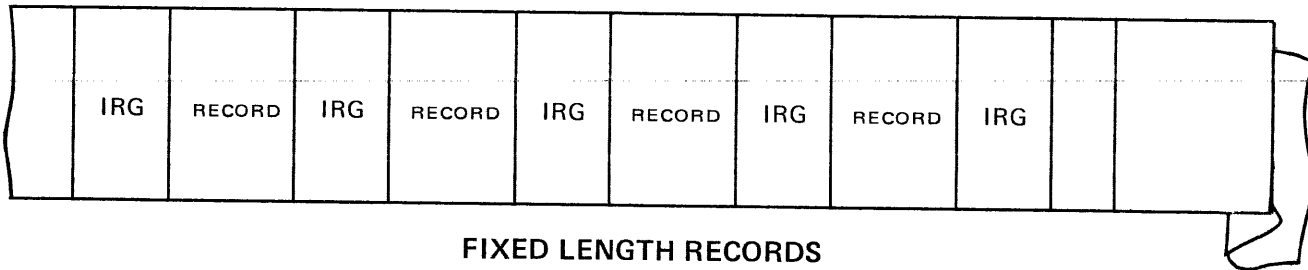

## INTERRECORD GAP

The interrecord gap (IRG) is the unrecorded portion between records on magnetic tape. This interval of space is deliberately in between recording portions of data to prevent errors through loss of data or overwriting and permits stop-start tape operations.

0.75 inch interrecord gap is used on 7 channel tapes.

# 1101 MOHAWK/735 NCR DATA RECORDER - MODEL A

## MODES OF OPERATION

The 1101 Data Recorder can be conditioned to operate in one of three modes: Entry, Verify or Search. As a general rule, it is not necessary to change from one mode to the other in the middle of a run. The 1101 has built-in features to allow for recovery without changing modes.

During entry and verification, the operator can make certain visual observations that will aid in proper transcription of information. The program codes, of the program being used, are displayed on the left side of the keyboard in the right-hand row of indicator lights. The code displayed will be the code in the memory position being keyed. The memory position being keyed is indicated by the position indicator lights on the control panel.

During verification, the character being verified is shown on the left side of the keyboard in the left hand row of lights. During entry, this row of lights displays the code that was last keyed in that position.

## ENTRY MODE

During a simple Entry run, the following series of events take place:

1. Data is key entered into data memory through the keyboard.
2. With REL switch "on," an automatic release action will occur at memory position 81. (A release action could be initiated from any position by manually depressing the keyboard REL key or by having the last field in the data block programmed for a skip or dup.) Regardless of when the release occurs, 80 characters are always written on tape.

*NOTE: During the tape write cycle, the erase head is turned on to erase the area of tape to be written on.*

3. During the release action, the keyed data is read from memory (but not erased), vertical and longitudinal parity are calculated, and the data with parity is written on tape as the tape moves forward under the read/write head.
4. The tape movement stops momentarily and the tape then moves backward one block length and then forward again.
5. During the second forward motion, the data block just written is read from tape and *compared* bit for bit and for parity accuracy with the data that is in memory.
6. The Error Tone sounds and the status indicators light if any difference is found.

With each release action a full 80-character block is always written on the tape regardless of the number of data characters keyed. Unused positions are recorded on tape as space codes. Each block is automatically separated by a three-quarter inch interrecord gap. The time required to write, read and compare the entire 80 character block is 240 milliseconds. If records to be written are short, more than one record may be entered in one 80-character data block.

# 1101 MOHAWK/735 NCR DATA RECORDER - MODEL A

## MODES OF OPERATION (CONT.)

### VERIFY MODE

During a Verify run, the following machine operations take place:

1. Upon depression of the REL key, the tape moves forward under the read/write head and the first data block is read into data memory.

*NOTE: In Verify mode, the erase head is not turned on, therefore, recorded data blocks are not damaged.*

2. The verify operator transcribes data from the source media. As each character is keyed, it is compared with the information in data memory. Any difference is signaled to the operator by the Error Tone.
3. When the last character of the data block is keyed, an automatic release will occur which moves the tape forward to read in the next data block.

*NOTE: Unlike the entry mode, there is no back and forth movement of tape during verify mode.*

The correcting of one or more errors during verification conditions the 1101 not to allow release action until the incorrect tape block is changed.

### SEARCH MODE

If it is desired to locate one record out of a group of records, the 1101 may be conditioned to do so.

1. With the tape positioned at the beginning of the run, an identifier, unique only to the record being searched for, is keyed into memory.
2. Depression of the REL key allows consecutive data blocks to be *read* from tape and *compared* with the identifier in memory. When a match is found, tape reading will stop with the read/write head positioned at the interrecord gap *just past* the "found" record. Consecutive data blocks will be read during a search operation at the rate of approximately 400 per minute. There is no tape erasure during a search.



# 1101 MOHAWK/735 NCR DATA RECORDER - MODEL A

## Tape Movement During Entry

After a record has been entered in data memory and the release action occurs, three things take place. (Red indicates action taking place.)

1. The record (7) is written on the tape as the tape moves forward under the read/write head. The information is now on the tape and still in data memory. When the entire record is on the tape, the movement stops for an instant and the position of the tape and the record in relation to the read/write head is shown below:

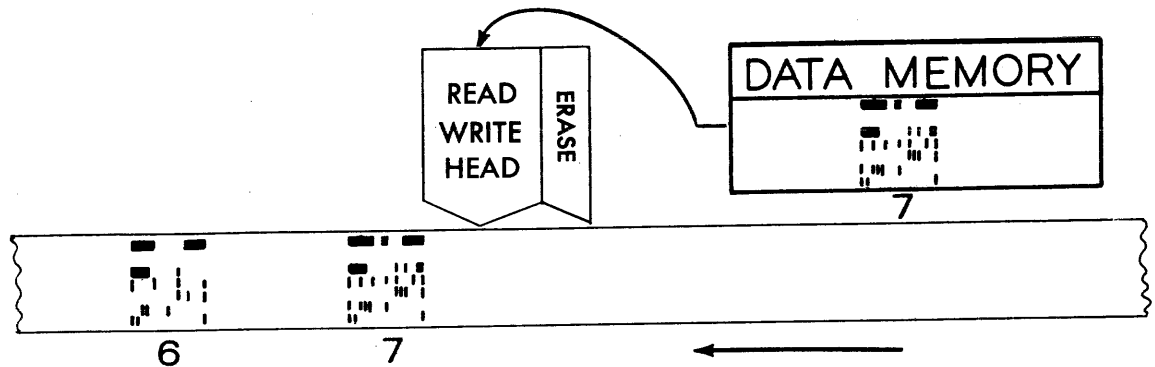

2. The tape then moves backward and movement stops momentarily. The tape and just recorded record is now in this position.

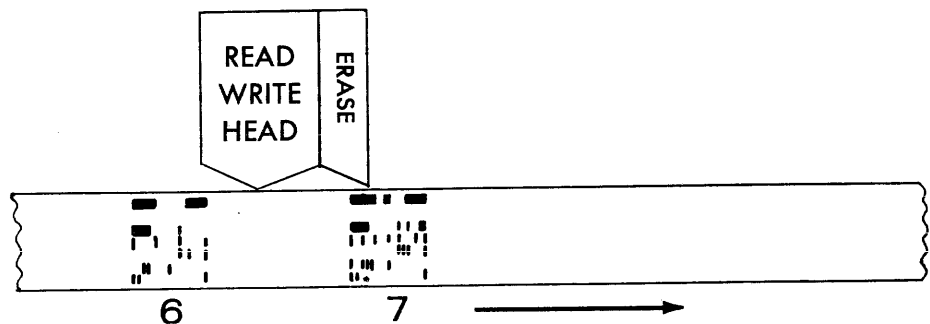

3. The tape then moves forward reading and comparing to see that the information recorded on tape is the same as the information in data memory. This action also positions the tape for the recording of the next record on tape.

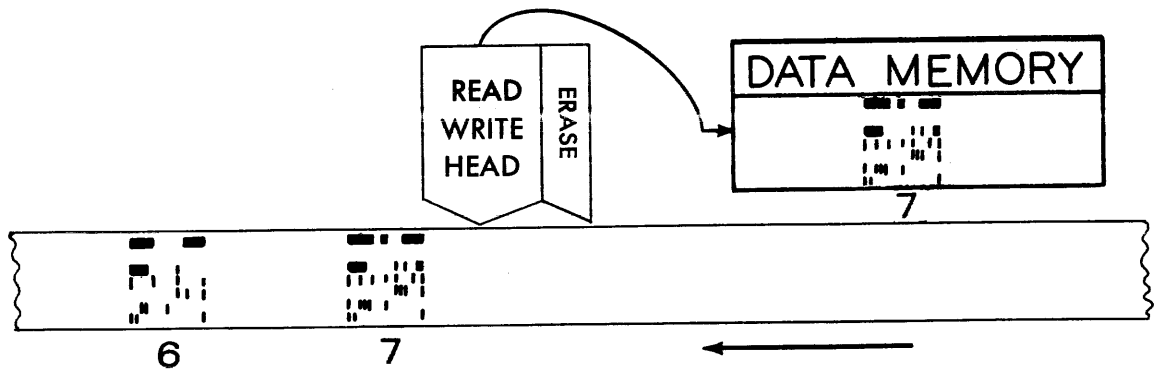

**Tape Movement During Verification**

1. At the beginning of a verify run, the records on tape and the position of the tape in relation to the read/write head are as shown:

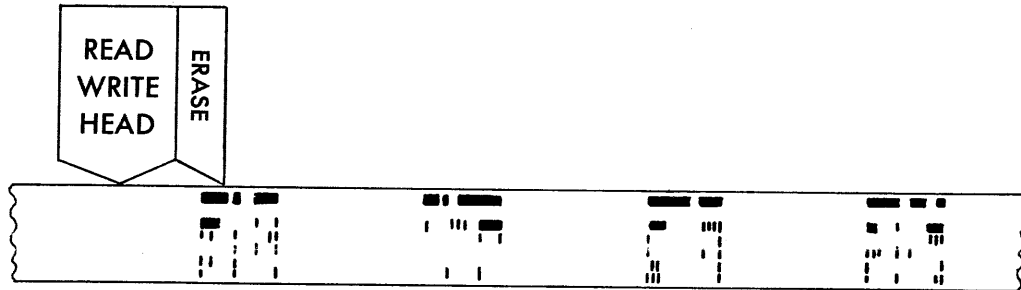

2. A depression of the REL key moves the tape past the read/write head and this action allows the first record to be read into data memory:

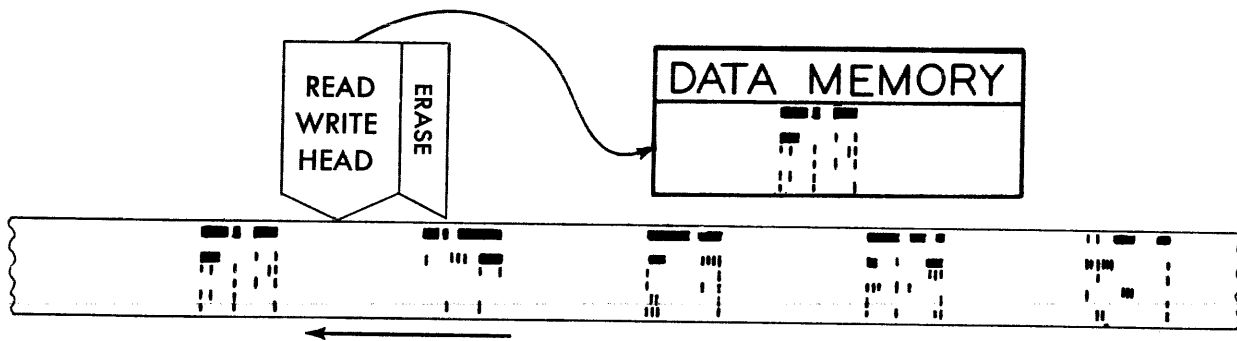

3. As the operator keys in the information to be verified, each keyboard depression is compared with each position in data memory. After a complete verification of the first record, a release action occurs and the next record passes under the read/write head and is read into memory. The position of the records and the tape are shown below:

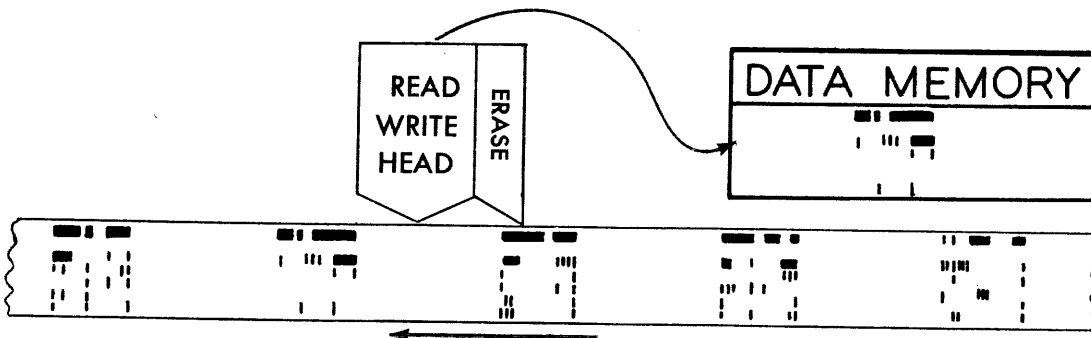

**Tape Movement During a Correction in Verification**

When an error is found during the verification of a record, it must be corrected in data memory. The tape must also be corrected. The position of the tape, the information being corrected in data memory, and the movement of the tape during correction is shown below:

(We will assume that the fourth record has an incorrect character in position 30. The character recorded is a 9 and it should be a 7).

1. A release action reads the record into data memory. The position of the record on tape and the information in data memory is as shown:

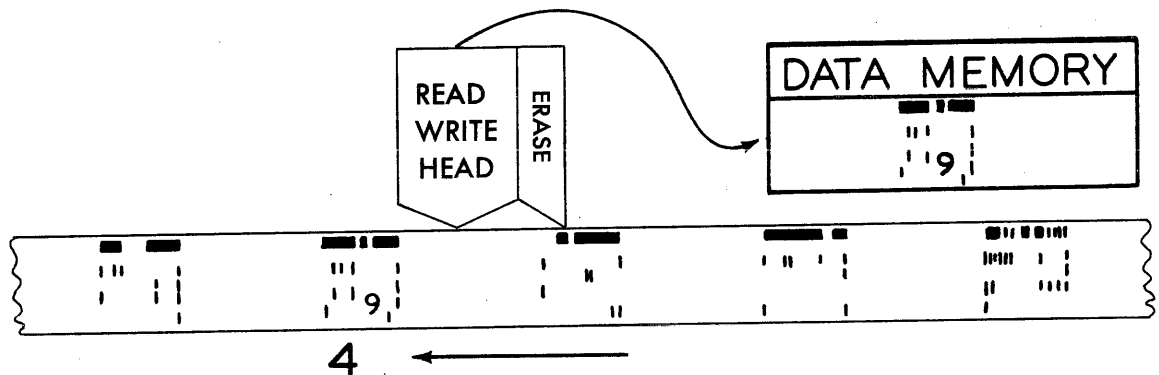

2. When an error is found, the operator corrects the error in data memory and then finishes verifying the record. The position of the record on tape is the same as above. The data memory has been corrected.

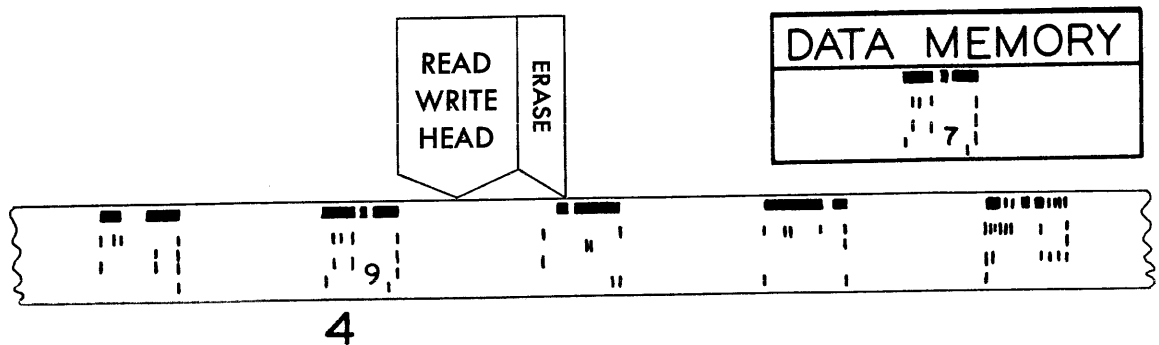

# 1101 MOHAWK/735 NCR DATA RECORDER - MODEL A

## ***It is Now Necessary to Write the Corrected Record on Tape***

3. A "get-tape-ready" action is necessary. Use of the TBS key positions the tape record:

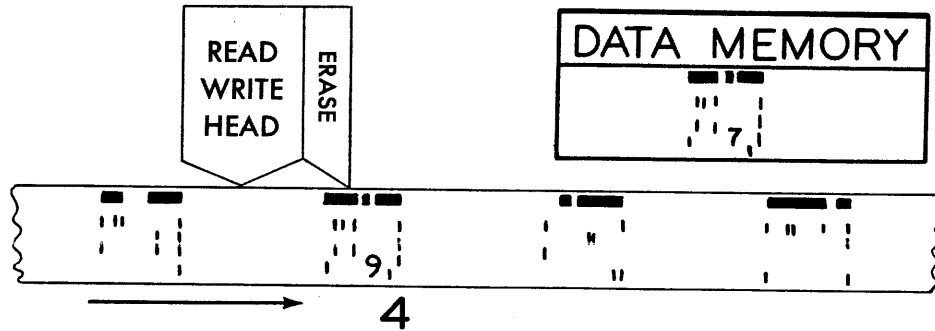

4. Use the REL key to write the correct record on tape. After this operation the corrected tape is in this position:

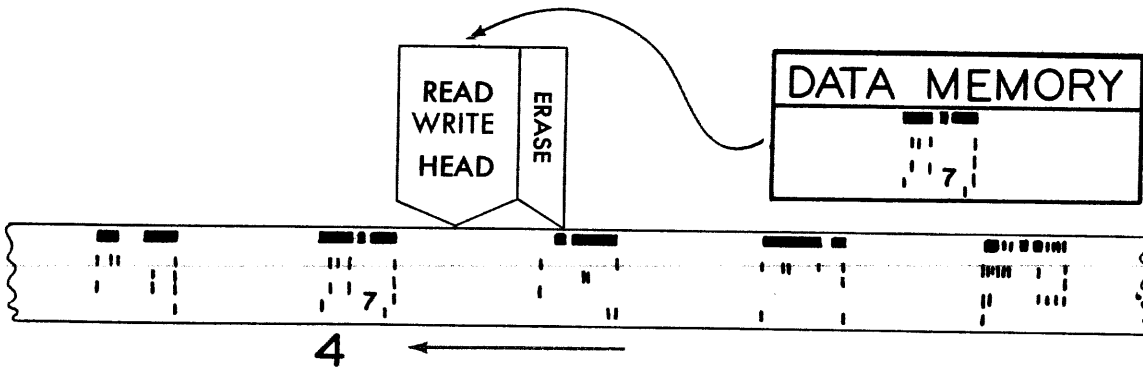

5. The tape then moves backward and movement stops momentarily. The tape and just corrected record is now in this position.

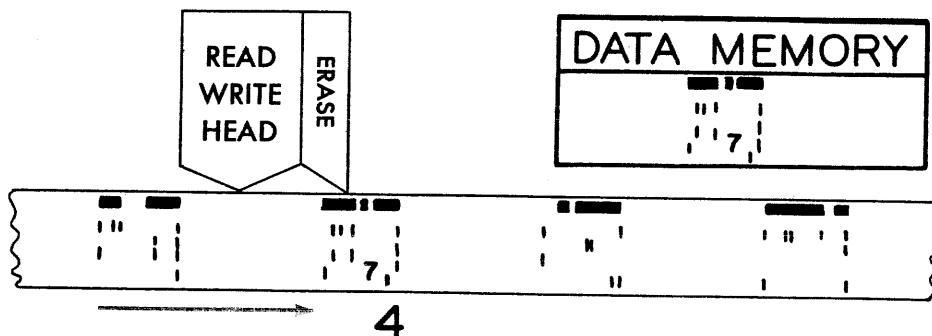

# 1101 MOHAWK/735 NCR DATA RECORDER - MODEL A

## TAPE MOVEMENT (CONT.)

- The tape moves forward reading and comparing to see that the information recorded on tape is the same as the information in data memory. This action also positions the tape for the reading of the next record on tape.

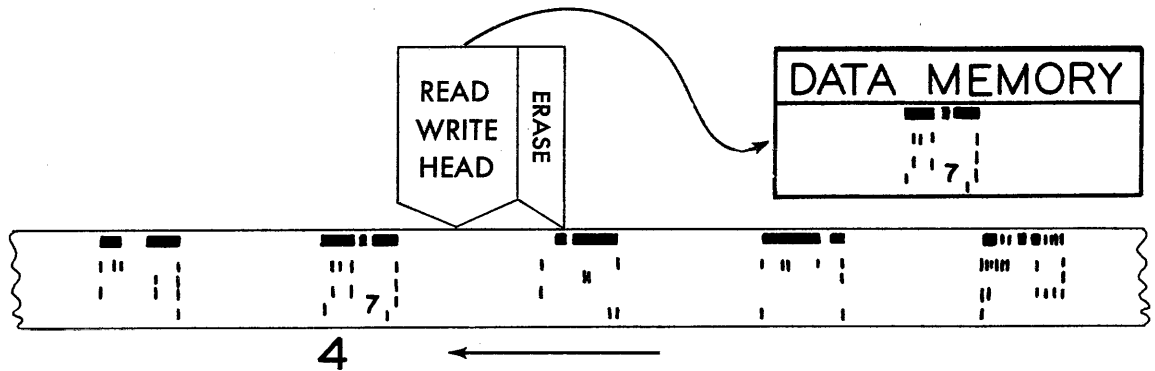

- The next record must be read into data memory. Use the REL key to read the next record:

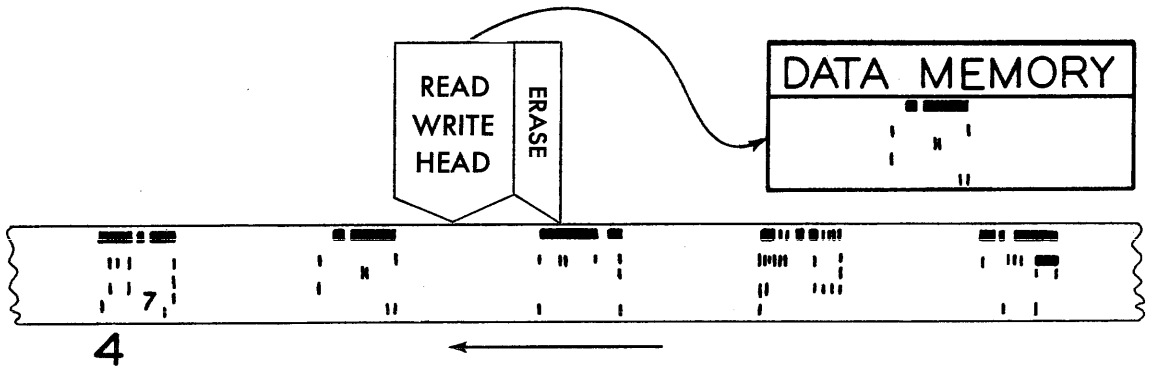

# 1101 MOHAWK/735 NCR DATA RECORDER -MODEL A

## CONTROL PANEL

The control panel containing switches and indicators is located immediately to the left of the tape deck.

### POWER SWITCH<sup>1</sup>

"ON" POSITION - with the POWER switch in the "on" position, electrical power is supplied to the tape capstan drive motor and to the control and logic modules. The following conditions are set up when the POWER switch is turned "on:"

1. REWIND switch is made ineffective for rewinding tape.
2. Error indicator lights and an audible signal is heard. (Depress ER key to extinguish light.)
3. Position counter reset to position 01.
4. Memory is not disturbed.

"OFF" POSITION - with the POWER switch in the "off" position, power is removed from capstan drive motor and control and logic modules and the REWIND switch is effective.

### REWIND SWITCH<sup>2</sup>

"ON" POSITION - with the REWIND switch in the "on" position, electrical power is supplied to the re-wind motor and causes the tape to be drawn back onto the supply reel. The supply reel will continue to rotate in a counterclockwise direction until the REWIND switch is manually set to the "off" position.

*CAUTION: Place the pressure pad on the tape deck in the REWIND position before placing the REWIND switch to the "on" position.*

If both the POWER and REWIND switches are placed in the "on" position, a safety interlock will render all machine functions inoperative and a "general clear" of machine controls is generated. A general clear will clear error conditions and reset the position counter to home position 01. (OFF - removes electrical power from the rewind motor.)

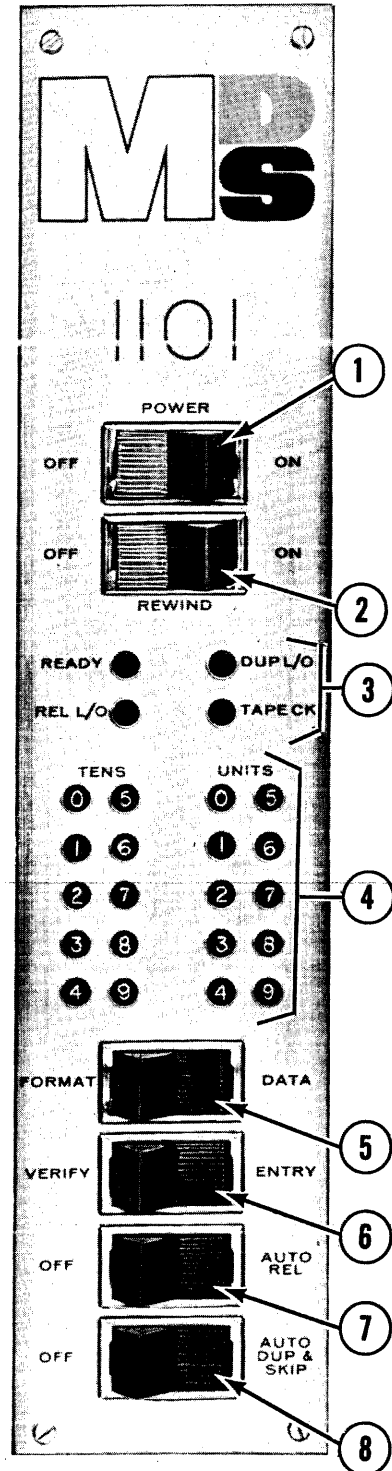

# 1101 MOHAWK/735 NCR DATA RECORDER - MODEL A

## STATUS INDICATORS<sup>3</sup>

A group of four indicators is provided to indicate various error and operating conditions within the machine. Their functions are described below:

### READY

The READY light is a green indicator which is lit when the machine is ready for operation.

When the READY light is extinguished, an abnormal condition exists and the keyboard is inoperative. The abnormal conditions which extinguish the READY light are:

1. Simultaneous operation of more than one character key.
2. Non-equal comparison during a read-after-write check.
3. Non-equal comparison of a manual entry when verifying.
4. Incorrect parity encountered during a tape-read operation. This includes the read-after-write check when in ENTRY mode and a release operation when in the VERIFY mode.
5. Operation of an alphabetic or special character key when in a position programmed for numeric entry.

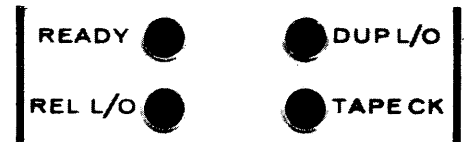

The READY light can be restored by depressing the ER key. The proper procedure to be followed when an abnormal condition has occurred is covered in detail in Section 9 of this manual.

### REL L/O (RELEASE LOCK-OUT)

The REL L/O indicator is lit following depression of the correction key during VERIFY mode, indicating that the current block must be rewritten.

This indicator is also lit, along with the DUP L/O indicator, if a non-compare occurs during the read-after-write check.

When a parity error is detected, this indicator is lit along with the TAPE CK and DUP L/O indicators.

The REL L/O indicator is reset by a Tape Backspace operation performed in preparation for rewriting the error block.

### TAPE CK (TAPE CHECK)

The TAPE CK indicator lights along with both the DUP L/O and the REL L/O indicators if a parity error is encountered during a tape-read operation.

The TAPE CK indicator is reset by a release operation following a tape backspace.

# 1101 MOHAWK/735 NCR DATA RECORDER - MODEL A

## STATUS INDICATORS (CONT.)

### DUP L/O (DUPLICATE LOCK-OUT)

The DUP L/O indicator lights along with the REL L/O indicator when a non-compare occurs during the read-after-write check.

This indicator also lights along with both the REL L/O and the TAPE CK indicators any time a parity check error is detected.

The DUP L/O indicator is reset by a release operation following a tape backspace.

ENTRY MODE		VERIFY MODE
Machine is ready to run		Machine is ready to run
Error Tone Depress ER key (No Error Tone) Check Power Check Breaker Switch Depress ER key		Error Tone Depress ER key Rekey character (If Error Tone sounds again, depress ER/COR keys and key correct character)
		Finish verifying record Depress ER/COR keys simultaneously Depress REL key <i>twice</i>
DUP/SKIP off Re-enter record Depress ER/TBS keys Depress REL key (If lights stay on, repeat)		Depress ER key Manually verify <i>entire</i> record Depress ER/TBS keys Depress REL key <i>twice</i>
Depress ER/TBS keys Depress ER/TEF keys Depress REL key (If lights stay on, repeat)		Depress ER/TBS keys Depress REL key (If lights stay on, repeat)

## MEMORY POSITION INDICATORS<sup>4</sup>

Two groups of ten indicators on the control panel display memory positions. The group on the right displays the units position and the group on the left displays the tens position.

During ENTRY mode, the count displayed indicates the memory position that will receive the next data entry. During VERIFY mode, the position displayed indicates the next position to be verified.

As entries are made, the count displayed advances from home position, 01, to position 80. Following a release action, the position counter is automatically reset to home position and then advances to the next position containing a stop code if position 01 is programmed for a dup or skip.



# 1101 MOHAWK/735 NCR DATA RECORDER - MODEL A

## FUNCTION SWITCHES

### MEMORY SELECTOR (MS) SWITCH<sup>5</sup>

DATA - this is the operating position during either an entry or verify operation. Data entered from the keyboard or from a data tape will be stored in the data portion of memory.

FORMAT - this is the setting when program codes are to be entered into program memory either from a program tape or key entered. This switch setting is also required for a search operation.

### MODE (M) SWITCH<sup>6</sup>

ENTRY - this position is used when data is to be entered from the keyboard and stored in memory for writing on tape or for duplicating into program memory.

VERIFY - this position is used during verification of data blocks. With the mode switch in this position, characters entered from the keyboard will not enter memory, but will be compared to a character in memory for purposes of verification. The characters to be verified are read into memory by the release action of the Data Recorder. The VERIFY position conditions the Data Recorder to read from tape. No tape erasure takes place during a VERIFY operation.

### AUTOMATIC RELEASE (R) SWITCH<sup>7</sup>

AUTO REL - with this switch in the AUTO REL position and the mode switch to ENTRY, data can be released from data memory to magnetic tape. This release action will occur when the memory position counter advances from position 80, either as a result of a keyed entry in position 80 or as a result of skipping or duplicating through position 80.

When the mode switch is in VERIFY position, the release action allows a data block to be read from tape into data memory. Also, in VERIFY mode, automatic release is inhibited if an error has been encountered and a correction entered. The automatic action is restored after the corrected data block has been re-verified without further correction.

OFF - with this switch in the "off" position, no release action will occur either automatically or manually.

### AUTO DUP/AUTO SKIP (AD/S 2) SWITCH<sup>8</sup>

DUP/SKIP 2 - the DUP/SKIP 2 switch on the control panel controls only those fields defined by program codes 12 and 13. During entry, if a code 12 is encountered, the data in memory for the field defined by code 12 will be duplicated in the data block being keyed. If a program code 13 is encountered, the field defined by the code 13 will be skipped. The positions so skipped will contain space codes on tape.

OFF - with this switch in the "off" position, automatic DUP 2 or SKIP 2 operations are prevented. DUP or SKIP operations can be initiated manually from the keyboard if the DUP/SKIP 2 switch is in the "off" position.

# 1101 MOHAWK/735 NCR DATA RECORDER - MODEL A

## TAPE TRANSPORT

This part of the equipment is kept dust-free by having a sliding window. The window must be closed during each operation except rewind. Two arrows on the back panel assist the Mohawk operator when she is positioning the tape for ENTRY or VERIFY. The reflective strip on the beginning of the tape is positioned with these arrows when starting the different runs. The top arrow is used to position the tape during the VERIFY and SEARCH modes and the bottom arrow is used to position the tape during the ENTRY mode.

Threading the tape is a relatively easy operation. The reel of tape is mounted on the hub and is held in place by expanding rubber when the hub is turned. The operator holds the reel of tape in front of her with the loose end of tape dangling from the right side of the reel. This assures that the oxide coating (dull side) of the tape will be on the "up side" when it passes under the read/write head.

## VERIFY INTERLOCK SWITCH<sup>1</sup>

The Verify Interlock switch is the only control component located on the Data Recorder tape deck.

This switch is a small two-position toggle switch that is located on the right side of the tension arm slot. The purpose of this switch is to prevent inadvertent erasure of data during verify and to allow the verify operator to change to ENTRY mode during verification for purposes of rekeying extension corrections, but without endangering other data blocks on tape.

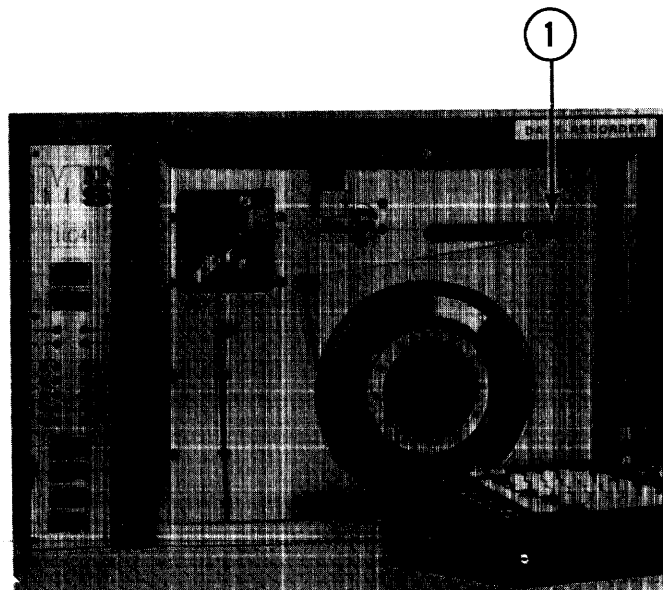

When this switch is in the "on" (Verify) position, some ENTRY mode functions are inhibited even though the mode switch may be set to ENTRY. For example, there can be no release - manual or automatic, and there will be no movement of tape if the ER/TEF keys are depressed. When the Verify Interlock switch is in the "off" (Entry) position, all of the usual ENTRY mode functions are available during an ENTRY mode operation.

With the Data Recorder conditioned for VERIFY mode and the Verify Interlock switch "on," the usual verify procedures can be followed.

The setting of the Verify Interlock switch will not affect a SEARCH operation. It is suggested, however, that the switch be set to "on" to protect the tape records during "after-search" operations.

# 1101 MOHAWK/735 NCR DATA RECORDER - MODEL A

## SPECIAL FUNCTION SWITCHES

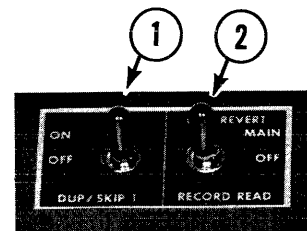
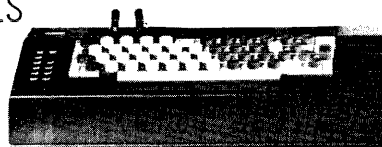

There are two special function switches located on the keyboard. One switch, the DUP/SKIP 1, is a two position ON-OFF switch. The second switch is a three position switch, the upper position being PROGRAM REVERT, the down position being RECORD READ. The center position is the OFF position. The function of these switches is described below.

### DUP/SKIP 1 (D/S 1) SWITCH<sup>1</sup>

DUP/SKIP 1 switch controls the automatic function of program codes 4 and 5. With the DUP/SKIP 1 switch "on," a program code 4 will allow a field of data, in memory, to be automatically duplicated in each record being entered. During verification, a program code 4 will allow the duplicate field to be machine verified. If a program code 5 is encountered, the field defined by the code 5 will be skipped. During entry, the positions so skipped will be space-filled.

The automatic DUP 1 or SKIP 1 operation will terminate when a stop-duplicate or stop skip code is encountered.

### PROGRAM REVERT/RECORD READ SWITCH<sup>2</sup>

The PRG REVERT position of the PRG REVERT/RECORD READ switch is effective *only* if the Data Recorder is equipped with the Alternate Program feature. This switch conditions the Data Recorder to *automatically change* from alternate program to main or regular program when the release action occurs at the end of a data block. The main program will continue to control 1101 functions until the alternate program is again selected.

### RECORD READ

The RECORD READ position of the PRG REVERT/RECORD READ switch is used when a data block is to be read from tape to data memory after a SEARCH or during an ENTRY run. *The RECORD READ should not be used during verification.*

With every release action during verification, the Data Recorder makes a comparison between the data being read into memory and the data already in memory from the previous record. For every position that does not compare, an 8-bit is set; i.e., the 8P core of program memory is set to the "on" condition. For every compare, the 8P core is set to the "off" condition. The setting, or not setting, of the 8-bits is the basis of the DUP-VERIFY feature of the Data Recorder. Therefore, if the program being used contained 8-bits such as required for codes 12 and 13 or for other special applications, these 8-bits could possibly be disturbed during the reading in of the data block. To prevent program disturbance when a data block is reread into memory in the middle of an entry run for checking, or after a SEARCH, the RECORD READ switch must be used. While rereading the data block into memory, place the switch in the RECORD READ position until the release is completed.

# 1101 MOHAWK/735 NCR DATA RECORDER - MODEL A

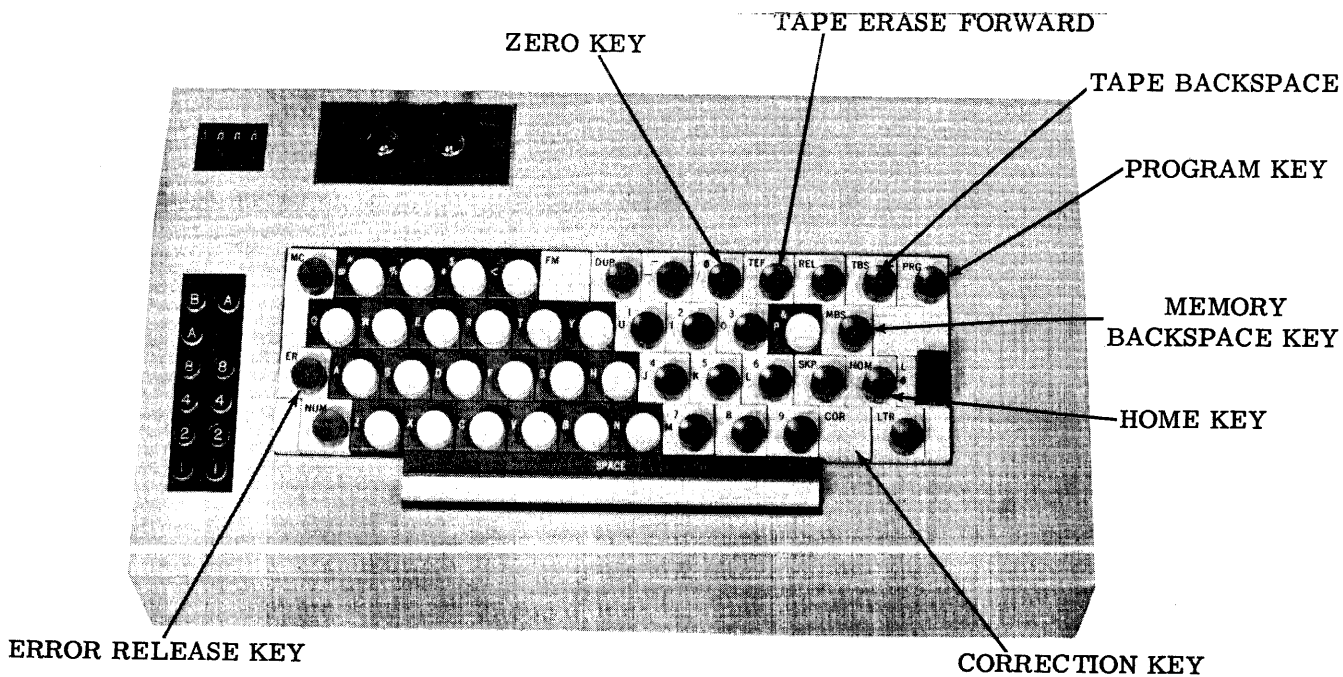

## KEYBOARD

The keyboard of the basic MDS 1101 Data Recorder consists of 34 character keys; 14 special function keys, and a space bar. The 34 character keys permit single key entry of 47 different character codes including the alphabet, numerics and 11 special characters. An expanded 64-character keyboard is available as an option.

The keys on the keyboard are basically color-coded in the following manner:

- White top keys - Alphabetic and special characters
- Blue top keys - All numerics and some alpha characters
- Red top keys - Special functions

## CHARACTER KEYS

Keyboard shift for numeric, alpha and special characters during data recording, is controlled by the program code present in memory. If, in a position programmed for a numeric character, any character key is depressed that does not represent a numeric character, 0-9, space or minus sign, the operator will be signaled by the flashing error light.

Program control, however, may be *overridden* through the use of the NUM and LTR keys. Alpha, or alpha shift special characters, can be entered into a position programmed for a numeric character by holding the letter shift (LTR) key depressed while entry is being made. Numeric shift characters can be entered into a position programmed for an alpha character by holding the numeric shift (NUM) key depressed during entry.

Numeric shift special characters can be entered only if the NUM key is held depressed while entry is being made, regardless of program code in memory.

# 1101 MOHAWK/735 NCR DATA RECORDER - MODEL A

## KEYBOARD (CONT.)

### SPACE BAR

The space bar can be used to enter or verify space codes in a record or in a program. The space bar is also used to clear program memory of all codes before a new program is key entered. One special use of the space bar is during SEARCH when all memory positions except the identifier must be space-filled. The space bar is also used to advance memory positions while sight-checking program or data memory if the Data Recorder is conditioned to ENTRY mode.

### NUM (NUMERIC SHIFT) KEY

The NUM key is used when a numeric character is to be entered into a position programmed for alpha characters. The NUM key must also be used whenever a numeric shift special character is to be entered into memory regardless of the program in memory.

The keyboard will remain in numeric shift as long as the NUM key is held depressed, overriding the program shift-control, and will assume the shift specified by the program code only when the NUM key is released.

### LTR (LETTER SHIFT) KEY

The LTR key is used when an alpha character or letter shift special character is to be entered into a position programmed for numerics. The keyboard will remain in letter shift as long as the LTR key is held depressed, overriding program shift-control, and will assume the shift specified by the program code only when the LTR key is released.

### ER (ERROR RELEASE) KEY

The ER key has multiple functions. After an abnormal or error condition has occurred, it is necessary to depress the error release key to extinguish the error light and reactivate the keyboard.

The second function of the error release key is to make the tape backspace, tape erase forward, memory backspace, home, correction and field modify keys effective. The error key must be held depressed when any of these six keys are to be used. This interlocking effect is designed to prevent inadvertent operation of these keys.

### HOM (HOME) KEY

The HOM key is effective only when the ER key is held depressed. Operating the HOM key will restore the memory position counter to position 01.

### MBS (MEMORY BACKSPACE) KEY

The MBS key is effective only when the ER key is held depressed. While in ENTRY mode a depression of the ER/MBS keys will reduce the memory position counter by a count of one. Holding the ER/MBS keys depressed will allow repetitive memory backspacing with the memory position counter reducing one for each backspace. MBS is not effective during verification. If a DUP or SKIP code is encountered during memory backspacing, a backward skip will be initiated and will terminate when a stop dup or skip code is encountered.

# 1101 MOHAWK/735 NCR DATA RECORDER - MODEL A

## KEYBOARD (CONT.)

### COR (CORRECTION) KEY

The COR key is effective only when the ER key is held depressed. The purpose of the correction key is to allow one new character to be written in memory to replace a character found to be in error during verification. Following the use of the COR key, the depression of one character key reverts the Data Recorder to the VERIFY mode. This eliminates the need for changing the mode selection switch to ENTRY for correcting single characters.

When a character being verified is determined to be in error, the correction key is depressed and then the correct character is keyed. Depression of the COR key lights the REL L/O indicator. This prevents automatic or manual release. After the data block is verified, a manual tape backspace operation is performed to position the tape for rewriting the data block and extinguishing the REL L/O indicator. A depression of the REL key now causes the corrected data block to be written on tape.

### FM (FIELD MODIFY) KEY

The FM key is effective only when the ER key is held depressed. The field modify key provides a method of changing or correcting an entire field during verification without changing to ENTRY mode. The Data Recorder remains in the modify condition until the start of the next field, at which time the Data Recorder reverts to the VERIFY mode. The modify condition can be terminated at any position within the field by depressing the DUP or SKIP key.

When an entire field is determined to be in error, the operator depressed the ER/FM keys and then keys the first replacement character of the field. If the first character is in a position programmed with an MSP code, the ER/FM keys must be depressed once more after the first character is keyed. Otherwise, no further depression of the ER/FM keys is required to correct the remainder of that field. In Field Modify condition, the REL L/O indicator is lit. Automatic and manual release is inhibited when the REL L/O indicator is lit. After the field is changed and the data block completely verified, a tape backspace operation positions the tape for rewriting the data block and extinguishing the REL L/O indicator. A depression of the REL key now writes the corrected data block on tape.

### TBS (TAPE BACKSPACE) KEY

The TBS key is effective only when the ER key is held depressed. Each depression of the ER/TBS keys will backspace the tape the length of one data block, usually for the purpose of rereading a block during an entry run. Only one Tape Backspace can be performed without an intervening operation such as a release or a general clear.

### TEF (TAPE ERASE FORWARD) KEY

The TEF key is used primarily for positioning the tape at the beginning of a run and for bypassing bad spots on tape. The ER key must be held depressed while the TEF key is being used. When the Data Recorder is conditioned for ENTRY, about three inches of tape will be erased when the ER/TEF keys are depressed. A TEF operation during VERIFY will move tape about three inches but no erasure will take place. The function of the TEF key is inoperative in ENTRY mode if the Verify Interlock switch is "on."

# 1101 MOHAWK/735 NCR DATA RECORDER - MODEL A

## KEYBOARD (CONT.)

### REL (RELEASE) KEY

The REL key is effective only when the release switch on the control panel is set to the REL ON position.

Depression of the REL key while the Data Recorder is in ENTRY mode will cause space codes to be entered in memory and written on tape for all unkeyed positions of the data block with the exception of programmed dup fields. A release action while the memory counter is in position 01 will cause all space codes to be entered into memory on tape. If the DUP/SKIP switches are "on," any duplicate data will be recorded as part of the data block. The usual write on tape and read-after-write check occurs with each manual release. The REL key is ineffective in ENTRY mode if the Verify Interlock switch is "on."

When in the VERIFY mode, without an error condition, depression of the release key will cause a data block to be read from tape and stored in memory. While being read, the data will be checked for parity. After each release action, the position counter returns to position 01. If position 01 contains a dup or skip code, the counter will advance to the first memory position that contains a stop dup or skip code. When conditioned for a tape search, depression of the REL key will cause consecutive data blocks to be read from tape. A specified portion of each block will be compared with an identifier stored in memory. When the block containing the matching identifier is reached, the search will terminate.

### DUP (DUPLICATE) KEY

The DUP key is used to manually duplicate data that is in data memory. The DUP key is used during data verification to verify identical or similar data fields in adjacent data blocks. If data being verified is identical in content and position to data in the preceding data block, a depression of the DUP key will automatically verify all identical data up to the point of the next difference or until a stop dup code is encountered. The similarity or dissimilarity of data is determined by the Data Recorder comparator circuits.

The program core 8-bits control the "Dup-Verify" function. A non-compare of data (on a position-for-position basis) between the data being read in and that data already in memory will cause an 8-bit to be set for each non-compare position. A data match in any position will condition the 8P core to OFF for that position.

Any position that does not set 8-bits (8P core - OFF) can be dup-verified. All other positions must be key verified or skipped by program control or skipped manually as dictated by the data structure.

During ENTRY mode, identical fields in adjacent data blocks can be duplicated by depressing the DUP key. The duplication operation is terminated when an stop dup code is encountered in program memory.

The DUP key is also used when a program is being entered into program memory from data memory.

## KEYBOARD (CONT.)

MC (MULTIPLE CODE) KEY

The MC key permits key entry of data into memory without advancing the memory position. One use for the MC key is to allow the operator to construct, in memory, a BCD code by combining the BCD codes of two or more characters. For example, this key is used when program control codes 12 and 13 for a DUP 2 or SKIP 2 operation are being key entered. To enter two codes into one memory position, the MC key is held depressed while one code is keyed and released when the second code is keyed. In the example given above, to construct a BCD code for program code 12 (1101); depress the MC key, key the numeric 8, release the MC key and key the numeric 4. Similarly, for program code 13 (1101), use numeric 8 and numeric 5 keys with the MC key.

If the MC key is not released before keying the last character of a multiple code entry, rekeying the last character after release of the MC key will give the proper result.

Another use for the MC key is to assist in adding or changing a code in program memory. To perform this operation, set the control panel switches to PROGRAM and ENTRY, hold the MC key depressed and key twice the code desired. The first depression puts the code in data memory. The second depression moves the code from data memory to program memory. The MC key holds the memory position for both depressions.

SKP (SKIP) KEY

The SKP key can be used when the Data Recorder is conditioned for either ENTRY or VERIFY mode.

During ENTRY, the SKP key can be used to skip a field or part of a field where no data entry is desired. The skip will be terminated when a stop-skip code is encountered. All positions so skipped will contain space codes on tape. If the spaces to be entered are part of a field, they must follow the data being entered.

During VERIFY, the SKP key can be used to verify spaces within a data block. After the data portion of a field has been verified, a depression of the SKP key will advance the memory counter to the start of the next field containing a stop-skip code.

The spaces in all intervening positions will be machine verified. If a non-space character is encountered during a verify manual skip, the skip action will be stopped at the non-space character with the error light flashing.

The DUP/SKIP 1 and DUP/SKIP 2 switches do not have to be on in order for the SKP key to be effective.



# 1101 MOHAWK/735 NCR DATA RECORDER - MODEL A

## KEYBOARD (CONT.)

### LØ (LEFT ZERO) KEY

The left zero key is used when the data characters entered for a specific field do not fill the assigned field to capacity and the data is to be right-justified within that field. Depression of this key shifts data characters to the low order positions within a field and fills unused high order positions with zeros. The LØ action will terminate when a stop LØ code is encountered.

In the VERIFY mode, the LØ key must be depressed to verify the preceding zeros. The position counter stops at the position containing the first non-zero number of the field after the zeros have been verified.

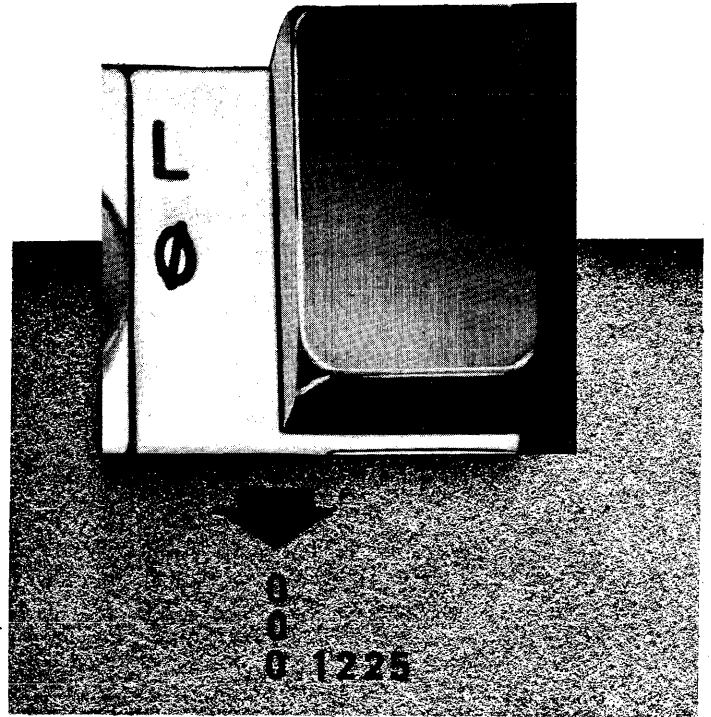

### PRG (PROGRAM) KEY

Depression of the PRG key<sup>1</sup> will shift control from main program to alternate program or from alternate program to main program. The indicator light is on the left side of the keyboard above the program memory display. When the "ALT" light<sup>2</sup> is lit, it shows that the machine is in alternate program control. Depression of the PRG key will turn off the light and switch the Data Recorder to the control of the main program.

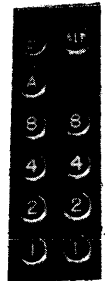

### RECORD COUNTER

In the upper left corner of the keyboard assembly there is an item counter. It has a capacity of nine-thousand, nine-hundred and ninety-nine. This counter will advance one every time a record is written on tape. It can be used to determine an operator's production and also by the computer operator in setting the computer to read a certain number of records into its memory. An accurate count is obtained because during error correction the counter will "hold".

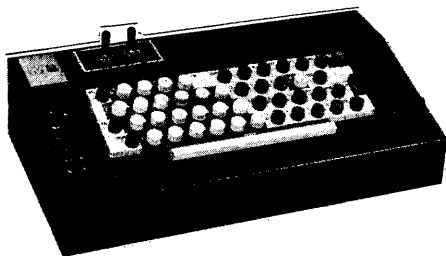

# 1101 MOHAWK/735 NCR DATA RECORDER - MODEL A

## MEMORY DISPLAY INDICATORS

There are two sets of memory display indicators on the 1101 keyboard. The set at the far left displays the contents of data memory; the other set displays the contents of program memory.

### DATA MEMORY INDICATORS

There are six data memory indicators, one each representing the six bits of the BCD code. From the top down, the indicators represent the B, A, 8, 4, 2 and 1 bits of the BCD code.

During entry, the code displayed represents the character in the corresponding position of the previous data block. If the position is observed after MBS, the character observed is from the record being keyed.

During verify, the code displayed represents the character to be verified.

### PROGRAM DISPLAY LIGHTS

There are four program display lights which represent the 8, 4, 2 and 1 bits of the BCD code. The program code displayed is the code that controls the memory position shown on the control panel position indicator lights. When none of the program display lights are lit, the controlling program code is a space code.

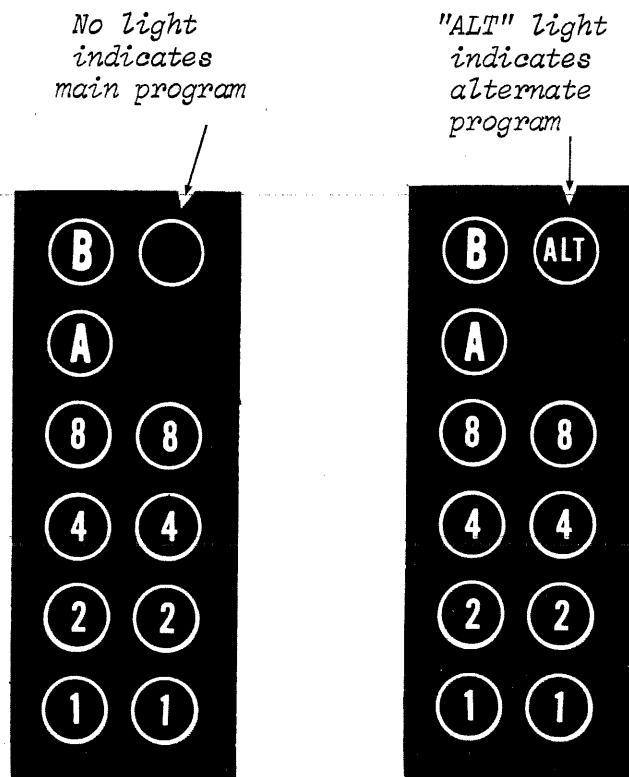

# 1101 MOHAWK/735 NCR DATA RECORDER - MODEL A

The glass door on the front of the Data Recorder serves as a dust protector and as a safety feature. This door should be kept closed when the machine is in use. Before each operational procedure, set the POWER switch to "on" and make sure the REWIND switch is in the "off" position.

## TO CLEAR MEMORIES

1. Turn the power switch to the "on" position.
2. Depress the ER/HOM keys simultaneously to turn off the "ER" light.
3. Set switches as follows:

SWITCH	POSITION	SWITCH	POSITION
MEMORY SELECTOR (MS)	FORMAT	VERIFY INTERLOCK (V/INT)	ON
MODE (M)	ENTRY		
AUTO REL (R)	OFF	PROGRAM REVERT (PR)	OFF
AUTO DUP/SKIP (AD/S) (D/S 2)	OFF	DUP SKIP 1 (D/S 1)	OFF

4. The program key to Main (regular program).
5. Depress the NUM key and space bar\* simultaneously until the position counter passes from position 01 through 00 *twice*. This clears Main program and data memory of all numeric bits.
6. The program key to Alternate.
7. Depress the ER/HOM keys simultaneously.
8. Depress the NUM key and space bar simultaneously until the position counter passes from position 01 through 00. This clears Alternate program memory of all numeric bits.

\*Enter appropriate character: Space for IBM, GE, Burroughs; Ø for Honeywell, NCR, RCA; + for Univac.

# 1101 MOHAWK/735 NCR DATA RECORDER - MODEL A

## TO LOAD ONE PROGRAM THROUGH THE KEYBOARD

*NOTE: Clear both Main and Alternate program memories.*

1. Set switches as follows:

SWITCH	POSITION	SWITCH	POSITION
MEMORY SELECTOR (MS)	DATA	VERIFY INTERLOCK (V/INT)	OFF
MODE (M)	ENTRY		
AUTO REL (R)	OFF	PROGRAM REVERT (PR)	OFF
AUTO DUP/SKIP (AD/S) (D/S 2)	OFF	DUP SKIP 1 (D/S 1)	OFF

2. Depress the ER/HOM keys simultaneously.
3. Program key to Main (regular) program.
4. Key enter the entire program, making a key depression for every memory position. Use the space bar for program spaces.
5. Change the mode switch to VERIFY.
6. Key verify the entire program, making a key depression for every memory position.

*NOTE: To correct an error, change the mode switch back to ENTRY and key the correct character. Return to VERIFY after each correction. After making all corrections, depress the ER/HOM keys simultaneously and key verify the entire program.*

7. Change switches: MS - FORMAT  
M - ENTRY
8. Depress the ER/HOM keys simultaneously.
9. Depress the DUP key to copy the program into program memory.
10. Immediately change the memory selector switch to DATA. Other switch settings will depend upon whether you are to enter or verify or search.

# 1101 MOHAWK/735 NCR DATA RECORDER - MODEL A

## TO LOAD TWO PROGRAMS THROUGH THE KEYBOARD

*NOTE: Clear both Main and Alternate program memories.*

1. Set switches as follows:

SWITCH	POSITION	SWITCH	POSITION
MEMORY SELECTOR (MS)	DATA	VERIFY INTERLOCK (V/INT)	ON
MODE (M)	ENTRY		
AUTO REL (R)	OFF	PROGRAM REVERT (PR)	OFF
AUTO DUP/SKIP (AD/S) (D/S 2)	OFF	DUP SKIP 1 (D/S 1)	OFF

### TO LOAD THE MAIN PROGRAM

2. Program key to Main (regular program).
3. Depress the ER/HOM keys simultaneously.
4. Key enter the main program; *hold down the numeric shift key while entering the program codes.*
5. Make a key depression for every program memory position.
6. Change mode switch to VERIFY.
7. Depress the ER/HOM keys simultaneously.
8. Key verify the entire main program.

*NOTE: To correct an error, change the mode switch to ENTRY and key the correct character. Return to the VERIFY mode after each correction. After making all corrections, key verify the entire program.*

9. Depress the ER/HOM keys simultaneously.
10. Change switches: MS - FORMAT  
M - ENTRY
11. Depress the DUP key to load the main program into program memory.
12. Change the MS switch to DATA.

# 1101 MOHAWK/735 NCR DATA RECORDERS - MODEL A

## TO LOAD TWO PROGRAMS THROUGH THE KEYBOARD (CONT.)

### TO LOAD THE ALTERNATE PROGRAM

13. Depress the program key to Alternate.

. Depress the ER/HOM keys simultaneously.

15. Key enter the entire Alternate program, depressing the NUM shift key when entering the program codes.

16. Make a key depression for every memory position.

*NOTE: If you want 8's in either program, enter them now.*

17. Change the mode switch to VERIFY.

18. Depress the ER/HOM keys simultaneously.

19. Key verify the entire Alternate program.

*NOTE: To correct an error, change the mode switch to ENTRY and key the correct character. Return to the VERIFY mode after each correction. After making all corrections, key verify the entire program.*

20. Depress the ER/HOM keys simultaneously.

21. Change switches: MS - FORMAT  
M - ENTRY

22. Depress the DUP key to load the Alternate program into alternate program memory.

23. Change the MS switch immediately to DATA.

24. Change other switch settings as required for data entry, verification or search.

*NOTE: The space bar is used to enter program spaces on equipment compatible with IBM, GE and Burroughs computers. The Ø for equipment compatible with Honeywell, NCR and RCA. The + for equipment compatible with Univac.*

# 1101 MOHAWK/735 NCR DATA RECORDER - MODEL A

## CHANGING A CHARACTER IN PROGRAM MEMORY

To change a single character in program memory, proceed as follows:

1. Set the function switches as follows:

SWITCH	POSITION	SWITCH	POSITION
MEMORY SELECTOR (MS)	DATA	VERIFY INTERLOCK (V/INT)	ON
MODE (M)	ENTRY		
AUTO REL (R)	OFF	PROGRAM REVERT (PR)	OFF
AUTO DUP/SKIP (AD/S) (D/S 2)	OFF	DUP SKIP 1 (D/S 1)	OFF

2. Advance the memory position counter to the position to be changed. If the contents of data memory are *not* to be disturbed, advance to the memory position by dopping through memory or re-keying the contents of memory to the position desired. If retaining the contents of data memory is not required, the memory position can be reached by manual skipping or spacing through memory.
3. Set MS switch to **FORMAT**.
4. Hold MC and NUM keys depressed as you key *twice* the character key for the program code to be inserted. The first depression enters the code into data memory; the second depression moves the code into program memory. The MC key holds the memory position for both depressions, and the NUM key overrides any alpha shift code that may have been present in that program memory position.
5. Immediately set MS switch to **DATA**.

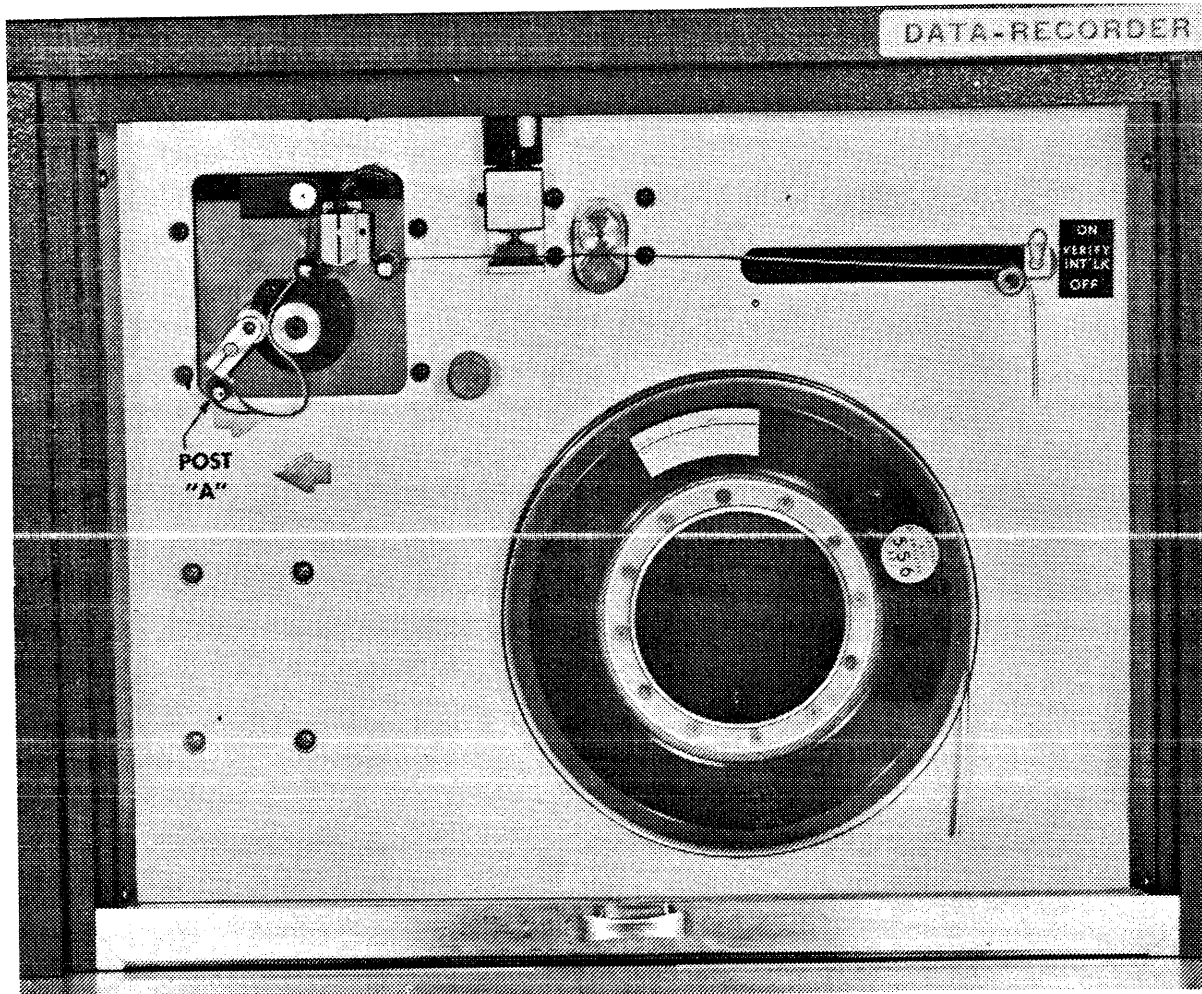

## Tape Deck with Program Tape

### POSITIONING A PROGRAM TAPE

1. Depress the ER/TEF keys simultaneously and hold until the tape motion stops. The Tape Erase Forward erases the tape area preceding the area where the program block is to be written. This will assure the reading of the program block with the first release when loading the program into program memory from tape.
2. Depress the ER/TBS keys simultaneously to position the tape for writing the program.



# 1101 MOHAWK/735 NCR DATA RECORDER - MODEL A

## WRITING A PROGRAM TAPE - ONE PROGRAM

1. Clear memories.
2. Position a program tape.
3. Set the function switches as follows:

SWITCH	POSITION	SWITCH	POSITION
MEMORY SELECTOR (MS)	DATA	VERIFY INTERLOCK (V/INT)	OFF
MODE (M)	ENTRY		
AUTO REL (R)	ON	PROGRAM REVERT (PR)	OFF
AUTO DUP/SKIP (AD/S) (D/S 2)	OFF	DUP SKIP 1 (D/S 1)	OFF

4. Hold the NUM key depressed as you key enter the program to position 81. Automatic release will occur writing the program as a data block on the program tape.

*NOTE: To key enter codes such as 12 ( $\frac{8}{4}$ ) or 13 ( $\frac{8}{5}$ ), hold the MC key depressed while the first character of the code is keyed. Release the MC key before keying the last character of the code.*

5. Depress the REL key. This action will write a block of spaces following the program block.
6. Place the rewind/run pressure pad in "rewind" position.
7. Reposition the program tape (leave a little slack).
8. Place the rewind/run pressure pad in the "run" position.
9. Change the mode switch to VERIFY.
10. Depress the REL key. The program has been read into data memory.
11. Hold the NUM key depressed while you key verify the program to position 81. Automatic release will occur if all 80 character positions have been verified without correction.

*NOTE: For each error found, depress the ER/COR keys and key in the correct character. Continue verifying the complete record; then, depress the ER/HOM keys, the ER/TBS keys and the REL key. Re-verify the entire record. Automatic release will occur if all 80 character positions have been verified without corrections.*

12. After the program has been verified and corrected (if necessary), make consecutive depressions of the ER/TEF keys until the program tape is free.

# 1101 MOHAWK/735 NCR DATA RECORDER - MODEL A

## WRITING A PROGRAM TAPE - TWO PROGRAMS

1. Clear memories.
2. Position a program tape.
3. Set the function switches as follows:

SWITCH	POSITION	SWITCH	POSITION
MEMORY SELECTOR (MS)	DATA	VERIFY INTERLOCK (V/INT)	OFF
MODE (M)	ENTRY		
AUTO REL (R)	ON	PROGRAM REVERT (PR)	OFF
AUTO DUP/SKIP (AD/S) (D/S 2)	OFF	DUP SKIP 1 (D/S 1)	OFF

4. Depress the program key to Main program.
5. Hold the NUM key depressed as you key enter the Main program to position 81; automatic release will occur. Then, depress the program key to Alternate program.
6. Hold the NUM key depressed as you key enter the Alternate program to position 81; automatic release will occur.
7. Depress the REL key.
8. Place the rewind/run pressure pad in the "rewind" position.
9. Reposition the program tape (leave a little slack).
10. Place the rewind/run pressure pad in the "run" position.
11. Change the mode switch to VERIFY.
12. Put the Verify Interlock switch in the "on" position.
13. Depress the REL key.
14. Key verify the Main program to position 81; automatic release will occur if there are no errors.
15. Key verify the Alternate program to position 81; automatic release will occur if there are no errors.
16. After the programs have been verified and corrected (if necessary), make consecutive depressions of the ER/TEF keys until the program tape is free.

# 1101 MOHAWK/735 NCR DATA RECORDER - MODEL A

## LOADING PROGRAM FROM A PROGRAM TAPE

1. Turn power switch to the "on" position.
2. Clear memories before loading program(s) from a program tape.
3. Turn power switch to the "off" position.
4. Set the function switches as follows:

SWITCH	POSITION	SWITCH	POSITION
MEMORY SELECTOR (MS)	FORMAT	VERIFY INTERLOCK (V/INT)	ON
MODE (M)	VERIFY		
AUTO REL (R)	ON	PROGRAM REVERT (PR)	OFF
AUTO DUP/SKIP (AD/S) (D/S 2)	OFF	DUP SKIP 1 (D/S 1)	OFF

5. Thread the program tape, leaving no slack in the tape.
6. Turn the power switch to the "on" position.
7. Depress the REL key. The program is now in program memory.

### TO LOAD ONLY THE MAIN PROGRAM

8. Program key to Main program.
9. Depress the REL key.
10. Change the MS switch to DATA.
11. Depress the ER/TEF keys until the tape is free; then, remove the tape from the anchor post.

### TO LOAD MAIN AND ALTERNATE PROGRAM

8. Program key to Main program.
9. Depress the REL key.
10. Program key to Alternate program.
11. Depress the REL key.
12. Change the MS switch to DATA.
13. Depress the ER/TEF keys until the tape is free; then, remove the tape from the anchor post.

# 1101 MOHAWK/735 NCR DATA RECORDER - MODEL A

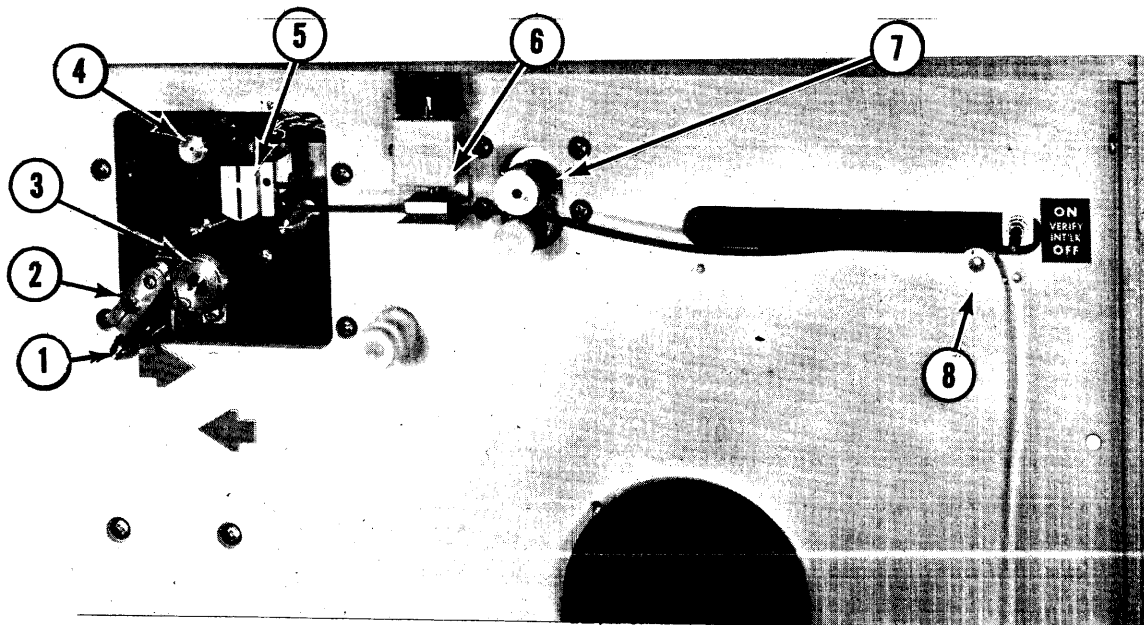

- |                         |                        |
|-------------------------|------------------------|
| 1. PROGRAM TAPE ANCHOR  | 5. READ-WRITE HEAD     |
| 2. PINCH ROLL           | 6. PRESSURE PAD        |
| 3. CAPSTAN              | 7. BACKSPACE MECHANISM |
| 4. SPRING TENSION CLAMP | 8. ROLLER              |

## THREADING PROGRAM TAPE

1. Lower window.
2. Position Pressure Pad<sup>6</sup> to "rewind" position.
3. Raise Spring Tension Clamp<sup>4</sup> (turn clockwise).
4. Slip the small loop in the end of the program tape over the Program Tape Anchor Post<sup>1</sup>.
5. *Keep dull side of tape "up."*
6. Thread tape between the Pinch Roll<sup>2</sup> and Capstan<sup>3</sup>, under Read-Write and Erase Heads<sup>5</sup>, through the Pressure Pad<sup>6</sup> and Backspace Mechanisms<sup>7</sup> and over Roller<sup>8</sup>.
7. Hold tape taut (no slack) with righthand. With the left hand, position the Pressure Pad<sup>6</sup> to the "run" position.
8. Lower Spring Tension Clamp<sup>4</sup> (turn counterclockwise to hold the tape in the groove of the guide post).
9. Close window.

## 1101 MOHAWK/735 NCR DATA RECORDER - MODEL A

The window serves as a dust protector and a safety feature. When operating the equipment, the power switch should be in the "on" position and the rewind switch in the "off" position and the window should be closed.

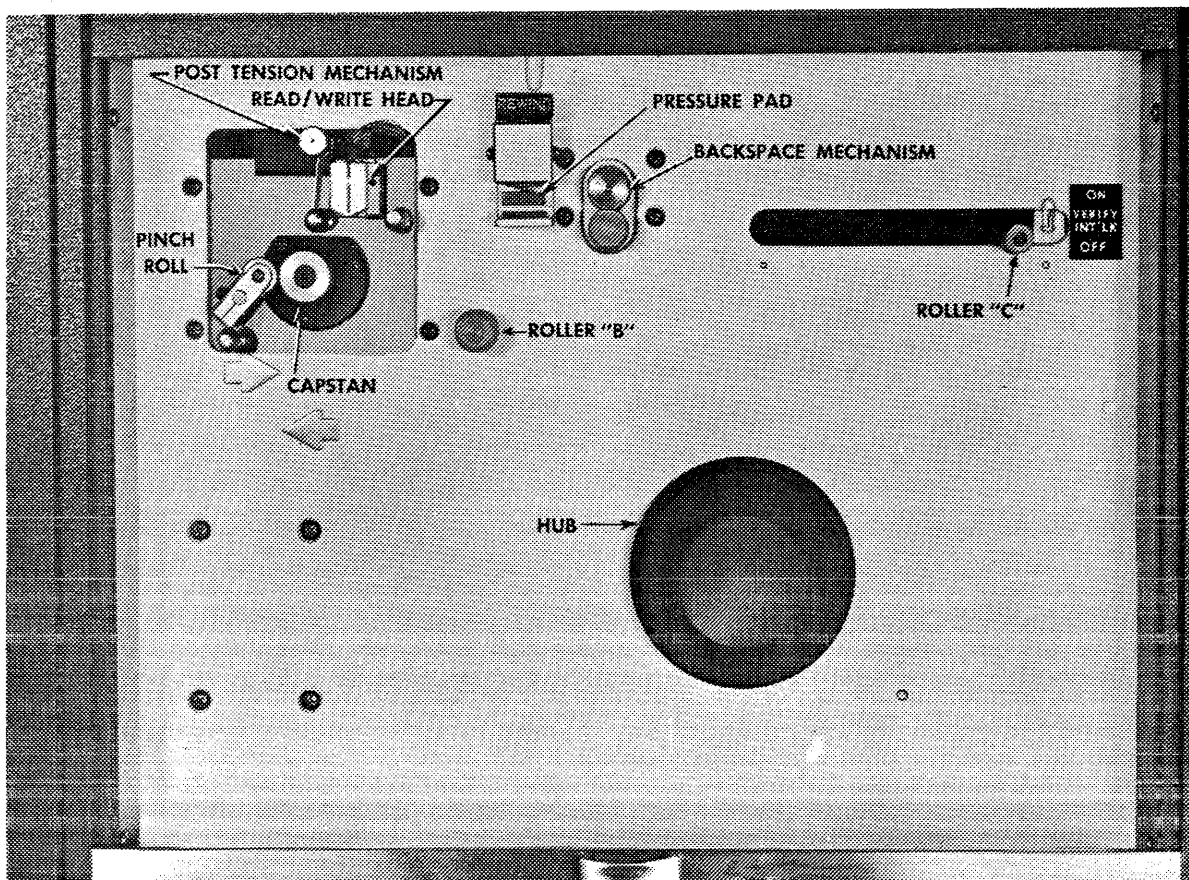

### CLEANING

At the start of each days operation, the Data Recorder should be cleaned using the procedure listed below. If good cleaning habits are not used, scratched and damaged tapes may result because of a dirty tape path. A cleaning kit is supplied with each Data Recorder. Dust on tapes has often been the cause of read-after-write errors.

1. Rewind the tape on tape reel.
2. Wipe CAPSTAN with a clean dry cloth only.
3. Moisten one of the square pads or swabs with the solvent supplied and wipe all rollers and parts the tape touches during machine operation.
4. Take *extra care* to clean the REWIND/RUN pressure pad and the Read/Write head.
5. Wipe off excess solvent.

# 1101 MOHAWK/735 NCR DATA RECORDER - MODEL A

## MOUNTING THE TAPE SUPPLY REEL

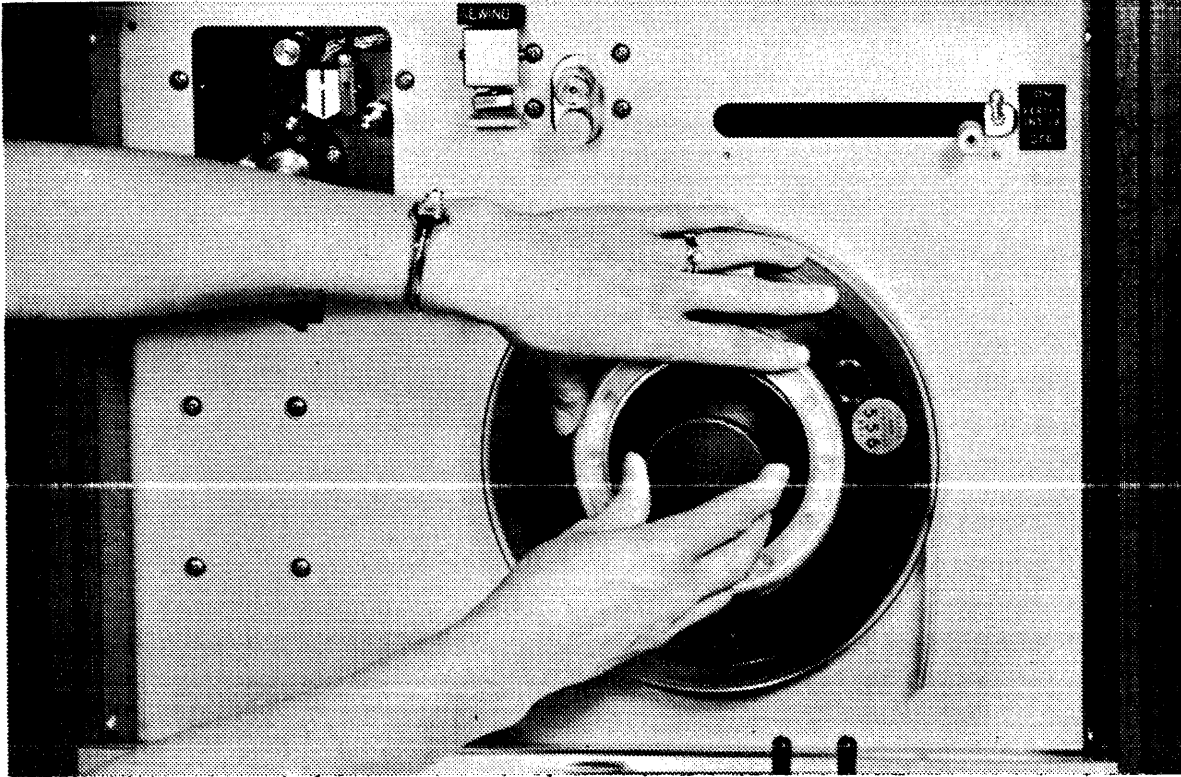

Pull reel hub outward; turn to the right or the left to lock into position. Then, place the supply reel over the hub so that the tape will unwind in a clockwise direction. (It will be coming off the bottom of the reel.)

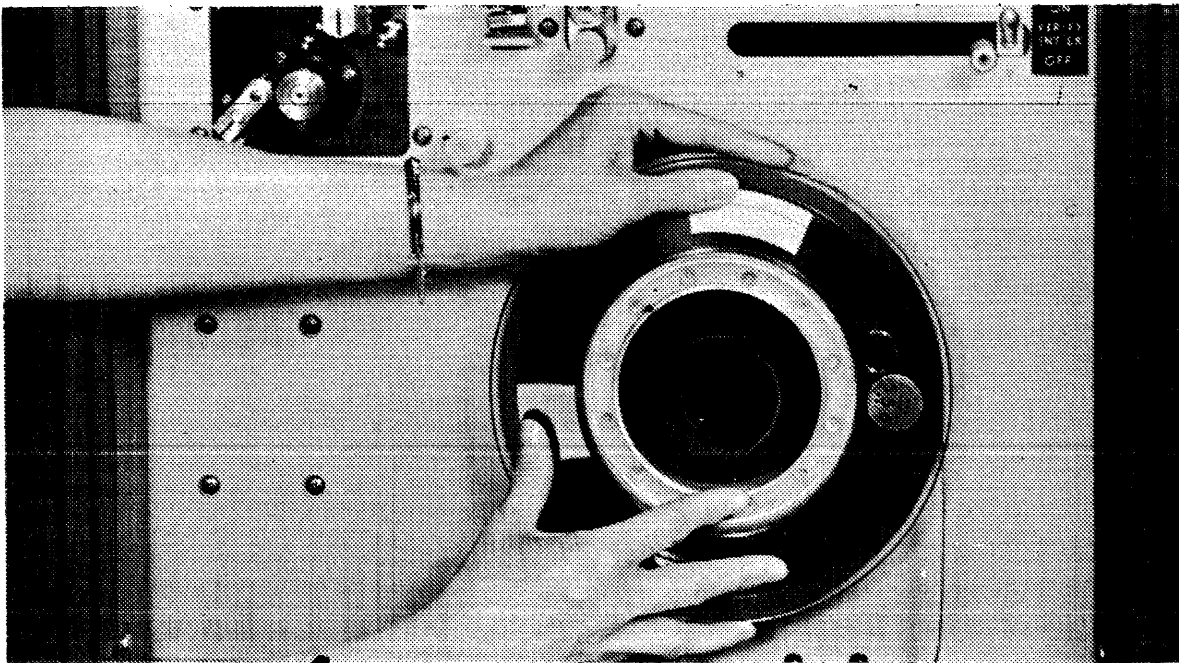

While applying pressure against the reel with the left hand, turn the hub slightly until it moves inward and locks in place seating the reel.

## 1101 MOHAWK/735 NCR DATA RECORDER - MODEL A

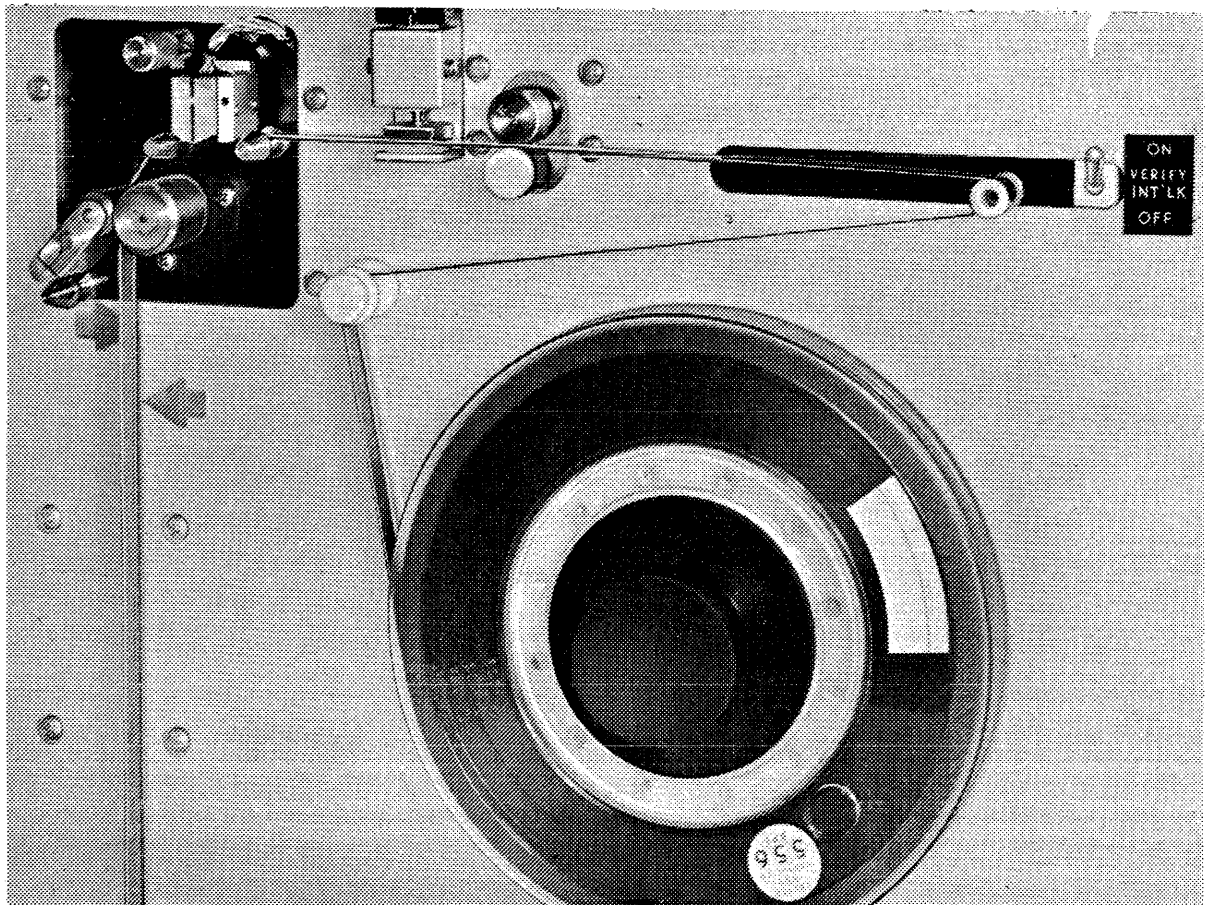

### THREADING TAPE

1. Lower the window and mount the supply reel.
2. After the supply reel has been mounted, unwind three feet of tape.
3. Set the Pressure Pad control to the "rewind" position.
4. Lift the Spring Tension Clamp by turning it to the left.
5. Thread the tape around Rollers "A" and "B," through the Backspace Mechanism, through the Pressure Pad, under the Read-Write Head and between the Capstan and the Pinch Roll.
6. Lower the Spring Tension Clamp by turning it to the right. This holds the tape in place.
7. Place the free end of the tape in the Tape Bin opening directly below the Capstan.
8. To advance the tape to the starting point, set the Pressure Pad mechanism to the "run" position and depress the ER/TEF keys simultaneously until the reflective strip on the tape is opposite the lower positioning arrow. *The tape will move forward, about three inches, with each depression of the ER/TEF keys.*
9. Pull the glass window up until it locks.

TAPE REWIND

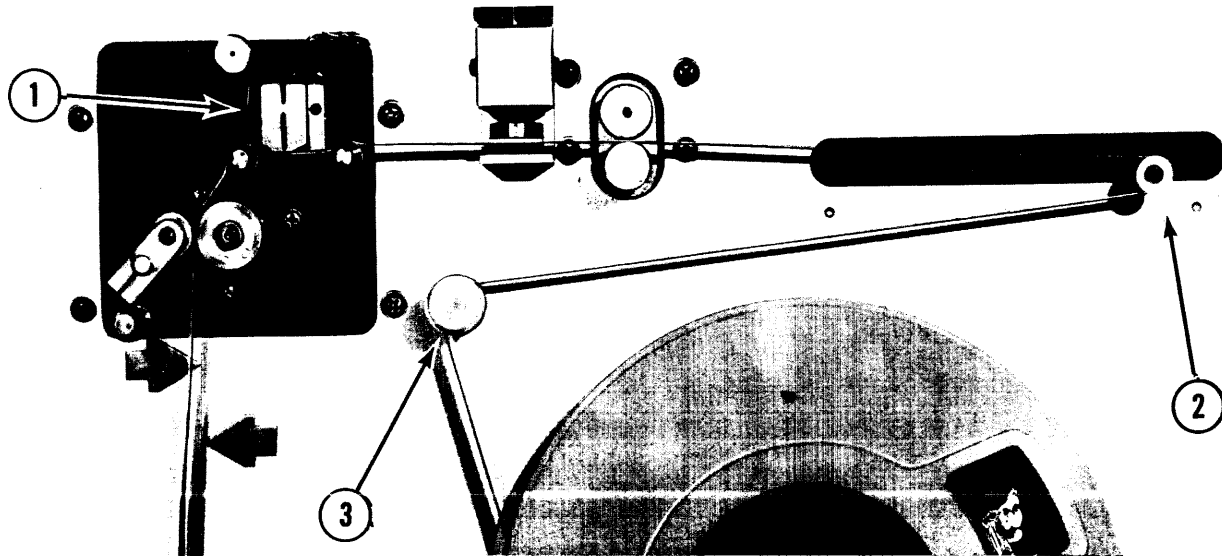

1. Set the power switch on the control panel to the "off" position.
2. Lower the window.
3. Set the Pressure Pad to the "rewind" position.
4. Remove the tape from around Roller<sup>2</sup>. Use the side of the finger to remove the tape to avoid getting oily deposits from the fingertips on the writing surface.
5. Manually rotate the supply reel to take up the slack in the tape<sup>3</sup>; turn the Reel Hub counterclockwise.
6. Ease tension slightly on Spring Tension Clamp<sup>1</sup>.
7. Close the window.
8. Set the rewind switch on the control panel to the "on" position. When the tape is completely rewound, turn the rewind switch "off."

*NOTE: The rewind switch must not be turned on until the power switch has been in the "off" position for approximately five seconds. This will assure the elimination of any transient signals in the Read/Write head.*

REMOVAL OF TAPE REEL

Remove the tape reel by applying pressure with the left hand and pulling out on the hub with the right hand while turning it slightly. The hub will remain in the "out" position and the reel will be free to be removed.

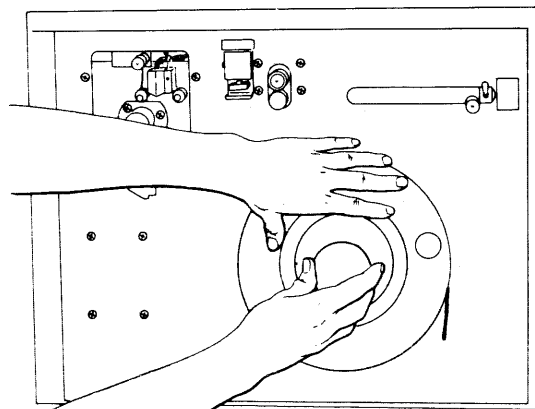



# 1101 MOHAWK/735 NCR DATA RECORDER - MODEL A

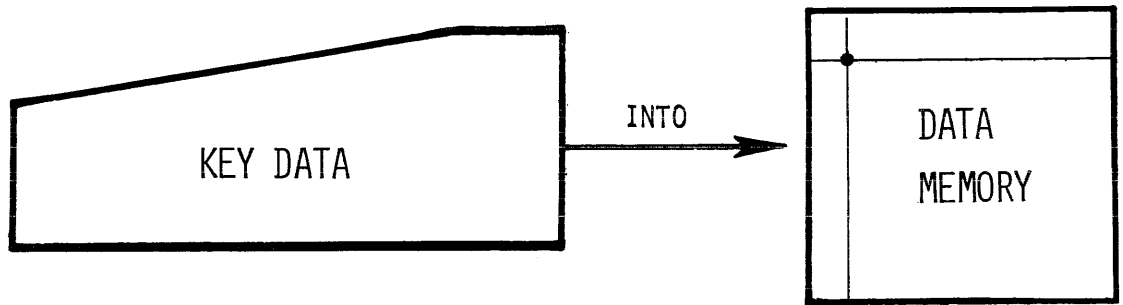

## DATA ENTRY

An "entry run" is the original recording of a series of data records on magnetic tape. In the entry mode (entry = write), you key a record into data memory. When the data memory has been filled, the Data Recorder will automatically write the contents of data memory on magnetic tape if the REL switch is in the "on" position.

It is through this "key, write, key, write..." process that a file of records is recorded on magnetic tape.

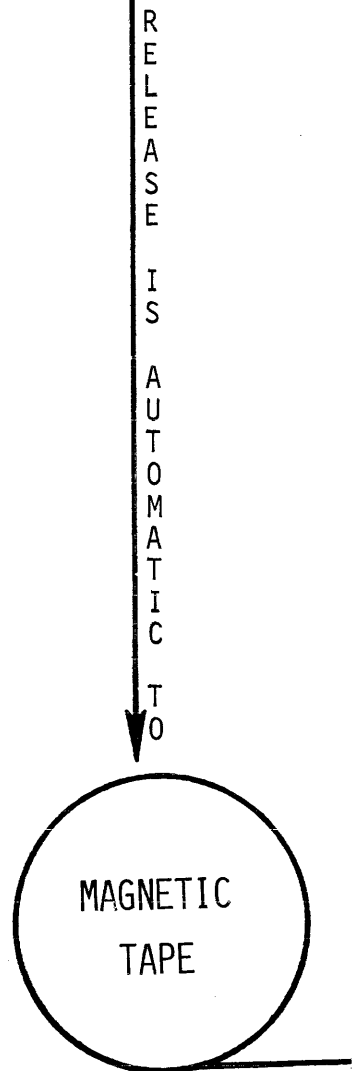

# 1101 MOHAWK/735 NCR DATA RECORDER - MODEL A

## PREPARING FOR DATA ENTRY

ACTION	EXPLANATION
1. Clear memory.	You wish to ENTER (write) program(s) into memory.
2. Load program(s).	Be sure the proper program is loaded.
3. Power "off."	
4. Set switches:	
MS - Data	To allow keying into data memory without changing program memory.
M - Entry	Allows you to write on tape (entry = write).
R - On	Allows information to be written on tape.
D/S 2 - Off	This switch is "off" so that the Data Recorder will not duplicate or skip if there are 12's or 13's in the program.
D/S 1 - Off	This is so that the Data Recorder will not duplicate or skip if there are 4's or 5's in the program.
PR - Off	This switch is always in the "off" position when entering the first record.
V/INT - Off	Since we are not verifying, the V/INT switch is "off."
5. Mount and thread data tape. (Leave no slack and start the tape into the bin.)	
6. Power switch to "on."	
7. Depress the ER/TEF keys simultaneously. (Repeat step until reflective marker is below arrows.)	Hold keys down until tape motion stops. Use of the ER/TEF keys will advance the tape so that you can find the reflective marker. Since the mode switch is in ENTRY, the tape is also being erased.
8. Manually position the bottom of the reflective marker at the tip of the lower arrow.	This will ensure that the information is recorded <i>after</i> the BOT (beginning of tape) reflective marker.

# 1101 MOHAWK/735 NCR DATA RECORDER - MODEL A

## ENTERING THE FIRST RECORD

ACTION	EXPLANATION
9. Key "header label" if necessary.	
10. Key in the first data record to position 81. Automatic release will occur. (Use the SKP key for skip fields. When entering alpha in dup fields, hold down the LTR key.	<p>Since the REL switch is in the "on" position, release will occur <i>after</i> all positions of the first record have been entered into data memory. Since a dup field is numeric in shift, the LTR key must be held down when entering alpha characters in a dup field.</p> <p>NOTE: During an entry run, if the data does not completely fill a field, the SKP key can be depressed to advance the memory position to the beginning of the next field containing a stop skip code. All positions so skipped will contain space codes on tape.</p> <p>NOTE: After entering the data in a left zero field, depress the LØ key. The data will be shifted to the right and all left positions of the field will contain zeros. A field followed by a left zero field, defined by a code 6 or 7, cannot be entered without first depressing the LØ key. Depressing the DUP, SKP or REL keys prior to depressing the LØ key will cause the error light to flash.</p>
<h3>VERIFYING FIRST RECORD</h3>	
11. Change switches: M - Verify R - Off	<p>The first data record is verified to ensure that all constant information for remaining records is correct.</p> <p>Since you wrote only one record, there is nothing to read into memory <i>after</i> verification.</p>
12. Key verify all positions of the first record.	<p>You verify the first record especially to be sure the dup fields are correct. If errors are found, change the REL switch to the "on" position so you will later be able to rewrite the correct record. Follow the regular correction procedure by depressing the ER/COR keys simultaneously to allow the changing of one character in data memory. Key the correct character (this makes the correction in data memory) and then continue verification. Then, depress the ER/HOM keys, the ER/TBS keys and the REL key. Re-verify the entire record. When all positions have been verified without error correction, automatic release occurs.</p>

# 1101 MOHAWK/735 NCR DATA RECORDER - MODEL A

## PROCEEDING WITH THE ENTRY RUN

ACTION	EXPLANATION
13. Change switches:	
M - Entry	This will enable you to enter the remainder of the source documents.
R - On	
D/S 2 - as required.	Put in the "on" position if any 12's or 13's are in the program(s).
D/S 1 - as required.	Put in the "on" position if any 4's or 5's are in the program(s).
PR - as required.	The PR switch is effective <i>only</i> if the Data Recorder is equipped with the alternate program feature. When this switch is in the record-read position, it conditions the equipment to only change from alternate program to main program. When the release action occurs at the end of a data block, the main program continues to control functions until the alternate program is again selected by depression of the program key. This switch is used when much of the information will be the same for each successive record.
14. Depress the ER/HOM keys.	To begin from the first keying position.
15. Proceed with the run.	Key the rest of the records.
END OF THE ENTRY RUN	
16. At the end of the entry run, change switches:	
D/S 2 - Off	
D/S 1 - Off	
17. Depress the ER/HOM keys simultaneously.	
18. Key required trailer labels and tape marks (if necessary).	The trailer label identifies the end of a file. It may contain totals, a record count, or other identifying characters. The tape mark signals the computer to stop reading.
19. Depress the ER/TEF keys twice.	This writes about 6 inches of blank tape to signal end of a batch during SEARCH or VERIFY run.

# 1101 MOHAWK/735 NCR DATA RECORDER - MODEL A

## HEADER AND TRAILER LABELS - TAPE MARKS

Header and trailer labels along with tape marks are used in a large number of installations. Variations exist as to content and/or placement of these records. A common sequence of placement on tape is shown in the drawing below:

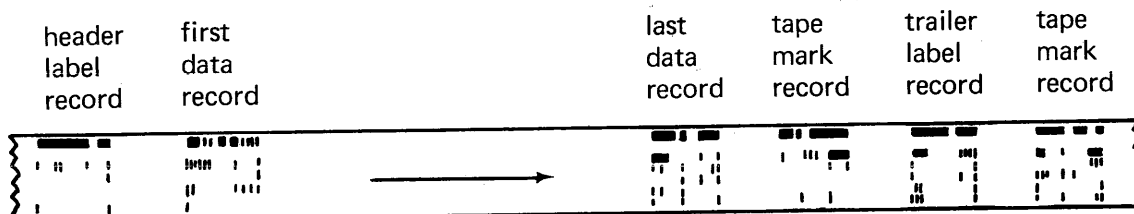

The header and trailer labels are used for identification while the tape mark instructs the computer to stop reading.

### HEADER LABEL

The Header Label identifies the beginning of a "file" (or series of data records) of information. It may have a date, serial number, or other identifying characters.

### TRAILER LABEL

The Trailer Label identifies the end of a file. It may contain totals of record count or other identifying characters.

### TAPE MARK

The Tape Mark signals the computer to stop reading because it has read all of the data records of the file. A very common tape mark is both the 7 and 8 in position 01 and spaces in all other positions. You must use the Multi-Code (MC) key in order to put two characters into one position. To write this record:

1. Hold down the MC and NUM keys; then, key a 7 to write a 7 into data memory.
2. Let up the MC key; hold down the NUM key and key an 8. This adds the 8 to the 7 in data memory.
3. Let up the NUM key and depress the REL key. This puts spaces in all other positions and then writes the record on tape.

# 1101 MOHAWK/735 NCR DATA RECORDER - MODEL A

## DATA VERIFICATION

1. Clear memory and load verification program(s).
2. Set function switches as follows:

SWITCH	POSITION	SWITCH	POSITION
MEMORY SELECTOR (MS)	DATA	VERIFY INTERLOCK (V/INT)	ON
MODE (M)	VERIFY		
AUTO REL (R)	ON	PROGRAM REVERT (PR)	OFF
AUTO DUP/SKIP (AD/S) (D/S 2)	OFF	DUP SKIP 1 (D/S 1)	OFF

NOTE: The Verify Interlock switch is in the "on" position. With the switch "on", a release (manual or automatic) will be prevented if the mode switch is set to ENTRY.

3. Mount and thread the data tape to be verified.
4. Turn the power switch to the "on" position and make consecutive depressions of the ER/TEF keys until the tape reflective marker is below the positioning arrows on the tape deck. Since the mode switch is in VERIFY and the V/INT switch is "on," the tape is *not* erased.
5. Manually position the bottom of the reflective marker at the tip of the upper arrow for verification.
6. Depress the REL key. The first data block will be *read* into memory. If the error tone comes on it will probably be an indication that the first data block is farther from the reflective marker than expected. Depress the ER/TBS keys and REL key to try again to read in the first data block. If the error tone comes on again, repeat the procedure using the ER/TBS and REL keys.
7. Key verify all positions of the first record, including dup and skip fields. Automatic release will occur if all 80 character positions have been verified correct. Correct errors according to error recovery procedures.
8. Set D/S 1 and D/S 2 switches to the "on" position, PR switch as required.
9. Depress ER/HOM keys.
10. Proceed with verification run. If positions that were automatically duplicated during entry are programmed for automatic duplication during verification, they will be machine verified. During verification, corresponding positions of consecutive data blocks that contain identical data can be manually "dup-verified" by depressing the DUP key. Dup verification will stop when a difference is encountered.

# 1101 MOHAWK/735 NCR DATA RECORDER - MODEL A

## READING A DATA BLOCK FROM DATA MEMORY

During entry it may become necessary to verify the last data block written. When this situation occurs, proceed as follows:

1. Set function switches as follows:

SWITCH	POSITION	SWITCH	POSITION
MEMORY SELECTOR (MS)	DATA	VERIFY INTERLOCK (V/INT)	OFF
MODE (M)	VERIFY		
AUTO REL (R)	ON	PROGRAM REVERT (PR)	RECORD READ
AUTO DUP/SKIP (AD/S) (D/S 2)	OFF	DUP SKIP 1 (D/S 1)	OFF

NOTE: Set Program Revert/Record Read switch on keyboard to RECORD READ position. This conditions the Data Recorder not to add or delete 8 bits in program memory while the data block is being read into data memory.

2. Depress ER/TBS keys to back the tape up *one* block length.
3. Depress REL key. The last data block has been read into data memory.

## VERIFYING THE LAST RECORD WRITTEN

4. Set REL switch to "off."
5. Set Program Revert/Record Read switch to "off."
6. Verify the entire data block. The SKP key may be used to verify skip fields.
7. Change switches:

SWITCH	POSITION	SWITCH	POSITION
MEMORY SELECTOR (MS)	DATA	VERIFY INTERLOCK (V/INT)	OFF
MODE (M)	ENTRY		
AUTO REL (R)	ON	PROGRAM REVERT (PR)	OFF
AUTO DUP/SKIP (AD/S) (D/S 2)	ON	DUP SKIP 1 (D/S 1)	ON

8. Depress ER/HOM keys.
9. Proceed with entry run.

# 1101 MOHAWK/735 NCR DATA RECORDER - MODEL A

## REPLACING DAMAGED DATA BLOCKS DURING VERIFICATION

To replace more than one data block in the middle of a data batch, proceed as follows:

1. Set the function switches as follows:

SWITCH	POSITION	SWITCH	POSITION
MEMORY SELECTOR (MS)	DATA	VERIFY INTERLOCK (V/INT)	OFF
MODE (M)	VERIFY		
AUTO REL (R)	ON	PROGRAM REVERT (PR)	OFF
AUTO DUP/SKIP (AD/S) (D/S 2)	OFF	DUP SKIP 1 (D/S 1)	OFF

2. Determine how many data blocks are damaged.
3. Read in the first damaged data block.
4. Depress the ER/COR keys. The read/write head will be turned on in preparation for erasing the error block and writing the new data block.
5. Set mode switch to ENTRY. Key enter the correct data for that data block.
6. Change mode switch to VERIFY.
7. Depress ER/HOM, ER/TBS and REL keys to back the tape up and write the good data block.
8. Repeat steps 4 through 7 until all except the last damaged data block is replaced. Read in the first data block following the group of data blocks being changed. Depress the ER/TBS key to back up the tape. Turn the REWIND switch ON and OFF to clear the machine so another TBS operation can be performed later. Repeat steps 4 through 7 to replace the last damaged data block.
9. Set D/S 1 and D/S 2 switches to "on."
10. Proceed with verification run.

*NOTE: Each replaced data block can be verified after it is rewritten or they can all be verified after they have all been rewritten. If verification is done after each data block is written turn the REL switch "off" before each is verified to prevent reading the next block.*



# 1101 MOHAWK/735 NCR DATA RECORDER - MODEL A

## PERFORMING A SEARCH

To condition the 1101 to search from the beginning of a tape for a record written on the magnetic tape, proceed as follows:

1. Power switch to the "off" position.
2. Set function switches as follows:

SWITCH	POSITION	SWITCH	POSITION
MEMORY SELECTOR (MS)	DATA	VERIFY INTERLOCK (V/INT)	ON
MODE (M)	VERIFY		
AUTO REL (R)	OFF	PROGRAM REVERT (PR)	OFF
AUTO DUP/SKIP (AD/S) (D/S 2)	OFF	DUP SKIP 1 (D/S 1)	OFF

3. Mount and thread data tape to be searched.
4. Power switch to the "on" position.
5. Make consecutive depressions of the ER/TEF keys until the reflective marker is below the positioning arrows on the tape deck.
6. Manually position the bottom of the reflective marker at the tip of the upper arrow.
7. Set mode switch to ENTRY.
8. Key enter a record identifier into data memory. The identifier must consist of data identical in content and memory position to the data of the record being searched for. The identifier can be from one to eighty characters long. Any position of the 80 character block that is not used as an identifier must contain a space. The identifier must also be unique to the record being searched for.
9. Set mode switch to VERIFY.
10. Depress ER/HOM keys.
11. Key verify the identifier. To correct an error, change mode switch to ENTRY and key correct character. Return to VERIFY position after each correction.
12. Change switches: MS - FORMAT  
M - ENTRY  
D/S 2 - ON
13. Hold REL key depressed for  $\frac{1}{2}$  second and release. Consecutive data blocks will be read into memory and compared to the identifier. The record being searched for has been found when the search stops without error condition. The record is to the left of the read/write head. The identifier is still in data memory.

# 1101 MOHAWK/735 NCR DATA RECORDER - MODEL A

*NOTE: If it is desired to work with the data block located by the search; i.e., verify, change or delete, proceed with steps 14 through 17 to read the data block into data memory. If an entry run is to be continued after the data block is located, proceed directly to step 18.*

## AFTER SEARCH - VERIFYING THE "FOUND" RECORD

14. Change function switches as follows:

SWITCH	POSITION	SWITCH	POSITION
MEMORY SELECTOR (MS)	DATA	VERIFY INTERLOCK (V/INT)	OFF
MODE (M)	VERIFY		
AUTO REL (R)	ON	PROGRAM REVERT (PR)	RECORD READ
AUTO DUP/SKIP (AD/S) (D/S 2)	OFF	DUP SKIP 1 (D/S 1)	OFF

*NOTE: Set Program Revert switch on keyboard to RECORD READ position. This conditions the Data Recorder not to add or delete 8-bits in program memory while the data block is being read into data memory.*

15. Depress ER/TBS keys to back the tape up one block length.
16. Depress the REL key. The record that was found by search is read into memory without disturbing program memory.
17. Set Program Revert switch to "off." Proceed with the verification.

## TO CONTINUE AN ENTRY RUN

18. To continue an entry run after a data block has been located by a search, set the function switches as follows:

SWITCH	POSITION	SWITCH	POSITION
MEMORY SELECTOR (MS)	DATA	VERIFY INTERLOCK (V/INT)	OFF
MODE (M)	ENTRY		
AUTO REL (R)	ON	PROGRAM REVERT (PR)	As Required
AUTO DUP/SKIP (AD/S) (D/S 2)	As Required	DUP SKIP 1 (D/S 1)	As Required

19. Proceed with entry run.

*NOTE: A search does not have to start at the beginning of the tape. If a search is to be started from some place other than the beginning of the tape, set the function switches as stated in Step 2 above and proceed with Steps 7 through 19.*

# 1101 MOHAWK/735 NCR DATA RECORDER - MODEL A

## ERROR RECOVERY DURING ENTRY

During data entry, certain errors may be encountered. Most of these errors are signaled to the operator by the Error Tone and some are also indicated by the REL L/O, DUP L/O and TAPE CK lights. The entry mode errors and the recovery procedures are discussed in the following paragraphs.

### MULTIPLE KEY ERROR - ERROR TONE SOUNDS, READY LIGHT OFF

If, during data entry, more than one character key is depressed at one time, an error indication will result. The Error Tone sounds and the READY light turns "off." The memory counter will not advance and further key entry will be prevented.

To recover from this type of error, depress the ER key. The Error Tone turns off, the READY light turns on and the keyboard is operational. The correct character can now be key entered in the proper position.

### SENSED KEYING ERROR - ERROR TONE SOUNDS

If an alpha or special character is keyed in a position programmed for numerics, the Error Tone sounds. The memory counter will not advance from the position where the keying error was made. Depressing the ER key will make the Data Recorder operational again.

Alpha characters and alpha shift special characters can be entered in a numeric field by holding the LTR key depressed while the character is being key entered. Numeric shift special characters can be entered in a numeric or alpha field by holding the NUM key depressed while the character is being key entered.

All machine operations take a certain amount of time to complete. For example, the write and read-after-write check will take approximately 240 milliseconds. If data is keyed into memory before a machine operation such as read-after-write, dup or skip is complete, the error light will come on at the end of the operation. The position indicator will be stopped at the beginning of a field. To recover from an error of this type, depress the ER key to extinguish the error light. Re-key the data, starting at the position indicated by the position counter.

### OPERATOR SENSED KEYING ERROR - NO ERROR TONE

When the operator senses that a keying error has been made (without an error indication), the correction can be made in the following way. Hold the ER key depressed and depress the MBS key once for every position to be back-spaced. The memory counter will be reduced by one for each depression of the MBS key. When the correct position has been reached, release the ER key and key the correct characters into the correct positions. Key entering the correct character will erase the previously entered incorrect character.

# 1101 MOHAWK/735 NCR DATA RECORDER - MODEL A

## ERROR RECOVERY DURING ENTRY (CONT.)

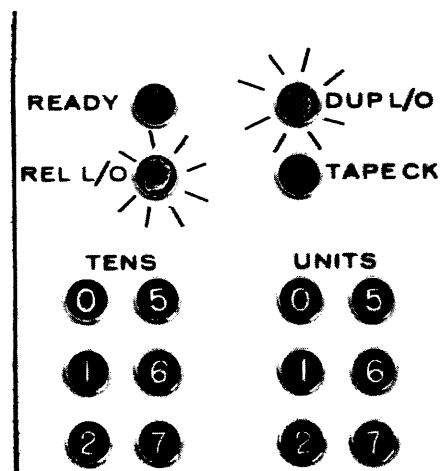

## READ-AFTER-WRITE ERROR - ERROR TONE SOUNDS, REL L/O & DUP L/O LIGHT

Following the writing of a data block on tape, an automatic read-after-write check is performed. This check consists of reading the data block just written, checking it for correct parity and comparing the data characters read, against the data characters retained in data memory. If a discrepancy is encountered during the read-after-write check, the Error Tone sounds and the REL L/O and DUP L/O indicators light. This error condition could be caused by a blank character in memory or a bad spot on tape. It is, therefore, necessary to rewrite the data block on tape. This is accomplished by following the procedure below:

1. Depress the ER/TBS keys. The Error Tone and REL L/O indicator are extinguished and the tape is backed up one block length.
2. Depress the ER/TEF keys to erase the error block and advance the bad tape past the read/write head.
3. Depress the REL key to rewrite the data block in a new location on tape. *If the error condition persists after the read-after-write check, proceed to step 4. If the Error Tone does not sound, the bad tape area has been by-passed. Proceed with Entry run.*
4. Depress the ER key to extinguish the Error Tone and reactivate the keyboard.
5. Depress the ER/TBS keys. The tape is backed up one block length and the REL L/O light is extinguished.
6. Re-key the entire data block making sure that no invalid characters are keyed into memory. When the last position is addressed, the rekeyed data block will be released to tape replacing the error block. The read-after-write check will take place again.

*NOTE: If, after rewriting the block, the automatic check again detects an error, the bad spot on tape has not been entirely passed and steps 1 through 3 should be repeated.*

# 1101 MOHAWK/735 NCR DATA RECORDER - MODEL A

## ERROR RECOVERY DURING VERIFICATION

During verification, the Data Recorder will detect keying errors made during entry and any parity errors that may exist on tape.

### AUTOMATIC VERIFICATION

Data fields that were auto duplicated during entry can be auto verified as the data block is being key verified. The constant data fields need only to be programmed with a program code 4 in the MSP of the field. The automatic verification works on the same principle as the Dup-Verify feature, except that the duplicate action is automatically initiated when program code 4 is encountered. If a non-compare between the dup-field data from one data block to the next is sensed, an 8 bit will be set and memory advance will stop at the position where the non-compare occurred.

## CORRECTING A CHARACTER ENTERED INCORRECTLY - USING ER/COR KEYS

During verification, a keyed character not identical to the character stored in memory, for the position being checked, will cause an error condition. The Error Tone sounds.

Depressing the ER key activates the keyboard and turns off the Error Tone for another keying attempt. If the error indication persists after two or more attempts, making sure that the proper character is being keyed, it must be assumed that the character in storage is in error and is to be corrected.

To replace the incorrect character in memory with the correct character and write the correct data block on tape, proceed as follows:

1. Depress the ER key to turn "off" the Error Tone.
2. Depress the ER/COR keys. The erase head and read/write head are turned on in preparation for erasing the error block and writing the corrected block, the Data Recorder will be conditioned for entry of one character into data memory, and automatic and manual release will be inhibited.
3. Key enter the correct character. The memory counter advances one position and the Data Recorder returns to verification mode.
4. Continue verification to the end of the data block. For each error encountered, depress the ER/COR keys and key the correct character.
5. Depress the ER/HOM keys simultaneously.
6. Depress the ER/TBS keys simultaneously. This draws the tape back the length of one record and also extinguishes the REL/LO light.
7. Depress the REL key to write the corrected record from the data memory onto tape. A read-after-write check is also performed.
8. Re-verify the entire record. Automatic release will occur.
9. Depress the REL key *a second time* to read the next record into data memory for verification and proceed with the verify run.

## 1101 MOHAWK/735 NCR DATA RECORDER - MODEL A

### CORRECTING A FIELD ENTERED INCORRECTLY - USING ER/FM KEYS

If an entire field has been entered incorrectly, proceed as follows:

1. Depress the ER/COR keys simultaneously.
2. Key enter the first correct character.
3. Depress the ER/FM keys simultaneously.
4. Key enter the rest of the correct characters of the field.
5. Continue verification of the entire data block.
6. After the last position of the data block has been verified, depress the ER/HOM keys simultaneously.
7. Depress the ER/TBS keys simultaneously.
8. Depress the REL key to write the corrected record.
9. Re-verify the entire record; automatic release will occur.
10. Proceed with the verify run. Depress the REL key to read in the next data block for verification.

### CORRECTING AN ENTIRE DATA BLOCK

If, *during verification*, it has been determined that an entire data block must be corrected, proceed as follows:

1. Change D/S 1 and D/S 2 switches to the "off" position.
2. Depress ER/HOM and ER/COR keys. The erase head and the read/write head are turned on in preparation for erasing the error block and writing the new data block.
3. Change mode switch to ENTRY.
4. Key enter the correct data.
5. Change the mode switch to VERIFY.
6. Depress ER/HOM, ER/TBS and REL keys.
7. Re-verify the data block. When all positions have been verified *without error correction*, automatic release occurs. If a correction using the COR key is made during re-verification, repeat steps 3 through 7.
8. After the read-after-write check is complete, depress the REL key to read in the next data block for verification.
9. Set D/S 1 and D/S 2 switches to "on" position. Proceed with verification.

# 1101 MOHAWK/735 NCR DATA RECORDER - MODEL A

## ERROR RECOVERY DURING SEARCH - ERROR TONE, REL L/O & DUP L/O LIGHT

A search operation should be completed without error indication. A parity error or blank tape encountered during search will cause an error condition.

A blank tape area could be the result of the entry operator erasing several blocks during entry because of a bad spot on tape. An improper identifier which would cause the search to go beyond the last data block on tape will also cause the search to stop with an error indication when blank tape is encountered. In each case, the Error Tone sounds and the REL L/O, DUP L/O and indicator lights turn on.

If blank tape in the middle of the run was the cause for the error condition, one to three tape backspace and release operations (hold REL key  $\frac{1}{2}$  second each time) should be sufficient to extinguish the error lights, move past the blank tape area and continue the search. If the error condition persists, the last data block read has a parity error or the search went beyond the last recorded data block.

To read the last data block into memory, set the function switches as follows:

SWITCH	POSITION	SWITCH	POSITION
MEMORY SELECTOR (MS)	DATA	VERIFY INTERLOCK (V/INT)	OFF
MODE (M)	VERIFY		
AUTO REL (R)	ON	PROGRAM REVERT (PR)	RECORD READ
AUTO DUP/SKIP (AD/S) (D/S 2)	OFF	DUP SKIP 1 (D/S 1)	OFF

Depress the ER/TBS and REL keys to read the data block into memory. An error indication with a display of "all-bits" indicates that blank tape has been read. One or two tape backspace and release operations should establish the fact if the last data block on tape has been bypassed or not and that the identifier used did not locate the desired record.

If the error indication is not accomplished by an "all-bits" display, the data block has a parity error. The disposition of the parity error block is at the discretion of the using installation. *The block can be rewritten or it can be deleted.* To resume a search from this point, the identifier must be rekeyed into memory and the function switches reset.

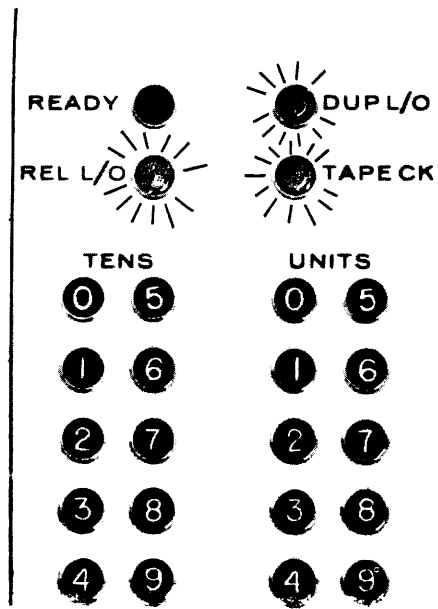

## PARITY ERROR - ERROR TONE, REL L/O, DUP L/O AND TAPE CK LIGHT

During the tape read operation, each character read from tape is checked for correct parity. At the same time, the entire block is checked for correct longitudinal parity. If an error is detected, the Error Tone sounds and the REL L/O, DUP L/O and TAPE CK indicators light.

If a parity error is detected when a data block is being read into memory for verification, depress the ER/TBS and REL keys to re-read the data block. If the error persists, it is necessary to manually verify the entire block to determine which characters are in error. To prevent the automatic advance across fields programmed for automatic skip, turn the DUP/SKIP 1 and DUP/SKIP 2 switches to "off," thereby permitting manual verification of those fields.

The ER key must be depressed to light the READY light and reactivate the keyboard before manual verification can begin. When an error character is found, it is corrected by replacing the character in memory and rewriting the data block. If all characters verify correctly, the parity error was caused by a discrepancy in the parity bit track and rewriting the block will correct the parity bits.

If, after correcting any errors and rewriting the block, an error persists during the read-after-write check, it must be assumed that the tape has been damaged and a bad spot exists. The error block should be deleted from the tape and the block rewritten at the end of the file.

While checking for the cause of the error indication, short data blocks or damaged data blocks may be found.



# 1101 MOHAWK/735 NCR DATA RECORDER - MODEL A

## DELETING A DATA BLOCK FROM TAPE

*If deleting a data block from tape is a requirement, the Customer Engineer must first perform a simple modification of the keyboard decoder board. This modification will cause simultaneous depression of the NUM and Z key to put a "no-bits" code in data memory.*

To delete a data block from the tape during verification, proceed as follows:

1. Read, the data block to be deleted, into memory.
2. Depress the ER/COR keys. The erase head and read/write head will be turned on in preparation for erasing the error block and writing the replacement data. Manual and automatic release will be inhibited.
3. Set the D/S 1 and D/S 2 switches to the "off" position.
4. Change the mode switch to ENTRY.
5. Depress the NUM and Z keys and hold to position 81. Data memory will contain all "no-bit" characters.
6. Change the mode switch to VERIFY.
7. Depress ER/HOM, ER/TBS and REL keys.
8. Re-verify the data block by holding the NUM and Z keys depressed. If no errors are encountered, an automatic write on tape and read-after-write check will take place. The Error Tone sounds and the REL L/O, DUP L/O and TAPE CK indicators light. During the read-after-write check, the blank data block was by-passed and the next data block was read in. A non-compare caused the error indication.
9. Depress the ER key.
10. Set the D/S 1 and D/S 2 switches to the "on" position.
11. Depress the ER/TBS keys to extinguish the REL L/O light.
12. If the next data block is to be read into memory, depress the REL key once.

# 1101 MOHAWK/735 NCR DATA RECORDER - FEATURE NO. 401

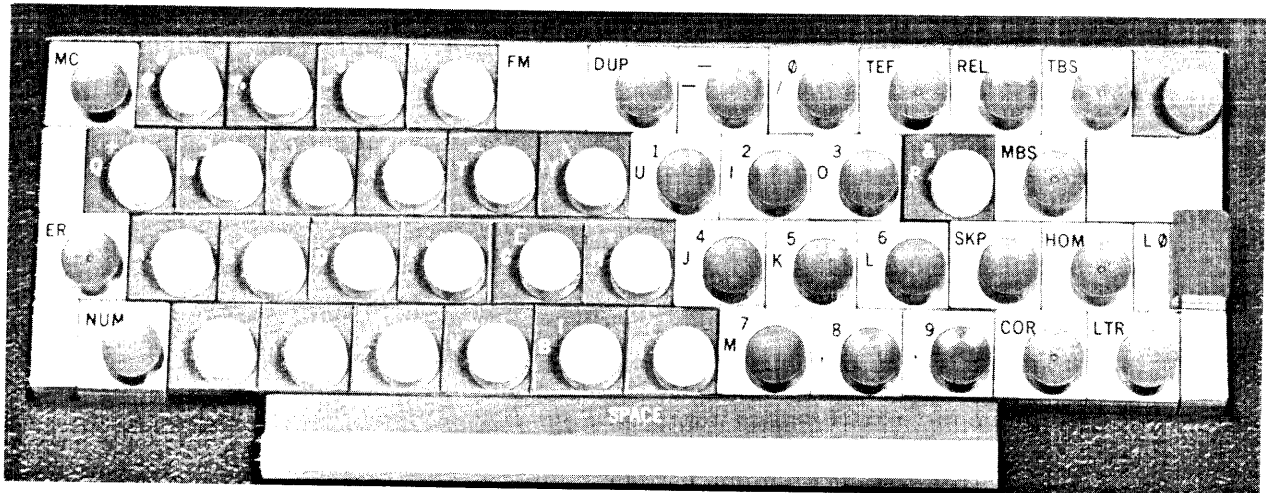

CHARACTER	B C D	CHARACTER	B C D	CHARACTER	B C D
A	A 1	V	B A 4 1	]	B A 8 4 2
B	A 2	W	B A 4 2	\	B A 8 4 2 1
C	A 2 1	X	B A 4 2 1	+	B 8 2 1
D	A 4	Y	B A 8	%	B 8 2 1
E	A 4 1	Z	B A 8 1	=	B 8 4 2 1
F	A 4 2	Ø	No Bits	\$	B 8 4 1
G	A 4 2 1	1	1	(	B 8 4 2 1
H	A 8	2	2	)	B 8 4 2 1
I	A 8 1	3	2 1	/	B 8 4 2 1
J	B 1	4	4	!	A 8 2 1
K	B 2	5	4 1	;	A 8 2 1
L	B 2 1	6	4 2	"	A 8 4 1
M	B 4	7	4 2 1	?	A 8 4 1
N	B 4 1	8	8	:	A 8 4 2 1
O	B 4 2	9	8 1	←	A 8 4 2 1
P	B 4 2 1	*	B A	↑	A 8 4 2 1
Q	B 8	#	B A 1	@	8 2 1
R	B 8 1	<	B A 8 2	,	8 2 1
S	B A 2	>	B A 8 2 1	Space	8 4 1
T	B A 2 1	'	B A 8 4	&	8 4 1
U	B A 4	[	B A 8 4 1	.	8 4 2 1
				-	8 4 2 1

64 Character NCR Compatible Keyboard and BCD Tape Code, Odd Parity.

1101 MOHAWK/735 NCR DATA RECORDER - FEATURE NO. 402

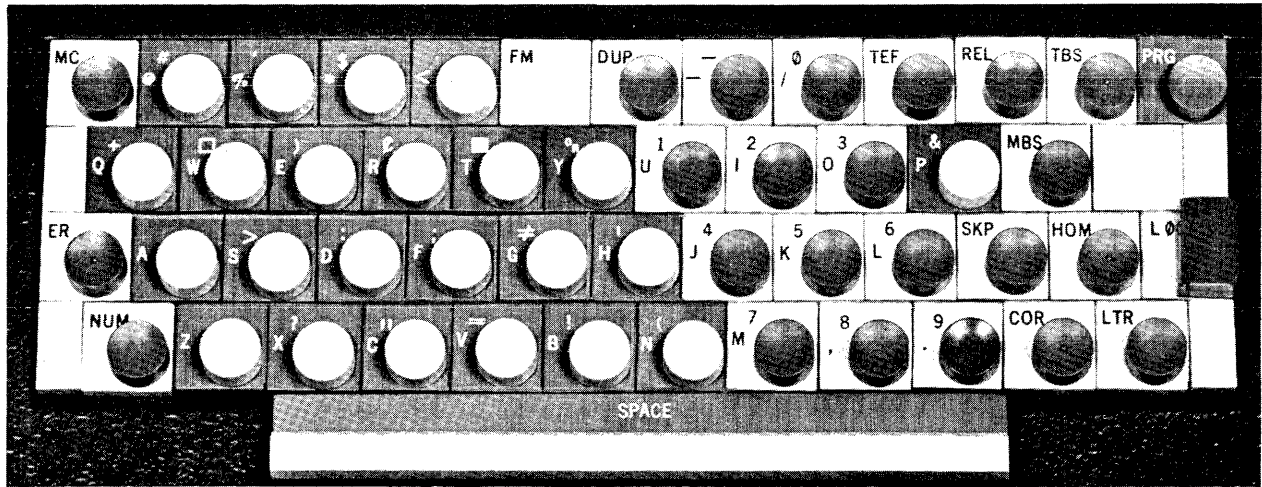

CHARACTER	B C D	CHARACTER	B C D	CHARACTER	B C D
A	A 1	V	B A 4 1	□	B A 8 4 2
B	A 2	W	B A 4 2	¢	B A 8 4 2 1
C	A 2 1	X	B A 4 2 1	-	B
D	A 4	Y	B A 8	#	B 8 2
E	A 4 1	Z	B A 8 1	\$	B 8 2 1
F	A 4 2	∅	No Bits	*	B 8 4
G	A 4 2 1	1	1	"	B 8 4 1
H	A 8	2	2	≠	B 8 4 2
I	A 8 1	3	2 1	!	B 8 4 2 1
J	B 1	4	4	+	A
K	B 2	5	4 1	;	A 8 2
L	B 2 1	6	4 2	.	A 8 2 1
M	B 4	7	4 2 1	)	A 8 4
N	B 4 1	8	8	%	A 8 4 1
O	B 4 2	9	8 1	■	A 8 4 2
P	B 4 2 1	<	B A	?	A 8 4 2 1
Q	B 8	/	B A 1	'	8 2
R	B 8 1	@	B A 8 2	=	8 2 1
S	B A 2	,	B A 8 2 1	:	8 4
T	B A 2 1	(	B A 8 4	Space	8 4 1
U	B A 4	C <sub>R</sub>	B A 8 4 1	>	8 4 2
				&	8 4 2 1

64 Character Honeywell Compatible Keyboard and BCD Tape Code, Odd Parity.

1101 MOHAWK/735 NCR DATA RECORDER - FEATURE NO. 403

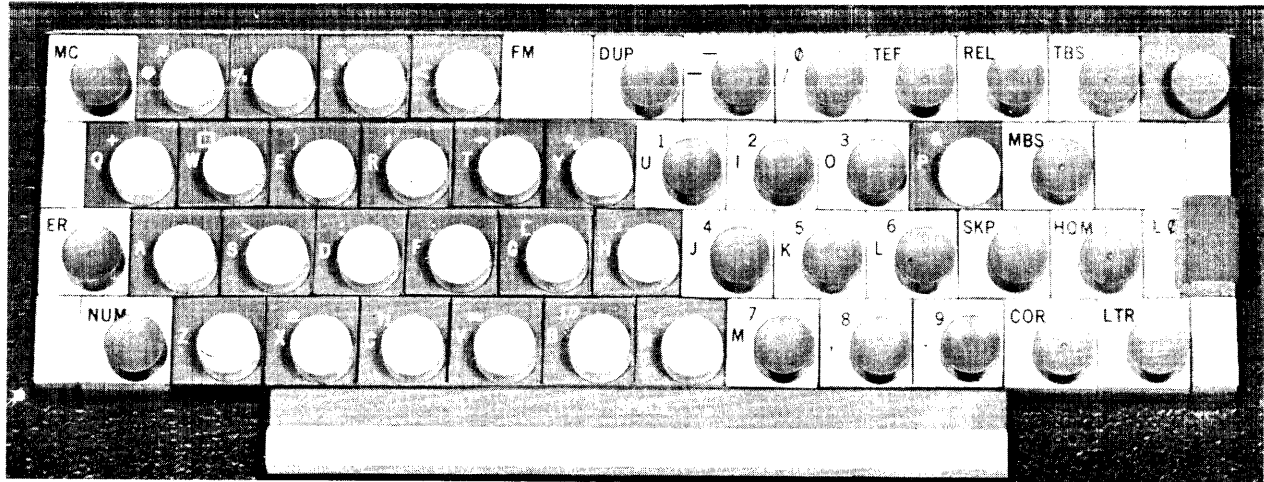

CHARACTER	B C D	CHARACTER	B C D	CHARACTER	B C D
A	A 1	V	B A 4 1	=	B A 8 4 2
B	A 2	W	B A 4 2	□	B A 8 4 2 1
C	A 2 1	X	B A 4 2 1	-	B 8 2
D	A 4	Y	B A 8	[	B 8 2 1
E	A 4 1	Z	B A 8 1	\$	B 8 2 1
F	A 4 2	∅	No Bits	*	B 8 4
G	A 4 2 1	1		>	B 8 4 1
H	A 8	2		<	B 8 4 2
I	A 8 1	3		10	B 8 4 2 1
J	B 1	4		&	A 8 4 2 1
K	B 2	5		+	A 8 2
L	B 2 1	6		.	A 8 2 1
M	B 4	7		;	A 8 4
N	B 4 1	8		:	A 8 4 1
O	B 4 2	9		'	A 8 4 2
P	B 4 2 1	"		C <sub>R</sub>	A 8 4 2 1
Q	B 8	/	B A 1	Space	8 2
R	B 8 1	÷	B A 8 2 1	#	8 2 1
S	B A 2	,	B A 8 2 1	@	8 4
T	B A 2 1	%	B A 8 4	(	8 4 1
U	B A 4	†	B A 8 4 1	)	8 4 2
				e	8 4 2 1

64 Character RCA Compatible Keyboard and BCD Tape Code, Odd Parity.

1101 MOHAWK/735 NCR DATA RECORDER - FEATURE NO. 404

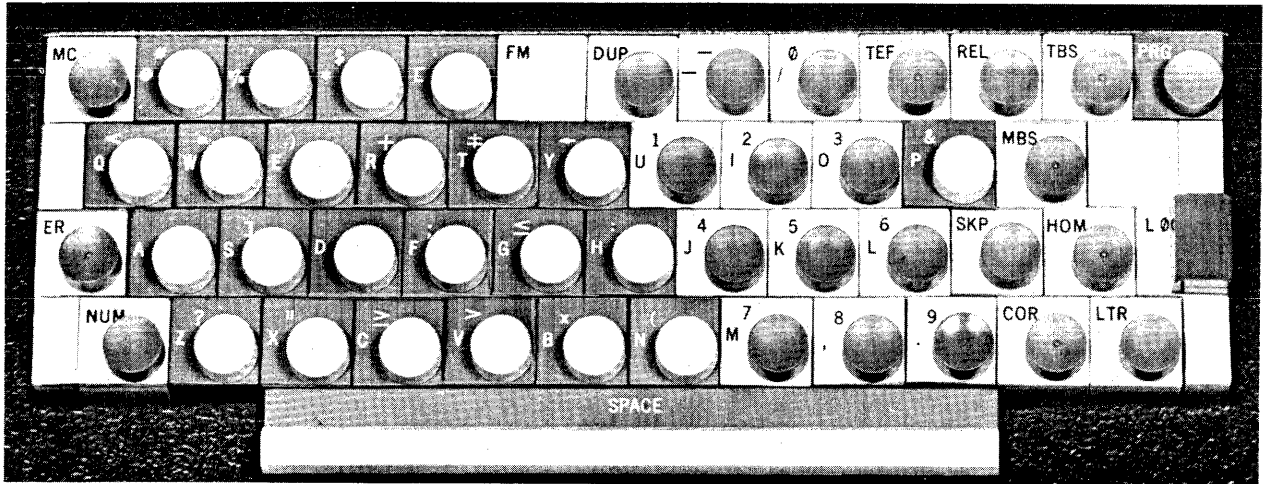

CHARACTER	B C L	CHARACTER	B C L	CHARACTER	B C L
A	B A 1	V	A 4 1	←	B A 8 4 2 1
B	B A 2	W	A 4 2	-	B
C	B A 2 1	X	A 4 2 1	x	B 8 2
D	B A 4	Y	A 8	\$	B 8 2 1
E	B A 4 1	Z	A 8 1	*	B 8 4
F	B A 4 2	1	1	)	B 8 4 1
G	B A 4 2 1	2	2	;	B 8 4 2
H	B A 8	3	2 1	≤	B 8 4 2 1
I	B A 8 1	4	4	Space	A
J	B 1	5	4 1	/	A 1
K	B 2	6	4 2	≠	A 8 2
L	B 2 1	7	4 2 1	,	A 8 2 1
M	B 4	8	8	%	A 8 4
N	B 4 1	9	8 1	=	A 8 4 1
O	B 4 2	Ø	8 2	]	A 8 4 2
P	B 4 2 1	&	B A	"	A 8 4 2 1
Q	B 8	+	B A 8 2	#	8 2 1
R	B 8 1	.	B A 8 2 1	@	8 4
S	A 2	[	B A 8 4	:	8 4 1
T	A 2 1	(	B A 8 4 1	>	8 4 2
U	A 4	<	B A 8 4 2	≥	8 4 2 1
				?	No Bits

64 Character Burroughs Compatible Keyboard and BCD Tape Code, Even Parity.

1101 MOHAWK/735 NCR DATA RECORDER - FEATURE NO. 405

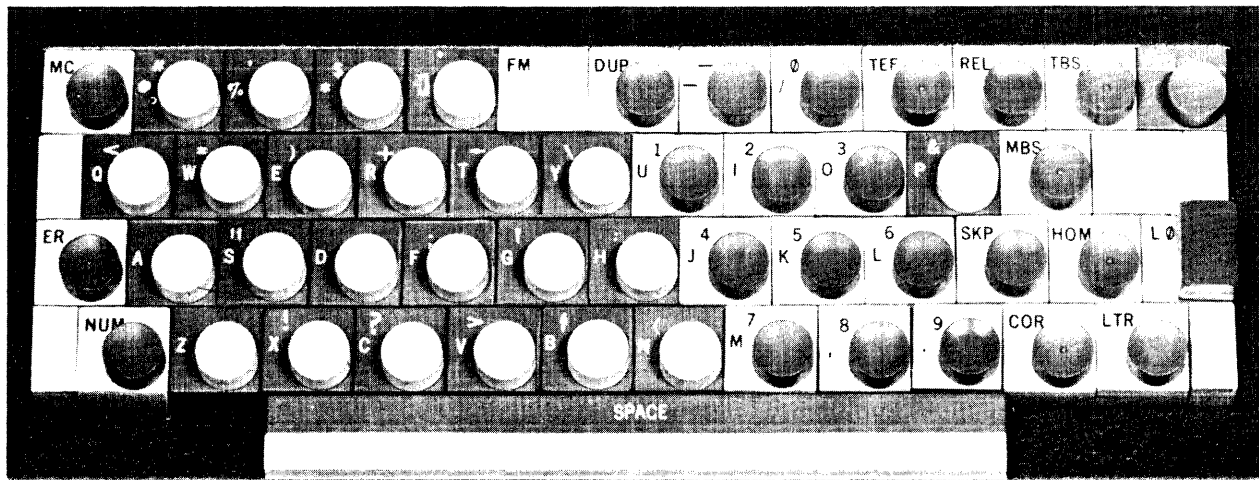

CHARACTER	B C D	CHARACTER	B C D	CHARACTER	B C D
A	B A 1	V	A 4 1	\	B A 8 4 2 1
B	B A 2	W	A 4 2	-	B
C	B A 2 1	X	A 4 2 1	†	B 8 2
D	B A 4	Y	A 8	\$	B 8 2 1
E	B A 4 1	Z	A 8 1	*	B 8 4
F	B A 4 2	1		)	B 8 4 1
G	B A 4 2 1	2		;	B 8 4 2
H	B A 8	3		‘	B 8 4 2 1
I	B A 8 1	4	4	Space	A
J	B 1	5	4 1	/	A 1
K	B 2	6	4 2	←	A 8 2
L	B 2 1	7	4 2 1	,	A 8 2 1
M	B 4	8	8	%	A 8 4
N	B 4 1	9	8 1	=	A 8 4 1
O	B 4 2	0	8 2	"	A 8 4 2
P	B 4 2 1	&	B A	!	A 8 4 2 1
Q	B 8	+	B A 8 2	#	8 2 1
R	B 8 1	.	B A 8 2 1	@	8 4
S	A 2	]	B A 8 4	:	8 4 1
T	A 2 1	(	B A 8 4 1	>	8 4 2
U	A 4	<	B A 8 4 2	?	8 4 2 1
				Invalid	No Bits

64 Character GE Compatible Keyboard and BCD Tape Code, Even Parity.

1101 MOHAWK/735 NCR DATA RECORDER - FEATURE NO. 407

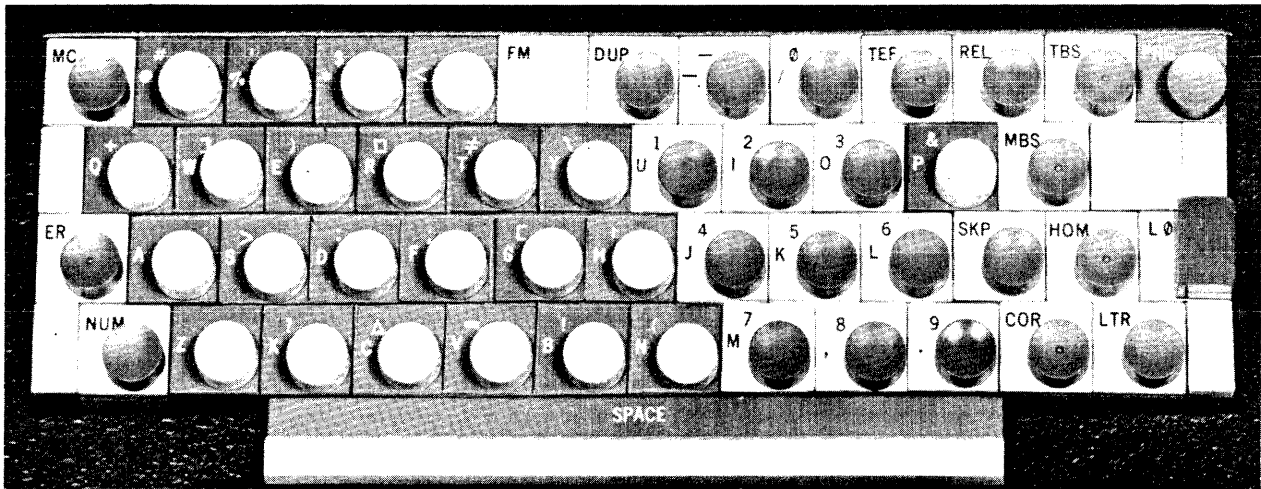

CHARACTER	B C D	CHARACTER	B C D	CHARACTER	B C D
A	A 4	V	B A 8	>	B A 8 4 2
B	A 4 1	W	B A 8 1	□	B A 8 4 2 1
C	A 4 2	X	B A 8 2	@	B
D	A 4 2 1	Y	B A 8 2 1	*	B 1
E	A 8	Z	B A 8 4	\$	B 2
F	A 8 1	Ø	2 1	!	B 2 1
G	A 8 2	1	4	%	B 8 4 1
H	A 8 2 1	2	4 1	'	B 8 4 2
I	A 8 4	3	4 2	△	B 8 4 2 1
J	B 4	4	4 2 1	+	A
K	B 4 1	5	8	:	A 1
L	B 4 2	6	8 1	.	A 2
M	B 4 2 1	7	8 2	?	A 2 1
N	B 8	8	8 2 1	=	A 8 4 1
O	B 8 1	9	8 4	<	A 8 4 2
P	B 8 2	#	B A	#	A 8 4 2 1
Q	B 8 2 1	(	B A 1	]	1
R	B 8 4	,	B A 2	-	2
S	B A 4 1	&	B A 2 1	\	8 4 1
T	B A 4 2	/	B A 4	;	8 4 2
U	B A 4 2 1	)	B A 8 4 1	[	8 4 2 1
				Space	No Bits

64 Character Univac 1050 Compatible Keyboard and BCD Tape Code, Odd Parity.







1101 MOHAWK/735 NCR DATA RECORDER - MODEL C

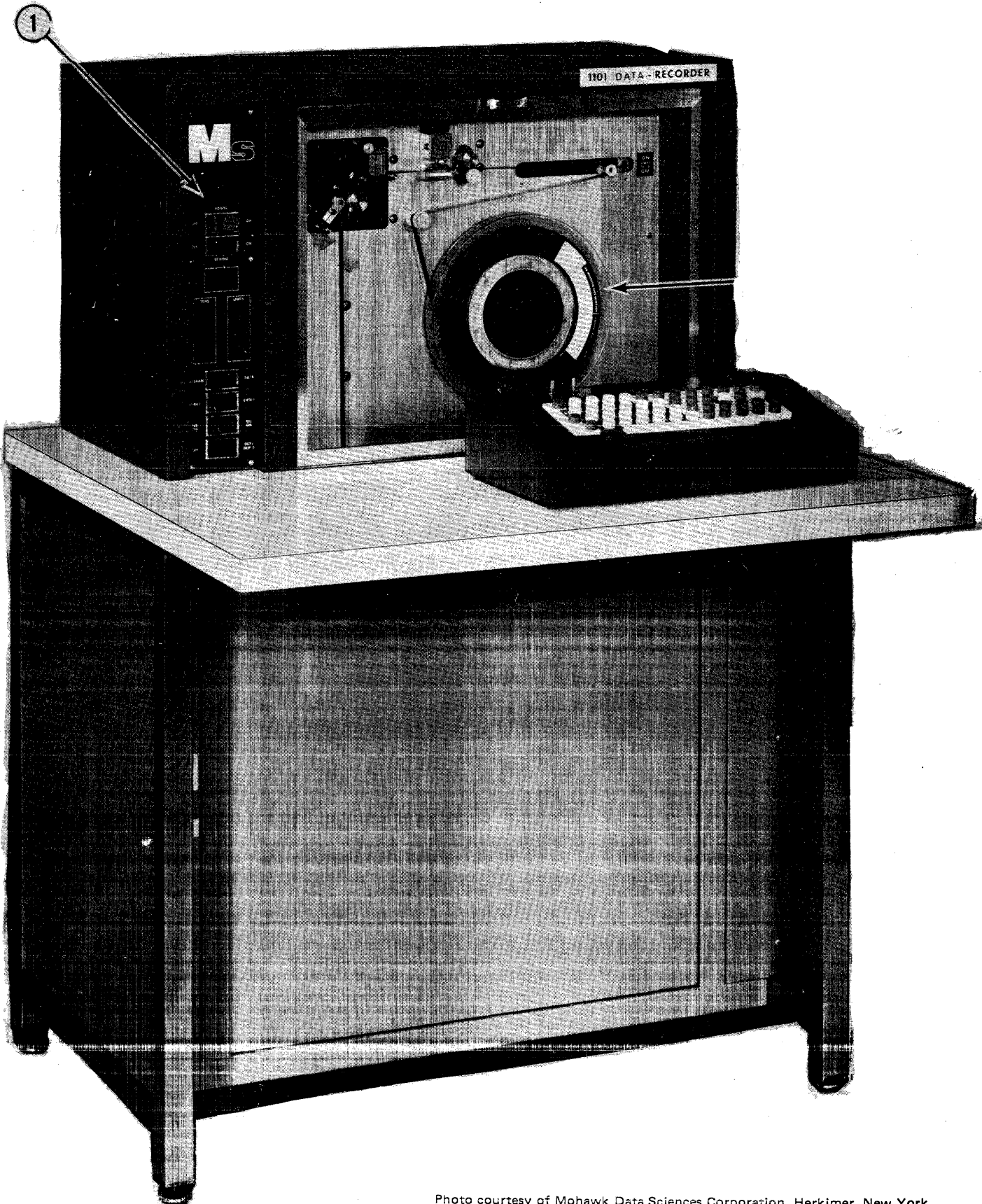

Photo courtesy of Mohawk Data Sciences Corporation, Herkimer, New York.

# 1101 MOHAWK/735 NCR DATA RECORDER - MODEL C

## DESCRIPTION

### CONTROL PANEL<sup>1</sup>

The control panel is made up of switches that control operational modes of the Data Recorder. Status and memory position indicator lights are also on this panel.

### TAPE DECK<sup>2</sup>

The Tape Transport and the Verify Interlock switch are on the Tape Deck. Two arrows on the back panel of the Tape Deck assist the operator when she is positioning the tape for different operational modes. The bottom arrow is used to position the BOT reflective marker during the entry mode. The top arrow is used to position the BOT reflective marker for verify and search modes.

### KEYBOARD<sup>3</sup>

The standard keyboard consists of 34 character keys, 14 special function keys, a space bar, and two special function switches. The 47 character keyboard is standard. A 64 character option is available. Program and data memory display indicators are also on the keyboard. The memory display indicators are used for reading the BCD code.

CHARACTER	B C D	CHARACTER	B C D	CHARACTER	B C D
A	B A 1	V	A 4 1		B A 8 4 2 1
B	B A 2	W	A 4 2	-	B 8 2
C	B A 2 1	X	A 4 2 1	!	B 8 2 1
D	B A 4	Y	A 8	\$	B 8 4
E	B A 4 1	Z	A 8 1	*	B 8 4 1
F	B A 4 2	1	1	)	B 8 4 2
G	B A 4 2 1	2	2	;	B 8 4 2 1
H	B A 8	3	2 1	⌋	A
I	B A 8 1	4	4	Space	A 1
J	B 1	5	4 1	/	A 8 2
K	B 2	6	4 2	≠	A 8 2 1
L	B 2 1	7	4 2 1	,	A 8 4
M	B 4	8	8	%	A 8 4 1
N	B 4 1	9	8 1	-	A 8 4 2
O	B 4 2	∅	8 2	>	A 8 4 2 1
P	B 4 2 1	&	B A 8 2	?	A 8 4 2 1
Q	B 8	¢	B A 8 2 1	#	8 2 1
R	B 8 1	.	B A 8 4	@	8 4
S	A 2	<	B A 8 4 1	'	8 4 1
T	A 2 1	(	B A 8 4 1	=	8 4 2
U	A 4	+	B A 8 4 2	"	8 4 2 1
				Invalid	No Bits

## MAGNETIC CORE MEMORY

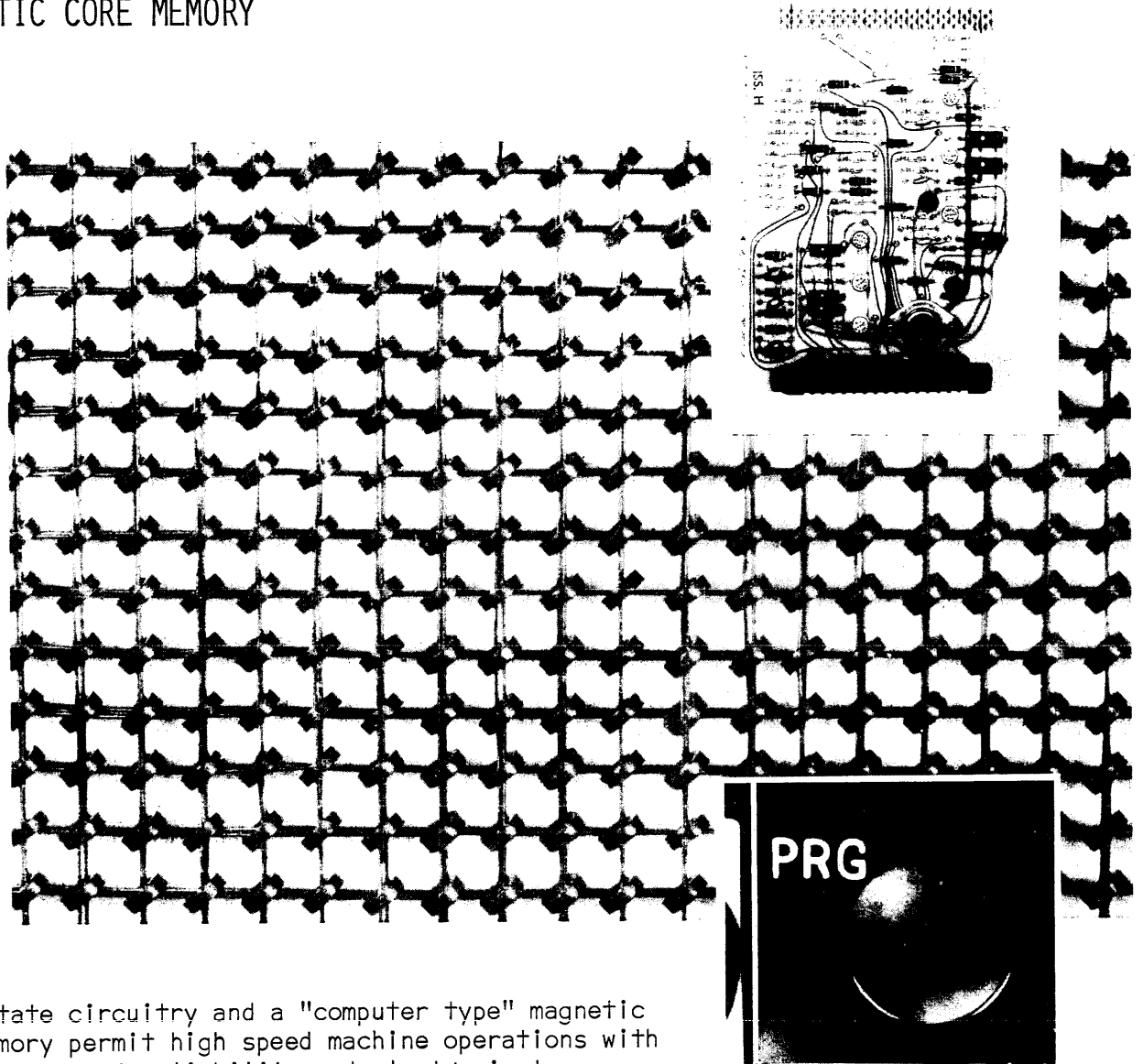

Solid-state circuitry and a "computer type" magnetic core memory permit high speed machine operations with a high degree of reliability and electronic tape encoding control. The magnetic core memory stores a regular and alternate program format. It also stores key entered data. The data patterns in data memory will change with each different data block because data is stored in memory before it is released to tape and operator need only to backspace to memory and key enter a new character if an error was made during a data entry run.

Each position of core memory has a section for program memory and a section for data memory. Six magnetic cores in each position of data memory enables the equipment to accept any 6 bit alpha-numeric code structure. Four core positions are assigned the decimal equivalents 8, 4, 2 and 1; above them are the A and B zone positions. There are four combinations for the zone bits, 00, 01, 10 and 11. With the 6 bit data memory section, the Data Recorder can recognize 64 total characters; alphabetic, numeric and symbols. There is also a parity check bit.

There are two sections of program memory, the main program memory and the alternate program memory. Both main and alternate program have their own core positions for the 4, 2 and 1 bits and they share the 8 bit position. The program key controls program selection. Codes in program memory remain unaltered during entry of records.

**MEMORY CORE POSITION**

This stylized illustration of magnetic cores in one memory position shows the name of each core to the left and the core condition for an 1101 "zero" on the right.

A magnetic core is defined as being either in an "on" or "off" condition. To designate the condition of a core, it is accepted practice to show a core in the "on" condition with the "1" and a core in the "off" condition with a "0." Thus, an era of six cores that store an 1101 "Zero" are conditioned **off, off, on, off, on, off**, and this is written 001010.

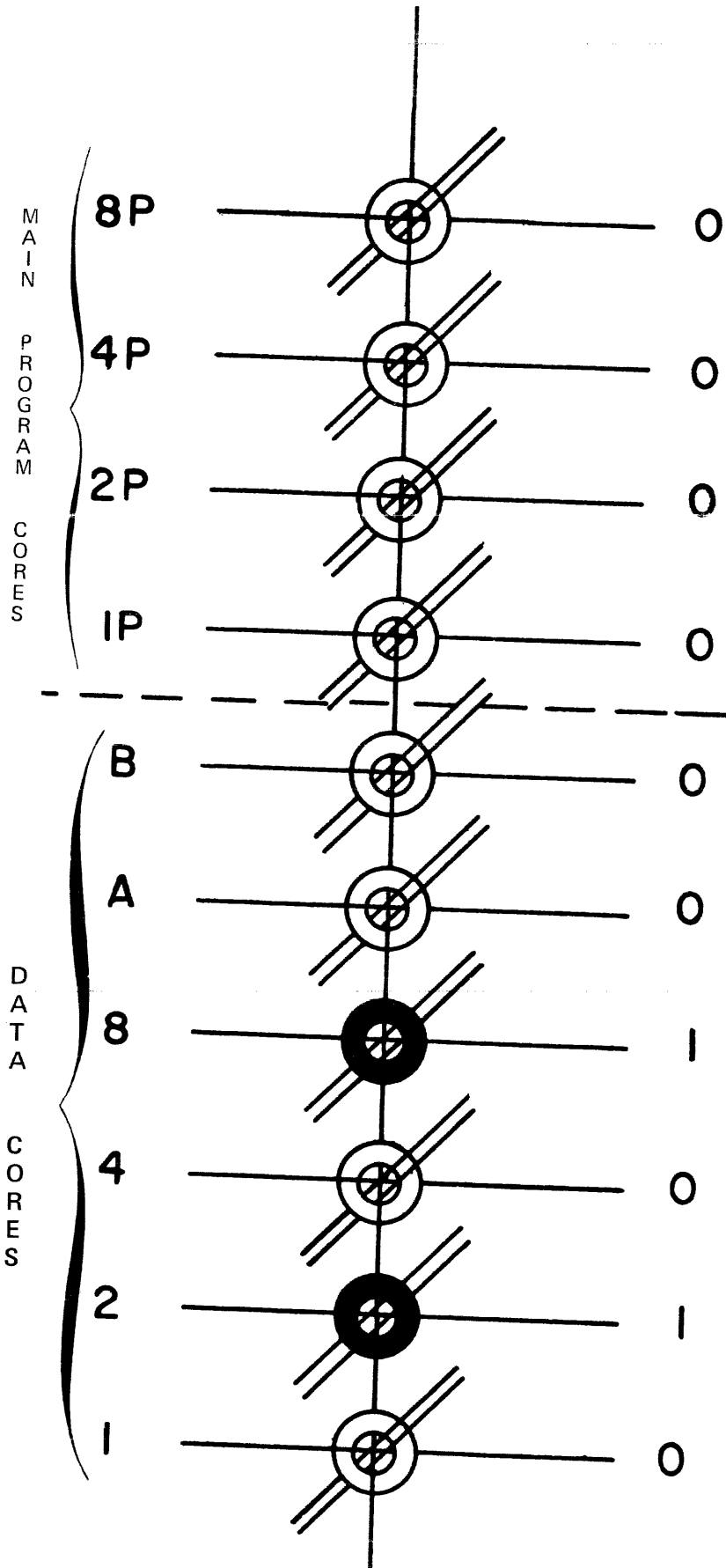

# 1101 MOHAWK/735 NCR DATA RECORDER - MODEL C

## MAGNETIC CORE MEMORY (CONT.)

Think of the magnetic core memory as the *heart* of the Data Recorder. It is the storage, or holding place, for the data being recorded or verified. The data patterns in data memory will change with each different data block because data is stored in memory before it is released to tape.

The program codes in program memory remain unchanged during entry of a given set of records. They are the program instructions that direct basic machine functions.

A magnetic core is defined in either an "on" or an "off" condition. The condition of a core in an "on" condition is designated with a "1" and a core in the "off" condition with an "0."

The combination of the program bits in any particular memory position is the program code that will control the machine functions for that position. These program codes are effective in both the entry and verify modes.

Notice in the illustration below that regular and alternate programs have their own core positions for the 4, 2 and 1 bits. Notice also that the 8 bit position is *shared* by both regular and alternate program.

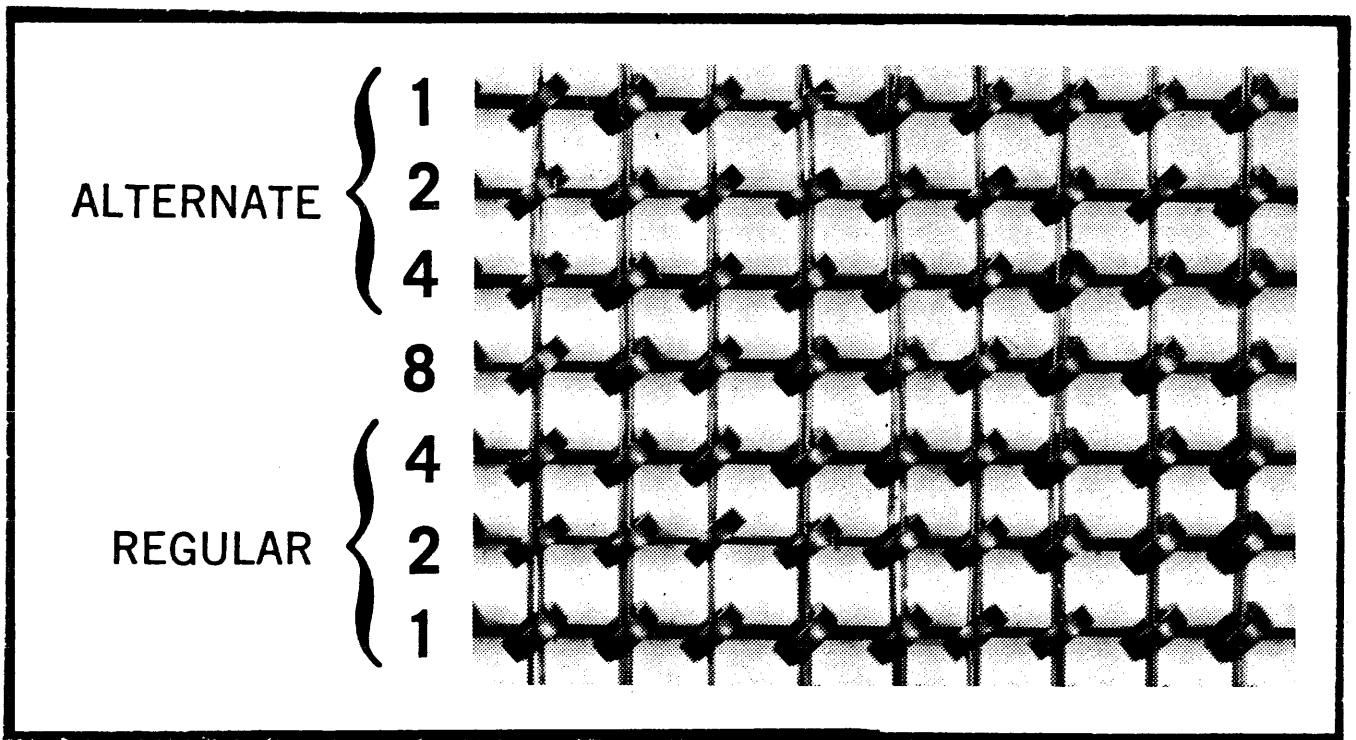

### PROGRAM KEY

The Program key is in the upper righthand corner of the keyboard and is labeled PRG. It works in conjunction with a small light in the display at the left of the keyboard. The lens over the light has an "ALT" etched on it. If the light is "on," this means that the Data Recorder is ready to accept data in the Alternate program format. A depression of this Program key will extinguish the light and condition the equipment to accept data in the Regular program format.

# 1101 MOHAWK/735 NCR DATA RECORDER - MODEL C

## PROGRAM PLANNING CARD

The program planning card can be used to direct keyboard entries of programs into program memory or for preparation of a program tape.

SOCIAL SECURITY NO.									EMPLOYEE NAME																		DEPT			EMPLOYEE NUMBER			DATE HIRED			RATE			RATE CHANGE DATE			DEDUCTIONS						MISC.																																										
1	2	3	4	5	6	7	8	9	10	11	12	13	14	15	16	17	18	19	20	21	22	23	24	25	26	27	28	29	30	31	32	33	34	35	36	37	38	39	40	41	42	43	44	45	46	47	48	49	50	51	52	53	54	55	56	57	58	59	60	61	62	63	64	65	66	67	68	69	70	71	72	73	74	75	76	77	78	79	80	81	82	83	84	85	86	87	88	89	90	91
2									3																		4			2			2			2		2		2		2		5																																														

<b>PROGRAM CODES</b> SPACE - Numeric Shift 1 - Letters Shift 2 - Numeric Shift - Stop, Skip & Dup	3 - Letters Shift - Stop, Skip & Dup 4 - Start Dup 5 - Start Skip	<b>BASE</b> <input checked="" type="checkbox"/> Entry <input type="checkbox"/> Verify <input type="checkbox"/> Entry & Verify	<b>ALT</b> <input type="checkbox"/> Entry <input type="checkbox"/> Verify <input type="checkbox"/> Entry & Verify	<b>MDS DATA-RECORDER</b> <b>PROGRAM PLANNING CARD</b>
--	---	--	--	--

APPLICATION PAYROLL MASTER AND DEDUCTION	PROGRAM TAPE NO. 1	PROGRAMMED BY J.J. JONES	DATE 8-20-66
---	-----------------------	-----------------------------	-----------------

Above is a reproduction of the program planning card. At the bottom of the card is the identifying information which includes the application, the program tape number, the name of the programmer, and the date.

Data field assignments are made from the specification sheets for the particular application. The names of these fields are entered in the data portion of the card. The first field, columns 1 through 9, is for the Social Security Number. It is programmed with a 2 in the most significant position for numeric entry. Spaces in the other positions of the field signify numeric shift. The second field, columns 10 through 27, is for the Employee Name. The most significant position of the field is programmed with a 3 for a alpha field. The other positions in the field are programmed with 1's for a letters shift. Program codes 2 and 3 stop skip, dup or left zero fill operations.

The third field, columns 28 through 30, is for the Department. The code 4 is in the most significant position of the field to start automatic duplication. Only position 28 is required to perform duplicate operation but the code 4 is also in position 30 to prevent backspacing into the field and inadvertently changing the constant data. Attempting to backspace into the dup field would produce a backward skip which would terminate at position 10. The contents of memory would not be disturbed. Note that column 29 of the department field is programmed with a space for numeric shift. Position 69 contains a 5; this is the start skip code. The rest of this field is programmed with spaces. This will cause skipping through position 80. An automatic release action at this time will write the data record on tape and advance the memory counter to home position, position 01. If position 01 contains a start skip or dup code, and the appropriate DUP/SKIP switch is "on," the counter advances to the first position containing a stop skip or dup code.

If the records for a particular run take up less than half the available memory positions, it may be advantageous to have more than one record occupy one data block. In this case, divide the program card and put identical programs in each section.

# 1101 MOHAWK/735 NCR DATA RECORDER - MODEL C

## PROGRAM CODES

To operate under program control, the first position of each field should be indicated by the program code that defines the MSP of that type of field. Program codes 2 through 7, 12 and 13, indicate the MSP of a field. Program codes 12 and 13 are composite codes made up of bits 8 and 4, and bits 8 and 5 respectively. The MC key must be used when keying program codes 12 and 13.

### "SP" (0000)

Program code SP (*Space*) identifies the memory position that is to contain a numeric data character. To enter an alpha or alpha shift character in a position programmed with 0000, the letter shift (LTR) key *must* be held depressed while entry is being made. To enter a numeric shift special character, the numeric shift (NUM) key *must* be held depressed while the entry is being made.

This code will not stop skipping, duplication, or left zero action and, therefore, should not be used in the first position of a field (MSP).

### "1" (0001)

Program Code 1 identifies a memory position that is to contain an *alpha* character. To enter a numeric or a numeric shift special character in a position programmed with a 0001, the numeric shift (NUM) key *must* be held depressed while entry is being made.

This code will not stop skipping, duplication, or left zero action and, therefore, should not be used in the first position of a field (MSP).

### "2" (0010)

Program Code 2 is used to stop skip, dup and left zero action and is commonly used to identify the first position of a *numeric* field.

### "3" (0011)

Program Code 3 is used to stop skip, dup and left zero action and is commonly used to identify the first position of an *alpha* field.

### "4" (0100)

Program Code 4 is used to start an *automatic duplicate* operation. This code is commonly used to identify the first position of a field that is to contain *semi-constant* information; information that is usually repeated for more than one data block but that periodically changes during the run. Program Code 4 is effective for automatic duplication *only* when the DUP/SKIP 1 switch is "on." An automatic Dup 1 operation ends only when a program code 2, 3, 5, 12 or 13 is encountered. With DUP/SKIP 1 switch "off," a code 4 in memory stops a manual Dup or Skip or an automatic Dup 2 or Skip 2 operation. Program Code 4 also *stops left zero fill* and conditions the 1101 for numeric entry. The Program code 4 is also used during verification to start a duplicate verify action for *constant* data fields that are to be *machine verified*.

PROGRAM CODES (CONT.)"5" (0101)

Program Code 5 is used to start an *automatic skip* action. Positions that are going to be skipped frequently in successive records, *but not for the entire run*, are programmed with Program Code 5. Program Code 5 is effective for automatic skip *only* when DUP/SKIP 1 switch is "on." An automatic Skip 1 operation ends only when a program code 2, 3, 4, 12 and 13 is encountered. With DUP/SKIP 1 switch "off," a code 5 in memory stops manual Dup or Skip or an automatic Dup 2 or Skip 2 operation. The Program Code 5 also stops *left zero fill* and conditions the 1101 for numeric entry.

Program code 5 is used during verification to start a skip action. Positions skipped during verification are *not verified*.

"6" (0110) AND "7" (0111)

Program codes 6 and 7 can be used interchangeably to identify the most significant position of a left zero field. If a code 6 or 7 is encountered during entry, a left zero control will be set. In order to advance from a left zero field defined by a code 6 or 7, the LØ key must be depressed. Operation of SKP, DUP or REL keys before using the LØ key will cause the Data Recorder to signal an error. Other ways to reset the left zero control are to depress the ER/HOM keys simultaneously or memory backspace past the MSP of the left zero field.

During verify, a code 6 or 7 encountered will cause the left zeros of that field to be machine verified. Machine verification will stop at the *first non-zero* position of the field. Program codes 6 and 7 will stop skip and dup operations.

"12" (1100)

Program Code 12 is used to start an *automatic duplicate* operation. This code is commonly used to identify the first position of a field that will contain *constant* information; information that remains *unchanged* during the run. Program Code 12 is effective for automatic duplication *only* if DUP/SKIP 2 switch is "on." An automatic Dup 2 operation ends only when a program code 2 through 5 or 13 is encountered. With DUP/SKIP 2 switch "off," a code 12 stops a manual Dup or Skip or an automatic Dup 1 or Skip 1 operation. Program code 12 also stops left zero fill and conditions the 1101 for numeric entry.

Program code 12 is *not used* during verification. Constant data fields that are to be machine verified are programmed with Code 4.

"13" (1101)

Program code 13 is used to start an *automatic skip* action for a field that is to be skipped *throughout* the entire run. Program code 13 is effective for automatic skipping *only* if DUP/SKIP 2 switch is "on." An automatic Skip 2 operation ends only when a program code 2 through 5 or 12 is encountered. With DUP/SKIP 2 switch "off," a code 13 stops manual Dup or Skip or automatic Dup 1 or Skip 1 operations. Program code 13 also stops *left zero fill* and conditions the 1101 for numeric entry.

Program code 13 *is not* used during verification. Fields to be skipped during verification are programmed with Code 5.



# 1101 MOHAWK/735 NCR DATA RECORDER - MODEL C

## PROGRAM CODES

CODE NUMBER	CODE BITS				FUNCTION
	8P	4P	2P	1P	
SP	0	0	0	0	NUMERIC SHIFT
1	0	0	0	1	LETTERS SHIFT
2	0	0	1	0	NUMERIC SHIFT - STOP SKIP AND DUP
3	0	0	1	1	LETTERS SHIFT - STOP SKIP AND DUP
4	0	1	0	0	START AUTOMATIC DUPLICATION
5	0	1	0	1	START AUTOMATIC SKIP
6	0	1	1	0	START LEFT ZERO
7	1	1	0	0	START LEFT ZERO
12	1	1	0	0	START AUTOMATIC DUPLICATION
13	1	1	0	1	START AUTOMATIC SKIP

*The program can be placed in memory either by key entry or from a previously prepared program tape. A program tape is a short length of magnetic tape on which the program codes for that particular application have been recorded.*

## MAKING A PROGRAM TAPE

To make a program tape, use a piece of magnetic tape approximately two feet in length - Fold one end of the tape back approximately 3/4 of an inch with the shiny non-oxide side on the outside of the fold. Seal the fold with a one inch gummed label.

The small loop formed at the end of the tape is used for positioning the tape on the Data Recorder. The loop may also be used to hold the program tape on a special program tape holding rack.

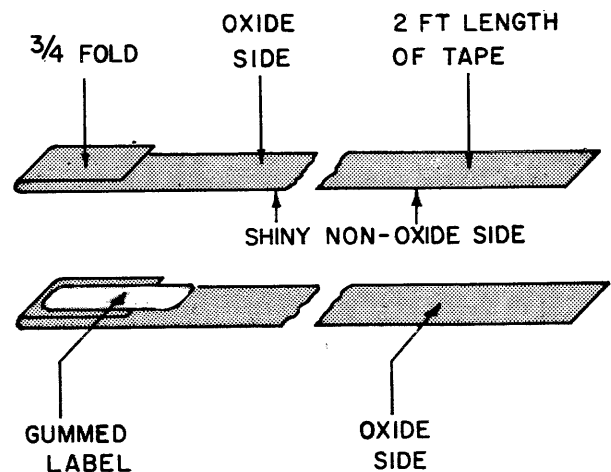

## PROGRAM TAPE

A program tape is a length of magnetic tape on which *permanent* programs can be stored. Program tapes can be used when more than one 1101 is to be programmed with identical programs or when a program is subject to occasional recall. The program tape gummed label must carry the *same* program tape number entered on the program card.

Additional data blocks may be stored on a program tape, if desired. For example, a block containing constant information, or data for a label block could be written on the program tape following the program block. The constant block can be read into memory following the program loading by merely changing the memory selection switch, to the DATA position and depressing the release key a *second time*.

More than one program may also be stored on a single program tape. The proper program is then selected by utilizing the Search function.

## MAGNETIC TAPE

The 1101 uses a standard one half inch wide computer magnetic tape. The Data Recorder tape handler will accommodate any IBM compatible tape reel, up to 10.5 inches in diameter. Recording is done in odd or even parity at a density of 200 bpi with fixed length blocks of 80 data characters.

Magnetic tapes are extremely durable under normal handling but misuse could cause the tape to be scratched or stretched. Usual care should be exercised whenever handling the tape.

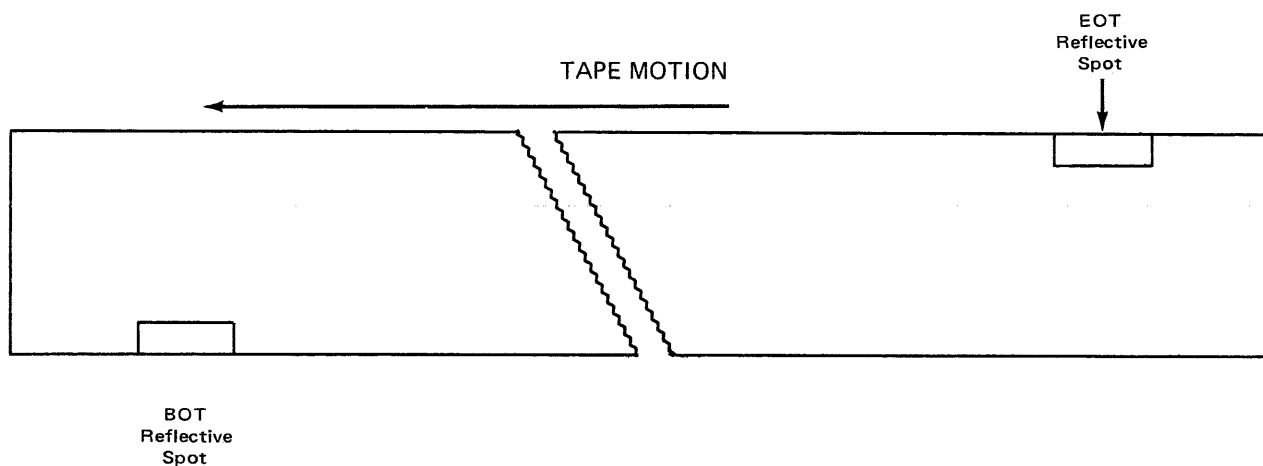

For an entry run, the beginning of tape reflective marker is positioned at the lower arrow on the tape deck. In the verify and search mode, the beginning of tape reflective marker is positioned at the upper arrow.

Tape should be stored under controlled environmental conditions. It is desirable to maintain the temperature between 40°F and 90°F and the relative humidity between 20% and 80%. Further, large or rapid changes in environment should be avoided.

# 1101 MOHAWK/735 NCR DATA RECORDER - MODEL C

## MODES OF OPERATION

The 1101 Data Recorder can be conditioned to operate in one of three modes: Entry, Verify or Search. As a general rule, it is not necessary to change from one mode to the other in the middle of a run.

### PROGRAM AND DATA DISPLAY

During entry and verification, the operator can make certain visual observations that will aid in proper transcription of information. The program codes of the program being used are displayed on the left side of the keyboard in the righthand row of indicator lights. The code displayed will be the code in the memory position being keyed. The memory position being keyed is indicated by the position indicator lights on the control panel.

During verification, the character being verified is shown on the left side of the keyboard in the left-hand row of lights. During entry, this row of lights displays the code that was last keyed in that position.

## ENTRY MODE

During a simple entry run, the following series of events take place:

1. Data is key entered into data memory through the keyboard.
2. With REL switch *on*, an automatic release action will occur at memory position 81. (*A release action could be initiated from any position by manually depressing the keyboard REL key or by having the last field in the data block programmed for a skip or dup.*) Regardless of when the release occurs, 80 characters are always written on tape.

NOTE: During the tape write cycle, the erase head is turned *on* to erase the area of tape to be written on.

3. During the release action, the keyed data is read from memory (but not erased), vertical and longitudinal parity are calculated, and the data with parity is written on tape as the tape moves forward under the read/write head.
4. The tape movement stops momentarily; the tape moves backward one block length and then forward again.
5. During the second forward motion, the data block just written is *read* from tape and *compared* bit for bit and for parity accuracy with the data that is now in memory.
6. The error light will flash and error indicators will light if any difference is found.

# 1101 MOHAWK/735 NCR DATA RECORDER - MODEL C

## ENTRY MODE (CONT.)

With each release action, a full 80-character block is always written on the tape regardless of the number of data characters keyed. Unused positions are recorded on tape as space codes. Each block is automatically separated by a three-quarter inch inter-record gap. The time required to write, read and compare the entire 80 character block is 240 milliseconds. If records to be written are short, more than one record may be entered in one 80-character data block.

## VERIFY MODE

During a verify run, the following machine operations take place:

1. Upon depression of the REL key, the tape moves forward under the read/write head and the first data block is read into data memory.

*NOTE: In verify mode, the erase head is not turned on, therefore, recorded data blocks are not damaged.*

2. The verify operator transcribes data from the source media. As each character is keyed, it is *compared* with the information in data memory. Any difference is signaled to the operator by the status indicators.
3. When the last character of the data block is keyed, an automatic release occurs which moves the tape forward to read in the next data block.

*NOTE: Unlike the entry mode, there is no back and forth movement of tape during verify mode.*

The correcting of one or more errors during verification conditions the 1101 *not* to allow release action until the incorrect tape block is changed.

## SEARCH MODE

This mode is used to locate *one* record out of a group of records.

1. With the tape positioned at the beginning of the run, an identifier, unique only to the record being searched for, is keyed into memory.
2. Depression of the REL key allows consecutive data blocks to be *read* from tape and *compared* with the identifier in memory. When a match is found, tape reading will stop with the read/write head positioned at the inter-record gap *just past* the "found" record. Consecutive data blocks will be read during a search operation at the rate of approximately 400 per minute. There is no tape erasure during a search.

# 1101 MOHAWK/735 NCR DATA RECORDER - MODEL C

## TAPE MOVEMENT

A complete working knowledge of the 1101 Data Recorder must include an understanding of tape movement during the different modes of operation. Error recovery procedures are greatly simplified if the operator understands what each action of the Data Recorder does in respect to the data block in question. The following paragraphs will explain tape movement during entry, verification, and correction during verification.

## TAPE MOVEMENT DURING ENTRY

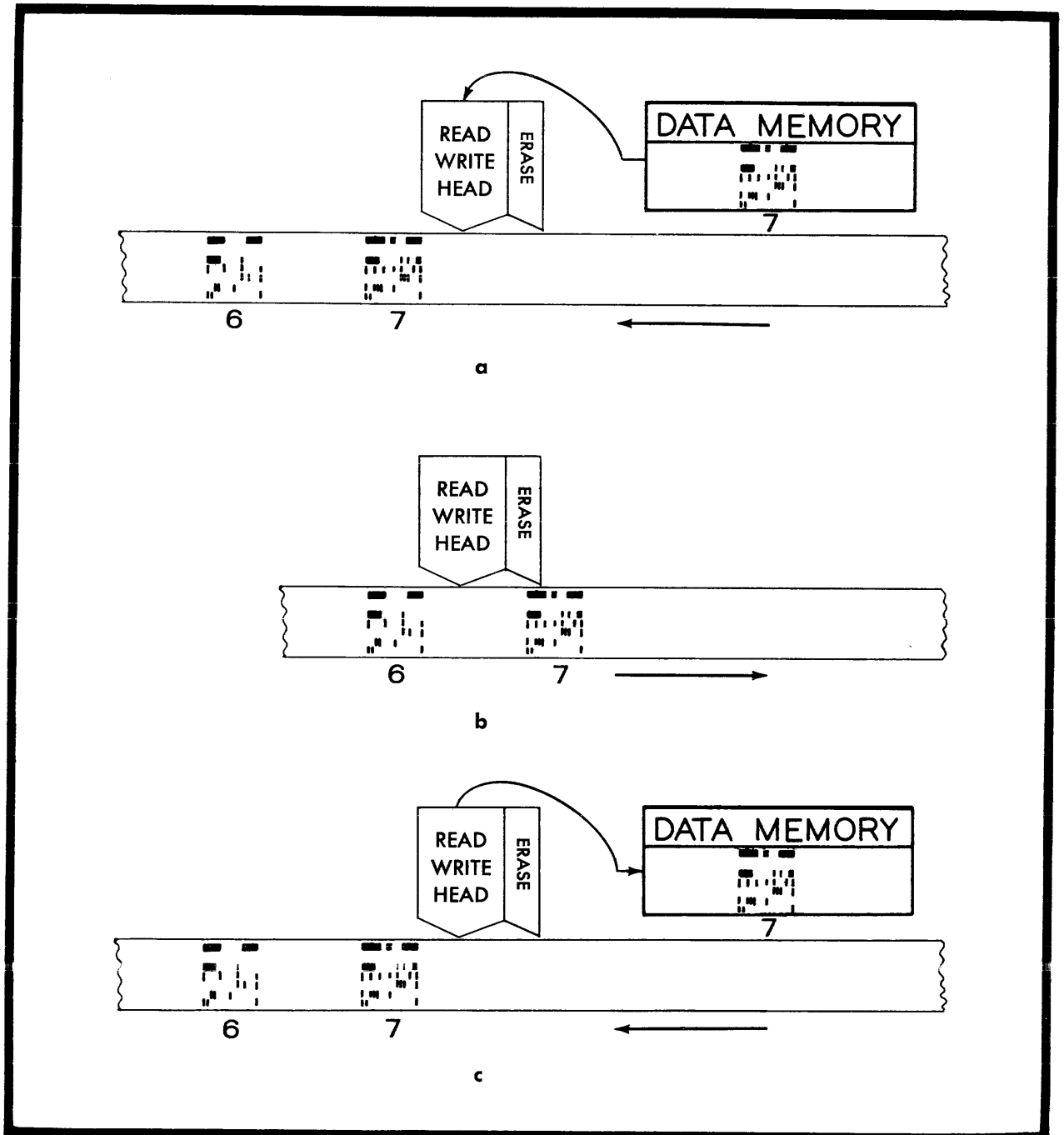

Diagram courtesy of Mohawk Data Sciences Corporation, Herkimer, New York.

# 1101 MOHAWK/735 NCR DATA RECORDER - MODEL C

## TAPE MOVEMENT DURING ENTRY (CONT.)

At the end of each data block being key entered into data memory, a release action occurs. During the release action, the following tape movements take place:

**FIGURE A** - The data block (7) in data memory is written on tape as the tape moves forward under the read/write head. The data block is now on tape as well as in data memory. When the entire data block is on tape, the movement stops for an instant and the position of the tape and data block in relation to the read/write head is shown in Figure A below.

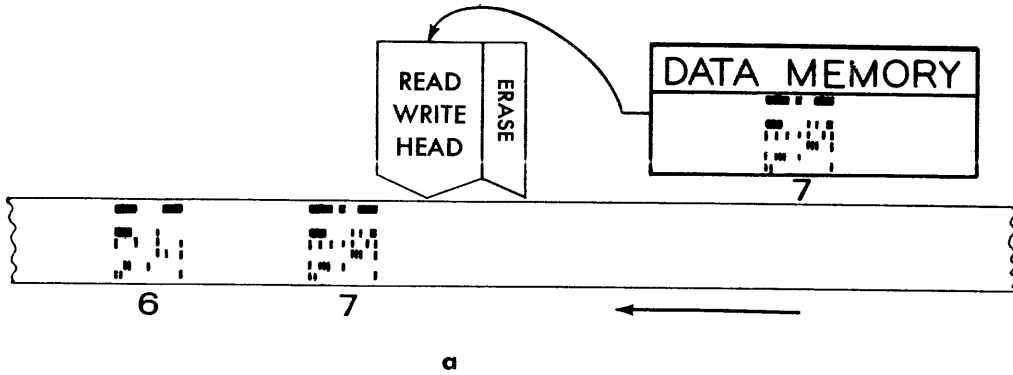

**FIGURE B** - The tape next moves the data block backwards and stops momentarily in the position shown in Figure B below.

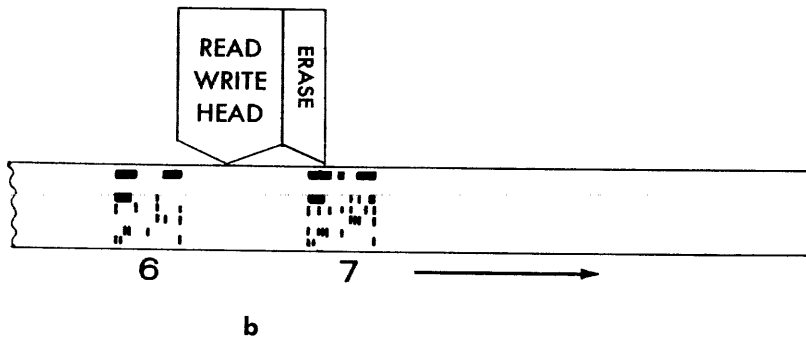

**FIGURE C** - Then, the tape moves forward again reading and comparing to see if the information recorded on tape is the same as in data memory. Vertical and longitudinal parity are also checked. The tape stops in the position shown in Figure C and is ready for the next data block to be recorded.

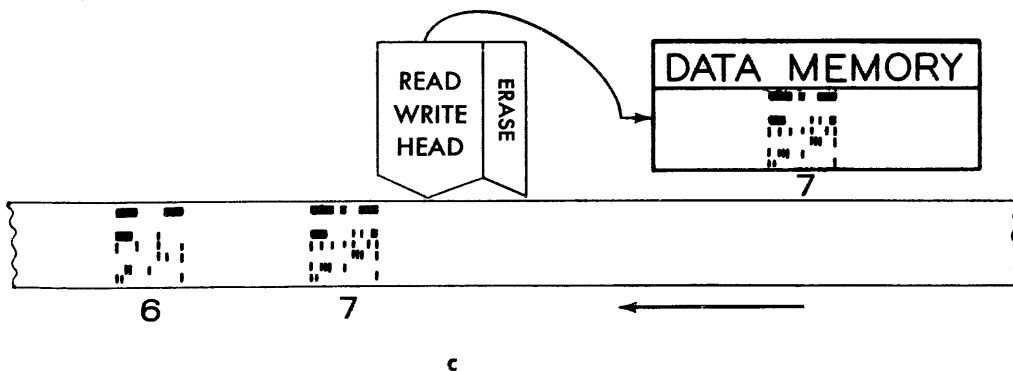

# 1101 MOHAWK/735 NCR DATA RECORDER - MODEL C

## TAPE MOVEMENT DURING VERIFICATION

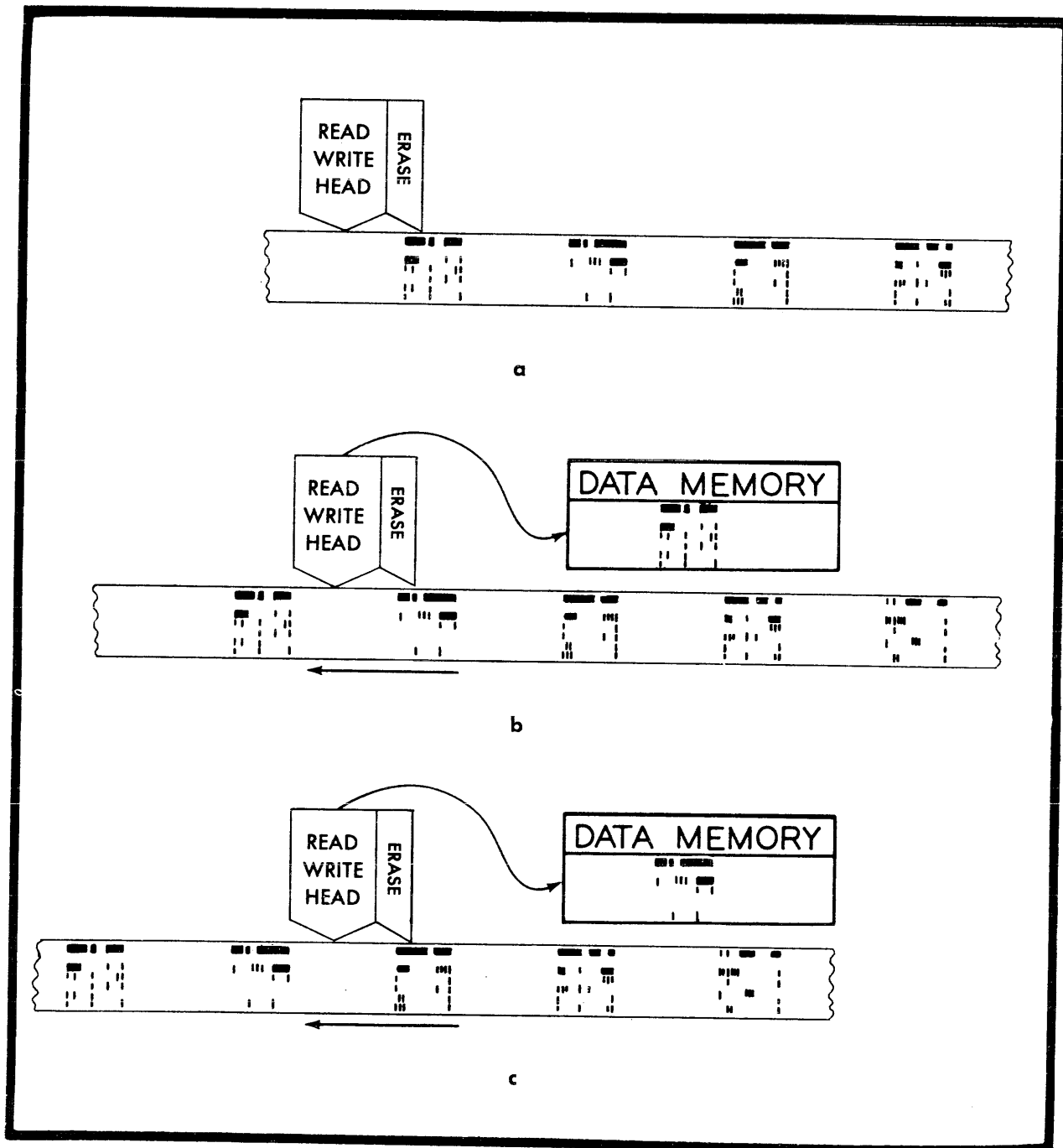
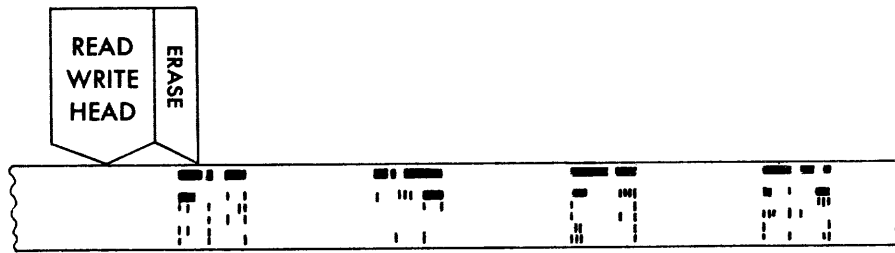

Diagram courtesy of Mohawk Data Sciences Corporation, Herkimer, New York.

TAPE MOVEMENT DURING VERIFICATION (CONT.)

**FIGURE A** - At the beginning of a verify run, the data block on tape and the position of the tape in relation to the read/write head are shown in Figure A below.



a

**FIGURE B** - When verification begins, a depression of the REL key moves the tape past the read/write head and the first data block is read into data memory and checked for correct parity (Figure B below).

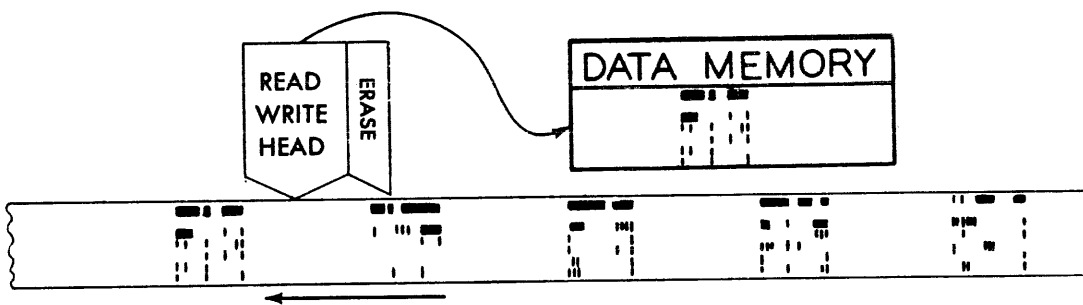

b

**FIGURE C** - With each depression of a key by the verify operator, a comparison is made between the keyed character and the character in that position in data memory. After a complete verification of a data block, a release action occurs and the next data block passes under the read/write head and read into memory. The position of the data blocks in relation to the read/write head are shown in Figure C below.

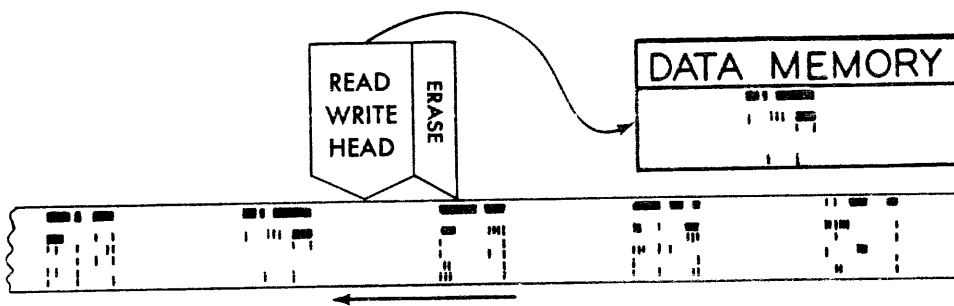

c



# 1101 MOHAWK/735 NCR DATA RECORDER - MODEL 1

## TAPE MOVEMENT DURING CORRECTION

When an error is found during verification, it must be corrected in data memory first; then, the tape must be corrected. The tape movement during a correction in verification is shown below. Assume that data block 4 has an incorrect character. The character recorded is a 9 and should be a 7.

## TAPE MOVEMENT DURING A CORRECTION IN VERIFICATION (DIAGRAM 1)

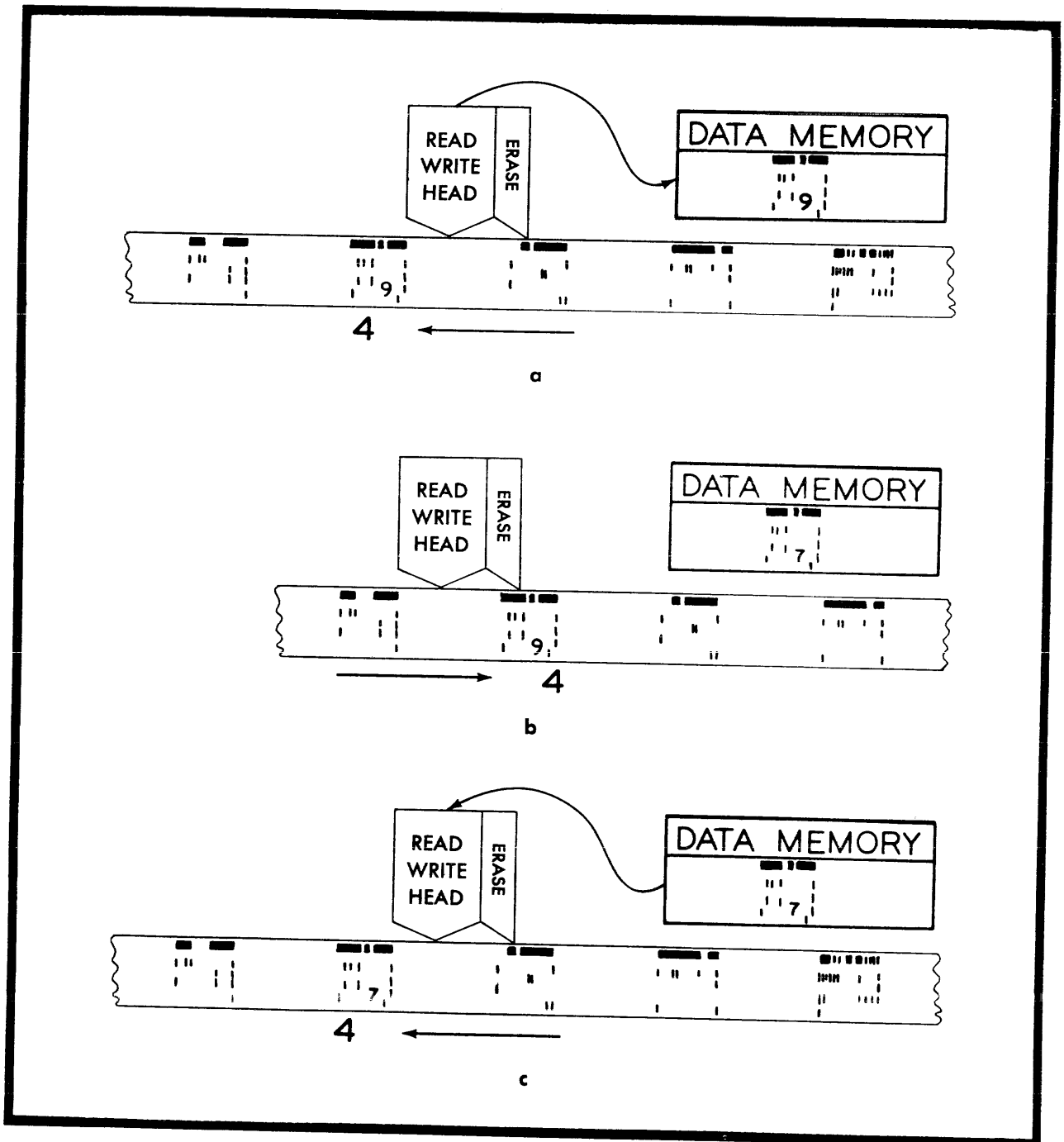
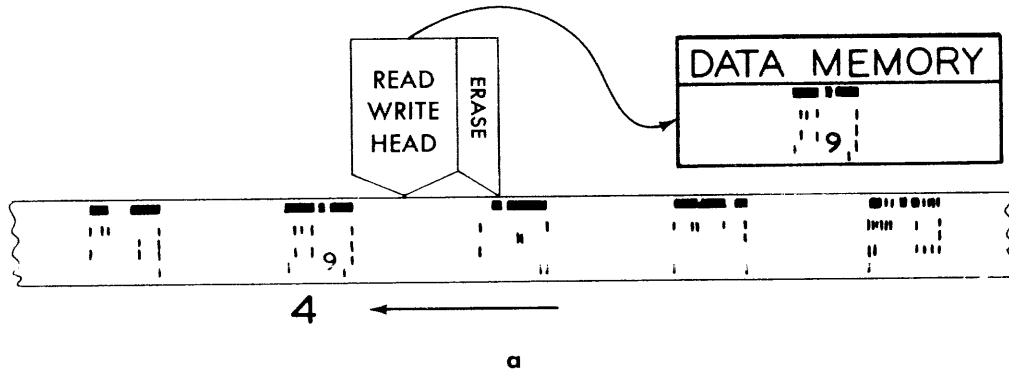

Diagram courtesy of Mohawk Data Sciences Corporation, Herkimer, New York.

# 1101 MOHAWK/735 NCR DATA RECORDER - MODEL C

## TAPE MOVEMENT DURING CORRECTION (CONT.)

**FIGURE A** - The release action reads the data block into data memory. The position of data block on tape, and the information in data memory, is shown in Figure A below. When the error is found, the operator corrects the error in data memory by depressing the ER/COR keys and then keying the correct character. She then will continue verification of the entire data block.



**FIGURE B** - After verification is complete, the operator depressed the ER/TBS keys to back the tape up one block length. The position of the tape and the corrected memory are shown in Figure B below.

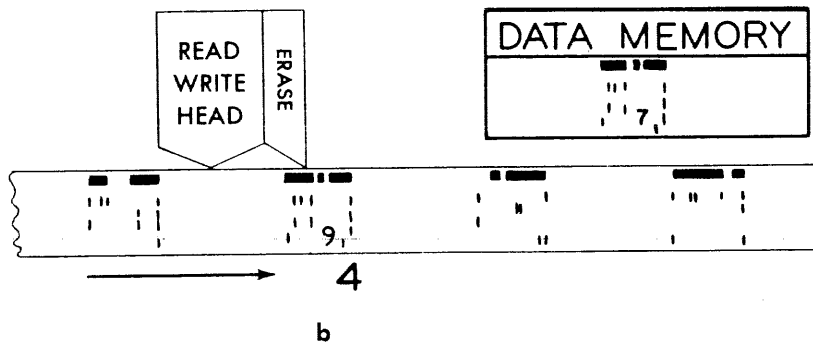

**FIGURE C** - To erase the error block and write the corrected block, the operator must depress the REL key. The tape is positioned as shown in Figure C below.

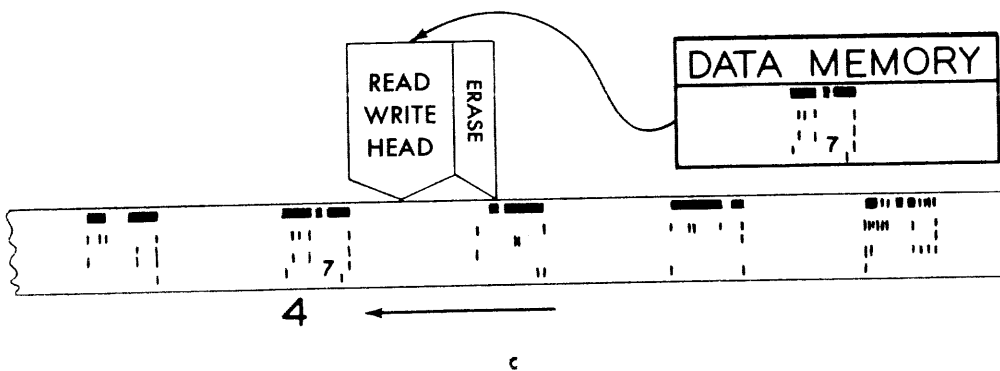

1101 MOHAWK/735 NCR DATA RECORDER - MODEL C

TAPE MOVEMENT DURING CORRECTION (CONT.)

TAPE MOVEMENT DURING A CORRECTION IN VERIFICATION (DIAGRAM 2)

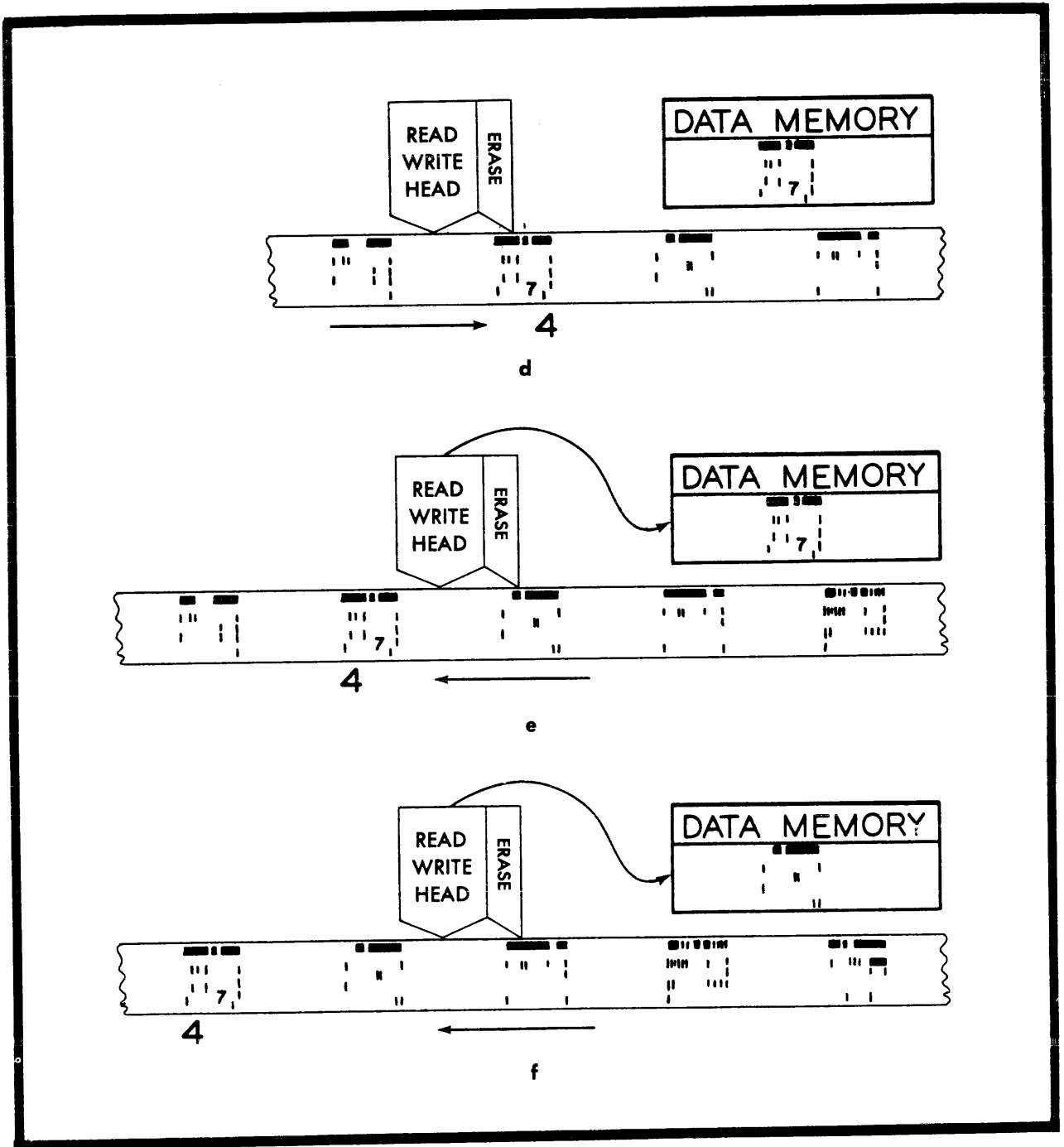
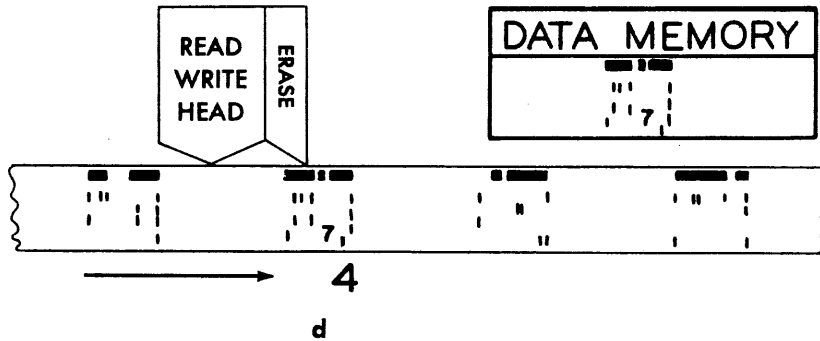

Diagram courtesy of Mohawk Data Sciences Corporation, Herkimer, New York.

TAPE MOVEMENT DURING CORRECTION (CONT.)

**FIGURE D** - The read-after-write check backs the tape up and stops it momentarily in the position shown in Figure D below.



**FIGURE E** - A forward motion, as shown in Figure E below, then causes the data on tape to be read and compared with the data in memory. The tape stops in the position that is shown below.

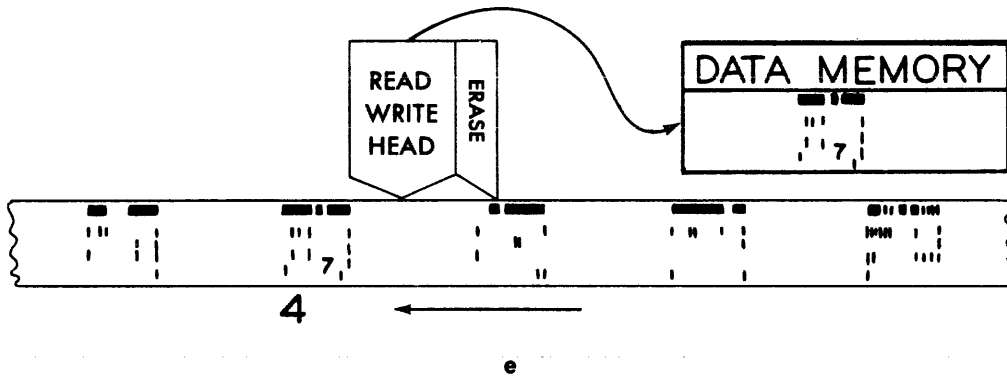

**FIGURE F** - A depression of the REL key now reads in the next data block for verification and positions the tape as shown in Figure F below.

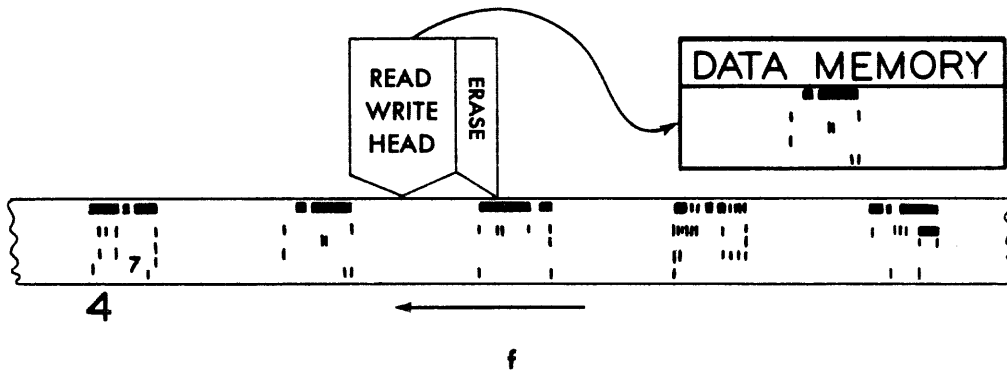

# 1101 MOHAWK/735 NCR DATA RECORDER - MODEL C

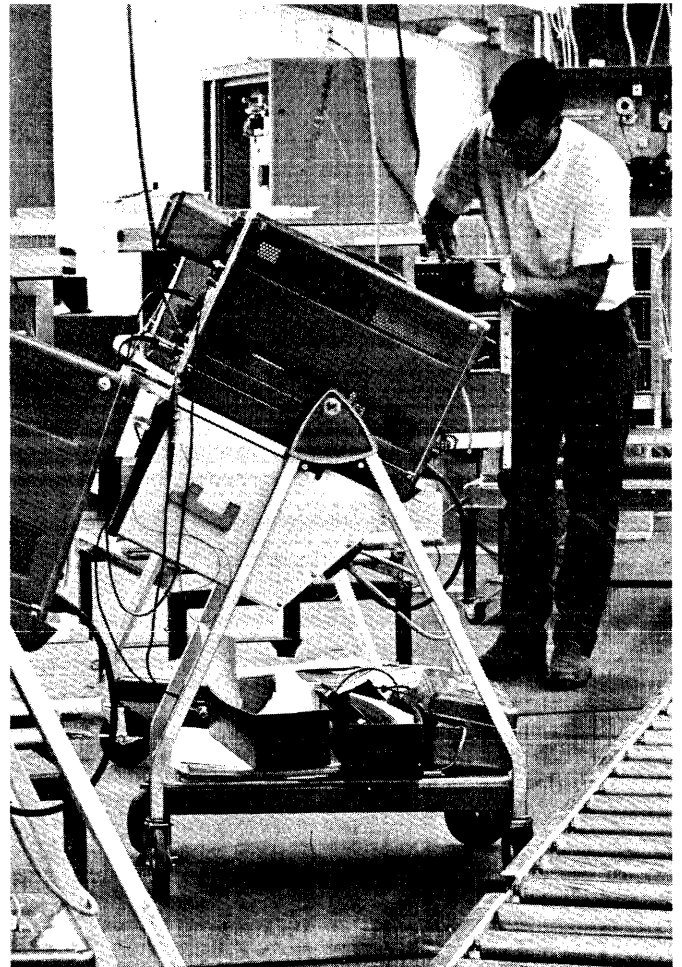
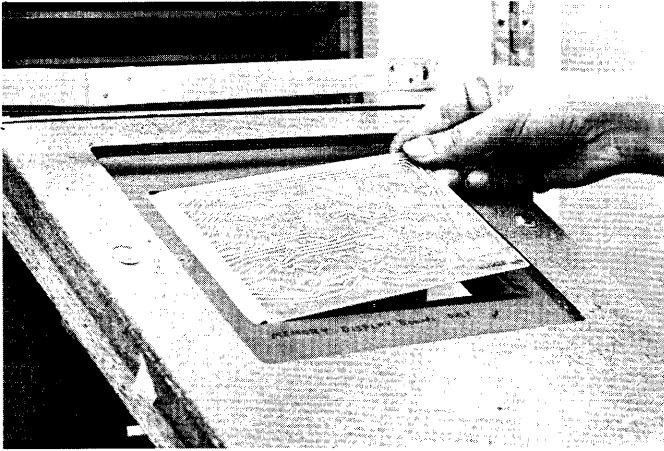

Photos courtesy of Mohawk Data Sciences Corporation

## BUILDING THE DATA RECORDER

Solid-state electronic elements, plus rigid quality control insure dependable performance of Mohawk Data Recorders.

# 1101 MOHAWK/735 NCR DATA RECORDER - MODEL C

## CONTROL PANEL

The control panel containing switches and indicators is located immediately to the left of the tape deck.

## SWITCHES

### POWER SWITCH<sup>1</sup>

**"ON" POSITION** - with the POWER switch in the "on" position, electrical power is supplied to the tape capstan drive motor and to the control and logic modules. The following conditions are set up when the POWER switch is turned "on:"

1. REWIND switch is made ineffective for rewinding tape.
2. Error indicator lights. (Depress ER key to extinguish the light.)
3. Position counter reset to position 01.
4. Memory is not disturbed.

**"OFF" POSITION** - with the POWER switch in the "off" position, power is removed from capstan drive motor and control and logic modules and the REWIND switch is effective.

### REWIND SWITCH<sup>2</sup>

**"ON" POSITION** - with the REWIND switch in the "on" position, electrical power is supplied to the rewind motor and causes the tape to be drawn back onto the supply reel. The supply reel will continue to rotate in a counterclockwise direction until the REWIND switch is manually set to the "off" position.

**CAUTION:** Place the pressure pad on the tape deck in the REWIND position before placing the REWIND switch to the "on" position.

If both the POWER and REWIND switches are placed in the "on" position, a safety interlock will render all machine functions inoperative and a "general clear" of machine controls is generated. A general clear will clear the 1101 of all error conditions and reset the position counter to home position 01. (Off - removes electrical power from the rewind motor.)

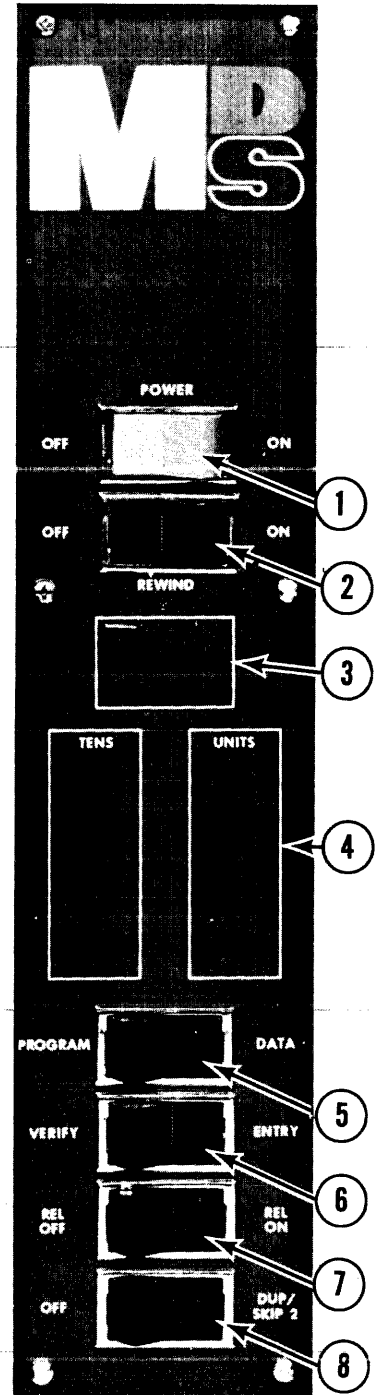

# 1101 MOHAWK/735 NCR DATA RECORDER - MODEL C

## MEMORY POSITION DISPLAY<sup>3</sup>

Two groups of ten indicators on the control panel display memory positions. The group on the right displays the units position and the group on the left displays the tens position.

During ENTRY mode, the count displayed indicates the memory position that will receive the next data entry. During VERIFY mode, the position displayed indicates the next position to be verified.

As entries are made, the count displayed advances from home position, 01, to position 80. Following a release action, the position counter is automatically reset to home position and then advances to the next position containing a stop code if position 01 is programmed for a DUP or SKIP.

## STATUS INDICATORS<sup>4</sup>

Three status indicator lights are located just above the memory position indicator light. These indicators are provided to indicate error and operating conditions within the Data Recorder.

### ERROR LIGHT

The error light is a red indicator light which flashes when an error condition exists.

When the error light is flashing an abnormal condition exists and the keyboard is inoperative for data recording. The error light can be extinguished by depressing the ER key on the keyboard.

Conditions that will cause the error light to flash are:

1. Simultaneous operation of more than one character key.
2. Non-equal comparison during a read-after-write check.
3. Non-equal comparison of a manual entry when verifying.
4. Attempted advance from a program left zero filled without depressing the LØ key.
5. Incorrect parity encountered during a tape-read operation. This includes the read-after-write check when in ENTRY mode; and a read operation when in VERIFY or SEARCH mode.
6. Operation of an alphabetic or special character key when in a position programmed for numeric entry.
7. Momentary loss of power.
8. Keying of data while a machine function, such as a release, was taking place.

# 1101 MOHAWK/735 NCR DATA RECORDER - MODEL C

## STATUS INDICATORS (CONT.)

### RLO (RELEASE LOCK-OUT)

The RLO indicator will be lit, along with the TCK indicator, if a character non-compare or if a parity error occurs during the read-after-write check.

Blank tape or a parity error character read during a verify or search read-operation will also cause the RLO indicator to light.

The RLO indicator is extinguished by a tape backspace operation performed in preparation for rewriting or rereading a data block.

### TCK (TAPE CHECK)

The TCK indicator will light along with the RLO indicator if a parity error is encountered during any tape-read operation. Blank or damaged tape will also cause TCK and RLO indicators to light.

The TCK indicator is reset by a release operation following a tape backspace.

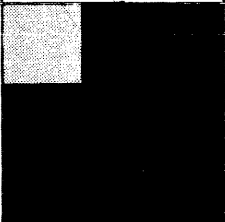
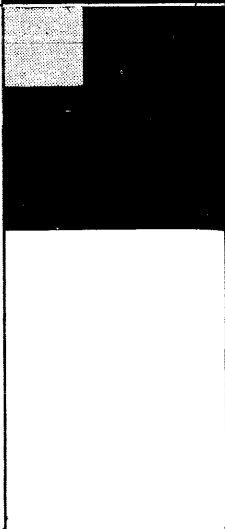
ENTRY MODE		VERIFY/SEARCH MODES
<p><b>"ER" LIGHT IS LIT</b></p> <p>Depress ER key. Key correct character.</p>		<p><b>"ER" LIGHT IS LIT</b></p> <p>Depress ER key. Key correct character; make correction if required.</p>
<p><b>ALL INDICATORS LIT</b></p> <p>1. Depress ER/TBS keys. Depress ER/TEF keys. Depress REL key. (If lights stay on, go to 2.)</p> <p>2. Depress ER/TBS keys. Rekey record. (If lights persist, repeat 1 until the lights stay off.)</p>		<p><b>ALL INDICATORS LIT</b></p> <p>Depress ER/TBS keys. Depress REL key.</p> <p>NOTE - During Verify:</p> <p>1. If data display shows "no bits," the Data Recorder has read blank tape.</p> <p>2. If data display shows other than "no bits," the Data Recorder has found a parity error.</p>



# 1101 MOHAWK/735 NCR DATA RECORDER - MODEL C

## FUNCTION SWITCHES

### MEMORY SELECTOR (MS) SWITCH<sup>5</sup>

DATA - this is the operating position during either an entry or verify operation. Data entered from the keyboard or from a data tape will be stored in the data portion of memory.

PROGRAM - this is the setting when program codes are to be entered into program memory either from a program tape or key entered. This switch setting is also required for a search operation.

### MODE (M) SWITCH<sup>6</sup>

ENTRY - this position is used when data is to be entered from the keyboard and stored in memory for writing on tape or for duplicating into program memory.

VERIFY - this position is used during verification of data blocks. With the mode switch in this position, characters entered from the keyboard will not enter memory, but will be compared to a character in memory for purposes of verification. The characters to be verified are read into memory by the release action of the Data Recorder. The VERIFY position conditions the Data Recorder to read from tape. No tape erasure takes place during a VERIFY operation.

### AUTOMATIC RELEASE (R) SWITCH<sup>7</sup>

AUTO REL - with this switch in the AUTO REL position and the mode switch to ENTRY, data can be released from data memory to magnetic tape. This release action will occur when the memory position counter advances from position 80, either as a result of a keyed entry in position 80 or as a result of skipping or duplicating through position 80.

When the mode switch is in VERIFY position, the release action allows a data block to be read from tape into data memory. Also, in VERIFY mode, automatic release is inhibited if an error has been encountered and a correction entered. The automatic action is restored after the corrected data block has been reverified without further correction.

OFF - with this switch in the "off" position, no release action will occur either automatically or manually.

### AUTO DUP/AUTO SKIP (AD/S 2) SWITCH<sup>8</sup>

DUP/SKIP 2 - the DUP/SKIP 2 switch on the control panel controls only those fields defined by program codes 12 and 13. During entry, if a code 12 is encountered, the data in memory for the field defined by code 12 will be duplicated in the data block being keyed. If a program code 13 is encountered, the field defined by the code 13 will be skipped. The positions so skipped will contain space codes on tape.

OFF - with this switch in the "off" position, automatic DUP 2 or SKIP 2 operations are prevented. DUP or SKIP operations can be initiated manually from the keyboard if the DUP/SKIP 2 switch is in the "off" position.

## TAPE TRANSPORT

This part of the equipment is kept dust-free by having a sliding window. The window must be closed during each operation except rewind. Two arrows on the back panel assist the Mohawk operator when she is positioning the tape for ENTRY or VERIFY. The reflective strip on the beginning of the tape is positioned with these arrows when starting the different runs. The top arrow is used to position the tape during the VERIFY and SEARCH modes and the bottom arrow is used to position the tape during the ENTRY mode.

Threading the tape is a relatively easy operation. The reel of tape is mounted on the hub and is held in place by expanding rubber when the hub knob is turned. The operator holds the reel of tape in front of her with the loose end of tape dangling from the right side of the reel. This assures that the oxide coating (dull side) of the tape will be on the "up side" when it passes under the read/write head.

## VERIFY INTERLOCK SWITCH<sup>1</sup>

The Verify Interlock switch is the only control component located on the Data Recorder tape deck.

This switch is a small two-position toggle switch located on the right side of the tension arm slot. The purpose of this switch is to prevent inadvertent erasure of data during verify and to allow the verify-operator to change to ENTRY mode, during verification, for purposes of rekeying extension corrections, but without endangering other data blocks on tape.

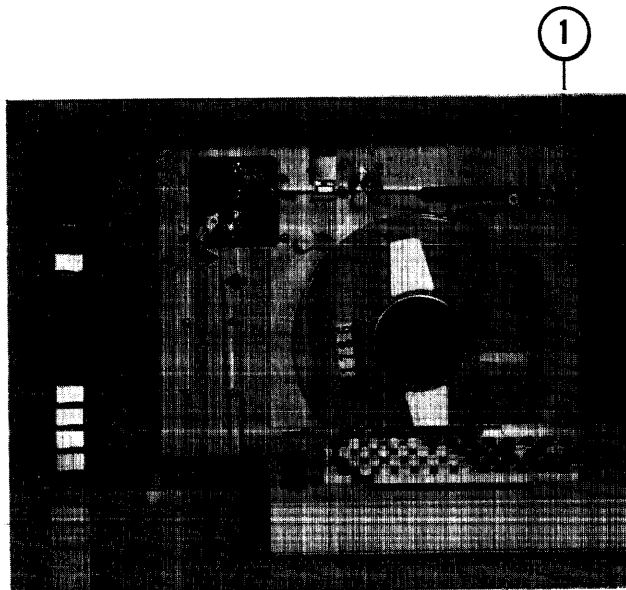

When this switch is in the "on" (Verify) position, some ENTRY mode functions are inhibited even though the mode switch may be set to ENTRY. For example, there can be no release - manual or automatic, and there will be no movement of tape if the ER/TEF keys are depressed. When the Verify Interlock switch is in the "off" (Entry) position, all of the usual ENTRY mode functions are available during an ENTRY mode operation.

With the Data Recorder conditioned for VERIFY mode and the Verify Interlock switch "on," the usual verify procedures can be followed.

The setting of the Verify Interlock switch will not affect a SEARCH operation. It is suggested, however, that the switch be set to "on" to protect the tape records during "after-search" operations.

# 1101 MOHAWK/735 NCR DATA RECORDER - MODEL C

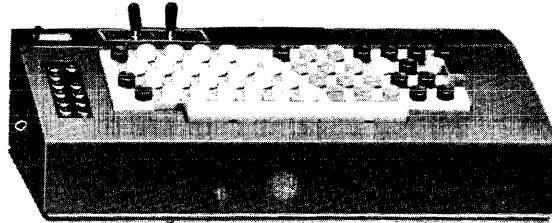

## SPECIAL FUNCTION SWITCHES

There are two special function switches located on the keyboard. One switch, the DUP/SKIP 1, is a two position ON-OFF switch. The second switch is a three position switch, the upper position being PROGRAM REVERT, the down position being RECORD READ. The center position is the OFF position. The function of these switches is described below.

### DUP/SKIP 1 (D/S 1) SWITCH

DUP/SKIP 1 switch controls the automatic function of program codes 4 and 5. With the DUP/SKIP 1 switch "on," a program code 4 will allow a field of data, in memory, to be automatically duplicated in each record being entered. During verification, a program code 4 will allow the duplicate field to be machine verified. If a program code 5 is encountered, the field defined by the code 5 will be skipped. During entry, the positions so skipped will be space-filled.

The automatic DUP 1 or SKIP 1 operation will terminate when a stop-duplicate or stop skip code is encountered.

### PROGRAM REVERT/RECORD READ SWITCH

The PRG REVERT position of the PRG REVERT/RECORD READ switch is effective *only* if the Data Recorder is equipped with the Alternate Program feature. This switch conditions the Data Recorder to *automatically change* from alternate program to main or regular program when the release action occurs at the end of a data block. The main program will continue to control 1101 functions until the alternate program is again selected.

### RECORD READ

The RECORD READ position of the PRG REVERT/RECORD READ switch is used when a data block is to be read from tape to data memory after a SEARCH or during an ENTRY run. *The RECORD READ should not be used during verification.*

With every release action during verification, the Data Recorder makes a comparison between the data being read into memory and the data already in memory from the previous record. For every position that does not compare, an 8-bit is set; i.e., the 8P core of program memory is set to the "on" condition. For every compare, the 8P core is set to the "off" condition. The setting, or not setting, of the 8-bits is the basis of the DUP-VERIFY feature of the Data Recorder. Therefore, if the program being used contained 8-bits such as required for codes 12 and 13 or for other special applications, these 8-bits could possibly be disturbed during the reading in of the data block. To prevent program disturbance when a data block is reread into memory in the middle of an entry run for checking, or after a SEARCH, the RECORD READ switch must be used. While rereading the data block into memory, place the switch in the RECORD READ position until the release is completed.

# 1101 MOHAWK/735 NCR DATA RECORDER - MODEL C

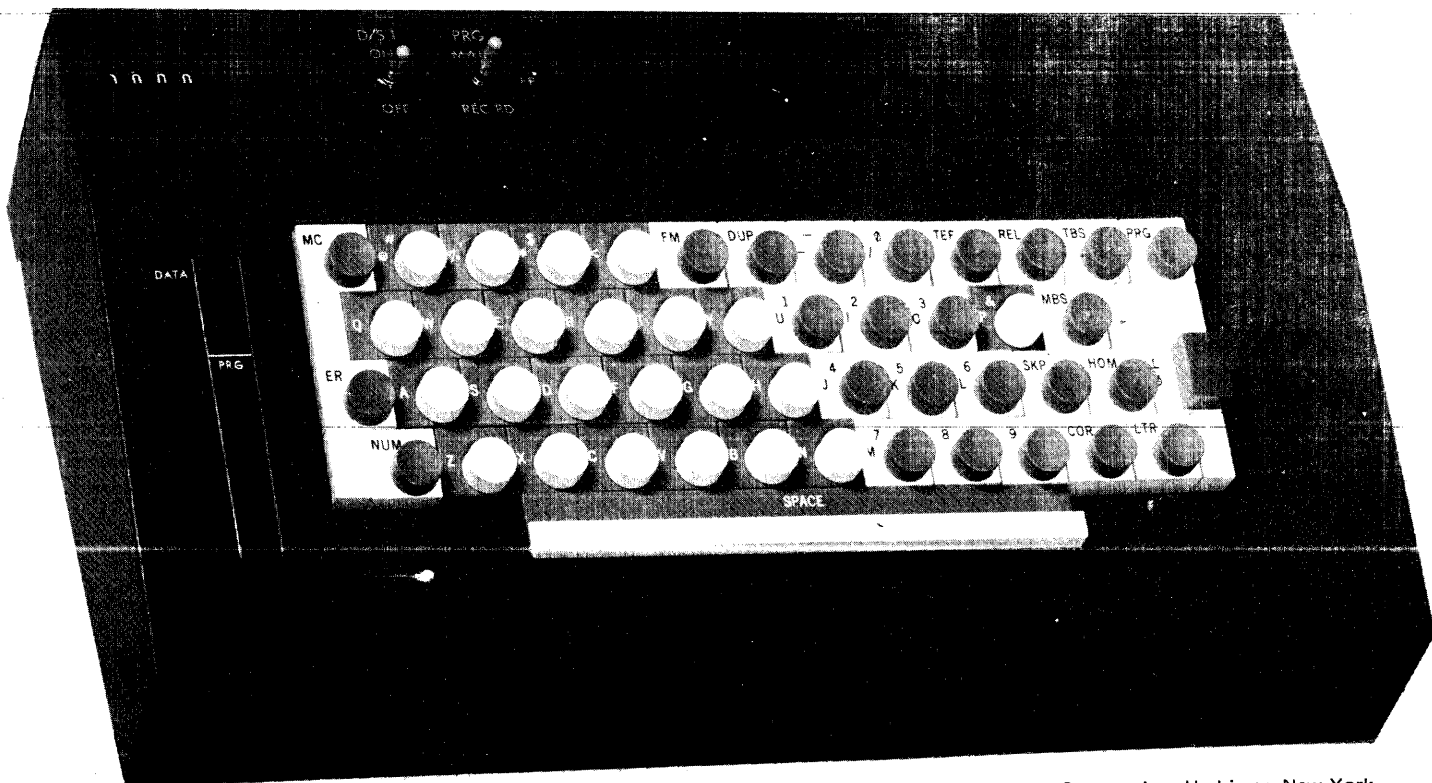

Photo courtesy of Mohawk Data Sciences Corporation, Herkimer, New York.

## KEYBOARD

The keyboard of the basic MDS 1101 Data Recorder consists of 34 character keys; 14 special function keys, and a space bar. The 34 character keys permit single key entry of 47 different character codes including the alphabet, numerics and 11 special characters. An expanded 64-character keyboard is available as an option.

The keys on the keyboard are basically color-coded in the following manner:

- White top keys - Alphabetic and special characters
- Blue top keys - All numerics and some alpha characters
- Red top keys - Special functions

## CHARACTER KEYS

Keyboard shift for numeric, alpha and special characters during data recording, is controlled by the program code present in memory. If, in a position programmed for a numeric character, any character key is depressed that does not represent a numeric character, 0-9, space or minus sign, the operator will be signaled by the flashing error light.

Program control, however, may be *overridden* through the use of the NUM and LTR keys. Alpha, or alpha shift special characters, can be entered into a position programmed for a numeric character by holding the letter shift (LTR) key depressed while entry is being made. Numeric shift characters can be entered into a position programmed for an alpha character by holding the numeric shift (NUM) key depressed during entry.

Numeric shift special characters can be entered only if the NUM key is held depressed while entry is being made, regardless of program code in memory.

# 1101 MOHAWK/735 NCR DATA RECORDER - MODEL C

## KEYBOARD (CONT.)

### SPACE BAR

The space bar can be used to enter or verify space codes in a record or in a program. The space bar is also used to clear program memory of all codes before a new program is key entered. One special use of the space bar is during SEARCH mode when all memory positions except the identifier must be space-filled. The space bar is also used to advance memory positions while sight-checking program or data memory if the Data Recorder is conditioned to ENTRY mode.

### NUM (NUMERIC SHIFT) KEY

The NUM key is used when a numeric character is to be entered into a position programmed for alpha characters. The NUM key must also be used whenever a numeric shift special character is to be entered into memory regardless of the program in memory.

The keyboard will remain in numeric shift as long as the NUM key is held depressed, overriding the program shift-control, and will assume the shift specified by the program code only when the NUM key is released.

### LTR (LETTER SHIFT) KEY

The LTR key is used when an alpha character or letter shift special character is to be entered into a position programmed for numerics. The keyboard will remain in letter shift as long as the LTR key is held depressed, overriding program shift-control, and will assume the shift specified by the program code only when the LTR key is released.

### ER (ERROR RELEASE) KEY

The ER key has multiple functions. After an abnormal or error condition has occurred, it is necessary to depress the error release key to extinguish the error light and reactivate the keyboard.

The second function of the error release key is to make the tape backspace, tape erase forward, memory backspace, home, correction and field modify keys effective. The error key must be held depressed when any of these six keys are to be used. This interlocking effect is designed to prevent inadvertent operation of these keys.

### HOM (HOME) KEY

The HOM key is effective only when the ER key is held depressed. Operating the HOM key will restore the memory position counter to position 01.

### MBS (MEMORY BACKSPACE) KEY

The MBS key is effective only when the ER key is held depressed. While in ENTRY mode, a depression of the ER/MBS keys will reduce the memory position counter by a count of one. Holding the ER/MBS keys depressed will allow repetitive memory backspacing with the memory position counter reducing one for each backspace. MBS is not effective during verification. If a DUP or SKIP code is encountered during memory backspacing, a backward skip will be initiated and will terminate when a stop dup or skip code is encountered.

# 1101 MOHAWK/735 NCR DATA RECORDER - MODEL C

## KEYBOARD (CONT.)

### COR (CORRECTION) KEY

The COR key is effective only when the ER key is held depressed. The purpose of the correction key is to allow one new character to be written in memory to replace a character found to be in error during verification. Following the use of the COR key, the depression of one character key reverts the Data Recorder to the VERIFY mode. This eliminates the need for changing the mode selection switch to ENTRY for correcting single characters.

When a character being verified is determined to be in error, the correction key is depressed and then the correct character is keyed. When the COR key is depressed, automatic and manual release functions are locked out. The only way to get a release is to depress the ER/HOM keys and re-verify the corrected block. When all of the positions have been verified *without further corrections*, an automatic release will occur.

### FM (FIELD MODIFY) KEY

The FM key is effective only when the ER key is held depressed. The field modify key provides a method of changing or correcting an entire field during verification without changing to ENTRY mode. The Data Recorder will remain in the modify condition until the start of the next field, at which time the Data Recorder reverts to verify mode. The modify condition can be terminated at any position within the field by depressing the DUP or SKP key.

When a field within a data block is to be modified, the operator depresses the ER/FM keys. When the FM key is depressed, the tape is automatically backspaced one block length. When this occurs, automatic and manual release functions are locked out. The only way to get a release is to depress the ER/HOM keys and re-verify the corrected block. When all positions have been verified *without further corrections*, an automatic release will occur. Additional use of the FM key within any one block will not backspace the tape.

Using the FM key also turns on the erase head and read/write head in preparation for erasing the error block and writing the corrected block when the automatic release occurs at the end of re-verification.

### TBS (TAPE BACKSPACE) KEY

The TBS key is effective only when the ER key is held depressed. Each depression of the ER/TBS keys will backspace the tape the length of one data block, usually for the purpose of re-reading a block during an entry run. Only one Tape Backspace can be performed without an intervening operation such as a release or a general clear.

### TEF (TAPE ERASE FORWARD) KEY

The TEF key is used primarily for positioning the tape at the beginning of a run and for by-passing bad spots on tape. The ER key must be held depressed while the TEF key is being used. When the Data Recorder is conditioned for entry, about three inches of tape will be erased when the ER/TEF keys are depressed. A TEF operation during verify will move tape about three inches but no erasure will take place.

# 1101 MOHAWK/735 NCR DATA RECORDER - MODEL C

## KEYBOARD (CONT.)

### REL (RELEASE) KEY

The REL key is effective only when the release switch on the control panel is set to REL ON position.

Depression of the REL key while the Data Recorder is in ENTRY mode will cause space codes to be entered in memory and written on tape for all unkeyed positions of the data block with the exception of programmed dup fields. A release action while the memory counter is in position 01 will cause all space codes to be entered into memory and on tape. If the DUP/SKIP switches are on, any duplicate data will be recorded as part of the data block. The usual write on tape and read-after-write check occurs with each manual release. The REL key is ineffective in ENTRY mode if the Verify Interlock switch is "on."

When in the VERIFY mode without an error condition, depression of the release key will cause a data block to be read from tape and stored in memory. While being read, the data will be checked for parity. After each release action, the position counter returns to position 01. If position 01 contains a dup or skip code, the counter will advance to the first memory position that contains a stop dup or skip code. When conditioned for a tape search, depression of the REL key will cause consecutive data blocks to be read from tape. A specified portion of each block will be compared with an identifier stored in memory. When the block containing the matching identifier is reached, the search will terminate.

### DUP (DUPLICATE) KEY

The DUP key is used to manually duplicate data that is in data memory. The DUP key is used during data verification to verify identical or similar data fields in adjacent data blocks. If data being verified is identical in content and position to data in the preceding data block, a depression of the DUP key will automatically verify all identical data up to the point of the next difference or until stop-dup code is encountered. The similarity or dissimilarity of data is determined by the Data Recorder comparator circuits.

The program core 8-bits control the "Dup-verify" function. A non-compare of data (on a position-for-position basis) between the data being read in and that data already in memory will cause an 8-bit to be set for each non-compare position. A data match in any position will condition the SP core to OFF for that position.

Any position that does not set 8-bits (SP core - OFF) can be Dup-verified. All other positions must be key verified or skipped by program control or skipped manually as dictated by the data structure.

During ENTRY mode, identical fields in adjacent data blocks can be duplicated by depressing the DUP key. The duplication operation is terminated when an stop-dup code is encountered in program memory.

The DUP key is also used when a program is being entered into program memory from data memory.

KEYBOARD (CONT.)MC (MULTIPLE CODE) KEY

The MC key permits key entry of data into memory without advancing the memory position. One use for the MC key is to allow the operator to construct, in memory, a BCD code by combining the BCD codes of two or more characters. For example, this key is used when program control codes 12 and 13 for a Dup 2 or Skip 2 operation are being key entered. To enter two codes into one memory position, the MC key is held depressed while one code is keyed and released when the second code is keyed. In the example given above, to construct a BCD code for program code 12 (1100); depress the MC key, key the numeric 8, release the MC key and key the numeric 4. Similarly, for program code 13 (1101), use numeric 8 and numeric 5 keys with the MC key.

If the MC key is not released before keying the last character of a multiple code entry, re-keying the last character after release of the MC key will give the proper result.

Another use for the MC key is to assist in adding or changing a code in program memory. To perform this operation, set the control panel switches to PROGRAM and ENTRY, hold the MC key depressed and key twice the code desired. The first depression puts the code in data memory. The second depression moves the code from data memory to program memory. The MC key holds the memory position for both depressions.

SKP (SKIP) KEY

The SKP key can be used when the Data Recorder is conditioned for either ENTRY or VERIFY mode.

During ENTRY, the SKP key can be used to skip a field or part of a field where no data entry is desired. The skip will be terminated when a stop-skip code is encountered. All positions so skipped will contain space codes on tape. If the spaces to be entered are part of a field, they must follow the data being entered.

During VERIFY, the SKP key can be used to verify spaces within a data block. After the data portion of a field has been verified, a depression of the SKP key will advance the memory counter to the start of the next field containing a stop-skip code.

The spaces in all intervening positions will be machine verified. If a non-space character is encountered during a verify manual skip, the skip action will be stopped at the non-space character with the Error Light flashing.

The DUP/SKIP 1 and DUP/SKIP 2 switches do not have to be on in order for the SKP key to be effective.



# 1101 MOHAWK/735 NCR DATA RECORDER - MODEL C

## KEYBOARD (CONT.)

### LØ (LEFT ZERO) KEY

The LØ key is used when the data characters entered for a specific field do not fill the assigned field to capacity and the data is to be right-justified within the field.

When entering data with the 1101-C in the ENTRY mode, the left zero key is depressed after the characters, for a field to be right-justified, have been entered. The data characters will be shifted into the low order positions within the field and any unused high order positions will be automatically zero-filled. The LØ action will be terminated when a stop LØ code is encountered.

When the Data Recorder is being operated in VERIFY mode and a program code 6 or 7 is encountered, preceding zeros of the field will be automatically verified, but all remaining data must be key verified. If any program code other than a 6 or 7 is in the MSP of a left zero field, the LØ key must be depressed to verify the preceding zeros. The position counter will stop at the position containing the first non-zero number of the field after the zeros have been verified.

### PRG (PROGRAM) KEY

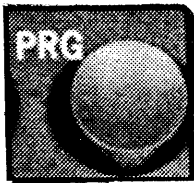

Depression of the PRG key<sup>1</sup> will shift control from main program to alternate program or from alternate program to main program. The indicator light is on the left side of the keyboard above the program memory display. When the "ALT" light<sup>2</sup> is lit, it shows that the machine is in alternate program control. Depression of the PRG key will turn off the light and switch the Data Recorder to the control of the main program.

DATA	ALT
B	
A	PRG
8	8
4	4
2	2
1	1

### RECORD COUNTER

In the upper left corner of the keyboard assembly there is an item counter. It has a capacity of nine-thousand, nine-hundred and ninety-nine. This counter will advance one every time a record is written on tape. It can be used to determine an operator's production and also by the computer operator in setting the computer to read a certain number of records into its memory. An accurate count is obtained because during error correction the counter will "hold."

# 1101 MOHAWK/735 NCR DATA RECORDER - MODEL C

## ~~MEMORY DISPLAY INDICATORS~~

There are two sets of memory display indicators on the 1101 keyboard. The set at the far left displays the contents of data memory; the other set displays the contents of program memory.

### DATA MEMORY INDICATORS

There are six data memory indicators, one each representing the six bits of the BCD code. From the top down, the indicators represent the B, A, 8, 4, 2 and 1 bits of the BCD code.

During entry, the code displayed represents the character in the corresponding position of the previous data block. If the position is observed after MBS, the character observed is from the record being keyed.

During verify, the code displayed represents the character to be verified.

### PROGRAM DISPLAY LIGHTS

There are four program display lights which represent the 8, 4, 2 and 1 bits of the BCD code. The program code displayed is the code that controls the memory position shown on the control panel position indicator lights. When none of the program display lights are lit, the controlling program code is a space code.

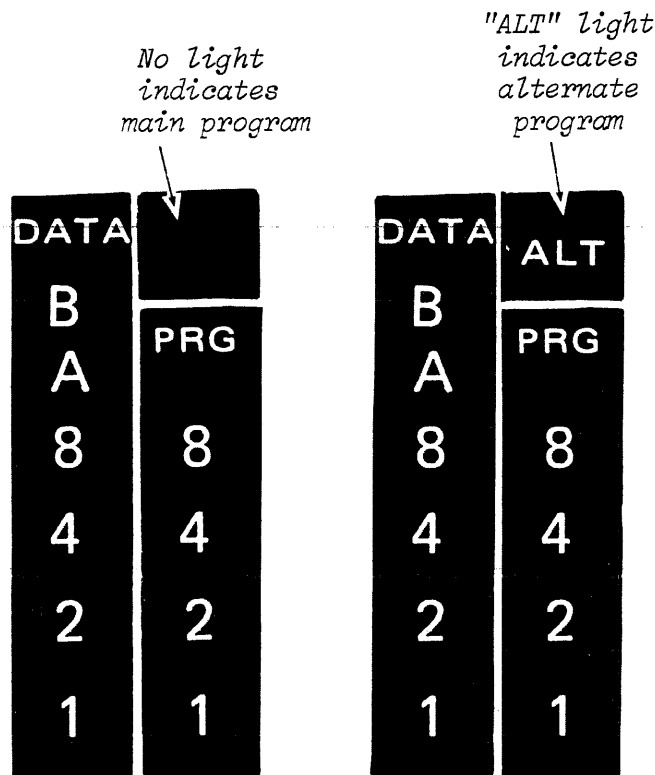

# 1101 MOHAWK/735 NCR DATA RECORDER - MODEL C

## TO CLEAR MEMORIES

1. Turn the power switch to the "on" position.
2. Depress the ER/HOM keys simultaneously to turn off the "ER" light.
3. Set function switches as follows:

SWITCH	POSITION	SWITCH	POSITION
MEMORY SELECTOR (MS)	PROGRAM	VERIFY INTERLOCK (V/INT)	ON
MODE (M)	ENTRY		
AUTO REL (R)	OFF	PROGRAM REVERT (PR)	OFF
AUTO DUP/SKIP (AD/S) (D/S 2)	OFF	DUP SKIP 1 (D/S 1)	OFF

4. The program key to Main (regular) program.
5. Depress the NUM key and space bar\* simultaneously until the position counter passes from position 01 through 00 *twice*. This clears Main program and data memory of all numeric bits.
6. The program key to Alternate program.
7. Depress the ER/HOM keys simultaneously.
8. Depress the NUM key and space bar simultaneously until the position counter passes from position 01 through 00. This clears Alternate program memory of all numeric bits.

\*Enter appropriate character: Space for IBM, GE, Burroughs; Ø for Honeywell, NCR, RCA; + for Univac.

# 1101 MOHAWK/735 NCR DATA RECORDER - MODEL C

## TO LOAD ONE PROGRAM THROUGH THE KEYBOARD

*NOTE: Clear both Main and Alternate program memories.*

1. Set switches as follows:

SWITCH	POSITION	SWITCH	POSITION
MEMORY SELECTOR (MS)	DATA	VERIFY INTERLOCK (V/INT)	OFF
MODE (M)	ENTRY		
AUTO REL (R)	OFF	PROGRAM REVERT (PR)	OFF
AUTO DUP/SKIP (AD/S) (D/S 2)	OFF	DUP SKIP 1 (D/S 1)	OFF

2. Depress the ER/HOM keys simultaneously.
3. Program key to Main (regular program).
4. Key enter the entire program, making a key depression for every memory position. Use the space bar for program spaces.
5. Change the mode switch to VERIFY.
6. Key verify the entire program, making a key depression for every memory position.

*NOTE: To correct an error, change the mode switch back to ENTRY and key the correct character. Return to VERIFY after each correction. After making all corrections, depress the ER/HOM keys simultaneously and key verify the entire program.*

7. Change switches: MS - PROGRAM  
M - ENTRY
8. Depress the ER/HOM keys simultaneously.
9. Depress the DUP key to copy the program into program memory.
10. Immediately change the memory selector switch to DATA. Other switch settings will depend upon whether you are to enter or verify or search.

# 1101 MOHAWK/735 NCR DATA RECORDER - MODEL C

## TO LOAD TWO PROGRAMS THROUGH THE KEYBOARD

*NOTE: Clear both Main and Alternate program memories.*

1. Set switches as follows:

SWITCH	POSITION	SWITCH	POSITION
MEMORY SELECTOR (MS)	DATA	VERIFY INTERLOCK (V/INT)	ON
MODE (M)	ENTRY		
AUTO REL (R)	OFF	PROGRAM REVERT (PR)	OFF
AUTO DUP/SKIP (AD/S) (D/S 2)	OFF	DUP SKIP 1 (D/S 1)	OFF

### TO LOAD THE MAIN PROGRAM

2. Program key to Main (regular program).
3. Depress the ER/HOM keys simultaneously.
4. Key enter the main program; *hold down the numeric shift key while entering the program codes.*
5. Make a key depression for every program memory position.
6. Change mode switch to VERIFY.
7. Depress the ER/HOM keys simultaneously.
8. Key verify the entire main program.

*NOTE: To correct an error, change the mode switch to ENTRY and key the correct character. Return to the VERIFY mode after each correction. After making all corrections, key verify the entire program.*

9. Depress the ER/HOM keys simultaneously.
10. Change switches: MS - PROGRAM  
M - ENTRY
11. Depress the DUP key to load the main program into program memory.
12. Change the MS switch to DATA.

# 1101 MOHAWK/735 NCR DATA RECORDER - MODEL C

## TO LOAD TWO PROGRAMS THROUGH THE KEYBOARD (CONT.)

### TO LOAD THE ALTERNATE PROGRAM

13. Depress the program key to Alternate.
14. Depress the ER/HOM keys simultaneously.
15. Key enter the entire Alternate program, depressing the NUM shift key when entering the program codes.
16. Make a key depression for every memory position.

*NOTE: If you want "8's" in either program, enter them now.*

17. Change mode switch to VERIFY.
18. Depress the ER/HOM keys simultaneously.
19. Key verify the entire Alternate program.

*NOTE: To correct an error, change the mode switch to ENTRY and key the correct character. Return to the VERIFY mode after each correction. After making all corrections, key verify the entire program.*

20. Depress the ER/HOM keys simultaneously.
21. Change switches: MS - PROGRAM  
M - ENTRY
22. Depress the DUP key to load the Alternate program into alternate program memory.
23. Change the MS switch immediately to DATA.
24. Change other switch settings as required for data entry, verification or search.

*NOTE: The space bar is used to enter program spaces on equipment compatible with IBM, GE and Burroughs computers. The Ø for equipment compatible with Honeywell, NCR and RCA. The + for equipment compatible with Univac computers.*

# 1101 MOHAWK/735 NCR DATA RECORDER - MODEL C

## CHANGING A CHARACTER IN PROGRAM MEMORY

To change a single character in program memory, proceed as follows:

1. Set the function switches as follows:

SWITCH	POSITION	SWITCH	POSITION
MEMORY SELECTOR (MS)	DATA	VERIFY INTERLOCK (V/INT)	ON
MODE (M)	ENTRY		
AUTO REL (R)	OFF	PROGRAM REVERT (PR)	OFF
AUTO DUP/SKIP (AD/S) (D/S 2)	OFF	DUP SKIP 1 (D/S 1)	OFF

2. Advance the memory position counter to the position to be changed. If the contents of data memory are *not* to be disturbed, advance to the memory position by dapping through memory or re-keying the contents of memory to the position desired. If retaining the contents of data memory is not required, the memory position can be reached by manual skipping or spacing through memory.
3. Set MS switch to PROGRAM.
4. Hold MC and NUM keys depressed as you key *twice* the character key for the program code to be inserted. The first depression enters the code into data memory; the second depression moves the code into program memory. The MC key holds the memory position for both depressions, and the NUM key overrides any alpha shift code that may have been present in that program memory position.
5. Immediately set MS switch to DATA.

## POSITIONING A PROGRAM TAPE

1. Depress the ER/TEF keys simultaneously and hold until the tape motion stops. The Tape Erase Forward erases the tape area preceding the area where the program block is to be written. This will assure the reading of the program block with the first release when loading the program into program memory from tape.
2. Depress the ER/TBS keys simultaneously to position the tape for writing the program.

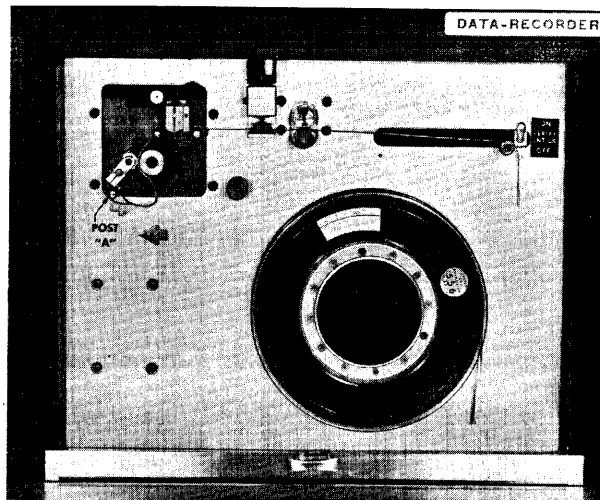

## PROGRAM TAPE

A program tape is a short length of magnetic tape on which permanent, often used, programs can be stored. Once the program is written on the program tape, it may be read directly into program memory of the Data Recorder at anytime it is required.

To make a program tape, use a piece of magnetic tape about two feet in length. Fold one end of the tape back about three-quarters of an inch with the shiny non-oxide side on the outside of the fold. Seal the fold with a one inch gummed label.

You should load the program, or programs, on a program tape *before* mounting the supply reel that will be used for data entry or verification.

After recording a program on a program tape strip, it may be read into program memory at any time. The same tape strip may be used day-after-day to provide an easy, accurate method of loading programs.

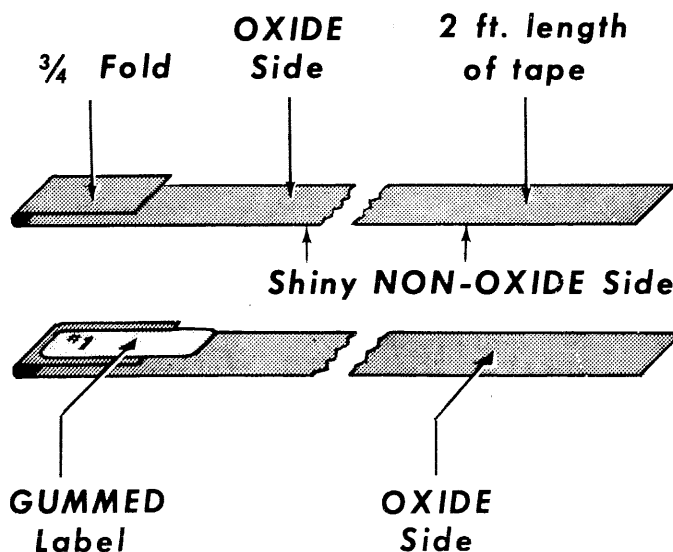



# 1101 MOHAWK/735 NCR DATA RECORDER - MODEL C

## WRITING A PROGRAM TAPE - ONE PROGRAM

1. Set the function switches as follows:

SWITCH	POSITION	SWITCH	POSITION
MEMORY SELECTOR (MS)	DATA	VERIFY INTERLOCK (V/INT)	OFF
MODE (M)	ENTRY		
AUTO REL (R)	ON	PROGRAM REVERT (PR)	OFF
AUTO DUP/SKIP (AD/S) (D/S 2)	OFF	DUP SKIP 1 (D/S 1)	OFF

2. Hold the NUM key depressed as you key enter the program to position 81. Automatic release will occur writing the program as a data block on the program tape.

*NOTE: To key enter codes such as 12 (  $\frac{8}{4}$  ) or 13 (  $\frac{8}{5}$  ), hold the MC key depressed while the first character of the code is keyed. Release the MC key before keying the last character of the code.*

3. Depress the REL key. This action will write a block of spaces following the program block.
4. Place the rewind/run pressure pad in rewind position.
5. Reposition the program tape (leave a little slack).
6. Place the rewind/run pressure pad in the run position.
7. Change the mode switch to VERIFY.
8. Depress the REL key. The program has been read into data memory.
9. Hold the NUM key depressed while you key verify the program to position 81. Automatic release will occur if all 80 character positions have been verified without correction.

*NOTE: For each error found, depress the ER/COR keys simultaneously and then key in the correct character. Depress the ER/HOM keys and re-verify the record; automatic release will occur if all 80 character positions have been verified without correction.*

10. After the program has been verified and corrected (if necessary), make consecutive depressions of the ER/TEF keys simultaneously until the program tape is free.

# 1101 MOHAWK/735 NCR DATA RECORDER - MODEL C

## ~~WRITING A PROGRAM TAPE - TWO PROGRAMS~~

1. Clear memories.
2. Set the function switches as follows:

SWITCH	POSITION	SWITCH	POSITION
MEMORY SELECTOR (MS)	DATA	VERIFY INTERLOCK (V/INT)	OFF
MODE (M)	ENTRY		
AUTO REL (R)	ON	PROGRAM REVERT (PR)	OFF
AUTO DUP/SKIP (AD/S) (D/S 2)	OFF	DUP SKIP 1 (D/S 1)	OFF

3. Depress the program key to Main program.
4. Hold the NUM key depressed as you key enter the Main program to position 81; automatic release will occur. Then, depress the program key to Alternate program.
5. Hold the NUM key depressed as you key enter the Alternate program to position 81; automatic release will occur.

*NOTE: If you want "8's" in either program, enter them now.*

6. Depress the REL key.
7. Place the rewind/run pressure pad in the rewind position.
8. Reposition the program tape (leave a little slack).
9. Place the rewind/run pressure pad in the run position.
10. Change the mode switch to VERIFY.
11. Put the Verify Interlock switch in the "on" position.
12. Depress the REL key.
13. Key verify the Main program to position 81; automatic release will occur if there are no errors.
14. Key verify the Alternate program to position 81; automatic release will occur if there are no errors.

*NOTE: For each error found, depress the ER/COR keys simultaneously and then key in the correct character. Depress the ER/HOM keys and re-verify the record; automatic release will occur if all 80 character positions have been verified without correction.*

15. After the programs have been verified and corrected (if necessary), make consecutive depressions of the ER/TEF keys until the program tape is free.

# 1101 MOHAWK/735 NCR DATA RECORDER - MODEL C

## LOADING PROGRAM FROM A PROGRAM TAPE

1. Turn power switch to the "on" position.
2. Clear memories before loading program(s) from a program tape.
3. Turn power switch to "off" position.
4. Set the function switches as follows:

SWITCH	POSITION	SWITCH	POSITION
MEMORY SELECTOR (MS)	PROGRAM	VERIFY INTERLOCK (V/INT)	ON
MODE (M)	VERIFY		
AUTO REL (R)	ON	PROGRAM REVERT (PR)	OFF
AUTO DUP/SKIP (AD/S) (D/S 2)	OFF	DUP SKIP 1 (D/S 1)	OFF

5. Thread the program tape, leaving no slack in the tape.
6. Turn the power switch to the "on" position.
7. Depress the REL key. The program is now in program memory.

### TO LOAD ONLY THE MAIN PROGRAM

8. Program key to main program.
9. Depress the REL key.
10. Change the MS switch to DATA.
11. Depress the ER/TEF keys until the tape is free; then, remove the tape from the anchor post.

### TO LOAD MAIN AND ALTERNATE PROGRAM

8. Program key to main program.
9. Depress the REL key.
10. Program key to alternate program.
11. Depress the REL key.
12. Change the MS switch to DATA.
13. Depress the ER/TEF keys until the tape is free; then, remove the tape from the anchor post.

# 1101 MOHAWK/735 NCR DATA RECORDER - MODEL C

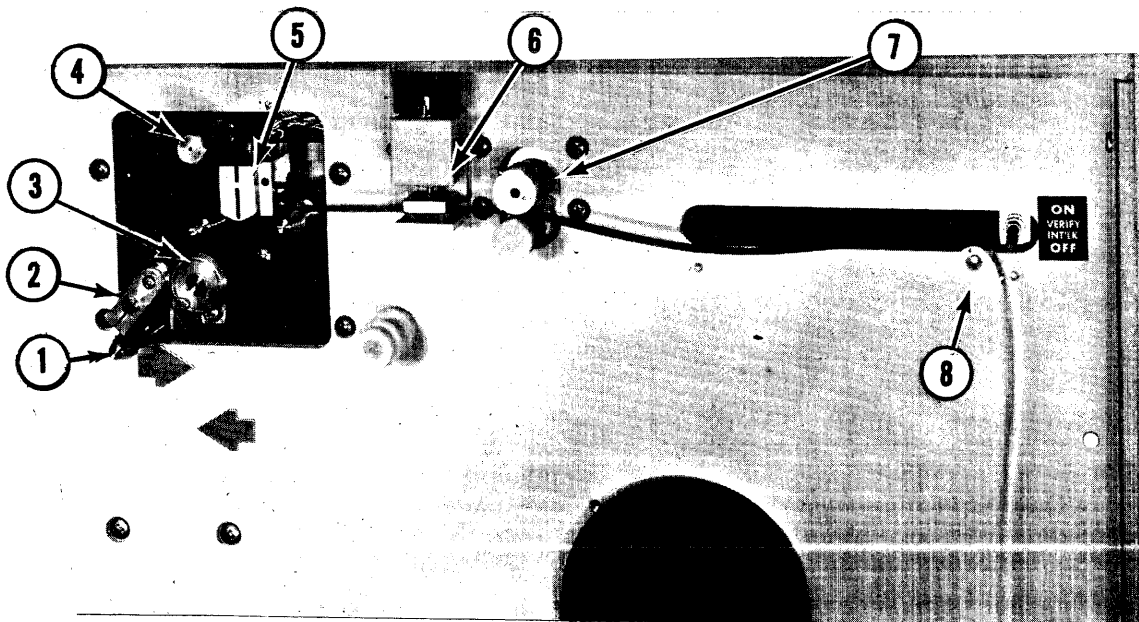

- |                         |                        |
|-------------------------|------------------------|
| 1. PROGRAM TAPE ANCHOR  | 5. READ-WRITE HEAD     |
| 2. PINCH ROLL           | 6. PRESSURE PAD        |
| 3. CAPSTAN              | 7. BACKSPACE MECHANISM |
| 4. SPRING TENSION CLAMP | 8. ROLLER              |

## THREADING PROGRAM TAPE

1. Lower window.
2. Position Pressure Pad<sup>6</sup> to "rewind" position.
3. Raise Spring Tension Clamp<sup>4</sup> (turn clockwise).
4. Slip the small loop in the end of the program tape over the Program Tape Anchor Post<sup>1</sup>.
5. *Keep dull side of tape "up."*
6. Thread tape between the Pinch Roll<sup>2</sup> and Capstan<sup>3</sup>, under Read-Write and Erase Heads<sup>5</sup>, through the Pressure Pad<sup>6</sup> and Backspace Mechanisms<sup>7</sup> and over the Roller<sup>8</sup>.
7. Hold tape taut (no slack) with righthand. With left hand, position Pressure Pad<sup>6</sup> to the "run" position.
8. Lower Spring Tension Clamp<sup>4</sup> (turn counterclockwise to hold the tape in the groove of the guide post).
9. Close window.

# 1101 MOHAWK/735 NCR DATA RECORDER - MODEL C

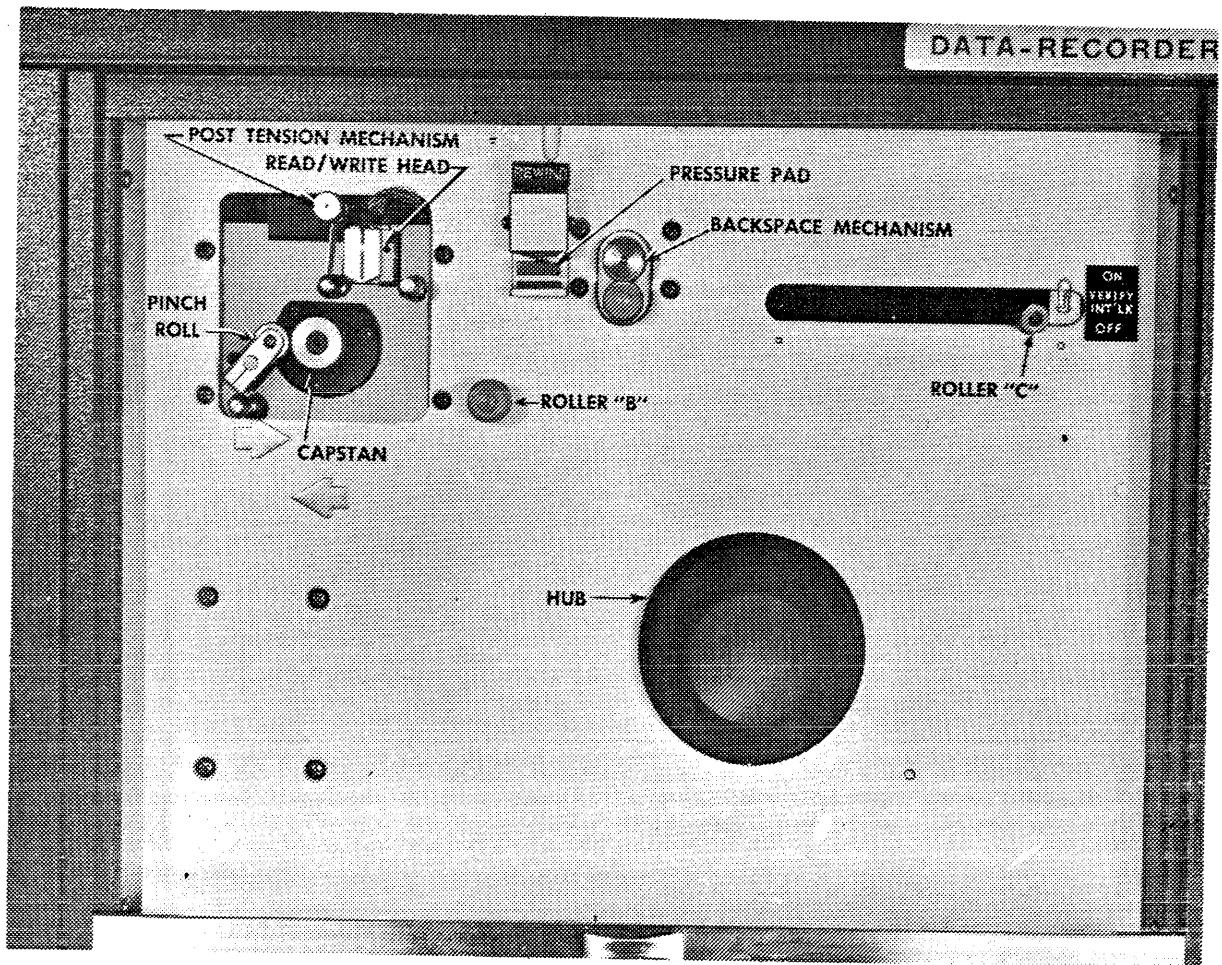

## Tape Deck

### CLEANING

At the start of each days operation, the Data Recorder should be cleaned using the procedure listed below. If good cleaning habits are not used, scratched and damaged tapes may result because of a dirty tape path. A cleaning kit is supplied with each Data Recorder. Dust on tapes has often been the cause of read-after-write errors.

1. Rewind tape on tape reel.
2. Wipe CAPSTAN with a clean dry cloth only.
3. Moisten one of the square pads or swabs with the solvent supplied and wipe all rollers and parts the tape touches during machine operation.
4. Take *extra care* to clean the REWIND/RUN pressure pad and the read/write head.
5. Wipe off excess solvent.

1101 MOHAWK/735 NCR DATA RECORDER - MODEL C

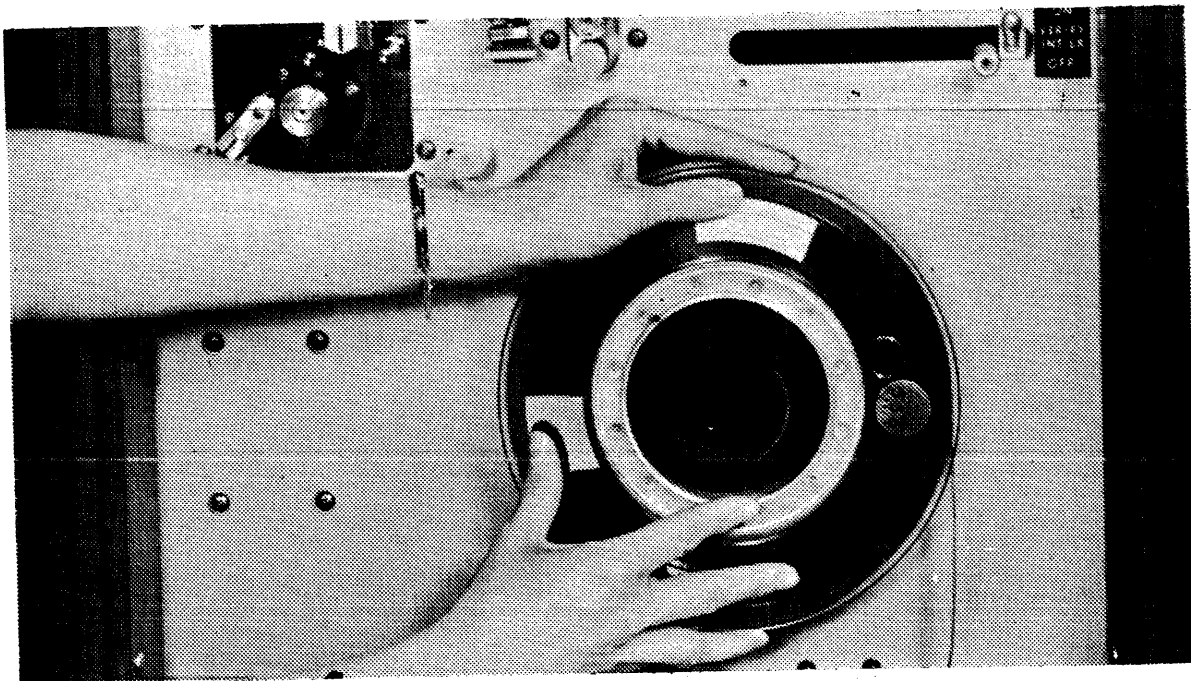
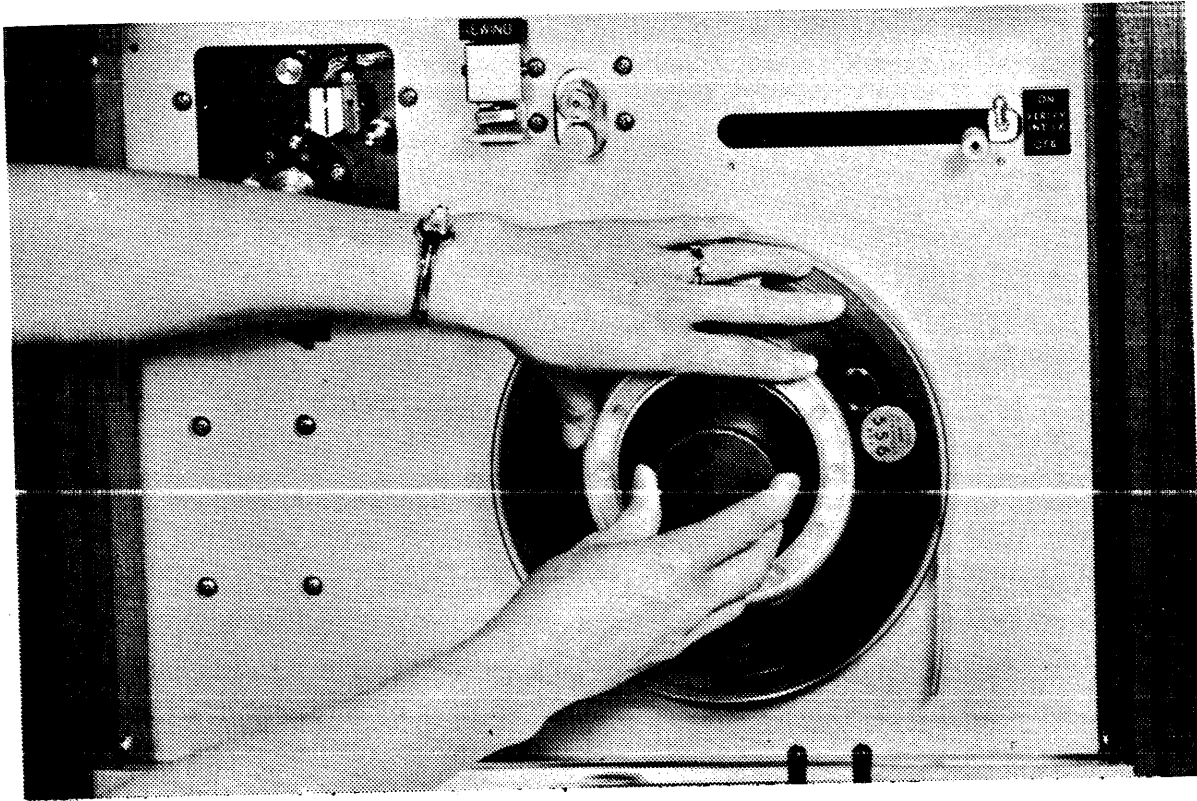

## 1101 MOHAWK/735 NCR DATA RECORDER - MODEL C

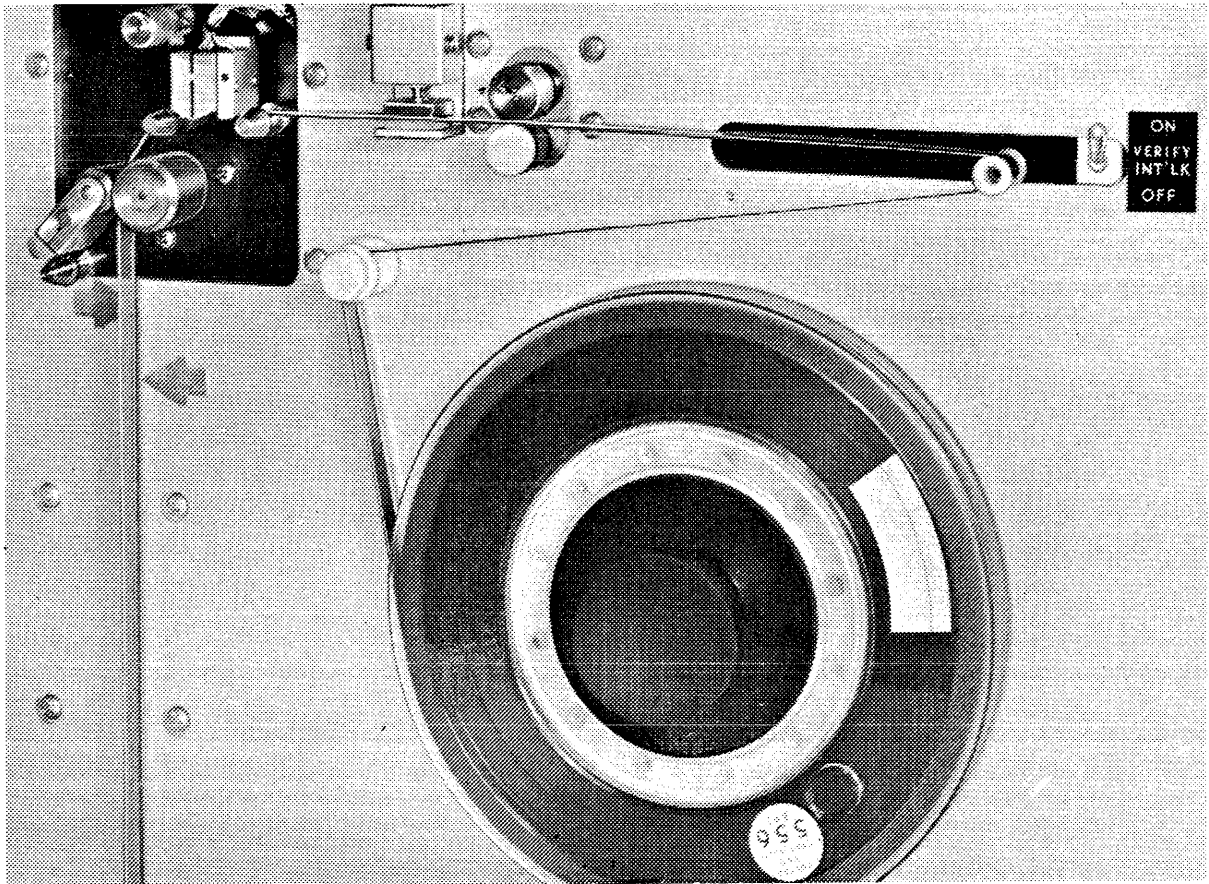

### THREADING TAPE

1. Lower the window and mount the supply reel.
2. After the supply reel has been mounted, unwind three feet of tape.
3. Set the Pressure Pad control to the "rewind" position.
4. Lift the Spring Tension Clamp by turning it to the left.
5. Thread the tape around Rollers "A" and "B" through the Backspace Mechanism, through the Pressure Pad, under the Read-Write Head and between the Capstan and the Pinch Roll.
6. Lower the Spring Tension Clamp by turning it to the right. This holds the tape in place.
7. Place the free end of the tape in the Tape Bin opening directly below the Capstan.
8. To advance the tape to the starting point, set the Pressure Pad mechanism to the "run" position and depress the ER/TEF keys simultaneously until the reflective strip on the tape is opposite the lower positioning arrow. *The tape will move forward about three inches with each depression of the ER/TEF keys.*
9. Pull the glass window up until it locks.

## 1101 MOHAWK DATA RECORDER

### TAPE REWIND

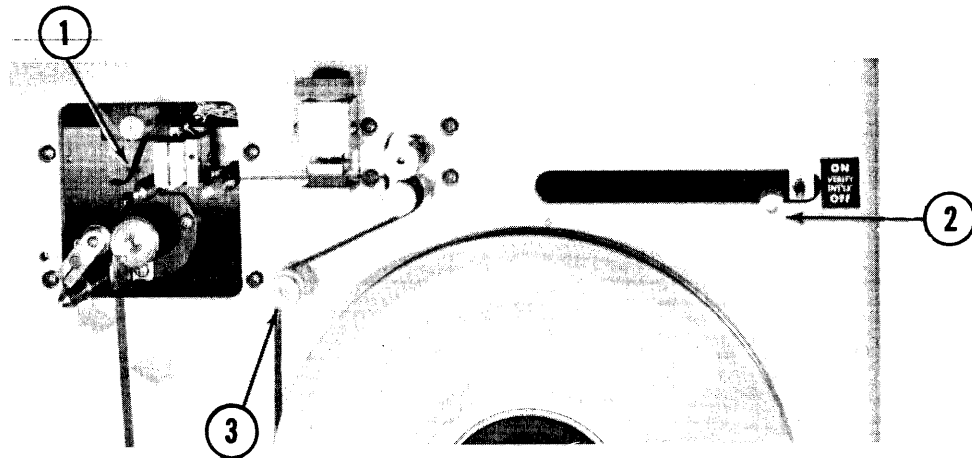

1. Set the power switch on the control panel to the "off" position.
2. Lower the window.
3. Set the Pressure Pad to the "rewind" position.
4. Remove the tape from around Roller<sup>2</sup>. Use the side of the finger to remove the tape to avoid getting oily deposits from the fingertips on the writing surface.
5. Manually rotate the supply reel to take up the slack in the tape<sup>3</sup>; turn the Reel Hub counterclockwise.
6. Ease tension slightly on Spring Tension Clamp<sup>1</sup>.
7. Close the window.
8. Set the rewind switch on the control panel to the "on" position. When the tape is completely rewound, turn the rewind switch "off."

*NOTE: The rewind switch must not be turned on until the power switch has been in the "off" position for approximately five seconds. This will assure the elimination of any transient signals in the Read/Write head.*

### REMOVAL OF TAPE REEL

Remove the tape reel by applying pressure with the left hand and pulling out on the hub with the right hand while turning it slightly. The hub will remain in the "out" position and the reel will be free to be removed.

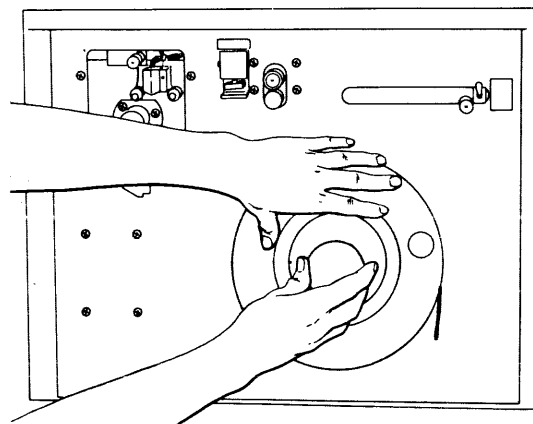



# 1101 MOHAWK/735 NCR DATA RECORDER - MODEL C

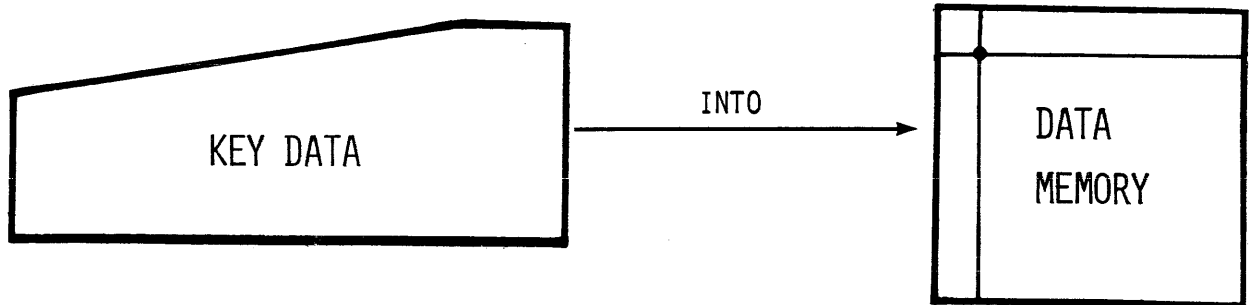

## DATA ENTRY

An "entry run" is the original recording of a series of data records on magnetic tape. In the entry mode (entry = write), you key a record into data memory. When the data memory has been filled, the Data Recorder will automatically write the contents of data memory on magnetic tape if the REL switch is in the "on" position.

It is through this "key, write, key, write..." process that a file of records is recorded on magnetic tape.

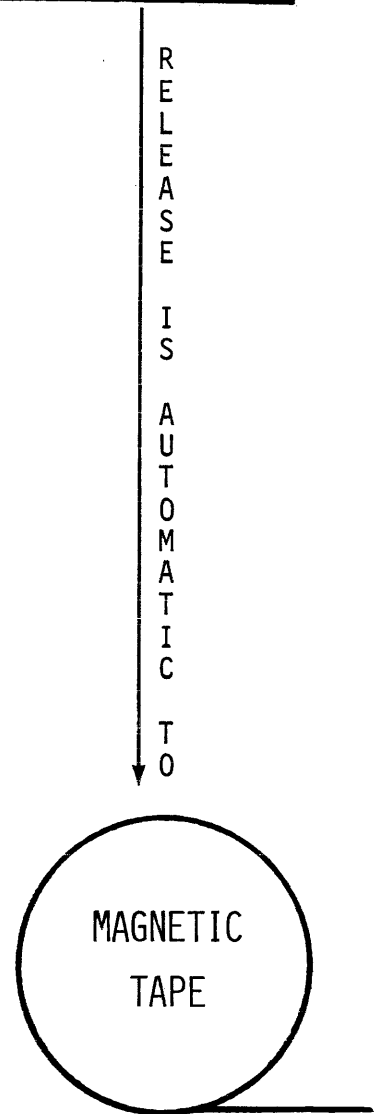

# 1101 MOHAWK/735 NCR DATA RECORDER - MODEL C

## PREPARING FOR DATA ENTRY

ACTION	EXPLANATION
1. Clear memory.	You wish to ENTER (write) program(s) into memory.
2. Load program(s).	Be sure the proper program is loaded.
3. Power "off."	
4. Set switches:	
MS - Data	To allow keying into data memory without changing program memory.
M - Entry	Allows you to write on tape (entry = write).
R - On	Allows information to be written on tape.
D/S 2 - Off	This switch is "off" so that the Data Recorder will not duplicate or skip if there are 12's or 13's in the program.
D/S 1 - Off	This is so that the Data Recorder will not duplicate or skip if there are 4's or 5's in the program.
PR - Off	This switch is always in the "off" position when entering the first record.
V/INT - Off	Since we are not verifying, the V/INT switch is "off."
5. Mount and thread data tape. (Leave no slack and start the tape into the bin.)	
6. Power switch to "on."	
7. Depress the ER/TEF keys simultaneously. (Repeat step until reflective marker is below the arrows.)	Hold keys down until tape motion stops. Use of the ER/TEF keys will advance the tape so that you can find the reflective marker. Since the mode switch is in ENTRY, the tape is also being erased.
8. Manually position the bottom of the reflective marker at the tip of the lower arrow.	This will ensure that the information is recorded <i>after</i> the BOT (beginning of tape) reflective marker.

# 1101 MOHAWK/735 NCR DATA RECORDER - MODEL C

## ENTERING THE FIRST RECORD

ACTION	EXPLANATION
<p>9. Key "header label" if necessary.</p> <p>10. Key in the first data record to position 81. Automatic release will occur. (Use the SKP key for skip fields. When entering alpha in dup fields, hold down the LTR key.</p>	<p>Since the REL switch is in the "on" position, release will occur <i>after</i> all positions of the first record have been entered into data memory. Since a dup field is numeric in shift, the LTR key must be held down when entering alpha characters in a dup field.</p> <p>NOTE: During an entry run, if the data does not completely fill a field, the SKP key can be depressed to advance the memory position to the beginning of the next field containing a stop skip code. All positions so skipped will contain space codes on tape.</p> <p>NOTE: After entering the data in a left zero field, depress the LØ key. The data will be shifted to the right and all left positions of the field will contain zeros. A field followed by a left zero field, defined by a code 6 or 7, cannot be entered without first depressing the LØ key. Depressing the DUP, SKP or REL keys prior to depressing the LØ key will cause the error light to flash.</p>
<h3 style="text-align: left;">VERIFYING FIRST RECORD</h3>	
<p>11. Change switches:</p> <p style="padding-left: 40px;">M - Verify</p> <p style="padding-left: 40px;">R - Off</p> <p>12. Key verify all positions of the first record.</p>	<p>The first data record is verified to ensure that all constant information for remaining records is correct.</p> <p>Since you wrote only one record, there is nothing to read into memory <i>after</i> verification.</p> <p>You verify the first record especially to be sure the dup fields are correct. If errors are found, change the REL switch to the "on" position so you will later be able to rewrite the correct record. Follow the regular correction procedure by depressing the ER/COR keys simultaneously to allow the changing of one character in data memory. Key the correct character (this makes the correction in data memory) and then continue verification. Then, depress the ER/HOM keys simultaneously to return to position 01. Re-verify the entire record. When all positions have been verified without error correction, automatic write on tape and read-after-write check will occur.</p>

# 1101 MOHAWK/735 NCR DATA RECORDER - MODEL C

## PROCEEDING WITH THE ENTRY RUN

ACTION	EXPLANATION
13. Change switches:	
M - Entry	This will enable you to enter the remainder of the source documents.
R - On	So the records will be written on tape.
D/S 2 - as required.	Put in the "on" position if any 12's or 13's are in the program(s).
D/S 1 - as required	Put in the "on" position if any 4's or 5's are in the program(s).
PR - as required	The PR switch is effective <i>only</i> if the Data Recorder is equipped with the alternate program feature. When this switch is in the record-read position, it conditions the equipment to only change from alternate program to main program. When the release action occurs at the end of a data block, the main program continues to control functions until the alternate program is again selected by depression of the program key. This switch is used when much of the information will be the same for each successive record.
14. Depress the ER/HOM keys.	To begin from the first keying position.
15. Proceed with the run.	Key the rest of the records.
<b>END OF THE ENTRY RUN</b>	
16. At the end of the entry run, change switches:	
D/S 2 - Off	
D/S 1 - Off	
17. Depress the ER/HOM keys simultaneously.	
18. Key required trailer labels and tape marks (if necessary).	The trailer label identifies the end of a file. It may contain totals, a record count, or other identifying characters. The tape mark signals the computer to stop reading. The tape mark signals the computer to stop reading because it has read all the data records. This writes about 6 inches of blank tape to signal end of a batch during a SEARCH or VERIFY run.
19. Depress ER/TEF keys twice.	

# 1101 MOHAWK/735 NCR DATA RECORDER - MODEL C

## HEADER AND TRAILER LABELS - TAPE MARKS

Header and trailer labels along with tape marks are used in a large number of installations. Variations exist as to content and/or placement of these records. A common sequence of placement on tape is shown in the drawing below:

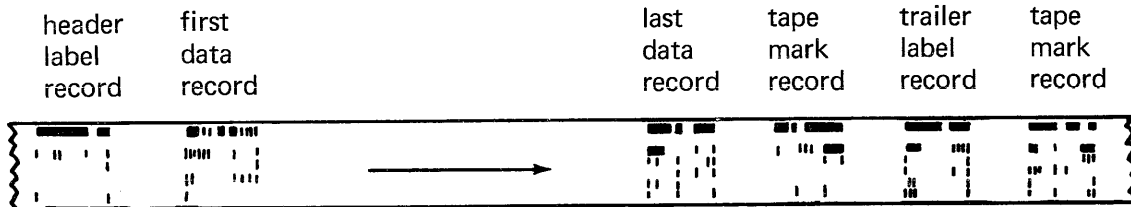

The header and trailer labels are used for identification while the tape mark instructs the computer to stop reading.

### HEADER LABEL

The Header Label identifies the beginning of a "file" (or series of data records) of information. It may have a date, serial number, or other identifying characters.

### TRAILER LABEL

The Trailer Label identifies the end of a file. It may contain totals of record count or other identifying characters.

### TAPE MARK

The Tape Mark signals the computer to stop reading because it has read all of the data records of the file. A very common tape mark is both the 7 and 8 in position 01 and spaces in all other positions. You must use the Multi-Code (MC) key in order to put two characters into one position. To write this record:

1. Hold down the MC and the NUM keys; then, key a 7 to write a 7 into data memory.
2. Let up the MC key; hold down the NUM key and key an 8. This adds the 8 to the 7 in data memory.
3. Let up the NUM key and depress the REL key. This puts spaces in all other positions and then writes the record on tape.

# 1101 MOHAWK/735 NCR DATA RECORDER - MODEL C

## DATA VERIFICATION

1. Clear memory and load verification program(s).
2. Set function switches as follows:

SWITCH	POSITION	SWITCH	POSITION
MEMORY SELECTOR (MS)	DATA	VERIFY INTERLOCK (V/INT)	ON
MODE (M)	VERIFY		
AUTO REL (R)	ON	PROGRAM REVERT (PR)	OFF
AUTO DUP/SKIP (AD/S) (D/S 2)	OFF	DUP SKIP 1 (D/S 1)	OFF

NOTE: The Verify Interlock switch is in the "on" position. With the switch "on," a release (manual or automatic) will be prevented if the mode switch is set to ENTRY.

3. Mount and thread the data tape to be verified.
4. Turn the power switch to the "on" position and make consecutive depressions of the ER/TEF keys until the tape reflective marker is below the positioning arrows on the tape deck. Since the mode switch is in VERIFY and the V/INT switch is "on," the tape is *not* erased.
5. Manually position the bottom of the reflective marker at the tip of the upper arrow for verification.
6. Depress the REL key. The first data block will be read into memory. If the error lights come on, it will probably be an indication that the first data block is farther from the reflective marker than expected. Depress the ER/TBS keys and the REL key to try again to read in the first data block. If the error lights come on again, repeat the procedure using the ER/TBS and REL keys.
7. Key verify all positions of the first record, including dup and skip fields. Automatic release will occur if all 80 character positions have been verified correct. Correct errors according to error recovery procedures.
8. Set D/S 1 and D/S 2 switches to the "on" position, PR switch as required.
9. Depress ER/HOM keys.
10. Proceed with verification run. If positions that were automatically duplicated during entry are programmed for automatic duplication during verification, they will be machine verified. During verification, corresponding positions of consecutive data blocks that contain identical data can be manually "dup-verified" by depressing the DUP key. Dup verification will stop when a difference is encountered.

# 1101 MOHAWK/735 NCR DATA RECORDER - MODEL C

## READING A DATA BLOCK RECORD FROM DATA MEMORY

During entry it may become necessary to verify the last data block written. When this situation occurs, proceed as follows:

1. Set function switches as follows:

SWITCH	POSITION	SWITCH	POSITION
MEMORY SELECTOR (MS)	DATA	VERIFY INTERLOCK (V/INT)	OFF
MODE (M)	VERIFY		
AUTO REL (R)	ON	PROGRAM REVERT (PR)	RECORD READ
AUTO DUP/SKIP (AD/S) (D/S 2)	OFF	DUP SKIP 1 (D/S 1)	OFF

NOTE: Set Program Revert/Record Read switch on keyboard to RECORD READ position. This conditions the Data Recorder not to add or delete 8 bits in program memory while the data block is being read into data memory.

2. Depress ER/TBS keys to back the tape up *one* block length.
3. Depress REL key. The last data block has been read into data memory.

## VERIFYING THE LAST RECORD WRITTEN

4. Set REL switch to "off."
5. Set Program Revert/Record Read switch to "off."
6. Verify the entire data block. The SKP key may be used to verify skip fields.
7. Change switches:

SWITCH	POSITION	SWITCH	POSITION
MEMORY SELECTOR (MS)	DATA	VERIFY INTERLOCK (V/INT)	OFF
MODE (M)	ENTRY		
AUTO REL (R)	ON	PROGRAM REVERT (PR)	OFF
AUTO DUP/SKIP (AD/S) (D/S 2)	ON	DUP SKIP 1 (D/S 1)	ON

8. Depress ER/HOM keys.
9. Proceed with entry run.

# 1101 MOHAWK/73F NCR DATA RECORDER - MODEL C

## REPLACING DAMAGED DATA BLOCKS DURING VERIFICATION

To replace more than one data block in the middle of a data batch, proceed as follows:

1. Set the function switches as follows:

SWITCH	POSITION	SWITCH	POSITION
MEMORY SELECTOR (MS)	DATA	VERIFY INTERLOCK (V/INT)	OFF
MODE (M)	VERIFY		
AUTO REL (R)	ON	PROGRAM REVERT (PR)	OFF
AUTO DUP/SKIP (AD/S) (D/S 2)	OFF	DUP SKIP 1 (D/S 1)	OFF

2. Determine how many data blocks are damaged.
3. Read in the first damaged data block.
4. Depress the ER/COR keys. The tape will be automatically backspaced *one* block length with the first depression of the ER/COR keys. The erase head and the read/write head will be turned on in preparation for erasing the error block and writing the new data block.
5. Set mode switch to ENTRY. Key enter the correct data for that data block.
6. Change mode switch to VERIFY.
7. Depress ER/HOM keys.
8. Re-verify the entire data block. When all positions have been re-verified without error correction, automatic write on tape and read-after-write check will occur. *If a correction using the FM or COR key is made during re-verification, the entire data block must be re-verified again.*
9. After the read-after-write check is complete, depress the REL key to read in the next data block for correction or verification.
10. Repeat steps 4 through 9 until all of the damaged data blocks are replaced.
11. Set D/S 1 and D/S 2 switches to the "on" position. Proceed with the verification run.



# 1101 MOHAWK/735 NCR DATA RECORDER - MODEL C

## PERFORMING A SEARCH

To condition the 1101 to search from the beginning of a tape for a record written on the magnetic tape, proceed as follows:

1. Power switch to the "off" position.
2. Set function switches as follows:

SWITCH	POSITION	SWITCH	POSITION
MEMORY SELECTOR (MS)	DATA	VERIFY INTERLOCK (V/INT)	ON
MODE (M)	VERIFY		
AUTO REL (R)	OFF	PROGRAM REVERT (PR)	OFF
AUTO DUP/SKIP (AD/S) (D/S 2)	OFF	DUP SKIP 1 (D/S 1)	OFF

3. Mount and thread data tape to be searched.
4. Power switch to the "on" position.
5. Make consecutive depressions of the ER/TEF keys until the reflective marker is below the positioning arrows on the tape deck.
6. Manually position the bottom of the reflective marker at the tip of the upper arrow.
7. Set mode switch to ENTRY.
8. Key enter a record identifier into data memory. The identifier must consist of data identical in content and memory position to the data of the record being searched for. The identifier can be from one to eighty characters long. Any position of the 80 character block that is not used as an identifier must contain a space. The identifier must also be unique to the record being searched for.
9. Set mode switch to VERIFY.
10. Depress ER/HOM keys.
11. Key verify the identifier. To correct an error, change mode switch to ENTRY and key correct character. Return to VERIFY position after each correction.
12. Change switches:
  - MS - PROGRAM
  - M - ENTRY
  - D/S2 - ON
13. Hold REL key depressed for  $\frac{1}{2}$  second and release. Consecutive data blocks will be read into memory and compared to the identifier. The record being searched for has been found when the search stops without error condition. The record is to the left of the read/write head. The identifier is still in data memory.

## 1101 MOHAWK/735 NCR DATA RECORDER - MODEL C

*NOTE: If it is desired to work with the data block located by the search; i.e., verify, change or delete, proceed with steps 14 through 17 to read the data block into data memory. If an entry run is to be continued after the data block is located, proceed directly to step 18.*

### AFTER SEARCH - VERIFYING THE "FOUND" RECORD

14. Change function switches as follows:

SWITCH	POSITION	SWITCH	POSITION
MEMORY SELECTOR (MS)	DATA	VERIFY INTERLOCK (V/INT)	OFF
MODE (M)	VERIFY		
AUTO REL (R)	ON	PROGRAM REVERT (PR)	RECORD READ
AUTO DUP/SKIP (AD/S) (D/S 2)	OFF	DUP SKIP 1 (D/S 1)	OFF

*NOTE: Set Program Revert switch on the keyboard to RECORD READ position. This conditions the Data Recorder not to add or delete 8-bits in program memory while the data block is being read into data memory.*

15. Depress ER/TBS keys to back the tape up one block length.
16. Depress the REL key. The record that was found by search is read into memory without disturbing program memory.
17. Set Program Revert switch to "off." Proceed with the verification.

### TO CONTINUE AN ENTRY RUN

18. To continue an entry run after a data block has been located by a search, set the function switches as follows:

SWITCH	POSITION	SWITCH	POSITION
MEMORY SELECTOR (MS)	DATA	VERIFY INTERLOCK (V/INT)	OFF
MODE (M)	ENTRY		
AUTO REL (R)	ON	PROGRAM REVERT (PR)	As Required
AUTO DUP/SKIP (AD/S) (D/S 2)	As Required	DUP SKIP 1 (D/S 1)	As Required

19. Proceed with entry run.

*NOTE: A search does not have to start at the beginning of the tape. If a search is to be started from some place other than the beginning of the tape, set the function switches as stated in Step 2 above and proceed with Steps 7 through 19.*

# 1101 MOHAWK/735 NCR DATA RECORDER - MODEL C

## ERROR RECOVERY DURING ENTRY

During data entry, certain errors may be encountered. Most of these errors are signaled to the operator by the flashing error light and some are also indicated by the RLO and TCK lights. The entry mode errors and the recovery procedures are discussed in the following paragraphs.

### MULTIPLE KEY ERROR - "ER" FLASHES

If, during data entry, more than one character key is depressed at one time, an error indication will result. The error light on the control panel will flash. The memory counter will not advance and further key entry will be prevented.

To recover from this type of error, depress the ER key. The error light will be extinguished and the keyboard will be made operational. The correct character can now be key entered in the proper position.

### SENSED KEYING ERROR - "ER" FLASHES

If an alpha or special character is keyed in a position programmed for numerics, the error light will flash. The memory counter will not advance from the position where the keying error was made. Depressing the ER key will make the Data Recorder operational again.

Alpha characters and alpha shift special characters can be entered in a numeric field by holding the LTR key depressed while the character is being key entered. Numeric shift special characters can be entered in a numeric or alpha field by holding the NUM key depressed while the character is being key entered.

All machine operations take a certain amount of time to complete. For example, the write and read-after-write check will take approximately 240 milliseconds. If data is keyed into memory before a machine operation such as read-after-write, dup or skip is complete, the error light will come on at the end of the operation. The position indicator will be stopped at the beginning of a field. To recover from an error of this type, depress the ER key to extinguish the error light. Re-key the data, starting at the position indicated by the position counter.

### OPERATOR SENSED KEYING ERRORS - NO ERROR LIGHT

When the operator senses that a keying error has been made (without an 1101-C error indication), the correction can be made in the following way. Hold the ER key depressed and depress the MBS key once for every position to be backspaced. The memory counter will be reduced by one for each depression of the MBS key. When the correct position has been reached, release the ER key and key the correct characters into the correct positions. Key entering the correct character will erase the previously entered incorrect character.

## ERROR RECOVERY DURING ENTRY (CONT.)

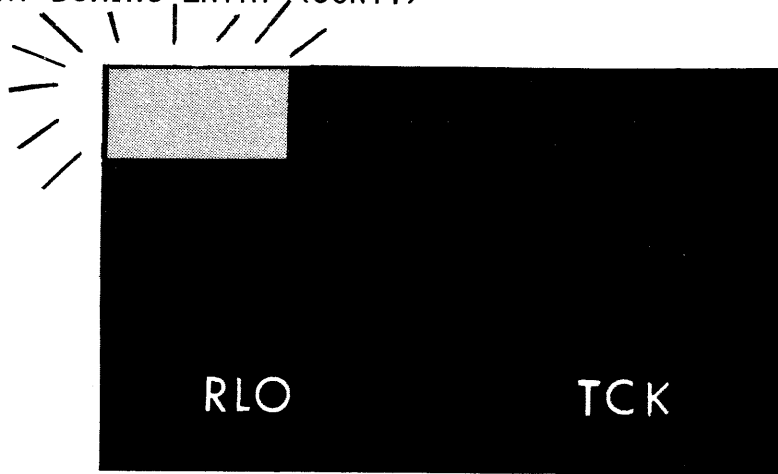

## READ-AFTER-WRITE ERROR - "ER" "RLO" AND "TCK" LIGHT

Following the writing of a data block on tape, an automatic read-after-write check is performed. This check consists of reading the data block just written, checking it for correct parity and comparing the data characters read against the data characters retained in data memory. If a discrepancy is encountered during the read-after-write check, the error light will flash and the RLO and TCK lights will be lit. This error condition could be caused by a blank character in memory or a bad spot on tape. It is, therefore, necessary to rewrite the data block on tape. This is accomplished by following the procedure below:

1. Depress the ER/TBS keys. The error light and RLO light will be extinguished and the tape will be backed up one block length.
2. Depress the ER/TEF keys to erase the error block and advance the bad tape past the read/write head.
3. Depress the REL key to rewrite the data block in a new location on tape.

*If the error condition persists after the read-after-write check, proceed to Step 4. If the error lights are not lit, the bad tape area has been bypassed. Proceed with entry run.*

4. Depress the ER key to extinguish the error light and reactivate the keyboard.
5. Depress the ER/TBS keys. The tape will be backed up one block length and the RLO light will be extinguished.
6. Re-key the entire data block making sure that no invalid characters are keyed into memory. When the last position is addressed, the re-keyed data block will be released to tape, replacing the error block. The read-after-write check will take place again.

NOTE: If, after rewriting the block, the automatic check again detects an error, the bad stop on tape has not been entirely passed and Steps 1 through 3 should be repeated.

# 1101 MOHAWK/735 NCR DATA RECORDER - MODEL C

## ERROR RECOVERY DURING VERIFICATION

During verification, the Data Recorder will detect keying errors made during entry and any parity errors that may exist on tape.

### AUTOMATIC VERIFICATION

Data fields that were automatically duplicated during entry can be automatically verified as the data block is being key verified. The constant data fields need only to be programmed with a program code 4 in the MSP of the field. The automatic verification works on the same principle as the Dup-Verify feature, except that the duplicate action is automatically initiated when program code 4 is encountered. If a non-compare between the dup-field data from one data block to the next is sensed, an 8 bit will be set and memory advance will stop at the position where the non-compare occurred.

## CORRECTING A CHARACTER ENTERED INCORRECTLY - USING ER/COR KEYS

During verification, a keyed character not identical to the character stored in memory, for the position being checked, will cause an error condition. The error light will flash.

Depressing the ER key will activate the keyboard and extinguish the error light for another keying attempt. If the error indication persists after two or more attempts, making sure that the proper character is being keyed, it must be assumed that the character in storage is in error and is to be corrected.

To replace the incorrect character in memory with the correct character and write the correct data block on tape, proceed as follows:

1. Depress the ER key to extinguish the error light.
2. Depress the ER/COR keys. The tape will be automatically backspaced one block length with the first depression of the ER/COR keys. The erase head and read/write head will be turned on in preparation for erasing the error block and writing the corrected block. The Data Recorder will be conditioned for entry of one character into data memory and automatic and manual release will be inhibited.
3. Key enter the correct character. The memory counter will advance one position and the Data Recorder will return to verification mode.
4. Continue verification to the end of the data block. For each error encountered, depress the ER/COR keys and key the correct character.
5. After the last position of the data block has been verified or corrected, depress the ER/HOM keys. Re-verify the entire data block. When all positions have been verified *without error correction*, automatic write on tape and read-after-write check will occur. If a correction using the COR key is made during re-verification, the entire data block must be reverified again.
6. After the read-after-write check is complete, depress the REL key to read in the next data block.

## ~~CORRECTING A FIELD ENTERED INCORRECTLY - USING ER/FM KEYS~~

If an entire field has been entered incorrectly, proceed as follows:

1. Depress the ER/FM keys. The tape will be automatically backspaced one block length with the first depression. The erase head and read/write head will be turned on in preparation for erasing the error block and writing the corrected block. Automatic and manual release will also be inhibited.
2. Key enter the correct characters of the field being changed. At the end of the field, the Data Recorder will automatically return to Verify mode.
3. Continue verification of the entire data block.
4. After the last position of the data block has been verified or corrected, depress the ER/HOM keys. Re-verify the entire data block. When all positions have been verified without error correction, automatic write on tape and read-after-write check will occur. If a correction using the COR or FM key is made during re-verification, the entire data block must be verified again.
5. After the read-after-write check is complete, depress the REL key to read in the next data block.

## CORRECTING AN ENTIRE DATA BLOCK

If, *during verification*, it has been determined that an entire data block must be corrected, proceed as follows:

1. Change D/S 1 and D/S 2 switches to "off" position.
2. Depress ER/HOM and ER/COR keys. The tape will be automatically backspaced one block length with the first depression of the ER/COR keys. The erase head and the read/write head will be turned on in preparation for erasing the error block and writing the new data block.
3. Change mode switch to ENTRY.
4. Key enter the correct data.
5. Change mode switch to VERIFY.
6. Depress ER/HOM keys.
7. Re-verify the data block. When all positions have been verified *without error correction*, automatic write on tape and read-after-write check will occur. If a correction using the COR key is made during re-verification, the entire data block must be re-verified again.
8. After the read-after-write check is complete, depress the REL key to read in the next data block for verification.
9. Set D/S 1 and D/S 2 switches to the "on" position. Proceed with verification.

# 1101 MOHAWK/735 NCR DATA RECORDER - MODEL C

## ERROR RECOVERY DURING SEARCH - "ER," "RLO" AND "TCK" LIGHT

A search operation should be completed without error indication. A parity error or blank tape encountered during search will cause an error condition.

A blank tape area could be the result of the entry operator *erasing* several blocks during entry because of a bad spot on tape. An improper identifier which would cause the search to go beyond the last data block on tape will also cause the search to stop with an error indication when blank tape is encountered. In each case, the error light will flash and the RLO and TCK lights will come on.

If blank tape in the middle of the run was the cause for the error condition, one to three tape backspace and release operations (hold REL key  $\frac{1}{2}$  second each time) should be sufficient to: extinguish the error lights, move past the blank tape area and continue the search. If the error condition persists, the last data block read has a parity error or the search went beyond the last recorded data block.

To read the last data block into memory, set the function switches as follows:

SWITCH	POSITION	SWITCH	POSITION
MEMORY SELECTOR (MS)	DATA	VERIFY INTERLOCK (V/INT)	OFF
MODE (M)	VERIFY		
AUTO REL (R)	ON	PROGRAM REVERT (PR)	RECORD READ
AUTO DUP/SKIP (AD/S) (D/S 2)	OFF	DUP SKIP 1 (D/S 1)	OFF

Depress the ER/TBS and REL keys to read the data block into memory. An error indication with a display of "all-bits" indicates that blank tape has been read. One or two tape backspace and release operations should establish the fact if the last data block on tape has been bypassed or not and that the identifier used did not locate the desired record.

If the error indication is *not* accompanied by an "all-bits" display, the data block has a parity error. The disposition of the parity error block is at the discretion of the using installation. *The block can be rewritten or it can be deleted.* To resume a search from this point, the identifier *must* be rekeyed into memory and the function switches reset.

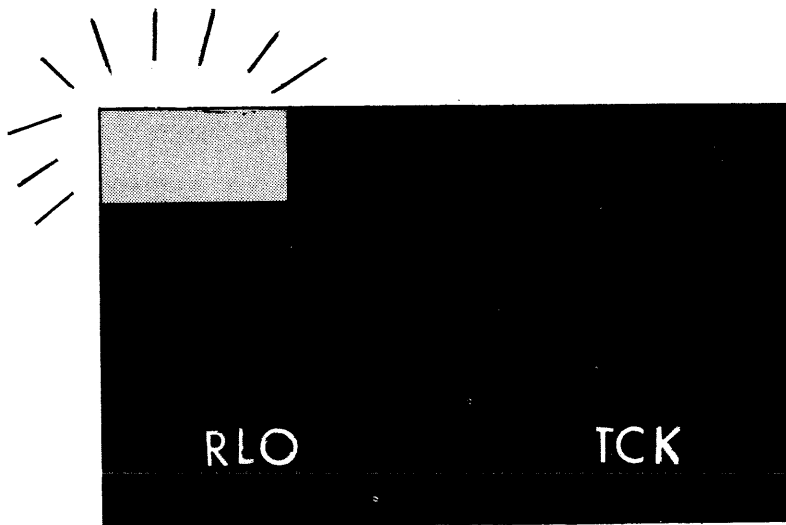

## PARITY ERROR - "ER," "RLO" AND "TCK" LIGHT

During the tape read operation, each character read from tape is checked for correct parity. At the same time, the entire block is checked for correct longitudinal parity. If an error is detected, the error light will flash and the RLO and TCK lights will light.

If a parity error is detected when a data block is being read into memory for verification, depress the ER/TBS and REL keys to reread the data block. If the error persists, it is necessary to manually verify the entire block to determine which characters are in error. To prevent the automatic advance across fields programmed for automatic skip, turn the DUP/SKIP 1 and DUP/SKIP 2 switches to "off," thereby permitting manual verification of those fields.

The ER key must be depressed to extinguish the error light and reactivate the keyboard before manual verification can begin. When an error character is found, it is corrected by replacing the character in memory and rewriting the data block. If all characters verify correctly, the parity error was caused by a discrepancy in the parity bit track and rewriting the block will correct the parity bits.

If, after correcting any errors and rewriting the block, an error persists during the read-after-write check, it must be assumed that the tape has been damaged and a bad spot exists. The error block should be deleted from the tape and the block rewritten at the end of the file.

While checking for the cause of the error indication, short data blocks or damaged data blocks may be found. To replace short or damaged data blocks refer to the next procedure.



## DELETING A DATA BLOCK FROM TAPE

*If deleting a data block from tape is a requirement, the Mohawk Customer Engineer must first perform a simple modification of the keyboard decoder board. This will cause simultaneous depression of the NUM and Z key to put a "no-bits" code into data memory.*

To delete a data block from tape during verification, proceed as follows:

1. Read the data block to be deleted into memory.
2. Depress the ER/COR keys; the tape will be automatically backspace *one* block length. The erase head and read/write head will be turned on in preparation for erasing the error block and writing the replacement data. *Manual and automatic release will be inhibited.*
3. Set D/S 1 and D/S 2 switches to the "off" position.
4. Change mode switch to ENTRY.
5. Depress the NUM and Z keys and hold to position 81. Data memory will contain all "no-bit" characters.
6. Change mode switch to VERIFY.
7. Depress ER/HOM keys.
8. Re-verify the data block by holding the NUM and Z keys depressed. If no errors are encountered, an automatic write on tape and read-after-write check will take place. The error light will flash and the RLO and TCK indicator lights will light. During the read-after-write check, the blank data block was bypassed and the next data block was read in. A non-compare caused the error indication.
9. Depress the ER key.
10. Set the D/S 1 and D/S 2 switches to the "on" position.
11. Depress the ER/TBS keys to extinguish the RLO light.
12. If the next data block is to be read into memory, depress the REL key once.

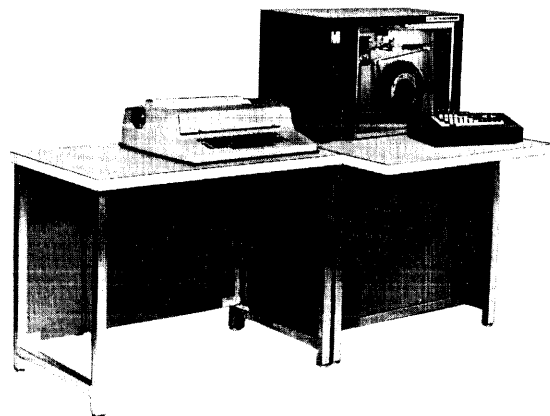
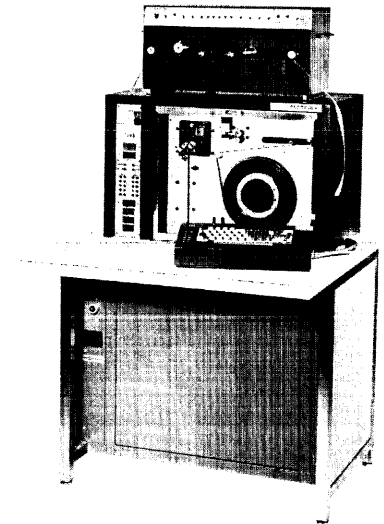
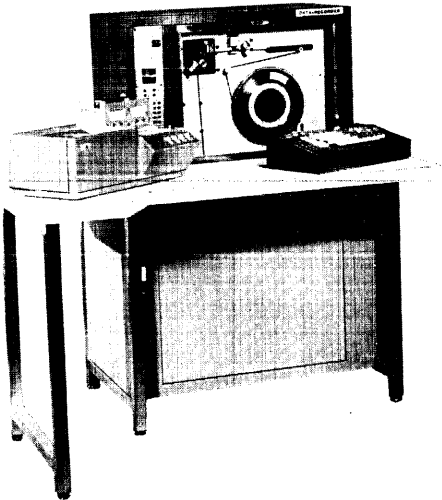
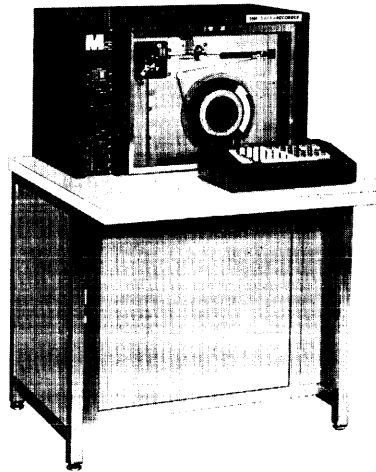
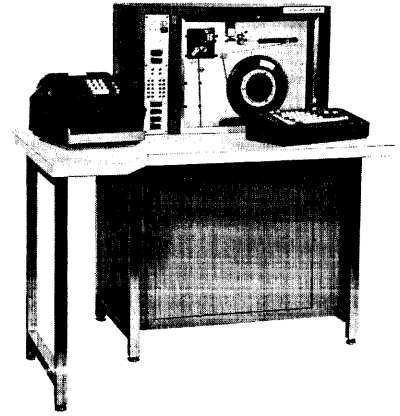
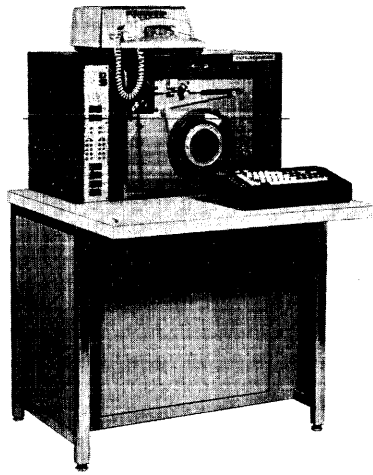
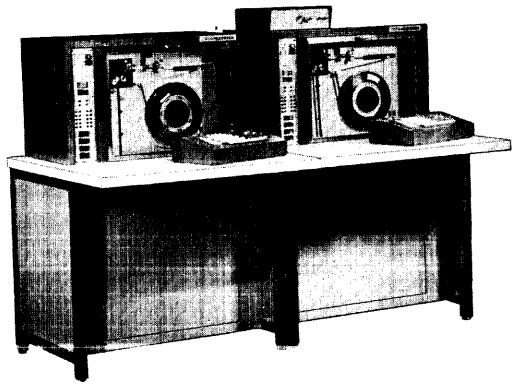

## DATA RECORDERS

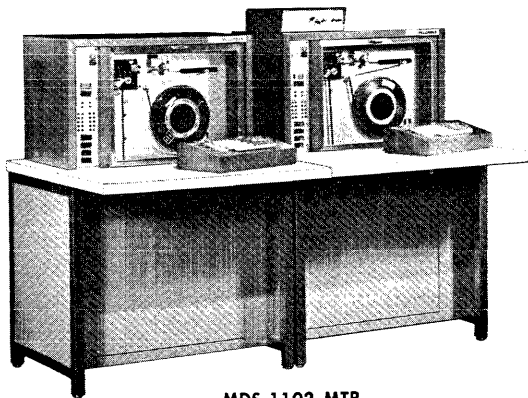

**MDS 1102 MTP  
DATA-RECORDER**

**MULTI-TAPE POOLER** - by using two or three 1102 units in conjunction with the Pooler Control (shown on top of right-hand unit), short batches of data previously recorded on magnetic tape in 1101's and 1102's can be consolidated on a single magnetic tape. May be used the same as the 1101 when the Pooler Control is made inoperable.

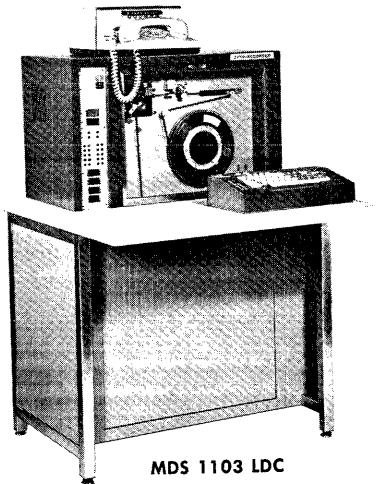

**MDS 1103 LDC  
DATA-RECORDER**

**FOR LONG DISTANCE COMMUNICATION OF DATA** - With the 1103, business information is transmitted accurately, economically, at high speed to a second 1103, over regular voice grade facilities. It originates, sends, receives . . . all on magnetic tape . . . and is designed for use with standard modems and transmission systems. It obsoletes the single-use terminal. May be used same as the 1101 when modem is made inoperable.

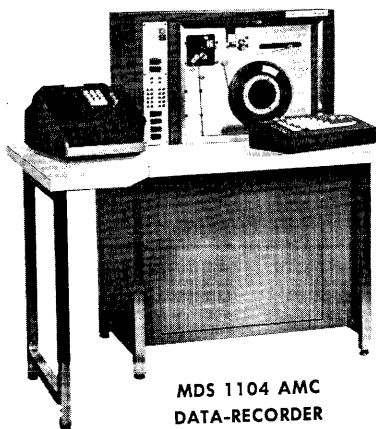

**MDS 1104 AMC  
DATA-RECORDER**

**ADDING MACHINE CONTROL** - the adding machine is a 14-column net balance adding/listing machine that, when connected to the 1104, can be operated from the 1104 keyboard. Amounts designated by stored program enter the 1104's data memory, and are also entered into the calculating section of the adding machine. Non-add identifying numbers can be entered and printed. The 1104 may be used same as the 1101 when Adding Machine is made inoperable.

## DATA RECORDERS

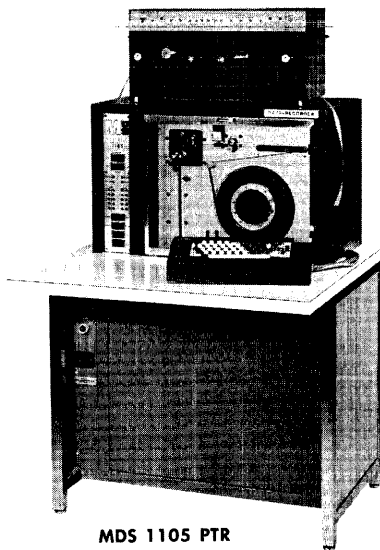

**MDS 1105 PTR  
DATA-RECORDER**

**PUNCHED PAPER TAPE READER** - automatically reads data punched in paper tape, converts it to recorded data on magnetic tape in the 1105. Variable data can be added to the magnetic tape by means of the 1105's keyboard. When Paper Tape Reader is made inoperable, the 1105 may be used the same as the 1101.

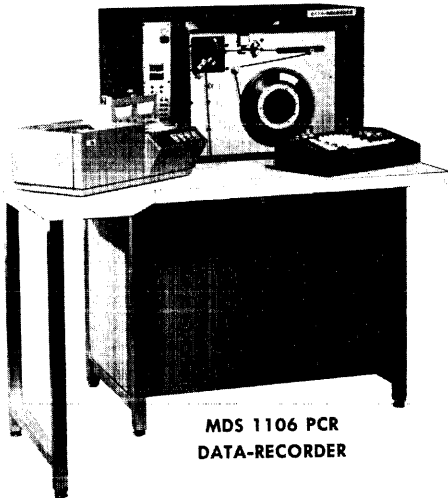

**MDS 1106 PCR  
DATA-RECORDER**

**PUNCHED CARD READER** - simplifies and speeds up the job of transcribing variable information, along with coded data from punched card turnaround documents, to magnetic tape. Automatically reads coded data, records it on magnetic tape in the 1106. In manual cycle, handwritten data or other variable information can be manually keyed on the tape. When Card Reader is made inoperable, the 1106 may be used the same as the 1101.

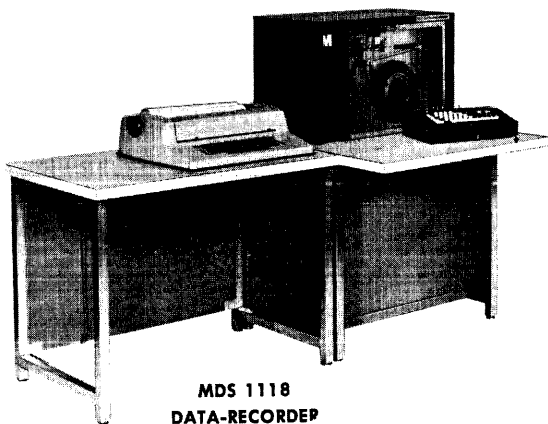

**MDS 1118  
DATA-RECORDER**

**PRINTER PROVIDES PRINTED OUTPUT** - from the computer magnetic tape read by the 1118, which controls operation of the Printer. The 1118 system may be operated either in automatic or manual cycle. When Printer is not in use, the 1118 may be used the same as the 1101.

6401 MOHAWK/736 NCR DATA RECORDER

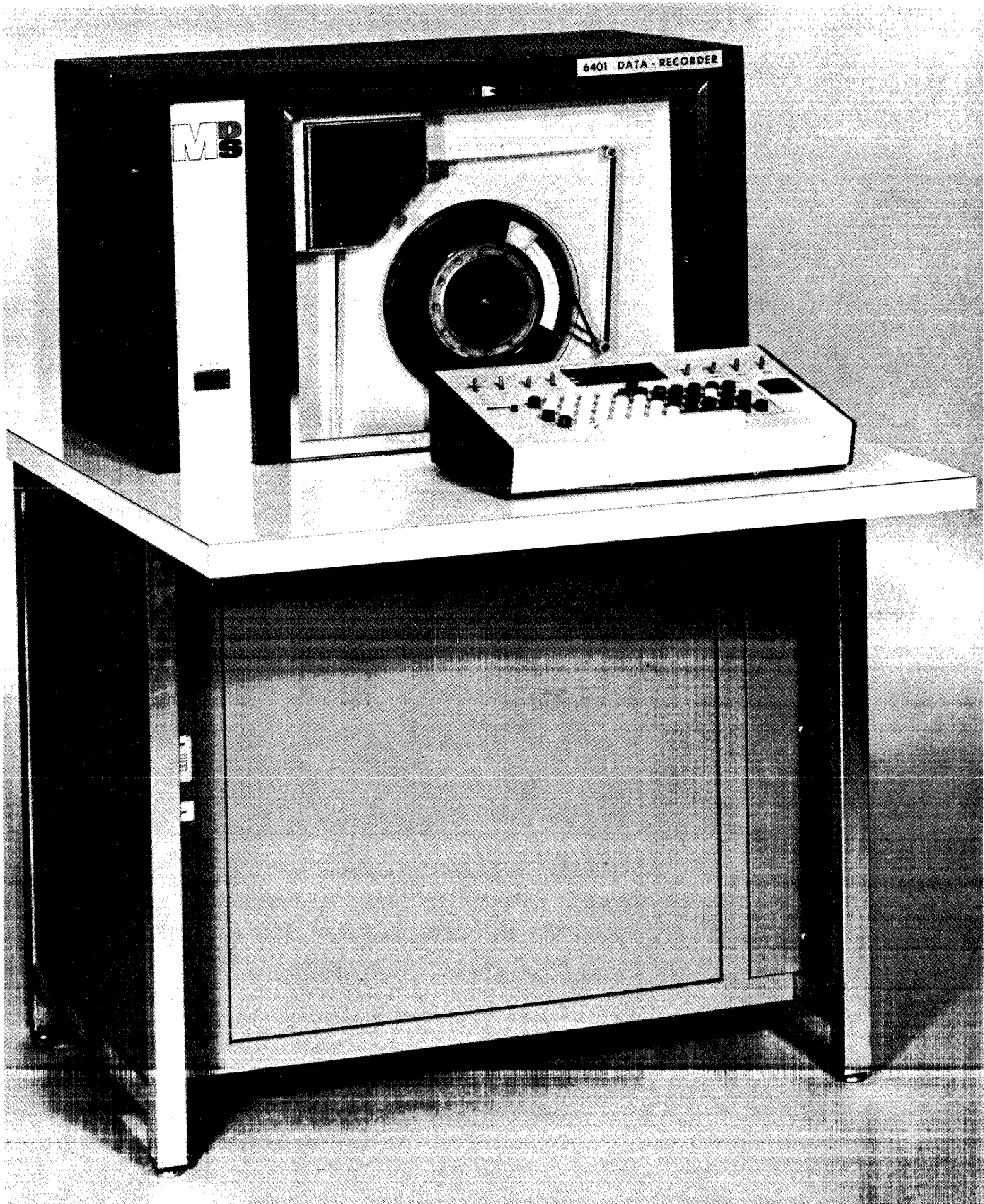

Photo Courtesy of Mohawk Data Sciences Corporation, Herkimer, New York.

# 6401 MOHAWK/736 NCR DATA RECORDER

## FEATURES

The MDS 6401 Keyed DATA RECORDER is designed for those computer installations that want to make better use of their computer time by having the input data arrive at the computer on magnetic tape.

Magnetic tapes prepared on the 6401 can be processed on computer systems that accommodate 800 bpi, 9 channel tapes. Recording is done on standard  $\frac{1}{2}$ ", 800 bpi density computer magnetic tapes. Characters are written on tape in Extended Binary Coded Decimal Interchange Code (EBCDIC). The 6401 is a multi-purpose machine that can be used for data verification as well as data entry. The 6401 can also be conditioned for a search operation so that any specified data block can be checked, changed, or corrected. Data blocks are searched for at a rate of approximately 1100 blocks per minute.

## MEMORY

In size, appearance and operating principles, the 6401 Keyed Data Recorder is a companion to the original MDS 1100 Keyed Data Recorder. The basic 6401 is equipped with a 100 character memory. A 180 character memory with a Selective Block Length feature is available as an option. With this option device, the size of the usable memory is variable in units of ten, from 10 to 180 positions.

## OPERATOR CONSOLE

The movable Operator Console, which rests on the reading table in front of the operator, contains all of the necessary operator controls required during the data recording operation. The standard 6401 Operator Console houses a 63 character keyboard. The multi-code key permits entry of each of the 256 code combinations available with the EBCDIC system.

## ERROR CORRECTION

~~The 6401 is a buffered unit, i.e., a complete data block is stored in the magnetic core memory before it is released and written on tape. Operator sensed keying errors can be corrected immediately by backspacing in memory and keying the correct character. This eliminates the need for special extra cost machines for correcting errors. This also allows for a read-after-write check to assure that the keyed data is properly written on tape.~~

## HIGH SPEED DUP AND SKIP

The duplicate and skip feature and the microsecond speed of duplicating and skipping, introduced in the MDS 1101, has been maintained in the 6401 Keyed Data Recorder. Keyboard lockout during the write-on-tape and read-after-write cycle is only 150 milliseconds. These high speed machine operations permit the operator to keep a constant keying cadence, which helps to account for the high output and low fatigue ratios attained on MDS Data Recorders.

## AUTOMATIC TAPE POSITIONING

Tape positioning on the 6401 is automatic. After placing the tape in position for tape feed, a single control advances the tape with continuous motion past the read/write head. Forward tape movement stops when the beginning of tape reflective marker passes the beginning of tape sensor. The tape is automatically positioned for operation.

# 6401 MOHAWK/736 NCR DATA RECORDER

## MODES OF OPERATION

### ENTRY MODE

During data entry, keyboard shift is under control of the program codes in the selected program memory. When required, program control can be overridden through the use of the Letter Shift and Number Shift keys. Data fields programmed for auto skip and auto duplication are skipped and duplicated at a rate of 80 microseconds per position.

Data from the source document is keyed through the keyboard on the operator console. The code for each character keyed is entered electronically into a single position in magnetic core data memory. With each key depression, the position counter advances one position. All codes for a single data block are stored in memory. When the last data position is keyed or reached by skipping or dopping, a release action occurs. During a release action, all data characters in memory are written on the magnetic tape as the tape passes the read/write head. During the write cycle, the contents of data memory is not destroyed. The data is retained for checking purposes.

During the write cycle, the erase head is turned on to erase the area of tape to be written on. Also, during the write cycle, vertical parity, longitudinal parity and cyclic redundancy characters are calculated. Each character is written on tape with odd vertical parity. The Cyclic Redundancy Check (CRC) character and longitudinal parity character are written on tape following the data block.

After the entire block is written, the tape movement stops momentarily. The tape then moves back one block length and then forward past the read/write head again. Before the tape is backed up, the erase heads turns off. During this second forward motion, the data block just written is read from tape. The data read from tape is compared bit-for-bit with the data retained in memory. Parity accuracy is also checked during the read operation. A non-compare of data on tape to data in memory signals the operator to take corrective action. At the completion of a successful read-after-write check, the tape is positioned and ready for the next data entry. The entire write on tape and read-after-write checks takes approximately 150 milliseconds. Each data block is separated by a nominal 0.6 inch interrecord gap.

During data entry, the following observations regarding the operation being performed can be made:

1. Memory position into which next character is to be entered.
2. Program code controlling memory position being displayed.
3. Number of data blocks recorded.
4. What character code from previous data blocks is in the memory position displayed.

# 6401 MOHAWK/736 NCR DATA RECORDER

## MODES OF OPERATION (CONT.)

### VERIFY MODE

During verification of data, each data block to be verified is read into data memory, one at a time. The verify operator then keys the data from the source document. As each character is keyed, the code for that character is automatically compared to the code in that position in memory. If the two codes compare, the operator may proceed to the next character. A non-compare between the keyed character and the character in memory is signaled to the operator. Corrective action must then be taken before verification can proceed. Corrective action consists of entering the correct character in memory and writing this character on tape in place of the incorrect character or characters. After each data block is completely verified, the next data block is automatically read into memory for verification.

During verification, the data tape moves only in the forward direction unless the tape is being corrected. During a correction in verification, the tape is backed up one block length for each error block, so the corrected block can be written on tape in place of the error block.

Program codes control keyboard shift during verification, as well as entry. The data within a field programmed for an automatic skip is not verified. A field of data that is repeated in consecutive data blocks can be machine verified by programming the field for auto-duplication. A "dup verify" feature allows the operator to use the DUP key for verifying corresponding memory positions of adjacent data blocks which contain identical data. When the DUP key is depressed, all consecutive positions up to the first point of difference are verified at dup speeds of 80 micro-seconds per position. This feature saves keystrokes and increases speed during the verification.

During data verification, the following observations regarding the operation being performed can be made:

1. Next memory position to be verified.
2. Program code controlling memory position being displayed.
3. Number of data blocks verified.
4. What character code is in the memory position about to be verified.



## 6401 MOHAWK/736 NCR DATA RECORDER

### MODES OF OPERATION (CONT.)

#### SEARCH MODE

The 6401 can be conditioned to search for one block out of a group of data blocks on tape. The data blocks on tape, during a search, are read at a nominal rate of 1100 data blocks per minute. A search is generally performed for purposes of making corrections or changes to existing data blocks on tape or to locate a starting point for a new days run.

Search is accomplished by automatically comparing each data block, as it is read, with an identifier which has been keyed into data memory. An identifier consists of data identical in content and memory position to the data in the data block being searched for. All other memory positions of the identifier block must contain space codes.

When a data block is read that contains data that matches the identifier, tape reading stops. The data block being searched for is positioned just past the read/write head. This data block can now be read into memory and can be corrected or updated, if desired, by following the detailed

A search can be used to locate the last data block on tape so a new days run can be added to the tape. When the last data block is located by the search, the Data Recorder can be conditioned for a new entry run by merely setting the Operator Console switches for ENTRY operation. Separation of batches, if required, can be accomplished in accordance with local procedure.

Parity error blocks, and more than three inches of blank tape, halt a search operation with an error condition indication. If a tape mark is read into position 001 during a search, the search operation stops.

# 6401 MOHAWK/736 NCR DATA RECORDER

ALPHA CHARACTER	E B C D I C CODE							HEXA- DECIMAL CODE	
	D	C	B	A	8	4	2		1
A	1	1	0	0	0	0	0	1	C1
B	1	1	0	0	0	0	1	0	C2
C	1	1	0	0	0	0	1	1	C3
D	1	1	0	0	0	1	0	0	C4
E	1	1	0	0	0	1	0	1	C5
F	1	1	0	0	0	1	1	0	C6
G	1	1	0	0	0	1	1	1	C7
H	1	1	0	0	1	0	0	0	C8
I	1	1	0	0	1	0	0	1	C9
J	1	1	0	1	0	0	0	1	D1
K	1	1	0	1	0	0	1	0	D2
L	1	1	0	1	0	0	1	1	D3
M	1	1	0	1	0	1	0	0	D4
N	1	1	0	1	0	1	0	1	D5
O	1	1	0	1	0	1	1	0	D6
P	1	1	0	1	0	1	1	1	D7
Q	1	1	0	1	1	0	0	0	D8
R	1	1	0	1	1	0	0	1	D9
S	1	1	1	0	0	0	1	0	E2
T	1	1	1	0	0	0	1	1	E3
U	1	1	1	0	0	1	0	0	E4
V	1	1	1	0	0	1	0	1	E5
W	1	1	1	0	0	1	1	0	E6
X	1	1	1	0	0	1	1	1	E7
Y	1	1	1	0	1	0	0	0	E8
Z	1	1	1	0	1	0	0	1	E9

SPECIAL CHARACTER	E B C D I C CODE							HEXA- DECIMAL CODE	
	D	C	B	A	8	4	2		1
Space	0	1	0	0	0	0	0	0	40
]	0	1	0	0	1	0	1	0	4A
.	0	1	0	0	1	0	1	1	4B
<	0	1	0	0	1	1	0	0	4C
(	0	1	0	0	1	1	0	1	4D
+	0	1	0	0	1	1	1	0	4E
!	0	1	0	0	1	1	1	1	4F
&	0	1	0	1	0	0	0	0	50
[	0	1	0	1	1	0	1	0	5A
\$	0	1	0	1	1	0	1	1	5B
*	0	1	0	1	1	1	0	0	5C
)	0	1	0	1	1	1	0	1	5D
;	0	1	0	1	1	1	1	0	5E
^	0	1	0	1	1	1	1	1	5F
-	0	1	1	0	0	0	0	0	60
/	0	1	1	0	0	0	0	1	61
,	0	1	1	0	1	0	1	1	6B
%	0	1	1	0	1	1	0	0	6C
	0	1	1	0	1	1	0	1	6D
>	0	1	1	0	1	1	1	0	6E
?	0	1	1	0	1	1	1	1	6F
:	0	1	1	1	1	0	1	0	7A
:	0	1	1	1	1	0	1	1	7B
#	0	1	1	1	1	0	1	1	7C
@	0	1	1	1	1	1	0	0	7D
-	0	1	1	1	1	1	0	1	7E
=	0	1	1	1	1	1	1	0	7F
"	0	1	1	1	1	1	1	1	7F
MC	0	0	0	0	0	0	0	0	00

NUMERIC CHARACTER	E B C D I C CODE							HEXA- DECIMAL CODE	
	D	C	B	A	8	4	2		1
0	1	1	1	1	0	0	0	0	F0
1	1	1	1	1	0	0	0	1	F1
2	1	1	1	1	0	0	1	0	F2
3	1	1	1	1	0	0	1	1	F3
4	1	1	1	1	0	1	0	0	F4
5	1	1	1	1	0	1	0	1	F5
6	1	1	1	1	0	1	1	0	F6
7	1	1	1	1	0	1	1	1	F7
8	1	1	1	1	1	0	0	0	F8
9	1	1	1	1	1	0	0	1	F9

# 6401 MOHAWK/736 NCR DATA RECORDER

## MAGNETIC MEMORY

The magnetic core memory is the heart of the 6401 Keyed DATA RECORDER. In this correctable or changeable memory are stored the program instructions that direct basic machine functions. The magnetic core memory is also the storage or holding place for data being recorded or verified. The core memory is made up of many strings of tiny "doughnut" shaped magnetic cores. There is one string of cores for each memory position. Each string consists of eight data cores and eight program cores.

A magnetic core is usually referred to as being in either an "on" or "off" condition. To designate the condition of a core, it is accepted practice to show a core in the "on" condition with a "1" and a core in the "off" condition with a "0". For example, the condition of the eight cores used to express a 6401 "zero" is ON, ON, ON, ON, OFF, OFF, OFF, OFF, and this is written as 11110000. This method of presenting core condition is used in this manual.

### PROGRAM CORES

Eight program cores in each memory position store the main and alternate program code for that position. The four program cores for each program memory position carry the notations 8, 4, 2 and 1. A combination of "1" and "0" cores in a memory position is referred to as a program code. Program codes in this manual are expressed in binary notation. Thus, a program code 5 is written as 0101. If each core is in the "off" condition, (program code 0), the binary notation is 0000.

### DATA CORES

Each memory position has eight magnetic cores for data storage. The 6401 uses the Extended Binary Coded Decimal Interchange Code System. The data bits carry the notations D, C, B, A, 8, 4, 2 and 1.

## PROGRAM CODES

There are eight program codes available to control Data Recorder functions. These program codes are entered into program memory either through the keyboard or from a program tape. The program codes in program memory remain unaltered during data entry. With both main and alternate program memories containing program codes, either memory may be selected to control Data Recorder functions.

To operate under program control, the Most Significant Position (first position) of each field is usually indicated by a program code that stops an automatic machine action such as a skip or dup and puts the machine in the proper shift for the next entry. Program codes 2 through 7 are used to define the Most Significant Position (MSP) of a field.

# 6401 MOHAWK/736 NCR DATA RECORDER

## CORE MEMORY

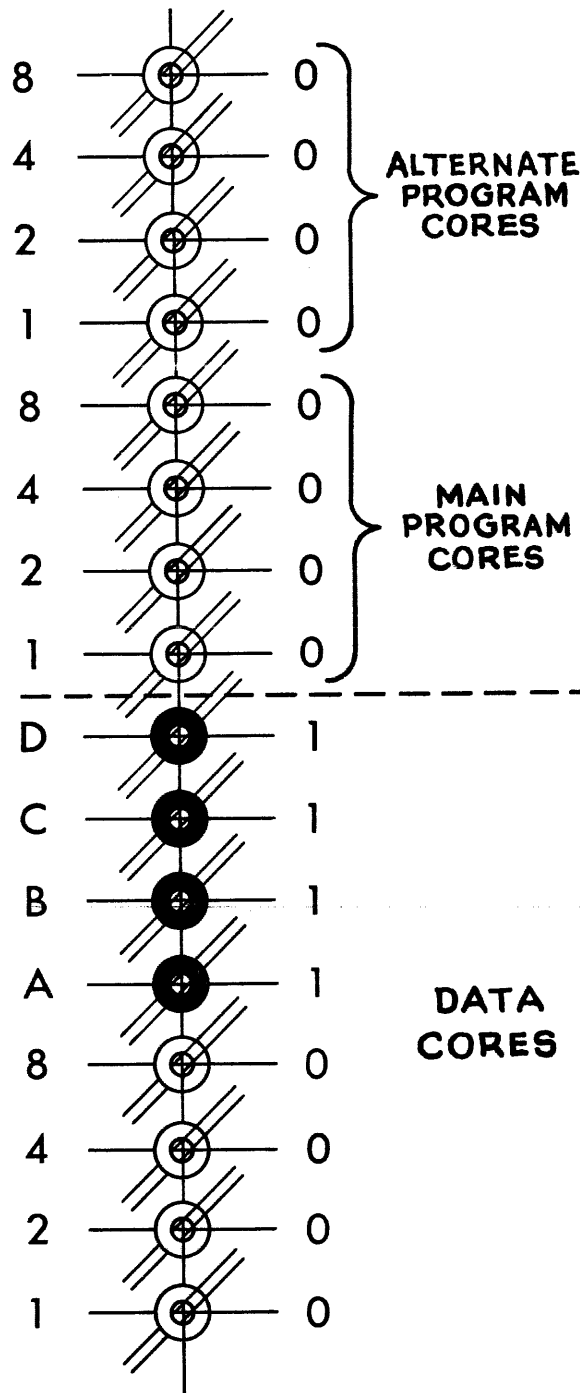

Diagram courtesy of Mohawk Data Sciences Corporation, Herkimer, New York.

## 6401 MOHAWK/736 NCR DATA RECORDER

### PROGRAM CODES (CONT.)

SP (0000) - Program code SP (0000) identifies a memory position that is to contain a numeric (0-9) character. To enter an alpha or alpha shift special character in a position programmed with a (0000), the letter shift (LTR) key is held depressed while entry is being made. To enter a numeric shift special character, the numeric shift (NUM) key is held depressed while entry is being made. Program code 0000 does not stop skipping, duplication or left zero action and, therefore, is generally not used in the MSP of a field.

1 (0001) - Program code 1 (0001) identifies the memory position that is to contain an alpha shift character. To enter a numeric or a numeric shift special character in a position programmed with a 0001, the numeric shift (NUM) key is held depressed while entry is being made. Program code 1 does not stop skipping, duplication or left zero action and, therefore, is generally not used in the MSP of a field.

2 (0010) - Program code 2 is used to stop skip, dup and left zero action and is commonly used to identify the MSP of a numeric field.

3 (0011) - Program code 3 is used to stop skip, dup and left zero action and is commonly used to identify the MSP of an alpha field.

4 (0100) - Program code 4 is used to identify a position that starts an automatic duplicate operation. During a duplicate operation, data from the effected memory positions is retained for use in the current data block. Program code 4 is effective for automatic duplication only if AUTO SKIP/DUP switch is "on". An automatic duplication operation ends when a program code 2 through 7, except 4, is encountered. With AUTO SKIP/DUP switch "off," a code 4 serves as a stop code for manual dup and skip and left zero action. Code 4 also conditions the 6401 for numeric entry. In VERIFY mode, the automatic dup function of program code 4 is used to automatically "dup-verify" constant data fields of consecutive data blocks.

5 (0101) - Program code 5 is used to identify a position that starts an automatic skip operation. Program code 5 is effective for automatic skipping only if the AUTO SKIP/DUP switch is "on." An automatic skip operation ends when a program code 2 through 7, except 5, is encountered. For every position that is skipped during entry, a space code is entered into that memory position. With the AUTO SKIP/DUP switch "off," a code 5 serves as a stop code for manual dup and skip and left zero action. A code 5 places the Data Recorder keyboard in numeric shift.

In VERIFY mode, the automatic skip function of program code 5 is used to automatically skip any positions that are not being verified.

6 (0110) AND 7 (0111) - Program codes 6 and 7 can be used interchangeably, during verification, to specify the MSP of a numeric field when automatic verification of left zeros is desired. Codes 6 and 7 also stop a skip or duplicate operation.

When a 6 or 7 is encountered during verification, all left zeros of that field are machine verified. The memory counter advances and stops at the first non-zero character.

# 6401 MOHAWK/736 NCR DATA RECORDER

## PROGRAM CODES (CONT.)

NOTE: Program codes 6 and 7 are effective during an ENTRY operation. Whenever a memory position with a code 6 or 7 in program memory is entered, a left zero function is automatically set. When this left zero function is set, data may be entered into the following memory positions only if these positions contain program codes (sp) 0000 or (1) 0001. To enter data into positions containing other codes such as (2) 0010 or (3) 0011, the left zero function must be reset by depressing the Left Zero key (LØ). The left zero function remains reset until another code 6 or 7 in program memory is encountered. Attempting to key out of a field programmed with a code 6 or 7 or operation of the SKP, DUP, or REL key, in such a field turns on the error light. This programmed left zero function is designed for use in numeric fields and prevents overrunning fields that require a LØ operation.

## DATA CODES

Data is written on 6401 magnetic tape in Extended Binary Coded Decimal Interchange Code (EBCDIC). Unlike the program codes, data codes in data memory change from data block to data block as new data is entered into memory. Any particular data code remains in memory until it is replaced by a different code. The eight bits of the EBCDIC code are represented by graphics D, C, B, A, 8, 4, 2 and 1. There are 64 different codes available by single key depressing of the 6401 keyboard. One additional code is obtained by depression of the space bar. Through the use of the Multi-Code (MC) key and the D, C, B, A, 8, 4, 2 and 1 keys, single bits can be entered into memory position without advancing the memory position. In this way, any of 256 codes can be constructed in one memory position.

POSITION			CHAR	PROG
HUN	TENS	UNITS		
	0		D 8	8
		1	C 4	4
●			B 2	2
●			A 1	1
				●

# PROGRAM PLANNING CARD

147

ALTERNATE PROGRAM Code Pos Data Code Pos Data 91 92 93 94 95 96 97 98 99 100 101 102 103 104 105 106 107 108 109 110 111 112 113 114 115 116 117 118 119 120 121 122 123 124 125 126 127 128 129 130 131 132 133 134 135 136 137 138 139 140 141 142 143 144 145 146 147 148 149 150 151 152 153 154 155 156 157 158 159 160 161 162 163 164 165 166 167 168 169 170 171 172 173 174 175 176 177 178 179 180		MAIN PROGRAM Code Pos Data Code Pos Data 91 92 93 94 95 96 97 98 99 100 101 102 103 104 105 106 107 108 109 110 111 112 113 114 115 116 117 118 119 120 121 122 123 124 125 126 127 128 129 130 131 132 133 134 135 136 137 138 139 140 141 142 143 144 145 146 147 148 149 150 151 152 153 154 155 156 157 158 159 160 161 162 163 164 165 166 167 168 169 170 171 172 173 174 175 176 177 178 179 180	
<b>PROGRAM CODES</b> SPACE - Numeric Shift 1 - Letters Shift 2 - Numeric Shift - Stop, Skip & Dup 3 - Letters Shift - Stop, Skip & Dup	<b>MAIN</b> <input checked="" type="checkbox"/> Entry <input type="checkbox"/> Verify <input type="checkbox"/> Entry & Verify	<b>ALT</b> <input type="checkbox"/> Entry <input type="checkbox"/> Verify <input type="checkbox"/> Entry & Verify	<b>MDS DATA-RECORDER PROGRAM PLANNING CARD</b>
CUSTOMER NO. 4 INVOICE NO. 4 INVOICE DATE 4 QTY. 42 UNIT 2 DESCRIPTION UNIT PRICE AMOUNT SALES BR. S'M'N ACCOUNT TYPE UNUSED	UNUSED	UNUSED	UNUSED

APPLICATION	PROGRAM TAPE NO.	PROGRAMMED BY	DATE
6401		MDS	8-15-67

M-263-67

6401 MOHAWK/736 NCR DATA RECORDER

Diagram courtesy of Mohawk Data Sciences Corporation, Herkimer, New York

# 6401 MOHAWK/736 NCR DATA RECORDER

## PROGRAM PLANNING CARD

The first step in job planning for the MDS 6401 Data Recorder is the preparation of the Program Planning Card. The Program Planning Card can be used to direct keyboard entry of programs into program memory or for the preparation of a program tape.

The illustration on the opposite page is a reproduction of the Program Planning Card. The identifying information, including the application name, program tape number, programmers name and date, should be entered first. Data field assignments should be made next and the names of these fields entered in the data portion of the card. When it has been decided what the Main and Alternate programs are to be used for, a check mark should be placed in the appropriate box in the information section of the program card.

After data field assignments have been made, the program codes can be entered. They are entered in the area labeled MAIN or ALT, which provides for the possibility of a code for each memory position. There are provisions on the Program Planning Card for 180 program codes for each program memory. The number of positions that you use depends on the memory capacity of your Data Recorder.

In the illustration, positions 01 through 21 are programmed for automatic duplication. Only position 01 is required to start the duplicate operation. Duplicate codes are in positions 09 and 16 only for field definition. The duplicate code is in position 21, the last position of the duplicate field, to prevent backspacing into the duplicate fields and inadvertently changing the constant data. Attempting to backspace into a dup field produces a backward skip which terminates at the next stop skip code. The contents of the backward skipped memory positions are not disturbed. Position 30 is programmed with program code 3 for alpha entry. The first position of each numeric field is programmed with program code 2. In this example, no data entry is required from position 87 to position 100. Position 87, therefore, contains a start skip code. The skip terminates with a release when the last memory position is addressed. All positions so skipped contain space codes on tape. The codes 2 and 3 not only put the Data Recorder in the proper shift but also serve as stop codes for duplicate, skip, and LØ actions. Un-needed positions in the middle of a data block may also be skipped during entry by depressing the SKP key.

If the records for a particular run take up less than half the available memory positions, it may be advantageous to have more than one record occupy one data block. In this case, divide the Program Planning Card into sections and enter identical programs in each section.



## 6401 MOHAWK/736 NCR DATA RECORDER

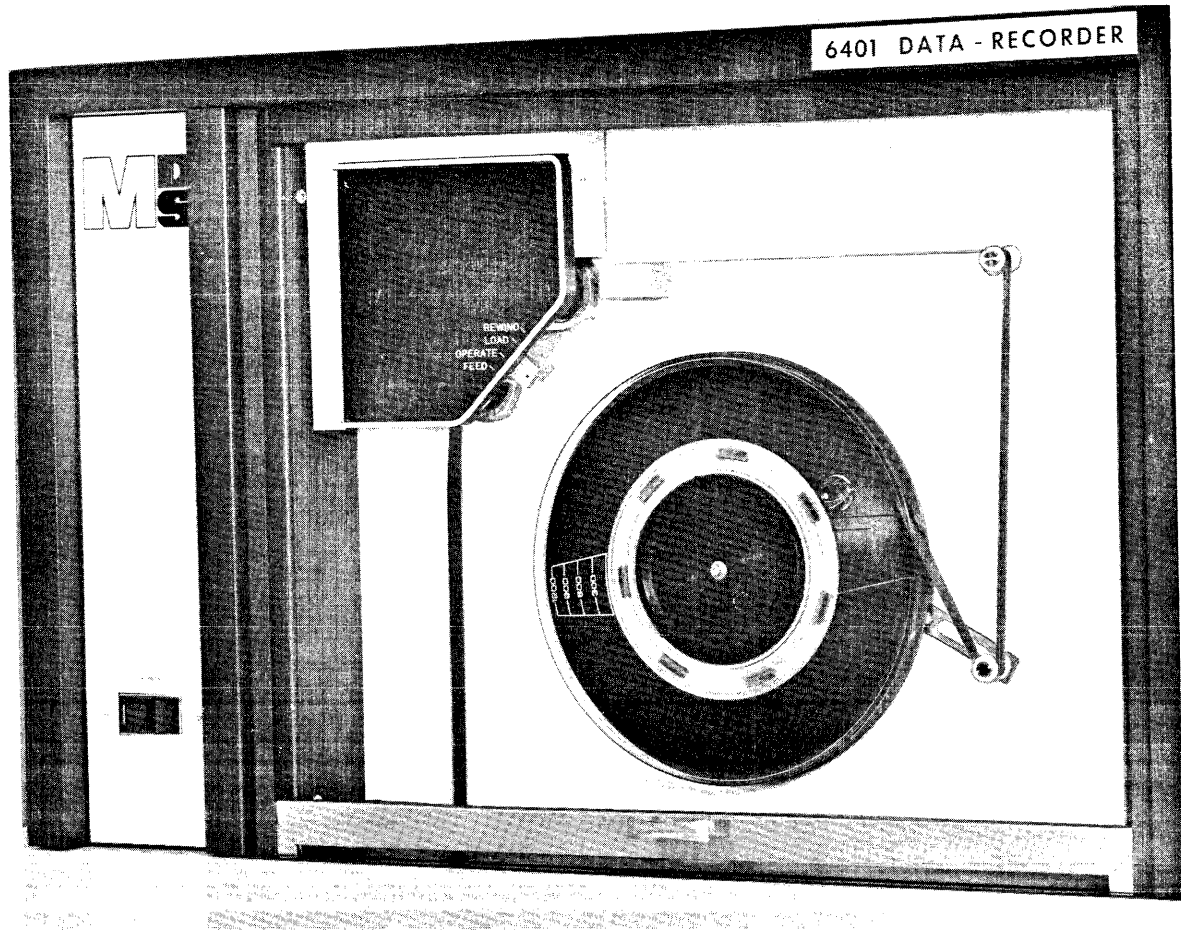

Photo courtesy of Mohawk Data Sciences Corporation, Herkimer, New York

### TAPE DECK

The tape deck contains the tape feed mechanism, the read/write and erase heads, and mounting facilities for the magnetic tape reel and master program tapes.

### MAGNETIC TAPE

The Data Recorder accommodates any IBM compatible tape reel up to 10.5 inches in diameter. Recording is done on standard 1/2" magnetic tape in odd parity at a density of 800 bpi. Data blocks written on the basic 6401 contain 100 data characters. There is no take-up reel for the recorded tape. The upspooled tape falls freely into an enclosed tape bin which is capable of holding approximately 1200 feet of 1/2" magnetic tape.

## 6401 MOHAWK/735 NCR DATA RECORDER

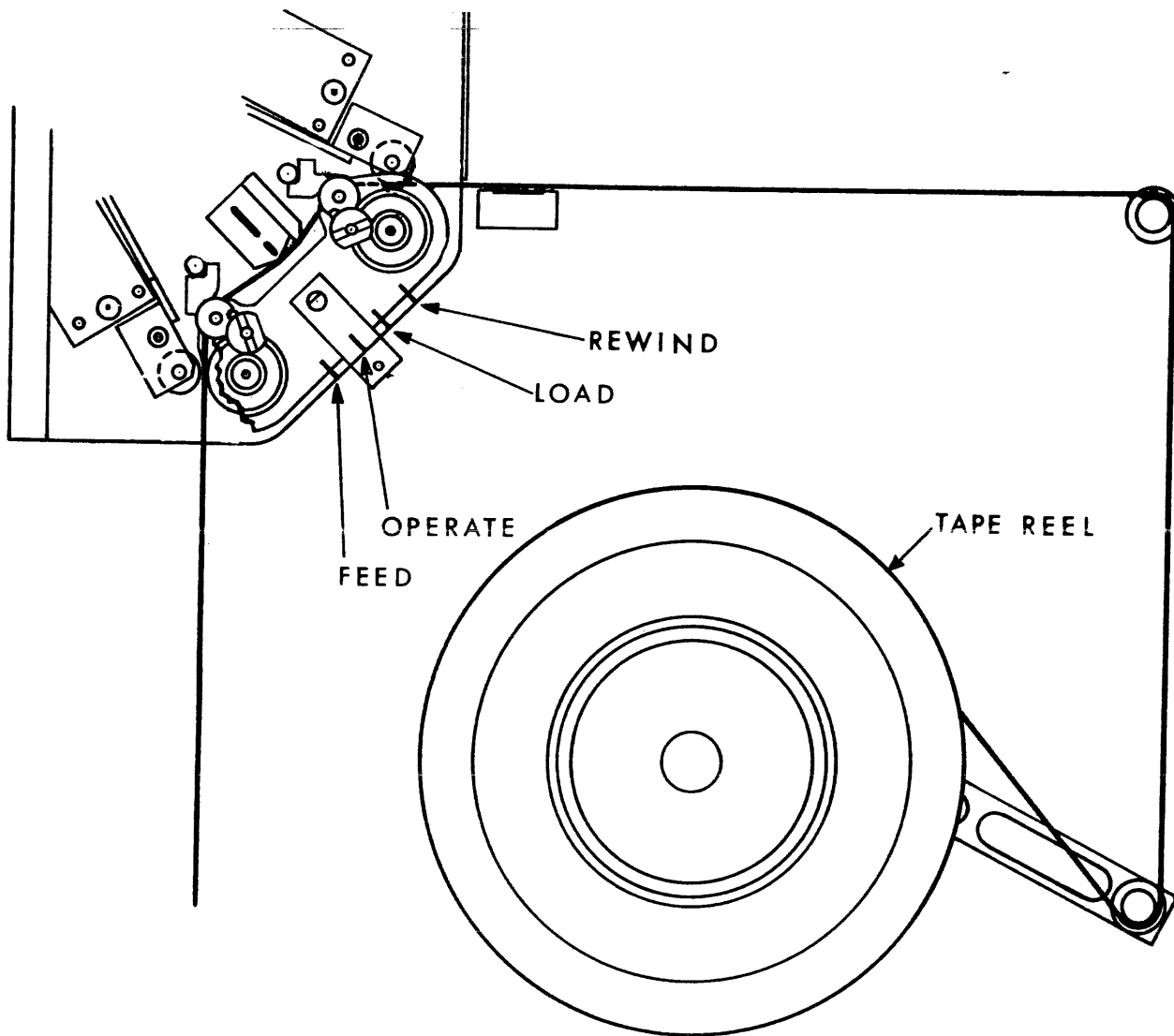

### TAPE FEED

Diagram courtesy of Mohawk Data Sciences Corporation

Tape feed and rewind is controlled by the FEED/REWIND switch located on the tape deck near the read/write head assembly. After the tape is placed in the tape feed path, under the read/write head and capstans, the FEED/REWIND switch is placed in FEED position to move the tape forward. Forward tape movement stops when the FEED/REWIND switch is released from the FEED position, or when the Beginning of Tape (BOT) reflective marker passes the BOT sensor. To rewind the tape, the POWER switch is placed in the "off" position and the FEED/REWIND switch is placed in the REWIND position. The tape, after a nominal five second delay, is drawn back onto the supply reel. When all is rewound, the FEED/REWIND switch must be returned to the OPERATE position to stop the rewind motor.

The tape feed mechanism, read/write head and erase head are located in the upper left corner of the tape deck in a glass covered enclosure. The purpose of the enclosure is to keep the tape path as clean and free from dirt and dust as possible. The hinged door on the enclosure does not have to be opened except during initial manual tape threading and during a cleaning operation.

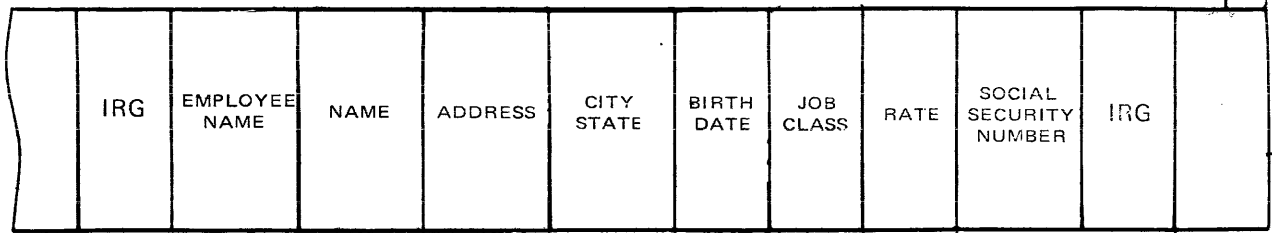

ONE TAPE RECORD

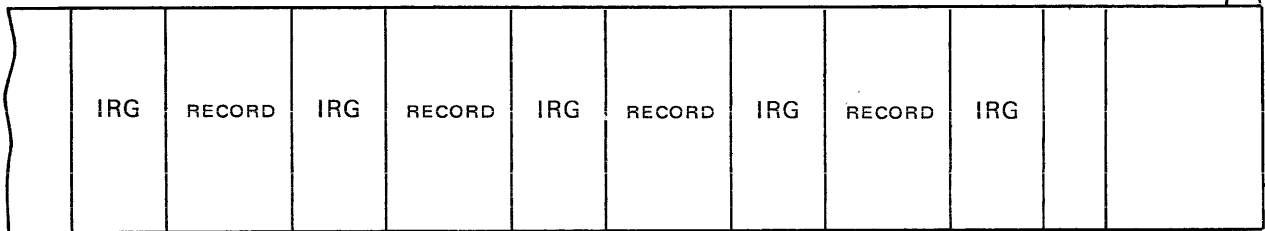

FIXED LENGTH RECORDS

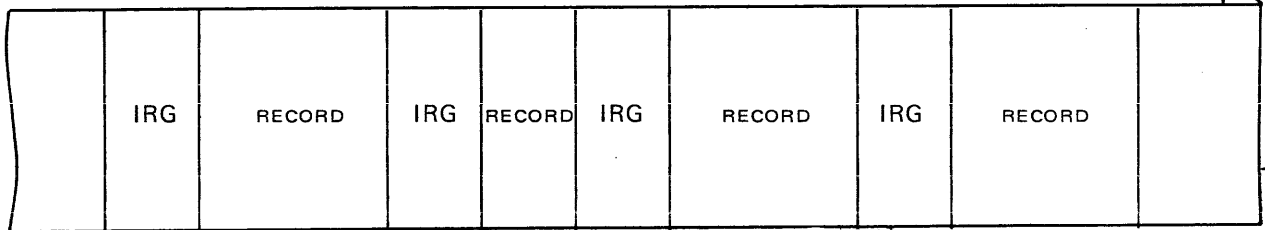

VARIABLE LENGTH RECORDS

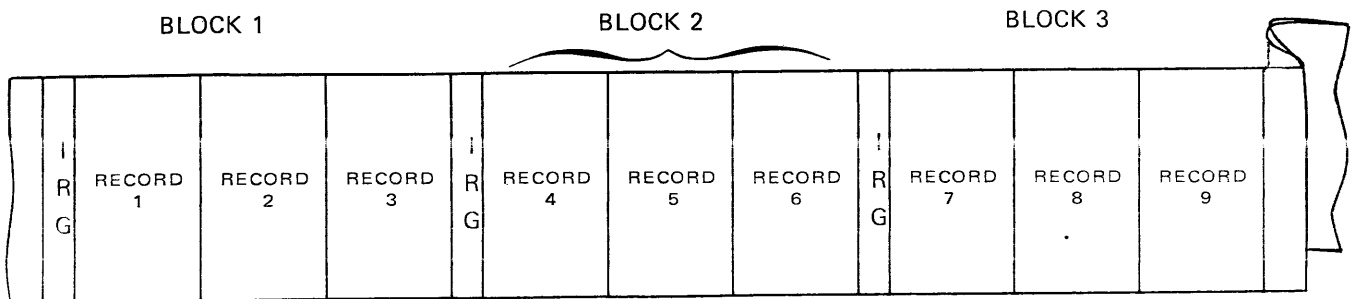

BLOCKED TAPE RECORDS -- BLOCKED THREE

# 6401 MOHAWK/736 NCR DATA RECORDER

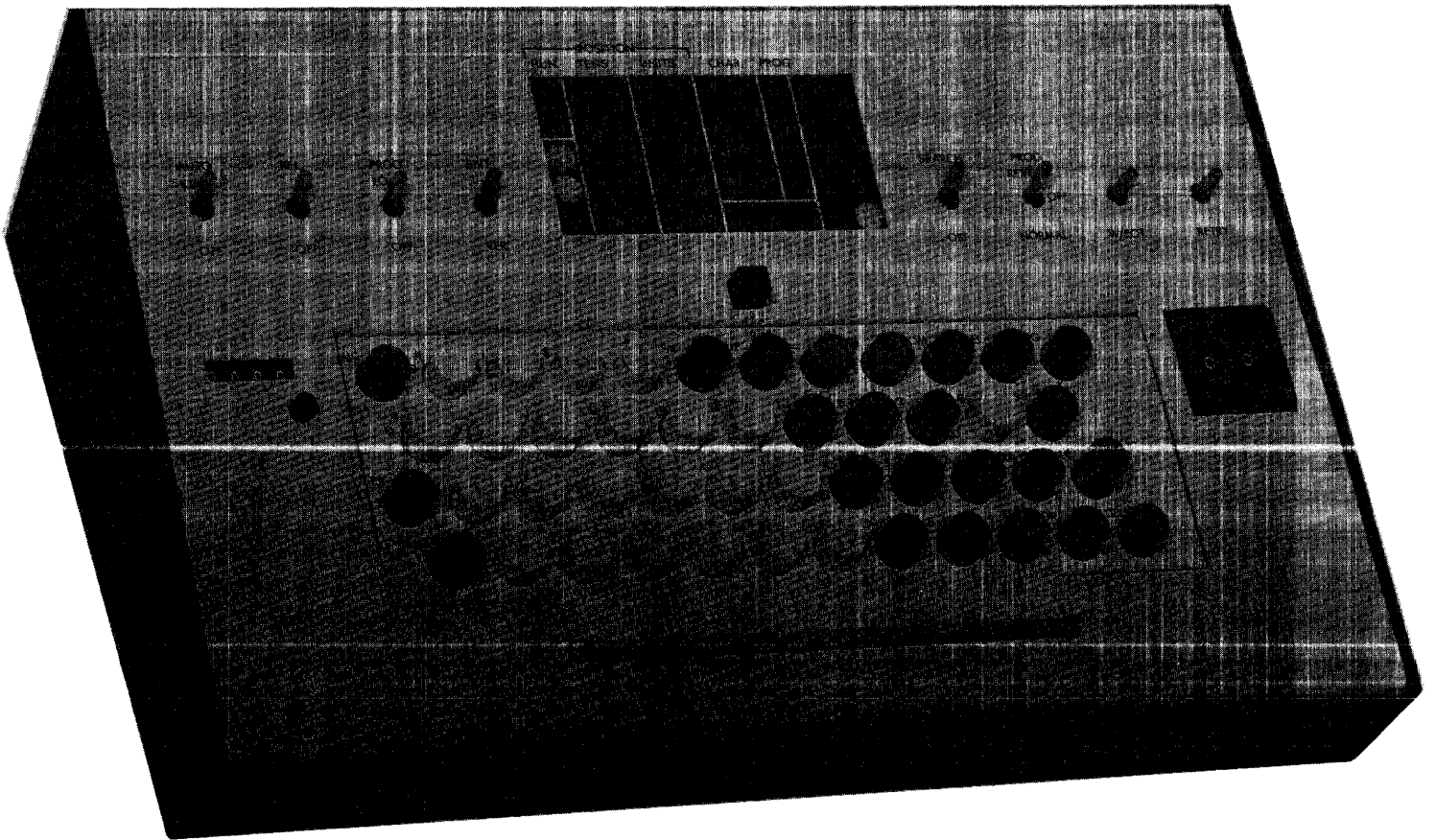

## OPERATOR CONSOLE

### DATA RECORDER KEYBOARD

The Operator Console, which measures approximately 9 inches by 14½ inches, rests on the reading table in front of the tape deck. The console is movable for operator convenience.

The Operator Console consists of two basic sections - the control/display section and the keyboard section.

### CONTROL/DISPLAY PANEL

All of the switches and indicators required for 6401 data recording functions are conveniently located in the Control/Display section of the Operator Console.

# 6401 MOHAWK/736 NCR DATA RECORDER

## CONTROL SWITCHES

AUTO SKIP/DUP SWITCH<sup>1</sup> - The AUTO SKIP/DUP switch controls the automatic function of program codes 4 and 5. With the AUTO SKIP/DUP switch "on," a program code 4 allows a field of data in memory to be automatically duplicated in each record being entered. During verification, a program code 4 allows the duplicate field to be machine verified. If a program code 5 is encountered during ENTRY or VERIFY, the field defined by code 5 is skipped. During ENTRY, the positions so skipped are space-filled.

An automatic Dup or Skip operation terminates when a stop duplicate or stop skip code is encountered. The AUTO SKIP/DUP switch is not effective if the Program Load switch is set to PROG LOAD. The use of the AUTO SKIP/DUP switch in conjunction with codes 4 and 5, increases the rate of data entry and verify by reducing the number of key-strokes required for each data block. At least one position of each data block must be keyed. All other positions may be duplicated or skipped.

RELEASE SWITCH<sup>2</sup> - The setting of the release switch to the REL position allows data to be released from data memory to tape during an ENTRY operation and to be read from tape into data memory during a VERIFY operation.

REL - With the release switch in the REL position and the mode switch to ENTRY, data can be released from data memory to magnetic tape. This release action occurs when the memory position counter advances from the last memory position, either as a result of a keyed entry or as a result of skipping or duplicating through the last memory position. The contents of each memory position is retained in memory until replaced by another keyed character.

When the mode switch is in VERIFY position, the release action allows a data block to be *read* from tape into data memory. However, in VERIFY mode, automatic release is inhibited if an error has been encountered and a correction procedure started. The automatic release action is restored after the corrected data block is re-verified without further correction. With the release switch in the REL position, manual release while in ENTRY or VERIFY mode can be initiated by depression of the keyboard REL key.

OFF - With the release switch in the "off" position, a release action and entry action, automatic or manual, is prevented.

PROGRAM LOAD SWITCH<sup>3</sup> - The setting of this switch permits access to program memory or data memory.

PROG LOAD - Program Load position permits access to program memory. With the switch in PROG LOAD position, program codes can be entered into program memory from program tapes or from memory.

OFF - This is the position that is used when data is keyed into data memory for writing on tape during an entry run or when data is being keyed, for comparison with data already in memory, during a verify run.

# 6401 MOHAWK/736 NCR DATA RECORDER

## CONTROL SWITCHES (CONT.)

**MODE SWITCH<sup>4</sup>** - The 6401 is conditioned for either ENTRY or VERIFY mode with the mode switch.

ENT - This position of the mode switch (ENTRY) is used when data is key entered and stored in memory for writing on tape or for duplicating into program memory. Setting the mode switch to ENT turns on the erase head for erasing the portion of the tape on which the new data block will be written.

VER - This position of the mode switch (VERIFY) is used during verification of data blocks. With the mode switch in this position, characters entered from the keyboard do not enter memory but are compared to a character in memory for verification. The data block to be verified is read into memory by the release action of the 6401 Data Recorder. No tape erasure takes place during a VERIFY operation.

**SEARCH SWITCH<sup>5</sup>** - This switch is used to condition the Data Recorder for a search operation. After a search identifier has been entered into memory, this switch is placed in SEARCH position and remains there throughout the search operation. During a search, consecutive data blocks are read and compared to the identifier in memory. When a data block matches the identifier, the search stops. The search identifier remains in memory until replaced by other data. When a tape mark is read into position 001, the search operation stops with the EOT indicator lit.

OFF - The off position of this switch disables a search operation.

**PROGRAM REVERT SWITCH<sup>6</sup>** - The three position Program switch is used to control program memory during a data recording operation.

REVERT - The Revert position of this switch conditions the Data Recorder to automatically change from alternate program control to main program control when a release occurs. The main program continues to control 6401 functions until the alternate program is again selected, using the keyboard PRG key. The Revert position of this switch is effective only if the Data Recorder is under control of the alternate program.

OFF - In the "off" position, the program codes in memory do not control the Data Recorder. All positions are effectively under alpha control. The alpha shift can be overridden by operating the keyboard NUM key. Automatic skip and dup is inoperative in the program OFF mode.

NORMAL - When this switch is in the NORMAL position, the data recording operation is under control of the program codes in one of the program memories. Either the alternate or main program may be manually selected for use while in the NORMAL program mode.

# 6401 MOHAWK/736 NCR DATA RECORDER



## CONTROL SWITCHES (CONT.)

**W/EOT SWITCH<sup>7</sup>** - The WRITE/END OF TAPE switch permits writing a one-character tape mark block on tape. One depression and release of this switch writes the one-character tape mark block on tape. This is generally used following the last data block on tape for computer recognition. The tape mark written is code 00010011. Following a tape mark, approximately seven inches of tape is erased.

**RETRY SWITCH<sup>8</sup>** - The RETRY switch is used to rewrite a data block on tape or to re-read a data block from tape. This switch is generally used following a tape error indication in VERIFY or ENTRY mode. The error light must be extinguished before the RETRY is effective.

In VERIFY mode, a depression of the RETRY switch backs the tape up one block length and then moves the tape forward, while reading a data block into memory. If the RETRY attempt is successful, there is no error indication. An unsuccessful reread causes the status indicators to light.

In ENTRY mode, a depression of the RETRY switch backs the tape up one block length, erases approximately three inches of tape during a tape forward movement and rewrites the data block. After a successful rewrite, there is no error indication.

POSITION				CHAR	PROG				
HUN	TENS	UNITS							
0	0	5	0	5	D	8	8	OMC	FE
1	1	6	1	6	C	4	4	EMC	VE
	2	7	2	7	B	2	2	CAR	CE
	3	8	3	8	A	1	1	OM	ALM
TE	4	9	4	9	FPR EOT AP			EM	

### STATUS Indicators

TE - Tape Error (red)  
 FPR - File Protect Ring (green)  
 EOT - End of Tape (green)  
 AP - Alternate Program (green)

### DATA TRANSMISSION Indicators

OMC - Odd Message Code  
 EMC - Even Message Code  
 CAR - Carrier  
 OM - Odd Mode  
 EM - Even Mode  
 FE - Format Error  
 VE - Validity Error  
 CE - Character Error  
 ALM - Alarm

# 6401 MOHAWK/736 NCR DATA RECORDER

## STATUS INDICATORS

The Status Indicators are located in the display section of the Operator Console.

**TE (TAPE ERROR)** - The red Tape Error Light is lit whenever a tape read error occurs. This indication can occur during an ENTRY, VERIFY or SEARCH operation. A tape error occurs because of an attempt to read a parity error block, a short data block, or blank tape. A non-compare, during a read-after-write check, also lights the Tape Error Light.

**FPR (FILE PROTECT RING)** - The green indicator is lit if a reel with the File Protect Ring removed is mounted on the 6401 Data Recorder while in the ENTRY mode. When the indicator is "on," the erase head is turned "off." This feature protects a data tape from erasure during a VERIFY operation if the mode switch is inadvertently set to ENTRY. However, the erase head is turned "on" during a "correction in verify" procedure in order to erase the old data block before writing a new data block. The erase head is turned "off" at the completion of the correction procedure.

When the FPR indicator is lit in ENTRY mode, writing and erasing of tape is inhibited, even though tape movement (release or manual retry) can take place. When a release or retry occurs, with the FPR indicator lit, a tape error (TE) is indicated.

**EOT (END-OF-TAPE)** - This indicator is lit whenever a tape mark code is read into memory position 001. This mark is an A21 code. This indicator also lights when a tape mark is written on tape with the W/EOT switch.

**AP (ALTERNATE PROGRAM)** - The Alternate Program indicator is located below the program code display. This indicator is lit when the alternate program is in control of the Data Recorder operation.

**ERROR LIGHT** - The red Error Light, located just below the display section of the keyboard, flashes when an error condition exists. The flashing Error Light indicates an abnormal condition and makes the keyboard inactive for data recording. The Error Light is extinguished by depressing the ER key on the keyboard. This activates the keyboard so that corrective action may be taken, or so the desired operation may be started.

Conditions which cause the Error Light to flash are:

1. Simultaneous operation of more than one character key.
2. Non-equal comparison of a manual entry when verifying.
3. Operation of an alphabetic or special character key when in a position programmed for numeric entry.
4. Momentary loss of power.
5. Keying of data while a machine function, such as a release, is taking place.
6. Non-equal comparison during a read-after-write check.
7. Incorrect parity encountered during a tape/read operation. This includes the read-after-write check when in ENTRY mode, and a read operation when in the VERIFY or SEARCH mode.
8. Reading short data blocks such as those written using the W/EOT switch.

NOTE: The Error Light flashes during a tape feed operation.



# 6401 MOHAWK/736 NCR DATA RECORDER

## DISPLAY

The Display section of the Operator Console is located directly above the keyboard. The core memory position display, data memory display, and program memory display are located in the Display section. In addition to the displays, the following status indicators are located in the Display section: Tape Error, File Protect Ring, End-of-File and Alternate Program. The keyboard lockout Error Light is located just below the Display section.

**MEMORY POSITION DISPLAY** - The active memory position during a data recording operation is visible in the POSITION section of the Display Panel. The display consists of a Hundreds (HUN), TENS and UNITS count. The number of active memory positions depends on the size of the memory. The number of an active memory position is always displayed as a three digit number. For example, active memory position "one hundred fifty-two" is displayed as 152, "fifty-two" as 052 and "two" as 002.

In ENTRY mode, the count displayed indicates the memory position that is to receive the next data character. In VERIFY mode, the count displayed indicates the next position to be verified.

During ENTRY or VERIFY, the memory position count advances one for each character key depressed, except during a multi-code operation. The count advances from Home Position 001 to the last available memory position. After the last memory position is entered, the release action automatically resets the position counter to Home Position 001. If Home Position 001 is programmed for a Dup or Skip, the count then advances to the next position containing a stop code.

**DATA DISPLAY** - The display for a single position of data memory is located in the section of the display panel labeled CHAR. The display consists of two groups of four indicators. The display for the 8, 4, 2 and 1 bits are located on the right and the display for the D, C, B and A bits are on the left. The display shown at any time is for the active memory position. During ENTRY, the code displayed represents the character in the corresponding position of the previous data block. During ENTRY, the characters in memory are replaced, one at a time, as a new character is keyed into their position. If a position is observed after memory backspacing, the character observed is from the data block being keyed.

During VERIFY, the code displayed represents the next character to be verified. Characters in memory are not replaced as characters are keyed for verification. The entire block of data in memory is replaced as a new block is read in for verification.

**PROGRAM DISPLAY** - The PROG section of the display panel contains the four program display indicators (8, 4, 2 and 1). The program display provides a visual display of the active program code. The code displayed is the code that controls the memory position shown on the memory position counter. When there is no program display, the controlling program code is a space code.

# 6401 MOHAWK/736 NCR DATA RECORDER

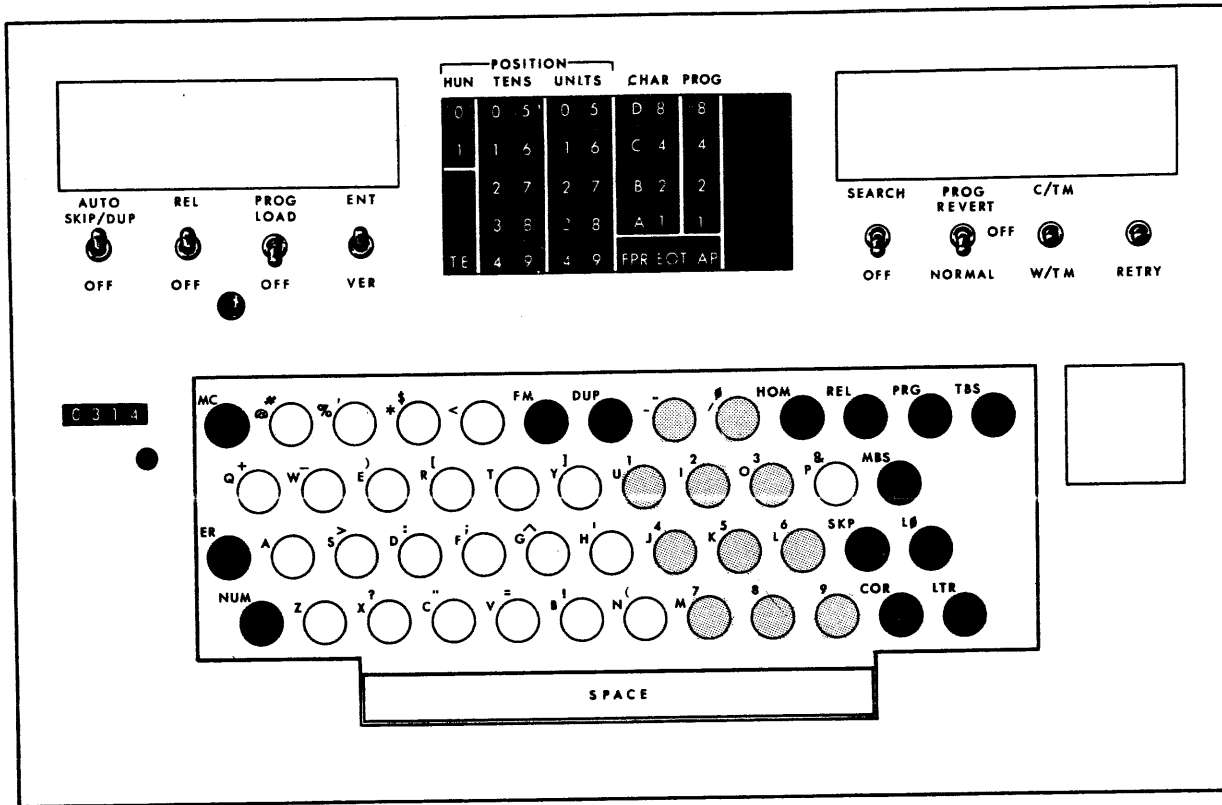

## KEYBOARD

The keyboard on a 6401 Operator Console consists of 34 character keys, 13 function keys and a space bar. The color-coded keyboard is designed for maximum keying speed and minimum operator fatigue. The keys are basically color coded as follows:

- Numeric Keys - Blue Top
- Special Functions Keys - Red Top
- Special Character Keys - White Top
- Alpha Keys (except combination alpha/numeric) - White Top

The 34 character keys permit key entry of 62 different character codes representing the alpha, numeric and 26 special characters. The Space Bar and MC key each generate one additional code. The bit arrangement for each character is shown in Table 5-1. Keyboard shift for numeric, alpha and special characters during data recording is controlled by the program code present in memory, if the PROG switch is in REVERT or NORMAL position. If the PROG switch is in OFF position, the keyboard is in alpha shift regardless of the program code in memory. Dup or Skip codes are ineffective. Keyboard shift, however, may be overridden through the use of the NUM key. With the PROG switch in NORMAL or REVERT, alpha or alpha shift special characters, can be entered into a position programmed for a numeric character by holding the letter shift (LTR) key depressed while entry is being made. Numeric shift special characters can be entered only if the (NUM) key is held depressed while entry is being made, regardless of program code in memory.

# 6401 MOHAWK/736 NCR DATA RECORDER

## SPECIAL FUNCTION KEYS

The purpose of each special function key and the space bar is described in the following paragraphs.

**ER (ERROR RELEASE)** - The ER key has multiple functions. After an abnormal or error condition occurs, it is necessary to depress the error release key to extinguish the Error Light and re-activate the keyboard.

The second function of the Error Release key is to make the Memory Backspace, Home, Correction and Field Modify keys effective. The Error Release key must be held depressed when any of these four keys are used. This interlocking effect is designed to prevent inadvertent operation of these keys.

**MC (MULTI-CODE)** - The MC key permits depression of more than one character key without advancing the memory position until the MC key is released. With the aid of the MC key, it is possible for the operator to construct in memory 256 different codes. These codes include the 64 codes available through single key depressions on the standard 6401 keyboard. The illustration below shows the single bit codes that can be obtained by depressing the MC and a character key at the same time. As long as the MC key is held depressed, the memory position does not change. Using this feature, several single bit codes can be added to each other in one memory position. The memory position advances one when the MC key is released. For example, to enter code 10101001, hold the MC key depressed and key the D, B, 8 and 1 keys. Release the MC key to advance the memory position. Depressing and releasing the MC key without keying another character enters a no-bit code into memory.

SPECIAL CODES

Depress keys:*	EBCDIC CODE								HEXADECIMAL CODE
	D	C	B	A	8	4	2	1	
MC/1	0	0	0	0	0	0	0	1	01
MC/2	0	0	0	0	0	0	0	10	02
MC/4	0	0	0	0	0	1	0	00	04
MC/8	0	0	0	0	1	0	0	00	08
MC/A	0	0	0	1	0	0	0	00	10
MC/B	0	0	1	0	0	0	0	00	20
MC/C	0	1	0	0	0	0	0	00	40
MC/D	1	0	0	0	0	0	0	00	80
MC	0	0	0	0	0	0	0	00	00

\*Depress the MC and the character key to enter the code shown in the Table.

# 6401 MOHAWK/736 NCR DATA RECORDER

## SPECIAL FUNCTION KEYS (CONT.)

**DUP (DUPLICATE)** - The DUP key is used to manually duplicate data fields from data block to data block during data entry operation. During data verification, the DUP key is used to verify identical or similar data fields. If data being verified is identical in content and position to data in the preceding data block, a depression of the DUP key automatically verifies all identical data up to the point of the next difference or until stop dup code is encountered. The similarity or dissimilarity of data is automatically calculated by the Data Recorder.

The program core "8" bits control this "Dup-Verify" function. A non-compare of data (on a position-for-position basis) between the data being read in and that data already in memory, causes the "8" bit of program memory to turn on for each non-compare position. A data match in any position conditions the program "8" bit core to OFF for that position.

Any position that does not set "8" bits (8 core - OFF) can be Dup-Verified by depressing the DUP key. If more than one consecutive position does not set the "8" bit, one depression of the DUP key verifies all of these consecutive positions. All other positions must be key verified, skipped by program control, or skipped manually as dictated by the data structure.

During ENTRY mode, identical data fields can be manually duplicated into succeeding data blocks by depressing the DUP key. If a field is to be duplicated in every data block, program the field for automatic duplication. The duplication operation is terminated when a stop dup code is encountered in program memory. The DUP key is also used when a program is being entered into program memory from data memory.

**REL (RELEASE)** - The REL key is effective only when the REL switch on the control panel is set to "on" (REL) position. Depression of the REL key while the Data Recorder is in the ENTRY mode causes space codes to be recorded in memory and written on tape for all unkeyed positions of the data block. A release action while the memory counter is in position 001 causes space codes to be entered into all memory positions and on tape. If the AUTO SKIP/DUP switch is "on" when the REL key is depressed, data within a programmed dup field is recorded as part of the data block. The usual write on tape and read-after-write check occurs with each manual release in ENTRY mode.

When in the VERIFY mode without an error condition, depression of the REL key causes a data block to be read from tape and stored in data memory. While being read, the data is checked for parity. After each release action, the position counter returns to position 001. If position 001 is programmed for a dup or skip, the counter then advances to the first memory position that contains a stop dup or stop skip code.

**MBS (MEMORY BACKSPACE)** - The MBS key is effective only when the ER key is held depressed. While in ENTRY mode, a depression of the ER/MBS keys reduces the memory position counter by a count of one. Holding the ER/MBS keys depressed allows for repetitive memory backspacing with the memory position counter reducing one for each backspace. If a dup or skip code is encountered during Memory Backspacing, a backward skip is initiated. The backward skip terminates when a stop dup or stop skip code is encountered.

## 6401 MOHAWK/736 NCR DATA RECORDER

### SPECIAL FUNCTION KEYS (CONT.)

**SKP (SKIP)** - The SKIP (SKP) key can be used when the Data Recorder is conditioned for either ENTRY or VERIFY mode. During ENTRY, the SKP key can be used to skip a field, or part of a field, where no data entry is desired. The skip is terminated when a stop skip code is encountered. All positions so skipped are written as space codes on tape. If the spaces to be entered are part of a field, they must follow the data being entered.

During VERIFY, the SKP key can be used to verify spaces within a data block. After the data portion of a field has been verified, a depression of the SKP key advances the memory counter to the start of the next field containing a stop skip code. The spaces in all intervening positions are machine verified.

**HOM (HOME)** - The HOM key is effective only when the ER key is held depressed. Operating the ER/HOM keys restores the memory position counter to position 001.

**COR (CORRECTION)** - The COR key is effective only when the ER key is held depressed. The purpose of the correction key is to allow one new character to be written in memory to replace a character found to be in error during the verification. Following the use of the COR key, depressing one character key reverts the Data Recorder to the VERIFY mode. This eliminates the need for changing the mode selection switch to ENTRY for correcting single characters.

Automatic manual release functions are locked out until the entire data block is re-verified. When all positions are re-verified *without further corrections*, the tape backs up one block length and the corrected block is then automatically rewritten in place of the error block. If the COR key is used during re-verification, the data block must be re-verified again.

**FM (FIELD MODIFY)** - The FM key is effective only when the ER key is held depressed. The FM key provides a method for changing or correcting an entire field during verification without changing to ENTRY mode. The Data Recorder remains in this modify condition until the start of the next field when the Data Recorder automatically reverts to VERIFY mode. The modify condition can be terminated at any position within the field by depressing the DUP or SKP key.

When a field within a record is to be modified, the operator depresses the ER/FM keys. Automatic and manual release functions are locked out until the entire data block is re-verified. When all positions are re-verified *without further corrections*, the tape backs up one block length and the corrected block is then automatically written in place of the error block. If the FM key is used during re-verification, the data block must be re-verified again.

**PRG (PROGRAM)** - The PRG key is used to shift control of the Data Recorder from Main program to Alternate program or vice-versa. Each depression of the PRG key changes control of the Data Recorder to the opposite program.

# 6401 MOHAWK/736 NCR DATA RECORDER

## SPECIAL FUNCTION KEYS (CONT.)

**LØ (LEFT ZERO)** - The LØ key is used when numeric data being entered for a specific field does not fill the assigned field to capacity and the data is to be right-justified within the field.

When entering data with the 6401 in the ENTRY mode, the left zero key is depressed after the characters for a field to be right-justified have been entered. The characters are shifted into the low order positions within the field and any unused high order positions are automatically zero-filled. The LØ action is terminated when a stop LØ code is encountered. In VERIFY mode, a depression of the LØ key at the beginning of a left zero field automatically verifies all preceding zeros. The position counter advances and stops at the position containing the first non-zero character of the field.

**NUM (NUMERIC SHIFT)** - The NUM key is used when a numeric character is entered into a position programmed for alpha characters. The NUM key must also be used whenever a numeric shift special character is entered into memory, regardless of the program code in memory.

The keyboard remains in numeric shift as long as the NUM key is held depressed, overriding the program control, and assumes the shift specified by the program code only when the NUM key is released.

**LTR (LETTER SHIFT)** - The LTR key is used when an alpha character or letter shift special character is entered into a position programmed for numerics. The keyboard remains in letter shift as long as the LTR key is held depressed, overriding program control, and assumes the shift specified by the program code only when the LTR key is released.

**SPACE BAR** - The space bar is used to enter or verify space codes in memory. The space bar is also used to clear program memory of all codes before a new program is key entered. One special use for the space bar is entering space codes in a search identifier. Space codes are required in all non-character positions of a search identifier.

# 6401 MOHAWK/736 NCR DATA RECORDER

## TAPE MOVEMENT DURING ENTRY

At the end of each data block being key entered into data memory, a release action occurs. During the release action, the following tape movements take place:

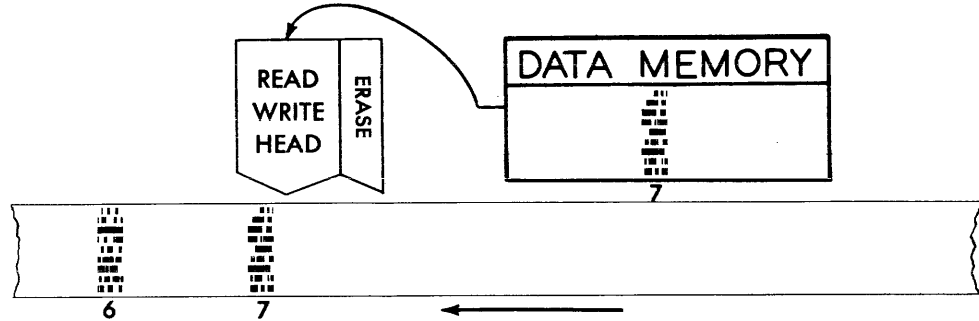

- a. The data block (7) in data memory is written on tape as the tape moves forward under the read/write head. The data block is now on tape as well as in data memory. When the entire data block is on tape, the tape movement stops for an instant. The position of the tape and data block in relation to the read/write head is shown above.

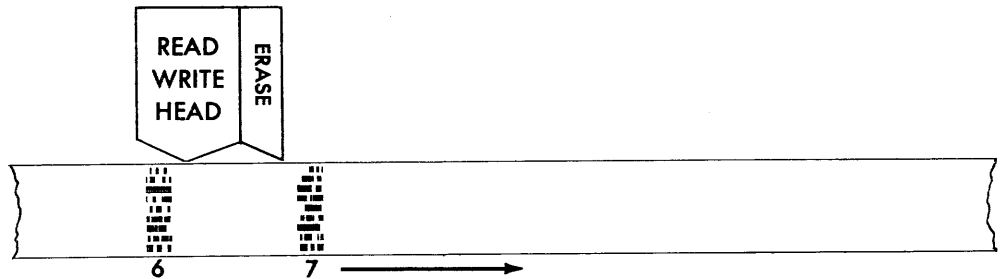

- b. The tape then moves the data block backwards and stops momentarily in the position shown above.

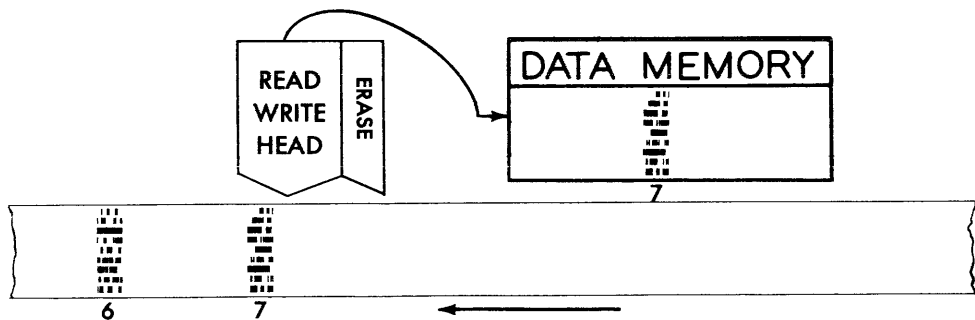

- c. The tape moves forward again reading and comparing to see if the information recorded on tape is the same as the information retained in data memory. Vertical and longitudinal parity are also checked. The tape stops in the position shown above and is ready for the next data block to be recorded.

# 6401 MOHAWK/736 NCR DATA RECORDER

## TAPE MOVEMENT DURING VERIFICATION

At the beginning of a verify run, the data blocks on tape and the position of the tape in relation to the read/write head are shown in figure (a) below. When verification begins, the following actions take place.

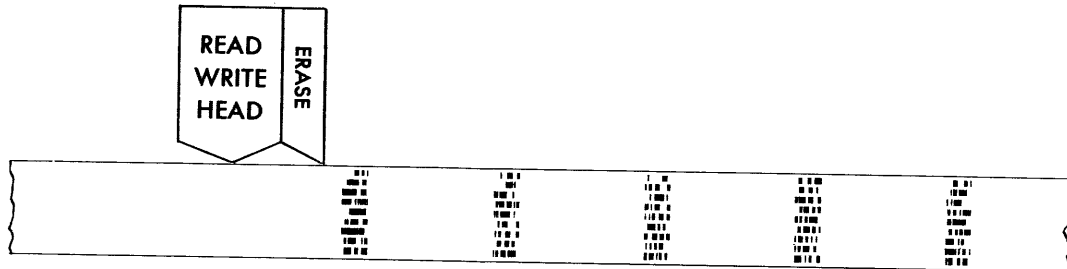

- a. A depression of the REL key moves the tape past the read/write head and the first data block is read into data memory and checked for correct parity.

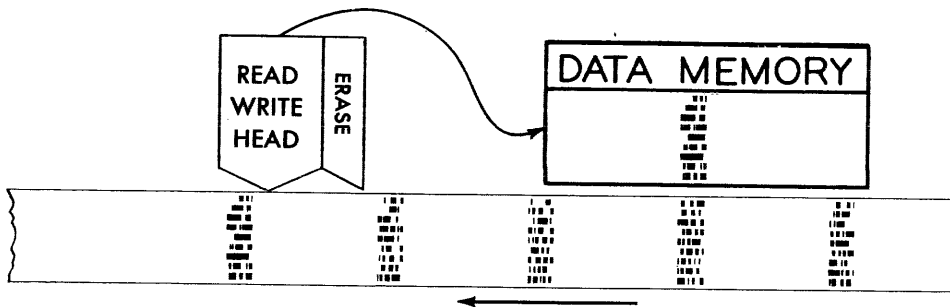

- b. With each depression of a key by the verify operator, a comparison is made between the keyed character and the character in that position in data memory. After a complete verification of a data block, a release action occurs and the next data block passes under the read/write head and is read into memory.

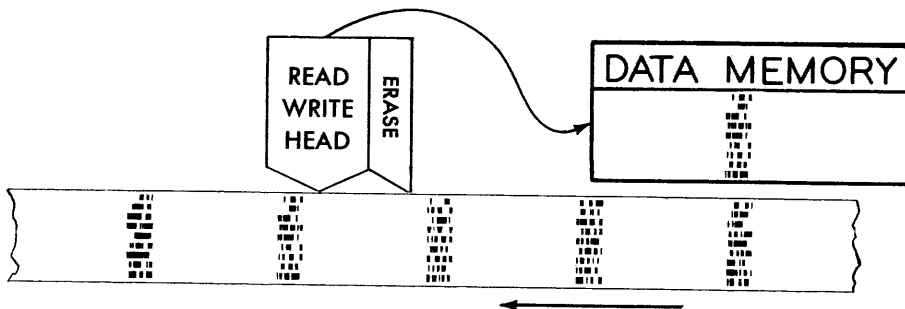

- c. The new position of the data blocks in relation to the read/write head is shown above.



# 6401 MOHAWK/736 NCR DATA RECORDER

## TAPE MOVEMENT DURING CORRECTION IN VERIFICATION

When a character error is found during verification, it must be corrected in data memory first and then the tape must be corrected. Assume that data block 4 has an incorrect character. The character recorded is a 9 and should be a 7.

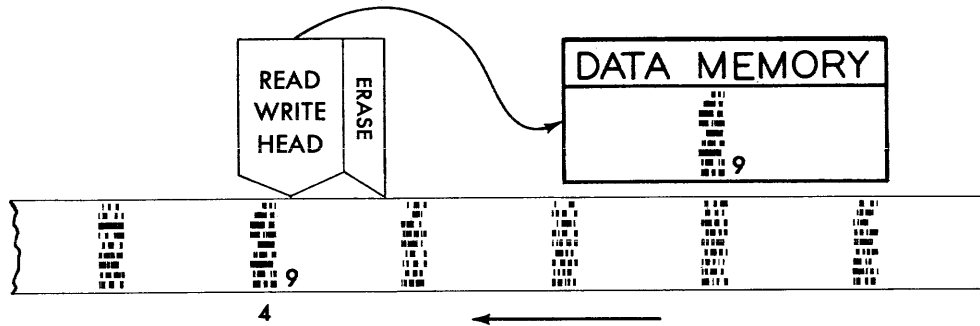

- a. The release action reads the data block into data memory. The position of data block on tape and the information in data memory is shown above.

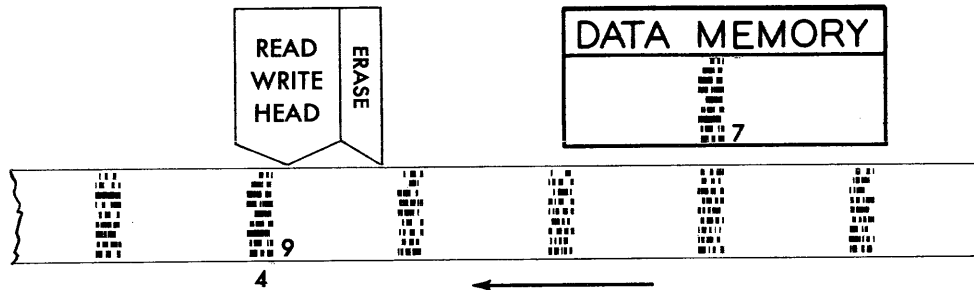

- b. When the error is found, the operator corrects the error in data memory by depressing the ER/COR keys and then keying the correct character. The position of the tape and the corrected memory after this action are shown above.

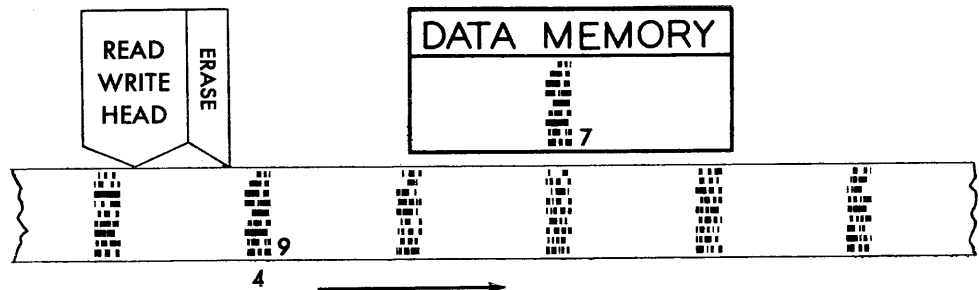

- c. After verification of that block is completed, no release takes place. Release is locked-out through the use of the COR key.

To erase the error block and write the corrected block that is now in memory, the operator must depress the ER/HOM keys and re-verify the data in memory. When all positions are re-verified without further error correction, the tape backs up one block length as shown above.

# 6401 MOHAWK/736 NCR DATA RECORDER

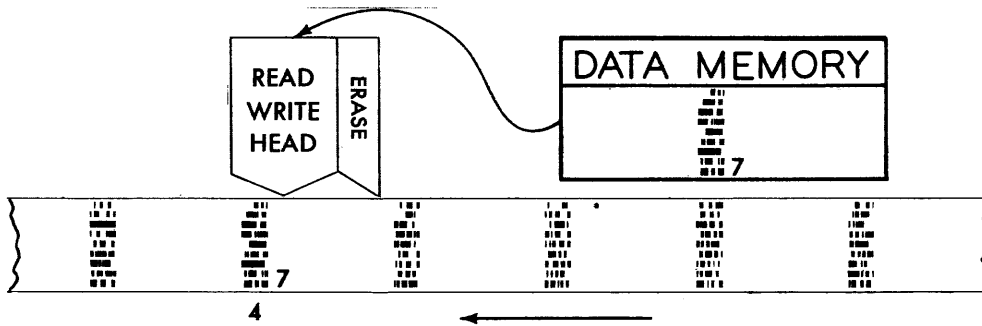

- d. The tape then moves forward erasing the error block and writing the corrected block.

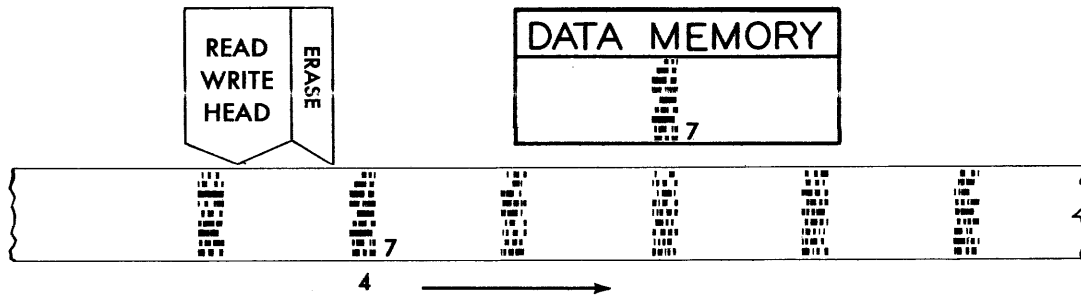

- e. The usual read-after-write check, that accompanies a write action, backs the tape up again and stops it momentarily in the position shown above.

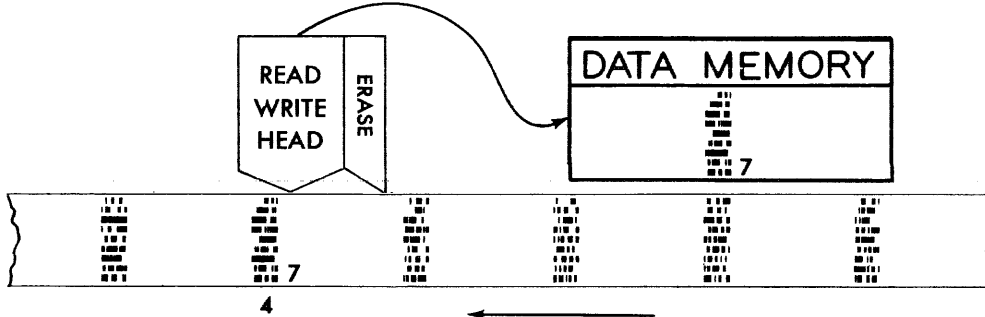

- f. A forward motion causes the data on tape to be read and compared with the data in memory. The tape stops in the position shown above.

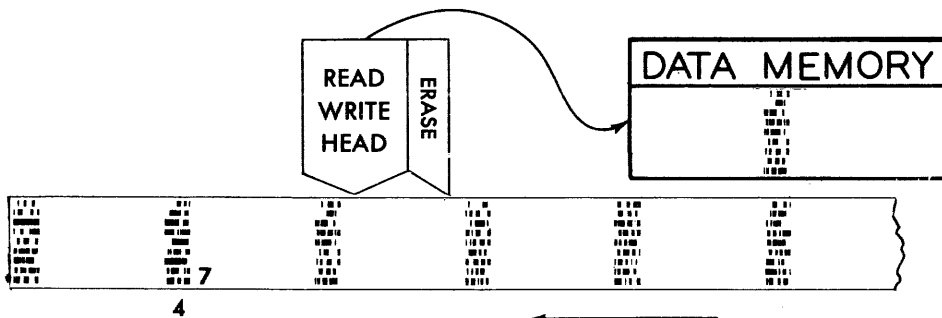

- g. A depression of the REL key now reads in the next data bloc for verification and positions the tape as shown above.

# 6401 MOHAWK/736 NCR DATA RECORDER

## PROGRAM ENTRY - LOADING A SINGLE PROGRAM THROUGH THE KEYBOARD

1. Power switch to the "on" position; Feed/Rewind to "operate."
2. Set function switches as follows:

SWITCH	POSITION	SWITCH	POSITION
AUTO SKIP/DUP (A S/D)	OFF	MODE (M)	ENTRY
RELEASE (R)	OFF	SEARCH (S)	OFF
PROGRAM LOAD (PL)	PROG LOAD	PROGRAM REVERT (PR)	NORMAL

3. Depress the ER/HOM keys.
4. Depress the program key for either Main or Alternate program. Depression of this key selects the program memory to be used.
5. Hold down the NUM key as you key enter the entire program. Make a key depression for every memory position. Use the space bar for program spaces.
6. Change the mode switch to VERIFY.
7. Depress the ER/HOM keys simultaneously.
8. Hold down the NUM key as you key verify the program.

NOTE: To correct an error do the following:

- a. Depress the ER key.
  - b. Set the mode switch to ENTRY.
  - c. Key the correct character.
  - d. Depress the ER/MBS keys.
  - e. Change the mode switch to VERIFY.
  - f. Re-verify the character and continue.
9. Depress the ER/HOM keys simultaneously.
  10. Change the PROGRAM LOAD switch to the "off" position.
  11. Proceed with the entry or verify run.

# 6401 MOHAWK/736 NCR DATA RECORDER

## PROGRAM ENTRY - LOADING TWO PROGRAMS THROUGH THE KEYBOARD

1. Power switch to the "on" position; Feed/Rewind to "operate."
2. Set function switches as follows:

SWITCH	POSITION	SWITCH	POSITION
AUTO SKIP/DUP (A S/D)	OFF	MODE (M)	ENTRY
RELEASE (R)	OFF	SEARCH (S)	OFF
PROGRAM LOAD (PL)	PROG LOAD	PROGRAM REVERT (PR)	NORMAL

### MAIN PROGRAM

3. Depress PRG key for *main* program.
4. Depress ER/HOM keys.
5. Hold down NUM key as you key enter MAIN program (make a key depression for every memory position). Use the space bar for program spaces.
6. Change mode switch to VERIFY.
7. Depress ER/HOM keys.
8. Hold NUM key as you key verify the program. To correct an error, set mode switch to ENT and key the correct character. Depress ER/MBS keys. Change mode switch to VER, re-verify character and continue with run.

### ALTERNATE PROGRAM

9. Depress PRG key for *alternate* program.
10. Change mode switch to ENTRY.
11. Depress ER/HOM keys.
12. Hold down NUM key as you key enter ALTERNATE program (make a key depression for every memory position).
13. Change switch to VERIFY.
14. Depress ER/HOM keys.
15. Hold NUM key as you key verify the program. To correct an error, set mode switch to ENT and key the correct character. Depress ER/MBS keys. Change mode switch to VER, re-verify character and continue with run.
16. Depress ER/HOM keys, set Program Load switch to "off," and other switches as required to proceed with desired operation.

# 6401 MOHAWK/736 NCR DATA RECORDER

## PROGRAM TAPE

A program tape is a length of magnetic tape on which a program for Data Recorder application is written. This tape can be stored and can be used over and over again to enter a program directly into program memory without the necessity of manually keying the program each time. If an installation is using several 6401's on one application, one program tape can be used to enter the desired program in each 6401.

More than one program may be stored on one program tape. If several programs are stored on one tape, the proper program can be selected by utilizing the search function of the 6401. Additional data blocks may be stored on a program tape, if so desired. For example, a block containing constant information, or data for a data label, could be written on the program tape following the program block. The constant block can be read into memory following program loading by placing the PROG LOAD switch to "off" and depressing the REL key.

To make a program tape, use a piece of magnetic tape approximately four feet long. Fold one end of the tape approximately 3/4 of an inch with the shiny non-oxide side on the inside of the fold. Seal the fold with a gummed label. The small loop formed at the end of the tape is used for holding the tape on the Data Recorder to prevent it from falling into the tape bin. The loop is at the trailing end of the program tape when the tape is on the Data Recorder.

Place a reflective marker midway between the two ends of the program tape on the shiny side. The reflective marker is required for proper positioning of the program tape for reading the program.

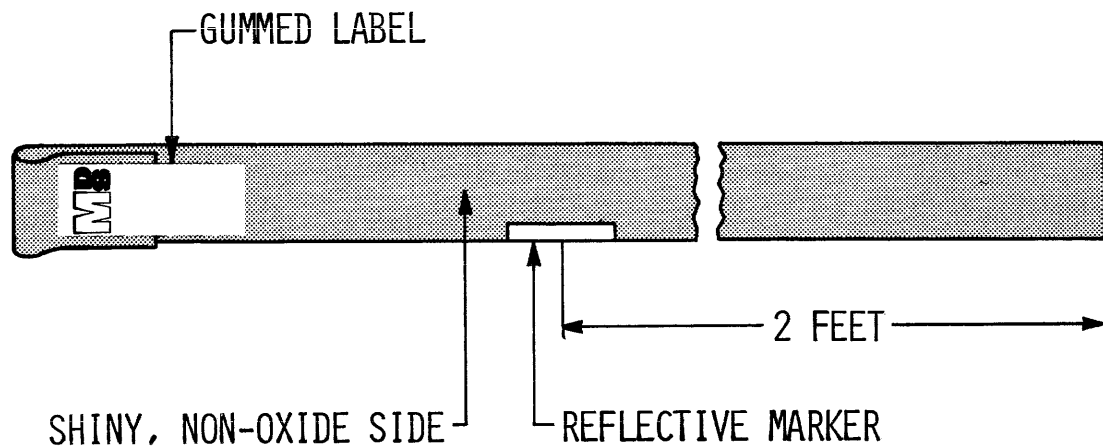

# 6401 MOHAWK/736 NCR DATA RECORDER

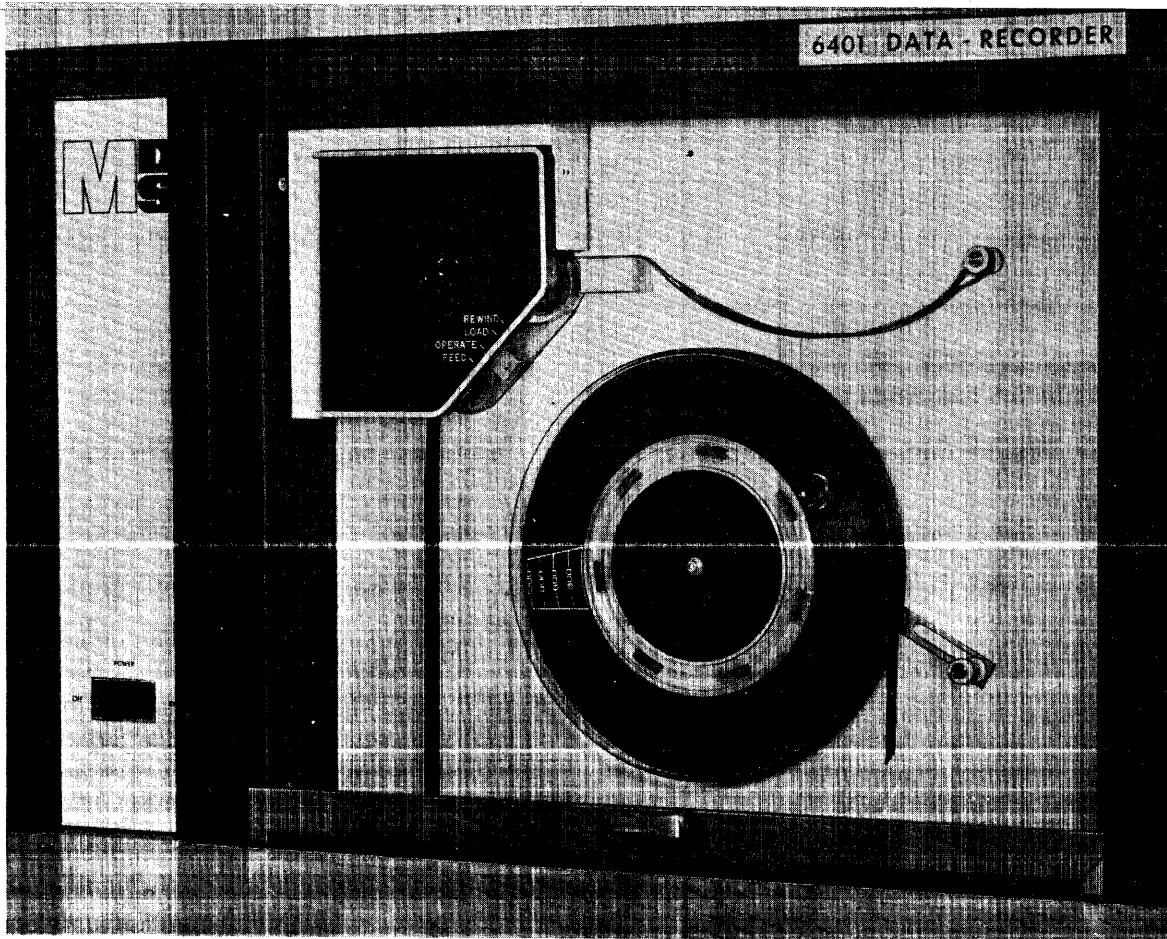

## LOADING A PROGRAM TAPE

Photo courtesy of Mohawk Data Sciences Corporation

The reflective marker must face down in order for the tape to stop at the proper position. Hold down NUM key as you key enter the program.

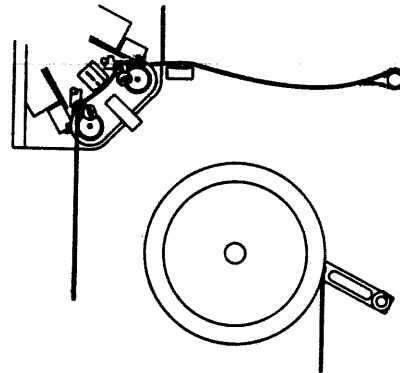

POSITION			CHAR	PROG
HUN	TENS	UNITS		
0			2	2
	1		1	
			AP	

If the *program indicator* shows AP, it indicates that the ALTERNATE program is the controlling program.

# 6401 MOHAWK/736 NCR DATA RECORDER

## WRITING A PROGRAM TAPE

If the Data Recorder application is such that one or more programs are going to be used over and over again for one or more Data Recorders, it may be advantageous to use master program tapes for program storage. The procedure for writing programs on program tapes is given below.

1. Set power to "on," Feed/Rewind to "load."
2. Place the program tape loop over roller so that the reflective marker faces down when the tape is extended to the left. Position the reflective marker at least six inches to the right of the tape sensor.
3. Set function switches as follows:

SWITCH	POSITION	SWITCH	POSITION
AUTO SKIP/DUP (A S/D)	OFF	MODE (M)	ENTRY
RELEASE (R)	ON	SEARCH (S)	OFF
PROGRAM LOAD (PL)	OFF	PROGRAM REVERT (PR)	NORMAL

4. Mount, but do not thread, a tape reel with the file protect ring inserted. This extinguishes the FPR indicator and enables the Data Recorder to write on the program tape.
5. Perform a tape feed operation; Feed/Rewind to "operate" and depress REL key.
6. Key enter the first program. When the last position is keyed, the entire program is automatically written on tape. Key enter other programs and/or constant information in the same manner.
7. Following the last data block, depress the W/EOT switch. This enters a tape mark on the program tape which serves as a control when reading the programs into program memory.
8. Place FEED/REWIND switch in LOAD position and pull the program tape back through the feed mechanism. Make sure the reflective marker is at least six inches to the right of the tape sensor.
9. Change mode switch to VERIFY. Perform a tape feed operation.
10. Depress the REL key. The first data block is in data memory.
11. Verify the first block. When the last position is keyed, the next block is read in. Continue verification. If an error is found during verification, perform the necessary error recovery procedure.
12. Place the FEED/REWIND switch in LOAD position and pull the program tape back through the tape feed mechanism. Remove the tape from roller. Label the tape and store until needed.

# 6401 MOHAWK/736 NCR DATA RECORDER

## LOADING A PROGRAM FROM A PROGRAM TAPE

To enter a program into program memory from a program tape, proceed as follows:

1. Power to "on," Feed/Rewind to "operate."
2. Place the program tape over roller so that the reflective marker faces down when the tape is extended to the left. Position the reflective marker at least six inches to the right of tape sensor.
3. Set function switches as follows:

SWITCH	POSITION	SWITCH	POSITION
AUTO SKIP/DUP (A S/D)	OFF	MODE (M)	VERIFY
RELEASE (R)	ON	SEARCH (S)	OFF
PROGRAM LOAD (PL)	PROG LOAD	PROGRAM REVERT (PR)	NORMAL

4. Perform a tape feed operation.
5. When tape feed is complete, select the program memory (alternate or main) that is to contain the first program to be read from the program tape.
6. Depress the REL key. The first program from the program tape is in program memory. If the error light flashes and the tape error indicator is lit, the first program block was not read properly. Depress the ER key and use the ENTRY switch to reread the first program block.
7. If there is another program on tape to be entered into the other program memory, depress the PRG key and depress the REL key once more.
8. Place the PROG LOAD switch to "off." If there is a constant information data block on tape for the entry run, depress the REL key to read this information into memory. The constant information is usually in memory positions programmed for automatic duplication. Therefore, place the AUTO SKIP/DUP switch to the Auto Skip/Dup position to protect this data.
9. Place the FEED/REWIND switch in LOAD position and pull the program tape back through the tape feed mechanism. Remove the tape from roller and store the program tape for future use.



# 6401 MOHAWK/736 NCR DATA RECORDER

## CHANGING A CHARACTER IN PROGRAM MEMORY

To change a single character in program memory, proceed as follows:

1. Power switch to the "on" position; Feed/Rewind switch to "operate."
2. Set function switches as follows:

SWITCH	POSITION	SWITCH	POSITION
AUTO SKIP/DUP (A S/D)	OFF	MODE (M)	ENTRY
RELEASE (R)	OFF	SEARCH (S)	OFF
PROGRAM LOAD (PL)	OFF	PROGRAM REVERT (PR)	NORMAL

3. Advance the memory position counter to the position to be changed. If the contents of data memory are not to be disturbed, advance to the memory position by dupping through memory or rekeying the contents of memory to the position so desired. If retaining the contents of data memory is not required, the memory position can be reached by manual skipping or spacing through memory.
4. Key the new program code into data memory. Position counter advances one.
5. Key the proper program code for the following position. Position counter advances another position.
6. Depress ER/MBS keys *twice*. Position counter backspaces two positions.
7. Change the Program Load (PL) switch to PROG LOAD.
8. Depress space bar *once*.
9. Turn PL switch "off."

NOTE: Repeat steps 3 through 9 for additional character changes.

10. After all changes are made, set control switches as required to proceed with the run.

## 6401 MOHAWK/736 NCR DATA RECORDER

### CLEANING

At the start of each days operation, clean the Data Recorder using the procedure listed below. If good cleaning habits are not used, scratched and damaged tapes may result because of a dirty tape path. A cleaning kit is supplied with each of the Data Recorders.

1. If the 6401 is threaded, rewind the magnetic tape.
2. Place FEED/REWIND switch<sup>1</sup> in LOAD position to raise the pressure pads<sup>2</sup> from the tape path.
3. Swing open the door<sup>3</sup> that covers the tape feed mechanism.
4. Remove the  $\frac{1}{2}$ " wide cleaning strip from the cleaning kit.
5. Moisten the cleaning strip with solvent and place the cleaning strip in the tape feed path, under the read/write head<sup>6</sup>, and between the capstans<sup>8</sup> and pinch rolls<sup>7</sup>. The cleaning strip must extend beyond each capstan.
6. Grasp each end of the cleaning strip and move the strip back and forth several times to clean the tape path.
7. Remove cleaning strip from tape feed mechanism.
8. Place Power switch to the "on" position.
9. Hold a clean *dry* cloth momentarily to the underside of each moving capstan<sup>8</sup>.
10. Clean the underside of the read/write head<sup>6</sup> and erase head<sup>11</sup> with a swab moistened with solvent.
11. Wipe off excess solvent.
12. Close the door covering the tape feed mechanism.
13. Moisten one of the square pads or swabs with the solvent supplied and wipe rollers<sup>4</sup> and<sup>5</sup>. Wipe off excess solvent.

### MOUNTING TAPE REEL

Hold the supply tape reel so that the tape on the reel is wound in a clockwise direction. Place the reel over the hub and push in firmly. The reel snap-locks into place.

# 6401 MOHAWK/736 NCR DATA RECORDER

## TAPE FEED MECHANISM

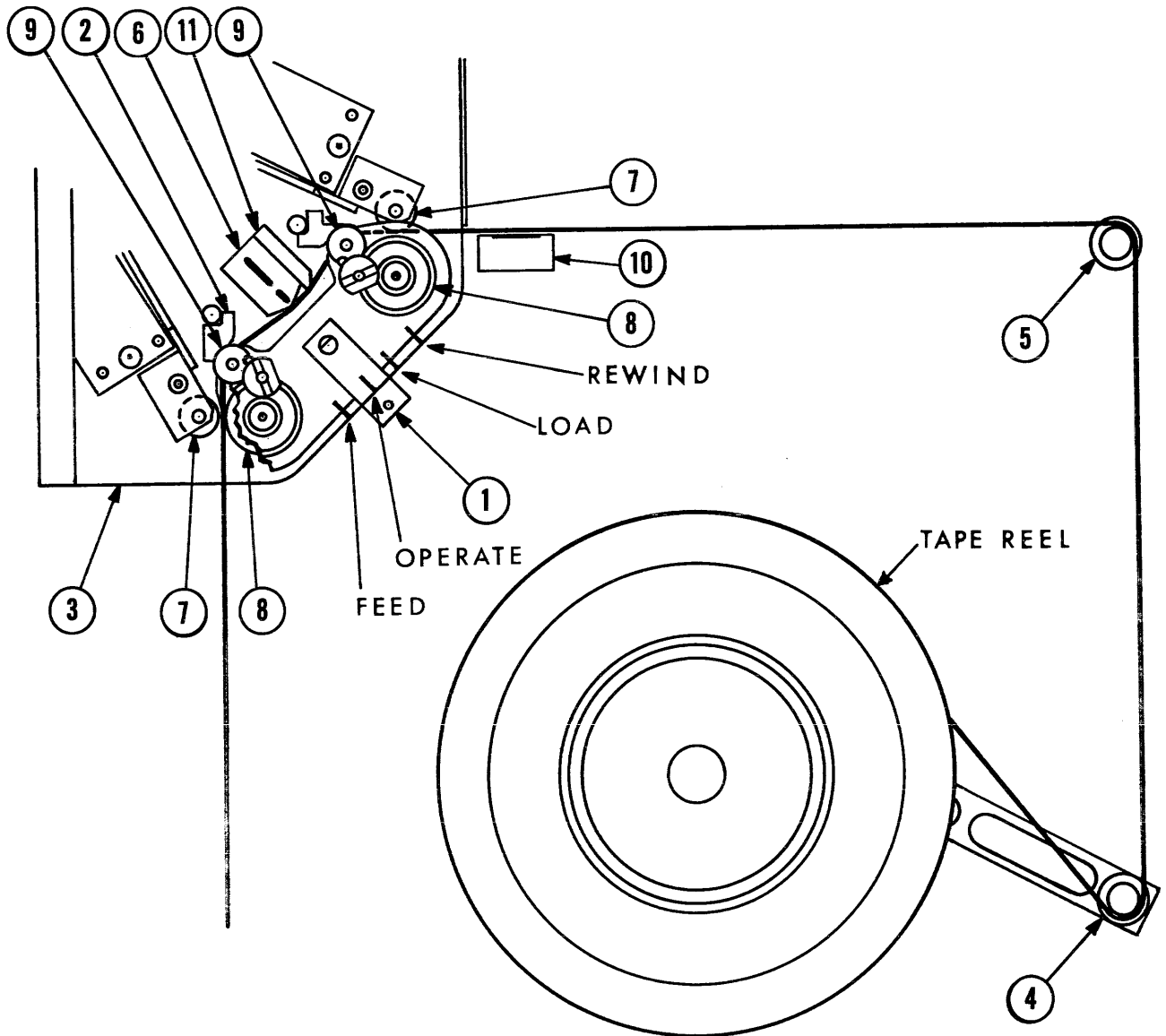

# 6401 MOHAWK/736 NCR DATA RECORDER

## TAPE FEED OPERATION

After the supply reel is mounted, proceed as follows:

1. Place Power switch to the "on" position. Place the mode switch to ENT or VER, according to the operation to be performed when tape feed is completed.
2. Unwind approximately two feet of tape.
3. Place FEED/REWIND switch<sup>1</sup> in LOAD position. The Error Light flashes when the FEED/REWIND switch<sup>1</sup> is placed in LOAD position. This does not effect the loading operation.
4. Swing open the door<sup>3</sup> that covers the tape feed mechanism.
5. Place the tape under roller<sup>4</sup> and over roller<sup>5</sup> between pinch rollers<sup>7</sup>, capstans<sup>8</sup> and under the read/write head<sup>6</sup>.
6. Make sure the tape is laying flat in the tape guides<sup>9</sup>. Close the door that covers the tape feed mechanism.
7. Hold the FEED/REWIND switch in the FEED position to start automatic tape feed.
8. Continue holding the switch in FEED position. Tape movement stops when the beginning of tape reflective marker passes the BOT sensor<sup>10</sup>.
9. Release FEED switch to OPERATE position when tape movement stops. The tape automatically positions itself for the start of the next operation.
10. Depress the ER key to extinguish the Error Light.

## TAPE REWIND

When the tape is to be rewound on the supply reel, proceed as follows:

1. Set Power switch to the "off" position.
2. Remove tape from roller<sup>4</sup> and take up slack.
3. Set FEED/REWIND switch to REWIND position.
4. After a nominal 5 second delay, the tape reel starts turning in a counterclockwise direction to rewind the tape.
5. When all of the tape has been rewound, place the REWIND switch in the OPERATE position. Do not stop power rewind until the reflective marker is to the right of the read/write head<sup>6</sup>.

## REMOVAL OF TAPE REEL

To remove the tape reel, grasp the reel firmly on two opposite sides, apply pressure on the center hub with the thumbs; pull gently outward on the reel.

# 6401 MOHAWK/736 NCR DATA RECORDER

## DATA ENTRY

1. Power switch to the "on" position; Feed/Rewind to "operate."
2. Enter the program(s) to be used through the keyboard or from a program tape.
3. Set function switches as follows:

SWITCH	POSITION	SWITCH	POSITION
AUTO SKIP/DUP (A S/D)	OFF	MODE (M)	ENTRY
RELEASE (R)	REL	SEARCH (S)	OFF
PROGRAM LOAD (PL)	OFF	PROGRAM REVERT (PR)	NORMAL

4. Insert File Protect Ring in tape reel. This enables the Data Recorder to write on tape.
5. Mount the tape reel and position the magnetic data tape in accordance with the tape feed instructions.
6. Depress ER/HOM keys.
7. Key enter the first data block. Automatic release occurs when the last position is reached. During entry of the first data block, key enter constant information for dup fields. If it is required to override numeric shift and alpha shift program codes at any time, use the LTR key and NUM key respectively.
8. Change switches:   M - VERIFY  
                          R - OFF
9. Key verify all positions. The first data block is verified to assure that the constant information in dup fields is correct before proceeding with the run. Make corrections according to error recovery procedures.
10. Change switches:   M - ENTRY  
                          R - REL  
                          A D/S and PR - as required depending on the program being used.
11. Depress the ER/HOM keys to set the position counter for data entry of the next data block.
12. Proceed with data entry run.
13. At the end of an entry run, write a tape mark on tape to define the stopping point. To write a tape mark, depress and release the W/EOT switch *once*. The tape mark is written and approximately six inches of tape is then erased.

If data does not completely fill a data block, the SKP key can be used to space fill the unused positions and release the data to tape. After entering data in a left zero field, depress the LØ key. The data in the LØ field is shifted to the right and all left positions of the field are zero filled.

# 6401 MOHAWK/736 NCR DATA RECORDER

## DATA VERIFICATION

1. Power switch to the "on" position; Feed/Rewind to "operate."
2. Enter the verification program(s) through the keyboard or from a program tape.
3. Set function switches as follows:

SWITCH	POSITION	SWITCH	POSITION
AUTO SKIP/DUP (A S/D)	OFF	MODE (M)	VERIFY
RELEASE (R)	REL	SEARCH (S)	OFF
PROGRAM LOAD (PL)	OFF	PROGRAM REVERT (PR)	NORMAL

4. Remove File Protect Ring. This protects the data tape from being inadvertently erased during a verify run.
5. Mount the tape reel and position the tape in accordance with the tape feed instructions.
6. Depress the REL key. The first data block is read into data memory. If the error lights comes on, it is probably an indication that the first data block is further from the reflective marker than expected. Depress the RETRY switch to try again to read in the first data block. If the error lights come on again, repeat the procedure using the RETRY switch.
7. Key verify all positions including dup and skip fields. Automatic release occurs if all character positions have been verified correct. Correct errors according to error recovery procedures.
8. Change the A S/D switch to the "on" position.
9. Proceed with verification run.

NOTE: If data fields that were auto duplicated during entry are programmed for auto duplication during verify, the data is machine verified. This auto duplication stops when a difference in duplicated data between the current data block and the previous data block is encountered. During verification, corresponding positions of consecutive data blocks that contain identical data can be manually "dup-verified" by depressing the DUP key. Dup verification stops when a difference is encountered.

If a left zero field is programmed with a code 6 or 7 in the first position, all leading zeros are automatically verified. Machine verification stops at the first non-zero position of the field.

# 6401 MOHAWK/736 NCR DATA RECORDER

## PERFORMING A SEARCH

1. Power switch to the "on" position; Feed/Rewind to "operate."
2. Set function switches as follows:

SWITCH	POSITION	SWITCH	POSITION
AUTO SKIP/DUP (A S/D)	OFF	MODE (M)	VERIFY
RELEASE (R)	OFF	SEARCH (S)	OFF
PROGRAM LOAD (PL)	OFF	PROGRAM REVERT (PR)	NORMAL

3. Insert File Protect Ring in tape reel if an ENTRY run is to follow the SEARCH.
4. Mount the tape reel and position the tape in accordance with the tape feed instructions.
5. Place mode switch to ENTRY and key enter a data block identifier. The identifier must consists of data identical in content and memory position to the data in the data block being searched for. The identifier can be any length. Memory positions that do not contain the identifier must contain space codes. The identifier must also be unique to the data block being searched for. If data entry is to follow the search, the tape mark written on tape after the last data block may be used as a search identifier.
6. Change the mode switch to VERIFY.
7. Depress the ER/HOM keys.
8. Key verify the identifier. To correct an error, change mode switch to ENTRY. Return to VERIFY position after each correction.
9. Change release switch to "REL" position.
10. Change mode switch to either ENT for an entry run, or to VER for verification.
11. Place Search switch in SEARCH position.
12. Depress REL key for  $\frac{1}{2}$  second. Consecutive data blocks are read into memory and compared to the identifier. The data block being searched for has been found when the search stops *without error condition*. The data block is positioned to the left of the read/write head. The data block identifier is still in data memory.

NOTE: If it is desired to work with the data block located by the search; i.e., verify, change or delete, proceed with steps 12 and 13 to read the data block into data memory.

## 6401 MOHAWK/736 NCR DATA RECORDER

### AFTER SEARCH

12. Change function switches as follows:

A D/S - as required by the program being used.  
SEARCH - OFF

13. Depress RETRY switch to back the tape up one block length and read the data block into memory.

14. Proceed with the desired operation.

### TO CONTINUE ENTRY RUN AFTER SEARCH

15. To continue an entry run after a data block has been located by a search, change function switches as follows and then start data entry procedure.

A D/S - as required by the program being used.  
SEARCH - OFF

16. To continue an entry run after a Tape Mark has been located by a search, proceed as follows:

A. Set the function switches as follows:

M - ENT  
S - OFF

B. Key enter the first data block of the new entry run.

C. Move Feed/Rewind lever to LOAD and then back to OPERATE. This will extinguish the EOT indicator and reactivate the keyboard.

D. Depress ER/HOM keys.

E. Depress the RETRY switch. The Tape Mark data block is erased and the new data block is written on tape.

F. Set the A D/S switch as required for the run and proceed with data entry.

NOTE: A search does not have to start at the beginning of the tape. If a search is to be started from some place other than the beginning of the tape, set the function switches as stated in step 2 above and proceed with steps 5 through 10. To stop a search operation, place the Search switch to "off." To restart the search, place the Search switch in SEARCH position, depress the ER key to extinguish the Error Light, and then depress the RETRY switch.



# 6401 MOHAWK DATA RECORDER

## ERROR RECOVERY DURING ENTRY

During data entry certain errors may be encountered. Most of these errors are signaled to the operator by the flashing Error Light and some are also indicated by the Tape Error (TE) status indicator. The recovery procedures for entry mode errors are discussed in the following paragraphs.

If, during data entry, more than one character key is depressed at one time, an error indicator results. The Error Light on the Operator Console flashes, the memory counter does not advance and further key entry is prevented. To recover from this type of error, depress the ER key. The Error Light is extinguished and the keyboard is made operational. The correct character can now be key entered in the proper position.

## SENSED KEYING ERRORS - ERROR LIGHT FLASHES

If an alpha or special character is keyed in a position programmed for numeric entry, the Error Light flashes and the keyboard is locked out. The memory counter does not advance from the position where the keying error was made. Depressing the ER key makes the Data Recorder operational again.

Alpha characters and letter shift special characters can be entered in a numeric field by holding the LTR key depressed while the character is being key entered. Numeric shift special characters can be entered in numeric or dual numeric fields by holding the NUM key depressed while the character is being key entered.

All machine operations take a certain amount of time to complete. For example, a read-after-write check takes approximately 150 milliseconds. If data is keyed into memory before a machine operation such as read-after-write, dup or skip is complete, the Error Light is lit at the end of the operation. The position indicator shows the first position of the next field. To recover from this type of error, depress the ER key to extinguish the Error Light, re-key the data, starting at the position indicated by the position counter.

## OPERATOR-SENSED KEYING ERRORS - NO INDICATOR LIGHTS

When the operator senses that a keying error has been made (without the Error Light flashing), the correction can be made in the following way as long as the data block has not been released to tape. Hold the ER key depressed and depress the MBS key once for every position to be backspaced. The memory counter is reduced by one for each depression of the MBS key. When the correct position is reached, release the ER key and key the correct character into the correct position. Key entering the correct character erases the previously entered incorrect character. Continue keying from this point. If the error is sensed after the data is released to tape, the error block can be corrected immediately or the correction can wait until the verification mode. To correct a data block that has just been written on tape, turn the release switch "off," re-enter the data block, place the release switch "on" and depress the RETRY switch. When the RETRY switch is used, the error block is erased and the new data block is written on tape.

# 6401 MOHAWK DATA RECORDER

## ERROR RECOVERY DURING ENTRY (CONT.)

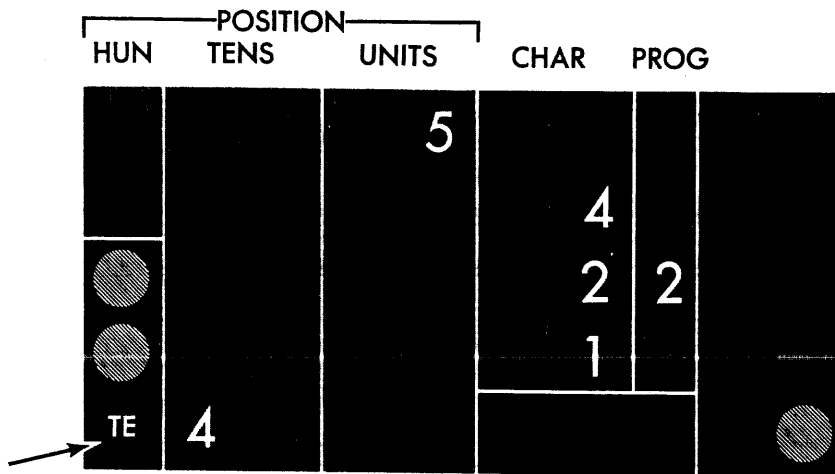

## READ-AFTER-WRITE ERROR - ERROR LIGHT FLASHES: TE INDICATOR LIGHTS

Following the writing of a data block on tape, an automatic read-after-write check is performed. This check consists of reading the data block just written, checking it for correct character parity, longitudinal parity, and comparing the data characters read against the data characters retained in data memory. If a discrepancy is encountered during the read-after-write check, the Error Light flashes and the TE indicator is lit. This error condition could be caused by a parity bit error, dust or dirt on the tape, or a bad spot on tape. It is therefore necessary to re-write the data block on tape. This is accomplished by following the procedures below:

1. Depress ER key to extinguish the Error Light. Depress the RETRY switch. The tape is backed up one block length, the error block is erased, and the data block rewritten in a new location on tape.
2. If the error condition persists, depress the ER key and the RETRY switch again. If the error condition is cleared, proceed with the entry run.
3. If the error condition is still present, depress the ER key and re-key the entire data block.
4. When the data block is re-entered, depress the RETRY switch to write the data block.

*NOTE: Persistent errors may be an indication of a dirty tape path or read/write head. Refer to cleaning instructions.*

# 6401 MOHAWK DATA RECORDER

## ERROR RECOVERY DURING VERIFICATION

During verification, the Data Recorder detects keying errors that were made during entry and any parity errors that may exist on tape.

### AUTOMATIC VERIFICATION

Data fields that were auto-duplicated during entry can be auto-verified as the data block is being key verified. The constant data fields need only to be programmed with a program code 4 in the MSP of the field and the A S/D switch must be "on." The automatic verification works on the same principle as the Dup-Verify feature, except that the duplicate action is automatically initiated when program code 4 is encountered. If a non-compare between the dup field data from one data block to the next is sensed, memory advance stops at the position where the non-compare occurred.

## CORRECTING A CHARACTER ENTERED INCORRECTLY - USING ER/COR KEYS

During verification, a keyed character not identical to the character stored in memory for the position being checked, causes an error condition and makes the keyboard inactive for further entries. Depressing the ER key reactivates the keyboard and extinguishes the Error Light for another keying attempt. If the error indication persists after two or more attempts making sure that the proper character is being keyed, it must be assumed that the character in storage is in error and is to be corrected.

To replace the incorrect character in memory with the correct character and write the correct data block on tape, proceed as follows:

1. Depress the ER key to extinguish the Error Light.
2. Depress the ER/COR keys. The erase head and read/write head are turned on in preparation for erasing the error block and writing the correct block. The Data Recorder is conditioned for entry of one character into data memory and automatic and manual release are inhibited.
3. Key enter the correct character. The memory counter advances one position and the Data Recorder returns to verification mode.
4. Continue verification to the end of the data block. For each error encountered, depress the ER/COR keys and key the correct character.
5. After the last position of the data block has been verified or corrected, depress the ER/HOM keys. Re-verify the entire data block. When all positions are re-verified *without further error condition*, the data tape backs up one block length and the new data block is then automatically written in place of the error block. If a correction using the COR key is made during re-verification, the entire data block must be re-verified again.
6. When the read-after-write check is complete, depress the REL key to read the next data block into memory.

# 6401 MOHAWK DATA RECORDER

## ERROR RECOVERY DURING VERIFICATION (CONT.)

### CORRECTING A FIELD ENTERED INCORRECTLY - USING ER/FM KEYS

If it has been determined that an entire field has been entered incorrectly, proceed as follows to correct the error:

1. Depress the ER/FM keys. The erase head and read/write head are turned on in preparation for erasing the error block and writing the corrected block. Automatic and manual release are inhibited.
2. Key enter the correct characters in the field. At the end of the field, the Data Recorder automatically returns to VERIFY mode.
3. Continue verification of the entire data block.
4. After the last position of the data block has been verified or corrected, depress the ER/HOM keys.
5. Re-verify the entire data block. When all positions are re-verified *without further error correction*, the data tape backs up one block length and the new data block is then automatically written in place of the error block. *If a correction using the COR or FM key is made during re-verification, the entire data block must be re-verified again.*
6. When the read-after-write check is complete, depress the REL key to read the next data block into memory.

### CORRECTING AN ENTIRE DATA BLOCK

If, during verification, it has been determined that an entire data block must be corrected, proceed as follows:

1. Change A S/D switch to the "off" position.
2. Depress the ER/FM keys and key the correct data.

*NOTE: Repeat this for each field of the data block.*

3. After the last position of the data block has been corrected, depress the ER/HOM keys.
4. Re-verify the entire data block. When all positions are re-verified *without further error corrections*, the data tape backs up one block length and the new data is then automatically written in place of the error block. *If a correction using the COR or FM key is made during re-verification, the entire data block must be re-verified again.*
5. When the read-after-write check is complete, depress the REL key to read in the next data block for verification.
6. Set A S/D switch to the "on" position and proceed with run.

## 6401 MOHAWK DATA RECORDER

### ERROR RECOVERY DURING SEARCH - ERROR LIGHT FLASHES; TE INDICATOR LIGHTS

A successful search operation is terminated without error indication. A parity error or blank tape encountered during search causes an error condition.

A blank tape area could be the result of the entry operator erasing tape with consecutive RETRY operations while attempting to rewrite a data block. An improper identifier which causes the search to go beyond the last data block on tape also causes the search to stop with an error indication when blank tape is encountered. In each case, the Error Light flashes and the TE indicator is lit.

If blank tape in the middle of the run was the cause for the error condition, one to three RETRY operations, preceded by depression of the ER key to extinguish the Error Light, should be sufficient to move past the blank tape area and restart the search. If the error condition persists, the last data block read has a parity error or the search went beyond the last recorded data block.

To read the last data block into memory after a search stops with an error indication, set the function switches as follows:

SWITCH	POSITION	SWITCH	POSITION
AUTO SKIP/DUP (A S/D)	OFF	MODE (M)	VERIFY
RELEASE (R)	REL	SEARCH (S)	OFF
PROGRAM LOAD (PL)	OFF	PROGRAM REVERT (PR)	NORMAL

Extinguish the Error Light and depress the RETRY switch to read the data block into memory. One or two RETRY operations should establish the fact if the last data block on tape has been bypassed or not, or, if a parity error block has been read. This fact is established by a visual observation of tape movement during the RETRY. In a blank tape area, the tape moves approximately five inches forward while attempting to read a data block. If a parity error block caused the error condition, the data tape does not advance forward during the RETRY operation.

The disposition of the parity error block is at the discretion of the using installation. The block can be rewritten or it can be deleted by entering delete codes instead of data. To resume a search from this point, the identifier must be rekeyed into memory and the function switches reset.

If the search ends with the EOT indicator lit and the Error Light flashing, the data block being searched for has been bypassed. This is assuming that the Tape Mark was not being used as an identifier.

If the desired data block is bypassed during a search, rewind the tape and restart the search, making sure that the proper identifier is used.

# 6401 MOHAWK DATA RECORDER

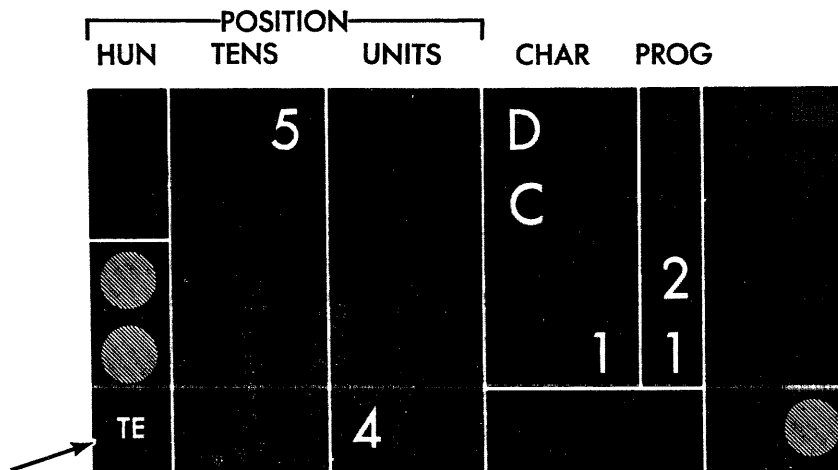

## PARITY ERROR - ERROR LIGHT FLASHES; TE INDICATOR LIGHTS

During the tape read operation, each character read from tape is checked for correct character parity. At the same time, the entire block is checked for correct longitudinal parity. If an error is detected, the Error Light flashes and the TE indicator is lit. If a parity error is detected when a data block is being read into memory for verification, depress the RETRY switch to reread the data block. If the error persists, it is necessary to manually verify the entire block to determine which characters are in error.

To prevent the automatic advance across fields programmed for automatic skip or dup, turn the A S/D switch to "off," thereby permitting manual verification of those fields. The ER key must be depressed to extinguish the Error Light and reactivate the keyboard before manual verification can begin.

When an error character is found, it is corrected by replacing the character in memory and rewriting the data block. If all characters verify correctly, the parity error was caused by a discrepancy in the parity bit track and rewriting the block will correct the parity bits.

If, after correcting any errors and rewriting the block, an error persists after the read-after-write-check, it must be assumed that the tape has been damaged and a bad spot exists. The error block should be rewritten at the end of the file. Enter delete codes in place of the damaged block.

# 6401 MOHAWK DATA RECORDER

## READING A DATA BLOCK FROM DATA MEMORY

During entry it may become necessary to verify the last data block written. When this situation occurs, proceed as follows:

1. Power switch to the "on" position; Feed/Rewind to "operate."
2. Set function switches as follows:

SWITCH	POSITION	SWITCH	POSITION
AUTO SKIP/DUP (A S/D)	OFF	MODE (M)	VERIFY
RELEASE (R)	REL	SEARCH (S)	OFF
PROGRAM LOAD (PL)	OFF	PROGRAM REVERT (PR)	As Required

3. Depress RETRY switch to back the tape up one block length and read the data block into data memory.
4. Change the release switch to "off."
5. Verify the entire data block.
6. Change function switches as follows:

SWITCH	POSITION	SWITCH	POSITION
AUTO SKIP/DUP (A S/D)	As Required	MODE (M)	ENTRY
RELEASE (R)	REL	SEARCH (S)	OFF
PROGRAM LOAD (PL)	OFF	PROGRAM REVERT (PR)	As Required

7. Depress ER/HOM keys.
8. Proceed with entry run.

# 6401 MOHAWK DATA RECORDER

## TO CODE A RECORD FOR COMPUTER DELETION

1. Power switch to the "on" position; Feed/Rewind to "operate."
2. Set function switches as follows:

SWITCH	POSITION	SWITCH	POSITION
AUTO SKIP/DUP (A S/D)	OFF	MODE (M)	VERIFY
RELEASE (R)	REL	SEARCH (S)	OFF
PROGRAM LOAD (PL)	DATA	PROGRAM REVERT (PR)	As Required

3. Depress the ER/HOM keys simultaneously.
4. Advance memory to the first position to be changed.
5. Using the ER/COR keys, key delete character in specified positions.\*\*
6. Depress the ER/HOM keys simultaneously.
7. Re-verify the entire data block. When the last position is verified, release occurs. Delete characters are written in place of the old unwanted data characters.
8. Change the AUTO DUP/SKIP switch as required.
9. Depress the REL key to read the next data block to be verified into data memory.
10. Proceed with the verification run.

\*As required for program being used.

\*\*Delete characters and positions must be specified.



## 6401 MOHAWK/736 NCR DATA RECORDER

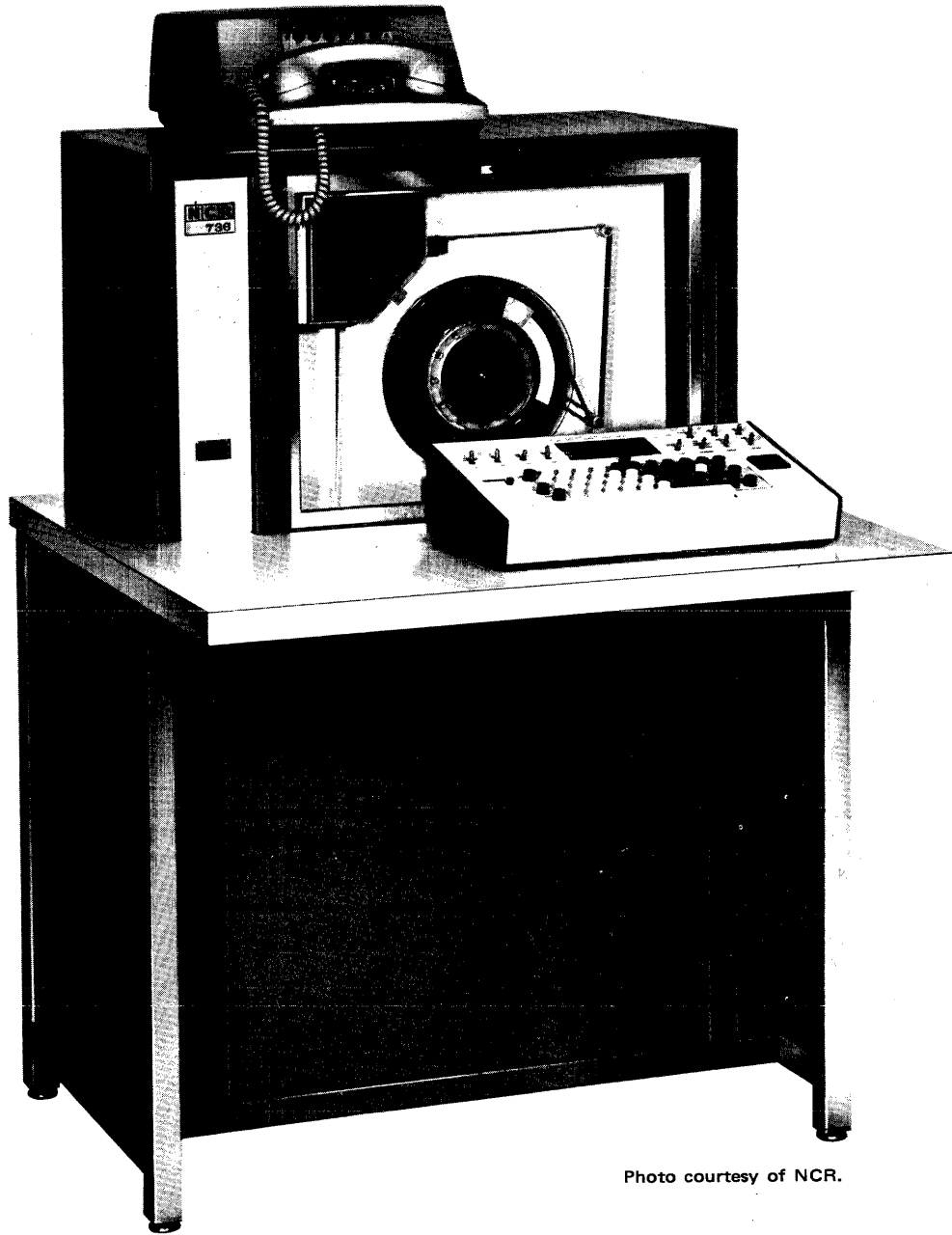

Photo courtesy of NCR.

### NCR 736 WITH DATA PHONE FOR TRANSMISSION

This equipment is manufactured by Mohawk Data Sciences Corporation. It is marketed in *blue* by Mohawk Data Sciences Corporation. The very same equipment is marketed in *brown* by National Cash Register.

## K-700 BASIC KEYS TAPE DEVICE

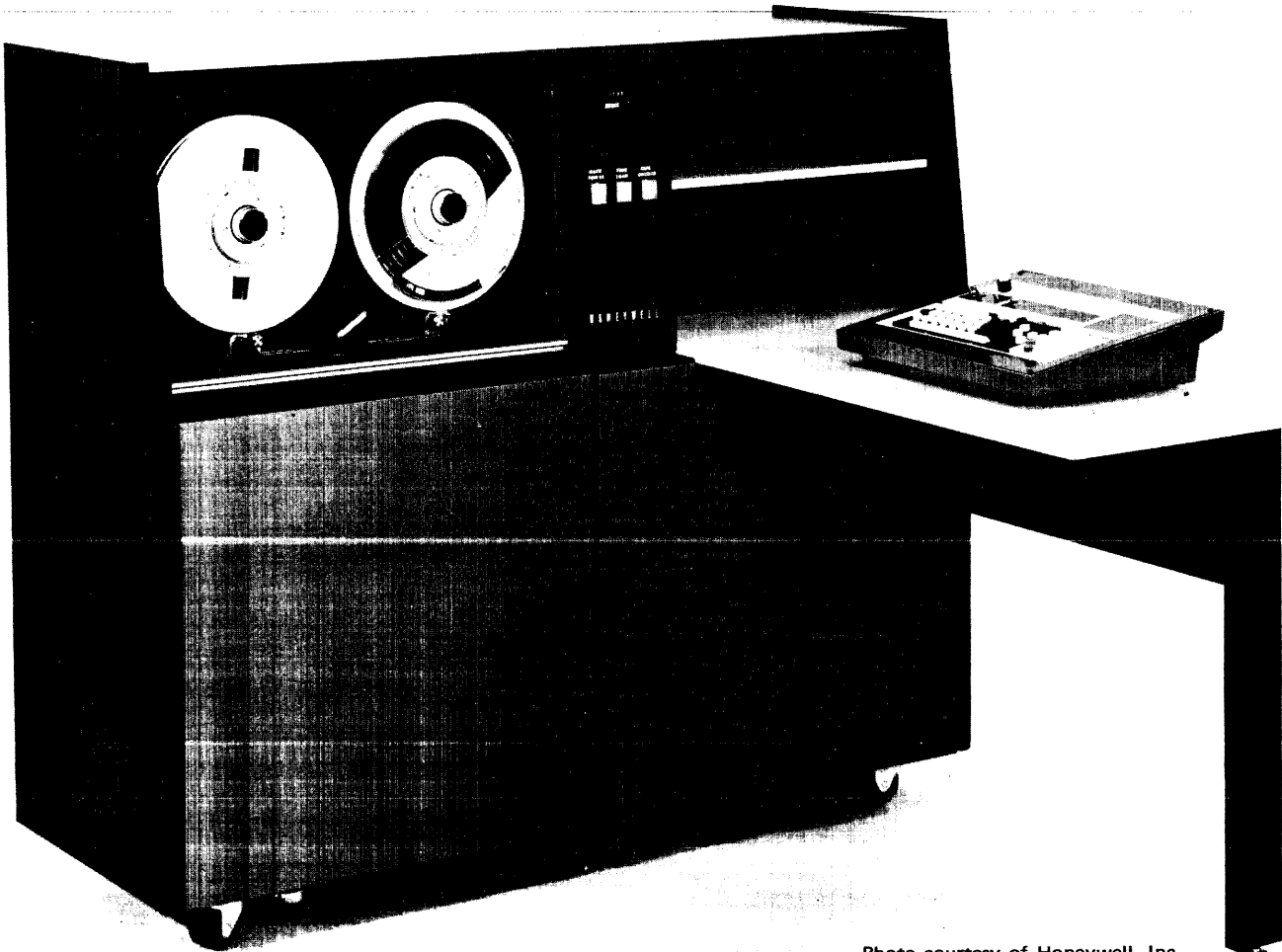

Photo courtesy of Honeywell, Inc.

The Keypunch device is designed for use in computer installations that rely on magnetic tape as the prime means of data entry. Direct entry of data from source documents to magnetic tape in a format suitable for computer input is possible with the use of the Keypunch device. It eliminates the need for intermediate paper medium such as punched cards or paper tape. Once on magnetic tape, the data can be read into the computer several times faster than it is possible via the fastest card reader.

Keypunch devices are available for recording on both 7- and 9-channel half-inch magnetic tape. Optional recording densities and even or odd parity tape codes are available to insure compatibility with a wide range of computer systems. This is an important feature for those data preparation installations that rely on service bureaus for data processing.

Error correction is one of the most costly items in Keypunch data preparation. This factor is significantly reduced because the Keypunch operator keys data into a buffer; which allows her to backspace and rekey if she senses that she has struck the wrong key.

Easily understood column position and data and program displays are features that increase operator efficiency. Automatic detection of the beginning of tape (BOT), including an audible BOT signal, are standard features on all Keypunch devices.

# K-700 BASIC KEYS TAPE DEVICE

## MAJOR COMPONENTS OF THE KEYS TAPE DEVICE

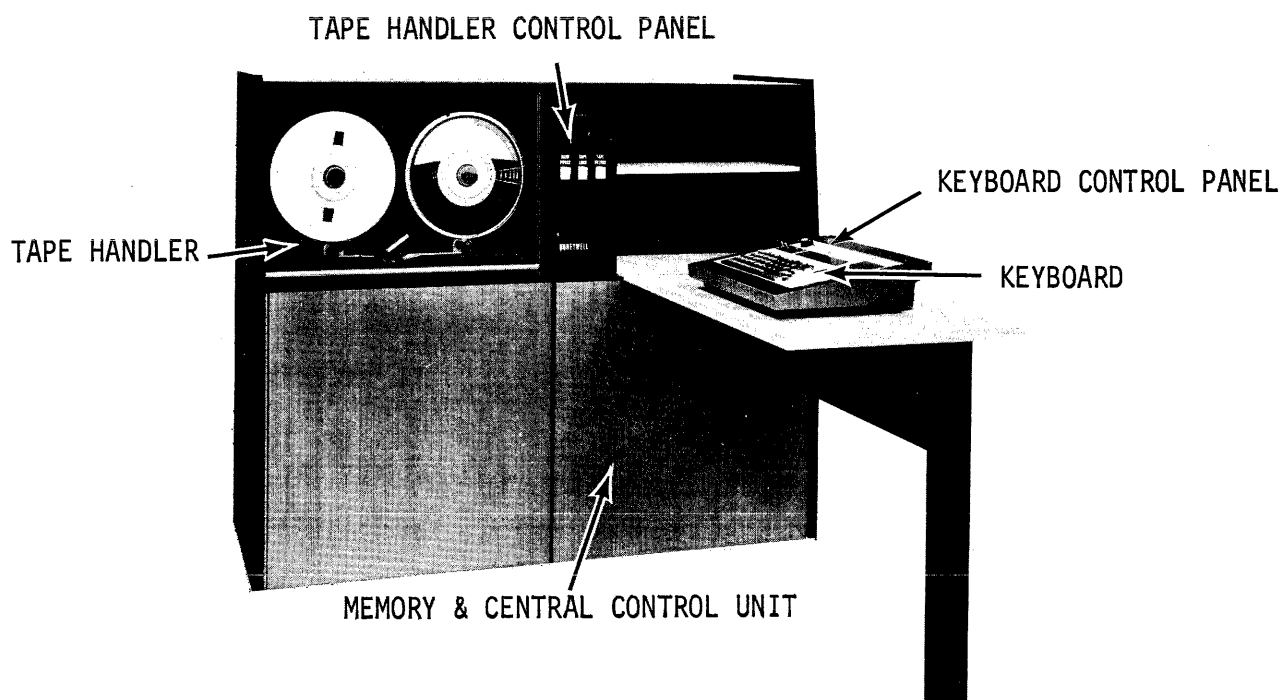

## BASIC KEYS TAPE DEVICES

Keystape models K-700 and K-900 are basic keyboard to tape devices that record keyboard entered data on 7- and 9-channel half-inch magnetic tape respectively, in a form suitable for entry to a computer. Data is recorded on the magnetic tape in fixed length records. The K-700 prepares and places 80 or 120 data character records on tape at a density of 556 bits per inch (bpi). The K-900 prepares and places 80, 90, 100, 110 or 120 data character records on tape at 800 bpi. Each Keystape device is also capable of verifying data previously recorded on tape. Correction can be made directly by the operator if errors are detected. Each device can also be used to search a prerecorded tape for a record specified by the operator.

## KEYBOARD

A complete 64-character color coded keyboard eliminates the need for multi-code keying on 7-channel devices and reduces it to a minimum on 9-channel devices. The keyboard is mounted in a moveable console that contains all the controls and indicators necessary for recording and verifying data on tape.

Although the operator cannot see or touch individual tape records as she can with cards, provisions have been made for the location and interpretation of records via a panel that can display any character within a record on tape. This is done by placing the record to be interpreted in an operator-addressable memory. Data fields within the record in memory may be deleted, added to, or shifted to the right or left via program control.

# K-700 BASIC KEYPAGE DEVICE

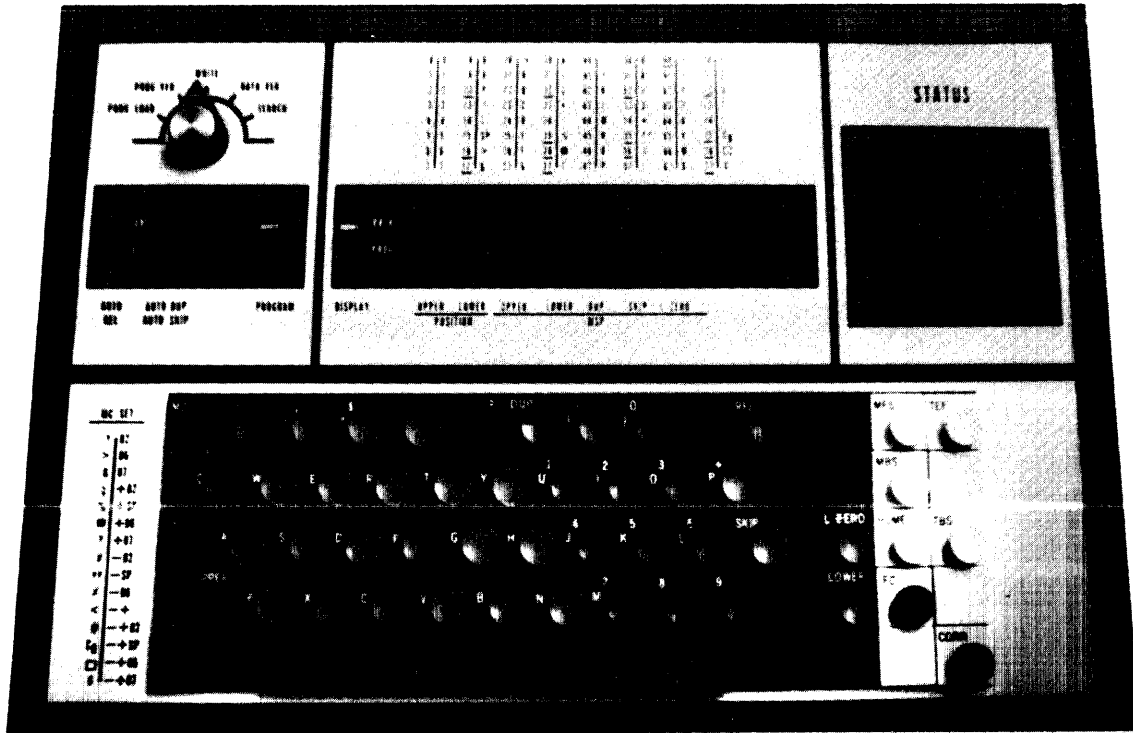

## KEYBOARD CONSOLE CONTROL PANEL

This panel is divided into three areas that are used for the following specific purposes:

- The first area is called the Functional Control Area<sup>1</sup> and contains four switches for the operator to select the mode of operation desired.
- The second area contains the Numeric Display<sup>2</sup> that is used by the operator to display either a program character or a data character that is stored in memory. When not being used for either of these purposes, this display automatically indicates the current column position.
- The third area contains the Status Indicators<sup>3</sup>. This normally blank panel is illuminated to indicate the status of the equipment. The word "ready" lights in green when the equipment is ready to operate. This normally blank panel illuminates when an error occurs to display the cause of the error and the steps that the operator must take to recover from that error.

*NOTE: The Keyboard<sup>4</sup> and Negative Number Set<sup>5</sup> are below the control panel.*

# K-700 BASIC KEYS TAPE DEVICE

## KEYTAPE SPECIFICATIONS

The specifications given below apply to all 7-channel Keypape models when they are used as keyboard-to-magnetic tape recording devices.

- |                                 |   |
|---------------------------------|---|
| KEYBOARD                        | - 34 data keys and a space bar capable of producing 64 characters plus control keys all mounted on a movable console.   |
| TAPE HANDLER                    | - Pneumatic tape handler transport employs 10.5-inch supply and takeup reels. A single-gap read/write head is used; a separate gap is used for erasing. Beginning of tape (BOT) sensing is standard.  |
| RECORDING DENSITY               | - Recording takes place at a density of 556 bpi (200 or 800 bpi is optional).   |
| DATA FORMAT                     | - 6-bit, binary-coded decimal (BCD) code plus parity, Honeywell or IBM-compatible code.   |
| RECORD FORMAT                   | - Data is placed on magnetic tape in standard 80-column card images (120-column records are optional) with a longitudinal redundancy character appended to each record. A 0.75-inch interrecord gap is used.  |
| MODES OF OPERATION              | - Program entry, program verify, data entry, data verify, and search.   |
| PROGRAMMED OPERATION            | - Seven individual types of fields are definable in two programs that may be stored in memory simultaneously and executed upon demand. (The second program capability is optional on the K-700.) A "no-program" mode for formatless recording is also standard. Either of the two programs or "no-program" mode can be manually selected by the operator. |
| TAPE SPEED                      | - 24 inches per second (forward, backspace, and rewind).  |
| AUTOMATIC DUPLICATE SKIP SPEEDS | - 30 microseconds per character.  |
| SEARCH SPEED                    | - 1400 to 1700 records per minute (nominal).  |
| ERROR DETECTION AND RECOVERY    | - Detection of errors and error recovery procedures are both displayed automatically.   |

## K-700 BASIC KEYS TAPE DEVICE

PATTERN NUMBER	PROGRAM PATTERN			FUNCTION
	2 <sup>3</sup>	2 <sup>1</sup>	2 <sup>0</sup>	
0	0	0	0	Upper Position Character
1	0	0	1	Lower Position Character
2	0	1	0	MSP* Upper Position Character
3	0	1	1	MSP* Lower Position Character
4	1	0	0	MSP DUP
5	1	0	1	MSP SKIP
6	1	1	0	MSP Left Zero

\*Most Significant Position

Program control of Keypunch operation provides the operator with all the automated functions that are available on Keypunch machines but performs these functions in a fraction of the time. Duplicating and skipping operations, which are essential to the data preparation function, are available as either manual or program control operations.

### DATA FORMATTING

It is possible to continue using 80 column punched card format in recording data on tape but this format is not a requirement for Keypunch operation. Techniques such as the use of item separator codes to define variable length fields can be used as is done in punched paper tape systems.

All Keypunch devices feature an optional Left Zero Fill capability to enable the right-justification of variable length entries within a record composed of several constant length fields. This capability allows simple line-by-line transcription of data from source documents to tape.

### CHECKING CAPABILITIES

Keypunch devices provide full checking capabilities in all modes of operation. The device automatically performs keyboard parity checks, memory parity checks, tape parity checks, and complete read-after-write check everytime it writes a record on tape. In addition to these checks, the device is constantly checking for erase current. It can detect a short record or "noise block" in search or verify modes and automatically bypasses a "noise block."

The minimum record detection function detects and automatically ignores any record read from the tape which contains less than 7 characters. When this condition occurs, the column position counter is reset to column 1 and the tape continues to move until a record having at least 7 characters is read. The minimum record detection function is not active when the tape is backspaced.

## K-700 BASIC KEYS TAPE DEVICE

### MEMORY

The memory, consisting of magnetic cores, is used as a buffer to store an entire record (80 to 120 columns) of data before it is written on tape. It is used to store a record read from tape so that record may be verified by the operator. It also stores characters that specify the program patterns. The memory is arranged in 80 columns (up to 120 with available features), each column containing 16 cores which are arranged as shown. The function of these cores are explained below:

- The first six cores are arranged in two sets of three bits each. These three bits define six octal characters used to represent the six available program patterns. These program patterns are used to define data fields within a record to enable automatic duplicating and skipping operations to be performed. This operation is analogous to the function of a program drum card in a card punch machine.
- Cores 7 through 14 store a single 6-bit or 8-bit data character, depending upon whether a 7-channel or a 9-channel device is used.
- Core 15 stores a single-bit indicator used in the data verify mode of operation to signify a compare or a non-compare condition.
- Core 16 stores a column parity bit. This parity bit is checked each time data is placed in or taken out of memory.

CORE POSITION	FUNCTION K-700	FUNCTION K-900
1 2 3	4 } 2 } Program No. 1 1 } (Octal character)	4 } 2 } Program No. 1 1 } (Octal character)
4 5 6	4 } 2 } Program No. 2 1 } (Octal character)	4 } 2 } Program No. 2 1 } (Octal character)
7 8 9 10 11 12 13 14	- } B } A } Data character 8 } binary-coded- 4 } decimal (BCD) 2 } 1 }	2 <sup>7</sup> } 2 <sup>6</sup> } 2 <sup>5</sup> } Data character 2 <sup>4</sup> } (EBCDIC coded) 2 <sup>3</sup> } 2 <sup>2</sup> } 2 <sup>1</sup> } 2 <sup>0</sup> }
15 16	2 <sup>0</sup> Parity bit 2 <sup>0</sup> Duplify bit	2 <sup>0</sup> Parity bit 2 <sup>0</sup> Duplify bit

# K-700 BASIC KEYS TAPE DEVICE

## MEMORY UNIT

The Keypate Memory Unit increases the ease and flexibility of preparing and verifying magnetic tape records. The Memory Unit is used as a buffer for holding keyed data when recording and for holding the record to be checked when verifying. Codes stored in the program area are used to define fields within a record as well as operations such as automatic duplication and skipping, and the upper or lower shift. An optional second program feature allows two different record formats to be defined. A program switch is used to select which of the two programs is to be active at the beginning of each record.

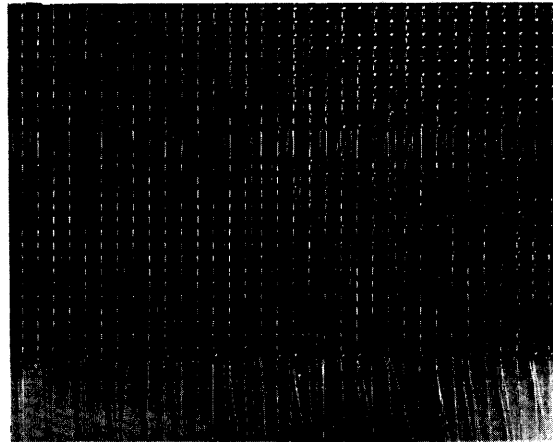

Photo courtesy of Honeywell, Inc.

## MEMORY PARITY CHECK

A standard feature of the Memory Unit is the Memory Parity Check. A parity bit is generated and checked every time a character and memory is addressed to guarantee the continued validity of the stored data. The contents of that character are read out of memory, checked for parity, and whether or not the contents are changed before writing them back into memory, a new parity bit is generated.

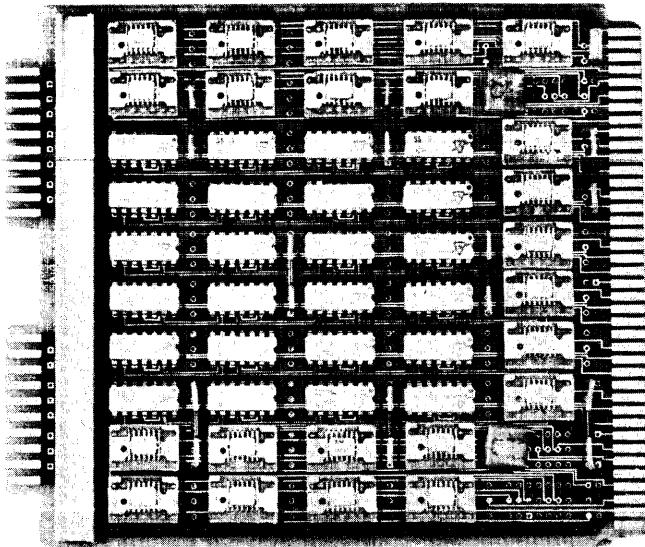

Photo courtesy of Honeywell, Inc.

## CENTRAL CONTROL UNIT

The central control unit contains the circuitry that controls the interaction of the third generation electronic components to insure maintenance free operation.



# K-700 BASIC KEYS TAPE DEVICE

## MODES OF OPERATION

### DATA ENTRY

DATA ENTRY mode is used to enter data onto magnetic tape. Data keyed from the keyboard enters a magnetic core memory (a storage device), character-by-character. When the last character of the record has been entered into memory, if the AUTO REL (Automatic Release) switch is set to "on," the unit record will automatically be released from the memory and written onto magnetic tape. If the AUTO REL switch is set to the "off" position, depression of the REL (Release) key will release the unit from the memory and will write it onto magnetic tape.

### DATA VERIFY

DATA VERIFY mode is used to check information previously recorded on magnetic tape and to correct any errors detected. A unit record of data is verified in the following manner:

1. A unit record of data is *read*, in its entirety, into the magnetic core memory from the magnetic tape.
2. The data record is then *rekeyed*, character-by-character, from the source document.

NOTE: As each character is keyed, it is compared internally with the corresponding character in memory. This will result in one of the following actions:

- 3a. No Error Condition - If the entire record has *no* errors, when the *last* character of the record has been verified and the AUTO REL switch is set to "on," the next unit record will *automatically be read into memory* from magnetic tape. If the AUTO REL switch is set to "off," depression of the REL (Release) key will read the next unit record into memory from magnetic tape.
- 3b. Error Condition - If a verification error is found, a correction is made by *replacing* the incorrect character in memory before advancing to verify the next character position in memory. Entering one or more corrections *conditions* the device not to allow *another* unit record to enter memory until the record on tape is corrected. When the *last* character of the record has been verified, a depression of the REL key will *rewrite* the corrected record onto magnetic tape and the REL key must be depressed *again* in order to read the next unit record into memory from magnetic tape.

### SEARCH

SEARCH mode is used to find a *particular* record which was previously written on magnetic tape. To search for a record, an *identifier* (character positions of a data record which make it unique from all other data records on the tape) is keyed into memory in the character positions corresponding to those which uniquely differentiate the particular record being sought from all other records written on the magnetic tape. Unused memory positions in the record identifier *must* be space-filled by the operator in order to be ignored in the comparison. Depression of the REL (Release) key will cause successive records to be read from tape and to be compared to the identifier in memory. When the correct record is found, tape reading will stop and the tape will be positioned in the interrecord gap immediately *following* the "found" record.

# K-700 BASIC KEYS TAPE DEVICE

## PROGRAM ENTRY

PROGRAM ENTRY mode is used to enter a program into memory, via the keyboard, that will allow an operator to perform duplicate, skip and other operations *automatically*, similar to the use of a keypunch drum card. The KEYS TAPE device can store *two separate programs* and also may operate under a "no program" mode. A program is entered into memory as follows:

1. The operator selects the desired program mode (PROGRAM 1, or PROGRAM 2).
2. The operator keys all eighty characters of the program into memory.

## PROGRAM VERIFY

PROGRAM VERIFY mode is used to *check* a program that was previously keyed into memory and to *correct* any miskeyed program characters. When a selected program (PROGRAM 1, or PROGRAM 2) is verified, the complete eighty character program is *rekeyed*, character-by-character, from the source document. As each program character is keyed, it is compared internally with the corresponding program character in memory. If a "compare" error is found, a correction is made by *replacing* the incorrect program character in memory with the correct one.

## PROGRAM CODES

When a program is used for keying data records, each character position must be defined with a particular program character. The available program characters are described below:

CHARACTER	FUNCTIONAL DESCRIPTION
0	Upper shift character position.
1	Lower shift character position.
2	Most significant position (MSP) of a data field with an <i>upper</i> shift character in the <i>first</i> position.
3	Most significant position (MSP) of a data field with a <i>lower</i> shift character in the <i>first</i> position.
4	Most significant position (MSP) of a data field to be automatically <i>duplicated</i> , with a <i>lower</i> shift character in the <i>first</i> position.
5	Most significant position (MSP) of a data field to be automatically <i>skipped</i> , with a <i>lower</i> shift character in the <i>first</i> position.
6	Most significant position (MSP) of a data field to be <i>left-zero-filled</i> (right justified), with an <i>upper</i> shift character in the <i>first</i> position.
7	Not used.



# K-700 BASIC KEYS TAPE DEVICE

## MOVEMENT OF DATA RECORDS ON TAPE

### DATA ENTRY

Record #3 has just been released from memory and has been written onto magnetic tape. The tape is now positioned at the end of record #3.

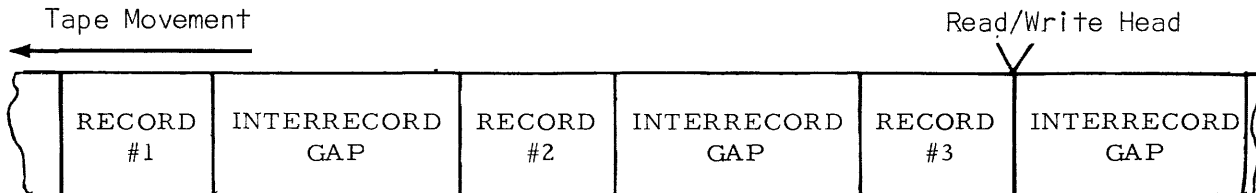

### DATA VERIFY

The AUTO REL switch is set to "on," record #2 has just been key-verified through character position eighty (80), and no compare errors were found. Therefore, record #3 has just been released into memory from magnetic tape to be verified. The tape is positioned at the end of record #3 ("c" on diagram).

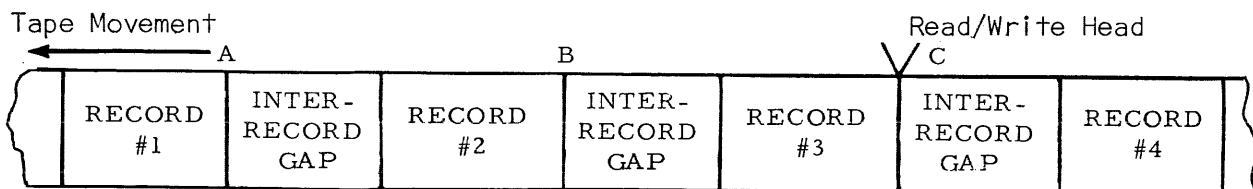

If a *compare error* (requiring the CORR key to be used for correction) has occurred while record #2 was being verified, then upon key verifying through character position eighty (80), and depressing the REL key, the tape would have *backspaced* to the beginning of record #2 ("A" on diagram), record #2 would have been *rewritten* correctly, and the tape would then have been *positioned* at the end of record #2 ("B" on diagram). Depression of the REL key again would then have caused record #3 to be *released into memory* to be verified, and the magnetic tape would have been positioned at the end of record #3 ("C" on diagram).

### SEARCH

The "*identified*" record, record #2, has just been found, and the magnetic tape is now positioned at the end of record #2 ("B" on diagram). The device is now conditioned for a *WRITE* operation, or upon depression of the REL key, the next record on tape, record #3, will be released into memory from magnetic tape to be verified, and the tape will be positioned at the end of record #3 ("C" on diagram). If it is desired to verify the "*found*" record (record #2), the tape must be backspaced to the beginning of record #2 ("A" on diagram). Depressing the REL key will then release record #2 from magnetic tape into memory to be verified. The tape will then be positioned at the end of record #2 ("B" on diagram).

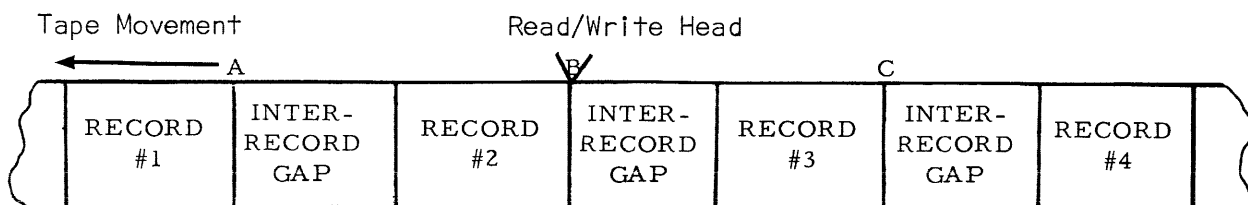

# K-700 BASIC KEYS TAPE DEVICE

## MODE SELECTOR SWITCH

This 5-position switch permits operator selection of five modes of operation:

### PROG ENTRY

The program entry mode is used to enter program patterns into either *two* possible program storage areas of memory. When in this mode, the KEYS TAPE unit is conditioned to accept *only numeric* character entry from the keyboard. Depression of a key while in this mode will automatically result in an upper-position entry. However, *entry of any character but a numeric will result in an error condition.*

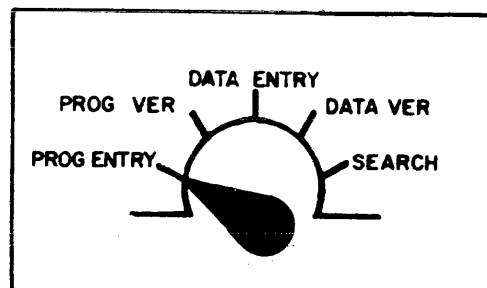

### PROG VER

The program verify mode of operation allows the operator to check the contents of a program stored in memory. The stored program characters are verified by rekeying the program; the KEYS TAPE unit automatically *compares* program characters being keyed with the corresponding characters that are stored in memory and signals the operator if any mismatch occurs.

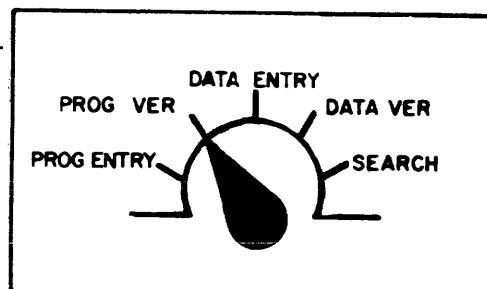

### DATA ENTRY

The data entry mode of operation is used to enter data onto magnetic tape. Data keyed from the keyboard is placed in the data storage area of memory until a *compare* record is stored. When the last column of memory is filled (column 80 or 120), the entire record is written on tape either automatically (AUTO REL on) or manually by depressing the REL key. Tape is automatically backspaced one record and the record just written is read and compared with the record stored in memory. Any mismatch detected causes a tape error signal to be activated.

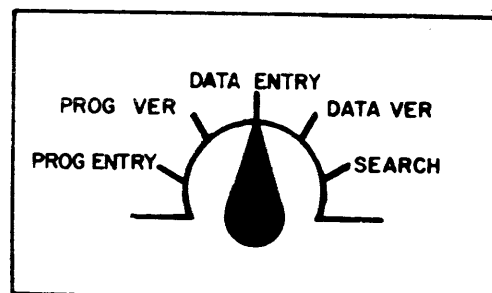

### DATA VER

The data verify mode of operation is used to check information previously recorded onto magnetic tape and to correct any errors found. When any corrections are made to a record while in this mode, the KEYS TAPE unit will *not* permit another record to be read until a corrected record is rewritten on tape.

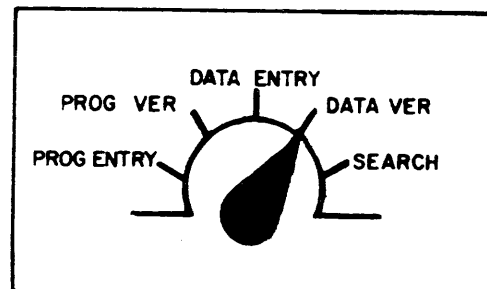

### SEARCH

The search mode of operation is used to find a *particular* record on a prerecorded tape. The search operation is performed by comparing records read from tape with an identifier keyed into memory. The search operation terminates when the record being sought is found or when at least 12 inches of unrecorded tape is encountered. The identifier used may be one or more characters which are *unique* to a particular record on the tape being searched.

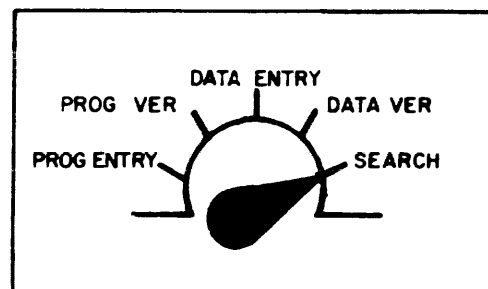

# K-700 BASIC KEYTAPE DEVICE

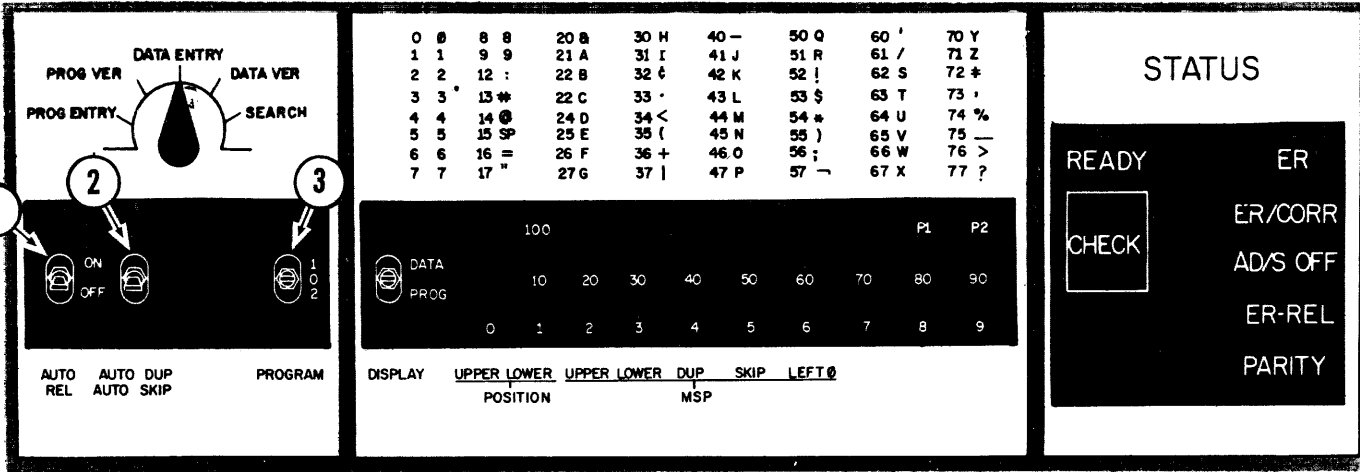

## FUNCTION CONTROL SWITCHES

### AUTO REL<sup>1</sup>

This 2-position switch enables or disables the automatic release capability of the KEYTAPE unit. When the switch is set to the "on" position, the automatic release function causes an *automatic transfer* of data between memory and magnetic tape. During data entry, when the last column in memory is filled, the transfer of data from memory to tape is automatically initiated. In data verify mode, when the last column in memory is verified and *no* compare errors have been found, the next record on tape is automatically read into memory. When the switch is set to the "off" position, the automatic release function is disabled, and the transfer of data between memory and tape is accomplished by depression of the REL key by the operator.

### AUTO DUP/AUTO SKIP<sup>2</sup>

This 2-position switch enables or disables the automatic duplicating and skipping functions of the K-700. When the switch is set to the "on" position, duplicating and skipping operations are performed automatically under control of a stored program. When the switch is set to the "off" position, duplicating and skipping operations are under the direct control of the operator via the DUP and SKIP keys.

### PROGRAM SWITCH<sup>3</sup>

This switch permits the operator to select either of two possible stored programs or to select a no-program mode of operation. When set to either position 1 or position 2, a program may be entered into the related program storage area of memory, or a program stored in that area may be verified or used to initiate one of the six programmable operations. When set to 0 (no program), all operations are under direct operator control.

When the Keypunch device is under Program control, it controls (1) automatic skipping, (2) automatic duplicating, (3) automatic checking to see that only numeric characters are going into numeric fields and that only alphabetic characters are going into alphabetic fields, and (4) automatic insertion of zeros to the left of the significant characters in a numeric field.

The Keypunch operator may override one or two programs in the memory of the device by setting the Program switch to NO PROGRAM (0).

## K-700 BASIC KEYPAGE DEVICE

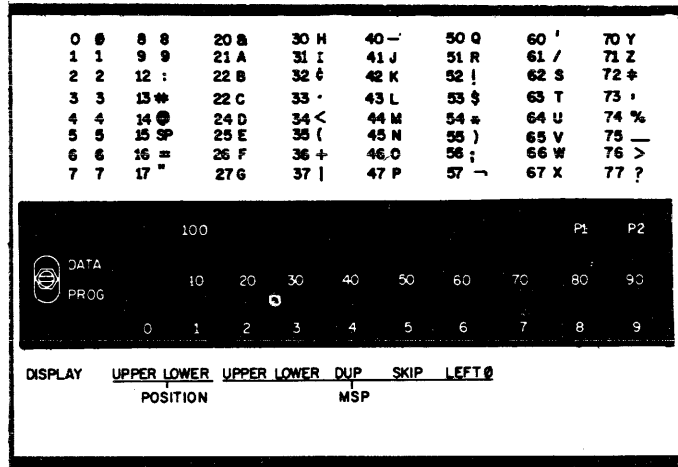

### TIME SHARED NUMERIC DISPLAY PANEL

The Display area allows the Keypage Operator to know which column is ready to be keyed into and to see the contents of memory. This area is truly the "window" into both Program memory and Data memory. The display is coded in pure numeric with columns, program codes, and numeric data characters coded in decimal notation. Alpha and special characters are coded in octal notation. The Display Panel contains all the numbers shown in the illustration above. However, the numbers can be seen only when lighted.

The Display Panel shows the column count - that is, it shows which column is ready to receive data. If the Keypage Operator depresses the ER/HOME keys simultaneously, the number "1" will be lit on the Display Panel. If she then depresses the Memory Forward Space Key five times, the number shown on the Display Panel will be "6". If she depresses the Memory Forward Space Key exactly ten more times, the Display Panel will show the numbers "10" and "6", which add up to 16. To learn which column is being indicated by the column counter, the Keypage Operator must mentally add all the numbers showing on the Display Panel. She must consider the lower row of numbers as representing the unit position; the second row, as representing the 10's position; and the top row, or 100, as representing the 100 position.

### DISPLAY SWITCH



At the left end of the Display Panel is a three position center return toggle switch. This means that this display switch can be moved up to the Data position, or down, to the Program position, but when released it always returns to the Center position. In the center position, it displays the column position; in the Data position, the Keypage operator is able to see the character in Data memory. If this switch is held in the data position, a number or numbers corresponding to the data character stored in that column will be displayed. There is a Code Conversion chart above the display panel which provides the operator with the means to convert the numeric characters displayed to the alphabetic and special characters that they represent. When the Display switch is held in the PROG position, the Keypage operator is able to see the character in a given column in Program memory. The program character stored in the column being interrogated is displayed by means of the numeric 0 thru 6, at the bottom of the Display Panel. The function of each program code is given below each numeric.

# K-700 BASIC KEYPAGE DEVICE

Two optional keys are available on the Keypage keyboard. P1 for program 1 and P2 for program 2. The indicators in the upper righthand corner of the Display Panel light when the corresponding key is depressed on the keyboard. If a Keypage operator is keying data under control of Program 2 and she depresses the P1 key on the keyboard, the controlling program becomes Program 1 and the P1 indicator illuminates. If the Keypage operator is operating under No Program (0) control and depresses P1 or P2, the corresponding indicator will illuminate.

*At the completion of the records being entered, the program control reverts (returns) to the setting of the Program switch in the Functional Control Area.*

0	0	8	B	20	+	30	H	40	-	50	Q	60	<	70	Y
1	1	9	9	21	A	31	I	41	J	51	R	61	/	71	Z
2	2	12	7	22	B	32	,	42	K	52	'	62	S	72	@
3	3	13	=	23	C	33	:	43	L	53	\$	63	T	73	,
4	4	14	:	24	D	34	)	44	M	54	*	64	U	74	(
5	5	15	SP	25	E	35	%	45	N	55	"	65	V	75	CR
6	6	16	>	26	F	36	■	46	O	56	≠	66	W	76	□
7	7	17	B	27	G	37	?	47	P	57	!	67	X	77	c

## CONVERSION CHART

The conversion chart is made up of pairs of columns. It is above the Display Panel. On the left side of the conversion chart are the numbers that will be lit on the display panel. Just opposite each number on the right side is the character which the number represents.

## READING DATA CHARACTERS

Look at the conversion chart and you will see how easy it is to convert the two digit numbers into data characters that they represent. The two digit number, 42, stands for the letter K. Therefore, when the display switch is in the data position, the number 40 will be illuminated in the 10's position and the number 2 will be illuminated in the units position.

## READING PROGRAM CHARACTERS

To examine the program characters of a program, you must set the Program switch to the desired position, 1 or 2, and set the display switch to Program. The character illuminated in the units position of the display panel will be the program character in that position of program memory.

	0	1	2	3	4	5	6	7	8	9
DISPLAY	UPPER	LOWER	UPPER	LOWER	DUP	SKIP	LEFT	Ø		
	POSITION		MSP							

## FUNCTIONS OF PROGRAM CHARACTERS

Look at the illustration, notice that the functions of the program characters are written in abbreviated form beneath numbers 0 thru 6 on the Display Panel. There is a continuous line extending under the words, "Upper" and "Lower". Under this line is the word, "Position". The term "UPPER" is written directly beneath the digit "0", and the term "LOWER" is written directly beneath the digit "1". One of these two digits, either "0" or "1", must be used in any position other than an MSP (most significant position).

There is another continuous line extending beneath the terms "UPPER", "LOWER", "DUP", "SKIP", and "LEFT Ø". Written beneath this line is the term MSP (most significant position). The digits 2 thru 6 are used in the high order position (left most) of UPPER, LOWER, DUP, SKIP and LEFT Ø fields.



# K-700 BASIC KEYS TAPE DEVICE

## STATUS PANEL

This panel is used to keep the operator informed of the current operational condition of the KEYS TAPE device. This is accomplished by activating lights behind the panel to illuminate one or more indicators by which the operator can ascertain whether the KEYS TAPE unit is ready for use or is inoperative due to an error condition. If the device is in an error condition, *the step to be taken to recover from the condition is displayed.*

## AUDIBLE ALARM

An audible alarm accompanies every error indication of the status panel. This audible alarm also serves as the beginning-of-tape (BOT) signal. When tape movement stops with the READY light "on", an active audible alarm signals that the BOT has been encountered.

## STATUS INDICATORS

On the left side are two words, "READY" and "CHECK". "READY" will illuminate with a green light if the device is ready to operate. When either the tape is not in the correct position or an error has occurred, the word "CHECK" will illuminate in red; the KEYS TAPE device *is not* ready to operate. "CHECK" is never lit by itself; an operator action term (on the right) will also light.

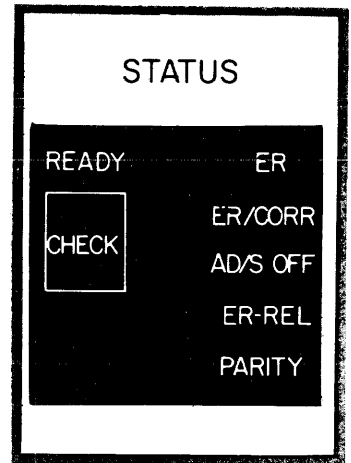

TERM	OPERATOR ACTION TO CLEAR ERROR CONDITION
ER	Depress the ERROR key
ER/CORR	Depress the ERROR and CORRECT keys simultaneously
AD/S OFF	Turn the AUTO DUP/AUTO SKIP switch "off"
ER/REL	Depress the ERROR and RELEASE keys

If the words, "CHECK" and "PARITY" light at the same time, reset the error indicator by depressing the ER key and rekey the character. (Check memory display to see if the correct character is in memory).

The parity error is always an equipment error. Parity checking is a technique of checking the accuracy of a character transferred electronically from one place to another. This type of error is caused by detection of incorrect parity in memory.

# K-700 BASIC KEYS TAPE DEVICE

## STATUS PANEL (CONT.)

### READY (Green)

This indicator, when illuminated, indicates that the KEYS TAPE device is in a "ready" condition. When not illuminated, it indicates that the tape unit is not ready for use, that there is tape movement in process, that the KEYS TAPE device is busy performing an automatic operation, or that an error condition exists.

### CHECK (Red)

This indicator is illuminated when any error condition exists. The particular error condition existing is defined by one or more of the five error indicators to the right of the CHECK indicator. The types of errors defined by these five indicators are explained below.

### ER (Red)

This indicator, when illuminated, indicates that the operator has committed an error.

### ER/CORR (Red)

This indicator is active *only in the data verify or program verify* modes of operation. When illuminated, it indicates that a mismatch exists between a character just keyed by the operator and a character stored in memory.

### AD/S OFF (Red)

This indicator is used in conjunction with the ER/REL (tape error) indicator. When the AD/S OFF indicator is illuminated, it directs the operator to set the AUTO DUP/AUTO SKIP switch to the "off" position.

### ER/REL (Red)

This indicator, when illuminated, alerts the operator to one of the following error conditions:

1. *Frame parity error* - the character written on tape does not contain the correct number of "1" bits.
2. *Longitudinal redundancy check error* - the number of "1's" in each channel does not add up to an even number.
3. *Incomplete record* - the number of data characters written on tape does not equal the number of data character positions in the memory (80 or 120).
4. *Read-after-write check error* - a mismatch between data on tape and the data in memory appeared during an automatic backspace and read operation.
5. *Erase current failure* - erase current appeared during reading or while writing.

### PARITY (Red)

When illuminated, this indicator signifies a memory parity error has occurred. Each character is checked during every data transfer operation to ensure it contains an even or "1" bit.

# K-700 KEYS TAPE DEVICE

## STATUS

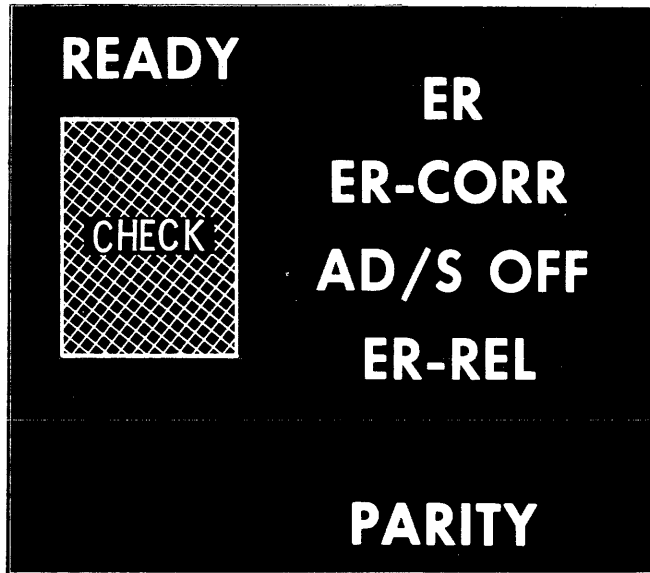

LIGHTED IN RED	POSITION OF MODE SWITCH WHEN ERROR WAS MADE	TYPE OF ERROR
CHECK ER	ANY MODE	KEYING ERROR
CHECK PARITY	ANY MODE (During Keying)	MEMORY PARITY ERROR ( KEYBOARD MEMORY )
CHECK, ER-REL, PARITY	DATA ENTRY, DATA VER, SEARCH (During Tape Motion)	TAPE PARITY ERROR (Memory tape)
CHECK AD/S OFF, ER-REL	DATA VER (When AD/S switch is "on")	TAPE ERROR
CHECK ER-CORR	PROG VER	COMPARE ERROR
CHECK ER-CORR	DATA VER	COMPARE ERROR
CHECK ER-REL	DATA ENTRY	TAPE ERROR
CHECK ER-REL	DATA VER	TAPE ERROR
CHECK ER-REL	SEARCH	TAPE ERROR

# K-700 KEYPAGE DEVICE

NEGATIVE NUMBER SET		KEYBOARD LAYOUT																MFS	TEF									
CHAR	KEY	Q	W	E	R	T	Y	U	I	O	P	8	7	6	5	4	3	2	1	0	REL	P2	P1	0	REL	P2	MFS	TEF
-0	-	Q	W	E	R	T	Y	U	I	O	P	8	7	6	5	4	3	2	1	0	REL	P2	P1	0	REL	P2	MFS	TEF
-1	J	Q	W	E	R	T	Y	U	I	O	P	8	7	6	5	4	3	2	1	0	REL	P2	P1	0	REL	P2	MBS	
-2	K	Q	W	E	R	T	Y	U	I	O	P	8	7	6	5	4	3	2	1	0	REL	P2	P1	0	REL	P2	MBS	
-3	L	ER	A	S	D	F	G	H	4	K	5	L	6	SKIP													HOME	TBS
-4	M	ER	A	S	D	F	G	H	4	K	5	L	6	SKIP													HOME	TBS
-5	N	UPPER	Z	X	C	V	P	N	(	M	7	8	9												LOWER	FC		
-6	O	UPPER	Z	X	C	V	P	N	(	M	7	8	9													LOWER	FC	
-7	P	UPPER	Z	X	C	V	P	N	(	M	7	8	9													LOWER	FC	
-8	Q	REW																								LEFT		CORR
-9	R	REW																								LEFT		CORR

## KEYBOARD

The standard keytape keyboard contains 34 data keys and a space bar that produce a total of 64 codes including ten decimal digits, twenty-six letters, twenty-seven special characters and a space code. 32 of the data keys produce upper and lower position codes. In addition, the keyboard contains 16 (17 for the model K-900) function control keys. The control keys direct tape movement, manual duplicating and skipping, special data entry conditions and error correction.

The Keytape keyboard is layed out similar to the most frequently used keypunch keyboard with regards to the arrangement of alphabetic and numeric keys. Compatibility with most computer systems in current use is insured by means of optional even or odd parity tape code sets that correspond to the tape codes of various computer systems.

*All keyboard character keys are capable of repetitive operation. As a key is held down, the corresponding character is repetitively entered into memory. To prevent inadvertent entry of unwanted characters, there is a half second delay after a key is depressed before the repetitive action begins.*

With the exception of "A" and "Z", each data key has two data characters inscribed on it. Alphabetic characters are lower shift characters. Numeric characters are upper shift characters. Special data characters such as the dollar sign, the @ sign and & may be either upper or lower shift characters.

On the left side of the keyboard is the negative number set chart. It shows the negative numbers and the key stroke required to produce each of these numbers in the units position of a negative field.

When program entry and program verify modes are used, only the numeric digits 0 thru 6 are available to the operator.

When no program is being used (Program switch is set to "0" position) and a data key is depressed, the data character inscribed on the data key in the lower position will be entered into data memory.

# K-700 BASIC KEYS

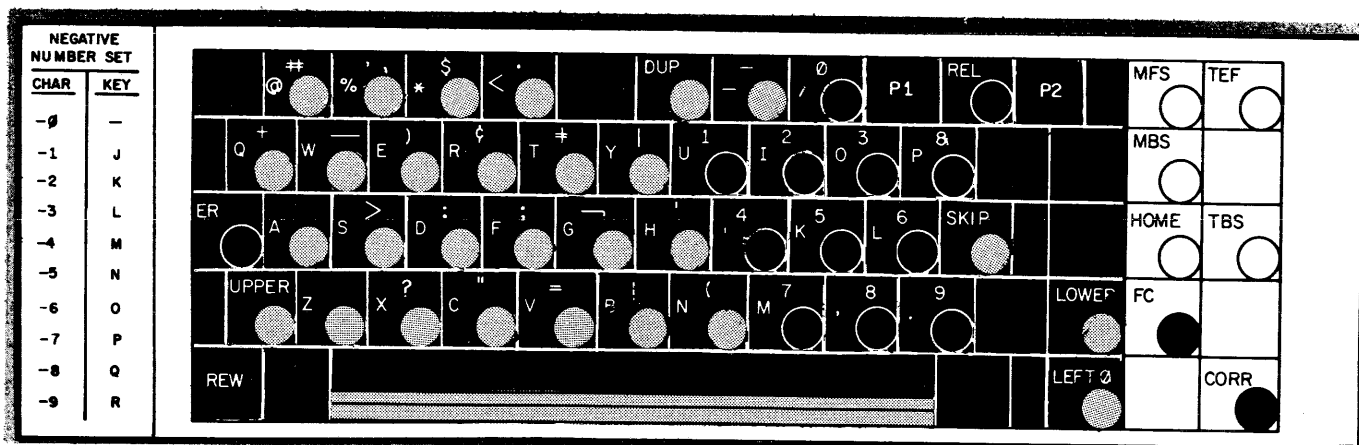

## CONTROL KEYS

### DUP (Duplicate) KEY

The DUP key provides a means of *manually* initiating a duplicate action. Duplicating consists of advancing past memory columns without disturbing their contents. This feature is made possible by the fact that the KEYS TAPE device's writing operation is nondestructive: that is, after a record is written on tape, that same record still exists in memory. This record or any part of it may be rewritten on tape without the necessity of rekeying the entire 80 or 120 columns.

When the KEYS TAPE device is operating *without* program control, each depression of the DUP key causes the column counter to advance one position; holding the key down will cause *repetitive* column advances until the DUP key is released or the last column in memory is encountered.

When operating under program control, a depression of the DUP key causes the column counter to increment until a column is encountered which contains a MSP program character (most significant position). The KEYS TAPE unit then performs the operation called for by that MSP character. In the data verify mode of operation, when a record is read into memory from magnetic tape, each column in memory that receives a character from tape that is identical to the character already stored in that column will have a special bit in that memory column, called a duplify bit, set to a "1" condition. Depression of the DUP key when *not* under program control causes the column counter to advance one position. As each column is passed, its DUPLIFY bit is checked to ensure that it is in a "1" state. Any DUPLIFY bit found set to "0" causes an error condition.

*Depression of the DUP key, when under program control, causes the column counter to automatically advance until an MSP is encountered. As each column is passed, its DUPLIFY bit is interrogated to ensure that it is set to a "1" state.*

# K-700 BASIC KEYS

## CONTROL KEYS (CONT.)

### REL (Release) KEY

The REL (release) key is used to *manually* transfer a record from memory to magnetic tape or vice versa. This key is active *only* in the DATA ENTRY, DATA VERIFY, and SEARCH modes of operation.

If this key is depressed when operating in the DATA ENTRY mode, any columns not having characters already entered will be filled with space code characters and then the entire record will be written onto the magnetic tape. However, if operating under program control, any fields programmed for automatic duplication will be duplicated.

If no errors have been detected and the REL key is depressed when operating in the DATA VERIFY mode, all remaining characters in the record are ignored and the next record is read into memory from the magnetic tape. However, if the AUTO DUP/AUTO SKIP switch is "on" and fields programmed for automatic duplication are encountered while the KEYS device is operating under program control, the data characters are verified by interrogating their duplicate bits. It should be noted that except for this last condition, whenever the REL key is depressed all remaining columns in a record are *not* verified; they are ignored. In the SEARCH mode, a depression of the REL key causes the remainder of the data record to be filled with space characters. A depression of the REL key is required to initiate the SEARCH operation.

The ER and REL keys depressed simultaneously enables the operator to bypass a record during DATA VERIFY and SEARCH operations.

### MFS (Memory Forward Space) KEY

A depression of the MFS (memory forward space) key causes the column counter to advance *one* position. Memory contents remain unchanged, and all duplicating and skipping functions are inhibited. If the MFS key is held depressed, the column counter continues to increment until either the end of memory is reached or an MSP is encountered (if under program control). *If a depression of the MFS key causes the column counter to reach either 81 or 121 while the AUTO REL switch is set to the "on" position, an automatic release operation will occur.*

### TEF (Tape Erase Forward) KEY

This key is interlocked with the ER key. Each depression of the TEF (tape erase forward) key while simultaneously depressing the ER key causes 9 inches of tape to be erased in the forward direction. This key is effective only in the DATA ENTRY mode of operation and is used primarily to place a blank section of tape over 12 inches long between data files. This blank section serves as a termination gap that automatically stops tape movement during a DATA VERIFY or SEARCH operation. The TEF key may also be used to bypass a bad section of tape.

### MBS (Memory Backspace) KEY

Each depression of the MBS (memory backspace) key causes the column counter to decrement by *one* position. This memory backspacing has no effect upon the contents of memory. If the MBS key is held depressed, backspacing will continue until column one is encountered or, if operating under program control, until an MSP is encountered.

# K-700 BASIC KEYS (CONT.)

## CONTROL KEYS (CONT.)

### ER (Error Reset) KEY

The ER (error reset) key is a dual-purpose key used as a first step in clearing error conditions and as an interlock to prevent the inadvertent depression of certain control keys from causing an unwanted operation.

Those keys which are interlocked with the ER key are: HOME, TEF, TBS, FC, CORR, and REW. Unless the ER key is depressed simultaneously with these keys, the operation specified for the particular key struck will *not* be performed.

The ER key, when depressed simultaneously with the REL key, enables an operator to bypass a record in error during a DATA VERIFY or SEARCH operation.

### SKIP KEY

The SKIP key provides the operator with the means of *manually* advancing past successive memory columns and either replacing the contents with space codes in the DATA ENTRY or SEARCH modes or ignoring the contents in the DATA VERIFY mode of operation. Skipping continues as long as the SKIP key is held depressed or until the last column in memory is encountered. When operating under program control, the skipping operation is terminated only after encountering an MSP program code on the last column in memory.

### HOME KEY

The HOME key is one of the keys which is interlocked with the ER key. Depression of both these keys simultaneously causes the device to assume an initialize condition; that is, the column counter is set to column 1 and all error indicators are reset. Any automatic operations in progress at the time of initialization are terminated.

NOTE: The K-700 should always be initialized immediately after applying power and before loading tape in the Tape Handler. This will avoid any possibility that a tape write or erase command could destroy data already on tape.

### TBS (Tape Backspace) KEY

The TBS (tape backspace) key, when depressed, causes the Tape Handler to backspace tape the length of *one record plus an interrecord gap*. The TBS key is interlocked with the ER key; therefore, both keys must be depressed simultaneously to effect a backspace operation. To ensure that the operator is aware of the fact that she is performing a backspace operation, the KEYS TAPE device is designed so that the operator must initialize (ER/HOME) before a backspace (TBS) operation can be performed. Backspacing is inhibited when the tape is positioned at the BOT (beginning of tape).

### UPPER SHIFT KEY

Depressing the UPPER key conditions the KEYS TAPE device to enter an upper-position character into memory, whether or not program control is in effect. The keyboard remains in the upper-position mode as long as the UPPER key is held depressed.

# K-700 BASIC KEYS (CONT.)

## CONTROL KEYS (CONT.)

### LOWER SHIFT KEY

Depressing the LOWER key allows the operator to override program control and enter a lower-position character in a column programmed for upper-position keyboard entry.

### FC (Field Correct) KEY

This key is interlocked with the ER key. The FC (field correct) key is effective only in the DATA VERIFY mode of operation; it is used to correct an entire field of data. To correct an entire field of data, the FC and ER keys are simultaneously depressed; the data is then entered up to the next MSP (if program control is in effect) or until the end of the record is encountered.

### REW (Rewind) KEY

The REW (rewind) and ER keys must be depressed simultaneously to initiate a tape rewind. Detection of the beginning-of-tape (BOT) causes a rewind operation to terminate.

### LEFT 0 (Left-Zero-Fill) KEY

The LEFT 0 (left-zero-fill) key permits right-justification of a data field(s) within an 80- or 120-character record and the filling of unused columns with zeros. This key is also used to automatically verify the zeros preceding a right-justified data field.

### DATA ENTRY

Data to be right-justified is keyed in; then the LEFT 0 key is depressed. This causes the data to be shifted to the right until the low-order character (first character keyed in) is in position 80 or 120 or, *if under program control, until an MSP is encountered*. All unfilled columns to the left of the data are then automatically filled with zeros.

NOTE: If during data entry an MSP character is encountered before the LEFT 0 key is depressed, the zero-fill operation will not be performed and another depression of the LEFT 0 key will be required in order to exit from the field programmed for left-zero-fill.

### DATA VERIFY

The LEFT 0 key is used in the data verify mode to verify any zeros preceding a data field. This is accomplished by depressing the LEFT 0 key at the *beginning* of the field to be verified. This causes the column counter to advance to the first column containing a non-zero data character. All preceding zeros are automatically verified, and the operator then key-verifies the non-zero data characters. If program control is in effect and the field to be verified has a LEFT 0 MSP program character stored in memory, all leading zeros are automatically verified *without need of depressing the LEFT 0 key*.

### CORR (Column Correct) KEY

The CORR (column correct) key enables an operator to enter data into a single memory column when the KEYS (CONT.) device is in one of the verify modes. The CORR key, which is interlocked with the ER key, must be depressed before each character is entered.



## K-700 BASIC KEYS

TYPE OF CONTROL	CONTROL KEYS	FUNCTION
SPECIAL DATA ENTRY CONDITIONS	LEFT ZERO (L ZERO) (optional)	Right justify fields in memory; program pattern enforces its use.
	UPPER	Enter upper position character in column programmed for lower position.
	LOWER	Enter lower position character in column programmed for upper position.
MANUAL DUPLICATION	DUP	Manual initiation of duplication.
MANUAL SKIPPING	SKIP	Manual initiation of skipping.
TAPE MOVEMENT	RELEASE (REL)	Manual release of a record. <i>(Writing or reading.)</i>
	TAPE BACK SPACE (TBS)*	Back space tape one record.
	TAPE ERASE FORWARD (TEF)*	Operator manually erases a fixed portion of the tape.
	REWIND (REW)*	Initiates tape rewind, and/or BOT (Beginning of Tape) positioning.
ERROR CONDITIONS	MEMORY FORWARD SPACE (MFS)	Memory forward-spaced one position; column counter increments one. <i>(Data content of memory ignored.)</i>
	MEMORY BACK SPACE (MBS)	Memory back-spaced one position; column counter decrements one. <i>(Data content of memory ignored.)</i>
	ERROR RESET (ER)	Clears error conditions. <i>(Interlocks other control keys.)</i>
	COLUMN CORRECT (CORR)*	Permits correction of one character in Data Verify Mode.
	FIELD CORRECT (FC)*	Permits correction of entire field in Data Verify Mode.
INITIALIZE	HOME*	Initializes KEYS device.

\* These keys are interlocked by the ER key. The ER key must be held depressed to use these keys.

## KEYTAPE ABBREVIATIONS

You will notice that the KEYTAPE keyboard has various abbreviations written on its keys and indicators. These abbreviations with their meanings are all listed below in alphabetical order to save you time when you will have the need to refer to them.

ABBREVIATION	MEANING
AUTO DUP/SKIP	Automatic duplicate/skip switch
AUTO REL ON	Automatic release switch in the "on" position
AUTO REL OFF	Automatic release switch in the "off" position
CORR	Character correction key
DUP	Duplicate key
ER	Error reset key
ER/FC	Depress the ER and FC keys simultaneously
ER/HOME	Depress the ER and HOME keys simultaneously
ER/REW	Depress the ER and REW keys simultaneously
ER/TBS	Depress the ER and TBS keys simultaneously
ER/TEF	Depress the ER and TEF keys simultaneously
FC	Field correct key
LOWER	Lower position shift key
MBS	Memory backspace key
MFS	Memory forward space key
MSP	Most significant position
PB	Push button
R/W	Read/Write
REL	Release key
REW	Tape rewind key
TBS	Tape backspace key
TEF	Tape erase forward key
UPPER	Upper position shift key

# K-700 BASIC KEYTAPE DEVICE

## TAPE HANDLER

The Tape Handler is a pneumatic tape transport capable of handling standard half-inch tape reels up to 10.5 inches in diameter. Both a supply and a take-up reel are used. The tape speed is 24 inches per second for forward motion, backspace, and rewind. A single-gap head is used for both reading and writing, and a separate gap is used for erasing. The Tape Handler is completely interlocked with the keyboard console to prevent any damage to the magnetic tape or any possible harm to the operator.

The control of tape tension is provided for forward, backward and rewind movements. Spring loaded guide paths control tape skew and prevent ripples. Because of the take-up reel, the tapes are protected from damage from handling, dirt and friction. Only the read/write head touches the recording surface.

Automatic positioning of the Beginning of Tape (BOT) and automatic control of the rewind function are standard features on all KEYTAPE devices.

Tape records are written in 7 Channel Binary Coded Decimal (BCD) format utilizing either even or odd parity which is compatible with the tape codes used on most currently installed computer systems.

*NOTE: 9 Channel tapes are written in System 360 Compatible EBCDIC (extended Binary Coded Decimal Interchange Code).*

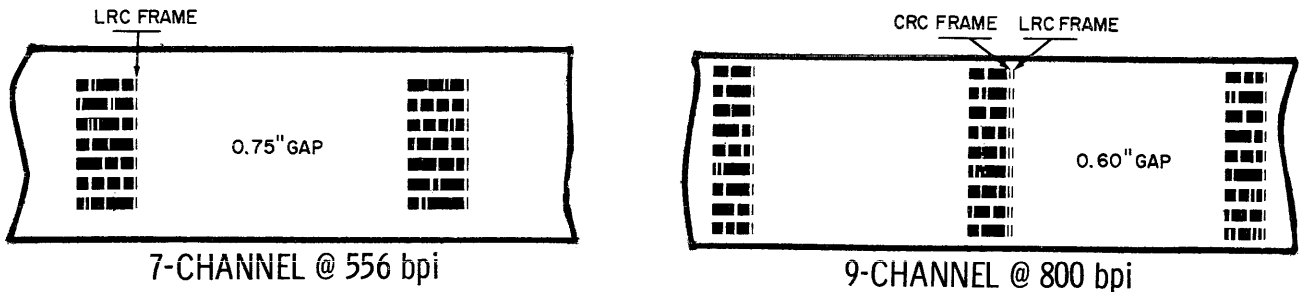

## TAPE RECORDING SYSTEM

The Tape Unit records data on tape in 81 Frame record. 7 Channel tape records have both a parity bit per frame and a longitudinal redundancy character (LRC) frame per record. The longitudinal redundancy character is automatically appended to the end of each record written on tape. Each time a record is written on tape, a read-after-write check is automatically performed to insure that the data written on tape is identical to that which is stored in memory. A check is also made to insure that each frame has the correct parity and that the longitudinal redundancy character is valid. A 0.75 inch interrecord gap is used on 7 Channel tapes. Data is written on tape at a density of 556 BPI, or, optionally, at 200 or 800 BPI.

*NOTE: 9 Channel Tape records have a parity bit per frame and two check frames per record; A longitudinal redundancy character (LRC) frame and a cyclic redundancy character (CRC) frame. Both the LRC and the CRC frames are checked on 9 Channel devices. A 0.60 inch interrecord gap is used on 9 Channel tapes.*

# K-700 BASIC KEYS TAPE DEVICE

## TAPE MAINTENANCE

Care of magnetic tape helps to insure long tape life and reliable reading back of the information stored on tape.

1. Never touch the oxide side of any section of tape that is to be used to store data.
2. Always store the tape in a dustproof container when not in use.
3. Whenever possible, store tapes in the same environment in which they are to be used - this will preclude subjecting the tapes to temperature and humidity conditions which exceed the following limits:

Relative humidity: 20 to 80%  
Temperature: 60 to 90° Fahrenheit

4. Identify reels with adhesive stickers which are easily removed and leave no residue.
5. If it becomes necessary to clean the tape, wipe it gently with a clean, lint free cloth (such as Selvyt or Miracloth), moistened with Freon.
6. Smoke and ashes are dirt and hot ashes are destructive to magnetic tape. As a general rule, keep cigarettes away from tape handling areas - be careful when smoking.

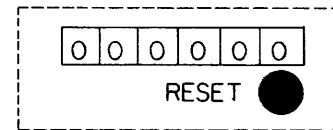

## TAPE UNIT CONTROL PANEL

The Tape Unit Control Panel contains the RESET, MAIN POWER (on/off), TAPE LOAD (vacuum on), and TAPE UNLOAD (vacuum off) pushbuttons.

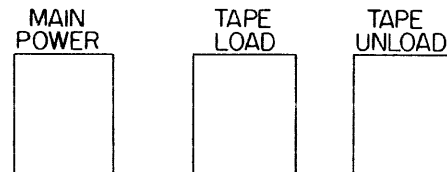

### MAIN POWER

This is an indicating pushbutton switch which controls the application of all DC power to the KEYS TAPE device. This indicator illuminates when DC power is applied to the KEYS TAPE device. *NOTE: The ER and HOME keys on the keyboard should always be depressed simultaneously immediately after applying DC power.*

### TAPE LOAD

This is an indicating pushbutton switch. Depressing this switch causes vacuum to be applied to the Tape Handler. When this switch is illuminated, the proper vacuum is present within the Tape Handler.

### TAPE UNLOAD

This is an indicating pushbutton switch which, when depressed, removes vacuum from the KEYS TAPE Tape Handler. This indicator is illuminated when there is a lack of vacuum in the Tape Handler.

### RESET

When depressed, this button restores the incrementing record counter to zero. *NOTE: This button is operable only if Feature 050 is installed.*

# K-700 BASIC KEYPAGE DEVICE

## TAPE LOADING PROCEDURE

1. Depress the **MAIN POWER** switch on the Tape Unit Control panel. This switch will then be illuminated.
2. Depress the **ER/HOME** keys simultaneously to reset the audible and visible alarm.
3. Open the window of the Tape Handler.
4. Mount a reel of tape onto the right hand tape reel hub.

a) Grasp the rim of the reel which contains the tape (the supply reel) and place it over the right hand reel mounting hub. While holding it in this position, depress the plunger in the center of the hub with both thumbs. (This will allow the rubber expansion ring on the reel hub to contract).

b) While holding the plunger in, slide the reel of tape onto the reel hub and release the plunger. To align the reel correctly, place the fingers and thumb of one hand firmly against the reel face so that equal pressure is being applied to all points on the face of the hub.

c) Depress the plunger again with the free hand and be sure that the reel seats firmly against the hub face. Release the plunger. The supply reel is now correctly mounted and aligned.

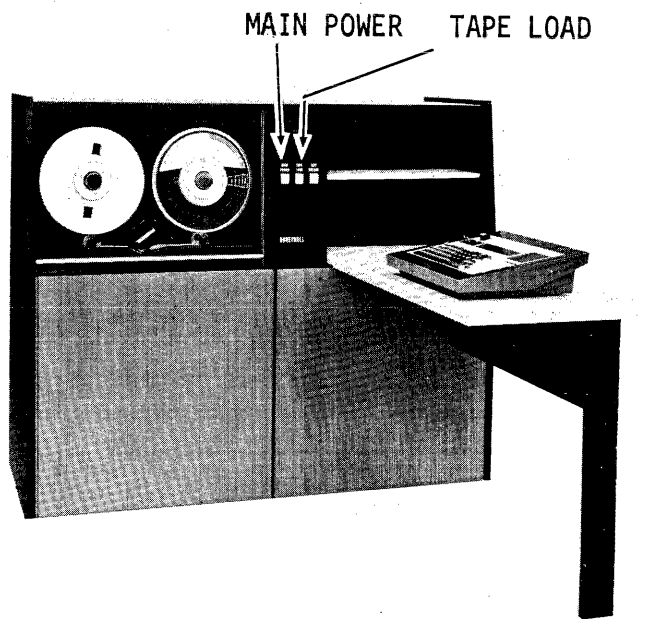

5. Mount and align the empty take-up reel at the left hand reel mounting hub.
6. Unwind, in a clockwise direction, a few feet of tape from the supply reel.
7. Thread the tape under the magnetic **READ/WRITE** head (The head must be raised to facilitate this). Holding the loose end of the tape, thread the tape between the right hand tape vacuum cleaner and the right hand tape roller. Across the tape brake lanes and under the magnetic head, between the left hand tape vacuum cleaner and the left hand tape roller and onto the left hand take-up reel, threading from the left hand side of the reel and winding in a clockwise direction. While holding the loop end of the tape (through one of the access holes) on the take-up reel, wind 10 or 12 turns of tape on the reel. *(Note: After the first few turns, it should be necessary to hold the tape with the finger, the natural tape surface friction will bind the tape to the reel).* Back off on both reels slightly until the tape lies flat across the tape brake lanes and the slight loop extends onto the top of both loop chambers.

## TAPE LOADING PROCEDURE (CONTINUED)

8. Depress the **TAPE LOAD** switch on the Tape Unit Control Panel. This causes vacuum to be applied to the Tape Handler. When this switch is illuminated, the proper vacuum is present within the Tape Handler.
9. After the vacuum motors have turned on (you will be able to hear this), spin the tape loop into the vacuum chamber; turn the tape reel clockwise and turn the take-up reel counterclockwise, feeding the tape into the loop chamber. The **TAPE LOAD** switch lights and an audible signal is heard.
10. Lower the magnetic **READ/WRITE** head into place (handle is horizontal).
11. Close the window of the Tape Handler.
12. Depress the **ER/HOME** keys simultaneously.
13. Depress the **ER/REW** keys simultaneously. When the "READY" indicator on the Status Display Panel lights and the audible signal sounds, it indicates that the beginning-of-tape (BOT) has been reached and the Tape Handler is ready to accept data input.
14. Depress the **ER/HOME** keys simultaneously to re-set the audible signal.

*Now the Keytape device is ready to set up for any mode of operation.*

## TAPE UNLOADING PROCEDURE

The following procedure should be used to remove a reel of tape from the Tape Handler when it is in a stand-by condition.

1. Depress the **TAPE UNLOAD** button on the Tape Unit Control Panel.
2. Wait for the cycle-down to be completed and for the **TAPE UNLOAD** indicator to light.
3. Manually complete the rewinding of tape onto the supply reel by turning the reel counterclockwise.

*NOTE: To avoid damage to the tape while manually rewinding, start the take-up reel moving counterclockwise prior to the time that the tape becomes taut across the brake lanes. This will prevent "snapping" the tape and causing it to crease inside the supply reel.*

4. Grasp the outer rim of the supply reel with the fingers of both hands.
5. Using both thumbs, depress the plunger in the center of the mounting hub.
6. Remove the reel from the mounting hub.

# K-700 BASIC KEYS TAPE DEVICE

## PROGRAM ENTRY

This mode of operation is used to set up the KEYS TAPE unit so that a program can be placed in memory to control the entry of data onto magnetic tape. If a tape is not already mounted on the tape handler, or if the MAIN POWER switch is not "on," then perform the operations described under TAPE LOADING PROCEDURE.

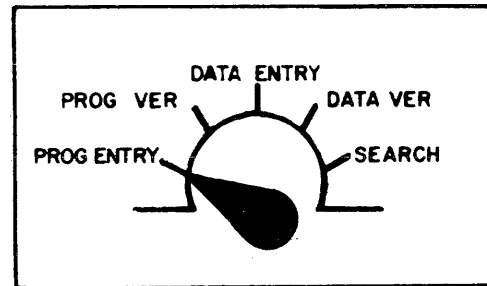

## PROGRAM LOADING PROCEDURE

1. Set the switches on the control console as follows:

SWITCH	POSITION
MODE	PROGRAM ENTRY
PROGRAM	Select the <i>desired</i> program (1 or 2)
AUTO REL	OFF
AUTO DUP/SKIP	OFF

2. Depress the ER/HOME keys simultaneously.
3. Key in the characters of the program through column position 80. *A space character in a data record may be either an upper or lower shift character and therefore either an "0" or a "1" can be used as a program character to fill spaces.*
4. When all 80 columns are coded, proceed to the PROGRAM VERIFY PROCEDURE.

## PARITY ERROR DURING PROGRAM ENTRY

1. Depress the ER key.
2. Depress the ER/HOME keys simultaneously.
3. Rekey the program; then, proceed to PROGRAM VERIFY.

# K-700 BASIC KEYS TAPE DEVICE

## PROGRAM VERIFY PROCEDURE

This operation mode permits the operator to verify a program that is stored into memory.

1. Set the switches on the control console as follows:

SWITCH	POSITION
MODE	PROGRAM VERIFY
PROGRAM	Select the <i>desired</i> program (1 or 2)
AUTO REL	OFF
AUTO DUP/SKIP	OFF

2. Depress the ER/HOME keys simultaneously.
3. Key verify the entire program record through column position 80.
- 4a. If there is *no* compare error, depress the ER/HOME keys simultaneously.

The verified program may now be used to control either the **DATA ENTRY** or **DATA VERIFY** modes of operation.

- 4b. If there is a compare error, perform the following steps:
  - Depress the ER key.
  - Rekey the correct program character from the source document.
  - If the error does not recur, continue key verifying the program record through character position 80; then, depress the ER/HOME keys simultaneously.
  - If the error recurs, depress the ER/CORR keys simultaneously; then, key in the correct character from the source document.
  - Continue key verifying the program record through character position 80; then, depress the ER/HOME keys simultaneously.
  - If a large portion of the program must be changed, set the MODE switch to **PROGRAM ENTRY**, then key the correct program character into memory.

The FC (Field Correct) key is disabled during PROGRAM VERIFY.



# K-700 BASIC KEYPAGE DEVICE

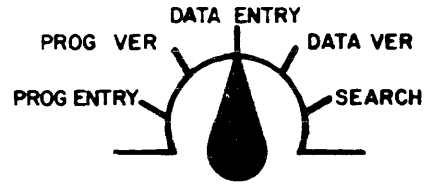

## DATA ENTRY PROCEDURE - NO PROGRAM, MANUAL RELEASE

1.

SWITCH	POSITION
MODE	DATA ENTRY
PROGRAM	0
AUTO REL	ON
AUTO DUP/AUTO SKIP	OFF

2. Depress the ER/HOME keys simultaneously.
3. Key in the first record.
4. Depress the RELEASE key.
5. Key in the remaining records and depress the RELEASE key after each record to write the record on tape.

## DATA ENTRY PROCEDURE - NO PROGRAM, AUTOMATIC RELEASE

1.

SWITCH	POSITION
MODE	DATA ENTRY
PROGRAM	0
AUTO REL	ON
AUTO DUP/AUTO SKIP	OFF

2. Depress the ER/HOME keys simultaneously.
3. Key in a record.

*NOTE: If the record fills position 80, the record will be released to tape automatically. If position 80 is not filled, depress the RELEASE key to write the record on tape.*

4. Key in the remaining records; release to tape is automatic.

# K-700 BASIC KEYS TAPE DEVICE

## VERIFICATION OF THE FIRST RECORD

SWITCH	POSITION
MODE	DATA VERIFY
PROGRAM	Select the <i>desired</i> program (1, 2, 0)
AUTO REL	OFF
AUTO DUP/SKIP	OFF

1. Depress the ER/HOME keys.
3. Key verify the record through character position 80. *Do not use the DUP key.*
- 4a. If there is no compare error, depress the REL key; then, change the mode switch to DATA ENTRY and continue the data entry operation.
- 4b. If ER/CORR indicators light, it indicates a mis-match between the character keyed and the character stored in memory. Use the following procedures:

### ERROR CORRECTION PROCEDURES

- Depress the ER key to reset the visible and audible error indicators.
- Rekey the correct character from the source document. (This recompares the stored data and the source data.)
- If the error *does not* recur, continue verifying the record through position 80; then, depress the REL key, change the mode switch to DATA ENTRY and proceed with the entry operation.
- If the error recurs, depress the ER/CORR keys simultaneously; then, key in the correct character from the source document. (This causes a new character to be stored.)
- Continue key-verifying the record through character position 80; then, depress the REL key to rewrite the corrected record on tape. Change the mode switch to DATA ENTRY and proceed with the entry operation.
- If a entire field is incorrect and must be replaced, depress the ER/FC (Error Reset and Field Correct) keys simultaneously. This allows the entire field to be rekeyed up to the next MSP (most significant position) program character when under program control.
- Continue verifying the record through position 80; then, depress the REL key to rewrite the corrected record onto tape. Change the mode switch to DATA ENTRY and continue the entry operation.

*NOTE: Since the first record has already been entered, you may put the AUTO DUP/AUTO SKIP operation into effect when you continue with the data entry.*

# K-700 BASIC KEYS TAPE DEVICE

## DATA ENTRY PROCEDURE - PROGRAM CONTROL, AUTOMATIC RELEASE

1. Set the switches on the control console as follows:

SWITCH	POSITION
MODE	DATA ENTRY
PROGRAM	Select the <i>desired</i> program "1" or "2"
AUTO REL	ON
AUTO DUP/AUTO SKIP	OFF

2. Depress the ER/HOME keys simultaneously.
3. Key in all 80 characters of the first record. This record will be automatically released from data memory and written onto magnetic tape.
4. Change the Mode switch to DATA VER and verify the first record. *Do not use the DUP key.*
5. Change the Mode switch to DATA ENTRY and the AUTO DUP/AUTO SKIP switch to "ON".
6. Key in the remaining records. They will be automatically released from data memory onto magnetic tape.

*NOTE: After entering data, it must be verified. Depress the ER/REW keys simultaneously to reposition the tape at the BOT (beginning-of-tape) mark. When the "Ready" indicator lights, the Tape Handler is ready for the Verification Procedure. If the data to be verified is not at the BOT, you must use the Search procedure to locate the first record to be verified.*

## ERROR CORRECTION DURING DATA ENTRY

When the Keypaper operator realizes that she has struck the wrong key, she *memory backspaces* to the desired memory position and strikes the correct key. This replaces the incorrect character in data memory with the correct one.

## HEADER, TRAILER AND END-OF-FILE RECORDS

If a Header label is necessary, key it in before entering the first record. If the AUTO REL switch is *off*, it must be released manually by depression of the RELEASE key. If a Trailer record or an end-of-file record is necessary, key it in after the last record. If the AUTO REL switch is *off*, it must be released manually by depression of the RELEASE key.

# K-700 BASIC KEYS TAPE DEVICE

## DATA VERIFICATION PROCEDURE

This operation is performed when it is necessary to verify prerecorded tape with a record at the beginning of tape (BOT). If the record you are about to verify is not at the BOT, you must use the SEARCH procedure. The REL switch is turned ON.

1.

SWITCH	POSITION
MODE	DATA VERIFY
PROGRAM	Select the <i>desired</i> program (0, 1, 2)
AUTO REL	ON
AUTO DUP/SKIP	OFF

2. Depress the ER/REW keys simultaneously.

3. Depress the REL key. The first data record is read into memory from magnetic tape and is ready to be verified.

4. Key verify the first record from the source document through position 80.  
*The DUP key is not to be used while verifying the first record.*

5a. If there is no "compare" error, release is automatic. Put the AUTO DUP/AUTO SKIP switch in the "on" position; then, continue to verify.

5b. If there is an error, use the following correction procedures:

- Depress the ER key to reset the error indicators and rekey the correct character from the source document.
- If the error does not recur, continue verifying the record through position 80. *Since neither the ER/CORR nor ER/FC keys were used, the next data record will be automatically read into memory to be verified.* Turn the AUTO DUP/SKIP switch to the "on" position and continue to verify the file.
- If the error recurs, depress the ER/CORR keys; then, key in the correct character from the source document and continue verifying the record.
- Depress the REL key and the corrected record will be written on tape. Then, depress the ER/HOME keys simultaneously and verify the corrected record.
- If an entire field is incorrect and must be replaced, depress the ER/FC keys and key in the correct characters from the source document. Continue to verify the record through position 80.
- Depress the REL key and the corrected record will be written onto tape. Then, depress the ER/HOME keys simultaneously and verify the corrected record.

*NOTE: After an automatic release it is not necessary to depress the ER/HOME keys but after a manual release it is necessary to depress the ER/HOME keys to get to the first position.*

# K-700 BASIC KEYS TAPE DEVICE

## SEARCH PROCEDURE

This operation is performed when it is desired to locate a record on a prerecorded tape. If the tape to be searched is not already mounted on the tape handler, or if the MAIN POWER switch is not lit, perform the operations described under TAPE LOADING PROCEDURE.

### IDENTIFIER ENTRY

1.

SWITCH	POSITION
MODE	SEARCH
PROGRAM	0
AUTO REL	OFF
AUTO DUP/SKIP	OFF

2. Key the *identifier* characters into memory. Use the space bar to insert blank codes into *unused* column positions within the identifier field.
3. Depress the REL key. This fills the remaining unused memory positions of the record through column 80 with blank codes. The identifier is now in memory and must be key-verified through column position 80.
4. Depress the ER/HOME keys simultaneously.
5. Set the MODE switch to **DATA VERIFY**. Key verify the entire identifier record through column position 80.
  - 6a. If there is *no* compare error, set the MODE switch to **SEARCH**.
  - 6b. If there is a compare error, use the following correction procedures.
    - Depress **the** ER key to reset the error indicators.
    - Rekey the correct character from the source document.
    - If the error does not recur, continue verifying the identifier record.
    - After verifying character position 80, set the MODE switch to **SEARCH**.
    - If the error recurs, depress the ER/CORR keys.
    - Key in the correct character from the source document.
    - Continue verifying the identifier record.
    - After verifying character position 80, set the MODE switch to **SEARCH**.

## K-700 BASIC KEYS TAPE DEVICE

### SEARCH PROCEDURE (CONT.)

7. Depress the REL key. Tape motion will begin and starting with record number 1, successive data records will be read from tape and will be compared with the identifier in memory. When a match is found, tape reading will stop with the read/write head positioned in the interrecord gap at the *end* of the "found" record which should now be verified.
8. Depress the ER/HOME keys simultaneously.
9. Depress the ER and TAPE BACKSPACE keys simultaneously. This backspaces the tape to the beginning of the "found" record.
10. Set the switches on the control console as follows:

SWITCH	POSITION
MODE	DATA VERIFY
PROGRAM	Select the <i>desired</i> program (0, 1, 2)
AUTO REL	OFF
AUTO DUP/SKIP	OFF

11. Depress the REL key. The "found" record will be released from magnetic tape and will be read into memory to be verified.
12. Depress the ER/HOME keys simultaneously.
13. Key verify the "found" record through column position 80.

*NOTE: When the record has been verified, either a DATA ENTRY operation or a DATA VERIFY operation can be performed; the tape is positioned at the end of the "found" record.*

### SEARCH SPEED

Search speed is a constant 24 inches per second. At 556 bpi recording density, about 1400 records per minute can be searched. If, during a search operation, a 12-inch section of blank tape is found, the search automatically halts. However, the search operation may be reinitiated by depressing the REL key.

# K-700 BASIC KEYS TAPE DEVICE

## UNPROGRAMMED LEFT ZERO FILL CAPABILITY

The KEYS TAPE device can perform the function of *right-justifying* significant character positions within a data field (called "left zero fill"). The L ZERO key on the control console is used to perform this function.

Shown below is an example of how data is placed in memory when forming an *unprogrammed* "left zero fill" operation for a data field in the DATA ENTRY and DATA VERIFY modes.

	DATA FIELD											
COLUMN POSITION	1	2	3	4	5	6	7	8	9	10	11	12
PROGRAM	2	0	0	0	0	0	0	0	0	0	0	3
DATA RECORD	0	0	0	0	0	0	0	0	3	5	8	A

## UNPROGRAMMED DATA ENTRY

In the DATA ENTRY mode, the operator depressed the 3, 5, and 8 keys, causing data characters "3," "5," and "8" to enter memory in columns 1, 2, and 3, respectively. Then, she depresses the L ZERO key, causing data characters "3," "5," and "8" to be shifted in memory into columns 9, 10, and 11, respectively; the KEYS TAPE device fills character positions 1 through 8 with zeros. The shifting ends at character position 11 because an MSP program pattern ("3") exists in column 12.

*NOTE: Any MSP program pattern will stop the shifting at that column.*

## UNPROGRAMMED DATA VERIFY

In the DATA VERIFY mode, the operator depresses the L ZERO key, causing the leading zeros in character position 1 through 8 to be automatically verified. The column counter stops at character position 9. The operator then key verifies the data characters in character positions 9, 10, and 11.

# K-700 BASIC KEYPAGE DEVICE

## PROGRAMMED LEFT ZERO FILL CAPABILITY

If the "left zero" program pattern is included in the device, it can be utilized to automatically right justify a data field as described in the following example:

	DATA FIELD											
COLUMN NUMBER	1	2	3	4	5	6	7	8	9	10	11	12
PROGRAM	6	0	0	0	0	0	0	0	0	0	0	3
DATA RECORD	0	0	0	0	0	0	0	0	3	5	8	A

## PROGRAMMED DATA ENTRY

In the **DATA ENTRY** mode, the operator depresses the 3, 5, and 8 keys, causing data characters "3," "5," and "8" to enter memory in columns 1, 2, and 3, respectively. Then, she depresses the L ZERO key, causing data characters "3," "5," and "8" to be shifted in memory into columns 9, 10, and 11, respectively. The device will then fill character positions 1 through 8 with zeros. The shifting will end at columns 11 because an MSP program pattern ("3") exists in column 12.

*NOTE: Any MSP program pattern will stop the shifting at that character position.*

## PROGRAMMED DATA VERIFY

In the **DATA VERIFY** mode, because the left zero program pattern ("6") exists in character position 1, the leading zeros in character positions 1 through 8 are *automatically verified*. The character position counter stops at character position 9. The operator then key verifies the data characters in character positions 9, 10, and 11.



# K-700 BASIC KEYS TAPE DEVICE

## ERROR RECOVERY PROCEDURES

There are four basic types of errors that can occur when the KEYS TAPE recorder is being operated; they are, keying, compare, tape, and parity.

This section explains how these errors are caused, describes how they are displayed and defines the steps that the operator must follow in order to correct them. In almost every case, the STATUS DISPLAY will indicate the exact steps that the operator must perform in order to recover from any error condition.

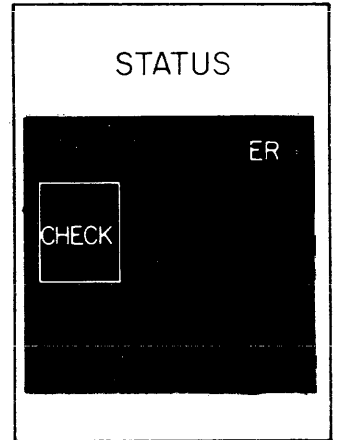

### KEYING ERROR - "CHECK" "ER" - ANY MODE

A *keying error* is indicated when both the "CHECK" and "ER" indicators are illuminated at the same time. The column position indicators display the column in error. This error can occur in any mode of operation for one of the following reasons:

1. Striking two or more keys simultaneously.
2. Illegal key stroke, e.g., striking a single character lower shift position key when the KEYS TAPE device is conditioned for upper shift position data entry or striking an "8" or "9" key when the unit is conditioned for lower shift position data entry.
3. Illegal program pattern entry (PROGRAM ENTRY mode only), e.g., depressing any key other than the "0" through "7" keys when keying in a program.
4. Quick keying error, e.g., depressing the DUP, SKIP, REL, MFS, MBS, L ZERO or a data key while the KEYS TAPE recorder is performing an automatic operation.
5. Keyboard parity error, e.g., bad parity received by the control unit from the keyboard.

### KEYING ERROR RECOVERY

The following steps must be performed in order to recover from a keying error:

1. Depress the ER key to reset the visual and audible error indicators.
2. Depress the proper key.

## K-700 BASIC KEYPAGE DEVICE

### COMPARE ERROR - "CHECK" "ER/CORR"

A *compare error* is displayed when both the "CHECK" and "ER/CORR" indicators are illuminated at the same time. The column position indicators display the column in error. This error is caused by a *mismatch* between the character in memory and the character keyed by the operator in the PROGRAM VERIFY or the DATA VERIFY modes of operation.

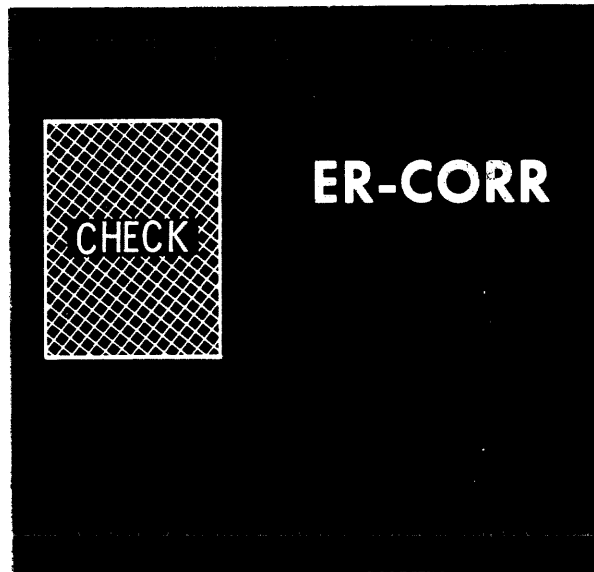

### COMPARE ERROR RECOVERY - "CHECK" "ER/CORR"

1. Depress the ER key to reset the visual and audible error indicators.
2. Rekey the correct character from the source document.
- 3A. If the error does not recur, resume the verification operation.
- 3B. If the error recurs, depress the ER/CORR keys simultaneously.

---

4. Key in the correct character from the source document and continue verifying the record to position 81.
5. When the character position 80 has been key verified, depress the REL key to write the corrected record onto tape.
6. Depress the ER/HOME keys simultaneously.
7. Key verify the corrected record to position 81.
8. Depress the REL key *again* to release the next data record into memory from tape.
9. Continue the normal DATA VERIFY operation.

## K-700 BASIC KEYS TAPE DEVICE

### TAPE ERROR - "CHECK" "ER/REL"

A *tape error* is displayed when both the "CHECK" and "ER-REL" indicators are illuminated at the same time. In the DATA VERIFY mode, the "AD/S OFF" indicator will also be illuminated if the AUTO DUP/AUTO SKIP switch is set to "on". The column position indicators will display column 81. The error can occur for one of the following reasons:

1. Detection of a frame parity error or a longitudinal parity error when reading a record from tape. The error also occurs when a record is read from a tape which does not have exactly 80 data characters.
2. Detection of a mismatch between tape and memory during an automatic check (backspace and read) operation.
3. Detection of erase current failure - no erase current while writing tape or erase current existing while reading tape.
4. Detection of a long tape record, i.e., a record that contains more characters than the particular KEYS TAPE device being used is capable of recording in an 80- or 120-character unit record. This error is indicated when the ER/REL and CHECK indicators light and there is illumination of a column position greater than 81 or 121, depending on the record size of the K-700 KEYS TAPE device being used.

*NOTE: If the following error recovery procedures do not eliminate the long tape record, the tape has been written using long records. In this case, it cannot be read on the K-700. If the tape has not been written using long records, the K-700 requires service.*

5. Detection of a short record containing six characters or less will normally be read and bypassed automatically (the next record will be read in).

This minimum record has been read into memory destroying the previous contents. If the field that it read into memory was a DUP field, it's possible that the next record read in will give an ER/CORR error but the data is correct. This is because the new information is being compared to data in a minimum record which is probably invalid data. The recovery procedure recommended is as follows:

- a. Turn "off" the AUTO DUP/AUTO SKIP switch.
- b. Key verify to column 81.
- c. Turn "on" the AUTO DUP/AUTO SKIP switch and proceed as normal.

### TAPE ERROR RECOVERY - "CHECK" "ER/REL" - DATA ENTRY MODE

1. Depress the ER key.
2. Depress the REL key to attempt to rewrite the record on tape.
- 3A. If the error does not recur, continue performing the DATA ENTRY operation.
- 3B. If the error does recur, depress the ER/REL key five times. If the error persists, bypass the bad section of tape.

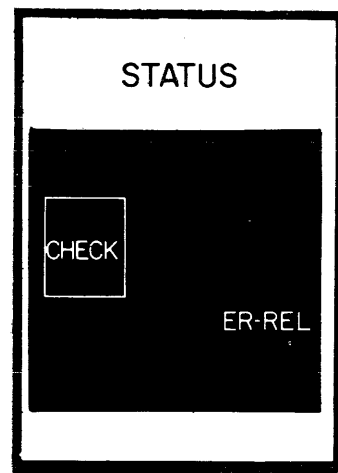

## K-700 BASIC KEYS TAPE DEVICE

### TAPE ERROR RECOVERY - "CHECK" "ER/REL" - DATA VERIFY MODE

1. Set the AUTO DUP/AUTO SKIP switch to the "off" position.
2. Set the AUTO REL switch to the "off" position.
3. Depress the ER key.
4. Depress the REL key.
- 5A. If the error does not recur, continue verifying the data record through column 80; then, set the AUTO DUP/AUTO SKIP and the AUTO REL switches as desired and proceed with the normal DATA VERIFY operation.
- 5B. If the error recurs and it is not desired to rewrite the record in error, you may bypass one record on tape by holding the ER key depressed and depressing the REL key once.

Then, depress the REL key and verify the next record to position 81. (Do not use the AUTO DUP/AUTO SKIP switch in the "on" position.)

- 5C. If the error recurs and it is desired to rewrite the record in error, continue to the following steps: (*The AUTO DUP/AUTO SKIP switch must be "off".*)
  - a. Set the Program switch to "0".
  - b. Depress the ER/HOME keys simultaneously.
  - c. Depress the ER/FC keys simultaneously.
  - d. Key the proper data record into memory.
  - e. Set the Program switch to the desired position ("1" or "2").
  - f. Depress the REL key to write the corrected record on tape.
  - g. Depress the ER/HOME keys simultaneously.
  - h. Key verify the rewritten record to position 81.
  - i. Depress the REL key to read in the next record from tape.

*NOTE: If an error does not recur, set the AUTO DUP/AUTO SKIP switch and the AUTO REL switch as desired and proceed with the normal DATA VERIFY operation.*

*If an error does recur, it is because there is a bad spot on the tape that must be bypassed. The record cannot be written in its correct position on tape but it can be written after the last record in the file that you are working on.*

## K-700 BASIC KEYPAGE DEVICE

### TAPE ERROR RECOVERY - "CHECK" "ER/REL" - SEARCH MODE

If a tape error occurs in the **SEARCH** mode, perform the following steps:

- 1A. If the column counter is at 81 or greater, depress the ER key.
- 1B. If the column counter is less than 81, depress the ER key and MFS (memory forward space) to column 81.
2. Depress the REL key.
- 3A. If the error does not recur, **SEARCH** will resume.
- 3B. If the error recurs and it is desired to rewrite the record in error, perform the following steps:
  - a. Set the Mode switch to **DATA VER.**
  - b. Set the REL switch to "off."
  - c. Set the Program switch to "0."
  - d. Depress the ER/HOME keys simultaneously.
  - e. Depress the ER/FC keys simultaneously.
  - f. Key the proper data record into memory.
  - g. Set the Program switch to the desired position ("1" or "2").
  - h. Depress the REL key to rewrite the record onto tape.
  - i. To continue the **SEARCH** operation, set the switches for the **SEARCH** operation.
  - j. Rewrite the identifier into memory.
  - k. Depress the REL key *again*.
- 3C. If the error recurs and it is not desired to rewrite the record in error, perform the following steps:
  - a. Hold the ER key depressed and depress the REL key once. (The record is now bypassed.)
  - b. Depress the ER/HOME keys simultaneously.
  - c. Depress the MFS key to position 81 in order to preserve the identifier.
  - d. Depress the REL key to continue the **SEARCH** operation.

# K-700 BASIC KEYS TAPE DEVICE

## PARITY ERROR\*

*Parity error* is indicated by the illumination of both "CHECK" and "PARITY" indicators at the same time. If the error occurs during either reading or writing tape, the "ER-REL" indicator will also be illuminated. The column position indicators display the column in error. This type of error alert indicates the detection of bad parity in memory.

\*Parity is a method of internal checking that is performed while reading a record that has been written on tape.

## KEYING PARITY ERROR RECOVERY - "CHECK" "PARITY" - ANY MODE

The following steps must be performed in order to recover from this error if it occurs *during keying*.

1. Depress the ER key.
2. Since the column position indicator displays the column in error, the character in that column should be visually displayed by setting the DISPLAY switch successively to **DATA** and **PROGRAM**.
3. If the program and/or data characters are incorrect, re-enter the proper characters.

*NOTE: To re-enter a data character, set the Mode switch to "Data Entry" and key in the correct data character; then, set the Mode switch to "Data Verify" and verify the character.*

*To re-enter a program character, set the Mode switch to "Prog Entry", key in the correct program character; set the Mode switch to "Prog Verify" and verify the program character.*

## TAPE PARITY ERROR RECOVERY - "CHECK" "ER/REL" "PARITY" - ANY MODE

The following steps must be performed in order to recover from a tape parity error if it occurs *during either the reading or writing of tape*: The record that was being *read* or *written* must be either *reread* or *rewritten* (depending on the operation that was being performed when the error occurred).

1. Depress the ER key.
2. Hold the MFS key depressed until the column position indicator displays "81".
3. Depress the REL key to reset the "ER-REL" indicator and to *reread* the record if in **DATA VERIFY** mode or to *rewrite* the record if in the **DATA ENTRY** mode.

*NOTE: If in the DATA VERIFY mode with an automatic duplication field present, the record must be verified with the AUTO DUP/AUTO SKIP switch set to "off".*

*If a record has been reached that cannot be read and it is desired to correct the record, it must first be bypassed; then, use the normal VERIFY CORRECT procedures.*

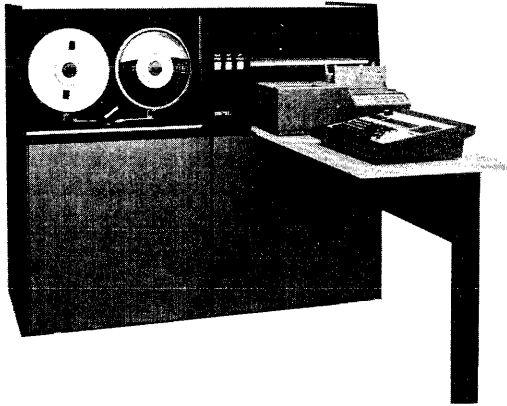

KEYTAPE/Card Reader

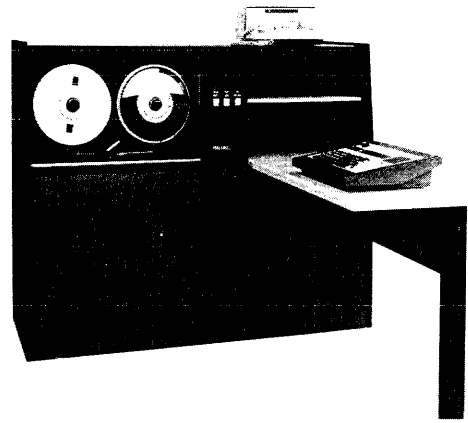

KEYTAPE/Communicator

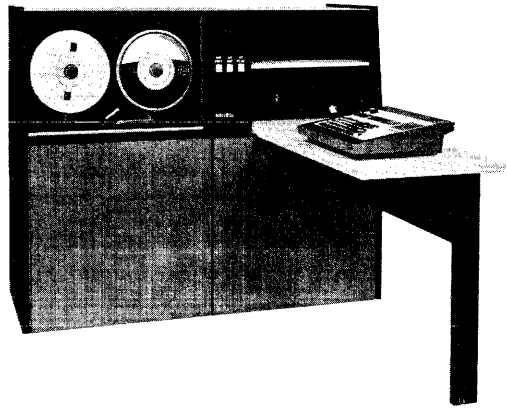

Basic KEYTAPE Device

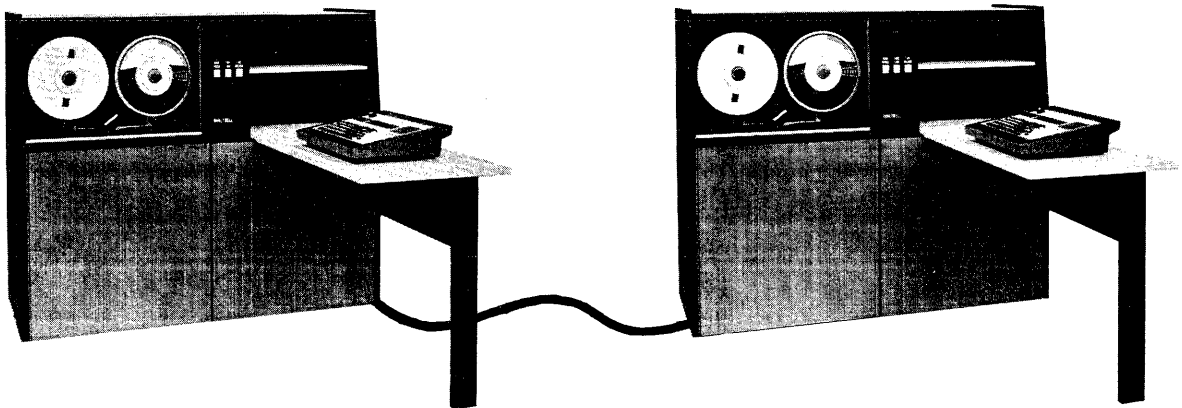

KEYTAPE Pooling System

Photo courtesy of Honeywell, Inc.

# MULTIPURPOSE KEYS TAPE DEVICES

## GENERAL DESCRIPTION

Because all Keypape devices are functionally identical in the keyboard to magnetic tape recording mode, the operators working in a Keypape data preparation area may be switched from one model to another. This feature allows full use of both personnel and equipment throughout the work day; e.g., a Keypape/Communicator can be used as a communication device part of the day and as a data preparation device for the remainder of the day. In fact, since these multipurpose devices require very little effort to change modes of operation, they can be used for the application most needed at any given time. Thus, during the work day, data preparation personnel can orient their facilities toward the particular needs of the moment.

Honeywell has provided some unique features to extend the usefulness of the multipurpose Keypape devices by enabling them to perform multiple operations. Two of the methods are employed to bring this about:

1. **Simultaneous Operation** - Two or more distinct functions available on a particular Keypape device can be active at one time and can operate in parallel. This type of operation is available on the following Keypape devices:
  - a. **ALL DEVICES** - Data entry and recording in conjunction with any one other available function.
  - b. **ALL KEYS TAPE/COMMUNICATORS** - Data entry and recording in conjunction with transmitting or receiving data.
  - c. **KEYS TAPE/COMMUNICATOR/PRINTER** - Data entry and recording in conjunction with printing and with transmitting or receiving data.
  - d. **ALL KEYS TAPE/ADDING MACHINES** - Data entry and recording in conjunction with adding/listing operations.
  - e. **ALL KEYS TAPE/CHECK DIGIT DEVICES** - Data entry and recording in conjunction with check digit entry.
2. **Interleaved Operation** - Two or more distinct functions available on a particular Keypape device can be active at one time and can operate in sequence under program control. Both operations can be performed on different fields within a single record. This type of operation is available on the following Keypape devices:
  - a. **KEYS TAPE ADDING MACHINE/CHECK DIGIT DEVICE** - Alternate adding/listing and check digit entry, in conjunction with data entry and recording.
  - b. **KEYS TAPE CARD READER/CHECK DIGIT DEVICE** - Alternate card reading and check digit entry, in conjunction with data entry and recording.
  - c. **KEYS TAPE CARD READER/ADDING MACHINE** - Alternate card reader and adding/listing operations, in conjunction with data entry and recording.



## K-710/K-910 KEYTAPE/COMMUNICATORS



Photo courtesy of Honeywell, Inc.

The Honeywell KEYTAPE/Communicator permits transfer of data over voice grade lines between KEYTAPE devices or between a KEYTAPE device and a central processor. In the transmit mode, data previously recorded on magnetic tape is read and formed into line blocks with suitable framing and check characters. This line block is transmitted serially by bit to the distant receiver. In the receive mode, data is accepted from the communications line serially by bit with suitable framing and check characters. This data is formed into a tape record and is subsequently written on magnetic tape.

The KEYTAPE/Communicators are able to transmit and receive any 8-level code provided that USASCII control characters and procedures specified are compiled with. Communication is via Bell Data Sets having reverse channel signaling.

Each data block consists of four control/framing characters plus the data characters. The number of data characters transmitted or received may vary from message to message, depending upon the record size used by the specific KEYTAPE/Communicator and the number of characters appearing in duplicated and skipped fields.

# K-710/K-910 KEYS TAPE COMMUNICATORS

CHARACTER	7	6	5	4	3	2	1
STX	0	0	0	0	0	1	0
DC1	0	0	1	0	0	0	1

DATA RECORD							
ETX	0	0	0	0	0	1	1
BCC	0	0	1	0	0	1	0

## DATA RECORD FORMAT - 7 CHANNEL

## DATA RECORD FORMAT 9 CHANNEL

CHARACTER
STX
DC1

9 <sup>1</sup>	8	7	6	5	4	3	2	1
0	1	0	0	0	0	0	1	0
0	0	0	0	1	0	0	0	1

ETX
BCC

DATA RECORD								
0	0	0	0	0	0	0	0	1
0	0	0	0	1	0	0	1	0

<sup>1</sup>The ninth bit is used on 9-channel devices only.

## CONTROL AND FRAMING CHARACTERS

Data characters are transmitted and framed by the control/framing characters shown in the illustration.

**START OF TEXT (STX)** - The STX character defines the *beginning* of a data block.

**DEVICE CONTROL CHARACTER (DC)** - The character position immediately following the start character is used to specify whether a block is *odd* or *even*-numbered.

DC1 = Odd Block (0010001)  
DC2 = Even Block (0010010)

DC1 is used on the first data block of each message and then appears alternately with DC2 on each succeeding block.

**END OF TEXT (ETX)** - The ETX character defines the *end* of a data block.

**BLOCK CHECK CHARACTER (BCC)** - The character immediately following the ETX character is the BCC character which is generated and checked by taking a binary sum independently on each of the seven or eight levels of the transmitted code. In each level, the number of "one bits," including the BCC character and excluding the start character (STX), is made even. The value of the BCC parity bit varies to ensure that the parity of the BCC character is always the same as that of the data characters, i.e., odd or even, depending upon the tape code being used. When the BCC is received and checked and no errors have been detected, the record is written on tape.

# K-710/K-910 KEYS TAPE COMMUNICATORS

## PROGRAM CONTROL

When a tape is written under program control, two programs are stored in the memory and the distant transmitter is informed that program control is being used. The program that is stored as program 2 controls reception of the *first* data block, while program 1 is considered the base program to control the remaining data blocks. Automatic duplication or skipping of message fields so coded in either program will occur between the reception of line characters.

When the first data block is received under control of program 2, any field programmed for AUTO-SKIP will be filled with blanks and any field programmed for AUTO-DUP will be duplicated. Since these fields are not received on the communication line, they are not included in the formation of the BCC character. If after the first block is written on tape, no errors have been detected, the communicator transfers control to program 1 to process the remaining data blocks. The processing of blocks under control of program 1 is identical to that for program 2.

Transmit Prog. 1	data	data	DUP	DUP	SKIP	SKIP	data	DUP	data
Transmit Prog. 2	data	data	data	data	SKIP	SKIP	data	data	data
Message to be Transmitted	NAME	ADDRESS	CITY <sup>1</sup>	STATE <sup>1</sup>	BLANK <sup>2</sup>	AMT. BILLED <sup>2</sup>	AMT. PAID	BILLING DATE <sup>1</sup>	ACCT. NUMBER
Message to be Received	RCVD <sup>3</sup> FROM	NAME	ADDRESS	CITY	STATE	BLANK <sup>3</sup>	AMT. PAID	BILLING DATE	ACCT. NUMBER
Receive Prog. 2	DUP	data	data	data	data	SKIP	data	data	data
Receive Prog. 1	DUP	data	data	DUP	DUP	SKIP	data	DUP	data

Diagrams courtesy of Honeywell, Inc.

1. Transmitted in first block only.
2. Not transmitted.
3. Generated at receiving device.

The above example shows how a message may be transmitted from one KEYS TAPE/Communicator in a given format and received by another device in a different format. In this example, the transmitter uses program 2 to transmit the first block and to eliminate the blank and Amt. Billed fields. Under control of program 1 for the remaining blocks, the transmitter also eliminates the City, State, and Billing Date fields.

The receiving operator has added an identifier to the record, indicating the transmitting station's code number. By keying this number into memory before receiving the first block and coding the field for AUTO DUP, the station code will be added to all succeeding records automatically. After receiving the first block, the receiving KEYS TAPE/Communicator also duplicates the City, State, and Billing Date fields.

# K-710/K-910 KEYSER COMMUNICATORS

## COMMUNICATOR SPECIFICATIONS

**TRANSMISSION MODE** - Half duplex by data block in a start/stop, asynchronous mode.

**TRANSMISSION CODE** - Eight-bit USASCII code (seven data bits plus a parity bit).

**DATA TRANSMISSION RATE** - Up to 260 messages per minute depending upon the number of characters per message.

**SYNCHRONIZATION** - Start/Stop.

**MESSAGE CONTROL** - USASCII control/formatting characters and reverse channel signal.

**DATA CHECKING** - Character parity, block length check, block check character, plus character format check.

**DATA SET ADAPTERS AND LINE SPEEDS** - 202E9 data set adapter (transmit only) with reverse channel capability, using 1,200-baud voice-grade line; 202C2 or 202D2 data set adapter (transmit/receive) with reverse channel capability, utilizing 1,200-baud switched lines; or 202D2 data set adapter utilizing 1,800-baud private lines. Data set adapter must be specified at time of order.

## AVAILABLE FEATURES

<u>FEATURE NO.</u>	<u>DESCRIPTION</u>
K-002 <sup>2</sup>	200 bpi Recording Density
K-004	800 bpi Recording Density
K-001	120-Character Record Length
K-020 <sup>2</sup>	Honeywell Tape Code, Odd Parity
K-021 <sup>2</sup>	IBM Tape Code, Even Parity
K-022	NCR Tape Code, Odd Parity
K-023	RCA Tape Code, Odd Parity
K-024 <sup>2</sup>	Burroughs Tape Code, Even Parity
K-025 <sup>2</sup>	General Electric Tape Code, Even Parity
K-026	UNIVAC Tape Code, Odd Parity
K-027 <sup>2</sup>	CDC Tape Code, Even Parity
K-041	Left Zero (Programmable)
K-070 <sup>2</sup>	"H" Extended Keyboard Arrangement
K-100 <sup>2</sup>	202C2, 202D2 Data Set Adapter (1,200 Baud)
K-101 <sup>2</sup>	202D2 Data Set Adapter (1,800 Baud)
K-102 <sup>2</sup>	202E9 Data Set Adapter (Transmit Only, 1,200 Baud)

# K-711/K911 KEYPHONE/CARD READERS

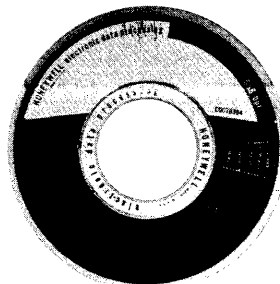
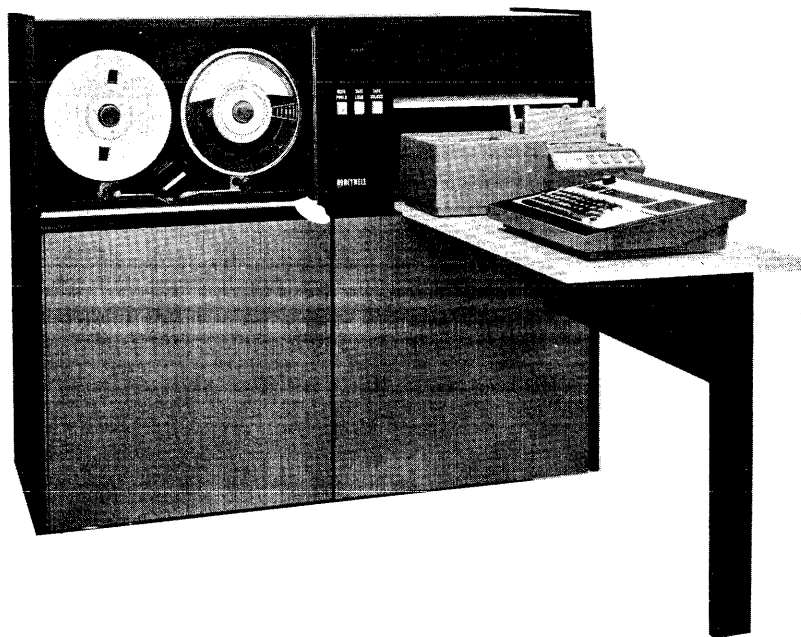
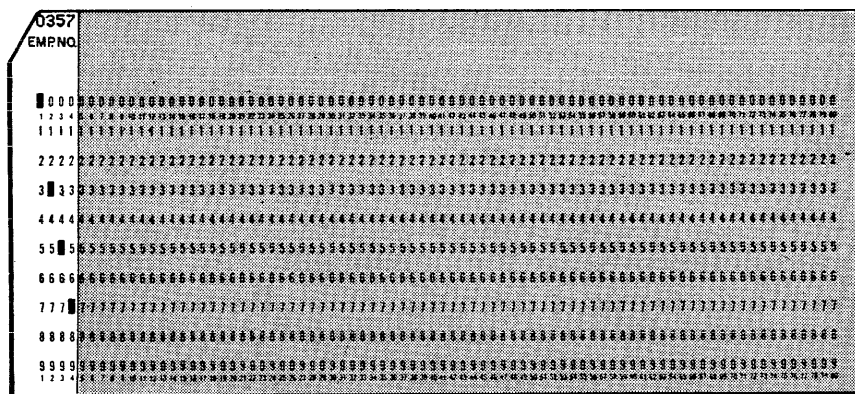

## K-711/K-911 KEYTAPE/CARD READERS

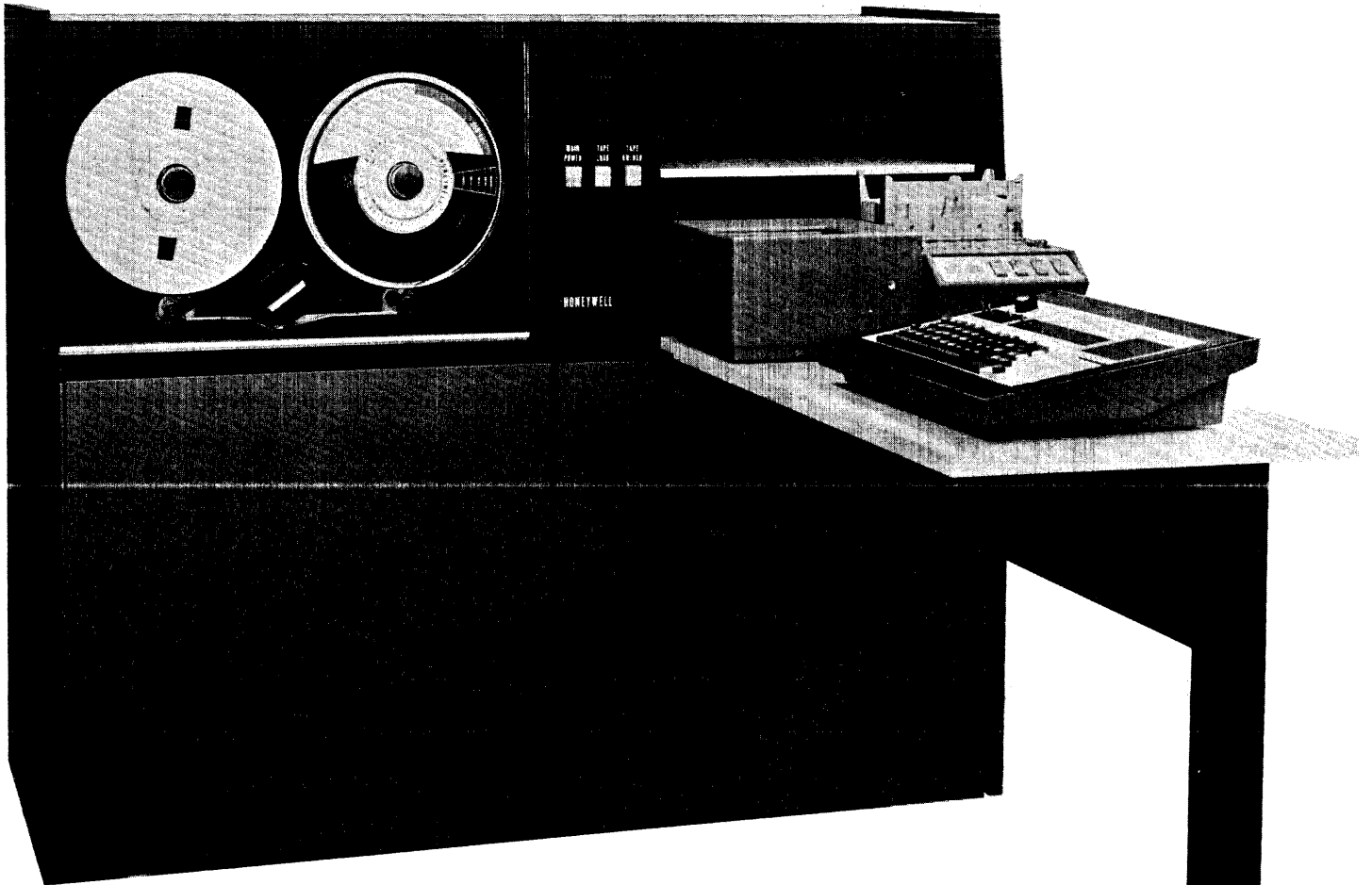

Photo courtesy of Honeywell, Inc.

The KEYTAPE/Card Readers, Model K-711 (7-channel) and Model K-911 (9-channel), permit punched card records to be transferred, off-line, directly onto magnetic tape from 80-column Hollerith-coded cards. The Model K-711 KEYTAPE/Card Reader may be ordered with the capability of reading either Honeywell or IBM Hollerith card codes. The Model K-911 KEYTAPE/Card Reader has the capability of reading IBM compatible Hollerith card codes. The data read from the cards is recorded on tape in the same manner as keyboard entered data on the basic K-700 and K-900 KEYTAPE devices.

The KEYTAPE/Card Readers may be used to enter data on tape from either the card reader or the keyboard, under either manual or program control. During card-to-tape conversion, this device can also, as a standard feature, modify a data record under the control of two stored programs. Utilizing skipping (SKIP) and duplicating (DUP) fields defined in the stored programs, card data entered on tape may be changed, added to, or omitted. Data can be entered into separate fields in a single record alternately from a punched card and from the keyboard.

An incrementing record counter, which can be reset by the operator, is provided as standard equipment. This counter automatically records each record entered on the tape. When not operating in the card-to-tape mode, the KEYTAPE/Card Readers can perform all the standard operations of the basic KEYTAPE devices.

# K-711/K-911 KEYS/TAPE/CARD READERS

## CARD-TO-TAPE OPERATION

The punched-card-to-tape operation may be controlled by the operator via the keyboard or indirectly via two stored programs. Under keyboard control, data records are transferred from cards to tape without alteration. Under program control, data records can be altered via the keyboard during card-to-tape transfer.

## ERROR CHECKING

Three standard checks - validity, cycle, and read - are performed at the time of data transfer from a card to memory. Validity check is for detection of an illegal punch; cycle check is for detection of a failure in the photocell circuit; read check is a double-strobe, read/compare check for detection of reading errors. Detection of any of these errors results in a visual error indication.

## KEYTAPE CARD READER SPECIFICATIONS

INPUT MEDIA - 80-column, 12-row punched cards with uncut square corners on leading edge.

CARD CODE TRANSLATION - Either Honeywell or IBM card code translation is available.

CARD READING METHOD - Photoelectric, column by column serially.

INPUT DATA PROTECTION - Validity check, cycle check, and read check.

HOPPER/STACKER CAPACITY - 430 cards.

CARD ENTRY MODE - Card "face-up" reading is standard; card "face-down" reading is available.

## AVAILABLE FEATURES

<u>Feature No.</u>	<u>Description</u>
K-002 <sup>2</sup>	200 bpi Recording Density
K-004	800 bpi Recording Density
K-011	120-Character Record Length
L-020 <sup>2</sup>	Honeywell Tape Code, Odd Parity
K-021 <sup>2</sup>	IBM Tape Code, Even Parity
K-022	NCR Tape Code, Odd Parity
K-023	RCA Tape Code, Odd Parity
K-024 <sup>2</sup>	Burroughs Tape Code, Even Parity
K-025 <sup>2</sup>	General Electric Tape Code, Even Parity
K-026	UNIVAC Tape Code, Odd Parity
K-027 <sup>2</sup>	CDC Tape Code, Even Parity
K-041	Left Zero (Programmable)
K-070 <sup>2</sup>	"H" Extended Keyboard Arrangement
K-110 <sup>2</sup>	Card "Face-Down" Reading Capability
K-113 <sup>2</sup>	Honeywell Card Code Translation
K-114 <sup>2</sup>	IBM Card Code Translation

## K-712/K-912 KEYS/POOLERS

A KEYS/POOLING system consists of either the Model K-712 (7-channel) or the Model K-912 (9-channel) KEYS/Poolers. Two or three KEYS/Poolers may be arranged in a pooling system to permit a number of individual tapes to be consolidated onto one large magnetic tape for more efficient entry to the computer.

Each device may be designated by the operator as either a read unit or a write unit for the data being pooled. Two modes of pooling are provided, manual and automatic. In the manual mode, the operator controls the transmitting of single records from a selected read unit to a selected write unit. In the automatic mode, the selected read unit transfers data records continuously to the selected write unit under control of two stored programs until either 12 inches of blank tape or a stop code is detected.

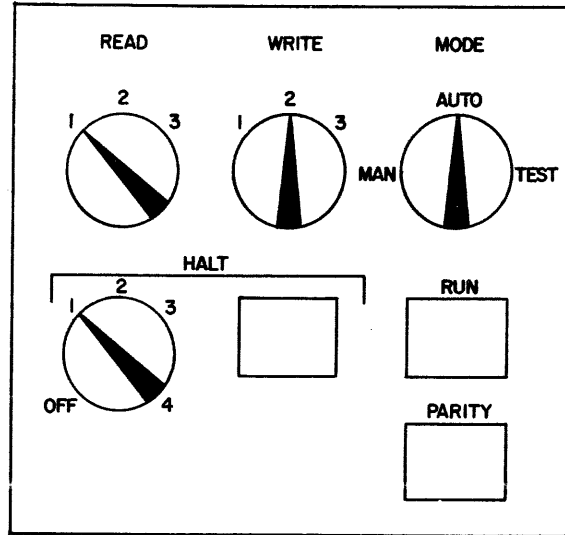

Diagram courtesy of Honeywell, Inc.

READ PROGRAM	DATA			SKIP	DATA
READ UNIT DATA	NAME	ACCT #	BAL.	10 BLANKS	BRANCH #
WRITE UNIT DATA	10 COL. DATE	NAME	ACCT #	BAL.	BRANCH #
WRITE PROGRAM	DUP		DATA		

### EDITING CAPABILITY

The KEYS/POOLER can also edit data being pooled. An example of this editing capability is illustrated.

In this example, it is desired to prefix each record being pooled with a data field and to eliminate the field between BAL and BRANCH #. The operator of the write unit keys the date into the first 10 columns of memory and programs this field for duplication. The date is automatically added to each record being pooled. The memory of the read unit is programmed to skip the 10 characters between BAL and BRANCH # so that the receiving unit does not record this field. Editing is made possible by the ability of the KEYS/POOLER to store two programs.

### OTHER STANDARD FEATURES

Other standard features of the pooler are an incrementing record counter and stop code recognition. The record counter specifies the number of records pooled. Stop code recognition permits the user to specify four unique codes which stop tape motion automatically during a pooling operation. Other (nonstandard) stop codes can be recognized as an optional capability.



## K-712/K-912 KEYS/TAPE/POOLERS

### POOLING SPEED

	RECORD LENGTH	RECORDING DENSITY	RECORDS/MIN. (NOMINAL)
<b>7-CHANNEL</b>	80	200	330
	80	556	400
	80	800	420
	120	200	290
	120	556	380
	120	800	402
<b>9-CHANNEL</b>	80	800	480
	90	800	480
	100	800	468
	110	800	462
	120	800	456

## K-713/K-913 KEYS/TAPE/ADDING MACHINES

The KEYS/TAPE/Adding Machines permit keyboard entry of data onto magnetic tape and into the accumulator of an attached adding machine. Under program control, fields within a data record may be added and listed or only listed on the adding machine. Two program codes stored in the memory direct numeric left-zero fields being entered either from the keyboard or from tape into the adding machine. Any keying errors during an adding machine operation can be corrected by backspacing before data is listed, since all data is entered into memory and into the adding machine accumulator before being recorded on magnetic tape and listed on the adding machine. Actual data recording and adding/listing operations do not occur until the operator presses the LEFT ZERO key.

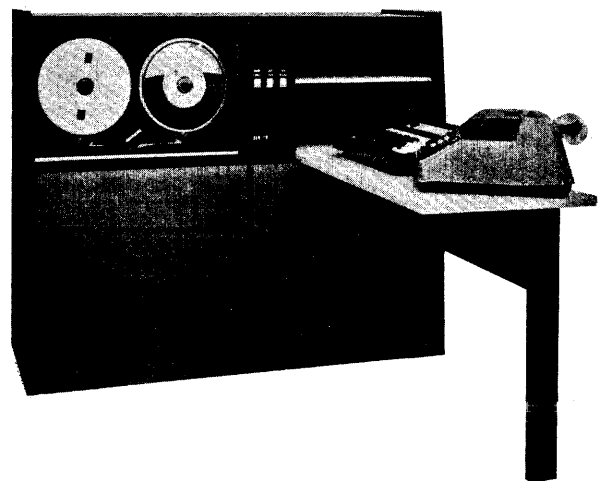

# IBM 50 MAGNETIC DATA INSCRIBER



Photo courtesy of International Business Machines Corporation

# IBM 50 MAGNETIC DATA INSCRIBER

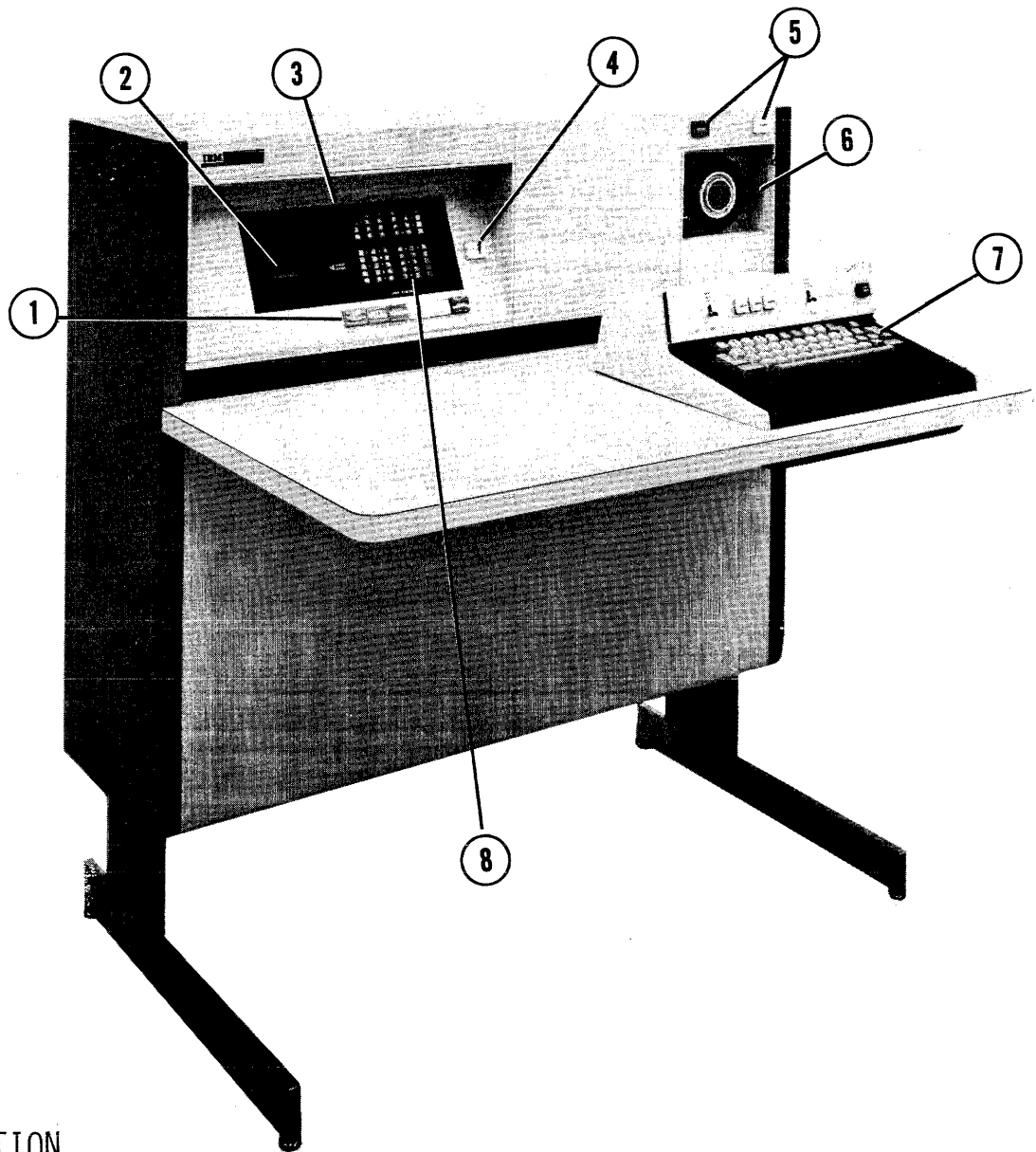

## DESCRIPTION

1. CONSOLE LIGHTS AND SWITCHES
2. PROGRAM INDICATOR
3. CONSOLE
4. POWER ON/OFF SWITCH
5. REWIND AND SEARCH BUTTONS
6. TAPE STATION
7. KEYBOARD
8. CHARACTER READOUT MATRIX

# IBM 50 MAGNETIC DATA INSCRIBER

## DESCRIPTION

The IBM 50 Magnetic Data Inscriber transfers data from source documents to magnetic tape which is then used as a vehicle for entering the data into an IBM System/360, Model 30, 40, or 50, equipped with a multi-plexer channel. While similar in several respects to IBM card punches, the IBM 50 Magnetic Data Inscriber offers advantages that are not obtainable with card-oriented machines. Among these are:

- Magnetic tape output
- Variable length records
- Eliminates card to tape conversion
- Automatic functions (skipping, duplication, etc.) are performed at 100 characters per second
- Eight program levels
- Ease of error correction

Data is entered into an IBM 50 by means of a keyboard similar to that used on the IBM 29 Card Punch. This permits transition from card punches to the IBM 50 with minimum operator training.

IBM 50 output tapes are housed in compact self-contained cartridges and each has a capacity of 23,000 characters. The tape cartridges require no threading or special handling by the operator. The output tape is reuseable and, while intended primarily for entering data into a data processing system, it may also be used to store data. The IBM 2495 Tape Cartridge Reader (TCR) is used to transfer data recorded on the tape into a data processing system.

As data is entered into the IBM 50, an incremental drive mechanism passes a magnetic tape over a read/write head where the key-entered data is transferred to (or read from) the tape in the form of magnetic impulses. Data is written in one character increments at a data density of 20 characters per minute, using the same code structure as that used on the IBM System/360's. This code, called Extended Binary Coded Decimal Interchange Code (EBCDIC), consists of eight data bits plus a parity bit.

Data entry, data formatting and automatic functions are controlled through the program unit which consists of a changeable program drum and card, a drive mechanism and a fiber optics/photocell sensing device. The program card is easy to prepare and change; a single card can store as many as eight different programs. Each program card contains, in addition to the program codes, an area on which information relating to the corresponding programs can be typed. This enables the operator to determine what program is being used and to what point in a record data keying has progressed.

To load a tape for writing, the operator simply inserts a cartridge into the machine and selects an operating mode. This causes the tape to be automatically threaded through the tape path and prepares for processing. An "operate" indicator, located on the operator's console, lights when the tape is loaded, indicating that data entry can begin. Tape rewind is also simple and efficient; a fully extended reel of tape rewinds in approximately 40 seconds.

During data entry, reading and backspacing, etc., the magnetic tape moves in synchronization with the program unit. Program selection is achieved either automatically by program chaining or manually by means of the Program Select key located on the keyboard. Depressing the Program Select key together with an appropriate numeric character key (1 through 8) causes the corresponding program to be selected.

# IBM 50 MAGNETIC DATA INSCRIBER

## KEYBOARD

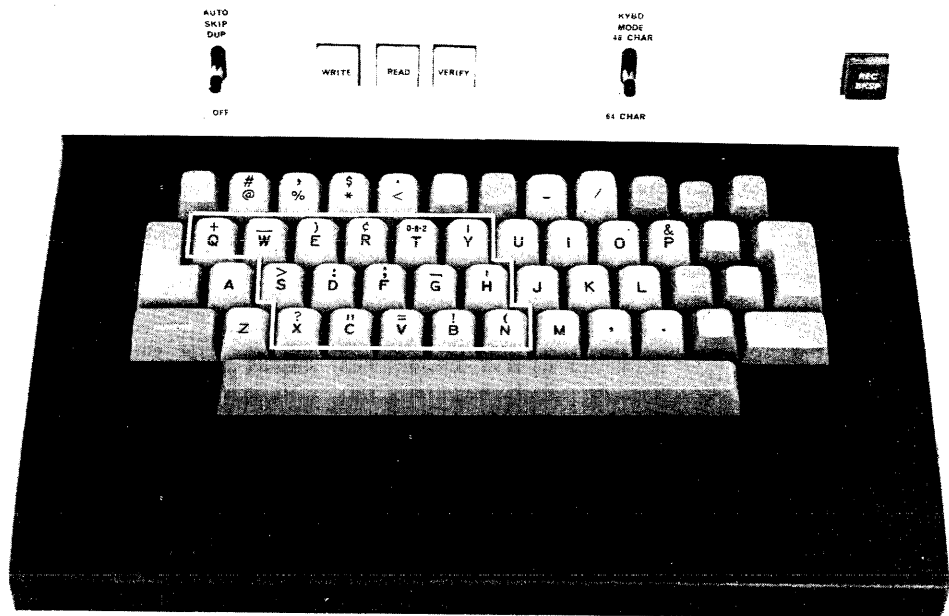

Data is entered into the IBM 50 by means of a keyboard similar to that used on the IBM 29 Card Punch. This familiar keyboard layout permits transition from card punches to the IBM 50 with minimum operator training.

The keyboard is mounted on the reading board (desk top), directly in front of the magnetic tape station. It can be swiveled within its mounting, 12 degrees left or right from the center, to provide the position most comfortable for the operator. The keyboard contains, in addition to the character keys, many of the controls, switches, and indicators used in operating the machine.

The keyboard is alphabetic and features the expanded character set compatible with the code structure used on IBM System/260's. The keyboard can generate the standard 64-character set which includes: 26 alphabetic, 10 numeric, and 28 special characters. An optional SPECIAL CODE key is also available to enable unique code configurations to be written.

A 48/64 character mode switch located on the upper portion of the keyboard enables the keyboard to be used as either a 48-character or 64-character keyboard. With this switch in the 48-character mode position, the characters that appear on the upper half of the keys outlined in white are disabled. Only the alphabetic character portion of those keys is activated during 48-character mode.

During a Write operation, operator-detected errors can be easily corrected on the IBM 50 by means of keyboard control keys. Through use of the appropriate control key, the tape can be backspaced to the beginning of a data field or to the beginning of a record, and the incorrect data can be replaced by overwriting the entire field with the correct data.

# IBM 50 MAGNETIC DATA INSCRIBER

## AUTO SKIP/DUP SWITCH

In Write mode with this switch "on," programmed field skip and duplicate (DUP) operations are performed automatically. The program device advances continuously through the field, the tape advances the same number of columns, and the respective codes (space or duplicate) are written in each tape position.

With the AUTO SKIP/DUP switch in the "off" position, each field becomes a manual field (either alpha or numeric, depending on programming). If the AUTO SKIP/DUP switch is turned "on" after a field has been entered (data written), the field remains a manual field. A manual skip or DUP operation may be initiated from the keyboard for the remaining positions of a field that has been entered.

In Read mode, with the AUTO SKIP/DUP switch "on," the magnetic tape is automatically advanced to the next field after the SPACE bar is depressed in the first position of a field that is programmed to skip or DUP. The readout matrix displays the last character read from that field, and the program indicator is positioned with that field in the top position of the indicator.

If the switch is turned "on" after one or more characters of a field have been displayed, the field remains a manual field.

## WRITE INDICATING PUSHBUTTON

When depressed, this pushbutton lights and places the IBM 50 in the Write mode.

## READ INDICATING PUSHBUTTON

When depressed, this pushbutton lights and places the IBM 50 in the Read mode.

## VERIFY INDICATING PUSHBUTTON

When depressed, this pushbutton lights and places the IBM 50 in the Verify mode.

## KEYBOARD MODE 48/64 SWITCH

This switch enables the keyboard to be used as either a 48-character or 64-character keyboard. In the 64 position, all the character keys are active in both alphabetic and numeric shift (except the A and Z keys which are active in alphabetic shift only). In the 48 position, the numeric shift portion of the keys outlined in Figure 3 is disabled (inoperable).

## RECORD BACKSPACE KEY

The RECORD BACKSPACE key is active in all modes. Depressing RECORD BACKSPACE returns the program card and magnetic tape to the beginning of the first field of that record. Each successive depression of this key positions the program card and the magnetic tape to the first field of the preceding record. If this key is operated while in a record and before a character key is depressed, the magnetic tape and program card are positioned to the first field of the preceding record. If the first field of a record is a skip or DUP field, RECORD BACKSPACE causes that field to become a manual field.

If RECORD BACKSPACE is depressed at the beginning of the first record on the tape, an automatic rewind occurs, necessitating a tape reload.

# IBM 50 MAGNETIC DATA INSCRIBER

## NUMERIC KEY

The NUMERIC key places the keyboard in numeric shift. If the field is programmed alphabetic, the keyboard returns to alphabetic shift when the NUMERIC key is released. (This key is *ineffective* during Read mode.)

## ALPHA (ALPHABETIC SHIFT)

This key places the keyboard in alphabetic shift. If the field is programmed numeric, the keyboard returns to numeric shift when the ALPHA key is released. (The ALPHA key is *ineffective* during Read mode.)

## DUP (DUPLICATION) KEY

Depressing the DUP key causes the magnetic tape to advance through the remainder of the current field and advances the program device one instruction (field). Duplication (DUP) codes are written in *all* duplicated columns of the field. (The DUP key is *ineffective* during Read mode.)

## SKIP KEY

Depressing the SKIP key advances the program device and tape through the *remainder* of the field in which it was depressed. A *space* code is written in each tape position skipped.

When in Write mode, the SKIP key positions the magnetic tape to accept the first data character in the *next* field.

The SKIP key, when operated in Read mode, skips the magnetic tape to the end of the field and advances the program card to the next instruction. The *last* character written in the field is displayed.

## REL (RELEASE) KEY

In Write mode, depressing the REL (Release) key, causes the program card to space forward until program end is reached. The magnetic tape moves forward in synchronism with the program card. A *space* code is written in each tape position released over. Programmed duplicate fields receive duplication (DUP) codes. Detection of program end causes a *record mark* (RM) to be written as the last character of the record.

In Read mode, the REL key advances the magnetic tape, in synchronism with the program card, to the start of the following record if one exists. The program device stops with the *program level* (PL) instruction in the top portion of the program indicator. The readout matrix displays the PL character that was read from tape, and the FIRST CHARACTER indicator is lit.

## VERIFY RESET KEY

The VERIFY RESET key is used during Verify mode to *reset* the keyboard following a first or second verify *error*. Following a second verify error, this key also causes the REWRITE CHARACTER indicator to go on, indicating that the erroneous character will be *replaced* with the keyed character at the next key stroke.

# IBM 50 MAGNETIC DATA INSCRIBER

## LEFT ZERO KEY

Left-zero insertion is a standard feature on the IBM 50. When activated, this feature automatically inserts special left-zero symbols in the unoccupied (blank) portion of that data field. These symbols actually appear to the right of the significant data; the computer program performs the shifting of the significant data to the right of each left-zero field, and inserts left zeros.

Depressing the LEFT ZERO key in a left-zero field causes the remainder of the field to be filled with left zero (LZ) codes. *Right justification must be accomplished during computer processing of the data.*

A significant digit or a zero must be keyed *before* the LEFT ZERO key is effective. If this key is depressed in the first position of any field, i.e., when the FIRST CHARACTER indicator is on, it is ignored. If the LEFT ZERO key is depressed in a field (other than in the first position) that is not programmed left-zero, the keyboard *locks* and FIELD BACKSPACE must be used to restore the keyboard. (This also causes a field backspace operation.)

NOTE: The keyboard *locks* if the SKIP key is operated in other than the first position of a programmed left-zero field. The DUP key should not be used in other than the first position of a programmed left-zero field.

## FIELD BACKSPACE KEY

Depressing the FIELD BACKSPACE key while in Write mode returns the tape and program drum to the beginning of the field. Successive field backspace operations can be performed until the beginning of the record is reached, whereupon FIELD BACKSPACE becomes inoperative.

If the program device is positioned for keying the first character in the field, FIELD BACKSPACE moves tape (backward) to the start of the previous *manual* field. A manual field is one which is not programmed to skip or DUP (or any field if the AUTO SKIP/DUP switch is in the "off" position).

In Read mode, the FIELD BACKSPACE key returns the tape to the beginning of the field, at which point the *readout display goes off*. In order to read and display the first character of the field, the SPACE bar must be depressed. As in Write mode, automatic fields are bypassed when field backspacing from the beginning of a manual field. FIELD BACKSPACE may also be used to restore the keyboard when it becomes locked.

When in Verify mode, FIELD BACKSPACE resets the VERIFY ERROR light and returns tape to the beginning of that field. The first character keyed in a field turns the FIRST CHARACTER light "off." If a *miscompare* occurs, depressing FIELD BACKSPACE resets the VERIFY ERROR light and turns on the FIRST CHARACTER light. When this key is operated with the FIRST CHARACTER light "on," the tape moves to the beginning of the previous *manual* field.



# IBM 50 MAGNETIC DATA INSCRIBER

## PROG SEL (PROGRAM SELECT)

The PROG SEL key is used to select any of the *eight* possible programs that can be stored on a program card. Depressing, in the proper sequence, the PROG SEL key and the numeric key that corresponds with the number of the program that is to be used causes that program to be selected. For example, program level 2 is selected by depressing the PROG SEL key and the numeric 2 key.

Manual program selection can be performed *only* in Write mode at the end of a program level, or at the beginning of a program level before data keying is started. At these two places, manual program selection is accomplished as follows: the PROG SEL key is depressed, causing the OPERATE indicator to go "off" momentarily. When the OPERATE indicator comes back "on," depressing the numeric character key that corresponds with the number of the program to be selected causes a *program search*, and places the program card at the beginning (program start) of the chosen program. If the program card runs continuously because the program number selected is not on the card, the sequence must be repeated using the correct number. Depressing the PROG SEL key will unlock the keyboard, and halt continuous search.

In Write mode, program selection as described above causes a *program level (PL) code* to be written on magnetic tape as soon as the program is selected. The PL code becomes the *first* character of the record. Following program selection the machine is ready to execute the first program field.

During Read or Verify mode, program selection is performed *automatically* as follows: when the PL code (generated during Write mode) is read, it initiates a program search, and the program card is automatically advanced to the beginning of the program indicated by the PL code. In Read mode, the PL character is displayed, and in Verify mode, the first data character of that record is ready for verification.

The PROG SEL key is also used in conjunction with the END GROUP key to write an end group (EG) character.

## END GROUP KEY

The END GROUP key is active *only* in Write mode and is used to write an end group (EG) code between records (the only place an EG code may be written). EG codes are treated in the IBM 50 as *separate and complete* records. An EG code can be written at the end of a program level when it is *not chained* to another program level, at the beginning of a program level before manual keying is started, or following a previously written EG code. An EG code is written as follows: the PROG SEL key must first be depressed, causing the OPERATE indicator to go "off" momentarily. As soon as the OPERATE indicator comes back "on," depressing END GROUP causes an EG code to be written on magnetic tape, following the last complete record or previous EG.

# IBM 50 MAGNETIC DATA INSCRIBER

## MINUS KEY

When in Write mode, *simultaneous* depression of the MINUS key and a numeric digit key (zero through nine) flags the numeric digit as a minus value. Minus flagging of a numeric character is accomplished by changing the high-order bit structure (bits 0123) from 1111 to 1101. This action is normally taken at the units position of a numeric field if that field is to be signed negative. If this key is not used, the high-order code 1111 in the units position indicates a plus field. If any key other than 0-9 is depressed when the MINUS key is depressed, the keyboard *locks* and FIELD BACKSPACE must be used to restore the keyboard.

When in Read mode, the numeric characters that are flagged as minus are displayed as shown.

Numeric Character	Display of Numeric Character Flagged Minus
0	0̄
1	J
2	K
3	L
4	M
5	N
6	O
7	P
8	Q
9	R

Diagram courtesy of International Business Machines Corporation

## SPEC CODE (SPECIAL CODE) KEY (OPTIONAL FEATURE)

The SPEC CODE (Special Code) key enables any desired code configuration to be written on tape. By holding the SPEC CODE key depressed and operating one or more of the character keys, the *combined* bit configuration of the corresponding characters is written in the same tape position. In this manner, any code configuration can be written in a single tape position.

NOTE: PL codes and tape control codes should not be generated by means of the SPEC CODE key.

Special characters generated using the SPEC CODE key are verified in the same manner as they are produced.

# IBM 50 MAGNETIC DATA INSCRIBER

## CODE SET

The chart shows the EBCDIC code structure of the 64 characters that can be generated by the IBM 50 keyboard, the program level codes (P1-P8), and the tape and record control codes; e.g., RM, ED, EG, etc.

### CONTROL CODES

LZ = Left zero  
 Dup = Duplicate  
 LZ start - Left zero start  
 Del = Delete  
 ED = End Data  
 RM = Record Mark  
 EG = End Group  
 VOK = Verify OK

### PROGRAM LEVEL CODES

P1 = Program Level 1  
 P2 = Program Level 2  
 P3 = Program Level 3  
 P4 = Program Level 4  
 P5 = Program Level 5  
 P6 = Program Level 6  
 P7 = Program Level 7  
 P8 = Program Level 8

		0	1	2	3	4	5	6	7	8	9	A	B	C	D	E	F	
<u>Bits</u>	3	0	1	0	1	0	1	0	1	0	1	0	1	0	1	0	1	
	2	0	0	1	1	0	0	1	1	0	0	1	1	0	0	1	1	
	1	0	0	0	0	1	1	1	1	0	0	0	0	1	1	1	1	
	0	0	0	0	0	0	0	0	0	1	1	1	1	1	1	1	1	
	4	5	6	7														
0	0	0	0	0	LZ					Space	&	Minus					0	
1	0	0	0	1		DUP								P1			A	J
2	0	0	1	0		LZ	START							P2			B	K
3	0	0	1	1										P3			C	L
4	0	1	0	0										P4			D	M
5	0	1	0	1										P5			E	N
6	0	1	1	0										P6			F	O
7	0	1	1	1										P7			G	P
8	1	0	0	0			DEL							P8			H	Q
9	1	0	0	1			ED										I	R
A	1	0	1	0						.	:							
B	1	0	1	1						.	\$	,	#					
C	1	1	0	0						<	>	%	@					
D	1	1	0	1			EG			(	)		Prime					
E	1	1	1	0			VOK			+	-	>	=					
F	1	1	1	1							^	?	~					

Diagram courtesy of International Business Machines Corporation

# IBM 50 MAGNETIC DATA INSCRIBER

## EBCDIC CODE STRUCTURE

LZ.....00000000	>.....01101110	K.....11010010
DUP.....00010001	?.....01101111	L.....11010011
LZ Start.00010010	:.:.:.....01111010	M.....11010100
DEL.....00001000	#.....01111011	N.....11010101
ED.....00011001	@.....01111100	O.....11010110
EG.....00011101	' Prime..01111101	P.....11010111
VOK.....00011110	=.....01111110	Q.....11011000
RM.....00111100	".....01111111	R.....11011001
Space....01000000	P1.....10000001	<sup>082</sup> .....11100000
φ.....01001010	P2.....10000010	S.....11100010
•.....01001011	P3.....10000011	T.....11100011
<.....01001100	P4.....10000100	U.....11100100
(.....01001101	P5.....10000101	V.....11100101
+.....01001110	P6.....10000110	W.....11100110
!.....01001111	P7.....10000111	X.....11100111
&.....01010000	P8.....10001000	Y.....11101000
!.....01011010	A.....11000001	Z.....11101001
\$.....01011011	B.....11000010	∅.....11110000
*.....01011100	C.....11000011	1.....11110001
).....01011101	D.....11000100	2.....11110010
;;.....01011110	E.....11000101	3.....11110011
¬.....01011111	F.....11000110	4.....11110100
- Minus..01100000	G.....11000111	5.....11110101
/.....01100001	H.....11001000	6.....11110110
,.....01101011	I.....11001001	7.....11110111
%.....01101100	∅.....11010000	8.....11111000
___.....01101101	J.....11010001	9.....11111001

# IBM 50 MAGNETIC DATA INSCRIBER

## PROGRAM CONTROL UNIT

The program control unit is located *behind* the front panel of the console. During data entry, reading, backspacing, etc., the magnetic tape moves in synchronization with the program unit. The unit consists of a changable program drum upon which the program card mounts, a drive mechanism and a fiber optics/photo cell sensing device for reading the program codes contained in the program card.

## THE PROGRAM CARD

The program card is easy to prepare and change. A single card can store as many as *eight* different programs. On the right half of each program card there is an area adjacent to each program field on which information relating to the corresponding program can be typed. This enables the operator to determine what program is selected and to what point of the record data keying has progressed. When the program card is mounted in the program unit, the type written information is then visible through an aperture in the front cover of the machine.

The program card contains program codes (punches) that initiate and control all automatic functions, determine the length of the field and the beginning and end of a record and also identifies the program. Program selection is achieved either automatically by program chaining or manually by means of the Program Select key located on the keyboard. Depressing the Program Select key together with the appropriate numeric character key (1 through 8) causes the corresponding program to be selected.

## DUPLICATING AND SKIPPING

Field duplicating and skipping can be performed on the IBM 50 at the speed of 100 characters per second. The ability to perform these functions at a speed up to five times faster than can be achieved by card punches gives the IBM 50 an important advantage in the preparation of data for processing. When activated, the duplicate feature inserts a special dup code in each position of a record which is to receive information that appears in the preceding record. This eliminates the necessity of keying repetitive information. These special symbols are interpreted by the computer program as positions which are to receive duplicated information.

Field skipping, an important data entry and formatting aid, enables data fields in which no data is to be entered, to be passed over (skipped) at 100 positions per second (a space code is written in each position).

*Both skipping and duplicating are program controlled; they can also be initiated by depressing the DUP and SKIP keys.*

# IBM 50 MAGNETIC DATA INSCRIBER

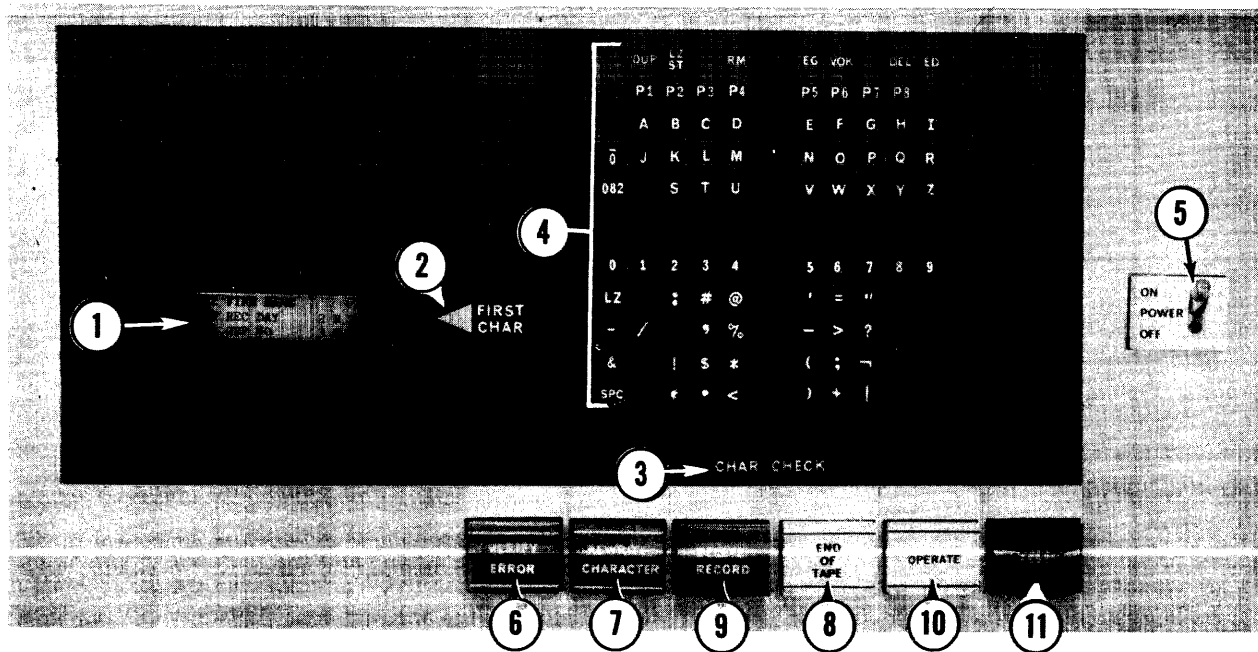

## CONTROLS AND INDICATORS ON THE CONSOLE

The operator's console (upper half of the cabinet) contains the following controls and indicators:

### PROGRAM FIELD APERTURE<sup>1</sup>

The program field aperture displays *three* program fields at a time. The top field visible in the aperture is the field previously processed, the middle field is the currently in process, and the bottom field is the next field to be processed. As each field is completed, the program card advances to the next.

### FIRST CHARACTER INDICATOR<sup>2</sup>

The FIRST CHARACTER indicator indicates that the first position of the field (MSP) is selected; i.e., ready to be written, read, or verified.

In Write mode, the FIRST CHARACTER light indicates that a new field has been entered and that *no* information has been written in that field.

In Read mode, FIRST CHARACTER light indicates that the first character of that field will be *read* and *displayed* upon depression of the Space bar.

In Verify mode, the FIRST CHARACTER light indicates that a new field has been entered and that the first character of that field is the *next* character to be verified.

In any mode, after the first position has been executed, the FIRST CHARACTER light goes "off."

# IBM 50 MAGNETIC DATA INSCRIBER

## CONTROLS AND INDICATORS (CONT.)

### CHAR CHECK INDICATOR<sup>3</sup>

The CHAR (Character) CHECK indicator signals detection of a parity error. Magnetic tape is read and parity-checked during a Search operation, while in Read mode, during a record backspace or field backspace operation in Write mode, and Verify mode. If a parity error is detected during any of these operations, the machine stops, the keyboard *locks*, the current mode is reset, and the CHAR CHECK indicator lights. The CHAR CHECK indicator is reset by performing the initialization procedure or a Search operation.

### CHARACTER READOUT MATRIX<sup>4</sup>

The character readout matrix enables the operator to display a character that has been written on tape. Active only when the machine is placed in Read mode, the matrix can display any of the characters that can be generated by the keyboard and all functional tape codes as well. In the illustration, vertical and horizontal lights indicate that the digit "3" has been written on tape.

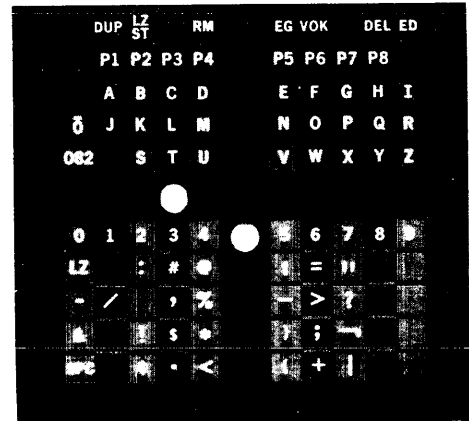

Photo courtesy of IBM

### POWER ON/OFF SWITCH<sup>5</sup>

### VERIFY ERROR INDICATOR<sup>6</sup>

The VERIFY ERROR indicator lights when a *miscompare* (verify error) has occurred. The indicator remains lit until the keyed character *agrees* with the character on tape or until a rewrite character operation occurs.

### REWRITE CHARACTER INDICATOR<sup>7</sup>

The REWRITE CHARACTER indicator is used during Verify mode to indicate that a character on tape that does not agree with the keyed character will be *replaced* with the keyed character at the next key stroke.

### END OF TAPE INDICATOR<sup>8</sup>

The END OF TAPE light indicates that the *end* of tape has been reached. It normally comes on at the end of a record to indicate that no further records can be recorded on the cartridge.

When the machine detects that the end of tape is *nearing*, the END OF TAPE indicator lights, and, if sufficient tape remains, the operator is allowed to finish the record in process. When the record is finished, the keyboard *locks*, inhibiting further keying. Tape rewind must then be initiated. If, after the END OF TAPE indicator lights, there is insufficient tape to finish, the operation is interrupted, and the keyboard is locked. The operator must then depress RECORD BACKSPACE and REWIND, causing an *end of data (ED) code* to be written following the previous (last complete) record. The uncompleted record must then be written, in its entirety, on another tape.

# IBM 50 MAGNETIC DATA INSCRIBER

## CONTROLS AND INDICATORS (CONT.)

### DELETE RECORD INDICATING PUSHBUTTON<sup>9</sup>

DELETE RECORD, a dual-purpose control located on the console, is active only at the *beginning* of a record. When operated, it causes a delete (Del) code to be *written over* the program level (PL) code.

*NOTE: If a deleted record contains information which was to be duplicated in the following record, that information should be entered in the succeeding record.*

As an indicator, DELETE RECORD signals, during Verify mode, detection of an *incorrect length* record. As a switch it enables, during Write mode, an *entire* record to be *deleted*. An incorrect record length condition detected during Verify mode lights the DELETE RECORD indicator, resets Verify mode, and *locks* the keyboard. To restore operation, Read or Write mode must be entered to return to the beginning of the record.

To delete the incorrect length record, depressing WRITE causes the tape to be returned to the beginning of the record. Following this, depressing DELETE RECORD writes a *delete code* over the PL code of the erroneous record and advances tape to the beginning of the following record.

If, following an incorrect record length condition, the record in error is to be identified, READ is depressed. This returns tape to the beginning of the record. After sufficient characters have been read to enable record identification, RECORD BACKSPACE is depressed to return to the start of record. The record may then be deleted by entering Write mode and depressing DELETE RECORD.

### OPERATE INDICATOR<sup>10</sup>

This light indicates that the machine is *ready* for keyboard operation. In Write mode, it indicates that two basic operations can be performed: Manual program select (at the beginning or end of a record) and/or write data. After a program has been selected and the tape is ready to accept data, OPERATE informs the operator that data keying can begin.

In Read mode, OPERATE indicates that the next character on tape can be read, and, in Verify mode, it indicates that verification can begin.

### RESET SWITCH<sup>11</sup>

The RESET switch performs a normal reset function; i.e., it resets selected mode, prepares machine for re-initialization when a non-existent program level is selected, etc.



# IBM 50 MAGNETIC DATA INSCRIBER



Photo courtesy of International Business Machines Corporation

INSERTING A TAPE CARTRIDGE INTO THE LOADING STATION

# IBM 50 MAGNETIC DATA INSCRIBER

## TAPE CARTRIDGE

The magnetic tape cartridge prepared on the IBM 50 Magnetic Data Inscrber contains 100 feet of Mylar tape with a data capacity of 23,000 characters at a density of 20 characters per inch. The self-threading tape has sprocketed holes on one edge to facilitate feeding and is contained in a protective plastic cartridge. It requires no special handling by the operator. The cartridge protects the tape from dust and damage, and previously recorded tapes can be used to record new information at any time. While the output tapes are intended primarily for entering data into a data processing system, they may also be used to store data. The IBM 2495 Tape Cartridge Reader (TCR) is used to transfer data recorded on the tape into a data processing system.

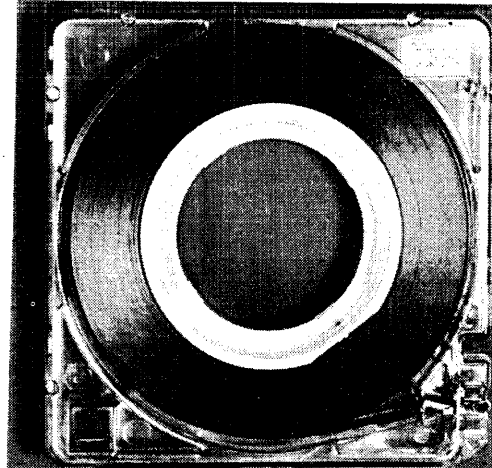

Photo courtesy of IBM

As data is entered into the IBM 50, an incremental drive mechanism passes the magnetic tape over a read/write head where the key-entered data is transferred to (or read from) the tape in the form of magnetic impulses. Data is written in one-character increments at a data density of 20 characters per inch, using the same code structure as that used on IBM System/360's. This code, called Extended Binary Coded Decimal Interchange Code (EBCDIC), consists of eight data bits plus a parity bit.

To load a tape for writing, the operator simply inserts a cartridge into the machine and selects an operating mode. This causes the tape to be automatically threaded through the tape path and prepared for processing. An OPERATE indicator, located on the operator's console, lights when the tape is loaded, indicating that data entry can begin. Tape rewind is also simple and efficient; a fully extended reel of tape rewinds in approximately 45 seconds.

## TAPE STATION

The tape station, located on the right side of the console, consists of a loading station, a tape drive mechanism, a read/write head, and a tape bin.

The loading station, where a tape cartridge is placed when in use, consists of a drive spool and guide pins which facilitate cartridge loading. An *automatic locking mechanism* is incorporated in the loading station to prevent removal of tape cartridge when the tape is loaded.

The tape drive mechanism consists of a sprocket wheel, incremental and rewind drive motors, a tape buffer arm, and associated circuitry. The sprocket wheel engages the sprocket holes along one edge of the magnetic tape. The tape is advanced or backspaced, incrementally, over the read/write head at a speed of 100 characters per second by means of the sprocket wheel and drive motor.

The tape read/write head records key-entered data on (or reads data from) the magnetic impulses (bits). The portion of tape that has advanced beyond the read/write head is stored in the tape bin.

# IBM 50 MAGNETIC DATA INSCRIBER

## TAPE STATION CONTROLS

The tape station, located to the right of the operator's console, contains the SEARCH and REWIND buttons.

### SEARCH BUTTON<sup>1</sup>

The SEARCH button (not lit) is located near the tape cartridge loading station. Depressing this button resets the selected mode and advances the tape in a forward direction (at 100 characters per second) until an end group (EG) or end of data (ED) code is detected. When an EG or ED is detected, the forward search stops, Read mode is entered (the READ indicator lights), and an EG or ED is displayed.

Upon detection of an EG, the SEARCH button may *again* be depressed to find the next EG. If the end of tape is reached before an EG or ED is detected, the END OF TAPE indicator lights, and the SEARCH button may no longer be used. SEARCH may be operated with tape rewind or with tape fed into the machine.

### REWIND<sup>2</sup>

The REWIND button is located near the tape cartridge loading station, next to the SEARCH button. REWIND is active only in Write or Read mode. In Read mode, depressing REWIND causes an automatic tape rewind. In Write mode, the REWIND button is effective only when a record is *not* in process, i.e., when at the beginning of a program format and before manual keying begins. When REWIND is operated under these conditions, an end of data (ED) code is automatically written at the end of the previous record, following the record mark (RM), and the tape is automatically rewind.

A tape rewind operation, i.e., removing tape from the tape bin and placing it back on the reel, is performed at a much higher rate of speed than that used when reading and writing. A fully extended reel of tape (100 feet) requires a maximum of 45 seconds to rewind. A tape reel security device prevents a tape cartridge from being removed unless the tape is fully rewind.

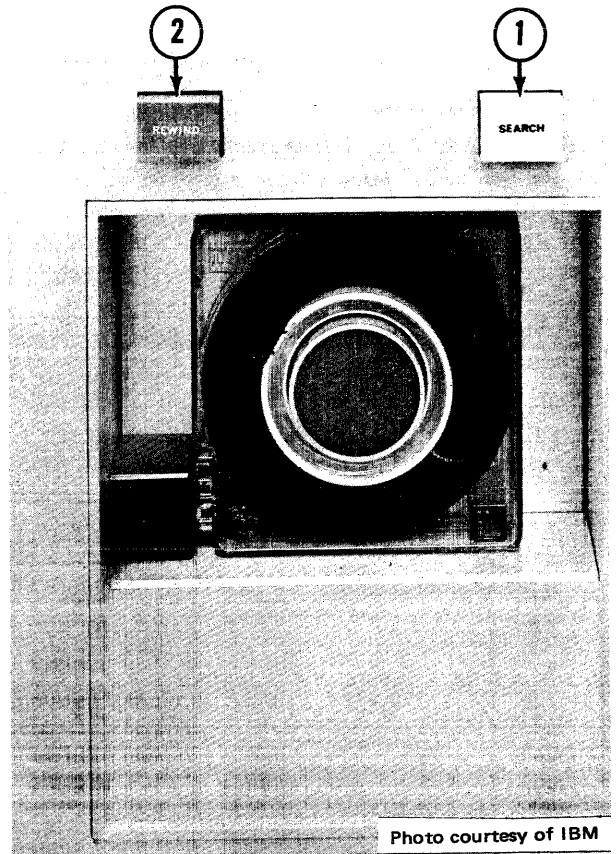

# IBM 50 MAGNETIC DATA INSCRIBER

## INITIALIZATION

### INITIAL LOADING

After a tape cartridge is inserted in the loading station, depressing the desired mode button places the machine in that particular mode and feeds the tape in a forward direction.

In Write mode, the tape feeds to the beginning of tape (BOT) position where a *manual* program selection must be made. Once selection has been made, the tape is automatically advanced to the usable area of tape where recording can begin. In Read and Verify modes, the tape feeds forward to the first program level (PL) character recorded on tape, and the corresponding program is automatically selected.

### INITIALIZATION FOLLOWING POWER LOSS

If power is removed or lost when tape is fed into the machine, initialization is as follows after power is restored. Depressing a mode button places the machine in that particular mode and feeds tape backwards until a program level (PL) character is detected. The program card is automatically positioned at the indicated program level and operation can begin.

If a PL character is *not* found before the beginning of tape is reached, the tape is fully rewound, and the mode light goes out. At this point the desired mode button may be depressed and the initial loading procedure repeated.

## MODES OF OPERATION

### WRITE MODE

Depressing the WRITE button places the machine in Write mode, lights the WRITE indicator, and resets any other mode. The machine is now ready for writing, starting with the *next* character position following the last character displayed (or verified) when Write mode was entered.

### READ MODE

Depressing the READ button places the machine in Read mode, lights the Read indicator, and resets any other mode. The *last* character written (or verified) when Read mode was entered is displayed. Display of other characters can then be made, one at a time, by depressing the SPACE bar. The normal function of the SPACE bar and all character keys is *inhibited* when in this mode. Depressing the SKIP key displays the *last* character of the skipped field. Depressing the REL (Release) key advances the tape to the start of the *next* record. Depressing any of the other keys while in Read mode causes the keyboard to *lock*. FIELD BACKSPACE must be used to restore the keyboard. RECORD BACKSPACE and FIELD BACKSPACE are operable during Read mode.

# IBM 50 MAGNETIC DATA INSCRIBER

## MODES OF OPERATION (CONT.)

### VERIFY MODE

The verify capability, standard on the IBM 50, enables the operator to verify and, if needed, correct tape produced on the same or other IBM 50's. Verification is performed by comparing the data stored on tape with that used to generate the tape. This requires rekeying the original data. As each character is keyed, the corresponding character is read from tape and the two are *compared* within the verify circuitry.

Tape stored data is verified by rekeying all data except data contained in non-verify (bypassed) fields. A non-verify field is one that does not require verification. Non-verification of a field is accomplished through programming by punching the non-verify code in the field of the program card that corresponds to the data field not to be verified.

*NOTE: Since the non-verify code is ineffective during the write mode, the same program card can be used for both data recording and data verification.*

Verification is performed as follows:

1. Load the tape to be verified.
2. Depress the verify button. This lights the verify indicator.

*NOTE: When the verify button is depressed, the first character of the record (the PL code) is automatically read and a program search is initiated to select the program level that was used when the tape was generated. Data keying can begin after the program search.*

3. Key data. If the keyed character matches the character on tape, verification proceeds without interruption.

### VERIFY ERROR INDICATOR LIGHTS

If the keyed character does not agree with the character on tape, the keyboard locks and the VERIFY ERROR indicator lights. The operator must then depress VERIFY RESET and rekey the character in error. If the keyed character *matches* after the second key stroke, the VERIFY ERROR indicator goes off and the operator is permitted to continue verification.

### MAKING A CORRECTION

If a mis-compare exists after the second try, the VERIFY RESET key must be depressed *again*. This causes the REWRITE CHARACTER indicators to go on; on the next key depression, the character on tape is *replaced* with the keyed character. The field in which the correction is made must be verified; tape advancement to the next record is prevented until re-verification is performed. After re-verification of a corrected record, the operator may continue to verify the files.

After an entire record has been verified, the IBM 50 automatically replaces the previously written record mark (RM) code with a verify OK (VER OK) code.

# IBM 50 MAGNETIC DATA INSCRIBER

## MODES OF OPERATION (CONT.)

### ENTERING ANOTHER MODE DURING VERIFICATION

If during the verification of a record it is necessary to enter another mode, e.g., READ MODE, this can be done providing that while in the new mode a key is not depressed in the next field. Return to verify mode is accomplished by depressing the FIELD BACKSPACE key and then depressing VERIFY. If a key is depressed while in the next field, the RECORD BACKSPACE key must be depressed, returning the record to the first field before the verify mode can be re-entered.

*NOTE: When a single character of a record is verified, the entire record must be verified before the machine will advance to the next record. If the operator chooses to end verification of the record once verification has been started, she must RECORD BACKSPACE and enter the read mode before the machine can be advanced to the next record.*

### END OF GROUP (EG) CODE

When an end group (EG) code is detected while in the verify mode, it indicates that verification of that group of records is complete. The machine automatically enters the read mode when the EG code is displayed. If succeeding records are to be verified, the space bar must be used to advance to the first record of the next group. When this record is located, verify mode must be re-entered and verification can be continued until the next end of group code is encountered. If desired, tape can be rewound when the end of group code is displayed by placing the machine in read mode. End of data (ED) is also treated as an end of group (EG); however, end of data indicates no succeeding records are to be verified.

## PROGRAM START

A program start code is punched at the beginning of *each* program level (in the Program Start section of the program card) to define the starting point of the respective programs. The program start code is also used with the program end code at the end of a program if the program for which the *two* codes form a terminus is to be re-selected. In addition to the program start code, the corresponding program number (1 through 8) must also be punched in the Program Level and Field Size column, opposite program start.

The Program Start column of each program must contain a punch at the beginning of the program to designate program start as well as a punch (or punches) in the Program Level and Field Size column, designating the level (number) of that program.
--

When the Program Start and Program End columns both contain punches at the terminus (program end) of a program, this causes the program to be re-selected. For example, if at the end of a program, both Program Start and Program End columns are punched and a 2 is also punched in the Program Level and Field Size column, program level 2 is automatically repeated (re-selected). (Program search in this case is in *reverse* direction, minimizing the time required to select a program.)

# IBM 50 MAGNETIC DATA INSCRIBER

## PROGRAM END

The end of each program is designated by a punch in the Program End column of the program card. When program end is detected, it causes a record mark (RM) to be written in the *corresponding* tape position. When program end is accompanied by a program number punched in the Program Level and Field Size column, it causes the designated program to be *automatically* selected. If program end is used alone, i.e., without an accompanying program number, the machine stops upon detecting program end, and a *manual* program selection must be made.

If the program start column and the program end column both contain punches in the same field, the program which they terminate is automatically re-selected upon their detection.

## PROGRAM LEVEL OR FIELD SIZE

The Program Level or Field Size column, when used in conjunction with Program Start and Program End, designates program number, and, with Field Functions, designates field length.

When used with Program Start, the punch or punches in this section define the numerical designation of the program. For example, a punch in the Program Start column, accompanied by a punch in columns 1 and 2 of the Program Level and Field Size column, designates the start of program number 3. When used with program end, these columns define the program that is to be used *next* and, further, cause the designated program to be *automatically selected*.

When used in conjunction with the Field Functions column, the Program Level and Field Size columns define the length of the associated field; i.e., the number of characters in the field. *Field length is limited to 15 characters. If a field greater than 15 characters is needed, chaining of instructions (fields) can be used.* When more than one instruction is chained, the first instruction defines the function to be performed and the number of characters. The successive instructions do not contain a function code but include the additional character count. *Chained instructions (fields) are treated as one field.*

# IBM 50 MAGNETIC DATA INSCRIBER

## FIELD FUNCTIONS

### MANUAL

When the manual position of the Field Function column of the program is punched, it indicates that the field is to be manually keyed. The length of the manual field is designated by a value punched in the associated Program Level and Field Size column.

### SKIP

The skip position of the Field Function column is punched to designate an automatic skip field. When the AUTO SKIP/DUP switch is "on" and a skip code is detected, a space code is automatically written in each position of the skip field. The length of the skip field is designated by a value punched in the Program Level and Field Size column, opposite the skip field.

### DUPLICATE (DUP)

The duplicate position of the Field Functions column is punched to designate an automatic duplication field. Detection of the DUP code when the AUTO SKIP/DUP switch is "on" causes DUP codes to be written in each position of the duplication field. The length of the duplication field is designated by a value punched in the Program Level and Field Size column, opposite the duplication field.

### CHAINED FIELD

When *none* of the positions of the Field Functions column are punched, the field is a *chained* field; i.e., a continuation of the previous field. (Field Size must be punched to designate length of the chained field.)

## FIELD MODIFIERS

### ALPHA (ALPHABETIC)

When the Alpha column of the Field Modifiers section of the program card is punched, it indicates that the corresponding field is an alphabetic field. *To enter numeric data in an alphabetic field, the numeric key must be depressed.*

### LEFT ZERO

The left zero program code causes a field to be filled with left-zero codes, following the last significant digit, when the LEFT ZERO key is depressed. (See "LEFT ZERO key".)

### NON-VERIFY

The non-verify code is used during Verify mode *only*. It indicates that the field is to be bypassed, i.e., not be key verified.

*NOTE: Bypassed fields are parity-checked.*



## IBM 2495 TAPE CARTRIDGE READER

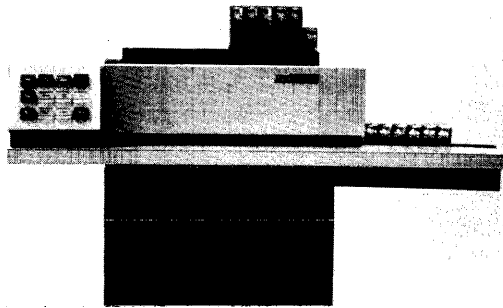
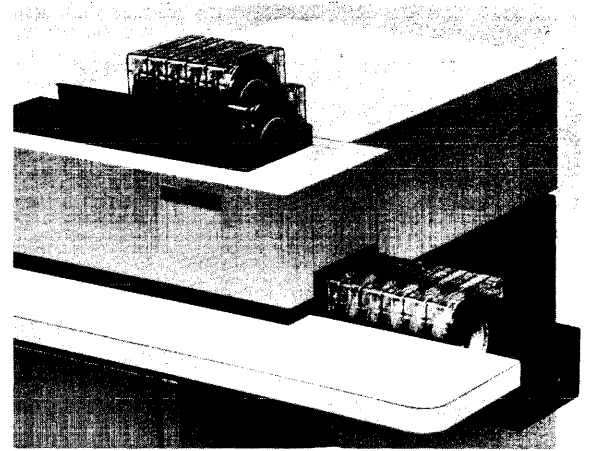
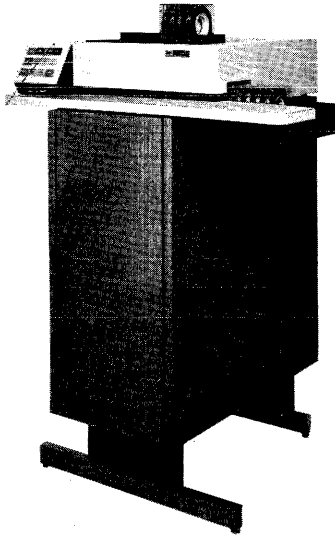

Photos courtesy of IBM

### FEATURES

1. The tape cartridge reader accepts cartridges produced on the IBM 50 Magnetic Data Inscriber.
2. It reads data into storage from a cartridge at 900 characters per second.
3. It provides direct input to multiplexor channel on System/360 Model 30,40 or 50.
4. Tape can be backspaced under program control.
5. There is odd parity checking of data going to System/360 channel.
6. There is logical (symbolic) input/output unit address of reader assigned by operator.
7. Up to 12 cartridges can be loaded into the hopper (additional cartridges can be loaded without stocking the reader during reading, but not during the load/unload cycle.)
8. Cartridges are loaded, read, rewound, and unloaded without operator intervention from start to finish.
9. Usage is metered only when the cartridge is loaded and the first read command is accepted.
10. Reader and control unit are mounted in the same housing.

# IBM 2495 TAPE CARTRIDGE READER

## DESCRIPTION

The IBM 2495 Tape Cartridge Reader (TCR) is used to *transfer* data stored on magnetic cartridge tape to an IBM System/360, Model 30, 40, or 50. The TCR attaches to a multiplexer channel and accepts cartridge tapes generated on either the IBM 50 Magnetic Data Inscrber or the IBM Magnetic Tape Selectric Typewriter (MTST) System. The TCR is program-controlled and reads tape-stored data at 900 characters per second; each character is parity-checked as it is read.

As many as 12 tape cartridges, each containing 100 feet of magnetic tape, can be loaded in the TCR feed (auto loader) at one time. Following initialization, each tape is automatically fed into the tape read station and loaded. After a tape has been read and rewound (at 45 inches per second), under control of the program, it is automatically unloaded, placed in the stacker, and the following tape is loaded. (The time required to unload one cartridge and load the following is approximately 5 seconds.)

Initialization is performed by operating the START button after the tape cartridges have been placed in the auto loader. This causes the first tape cartridge to be fed, mounted on the tape read station, and readied for reading. (*Note: The TCR is readied as soon as the cartridge is mounted, and threading does not take place until the first Read command is initiated.*)

## COMPONENTS

### AUTO LOADER

The Auto Loader stores the tape cartridges that are to be read and *automatically* feeds each cartridge to the tape read station as the preceding cartridge is unloaded. The auto loader can accommodate 12 tape cartridges at one time.

### TAPE READ STATION

The Tape Read Station consists of the tape drive mechanism and tape read head. It is at this station that the tape-stored data is *read* from the magnetic tape. Tape is read serially (one character at a time) and placed in registers where it is then checked for parity and transferred to the channel.

### TAPE BIN

The Tape Bin provides a temporary storage for the tape that has been read. As tape is pulled from the cartridge, it is collected in the tape bin.

### STACKER

The Stacker stores the tape cartridges that have been read. After the tape has been read and rewound, the tape cartridge is ejected into the stacker. The stacker can hold 12 tape cartridges. An indicator is provided to signal a full stacker.

### INTERFACE

The TCR/Channel Interface contains the circuitry required to exchange control signals, data bytes, and command bytes with the associated System/360 multiplexer channel.

# IBM 2495 TAPE CARTRIDGE READER

## CONTROLS AND INDICATORS

### START BUTTON

Depressing the START button places the TCR in the *ready* state if a tape is loaded and each of the following conditions exists:

1. The TCR is not communicating with the channel.
2. The TCR does not contain unaccepted status.
3. The tape is not moving.
4. Select Out is inactive.
5. The stacker is *not* full.
6. A cartridge is in the hopper, or the END OF FILE indicator is "on."

If a tape cartridge is not loaded, depressing START causes a cartridge to be loaded, provided a cartridge is in the hopper and the stacker is not full. When loaded, the TCR enters the ready state if a cartridge is in the hopper, or if the END OF FILE indicator is "on" and the STOP button is not depressed during cartridge loading.

The TCR must be in the ready state before any command other than Sense or Test I/O will be accepted. If the TCR is not in the ready state, Intervention Required is set in the sense byte (see Sense Bit 1).

### STOP BUTTON

The STOP button places the TCR in the not-ready state if each of the following conditions exists:

1. TCR is not communicating with the channel.
2. TCR does not contain unaccepted status.
3. The tape is not moving.

If all of the above conditions do not exist at the time STOP is depressed, transition to the not-ready state occurs when these conditions are satisfied.

If the STOP button is depressed during a rewind and unload operation (initiated by a Control Rewind and Unload command), the changer will stop in the discharge position.

Depressing STOP during cartridge-loading prevents the TCR from entering the ready state. If STOP is depressed during cartridge-loading and while the TCR is in the ready state, it will enter the not-ready state after Device End is presented to the channel.

Depressing STOP turns "off" the END OF FILE indicator.

# IBM 2495 TAPE CARTRIDGE READER

## CONTROLS AND INDICATORS (CONT.)

### UNLOAD BUTTON

Depressing the UNLOAD button causes the tape to unload if the TCR is in the *not-ready* state. When the tape is unloaded, depressing UNLOAD causes the mounted cartridge to be ejected and the next to be mounted. The TCR is not made ready as it is when the START button is depressed.

### END OF FILE BUTTON

The End of File button is depressed when the last stack of cartridges of a given file is positioned in the hopper. This lights the END OF FILE indicator and causes the TCR to signal the channel when the end of the last tape in the stack is reached by setting Unit Exception along with Channel End in the status byte. *(The last cartridge is not processed unless the END OF FILE button has been operated.)*

### READY INDICATOR

The READY indicator lights when the TCR is ready; i.e., the tape is properly loaded, the START button has been depressed, and the TCR is ready for operation with the channel.

### NOT READY INDICATOR

The NOT READY indicator lights when the TCR is not ready.

### END OF FILE INDICATOR

The END OF FILE indicator lights when the END OF FILE button is depressed. It remains on until the STOP button is depressed, or until Channel End status is accepted following the command that causes the last cartridge to be rewound.

### STACKER FULL INDICATOR

The STACKER FULL indicator lights when the stacker is full.

### LOAD POSITION INDICATOR

The LOAD POSITION indicator lights when a cartridge is loaded on the tape deck and no tape has been removed from the cartridge.

### RUN INDICATOR

The RUN indicator lights when tape is being moved.

### AUTO LOAD INDICATOR

The AUTO LOAD indicator lights during a tape cartridge load or unload operation.

# IBM 2495 TAPE CARTRIDGE READER

## ADDRESSING

The IBM 2495 TCR uses standard IBM System/360 addressing and selection sequences. The TCR is addressed by an eight-bit address byte of a preassigned configuration and must be adapted at time of installation to respond only to its assigned address.

## CODE SETS

The TCR accepts and parity checks the code generated by either the IBM 50 Magnetic Data Inscrber or the IBM Magnetic Tape Selectric Typewriter (MTST) System. *The EBCDIC code generated by the IBM 50 is compatible with that used on IBM System/360's.* The code generated by the MTST system may be translated to EBCDIC or any other desired translation by the computer program.

## COMMANDS AND COMMAND OPERATION

The following commands can be executed by the IBM TCR:

COMMAND	COMMAND BYTE								
	P	0	1	2	3	4	5	6	7
READ	0	0	0	0	0	0	0	1	0
CONTROL BACKSPACE	1	0	0	1	0	0	1	1	1
CONTROL REWIND AND UNLOAD	1	0	0	0	0	1	1	1	1
CONTROL NO-OP	1	0	0	0	0	0	0	1	1
SENSE	0	0	0	0	0	0	1	0	0

### READ COMMAND

The Read command causes data to be transferred from the TCR to the channel. Once the record area of the tape has been reached, data is read, at approximately 1.1ms per byte, until the channel count reaches 0 or until a stop code, data check, or end of tape is detected. When the command is terminated, Channel End is immediately presented to the channel along with any other status generated during execution of the Read command.

If Unit Check is *not* presented with Channel End, the data transferred during the Read command is considered valid. If command chaining is not indicated when Channel End is presented, a *repositioning* cycle is initiated to stop the tape. Device End is presented when the repositioning cycle is completed (approximately 300ms). If command chaining is indicated, Device End is presented immediately following Channel End.

A parity error causes the TCR to terminate data transmission following acceptance of the erroneous character by the channel. Unit Check is set in the TCR status byte and Data Check is set in the sense byte. The location of the erroneous character can be determined by the residual channel control word (CCW) count.

# IBM 2495 TAPE CARTRIDGE READER

## COMMANDS AND COMMAND OPERATION (CONT.)

### CONTROL BACKSPACE COMMAND

The Control Backspace command is used to backspace tape under channel control. When tape stop occurs, Channel End status is presented immediately, along with any other status generated.

If command chaining is not indicated when Channel End is presented, a reposition cycle is initiated to stop the tape. Device End is presented when the repositioning cycle is completed (approximately 300ms). If command chaining is indicated, Device End is presented immediately following Channel End.

### CONTROL REWIND AND UNLOAD COMMAND

The Control Rewind and Unload command causes the tape to be rewound, the cartridge to be unloaded (placed in the stacker), and the following cartridge to be loaded.

Upon acceptance of the Control Rewind and Unload command, Channel End is presented to the channel and tape rewind begins. After the tape is rewound, the cartridge unloaded, and the following cartridge loaded, Device End is presented.

Upon conclusion of this command, the TCR remains ready unless one of the following conditions exists:

1. The stacker is full.
2. The feed hopper is empty and the END OF FILE indicator is "off."
3. The STOP button is depressed during cartridge loading.

Under a full stacker condition, the TCR becomes *ready* when the stacker is emptied and the START button is depressed. If the hopper is empty, or if the STOP button is depressed during command execution, the command is terminated with the cartridge in the unload position. Device End is presented, and the TCR becomes *not ready*.

When the last cartridge is rewound and unloaded, the TCR becomes not ready and remains so until additional cartridges are loaded.

### CONTROL NO-OPERATION COMMAND

The Control No-Operation (No-Op) command is accepted only if the TCR is *not busy* and Unit Check status is *not present*. If the command is accepted, Channel End and Device End status are presented to the channel during initial selection.

If the Control No-Op command is issued when the TCR is not ready, the command is rejected. Unit Check is set in the status byte, and Intervention Required is set in the sense byte.

If the Control No-Op command is issued when the TCR is busy, the command is rejected and Busy is set in the status byte.

### SENSE COMMAND

The Sense command causes the TCR sense byte to be transferred to main storage for program analysis. The sense byte is placed in the storage location specified by the CCW.

# IBM 2495 TAPE CARTRIDGE READER

## SENSE AND STATUS BYTES

### STATUS BYTE

The status byte is used to relate to channel the current status of the 2495 TCR; e.g., it may indicate the detection of an error, that the TCR is busy, or that it is ready to accept a command. The status byte is presented to the channel during initial and ending sequences and is reset upon channel acceptance.

Each bit of the TCR status byte is described below.

PARITY (BIT P): provides *odd* parity in the status byte.

ATTENTION (BIT 0): not used.

STATUS MODIFIER (BIT 1): not used.

CONTROL UNIT END (BIT 2): not used.

BUSY (BIT 3): included in the status response when a command is received while another command is in progress. The only exception to this is when a Test I/O instruction is received and ending status (Channel End or Device End) for the command in progress is available. *A command is considered in progress from the time it is accepted by the TCR until Device End for that command is accepted by the channel, or until Device End is cleared by a Test I/O instruction.*

The Busy bit is set when any command, except Test I/O, is issued while unaccepted status exists. Busy is set as a result of a Test I/O instruction only if a previously initiated operation is being performed and ending status is not available.

CHANNEL END (BIT 4): included in the status response:

1. Immediately following the transfer of the last byte of data during a Read command, Control Backspace command, or Sense command. If Channel End is not accompanied by Unit Check, the data transferred is considered valid.
2. Immediately after the acceptance of a Control Rewind and Unload command.
3. During the initial selection of Control No-Operation command if the command is accepted.

DEVICE END (BIT 5): included in the status response:

1. After the last reposition cycle has been completed for a Read or Control Backspace command except when command chaining.
2. After the presentation of Channel End if command chaining is indicated for a Read or Control Backspace command.
3. After the last byte of data has been transferred during a Sense command.
4. After entering the ready state.
5. Upon termination of the cartridge change operation during a Control Rewind and Unload command.

# IBM 2495 TAPE CARTRIDGE READER

## SENSE AND STATUS BYTES (CONT.)

### STATUS BYTE (cont.)

UNIT CHECK (BIT 6): included in the status response when any of the Sense bits are set except during a Sense command. Sense status resulting from a previous operation does not cause Unit Check to be set in response to a Test I/O instruction or Control No-Op command unless Intervention Required is also set in the Sense byte.

UNIT EXCEPTION (BIT 7): set when:

1. Channel End is presented following a Read command that is terminated by transfer of a Stop code.
2. Channel End is presented following a Control Rewind command that causes the last cartridge of a file to be rewound.
3. Initial status is presented in response to a Test I/O instruction if status is stacked and request for service has not been honored.

### SENSE BYTE

The TCR sense byte is presented to the channel in response to the Sense command. The sense byte records and provides the channel with information regarding unusual conditions that occurred during the preceding operation. The sense byte is reset by any command other than Test I/O, Sense, or No-Op.

Each of the sense bits is described below.

PARITY: provides odd parity in the sense byte.

COMMAND REJECT (BIT 0): set under any of the following conditions:

1. An *invalid* command is received and the TCR is not busy nor holding status. (A command with even parity is not considered an invalid command.)
2. A Read command is received when the tape is positioned at the end of the tape area.
3. A Control Rewind and Unload or Control Backspace command is received when a tape is in the load position.

INTERVENTION REQUIRED (BIT 1): set when the TCR is in the *not ready* state.

BUS OUT CHECK (BIT 2): set when a command byte of *even* parity is detected.

EQUIPMENT CHECK (BIT 3): not used.

DATA CHECK (BIT 4): set if a data byte of *even* parity is detected in the data register during a Read command.

OVERRUN (BIT 5): not used.



# IBM 2495 TAPE CARTRIDGE READER

## SENSE AND STATUS BYTES (CONT.)

### SENSE BYTE (cont.)

POSITION CHECK (BIT 6): can be set during a Read or Control Backspace command. This bit indicates that the command has positioned the tape *beyond* the record area. Position Check is set during a Read command if both the end of the record area and the end of tape slot are reached before an end of tape code is detected.

During a Control Backspace command, Position Check occurs if the tape is backspaced into the beginning of tape slot (approximately 20 positions *before* the oxide portion of tape).

END OF FILE (BIT 7): Bit 7 is not used.

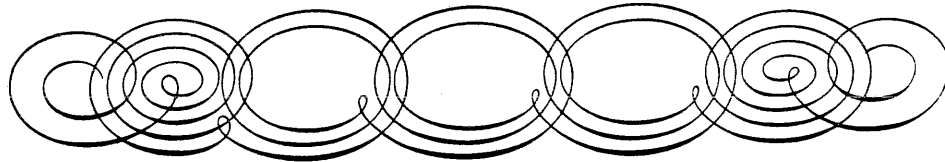

**PROGRAM CODES**

- SPACE - Numeric Shift Carry      5 - Start Auto Skip No. 1
- 1 - Letter Shift Carry            6 - Left Zero Control
- 2 - MSP of Numeric Field        7 - Left Zero Control
- 3 - MSP of Alpha Field         \*\* 12 - Start Auto Dup. No. 2
- 4 - Start Auto Dup No. 1        \*\* 13 - Start Auto Skip No. 2

\*(Not applicable to 1101/735 Model A)

\*\* (1101/735 only)

**MAIN**

- ENTRY
- VERIFY
- ENTRY & VERIFY

**ALT**

- ENTRY
- VERIFY
- ENTRY & VERIFY



**DATA RECORDER  
PROGRAM PLANNING CARD**

ALTERNATE PROGRAM				MAIN PROGRAM			
Code Pos.	Data	Code Pos.	Data	Code Pos.	Data	Code Pos.	Data
91		91		91		91	
92		92		92		92	
93		93		93		93	
94		94		94		94	
95		95		95		95	
96		96		96		96	
97		97		97		97	
98		98		98		98	
99		99		99		99	
100		100		100		100	
101		101		101		101	
102		102		102		102	
103		103		103		103	
104		104		104		104	
105		105		105		105	
106		106		106		106	
107		107		107		107	
108		108		108		108	
109		109		109		109	
110		110		110		110	
111		111		111		111	
112		112		112		112	
113		113		113		113	
114		114		114		114	
115		115		115		115	
116		116		116		116	
117		117		117		117	
118		118		118		118	
119		119		119		119	
120		120		120		120	
121		121		121		121	
122		122		122		122	
123		123		123		123	
124		124		124		124	
125		125		125		125	
126		126		126		126	
127		127		127		127	
128		128		128		128	
129		129		129		129	
130		130		130		130	
131		131		131		131	
132		132		132		132	
133		133		133		133	
134		134		134		134	
135		135		135		135	
136		136		136		136	
137		137		137		137	
138		138		138		138	
139		139		139		139	
140		140		140		140	
141		141		141		141	
142		142		142		142	
143		143		143		143	
144		144		144		144	
145		145		145		145	
146		146		146		146	
147		147		147		147	
148		148		148		148	
149		149		149		149	
150		150		150		150	
151		151		151		151	
152		152		152		152	
153		153		153		153	
154		154		154		154	
155		155		155		155	
156		156		156		156	
157		157		157		157	
158		158		158		158	
159		159		159		159	
160		160		160		160	
161		161		161		161	
162		162		162		162	
163		163		163		163	
164		164		164		164	
165		165		165		165	
166		166		166		166	
167		167		167		167	
168		168		168		168	
169		169		169		169	
170		170		170		170	
171		171		171		171	
172		172		172		172	
173		173		173		173	
174		174		174		174	
175		175		175		175	
176		176		176		176	
177		177		177		177	
178		178		178		178	
179		179		179		179	
180		180		180		180	

JOB NAME	JOB NO.	SOURCE DOCUMENT
STUDENT NAME	DATE	CLASS
	<input type="checkbox"/> A.M.	<input type="checkbox"/> P.M. <input type="checkbox"/> EVE.