

# REFLEX II

**Microdata**

**Video Training Workbook**

## PREFACE

The purpose of this training program is to familiarize you with the Reflex II Disc Drive. This is a programmed self-education program utilizing video tape as a primary training medium. The other media that you will use in this program are this workbook, the Reflex II Instruction Manual, and the actual Reflex II unit. Since this is a self-paced program, what you obtain from it will depend greatly upon the amount of effort that you spend on it.

Video tape was selected as a training medium for several reasons. They are:

- It conveys motion.

- It conveys size ratio.

- The camera can give you a close-up view of the particular item being discussed.

- Studies have indicated that retention rate is 35% higher than with a lecture.

- If you did not understand something the first time through, you can review the procedure again.

- You stay on the job, only using the time required to learn one particular unit.

- The program results in a saving of money for Microdata and of time for you.

There are two distinct disadvantages; video does not provide hands-on training time and it does not replace a strong instructor/classroom situation. The one disadvantage can be overcome by using this workbook, the Instruction Manual, and an actual unit, and performing work under proper supervision. The second disadvantage can be overcome by perseverance on your part and by conscientious application of the material presented herein.

In developing this program, it was determined that the advantages far outweigh the disadvantages as long as the program is in support of the present Microdata training program for customer engineers in the field and for technicians at our repair centers.

The video tape training programs are designed to get new developments to you faster, providing increased training in a more timely manner and at less overall cost in time and money.

## TABLE OF CONTENTS

<u>SECT.</u>	<u>CONTENTS</u>	<u>PAGE</u>
	Preface	i
	Table of Contents	ii
	List of Illustrations	iv
	Introduction	1
1.	Reflex I and How It Functions	3
	Scope	3
	Video Tape	3
	Reading	3
	Review	4
	Self Test	8
2.	Physical Comparison of Reflex I and Reflex II	9
	Scope	9
	Video Tape	9
	Reading	9
	Review	10
	Self Test	12
3.	Components of Reflex II	13
	Scope	13
	Video Tape	13
	Reading	13
	Review	14
	Self Test	18
4.	Pre-Installation Considerations	19
	Scope	19
	Video Tape	19
	Reading	19
	Review	19
5.	Installation	21
	Scope	21
	Video Tape	21
	Reading	21
	Review	22
	Self Test	24
6.	Post-Installation Testing	25
	Scope	25
	Video Tape (Part One)	25
	Reading (Part One)	25
	Video Tape (Part Two)	26
	Reading (Part Two)	26
	Review	26
	Power Up Sequence	27
	Integrating With System	28
	Logic/Interface PCB Configuration	29
	Self Test	30

<u>SECT.</u>	<u>CONTENTS</u>	<u>PAGE</u>
7.	Maintenance	31
	Scope	31
	Video Tape	31
	Reading	31
	Review	32
	Corrective Maintenance	32
	Cooling Fans/Spindle Motor	34
	Logic/Interface DC Voltages Dist.	35
	Servo PCB DC Voltage Dist.	36
	Read/Write PCB Voltages	37
	Self-Test	38
8.	Troubleshooting and Adjustments	40
	Scope	40
	Video Tape	40
	Reading	40
	Review	41
	Servo Speed Adjustment	42
	Servo Balance	43
	Velocity Verification	43
	Phase Detector Offset Verification	45
	Read/Write Pulse Width Verification	46
	Brake Verification	47
	Ground Brush Assembly Check	47
9.	Removal and Replacement	49
	Scope	49
	Video Tape	49
	Reading	49
	Review	49
	Circuit Board Removal	50
	Read/Write PCB Removal	51
	Servo PCB Removal	52
	Logic/Interface PCB Removal	53
	Power Supply/Amp PCB Removal	54
	LED/Switch PCB Removal	55
	Electromechanical Assemblies	57
	Sealed Module and Motor	57
	Cooling Fan	57
	Transformer Assembly	59
	Drive Belt	60
	AC Motor Pulley	61
	AC Spindle Motor	61
	Ground Brush Assembly	62
	Brake Assembly	63
	Line Filter Assembly	64
10.	Final Review and Test	65



## LIST OF ILLUSTRATIONS

<u>DESCRIPTION</u>	<u>FIG.</u>	<u>PAGE</u>
Reflex I Sealed Module (Cutaway View)	1	4
Reflex I Heads and Platters	2	5
Reflex I Components	3	6
Reflex I Components	4	7
Reflex II Sealed Module (Cutaway View)	5	10
Reflex II Components	6	15
Reflex II Components	7	16
Cooling Fan Location	8	16
Power Components	9	17
Logic/Interface PCB	10	23
Power Supply and Components	11	33
Power Interlock Connector and Line Filter	12	33
Logic Interface Test Point Locations	13	35
Servo PCB Test Point Locations	14	36
Read/Write PCB Test Point Locations	15	37
Verification of Index/Up-To-Speed Pulses	16	41
Adjustment For Disc Speed	17	42
Velocity Adjustment	18	44
Phase Detector Offset Verification	19	45
Read/Write Pulse Width Verification	20	46
Ground Brush Assembly	21	47
Disc Brake Assembly	22	48
Ground Brush Assembly	23	48
Reflex II PCB Replacement Access	24	50

LIST OF ILLUSTRATIONS (CONT.)

<u>DESCRIPTION</u>	<u>FIG.</u>	<u>PAGE</u>
Read/Write PCB Removal	25	51
Servo PCB Removal	26	52
Logic/Interface PCB Removal	27	53
Power Supply/Amplifier PCB Removal	28	54
LED/Switch PCB Removal	29	55
Reflex II, Access For Maintenance	30	56
Cooling Fan Placement	31	58
Cooling Fan Removal	32	58
Transformer Assembly Removal	33	59
Motor Pulley And Drive Belt	34	60
Ground Brush Assembly	35	62
Brake Assembly	36	63
Line Filter Assembly	37	64

## INTRODUCTION

This program is designed to help you gain a working knowledge of the Reflex II Disk Drive. Upon the completion of the program, you should have the knowledge necessary to install, maintain and service the Reflex II. The knowledge factors that you should obtain from this course are:

- Operational theory.
- Installation procedures.
- Voltage measurements.
- Adjustments.
- Troubleshooting to modular level.
- Disassembly to modular level and reassembly.

This program does not provide a detailed theory of operation nor does it present the material necessary to troubleshoot or service the unit to a component level. However, it does prepare one for further study in that direction. With the knowledge gained in this program, one should be better able to pursue a more detailed study of the theory of operation using the Instruction Manual, if he/she has the desire and/or the need.

The video tape is divided into segments; each segment encompasses a specific subject matter. This workbook is divided into sections that correspond to the video tape segments. Each workbook section consists of a brief introduction, a synopsis of the material to be presented, a listing of Instruction Manual supplementary reading, directions to view the video tape segment for that section, review material consisting of text and/or illustrations, and a self test.

To study each section of this program, procede as follows:

1. Read the introductory material in this workbook for that section.
2. View the video tape segment for that section. You may view the video tape segment as many times as you wish or view any portion of it over again. Detailed instructions for the use of the video equipment are provided as an appendix to this workbook.
3. Refer to the Instruction Manual reading assignment for that section. The reading assignments are optional and supplement the material presented on the video tape and in this workbook. If you

feel that you need the reading, do it. If you feel that you understand the material after viewing the video tape and studying this workbook, you may opt to omit the reading. It is recommended that you at least browse through it.

4. Study the review material in this workbook for that section. The review material consists of some text, or a listing of key points, or of illustrations coinciding with scenes from the video tape. It is also designed to provide you with a method of reviewing this program at a later date when the video tape and equipment may not be available to you.
5. When you are confident that you understand the material of that section, proceed with the self test. Upon completion of the self test, present it to your course administrator for grading. Discuss with him any problems that you have with that section and review any missed questions.
6. Do not begin a section until you have completed the previous section and successfully passed the test for the previous section.

At the end of the program, you should review this workbook thoroughly. You should also review any video tape segments that you don't completely understand and review any of the supplementary reading that you might require. When you are ready, your course administrator will give you the final examination. If you receive a score of 75% or better, your score will be recorded in your education file and a certificate of completion will be issued to you.

Your responsibility does not end with receiving a certificate. You are going to need to know how to install and service the Reflex II. This workbook, as well as the Instruction Manual, will be aids to you in the future. Whenever possible, work with another customer engineer or technician with experience on the Reflex II to gain as much hands-on experience as possible. Such experience, coupled with a self-study course, should increase your knowledge and ensure your future competency.



## SECTION 1

### REFLEX I AND HOW IT FUNCTIONS

#### SCOPE

This section reviews the principles of operation of the Reflex I Disk Drive. Such a review will enable you more readily to see the differences incorporated into the Reflex II. This section is not designed to be definitive in it's treatment of the Reflex I but is, rather, a brief review of the basic principles of operation.

If you are quite familiar with the Reflex I, this section should serve as a brief review. If you are not, then a more in-depth study is necessary.

#### VIDEO TAPE

View Segment 1 of the Video Tape, Reel 1, Index

If the material presented on the Video Tape seems familiar to you, then you can be reasonably assured that you understand it. If it does not seem familiar, review the tape until you do understand it. Some supplementary reading may be necessary, after which a review of the Video Tape will be much more meaningful.

#### READING

There is no specific reading assignment for this section. However, if you had any difficulty in understanding any of the material presented in the Video Tape segment, a review of the Reflex I Instruction Manual should prove beneficial.

REVIEW

Study Figures 1, 2, 3, and 4, and the accompanying notes. Various features of the Reflex I are shown in those figures that reflect what was pointed out on the Video Tape segment.

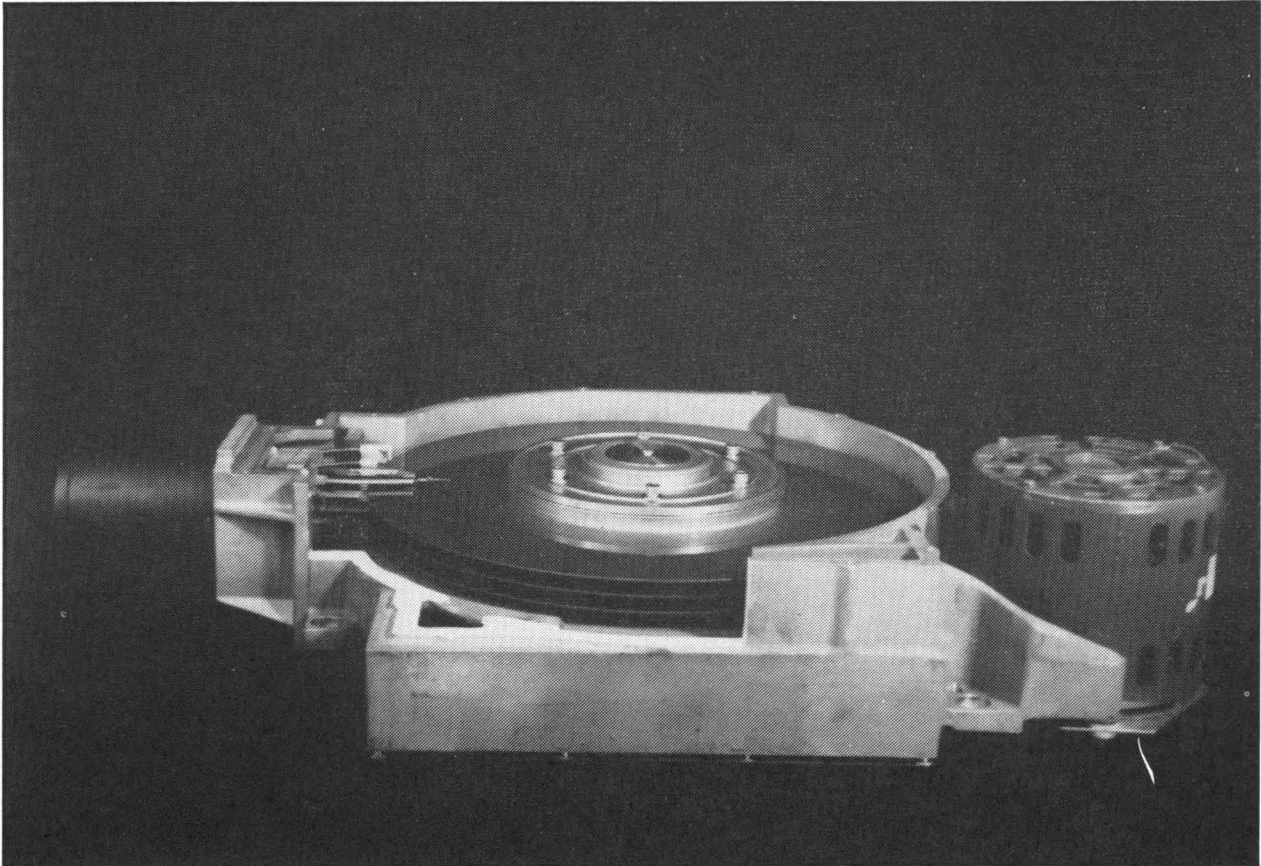

Figure 1. Reflex I Sealed Module (Cutaway View)

Winchester (Sealed Drive) System  
Three discs on the spindle, 5 Data surfaces  
10 Data heads  
One Servohead  
350 Cylinders per head, 700 cylinders per surface  
300 cylinders (tracks) per inch



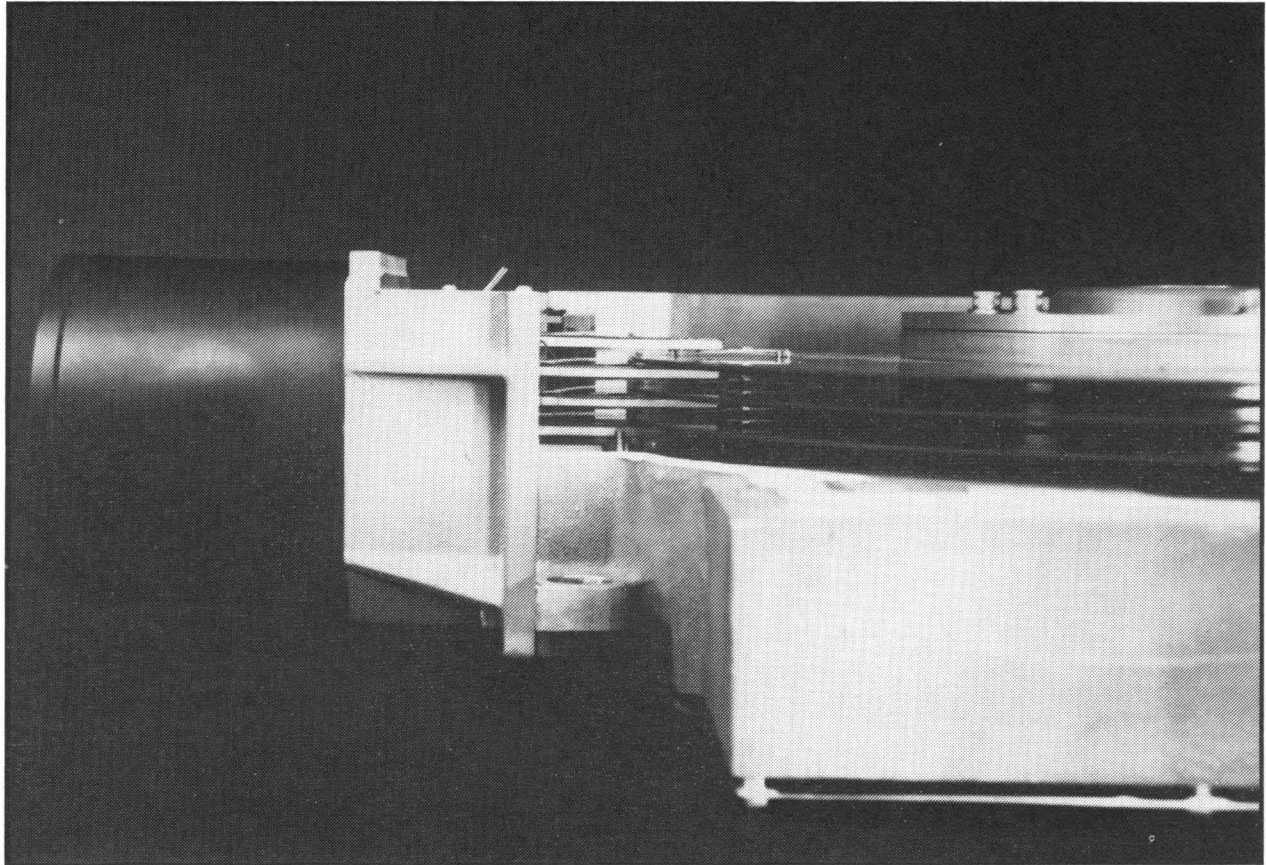

Figure 2. Reflex I Heads and Platters

Read/Write Head Positioning

- Heads move in unison to desired track.
- Head carriage propelled by linear motor
- Activated by servo logic.
- Receives input from controller.

Two modes of servo operation

- Velocity Mode - to move heads from cylinder to cylinder
- Track Follow Mode - to maintain desired track position

Servo disc is prerecorded, monitored by read-only servo head.

Reflex I Byte Transfer Rate = 885 khz (1 Byte per 1.13 Microsec.)  
Controller Byte Transfer Rate = 200 Khz (5 microsec. per byte)



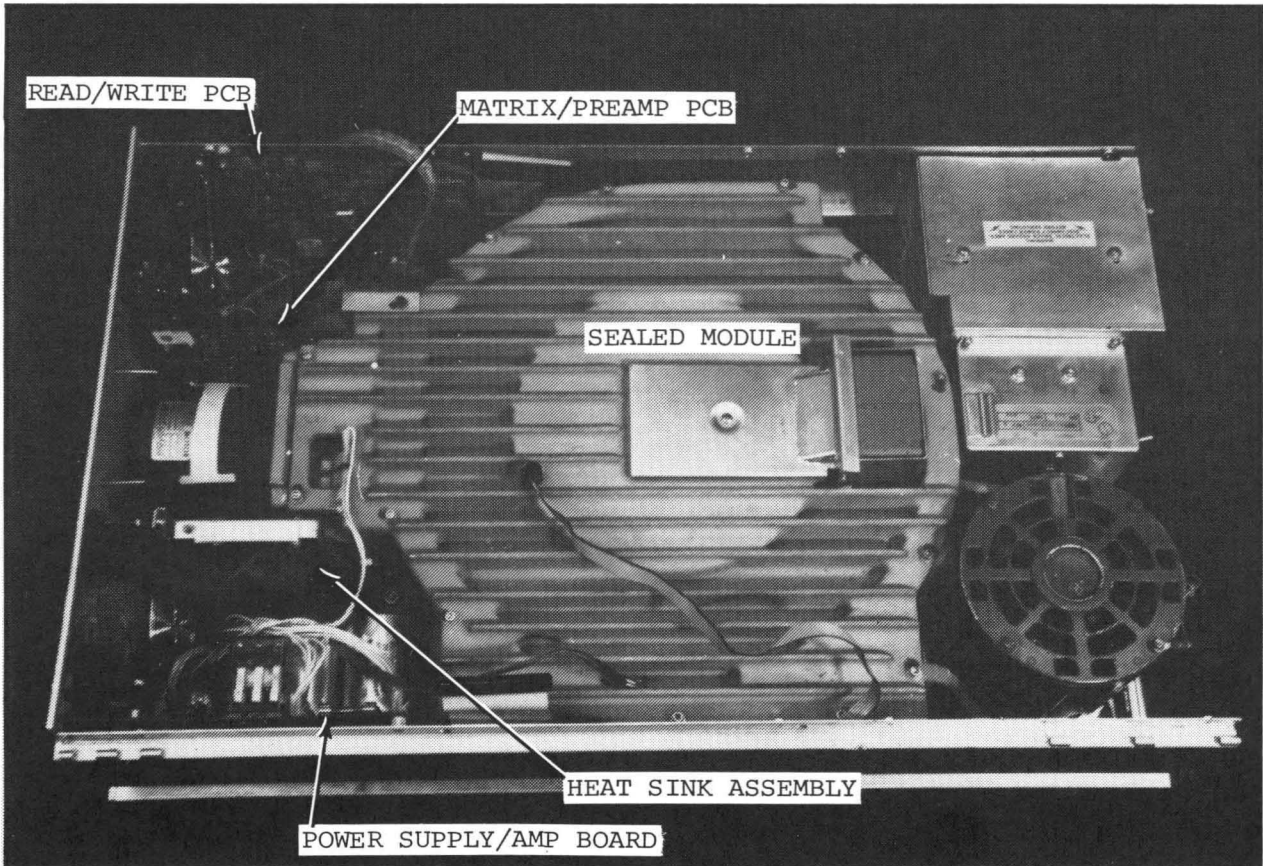

Figure 3. Reflex I Components

The major components of the Reflex I are:  
Power Supply/Amp Board (See Fig. 3)  
Sealed Module (See Fig. 3)  
Interface/Logic PCB (See Fig. 4)  
Servo Control PCB (See Fig. 4)  
Matrix/Preamp PCB (See Fig. 3)  
Read/Write PCB (See Fig. 3)  
Heat Sink Assembly (See Fig. 3)  
Power Supply (See Fig. 4)  
Control Option (See Fig. 4)



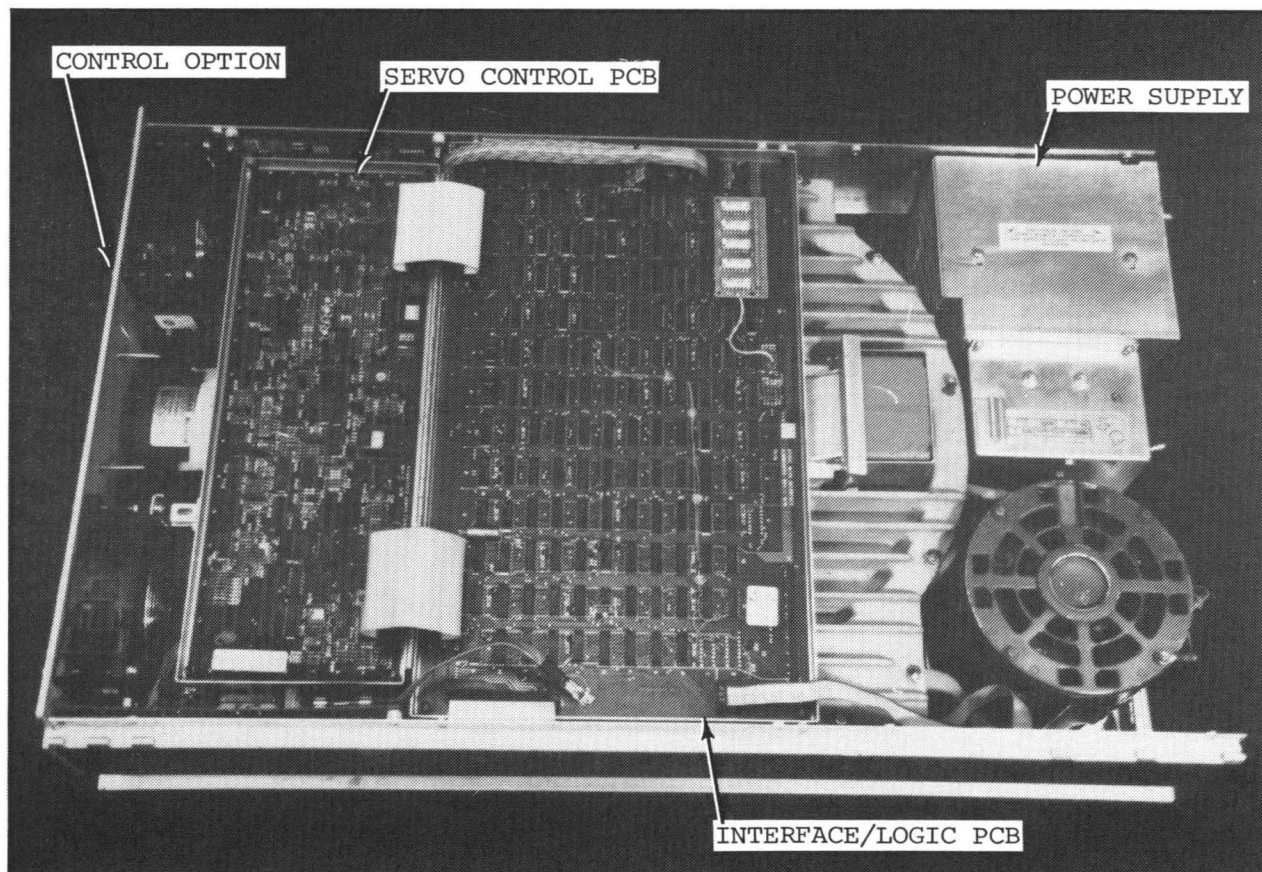

Figure 4. Reflex I Components

## SECTION 1

### Reflex I And How It Functions

#### SELF TEST

1. The "sealed module" concept used in the Reflex I is also referred to as the \_\_\_\_\_ technique.
2. When the drive is not energized, the platters are prevented from turning through the use of:
  - a. A thermal relay in the spindle motor
  - b. The carriage-lock solenoid
  - c. The friction of the heads on the platter
  - d. An electrical disc brake
3. Movement of the heads within the sealed module is effected by:
  - a. A linear motor
  - b. A stepper motor
  - c. A photo-optic control system
  - d. A system of relays
4. How often should the absolute filter within the sealed module be changed in the field?  
\_\_\_\_\_
5. The Reflex I servo control is a two-mode, closed loop system. When the heads are alligned with a desired track, the servo drive is in the \_\_\_\_\_ mode and when moving between cylinders, the servo drive in in the \_\_\_\_\_ mode.
6. Head positioning in the Reflex I is controlled by:
  - a. Coded tracks on a servo surface
  - b. Electro-magnetic sensors
  - c. A photo transducer
  - d. Mechanical detents

## SECTION 2

### INTRODUCTION TO REFLEX II PHYSICAL COMPARISON OF REFLEX I AND REFLEX II

#### SCOPE

This section premieres the major differences between the Reflex I and Reflex II. It presupposes that you have a good knowledge of the Reflex I, either from your previous experience or through a definitive study of Section 1 of this course.

In this section, you will be presented with numerous facts concerning the physical characteristics of the Reflex II without much explanation or elaboration on those facts. It is done mainly, to acquaint you with those facts as they differ from Reflex I, rather than to acquaint you with the working details of the Reflex II.

#### VIDEO TAPE

View Segment 2 of the Video Tape, Reel 1, Index

This tape segment will present you with many facts concerning the Reflex II and will present them to you in a fairly rapid sequence. Listen carefully, take notes, and/or review as necessary in order to remember what is said concerning the working parameters of the Reflex II.

#### READING

For supplementary or additional information on this section, read the following portions of the Reflex II Instruction Manual (Microdata Publication 791091):

- Section 1, General Description
  - Introduction, pp. 1-1, 1-4
  - General, page 1-4
  - Physical Description, pp. 1-10, 1-11
  - Table 1-1, pp. 1-12, 1-14

Pay particular attention to Figures 1-1, 1-2, and 1-3, and to Table 1-1.



REVIEW

Observe Figure 5 and compare it with Figure 1 and Figure 2. Study Table 1, which compares major differences between the Reflex I and Reflex II. Review the Video Tape as required.

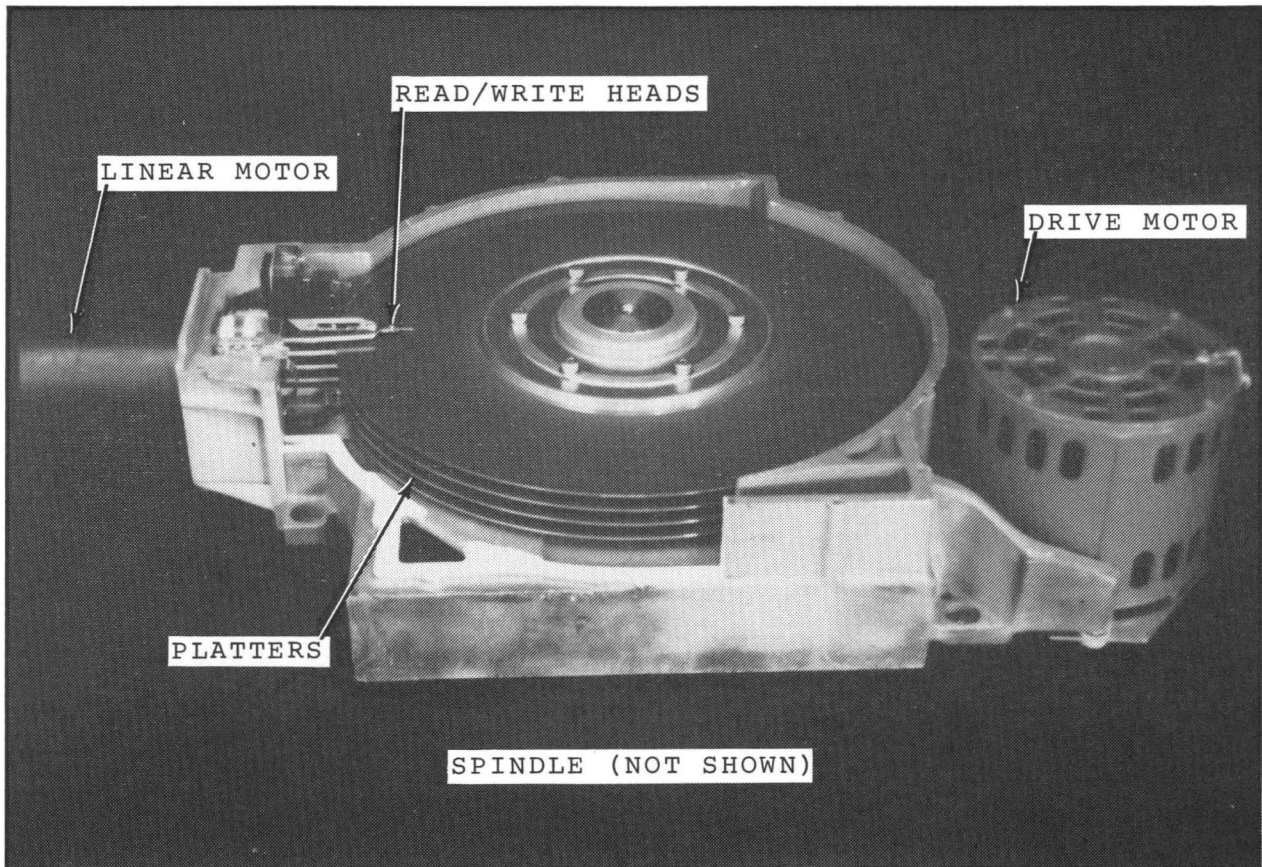

Figure 5. Reflex II Sealed Module (Cutaway View)



TABLE 1  
PHYSICAL COMPARISON

	<u>REFLEX I</u>	<u>REFLEX II</u>
Storage Capacity - Unformatted	62.7 Mbyte	158.3 Mbyte
Storage Capacity - Formatted	50 Mbyte	125 Mbyte
Platters	3	4
Data Surfaces	5	7
Data (Read/Write) Heads	10	14
Data Cylinders*	350	561
Track Density*	300 TPI	478 TPI
Rotational Speed	2964 rpm	3530 rpm
Transfer Rate - Bit	7.07 Mhz	9.48 Mhz
Transfer Rate - Byte	885 Khz	1.185 Mhz
Head Selection	Matrix/Preamp PCB	Chips on Data Arms
Head Parking	Inner Guard Band	Outer Guard Band
Internal Cables	14	5

\* Although the Reflex II has a greater number of cylinders, the increased track density reduces the overall movement of the head carriage and therefore reduces the seek time from that of the Reflex I.

## Section 2

### Physical Comparison Of Reflex I And Reflex II

#### SELF TEST

Listed below are some of the pertinent functional and physical characteristics of either the Reflex I or the Reflex II. In the space provided at the left of each item, indicate whether the characteristic is unique to the Reflex I or the Reflex II.

- |   |   |
|---|---|
| 1. <u>2</u> Four Platters                   | 10. <u>2</u> 561 Data Cylinders           |
| 2. <u>1</u> Five Data Surfaces              | 11. <u>2</u> Heads Parked In Inner Guard  |
| 3. <u>2</u> 3530 rpm Rotational Speed       | Band                                      |
| 4. <u>2</u> Heads Parked In The Outer       | 12. <u>1</u> 14 Internal (interboard)     |
| Band  | Connection Cables                         |
| 5. <u>1</u> Three Platters                  | 13. <u>2</u> 158.3 Mbyte Storage          |
| 6. <u>2</u> 14 Read/Write Heads             | 14. <u>1</u> 300 TPI                      |
| 7. <u>1</u> Matrix/Preamp PCB               | 15. <u>1</u> 1.185 Mhz Byte Transfer Rate |
| 8. <u>1</u> 2964 rpm Rotational Speed       | 16. <u>2</u> Byte Transfer Time of 1.13   |
| 9. <u>2</u> Special Chip On Each Read/Write | microseconds                              |
| Head  |   |

17. Which of the following components

is NOT interchangeable between  
the Reflex I and the Reflex II?

- a. Motor (except spindle)
- b. Servo PCB
- c. Control Panel
- d. Terminator

### SECTION 3

#### INTRODUCTION TO REFLEX II (CONT.)

#### COMPONENTS OF REFLEX II

##### SCOPE

This section is to familiarize you with the major assemblies of the Reflex II; the four circuit boards, spindle motor system, power components, and sealed module. At the completion of this section, you should have an understanding of the major functions and circuits of those assemblies.

##### VIDEO TAPE

View Segment 3 of the Video Tape, Reel 1, Index

At the first part of the tape segment, the circuit boards are introduced with a brief explanation of the function of each. This portion should be reviewed thoroughly. You may want to review the tape and at the same time, follow along with the outline provided in the Review part of this section.

##### READING

For supplementary or additional information on this section, read the following portions of the Reflex II Instruction Manual:

- Section 1, General Description
  - Functional Description, pp. 1-4, 1-10
- Section 4, Theory of Operation
  - Physical Description, pp. 4-1, 4-4

## REVIEW

The following outline lists the major components of the Reflex II with a brief description of the function of each. Figures 6, 7, 8, and 9 show the location of the components.

### Logic Board

- Interface Drivers/Receivers
- Multiplexers
- Seek Logic
- Power Sequencing
- Fault Logic

### Servo Board

Decodes Servo Pattern and Generates:

- INDEX
- Speed
- Outer Guard Band (OGB)
- 19 Mhz Phase Locked Oscillator
- Analog Circuitry to Control Head Positioning

### Read/Write Board

- Converts NRZ to MFM during Write
- Converts MFM to NRZ during Read
- Develops Read Clocks

### Power Supply/Amp Board

- Filters, Fuses and Voltage Regulators
- Voltage Comparators for DCSAFE
- Fuses For Linear Motor (3 amp)

### Control/Indicator Panel

- Write Enable/Disable Switch
- LED's for:
  - Write Enable
  - Fault
  - READY



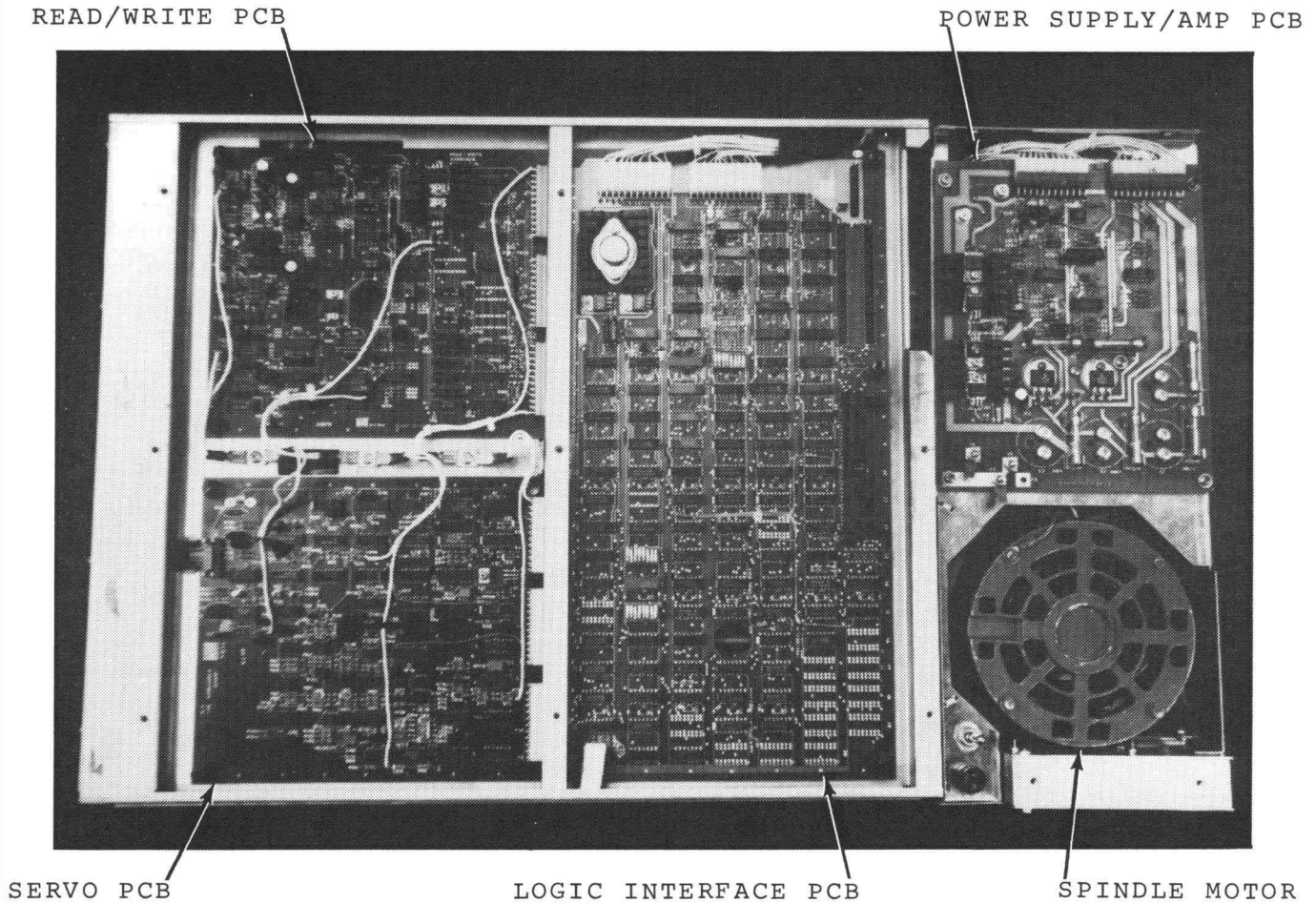

Figure 6. Reflex II Components

Figure 6 is a top view of the Reflex II showing the location of the printed circuit boards and the spindle motor.

The motor is the same as that used in the Reflex I. The spindle size has been changed in the Reflex II providing an increased platter rotational speed of 3530 rpm.



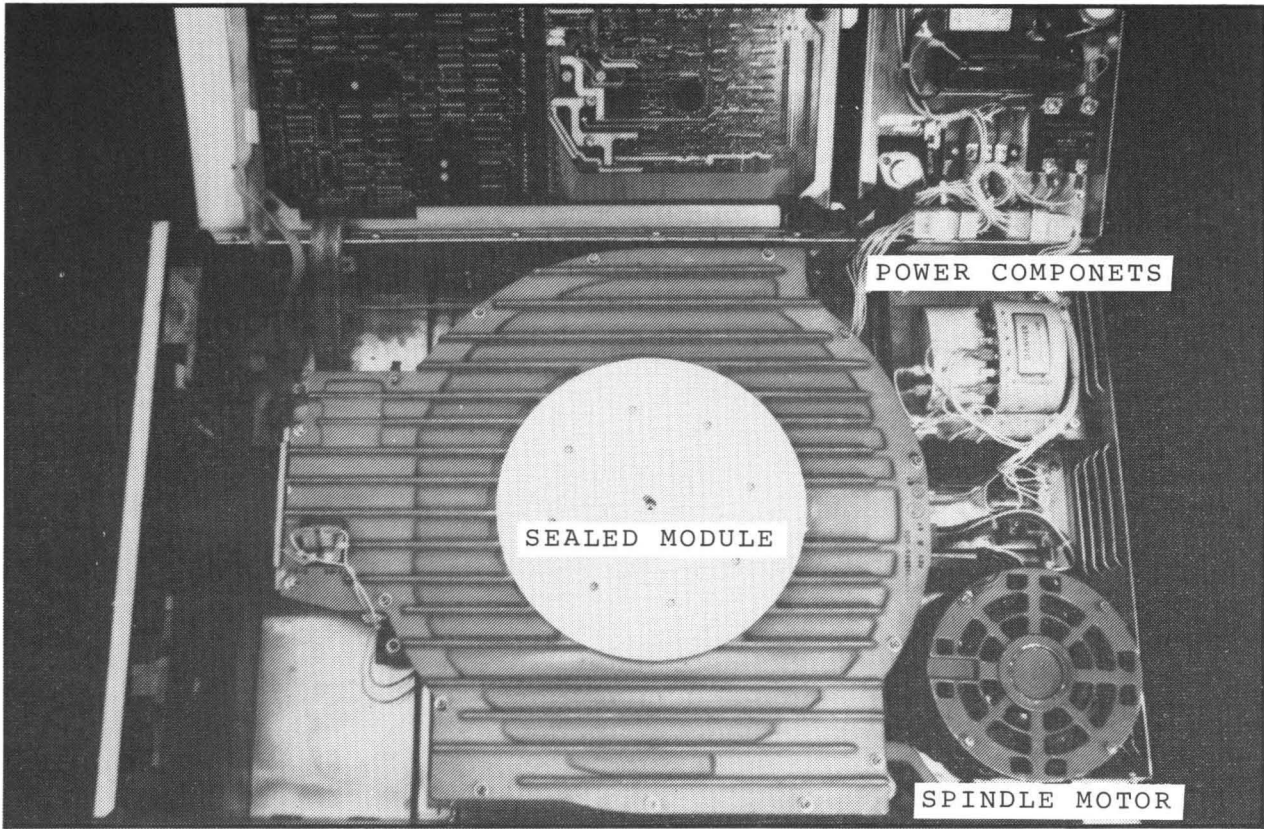

Figure 7. Reflex II Components

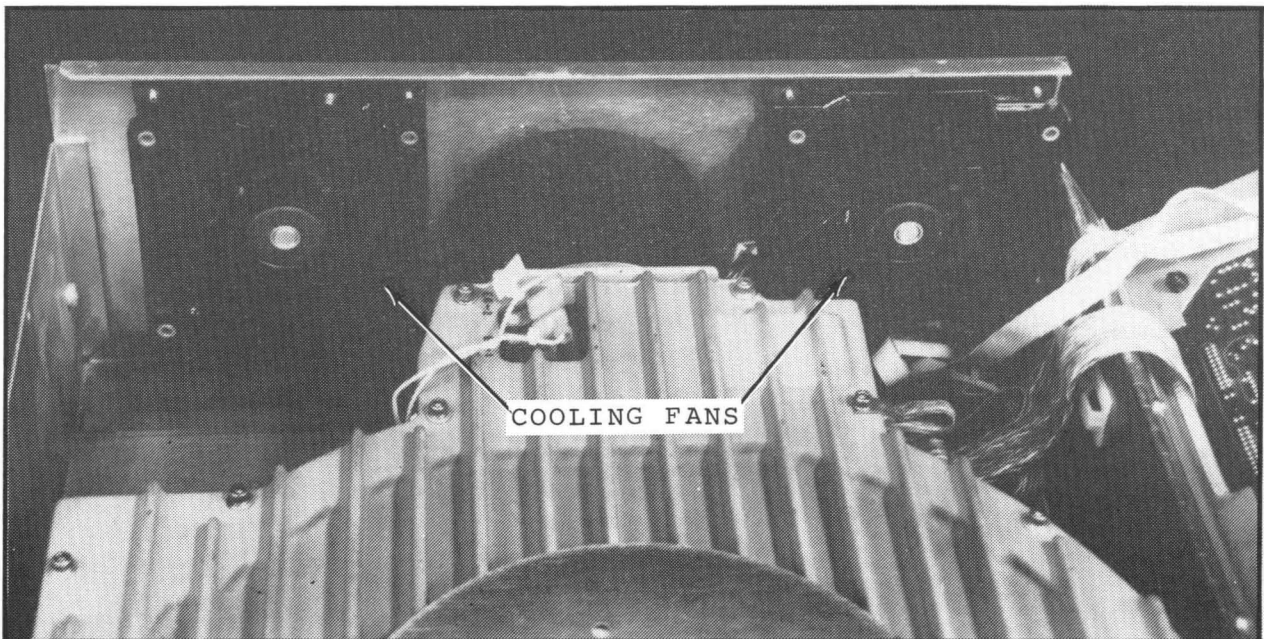

Figure 8. Cooling Fan Location  
16



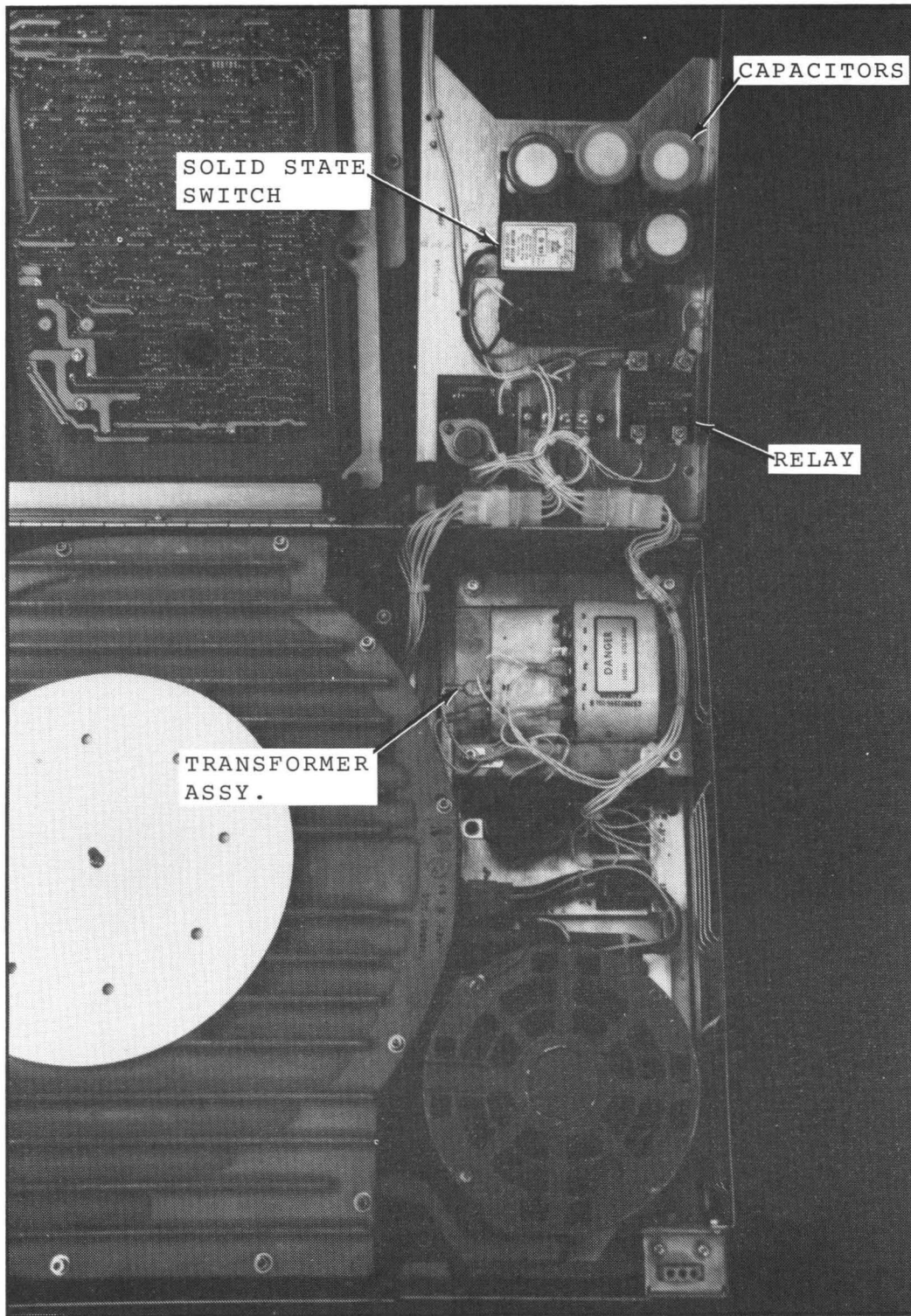

Figure 9. Power Components



### SECTION 3

#### REFLEX II COMPONENTS

#### SELF TEST

The left-hand column lists some of the major functions and circuits within the Reflex II while the assemblies are shown in the right-hand column. In the space provided, write the letter that corresponds with the assembly where that function or circuit originates.

_____ Develops Read Clocks	A. Logic/Interface
_____ Linear Motor Fuses	B. Read/Write
_____ Generates INDEX	C. Servo
_____ Generates DC SAFE	D. Power Supply/Amp
_____ Converts NRZ to MFM	E. Indicator Panel
_____ Phase Locked Oscillator	
_____ Interface Drivers/Receivers	
_____ Detection of OGB	
_____ Seek Logic	
_____ Write Enable/Disable Switch	
_____ READY LED	
_____ Power Sequencing	

## SECTION 4

### PRE-INSTALLATION CONSIDERATIONS

#### SCOPE

This brief section lists tools and equipment that are required to install and service the Reflex II. It also contains a discussion of some of the environmental requirements of the Reflex II.

There is no self-test for this section.

#### VIDEO TAPE

View Segment 4 of the Video Tape, Reel 1, Index

The Video Tape titles Segment 4, "Tools and Equipment, And Environmental Requirements." Don't be confused by the difference. It was easier to change this workbook than to change the Video Tape. Cheaper too.

#### READING

For supplementary information on this section, read the following portions of the Reflex II Instruction Manual:

- Section 2, Physical Planning and Interface Requirements
  - Environmental Conditions, pp. 2-1, 2-1
  - Space Requirements, page 2-2
  - Power Requirements, pp. 2-2, 2-8

#### REVIEW

The following pages contain an outline review of the material presented on the Video Tape.

## TOOLS AND EQUIPMENT

Tools required for installation and maintenance of the Reflex II Disk Drive:

- Dual Trace Oscilloscope, 100 Mhz
- Digital VOM with 0.1 volts or better accuracy
- Off-Line Exerciser, MOD III
- #1 Phillips Screwdriver with 4 inch blade
- #2 Phillips Screwdriver with 6 inch blade, screwholding
- ¼ X 6 inch screwholding screwdriver
- 11/32 inch open end wrench
- 3/32 inch Allen Wrench
- 5/32 inch Allen Wrench
- 2 IC chip clips
- Alignment Tool (tweezer)
- Bearing Puller
- 7/16 inch Hex Driver

## ENVIRONMENTAL REQUIREMENTS

The best environment is an air conditioned office or data processing center. IN NO CASE SHOULD THE REFLEX II BE EXPOSED TO OUTSIDE WEATHER OR UNUSUAL CHEMICAL OR ATMOSPHERIC GAS CONDITIONS.

Check for correct power installation.

If Reflex II is to be housed with other equipment, be sure there is enough power for all of the equipment BEFORE proceeding with the installation.

Make sure the Reflex will be connected to separate circuit breakers because of the 20 amp surge at power on.



SECTION 5  
INSTALLATION

SCOPE

This section covers the installation procedure for the Reflex II. The lesson mainly discusses how to inspect the unit and ready it for installation, then how to install it and connect the appropriate cables. The main points are demonstrated on the Video Tape but for more detail, the supplementary assignment should definitely be completed.

VIDEO TAPE

View Segment 5 of the Video Tape, Reel 1, Index

The Tape presents the cause of some common problems encountered during installation, physical inspection, and a demonstration of connection of cabling and ground strapping. The tape titles Segment 5 "Installation and Testing." This is slightly erroneous because testing is presented in a later section.

READING

For supplementary information concerning this section, read the following portions of the Reflex II Instruction Manual:

Section 3, Installation and Operation  
Introduction, page 3-1  
Installation Check List, pp. 3-1, 3-1  
Unpacking, pp. 3-2, 3-4  
Physical Inspection, pp. 3-4, 3-9  
Power Verification, pp. 3-13, 3-14

For additional familiarization, you may want to skim over the remainder of Section 2 of the Instruction Manual, pages 2-8 through 2-34.

Note Figure 3-2 which shows the location of Power Connector (J26) and Figure 3-3 which shows the location of ground connections.

## REVIEW

Before beginning the installation;

Look for the most obvious problems:  
Broken or loose connections  
Broken cable wire  
Something not connected.

Check to ensure that proper cables, terminator, or terminators are present.

Check power rating identification tag.

Check for damaged wires on carriage lock solenoid.

### CAUTION

WHEN INSPECTING THE SPINDLE DRIVE BELT AND TENSION SPRING, MAKE NO ATTEMPT TO ROTATE THE SPINDLE BY HAND. RESULT CAN DAMAGE THE HEADS, THE DISC, OR BOTH.

## Internal Power Supply

Power supplied through connector J26 (DC Voltage Connector).

115 Volt AC power units are supplied with line cord and plug.

Units to be supplied with other power requirements do not come with plug. (See Instruction Manual for installation procedure).

## Two Point Ground System

The frame ground and the signal ground must be tied together, either in the drive or remotely in the controller or CPU.

On delivery, the grounds are strapped together on terminals E2 and E4 on the Power Supply/Amp PCB.

If set-up calls for single point ground, disconnect the E2 - E4 strap. Use the braided wire strap from E2 to the common tie point in the system design. Signal Ground (DC) will be provided through the signal cable.

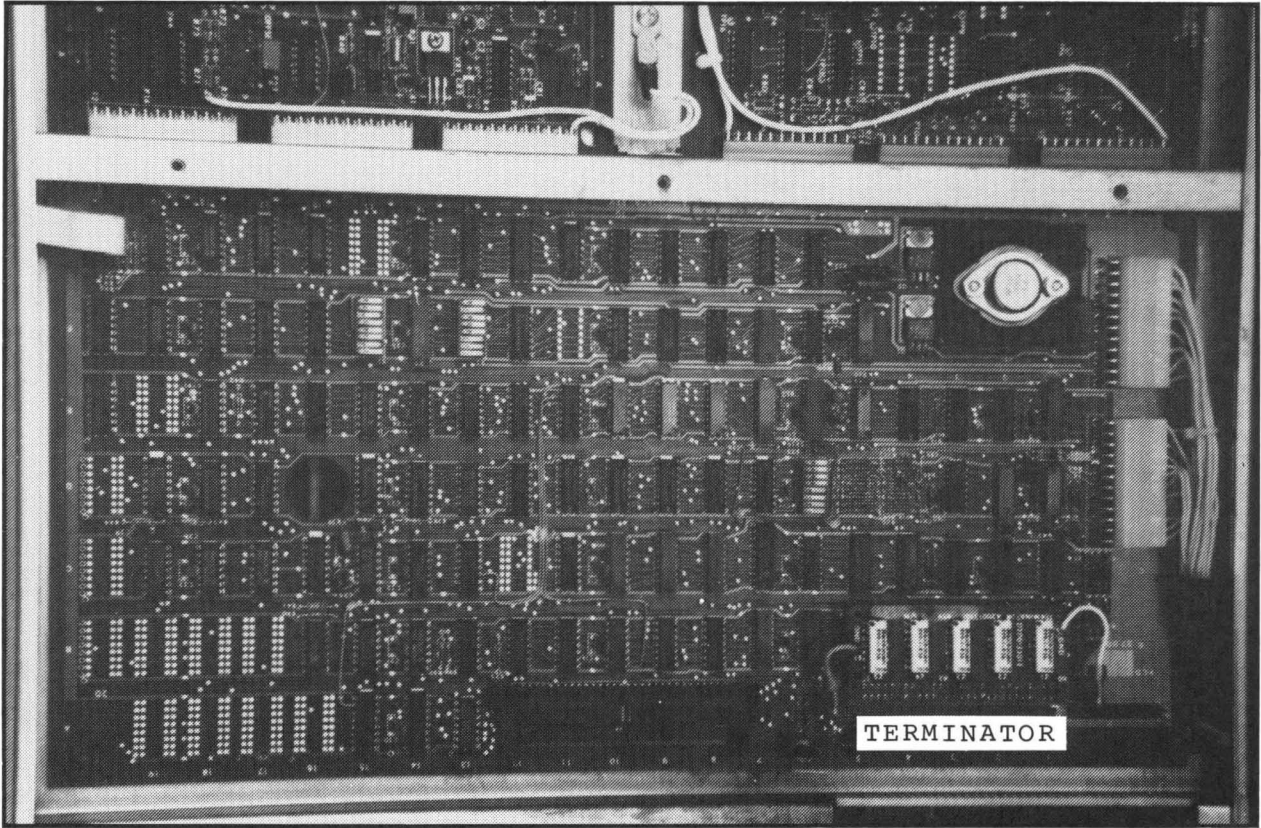

Figure 10. Logic Interface PCB

Figure 10 shows the location of the terminator installed on the Logic Interface PCB.

#### Signal, Data Exerciser Cables and Terminators.

Jacks for cables located on Logic Interface PCB.

Signal cable in daisy chain or to single unit.

Signal cable connects to J2.

If this drive is the only drive or the last drive in a daisy chain, install a terminator on J3. If unit is not the last in a daisy chain, install signal cable on J3 and connect other end to J2 on the next unit. Connect ground lug on terminator to E1.

Data cable connects to J1, BUT NOT UNTIL INITIAL CHECKOUT OF THE DRIVE IS COMPLETED.

SECTION 5  
INSTALLATION

SELF TEST

1. When beginning an installation of a Reflex II, the customer engineer should visually inspect for, or verify: (In the spaces provided below, write a T if the item applies and an F if the item does not apply.)
  - \_\_\_\_\_ AC and DC ground must be common.
  - \_\_\_\_\_ Lack of abrasions on cables.
  - \_\_\_\_\_ Correct settings of all switches.
  - \_\_\_\_\_ Security of all connectors.
  - \_\_\_\_\_ Moving parts must be free of obstructions.
  - \_\_\_\_\_ Separate 20 amp circuit breaker.
  - \_\_\_\_\_ Ground points E2 and E4 connected.
  - \_\_\_\_\_ Cleanliness of the internal absolute filter.
  
2. Before plugging the Reflex II into an external AC power source, the C.E. must verify the voltage compatibility. The voltage rating of the Reflex II is:
  - a. Determined by checking the wiring of transformer T1.
  - b. Silk screen etched on the Power supply/Amp PCB.
  - c. Painted on the sealed module.
  - d. Indicated on the nameplate.
  
3. All cables from the controller to the drive are connected to the \_\_\_\_\_ board.
  
4. The \_\_\_\_\_ cable is not connected until the initial checkout of the drive is completed.



## SECTION 6

### POST-INSTALLATION TESTING

#### SCOPE

This section completes the instruction on the installation of the Reflex II, presenting the check-out and testing that is a requisite part of the installation. The section is presented on the Video Tape in two segments. The first segment contains the power-up sequence and off-line check. The second segment contains the steps required to integrate the Reflex II into the system.

#### VIDEO TAPE (Part One)

View Segment 6 of the Video Tape, Reel , Index

The tape refers you several times to items in the Instruction Manual. Complete the reading assignment, note the references, and review the Video Tape as necessary.

Note also that Segment 6 on the Video Tape is titled "Testing and Adjustments." This is erroneous in that the segment only refers to post-installation testing, there is more to follow later in the Maintenance section. Also, there are no adjustments, they are presented in the Troubleshooting and Adjustments section.

#### READING (Part One)

For supplementary information concerning this section, read the following portions of the Reflex II Instruction Manual:

Section 3, Installation and Operation

Initial Checkout Procedure, pp. 3-10, 3-11

System Installation, pp. 3-11, 3-13

The Video Tape refers you to the Maintenance Section of the Instruction Manual to verify DC voltages. That information will be found on pages 5-4 through 5-7 of the Instruction Manual.

The Video Tape also refers you to the Maintenance Section of the Instruction Manual several times for steps to follow should a malfunction occur and for the oscilloscope settings to verify read/write alignment. That material will also be presented later in this course. For now, it is recommended that you brief through Section Five of the Instruction Manual to at least be familiar with where the information is contained.

VIDEO TAPE (Part Two)

View Segment 7 of the Video Tape, Reel , Index

READING (Part Two)

For supplementary information concerning this section, read the following portions of the Reflex II Instruction Manual:

Section 3, Installation and Operation  
Operation, pp. 3-15, 3-25

REVIEW

The following pages contain an outline review of the material presented on the Video Tape. While the tape and the Instruction Manual both describe or list the switch settings for the Logic/Interface PCB, this section contains a graphic representation of the Logic/Interface PCB configuration which should be reviewed and can be saved for future reference.

## Power Up Sequence

Connect the Exerciser to J4 on the Logic/Interface PCB. Set control to Seek Random. Set Reflex switch to "UP" and Seek Error Inhibit to "DOWN".

Set Exerciser monitor switch to "B".

Set "Act" and "Restore" to "OFF".

Turn drive power switch "ON".

State Zero (STO) Indicator will light indicating +5 Volts DC.

DC Voltage Safe (DCSAFE), Brake Safe (BRKSF), and Start Motor (SMTR) Indicators will light.

Spindle drive motor start up.

Head Load (HDL) Indicator will light.

Disc attains full operating speed.

Entire procedure takes place in less than 25 sec.

Verify all DC voltages using the Instruction Manual as a guide.

Verify servo function with exerciser, cause random seeks.

Initiate several restore procedures, followed by random seek executions.

Connect Exerciser cable to J1 of Logic/Interface PCB.

Verify Read/Write alignment using oscilloscope to read pulse width and phase detector offset.

Using Exerciser, execute read function and monitor display for fault conditions.

If all tests have gone well, the unit is ready for integration with the system. If problems have developed, use the Instruction Manual for troubleshooting procedures.

Integrating the Reflex II with its system.

Make data cable connection to J1 on the Logic/  
Interface PCB.

Re-check all cable connections.

Set switches on the Logic/Interface PCB. See the  
following page for switch configuration data.

Unit Address

I Configuration Disable

Illegal Head Address

Sector Count

Sequence Enable

Turn on power switch.

On completion of first seek, run all diagnostic routines.  
If errors are encountered, refer to the Instruction  
Manual, Maintenance Section.

If testing is successful:

Replace screws securing printed circuit board  
chassis and power supply/amplifier chassis.

Install top and bottom covers on the drive.

Install Disc Drive in its cabinet space.

Run a final check for proper execution with all  
user programs.



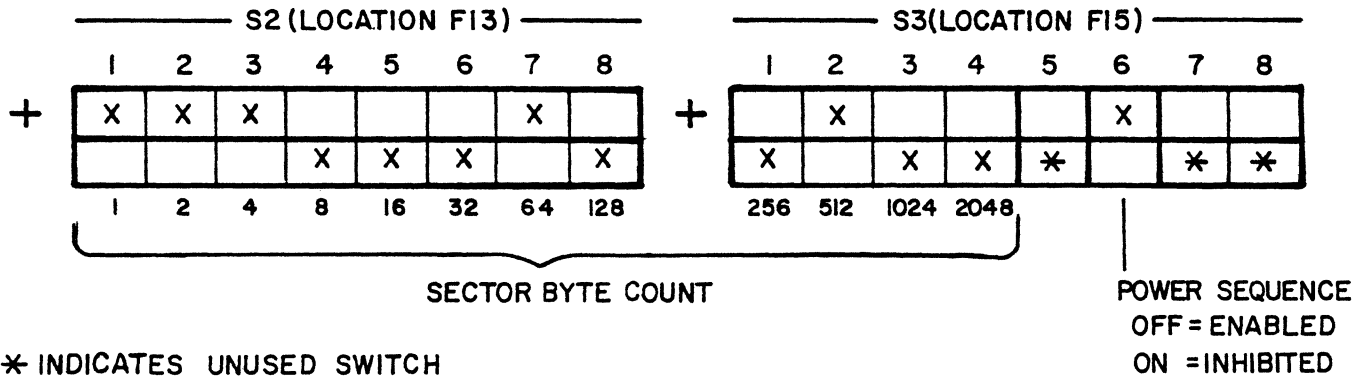
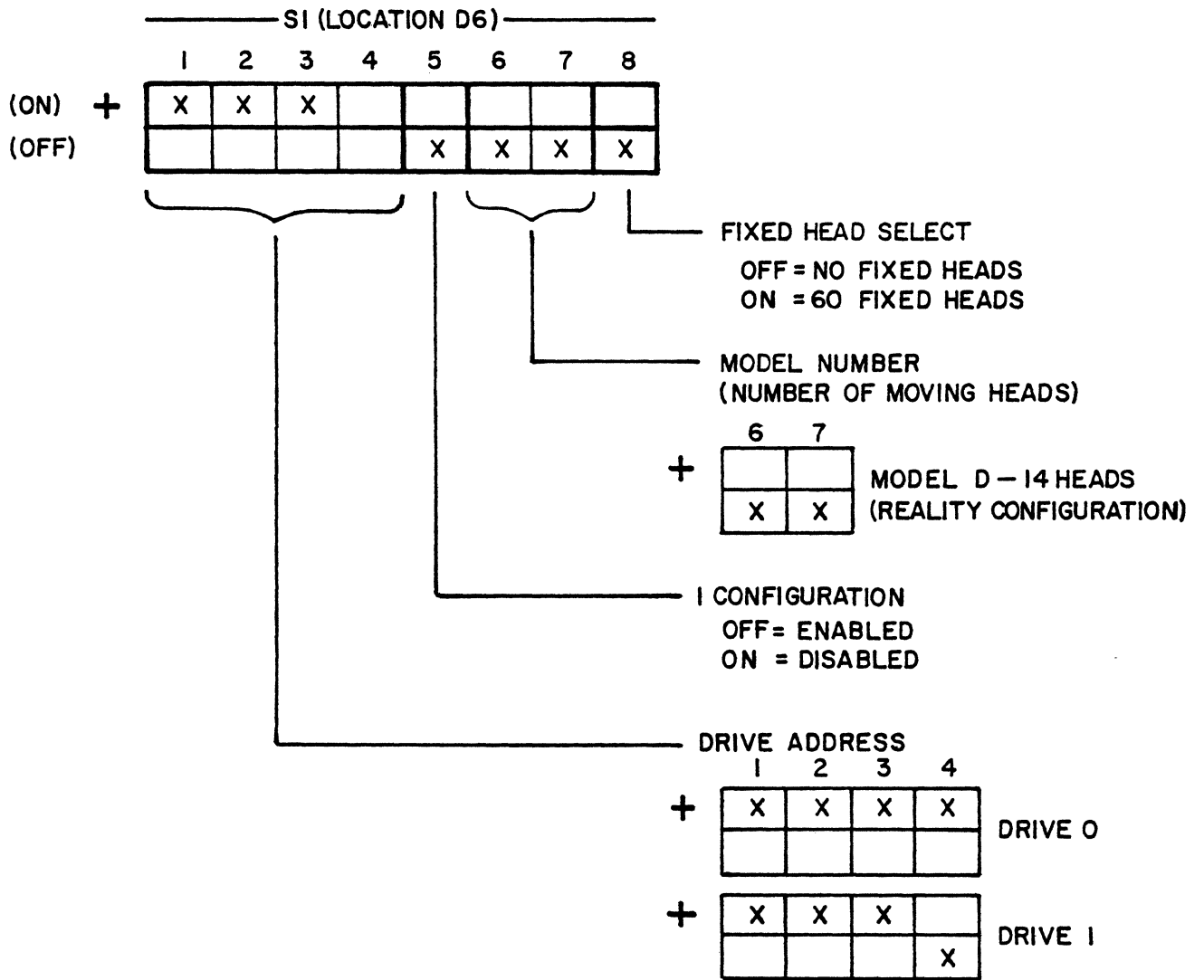

## LOGIC/INTERFACE PCB CONFIGURATION.

### REFLEX II

## SECTION 6

### Post-Installation Testing

#### SELF TEST

1. The Reflex II requires \_\_\_\_\_ seconds from power on until the heads are over track 0 and the drive is READY.
  5. S1-1 must be \_\_\_\_\_
  6. S1-2 must be \_\_\_\_\_
  7. S1-3 must be \_\_\_\_\_
  8. S1-4 must be \_\_\_\_\_
2. Setting the exerciser for Random Seeks (SK-R) verifies:
  - a. Servo board functions.
  - b. Proper write current.
  - c. Operation of the time disc brake.
  - d. Action of the Write Disable circuit.
3. In order to configure the Reflex II for "no fixed heads":
  - a. S1-8 must be OFF.
  - b. S1-5 must be OFF.
  - c. S1-8 must be ON.
  - d. S1-5 must be ON.
4. In order to monitor the State 0, 1, 2, & 3 LED's (ST0, ST1, ST2, ST3) on the exerciser, the Monitor switch must be in the \_\_\_\_\_ position.
  - a. A
  - b. B
  - c. C
  - d. D
- In order to configure the Reflex II Logic/Interface board as Drive 0, Switch:
  9. If Switch S1-6 is OFF and S1-7 is OFF, the Reflex II is configured for:
    - a. 2 moving heads.
    - b. 6 moving heads.
    - c. 10 moving heads.
    - d. 14 moving heads.
  10. When performing an initial checkout, the ACT and RESTORE switches must be set to:
    - a. ACT off, RESTORE off
    - b. ACT off, RESTORE on
    - c. ACT on, RESTORE off
    - d. ACT on, RESTORE on

## SECTION 7

### MAINTENANCE

#### SCOPE

This and the following section cover preventive and corrective maintenance of the Reflex II. This section discusses corrective maintenance in a general nature, showing how to functionally isolate a problem, perform visual checks for obvious malfunctions and enumerates test points for voltage checks. The following section discusses troubleshooting utilizing the exerciser and demonstrates adjustment procedures.

The material presented on the Video Tape segment for this section is rather brief and you will be required to do more reading and review in order to assimilate the material. Give yourself enough time to perform the reading assignment and a definitive review.

#### VIDEO TAPE

View segment 8 of the Video Tape, Reel , Index

It is recommended that you first view the tape, then complete the reading assignment and skim through the review material. You may then wish to review the Video Tape, while at the same time referring to the Review material in this section and/or the Instruction Manual. Please note that while this is Section 7, you are viewing Segment 8 of the Video Tape. This is due to the last section encompassing two segments of the Video Tape.

#### READING

For supplementary information concerning this section, read the following portions of the Reflex II Instruction Manual:

Section 5, Maintenance

Introduction, page 5-1

Preventive Maintenance, page 5-5

Corrective Maintenance, pp. 5-1, 5-11

## REVIEW

### Preventive Maintenance

On regularly scheduled PM, check the unit carefully. Any accumulation of dust and dirt should be removed and all cables should be checked to insure tightness and that no connectors are broken. Be especially sure to inspect fans and brakes.

### Corrective Maintenance

When troubleshooting, break the system down to:

Read/Write errors.

Seek errors.

Bad status, such as fault, not ready, not on cylinder.

Communication loss.

Apparent loss of power.

When checking visually, check:

Switch position and panel indicators for correct settings and indications.

Wiring, connections, and cabling for secure connections and no abrasions.

Moving parts for obstructions, wear and damage.

Blown fuses.

During power, or electronic checks, look for:

Power source or main fuse problems.

Correct DC voltages at the power supply.

All power distribution and voltage levels throughout the unit are correct.

Connections to printed circuit boards are good.

### Maintenance Checks

Power supply

Verify 115 volts AC by checking to see if fans are running. Lack of power probably indicates:

PJ26 Connector missing or defective.

Switch 1 defective or not turned on.

XF1 or F1, missing or open fuse or defective holder.

Line Filter assembly defective.

PJ29 missing or defective connector.

Line cord defective.

Power source unavailable.



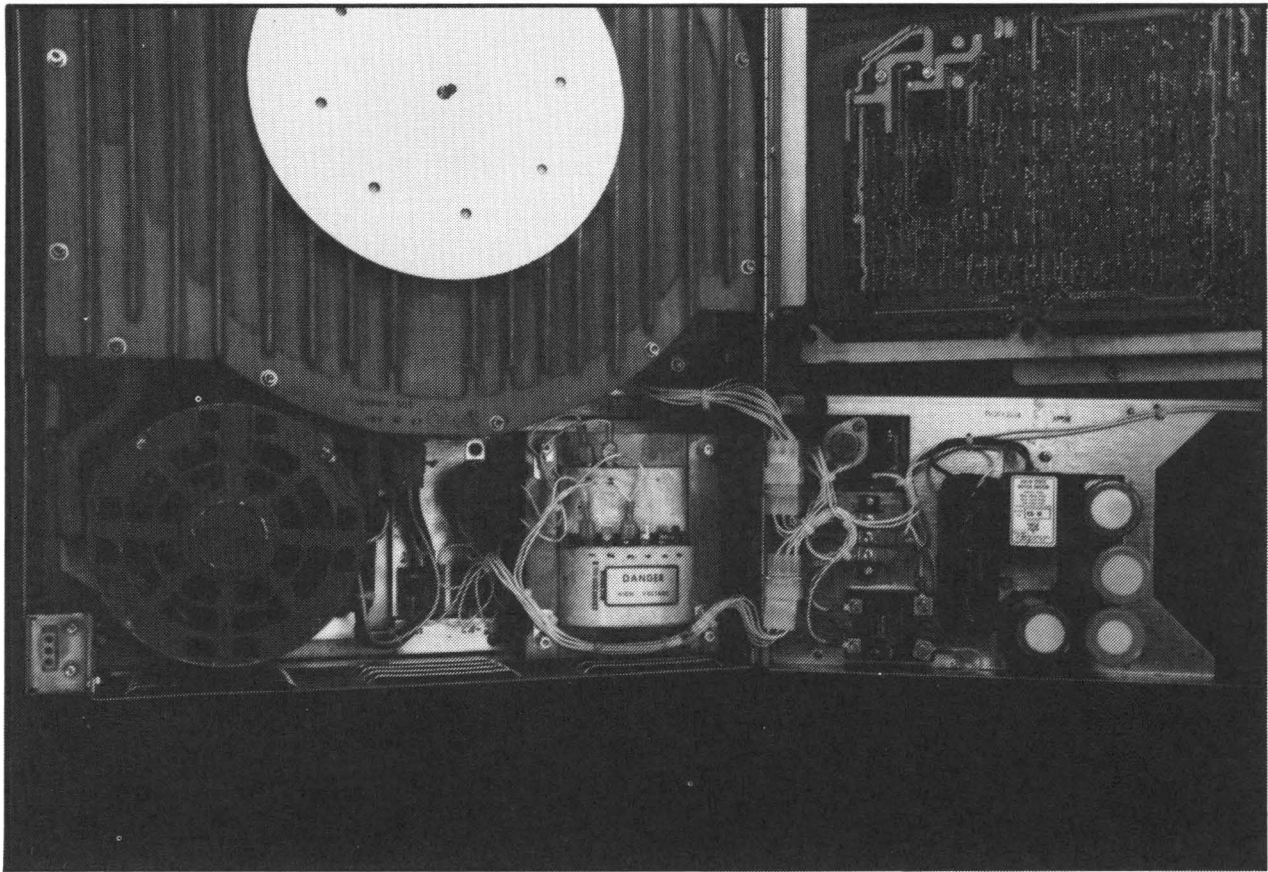

Figure 11. Power Supply And Components

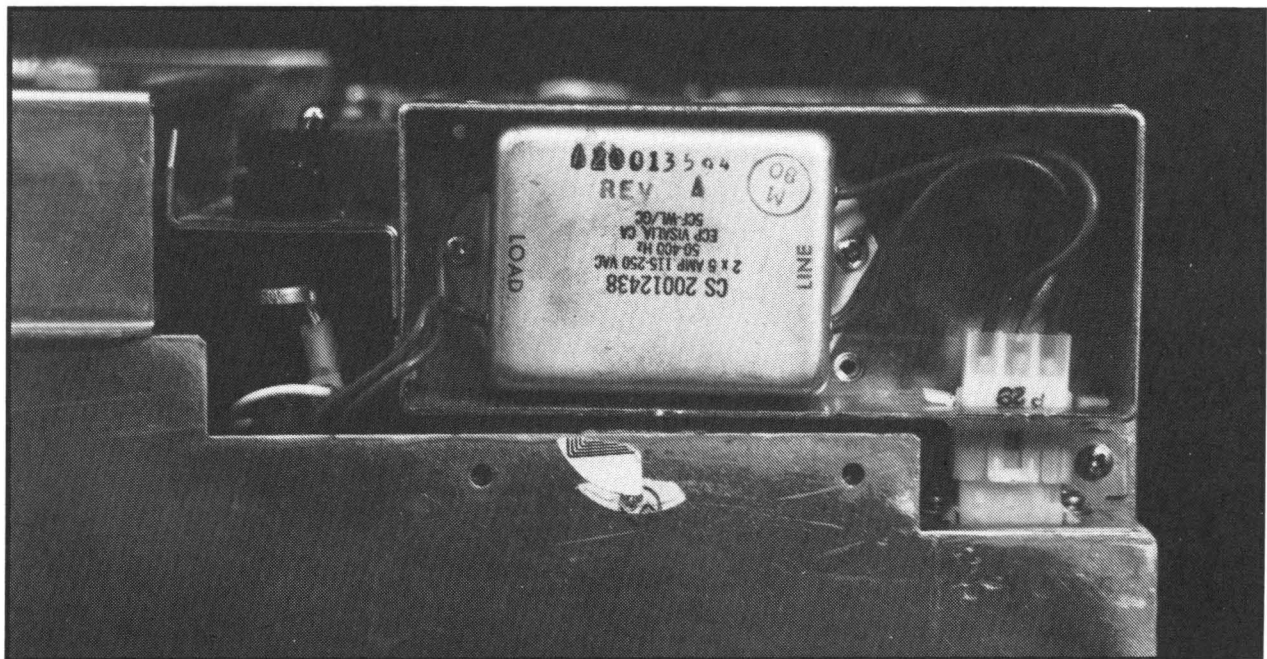

Figure 12. Power Interlock Connector And Line Filter

Corrective Maintenance

Cooling Fans/Spindle Motor

Fans not operating

Defective connection from TB1 to fans.

Spindle Motor not operating

K1 defective or not energized.

S2 defective.

C2 defective.

PJ30 missing or connection defective.

PJ33 missing or connection defective.

Motor thermal defective or overheating.

PJ8 Missing or defective connection.

DC voltage missing.

Logic/Interface PCB defective.

Sequence Enable not active.

Brake is active.

Disc spin speed unsafe.

Check power supply voltages. (Refer to the Instruction



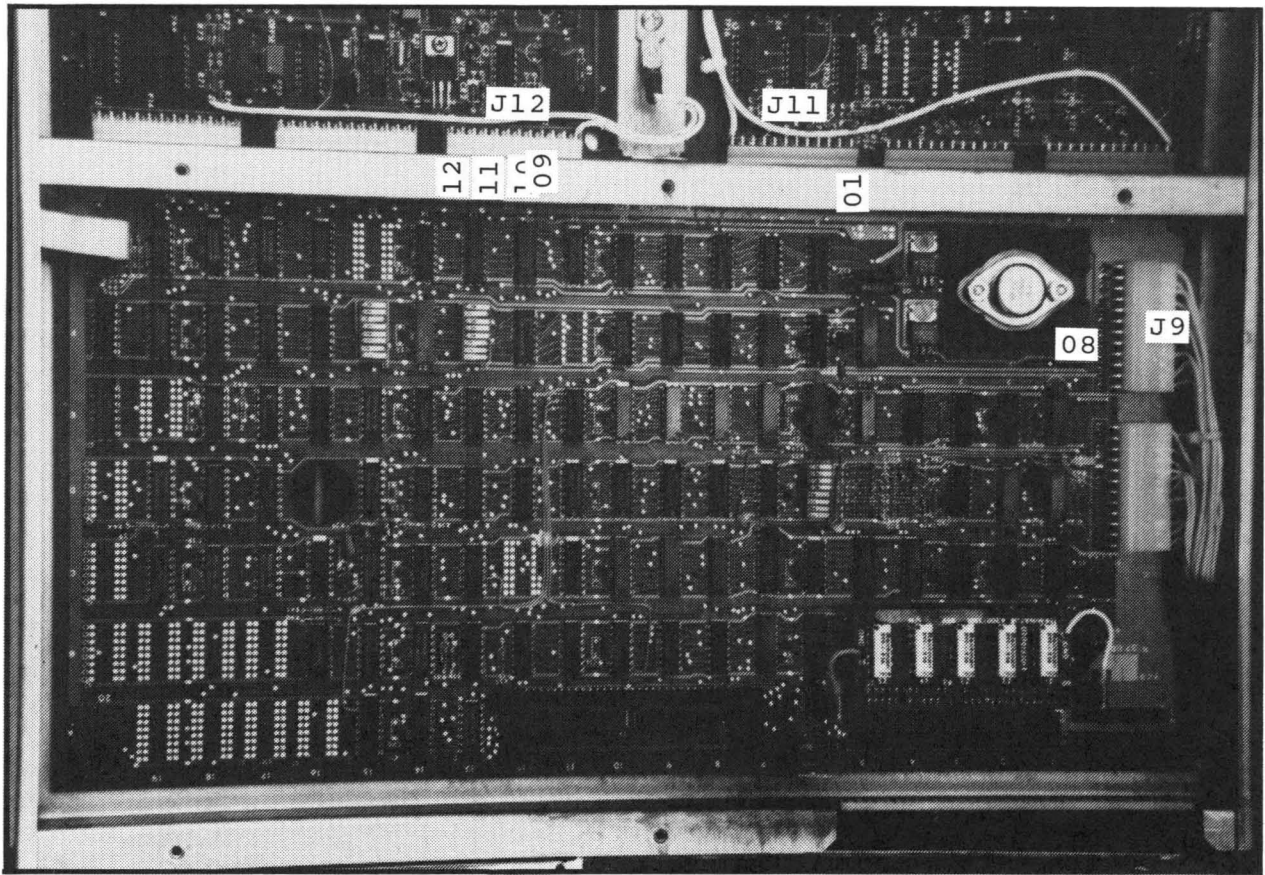

Figure 13. Logic Interface Test Point Locations

DC Voltage Distribution - Logic Interface

Voltages from Power Supply/Amplifier Board

<u>VOLTAGE</u>	<u>TEST POINT</u>	<u>PROBABLE CAUSE IF MISSING</u>
+5V	J12-12	Connection to PCB or Source
-5.2V	J11-01	Logic Interface PCB, Connection to PCB or Source (+9V)
+9V	J9-08	Connection to PCB or Source
-9V	J12-11	Connection to PCB or Source
+12V	J12-09	Connection to PCB or Source
-12V	J12-10	Connection to PCB or Source



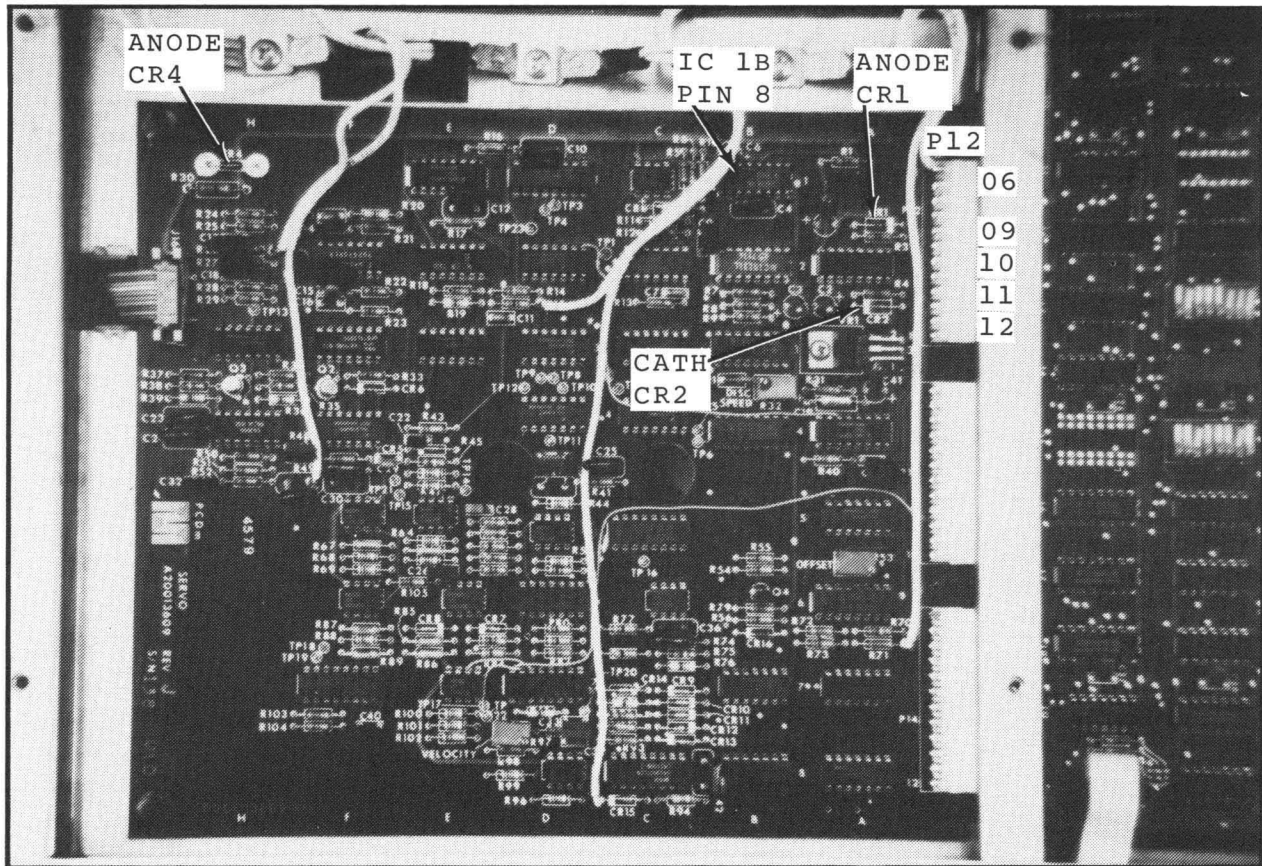

Figure 14. Servo PCB Test Point Locations

Voltage Distribution Servo PCB

<u>VOLTAGE</u>	<u>TEST POINT</u>	<u>POSSIBLE CAUSE IF MISSING</u>
+5V	P12-12	Connection to PCB or Source
-5.2V	P12-06	Connection to PCB or Source
-5.2V	IC 1B Pin 8	Connection to PCB or -9V Source
+6.2V	Cath. CR2	Connection to PCB or +12V Source
-6.2V	Anode CR1	Connection to PCB or -12V Source
-8.2V	Anode CR4	Connection to PCB, Servo Head, and/or -12V Source
-9V	P12-11	Connection to PCB or Source
+12V	P12-09	Connection to PCB or Source
-12V	P12-10	Connection to PCB or Source



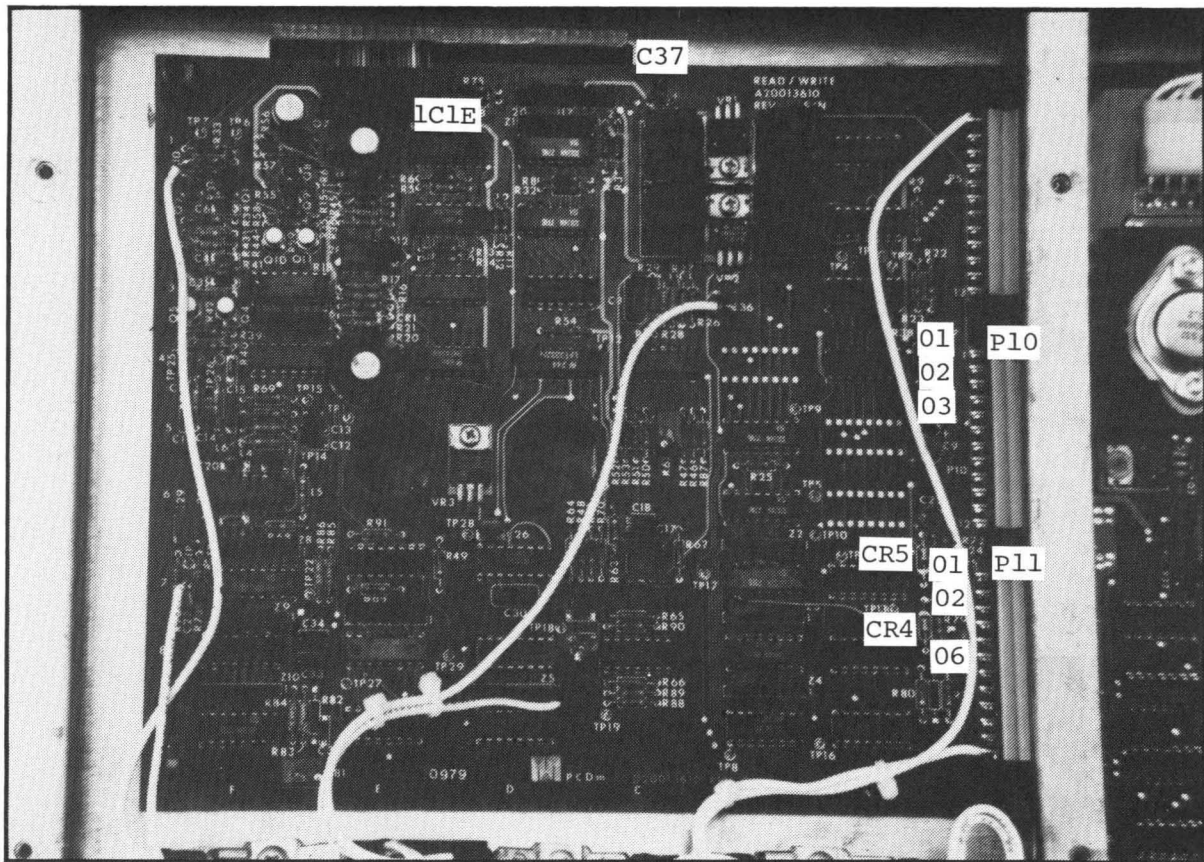

Figure 15. Read/Write PCB Test Point Locations

Read/Write PCB Voltages

<u>VOLTAGE</u>	<u>TEST POINT</u>	<u>PROBABLE CAUSE IF MISSING</u>
-4V	Minus Side of C37	Read/Write PCB, connection to PCB, Head IC and/or Cable, or Source
+5V	P10-01	Connection to PCB or Source
-5.2V	P11-01	Connection to PCB or Source
-5.2V	TP-28	Connection to PCB or Source (-9V)
+6V	Plus Side	Connection to PCB or Source (+9V)
+6V RW	IC 1E Pin 6	Connection to PCB, Head IC and/or Cable or Source (+9V)
+6.2V	Cath.CR4	Connection to PCB or Source (+12V)
-6.2V	Anode CR5	Read/Write PCB Connection or Source
+9V	P10-02	Connection to PCB or Source
-9V	P10-03	Connection to PCB or Source
+12V	P11-06	Connection to PCB or Source
-12V	P11-02	Connection to PCB or Source

SECTION 7

MAINTENANCE

SELF TEST

1. The first stage of effective troubleshooting is a thorough visual inspection of the equipment. List, in your own words, five different items you would inspect when starting to troubleshoot a Reflex II.

---

---

---

---

---

2. In coming to the "READY" condition, certain events in the Reflex II follow a definite sequential pattern. The events are shown below in a jumbled sequence. Indicate, in the spaces provided, whether the event is the first, or second, or third, etc., in the sequence.

- \_\_\_\_\_ Heads aligned with Track 0, drive READY.
- \_\_\_\_\_ 115 VAC applied to drive.
- \_\_\_\_\_ Servo Board reports "Up to Speed".
- \_\_\_\_\_ DCSAFE sent to Logic Board.
- \_\_\_\_\_ Power Supply/Amp Board reports "Brake Released".
- \_\_\_\_\_ Logic Board activates signal to energize spindle motor.
- \_\_\_\_\_ Logic Board activates signal to activate brake release solenoid.
- \_\_\_\_\_ Disc speed up to 80% of full rotational speed.

Section 7, SELF TEST (cont.)

3. List, in the space provided, which voltages are monitored in the generation of DC SAFE.

---

4. The +5V is generated by:

- a. Its own individual rectifier circuit.
- b. Dropping the +9V through a step-down transformer.
- c. Dropping the +18V across a voltage divider.
- d. Passing the +9V through a voltage regulator.

5. A DVM connected between ground and the minus (-) side of capacitor C1 should indicate a voltage reading of\*

- a. -18V
- b. +18V
- c. -9V
- d. +9V

## SECTION 8

### TROUBLESHOOTING AND ADJUSTMENTS

#### SCOPE

This section is a continuation of the previous section covering maintenance of the Reflex II. The previous section covered visual checks and voltage test points. This section discusses troubleshooting utilizing the exerciser and demonstrates adjustment procedures.

#### VIDEO TAPE

View Segment 9 of the Video Tape, Reel , Index

This segment is, perhaps, the most comprehensive part of the entire course. Each procedure is demonstrated on the Video Tape as well as explained in this workbook. A very thorough review of the Video Tape and of this workbook is required. You should plan on spending more time on this section than on any other in the course.

Please note that while this is Section 8 of the course, you are viewing Segment 9 of the Video Tape. This is due to the fact that Section 6 encompassed Segments 6 and 7 of the Video Tape.

#### READING

For supplementary information concerning this section, read the following portions of the Reflex II Instruction Manual:

Section 5, Maintenance

Corrective Maintenance, pp. 5-11, 5-13

Adjustments, pp. 5-13, 5-22

THERE IS NO SELF TEST FOR THIS SECTION. It is recommended that, in addition to a thorough review of the material herein, you work under supervision and perform as many of the maintenance procedures and adjustments as possible.



REVIEW

ADJUSTMENT PROCEDURES

Use exerciser (MOD III) during "Sequence Up". When point of failure has been determined, troubleshooting can be restricted to that area. With the use of oscilloscope and Volt Ohm Meter:

Disc up to speed

Channel B of scope at P13-2 and Channel A at P13-1, monitor during power-on cycle.

Sync scope internal, Channel A, Negative.

Check for up-to-speed to become active when pulses are within 20.3 milliseconds apart.

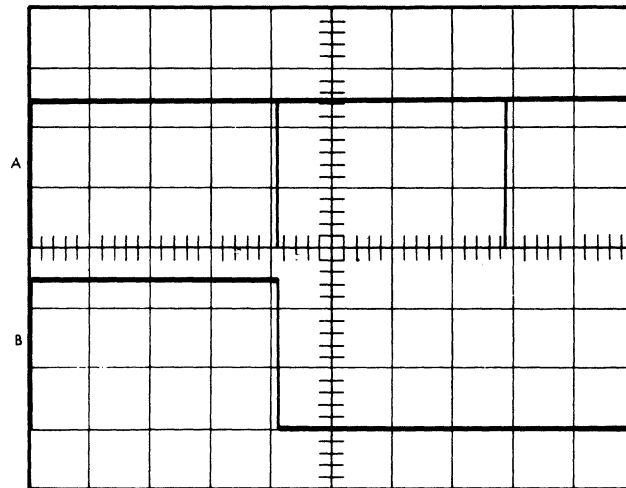

PROG: Apply power to unit, check up-to-speed during sequence-up  
SYNC: Channel A Internal Negative 5ms  
CHAN: A DC 2V P13 pin 1  
CHAN: B DC 2V P13 pin 2  
MODE: Chopped  
NOTE: Verify Channel B (up-to-speed) goes and stays negative when Channel A (Index) pulses are more frequent than 20.3ms.

Figure 16. Verification of Index/Up-To-Speed Pulses

If servo speed needs adjusting:  
 Allow disc to attain speed.  
 Rotate R-32 fully clockwise.  
 Set scope interval sync, Channel A, Positive,  
 Time Base 5 milliseconds per division.  
 Channel A DC coupled at 2 volts.  
 Chip clips on IC's 2D and 4A.  
 Connect scope Channel A to IC 4A Pin 6.  
 Ground P13 Pin 1 on Servo PCB.  
 Momentarily ground IC 2D Pin 11 to trigger input  
 to Speed One Shot.  
 Adjust R32 for positive pulse of 20.3 milliseconds  
 for each grounding.  
 Remove power.  
 Remove ground from IC 2D Pin 12.  
 Remove both chip clips.  
 Change sync of scope to negative, scope mode to  
 chopped, set Channel B for DC coupled at  
 2 volts.  
 Connect Channel A to P13 Pin 1.  
 Connect Channel B to P13 Pin 2.  
 Apply unit power and verify that Channel B goes  
 and stays negative when Channel A pulses are  
 closer than 20.3 milliseconds.

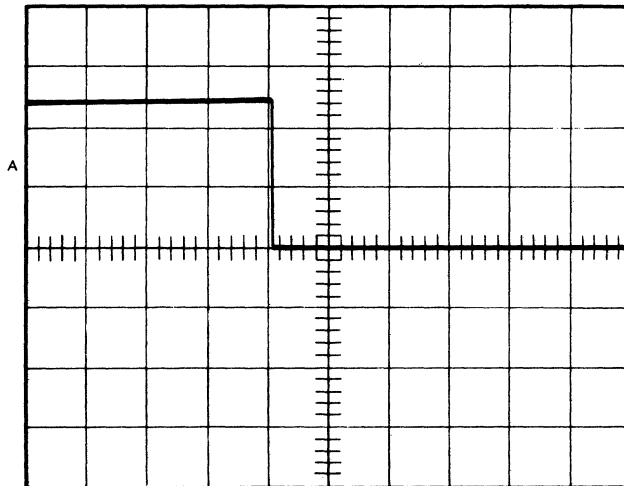

PROG: Ground 2D12; momentarily ground 2D11 to generate pulses  
 SYNC: Channel A            Internal            Positive            5 ms  
 CHAN: A                    DC                    2V                IC 4A pin 6  
 MODE: Channel A only  
 NOTE: Adjust R32 for a positive pulse of 20.3 ms for each grounding of 2D11.

Figure 17. Adjustment For Disc Speed

## Servo Balance

Set scope to 50 millivolts per division.

Connect Digital Voltmeter to TP16 on the Servo PCB.

Check unit in track follow mode. Check voltage level when carriage is located at cylinder 000 and cylinder 560. DC voltage level should be equal above and below ground and should not exceed 200 millivolts total. Allow the carriage to remain at 000 or 560 to allow the DVM readings to stabilize.

To adjust balance

Verify track follow mode is active when unit is in ready status.

Connect DVM to TP 16 and record the level.

Perform seek operation to cylinder 560. Record the DC voltage level.

Adjust Balance Pot R53 so that the DC voltage levels are equally displaced above and below zero volts on cylinder 000 and cylinder 560.

Perform seeks on cylinders 000 and 560. Note the voltage level at TP16.

Adjust R53 until there is equal DC voltage displacement above and below zero volts. Maximum voltage levels should not exceed plus or minus 200 millivolts.

## Velocity Verification

Set scope for 2 volts per division with time base of 10 milliseconds per division.

Install chip clip on IC 19C on Logic/Interface PCB.

Sync negative on IC 19C-2, Seek Start.

Scope IC 19C-8, Seek Ready.

Perform full stroke seeks verifying 19C-8 is inactive for 55 milliseconds.

If velocity needs adjusting:

Allow unit to reach ready status. Install chip clip on IC 19C on Logic/Interface PCB.

Set scope for Internal negative sync on Channel A with time base of 10 milliseconds per division. Set Channels A and B for DC coupling at 2 volts per division with alternate mode selected.

Connect Channel A to IC 19C Pin 2 on Logic Interface PCB. Connect Channel B to IC 19C Pin 8.

Program drive to do alternate full stroke seeks. Adjust velocity for R97 so that Channel B is negative for 55 milliseconds. The time difference between forward and reverse sync should be within 3 milliseconds.

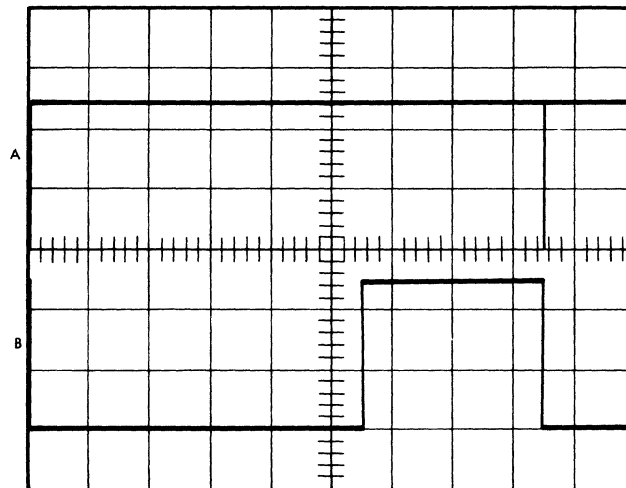

PROG: Alternate seeks between cylinders 000 and 560  
 SYNC: Channel A Internal Negative 10ms  
 CHAN: A DC 2V 19C2 (SK STRT/)  
 CHAN: B DC 2V 19C8 (SKRDY)  
 MODE: Alternate  
 NOTE: Adjust R97 for Channel B (SKRDY) to go negative (inactive) for 55 ± 3ms.

Figure 18. Velocity Adjustment

## Phase Detector Offset Verification

Set scope for 0.5 volts per division with a time base of 5 nanoseconds per division. Sync scope internal on Channel A. Connect A to test point 18 and Channel B to test point 19 of Read/Write PCB.

Look at signals on alternate mode. While unit is in track follow mode and no read/write commands are active, verify positive going edges of the two signals are within zero (plus or minus two nanoseconds) of each other at the threshold point (1.3 volts).

To make the Phase Detector offset adjustment:

Apply power to the unit and allow it to attain READY STATUS.

Set scope for internal, positive sync from Channel A with time base of 5 nanoseconds per division.

Set Channel A and B for DC coupling of 0.5 volts per division, with alternate mode.

Adjust the base lines (zero volt level) of both Channels A and B so that the base line is 1.3 volts above the center line of the scope.

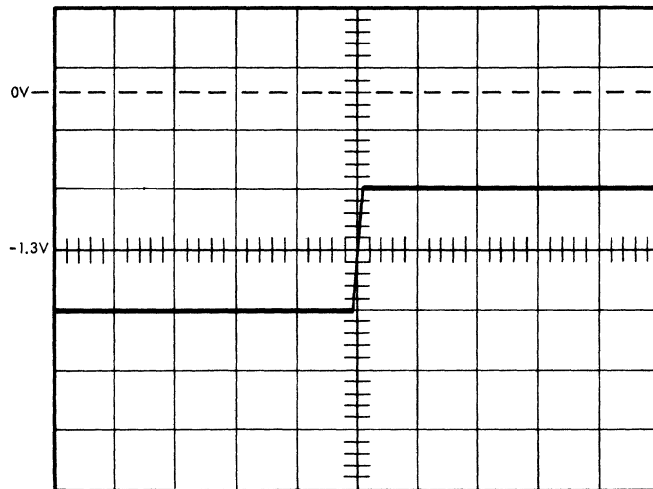

Connect Channel A to test point 19 and Channel B to test point 18 of Read/Write PCB.

Adjust the position of the signal so that the positive going edge of the signal from Channel A has 1.3 volt level at the center of the scope.

Place the drive in track follow mode, no active read or write command. Adjust the Phase Detector Offset Pot R61 so that the positive going edge of Channel B lines up with the positive going edge of Channel A (plus or minus one nanosecond).

PROG: Disc ready; no seek, read or write; verify to  $0 \pm 2\text{ns}$ ; adjust to  $0 \pm 1\text{ns}$

SYNC: Channel A Internal Positive 5ns

CHAN: A DC 0.5V TP18 (XOVERDET/)

CHAN: B DC 0.5V TP19 (FDBK)

MODE: Alternate

NOTE: Adjust R61 so that the positive going edge of both pulses are coincident ( $0 \pm 1\text{ns}$ ) at the threshold level (-1.3V)

Figure 19. Phase Detector Offset Verification



## Read/Write pulse width verification

Set scope to 0.5 volts per division. Sync scope internal on Channel A and connect to test point 18 of Read/Write PCB.

Connect Channel B to test point 29 of Read/Write PCB and center negative pulse.

Adjust base line of Channel A to 1.3 volts above the center line of the scope. Adjust the base line of Channel B to 1.0 volts above the center line.

Place Disc Drive in track follow mode with no active read or write command. Verify negative going edge of Channel A has threshold point (1.3 volts) at center of scope when the negative pulse of Channel B is centered on scope.

To make pulse width adjustment:

Apply power to Disc Drive, allow to attain READY STATUS.

Set scope internal, positive sync, Channel A, time base of 10 nanoseconds per division. Set Channels A and B for DC coupling at 0.5 volts per division with alternate mode.

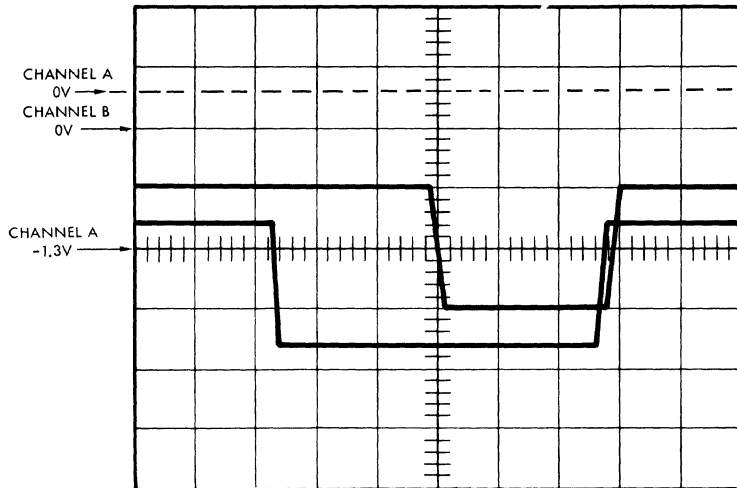

Adjust base line (zero volts) for Channel A so that the base line is 1.3 volts above the center line of the scope. Adjust the base line of Channel B to 1.0 volts above the center line of the scope.

Connect Chan. A to TP18 and Chan. B to TP29 of Read/Write PCB.

Adjust position of negative pulse of Channel B to be centered at the vertical center line of the scope.

Place Disc Drive in track follow mode, no active read or write command. Adjust pulse width Pot R81 so that the negative going edge of Channel A has a threshold point exactly at the center of scope when negative pulse of Channel B is centered on scope.

PROG: Disc ready; no seek, read or write; verify to  $0 \pm 2\text{ns}$ ; adjust to  $0 \pm 1\text{ns}$   
 SYNC: Channel A Internal Positive 10ns  
 CHAN: A DC 0.5V TP18 (XOVERDET/)  
 CHAN: B DC 0.5V TP29 (WINDOW)  
 MODE: Alternate

NOTE: Adjust R81 so that the negative going edge of TP18 (XOVERDET) has its threshold point (-1.3V) exactly at the center of the scope ( $0 \pm 1\text{ns}$ ), when TP29 (WINDOW) is properly adjusted. When properly adjusted, its negative pulse is centered exactly about the center of the scope face.

Figure 20. Read/Write Pulse Width Verification

## Brake Verification

### Mechanical check

Remove the bottom access cover making sure that no material touches the brake disc when the brake solenoid is energized.

Brake should stop spindle within 15 seconds.

If replacement is required, follow the explanation given in the Maintenance Section (Section 5) of the Instruction Manual.

### Ground brush assembly check

Poor ground brush contact causes soft data errors sporadically.

Check continuity between base of spindle shaft and ground brush assembly. If resistance is greater than 1 ohm, clean the surface of the ground brush with fine emery cloth.

While the spindle is spinning, insert the emery cloth between the spindle and the ground brush. Avoid bending the ground spring as it must maintain 150 gram force to insure proper contact.

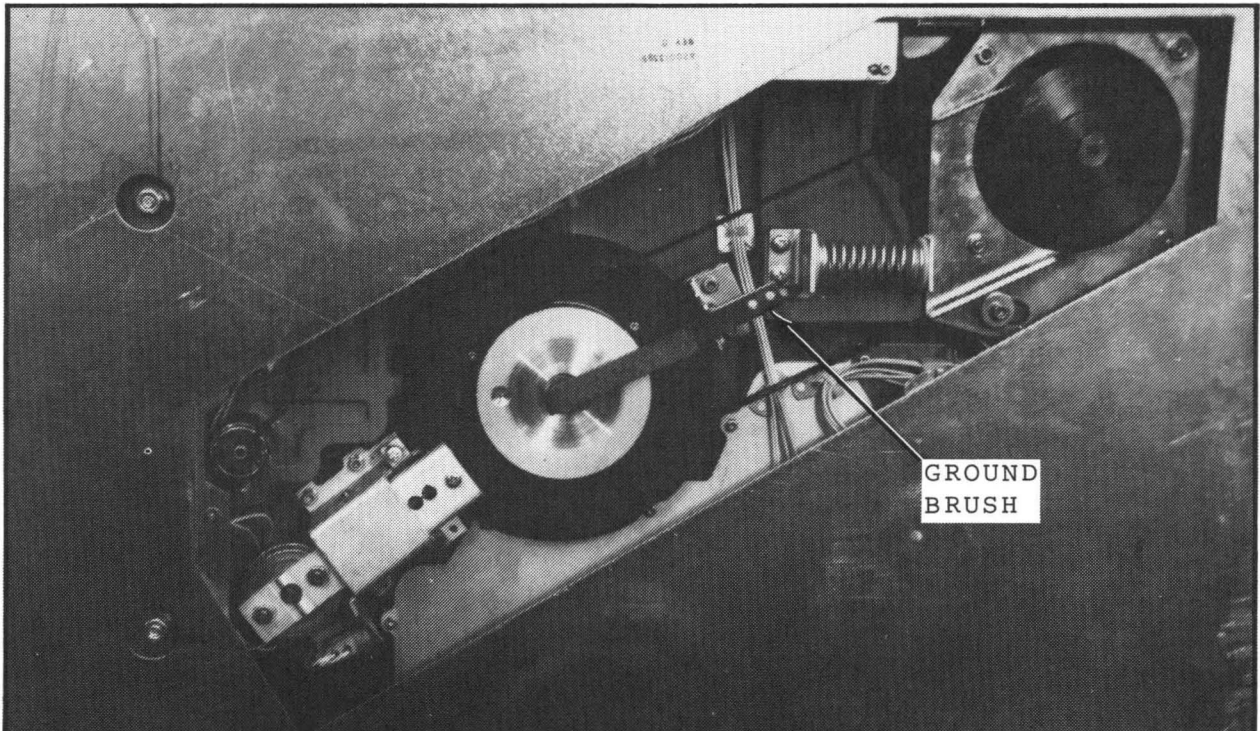

Figure 21. Ground Brush Assembly



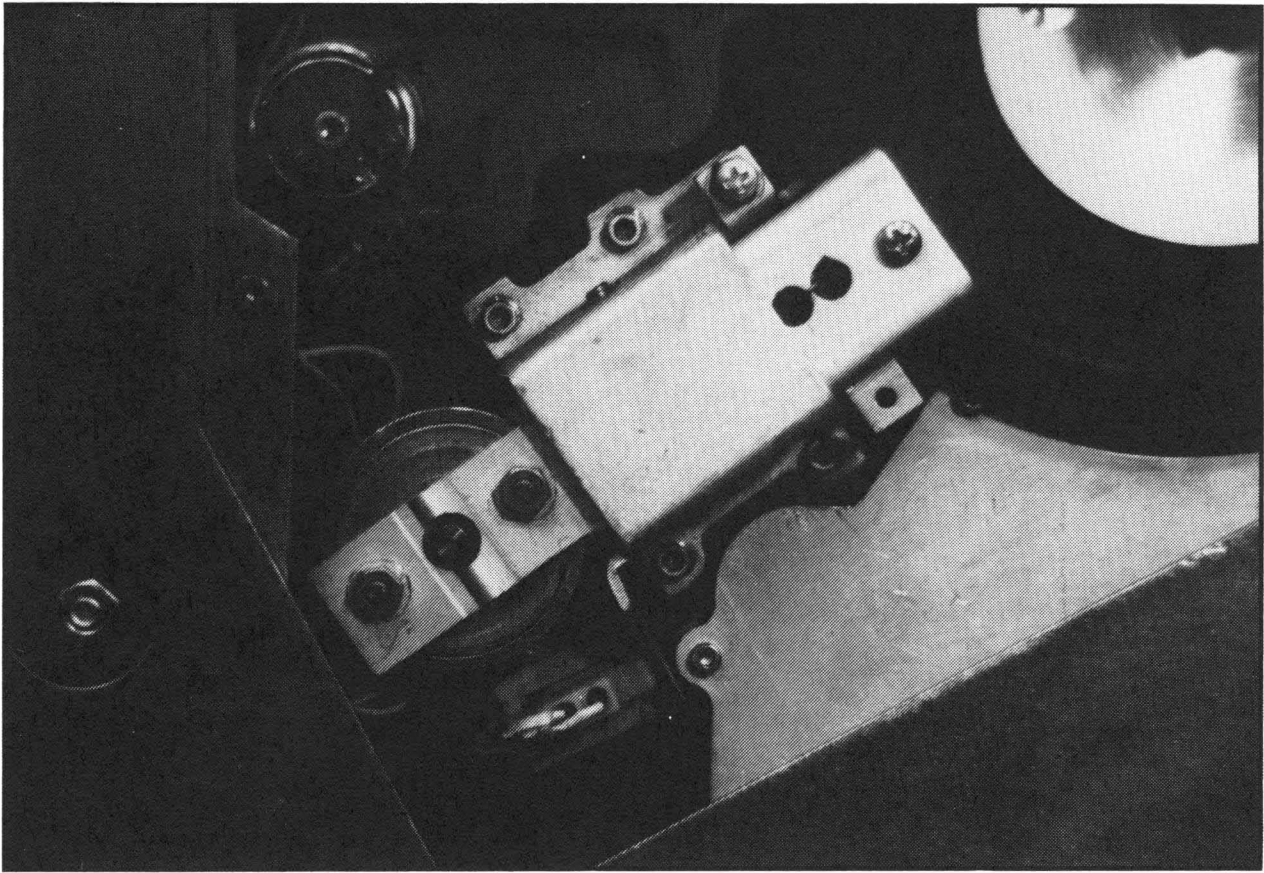

Figure 22. Disc Brake Assembly

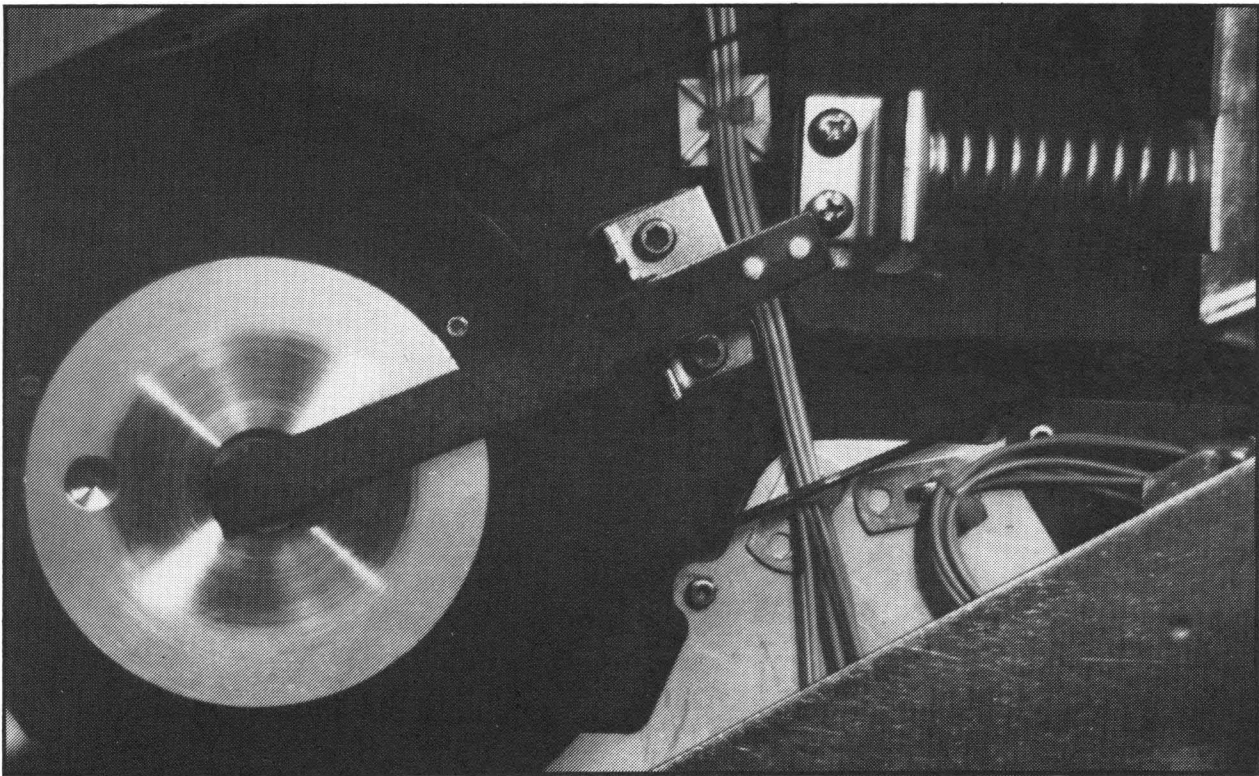

Figure 23. Ground Brush Assembly



## SECTION 9

### REMOVAL AND REPLACEMENT

#### SCOPE

This section demonstrates and explains the procedures to be followed to remove and replace the major units and assemblies of the Reflex II Disc Drive. It begins with the removal and replacement of the Printed Circuit Boards and progresses through the removal and replacement of mechanical and electromechanical assemblies.

#### VIDEO TAPE

View Segment 10 of the Video Tape, Reel , Index

Each procedure is shown and explained on the Video Tape segment for this section. It is recommended that you first view the entire tape segment, then complete the reading and review. Then, when reviewing the Video Tape, refer to the review section of this workbook at the same time.

#### READING

For supplementary information concerning this section, refer to the following portions of the Reflex II Instructional Manual.

Section 5, Maintenance

Removal and Replacement, pp. 5-22, 5-32

Test Equipment and Tools, page 5-33

#### REVIEW

The following pages contain an outline of procedures for the removal and replacement of modules and major assemblies of the Reflex II Disc Drive. They are accompanied by photographs to aid in the understanding of the described procedures. This section also sequentially follows the procedures as they are demonstrated on the Video Tape. This will allow you to easily follow along with the Video while referring to this workbook. The following outlines and accompanying photographs will also provide you with a means of review with or without the Video Tape.

THERE IS NO SELF-TEST FOR THIS SECTION. It is recommended that, in addition to reviewing the material, you attempt to actually perform as many of the part removals and replacements as possible.

## Circuit Board Removal

For all circuit boards:

Turn off power.

Remove power cord from the power outlet.

Remove the appropriate external covers (Refer to Figure 24)

For Read/Write, Servo, and Logic Interface PCB's:

Remove PCB chassis cover and interface cover.

For Power Supply/Amp PCB:

Remove interface cover and Power Supply/Amp cover.

Remove and replace the appropriate PCB.

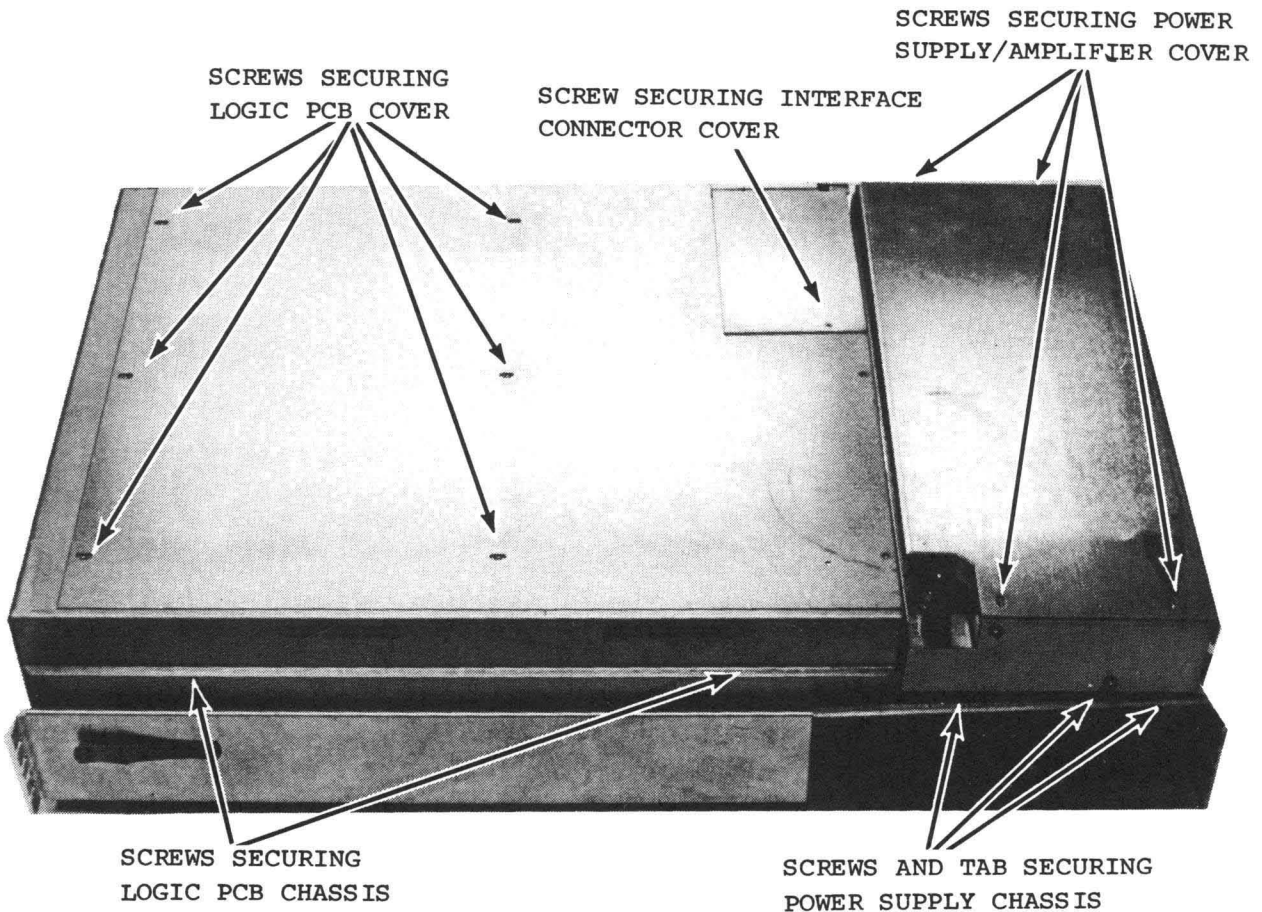

Figure 24. Reflex II PCB Replacement Access



## Read/Write PCB Removal

Refer to Page 50 and Figure 24 for access to PCB.

Disconnect P15 and P17.

Remove or disconnect ground straps.

Disengage Quick Locks.

Lift PCB clear of frame and pull out from connectors.

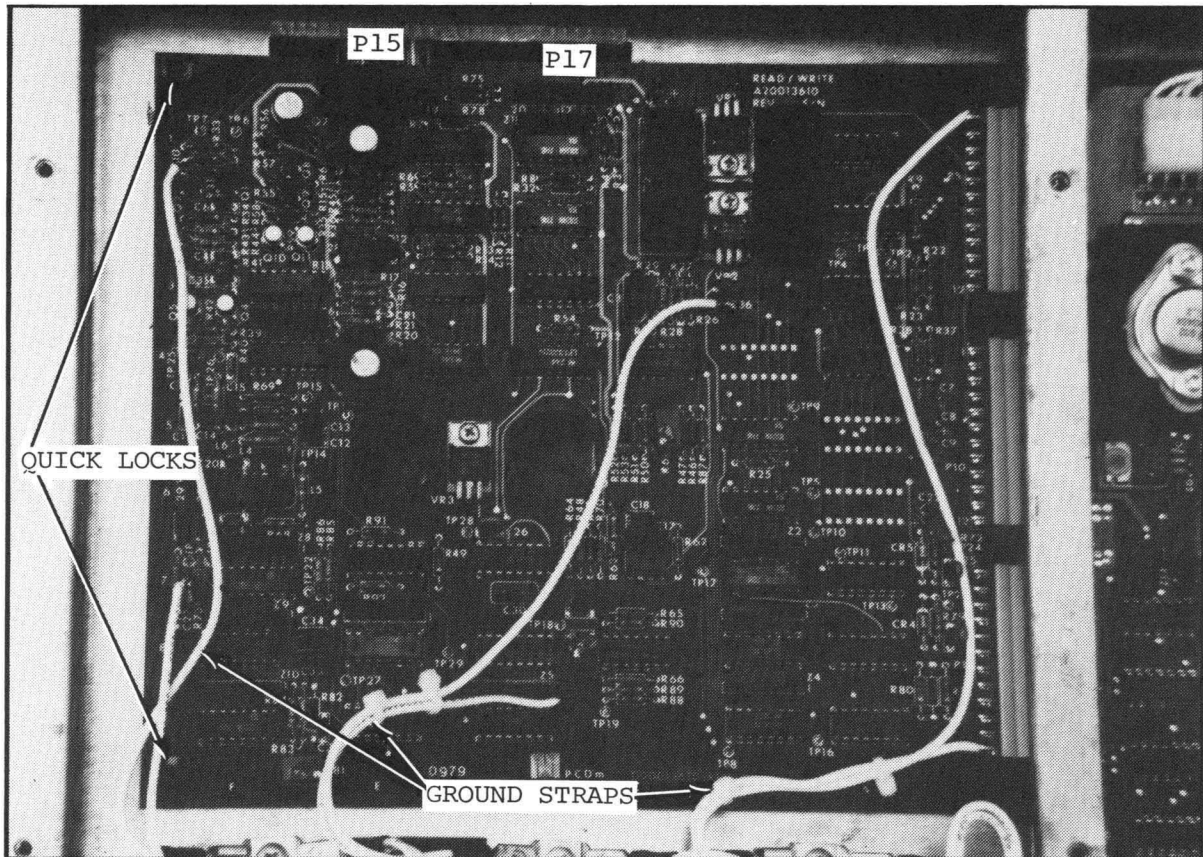

Figure 25. Read/Write PCB Removal.

## Read/Write PCB Replacement

Follow the above procedure in reverse.

Refer to Page 5-22 of the Reflex II Instruction Manual for cable/connector alignment hints.

Verify read/write adjustments.



## Servo PCB Removal

Refer to Page 50 and Figure 24 for access to PCB.

Disconnect P16.

Remove or disconnect ground straps.

Disengage Quick Locks.

Lift board to clear frame and pull out from connectors.

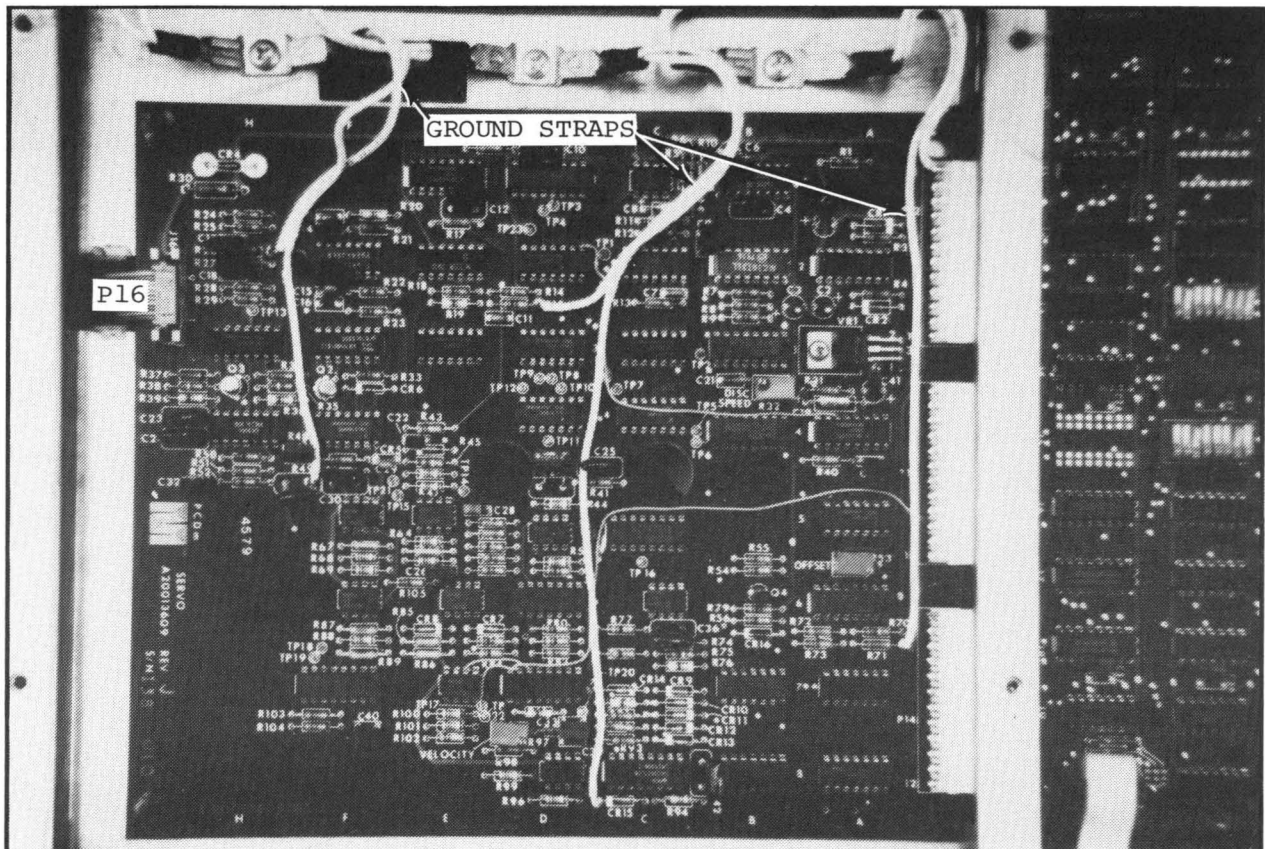

Figure 26. Servo PCB Removal

## Servo PCB Replacement

Perform the above steps in reverse.

Refer to Page 5-23 of the Reflex II Instruction Manual for connector orientation.

Verify servo adjustments.



## Logic/Interface PCB Removal

Refer to Page 50 and Figure 24 for access to PCB.

Remove Read/Write and Servo PCB's.

Remove interface cables, P1, P2, and P3.

Disengage Quick Locks.

Lift PCB from the end with Quick Locks and P8 and P9.

Work the board out to give clearance in order to disconnect P8 and P9.

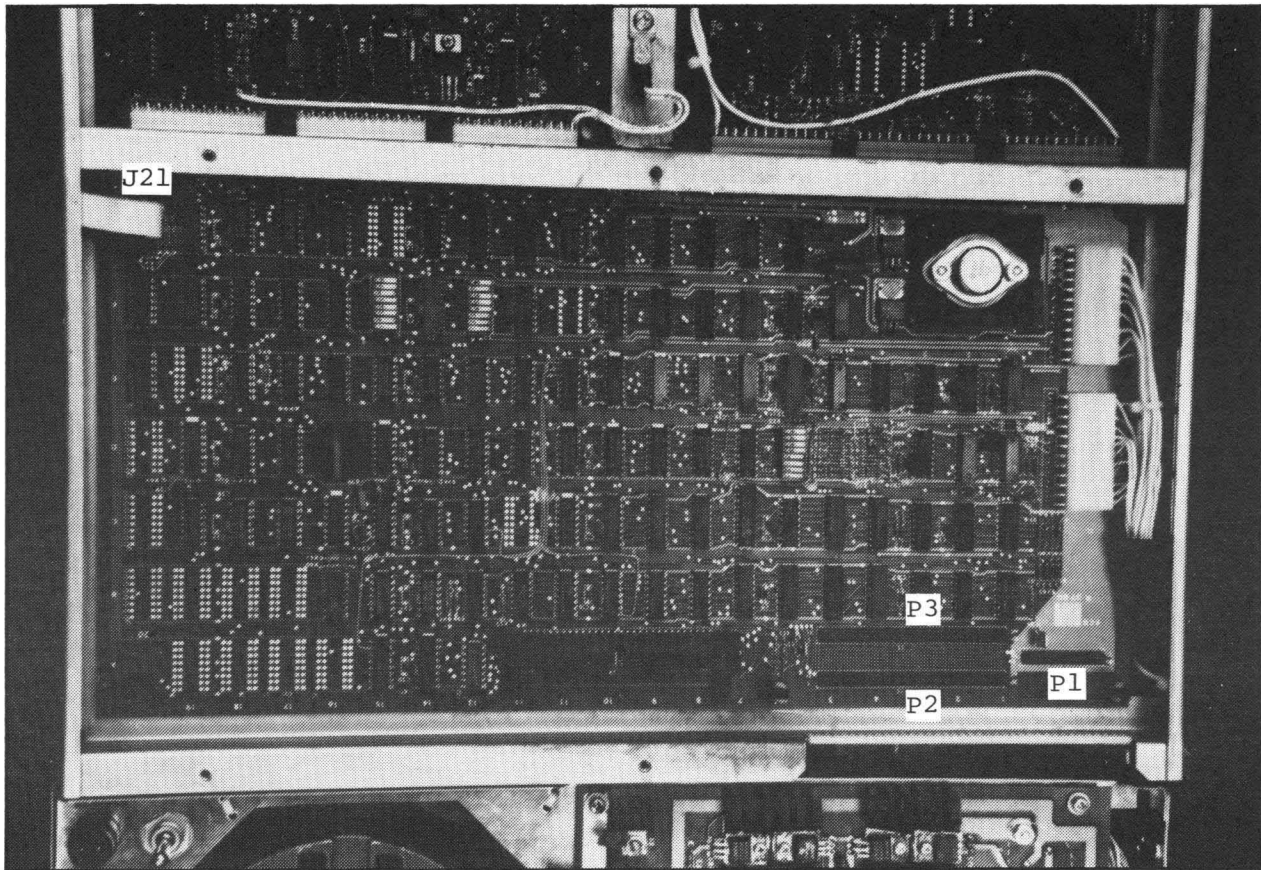

Figure 27. Logic Interface PCB Removal

## Logic/Interface PCB Replacement

Perform the above procedure in reverse.

Refer to Page 5-23 of the Reflex II Instruction Manual for connector orientation.

Verify the switch settings on the Logic/Interface PCB.  
(Refer to Page 29 of this workbook).



## Power Supply/Amplifier PCB Removal

Refer to Page 50 and Figure 24 for access to PCB.

### Remove:

- Interface Cover.
- Power Supply/Amplifier chassis cover.
- Interface cables at P1, P2, and P3.
- Ground strap from E1, if necessary.
- The six screws holding the circuit board in place.
- P18 and P19.
- The Power Supply/Amplifier PCB.

Do not lose the spacers between PCB and frame.

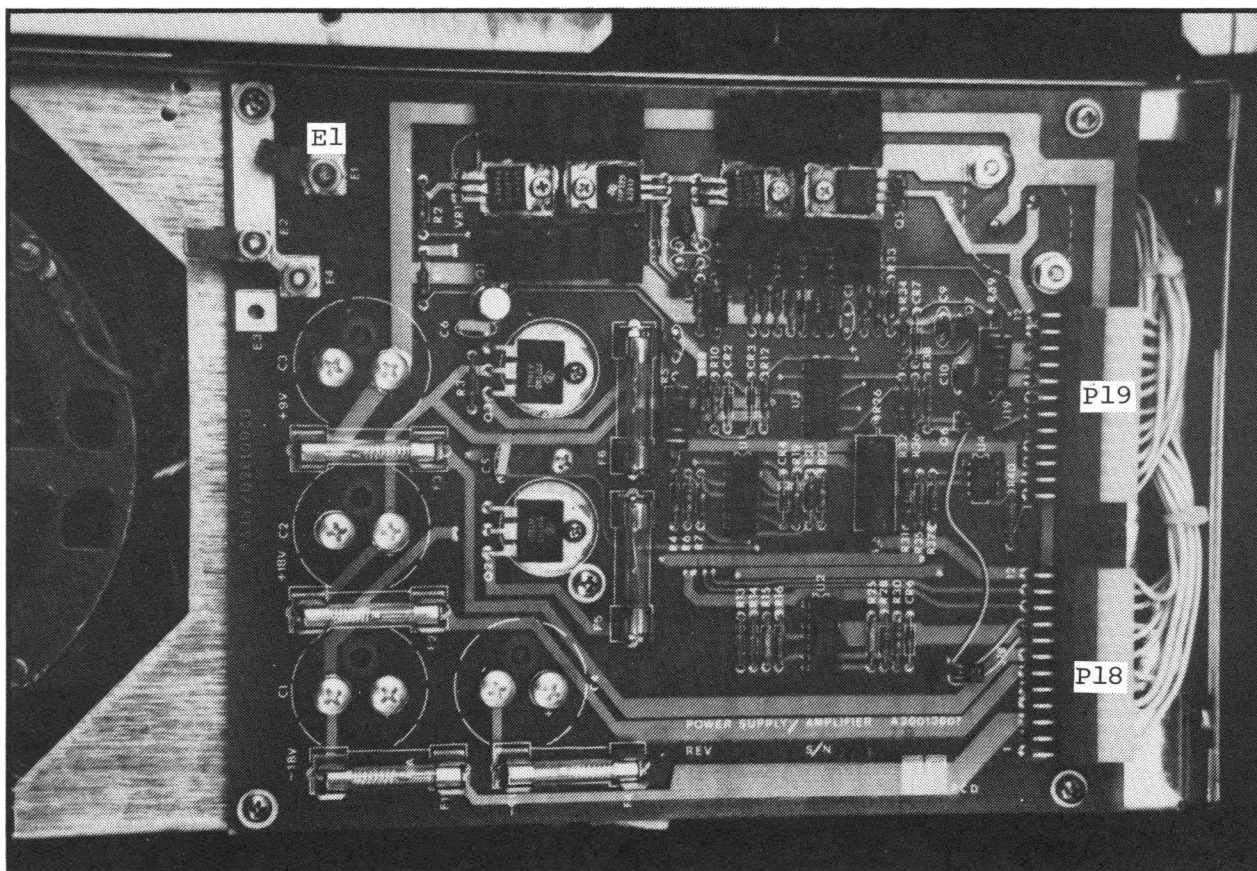

Figure 28. Power Supply/Amplifier PCB Removal

## Power Supply/Amplifier PCB Replacement

Perform the above procedure in reverse.

### Verify:

- ground connection for E2 and E4.
- DC voltages.



## LED/Switch PCB Removal

Refer to Page 50 and Figure 24 for access to PCB.

Remove the two screws securing the PCB chassis and swing the PCB Chassis open.

Remove the two screws securing the LED/Switch PCB and remove P39.

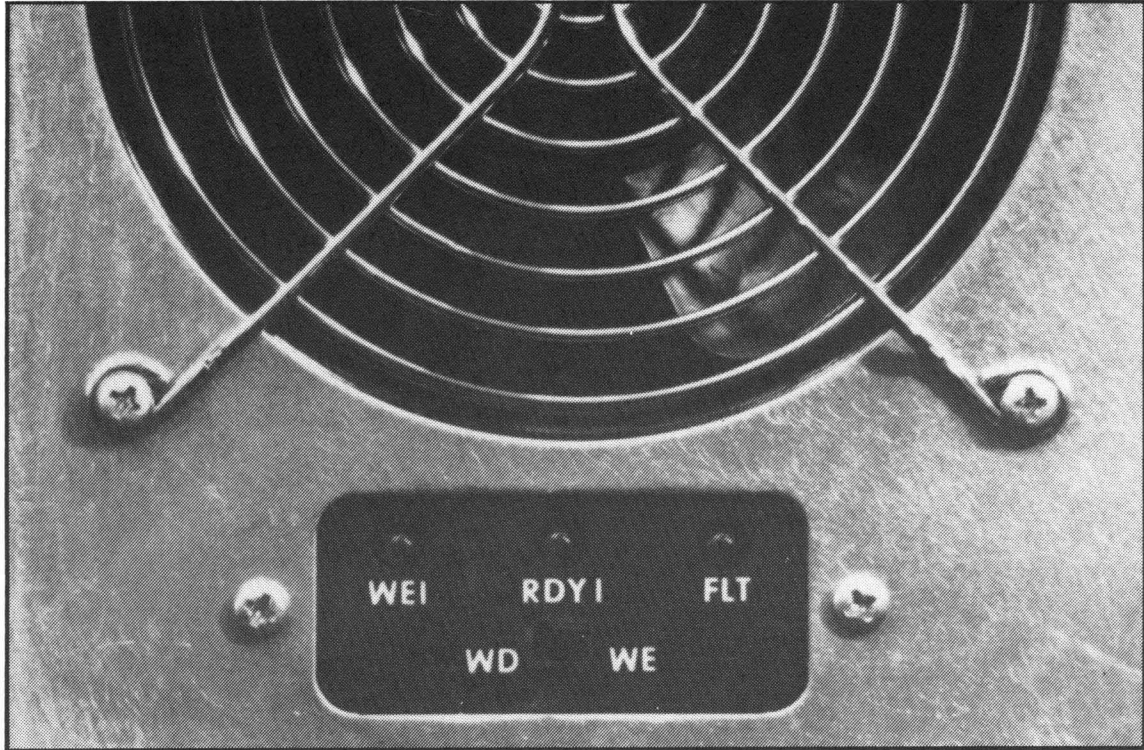

Figure 29. LED/Switch PCB Removal

## LED/Switch PCB Replacement

Install P39 of the replacement PCB. Refer to Page 5-25 of the Reflex II Instruction Manual for connector orientation.

Align one hole of the PCB with the frame and insert a screw.

Locate the PCB to align the LED's with the holes in the panel. The alignment should allow the previously inserted screw to be started in the PCB.

Align the second screw hole, install the second screw, and fasten both screws.

Replace the PCB chassis.

Servo velocity and offset adjustments.



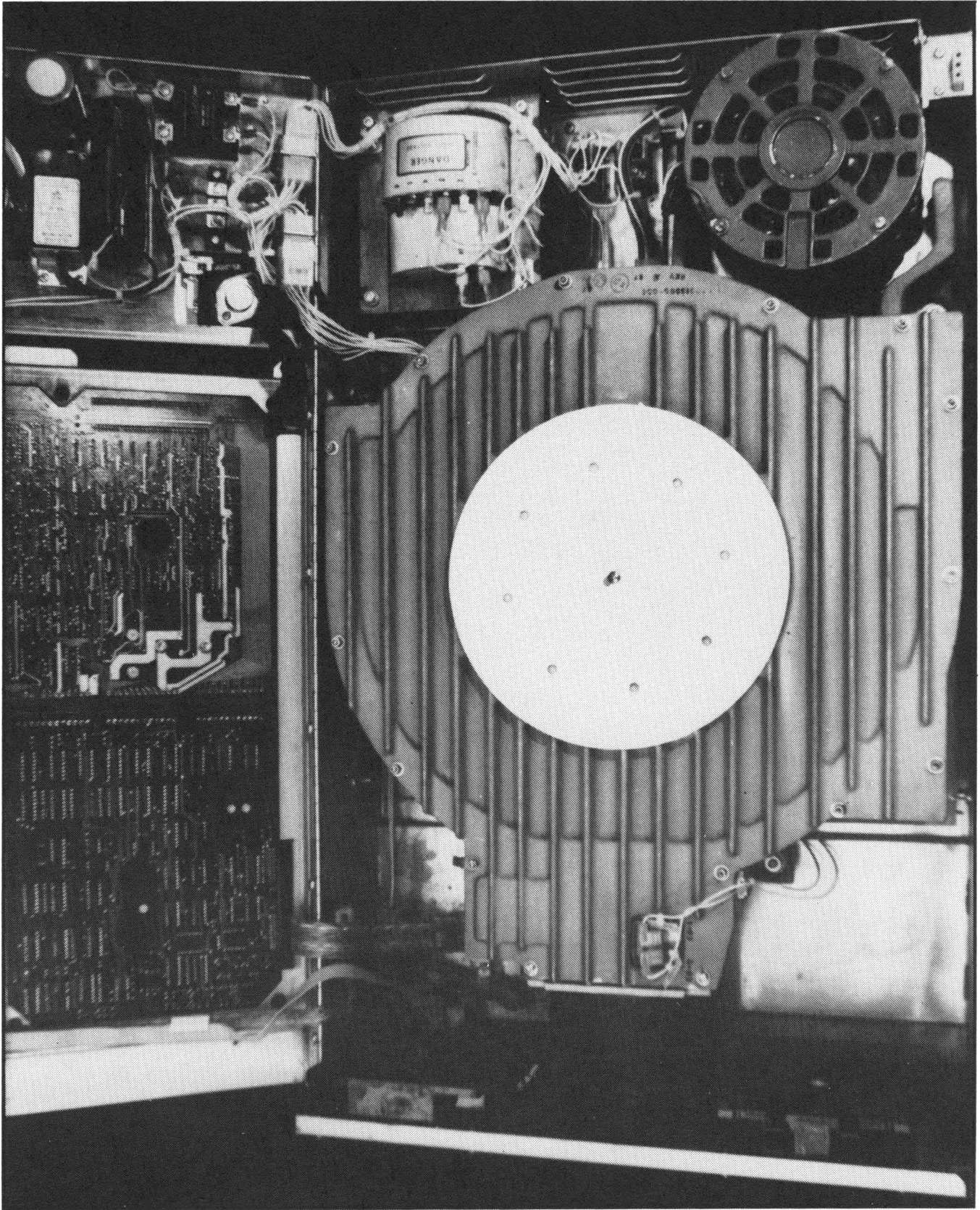

Figure 30. Reflex II, Access for Maintenance



## Electromechanical Assemblies

### Sealed Module and Motor Assembly Removal

Remove the power from the unit.

Remove the two screws securing the PCB chassis and the two screws securing the Power Supply/Amplifier chassis. (Refer to Figure 24 on Page 50 of this workbook.)

Swing open both the PCB chassis and the Power Supply/Amp chassis.

Remove P30, P6, P7, the ground terminal from E1 of module assembly, and P22 (if applicable). (Refer to Figure 30 on the preceding page.)

Remove the four nuts securing the module and motor assembly to the shock mounts on the frame.

Lift the entire module and motor assembly from the frame.

### Sealed Module and Motor Assembly Replacement

Perform the above procedure in reverse.

Verify disc drive operations.

### Cooling Fan Removal

Remove power from the unit.

Remove the two screws securing the PCB chassis and swing open the PCB chassis. Refer to Figure 24 on Page 50 of this workbook.

Remove P35 (or P36) from the fan and remove the fan from the assembly. Refer to Figure 32 on the following page.

Remove the self-locking hardware from the old fan.

### Cooling Fan Replacement

Install self-locking hardware on the new fan.

Follow the above procedure in reverse.

Observe that the air flow is in the proper direction, ie., into the drive from front to rear.

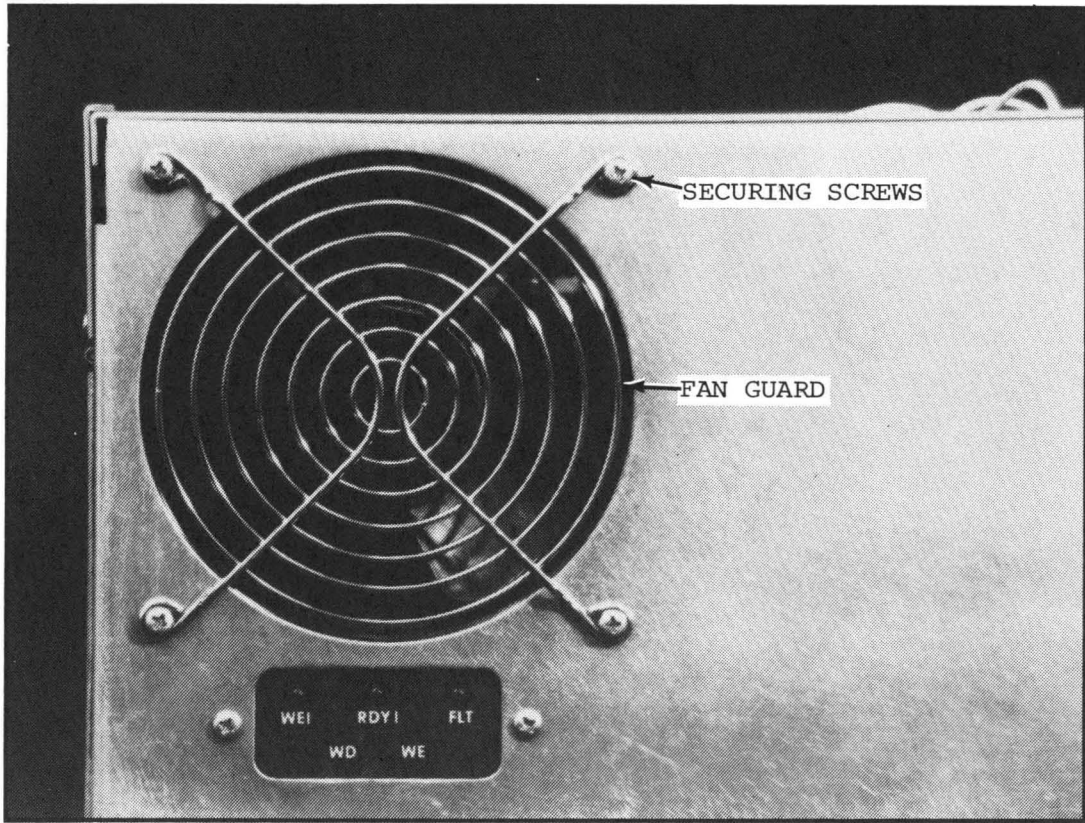

Figure 31. Cooling Fan Placement

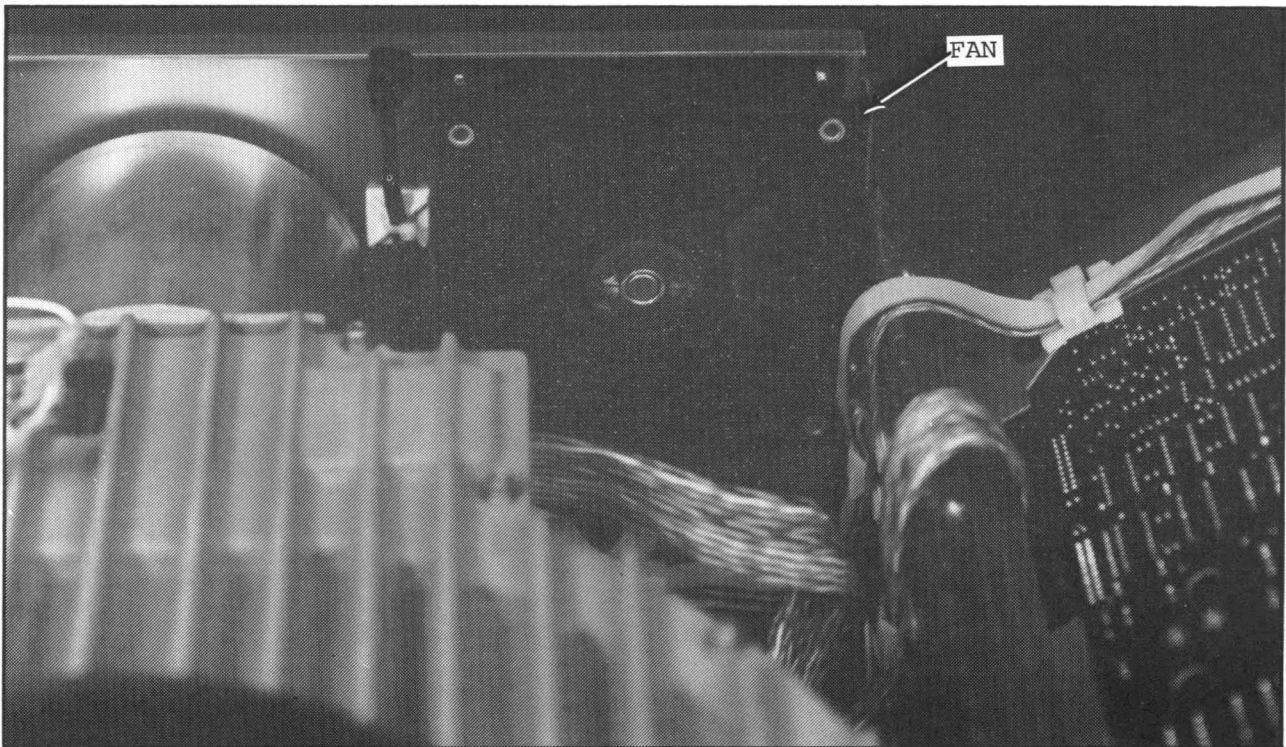

Figure 32. Cooling Fan Removal



### Transformer Assembly (DC Voltage Supply) Removal

Remove power from the unit. Make certain that there is no connection of any type to a power source.

Remove the two screws securing the rear cover and remove the rear cover. Refer to Figure 33.

Remove the two screws securing the Power Supply/Amplifier chassis.

Remove interface connections P1, P2, and P3 on the Logic/Interface PCB. Refer to Figure 27 on Page of this workbook.

Swing open the Power Supply/Amplifier chassis.

Remove P26.

Remove the screw securing the transformer assembly to the frame and lift the transformer assembly out through the rear of the unit.

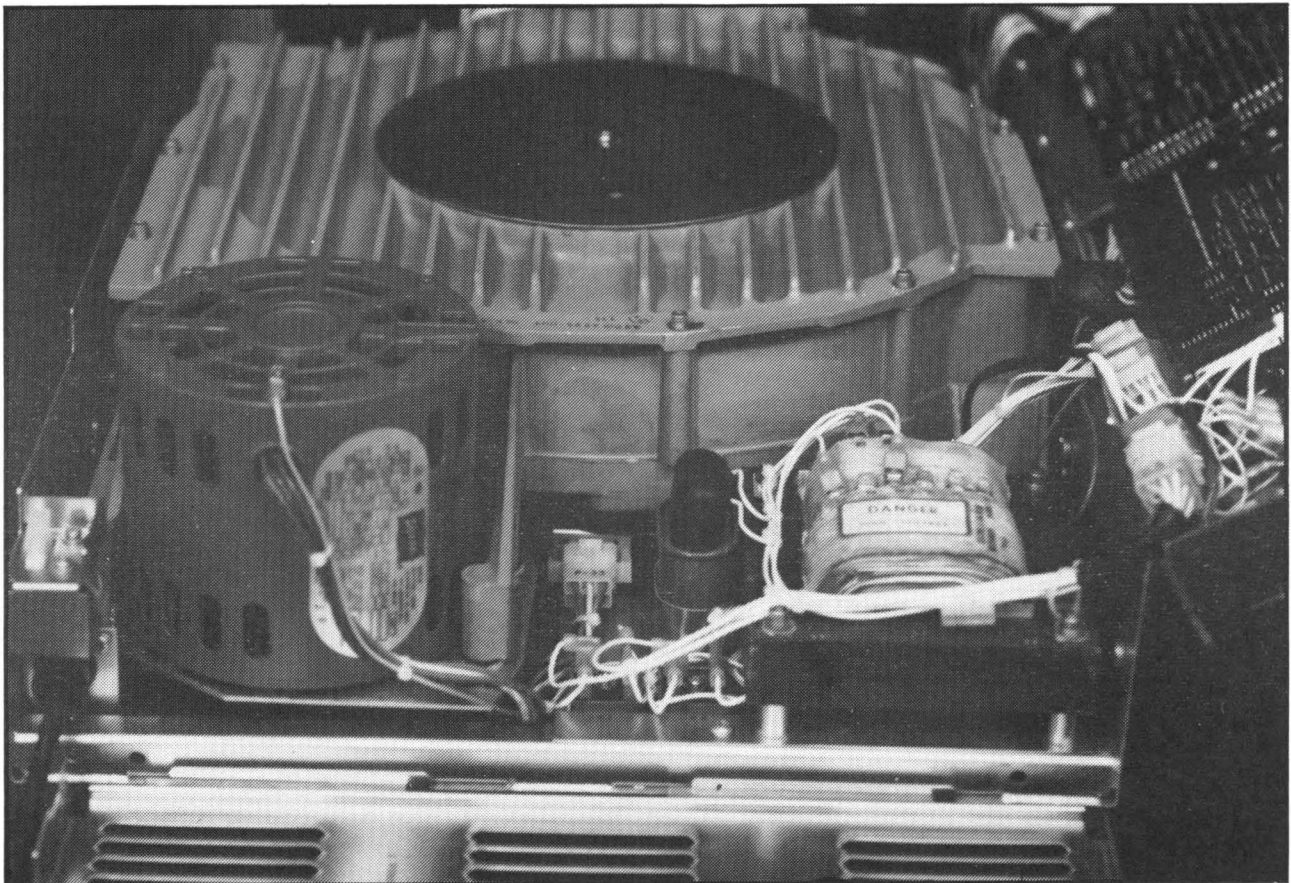

Figure 33. Transformer Assembly Removal.



### Transformer Assembly Replacement

Perform the procedure on the preceding page in reverse.

Select the proper tap on the transformer. Refer to Power Verification in Section 3 of the Reflex II Instruction Manual.

Verify DC voltages on the Power Supply/Amplifier PCB.

### Drive Belt Removal and Replacement

Remove power from the unit.

Remove the bottom access cover. Refer to Figure 34.

Squeeze together the drive belt tension spring and remove the belt.

While squeezing the drive belt tension spring, install and align the new belt to the spindle and motor pulley centers.

Apply power to the unit to verify the dynamic alignment of the drive belt.

Remove Power. Replace the bottom access cover. Ensure that there is not interference between the cover and the drive belt or pulleys.

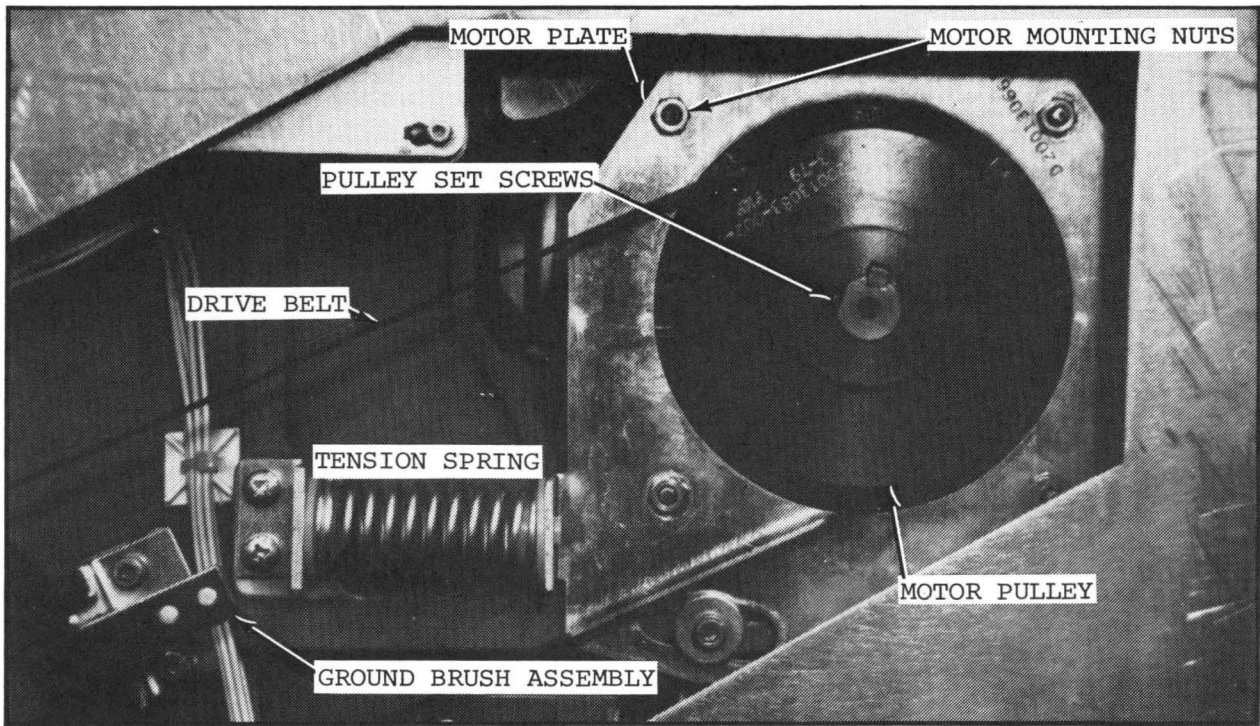

Figure 34. Motor Pulley and Drive Belt

**CAUTION: During replacement of the Drive Belt, etc., DO NOT ATTEMPT TO TURN THE SPINDLE BY HAND. Manual rotation of the spindle may cause damage to the heads or the discs.**

#### AC Motor Pulley Removal and Replacement

Remove power from the unit.

Remove the bottom access cover.

Remove the Drive Belt. Refer to the procedure on the preceding page.

Refer to Figure 34 on the preceding page. Remove the two Allen screws that secure the pulley to the motor shaft. Note the position of the pulley on the shaft for alignment purposes.

Remove the pulley from the shaft using care not to lose the key. If the pulley has been on the shaft for an extended period, it may be necessary to use a bearing puller to remove the pulley from the motor shaft.

To replace the pulley, perform the above procedure in reverse. Ensure that the pulley is properly aligned on the shaft. When replacing the bottom access cover, make certain that there is no interference between the cover and the drive belt or pulley.

#### AC Spindle Motor Removal and Replacement

Remove power from the unit.

Remove the bottom access cover.

Remove the rear access cover.

Remove the Drive Belt.

Remove the Motor Pulley. Refer to the above procedure. This is necessary only if the old pulley is required for the new motor.

Remove the four nuts securing the motor to the motor plate.

Remove the two screws securing the Power Supply/Amplifier chassis. Refer to Figure 24.

Remove the interface connections P1, P2, and P3 on the Logic/Interface PCB and swing open the Power Supply/Amplifier Chassis. Refer to Figure 27.

Remove P33 and lift the motor from the disc drive unit.

To replace the motor, perform the above procedure in reverse.



## Ground Brush Assembly Removal and Replacement

Remove power from the unit.

Remove the bottom access cover.

Remove the two Allen head screws securing the ground brush assembly to the deck plate. Refer to Figure 35 (below).

Remove the Ground Brush Assembly.

**NOTE:** When replacing the Ground Brush Assembly, it is necessary to acquire both the Ground Brush Assembly and the Ground Brush Damper since they are separate parts. The Ground Brush Damper must be glued into the Ground Brush Assembly.

To replace the Ground Brush Assembly, perform the above procedure in reverse. Be sure that the Ground Brush Damper is in place and that there is no interference between the bottom access cover and the Drive Belt, Pulley, or Ground Brush Damper.

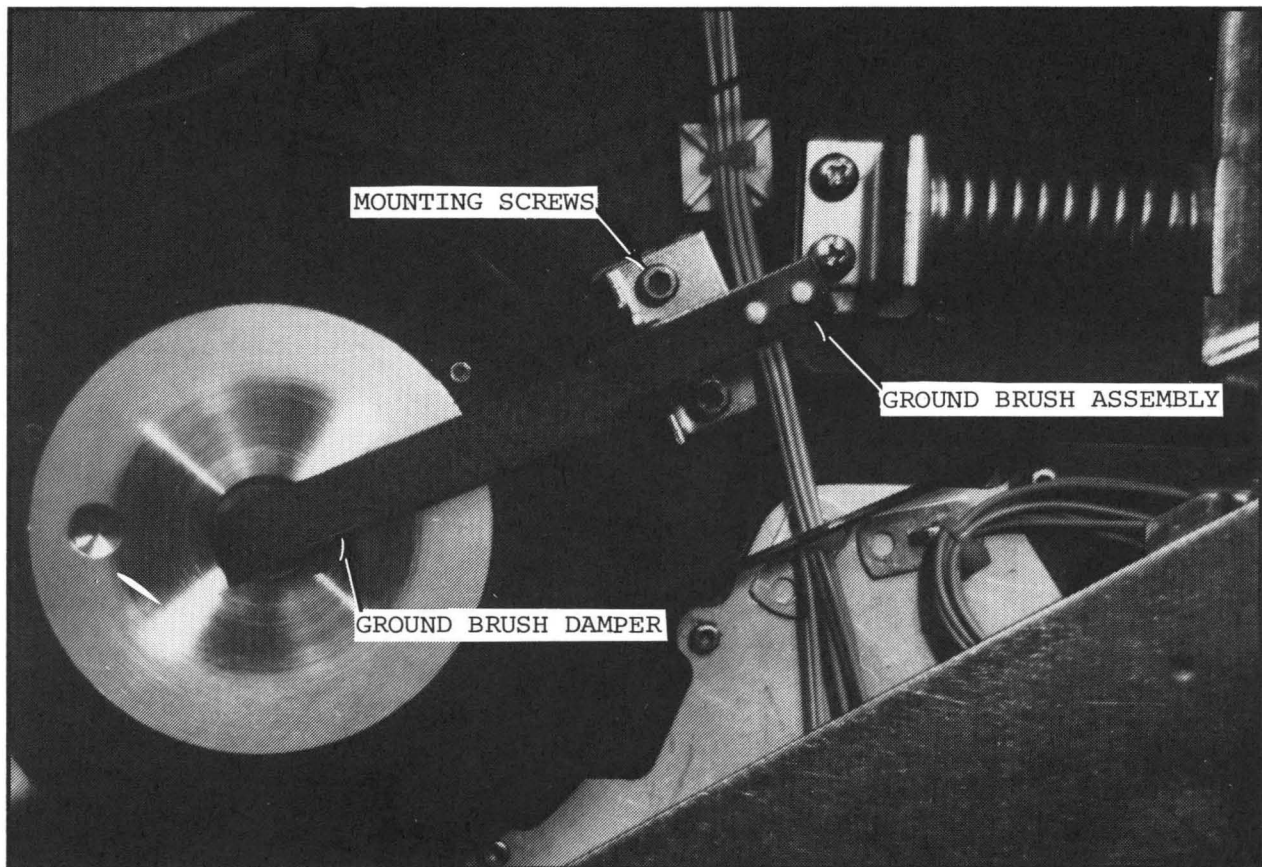

Figure 35. Ground Brush Assembly



## Brake Assembly Removal and Replacement

Remove power from the unit.

Remove the bottom access cover.

Remove P46 from the Brake Assembly. Refer to Figure 36 (below).

### CAUTION

Care must be exercised to prevent rotation of the spindle. Manual rotation of the spindle may cause damage to the heads or the discs, or both.

Remove the four screws securing the Brake Assembly to the Deck Plate.

Using care not to rotate the Brake Disc, release the brake pads from the disc and remove the Brake Assembly.

To replace the Brake Assembly, perform the above procedure in reverse.

Verify the Brake Assembly adjustment.

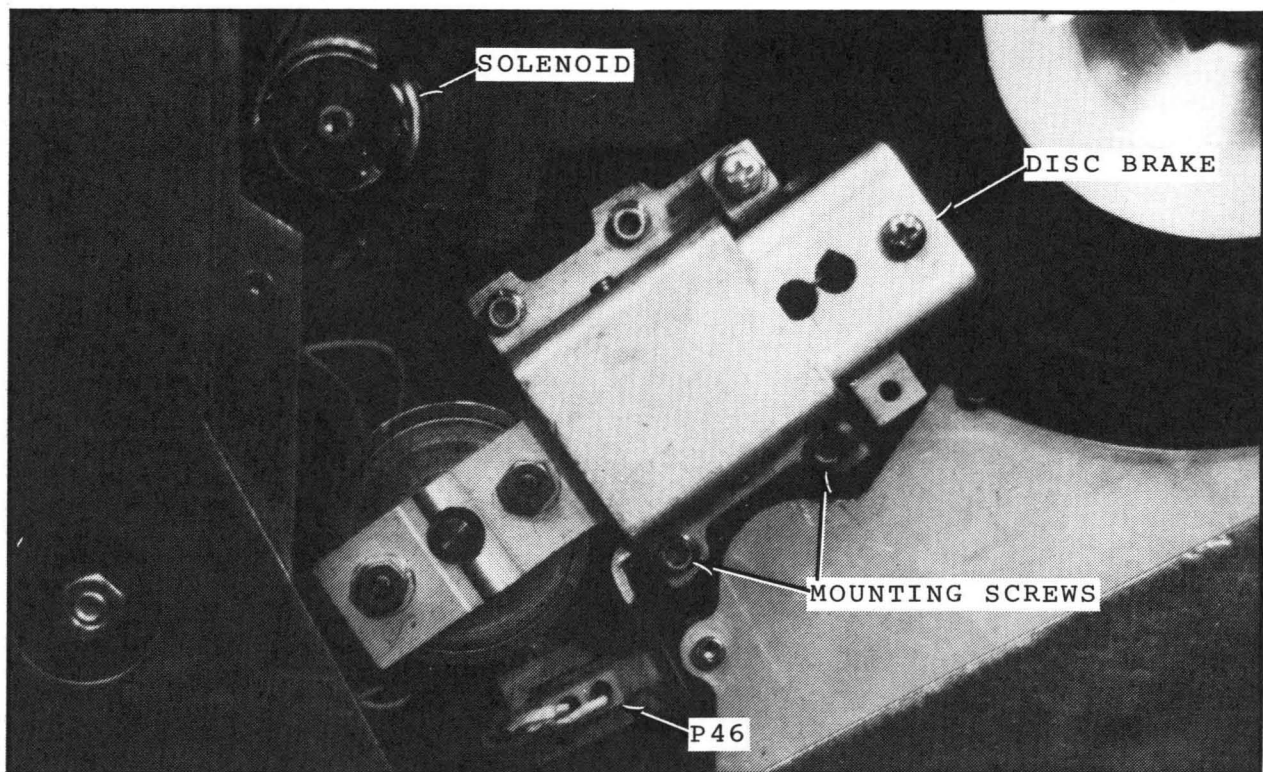

Figure 36. Brake Assembly

## Line Filter Assembly Removal and Replacement

Remove power from the unit and ensure that the AC power cord is disconnected (unplugged) from the power source.

Remove the Interface Cover and interface connections, P1, P2, and P3 on the Logic/Interface PCB.

Remove the two screws securing the Power Supply/Amplifier Chassis.

Remove the two screws securing the cover over the Line Filter Assembly and remove the cover. Refer to Figure 37 (below).

Open the Power Supply/Amplifier Chassis.

Remove P29 from the chassis.

Remove the wires from S-1 that go to the Line Filter. Note the connection points of those wires for reconnection or, if necessary, refer to the Line Filter Drawing in Section 6 of the Instruction Manual for reconnection.

Remove the two screws securing the Line Filter Assembly to the chassis and remove the Line Filter Assembly.

To replace the Line Filter Assembly, perform the above procedure in reverse. Locate P29 in the chassis so that the tab release is toward the outside of the unit.

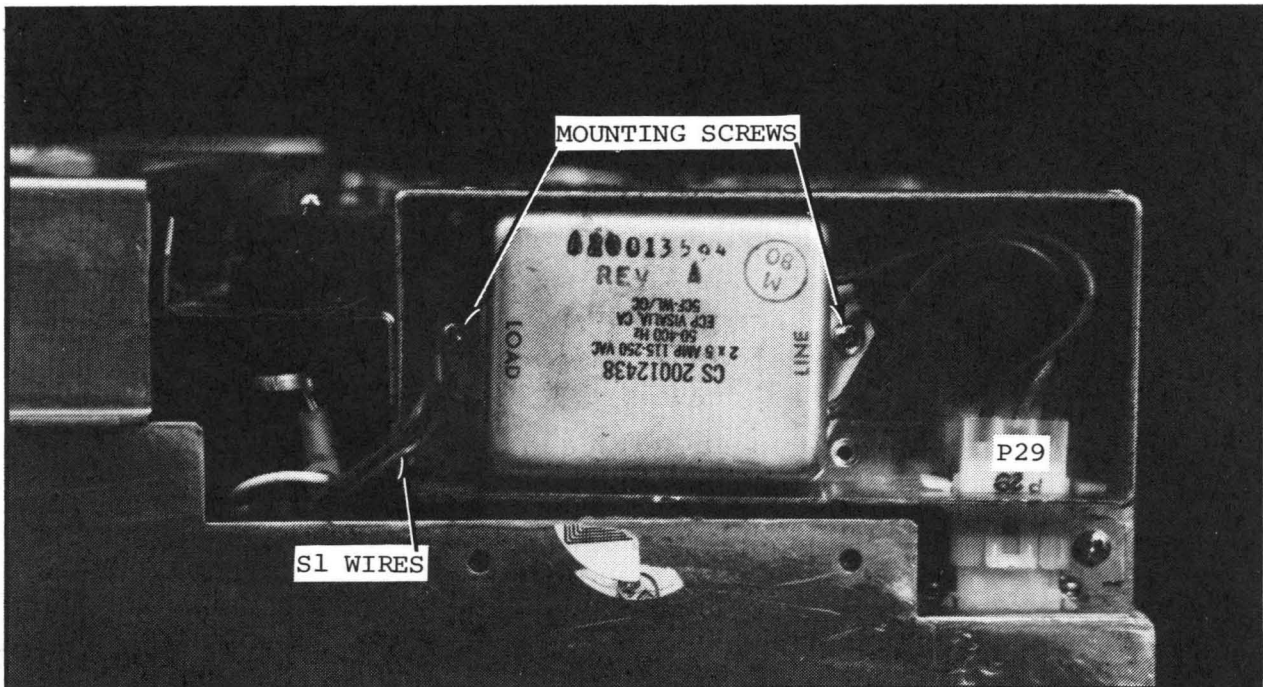

Figure 37. Line Filter Assembly



SECTION 10

FINAL REVIEW AND TEST

You are now at the end of the Reflex II Video Training Program.

It is recommended that you now review this workbook, study any items that you are not completely certain of.

Review any portions of the Video Tape that you feel you need.

Review and evaluate yourself with the self-tests included in this workbook.

When you believe that you are ready, contact the person who is administering this course to you in order to take the Final Examination.

Then go out and fix Reflex II's..... and GOOD LUCK!