

# **MODELS 6312 AND 6312+ VIDEO DISPLAY UNIT (VDU)**

User Guide

50-030 R07



ed in this document is subject to Concurrent Computer Corporation has taken efforts to remove errors from this document, however, Concurrent Computer Corporation's only liability regarding errors that may still exist is to correct said errors upon their being made known to Concurrent Computer Corporation.

The software described in this document is furnished under a license, and it can be used or copied only in a manner permitted by that license. Any copy of the described software must include all copyright notice, trademarks, or other legends or credits of Concurrent Computer Corporation and/or its suppliers. Title to and ownership of the described software and any copies thereof shall remain in Concurrent Computer Corporation and/or its suppliers.

The licensed program described herein may contain certain encryptions or other devices which may prevent or detect unauthorized use of the Licensed Software. Temporary use permitted by the terms of the License Agreement may require assistance from Concurrent Computer Corporation.

The hardware description contained in this document is intended solely for use in operation, installation, maintenance, or repair of Concurrent Computer Corporation equipment. Use of this document for all other purposes, without prior written approval from Concurrent Computer Corporation is prohibited.

Concurrent Computer Corporation assumes no responsibility for the use or reliability of this software if used on equipment that is not supplied by Concurrent Computer Corporation.

XELOS is a trademark of Concurrent Computer Corporation.  
Reliance is a trademark of Concurrent Computer Corporation.

© 1984, 1985, 1988, 1990 Concurrent Computer Corporation — All Rights Reserved

Concurrent Computer Corporation, 106 Apple Street

Tinton Falls, New Jersey 07794

## TABLE OF CONTENTS

|          |                               |      |
|----------|-------------------------------|------|
| PREFACE  |                               | xi   |
| CHAPTERS |                               |      |
| 1        | GENERAL DESCRIPTION           |      |
| 1.1      | INTRODUCTION                  | 1-1  |
| 1.1.1    | Terminal Features             | 1-2  |
| 1.1.2    | Keyboard Features             | 1-3  |
| 1.1.3    | Display Features              | 1-4  |
| 1.2      | SPECIFICATIONS                | 1-4  |
| 1.2.1    | Physical Specifications       | 1-4  |
| 1.2.2    | Screen Specifications         | 1-5  |
| 1.2.3    | Keyboard Specifications       | 1-5  |
| 1.2.4    | Communications Specifications | 1-6  |
| 1.2.5    | Environmental Specifications  | 1-6  |
| 1.2.6    | Power Specifications          | 1-6  |
| 1.3      | OPERATOR CONTROLS             | 1-6  |
| 1.4      | MODES OF OPERATION            | 1-7  |
| 1.4.1    | Set-Up Configuration Mode     | 1-7  |
| 1.4.2    | Local Mode                    | 1-7  |
| 1.4.3    | Transparent Mode              | 1-7  |
| 1.4.4    | Full-/Half-Duplex Mode        | 1-9  |
| 1.4.5    | Conversational Mode           | 1-9  |
| 1.4.6    | Block Mode                    | 1-9  |
| 1.4.6.1  | Send Immediate                | 1-10 |
| 1.4.6.2  | Request to Send               | 1-10 |
| 1.4.7    | Screen Program Mode           | 1-10 |
| 1.4.8    | Business Graphics             | 1-11 |
| 1.4.9    | Polled Environment            | 1-12 |
| 2        | TESTING                       |      |
| 2.1      | INTRODUCTION                  | 2-1  |
| 2.2      | FUNCTIONAL TEST               | 2-1  |

## CHAPTERS (Continued)

|          |  |      |
|----------|--|------|
| 2.3      | POWER-UP/RESET SELF-TEST   | 2-2  |
| 2.4      | SCREEN FILL DIAGNOSTIC TEST  | 2-3  |
| 2.5      | MODEL 6312 VIDEO DISPLAY UNIT (VDU) TEST<br>(06-295)                     | 2-3  |
| 3        | SET-UP CONFIGURATION   |      |
| 3.1      | INTRODUCTION   | 3-1  |
| 3.2      | CONFIGURATION MENU   | 3-1  |
| 3.3      | CONFIGURATION OPTIONS  | 3-2  |
| 3.3.1    | Keyboard Options Category  | 3-4  |
| 3.3.1.1  | Keyboard Control (KBD CTRL)  | 3-4  |
| 3.3.1.2  | Keyboard Lock (KBD LOCK)   | 3-5  |
| 3.3.2    | Mode Control Options Category  | 3-5  |
| 3.3.2.1  | Scroll Option (SCROLL)   | 3-6  |
| 3.3.2.2  | Auto Line Feed Option (AUTO LINE FEED)                                   | 3-6  |
| 3.3.2.3  | Auto Tab Option (AUTO TAB)   | 3-6  |
| 3.3.2.4  | New Line Option (NEW LINE)   | 3-6  |
| 3.3.2.5  | Upper-Case Option (UPPER CASE)   | 3-6  |
| 3.3.2.6  | Inverse Video Option (INVERSE VIDEO)                                     | 3-7  |
| 3.3.2.7  | Blinking Cursor Option (BLINK CURSOR)                                    | 3-7  |
| 3.3.2.8  | Block Cursor Option (BLOCK CURSOR)                                       | 3-7  |
| 3.3.2.9  | Key Click Option (KEY CLICK)   | 3-7  |
| 3.3.2.10 | Screen Saver Option (SCREEN SAVE)  | 3-7  |
| 3.3.2.11 | Smooth Scrolling Option (SMOOTH SCROLL)                                  | 3-7  |
| 3.3.3    | Systems Options Category   | 3-7  |
| 3.3.3.1  | Send Status Line Option (SEND STAT LINE)                                 | 3-8  |
| 3.3.3.2  | Status Line Display Option (DSPLAY STAT LN)                              | 3-8  |
| 3.3.3.3  | Power-Up On-Line Option (PWR UP ON LINE)                                 | 3-8  |
| 3.3.3.4  | Return=Send Option (RETURN = SEND)                                       | 3-8  |
| 3.3.3.5  | Screen Refresh Rate Option (60 HZ)                                       | 3-9  |
| 3.3.3.6  | Clear to Spaces Option (CLEAR TO SPACES)                                 | 3-9  |
| 3.3.3.7  | Send Cursor and Edit Keys Option<br>(SEND CRSR,EDIT)                     | 3-9  |
| 3.3.3.8  | Send Clear All Option (SEND CLEAR ALL)                                   | 3-9  |
| 3.3.4    | Communication Options Category   | 3-9  |
| 3.3.4.1  | Block Mode Option (BLOCK)  | 3-10 |
| 3.3.4.2  | Polled Option (POLLED)   | 3-10 |
| 3.3.4.3  | Half-Duplex Option (HALF DUPLEX)   | 3-10 |
| 3.3.4.4  | Null Suppression on Unformatted Transmission<br>Option (NULL SUPP UNFOR) | 3-10 |
| 3.3.4.5  | Null Suppression on Formatted Transmission<br>Option (NULL SUPP FORMT)   | 3-11 |
| 3.3.4.6  | XON/XOFF Option (XON/OFF)  | 3-11 |
| 3.3.4.7  | 113J Option (113J)   | 3-11 |
| 3.3.4.8  | Send Line, Message, Page Option<br>(LINE,MSG,PAG)                        | 3-11 |

## CHAPTERS (Continued)

|          |   |      |
|----------|---|------|
| 3.3.4.9  | Parity Option (ODD, EVN, MRK, SPC)                            | 3-12 |
| 3.3.4.10 | Baud Rate Option<br>(300, 600, 1200, 2400, 4800, 9600, 19.2K) | 3-12 |
| 3.3.5    | Printer Port Options Category                                 | 3-12 |
| 3.3.5.1  | Line Drawing Option (LINE DRAWING)                            | 3-12 |
| 3.3.5.2  | Ready Option (READY (-))                                      | 3-12 |
| 3.3.5.3  | Print Line, Message, Page Option<br>(LINE, MSG, PAG)          | 3-13 |
| 3.3.5.4  | Parity Option (ODD, EVN, MRK, SPC)                            | 3-13 |
| 3.3.5.5  | Baud Rate Option<br>(300, 600, 1200, 2400, 4800, 9600, 19.2K) | 3-13 |
| 3.3.6    | International Font Selection                                  | 3-13 |
| 3.3.7    | Communication Terminator Category                             | 3-14 |
| 3.3.7.1  | Send Line Terminator Option (SEND LINE)                       | 3-14 |
| 3.3.7.2  | Field Terminator Option (FIELD)                               | 3-15 |
| 3.3.7.3  | Unformatted Line Terminator Option<br>(UNFORMAT LINE)         | 3-15 |
| 3.3.7.4  | Unformatted Page Terminator Option<br>(UNFORMAT PG)           | 3-16 |
| 3.3.7.5  | Formatted Page Terminator Option (FORMAT PG)                  | 3-16 |
| 3.3.7.6  | Request to Send Terminator Option<br>(REQ TO SEND)            | 3-16 |
| 3.3.7.7  | Print Line Terminator Option (PRINT LINE)                     | 3-16 |
| 3.3.8    | Special Characters Category                                   | 3-16 |
| 3.3.8.1  | Multicode Character Option (MULTICODE CHAR)                   | 3-17 |
| 3.3.8.2  | Polling/Selection Address Option (POLL CHAR)                  | 3-17 |
| 3.3.8.3  | Pause Character Option (PAUSE CHAR)                           | 3-17 |
| 3.3.8.4  | Resume Character Option (RESUME CHAR)                         | 3-17 |
| 3.3.8.5  | Ring Bell Option (RING BELL)                                  | 3-17 |
| 3.3.9    | Function Key Definition Category                              | 3-18 |
| 3.3.9.1  | The HERE IS Function Key                                      | 3-18 |
| 3.3.9.2  | Function Key Definition                                       | 3-18 |
| 3.4      | CONFIGURATION BY THE OPERATOR                                 | 3-19 |
| 3.5      | CONFIGURATION BY THE HOST COMPUTER                            | 3-20 |
| 3.5.1    | General Terminal Attributes                                   | 3-24 |
| 3.5.2    | Right Margin Warning Bell                                     | 3-24 |
| 3.5.3    | Modes and Terminal Features                                   | 3-25 |
| 3.5.4    | Baud Rate Setting   | 3-25 |
| 3.5.5    | Parity Setting  | 3-25 |
| 3.5.6    | Scrolling   | 3-26 |
| 3.5.7    | l13J Setting  | 3-26 |
| 3.5.8    | Poll Address  | 3-26 |
| 3.5.9    | Multicode Character Selection                                 | 3-26 |
| 3.5.10   | Format  | 3-26 |
| 3.5.11   | Control Protect Function and Edit Keys                        | 3-27 |
| 3.5.12   | Lockout Function and Edit Keys                                | 3-28 |
| 3.5.13   | Printer Port Operations                                       | 3-28 |
| 3.5.13.1 | Print Type  | 3-28 |
| 3.5.13.2 | Printer Port Baud Rate  | 3-28 |
| 3.5.13.3 | Printer Port Parity   | 3-29 |
| 3.5.13.4 | Printer Port Stop Bit Setting                                 | 3-29 |

## CHAPTERS (Continued)

|          |   |      |
|----------|---|------|
| 3.5.13.5 | Print Line Terminator                               | 3-29 |
| 3.5.13.6 | Ready (-) and Line Drawing                          | 3-29 |
| 3.5.13.7 | Pause Character                                     | 3-29 |
| 3.5.13.8 | Resume Character                                    | 3-30 |
| 3.5.14   | Terminator Character Sequences                      | 3-30 |
| 3.5.14.1 | Send Line   | 3-30 |
| 3.5.14.2 | Unformatted Page Terminator                         | 3-30 |
| 3.5.14.3 | Unformatted Line Terminator                         | 3-30 |
| 3.5.14.4 | Formatted Page Terminator                           | 3-30 |
| 3.5.14.5 | Field Terminator                                    | 3-30 |
| 3.5.14.6 | Request to Send Terminator                          | 3-31 |
| 3.5.15   | Function Key Definition                             | 3-31 |
| 3.6      | DEFAULT CONFIGURATION                               | 3-33 |
| 3.7      | READING CONFIGURATION PARAMETERS<br>(HOST COMPUTER) | 3-35 |
| 3.8      | STANDARD CONFIGURATIONS                             | 3-35 |
| 4        | OPERATION   |      |
| 4.1      | INTRODUCTION  | 4-1  |
| 4.2      | ASCII CHARACTER SET                                 | 4-2  |
| 4.2.1    | Single Character ASCII Functions                    | 4-5  |
| 4.2.1.1  | Space   | 4-5  |
| 4.2.1.2  | Return (RETURN) Key                                 | 4-5  |
| 4.2.1.3  | Backspace (BACKSPACE) Key                           | 4-5  |
| 4.2.1.4  | Displayable Characters                              | 4-5  |
| 4.2.1.5  | Bell  | 4-5  |
| 4.2.1.6  | Tab (TAB) Key                                       | 4-6  |
| 4.2.1.7  | Delete (CLEAR/DELETE) Key                           | 4-6  |
| 4.2.1.8  | Escape (LOCAL ESCAPE/ESCAPE) Key                    | 4-6  |
| 4.3      | KEYBOARD FUNCTIONS                                  | 4-6  |
| 4.3.1    | Shift (SHIFT) Key                                   | 4-7  |
| 4.3.2    | Cap Lock (CAP LOCK) Key                             | 4-7  |
| 4.3.3    | Auxiliary Port (AUX PORT) Key                       | 4-7  |
| 4.3.4    | Print (PRINT) Key                                   | 4-7  |
| 4.3.5    | Set-Up/Status (SET UP/STATUS) Key                   | 4-7  |
| 4.3.6    | Erase Page/Line (ERASE PAGE/LINE) Key               | 4-8  |
| 4.3.7    | Delete Line/Character (DELETE LINE/CHAR) Key        | 4-8  |
| 4.3.8    | Clear (CLEAR/DELETE) Key                            | 4-9  |
| 4.3.9    | Insert Line/Character (INSERT LINE/CHAR) Key        | 4-9  |
| 4.3.10   | Page Edit/Insert Mode (PG EDT/INSERT MODE) Key      | 4-10 |
| 4.3.11   | Send (SEND) Key                                     | 4-11 |
| 4.3.12   | Send Message (SEND MSG) Key                         | 4-11 |
| 4.3.13   | Home (HOME) Key                                     | 4-11 |
| 4.3.14   | Line Feed (LINE FEED) Key                           | 4-11 |
| 4.3.15   | Break (BREAK) Key                                   | 4-12 |
| 4.3.16   | Scroll (SCROLL) Key                                 | 4-12 |

## CHAPTERS (Continued)

|         |   |      |
|---------|---|------|
| 4.3.17  | Reverse/Normal Background<br>(BK GND REV/NORM) Key        | 4-12 |
| 4.3.18  | Graphics/Normal (GRAPH/NORM) Key                          | 4-12 |
| 4.3.19  | Page/New Line (PAGE/NEW LINE) Key                         | 4-12 |
| 4.3.20  | Backtab (TAB) Key   | 4-13 |
| 4.3.21  | Enter (ENTER) Key   | 4-13 |
| 4.3.22  | Cursor Up ( ) Key   | 4-13 |
| 4.3.23  | Cursor Down ( ) Key                                       | 4-14 |
| 4.3.24  | Cursor Right ( ) Key                                      | 4-14 |
| 4.3.25  | Cursor Left ( ) Key                                       | 4-14 |
| 4.3.26  | Auto-Repeat Feature                                       | 4-15 |
| 4.4     | FUNCTION KEYS   | 4-16 |
| 4.5     | STATUS LINE DESCRIPTION                                   | 4-17 |
| 4.5.1   | User Area (Columns 1-31)                                  | 4-18 |
| 4.5.2   | Line Number (Columns 33-35)                               | 4-18 |
| 4.5.3   | Column Number (Columns 37-40)                             | 4-18 |
| 4.5.4   | Page Number (Columns 42-43)                               | 4-18 |
| 4.5.5   | Error Indicator (Columns 45-52)                           | 4-19 |
| 4.5.6   | Communications Status Field (Columns 54-56)               | 4-19 |
| 4.5.7   | Modem Status Field (Columns 58-59)                        | 4-19 |
| 4.5.8   | Send Mode Field (Columns 61-68)                           | 4-19 |
| 4.5.9   | Auxiliary Port Field (Columns 70-72)                      | 4-20 |
| 4.5.10  | Scroll Hold Key Field (Columns 74-76)                     | 4-20 |
| 4.5.11  | Reminder Field (Columns 78-80)                            | 4-20 |
| 4.6     | MESSAGE LINE DESCRIPTION                                  | 4-20 |
| 4.7     | ERROR MESSAGES  | 4-21 |
| 4.8     | SETTING FORMATTED FIELDS                                  | 4-22 |
| 4.8.1   | Defining Fields Via the Keyboard<br>(Screen Program Mode) | 4-24 |
| 4.8.2   | Defining Fields Over the Communications Line              | 4-25 |
| 4.9     | BLOCK MODE TRANSMISSION FORMATS                           | 4-25 |
| 4.9.1   | Block Mode Immediate and Block Mode Request<br>to Send    | 4-25 |
| 4.9.2   | Host Computer Read Requests                               | 4-26 |
| 4.9.3   | All Data Transmission                                     | 4-27 |
| 4.9.4   | Unprotected Field Data Transmission                       | 4-27 |
| 4.9.4.1 | Unprotected Line Data Transmission                        | 4-29 |
| 4.9.4.2 | Unprotected Message Data Transmission                     | 4-29 |
| 4.9.4.3 | Unprotected Page Data Transmission                        | 4-29 |
| 4.9.5   | Modified Field Data Transmission                          | 4-30 |
| 4.9.5.1 | Modified Line Data Transmission                           | 4-30 |
| 4.9.5.2 | Modified Message Data Transmission                        | 4-30 |
| 4.9.5.3 | Modified Page Data Transmission                           | 4-31 |

## CHAPTERS (Continued)

|        |   |      |
|--------|---|------|
| 4.10   | POLLING   | 4-32 |
| 4.10.1 | Broadcast   | 4-34 |
| 4.10.2 | Group/Fast Select                                       | 4-34 |
| 4.10.3 | Poll  | 4-35 |
| 4.11   | LIGHT PEN OPERATION                                     | 4-36 |
| 4.11.1 | Transmitting Light Pen Fields                           | 4-37 |
| 4.11.2 | Defining Light Pen Fields                               | 4-38 |
| 4.11.3 | Light Pen Field Operation                               | 4-39 |
| 4.11.4 | Recommendations for Light Pen Use                       | 4-40 |
| 5      | MULTICODE SEQUENCES                                     |      |
| 5.1    | INTRODUCTION  | 5-1  |
| 5.2    | THE MULTICODE CHARACTER                                 | 5-1  |
| 5.3    | CURSOR FUNCTIONS  | 5-2  |
| 5.3.1  | Multicode A (Cursor Up)                                 | 5-2  |
| 5.3.2  | Multicode B (Cursor Down)                               | 5-2  |
| 5.3.3  | Multicode C (Cursor Right)                              | 5-2  |
| 5.3.4  | Multicode D (Cursor Left)                               | 5-2  |
| 5.3.5  | Multicode H (Cursor Home)                               | 5-2  |
| 5.3.6  | Multicode T (Insert Cursor - Line Only)                 | 5-2  |
| 5.3.7  | Multicode X x (Direct Cursor Address - Line Position)   | 5-3  |
| 5.3.8  | Multicode Y y (Direct Cursor Address - Column Position) | 5-3  |
| 5.3.9  | Multicode Z (Read Cursor Address)                       | 5-3  |
| 5.3.10 | Multicode ~1 (Blank Cursor)                             | 5-3  |
| 5.3.11 | Multicode ~2 (Restore Cursor)                           | 5-3  |
| 5.3.12 | Multicode } (Last)                                      | 5-3  |
| 5.4    | LOCK/UNLOCK OPERATIONS                                  | 5-3  |
| 5.4.1  | Multicode ( (Lock Keyboard - Line Only)                 | 5-3  |
| 5.4.2  | Multicode ) (Unlock Keyboard - Line Only)               | 5-4  |
| 5.4.3  | Multicode 8 (Lock Light Pen - Line Only)                | 5-4  |
| 5.4.4  | Multicode 9 (Unlock Light Pen - Line Only)              | 5-4  |
| 5.5    | BLANK/RESTORE SCREEN OPERATIONS                         | 5-4  |
| 5.5.1  | Multicode (space) (Blank Display)                       | 5-4  |
| 5.5.2  | Multicode @ (Restore Screen)                            | 5-4  |
| 5.6    | TAB OPERATIONS  | 5-4  |
| 5.6.1  | Multicode 1 (Set Tab)                                   | 5-5  |
| 5.6.2  | Multicode 2 (Clear Tabs)                                | 5-5  |
| 5.6.3  | Multicode 3 (Clear All Tabs)                            | 5-5  |
| 5.6.4  | Multicode   (Backtab)                                   | 5-5  |
| 5.7    | EDITING AND CLEARING OPERATIONS                         | 5-5  |
| 5.7.1  | Multicode I (Clear Line)                                | 5-5  |
| 5.7.2  | Multicode J (Clear Unprotected)                         | 5-5  |



## CHAPTERS (Continued)

|        |  |      |
|--------|--|------|
| 5.7.3  | Multicode K (Clear All)                            | 5-6  |
| 5.7.4  | Multicode L (Insert Line)                          | 5-6  |
| 5.7.5  | Multicode M (Delete Line)                          | 5-6  |
| 5.7.6  | Multicode N n (Insert Character)                   | 5-6  |
| 5.7.7  | Multicode O (Delete Character)                     | 5-6  |
| 5.7.8  | Multicode DEL (Hex '7F') (Display Hash Mark)       | 5-6  |
| 5.7.9  | Multicode Multicode                                | 5-6  |
| 5.8    | STATUS LINE OPERATIONS                             | 5-6  |
| 5.8.1  | Multicode 4 (Move Cursor to Status Line)           | 5-6  |
| 5.8.2  | Multicode 5 (Return Cursor from Status Line)       | 5-6  |
| 5.8.3  | Multicode [ (Enable Status Line Display)           | 5-7  |
| 5.8.4  | Multicode ] (Disable Status Line Display)          | 5-7  |
| 5.8.5  | Multicode h (Enable Status Line)                   | 5-7  |
| 5.9    | MESSAGE LINE OPERATION                             | 5-7  |
| 5.9.1  | Multicode g (Enable 80-Character Message Line)     | 5-8  |
| 5.9.2  | Multicode m (Write 80-Character Message Line)      | 5-8  |
| 5.10   | ATTRIBUTE BYTES                                    | 5-8  |
| 5.10.1 | Multicode !x (Set Attributes)                      | 5-10 |
| 5.10.2 | Multicode . (Disable Attributes)                   | 5-10 |
| 5.10.3 | Multicode / (Enable Attributes)                    | 5-10 |
| 5.10.4 | Multicode " x (Set Attribute Byte Light Pen Field) | 5-10 |
| 5.11   | SENDING SCREEN DATA                                | 5-10 |
| 5.11.1 | Multicode E (Set Full Screen Mode)                 | 5-10 |
| 5.11.2 | Multicode <x (Send Key Override - Line Only)       | 5-11 |
| 5.12   | SETTING TRANSMISSION MODE                          | 5-11 |
| 5.12.1 | Multicode G (Set Conversational Mode)              | 5-11 |
| 5.12.2 | Multicode R (Request to Send)                      | 5-11 |
| 5.12.3 | Multicode U (Set Send Immediate All)               | 5-11 |
| 5.12.4 | Multicode V (Set Send Immediate Unprotected)       | 5-11 |
| 5.12.5 | Multicode W (Set Send Immediate Modified)          | 5-12 |
| 5.13   | BLOCK MODE READ REQUESTS                           | 5-12 |
| 5.13.1 | Multicode Q (Reset Modified Data Tags)             | 5-12 |
| 5.13.2 | Multicode = (Read All)                             | 5-12 |
| 5.13.3 | Multicode > (Read Unprotected)                     | 5-12 |
| 5.13.4 | Multicode ? (Read Modified)                        | 5-12 |
| 5.14   | SETTING PRINT OPTIONS                              | 5-12 |
| 5.14.1 | Multicode ;x (Set Print Options)                   | 5-13 |
| 5.15   | HOST CONFIGURATION OF TERMINAL                     | 5-14 |
| 5.15.1 | Multicode # (Configuration Ready)                  | 5-14 |
| 5.15.2 | Multicode - (EAROM Configuration Update)           | 5-14 |
| 5.15.3 | Multicode 6 (Read Configuration Update)            | 5-14 |
| 5.15.4 | Multicode 7 (RAM Configuration Update)             | 5-15 |
| 5.15.5 | Multicode 0 (Configuration Checksum)               | 5-15 |

## CHAPTERS (Continued)

|        |   |      |
|--------|---|------|
| 5.16   | READING TERMINAL STATUS                       | 5-15 |
| 5.16.1 | Multicode \$ (Read Status Immediate)          | 5-15 |
| 5.16.2 | Multicode % (Read Status When Ready)          | 5-15 |
| 5.17   | DIAGNOSTIC TESTS                              | 5-16 |
| 5.17.1 | Multicode :n (Fill Screen)                    | 5-16 |
| 5.17.2 | Multicode o! (Diagnostic Test/Reset)          | 5-17 |
| 5.18   | SCROLLING OPTIONS                             | 5-17 |
| 5.18.1 | Multicode _ (Scroll On With Attribute)        | 5-17 |
| 5.18.2 | Multicode ^ (Scroll Off With Attribute)       | 5-17 |
| 5.19   | MULTICODE p (ENTER/EXIT SCREEN PROGRAM MODE)  | 5-17 |
| 5.20   | MULTICODE S x y (SET BUFFER ADDRESS)          | 5-17 |
| 5.21   | MULTICODE & (TOGGLE PAGE)                     | 5-18 |
| 5.22   | MULTICODE oS (DEFAULT SET-UP CONFIGURATION)   | 5-18 |
| 5.23   | MULTICODE o9 (DISPLAY FIRMWARE REVISION)      | 5-18 |
| 5.24   | POLLING                                       | 5-18 |
| 5.24.1 | Multicode * (Broadcast)                       | 5-18 |
| 5.24.2 | Multicode + xx yy ... STX (Group/Fast Select) | 5-18 |
| 5.24.3 | Multicode P xx (Poll Select)                  | 5-18 |

## APPENDIXES

|   |                         |     |
|---|-------------------------|-----|
| A | MULTICODE SEQUENCES     | A-1 |
| B | CURSOR ADDRESSING CHART | B-1 |
| C | ASCII CODING CHART      | C-1 |

## FIGURES

|     |                                    |     |
|-----|------------------------------------|-----|
| 1-1 | Model 6312 VDU                     | 1-1 |
| 1-2 | Model 6312+ VDU                    | 1-2 |
| 1-3 | Sample Transparent Mode Display    | 1-8 |
| 2-1 | Error Byte Format                  | 2-3 |
| 3-1 | Model 6312+ VDU Configuration Menu | 3-2 |
| 3-2 | Option Categories                  | 3-3 |
| 3-3 | Keyboard Options Category          | 3-4 |

## FIGURES (Continued)

|      |   |      |
|------|---|------|
| 3-4  | Mode Control Options Category                     | 3-5  |
| 3-5  | Systems Options Category                          | 3-8  |
| 3-6  | Communications Options Category                   | 3-10 |
| 3-7  | Printer Port Options Category                     | 3-12 |
| 3-8  | International Font Selection (Model 6312+ Only)   | 3-14 |
| 3-9  | Communication Terminator Options Category         | 3-14 |
| 3-10 | Special Characters Options Category               | 3-16 |
| 3-11 | Function Key Definition Category                  | 3-18 |
| 3-12 | Host Configuration Data Stream                    | 3-20 |
| 3-13 | Sample Configuration Menu                         | 3-36 |
|      |   |      |
| 4-1  | Model 6312+ Keyboard                              | 4-1  |
| 4-2  | Function Keys                                     | 4-16 |
| 4-3  | Status Line Fields                                | 4-18 |
| 4-4  | Read/Send Unprotected Format                      | 4-28 |
| 4-5  | Read/Send Modified Format                         | 4-32 |
| 4-6  | Host/Terminal Interaction in a Polled Environment | 4-33 |
| 4-7  | Broadcast Format                                  | 4-34 |
| 4-8  | Group/Fast Select Format                          | 4-35 |
| 4-9  | Polling Format                                    | 4-36 |
| 4-10 | Send Unprotected Format                           | 4-38 |
| 4-11 | Light Pen Fields                                  | 4-40 |
|      |   |      |
| 5-1  | Attribute Byte Format                             | 5-9  |
| 5-2  | Status Byte Format                                | 5-16 |

## TABLES

|     |  |      |
|-----|--|------|
| 1-1 | BUSINESS GRAPHICS CHARACTER SET              | 1-12 |
| 3-1 | ASCII CHARACTER DEFINITIONS                  | 3-15 |
| 4-1 | ASCII CONTROL CHARACTERS                     | 4-2  |
| 4-2 | FUNCTION KEY ATTENTION IDENTIFIER CHARACTERS | 4-17 |
| A-1 | MULTICODE SEQUENCE SUMMARY                   | A-1  |

## INDEX

IND-1



## PREFACE

This manual provides the information necessary to test, configure, and operate a Concurrent Computer Corporation Model 6312 or 6312+ video display unit (VDU). It is intended for use by operators and terminal users.

Chapter 1 lists the terminal specifications and describes the modes of operation for the Model 6312 VDU. Chapter 2 describes the tests for the Model 6312 VDU. Chapter 3 describes the menu used to configure the terminal and the various configuration options within this menu. Instructions for configuring the terminal via the keyboard or from the host computer are also provided in Chapter 3. Chapter 4 illustrates the terminal keyboard and describes keyboard operation. Chapter 5 explains the multicode sequences. The Appendixes provide a summary of multicode sequences, a cursor addressing chart, and an ASCII coding chart.

Revision 07 adds a note concerning multicode sequences received while the message line is being written. |

### NOTE

Throughout this manual, all references to the Model 6312 VDU refer to both the Model 6312 and 6312+, except where otherwise noted.



## CHAPTER 1 GENERAL DESCRIPTION

### 1.1 INTRODUCTION

The VDU is a complete stand-alone data terminal, consisting of a green or amber phosphorous monitor and a detached, low-profile keyboard. The Model 6312 VDU, Figure 1-1, is designed for maximum user comfort. The monitor is equipped with an antiglare screen and tilt/swivel capabilities. The keyboard has two positions for typing comfort. The keyboard comes equipped with a 6' (1.83m) coiled cable for operator flexibility and mobility.

030-1

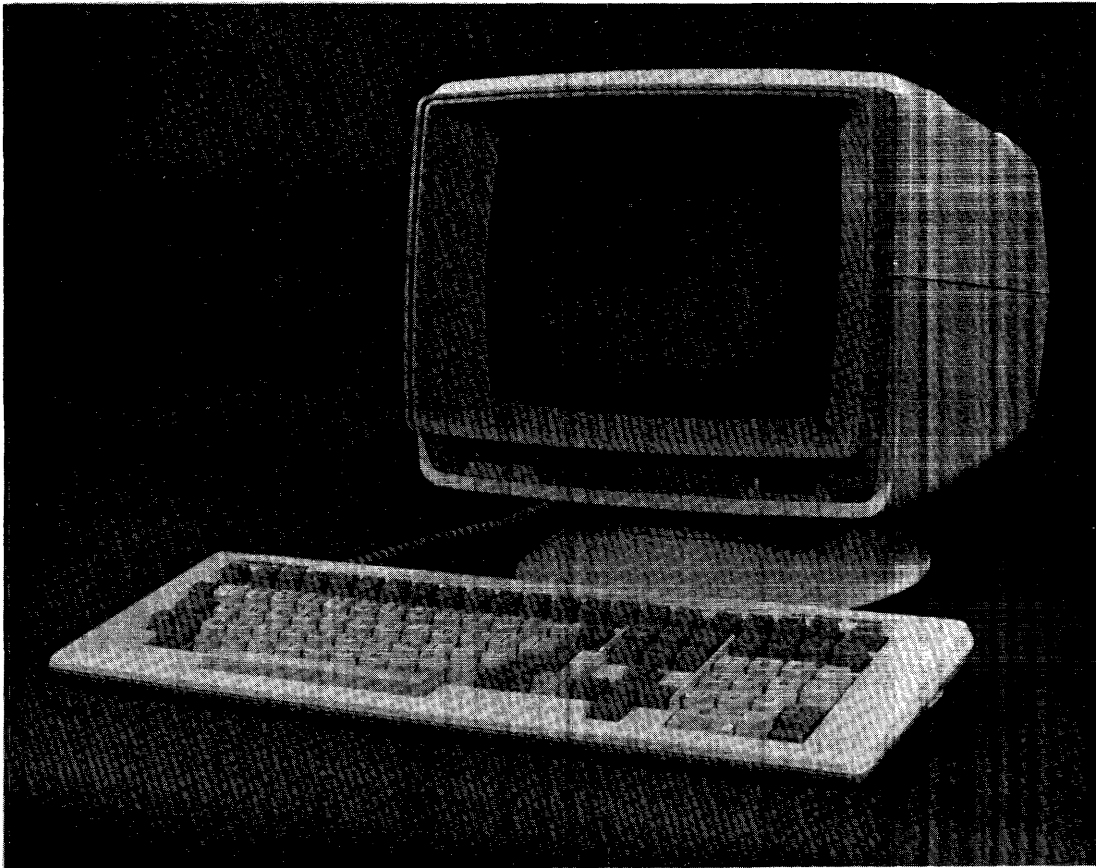
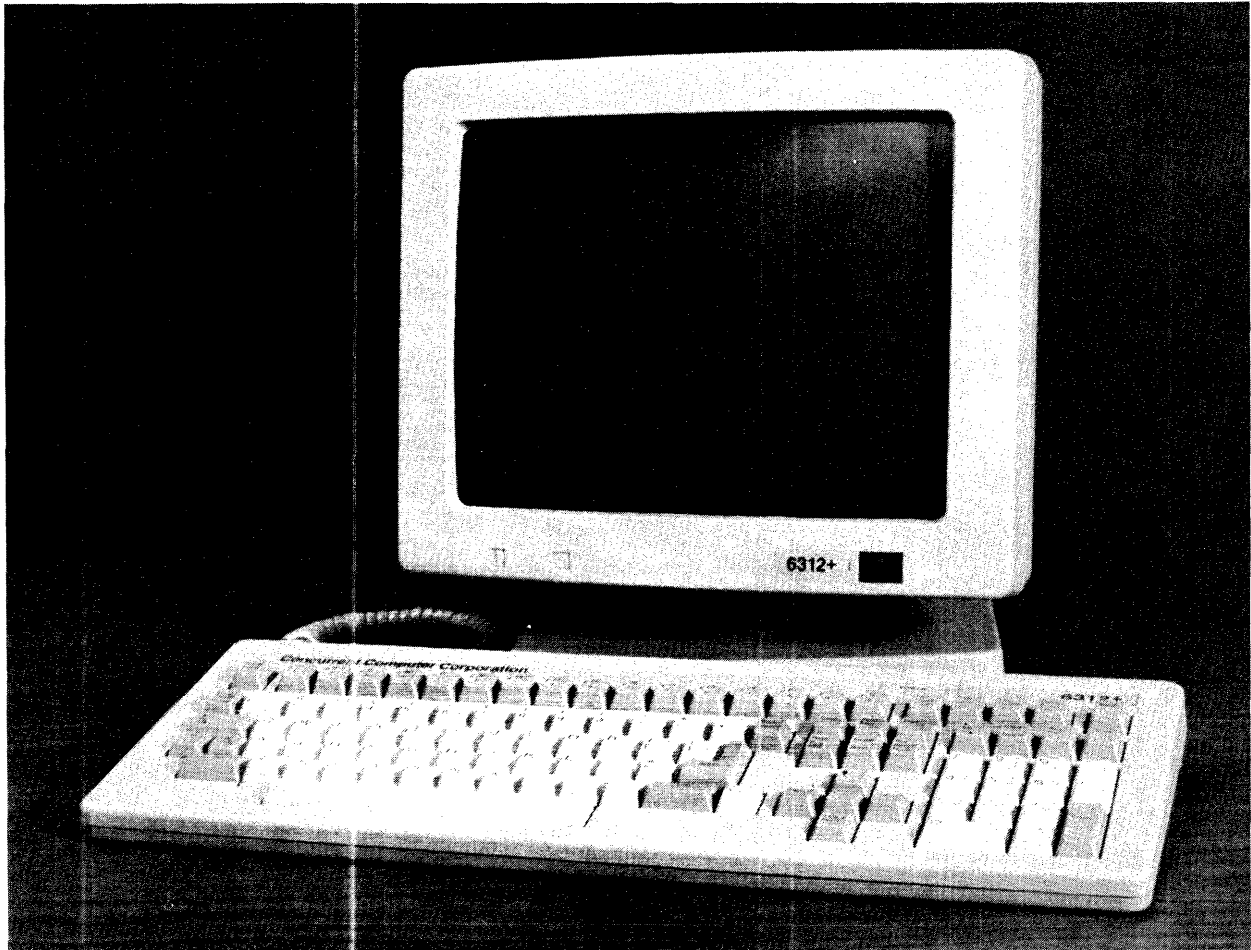

Figure 1-1 Model 6312 VDU

| Throughout this manual, all references to the Model 6312 video  
| display unit (VDU) refer to both the Model 6312 (Figure 1-1) and  
| 6312+ (Figure 1-2), unless otherwise noted.

030-26



| Figure 1-2 Model 6312+ VDU

### 1.1.1 Terminal Features

Some of the Model 6312 VDU features are:

- Full 128 ASCII character set
- 25th status line
- On-line or local modes
- Conversational or block modes



- Program mode
- Request to send block mode transmission
- Protected fields
- Business graphics
- Absolute cursor positioning
- 7-bit data word structure
- Seven communication rates in full-duplex and half-duplex send/receive modes
- RS-232C modem interface and RS-232C auxiliary interface port
- Five print modes:
  - Page print
  - Line print
  - Message print
  - Display and print from host
  - Transparent print from host
- Nonvolatile memory for:
  - Set up modes
  - Programmable function keys
  - Edit keys
- Double page memory

### 1.1.2 Keyboard Features

The Model 6312 keyboard provides a user-friendly layout to reduce operator error. The following are features of the keyboard:

- Numeric keypad with 14 keys
- Five cursor control keys arranged in a cross-pattern
- 16 programmable function keys (shiftable to 32)
- Six edit keys (shiftable to 12)
- CAP LOCK key
- SET UP/STATUS key
- SCROLL key
- 3-key rollover and 32 keystroke buffer
- Tilt mechanism

### 1.1.3 Display Features

- Full screen inverse (reverse) video
- Embedded attributes:
  - Blank
  - Blink
  - Underline (combination of blink and blank)
  - Inverse video
  - Reduced intensity
- Character matrix (field size)
  - 6312 = 8 x 11
  - 6312+ = 9 x 12

## 1.2 SPECIFICATIONS

This section describes the physical, screen, keyboard, and communication specifications for the Model 6312 VDU.

### 1.2.1 Physical Specifications

|                      | 6312                                   | 6312+                                  |
|----------------------|--|--|
| Monitor swivel range | 360° capability                        | 180° capability                        |
| Monitor tilt range   | 0° to 5° forward<br>0° to 10° backward | 0° to 5° forward<br>0° to 15° backward |
| Measurements         | Monitor                                | Keyboard                               |
| (6312+)              |  |  |
| Height               | 12.75" (32.4cm)                        | 1.19" (3.0cm)                          |
| Width                | 13.0" (33.0cm)                         | 19.0" (48.3cm)                         |
| Depth                | 13.8" (35.0cm)                         | 7.1" (18.0cm)                          |
| Weight               | 22lbs. (10.0kg)                        |  |
| (6312)               |  |  |
| Height               | 12.5" (31.7cm)                         | 1.6" (3.8cm)                           |
| Width                | 13.5" (34.3cm)                         | 20.5" (52.1cm)                         |
| Depth                | 14.5" (36.8cm)                         | 7.0" (17.8cm)                          |
| Weight               | 23.2lbs. (10.4kg)                      |  |

### 1.2.2 Screen Specifications

|                        |  |
|------------------------|--|
| Screen capacity        | 2,000 characters   |
| Characters per line    | 80   |
| Number of lines        | 25: 24 data lines and 1 status line  |
| Screen size (6312+)    | 14" (35.56cm) (measured diagonally)  |
| (6312)                 | 12" (30.5cm) (measured diagonally)   |
| Screen phosphor        | Green P31<br>Amber PLA   |
| Displayable characters | Full 128-character ASCII set plus 32 control characters in transparent mode and 32 distinct business graphic characters. |
| Display format         | Two independent 24 x 80 displays   |
| Cursor format          | Steady or blinking block<br>Steady or blinking underline   |
| Character generation   | 7 x 9 upper-case<br>7 x 10 lower-case with descenders  |
| Scans per line         | 12   |
| Refresh rate           | 6312 - 50/60Hz noninterlaced<br>6312+ - 60/70Hz noninterlaced  |
| Normal display         | Light characters on dark screen  |
| Inverse display        | Dark characters on light screen  |

### 1.2.3 Keyboard Specifications

|                 |   |
|-----------------|---|
| Type            | Detached, low-profile, adjustable angle |
| Number of keys  | 107                                     |
| Cord length     | 6' (1.83m) coiled                       |
| Character code  | ASCII                                   |
| Keyboard layout | ASCII typewriter pairing                |
| Repeat key rate | 15 characters per second                |

#### 1.2.4 Communications Specifications

|                       |  |
|-----------------------|--|
| Baud rate             | 300, 600, 1200, 2400, 4800, 9600, or 19200 (EIA or 20mA current loop-optional) |
| Stop bits             | One stop bit   |
| Transmission          | Full-duplex or half-duplex   |
| Parity                | Space, mark, even, or odd  |
| Modem types supported | Acoustic coupler, 103J, 113J, 212A, or direct communication to host computer   |

#### 1.2.5 Environmental Specifications

|                |   |
|----------------|---|
| Operational    | Ambient temperature range<br>5° to 40° Celsius<br>(41° to 104° Fahrenheit);<br>10% to 85% relative humidity,<br>noncondensing     |
| Nonoperational | Ambient temperature range<br>-20° to +65° Celsius<br>(-04° to 149° Fahrenheit);<br>10% to 95% relative humidity,<br>noncondensing |

#### 1.2.6 Power Specifications

|          |   |
|----------|---|
| Standard | 115V (+/- 10%) @ 1.5A<br>50/60Hz, 50 watts                          |
| European | 115V (+/- 10%) @ 1.5A<br>230V (+/- 10%) @ 0.7A<br>50/60Hz, 50 watts |

#### | 1.3 OPERATOR CONTROLS

| On the Model 6312 VDU, the AC power switch is located under the  
| bezel on the right side. The contrast control is under the bezel  
| on the left side.

| On the Model 6312+ VDU, the AC power switch is located on the  
| lower right front of the bezel. Contrast and brightness controls  
| are under the bezel on the left side. These are the only  
| operator accessible controls.

## 1.4 MODES OF OPERATION

Operation of the Model 6312 VDU is controlled by the host computer and/or the keyboard described in the following sections.

### 1.4.1 Set-Up Configuration Mode

The operation of the Model 6312 VDU is determined by entries made in the set-up configuration mode. The set-up configuration mode may be modified by the operator through keyboard entry or by the host computer through multicode sequences. Configuration of the VDU takes into account communications options, keyboard options, printer port options, communication terminator definitions, and function key definitions. See Chapter 3 for further information on the set-up configuration mode.

### 1.4.2 Local Mode

In the local mode, data terminal ready (DTR) is deactivated and no data is transmitted or received over the communications line. Keyboard entries cause the appropriate action directly on the screen display. A shifted depression of the SCROLL key alternately selects on-line or local mode. The condition of the line is also selected, when exiting the set-up configuration, by enabling or disabling PWR UP ON LINE in the configuration menu.

### 1.4.3 Transparent Mode

In the transparent mode, control characters are displayed but not acted upon; e.g., carriage return and line feed are displayed as CR and LF respectively, but the cursor is only advanced to the next position, not moved to column 1 nor advanced by a line. The transparent mode is a useful communications debugging tool.

Control characters are displayed in the transparent mode as shown in Figure 1-3. Control character descriptions are provided in Table 4-1. In the transparent mode, multicode sequences (explained in Chapter 5) are displayed as a 2- or 3-character sequence, the first character being the multicode character. The VDU does not perform the multicode sequence in the transparent mode.

N S S E E E A B B H L V F C S S D D D D D N S E C E S E F G R U  
 U H X X T Q K L S T F T F R O I L 1 2 3 4 K Y B N M B C S S S S

**Where:**

NU = NULL  
 SH = START OF HEADING  
 SX = START OF TEXT  
 EX = END OF TEXT  
 FT = END OF TRANSMISSION  
 EQ = ENQUIRY  
 AK = ACKNOWLEDGE  
 BL = BELL  
 BS = BACKSPACE  
 HT = HORIZONTAL TAB  
 LF = LINE FEED  
 VT = VERTICAL TAB  
 FF = FORM FEED  
 CR = CARRIAGE RETURN  
 SO = SHIFT OUT  
 SI = SHIFT IN  
 DL = DATA LINK ESCAPE  
 D1 = DEVICE CONTROLS  
 D2 = DEVICE CONTROLS  
 D3 = DEVICE CONTROLS  
 D4 = DEVICE CONTROLS  
 NK = NEGATIVE ACKNOWLEDGE  
 SY = SYNCHRONOUS IDLE  
 EB = END OF TRANSMISSION BLOCK  
 CN = CANCEL  
 EM = END OF MEDIUM  
 SB = SUBSTITUTE  
 EC = ESCAPE  
 FS = FILE SEPARATOR  
 GS = GROUP SEPARATOR  
 RS = RECORD SEPARATOR  
 US = UNIT SEPARATOR

**Figure 1-3 Sample Transparent Mode Display**

The VDU enters the transparent mode when it receives CTRL P (DLE) followed by CTRL B (STX) either from the VDU keyboard or over the communications line. The VDU exits the transparent mode when it receives CTRL P (DLE) followed by CTRL C (ETX). See Table 4-1 for an explanation of the control characters.

In the transparent mode, the screen is filled with null characters or spaces, depending on the set-up configuration. The scroll feature is disabled and the new line feature is enabled, regardless of configuration or settings. All attribute characters are displayed in the transparent mode.

#### 1.4.4 Full-/Half-Duplex Mode

The Model 6312 VDU can be set to operate in half-duplex or full-duplex mode. In full-duplex, the data transmitted through the keyboard does not appear on the screen unless the host computer is programmed to echo back the characters (Echoplex).

In half-duplex, Echoplex is not required; queries and acknowledgements from both the host computer and the terminal keyboard are displayed on the terminal screen as received/entered. However, if the keyboard and the host computer generate data simultaneously, the resultant display shows intermixed characters.

#### 1.4.5 Conversational Mode

Conversational mode enables the terminal to transmit and receive data on a character-by-character basis in the same manner as a Teletype.

The terminal can be placed in conversational mode by disabling BLOCK in the configuration menu during set-up configuration. The terminal can also be placed in conversational mode by receipt of a multicode G sequence.

In the conversational mode, a scroll type of representation is usually employed. When the cursor is at the bottom line of the display and an attempt is made to advance to a new line, all data lines are advanced upward. The visual effect is an upward scroll with new data entered from the bottom line moving upward one line at a time.

#### 1.4.6 Block Mode

In block transmission mode, an entire block of data can be entered on the screen, edited, and then transmitted to the host computer. Transmission does not take place until the terminal receives a specific transmit command from either the keyboard (depressing the SEND key or the RETURN key if RETURN=SEND is enabled in the set-up configuration) or the host computer (a read command).

The terminal can be placed in block mode by enabling the block mode option during set-up configuration or by receipt of either a multicode R, multicode U, multicode V, or multicode W sequence transmitted from the host computer or entered from the keyboard. These multicode sequences are described in detail in Section 5.12. Additional information on block mode transmission can be found in Section 4.9.

Within the block transmission mode, operation can be either block mode-immediate or block mode-request to send.

#### 1.4.6.1 Send Immediate

For the send immediate subset, the terminal sends the data immediately upon depression of the SEND key or upon a read request from the host. Upon depression of the SEND key, data is transmitted according to the send condition of the terminal determined during set-up configuration (LINE,MSG,PAG) unless the host computer overrides this send condition. See Section 5.11.2 for details on the multicode sequence transmitted by the host to override the send condition.

The read request from the host may be read all, read unprotected, or read modified. Using multicode sequences (U, V, or W), the programmer can specify data sent as send all, send unprotected, or send modified. For details on these multicode sequences, see Section 5.12. For additional information on block mode transmission formats, see Section 4.9.

#### 1.4.6.2 Request to Send

A special application of block mode is request to send. As in block mode-immediate operation, data is entered and edited on the keyboard and stored in terminal memory. When the SEND or RETURN key is depressed, however, the request to send multicode R sequence followed by an attention identifier character indicating the SEND key condition (line, message, or page) is transmitted to the host computer. The sequence is appended with the request to send terminator as defined in the set-up configuration.

At its convenience, the host computer program allocates necessary buffer storage and issues the proper read multicode sequence to initiate transmission.

The request to send application of block mode allows the system designer to fully optimize the allocation of host computer time and memory.

#### 1.4.7 Screen Program Mode

The screen program mode enables the programmer to arrange and organize display data into fields, thus making transfer and display operations easier for the operator. Fields are designated by attribute characters which define the end of the previous field and the start of a new field.

The screen program mode is initiated by entering the multicode (ESC) p sequence from the keyboard. On entering the screen program mode, PG is displayed in columns 78 and 79 of the status line. LOC is displayed in columns 54 through 56 of the status line indicating no terminal/host transmission can take place. DTR remains active in screen program mode.



Using the cursor control keys, the programmer moves the cursor to the desired positions to create attribute characters. The depression of the TAB key defines the start of an attribute field. The programmer then enters a mnemonic indicating the type of attribute character desired. More than one mnemonic may be entered for combinations of field types. Depressing the TAB key a second time defines the end of an attribute byte.

The mnemonic or combinations of mnemonics selected determine the type of field, specifying video and operational characteristics. For example, the programmer may designate inverse video fields, half-intensity fields, nondisplay (security) fields, etc. Further information on setting format fields is provided in Section 4.8.1.

Entering the multicode (ESC) p sequence a second time causes the Model 6312 VDU to exit the screen program mode.

#### 1.4.8 Business Graphics

The business graphics mode of the Model 6312 VDU enables the user to draw business type forms or simple graphs to enhance the information presentation. The graphics mode can be entered from the keyboard by depressing the GRAPH key with the SHIFT key or by entering an ASCII SO (shift out) character (CTRL N). The graphic symbols that are available and the associated ASCII codes are shown in Table 1-1. The graphics mode can be exited by depressing the NORM key on the keyboard or by entering an ASCII SI (shift in) character (CTRL O).

TABLE 1-1 BUSINESS GRAPHICS CHARACTER SET

030-3

| BITS | b7 →<br>b6 →<br>b5 → |    |    |    | X     | X | 0 | X     | X | 1 |
|------|----------------------|----|----|----|-------|---|---|-------|---|---|
|      | b4                   | b3 | b2 | b1 | 2/4/6 |   |   | 3/5/7 |   |   |
| 0    | 0                    | 0  | 0  | 0  | @     | — | P | ⌒     |   |   |
| 0    | 0                    | 0  | 1  | 1  | A     |   | Q | ┌     |   |   |
| 0    | 0                    | 1  | 0  | 2  | B     | + | R | └     |   |   |
| 0    | 0                    | 1  | 1  | 3  | C     | ⊥ | S | └     |   |   |
| 0    | 1                    | 0  | 0  | 4  | D     | ⊥ | T | └     |   |   |
| 0    | 1                    | 0  | 1  | 5  | E     | ⌒ | U | └     |   |   |
| 0    | 1                    | 1  | 0  | 6  | F     | ┌ | V | ⊕     |   |   |
| 0    | 1                    | 1  | 1  | 7  | G     | └ | W | ⊕     |   |   |
| 1    | 0                    | 0  | 0  | 8  | H     | └ | X | ÷     |   |   |
| 1    | 0                    | 0  | 1  | 9  | I     | └ | Y | >     |   |   |
| 1    | 0                    | 1  | 0  | A  | J     | └ | Z | <     |   |   |
| 1    | 0                    | 1  | 1  | B  | K     | — | [ | →     |   |   |
| 1    | 1                    | 0  | 0  | C  | L     | ¥ | \ | ←     |   |   |
| 1    | 1                    | 0  | 1  | D  | M     | + | ] | ↑     |   |   |
| 1    | 1                    | 1  | 0  | E  | N     | ⊥ | ^ | ↓     |   |   |
| 1    | 1                    | 1  | 1  | F  | O     | ⊥ | - |       |   |   |

1.4.9 Polled Environment

The Model 6312 VDU can operate within a system of polled terminals, thereby utilizing many terminals. This does not require physical modification of the terminal or the purchase of any extra options. Additional hardware, such as a modem splitter, may be necessary according to the requirements of the installation.

## CHAPTER 2 TESTING

### 2.1 INTRODUCTION

This chapter describes the tests for the Model 6312 and 6312+ video display units (VDUs). The following sections describe the functional test, the reset self-test, and the screen fill diagnostic test.

#### NOTE

Throughout this manual, all references to the Model 6312 VDU refer to both the Model 6312 and 6312+, unless otherwise noted.

### 2.2 FUNCTIONAL TEST

To perform the functional test, set the Model 6312 VDU ON/OFF power switch to the ON (1) position. Allow a minute or so for the terminal to warm up.

Adjust the contrast of the screen to suit your individual preference using the contrast control located on the bottom left front of the monitor.

Ensure the terminal is off-line by entering the set-up configuration mode and typing an N (no) in the PWR UP ON LINE field in the configuration menu or by depressing the SCROLL key with the SHIFT key. See Chapter 3 for details on the set-up configuration mode.

Depress each key from 1 to 0 on the top row and each key on the numeric pad on the right, verifying the correct display of the selected character. Continue this procedure with the alphabetic keys (A to Z), both shifted and unshifted, and the punctuation characters.

Use the HOME key to move the cursor to the top left of the screen. Depress each of the other cursor keys to verify correct operation.

Enter the transparent mode by depressing P, then B while the CTRL key is depressed. If the screen displays null characters, i.e., an "N" and a "U" depicting the ASCII null character, hold the space bar down to enter space characters on the top line of the screen and press the HOME key once more.

While depressing the CTRL key, first depress the @ key (SHIFT 2) and then the alphabetic keys A through P, P again, and Q through Z. Then depress the following punctuation keys:

[ \ ] ^ \_

The characters displayed on the screen should match the following:

030-2

N S S E E E A B B H L V F C S S D D D D D N S E C E S E F G R U  
U H X X T Q K L S T F T F R O I L 1 2 3 4 K Y B N M B C S S S S

Exit the transparent mode by depressing P then C simultaneously with the CTRL key.

Depress the CLEAR key with the SHIFT key to clear the screen.

The terminal can be put back on-line by entering the configuration mode and entering a Y (yes) in the PWR UP ON LINE field in the configuration menu or by depressing the SHIFT and SCROLL keys simultaneously.

### 2.3 POWER-UP/RESET SELF-TEST

The reset self-test, initiated by entering the multicode (ESC) o! sequence, verifies the integrity of external random access memory (RAM), screen RAM, default set-up, internal RAM, program read-only memory (ROM), attribute RAM, and associated internal logic. Upon successful completion of the test, CONCURRENT Computer Corp. appears in the upper left portion of the screen. All set-up options stored in nonvolatile memory are restored to the present operating mode. A test failure causes FAIL to display on the screen. Entering a multicode (ESC) o9 sequence displays the revision of the firmware and indicates the results of the test in the last character position of the field. If a space appears in this position, no error was detected. If a character appears in this position, it is the value indicated in the error bit position added to an X'20' (ASCII space). See Figure 2-1 for the format of the error byte.

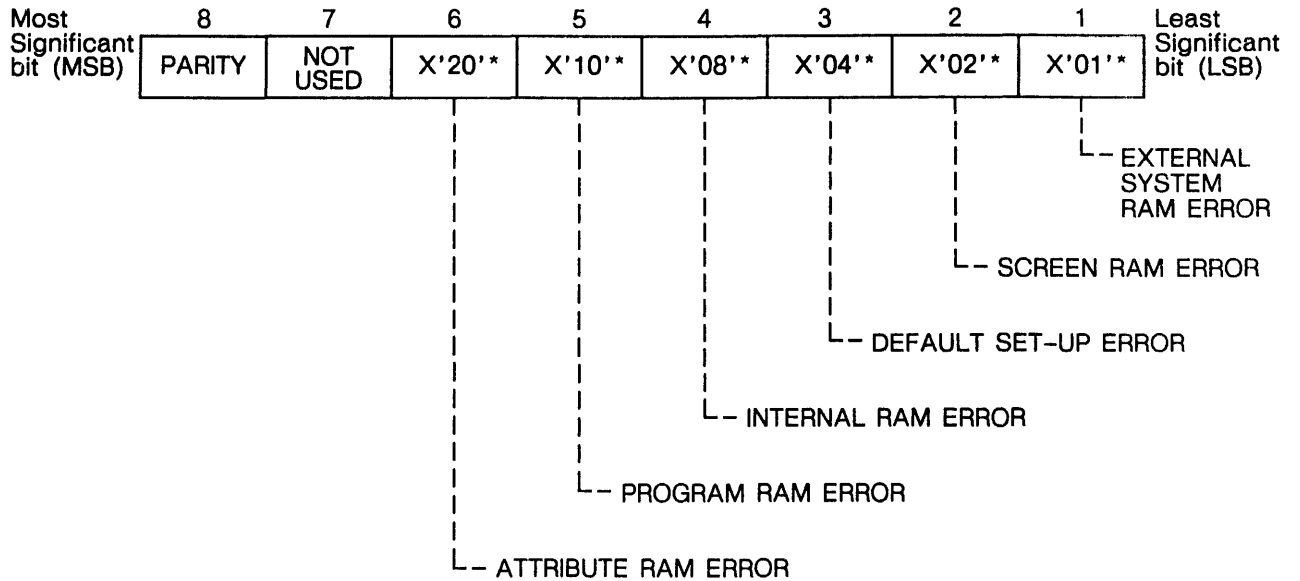

\*THIS VALUE ADDED TO X'20' INDICATES ERROR

Figure 2-1 Error Byte Format

#### 2.4 SCREEN FILL DIAGNOSTIC TEST

The screen fill diagnostic test tests the alignment of characters on the screen. This test may be initiated from the keyboard by entering the multicode (ESC) sequence:

MULTICODE : (character)

This sequence fills the screen (including the status line) with the character entered.

#### 2.5 MODEL 6312 VIDEO DISPLAY UNIT (VDU) TEST (06-295)

The 06-295 diagnostic tests the Model 6312 VDU. For details on this diagnostic, see the diagnostic program description 06-295 A15.



## CHAPTER 3 SET-UP CONFIGURATION

### 3.1 INTRODUCTION

The operation of the Model 6312 and 6312+ video display units (VDUs) is controlled by the set-up configuration. The VDU can be configured by the operator via the keyboard or by the host computer through encoded ASCII sequences. Configuration by the host allows entries to the random access memory (RAM) for temporary use or to the electrically alterable read-only memory (EAROM) for permanent use.

#### NOTE

Throughout this manual, all references to the Model 6312 VDU refer to both the Model 6312 and 6312+, except where otherwise noted.

### 3.2 CONFIGURATION MENU

The Model 6312 VDU configuration menu is a full-screen display that contains all available options for configuration of the terminal. Figure 3-1 illustrates a sample configuration menu for the Model 6312+ VDU. The Model 6312 configuration menu has the same format except for the KEYBOARD COUNTRY line. On the Model 6312, this line is blank.

|                          |   |  |   |                    |   |   |   |                |
|--------------------------|---|--|---|--------------------|---|---|---|----------------|
| KBD CTRL                 | N   | ESC  | N   | CURSOR, EDIT KYS   | N   | TAB BACKTAB   | N   | CR, LR         |
|                          | N   | F01-F04                                      | N   | F05-F08            | N   | F09-F12   | N   | F13-F16        |
| KBD LOCK                 | N   | ESC  | N   | CURSOR KYS         | N   | TAB BACKTAB   | N   | CR, LF         |
|                          | N   | F01-F04                                      | N   | F05-F08            | N   | F09-F12   | N   | F13-F16        |
| MODE                     | Y   | SCROLL                                       | N   | AUTO LINE FEED     | Y   | AUTO TAB  | Y   | NEW LINE       |
|                          | Y   | UPPER CA3E                                   | N   | INVERSE VIDEO      | N   | BLINK CURSOR  | Y   | BLOCK CURSOR   |
|                          | N   | KEY CLICk                                    | Y   | SCREEN SAVE        | N   | SMOOTH SCROLL   |   |                |
| SYSTEM                   | Y   | SEND STAT LINE                               | Y   | DSPLAY STAT LN     | Y   | PWR UP ON LINE  | N   | RETURN = SEND  |
|                          | Y   | 60 HZ  | N   | CLEAR TO SPACES    | Y   | SEND CRSR, EDIT   | N   | SEND CLEAR ALL |
| COMM                     | N   | BLOCK  | N   | POLLED             |   |   | N   | HALF DUPLEX    |
|                          | Y   | NULL SUPP UNFOR                              | Y   | NULL SUPP FORMT    | Y   | XON/OFF   | N   | 113J           |
| PRINTER                  | Y   | LINE DRAWING                                 | Y   | READY (-)          |   |   |   |                |
| COM                      | PAG   | LINE, MSG, PAG                               | EVN   | ODD, EVN, MRK, SPC | 9600  | 300, 600, 1200, 2400, 4800, 9600, 19.2K   |   |                |
| PRT                      | PAG   | LINE, MSG, PAG                               | SPC   | ODD, EVN, MRK, SPC | 9600  | 300, 600, 1200, 2400, 4800, 9600, 19.2K   |   |                |
| KEYBOARD COUNTRY         | U   | US, UK, FREN, SWED, GERM, SPAN, DAN          |   |                    |   |   |   |                |
| TERMINATOR:              | E <sub>X</sub> C <sub>N</sub> C <sub>N</sub> C <sub>N</sub> | SEND LINE                                    | C <sub>S</sub> C <sub>N</sub> C <sub>N</sub> C <sub>N</sub> | FIELD              | C <sub>N</sub> C <sub>N</sub> C <sub>N</sub> C <sub>N</sub> | UNFORMAT LINE   | E <sub>X</sub> C <sub>N</sub> C <sub>N</sub> C <sub>N</sub> | UNFORMAT PG    |
|                          | E <sub>X</sub> C <sub>N</sub> C <sub>N</sub> C <sub>N</sub> | FORMAT PG                                    | C <sub>N</sub> C <sub>N</sub> C <sub>N</sub> C <sub>N</sub> | REQ TO SEND        |   | C <sub>R</sub> L <sub>F</sub> C <sub>N</sub> C <sub>N</sub> C <sub>N</sub> C <sub>N</sub> C <sub>N</sub> C <sub>N</sub> | PRINT LINE  |                |
| SPCL CHAR                | E <sub>C</sub>  | MULTICODE CHAR                               | N <sub>U</sub>  | POLL CHAR          | D <sub>3</sub>  | PAUSE CHAR  | D <sub>1</sub>  | RESUME CHAR    |
|                          |   |  |   |                    |   |   |   | 72             |
| RING BELL                |   |  |   |                    |   |   |   |                |
| FUNCTION KEYS: HERE IS = |   | C <sub>N</sub> C <sub>N</sub> C <sub>N</sub> |   |                    |   |   |   |                |

Figure 3-1 Model 6312+ VDU Configuration Menu

### 3.3 CONFIGURATION OPTIONS

Configuration of a Model 6312 VDU for a particular operating environment is controlled by setting various configuration options contained in the configuration menu. These options are logically grouped into nine categories according to function. Figure 3-2 associates each category name with its related options in a sample configuration menu. These categories are:

- Keyboard control options
- Mode control options
- Systems options
- Communications options
- Printer port options
- International font selection (Model 6312+ only)
- Communication terminators
- Special characters
- Function key definitions



030-5-2

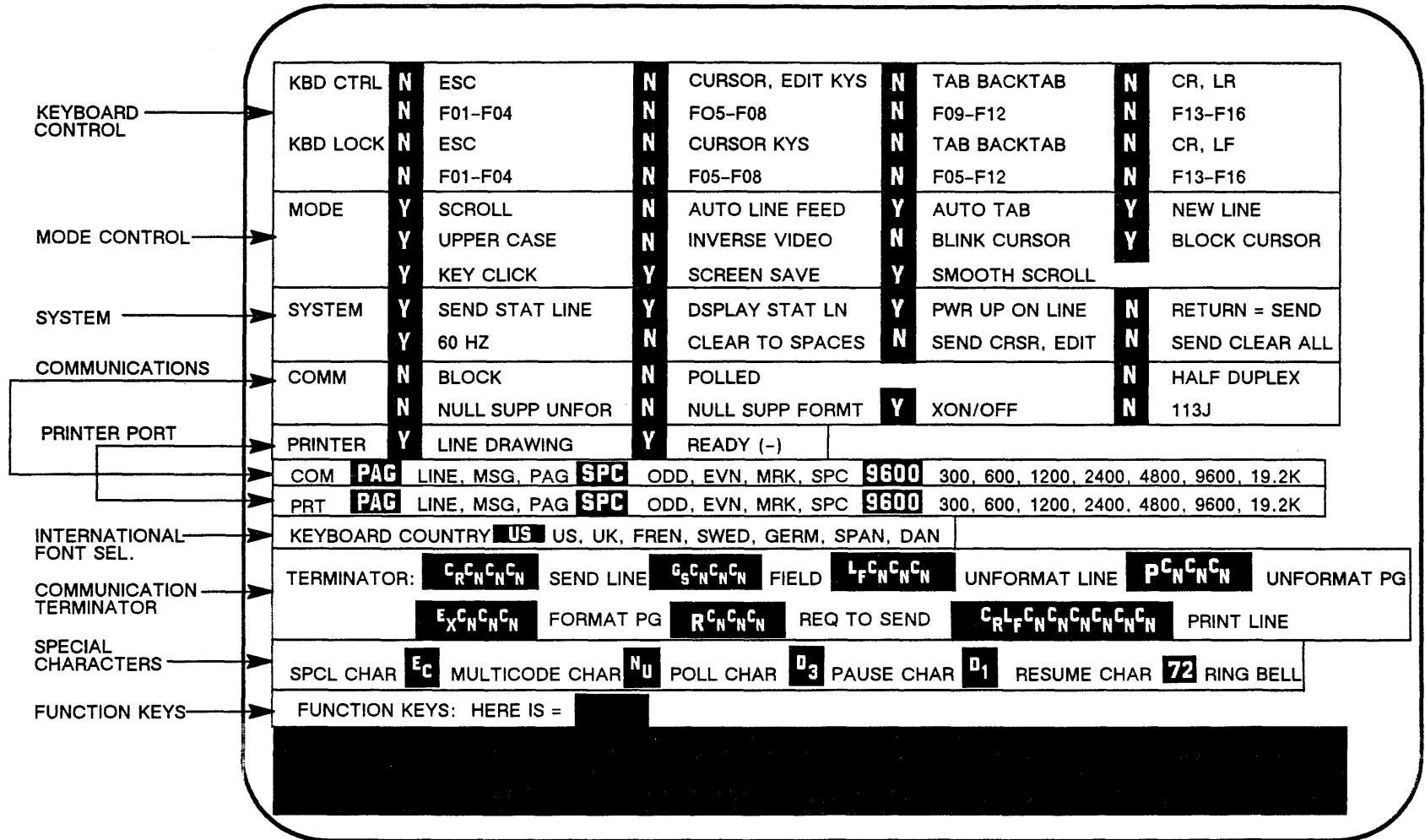

Figure 3-2 Option Categories

1

### 3.3.1 Keyboard Options Category

Figure 3-3 illustrates the options which comprise the keyboard options category. The desired options may be selected by entering the proper response in the field preceding the particular option. An option is enabled by entering a Y (yes) or an N (no) in the inverse field of the option. If the currently configured setting is desired, tab to the next desired option.

030-6

|          |   |         |   |                  |   |             |   |         |
|----------|---|---------|---|------------------|---|-------------|---|---------|
| KBD CTRL | N | ESC     | N | CURSOR, EDIT KYS | N | TAB BACKTAB | N | CR, LF  |
|          | N | F01-F04 | N | F05-F08          | N | F09-F12     | N | F13-F16 |
| KBD LOCK | N | ESC     | N | CURSOR KYS       | N | TAB BACKTAB | N | CR, LF  |
|          | N | F01-F04 | N | F05-F08          | N | F05-F12     | N | F13-F16 |

Figure 3-3 Keyboard Options Category

#### 3.3.1.1 Keyboard Control (KBD CTRL)

If the control protect function is enabled for a specified set of keys, called a key group, the control (CTRL) key must be simultaneously depressed with one of the keys within the key group. If this function is disabled, the specified key group is not control-protected and it is not necessary to depress the CTRL key.

The first key group consists of the escape (LOCAL ESCAPE/ESCAPE) key.

The second key group consists of the cursor position keys and the edit keys. The cursor position keys are the home (HOME) key, the cursor up (↑) key, cursor left (←) key, cursor right (→) key, and the cursor down (↓) (LINE FEED) key. The edit keys are the insert line/character (INSERT LINE/CHAR) key, the erase line/page (ERASE LINE/PAGE) key, the delete line/character (DELETE LINE/CHAR) key, the send (SEND) key, the send message (SEND MSG) key, and the print (PRINT) key.

The third key group consists of the unshifted TAB key and the shifted TAB key (backtab).

The key in the fourth group is the carriage return (RETURN) key.

The fifth control protect key group consists of four sets of function key subgroups. If the control protect function is enabled for one of the function key subgroups, both the unshifted and shifted counterparts of these keys are control-protected.

### 3.3.1.2 Keyboard Lock (KBD LOCK)

If the lockout function is enabled for a specified key group, no action occurs upon depression of any of the keys in the key group. If this function is disabled, the keys within a specified key group can be used.

The first key group consists of the escape (LOCAL ESCAPE/ESCAPE) key.

The second key group consists of the cursor position keys. The cursor position keys are the home (HOME) key, the cursor up (↑) key, cursor left (←) key, cursor right (→) key, and the cursor down (↓) (LINE FEED) key.

The third key group consists of the unshifted TAB key and the shifted TAB key (backtab).

The key in the fourth group is the carriage return (RETURN) key.

The fifth keyboard lock key group consists of four sets of function key subgroups. If the keyboard lock function is enabled for one of the function key subgroups, both the unshifted and shifted counterparts of these keys are locked out.

### 3.3.2 Mode Control Options Category

Figure 3-4 illustrates the contents of the mode control options category. The desired options may be selected by entering the proper response in the field preceding the particular option. An option is enabled by entering a Y (yes) or an N (no) in the inverse field of the option. If the currently configured setting is desired, tab to the next desired option.

030-7

|      |                                     |            |                          |                |                                     |               |                                     |              |
|------|-------------------------------------|------------|--------------------------|----------------|-------------------------------------|---------------|-------------------------------------|--------------|
| MODE | <input checked="" type="checkbox"/> | SCROLL     | <input type="checkbox"/> | AUTO LINE FEED | <input checked="" type="checkbox"/> | AUTO TAB      | <input checked="" type="checkbox"/> | NEW LINE     |
|      | <input checked="" type="checkbox"/> | UPPER CASE | <input type="checkbox"/> | INVERSE VIDEO  | <input checked="" type="checkbox"/> | BLINK CURSOR  | <input checked="" type="checkbox"/> | BLOCK CURSOR |
|      | <input checked="" type="checkbox"/> | KEY CLICK  | <input type="checkbox"/> | SCREEN SAVE    | <input checked="" type="checkbox"/> | SMOOTH SCROLL |                                     |              |

Figure 3-4 Mode Control Options Category

### 3.3.2.1 Scroll Option (SCROLL)

If the scroll option is enabled and a line of data is entered on line 24 of the screen, followed by a carriage return (CR) and a line feed (LF), the cursor is returned to column 1 of line 24 and line 1 is scrolled off the screen. Line 24 is cleared to nulls or spaces depending on the configuration. If this option is disabled and a line of data is entered on line 24 of the screen, followed by a CR and LF, the cursor is returned to column 1 of line 1 of the screen. If the new line option is enabled, it is not necessary to enter a CR and an LF. See Section 3.3.2.4 for information on the new line option. The scroll option works in the same manner when receiving data on-line from the host.

### 3.3.2.2 Auto Line Feed Option (AUTO LINE FEED)

If the auto line feed option is enabled, the cursor moves to column 1 of the next line when the RETURN key is depressed or a return code is received from the host. If this option is disabled, the cursor moves to column 1 of the same line when the RETURN key is depressed. If the scroll option is enabled and the cursor is at line 24, the screen scrolls up one line.

### 3.3.2.3 Auto Tab Option (AUTO TAB)

If the auto tab option is enabled, the cursor automatically passes over protected fields and attribute characters without causing the keyboard to lock. If this option is disabled, it is necessary to manually tab past protected fields and attribute characters to access fields.

### 3.3.2.4 New Line Option (NEW LINE)

If the new line option is enabled, the entry to or receipt from the host of a displayable character past column 80 generates an automatic CR and LF. If this option is disabled and an attempt is made to enter data past column 80, any character entered overprints at column 80.

### 3.3.2.5 Upper-Case Option (UPPER CASE)

If the upper-case only option is enabled, lower-case characters are converted to their upper-case counterparts. Lower-case characters received via the communications line are not affected by this option. If this option is disabled, lower-case characters are not converted to upper-case.

### 3.3.2.6 Inverse Video Option (INVERSE VIDEO)

If the inverse video option is enabled, dark characters are displayed on a light screen. If this option is disabled, the display is standard with light characters on a dark screen.

### 3.3.2.7 Blinking Cursor Option (BLINK CURSOR)

If the blinking cursor option is enabled, the cursor blinks continuously. The blink cycle is every 500ms  $\pm$  20%. If this option is disabled, the cursor does not blink.

### 3.3.2.8 Block Cursor Option (BLOCK CURSOR)

If the block cursor option is enabled, the cursor appears as an inverse video block (assuming the inverse video option is not enabled). If this option is disabled, the cursor appears as an inverse video underline character.

### 3.3.2.9 Key Click Option (KEY CLICK)

If the key click option is enabled, an audible click occurs upon depression of any key on the keyboard. If this option is disabled, keyboard operation is silent.

### 3.3.2.10 Screen Saver Option (SCREEN SAVE)

If the screen saver option is enabled, the screen clears after approximately 15 minutes of inactivity. Screen memory remains intact. Any keyboard operation or host transmission restores the screen. To restore the screen without generating characters, depress the SET UP/STATUS key.

If this option is disabled, characters remain displayed on the screen until the screen is manually cleared.

### 3.3.2.11 Smooth Scrolling Option (SMOOTH SCROLL)

If the smooth scrolling option is enabled, characters are vertically scrolled by scan line. If this option is disabled, an entire character line is scrolled.

## 3.3.3 Systems Options Category

Figure 3-5 illustrates the contents of the systems options category. The desired options are enabled by entering a Y (yes) or disabled by entering an N (no) in the inverse field preceding the option. If the currently configured setting is desired, tab to the next desired option.



Figure 3-5 Systems Options Category

### 3.3.3.1 Send Status Line Option (SEND STAT LINE)

If the send status line option is enabled in block mode, block mode communication is allowed from the status line. In conversational mode, data is sent to the host character-by-character. If this option is disabled, there is no communication with the host computer from the status line.

### 3.3.3.2 Status Line Display Option (DSPLAY STAT LN)

If the status line display option is enabled, the status line is displayed on line 25 of the screen. If this option is disabled, the status line is not displayed. The status line is displayed on entering the screen program mode, the configuration mode, and whenever a terminal error occurs.

### 3.3.3.3 Power-Up On-Line Option (PWR UP ON LINE)

If the power-up on-line option is enabled, the terminal is on-line upon power-up. If this option is disabled, the terminal is in local mode upon power-up. In local mode, no data is transmitted to or received from the host. Keyboard entries cause the appropriate action to be sent directly to the screen. The terminal can be placed on-line by depressing the SHIFT and SCROLL keys simultaneously. In local mode, data terminal ready (DTR) is inactive.

### 3.3.3.4 Return=Send Option (RETURN = SEND)

If the return=send in block mode option is enabled, the RETURN key operates the same as the SEND key by transmitting data to the host. If this function is disabled, no data is transmitted and the cursor is placed at the beginning of the next line when the RETURN key is depressed.

### 3.3.3.5 Screen Refresh Rate Option (60 HZ)

If this option is enabled the screen is scanned at a 60Hz rate. If this option is disabled on the Model 6312, the refresh rate is 50Hz. If disabled on the 6312+, the rate is 70Hz.

### 3.3.3.6 Clear to Spaces Option (CLEAR TO SPACES)

If the clear to spaces option is enabled, the terminal screen is cleared to spaces (X'20'). If this option is disabled, the terminal screen is cleared to nulls (X'00').

### 3.3.3.7 Send Cursor and Edit Keys Option (SEND CRSR,EDIT)

If the send cursor and edit keys option is enabled, the VDU transmits the associated multicode sequence to the host computer. The host computer then provides the appropriate command for the desired action to occur. For example, if the cursor up key ( ) is depressed, a multicode (ESC) A sequence is transmitted to the host computer. The host responds by transmitting a multicode (ESC) A sequence back to the VDU to move the cursor up one line. If this option is disabled, the depression of the cursor and edit keys causes the action to take place locally at the terminal with the exception of the LINE FEED key, which causes an X'0A' to be transmitted.

### 3.3.3.8 Send Clear All Option (SEND CLEAR ALL)

If the send clear all option is enabled, the terminal transmits a request to send multicode R\_ sequence to the host computer when the SHIFT and CLEAR DELETE keys are depressed simultaneously. After the host responds with a read request, the screen is cleared. If the host does not respond with a read request, the screen is not cleared. If this option is disabled, the screen is cleared when the SHIFT and CLEAR DELETE keys are depressed simultaneously.

## 3.3.4 Communication Options Category

Figure 3-6 illustrates the contents of the communication options category. Certain desired options may be enabled by entering a Y (yes) or disabled by entering an N (no) in the inverse field immediately preceding the option.

Other options in this category can be selected from a list of options settings shown immediately to the right of the entry field. If the currently configured setting is desired, tab to the next desired option.

|      |                              |                 |                              |                    |                                       |  |
|------|------------------------------|-----------------|------------------------------|--------------------|---------------------------------------|--|
| COMM | <input type="checkbox"/> N   | BLOCK           | <input type="checkbox"/> N   | POLLED             | <input type="checkbox"/> N            | HALF DUPLEX                              |
|      | <input type="checkbox"/> N   | NULL SUPP UNFOR | <input type="checkbox"/> N   | NULL SUPP FORMT    | <input checked="" type="checkbox"/> Y | 113J                                     |
| COM  | <input type="checkbox"/> PAG | LINE, MSG, PAG  | <input type="checkbox"/> SPC | ODD, EVN, MRK, SPC | <input type="checkbox"/> 9600         | 300, 600, 1200, 2400, 4800, 9600, 19. 2K |

Figure 3-6 Communications Options Category

#### 3.3.4.1 Block Mode Option (BLOCK)

If the block mode option is enabled, an entire block of data is transmitted to the host when the SEND key is depressed. If this option is not enabled, the terminal operates in conversational mode and data is transmitted to the host character-by-character.

#### 3.3.4.2 Polled Option (POLLED)

If the polled option is enabled, the terminal responds only after receipt of multicode sequences BROADCAST, GROUP/FAST SELECT, or POLL. The polled option is used with the POLL CHAR described in Section 3.3.8.2.

#### 3.3.4.3 Half-Duplex Option (HALF DUPLEX)

If the half-duplex option is enabled, all keyboard input is displayed on the screen and transmitted on the communication line. If this option is disabled, all keyboard input is transmitted over the communication line only.

#### 3.3.4.4 Null Suppression on Unformatted Transmission Option (NULL SUPP UNFOR)

If the null suppression on unformatted transmission option is enabled, nulls are suppressed in transmission of an unformatted screen. If this option is disabled, nulls are not suppressed in transmission of an unformatted screen.



#### 3.3.4.5 Null Suppression on Formatted Transmission Option (NULL SUPP FORMT)

If the null suppression on formatted transmission option is enabled, nulls are suppressed in transmission of a formatted screen. If this option is disabled, nulls are not suppressed in transmission of a formatted screen.

#### 3.3.4.6 XON/XOFF Option (XON/OFF)

If the XON/XOFF option is enabled, the host computer has the option of sending the XOFF character (as defined by the pause character) to the terminal to pause transmission from the terminal. The terminal makes no further transmission until it receives an XON character (as defined by the resume character). If this option is disabled, the host does not have the option of pausing transmission from the terminal.

#### 3.3.4.7 113J Option (113J)

If the 113J option is enabled, the carrier on (CF) signal (pin #8) is automatically tied to +12V so that the terminal may operate with 113J and 103J type modems. If this option is not enabled, the carrier on (CF) signal (pin #8) is not tied to +12V.

#### NOTE

This designation is required only for 113J and 103J modems. The configuration should be set to N for other types of modems, such as the 212A.

#### 3.3.4.8 Send Line, Message, Page Option (LINE,MSG,PAG)

If the send condition is designated as LINE, the line of data on which the cursor is located is transmitted to the host upon transmission of the SEND key.

If the send condition is designated as MSG, data is transmitted starting with the character following the end of the previously sent message or with the start of page and ending with the character before the current cursor position.

If the send condition is designated as PAG, an entire screen of data is transmitted to the host when the SEND key is depressed.

The type of send condition is designated by entering LINE, MSG, or PAG in the inverse field of the option.

### 3.3.4.9 Parity Option (ODD, EVN, MRK, SPC)

The type of parity is designated by entering one of the four parity types (odd, even, mark, or space) in the inverse field of the option.

### 3.3.4.10 Baud Rate Option (300,600,1200,2400,4800,9600,19.2K)

The baud rate is the rate of speed at which data is transmitted and received between the host and terminal. The highest rate of transmission speed is 19.2K. The baud rate must correspond with the rate expected by the host or the terminal will not function on-line.

The baud rate is designated by entering one of the baud rate settings in the inverse field of the option.

## 3.3.5 Printer Port Options Category

Figure 3-7 illustrates the contents of the printer port options category. Certain desired options may be enabled by entering a Y (yes) or disabled by entering an N (no) in the inverse field immediately preceding the option. Other options in this category can be selected from a list of option settings shown immediately to the right of the entry field. If the currently configured setting is desired, tab to the next desired option.

030-10

```
PRINTER  Y  LINE DRAWING  Y  READY (-)
PRT  PAG  LINE, MSG, PAG  SPC  ODD, EVN, MRK, SPC  9600  300, 600, 1200, 2400, 4800, 9600, 19.2K
```

Figure 3-7 Printer Port Options Category

### 3.3.5.1 Line Drawing Option (LINE DRAWING)

If the print line drawing option is enabled, attribute and graphics characters are transmitted to the printer. If this option is disabled, attribute characters and graphic characters are converted to spaces before they are transmitted to the printer.

### 3.3.5.2 Ready Option (READY (-))

The ready option determines whether the voltage level that indicates a ready state is plus or minus for the print device. If the ready option is enabled, the ready state is a minus. For example, clear to send (CTS) is low for the ready state and high for the busy state. If the ready option is disabled, the ready state is a plus. For example, CTS is high for the ready state and low for the busy state.

### 3.3.5.3 Print Line, Message, Page Option (LINE,MSG,PAG)

If the printer port option is designated as LINE, the line of data where the cursor is located is transmitted to the print device when the PRINT key is depressed.

If the printer port option is designated as MSG, upon transmission of the PRINT key, data is transmitted starting with the character following the end of the previously sent message or with start of page and ending with the character before the current cursor position.

If the printer port option is designated as PAG, a local printout of an entire screen of data is initiated when the PRINT key is depressed.

The print line, message or page option is designated by entering LINE, MSG, or PAG in the inverse field of the option.

### 3.3.5.4 Parity Option (ODD,EVN,MRK,SPC)

The type of parity is designated by entering one of the four parity types (odd, even, mark, or space) in the inverse field of the option.

### 3.3.5.5 Baud Rate Option (300,600,1200,2400,4800,9600,19.2K)

The baud rate is the rate of speed at which data is transmitted between the print device and the terminal. The highest rate of transmission speed is 19.2K. This speed must correspond to the speed expected by the print device.

The baud rate is designated by entering one of the baud rates in the inverse field of the option.

### 3.3.6 International Font Selection

Only the Model 6312+ has selectable character fonts for seven different countries (see Figure 3-8). They are: United States, United Kingdom, France, Sweden, Germany, Spain, and Denmark. The fonts also have corresponding key caps available to insert on the keyboard. Refer to the Model 6312 and 6312+ Video Display Unit (VDU) Installation Manual for details.

030-30

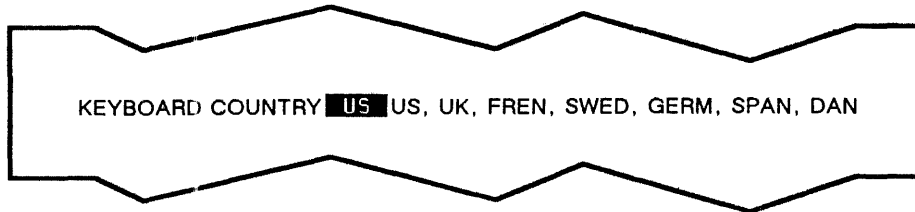

Figure 3-8 International Font Selection (Model 6312+ Only)

### 3.3.7 Communication Terminator Category

Figure 3-9 shows the contents of the communication terminator category of the configuration menu. These options are selected by entering one to four ASCII characters in the inverse field of the option. The cancel (CN) character, generated by simultaneously depressing the CTRL and X keys, must be entered as the last character of this field but is not part of the communication terminator. If no terminator is desired, enter four CN characters. If the currently configured setting is desired, tab to the next desired option. See Table 3-1 for a list of the ASCII characters normally used as communication terminators.

030-11

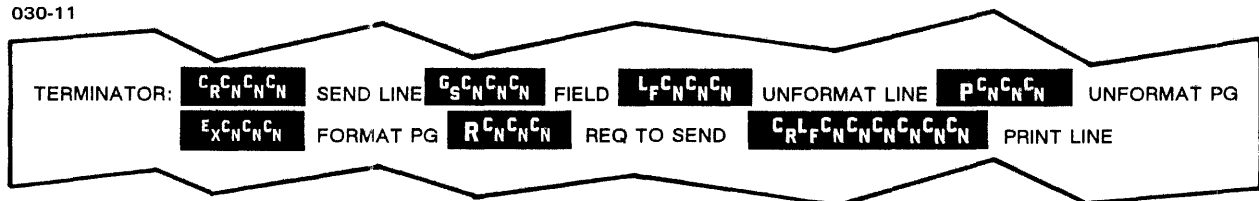

Figure 3-9 Communication Terminator Options Category

TABLE 3-1 ASCII CHARACTER DEFINITIONS

| 6312<br>SCREEN<br>ABBREVI-<br>ATION | ASCII<br>CHARAC-<br>TERS | KEYS<br>DEPRESSED<br>SIMULTA-<br>NEOUSLY | MEANING                        | ASCII<br>IN<br>HEXA-<br>DECIMAL | CATEGORIES<br>CONTAINING OPTION   |
|-------------------------------------|--------------------------|--|--------------------------------|---------------------------------|---|
| CW                                  | CAN                      | CTRL X                                   | CANCEL                         | 18                              | Printer port options<br>Communication terminators options<br>Function key definition menu |
| CR                                  | CR                       | CTRL M                                   | CARRIAGE RETURN                | 0D                              | Communication terminators option  |
| D3                                  | DC3                      | CTRL S                                   | PAUSE CHARACTER                | 13                              | Special characters option   |
| D1                                  | DC1                      | CTRL Q                                   | RESUME CHARACTER               | 11                              | Special characters option   |
| EC                                  | ESC                      | CTRL [                                   | ESCAPE; MULTICODE<br>CHARACTER | 1B                              | Special characters option   |
| EX                                  | ETX                      | CTRL C                                   | END TRANSMISSION               | 03                              | Communication terminators   |
| GS                                  | GS                       | CTRL ]                                   | GROUP SEPARATOR                | 1D                              | Communication terminators   |
| LF                                  | LF                       | CTRL J                                   | LINE FEED                      | 0A                              | Communication terminators   |
| NU                                  | NULL                     | CTRL @                                   | NULL                           | 00                              | Special characters option   |

### 3.3.7.1 Send Line Terminator Option (SEND LINE)

This terminator is automatically appended to each line for the send line condition of both formatted and unformatted screens. It is also automatically appended to the transmission of a function key message that is defined in the configuration. For example, CR CN CN CN may be designated as the send line terminator in the inverse field of the option.

### 3.3.7.2 Field Terminator Option (FIELD)

This terminator is automatically appended to each field on the transmission of formatted screens. For example, GS CN CN CN may be designated as the field terminator in the inverse field of the option.

### 3.3.7.3 Unformatted Line Terminator Option (UNFORMAT LINE)

This terminator is automatically appended to each line for the send message and send page conditions on the transmission of unformatted screens. For example, LF CN CN CN may be designated as the unformatted line terminator in the inverse field of the option.

### 3.3.7.4 Unformatted Page Terminator Option (UNFORMAT PG)

This terminator is automatically appended to each message or page for the send message or send page conditions on the transmission of unformatted screens. For example, P CN CN CN may be designated as the unformatted page terminator in the inverse field of the option.

### 3.3.7.5 Formatted Page Terminator Option (FORMAT PG)

This terminator is automatically appended to each message or page for the send message and send page conditions on the transmission of formatted screens. For example, EX CN CN CN may be designated as the formatted page terminator in the inverse field of the option.

### 3.3.7.6 Request To Send Terminator Option (REQ TO SEND)

This terminator is automatically appended to each transmission of a request to send multicode sequence. This includes a transmission as a result of a function key that is not defined in the configuration. For example, R CN CN CN may be designated as the request to send terminator in the inverse field of the option.

### 3.3.7.7 Print Line Terminator Option (PRINT LINE)

This terminator is automatically appended to each line of data that is transmitted through the printer port of the terminal. For example, CR LF CN CN CN CN CN CN may be designated as the print line terminator in the inverse field of the option.

### 3.3.8 Special Characters Category

Figure 3-10 illustrates the contents of the special characters option category of the configuration menu. These options are selected by entering a single ASCII character in the inverse field preceding the option.

030-12

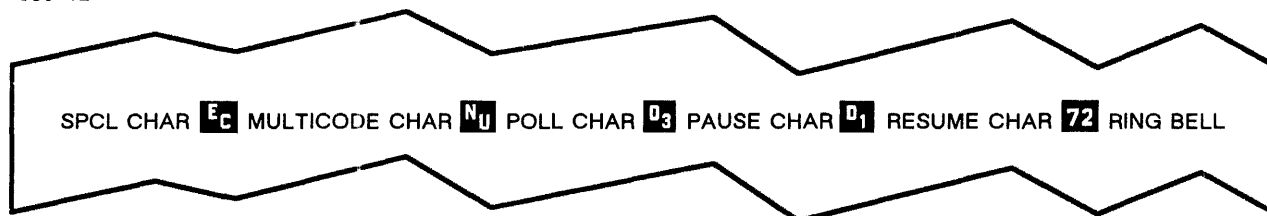

Figure 3-10 Special Characters Option Category

### 3.3.8.1 Multicode Character Option (MULTICODE CHAR)

It is necessary to designate a multicode character to execute or send multicode sequences from the host. This key must correspond with the multicode character expected by the host. The escape (ESC) key is designated as the multicode character for Model 6312 configuration.

The multicode character is designated by entering the desired ESC character in the inverse field of the option.

### 3.3.8.2 Polling/Selection Address Option (POLL CHAR)

In the event that the terminal is used within a system of polled terminals (POLLED = Y), the ASCII character designated as the POLL CHAR is used to distinguish one terminal from another. A more detailed description is in Section 4.10.

### 3.3.8.3 Pause Character Option (PAUSE CHAR)

When the ASCII character designated as the pause character is depressed, the flow of data is stopped. ASCII character DC3 or DC4 is normally designated as the pause character, although any ASCII character may be used.

The pause character is designated by entering the desired ASCII character in the inverse field of the option. See Table 3-1 for details on the ASCII character normally used as the pause character.

### 3.3.8.4 Resume Character Option (RESUME CHAR)

When the ASCII character designated as the resume character is depressed, the flow of data that was stopped by depressing the pause character is continued. ASCII character DC1 or DC2 is normally designated as the resume character, although any ASCII character may be used.

The resume character is designated by entering the desired ASCII character in the inverse field of the option. See Table 3-1 for details on the ASCII character normally used as the resume character.

### 3.3.8.5 Ring Bell Option (RING BELL)

A two-digit column number can be entered in the inverse field of the option. While entering data, the bell sounds when the cursor enters the designated column. This option is equivalent to a typewriter bell that sounds just before the right margin is reached. If the ring bell column number option is not desired, enter 90 or 00 in the inverse field of the option.

### 3.3.9 Function Key Definition Category

Figure 3-11 illustrates the function key definition category of the configuration menu.

030-13

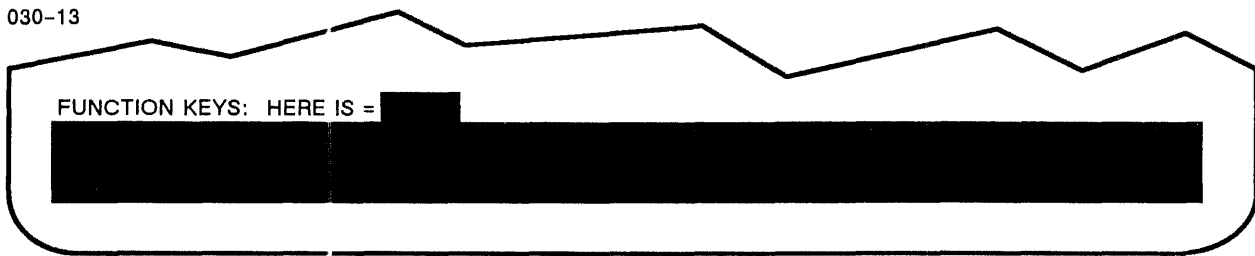

Figure 3-11 Function Key Definition Category

#### 3.3.9.1 The HERE IS Function Key

The operator or the host computer may designate any one of the function keys as the HERE IS key. The message of the HERE IS key is transmitted in response to the ASCII ENQ (enquiry) character sent by the host computer. A function key is designated as the HERE IS key by entering the letter F and the two-digit number of the function key (leading zeros must be entered) in the inverse field of the option.

#### 3.3.9.2 Function Key Definition

For the Model 6312 VDU, an inverse field of five lines in length (representing 400 characters of EAROM memory) is provided for function key definition. Function keys may be defined in any order. The function keys are defined as follows:

1. Enter the letter F.
2. Enter the two-digit number of the function key (leading zeros must be entered).
3. Enter the equals (=) character.
4. Enter the desired message in the inverse field (up to five lines in length).



5. Terminate the function key definition with the ASCII cancel character (CTRL X). This character is not a character in the function key message and is not transmitted upon depression of the function key.

#### NOTE

When defining a function key, communication control characters and format effector codes are generated by simultaneously depressing the CTRL key and the character key as indicated in table 4-1. For example: a carriage return is generated by depressing the CTRL and M keys simultaneously.

### 3.4 CONFIGURATION BY THE OPERATOR

The Model 6312 VDU may be configured by the operator through keyboard entries. The set-up configuration mode is entered by depressing the SHIFT and SET UP/STATUS keys simultaneously. This puts the VDU in the local mode and the configuration menu (shown in Figure 3-1) is displayed. This display includes an area of 400 bytes used to program the function keys. Data terminal ready (DTR) is forced inactive in the set-up mode.

The desired options are selected by entering the proper response in the field preceding the particular option. For most options the entry is either a Y (yes) or an N (no). The others are a choice from a list of option settings shown immediately to the right of the entry field or one or more ASCII characters.

#### NOTE

Control characters entered in the set-up configuration mode are displayed as in the transparent mode.

In the set-up configuration mode, depressing either the TAB key or the shifted TAB key (backtab) causes advancement to the next or previous option field, respectively. The cursor position keys may also be used to advance the cursor.

An attempt to make an entry into a nonoption field forces an error condition and FLD PROT is displayed on the status line. Cursor movement clears such errors.



```

BYTE
=====
 1  SCROLL
    AUTO LINE FEED
    AUTO TAB
    NEW LINE ENABLE
    -----
 2  UPPER-CASE
    INVERSE VIDEO
    BLINK CURSOR
    BLOCK CURSOR
    -----
 3
 :  RING BELL ON COLUMN
 6
=====
 7  BLOCK MODE
    KEY CLICK
    SCREEN SAVER
    -----
 8  COMMUNICATIONS SEND CONDITION
    -----
 9  COMMUNICATIONS BAUD RATE
    -----
10  COMMUNICATIONS PARITY
=====
11  SMOOTH SCROLL
=====
12  113J
    -----
13  RESERVED FOR
14  FUTURE USE
    -----
15  MULTICODE
16  CHARACTER
=====
17  HALF- or FULL-DUPLEX
    NULL SUPPRESS FORMATTED DATA
    NULL SUPPRESS UNFORMATTED DATA
    XON/XOFF
=====
18  SEND STATUS LINE
    DISPLAY STATUS LINE
    POWER-UP ON-LINE
    RETURN = SEND (BLOCK MODE)
    -----
19  AC LINE FREQUENCY 50/60HZ
    CLEAR TO SPACES/NULLS
    SEND CURSOR, EDIT KEY CODES
    SEND CLEAR ALL

```

Figure 3-12 Host Configuration Data Stream (Continued)

```

=====
20 CONTROL PROTECT ESC KEY
    CURSOR, EDIT KEYS
    TAB/BACKTAB KEY
    CR, LINE FEED KEYS
-----
21 CONTROL PROTECT F01-F04, F17-F20
    F05-F08, F21-F24
    F09-F12, F25-F28
    F13-F16, F29-F32
=====
22 KEYBD LOCK OUT ESC KEY
    CURSOR KEYS
    TAB/BACKTAB KEY
    CR, LINE FEED KEYS
-----
23 KEYBD LOCK OUT F01-F04, F17-F20
    F05-F08, F21-F24
    F09-F12, F25-F28
    F13-F16, F29-F32
=====
24 PRINT CONDITION - LINE,MSG,PAGE
-----
25 PRINTER BAUD RATE
-----
26 PRINTER PARITY
-----
27 PRINTER STOP BITS
-----
28
: PRINT LINE
: TERMINATOR
43
=====
44 LINE DRAWING
    READY MINUS
=====
45 PAUSE
46 CHARACTER
-----
47 RESUME
48 CHARACTER
=====
49
: SEND LINE
: TERMINATOR
56
=====
57
: UNFORMATTED PAGE
: TERMINATOR
64
=====

```

Figure 3-12 Host Configuration Data Stream (Continued)



```

(Model 6312 VDU transmits to host)
=====
Multicode
-----
0
-----
Checksum
=====

```

Figure 3-12 Host Configuration Data Stream (Continued)

**NOTE**

Host computer configuration of the terminal requires 30 seconds; i.e., after the multicode sequence to configure the terminal is transmitted, 30 seconds must elapse before the host computer should transmit any other data.

**3.5.1 General Terminal Attributes**

The following bytes are coded to set the functions as indicated below. The bit not set indicates that the feature is not invoked.

| BYTE NO. | BIT POSITION   |                   |                 |                    |
|----------|----------------|-------------------|-----------------|--------------------|
|          | 12             | 13                | 14              | 15                 |
| 1        | SCROLL         | AUTO<br>LINE FEED | AUTO<br>TAB     | NEW LINE<br>ENABLE |
| 2        | UPPER-<br>CASE | INVERSE<br>VIDEO  | BLINK<br>CURSOR | BLOCK<br>CURSOR    |

**3.5.2 Right Margin Warning Bell**

Bytes 3 through 6 are coded to determine at which column the bell sounds when the cursor is at that position. The ASCII code hex sequence is the decomposition of the two-digit column number into its ASCII hex equivalent. From that step, the nibble from each hex byte is ORed with the byte X'30'. For example, to set the right margin warning position to column 48, the ASCII characters would be X'34', X'38'. The encoded sequence would appear as X'33', X'34', X'33', X'38'. If the right margin warning bell is set to column 00, the bell is disabled.

### 3.5.3 Modes and Terminal Features

The following bytes enable additional terminal features. In byte 7, deactivating bit 12 indicates conversation mode. If bits 14 and 15 in byte 7 are inactive, the specified feature is inactive. Bits 12 and 13 of byte 8 must be zero. When bits 14 and 15 of byte 8 are active, SEND PAGE is specified. When bits 14 and 15 are both inactive, an undefined condition results.

| BYTE NO. | BIT POSITION |              |              |                 |
|----------|--------------|--------------|--------------|-----------------|
|          | 12           | 13           | 14           | 15              |
| 7        | BLOCK        | NOT<br>USED  | KEY<br>CLICK | SCREEN<br>SAVER |
| 8        | MUST<br>BE 0 | MUST<br>BE 0 | SEND<br>MSG  | SEND<br>LINE    |

### 3.5.4 Baud Rate Setting

Byte 9 identifies the communication line baud rate. Undefined codes are not used. The possible settings and their codes are as follows:

| CODE (hex) | BAUD RATE      |
|------------|----------------|
| 31         | 110 (not used) |
| 32         | 300            |
| 33         | 600            |
| 34         | 1,200          |
| 35         | 2,400          |
| 36         | 4,800          |
| 37         | 9,600          |
| 38         | 19,200         |

### 3.5.5 Parity Setting

Byte 10, coded as shown below, determines the setting of the communication line parity setting. Undefined codes are not used.

| CODE (hex) | PARITY |
|------------|--------|
| 31         | ODD    |
| 32         | EVEN   |
| 33         | MARK   |
| 34         | SPACE  |

### 3.5.6 Scrolling

Byte 11 allows the terminal to perform smooth vertical scrolling.

|          | BIT POSITION     |             |              |              |
|----------|------------------|-------------|--------------|--------------|
| BYTE NO. | 12               | 13          | 14           | 15           |
| 11       | SMOOTH<br>SCROLL | NOT<br>USED | MUST<br>BE 0 | MUST<br>BE 1 |

### 3.5.7 113J Setting

Byte 12 indicates whether the communication line is to be configured to function with 113J protocol. A code of X'31' indicates that 113J protocol is inactive. A code X'32' indicates 113J protocol is active. All other codes are invalid.

### 3.5.8 Poll Address

Bytes 13 and 14 are coded to indicate the ASCII poll character the terminal is to recognize. The character is encoded with two bytes. This ASCII code hex sequence is the decomposition of the byte into two nibbles. From that step, the nibble from each hex byte is ORed with the byte X'30'. For example, to define the character A, the ASCII character would be X'41'. The encoded sequence would appear as X'34', X'31'.

### 3.5.9 Multicode Character Selection

Bytes 15 and 16 designate the ASCII character to be used as the multicode sequence. The character is encoded with two bytes. This ASCII code hex sequence is the decomposition of the byte into two nibbles. The nibble from each hex byte is ORed with the byte X'30'. For example, to define an ESC, the ASCII character would be X'1B'. The encoded sequence would appear as X'31', X'3B'.

### 3.5.10 Format

Attributes in the following bytes identify various terminal actions based on terminal operations performed.

In byte 17, bit 12 inactive indicates full-duplex operation. Bits 13 and 14 indicate null suppression and bit 15 active indicates the terminal ceases transmission upon receipt from the host of an XOFF character and resumes transmission when an XON character is received. No action is taken for XON characters received out of sequence.



In byte 18, bit 12 active allows block transmission mode communication from the status line. Bit 13 of this byte must also be active. Bit 13 allows display of the status line when active. The terminal automatically assumes an on-line state when bit 14 is set. The send function is initiated if bit 15 is active when the RETURN key is depressed. In byte 19, if bit 12 is active, the unit is set for an AC line frequency of 60Hz. Bit 13 active indicates clear to spaces. Bit 14 of this byte allows generation of multicode(x) sequences for the following cursor and edit keys: home key, cursor up key, cursor down key, cursor right key, cursor left key, insert line/page key, erase page/line key, delete line/character key, send key, send message key and print key. If bit 15 is active, a multicode R sequence is sent to the host if the CLEAR key is depressed.

BIT POSITION

| BYTE NO. | 12               | 13                   | 14                     | 15             |
|----------|------------------|----------------------|------------------------|----------------|
| 17       | HALF-DUPLEX      | NULL SUPP. FRMT.     | NULL SUPP. UNFRMT.     | XON XOFF       |
| 18       | SEND STATUS LINE | DISPLAY STATUS LINE  | POWER-UP ON-LINE       | RETURN = SEND  |
| 19       | 60 HERTZ         | CLEAR SCREEN TO SPC. | SEND CURSOR, EDIT KEYS | SEND CLEAR ALL |

3.5.11 Control Protect Function and Edit Keys

Bytes 20 and 21, shown below, define keys which are activated only when depressed simultaneously with the control (CTRL) key.

BIT POSITION

| BYTE NO. | 12               | 13               | 14                | 15                 |
|----------|------------------|------------------|-------------------|--------------------|
| 20       | ESCAPE           | CURSOR EDIT      | TAB BACKTAB       | RETURN LINE FEED   |
| 21       | F1-F4<br>F17-F20 | F5-F8<br>F21-F24 | F9-F12<br>F25-F28 | F13-F16<br>F29-F32 |

### 3.5.12 Lockout Function and Edit Keys

The following bytes define various keyboard keys which become inoperative when the identified bits are activated.

| BYTE NO. | BIT POSITION     |                  |                   |                     |
|----------|------------------|------------------|-------------------|---------------------|
|          | 12               | 13               | 14                | 15                  |
| 22       | ESCAPE           | CURSOR<br>KEYS   | TAB<br>BACKTAB    | RETURN<br>LINE FEED |
| 23       | F1-F4<br>F17-F20 | F5-F8<br>F21-F24 | F9-F12<br>F25-F28 | F13-F16<br>F29-F32  |

### 3.5.13 Printer Port Operations

The following bytes define attributes of the printer port connection.

#### 3.5.13.1 Print Type

Byte 24, as shown below, designates the print condition. Undefined codes are not used.

| CODE (hex) | PRINT CONDITION |
|------------|-----------------|
| 31         | LINE            |
| 32         | MESSAGE         |
| 33         | PAGE            |

#### 3.5.13.2 Printer Port Baud Rate

Byte 25, as shown below, indicates the printer port baud rate. Undefined codes are not used.

| CODE (hex) | BAUD RATE      |
|------------|----------------|
| 31         | 110 (not used) |
| 32         | 300            |
| 33         | 600            |
| 34         | 1,200          |
| 35         | 2,400          |
| 36         | 4,800          |
| 37         | 9,600          |
| 38         | 19,200         |

### 3.5.13.3 Printer Port Parity

Byte 26 indicates the printer port parity. Undefined codes are not used.

| CODE (hex) | PARITY |
|------------|--------|
| 31         | ODD    |
| 32         | EVEN   |
| 33         | MARK   |
| 34         | SPACE  |

### 3.5.13.4 Printer Port Stop Bit Setting

Byte 27 indicates the number of stop bits contained in characters contained on the printer port line. X'31', indicating one stop bit, is the only legal setting.

### 3.5.13.5 Print Line Terminator

Bytes 28 through 43 identify the ASCII character sequence which represents the end of the print line. This sequence (up to eight bytes) is appended to each line transmitted on the printer port. Each character requires two encoded bytes for proper definition. The ASCII code hex sequence is the decomposition of each byte into two nibbles, and the nibble from each hex byte is ORed with an X'30'. For example, to define a carriage return, the ASCII character would be X'0D'. The encoded sequence would appear as X'30',X'3D', followed by seven X'31', X'38' (cancel) characters.

### 3.5.13.6 Ready (-) and Line Drawing

Byte 44 indicates the ready (-) and line drawing options.

| BYTE NO. | BIT POSITION    |                |             |             |
|----------|-----------------|----------------|-------------|-------------|
|          | 12              | 13             | 14          | 15          |
| 44       | LINE<br>DRAWING | READY<br>MINUS | NOT<br>USED | NOT<br>USED |

### 3.5.13.7 Pause Character

Bytes 45 and 46 designate the ASCII character used to stop host transmission. The two encoded bytes are required for proper definition. The ASCII code hex sequence is the decomposition of each byte into two nibbles. The nibble from each hex byte is ORed with the byte X'30'. For example, to define a DC3, the ASCII character in hex would be X'13'. The encoded sequence would appear as X'31', X'33'. Either DC3 or DC4 is normally used as the pause character.

### 3.5.13.8 Resume Character

Bytes 47 and 48 designate the ASCII character which allows the host to resume transmission to the terminal. Two encoded bytes are required. The ASCII code hex sequence is the decomposition of each byte into two nibbles. The nibble from each hex byte is ORed with the byte X'30'. To define a DC1, the ASCII character would be X'11'. The encoded sequence would appear as X'31', X'31'. Either DC1 or DC2 is normally used as resume characters.

### 3.5.14 Terminator Character Sequences

The following bytes identify the various terminator character sequences required by terminal operations. All sequence definitions require two encoded bytes per character for the definition. The ASCII code hex sequence is the decomposition of each byte into two nibbles. The nibble from each hex byte is ORed with the byte X'30'. For example, to define an ETX, the ASCII character would be X'03'. The encoded sequence would appear as X'30',X'33'.

#### 3.5.14.1 Send Line

Bytes 49 through 56 identify the sequence of characters appended to each line for both formatted and unformatted screens. This sequence is also appended to function key messages.

#### 3.5.14.2 Unformatted Page Terminator

Bytes 57 through 64 identify the terminator sequence appended to each page for the send message and send page conditions of the transmission of unformatted screens.

#### 3.5.14.3 Unformatted Line Terminator

Bytes 65 through 72 identify the terminator sequence appended to each line for the send message and send page conditions of the transmission of unformatted screens.

#### 3.5.14.4 Formatted Page Terminator

Bytes 73 through 80 identify the terminator sequence appended to each page for the send message and send page conditions of the transmission of formatted screens.

#### 3.5.14.5 Field Terminator

Bytes 81 through 88 identify the terminator sequence appended to each field on the transmission of formatted screen.

### 3.5.14.6 Request to Send Terminator

Bytes 89 through 96 identify the terminator sequence automatically appended to each transmission sequence of a request to send multicode sequence. This also applies to the data transmission as the result of a function key depression.

### 3.5.15 Function Key Definition

The next 806 bytes of configuration data provide the designation of the HERE IS key and the definition of the individual function keys.

Bytes 97 through 102 designate which of the function keys, from F01 through F32, is to be utilized as the HERE IS key. For each character (F and the two digits for the key number), two encoded ASCII characters must be transmitted by the host. For example, if F01 is to be the HERE IS key, the host must transmit:

|   |          |   |
|---|----------|---|
| 4 | (HEX 34) | F |
| 6 | (HEX 36) |   |
| 3 | (HEX 33) | 0 |
| 0 | (HEX 30) |   |
| 3 | (HEX 33) | 1 |
| 1 | (HEX 31) |   |

Bytes 103 through 902 provide function key definitions. Unlike all other variable length configuration parameters such as terminators, the host need not transmit the exact number of bytes.

Function keys are defined by the host in much the same manner as by the operator, except that for each character desired, two encoded ASCII characters must be transmitted. Function key definition is in the following format:

```
FUNCTION KEY NUMBER (F01 THROUGH F32)
the EQUALS SIGN
MESSAGE
the ASCII CANCEL character
```

Keep in mind that function keys F01 through F12 and their shifted counterparts, F17 through F28, transmit their messages to the host and function keys, F13 through F16, and their shifted counterparts, F29 through F32, write their messages to the screen at the cursor position.

The ASCII cancel character (CTRL X) must be used to end the function key definition. This character is not a character in the function key message and is not transmitted upon depression of the function key.

For example, if the operator wishes the terminal to transmit the message END, followed by a CR/LF to the host, upon depression of function key F02, the following configuration data bytes are required:

|   |          |        |
|---|----------|--------|
| 4 | (HEX 34) | F      |
| 6 | (HEX 36) |        |
| 3 | (HEX 33) | 0      |
| 0 | (HEX 30) |        |
| 3 | (HEX 33) | 2      |
| 2 | (HEX 32) |        |
| 3 | (HEX 33) | =      |
| = | (HEX 3D) |        |
| 4 | (HEX 34) | E      |
| 5 | (HEX 35) |        |
| 4 | (HEX 34) | N      |
| > | (HEX 3E) |        |
| 4 | (HEX 34) | D      |
| 4 | (HEX 34) |        |
| 0 | (HEX 30) | CR     |
| = | (HEX 3D) |        |
| 0 | (HEX 30) | LF     |
| : | (HEX 3A) |        |
| 1 | (HEX 31) | CANCEL |
| 8 | (HEX 38) |        |

After function key definition configuration data is transmitted, the host may terminate configuration with the multicode - sequence or the multicode 7 sequence. When multicode - sequence is used, the configuration data is saved in EAROM. When multicode 7 sequence is used, configuration data is saved in RAM and the function keys are not programmed. The terminal now takes the configuration parameters.

### 3.6 DEFAULT CONFIGURATION

When selected configuration data is written to the EAROM, a checksum byte is saved. This checksum byte is tested upon completion of an EAROM read. If a nonmatching checksum byte is found, the Model 6312 VDU assumes a default configuration as shown below. Entering a multicode (ESC) oS sequence when not in the set-up configuration mode also forces the set up values to the default configuration.

#### NOTE

For some of the various settings shown below, NOT ASSIGNED indicates that the configuration parameter is not assigned reliable data.

#### MODE CONTROL OPTIONS

|                    |     |
|--------------------|-----|
| SCROLL             | YES |
| AUTO - LF          | YES |
| AUTO TAB           | YES |
| NEW LINE           | YES |
| UPPER-CASE ONLY    | YES |
| INVERSE VIDEO      | NO  |
| BLINK CURSOR       | YES |
| BLOCK CURSOR       | YES |
| RING BELL COLUMN # | 80  |

#### SYSTEM OPTIONS

|                           |     |
|---------------------------|-----|
| SEND STATUS LINE          | YES |
| STATUS LINE DISPLAY       | YES |
| ON-LINE WHEN POWERED UP   | YES |
| RETURN=SEND IN BLOCK MODE | NO  |
| 60HZ                      | YES |
| CLEAR TO SPACES           | YES |
| SEND CRSR, EDIT KYS       | YES |
| SEND CLEAR ALL CODE       | NO  |

#### KEYBOARD OPTIONS

NOTE: No keyboard options are control-protected nor locked-out.

#### COMMUNICATION OPTIONS

|                            |                     |
|----------------------------|---------------------|
| BLOCK (MODE)               | NO (CONVERSATIONAL) |
| POLLED TERMINAL            | NO                  |
| SEND LINE, MESSAGE OR PAGE | LINE                |
| BAUD RATE                  | 9600                |

|   |      |
|---|------|
| PARITY  | EVEN |
| 113J (MODEM TYPE)                               | NO   |
| MULTICODE CHARACTER                             | ESC  |
| POLL/SELECT CHARACTER                           | A    |
| NULL SUPPRESSION ON<br>UNFORMATTED TRANSMISSION | YES  |
| NULL SUPPRESSION ON<br>FORMATTED TRANSMISSION   | YES  |

PRINTER PORT OPTIONS

|  |                                     |
|--|-------------------------------------|
| PRINT LINE, MESSAGE, OR PAGE                   | PAGE                                |
| BAUD RATE                                      | 300                                 |
| PARITY   | SPACE                               |
| PRINT LINE TERMINATOR                          | NOT ASSIGNED (6312)<br>CRLF (6312+) |
| PRINT FORM DRAWING AND<br>ATTRIBUTE CHARACTERS | NO                                  |
| READY (-)                                      | NO                                  |
| PAUSE CHARACTER                                | DC3                                 |
| RESUME CHARACTER                               | DC1                                 |

|                  |                 |
|------------------|-----------------|
| KEYBOARD COUNTRY | US (6312+ only) |
|------------------|-----------------|

|                    |              |
|--------------------|--------------|
| TERMINATORS (6312) | NOT ASSIGNED |
|--------------------|--------------|

|                     |  |
|---------------------|--|
| TERMINATORS (6312+) |  |
|---------------------|--|

|                  |                         |
|------------------|-------------------------|
| SEND LINE        | EX CN CN CN             |
| FIELD            | GS CN CN CN             |
| UNFORMATTED LINE | CN CN CN CN             |
| UNFORMATTED PAGE | EX CN CN CN             |
| FORMATTED PAGE   | EX CN CN CN             |
| REQUEST TO SEND  | CN CN CN CN             |
| PRINT LINE       | CR LF CN CN CN CN CN CN |

|               |              |
|---------------|--------------|
| FUNCTION KEYS | NOT ASSIGNED |
|---------------|--------------|



### 3.7 READING CONFIGURATION PARAMETERS (HOST COMPUTER)

Upon receipt of the multicode (ESC) 6 sequence, the terminal transmits a series of encoded ASCII characters designating the configuration parameters of the terminal. This sequence is exactly the same as the sequence for host configuration.

If the programmer only wishes to change one or several parameters, then:

1. The multicode (ESC) 6 sequence may be used to transmit this data into a buffer,
2. The changes may be made within the buffer, and
3. The host computer may transmit this data prefaced by a multicode (ESC) # to reconfigure the terminal.

### 3.8 STANDARD CONFIGURATIONS

Figure 3-13 provides sample standard configuration settings for the Model 6312 VDU to operate in the multi-terminal monitor (MTM), XELOS™, and Reliance™ environments.

-----  
XELOS is a trademark of Concurrent Computer Corporation.  
Reliance is a trademark of Concurrent Computer Corporation.

|          |          |                 |          |                  |          |                 |          |                |
|----------|----------|-----------------|----------|------------------|----------|-----------------|----------|----------------|
| KBD CTRL | <b>N</b> | ESC             | <b>N</b> | CURSOR, EDIT KYS | <b>N</b> | TAB BACKTAB     | <b>N</b> | CR, LR         |
|          | <b>N</b> | F01-F04         | <b>N</b> | F05-F08          | <b>N</b> | F09-F12         | <b>N</b> | F13-F16        |
| KBD LOCK | <b>N</b> | ESC             | <b>N</b> | CURSOR KYS       | <b>N</b> | TAB BACKTAB     | <b>N</b> | CR, LF         |
|          | <b>N</b> | F01-F04         | <b>N</b> | F05-F08          | <b>N</b> | F09-F12         | <b>N</b> | F13-F16        |
| MODE     | <b>Y</b> | SCROLL          | <b>N</b> | AUTO LINE FEED   | <b>Y</b> | AUTO TAB        | <b>Y</b> | NEW LINE       |
|          | <b>Y</b> | UPPER CASE      | <b>N</b> | INVERSE VIDEO    | <b>N</b> | BLINK CURSOR    | <b>Y</b> | BLOCK CURSOR   |
|          | <b>N</b> | KEY CLICK       | <b>Y</b> | SCREEN SAVE      | <b>N</b> | SMOOTH SCROLL   |          |                |
| SYSTEM   | <b>Y</b> | SEND STAT LINE  | <b>Y</b> | DSPLAY STAT LN   | <b>Y</b> | PWR UP ON LINE  | <b>N</b> | RETURN = SEND  |
|          | <b>Y</b> | 60 HZ           | <b>N</b> | CLEAR TO SPACES  | <b>Y</b> | SEND CRSR, EDIT | <b>N</b> | SEND CLEAR ALL |
| COMM     | <b>N</b> | BLOCK           | <b>N</b> | POLLED           |          |                 | <b>N</b> | HALF DUPLEX    |
|          | <b>Y</b> | NULL SUPP UNFOR | <b>Y</b> | NULL SUPP FORMT  | <b>Y</b> | XON/OFF         | <b>N</b> | 113J           |
| PRINTER  | <b>Y</b> | LINE DRAWING    | <b>Y</b> | READY (-)        |          |                 |          |                |

COM **PAG** LINE, MSG, PAG **EVN** ODD, EVN, MRK, SPC **9600** 300, 600, 1200, 2400, 4800, 9600, 19.2K  
PRT **PAG** LINE, MSG, PAG **SPC** ODD, EVN, MRK, SPC **9600** 300, 600, 1200, 2400, 4800, 9600, 19.2K  
KEYBOARD COUNTRY **US** US, UK, FREN, SWED, GERM, SPAN, DAN  
TERMINATOR: **EXCNCN** SEND LINE **GSNCNCN** FIELD **CNCNCNCN** UNFORMAT LINE **EXCNCNCN** UNFORMAT PG  
**EXCNCNCN** FORMAT PG **CNCNCNCN** REQ TO SEND **CRFCNCNCNCNCN** PRINT LINE  
SPCL CHAR **EC** MULTICODE CHAR **NU** POLL CHAR **D3** PAUSE CHAR **D1** RESUME CHAR **72** RING BELL  
FUNCTION KEYS: HERE IS = **CNCNCN**

Figure 3-13 Sample Configuration Menu

## CHAPTER 4 OPERATION

### 4.1 INTRODUCTION

This chapter provides the information necessary for proper operation of the Model 6312 and 6312+ video display unit (VDU). The following sections describe the functions of the Model 6312 keyboard. The layout of the keyboard is shown in Figure 4-1.

#### NOTE

Throughout this manual, all references to the Model 6312 VDU refer to both the Model 6312 and 6312+, except where otherwise noted.

030-15-1

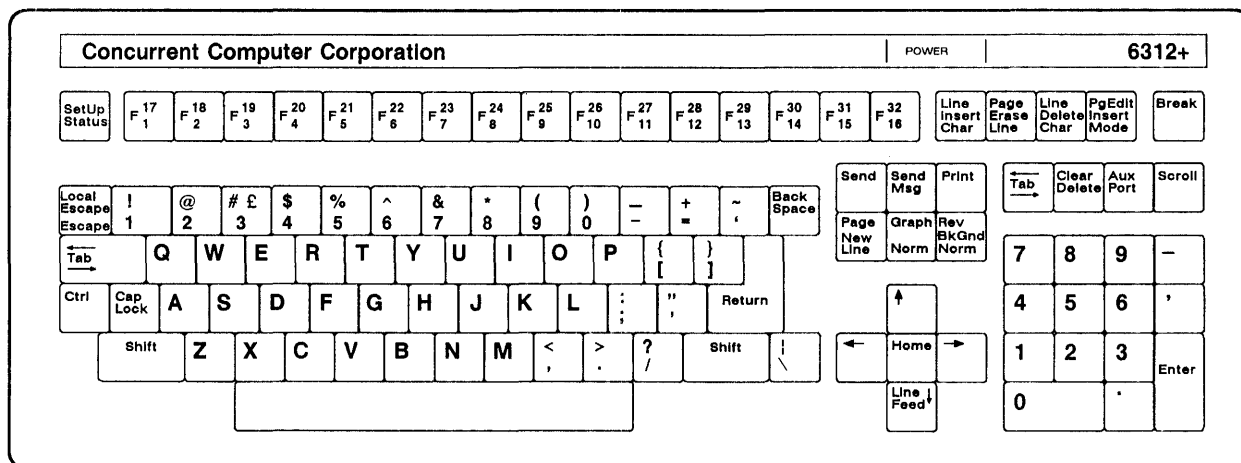

Figure 4-1 Model 6312+ Keyboard

## 4.2 ASCII CHARACTER SET

In addition to a set of displayable characters, ASCII provides a set of transmittable characters generated by depressing the CTRL key with the character key as indicated in Table 4-1. The characters are functionally grouped as follows:

- Communication control characters

Functional characters that control or facilitate transmission of information over communications networks.

- Format effector codes

Functional characters that control the layout or position of information in printing or display devices.

- Information separator codes

A group of four characters used in graded order that separate and qualify information.

TABLE 4-1 ASCII CONTROL CHARACTERS

| HEX | CTRL | CONTROL CHARACTER  |
|-----|------|--|
| 00  | @    | NULL - All-zeros character used to accomplish time and media fill.   |
| 01  | A    | SOH (Start of Heading) - Communications control character used at beginning of sequence of characters constituting machine-sensible address or routing information.                  |
| 02  | B    | STX (Start of Text) - Communications control character which precedes transmission of message text. Used following DLE to enter the transparent mode.                                |
| 03  | C    | ETX (End of Text) - Communications control character used to terminate a message. Used following DLE to exit the transparent mode.   |
| 04  | D    | EOT (End of Transmission) - Communications control character used to indicate conclusion of a message transmission. Used following DLE to perform a momentary (1 second) disconnect. |

TABLE 4-1 ASCII CONTROL CHARACTERS (Continued)

| HEX | CTRL | CONTROL CHARACTER  |
|-----|------|--|
| 05  | E    | ENQ (Enquiry) - Communications control character. When received causes transmission by the VDU of the answerback message contents as defined in the set-up configuration.  |
| 06  | F    | ACK (Acknowledge) - Communications control character transmitted by receiver as affirmative response to sender.  |
| 07  | G    | BEL (Bell) - Character used to cause audible alarm at a remote terminal.   |
| 08  | H    | BS (Backspace) - Format effector causing movement of cursor one space backward on same line.   |
| 09  | I    | HT (Horizontal Tabulation) - Format effector causing movement of cursor to next-in-series of predetermined positions along line.   |
| 0A  | J    | LF (Line Feed) - Format effector causing advancement of cursor to next line.   |
| 0B  | K    | VT* (Vertical Tabulation) - Format effector causing movement of first predetermined line on next form or page.   |
| 0C  | L    | FF (Form Feed) - Format effector causing all unprotected fields to clear and the cursor to move to the home position. For scroll enabled feature, this is equivalent to line feed.   |
| 0D  | M    | CR (Carriage Return) - Format effector causing the cursor to move to column 1 of the next line.  |
| 0E  | N    | SO (Shift Out) - Code used to indicate that code combinations which follow are interpreted as unique graphic characters as shown in Table 1-1. The terminal remains in this mode until an SI (Shift In) character is encountered.    |
| 0F  | O    | SI (Shift In) - Code used to indicate that code combinations which follow conform to standard ASCII code. Used to exit the graphics character set.   |
| 10  | P    | DLE (Data Link Escape) - Communications control character which changes the meaning of a limited number of continuously following characters. If followed by STX, it is used to enter the transparent mode. In transparent mode, all |

characters including control are stored in memory and displayed, new line is enabled and scroll disabled. If DLE is received in transmission mode, the following code is examined. If it is ETX, the unit is returned to normal mode. If DLE is followed by EOT, a disconnect occurs; that is, the terminal drops data terminal ready (DTR) lead to the modem for one second, disconnecting a switched connection.

|    |   |      |  |
|----|---|------|--|
| 11 | Q | DC1  | (Device Controls) - Used for control of  |
| 12 | R | DC2  | auxiliary devices associated with  |
| 13 | S | DC3  | communication systems, especially  |
| 14 | T | DC4  | switching devices on or off. Normally used as the pause and resume characters.   |
| 15 | U | NAK* | (Negative Acknowledgement) - Communications control character transmitted by receiving station as negative response to sending station.  |
| 16 | V | SYN* | (Synchronous Idle) - Communications control character used by synchronous transmission system.   |
| 17 | W | ETB* | (End of Transmission Block) - Communications control character used to indicate end of block data.   |
| 18 | X | CAN  | (Cancel) - Control character used to indicate that the data with which it is sent is in error or is to be disregarded. Used to terminate definition of function keys and terminator sequences in the configuration mode. |
| 19 | Y | EM*  | (End of Medium) - Control character used to indicate physical need of medium, or end of unwanted portion of information recorded on medium.  |
| 1A | Z | SUB* | (Substitute) - Character used for substitution of character determined to be invalid or in error.  |
| 1B | [ | ESC  | (Escape) - Control character used to provide code extension. The escape character itself is a prefix affecting interpretation of limited number of suffix characters.  |
| 1C | \ | FS*  | (File Separator)   |
| 1E | ^ | GS*  | (Group Selector)   |
| 1F | _ | RS*  | (Record Separator)   |
|    |   | US*  | (Unit Separator)   |

\*Ignored when received by the terminal

### 4.2.1 Single Character ASCII Functions

The following sections describe the single character ASCII functions performed upon depression of the indicated key.

#### 4.2.1.1 Space

The ASCII character X'20' is written into memory and a blank is displayed at the present cursor position.

#### 4.2.1.2 Return (RETURN) Key

If AUTO LINE FEED is not enabled, depressing the RETURN key in conversational mode returns the cursor to column 1 of the present line. Depression of the RETURN key in block transmission mode, when RETURN=SEND is enabled in the set-up configuration, transmits the screen data as send line, send message or send page as defined in the set-up configuration. Depression of the RETURN key with the SHIFT key in block transmission mode performs a carriage return (CR). The operation of this key is controlled in the set-up configuration by CR,LF in the KBD CTRL and KBD LOCK headings.

#### 4.2.1.3 Backspace (BACKSPACE) Key

The cursor position is shifted left one position when the cursor is in an unprotected field. With no other local operator controls active, cursor movement ceases at column 1. If the cursor is at column 1 of a line, the receipt of a backspace character causes the cursor to wrap around to the right margin of the previous line. The cursor does not move beyond the home position (line 1, column 1).

#### 4.2.1.4 Displayable Characters

All displayable characters, as shown in Appendix C, are written into display memory and displayed on the screen. The cursor moves one position to the right and remains at the right margin unless the new line enable feature is active. If the new line enable feature is active, the cursor moves to column 1 of the next line.

#### 4.2.1.5 Bell

The bell is an internal alarm which sounds upon receipt of an ASCII BEL (X'07') CTRL G character except when the RING BELL column number is set to X'00'.

#### 4.2.1.6 Tab (TAB) Key

The cursor moves to the right to the next previously defined position, either tab stops or as set by the attribute character. The tab stops are set on power-up of the VDU at every eighth column. Tab stops are settable for every position from column 1 to the right margin and are in effect for every line.

If the new line enable feature is selected and the cursor is to the right of the last tab position, the cursor moves to the first tab position on the next line. If the new line enable feature is not selected and the cursor is positioned past the last tab position, receipt of a tab character moves the cursor to the right margin. If no tab stops are set, receipt of a tab character positions the cursor to the right margin if new line enable is not selected. If new line enable is selected and no tab stops are set, receipt of a tab character positions the cursor at the right margin of line 24.

The operation of this key is controlled in set-up configuration mode by TAB BACKTAB under the KBD CTRL and KBD LOCK headings.

#### 4.2.1.7 Delete (CLEAR/DELETE) Key

The unshifted depression of the delete (CLEAR/DELETE) key transmits the ASCII DEL character (X'7F') to the host computer.

#### 4.2.1.8 Escape (LOCAL ESCAPE/ESCAPE) Key

The unshifted depression of the escape (LOCAL ESCAPE/ESCAPE) key generates a special control character (normally a X'1B') which is defined in the set-up configuration mode under the MULTICODE CHAR heading. This multicode character is followed by one or more characters, which enables special terminal control operations as explained in Chapter 5. When the LOCAL ESCAPE/ESCAPE key is depressed with the SHIFT key, a local multicode function is processed. During a local multicode function, control operation is acted upon by the terminal but the entire multicode sequence is not transmitted to the host.

The operation of the unshifted portion of this key is controlled in the set-up configuration mode by ESC under the KBD CTRL and KBD LOCK headings.

### 4.3 KEYBOARD FUNCTIONS

The following sections describe the keyboard functions performed upon depression of the indicated keys.



#### 4.3.1 Shift (SHIFT) Key

The SHIFT key, when depressed with any other character key, translates all alphabetic characters to upper-case. All other numeric and punctuation characters are translated to the character indicated on the upper half of the key cap. Characters contained in the numeric keypad area of the keyboard are not affected by the condition of the SHIFT key.

#### 4.3.2 Cap Lock (CAP LOCK) Key

Depression of this alternate action key forces all lower-case alphabetic characters entered from the keyboard to upper-case. All other keys remain as indicated on the lower half of the key cap.

#### 4.3.3 Auxiliary Port (AUX PORT) Key

Depression of this alternate action key enables/disables auxiliary port operation. The unshifted depression of this key causes all received data to be displayed on the screen and transmitted to the auxiliary port.

When the unshifted feature of this key is active, AU is displayed on the status line, if status line display is enabled in the set-up configuration. When depressed with the SHIFT key, received characters are transmitted to the auxiliary port but not displayed on the screen. When the shifted feature of this key is active, AUX is displayed on the status line in columns 70-72, if the status line display is enabled in the set-up configuration.

#### 4.3.4 Print (PRINT) Key

This momentary action edit key transmits screen data (line, message, or page) to the auxiliary port as defined in the set-up configuration. See Section 3.3.5.3 for details on enabling the print line, message, or page option in the set-up configuration. Transmission is disabled if the auxiliary port is enabled from the keyboard.

#### 4.3.5 Set-Up/Status (SET UP/STATUS) Key

This key, when depressed with the SHIFT key, forces the VDU off-line (DTR becomes inactive) and causes the terminal to enter the set-up configuration mode. The entire configuration menu, shown in Figure 3-1, is displayed on the screen. Chapter 3 describes the configuration menu and provides configuration details.

Depression of the SET UP/STATUS key a second time causes the terminal to exit set-up configuration mode. While on-line, error conditions contained in the status line (with the exception of KBD LOCK from the host) are cleared upon depression of this key. The entire status line is cleared by the depression of this key if the status line display was not enabled during set-up configuration, and the status line was previously displayed due to an error condition.

#### 4.3.6 Erase Page/Line (ERASE PAGE/LINE) Key

Unshifted depression of this momentary action edit key clears the line to nulls or spaces (specified during set-up configuration) from the cursor to the end of the line. When the screen is formatted, unshifted depression of this key clears all unprotected characters in the field from the present cursor position to the first field attribute character encountered on the screen.

When this key is depressed with the SHIFT key, all unprotected characters from the cursor position to the end of the screen are cleared, as defined in set-up configuration mode.

When the SEND CRSR,EDIT parameter is enabled in the configuration menu, no local action occurs upon depression of the ERASE PAGE/LINE key but the indicated code is transmitted to the host.

When the SEND CRSR,EDIT parameter is disabled, the indicated action is performed locally and no transmission to the host takes place.

The operation of this key is controlled in the set-up configuration mode by CURSOR,EDIT KYS under the headings KBD CTRL and KBD LOCK.

The unshifted operation of this key corresponds with a multicode I (clear line) sequence, and the shifted operation of this key corresponds with the multicode J (clear unprotected) sequence.

#### 4.3.7 Delete Line/Character (DELETE LINE/CHAR) Key

The depression of the DELETE LINE/CHAR edit key with the SHIFT key deletes the line at which the cursor is currently located. All lines below the cursor are moved up one line on an unformatted screen. When the screen contains formatted fields, all lines within the field (up to the attribute byte of the next field) are moved up one line. The last line of the display (or field) is cleared to the character as defined in set-up configuration. An attempt to delete a line containing an attribute character generates a keyboard lockout and displays INPUT ER in the error field of the status line.

Unshifted depression of the DELETE LINE/CHAR edit key deletes the character under the cursor and moves all remaining characters on the line one position to the left. The trailing edge of this left shift movement generates nulls or spaces (as defined during set-up configuration) in the vacated positions.

When the SEND CRSR,EDIT parameter is enabled in the configuration menu, no local action occurs upon depression of the this key but the indicated code is transmitted to the host. When the SEND CRSR,EDIT parameter is disabled, the indicated action is performed locally and no transmission to the host takes place.

The operation of this key is controlled in the set-up configuration mode by CURSOR,EDIT KYS under the headings KBD CTRL and KBD LOCK.

The unshifted operation of this key corresponds with the multicode O (delete character) sequence, and the shifted operation corresponds with the multicode M (delete line) sequence.

#### 4.3.8 Clear (CLEAR/DELETE) Key

This key, when depressed with the SHIFT key, causes all data on the screen and in display memory to be cleared to nulls or spaces (as defined during set-up configuration) and causes the cursor to return to the home position. Tab stops are reset to the default positions (every eighth column).

If the SEND CLEAR ALL feature is enabled in the configuration menu, a request to send sequence (multicode R) is transmitted to the host. Until the host responds with a read sequence, screen data is not cleared.

When the SEND CRSR,EDIT parameter is enabled in the configuration menu, no local action occurs upon depression of this key but the indicated code is transmitted to the host. When the SEND CRSR,EDIT parameter is disabled, the indicated action is performed locally and no transmission to the host takes place.

The shifted operation of this key corresponds with a multicode K (clear all) sequence except the multicode k sequence clears all tab stops.

#### 4.3.9 Insert Line/Character (INSERT LINE/CHAR) Key

This edit key, when depressed with the SHIFT key, inserts a line of nulls or spaces (defined in the set-up configuration) at the current cursor position. All data below the line is moved down one line. The last line or field is lost. On a formatted screen, the insert line operation is confined to the current field provided room is available (sufficient null/space lines at the end of the field) and no attribute is contained on the line.

INPUT ER is displayed in the status field of the status line if the above constraints are violated. The terminal causes a keyboard lock if the above cannot be accommodated. To clear the INPUT ER message, move the cursor within the field or depress the SET UP/STATUS key.

Unshifted depression of this key allows the insertion of alphanumeric characters at the current cursor position. The character at the cursor position and the characters to its right are shifted one position to the right for each character inserted. Characters at the right margin wrap to column one of the next line. Characters may be inserted so that the shifted characters, other than spaces/nulls, do not intrude on another field or (for an unformatted screen) the end of the screen. Either of these generates a keyboard lockout condition and displays INPUT ER in the status field of the status line. If the Model 6312 VDU is configured to clear to nulls, this right shift is at the expense of the first null character encountered. If the Model 6312 VDU is configured to clear to spaces, each right shift is at the expense of a space/null character at the end of the field or (for an unformatted screen) the end of the screen (not the status line).

The operation of this key is controlled in the set-up configuration mode by KBD CTRL and KBD LOCK.

When the SEND CRSR,EDIT parameter is enabled in the configuration menu, no local action occurs upon depression of this key but the indicated code is transmitted to the host. When the SEND CRSR,EDIT parameter is disabled, the indicated action is performed locally and no transmission to the host takes place.

The unshifted operation of this key corresponds with the multicode N (insert character) sequence except the multicode N sequence can only insert one character. The shifted operation of this key corresponds with the multicode L (insert line) sequence.

#### 4.3.10 Page Edit/Insert Mode (PG EDT/INSERT MODE) Key

This momentary action key, when depressed in the unshifted condition, moves the character under the cursor and all following characters on the line one position to the right. The vacated position is replaced with a null or space as defined in the set-up configuration. Any null/space character at the right margin or prior to a field attribute character is discarded.

Nulls/spaces may be inserted so that the shifted characters, other than spaces/nulls, do not intrude on another field or (for an unformatted screen) the end of the line; either of these generates a keyboard lockout condition and displays INPUT ER in the status field of the status line. To clear the INPUT ER message, move the cursor within the field or depress the SET/UP STATUS key.

When depressed in conjunction with the SHIFT key, the operation performed is the same as for insert mode except that the character at the right margin wraps to column one of the next line and an INPUT ER occurs only when shifted characters, other than nulls/spaces, attempt to intrude on another formatted field or the end of the screen.

The operation of this key, shifted or unshifted, is controlled in the set-up configuration mode by CURSOR,EDIT KYS under the headings KBD CTRL and KBD LOCK.

#### 4.3.11 Send (SEND) Key

This momentary action edit key, when depressed (shifted or unshifted) in block mode, transmits a multicode R (request to send) sequence followed by an attention identifier character indicating the send key condition (LINE, MSG, or PAG) and the request to send terminator as defined in the set-up configuration.

#### 4.3.12 Send Message (SEND MSG) Key

This momentary action key performs a default configuration when depressed simultaneously with the CTRL and SHIFT keys.

#### 4.3.13 Home (HOME) Key

This momentary action key, when depressed in conversation mode, positions the cursor to line 1, column 1. When in a protected field, depressing this key causes the cursor to move to the first position of the first unprotected field on the screen. No action occurs if the cursor is already in the appropriate position. Transmission to the host (multicode H), with no local action, can only occur when this key is depressed and SEND CURSOR,EDIT is enabled in the set-up configuration. The operation of this key is controlled in set-up configuration mode by CURSOR,EDIT KYS under the headings KBD CTRL and KBD LOCK. The operation of this key corresponds with a multicode H sequence except that multicode H is an unconditional Home.

#### 4.3.14 Line Feed (LINE FEED) Key

Depression of this key transmits a line feed code (hex '0A') and moves the cursor to the same column position on the next line if SEND CRSR,EDIT is disabled in the set-up configuration. See Section 4.3.23 if SEND CRSR,EDIT is enabled in the set-up configuration. The screen scrolls if the cursor is at line 24 and SCROLL is enabled in the set-up configuration. If SCROLL is not enabled, the cursor wraps to the same column position on line 1. The operation of this key is controlled in set-up configuration mode by CR,LF under the headings KBD CTRL and KBD LOCK.

#### 4.3.15 Break (BREAK) Key

This single action key, when depressed, forces the communication transmit line to a space. This line spacing condition remains for 350ms  $\pm$  10%.

#### 4.3.16 Scroll (SCROLL) Key

Initial depression of this alternate action key stops the further display of data and performs the required handshaking (following 75% of the terminal's internal 1kB receive buffer being filled) as defined in set-up configuration to inform the host that further data cannot be accepted. Depression of this key a second time resumes normal screen operations and informs the host, as defined in the set-up handshake option.

The operation of this key corresponds with the pause and resume control sequences.

#### 4.3.17 Reverse/Normal Background (BK GND REV/NORM) Key

Unshifted depression of this key returns the display background to normal (light characters on a dark background) if it were previously set to reverse (inverse) background. No action is performed if this key is depressed when the terminal is in normal video mode.

Depression of this key with the SHIFT key causes the entire background to be displayed in reverse (inverse) video (dark characters on a light background). No action is performed if this key is depressed when the terminal is in inverse video mode.

#### 4.3.18 Graphics/Normal (GRAPH/NORM) Key

Depression of this key with the SHIFT key puts the terminal in graphics mode, in which all further characters displayed on the screen are translated to their respective graphics character as shown in Table 1-1. No action is performed if the display is in graphics display when this key is depressed with the SHIFT key.

Unshifted depression of this key when in graphics mode, returns the terminal to normal alphanumeric display. No action is performed if the display is in alphanumeric display when this key is depressed.

#### 4.3.19 Page/New Line (PAGE/NEW LINE) Key

When this key is depressed unshifted, the terminal transmits a CR (hex '0D') and performs a local LF which in effect overrides the setting of the AUTO LINE FEED option in the set-up configuration.

The Model 6312 VDU provides two independent 24 x 80 character displays. When the PAGE/NEW LINE key is depressed with the SHIFT key, a switch to alternate page is performed.

#### 4.3.20 Backtab (TAB) Key

Depression of this key with the SHIFT key moves the cursor to the previous tab stop. The first data character of an unprotected field is also a tab stop. Cursor movement ceases at column 1 of the current line when NEW LINE is disabled in the set-up configuration. When NEW LINE is enabled, depression of this key at column 1 positions the cursor at the last tab stop on the previous line and movement ceases when the cursor reaches the home position.

When the SEND CRSR,EDIT parameter is enabled in the configuration menu, no local action occurs upon depression of this key but the indicated code is transmitted to the host. When the SEND CRSR,EDIT parameter is disabled, the indicated action is performed locally and no transmission to the host takes place.

The operation of this key is controlled in set-up configuration mode by TAB BACKTAB under headings KBD CTRL and KBD LOCK.

The operation of this key corresponds with the multicode | sequence.

#### 4.3.21 Enter (ENTER) Key

Depression of this key performs a CR when in conversational mode. In block mode, this key functions as a tab key positioning the cursor to the next unprotected screen position. The operation of this key is controlled in set-up configuration mode by KBD CTRL and KBD LOCK.

#### 4.3.22 Cursor Up (↑) Key

Depression of this key moves the cursor up one line. If the cursor is at line 1, it wraps around to line 24. Transmission to the host (no local action) can only occur when this key is depressed while SEND CRSR,EDIT is enabled in the set-up configuration. Local cursor movement occurs when SEND CRSR,EDIT is set to disabled. The operation of this key is controlled in set-up configuration mode by CURSOR,EDIT KYS under the headings KBD CTRL and KBD LOCK.

The operation of this key corresponds with the multicode A sequence.

#### 4.3.23 Cursor Down (↓) Key

Depression of this key moves the cursor down one line. If the cursor is positioned on line 24, it wraps to line 1 at the same column position. Transmission to the host (no local action) can only occur when this key is depressed while SEND CURSOR,EDIT is enabled in the set-up configuration. When SEND CURSOR,EDIT is disabled, depression of this key transmits a LF character (hex '0A') to the host. The operation of this key (cursor down arrow only) is controlled in set-up configuration mode by CURSOR,EDIT KYS under the headings KBD CTRL and KBD LOCK. LF is controlled by CR,LF under the headings KBD CTRL and KBD LOCK.

The operation of this key corresponds with the multicode B sequence.

#### 4.3.24 Cursor Right (→) Key

Depression of this key moves the cursor position one position to the right. When the cursor is moved beyond the right margin, it wraps around to column 1 of the following line. Transmission to the host (no local action) can only occur upon depression of this key when SEND CRSR,EDIT is enabled in the set-up configuration. Local cursor movement occurs when SEND CRSR,EDIT is disabled. The operation of this key is controlled in set-up configuration mode by CURSOR,EDIT KYS under the headings KBD CTRL and KBD LOCK.

The operation of this key corresponds with the multicode C sequence.

#### 4.3.25 Cursor Left (←) Key

Depression of this key moves the cursor one position to the left. When the cursor is moved beyond column 1, the cursor wraps around to the right margin position on the previous line. The cursor does not move beyond the home position. Transmission to the host (no local action) can only occur upon depression of this key when SEND CRSR,EDIT is enabled in the set-up configuration. Local cursor movement occurs when SEND CRSR,EDIT is disabled. The operation of this key is controlled in set-up configuration mode by CURSOR,EDIT KYS under the headings KBD CTRL and KBD LOCK.

The operation of this key corresponds with the multicode D sequence.



#### 4.3.26 Auto-Repeat Feature

Any key depressed for a minimum of one second causes a continuous stream of that character to be repeated at a rate of 15 characters per second until that key is released. The following keys are not included in the auto-repeat feature:

- AUX PORT
- BREAK
- CAP LOCK
- CLEAR/DELETE
- CTRL
- ERASE LINE/PAGE
- Function keys
- GRAPH/NORM
- HOME
- INSERT LINE/CHAR
- LOCAL ESCAPE/ESCAPE
- PAGE/NEW LINE
- PG EDT/INSERT MODE
- BK GND REV/NORM
- SCROLL
- SEND
- SEND MSG
- SET UP/STATUS
- SHIFT

#### 4.4 FUNCTION KEYS

The Model 6312 VDU features 16 (shiftable to 32) function keys for transmission to the host computer. The function keys, shown in Figure 4-2, are labeled for convenience with the unshifted value of the function key indicated on the lower-half of the key cap and the shifted value of the function key indicated on the upper-half of the key cap. For example, function key F1/17 responds as F01 when depressed unshifted and as F17 when depressed with the SHIFT key.

030-16

|                      |                      |                      |                      |                      |                      |                      |                      |                      |                       |                       |                       |                       |                       |                       |                       |
|----------------------|----------------------|----------------------|----------------------|----------------------|----------------------|----------------------|----------------------|----------------------|-----------------------|-----------------------|-----------------------|-----------------------|-----------------------|-----------------------|-----------------------|
| F <sup>17</sup><br>1 | F <sup>18</sup><br>2 | F <sup>19</sup><br>3 | F <sup>20</sup><br>4 | F <sup>21</sup><br>5 | F <sup>22</sup><br>6 | F <sup>23</sup><br>7 | F <sup>24</sup><br>8 | F <sup>25</sup><br>9 | F <sup>26</sup><br>10 | F <sup>27</sup><br>11 | F <sup>28</sup><br>12 | F <sup>29</sup><br>13 | F <sup>30</sup><br>14 | F <sup>31</sup><br>15 | F <sup>32</sup><br>16 |
|----------------------|----------------------|----------------------|----------------------|----------------------|----------------------|----------------------|----------------------|----------------------|-----------------------|-----------------------|-----------------------|-----------------------|-----------------------|-----------------------|-----------------------|

Figure 4-2 Function Keys

The depression of a function key transmits a predefined message to the host computer. These messages are defined during set-up configuration as explained in Section 3.3.9.2.

If a function key has not been defined, the depression of that function key transmits a special sequence of characters to the host computer. That sequence is as follows:

- The multicode special character
- ASCII capital R
- An attention identifier character
- The request to send terminator character(s)

Each function key has a different, predetermined attention identifier character. This character enables the host computer to identify which function key was depressed. Table 4-2 identifies the attention identifier character transmitted for each of the function keys.

In the block transmission mode, the keyboard is locked after function keys F01 through F12 and F17 through F28 are depressed. The host computer must reply with a read request to unlock the keyboard. Function keys F13 through F16 and F29 through F32 do not transmit their associated messages to the host. Their messages are displayed on the screen and acted upon as if they were entered from the keyboard.

On transmission, function keys are automatically appended with the send line terminator.

TABLE 4-2 FUNCTION KEY ATTENTION IDENTIFIER CHARACTERS

| FUNCTION KEY | ASCII CHARACTER | HEX | FUNCTION KEY | ASCII CHARACTER | HEX |
|--------------|-----------------|-----|--------------|-----------------|-----|
| F01          | A               | 41  | F17          | a               | 61  |
| F02          | B               | 42  | F18          | b               | 62  |
| F03          | C               | 43  | F19          | c               | 63  |
| F04          | D               | 44  | F20          | d               | 64  |
| F05          | E               | 45  | F21          | e               | 65  |
| F06          | F               | 46  | F22          | f               | 66  |
| F07          | G               | 47  | F23          | g               | 67  |
| F08          | H               | 48  | F24          | h               | 68  |
| F09          | I               | 49  | F25          | i               | 69  |
| F10          | J               | 4A  | F26          | j               | 6A  |
| F11          | K               | 4B  | F27          | k               | 6B  |
| F12          | L               | 4C  | F28          | l               | 6C  |
| F13          | M               | 4D  | F29          | m               | 6D  |
| F14          | N               | 4E  | F30          | n               | 6E  |
| F15          | O               | 4F  | F31          | o               | 6F  |
| F16          | P               | 50  | F32          | p               | 70  |

#### 4.5 STATUS LINE DESCRIPTION

The Model 6312 VDU features a status line so that the operator can visually monitor the modem interface and current transmission mode as well as indicate the current operator option settings and several operating modes of the terminal.

The status line also permits communication with the host computer without disturbing work in progress.

The status line may be configured so that it is displayed or not displayed. Even when the configuration of the terminal calls for the display of the status line to be off, the status line reappears during set-up configuration mode, program mode, and while displaying terminal error messages.

The status line is divided into separate fields as shown in Figure 4-3. These fields are described in the following sections.

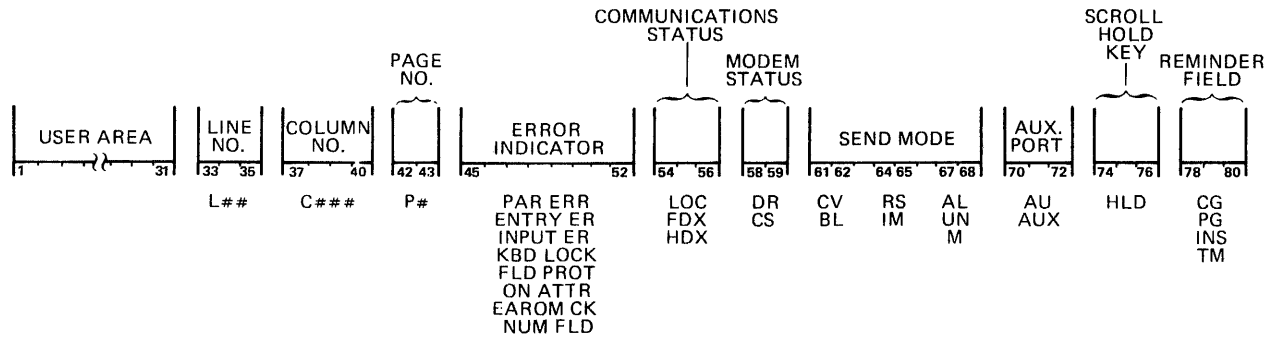

Figure 4-3 Status Line Fields

#### 4.5.1 User Area (Columns 1-31)

Once the cursor is positioned in this area, data can be placed in this area by either the operator or the host computer.

The cursor can be moved to the user area of the status line with the multicode 4 sequence and returned to its previous location with a multicode 5 sequence. Information can be entered in the user area without changing the existing screen. When the ENTER key is depressed, only the data entered in the user area is transmitted to the host computer. Column 1 is a reserved normal attribute character position.

#### 4.5.2 Line Number (Columns 33-35)

The character L and the number of the line where the cursor is currently located are displayed in this field.

#### 4.5.3 Column Number (Columns 37-40)

The character C and the number of the column where the cursor is currently located are displayed in this field.

#### 4.5.4 Page Number (Columns 42-43)

The character P is displayed in column 42 of this field. Column 43 indicates the current page number being displayed when in 2-page mode.

#### 4.5.5 Error Indicator (Columns 45-52)

When an error occurs, the bell sounds and an error message is displayed on the status line (regardless of the display status line configuration option). Normal VDU operation occurs when the SET UP/STATUS key is depressed. The error messages displayed are as follows:

|          |  |
|----------|--|
| PAR ERR  | Received parity error  |
| ENTRY ER | Entry error in set-up configuration                            |
| INPUT ER | An illegal entry was attempted                                 |
| KBD LOCK | Keyboard locked  |
| FLD PROT | An entry was attempted in a protected field                    |
| ON ATTR  | An entry was attempted at an attribute character               |
| EAROM CK | Electrically alterable read-only memory (EAROM) checksum error |
| NUM FLD  | An alpha entry was attempted in numeric field                  |

#### 4.5.6 Communications Status Field (Columns 54-56)

Mnemonics indicating the operating mode of the terminal are displayed in this field. They are LOC (local), FDX (full-duplex), or HDX (half-duplex).

#### 4.5.7 Modem Status Field (Columns 58-59)

The data displayed in this field indicates the state of the communication line. When the VDU asserts the RS-232C signal, data terminal ready (DTR) and data are being received, the mnemonic DR flashes for all data received on the communication line.

When the VDU receives an active state of the RS-232C control line clear to send (CB), any transmission to the communication line is indicated by a flashing CS for each byte sent.

#### 4.5.8 Send Mode Field (Columns 61-68)

Mnemonics indicating the current transmission mode of the terminal are displayed in this field. They are CV for conversational mode and BL for block mode.

When the terminal is in block mode, the following additional mnemonics are displayed in this field.

|    |                  |
|----|------------------|
| RS | Request to Send  |
| IM | Send Immediate   |
| AL | Send All         |
| UN | Send Unprotected |
| M  | Send Modified    |

#### 4.5.9 Auxiliary Port Field (Columns 70-72)

This field indicates the condition of the auxiliary port. AU indicates that simulprint is enabled (displayed characters are transmitted to the auxiliary port). AUX indicates that received characters are transmitted to the auxiliary port but are not displayed on the screen.

#### 4.5.10 Scroll Hold Key Field (Columns 74-76)

This field displays the condition of the scroll hold key. HLD is displayed when this feature is active. See Section 4.3.16 for details on the operation of the SCROLL key.

#### 4.5.11 Reminder Field (Columns 78-80)

The data contained in this field indicates the current mode of the VDU. Set-up configuration modes and screen program modes are indicated by the mnemonics CG and PG, respectively. When configuration mode is active, the terminal is off-line and the mnemonics displayed are CG in columns 78-80 and LOC in columns 54-56. INS is displayed when the insert character function is on. In transparent mode, TM is displayed in this field.

### 4.6 MESSAGE LINE DESCRIPTION

The Model 6312 VDU contains two separate character message buffers, writable from the host only, which when written to are displayed on the 25th line of the screen. See Section 5.9 for information on the multicode sequences that control message line operation. Either the message line or the status line, if enabled in the set-up configuration, may be selected for display on the screen. The occurrence of any error condition listed in Section 4.5.5 automatically causes the status line to be displayed in place of either message. Correction of the error condition returns the previous selection to the 25th line.

## 4.7 ERROR MESSAGES

Whenever an error related to the operation of the terminal occurs, the bell sounds and an error message is displayed in the error message field of the status line. If an error occurs, the status line is displayed regardless of the setting in the set-up configuration mode.

The following lists the error messages and provides information to rectify each error.

- |          |  |
|----------|--|
| EAROM CK | There is a checksum error in the configuration EAROM. Reconfigure the set-up options.  |
| ENTRY ER | During configuration, an entry was made that did not match the parameter expected. This error only occurs when the operator tries to exit the configuration mode. At this time, the terminal is checking the entries. The terminal will not exit the configuration mode for this error. Instead, it positions the cursor over the (first) invalid configuration parameter. Inserting a valid entry clears the error.   |
| FLD PROT | During entry, the operator tried to enter data in a protected field. To remedy, move the cursor to the next unprotected field.   |
| INPUT ER | This error message indicates an attempted insertion into a field that could not accommodate that insertion. Usually, this occurs with the insert line operation. The insertion is not completed. To remove the error message, move the cursor within the field or depress the SET UP/STATUS key.   |
| KBD LOCK | The terminal keyboard may be locked either by the host computer or by the printer. When the host computer is responsible for the locked keyboard, the terminal must wait until the host computer unlocks it. When the printer is responsible for the locked keyboard, then the terminal must again wait until printing is complete. If the operator senses a problem with the printer, it may be necessary to power-down either the terminal or the printer to restore normal operation. |
| NUM FLD  | This error message indicates that the field is a numeric field, therefore, the entry must be numeric. Alphabetic entries are not accepted. Enter a valid entry to remove the error message.  |

ON ATTR        This error indicates that the operator attempted to enter data over an attribute character. This error prevents the operator from destroying the field. Move the cursor to the first data character of an unprotected field.

PAR ERR        A receive parity error is detected from the line. Depression of the SET UP/STATUS key clears this error.

#### 4.8 SETTING FORMATTED FIELDS

The screen of the Model 6312 VDU can be subdivided into two or more fields. There can be an attribute character for every character position on the screen. Each field carries its own visual or operational attributes. Furthermore, many combinations of the fields can be utilized.

Once a field is generated on the screen, the Model 6312 VDU turns the scrolling feature (if on) off to protect data at the top of the screen from being lost. In the conversational transmission mode, the host computer can transmit attribute characters to generate fields. There are two multicode sequences that can be used alternately according to the needs of the application. Multicode    (underline) instructs the terminal that, even if an attribute character is received, scrolling remains on. Multicode <sup>^</sup> instructs the terminal that, when an attribute character is received, scrolling is turned off.

The field types are defined below.

- Normal

White data characters are displayed on a dark field. Or, if the Model 6312 VDU is configured to enable the inverse video feature, dark data characters are displayed on a light field.

- Inverse Video

Dark data characters are displayed on a light field. Or, if the Model 6312 VDU is configured to enable the inverse video feature, white data characters are displayed on a dark field.

- Nondisplay

Data characters entered in a nondisplay field are not displayed on the screen. This type of field is useful for security situations such as passwords for signing on.



- Half Intensity

For a field combining normal and half intensity attributes, half intensity characters are displayed on a dark screen. For example, grey characters are displayed on a charcoal screen. For a field combining inverse video and half intensity attributes, dark characters are displayed on a half intensity field. For example, charcoal characters are displayed on a grey screen.

- Blink

Characters entered in a blinking field blink on and off. This type of field is desirable for bringing a message to the attention of an operator.

- Numeric

Only numeric data is accepted in this field type.

- Underlined

Data is displayed on field that also displays an underline.

**NOTE**

The underline attribute cannot be used with the inverse video, nondisplay, and/or blink attributes.

- Protected

Characters cannot be entered in this type of field from the keyboard. This type of field prevents keyboard overwriting of data written by the host computer. Protected fields are particularly useful when used with the graphics character set for display of form facsimiles.

- Modified

Whenever an entry is made in a field, the modify data tag bit of the attribute character is set. This type of field is used in block transmission mode for modified field data transmission. In this case, the terminal sends only those fields whose modify data tags are set.

- Light Pen Detectable

This type of field is required for Light Pen operation. For further information, see Section 4.11.

Screen fields may be set by the programmer through the keyboard or by the host computer over the communication line as described in the following sections.

#### 4.8.1 Defining Fields Via the Keyboard (Screen Program Mode)

To set the screen into various fields from the keyboard, the programmer must enter the screen program mode by entering a multicode (ESC) p sequence. Regardless of the configuration option setting for the status line display, the status line is displayed when the terminal enters the screen program mode.

The programmer positions the cursor to the desired location for an attribute character (defining the beginning of the field) by using the cursor position keys.

The depression of the TAB key defines the start of an attribute field. A null character is displayed at the cursor position until the first attribute mnemonic is entered. The cursor remains stationary until the entire attribute is defined. Any combination of attributes may be chosen by inserting each attribute mnemonic desired in succession. These attribute mnemonics are as follows:

- B for Blink Field
- D for Nondisplay Field
- I for Half Intensity Field
- L for Light Pen Detectable
- M for Modified Field
- N for Numeric Field
- P for Protected Field
- U for Underlined Field
- V for Inverse Video Field

The entry of a legal mnemonic is echoed in the attribute character location. An attribute is negated if the same mnemonic is entered a second time. A normal field is assumed if no mnemonic is entered. Attribute mnemonics are displayed in the status line at column 3.

If a character other than the above mnemonics is entered, the Model 6312 VDU ignores it. The attribute byte, when completely defined, takes one character position on the screen.

After all the mnemonics are entered, the TAB key is depressed a second time. The field is now defined and the programmer may move the cursor to the first position of the next desired field.

The characteristics of the field do not take effect until the terminal exits the screen program mode. Entering a multicode (ESC) p sequence a second time causes the Model 6312 VDU to exit the screen program mode.

#### NOTE

No transmission to or from the host can occur while the terminal is in screen program mode.

#### 4.8.2 Defining Fields Over the Communications Line

Attribute fields are set through multicode sequences sent from the host computer over the communication line. The host computer sends a multicode sequence to position the cursor at the desired location. Next a multicode sequence establishes that position as a distinct attribute character. The bit format for the attribute character is shown in Figure 5-1. Details on the multicode sequences to set attribute fields are provided in Section 5.10.

#### 4.9 BLOCK MODE TRANSMISSION FORMATS

When the host computer and the terminal operate in the block transmission mode, depressing the SEND key (or the RETURN key if RETURN=SEND is enabled in the set-up configuration) initiates transmission of data to the host computer. Also, the host computer may issue one of several read requests (multicode sequences) to receive an automatic transmission of data from the terminal.

Data is transmitted according to the send condition of the terminal determined during set-up configuration (LINE,MSG,PAG) unless the host computer overrides this send condition. See Section 5.11.2 for details on the multicode sequence transmitted by the host to override the send condition.

The Model 6312 VDU is capable of operating within a number of various block mode situations as described in the following sections.

##### 4.9.1 Block Mode Immediate and Block Mode Request to Send

There are two subsets of the block transmission mode; they are send immediate and request to send.

For the send immediate subset, the host computer issues one of three multicode sequences to set the terminal in a specific state that determines the data to be transmitted:

- Multicode U - set to send all data transmission
- Multicode V - set to send unprotected field data transmission
- Multicode W - set to send modified field data transmission

The transmission state of the terminal should be set by the host computer before any transmission. Whenever the terminal operator has data to transmit to the host computer, the operator depresses the SEND key (or the RETURN key if RETURN=SEND is enabled in the set-up configuration) to send that data immediately. The host computer can issue a read request to receive the data from the terminal. See Section 4.9.2 for details on host computer read requests.

For the request to send subset, upon depression of the SEND key (or the RETURN key if RETURN=SEND is enabled in the set-up configuration) the terminal sends only a multicode R sequence followed by an ASCII numeric character (1, 2, or 3) and the request to send terminator. The numeric character specifies the configured send condition (LINE,MSG,PAG) of the terminal. The host computer replies with a read request and the data is transmitted. See Section 4.9.2 for details on host computer read requests.

#### 4.9.2 Host Computer Read Requests

The host computer may initiate an automatic transmission of data from the terminal by issuing one of three multicode sequences, described as read requests. These read requests correspond to the transmission states that are set for the send immediate subset.

The read request from the host computer may be any of the following:

- Read all data transmission
- Read unprotected field data transmission
- Read modified field data transmission

Unless the terminal screen is formatted, the read all data request is generally preferred. When the terminal screen is formatted, the read all data request may still be used, but the read unprotected field data and the read modified field data requests offer improved capabilities. These transmission states are covered in the following sections.

#### 4.9.3 All Data Transmission

The all data transmission state sets the condition where all data (defined by the configured send condition or by the transmission from the host computer of a send condition override multicode sequence) is transmitted to the host computer.

For the send line condition, whether the screen is formatted or not, the send line terminator (SEND LINE in the configuration menu) is automatically appended to the data. If the screen is formatted, data is transmitted from the cursor position to the end of the line. If the screen is unformatted, the entire line of data at which the cursor is located is transmitted.

For either the send message or the send page condition with an unformatted screen, the unformatted line terminator (UNFORMAT LINE in the configuration menu) is automatically appended to each line and the unformatted page terminator (UNFORMAT PG in the configuration menu) is appended to the last field of transmitted data.

For either the send message or the send page condition with a formatted screen, data transmitted from each field prefaced with an attribute is preceded by the ASCII hex equivalent of the multicode ! sequence and the attribute. The formatted page terminator (FORMAT PG in the configuration menu) is appended to the last field of transmitted data.

#### 4.9.4 Unprotected Field Data Transmission

The Model 6312 VDU has several capabilities that decrease the amount of data transmitted and consequently, the time required for data transmission. Unprotected field data transmission is one such capability. It is particularly useful for formatted screen data. On a formatted screen, each field is defined by an attribute character. Fields placed on the screen may be designated as protected. The operator may not enter data in these fields. A protected field is usually put on the screen with prompts as to what the operator should enter in the next field. For this type of screen formatting, the host computer does not need to examine these fields, so the Model 6312 VDU does not send them.

Unprotected field data transmission is designed for block mode transmission of a formatted screen. If the screen is unformatted, however, this operation has the same effect as all data transmission discussed in Section 4.9.3.

On transmission of a formatted screen, only the data from unprotected fields is transmitted (nulls are suppressed). The field terminator (FIELD in the configuration menu) precedes transmitted field data. Should a field contain only ASCII null characters, its presence is indicated by the transmission of a single field terminator. The format of an unprotected field data transmission is illustrated in Figure 4-4.

030-18

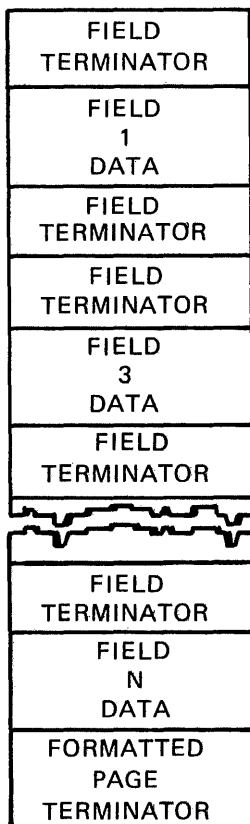

**NOTE**

For this example, there were only three fields. Field 2 contains all nulls.

**Figure 4-4 Read/Send Unprotected Format**

#### 4.9.4.1 Unprotected Line Data Transmission

When the configuration is set for a send line operation on a formatted screen, unprotected data is transmitted starting with the first unprotected field following the cursor position and terminating at the next field attribute byte. If no other attributes exist prior to the end of the screen, data transmission wraps from line 24 to line 1 and continues until the first attribute byte is encountered. The transmitted field is preceded by the field terminator (FIELD in the configuration menu). The character(s) appended to the transmitted field vary depending on whether a wrap occurred. If no wrap occurred, the last characters are the field terminator followed by the send line terminator (SEND LINE in the configuration menu). If wrap occurred, only the send line terminator is transmitted.

#### 4.9.4.2 Unprotected Message Data Transmission

When the configuration is set up for a send message operation on a formatted screen, the data transmitted is cursor-dependent. If the cursor is positioned in an unformatted area of the screen (no attributes from the home position to the cursor), the formatted page terminator is the only data transmitted. If the cursor is positioned in a protected field, data preceding the cursor is transmitted from the first unprotected area of the screen preceded by an attribute to the last unprotected field preceding the cursor.

If the cursor is positioned in an unprotected field, data is transmitted from the first unprotected area of the screen prefaced by an attribute up to the next attribute byte following the cursor location. Data wraps from line 24 to line 1 and terminates at the first attribute encountered on the screen when no attribute exists between the cursor position and the last character position on the screen.

#### 4.9.4.3 Unprotected Page Data Transmission

When the configuration is set for a send page operation on a formatted screen, all unprotected data is transmitted beginning with the first unprotected field that is preceded by an attribute. If an attribute exists at the home position, all unprotected data is transmitted from the first character following the attribute to the end of the screen. If no attribute exists at the home position, transmission wraps from line 24 to line 1 and terminates at the first attribute encountered. (Each field is preceded by the field terminator (FIELD in the configuration menu) while the last transmitted field is appended with the formatted page terminator (FORMAT PG in the configuration menu).)

#### 4.9.5 Modified Field Data Transmission

Another capability of the Model 6312 VDU for reducing the amount of data transmitted is modified field data transmission, which is valid only for formatted screen data.

On a formatted screen, each field is defined by an attribute character. One bit of the attribute character is dedicated as a modify data tag. This bit is set if data is entered in the associated field. Otherwise, the bit is clear (or reset).

##### 4.9.5.1 Modified Line Data Transmission

When the configuration is set up for a send line operation on a formatted screen, modified data is transmitted from the first modified field following the cursor position and terminates at the next field attribute encountered. If no attribute byte is detected prior to the end of the screen, data transmission wraps from line 24 to line 1 and continues until the first attribute byte is encountered. The first transmitted character is the ASCII start of heading (SOH) character followed by the address of the current cursor position. Transmitted data is preceded by the field terminator (FIELD in the configuration menu) followed by the screen address of the first character of that field. Transmitted data is terminated by the send line terminator (SEND LINE in the configuration menu).

##### 4.9.5.2 Modified Message Data Transmission

When the configuration is set up for send message operation on a formatted screen, the data transmission depends on the position of the cursor.

If the cursor is not positioned in a modified field, data preceding the cursor is transmitted from the first modified field preceded by an attribute to the last modified field preceding the cursor.

If the cursor is positioned in a modified field, data is transmitted from the first modified area of the screen prefaced by an attribute up to the next attribute byte following the cursor location. If the cursor is positioned within a modified field and no attribute exists prior to the end of the screen, data transmission wraps from line 24 to line 1 and terminates at the first attribute encountered.



The first character transmitted is the ASCII start of heading (SOH) character followed by the address of the cursor position. Each transmitted field is preceded by the field terminator (FIELD in the configuration menu) and the screen address of the first character of the field. The formatted page terminator (FORMAT PG in the configuration menu) is appended to the last transmitted field. If no modified field exists before the cursor position, the SOH, cursor address, and the formatted page terminator are transmitted but no data is transmitted.

#### 4.9.5.3 Modified Page Data Transmission

When the configuration is set for a send page operation on a formatted screen, all modified data is transmitted beginning with the first modified field that is preceded by an attribute. If an attribute exists at the home position, all modified data is transmitted from the first character following the attribute to the end of the screen. If no attribute exists at the home position, data transmission wraps from line 24 to line one and terminates at the first attribute encountered.

The first transmitted character is the ASCII start of heading (SOH) character followed by the address of the current cursor position. Each transmitted field is preceded by the field terminator (FIELD in the configuration menu) followed by the screen address of the first character of that field. The formatted page terminator (FORMAT PG in the configuration menu) is appended to the last transmitted field.

Figure 4-5 illustrates the data format for a formatted screen where only the first and third fields have been altered by keyboard entry (the second field was bypassed). Field 1 data and field 3 data are not applicable for the Light Pen operation.

|                                 |
|---------------------------------|
| SOH                             |
| CURSOR<br>ADDRESS               |
| FIELD<br>TERMINATOR             |
| FIELD 1<br>ADDRESS              |
| FIELD<br>1<br>DATA              |
| FIELD<br>TERMINATOR             |
| FIELD 3<br>ADDRESS              |
| FIELD<br>3<br>DATA              |
| FORMATTED<br>PAGE<br>TERMINATOR |

| **Figure 4-5 Read/Send Modified Format**

| **NOTE**

| Light Pen operation does not transmit the  
| field data if the asterisk designator is  
| used in the send field.

#### 4.10 POLLING

Within the configuration menu of the Model 6312 VDU there are two parameters that permit easy integration into a polled environment. The first of these parameters, POLLED, must be set to a "Y". The other parameter, POLL CHAR, specifies the poll selection address that identifies a specific terminal. The host computer may issue a general broadcast, a group notification, or poll a single terminal at a time.

Figure 4-6 is a flowchart that shows the host computer/terminal interaction in a polled environment.



#### 4.10.1 Broadcast

When a message is to be sent to all terminals, the host computer may issue a multicode \* sequence followed by the message. Figure 4-7 illustrates the broadcast format.

030-24

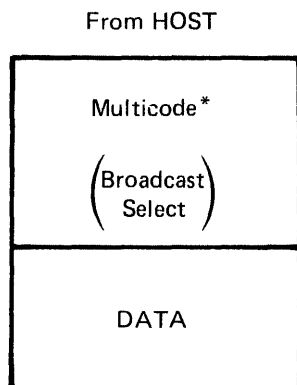

Figure 4-7 Broadcast Format

#### 4.10.2 Group/Fast Select

A message may be sent to a specified group of terminals by issuing the multicode + sequence followed by the polling selection address of each terminal to receive the data.

Each poll selection address must be repeated. To designate the end of the list of terminals desired to receive data, the host must transmit the ASCII STX character after the last poll address character. Figure 4-8 illustrates the group/fast select format.

From HOST

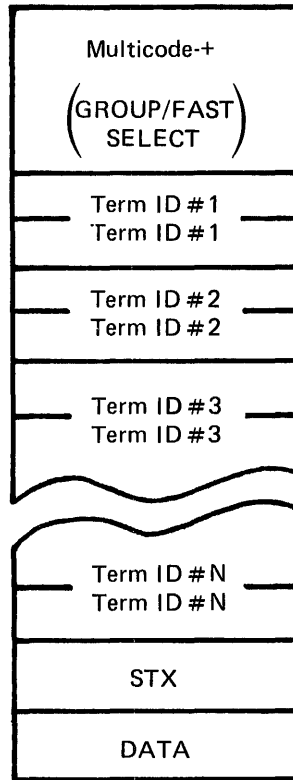

Figure 4-8 Group/Fast Select Format

#### 4.10.3 Poll

The host may communicate with a single terminal through the use of multicode P. To poll the desired terminals, the host must issue the multicode P followed by the desired terminal's poll address character repeated twice. Once polled, the host interrogates the terminal to see if it has any data to transmit.

If the terminal is in conversational mode, the terminal responds with an end of transmission (EOT). If in block mode, the host effectively needs to know whether the SEND key is depressed, or whether there is data to be transmitted by the terminal. If not, the terminal responds with the ASCII EOT character indicating there is no data to be transmitted. If there is data to be transmitted for block mode immediate, the data is then sent. For block mode request to send, a REQUEST TO SEND sequence is transmitted to the host and the host must respond with a read request before the data is transmitted. Furthermore, the host may poll a terminal but immediately transmit an ASCII EOT character indicating that the host has no data to transmit and does not wish to receive data. Figure 4-9 illustrates the format for the multicode P sequence.

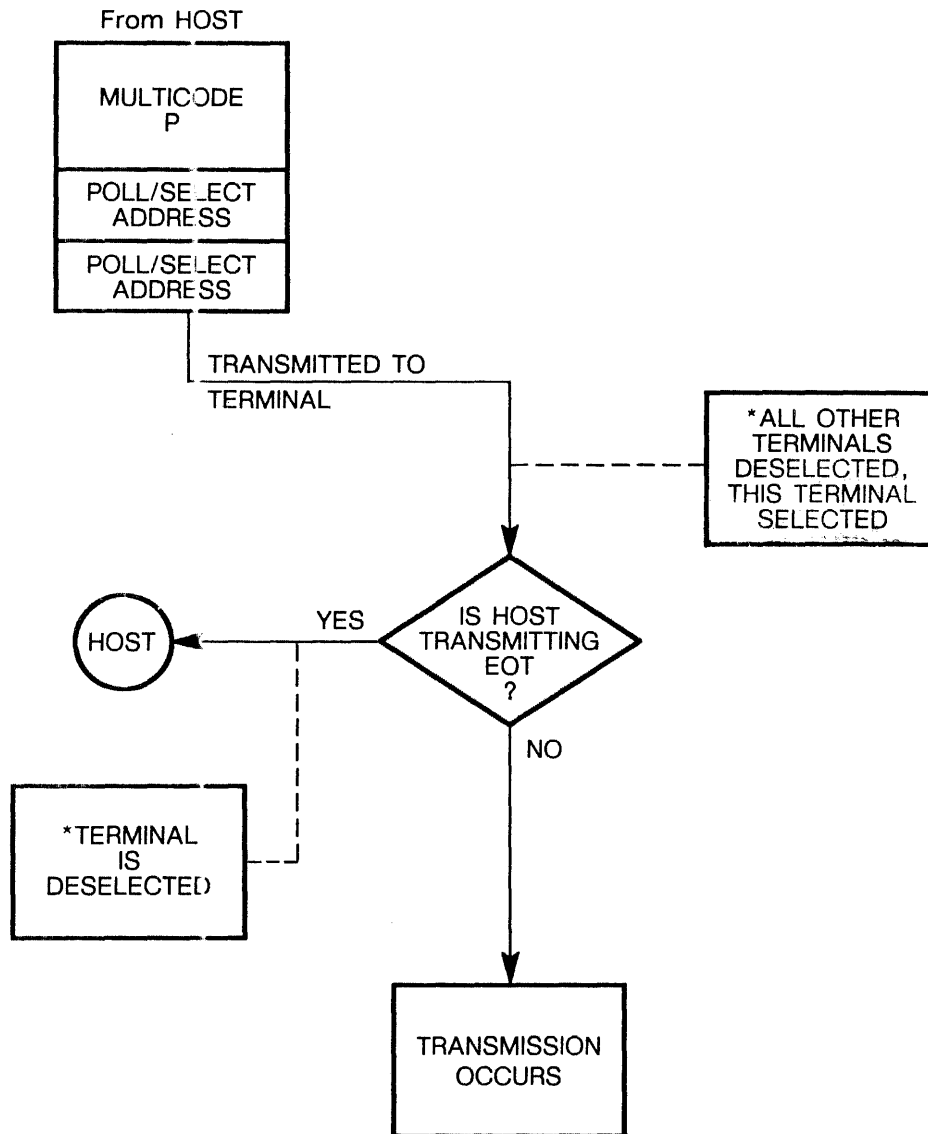

Figure 4-9 Polling Format

#### 4.11 LIGHT PEN OPERATION

One of the options featured with the Model 6312 VDU is the capability to operate the terminal with a Light Pen. The Light Pen is a light-sensitive instrument connected to the monitor. The Light Pen operates by detecting variations in light emitted by the data characters on the screen. Detection of a light by the Light Pen results in a hardware interrupt. The terminal's internal coding retrieves the location of the Light Pen's detected character.

The Light Pen gives the operator the ability to select data by pointing or pressing the pen at the data fields defined as Light Pen Selectable.

Light Pen fields must be defined on the screen and selected by the user; they are then transmitted to the host computer for interpretation.

#### 4.11.1 Transmitting Light Pen Fields

Although the terminal may be operating in the conversational mode, the terminal responds as though it is configured for block mode transmission. Transmission occurs either as block mode immediate or block mode request to send as determined by the host computer. This may be Send All, Send Unprotected, or Send Modified.

For the Send All transmission state, the entire screen (including attribute characters) is sent. The host computer determines the changed Designator Characters (see below) and responds accordingly.

For the Send Unprotected state, the addresses of all unprotected fields, Light Pen, and non-Light Pen alike, are transmitted to the host computer. Figure 4-10 is an illustration of the data stream.

For Send Modified transmission, the two-character address of the current position is followed by the address of all the fields whose Modify Data Tags have been set.

#### NOTE

When the screen is formatted for at least one Light Pen field, the data itself is not transmitted unless the ampersand designator was used in the send field.

The Send field (described in Section 4.11.2) is always considered a Modified Field Data transmission.

#### NOTE

The Light Pen and the keyboard are locked out during transmission regardless of whether the transmission resulted from depression of the ENTER key or by the Light Pen selection of a Send field.

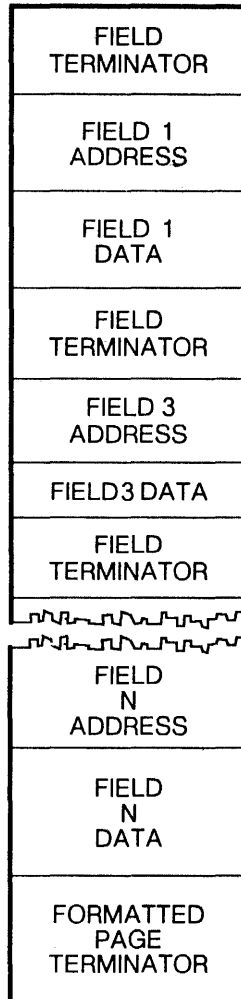

| **Figure 4-10 Send Unprotected Format**

| **NOTE**

| For this example, there are only three  
| fields. Field 2 contains all nulls.

#### 4.11.2 Defining Light Pen Fields

A Light Pen Detectable field is defined in much the same manner as other fields, whether by the host over the communications line or by the user via the program mode (described in Section 4.8). For most applications, Light Pen fields are generated by the host computer over the communications line. The host computer must use the multicode " sequence instead of the multicode ! sequence to define a Light Pen field.



There are two different types of Light Pen fields that may be defined. The first type is the Selector field. Pressing the Light Pen against the Selector field indicates this data is chosen. The second type is the Send field. Pressing the Light Pen against the Send field initiates the transmission of data to the host computer. The Send field is an alternative to using the SEND key. This field allows the terminal to be used without the keyboard. There may be more than one Send field on the screen at a time. It may be useful to keep the Send field in the same location on the screen for different screens. It would be also helpful for the operator if the Send field were distinct from the Selector fields.

The composition of the Light Pen field is in the following form:

- an attribute character for the Light Pen field,
- a Light Pen designator character, and
- at least three padding characters.

The designator character is an integral part of the Light Pen field. For Selector fields, the designator character is the question mark character "?". When a Light Pen selects its associated field, the modified data tag is set and the designator character is changed to the greater than character ">". This change is automatically done by the Model 6312 VDU. For Send fields, the designator character is the asterisk "\*" or the ampersand "&".

There must be at least three padding characters before the start of any other field. Usually there are more than three characters and they serve to identify the choice. Remember that the Light Pen can be pointed at one of these padding characters instead of the designator character and the selection or transmission still takes place.

#### 4.11.3 Light Pen Field Operation

When Light Pen fields are placed on the screen, a "menu" of options is presented for operator selection. Selection requires the application of the Light Pen to the field on the screen with the desired information. Some applications may require that only one choice is selected and that the options are usually exclusive. In other applications, more than one choice can be made.

When the operator selects a Light Pen field, the designator character of that (Selector) field changes from "?" to ">". If this is not the right field, depressing the Light Pen to the previously selected field resets the modified data tag and the designator character is returned to "?".

When the selection process is complete, the Light Pen is applied to the Send field. This action, like pressing the SEND key, begins the process of transmitting data to the host computer. The host computer analyzes the data received and responds appropriately.

#### 4.11.4 Recommendations For Light Pen Use

Light Pen detection occurs with characters having sufficient light resolution. The following situations may not provide enough resolution and should not be used as the padding characters in a Light Pen field.

- Half intensity fields
- A line of space characters
- A sequence of low contrast characters. These characters are:
  - the period (.)
  - the comma (,)
  - the apostrophe (')
  - the colon (:)
  - the caret (^)
  - the reverse apostrophe (`)

If only space or low contrast characters can be used, then reverse video Light Pen fields should be used.

Light Pen fields should be doublespaced. This means separate lines with Light Pen fields that have an unprotected field running the entire length of the line. This ensures that an accidental selection does not occur. A sample screen using Light Pen fields is shown in Figure 4-11.

030-22

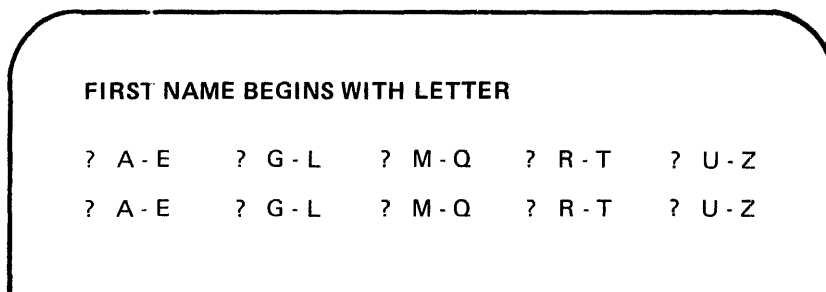

Figure 4-11 Light Pen Fields

## CHAPTER 5 MULTICODE SEQUENCES

### 5.1 INTRODUCTION

Multicode sequences provide the programmer with a means of implementing a wide range of special functions. The following multicode sequences are described primarily for the host computer programmer, although many of these sequences may be accessed by the terminal operator. Those multicode sequence operations indicated as "host computer control only" may not be executed from the keyboard.

In the following sections, the multicode sequences for similar operations are grouped together. A summary of the multicode sequences appears in Appendix A.

#### NOTE

Throughout this manual, all references to the Model 6312 video display unit (VDU) refer to both the Model 6312 and 6312+, except where otherwise noted.

### 5.2 THE MULTICODE CHARACTER

Executing multicode operations from the host computer involves the transmission of a specific character, specified by Concurrent Computer Corporation as escape (ESC), designated as the multicode character. This designation occurs during the configuration of the terminal. For example, the transmission of the two ASCII characters ESC and H place the cursor in the home position.

The Model 6312 VDU configuration allows the programmer to designate any ASCII character (except DEL) as the multicode character in the event that the ESC character is dedicated to another system function.

In the transparent mode, multicode sequences are displayed but not acted upon.

In order to store a multicode character as itself, it must be entered through the keyboard or transmitted over the communications line twice, i.e., multicode multicode (see Section 5.7.9).

### 5.3 CURSOR FUNCTIONS

The following sections describe the multicode sequences that control the cursor.

#### 5.3.1 Multicode A (Cursor Up)

Entering a multicode A sequence moves the cursor up by one line. If the cursor is at line 1, it wraps around to line 24. This sequence corresponds to the depression of the cursor up (↑) key.

#### 5.3.2 Multicode B (Cursor Down)

Entering a multicode B sequence moves the cursor down by one line. If the cursor is on line 24, it wraps around to line 1 at the same column position. This sequence corresponds to the depression of the cursor down (LINE FEED (↓)) key.

#### 5.3.3 Multicode C (Cursor Right)

Entering a multicode C sequence moves the cursor one column to the right. When a cursor is moved beyond the right margin, the cursor wraps around to column 1 of the following line. This sequence corresponds to the depression of the cursor right (→) key.

#### 5.3.4 Multicode D (Cursor Left)

Entering a multicode D sequence moves the cursor one column to the left. When the cursor is moved beyond column 1, the cursor wraps around to the right margin column position on the previous line. The cursor does not move beyond the home position. This sequence corresponds to the depression of the cursor left (←) key.

#### 5.3.5 Multicode H (Cursor Home)

Entering a multicode H sequence moves the cursor to column 1, line 1 (home). This sequence corresponds to the depression of the HOME key.

#### 5.3.6 Multicode T (Insert Cursor - Line Only)

Entering a multicode T sequence sets the cursor position to the current buffer address.

### 5.3.7 Multicode X x (Direct Cursor Address - Line Position)

Entering a multicode X x sequence moves the cursor vertically to the line indicated by 'x' as specified in Appendix B. Appendix B consists of a cursor address chart which provides the line and column positions specified by the different ASCII characters.

### 5.3.8 Multicode Y y (Direct Cursor Address-Column Position)

Entering a multicode Y y sequence moves the cursor horizontally to the column indicated by 'y' as specified in Appendix B.

### 5.3.9 Multicode Z (Read Cursor Address)

When a multicode Z sequence is entered, the terminal responds by transmitting two bytes to the host computer indicating the line and column position of the cursor, as specified in Appendix B.

### 5.3.10 Multicode ~1 (Blank Cursor)

Entering a multicode ~1 sequence blanks the cursor until a multicode ~2 sequence is initiated.

### 5.3.11 Multicode ~2 (Restore Cursor)

Entering a multicode ~2 sequence restores the previously blanked cursor to its original set-up configuration mode attribute setting.

### 5.3.12 Multicode } (Last)

Entering a multicode } sequence instructs the terminal to position the cursor to the last character position on the screen (line 24, column 80 on an unformatted screen). The cursor is positioned to the first data character of the last unprotected field on a formatted screen.

## 5.4 LOCK/UNLOCK OPERATIONS

The following sections describe the multicode sequences that lock/unlock the keyboard.

### 5.4.1 Multicode ( (Lock Keyboard - Line Only)

The keyboard is locked on receipt of this sequence. The message KBD LOCK is displayed in the error field of the status line. The keyboard may only be unlocked by an unlock keyboard multicode sequence from the line or by entering set-up configuration mode. This sequence is host computer controlled only.

#### 5.4.2 Multicode ) (Unlock Keyboard - Line Only)

The keyboard is unlocked, if previously locked from the line. This sequence is host computer controlled only.

#### 5.4.3 Multicode 8 (Lock Light Pen - Line Only)

This multicode sequence locks out the operation of the Light Pen. This sequence is host computer controlled only.

#### 5.4.4 Multicode 9 (Unlock Light Pen - Line Only)

This multicode sequence unlocks the operation of the Light Pen previously locked by the multicode 8 sequence. This sequence is host computer controlled only.

### 5.5 BLANK/RESTORE SCREEN OPERATIONS

The following sections describe the multicode sequences used to blank/restore the screen image.

#### 5.5.1 Multicode (space) (Blank Display)

Entering a multicode space sequence blanks the display screen without affecting the memory contents of the terminal. The display is restored by:

- cursor movement causing a scroll,
- overwriting the last attribute byte on the screen,
- any insert, delete, or clear operation, or
- multicode @ sequence.

#### 5.5.2 Multicode @ (Restore Screen)

The previously blanked screen reappears when this sequence is received. No data displayed is changed by this sequence.

### 5.6 TAB OPERATIONS

The following sections describe the multicode sequences that control the tab stops.

### 5.6.1 Multicode 1 (Set Tab)

Entering a multicode 1 sequence sets the tab stop at the current cursor column position. This tab stop is effective for all display lines. The tab stop cannot be set at column 1.

### 5.6.2 Multicode 2 (Clear Tabs)

Entering a multicode 2 sequence clears the tab stop at the current column position. This tab stop is cleared for all display lines.

### 5.6.3 Multicode 3 (Clear All Tabs)

Entering a multicode 3 (three) sequence clears all tab stops on the screen.

### 5.6.4 Multicode | (Backtab)

Entering a multicode | sequence moves the cursor to the previous tab stop. Cursor movement ceases at the first tab stop encountered on the line. A video attribute is also considered a tab stop.

## 5.7 EDITING AND CLEARING OPERATIONS

The following sections describe the multicode sequences for editing and clearing operations.

### 5.7.1 Multicode I (Clear Line)

Entering a multicode I sequence clears the line (to nulls or spaces as defined in the set-up configuration) starting with the present cursor position to the end of line. When the screen is formatted, this sequence clears all unprotected characters in the field from the present cursor position to the first field attribute character encountered on the screen.

### 5.7.2 Multicode J (Clear Unprotected)

Entering a multicode J sequence clears all unprotected fields (to that which is defined in set-up configuration) starting with the present cursor position to the end of the screen.

### 5.7.3 Multicode K (Clear All)

Entering a multicode K sequence clears the display memory to nulls or spaces (as defined in set-up configuration) and returns the cursor to the home position. All video attributes, tab stops, and the message field of the status line are also cleared.

### 5.7.4 Multicode L (Insert Line)

The multicode L sequence functions the same as the shifted depression of the INSERT LINE/CHAR key. See Section 4.3.9 for details on the operation of the INSERT LINE/CHAR key.

### 5.7.5 Multicode M (Delete Line)

The multicode M sequence functions the same as the shifted depression of the DELETE LINE/CHAR key. See Section 4.3.7 for details on the operation of the DELETE LINE/CHAR key.

### 5.7.6 Multicode N n (Insert Character)

Entering a multicode N n sequence inserts a character (denoted by n) at the current cursor position. This multicode sequence differs from the insert character operation of the INSERT LINE/CHAR key in that only one character may be inserted.

### 5.7.7 Multicode O (Delete Character)

A multicode O sequence functions the same as the unshifted depression of the DELETE LINE/CHAR key. See Section 4.3.7 for details on the operation of the DELETE LINE/CHAR key.

### | 5.7.8 Multicode DEL (Hex '7F') (Display Hash Mark)

| This sequence causes a "hash" mark to be displayed and stored in  
| screen memory.

### | 5.7.9 Multicode Multicode

| When a second escape character follows an escape character, the  
| second escape is written to the screen (displayable in  
| transparent mode). Inputs following the last escape character  
| perform their respective multicode operation.



## 5.8 STATUS LINE OPERATIONS

The following sections describe the multicode sequences that control the status line display.

### 5.8.1 Multicode 4 (Move Cursor to Status Line)

When a multicode 4 sequence is received, the cursor moves to column 1 of line 25. This sequence can also be used to return the cursor to column 1 of the status line if the cursor is already on the status line. The operation of this code assumes the status line (line 25) display is enabled. Print operations cannot be performed while the cursor is in the status line.

### 5.8.2 Multicode 5 (Return Cursor from Status Line)

The multicode 5 sequence returns the cursor from line 25 (user area) to the previous location on a display line. This operation assumes the status line display is enabled.

### 5.8.3 Multicode [ (Enable Status Line Display)

This sequence allows the host computer to restore the status line display (line 25) previously blanked with the multicode ] sequence.

### 5.8.4 Multicode ] (Disable Status Line Display)

This sequence provides the host computer with the ability to blank the display of the status line without affecting its contents.

### 5.8.5 Multicode h (Display Status Line)

The multicode h sequence sets the terminal to display the status line on the 25th line of the screen if the message line was previously selected. DSPLAY STAT LN must be enabled in the set-up configuration for display of the status line. If not enabled, the status line is blanked.

## 5.9 MESSAGE LINE OPERATION

The following sections describe the multicode sequences used to control the message line.

### 5.9.1 Multicode g (Enable 80-Character Message Line)

The multicode g sequence sets the terminal to display the 80-character message line on the 25th line of the screen if the status line was previously selected. Display of this line is not controlled by DISPLAY STAT LN in the set-up configuration.

### 5.9.2 Multicode m (Write 80-Character Message Line)

The characters that are received (80 maximum) following this sequence are directed by the terminal to the 80-character message buffer. The message is displayed when the buffer becomes full or a CR is received.

#### NOTE

Undefined results may occur if multicode sequences are issued while the message line is being written and therefore should be avoided.

## 5.10 ATTRIBUTE BYTES

Attribute bytes (or characters) define the start of a field and the end of the preceding field. The choice of the defining character determines how the contents of the field are displayed and what types of entries are permitted in the field. The following sections describe the multicode sequences transmitted by the host to enable/disable the attribute bytes.

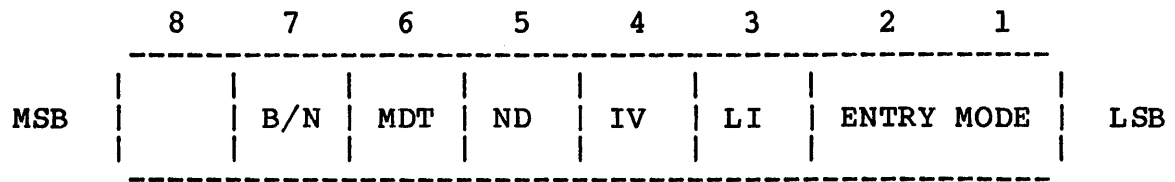

| Bit | Meaning  |
|-----|--|
| 8   | Parity bit   |
| 7   | 0 = normal field<br>1 = blinking field   |
| 6   | Modified Data Tag - identifies modified fields for Read/Send modified transmissions.<br><br>0 = not modified<br>1 = modified |
| 5   | 0 = display field<br>1 = nondisplay field (security)   |
| 4   | 0 = normal video<br>1 = inverse video  |
| 3   | 0 = normal intensity<br>1 = low intensity  |
| 2-1 | 00 = alphanumeric<br>01 = numeric entry only (1-9., + - \$)<br>10 = protected field<br>11 = used internally                  |

**NOTE**

The combination of blink and nondisplay active produces underline.

**Figure 5-1 Attribute Byte Format**

### 5.10.1 Multicode !x (Set Attribute Byte)

The character following multicode ! (denoted by x) is the field attribute character. The binary equivalent of the ASCII character determines the display mode. The binary format of the attribute byte is shown in Figure 5-1. Bit 8 is transmitted based on the parity options. The maximum quantity of embedded attributes which may be contained on a display is 1,920 (single page) or 3,840 (double page). To perform this option via the keyboard, see Section 4.8.1.

### 5.10.2 Multicode . (Disable Attributes)

The multicode . sequence disables all screen attribute characteristics, displays all attribute characters as an inverse character field, and prevents the defined operation from occurring.

### 5.10.3 Multicode / (Enable Attributes)

This sequence enables all screen attributes previously disabled with the multicode . sequence.

### 5.10.4 Multicode " x (Set Attribute Byte Light Pen Field)

This multicode sequence creates an attribute byte for a Light Pen detectable field at the current cursor position. The attribute defining character, indicated by x, determines the field characteristics. The binary equivalent of this ASCII character determines the display mode. See Figure 5-1 for the binary format of the attribute byte.

## 5.11 SENDING SCREEN DATA

The following sections describe the multicode sequences that the host computer can specify for block mode transmission to receive the entire screen or a designated portion of the screen.

### 5.11.1 Multicode E (Set Full Screen Mode)

The multicode E sequence defines the start of transmission for the send page as the home position.

### 5.11.2 Multicode <x (Send Key Override - Line Only)

The character (x) following the multicode sequence determines the type of transmission to be initiated on the next read multicode sequence, regardless of the send parameter configured. Note that this multicode sequence remains in effect for only one transmission; it must follow the depression of the ENTER key by the operator and precede the read multicode sequence. Thus, it is only useful in block transmission mode-request to send transmission. No action is performed if the terminal is in block mode-immediate transmission mode.

- 1 (hex 31) = Send Page
- 2 (hex 32) = Send Line
- 3 (hex 33) = Send Message

## 5.12 SETTING TRANSMISSION MODE

This section describes the multicode sequences used to set the terminal to conversational or request to send mode. This section also describes set send modes.

### 5.12.1 Multicode G (Set Conversational Mode)

The multicode G sequence returns the terminal to conversational mode. Depression of the ENTER key performs a CR in the conversational transmission mode.

### 5.12.2 Multicode R (Request to Send)

When the multicode R sequence is received, the terminal is placed into request to send mode. Upon depression of the SEND key, the terminal transmits a request to send multicode sequence to the host. The host can start a transmission by sending one of three multicode sequences: "read immediate all", "read immediate modified", or "read immediate unprotected". See Section 5.13 for details on these multicode sequences.

### 5.12.3 Multicode U (Set Send Immediate All)

Upon depression of the SEND key, the terminal transmits the contents of memory based upon the current send condition. Field attribute codes and graphic characters are prefaced by their equivalent multicode sequences and then transmitted.

### 5.12.4 Multicode V (Set Send Immediate Unprotected)

Upon depression of the ENTER key, the terminal transmits the contents of all unprotected fields based on the current send condition (send line, send message or send page).

### 5.12.5 Multicode W (Set Send Immediate Modified)

Upon depression of the SEND key, the terminal transmits the contents of all modified fields.

## 5.13 BLOCK MODE READ REQUESTS

The following sections describe the multicode sequences that determine which data in the terminal memory is transmitted in response to a request to send (multicode R) sequence.

### 5.13.1 Multicode Q (Reset Modified Data Tags)

| This sequence resets all modified data tags. This operation  
| causes all ">" Light Pen designator characteristics to revert to  
| "?" designators.

### 5.13.2 Multicode = (Read All)

The multicode = sequence initiates transmission of all data in terminal memory.

### 5.13.3 Multicode > (Read Unprotected)

The multicode > sequence initiates transmission of all unprotected data in terminal memory.

### 5.13.4 Multicode ? (Read Modified)

The multicode ? sequence initiates transmission of data in modified fields.

## 5.14 SETTING PRINT OPTIONS

The following multicode sequences determine the operation of the auxiliary port.

### 5.14.1 Multicode ;x (Set Print Options)

The auxiliary port option stays in effect until changed with another multicode ;x sequence. The terminal contains a six-character overflow buffer reserved to hold any characters received from the host after the auxiliary port device issues a pause character (DC2 or DC4), but before the host can react. The printout options "x" are defined as:

- Option 1 - Stop Printout

The auxiliary port transmission currently in progress is allowed to finish, then transmission stops. Simulprint is then terminated.

- Option 2 - Transmit Screen From Home Position

The entire screen, from the home position to the end of the screen, is transmitted to the auxiliary port.

- Option 3 - Print Screen From Cursor Position

The screen, from the current position to the end of the screen, is transmitted to the auxiliary port.

- Option 4 - Simulprint - FF Control

Upon receipt of a form feed (FF) character, the contents of the screen are transmitted to the auxiliary port and transmission is complete.

If read status when ready (multicode %) is in effect, a status byte is transmitted when auxiliary port transmission is complete.

- Option 5 - Simulprint - Continuous/Display

Characters, as they are received, are simultaneously transmitted to the auxiliary port and displayed.

- Option 6 - Simulprint - Continuous Display/Nondisplay

Characters, as they are received, are transmitted to the auxiliary port but not displayed.

- Option 7 - Print Unprotected

The contents of all unprotected fields from the current cursor position to the end of the screen are transmitted to the auxiliary port. Protected fields are printed as spaces.

- Option 8 - Print Message

The screen contents are transmitted to the auxiliary port from the end of the previous print message operation (or from the home position if there were no previous print message operations) to the current cursor position. This gives the same result as if the Model 6312 were configured for the print message condition.

## 5.15 HOST CONFIGURATION OF TERMINAL

The following sections describe the multicode sequences received from the host to set up the configuration of the terminal.

### 5.15.1 Multicode # (Configuration Ready)

The multicode # sequence prepares the terminal for a configuration transmission from the host.

### 5.15.2 Multicode - (EAROM Configuration Update)

When the multicode - sequence is received, set-up configuration is terminated and the data displayed on the screen, starting with the byte at line 2, column 1 for the next 902 bytes, is stored in the configuration EAROM.

### 5.15.3 Multicode 6 (Read Configuration Update)

When the multicode 6 sequence is received, the terminal transmits to the host a sequence of 902 encoded ASCII bytes representing the configuration options.



#### 5.15.4 Multicode 7 (RAM Configuration Update)

The multicode 7 sequence terminates the set-up configuration by the host and defines the data displayed starting on line 2, column 1, as configuration data to be stored in RAM.

#### 5.15.5 Multicode 0 (Configuration Checksum)

This multicode sequence is transmitted by the Model 6312 VDU upon completion of an EAROM update request. A third byte is transmitted which indicates the checksum of the set-up configuration.

### 5.16 READING TERMINAL STATUS

The following sections describe the multicode sequences used to transmit the status byte to the host.

#### 5.16.1 Multicode \$ (Read Status Immediate)

If a multicode \$ is received, the terminal immediately transmits the status byte to the host computer. The format of the status byte (eight bits) is shown in Figure 5-2.

#### 5.16.2 Multicode % (Read Status When Ready)

When the terminal completes the next or current insert/delete or print operation, it transmits a status byte to the host. If no operation is in progress, status is transmitted immediately. The format of the status byte (eight bits) is shown in Figure 5-2.

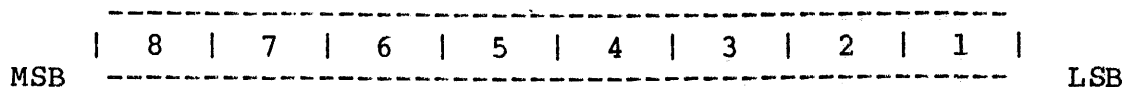

| Bit | Meaning   |
|-----|---|
| 8   | Parity bit. Set according to parity configuration parameter.                        |
| 7   | 0 = No overrun<br>1 = Overrun - Data lost because host is sending data too quickly. |
| 6   | 0 = Parity OK<br>1 = Parity error detected on incoming data                         |
| 5   | NOT USED  |
| 4   | 0 = Printer ready<br>1 = Printer busy   |
| 3   | 0 = Keyboard OK<br>1 = Keyboard locked  |
| 2   | 0 = Command OK<br>1 = Invalid Command, e.g., Nonexistent cursor                     |
| 1   | 0 = Terminal ready<br>1 = Terminal busy, e.g., "Clear Unprotected" in operation     |

Figure 5-2 Status Byte Format

### 5.17 DIAGNOSTIC TESTS

The following sections describe the multicode sequences used for the screen fill and reset diagnostic tests.

#### 5.17.1 Multicode :n (Fill Screen)

Entering a multicode :n sequence fills the screen with the character following the colon (:) and the cursor returns to the home position. No change to either external port interface occurs.

### 5.17.2 Multicode o! (Diagnostic Test/Reset)

All internal terminal logic is tested upon power-up or by the initiation of a multicode o! sequence. This action causes the terminal to display CONCURRENT Computer Corp. upon successful completion of the test. This sequence returns all set-up features in the nonvolatile memory to volatile RAM. No change to either external port interface occurs.

FAIL is displayed if an error is encountered. A multicode o9 sequence must be entered to determine the error as explained in Section 2.3.

## 5.18 SCROLLING OPTIONS

The following sections describe the multicode sequences used to set the scrolling options.

### 5.18.1 Multicode \_ (Scroll On With Attribute)

The multicode \_ sequence instructs the terminal to continue scrolling even if video attributes are received.

### 5.18.2 Multicode ^ (Scroll Off With Attribute)

The multicode ^ sequence instructs the terminal not to scroll when a video attribute character is received.

## 5.19 MULTICODE p (ENTER/EXIT SCREEN PROGRAM MODE)

Entering a multicode p sequence from the keyboard places the terminal in local mode and enables the operator to set formatted fields. For details on defining the formatted fields see Section 4.8.1.

## 5.20 MULTICODE S x y (SET BUFFER ADDRESS)

The multicode S sequence moves the buffer address (i.e., the screen position into which data is being written from the communications line) to anywhere on the screen without changing the cursor address (the position at which keyboard data is entered). Line and character addresses are specified by the two characters which follow the multicode S sequence (x y). Any subsequent multicode sequence involving cursor movement, including toggle page, automatically resets the buffer address to the cursor address.

## 5.21 MULTICODE & (TOGGLE PAGE)

The multicode & sequence toggles the page displayed when the terminal is set for independent two-page display.

## 5.22 MULTICODE oS (DEFAULT SET-UP CONFIGURATION)

Upon receipt of a multicode oS sequence, all active set-up conditions are set to their default values. The default configuration values are provided in Section 3.6.

## 5.23 MULTICODE o9 (DISPLAY FIRMWARE REVISION)

In response to this sequence, the terminal displays the revision of the firmware. The last character of the field is the error code from the power-up or diagnostic test/reset (multicode o!) operation. A space in this position indicates no error. If a character appears in this position, an error occurred. See Section 2.3 for a description of these error codes.

## 5.24 POLLING

The following sections describe the multicode sequences used in a polling environment.

### 5.24.1 Multicode \* (Broadcast)

All terminals are selected to receive subsequent data from the host. No terminal may transmit. This sequence can only be issued from the host.

### 5.24.2 Multicode + xx yy ... STX (Group/Fast Select)

The host only designates terminals that receive the subsequent data. The characters following the + are the polling selection addresses for those terminals. The polling selection for each terminal must be transmitted twice prior to transmitting the next polling selection address. The host must append the polling selection addresses with the ASCII STX to indicate that no other terminals are to receive data. During this sequence, which can only be initiated by the host, no terminal may transmit.

### 5.24.3 Multicode P xx (Poll Select)

The characters following the P in this multicode sequence are the poll selection address of the terminal currently being polled by the host computer. The polling selection address must be issued twice. If transmission from the terminal does not occur, the Model 6312 VDU responds with the ASCII EOT to indicate this to the host.

**APPENDIX A  
MULTICODE SEQUENCES**

Table A-1 provides a summary of the multicode sequences used with the Model 6312 video display unit (VDU). Details on these multicode sequences are provided in Chapter 5.

The escape (ESC) character is normally designated as the multicode character. This designation normally occurs during set-up configuration. For example, the transmission of the two ASCII characters ESC and A, either from the keyboard or the host computer, moves the cursor up one line.

**TABLE A-1 MULTICODE SEQUENCE SUMMARY**

| MULTICODE SEQUENCE | FUNCTION                         |
|--------------------|----------------------------------|
| Multicode A        | Cursor Up                        |
| Multicode B        | Cursor Down                      |
| Multicode C        | Cursor Right                     |
| Multicode D        | Cursor Left                      |
| Multicode E        | Set Full Screen Mode             |
| Multicode F        | Set Partial Screen Mode          |
| Multicode G        | Set Conversational Mode          |
| Multicode H        | Cursor Home                      |
| Multicode I        | Clear Line                       |
| Multicode J        | Clear Unprotected                |
| Multicode K        | Clear All                        |
| Multicode L        | Insert Line                      |
| Multicode M        | Delete Line                      |
| *Multicode N n     | Insert Character                 |
| Multicode O        | Delete Character                 |
| *Multicode P xx    | Poll Select                      |
| Multicode Q        | Reset Modify Data Tags           |
| Multicode R        | Request to Send                  |
| *Multicode S x y   | Set Buffer Address               |
| Multicode T        | Insert Cursor - Line Only        |
| Multicode U        | Set Send Immediate All           |
| Multicode V        | Set Send Immediate Unprotected   |
| Multicode W        | Set Send Immediate Modified      |
| *Multicode X x     | Direct Cursor Address - Line     |
| *Multicode Y y     | Direct Cursor Address - Column   |
| Multicode Z        | Read Cursor Address              |
| Multicode g        | Enable 80-Character Message Line |
| Multicode h        | Display Status Line              |

TABLE A-1 MULTICODE SEQUENCE SUMMARY (Continued)

| MULTICODE SEQUENCE            | FUNCTION                           |
|-------------------------------|------------------------------------|
| *Multicode n                  | Write 80-Character Message Line    |
| *Multicode o!                 | Diagnostic Test/Reset              |
| *Multicode oS                 | Default Set-Up Configuration       |
| *Multicode o9                 | Display Firmware Revision          |
| Multicode p                   | Enter/Exit Screen Program Mode     |
| Multicode l                   | Set Tab                            |
| Multicode 2                   | Clear Tabs                         |
| Multicode 3                   | Clear All Tabs                     |
| Multicode 4                   | Move Cursor to Status Line         |
| Multicode 5                   | Return Cursor from Status Line     |
| Multicode 6                   | Read Configuration Update          |
| Multicode 7                   | RAM Configuration Update           |
| Multicode 8                   | Lock Light Pen - Line Only         |
| Multicode 9                   | Unlock Light Pen - Line Only       |
| Multicode 0                   | Configuration Checksum             |
| Multicode (space)             | Blank Display                      |
| *Multicode !x                 | Set Attribute Byte                 |
| Multicode #                   | Configuration Ready                |
| Multicode \$                  | Read Status Immediate              |
| Multicode %                   | Read Status When Ready             |
| Multicode &                   | Toggle Page                        |
| Multicode (                   | Lock Keyboard - Line Only          |
| Multicode )                   | Unlock Keyboard - Line Only        |
| Multicode -                   | EAROM Configuration Update         |
| Multicode .                   | Disable Attributes                 |
| Multicode /                   | Enable Attributes                  |
| *Multicode <x                 | Send Key Override - Line Only      |
| Multicode =                   | Read All                           |
| Multicode >                   | Read Unprotected                   |
| Multicode ?                   | Read Modified                      |
| Multicode @                   | Restore Screen                     |
| Multicode [                   | Enable Status Line Display         |
| Multicode ]                   | Disable Status Line Display        |
| *Multicode :n                 | Fill Screen                        |
| *Multicode ;x                 | Set Print Options                  |
| Multicode ^                   | Scroll Off With Attribute          |
| Multicode _                   | Scroll On With Attribute           |
| Multicode                     | Backtab                            |
| Multicode }                   | Last                               |
| *Multicode ~1                 | Blank Cursor                       |
| *Multicode ~2                 | Restore Cursor                     |
| *Multicode " x                | Set Attribute Byte Light Pen Field |
| Multicode *                   | Broadcast                          |
| *Multicode + xx yy<br>... STX | Group/Fast Select                  |
| Multicode DEL                 | Display Hash Mark                  |
| Multicode multicode           | Display Escape                     |

\*Multiple Character Sequences

**APPENDIX B  
CURSOR ADDRESSING CHART**

| ASCII | HEX | CHARACTER<br>LINE | CHARACTER<br>COLUMN | ASCII | HEX | CHARACTER<br>COLUMN |
|-------|-----|-------------------|---------------------|-------|-----|---------------------|
| (SP)  | 20  | 1                 | 1                   | H     | 48  | 41                  |
| !     | 21  | 2                 | 2                   | I     | 49  | 42                  |
| "     | 22  | 3                 | 3                   | J     | 4A  | 43                  |
| #     | 23  | 4                 | 4                   | K     | 4B  | 44                  |
| \$    | 24  | 5                 | 5                   | L     | 4C  | 45                  |
| %     | 25  | 6                 | 6                   | M     | 4D  | 46                  |
| &     | 26  | 7                 | 7                   | N     | 4E  | 47                  |
| '     | 27  | 8                 | 8                   | O     | 4F  | 48                  |
| (     | 28  | 9                 | 9                   | P     | 50  | 49                  |
| )     | 29  | 10                | 10                  | Q     | 51  | 50                  |
| *     | 2A  | 11                | 11                  | R     | 52  | 51                  |
| +     | 2B  | 12                | 12                  | S     | 53  | 52                  |
| ,     | 2C  | 13                | 13                  | T     | 54  | 53                  |
| -     | 2D  | 14                | 14                  | U     | 55  | 54                  |
| .     | 2E  | 15                | 15                  | V     | 56  | 55                  |
| /     | 2F  | 16                | 16                  | W     | 57  | 56                  |
| 0     | 30  | 17                | 17                  | X     | 58  | 57                  |
| 1     | 31  | 18                | 18                  | Y     | 59  | 58                  |
| 2     | 32  | 19                | 19                  | Z     | 5A  | 59                  |
| 3     | 33  | 20                | 20                  | [     | 5B  | 60                  |
| 4     | 34  | 21                | 21                  | \     | 5C  | 61                  |
| 5     | 35  | 22                | 22                  | ]     | 5D  | 62                  |
| 6     | 36  | 23                | 23                  | ^     | 5E  | 63                  |
| 7     | 37  | 24                | 24                  | _     | 5F  | 64                  |
| 8     | 38  |                   | 25                  | `     | 60  | 65                  |
| 9     | 39  |                   | 26                  | a     | 61  | 66                  |
| :     | 3A  |                   | 27                  | b     | 62  | 67                  |
| ;     | 3B  |                   | 28                  | c     | 63  | 68                  |
| <     | 3C  |                   | 29                  | d     | 64  | 69                  |
| =     | 3D  |                   | 30                  | e     | 65  | 70                  |
| >     | 3E  |                   | 31                  | f     | 66  | 71                  |
| ?     | 3F  |                   | 32                  | g     | 67  | 72                  |
| @     | 40  |                   | 33                  | h     | 68  | 73                  |
| A     | 41  |                   | 34                  | i     | 69  | 74                  |
| B     | 42  |                   | 35                  | j     | 6A  | 75                  |
| C     | 43  |                   | 36                  | k     | 6B  | 76                  |
| D     | 44  |                   | 37                  | l     | 6C  | 77                  |
| E     | 45  |                   | 38                  | m     | 6D  | 78                  |
| F     | 46  |                   | 39                  | n     | 6E  | 79                  |
| G     | 47  |                   | 40                  | o     | 6F  | 80                  |





## APPENDIX C ASCII CODING CHART

030-20

|                          |    |    |    |              | CONTROL CODES |     | DISPLAYABLE CHARACTERS |   |   |   |   |     |   |
|--------------------------|----|----|----|--------------|---------------|-----|------------------------|---|---|---|---|-----|---|
| BITS<br>B<br>I<br>T<br>S | b7 | b6 | b5 |              | 0             | 0   | 0                      | 0 | 1 | 1 | 1 | 1   | 1 |
|                          |    |    |    | COL.<br>ROW. | 0             | 1   | 2                      | 3 | 4 | 5 | 6 | 7   |   |
|                          | 0  | 0  | 0  | 0            | NUL           | DLE | SP                     | 0 | @ | P | ` | p   |   |
|                          | 0  | 0  | 0  | 1            | SOH           | DC1 | !                      | 1 | A | Q | a | q   |   |
|                          | 0  | 0  | 1  | 0            | STX           | DC2 | "                      | 2 | B | R | b | r   |   |
|                          | 0  | 0  | 1  | 1            | ETX           | DC3 | #                      | 3 | C | S | c | s   |   |
|                          | 0  | 1  | 0  | 0            | EOT           | DC4 | \$                     | 4 | D | T | d | t   |   |
|                          | 0  | 1  | 0  | 1            | ENQ           | NAK | %                      | 5 | E | U | e | u   |   |
|                          | 0  | 1  | 1  | 0            | ACK           | SYN | &                      | 6 | F | V | f | v   |   |
|                          | 0  | 1  | 1  | 1            | BEL           | ETB | '                      | 7 | G | W | g | w   |   |
|                          | 1  | 0  | 0  | 0            | BS            | CAN | (                      | 8 | H | X | h | x   |   |
|                          | 1  | 0  | 0  | 1            | HT            | EM  | )                      | 9 | I | Y | i | y   |   |
|                          | 1  | 0  | 1  | 0            | LF            | SUB | *                      | : | J | Z | j | z   |   |
|                          | 1  | 0  | 1  | 1            | VT            | ESC | +                      | ; | K | [ | k | {   |   |
|                          | 1  | 1  | 0  | 0            | FF            | FS  | ,                      | < | L | \ | l | l   |   |
|                          | 1  | 1  | 0  | 1            | CR            | GS  | -                      | = | M | ] | m | }   |   |
|                          | 1  | 1  | 1  | 0            | SO            | RS  | .                      | > | N | ^ | n | ~   |   |
|                          | 1  | 1  | 1  | 1            | SI            | US  | /                      | ? | O | _ | o | DEL |   |



## INDEX

|   |      |   |      |
|---|------|---|------|
| A   |      |   |      |
| Address                                   |      | Clear (CLEAR/DELETE) key                    | 4-9  |
| poll                                      | 3-26 | Clear to spaces option<br>(CLEAR TO SPACES) | 3-9  |
| ASCII                                     |      | Clearing operation multicode                |      |
| character set                             | 4-2  | 2 (clear tabs)                              | 5-5  |
| coding chart                              | C-1  | 3 (clear all tabs)                          | 5-5  |
| control characters                        | 4-2  | I (clear line)                              | 5-5  |
| Attribute byte format                     | 5-9  | J (clear unprotected)                       | 5-5  |
| Attribute byte multicode                  |      | K (clear all)                               | 5-6  |
| !x (set attribute byte)                   | 5-10 | Communication options                       |      |
| " x (set light pen field)                 | 5-10 | category                                    | 3-9  |
| . (disable attributes)                    | 5-10 | Communication terminator                    |      |
| / (enable attributes)                     | 5-10 | options category                            | 3-14 |
| Auto line feed option (AUTO<br>LINE FEED) | 3-6  | Configuration by host                       | 3-20 |
| Auto-repeat feature                       | 4-15 | ll3J setting                                | 3-26 |
| Auto tab option (AUTO TAB)                | 3-6  | baud rate setting                           | 3-25 |
| Auxiliary port (AUX PORT) key             | 4-7  | control protect function<br>and edit keys   | 3-27 |
|   |      | format                                      | 3-26 |
|   |      | function key definition                     | 3-31 |
|   |      | general terminal<br>attributes              | 3-24 |
|   |      | lockout function and<br>edit keys           | 3-28 |
|   |      | modes and terminal<br>features              | 3-25 |
|   |      | multicode character<br>selection            | 3-26 |
|   |      | parity setting                              | 3-25 |
|   |      | poll address                                | 3-26 |
|   |      | printer port operations                     | 3-28 |
|   |      | right margin warning bell                   | 3-24 |
|   |      | scrolling                                   | 3-26 |
|   |      | terminator character<br>sequences           | 3-30 |
|   |      | Configuration by the operator               | 3-19 |
|   |      | Configuration checksum,<br>multicode 0      | 5-15 |
|   |      | Configuration menu                          | 3-1  |
|   |      | Configuration options                       |      |
|   |      | categories                                  |      |
|   |      | communication                               | 3-9  |
|   |      | communication terminator                    | 3-14 |
|   |      | function key definitions                    | 3-18 |
|   |      | international font<br>selection             | 3-14 |
|   |      | keyboard                                    | 3-4  |
|   |      | mode control                                | 3-5  |
|   |      | printer port                                | 3-12 |
|   |      | special characters                          | 3-16 |
|   |      | systems                                     | 3-7  |
|   |      | Configurations                              |      |
|   |      | standard                                    | 3-35 |
|   |      | Controls                                    |      |
|   |      | operator                                    | 1-6  |
|   |      | Cursor addressing chart                     | B-1  |
|   |      | Cursor control keys                         |      |
|   |      | down (↓)                                    | 4-14 |
|   |      | left (←)                                    | 4-14 |
|   |      | right (→)                                   | 4-14 |
|   |      | up (↑)                                      | 4-13 |
| B   |      |   |      |
| Backspace (BACKSPACE) key                 | 4-5  |   |      |
| Backtab, multicode                        | 5-5  |   |      |
| Backtab (TAB) key                         | 4-13 |   |      |
| Baud rate option                          |      |   |      |
| communications                            | 3-12 |   |      |
| printer port                              | 3-13 |   |      |
| Blank/restore screen<br>multicode         |      |   |      |
| @ (restore screen)                        | 5-4  |   |      |
| space (blank display)                     | 5-4  |   |      |
| Blinking cursor option<br>(BLINK CURSOR)  | 3-7  |   |      |
| Block cursor option (BLOCK<br>CURSOR)     | 3-7  |   |      |
| Block mode option (BLOCK)                 | 3-10 |   |      |
| Block mode read request<br>multicode      |      |   |      |
| = (read all)                              | 5-12 |   |      |
| > (read unprotected)                      | 5-12 |   |      |
| ? (read modified)                         | 5-12 |   |      |
| Q (reset modified data<br>tag)            | 5-12 |   |      |
| Block mode transmission<br>formats        |      |   |      |
| all data                                  | 4-27 |   |      |
| host read requests                        | 4-26 |   |      |
| request to send                           | 1-9  |   |      |
|   | 4-25 |   |      |
| send immediate                            | 1-9  |   |      |
|   | 4-25 |   |      |
| unprotected field data                    | 4-27 |   |      |
| Break (BREAK) key                         | 4-12 |   |      |
| Broadcast                                 | 4-34 |   |      |
| C   |      |   |      |
| Cap lock (CAP LOCK) key                   | 4-7  |   |      |



|   |      |   |      |
|---|------|---|------|
| K                                       |      |   |      |
| Key click option (KEY CLICK)            | 3-7  | Modified field data transmission                  |      |
| Keyboard                                |      | line  | 4-30 |
| features                                | 1-3  | message   | 4-30 |
| functions                               | 4-6  | page  | 4-31 |
| international fonts                     | 3-14 | Multicode   |      |
| specifications                          | 1-5  | character   | 5-1  |
| Keyboard control option (KBD CTRL)      | 3-4  | sequence summary                                  | A-1  |
| Keyboard lock option (KBD LOCK)         | 3-5  | Multicode character option (MULTICODE CHAR)       | 3-17 |
| Keyboard options category               | 3-4  | Multicode sequences. See individual operations.   |      |
| L                                       |      | N   |      |
| Light pen                               |      | New line option (NEW LINE)                        | 3-6  |
| operation                               | 4-36 | Null suppression/formatted option                 | 3-11 |
| recommendations for use                 | 4-40 | Null suppression/unformatted option               | 3-10 |
| Light pen fields                        | 4-41 | O   |      |
| composition                             | 4-39 | Operation modes                                   | 1-6  |
| defining                                | 4-39 | Operation of terminal                             | 4-1  |
| designator character                    | 4-39 | Operator controls                                 | 1-6  |
| operation                               | 4-39 | P,Q   |      |
| padding character                       | 4-39 | Page edit/insert mode (PG EDT/INSERT MODE) key    | 4-10 |
| send all                                | 4-37 | Page/new line (PAGE/NEW LINE) key                 | 4-12 |
| send modified                           | 4-37 | Parity option (ODD, EVN, MRK, SPC) communication  | 3-12 |
| send unprotected                        | 4-37 | printer port                                      | 3-13 |
| transmitting                            | 4-37 | Pause character option (PAUSE CHAR)               | 3-17 |
| Line drawing option (LINE DRAWING)      | 3-12 | Poll  | 4-35 |
| Line feed (LINE FEED) key               | 4-11 | Polled environment                                | 1-11 |
| Lock keyboard - line only, multicode (  | 5-3  | Polled option (POLLED)                            | 3-10 |
| Lock light pen - line only, multicode 8 | 5-4  | Polling   | 4-32 |
| Lock/unlock operation multicode         |      | broadcast message                                 | 4-34 |
| ( lock keyboard - line)                 | 5-3  | group/fast select                                 | 4-34 |
| 7 (unlock keyboard - line)              | 5-4  | Polling multicode                                 |      |
| 8 (lock light pen - line)               | 5-4  | * (broadcast)                                     | 5-18 |
| 9 (unlock light pen - line)             | 5-4  | + xx yy (group/fast select)                       | 5-18 |
| M                                       |      | P xx (poll select)                                | 5-18 |
| Message line                            |      | Polling/selection address option (POLL CHAR)      | 3-17 |
| description                             | 4-20 | Power specifications                              | 1-6  |
| operation                               | 5-7  | Power-up on-line option (PWR UP ON LINE)          | 3-8  |
| Message line multicode                  |      | Power-up/reset self-test                          | 2-2  |
| g (enable message line)                 | 5-8  | Print (PRINT) key                                 | 4-7  |
| m (write message line)                  | 5-8  | Print line, message, page option (LINE, MSG, PAG) | 3-13 |
| Mode control options                    | 3-5  | Print line terminator option (PRINT LINE)         | 3-16 |
| Modes of operation                      |      | Printer port options category                     | 3-12 |
| block                                   | 1-9  |   |      |
| business graphics                       | 1-10 |   |      |
| conversational                          | 1-8  |   |      |
| full-/half-duplex                       | 1-8  |   |      |
| local                                   | 1-7  |   |      |
| screen program                          | 1-10 |   |      |
| set-up configuration                    | 1-6  |   |      |
| transparent                             | 1-7  |   |      |

| R   |      |  |      |
|---|------|--|------|
| RAM configuration update,<br>multicode 7              | 5-15 | Set-up configuration                           | 3-1  |
| Random access memory. See<br>RAM.                     |      | Set-up/status (SET<br>UP/STATUS) key           | 4-7  |
| Reading configuration<br>parameters (host computer)   | 3-35 | Setting formatted fields                       |      |
| Reading terminal status<br>multicodes                 |      | communications line                            | 4-25 |
| \$ (read status immediate)                            | 5-15 | screen program mode                            | 4-24 |
| % (read status when<br>ready)                         | 5-15 | via keyboard                                   | 4-24 |
| Ready option (READY (-))                              | 3-13 | Setting print options                          |      |
| Request to send, multicode R                          | 5-11 | multicode ;x (set print<br>options)            | 5-13 |
| Request to send terminator<br>option (REQ TO SEND)    | 3-16 | Setting transmission mode<br>multicodes        |      |
| Reset modified data tag,<br>multicode Q               | 5-12 | G (set conversational<br>mode)                 | 5-11 |
| Restore screen, multicode @                           | 5-4  | R (request to send)                            | 5-11 |
| Resume character option<br>(RESUME CHAR)              | 3-17 | U (set send immediate<br>all)                  | 5-11 |
| Return (RETURN) key                                   | 4-5  | V (set send immediate<br>unprotected)          | 5-11 |
| Return=send option (RETURN =<br>SEND)                 | 3-8  | W (set send immediate<br>modified)             | 5-12 |
| Reverse/normal background<br>(BK GND REV/NORM) key    | 4-12 | Shift (SHIFT) key                              | 4-7  |
| Ring bell option (RING BELL)                          | 3-17 | Single character ASCII<br>functions            |      |
|   |      | backspace (BACKSPACE)                          | 4-5  |
|   |      | bell   | 4-5  |
|   |      | delete (CLEAR/DELETE)                          | 4-6  |
|   |      | displayable characters                         | 4-5  |
|   |      | local escape/escape                            | 4-6  |
|   |      | return (RETURN)                                | 4-5  |
|   |      | space  | 4-5  |
|   |      | tab (TAB)                                      | 4-6  |
|   |      | Smooth scrolling option<br>(SMOOTH SCROLL)     | 3-7  |
|   |      | Special characters category                    | 3-16 |
|   |      | Specifications                                 |      |
|   |      | communications                                 | 1-5  |
|   |      | environmental                                  | 1-6  |
|   |      | keyboard                                       | 1-5  |
|   |      | physical                                       | 1-4  |
|   |      | power  | 1-6  |
|   |      | screen   | 1-4  |
|   |      | Standard configurations                        | 3-35 |
|   |      | Status byte                                    |      |
|   |      | format   | 5-16 |
|   |      | Status line description                        | 4-17 |
|   |      | auxiliary port field                           | 4-20 |
|   |      | column number field                            | 4-18 |
|   |      | communications field                           | 4-19 |
|   |      | error indicator field                          | 4-19 |
|   |      | line number field                              | 4-18 |
|   |      | modem field                                    | 4-19 |
|   |      | page number field                              | 4-18 |
|   |      | reminder field                                 | 4-20 |
|   |      | scroll hold key field                          | 4-20 |
|   |      | send mode field                                | 4-19 |
|   |      | user area field                                | 4-18 |
|   |      | Status line display option<br>(DSPLAY STAT LN) | 3-8  |
|   |      | Status line multicodes                         |      |
|   |      | 4 (move cursor to status<br>line)              | 5-7  |
|   |      | 5 (return cursor from<br>status line)          | 5-7  |
|   |      | h (display status line)                        | 5-7  |
|   |      |  |      |
| S   |      |  |      |
| Screen fill diagnostic test                           | 2-3  |  |      |
| Screen refresh rate option<br>(60Hz)                  | 3-9  |  |      |
| Screen saver option (SCREEN<br>SAVE)                  | 3-7  |  |      |
| Screen specifications                                 | 1-4  |  |      |
| Scroll (SCROLL) key                                   | 4-12 |  |      |
| Scroll multicodes                                     |      |  |      |
| ^ (off with attribute)                                | 5-17 |  |      |
| _ (on with attribute)                                 | 5-17 |  |      |
| Scroll option (SCROLL)                                | 3-6  |  |      |
| Send (SEND) key                                       | 4-11 |  |      |
| Send clear all option (SEND<br>CLEAR ALL)             | 3-9  |  |      |
| Send cursor and edit keys<br>option (SEND CRSR, EDIT) | 3-9  |  |      |
| Send key override - line,<br>multicode <x             | 5-11 |  |      |
| Send line, message, page<br>option (LINE,MSG,PAG)     | 3-11 |  |      |
| Send line terminator option<br>(SEND LINE)            | 3-15 |  |      |
| Send message (SEND MSG) key                           | 4-11 |  |      |
| Send status line option<br>(SEND STAT LINE)           | 3-8  |  |      |
| Sending screen data<br>multicodes                     |      |  |      |
| <x (key override - line<br>only)                      | 5-11 |  |      |
| E (set full screen mode)                              | 5-10 |  |      |
| Set buffer address,<br>multicode S x y                | 5-17 |  |      |

|                                 |     |
|---------------------------------|-----|
| Status line multICODES          |     |
| (Continued)                     |     |
| [ (enable status line display)  | 5-7 |
| ] (disable status line display) | 5-7 |
| Systems options category        | 3-7 |

T

|                          |      |
|--------------------------|------|
| Tab (TAB) key            | 4-6  |
| Tab operation multICODES | 5-4  |
| 1 (set tab)              | 5-5  |
| 2 (clear tabs)           | 5-5  |
| 3 (clear all tabs)       | 5-5  |
| (backtab)                | 5-5  |
| Terminal                 |      |
| features                 | 1-2  |
| Testing                  |      |
| functional               | 2-1  |
| power-up/reset self-test | 2-2  |
| screen fill diagnostic   | 2-3  |
| VDU                      | 2-3  |
| Toggle page, multICODE & | 5-18 |

U

|  |      |
|--|------|
| Unformatted line terminator option (UNFORMAT LINE) | 3-15 |
| Unformatted page terminator option (UNFORMAT PG)   | 3-16 |
| Unlock keyboard - line only, multICODE )           | 5-4  |
| Unlock light pen multICODE 9 (line only)           | 5-4  |
| Unprotected field data transmission                |      |
| line   | 4-29 |
| message  | 4-29 |
| page   | 4-29 |
| Upper-case option (UPPER CASE)                     | 3-6  |

V,W

|                              |     |
|------------------------------|-----|
| VDU test (06-295)            | 2-3 |
| Video display unit. See VDU. |     |

X,Y,Z

|                            |      |
|----------------------------|------|
| XON/XOFF option (XON/XOFF) | 3-11 |
| 113J option (113J)         | 3-11 |







FOLD

FOLD



NO POSTAGE  
NECESSARY  
IF MAILED  
IN THE  
UNITED STATES

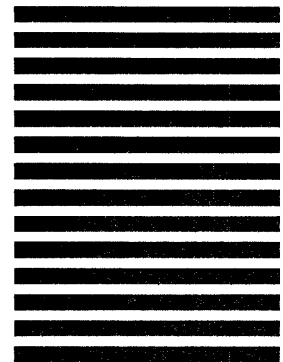

**BUSINESS REPLY MAIL**  
FIRST CLASS      PERMIT NO. 22      OCEANPORT, NJ

POSTAGE WILL BE PAID BY ADDRESSEE

**Concurrent Computer Corporation**  
2 Crescent Place  
Oceanport, NJ 07757

**ATTN:**  
**DOCUMENTATION DESIGN & DEVELOPMENT, M.S. 345**

FOLD

FOLD

STAPLE

STAPLE



# Document Comment Form

In reference to...

Manual Title

Number & Revision Level

We try to make our documentation easy to use, easy to understand, and free from errors. We invite your comments and suggestions to assist us in improving our documentation to suit your needs.

Please send us comments, corrections, suggestions, etc. Use the SCR system to report software documentation or software problems.

I think this manual...

|                                     | Strongly Agree           | Agree                    | Disagree                 | Strongly Disagree        |
|-------------------------------------|--------------------------|--------------------------|--------------------------|--------------------------|
| is easy to read                     | <input type="checkbox"/> | <input type="checkbox"/> | <input type="checkbox"/> | <input type="checkbox"/> |
| is easily understood                | <input type="checkbox"/> | <input type="checkbox"/> | <input type="checkbox"/> | <input type="checkbox"/> |
| is concise & to the point           | <input type="checkbox"/> | <input type="checkbox"/> | <input type="checkbox"/> | <input type="checkbox"/> |
| covers the subject                  | <input type="checkbox"/> | <input type="checkbox"/> | <input type="checkbox"/> | <input type="checkbox"/> |
| has enough detail                   | <input type="checkbox"/> | <input type="checkbox"/> | <input type="checkbox"/> | <input type="checkbox"/> |
| is well organized                   | <input type="checkbox"/> | <input type="checkbox"/> | <input type="checkbox"/> | <input type="checkbox"/> |
| provides easy-to-locate information | <input type="checkbox"/> | <input type="checkbox"/> | <input type="checkbox"/> | <input type="checkbox"/> |
| is aesthetically pleasing           | <input type="checkbox"/> | <input type="checkbox"/> | <input type="checkbox"/> | <input type="checkbox"/> |
| has clear illustrations             | <input type="checkbox"/> | <input type="checkbox"/> | <input type="checkbox"/> | <input type="checkbox"/> |
| has enough illustrations            | <input type="checkbox"/> | <input type="checkbox"/> | <input type="checkbox"/> | <input type="checkbox"/> |
| has meaningful examples             | <input type="checkbox"/> | <input type="checkbox"/> | <input type="checkbox"/> | <input type="checkbox"/> |
| has a helpful index                 | <input type="checkbox"/> | <input type="checkbox"/> | <input type="checkbox"/> | <input type="checkbox"/> |

My other comments...

Please make any additional specific comments. (Include chapter, page, table or figure number.)

\_\_\_\_\_  
\_\_\_\_\_  
\_\_\_\_\_

About myself...

Job Function:  Dev. Engineer     Sys. Analyst     Sys./App. Prog.  
 Technician     Administrator     Casual user  
 Service Eng.     Operator     Other \_\_\_\_\_

What hardware system are you using? \_\_\_\_\_

What revision level of system software are you using? \_\_\_\_\_

Name/Title: \_\_\_\_\_

Company/Organization: \_\_\_\_\_

Address: \_\_\_\_\_

May we contact you?     Yes     No

Telephone: \_\_\_\_\_                      Date: \_\_\_\_\_

FOLD

FOLD



NO POSTAGE  
NECESSARY  
IF MAILED  
IN THE  
UNITED STATES

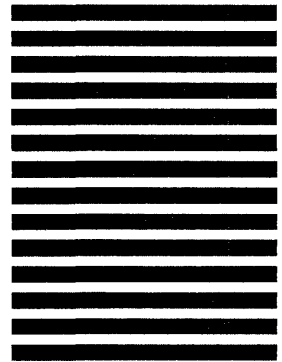

**BUSINESS REPLY MAIL**  
FIRST CLASS      PERMIT NO. 22      OCEANPORT, NJ

POSTAGE WILL BE PAID BY ADDRESSEE

**Concurrent Computer Corporation**  
2 Crescent Place  
Oceanport, NJ 07757

**ATTN:  
DOCUMENTATION DESIGN & DEVELOPMENT, M.S. 345**

FOLD

FOLD

STAPLE

STAPLE