

Installing and Customizing the AIX Operating System

Programming Family



Personal
Computer
Software

Installing and Customizing the AIX Operating System

Programming Family



Personal
Computer
Software

First Edition (January 1987)

This edition applies to Version 2.1 of AIX Operating System, and to all subsequent releases until otherwise indicated in new editions or technical newsletters. Changes are made periodically to the information herein; these changes will be reported in technical newsletters or in new editions of this publication.

References in this publication to IBM products, programs, or services do not imply that IBM intends to make these available in all countries in which IBM operates. Any reference to an IBM licensed program in this publication is not intended to state or imply that only IBM's licensed program may be used. Any functionally equivalent program may be used instead.

International Business Machines Corporation provides this manual "as is," without warranty of any kind, either express or implied, including, but not limited to, the implied warranties of merchantability and fitness for a particular purpose. IBM may make improvements and/or changes in the product(s) and/or the program(s) described in this manual at any time.

Products are not stocked at the address given below. Requests for copies of this product and for technical information about the system should be made to your authorized IBM RT PC dealer or your IBM marketing representative.

A reader's comment form is provided at the back of this publication. If the form has been removed, address comments to IBM Corporation, Department 997, 11400 Burnet Road, Austin, Texas 78758. IBM may use or distribute whatever information you supply in any way it believes appropriate without incurring any obligation to you.

About This Book

Purpose

This book discusses how to install the IBM RT Personal Computer² Advanced Interactive Executive (AIX¹) Operating System and how to customize your IBM RT² PC system to suit your needs. The step-by-step instructions enable you to install the operating system with IBM-supplied defaults or to change those defaults. The operating system consists of the Virtual Resource Manager Program, the Base System Program, and several additional operating system programs.

With the **devices** command, you can customize your RT PC² by adding or deleting various components or by changing information about those components. The **minidisks** command enables you to add, delete, or modify user-defined minidisks (divisions on the fixed disks in your system).

Who Should Read This Book

This book is designed both for those who are unfamiliar with computer systems and for those who have computer systems experience. The step-by-step instructions explain how you can install the operating system and how you can change choices to

¹ AIX is a trademark of International Business Machines Corporation

² RT, RT PC, and RT Personal Computer are trademarks of International Business Machines Corporation

suit your own system needs. The AIX Operating System is based on UNIX³ System V.

Before You Begin

Before you use the instructions in this book, make certain that your IBM RT PC system hardware is installed. You should also be familiar with your system keyboard and have the AIX Operating System diskettes at hand.

How to Use This Book

The operating system installation program is menu-driven; that is, you will be presented with a list of items from which you are to choose. After you select an item and press **Enter**, you may be asked to supply information. But the installation procedures are set up for you.

Before you select an option, you should read enough about the various installation options to understand exactly what each option does. Then, knowing your own system needs and requirements, you can decide which option to choose.

The same guidelines apply to the chapters on using the **devices** and **minidisks** commands. You should understand the various options before selecting one. Understanding how the **minidisks** command works is especially important. The more early planning you do for arranging the minidisks on your fixed disk, the more time you will save later.

Chapter 1, "Planning For Installation" explains how to plan ahead for minidisk space allocation. It describes the types of minidisks used on the RT PC, the data capacity of the available fixed disks, and minidisk space requirements for Base System Program files and optionally available licensed programs.

³ UNIX is a registered trademark of AT&T Bell Laboratories

Chapter 2, “Getting Ready to Install the AIX Operating System” introduces the operating system and its functions. It also discusses which keys on your IBM RT PC you will use to install the Virtual Resource Manager Program and the AIX Operating System. In addition, it explains how to turn on the system and how to handle and load your diskettes.

Chapter 3, “Installing the VRM Program” shows you how to select the keyboard layout you want to use with RT PC and guides you through three options in the installation program. These options are installing the VRM with current choices, showing current and recommended choices, and changing current choices and installing the VRM.

Chapter 4, “Installing the AIX Operating System” discusses how to install the AIX Operating System with defaults; it also discusses how to see and change values for the AIX minidisks.

Chapter 5, “Installing Additional Operating System Programs” discusses how to install the additional programs that are part of the operating system. It also explains how operating system programs are updated from time to time.

Chapter 6, “Customizing System Devices” discusses how you can add, delete, or change information about IBM RT PC devices.

Chapter 7, “Customizing System Minidisks” discusses how to add, change, and delete user-defined minidisks on system fixed disks.

Appendix A, “Enlarging the VRM and Page Space Minidisks” discusses the VRM defaults and steps to increase the size of the VRM minidisk and the page space minidisk. This procedure involves backing up files from one or more minidisks, deleting minidisks, creating new minidisks, and restoring files.

Appendix B, “Keyword Descriptions” describes the most common keywords found in device-dependent information files. These keywords identify attributes, especially for printers, that you can change to suit your needs. Understanding how the keywords relate to specific devices and commands helps you know whether you want to change the settings.

Appendix C, “Special Processing for Devices and Minidisks” discusses how to change some files in order to complete the special processing that occurs when you add or delete certain system devices and add minidisks.

Appendix D, “Installing the VRM with Non-IBM RT PC Hardware” explains how to install the VRM if you have a display produced by another manufacturer or produced by IBM (but not supported for use with the IBM RT PC).

Appendix E, “Conflicting Adapter Levels” discusses conflicts that you might encounter with the various adapters that you install in your system. This appendix helps you prepare for and correct these conflicts during installation.

The Glossary defines terms that you may find unfamiliar. Terms appearing in bold italics in the book are defined in the Glossary.

A Reader’s Comment Form and Book Evaluation Form are provided at the back of this book. Use the Reader’s Comment Form at any time to give IBM information that may improve the book. After you become familiar with the book, use the Book Evaluation Form to give IBM specific feedback about the book.

How Each Chapter Is Organized

Most of the chapters have the same basic structure. For each major task, you will find a brief discussion of the task and a quick-reference box containing the steps for performing that option. For some tasks, you also will see additional screens and technical information under the heading, “More Detailed Information.”

Typically, the quick reference box contains no examples or sample screens or additional information. It serves only as a reference or as a reminder of the basic steps. Here is an example:

To Get Ready to Install

1. Turn the key to the unlocked position.
2. Turn on the power switch.
3. Insert the Installation/Maintenance diskette into the top diskette drive and close the lever.
4. Press **Ctrl-Alt-Pause**.

You may want to read all of the information on the task before you do it. Remember that the quick reference box is only for reference. It should not take the place of the examples and explanations in the “More Detailed Information” sections.

Related Information

For additional information, you may want to use other guides and reference materials. Here are items you may find useful:

- *IBM RT PC General Information* gives an overview of the RT PC's hardware, software, and communications facilities. It also includes information on international character support. This manual is intended to provide information to help you decide whether to buy an RT PC.
- *IBM RT PC Planning Guide* provides information for site planning and preparation, software planning, and communications planning. The site planning and preparation information includes some physical specifications of the RT PC system units, devices, and cables. The software planning information includes prerequisites, corequisites, and recommended memory for certain software products. The communications planning information includes prerequisites, corequisites, and network configuration requirements of certain communications products. This book should be consulted before ordering RT PC products.
- *IBM RT PC Guide to Operations* describes the IBM 6151 and IBM 6150 system units, the displays, keyboard, and other devices that can be attached. This guide also includes procedures for operating the hardware and moving the IBM 6151 and IBM 6150 system units.
- *IBM RT PC Problem Determination Guide* provides instructions for running diagnostic routines to locate and identify hardware problems. A problem determination guide for software and three high-capacity (1.2MB) diskettes containing the IBM RT PC diagnostic routines are included.
- *IBM RT PC AIX Operating System Communications Guide* provides information and customizing details on communicating with other users in a multiple work station environment and in two system-to-system configurations. One configuration links a single interactive work station with a remote host, and the other links two AIX-based systems for batch file transfer.

-
- *IBM RT PC Using the AIX Operating System* describes using the AIX Operating System commands, working with file systems, and developing shell procedures.
 - *IBM RT PC Managing the AIX Operating System* provides instructions for performing such system management tasks as adding and deleting user IDs, creating and mounting file systems, and repairing file system damage.
 - *IBM RT PC AIX Operating System Commands Reference* lists and describes the AIX Operating System commands.
 - *IBM RT PC Usability Services Guide* shows how to create and print text files, work with directories, start application programs, and do other basic tasks with the Usability Services. (Packaged with *Usability Services Reference*)
 - *IBM RT PC Usability Services Reference* supplements *IBM RT PC Usability Services Guide* by including information on using all of the Usability Services commands. (Packaged with *Usability Services Guide*)
 - *IBM RT PC INed* provides guide and reference information for using the INed program to create and revise files.
 - *IBM RT PC Bibliography and Master Index* provides brief descriptive overviews of the books and tutorial program that support the IBM RT PC hardware and the AIX Operating System. In addition, this book contains an index to the RT PC and AIX Operating System library.
 - *IBM RT PC Virtual Resource Manager Technical Reference* is a two-volume set. The first volume, *Virtual Resource Manager Programming Reference*, describes the VRM programming environment, including the internal VRM routines, VRM floating-point support, use of the VRM debugger, and the supervisor call instructions that form the Virtual Machine Interface. The second volume, *Virtual Resource Manager Device Support*, describes device IPL and configuration, minidisk management, the virtual terminal and block I/O subsystems, as well as the interfaces to the predefined VRM device drivers.

This volume also describes the programming conventions for developing your own VRM code and installing it on the system.

- *IBM RT PC Using AIX Operating System DOS Services* provides step-by-step information for using AIX Operating System DOS Services. (Available optionally; packaged with *IBM RT PC AIX Operating System DOS Services Reference*)
- *IBM RT PC AIX Operating System DOS Services Reference* provides reference information about the AIX Operating System DOS Services. This book also includes information on sharing DOS files with Personal Computer AT Coprocessor Services, and on the differences between PC DOS and DOS Services. (Available optionally; packaged with *IBM RT PC Using AIX Operating System DOS Services*)
- *IBM RT PC Keyboard Description and Character Reference* describes the national character and keyboard support for the 101-key, 102-key, and 106-key keyboards, including keyboard position codes, keyboard states, control code points, code sequence processing, and nonspacing character sequences.

Ordering Additional Copies of This Book

To order additional copies of this publication (without program diskettes), use either of the following sources:

- To order from your IBM representative, use Order Number SBOF-0127.
- To order from your IBM dealer, use Part Number 79X3852.

A binder, Library Overview Card, and Bibliography and Master Index are included with the order.

Contents

Chapter 1. Planning For Installation	1-1
About This Chapter	1-3
Understanding RT PC Software	1-4
Random Access Memory Recommendations	1-6
Planning Ahead for Software Installation	1-8
Minidisk Types	1-8
Fixed-Disk Drive Data Capacity	1-12
Using the Calculation Worksheets	1-13
Minidisk Size Requirements	1-15
Example of Calculating Disk Space Requirements	1-23
Chapter 2. Getting Ready to Install the AIX	
Operating System	2-1
About This Chapter	2-3
Introducing the AIX Operating System	2-4
Identifying Special Keys	2-5
Keyboard	2-5
Keys	2-6
Locating the Keylock and Power Switch	2-9
Handling and Loading Diskettes	2-9
Chapter 3. Installing the VRM Program	3-1
About This Chapter	3-3
Locating the VRM Diskette	3-4
Loading Your VRM Diskette	3-5
Understanding Your Choices	3-7
Selecting the Keyboard for Use with the VRM	3-10
Installing the VRM with Defaults	3-11
Viewing the Choices	3-13
Changing the Choices and Installing the VRM	3-16
Changing Only the Page Space Minidisk	3-20
Changing the Date and Time	3-22
Installing Updates to the Virtual Resource Manager	3-25
Reinstalling the VRM	3-27

Chapter 4. Installing the Base System Program . . .	4-1
About This Chapter	4-3
Previewing Your Installation Options	4-4
Customizing Your System	4-5
Loading the Installation/Maintenance Diskette	4-7
Understanding Your Choices	4-9
Selecting an Installation Option	4-11
Installing the Base System Program with Defaults	4-13
Viewing the Current Choices	4-27
Changing Choices and Installing the AIX Operating System	4-32
Backing Up Your AIX Operating System	4-36
Reinstalling the Base System Program	4-37
Merging the Base System Program with a New Version	4-38
Replacing the Base System Program with a New Version	4-42
Logging In to the AIX Operating System	4-43
Logging Off the AIX Operating System	4-45

Chapter 5. Installing Additional Operating System Programs	5-1
About This Chapter	5-3
Selecting Additional Programs	5-4
INed	5-4
Usability Services	5-4
Asynchronous Terminal Emulation	5-4
Multi-User Services	5-5
Extended Services	5-6
Base PC Network Services	5-7
Update	5-7
Exploring Usability Services	5-7
Interface Program for use with TCP/IP	5-8
VRM Device Driver Diskette	5-8
SNA Services	5-9
Installing Additional Programs	5-10
Installing Programs with Separate Components	5-12
Grouplist Files	5-12
Apply List Files	5-13
History Files	5-13
Updating Additional Programs	5-14
Starting from the AIX Shell, Usability Services, or	
DOS Services	5-17
Starting Usability Services from the AIX Operating System	5-18

Starting Usability Services Automatically	5-19
Starting DOS Services from the AIX Shell	5-20
Starting DOS Services Automatically	5-21
Chapter 6. Customizing System Devices	6-1
About This Chapter	6-3
Using Devices to Customize Your System	6-4
IBM-Defined Devices	6-5
Customization Files	6-8
Configuration Files	6-8
Device-Dependent Information Files	6-9
Getting Ready to Use the Devices Command	6-10
Starting and Exiting Devices	6-11
Using Abbreviated Commands	6-11
Handling Errors	6-12
Adding a Device May Require Restarting the AIX Operating System	6-12
Understanding the Devices Commands	6-13
Adding Devices	6-14
Deleting Devices	6-14
Changing Device Information	6-14
Showing Device Information	6-15
Using the Devices Commands	6-16
Displaying All Devices In Your System	6-17
Displaying Information About Specific Devices	6-19
Adding Devices to Your System	6-21
Example: Adding an IBM-Defined Device With Defaults ..	6-22
Example: Adding An Asynchronous Terminal	6-28
Example: Adding an Unsupported Printer	6-35
Example: Adding a Device for the Coprocessor	6-39
Deleting Devices from the System	6-44
Changing Information About System Devices	6-47
Other Device Specific Information	6-52
Chapter 7. Customizing System Minidisks	7-1
About This Chapter	7-3
Learning About Minidisks	7-4
Using the Minidisks Command	7-8
Starting and Exiting Minidisks	7-8
Using Abbreviated Commands	7-9
Using Minidisks Commands	7-10
Showing Minidisk Information and Planning Ahead	7-10

Adding Minidisks	7-12
Deleting Minidisks	7-12
Changing Mount Attributes	7-13
Example: Using the Minidisks Command	7-14
Example: Displaying Minidisk Information	7-16
Example: Adding an AIX Minidisk	7-18
Example: Adding Coprocessor and Non-AIX Minidisks	7-29
Example: Deleting a Minidisk	7-35
Example: Changing Minidisk Mount Attributes	7-37
Accessing User-Created Minidisks After Reinstalling (Using the Replace Option)	7-41

Appendix A. Enlarging the VRM and Page Space

Minidisks	A-1
Assumptions	A-1
Procedures for Enlarging a Minidisk	A-3

Appendix B. Keyword Descriptions

Printer and Plotter Values/Parameters	B-2
Fonts	B-8
IBM 5201 Quietwriter	B-8
IBM Proprinter (4201)	B-9
IBM Pageprinter (3812)	B-10
Minidisks	B-11
Adapters	B-12
Tty or Pty Devices	B-13
SCSI Devices	B-15

Appendix C. Special Processing for Devices and

Minidisks	C-1
Devices	C-2
Printer or Plotter	C-2
pty	C-4
Adding or Deleting a tty Device	C-7
Tape	C-9
Floating Point Accelerator	C-10
IBM 9332 DASD Attachment	C-11
Minidisks	C-12

Appendix D. Installing the VRM with Non-IBM RT

PC Hardware	D-1
--------------------------	------------

Appendix E. Conflicting Adapter Levels	E-1
Conflicting Interrupt Levels	E-1
Conflicting DMA Channels	E-1
Determining Adapter Conflicts	E-2
Examples	E-5
Example 1	E-5
Example 2	E-7
Glossary	X-1
Index	X-5
Summary of Changes	X-18

Chapter 1. Planning For Installation

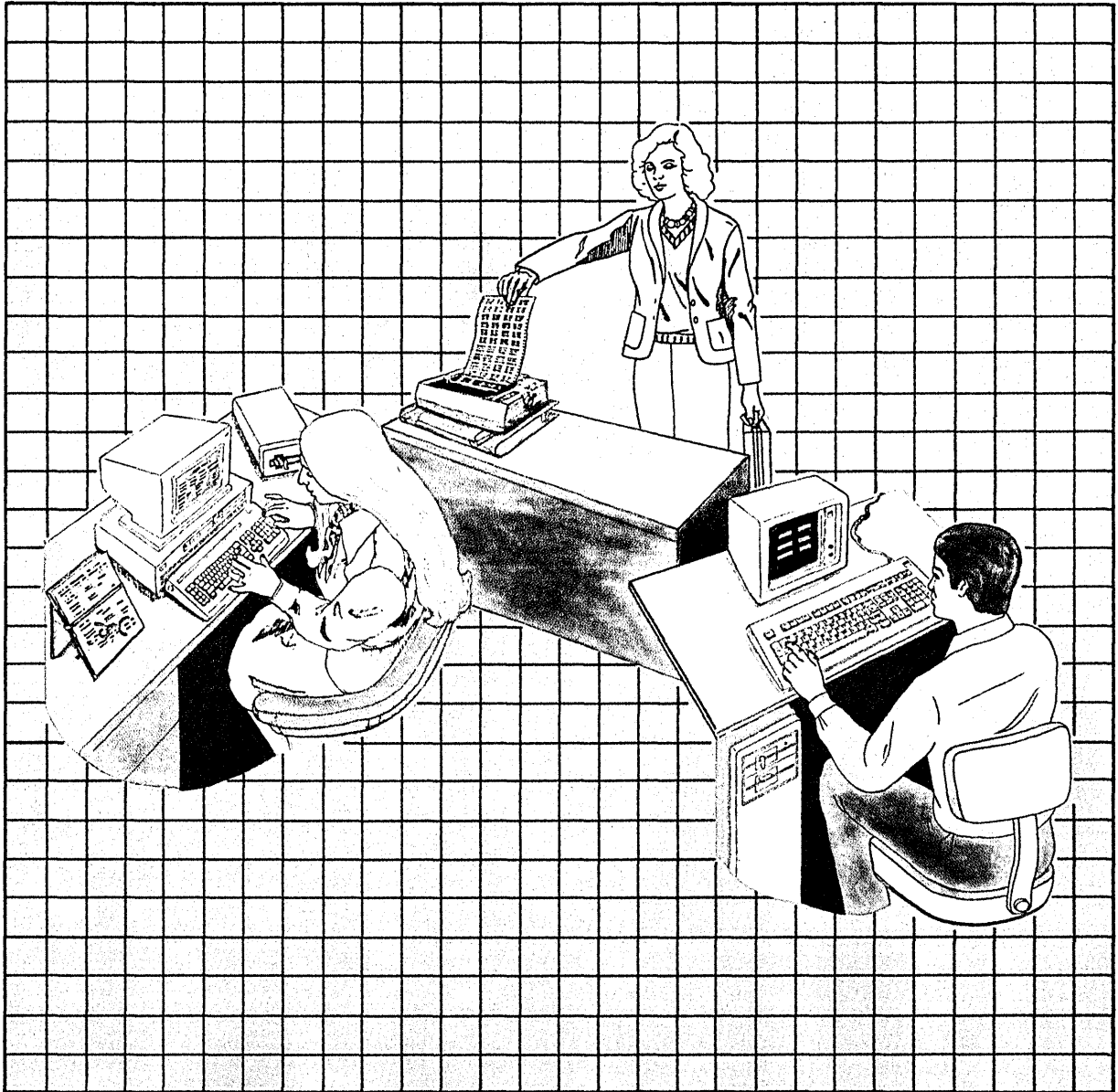

CONTENTS

About This Chapter	1-3
Understanding RT PC Software	1-4
Random Access Memory Recommendations	1-6
Planning Ahead for Software Installation	1-8
Minidisk Types	1-8
Fixed-Disk Drive Data Capacity	1-12
Using the Calculation Worksheets	1-13
Minidisk Size Requirements	1-15
Example of Calculating Disk Space Requirements	1-23

About This Chapter

This chapter describes the following:

- Types of RT PC software
- Planning for software installation
- The types of minidisks used on the RT PC
- The data capacity of the available RT PC fixed disks
- Using the minidisk space requirement worksheets.

Understanding RT PC Software

The RT PC uses two basic types of software. They are:

1. Operating system

An *operating system* controls and coordinates how programs run in a system. An operating system also provides services, such as resource allocation, input/output control, and data management. The operating system for the RT PC is the IBM RT PC Advanced Interactive Executive (AIX) Operating System Licensed Program. This operating system includes the Virtual Resource Manager, the INed¹ editor, and various optionally installable features and services. Figure 1-2 on page 1-17 lists all the AIX Operating System components.

2. Licensed programs

A *licensed program* is a program or group of programs that performs a particular task. Licensed programs are optionally available products for which the user pays a license fee. The programs themselves remain the property of the licensor.

Licensed programs available for the RT PC include, but are not limited to the following:

- Applix IA²
- CAEDS for the RT PC³
- CATIA for the RT PC⁴

¹ INed is a registered trademark of INTERACTIVE Systems Corporation.

² Applix IA is a trademark of Applix Incorporated.

³ CAEDS is a registered trademark of International Business Machines Corporation.

⁴ CATIA is a registered trademark of Dassault Systemes.

⁵ CIEDS is a registered trademark of International Business Machines Corporation.

- CIEDS (Computer-Integrated Electrical Design Series) for the RT PC⁵
- Common Lisp for the IBM RT Personal Computer⁶
- IBM RT PC AT Coprocessor Services
- IBM RT PC BASIC Interpreter and Compiler
- IBM RT PC Data Management Services
- IBM RT PC Distributed Services
- IBM RT PC FORTRAN 77
- IBM RT PC INmail/INnet/FTP⁷
- IBM RT PC Pascal
- IBM RT PC Personal graPHIGS⁸
- IBM RT PC Professional Graphics Series
- IBM RT PC SQL/RT Data Base
- IBM RT PC VS Pascal
- IBM RT PC Workstation Host Interface Program
- IBM RT PC 3278/79 Emulation
- IMSL Problem Solving Systems⁹
- NETWORK 3270-PLUS (SNA)¹⁰
- NETWORK 3270-PLUS (BSC)¹⁰
- NETWORK RJE-PLUS (SNA)¹⁰
- NETWORK RJE-PLUS (BSC)¹⁰
- PROFESSIONAL CADAM¹¹
- RM/COBOL¹²
- RS/1¹³
- RT PC VS FORTRAN

⁶ Common Lisp for the RT PC was developed by Lucid, Inc.

⁷ INmail and INnet are trademarks of INTERACTIVE Systems Corporation.

⁸ Personal graPHIGS is a trademark of International Business Machines Corporation.

⁹ IMSL Problem Solving Systems is a trademark of IMSL incorporated.

¹⁰ RJE-PLUS and 3270-PLUS are trademarks of Rabbit Software Corporation.

¹¹ PROFESSIONAL CADAM is a registered trademark of CADAM INC.

¹² RM/COBOL is a trademark of Ryan-McFarland Corporation.

¹³ RS/1 is a trademark of Bolt, Beranek, and Newman, Inc.

- RT PC X-Windows
- RT Publishing Software¹⁴
- RT Workstation Publishing Software¹⁵
- SAMNA + ¹⁶
- SOLOMON III¹⁷
- UNIRAS¹⁸

For a complete list of software for the RT PC, see the *IBM RT Personal Computer Software Catalog*, GH23-0150.

For more information on any of these programs, see the documentation for the specific program.

¹⁴ RT Publishing Software is a trademark of Interleaf, Inc.

¹⁵ RT Workstation Publishing Software is a trademark of Interleaf, Inc.

¹⁶ SAMNA + is a trademark of SAMNA Corporation.

¹⁷ SOLOMON III is a trademark of TLB Incorporated.

¹⁸ UNIRAS is a trademark of UNIRAS Incorporated.

Random Access Memory Recommendations

The RT PC can be configured with 1 through 16 megabytes of RAM. The amount of RAM your system requires depends on the number of system users, the number and size of licensed programs used, and the response time desired. As the number of users increases, you may want to increase RAM to maintain performance.

The following table shows the recommended minimum amount of RAM for some of the available programs on a *single-user* system.

Program Name	Recommended RAM
Applix IA	2 Megabytes
BASIC Interpreter and Compiler	1 Megabyte
CAEDS	8 Megabytes
CATIA	4 Megabytes
CIEDS	8 Megabytes
Common Lisp for the RT PC	4 Megabytes
Data Management Services	1 Megabyte
Distributed Services	2 Megabytes
FORTRAN 77	1 Megabyte
IMSL	1 Megabyte
INmail/INnet/FTP	1 Megabyte
NETWORK 3270-PLUS (SNA)	2 Megabytes
NETWORK 3270-PLUS (BSC)	1 Megabyte
NETWORK RJE-PLUS (SNA)	2 Megabytes
NETWORK RJE-PLUS (BSC)	1 Megabyte
Pascal	1 Megabyte
Personal Computer AT Coprocessor Services (with the AT 512 KB Memory Expansion Option)	1 Megabyte

Figure 1-1 (Part 1 of 2). Recommended Minimum RAM in a Single-User Environment

Program Name	Recommended RAM
Personal Computer AT Coprocessor Services (without the AT 512 KB Memory Expansion Option)	2 Megabytes
Personal graPHIGS	1 Megabyte
Professional Graphics Series	1 Megabyte
PROFESSIONAL CADAM	4 Megabytes
RM/COBOL	1 Megabyte
RS/1	2 Megabytes
RT Publishing Software	2 Megabytes
SAMNA +	1 Megabyte
SOLOMON III	2 Megabytes
SQL/RT Data Base	2 Megabytes
UNIRAS	1 Megabyte
VS FORTRAN	2 Megabytes
VS Pascal	2 Megabytes
Workstation Host Interface Program	2 Megabytes
Workstation Publishing Software	2 Megabytes
X-Windows	2 Megabytes
3278/79 Emulation	1 Megabyte

Figure 1-1 (Part 2 of 2). Recommended Minimum RAM in a Single-User Environment

Planning Ahead for Software Installation

Before you install the AIX Operating System, other AIX programs, or optionally available licensed programs, you should complete the planning worksheets included in this chapter. These worksheets are provided so that you can be reasonably sure that you have enough fixed-disk space to support the operating system and licensed programs you intend to use. Planning ahead for minidisk size requirements is much easier than making corrections if you should run out of space.

In order to plan for installation of the operating system and licensed programs, you may find the information on the following topics helpful:

- RT PC minidisk types
- RT PC fixed-disk drive capacity.

Both of these topics are discussed in the following sections.

If you completed the worksheets provided in *IBM RT PC Planning Guide* to plan for your software installation, take your completed worksheets and begin the installation process with “Loading the Installation/Maintenance Diskette” on page 4-7.

Note: If you are using the merge command to upgrade a 40-megabyte system from AIX Version 1.1 to AIX Version 2.1, see the special instructions enclosed in the RT PC Diskette binder.

Minidisk Types

The RT PC requires that different parts of the system, various working files, and user data be placed on partitions of the fixed disk called *minidisks*. A minidisk is a variable-sized portion of contiguous space on a fixed disk. Minidisks consist of 512-byte segments called *blocks*. All references to minidisk size are expressed as number of blocks.

All the space on a fixed disk does not have to be included in a defined minidisk. Free space on a fixed disk can always be used for future expansion and to maintain flexibility.

Minidisks Defined by the System

During installation and configuration of a typical RT PC, the system defines several minidisks for its basic software components and requirements. These system minidisks reside only on internal disks, and include:

- `/vrm`

This minidisk contains the Virtual Resource Manager (VRM) code and is the first software component installed. The VRM manages RT PC hardware and memory for the operating system.

- `Paging`

The VRM requires this minidisk to perform *paging*. Paging is the act of copying virtual memory into or out of the available real memory. The default paging minidisk sizes are determined by the fixed-disk configuration and the amount of random-access memory. These defaults can be changed when the VRM is installed, if desired. The following table shows the approximate default paging minidisk sizes.

Physical Disks	Random Access Memory Size — Megabytes (Mb)								
	1 Mb	2 Mb	3 Mb	4 Mb	5 Mb	6 Mb	8 Mb	12 Mb	16 Mb
40Mb (1)	7580	9510	11440	13400	15334	17270	21141	28076	35602
40Mb (2)	9750	12235	14720	17210	19695	22181	27152	36338	46078
40Mb (3)	11025	13830	16640	19450	22267	25677	30698	41171	52206
70Mb (1)	10000	11410	13730	16050	18366	20684	25320	34746	44060
70Mb (2)	12265	14135	17010	19880	22752	25624	31367	43008	54536
70Mb (3)	12535	15730	18925	22120	25315	28510	34900	47841	60665
40Mb (1) 70Mb (1)	10600	13300	16000	18700	21394	24094	29494	40134	50891
40Mb (2) 70Mb (1)	11610	14570	17530	20490	23450	26409	32329	43831	55579
40Mb (1) 70Mb (2)	12110	15200	18280	21365	24451	27537	33709	46004	58335

- **/ (root)**

The **/** minidisk, called the root minidisk, is the highest level file system of the AIX Operating System. This minidisk can also contain some of the system files and licensed program files, but should not be used for personal user files.

- **/usr**

The **/usr** minidisk is a file system that contains most of the licensed programs, as well as some system programs.

- **/tmp**

The **/tmp** minidisk is a file system used for temporary files. IBM recommends that you allocate at least 2000 blocks for **/tmp**; some programming and development environments require more than 2000 blocks.

- **/u**

The **/u** minidisk is created for storage of user files. The amount of fixed-disk space to allow for **/u** depends on how many users your system will be supporting and the licensed programs you plan to use. Note that about 5 percent of the space is used for indexes, so the actual space available for data is about 95 percent of the total minidisk space.

- **Dump**

The dump minidisk contains operating system memory dumps. This information is helpful in case you experience problems or require diagnostic service at your site. If your system has only one 40-megabyte fixed disk, IBM recommends you allocate 3000 blocks for dump; all other systems should use 5000 blocks for dump.

You can store user files on the **/**, **/tmp**, or **/usr** minidisk. However, if the operating system is ever reinstalled using the replace option rather than the merge option, these minidisks may be completely replaced, and user files lost. IBM recommends that you place user files only on the **/u** minidisk or on minidisks you define. See "Reinstalling the AIX Operating System" on page 4-37 for more information on reinstalling AIX.

Minidisks Defined by the User

You can define your own minidisks in addition to the default minidisks defined by the system. These user-defined minidisks can be used to store files, programs, or for any purpose you desire.

Some licensed programs, such as PROFESSIONAL CADAM, require that you define a separate minidisk for their files. For some large programs (Applix IA and SOLOMON III), IBM recommends that you define separate minidisks.

“Learning About Minidisks” on page 7-4 provides more information on user-defined minidisks, as well as the default locations of minidisks for systems with one, two, or three fixed disks.

Fixed-Disk Drive Data Capacity

You can have as many as 3 internal fixed disks and up to 28 external fixed disks on the RT PC. Internal disks come in 40- and 70-megabyte models while the external disks come in 200- and 400-megabyte models. The capacity of the internal and external fixed disks, expressed as 512-byte blocks, is approximately:

- **Internal Disks**

40-megabyte drive = 86,000 blocks

70-megabyte drive = 138,000 blocks

- **External Disks**

200-megabyte drive = 409,600 blocks

400-megabyte drive = 819,200 blocks

Note: Only disks in the RT PC system unit (40- and 70-megabyte disks) can be used for system minidisks.

Using the Calculation Worksheets

The worksheets on the next pages are provided so you can figure the fixed-disk requirements for a given set of software components and plan for the placement of minidisks on the fixed disks.

Fill out the Minidisk Calculation Worksheet (Figure 1-4 on page 1-23) using the block sizes from Figure 1-2 on page 1-17 and Figure 1-3 on page 1-19. Additional space is provided on the worksheet along the top for minidisks you have defined and along the side for programs not listed in the tables.

The shaded areas in the Minidisk Calculation Worksheet (Figure 1-4 on page 1-23) indicate minidisk locations that are not valid or not recommended for specific types of data. The **Future Uses** row allows you to include an expansion factor for minidisk size, if desired.

The Disk Configuration Worksheet (Figure 1-5 on page 1-24) helps to verify that the number and size of fixed disks you have chosen will support your software.

If the total number of blocks exceeds the number of blocks available with your fixed-disk configuration, consider the following actions:

- Rearrange the minidisks in the following order to use the available disk space more efficiently.
 - The dump minidisk can be moved without affecting performance.
 - The **/u** or user-defined minidisks can be moved.
 - The **/tmp** minidisk can be moved.
 - If necessary, move either **/** (root) or **/usr**.
- Divide user data into several smaller minidisks to spread the data across multiple disks.
- Use a 70-megabyte disk instead of a 40-megabyte disk, or use an additional disk drive. Either of these actions will require that you change the paging space if default values are used.

After you have decided which programs to install, follow these steps to calculate fixed-disk requirements and plan for minidisk placement:

1. Make photocopies of Figure 1-2 on page 1-17, Figure 1-3 on page 1-19, Figure 1-4 on page 1-23, and Figure 1-5 on page 1-24, if needed. Fill out the copies, not the originals.
2. Find the operating system features on the Base Operating System Disk Space Worksheet that you intend to use. Circle (or highlight in some way) the block size requirement values that correspond to the programs you have selected. Add the block size totals for each minidisk. Place the total operating system block requirements for each minidisk on the Minidisk Calculation Worksheet.
3. Find the licensed programs on the Licensed Program Disk Space Worksheet that you intend to use. Circle (or highlight in some way) the block size requirement values that correspond to the programs you have selected. Add the block size totals for each minidisk. Place the total licensed program block requirements for each minidisk on the Minidisk Calculation Worksheet.
4. If you plan to use a software product not listed in this publication, write the product name in one of the blank spaces in the **Program** row and indicate the required block size in the appropriate minidisk column.
5. If you plan to define minidisks not listed, write the minidisk name in one of the blank spaces in the **Minidisk Requirements** row and indicate the required block size below.
6. If you plan to allow minidisk space for future expansion, write the block size requirements in the **Future Uses** row for the appropriate minidisks.
7. Write the total block size requirement for each minidisk (including dump, paging, and user-defined minidisks) in the **Totals** row.

8. Now fill out the Disk Configuration Worksheet with the results from the Minidisk Calculation Worksheet. Write the minidisk name and total number of blocks required in the spaces provided for systems with 1, 2 or 3 fixed disks. Be sure that you have enough disk space to support your planned software.

Minidisk Size Requirements

Figure 1-2 on page 1-17 shows the minidisk space requirements for operating system components. Figure 1-3 on page 1-19 shows the values for optionally available licensed programs.

Multi-User Services and Extended Services, which consist of multiple diskettes included with the AIX Operating System, contain modules that can be installed separately. Installing only those you need will make space available for other uses. See Chapter 5, "Installing Additional Operating System Programs" for descriptions of each module and of other additional AIX Operating System programs. These descriptions may help you decide whether to install some or all of the programs. You should install only those that you think you will need.

Note: Block size requirement values provided in this publication for software components are accurate as of the date of this publication. Variations to the sizes provided may occur as a result of modifications to the software components made by the manufacturer. IBM is not responsible for variations made to these components after the date of this publication.

Program Name	Minidisk Requirements		
	/	/usr	/vrm
Asynchronous Terminal Emulator	0	500	0
Base System Program	11580	11000	0
Base PC Network Services	130	680	0
Distributed Services	700	1700	0
Exploring Usability Services	0	2250	0
Extended Services	0	60	
Administrative Support	310	260	0
Extended Programming Support	370	960	0
Source Code Control	0	710	0
DOS Services	0	2500	0
Text Support	40	1880	0
<u>u</u> u <u>c</u> p Support	0	720	0
<u>v</u> i Editor	0	450	0
Games	0	740	0
INed	0	3820	0
Interface for use with TCP/IP	1550	2600	0
Multi-User Services	0	1200	0
Accounting Support	80	550	0
System Activity Recording	0	230	0
Inter-Workstation Commands	40	80	0
Terminal Support	0	510	0
Graphics Device Drivers	0	2500	0
Advanced Display GSL	600	1480	0
Graphics and Statistics Commands	0	2130	0
Sockets/BSD Portability Files	0	800	0
HFT Examples Programs	0	2000	0
SNA Services	3500	5800	0
Totals (Part 1)			

Figure 1-2 (Part 1 of 2). Base Operating System Disk Space Worksheet

Program Name	Minidisk Requirements		
	/	/usr	/vrn
Update to Operating System	1500	4000	0
Usability Services	110	3400	0
Virtual Resource Manager	0	0	3500
VRM Device Driver Diskette			
Baseband Adapter	35	15	0
Multiprotocol Adapter	70	15	0
Distributed Function Terminal	50	15	0
SCSI Adapter	100	15	0
3270 AIX	170	100	0
Token Ring Adapter	110	15	0
Totals (Part 2)			
Totals (Parts 1, 2)			

Figure 1-2 (Part 2 of 2). Base Operating System Disk Space Worksheet

Program Name	Minidisk Requirements		
	/	/usr	Comments
Applix IA	0	36000	Consider defining a separate minidisk.
BASIC	0	4800	
CAEDS	0	24000	
Object Modeler	0	28000	
System Modeler	0	8000	
Graphics Finite Element Modeler	0	30000	
Integrated Finite Element Solver	0	22000	
Dimensioning	0	30000	
CATIA	0	100000	Requires a 70Mb disk drive and a separate 100,000 block minidisk — /u/catia.
	0	100000	Requires a separate 15,000 block minidisk — /u/catia.
CIEDS			
Design Capture	0	24000	
Design Simulation Base	0	8000	
Interfaces	0	6000	
Engineering Access Routines	0	2000	
Behavioral Simulator	0	10000	
Logic Simulator	0	25000	
Analog-Digital Simulator	0	5000	
Switched Capacitor Simulator	0	3000	
Totals (Part 1)			

Figure 1-3 (Part 1 of 4). Licensed Program Disk Space Worksheet

	Minidisk Requirements		
Program Name	/	/usr	Comments
Common Lisp Development Environment Application Environment	0 0	36000 24000	Consider defining a separate minidisk. Requires 48,000 blocks paging space for small programs and 64,000 blocks paging space for larger programs.
Data Management Services	0	3064	
FORTRAN 77	4	1600	
IMSL Base MATH/PROTRAN STAT/PROTRAN LP/PROTRAN	0	2000 6700 11000 4800	/usr is the recommended minidisk.
MATH/LIBRARY STAT/LIBRARY SFUN/LIBRARY		12000 10500 700	The base is included in each of the following three packages, but appears only once no matter how many libraries are installed.
INmail/INnet/FTP	580	1350	
NETWORK RJE-PLUS (BSC)	4	4350	
NETWORK RJE-PLUS (SNA)	4	4350	
NETWORK 3270-PLUS (BSC)	4	5200	
NETWORK 3270-PLUS (SNA)	4	5100	
Pascal	0	1696	
Personal Computer AT Coprocessor Services	660	480	
Personal graPHIGS	1087	4011	
Totals (Part 2)			

Figure 1-3 (Part 2 of 4). Licensed Program Disk Space Worksheet

Program Name	Minidisk Requirements		
	/	/usr	Comments
PROFESSIONAL CADAM	50	50	Requires a separate 50,000-block minidisk.
Professional Graphics Series			Graphics device drivers are part of AIX.
Graphics Development Toolkit	0	820	
Graphics Terminal Emulator	0	480	
Plotting System	0	3720	
Graphical File System	0	1900	
RM/COBOL	0	550	Requires 1348 blocks in a separate directory to install.
RS/1	0	7200	/usr is the recommended minidisk.
RT Publishing Software	0	11000	/usr is the recommended minidisk.
SAMNA +	0	4800	/usr is the recommended minidisk.
SOLOMON III	0	13050	Consider a separate minidisk. 13050 blocks required once with any package. Size can be 15960 to 136180 blocks. Log File average - size will vary.
General Ledger		2870	
Payroll		4240	
Accounts Payable		3030	
Accounts Receivable		2830	
Purchasing		1110	
Order/Entry Invoicing		1860	
Job Costing		2430	
Fixed Assets		1310	
Sales Analysis		1130	
Inventory		2420	
Address and Mail List		550	
Database Reporter		320	
Production Database		15960	
Trial Database		720	
Log File		4300	
SQL/RT Data Base	4	4650	
Totals (Part 3)			

Figure 1-3 (Part 3 of 4). Licensed Program Disk Space Worksheet

Program Name	Minidisk Requirements		Comments
	/	/usr	
UNIRAS	0		BASE required once with any of the next three packages. BASE, DRIVERS, and FORTRAN 77 required once with any of the next eight packages.
BASE		2640	
DRIVERS		4800	
UNIGRAPH		2364	
UNIMAP		2436	
UNIEDIT		2044	
RASPAK SOLIDS		152	
BIZPAK		588	
GEOPAK		572	
KRIGPAK		280	
SEISPAK		244	
GEOINT		328	
GIMAGE		52	
RASPAK		1744	
VS FORTRAN	0	3900	
VS Pascal	0	3210	
Workstation Host Interface Program	50	400	
Workstation Publishing Software	0	7200	
X-Windows	0	11500	
3278/79 Emulation	40	790	
Totals (Part 4)			
Totals (Parts 1, 2, 3)			
Totals (Parts 1, 2, 3, 4)			

Figure 1-3 (Part 4 of 4). Licensed Program Disk Space Worksheet

PROGRAM	MINIDISK REQUIREMENTS										
	/	/usr	/vrm	/tmp	/u	dump	paging				
User Files											
Future Uses											
Totals-Operating System											
Totals-Licensed Programs											
TOTALS -											

Total Minidisk 512-Byte Blocks = Total of the Line Above =

Figure 1-4. Minidisk Calculation Worksheet. Remember to include user-defined minidisks in this table.

Disk __		Disk __		Disk __	
Minidisk Name	Number of Blocks	Minidisk Name	Number of Blocks	Minidisk Name	Number of Blocks
TOTALS =					

Figure 1-5. Disk Configuration Worksheet

Example of Calculating Disk Space Requirements

The user in this example is Mary. Mary is planning to install an IBM RT PC with one 70-megabyte fixed disk and intends to use the following programs:

- Operating System
 - Virtual Resource Manager
 - Base System Program
 - INed
 - Usability Services
 - Extended Programming Support
 - General (must be included if any Extended Programming Support functions are included)
 - Source Control Code System (SCCS)
- Licensed Programs
 - Personal Computer AT Coprocessor Services
 - BASIC Interpreter and Compiler
 - Data Management Services
 - Pascal
 - Applix IA.

In addition to the listed programs, Mary will allocate the following minidisk space:

- 35,000 blocks in **/u** for anticipated user files
- 2000 blocks in **/tmp**

- 11,410 blocks in the paging minidisk (2 Megabytes RAM)
- Extra space in the following minidisks to allow for expansion:
 - `/usr` - 4000 blocks
 - `/` (root) - 1000 blocks
 - `/tmp` - 2000 blocks
- Dump - 5000 blocks for the dump minidisk (70-megabyte disk system)
- Free space - Mary wants 15,000 blocks left free for future uses.
- COP - an 8000-block, user-defined minidisk for the Coprocessor

Mary follows the steps described in “Using the Calculation Worksheets” on page 1-14 to complete the worksheets.

1. First, Mary makes copies of all the worksheets.
2. Mary adds the block size requirements from Figure 1-2 on page 1-17 for the operating system features listed above (including the Update to the Operating System) and writes the total for each minidisk in the proper row and columns of Figure 1-6 on page 1-28.
3. Mary now adds the block size requirements from Figure 1-3 on page 1-19 for the licensed programs listed above and writes the total for each minidisk in the proper row and columns of Figure 1-6 on page 1-28.
4. Now Mary indicates the space to allocate for the dump minidisk (5000 blocks), Coprocessor minidisk (8000 blocks), and free space (15,000 blocks).

5. Next, the expansion factor for the minidisks listed above is put in the **Future Uses** row.
6. From Figure 1-1 on page 1-7, Mary determines that 2 megabytes of RAM are recommended to support Applix IA on a single-user system. The default paging space for an IBM RT PC with 2 megabytes of RAM and a 70-megabyte fixed disk is 11,410 blocks (from the "Default Paging Minidisk Sizes" table in this chapter).

When the totals for each minidisk are added, the total minidisk requirement is 165,008 blocks. A 70-megabyte fixed disk, with a capacity of about 138,000 blocks, will not support this software configuration. Therefore, Mary chooses a system with two 40-megabyte fixed-disk drives. Two 40-megabyte disks will support about 172,000 blocks.

PROGRAM	MINIDISK REQUIREMENTS											
	/	/usr	/var	/tmp	/u	dump	paging	COP	FREE			
User Files					35000							
Future Uses	1000	4000		2000					15000			
Totals-Operating System	11980	19950	3500	2000		5000	11410					
Totals-Licensed Programs	660	54508						8000				
TOTALS =	13640	78458	3500	4000	35000	5000	11410	8000	15000			

Total Minidisk 512-Byte Blocks = Total of the Line Above = 174008

Figure 1-6. Minidisk Calculation Worksheet

- Mary now plans for placement of the programs on the two 40-megabyte disk drives.

The capacity of a 40-megabyte fixed disk is recalled from "Fixed-Disk Drive Data Capacity" on page 1-13:

- 40-megabyte drive = 86,000 blocks

Mary checks the figure on page 7-6 and sees the default minidisk locations will work if the Coprocessor minidisk is placed on the fixed disk that contains / (root).

Because the total number of blocks on each fixed disk is less than the capacity for a 40-megabyte drive, the configuration is valid. Mary also has at least 21,157 blocks of free space. When the time comes to actually install the system, this space can be left free for future expansion, added to the defined minidisks, or defined as separate minidisks.

Disk <u>1</u>		Disk <u>2</u>		Disk <u>3</u>	
Minidisk Name	Number of Blocks	Minidisk Name	Number of Blocks	Minidisk Name	Number of Blocks
<i>/vrm</i>	<i>3500</i>	<i>1</i>	<i>13640</i>		
<i>Paging</i>	<i>12235</i>	<i>lu</i>	<i>35000</i>		
<i>lusr</i>	<i>69458</i>	<i>COP</i>	<i>8000</i>		
		<i>ltmp</i>	<i>4000</i>		
		<i>DUMP</i>	<i>3600</i>		
TOTALS =	<i>85193</i>		<i>64240</i>		

Figure 1-7. Disk Configuration Worksheet

Chapter 2. Getting Ready to Install the AIX Operating System

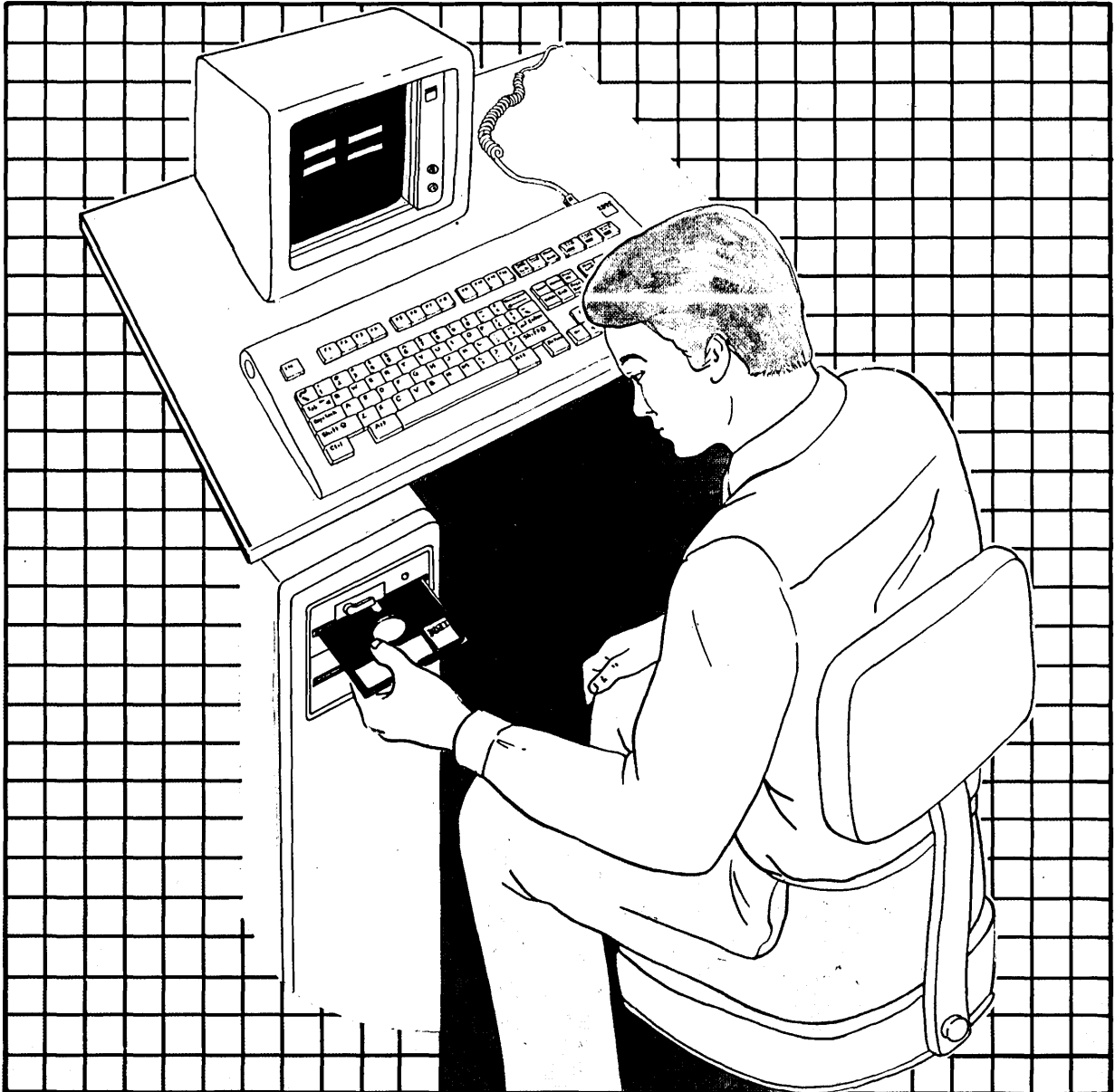

CONTENTS

About This Chapter	2-3
Introducing the AIX Operating System	2-4
Identifying Special Keys	2-5
Keyboard	2-5
Keys	2-6
Locating the Keylock and Power Switch	2-9
Handling and Loading Diskettes	2-9

About This Chapter

This chapter describes the following items for you as you prepare to install the AIX Operating System:

- The AIX Operating System and its functions in your IBM RT PC
- The system keyboard and special keys that you will use to install programs
- Locating the power switch on the RT PC
- Procedures for handling and for loading diskettes.

Introducing the AIX Operating System

After your IBM RT PC system components are unpacked, assembled, and running correctly, you must install the IBM RT PC AIX Operating System licensed program. The AIX Operating System manages system resources for you. It enables you to use several complex functions without having to know how those functions work. For instance, the AIX Operating System gives you access to system programs that handle processing, scheduling, storage, file systems, and printing for you. In addition, it accommodates several users at one time. It also enables those users to run several processes at one time.

The AIX Operating System consists of these programs:

- ***Virtual Resource Manager Program (VRM)***

The VRM is a set of programs that manages the ***hardware (work stations, main storage, and disk storage)*** and ***software*** resources of your system. These programs must be installed in your system before you can install the Base System Program or any other ***operating system***.

- ***Base System Program***

The Base System Program contains the operating system code that performs many of the processing tasks on your RT PC. The Base System Program interprets a set of commands that perform a variety of tasks, including management of the AIX file system.

- **Additional operating system features**

The additional operating system features provide a variety of options to extend the function and capabilities of your RT PC. These optionally installable features include an editor, support for additional device types, communications capabilities, and so on. Each of these features, along with installation instructions, is described in Chapter 5, "Installing Additional Operating System Programs."

The two most important programs in the AIX Operating System are the Virtual Resource Manager Program and the Base System Program. You must install these two programs before your IBM RT PC is ready for you to do work.

Identifying Special Keys

This section briefly describes specific keys that you use as you install the VRM and Base System Program.

Keyboard

To install the VRM and Base System Program, you must use the keyboard supplied with your IBM RT PC.



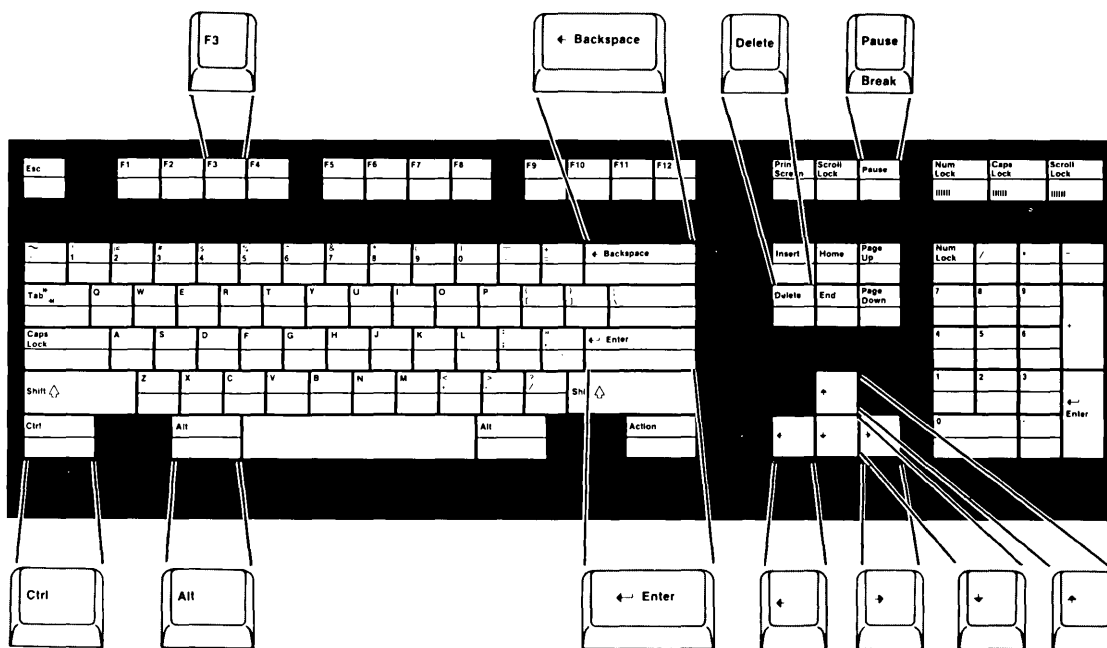

The drawing on the next page shows the 101-key Enhanced Personal Computer Keyboard that comes with the IBM RT PC 6150 System Unit or IBM RT PC 6151 System Unit. The highlighted keys are those keys you will use the most to install the AIX Operating System. See *IBM RT PC Guide to Operations* for a full description of the Enhanced Personal Computer Keyboard. See *IBM RT PC Keyboard Description and Character Reference* for a description of the other available keyboards.

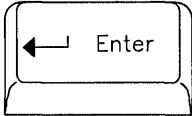
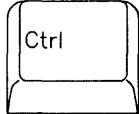

Keys

As you install the VRM and Base System Program, you will use the keys highlighted in the figure above. You will also use some of the keys in the typewriter keyboard area to enter information. You will not, however, use any of the keys in the numeric keypad on the right side of the keyboard.

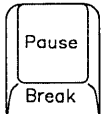
The keys you will use most often are described next. Locate them on your keyboard. If necessary, see *Guide to Operations* for a full description of all of the keys on your keyboard.

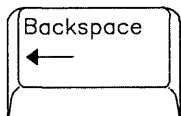
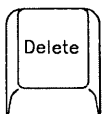
Engraving	Function	What It Does
	Enter	Enters information or commands into the RT PC system.
	Control	Works with other keys to perform various functions.
	Alternate	Works with other keys to perform various functions.
	Pause	Works in combination with the Alt and Ctrl keys to start or restart the system.
	Quit	Cancels a particular action.
	Backspace	Moves the <i>cursor</i> to the left and deletes characters.
	Delete	Erases the character where the cursor is positioned. When a character is deleted, all data to the right of the cursor moves left one position.

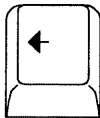
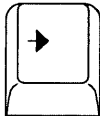
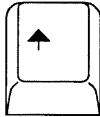
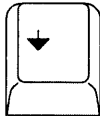
Engraving	Function	What It Does
	Cursor Left	Moves the cursor horizontally to the left across the screen.
	Cursor Right	Moves the cursor horizontally to the right across the screen.
	Cursor Up	Moves the cursor vertically up the screen or displays previous screen.
	Cursor Down	Moves the cursor vertically down the screen or displays new screen.

Locating the Keylock and Power Switch

The following figure shows the locations of the keylock and power switch on your system unit.

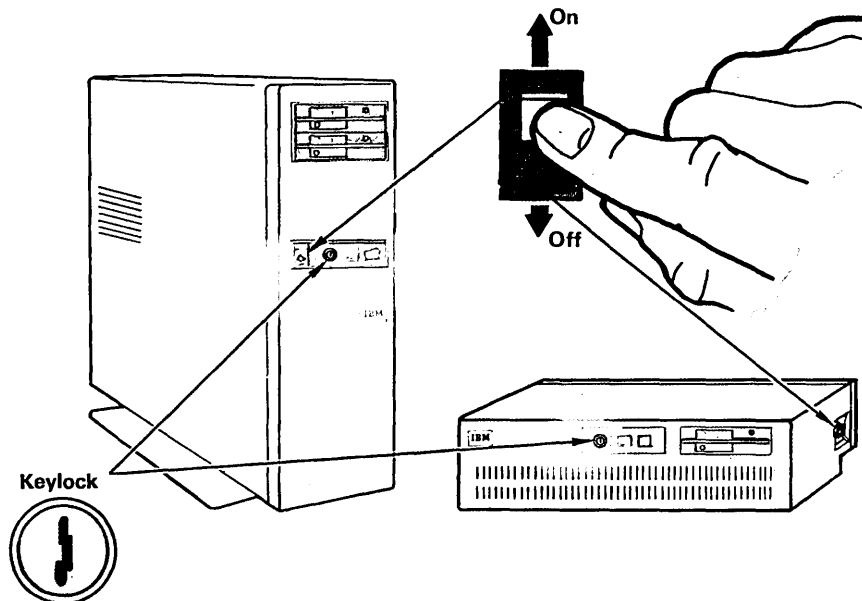

Handling and Loading Diskettes

IBM diskettes are designed to stand up to normal and frequent handling. You should, however, handle them carefully to ensure reliable service.

Look carefully at the back of one of the paper envelopes containing your diskettes. The diagrams picture both correct and incorrect ways to handle your diskette.

Always return the diskette to the protective paper envelope when you remove the diskette from the diskette drive. Unprotected diskettes can be damaged easily. Although you can replace

diskettes, you may not be able to replace the information on some diskettes.

If you have two diskette drives, at least one is a 1.2M-byte drive. If you are not sure which is the 1.2M-byte drive, use the top diskette drive. If both are 1.2M-byte drives, you can use either one. The only difference in appearance between the 1.2M-byte drive and the 360K-byte drive is a small star just below the light on the 360K-byte drive. The top drive is drive 0, while the bottom drive is drive 1.

Notice the correct way to insert the diskette into the diskette drive. Make sure that the diskette is positioned as shown in the figure. Close the diskette drive (turn the lever clockwise).

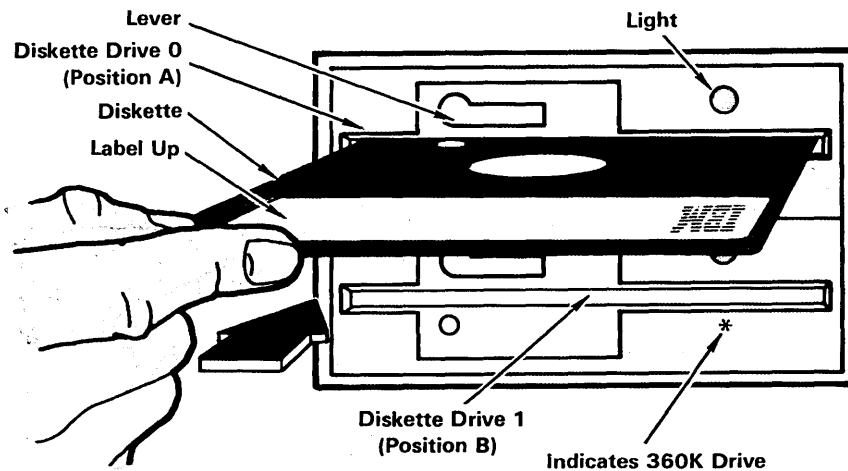

Now that you are familiar with some of the RT PC features, you are ready to install the Virtual Resource Manager Program, which is the first step in installing the AIX Operating System.

Chapter 3. Installing the VRM Program

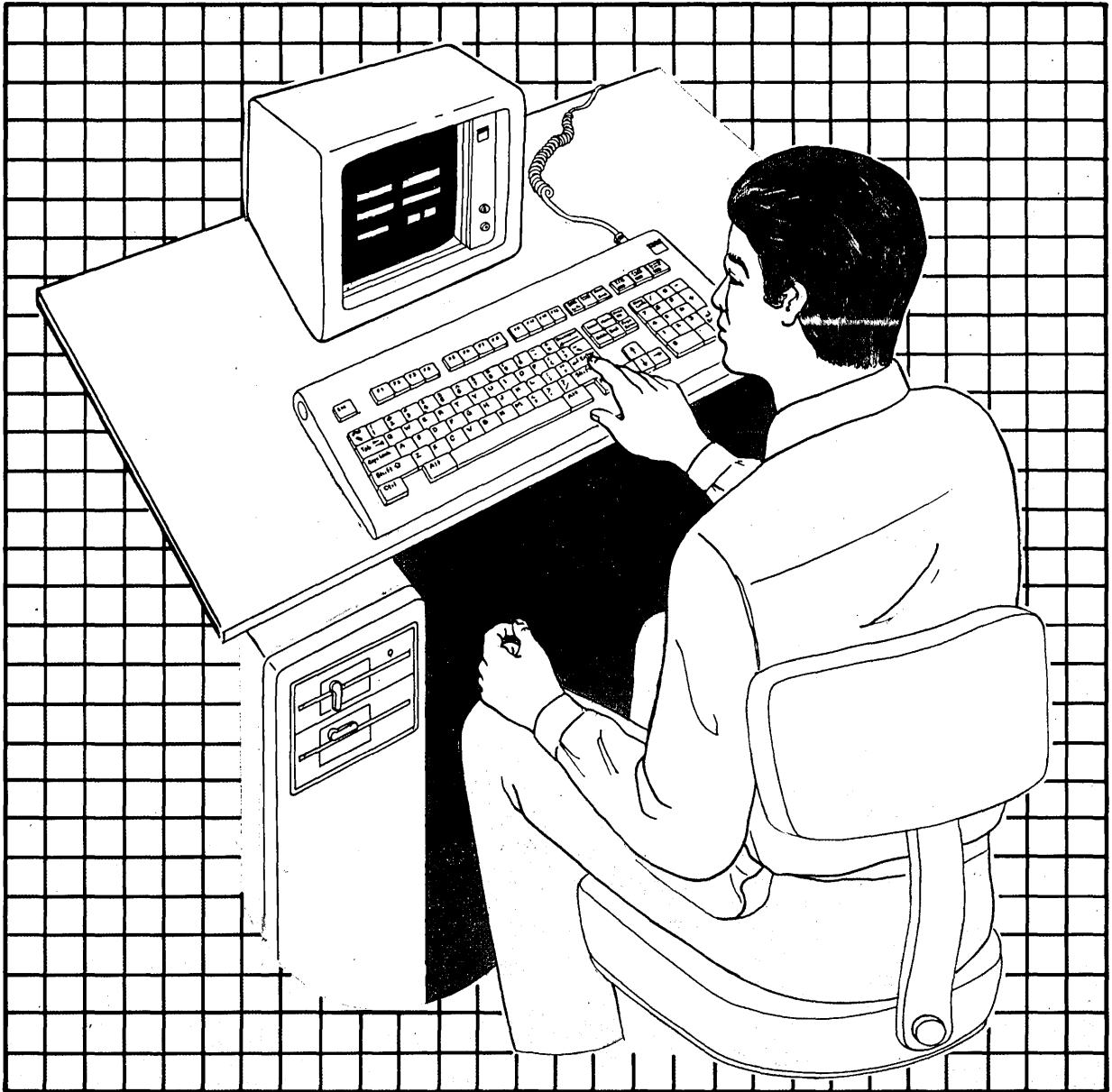

CONTENTS

About This Chapter	3-3
Locating the VRM Diskette	3-4
Loading Your VRM Diskette	3-5
Understanding Your Choices	3-7
Selecting the Keyboard for Use with the VRM	3-10
Installing the VRM with Defaults	3-11
Viewing the Choices	3-13
Changing the Choices and Installing the VRM	3-16
Changing Only the Page Space Minidisk	3-20
Changing the Date and Time	3-22
Installing Updates to the Virtual Resource Manager	3-25
Reinstalling the VRM	3-27

About This Chapter

This chapter explains how to locate the VRM diskette and install the VRM. The first step in this process is selecting the keyboard layout you want to use with the RT PC. This chapter then describes three of the items you may select from the **INSTALL AND CUSTOMIZE THE VIRTUAL RESOURCE MANAGER** menu. These items are:

- Installing the VRM with current choices (defaults)
- Viewing the choices
- Changing the current choices and installing the VRM.

In addition, this chapter provides information about installing updates to the VRM or reinstalling the VRM.

Locating the VRM Diskette

Locate the VRM diskette or diskettes in the diskette binder. You might have more than one VRM diskettes. The label on a VRM diskette will look similar to the one shown below.

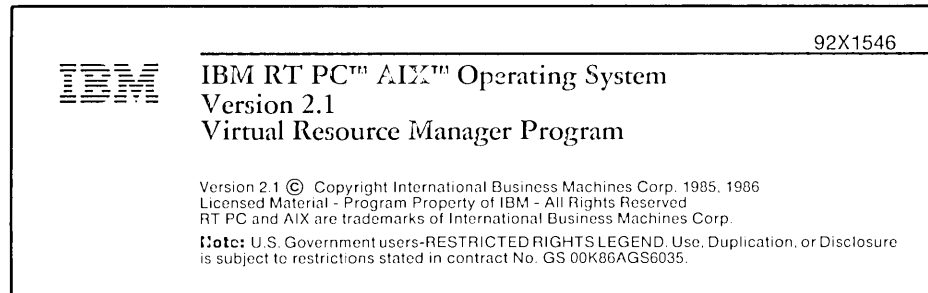

Loading Your VRM Diskette

To load the VRM diskette or diskettes, follow these steps:

To Load VRM Diskettes

1. Turn the key in the keylock to the unlocked position.
2. Turn on the power switches to your system components (see the diagram on the next page).
3. Open the door to diskette drive 0 (turn it counterclockwise). This is a 1.2M-byte drive, always in the top position in your system. When requested to do so, insert the appropriate VRM diskette as shown on the next page. Close the drive door (turn the lever clockwise).
4. Press **Ctrl-Alt-Pause**. *see page 3.4*
5. Follow the prompts to install VRM. If you have more than one VRM diskette, the system will tell you when (and in what sequence) to load them.

After you turn on the system and insert the diskette, the VRM programs are loaded into *memory*. You will know that the process is complete when you see the VIRTUAL RESOURCE MANAGER INSTALLATION: KEYBOARD LAYOUT menu on your display. The green power-on light indicates that the power supply is functioning correctly.

The system automatically runs a series of internal tests. You will see various numbers displayed on the *two-digit display* as the system runs the tests. If the system detects a serious problem, a number corresponding to the number of the test being run remains on the two-digit display. System operation stops at this point.

Nonblinking numbers indicate problems found by the hardware tests. Blinking numbers indicate that problems occurred during the initial loading of the system. See *Problem Determination Guide* for an explanation of the number displayed on the two-digit

display. The same book also suggests the actions you may take to resolve the problem.

The first time you turn on the system, it will not run all the internal tests automatically unless the VRM diskette or the diagnostics diskette is in the diskette drive. But after you install the VRM, the system runs all the internal tests each time you turn on the power switch.

Notes:

1. If you see a *message* on the display *after* the system starts, see *Messages Reference*. There you may find suggestions about what caused the error, as well as how to correct it. Locate the explanation by finding the six-digit number corresponding to the number shown on your display.
2. If you see a flashing 45 on the two-digit display, see Appendix D, “Installing the VRM with Non-IBM RT PC Hardware” to install the VRM with a non-IBM RT PC display.

Understanding Your Choices

After the system runs the internal tests, you will see the VIRTUAL RESOURCE MANAGER INSTALLATION: KEYBOARD LAYOUT menu on your display.

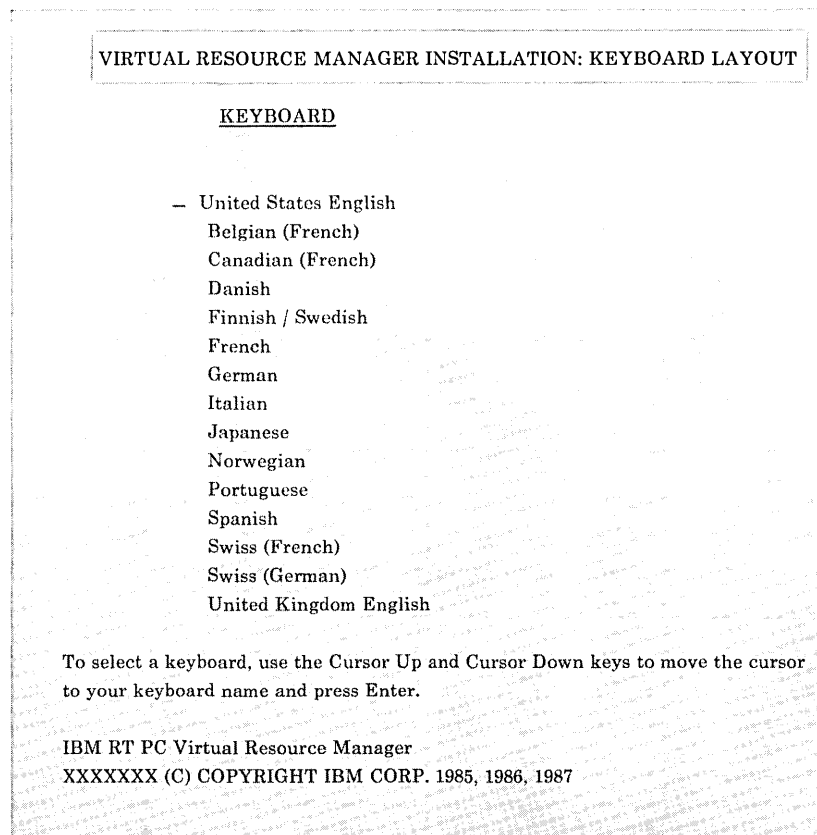

After the keyboard is configured, you will see the INSTALL AND CUSTOMIZE THE VIRTUAL RESOURCE MANAGER menu on your display.

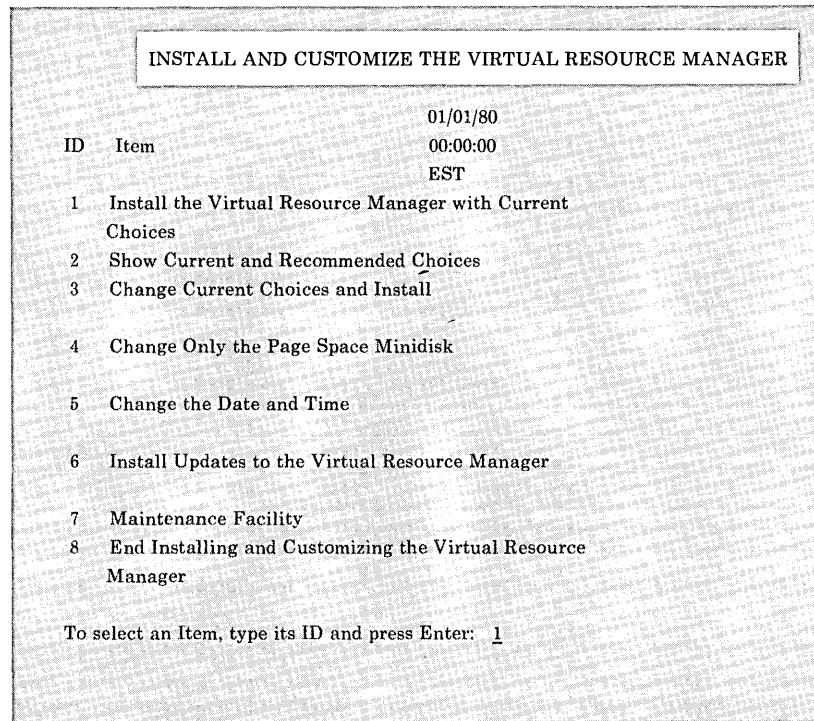

To choose an item from the menu, you type the ID number for the item you want. Then press **Enter**.

To accept the default ID number (located above the cursor), simply press **Enter**.

The installation procedures are menu-driven; that is, each time you choose an item, the system responds with a menu from which you make other choices or provide information. You always have the option of canceling the installation process and returning to the **INSTALL AND CUSTOMIZE THE VIRTUAL RESOURCE MANAGER** menu. You do so by pressing **F3 (Quit)**.

For more information about the options, see the pages listed below:

- To select the keyboard layout you want to use with the VRM, see “Selecting the Keyboard for Use with the VRM” on page 3-10.
- To install the VRM with the defaults, see “Installing the VRM with Defaults” on page 3-11.
- To see the current choices, as well as recommended and possible choices, see “Viewing the Choices” on page 3-13.
- To change one or more choices and then install the VRM, see “Changing the Choices and Installing the VRM” on page 3-16. This section describes the choices that you can change. It also explains why you might want to make changes.
- To change only the choices for the page space minidisk, see “Changing Only the Page Space Minidisk” on page 3-20.
- To set or change the date and time, see “Changing the Date and Time” on page 3-22. If you select items 1, 2, or 3 and have not yet initialized the date and time clock, you will be asked to do so before completing the installation process.
- To install updates to the Virtual Resource Manager, see “Installing Updates to the Virtual Resource Manager” on page 3-25. After the VRM has been installed, use this option to install a VRM update diskette or to install a program which is to reside on the VRM minidisk (such as device driver information supplied by a manufacturer).
- To learn how to use the VRM Maintenance Facility, see *IBM RT PC Software Problem Determination Guide*. This facility should be used only by service personnel or experienced programmers.
- To leave the installation program, select item 8, “End Installing and Customizing the Virtual Resource Manager.” This option is not discussed in this book, but choosing item 8 gives you information on leaving the installation program.

Selecting the Keyboard for Use with the VRM

The RT PC is used all over the world by people of diverse cultures and languages. All of the keyboard layouts have unique characters, punctuation, and symbols. For this reason, the RT PC supports 15 different keyboard layouts.

The first step in installing the VRM is to choose the keyboard layout that includes the characters, punctuation marks, and symbols you intend to use. To select the keyboard layout to use with the VRM, complete the following steps.

To Select the Keyboard for Use with VRM

1. When the **KEYBOARD LAYOUT** menu is displayed, the cursor is located next to the United States English keyboard. If this is the keyboard you want to use, simply press **Enter**. If you want to select another keyboard, go to step 2.
2. Using the **Cursor Up** and **Cursor Down** keys, place the cursor next to the name of the keyboard you want to use. Be sure the cursor is on the same line as the keyboard you want to use, then press **Enter**.
3. The next menu shows you the keyboard you selected. If this is the keyboard you want to use, press **Enter**. If this is not the keyboard you want to use, press **Ctrl-Alt-Pause** to return to the keyboard list menu.

Note: If you decide to change your keyboard selection after the VRM is installed, you must reinstall the entire VRM. Also, anytime you load the VRM diskette to change values, install updates, use the Maintenance Facility, and so on, the keyboard selection menu is displayed. You must select the keyboard each time you load the VRM diskette so keystrokes will be processed correctly.

For more information on the characters, punctuation marks, and symbols supported by the various keyboard layouts, see *IBM RT PC Keyboard Description and Character Reference*.

Installing the VRM with Defaults



Your VRM installation program comes equipped with IBM-supplied choices (defaults) for certain settings (these are always the defaults when you are installing the VRM for the first time). These choices are:

- The number of the fixed disk on which the VRM is stored
- The size in *blocks* that the *VRM minidisk* occupies
- The maximum number of files the VRM minidisk may contain
- The number of the fixed disk on which the page space minidisk resides
- The size in blocks that the page space minidisk occupies.

You may want to install the VRM with the recommended choices. If you plan to install your own programs on the VRM minidisk, you may need to enlarge the VRM minidisk. If you have several work stations, you may need to enlarge the page space minidisk.

See Chapter 1, “Planning For Installation” and Appendix A, “Enlarging the VRM and Page Space Minidisks” for information about system defaults.

If you are installing the VRM for the first time, installing with the recommended choices should be simple. Choose the option that installs the VRM with the current choices because the current choices are the same as the recommended choices when no VRM minidisk exists. If you are reinstalling the VRM, the current choices are those in effect for the current VRM and page space minidisks.

To install the VRM with the IBM-recommended choices, complete the following steps.

— To Install the VRM with Defaults —

1. While the **INSTALL AND CUSTOMIZE THE VIRTUAL RESOURCE MANAGER** menu is displayed, press **Enter** to select item 1.

To select an item, type its ID and press Enter: 1

(When an ID number already is in place on a menu with the cursor at that position, you can simply press **Enter** to accept that choice.)

If you have not set the date and time, prompts will ask you to do so at this point.

2. A message tells you that the VRM is being installed. When installation is complete, a message tells you that the VRM has been installed. Remove the VRM diskette from the diskette drive and store it in a safe place.
3. If you have a VRM update diskette, you should install it now. See “Installing Updates to the Virtual Resource Manager” on page 3-25 for details.
4. You are now ready to install the Base System Program. See Chapter 4, “Installing the Base System Program.”

Viewing the Choices



This section explains how you can see the choices currently in effect, as well as recommended choices and possible choices for the VRM minidisk and the page space minidisk. To see the choices, choose item 2 on the **INSTALL AND CUSTOMIZE THE VIRTUAL RESOURCE MANAGER** menu.

You may want to see the choices for these reasons:

- To change current choices
- To prepare to enlarge the VRM minidisk (for adding non-IBM programs)
- To prepare to enlarge the page space minidisk.

The SHOW CURRENT AND RECOMMENDED CHOICES menu lists the current, recommended, and possible choices for several items. For more information about these items, see “Changing the Choices and Installing the VRM” on page 3-16.

Follow these steps to see the current and recommended choices. Unless you have already made changes in a previous installation of the VRM, the current and recommended choices are the same.

If you have previously installed the VRM and made changes, the current choices (defaults) are those now in effect for the current VRM and page space minidisks.

To View Choices

1. On the INSTALL AND CUSTOMIZE THE VIRTUAL RESOURCE MANAGER menu, type 2. Then press **Enter**.
2. After seeing the choices on the SHOW CURRENT AND RECOMMENDED CHOICES menu, choose one of these options:
 - To return to the INSTALL AND CUSTOMIZE THE VIRTUAL RESOURCE MANAGER menu, press **F3 (Quit)**.
 - To install the VRM with the current choices, press **Enter**.

If you have not already set the date and time clock, prompts will ask you to do so at this point.

- After installation is complete, remove the VRM diskette and store it in a safe place. Check to see whether you have a VRM update diskette. If so, you should install it now. See “Installing Updates to the Virtual Resource Manager” on page 3-25 for details.

The SHOW CURRENT AND RECOMMENDED CHOICES menu on your display screen should resemble the following:

	Current Choice	Recommended Choice	Possible Choices
Virtual Resource Manager			
Fixed Disk Number	0	0	0, 1, 2
Size in Blocks	2821	2821	2192 - 6344
Max Number of Files	128	128	96 - 320
Page Space Minidisk			
Fixed Disk Number	0	0	0, 1, 2
Size in Blocks	11424	11424	2048 - 85884
To cancel and go back to the INSTALL AND CUSTOMIZE THE VIRTUAL RESOURCE MANAGER menu, press F3.			
To install the Virtual Resource Manager with the current choices, press Enter.			

Changing the Choices and Installing the VRM



This section explains how you can change choices for the VRM and page space minidisks and then install the VRM. To change choices, choose item 3 on the **INSTALL AND CUSTOMIZE THE VIRTUAL RESOURCE MANAGER** menu.

The items that you can change for the VRM minidisk and the page space minidisk are described on the next page. After making the changes, you can install the VRM.

For each item that you can change, the display shows current, recommended, and possible choices. The current choices are those now in effect. Recommended choices may be suitable for many system users and are those sent with the VRM. (If you have not

changed these choices, they are defaults for the items.) Possible choices show you the range of choices from which you may select as you make changes.

You can change choices for the following items:

- Fixed disk where the VRM will be stored

You can store the VRM on any internal fixed disk in your system (fixed disks 0, 1, or 2).

- Size in blocks for the VRM

If you want to add non-IBM code to the VRM minidisk, you may need to increase the size in blocks to have enough space to install the modules. A block consists of 512 bytes.

- Maximum number of files for the VRM

If you want to add non-IBM code to the VRM minidisk, you may want to increase the maximum number of files. The value for the maximum number of files really represents the maximum number of *indexes* that can be contained in the file system. The actual number for the maximum number of files is a multiple of the block size of a file system block (2048 bytes) divided by the size of the file index (64 bytes). The maximum number of files that can be contained on the VRM minidisk may often be larger than the number you enter, but it should never be smaller.

- Fixed disk where the page space will be located

The page space is an area on the fixed disk that temporarily stores instructions or data currently being executed. You may want to change the number of the fixed disk on which the page space minidisk resides. You can put the page space minidisk on any fixed disk in your system. See Appendix A, “Enlarging the VRM and Page Space Minidisks” for information about positioning the page space minidisk on the fixed disk.

-
- Size in blocks for the page space.

Usually, the more applications you run concurrently, the larger the page space should be. Knowing the requirements of your applications should help you determine approximate size requirements.

To Change Choices and Install the VRM

1. On the **INSTALL AND CUSTOMIZE THE VIRTUAL RESOURCE MANAGER** menu, type 3. Then press **Enter**.

If you have not set the date and time clock, prompts ask you to do so at this point.

2. On the **CHANGE CURRENT CHOICES AND INSTALL** screens, type the new choice for each item you see on each of the five screens. Then press **Enter**. If an item is acceptable, and you do not wish to change it, press **Enter** to go to the next screen. To cancel the changes, press **F3** to return to the **INSTALL AND CUSTOMIZE THE VIRTUAL RESOURCE MANAGER** menu and begin the sequence again.

3. A screen summarizing your choices appears so you can check your choices. This screen is similar in format to the **SHOW CURRENT AND RECOMMENDED CHOICES** screen on page 2-8. If the choices under the "Current Choices" column are acceptable, press **Enter** to install the VRM.

Note: If you should receive a warning regarding the placement of the VRM minidisk and the page space minidisk, or both, turn to "Procedures for Enlarging a Minidisk" on page A-3 for more information.

4. After installation is complete, remove the VRM diskette and store it in a safe place. Check to see whether you have a VRM update diskette. If so, you should install it now. See "Installing Updates to the Virtual Resource Manager" on page 3-25 for details.

After installing the VRM program, you are ready to do one of the following:

- To install the Base System Program, see Chapter 4, “Installing the Base System Program.”
- If the operating system is already installed, press **Ctrl-Alt-Pause** to restart the system.

Note: If a message indicates that the installation process was not successful, see *Messages Reference* for details.

Changing Only the Page Space Minidisk



To change the size or location of the page space minidisk without having to reinstall the VRM, choose item 4 from the **INSTALL AND CUSTOMIZE THE VIRTUAL RESOURCE MANAGER** menu.

You can change both the number of the fixed disk on which you want the page space minidisk and the size in blocks. After you select item 4, make your changes. Then verify that you want the changes shown on the summary screen. The screens on which you make changes and the summary screen are similar in format to the **SHOW CURRENT AND RECOMMENDED CHOICES** screen on page 3-15.

Follow these steps to change the page space minidisk:

— To Change Only the Page Space Minidisk —

1. On the INSTALL AND CUSTOMIZE THE VIRTUAL RESOURCE MANAGER menu, type 4. Then press **Enter** to go to the first CHANGE ONLY THE PAGE SPACE MINIDISK screen. For information on the choices for the page space minidisk, see “Changing the Choices and Installing the VRM” on page 3-16.
2. Type your new choice for the number of the fixed disk on which you want the page space minidisk. Then press **Enter**.
3. On the second screen, type your new choice for the size in blocks. Then press **Enter**.
4. Verify that the choices on the summary screen are the ones that you want. Press **Enter** to create the page space minidisk with the current choices.

When installation is complete, remove the VRM diskette. Press **Ctrl-Alt-Pause** to restart the system.

Changing the Date and Time



To have the current date and time on your display, you must set the date and time. You should have to set it only once unless you have to change the battery for the battery-powered clock in your system.

To set the date and time, select item 5 from the **INSTALL AND CUSTOMIZE THE VIRTUAL RESOURCE MANAGER** menu. Then do the steps on the next page.

The current date and time for your system will display in the upper right portion of the **INSTALL AND CUSTOMIZE THE VIRTUAL RESOURCE MANAGER** menu. (Note that the time is not updated constantly, but it shows the correct time when the screen first

displays.) For your first installation, when the date and time clock has not yet been initialized, a default date and time appear.

Even if you do not choose item 5 to change the date and time, you will be asked to set the date and time clock during any of the installation options, when the clock is not yet initialized. In the future, you can choose item 5 to change the date and time.

— To Change the Date and Time —

1. On the INSTALL AND CUSTOMIZE THE VIRTUAL RESOURCE MANAGER menu, type 5. Then press **Enter**.
2. On the first CHANGE THE DATE AND TIME screen, enter the new date in the correct date format (MMDDYY). Then press **Enter**.
3. On the next screen, type the number corresponding to the time zone in which you live. Then press **Enter**.
4. On the next screen, type the current time in the correct time format (HHMMSSd). Then press **Enter**.

The screens you see as you change the date and time ask you to do the following:

1. Enter the date

You enter the date in the format MMDDYY, where:

MM is the number of the month,
DD is the day, and
YY is the year.

2. Indicate the time zone

You enter a number from 1 to 24 to indicate the time zone you wish to use. Note that there is no provision for entering a time difference that includes a partial hour. On the CHANGE THE DATE AND TIME menu are areas of the world associated with the time zone number. Also, the time difference from Greenwich Mean Time is shown.

3. Enter the time.

You enter the time in the format HHMMSSd, where:

HH is the hour in the 24-hour clock,

MM is the minutes,

SS is the seconds, and

d is Y if Daylight Savings Time is currently in use in your time zone.

d is N if Daylight Savings Time is not in use in your time zone.

Installing Updates to the Virtual Resource Manager



By selecting item 6 from the **INSTALL AND CUSTOMIZE THE VIRTUAL RESOURCE MANAGER** menu, you can:

- Install a VRM update diskette
- Install a program supplied by a manufacturer for installation on the VRM minidisk.

Notes:

1. If you are using the AIX Operating System, you must use the **shutdown** command to shut down the system before you install an update or other program on the VRM minidisk. Then you must insert the VRM diskette and press **Ctrl-Alt-Pause**.
2. Some non-IBM RT PC components require that you follow the steps described in Appendix D, "Installing the VRM with Non-IBM RT PC Hardware" to install the VRM and any device driver information.

— To Install Updates to the VRM —

1. If you are using the AIX Operating System, use the **shutdown** command to shut down the system. Then insert the VRM diskette and press **Ctrl-Alt-Pause**.
2. On the **INSTALL AND CUSTOMIZE THE VIRTUAL RESOURCE MANAGER** menu, type 6. Then press **Enter**.
3. On the **INSTALL UPDATES TO THE VIRTUAL RESOURCE MANAGER** menu, follow the prompt to insert the program or update diskette. Then press **Enter**.
4. When the updates from the diskette have been installed successfully, the system prompts you to insert another update diskette if you have another to install. If you insert another one, press **Enter**. Otherwise, press **F3**.
5. When installation of updates is complete, follow the prompts to start the operating system or to return to the **INSTALL AND CUSTOMIZE THE VIRTUAL RESOURCE MANAGER** menu.

The system temporarily saves a copy of the VRM minidisk when the update process begins. Then, should an error occur during the update process, the copy is restored to the VRM minidisk so that the fixed disk still contains the VRM. For additional information on error messages, see *Messages Reference*.

Reinstalling the VRM

You may need to reinstall the VRM as a result of new VRM releases provided by IBM or for other reasons.

If you are installing a new VRM provided by IBM, the recommended size in blocks of the new VRM may be different from the old VRM. You should attempt to install the new VRM and paging minidisk with option 1 (Install the Virtual Resource Manager with Current Choices) from the INSTALL AND CUSTOMIZE THE VIRTUAL RESOURCE MANAGER menu. If there is not enough fixed-disk space for the VRM or paging minidisk, a message will inform you of that.

If there is not enough space for the VRM or paging minidisk, select option 3 (Change Current Choices and Install) from the INSTALL AND CUSTOMIZE THE VIRTUAL RESOURCE MANAGER menu. Perform the following procedures until the VRM and paging minidisk are successfully installed:

- If you have multiple fixed disks, select another disk for the VRM or paging minidisk. Although performance may be enhanced by placing the VRM and paging minidisk next to each other on the same fixed disk, you may not have enough space for both minidisks on the same fixed disk.
- Reduce the size of either the VRM or paging minidisk and install.
- Use the VRM Maintenance Facility commands described in *IBM RT PC Software Problem Determination Guide*. Maintenance commands are available to determine the available space on a fixed disk, create or delete minidisks, and so on.

If you still cannot install the VRM and paging minidisk, you may have to back up the contents of the fixed disk that contains the VRM and paging minidisks and delete all the other minidisks on that disk. After backing up and deleting the existing minidisks, your fixed disk has only the VRM and paging minidisk loaded on it. Reinstall the VRM and paging minidisks with the current

choices, then load your other files and data on the available fixed-disk space. Appendix A, “Enlarging the VRM and Page Space Minidisks” on page A-1 describes this procedure.

Another message you may see while reinstalling the VRM relates to the level of the VRM. For instance, if you are installing the same version (or an older one) as you already have in your system, a message will inform you of that. You can then decide whether to continue reinstalling.

Keep in mind that if you have installed additional programs on the VRM minidisk, these programs will be lost when you install new VRM releases provided by IBM. Therefore, reinstalling the VRM may require that you reinstall these programs. If so, while you are reinstalling the VRM, a list will display to show the programs you should reinstall.

If you are reinstalling the VRM with a backup copy you created with the **cvid** command, you may not need to reinstall these programs. You can compare the history files on your system against those on the backup diskette for information.

The history file contains a record for each program that has modified the VRM minidisk. If you are using a backup diskette created with the **cvid** command and want to check its history information, follow the steps in this example:

1. Insert the VRM diskette in drive 0.
2. Type `mount /diskette0` and press **Enter**.
3. Type `cat /diskette0/lpp/vrm/lpp.hist` and press **Enter**.

See *AIX Operating System Commands Reference* for more information on **cvid**.

Chapter 4. Installing the Base System Program

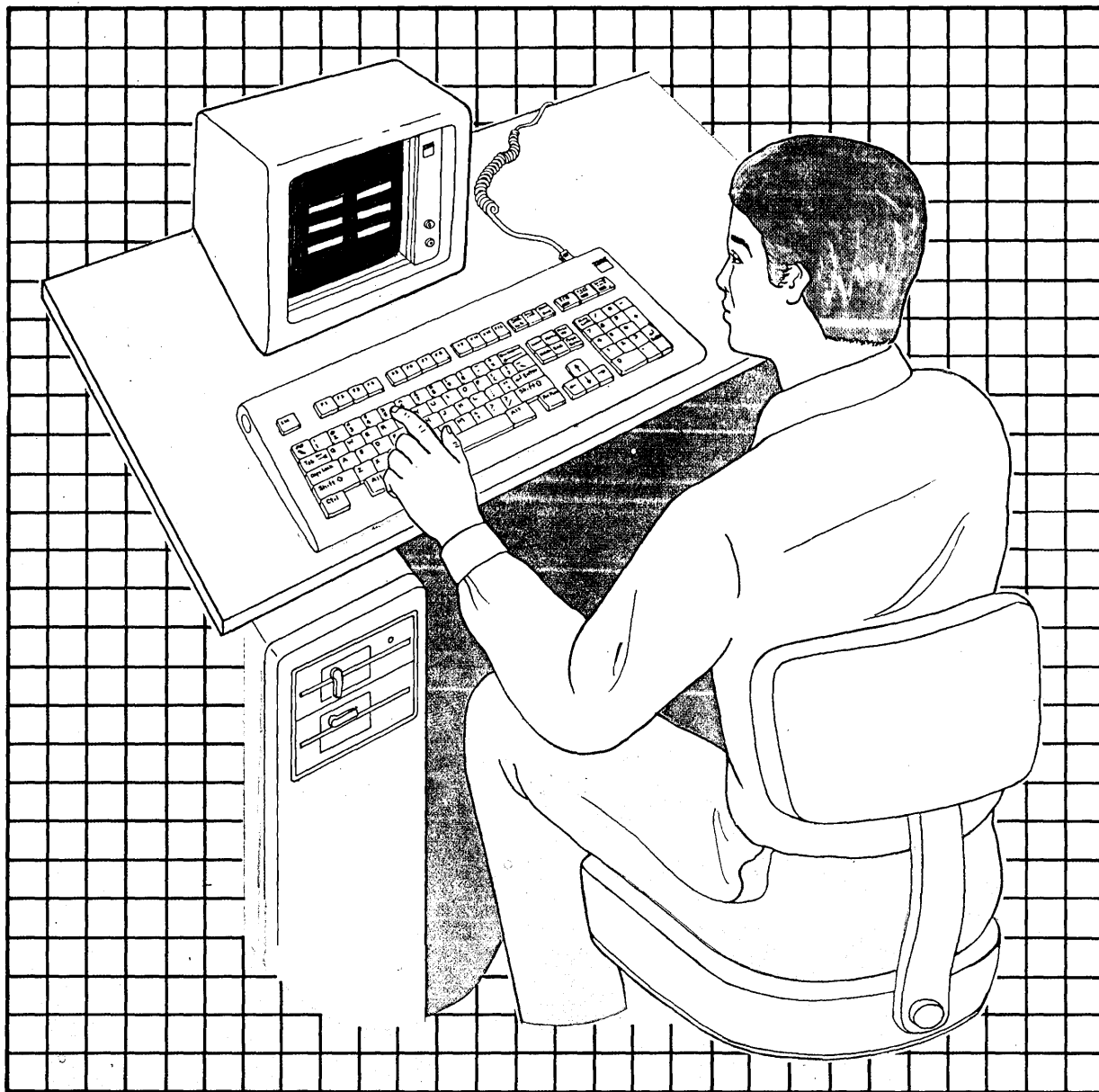

CONTENTS

About This Chapter	4-3
Previewing Your Installation Options	4-4
Customizing Your System	4-5
Loading the Installation/Maintenance Diskette	4-7
Understanding Your Choices	4-9
Selecting an Installation Option	4-11
Installing the Base System Program with Defaults	4-13
Viewing the Current Choices	4-27
Changing Choices and Installing the AIX Operating System	4-32
Backing Up Your AIX Operating System	4-36
Reinstalling the Base System Program	4-37
Merging the Base System Program with a New Version	4-38
Replacing the Base System Program with a New Version	4-42
Logging In to the AIX Operating System	4-43
Logging Off the AIX Operating System	4-45

About This Chapter

This chapter explains these items:

- How to install or reinstall the Base System Program file systems
- How to view and change defaults
- How to log in and log off.

Note: If you are using the merge command to upgrade a 40-megabyte system from AIX Version 1.1 to AIX Version 2.1, see the special instructions enclosed in the RT PC Diskette binder.

Previewing Your Installation Options

Note: You must install the Virtual Resource Manager Program before you install the Base System Program. If you have not installed the VRM, see Chapter 3.

During the installation process described in this chapter, you can examine the IBM-supplied defaults and decide whether to accept those choices. You will have these options:

- **Installing the Installation/Maintenance programs with defaults**

The programs on the Installation/Maintenance diskette come equipped with IBM-supplied defaults. You probably will want to install these programs and the others in the Base System Program and use them for a while before deciding whether you want to change the defaults. Factors that may help you decide to change the defaults include: the number of people using your system, the number of programs you install, the storage size required for those programs, and similar concerns.

- **Viewing the current choices**

The current choices for the disk number, location on the fixed disk, size in blocks, and maximum number of files on your AIX Operating System minidisks have been supplied by IBM. You can see the current choices as well as the recommended choices. Unless you have already installed the AIX Operating System and made changes, both current and recommended choices are the same. You also may see the the range of possible choices.

- **Changing choices and installing the operating system**

When necessary, you can change the IBM-supplied defaults and then install the operating system. If you are reinstalling the Base System Program, or using the procedures in Appendix A to enlarge a minidisk (when there is not enough free space to do so), you must back up some of your data. Before reinstalling, see “Reinstalling the Base System Program” on page 4-37.

Customizing Your System

Planning minidisk space requirements, as you have already done, is an important part of customizing your system. As you install the operating system, you have further opportunities to tailor the system for your needs.

As you install the AIX Operating System, the system automatically configures your system with the basic hardware components (system unit, display, keyboard). But as you add other hardware components (a printer, for example) and users to your system, and as you change the defaults, you customize your system. Chapter 6, “Customizing System Devices” and Chapter 7, “Customizing System Minidisks” help you customize your system.

When you customize your system, you describe (to the system) the devices, programs, and users for a particular data processing system. You have the options of using IBM-supplied defaults or of tailoring information about minidisks, devices, programs, users, and system values to suit your own needs. You may customize your system as you install the AIX Operating System or any time thereafter.

You use two basic commands to customize your system: **devices** and **minidisks**.

1. With **devices**, you can add predefined devices to your system, delete devices already attached to your system, and display or change device information describing your system. Chapter 6, “Customizing System Devices” on page 6-1 explains how to use the **devices** command.
2. With **minidisks**, you can add minidisks to your fixed disk. You also can delete minidisks from your fixed disk or change the choices for minidisk characteristics. Chapter 7, “Customizing System Minidisks” explains how to use the **minidisks** command.

Another command that you may use to customize your system is the **users** command described in *Managing the AIX Operating*

System and AIX Operating System Commands Reference. With **users**, you can add system users to or delete them from the system, invalidate or validate user passwords, and display or change information about system users.

Loading the Installation/Maintenance Diskette

Locate the Installation/Maintenance diskette and the diskettes containing the AIX Operating System file systems. The label of the Installation/Maintenance diskette is similar to the one shown below.

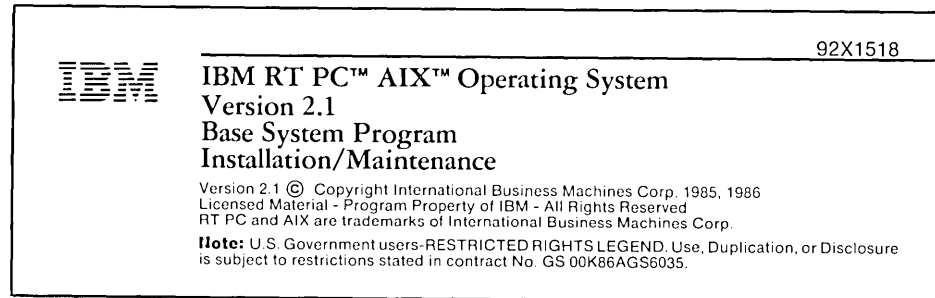

To begin the installation procedure, complete the following instructions to load the Installation/Maintenance diskette.

To Load the Installation/Maintenance Diskette

- If the system is running,
 1. Insert the Installation/Maintenance diskette into the top diskette drive, and turn the lever into the locked position.
 2. Press **Ctrl-Alt-Pause** to load the programs from the diskette into memory.
- If the system is not running,
 1. Turn the key to the unlocked position.
 2. Turn on the power switches.
 3. Insert the Installation/Maintenance diskette into the top diskette drive, and turn the lever into the locked position.
 4. Press **Ctrl-Alt-Pause** to load the programs from the diskette into memory.

Note: If you see an error message on the display after the system starts, see *Messages Reference*. Locate the message by finding the six-digit number corresponding to the number shown on your display. Then read about what caused the message to appear and about what you may do to resolve the problem.

Understanding Your Choices

After the system loads the programs, you will see the SYSTEM MANAGEMENT menu.

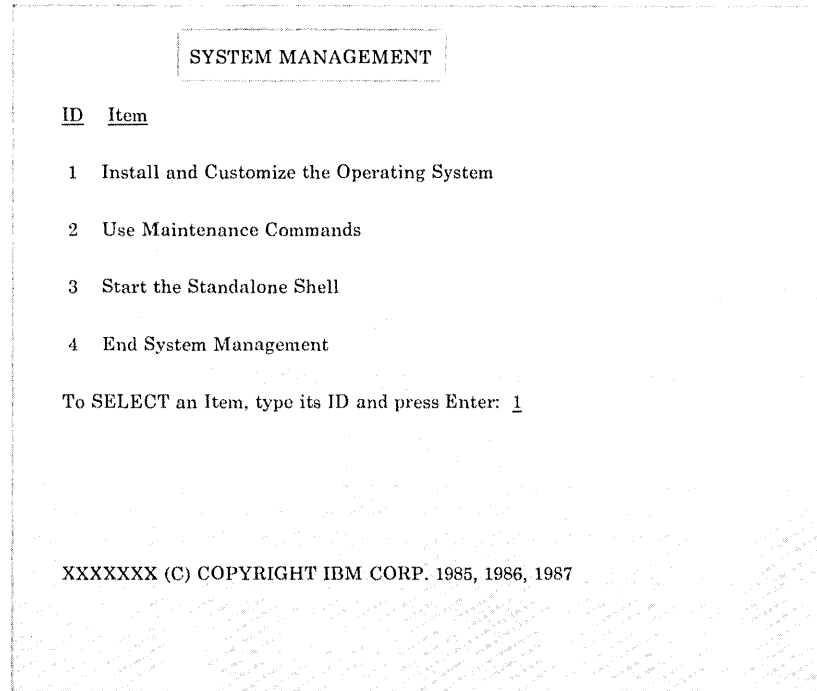

The SYSTEM MANAGEMENT menu lists four options from which you may choose:

- 1. Install and Customize the Operating System.** This option takes you to one of two installation menus, depending on whether you are installing the operating system for the first time or reinstalling the operating system. If you are installing the operating system for the first time, this option takes you to the INSTALL AND CUSTOMIZE THE OPERATING SYSTEM menu. "Installing the Base System Program with Defaults" on page 4-13 describes this option.

By following the prompts from this menu, you can do these steps:

- Install the operating system with current choices
- Show current and recommended choices
- Change current choices and install the operating system.

If you are reinstalling the operating system, this option takes you to the **INSTALL NEW VERSION OF AIX** menu. By following the prompts from this menu, you can do these steps:

- Merge your existing operating system files with the new version of the operating system files. “Merging the Base System Program with a New Version” on page 4-38 describes this option.
- Install the new version of the operating system over your existing version. “Replacing the Base System Program with a New Version” on page 4-42 describes this option.

2. **Use Maintenance Commands.** Choosing this option provides you with several maintenance tools. These tools are especially useful if you have system problems. If your fixed disk and files are not usable because of system failure or some other problem, you may start up your system with the Installation/Maintenance diskette. When you do so, you may use any of these maintenance tools:

- Show minidisk information
- Change load status of a minidisk
- Create a minidisk
- Delete a minidisk
- Check a file system
- Make a file system
- Format a diskette
- Restore commands
 - Restore a file system
 - Restore a minidisk image.
- Backup commands.
 - Back up a file system
 - Back up a minidisk image.

For information on using these commands, see *Managing the AIX Operating System*.

3. **Start the Standalone Shell.** Choosing this option starts the standalone shell from which you can issue any of the commands contained on the Installation/Maintenance diskette. See *Managing the AIX Operating System* for a list of those commands.
4. **End System Management.** This option allows you to choose the method of running the AIX Operating System. The choices are:
 - Item 1 - Normal startup
 - Item 2 - Maintenance startup.

Selecting an Installation Option

After you have loaded the Installation/Maintenance diskette, you are ready to install the Base System Program. You should have the SYSTEM MANAGEMENT menu on your display.

If you have the AIX Operating System installed on your RT PC, the Installation/Maintenance programs automatically take you to the INSTALL NEW VERSION OF AIX menu when you select option 1 (Install and Customize the Operating System). See “Reinstalling the Base System Program” on page 4-37.

If you are installing the AIX Operating System for the first time, continue with the next sections.

Using your planning worksheets as a guide, decide whether you want to install the Base System Program using system defaults or whether you want to change the system defaults to better meet the requirements from your worksheets.

Select from these options:

- To install the Base System Program with system defaults, continue on the next page.
- To view the system defaults, see “Viewing the Current Choices” on page 4-27.
- To override the defaults and make changes, see “Changing Choices and Installing the AIX Operating System” on page 4-32.

Installing the Base System Program with Defaults



To install the operating system with defaults, choose item 1. The defaults include:

- The number of the fixed disk or disks where the AIX Operating System minidisks will be stored.
- The size in blocks for the AIX Operating System minidisks.
- The maximum number of files for the AIX Operating System minidisks.

Note: To see these choices before you install the Base System Program, turn to “Viewing the Current Choices” on page 4-27. After seeing the current choices, you may install from that menu or return to the **INSTALL AND CUSTOMIZE THE OPERATING SYSTEM** menu.

To install the Base System Program, along with the recommended choices for the previously listed items, perform the following steps:

To Install the Base System Program

1. On the SYSTEM MANAGEMENT menu, press **Enter** to select the Install option.
2. On the INSTALL AND CUSTOMIZE THE OPERATING SYSTEM menu, press **Enter** to choose the Install with Current Choices option.
3. Follow instructions to add the name you will use to log in to the system.
4. On the next screen, choose whether you want the system to ask for the user name and password.
5. Choose the input device from which you wish to install the operating system. Then press **Enter**. If you are installing from tape, disregard the following steps about diskettes.
6. Press **Enter** to proceed with installation. Follow the prompts to load the operating system diskettes into diskette drive 0.
7. Insert all the diskettes until the entire operating system is installed.
8. When AIX is installed, press **Enter** to continue with post-installation processing. When post-installation processing is completed, press **Enter** to return to the SYSTEM MANAGEMENT menu. Select Item 4, "End System Management," and choose a method of running your system.

(Continued next page)

To Install the Base System Program (Continued)

9. Read the rest of this chapter, beginning with “Logging In to the AIX Operating System” on page 4-43.
10. If you want to install any of the additional operating system programs described in Chapter 5, do it now with the **installp** command. If your diskette binder includes an operating system update diskette, install it with the **updatep** command after the operating system and any additional programs are installed.

More Detailed Information

1. On the SYSTEM MANAGEMENT menu, press **Enter** to select the Install option. When a number is already in the column where you type choices, you can press **Enter** to select that number. The Install option provides you with these choices:
 - Install the Operating System with current choices. If you have not installed the Base System Program before, the current choices are IBM-recommended defaults. If you have installed it before, the choices identified as current choices are those now in effect.
 - Show current and recommended choices. Unless you have already installed the Base System Program with changes, the current and recommended choices are the same.
 - Change current choices and install. You can change the current choices and then install the Base System Program.

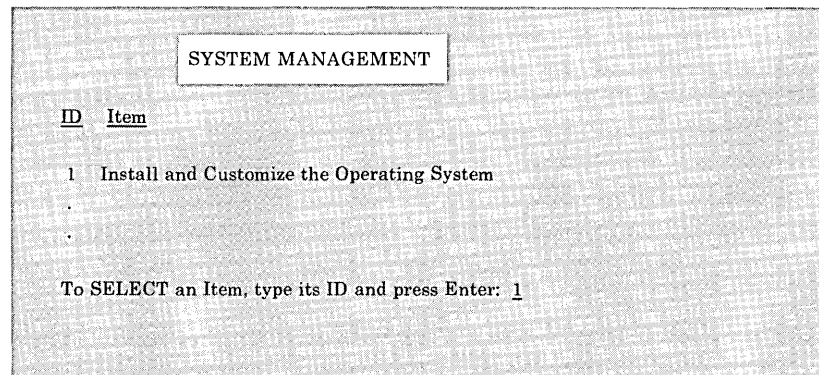

-
2. On the **INSTALL AND CUSTOMIZE THE OPERATING SYSTEM** menu, press **Enter** to go to the next screen.

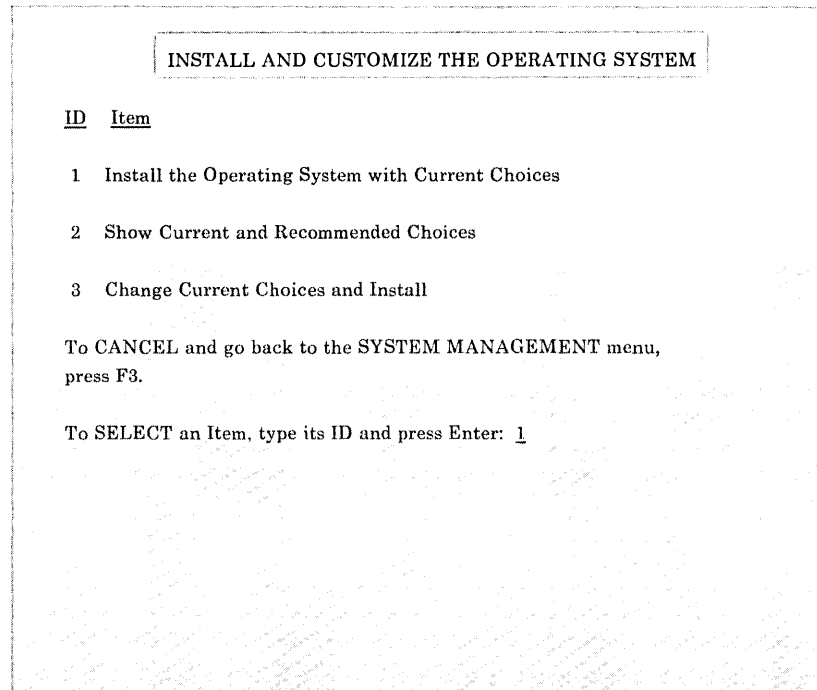

-
3. Follow instructions to add the name you will use to log in to the system.

INSTALL THE OPERATING SYSTEM WITH CURRENT CHOICES

This step creates the name that you will use to log in to the system. You may use up to 8 characters for this name. Use all lowercase characters for the name.

To CANCEL and go back to the INSTALL AND CUSTOMIZE THE OPERATING SYSTEM menu, press F3.

To CREATE your user name, type the name and press Enter:

Only one user on your system can use the autolog function. The user must be using the system console. Any user name that you specify in response to the autolog prompt automatically becomes a member of the system group. See *Managing the AIX Operating System* for a discussion of different classes of users. Members of the system group have privileges that many other users do not. You can, of course, choose to have the system request your user name and login for security purposes.

-
4. On the next screen, choose whether you want the system to request the user name and password. For more information on passwords and on security concerns, see *Managing the AIX Operating System*. Maintaining strict security is always important, especially if several people will be using your system.

INSTALL THE OPERATING SYSTEM

<u>ID</u>	<u>Item</u>
1	User login. You WILL be prompted for your user name and password when you start your system.
2	Automatic login. You WILL NOT be prompted for your user name and password when you start your system.

To CANCEL and go back to the INSTALL AND CUSTOMIZE THE OPERATING SYSTEM menu, press F3.

To SELECT an Item, type its ID and press Enter: 1

-
5. Choose whether you wish to install the Base System Program from diskette drive 0, diskette drive 1, or tape. Type the number for your choice. Then press **Enter**.

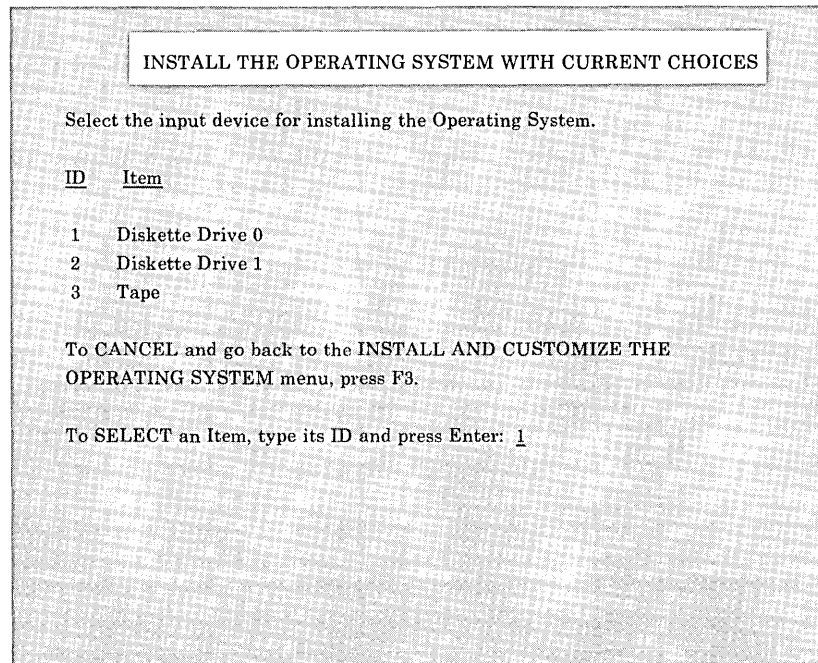

To work properly, diskette drive 1 (item 2) must be a 1.2M-byte drive.

-
6. Indicate whether you wish to proceed with the installation process or cancel and return to the **INSTALL AND CUSTOMIZE THE OPERATING SYSTEM** menu. To proceed, remove the Installation/Maintenance diskette. Then press **Enter**.

INSTALL THE OPERATING SYSTEM WITH CURRENT CHOICES

Installation of the Operating System will take several minutes.

To **CANCEL** and go back to the **INSTALL AND CUSTOMIZE THE OPERATING SYSTEM** menu, press **F3**.

To **INSTALL** the Operating System, remove the Installation/Maintenance diskette from diskette drive 0 and press **Enter**.

To prepare for installation, the system proceeds to make file systems on the default minidisks (**/**, **/usr**, **/tmp**).

-
7. Follow the prompts to insert the appropriate operating system diskette into the diskette drive. Note that the word `volume` means diskette and that `/dev/fd0` refers to the top diskette drive.

```
Use the Operating System diskettes.

Please mount volume 1 on /dev/fd0
...and press Enter to continue.

Please mount volume 2 on /dev/fd0
...and press Enter to continue.

Please mount volume 3 on /dev/fd0
...and press Enter to continue.

Please mount volume 4 on /dev/fd0
...and press Enter to continue.
```

The prompts ask you to insert each operating system diskette at the appropriate time and press **Enter**. After you press **Enter**, messages will indicate that processing is taking place, and a list of the files being installed is displayed for each diskette. When all operating system diskettes have been installed, more messages indicate the processing taking place (mounting file systems, configuring the system, and so on). Another message informs you when the AIX Operating System is installed successfully.

-
8. If Daylight Savings Time is used in your time zone, type *Y* and press **Enter**.

Will the U.S. Daylight Savings Time rules be applied in this time zone? (y/n)

9. Next, you are prompted to continue with the Post-Installation procedures. Post-Installation procedures handle the configuration files specific to your system, such as for your system devices.

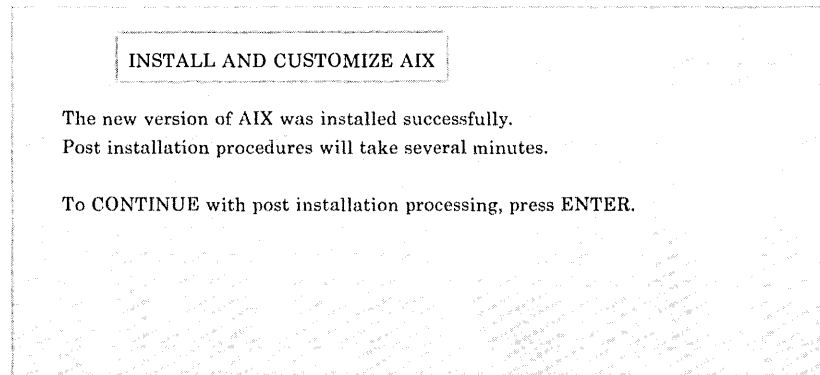

Press **Enter** to proceed with the post-installation procedures. Your operating system installation is not complete until this processing is performed.

When the post-installation processing is completed, the SELECT LANGUAGE MENU will be displayed.



Note: If you are doing the initial installation or a re-installation (not a merge) the default language (item1) is U.S. English. If you are doing a merge, the current/default language is whatever language you last chose. If you did not previously choose a language, the current/default language will again be U.S. English.

At this point you are prompted to return to the SYSTEM MANAGEMENT menu to start your system. Press **Enter** to return to the System Management menu. Select Item 4, "End System Management," to choose how to start up the AIX Operating System. The following menu is displayed.

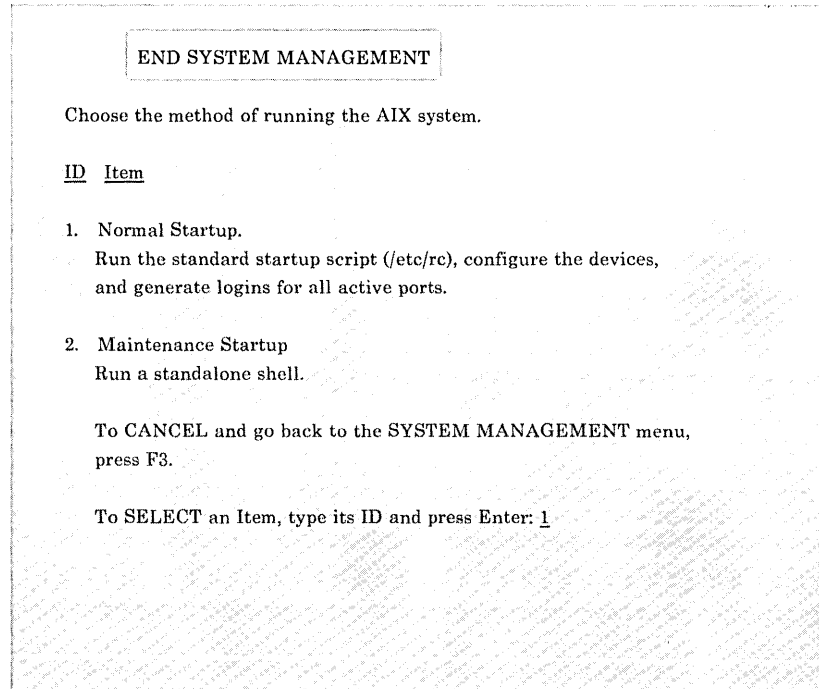

If you receive a message indicating that the programs did not load successfully, try the installation procedure again. If numbered messages appear, go to *Messages Reference* for suggested actions.

10. Read the rest of this chapter, beginning with "Logging In to the AIX Operating System" on page 4-43.
11. If you want to use any of the additional operating system programs, install them now with the **installp** command. Chapter 5, "Installing Additional Operating System Programs"

describes all the additional programs and provides installation instructions. If your diskette binder contains an update diskette to the AIX Operating System, install it with the **updatep** command after the operating system (including any of the additional operating system programs) is installed. See Chapter 5, “Installing Additional Operating System Programs” for instructions on using either the **installp** or **updatep** commands.

Viewing the Current Choices



You may want to see the choices available for the Base System Program. To do so, choose item 2 on the INSTALL AND CUSTOMIZE THE OPERATING SYSTEM menu.

The Base System Program consists of four file systems (on four minidisks). In addition, a dump minidisk is available in case of a system failure. In case of a system failure, see *Managing the AIX Operating System* for information on recovering your data.

While you may find the default settings for these minidisks satisfactory, you may also wish to see the settings to determine whether you wish to change them. Selecting option 2 from the

INSTALL AND CUSTOMIZE THE OPERATING SYSTEM menu lets you see the choices currently in effect.

After seeing the choices, you may install the Base System Program with the current choices in effect or return to the INSTALL AND CUSTOMIZE THE OPERATING SYSTEM menu to select another option.

To display the current choices for the fixed disk number, the size in blocks, and the maximum number of files, follow these steps:

— To Display Current Choices —

1. On the INSTALL AND CUSTOMIZE THE OPERATING SYSTEM menu, type 2, and press **Enter**.
2. On the SHOW CURRENT AND RECOMMENDED CHOICES menu, you will see the current, recommended, and possible choices for the / (root) minidisk.

To see choices for the other four minidisks, press the **Cursor Down** key.

More Detailed Information

1. On the **INSTALL AND CUSTOMIZE THE OPERATING SYSTEM** menu, type 2, and press **Enter**. Doing so takes you to the **SHOW CURRENT AND RECOMMENDED CHOICES** menu.
2. On the **SHOW CURRENT AND RECOMMENDED CHOICES** menu appear the current, recommended, and possible choices for the / (root) file system. The choices on your display may not be the same as those shown on 4-30. The default minidisk sizes may vary according to the size of the fixed disks in your system. To determine the default sizes for your system, refer to the following table, Figure 4-1. The sizes under the heading **40M System** are to be used only if your system has one 40-megabyte fixed disk. All other systems should use the sizes under the heading **All Others**.

Minidisk	40M System	All Others
/ (root)	20000	24000
/usr	42200	60000
/u	6000	12000
/tmp	2000	2000
Paging	See page 1-11	See page 1-11
Dump	3000	5000

To see choices for the `/usr` minidisk, the `/u` minidisk, the `/tmp` minidisk, and the Dump minidisk, use the **Cursor Down** key. You can return to a previous screen by pressing the **Cursor Up** key. If you want to install with the current choices, press **Enter**. If you want to change any of the choices, return to the **INSTALL AND CUSTOMIZE THE OPERATING SYSTEM** menu by pressing **F3**.

SHOW CURRENT AND RECOMMENDED CHOICES			
<u>/root Minidisk:</u>	<u>Current</u>	<u>Recommended</u>	<u>Possible</u>
	<u>Choice</u>	<u>Choice</u>	<u>Choices</u>
Fixed Disk Number	1	0	0 - 2
Number of Blocks	24000	24000	1-66900
Number of Files	6000	6000	1-64800

To SEE choices for other minidisks, use the Cursor Down or Cursor Up keys

To CANCEL and go back to the **INSTALL AND CUSTOMIZE THE OPERATING SYSTEM** menu, press F3.

To **INSTALL** the Operating System with the current choices, press Enter.

Here is some information about the choices you see on the screen:

- Fixed Disk Number

You can locate the file system minidisk on any internal (40- or 70-megabyte) fixed disk in your system. Notice that the **current** choices are now in effect. The **recommended** choices are the values supplied by IBM when you first receive the program. Unless you have made changes, the current and recommended choices are the same. The

possible choices indicate the range of choices within which you may select.

- Number of Blocks

If you install the operating system with the defaults, the sizes in blocks are assigned and allocated for you. If you wish to override those defaults and adjust the sizes in blocks on one or more minidisks, see the table in Chapter 1, “Planning For Installation” for information about the number of blocks each of the AIX Operating System programs contains.

- Number of Files

If you plan to install several programs in addition to those included in the AIX Operating System, you may, at some point, want to increase the maximum number of files. However, the number of files available generally is quite large. See the following pages to change the maximum number of files. See *Managing the AIX Operating System* for information on the file system.

Changing Choices and Installing the AIX Operating System



To change the current choices and then install the Base System Program, choose option 3 from the **INSTALL AND CUSTOMIZE THE OPERATING SYSTEM** menu. See “More Detailed Information” on page 4-29 for an explanation of these items:

- Fixed disk number on which a file system minidisk is located
- Size in number of blocks
- Maximum number of files.

Before changing any of the choices, you may want to see *Managing the AIX Operating System* for additional information on these topics.

To change the current choices and install the AIX Operating System, do the following steps:

— To Change Choices and Install —

1. From the **INSTALL AND CUSTOMIZE THE OPERATING SYSTEM** menu, type 3 and press **Enter**.
2. From the **CHANGE CURRENT CHOICES AND INSTALL** menu, choose the number of the minidisk you wish to change. Then press **Enter**.
3. Follow the prompts to change the choices for the fixed disk number, size in blocks, and maximum files for the file system minidisk selected.
4. Check the summary screen to make sure that the new current choices are the ones you want. If you want to make additional changes, repeats steps 2 and 3.
5. To install the AIX Operating System with the new current choices, type 6 and press **Enter**.
6. Turn to step 3 on page 4-14 and follow steps 3 through 9.
7. Continue reading in this chapter, beginning with “Logging In to the AIX Operating System” on page 4-43.

More Detailed Information

1. From the **INSTALL AND CUSTOMIZE THE OPERATING SYSTEM** menu, type 3 and press **Enter**.
2. From the **CHANGE CURRENT CHOICES AND INSTALL** menu, choose the number of the minidisk you want to change, and press **Enter**.

CHANGE CURRENT CHOICES AND INSTALL				
ID	Item	Fixed Disk	Number of Blocks	Number of Files
1	/(root)	0	24000	6000
2	/usr	0	60000	15000
3	/u	0	12000	3000
4	/tmp	0	2000	500
5	Dump	0	5000	0
6	Install the Operating System and cause the current choices to take effect			

To CANCEL all changes and go back to the **INSTALL AND CUSTOMIZE THE OPERATING SYSTEM** menu, press F3.

To SELECT an Item, type its ID and press Enter: 1

For additional information on the number of blocks contained in each AIX Operating System program and the number of blocks allocated to the / (root), /usr, and /var minidisks, see the tables in Chapter 1, "Planning for Installation," and Figure 4-1 on page 4-29 .

3. Follow the prompts and supply information to change the choices for the following items for each minidisk you want to change. A separate screen appears for each of these three items (for each minidisk):

- Number of the fixed disk on which you want the minidisk (this screen appears only when there is more than one fixed disk)
- Number of blocks to allocate for the minidisk
- Maximum number of files for the minidisk (does not appear for the dump minidisk).

The CHANGE CURRENT CHOICES AND INSTALL menus show current and recommended choices and the range of possible choices. The current and recommended choices are the same until you install the operating system with changes. At any point, you may press **F3** to cancel all changes and return to the INSTALL AND CUSTOMIZE THE OPERATING SYSTEM menu.

4. Check the summary screen to ensure that all the data shown reflects the changes you want. You can still make changes to any of the information displayed by repeating steps 2 and 3.
5. After making all your changes and returning to the menu that shows all choices for the minidisks, type 6 and press **Enter** to make the changes take effect.
6. Follow steps 3 through 9 beginning with step 3 on page 4-14.
7. Continue reading the rest of this chapter.

Backing Up Your AIX Operating System

After you have installed the VRM, the Base System Program and any additional operating system programs or licensed programs, you should make backup copies of all your minidisks. Having **backup diskettes** (or tapes) helps protect you against possible loss of programs and files. Make sure you have several formatted diskettes to contain the backup data. If you are backing up to tape, note that the default setting for the streaming tape drive (**/dev/rmt0**) causes the tape to rewind after each file system or minidisk is backed up. Either use a separate tape for each minidisk to be backed up, or change the tape setting to **/dev/rmt4**, which does not rewind the tape after each backup operation. See *Managing the AIX Operating System* for more information about backup procedures and security concerns.

To back up the VRM minidisk, you must use the **cvid** command discussed in *Managing the AIX Operating System* and in *AIX Operating System Commands Reference*.

Reinstalling the Base System Program

If you have previously installed the Base System Program on your RT PC and you select Item 1 (Install and Customize the Operating System) from the SYSTEM MANAGEMENT menu, the INSTALL NEW VERSION OF AIX menu is displayed.

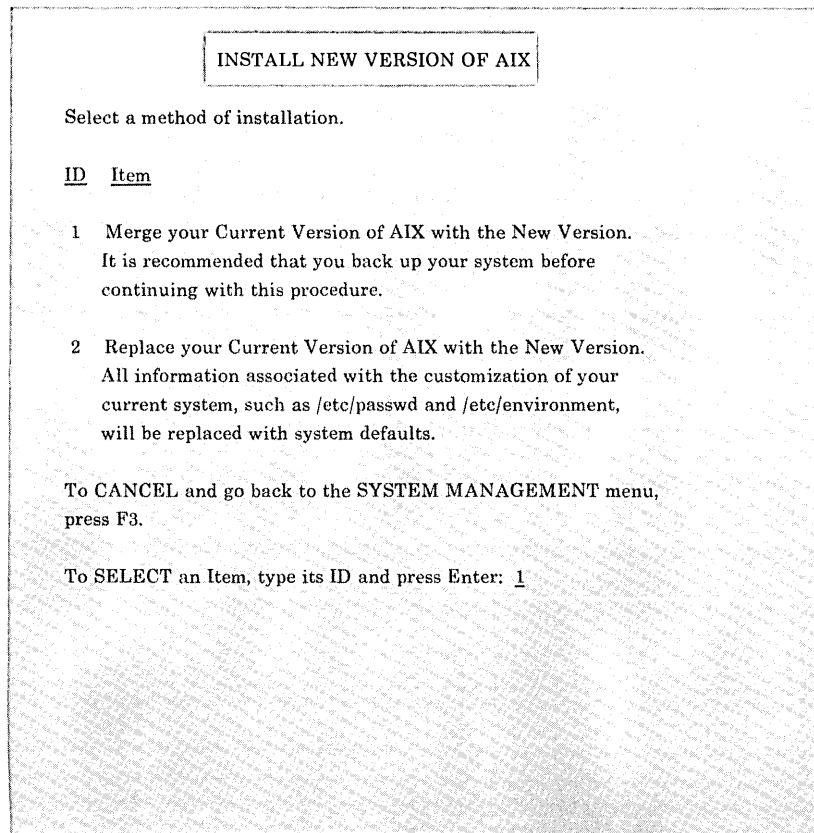

Choosing to merge or replace your existing Base System Program with the new version depends on your specific needs and the amount of customization you have done to your existing system. Both methods are described in the following sections.

Merging the Base System Program with a New Version

If you have been using the Base System Program on your RT PC, you may have changed default values, added files and devices, and performed other customization procedures on your configuration files. You may have defined your own minidisks for data, licensed programs, and so on.

The merge option, which is the default path for reinstalling the Base System Program, allows you to save your customized files by listing all the files on your current system that differ from those about to be installed. You can then back up these customized files, install the new version of the Base System Program, and add your modifications to the new files as desired.

The merge of the configuration files is handled separately by the Post-Install Configuration Procedure. This procedure also gives you a chance to back up configuration files that will be modified or replaced. See “Post-Install Configuration Procedures” on page 4-40.

If you plan to back up your customized files, be sure you have enough media (formatted diskettes or tapes) to contain the data you want to back up. The amount of media required depends on the number and size of the files to be backed up.

Note: The configuration files that were backed up should only be used if you modified any of these files yourself and you want to save the changes you made. Once the install process is complete, you can then restore these files to your own directory and modify the new configuration files with the changes. **DO NOT** replace the new configuration files with the backed up version as you will lose important updates made to these files.

After you select the merge option, you are prompted to choose the device (diskette or tape) for merging the new Base System Program.

At this point, you are prompted to insert the first Base System Program diskette (volume 1). A program on volume 1 compares your existing operating system files with those about to be installed. If the files on your system have been modified since they were installed, you are given a chance to see a list of these files

and back them up before proceeding with the merge. The following menu is displayed.

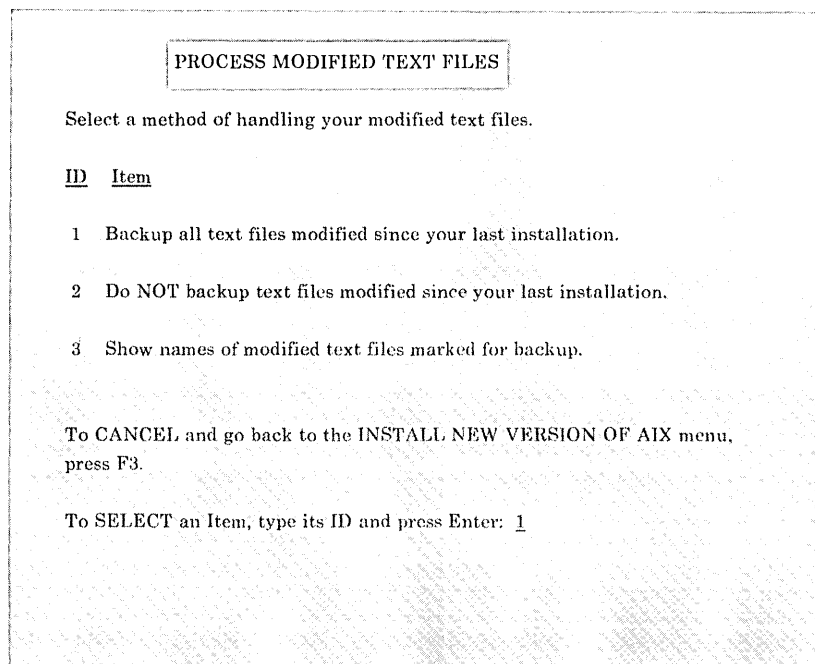

If you select Item 1 from the PROCESS MODIFIED TEXT FILES menu, you must indicate the device to be used for backing up the files. After selecting the device and pressing **Enter**, the system indicates the approximate amount of media (diskettes or tape) you need to contain the backup. You are then prompted to insert the appropriate media until the backup is completed. IBM recommends that you back up modified text files before you proceed with the merge.

If you select Item 2 from the PROCESS MODIFIED TEXT FILES menu, a warning screen is displayed indicating that your modified files will be replaced with system defaults.

If you select Item 3 from this menu, you will see a list of the files marked for backup. This option provides additional information on

these files, such as the full path name of the file and the size of the file in blocks.

After you have indicated how to process your modified text files, a menu will prompt you to proceed with or cancel the merge. Press **Enter** to proceed or **F3** to cancel.

At this point, you are prompted to insert the operating system diskettes (beginning with volume 1) until all are installed.

Post-Install Configuration Procedures

The configuration files, which contain customization information for the devices on your system, are updated or replaced when you select the merge option for reinstalling the AIX Operating System. The configuration files are changed to provide your system with the most current support for devices, keywords, and so on, without requiring you to reconfigure the entire system.

Before any configuration files are changed, however, a list is displayed that indicates which files will be updated and which will be replaced. In general, the device-specific configuration files (such as **/etc/system** and many of the **/etc/ddi** files) are updated and the system-wide support files (**/etc/rc**, **/etc/master**, and **/etc/predefined**) are replaced. At this point, you are given an opportunity to back up these files before any changes are processed.

IBM recommends you perform this backup so you will have a record of your current configuration. This backup is particularly important if you have changed the files that will be replaced (**/etc/rc**, **/etc/master**, **/etc/predefined**).

Note: The configuration files that were backed up should only be used if you modified any of these files yourself and you want to save the changes you made. Once the install process is complete, you can then restore these files to your own directory and modify the new configuration files with the changes. **DO NOT** replace the new configuration files with the backed up version as you will lose important updates made to these files.

To back up the configuration files, type **y** when the prompt is displayed. One diskette is required to contain the backup data.

A message is displayed when the post-install configuration procedure completes successfully. This message lists the files that were replaced so you can merge your previous versions of these files into the new versions, if desired.

If the configuration file updates are unsuccessful for any reason, an error message will be displayed. This message indicates whether the error occurred during update of the **/etc/system** file or during update of one the **/etc/ddi** files.

If an error occurred during the **/etc/system** update, all configuration files will be replaced by files from the new version of the Base System Program. If you added any devices to your previous system, you must use the **add** option of the **devices** command to add the device to the new version. If you created any minidisks on your previous system, you must run the **mdrc** command to recall these minidisks to the new version.

If an error occurred during update of the **/etc/ddi** files, the **/etc/ddi** files displayed on the POST-INSTALL CONFIGURATION PROCEDURE menu will be replaced by files from the new version of the Base System Program. In this case, customization of device-dependent information is lost. If you added any devices to your previous system, the devices may work differently (or not at all) from the way they worked on your previous system. You may have to run the **change** option of the **devices** command to set the device-dependent information to the values you were using with your previous system.

After the Base System Program is successfully installed and post-installation processing is complete, press **Enter** to return to the SYSTEM MANAGEMENT menu. Select Item 4, End System Management, and indicate whether you want to start up your system in normal or maintenance mode.

Replacing the Base System Program with a New Version

Warning: Reinstalling the Base System Program with the replace option rather than the merge option replaces the contents of the files on the / (root), /usr, /tmp, and dump minidisks, as well as device and configuration files. Be sure to back up files you wish to save before you replace the Base System Program.

Replacing your existing version of the Base System Program with a new version is very similar to installing the Base System Program for the first time. You have the same options (installing with defaults, showing the current choices, and changing the current choices and installing) as you do with the first Base System Program installation. See “Installing the Base System Program with Defaults” on page 4-13 for a detailed description of the steps and options available to you as you reinstall the Base System Program.

If you reinstall the Base System Program without changing any characteristic of the /u minidisk, the user data on that minidisk remains intact.

However, you will be unable to access minidisks that you have created until you run the **mdrc** command. “Accessing User-Created Minidisks After Reinstalling (Using the Replace Option)” on page 7-41 describes the **mdrc** command.

For information on backing up the files on your minidisks, see *Managing the AIX Operating System*.

Logging In to the AIX Operating System

Earlier, you chose to have the system either log you in automatically, without asking for your user name and password, or ask you for your user name and password. The steps you follow to log in to the system vary, depending upon the option you chose.

To Log Into the AIX Operating System

1. If your system is not running,
 - a. Turn the keylock to the unlocked position.
 - b. Turn on the power switches.
 - c. If necessary, enter your user name. (Generally, you should type information in lowercase letters. If you mistakenly type in uppercase, log off and then log in to the system again.)
 - d. If necessary, enter your password.
2. If your system is running,
 - a. If necessary, enter your user name.
 - b. If necessary, enter your password.

More Detailed Information

1. Turn the keylock to the unlocked position.
2. Turn on the power switches. As described in Chapter 2, "Getting Ready to Install the AIX Operating System," when you start your IBM RT PC system, the system goes through a series of internal tests before it is ready to use. While these procedures are running, various messages about system activities display on the screen. Depending upon a

number of variables, these procedures usually take several seconds to run, but may take longer. When the system is ready, it displays a two-line copyright statement.

3. If necessary, enter your user name in lowercase letters. Should you mistakenly use all uppercase letters, log off the system (see next page) and log in again, using lowercase letters. If your terminal does not accept lowercase, you may use uppercase. If you chose to be prompted for your user name, enter it after the prompt login: and press **Enter**. If your system does not require a user name, the message Autologin of (user name) is displayed, followed by the shell (\$) prompt. You are now ready to begin using the system.
4. If necessary, enter your password. If you have just installed the AIX Operating System and have no password, you will not be prompted for one. Instead, you will see the \$ or # prompt. If you do have a password and enter it when requested, the \$ or # prompt appears.

For security reasons, the system does not display your password as you type it. See *Managing the AIX Operating System* for information on passwords and security procedures.

The system is now ready to accept a command.

If your system redisplay the login prompt, you are not logged in. Try to log in again. You may have typed your password incorrectly.

Logging Off the AIX Operating System

You can log off the system in two ways:

- Log off and leave the system running for others to use
- Log off and turn off the system.

Follow these instructions to log off and leave the system running:

To Leave the System Running

1. Be sure that the \$ or # prompt displays on the screen.
2. Press **Ctrl-d**.

To log off the system and turn off the power to the system, follow these steps:

To Log Off and Stop the System

1. Be sure that the \$ or # prompt displays on the screen.
2. Type shutdown. Then press **Enter**. See the warning on the following page.
3. All users are now informed of the impending shutdown. To proceed with the shutdown, type y and press **Enter** when prompted.
4. Turn off the power to the system.

More Detailed Information

Warning: It is very important that you use the **shutdown** command before you turn off the power to your system. Failure to do so may result in the loss of data, damage to the AIX Operating System or both.

When you issue the **shutdown** command, the system notifies all users of the impending shutdown. After a short interval, you are prompted to indicate whether to proceed with the shutdown. Type **y** and press **Enter** to proceed with the shutdown.

When the AIX Operating System stops running, you receive the message:

```
. . .shutdown completed. . .
```

Note: Only certain system users may use the **shutdown** command. These users are responsible for shutting down the system. If you are not the person responsible for shutting down your system, log off and leave the system running.

For more information about **shutdown**, see *Managing the AIX Operating System*.

Chapter 5. Installing Additional Operating System Programs

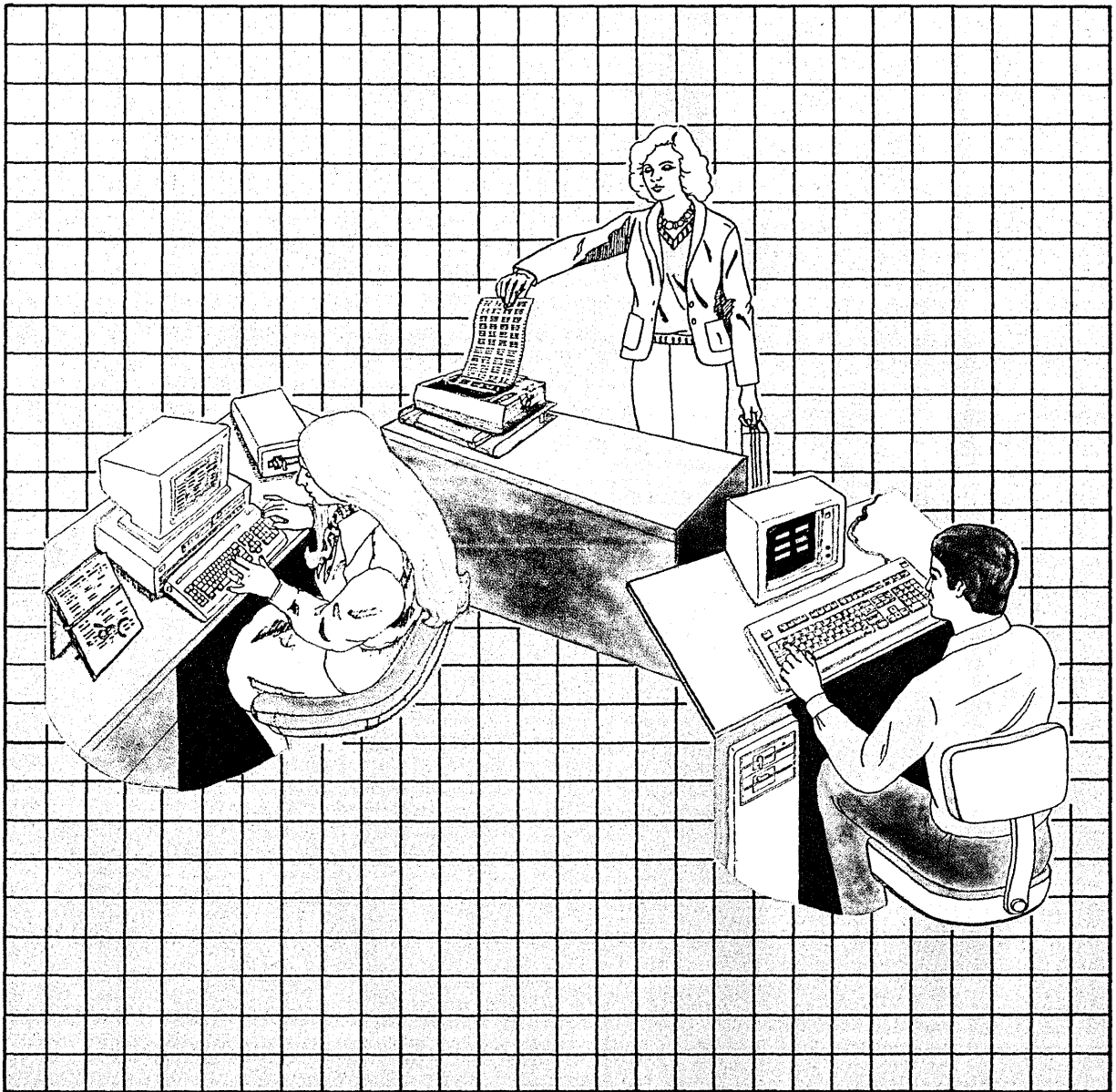

CONTENTS

About This Chapter	5-3
Selecting Additional Programs	5-4
INed	5-4
Usability Services	5-4
Asynchronous Terminal Emulation	5-4
Multi-User Services	5-5
Extended Services	5-6
Base PC Network Services	5-7
Update	5-7
Exploring Usability Services	5-7
Interface Program for use with TCP/IP	5-8
VRM Device Driver Diskette	5-8
SNA Services	5-9
Installing Additional Programs	5-10
Installing Programs with Separate Components	5-12
Grouplist Files	5-12
Apply List Files	5-13
History Files	5-13
Updating Additional Programs	5-14
Starting from the AIX Shell, Usability Services, or DOS Services	5-17
Starting Usability Services from the AIX Operating System	5-18
Starting Usability Services Automatically	5-19
Starting DOS Services from the AIX Shell	5-20
Starting DOS Services Automatically	5-21

About This Chapter

This chapter explains how to install additional operating system programs (after installing the Base System Program) by using the **installp** command. It explains how to install these programs:

- INed
- Usability Services
- Asynchronous Terminal Emulation
- Multi-User Services
- Extended Services
- Base PC Network Services
- Exploring Usability Services
- Interface Program for use with TCP/IP
- VRM Device Driver Diskette
- SNA Services.

These programs are installed with the **installp** command. If you have an update diskette for any of the AIX Operating System programs, see “Updating Additional Programs” on page 5-14 for installation instructions.

You can also tailor your system so that it starts up in the AIX shell, DOS Services, or Usability Services.

Selecting Additional Programs

The programs described below are part of the AIX Operating System received with your IBM RT PC. You may choose to install none of the programs, or one or two, or all of them. IBM recommends that you install the programs in order, according to the amount of use they will receive. For instance, if you believe that you will use the INed program most, you should install it first. If you plan to install all of the additional programs, you may wish to install them in the sequence in which they are described below.

INed ✓

The INed is a full-screen text editor that enables you to enter programs, memos, and other text documents into files. By using the INed key commands, you can view, revise, and delete files.

Usability Services ✓

Usability Services provides a menu-driven program that lets you choose commands and make choices to use your system. But Usability Services translates those commands into ones that the AIX Operating System understands. Usability Services also has a window function that lets you work on a number of files and tasks at the same time if you have an appropriate display station.

Asynchronous Terminal Emulation ✓

Asynchronous Terminal Emulation allows you to establish a connection between your work station and another computer. Your work station acts as a terminal connected to that computer. Asynchronous Terminal Emulation provides a way to establish the connection and allows you to record and control the session. Asynchronous Terminal Emulation can be used to connect to, and exchange data with, remote private data bases and other AIX systems. After logging in to the remote system, you may execute

programs, issue commands, and use files on that system as a local user.

Multi-User Services ✓

Multi-User Services provides these functions:

- Accounting capabilities for managing the system, including resource management and online labor distribution
- Group conferencing and messaging capabilities
- Programming and graphics support for specified terminals
- Device support for most RT PC graphics displays, printers, and plotters.

Each component in Multi-User Services is separately installable. You can install the entire program or only those components you believe you will use. If you do not need the entire program, you can save minidisk space for other uses by selecting and installing only those components you need.

These are the separately installable components:

- Accounting Support (process and activity accounting)
- System Activity Recording (recording of system activity)
- Inter-Workstation Commands (conferencing, messaging)
- Terminal Support (terminal functions)
- Advanced Display Graphics Support Library (program interface for graphics applications used with certain displays)
- Graphics Device Drivers (support most RT PC graphics displays, printers, and plotters)

These device drivers can be used with the IBM RT PC Professional Graphics Series licensed program (see the documentation with the licensed program) or the with the Graphics Support Library subroutines (see *AIX Operating System Technical Reference*).

- Sockets and BSD Portability Files (provides an interprocess communication facility).

See “Minidisk Size Requirements” on page 1-16 for information on the required block sizes of each component.

Extended Services ✓

Extended Services provides additional AIX commands and subroutines to complement the AIX commands already part of the AIX Operating System. You can also install DOS Services, which is a program that translates DOS-like commands into a form the AIX Operating System can understand. Extended Services contains the following features:

- Translation of DOS-like commands for AIX Operating System processing
- Text processing/typesetting functions
- Application development tools, including:
 - System commands
 - Source Code Control System
 - Miscellaneous languages and processes
- Enhanced file system functions
- Enhanced data manipulation functions
- Enhanced system management functions
- Electronic mail/file interchange
- Games.

Each component in Extended Services is separately installable. You can install the entire program or only those you believe you will use. If you do not need the entire program, you can save minidisk space for other uses by selecting and installing only those components you need.

These are the separately installable components:

- DOS Services
- Text Support (text processing/typesetting functions)
 - vi Editor (full-screen editor)
- Extended Programming Support
- Source Code Control
- uucp Support (copying one or more sources from one system to a single destination on another system)
- Administrative Support (directory profiling, password check, archiving, terminal information)
- Games.

See “Minidisk Size Requirements” on page 1-16 for information on the required block sizes of each component.

Base PC Network Services

Base PC Network Services provides the basic support for the IBM RT PC and the IBM Personal Computer to exchange messages and data across the IBM PC Network to another IBM RT PC using the IBM PC Network Adapter. This program is designed to be a general service program, usable by your application programs or by other IBM RT PC-compatible programs.

Update ✓

You may have received an update diskette with your other diskettes. If so, it contains updates and enhancements to one or more of the AIX Operating System programs and should be installed after you install all of the AIX Operating System programs. To update one or more of the AIX Operating System programs using the update diskette, see “Updating Additional Programs” on page 5-14.

Exploring Usability Services

The Exploring Usability Services diskette is an online tutorial designed to introduce you to the functions available through the Usability Services program. It should help you become familiar with the capabilities of Usability Services. By responding to questions and entering choices, you do exercises designed to help you experience the windowing functions of the Usability Services program. You should install Usability Services before using Exploring Usability Services.

Interface Program for use with TCP/IP

Interface Program for use with TCP/IP supports certain communications protocols, commands, and an applications programming interface. These features allow an RT PC and another system with equivalent protocols to transfer files, relay mail, and perform network management tasks. In addition, Interface Program for use with TCP/IP allows remote connection to a host system and remote login capability.

VRM Device Driver Diskette ✓

The VRM Device Driver Diskette contains additional VRM Device Drivers for optional adapters and licensed programs.

Each component on the VRM Device Driver Diskette can be installed separately. You can install the entire program or only those you believe you will use. If you do not need the entire program, you can save minidisk space for other uses by selecting and installing only those components you need. The programs you install will depend on the hardware adapters and communications protocols you want to use.

These are the separately installable components:

- VRM Baseband Adapter Device Driver — Used with the Baseband Adapter and Interface Program for use with TCP/IP
- IBM RT PC Multiprotocol Adapter Device Driver — Used with the Multiprotocol Adapter
- Distributed Function Terminal Device Driver — Used with the Advanced 3278/79 Emulation Adapter
- ✓ • RT PC Small Computer Systems Interface (SCSI) Device Driver — Used with SCSI Adapter which supports devices such as IBM 9332 DASD Attachment and certain streaming tape devices.
- ~~Token-Ring~~ Device Driver — Used with the IBM Token-Ring Network RT PC Adapter to support various communications protocols and architectures on the RT PC.

¹ Ethernet is a registered trademark of Xerox, Inc.

- 3270 AIX Device Driver — Used by the Distributed Function Terminal VRM device driver and the BSC link level control process contained in NETWORK 3270-PLUS (BSC) and NETWORK RJE-PLUS (BSC). The NETWORK 3270-PLUS (BSC) and NETWORK RJE-PLUS (BSC) programs also use the 3270 AIX device driver at the application level.

See “Minidisk Size Requirements” on page 1-16 for information on the required block sizes of each component.

The VRM Device Drivers are described in more detail in *Virtual Resource Manager Technical Reference*.

Other installations:

FORTRAN 77 ✓

X-WINDOWS ✓

GRAPHICS TERMINAL EMULATOR ✓

PLOTTING SYSTEM ✓

SNA Services

SNA Services enables application programs to communicate with cooperating applications within an SNA network. The cooperating applications must reside on systems that are connected by an Ethernet local area network or that use SDLC as the method of network data exchange. SNA Services is included with Version 2.1 of AIX Operating System only.

SNA Services provides the following:

- An API (APPC) to LU 6.2
- An API to LU 1,2,3
- Profile Services, which provides a menu interface for configuring, changing, and saving network information.

SNA Services enables communication over:

- An Ethernet¹ network, using LU 6.2
- An RS232C connection, using either LU 6.2 or LU 1,2,3
- An X.21 connection, using either LU 6.2 or LU 1,2,3.

SNA Services provides several interfaces to allow an application program access to SNA resources. Using these interfaces, a program can transfer data over a network without being concerned with the details of a specific network protocol. Depending on the level of control and portability between different systems, a programmer can choose one of the following interfaces:

- **SNA Library**—This library provides a collection of subroutines to be called from a C language program. The subroutines provide a standardized interface that allows easier portability of programs to other systems using SNA networks.

¹ Ethernet is a registered trademark of Xerox, Inc.

-
- **System Program Controller Library**—This library provides a collection of subroutines that allow a C language program to start and stop a server program that runs under the control of the system program controller. SNA Services is such a server program.
 - **Standard I/O Library**—This library is part of the standard C language library. Programs that use this library for input/output to standard input and output can also access the SNA network through redirection of I/O.
 - **System Calls**—The standard set of I/O system calls (**open**, **close**, **read**, **write**, **ioctl**, **readx** and **writex**) can be used to access the SNA network through the multiplexed device driver, **/dev/sna**.

Installing Additional Programs

Locate in the diskette binder the diskettes for the additional programs you wish to install.

Remember that it is important to install the programs in the order in which you expect to use them most. You may wish to install them in the sequence in which they are described in the previous section.

To install the additional programs, you use the **installp** command. The installation process described on the next page is essentially the same for each of the programs. You may see some variation in the wording and messages on the screen, but the steps are very similar.

Should an error message display on the screen, see *Messages Reference* for details. See *AIX Operating System Commands Reference* for a detailed discussion of the **installp** command.

To install an additional program, follow these basic steps:

— To Install an Additional Program —

1. Make sure that no one else is using the system and that no user programs are running.
2. Log in as superuser or as a member of the system group.
3. Type `installp`. Then press **Enter**.
4. When requested to do so, insert the appropriate diskette into the top diskette drive (drive 0 in position A).
5. Follow the prompts to install the additional program. If the program has multiple diskettes, the system tells you when (and in what sequence) to load them. As various files are restored from the diskette, they may be listed on the screen. If a program has components that can be installed separately, a menu will let you select the components you wish to install. See “Installing Programs with Separate Components” on page 5-12 for more information.
6. When installation is complete, remove the diskette and return it to its protective diskette holder in the binder. In some cases, the system may restart at this point. If so, a message will advise you.
7. Log off as superuser or as a member of the system group.

If you install Usability Services, you can perform many of the same tasks that you can do from the AIX shell, including the installation of programs described above.

Warning: You must install Usability Services from the AIX shell. Do not attempt to install Usability Services from within Usability Services. Doing so may damage certain files.

Installing Programs with Separate Components

Some programs have components that can be installed separately, enabling you to select only those components you plan to use. By being selective, you also save minidisk space for other uses.

To install these modules, you type `installp`, insert the diskette, and then select modules from a menu.

The following discussions of related files may be useful to you as you install and later update the components.

Grouplist Files

In the future, if you have installed at least one component from a program, you can check the grouplist files for useful information about the version and release level. For instance, the grouplist file name for Multi-User Services is `/usr/lpp/multiple/lpp.grouplist`. The grouplist file name for Extended Services is `/usr/lpp/osplus/lpp.grouplist`.

Each grouplist file contains an entry for each installed component, in this format:

```
<group_abbreviation> <x> <y> <group name>
```

where `x` and `y` together indicate the version (for example `x.y`).

The file named `/usr/lpp/multiple/lpp.grouplist` might contain, for example, the following:

```
act 01 01 Accounting Support
sar 01 01 System Activity Recording
```

Apply List Files

Some components, whether installed or not, contain an apply list file listing the names of all files in that component. For instance, the apply list file for Multi-User Services is called `/usr/lpp/multiple/lpp.al.<group_abbreviation>`. The apply list file for Extended Services is called `/usr/lpp/osplus/lpp.al.<group_abbreviation>`.

History Files

The history file, `/usr/lpp/<pgm-name>/lpp.hist` also contains comment records identifying the installed components. For example, `/usr/lpp/multiple/lpp.hist` might contain the following records:

```
c multiple 01.01.000 (date) (installer)
t Multi-user Services Program
* Accounting Support is installed
* System Activity Recording is installed
```

Updating Additional Programs

You may have received an update diskette with the other diskettes in the AIX Operating System. And, in the future, you may periodically receive one or more diskettes containing updates to the operating system programs. The updates may consist of enhancements or changes to one or more programs.

You will want to apply the updates to use the enhancements and changes. You should install all AIX programs that you plan to install before you apply the update diskette. To apply an update diskette, you use the **updatep** command. The process described on the next page is essentially the same for every update diskette containing updates to the AIX Operating System. Depending upon the content of the update diskette, you may see some variations in wording and messages on the screen, but the steps are very similar.

Should an error message display on the screen, see *Messages Reference* for details. For a detailed discussion of the **updatep** command and its parameters, see *AIX Operating System Commands Reference*.

To update an existing program, follow these basic steps:

To Update a Program

1. Restart your system.
2. Make sure that no other terminals are enabled and that no programs are running. You must be a member of the system group to use **updatep**.
3. Insert the update diskette into the top diskette drive.
4. Type `updatep` with the **-a** (apply) option (`updatep -a`). Then press **Enter**.
5. From the Apply Updates menu, type the numbers of the programs you wish to update, and press **Enter**.
6. When the update has been applied and the files restored, the system may restart or provide messages for your benefit. When you see a message indicating that the update process has completed, remove the update diskette.
7. Log off as superuser. You may now continue with other tasks.

The **updatep** command enables you to apply, commit, or reject updates to the programs in the AIX Operating System.

When you *apply* an update, you update the existing program on your system. You may use the updated program for some time to determine whether it is more acceptable to you than the previous level of the program.

If you decide that the updated program is satisfactory, you may decide to *commit* the update. That is, you permanently update the existing program with whatever enhancements and changes may be on the updated program.

If you decide that the updated program is not satisfactory, you may decide to *reject* the update. In this case, you decide that you will

bring your program back to its former state, before you applied the update. See *AIX Operating System Commands Reference* for more information.

Starting from the AIX Shell, Usability Services, or DOS Services

Ordinarily, you operate your system from the AIX shell. The AIX shell accepts and interprets commands for the operating system. But if you have installed Usability Services, you can tailor your system so that after it starts, it goes immediately to Usability Services. In addition, you may wish to have your system start in DOS Services if you have installed it.

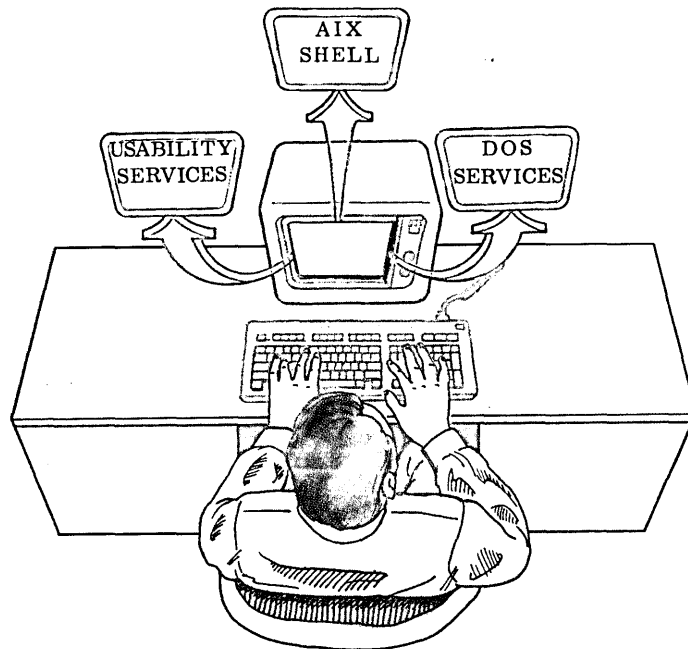

The following sections explain how to start Usability Services and DOS Services from the AIX shell and how to tailor your system to start in Usability Services or DOS Services when you turn on your system.

Starting Usability Services from the AIX Operating System

To start Usability Services from the AIX shell, do these steps:

To Start Usability Services

1. After the system prompt, type `actmng`
2. Press **Enter**.

Starting Usability Services Automatically

To cause Usability Services to start automatically after you log in to the system, do these steps:

To Start Usability Services Automatically

1. If you do not already have a user name, see *Managing the AIX Operating System* for information.
2. On the command line, type `users`, and press **Enter**.
3. When the `users` command list displays, type `c u username` and press **Enter** to go to your user profile.
4. To make changes to the displayed information, type `n` after the **OK? (y)** prompt. Then press **Enter**.
5. Type `program` as the name of the field you want to change. Then press **Enter**.
6. Type `/usr/bin/actmng` as the information for the program field. Then press **Enter**.
7. Type `q` to exit the `users` command.

Now, after you log in, the system starts Usability Services automatically.

Starting DOS Services from the AIX Shell

You can start DOS Services from the AIX shell with the **dos** command. Follow these steps:

Starting DOS Services from the AIX Shell

1. After the system prompt, type `dos [-a]`.
2. Press **Enter**.

1. After the system prompt, type `dos [-a]`.

The **dos** command starts the DOS Services. **-a** is an optional flag that starts the DOS Services without searching for an **autoexec.bat** batch file.

You may have or may want to create an **autoexec**. An **autoexec** is a DOS Services batch program that runs automatically when you start DOS Services. This program must be named **autoexec.bat** and must be in the root directory. An **autoexec** is useful for setting paths, prompts, and other features of DOS Services that you use often. For more information on autoexecs, see the optionally available *AIX Operating System DOS Services Reference*.

If you do not want your **autoexec** to run when you start the DOS Services, type `dos -a`.

2. Press **Enter**.

Starting DOS Services Automatically

To cause DOS Services to start automatically after you log in to the system, do these steps:

To Start DOS Services Automatically

1. If you do not already have a user name, see *Managing the AIX Operating System* for information.
2. On the command line, type `users`, and press **Enter**.
3. When the `users` commands list displays, type `c u username` and press **Enter** to go to your user profile.
4. To make changes to the displayed information, type `n` after the **OK? (y)** prompt. Then press **Enter**.
5. Type `program` as the name of the field you want to change. Then press **Enter**.
6. Type `/usr/bin/dos` as the information for the program field. Then press **Enter**.
7. Type `q` to exit the `users` command.

Now, after you log in, the system starts DOS Services automatically.

Chapter 6. Customizing System Devices

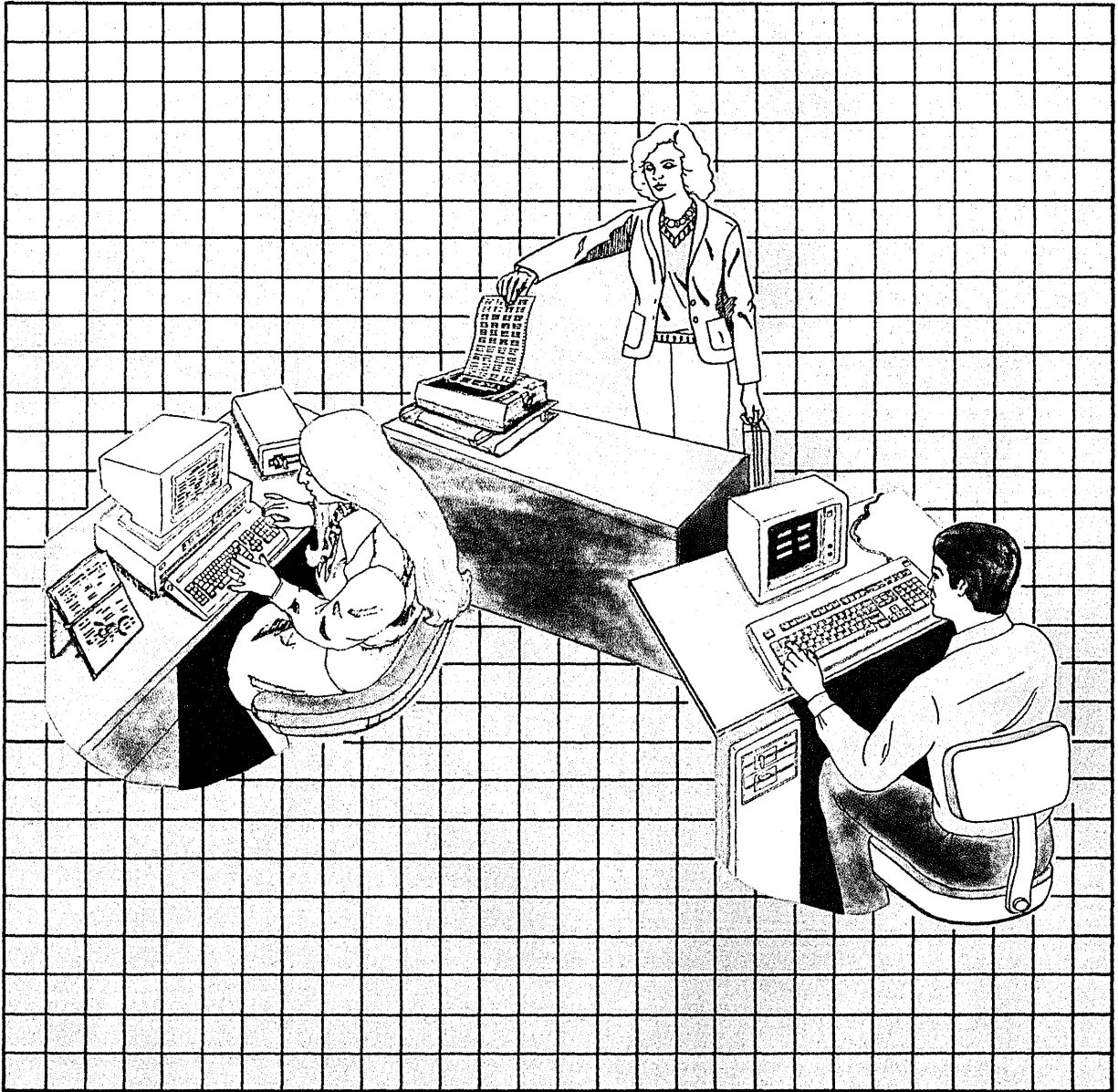

CONTENTS

About This Chapter	6-3
Using Devices to Customize Your System	6-4
IBM-Defined Devices	6-5
Customization Files	6-8
Configuration Files	6-8
Device-Dependent Information Files	6-9
Getting Ready to Use the Devices Command	6-10
Starting and Exiting Devices	6-11
Using Abbreviated Commands	6-11
Handling Errors	6-12
Adding a Device May Require Restarting the AIX Operating System	6-12
Understanding the Devices Commands	6-13
Adding Devices	6-14
Deleting Devices	6-14
Changing Device Information	6-14
Showing Device Information	6-15
Using the Devices Commands	6-16
Displaying All Devices In Your System	6-17
Displaying Information About Specific Devices	6-19
Adding Devices to Your System	6-21
Example: Adding an IBM-Defined Device With Defaults	6-22
Example: Adding An Asynchronous Terminal	6-28
Example: Adding an Unsupported Printer	6-35
Example: Adding a Device for the Coprocessor	6-39
Deleting Devices from the System	6-44
Changing Information About System Devices	6-47
Other Device Specific Information	6-52

About This Chapter

This chapter explains how you can customize your IBM RT PC System by using the **devices** command to:

- Add devices to your system
- Delete devices from your system
- Change information about devices in your system.

This chapter also explains how you can display information about devices in your system. By following the steps to add or delete devices or to change information about devices, you can customize your system with IBM-defined devices. Customizing with devices not defined or supported by IBM may require extra steps and extra information.

Using Devices to Customize Your System

If you are using the **devices** command for the first time, see the "Devices Information Form" delivered with your system unit. By following instructions on the form, you may be able to simplify the configuration process.

After installing the AIX Operating System, you should be ready to begin using your system. You may, however, want to add some of the optional devices supported by IBM. To do so, you use the **devices** command. With the **devices** command, you can also remove devices from your system, and you can also display and change information about devices.

Adding devices, removing them, and changing the information that describes them are ways that you customize your system. If you are using IBM-supported devices, you can customize your system with standardized procedures. If the devices are not IBM-supported, you may need to take extra steps to customize your system. You should also recognize that while the **devices** command does the processing required to configure devices into your system, the device must be properly set up. See the installation instructions shipped with the device for details.

Before you begin using the **devices** command, read the following sections to learn how to supply the information **devices** will request from you. This chapter contains several examples of using the **devices** command. You should be able to find an example similar to the task that you want to do. Following the example closely should guide you in doing your own task.

If you have the PC AT Coprocessor in your system, you have the option of making some devices shareable. For instance, you might add a printer that both the PC AT Coprocessor and your RT PC can use. However, both cannot use the device simultaneously.

IBM-Defined Devices

In addition to the IBM-defined standard devices that were configured automatically as part of your operating system, you can add many other IBM-defined devices to your system.

The following chart describes representative devices supported by IBM:

- The Device Class is the name for the category (for example, terminal or printer).
- The Device Type is the name that identifies the device.
- The Device Description provides you with information about the device type. For instance, 5152 (type) is an IBM PC Graphics Printer (description).

Device Class	Device Type	Description
printer	3812	IBM Pageprinter (3812)
printer	3852	IBM 3852 Color Jet Printer Model 2
printer	4201s	IBM 4201 Proprinter, serial port
printer	4201p	IBM 4201 Proprinter, parallel port
printer	4202s	IBM Proprinter XL, serial port
printer	4202p	IBM Proprinter XL, parallel port
printer	5152	IBM PC Graphics Printer
printer	5182	IBM PC Color Printer
printer	5201p1	IBM PC QUIETWRITER® Printer Model 1
printer	5201p2	IBM PC QUIETWRITER® Printer Model 2
printer	5202	IBM 5202 Quietwriter III Printer
ttydev	tty	Any device on an async port (except printers)
printer	6180	IBM 6180 Color Plotter
printer	6184	IBM 6184 Color Plotter
printer	6186	IBM 6186 Color Plotter
printer	7371	IBM 7371 Plotter
printer	7372	IBM 7372 Plotter
printer	7374	IBM 7374 Color Plotter
printer	7375	IBM 7375 Color Plotter (Model 1 or 2)
floating	floating	IBM RT PC Floating Point Accelerator
tape	tape	IBM RT PC Streaming Tape Drive
adapters	net	VRM Baseband Adapter Device Driver
adapters	dft	Distributed Function Terminal
adapters	mpd	Multiprotocol Adapter

Device Class	Device Type	Description
scsi	disk	IBM 9332 DASD
scsi	other	Other SCSI devices
coprcdev	coprcdev0 through coprcdev9	Coprocessor-only devices (up to 10)
coprcdev	3812, 3852, 4201s, 4201p, 4202s, 4202p,5152, 5182, 5201p1, 5201p2, 5202, 6180, 6184, 6186, 7371, 7372, 7374, 7375, tty	Coprocessor-shareable devices (printers and ttydevs). A shareable device (a printer, for instance) is one that both the Coprocessor and the IBM RT PC can use. However, both cannot use it simultaneously.

While you do not have to use the **devices** command to add a second diskette drive, you do have to edit a file to mount the diskette drive automatically. See *Managing the AIX Operating System*.

Customization Files

Your system uses two types of files in customization activities: configuration files and device-dependent information files. These files contain information about the IBM-supported devices and about the devices installed in your system. The **devices** command keeps these files updated as you add a printer, for instance, or change some of the device information.

After you have installed the VRM, the AIX Operating System, and the additional programs described in Chapter 5, “Installing Additional Operating System Programs,” and after you have customized your system by adding devices and user information, you should back up your files to prevent the loss of valuable information. See *Managing the AIX Operating System* for details.

A description of the configuration files and the device-dependent information files follows.

Configuration Files

You can learn more about the various configuration files from *Managing the AIX Operating System*. In some cases, you may wish to read or edit them. Detailed information about system configuration is recorded in these files.

The following files contain information about your system configuration:

- **/etc/master** — Contains configuration information about IBM-supported devices for the system, including AIX and Virtual Resource Manager device drivers.
- **/etc/predefined** — Contains configuration information about IBM-supported devices for the system, but does not contain device driver information.
- **/etc/system** — Contains configuration information about IBM-supported devices currently configured in your system. This file is similar in format to the **/etc/predefined** file.

- **/etc/ddi** — A directory that contains device-dependent information; the number and types of files in this directory depend upon the options and programs installed. See the next section for more information on these files.

Device-Dependent Information Files

Device-dependent information files contain information describing a particular device. For example, a printer's device-dependent information includes such items as port address (where the device is attached), color (whether the printer has color), left and right margin settings, and so on. You can change some of these items, but not all of them. For instance, while you cannot change the color characteristic of a printer, you can change the margin settings. Some devices and adapters have no information that can be changed.

As you use **devices**, you will notice that the **showdev** command shows you all the device information. The **add** and **change** commands show only the device information that you can change.

The device-dependent information files are contained in the **/etc/ddi** directory. For example, the device-dependent information file for the asynchronous device is **/etc/ddi/tty**. The files for a serial printer and a parallel printer are **/etc/ddi/sprinter** and **/etc/ddi/pprinter**, respectively.

To learn more about using device-dependent information, turn to Appendix B, "Keyword Descriptions." Keywords are an important part of the ddi files. You may occasionally want to change defaults for a printer or other device. To do so, you should understand the meanings of the keywords so that you can make better choices. Appendix B, "Keyword Descriptions" provides a brief description of these keywords and of the various choices available for each keyword.

Getting Ready to Use the Devices Command

Now that you understand the general purposes of the **devices** command, the IBM-defined devices, and the customization files, you can prepare to use the choices on the DEVICE CUSTOMIZING COMMANDS menu.

When you see the DEVICE CUSTOMIZING COMMANDS screen, you can begin using any of the **devices** commands.

```

                                DEVICE CUSTOMIZING COMMANDS

Devices commands are:

Command Description

add      Add a new device
change   Change information about an existing device
delete   Delete an existing device
showall  Show general information about all existing devices
showdev  Show detailed information about an existing device

To EXIT the devices command, press F3.
To USE a devices command, type the Command and press
Enter.

>
```

The following sections describe how to use **devices**.

Starting and Exiting Devices

To start **devices**, you must first be logged in as a member of the system group or you must have superuser authority. The # prompt appears when you are logged in as superuser. The \$ prompt appears when you are logged in as a system or regular user. After the system prompt, type **devices** and press **Enter**. See *Managing the AIX Operating System* for information about devices.

Using Abbreviated Commands

To reduce the number of keystrokes you must enter, you can abbreviate the **devices** commands, the device class, device type and adapter fields, and the yes/no responses. Simply type the letters that uniquely identify the desired command, device, or response. For the **add**, **change**, and **delete** commands, you can type a single letter or multiple letters, as in: a, ad, or the full add. Or you can type c, ch, cha, and so on for **change**.

For the **showall** and **showdev** commands, however, you must type at least showa or showd to identify the desired command.

Whenever you are asked to type yes or no, you can type y or n.

If you already know the device class and device type for the device you want to add, delete, change, or show, you can enter valid abbreviations for the command, the device class and the device type. For example, a pr 5152 adds a 5152 printer. To add a tty or streaming tape device, you must type at least a tt for tty or a ta for tape. Entering these three items means that you can bypass the lists of device classes and device types.

Handling Errors

If you should supply an incorrect response while responding to **devices** prompts, you will be asked again to supply correct information. If you are unable to supply correct information and want to go back to the **DEVICE CUSTOMIZING COMMANDS** screen, press **F3**.

Adding a Device May Require Restarting the AIX Operating System

To be recognized by the system, some devices require restarting the AIX Operating System after you add them to the system configuration. Another word for a system restart is *initial program load* (or *IPL*). Restarting means that the system loads the AIX Operating System and the changes you've made in order to begin operation. If necessary, the system automatically restarts at the end of the **devices** session after you press **F3**.

| In these cases, a message tells you that a restart will occur if you
| confirm your request to exit **devices**. This message will also tell
| you not to exit **devices** as a kernel rebuild is taking place. The
| rebuild will take several minutes and the IPL will be performed
| after the rebuild is complete. You can, however, complete any
| other devices activity before pressing **F3** to restart the system.
| Make certain that no other users are using the system and that no
| user programs are running when the restart occurs.

| When you exit, a kernel rebuild will be performed. This will
| take several minutes. An IPL will be performed after the kernel
| rebuild has completed.

| Exit Devices?

| yes

| no

| To CANCEL and return to the list of commands, press F3.

| To CHOOSE, type yes or no and press Enter.

If restarting is not required as you exit **devices, you will return to
the \$ or # prompt.**

Understanding the Devices Commands

The five **devices** commands are:

- **add**
- **change**
- **delete**
- **showall**
- **showdev.**

When you type **devices** after the system prompt and press **Enter**, the **DEVICE CUSTOMIZING COMMANDS** screen appears. Each time you want to use a **devices** command, you must begin with this screen.

DEVICE CUSTOMIZING COMMANDS

Devices commands are:

Command	Description
add	Add a new device
change	Change information about an existing device
delete	Delete an existing device
showall	Show general information about all existing devices
showdev	Show detailed information about an existing device

To EXIT the devices command, press F3.

To CHOOSE a devices command, type the Command and press Enter.

>

The following sections provide information on each command. In this chapter, you will also find examples of using each command.

Adding Devices

With the **add** command, you can do these tasks:

- Add IBM-defined devices to your system
- Assign a device for use by the Coprocessor, if your system has one
- Add an unsupported printer to your system.

Deleting Devices

You can use the **delete** command to delete almost any device in your system. You can physically remove the device either before or after you delete it from your system configuration. You cannot, of course, delete a device while it is actively in use; for instance, you cannot delete a printer while it is printing or a tty device while it is enabled.

Should you have to remove a device for adjustments or repairs, you do not have to delete it from the system. You can re-attach the device and continue to use it as before.

Changing Device Information

The **/etc/ddi** (device class) files contain information about your system devices. Each time you add a device, you can see information about the device in the **/etc/ddi** file for that device class. While you may find most default settings or choices acceptable, you may also want to change some settings. Before you do so, read the keyword descriptions in Appendix B, “Keyword Descriptions” to better understand whether you need to change device settings.

With the **change** command, you can display any device or adapter settings that can be changed.

Note: If you use the **change** option of the **devices** command to change any of the settings for your system devices and you notice that your requested changes are not implemented, perform either of the following steps:

- Issue the following commands:

- **vrconfig -d <device name>**
- **vrconfig -a <device name>**

where **<device name>** is the name of the device on which you did the **change**. Note that **vrconfig -d** will not work if the device is in use.

- Perform a re-IPL of the system after issuing the **shutdown** command.

Showing Device Information

With the **showall** and **showdev** commands, you can display the following:

- A list of all devices configured in your system. (Type **showall**, and press **Enter**.)
- A list of all devices of a particular class. (Type **showdev** and the device class, as in: **showdev printer**).
- Device-dependent information for a device. (Type **showdev** and the device class and name, as in: **showdev printer lp0**).

Using the Devices Commands

The rest of this chapter shows examples of how you can use the **devices** commands. In each case, the box contains steps that apply to any device. If you are somewhat familiar with **devices**, you might use the boxed information as a reminder of the steps involved.

Under the "More Detailed Information" sections, you will find specific examples of using **add**, **delete**, **change**, **showall**, and **showdev**. In addition, you will see the information that displays on the screen, along with an explanation of what the prompts mean and how to answer them.

The first step when using **devices** is to request the DEVICE CUSTOMIZING COMMANDS screen. This list shows you the available options.

To Request Devices

1. Log in to the system.
2. After the system prompt, type **devices**, and press **Enter** to see the DEVICE CUSTOMIZING COMMANDS screen.

Now you can select the command you want to enter. See the examples that follow for specific steps.

Displaying All Devices In Your System

To see a list of all the devices that currently are part of your system, use the **showall** command.

To Display a List of All Devices

1. On the DEVICE CUSTOMIZING COMMANDS screen, type **showall**. Press **Enter**.

```
> showall
```

2. To return to the DEVICE CUSTOMIZING COMMANDS screen after seeing the list of devices, press **F3**. To print a copy of the list (if your printer is configured and working), press **F4**.

You will see a list of devices similar to the following one. If your system has more devices than one screen can contain, you will see a prompt to continue to the next screen. You go to the next screen by scrolling. Use the **Cursor Up** key to move to a previous screen and the **Cursor Down** key to move to a following screen.

The following devices are configured in your system. A zero (0) in the Port, Slot, or IODN field indicates information is not available or not applicable.

Name	Type	Class	Adapter	Port	Slot	IODN
hdisk0	hdisk0	disk	disk/disket	0	0	1
lp0	5152	printer	mono disp/paral	prtr 2	3	12000
tty0	tty	ttydev	ser/paral	adptr 3	4	12001
fd0	fd0	diskette	disk/disket	0	0	4

To RETURN to the list of commands, press Enter.

To PRINT this list of devices, press F4.

```
>
```

If your printer is configured and working, you can print the list of devices on the screen by pressing **F4**. A summary report is also written to the file **/tmp/CONFIGREPORT** that contains the information on each screen, where you have pressed **F4** during a devices session.

Displaying Information About Specific Devices

To see information about specific devices in your system, use the **showdev** command.

To Display Information About Specific Devices

1. On the DEVICE CUSTOMIZING COMMANDS screen, type **showdev** to display a list of device classes currently configured in your system.

```
> showdev
```

2. To see information about a specific device, type the name of the device class. Press **Enter**. For instance, if you want to see information about a printer, type **printer**.

```
> printer
```

You can combine both steps by typing **showdev printer**.

3. Type the name of a specific device from the list of devices configured in your system. For instance, type the name of a specific printer, such as **lp0**. Then press **Enter** to see the information. If you have a printer that is configured and working, you can print a copy of the list of device information by pressing **F4**.
4. To return to the DEVICE CUSTOMIZING COMMANDS screen, press **F3**.

After you enter the **showdev** command and the name of the device you want to see information about, a list of device names similar to the following appears.

The following devices are available.

Device Name	Description
lp0	IBM PC Graphics Printer (5152)
lp1	IBM 4201 Proprinter . . .serial

To RETURN to the list of commands, press F3.

To CHOOSE from the list, type the Device Name and press Enter.

>lp1

After you type the name of the device about which you want information, that information appears.

Name	Description	Current Choice	Possible Choices
fl	Form (page) Length	50	1 - length (in . . .
tm	Top Margin	0	0 - length (in . . .
bm	Bottom Margin	50	1 - length (in . . .
lm	Left Margin	0	0 - length (in . . .
fw	Form Width	80	1 - width (in . . .

To SEE additional items, use the Cursor Down or Cursor Up keys.

To RETURN to the list of commands, press Enter.

To PRINT this device information, press F4.

>

If your printer is configured and working, you can print the list of devices on the screen by pressing **F4**. A summary report is also written to the file **/tmp/CONFIGREPORT** that contains the information on each screen, where you have pressed **F4** during a devices session.

Adding Devices to Your System

To add a device to your system, you use the **add** command. Several examples are included in this section to help you better understand the procedures. These examples include:

- Adding an IBM-defined device with defaults
- Adding an IBM-defined device and changing device information
- Adding an unsupported printer
- Adding a device for the Coprocessor.

Remember that these are typical examples. The lists of device classes, device types, and adapters that you see on your screen may not be exactly the same as those shown in the examples. But the basic procedures are very similar. You need only follow the numbered steps for the example most like the task that you want to perform.

Example: Adding an IBM-Defined Device With Defaults

This first example shows how to add an IBM-defined device to a serial or parallel adapter. Because it is an IBM-defined device, you may not need to change any of the settings (device-dependent information).

To Add an IBM-Defined Device

1. On the DEVICE CUSTOMIZING COMMANDS screen, type **a** to select the **add** command. Then press **Enter**.
2. Type the name of the device class. Then press **Enter**.
3. Type the name of the device type. Then press **Enter**.
4. Type the name of the adapter to which you want to add the device. Then press **Enter**.
5. If requested to do so, supply the requested information for the adapter. Then press **Enter**.
6. Indicate whether you want to display or change predefined device information (printer settings, for example).
7. Verify that you want to add the device by pressing **Enter**.
8. After you receive a message indicating that the device has been added, press **Enter** to return to the DEVICE CUSTOMIZING COMMANDS screen.

More Detailed Information

The following example shows you how to add an IBM 5152 printer to your system.

1. On the **DEVICE CUSTOMIZING COMMANDS** screen, type a to select the **add** command. Then press **Enter**.

```
> a
```

2. From the list of device classes, type printer as the device class, and press **Enter**. The following are examples of device classes that are available:

Device Class	Description
printer	Printer or Plotter
ttydev	Asynchronous Terminal (Any Non-Printer Device on an Async Port)
lan	Local Area Network
tape	Streaming Tape Drive
coprcdev	Coprocessor Device
floating	Floating Point Accelerator
ptydev	Asynchronous Pseudo-Terminal

To **CANCEL** and return to the list of commands, press F3.
To **CHOOSE** from the list, type the Device Class and press Enter.

```
> printer
```

-
- The list of printers that is displayed for your system may not exactly match the example shown below. From the list of printers, type 3812 as the name of the printer, and press **Enter**. Remember that if you have all of the information you need, you can combine these steps by typing a pr 3812.

The following devices are available.

Device Type	Description
5152	IBM PC Graphics Printer (5152)
5182	IBM PC Color Printer (5182)
5201p1	IBM PC Quietwriter 1 Printer on a Parallel Port
5201p2	IBM PC Quietwriter 2 Printer on a Parallel Port
4201s	IBM Proprinter (4201) on a Serial Port
4201p	IBM Proprinter (4201) on a Parallel Port
3812	IBM Pageprinter (3812)
opp	Other Parallel Printer
osp	Other Serial Printer

To CANCEL and return to the list of commands, press F3.
To CHOOSE from the list, type the Device Type and press Enter.

> 3812

- Type the name of the adapter to which you want to add the 3812 printer (for instance, mp). Then press **Enter**.

The following adapters are available.

Adapter Name	Description
sp1	IBM Ser/Par Adptr, Primary
sp2	IBM Ser/Par Adptr, Alternate

To CANCEL and return to the list of commands, press F3.
To CHOOSE from the list, type an Adapter Name and press Enter.

> sp1

5. You might type sn 6 to indicate that you changed the slot that the adapter is in.

Note: Although the slot number is supplied, you can still change it, if desired. If the information is valid, however, press **Enter** to select the indicated settings.

Change any of the following information that does not match your system configuration.

Name	Description	Current Choice	Possible Choices
sn	Slot Number	5	2 - 7

To CANCEL and return to the list of commands, press F3.
To CHANGE a current choice, type the Name followed by your new choice (example sn 4) and press Enter.
To COMMIT the changes you have made, press Enter.

> sn 6

-
6. Type **n** and press **Enter** to accept predefined information. Unless you want to change printer characteristics (such as margin, page length, and so on), all of the device information needed by the system is already set up for you.

All device information for this device has been set
for you.

Do you want to show or change this information?

yes

no

To CANCEL and return to the list of commands, press F3.
To CHOOSE, type yes or no and press Enter.

> no

7. Press **Enter** to add the printer or press **F3** to cancel the request.

To CANCEL adding the device, press F3.

To ADD the device with the current information,
press Enter.

>

-
8. After you receive a message indicating that the printer has been added, press **Enter** to return to the DEVICE CUSTOMIZING COMMANDS screen.

The device was added to the system.

Device Name: 1p0
Device Type: 3812
Device Class: printer

To RETURN to the list of commands, press Enter.

The system has assigned a new name to the device. This is the name to use when you issue the **print** command for this device.

Note: The first printer you add is the default printer. The order of the printers in the print queue is determined by the order of stanzas in `/etc/config`.

Example: Adding An Asynchronous Terminal

Follow these steps to add an asynchronous terminal (an IBM-defined device) to your system.

To Add an IBM-Defined Device

1. On the DEVICE CUSTOMIZING COMMANDS screen, type a to select the **add** command. Then press **Enter**.
2. Type the name of the device class. Then press **Enter**.
3. From the list of devices that you can add, type the name of the device type. Then press **Enter**.
4. Type the name of the adapter to which you want to add the device. Then press **Enter**.
5. If you select a 4-port adapter, indicate which port you will attach the device to. Then press **Enter**.
6. If requested to do so, supply the requested information for the adapter. Then press **Enter**.
7. Type n and press **Enter** if you do not want to show and change settings for the device.
8. To verify that you want to add the device, press **Enter**.
9. After receiving a message indicating that the device has been added, press **Enter** to return to the DEVICE CUSTOMIZING COMMANDS screen.

More Detailed Information

1. On the **DEVICE CUSTOMIZING COMMANDS** screen, type a to select the **add** command. Then press **Enter**. The system displays a list of devices that you can add to your system. The list you see may differ some from the one shown here.

The following device classes are available.

Device Class	Description
printer	Printer or Plotter
ttydev	Asynchronous Terminal (Any Non-Printer Device on an Async Port)
lan	Local Area Network
tape	Streaming Tape Drive
coprcdev	Coprocessor Device
floating	Floating Point Accelerator

To **CANCEL** and return to the list of commands, press F3.
To **CHOOSE** from the list, type the Device Class and press **Enter**.

>

2. On the list of device classes, type `ttydev` as the device class, and press **Enter**.

> `ttydev`

-
3. On the list of available terminals, type `tty` as the name of the terminal, and press **Enter**. Remember that if you have all of the information you need, you can combine these steps by typing a `ttydev tty`.

The following devices are available.

Device Type	Description
.	.
tty	Async Terminal
:	:
.	.

To CANCEL and return to the list of commands, press F3.
To CHOOSE from the list, type the Device Type and press Enter.

> tty

4. Type the name of the adapter to which you want to add the terminal. Then press **Enter**.

The following adapters are available.

Adapter Name	Description
sp1	IBM Ser/Par Adptr, Primary
sp2	IBM Ser/Par Adptr, Secondary
rs232c1	232C, 4-Port Async Adptr Port 1
rs422a1	422C, 4-Port Async Adptr Port 1
s1	IBM RT PC Serial Port 1
s2	IBM RT PC Serial Port 2

To CANCEL and return to the list of commands, press F3.
To CHOOSE from the list, type the Adapter Name and press Enter.

> rs232c1

-
5. If you select one of the 4-port adapters, you will be prompted to supply the number of the port to which you are attaching the terminal. You might type 1, and press **Enter**.

The adapter has the following ports:

Port Number	Description
1	First port
2	Second port
3	Third port
4	Fourth port

To CANCEL and return to the list of commands, press F3.
To CHOOSE from the list, type the Port Number and
press Enter.

> 1

-
6. Supply the following information unless the default values in Current Choice suit your needs. In this example, the current choice is the VT100¹ terminal. You may wish to check the meaning of the keywords, as described in Appendix B, "Keyword Descriptions."

Change any of the following information that does not match your system configuration.

Name	Description	Current Choice	Possible Choices
tt	Terminal Type	dumb	ibm3161. . . .
ae	Automatic Enable	false	true, false
sn	Slot Number	0	1-8
dvam	Device Attachment Method	0	0=local 1=remote (modem)

To CANCEL and return to the list of commands, press F3.
To CHANGE a current choice, type a name followed by your choice (example sn 4) and press Enter.
To COMMIT the changes you have made, press Enter.

> dvam 1

¹ VT100 is a trademark of Digital Equipment Corporation

-
7. If you want to change any of the device settings, type `y` and press **Enter**.

Note: The device settings must match the way the terminal is set (parity, bits per character, receive/transmit speed, and so on).

All device information for this device has been set for you. Do you want to show or change this information?

yes
no

Type yes or no and press Enter.

> no

8. Verify that you want to add the terminal with the changes you have made by pressing **Enter**. Or, to cancel the request to add the device, press **F3**.

To CANCEL adding the device, press F3.
To ADD the device with the current information,
press Enter.

>

-
9. After receiving a message indicating that the terminal has been added, press **Enter** to return to the DEVICE CUSTOMIZING COMMANDS screen.

The device was added to the system.

```
Device Name:  tty0
Device Type:  tty
Device Class: ttydev
```

> To RETURN to the list of commands, press Enter.

Note: To use the tty immediately after adding it, type penable tty0 after the system prompt. Then press **Enter**.

Example: Adding an Unsupported Printer

With the **devices** commands, you can add an unsupported printer to your system. The procedures are similar to those for adding any other device, but you must supply a little more information.

Follow these steps to add an unsupported printer to your system.

To Add an Unsupported IBM Printer

1. On the DEVICE CUSTOMIZING COMMANDS screen, type the following: a printer osp. Then press **Enter**. osp stands for other serial printer.
2. Type the name of the adapter to which you want to add the printer. Then press **Enter**.
3. Supply the requested parameter information.
4. Indicate whether you want to see or change the settings.
5. Verify that you want to add the printer.
6. When the printer has been added, press **Enter** to return to the DEVICE CUSTOMIZING COMMANDS screen.

More Detailed Information

1. From the DEVICE CUSTOMIZING COMMANDS screen, type the following: a printer osp

```
> a printer osp
```

Type osp for other serial printer and opp for other parallel printer.

-
2. Type the name of the adapter to which you want to add the printer. Then press **Enter**.

The following adapters are available.

Adapter Name	Description
sp1	IBM Ser/Par Adptr, Primary
sp2	IBM Ser/Par Adptr, Alternate
rs232c1	232C, 4-Port Async Adptr Port 1
rs422a1	422C, 4-Port Async Adptr Port 1
s1	IBM RT PC Serial Port 1
s2	IBM RT PC Serial Port 2

To CANCEL and return to the list of commands, press F3.
To CHOOSE from the list, type the Adapter Name and
press Enter.

> sp2

-
3. As requested, supply the necessary information to complete the parameters for the printer and adapter.

Change any of the following information that does not match your system configuration.

Name	Description	Current Choice	Possible Choices
sn	Slot Number	3	2 - 7
f1	Form (page) Length	50	1 - length (in . . .
.			
.			

To CANCEL and return to the list of commands, press F3.
To CHANGE a current choice, type the Name followed by your new choice (example sn 4) and press Enter.
To COMMIT the changes you have made, press Enter.

> f1 40

4. Indicate whether you want to see or change other settings.

All device information for the device has been set for you.
Do you want to show or change this information?

yes
no

To CANCEL and return to the list of commands, press F3.
To CHOOSE, type yes or no and press Enter.

> n

-
5. Verify that you want to add the printer to your system.

To CANCEL adding the device, press F3.

To ADD the device with the current information, press
Enter.

>

6. When the printer has been added, press **Enter** to return to the
DEVICE CUSTOMIZING COMMANDS screen.

Example: Adding a Device for the Coprocessor

You can assign certain devices for use by the Personal Computer AT Coprocessor if the Personal Computer AT Coprocessor adapter and licensed program are installed in your system. You can add some devices for use only by the Coprocessor. You can add other devices (such as printers) that can be shared by the Coprocessor. A shareable device, such as a printer, can be used by the standard system or by the Coprocessor. However, both cannot use it at the same time.

To Add Devices to the Coprocessor

1. On the DEVICE CUSTOMIZING COMMANDS screen, type **add**. Then press **Enter**.
2. From the list of available devices, type **coprcdev** as the device class. Then press **Enter**.
3. From the list, type the name of the device (Coprocessor-only or shareable). Then press **Enter**.
4. Indicate whether you want to see or change device information.
5. To verify that you want to add the device for use by the Coprocessor, press **Enter**.
6. After receiving a message indicating that the device has been added, press **Enter** to return to the DEVICE CUSTOMIZING COMMANDS screen.

More Detailed Information

1. From the **DEVICE CUSTOMIZING COMMANDS** screen, type a and press **Enter** to select the **add** command.
2. On the list of device classes, type **coprcdev**, and press **Enter**. The system displays a list of devices that you can add to the Coprocessor.

The following device classes are available.

Device Class	Description
printer	Printer or Plotter
ttydev	Async Terminal
lan	Local Area Network
tape	Streaming Tape Drive
coprcdev	Coprocessor Device
floating	Floating Point Accelerator

To CANCEL and return to the list of commands, press Enter.
To CHOOSE from the list, type the Device Class and press Enter.

> coprcdev

-
3. From the list of devices, type the name of the device you want to add to the Coprocessor. For instance, you might type coprcdev0. Then press **Enter** to see Coprocessor-shareable and Coprocessor-only devices.

The following devices are available.

Device Name	Description
coprcdev0	A Coprocessor-Only Device
coprcdev1	A Coprocessor-Only Device
coprcdev2	A Coprocessor-Only Device
coprcdev3	A Coprocessor-Only Device
lp0	IBM PC Graphics printer (5152)
lp1	IBM Pageprinter (3812)

To CANCEL and return to the list of commands, press F3.
To CHOOSE from the list, type the Device Name and press Enter.

> coprcdev0

The system prompts you for other adapter-related information at this point. This information must correspond to the adapter specifications usually supplied in the adapter's technical reference information.

Change any of the following information that does not match your system configuration.

Name	Description	Current Choice	Possible Choices
sn	Slot Number	2	2 - 7
nops	Number of Operations	2	0-8
iofl	Input/Output Flag	1	0 = Input, 1 = Output

To CANCEL and return to the list of commands, press F3.

To CHANGE a current choice, type the Name followed by your new choice (example sn 4) and press Enter.

To COMMIT the changes you have made, press Enter.

> nops 3

4. Indicate whether you want to see or change device information. If you enter y, follow the prompts to supply the necessary information.

All device information for this device has been set for you. Do you want to show or change this information?

yes

no

To CANCEL and return to the list of commands, press F3.

To CHOOSE, type yes or no and press Enter.

> no

-
5. Verify that you want to add the device for use by the Coprocessor by pressing **Enter**.

To CANCEL adding the device, press F3.

To ADD the device with the current information, press Enter.

>

6. After receiving a message indicating that the device has been added, press **Enter** to return to the DEVICE CUSTOMIZING COMMANDS screen or **F3** to cancel the request.

The device was added to the system.

Device Name: coprcdev
Device Type: coprcdev
Device Class: coprcdev

To return to the list of commands, press Enter.

Deleting Devices from the System

When you decide that you no longer need a certain printer or other device in the system, you must delete that device from the system configuration. To delete a device, you use the **delete** command.

The following steps show you how to delete a typical device from your system.

To Delete a Device

1. From the DEVICE CUSTOMIZING COMMANDS screen, type **delete**. Then press **Enter**.
2. From the list of device classes, type in one of the choices. Then press **Enter**.
3. From the list of devices, type the name of the device you want to delete. Then press **Enter**.
4. To verify that you want to delete the device, press **Enter**.
5. After you receive a message telling you that the device has been deleted, press **Enter** to return to the DEVICE CUSTOMIZING COMMANDS screen.

Note: See the appropriate setup information for instructions on physically removing the device you have just deleted from your system.

More Detailed Information

The following example shows how you delete a device from your system. In this example, you are deleting the printer lp0.

1. On the DEVICE CUSTOMIZING COMMANDS screen, type delete. Then press **Enter**.
2. From the list of device classes, type printer as the name of the device class you want to delete. Then press **Enter**.

The following device types are available.

Device Class	Description
printer	Printer or Plotter
ttydev	Async Terminal
lan	Local Area Network
tape	Streaming Tape Drive
coprocdev	Device for Coprocessor
floating	Floating Point Accelerator

To CANCEL and return to the list of commands, press F3.
To CHOOSE from the list, type the Device Class and press Enter.

```
> printer
```

-
3. From the list of printers available to be deleted, type lp0 as the name of the printer you want to delete from the system. Then press **Enter**.

The following devices are available.

Device Name	Description
lp0	IBM PC Graphics Printer (5152)
lp1	IBM Pageprinter (3812)
lp2	Other Serial Printer

To CANCEL and return to the list of commands, press F3.
To CHOOSE from the list, type the Device Name and press Enter.

> lp0

4. Verify that you want to delete the printer by pressing **Enter**.

To CANCEL deleting the device, press F3.
To DELETE the device from the system, press Enter.

>

5. After you receive a message telling you that the printer has been deleted, press **Enter** to return to the DEVICE CUSTOMIZING COMMANDS screen.

The device was deleted from the system.

Device Name: lp0
Device Type: 5152
Device Class: printer

To RETURN to the list of commands, press Enter.

Changing Information About System Devices

You may want to change the settings (device information) for a device in your system. For instance, you may want to change the margin settings for printing documents. The **change** command lets you change settings for a device already installed in your system.

The following example shows how you might change settings for a typical device. (The lists of device types and device classes shown in the example may not be exactly the same as those you see on your screen.)

To Change Device Information

1. On the DEVICE CUSTOMIZING COMMANDS screen, type **c** if you want to change device information. Then press **Enter**.
2. From the list of available devices, type the device class for which you want to change information. Then press **Enter**.
3. From the list of device names, type the name of the device for which you want to change information. Then press **Enter**.
4. Follow the prompts to change the settings displayed on the screen.
5. Verify that you want to commit the device information by pressing **Enter**.
6. After receiving a message indicating that the device information has changed, press **Enter** to return to the DEVICE CUSTOMIZING COMMANDS screen.

More Detailed Information

The following example shows how you change information about a printer in the system.

1. On the **DEVICE CUSTOMIZING COMMANDS** screen, type **c** to choose the **change** command. Then press **Enter**.
2. From the list of available device classes, type **printer** as the device class for which you want to change information. Then press **Enter**.

The following device classes are available.

Device Class	Description
printer	Printer or Plotter
ttydev	Async Terminal
lan	Local Area Network
.	.
.	.

To **CANCEL** and return to the list of commands, press **Enter**.
To **CHOOSE** from the list, type the Device Class and press **Enter**.

```
> printer
```

-
3. From the list of available devices, type in lp0 as the name of the printer for which you want to change information. Then press **Enter**.

The following devices are available.

Device Name	Description
lp0	IBM PC Graphics Printer (5152)
lp1	IBM Proprinter (4201) on a Serial Port

To CANCEL and return to the list of commands, press F3.
To CHOOSE from the list, type the Device Name and press Enter.

> lp0

-
- When the list of settings for printer lp0 displays, make the changes that you want. Type the name of the setting, followed by a space and the new choice (which must be one of the choices in the "Possible Choices" column). For example, to change the left margin setting from 0 (current choice) to 5, type `lm 5`. Then press **Enter**. Make changes and press **Enter** until you have changed all settings that you want to change.

Name	Description	Choice	Choices
fl	Form (page) Length	50	1 - length (in . . .)
tm	Top Margin	0	0 - length (in . . .)
bm	Bottom Margin	50	1 - length (in . . .)
lm	Left Margin	0	0 - width (in . . .)
fw	Form Width	80	1 - width (in . . .)
.			
.			
.			
pitch	Character Pitch	10	10, 12, 15
.			
.			

To CANCEL and return to the list of commands, press F3.
To CHANGE a current choice, type a name followed by your choice (example sn 4) and press Enter.
To COMMIT the changes you have made, press Enter.

> lm 5

- Verify (by pressing **Enter**) that the changed choices are accurate and that you want to make the changes take effect. To cancel the changes, press **F3**.

To CANCEL changing the device, press F3.
To CAUSE the current choices to take effect, press Enter.

>

6. You will see a message indicating that the device information has been changed. Press **Enter** to return to the **DEVICE CUSTOMIZING COMMANDS** screen.

The device information was changed.

```
Device Name: lp0
Device Type: 5152
Device class: printer
```

To RETURN to the list of commands, press Enter.

>

Note: If you use the **change** option of the **devices** command to change any of the settings for your system devices and you notice that your requested changes are not implemented, perform either of the following steps:

- Issue the following commands:

- **vrconfig -d <device name >**
- **vrconfig -a <device name >**

where **<device name >** is the name of the device on which you did the **change**. Note that **vrconfig -d** will not work if the device is in use.

- Perform a re-IPL of the system after issuing the **shutdown** command.

Other Device Specific Information

The following list contains information specific to certain devices that you will need to know when adding or deleting devices from your system:

- IBM 4201 Proprinters – Change the *cp* keyword to *MLP* to use the international language fonts
- IBM 4202 Proprinter – Change the *cp* keyword to *MLP* to use the international language fonts
- IBM PC QUIETWRITER® Printer Model 2 – Change the *big*s keyword to *yes*
- *tty*
 - Once the *tty* is added using **devices**, the **penable** command must be run to enable the *tty* port before it can be used
 - To add a remote *tty*, the *dvam* keyword must be set to 1.
- Personal Computer AT Coprocessor Services Device – Must be attached to a PC-supported adapter (IBM Serial/Parallel Adapter, IBM Mono display/par printer adapter)
- Baseband Adapter
 - If only one Baseband Adapter is being installed, you can usually use the default (factory) memory address setting. This is the setting that the **devices** command assumes, and it supplies default settings for the other three memory addresses that have to be set.
 - If more than one Baseband Adapter is being installed:
 - The first adapter can be installed with default memory address settings, but subsequent adapters cannot as there will be memory address conflicts. You must select a different starting address on the card with the jumper (see *option*) and then supply the other three addresses when you run the **devices** command. These addresses have a precise relationship to each other. This relationship is called their **offset**, if you know the first

address (the one that you set with the jumper), then you can calculate the other three addresses. Offsets are described in *Virtual Resource Manager Technical Reference*.

- Each adapter must have different a interrupt level. These interrupt levels are also set with a jumper on the adapter itself. These jumper settings are described in *Options Installation*.
- If an adapter is being installed in a machine that has an IBM RT PC Personal Computer AT Coprocessor Services card with more than 512K of bus memory dedicated to it, the starting address on the adapter must be set to 98000. The other three addresses are calculated and entered when the **devices** command is run. The starting address must be set even even if only one adapter card is being installed.

If a second adapter is installed, set the address with the jumper at 90000. Then, the other addresses must be calculated and entered when the **devices** command is run.

- 9332 DASD

- The IBM 9332 DASD Attachment is a fixed-disk storage unit available in 200-megabyte and 400-megabyte disks. The 400-megabyte disks are actually two 200-megabyte disks under one cover. All AIX commands recognize one 400-megabyte disk as two 200-megabyte disks.
- A 200-megabyte disk or disks must be added to your system at logical unit number 0 (LUN0) only. For the 400-megabyte disk, the first 200-megabytes must be added at LUN0 only and the second 200-megabytes must be added at LUN1 only. The *lun* keyword must be set to the appropriate value using the **devices** command.
- The SCSI Controller ID (*sid* keyword) should be set to the same value as the switch on the back of the disk drive. LUN0 and LUN1 of a 400-megabyte disk must have the same *sid* keyword. The *sid* keyword must be set to the appropriate value using the **devices** command.

i.e.
varyon -d hdisk6 hdisk7

- After adding a 9332 disk using the **devices** command, the **varyon** command must first be run to configure the disk and to configure, check, and mount the minidisks on it before it can be used. See *AIX Operating System Commands Reference* for more information on the **varyon** command.
- Before you delete a 9332 disk, be sure that all minidisks on that disk are unmounted. If any minidisks are still mounted, they will be displayed by the **devices** command and the disk will not be deleted. See *AIX Operating System Commands Reference* for more information on the **umount** command.
- Note that deleting a disk using the **devices** command does not remove the minidisks or data from the disk. If you would like the disk to be free of data once it is deleted, first delete the minidisks on the disk using the **minidisks (delete)** command. Then, delete the disk using the **devices** command. You can also reformat the disk using the SCSI diagnostic utilities in *IBM RT PC Problem Determination Guide*.
- IBM Megapel Display Adapter
 - This adapter contains a parallel printer port that is equivalent to the parallel port on the IBM Monochrome Display and Printer Adapter. If an IBM Monochrome Display and Printer Adapter already exists on an RT PC, you can disable the parallel port on the IBM Megapel Display Adapter. The *IBM RT PC User Setup Guide* will provide this information for you.
 - Note that when you want to display a list of all devices using the **devices** command shown in "Displaying All Devices In Your System" on page 6-17, the description of either adapter will be shown as mono/par or megapel/par adapters.
- Extended ESDI Adapter — The adapters you choose for your system can conflict in two ways: Interrupt level or DMA channel. See Appendix E, "Conflicting Adapter Levels" on page E-1 for more detailed information to help you solve these conflicts.

Chapter 7. Customizing System Minidisks

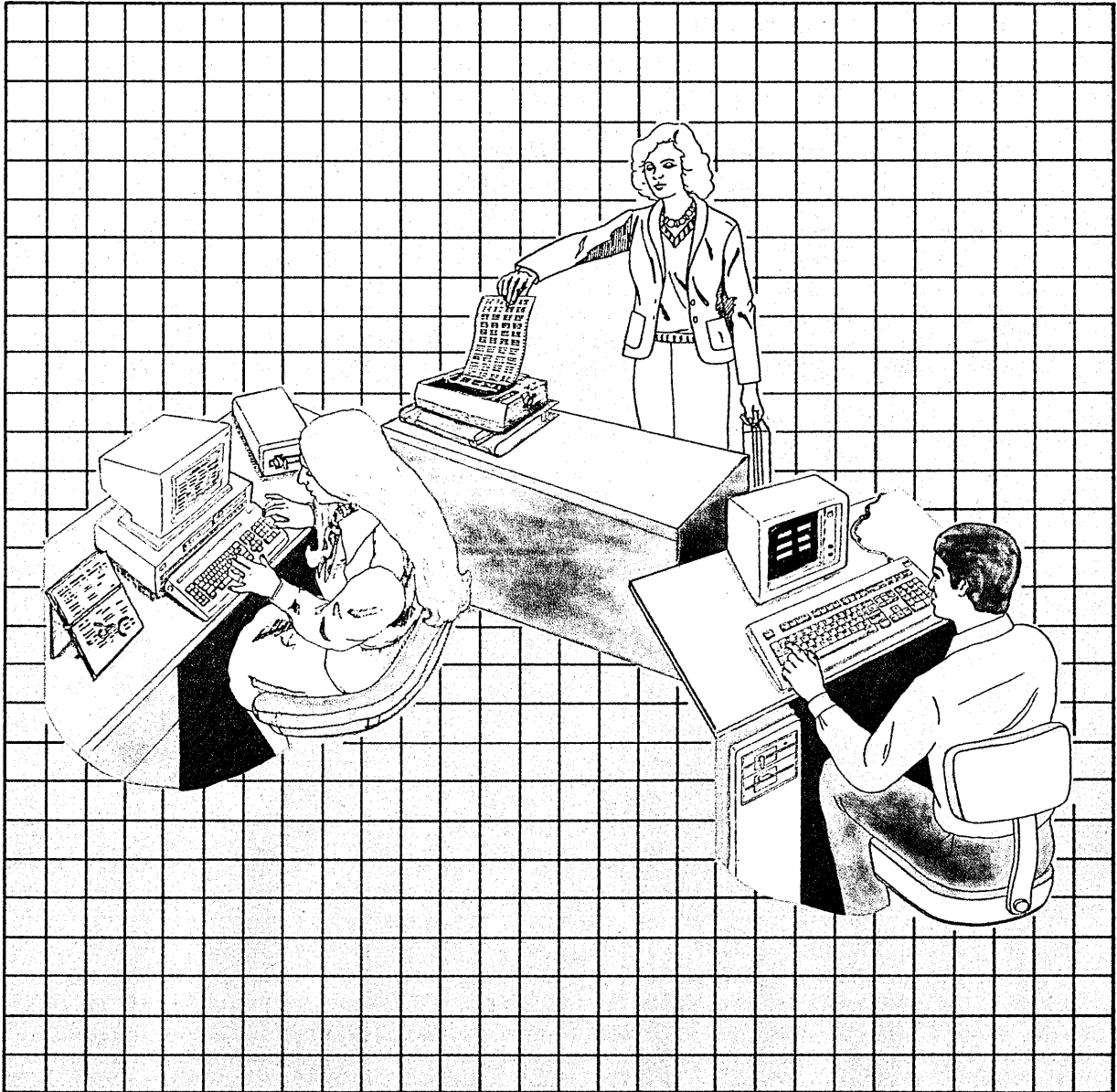

CONTENTS

About This Chapter	7-3
Learning About Minidisks	7-4
Using the Minidisks Command	7-8
Starting and Exiting Minidisks	7-8
Using Abbreviated Commands	7-9
Using Minidisks Commands	7-10
Showing Minidisk Information and Planning Ahead	7-10
Adding Minidisks	7-12
Deleting Minidisks	7-12
Changing Mount Attributes	7-13
Example: Using the Minidisks Command	7-14
Example: Displaying Minidisk Information	7-16
Example: Adding an AIX Minidisk	7-18
Example: Adding Coprocessor and Non-AIX Minidisks	7-29
Example: Deleting a Minidisk	7-35
Example: Changing Minidisk Mount Attributes	7-37
Accessing User-Created Minidisks After Reinstalling (Using the Replace Option) ..	7-41

About This Chapter

This chapter explains how you can create minidisks (or divisions) on your system fixed disks to contain specific pieces of information necessary for your system to function. If you have installed the Virtual Resource Manager and the Base System Program, you already have several minidisks on your fixed disk. These minidisks may be adequate for your system needs.

But if you have installed the Coprocessor or want to create other minidisks, then you must follow instructions in this chapter to create and delete minidisks. This chapter also contains instructions for changing the mount attributes of an existing AIX minidisk and for reaccessing AIX minidisks created with the **minidisks** command (necessary if you reinstall the Base System Program) using the replace option.

Note: The **minidisks** command works only for creating or changing user-defined minidisks, not system-created minidisks such as `/`, `/usr`, `/vrm`, and so on. For system minidisks, use the commands available on the Installation/Maintenance diskette. These commands are described in *Managing the AIX Operating System*.

Learning About Minidisks

Your IBM RT PC system has up to 3 internal and 14 IBM 9332 DASD Attachment. A fixed disk can be divided into separate areas called *minidisks*. Each contains information used by the system, and the various minidisks can be different sizes.

A maximum of 64 minidisks can be configured at one time across your system with a limit of 47 minidisks per disk. At this point, you already have several minidisks on your system:

- Two minidisks were created when you installed the Virtual Resource Manager: the Virtual Resource Manager minidisk and the paging minidisk.
- The operating system minidisks, which include `/(root)`, `/usr`, `/tmp`, `/u`, and `Dump`, were created when you installed the Base System Program.

If you need no more than these minidisks, you can use your system without ever using the **minidisks** command. If you have installed the Coprocessor or want to create other minidisks, then you must use the **minidisks** command discussed in this chapter.

Note: System minidisks can only reside on internal disks.

Warning: If you ever reinstall the Base System Program with the replace option (rather than the merge option), remember that doing so automatically destroys the files on all of the operating system minidisks, except for the `/u` minidisk. See “Reinstalling the Base System Program” on page 4-37 for details.

If you have one fixed disk, it probably is partitioned as shown below. While you were installing the AIX Operating System, you may have indicated that you wanted to reserve space on the fixed disk for other programs. If so, there is an area of free space at the end of the disk for you to create a minidisk. Instructions in this chapter explain how to create minidisks, with an example of how to create one for the Coprocessor.

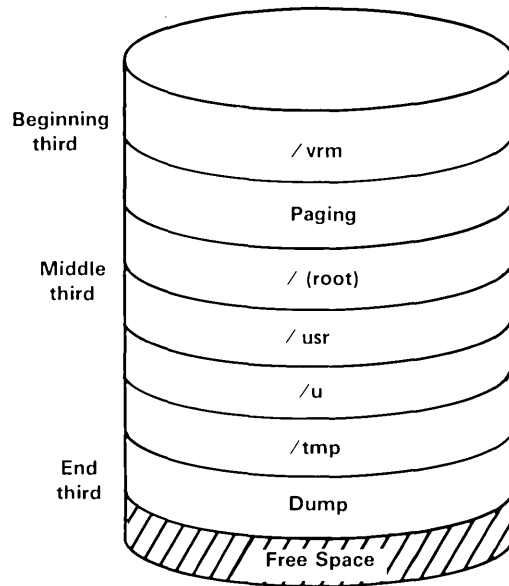

If you have two fixed disks and have installed the Virtual Resource Manager and the AIX Operating System with the recommended choices, then the fixed disks may be divided as shown below. The configuration on your system may differ.

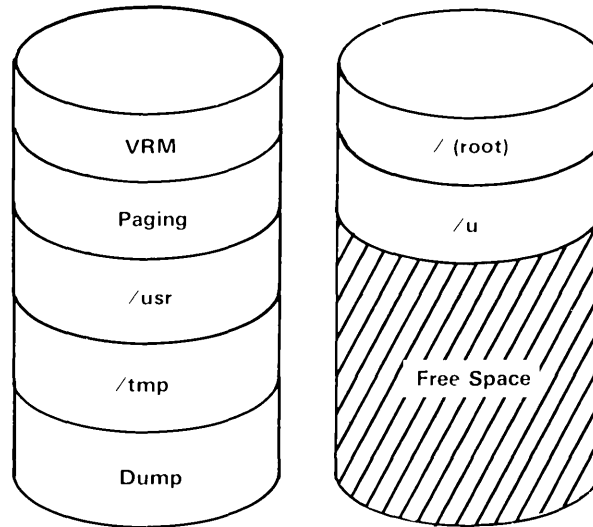

If you have three fixed disks and have installed the Virtual Resource Manager and the AIX Operating System with the recommended choices, then the fixed disks may be divided as shown on the following page. The configuration on your system may differ.

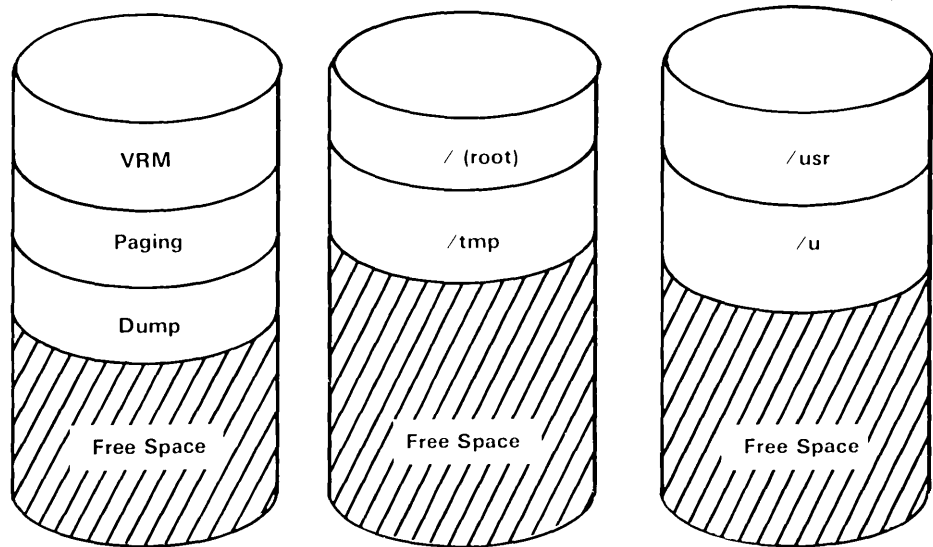

Available free space cannot be used until you create a minidisk from it. You can use the **minidisks** command to create a different minidisk from each area of free space.

If you have added a second or third fixed disk after installing the Virtual Resource Manager and the AIX Operating System, this disk will be one large area of free space. You may create one minidisk for the entire disk, or divide it into several minidisks.

Using the Minidisks Command

Now that you better understand the relationship of minidisks to the fixed disks in your system, you can prepare to use the **minidisks** commands (**show**, **add**, **delete**, and **change**). The following sections describe how to use the **minidisks** commands.

Starting and Exiting Minidisks

To start the **minidisks** command, you must first be logged in to the system. In addition, you must have superuser authority or be a member of the system group. After the system prompt, type **minidisks**, and press **Enter**. You will see the MINIDISK CUSTOMIZING COMMANDS screen, and you can begin using any of those commands.

MINIDISK CUSTOMIZING COMMANDS

Minidisks commands are:

Command Description

add	Create a new minidisk
change	Change mount characteristics of an existing minidisk
delete	Delete an existing minidisk
show	Show minidisk information

To EXIT the minidisks command, press F3.

To USE a minidisks command, type the command and press Enter.

>

You can exit **minidisks** at any time by pressing **F3** on the keyboard. When you press **F3**, you return to the list of commands. If you press **F3** from the list of commands, you exit **minidisks**. You will see the \$ or # prompt displayed.

Using Abbreviated Commands

To save time, you can abbreviate the **minidisks** commands by typing only the first letter for each command. That is, type s for **show**, a for **add**, d for **delete**, or c for **change**. You can also type y for yes and n for no. You must spell out in full all minidisk names, directory names, and fixed-disk names.

Using Minidisks Commands

The four **minidisks** commands are:

- **show**
- **add**
- **delete**
- **change.**

The following sections provide information on each command, and you will find examples of how to use each command later in this chapter.

Showing Minidisk Information and Planning Ahead

The **show** command lists all minidisks and areas of free space for all disks configured in your system. Any external disks that are not powered on and configured will be displayed. Also, while you are using the **minidisks** commands, you can see this information by pressing the **F2** key. A line on the screen identifies those times when that information is available. In the example on the next page, **hd0** is the AIX Operating System / (root) file system minidisk, and **hd8** is a minidisk that has been created on free space similar to the remaining area of free space on **hdisk0**. **hd8** is mounted at IPL time on the directory **/usr/hd8**, with read-write access.

If you are planning to create a minidisk, record the following information to use for that procedure:

- Location and number of blocks of the free space area to be partitioned

If the free space spans more than one position, you can request either position and your minidisk will be created such that all of the contiguous space in the requested position is taken, with some overlap on the adjacent position, if necessary. You should specify the beginning or middle position for best results. The space can overlap the beginning and middle positions or the middle and ending positions. But if you specify the ending

position, the system cannot create a minidisk that overlaps free space in the middle position.

- Name of the fixed disk.

Note that there are different block sizes. All free space is reported in terms of 512-byte blocks, and most minidisks have a block size of 512 bytes.

Block Size x Number Blocks = Number of Bytes in Minidisk
512 x 5000 = 2,560,000 bytes
1024 x 2500 = 2,560,000 bytes
2048 x 1250 = 2,560,000 bytes

A minidisk of block size 512 having 5000 blocks is the same size as a minidisk of block size 1024 having 2500 blocks, and also the same size as a minidisk of block size 2048 having 1250 blocks.

Because 2048 is four times 512, if you create a minidisk of block size 2048 on an area of free space having 24,000 blocks, you request 24,000 divided by 4, or 6000 blocks.

Note in the following example that minidisk `hd8` and the remaining area of free space on `hdisk0` are the same size. To create a minidisk on the remaining area of free space with a block size of 2048, write down 12500 as the number of blocks to request.

Fixed Disk `hdisk0` has the following Minidisks:

Mdisk Name	Mdisk IODN	Mdisk Type	Block Size	Number Blocks	Mdisk Loc	Mount Directory	Auto IPL	Auto Mount	R/w Status
Available Space			512	50000	B	*****			
hd0	16384	AIX	512	10375	B,M,E	/	Y	Y	R/W
hd8	20002	AIX	512	50000	E	/usr/hd8	N	Y	R/W

To CONTINUE, press Enter.

To PRINT this list of minidisks, press F4.

>

Adding Minidisks

Once you decide to add a minidisk, you select **add** from the list of **minidisks** commands. When a line on the screen indicates that you can do so, you can press **F2** to see where the free space is, and how large it is. At other times, you may use the **show** command to see this information.

After you enter the **add** command, you must answer a series of questions to help you provide the needed information for the system to add the minidisk. For example, you will be asked to provide the block size, the location on the disk, and other information. These are items that you should have recorded while using the **show** command.

Note: The **add** command will not recognize external disks that are not powered-on and configured.

Deleting Minidisks

Once you enter the **delete** command, you will be asked to enter the name of the minidisk you want to delete. Then you will see information about the minidisk and be asked to verify that you want to delete that minidisk.

Warning: When you delete a minidisk, any files on that minidisk are likely to be lost. Be certain to copy any files you want to keep. Otherwise, you may lose valuable information. See *Managing the AIX Operating System* for information about guidelines for backing up your files.

Changing Mount Attributes

With the **change** command, you can make the following changes to AIX minidisks:

- Change the directory on which a minidisk is mounted
- Change whether the minidisk is automatically mounted after it is configured.
- Change whether the minidisk is mounted read-only or read-write.

See *Managing the AIX Operating System* for more information on these topics.

After you enter the **change** command, you will be asked to answer several questions to guide you through steps to change the settings for the minidisk.

Example: Using the Minidisks Command

The rest of this chapter presents several examples to show you how to use the **minidisks** commands. In each case, the box contains steps for the use of the command. If you are somewhat familiar with **minidisks**, you might use the boxed information as a reminder of the steps involved.

Under "More Detailed Information" is information that displays on the screen, along with an explanation of what the prompts mean and how to respond to them.

The first step when using **minidisks** is to request the list of **minidisks** commands. This list shows you the available options.

To Request Minidisks

1. After the \$ or # prompt, type `minidisks`.
2. Press **Enter**.

More Detailed Information

1. After the \$ or # prompt, type `minidisks`.

```
# minidisks
```

-
2. Press **Enter** to see the MINIDISK CUSTOMIZING COMMANDS screen.

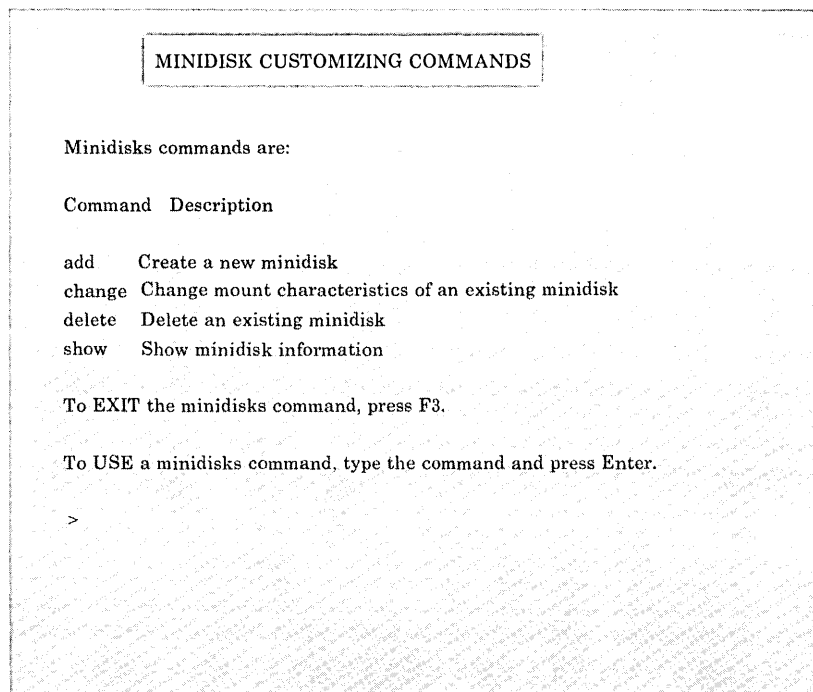

Example: Displaying Minidisk Information

To display information about existing minidisks, select **show** from the **minidisks** commands screen.

To Display Minidisk Information

1. On the MINIDISK CUSTOMIZING COMMANDS screen, type **show** (or **s**) to see information about minidisks. Press **Enter**.

```
> show
```

Remember that as you use the **add**, **change**, or **delete** commands, you can display information about disks by pressing **F2**.

2. To return to the MINIDISK CUSTOMIZING COMMANDS screen, press **Enter**.

More Detailed Information

After entering **show** (or **s**) to display information about existing minidisks, you will see a screen similar to this one:

You may show the minidisk information for every fixed disk or for one disk only.

To CHOOSE from the list, type your choice and press **Enter**.

```
hdisk0  
hdisk1  
all
```

```
> hdisk0
```

After entering the name of the fixed disk about which you wish to see information, you see minidisk information similar to the following:

Fixed Disk hdisk0 has the following minidisks:

MD Name	MD IODN	MD Type	Block Size	Number Blocks	MD Loc	Mount Direct	Auto IPL	Auto Mount	R/w Status
Available Space	512	50000	B,M	*****					
hd0	16384	AIX	512	10375	M	/	Y	Y	R/W
Available Space	512	50000	M,E	*****					

To CONTINUE, press Enter.

To PRINT this list of minidisks, press F4.

>

To better understand this information, you may want to review the information about minidisks at the beginning of this chapter.

If you have a printer configured and running, you may print the information you see on the screen by pressing **F4**. A summary report is also written to the file **/tmp/CONFIGREPORT** that contains the information on each show screen, where **F4** has been pressed during the **minidisks** session.

Example: Adding an AIX Minidisk

To add an AIX minidisk to the system and specify characteristics for that minidisk, select **add** from the **minidisks** list. Follow these instructions:

To Add an AIX Minidisk--Part 1

1. On the MINIDISK CUSTOMIZING COMMANDS screen, type add (or a). Then press **Enter**.
2. After the > prompt, indicate that there will be an AIX file system on the minidisk by typing yes. Then press **Enter**.
3. Type the full path name of the directory on which the minidisk is to be mounted. Press **Enter**.
4. Indicate whether you want the minidisk mounted after it is configured, and press **Enter**.
5. Indicate whether you want the minidisk to be read-only or read-write. Press **Enter**.
6. Continue with "To Add a Minidisk--Part 2" on page 7-21.

More Detailed Information

1. On the MINIDISK CUSTOMIZING COMMANDS screen, type add to indicate that you want to add a minidisk. Press **Enter**.

> add

-
2. Type `yes` to indicate that you want an AIX file system on the minidisk. Press **Enter**.

Will there be an AIX file system on this minidisk?

`yes`

`no`

Type `yes` or `no` and press `Enter`.

`> yes`

3. Type the full path name of the directory on which to mount the new minidisk, and press **Enter**.

Type the full path name of the directory on which you want to mount this minidisk (example: `/usr/mine`). Then press **Enter**.

`> /u/amy`

A full path name begins with the `/` (root) directory. For example, if your minidisk is to be mounted on `/u/amy`, the files `file1` and `file2` will have the path names `/u/amy/file1` and `/u/amy/file2`.

The following example depicts how a new minidisk can be mounted on the directory `/u/amy`.

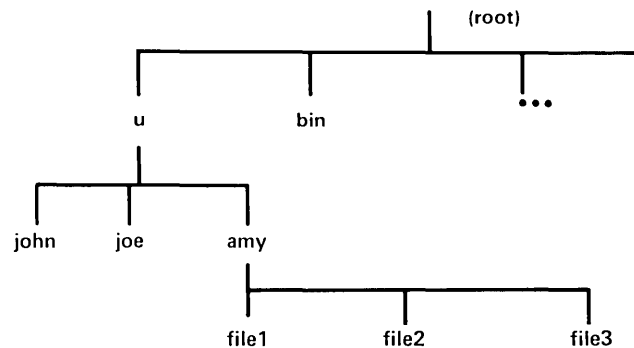

-
4. Next, indicate whether you want the new minidisk mounted when it is configured, and press **Enter**.

Do you want this minidisk to be automatically mounted after it is configured?

yes
no

Type yes or no and press Enter.

> yes

Internal disks and the minidisks on them are configured each time you start the system. If the minidisk is automatically mounted each time you start the system, you can access the files stored on the minidisk without using the **mount** command. But if the minidisk is not automatically mounted each time you start up the system, you must use the **mount** command to mount the minidisk before you can access the files on that minidisk.

External disks and minidisks are not configured at IPL time and must be configured with the **varyon** command. If you specify on this screen that the minidisk should be automatically mounted, the **varyon** command will mount it. Otherwise, you must run the **mount** command to access the files on an external minidisk.

-
5. Now indicate whether you want the minidisk to be read-only or read-write, and press **Enter**.

The following access permissions are available:

Name	Description
rw	read/write
ro	read-only

To choose a permission, type the name and press Enter.

```
> rw
```

The minidisk can be mounted with either read-only or read-write access. With read-only access, you only will be able to read files on your minidisk. If you choose the read-write option, you will be able to both read and write to the files on your minidisk.

6. Continue with "To Add a Minidisk--Part 2" on the next page.

To Add an AIX Minidisk--Part 2

1. After the `>` prompt, establish the size of the minidisk by typing the number of 512-byte blocks. Press **Enter**.
2. Choose the disk where the new minidisk will be located. Type in the disk name, and press **Enter**.
3. Choose whether you want to place the new minidisk on the next available free space or on a specific disk location. Type `yes` or `no`, and press **Enter**. If `yes`, continue with step 4. If `no`, go to step 5.
4. Choose the starting position for the new minidisk (beginning, middle, or end of the fixed disk). After the `>` prompt, type the name of the starting position, and press **Enter**.
5. Review the settings for the new minidisk, and follow directions on the screen to change choices, to cancel the creation of the minidisk, or to create the new minidisk.
6. If the mount directory does not exist, use the **mkdir** command to create it.
7. For an existing minidisk, mount it before you use it. Type:
`mount /u/minidisk`. Then press **Enter**.

More Detailed Information

1. After the `>` prompt, establish the size of the minidisk by typing the number of 512-byte blocks. Then press **Enter**.

The block size for AIX minidisks is 512 bytes. Type the number of blocks for this minidisk and press Enter.

To SHOW minidisk information in requested block size, press F2.

```
> 60000
```

The number of blocks determines how large your minidisk will be. AIX minidisks have a blocksize of 512-bytes. You can press **F2** for the **show** command at this time. Doing so displays free space in 512 blocks. Note that some of this space (about 5%) is used for indexes, not data. See “Showing Minidisk Information and Planning Ahead” on page 7-10.

2. The next screen shows the disk names that are currently configured into the system. Choose the disk where the new minidisk will be located. Type in the disk name, and press **Enter**.

The following fixed disks are available:

```
hdisk0  
hdisk1
```

Type the fixed disk on which to create this minidisk and press Enter.

To SHOW minidisk information in requested block size, press F2.

```
> hdisk0
```

There may not be enough free space for a minidisk of the size you have requested on each disk in the list. If you do select a fixed disk without adequate space for your minidisk, you will see an error message, and then a summary screen from which you can select a different fixed disk.

3. Next decide whether you want to choose a particular location for your minidisk. Type `yes` or `no`, and press **Enter**. See “Showing Minidisk Information and Planning Ahead” on page 7-10 for guidelines.

If you do not choose a location for this minidisk on the disk, the minidisk will be placed in the first available space on the disk.

Do you want to choose a location?

`yes`

`no`

Type `yes` or `no` and press **Enter**.

To **SHOW** minidisk information in requested block size, press **F2**.

> `yes`

-
4. Choose the position for your minidisk from the available locations shown on the screen. In this example, you can select the middle or the end. Or, if you want, you can select *no preference*. Type m, e, or n, and press **Enter**.

The following positions for this minidisk are available:

Name	Description
m	middle
e	end
n	no preference

To CHOOSE a starting position, type the name and press Enter.

To SHOW minidisk information in requested block size, press F2.

> e

-
5. Now you will see a screen summarizing the current choices and any choices you may have indicated that you want to make. You have the option of changing current choices, cancelling the creation of this minidisk, or creating the new minidisk with the current choices. If you make any changes, you must verify those changes before the new minidisk is created. You will also be prompted again (see steps 3 and 4) for location on the disk, if the number of blocks is too large for the fixed disk you selected. The following example assumes that the number of blocks will be changed to 50000.

```
Minidisk name:  hd8
Minidisk location:  end
Directory:  /u/amy
Automatic Mount:  yes
Read Permission:  read/write
```

The following information can be changed:

Name	Description	Current Choice	Possible Choices
nob	Number of Blocks	60000	
fd	Fixed Disk	hdisk0	hdisk0,hdisk1, . . .

To CHANGE a current choice, type the name followed by your new choice (example: nob 1000) and press Enter.

To CANCEL creation of this minidisk, press F3.

To CREATE this minidisk with the current choices, press Enter.

To SHOW minidisk information, press F2.

```
> nob 50000
```

To make changes, type the name, a space, and the new choice. Then press **Enter**, as shown in the example above. If you change the fixed disk (for example, from hdisk1 to hdisk0), you will be asked to indicate a location on the new fixed disk.

Press **Enter** when you have completed your changes. If you made any changes, you will see the changed choices on the summary screen, as in the following example.

Minidisk name: hd8
Minidisk location: end
Directory: /u/amy
Automatic Mount: yes
Read Permission: read/write

The following information can be changed:

Name	Description	Current Choice	Possible Choices
nob	Number of Blocks	50000	
fd	Fixed Disk	hdisk0	hdisk0,hdisk1, . . .

To CHANGE a current choice, type the name followed by your new choice (example: nob 1000) and press Enter.

To CANCEL creation of this minidisk, press F3.

To CREATE this minidisk with the current choices, press Enter.

To SHOW minidisk information, press F2.

>

When you press **Enter** without making any changes, the minidisk is added to the system. For large minidisks, this process may take a few minutes. During this time, the minidisk is being defined and the **lost + found** directory is created. The **lost + found** directory is created with N slots for lost files, where N is the total number of inodes in the file system divided by 10, with a minimum of 128 and a maximum of 1024 slots.

If you receive a "special processing" error message while the minidisk is being added, see Appendix C, "Special Processing for Devices and Minidisks" for error recovery procedures.

-
6. If the mount directory does not exist, use the **mkdir** command to create it. For more details on **mkdir**, see *AIX Operating System Commands Reference*.
 7. The system displays a message confirming the addition of the new minidisk, then returns to the list of **minidisks** commands.

The minidisk has been successfully created. The minidisk name is hd8.

To CONTINUE, press Enter.

Note: The directory, /u/amy, must exist before you try to mount the minidisk for the first time.

If the directory is /u/amy, and /u does not exist, you must exit **minidisks** and type:

```
mkdir /u          (Press Enter)  
mkdir /u/amy (Press Enter)
```

These steps will create the directory /u/amy. See *Managing the AIX Operating System* for more information on creating new file systems.

Mount the minidisk before you use it the first time. To do this, type: mount /u/amy. Then press **Enter**.

Example: Adding Coprocessor and Non-AIX Minidisks

To use a Coprocessor (if one is installed in your system), you can create a minidisk for the Coprocessor to use. To do so, use the **add** command. Use the following instructions to create a minidisk after installing the Coprocessor.

To Add a Non-AIX Minidisk--Part 1

1. On the MINIDISK CUSTOMIZING COMMANDS screen, type add (or a). Press **Enter**.
2. After the > prompt, type no to indicate that there will be no AIX file systems on this minidisk, and press **Enter**.
3. Type yes and press **Enter** to indicate that the minidisk will be used by the Coprocessor.
4. Continue with "To Add Minidisk--Part 2" on page 7-29.

More Detailed Information

1. On the MINIDISK CUSTOMIZING COMMANDS screen, type add (or a), and press **Enter**.

```
> add
```

2. After the > prompt, type no to indicate that you do not want a AIX file system on the minidisk, and press **Enter**.

```
Will there be an AIX file system on this minidisk?
```

```
yes
```

```
no
```

```
Type yes or no and press Enter.
```

```
> no
```

-
3. To indicate that the new minidisk will be used by the Coprocessor, type *yes*. Press **Enter**.

Will this minidisk be used by the Coprocessor?

yes

no

Type *yes* or *no* and press Enter.

> *yes*

You will be asked to indicate whether the new minidisk is to be associated with the Coprocessor only if the Coprocessor is already configured in your system. If you enter *no*, the minidisk is available as a device, but it will not contain an AIX file system.

4. Continue with "To Add Minidisk--Part 2" on the next page.

To Add a Non-AIX Minidisk--Part 2

1. After the > prompt, type the number of blocks to give to the minidisk, and press **Enter**.
2. Type the name of the fixed disk on which you want the minidisk, and press **Enter**.
3. To indicate whether you want to choose a location on the disk for the minidisk, type yes or no. If you enter yes, continue with step 4. If no, go to step 5.
4. From the list, choose a location on the fixed disk for your minidisk. Type in the location, and press **Enter**.
5. On the summary screen, press **Enter** to add the minidisk. To cancel the add minidisk session, press **F3**. To change any of the displayed settings, enter the setting name and the new choice after the > prompt. To add or cancel the minidisk after changes, press **Enter** or **F3**.

More Detailed Information

1. After the > prompt, type the number of blocks to give to the minidisk, and press **Enter**.

Type the number of 512 blocks for this minidisk and press Enter.

To SHOW minidisk information in requested block size, press F2.

> 1250

The size of your minidisk (in bytes) is the block size times the number of blocks that you specify now. If you want your minidisk to fit into a certain free space as shown by the **show** command, press **F2**.

You should allocate at least 780 512-byte blocks for a Coprocessor minidisk to run DOS 3.0 or BASIC. More blocks may be required to run other PC applications. Check the documentation for the specific application to determine size requirements.

2. After the > prompt, type the name of the fixed disk on which you want the minidisk (as shown below), and press **Enter**.

The following fixed disks are available:

```
hdisk0  
hdisk1
```

Type the fixed disk on which to create this minidisk and press Enter.

To SHOW minidisk information in requested block size, press F2.

```
> hdisk0
```

The screen shows all the fixed disks currently configured in your system. None of the fixed disks listed may have enough free space for a minidisk of the size you want. If you do select a fixed disk without adequate space for your minidisk, you will see an error message and then a summary screen from which you can select a different fixed disk.

-
3. To indicate whether you want to choose a location on the disk for the minidisk, type yes or no, and press **Enter**. If you enter no, go to step 5.

If you do not choose a location for this minidisk on the disk, the minidisk will be placed in the first available space on the disk.

Do you want to choose a location?

yes
no

Type yes or no and press Enter.

To SHOW minidisk information in requested block size, press F2.

> yes

4. Choose a position for your minidisk from the list of available locations. Type b, m, e, or n, and press **Enter**.

The following positions for this minidisk are available:

Name	Description
b	beginning
m	middle
e	end
n	no preference

To CHOOSE a starting position, type the name and press Enter.

To SHOW minidisk information in requested block size, press F2.

> e

-
5. On the summary screen, to add the new minidisk, press **Enter**. To cancel the add minidisk session, press **F3**. To change any of the displayed settings, enter the setting name and the new choice after the > prompt. To add or cancel the minidisk after changes, press **Enter** or **F3**.

Minidisk Name: hd7

The following information can be changed:

Name	Description	Current Choice	Possible Choices
nob	Number of Blocks	1250	
fd	Fixed Disk	hdisk0	hdisk0,hdisk1, . . .

To CHANGE a current choice, type the name followed by your new choice (example: nob 1000) and press Enter.

To CANCEL creation of this minidisk, press F3.

To CREATE this minidisk with the current choices, press Enter.

To SHOW minidisk information, press F2.

>

After you press Enter, a message indicates that the minidisk has been created:

The minidisk has been successfully created. The minidisk name is hd7.

To CONTINUE, press Enter.

>

Example: Deleting a Minidisk

To delete a minidisk, select the **delete** option from the list of **minidisks** commands.

Note: Be certain to copy any files that you want to save before you delete the minidisk. See *Managing the AIX Operating System* for information on copying files.

To Delete a Minidisk

1. On the MINIDISK CUSTOMIZING COMMANDS screen, type **delete**, and press **Enter**.
2. After the **>** prompt, type the name of the minidisk you want to delete. Press **Enter**.
3. On the summary screen, verify that you want to delete the minidisk by pressing **Enter**. To cancel the deletion process, press **F3**.

More Detailed Information

1. On the MINIDISK CUSTOMIZING COMMANDS screen, type **delete**. Press **Enter**.

```
> delete
```

2. After the **>** prompt, type name of the minidisk you want to delete. Press **Enter**.

```
Type the name of the minidisk you want to delete and press  
Enter.
```

```
To SHOW minidisk information, press F2.
```

```
> hd8
```

-
3. On the summary screen, verify that you want to delete the minidisk by pressing **Enter**. To cancel the deletion process, press **F3**.

Minidisk name: hd8
Directory: /u/amy
Automatic Mount: yes
Read Permission: read/write

Name	Description	Current Choice	Possible Choices
nob	Number of Blocks	50000	
fd	Fixed Disk	hdisk0	hdisk0,hdisk1, . . .

WARNING: ALL FILES ON THIS MINIDISK MAY BE DESTROYED

To DELETE this minidisk, press Enter.
To CANCEL deletion of this minidisk press F3.

>

After the minidisk has been deleted, this message appears:

Minidisk hd8 has been deleted.

To CONTINUE, press Enter.

Note: You cannot delete a minidisk that is in use.

Example: Changing Minidisk Mount Attributes

To change the mount attributes for an existing AIX minidisk, select **change** from the list of **minidisks** commands.

The mount attributes (automount, permissions, and so on) usually are set so that existing minidisks are automatically mounted each time you start up the system. However, if you want to change the attributes of one or more minidisks so that they are not automatically loaded at startup time, you can do so with the **change** command. To change mount attributes, follow these steps:

To Change Mount Attributes

1. On the MINIDISK CUSTOMIZING COMMANDS screen, type **change**. Press **Enter**.
2. After the **>** prompt, type the name of the minidisk you want to change. Press **Enter**.
3. After the **>** prompt, type **yes** or **no** to indicate whether you want to change the directory on which the minidisk is mounted. Then press **Enter**.
4. Type **yes** or **no** to indicate whether you want to change the automatic mount status of the minidisk. Then press **Enter**.
5. Type **yes** or **no** to indicate whether you want to change the read/write status of the minidisk. Then press **Enter**.
6. On the summary screen, press **Enter** to change the mount attributes or press **F3** to cancel the mount process.

More Detailed Information

1. On the MINIDISK CUSTOMIZING COMMANDS screen, type change (or c or ch). Then press **Enter**. This selects the change mount attributes option.

> change

2. After the > prompt, type the name of the minidisk you want to change. Then press **Enter**.

Type the name of the minidisk you want to change and press Enter.

To SHOW minidisk information, press F2.

> hd8

3. Type yes or no to indicate whether you want to change the directory on which the minidisk is mounted. Then press **Enter**.

This minidisk is mounted on directory /u/amy.

Do you want to change the directory?

yes
no

Type yes or no and press Enter.

> no

-
4. Type **yes** or **no** to indicate whether you want to change the automatic mount status of the minidisk--that is, whether you want the minidisk automatically mounted after it is configured. Then press **Enter**.

This minidisk is automatically mounted after it is configured.

Do you want to change the automatic mount status?

yes
no

Type **yes** or **no** and press **Enter**.

> no

5. Type **yes** or **no** to indicate whether you want to change the read/write status of the minidisk. Then press **Enter**.

This minidisk is mounted with read/write permission.
Do you want to change the mount permission?

yes
no

Type **yes** or **no** and press **Enter**.

> yes

-
6. On the summary screen, press **Enter** to change the mount attributes. Or press **F3** to cancel.

Current mount characteristics for minidisk hd8.

Minidisk name: hd8
Directory: /u/amy
Automatic Mount: yes
Read Permission: read only

To CANCEL changing the mount characteristics, press F3.

To CAUSE the mount characteristics to take effect,
press Enter.

>

Accessing User-Created Minidisks After Reinstalling (Using the Replace Option)

After reinstalling the Base System Program using the replace option, you will not be able to access data on minidisks that you have created using the **minidisks** command. Also, if either the **/etc/system** file or **/etc/filesystems** file is damaged, you may not be able to access data on minidisks that you have created. To regain access to these minidisks, you **must** run the **mdrc** command immediately after reinstalling the Base System Program. You must have superuser authority or be a member of the system group to use the **mdrc** command.

The **mdrc** command creates a temporary mount directory if data is not available from **/u/filesystems**, the backup version of **/etc/filesystems**. In this case, **mdrc** creates temporary filesystems entries with an Auto Mount status of "N (No)" and a Read/Write status of "R/W." Run the **minidisks** command with the **change** option discussed in this chapter to give the minidisk the desired Mount Directory, Read/Write status, and Auto Mount characteristics. You may also have to run the **mkdir** command to create a directory if you reinstalled all of the Base System Program.

Note: The **mdrc** command will not recognize minidisks that are not configured. Be sure any external disks are powered on and configured with the **varyon** command.

If a minidisk is for use by the Coprocessor and the Coprocessor is not installed when you run the **mdrc** command, run the **mdrc** command again, after installing the Coprocessor licensed program.

See the *AIX Operating System Commands Reference* for more information on the **minidisks**, **mkdir**, **mdrc**, and **varyon** commands.

Appendix A. Enlarging the VRM and Page Space Minidisks

This appendix identifies points you should know when thinking of enlarging the VRM minidisk and the page space minidisk. While there is no specific formula for calculating the optimum minidisk size, after you understand the assumptions you may be better prepared to adjust the size of the minidisks.

This appendix also explains the steps necessary to enlarge the page space minidisk after you have been running the system for a while and have created and deleted other minidisks residing on the same fixed disk. While the example in this section relates to the page space minidisk, the steps for enlarging the VRM minidisk and other AIX minidisks are similar.

Warning: See Chapter 7, “Customizing System Minidisks” for information about files being destroyed when you delete a minidisk. Also see “Reinstalling the VRM” on page 3-27 for information about files being destroyed when you reinstall the Virtual Resource Manager. For more information on backing up files before you delete minidisks, see *Managing the AIX Operating System*.

Assumptions

The defaults for the Virtual Resource Manager are those that IBM assumes may meet system needs for most users. After using your system for a while, you may decide to change the defaults as you add application programs or work stations.

Keep the following assumptions in mind as you consider changing the size of the VRM minidisk and the page space minidisk:

1. The fact that there can be many jobs and users in a system at the same time complicates the task of trying to calculate the optimum page space size.
2. The disk is a physical device with high storage capacity. But it may seem to have a relatively long data access time. It takes longer to retrieve data from the disk and use it than it does to use data already stored in memory.
3. The performance for an application is usually better when the running of that application requires no paging in or out of the text or data for that application. This arrangement requires a memory size in direct proportion to the memory requirements for the application.
4. For the VRM minidisk, the recommended size is as much space as is needed, unless you intend to install non-IBM code onto the VRM minidisk. If you do install code, you should increase the size of the VRM minidisk by the size of the code. (See the optionally available *Virtual Resource Manager Technical Reference* for information on developing and installing code on the VRM minidisk.)

Procedures for Enlarging a Minidisk

After much activity in creating and deleting minidisks from the fixed disks, the free space on a fixed disk can become fragmented. Fragmented free space consists of several small pieces located at various points on the fixed disk, rather than being packed together in one continuous area. To enlarge the VRM or page space minidisk or to create a new minidisk on a fixed disk, it may sometimes be necessary to rearrange the existing minidisks so that they are all packed together. This arrangement leaves the free space in one contiguous area at the end of the fixed disk. Rearranging minidisks is *not* a simple process, and it can be very time-consuming if you must move large amounts of data from one fixed disk to another. So you probably will want to rearrange minidisks as seldom as possible.

The example in this appendix shows you how to enlarge the page space minidisk when you want to keep it next to the VRM minidisk and when other minidisks exist on the fixed disk. Performance may be enhanced when these two minidisks are kept together.

Although this example relates to the page space minidisk, the principles and techniques usually can be applied whenever you must do any of these steps:

- Change the size of an existing minidisk
- Rearrange the order of the minidisks on a fixed disk
- Combine all free space into one continuous area.

Insert the VRM diskette in drive 0, and press **Ctrl-Alt-Pause**. When the **INSTALL AND CUSTOMIZE THE VIRTUAL RESOURCE MANAGER** menu appears, select item 4 to change only the page space minidisk. The figure on the next page shows what a fixed disk might look like as you prepare to increase the size of the page space minidisk.

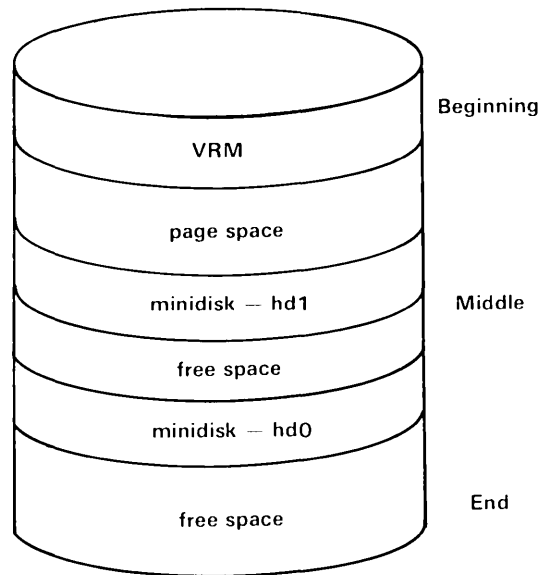

If there is not enough contiguous free space on the disk to create a minidisk of the requested size, a message will tell you so. Enough free space for the minidisk may exist.

Performance may be enhanced by placing the VRM and the page space minidisks next to each other and at the beginning of the fixed disk when they are located on the same disk. This is the default positioning when fixed-disk space permits.

Assume that you wish to increase page space size and also wish to keep the VRM and page space minidisks located at the beginning of the fixed disk. Follow these steps:

1. After returning to the **INSTALL AND CUSTOMIZE THE VIRTUAL RESOURCE MANAGER** menu, remove the VRM diskette from the diskette drive.
2. Insert the Base System Program Installation/Maintenance diskette into the diskette drive, close the drive door, and press **Ctrl-Alt-Pause**.

-
3. When the SYSTEM MANAGEMENT menu appears, choose Use Maintenance Commands. (See *Managing the AIX Operating System* for information on the system maintenance commands.)
 4. From the USE MAINTENANCE COMMANDS menu, choose:
 - a. The option to show minidisk information.

In the example in this section, the minidisks are named hd0 and hd1. But as you use some of the maintenance commands, minidisks are identified by five-digit numbers in the column "Minidisk IODN" (input-output device number). Unused space is listed as "free space."

You may find information about the type of minidisk and the number of blocks to be important. You can identify the VRM and the page space minidisks by their type.

- b. The **backup** command option and then the option that lets you do a logical backup of the file systems from minidisks hd0 and hd1 to diskette or tape.

From the list of minidisks that can be backed up, only AIX minidisks can be backed up with this option. If you have a non-AIX minidisk (for example, a Coprocessor minidisk), see related documentation to determine how to back up information from that minidisk.

Note: You can back up and restore AIX Operating System minidisks in other ways. See the last paragraph in this appendix for more information.

Also, there is an option for an image backup of a minidisk that can be used only if you are backing up on tape. One advantage of the image backup is that it can be used for non-AIX minidisks.

- c. The option that lets you delete minidisks hd0 and hd1 from the fixed disk. Remember to note the type of minidisk and the number of blocks for use when you recreate these minidisks.

-
5. Remove the Installation/Maintenance diskette from the diskette drive. Insert the VRM diskette, close the drive door, and press **Ctrl-Alt-Pause**.
 6. From the **INSTALL AND CUSTOMIZE THE VIRTUAL RESOURCE MANAGER** menu, choose item 4 to change the size of the page space minidisk.
 7. After creating the new page space, remove the VRM diskette from the diskette drive. Insert the Installation/Maintenance diskette, close the drive door, and press **Ctrl-Alt-Pause**.
 8. When the **SYSTEM MANAGEMENT** menu appears, choose **Use Maintenance Commands**.
 9. From the **USE MAINTENANCE COMMANDS** menu, choose:
 - a. The option that lets you create a minidisk for the file systems that were on **hd0** and **hd1**. Use the information you saved concerning the type of minidisk and number of blocks.

When you create the minidisk, use the option that lets you choose the minidisk **IODN**. It is important when you create a new AIX minidisk that it have the same **IODN** that it had previously. Certain files in the AIX Operating System relate the minidisk **IODN** to the device name, and if the **IODN** is incorrect, unpredictable results may occur.

Usually, when you create a minidisk to contain a file system that you have backed up, you use the same number of blocks as were on the minidisk you deleted. But you may want to increase the number of blocks if you know that there is little free space left and that you may add new files to this file system in the future. Or you may want to decrease the number of blocks if you have ample free space available on the minidisk, if you do not plan to add many files to this file system in the future, and if you know that you are running out of free space on your fixed disk.

- b. The option to make a file system on the new minidisks **hd0** and **hd1**.

-
- c. The restore commands option and then the option to restore a file system. You want to restore to minidisks hd0 and hd1 the information backed up on diskette or tape.

You can use this restore procedure only for AIX minidisks. For non-AIX minidisks, see related documentation to determine how to restore information to the new minidisk. Also, you may need to use the **mdrc** command to reaccess user-created minidisks. For more information, see “Accessing User-Created Minidisks After Reinstalling (Using the Replace Option)” on page 7-41.

10. Remove the Installation/Maintenance diskette from the diskette drive. Press **Ctrl-Alt-Pause** to load the system from the fixed disk.

The backup and restore functions, as well as the creation and deletion of minidisks, can also be done in other ways:

- Through the AIX shell and the **backup** and **restore** commands (see *AIX Operating System Commands Reference*)
- Through the **minidisks** command (only for user-created minidisks). See Chapter 7, “Customizing System Minidisks” for information on using the **minidisks** command.
- Through the options on the Installation/Maintenance diskette (for system-generated minidisks).
- Through the commands provided with the VRM Maintenance Facility (VMF).

Appendix B. Keyword Descriptions

Some of the keywords described in this appendix appear on your display screen as you use the **devices** command. Reading the description may help you understand the meaning of the keyword and the parameter to which it refers.

Printer and Plotter Values/Parameters

Keywords followed by an asterisk (*) can be changed only when adding or changing information about a non-IBM printer.

Key Word	Description	Possible Choices
ars*	Aspect Ratio Support: Does the printer have a "Set Aspect Ratio" control?	yes, no
backs*	Backspace Support: Does the printer have the ability to backspace (move print head backward while printing a line)?	yes, no
big	Bit-Image Graphics Support: Does the printer have bit image graphics controls?	yes, no
bm	Bottom Margin (last line): Refers to last line of text at bottom of a page; for instance, to leave a one-inch bottom margin on a page 66 lines long, you might set the margin on line 60. The value is determined by multiplying the length of the page in inches by the number of lines per inch.	1 - [length(in.) x lines/in.]
cdp	Condensed Print: Should a file be printed with condensed print?	yes, no
cps*	Condensed Print Support: Does the printer support printing in condensed characters?	yes, no
colp*	Color Printer: Is the printer capable of printing in color?	yes, no

Key Word	Description	Possible Choices
cr	Color Ribbon: Is the printer capable of using a color ribbon?	yes, no
cs	Character Set: Refers to the specific character set to be used for printing.	1, 2
cus*	Continuous Underscore Support: Is the printer capable of underscoring characters?	yes, no
dpc	Default Print Color: Refers to the color to use for printing when a file doesn't contain codes that specify a color: usually black, blue, red, or yellow.	black, blue, red, yellow
dsp	Double Strike Print: Should double-strike be turned on?	yes, no
dsps*	Double Strike Print Support: Does the printer have a control to double-strike characters and provide boldface?	yes, no
dwp	Double Width Print: Should a file be printed with a double-width character set?	yes, no
dwps*	Double Width Print Support: Does the printer have the ability to print with a double-width character set?	yes, no
ep	Emphasized Print: Should emphasized print be turned on? Every character is overstruck with a second pass of the print head.	yes, no
eps*	Emphasized Print Support: Does the printer have a control to do emphasized print?	yes, no

Key Word	Description	Possible Choices
fl	Form (page) Length: Refers to the length of the paper in terms of the number of lines per page. The value is determined by multiplying the length of paper (in inches) by the number of lines printed per inch.	1 - [length (in.) x lines/in.]
fw	Form Width (right margin): Refers to the width of paper in terms of the number of characters per line. The value is determined by multiplying the width of the paper (in inches) by the number of characters printed per inch).	1 - [width(in.) x pitch]
hsi*	Horizontal Spacing Increment: What horizontal increment is used in the ESC K control?	60, 70
hts*	Horizontal Tab Support: Does the printer have horizontal tab controls?	yes, no
js*	Justification Support: Refers to printing with the right margin even.	yes, no
kpoe	Keep Printing on Error: Should the printer complete the print job despite errors (without sending an error message to the user)?	yes, no
lm	Left Margin: Refers to the area on a page between the left edge and the leftmost character position on the page.	0 - [width(in.) x pitch]
lpi	Lines Per Inch: Refers to the number of print lines per inch, to line spacing density, and to the distance paper moves during a line feed.	6, 8

Key Word	Description	Possible Choices
lrmc*	Left/Right Margin Controls: Does the printer have the ability to change left and right margins (does it have left and right margin control codes)?	yes, no
mccs*	Multibyte Control Code Support: Does the printer support IBM/OEM multibyte controls? Or does the printer act like an Epson (5152)?	yes, no
pacs*	Print All Characters Support: Does the printer support ESC and ESC- controls?	yes, no
ph	Paper Handling: Refers to the ways the printer handles different types of paper. The manual-feed printer stops at the end of each page and waits for the user to insert another sheet and press the start button. A printer with an automatic sheet-feed mechanism feeds paper to the printer.	0 = manual; 1 = automatic; 2 = continuous (continuous form paper)
pitch	Character Pitch: Refers to the number of characters per linear inch; for instance, 10-pitch type has 10 characters per inch.	10, 12, 15
pq	Print Quality: May select (on some printers) degrees of print quality: dp (for fast, low quality), text (for better draft quality), letter (for high-quality final text).	dp, text, letter
prin*	Printer Type: 0 = unspecified (functionally 5152); 1 = 5152; 2 = 5182; 3 = 3812; 4 = 5201; 5 = 4201; 6 = 4202; 7 = 3852; 8 = 5202	0, 1, 2, 3, 4, 5, 6, 7, 8

Key Word	Description	Possible Choices
psd	Paper Source Drawer: Refers to the location of the paper drawer from which paper is drawn for printing.	1 = top; 2 = bottom
pss*	Proportional Spacing Support: Does the printer support proportionally spaced printing?	yes, no
rlfs*	Reverse Line Feed Support: Does the printer support the ESC J control?	yes, no
rtrig	Receive Buffer Trigger: If the buffer has receive data buffering capability, this field selects the number of bytes that will trigger a received data interrupt.	1, 4, 8, 14
slap	Skip Lines at Perforation: Refers to the number of lines skipped at page breaks. The number is divided by 2, so that half the blank lines appear at the bottom of one page and half at the top of the next.	0-[length(in.) x lines/in.]
sss*	Superscript/Subscript Support: Does the printer have the ability to print in superscript and subscript mode?	yes, no
tbc	Transmit Buffer Control: Number of bytes to buffer for transmitter.	0x00 - 0x10
tm	Top Margin: Refers to the number of lines to be skipped at the top of a page before printing begins. If the user specifies 6 lines, the first print line will be line 7. The value is determined by the length of paper (in inches) multiplied by the number of lines per inch.	0 - [length(in.) x lines/in.]

Key Word	Description	Possible Choices
urpim	User to Receive Printer Intervention Messages: Refers to whether printer intervention messages are sent to any valid user or to the user who queued the print job.	Any user ID, pjo = Print Job Owner
vhs*	Variable Horizontal Spacing: Does the printer have ESC d and ESC e controls?	yes, no
vpqs*	Variable Print Quality Support: Does the printer have the ability to print different degrees of quality?	yes, no
vsi*	Vertical Spacing Increment: Refers to parts of inch supported in ESC J and ESC 3 control.	216, 144
vts*	Vertical Tab Support: Does printer support vertical tabs?	yes, no
wll	Wrap Long Lines: Does the printer "wrap" lines? That is, will it break at the right margin those lines longer than specified form width and print the remainder on the next line?	yes, no
12ps*	12 Pitch Support: Does printer support the printing of 12 characters per inch?	yes, no

Fonts

You can select any of the fonts or print typestyles included on the font diskette. You must type the name of the font and the typestyle exactly as they appear on the diskette.

IBM 5201 Quietwriter

Key Word	Description	Possible Choices
fnt1	Font 1	
type1	Typestyle 1.	
pitch1	Character Pitch 1	
cp1	Code Page 1	PC, A, B, C, D

IBM Proprinter (4201)

Four different sets of values are available for the IBM 4201 Proprinter (character pitch 1-4 and code page 1-4). Each set contains a designation for character pitch and code page. The possible choices for each of the four sets are shown below.

The code page choices for the IBM 4201 are the **PC** or multilingual code page (**MLP**). The **PC** code page contains the standard U.S. English alphabet, symbols, and punctuation marks. The **MLP** code page contains characters, symbols, and punctuation marks from many alphabets and languages.

Key Word	Description	Possible Choices
pitch	Character Pitch	10, 12
cp1	Code Page 1	PC, MLP

IBM Pageprinter (3812)

Eight different sets of values are available for the IBM 3812 Pageprinter (font 1-8, type 1-8, character pitch 1-8, code page 1-8). Each set contains a designation for font, typestyle, character pitch, and code page. The possible choices for each of the eight sets are similar.

For the number in each of the key words and descriptions below, substitute a different number to indicate another of the eight choices. You might, for instance, see `fnt2`, `type2.`, `pitch2.`, and `cp2.` for the second set of values.

Key Word	Description	Possible Choices
<code>fnt1</code>	Font 1	
<code>type1</code>	Typestyle 1.	
<code>pitch1</code>	Character Pitch 1	10, 12, 15
<code>cp1</code>	Code Page 1	P0, P1, P2, ASCII

Minidisks

Key Word	Description	Possible Choices
bs	Block Size: Refers to the size of sectors of storage on the fixed disk; changes in number of blocks on minidisks may affect system performance.	512, 1024, 2048
fd	Fixed Disk: Refers to the circular plates used for storing data.	hdisk0, hdisk1, ...
nob	Number of Blocks: Refers to the number of blocks in a minidisk.	

Adapters

Key Word	Description	Possible Choices
cn	DMA Channel Number: Refers to DMA channel number.	0 - 9
il1	Interrupt Level Number of First Interrupt: Refers to hardware adapter interrupt levels 1 through 4.	10
pn	Port Number on Adapter: Refers to hardware adapter port.	1 - 4
sn	Adapter Slot Number: Refers to the slot in which an adapter is installed.	1 - 8

Tty or Pty Devices

Key Word	Description	Possible Choices
ae	Automatic Enable: Do you want the port to be enabled automatically?	true, false
bpc	Bits Per Character: Refers to the character length in bits.	5, 6, 7, 8
dvam	Device Attachment Method: Refers to whether the device is attached locally with a cable or connected through a modem.	0 = local, 1 = remote (modem)
ixp	Include Xon/Xoff Protocol: Refers to whether communication protocol is included.	true, false
logger	Does the pty device support a login shell ?	true, false
nosb	Number of Stop Bits: Refers to the number of stop bits in a communication character.	1, 1.5, 2
om	Operation Mode: Refers to whether communications operation mode is set.	tx, rx, full duplex, half duplex
pro	Protocol: Refers to communication protocol.	dtr, cdstl, dc
pt	Parity Type: Refers to communication character parity.	even, odd, mark, space, none
roffv	Receive Xoff Value: Refers to character to transmit in order to inform remote device to cease sending data.	0-ff

Key Word	Description	Possible Choices
ronv	Receive Xon Value: Refers to character to transmit in order to inform remote device to resume sending data.	0-ff
rtrig	Receive Buffer Trigger: If the buffer has receive data buffering capability, this field selects the number of bytes that will trigger a received data interrupt.	1, 4, 8, 14
rts	Receive/Transmit Speed: Refers to the communication baud rate.	50, 75, 110, 134.5, 150, 300, 600, 1200, 1800, 2000, 2400, 3600, 4800, 7200, 9600, 19200
sns	Switched/Nonswitched: Refers to the state of the communication line connection.	true = switched; false = nonswitched
tbc	Transmit Buffer Control: Number of bytes to buffer for transmitter.	0x00 - 0x10
toffv	Transmit Xoff Value: Refers to the communication character to transmit in order to inform remote device to cease sending data.	0-ff
tonv	Transmit Xon Value: Refers to the communication character to transmit in order to inform remote device to resume sending data.	0-ff

SCSI Devices

Key Word	Description	Possible Choices
pdt	Peripheral Device Type	printer, tape, disk, CD-ROM, WO
nobub	Number of 256-Byte Units/Block: Number of 256-byte units on each block.	
lun	Logical Unit Number: The number associated with an addressable physical or logical device.	0 - 7
sid	SCSI ID	0 - 6
nospt	Number of sectors per track	
noabb	Number of Allowed Bad Blocks:	
ds	Disk Size	200, 400

Appendix C. Special Processing for Devices and Minidisks

While adding or deleting certain devices or adding minidisks, you may receive a message that *special processing* has failed. Special processing automatically makes appropriate changes in the files when a printer, a tty, a pty device, a streaming tape drive, or a floating-point adapter card, or other device is either added to or deleted from the system configuration through the **devices** command or when a minidisk is added.

When a system user has inadvertently edited certain files, a message on the display screen may indicate that processing has failed. Then you must edit the files to make the necessary changes. The **devices** command has already added the device to the system, but that device is not usable until you make changes in the files. For directions on editing files, see *Managing the AIX Operating System* and *IBM RT PC INed*.

Devices

Should you receive a message that special processing for devices has failed, read the following sections to determine what action to take.

Printer or Plotter

When a printer or plotter is added, a new print queue (with the same name as the printer or plotter) is created. For example, the first printer added to the system is assigned the name “lp0,” and the queue associated with that printer is also assigned the name “lp0.” You can print jobs on the printer by using the command **print lp0 filename**. This printer/queue association is established by updating the **/etc/qconfig** file. In addition, the special processing routine issues the **print -rr** command to activate the new print queue. (When the printer is deleted through the **devices** command, the queue is also deleted.) For more information on the format of the **/etc/qconfig** file, see *AIX Operating System Technical Reference*.

When special processing fails, take these actions to add or delete a printer.

Adding a Printer or Plotter

Edit the `/etc/qconfig` file to add a new queue for the printer. You must add two stanzas to the file, one for the queue and one for the printer. For example, add the following stanzas to the `/etc/qconfig` file to add a printer:

```
lp0:
    argname = lp0
    device = dlp0

dlp0:
    file = /dev/lp0
    backend = /usr/lpd/piobe -pname=name -device=dname
        -profile=/etc/ddi/dfilename -statusfile
```

where,

- *name* is the name of lp#.
- *dname* is the ddi stanza name. You can find this name by looking at the lp0 stanza in the `/etc/system` file and getting the value of the keyword “use.”
- *dfilename* is the ddi file name. You can find this name by looking at the lp0 stanza in the `/etc/system` file and getting the value of the “ddi-file” keyword.

Add the following stanzas to the `/etc/qconfig` file to add a plotter:

```
lp1:
    argname = lp1
    device = dlp1

dlp1:
    file = /dev/lp1
    backend = /usr/lpd/piobe -statusfile -pname=name -plot
```

Deleting a Printer or Plotter

Edit the **/etc/qconfig** file to delete the queue associated with the plotter or printer that you deleted. You must delete two stanzas from **/etc/qconfig**, the queue stanza and the device stanza. For example, delete stanzas **lp0** and **dlp0** from the **/etc/qconfig** file.

pty

When a new pty device is added, a new entry is made in the **/etc/systems** file for the controller side (**ptc**) of the pty device and the server side (**pts**) of the device. Special processing involves only the controller side (**ptc**). When a pty device is deleted with the **devices** command, the special processing routine removes the **ptc** entry from **/etc/system**.

When a new pty device is added to the system and the **logger** keyword is set to **true**, a new entry is made in the **/etc/ports** file for the pty device. Information about the terminal type, parity type, bits per character, number of stop bits, herald, location, and choice of whether the pty is to be automatically enabled during system start is copied from the device information file to the new entry in **/etc/ports**. The new entry sets the pty's characteristics when the pty device is enabled. When the pty is deleted through the **devices** command, the entry in **/etc/ports** is also deleted. For information about the format of the **/etc/ports** file, see *AIX Operating System Technical Reference*.

To perform special processing when adding or deleting a pty device, take the following actions.

Adding a pty Device

Edit the `/etc/system` file to add a new entry for the controller side of the pty device. You may also have to add an entry in `/etc/ports` for the device. You must add one stanza to the `/etc/systemfile`. For example, if `pts0` is added to the system but special processing fails, add the following stanza to the `/etc/system` file:

```
pts0:
    driver = uptyc
    minor = c0
    modes = rw-rw-rw-
```

Note that the minor keyword value is “c” appended with the pty number.

Each pty device has a stanza associated with that device in the `/etc/ddi/pty` file. Each stanza contains a `logger` keyword. If the `logger` keyword is not present in the pty device’s stanza, the pty device uses the `logger` keyword from the default stanza. If `logger = true` for the pty device, you must edit the `/etc/ports` file, adding a new stanza for the pty device. For example, if `pts0` is added to the system but special processing fails and `logger = true`, add the following stanza to `/etc/ports`:

```
/dev/pts0 :
    loc = "pts0"
    term = tt
    parity = pt
    enabled = true/false
    logmodes = (see below)
    herald = "IBM RT PC Advanced Interactive Executive
              Operating System\r\
              nxxXxxx(c) Copyright IBM Corp. 1985,1986,
              1987\r\n
              (/dev/pts0)\r\nlogin:"
```

where:

-
- *term* is the terminal type that was specified when the pty was added with **devices**. It is the value entered for the keyword "tt."
 - *parity* is the parity specified when you added the pty device with the **devices** command. Its corresponding value in the ddi file is "pt," shown on the left below. The value on the right is in the **/etc/ports** file. The values map as follows:

```
pt even --> parity even
pt odd  --> parity odd
pt none --> parity none
pt space --> parity space
pt mark --> parity mark
```

- *enabled* refers to whether you want the terminal functional when you start the system. Choose either true or false. If you choose false, you must use the **penable** command to enable the terminal.
- *logmodes* consists of three parts: `echoe+CSNSTOP`. These parts are defined as follows:

- `echoe` is part of all logmodes for a pty device.
- `CSN` is determined by the `bpc` value in the device's ddi stanza:

```
bpc = 5 --> cs5
bpc = 6 --> cs6
bpc = 7 --> cs7
bpc = 8 --> cs8
```

- `STOP` is determined by the `nosb` value in the device's ddi stanza:

```
nosb = 1 --> -cstopb
nosb = 1.5 --> -cstopb
nosb = 2 --> +cstopb
```

For example, a pty device with `bpc = 8` and `nosb = 2` has
`logmodes = echoe+cs8+cstopb`

Deleting a pty Device

Edit the `/etc/system` file to delete the ptc stanza associated with the pty device. You must delete one stanza from `/etc/system`. If there is a corresponding entry in `/etc/ports` for the entry you deleted from `/etc/system`, edit `/etc/ports` to delete the corresponding entry. For example, if pts3 is deleted from the system but special processing fails, delete stanza ptc3 from the `/etc/system` file and delete stanza pts3 from `/etc/ports`.

Adding or Deleting a tty Device

When a new tty is added, a new entry is made in the `/etc/ports` file for the tty. Information about the terminal type, receive/transmit speed, parity type, bits per character, number of stop bits, and choice of whether the tty is to be automatically enabled during system start is copied from the device information file to the new entry in `/etc/ports`. The new entry sets the tty's characteristics when the tty is enabled. When the tty is deleted through the `devices` command, the entry in `/etc/ports` is also deleted. For information about the format of the `/etc/ports` file, see *AIX Operating System Technical Reference*.

Take these actions to do special processing when adding or deleting a tty.

Adding a Terminal

Edit the `/etc/ports` file to add a new entry for the tty. You must add one stanza to the file. For example, if tty0 is added to the system but special processing fails, add the following stanza to the `/etc/ports` file:

```
/dev/tty0:  
  term = tt  
  enabled = true/false  
  speed = rts  
  logmodes = (see below)  
  parity = pt
```

where,

- *term* is the terminal type that was specified when the tty was added with the program devices. It is the value entered for the keyword "tt."
- *enabled* refers to whether you want the terminal functional when you start the system. Choose either true or false. If you choose false, you must use the **penable** command to enable the terminal.
- *speed* is the receive/transmit speed specified when you added the terminal with the **devices** command. It is the value for the keyword "rts."
- *logmodes* can contain multiple values, but at least two of those values are always the bits per character and number of stop bits. Special processing maps these two values from the ddi file, where the corresponding keywords are "bpc" and "nosb." The logmode value is divided into two parts: logmodes = bpc and nosb, with no space between them. It maps as follows:

```
logmode = ixon+echoe+cs8 + cstopb+hupcl
```

```
nosb 1    --> -cstopb
nosb 1.5  --> -cstopb
nosb 2    --> +cstopb
```

```
bpc 5 --> cs5
bpc 6 --> cs6
bpc 7 --> cs7
bpc 8 --> cs8
```

- *parity* is the parity specified when you added the terminal with the **devices** command. Its corresponding value in the ddi file is "pt," shown on the left below. The value on the right is in the **/etc/ports** file. The values map as follows:

```
pt even --> parity even
pt odd  --> parity odd
pt none --> parity none
pt space --> parity none
pt mark --> parity none
```

Deleting a Terminal

Edit the **/etc/ports** file to delete the entry associated with the tty that you deleted. You must delete one stanza from **/etc/ports**. For example, if **tty0** is deleted from the system but special processing fails, delete stanza **tty0** from the **/etc/ports** file.

Tape

When a streaming tape drive is added to the system through the **devices** command, the default dump device becomes the tape instead of diskette. This is accomplished by changing the **backupdev** and **backuplen** keywords in the **/etc/filesystems** file to be the values for tape. The **backupdev** keyword value is set to **/dev/rmt0**, and the **backuplen** keyword value is set to **2700**. When the streaming tape drive is deleted from the system configuration, the values are changed back to the diskette values, **backupdev** is set to **/dev/fd0** and **backuplen** is set to **2400**.

When special processing fails, take these actions when adding or deleting a tape.

Adding a Tape

Edit the **/etc/filesystems** file to change two keywords in the default stanza:

```
default:
    backupdev = /dev/rmt0
    backuplen = 2700
```

Ignore other keywords in the default stanzas.

Deleting a Tape

Edit the `/etc/filesystems` file to change two keywords in the default stanza:

```
default:
    backupdev = /dev/fd0
    backuplen = 2400
```

Ignore other keywords in the default stanzas.

Floating Point Accelerator

When a floating point accelerator is added to the system through the `devices` command, the `float` keyword in the `sysparms` section of the `/etc/master` file is changed from the value `software` to the value `hardware`.

When special processing fails, take these actions when adding or deleting a floating point accelerator.

Adding a Floating Point Accelerator

Edit the `sysparms` stanza in the `/etc/master` file to change the `float` keyword:

```
sysparms:
    floating = hardware
```

Ignore other keywords in the default stanzas.

Deleting a Floating Point Accelerator

Edit the `sysparms` stanza in the `/etc/master` file to change the keyword "floating."

```
sysparms:  
    floating = software
```

Ignore other keywords in the default stanzas.

IBM 9332 DASD Attachment

When you delete an IBM 9332 DASD Attachment from the system, the VRM is informed that the disk is no longer available and the `mdrc` command is run to remove the information in the configuration files for the minidisks on this disk. This special processing might fail if one of the minidisks on the disk is still mounted. If this processing fails, the disk may not be deleted or the configuration files may not be in sync.

Deleting the IBM 9332 DASD Attachment

After the system startup, the disk will be completely deleted. Then, you should run the following command:

```
mdrc -h hdisk#
```

`hdisk#` is the system name of the disk you deleted. By running this command, you will remove the information in the configuration files for the minidisks on the disk.

Minidisks

While adding an AIX minidisk, you may receive a message that the *special processing* has failed. Special processing automatically creates a lost+found directory for the added minidisk. This process may fail if the **minidisks** command was not able to mount the minidisk or create the lost+found directory. In such cases, the minidisk is added, but the lost+found directory must be created manually.

Follow these steps to create the lost+found directory:

1. Create the minidisk mount directory: `mkdir <dir name>`
2. Mount the minidisk: `mount <dir name>`
3. Change to the mounted directory: `cd <dir name>`
4. Make the lost+found directory: `mkdir lost+found`
5. Create the lost+found entries by running the shell procedure below from the mount directory. Type this shell procedure in a file and run it:

```
cd lost+found

for i in a b c d e f g h i j k l m n o
do
  for j in 0 1 2 3 4 5 6 7 8 9
  do
    >${i}$j
  done
done
for i in a b c d e f g h i j k l m n o
do
  for j in 0 1 2 3 4 5 6 7 8 9
  do
    rm ${i}$j
  done
done
```

The cross product of **i** and **j** is the number of entries you want in your `lost+found` directory. The algorithm used by the **minidisks** command to produce this number is described in Chapter 7, “Customizing System Minidisks.”

Appendix D. Installing the VRM with Non-IBM RT PC Hardware

If you intend to install the Virtual Resource Manager Program with a display other than that usually shipped with the IBM RT PC, you must have either of the following:

- A display that is hardware-compatible with the IBM RT PC so that it can communicate with existing VRM device drivers
- For components that are not hardware-compatible, a program diskette containing the device driver and other modules necessary to make the display compatible with the VRM.

If your components are compatible with the IBM RT PC, then you can install the VRM as explained in the first three chapters of this book. But if your components are not compatible with the IBM RT PC, then you should be able to install the VRM using the two-digit display on your IBM RT PC system unit.

Note: It is possible that you may have purchased an IBM RT PC display but also have purchased an additional display from another manufacturer. If so, you should have received a program diskette with the component and instructions from the manufacturer on updating the VRM minidisk with the device information from the program diskette. If you have an IBM RT PC display, you can install the VRM as described in the first three chapters of this book. After installing the VRM, you can then install your program diskette by choosing item 6 (*Install Updates to the Virtual Resource Manager*) from the INSTALL AND CUSTOMIZE THE VIRTUAL RESOURCE MANAGER menu described in Chapter 3, "Installing the VRM Program."

To Install the VRM Using the Two-Digit Display

1. Turn the key in the keylock to the unlocked position.
2. Turn on the power switches to your system components.
3. Open the door to diskette drive 0 (turn the lever counterclockwise). Insert the VRM diskette. Close the drive door (turn the lever clockwise).
4. Press **Ctrl-Alt-Pause**.
5. When the number 45 flashes on the two-digit display on the system unit, remove the VRM diskette and insert the program diskette for the display and close the drive door. The number on the two-digit display will disappear while the diskette is being read.
6. Follow the prompts on the display screen to remove the program diskette and insert the VRM diskette. Also, read the additional information in the notes below. Then turn to Chapter 2, "Getting Ready to Install the AIX Operating System" to read about the various options available to you.

Notes:

1. Once the IBM RT PC recognizes that a display is present, the flashing 45 will no longer show on the two-digit display.
2. If the flashing 45 reappears after the system has processed the program diskette for your display, contact the supplier from which you received your diskette and explain the problem. If a number other than the 45 flashes on the two-digit display, see the *Problem Determination Guide* for information on how to proceed.
3. After you have installed the VRM, you will be asked whether you wish to update the VRM minidisk with information about the display from the program diskette. Follow the prompts to do so at this point.

Appendix E. Conflicting Adapter Levels

The adapters you choose for your system can conflict in two ways: interrupt level or direct memory addressing (DMA) channel.

Conflicting Interrupt Levels

All interrupt levels on the RT PC can be shared. Some adapters are designed to either allow or not allow interrupt sharing. Two or more adapters that support interrupt sharing can share the same interrupt level. Only one non-sharing adapter can be assigned to a given interrupt level.

Refer to the Interrupt and DMA Usage Chart, Figure E-1 on page E-3, to assure that your adapters do not have conflicting interrupt levels.

Conflicting DMA Channels

Each DMA channel can be used by one adapter at a time. DMA channel conflicts usually can be resolved by changing DMA channel on the applicable adapter. "Examples" on page E-5 shows you how to resolve DMA channel conflicts using both hardware and software methods.

Refer to the Interrupt and DMA Usage Chart, Figure E-1 on page E-3, to assure that your adapters do not have conflicting DMA channels.

Determining Adapter Conflicts

Figure E-1 on page E-3 shows the interrupt levels and DMA channels used by various adapters.

Make a list of all the adapters you intend to use in one machine. To the right of the adapter list create two columns, one for interrupt levels and one for DMA channels.

If any DMA channel appears twice, a conflict exists and must be resolved using the methods shown in "Examples" on page E-5.

If an interrupt level appears twice or more, determine whether the conflicting adapters have changeable or shareable interrupt levels. Then refer to the installation instructions for the conflicting adapters.

Interrupt and DMA Usage																							
Device/Adapter	Interrupt Level															DMA Channel							
	3	4	5	6	7	9	10	11	12	14	15	0	1	2	3	5	6	7	8				
Extended ESDI Fixed-Disk and Diskette Drive ^{1 2 3}				DX					(O)	(O)		FO	FO	DX	FO								
ESDI Fixed-Disk and Diskette Drive				DX						FX				DX									
Personal Computer AT Fixed Disk and Diskette Drive				DX						FX				DX									
SCSI ²									(DO)	(O)		O	O		O	O	O	O					
Streaming Tape										(X)													
5081 Display Adapter ^{5 11}										(X)					O	O	DO						
5081 Printer Port					X																		
Advanced Mono. Graphics										(X)													
Extended Mono. Graphics										(X)													
Advanced Color Graphics										(X)													
Enhanced Graphics ⁴						X																	
Mono./Printer					X																		
Multiprotocol									(DO)	(O)		DO			O								
Token-Ring ^{8 10 12}										(DO)	(O)			O	DO	O	O						
3278/79 Emulation ⁴						X																	
PC Network ⁶	O													X									
Baseband Network ^{8 9}	O	O	O		O																		
Personal Computer AT Serial/Parallel Adapter	SO	SO	PO		PO																		
4-Port Asynchronous						(O)	(DO)	(O)															
5080 Peripheral Attachment						(O)	(DO)	(O)															
5080 Attachment ⁵								(X)							O	DO	O						
S/370 Host Interface ⁵								(X)							DO	O	O						
Personal Computer AT Coprocessor Option											(X)								X				
6150 Serial Port 2 ⁷												O		O									
6150 Serial Port 1													O		DO								

X - Required
 O - Optional
 DO - Optional Default
 (Shipped W/This Setting)

() - Shareable
 PO - Optional for Parallel
 SO - Optional for Serial

DX - Required for Diskette
 FX - Required for Fixed-Disk
 FO - Optional for Fixed-Disk

Figure E-1. Interrupt and DMA Usage Chart

Notes:

1. Level 6 is used in nonshared mode for compatibility, or levels 12 and 14 can share for a new mode.
2. Optional interrupt levels and DMA channels can be set through software.
3. DMA channel 3 is only available when a second Extended ESDI Adapter is used.
4. The enhanced graphics adapter (EGA) and 3278/79 Emulation Adapter can be used together; at this printing, there is no known program that uses interrupt level 9 on the EGA.
5. IBM application software supports only the default DMA channels for these adapters.
6. When this adapter is used with the Personal Computer AT Coprocessor Option or with a version of the `&aix.` that is earlier than Version 2.1, this adapter requires DMA channel 3. Otherwise, this adapter does not use DMA channel 3.
7. The AIX Operating System restricts Serial Port 2 to use of DMA channel 0; DMA channel 2 is used by diskette adapter. DMA channel 2 may be available when other operating systems are used.
8. Only two adapters per configuration are supported.
9. This card will not work in slot 8 of the 6150 or slot 5 of the 6151.
10. This card will not work in slot 8 of the 6150 or slot 5 of the 6151 when DMA channel 7 is used.
11. This card must be plugged into slots 4 and 5 of the 6150 and slots 2 and 3 of the 6151.
12. When multiple adapters are used, each adapter must be set to a different DMA channel.

Examples

The following three examples show three ways that DMA channels can be changed. The first example changes the Extended ESDI Adapter DMA channels by using the **setdma** command. The second example changes DMA channels for all other adapters and uses the **devices** command as well as setting hardware jumpers. The third example involves changing all types of adapter channels.

Example 1

Configuration — 1 Extended ESDI Adapter, 2 Multiprotocol Adapters

In this configuration, you are installing one extended ESDI Adapter and two Multiprotocol Adapters.

Use the following procedure to change Extended ESDI Adapter DMA channels:

1. Power on.
2. Log on.
3. Look at Figure E-1 on page E-3. This chart tells you:
 - a. The Extended ESDI Adapter can use channels 0 or 1 optionally for the fixed disk (F0). Channel 2 is required for the diskette drive (DX).
 - b. The Multiprotocol Adapter uses channels 1 and 5 optionally (O), with channel 1 being the default (DO).
4. Since you require two Multiprotocol Adapters, both channels 1 and 5 must be used, leaving a conflict with the Extended ESDI Adapter on DMA channel number 1.
5. To choose DMA channel 0 (instead of 1) for the Extended ESDI Adapter, you are changing the DMA channel used by the adapter. To do this type of change, use the **setdma** command:

| setdma eesdi 0

| The changes will be effective when you re-IPL your system.

| Since Serial Port 2 uses DMA channel 0, you will not be able to
| use Serial Port 2.

Example 2

Configuration — One Serial Port 1, Personal Computer AT Coprocessor Services with the PC Network Adapter, Multiprotocol Adapter

In this configuration, you have one printer attached to Serial Port 1. You will add devices attached to a PC Network Adapter and a Multiprotocol Adapter.

Use the following procedure to add these devices:

1. Power on.
2. Log on.
3. Look at Figure E-1 on page E-3. This chart tells you:
 - a. Serial Port 1 can optionally use channels 1 or 3 (O), where 3 is the default channel (DO).
 - b. The PC Network Adapter is required to use DMA channel 3 (X)
 - c. The Multiprotocol Adapter can optionally use channels 1 or 5 (O), where channel 1 is the default channel (DO).
 - d. The Personal Computer AT Coprocessor Services is required to use DMA channel 8 (X).
4. No change is required to use Personal Computer AT Coprocessor Services.
5. Serial Port 1 is already using DMA channel 3.
6. To change the DMA channel for Serial Port 1, use the **devices** command. See *IBM RT PC Installing and Customizing the AIX Operating System* to aid you in changing the channel assignment from channel 3 to channel 1 using the **cn** keyword.

7. To add a Multiprotocol device to your system, you must add a Multiprotocol adapter which uses channels 1 and 5 optionally (O), with channel 1 being the default channel (DO).
8. To change a Multiprotocol Adapter channel setting, you must change the hardware setting as well as the software setting. Change the software setting as you did in the previous step by changing the channel settings from channel 1 (which is the default setting) to channel 5. Changing the hardware setting requires you to change the jumper setting. To do this, see *User Setup Guide* and *Options Installation*.

9. You now have the following DMA channel settings:

- Serial Port 1 — DMA channel 1
- PC Network Adapter — DMA channel 3
- Multiprotocol Adapter — DMA channel 5
- Personal Computer AT Coprocessor Services — DMA channel 8.

The changes will be effective when you re-IPL your system.

Glossary

application. (1) A particular task, such as inventory control or accounts receivable. (2) A program or group of programs that apply to a particular business area, such as the Inventory Control or the Accounts Receivable application.

application program. A program used to perform an application or part of an application.

backup diskette. A diskette containing information copied from another diskette. It is used in case the original information is unintentionally destroyed.

Base System Program. That part of the AIX Operating System that contains operating system files and data. The AIX Operating System consists of the Base System Program, which contains the operating system files, and the Virtual Resource Manager, which manages RT PC hardware and software resources. See also *Virtual Resource Manager*.

block. A group of records that is recorded or processed as a unit.

byte. The amount of storage required to represent one character; a byte is 8 bits.

cancel. To end a task before it is completed. *recommended* and *current* choices are the same.

cursor. A movable symbol (such as an underline) on a display, usually used to indicate to the operator where to type the next character.

device driver. A program that operates a specific device, such as a printer, disk drive, or display.

diskette. A thin, flexible magnetic plate that is permanently sealed in a protective cover. It can be used to store information copied from the disk.

diskette drive. The mechanism used to read and write information on diskettes.

display screen. The part of the display device that displays information visually.

file index. Sixty-four bytes of information describing a file. Information such as the type and size of the file and the location on the physical device on which the data in the file is stored is kept in the file index. This index is the same as the AIX Operating System i-node.

fixed disk. A storage device made of one or more flat, circular plates with magnetic

surfaces on which information can be stored.

fixed disk drive. The mechanism used to read and write information on a fixed disk.

hardware. The equipment, as opposed to the programming, of a system.

index. See *file index*.

initial program load. The process of loading the system programs and preparing the system to run jobs.

IPL. See *initial program load*.

keyboard. An input device consisting of various keys allowing the user to input data, control cursor and pointer locations, and to control the user/work station dialogue.

memory. Storage on electronic memory such as random access memory, read only memory, or registers. See *storage*.

message. Information displayed about an error or system condition that may or may not require a user response.

minidisk. A logical subdivision of a fixed disk that has its own virtual device address.

operating system. The programs and procedures designed to cause a computer to function, enabling the user to interact with the system.

page space minidisk. The area on a fixed disk that temporarily stores instructions or data currently being run. See also *minidisk*.

prompt. A displayed request for information or operator action.

screen. See *display screen*.

software. Programs.

storage. In contrast to memory, the saving of information on physical devices such as fixed disk or tape. See *memory*.

store. To place information in memory or onto a diskette, fixed disk, or tape so that it is available for retrieval and updating.

system. The computer and its associated devices and programs.

system unit. The part of the system that contains the processing unit, the disk drive and the disk, and the diskette drive.

two-digit display. Two seven-segment light-emitting diodes (LEDs) on the operating panel used to track the progress of power-on self-tests (POSTs).

Virtual Resource Manager (VRM). A set of programs that manage the hardware resources (main storage, disk storage, display stations, and other devices) and software resources of the system so that these resources can be used independently of each other.

VRM. See *Virtual Resource Manager*.

VRM minidisk. An area on a fixed disk on which the Virtual Resource Manager resides.

work station. A device that includes a keyboard from which an operator can send

information to the system and a display screen on which an operator can see the information sent to or received from the computer.

Special Characters

/ minidisk 1-10
/etc/ddi, error during update 4-41
/etc/system, error during update 4-41
/tmp minidisk 1-10
/u space allocation 1-11
/usr minidisk 1-10
/usr/lpp/<pgm-name>/lpp.hist 5-13
/usr/lpp/multiple/lpp.al 5-13
/usr/lpp/multiple/lpp.grouplist 5-12
/usr/lpp/osplus/lpp.al 5-13
/vrm minidisk 1-9
/vrm/lpp/vrm/lpp.hist 3-28

A

abbreviated commands 6-11
accessing minidisks after
 reinstalling 7-41
adapter keywords B-13
add command 6-13
add minidisk command 7-18
adding
 coprocessor device 6-21
 devices 6-21
 with changes 6-21
 with defaults 6-21
 minidisk 7-18
adding a minidisk 7-18
additional operating system programs,
 updating 5-14
additional programs

 installing 5-10
advanced display graphics support
 library 5-5
ae keyword B-14
allocating minidisk space for users 1-11
Alternate key 2-7
apply list files 5-13
ars keyword B-2
assumptions about minidisks A-2
Asynchronous Terminal Emulation 5-4

B

backing up files or minidisks 4-36
backs keyword B-2
Backspace key 2-7
backup copies of files or minidisks 4-36
Base PC Network Services 5-7
Base System Program, backing up 4-36
Base System Program, merging current
 and new version 4-38
Base System Program, reinstalling 4-42
bigd keyword B-2
block 1-15
 increasing size of 4-31
 minidisk 4-31
 size for VRM minidisk 3-11
 size requirements for operating
 system 1-15
block capacity, fixed disk 1-12
bm keyword B-2
bpc keyword B-14
bs keyword B-12
bytes 3-17

C

- cdp keyword B-2
- cdpg keyword B-11
- change command 6-13
- change current choices and install menu 3-18
- change only the page space minidisk menu 3-21
- change settings 6-47
- changing date and time 3-22
- changing device information 6-47
 - printer (example) 6-47
- changing minidisk characteristics 7-37
- changing page space minidisk
 - fixed disk number 3-11
 - size in blocks 3-11
- changing the choices, VRM
 - files, maximum number 3-11
 - size in blocks 3-11
- choices
 - current 4-27
 - viewing 4-27
 - defaults 4-27
 - viewing 4-27
- cn keyword B-13
- colp keyword B-2
- command
 - abbreviated forms 6-11
 - devices 6-4, 6-11, 6-12
 - prompts 6-12
 - installp 5-11
 - mdrc 7-41
 - minidisks 7-4
 - updatep 5-15
- communications protocols 5-8
- configuration file update, error during 4-41
- Control key 2-7
- coprocessor 6-21, 6-39
 - adding a minidisk to 7-29

- adding device for 6-21
- adding devices to 6-39
- cps keyword B-2
- cr keyword B-3
- cs keyword B-3
- current choices 3-14
 - changing 4-32
 - defaults 4-32
 - changing 4-32
 - displaying 4-28
- Cursor Down key 2-8
- Cursor Left key 2-8
- Cursor Right key 2-8
- Cursor Up key 2-8
- cus keyword B-3
- customizing, system 4-5
- cvid command 4-36

D

- data capacity, fixed disk 1-3, 1-12
- date and time, changing 3-22
- default paging space values 1-10
- defaults A-1
 - files, maximum number 3-11
 - minidisk, page space 3-11
 - size in blocks 3-11
 - number of fixed disk 3-11
 - size in blocks 3-11
- delete command 6-13
- Delete key 2-7
- deleting
 - devices 6-44
 - minidisk 7-35
 - printer (example) 6-44
- descriptions, keywords B-1
- device drivers, for graphics devices 5-5
- device information 6-15
- devices
 - adding 6-13, 6-14, 6-22, 6-28, 6-35

- device to serial/parallel
 - adapter 6-22
 - IBM-defined 6-22
 - IBM-supported 6-22
 - printer, unsupported 6-14
 - shareable 6-13
 - unsupported printer 6-14
- changing information 6-14, 6-47
 - printer (example) 6-47
- Coprocessor, adding 6-39
- deleting 6-14
- description 4-5
- displaying IBM-supported 6-17
- IBM-supported 6-5
 - device class 6-5
 - device description 6-5
 - device type 6-5
 - list of 6-5
- listing 6-17
- screen 6-17
- shareable 6-13
- showing information 6-15
- similar 6-13
- special processing C-1
- unsupported printer 6-35
 - adding 6-35
- devices command 6-4, 6-11, 6-13
 - abbreviated forms 6-11
 - add 6-13
 - change 6-13
 - delete 6-13
 - examples of using 6-16
 - exiting 6-11
 - general information 6-4
 - requesting 6-16
 - showall 6-13
 - showdev 6-13
 - starting 6-11
- diagnostics diskette 3-6
- diskette
 - damaging 2-9
 - formatting 4-10
 - handling correctly 2-9
 - handling incorrectly 2-9
 - installation/maintenance 4-7
 - loading 3-5, 4-7
 - VRM 3-4
 - VRM diskette 3-12
- diskette drive
 - drive 0 2-10
 - loading diskette 2-10
 - top 2-10
 - 1.2M-byte 2-10
- displaying 6-15
 - configured devices 6-15
 - device classes 6-15
 - device-dependent information 6-15
- DOS Services
 - autoexec 5-20
 - batch program 5-20
 - starting 5-20
 - from AIX shell 5-20
 - starting automatically 5-21
- DOS Services, definition of 5-6
- dpc keyword B-3
- ds keyword B-16
- dsp keyword B-3
- dsps keyword B-3
- dvam keyword B-14
- dwp keyword B-3
- dwps keyword B-3

E

- Enter key 2-7
- ep keyword B-3
- eps keyword B-3
- Exploring Usability Services 5-7
- Extended Services 5-6

F

fd keyword B-12
file index 3-17
file system
 backing up 4-10
 checking 4-10
 making 4-10
 restoring 4-10
file transfer protocols 5-8
files
 apply list 5-13
 grouplist 5-12
 history 5-13
 increasing maximum number 4-31
 reasons for 4-31
 VRM history 3-28
files, backing up 4-36
fixed disk 3-11
 defaults 3-11
 locating the file system minidisk 4-31
 minidisk, page space 3-11
 number 3-11
 0, 1, 2 4-31
fixed-disk data capacity 1-3
fixed-disk drive data capacity 1-12
fl keyword B-4
fnt1 keyword B-8, B-10
font keywords B-8, B-9, B-10
 IBM 3812 B-10
 IBM 4201 B-9
 IBM 5201 B-8
fw keyword B-4

G

graphics device drivers 5-5
graphics support library 5-5
grouplist files 5-12

H

history files 3-28, 5-13
hsi keyword B-4
hts keyword B-4

I

IBM-defined device 6-28
 adding 6-28
IBM-supplied choices (see defaults) 3-11
IBM 3812 font keywords B-10
IBM 4201 font keywords B-9
IBM 5201 font keywords B-8
il1 keyword B-13
index 3-17
INed 5-4
initial program load (see "restarting the system") 6-12
install and customize the VRM
 menu 3-14, 3-16, 3-18, 3-20, A-3
 changing the choices 3-16
installation options 3-8
installing
 additional operating system
 programs 5-10
 operating system 4-25
 messages 4-25
 programs with separate
 components 5-12
 Virtual Resource Manager 3-11, 3-25

program information 3-25
update diskette 3-25
VRM update diskette 3-12
installing a new version of the Base
System Program 4-42
installing DOS Services 5-6
installing updates to the VRM 3-25
installp command 5-11
Interface Program for use with
TCP/IP 5-8
internal tests 3-5
ixp keyword B-14

J

js keyword B-4

K

keyboard 2-5, 2-6
keys 2-6
keys
Alternate 2-7
Backspace 2-7
Control 2-7
Cursor Down 2-8
Cursor Left 2-8
Cursor Right 2-8
Cursor Up 2-8
Delete 2-7
descriptions 2-6
Enter 2-7
Pause 2-7
Quit 2-7
keyword descriptions B-1
keywords
adapters B-12, B-13
printer B-2

printer font B-8, B-9, B-10
scsi devices B-16
tty devices B-14
keywords, printer B-2
kpoe keyword B-4

L

licensed program 1-15
allocated sizes in blocks 1-15
minidisk size requirements in
blocks 1-15
lm keyword B-4
loading installation/maintenance
diskette 4-7
loading VRM diskette 3-5
logger keyword B-14
logging in 4-43
logging off 4-45
lpi keyword B-4
lrmc keyword B-5
lunm keyword B-16

M

mail relay, with Interface Program for use
with TCP/IP 5-8
mccs keyword B-5
mdrc command 7-41
menu
change current choices and
install 3-18
change only the page space
minidisk 3-21
install and customize 4-28
install and customize the VRM 3-14,
3-16, 3-18, 3-20, 3-21, A-3

- show current and recommended
 - choices 3-14, 3-15
 - system management 4-9
- merging a new version of the Base System Program 4-38
- message 3-6
- minidisk
 - accessing after reinstalling 7-41
 - adding 7-18
 - adding with coprocessor installed 7-29
 - allocating space requirements 1-12
 - changing minidisk characteristics 7-37
 - defaults 3-11
 - deleting 7-35
 - displaying 7-16
 - managing system 7-3
 - non-AIX 7-29
 - planning for space requirements 1-12
 - requesting the minidisks screen 7-8
 - show command 7-16
 - size in blocks 3-11
 - space requirements 1-12
- minidisk space, for user files 1-11
- minidisk types 1-3, 1-9
- minidisk, page space
 - changing 3-18, 3-20
 - number of fixed disk 3-18
 - size in blocks 3-18
 - defaults 3-11
 - free space A-4
 - increasing size A-3
 - number of fixed disk 3-11
 - size in blocks 3-11
- minidisk, VRM 3-12
 - changing 3-17
 - files, maximum number 3-17
 - number of fixed disk 3-17
 - size in blocks 3-17
 - defaults 3-11
 - files, defaults 3-11

- files, maximum number 3-11
- free space A-4
- increasing size A-3
- minidisks
 - description 4-5
 - keywords B-12
 - special processing C-1
- minidisks defined by the user 1-11
- minidisks keywords B-12
- minidisks screen 7-8
- minidisks, backing up 4-36
- Multi-User Services 5-5

N

- network features, with Interface Program for use with TCP/IP 5-8
- new version of Base System Program, merging 4-38
- new version of Base System Program, replacing current version with 4-42
- noabb keyword B-16
- nob keyword B-12
- nobub keyword B-16
- nosb keyword B-14
- nospt keyword B-16

O

- om keyword B-14
- operating system 1-15
 - additional programs 5-4
 - logging in 4-43
 - logging off 4-45
 - minidisk size requirements in blocks 1-15
 - reinstalling 4-37

P

pac keyword B-5
page space minidisk
 changing 3-12
 increasing size A-3
paging minidisk 1-9
paging space defaults 1-10
Pause key 2-7
pdt keyword B-16
ph keyword B-5
pitch keyword B-5, B-9
pitch1 keyword B-8, B-10
planning for software installation 1-3
pn keyword B-13
possible choices 3-13
power-on light 3-5
power switches 3-5
pq keyword B-5
prin keyword B-5
printer 6-44
 adding 6-14
 supported 6-6
 unsupported 6-14
printer keywords B-2
pro keyword B-14
protocols, communications 5-8
psd keyword B-6, B-11
pss keyword B-6
pt keyword B-14

Q

Quit key 2-7

R

recommended choices 3-13, 3-14
recovery procedures, for error during Base
 System Program reinstall 4-41
reinstalling programs 3-28
reinstalling the operating system 4-4,
 4-37, 7-41
 accessing minidisks 7-41
 warning 4-37
reinstalling VRM 3-28, A-4
 with a larger page space minidisk A-4
 with new release or backup copy 3-28
remote login, with Interface Program for
 use with TCP/IP 5-8
requesting devices command 6-16
restarting the system 6-12
rlfs keyword B-6
roffv keyword B-14
ronv keyword B-15
root (/) minidisk 1-10
rtrig keyword B-6, B-15
rts keyword B-15

S

screen
 device customizing commands 6-17
 devices 6-19
 listing 6-19
 minidisks 7-8
scsi devices keywords B-16
selecting a keyboard 3-10
serial/parallel adapter 6-22
settings, changing 6-47
show current and recommended choices
 menu 3-14, 3-15
show minidisk command 7-16
showall command 6-13

showdev command 6-13
showing minidisks 7-16
sid keyword B-16
slap keyword B-6
sn keyword B-13
SNA Services 5-9
sns keyword B-15
software, planning to install 1-3
space requirements, minidisk 1-12
special processing C-1
 devices C-1
 minidisks C-1
sss keyword B-6
standalone shell
 starting 4-11
system
 internal tests 3-5
 starting 3-5
system defaults A-1
system management menu 4-9
system start 6-12

T

tbc keyword B-6, B-15
tests, internal 3-5
tm keyword B-6
toffv keyword B-15
tonv keyword B-15
translating DOS-like commands 5-6
tt keyword B-15
tty devices keywords B-14
two-digit display 3-5

U

United States keyboard 3-10
update diskette 3-12
 VRM 3-12
 installing 3-12
update to operating system 5-7
updatep command 5-15
urpim keyword B-7
Usability Services 5-4
 starting automatically 5-19
 starting from AIX shell 5-18
 user name 5-19
 creating 5-19
 user profile 5-19
 changing 5-19
user-defined minidisks 1-11
user name
 entering 4-18
users
 description 4-6

V

vhs keyword B-7
viewing the choices
 reasons for 3-13
Virtual Resource Manager
 defaults A-1
 installation options
 changing choices and installing or
 reinstalling 3-8
 changing page space minidisk 3-8
 installing with defaults 3-8
 viewing choices 3-8
 minidisk A-3
 increasing size A-3
vpqs keyword B-7
VRM

installing
 for the first time 3-12
 with current choices 3-12
 with recommended choices 3-12
VRM device driver diskette 5-8
VRM diskette
 inserting 3-5
 loading 3-5
 locating 3-4
 removing 3-12
 storing 3-12
VRM, backing up 4-36
vsi keyword B-7

vts keyword B-7

W

wll keyword B-7
work stations, multiple 3-11

Numerics

12ps keyword B-7



IBM RT PC

Product Comment Form

**Installing and Customizing
the AIX Operating System**

SC23-0787

Your comments assist us in improving our products. IBM may use and distribute any of the information you supply in any way it believes appropriate without incurring any obligation whatever. You may, of course, continue to use the information you supply.

For prompt resolution to questions regarding set up, operation, program support, and new program literature, contact the authorized IBM RT PC dealer in your area.

Comments:



NO POSTAGE
NECESSARY
IF MAILED
IN THE
UNITED STATES

BUSINESS REPLY MAIL

FIRST CLASS PERMIT NO. 40 ARMONK, NEW YORK

POSTAGE WILL BE PAID BY ADDRESSEE

International Business Machines Corporation
Department 997, Building 998
11400 Burnet Rd.
Austin, Texas 78758



Fold and tape

old and tape

Cut or Fold Along Line

ade

adps

Book Title

Order No.

Book Evaluation Form

Your comments can help us produce better books. You may use this form to communicate your comments about this book, its organization, or subject matter, with the understanding that IBM may use or distribute whatever information you supply in any way it believes appropriate without incurring any obligation to you. Please take a few minutes to evaluate this book as soon as you become familiar with it. Circle Y (Yes) or N (No) for each question that applies and give us any information that may improve this book.

Y N Is the purpose of this book clear?

Y N Are the abbreviations and acronyms understandable?

Y N Is the table of contents helpful?

Y N Are the examples clear?

Y N Is the index complete?

Y N Are examples provided where they are needed?

Y N Are the chapter titles and other headings meaningful?

Y N Are the illustrations clear?

Y N Is the information organized appropriately?

Y N Is the format of the book (shape, size, color) effective?

Y N Is the information accurate?

Other Comments

What could we do to make this book or the entire set of books for this system easier to use?

Y N Is the information complete?

Y N Is only necessary information included?

Y N Does the book refer you to the appropriate places for more information?

Optional Information

Y N Are terms defined clearly?

Your name _____

Company name _____

Street address _____

Y N Are terms used consistently?

City, State, ZIP _____



NO POSTAGE
NECESSARY
IF MAILED
IN THE
UNITED STATES

BUSINESS REPLY MAIL

FIRST CLASS PERMIT NO. 40 ARMONK, NEW YORK

POSTAGE WILL BE PAID BY ADDRESSEE

International Business Machines Corporation
Department 997, Building 998
11400 Burnet Rd.
Austin, Texas 78758



Fold and tape

fold and tape

Cut or Fold Along Line

tape

address on envelope

© IBM Corp. 1987
All rights reserved.

International Business
Machines Corporation
Department 997, Building 998
11400 Burnet Rd.
Austin, Texas 78758

Printed in the
United States of America

SC23-0787-0

IBM
®

SC23-0787-00

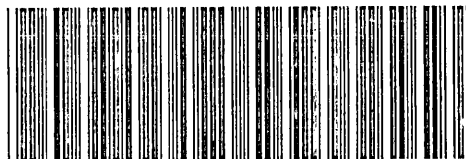

92X1260