

IBM 705
Console Manual

This manual is the result of work contributed by

T. E. Bradshaw, Jr.

F. E. Ross

R. T. Wierzbicki

CONTENTS

	Page
Part I--The 705 Console	
Timing Cycles in the 705	1
Operation Register	2
Operation Decoder	2
Memory Address Register (MAR)	2
Instruction Counter (IC)	2
Memory Address Counter I (MAC I)	3
Memory Address Counter II (MAC II)	4
Select Register	4
Storage Select Register	4
Schematic Representation of Mechanical Console Operation	5
Memory Display CR-1; Storage Display CR-2	6
Alteration Switches	6
Instruction Check Indicator--0900	6
Machine Check Indicator--0901	7
Read-Write Check Indicators--0902	8
Record Check Indicator--0903	8
Overflow Check Indicator--0904	9
Sign Check Indicator--0905	9
Input-Output No Response	10
Storage Sign (-)	10
Storage Selector Keyboard	10
Memory Address Selector Keyboard	10
Character Keyboard	11
Manual Stop	11
Machine Stop	11
Display; Display Step	11
Store	12
Instruct	12
Half-Multiple Step Key	13
Start	13
Reset	13
Clear Memory	13
Stop Timing (I-Time, E-Time)	14
Part II--705 Console Conditions	
Introduction	15
Input-Output No Response Stops	18
Control Error Stops	21
Program Stops	22

	Page
Check Stops	23
A 0900 Instruction Check	23
B 0901 Machine Check	26
C 0902 Read/Write Check	33
D 0903 Record Check	35
E 0904 Overflow Check	36
F 0905 Sign Check	38
 Appendix--Miscellaneous Operating Notes	 41
A Use of the Machine Stop and Reset Keys	41
B The Any Indicator	42
C Memory Search for Redundant Characters-- B-V-8	43
D Use of the Half-Multiple Step Key	44
 Part III--How to Look at the 705 Console	 46
 Part IV--705 Console Exercises	 49
Console Schematics	50
Explanation of Console Exercises	77
Index of Console Exercises by Error Conditions	89
 Part V--Case Study for 705 Console	 92
Program	93
Console Schematics	95
Answers for Console Case Study	108

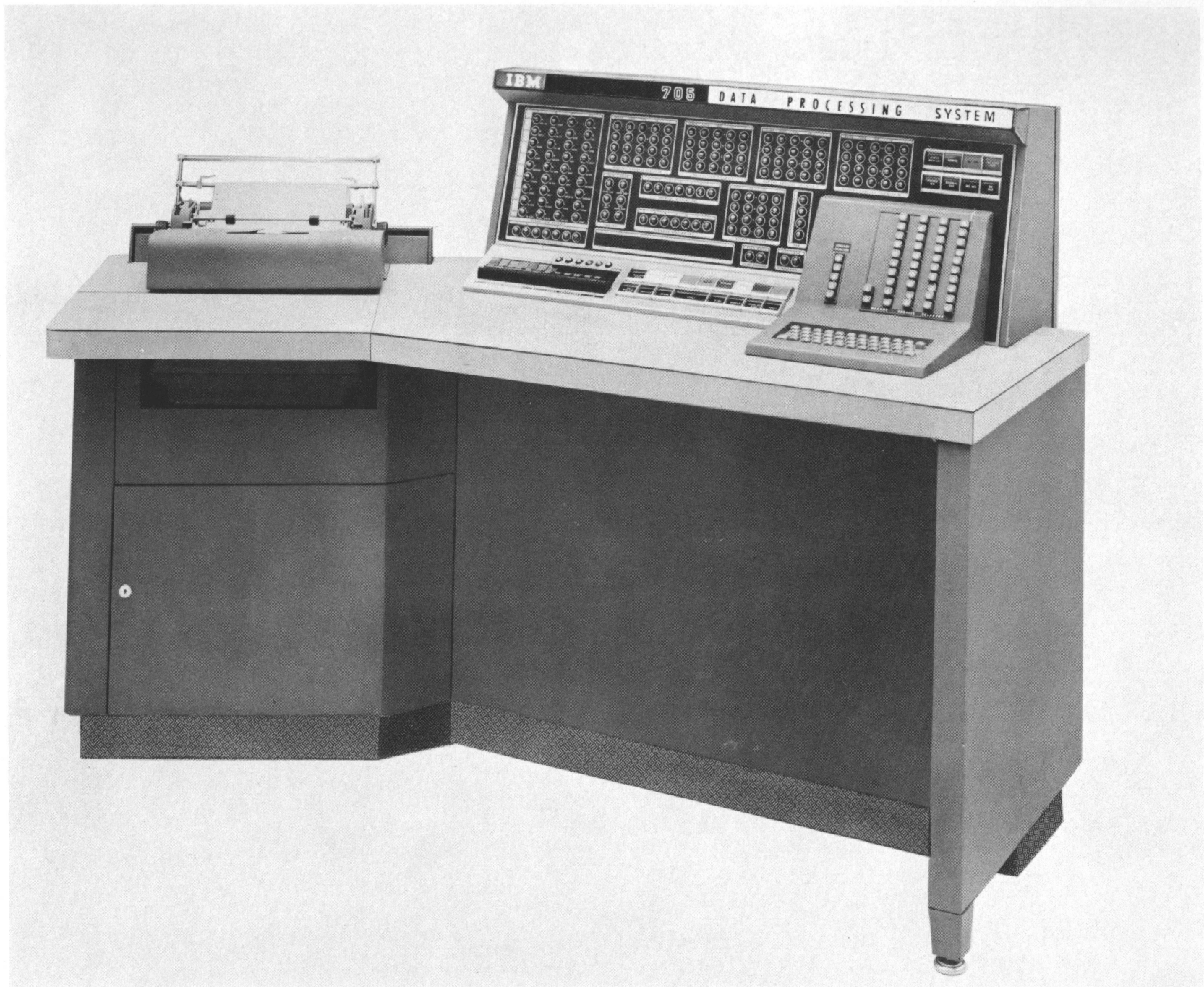

IBM 705 CONSOLE

INTRODUCTION TO THE 705 CONSOLE MANUAL

Competent operation of the 705 Console is necessary for effective utilization of a 705 installation. It may save a large amount of machine time, particularly during program testing operations.

This manual is intended as an aid in the training of Console operators and as a reference manual on Console operations.

The manual presupposes knowledge of the subject matter contained in the "Preliminary Manual of Operation, Type 705", Form No. 22-6627 and subsequent revisions.

Material in this manual is arranged in five parts which are largely self contained:

Part I describes the counters, registers, switches, and lights of the Console and gives an introduction into their operation.

Part II discusses the various stop and error conditions which may occur during automatic operation. It includes an explanation of the causes of these conditions, and how to recognize and remedy them.

The Appendix contains miscellaneous operating notes explaining the use of the Machine Stop and Reset Keys, the functioning of the Any Indicator, the use and method of memory search for redundant characters, and the use of the Half-Multiple Step Key.

Part III describes a systematic method of looking at the Console when the machine stops.

Part IV consists of the Console exercises showing various conditions on schematics of the Console. They are arranged in random order for classroom instruction and self training. This part also includes an explanation of the exercises in order of sequence and an index of the exercises according to error conditions.

Part V is a case study of error conditions arising during the running of a short payroll program listed in this part. Each one of these conditions is analyzed as would be done by a competent operator in actual operation.

PART I

THE 705 CONSOLE*

This bulletin describes the purpose and function of each of the lights and switches located on the 705 Console. In order to aid the Console operator in analyzing special situations which may arise, some of the logic behind the operation of these units is covered.

TIMING CYCLES IN THE 705

The 705 is governed by an electronic clock which operates at a frequency of one megacycle. Or stated another way, the clock emits an electrical pulse one million times a second. A series or group of these pulses constitute a "character cycle". The character cycle is the basic unit of time in the 705. Depending upon the operation being performed, the character cycle in the 705 consists of either 9 or 17 pulses from the clock. This is a time period of either 9 or 17 millionths of a second. (This would more normally be called 9 or 17 microseconds, the microsecond being equal to one millionth of a second.) The character cycle is the time which it takes the 705 to operate upon one character or, where there are special conditions such as the reading and interpreting of an instruction or in high-speed transmission, the 705 will operate upon five characters in one character cycle. In these cases, however, all five of the characters are operated upon at the same time so that there is a parallel handling of the five characters.

Character cycles are classified according to the time of their occurrence during an operation. An operation for this purpose is defined as the period of time during which the 705 reads, interprets, and performs an instruction. The first character cycle of an operation is called the instruction character cycle or ICC. The time during which this cycle occurs is often called "Instruction" time or simply "I" time. I-time is that time during which the machine reads and interprets the five characters of an instruction. The next character cycle to occur is called Execution Character Cycle One or ECC1. Following ECC1 are as many Execution cycles as are needed to perform the instruction. The time during which ECC1 and the other Execution cycles occur is often called Execution time or "E" time. ECC1 is distinguished from other cycles that occur during E-time in that the functions that occur during the first execution cycle are different from those that occur during the remaining character cycles. E-time might be defined as that time during which the machine carries out the instruction.

*This part has previously appeared, with minor differences, as Customer Assistance 702/705 Bulletin No. 21.

OPERATION REGISTER

In the Operation Register is shown the bit structure of the operation code of the current instruction. This bit structure is placed in the Operation Register during I-time and remains there during all of E-time. During the next I-time the Operation Register is set to the bit structure of the next operation. As an example, if the instruction is a RAD, the bit structure shown in the Operation Register will be that of an "H", or C, B, A, and 8 bits.

OPERATION DECODER

In the Operation Decoder is shown the result of the interpretation of the operation code character. This is placed in the Operation Decoder during I-time and remains there during all of E-time.

MEMORY ADDRESS REGISTER--MAR

This register contains the address portion of the instruction being executed. On a RD, WR, WRE, and serial TMT instruction this is the high order or left hand character of the field addressed. On a high-speed TMT instruction it is the fifth digit from the left end of the field addressed. On all other instructions it will be the low order or right hand character of the field addressed. When the 705 is in Automatic status the Memory Address Register is set during I-time and remains the same during all of E-time. The Memory Address Register contains only the numerical portion of the four characters of the address of the instruction plus the decoded zoning over the fourth or high-order position of the address in order to designate which section of memory is being addressed. The zoning over the tens and hundreds digits is placed in the Storage Select Register. Zoning over the units position of the instruction will be ignored. The Memory Address Register is particularly helpful on Sign Check stops since it is here and not in the Memory Address Counter I that the address of the unsigned character will be found.

INSTRUCTION COUNTER--IC

This counter contains instruction locations. Under normal conditions it is simply stepped up five positions during I-time so that at the end of I-time it is always at an address that is five positions higher than the instruction being executed. (When there is an Instruction Check stop, however, IC is not stepped up, and will thus be at the address of the instruction in error.) It remains in this position until the end of E-time at which time Memory Address Counter I will be set to the address indicated by the Instruction Counter. The units position of IC changes between 4 and 9. On a transfer instruction the Instruction Counter is set to the address in the Memory Address Register. Should this address not contain a units position of 4 or 9, the 705 will stop at the end of I-time of the transfer instruction so that it is never possible to get an address ending in anything other than 4 or 9 into the Instruction Counter.

NOTE: When using a Tape Record Coordinator with a 705 system some TRS instructions may have zoning over the tens and hundreds position to indicate an ASU and change the instruction to a Transfer Ready. If there is no Tape Record Coordinator in the system a TRS instruction with ASU zoning will always be ignored by the 705. That is, no transfer will ever be effected.

MEMORY ADDRESS COUNTER I--MAC-I

This counter normally contains the memory address of the character or characters being operated on at a particular time. It is set from either MAR or from IC. There are certain instructions, such as, SET, LNG, SHR, and RND where MAC-I does not indicate a memory address but is simply used as a counter. Also there are certain functions controlled by the Memory Address Counter II. These are the receiving of characters, and the reading of characters when a RWW instruction has been used. When five characters are being processed in parallel as in high-speed TMT, MAC-I will show the address of the fifth or low-order character of the group being transmitted. This is an address with a 4 or 9 in the units position.

During E-time this register is normally stepped during each execution cycle. It may be stepped in either of three ways. The first of these is +1 or up one each execution cycle. This occurs on all WR and WRE instructions, on all serial TMT instructions, and on all RD instructions which have not been preceded by a RWW instruction. On high-speed TMT the counter is stepped +5 or up five at a time during each execution character cycle. The four instructions noted above are the only ones which proceed from left to right. With the exceptions noted below, on all other instructions the Memory Address Counter I is stepped -1 or down one at a time. There are certain instructions which do not require that the Memory Address Counter I be stepped. These instructions are NOP, TRA, HLT, TRH, TRE, TRP, TRZ, TRS, RWW, SGN, RCV, NTR, TR, SEL, and CTRL.

It should be noted that MAC-I is normally stepped during the character cycle and so at the end of a character cycle or at the end of E-time the Memory Address Counter I will be one step ahead, either +1, +5, or -1 of the character last handled. This is also true when manual Store, Display, or Instruct operations are taking place.

When an 0901 stop occurs, MAC-I is not stepped and it will, therefore, contain the address of the character in error. No manual Instruct operation can be performed which causes MAC-I to step following an automatic check indicator stop caused by either an 0902, 0903, 0904, or 0905, while the check switch remains in Automatic. In order to perform any manual Instruct operation requiring MAC-I to step it will be either necessary to place the indicator switch in question to Program position or depress the Reset key in order to turn off the check indicator. This re-

striction does not apply to manual Store or Display operations or to one single manual transfer instruction. (See also notes on Check Indicators 0902, 0903, 0904, and 0905)

MEMORY ADDRESS COUNTER II--MAC-II

This counter contains the memory location where characters will be received from a TMT instruction and also where characters will be read into memory following a RWW instruction. It is set from MAR. It may be stepped in either of two ways, +1 at a time or +5 at a time. It is similar to MAC-I in that it is stepped during the execution cycle and so at the end of any cycle it is always sitting at the next position to be read into or received. It is stepped +5 at a time when a high-speed TMT is being executed.

SELECT REGISTER

In this register is displayed the last I/O unit, check indicator or alteration switch selected by the 705. This register is only reset by another SEL instruction. Any number may be placed in the Select Register by a SEL instruction. Even if the SEL address is erroneous, nothing will happen unless an attempt is made to execute a RD, WR, WRE, or CTRL instruction which is impossible. Then the 705 will stop in Automatic status. A SEL instruction can cause no kind of stop in the execution portion of the instruction.

STORAGE SELECT REGISTER

In this register is displayed in binary form the number of the ASU designated by the instruction. If no lights are on, it indicates that the accumulator is designated. This register, like the Operation Register, Memory Address Register and Instruction Counter is set during I-time and remains the same during all of E-time. It is set each I-time even though the instruction might be one, such as, RD or RWW, where no storage unit is involved. Where there is no zoning over the tens and hundreds position of the instruction, the accumulator will be designated even though it is not used.

MAGNETIC CORE MEMORY

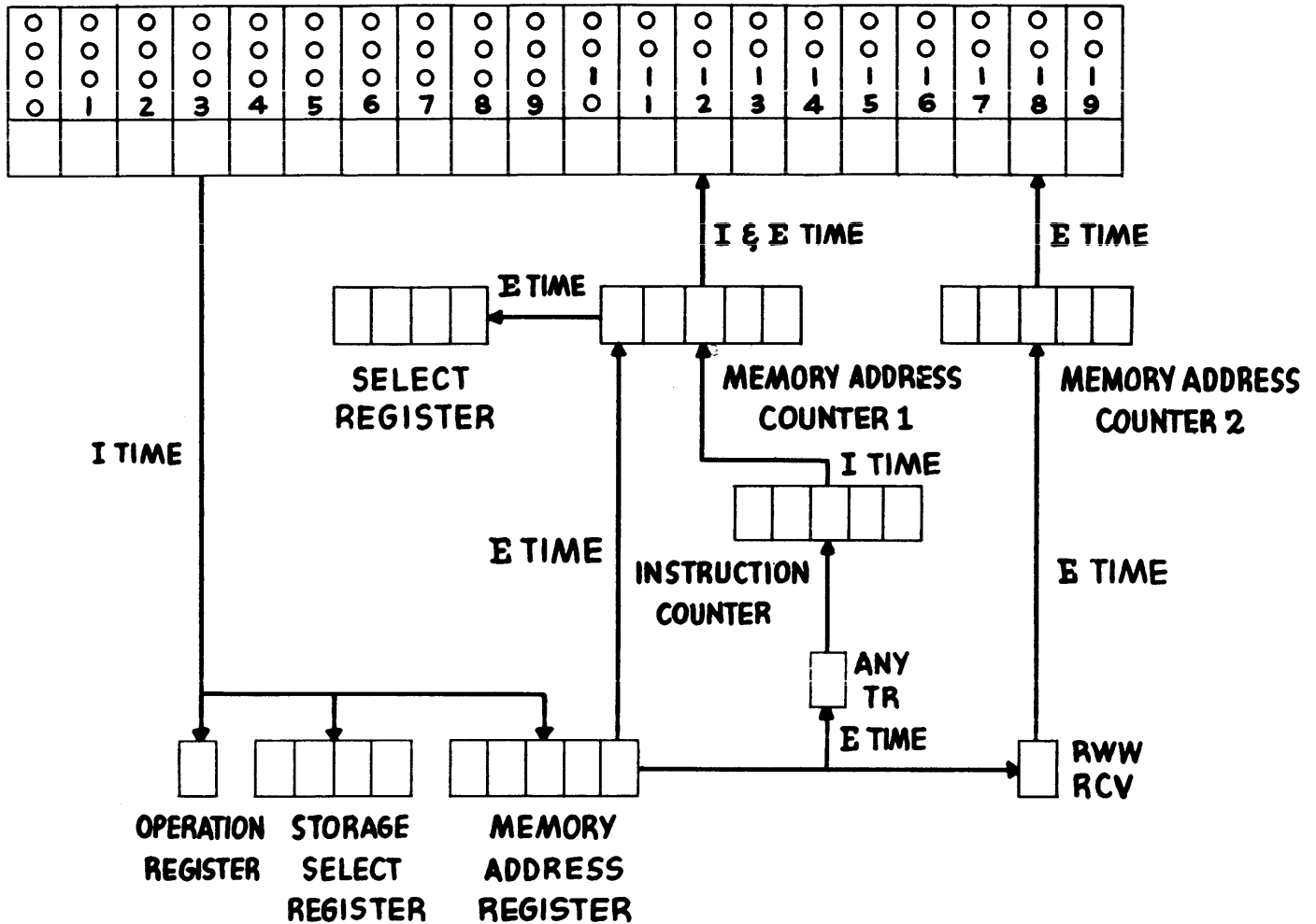

SCHEMATIC REPRESENTATION OF RELATIONSHIP BETWEEN.
 MEMORY ADDRESS REGISTER
 OPERATION REGISTER
 INSTRUCTION COUNTER
 MEMORY ADDRESS COUNTER 1
 MEMORY ADDRESS COUNTER 2
 SELECT REGISTER
 STORAGE SELECT REGISTER

During I-time MAC-I reads from memory the five characters specified by IC and places these in MAR, the Operation Register, and the Storage Select Register. At the end of I-time the contents of MAR are sent to MAC-I. During E-time the contents of MAR may be sent to either of two places depending on the instructions involved. If the instruction is RWW or RCV, the contents are sent to MAC-II. If the instruction is to effect a transfer, the contents are sent to IC. On RCV-TMT operations and simultaneous RWW, MAC-I handles the TMT and writing operations while MAC-II handles the receiving and reading operations. On a SEL instruction, the contents of MAC-I are sent to the Select Register during E-time.

MEMORY DISPLAY CR-1; STORAGE DISPLAY CR-2

CR-1 and CR-2 are character registers. In these are shown the character being handled by the 705 at that particular time. These registers are reset at the beginning of each character cycle with one exception, and that is CR-1 when a RCV-TMT operation is taking place. One of the functions of these character registers is to recognize a redundant character, that is, one that has an odd number of bits. CR-1 contains characters coming from memory, and CR-2 contains characters coming from the storage units.

When characters are being read into the 705 memory, they come in through CR-2. When characters are being written out of the 705 memory, the characters are shown in CR-1. On a WR or WRE instruction a redundant character in memory will cause CR-1 to have an odd number of bits and turn on the 0901 check indicator. If an 0902 check stop occurs at the end of a RD, WR, or WRE instruction, both CR-1 and CR-2 will be blank. The reason for this is that an extra cycle is taken on these instructions at the end of E-time in which no characters are handled and so both CR-1 and CR-2 will show a no-bit structure. During the execution of any instruction other than the three previously mentioned, an odd number of bits in either CR-1 or CR-2 will cause an 0901 check stop. Some instructions, such as, SET, LNG, SHR, and RND, do not use CR-1, and a number of instructions, such as, HLT, TR, etc. use neither CR-1 nor CR-2.

ALTERATION SWITCHES

These six switches may be kept at either the On or Off positions depending upon the instructions of the program. If the alteration switches are never interrogated in a program it will make no difference at which position the switches are set, although, as a general rule, it would be better to keep all of them in the Off position.

INSTRUCTION CHECK INDICATOR--0900

This switch is normally kept in the Automatic position as there is no practical way to program for Instruction Check errors. Should there be an Instruction Check Stop, the machine will go to Manual Status at the end of I-time. The cause or causes of the Instruction Check stop are indicated by the three neons at the left side of the check panel which is immediately above the check indicator lights.

The CR-1 code check indicates that there is a redundant character within one of the five characters of the instruction.

The 4 or 9 check indicates that an attempt has been made to transfer to an instruction that does not have a location ending in 4 or 9. If any of the conditional transfers contain an address, the units position of which is different from 4 or 9, a stop will occur even though the conditions for a transfer are not satisfied. This stop will also occur if the units position of the address of a high-speed TMT instruction has a numerical part other than 4 or 9.

The Op. Chk. (Operation Check) indicates that an operation code character does not have an existing operation code. This could be a character such as the numerical zero or a slash or a dollar sign.

Should two of these lights go on at the same time, the CR-1 check should be corrected first as, possibly, after it is corrected it will eliminate the other check neon. The CR-1 check indicates a redundancy in one of the characters of the instruction. In order to determine which character is redundant it will be necessary to perform a Display and Display Step operation of the entire instruction. The Instruction Counter will be at the location of the instruction in error. This is true even in the case in which the instruction in error was a Transfer instruction as the instruction has been interpreted but not executed. The Memory Address Register will be set to the address specified by the instruction. MAC-I will be the same as IC. Should an Instruction Check stop occur for any reason, the addressable position of the instruction is the address shown in the Instruction Counter as indicated above.

As a suggested corrective routine, the program error or redundancy should be corrected with reference to the program listing and then a transfer made to the corrected instruction. These corrections may be done from the console. This same routine would in general be followed for any of the Instruction check stops.

MACHINE CHECK INDICATOR--0901

This switch will usually be kept on Automatic, except when check point and restart procedures are employed. For the rest of this discussion it will be assumed that it is on Automatic. If the switch is in the Automatic position it will work in two different ways depending upon the instructions involved. A machine check will cause the 705 to go into manual status at the end of the particular execution cycle in which the redundant character is encountered if the instruction involved is not a Write or Write-Erase. If the instruction involved is a Write or Write-Erase and a redundant character is encountered, it will not cause the 705 to go into Manual status at any time. The purpose of the use of an 0901 Machine Check during a WR or WRE instruction is to distinguish between errors in memory and errors in the transmission from memory to some output unit, errors in memory being represented by the 0901 check and errors in transmission only being represented by the 0902 check. Obviously, if an 0901 error is present there is no point in rewriting the record in order to try to correct the 0902 error. If there is an 0901 error there will also be an 0902 error, since a redundant character in memory will also cause the redundant transmission of a character. Also, it should be noted that even though the 0901 switch is on Automatic it can be programmed for in the above case. An 0901 Machine Check will not occur on a RD instruction.

The cause of the Machine Check stop is indicated by the two neons at the right of the check panel immediately above the check indicators. CR-1 indicates a redundancy in characters coming out of memory. CR-2 indi-

cates a redundancy in characters coming out of the Accumulator or Auxiliary Storage Units. The redundant character will be shown in either CR-1 or CR-2. On all instructions other than Write and Write-Erase (which have been discussed previously and will be omitted from the rest of this discussion) and high-speed TMT, MAC-I will stop at the address of the redundant character. On serial transmit the Memory Address Counter I will also stop at the address of the redundant character. On high-speed transmit the Memory Address Counter I will stop at the address of the right hand character (the 4 or 9 address) of the group of characters in error. It will be necessary as it was in the Instruction Check to display all five characters in order to determine which character is redundant. It may be possible to correct the faulty character by reference to the program listing.

In general it is not possible to give a suggested correction routine for 0901 errors as the correction routine will depend upon the instruction involved. For example, on an ADD instruction a redundant character might occur in the middle of the field to be added. In this event the numbers from the units position of the field up to and including the redundant character have been added. Consequently, if the redundancy is corrected and a transfer made to the ADD instruction a part of the field will be added twice. Corrective action on a Machine Check stop will usually involve either a reprocessing of a record or a return to a check point.

READ-WRITE CHECK INDICATOR--0902

This switch is usually kept in the Program position as in the event of an error it is possible to reread or rewrite. However, in the event that it is in the Automatic position, it will not put the 705 in Manual status until the end of E-time. If a simultaneous reading and writing is taking place, the 705 will not be placed in Manual status until the end of both reading and writing. In this case the 0902 may be caused by either the input, or output, or both. The Read-Write Check indicator is turned on when a redundant character is encountered in either reading, or writing from memory. Corrective action consists of rereading or rewriting the record and then transferring to continue the program.

NOTE: In connection with 0902 check stops see discussion on Memory Address Counter I.

RECORD CHECK INDICATOR--0903

This switch may be kept in either the Program or Automatic position. When it is in Automatic, it will not put the 705 into Manual status until the end of E-time of the WR or WRE instruction addressed to the same printer following the WR or WRE instruction which caused the error. On the Punch it will be the second WR or WRE instruction following the WR or WRE instruction which caused the error. A distinction between the 0902 check stop and the 0903 check stop is that an 0902 places the 705 in Manual status at the end

of the reading or writing of the record in error while the 0903 will not place the 705 in Manual status until some following record has been written. This check indicator is turned on when a record written from a buffer storage unit does not agree with the record that was in the buffer storage. Correction routines would consist of reproducing the record in error.

NOTE 1: In connection with 0903 stops see discussion on Memory Address Counter I.

NOTE 2: In the case of the 760 Printer Control Unit and the 777 Tape Record Coordinator information on 0902 and 0903 checking can be obtained from the manuals on this equipment.

OVERFLOW CHECK INDICATOR--0904

This switch is normally kept in the Automatic position. Only four instructions normally cause an Overflow Check stop. These are ADD, SUB, RND, and DIV. With the first three of these instructions the 705 will be placed in Manual status at the end of E-time. On a DIV instruction the 705 will be placed in Manual status before the division has been completed.

The stop is caused with an ADD or SUB instruction when the number of digits in the result is greater than the longer of the fields added or subtracted. On RND the stop is caused when there is a carry beyond the high-order digit of the accumulator field. In all of these three above cases the operation is properly completed as distinguished from DIV where the operation is not properly completed. In a DIV instruction, when the machine finds that the absolute value rule has been violated, the 705 is placed in Manual status.

In general it is best not to try to correct this type of error from the console but to take a memory print out and get off of the machine. In particular this would be true if the stop were caused by a DIV instruction. This check stop would normally occur only while a program is being "debugged".

NOTE: In connection with 0904 Check stops see discussion on Memory Address Counter I.

SIGN CHECK INDICATOR--0905

This switch is normally kept in the Automatic position. Six instructions can cause a sign Check stop. These are RAD, RSU, MPY, DIV, ADD, and SUB. This stop is caused by having an unsigned character in the units position of the field addressed by any of the above instructions. On this Check stop, the 705 will be placed in Manual status at the end of the second cycle after the unsigned field has been recognized. As with the Overflow Check stop, no general corrective action can be suggested. As an example, if an ADD instruction is involved, the first two characters of the field have been added and the sign of the field is assumed to be a plus.

NOTE: In connection with 0905 stops see discussion on Memory Address Counter I.

I/O NO RESPONSE

Input or Output No Response. Only three instructions can cause these lights to be turned on. These are RD, WR, and WRE, which automatically turn on the I/O No Response lights. When the 705 performs a reading or writing operation it sends out read "calls" or write "calls" from the central processing unit to the unit or units selected. When these "calls" are answered by "responses" the Read or Write neons of the I/O No Response are turned off. When one or both of these lights remain on, it indicates that the unit selected is unable to perform the reading or writing operation. This may be for several reasons. The unit may not be "ready" or in a Ready status. That can be a tape unit which may not have been loaded or the card reader may not have been loaded. The unit may not exist for the 705. Tape unit 0200 may be selected but no dial on a tape unit set to 0. Or it may not be possible for the unit to perform the operation. For example, a writing operation can not be performed by the card reader or on a file protected tape, or a reading operation by the card punch or printer.

When the I/O No Response light remains on, the 705 will stop but will remain in an Automatic status. It is waiting for a response. Where a tape unit dial was not set properly or a card reader, punch, or printer is not ready, it is possible to correct this condition from the individual unit concerned and then the 705 will continue with the program. If it is necessary to perform operations from the console it will first be necessary to depress the Machine Stop key. The reason for this is explained under Machine Stop key.

STORAGE SIGN (-)

These lights come on when either the sign of the accumulator or ASU's is minus.

STORAGE SELECTOR KEYBOARD

During a manual Display operation the position of these keys will determine whether the accumulator or one of the ASU's will be shown in CR-2. They also provide ASU or accumulator designation for a manual instruction which is performed from the console. When the machine is in Automatic status depressing these keys will have no effect.

MEMORY ADDRESS SELECTOR KEYBOARD

This keyboard determines at which memory address a manual Store or Display operation will start. When the machine is in Instruct status this keyboard would be set to the address portion of the instruction it is desired to execute. Depressing these keys when the machine is in Automatic status will have no effect.

CHARACTER KEYBOARD

This keyboard is used when the machine is in either Store or Instruct status. When the 705 is in Store status depressing a key on this keyboard will cause a character to be placed in memory. When the 705 is in Instruct status this keyboard is used to supply the operation code character of an instruction.

MANUAL STOP

Depressing this key will place the 705 in Manual status at the end of E-time of the instruction which it is then performing. Should it be desired to stop the machine when it is in Automatic status this is the key that would normally be used.

MACHINE STOP

Depressing this key will place the 705 in Manual status immediately. It does not wait for the end of E-time as the Manual Stop key does. It artificially ends either I or E-time when it is pressed. Consequently, it should not normally be used when the 705 is running in Automatic status. There are, however, some cases where it is necessary to use it.

One of these cases is where an I/O No Response stop has occurred. In that case the 705 has stopped in Automatic status. If it is desired to perform any console operations or even to continue the program, it will be necessary to depress the Machine Stop key in order to place the 705 in Manual status. The Manual Stop key will not work here as it will wait until the end of E-time before it places the 705 in Manual status and with a no response condition E-time will never be ended.

The same general rules as apply to I/O No Response stops also apply to Control Errors. These are stops with the 705 in Automatic status caused by giving a CTRL instruction to a unit that cannot carry out that particular instruction at that particular time. As examples, the card reader cannot be back-spaced (CTRL 0004) nor can a RWD instruction be carried out on a tape drive which is not ready or not available at that installation. As was the case with No Response stops, the 705 stops in Automatic status. The I/O lights will not be on. CTRL will be displayed in the Operation Decoder. Again it will be necessary to use Machine Stop to place the 705 in Manual status.

DISPLAY; DISPLAY STEP

The purpose of these keys is to allow the operator to observe the contents of memory and of the storage units. Memory is shown in Memory Display CR-1. Storage units are shown in Storage Display CR-2. Each time the Display Step key is depressed another character is displayed. Display is from right to left and starts from the starting point counter of the storage unit designated by the Storage Selector keyboard and from the memory address designated by the Memory Address Selector keyboard. After the first character is displayed MAC-I will always be at the next position to be displayed. The sequence in which the keys should be depressed is as follows:

1. Memory Address Selector or Storage Selector or both.
2. Display
3. Display Step

This will display one character. To continue displaying, repeat step 3. Should the Display key be depressed while the 705 is in Automatic status, the 705 will be placed in Manual status at the end of E-time of the instruction then being executed and the Manual light will be turned on as well as the Display light; but this should not be used in lieu of the Manual Stop.

STORE

The purpose of this key is to allow the operator to manually place characters in the 705 memory. It is not possible to directly store characters in the storage units. When characters are being stored manually, the character being displaced in memory is shown in CR-1. Characters are stored in the same way that they are read or written, that is, from left to right. Storing starts from the memory address designated by the Memory Address Selector keyboard and characters are stored from the Character keyboard. After the first character is stored MAC-I will always be at the next position to be stored. The sequence the keys should be depressed in is as follows:

1. Memory Address Selector
2. Store
3. Character Keyboard

This will store one character. To continue storing, repeat step 3.

Should the Store key be depressed while the 705 is in Automatic status, the 705 will be placed in Manual Status in the same manner that it would be by the Display key; but this should not be used in lieu of the Manual Stop. It is important to take the 705 out of Store status as soon as the desired storing has been completed as otherwise any accidental touching of the Character Keyboard may result in unwanted storing of information.

INSTRUCT

The purpose of this key is to allow the operator to manually instruct the 705. The address of the instruction including storage unit designation, if any is needed, is first set up on the Memory Address Selector keyboard and on the Storage Selector. Next the operation code of the instruction is depressed on the Character keyboard. The 705 then goes in to Automatic status for long enough to execute the instruction. When the instruction is completely executed, the 705 returns to Manual status. Normally this happens so rapidly

that the Automatic light will not have time to come on. However, should an I/O No Response or Impossible Instruction stop occur, the 705 will stop in Automatic status. The sequence the keys should be depressed in is as follows:

1. Memory Address Selector and Storage Selector if needed.
2. Instruct
3. Character Keyboard

This will execute one instruction. To execute more instructions, steps 1 and 3 should be repeated.

Should the Instruct key be depressed while the 705 is in Automatic status, the 705 will be placed in Manual status in the same manner as it would by the Display key, but this should not be used in lieu of the Manual Stop.

HALF-MULTIPLE STEP KEY

The purpose of this key is to provide the 705 with slow motion speed. Depressing the key will cause the 705 to perform one-half of an instruction, that is, either I-time or E-time each time the key is depressed. It will alternate between I and E-time. If the key is held down for more than one second, it will cause the 705 to execute steps at about 10 per second. While the Half-Multiple Step key is being continuously depressed, the 705 goes into Automatic status for long enough to execute one-half of an instruction and then returns to Manual status and waits for a timing circuit before it returns to Automatic status to execute the other half of the instruction. Should the Half-Multiple Step key be depressed while the 705 is in Automatic status, the 705 will be placed in Manual status in the same manner as it was by the Display key.

START

This key is used to place the 705 in Automatic status. When it is depressed it turns off all of the Check Indicators and the Any indicator.

RESET

Depressing this key will turn off all of the Check Indicators and the Any indicator as the Start key does and also set the Instruction Counter to 0004.

CLEAR MEMORY

Depressing this key will carry out all of the functions performed by the Reset key, and in addition, it will set all of storage to accumulator marks (an absence of bits) and memory to blanks (a C and an A bit).

NOTE: The three keys mentioned above may all be thought of as "resets",

with the Start key being the lowest in order or doing the least and Clear Memory being the highest in order or doing the most.

POWER ON; NORMAL OFF; DC ON; DC OFF; MASTER OFF

These keys normally should not be used by the operator of the console.

STOP TIMING

All types of stops may be discussed in terms of the time of their occurrence relative to machine operation. Below is given a brief table of what stops may occur at what times:

Stops at the end of a current
character cycle

Machine Stop

Stops at the end of I-time

Instruction Check--0900

Stops at the end of a character cycle
but within E-time

Machine Check--0901

Sign Check--0905

Overflow Check--0904
upon DIV only

Stops at the end of E-time

HLT instruction

Read-Write Check--0902

Record Check--0903

Overflow Check--0904
(except on DIV)

Manual Stop

Store

Display

Instruct

Half-Multiple Step

All of these stops place the 705 in manual status. There are only two types of stops which do not place the 705 in manual status. The two types are Input-Output No Response and Control Error stops.

PART II

705 CONSOLE CONDITIONS

INTRODUCTION

The following conclusions, which are entirely pragmatic in nature, have been reached after a limited amount of testing of error conditions and stops on the Electronic Data Processing Machine 705. As it was considered essential to get the maximum amount of information to all users at the earliest possible time, the following pages do not purport to be the result of exhaustive studies of all possible conditions and all possible combinations of instructions. They are intended to show console conditions for the most frequent types of error conditions, to indicate their patterns, usual causes and remedial routines, and to give an approach to machine operation based on practical experience. Examples for conditions described may be observed among the Console Exercises in Part IV of this Manual.

NORMAL OPERATION

The following table will indicate, in simplified form, the condition of the most significant registers and counters during normal operation of the 705:

Assume that the instruction processed, located in memory positions 1560-1564, is R 3101 and that the record to be written covers positions 3101-3150, with the Group-Mark at 3151.

	<u>Memory Address Register</u>	<u>Instruction Counter</u>	<u>Memory Address Counter I</u>
Early I-Time	3101	1564	1564
I-Time, End	3101	1569	3101
E-Time, Beginning	3101	1569	3101
E-Time, End	3101	1569	3152
		Thereafter:	1569

TYPES OF STOPS FROM AUTOMATIC OPERATION

The stops considered under this heading are all stops not caused by outside interference in the automatic operation of the Electronic Data Processing Machine 705:

	<u>Designation of Stop</u>	<u>Status of 705</u>	<u>How Recognized</u>
I	I/O No Response	Automatic	One or two "I/O No Response" lights "ON"
II	Control Error	Automatic	Instruction causing stop always a "Control" instruction
III	Program Stop	Manual	Instruction causing stop is always a "Halt" instruction
IV	Check Stops	Manual	Relevant check indicator light is "ON"

The patterns of the above stops and their subdivisions will be discussed below under the appropriate headings.

The following observations hold quite generally for all types of stops:

1. All stops, except for the Instruction Check stop, occur in execution time. It follows, therefore, that the Instruction Counter will contain at all stops, other than at an Instruction Check stop, the location of the current instruction plus five. During an Instruction Check stop, the Instruction Counter contains the location of the current instruction then being interpreted.
2. The Memory Address Register will show the address of the current instruction.
3. The Operation Code of the current instruction will be shown in the Operation Decoder and in 705 machine code in the Operation Register.
4. Similarly, the Storage Select Register will give in true binary form the Auxiliary Storage Unit selected in the current instruction.
5. The Select Register will always contain the last input-output unit, check indicator or alteration switch selected.
6. Similarly, the Memory Address Counter II will show, at all instructions during which its operation is not required, the memory location it contained when completing execution of the last instruction (RD or WR preceded by a RWW; TMT) necessitating its operation.

NOTE: With regard to 5 and 6 above, it is noted that neither the Select Reg-

ister nor the Memory Address Counter II are reset by any of the manual switches (i. e. , Reset, Clear Memory) which turn off or change the lights on the other registers and counters.

It follows from the above, that in most cases it will be sufficient to outline the condition of Memory Address Counters I and II and Character Registers 1 and 2 in order to give the complete console picture.

I I/O NO RESPONSE STOPS

This category has the following subdivisions which differ mainly in the console picture:

- A I/O No Response--Read
- B I/O No Response--Write
- C I/O No Response--Read and Write

CAUSE

These stops are caused during execution time of a RD, WR, or WRE instruction (and only these instructions) under any of the following conditions:

1. The unit selected is not on line which may mean that it is non-existent (e. g. , SEL 0095), not available at that installation (it may only be temporarily not available, e. g. , if the Address Selector Switch of the relevant tape drive has not been set as required), or not ready. A special case falling into this class is a RD, WR, or WRE instruction directed to an even-numbered tape unit if this number has been set on the odd side of tapes, or vice versa with an odd-numbered tape unit on the even side.
2. The combination of the unit last selected and the RD, WR, or WRE instruction being executed is impossible (e. g. , WR with Card Reader Selected, RD with Printer selected, a RWW routine with the two tapes selected being either both even or both odd,WRE with 0902 selected).
3. A WR or WRE instruction is given when the last selected tape unit is file protected.

CONSOLE PICTURE

A I/O NO RESPONSE--READ

MAC-I: Address of the RD instruction

MAC-II: Not involved

CR-1: Units position of the address

CR-2: No bits

I/O No Response--Read light is lit

If this condition occurs during a sequence involving a RWW instruction, MAC-II controls reading and will thus show the address of the RD or RWW instruction; the contents of MAC-I and CR-1 will vary with the sequence of instructions.

B I/O NO RESPONSE--WRITE

MAC-I: Address of the WR or WRE instruction, plus one

MAC-II: Not involved, except following a RWW instruction when MAC-II controls the reading function

CR-1: Character at the memory position addressed by the WR or WRE instruction

CR-2: No bits

I/O No Response--Write light is "ON"

C I/O NO RESPONSE--READ AND WRITE

This condition may be caused by a RWW routine in which the two tapes selected are either both odd or both even, with the stop occurring during the WR instruction. Another sequence of instructions creating an I/O No Response--Read and Write consists of following the selection of a tape unit and a RWW instruction by a WR without selecting a second tape unit.

MAC-I: Address of the WR instruction, plus one

MAC-II: Address of the RWW instruction

CR-1: Character at the memory position addressed by the WR instruction

CR-2: No bits

Select Register: Output unit last selected to carry out the WR instruction.

I/O No Response--Read and Write lights are both "ON"

In addition, this particular error condition will cause the one or two tape units selected to revolve forward until stopped manually. The tape unit selected earlier, if there are two tape units involved, may be stopped by depressing the Machine Stop key. The last tape unit selected, however, will continue revolving until unwound or stopped by the selection of another unit from the console or stopped by taking the tape unit out of ready status.

NOTE: In the above case, when the tape unit or tape units revolve out of control, resumption of operation has been made impossible and the program has to be restarted. It, therefore, follows that this condition should be avoided under all circumstances. One way in which this condition can be created is by switching input tapes and/or output tapes each between odd and even tape unit numbers. This method of changing tape numbers should, therefore, never be used. Input tape units should be even and output tape units odd, or vice versa.

CORRECTIVE ACTION

Remedial action does, of course, depend on the cause of the stop. It should, however, be noted that, as the 705 hangs up in Automatic status, it will sometimes only be necessary to make a simple adjustment to the relevant input-output unit, e. g. , push the Start button on the Card Reader to put it in Ready Status, put cards into the punch hopper, set the Address Selector Switch of the proper tape drive as required, etc. , without manipulating any of the keys and buttons of the 705 console and, as soon as corrective action is completed, the 705 will continue operation.

If manual operation at the console should be necessary, the 705 has to be brought first into Manual status. This is achieved by pressing the Machine Stop key, and it is recommended that this be followed by a depression of the Reset key. (See discussion of the Machine Stop and Reset keys in the Appendix of this part) The manual operation at the console must then be concluded by transferring to the instruction at which resumption of automatic operation is desired.

NOTE: It is noted that a SEL instruction merely sets the Select Register to the address contained in MAR. Therefore, an impossible or inappropriate SEL instruction will result in stops only when RD, WR, WRE or Control instructions are directed to the unit thus last selected.

II CONTROL ERROR STOPS

CAUSE

This stop is caused during execution time of a Control instruction only, in much the same manner as a No Response stop, for any of the following reasons:

1. The last unit selected is not on line, which means that it is not existent, not available at that installation or not ready.
2. The combination of the last unit selected and the current Control instruction is impossible.
3. In a Control instruction, the units position of the address, which is the only part of the address examined in this instruction, is a digit other than 0, 1, 2, 3, 4, or 5. (This will, of course, no longer hold when a 777 Tape Record Coordinator or 760 Control Unit is connected to the 705.)

CONSOLE PICTURE

MAC-I: Address of the Control instruction

MAC-II: Not involved

CR-1: No bits

CR-2: No bits

Neither I/O No Response light is "ON"

CORRECTIVE ACTION

As the 705 hangs up in Automatic status and as the causes of this error condition are so similar to those of an I/O No Response Stop, corrective action is identical to that described above for I/O No Response Stops for corresponding causes. Upon a non-existent Control instruction, the 705 must be brought into Manual status, with further action depending on the program.

III PROGRAM STOPS

CAUSE

As implied by its designation, this type of stop has been planned by the programmer to occur under predetermined conditions.

CONSOLE PICTURE

MAC-I:	Location of the current instruction plus five. (Identical with the contents of the Instruction Counter.)
MAC-II:	Not involved
CR-1:	No bits
CR-2:	No bits

The Operation Decoder shows a "J" or "Stop" instruction

(The address of the Program Stop is only contained in the Memory Address Register)

CORRECTIVE ACTION

As the 705 stops at the end of E-time, depression of the Start key will cause the machine to operate on the next sequential instruction. The Program Stop, which should be identifiable by its address, is used mainly to indicate existence of some special condition or completion of some phase of the program, or to allow the operator to make a decision and/or take some special action. In order to minimize delay at the console a clearly indexed sheet, containing a concise statement of the reason and the necessary action for each stop programmed, should be included in the operating instructions to the operator. Each Program Stop, after which resumption of operation may be desirable, should be followed by instructions which allow continuation by a mere depressing of the Start button.

IV CHECK STOPS

There are six different types of Check switches all of which may be set to "Automatic" or "Program".

If a Check switch is set to "Automatic" and, during some instruction, the type of error occurs which is checked by the relevant checking circuits, the 705 will usually stop before progressing to the next instruction. (For exception see the 0901 Machine Check and the 0903 Record Check) If, however, the Check switch is set to "Program" such an error will merely turn on the Check Indicator light, and the action taken depends upon the program under operation. It is emphasized that if a Check switch is in the "Program" position and the relevant Check Indicator is not interrogated by the program, the turning on of the indicator light has no effect whatever and the output of the program may then contain serious flaws or consist of useless "garbage" (a programmer's term for a meaningless conglomeration of characters).

The Check Stops in this discussion are assumed to result from the related switch having been turned to "Automatic".

Check Stops will be discussed herein under the following sub-headings:

- A 0900 Instruction Check
- B 0901 Machine Check
- C 0902 Read-Write Check
- D 0903 Record Check
- E 0904 Overflow Check
- F 0905 Sign Check

A. 0900 INSTRUCTION CHECK

This Check Stop is the only type of stop which may occur during I-time, while the current instruction is being read and interpreted by the 705.

CAUSE

An Instruction Check stop may be caused by any, or a combination, of the following error conditions which are specified by the three auxiliary Instruction Check lights immediately to the right of the Operation Decoder. These errors have in common the existence of a basic flaw in the formal construction of the five characters of the instruction itself.

1. CR-1 CODE CHECK

A redundancy exists in any character of the current instruction. A redundancy is a character consisting of an odd number of bits caused by a supernumerary bit having been picked up or by a necessary bit having been dropped. In memory, a character consisting of no bits (a storage mark or drum mark) is also treated as a redundant character.

AN IMPORTANT POINT SHOULD BE NOTED IN CONNECTION WITH THIS STATEMENT:

PRESENT EXPERIENCE INDICATES THAT MEMORY ERRORS IN THE CORE MEMORY OF THE 705 ARE EXCEEDINGLY RARE. MANY HOURS OF OPERATION MAY PASS WITHOUT PRODUCING EVEN ONE GENUINE MEMORY ERROR. ACCORDINGLY, IF A REDUNDANCY IS NOTED ANYWHERE IN MEMORY OR IN THE STORAGE UNITS, IT HAS PROBABLY BEEN CREATED BY IMPROPER PROGRAMMING, SUCH AS, THE APPLICATION OF ARITHMETICAL INSTRUCTIONS TO NON-NUMERICAL DATA OR BLANKS, OR THE INTRODUCTION OF IMPROPER CHARACTERS FROM AN INPUT UNIT, SUCH AS, THE READING OF A TAPE BEYOND THE TAPE MARK.

Such a redundancy error will light, in addition to the 0900 light, the CR-1 Code Check light and may also light either of the other auxiliary Instruction Check lights, depending on whether the redundancy has also caused a violation of the other two requirements.

2. OPERATION CODE CHECK

The Operation Code of the current instruction is not recognized as a proper Operation Code by the 705. This will happen if the character serving as Operation Code is

1. redundant

or

2. a blank, zero or a special character

This error condition will light, in addition to the 0900 light, the Operation Code Check light and, in case (1) above, also the CR-1 Code Check light.

3. 4 OR 9 CHECK

The numerical part of the units position of the address of any transfer (including conditional transfers) instruction or of a

TMT (00) instruction is not a 4 or a 9. This error condition will light, in addition to the 0900 light, the 4 or 9 Check light, and also the CR-1 Code Check light, if the reason for this type of error is the existence of a redundancy in the units position of the address.

As has been implied in the above statement, the 4 or 9 check only tests the numerical part of the units position of the address. The units position of the address may have any zoning whatsoever without interfering with proper operation. As the Instruction Check stop takes place during I-time, it is quite immaterial, in the case of a conditional transfer, whether the conditions for the carrying out of an actual transfer do or do not exist. The 4 or 9 check will be turned on as soon as the machine recognizes that the current instruction is potentially a transfer instruction.

No condition other than those indicated in 1, 2, and 3 above is known at present to cause an Instruction Check stop. Thus, for instance, zoning of the tens' and hundreds' position of an instruction not requiring the selection of a storage unit will not cause an Instruction Check although the ASU indicated by such zoning will be shown in the Storage Select Register (SSR). Similarly, a special character in the tens, hundreds, and/or thousands position of the address of an instruction will be interpreted by the 705 as one of the characters which may legitimately occur in the address of an instruction, the interpretation depending, of course, on the bit structure of the special character in question. A special character may even be in the units position of the address of an instruction without stopping the operation of the 705 provided the 4 or 9 Check rules, mentioned in 3 above, have not been violated.

It follows from the characteristics just mentioned that an incorrect transfer instruction into a work or constant area, which thus treats data as instructions, will usually not result in an early Instruction Check, but the 705 may continue operating for some time.

It is noted that an Operation Code Check or 4 or 9 check may be caused by the instruction or instructions concerned being deposited incorrectly in memory.

CONSOLE PICTURE

Due to the parallel processing of the five characters of the instruction during I-time, an Instruction Check stop will present the same basic picture irre-

spective of the character and condition that caused it. As the Operation Register shows the bit structure of the Operation Code, a redundancy or other error in the first character of the instruction can be examined in the Operation Register. In such a case, the Operation Decoder may either remain completely turned off, e. g. , in case of a zero Operation Code, or it may give a wrong interpretation of the improper code, e. g. , a Y which has dropped its "A" bit (i. e. , a single 8 bit) will show as a "Load" in the Operation Decoder.

IC:	Location of the instruction
MAC-I:	Location of the current instruction (same as Instruction Counter)
MAC-II:	Not involved
CR-1:	Units position of the address of the instruction
CR-2:	No bits

The 0900 Instruction Check light and auxiliary error lights depending on the cause of the Instruction Check stop, will be "ON".

CORRECTIVE ACTION

This, of course, depends on the condition which gave rise to the stop and on the surrounding circumstances. The operator should, however, realize that the instruction in question is incapable of being properly executed until the underlying error condition has been corrected. As may have become apparent in the discussion under the heading "Console Picture" above, any error condition involving the Operation Code or the units position of the address of the instruction can be seen on the console without any manual operation. If any of the characters in the tens, hundreds, and/or thousands positions of the instruction is redundant, these characters must be displayed manually to identify the offending character. After storing the correct character in the current instruction, it is only necessary to depress the Start key to recommence interpretation and execution of the current instruction. (See notes at end of section)

B 0901 MACHINE CHECK

CAUSE

This Check stop will be caused if, during execution of an instruction, redundancies are encountered among the characters processed or interrogated. Thus, a Machine Check stop may be caused by any, or a combination, of the following error conditions, which are specified by the two auxiliary Machine Check lights next to the auxiliary Instruction Check lights (the third light below the CR-1 and CR-2 lights has at present no function). As each of these error

conditions causes a slightly different console picture, the type of 0901 check and the console picture caused by it will be discussed together in the following paragraphs:

1. REGULAR CR-1 CODE CHECK

A redundant character in memory encountered during execution of an instruction, other than a TMT (00), WR or WRE instruction. Examples are redundant characters in memory among data to be loaded upon LOD, added upon ADD, or transmitted upon a single character TMT instruction.

CONSOLE PICTURE (1)

- MAC-I: Location of the redundant character in memory
- MAC-II: The only regular CR-1 Code Check at which this counter will operate (and thus will not simply continue to hold the address contained at the end of the previous instruction) is during serial transmission. MAC-II will then contain the memory location to which the redundant character is being transmitted.
- CR-1: The redundant character
- CR-2: The character in the storage unit selected corresponding to the redundant character in memory.

Examples:

Upon execution of a LOD, the character in CR-2 is the character in the storage unit displaced by the redundant character.

During single character transmission, the character in CR-2 is the character in the ASU selected which, not being a storage mark, allows transmission of the redundant character.

The CR-1 light will be ON in addition to the 0901 Check Indicator light.

2. CR-1 CODE CHECK UPON TMT (00)

A redundant character in a memory location ending in 4 or 9, encountered upon execution of a TMT (00) instruction.

CONSOLE PICTURE (2)

- MAC-I: Memory location of the redundant character to be transmitted (will always end in 4 or 9).
- MAC-II: Memory location where the redundant character is to be received (also, this location will always end in 4 or 9).
- CR-1: The redundant character.
- CR-2: No bits

The CR-1 light will be ON in addition to the 0901 Check Indicator light.

3. 0901 WITHOUT CR CODE CHECK UPON TMT (00)

A redundant character in a memory location ending in a digit other than 4 or 9 encountered upon execution of a TMT (00) instruction. This is an exceptional case as it is the only case known at present in which an 0901 Machine Check is not accompanied by either a CR-1 or CR-2 Code Check.

CONSOLE PICTURE (3)

- MAC-I: Counting from the location of the redundant character the next higher memory location which ends in 4 or 9.
- MAC-II: The memory location to which the character shown in CR-1 below is being transmitted. (This location will also end in 4 or 9.)
- CR-1: The character, the location of which is shown in MAC-I.
- CR-2: No bits

Neither the CR-1 light nor the CR-2 light only the 0901 Check Indicator light will be turned on.

If manual displaying is started with the location in MAC-I, the redundant character will be one of the first five characters displayed.

4. CR-1 CODE CHECK UPON WR AND WRE

A redundant character in memory encountered upon execution of a WR or WRE instruction.

In this case, the 0901 machine check will not cause the 705 to stop even though the check switch be set to Automatic. The 0901 Machine Check Indicator, however, will be turned on and may be interrogated.

This was planned in order to allow differentiation, upon execution of a WR or WRE instruction, between 0902 Read/Write errors caused during transmission and those caused by redundant characters in the record written. Write errors caused during transmission can be corrected by rewriting and do not bring about an 0901 Machine Check. This feature enables the programmer to provide, through his program, for re-creation, or some other correction, of redundant records without the necessity of having the 0901 Check Indicator switch set to "Program" during the whole program under operation.

It should be noted that if the 0902 Check Indicator switch is set to Automatic, operation of the 705 will be stopped upon writing a redundant record by the 0902 Check at the end of the current WR or WRE instruction (see 0902 Read/Write check below). If, however, the 0902 Check Indicator is set to "Program" and is interrogated and the 0901 Check Indicator is not interrogated, the 0901 Check Indicator light will remain turned on but will not impede the execution of subsequent instructions. If then, during any subsequent instruction other than a WR or WRE, a redundancy is again encountered, the relevant type of 0901 Machine Check stop will result.

CONSOLE PICTURE (4)

If the machine stops at the end of a WR or WRE instruction with the 0901 Check Indicator light on, such stop is caused by the 0902 Read/Write Check. The console picture, therefore, is as indicated below upon an 0902 Read/Write stop caused during execution of a WR or WRE instruction.

5. CR-2 CODE CHECK

A redundant character in accumulator or auxiliary storage encountered during execution of an instruction other than SET, RND, and SHR. Examples are redundant characters in storage among data to be unloaded upon UNL, to be stored upon ST, or any numerical fields in storage addressed during execution of an arithmetic instruction.

Another case causing a CR-2 Code Check is a redundant character in the ASU controlling single character transmission. This may be surprising as, at first glance, no useful purpose appears to be served by making a character code check of the characters in the ASU. It should be noted, however, that, if the storage mark were the character to pick up an extra bit, transmission would continue beyond the field size originally planned.

CONSOLE PICTURE (5)

MAC-I: Memory location into which the redundant character

is to be unloaded, at which it is to be stored, or at which the character is located which corresponds to the redundant character in storage.

MAC-II: The only possible CR-2 Code Check at which this counter will operate (and thus will not simply continue to hold the address it contained at the end of the previous instruction) is during serial transmission. MAC-II will then contain the memory location to which the character in CR-1 is being transmitted.

CR-1: The character in memory which is to be displaced by the redundant character to be unloaded, stored, or which corresponds to the redundant character in storage.

CR-2: The redundant character in storage.

The CR-2 light will be ON in addition to the 0901 Check Indicator light.

6. REGULAR CR-1 AND CR-2 CODE CHECK

Apart from the cases mentioned in 7 below, a simultaneous CR-1 and CR-2 Code Check is the result of a double redundancy, a redundant character in memory and a redundant character in storage in corresponding memory and storage locations.

Examples:

Upon a CMP instruction, a redundant character encountered in storage and a redundant character in the corresponding location in memory.

During a single character TMT instruction, a redundant character encountered in memory, with the corresponding character in the controlling ASU also redundant.

CONSOLE PICTURE (6)

MAC-I: Memory location of the redundant character in memory

MAC-II: The only possible CR-1 and CR-2 Code Check at which this counter will operate (and thus will not simply continue to hold the address it contained

at the end of the previous instruction) is during serial transmission. MAC-II will then contain the memory location to which the character in CR-1 is being transmitted.

CR-1: The redundant character in memory.

CR-2: The redundant character in storage.

Both, the CR-1 light and CR-2 light, will be lit in addition to the 0901 Check Indicator light.

7. CR-1 AND CR-2 CODE CHECK UPON SET, RND, AND SHR

If an 0901 Machine Check results from the execution of any of the three above instructions, then both a CR-1 and CR-2 Code Check will show. It is noted, however, that the only character which can trigger an 0901 Machine Check upon these instructions are redundant characters, which are actually interrogated during the execution of the instruction. Thus, for instance, if the 5th character in storage is redundant, a SET 0003 instruction will not cause a Machine Check as the 5th character in storage is not interrogated. Under the same conditions, however, a SET 0006 instruction will cause an 0901 Machine Check of the type treated herein. Again, with the 5th character in storage being redundant, a SHR 0003 instruction will not cause an 0901 Machine Check unless the 4th character in storage is a zero. In the latter case, the 705, subsequent to shortening, interrogates all remaining characters from left to right until it finds a non-zero character and, therefore, in this case, the redundant character will be interrogated. The RND instruction operates similarly.

CONSOLE PICTURE (7)

MAC-I: Upon SET:

The number of positions to be set as shown in MAR less n if the redundant character is in the nth position of storage, counting from the Starting Point Counter.

Upon RND and SHR:

19,999

MAC-II: Not involved

CR-1: No bits

CR-2: The redundant character in storage.

Both the CR-1 light and the CR-2 light will be lit in addition to the 0901 Check Indicator light.

CORRECTIVE ACTION (For all types of 0901 Machine Check)

An 0901 Machine Check does not occur when the redundant character is displaced by manual storing or by manual or automatic execution of instructions which displace the redundant character, whether it be in memory or storage. (There are only minor exceptions to this rule.)

It is important to realize that if a Machine Check occurs during an instruction which is intended to move a field or record containing the redundant character, such as, a LOD, TMT, or ST instruction, the redundant character in fact has been moved. Therefore, in such cases, the redundant character exists in two locations, for instance, if a record containing a redundant character has been addressed by a serial TMT instruction, the redundant character is the last one to have been transmitted and, at the time of the Machine Check Stop, can be found at the location at which it has been received. The same applies to LOD, ST, UNL, and similar instructions. During high-speed transmission, the 5-character group containing the redundant character is the last one to be transmitted before the 0901 Machine Check forces the 705 into MANUAL status. Also in this case, the redundant character will be at the location from which it was transmitted and the location at which it was received.

The fact that in the cases explained above two redundancies may exist upon the 0901 Machine Check stop is not a drawback as it would appear at first glance, for, in order to successfully complete the program in operation, the instruction during which the Machine Check occurred will have to be repeated in any case. After a Machine Check has occurred it is not possible simply to progress to the next instruction by depressing the Start button, but it is necessary to first replace the redundancy by a legitimate character.

In practice during program testing it will usually be best to get off the machine and to examine the instructions of the program to determine whether the Machine Check has been created by the program, for instance, by storing non-numericals or by bringing in redundant characters from input units. If, in some particular case, the operator has reason to believe that the redundant character was not created or brought into memory by the 705 program which is being tested, he should try to store the proper character if it is ascertainable from the program or data. If this information is not available he may, in the case of a long program, replace the redundant character by an arbitrary legitimate character, note the record and take into consideration such action upon his review of operating results. Programs operating for production should always contain check point and restart procedures

if their running time justifies it. If such programs are very short, however, and therefore do not contain check point and restart procedures, they may be treated in the same way as programs which are being tested unless the need for great accuracy imposes the necessity for a rerun.

C 0902 READ/WRITE CHECK

CAUSE

This Check stop may be encountered during a RD, WR, or WRE instruction. It can be triggered by an error in transmission or by a redundant character found upon the vertical check, certain multiple punches from the card reader, and discrepancies in the odd-even count recognized by the horizontal check.

1. 0902 UPON RD INSTRUCTION

A read error which may be caused during reading from any input unit.

CONSOLE PICTURE (1)

- MAC-I: Location in memory of the last character read in plus one, except during an instruction sequence including a RWW instruction, in which case the contents of MAC-I will depend on the last instruction.
- MAC-II: During the read-while-write mode, this counter will control the reading operation. If an 0902 Read error occurs in such a case, it will be at the equivalent position to the one at which MAC-I would stand if MAC-I were in control of the reading operation. Location in memory of the last character read in plus one.
- CR-1: No bits
- CR-2: No bits

The 0902 Read/Write Check Indicator light is lit.

CORRECTIVE ACTION (1)

Remedial action will depend upon the input-output unit from which the 0902 Check was obtained. If the card reader caused the 0902 Check, then the error card will be the 4th card out when cards are run out from the card reader by depressing the Feed key. (If the error card is one of the first three cards loaded into the card reader, then it will be the next to the last card to be run out.) The error card can then be examined and multiple punches, off punching or any other defects corrected. If no error can be discerned in the 4th

card it is worthwhile to check the card preceding and the card following it. If neither of those two cards show an obvious error, according to experience, it is usually best to duplicate the 4th card and use the duplicate for subsequent operation. Operation should be continued by starting with the error card.

If the error comes from tape or the drum, two possibilities exist:

1. The error is correctable (if it is an error of transmission) by rereading the record which has caused the read error.
2. The error is not capable of being corrected, that is, when either the vertical check shows a redundant character or the horizontal check shows a discrepancy. In those cases rereading will not cure the defect. A method of dealing with such a case is to write the error record onto a tape which is reserved for just such purposes. If the 0902 Read/Write Check Indicator switch is at Automatic, however, then there will result invariably an 0902 Write Check when the error record is written onto the tape reserved for redundant records and other questionable output.

2. 0902 UPON WR AND WRE INSTRUCTION

A write error which may be caused upon writing on some output unit.

CONSOLE PICTURE (2)

MAC-I: Location in memory of the group mark terminating the record written plus one.

MAC-II: During the read-while-write mode this counter will control the reading operation. If in such a case an 0902 Write error occurs, MAC-II will show the memory location of the last character of the record read into memory plus one.

CR-1: No bits

CR-2: No bits

The 0902 Read/Write Check Indicator light is lit, the Machine Check Indicator and the Machine Check CR-1 lights are also lit if the record written is redundant.

CORRECTIVE ACTION (2)

Remedial action will largely depend upon whether the instruction causing the error was a WR or WRE instruction.

If the error causing the 0902 Check Stop occurred during a WRE instruction, then the output record has to be recreated and rewritten.

If the 0902 Read/Write error occurred upon a WR instruction, then remedial action will depend upon whether the 0901 Machine Check light is lit or not. (See also 0901 Machine Check; CR-1 Code Check Upon WR and WRE)

Assume the 0901 Machine Check light is not lit, then the record written is not redundant and the 0902 error is an error of transmission. Repeated writing should eventually overcome the difficulty.

If the 0901 Check Indicator light is lit, then the record written is redundant, i. e. , it contains at least one redundant character. If writing of that record is repeated, every WR instruction will be followed by an 0902 and 0901 Check. Re-creation of the output record is then a prerequisite to writing it successfully on an output unit.

It is noted that, in the case of an 0902 Read/Write Check, the 0901 Machine Check will not stop machine operation even though the 0901 Machine Check Indicator switch be set to Automatic. (See also 0901 Machine Check; CR-1 Code Check Upon WR and WRE above)

D 0903 RECORD CHECK

CAUSE

In the following, it will be assumed that the 705 is not connected to a 777 Tape Record Coordinator or 760 Control Unit.

An 0903 Record Check occurs whenever a record punched on the 722 card punch or printed on the 717 printer contains at least one character which is punched or printed in a different way than the 7-bit character in the relevant buffer would indicate. It should thus be noted that the 0903 Record Check is an indication of a mechanical failure and not of an electronic type of failure. For instance, an 0903 on the punch will not be caused by a redundant character in the buffer--the redundant bit structure will be interpreted in a certain way before punching and will be interpreted consistently in the same way upon checking.

If the records to be punched exceed 80 characters each and if the records to be printed exceed 120 characters each, the 0903 Record Check will not be effective except for the last line printed or last card punched of each such record. Upon punching, the 0903 Record Check will light the Check Indicator light and stop the 705 (if the 0903 Check Indicator switch is set to Automatic) at the end of the second WR or WRE instruction, directed to the same card punch, following the WR or WRE instruction which originally caused the 0903 error.

Upon printing, the 0903 Check will similarly light the Check Indicator light and stop the 705 at the end of the WR or WRE instruction, directed to the same printer, immediately following upon the WR or WRE instruction which caused the 0903 error.

CONSOLE PICTURE

MAC-I: Location in memory of the group mark terminating the record punched or printed at the time the 705 stops, plus one.

MAC-II: Not applicable

CR-1: No bits

CR-2: No bits

The 0903 Check Indicator light is lit.

Upon an 0903 error on the card punch, the error card is the top card in the stacker. The record addressed by the last WR or WRE instruction has in fact been punched on the card punch or printed on the printer, as the case may be, upon an 0903 Record Check.

CORRECTIVE ACTION

Remedial action will depend on the circumstances in each particular case. Proper instructions should be given to the operator. The difficulty of a correction, other than through programming, is due to the fact that the error record is the one before the last record printed or the second one before the last record punched. Frequently, the best that can be done is to mark the error line printed or the error card punched for subsequent investigation.

E. 0904 OVERFLOW CHECK

CAUSE

This error condition is caused when the storage positions allowed for some arithmetical operation are exceeded. It will occur upon an ADD or SUB instruction if the resultant field has more digits than either of the data fields in memory and storage, and when a carry beyond the high-order position results from the execution of a RND instruction. It also indicates a violation of the Absolute Value Rule of division. Furthermore, it may also occur when special characters, the numerical value of whose bit structure exceeds 9, are brought into storage by an RAD or RSU instruction.

As the Overflow Check presents a wholly different console picture when it occurs upon a DIV instruction, this case will be treated separately below.

1. REGULAR OVERFLOW CHECK

As explained above this will usually occur upon execution of ADD, SUB, or RND instructions.

CONSOLE PICTURE (1)

MAC-I: High-order position of the field in memory addressed less one, upon ADD or SUB instructions; 19,999 upon a RND instruction.

MAC-II: Not involved

CR-1: No bits

CR-2: Character in storage displaced by the new storage mark.

The 0904 Overflow Check Indicator light is lit.

CORRECTIVE ACTION (1)

The correct result of the operation producing the Overflow Check appears in storage. Occurrence of an Overflow usually indicates that the program has not worked out as anticipated, during debugging. In that case, it will usually be most effective, in the long run, to print out memory and get off the machine.

During production the occurrence of an Overflow Check may be indicative of the fact that predetermined numerical limits in data fields have been exceeded. In such a case, the operator may, depending on his instructions and judgment, decide to identify the record by displaying it and then continue operation. Upon a Regular Overflow Check, the 705 always stops at the end of E-time, and the program may be continued, starting with the next instruction, by depressing the Start key.

2. OVERFLOW CHECK UPON DIV

This will only occur when the Absolute Value Rule of division has been violated. The Absolute Value Rule provides that the divisor shall be numerically greater than the same number of high-order positions of the dividend. It is important to note that when the Absolute Value Rule is violated, and the 0904 Check Indicator switch is at "Automatic", the 705 will stop. Upon violation of the Absolute Value Rule, the 705 will continue operation, turning on the Overflow Indicator light and putting a single zero into the accumulator, only if the 0904 Overflow Check Indicator switch has been set to "Program".

CONSOLE PICTURE (2)

MAC-I: The address of the DIV instruction

MAC-II: Not involved

- CR-1: No bits
- CR-2: Units position of an intermediate result then in
the accumulator.*

The 0904 Overflow Check Indicator is lit.

CORRECTIVE ACTION (2)

The dividend appearing in storage before start of the DIV instruction has been destroyed. Furthermore, violation of the Absolute Value Rule of division usually indicates a basic error in program or data. Therefore, it will usually be best to print out memory and get off the machine.

If, in a particular case, the programmer desires to continue operation, the following should be noted:

If the operator, immediately upon occurrence of the Overflow Check stop, presses the Start button, the 705 will continue operation leaving at the end of the DIV instruction a single zero in the accumulator. If the operator, however, displays the contents of storage or manually stores and/or instructs, and then presses the Start key, the intermediate result contained in the accumulator upon the Overflow Check stop will persist. (Manual displaying, storing, or instructing forces the end of execution time.)

F. 0905 SIGN CHECK

CAUSE

A Sign Check is caused whenever an arithmetic instruction addresses an unsigned field in memory. A field is said to be unsigned if the units position of such a field has no zoning or a zero zone, in other words, if it does not have a plus or minus zoning. (Plus or minus zoning have in common that both contain a B bit.)

CONSOLE PICTURE

In order to understand the Console Picture more easily, one must realize that whenever a Sign Check occurs the 705 stops at the end of the execution of the next character cycle after the unsigned character has been recognized.

- MAC-I: Memory position addressed less one. (Thus MAC-I will always be less by one than MAR.)

*The intermediate result then in the accumulator is the tens complement of the remainder obtained when subtracting 10 times the divisor (herein assumed to have n positions) from the n + 1 high-order positions of the dividend.

- MAC-II: Not involved
- CR-1: Character in the memory location shown in MAC-I.
- CR-2: Second character in the storage unit addressed. There are exceptions. Thus, on a DIV instruction, CR-2 will show the second high-order position of the dividend. The other exception is the MPY instruction.

The 0905 Sign Check Indicator light is lit.

CORRECTIVE ACTION

For planning proper remedial action the following must be clearly understood:

As stated above, the 705 stops after completing the next execution character cycle after the unsigned character has been recognized. If the Start button is depressed after the 705 has stopped upon a Sign Check, automatic operation resumes with the same execution character cycle of the current instruction, and, therefore, this execution character cycle is repeated. In the case of a RAD, RSU, ADD, or SUB instruction, it is the second execution character cycle which is being repeated.

It follows, therefore, that it is possible to simply depress the Start button after an 0905 Sign Check has occurred during execution of a RAD or RSU instruction. The correct field will then be brought into storage, as repetition of the second character cycle only means in that case that the character in the tens position is displaced by the same character. Whenever operation is continued after an 0905 Sign Check, the 705 assumes that the unsigned field was signed plus.

A DIV instruction will yield the correct result, if, upon a 0905 Sign Check, operation is continued by simply depressing the Start key, but it should be noted that manual display, store, or instruct operations will force the end of E-time leaving in the accumulator a field different from the original dividend, and an incorrect result of division. Under such circumstances, to resume operation, it is necessary to transfer back to the instruction which originally brought the dividend into storage.

In an ADD or SUB instruction, the repetition of the second character cycle will almost invariably cause an erroneous result, and therefore, in all those cases operation should not be continued by merely pressing the Start button. As the first two execution character cycles have been completed, contents of accumulator or ASU storage have already been changed, and thus it becomes necessary to transfer back to the instruction at which the present contents of

storage were originally brought into the relevant storage unit.

If an 0905 Sign Check is incurred upon a MPY instruction, depression of the Start key will render an incorrect result and the multiplier is no longer intact in the accumulator. To resume operation, it is necessary to transfer back to the instruction which originally brought the multiplier into storage.

Extreme care should be exercised when transferring back to the instruction by which the present contents of the relevant storage unit were originally brought into such storage unit. In such a case, a number of unrelated but intervening instructions may also be repeated. If any of these intervening instructions are ADM instructions or operations in other storage units, such as additions to counters, their repetition is liable to cause incorrect results.

NOTES:

1. The RCV instruction for high-speed transmission does require a 4 or 9 in the units position of the address. If this requirement is not satisfied, an Instruction Check will, of course, not result, as only the subsequent TMT instruction indicates whether serial or high-speed transmission is involved. Violation of this rule will usually entail transmission of jumbled records.
2. Instructions requiring moving of the Starting Point Counter can only be executed in the accumulator as the Starting Point Counters of the ASU's are fixed. The instructions involved are the LNG, SHR, RND, MPY and DIV instructions.

If any of these instructions should stipulate an ASU by zoning over the tens or hundreds position of its address, contents of the accumulator, the selected ASU, and an adjoining ASU are usually impaired without leaving in storage the desired result of the operation. Furthermore, the MPY instruction will not end E-time without intervention from the Console.

APPENDIX

MISCELLANEOUS OPERATING NOTES

A. USE OF THE MACHINE STOP AND RESET KEYS

Whenever cessation of automatic operation is desired, the Manual Stop button, which takes effect at the end of Execution Time, should be depressed. In the following cases, Execution Time will continue indefinitely, and it is therefore necessary to use the Machine Stop button, which will terminate the Automatic status at the end of the current character cycle:

- a If the 705 hangs up in Automatic status:
 - 1. I/O No Response Stop
 - 2. Control Error Stop
- b During execution of the following instruction under conditions stated:
 - 1. WR or WRE without group mark in memory.
 - 2. LOD without storage mark (during a B-V-8 routine) and CMP without storage mark (during a B-V-4 routine).
 - 3. TMT (00) without record mark in any memory location the units position of which is a 4 or 9.
 - 4. RD if there is no inter-record gap on the tape unit being read (a very rare occurrence); etc.

Whenever the Machine Stop key is depressed, the end of execution time is forced in the Console, but Input/Output units may still continue in the RD or WR status in which they were put by the current instruction. Similarly, if the Machine Stop was depressed while some tape unit was in the special select status induced by a RWW instruction, then such depression of the Machine Stop will not terminate this special select status. Under any of these conditions, the Reset Key should be depressed after depression of the Machine Stop key.

As has been noted in Part I of this manual, if anyone of certain Check Indicators (0902-0905) is turned on, while the relevant Check Indicator switch is set to "AUTOMATIC", it will not permit MAC-I to step. In these cases, if it is desired to manually execute instructions which require MAC-I to step (does not include a single transfer instruction), the Reset Key should also be depressed or the relevant Check Indicator switch should be set to "PROGRAM".

For the learning or inexperienced console operator, it may be best and simplest to observe the following rule until additional experience is acquired:

Whenever the Machine Stop key is depressed or whenever a Check Indicator stop occurs, depress the Reset Key and transfer manually to the instruction at which resumption of automatic operation is desired. Make sure, however, that you have noted the contents of the registers and counters needed, before depressing the Reset Key as the Reset Key will reset the Instruction Counter to 0004. If it is intended, upon occurrence of a Check Indicator stop, to half multiple step through subsequent instructions, the Reset Key should not be depressed.

B. THE ANY INDICATOR

The Any Indicator of the 705 is activated by the Check Indicator switches and End-of-File conditions only. It operates in the following manner:

TURNING ON

CHECK INDICATORS

The Any Indicator is turned on by the very act of the turning on of a Check Indicator. In no other way will a Check Indicator activate the Any Indicator. For instance, if a Check Indicator has been "ON" and is being interrogated, the act of interrogation will not turn on the Any Indicator.

END-OF-FILE

The Any Indicator is turned on at the end of a RD, WR, or WRE instruction if the I/O Indicator of the same Input/Output unit is "ON". The I/O Indicator may have been turned on during the execution of the current instruction or during the execution of some prior instruction directed to the same Input-Output unit. (It is noted that, in this case, only the execution of a RD, WR, or WRE instruction can activate the Any Indicator.)

Therefore, the Any Indicator is not turned on by:

1. A control instruction directed to an Input-Output unit which has an I/O Indicator turned on.
2. The mere fact that there exists in the installation an Input-Output unit which is on line and which has its I/O Indicator still turned on from some prior RD or WR instruction.
3. Addressing a RD, WR, or WRE instruction to an Input-Output unit other than the one whose I/O Indicator is still turned on.

TURNING OFF

The TRA instruction will turn off the Any Indicator. It is also turned off by a depression of the Start, Reset, or Clear Memory keys.

C. MEMORY SEARCH FOR REDUNDANT CHARACTERS--B-V-8

In most cases when a redundancy occurs, the location of the redundant character in memory or storage is clearly indicated by MAC-I. When writing a redundant record in memory or reading a redundant record from tape or drum, the location of the redundant record in memory will, however, not be known. If the record is short, it may, of course, be displayed; but if it consists of a large number of characters, manual displaying will be exceedingly inefficient. It is for this type of contingency that the following method is used:

The following instructions are carried out with the 0901 Machine Check Indicator set to "AUTOMATIC":

1. SET 0000
2. SET 0256
3. MPY 0256
4. LOD 0256

The first two of these instructions assure that all characters in the accumulator are numerical (zeros) and that the Storage Mark will be over the Starting Point Counter. The MPY instruction destroys the Storage Mark, and the LOD instruction causes a continuous loading of the characters in memory into the accumulator. As soon as a redundant character is sensed, the 705 stops with the redundant character displayed in CR-1 and its location shown in MAC-I (0901 Machine Check; Regular CR-1 Code Check).

The proper character, if known, or some arbitrary but suitable character* should be manually stored at the memory position indicated by MAC-I, and then the same above set of four instructions should be executed in order to locate additional redundant characters, if any. The SET 0000 instruction has now the additional function of clearing the redundant character out of the accumulator.

The above routine should be repeated until memory is found to circulate freely through the accumulator without sensing any further redundant characters. The continuous LOD instruction can only be stopped by depressing the Machine Stop Key.

*Storing of an arbitrary character, of course, does not apply to instructions but only to data. A note of the record changed should be made.

If it is then intended to continue with the instruction located in the Instruction Counter, it is only necessary to press the Start button. Otherwise, manual transfer to the desired instruction is necessary.

One special case should be noted. If the redundant character should happen to be loaded into the accumulator position just above the Starting Point Counter, an 0901 Machine Check will result upon execution of the SET 0000 instruction after the proper character has been manually stored in memory. The 0901 Machine Check, in this case, is a "CR-1 and CR-2 Code Check upon SET, RND, and SHR". If that occurs, a second SET 0000 instruction eliminates the redundancy.

The above B-V-8 routine can be programmed advantageously as has been done in Sort 53 sorting program.

Before commencing the B-V-8, the contents of the accumulator must, of course, be temporarily unloaded in some unused memory area.

There is an alternative and faster routine, the B-V-4, which consists of the following instructions:

1. SET 0512
2. MPY 0512
3. CMP 0512

The SET 0512 assures that all characters in the accumulator are numerical (zeros). The function of the MPY 0512 is the same as the function of the MPY instruction in the B-V-8. The CMP 0512 will locate a redundant character anywhere in memory in just the same way as the LOD instruction of the B-V-8, as described above.

The advantage of the CMP instruction is that no character from memory will be moved into the accumulator, and thus there is no necessity to clear the accumulator of redundant characters which have been located by the routine. This saves the preliminary SET 0000 instruction of the B-V-8 and allows continued search, after the first execution of the above three instructions, by merely repeating the CMP 0512 instruction. For that reason, also, the special case mentioned in the B-V-8, when the redundant character is loaded into the accumulator position right over the Starting Point Counter, cannot happen in the B-V-4, and the delay associated with the additional 0901 Machine Check and the resulting manual manipulations is avoided.

Care should be taken in all cases in which a comparison preceded the execution of a B-V-4 routine, as this routine may obviously change the result of the prior comparison.

D. USE OF THE HALF-MULTIPLE STEP KEY

This Console Key, operation of which is explained in Part I, can be efficiently

used in the following ways:

1. To gauge the extent of a program loop from which the 705 cannot exit. This, of course, will only be used for short loops, otherwise, it is more efficient to use tracing or some other routine to monitor the program under operation.
2. It is sometimes efficient during program testing to put all Check Indicator switches to "AUTOMATIC", although error routines for some of the Check Indicators have been included in the program under operation. Whenever in such a case the 705 stops due to a Check Indicator stop for which an error routine has been programmed, it is usually considered desirable to continue operation by passing through the error routine programmed. If the Start Key is depressed, the Check Indicator light is turned out and the 705 will not transfer on signal and, therefore, will avoid the error routine. Resumption of operation with subsequent pass through the error routine is then effectively accomplished by depressing the Half-Multiple Step Key. As soon as the Check Indicator light is turned off, automatic operation can be resumed by depressing the Start button.
3. To monitor or trace any short sequences of instructions which seem to cause difficulties in the operation of a program.

PART III

HOW TO LOOK AT THE 705 CONSOLE

The following is intended as a guide for an inexperienced Console Operator. It is the result of experience in Console Operation and also parallels closely the above exposition of the various types of stops which may result during automatic operation.

Let us assume that the Console Operator for some reason believes that the 705 has stopped operation. He should first look at the Automatic (Green) and Manual (Red) lights on the Console to find out which is lit.

MANUAL

Say the Manual light is "ON", then we really know two things:

1. The machine has actually stopped.
2. There are only two types of stops which may occur:

A Programmed Stop or a Check Indicator Stop.

To find which of the two types of stops mentioned in 2 above has halted operation, look first at the Operation Decoder: If there is a "J" or "Stop" light on, then the 705 has come to a Program Stop. Next, look at MAR (Memory Address Register) for the stop number to identify the stop. The reason for the Program Stop and the necessary action to be taken should be listed in the Operator's Instructions. If an instruction other than a Program Stop is in the Operation Decoder, then look at the check indicators to determine which one is lit. If no Check Indicator is "ON", (lit), something irregular has happened: Call the Customer Engineer. If a Check Indicator is lit, however, identify which it is. 0900, the Instruction Check, is the only one which stops in I-time (Instruction Time). Ascertain the location of the instruction at which the 705 stopped by the actual number shown in the Instruction Counter. In all other cases, the 705 is in E-time, (Execution Time) and the location of the instruction at which the 705 stopped is the number indicated in the Instruction Counter less five. Other necessary information will depend to some extent on which particular Check Indicator is "ON", but in general, observe and make a note of the counters and registers which will identify uniquely the particular instruction at which the 705 stopped: Operation Decoder, Operation Register, Memory Address Register, and Storage Select Register. It is frequently essential to note the particular execution character cycle at which the stop occurred (although for some of the Check stops this is standard); for this purpose look at MAC-I, CR-1, and CR-2, and depending upon the instruction also at MAC-II. Information in the Select Register should usually be noted. To note the type of Check Indicator stop, as discussed under Console Conditions above, is, of course, of paramount importance. For all Console work, it is significant to note that

only three registers show the actual 7-bit structure of the character in memory or storage: Operation Register, CR-1, and CR-2. All other registers and counters except for the Storage Select Register, are merely interpretations of the 7-bit characters in memory.

AUTOMATIC

Now let us assume that the Automatic Indicator is still lit, although the Console Operator believes that the machine has stopped: Then any of the following three conditions may prevail:

1. The machine is carrying out an instruction which is never ending and where the end of execution time cannot be reached.
2. The machine is continuously going through a program loop.
3. The 705 has hung up in AUTOMATIC on an I/O No Response or on a Control Error.

The first condition is usually very easy to recognize, for instance, a high-speed transmission of a record not limited by a record mark in a memory location ending in 4 or 9, will cause MAC-I and MAC-II to continuously wrap around memory. Similarly, a continuous LOD instruction of a BV 8, when no redundancy exists in memory, can be recognized by MAC-I moving through all possible memory positions. In such a case, of course, the 705 has not hung up, and it is up to the operator to depress the Machine Stop key and Reset key in succession, and then to decide upon his next step according to the program.

The existence of a program loop is much harder to spot. A large loop, consisting of many instructions, cannot be recognized unless the 705 program is operating under control of a tracing program and the recurrence of the same transfers in equal intervals is noted, or if the 705 program incorporates some editing routine which types out certain messages or symbols at frequent and more or less equal intervals on the typewriter. As a matter of fact, if the program is in a large loop, the operator would never receive the impression that the 705 has hung up.

If the program is in a small loop, then at least the Instruction Counter and MAC-I will show several lights for the same digit rather faintly lit; that means that the Instruction Counter and MAC-I are flickering too fast for the human eye to discern. If the loop consists of more than one instruction, then the same flickering effect will also exist in the Operation Decoder, the Operation Register, the Memory Address Register, and CR-1. To gauge the extent of a program loop, the operator will frequently find the use of the Half-Multiple Step key very effective. If the operator is satisfied that the program will not exit from the loop, he should, of course, depress the manual stop and then take action according to the instructions given to him regarding the program under operation. (A special case of a loop is the MPY instruction with ASU zoning in which case the 705 gets into a never ending loop within E-time

of the MPY instruction.)

After the operator feels certain that he has actually hung up, he should look at the I/O No Response lights. If either one or both of these lights are "ON", a No Response condition exists, and this should be borne out by a RD, WR, or WRE instruction in the Operation Decoder and Operation Register.

If a No Response condition is NOT found to exist the next place to look is the Operation Decoder or the Operation Register. Should a CTRL (3) instruction be shown, then it is clear that we are dealing with a Control Error.

Assuming that the operator has gone through the above steps and is sure that he is dealing neither with a I/O No Response nor with a Control Error, he should once again examine the possibility that the 705 is in a never ending loop. If he is satisfied that this is not the case, he should notify the Customer Engineer.

It should be noted that as an operator acquires experience and depending on whether he is debugging or running a program for production, the above sequence of looking at the console may, of course, be varied. For instance, when a program is fully checked out, the most frequent stop, is a Program Stop and will usually be the one which the operator will expect. In general, it may be said, however, that the above sequence of looking at the console in case of the machine hanging up or stopping, is efficient and will, in addition, systematically acquaint the operator with all possible stops and error conditions and will increase his proficiency. As an additional aid to the beginning operator, schematics of the console as used in the Console Exercises may be provided for making a record of error conditions encountered. Once experience is acquired, this procedure, of course, will be discontinued as unnecessary and too time consuming.

PART IV
CONSOLE EXERCISES

11 10 01 00
0001 A J / 1
NO OP STOP TR

0010 B O S 2
SET L TR HI R W SEL

0011 C L T 3
SHOR TR SIGN CTRL

0100 D M U 4
LENG TR RCV COMP PLS

0101 E N V 5
ROUND TR MPY ST PR ZRO

0110 F O W 6
STORE TR DIV ADD MEM

0111 G P X 7
ADD SUB NORM UN TR LOAD

1000 H Q Y 8
R ADD R SUB READ LOAD

1001 I R Z 9
TR WRITE WR TSM T ANY TR

OPERATION DECODER

10000 1000 100 10 1
MEMORY ADDRESS REGISTER

10000 1000 100 10 1
INSTRUCTION COUNTER

10000 1000 100 10 1
MEMORY ADDRESS COUNTER 1

10000 1000 100 10 1
MEMORY ADDRESS COUNTER 11

CLEAR MEMORY POWER DC ON MASTER OFF
POWER ON NORM OFF DC ON DC OFF

INSTR MACH
CR 1 CODE CHECK CR 1 CODE CHECK

4 OR 9 CHK CR 2 CODE CHK
OP CHECK

C B A 8 4 2 1
MEMORY DISPLAY CR 1

C B A 8 4 2 1
STORAGE DISPLAY CR 2

8 4 2 1
SELECT REGISTER

8 4 2 1
SSR

READ WRITE ACC AUX
1/0 NO RESPONSE STORAGE SIGN (-)

STORAGE SELECTOR

STORAGE SELECTOR

8 4 2 1
00

9 9 9 9
8 8 8 8
7 7 7 7
6 6 6 6
5 5 5 5
4 4 4 4
3 3 3 3
2 2 2 2
1 1 1 1
0 0 0 0

10000 1000 100 10 1

C B A 8 4 2 1
OPERATION REGISTER

OFF						PROGRAM CONTROL					
						INSTR	MACH	READ	REC	OV	SIGN
0911	0912	0913	0914	0915	0916	0900	0901	0902	0903	0904	0905
						WRITE	FLW				
ON						AUTOMATIC					
PROGRAM ALTERATION						CHECK INDICATORS					

MACH STOP IN STRUCT STORE
HALF MULT STEP IN STRUCT STORE

MANUAL DISPLAY
START STOP DISPLAY DISPLAY STEP RESET

A B C D E F G H I J K L M N O P Q R S T U V W X Y Z

SHIFT 1 2 3 4 5 6 7 8 9 0 RESTORE

11 10 01 00
0001 A J / 1
NO OP STOP TR

0010 B O S 2
SET L TR HI R W SEL

0011 C L T 3
SHOR TR SIGN CTRL

0100 D M U 4
LENG TR RCV COMP PLS

0101 E N V 5
ROUND TR MPY ST PR ZRO

0110 F O W 6
STORE TR DIV ADD MEM

0111 G P X 7
ADD SUB NORM UN TR LOAD

1000 H Q Y 8
R ADD R SUB READ LOAD

1001 I R Z 9
TR WRITE WR TSM T ANY TR

OPERATION DECODER

10000 1000 100 10 1
MEMORY ADDRESS REGISTER

10000 1000 100 10 1
INSTRUCTION COUNTER

10000 1000 100 10 1
MEMORY ADDRESS COUNTER 1

10000 1000 100 10 1
MEMORY ADDRESS COUNTER 11

CLEAR MEMORY POWER DC ON MASTER OFF
POWER ON NORM OFF DC ON DC OFF

INSTR MACH
CR 1 CODE CHECK CR 1 CODE CHECK

4 OR 9 CHK CR 2 CODE CHK
OP CHECK

C B A 8 4 2 1
MEMORY DISPLAY CR 1

C B A 8 4 2 1
STORAGE DISPLAY CR 2

8 4 2 1
SELECT REGISTER

8 4 2 1
SSR

READ WRITE ACC AUX
1/0 NO RESPONSE STORAGE SIGN (-)

STORAGE SELECTOR

STORAGE SELECTOR

8 4 2 1
00

9 9 9 9
8 8 8 8
7 7 7 7
6 6 6 6
5 5 5 5
4 4 4 4
3 3 3 3
2 2 2 2
1 1 1 1
0 0 0 0

10000 1000 100 10 1

C B A 8 4 2 1
OPERATION REGISTER

OFF						PROGRAM CONTROL					
						INSTR	MACH	READ	REC	OV	SIGN
0911	0912	0913	0914	0915	0916	0900	0901	0902	0903	0904	0905
						WRITE	FLW				
ON						AUTOMATIC					
PROGRAM ALTERATION						CHECK INDICATORS					

MACH STOP IN STRUCT STORE
HALF MULT STEP IN STRUCT STORE

MANUAL DISPLAY
START STOP DISPLAY DISPLAY STEP RESET

A B C D E F G H I J K L M N O P Q R S T U V W X Y Z

SHIFT 1 2 3 4 5 6 7 8 9 0 RESTORE

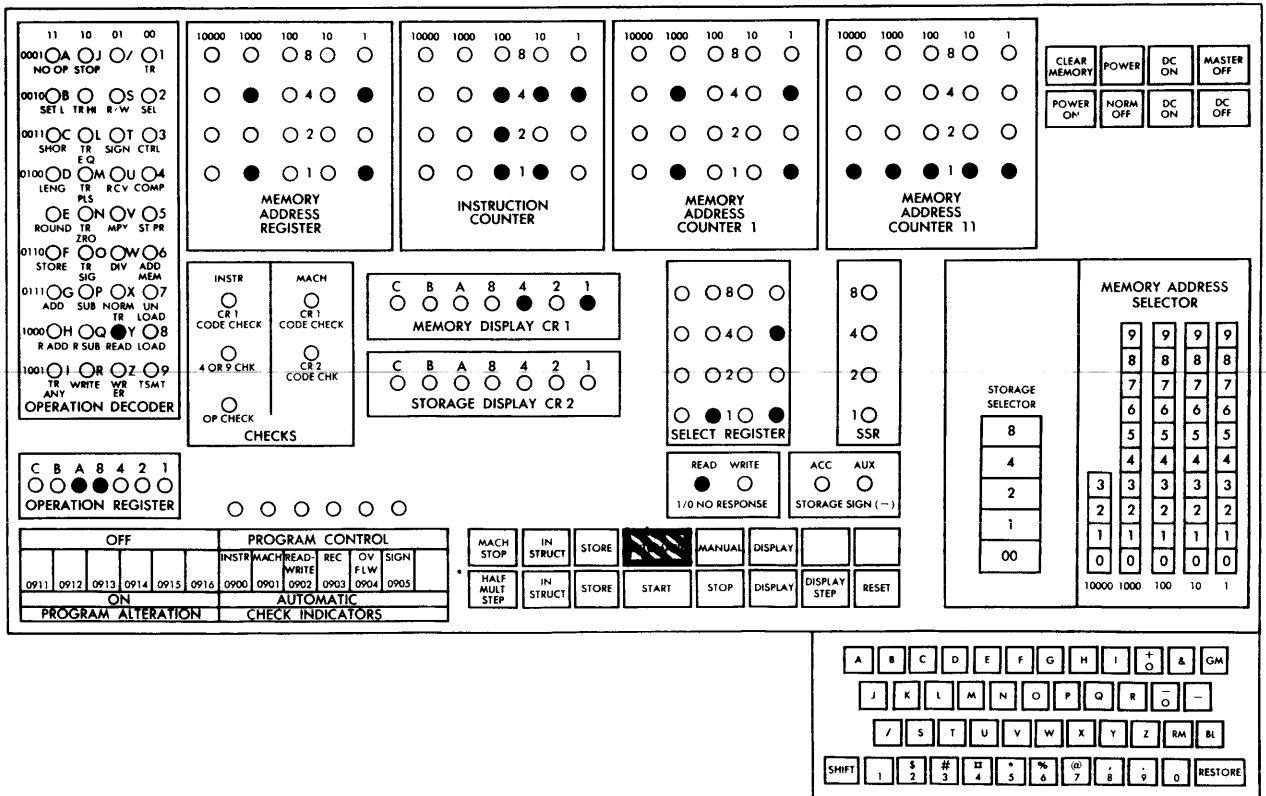
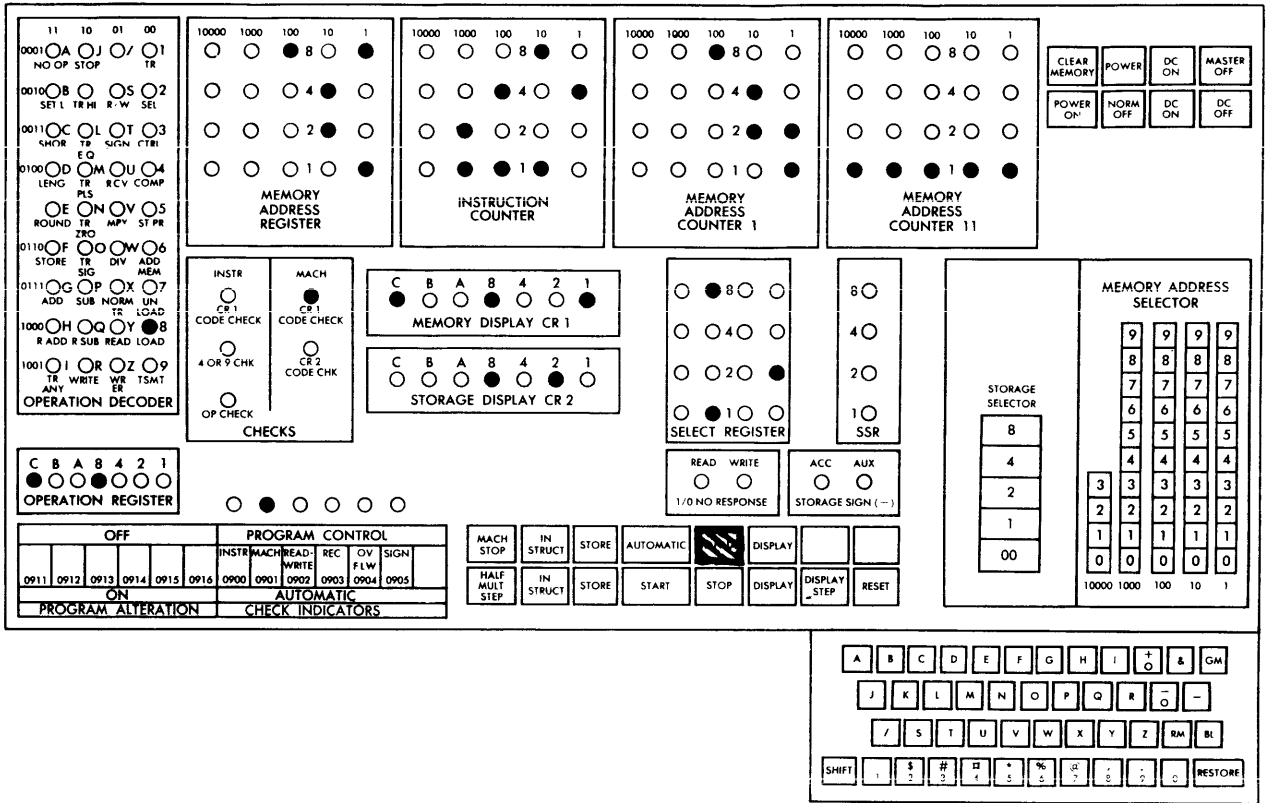

Control panel for page 5. It features several registers and displays:

- Operation Decoder:** A vertical column of 12 switches labeled 0001 through 1001, each with a specific function like 'NO OP STOP', 'SET L TR HI R W SEL', etc.
- Memory Address Register:** A 4-bit register with bits 1000, 1000, 100, 10, 1.
- Instruction Counter:** A 4-bit counter with bits 1000, 1000, 100, 10, 1.
- Memory Address Counter 1:** A 4-bit counter with bits 1000, 1000, 100, 10, 1.
- Memory Address Counter 11:** A 4-bit counter with bits 1000, 1000, 100, 10, 1.
- Checks:** A section with 'INSTR' and 'MACH' code check buttons, and '4 OR 9 CHK' and 'CR 2 CODE CHK' buttons.
- Memory Display CR 1:** A 4-bit display with bits C, B, A, 8, 4, 2, 1.
- Storage Display CR 2:** A 4-bit display with bits C, B, A, 8, 4, 2, 1.
- Select Register:** A 3-bit register with bits 8, 4, 2, 1.
- SSR:** A 3-bit register with bits 8, 4, 2, 1.
- Memory Address Selector:** A 4x4 grid of buttons for selecting memory addresses, with a 'STORAGE SELECTOR' section below it.
- Operation Register:** A 5-bit register with bits C, B, A, 8, 4, 2, 1.
- Program Control:** A table with columns for 'OFF', 'PROGRAM CONTROL', and 'ON', with sub-columns for 'PROGRAM ALTERATION' and 'CHECK INDICATORS'.
- Control Buttons:** A row of buttons including 'MACH STOP', 'IN STRUCT', 'STORE', 'AUTOMATIC', 'DISPLAY', 'RESET', etc.

Control panel for page 6. It features several registers and displays:

- Operation Decoder:** A vertical column of 12 switches labeled 0001 through 1001, each with a specific function like 'NO OP STOP', 'SET L TR HI R W SEL', etc.
- Memory Address Register:** A 4-bit register with bits 1000, 1000, 100, 10, 1.
- Instruction Counter:** A 4-bit counter with bits 1000, 1000, 100, 10, 1.
- Memory Address Counter 1:** A 4-bit counter with bits 1000, 1000, 100, 10, 1.
- Memory Address Counter 11:** A 4-bit counter with bits 1000, 1000, 100, 10, 1.
- Checks:** A section with 'INSTR' and 'MACH' code check buttons, and '4 OR 9 CHK' and 'CR 2 CODE CHK' buttons.
- Memory Display CR 1:** A 4-bit display with bits C, B, A, 8, 4, 2, 1.
- Storage Display CR 2:** A 4-bit display with bits C, B, A, 8, 4, 2, 1.
- Select Register:** A 3-bit register with bits 8, 4, 2, 1.
- SSR:** A 3-bit register with bits 8, 4, 2, 1.
- Memory Address Selector:** A 4x4 grid of buttons for selecting memory addresses, with a 'STORAGE SELECTOR' section below it.
- Operation Register:** A 5-bit register with bits C, B, A, 8, 4, 2, 1.
- Program Control:** A table with columns for 'OFF', 'PROGRAM CONTROL', and 'ON', with sub-columns for 'PROGRAM ALTERATION' and 'CHECK INDICATORS'.
- Control Buttons:** A row of buttons including 'MACH STOP', 'IN STRUCT', 'STORE', 'AUTOMATIC', 'DISPLAY', 'RESET', etc.

Alphanumeric keypad for page 6. It includes a grid of letters A-Z, numbers 0-9, and special keys like 'SHIFT', 'RESTORE', and 'GM'.

OPERATION DECODER

11	10	01	00
0001	0A	0J	0/01
NO OP STOP TR			
0010	0B	0S	02
SET L TR HI R-W SEL			
0011	0C	0L	0T
SHOR TR SIGN CTRL EQ			
0100	0D	0M	0U
LENG TR RCV COMP PLS			
0101	0E	0N	0V
ROUND TR MPY ST PR ZRO			
0110	0F	0O	0W
STORE TR SIG DIV ADD MEM			
0111	0G	0P	0X
ADD SUB NORM UN TR LOAD			
1000	0H	0Q	0Y
R ADD R SUB READ LOAD			
1001	0I	0R	0Z
TR WRITE WR TSM T ANY			

MEMORY ADDRESS REGISTER

INSTR COUNTER

MEMORY ADDRESS COUNTER 1

MEMORY ADDRESS COUNTER 11

OPERATION REGISTER

C	B	A	B	4	2	1
●	●	●	●	●	●	●

PROGRAM CONTROL

OFF	PROGRAM CONTROL										
0911	0912	0913	0914	0915	0916	0900	0901	0902	0903	0904	0905
ON						AUTOMATIC					
PROGRAM ALTERATION						CHECK INDICATORS					

SELECT REGISTER

SSR

MEMORY DISPLAY CR 1

STORAGE DISPLAY CR 2

CHECKS

STORAGE SIGN (-)

MEMORY ADDRESS SELECTOR

9	9	9	9
8	8	8	8
7	7	7	7
6	6	6	6
5	5	5	5
4	4	4	4
3	3	3	3
2	2	2	2
1	1	1	1
0	0	0	0

STORAGE SELECTOR

8
4
2
1
00

CONTROL PANEL

MACH STOP	IN STRUCT	STORE	AUTOMATIC	MANUAL	DISPLAY		
HALF MULT STEP	IN STRUCT	STORE	START	STOP	DISPLAY	DISPLAY STEP	RESET

POWER CONTROLS

CLEAR MEMORY	POWER ON	DC ON	MASTER OFF
POWER ON	NORM OFF	DC ON	DC OFF

OPERATION DECODER

11	10	01	00
0001	0A	0J	0/01
NO OP STOP TR			
0010	0B	0S	02
SET L TR HI R-W SEL			
0011	0C	0L	0T
SHOR TR SIGN CTRL EQ			
0100	0D	0M	0U
LENG TR RCV COMP PLS			
0101	0E	0N	0V
ROUND TR MPY ST PR ZRO			
0110	0F	0O	0W
STORE TR SIG DIV ADD MEM			
0111	0G	0P	0X
ADD SUB NORM UN TR LOAD			
1000	0H	0Q	0Y
R ADD R SUB READ LOAD			
1001	0I	0R	0Z
TR WRITE WR TSM T ANY			

MEMORY ADDRESS REGISTER

INSTR COUNTER

MEMORY ADDRESS COUNTER 1

MEMORY ADDRESS COUNTER 11

OPERATION REGISTER

C	B	A	B	4	2	1
●	●	●	●	●	●	●

PROGRAM CONTROL

OFF	PROGRAM CONTROL										
0911	0912	0913	0914	0915	0916	0900	0901	0902	0903	0904	0905
ON						AUTOMATIC					
PROGRAM ALTERATION						CHECK INDICATORS					

SELECT REGISTER

SSR

MEMORY DISPLAY CR 1

STORAGE DISPLAY CR 2

CHECKS

STORAGE SIGN (-)

MEMORY ADDRESS SELECTOR

9	9	9	9
8	8	8	8
7	7	7	7
6	6	6	6
5	5	5	5
4	4	4	4
3	3	3	3
2	2	2	2
1	1	1	1
0	0	0	0

STORAGE SELECTOR

8
4
2
1
00

CONTROL PANEL

MACH STOP	IN STRUCT	STORE	AUTOMATIC	MANUAL	DISPLAY		
HALF MULT STEP	IN STRUCT	STORE	START	STOP	DISPLAY	DISPLAY STEP	RESET

POWER CONTROLS

CLEAR MEMORY	POWER ON	DC ON	MASTER OFF
POWER ON	NORM OFF	DC ON	DC OFF

OPERATION DECODER

11 10 01 00
 0001 A J / 1
 NO OP STOP TR
 0010 B O S 2
 SET L TR HI R W SEL
 0011 C L T 3
 SHOR TR SIGN CTRL
 EQ
 0100 D M U 4
 LENG TR RCV COMP
 PLS
 0 E N O V 5
 ROUND TR M PY ST PR
 ZRO
 0110 F O W 6
 STORE TR DIV ADD
 SIG MEM
 0111 G P O X 7
 ADD SUB NORM UN
 TR LOAD
 1000 H Q Y 8
 R ADD R SUB READ LOAD
 1001 I R Z 9
 TR WRITE WR TSM T
 ANY ER

MEMORY ADDRESS REGISTER

10000 1000 100 10 1
 0 0 0 8 0 0
 0 0 0 4 0 0
 0 0 0 2 0 0
 0 0 0 1 0 0

INSTRUCTION COUNTER

10000 1000 100 10 1
 0 0 0 8 0 0
 0 0 0 4 0 0
 0 0 0 2 0 0
 0 0 0 1 0 0

MEMORY ADDRESS COUNTER 1

10000 1000 100 10 1
 0 0 0 8 0 0
 0 0 0 4 0 0
 0 0 0 2 0 0
 0 0 0 1 0 0

MEMORY ADDRESS COUNTER 11

10000 1000 100 10 1
 0 0 0 8 0 0
 0 0 0 4 0 0
 0 0 0 2 0 0
 0 0 0 1 0 0

CHECKS

INSTR MACH
 CR 1 CR 1
 CODE CHECK CODE CHECK
 4 OR 9 CHK CR 2
 OP CHECK CODE CHK

MEMORY DISPLAY CR 1

C B A B 4 2 1
 0 0 0 0 0 0

STORAGE DISPLAY CR 2

C B A B 4 2 1
 0 0 0 0 0 0

SELECT REGISTER

0 0 8 0
 0 0 4 0
 0 0 2 0
 0 0 1 0

SSR

8 0
 4 0
 2 0
 1 0

OPERATION REGISTER

C B A B 4 2 1
 0 0 0 0 0 0

PROGRAM CONTROL

OFF						PROGRAM CONTROL					
						INSTR	MACH	READ	REC	OV	SIGN
0911	0912	0913	0914	0915	0916	0900	0901	0902	0903	0904	0905
ON						AUTOMATIC					
PROGRAM ALTERATION						CHECK INDICATORS					

CONTROL PANEL

MACH STOP IN STRUCT STORE AUTOMATIC DISPLAY
 HALF MULT STEP IN STRUCT STORE START STOP DISPLAY DISPLAY STEP RESET

POWER CONTROLS

CLEAR MEMORY POWER DC ON MASTER OFF
 POWER ON NORM OFF DC ON DC OFF

STORAGE SELECTOR

8
 4
 2
 1
 00

MEMORY ADDRESS SELECTOR

9	9	9	9
8	8	8	8
7	7	7	7
6	6	6	6
5	5	5	5
4	4	4	4
3	3	3	3
2	2	2	2
1	1	1	1
0	0	0	0

10000 1000 100 10 1

A B C D E F G H I + & GM
 J K L M N O P Q R -
 / S T U V W X Y Z RM BL
 SHIFT 1 2 3 4 5 6 7 8 9 0 RESTORE

OPERATION DECODER

11 10 01 00
 0001 A J / 1
 NO OP STOP TR
 0010 B O S 2
 SET L TR HI R W SEL
 0011 C L T 3
 SHOR TR SIGN CTRL
 EQ
 0100 D M U 4
 LENG TR RCV COMP
 PLS
 0 E N O V 5
 ROUND TR M PY ST PR
 ZRO
 0110 F O W 6
 STORE TR DIV ADD
 SIG MEM
 0111 G P O X 7
 ADD SUB NORM UN
 TR LOAD
 1000 H Q Y 8
 R ADD R SUB READ LOAD
 1001 I R Z 9
 TR WRITE WR TSM T
 ANY ER

MEMORY ADDRESS REGISTER

10000 1000 100 10 1
 0 0 0 8 0 0
 0 0 0 4 0 0
 0 0 0 2 0 0
 0 0 0 1 0 0

INSTRUCTION COUNTER

10000 1000 100 10 1
 0 0 0 8 0 0
 0 0 0 4 0 0
 0 0 0 2 0 0
 0 0 0 1 0 0

MEMORY ADDRESS COUNTER 1

10000 1000 100 10 1
 0 0 0 8 0 0
 0 0 0 4 0 0
 0 0 0 2 0 0
 0 0 0 1 0 0

MEMORY ADDRESS COUNTER 11

10000 1000 100 10 1
 0 0 0 8 0 0
 0 0 0 4 0 0
 0 0 0 2 0 0
 0 0 0 1 0 0

CHECKS

INSTR MACH
 CR 1 CR 1
 CODE CHECK CODE CHECK
 4 OR 9 CHK CR 2
 OP CHECK CODE CHK

MEMORY DISPLAY CR 1

C B A B 4 2 1
 0 0 0 0 0 0

STORAGE DISPLAY CR 2

C B A B 4 2 1
 0 0 0 0 0 0

SELECT REGISTER

0 0 8 0
 0 0 4 0
 0 0 2 0
 0 0 1 0

SSR

8 0
 4 0
 2 0
 1 0

OPERATION REGISTER

C B A B 4 2 1
 0 0 0 0 0 0

PROGRAM CONTROL

OFF						PROGRAM CONTROL					
						INSTR	MACH	READ	REC	OV	SIGN
0911	0912	0913	0914	0915	0916	0900	0901	0902	0903	0904	0905
ON						AUTOMATIC					
PROGRAM ALTERATION						CHECK INDICATORS					

CONTROL PANEL

MACH STOP IN STRUCT STORE AUTOMATIC DISPLAY
 HALF MULT STEP IN STRUCT STORE START STOP DISPLAY DISPLAY STEP RESET

POWER CONTROLS

CLEAR MEMORY POWER DC ON MASTER OFF
 POWER ON NORM OFF DC ON DC OFF

STORAGE SELECTOR

8
 4
 2
 1
 00

MEMORY ADDRESS SELECTOR

9	9	9	9
8	8	8	8
7	7	7	7
6	6	6	6
5	5	5	5
4	4	4	4
3	3	3	3
2	2	2	2
1	1	1	1
0	0	0	0

10000 1000 100 10 1

A B C D E F G H I + & GM
 J K L M N O P Q R -
 / S T U V W X Y Z RM BL
 SHIFT 1 2 3 4 5 6 7 8 9 0 RESTORE

OPERATION DECODER

11 10 01 00
0001 A J / 1
NO OP STOP TR

0010 B O S 2
SET L TR HI R W SEL

0011 C L O T 3
SHOR TR SIGN CTRL F Q

0100 D M U 4
LENG TR RCV COMP PLS

0101 E N O V 5
ROUND TR MPY ST PR ZRO

0110 F O W 6
STORE TR DIV ADD MEM SIG

0111 G O P X 7
ADD SUB NORM UN TR LOAD

1000 H O Q Y 8
R ADD R SUB READ LOAD

1001 I O R Z 9
TR WRITE WR / TSMT ANY

OPERATION REGISTER

C B A 8 4 2 1
● ● ● ● ● ●

PROGRAM CONTROL

OFF						PROGRAM CONTROL					
INSTR	MACH	READ	REC	OV	SIGN	INSTR	MACH	STORE	AUTOMATIC	DISP	DISP
0911	0912	0913	0914	0915	0916	0900	0901	0902	0903	0904	0905
ON						AUTOMATIC					
PROGRAM ALTERATION						CHECK INDICATORS					

MEMORY ADDRESS REGISTER

10000 1000 100 10 1
● ● ● ● ●

INSTRUCTION COUNTER

10000 1000 100 10 1
● ● ● ● ●

MEMORY ADDRESS COUNTER 1

10000 1000 100 10 1
● ● ● ● ●

MEMORY ADDRESS COUNTER 11

10000 1000 100 10 1
● ● ● ● ●

CHECKS

INSTR MACH
CR 1 CODE CHECK CR 1 CODE CHECK

4 OR 9 CHK CR 2 CODE CHK

OP CHECK

MEMORY DISPLAY CR 1

C B A 8 4 2 1
● ● ● ● ●

STORAGE DISPLAY CR 2

C B A 8 4 2 1
● ● ● ● ●

SELECT REGISTER

8 4 2 1
● ● ● ●

SSR

8 4 2 1
● ● ● ●

STORAGE SELECTOR

8 4 2 1 00

MEMORY ADDRESS SELECTOR

9 9 9 9
8 8 8 8
7 7 7 7
6 6 6 6
5 5 5 5
4 4 4 4
3 3 3 3
2 2 2 2
1 1 1 1
0 0 0 0

10000 1000 100 10 1

POWER CONTROLS

CLEAR MEMORY POWER DC ON MASTER OFF
POWER ON NORM OFF DC ON DC OFF

ALPHANUMERIC KEYPAD

A B C D E F G H I + & GM
J K L M N O P Q R - -
/ S T U V W X Y Z RM BL
SHIFT 1 2 3 4 5 6 7 8 9 0 RESTORE

OPERATION DECODER

11 10 01 00
0001 A J / 1
NO OP STOP TR

0010 B O S 2
SET L TR HI R W SEL

0011 C L O T 3
SHOR TR SIGN CTRL F Q

0100 D M U 4
LENG TR RCV COMP PLS

0101 E N O V 5
ROUND TR MPY ST PR ZRO

0110 F O W 6
STORE TR DIV ADD MEM SIG

0111 G O P X 7
ADD SUB NORM UN TR LOAD

1000 H O Q Y 8
R ADD R SUB READ LOAD

1001 I O R Z 9
TR WRITE WR / TSMT ANY

OPERATION REGISTER

C B A 8 4 2 1
● ● ● ● ● ●

PROGRAM CONTROL

OFF						PROGRAM CONTROL					
INSTR	MACH	READ	REC	OV	SIGN	INSTR	MACH	STORE	AUTOMATIC	DISP	DISP
0911	0912	0913	0914	0915	0916	0900	0901	0902	0903	0904	0905
ON						AUTOMATIC					
PROGRAM ALTERATION						CHECK INDICATORS					

MEMORY ADDRESS REGISTER

10000 1000 100 10 1
● ● ● ● ●

INSTRUCTION COUNTER

10000 1000 100 10 1
● ● ● ● ●

MEMORY ADDRESS COUNTER 1

10000 1000 100 10 1
● ● ● ● ●

MEMORY ADDRESS COUNTER 11

10000 1000 100 10 1
● ● ● ● ●

CHECKS

INSTR MACH
CR 1 CODE CHECK CR 1 CODE CHECK

4 OR 9 CHK CR 2 CODE CHK

OP CHECK

MEMORY DISPLAY CR 1

C B A 8 4 2 1
● ● ● ● ●

STORAGE DISPLAY CR 2

C B A 8 4 2 1
● ● ● ● ●

SELECT REGISTER

8 4 2 1
● ● ● ●

SSR

8 4 2 1
● ● ● ●

STORAGE SELECTOR

8 4 2 1 00

MEMORY ADDRESS SELECTOR

9 9 9 9
8 8 8 8
7 7 7 7
6 6 6 6
5 5 5 5
4 4 4 4
3 3 3 3
2 2 2 2
1 1 1 1
0 0 0 0

10000 1000 100 10 1

POWER CONTROLS

CLEAR MEMORY POWER DC ON MASTER OFF
POWER ON NORM OFF DC ON DC OFF

ALPHANUMERIC KEYPAD

A B C D E F G H I + & GM
J K L M N O P Q R - -
/ S T U V W X Y Z RM BL
SHIFT 1 2 3 4 5 6 7 8 9 0 RESTORE

Control panel for page 13. It includes an OPERATION DECODER with 12 buttons (0001-1001) and their functions. Four 4-bit registers (MEMORY ADDRESS REGISTER, INSTRUCTION COUNTER, MEMORY ADDRESS COUNTER 1, MEMORY ADDRESS COUNTER 11) are shown with their bit patterns. MEMORY DISPLAY CR 1 and STORAGE DISPLAY CR 2 are 4-bit displays. A SELECT REGISTER and SSR are also present. The bottom section contains PROGRAM CONTROL and CHECK INDICATORS, along with a keyboard.

OPERATION DECODER:

- 0001: NO OP STOP
- 0010: SET L TR HI R W SEL
- 0011: SHOR TR SIGN CTRL
- 0100: LENG TR RCV COMP
- 0101: ROUND TR MPY ST PR
- 0110: STORE TR SIG DIV ADD MEM
- 0111: ADD SUB NORM UN TR LOAD
- 1000: R ADD R SUB READ LOAD
- 1001: TR WRITE WR TSM T ANY ER

Registers and Displays:

- MEMORY ADDRESS REGISTER: 1000 1000 100 10 1 (bits 8, 4, 2, 1)
- INSTRUCTION COUNTER: 10000 1000 100 10 1 (bits 8, 4, 2, 1)
- MEMORY ADDRESS COUNTER 1: 10000 1000 100 10 1 (bits 8, 4, 2, 1)
- MEMORY ADDRESS COUNTER 11: 10000 1000 100 10 1 (bits 8, 4, 2, 1)
- MEMORY DISPLAY CR 1: C B A 8 4 2 1
- STORAGE DISPLAY CR 2: C B A 8 4 2 1
- SELECT REGISTER: 8 4 2 1
- SSR: 8 4 2 1

PROGRAM CONTROL:

OFF	PROGRAM CONTROL										
0911	0912	0913	0914	0915	0916	0900	0901	0902	0903	0904	0905
ON				AUTOMATIC							
PROGRAM ALTERATION				CHECK INDICATORS							

Other Controls: CLEAR MEMORY, POWER ON/OFF, DC ON/OFF, MASTER OFF, MACH STOP, IN STRUCT, STORE, MANUAL, DISPLAY, STORAGE SIGN (-), READ WRITE, ACC AUX, STORAGE SIGN (-).

Control panel for page 14. It is identical to page 13, but the MEMORY ADDRESS REGISTER shows a different bit pattern: 1000 1000 100 10 1 (bits 8, 4, 2, 1).

OPERATION DECODER:

- 0001: NO OP STOP
- 0010: SET L TR HI R W SEL
- 0011: SHOR TR SIGN CTRL
- 0100: LENG TR RCV COMP
- 0101: ROUND TR MPY ST PR
- 0110: STORE TR SIG DIV ADD MEM
- 0111: ADD SUB NORM UN TR LOAD
- 1000: R ADD R SUB READ LOAD
- 1001: TR WRITE WR TSM T ANY ER

Registers and Displays:

- MEMORY ADDRESS REGISTER: 1000 1000 100 10 1 (bits 8, 4, 2, 1)
- INSTRUCTION COUNTER: 10000 1000 100 10 1 (bits 8, 4, 2, 1)
- MEMORY ADDRESS COUNTER 1: 10000 1000 100 10 1 (bits 8, 4, 2, 1)
- MEMORY ADDRESS COUNTER 11: 10000 1000 100 10 1 (bits 8, 4, 2, 1)
- MEMORY DISPLAY CR 1: C B A 8 4 2 1
- STORAGE DISPLAY CR 2: C B A 8 4 2 1
- SELECT REGISTER: 8 4 2 1
- SSR: 8 4 2 1

PROGRAM CONTROL:

OFF	PROGRAM CONTROL										
0911	0912	0913	0914	0915	0916	0900	0901	0902	0903	0904	0905
ON				AUTOMATIC							
PROGRAM ALTERATION				CHECK INDICATORS							

Other Controls: CLEAR MEMORY, POWER ON/OFF, DC ON/OFF, MASTER OFF, MACH STOP, IN STRUCT, STORE, MANUAL, DISPLAY, STORAGE SIGN (-), READ WRITE, ACC AUX, STORAGE SIGN (-).

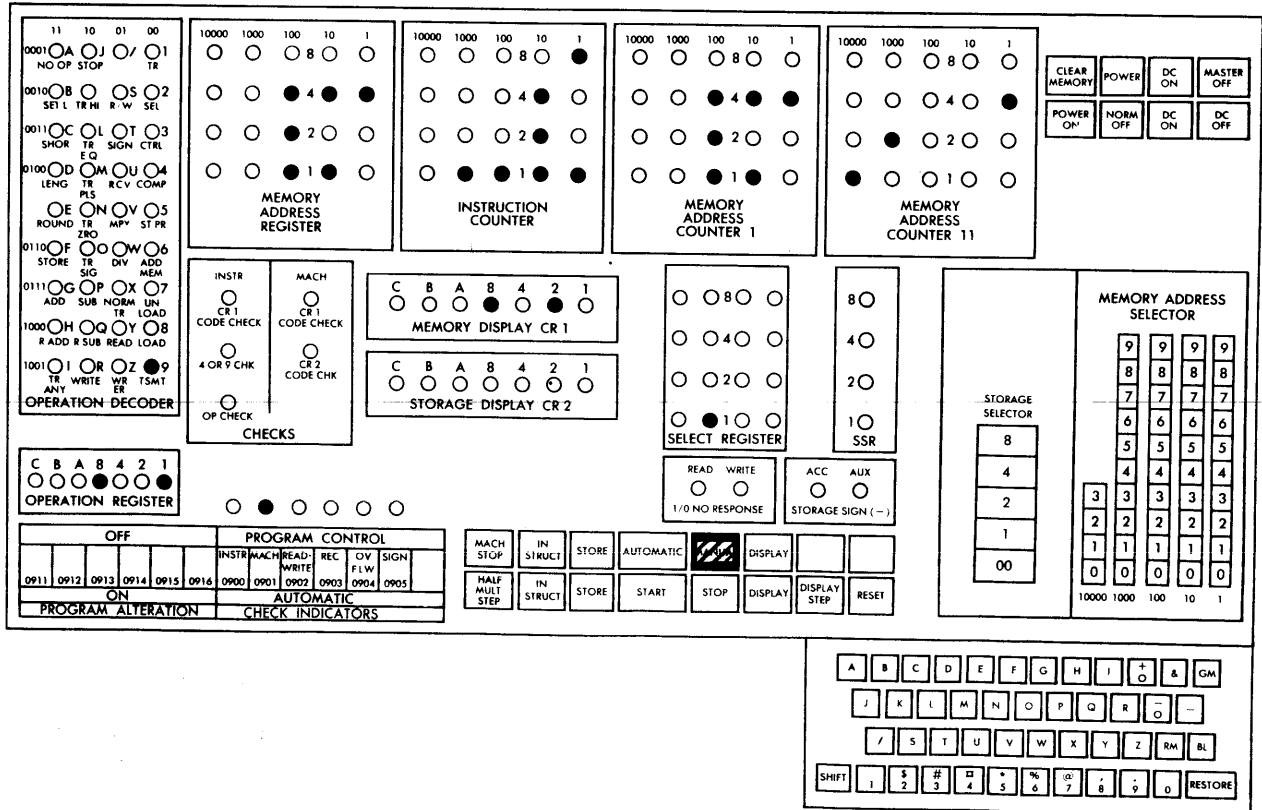
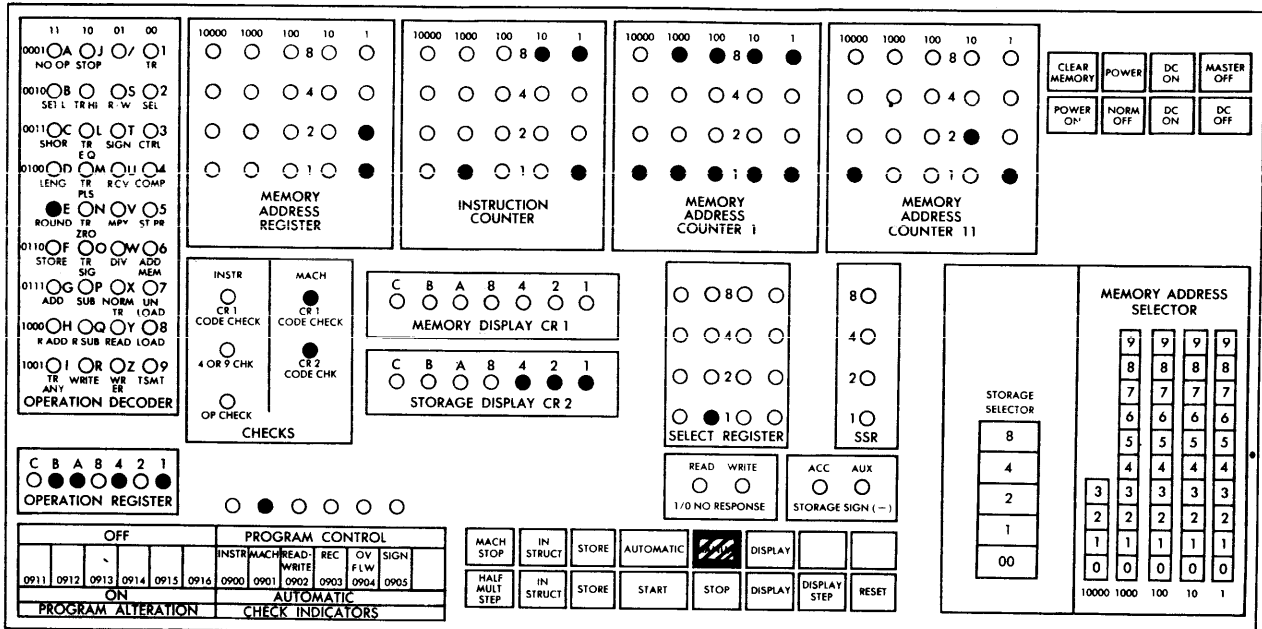

OPERATION DECODER

11	10	01	00
0001	OA	J	O
NO OP	STOP	TR	
0010	OB		OS
SEI	L	TR	HI
R	W	SEL	
0011	OC	OL	OT
SHOR	TR	SIGN	CTRL
E	Q		
0100	OD	OM	OU
LENG	TR	RCV	COMP
PLS			
0E	ON	OV	OS
ROUND	TR	MPY	ST PR
ZRO			
0110	OF	OW	OW
STORE	TR	DIV	ADD
SIG			MEM
0111	OG	OP	OX
ADD	SUB	NORM	UN
TR	LOAD		
1000	OH	OQ	OY
R	ADD	R	SUB
READ	LOAD		
1001	OI	OR	OZ
TR	WRITE	WR	TSMT
ER			
ANY			

OPERATION REGISTER

C B A 8 4 2 1

PROGRAM CONTROL

OFF	PROGRAM CONTROL							
	INSTR	MACH	READ	REC	OV	SIGN		
	WRITE			FLW				
0911	0912	0913	0914	0915	0916	0900	0901	0902
						0903	0904	0905
ON	AUTOMATIC							
PROGRAM ALTERATION	CHECK INDICATORS							

MEMORY ADDRESS REGISTER

10000 1000 100 10 1

INSTRUCTION COUNTER

10000 1000 100 10 1

MEMORY ADDRESS COUNTER 1

10000 1000 100 10 1

MEMORY ADDRESS COUNTER 11

10000 1000 100 10 1

MEMORY DISPLAY CR 1

C B A 8 4 2 1

STORAGE DISPLAY CR 2

C B A 8 4 2 1

SELECT REGISTER

8 4 2 1

SSR

8 4 2 1

READ WRITE

1/0 NO RESPONSE

ACC AUX

STORAGE SIGN (-)

STORAGE SELECTOR

8 4 2 1 00

MEMORY ADDRESS SELECTOR

9	9	9	9
8	8	8	8
7	7	7	7
6	6	6	6
5	5	5	5
4	4	4	4
3	3	3	3
2	2	2	2
1	1	1	1
0	0	0	0

10000 1000 100 10 1

OPERATION DECODER

11	10	01	00
0001	OA	J	O
NO OP	STOP	TR	
0010	OB		OS
SEI	L	TR	HI
R	W	SEL	
0011	OC	OL	OT
SHOR	TR	SIGN	CTRL
E	Q		
0100	OD	OM	OU
LENG	TR	RCV	COMP
PLS			
0E	ON	OV	OS
ROUND	TR	MPY	ST PR
ZRO			
0110	OF	OW	OW
STORE	TR	DIV	ADD
SIG			MEM
0111	OG	OP	OX
ADD	SUB	NORM	UN
TR	LOAD		
1000	OH	OQ	OY
R	ADD	R	SUB
READ	LOAD		
1001	OI	OR	OZ
TR	WRITE	WR	TSMT
ER			
ANY			

OPERATION REGISTER

C B A 8 4 2 1

PROGRAM CONTROL

OFF	PROGRAM CONTROL							
	INSTR	MACH	READ	REC	OV	SIGN		
	WRITE			FLW				
0911	0912	0913	0914	0915	0916	0900	0901	0902
						0903	0904	0905
ON	AUTOMATIC							
PROGRAM ALTERATION	CHECK INDICATORS							

MEMORY ADDRESS REGISTER

10000 1000 100 10 1

INSTRUCTION COUNTER

10000 1000 100 10 1

MEMORY ADDRESS COUNTER 1

10000 1000 100 10 1

MEMORY ADDRESS COUNTER 11

10000 1000 100 10 1

MEMORY DISPLAY CR 1

C B A 8 4 2 1

STORAGE DISPLAY CR 2

C B A 8 4 2 1

SELECT REGISTER

8 4 2 1

SSR

8 4 2 1

READ WRITE

1/0 NO RESPONSE

ACC AUX

STORAGE SIGN (-)

STORAGE SELECTOR

8 4 2 1 00

MEMORY ADDRESS SELECTOR

9	9	9	9
8	8	8	8
7	7	7	7
6	6	6	6
5	5	5	5
4	4	4	4
3	3	3	3
2	2	2	2
1	1	1	1
0	0	0	0

10000 1000 100 10 1

OPERATION DECODER

11	10	01	00
0001	OA	J	O
NO OP	STOP	TR	
0010	OB		OS
SEI	L	TR	HI
R	W	SEL	
0011	OC	OL	OT
SHOR	TR	SIGN	CTRL
E	Q		
0100	OD	OM	OU
LENG	TR	RCV	COMP
PLS			
0E	ON	OV	OS
ROUND	TR	MPY	ST PR
ZRO			
0110	OF	OW	OW
STORE	TR	DIV	ADD
SIG			MEM
0111	OG	OP	OX
ADD	SUB	NORM	UN
TR	LOAD		
1000	OH	OQ	OY
R	ADD	R	SUB
READ	LOAD		
1001	OI	OR	OZ
TR	WRITE	WR	TSMT
ER			
ANY			

OPERATION REGISTER

C B A 8 4 2 1

PROGRAM CONTROL

OFF	PROGRAM CONTROL							
	INSTR	MACH	READ	REC	OV	SIGN		
	WRITE			FLW				
0911	0912	0913	0914	0915	0916	0900	0901	0902
						0903	0904	0905
ON	AUTOMATIC							
PROGRAM ALTERATION	CHECK INDICATORS							

MEMORY ADDRESS REGISTER

10000 1000 100 10 1

INSTRUCTION COUNTER

10000 1000 100 10 1

MEMORY ADDRESS COUNTER 1

10000 1000 100 10 1

MEMORY ADDRESS COUNTER 11

10000 1000 100 10 1

MEMORY DISPLAY CR 1

C B A 8 4 2 1

STORAGE DISPLAY CR 2

C B A 8 4 2 1

SELECT REGISTER

8 4 2 1

SSR

8 4 2 1

READ WRITE

1/0 NO RESPONSE

ACC AUX

STORAGE SIGN (-)

STORAGE SELECTOR

8 4 2 1 00

MEMORY ADDRESS SELECTOR

9	9	9	9
8	8	8	8
7	7	7	7
6	6	6	6
5	5	5	5
4	4	4	4
3	3	3	3
2	2	2	2
1	1	1	1
0	0	0	0

10000 1000 100 10 1

ALPHANUMERIC KEYPAD

A	B	C	D	E	F	G	H	I	+	&	GM
J	K	L	M	N	O	P	Q	R	-		
/	S	T	U	V	W	X	Y	Z	RM	BL	
SHIFT	1	2	3	4	5	6	7	8	9	0	RESTORE

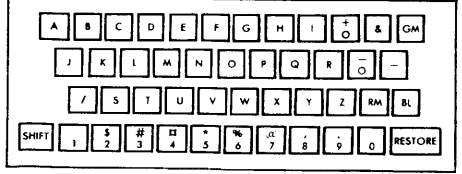
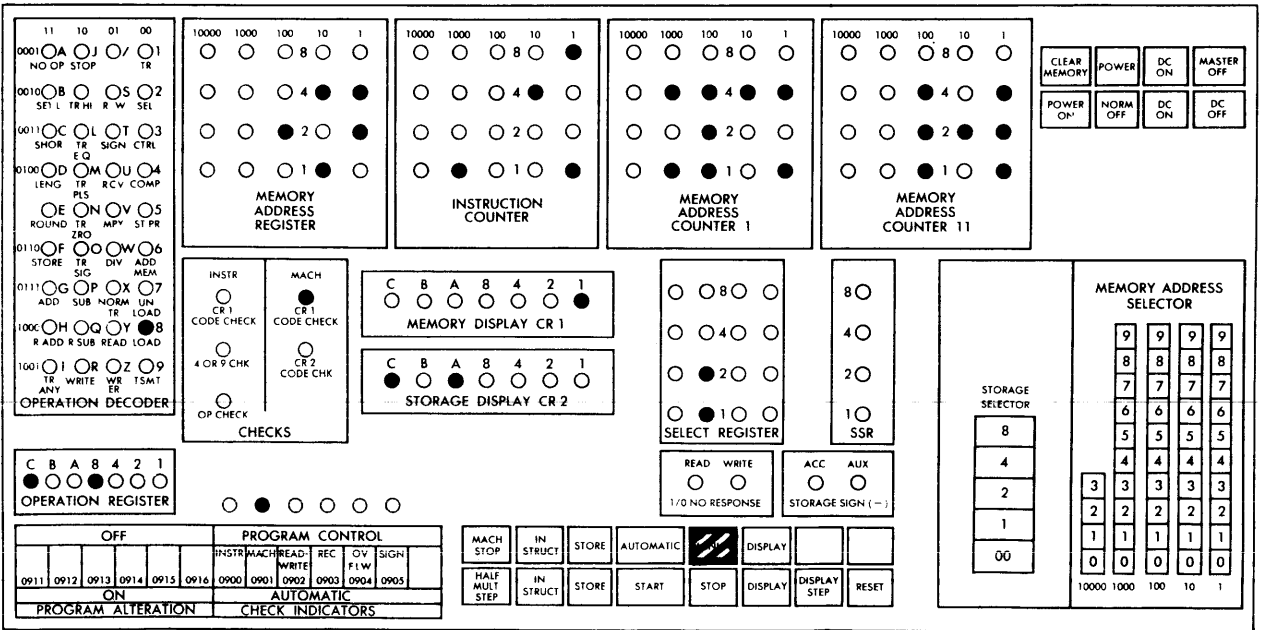
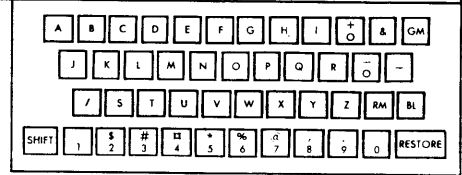
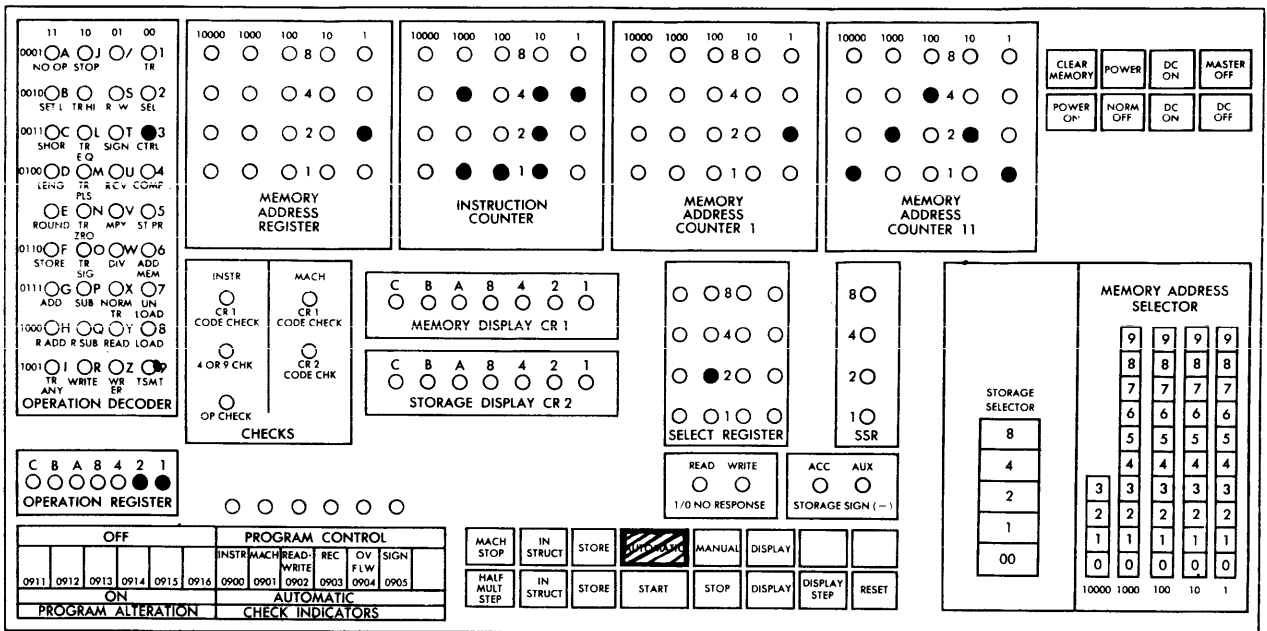

OPERATION DECODER

11 10 01 00
0001 ○ A ○ J ○ / ○ 1
NO OP STOP TR SEL

0010 ○ B ○ ○ S ○ 2
SEL L TR HI R W SEL

0011 ○ C ○ L ○ T ○ 3
SHOR TR SIGN CTRL EQ

0100 ○ D ○ M ○ U ○ 4
LENG TR RCV COMP PLS

○ E ○ N ○ V ○ 5
ROUND TR MPY ST PR ZRO

0110 ○ F ○ ○ W ○ 6
STORE TR DIV ADD MEAM SIG

0111 ○ G ○ P ○ X ○ 7
ADD SUB NORM UN TR LOAD

1000 ○ H ○ Q ○ Y ○ 8
R ADD R SUB READ LOAD

1001 ○ I ○ R ○ Z ○ 9
TR WRITE WR TSM T ANY ER

OPERATION REGISTER

C B A 8 4 2 1
○ ○ ○ ○ ○ ○ ○ ○

PROGRAM CONTROL

OFF	PROGRAM CONTROL						
	INSTR	MACH	READ	REC	OV	SIGN	
	0911	0912	0913	0914	0915	0916	
	0900	0901	0902	0903	0904	0905	
ON	AUTOMATIC						
PROGRAM ALTERATION	CHECK INDICATORS						

MEMORY ADDRESS REGISTER

10000 1000 100 10 1
○ ○ ○ ○ 8 ○ ○ ○ ○

INSTRUCTION COUNTER

10000 1000 100 10 1
○ ○ ○ ○ 4 ○ ○ ○ ○

MEMORY ADDRESS COUNTER 1

10000 1000 100 10 1
○ ○ ○ ○ 2 ○ ○ ○ ○

MEMORY ADDRESS COUNTER 11

10000 1000 100 10 1
○ ○ ○ ○ 1 ○ ○ ○ ○

MEMORY DISPLAY CR 1

C B A 8 4 2 1
○ ○ ○ ○ ○ ○ ○ ○

STORAGE DISPLAY CR 2

C B A 8 4 2 1
○ ○ ○ ○ ○ ○ ○ ○

CHECKS

INSTR MACH
CR 1 CR 1
CODE CHECK CODE CHECK

4 OR 9 CHK CR 2
OP CHECK CODE CHK

SELECT REGISTER

○ ○ 8 ○ ○ ○ ○ ○ ○ ○ ○

○ ○ 4 ○ ○ ○ ○ ○ ○ ○ ○

○ ○ 2 ○ ○ ○ ○ ○ ○ ○ ○

○ ○ 1 ○ ○ ○ ○ ○ ○ ○ ○

READ WRITE ACC AUX
1/0 NO RESPONSE STORAGE SIGN (-)

STORAGE SELECTOR

8
4
2
1
00

MEMORY ADDRESS SELECTOR

9	9	9	9
8	8	8	8
7	7	7	7
6	6	6	6
5	5	5	5
4	4	4	4
3	3	3	3
2	2	2	2
1	1	1	1
0	0	0	0

10000 1000 100 10 1

CONTROL PANEL

CLEAR MEMORY	POWER	DC ON	MASTER OFF
POWER ON	NORM OFF	DC ON	DC OFF

MACH STOP IN STRUCT STORE AUTOMATIC DISPLAY

HALF MULT STEP IN STRUCT STORE START STOP DISPLAY DISPLAY STEP RESET

A B C D E F G H I J K L M N O P Q R S T U V W X Y Z

SHIFT 1 2 3 4 5 6 7 8 9 0 RESTORE

OPERATION DECODER

11 10 01 00
0001 ○ A ○ J ○ / ○ 1
NO OP STOP TR SEL

0010 ○ B ○ ○ S ○ 2
SEL L TR HI R W SEL

0011 ○ C ○ L ○ T ○ 3
SHOR TR SIGN CTRL EQ

0100 ○ D ○ M ○ U ○ 4
LENG TR RCV COMP PLS

○ E ○ N ○ V ○ 5
ROUND TR MPY ST PR ZRO

0110 ○ F ○ ○ W ○ 6
STORE TR DIV ADD MEAM SIG

0111 ○ G ○ P ○ X ○ 7
ADD SUB NORM UN TR LOAD

1000 ○ H ○ Q ○ Y ○ 8
R ADD R SUB READ LOAD

1001 ○ I ○ R ○ Z ○ 9
TR WRITE WR TSM T ANY ER

OPERATION REGISTER

C B A 8 4 2 1
○ ○ ○ ○ ○ ○ ○ ○

PROGRAM CONTROL

OFF	PROGRAM CONTROL						
	INSTR	MACH	READ	REC	OV	SIGN	
	0911	0912	0913	0914	0915	0916	
	0900	0901	0902	0903	0904	0905	
ON	AUTOMATIC						
PROGRAM ALTERATION	CHECK INDICATORS						

MEMORY ADDRESS REGISTER

10000 1000 100 10 1
○ ○ ○ ○ 8 ○ ○ ○ ○

INSTRUCTION COUNTER

10000 1000 100 10 1
○ ○ ○ ○ 4 ○ ○ ○ ○

MEMORY ADDRESS COUNTER 1

10000 1000 100 10 1
○ ○ ○ ○ 2 ○ ○ ○ ○

MEMORY ADDRESS COUNTER 11

10000 1000 100 10 1
○ ○ ○ ○ 1 ○ ○ ○ ○

MEMORY DISPLAY CR 1

C B A 8 4 2 1
○ ○ ○ ○ ○ ○ ○ ○

STORAGE DISPLAY CR 2

C B A 8 4 2 1
○ ○ ○ ○ ○ ○ ○ ○

CHECKS

INSTR MACH
CR 1 CR 1
CODE CHECK CODE CHECK

4 OR 9 CHK CR 2
OP CHECK CODE CHK

SELECT REGISTER

○ ○ 8 ○ ○ ○ ○ ○ ○ ○ ○

○ ○ 4 ○ ○ ○ ○ ○ ○ ○ ○

○ ○ 2 ○ ○ ○ ○ ○ ○ ○ ○

○ ○ 1 ○ ○ ○ ○ ○ ○ ○ ○

READ WRITE ACC AUX
1/0 NO RESPONSE STORAGE SIGN (-)

STORAGE SELECTOR

8
4
2
1
00

MEMORY ADDRESS SELECTOR

9	9	9	9
8	8	8	8
7	7	7	7
6	6	6	6
5	5	5	5
4	4	4	4
3	3	3	3
2	2	2	2
1	1	1	1
0	0	0	0

10000 1000 100 10 1

CONTROL PANEL

CLEAR MEMORY	POWER	DC ON	MASTER OFF
POWER ON	NORM OFF	DC ON	DC OFF

MACH STOP IN STRUCT STORE AUTOMATIC DISPLAY

HALF MULT STEP IN STRUCT STORE START STOP DISPLAY DISPLAY STEP RESET

A B C D E F G H I J K L M N O P Q R S T U V W X Y Z

SHIFT 1 2 3 4 5 6 7 8 9 0 RESTORE

OPERATION DECODER

11 10 01 00
 0001 A J / 01 TR
 NO OP STOP

0010 B O S 02
 SET L TR HI R W SEL

0011 C L T 03
 SHOR TR SIGN CTRL
 EQ

0100 D M U 04
 LENG TR RCV COMP
 PLS

0101 E N V 05
 ROUND TR MPY ST PR
 ZRO

0110 F W 06
 STORE TR DIV ADD
 SIG MEM

0111 G P X 07
 ADD SUB NORM UN
 TR LOAD

1000 H Q Y 08
 R ADD R SUB READ LOAD

1001 I R Z 09
 TR WRITE WR TSM1
 ANY

MEMORY ADDRESS REGISTER

10000 1000 100 10 1
 ○ ○ ○ 8 ○ ○

INSTRUCTION COUNTER

10000 1000 100 10 1
 ○ ○ ○ 4 ○ ○

MEMORY ADDRESS COUNTER 1

10000 1000 100 10 1
 ○ ○ ○ 2 ○ ○

MEMORY ADDRESS COUNTER 11

10000 1000 100 10 1
 ○ ○ ○ 1 ○ ○

OPERATION REGISTER

C B A 8 4 2 1
 ○ ○ ○ ○ ○ ○ ○

PROGRAM CONTROL

OFF	INSTR	MACH	READ	REC	OV	SIGN
0911	0912	0913	0914	0915	0916	0900
ON	AUTOMATIC					
PROGRAM ALTERATION	CHECK INDICATORS					

CHECKS

INSTR MACH
 CR 1 CODE CHECK CR 1 CODE CHECK

4 OR 9 CHK CR 2 CODE CHK
 OP CHECK

MEMORY DISPLAY CR 1

C B A 8 4 2 1
 ○ ○ ○ ○ ○ ○ ○

STORAGE DISPLAY CR 2

C B A 8 4 2 1
 ○ ○ ○ ○ ○ ○ ○

SELECT REGISTER

8 ○ ○
 4 ○ ○
 2 ○ ○
 1 ○ ○

SSR

8 ○
 4 ○
 2 ○
 1 ○

STORAGE SIGN (-)

ACC AUX
 ○ ○

STORAGE SELECTOR

8
 4
 2
 1
 00

MEMORY ADDRESS SELECTOR

9	9	9	9
8	8	8	8
7	7	7	7
6	6	6	6
5	5	5	5
4	4	4	4
3	3	3	3
2	2	2	2
1	1	1	1
0	0	0	0

10000 1000 100 10 1

POWER CONTROL

CLEAR MEMORY POWER DC ON MASTER OFF
 POWER ON NORM OFF DC ON DC OFF

FUNCTION KEYS

A B C D E F G H I + & GM
 J K L M N O P Q R -
 / S T U V W X Y Z RM BL
 SHIFT 1 2 3 4 5 6 7 8 9 0 RESTORE

OPERATION DECODER

11 10 01 00
 0001 A J / 01 TR
 NO OP STOP

0010 B O S 02
 SET L TR HI R W SEL

0011 C L T 03
 SHOR TR SIGN CTRL
 EQ

0100 D M U 04
 LENG TR RCV COMP
 PLS

0101 E N V 05
 ROUND TR MPY ST PR
 ZRO

0110 F W 06
 STORE TR DIV ADD
 SIG MEM

0111 G P X 07
 ADD SUB NORM UN
 TR LOAD

1000 H Q Y 08
 R ADD R SUB READ LOAD

1001 I R Z 09
 TR WRITE WR TSM1
 ANY

MEMORY ADDRESS REGISTER

10000 1000 100 10 1
 ○ ○ ○ 8 ○ ○

INSTRUCTION COUNTER

10000 1000 100 10 1
 ○ ○ ○ 4 ○ ○

MEMORY ADDRESS COUNTER 1

10000 1000 100 10 1
 ○ ○ ○ 2 ○ ○

MEMORY ADDRESS COUNTER 11

10000 1000 100 10 1
 ○ ○ ○ 1 ○ ○

OPERATION REGISTER

C B A 8 4 2 1
 ○ ○ ○ ○ ○ ○ ○

PROGRAM CONTROL

OFF	INSTR	MACH	READ	REC	OV	SIGN
0911	0912	0913	0914	0915	0916	0900
ON	AUTOMATIC					
PROGRAM ALTERATION	CHECK INDICATORS					

CHECKS

INSTR MACH
 CR 1 CODE CHECK CR 1 CODE CHECK

4 OR 9 CHK CR 2 CODE CHK
 OP CHECK

MEMORY DISPLAY CR 1

C B A 8 4 2 1
 ○ ○ ○ ○ ○ ○ ○

STORAGE DISPLAY CR 2

C B A 8 4 2 1
 ○ ○ ○ ○ ○ ○ ○

SELECT REGISTER

8 ○ ○
 4 ○ ○
 2 ○ ○
 1 ○ ○

SSR

8 ○
 4 ○
 2 ○
 1 ○

STORAGE SIGN (-)

ACC AUX
 ○ ○

STORAGE SELECTOR

8
 4
 2
 1
 00

MEMORY ADDRESS SELECTOR

9	9	9	9
8	8	8	8
7	7	7	7
6	6	6	6
5	5	5	5
4	4	4	4
3	3	3	3
2	2	2	2
1	1	1	1
0	0	0	0

10000 1000 100 10 1

POWER CONTROL

CLEAR MEMORY POWER DC ON MASTER OFF
 POWER ON NORM OFF DC ON DC OFF

FUNCTION KEYS

A B C D E F G H I + & GM
 J K L M N O P Q R -
 / S T U V W X Y Z RM BL
 SHIFT 1 2 3 4 5 6 7 8 9 0 RESTORE

11 10 01 00
0001 A J O 1
NO OP STOP TR

0010 B O S 2
SET L TR HI R W SEL

0011 C L O T 3
SHOR TR SIGN CTRL EQ

0100 D M U 4
LENG TR RCV COMP PLS

0110 F O W 6
STORE TR DIV ADD MEM SIG

0111 G O X 7
ADD SUB NORM UN TR LOAD

1000 H O Y 8
R ADD R SUB READ LOAD

1001 I O Z 9
TR WRITE WR TSMT ANY ER

OPERATION DECODER

10000 1000 100 10 1
MEMORY ADDRESS REGISTER

10000 1000 100 10 1
INSTRUCTION COUNTER

10000 1000 100 10 1
MEMORY ADDRESS COUNTER *1

10000 1000 100 10 1
MEMORY ADDRESS COUNTER 11

CLEAR MEMORY POWER DC ON MASTER OFF
POWER ON NORM OFF DC ON DC OFF

INSTR MACH
CR 1 CODE CHECK CR 1 CODE CHECK

4 OR 9 CHK CR 2 CODE CHK
OP CHECK

C B A 8 4 2 1
MEMORY DISPLAY CR 1

C B A 8 4 2 1
STORAGE DISPLAY CR 2

8 4 2 1
SELECT REGISTER

8 4 2 1
SSR

READ WRITE ACC AUX
1/0 NO RESPONSE STORAGE SIGN (-)

MEMORY ADDRESS SELECTOR

STORAGE SELECTOR

8
4
2
1
00

9 9 9 9
8 8 8 8
7 7 7 7
6 6 6 6
5 5 5 5
4 4 4 4
3 3 3 3
2 2 2 2
1 1 1 1
0 0 0 0

10000 1000 100 10 1

C B A 8 4 2 1
OPERATION REGISTER

OFF						PROGRAM CONTROL					
0911	0912	0913	0914	0915	0916	INSTR	MACH	READ	REC	OV	SIGN
						WRITE		FLW			
ON						AUTOMATIC					
PROGRAM ALTERATION						CHECK INDICATORS					

MACH STOP IN STRUCT STORE AUTOMATIC DISPLAY
HALF MULT STEP IN STRUCT STORE START STOP DISPLAY DISPLAY SLEP RESET

A B C D E F G H I + & GM
J K L M N O P Q R -
/ S T U V W X Y Z RM BL
SHIFT 1 2 3 4 5 6 7 8 9 0 RESTORE

11 10 01 00
0001 A J O 1
NO OP STOP TR

0010 B O S 2
SET L TR HI R W SEL

0011 C L O T 3
SHOR TR SIGN CTRL EQ

0100 D M U 4
LENG TR RCV COMP PLS

0110 F O W 6
STORE TR DIV ADD MEM SIG

0111 G O X 7
ADD SUB NORM UN TR LOAD

1000 H O Y 8
R ADD R SUB READ LOAD

1001 I O Z 9
TR WRITE WR TSMT ANY ER

OPERATION DECODER

10000 1000 100 10 1
MEMORY ADDRESS REGISTER

10000 1000 100 10 1
INSTRUCTION COUNTER

10000 1000 100 10 1
MEMORY ADDRESS COUNTER 1

10000 1000 100 10 1
MEMORY ADDRESS COUNTER 11

CLEAR MEMORY POWER DC ON MASTER OFF
POWER ON NORM OFF DC ON DC OFF

INSTR MACH
CR 1 CODE CHECK CR 1 CODE CHECK

4 OR 9 CHK CR 2 CODE CHK
OP CHECK

C B A 8 4 2 1
MEMORY DISPLAY CR 1

C B A 8 4 2 1
STORAGE DISPLAY CR 2

8 4 2 1
SELECT REGISTER

8 4 2 1
SSR

READ WRITE ACC AUX
1/0 NO RESPONSE STORAGE SIGN (-)

MEMORY ADDRESS SELECTOR

STORAGE SELECTOR

8
4
2
1
00

9 9 9 9
8 8 8 8
7 7 7 7
6 6 6 6
5 5 5 5
4 4 4 4
3 3 3 3
2 2 2 2
1 1 1 1
0 0 0 0

10000 1000 100 10 1

C B A 8 4 2 1
OPERATION REGISTER

OFF						PROGRAM CONTROL					
0911	0912	0913	0914	0915	0916	INSTR	MACH	READ	REC	OV	SIGN
						WRITE		FLW			
ON						AUTOMATIC					
PROGRAM ALTERATION						CHECK INDICATORS					

MACH STOP IN STRUCT STORE AUTOMATIC DISPLAY
HALF MULT STEP IN STRUCT STORE START STOP DISPLAY DISPLAY SLEP RESET

A B C D E F G H I + & GM
J K L M N O P Q R -
/ S T U V W X Y Z RM BL
SHIFT 1 2 3 4 5 6 7 8 9 0 RESTORE

Control panel for page 27. It features several registers and counters with 10-bit displays (bits 10000 to 1). The MEMORY ADDRESS REGISTER, INSTRUCTION COUNTER, MEMORY ADDRESS COUNTER 1, and MEMORY ADDRESS COUNTER 11 are all set to 0. The MEMORY DISPLAY CR 1 and STORAGE DISPLAY CR 2 are also set to 0. The SELECT REGISTER is set to 1. The STORAGE SIGN (-) is set to 0. The STORAGE SELECTOR is set to 8. The MEMORY ADDRESS SELECTOR is set to 0. The OPERATION DECODER is set to 0. The CHECKS section shows 4 OR 9 CHK and OP CHECK. The PROGRAM CONTROL section shows MACH STOP, IN STRUCT, STORE, AUTOMATIC, and DISPLAY. The PROGRAM ALTERATION section shows OFF and ON. The CHECK INDICATORS section shows MACH STOP, IN STRUCT, STORE, START, STOP, DISPLAY, and RESET. The OPERATION REGISTER shows C B A B 4 2 1. The POWER and DC ON buttons are set to ON. The MASTER OFF and DC OFF buttons are set to OFF.

Alphanumeric keypad for page 27. It includes letters A through Z, numbers 0 through 9, and special characters like @, %, #, \$, %, &, and GM. The SHIFT key is on the left, and the RESTORE key is on the right.

Control panel for page 28. It features several registers and counters with 10-bit displays (bits 10000 to 1). The MEMORY ADDRESS REGISTER, INSTRUCTION COUNTER, MEMORY ADDRESS COUNTER 1, and MEMORY ADDRESS COUNTER 11 are all set to 0. The MEMORY DISPLAY CR 1 and STORAGE DISPLAY CR 2 are also set to 0. The SELECT REGISTER is set to 1. The STORAGE SIGN (-) is set to 0. The STORAGE SELECTOR is set to 8. The MEMORY ADDRESS SELECTOR is set to 0. The OPERATION DECODER is set to 0. The CHECKS section shows 4 OR 9 CHK and OP CHECK. The PROGRAM CONTROL section shows MACH STOP, IN STRUCT, STORE, AUTOMATIC, and DISPLAY. The PROGRAM ALTERATION section shows OFF and ON. The CHECK INDICATORS section shows MACH STOP, IN STRUCT, STORE, START, STOP, DISPLAY, and RESET. The OPERATION REGISTER shows C B A B 4 2 1. The POWER and DC ON buttons are set to ON. The MASTER OFF and DC OFF buttons are set to OFF.

Alphanumeric keypad for page 28. It includes letters A through Z, numbers 0 through 9, and special characters like @, %, #, \$, %, &, and GM. The SHIFT key is on the left, and the RESTORE key is on the right.

11 10 01 00
0001 ○ A ○ J ○ / ○ 1
NO OP STOP TR

0010 ○ B ○ ○ ○ 5 ○ 2
SEL L TR HI R W SEL

0011 ○ C ○ L ○ T ○ 3
SHOR TR SIGN CTRL E Q

0100 ○ D ○ M ○ U ○ 4
LENG TR RCV COMP PLS

○ E ○ N ○ V ○ 5
ROUND TR MPY ST PR ZRO

0110 ○ F ○ ○ ○ W ○ 6
STORE TR DIV ADD MEM

0111 ○ G ○ P ○ X ○ 7
ADD SUB NORM LN TR LOAD

1000 ○ H ○ Q ○ Y ○ 8
R ADD R SUB READ LOAD

1001 ○ I ○ R ○ Z ○ 9
TR WRITE WR ER TSMT ANY

OPERATION DECODER

10000 1000 100 10 1
○ ○ ○ ○ 8 ○ ○
MEMORY ADDRESS REGISTER

10000 1000 100 10 1
○ ○ ○ ○ 4 ● ○ ○
INSTRUCTION COUNTER

10000 1000 100 10 1
○ ○ ○ ○ 8 ○ ○
MEMORY ADDRESS COUNTER 1

10000 1000 100 10 1
○ ○ ○ ○ 4 ○ ○
MEMORY ADDRESS COUNTER 11

INSTR MACH
CR1 CODE CHECK CR1 CODE CHECK

4 OR 9 CHK CR2 CODE CHK

OP CHECK

C B A 8 4 2 1
○ ○ ○ ○ ○ ○ ○
MEMORY DISPLAY CR 1

C B A 8 4 2 1
● ○ ○ ○ ○ ○ ○
STORAGE DISPLAY CR 2

○ ○ 8 ○ ○
○ ○ 4 ○ ○
○ ○ 2 ○ ○
○ ● 1 ○ ○
SELECT REGISTER

8 ○
4 ○
2 ○
1 ○
SSR

READ WRITE ACC AUX
1/0 NO RESPONSE STORAGE SIGN (-)

C B A 8 4 2 1
○ ○ ○ ○ ● ○ ○
OPERATION REGISTER

OFF						PROGRAM CONTROL					
0911	0912	0913	0914	0915	0916	INSTR	MACH	READ	REC	OV	SIGN
						WRITE	WRITE	FLW	FLW	0904	0905
ON						AUTOMATIC					
PROGRAM ALTERATION						CHECK INDICATORS					

MACH STOP IN STRUCT STORE ~~OPERATION~~ MANUAL DISPLAY

HALF MULT STEP IN STRUCT STORE START STOP DISPLAY DISPLAY STEP RESET

CLEAR MEMORY POWER DC ON MASTER OFF

POWER ON NORM OFF DC ON DC OFF

MEMORY ADDRESS SELECTOR

9	9	9	9
8	8	8	8
7	7	7	7
6	6	6	6
5	5	5	5
4	4	4	4
3	3	3	3
2	2	2	2
1	1	1	1
0	0	0	0

STORAGE SELECTOR

8
4
2
1
00

A	B	C	D	E	F	G	H	I	+	&	GM
J	K	L	M	N	O	P	Q	R	-		
/	S	T	U	V	W	X	Y	Z	RM	BL	
SHIFT	1	2	3	4	5	6	7	8	9	0	RESTORE

11 10 01 00
0001 ○ A ○ J ○ / ○ 1
NO OP STOP TR

0010 ○ B ○ ○ ○ 5 ○ 2
SEL L TR HI R W SEL

0011 ○ C ○ L ○ T ○ 3
SHOR TR SIGN CTRL E Q

0100 ○ D ○ M ○ U ○ 4
LENG TR RCV COMP PLS

○ E ○ N ○ V ○ 5
ROUND TR MPY ST PR ZRO

0110 ○ F ○ ○ ○ W ○ 6
STORE TR DIV ADD MEM

0111 ○ G ○ P ○ X ○ 7
ADD SUB NORM LN TR LOAD

1000 ○ H ○ Q ○ Y ○ 8
R ADD R SUB READ LOAD

1001 ○ I ○ R ○ Z ○ 9
TR WRITE WR ER TSMT ANY

OPERATION DECODER

10000 1000 100 10 1
○ ○ ○ ○ 4 ● ○ ○
MEMORY ADDRESS REGISTER

10000 1000 100 10 1
○ ○ ○ ○ 4 ● ○ ○
INSTRUCTION COUNTER

10000 1000 100 10 1
○ ○ ○ ○ 8 ○ ○
MEMORY ADDRESS COUNTER 1

10000 1000 100 10 1
○ ○ ○ ○ 4 ○ ○
MEMORY ADDRESS COUNTER 11

INSTR MACH
CR1 CODE CHECK CR1 CODE CHECK

4 OR 9 CHK CR2 CODE CHK

OP CHECK

C B A 8 4 2 1
○ ○ ○ ○ ○ ○ ○
MEMORY DISPLAY CR 1

C B A 8 4 2 1
● ○ ○ ○ ○ ○ ○
STORAGE DISPLAY CR 2

○ ○ 8 ○ ○
○ ○ 4 ○ ○
○ ○ 2 ○ ○
○ ● 1 ○ ○
SELECT REGISTER

8 ●
4 ●
2 ●
1 ○
SSR

READ WRITE ACC AUX
1/0 NO RESPONSE STORAGE SIGN (-)

C B A 8 4 2 1
● ○ ○ ○ ● ○ ○
OPERATION REGISTER

OFF						PROGRAM CONTROL					
0911	0912	0913	0914	0915	0916	INSTR	MACH	READ	REC	OV	SIGN
						WRITE	WRITE	FLW	FLW	0904	0905
ON						AUTOMATIC					
PROGRAM ALTERATION						CHECK INDICATORS					

MACH STOP IN STRUCT STORE AUTOMATIC ~~OPERATION~~ DISPLAY

HALF MULT STEP IN STRUCT STORE START STOP DISPLAY DISPLAY STEP RESET

CLEAR MEMORY POWER DC ON MASTER OFF

POWER ON NORM OFF DC ON DC OFF

MEMORY ADDRESS SELECTOR

9	9	9	9
8	8	8	8
7	7	7	7
6	6	6	6
5	5	5	5
4	4	4	4
3	3	3	3
2	2	2	2
1	1	1	1
0	0	0	0

STORAGE SELECTOR

8
4
2
1
00

A	B	C	D	E	F	G	H	I	+	&	GM
J	K	L	M	N	O	P	Q	R	-		
/	S	T	U	V	W	X	Y	Z	RM	BL	
SHIFT	1	2	3	4	5	6	7	8	9	0	RESTORE

OPERATION DECODER

11	10	01	00
0001	0A	J	/
TR	NO OP	STOP	1
0010	0B	0	5
02	SEL L	TR HI	R-W
SEL			
0011	0C	L	0
03	SHOR	TR	SIGN
EQ			
0100	0D	0	M
04	LENG	TR	RCV
COMP			
0101	0E	0	N
05	ROUND	TR	MPY
ST PR			
0110	0F	0	0
06	STORE	TR	DIV
ADD			
0111	0G	0	P
07	ADD	SUB	NORM
UN			
1000	0H	0	Q
08	R ADD	R SUB	READ
LOAD			
1001	0I	0	R
09	TR	WRITE	WR
TSMT			
ER			

OPERATION REGISTER

C	B	A	8	4	2	1
●	●	●	●	●	●	●

MEMORY ADDRESS REGISTER

10000	1000	100	10	1
●	●	●	●	●

INSTRUCTION COUNTER

10000	1000	100	10	1
●	●	●	●	●

MEMORY ADDRESS COUNTER 1

10000	1000	100	10	1
●	●	●	●	●

MEMORY ADDRESS COUNTER 11

10000	1000	100	10	1
●	●	●	●	●

MEMORY DISPLAY CR 1

C	B	A	8	4	2	1
○	○	○	○	○	○	○

STORAGE DISPLAY CR 2

C	B	A	8	4	2	1
○	○	○	○	○	○	○

SELECT REGISTER

8	○
4	○
2	○
1	○

SSR

8
4
2
1

STORAGE SELECTOR

8
4
2
1
00

MEMORY ADDRESS SELECTOR

9	9	9	9
8	8	8	8
7	7	7	7
6	6	6	6
5	5	5	5
4	4	4	4
3	3	3	3
2	2	2	2
1	1	1	1
0	0	0	0

CONTROL PANEL

CLEAR MEMORY	POWER ON	DC ON	MASTER OFF
POWER ON	NORM OFF	DC ON	DC OFF

PROGRAM CONTROL

OFF	PROGRAM CONTROL										
0911	0912	0913	0914	0915	0916	0900	0901	0902	0903	0904	0905
ON	AUTOMATIC										

CONTROL PANEL

MACH STOP	IN STRUCT	STORE	AUTOMATIC	MANUAL	DISPLAY	RESET
HALF MULT STEP	IN STRUCT	STORE	START	STOP	DISPLAY	DISPLAY STEP

ALPHANUMERIC KEYPAD

A	B	C	D	E	F	G	H	I	+	&	GM
J	K	L	M	N	O	P	Q	R	-		
/	S	T	U	V	W	X	Y	Z	RM	BL	
SHIFT	1	2	3	4	5	6	7	8	9	0	RESTORE

OPERATION DECODER

11	10	01	00
0001	0A	J	/
TR	NO OP	STOP	1
0010	0B	0	5
02	SEL L	TR HI	R-W
SEL			
0011	0C	L	0
03	SHOR	TR	SIGN
EQ			
0100	0D	0	M
04	LENG	TR	RCV
COMP			
0101	0E	0	N
05	ROUND	TR	MPY
ST PR			
0110	0F	0	0
06	STORE	TR	DIV
ADD			
0111	0G	0	P
07	ADD	SUB	NORM
UN			
1000	0H	0	Q
08	R ADD	R SUB	READ
LOAD			
1001	0I	0	R
09	TR	WRITE	WR
TSMT			
ER			

OPERATION REGISTER

C	B	A	8	4	2	1
○	○	○	○	○	○	○

MEMORY ADDRESS REGISTER

10000	1000	100	10	1
○	○	○	○	○

INSTRUCTION COUNTER

10000	1000	100	10	1
○	○	○	○	○

MEMORY ADDRESS COUNTER 1

10000	1000	100	10	1
○	○	○	○	○

MEMORY ADDRESS COUNTER 11

10000	1000	100	10	1
○	○	○	○	○

MEMORY DISPLAY CR 1

C	B	A	8	4	2	1
○	○	○	○	○	○	○

STORAGE DISPLAY CR 2

C	B	A	8	4	2	1
○	○	○	○	○	○	○

SELECT REGISTER

8	○
4	○
2	○
1	○

SSR

8
4
2
1

STORAGE SELECTOR

8
4
2
1
00

MEMORY ADDRESS SELECTOR

9	9	9	9
8	8	8	8
7	7	7	7
6	6	6	6
5	5	5	5
4	4	4	4
3	3	3	3
2	2	2	2
1	1	1	1
0	0	0	0

CONTROL PANEL

CLEAR MEMORY	POWER ON	DC ON	MASTER OFF
POWER ON	NORM OFF	DC ON	DC OFF

PROGRAM CONTROL

OFF	PROGRAM CONTROL										
0911	0912	0913	0914	0915	0916	0900	0901	0902	0903	0904	0905
ON	AUTOMATIC										

CONTROL PANEL

MACH STOP	IN STRUCT	STORE	MANUAL	DISPLAY	RESET
HALF MULT STEP	IN STRUCT	STORE	START	STOP	DISPLAY

ALPHANUMERIC KEYPAD

A	B	C	D	E	F	G	H	I	+	&	GM
J	K	L	M	N	O	P	Q	R	-		
/	S	T	U	V	W	X	Y	Z	RM	BL	
SHIFT	1	2	3	4	5	6	7	8	9	0	RESTORE

Control panel for page 33. It features several 4-bit binary displays (10000, 1000, 100, 10, 1) for MEMORY ADDRESS REGISTER, INSTRUCTION COUNTER, MEMORY ADDRESS COUNTER 1, and MEMORY ADDRESS COUNTER 11. There are also MEMORY DISPLAY CR 1 and STORAGE DISPLAY CR 2. The panel includes an OPERATION DECODER with 12 buttons (A-Z), a CHECKS section with INSTR and MACH code check buttons, and a MEMORY ADDRESS SELECTOR keypad. Control buttons include CLEAR MEMORY, POWER, DC ON, MASTER OFF, and STORAGE SELECTOR (8, 4, 2, 1, 00). A PROGRAM CONTROL table is located at the bottom left.

OFF						PROGRAM CONTROL					
						INSTR	MACH	READ	REC	OV	SIGN
0911	0912	0913	0914	0915	0916	0900	0901	0902	0903	0904	0905
ON						AUTOMATIC					
PROGRAM ALTERATION						CHECK INDICATORS					

Control panel for page 34, identical in layout to page 33. The button states and display values are different. For example, the MEMORY ADDRESS REGISTER shows 1000, INSTRUCTION COUNTER shows 0001, and MEMORY ADDRESS COUNTER 1 shows 0001. The MEMORY ADDRESS SELECTOR keypad shows 0000. The PROGRAM CONTROL table is also present.

OFF						PROGRAM CONTROL					
						INSTR	MACH	READ	REC	OV	SIGN
0911	0912	0913	0914	0915	0916	0900	0901	0902	0903	0904	0905
ON						AUTOMATIC					
PROGRAM ALTERATION						CHECK INDICATORS					

Control panel for page 35. It features several registers and control elements:

- OPERATION DECODER:** 12-bit register with bits 11-00 and functions like NO OP STOP, SET L TR HI, SHOR TR, LENG TR, ROUND TR, STORE TR, ADD SUB, R ADD R SUB, TR WRITE ANY.
- MEMORY ADDRESS REGISTER:** 10-bit register (10000-1).
- INSTRUCTION COUNTER:** 10-bit register (10000-1).
- MEMORY ADDRESS COUNTER 1:** 10-bit register (10000-1).
- MEMORY ADDRESS COUNTER 11:** 10-bit register (10000-1).
- OPERATION REGISTER:** 5-bit register (C B A B 4 2 1).
- MEMORY DISPLAY CR 1:** 5-bit register (C B A B 4 2 1).
- STORAGE DISPLAY CR 2:** 5-bit register (C B A B 4 2 1).
- SELECT REGISTER:** 3-bit register (8, 4, 2, 1).
- SSR:** Single bit selector (8, 4, 2, 1).
- STORAGE SELECTOR:** 4-bit selector (8, 4, 2, 1).
- MEMORY ADDRESS SELECTOR:** 10-bit selector (9-0).
- CHECKS:** INSTR, MACH, CR1, CR2, 4 OR 9 CHK, OP CHECK.
- PROGRAM CONTROL:** OFF, ON, PROGRAM ALTERATION, CHECK INDICATORS.
- CONTROL PANEL:** MACH STOP, IN STRUCT, STORE, AUTOMATIC, DISPLAY, RESET.
- POWER CONTROLS:** CLEAR MEMORY, POWER ON, DC ON, MASTER OFF, NORM OFF, DC OFF.

Alphanumeric keypad for page 35. It includes letters A-Z, numbers 0-9, function keys like SHIFT, RESTORE, and symbols like %, @, #, \$, &, GM.

Control panel for page 36, which is identical in layout and components to the panel on page 35. It includes the same registers, counters, and control elements.

Alphanumeric keypad for page 36, which is identical in layout and components to the keypad on page 35.

OPERATION DECODER

11 10 01 00
0001 ○ A ○ J ○ / ○ 1
NO OP STOP TR

0010 ○ B ○ ○ ○ 05 ○ 2
SET L TR HI R W SEL

0011 ○ C ○ L ○ T ○ 3
SHOR TR SIGN CTRL
EQ

0100 ○ D ○ M ○ U ○ 4
LENG TR RCV COMP
PLS

0101 ○ E ○ N ○ V ○ 5
ROUND TR MPY ST PR
ZRO

0110 ○ F ○ ○ ○ W ○ 6
STORE TR DIV ADD
SIG MEM

0111 ○ G ○ P ○ X ○ 7
ADD SUB NORM UN
TR LOAD

1000 ○ H ○ Q ○ Y ○ 8
R ADD R SUB READ LOAD

1001 ○ I ○ R ○ Z ○ 9
TR WRITE WR TSMT
ANY ER

MEMORY ADDRESS REGISTER

10000 1000 100 10 1
○ ○ ○ ○ 8 ○ ○ ○ ○

INSTRUCTION COUNTER

10000 1000 100 10 1
○ ○ ○ ○ 8 ○ ○ ○ ○

MEMORY ADDRESS COUNTER 1

10000 1000 100 10 1
○ ○ ○ ○ 8 ○ ○ ○ ○

MEMORY ADDRESS COUNTER 11

10000 1000 100 10 1
○ ○ ○ ○ 8 ○ ○ ○ ○

CHECKS

INSTR MACH
○ CR1 CODE CHECK ○ CR1 CODE CHECK

○ 4 OR 9 CHK ○ CR2 CODE CHK

○ OP CHECK

MEMORY DISPLAY CR 1

C B A 8 4 2 1
○ ○ ○ ○ ○ ○ ○ ○

STORAGE DISPLAY CR 2

C B A 8 4 2 1
○ ○ ○ ○ ○ ○ ○ ○

SELECT REGISTER

○ ○ 8 ○ ○ ○
○ ○ 4 ○ ○ ○
○ ○ 2 ○ ○ ○
○ ○ 1 ○ ○ ○

SSR

8 ○
4 ○
2 ○
1 ○

OPERATION REGISTER

C B A 8 4 2 1
○ ○ ○ ○ ○ ○ ○ ○

PROGRAM CONTROL

OFF						PROGRAM CONTROL					
0911	0912	0913	0914	0915	0916	INSTR	MACH	READ	REC	OV	SIGN
						WRITE		FLW			
ON						AUTOMATIC					
PROGRAM ALTERATION						CHECK INDICATORS					

CONTROL PANEL

MACH STOP IN STRUCT STORE ~~MANUAL~~ DISPLAY

HALF MULT STEP IN STRUCT STORE START STOP DISPLAY DISPLAY STEP RESET

MEMORY ADDRESS SELECTOR

STORAGE SELECTOR

8
4
2
1
00

9 9 9 9
8 8 8 8
7 7 7 7
6 6 6 6
5 5 5 5
4 4 4 4
3 3 3 3
2 2 2 2
1 1 1 1
0 0 0 0

10000 1000 100 10 1

POWER CONTROLS

CLEAR MEMORY POWER DC MASTER
POWER ON NORM OFF DC ON DC OFF

A B C D E F G H I + & GM
J K L M N O P Q R - -
/ S T U V W X Y Z RM BL
SHIFT 1 2 3 4 5 6 7 8 9 0 RESTORE

OPERATION DECODER

11 10 01 00
0001 ○ A ○ J ○ / ○ 1
NO OP STOP TR

0010 ○ B ○ ○ ○ 05 ○ 2
SET L TR HI R W SEL

0011 ○ C ○ L ○ T ○ 3
SHOR TR SIGN CTRL
EQ

0100 ○ D ○ M ○ U ○ 4
LENG TR RCV COMP
PLS

0101 ○ E ○ N ○ V ○ 5
ROUND TR MPY ST PR
ZRO

0110 ○ F ○ ○ ○ W ○ 6
STORE TR DIV ADD
SIG MEM

0111 ○ G ○ P ○ X ○ 7
ADD SUB NORM UN
TR LOAD

1000 ○ H ○ Q ○ Y ○ 8
R ADD R SUB READ LOAD

1001 ○ I ○ R ○ Z ○ 9
TR WRITE WR TSMT
ANY ER

MEMORY ADDRESS REGISTER

10000 1000 100 10 1
○ ○ ○ ○ 8 ○ ○ ○ ○

INSTRUCTION COUNTER

10000 1000 100 10 1
○ ○ ○ ○ 8 ○ ○ ○ ○

MEMORY ADDRESS COUNTER 1

10000 1000 100 10 1
○ ○ ○ ○ 8 ○ ○ ○ ○

MEMORY ADDRESS COUNTER 11

10000 1000 100 10 1
○ ○ ○ ○ 8 ○ ○ ○ ○

CHECKS

INSTR MACH
○ CR1 CODE CHECK ○ CR1 CODE CHECK

○ 4 OR 9 CHK ○ CR2 CODE CHK

○ OP CHECK

MEMORY DISPLAY CR 1

C B A 8 4 2 1
○ ○ ○ ○ ○ ○ ○ ○

STORAGE DISPLAY CR 2

C B A 8 4 2 1
○ ○ ○ ○ ○ ○ ○ ○

SELECT REGISTER

○ ○ 8 ○ ○ ○
○ ○ 4 ○ ○ ○
○ ○ 2 ○ ○ ○
○ ○ 1 ○ ○ ○

SSR

8 ○
4 ○
2 ○
1 ○

OPERATION REGISTER

C B A 8 4 2 1
○ ○ ○ ○ ○ ○ ○ ○

PROGRAM CONTROL

OFF						PROGRAM CONTROL					
0911	0912	0913	0914	0915	0916	INSTR	MACH	READ	REC	OV	SIGN
						WRITE		FLW			
ON						AUTOMATIC					
PROGRAM ALTERATION						CHECK INDICATORS					

CONTROL PANEL

MACH STOP IN STRUCT STORE ~~MANUAL~~ DISPLAY

HALF MULT STEP IN STRUCT STORE START STOP DISPLAY DISPLAY STEP RESET

MEMORY ADDRESS SELECTOR

STORAGE SELECTOR

8
4
2
1
00

9 9 9 9
8 8 8 8
7 7 7 7
6 6 6 6
5 5 5 5
4 4 4 4
3 3 3 3
2 2 2 2
1 1 1 1
0 0 0 0

10000 1000 100 10 1

POWER CONTROLS

CLEAR MEMORY POWER DC MASTER
POWER ON NORM OFF DC ON DC OFF

A B C D E F G H I + & GM
J K L M N O P Q R - -
/ S T U V W X Y Z RM BL
SHIFT 1 2 3 4 5 6 7 8 9 0 RESTORE

Control panel for page 39. It includes an OPERATION DECODER with 12 function buttons (0001-1001), MEMORY ADDRESS REGISTER, INSTRUCTION COUNTER, MEMORY ADDRESS COUNTER 1, MEMORY ADDRESS COUNTER 11, MEMORY DISPLAY CR 1, STORAGE DISPLAY CR 2, SELECT REGISTER, STORAGE SELECTOR, MEMORY ADDRESS SELECTOR, and various control buttons like CLEAR MEMORY, POWER, DC ON, MASTER OFF, etc. It also features a PROGRAM CONTROL table and a CHECKS section.

OFF						PROGRAM CONTROL					
0911	0912	0913	0914	0915	0916	INSTR	MACH	READ	REC	OV	SIGN
						WRITE	WRITE	FLW	FLW		
ON						AUTOMATIC					
PROGRAM ALTERATION						CHECK INDICATORS					

Control panel for page 40. It is identical in layout to the panel on page 39, but with different button states. For example, the 'MANUAL' button in the PROGRAM CONTROL table is now highlighted with a diagonal line, and the 'MACH STOP' button is also highlighted. The MEMORY ADDRESS REGISTER and INSTRUCTION COUNTER displays show different values compared to page 39.

OFF						PROGRAM CONTROL					
0911	0912	0913	0914	0915	0916	INSTR	MACH	READ	REC	OV	SIGN
						WRITE	WRITE	FLW	FLW		
ON						AUTOMATIC					
PROGRAM ALTERATION						CHECK INDICATORS					

OPERATION DECODER

11	10	01	00
0001	0A	0J	0/
NO OP STOP TR			
0010	0B	0S	02
SET L TR HI R W SEL			
0011	0C	0L	0T
SHOR TR SIGN CTRL EQ			
0100	0D	0M	0U
LENG TR RCV COMP PLS			
0101	0E	0N	0V
ROUND TR MPY ST PR ZRO			
0110	0F	0O	0W
STORE TR DIV ADD MEM SIG			
0111	0G	0P	0X
ADD SUB NORM UN TR LOAD			
1000	0H	0Q	0Y
R ADD R SUB READ LOAD			
1001	0I	0R	0Z
TR WRITE WR TSMT ER ANY			

MEMORY ADDRESS REGISTER

INSTR COUNTER

MEMORY ADDRESS COUNTER 1

MEMORY ADDRESS COUNTER 11

CHECKS

INSTR	MACH
CR 1	CR 1
CODE CHECK	CODE CHECK
4 OR 9 CHK	CR 2
OP CHECK	CODE CHK

MEMORY DISPLAY CR 1

STORAGE DISPLAY CR 2

SELECT REGISTER

STORAGE SELECTOR

OPERATION REGISTER

C	B	A	8	4	2	1
●	●	●	●	●	●	●

PROGRAM CONTROL

OFF	PROGRAM CONTROL										
0911	0912	0913	0914	0915	0916	0900	0901	0902	0903	OV	SIGN
						WRITE	REC	FLW	0904	0905	
ON						AUTOMATIC					
PROGRAM ALTERATION						CHECK INDICATORS					

CONTROL PANEL

MACH STOP	IN STRUCT	STORE	AUTOMATIC	DISPLAY		
HALF MULT STEP	IN STRUCT	STORE	START	STOP	DISPLAY	RESET

POWER/DC OFF

CLEAR MEMORY	POWER	DC ON	MASTER OFF
POWER ON	NORM OFF	DC ON	DC OFF

KEYBOARD

A	B	C	D	E	F	G	H	I	+	O	&	GM
J	K	L	M	N	O	P	Q	R	-			
/	S	T	U	V	W	X	Y	Z	RH	RL		
SHIFT	1	2	3	4	5	6	7	8	9	0	RESTORE	

OPERATION DECODER

11	10	01	00
0001	0A	0J	0/
NO OP STOP TR			
0010	0B	0S	02
SET L TR HI R W SEL			
0011	0C	0L	0T
SHOR TR SIGN CTRL EQ			
0100	0D	0M	0U
LENG TR RCV COMP PLS			
0101	0E	0N	0V
ROUND TR MPY ST PR ZRO			
0110	0F	0O	0W
STORE TR DIV ADD MEM SIG			
0111	0G	0P	0X
ADD SUB NORM UN TR LOAD			
1000	0H	0Q	0Y
R ADD R SUB READ LOAD			
1001	0I	0R	0Z
TR WRITE WR TSMT ER ANY			

MEMORY ADDRESS REGISTER

INSTR COUNTER

MEMORY ADDRESS COUNTER 1

MEMORY ADDRESS COUNTER 11

CHECKS

INSTR	MACH
CR 1	CR 1
CODE CHECK	CODE CHECK
4 OR 9 CHK	CR 2
OP CHECK	CODE CHK

MEMORY DISPLAY CR 1

STORAGE DISPLAY CR 2

SELECT REGISTER

STORAGE SELECTOR

OPERATION REGISTER

C	B	A	8	4	2	1
○	○	○	○	○	○	○

PROGRAM CONTROL

OFF	PROGRAM CONTROL										
0911	0912	0913	0914	0915	0916	0900	0901	0902	0903	OV	SIGN
						WRITE	REC	FLW	0904	0905	
ON						AUTOMATIC					
PROGRAM ALTERATION						CHECK INDICATORS					

CONTROL PANEL

MACH STOP	IN STRUCT	STORE	AUTOMATIC	DISPLAY		
HALF MULT STEP	IN STRUCT	STORE	START	STOP	DISPLAY	RESET

POWER/DC OFF

CLEAR MEMORY	POWER	DC ON	MASTER OFF
POWER ON	NORM OFF	DC ON	DC OFF

KEYBOARD

A	B	C	D	E	F	G	H	I	+	O	&	GM
J	K	L	M	N	O	P	Q	R	-			
/	S	T	U	V	W	X	Y	Z	RH	RL		
SHIFT	1	2	3	4	5	6	7	8	9	0	RESTORE	

OPERATION DECODER

11	10	01	00
0001	A	J	TR
	NO OP	STOP	
0010	B	S	2
	SET L	TR HI	R W SEL
0011	C	L	3
	SHOR	TR	SIGN CTRL
		EQ	
0100	D	M	4
	LENG	TR	R CV COMP
		PLS	
	E	N	5
	ROUND	TR	MPY ST PR
		ZRO	
0110	F	W	6
	STORE	TR	DIV ADD MEM
		SIG	
0111	G	P	7
	ADD	SUB	NORM UN
		TR	LOAD
1000	H	Q	8
	R	ADD R	SUB READ LOAD
1001	I	R	9
	TR	WRITE	WR TSM1
		ANY	ER

OPERATION REGISTER

C	B	A	8	4	2	1
○	○	○	○	○	○	○

MEMORY ADDRESS REGISTER

10000	1000	100	10	1
○	○	○	○	○
○	○	○	○	○
○	○	○	○	○
○	○	○	○	○

INSTRUCTION COUNTER

10000	1000	100	10	1
○	○	○	○	○
○	○	○	○	○
○	○	○	○	○
○	○	○	○	○

MEMORY ADDRESS COUNTER 1

10000	1000	100	10	1
○	○	○	○	○
○	○	○	○	○
○	○	○	○	○
○	○	○	○	○

MEMORY ADDRESS COUNTER 11

10000	1000	100	10	1
○	○	○	○	○
○	○	○	○	○
○	○	○	○	○
○	○	○	○	○

CHECKS

INSTR	MACH
CR 1	CR 1
CODE CHECK	CODE CHECK
4 OR 9 CHK	CR 2
OP CHECK	CODE CHK

MEMORY DISPLAY CR 1

C	B	A	8	4	2	1
○	○	○	○	○	○	○

STORAGE DISPLAY CR 2

C	B	A	8	4	2	1
○	○	○	○	○	○	○

SELECT REGISTER

8	4	2	1
○	○	○	○
○	○	○	○
○	○	○	○
○	○	○	○

SSR

8	4	2	1
○	○	○	○
○	○	○	○
○	○	○	○

STORAGE SIGN (-)

ACC	AUX
○	○

STORAGE SELECTOR

8	4	2	1	00
○	○	○	○	○
○	○	○	○	○
○	○	○	○	○

MEMORY ADDRESS SELECTOR

9	9	9	9
8	8	8	8
7	7	7	7
6	6	6	6
5	5	5	5
4	4	4	4
3	3	3	3
2	2	2	2
1	1	1	1
0	0	0	0

PROGRAM CONTROL

OFF	ON				
0911	0912	0913	0914	0915	0916
INSTR	MACH	READ	REC	OV	SIGN
WRITE	0901	0902	0903	0904	0905
AUTOMATIC					
PROGRAM ALTERATION					
CHECK INDICATORS					

CONTROL PANEL

MACH STOP	IN STRUCT	STORE	AUTOMATIC	DISPLAY	RESET
HALF MULT STEP	IN STRUCT	STORE	START	STOP	DISPLAY
				DISPLAY STEP	

POWER/DC OFF

CLEAR MEMORY	POWER	DC ON	MASTER OFF
POWER ON	NORM OFF	DC ON	DC OFF

Alphanumeric keypad with letters A-Z, numbers 0-9, and special keys like SHIFT, RESTORE, and function keys.

OPERATION DECODER

11	10	01	00
0001	A	J	TR
	NO OP	STOP	
0010	B	S	2
	SET L	TR HI	R W SEL
0011	C	L	3
	SHOR	TR	SIGN CTRL
		EQ	
0100	D	M	4
	LENG	TR	R CV COMP
		PLS	
	E	N	5
	ROUND	TR	MPY ST PR
		ZRO	
0110	F	W	6
	STORE	TR	DIV ADD MEM
		SIG	
0111	G	P	7
	ADD	SUB	NORM UN
		TR	LOAD
1000	H	Q	8
	R	ADD R	SUB READ LOAD
1001	I	R	9
	TR	WRITE	WR TSM1
		ANY	ER

OPERATION REGISTER

C	B	A	8	4	2	1
○	○	○	○	○	○	○

MEMORY ADDRESS REGISTER

10000	1000	100	10	1
○	○	○	○	○
○	○	○	○	○
○	○	○	○	○
○	○	○	○	○

INSTRUCTION COUNTER

10000	1000	100	10	1
○	○	○	○	○
○	○	○	○	○
○	○	○	○	○
○	○	○	○	○

MEMORY ADDRESS COUNTER 1

10000	1000	100	10	1
○	○	○	○	○
○	○	○	○	○
○	○	○	○	○
○	○	○	○	○

MEMORY ADDRESS COUNTER 11

10000	1000	100	10	1
○	○	○	○	○
○	○	○	○	○
○	○	○	○	○
○	○	○	○	○

CHECKS

INSTR	MACH
CR 1	CR 1
CODE CHECK	CODE CHECK
4 OR 9 CHK	CR 2
OP CHECK	CODE CHK

MEMORY DISPLAY CR 1

C	B	A	8	4	2	1
○	○	○	○	○	○	○

STORAGE DISPLAY CR 2

C	B	A	8	4	2	1
○	○	○	○	○	○	○

SELECT REGISTER

8	4	2	1
○	○	○	○
○	○	○	○
○	○	○	○
○	○	○	○

SSR

8	4	2	1
○	○	○	○
○	○	○	○
○	○	○	○

STORAGE SIGN (-)

ACC	AUX
○	○

STORAGE SELECTOR

8	4	2	1	00
○	○	○	○	○
○	○	○	○	○
○	○	○	○	○

MEMORY ADDRESS SELECTOR

9	9	9	9
8	8	8	8
7	7	7	7
6	6	6	6
5	5	5	5
4	4	4	4
3	3	3	3
2	2	2	2
1	1	1	1
0	0	0	0

PROGRAM CONTROL

OFF	ON				
0911	0912	0913	0914	0915	0916
INSTR	MACH	READ	REC	OV	SIGN
WRITE	0901	0902	0903	0904	0905
AUTOMATIC					
PROGRAM ALTERATION					
CHECK INDICATORS					

CONTROL PANEL

MACH STOP	IN STRUCT	STORE	AUTOMATIC	DISPLAY	RESET
HALF MULT STEP	IN STRUCT	STORE	START	STOP	DISPLAY
				DISPLAY STEP	

POWER/DC OFF

CLEAR MEMORY	POWER	DC ON	MASTER OFF
POWER ON	NORM OFF	DC ON	DC OFF

Alphanumeric keypad with letters A-Z, numbers 0-9, and special keys like SHIFT, RESTORE, and function keys.

Control panel for page 45. It features several registers and counters with indicator lights:

- OPERATION DECODER:** 11 10 01 00 (NO OP STOP TR), 0001 A J / 01 TR, 0010 B O S 02 (SET L TR HI R W SEL), 0011 C L O T 03 (SHOR TR SIGN CTRL EQ), 0100 D M U 04 (LENG TR RCV COMP PLS), 0101 E N V 05 (ROUND TR MPV ST PR ZRO), 0110 F O W 06 (STORE TR DIV ADD MEM SIG), 0111 G P X 07 (ADD SUB NORM UN TR LOAD), 1000 H Q Y 08 (R ADD R SUB READ LOAD), 1001 I O R Z 09 (TR WRITE WR TSM1 ANY).
- MEMORY ADDRESS REGISTER:** 10000 1000 100 10 1
- INSTRUCTION COUNTER:** 10000 1000 100 10 1
- MEMORY ADDRESS COUNTER 1:** 10000 1000 100 10 1
- MEMORY ADDRESS COUNTER 11:** 10000 1000 100 10 1
- MEMORY DISPLAY CR 1:** C B A 8 4 2 1
- STORAGE DISPLAY CR 2:** C B A 8 4 2 1
- SELECT REGISTER:** 8 0, 4 0, 2 0, 1 0
- SSR:** 8 0, 4 0, 2 0, 1 0
- OPERATION REGISTER:** C B A 8 4 2 1
- CHECKS:** INSTR CR 1 CODE CHECK, MACH CR 1 CODE CHECK, 4 OR 9 CHK, CE 2 CODE CHK, OP CHECK.
- STORAGE SELECTOR:** 8, 4, 2, 1, 00
- MEMORY ADDRESS SELECTOR:** 9 9 9 9, 8 8 8 8, 7 7 7 7, 6 6 6 6, 5 5 5 5, 4 4 4 4, 3 3 3 3, 2 2 2 2, 1 1 1 1, 0 0 0 0
- CONTROL TABLES:**

OFF					PROGRAM CONTROL						
					INSTR	MACH	READ	REC	OV	SIGN	
0911	0912	0913	0914	0915	0916	0900	0901	0902	0903	0904	0905
ON					AUTOMATIC						
PROGRAM ALTERATION					CHECK INDICATORS						

MACH STOP	IN STRUCT	STORE	AUTOMATIC	MANUAL	DISPLAY		
HALF MULT STEP	IN STRUCT	STORE	START	STOP	DISPLAY	DISPLAY STEP	RESET

Control panel for page 46. It features several registers and counters with indicator lights:

- OPERATION DECODER:** 11 10 01 00 (NO OP STOP TR), 0001 A J / 01 TR, 0010 B O S 02 (SET L TR HI R W SEL), 0011 C L O T 03 (SHOR TR SIGN CTRL EQ), 0100 D M U 04 (LENG TR RCV COMP PLS), 0101 E N V 05 (ROUND TR MPV ST PR ZRO), 0110 F O W 06 (STORE TR DIV ADD MEM SIG), 0111 G P X 07 (ADD SUB NORM UN TR LOAD), 1000 H Q Y 08 (R ADD R SUB READ LOAD), 1001 I O R Z 09 (TR WRITE WR TSM1 ANY).
- MEMORY ADDRESS REGISTER:** 10000 1000 100 10 1
- INSTRUCTION COUNTER:** 10000 1000 100 10 1
- MEMORY ADDRESS COUNTER 1:** 10000 1000 100 10 1
- MEMORY ADDRESS COUNTER 11:** 10000 1000 100 10 1
- MEMORY DISPLAY CR 1:** C B A 8 4 2 1
- STORAGE DISPLAY CR 2:** C B A 8 4 2 1
- SELECT REGISTER:** 8 0, 4 0, 2 0, 1 0
- SSR:** 8 0, 4 0, 2 0, 1 0
- OPERATION REGISTER:** C B A 8 4 2 1
- CHECKS:** INSTR CR 1 CODE CHECK, MACH CR 1 CODE CHECK, 4 OR 9 CHK, CE 2 CODE CHK, OP CHECK.
- STORAGE SELECTOR:** 8, 4, 2, 1, 00
- MEMORY ADDRESS SELECTOR:** 9 9 9 9, 8 8 8 8, 7 7 7 7, 6 6 6 6, 5 5 5 5, 4 4 4 4, 3 3 3 3, 2 2 2 2, 1 1 1 1, 0 0 0 0
- CONTROL TABLES:**

OFF					PROGRAM CONTROL						
					INSTR	MACH	READ	REC	OV	SIGN	
0911	0912	0913	0914	0915	0916	0900	0901	0902	0903	0904	0905
ON					AUTOMATIC						
PROGRAM ALTERATION					CHECK INDICATORS						

MACH STOP	IN STRUCT	STORE	AUTOMATIC	MANUAL	DISPLAY		
HALF MULT STEP	IN STRUCT	STORE	START	STOP	DISPLAY	DISPLAY STEP	RESET

Control panel for page 47. It features several registers and counters with indicator lights:

- OPERATION DECODER:** 12 rows of 4 buttons each, labeled with binary values (11, 10, 01, 00) and functions like NO OP STOP, SE L TR HI R W SEL, SHOR TR SIGN CTRL, LENG TR RCV COMP, ROUND TR MPY ST PR, STORE TR DIV ADD MEM, ADD SUB NORM UN TR LOAD, R ADD R SUB READ LOAD, TR WRITE WR TSM T ER.
- MEMORY ADDRESS REGISTER:** 4 columns of 4 buttons each, labeled 10000, 1000, 100, 10, 1.
- INSTRUCTION COUNTER:** 4 columns of 4 buttons each, labeled 10000, 1000, 100, 10, 1.
- MEMORY ADDRESS COUNTER 1:** 4 columns of 4 buttons each, labeled 10000, 1000, 100, 10, 1.
- MEMORY ADDRESS COUNTER 11:** 4 columns of 4 buttons each, labeled 10000, 1000, 100, 10, 1.
- MEMORY DISPLAY CR 1:** 5 buttons labeled C, B, A, 8, 4, 2, 1.
- STORAGE DISPLAY CR 2:** 5 buttons labeled C, B, A, 8, 4, 2, 1.
- CHECKS:** INSTR CR1 CODE CHECK, MACH CR1 CODE CHECK, 4 OR 9 CHK, CR2 CODE CHK, OP CHECK.
- SELECT REGISTER:** 8, 4, 2, 1 buttons.
- SSR:** 8, 4, 2, 1 buttons.
- OPERATION REGISTER:** 5 buttons labeled C, B, A, 8, 4, 2, 1.
- PROGRAM CONTROL:** OFF/ON indicators for INSTR, MACH, READ, WRITE, REC, OV, FLW, SIGN, and AUTOMATIC.
- CONTROL INDICATORS:** MACH STOP, IN STRUCT, STORE, AUTOMATIC, DISPLAY, 1/0 NO RESPONSE, ACC, AUX, STORAGE SIGN (-).
- STORAGE SELECTOR:** 8, 4, 2, 1, 00 buttons.
- MEMORY ADDRESS SELECTOR:** 4x4 grid of buttons labeled 9, 8, 7, 6, 5, 4, 3, 2, 1, 0.
- POWER CONTROLS:** CLEAR MEMORY, POWER ON/OFF, DC ON/OFF, MASTER OFF.

Alphanumeric keypad for page 47 with 26 letters (A-Z), numbers (0-9), and special keys like SHIFT, RESTORE, and function keys.

Control panel for page 48, identical in layout to page 47 but with different indicator light states. For example, the MEMORY ADDRESS REGISTER and INSTRUCTION COUNTER lights are now lit.

Alphanumeric keypad for page 48, identical to the one on page 47.

OPERATION DECODER

11	10	01	00
0001	A	J	/
	NO OP	STOP	TR
0010	B	S	02
	SEL L	TR HI	R W SEL
0011	C	L	T
	SHOR	TR	SIGN CTRL
	EQ		
0100	D	M	U
	LENG	TR	RCV COMP
	PLS		
0101	E	N	V
	ROUND	TR	MPY ST PR
	ZRO		
0110	F	O	W
	STORE	TR	DIV ADD
	SIG		MEM
0111	G	P	X
	ADD	SUB	NORM UN
	TR	LOAD	
1000	H	Q	Y
	R ADD	R SUB	READ LOAD
1001	I	R	Z
	TR	WRITE	WR TSM T
	ANY	ER	

OPERATION REGISTER

C	B	A	8	4	2	1
●	○	○	○	○	○	○

MEMORY ADDRESS REGISTER

10000	1000	100	10	1
○	○	○	8	○
○	○	○	4	○
○	○	○	2	○
○	○	○	1	○

INSTRUCTION COUNTER

10000	1000	100	10	1
○	○	○	8	○
○	○	○	4	○
○	○	○	2	○
○	○	○	1	○

MEMORY ADDRESS COUNTER 1

10000	1000	100	10	1
○	○	○	8	○
○	○	○	4	○
○	○	○	2	○
○	○	○	1	○

MEMORY ADDRESS COUNTER 11

10000	1000	100	10	1
○	○	○	8	○
○	○	○	4	○
○	○	○	2	○
○	○	○	1	○

MEMORY DISPLAY CR 1

C	B	A	8	4	2	1
○	○	○	○	○	○	○

STORAGE DISPLAY CR 2

C	B	A	8	4	2	1
○	○	○	○	○	○	○

SELECT REGISTER

8	○
4	○
2	○
1	○

SSR

8
4
2
1

CHECKS

INSTR	MACH
CR1	CR1
CODE CHECK	CODE CHECK
4 OR 9 CHK	CR2
OP CHECK	CODE CHK

STORAGE SIGN (-)

READ	WRITE	ACC	AUX
○	○	○	○
1/0 NO RESPONSE		STORAGE SIGN (-)	

PROGRAM CONTROL

OFF	PROGRAM CONTROL							
	INSTR	MACH	READ	REC	OV	SIGN		
0911	0912	0913	0914	0915	0916	0900	0901	0902
	WRITE	WRITE	FLW	FLW	FLW	0904	0905	
ON	AUTOMATIC							
PROGRAM ALTERATION	CHECK INDICATORS							

CONTROL PANEL

MACH STOP	IN STRUCT	STORE	AUTOMATIC	MANUAL	DISPLAY		
HALF MULT STEP	IN STRUCT	STORE	START	STOP	DISPLAY	DISPLAY STEP	RESET

POWER CONTROLS

CLEAR MEMORY	POWER	DC ON	MASTER OFF
POWER ON	NORM OFF	DC ON	DC OFF

MEMORY ADDRESS SELECTOR

9	9	9	9
8	8	8	8
7	7	7	7
6	6	6	6
5	5	5	5
4	4	4	4
3	3	3	3
2	2	2	2
1	1	1	1
0	0	0	0

STORAGE SELECTOR

8
4
2
1
00

Alphanumeric keyboard with keys: A-Z, 0-9, +, -, /, #, %, @, ., ', RESTORE.

OPERATION DECODER

11	10	01	00
0001	A	J	/
	NO OP	STOP	TR
0010	B	S	02
	SEL L	TR HI	R W SEL
0011	C	L	T
	SHOR	TR	SIGN CTRL
	EQ		
0100	D	M	U
	LENG	TR	RCV COMP
	PLS		
0101	E	N	V
	ROUND	TR	MPY ST PR
	ZRO		
0110	F	O	W
	STORE	TR	DIV ADD
	SIG		MEM
0111	G	P	X
	ADD	SUB	NORM UN
	TR	LOAD	
1000	H	Q	Y
	R ADD	R SUB	READ LOAD
1001	I	R	Z
	TR	WRITE	WR TSM T
	ANY	ER	

OPERATION REGISTER

C	B	A	8	4	2	1
○	○	○	○	○	○	○

MEMORY ADDRESS REGISTER

10000	1000	100	10	1
○	○	○	8	○
○	○	○	4	○
○	○	○	2	○
○	○	○	1	○

INSTRUCTION COUNTER

10000	1000	100	10	1
○	○	○	8	○
○	○	○	4	○
○	○	○	2	○
○	○	○	1	○

MEMORY ADDRESS COUNTER 1

10000	1000	100	10	1
○	○	○	8	○
○	○	○	4	○
○	○	○	2	○
○	○	○	1	○

MEMORY ADDRESS COUNTER 11

10000	1000	100	10	1
○	○	○	8	○
○	○	○	4	○
○	○	○	2	○
○	○	○	1	○

MEMORY DISPLAY CR 1

C	B	A	8	4	2	1
○	○	○	○	○	○	○

STORAGE DISPLAY CR 2

C	B	A	8	4	2	1
○	○	○	○	○	○	○

SELECT REGISTER

8	○
4	○
2	○
1	○

SSR

8
4
2
1

CHECKS

INSTR	MACH
CR1	CR1
CODE CHECK	CODE CHECK
4 OR 9 CHK	CR2
OP CHECK	CODE CHK

STORAGE SIGN (-)

READ	WRITE	ACC	AUX
○	○	○	○
1/0 NO RESPONSE		STORAGE SIGN (-)	

PROGRAM CONTROL

OFF	PROGRAM CONTROL							
	INSTR	MACH	READ	REC	OV	SIGN		
0911	0912	0913	0914	0915	0916	0900	0901	0902
	WRITE	WRITE	FLW	FLW	FLW	0904	0905	
ON	AUTOMATIC							
PROGRAM ALTERATION	CHECK INDICATORS							

CONTROL PANEL

MACH STOP	IN STRUCT	STORE	AUTOMATIC	MANUAL	DISPLAY		
HALF MULT STEP	IN STRUCT	STORE	START	STOP	DISPLAY	DISPLAY STEP	RESET

POWER CONTROLS

CLEAR MEMORY	POWER	DC ON	MASTER OFF
POWER ON	NORM OFF	DC ON	DC OFF

MEMORY ADDRESS SELECTOR

9	9	9	9
8	8	8	8
7	7	7	7
6	6	6	6
5	5	5	5
4	4	4	4
3	3	3	3
2	2	2	2
1	1	1	1
0	0	0	0

STORAGE SELECTOR

8
4
2
1
00

Alphanumeric keyboard with keys: A-Z, 0-9, +, -, /, #, %, @, ., ', RESTORE.

OPERATION DECODER

11 10 01 00
0001 OA OJ OI O1
NO OP STOP TR

0010 OB OS O2
SET L TR HI R W SEL

0011 OC OT O3
SHOR TR SIGN CTRL
EQ

0100 OD OU O4
LENG TR RCV COMP
PLS

OE ON OV O5
ROUND TR MPY ST PR
ZRO

0110 OF OW O6
STORE TR DIV ADD
SIG MEM

0111 OG OX O7
ADD SUB NORM UN
TR LOAD

1000 OH OY O8
R ADD R SUB READ LOAD

1001 OI OZ O9
TR WRITE WR TSM1
ANY ER

OPERATION REGISTER

C B A 8 4 2 1
● ● ● ● ● ● ● ●

PROGRAM CONTROL

OFF	INSTR	MACH	READ	REC	OV	SIGN
0911	0912	0913	0914	0915	0916	0900
ON	INSTR	MACH	WRITE	FLW	0903	0904
0905	AUTOMATIC					0902
PROGRAM ALTERATION			CHECK INDICATORS			

MEMORY ADDRESS REGISTER

10000 1000 100 10 1
● ● ● ● ●

INSTRUCTION COUNTER

10000 1000 100 10 1
● ● ● ● ●

MEMORY ADDRESS COUNTER 1

10000 1000 100 10 1
● ● ● ● ●

MEMORY ADDRESS COUNTER 11

10000 1000 100 10 1
● ● ● ● ●

MEMORY DISPLAY CR 1

C B A 8 4 2 1
● ● ● ● ● ● ● ●

STORAGE DISPLAY CR 2

C B A 8 4 2 1
● ● ● ● ● ● ● ●

SELECT REGISTER

8 4 2 1
○ ○ ○ ○

SSR

8 4 2 1
○ ○ ○ ○

READ WRITE

○ ○

ACC AUX

○ ○

STORAGE SIGN (-)

○ ○

1/0 NO RESPONSE

○ ○

STORAGE SELECTOR

8 4 2 1 00

MEMORY ADDRESS SELECTOR

9	9	9	9
8	8	8	8
7	7	7	7
6	6	6	6
5	5	5	5
4	4	4	4
3	3	3	3
2	2	2	2
1	1	1	1
0	0	0	0

10000 1000 100 10 1

POWER DC ON MASTER OFF

POWER ON NORM OFF DC ON DC OFF

A B C D E F G H I + & GM

J K L M N O P Q R - -

/ S T U V W X Y Z RM BL

SHIFT 1 2 3 4 5 6 7 8 9 0 RESTORE

OPERATION DECODER

11 10 01 00
0001 OA OJ OI O1
NO OP STOP TR

0010 OB OS O2
SET L TR HI R W SEL

0011 OC OT O3
SHOR TR SIGN CTRL
EQ

0100 OD OU O4
LENG TR RCV COMP
PLS

OE ON OV O5
ROUND TR MPY ST PR
ZRO

0110 OF OW O6
STORE TR DIV ADD
SIG MEM

0111 OG OX O7
ADD SUB NORM UN
TR LOAD

1000 OH OY O8
R ADD R SUB READ LOAD

1001 OI OZ O9
TR WRITE WR TSM1
ANY ER

OPERATION REGISTER

C B A 8 4 2 1
● ● ● ● ● ● ● ●

PROGRAM CONTROL

OFF	INSTR	MACH	READ	REC	OV	SIGN
0911	0912	0913	0914	0915	0916	0900
ON	INSTR	MACH	WRITE	FLW	0903	0904
0905	AUTOMATIC					0902
PROGRAM ALTERATION			CHECK INDICATORS			

MEMORY ADDRESS REGISTER

10000 1000 100 10 1
○ ○ ● ● ●

INSTRUCTION COUNTER

10000 1000 100 10 1
○ ○ ● ● ●

MEMORY ADDRESS COUNTER 1

10000 1000 100 10 1
○ ○ ● ● ●

MEMORY ADDRESS COUNTER 11

10000 1000 100 10 1
○ ○ ● ● ●

MEMORY DISPLAY CR 1

C B A 8 4 2 1
○ ○ ○ ○ ○ ○ ○ ○

STORAGE DISPLAY CR 2

C B A 8 4 2 1
○ ○ ○ ○ ○ ○ ○ ○

SELECT REGISTER

8 4 2 1
○ ○ ○ ○

SSR

8 4 2 1
○ ○ ○ ○

READ WRITE

○ ○

ACC AUX

○ ○

STORAGE SIGN (-)

○ ○

1/0 NO RESPONSE

○ ○

STORAGE SELECTOR

8 4 2 1 00

MEMORY ADDRESS SELECTOR

9	9	9	9
8	8	8	8
7	7	7	7
6	6	6	6
5	5	5	5
4	4	4	4
3	3	3	3
2	2	2	2
1	1	1	1
0	0	0	0

10000 1000 100 10 1

POWER DC ON MASTER OFF

POWER ON NORM OFF DC ON DC OFF

A B C D E F G H I + & GM

J K L M N O P Q R - -

/ S T U V W X Y Z RM BL

SHIFT 1 2 3 4 5 6 7 8 9 0 RESTORE

Control panel for page 53. It features several registers and displays:

- OPERATION DECODER:** A vertical column of 10 switches labeled 0001 through 1001, each with multiple sub-switches for different operations like NO OP STOP, SET L TR HI R W SEL, SHOR TR SIGN CTRL EQ, LENG TR RCV COMP PLS, ROUND TR MPY ST PR ZRO, STORE TR DIV ADD MEM SIG, ADD SUB NORM UN TR LOAD, R ADD R SUB READ LOAD, and TR WRITE WR TSM1 ANY.
- MEMORY ADDRESS REGISTER:** A 4-digit display with bits 10000, 1000, 100, 10, 1.
- INSTRUCTION COUNTER:** A 4-digit display with bits 10000, 1000, 100, 10, 1.
- MEMORY ADDRESS COUNTER 1:** A 4-digit display with bits 10000, 1000, 100, 10, 1.
- MEMORY ADDRESS COUNTER 11:** A 4-digit display with bits 10000, 1000, 100, 10, 1.
- MEMORY DISPLAY CR 1:** A 4-digit display with bits C, B, A, 8, 4, 2, 1.
- STORAGE DISPLAY CR 2:** A 4-digit display with bits C, B, A, 8, 4, 2, 1.
- SELECT REGISTER:** A 4-digit display with bits 8, 4, 2, 1.
- SSR:** A single digit display with bit 1.
- OPERATION REGISTER:** A 5-digit display with bits C, B, A, 8, 4, 2, 1.
- CHECKS:** A section with switches for INSTR CR 1 CODE CHECK, MACH CR 1 CODE CHECK, 4 OR 9 CHK, and OP CHECK.
- CONTROL TABLES:**
 - PROGRAM CONTROL:** A table with columns for INSTR, MACH, READ, REC, OV, SIGN and rows for 0911-0915 (OFF) and 0900-0905 (ON).
 - CHECK INDICATORS:** A table with columns for MACH STOP, IN STRUCT, STORE, AUTOMATIC, DISPLAY, and rows for HALF MULT STEP, IN STRUCT, STORE, START, STOP, DISPLAY, DISPLAY STEP, and RESET.
- POWER AND DC ON/OFF:** A grid of switches for CLEAR MEMORY, POWER ON, DC ON, MASTER OFF, and NORM OFF.
- STORAGE SELECTOR:** A vertical column of switches labeled 8, 4, 2, 1, 00.
- MEMORY ADDRESS SELECTOR:** A 4x4 grid of switches labeled with digits 0-9.

Alphanumeric keyboard for page 53. It includes letters A-Z, numbers 0-9, function keys like SHIFT, #, %, @, -, ., and a RESTORE key.

Control panel for page 54, identical in layout to page 53 but with different switch states:

- OPERATION DECODER:** Switch 0001 (NO OP STOP) is set to 'O'.
- MEMORY ADDRESS REGISTER:** Display shows 0008.
- INSTRUCTION COUNTER:** Display shows 0004.
- MEMORY ADDRESS COUNTER 1:** Display shows 0002.
- MEMORY ADDRESS COUNTER 11:** Display shows 0001.
- MEMORY DISPLAY CR 1:** Display shows 0008.
- STORAGE DISPLAY CR 2:** Display shows 0004.
- SELECT REGISTER:** Display shows 0004.
- SSR:** Display shows 0.
- OPERATION REGISTER:** Display shows 0000.
- CHECKS:** MACH CR 1 CODE CHECK is set.
- CONTROL TABLES:**
 - PROGRAM CONTROL:** Row 0900 (ON) is selected.
 - CHECK INDICATORS:** MACH STOP, IN STRUCT, STORE, and AUTOMATIC are set.
- POWER AND DC ON/OFF:** POWER ON and DC ON are set.
- STORAGE SELECTOR:** Switch 8 is selected.
- MEMORY ADDRESS SELECTOR:** Grid shows 0000.

Alphanumeric keyboard for page 54, identical to the one on page 53.

EXPLANATION OF THE 705 CONSOLE EXERCISES

(in order of sequence)

Characters in accumulator or auxiliary storage are counted
starting from the Starting Point Counter.

<u>Exercise Number</u>	<u>Location</u>	<u>Operation Code</u>	<u>Address</u>	<u>Storage</u>	<u>Explanation</u>
1	0719	Y	1211		<u>I/O No Response--Read:</u> Card Reader not ready.
2	0859	O	3559		<u>0900 Instruction Check:</u> Operation Code Check: Operation Code is the number zero.
3	3589	8	0869	(00)	<u>0901 Machine Check:</u> Regular CR-1 Code Check Redundant Character in memory position 0863 sensed during execution of LOD instruction.
4	0749	Y	5005		<u>I/O No Response--Read:</u> Card Reader 105 not in the 705 installation.
5	1049	B	0013	(00)	<u>0901 Machine Check:</u> CR-1 and CR-2 Code Check Upon SET, RND, and SHR: Fourth character in the accumulator is redundant.
6	3674	H	0505	(06)	<u>0905 Sign Check:</u> RAD instruction address to unsigned field.

<u>Exercise Number</u>	<u>Location</u>	<u>Operation Code</u>	<u>Address</u>	<u>Storage</u>	<u>Explanation</u>
7	0774	Z	7621		<u>I/O No Response--Write:</u> WRE instruction with the Card Reader being the last selected unit.
8	13019	7	6009	(10)	<u>0901 Machine Check:</u> CR-2 Code Check: Fourth character in ASU 10 is redundant. Sensed during execution of UNL instruction.
9	13184	W	0556	(00)	<u>0904 Overflow Check:</u> 0904 Upon DIV: Absolute Value Rule violated. (e. g. , Division of 982647 by 523)
10	1059	C	0005	(00)	<u>0901 Machine Check:</u> CR-1 and CR-2 Code Check Upon SET, RND, and SHR: Sixth character in the accumulator is redundant.
11	0844	Y	5764	(00)	<u>0900 Instruction Check:</u> CR-1 Code Check and Operation Code Check: Redundant character in memory position 0840 which is the location of the operation code of the current instruction.
12	3539	J	1111		<u>Program Stop:</u> 0902 Read/Write error routine, terminating in a

<u>Exercise Number</u>	<u>Location</u>	<u>Operation Code</u>	<u>Address</u>	<u>Storage</u>	<u>Explanation</u>
					programmed stop, as the 0902 Read/Write Check Indicator switch has been set to "Program".
13	12809	Y	0494		<u>I/O No Response--Read:</u> Tape Unit 0208 not ready or not in system.
14	8764	3	0009		<u>Control Error:</u> In a 705 installation which does not include a 760 control and storage unit, no such CTRL instruction is recognized.
15	1084	E	0003	(00)	<u>0901 Machine Check:</u> CR-1 and CR-2 Code Check Upon SET, RND, and SHR: Fourth character in the accumulator is redundant.
16	1174	9	0754	(00)	<u>0901 Machine Check:</u> 0901 Without CR Code Check Upon TMT (00): Redundant character in memory position 0752, in first group of five of record to be transmitted. Note: From the exercise, it can only be concluded that one or more of the characters at 0750-0753 are redundant.
17	12949	H	5684	(12)	<u>0901 Machine Check:</u> Regular CR-1 Code Check: Redundant character in memory position 5682

<u>Exercise Number</u>	<u>Location</u>	<u>Operation Code</u>	<u>Address</u>	<u>Storage</u>	<u>Explanation</u>
					sensed during execution of RAD instruction.
18	3749	W	5678	(00)	<u>0905 Sign Check:</u> Divisor field, to which the current DIV instruction is addressed is unsigned.
19	5169	3	0002		<u>Control Error:</u> RWD instruction directed to tape unit which is not on line, i. e., it is either not ready or not in the system.
20	1044	8	0256	(00)	<u>0901 Machine Check:</u> Regular CR-1 Code Check: Redundant character in memory position 5745. This redundancy was sensed during execution of the LOD instruction of a B-V-8 routine.
21	3729	E	0003	(00)	<u>0904 Overflow Check:</u> Regular Overflow Check: Accumulator field exceeded during RND instruction due to a resulting carry from the high-order position.
22	0864	B	0017	(12)	<u>0900 Instruction Check:</u> CR-1 Code Check: Redundant character in memory position 00863 which is the tens position of the current instruction. An "8" bit

<u>Exercise Number</u>	<u>Location</u>	<u>Operation Code</u>	<u>Address</u>	<u>Storage</u>	<u>Explanation</u>
					has been picked up and the redundant character is interpreted by MAR as a "9".
23	13039	F	12125	(11)	<u>0901 Machine Check:</u> CR-2 Code Check: Sixth character in ASU11 is redundant.
24	3414	R	0095		<u>I/O No Response--Write:</u> Tape Unit 0209 is file protected. Note: The console condition only indicates that tape unit 0209 is not on line.
25	3514	M	9954	(15)	<u>0900 Instruction Check:</u> CR-1 Code Check: Redundant character in memory position 3511 which is the thousands position of the current instruction. <u>Note: From the console,</u> it can only be ascertained that one or more of the characters at 3511-3513 are redundant.
26	3609	9	0558	(11)	<u>0901 Machine Check:</u> CR-2 Code Check: Sixth character in ASU 11 is redundant.

<u>Exercise Number</u>	<u>Location</u>	<u>Operation Code</u>	<u>Address</u>	<u>Storage</u>	<u>Explanation</u>
27	13069	Y	4001		<p><u>0902 Read/Write Check:</u></p> <p>0902 Upon RD:</p> <p>Redundant character read on Tape Unit 0201. Its location, without manual displaying or B-V-8 is unknown.</p>
28	3444	R	19800		<p><u>I/O No Response--Write:</u></p> <p>The current instruction is a WR instruction, with 0902 Read/Write Check indicator being the last selected unit.</p>
29	12854	3	0001		<p><u>Control Error:</u></p> <p>The current instruction is WTM with the card reader being the last selected unit.</p>
30	3699	G	6576	(14)	<p><u>0905 Sign Check:</u></p> <p>Field addressed by ADD instruction has zero zoning. (Equality of symbols in CR-1 and CR-2 is coincidental)</p> <p>Note: The console itself only indicates that the character at 6576 is unsigned.</p>
31	0994	Z	19800		<p><u>0901 Machine Check:</u></p> <p>CR-1 Code Check Upon WR and WRE:</p> <p><u>0902 Read/Write Check:</u></p> <p>0902 Upon WR and WRE:</p>

<u>Exercise Number</u>	<u>Location</u>	<u>Operation Code</u>	<u>Address</u>	<u>Storage</u>	<u>Explanation</u>
					<p>Redundant character in memory position 19802 sensed during execution of WRE instruction with the typewriter selected.</p> <p>Note: The console condition is the same, whichever character or characters of the record written are redundant.</p>
32	12834	Y	10000		<p><u>I/O No Response--Read:</u></p> <p>Only one drum, with drum sections 1000-1299, is available at this 705 installation.</p>
33	0199	b	bbbb	(05)	<p><u>0900 Instruction Check:</u></p> <p>Operation Code Check:</p> <p>This operation code is a blank. Also, the remaining four characters of the current instruction are blanks, the zero zoning of the thousands, hundreds, and tens positions interpreting as upper memory and ASU 5, respectively. The error was evidently caused by the neglect to put an unconditional transfer instruction as last instruction of a 00 transfer control card.</p>
34	10014	3	0000		<p><u>Control Error:</u></p> <p>IOF instruction with 0901 Machine Check Indicator being the last selected unit.</p>
35	0899	9	0562	(00)	<p><u>0900 Instruction Check:</u></p> <p>4 or 9 Check: 83</p>

<u>Exercise Number</u>	<u>Location</u>	<u>Operation Code</u>	<u>Address</u>	<u>Storage</u>	<u>Explanation</u>
					Units position of address of TMT instruction specifying accumulator 00, is neither 4 nor 9.
36	1024	R	0558		<u>0903 Record Check:</u> Punch error on second preceding WR instruction directed to the same card punch 0300.
37	3494	R	0494		<u>I/O No Response--Write:</u> Printer 0400 not ready.
38	12879	3	0002		<u>Control Error:</u> RWD instruction with card punch 0300 being the last selected unit.
39	0969	R	19800		<u>0901 Machine Check:</u> CR-1 Code Check Upon WR and WRE: <u>0902 Read/Write Check:</u> 0902 Upon WR and WRE: Redundant character sensed during execution of the WR instruction of a read-while-write sequence.
40	3809	R	0558		<u>I/O No Response--Read and Write:</u> Read and write tapes are both even during a read-while-write sequence. In addition to the I/O No Response condition, both tapes, 0204 and 0202 are revolving forward out of control. Note: The console will not indicate which is the tape unit in the special select status.

<u>Exercise Number</u>	<u>Location</u>	<u>Operation Code</u>	<u>Address</u>	<u>Storage</u>	<u>Explanation</u>
41	3714	G	0509	(15)	<u>0904 Overflow Check:</u> Regular Overflow Check: Length of the field of the result of addition in ASU 15 exceeds the length of the field of either of the addends.
42	0924	M	3608	(15)	<u>0900 Instruction Check:</u> 4 or 9 Check: Units position of the address of a conditional transfer instruction is neither 4 nor 9.
43	3634	9	0488	(10)	<u>0901 Machine Check:</u> Regular CR-1 Code Check: Redundant character at memory position 0493 sensed during execution of TMT instruction specifying ASU 10 (single character transmission).
44	12904	3	0004		<u>Control Error:</u> BSP instruction with printer 0400 being the last selected unit.
45	3664	9	19804	(00)	<u>0901 Machine Check:</u> 0901 Without CR Code Check Upon TMT (00): Redundant character at memory position 19822 sensed during execution of a TMT (00) instruction. Note: From the console, it can only be concluded

<u>Exercise Number</u>	<u>Location</u>	<u>Operation Code</u>	<u>Address</u>	<u>Storage</u>	<u>Explanation</u>
					that one or more characters at 19820-19823 are redundant.
46	12929	3	0005		<u>Control Error:</u> SUP instruction with Tape Unit 0207 being the last unit selected.
47	13164	R	0558		<u>0902 Read/Write Check:</u> 0902 Upon RD: Redundant character on input Tape Unit 0208 sensed during reading in the execution of the WR instruction of a read-while-write routine.
48	3824	9	6574	(00)	<u>0901 Machine Check:</u> CR-1 Code Check Upon TMT (00): Redundant character at memory location 6579 sensed during execution of TMT (00) instruction.
49	3894	R	16001		<u>I/O No Response--Read and Write:</u> Attempt to perform RWW sequence with only one Tape Unit (0201) selected: SEL, RWW, WR. Tape Unit 0201 is revolving forward out of control.
50	13244	9	5725	(09)	<u>0901 Machine Check:</u> Regular CR-1 and CR-2 Code Check: The twenty-first character

<u>Exercise Number</u>	<u>Location</u>	<u>Operation Code</u>	<u>Address</u>	<u>Storage</u>	<u>Explanation</u>
					in ASU 9 and the character in memory position 5745 are redundant. This double redundancy in corresponding positions of memory and auxiliary storage occurs during execution of a serial TMT instruction
51	2419	Z	9201		<u>0902 Read/Write Check:</u> 0902 Upon WR and WRE: Transmission error upon punching an 80-column card record. The record has to be recreated as it was erased upon execution of the WRE instruction.
52	1214	W	0554	(00)	<u>0904 Overflow Check:</u> 0904 Upon DIV: Absolute Value Rule violated. (e. g. , 6878357 divided by 3829)
53	3124	C	0002	(00)	<u>0901 Machine Check:</u> CR-1 and CR-2 Code Check Upon SET, RND, and SHR: Fourth character in the accumulator is redundant. As the third character is a zero, interrogation of subsequent characters in the accumulator (to test whether they are all zero) locates the redundancy. Note: The console con-

<u>Exercise Number</u>	<u>Location</u>	<u>Operation Code</u>	<u>Address</u>	<u>Storage</u>	<u>Explanation</u>
54	6999	R	11200		<p>dition only indicates that the redundant character is the third or a subsequent character in the accumulator.</p> <p><u>I/O No Response--Read:</u></p> <p>Input tape unit not on line during a read-while-write sequence:</p> <p>2-0202 S-16341 2-0207 R-11200</p> <p>Note that the output record has been fully written.</p>

Index of 705 Console Exercises

by Error Conditions

In this index, the first number indicates the console exercise serial number, and the second number in parentheses gives the page number on which this console exercise is located.

I/O No Response:

Read	1 (50)	4 (51)	13 (56)
------	--------	--------	---------

	32 (65)	54 (76)	
--	---------	---------	--

Write	7 (53)	24 (61)	28 (63)
-------	--------	---------	---------

	37 (68)		
--	---------	--	--

Read and Write	40 (69)	49 (74)	
----------------	---------	---------	--

<u>Control Error:</u>	14 (56)	19 (59)	29 (64)
-----------------------	---------	---------	---------

	34 (66)	38 (68)	44 (71)
--	---------	---------	---------

	46 (72)		
--	---------	--	--

<u>Program Stop:</u>	12 (55)		
----------------------	---------	--	--

0900 Instruction Check:

CR-1 Code Check	11 (55)	22 (60)	25 (62)
-----------------	---------	---------	---------

Operation Code Check	2 (50)	11 (55)	33 (66)
----------------------	--------	---------	---------

4 or 9 Check	35 (67)	42 (70)	
--------------	---------	---------	--

0901 Machine Check:

Regular CR-1 Code Check	3 (51)	17 (58)	20 (59)
	43 (71)		
CR-1 Code Check Upon TMT (00)	48 (73)		
0901 Without CR Code Check Upon TMT (00)	16 (57)	45 (72)	
CR-1 Code Check Upon WR and WRE	31 (65)	39 (69)	
CR-2 Code Check	8 (53)	23 (61)	26 (62)
Regular CR-1 and CR-2 Code Check	50 (74)		
CR-1 and CR-2 Code Check Upon	5 (52)	10 (54)	15 (57)
SET, RND, and SHR	53 (76)		

0902 Read/Write Check:

0902 Upon RD	27 (63)	47 (73)	
0902 Upon WR and WRE	31 (65)	39 (69)	
	51 (75)		

0903 Record Check:

36 (67)

0904 Overflow Check:

Regular Overflow Check 21 (60) 41 (70)

0904 Upon DIV 9 (54) 52 (75)

0905 Sign Check:

6 (52) 18 (58) 30 (64)

PART V

CASE STUDY FOR THE 705 CONSOLE

The following 705 program which is loaded into the 705 memory by an Upper Load (LOD 52) has been written to indicate various typical error conditions and the circumstances under which they may arise. It is, therefore, not to be construed as a correct or typical program and should not be used as a pattern for programming applications.

In conformity with the Appendix of Part II above, it is suggested that learners and inexperienced operators should use the Reset key after depressing the Machine Stop key and upon all Check Indicator stops, except when it is intended to follow up by using the Half-Multiple Step key. In the Answer Sheet to the Case Study, this technique has been invariably followed. As the operator gains experience, he will learn to distinguish the conditions in which depression of the Reset key is not necessary and in which the mere depression of the Start key, without manual transfer, will cause resumption of automatic operation. The operator should note the contents of the Instruction Counter, if needed, before depressing the Reset key, as the latter resets the Instruction Counter to 0004.

CASE STUDY FOR THE 705 CONSOLE

<u>LOC.</u>	<u>OP.</u>	<u>ADDR.</u>	<u>CODE</u>	<u>EXPLANATION</u>
0004	SET	0001	01	
09	LOD	0195	01	G/M
14	UNL	12040	01	G/M to Output Area
19	SEL	0200		Input Tape
24	RD	1150		RD 1st record
29	RCV	12024		Designate Output Area
34	TMT	1154	00	TMT Record to Output Area
				CALCULATE HOURLY RATE
39	RAD	12025	00	Weekly rate in Acc.
44	DIV	12028	00	Div. by hrs. per wk.
49	ST	12032	00	Hrly. rate
				WR RECORD
54	SEL	0200		Input Tape
59	RWW	1150		Prepare input to RD
64	SEL	0201		Output Tape
69	WR	12020		Write Record
74	SEL	0300		SEL punch
79	WR	12020		Punch Record
84	SEL	0902		SEL 0902
89	TRS	0119		To 0902 routine
94	SEL	0200		SEL 0200
99	TRS	0159		To E. O. F. 0200
104	SEL	0201		SEL 0201
109	TRS	0184		To E. O. F. 0201
114	TR	0029		To process next record
				0902 ROUTINE
119	SEL	0300		Punch
124	CTR	0005		SUP
129	SEL	0200		Input Tape
134	CTR	0004		BSP
139	SEL	0201		Output Tape
144	CTR	0004		BSP
149	HLT	0001		0902 error
154	TR	0054		Try to RWW again
				E. O. F. 0200
159	CTR	0002		RWD--0200
164	SEL	0201		Output Tape--0201
169	CTR	0001		W. T. M.
174	CTR	0002		RWD
179	HLT	9999		End of job

OPERATION DECODER

11 10 01 00
0001 ○ A ○ J ○ / ○ 1
NO OP STOP TR

0010 ○ B ○ S ○ 2
SET L TR HI R W SEL

0011 ○ C ○ L ○ T ○ 3
SHOR TR SIGN CTRL EQ

0100 ○ D ○ M ○ U ○ 4
LENG TR RCV COMP PLS

○ E ○ N ○ V ○ 5
ROUND TR MPY ST PR ZRO

0110 ○ F ○ W ○ 6
STORE TR DIV ADD MEM SIG

0111 ○ G ○ P ○ X ○ 7
ADD SUB NORM LIN TR LOAD

1000 ○ H ○ Q ○ Y ○ 8
R ADD R SUB READ LOAD

1001 ○ I ○ R ○ Z ○ 9
TR WRITE WR TSM1 ANY ER

MEMORY ADDRESS REGISTER

10000 1000 100 10 1
○ ○ ○ ○ 8 ○ ○ ○ ○

INSTRUCTION COUNTER

10000 1000 100 10 1
○ ○ ○ ○ 4 ● ○ ○ ○ ○

MEMORY ADDRESS COUNTER 1

10000 1000 100 10 1
○ ○ ○ ○ 4 ● ○ ○ ○ ○

MEMORY ADDRESS COUNTER 11

10000 1000 100 10 1
○ ○ ○ ○ 4 ● ○ ○ ○ ○

MEMORY DISPLAY CR 1

C B A B 4 2 1
○ ● ○ ○ ○ ○ ○ ○

STORAGE DISPLAY CR 2

C B A B 4 2 1
○ ○ ○ ○ ○ ○ ○ ○

SELECT REGISTER

○ ○ 8 ○ ○ ○ ○ ○ ○ ○ ○
○ ○ 4 ○ ○ ○ ○ ○ ○ ○ ○
○ ○ 2 ○ ○ ○ ○ ○ ○ ○ ○
○ ○ 1 ○ ○ ○ ○ ○ ○ ○ ○

SSR

8 ○ ○ ○ ○ ○ ○ ○ ○
4 ○ ○ ○ ○ ○ ○ ○ ○
2 ○ ○ ○ ○ ○ ○ ○ ○
1 ○ ○ ○ ○ ○ ○ ○ ○

MEMORY ADDRESS SELECTOR

STORAGE SELECTOR

8
4
2
1
00

9 9 9 9
8 8 8 8
7 7 7 7
6 6 6 6
5 5 5 5
4 4 4 4
3 3 3 3
2 2 2 2
1 1 1 1
0 0 0 0

10000 1000 100 10 1

OPERATION REGISTER

C B A B 4 2 1
○ ○ ○ ○ ○ ○ ○ ○

PROGRAM CONTROL

OFF						PROGRAM CONTROL					
						INSTR	MACH	READ	REC	OV	SIGN
0911	0912	0913	0914	0915	0916	0900	0901	0902	0903	0904	0905
ON						AUTOMATIC					
PROGRAM ALTERATION						CHECK INDICATORS					

CONTROL PANEL

MACH STOP	IN STRUCT	STORE	START	MANUAL	DISPLAY		
HALF MULT STEP	IN STRUCT	STORE	START	STOP	DISPLAY	DISPLAY STEP	RESET

KEYBOARD

A B C D E F G H I + & GM
J K L M N O P Q R - _
/ S T U V W X Y Z RM BL
SHIFT 1 2 3 4 5 6 7 8 9 0 RESTORE

OPERATION DECODER

11 10 01 00
0001 ○ A ○ J ○ / ○ 1
NO OP STOP TR

0010 ○ B ○ S ○ 2
SET L TR HI R W SEL

0011 ○ C ○ L ○ T ○ 3
SHOR TR SIGN CTRL EQ

0100 ○ D ○ M ○ U ○ 4
LENG TR RCV COMP PLS

○ E ○ N ○ V ○ 5
ROUND TR MPY ST PR ZRO

0110 ○ F ○ W ○ 6
STORE TR DIV ADD MEM SIG

0111 ○ G ○ P ○ X ○ 7
ADD SUB NORM LIN TR LOAD

1000 ○ H ○ Q ○ Y ○ 8
R ADD R SUB READ LOAD

1001 ○ I ○ R ○ Z ○ 9
TR WRITE WR TSM1 ANY ER

MEMORY ADDRESS REGISTER

10000 1000 100 10 1
○ ○ ○ ○ 4 ● ○ ○ ○ ○

INSTRUCTION COUNTER

10000 1000 100 10 1
○ ○ ○ ○ 4 ● ○ ○ ○ ○

MEMORY ADDRESS COUNTER 1

10000 1000 100 10 1
○ ○ ○ ○ 4 ● ○ ○ ○ ○

MEMORY ADDRESS COUNTER 11

10000 1000 100 10 1
○ ○ ○ ○ 4 ● ○ ○ ○ ○

MEMORY DISPLAY CR 1

C B A B 4 2 1
○ ● ○ ○ ○ ○ ○ ○

STORAGE DISPLAY CR 2

C B A B 4 2 1
○ ○ ○ ○ ○ ○ ○ ○

SELECT REGISTER

○ ○ 8 ○ ○ ○ ○ ○ ○ ○ ○
○ ○ 4 ○ ○ ○ ○ ○ ○ ○ ○
○ ○ 2 ○ ○ ○ ○ ○ ○ ○ ○
○ ○ 1 ○ ○ ○ ○ ○ ○ ○ ○

SSR

8 ○ ○ ○ ○ ○ ○ ○ ○
4 ○ ○ ○ ○ ○ ○ ○ ○
2 ○ ○ ○ ○ ○ ○ ○ ○
1 ○ ○ ○ ○ ○ ○ ○ ○

MEMORY ADDRESS SELECTOR

STORAGE SELECTOR

8
4
2
1
00

9 9 9 9
8 8 8 8
7 7 7 7
6 6 6 6
5 5 5 5
4 4 4 4
3 3 3 3
2 2 2 2
1 1 1 1
0 0 0 0

10000 1000 100 10 1

OPERATION REGISTER

C B A B 4 2 1
○ ○ ○ ○ ○ ○ ○ ○

PROGRAM CONTROL

OFF						PROGRAM CONTROL					
						INSTR	MACH	READ	REC	OV	SIGN
0911	0912	0913	0914	0915	0916	0900	0901	0902	0903	0904	0905
ON						AUTOMATIC					
PROGRAM ALTERATION						CHECK INDICATORS					

CONTROL PANEL

MACH STOP	IN STRUCT	STORE	AUTOMATIC	START	DISPLAY		
HALF MULT STEP	IN STRUCT	STORE	START	STOP	DISPLAY	DISPLAY STEP	RESET

KEYBOARD

A B C D E F G H I + & GM
J K L M N O P Q R - _
/ S T U V W X Y Z RM BL
SHIFT 1 2 3 4 5 6 7 8 9 0 RESTORE

OPERATION DECODER

11	10	01	00
0001	A	J	/
	NO	OP	STOP
0010	B	S	2
	SET	L	TR
	TR	H	R-W
	R	-W	SEL
0011	C	L	T
	SHOR	TR	SIGN
	TR	CTRL	EQ
0100	D	M	U
	LENG	TR	RCV
	TR	COMP	PLS
	OE	ON	OV
	ROUND	TR	MPY
	TR	ST	PR
	ZRO		
0110	F	O	W
	STORE	TR	DIV
	TR	ADD	MEM
	SIG		
0111	G	P	X
	ADD	SUB	NORM
	TR	UN	LOAD
1000	H	Q	Y
	R	ADD	R
	SUB	READ	LOAD
1001	I	R	Z
	TR	WRITE	WR
	TR	TSMT	ANY

OPERATION REGISTER

C	B	A	B	4	2	1
●	○	○	○	○	○	○

PROGRAM CONTROL

OFF						
INSTR	MACH	READ	REC	OV	SIGN	
0911	0912	0913	0914	0915	0916	0900
ON						
AUTOMATIC						
PROGRAM ALTERATION						
CHECK INDICATORS						

CHECKS

MEMORY DISPLAY CR 1

C	B	A	B	4	2	1
○	○	○	○	○	○	○

MEMORY DISPLAY CR 2

C	B	A	B	4	2	1
○	○	○	○	○	○	○

SELECT REGISTER

8	○	○
4	○	○
2	○	○
1	○	○

SSR

8
4
2
1

MEMORY ADDRESS REGISTER

10000	1000	100	10	1
○	○	○	○	○
○	○	○	○	○
○	○	○	○	○
○	○	○	○	○

INSTRUCTION COUNTER

10000	1000	100	10	1
○	○	○	○	○
○	○	○	○	○
○	○	○	○	○
○	○	○	○	○

MEMORY ADDRESS COUNTER 1

10000	1000	100	10	1
○	○	○	○	○
○	○	○	○	○
○	○	○	○	○
○	○	○	○	○

MEMORY ADDRESS COUNTER 11

10000	1000	100	10	1
○	○	○	○	○
○	○	○	○	○
○	○	○	○	○
○	○	○	○	○

STORAGE SELECTOR

8
4
2
1
00

MEMORY ADDRESS SELECTOR

9	9	9	9
8	8	8	8
7	7	7	7
6	6	6	6
5	5	5	5
4	4	4	4
3	3	3	3
2	2	2	2
1	1	1	1
0	0	0	0

CONTROL PANEL

CLEAR MEMORY	POWER	DC ON	MASTER OFF
POWER ON	NORM OFF	DC ON	DC OFF

FUNCTION KEYS

MACH STOP	IN STRUCT	STORE	AUTOMATIC	DISPLAY		
HALF MULT STEP	IN STRUCT	STORE	START	STOP	DISPLAY	RESET

OPERATION DECODER

11	10	01	00
0001	A	J	/
	NO	OP	STOP
0010	B	S	2
	SET	L	TR
	TR	H	R-W
	R	-W	SEL
0011	C	L	T
	SHOR	TR	SIGN
	TR	CTRL	EQ
0100	D	M	U
	LENG	TR	RCV
	TR	COMP	PLS
	OE	ON	OV
	ROUND	TR	MPY
	TR	ST	PR
	ZRO		
0110	F	O	W
	STORE	TR	DIV
	TR	ADD	MEM
	SIG		
0111	G	P	X
	ADD	SUB	NORM
	TR	UN	LOAD
1000	H	Q	Y
	R	ADD	R
	SUB	READ	LOAD
1001	I	R	Z
	TR	WRITE	WR
	TR	TSMT	ANY

OPERATION REGISTER

C	B	A	B	4	2	1
○	○	○	○	○	○	○

PROGRAM CONTROL

OFF						
INSTR	MACH	READ	REC	OV	SIGN	
0911	0912	0913	0914	0915	0916	0900
ON						
AUTOMATIC						
PROGRAM ALTERATION						
CHECK INDICATORS						

CHECKS

MEMORY DISPLAY CR 1

C	B	A	B	4	2	1
○	○	○	○	○	○	○

MEMORY DISPLAY CR 2

C	B	A	B	4	2	1
○	○	○	○	○	○	○

SELECT REGISTER

8	○	○
4	○	○
2	○	○
1	○	○

SSR

8
4
2
1

MEMORY ADDRESS REGISTER

10000	1000	100	10	1
○	○	○	○	○
○	○	○	○	○
○	○	○	○	○
○	○	○	○	○

INSTRUCTION COUNTER

10000	1000	100	10	1
○	○	○	○	○
○	○	○	○	○
○	○	○	○	○
○	○	○	○	○

MEMORY ADDRESS COUNTER 1

10000	1000	100	10	1
○	○	○	○	○
○	○	○	○	○
○	○	○	○	○
○	○	○	○	○

MEMORY ADDRESS COUNTER 11

10000	1000	100	10	1
○	○	○	○	○
○	○	○	○	○
○	○	○	○	○
○	○	○	○	○

STORAGE SELECTOR

8
4
2
1
00

MEMORY ADDRESS SELECTOR

9	9	9	9
8	8	8	8
7	7	7	7
6	6	6	6
5	5	5	5
4	4	4	4
3	3	3	3
2	2	2	2
1	1	1	1
0	0	0	0

CONTROL PANEL

CLEAR MEMORY	POWER	DC ON	MASTER OFF
POWER ON	NORM OFF	DC ON	DC OFF

FUNCTION KEYS

MACH STOP	IN STRUCT	STORE	AUTOMATIC	MANUAL	DISPLAY		
HALF MULT STEP	IN STRUCT	STORE	START	STOP	DISPLAY	DISPLAY STEP	RESET

Control panel for page 5. It features several registers and counters with 10000, 1000, 100, 10, and 1 scale indicators. The registers include MEMORY ADDRESS REGISTER, INSTRUCTION COUNTER, MEMORY ADDRESS COUNTER 1, and MEMORY ADDRESS COUNTER 11. There are also MEMORY DISPLAY CR 1, STORAGE DISPLAY CR 2, and SELECT REGISTER. Control buttons include CLEAR MEMORY, POWER, DC ON, MASTER OFF, and a set of PROGRAM CONTROL buttons (OFF, INSTR, MACH, READ, REC, OV, SIGN, WRITE, FLW, 0905, 0904, 0903). A PROGRAM ALTERATION section includes ON and AUTOMATIC indicators. A CHECKS section includes MACH STOP, IN STRUCT, STORE, and AUTOMATIC buttons. A STORAGE SIGN selector is also present.

Alphanumeric keypad for page 5. It includes letters A-Z, numbers 0-9, and special characters like \$, #, %, @, ~, and RESTORE. The keypad is organized in a grid with a SHIFT key on the left.

Control panel for page 6. It is identical in layout to page 5 but shows different states for various indicators and buttons. For example, the MEMORY ADDRESS COUNTER 11 has a different pattern of lights, and the PROGRAM CONTROL buttons have different active states.

Alphanumeric keypad for page 6, identical in layout to the one on page 5.

OPERATION DECODER

11	10	01	00
0001	A	J	/
	NO OP	STOP	TR
0010	B	S	2
	SET L	TR HI	R W SEL
0011	C	L	T
	SHOR	TR	SIGN CTRL
0100	D	M	U
	LENG	TR	PLS
	EQ	RVC	COMP
0101	E	N	V
	ROUND	TR	MPY ST PR
	ZRO		
0110	F	O	W
	STORE	TR	DIV
	SIG	ADD	MEM
0111	G	O	X
	ADD	SUB	NORM UN
	TR	LOAD	
1000	H	O	Y
	R ADD	R SUB	READ LOAD
1001	I	R	Z
	TR	WRITE	WR
	ANY	TSMT	ER

OPERATION REGISTER

C	B	A	8	4	2	1
●	○	○	○	○	○	○

PROGRAM CONTROL

OFF						
0911	0912	0913	0914	0915	0916	0917
ON						
PROGRAM ALTERATION						
CHECK INDICATORS						

MEMORY ADDRESS REGISTER

10000	1000	100	10	1
○	○	○	○	○
○	○	○	○	○
○	○	○	○	○
○	○	○	○	○
○	○	○	○	○
○	○	○	○	○
○	○	○	○	○
○	○	○	○	○
○	○	○	○	○

INSTRUCTION COUNTER

10000	1000	100	10	1
○	○	○	○	○
○	○	○	○	○
○	○	○	○	○
○	○	○	○	○
○	○	○	○	○
○	○	○	○	○
○	○	○	○	○
○	○	○	○	○
○	○	○	○	○

MEMORY ADDRESS COUNTER 1

10000	1000	100	10	1
○	○	○	○	○
○	○	○	○	○
○	○	○	○	○
○	○	○	○	○
○	○	○	○	○
○	○	○	○	○
○	○	○	○	○
○	○	○	○	○
○	○	○	○	○

MEMORY ADDRESS COUNTER 11

10000	1000	100	10	1
○	○	○	○	○
○	○	○	○	○
○	○	○	○	○
○	○	○	○	○
○	○	○	○	○
○	○	○	○	○
○	○	○	○	○
○	○	○	○	○
○	○	○	○	○

OPERATION REGISTER

C	B	A	8	4	2	1
○	○	○	○	○	○	○

MEMORY DISPLAY CR 1

C	B	A	8	4	2	1
○	○	○	○	○	○	○

MEMORY DISPLAY CR 2

C	B	A	8	4	2	1
○	○	○	○	○	○	○

SELECT REGISTER

8	○	○
4	○	○
2	○	○
1	○	○

SSR

8
4
2
1
00

MEMORY ADDRESS SELECTOR

9	9	9	9
8	8	8	8
7	7	7	7
6	6	6	6
5	5	5	5
4	4	4	4
3	3	3	3
2	2	2	2
1	1	1	1
0	0	0	0

STORAGE SELECTOR

8
4
2
1
00

STORAGE SIGN (-)

ACC	AUX
○	○

CONTROL PANEL

MACH STOP	IN STRUCT	STORE	AUTOMATIC	MANUAL	DISPLAY	
○	○	○	○	○	○	○
HALF MULT STEP	IN STRUCT	STORE	START	STOP	DISPLAY	RESET
○	○	○	○	○	○	○

POWER CONTROLS

CLEAR MEMORY	POWER	DC ON	MASTER OFF
○	○	○	○
POWER ON	NORM OFF	DC ON	DC OFF
○	○	○	○

OPERATION DECODER

11	10	01	00
0001	A	J	/
	NO OP	STOP	TR
0010	B	S	2
	SET L	TR HI	R W SEL
0011	C	L	T
	SHOR	TR	SIGN CTRL
0100	D	M	U
	LENG	TR	PLS
	EQ	RVC	COMP
0101	E	N	V
	ROUND	TR	MPY ST PR
	ZRO		
0110	F	O	W
	STORE	TR	DIV
	SIG	ADD	MEM
0111	G	O	X
	ADD	SUB	NORM UN
	TR	LOAD	
1000	H	O	Y
	R ADD	R SUB	READ LOAD
1001	I	R	Z
	TR	WRITE	WR
	ANY	TSMT	ER

OPERATION REGISTER

C	B	A	8	4	2	1
○	○	○	○	○	○	○

PROGRAM CONTROL

OFF						
0911	0912	0913	0914	0915	0916	0917
ON						
PROGRAM ALTERATION						
CHECK INDICATORS						

MEMORY ADDRESS REGISTER

10000	1000	100	10	1
○	○	○	○	○
○	○	○	○	○
○	○	○	○	○
○	○	○	○	○
○	○	○	○	○
○	○	○	○	○
○	○	○	○	○
○	○	○	○	○
○	○	○	○	○

INSTRUCTION COUNTER

10000	1000	100	10	1
○	○	○	○	○
○	○	○	○	○
○	○	○	○	○
○	○	○	○	○
○	○	○	○	○
○	○	○	○	○
○	○	○	○	○
○	○	○	○	○
○	○	○	○	○

MEMORY ADDRESS COUNTER 1

10000	1000	100	10	1
○	○	○	○	○
○	○	○	○	○
○	○	○	○	○
○	○	○	○	○
○	○	○	○	○
○	○	○	○	○
○	○	○	○	○
○	○	○	○	○
○	○	○	○	○

MEMORY ADDRESS COUNTER 11

10000	1000	100	10	1
○	○	○	○	○
○	○	○	○	○
○	○	○	○	○
○	○	○	○	○
○	○	○	○	○
○	○	○	○	○
○	○	○	○	○
○	○	○	○	○
○	○	○	○	○

OPERATION REGISTER

C	B	A	8	4	2	1
○	○	○	○	○	○	○

MEMORY DISPLAY CR 1

C	B	A	8	4	2	1
○	○	○	○	○	○	○

MEMORY DISPLAY CR 2

C	B	A	8	4	2	1
○	○	○	○	○	○	○

SELECT REGISTER

8	○	○
4	○	○
2	○	○
1	○	○

SSR

8
4
2
1
00

MEMORY ADDRESS SELECTOR

9	9	9	9
8	8	8	8
7	7	7	7
6	6	6	6
5	5	5	5
4	4	4	4
3	3	3	3
2	2	2	2
1	1	1	1
0	0	0	0

STORAGE SELECTOR

8
4
2
1
00

STORAGE SIGN (-)

ACC	AUX
○	○

CONTROL PANEL

MACH STOP	IN STRUCT	STORE	AUTOMATIC	MANUAL	DISPLAY	
○	○	○	○	○	○	○
HALF MULT STEP	IN STRUCT	STORE	START	STOP	DISPLAY	RESET
○	○	○	○	○	○	○

POWER CONTROLS

CLEAR MEMORY	POWER	DC ON	MASTER OFF
○	○	○	○
POWER ON	NORM OFF	DC ON	DC OFF
○	○	○	○

OPERATION DECODER

11 10 01 00
0001 A J / 01 TR
NO OP STOP

0010 R S 02
SEL TR HI R W SEL

0011 C L T 03
SNOR TR SIGN CTRL

0100 D M U 04
LENG TR RCV COMP

0101 E N V 05
ROUND TR MP* ST PR

0110 F O W 06
STORE TR DIV ADD MEM

0111 G P X 07
ADD SUB NORM UN TR LOAD

1000 H Q Y 08
R ADD R SUB READ LOAD

1001 I R Z 09
TR WRITE WR TSM T

ANY ER

MEMORY ADDRESS REGISTER

10000 1000 100 10 1
0 0 0 8 0 0

INSTRUCTION COUNTER

10000 1000 100 10 1
0 0 0 4 0 0

MEMORY ADDRESS COUNTER 1

10000 1000 100 10 1
0 0 0 2 0 0

MEMORY ADDRESS COUNTER 11

10000 1000 100 10 1
0 0 0 1 0 0

OPERATION REGISTER

C B A 8 4 2 1
0 0 0 0 0 0 0

PROGRAM CONTROL

OFF	INSTR	MACH	READ	REC	OV	SIGN
0911	0912	0913	0914	0915	0916	0900
ON	WRITE	FLW	0903	0904	0905	
PROGRAM ALTERATION	AUTOMATIC CHECK INDICATORS					

CHECKS

INSTR CR 1 CODE CHECK
MACH CR 1 CODE CHECK

4 OR 9 CHK
OP CHECK

CR 2 CODE CHK

MEMORY DISPLAY CR 1

C B A 8 4 2 1
0 0 0 0 0 0 0

STORAGE DISPLAY CR 2

C B A 8 4 2 1
0 0 0 0 0 0 0

SELECT REGISTER

0 8 0 0
0 4 0 0
0 2 0 0
0 1 0 0

SSR

8 0
4 0
2 0
1 0

STORAGE SIGNATOR

READ WRITE
1/0 NO RESPONSE

ACC AUX
STORAGE SIGN (-)

STORAGE SELECTOR

8
4
2
1
00

MEMORY ADDRESS SELECTOR

9	9	9	9
8	8	8	8
7	7	7	7
6	6	6	6
5	5	5	5
4	4	4	4
3	3	3	3
2	2	2	2
1	1	1	1
0	0	0	0

10000 1000 100 10 1

CONTROL PANEL

MACH STOP IN STRUCT STORE AUTOMATIC DISPLAY

HALF MULT STEP IN STRUCT STORE START STOP DISPLAY DISPLAY STEP RESET

CLEAR MEMORY POWER DC ON MASTER OFF
POWER ON NORM OFF DC ON DC OFF

ALPHANUMERIC KEYPAD

A	B	C	D	E	F	G	H	I	+	&	GM
J	K	L	M	N	O	P	Q	R	-	-	
/	S	T	U	V	W	X	Y	Z	RM	BL	
SHIFT	1	2	3	4	5	6	7	8	9	0	RESTORE

OPERATION DECODER

11 10 01 00
0001 A J / 01 TR
NO OP STOP

0010 R S 02
SEL TR HI R W SEL

0011 C L T 03
SNOR TR SIGN CTRL

0100 D M U 04
LENG TR RCV COMP

0101 E N V 05
ROUND TR MP* ST PR

0110 F O W 06
STORE TR DIV ADD MEM

0111 G P X 07
ADD SUB NORM UN TR LOAD

1000 H Q Y 08
R ADD R SUB READ LOAD

1001 I R Z 09
TR WRITE WR TSM T

ANY ER

MEMORY ADDRESS REGISTER

10000 1000 100 10 1
0 0 0 8 0 0

INSTRUCTION COUNTER

10000 1000 100 10 1
0 0 0 4 0 0

MEMORY ADDRESS COUNTER 1

10000 1000 100 10 1
0 0 0 2 0 0

MEMORY ADDRESS COUNTER 11

10000 1000 100 10 1
0 0 0 1 0 0

OPERATION REGISTER

C B A 8 4 2 1
0 0 0 0 0 0 0

PROGRAM CONTROL

OFF	INSTR	MACH	READ	REC	OV	SIGN
0911	0912	0913	0914	0915	0916	0900
ON	WRITE	FLW	0903	0904	0905	
PROGRAM ALTERATION	AUTOMATIC CHECK INDICATORS					

CHECKS

INSTR CR 1 CODE CHECK
MACH CR 1 CODE CHECK

4 OR 9 CHK
OP CHECK

CR 2 CODE CHK

MEMORY DISPLAY CR 1

C B A 8 4 2 1
0 0 0 0 0 0 0

STORAGE DISPLAY CR 2

C B A 8 4 2 1
0 0 0 0 0 0 0

SELECT REGISTER

0 8 0 0
0 4 0 0
0 2 0 0
0 1 0 0

SSR

8 0
4 0
2 0
1 0

STORAGE SIGNATOR

READ WRITE
1/0 NO RESPONSE

ACC AUX
STORAGE SIGN (-)

STORAGE SELECTOR

8
4
2
1
00

MEMORY ADDRESS SELECTOR

9	9	9	9
8	8	8	8
7	7	7	7
6	6	6	6
5	5	5	5
4	4	4	4
3	3	3	3
2	2	2	2
1	1	1	1
0	0	0	0

10000 1000 100 10 1

CONTROL PANEL

MACH STOP IN STRUCT STORE AUTOMATIC DISPLAY

HALF MULT STEP IN STRUCT STORE START STOP DISPLAY DISPLAY STEP RESET

CLEAR MEMORY POWER DC ON MASTER OFF
POWER ON NORM OFF DC ON DC OFF

ALPHANUMERIC KEYPAD

A	B	C	D	E	F	G	H	I	+	&	GM
J	K	L	M	N	O	P	Q	R	-	-	
/	S	T	U	V	W	X	Y	Z	RM	BL	
SHIFT	1	2	3	4	5	6	7	8	9	0	RESTORE

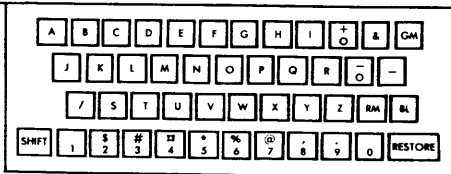
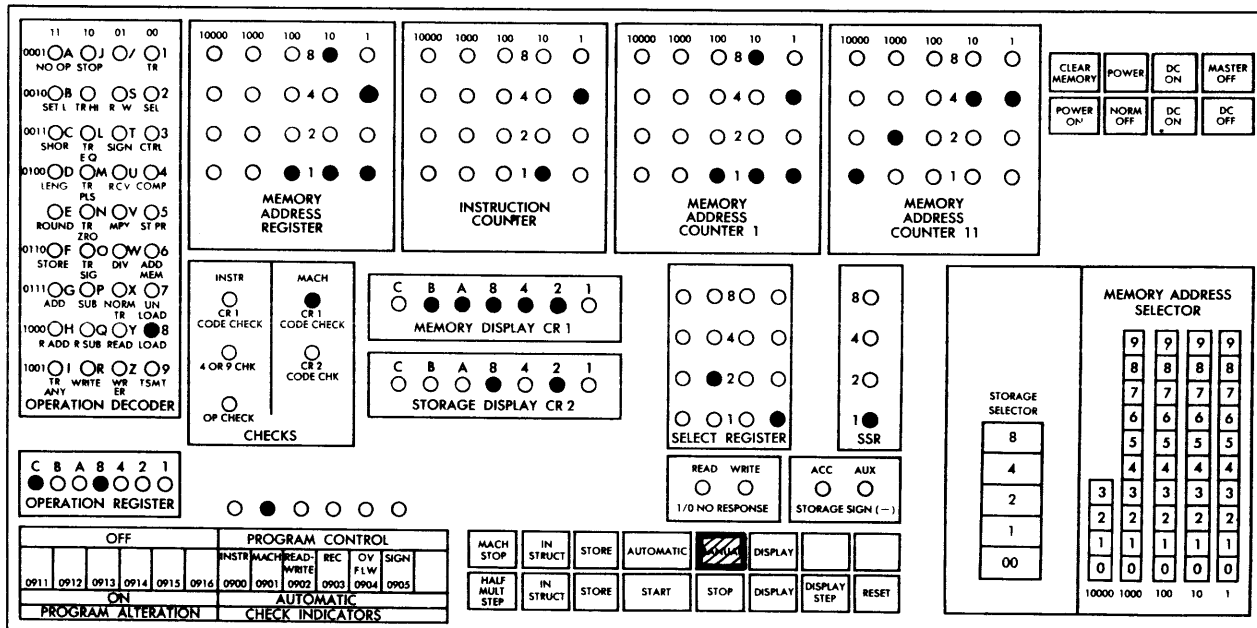
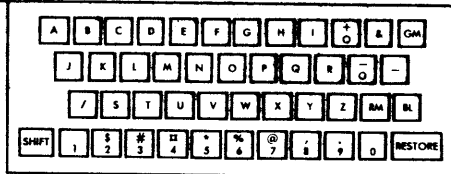
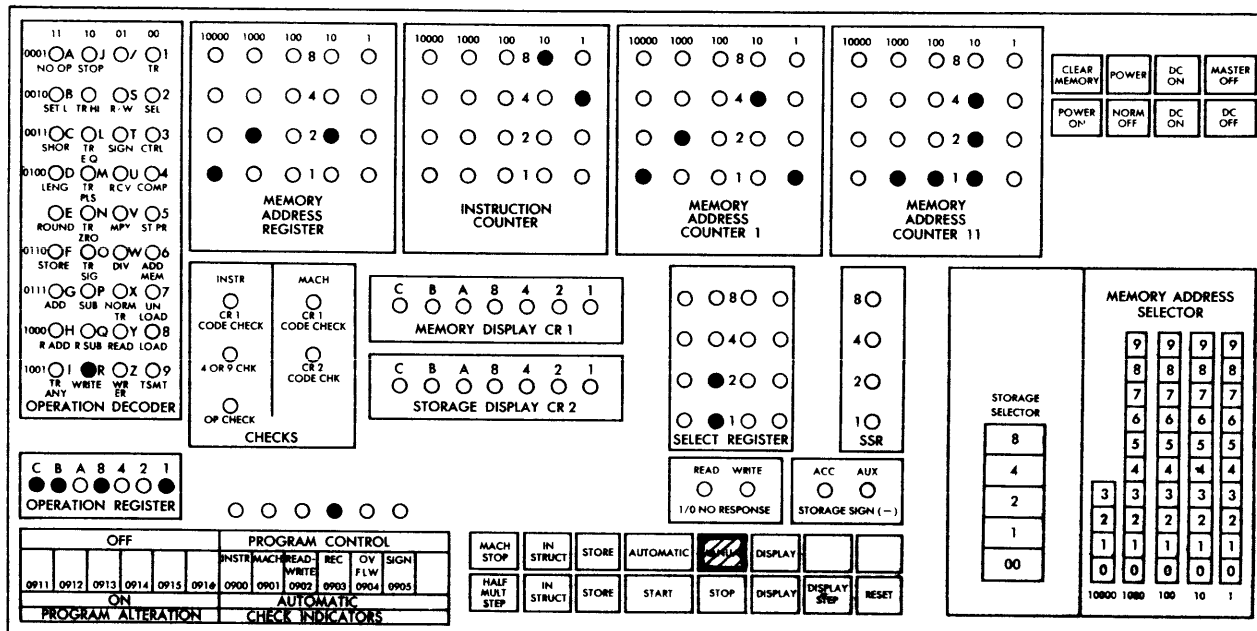

OPERATION DECODER

11	10	01	00
0001	A	J	/
	NO OP	STOP	TR
0010	B	/	S
	SET L	TR HI	R-W SEL
0011	C	L	T
	SHOR	TR	SIGN CTRL
0100	D	M	U
	LENG	TR	RCV COMP
		PLS	
	E	N	V
	ROUND	TR	MPY ST PR
		ZRO	
0110	F	O	W
	STORE	TR	DIV ADD
		SIG	MEM
0111	G	P	X
	ADD	SUB	NORM UN
		TR	LOAD
1000	H	Q	Y
	R	ADD	R SUB
		READ	LOAD
1001	I	R	Z
	TR	WRITE	WR
		TSMT	ANY

OPERATION REGISTER

C B A 8 4 2 1

MEMORY ADDRESS REGISTER

10000 1000 100 10 1

INSTRUCTION COUNTER

10000 1000 100 10 1

MEMORY ADDRESS COUNTER 1

10000 1000 100 10 1

MEMORY ADDRESS COUNTER 11

10000 1000 100 10 1

MEMORY DISPLAY CR 1

C B A 8 4 2 1

STORAGE DISPLAY CR 2

C B A 8 4 2 1

SELECT REGISTER

8 4 2 1

SSR

8 4 2 1

STORAGE SIGN (-)

ACC AUX

STORAGE SELECTOR

9	9	9	9
8	8	8	8
7	7	7	7
6	6	6	6
5	5	5	5
4	4	4	4
3	3	3	3
2	2	2	2
1	1	1	1
0	0	0	0

POWER CONTROLS

CLEAR MEMORY	POWER	DC ON	MASTER OFF
POWER ON	NORM OFF	DC ON	DC OFF

PROGRAM CONTROL

OFF	PROGRAM CONTROL										
	INSTR	MACH	READ	REC	OV	SIGN					
			WRITE	FLW							
0911	0912	0913	0914	0915	0916	0900	0901	0902	0903	0904	0905
ON					AUTOMATIC						
PROGRAM ALTERATION					CHECK INDICATORS						

CONTROL INDICATORS

MACH STOP	IN STRUCT	STORE	AUTOMATIC	STOP	DISPLAY		
HALF MULT STEP	IN STRUCT	STORE	START	STOP	DISPLAY	DISPLAY STEP	RESET

A B C D E F G H I + & CM

J K L M N O P Q R - -

/ S T U V W X Y Z RM BL

SHIFT 1 2 3 4 5 6 7 8 9 0 RESTORE

OPERATION DECODER

11	10	01	00
0001	A	J	/
	NO OP	STOP	TR
0010	B	/	S
	SET L	TR HI	R-W SEL
0011	C	L	T
	SHOR	TR	SIGN CTRL
0100	D	M	U
	LENG	TR	RCV COMP
		PLS	
	E	N	V
	ROUND	TR	MPY ST PR
		ZRO	
0110	F	O	W
	STORE	TR	DIV ADD
		SIG	MEM
0111	G	P	X
	ADD	SUB	NORM UN
		TR	LOAD
1000	H	Q	Y
	R	ADD	R SUB
		READ	LOAD
1001	I	R	Z
	TR	WRITE	WR
		TSMT	ANY

OPERATION REGISTER

C B A 8 4 2 1

MEMORY ADDRESS REGISTER

10000 1000 100 10 1

INSTRUCTION COUNTER

10000 1000 100 10 1

MEMORY ADDRESS COUNTER 1

10000 1000 100 10 1

MEMORY ADDRESS COUNTER 11

10000 1000 100 10 1

MEMORY DISPLAY CR 1

C B A 8 4 2 1

STORAGE DISPLAY CR 2

C B A 8 4 2 1

SELECT REGISTER

8 4 2 1

SSR

8 4 2 1

STORAGE SIGN (-)

ACC AUX

STORAGE SELECTOR

9	9	9	9
8	8	8	8
7	7	7	7
6	6	6	6
5	5	5	5
4	4	4	4
3	3	3	3
2	2	2	2
1	1	1	1
0	0	0	0

POWER CONTROLS

CLEAR MEMORY	POWER	DC ON	MASTER OFF
POWER ON	NORM OFF	DC ON	DC OFF

PROGRAM CONTROL

OFF	PROGRAM CONTROL										
	INSTR	MACH	READ	REC	OV	SIGN					
			WRITE	FLW							
0911	0912	0913	0914	0915	0916	0900	0901	0902	0903	0904	0905
ON					AUTOMATIC						
PROGRAM ALTERATION					CHECK INDICATORS						

CONTROL INDICATORS

MACH STOP	IN STRUCT	STORE	AUTOMATIC	STOP	DISPLAY		
HALF MULT STEP	IN STRUCT	STORE	START	STOP	DISPLAY	DISPLAY STEP	RESET

A B C D E F G H I + & CM

J K L M N O P Q R - -

/ S T U V W X Y Z RM BL

SHIFT 1 2 3 4 5 6 7 8 9 0 RESTORE

OPERATION DECODER

11	10	01	00
0001	0A	0J	0/01
NO OP STOP TR			
0010	0B	0S	02
SET L TR HI R W SEL			
0011	0C	0L	0T03
SHOR TR SIGN CTRL EQ			
0100	0D	0M	0U04
LENG TR RCV COMP PLS			
0E	0N	0V	05
ROUND TR MPY ST PR ZRO			
0110	0F	0O	0W06
STORE TR DIV ADD MEM SIG			
0111	0G	0P	0X07
ADD SUB NORM UN TR LOAD			
1000	0H	0Q	0Y08
R ADD R SUB READ LOAD			
1001	0I	0R	0Z09
TR WRITE WR TSMIT ANY ER			
OPERATION DECODER			

MEMORY ADDRESS REGISTER

10000	1000	100	10	1
0	0	0	8	0
0	0	0	4	0
0	0	0	2	0
0	0	0	1	0

INSTRUCTION COUNTER

10000	1000	100	10	1
0	0	0	8	0
0	0	0	4	0
0	0	0	2	0
0	0	0	1	0

MEMORY ADDRESS COUNTER 1

10000	1000	100	10	1
0	0	0	8	0
0	0	0	4	0
0	0	0	2	0
0	0	0	1	0

MEMORY ADDRESS COUNTER 11

10000	1000	100	10	1
0	0	0	8	0
0	0	0	4	0
0	0	0	2	0
0	0	0	1	0

OPERATION REGISTER

C	B	A	B	4	2	1
0	0	0	0	0	0	0

MEMORY DISPLAY CR 1

C	B	A	B	4	2	1
0	0	0	0	0	0	0

STORAGE DISPLAY CR 2

C	B	A	B	4	2	1
0	0	0	0	0	0	0

SELECT REGISTER

8	0	0	0
4	0	0	0
2	0	0	0
1	0	0	0

SSR

8	0	0	0
4	0	0	0
2	0	0	0
1	0	0	0

MEMORY ADDRESS SELECTOR

9	9	9	9
8	8	8	8
7	7	7	7
6	6	6	6
5	5	5	5
4	4	4	4
3	3	3	3
2	2	2	2
1	1	1	1
0	0	0	0

STORAGE SELECTOR

8
4
2
1
00

PROGRAM CONTROL

OFF	PROGRAM CONTROL										
	INSTR	MACH	READ	REC	OV	SIGN					
0911	0912	0913	0914	0915	0916	0900	0901	0902	0903	0904	0905
ON											
AUTOMATIC											
PROGRAM ALTERATION											
CHECK INDICATORS											

CONTROL PANEL

MACH STOP	IN STRUCT	STORE	AUTOMATIC	MANUAL	DISPLAY		
HALF MULT STEP	IN STRUCT	STORE	START	STOP	DISPLAY	DISPLAY STEP	RESET

POWER CONTROLS

CLEAR MEMORY	POWER	DC ON	MASTER OFF
POWER ON	NORM OFF	DC ON	DC OFF

ALPHANUMERIC KEYPAD

A	B	C	D	E	F	G	H	I	+O	&	GM
J	K	L	M	N	O	P	Q	R	-		
/	S	T	U	V	W	X	Y	Z	RM	BL	
SHIFT	1	2	3	4	5	6	7	8	9	0	RESTORE

OPERATION DECODER

11	10	01	00
0001	0A	0J	0/01
NO OP STOP TR			
0010	0B	0S	02
SET L TR HI R W SEL			
0011	0C	0L	0T03
SHOR TR SIGN CTRL EQ			
0100	0D	0M	0U04
LENG TR RCV COMP PLS			
0E	0N	0V	05
ROUND TR MPY ST PR ZRO			
0110	0F	0O	0W06
STORE TR DIV ADD MEM SIG			
0111	0G	0P	0X07
ADD SUB NORM UN TR LOAD			
1000	0H	0Q	0Y08
R ADD R SUB READ LOAD			
1001	0I	0R	0Z09
TR WRITE WR TSMIT ANY ER			
OPERATION DECODER			

MEMORY ADDRESS REGISTER

10000	1000	100	10	1
0	0	0	8	0
0	0	0	4	0
0	0	0	2	0
0	0	0	1	0

INSTRUCTION COUNTER

10000	1000	100	10	1
0	0	0	8	0
0	0	0	4	0
0	0	0	2	0
0	0	0	1	0

MEMORY ADDRESS COUNTER 1

10000	1000	100	10	1
0	0	0	8	0
0	0	0	4	0
0	0	0	2	0
0	0	0	1	0

MEMORY ADDRESS COUNTER 11

10000	1000	100	10	1
0	0	0	8	0
0	0	0	4	0
0	0	0	2	0
0	0	0	1	0

OPERATION REGISTER

C	B	A	B	4	2	1
0	0	0	0	0	0	0

MEMORY DISPLAY CR 1

C	B	A	B	4	2	1
0	0	0	0	0	0	0

STORAGE DISPLAY CR 2

C	B	A	B	4	2	1
0	0	0	0	0	0	0

SELECT REGISTER

8	0	0	0
4	0	0	0
2	0	0	0
1	0	0	0

SSR

8	0	0	0
4	0	0	0
2	0	0	0
1	0	0	0

MEMORY ADDRESS SELECTOR

9	9	9	9
8	8	8	8
7	7	7	7
6	6	6	6
5	5	5	5
4	4	4	4
3	3	3	3
2	2	2	2
1	1	1	1
0	0	0	0

STORAGE SELECTOR

8
4
2
1
00

PROGRAM CONTROL

OFF	PROGRAM CONTROL										
	INSTR	MACH	READ	REC	OV	SIGN					
0911	0912	0913	0914	0915	0916	0900	0901	0902	0903	0904	0905
ON											
AUTOMATIC											
PROGRAM ALTERATION											
CHECK INDICATORS											

CONTROL PANEL

MACH STOP	IN STRUCT	STORE	AUTOMATIC	MANUAL	DISPLAY		
HALF MULT STEP	IN STRUCT	STORE	START	STOP	DISPLAY	DISPLAY STEP	RESET

POWER CONTROLS

CLEAR MEMORY	POWER	DC ON	MASTER OFF
POWER ON	NORM OFF	DC ON	DC OFF

ALPHANUMERIC KEYPAD

A	B	C	D	E	F	G	H	I	+O	&	GM
J	K	L	M	N	O	P	Q	R	-		
/	S	T	U	V	W	X	Y	Z	RM	BL	
SHIFT	1	2	3	4	5	6	7	8	9	0	RESTORE

OPERATION DECODER

11 10 01 00
0001 ○ A J / ○ 1
NO OP STOP TR

0010 ○ B ○ S ○ 2
SET L TR HI R-W SEL

0011 ○ C L T ○ 3
SHOR TR SIGN CTRL EQ

0100 ○ D M U ○ 4
LENG TR RCV COMP PLS

○ E N V ○ 5
ROUND TR MPY ST PR ZRO

0110 ○ F ○ W ○ 6
STORE TR DIV ADD MEM SIG

0111 ○ G O P X ○ 7
ADD SUB NORM UN TR LOAD

1000 ○ H Q Y ○ 8
R ADD R SUB READ LOAD

1001 ○ I R Z ○ 9
TR WRITE WR TSMT ANY ER

MEMORY ADDRESS REGISTER

10000 1000 100 10 1
○ ○ ○ ○ 8 ○ ○ ○ ○

INSTRUCTION COUNTER

10000 1000 100 10 1
○ ○ ○ ○ 4 ○ ○ ○ ○

MEMORY ADDRESS COUNTER 1

10000 1000 100 10 1
○ ○ ○ ○ 2 ○ ○ ○ ○

MEMORY ADDRESS COUNTER 11

10000 1000 100 10 1
○ ○ ○ ○ 2 ○ ○ ○ ○

OPERATION REGISTER

C B A B 4 2 1
● ○ ○ ○ ○ ○ ○ ○

PROGRAM CONTROL

OFF	INSTR	MACH	READ	REC	OV	SIGN
0911	0912	0913	0914	0915	0916	0900
ON	MACH	WRITE	REC	OV	FLW	SIGN
0901	0902	0903	0904	0905		
PROGRAM ALTERATION			CHECK INDICATORS			

CONTROL PANEL

MACH STOP IN STRUCT STORE AUTOMATIC **STOP** DISPLAY

HALF MULT STEP IN STRUCT STORE START STOP DISPLAY DISPLAY STEP RESET

SELECT REGISTER

○ ○ 8 ○ ○
○ ○ 4 ○ ○
○ ○ 2 ○ ○
○ ● 1 ○ ○

STORAGE SELECTOR

8
4
2
1
00

MEMORY ADDRESS SELECTOR

9	9	9	9
8	8	8	8
7	7	7	7
6	6	6	6
5	5	5	5
4	4	4	4
3	3	3	3
2	2	2	2
1	1	1	1
0	0	0	0

10000 1000 100 10 1

A B C D E F G H I J K L M N O P Q R S T U V W X Y Z

SHIFT 1 2 3 4 5 6 7 8 9 0 RESTORE

OPERATION DECODER

11 10 01 00
0001 ○ A J / ○ 1
NO OP STOP TR

0010 ○ B ○ S ○ 2
SET L TR HI R-W SEL

0011 ○ C L T ○ 3
SHOR TR SIGN CTRL EQ

0100 ○ D M U ○ 4
LENG TR RCV COMP PLS

○ E N V ○ 5
ROUND TR MPY ST PR ZRO

0110 ○ F ○ W ○ 6
STORE TR DIV ADD MEM SIG

0111 ○ G O P X ○ 7
ADD SUB NORM UN TR LOAD

1000 ○ H Q Y ○ 8
R ADD R SUB READ LOAD

1001 ○ I R Z ○ 9
TR WRITE WR TSMT ANY ER

MEMORY ADDRESS REGISTER

10000 1000 100 10 1
○ ○ ○ ○ 8 ○ ○ ○ ○

INSTRUCTION COUNTER

10000 1000 100 10 1
○ ○ ○ ○ 4 ● ○ ○ ○

MEMORY ADDRESS COUNTER 1

10000 1000 100 10 1
○ ○ ○ ○ 2 ○ ○ ○ ○

MEMORY ADDRESS COUNTER 11

10000 1000 100 10 1
○ ○ ○ ○ 2 ○ ○ ○ ○

OPERATION REGISTER

C B A B 4 2 1
○ ○ ○ ○ ○ ○ ○ ●

PROGRAM CONTROL

OFF	INSTR	MACH	READ	REC	OV	SIGN
0911	0912	0913	0914	0915	0916	0900
ON	MACH	WRITE	REC	OV	FLW	SIGN
0901	0902	0903	0904	0905		
PROGRAM ALTERATION			CHECK INDICATORS			

CONTROL PANEL

MACH STOP IN STRUCT STORE AUTOMATIC **STOP** DISPLAY

HALF MULT STEP IN STRUCT STORE START STOP DISPLAY DISPLAY STEP RESET

SELECT REGISTER

○ ○ 8 ○ ○
○ ○ 4 ○ ○
○ ○ 2 ○ ○
○ ○ 1 ○ ○

STORAGE SELECTOR

8
4
2
1
00

MEMORY ADDRESS SELECTOR

9	9	9	9
8	8	8	8
7	7	7	7
6	6	6	6
5	5	5	5
4	4	4	4
3	3	3	3
2	2	2	2
1	1	1	1
0	0	0	0

10000 1000 100 10 1

A B C D E F G H I J K L M N O P Q R S T U V W X Y Z

SHIFT 1 2 3 4 5 6 7 8 9 0 RESTORE

Control panel for page 19. It features several registers and counters with binary indicators (0/1) and a 4x4 grid of buttons. The registers include:

- OPERATION DECODER:** 11 bits (0001-1001) with functions like NO OP STOP, SET L TR HI R W SEL, SHOR TR SIGN CTRL EQ, LENG TR RCV COMP PLS, ROUND TR MPY ST PR ZRO, STORE TR DIV ADD MEM SIG, ADD SUB NORM UN TR LOAD, R ADD R SUB READ LOAD, and TE WRITE WR TSMT ANY.
- MEMORY ADDRESS REGISTER:** 10000-10001 bits.
- INSTRUCTION COUNTER:** 10000-10001 bits.
- MEMORY ADDRESS COUNTER 1:** 10000-10001 bits.
- MEMORY ADDRESS COUNTER 11:** 10000-10001 bits.
- MEMORY DISPLAY CR 1:** C B A B 4 2 1 bits.
- STORAGE DISPLAY CR 2:** C B A B 4 2 1 bits.
- SELECT REGISTER:** 8 4 2 1 bits.
- SSR:** 8 4 2 1 bits.
- OPERATION REGISTER:** C B A B 4 2 1 bits.
- CHECKS:** INSTR, MACH, CR 1, CR 2, 4 OR 9 CHK, OP CHK.
- PROGRAM CONTROL:** OFF/ON buttons for INSTR, MACH, READ, WRITE, REC, OV, F, W, SIGN, and AUTOMATIC.
- PROGRAM ALTERATION:** OFF/ON buttons for PROGRAM ALTERATION and CHECK INDICATORS.
- CONTROL PANEL:** MACH STOP, IN STRUCT, STORE, AUTOMATIC, MANUAL, DISPLAY, HALF MULT STEP, IN STRUCT, STORE, START, STOP, DISPLAY, DISPLAY STEP, RESET.
- STORAGE SELECTOR:** 8 4 2 1 bits.
- MEMORY ADDRESS SELECTOR:** 4x4 grid of buttons (0-9).
- POWER/DC ON/OFF:** CLEAR MEMORY, POWER ON, NORM OFF, DC ON, MASTER OFF, DC OFF.

Control panel for page 20, identical in layout to page 19 but with a different state of indicators. The registers and counters show different binary values. The PROGRAM CONTROL panel shows the AUTOMATIC button is lit. The MEMORY ADDRESS REGISTER shows 10001. The INSTRUCTION COUNTER shows 10001. The MEMORY ADDRESS COUNTER 1 shows 10001. The MEMORY ADDRESS COUNTER 11 shows 10001. The MEMORY DISPLAY CR 1 shows 10001. The STORAGE DISPLAY CR 2 shows 10001. The SELECT REGISTER shows 1000. The SSR shows 1000. The OPERATION REGISTER shows 10001. The CHECKS panel shows INSTR, MACH, CR 1, CR 2, 4 OR 9 CHK, and OP CHK are all lit. The PROGRAM CONTROL panel shows the AUTOMATIC button is lit. The PROGRAM ALTERATION panel shows the CHECK INDICATORS button is lit. The STORAGE SELECTOR shows 1000. The MEMORY ADDRESS SELECTOR shows 1000. The POWER/DC ON/OFF panel shows the DC ON button is lit.

Control panel for page 21. It features several registers and counters with 10000, 1000, 100, 10, and 1 scale indicators. The registers include MEMORY ADDRESS REGISTER, INSTRUCTION COUNTER, MEMORY ADDRESS COUNTER 1, and MEMORY ADDRESS COUNTER 11. There are also MEMORY DISPLAY CR 1, STORAGE DISPLAY CR 2, SELECT REGISTER, and SSR. Control buttons include CLEAR MEMORY, POWER, DC ON, MASTER OFF, POWER ON, NORM OFF, DC ON, and DC OFF. A keyboard is shown at the bottom right with letters A-Z, numbers 0-9, and function keys like SHIFT, RESTORE, and a numeric keypad.

Control panel for page 22, identical in layout to page 21. The states of the buttons and indicators are different. For example, the 'AUTOMATIC' button is now highlighted with a diagonal line, and the 'STOP' button is also highlighted. The registers and counters show different values compared to page 21. The keyboard at the bottom right is also present.

Control panel for page 23. It features several registers and counters with 10000, 1000, 100, 10, and 1 scale indicators. The registers include MEMORY ADDRESS REGISTER, INSTRUCTION COUNTER, MEMORY ADDRESS COUNTER 1, and MEMORY ADDRESS COUNTER 11. There are also MEMORY DISPLAY CR 1, STORAGE DISPLAY CR 2, and an OPERATION DECODER. Control buttons include CLEAR MEMORY, POWER, DC ON, MASTER OFF, and various program control buttons like MACH STOP, IN STRUCT, STORE, AUTOMATIC, and DISPLAY. A keyboard is shown at the bottom right.

Control panel for page 24, identical in layout to page 23. The states of the buttons and indicators are different. For example, the 'STOP' button is highlighted with a diagonal line, and the 'MACH STOP' button is pressed. The registers and counters show different values compared to page 23.

Control panel for page 25. It features several indicator lights and control buttons. On the left, there is an 'OPERATION DECODER' with 10 rows of lights labeled A through Z. Below it is an 'OPERATION REGISTER' with lights for C, B, A, 8, 4, 2, 1. The top row of lights is labeled 'NO OP STOP' and 'TR'. The middle section contains four 'MEMORY ADDRESS COUNTER' units (0, 1, 11) and an 'INSTRUCTION COUNTER', each with lights for 10000, 1000, 100, 10, and 1. Below these are 'MEMORY DISPLAY CR 1' and 'STORAGE DISPLAY CR 2' with lights for C, B, A, 8, 4, 2, 1. To the right are 'SELECT REGISTER' (lights 8, 4, 2, 1) and 'SSR' (lights 8, 4, 2, 1). Further right are 'STORAGE SELECTOR' (lights 8, 4, 2, 1) and 'MEMORY ADDRESS SELECTOR' (a 4x4 grid of lights). At the bottom left is a 'PROGRAM CONTROL' table with columns for 'OFF', 'ON', 'PROGRAM ALTERATION', and 'CHECK INDICATORS'. To its right are 'CHECKS' (INSTR, MACH, 4 OR 9 CHK, OP CHECK) and 'MACH STOP' (MACH STOP, HALF MULT STEP). At the bottom right are 'READ WRITE' and 'ACC AUX' buttons, and a 'STORAGE SIGN (-)' indicator.

Alphanumeric keypad for page 25. It includes letters A through Z, numbers 0 through 9, and special keys like '+', '&', 'GM', 'RM', 'BL', 'RESTORE', and 'SHIFT'.

Control panel for page 26. It features several indicator lights and control buttons. On the left, there is an 'OPERATION DECODER' with 10 rows of lights labeled A through Z. Below it is an 'OPERATION REGISTER' with lights for C, B, A, 8, 4, 2, 1. The top row of lights is labeled 'NO OP STOP' and 'TR'. The middle section contains four 'MEMORY ADDRESS COUNTER' units (0, 1, 11) and an 'INSTRUCTION COUNTER', each with lights for 10000, 1000, 100, 10, and 1. Below these are 'MEMORY DISPLAY CR 1' and 'STORAGE DISPLAY CR 2' with lights for C, B, A, 8, 4, 2, 1. To the right are 'SELECT REGISTER' (lights 8, 4, 2, 1) and 'SSR' (lights 8, 4, 2, 1). Further right are 'STORAGE SELECTOR' (lights 8, 4, 2, 1) and 'MEMORY ADDRESS SELECTOR' (a 4x4 grid of lights). At the bottom left is a 'PROGRAM CONTROL' table with columns for 'OFF', 'ON', 'PROGRAM ALTERATION', and 'CHECK INDICATORS'. To its right are 'CHECKS' (INSTR, MACH, 4 OR 9 CHK, OP CHECK) and 'MACH STOP' (MACH STOP, HALF MULT STEP). At the bottom right are 'READ WRITE' and 'ACC AUX' buttons, and a 'STORAGE SIGN (-)' indicator.

Alphanumeric keypad for page 26. It includes letters A through Z, numbers 0 through 9, and special keys like '+', '&', 'GM', 'RM', 'BL', 'RESTORE', and 'SHIFT'.

ANSWER SHEET FOR THE 705 CONSOLE CASE STUDY

EXHIBIT I

The 705 is in AUTOMATIC status and the No Response--Read light is "ON". The 705 Console operator knows that the 705 is in E-time (as this is clearly not an Instruction Check), and he obtains the location of the instruction that stopped him from the Instruction Counter--0074 minus 5 or 0069.

From the listing he finds that he is in a read-while-write routine and at the WR instruction. This is confirmed from the Operation Decoder.

As the 705 has been stopped by a No Response--Read condition, the operator surmises that something is wrong with the input unit. He checks and finds that his input tape unit 0200, is in Ready status, but the Select light is not lit. (If tape unit 0200 were not ready, it could have caused this stop.) He therefore displays memory positions 0054-0051 to determine whether he really has selected 0200 for the reading function of the read-while-write routine. The number displayed is "0100". Tapes are the only input-output units which are capable of remaining selected in a Special Select status by being addressed by a RWW instruction. The 705 does not hang up until it reaches the WR instruction which starts execution of the reading-while-writing operation.

To correct this condition, the operator must depress the Machine Stop key to get into MANUAL status, reset and store a "2" at 0052. To recommence automatic operation, the operator should realize that he has written the previous, processed record on the output tape but has not read in the new record to be processed. Therefore, he must transfer to 0139 which will backspace the output tape and then, after depression of the START key upon HLT 0001, transfer back to the beginning of the read-while-write routine. In this way, there will be no duplication of the output record, and a minimum of manual operation.

EXHIBIT II

The 705 is in MANUAL status; 0901 Machine Check. As neither the CR-1 nor the CR-2 light is lit, the operator should have no trouble in recognizing that he is faced with "0901 Machine Check without CR Code Check upon TMT (00)". A glance at the Operation Decoder and Storage Select Register will confirm this.

Contents of the Instruction Counter less 5 will give him the location of the current instruction. To find where the redundancy has actually occurred, the operator will look at MAC-I which will indicate to him in which group of 5 characters there is a redundancy. Displaying in CR-1 the memory address shown in MAC-I and the following next lower 4 memory positions will

identify the redundant character.

To correct this condition, reset and manually store the proper character in memory instead of the redundant character and manually transfer back to the TMT (00) instruction. If the redundant character is not in the first group of 5 characters to be transmitted, the operator should transfer back to the RCV instruction in order to reinitialize MAC-II.

EXHIBIT III

The 705 has stopped in MANUAL status; 0900 Instruction Check, 4 or 9 Check. Therefore, the 705 has stopped in I-time, and the Instruction Counter will yield the location of the instruction in error--0154. As it is a 4 or 9 Check, the Operation Register and CR-1 will indicate the reason for the stop--the instruction is a TR (Operation Register), and there is a "5" in the units position of the address of the instruction (CR-1 Memory Display). MAR shows the full instruction address--0055. From the listing, it is verified that the instruction should have been 1-0054.

To correct this condition, reset, manually store a "4" at 0154, and then manually transfer back to 0154 where the current instruction is located.

EXHIBIT IV

The machine has hung up in AUTOMATIC status; it is not a No Response condition, so look at the Operation Decoder which shows a CTRL (3) instruction--a Control Error. Whenever the 705 hangs up in AUTOMATIC status, it is in Execution time. A glance at the Instruction Counter indicates that the 705 is not under control of our 705 program but under control of the Upper Load (LOD 52). Therefore, the current instruction is on a 00 Transfer Control Card. From MAR and the Select Register it is learned that the current instruction is a BSP directed to tape unit 0200. The cause for the stop could be any of the following: that there is no 0200 on the line, that 0200 is not in Ready status, that 0200 is at load point, or that the instruction should not really have been a BSP instruction.

To correct this condition, the action to be taken will depend on the cause: If 0200 is not Ready, put the tape unit in Ready status; if there is no 0200 on line, set the Tape Selector Switch of the desired tape drive to 0200. In both cases, as soon as the adjustment has been made, operation will immediately continue without manual action at the 705 console.

If 0200 is at load point or if the instruction should not have been a BSP instruction, the 705 has to be brought into MANUAL status first by depressing the Machine Stop key and Reset key in succession. Then, it is possible to manually store a correction and/or transfer manually to the desired instruction, or print out memory if there appears to be some basic fault in the logic of the 705 program. This exhibit points up the lesson that a listing of all control cards, and particularly 00 Transfer Control Cards, should be available to the 705 Console operator together with the regular 705 program listing.

EXHIBIT V

The 705 is in MANUAL status and the Overflow Check Indicator is "ON". The Operation Decoder shows a DIV instruction. An Overflow Check during a DIV instruction always indicates a violation of the absolute value rule. The location of the instruction is found by subtracting 5 from the number contained in the Instruction Counter. The error causing a violation of the absolute value rule was a transposition in the divisor--09510 was divided by 04 instead of by 40.

To correct this condition, reset, store the corrected divisor in memory, and then manually transfer to the instruction which brings the dividend into storage, as the dividend is no longer intact in the accumulator.

EXHIBIT VI

The 705 has stopped in MANUAL status; 0901 Machine Check and the CR-2 lights are lit. The redundant character is displayed in CR-2. From the Instruction Counter, Operation Decoder, Memory Address Register, and the Storage Select Register, it is possible to write down the current instruction--0049 ST 12032 (00) which agrees with the program listing. As MAR is at 12032 and MAC-I at 12031, it follows that the redundancy is at the second character in storage.

To correct this condition, one must realize that the numerical field when brought into the accumulator originally could not have been redundant. Otherwise, an 0901 Machine Check would have resulted at that time. In this case, it is sufficient to restart at the point where the numerical field was brought into storage by a RAD instruction. Therefore, reset and manually transfer to 0039. In a more complex program, it would be important to note that the repetition of the intervening program steps may introduce incorrect values, e. g. , by repeating an ADM instruction or by repeating additions in an ASU containing a counter.

EXHIBIT VII

The Machine is hung up in AUTOMATIC status; No Response--Write. The Select Register shows output tape unit 0201 but tape unit 0201 is not in Ready status.

(It is noted from the program listing that the current WR instruction is part of a read-while-write routine, which reads a record into 1150. MAC-II, however, indicates memory location 1170. Thus, the new record has been read into memory from the input tape although the writing has not been executed.)

To correct this condition, put tape unit 0201 in Ready status. Automatic operation will then immediately continue.

EXHIBIT VIII

The 705 has stopped in MANUAL status; 0901 Machine Check with its CR-1 Code Check lights are "ON". In addition the 0902 Read/Write check light is lit. The important point here is that the current instruction, as obtained from the Operation Decoder and Storage Select Register is TMT (00): If the operator realizes that a Read/Write check, as implied by its name, can only occur on RD, WR, and WRE instructions he will conclude that the reason for the stop is the 0901 Machine Check and that the 0902 light, 0902 being set to program, is merely still lit from a prior RD, WR, or WRE instruction after which the 0902 Check Indicator was not turned off. He, therefore, has to deal with a TMT (00) instruction located at 0034 (contents of Instruction Counter minus 5), during the execution of which a redundancy error has occurred, which lit the CR-1 Code Check (the redundant character showing in CR-1) This is a CR-1 Code Check upon TMT (00). The location of the redundant character can be obtained from MAC-I (1159), and the difference between MAC-I and MAR indicates that the redundancy is in the 2nd group of 5 characters to be transmitted.

This error condition emphasizes the importance of turning off Check Indicators, which have been set to PROGRAM, at all places where they may arise whether or not it is intended to pass subsequently through an error routine.

To correct this condition, replace the redundant character by manually storing the proper character at location 1159 and manually transfer to the RCV instruction to reinitialize MAC-II.

EXHIBIT IX

The 705 has stopped in MANUAL status; 0900 Instruction Check Stop with Operation Code Check. No lights are lit on the Operation Decoder, but the Operation Register shows a zero which is not a proper operation code. As the 705 is in I-time, the Instruction Counter shows the correct location of the error instruction. A reference to the listings will indicate that the instruction is really TRS or the letter "O" which was evidently mistaken by the key punch operator for a numerical zero.

This case points up the necessity of looking at the Operation Register in preference to the Operation Decoder whenever an Operation Code Check is incurred, as this is the only condition in which the Operation Decoder and the Operation Register may differ.

To correct this condition, reset, manually store the letter "O" at 0105 and manually transfer back to instruction 0109. (The I/O indicator is not turned off by depressing the START button.)

EXHIBIT X

The 705 has hung up in AUTOMATIC status; there is a CTRL instruction in the Operation Decoder--a Control Error. From MAR the operator obtains

the type of CTRL instruction--IOF. Tape unit 0200 is selected. The Instruction Counter indicates that the current instruction is at location 19939, and thus on a 00 Transfer Control Card.

Tape unit 0200 is either not on the line or not in Ready status.

To correct this condition, put the desired tape unit in Ready status or set the Tape Selector Switch of the desired tape drive to 0 (zero), as the case may be. In both cases, the 705 will resume operation without any manual operation at the console.

It may sometimes be the case that the 00 Transfer Control Card carries out IOF and RWD for tape unit numbers in addition to those actually needed for the current program. In that case, the operator should depress the Machine Stop key, and manually transfer to the instruction at which resumption of operation is desired.

EXHIBIT XI

The 705 has stopped in MANUAL status; 0903 Record Check Indicator is "ON". The instruction is a WR with 0300 (card punch) selected. From the Instruction Counter and MAR, the operator obtains the additional information necessary to reconstruct the current instruction--0079 WR 12020. When its Check Indicator switch is set to AUTOMATIC, the 0903 Record Check forces the 705 into MANUAL status at the end of the second WR instruction directed to the same output unit, following the WR instruction during which the error was caused. At that time, the mispunched card is the top card in the stacker of the card punch. The card punched with the record addressed by the last WR instruction is the second card out when the card punch is emptied by depressing the Feed key.

To correct this condition, the operator has to depend upon the instructions he has received for the case of an 0903 Record Check stop. To resume operation, he will reset, and manually transfer to the instruction desired to be executed next.

EXHIBIT XII

The 705 has stopped in MANUAL status; 0901 Machine Check and CR-1 Code Check lights are lit. The current instruction is a LOD, the redundant character is displayed in CR-1. MAR and MAC-I, both, show the same memory address, which indicates that the redundant character is the first character to be loaded. Reference to the 705 program indicates that the current LOD instruction, located at 0009, is intended to load a group mark into storage, and it is apparent that the group mark has lost its "1" bit.

To correct this condition, the operator should reset, store a group mark at 0195 and manually transfer back to the instruction located at 0009.

EXHIBIT XIII

The 705 has stopped in MANUAL status; 0901 Machine Check and the CR-1 Code Check lights are "ON". The Operation Decoder indicates a Program Stop. From this the alert operator will deduce that the 0901 Machine Check stop and CR-1 lights are "ON" from some prior instruction, as it is impossible for a Machine Check stop to occur during the execution of a Program Stop. The current instruction, HLT 0001, is indicative of an 0902 error, but the 0902 Check Indicator light was turned off by a TRS instruction.

The 0901 Machine Check switch has been set to AUTOMATIC, and the only instructions which will not automatically stop the 705 upon the turning on of the 0901 Machine Check are the WR and WRE instructions. It follows therefore that the 0901 Machine Check was turned on during the recent WR instruction which caused the 0902 Read/Write check, and that the cause, for both, the 0902 and the 0901 checks, was the same--a redundant character (at least one) in the record to be written out on tape 0201 which is selected. The 0901 Check Indicator was not interrogated and, therefore, the light was not turned off.

To correct this condition, the operator need only press the START key which will automatically turn off all indicator lights. The program has backspaced the input and output tapes and will now reprocess the same record.

EXHIBIT XIV

The 705 is in MANUAL status; the 0905 Sign Check indicator is "ON". Reconstructing the instruction from the appropriate counters and registers the operator obtains--0044 DIV 12028. The character at 12028, the low-order position of the divisor, is unsigned. As typical of the Sign Check, MAC-I has stepped down by 1. Accordingly, there is in CR-1 the character in the tens position of the divisor, and (in this the Sign Check upon a DIV instruction differs) in CR-2 the character of the second high-order position of the dividend (second digit from the left).

To correct this condition, it is actually only necessary to press the Start button if the divisor is a positive number. (With a negative divisor, the sign of the quotient will be incorrect.) If the divisor is not known to be positive, or for the sake of uniform console operation in all cases of Sign Check stops, the following alternative procedure is correct: Reset, manually store the proper signed character at 12028 (units position of the divisor) and manually transfer back to the instruction at which the dividend was brought into accumulator storage, paying due regard to the intervening instructions, which are re-executed, so that no erroneous solutions will result.

EXHIBIT XV

The machine has stopped in MANUAL status; 0900 Instruction Check and the 4 or 9 check lights are lit. From the Operation Decoder, the Storage Select

Register and the Memory Address Register, the operator learns that he is dealing with a TMT (00) instruction having 1155 as its address. He knows, of course, that the address of a TMT (00) instruction should always have a 4 or 9 in the units position. As the 705 is in I-time, the Instruction Counter yields the location of the current instruction--it is 0034. From the program listing, the correct address of the current instruction is obtained--it is 1154.

To correct this condition, the operator will rest, manually store a 4 at 0034 and manually transfer back to the current instruction.

EXHIBIT XVI

The 705 has hung up in AUTOMATIC status; the I/O No Response--Read and Write lights are both lit. Two tape units on the odd side are revolving forward. In this case the operator will not waste time by looking at various counters and registers, but will depress the Machine Stop button. This will stop one of the tape units, the one selected earlier; tape unit 0201, shown in the Select Register, can only be stopped by either taking it off the line or by getting some other number than 0201 into the Select Register by manually executing a SEL instruction. Now the operator will reconstruct the current instruction from the appertaining counters and registers--0069 WR 12020, the WR instruction of a read-while-write sequence. He will display the instruction at 0054 to verify that, as he surmises, the tape unit earlier selected is also an odd numbered tape unit.

To correct this condition, the operator has no alternative but to restart the program from the beginning, as the reading and writing positions in the tapes have been completely lost. It should be noted from this condition that a method of tape unit number modification which changes the input tape unit number from even to odd or from odd to even, as the case may be, is fraught with danger; input tape units should remain either consistently odd or consistently even. The same applies to the output tape units.

EXHIBIT XVII

The 705 has stopped in MANUAL status. The Operation Decoder indicates a Program Stop. From MAR the operator obtains the stop number--0129. He realizes that he has no such stop in his 705 program. By looking at the Instruction Counter he obtains the location of the current instruction--19909 which is in his Upper Load program. Stop 0129 is the card reader end of file. Thus, it may have been caused by not inserting behind the 705 program deck a 00 Transfer Control Card, the purpose of which is to transfer into the 705 program

To correct this condition, the operator will either insert the 00 card behind his program deck or take such other action as may be indicated in the circumstances.

EXHIBIT XVIII

The 705 has stopped in MANUAL status; the 0905 Sign Check light is lit. The current instruction, as obtained by the operator from the relevant registers and counters is 0039 RAD 12025(00). As usual at a Sign Check, the execution of the second character cycle has been completed and MAC-I stands at 12024. The cause of this check stop, verifiable by displaying 12025, is that the units position of the arithmetic field to be brought into accumulator storage either has no zoning at all or "0" zoning (in other words, it has neither plus nor minus zoning).

To correct this condition, the operator should reset, manually store the proper character at 12025 and transfer back to the current RAD instruction.

If he believes that this is the only one of his input data which was left unsigned, an experienced operator may realize that in a RAD instruction depression of the START key is all that is really necessary, as the repetition of the execution of the second character cycle which would cause erroneous results in other instructions does not introduce an error upon a RAD or RSU instruction.

EXHIBIT XIX

The 705 has hung up in AUTOMATIC status; a CTRL instruction in the Operation Decoder indicates a control error. MAR contains 0007 which is not a proper control instruction if the 705 is not equipped with a 777 Tape Record Coordinator and/or a 760 Control and Storage Unit for a High-Speed Printer. Having obtained from the Instruction Counter 0174 as location of the current instruction, the operator verifies from the 705 program listing that the instruction should have been a RWD, 3-0002.

To correct this condition, the operator depresses the Machine stop to get the 705 into MANUAL status, resets, manually stores a "2" at 0174 and manually transfers to 0174 to resume operation with the current instruction.

EXHIBIT XX

The 705 has stopped in MANUAL status; the 0902 Read/Write check light is lit. The current instruction is a RD with tape unit 0200 selected. It is, therefore, obvious that the 0902 Read/Write check must have been the cause of the stoppage. The operator knows that if the program is run according to his instructions, 0902 should not stop his operation but should cause the program to pass through an 0902 error routine. He, therefore, realizes that he has neglected to set the 0902 Check Indicator Switch to PROGRAM and has left it at AUTOMATIC.

To correct this condition, in this particular case, the operator should set the 0902 Check Indicator to PROGRAM, reset, rewind his tape from the console and start the program all over as he was clearly executing the initial RD instruction of the 705 program.

NOTE: In this case, for reasons of demonstration, the initial RD instruction was not followed by 0902 interrogation. If it had been followed by 0902 interrogation and transfer upon signal to an 0902 error routine, the operator should have resumed operation by depressing the Half-Multiple Step until the 0902 Read/Write Check light is turned off. Then he should press the START key. This method assures that the 705 will pass through the error routine, while a mere depression of the START key would have turned off the 0902 light and the 705 would not have transferred upon signal during 0902 interrogation.

EXHIBIT XXI

The 705 has stopped in MANUAL status; 0900 Instruction Check and CR-1 Code Check lights are "ON". The Operation Decoder shows a SET instruction. Thus, the operator knows that 1 of the 5 characters of the current instruction is redundant and, as he can observe in the Operation Register and CR-1 the bit structure of the Operation Code and of the units position of the address of the instruction, respectively, he concludes that he has to display the characters in the tens, hundreds, thousands positions of the address in order to identify the redundant character. Upon display he finds that the character in the hundreds position has picked up an "A" bit which has also resulted in an incorrect ASU designation as shown in the Storage Select Register.

To correct this condition, reset, manually store a zero at 0002 and depress the START button to resume operation.

EXHIBIT XXII

The 705 is in AUTOMATIC status; but almost all the neons lit remain on with a steady glow. MAC-I and MAC-II, however, are flickering rapidly. From this alone the operator should recognize the prevailing condition, but he looks also at the Operation Decoder and Storage Select Register to verify that the 705 is executing a high-speed transmission. The record which was originally intended for transmission either did not have a record mark or had it in a memory position other than one ending in 4 or 9.

To correct this condition, it is impossible. By the time the operator has identified the error condition, the high-speed transmission has wrapped around memory a number of times and the whole of memory has been lost to all intents and purposes.

It should be noted that in such a case some desk checking of the 705 program and input data should be done before the program is put on the machine again. The reason is that merely reloading the program with unedited input data would produce the same error and, therefore, cause the loss of all running time.

NOTE: If memory contains a large program so that most of the characters are not blanks, CR-1 will have all its lights dimly lit.

EXHIBIT XXIII

The 705 has stopped in MANUAL status; 0901 Machine Check with the CR-1 Code Check and 0902 Read/Write Check lights are lit. A WR instruction was being executed. As an 0901 Machine Check, though being on AUTOMATIC, will not terminate execution of a WR instruction, the 0902 Check Indicator switch must have been set to AUTOMATIC in contravention of the operator's instructions. As the 0901 and 0902 Check Indicator lights are both "ON", the cause of the stop is a redundant character in the output area. Having verified the location of the current instruction, the operator learns from the program listing that he was executing the WR instruction of the read-while-write routine. MAR, which shows the instruction address, indicates the beginning of the output area. MAC-I stands at an address which is one memory position higher than the group mark terminating the record just written.

To correct this condition, set 0902 to PROGRAM and Half-Multiple Step until the 0902 light is turned off; then the 705 has transferred on signal and is in the 0902 error routine. Hitting the START key after the program is in the 0902 error routine will turn off the 0901 Check Indicator light. Alternatively, the operator may set the 0902 Check Indicator switch to PROGRAM, reset, and manually transfer to 0129 where the 0902 error routine for this case starts.

EXHIBIT XXIV

The machine has stopped in MANUAL status; 0900 Instruction Check with CR-1 Code Check lights are "ON". The Operation Decoder shows a SET instruction. CR-1 is displaying the redundant character--the number 1 with an additional "A" bit. As the 705 is in I-time, the redundant character is the units position of the current instruction the location of which, 0004, is obtained from the Instruction Counter. From the program listing, it is verified that the redundant character should have been a "1". As MAR only displays the numerical portion of the address of the instruction, any error, such as a redundancy, in the zoning of the address will not be indicated in MAR.

To correct this condition, reset, manually store a "1" at 0004 and press the START button to resume operation.

EXHIBIT XXV

The machine has stopped in MANUAL status; 0900 Instruction Check with CR-1 Code Check and Operation Check neons are lit. From this combination of indicators the operator should conclude that the Operation Code of the instruction currently interpreted is redundant. A glance at the Operation Register will confirm--3 bits, a 2, a 4, and a "C" bit. From the Instruction Counter he obtains the location of the current instruction 0109, and he verifies from the program listing that the Operation Code should have been the letter "O", TRS. To be on the safe side, a cautious operator will also display the tens, hundreds, and thousands positions to verify that they are proper characters.

It is of interest to note that the Operation Decoder shows a "6" or ADM instruction, as it merely decodes the bit structure, other than the "C" bit, of the character in the position of the Operation Code.

To correct this condition, reset, manually store the letter "O" at 0105 and manually transfer to 0109 to restart operation.

EXHIBIT XXVI

The 705 has hung up in AUTOMATIC status; the absence of an I/O No Response light plus the fact that there is a CTRL instruction in the Operation Decoder indicates a control error. From MAR and the Instruction Counter the operator obtains the information that the current instruction is a SUP located at 0124. A glance at the Select Register will indicate the cause of the control error--Check Indicator 0902 is the last unit selected. If the operator will display the instruction at 0089 which transfers into the 0902 error routine, he probably will find that its address is 0124, and thus bypasses the selection of card punch 0300. This SEL instruction could not be omitted, as punching by the card punch was to be suppressed by the current CTRL instruction which has to be preceded by SEL 0300. Bypassing of this SEL instruction caused the SUP instruction to be directed to 0902 which brought about the Control Error. This type of mistake may be caused by a key punch error, an incorrect correction card, improper address modification, or a faulty manual transfer, among other things.

To correct this condition, depress the Machine Stop key to set the 705 in MANUAL status, reset and transfer to the next instruction at 0129. It should be noted that the error card has in fact been punched.

IBM®
*International
Business Machines
Corporation*

590 MADISON AVENUE
NEW YORK 22, N. Y.

32-7077

PRINTED IN U. S. A.