

GA32-0039-1
File No. S370-00

Systems

**IBM Input/Output
Device Summary**

IBM[®]

GA32-0039-1
File No. S370-00

Systems

**IBM Input/Output
Device Summary**



Second Edition (July 1980)

This a major revision that replaces GA32-0039-0 and its Technical Newsletters, GN32-0126 and GN32-0142, and makes them all obsolete. Changes are continually made to the information herein; before using this publication in connection with the operation of IBM systems, consult the latest *IBM System/370 Bibliography*, GC20-0001, for the editions that are applicable and current.

References in this publication to IBM products, programs, or services do not imply that IBM intends to make these available outside the United States.

Publications are not stocked at the address given below; requests for IBM publications should be made to your local IBM representative or to the IBM branch office serving your locality.

A form for reader's comments is supplied at the back of this publication. If the form has been removed, comments may be addressed to IBM Corporation, General Products Division, Information Development, Department 61C, Tucson, Arizona, U.S.A. 85744. IBM may use or distribute any of the information you supply in any way it believes appropriate without incurring any obligation whatever. You may, of course, continue to use the information you supply.

Preface

This publication has general information about IBM input/output (I/O) equipment (devices and systems) that can operate locally with the IBM processors. More specifically, only equipment sold through the IBM Data Processing Division and not through the IBM General System Division are described herein. These devices and systems can be attached to a channel or to an integrated adapter on the processor.

The purpose of this publication is to summarize high-level information of IBM I/O devices and systems for easy reference and comparison. The primary audiences for this publication are customer executives, data processing managers, IBM Data Processing Division managers and IBM marketing representatives who need a general overview of the various IBM I/O equipment.

Input/output devices and systems that can be locally attached to a specific IBM processor are listed in the input/output configurator for that processor. For example, see *IBM System/370 Input/Output Configurator*, for System/370 I/O configurations.

Major Divisions of This Publication

This publication is divided into 13 chapters and one appendix. Each chapter is about devices that are similar in the work performed or storage device used, as follows:

- “Chapter 1. Audio Communications Devices” describes the characteristics of the 7770 Audio Response Unit.
- “Chapter 2. Auxiliary Processors” describes the characteristics of the 3838 Array Processor and the 3848 Cryptographic Unit.
- “Chapter 3. Direct Access Storage Devices” describes and summarizes the characteristics of the direct access devices that use the magnetic disk to store data.
- “Chapter 4. Diskette Input/Output Devices” describes the characteristics of the 3540 Diskette Input/Output Unit.
- “Chapter 5. Display Devices” describes the characteristics of the cathode-ray tube display stations.
- “Chapter 6. Magnetic Character Readers” describes and summarizes the characteristics of the magnetic character readers.

- “Chapter 7. Magnetic Tape Devices” describes and summarizes the characteristics of the magnetic tape devices.
- “Chapter 8. Optical Readers” describes and summarizes the characteristics of the optical readers.
- “Chapter 9. Printer-Keyboards” describes the characteristics of the 3215 Printer Keyboard.
- “Chapter 10. Printers” describes and summarizes the characteristics of serial, line, and page printers. Printers that are a part of a system are described in Chapter 13.
- “Chapter 11. Punched Card Devices” describes and summarizes the characteristics of card readers, card punches, and card printers.
- “Chapter 12. Punched Tape Devices” describes the characteristics of the 2671 Paper Tape Reader.
- “Chapter 13. Systems” describes the characteristics of systems that can attach to a host processor similar to an input/output device.
- “Appendix A. I/O Attachment Data” consists of a chart showing the I/O devices and systems and their means of attachment to a processor.

Related Publications

The following publications are referred to in this publication:

- *An Introduction to the IBM 3250 Graphics Display System*, GA33-3035 contains introductory information on the 3250.
- *IBM Data Communication Device Summary*, GA27-3185, describes the devices that use communication systems to communicate with a host system.
- *IBM Data Processing Glossary*, GC20-1699, contains definitions of terms used in the data processing field.
- *IBM System/370 Input/Output Configurator*, GA22-7002, contains information on devices and systems that can be locally attached to, and communicate over communication lines with, a System/370.
- *IBM 3270 Information Display System: Color and Programmed Symbols*, GA33-3056 describes in detail programming support information.

- *IBM 3270 Information Display System Configurator*, GA27-2849 describes the various devices that are a part of the 3270 system.
- *Tape Requirements for IBM One-Half Inch Tape Drives at: 556, 800, 1600, and 6250 BPI*, GA32-0006-5, describes the tape requirements for IBM one-half inch magnetic tape devices.
- *Operator/Reference Manual for the IBM 3800 Tape-To-Printing Subsystem Feature*, GA26-1654, contains operating instructions and programming information for the IBM 3800 tape-to-printing subsystem feature.

Summary of Amendments

Major Technical Changes - Second Edition

Elimination of the Vertical Change Bar

This publication has been completely arranged and formatted again for easy reference. Each device section is now a chapter and each topic is now highlighted. The change bar is not used in this edition because the new arrangement and format would result in a change bar on the left margin throughout the publication.

Update of Input/Output Equipment Data

As part of the updating procedure, equipment that is no longer available has been deleted and new

equipment has been added. This has also been done for different models of the equipment.

Mention of System/360 Processors

The mention of the System/360 processors has been removed because they can no longer be ordered, although there are many still in use today.

Metric Conversion

All measurements have been converted to International System of Units (SI). All standards of measurements such as bytes per inch and characters per inch have not been converted to metric measurements.

Contents

Preface	iii	Chapter 7. Magnetic Tape Devices	7-1
Major Divisions of This Publication	iii	3410 Magnetic Tape Unit Models 1 through 3	
Related Publications	iii	3411 Magnetic Tape Unit and Control	
Summary of Amendments	v	Models 1 through 3	7-1
Chapter 1. Audio Communication Devices	1-1	Special Features	7-2
7770 Audio Response Unit Model 3	1-1	3420 Magnetic Tape Unit Models 3 through 8	7-2
Special Features	1-1	Special Features	7-4
Chapter 2. Auxiliary Processors	2-1	3803 Tape Control Models 1, 2, and 3	7-4
3838 Array Processor Models 1 through 3	2-1	Special Features	7-5
Special Features	2-2	8809 Magnetic Tape Unit Models 1A, 1B, 2, and 3	7-5
3848 Cryptographic Unit Model 1	2-2	Special Features	7-6
Chapter 3. Direct Access Storage Devices	3-1	Data Comparison Table	7-6
2835 Storage Control	3-1	Chapter 8. Optical Readers	8-1
Special Features	3-2	1287 Optical Reader Models 1, 3, and 5	8-1
3830 Storage Control	3-2	Special Features	8-2
Special Features	3-2	1288 Optical Page Reader Model 1	8-2
3880 Storage Control	3-3	Special Features	8-3
Special Features	3-4	3881 Optical Mark Reader Model 1	8-4
2305 Fixed Head Storage	3-5	Special Features	8-4
3310 Direct Access Storage	3-5	3886 Optical Character Reader Model 1	8-5
3333 Disk Storage and Control and 3330 Disk Storage	3-6	Special Features	8-6
Special Features	3-6	Data Comparison Table	8-6
3340 and 3344 Direct Access Storage	3-7	Chapter 9. Printer-Keyboards	9-1
Special Features for the 3340	3-8	3215 Console Printer-Keyboard Model 1	9-1
3350 Direct Access Storage	3-8	Chapter 10. Printers	10-1
Special Features	3-9	1403 Printer Models 2, 7, and N1	10-1
3370 Direct Access Storage	3-9	Special Features	10-2
Special Features	3-10	1443 Printer Model N1	10-3
Data Comparison Tables	3-11	Special Features	10-3
Chapter 4. Diskette Input/Output Devices	4-1	2821 Control Unit Models 1, 2, 3, 5, and 6	10-3
3540 Diskette Input/Output Unit Models B1 and B2	4-1	Special Features	10-4
Chapter 5. Display Devices	5-1	3203 Printer Models 1 through 5	10-4
3251 Display Station Model 1	5-1	Special Features	10-5
Special Features	5-2	3211 Printer	10-5
3277 Display Station Models 1 and 2 with		Special Features	10-6
3272 Control Unit Models 1 and 2 or		3262 Line Printer Models 1, 2, 3, 11, 12, and 13	10-6
3274 Control Unit Models 1A, 1B, and 1D	5-2	3800 Printing Subsystem	10-9
Special Features	5-3	Special Features	10-11
3278 Display Station Models 1 through 5 with		3811 Printer Control Unit Model 1	10-12
3274 Control Unit Models 1A, 1B, and 1D	5-3	5203 Printer Model 3	10-12
Special Features	5-4	Special Features	10-13
3279 Color Display Station Models 2A, 2B, 3A, and 3B	5-5	5213 Printer Model 1	10-13
Special Features	5-5	Data Comparison Table	10-14
Programming Support	5-6	Chapter 11. Punched Card Devices	11-1
8775 Display Terminal Models 1, 2, 11, and 12	5-6	1442 Card Read Punch Model N1	11-1
Special Features	5-6	Special Features	11-2
Programming Support	5-8	1442 Card Punch Model N2	11-2
Chapter 6. Magnetic Character Readers	6-1	2501 Card Reader Models B1 and B2	11-2
1255 Magnetic Character Reader Models 1, 2, and 3	6-1	Special Features	11-3
Special Features	6-2	2520 Card Read Punch Model B1	11-3
1419 Magnetic Character Reader Model 1	6-2	Special Features	11-3
Special Features	6-3	2520 Card Punch Models B2 and B3	11-4
3890 Document Processor Models A1 through A6,		Special Features	11-4
and B1 through B6	6-4	2540 Card Read Punch Model 1	11-4
Special Features	6-5	Special Features	11-4
Data Comparison Tables	6-5	2560 Multi-Function Card Machine Models A1 and A2	11-5
		Special Features	11-6
		3504 Card Reader Models A1 and A2	11-6
		Special Features	11-6

3505 Card Reader Models B1 and B2	11-7
Special Features	11-8
3525 Card Punch Models P1, P2, and P3	11-8
Special Features	11-9
5425 Multi-Function Card Unit Models A1 and A2	11-9
Data Comparison Table	11-11
Chapter 12. Punched Tape Devices	12-1
2671 Paper Tape Reader	12-1
Special Features	12-1
2822 Paper Tape Reader Control	12-2
Chapter 13. Systems	13-1
3250 Graphics Display System	13-1
3251 Display Station	13-2
3255 Display Control Unit	13-2
3258 Control Unit	13-3
3270 Information Display System	13-3
3272 Control Unit (Local Attachment)	
Models 1 and 2	13-4
3274 Control Unit Models 1A, 1B, and 1D	13-4
3277 Display Station Models 1 and 2	13-5
3278 Display Station Models 1 through 5	13-5
3279 Color Display Station Models 2A, 2B,	
3A, and 3B	13-6
3284 Printer Models 1 and 2	13-6
3286 Printer Models 1 and 2	13-6
3287 Printer Models 1, 1C, 2 and 2C	13-7
3288 Line Printer Model 2	13-7

3289 Line Printer Models 1 and 2	13-8
Special Features	13-8
3730 Distributed Office Communication System	13-9
3732 Text Display Station	13-9
3736 Printer	13-9
3791 Controller Models 11C, 12A, and 12B	13-10
3790 Communication System	13-10
3791 Controller Models 1C, 2A, and 2B	13-11
3792 Auxiliary Control Unit	13-11
3793 Keyboard-Printer	13-11
3790 Communication System—Miscellaneous Equipment	13-12
2741 Communication Terminal	13-12
3277 Display Station Models 1 and 2	13-12
3284 Printer Models 1 and 2	13-12
3286 Printer Models 1 and 2	13-12
3288 Line Printer Model 2	13-12
3790 Communication System/Data Entry Configuration	13-12
3760 Key Entry Station Models 1, 2, and 3	13-12
3762 Payment Transaction Processor	13-13
3850 Mass Storage System	13-13
3851 Mass Storage Facility	13-14
Staging Adapter	13-15
Direct Access Storage Devices	13-15
Appendix A. I/O Attachment Data	A-1
Glossary and Abbreviations	G-1
Index	I-1

Figures

Figure 1-1. IBM 7770 Audio Response Unit	1-1
Figure 2-1. IBM 3838 Array Processor	2-1
Figure 2-2. IBM 3848 Cryptographic Unit Model 1	2-3
Figure 2-3. Personalization/Key Entry Unit and Operator Panel	2-4
Figure 3-1. IBM 2835 Storage Control and IBM 2305 Fixed Head Storage	3-1
Figure 3-2. IBM 3830 Storage Control	3-2
Figure 3-3. IBM 3880 Storage Control	3-4
Figure 3-4. IBM 3310 Direct Access Storage	3-5
Figure 3-5. IBM 3330 and 3333 Disk Storage	3-6
Figure 3-6. IBM 3340 Direct Access Storage Facility	3-7
Figure 3-7. IBM 3344 Direct Access Storage	3-7
Figure 3-8. IBM 3348 Data Module	3-8
Figure 3-9. IBM 3350 Direct Access Storage	3-9
Figure 3-10. IBM 3370 Direct Access Storage	3-10
Figure 3-11. Comparison of Features for Storage Controls and Disk Storage	3-11
Figure 3-12. Comparison of Characteristics for Storage Controls	3-12
Figure 3-13. Comparison of Characteristics for Disk Storage	3-12
Figure 3-14. Comparison of Capacities for Disk Storage	3-13
Figure 3-15. Comparison of Performance for Disk Storage	3-13
Figure 4-1. IBM 3540 Diskette Input/Output Unit Model B2	4-1
Figure 5-1. IBM 3251 Display Station	5-2
Figure 5-2. IBM 3277 Display Station	5-3
Figure 5-3. IBM 3278 Display Station	5-4
Figure 5-4. IBM 3279 Color Display Station	5-6
Figure 5-5. IBM 8775 Display Terminal	5-6

Figure 6-1. IBM 1255 Magnetic Character Reader Model 1 or 2	6-1
Figure 6-2. IBM 1255 Magnetic Character Reader Model 3	6-1
Figure 6-3. The 14 Magnetic-Ink Characters of Font E13B	6-2
Figure 6-4. Magnetic Inscription—Translation of Characters and Definitions of Fields	6-3
Figure 6-5. IBM 1419 Magnetic Character Reader	6-3
Figure 6-6. IBM 3890 Document Processor Model A3	6-4
Figure 6-7. Comparison Data for Magnetic Character Readers	6-5
Figure 7-1. IBM 3410 Magnetic Tape Unit Models 1, 2, or 3	7-2
Figure 7-2. IBM 3420 Magnetic Tape Unit	7-4
Figure 7-3. IBM 3803 Tape Control Unit Model 1	7-5
Figure 7-4. IBM 8809 Magnetic Tape Unit	7-6
Figure 7-5. Comparison of Characteristics for Magnetic Tape Devices	7-7
Figure 8-1. IBM 1287 Optical Reader Model 5	8-1
Figure 8-2. Fonts, Letters, and Symbols Read by the 1287	8-2
Figure 8-3. IBM 1288 Optical Page Reader	8-3
Figure 8-4. IBM 3881 Optical Mark Reader	8-4
Figure 8-5. IBM 3886 Optical Character Reader	8-5
Figure 8-6. Fonts, Letters, Numbers, and Symbols Read by the 3886 Model 1	8-5
Figure 8-7. Comparison Data of Optical Character Readers	8-6
Figure 9-1. IBM 3215 Console Printer-Keybaord	9-1
Figure 10-1. IBM 1403 Printer Models 2 and 7	10-1
Figure 10-2. Selective Tape Characteristics for the 1403	10-2

Figure 10-3.	IBM 1403 Printer Model N1	10-2	Figure 13-3.	IBM 3255 Display Control Unit or IBM 3258 Control Unit	13-3
Figure 10-4.	IBM 1443 Printer Model N1	10-3	Figure 13-4.	Simplified Configuration of a 3250 System	13-3
Figure 10-5.	IBM 3203 Printer	10-4	Figure 13-5.	IBM 3270 Information Display System— Line Printer, Display Terminals, and Control Unit	13-4
Figure 10-6.	IBM 3211 Printer and 3811 Printer Control Unit	10-5	Figure 13-6.	IBM 3277 Display Station Model 2	13-5
Figure 10-7.	IBM 3262 Line Printer	10-6	Figure 13-7.	IBM 3278 Display Station	13-6
Figure 10-8.	Comparison of 3262 Printer Rated Speeds	10-6	Figure 13-8.	IBM 3279 Color Display Station	13-6
Figure 10-9.	Attachment of IBM 3262 Models 1 and 11 to a 4331 Processor	10-7	Figure 13-9.	IBM 3284 Models 1 and 2 or IBM 3286 Printer Models 1 and 2	13-7
Figure 10-10.	Attachment of IBM 3262 Models 2 and 12 to an 8130 or 8140 Processor	10-8	Figure 13-10.	IBM 3287 Printer	13-7
Figure 10-11.	Attachment of IBM 3262 Models 3 and 13 to a 3274 or 3276 Control Unit	10-8	Figure 13-11.	IBM 3288 Line Printer Model 2	13-8
Figure 10-12.	IBM 3800 Printing Subsystem	10-9	Figure 13-12.	IBM 3289 Line Printer	13-8
Figure 10-13.	3800 Print Speed Ranges	10-10	Figure 13-13.	IBM 3732 Text Display Station	13-9
Figure 10-14.	Path of Paper Forms through the 3800 Printing Subsystem	10-11	Figure 13-14.	IBM 3736 Printer	13-10
Figure 10-15.	IBM 5203 Printer Model 3	10-13	Figure 13-15.	IBM 3791 Controller with Line Printer Feature	13-10
Figure 10-16.	IBM 5213 Printer Model 1	10-13	Figure 13-16.	IBM 3790 Communication System	13-10
Figure 10-17.	Comparison Data for Printers	10-14	Figure 13-17.	IBM 3792 Auxiliary Control Unit	13-11
Figure 11-1.	80- and 96-Column Cards	11-1	Figure 13-18.	Print Rates of the Line Printer Attachment to the 3791 and 3792	13-11
Figure 11-2.	IBM 1442 Card Punch Model N2	11-2	Figure 13-19.	IBM 3793 Keyboard-Printer	13-12
Figure 11-3.	IBM 2501 Card Reader	11-2	Figure 13-20.	IBM 2741 Communication Terminal	13-12
Figure 11-4.	IBM 2520 Card Read Punch Model B1	11-3	Figure 13-21.	IBM 3760 Dual Key Entry Station	13-13
Figure 11-5.	Card Path in the 2520 Card Read Punch Model B1	11-4	Figure 13-22.	IBM 3762 Payment Transaction Processor	13-13
Figure 11-6.	IBM 2540 Card Read Punch	11-4	Figure 13-23.	IBM 3850 Mass Storage System with 3851 Mass Storage Facility, System/370 Model 158 and 3330 Disk Storage	13-14
Figure 11-7.	IBM 2560 Multi-Function Card Machine	11-5	Figure 13-24.	Characteristics of the IBM 3851 Mass Storage Facility Models	13-15
Figure 11-8.	IBM 3504 or 3505 Card Reader	11-7	Figure 13-25.	Logical Units of the Mass Storage System	13-16
Figure 11-9.	IBM 3525 Card Punch	11-9	Figure A-1.	Attachment Data for Local I/O Equipment	A-1
Figure 11-10.	IBM 5425 Multi-Function Card Unit with System/370 Model 115	11-10			
Figure 11-11.	Comparison Data for Card Devices	11-11			
Figure 12-1.	IBM 2671 Paper Tape Reader and IBM 2822 Paper Tape Reader Control	12-1			
Figure 13-1.	IBM 3250 Graphics Display System	13-1			
Figure 13-2.	IBM 3251 Display Station	13-2			

Chapter 1. Audio Communication Devices

The audio communication devices supply audio responses to digital inquiries from telecommunication devices.

7770 Audio Response Unit Model 3

The 7770 Audio Response Unit Model 3 (Figure 1-1) supplies a composed audio response to digital inquiries from a 1001 Data Transmission Terminal, a telephone set, or other inquiry-type terminals.

The highlights of the 7770 follow.

Voice Communication

The spoken response is composed from an American-English vocabulary recorded earlier in a male or female voice on a magnetic drum inside the 7770. The response is transmitted over suitable common-carrier communication facilities back to the inquiring terminal. When the 7770 is operating in conversational mode, the inquiry-response sequence can be repeated any number of times without dialing the 7770 again.

Operation

To make an inquiry of the 7770, the calling party enters a series of characters from his or her terminal. The 7770 passes these characters one by one through the byte multiplexer channel to the processor, which processes the inquiry and sends a response message back, character by character, to the 7770. This response message is a series of drum word addresses that the 7770 uses to select the correct words for its spoken reply. There are no limits to the length of the inquiry or of the response.

Attachment to a Processor

The 7770 Audio Response Unit Model 3 attaches to an IBM processor through the byte multiplexer channel. Each 7770 occupies one control-unit position and needs one byte multiplexer subchannel for each communication line.

Telecommunication Facilities

The basic 7770 operates four half-duplex, voice-grade communication lines, but this capacity can be expanded in four-line additions to 48 lines. Random inquiries on all input/output lines can be responded to simultaneously. A common carrier must supply all data sets.

32-Word Vocabulary

Each 7770 comes with a 32-word vocabulary that can be expanded with a special feature. Vocabulary words can be specified by the user as described by the message specifications. However, lengthy words must be divided and will be considered as two words. The vocabulary can be changed at any time by removing the drum and replacing it with another that has a different vocabulary. One word of each user vocabulary must be silence.



Figure 1-1. IBM 7770 Audio Response Unit

Special Features

The following features can be ordered through the IBM sales representative to expand or customize the user's operation. The list of features may not be complete and more may be available. For more information about features, see the IBM sales representative.

End Of Inquiry (EOI) Disable

The end of inquiry disable feature permits an EOI character on pushbutton telephones to be used as a data character instead of an EOI character.

I/O Line Expander

Each I/O line expander feature permits attachment of four additional input/output lines. A maximum of 11 of these features is permitted.

I/O Line Frame

The I/O line frame feature supplies an additional frame when the number of input/output lines is more than 16.

I/O Line Panel

An I/O line panel feature is needed for each group of eight input/output lines or portion thereof added beyond the first eight lines. A maximum of five panels is permitted.

Vocabulary Words, Additional

The vocabulary words, additional feature permits increments of 16 words to be added, up to a maximum of 128 words.

Chapter 2. Auxiliary Processors

An auxiliary processor attaches to a channel to expand the capabilities of the host processor.

3838 Array Processor Models 1 through 3

The 3838 Array Processor (Figure 2-1) is a high-speed auxiliary processor that performs complex, repeated mathematical calculations in the analysis of periodically tested input data for petroleum industry applications.

The 3838 has the following bulk storage capacities:

- Model 1 has a capacity of 262,144 (256K) bytes.
- Model 2 has a capacity of 524,288 (512K) bytes.
- Model 3 has a capacity of 1,048,576 (1,024K) bytes.

The highlights of the 3838 follow.

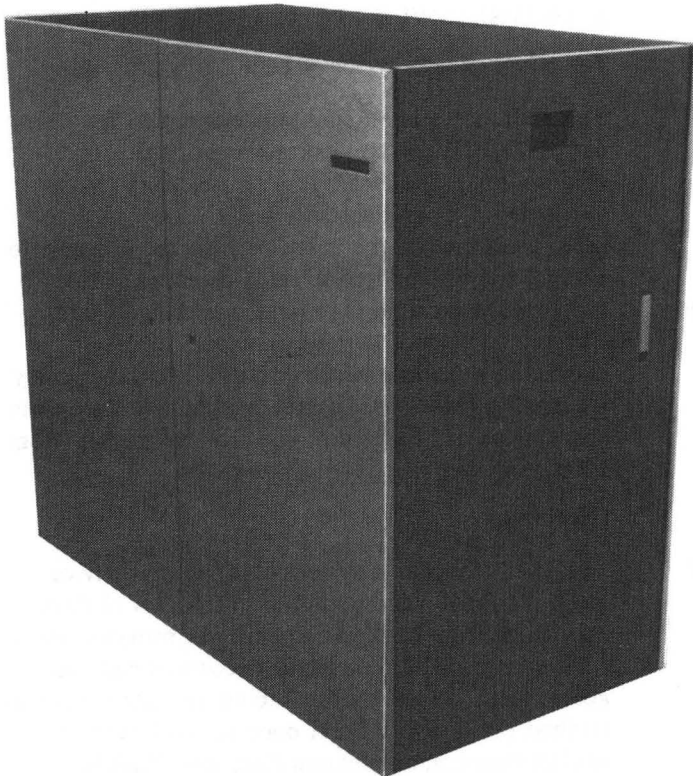

Figure 2-1. IBM 3838 Array Processor

Operation

The calculations are user-specified tasks in the application program and are processed by the 3838 concurrent with the processing of other data by the host processor. The 3838 generates either a single result or an array of results from its calculations. Input data elements can be 16-bit fixed-point halfwords, 32-bit floating-point words, or 64-bit floating-point doublewords. Among the calculations performed by the 3838 are: convolution, correlation, vector and scalar multiplication, vector addition, division, square root, format conversion, and branching and sequencing control.

Attachment to Processor

The 3838 is supported by OS/VS2 (MVS) and can be attached to an IBM processor through a block multiplexer channel.

Functional Units

The 3838 has the following functional units:

- The channel interface, which supplies the link between the array processor and the processor through the block multiplexer channel.
- The control processor, which receives commands from the processor over the channel interface, and schedules and controls the processing functions in the other elements of the 3838.
- The arithmetic processor, which performs arithmetic operations. It includes: an arithmetic element control with writable control storage; arithmetic elements (2 four-stage adders, a four-stage multiplier, and a sine/cosine generator); and working storage (two 8,192 byte sections).
- Bulk storage, which supplies storage for data buffers, coefficients, and program parameters. The interleaving operation of the storage modules in bulk storage reaches data rates of up to 40 megabytes per second.
- The data transfer controller, which sends data and parameters between bulk storage and the other 3838 elements. The data transfer controller performs logical operations on data during a transfer between bulk storage and the working storage of the arithmetic processor.

Special Features

The following features can be ordered through the IBM sales representative to expand or customize the user's operation. The list of features may not be complete and more may be available. For more information about features, see the IBM sales representative.

Arithmetic Element Control Storage Additional

The arithmetic element control storage additional feature increases the control storage capacity by an additional 16,384 bytes for more algorithm capability.

Two Byte Interface

The two byte interface feature supplies a two-byte parallel transfer on the IBM 2880 Block Multiplexer Channel to reach data transfer rates of up to 3 megabytes.

3848 Cryptographic Unit Model 1

The 3848 Cryptographic Unit Model 1 (Figure 2-2) is an auxiliary unit that enciphers and decipheres data. It is designed to strengthen data processing installation and network security by supporting the encryption and decryption of stored data files as well as transmitted data. The major functions performed by the 3848 are internal control, data buffering (4,096-byte buffer), and encryption/decryption. It attaches to the virtual storage System/370 Models 145 through 168, and the 3031, 3032, and 3033 Processors.

The highlights of the 3848 follow.

Program Support

The 3848 enciphers and decipheres data under program control when operating with a System/370 selector or block multiplexer channel.

The 3848, which operates under the data encryption standard of the U. S. National Bureau of Standards, is controlled by the IBM Cryptographic Unit Support Program Product running under OS/VS1 or OS/VS2 (MVS).

Personalization/Key Entry Unit

The 3848 has a hand-held personalization key entry unit (P/KEU) and an operator control panel (Figure 2-3). The P/KEU is an accessory that is available on a purchase-only basis. The P/KEU, when connected to the 3848, permits the operator to enter a unique, random-selected master key that supports the enciphering and deciphering of data. The key consists of two 8-byte blocks of data entered as hexadecimal characters. Character entry is aided by color-coded status indicator lights on the operator panel. Battery power protects the key from being erased if a power failure occurs.

Operation

The 3848 works as a system input/output device. Requests for the encryption or decryption of data may come from either an application program, or a subsystem such as the virtual telecommunications access method (VTAM) or the virtual storage access method (VSAM). VTAM operates with remote devices over communication lines, and VSAM operates with data storage devices. Data is moved from processor storage through a channel to the 3848 where it is enciphered or deciphered and returned to the processor. Enciphered or deciphered data is then moved from the processor to its destination.

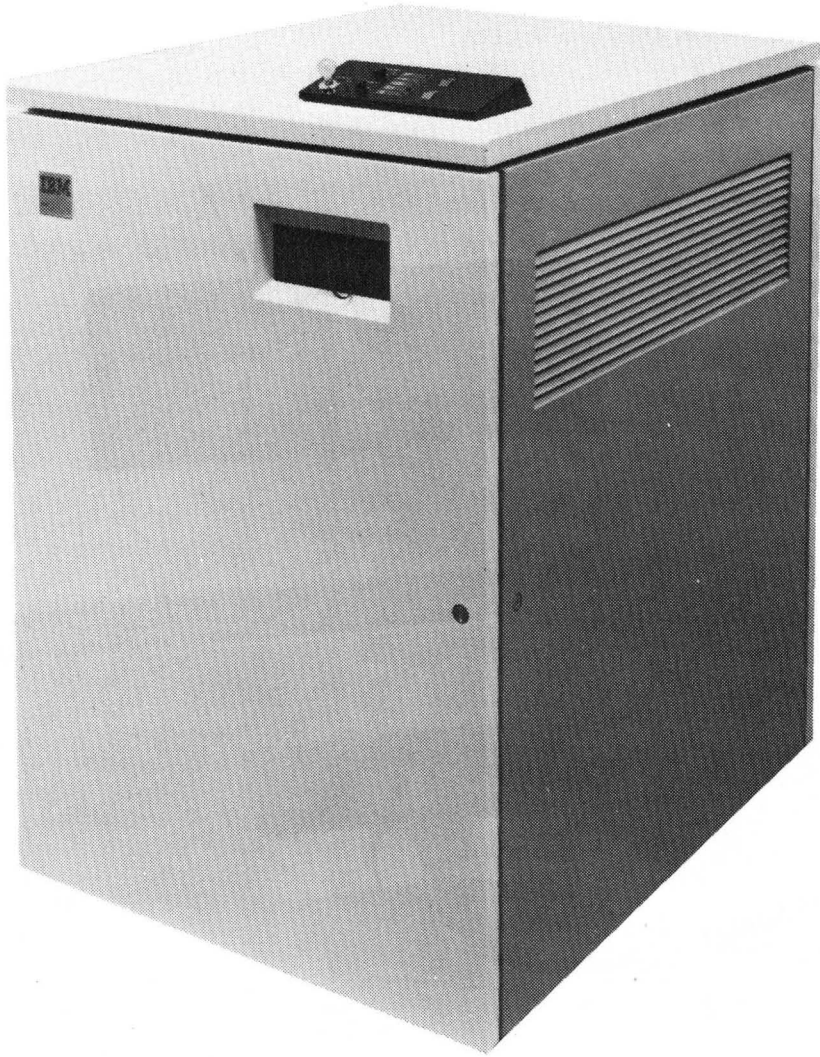

Figure 2-2. IBM 3848 Cryptographic Unit Model 1

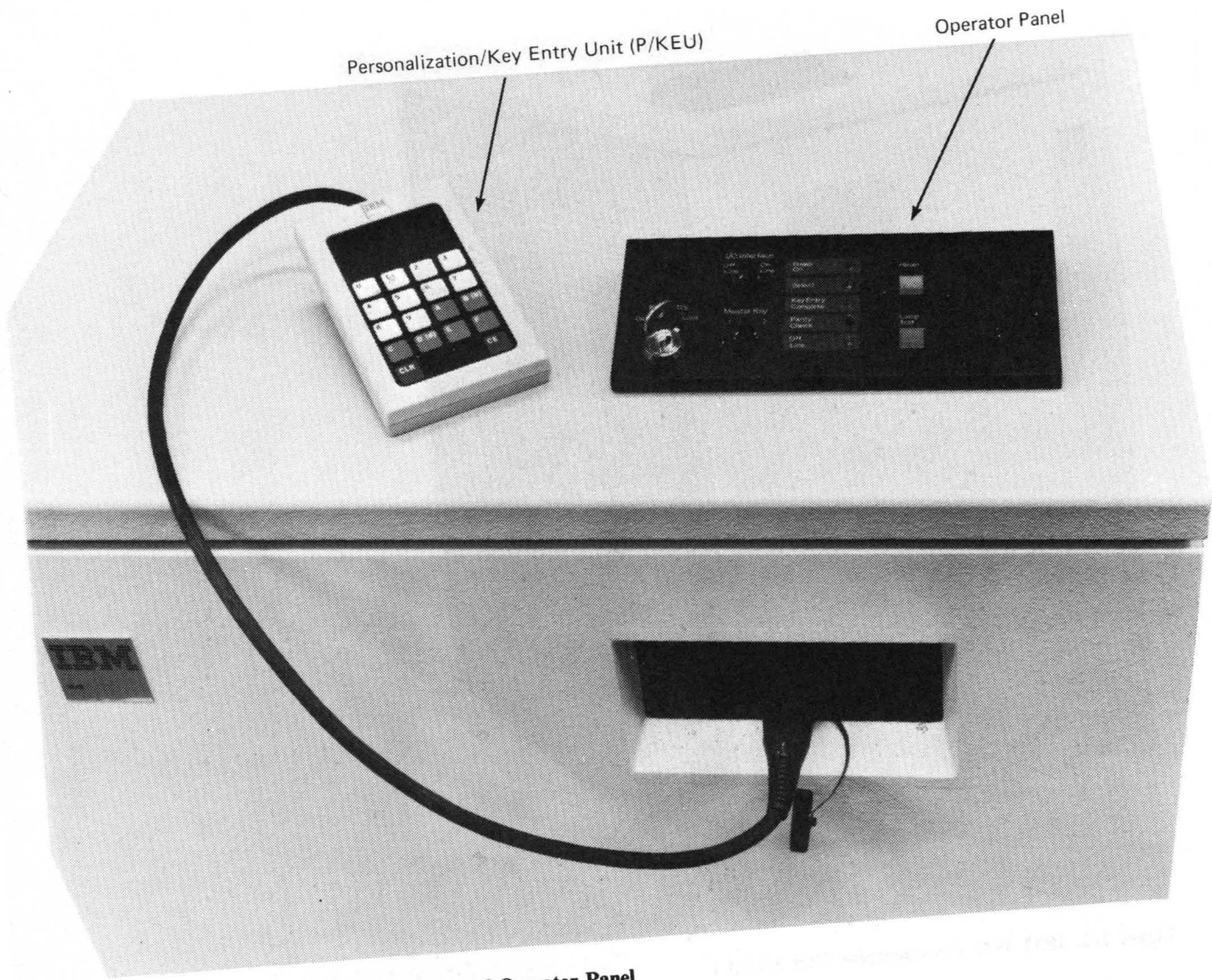

Figure 2-3. Personalization/Key Entry Unit and Operator Panel

Chapter 3. Direct Access Storage Devices

Direct access storage devices supply the capacity for storing large amounts of data and give direct access to physical records. They are used for storing programs, data bases, and other information needed for operating a system and implementing user applications.

A variety of direct access storage devices is available. All use magnetic disks to store data, but they vary in technical implementation. These variations in technology result in differences in the time needed for locating and transferring data, and in storage capacities. The devices also vary in terms of the processors to which they can be attached and the attachment methods.

The following section describes the storage controls and the disk storage devices. The individual descriptions are followed by Figures 3-11 through 3-15, which compare the products by features, characteristics, capacities, and performance. Features that are standard on most products are described in summary in Figure 3-11 rather than included in each individual device description.

2835 Storage Control

The 2835 Storage Control and the 2305 Fixed Head Storage (Figure 3-1) are always used together. The 2835 supplies all the controls between the channel and the 2305 disk storage. The 2835 also supplies power for the disk storage. The 2835 Model 2 supports one or two 2305 Model 2 units.

The highlights of the 2835 follow.

Attachment to a Processor

The 2835 Model 2 can attach to: System/360 Models 85 and 195; System/370 Models 145, 148, 155, 158, 165, 168, 195; and to 3031, 3032, 3033, and 4341 Processors. It attaches through a block multiplexer channel.

Channel Commands Supported

The 2835 supports channel commands used for count, key, and data formatted records.

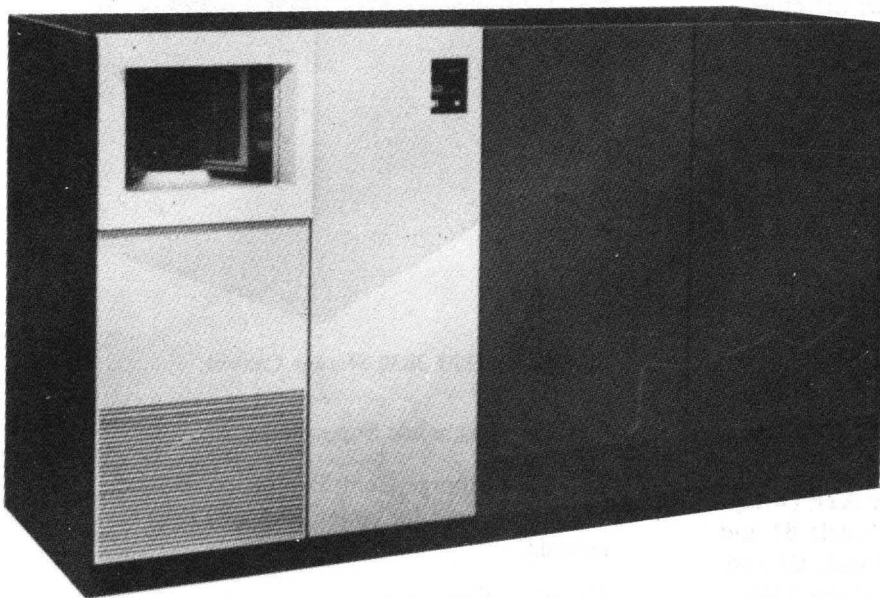

Figure 3-1. IBM 2835 Storage Control and IBM 2305 Fixed Head Storage

Special Features

The following features can be ordered through the IBM sales representative to expand or customize the user's operation. The list of features may not be complete and more may be available. For more information about features, see the IBM sales representative.

Two Channel Switch

The two channel switch feature permits the 2835 and its attached 2305 Fixed Head Storage drives to be shared by two different channels of the same or different processors. The storage control is made available to a channel by Enable/Disable switches on the operator panel or through commands.

Remote Switch Attachment

The remote switch attachment feature moves the Enable/Disable switches of the two channel switch feature from the 2835 operator panel to a configuration control panel of a System/370 Model 158MP or 168MP.

3830 Storage Control

The 3830 Storage Control supports disk storage types that include a string controller; therefore, different disk storage types can be supported and intermixed on the same control unit. For example, 3333/3330 Disk Storage and 3350 Disk Storage both can attach to a 3830 Model 2, and both can attach to the same 3830 Model 2. The 3830 supplies the control between the channel and the string controller. It contains its own power but none for the attached disk storage.

The 3830 has two models: Models 2 and 3. Model 2 supports the following types of disk storage:

- 3333 Disk Storage Models 1 and 11, (with controller) and attached 3330 Disk Storage Models 1, 2, and 11.
- 3340 Disk Storage Models A2 or A2F (with controller), and attached 3340 Models B1 and B2. The larger capacity 3344 Models B2 and B2F can take the place of some of the 3340 Models B2 and B2F.
- 3350 Direct Access Storage Model A2 or A2F (with controller), or Model C2 or C2F (with alternate controller) and attached 3350 Models B2 and B2F.
- Combinations of the following: 3333; 3340 Model A2 or A2F; and 3350 Model A2 or A2F. These string controllers and attached disk storages can

be intermixed on a 3830 Model 2; however, if a 3344 disk storage unit is included in a 3340 Model A2 or A2F string, neither a 3330 nor a 3350 disk storage unit can be attached to the same 3830 Model 2 storage control.

Model 3 supplies the attachment of 3333/3330 and 3350 disk storage drives in a 3850 Mass Storage System.

Attachment to a Processor

The 3830 can attach through a block multiplexer channel to: a System/360 Model 195; System/370 Models 135, 138, 145, 148, 155, 158, 165, 168, and 195; and 3031, 3032, 3033, and 4341 Processors. It can also attach to System/370 Models 135 and 145 selector channels.

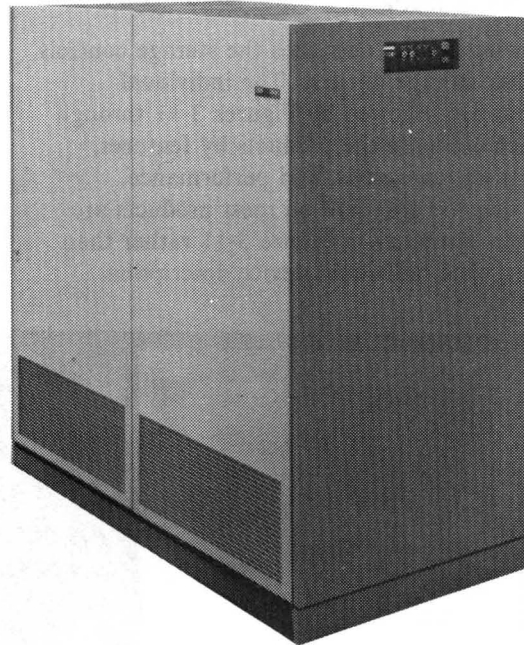

Figure 3-2. IBM 3830 Storage Control

Channel Commands Supported

The 3830 Storage Control supports channel commands used for count, key, and data formatted records.

Special Features

The following features can be ordered through the IBM sales representative to expand or customize the user's operation. The list of features may not be complete and more may be available. For more information about features, see the IBM sales representative.

Control Store Extension, Expanded Control Store, and Register Expansion

The control store extension, expanded control store and register expansion features have a variety of functions. Depending on the attached disk storage type, one or more of these features are used to double the number of strings of disk storage that can be attached, and to intermix strings of different disk storage products. These features also support the string switch and fixed head features on disk storage products. The three features apply to the 3830 Models 2 and 3.

Control Store Extension: The control store extension feature uses 32 device addresses and permits attachment of two additional strings of 3333/3330s, or two additional strings of 3340s.

Control Store Extension plus Register Expansion: The combination of the control store extension and the register expansion features uses 64 device addresses and permits attachment of two additional strings of 3340s, with 3344s attached to two out of four 3340 Model As.

Control Store Expansion, plus Register Expansion, plus Expanded Control Store: The combination of the control store extension, the register expansion, and the expanded control store features uses up to 64 device address (8, 16, 32 or 64) depending on the configuration installed. This permits attachment of two additional strings of 3350s or any combination of two, three, or four strings of 3333/3330s, 3340s and 3350s.

Control Store Additional

The control store additional feature is available for the 3830 Model 3 and is used in addition to the above expansion features if the 3350 Direct Access Storage is attached.

3350 Staging

The 3350 staging feature is available for the 3830 Model 3 and is used in addition to the above control store additional feature. It enables the 3350 disk storage drive to be used as staging or conventional drives with the 3850 Mass Storage System.

Two Channel Switch

The two channel switch feature permits the 3830 Model 2 and attached disk storage to be shared by two different channels of the same or different processors. The storage control is made available to a channel by Enable/Disable switches on the 3830 operator panel or through commands.

With the Model 3, attachment to the channel of a single processor requires a two channel switch.

Two Channel Switch, Additional

The two channel switch, additional feature permits the 3830 Model 2 and attached disk storage to be shared by four different channels, two of which may be on the same processor.

On the 3830 Model 3, the two channel switch, additional feature permits three channels, two of which may be on the same processor, to have access to the 3830.

The two channel switch feature is a prerequisite for the two channel switch, additional feature.

Remote Switch Attachment and Remote Switch Attachment, Additional

The remote switch attachment and remote switch attachment, additional features move the Enable/Disable switches of the two channel switch feature from the 3830 Model 2 or Model 3 operator panel to a configuration control panel.

3880 Storage Control

The 3880 Storage Control (Figure 3-3) supplies the control between the channel and the controller of a string of disk drives. It supplies the control between the channel and the string controller.

The highlights of the 3880 follow.

Storage Directors

The 3880 has two control paths, called storage directors, which permit it to support more types of disk storage and twice as many drives as the 3830 Storage Control.

Each storage director operates independently, with separate control paths, data paths, and addresses. When the two directors are attached to two channels, the 3880 can control two data-transfer operations simultaneously, one for each storage director.

The types of disk storage controlled by a director are determined from information in the 3880, which initializes a director to control particular disk storage types. The initialization information is transferred from diskette to 3880 storage at installation. A director can control 3340 and 3344 disk storage devices, 3333/3330 and 3350 disk storage devices, or 3370 disk storage devices. For example, one director can control 3340s (and 3344s) while the other director controls 3370s. The same director can control both 3333 (with attached

3330s) and 3350 disk storage units. The 3880 is different from the 3830 Model 2 in that the 3340 cannot be intermixed (on the same director) with 3333 and 3350 storage units.

Channel Commands Supported

The 3880 supports both the channel commands used for count, key, and data formatted records, and the commands used for fixed-block formatted records. The commands supported by a director depend on the information in 3880 storage. For example, a director that supports 3340s would implement the commands used for count, key, and data records; a director that supports 3370s would implement the commands used for fixed-block records. When supporting commands for fixed-block records, the 3880 translates the block numbers in the address into the physical locations of the data on the disk.

Attachment to a Processor

The 3880 can attach, through a block multiplexer channel, to a System/370 Models 145, 148, 155, 158, 165, and 168, and to 3031, 3032, 3033, and 4341 Processors. The data-rate capabilities are 1.0, 1.5 or 2.0 megabytes per second depending on the processors and disk storage types to which it is attached.

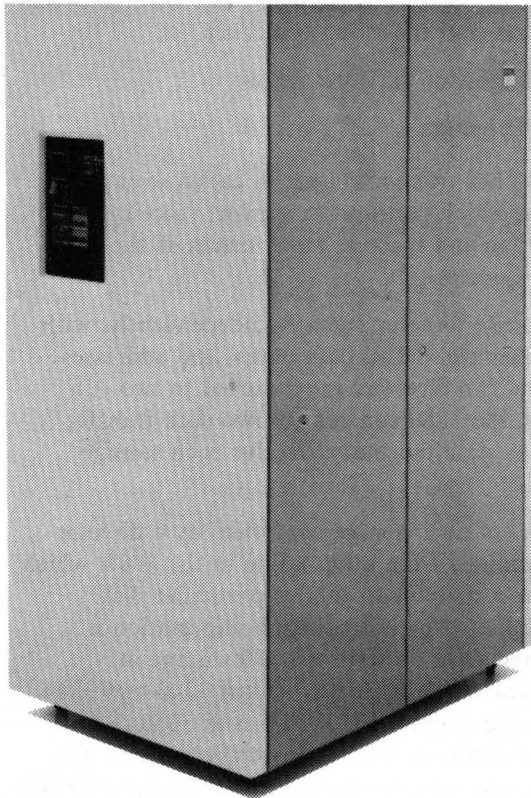

Figure 3-3. IBM 3880 Storage Control

Disk Storage Attachment to the 3880

The following disk storage types and models attach to a 3880 Storage Control:

- 3333 Disk Storage Models 1 and 11 (with controller), and attached 3330 Models 1, 2, and 11.
- 3340 Disk Storage Models A2 or A2F (with controller), and attached 3340 Models B1 and B2. The larger capacity 3344 Model B2 or B2F can take the place of a 3340 Model B1 or B2.
- 3350 Direct Access Storage Model A2 or A2F (with controller), or Model C2 or C2F (alternate controller), and attached 3350 Model Bs.
- 3370 Direct Access Storage Model A (with controller), and attached Model Bs (only for the 4341 Processor).

Availability and Reliability

The 3880 has several advantages that help ensure availability and reliability.

If service is needed, diagnostic information can be obtained and interpreted with the maintenance device (MD), used by the customer engineer. With two storage directors, if one fails, error sense information associated with the failing director can be transferred to the system through the other storage director.

Special Features

The following features can be ordered through the IBM sales representative to expand or customize the user's operation. The list of features may not be complete and more may be available. For more information about features, see the IBM sales representative.

Two Channel Switch-Pair

The two channel switch-pair feature permits each storage director and its attached disk storage to be shared by two channels of the same or different processors. This makes it possible for a 3880 Storage Control to be accessed by four different channels. A storage director is made available to a channel by Enable/Disable switches on the operator panel or through commands.

Two Channel Switch-Pair, Additional

The two channel switch-pair, additional feature permits each storage director and its attached disk storage to be shared by four channels. This makes it possible for a 3880 Storage Control to be accessed by eight different channels.

Remote Switch Attachment

The remote switch attachment feature moves the Enable/Disable switches of the two channel switch-pair feature from the 3880 operator panel to a configuration control panel.

2305 Fixed Head Storage

The 2305 Fixed Head Storage consists of one drive with permanently mounted disks. All addressable tracks have fixed read/write heads, which completely eliminates track seek time.

The 2305 attaches to a 2835 Storage Control, which supplies all the controls and power for the 2305 disk storage.

The only available model of the 2305, Model 2, has one read/write fixed head per track. It has a storage capacity of 11.2 megabytes, an average data locate (rotational delay) time of 5.0 milliseconds, and a data rate of 1.5 megabytes per second. One or two Model 2 units can attach to a 2835 Storage Control Model 2.

Data Format

The 2305 Fixed Head Storage uses count, key, and data formatted records and the channel commands that support them.

3310 Direct Access Storage

The 3310 Direct Access Storage (Figure 3-4) attaches to a 4331 Processor by way of an integrated direct access storage device (DASD) adapter.

The 3310 has four models:

- Model A1 contains a controller and one disk storage drive.
- Model A2 contains a controller and two disk storage drives. It provides the logic for attaching Model B1 or B2.
- Model B1 contains one disk storage drive.
- Model B2 contains two disk storage drives.

The highlights of the 3310 follow.

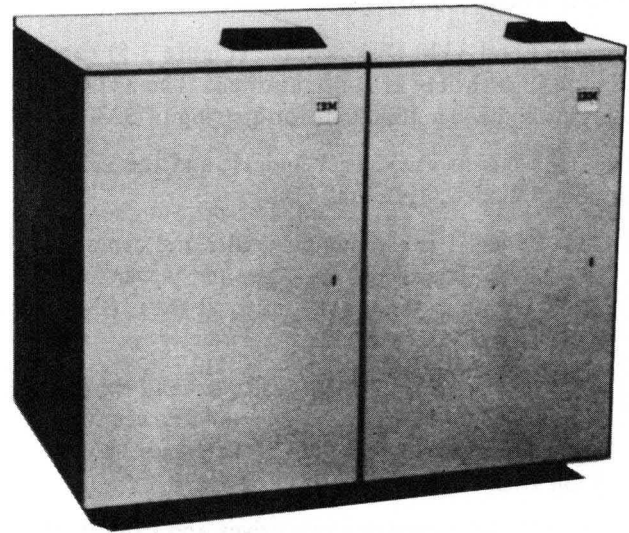

Figure 3-4. IBM 3310 Direct Access Storage

Attachment of the 3310

The two Models B of the 3310 attach to the DASD adapter through a Model A2; Model A1 attaches alone to the adapter. A string consists of a Model A2 and Model B1 or B2 for a total of up to four drives. Up to four strings can attach to the DASD adapter.

Storage Drive

The disks, spindle, and access mechanism with its read and write heads are sealed in an enclosure and permanently mounted on a drive. Each drive has a storage capacity of 64,520,192 bytes for a total of approximately 258 megabytes per maximum string.

The 3310 has an average seek time of 27 milliseconds, an average rotational delay of 9.6 milliseconds, and a data rate of 1,031,000 bytes per second.

Data Format

The 3310 uses a fixed-block record format and the channel commands that support it. Records are formatted in a fixed record length on the tracks, and data is stored and transferred in 512-byte blocks.

3333 Disk Storage and Control and 3330 Disk Storage

The 3333 and 3330 Disk Storage (Figure 3-5) can be used in a variety of configurations. The 3333 contains controller functions for a string of 3330s.

The 3333 has two models, 1 and 11, and the 3330 has three models, 1, 2, and 11:

- 3333 Model 1 is a string controller and contains two drives. It provides the logic and power for attaching up to three 3330 units. It uses IBM 3336 Disk Packs Model 1.
- 3333 Model 11 is a string controller and contains two drives. It provides the logic and power for attaching up to three 3330 units. It uses IBM 3336 Disk Packs Model 11.
- 3330 Model 1 contains two drives and can attach to a 3333 Model 1 or 11. It uses IBM 3336 Disk Packs Model 1.
- 3330 Model 2 contains one drive and can attach to a 3333 Model 1 or 11. It uses IBM 3336 Disk Packs Model 1.
- 3330 Model 11 contains two drives and can attach to a 3333 Model 1 or 11. It uses IBM 3336 Disk Packs Model 11.

All models of the 3333 and 3330 have an average seek time of 30 milliseconds, an average rotational delay of 8.4 milliseconds, and a data rate of 806,000 bytes per second.

The highlights of the 3330 and 3333 follow.

3336 Disk Pack

IBM 3336 Disk Packs are removable from the drives by the customer. The disk packs are mounted in drawers that open and close automatically. The 3336 Disk Pack Model 1 has a storage capacity of 100 megabytes, and the Model 11 has a storage capacity of 200 megabytes. The 3336 Model 1 is interchangeable on 3330 Models 1 and 2 and 3333 Model 1 drives. It cannot be used on Model 11 of either the 3333 or 3330. The 3336 Model 11 is interchangeable on the 3333/3330 Model 11s. It cannot be used on 3330 Models 1 and 2 or 3333 Model 1. The 3336 Model 1 can be factory-converted to a 3336 Model 11.

Attachment of the 3330 and 3333

The 3333 can attach to a 3830 Storage Control Model 2 or 3, a 3880 Storage Control, an integrated storage control (ISC), integrated file adapter (IFA), or direct disk attachment (DDA).

Data Format

The 3333/3330s use count, key, and data formatted records and the channel commands that support them. The user determines the length and arrangement of the records on the tracks.

Special Features

The following features can be ordered through the IBM sales representative to expand or customize the user's operation. The list of features may not be complete and more may be available. For more information about features, see the IBM sales representative.

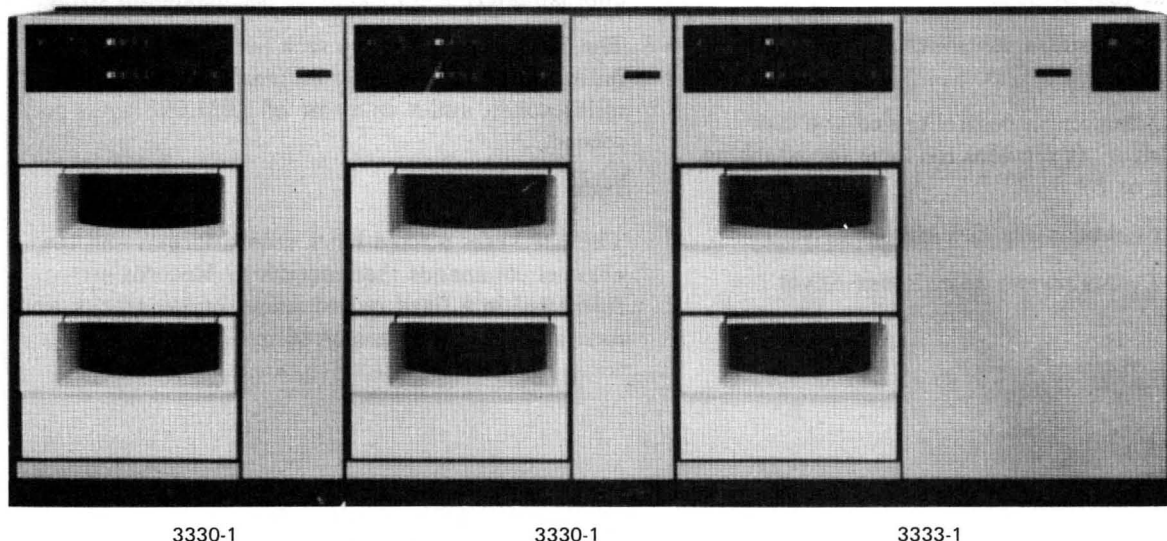

Figure 3-5. IBM 3330 and 3333 Disk Storage

String Switch

The string switch feature permits the 3333 and its connected 3330 disk storage to be shared by two storage controls (or storage directors) on the same or different processors. The 3333/3330 string is made available to a channel by Enable/Disable switches on the operator panel or through commands.

Remote Switch Attachment

The remote switch attachment feature moves the Enable/Disable switches of the string switch feature from the 3333 operator panel to a configuration control panel.

3340 and 3344 Direct Access Storage

The 3340 Direct Access Storage Facility (Figure 3-6) has two different storage capacities, and the 3344 Direct Access Storage (Figure 3-7) has four times the capacity of the largest 3340. Both the 3340 and 3344 are available with fixed heads on some tracks for faster access to high-priority data.

The 3340 has three models, A2, B1, and B2:

- Model A2 is the string controller and contains two disk storage drives. It provides the logic and power for attaching up to three 3340 and 3344 Model B units, which can be intermixed in a string. The total number of drives that can be included in a string depends on the method of attaching the Model A2 to the processor, but in all configurations, eight drives are the maximum that can be included.
- Model B1 contains one disk storage drive.
- Model B2 contains two disk storage drives.

The 3344 has two models, B2 and B2F. Both models contain two disk storage drives. Each drive has a fixed, sealed assembly of disks, spindle, and access mechanism with read/write heads. Model B2 has a storage capacity of 279,558,144 bytes and an average seek time of 25 milliseconds. In Model B2F, 1,004,160 bytes are accessible by fixed heads with zero seek time. The 3344 attaches in a string to a 3340 Model A2. There are some prerequisites and limitations on the attachment of 3344s.

All models of the 3340/3344 have an average rotational delay time of 10.1 milliseconds and a data rate of 885,000 bytes per second.



Figure 3-6. IBM 3340 Direct Access Storage Facility

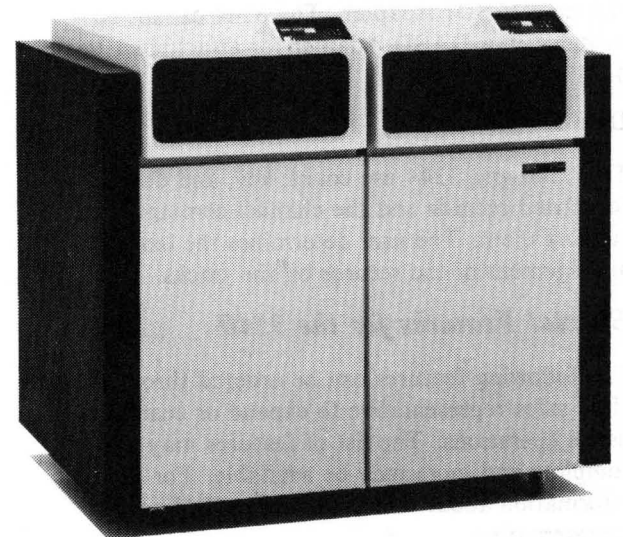

Figure 3-7. IBM 3344 Direct Access Storage

The highlights of the 3340 and 3344 follow.

3348 Disk Pack

The 3340 uses IBM 3348 Data Modules (Figure 3-8). The 3348 is a sealed assembly that contains the disks, spindle, and access arms with read/write heads. It is removable from the drive by the customer and is available in two capacities: Model 35 with a 34,944,768-byte capacity and Model 70 with a 69,889,536-byte capacity. With both models, the average seek time is 25 milliseconds. Model 70F has the same total capacity as the Model 70 but with 502,080 bytes of storage accessible by fixed heads with zero seek time. Models 35 and 70 are

interchangeable on all drives, but use of the Model 70F needs the fixed head feature on the 3340.



Figure 3-8. IBM 3348 Data Module

Attachment of the 3340 and 3344

The 3340 Model A2 attaches to the following storage controls: 3830 Storage Control Model 2, 3880 Storage Control, Integrated File Adapter (IFA), Integrated Storage Control (ISC), Direct Disk Attachment (DDA), or Direct Access Storage Device (DASD) Adapter. The 3344 cannot be included in a DASD Adapter for attachment to the 4331 Processor.

Data Format

The 3340 and 3344 use count, key, and data formatted records and the channel commands that support them. The user determines the length and arrangement of the records on the tracks.

Special Features for the 3340

The following features can be ordered through the IBM sales representative to expand or customize the user's operations. The list of features may not be complete and more may be available. For more information about features, see the IBM sales representative.

Fixed Head

The fixed head feature permits Models A2, B1, and B2 to operate the 3348 Model 70F.

Rotational Position Sensing

The rotational position sensing feature permits the channel to disconnect during most of rotational delay time. It is standard on the 3344.

String Switch

The string switch feature permits the 3340 Model A2 and its connected 3340 and 3344 disk storage to be shared by two storage controls on the same or different processors. The 3340 is made available to a channel by Enable/Disable switches on the operator panel or through commands.

Remote Switch Attachment

The remote switch attachment feature moves the Enable/Disable switches of the string switch feature from the 3340 operator panel to a configuration control panel.

3350 Direct Access Storage

The 3350 Direct Access Storage (Figure 3-9) is a high-speed, large-capacity, disk storage device for attachment to any virtual storage System/370 Processor (except Models 115 and 125) or to a 4341 Processor.

The 3350 has six models: A2, A2F, B2, B2F, C2, and C2F.

All models contain two drives with fixed, sealed assemblies of disks, spindles, and access mechanisms with read/write heads. Each drive has a storage capacity of 317.5 megabytes.

The characteristics of the six models are:

- Model A2 is a string controller and contains two disk storage drives. It provides power and logic to attach up to three units of Models B2 and B2F. One unit of Model C2 or C2F can be used in place of a Model B2 or B2F.
- Model A2F is the same as Model A2 except it has fixed heads on each drive for access to 1,144,140 bytes of the 317.5 megabyte storage.
- Model B2 contains two drives and attaches to a Model A2 or A2F.
- Model B2F is the same as the Model B2 except it has fixed heads on each drive for access to 1,144,140 bytes of the 317.5 megabyte storage.
- Model C2 contains two drives and supplies alternate controller functions in a 3350 string. It functions as a Model A or Model B depending on a manual switch setting. If a Model C2 is included in a string, a primary controller adapter feature is needed on the Model A2 to which the Model C2 attaches.
- Model C2F is the same as Model C2 except it has fixed heads on each drive for access to 1,144,140 bytes of the 317.5 megabyte storage.

The average seek time with movable heads is 25 milliseconds, the average rotational delay is 8.4 milliseconds, and the data rate is 1,198,000 bytes per second.

The highlights of the 3350 follow.

3350 Controller

The 3350 Direct Access Storage can include two controllers in a string of units. Besides the primary controller unit, an alternate controller unit, Model C2 or C2F, can be added. A manual switch on the C2 or C2F unit selects the controller that controls online operations. If the active controller needs service, the other controller can continue operations, but when control is switched, status information is not preserved.

Modes of Operation

The 3350 operates in different modes. It functions in a real (3350) mode or in modes that are compatible with the IBM 3330 Disk Storage Models 1 and 11. The mode of operation, real (3350) or 3330-compatible, can be specified for each drive at manufacture and can be changed in the field by a customer engineer. When the 3350 operates in compatibility mode, the storage capacity is 200 megabytes per drive. On Models A2F, B2F, and C2F the fixed heads have access to 742,710 bytes of data.

Attachment of the 3350

The 3350 Model A2 attaches to the following storage controls: 3830 Storage Control Models 2 and 3, 3880 Storage Control (3350 real mode only); and Integrated Storage Control (ISC).

Data Format

The 3350 use count, key and data formatted records and the channel commands that support them. The user determines the length and arrangement of the records on the tracks.

Special Features

The following features can be ordered through the IBM sales representative to expand or customize the user's operation. The list of features may not be complete and more may be available. For more information about features, see the IBM sales representative.

Primary Controller Adapter

The primary controller adapter feature permits use of the alternate controller when it is selected through a switch on the alternate controller.

String Switch

The string switch feature permits a 3350 Model A2 or A2F and C2 or C2F and connected disk storage to be shared by two storage controls. The 3350 is made available to a channel by Enable/Disable switches on the operator panel or through commands.

Remote Switch Attachment

The remote switch attachment feature moves the Enable/Disable switches of the string switch feature from the 3350 operator panel to a configuration control panel of a System/370 Model 158MP or 168MP.

3370 Direct Access Storage

The 3370 Direct Access Storage is a high-speed, fixed-media, disk storage for attachment to a 4331 or 4341 Processor.

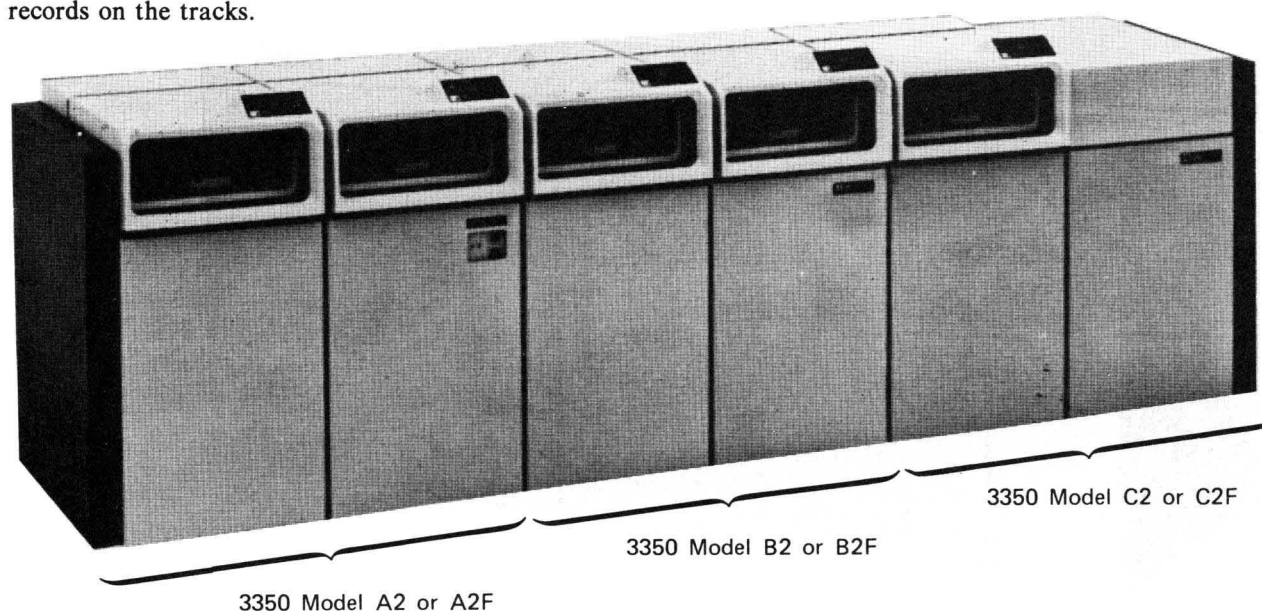

Figure 3-9. IBM 3350 Direct Access Storage

The 3370 has two models, A1 and B1:

- Model A1 is a string controller and contains one drive with two access mechanisms. It supplies the logic for attachment of up to three Model B1 units.
- Model B1 contains one drive with two access mechanisms.

The 3370 has an average seek time of 20 milliseconds, an average rotational delay of 10.1 milliseconds, and a data rate of 1,859 kilobytes per second.

The highlights of the 3370 follow.

Access Operation

The 3370 Direct Access Storage (Figure 3-10) overlaps operations by having two access mechanisms for each drive. Each access mechanism is separately addressable and can access 285.6 megabytes of data. One access mechanism services one-half of the disks on the drive and the other services the other half. While one access mechanism is seeking or transferring data, the other can be seeking data on the same drive.

The disks, spindle, and access mechanism with read/write heads are permanently mounted on the drive.

Attachment of the 3370

The 3370 Model A1 attaches to a 3880 Storage Control, which attaches to a 4341 Processor, and to a Direct Access Storage Device (DASD) adapter, for attachment to a 4331 Processor. The 3370 also can be attached by an integrated adapter to a System/38; however, the units have different model designations, Models A11 and B11.

Data Format

The 3370 uses a fixed-block record format and the commands that support it. Records are formatted in a fixed record length on the tracks, and data is stored and transferred in 512-byte blocks.

Serviceability

If service is needed on the 3370, diagnostic information can be obtained and interpreted with a maintenance device (MD) used by the customer engineer.

Special Features

The following feature can be ordered through the IBM sales representative to expand or customize the user's operation. For more information about this feature, see the IBM sales representative.

String Switch

The string switch feature permits the 3370 Model A1 and its connected disk storage to be shared by two storage controls. These controls may be either 3880s or DASD adapters.

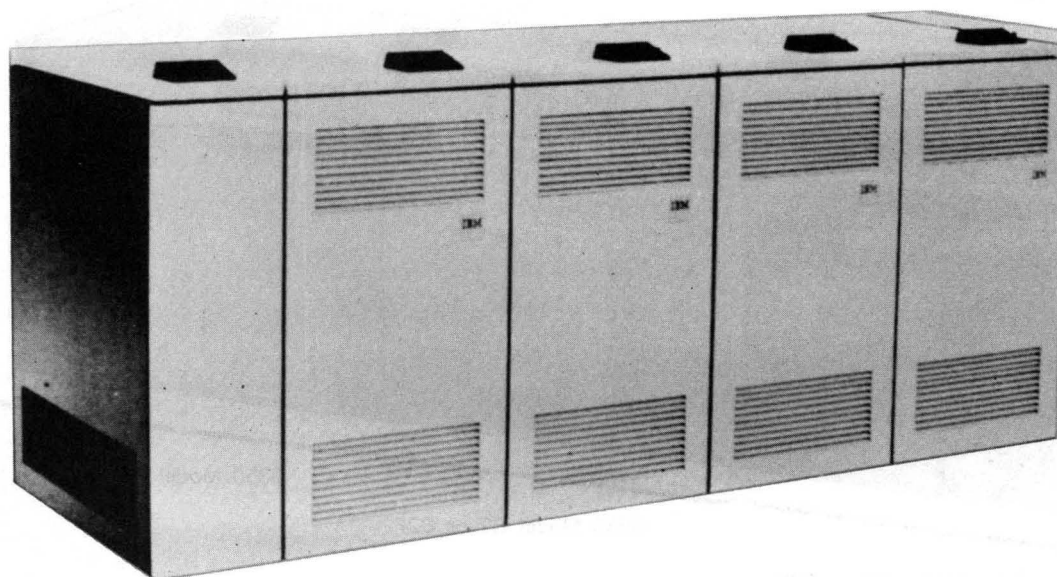

Figure 3-10. IBM 3370 Direct Access Storage

Data Comparison Tables

Figures 3-11 through 3-12 give comparisons of data for the storage controls and disk storages mentioned in this chapter.

Features*	Notes	Storage Controls			Disk Storage							
		2835	3830	3880	2305	3310	3330	3333	3340	3344	3350	3370
Command Retry	1	–	Supported	Supported	–	Standard	Standard	Standard	–	–	Standard	Standard
Rotational Position Sensing	2	Supported	Supported	Supported	Standard	Standard	Standard	Standard	Special	Standard	Standard	Standard
Multiple Requesting	3	Supported	Supported	Supported	Standard	–	Standard	Standard	Standard	Standard	Standard	–
Record Overflow	4	Supported	Supported	Supported	Standard	–	Standard	Standard	Standard	Standard	Standard	–
End of File	5	–	–	–	–	–	Standard	Standard	Standard	Standard	Standard	–
Multiple Track Operations	6	–	Supported	Supported	Standard	–	Standard	Standard	Standard	Standard	Standard	–
Write Format Release	7	–	–	–	–	–	Standard for Model 11	Standard for Model 11	–	–	Standard	–
Primary Controller Adapter	8	–	–	–	–	–	–	–	–	–	Special	–
String Switch	9	–	Special Support	–	–	–	–	Special	Special	–	Special	Special
Two Channel Switch	10	Special	Special	Special (Pair)	–	–	–	Special	Special	–	Special	–
Two Channel Switch, Additional	10	–	Special	Special (Pair)	–	–	–	–	–	–	–	–
Remote Switch (For String Switch)	11	Special	Special	Special	–	–	–	–	–	–	–	–
Remote Switch, Additional	11	–	Special	–	–	–	–	–	–	–	–	–
Fixed Head	12	–	–	–	Standard	–	–	–	Special	Standard (Model B2F only)	Standard (Models A2F, B2F, and C2F only)	–

*Standard features are part of the basic machine; special features can be ordered. For possible limitations, consult your IBM sales representative.

Notes:

1. Command retry is a storage control and channel procedure that permits a command to be sent again without interrupting the program. It serves an important role as a means of correcting data errors without involving system recovery procedures. It also is used to send again commands in other situations.
2. Rotational position sensing permits the channel to send a command to find a record and then disconnect while the disk rotates to the record's location. It is implemented in the storage control and is based on the division of the tracks into sectors that can be sensed during disk rotation.
3. Multiple requesting permits the storage control to execute multiple channel programs concurrently for its attached devices by queuing commands. Rotational position sensing at the disks and block multiplexing in the channel make multiple requests possible.
4. Record overflow permits a record to extend to another track to give a means of processing logical records that exceed the capacity of the track. It applies to count, key, and data records.
5. End of file permits defining the end of a logical group of records. It applies to count, key, and data records.
6. Multiple track permits the storage control to select the next sequentially numbered head without sending Seek Head commands. It applies to count, key, and data records.
7. Write format release, or write padding, frees the subsystem and erases to the end of the track after a write format command. It applies to count, key, and data records.
8. Primary controller adapter permits use of the alternate controller when selected through a switch on the alternate controller.
9. String switches permit disk storage units in a string to be accessed and shared by different storage controls on the same or different channels.
10. Channel switches permit a storage control to be accessed and shared by different channels on the same or different processors.
11. Remote switches move the channel and string switch controls to a remote panel.
12. Fixed head feature eliminates track access time for some or all of the addressable locations.

Figure 3-11. Comparison of Features for Storage Controls and Disk Storage

Characteristics	Storage Controls		
	2835	3830	3880
Commands Supported	Count, Key, Data	Count, Key, Data	Count, Key, Data; Fixed Block
Strings Attachable (Standard)	—	Two	Eight; Four for Each Storage Director
Strings Attachable (Special)	—	Special Extension Features for Two Additional Strings	—
Attaches	2305 Model 2	<ul style="list-style-type: none"> • 3333 Models 1, 11 3330 Models 1, 2, 11 • 3340 Models A2, A2F, B1, B2, B2F 3344 Models B2, B2F • 3350 Models A2, A2F, B2, B2F, C2, C2F 	<ul style="list-style-type: none"> • 3333 Models 1, 11 3330 Models 1, 2, 11 • 3340 Models A2, A2F, B1, B2, B2F 3344 Models B2, B2F • 3350 Models A2, A2F, B2, B2F, C2, C2F • 3370 A1, B1

Figure 3-12. Comparison of Characteristics for Storage Controls

Characteristics	Disk Storage							
	2305	3310	3330	3333	3340	3344	3350	3370
Data Format	Count, Key, Data	Fixed Block	Count, Key, Data	Count, Key, Data	Count, Key, Data	Count, Key, Data	Count, Key, Data	Fixed Block
Storage	Fixed Disks	Fixed Sealed Assembly	Removable Disk Pack	Removable Disk Pack	Removable Sealed Module	Fixed Sealed Assembly	Fixed Sealed Assembly	Fixed Sealed Assembly
Fixed Heads	All Tracks	—	—	—	Some Tracks on 3348 Model 70F (Requires Special Feature)	Some Tracks on Model B2F	Some Tracks on Models A2F, B2F, and C2F	—
Access Mechanisms Per Drive	None	One	One	One	One	One	One	Two
Drives Per Unit (By Model)	2-One	A1-One A2-Two B1-One B2-Two	1-Two 2-One 11-Two	1-Two 11-Two	A2-Two B1-One B2-Two	B1-One B2-Two	A2-Two A2F-Two B2-Two B2F-Two C2-Two C2F-Two	A1-One B1-One
Units Per String (Maximum)	Two	One 3310 Model A2 + One 3310 Model B2	One 3333 + Three 3330s	One 3333 + Three 3330s	One 3340 Model A + Three 3340 Model Bs or 3344 Model Bs	One 3340 Model A + Three 3344 Model Bs	One 3350 Model A + Three 3350 Model Bs or Two 3350 Model Bs and One 3350 Model C	One 3370 Model A + Three 3370 Model Bs
Attaches to Note: The number of strings that can be attached depends on the attachment method, the processor, and, in some cases, special extension features.	2835 Model 2	DASD Adapter (4331)	3333 Model 1, 11	3830 Model 2*, 3830 Model 3, 3880, ISC (145, 148, 158, 168), IFA (135, 138), DDA (125)	3830 Model 2*, 3880, ISC (145, 148, 158, 168), IFA (135, 138), DDA (115, 125), DASD Adapter (4331)	3340 Model A2	3830 Model 2*, 3830 Model 3, 3880, ISC (145, 148, 158, 168)	3880*, DASD Adapter (4331, System/38)
*Numbers within parentheses are models of the System/370 or processor numbers.								

Figure 3-13. Comparison of Characteristics for Disk Storage

Disk Storage	Megabytes Per Access Mechanism	Megabytes Per Drive	Megabytes Per Unit	Megabytes Per String (Maximum)
2305 Model 2	–	11.2	11.2	22.4 (2 Drives)
3310	64	64	128	256 (4 Drives)
3333/3330				
3336 Model 1	100	100	200	800 (8 Drives)
3336 Model 11	200	200	400	1,600 (8 Drives)
3340				
3348 Model 35	35	35	70	280 (8 Drives)
3348 Model 70	70	70	140	560 (8 Drives)
3344	280	280	560	1,820 (2 Drives 3340 Model A, 6 Drives 3344)
3350	317	317	635	2,540 (8 Drives)
3370	285	571	571	2,284 (4 Drives)

Figure 3-14. Comparison of Capacities for Disk Storage

Disk Storage	Access-Motion (Seek) Time, Average Milliseconds (See Note 1)	Rotational Delay Time, Average Milliseconds (See Note 2)	Data Rate Kilobytes Per Second (See Note 3)
2305 Model 2	0	5.0	1,500
3310	27	9.6	1,031
3333/3330	30	8.4	806
3340	25*	10.1	885
3344	25*	10.1	885
3350	25*	8.4	1,198
3370	20	10.1	1,859

*Times with movable heads. Some models have fixed heads at some tracks.

Notes:

1. Access motion time, or seek time, is the time needed to position the access mechanism at the track (cylinder). If the mechanism is already at the correct track (cylinder) or if fixed heads are used, there is no access motion.
2. Rotational delay time is the average time needed for the specified record to turn to the read/write head so that the data transfer can begin.
3. Data rate is the instantaneous speed at which bytes are transferred.

Figure 3-15. Comparison of Performance for Disk Storages

Chapter 4. Diskette Input/Output Devices

The diskette input/output devices read and write data on the IBM diskette, which permits an IBM processor to have access to the data through the diskette.

3540 Diskette Input/Output Unit Models B1 and B2

The 3540 Diskette Input/Output Unit (Figure 4-1) is an efficient and economical data input/output device. There is no contention for devices between data entry and processing programs.

The 3540 has two models:

- Model B1 has one diskette drive.
- Model B2 has two diskette drives, which operate independently from each other. Each drive has a separate hopper and a separate stacker that can hold up to 20 diskettes.



Figure 4-1. IBM 3540 Diskette Input/Output Unit
Model B2

The highlights of the 3540 follow.

Attachment to a Processor

The 3540 needs a control unit position on a system channel. The 3540 attaches to a byte multiplexer channel, block multiplexer channel, or selector channel.

IBM Diskette

The 3540 reads and writes on the IBM diskette, which is the same diskette used by the 3740 Data Entry System. The 3540 reads up to 3600 diskette records per minute and writes up to 2200 records per minute.

Automatic Feed

Under program control, diskettes are automatically fed, one at a time, from the hopper and mounted on the drive spindle for a read or write operation. At the end of the operation, the diskette is automatically removed from the spindle and stacked, which permits uninterrupted processing. Diskettes are loaded and removed by the program while the device is operating.

Data Integrity

Data integrity is ensured because each diskette goes through label checking before the data is read.

Data Entry From 3740

The 3540, because it uses the IBM diskette, also supplies a way for entering data recorded by the 3740 directly into an IBM processor.

Chapter 5. Display Devices

The display devices supply high-speed visual communication between an IBM processor and its user. Tables, graphs, charts, and alphanumeric data are displayed on a cathode-ray tube. Keyboards and a light pen (Figure 5-1) supply the way for entering and changing processor information.

3251 Display Station Model 1

The 3251 Display Station (Figure 5-1) is an interactive computer graphics display station for the display of graphic and alphanumeric data generated by an IBM processor. The display station has attachments for operator interaction with the displayed picture, which permits considerable interactive operator-machine communications.

The 3251 is a free-standing, table-top display, for easy incorporation into a user's office environment. Its keyboards special features are separate and movable, for operator convenience.

The highlights of the 3251 follow.

Configuration of the 3251 Attachment to a Control Unit

Together with the 3255 Display Control and the 3258 Control Unit, the 3251 forms part of the 3250 Graphics Display System and can be used in multiple display station configurations for computer-aided design, computer-aided manufacturing, and scientific analysis applications. It is particularly suited to those applications that need considerable interaction and the display of pictures that contain a high-vector and character content.

Up to two 3251s can be attached to each 3255; the first 3251 must be next to the 3255; the second 3251 can be located up to 15.2 m (50 ft) from the 3255. Up to four 3255s can be attached to each channel-attached 3258; each 3255 can be located up to 1525 m (5,000 ft) from the 3258.

CRT Display Characteristics

The characteristics of the CRT display are:

- A 534 mm (21 in.) diagonal, directed beam, display unit that has a 305 by 305 mm (12 by 12 in.) viewing area.
- Vector graphics—straight lines that can be displayed between any of the 1024 by 1024 addressable positions on the screen. Through display buffer orders, vector endpoint coordinates

can be expressed in absolute form or incrementally, relative to the current beam position.

- Graphical data that can be displayed as a series of points (point plot orders), or in one of four line types: solid, dotted, dashed, or dot-dashed (vector plot orders).
- A high-quality character set that comprises both uppercase and lowercase, which can be displayed either horizontally or vertically (90 degrees counterclockwise) in any of four sizes.
- A vector-draw speed of 8890 m (350,000 in.) per second, that is, 34 microseconds for 305 mm (12 in.) screen deflection.
- A vector-move speed of 22 microseconds for 305 mm (12 in.) screen deflection.
- A character-draw average speed of 4.2 microseconds for a BASIC size character (height 4.1 mm [0.16 in.]).
- Eight programmable intensities (including blank) for points, vectors, or characters; the three brightest levels can be sensed by the light pen.
- Audible and visible (blink) alerts that can be programmed to notify the display station operator of exceptional conditions.
- Displayable data—the amount of data displayable depends on many factors, including the mix of vectors and characters. With one 3251 attached to a 3255, then at 40 cycles per second regeneration rate, at least the following can be displayed:
 - Either 9500 incremental vectors of 9.5 mm (0.375 in.),
 - or 2150 absolute vectors of 76 mm (3 in.),
 - or 5250 BASIC size characters (average mix).With two 3251s attached to a 3255, the performance is slightly less than half that shown above.
- Regeneration of display image—when the 3251 displays images at a regeneration rate of 40 cycles per second, the picture quality is superior to that of images displayed by the 2250 Display Unit Model 3 at 40 cycles per second. As the picture content is reduced, the regeneration rate increases up to a maximum of 46 cycles per second.

Program Support

Software support is through Graphic Programming Services (GPS), which includes the Graphic Access Method (GAM), and the Graphic Subroutine Package (GSP). These are system control programs running under OS/VS1 and OS/VS2 operating systems.

Special Features

The following features can be ordered through the IBM sales representative to expand or customize the user's operations. The list of features may not be complete and more may be available. For more information about features, see the IBM sales representative.

Alphanumeric Keyboard

The alphanumeric keyboard feature supplies a typewriter-like layout for entering data and controls. The keyboard for US English, UK English, French, German, and Italian character sets has 75 keys with two shifts, and has uppercase and lowercase alphabets, numbers, symbols, and control functions. The Katakana character set needs a 76-key four-shift keyboard and has alphanumeric data, symbols, control functions, and Katakana characters. Input is aided through a visible cursor on the screen and display buffer orders that specify fields which the operator can or cannot use for input.

Program Function Keyboard

The program function keyboard feature supplies 32 backlit keys for operator interaction with an IBM processor program. When a key is pressed a unique code is transferred to the processor; the processor program communicates with the operator by making inactive one or more backlit keys. The keyboard is at an angle for operator convenience.

Light Pen

The light pen feature supplies a hand-held, pen-like device for interaction with the displayed image. When the light pen is pointed at a component of the displayed image, it permits sensing and, under program control, selection of that component. A tip switch on the pen permits the selection to be indicated to the processor program, also under program control.

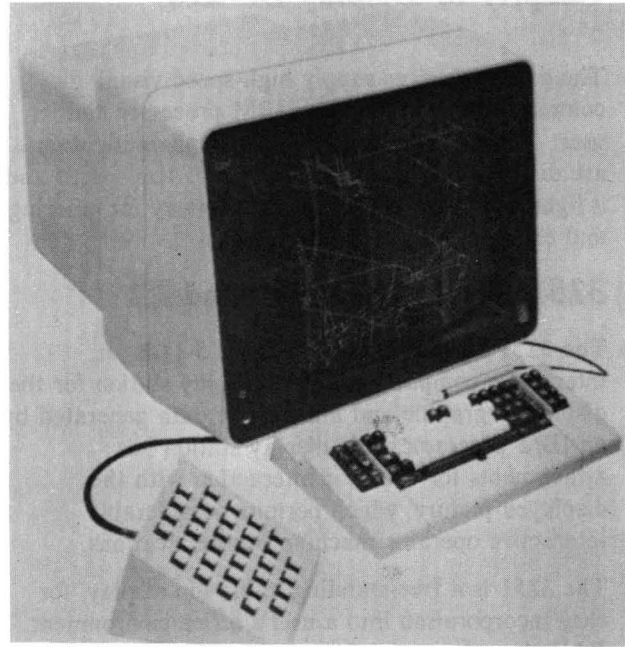

Figure 5-1. IBM 3251 Display Station

3277 Display Station Models 1 and 2 with 3272 Control Unit Models 1 and 2 or 3274 Control Unit Models 1A, 1B, and 1D

The 3277 Display Station (Figure 5-2) is a high-performance cathode-ray tube (CRT) station for displaying alphanumeric data, and for entering data into and retrieving data from a processor through a 3272 or 3274 Control Unit. The 3277 permits an operator to use the keyboard and selector light pen to display and manipulate data on the CRT screen.

The 3277 Display Station is considered to be a unit of the 3270 Information Display System, although it can attach to other systems, such as the 3790 Communications System and 8100 Information System, with the appropriate adapter.

The character set of the 3277 includes 36 alphanumeric and 27 special characters. A choice of keyboards, a selector light pen, and a set of program function keys supply input flexibility.

The 3277 is available in two models:

- Model 1 displays up to 480 characters in 12 lines of up to 40 characters per line, and needs a 3272 Control Unit Model 1 or 2, or a 3274 Control Unit with a Type B adapter to attach to a control unit position on a system channel.

- Model 2 displays up to 1,920 characters in 24 lines of up to 80 characters per line and needs a 3272 Control Unit Model 2, or a 3274 Control Unit with a Type B adapter to attach to a control unit position on a system channel.

Fields Specified by the Program

Individual fields of data on the screen of the 3277 can be program-specified for protected or unprotected storage, alphameric or numeric display, nondisplay, and normal or brightened character intensity. The program can also permit or prevent the sensing of the selector light pen.



Figure 5-2. IBM 3277 Display Station

Special Features

The following features can be ordered through the IBM sales representative to expand or customize the user's operations. The list of features may not be complete and more may be available. For more information about features, see the IBM sales representative.

Audible Alarm

The audible alarm feature supplies an alarm that sounds when a character is entered in the next-to-last position on the display screen. The alarm can also be activated, under program control, to alert the operator to a special condition.

Data Analysis-APL feature (3277 Model 2)

The data analysis-APL feature supplies an interactive APL or text capability.

Keyboards

There are 10 keyboards to choose from. The keyboards have 66 or 78 keys for alphameric, control, or program selection. There are two EBCDIC typewriter keyboards, two EBCDIC data entry keyboards, one operator console keyboard, two ASCII typewriter keyboards, two EBCDIC typewriter/APL keyboards, and one EBCDIC fast cursor text keyboard.

Keyboard Numeric Lock

The keyboard numeric lock feature supplies a means of alerting the keyboard operator to certain keying errors. When the cursor is positioned within a numeric input field and the keyboard numeric lock feature has been installed, the keyboard is electrically locked if any key is pressed other than the numerals 0 through 9, minus (-), decimal sign, or duplicate (DUP).

Operator Identification Card Reader

The operator identification card reader feature gives the ability to enter magnetically coded data from a 53.9 by 85.7 mm (2-1/8 by 3-3/8 in.) plastic data-processing card with an encoded magnetic stripe. Badges and ID cards are examples of the uses of plastic data-processing cards.

Security Keylock

The security keylock feature prevents modification and display of data in the display terminal unless the key is in the ON position.

Selector Light Pen

The selector light pen feature supplies a hand-held, pen-like device for interaction with the displayed image. When the light pen is pointed at a component of the displayed image, it permits sensing and, under program control, selection of that component. A tip switch on the pen permits the selection to be indicated to the processor program, also under program control.

3278 Display Station Models 1 through 5 with 3274 Control Unit Models 1A, 1B, and 1D

The 3278 Display Station (Figure 5-3) has a cathode-ray tube (CRT) for displaying data, and a keyboard for entering data into and retrieving data from a processor through a 3274 Control Unit. The 3278 handles alphameric and graphic data. It permits the operator to use the keyboard and selector light pen to display and manipulate data on

the display screen. The 3278 Display Station is considered to be a unit of the 3270 Information Display System.

The 3278 Display Station is available in five models and can display up to 3564 characters on the screen:

- Model 1 displays 960 characters (12 lines of 80 characters).
- Model 2 displays 1920 characters (24 lines of 80 characters).
- Model 3 displays 2560 character (32 lines of 80 characters).
- Model 4 displays 3440 characters (43 lines of 80 characters).
- Models 5 displays 3564 characters (27 lines of 132 characters).

When operating in 3277-compatible data format, the 3278 Model 1 displays 480 characters (40 characters per line), and Models 2, 3, 4, and 5 display 1920 characters (80 characters per line).

A choice of keyboards, a selector light pen, a magnetic slot reader, a magnetic hand scanner, and program function keys give input flexibility.

Fields Specified by the Program

Individual fields of data on the screen can be program-specified for protected or unprotected storage, alphanumeric or numeric display, nondisplay, and normal or brightened character intensity. The program can also permit or prevent the sensing of the selector light pen.

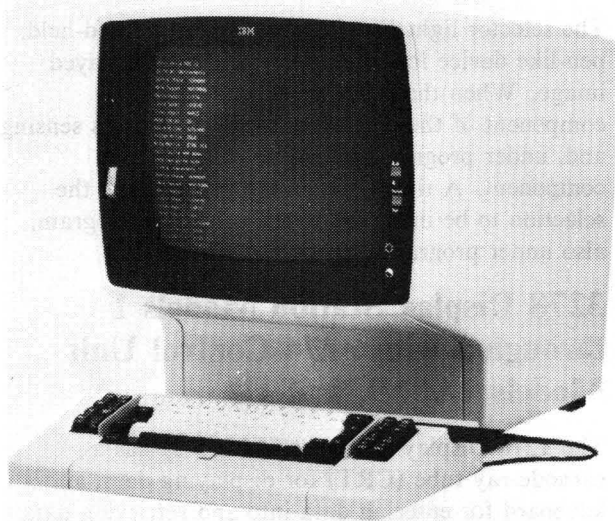

Figure 5-3. IBM 3278 Display Station

Special Features

The following features can be ordered through the IBM sales representative to expand or customize the user's operations. The list of features may not be complete and more may be available. For more information about features, see the IBM sales representative.

APL/Text

The APL/text feature, with its prerequisite extended character set adapter feature, enables the 3278 to display (with modified user application programs) the 222-character APL/text character set, including the 94-character EBCDIC set.

Audible Alarm

The audible alarm feature supplies an alarm that sounds when a character is entered in the next-to-last position on the display screen. The alarm can also be activated, under program control, to alert the operator to a special condition.

Extended Character Set Adapter

The extended character set adapter feature supplies the additional control and buffering necessary to have access to the APL/text feature.

Extended Highlighting

The extended highlighting feature (underscore, blink, or reverse video) is available when the 3278 is attached to a 3274 Control Unit Model 1A or 1D.

Keyboard Numeric Lock

The keyboard numeric lock feature supplies a means of alerting the keyboard operator to certain keying errors. When the cursor is positioned within a numeric input field and the keyboard numeric lock feature has been installed, the keyboard is electrically locked if any key is pressed other than the numerals 0 through 9, minus (-), decimal sign, or duplicate (DUP).

Magnetic Reader Control

The magnetic reader control feature permits the attachment of a magnetic slot reader or a magnetic hand scanner.

Programmed Symbols (PS)

The programmed symbols feature permits the customer to specify, store, have access to, and display symbols and special characters. It also supplies graphic capability.

Security Keylock

The security keylock feature supplies a lock and key control over the display station and all attached devices, such as the selector light pen, keyboard, and magnetic slot reader.

Selector Light Pen

The selector light pen feature is a hand-held, light-sensitive pen that enables the operator to interact directly with the display image by selecting fields of data for input to the host system.

Switch Control Unit

The switch control unit feature permits changing operational control of the display station between two different control units.

3279 Color Display Station Models 2A, 2B, 3A, and 3B

The 3279 Color Display Station (Figure 5-4), a table-top display that uses a high-resolution color cathode-ray tube (CRT), is a member of the 3270 Information Display System. It can be used in clusters with the 3274 Control Unit or the 3276 Control Unit Display Station*, and in combination with 3278 Display Stations and 3287 and 3289 Printers. When connected to the 3274 Control Unit, the 3279 can also be used in combination with the 3277 Display Stations and the 3284, 3286, and 3288 Printers.

The 3279 is available in four models:

- Model 2A offers base-color mode only with a screen capacity of 1920 characters in 24 lines of 80 characters.
- Model 2B offers both base-color and extended-color modes, extended highlighting, and APL/text capability with a screen capacity of 1920 characters in 24 lines of 80 characters.
- Model 3A offers base-color mode only with a screen capacity of 2560 characters in 32 lines of 80 characters.
- Model 3B offers both base-color and extended-color modes, extended highlighting, and APL/text capability with a screen capacity of 2560 characters in 32 lines of 80 characters.

The highlights of the 3279 follow.

Attachment of the 3279 with Base-Color Mode

The different models of the 3279 with color-base mode can be attached as follows:

- All models of the 3279 can be attached to the 3274 Control Unit Models 1A and 1D.
- Models 2A and 2B of the 3279 can be attached to any model of the 3276 Control Unit Display Station*, except Model 1.
- Models 3A and 3B of the 3279 can be attached to any model of the 3276 Control Unit Display Station*, except Models 1 and 2.

Attachment of the 3279 with Extended-Color Mode

Models 2B and 3B of the 3279 can be attached only to the 3274 Control Unit Models 1A and 1D.

Special Features

The following features can be ordered through the IBM sales representative to expand or customize the user's operations. The list of features may not be complete and more may be available. For more information about features, see the IBM sales representative.

Keyboard Numeric Lock

The keyboard numeric lock feature supplies a means of alerting the keyboard operator to certain keying errors. When the cursor is positioned within a numeric input field and the keyboard numeric lock feature has been installed, the keyboard is electrically locked if any key is pressed other than the numerals 0 through 9, minus (-), decimal sign, or duplicate (DUP).

Magnetic Reader Control

The magnetic reader control feature permits the attachment of a magnetic slot reader or a magnetic hand scanner.

Programmed Symbols (PS)

The programmed symbols feature permits storage of and access to either two or six sets of 190 symbols, which can be specified by the user to meet requirements for technical symbols, foreign language letters, or sets of graphic elements for pictorial display.

Security Keylock

The security keylock feature prevents modification and display of data in the display terminal unless the key is in the ON position.

* See *IBM Data Communication Device Summary* for more information on the 3276.

Selector Light Pen

The selector light pen feature is a hand-held, light-sensitive pen that enables the operator to interact directly with the display image by selecting fields of data for input to the host system.

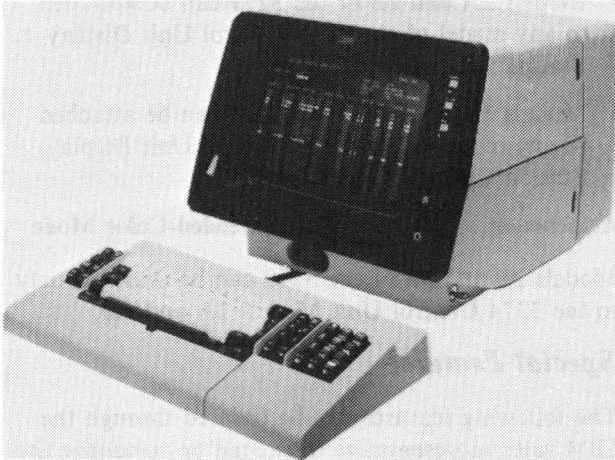

Figure 5-4. IBM 3279 Color Display Station

Switch Control Unit

The switch control unit feature permits changing operational control of the display station between two different control units.

Programming Support

The existing host application programs that support the 3278 Display Station attached to a 3274 Control Unit or a 3276 Control Unit Display Station, support the 3279 Color Display Station operating in the monochrome and base-color modes. Optimum use of colors in the base-color mode may need changes to the customer-written programs.

Functions and features such as extended highlighting, extended color, and programmed symbols available on the 3279 Models 2B and 3B, need extensions to the 3270 data stream, and the displays must be attached to a 3274 with the appropriate features.

For more detailed information about the 3279 and programming support, see *IBM 3270 Information Display System: Color and Programmed Symbols*.

8775 Display Terminal Models 1, 2, 11, and 12

The 8775 Display Terminal (Figure 5-5) consists of a display unit, its attached keyboard, and as special features, a selector light pen and magnetic slot reader. The 8775 is designated as a customer setup

device. For additional information on customer setup devices, see the IBM sales representative.

The 8775 is available in four models:

- Models 1 and 11 offer a screen capacity of 960, 1920, or 2560 display characters in a 9 by 16 dot-character matrix.
- Models 2 and 12 offer a screen capacity of 960, 1920, or 2560 display characters in a 9 by 16 character matrix, and 3440 characters in a 9 by 12 dot-character matrix.

Attachment to a Processor

Models 1 and 2 of the 8775 attach to an 8100 Information System either locally through a directly attached loop, or remotely through a data-link attached loop using synchronous data link control (SDLC) protocol.

Models 11 and 12 of the 8775 attach to an 8100 Information System over data-link communication features. The logical structure formats, protocols, and operational sequences used for transmitting data between an 8775 and an 8100 Information System are specified by the System Network Architecture (SNA).

The data rate of a loop cannot be higher than that of the slowest device on the loop. It may be desirable to attach slower devices to a separate loop when the 8775 must be operated at its maximum data rate. The 8775 can operate on a 34,800 bits-per-second loop.



Figure 5-5. IBM 8775 Display Terminal

Special Features

The following features can be ordered through the IBM sales representative to expand or customize the

user's operations. The list of features may not be complete and more may be available. For more information about features, see the IBM sales representative.

Audible Alarm

The audible alarm feature supplies a short variable-amplitude tone alarm when a character is entered in the next-to-last position of the partition under keyboard operation. The alarm can also be activated, under program control, to alert the operator to a special condition.

Enhanced Function Feature

The enhanced function feature controls the action of the operator and assists as follows:

Highlighting: This function highlights data on a per-character basis in one of three user-selectable modes (blink, reverse video, or underscore), and additionally on a field basis for intensity.

Multiple Partitions: This function displays data in up to eight user-defined rectangular areas, each area functioning as a separate display. Also, the operator can continue to enter data in one partition while the application program processes data in or writes to another partition.

Field Validation: This function permits the application program to identify data fields as:

- **Mandatory Enter**—fields that must be completed before the ENTER key is pressed.
- **Mandatory Fill**—fields that must be completed before the cursor can be moved to another field.
- **Trigger Field**—automatic data transfer to the processor. The function is triggered by the operator's attempt to move the cursor from the designated field.

Keyboard

The keyboard features give a choice of 75- and 87-key typewriter keyboards, two types of data entry keyboards, APL and overlay keyboards, and Japanese English and Japanese Katakana keyboards.

Each keyboard is movable and each has editing features such as: repeat-action, cursor move, tab, back tab, protect data, insert, delete, extended erase (erase to end of field, erase all keyboard input data, and erase entire screen), and cursor select.

All alphanumeric, special symbol, and cursor move keys have repeat-action capability. Fields of data can be sensed by positioning the cursor and pressing

the Cursor Select key instead of using the selector light pen.

Keyboard Numeric Lock

The keyboard numeric lock feature supplies a means of alerting the keyboard operator to certain keying errors. When the cursor is positioned within a numeric input field and the keyboard numeric lock feature has been installed, the keyboard is electrically locked if any key is pressed other than the numerals 0 through 9, minus (-), decimal sign, or duplicate (DUP).

Magnetic Reader Control

The magnetic reader control feature permits the attachment of a magnetic slot reader that reads encoded information from a magnetic stripe. The magnetic slot reader is available as a part number from the IBM sales representative or can be ordered by feature code for a new terminal.

Monocase Switch

The monocase switch feature permits the choice of displaying either uppercase characters only or both uppercase and lowercase characters.

Multiple Partitions and Scrolling

The multiple partitions and scrolling feature gives the ability to divide the screen in up to eight user-defined rectangular data areas. Vertical scrolling within a specified partition is achieved without intervention by the host system. Line-by-line scrolling is controlled from the keyboard using the scroll-up and scroll-down keys.

Note: *The multiple partitions and scrolling feature and the enhanced function feature may be present on the same terminal, but the user can only select the functions of one and not of both features at any one time.*

Programmed Symbols (PS)

The programmed symbols feature permits storage of and access to either two or six sets of 190 symbols, which can be specified by the user to meet requirements for technical symbols, foreign language letters, or sets of graphic elements for pictorial display.

Security Keylock

The security keylock feature prevents modification and display of data in the display terminal unless the key is in the ON position.

Selector Light Pen

The selector light pen feature permits the operator to select information from the display screen and cause the selections to be identified to the application program.

Set Up Keylock

The set up keylock feature controls access by the operator to change the unit address of the terminal through the keyboard.

Programming Support

Programming support for the 8775 is supplied by the Distributed Processing Programming Executive (DPPX) and the Distributed Processing Control Executive (DPCX) program products described below.

DPPX Support

The DPPX base and associated DPPX program products support consists of:

- The 3270 Data-Stream Compatibility (DPPX/DSC) program product, which enables existing System/370 applications to be used with the 8775.
- Basic support for writing application programs. Application programs that take advantage of the 8775's enhanced functions can be written at the data-stream level using DPPX Base support.
- High-level support for writing application programs. The Distributed Presentation Services program supplies high-level support for writing

applications that take advantage of 8775 functions. Such applications can be written in COBOL (DPPX/COBOL) or Assembler (DPPX/ASSM) language. The Distributed Presentation Services program has two components: Interactive Map Definition (a special feature) and Format Management (the base product). Interactive Map Definition enables formatted screens to be interactively designed during program development; Format Management supplies an interface enabling the application program to use the screens that have been designed, and build the needed format on the screen at run time.

- Control of the 8775 microcode library and loading of the 8775 enhanced function feature and the multiple partitions and scrolling feature.
- Support for the system copy feature (a feature available only on Models 1 and 2).

DPCX Support

The DPCX Base program and DPCX Feature support is as follows:

- The single-station 8775 Display Terminal is supported as a 3276.
- The 3270 Data-Stream Compatibility (DPPX/DSC) program product enables existing System/370 applications to be used with the 8775.
- The user programs can communicate with the 8775 using full-screen processing.

Chapter 6. Magnetic Character Readers

The magnetic character readers use magnetic ink character recognition (MICR) to read and sort card and paper documents in banking applications. These devices operate on documents whose type font (MICR E13B, see Figure 6-3), print quality, and code-line arrangement meet the specifications recommended by the American Bankers Association. See Figure 6-7 at the end of this chapter for a comparison of the characteristics of the magnetic character readers.

1255 Magnetic Character Reader Models 1, 2, and 3

The 1255 Magnetic Character Reader (Figures 6-1 and 6-2) can read and sort a variety of magnetically inscribed documents at relatively high speeds.

In a typical application, the 1255 performs selective data storing from MICR-encoded checks for updating of demand-deposit accounts. Continuous document loading, optimum document stacking, and simplicity of operation help improve throughput.

The 1255 is available in three models:

- Model 1 reads and sorts up to five hundred 152 mm (6 in.) long documents per minute into six stackers.
- Model 2 reads and sorts up to seven hundred fifty 152 mm (6 in.) long documents per minute into six stackers.
- Model 3 reads and sorts up to seven hundred fifty 152 mm (6 in.) long documents per minute into 12 stackers.

The speed of processing varies with the 1255 model as well as with factors such as document length and paper quality.

The highlights of the 1255 follow.

Attachment to a Processor

The 1255 needs one control unit position on a system channel.

Document Feed

The documents can be intermixed and can range from 64 to 108 mm (2.5 to 4.25 in.) wide, 146 to 225 mm (5.75 to 8.875 in.) long, and 0.076 to 0.178 mm (0.003 to 0.007 in.) thick.

Stackers

The 1255 has horizontal stackers, each of which can hold a 635 mm (2.5 in.) stack of documents. Models 1 and 2 have six stackers in one vertical bay, and the Model 3 has 12 in two bays.

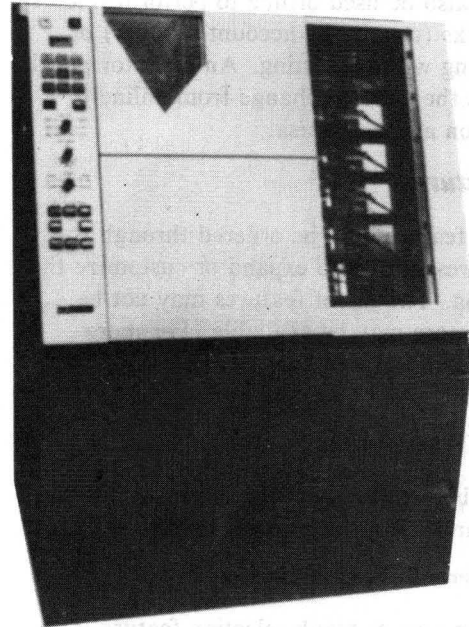

Figure 6-1. IBM 1255 Magnetic Character Reader Model 1 or 2



Figure 6-2. IBM 1255 Magnetic Character Reader Model 3

Operator Panel

The operator panel contains switches, indicators, and an operator-resettable document counter. This panel is grouped with the feed hopper and the stackers for operator convenience. This grouping also makes operator training easier, and helps minimize space needs.

Offline Sorting

The 1255 can also be used offline to perform fine sorting of checks (usually by account number) or validity checking without sorting. An operator panel switch permits the 1255 to change from online to offline operation and vice versa.

Special Features

The following features can be ordered through the IBM sales representative to expand or customize the user's operation. The list of features may not be complete and more may be available. For more information about features, see the IBM sales representative.

Dash Symbol Transmission

The dash symbol transmission feature transmits the E13B dash symbol from the transit field to storage.

High-Order Zero & Blank Selection

The high-order zero & blank selection feature is an offline feature for the Model 3. It permits selection of specified documents into a specific stacker. These are documents that have only blanks in the sort position and in all higher order positions of the field.

Self-Checking Number/Improved Recognition

The self-checking number/improved recognition feature reduces account number rejects besides performing the basic self-checking number function. The account field is especially subject to folds, banding, and print specification deviations. Character rejects are reduced relative to the damage of the documents, thereby reducing the user's check-processing expense.

51-Column Card Sorting

The 51-column card sorting feature permits the 1255 to read and sort 51-column cards that are magnetically inscribed.

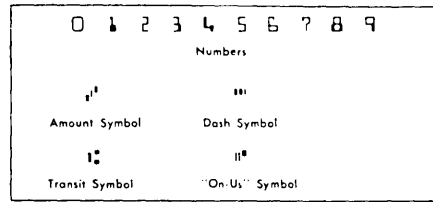

Figure 6-3. The 14 Magnetic-Ink Characters of Font E13B

1419 Magnetic Character Reader Model 1

Data inscribed magnetically on checks (Figure 6-4) and other banking documents is read at nominal speeds of 1600 documents per minute by the 1419 Magnetic Character Reader (Figure 6-5). Specific speeds vary with document length as well as with the program used.

The highlights of the 1419 follow.

Attachment to a Processor

The 1419 needs a channel control unit position on a system channel.

Stackers

The 1419 has 13 stackers for a wide range of sorting or selection needs. As the documents are read, they can be sorted into as many as 13 pockets classified as follows: A, B, 0 through 9, and R (reject). All magnetic inscriptions can be checked for validity.

Document Feed

Documents read by the 1419 can be of intermixed sizes and thicknesses, as typically encountered in check-handling operations. The standard minimum length is 152 mm (6 in.); shorter documents, such as the 51-column postal money order need the 51-column card sort feature and can be read into the system at a maximum rate of 1960 per minute.

These shorter documents can be intermixed with standard-length documents, and can also be sorted if a no-charge 51-column card sorting special feature for that purpose is installed. If the feature is not installed on the 1419, 51-column cards and other documents shorter than 127 mm (5 in.) are sent to the reject pocket. If the feature is installed, 1419 speed is reduced by an amount that increases

slightly with the average length of documents and is 4.3 percent for 51-column cards, and 5.3 percent for 152 mm (6 in.) checks.

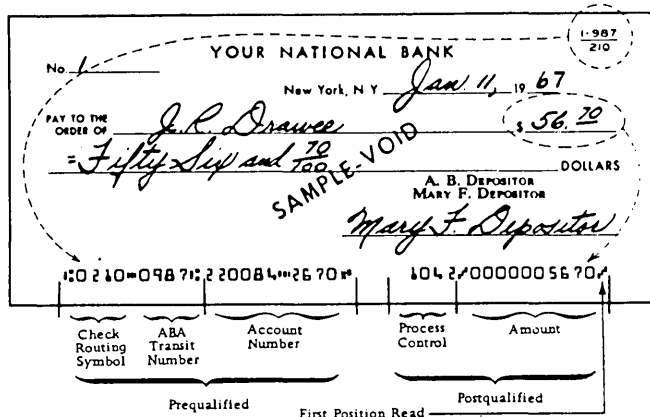

Figure 6-4. Magnetic Inscription—Translation of Characters and Definitions of Fields

Special Features

The following features can be ordered through the IBM sales representative to expand or customize the user's operation. The list of features may not be complete and more may be available. For more information about features, see the IBM sales representative.

Batch Numbering

The batch numbering feature supplies an automatic method of advancing a batch number document identification under program control. It contains a six-position impact printer that prints up to 999,999 in any one of six locations on the back of the document. The high-order digit is set by hand and

the remaining digits are advanced under program control.

Dash Symbol Transmission

The dash symbol transmission feature distinguishes U.S. from Canadian transmit-routing numbers (leftmost eight magnetic digits) to prevent duplications.

Endorser

The endorser feature permits the 1419 to print the bank's endorsement on the back of each document without reducing its operating speed.

Expanded Capability

The expanded capability feature supplies a command for operation under OS, which removes the exposure to data overruns caused by 1419s interfering with other 1419s operating on the same channel.

Multiple Column Control

The multiple column control feature permits the 1419 to select documents with specific numbers in four or less columns of any field.

Program Control for Pocket Lights

The program control for pocket lights feature improves control of output batches by stopping the reading-sorting operation and turning on pocket lights(s) when a predetermined number of documents has entered one of the corresponding six pockets (with a second feature, 12 pockets) specified by the program.

Figure 6-5. IBM 1419 Magnetic Character Reader

Self-Checking Number

The self-checking number feature automatically performs mathematical proof that account numbers are correctly recorded and read.

Split Field

The split field feature separates any field into two elements after the first ABA dash symbol that follows a digit.

51-Column Card Sorting

The 51-column card sorting feature permits the 1419 to sort 51-column card documents, which can be intermixed with documents and cards within specifications.

3890 Document Processor Models A1 through A6, and B1 through B6

The 3890 Document Processor (Figure 6-6) has continuous operation (often with only one operator) for reading magnetically inscribed data from card and paper documents into an IBM processor at a rate of 2400 documents 152 mm (6 in.) long per minute. Actual throughput varies with the length of the documents. The built-in control and logic functions permit the 3890 to operate time-independently of the IBM processor during online operation. The 3890 can also be used offline for document sorting. It attaches to an IBM processor through a byte or block multiplexer channel.

The six A models (A1 through A6) and six B models (B1 through B6) parallel each other in number of pockets, starting with six in Models A1 and B1, increasing by six for each succeeding model, to 36 in Models A6 and B6. A models differ from B-models in storage capacity. A models have a 13,312-byte storage capacity; B models have a 29,696-byte storage capacity, which permits

customer-written stacker-select programs to use larger sort tables than those which the A models use. The storage capacity is reduced to 10,240 bytes for A models and 26,624 bytes for B models when the 3890 is used for image processing (sorting by comparing a document to an image in a buffer).

The highlights of the 3890 follow.

Stackers

Each stacker pocket holds 800 to 1000 documents per pocket (up to 36 pockets are available). All but the last 200 to 300 documents can be unloaded by the operator without stopping the 3890.

Input Hoppers

The input hopper with built-in jogger holds approximately 4800 documents.

Merge Feed

The merge feed unit permits the merging of documents into a normal input stream from a separate hopper.

Logic and Control Section

The control program is loaded online from an IBM processor or loaded offline from a removable IBM diskette. The logic capability permits the following standard programmable functions: split field, self-check number verification, multiple-column control, and base-number conversion.

Documents

The documents can be intermixed and can range from 123 to 223 mm (4.85 to 8.75 in.) long, 70 to 106 mm (2.75 to 4.17 in.) wide, and 0.064 to 0.178 mm (0.0025 to 0.007 in.) thick.

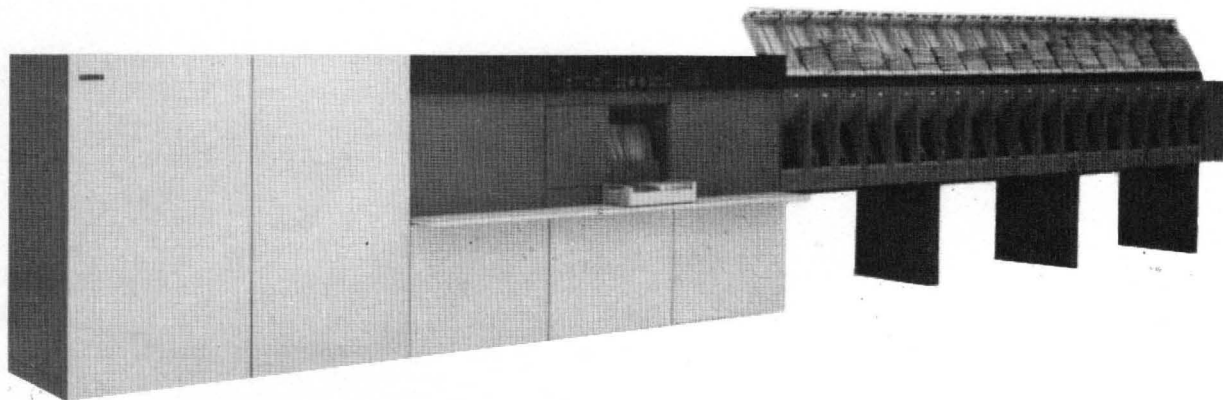

Figure 6-6. IBM 3890 Document Processor Model A3

Special Features

The following features can be ordered through the IBM sales representative to expand or customize the user's operations. The list of features may not be complete and more may be available. For more information about features, see the IBM sales representative.

Item Numbering/Endorsing

The item numbering/endorsing feature permits the printing of an eight-digit number or full endorsement on the back of each document. The new endorser design reduces the time needed to change the plate by the operator. This is for users that have a need to print different endorsements for different types of work.

Microfilming

The microfilming feature permits selective filming of some or all items being processed without reducing throughput. Document filming can be either front and back or front only. Filming and indexing are separately controlled. The film cassette (available as an accessory) has a capacity of up to 610 m (2000 ft) of 0.069 mm (0.0027 in.) thick polyester thin-base 16 mm film, which will record approximately 380,000 front-and-back images of an average document mix. Loading and unloading of the film from the cassette into the film transport is automatic under operator control.

Data Comparison Table

Figure 6-7 gives a comparison of data for the magnetic character readers mentioned in this chapter.

I/O Devices	Models	Documents Sizes and Specifications		Maximum Speed (Documents Per Minute)	Stackers (Pockets)	Reading Capabilities*
		mm	in.			
1255	1	w - 64 to 108 l - 146 to 225 t - 0.076 to 0.178	2.5 to 4.25 5.75 to 8.875 0.003 to 0.007	500 (6-inch documents)	6	Reads magnetically inscribed MICR E13B printing that meets the specifications recommended by the American Bankers Association Technical Committee on Mechanization of Check Handling.
	2			750 (6-inch documents)	6	
	3			750 (6-inch documents)	12	
1419	1	w - 70 to 93 l - 152 to 225 t - 0.076 to 0.178	2.75 to 3.66 6 to 8.875 0.003 to 0.007	1600	13	
3890	A1, B1	w - 70 to 106 l - 123 to 222 t - 0.064 to 0.178	2.75 to 4.17 4.85 to 8.75 0.0025 to 0.007	2400 (minimum)	6	
	A2, B2				12	
	A3, B3				18	
	A4, B4				24	
	A5, B5				30	
	A6, B6				36	
w - width l - length t - thickness * There are more capabilities and features available; see the IBM sales representative for more information.						

Figure 6-7. Comparison Data for Magnetic Character Readers

Chapter 7. Magnetic Tape Devices

The IBM magnetic tape devices read and write on 12.7 mm (1/2 in.) magnetic tape mounted on reels. The reels can be 158.75, 177.8, 215.9, or 266.7 mm (6.25, 7.0, 8.5, or 10.5 in.) in diameter. The tape units, which operate at data densities of up to 6250 bytes per inch (BPI), use IBM Multi-System tape or competitive tape. Competitive tape formulations should meet the tape requirements described in *Tape Requirements for IBM One-Half Inch Tape Drives at: 556, 800, 1600, and 6250 BPI*.

These devices operate in seven- or nine-track format except the 8809, which operates in the nine-track format only. The seven-track format uses the seven-bit binary-coded decimal (BCD) representation so that each track represents a bit of the BCD code. The nine-track uses eight of the nine bits for data and the last one for parity. The data bits can represent an alphanumeric or special character, two decimal digits, one signed decimal digit, or eight binary digits.

One of the practical uses of the magnetic tape device is the creation of a data file on a reel of tape so that it can be stored offline.

See Figure 7-5 at the end of this chapter for a comparison of the characteristics of the magnetic tape devices.

3410 Magnetic Tape Unit Models 1 through 3

3411 Magnetic Tape Unit and Control Models 1 through 3

The 3410 Magnetic Tape Unit (Figure 7-1) and 3411 Magnetic Tape Unit and Control are members of the 3400-series tape unit family. The 3410 and 3411 tape subsystem includes one 3411 tape unit and control and up to five 3410 tape units.

The 3410 and the 3411 look similar and each contains one tape unit, but the 3411 also contains the common control unit and power supply. The 3411 Model 1 can attach up to three 3410 Model 1's, the 3411 Model 2 up to five 3410 Model 2s, and the 3411 Model 3 up to five 3410 Model 3s.

The 3410 and 3411 are each available in three models, as follows:

- Model 1 has a nominal data rate of 20 kilobytes per second, a tape speed of 317.5 mm (12.5 in.) per second, and a rewind time of 3 minutes for a full reel.

- Model 2 has a nominal data rate of 40 kilobytes per second, a tape speed of 635 mm (25 in.) per second, and a rewind time of 3 minutes for a full reel.
- Model 3 has a nominal data rate of 80 kilobytes per second, a tape speed of 1270 mm (50 in.) per second, and a rewind time of 2 minutes for a full reel.

The 3410 tape units must be the same model as the 3411.

The highlights of the 3410 and 3411 follow.

Attachment to a Processor

The 3411 Magnetic Tape Unit and Control is very versatile and attaches to various systems and devices. It can attach to a control unit position on a system channel, or through an integrated adapter on a system or device. The 3411 attaches to a byte multiplexer channel, block multiplexer channel, or selector channel.

Table-Height Horizontal Transport Deck

Both the 3410 and 3411 are desk-height units that have tapes mounted horizontally rather than vertically. A transparent sliding cover, similar to the cover of a roll-top desk, gives easy access to the tape reels.

Tape-Threading Path

A simplified tape-threading path and a push-pull quick release latch (for quicker mounting and removing of the tape supply reel) increase ease of operation.

Compact Design

The diagnostic capabilities of the units permit normal servicing to be done from the front, and internal cables between the tape units and the tape control remove the requirement for under-the-floor cables. Both these designs permit the units to be placed side by side and near to walls, thereby permitting better use of space.

Independent Tape-Unit Attachment

The method of attaching a 3410 to a 3411 (radial attachment) permits a 3410 to be taken out of operation for maintenance without changing cables or interrupting the work done by any of the other units.

Error Correction

Single-track read errors are corrected in flight in 1600 BPI phase-encoding (PE) recording, and track-in-error detection is supplied for nine-track 800 BPI recording.

Parity Checking

Parity checking is done during tape reading (in both 800 and 1600 BPI recording) and during read-back check of tape writing.

Amplitude Checking

In 1600 BPI PE recording, the amplitude of the signal is checked against a predetermined threshold level. This check determines whether the signal of the data being recorded is strong enough to permit the data to be read.

Read Backwards

Tapes can be read by the 3410 and 3411 in a forward or backward direction. The data conversion function is inoperative during a backward read operation of seven-track tapes.

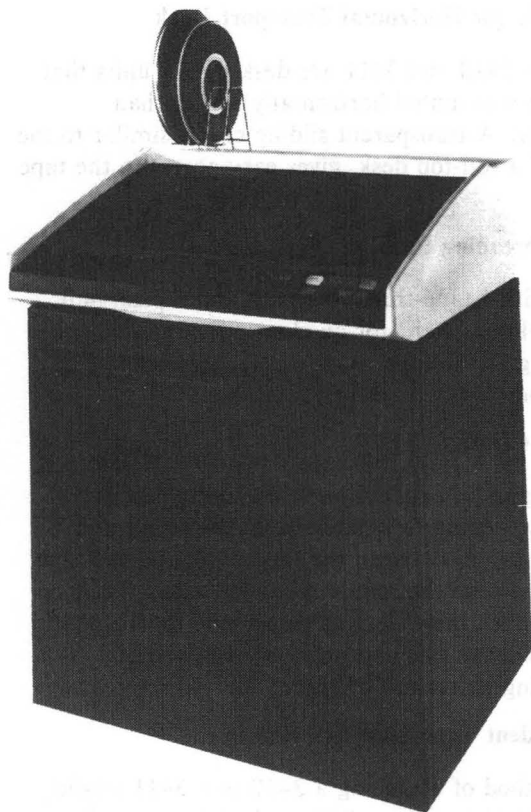

Figure 7-1. IBM 3410 Magnetic Tape Unit Model 1, 2, or 3

Special Features

The following features can be ordered through the IBM sales representative to expand or customize the user's operation. The list of features may not be complete and more may be available. For more information about features, see the IBM sales representative.

Dual-Density, Tape Unit

The dual-density, tape unit feature, available for both the 3410 and 3411, permits the nine-track tape units to read and write either at 800 BPI in non-return-to-zero change-on-ones recording (NRZI) mode or at 1600 BPI in phase-encoded mode. This feature is especially useful in library conversion and for data interchange between systems. Where only 1600 BPI PE operations are performed, the single density feature is needed.

Seven Track, Tape Unit

The seven track, tape unit feature permits a 3410 or 3411 to operate at 200, 556, or 800 BPI in NRZI mode, in seven-track format only.

Single Density, Tape Unit

The single density, tape unit feature permits the 3410 or the tape unit on the 3411 to operate at 1600 BPI PE only.

3420 Magnetic Tape Unit Models 3 through 8

The 3420 Magnetic Tape Unit (Figure 7-2) offers compatibility with existing seven- and nine-track tape volumes and programs. It also offers enhanced reliability, availability, and serviceability features.

The 3420 has six models, as follows:

- Model 3 has a nominal data rate of 120 kilobytes per second, a tape speed of 1.905 m (75 in.) per second, and a rewind time of 60 seconds for a full reel.
- Model 4 has a nominal data rate of up to 470 kilobytes per second, a tape speed of 1.905 m (75 in.) per second, and a rewind time of 60 seconds for a full reel.
- Model 5 has a nominal data rate of up to 200 kilobytes per second, a tape speed of 3.175 m (125 in.) per second, and a rewind time of 60 seconds for a full reel.

- Model 6 has a nominal data rate of up to 780 kilobytes per second, a tape speed of 3.175 m (125 in.) per second, and a rewind time of 60 seconds for a full reel.
- Model 7 has a nominal data rate of up to 320 kilobytes per second, a tape speed of 5.080 m (200 in.) per second, and a rewind time of 45 seconds for a full reel.
- Model 8 has a nominal data rate of up to 1250 kilobytes per second, a tape speed of 5.080 m (200 in.) per second, and a rewind time of 45 seconds for a full reel.

6250 BPI (GCR Mode)

6250 BPI is synonymous with group coded recording (GCR) and is a recording mode of the 3420 Models 4, 6, and 8. When the 3420 records at 6250 BPI (GCR mode), the nominal interblock gap (IBG) is 7.6 mm (0.3 in.), instead of 15.2 mm (0.6 in.) as at 1600 BPI (PE mode), and makes more tape space available to the user.

Also with 6250 BPI (GCR mode), self-adjusting gain control is used, which adjusts the read amplitude to a signal recorded at the beginning of the tape to improve read performance.

The highlights of the 3420 follow.

Attachment to a Processor

The 3420 Magnetic Tape Unit attaches to a control unit position of a system or device through the 3803 Tape Control Unit.

Tape Path

Tape wear and contamination are minimized by extensive use of air bearings and surface treatments. The path that the tape takes through the tape unit, from reel to reel, permits the recording side of the tape to touch only two surfaces during read and write operations: the tape cleaner and the read/write head. In addition, the cleaning mechanism (supplied only on Models 4, 6, and 8) removes loose contaminants from the tape and protects the read/write head from tape contamination during high-speed rewind and tape load and unload operations.

Read-Access Time

Each model of the 3420 has a short nominal read-access time that can improve system throughput. Optical tachometers, built into the tape

unit, sense small variations in the speed of the capstan and the tape and generate corrective signals. This precise control is one of the keys to the 3420's quick read-access and rewind times.

Automatic Threading and Cartridge Loading

An automatic reel latch mechanically seats the file reel in position and pneumatically locks it on the hub for tape movement. With automatic threading and cartridge loading, the time to mount and remove tapes is reduced.

Independent Tape-Unit Attachment

Radial attachment of a 3420 permits it to be taken out of operation for maintenance without changing cables or interrupting the work done by any of the other units.

Nine-Track 1600 BPI Phase-Encoding Operation

Data is recorded parallel by bit, serially by byte at 1600 BPI, phase encoded, in nine tracks across the width of the tape. This operation can be available on all models of the 3420. See special features.

Parity Checking (PE Mode)

Each byte is checked for odd parity while tape is being read. Data written on tape is read back instantly and checked as in a read operation with full parity checking.

Error Correction

Single-track errors consisting of missing or incorrectly read bits are corrected "in flight" during 1600 BPI PE read operation.

In 6250 BPI (GCR mode), there is "in-flight" detection and correction of single-track errors on write operations and double-track errors on read operations.

Read Backwards

Tapes can be read by the 3420 in a forward or backward direction. The data conversion function is inoperative during a backward read operation of seven-track tapes.

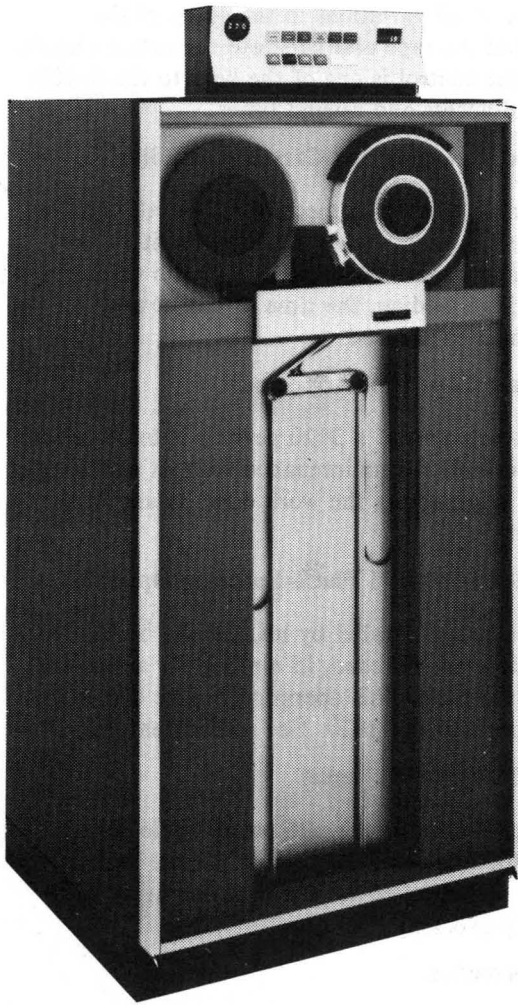

Figure 7-2. IBM 3420 Magnetic Tape Unit

Special Features

The following features can be ordered through the IBM sales representative to expand or customize the user's operation. The list of features may not be complete and more may be available. For more information about features, see the IBM sales representative.

Dual Density

The dual density feature is for Models 3, 5, and 7 only and permits the tape unit to operate in 800 BPI NRZI nine-track format as well as in 1600 BPI PE.

Seven Track

The seven track feature is for Models 3, 5, and 7 only and permits the tape unit to operate at either 556 or 800 BPI NRZI in the seven-track format.

6250 Density

The 6250 density feature is for Models 4, 6, and 8 only, and permits the tape unit to operate in 6250 BPI nine-track format.

6250/1600 Density

The 6250/1600 density feature is for Models 4, 6, and 8 only, and permits the tape unit to operate at 6250 BPI density and 1600 BPI density.

3803 Tape Control Models 1, 2, and 3

The 3803 Tape Control (Figure 7-3) is the control unit for the 3420 Magnetic Tape Unit. The 3803 is half the size of earlier IBM tape control units and uses monolithic circuitry for all logic and control functions. The monolithic read-only control storage of the 3803 contains all the information needed to coordinate effective operation of the 3420 Magnetic Tape Unit. The 3803 also has diagnostic capabilities that can quickly pinpoint problems.

The 3803 has three models, as follows:

- Model 1 is the control unit for 3420 Models 3, 5, and 7.
- Model 2 is the control unit for 3420 Models 3 through 8. Seven- and nine-track 3420s and multiple densities can be mixed on the Model 2 when it has the appropriate features installed.
- Model 3 is the control unit for 3420 Models 3 and 5 for attachment to smaller IBM processors.

The highlights of the 3803 follow.

Radial Attachment

Through a radial interface attachment, up to eight 3420s can be connected to a 3803 in a way that permits a 3420 to be taken out of operation for maintenance without changing cables or interrupting the work done by any of the other units. This attachment makes it possible to change tape units online and offline for easier maintenance. (Earlier IBM tape units are connected to their control units serially through units placed next to them.)

Encode Checking

The 3803 Model 2 uses an improved encode-checking method that permits error correction in 6250 BPI mode for any single track, or a combination of two tracks simultaneously, while the tape is in motion.

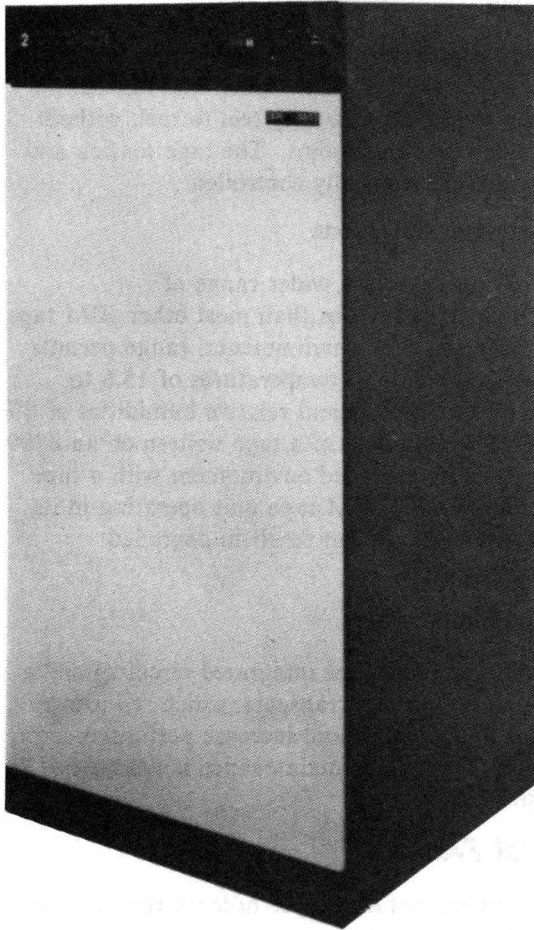

Figure 7-3. IBM 3803 Tape Control Unit Model 1

Special Features

The following features can be ordered through the IBM sales representative to expand or customize the user's operation. The list of features may not be complete and more may be available. For more information about features, see the IBM sales representative.

The 3803 must have the appropriate density and tape format features to control the 3420 tape units attached to it (such as single density, dual density, and seven track).

Remote Switch Attachment

The remote switch attachment feature (for the Models 1 and 2 only) make possible the enabling and disabling of the two channel switch feature on the 3803 from a remote console such as the configuration control panel of a System/370 Model 158MP or 168MP.

Tape Switching

The tape switching feature on 3803 Models 1 and 2 permits as many as sixteen 3420s to be changed among two, three, or four 3803s.

Two Channel Switch

With the two channel switch feature installed, a 3803 Model 1 or 2 can attach to a second channel and change between two channels under program control. This feature permits one or more processors to have access to tape units that otherwise might not be available to them.

8809 Magnetic Tape Unit Models 1A, 1B, 2, and 3

The 8809 Magnetic Tape Unit (Figure 7-4) supplies high-speed save and restore capabilities for: DASD, journaling for data base/data communication, tape swapping, and processing of the host system.

The 8809 is available in four models, which may be attached to either an 8100 System (four 8809s maximum) or a 4331 or 4341 Processor (up to six 8809s maximum). A Model 1A or 1B must be the first drive in the string. The attachment of the four models is as follows:

- Model 1A attaches either directly to the 4331 or 4341 Processor or to the 8101 Storage and I/O Unit of an 8100 System. It supplies power to an attached Model 2.
- Model 1B attaches directly to the 8100 System because it contains a Tape Unit Adapter that is not present in the Model 1A. It also supplies power to an attached Model 2
- Model 2 attaches to a Model 1A or 1B and is the second, fourth, or sixth (4331 or 4341 Processor only) unit in the string. This model contains no power.
- Model 3 attaches to a Model 2 and is the third or fifth (4331 or 4341 Processor only) unit. It supplies power to an attached Model 2.

Each model can operate in start-and-stop or streaming mode with a rewind time of 2.6 minutes for a full reel.

The highlights of the 8809 follow.

Attachment to a Processor

The 8809 Magnetic Tape Unit attaches to an IBM processor through an integrated tape adapter.

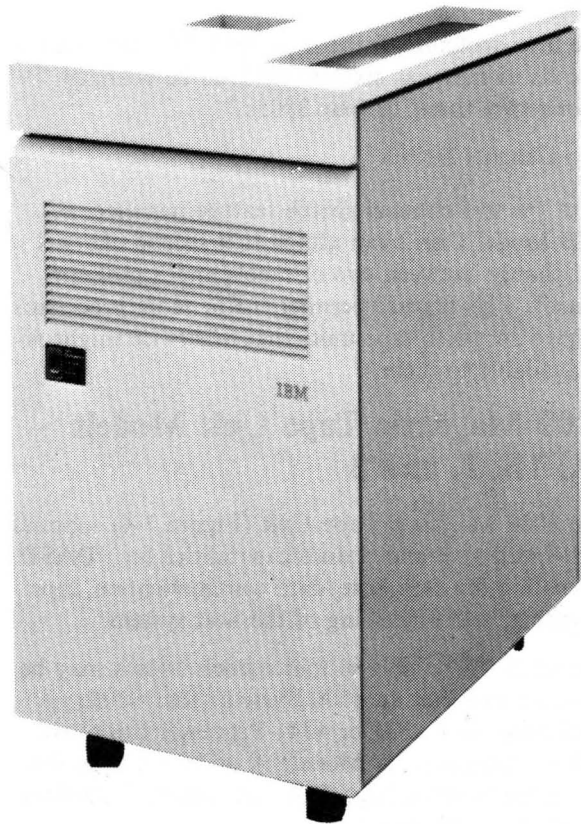

Figure 7-4. IBM 8809 Magnetic Tape Unit

Modes of Operation

The 8809 operates in two modes:

- Start-and-stop mode, which moves tape at 317.5 mm (12.5 in.) per second with a nominal data rate of 20 kilobytes per second and starts and stops within the IBG.
- Streaming mode, which moves tape at 2540 mm (100 in.) per second with a nominal data rate of 160 kilobytes per second and maintains velocity through the IBG while anticipating the next command.

1600 BPI PE Mode

The 8809 uses the 1600 BPI phase-encoded tape format, which is compatible with IBM 2400-and 3400-series tape units.

Tape Path

The 8809 uses a simplified reel-to-reel tape path design. After the tape is threaded and loaded, the tape unit moves tape directly reel to reel, without capstan or vacuum columns. The tape tension and velocity are electronically controlled.

Environmental Conditions

The 8809 operates in a wider range of environmental conditions than most other IBM tape units. This extended environmental range permits the 8809 to operate at temperatures of 15.6 to 37.8°C (60 to 100°F) and relative humidities of 8% to 80%. The swapping of a tape written on an 8809 operating in its extended environment with a tape written on another IBM tape unit operating in its normal environment can result in degraded performance.

Reduced Maintenance

The 8809 tape unit uses integrated circuitry and a simplified reel-to-reel transport, which reduce the need for maintenance and increase performance reliability. Preventive maintenance is not needed for the 8809.

Special Features

The following feature can be ordered through the IBM sales representative to expand or customize the user's operation. For more information about this feature, see the IBM sales representative.

8100 System Multi-Drive

The 8100 system multi-drive feature is needed on a 8809 Model 1B if more than one tape unit (additional Model 2 or Model 3) is attached to an 8100 System.

Data Comparison Table

Figure 7-5 gives a comparison of data for the magnetic tape devices mentioned in this chapter.

Magnetic Tape Unit		Nominal Data Rates (kilobytes per second)				Tape Speed		Nominal Read Access Time* (ms)	Nominal Interblock Gap						Nominal Interblock-Gap Time			Rewind Time (sec)	Rewind and Unload Time
		556 BPI	800 BPI	1600 BPI	6250 BPI	m/sec	in./sec		mm			in.			ms				
Number	Model	Seven Track NRZI	Seven or Nine Track NRZI	Nine Track PE							Seven Track	Nine Track	6250 BPI	Seven Track	Nine Track	6250 BPI	Seven Track	Nine Track	6250 BPI
3410/ 3411	1	6.9	10	20	-	0.318	12.5	15.0	19.1	15.2	-	0.75	0.6	-	60.0	48.0	-	180	-
	2	13.9	20	40	-	0.635	25.0	12.0	19.1	15.2	-	0.75	0.6	-	30.0	24.0	-	180	-
	3	27.8	40	80	-	1.270	50.0	6.0	19.1	15.2	-	0.75	0.6	-	15.0	12.0	-	120	-
3420	3	41.7	60	120	-	1.905	75.0	4.0	19.1	15.2	-	0.75	0.6	-	10.0	8.0	-	60	66
	4	-	-	120	470	1.905	75.0	2.3	-	15.2	7.6	-	0.6	0.3	-	8.0	4.0	60	66
	5	69.5	100	200	-	3.175	125.0	2.9	19.1	15.2	-	0.75	0.6	-	6.0	4.8	-	60	66
	6	-	-	200	780	3.175	125.0	1.6	-	15.2	7.6	-	0.6	0.3	-	4.8	2.4	60	66
	7	111.2	160	320	-	5.080	200.0	2.0	19.1	15.2	-	0.75	0.6	-	3.8	3.0	-	45	51
	8	-	-	320	1250	5.080	200.0	1.1	-	15.2	7.6	-	0.6	0.3	-	3.0	1.5	45	51
8809**	1A, 1B, 2, 3	-	-	20	-	0.318	12.5	44.0	-	15.2	-	-	0.6	-	-	48.0	-	156	-
8809***	1A, 1B, 2, 3	-	-	160	-	2.540	100.0	335.0	-	15.2	-	-	0.6	-	-	6.0	-	156	-

*The read access time is the interval from the beginning of a forward read operation, when the tape is not at a load point, until the first data byte is read after the tape has reached the correct speed from a stopped state. The times given for 3420 Models 4, 6, and 8 are for 6250-BPI operation.
**8809 is operating in start/stop mode.
***8809 is operating in the streaming mode.

Figure 7-5. Comparison of Characteristics for Magnetic Tape Devices

Chapter 8. Optical Readers

Online optical readers can enter data into a system directly from machine-readable source documents, thereby eliminating transcription operations such as card punching, verifying, and taping. This also reduces data-entry transcription errors, one of the most important advantages of the optical readers. Consequently, optical readers offer reduced processing costs, quicker turnaround, fewer data-entry errors, and improved overall system efficiency. Nurses, teachers, sales people, meter readers, driver's license applicants, and many others can originate data that can be directly entered for processing. See Figure 8-7 at the end of this chapter for a comparison of the characteristics of the optical readers.

1287 Optical Reader Models 1, 3, and 5

The 1287 Optical Reader (Figure 8-1) can read typed and machine-printed alphanumeric data and hand-printed numbers, letters, and marks from cut-form documents that have a variety of formats, orientations, types of data, and field lengths. The data of source documents can be organized in fixed- or variable-length fields, in columns or rows, and can be read in any sequence.

The 1287 is available in three models:

- Model 1 reads up to 24 lines of data from a document, each line having as many as 84 characters.
- Model 3 has the capabilities of the Model 1 plus the ability to read the alphanumeric OCR-A font size I (Figure 8-2) printed by the IBM SELECTRIC® typewriter or 1403 Printer.

- Model 5 (Figure 8-1), as its basic function, reads multiple lines of handprinted digits and some alphabetic characters (0 through 9, C, S, T, X, and Z) from cut-form documents.

The highlights of the 1287 follow.

Attachment to a Processor

The 1287 contains its own control unit and needs a control unit position on a system channel. It can attach to a byte multiplexer channel, block multiplexer channel, or selector channel.

Document Sizes

The 1287 reads data from input forms in a variety of widths and lengths. The document size can range from 76 to 229 mm (3 to 9 in.) in length and 57 to 150 mm (2.25 to 5.91 in.) in width.

Throughput Rates

The speed of document processing varies with the size of each document and the number of characters and fields to be read, and is calculated from established formulas. Maximum document throughput can be as high as 665 documents per minute for 76 mm (3 in.) stubs, each with one field of 20 machine-printed characters.

Character Recognition

The 1287 reads the symbols and characters of the OCR-A font sizes I and IV (Figure 8-2). Reading ability can be expanded with special features. When the 1287 encounters a character that it does not recognize, it automatically starts another scan operation. If the character is not recognized after 10 scan operations, the 1287 either displays the

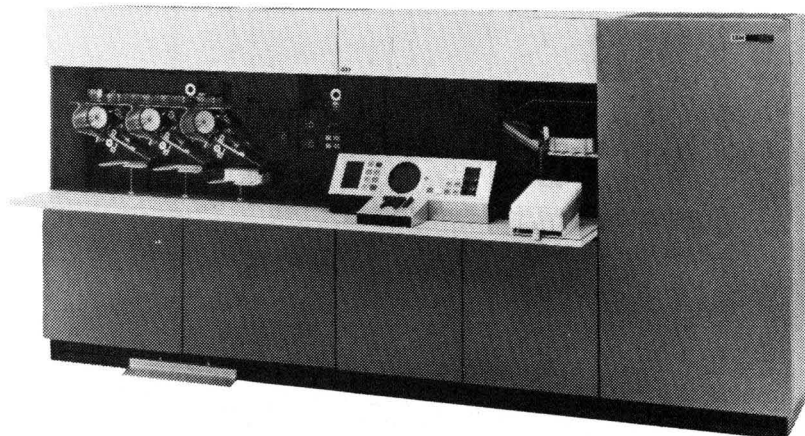

Figure 8-1. IBM 1287 Optical Reader Model 5

character on a cathode-ray tube for keyboard (online) correction and then goes to the next character, or the unrecognized character is transmitted to the processor as the standard EBCDIC substitute character code.

Special Features

The following features can be ordered through the IBM sales representative to expand or customize the user's operation. The list of features may not be complete and more may be available. For more information about features, see the IBM sales representative.

Expanded Symbol Set

The expanded symbol set feature increases the reading capability of the 1287 Model 3 by permitting it to read the symbols + = { } ? % ' " made by an IBM Selectric typewriter or similar machine.

Farrington 7B Font

The Farrington 7B font feature permits Models 1 and 3 to read characters in Farrington Selfchek^{®1} 7B font on documents imprinted by credit-plate imprinters.

Machine Printed OCR Font

The machine printed OCR font feature permits the Model 5 to read numeric 1428, OCR-A, and

Farrington Selfchek 7B fonts, each in separate specified fields in a document.

Numeric Handwriting

The numeric handwriting feature permits the 1287 to read handprinted numbers and letters (0 through 9, C, S, T, X, and Z, blockprinted with a No. 2 pencil or with HB lead) and numbers printed in Gothic 3/16-inch font.

Optical Mark Reading

The optical mark reading feature permits Models 1, 3, and 5 to recognize penciled marks entered as data. The marks (made with a No. 2 pencil) can be vertical, at an angle of 45 degrees, or horizontal.

Serial Numbering

The serial numbering feature permits operator-controlled numbering of documents for visual reading. Documents as small as 76 by 121 mm (3 by 4.75 in.) can be numbered from 00000 to 99999.

1428 and ANSCS OCR Font

The 1428 and ANSCS OCR font feature permits Models 1 and 3 of the 1287 to read the 1428 and OCR-A fonts separately in specified fields in a document.

1288 Optical Page Reader Model 1

The 1288 Optical Page Reader (Figure 8-3) reads data from cut-form documents that range in size from 76 by 165 mm (3 by 6.5 in.) to 229 by 356

¹ Trademark of Farrington Manufacturing Company.

IBM 1428 Font	OCR-A Font		Farrington Selfchek 7B* Font	Handprinted Character Set	NCR Optical Font (NOF)**	OCR-A Font Size I			
	Size I	Size IV				IBM SELECTRIC [®] (or equivalent)	IBM 1403 (or equivalent)		
0	0	0	0	0	0	0	0	A	N
1	1	1	1	1		1	1	B	O
2	2	2	2	2	1	2	2	C	P
3	3	3	3	3		3	3	D	Q
4	4	4	4	4	2	4	4	E	R
5	5	5	5	5		5	5	F	S
6	6	6	6	6	3	6	6	G	T
7	7	7	7	7		7	7	H	U
8	8	8	8	8	4	8	8	I	V
9	9	9	9	9		9	9	J	W
	C			C	5			K	X
	N			N				L	Y
	S			S	6			M	Z
	T			T				blank	blank
	X			X				Expanded Symbol Set	
	Z			Z	7			+ %	
								= ?	
blank	blank			blank	8			{ *	
					9			} "	

*Farrington Selfchek 7B shown by permission of Farrington Manufacturing Co.
 **NCR Optical Font shown by permission of National Cash Register Co.

Note: Characters and symbols are shown reduced in size.

Figure 8-2. Fonts, Letters, and Symbols Read by the 1287

mm (9 by 14 in.). Because the 1288 can read mixed data on documents smaller than punched cards and as large as legal-size forms, it can be used in a variety of applications in government, business, and industry.

The highlights of the 1288 follow.

Attachment to a Processor

The 1288 contains its own control unit and needs a control unit position on a system channel. It can attach to a byte multiplexer channel, block multiplexer channel, or selector channel.

Modes of Operation

The 1288 can process both formatted and unformatted documents. In formatted mode, the 1288 reads fixed- and variable-length fields in any sequence. In unformatted mode, the machine reads multiple and continuous variable-length lines of alphanumeric data, up to 6 lines per inch, right- or left-justified.

Processing Speed

The speed of document processing varies with the size of each document, the format (if any), and the organization of the processing program, and can be calculated from established formulas.

Input Hopper

The input hopper unit of the 1288 can hold a 254 mm (10 in.) stack of documents, and the two output stackers can hold either a 114 mm (4.5 in.) stack of short documents or a 76 mm (3 in.) stack of long documents. Each document, after being read, is routed to one of the two output stackers, one of which is reserved for documents that contain unrecognizable characters.

Unrecognizable Characters

When the 1288 encounters a printed Gothic or handprinted character that it does not recognize, it automatically scans it again. If the character remains unreadable, the 1288 transmits a substitute character to the processor and, under program control, sends the document to the output stacker for offline correction.

Special Features

The following features can be ordered through the IBM sales representative to expand or customize the user's operation. The list of features may not be complete and more may be available. For more information about features, see the IBM sales representative.

Expanded Symbol Set

The expanded symbol set feature permits the 1288 to read the symbols + = { } % ? ' " made by an IBM Selectric typewriter or similar machine.

Numeric Handwriting

The numeric handwriting feature permits the 1288 to read handprinted numbers and letters (0 through 9, C, S, T, X, and Z) and printed numbers in 3/16-inch Gothic font.

Optical Mark Reading

The optical mark reading feature permits the 1288 to read vertical or 45-degree-angle penciled lines entered as data.

Serial Numbering

The serial numbering feature permits operator-controlled numbering of documents for visual

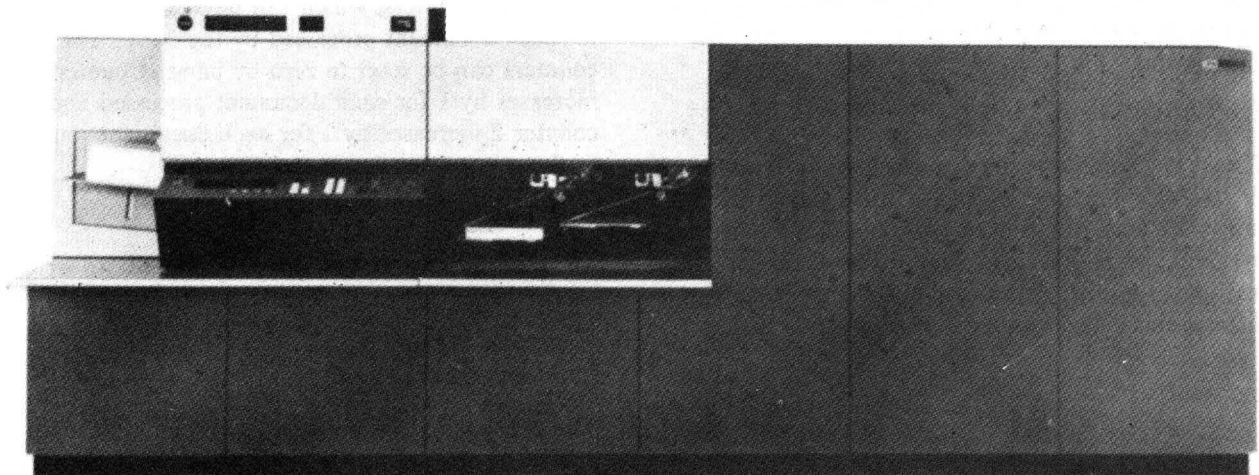

Figure 8-3. IBM 1288 Optical Page Reader

reading. Documents as small as 76 by 121 mm (3 by 4.75 in.) can be numbered from 00000 to 99999.

3881 Optical Mark Reader Model 1

The 3881 Optical Mark Reader Model 1 (Figure 8-4) is well suited for convenient, quick, and economical data input in a variety of applications in industry, commerce, and institutional organizations. This high-speed optical mark reader reads penciled and machine-printed marks on a variety of document sizes, weights, and formats.

The highlights of the 3881 follow.

Attachment to a Processor

The 3881 contains its own control unit and needs a control unit position on a multiplexer channel.

Form Sizes

The 3881 is flexible. It can be easily adjusted so as to read data from forms ranging in size from 76 by 76 mm (3 by 3 in.) bill stubs to 229 by 305 mm (9 by 12 in.) sheets. It accepts paper ranging from 20-pound stock to card stock and it can read as many as six different formats on the same-size document, in a single pass.

Document Feed

Documents are sent through the read area from a 600-sheet hopper and then into one of two stackers, in the sequence in which they are entered. The processed documents go into a 600-sheet stacker, and those with errors are sent to a 100-sheet select stacker.

Processing Speed

The 3881 can read as many as 100 documents 76 by 76 mm (3 by 3 in.) per minute and 66 documents 216 by 279 mm (8.5 by 11 in.) per minute. Data is sent to the processor, one page at a time, from the 3881 buffer.

Functional Units

The 3881 can do a variety of applications because of its internal processor, its high-density mark reading (up to 2480 mark positions per 229 by 305 mm (9 by 12 in.) form, and its flexible forms-feeding transport. Adjusting the reader for documents of different sizes takes only a few seconds.

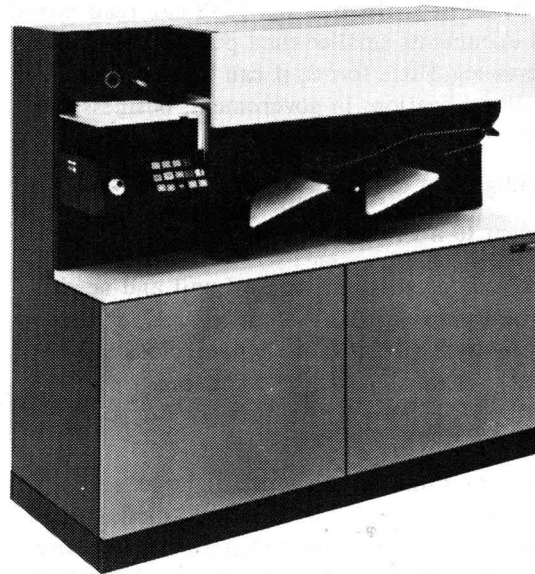

Figure 8-4. IBM 3881 Optical Mark Reader

Special Features

The following features can be ordered through the IBM sales representative to expand or customize the user's operations. The list of features may not be complete and more may be available. For more information about features, see the IBM sales representative.

BCD Read

The BCD read feature permits the 3881 to read turnaround documents, which are forms printed by line printers as output from a data-processing system, distributed for action, then returned to be read as input to the system.

Document Counter

The document counter feature makes available two 5-position counters, which can be increased by one for each document processed by the 3881. The counters can be reset to zero by hand. Counter 1 increases by 1 for each document processed and counter 2 increases by 1 for each document routed to the select stacker.

Dual Density

The dual density feature permits the 3881 to write on the 3410 Magnetic Tape Unit in either 800 BPI NRZI or 1600 BPI phase-encoded modes.

Expanded Storage

The expanded storage feature gives an additional 512 bytes of storage needed in situations where the

number of formats, fields, and characters processed is more than the maximum number of positions available in the basic data storage.

Serial Numbering

The serial numbering feature permits operator-controlled numbering of documents for visual reading. Documents as small as 76 by 121 mm (3 by 4.75 in.) can be numbered from 00000 to 99999.

3886 Optical Character Reader Model 1

The 3886 Optical Character Reader (Figure 8-5) is an online optical reader for an IBM processor. The 3886 is a compact, economical version of the larger IBM optical character readers. This buffered general-purpose unit reads machine-printed OCR-A and -B font characters and symbols, handprinted numbers, and printed 3/16-inch Gothic numbers (Figure 8-6) from a variety of documents.

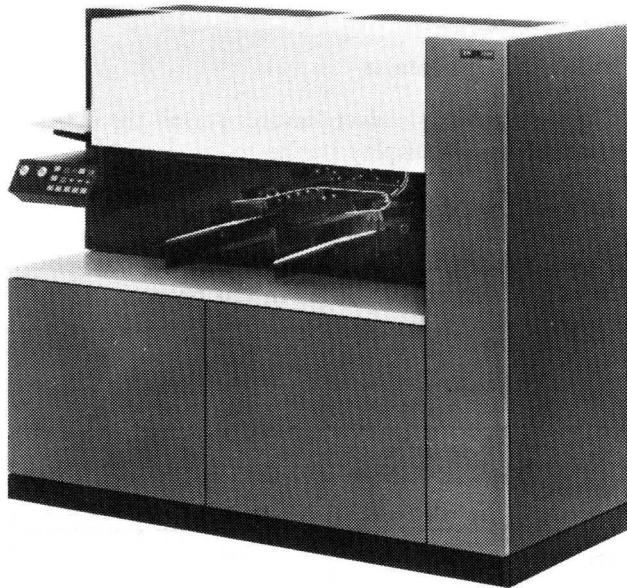

Figure 8-5. IBM 3886 Optical Character Reader

The highlights of the 3886 follow.

Attachment to a Processor

The 3886 contains its own control unit and needs a control unit position on a system channel. It can attach to a byte multiplexer channel, block multiplexer channel, or selector channel.

Document Feed

The documents can have a variety of formats, types of data, field lengths, and background colors and

shades. The 3886 reads multiple lines of print from forms ranging in size from 76 to 229 mm (3 to 9 in.) wide (the direction of printing), and 76 to 305 mm (3 to 12 in.) long. The acceptable weight of paper ranges from 16-pound stock to card stock.

Functional Units

The 3886 has one input hopper and two output stackers, each of which can hold a one-inch stack of documents. The two stackers permit separation of the processed documents from the documents containing errors.

Control Circuits

The 3886 uses several new technologies that make it a compact and highly reliable modular device. A powerful microcoded recognition and control processor performs machine-control and character-recognition functions, permitting the 3886 to perform sophisticated data and blank editing as well as output record formatting.

Processing Speed

The speed of document processing varies with document length, number and kind of characters to be read, amount of editing and formatting specified, and the programs used. Speeds range from approximately 4.4 to 94 documents per minute. The low rate could be, for example, for 216 by 279 mm (8.5 by 11 in.) sheets with 29 lines per sheet, 78 characters per line (approximately 2260 characters); the high rate could be for 76 mm (3 in.) machine-printed turnaround documents, each with a single eight-character line.

Alphameric OCR-A Font

```

ABCDEFGHIJKLMN O PQRSTU VWXYZ
0123456789 . : ; + / * * * & | ' -
{ } % ? \ ^ _ ` ~ Blank
0 1 2 3 4 5 6 7 8 9
one one one

```

Alphameric OCR-B Font

```

ABCDEFGHIJKLMN O PQRSTU VWXYZ
0123456789 | . < > + * - / , Blank
0 1 2 3 4 5 6 7 8 9
one one one

```

Numeric Handprint Character Shapes

```

0 1 2 3 4 5 6 7 8 9 X

```

3/16-inch Gothic Font

```

0123456789

```

Note: Characters and symbols are shown reduced in size.

Figure 8-6. Fonts, Letters, Numbers, and Symbols Read by the 3886 Model 1

Special Features

The following features can be ordered through the IBM sales representative to expand or customize the user's operation. The list of features may not be complete and more may be available. For more information about features, see the IBM sales representative.

Data Storage, Additional

OCR-B font and numeric handprinting recognition need the data storage, additional feature to execute the more complex character shapes that appear in them.

Hopper and Stacker Capacity, Additional

The hopper and stacker capacity, additional feature permits the 3886 hopper and stacker to hold 102 mm (4 in.) stacks of documents.

Instruction Storage, Additional

The instruction storage, additional feature supplies the necessary additional storage increases of 8192 bytes for microcode that needs storage capacity greater than is available in the basic 3886 storage.

Line Marking

The line marking feature permits the 3886 to print any one of 15 codes on any line of a document and at the bottom of a page. The user chooses the meaning and application of the codes, such as pointing to a field in error or indicating one type of error in the line.

Numeric Handwriting

The numeric handwriting feature makes it possible to have machine reading of handprinted numbers and the letter X.

Serial Numbering

The serial numbering feature permits operator-controlled numbering of documents for visual reading. Documents as small as 76 by 121 mm (3 by 4.75 in.) can be numbered from 00000 to 99999.

Tape Adapter, Dual Density

The tape adapter, dual density feature supplies the adapter for the 3886 to attach a 3410 Magnetic Tape Unit Model 1 for recording in 1600 BPI PE or 800 BPI NRZI mode.

Tape Adapter, Single Density

The tape adapter, single density feature supplies the adapter for the 3886 to attach a 3410 Magnetic Tape Unit Model 1 for recording in 1600 BPI PE mode.

Video Collect Features

The various video collect features permit the direct attachment of a display station to the 3886.

Data Comparison Table

Figure 8-7 gives a comparison of data for the optical character readers mentioned in this chapter.

I/O Devices	Document Sizes		Reading Capabilities*				
	millimeter	inch	BCD	Handprinting Numbers	Mark Read	OCR-A	OCR-B
1287	w - 57 to 76 l - 76 to 229	2.25 to 5.91 3 to 9	no	yes	no	yes	no
1288	w - 76 to 229 l - 165 to 356	3 to 9 6.5 to 14	no	yes	yes	yes	no
3881	w - 76 to 229 l - 76 to 305	3 to 9 3 to 12	yes	no	yes	no	no
3886	w - 76 to 229 l - 76 to 305	3 to 9 3 to 12	no	yes	no	yes	yes

w - width
l - length
*There are more capabilities and features available; for more information see the IBM sales representative.

Figure 8-7. Comparison Data for Optical Character Readers

Chapter 9. Printer-Keyboards

The printer-keyboard units permit interaction between the system and the operator; this results in a message flow between the operator and the system.

3215 Console Printer-Keyboard Model 1

The 3215 Console Printer-Keyboard (Figure 9-1) permits communication between the system and the operator, and gives printed output. Under program control, printing occurs at up to 85 characters per second, relative to the system.

The highlights of the 3215 follow.

Printer Characteristics

Character spacing is 10 characters per inch and up to 126 characters per line. Both left and right margins are fixed as specified by the platen width used. Vertical single spacing is 6 lines per inch; double spacing is 3 lines per inch. All power, control, and data signals come from the processor.

Characters Printed

The 3215 prints 26 alphabetic, 10 numeric, and up to 29 special characters from the extended binary-coded decimal interchange code (EBCDIC). Other unique graphics are available for language and special character needs.

Control Functions

All functions of the 3215: printing, spacing, carrier return, and vertical spacing are controlled either by hand or by program control.

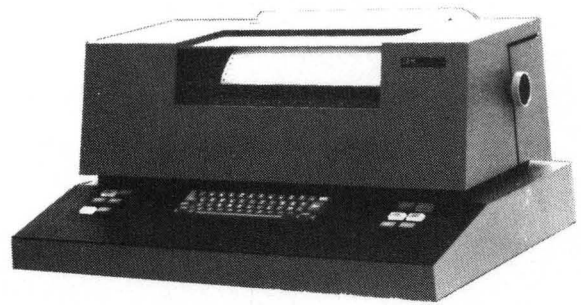

Figure 9-1. IBM 3215 Console Printer-Keyboard

Chapter 10. Printers

The printers described in this chapter are document output devices for IBM processors. They all print on continuous forms. Each printer can either print a character at a time, a line at a time, or a page at a time. The rated speed of these printers varies from 85 characters per second to 215 pages (8-1/2 in. page) per minute. The printed line may be from 96 to 204 characters long. The vertical line spacing may vary from 6 to 12 lines per inch and the pitch may be 10, 12, or 15 characters per inch. Each printer has characteristics and features that are suitable for its different applications.

See Figure 10-17 at the end of this chapter for a comparison of the characteristics of printers.

1403 Printer Models 2, 7, and N1

The 1403 is available in three models (Figures 10-1 and 10-3), as follows:

- Model 2 has 132 print positions and prints up to 600 lines per minute.
- Model 7 has 120 print positions and prints up to 600 lines per minute.
- Model N1 has 132 print positions and prints up to 1100 lines per minute.

Models 2 and N1 can operate at still higher speeds with the universal character set feature, described later.

The highlights of the 1403 follow.

Attachment to a Processor

The attachment and control for 1403s are supplied by a 2821 Control Unit or by an integrated printer attachment. Up to three 1403s can be controlled by a 2821 and the number is determined by the 2821 model. One 1403 can be controlled by an integrated printer attachment. The 2821 needs a control unit position on a system channel and can attach to a byte multiplexer channel, block multiplexer, channel, multiplexer channel, or selector channel.

Dual-Speed Carriage

The dual-speed carriage supplies a high-speed and a low-speed forms skip operation, as follows:

- High-speed skips are at 1.9 m (75 in.) per second when more than eight lines are skipped.
- Low-speed skips are at 86 mm (33 in.) per second.

The Model 7 is the only model that does not have a dual-speed carriage and therefore has only low-speed skips.

Covers

The 1403 Model N1 (Figure 10-3) differs from the other 1403 models because it has sound-absorbent covers that extend to the floor, power-operated front and top covers, and a forms cart.

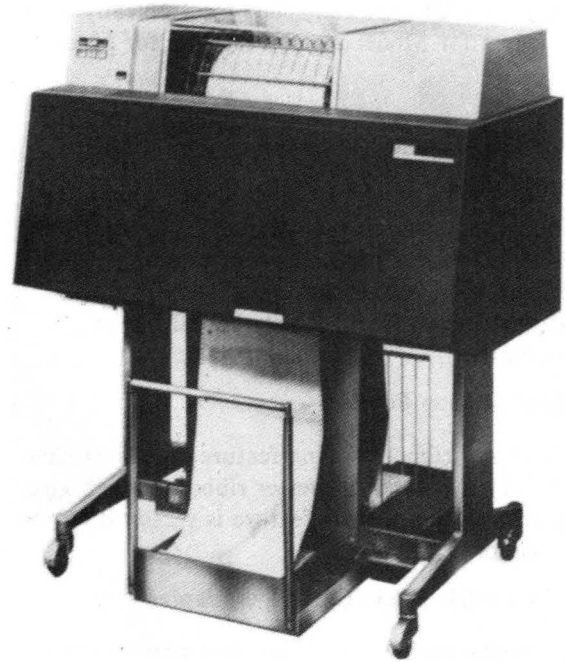

Figure 10-1. IBM 1403 Printer Models 2 and 7

Print Cartridge

Models 2 and 7 use a chain of linked characters for printing, and the Model N1 uses a train of characters not linked together. Characters are printed 10 to the inch, and lines are spaced either 6 or 8 to the inch under operator control.

At least one 1416 Interchangeable Train Cartridge is needed for each Model N1. The chain or train cartridge has 240 type positions, which, before the introduction of the universal character set (UCS) feature, were divided into five equal sets of 48 characters each. The rated maximum printing speed of a given printer is based, partially, on this division into five equal sets. If characters are included only once, twice, or even four times on the chain or train, the rated maximum printing speed is necessarily reduced. The reduction, however, is not linear, because of factors other than the number of

character sets (for example, single spacing versus skipping). Conversely, if the characters are included more than five times, the printing speed is increased beyond the rated maximum.

As already indicated, the Model 2 has a maximum rated speed of 600 lines per minute (lpm) when its chain contains the conventional five sets. If the installed set contains 240 different characters (the widest possible variety), printing takes place on the Model 2 at up to 140 lpm. Under the same conditions, printing takes place on the 1403 Model N1 at up to 310 lpm. The maximum printing speeds, with UCS, are controlled electronically and are 750 lpm for Model 2 and 1400 lpm for Model N1.

Special Features

The following features can be ordered through the IBM sales representative to expand or customize the user's operations. The list of features may not be complete and more may be available. For more information about features, see the IBM sales representative.

Auxiliary Ribbon Feeding

The auxiliary ribbon feeding feature adapts Models 2 and 7 for the use of polyester ribbons, which give sharper impressions. This feature is standard on the 1403 Model N1.

Interchangeable Chain Cartridge Adapter

The interchangeable chain cartridge adapter feature is available for Models 2 and 7. It permits the operator to insert an interchangeable chain cartridge with different type font, style, or special character arrangement. The cartridge adapts the 1403 for quick and convenient changing of type fonts or character arrangements for special printing jobs.

Selective Tape Listing

The selective tape listing feature is available for Models 2 and N1. It gives the capability of substituting longitudinal strips for the normal paper sheet forms. See Figure 10-2 for the different selective tape formats available.

Maximum Number of Tapes	Width		Characters per Tape
	mm	in.	
4	79	3.1	29
8	38	1.5	13

Note: A combination of widths less than 335 mm (13.2 in.) wide can be printed.

Figure 10-2. Selective Tape Characteristics for the 1403

Each tape is individually line-spaced under program control, with no skipping permitted. The operator can easily change from tapes to standard forms, or vice versa. A newer selective tape listing feature is available for a Model N1. This feature permits skipping at the rate of 838 mm (33 in.) per second over a distance fixed by IBM Field Engineering adjustment at a value in the range of 76 to 558 mm (3 to 22 in.); this is instead of the repeated line spacing needed by the other type of selective tape feature. Operation is quieter. Change-over from tape listing mode to full-sheet printing is made still easier; this and other new operator conveniences have a beneficial effect on the feature's overall efficiency.

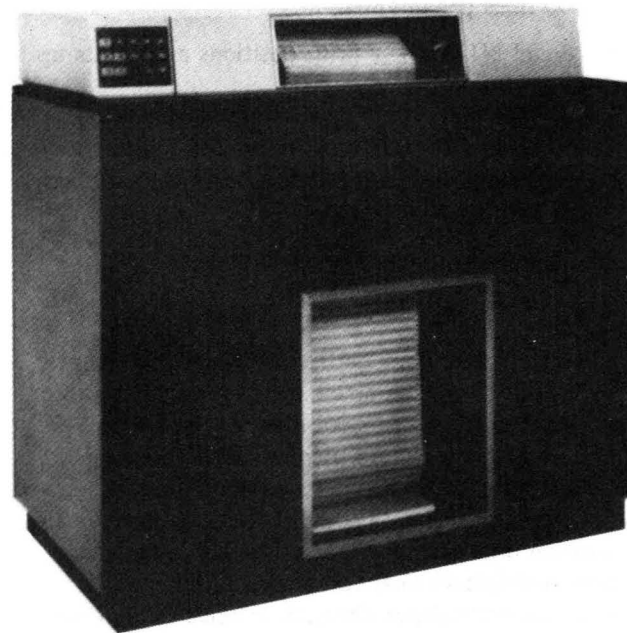

Figure 10-3. IBM 1403 Printer Model N1

Universal Character Set

The universal character set (UCS), is available for Models 2 and N1. It gives the user the ability to load into a special storage area in the 2821 Control Unit any set of discrete codes up to a maximum of 240. The codes in 2821 storage match specifically

and sequentially the characters on the train or chain. The user can order any characters for a given set, including custom designs for special applications.

1443 Printer Model N1

The 1443 Printer Model N1 (Figure 10-4) prints from 200 to 600 (maximum) lines per minute, and the print speed is determined by the number of characters in the set being used.

The highlights of the 1443 follow.

Character sets

The 1443 Model N1 prints up to 600 lines per minute with a 13-character set. The 1443 also has 39-, 52-, and 63-character sets which print at 300, 240, and 200 lines per minute, respectively.

The 52-character set is standard, and the other sets are available through the selective character set special feature. The user can order any characters for any set, including custom-made designs of special graphics.

Print Line

The standard print line for all sets is 120 characters long, spaced horizontally at 10 characters to the inch. Twenty-four additional printing positions are available as a special feature, increasing the total number of printing positions to 144.

Printing Operation

All characters of the print set are on one type bar that moves back and forth across the paper. The bar is so made that each different character passes each print position. Printing takes place when the character to be printed matches the character read from the printer's self-contained storage buffer.

Carriage Control

A tape-controlled carriage, working under program control, advances paper and supplies the vertical print formats. Lines are spaced 6 or 8 to the inch under operator control. Skipping is at 381 mm (15 in.) per second.

Attachment to a Processor

No external control unit is needed for attachment; the control circuits and print storage buffer are inside the 1443 Model N1. The 1443 needs a control unit position on a system channel.

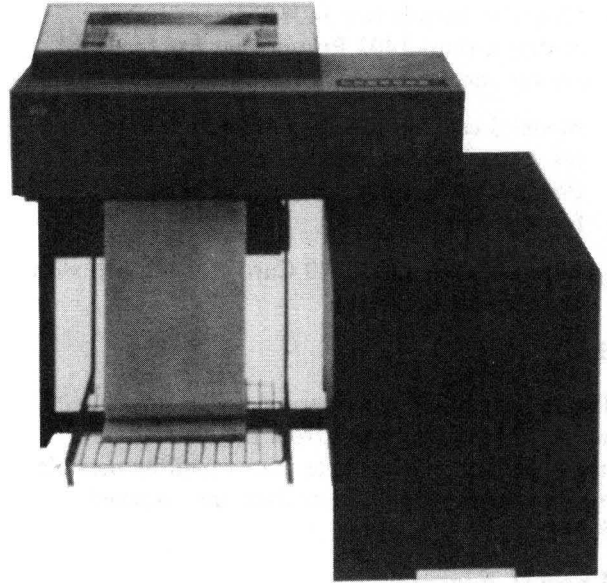

Figure 10-4. IBM 1443 Printer Model N1

Special Features

The following features can be ordered through the IBM sales representative to expand or customize the user's operation. The list of features may not be complete and more may be available. For more information about features, see the IBM sales representative.

Print Positions, 24 Additional

The print positions, 24 additional feature increases the print span from 120 to 144 positions.

Selective Character Set

The selective character set feature is needed if any type bar other than the standard 52-character bar is used. This feature supplies the controls that permit the 1443 to use all available character sets.

2821 Control Unit Models 1, 2, 3, 5, and 6

The 2821 Control Unit contains the control and buffer circuits to transmit information between the associated channel and the 2540 Card Read Punch, and one or more 1403 Printers Model 2, 7, or N1.

Each of the five models of the 2821 supplies control for the following types and quantities of I/O devices:

- Model 1 controls a 2540 Card Reader Punch and one 1403 Printer.
- Model 2 controls one 1403 Printer.

- Model 3 controls two 1403 Printers and can control a third 1403 Printer that has the third printer control special feature installed.
- Model 5 controls a 2540 Card Read Punch and two 1403 Printers, and can control a third 1403 Printer that has the third printer control special feature installed.
- Model 6 controls a 2540 Card Read Punch with no printer attachment.

Buffers

The buffers in the 2821 permit the sending of accumulated data to and from the channel at a much quicker rate per byte than would be possible by direct transmission to or from the attached device.

Special Features

The following features can be ordered through the IBM sales representative to expand or customize the user's operation. The list of features may not be complete and more may be available. For more information about features, see the IBM sales representative.

Column Binary

The column binary feature can be installed on the 2821 Model 1, 5, or 6 to permit multiple punching in rows 1 through 7 of a card column, or the reading of such multiple punches by the 2540. This feature is not needed to read or punch EBCDIC. (See "2540 Card Read Punch" in Chapter 11 for more information on the column binary feature.)

Third Printer Control

The third printer control feature (for Models 3 and 5 only) attaches a third printer. Any model combination of 1403s can be used.

3203 Printer Models 1 through 5

The 3203 Printer (Figure 10-5) combines advanced functions and components to offer greater speed, quieter operation, improved efficiency, and greater reliability than is now available with the 1403 Printer.

All models of the 3203 print either 6 or 8 lines per inch, under operator control. The printing rates in alphameric lines per minute follow:

- 600 for Model 1
- 1200 for Model 2
- 1000 for Model 3

- 1200 for Model 4
- 1200 for Model 5

The highlights of the 3203 follow.

Train Printing

The 3203 uses the IBM 1416 Interchangeable Train Cartridge, which is the same cartridge used by the 1403 Model N1. The train printing method used by the 1403 Model N1 and 3203 maintains a high-quality of printing.

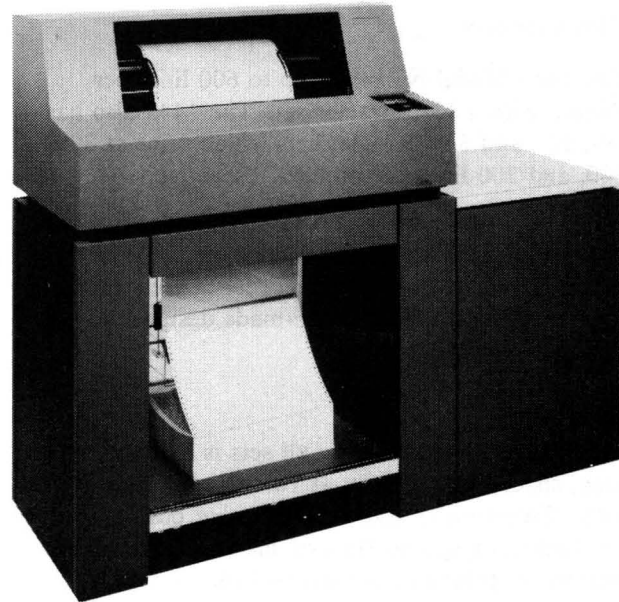

Figure 10-5. IBM 3203 Printer

Attachment to a Processor

The 3203 Models 1 through 4 attach to processors that have an integrated 3203 printer attachment, thereby eliminating the need for a separate channel or control unit. Only the 3203 Model 5 attaches to a control unit position on a channel because it has an internal control unit.

Forms

The 3203 uses margin-punched, pin-fed, continuous forms. The size of individual documents that make up the continuous forms can range from 88.9 to 508 mm (3.5 to 20 in.) wide and from 76 to 610 mm (3 to 24 in.) long.

Universal Character Set

The universal character set (UCS) gives the user the ability to load, into a special storage area, any set of discrete codes up to a maximum of 240. The UCS permits optimizing the character arrangement to maximum printing speeds for different applications.

Power-Assisted Stacker

A power-assisted stacker improves the stacking of forms and reduces the need for operator attention.

Forms-Control Buffer

The forms-control buffer controls the vertical format and movement (spacing and skipping) of the forms, and removes the need for separate carriage-control tapes.

Vacuum Cleaning System

The vacuum cleaning system continuously cleans the print train, and the operator can also use it to clean the print area.

Special Features

The following feature can be ordered through the IBM sales representative to expand or customize the user's operation. For more information about this feature, see the IBM sales representative.

Speed Enhancement

The speed enhancement feature gives the Model 3 the capability to operate at 1200 lines per minute.

3211 Printer

The 3211 Printer (Figure 10-6) is a high-speed printer with speeds of 2000 lines per minute single spaced, using a 48-element character set. The printer uses a train of characters that are not linked together. Characters are printed 10 to the inch, and

lines are spaced either 6 or 8 to the inch under program control.

The highlights of the 3211 follow.

Attachment to a Processor

The 3211 Printer is controlled and buffered by a 3811 Control Unit. The control unit is physically attached to the 3211 Printer. The 3811 needs a control unit position on a system channel and can attach to a byte multiplexer channel, block multiplexer channel, multiplexer channel, or selector channel.

Interchangeable Train Cartridge

The 3216 Interchangeable Train Cartridge contains a continuous train of 432 characters. EBCDIC permits using up to 254 different characters (alphabetic, numeric, and special) on a print train.

Universal Character Set

The universal character set (UCS) gives the user the ability to load, into a special storage area, any set of discrete codes up to a maximum of 240. The UCS permits optimizing the character arrangement to maximum printing speeds for different applications.

Program-Controlled Carriage

The vertical format for each form is stored in the control unit by the program. Forms movement (spacing and skipping) is initiated by the program as specified in the stored format. Line feeding (6 or

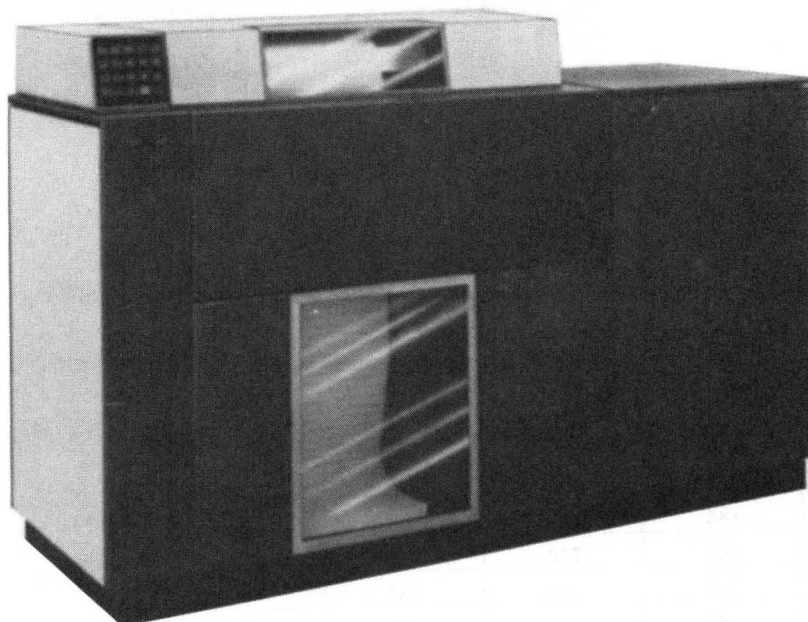

Figure 10-6. IBM 3211 Printer and IBM 3811 Printer Control Unit

8 lines per inch) is also controlled by the stored format.

Form Sizes

The form width can vary from 88.9 to 476.25 mm (3.5 to 18.75 in.); the minimum length is 76 mm (3 in.).

Self-Adjusting Power Stacker

The self-adjusting power stacker advances and stacks the forms for optimum high-speed forms movement. It varies with the thickness of the forms.

Automatic Forms-Thickness Control

The automatic forms-thickness control adjusts the platen to the appropriate setting for the forms used. This ensures maximum print quality and maintains enough clearance for high-speed forms movement.

Motorized Cover

The cover on the printer gives controlled access to the forms transport area. When a forms condition occurs, the cover movement immediately alerts the operator that action is needed.

Speed

The printer speed varies with the arrangement of the characters in the type array and the number of arrays in the print train. By optimizing the universal character set, each application can attain maximum printing speeds, based on the frequency of the characters in the print train. Speeds of up to 2500 lines per minute, with reduced character sets and customized print trains, are possible.

Special Features

The following features can be ordered through the IBM sales representative to expand or customize the user's operation. The list of features may not be complete and more may be available. For more information about features, see the IBM sales representative.

OCR Print Package

The OCR print package feature supplies additional manual operator platen controls needed for optical-character-recognition (OCR) applications.

Print Positions, 18 Additional

The print positions, 18 additional feature increases the print positions from 132 to 150. The operation of the 3211 remains the same.

3262 Line Printer Models 1, 2, 3, 11, 12, and 13

The 3262 Line Printer (Figure 10-7) is controlled by the host system. It supplies impact printing capabilities for small and intermediate systems. The 3262 uses a steel band etched with 288 characters. Continuous forms are pin fed and margin holes are already punched. The pin-feed tractors can be adjusted to feed forms from 89 to 406 mm (3.5 to 16 in.) overall width. The form length can be 76 to 356 mm (3 to 14 in.).

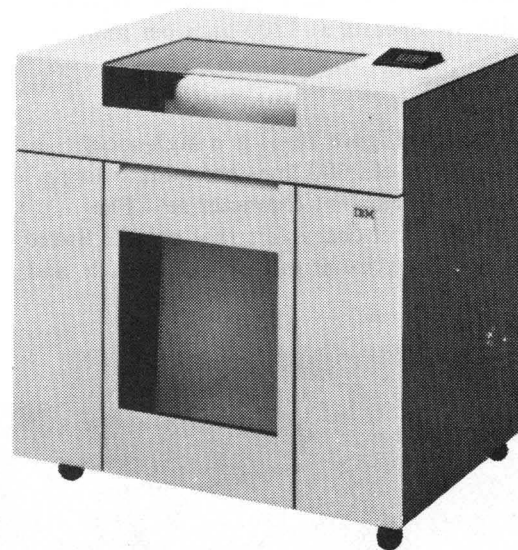

Figure 10-7. IBM 3262 Line Printer

Print Belt Character Per Set	Nominal Speed (lines per minute)					
	Model 1	Model 11	Model 2	Model 12	Model 3	Model 13
48	650	325	650	325	650	325
64	465	230	465	230	465	230
96	364	180	364	180	364	180
128	252	125	252	125	252	125

Figure 10-8. Comparison of 3262 Printer Rated Speeds

The rated printing speed in lines per minute (single-spaced) varies with the size of the character set on the print belt. See Figure 10-8 for the rated speed of the 3262 Models 1, 2, 3, 11, 12, and 13.

The highlights of the 3262 follow.

Print Characteristics

The print line is 132 characters long, spaced 2.54 mm (0.10 in.) on centers. Vertical line spacing is 6

or 8 lines per inch. System programs control all printing and forms movement.

Attachment to a Processor

The 3262 models attach to the system through cables to the printer control, as shown in Figures 10-9 through 10-11.

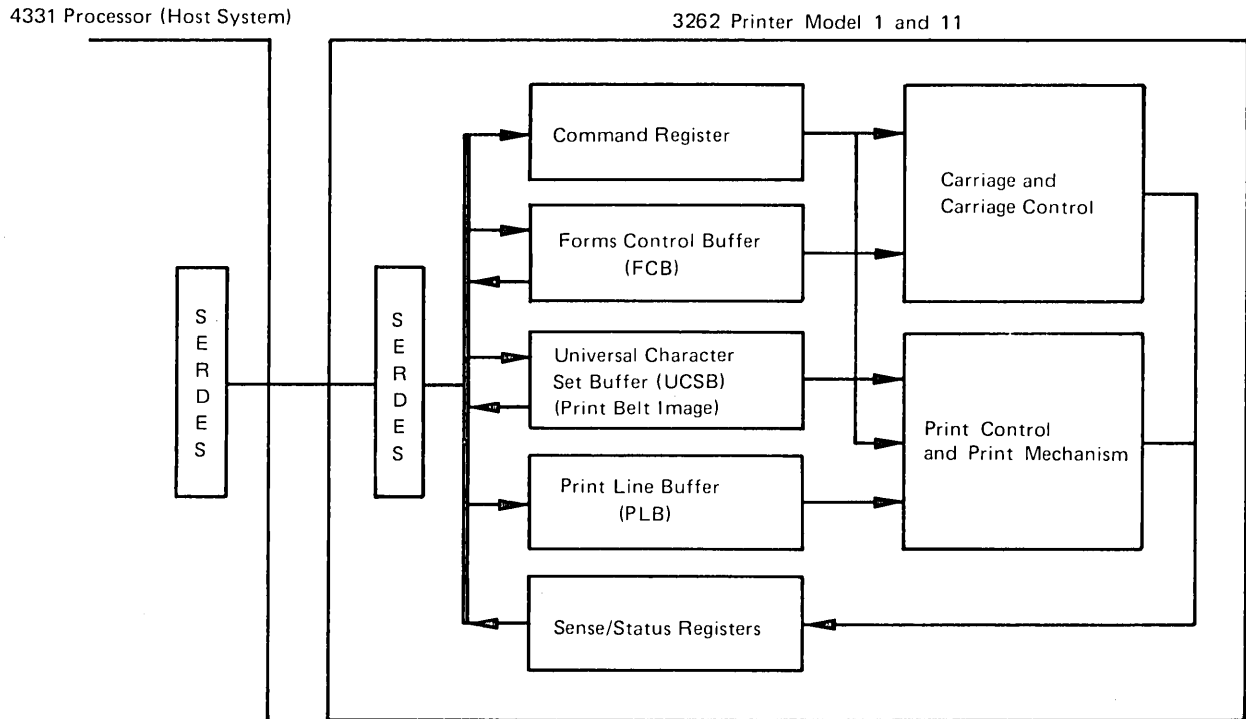

Figure 10-9. Attachment of IBM 3262 Models 1 and 11 to a 4331 Processor

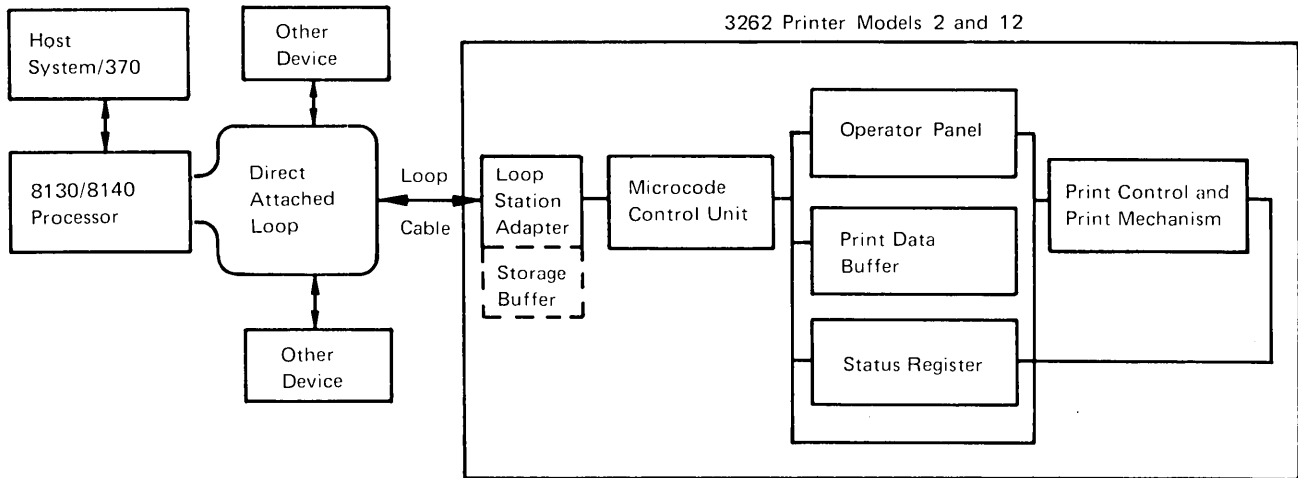

Figure 10-10. Attachment of IBM 3262 Models 2 and 12 to an 8130 or 8140 Processor

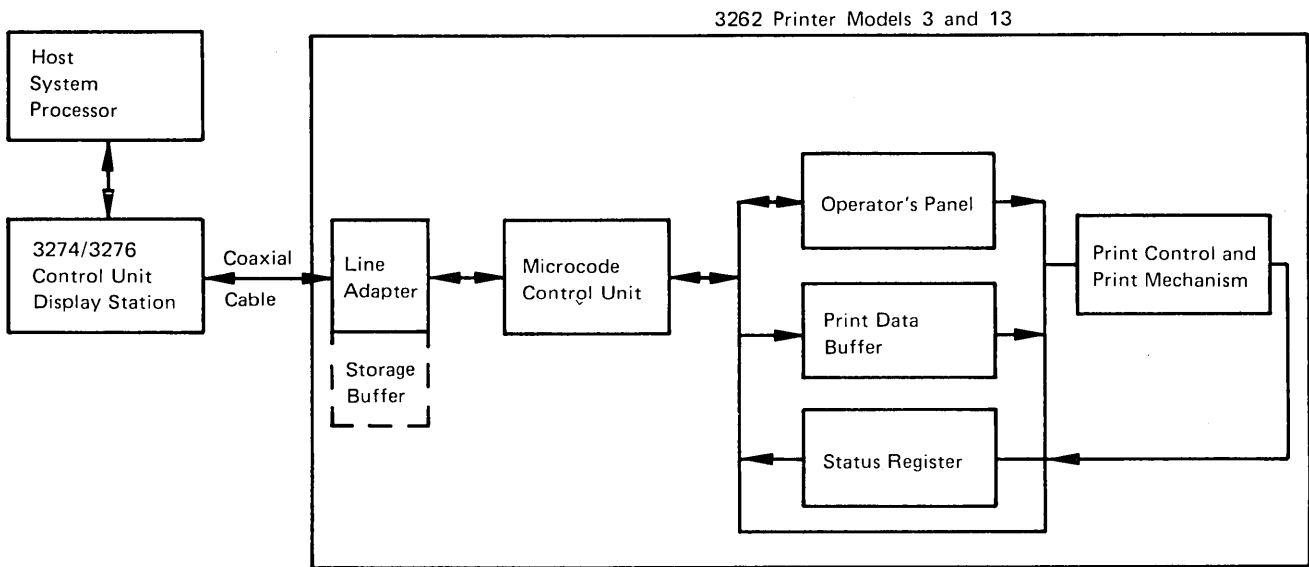

Figure 10-11. Attachment of IBM 3262 Models 3 and 13 to a 3274 or 3276 Control Unit

3800 Printing Subsystem

The 3800 Printing Subsystem (Figure 10-12) is a high-speed, nonimpact printer that produces characters on paper through electrophotographic and laser technology.

A special feature permits input of data from magnetic tape without attachment of a printer output unit to a system.

The highlights of the 3800 follow.

Attachment to a Processor

The 3800 needs a control unit position on a system channel or a tape-to-printing subsystem feature. The control unit position on a system channel can be on a byte multiplexer channel, selector channel, block multiplexer channel, or multiplexer channel.

Forms

The 3800 uses single-ply, edged-punched, perforated, and stacked continuous forms in any combination of five lengths and 10 widths (common-use sizes). ISO (International Organization for Standardization) sizes are available for World Trade, except in North America. Printing is repeated for multiple copies, so every copy has the quality of the original.

Print Line

The 3800 has a maximum of 136 print positions at 10 characters per inch (cpi) and 163 and 204 positions at 12 and 15 cpi, respectively. See Figure 10-13 for rated speeds of the 3800 Printer. The vertical line spacing is under program control and can be 6, 8, or 12 lines per inch (separately or mixed on a page). There are 20 different character sets, including six special underscored sets.

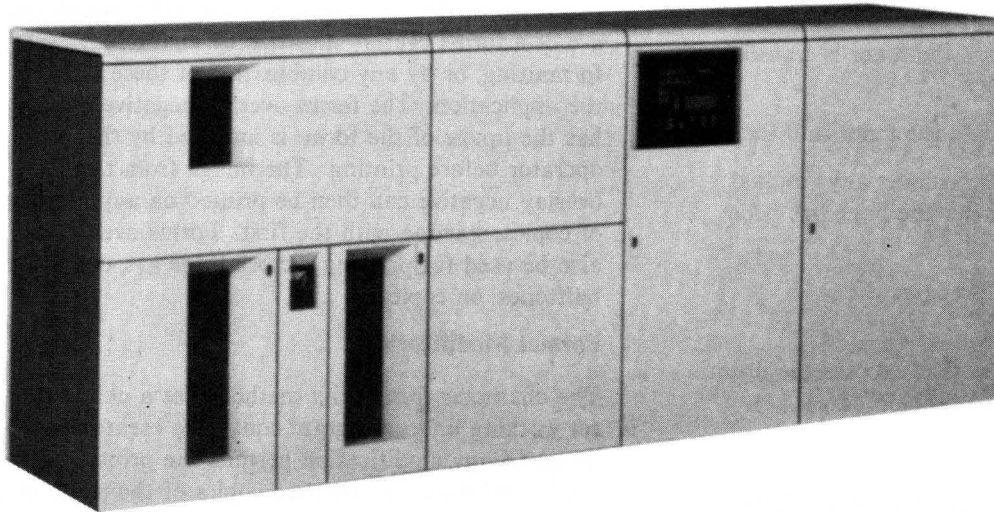

Figure 10-12. IBM 3800 Printing Subsystem

Forms Length		Forms Per Minute (Maximum)	Lines Per Minute (Single Copy)		
in.	mm		6 Lines per Inch	8 Lines per Inch	12 Lines per Inch
3-1/2	90	526	7,890	10,520	15,780
5-1/2	140	334	9,018	12,024	18,036
7	178	263	9,468	12,624	18,936
8-1/2	216	215	9,675	12,900	19,350
11	279	167	10,020	13,360	20,040

Figure 10-13. 3800 Print Speed Ranges

Electrophotographic Process

The 3800 uses an electrophotographic process, which includes the following:

- A continually revolving drum on which a charged photoconductive surface is selectively discharged by a low-power laser to produce images of the printed data
- A developer station where black toner is attracted to the image
- A transfer station where the toner is transferred to the paper forms
- A fuser station that fuses the toner into the paper
- A cleaning station that removes any residual toner from the drum after the page has been printed
- A charge station that prepares the photoconductor
- A forms overlay station that exposes the drum with form images or other fixed data

Operation

In operation, data to be printed is moved from the processor to the 3800 a line at a time, is translated into graphic code using a set of translate tables, and is stored in the page buffer. When the page buffer contains a full page, the code is used, through interaction with character-generation storage, to modulate the laser in exposing the revolving drum. Exposure is by horizontal-line scanning, similar to the way a cathode-ray gun scans a TV screen to produce a picture. The image is developed with toner, transferred to paper, and fused. The photoconductor surface of the drum is cleaned and conditioned again after each exposure. Finished copies are folded again and stacked in the continuous forms stacker. Figure 10-14 is a schematic diagram of the 3800 printing mechanism.

Electronic Character Generation

Graphic character modification permits user- or IBM-designed characters to take the place of an equal number of standard characters in the character generation storage, which stores 128 characters.

Fixed Print Data Options

Preprinted forms can be used, or the form image can be printed simultaneously with text through the use of a forms overlay negative by character formatting, or by any combination of these to suit the application. The forms overlay negative, which has the image of the form, is installed by the operator before printing. The image from the overlay negative can then be printed on any number of copies, starting with the first. Forms overlay can also be used for printing pictorial line art, or halftones, on copies.

Format Modification

The character formatting method uses a character set working under program control to create a line image. Copy modification permits the printing of predefined data, on specified copies of the pages of a data set. The data can be legends, column headings, or other information; or it can be blanks to delete the printing of data. The modification can vary from copy to copy.

The overall effect of forms overlay, character formatting, and copy modification is functionally equal to the use of conventional numbered, preaddressed, multiple-part forms with standard features such as legends, spot carbons, short plies, and printed blackout areas.

Job and Copy Separation Marking

To assist in job and copy separation after processing, identifying marks can be printed on the page perforations. These two types of separation marks are the only type of printing allowed within one-half inch of the horizontal page perforation.

Recovery and Status Information

The 3800 has page accounting and configuration information that is used for recovery and status actions. Four two-byte (halfword) counters keep track of the page as it moves from the page buffer to the stacker.

Special Features

The following features can be ordered through the IBM sales representative to expand or customize the user's operation. The list of features may not be complete and more may be available. For more information about features, see the IBM sales representative.

Burster-Trimmed-Stacker

The burster-trimmer-stacker feature bursts printed output into individual sheets with the right and left carrier strips trimmed off. Jobs or single copies are separated by offsetting one job or copy from another in the stacker, and are ready for distribution without postprinting delays.

Extended Graphics

The extended graphics feature permits the 3800 to print characters that are twice the width of standard characters (that is, a 7.5-pitch in place of two 15-pitch) as a single extended graphics character,

and to intermix these with various character sets now available for the 3800. A 3800 with the extended graphics feature can process jobs that do not contain extended graphics data, because the standard 3800 functions are not affected except for a slight reduction in the page buffer capacity.

This feature operates with the Common Use or ISO size paper and on 50 or 60 hertz machines. Separate microcode diskettes are used for the extended graphics feature. This feature does not function with the IBM 3800 tape-to-printing subsystem feature.

Note: *This feature is only available for A/FE World Trade countries.*

127 Writable Character Generation Storage Positions, Additional

The 127 writable character generation storage positions, additional feature supplies additional character-generation storage for 127 characters to permit a maximum print capability of 255 different characters.

Remote Switch Attachment

The remote switch attachment supplies two-channel switching at a configuration control panel.

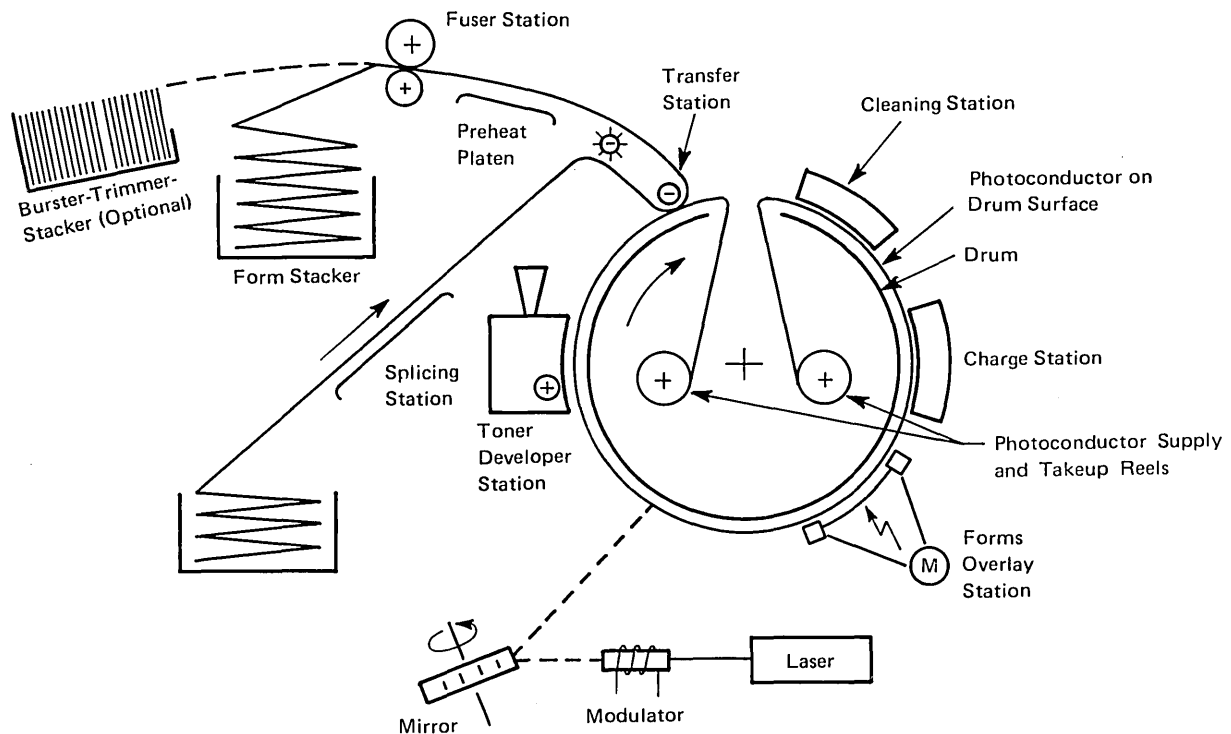

Figure 10-14. Path of Paper Forms through the 3800 Printing Subsystem

Tape-To-Printing Subsystem Feature

The tape-to-printing subsystem feature permits the 3800 to be operated from magnetic tape data. The printer can be attached to a 3410/3411 Model 3 Magnetic Tape Subsystem or a 3803 Model 1 or 2 with the 3420 Models 3 through 8 Magnetic Tape Subsystem. All magnetic tape recording densities permitted for the magnetic tape subsystem can be used. The configuration can be arranged to let the tape subsystem be used online by supplying a separate switchable path from the tape control to the system.

Selection of 3800 functions when the printer is attached to a magnetic tape subsystem can be accomplished by three methods: a user-generated control tape, controls available on the 3800 internal diskette, or entries at the auxiliary operator panel. These methods can be used alone, or in combination, to achieve flexible use of the 3800 printing functions. For example, a control tape may be used for multiple print jobs, with additional parameters entered at the auxiliary operator panel for some jobs. Internal diskette controls can be used for other jobs. A standard set of control tapes can be created and maintained for use when they are needed.

If control tapes are to be used, the Offline IBM 3800 Utility program (Program Product 5748-UT2) is available to help the user prepare them. The utility program operates in an online system environment. Print selections are specified to the utility program through control statements, and the utility program produces a control tape containing instructions for printing one or more print data sets.

The tape-to-printing subsystem feature supports all IBM System/360 and System/370 print tape formats. Print tape formats generated by Burroughs¹ B7000/B6000, Honeywell² Series 60 (level 66/6000), and Sperry Univac³ 1100 Series are also supported if they are as specified in *Operator/Reference Manual for the IBM 3800 Tape-To-Printing Subsystem Feature*.

Two Channel Switch

The two channel switch feature supplies an operator-controlled two-channel switch, which permits the 3800 to obtain data from two separate processors. Automatic switching is supplied by the dynamic two channel switch feature for two processors sharing main storage, and for two channels on a single processor.

3811 Printer Control Unit Model 1

The 3811 Printer Control Unit Model 1 is the control unit for the 3211 Printer. The 3811 (Figure 10-6) is physically attached to the 3211 and contains the electronic circuits needed to adapt the printer to the channel.

The highlights of the 3811 follow.

Attachment to a Processor

The 3811 needs a control unit position on a system channel and can attach to a byte multiplexer channel, block multiplexer channel, multiplexer channel, or selector channel. The 3811 Control Unit supplies all the necessary electronic controls and buffers to adapt the 3211 Printer to the I/O channel supplied by the processor.

Functional Units

The logic, buffers, and controls for the universal character set and forms-control buffer are located in the 3811.

5203 Printer Model 3

The 5203 Printer Model 3 (Figure 10-15) is a line printer that prints 10 characters per inch. The standard 5203 has 96 print positions but can be expanded through special features to 120 or 132 positions.

The highlights of the 5203 follow.

Attachment to a Processor

The 5203 attaches to an IBM processor equipped with integrated 5203 printer attachment, thereby eliminating the need for a separate channel or control unit. Only one 5203 can be attached.

Print Rate

Using the standard 48-character set, the 5203 Printer Model 3 prints 300 lines per minute (maximum) on continuous forms that are margin-punched and pin-fed.

Forms Size

The individual documents that make up the continuous forms can range from 98 to 425 mm (3-7/8 to 16-3/4 in.) in width and from 76 to 356 mm (3 to 14 in.) in length.

Forms Control

The forms control buffer controls the vertical format and movement (spacing and skipping). The 5203

¹ Burroughs Corporation, Detroit, Michigan

² Honeywell Information Systems, Waltham, Massachusetts

³ Sperry Univac, Roseville, Minnesota

has vertical line spacing of either 6 or 8 lines per inch that is under operator control.

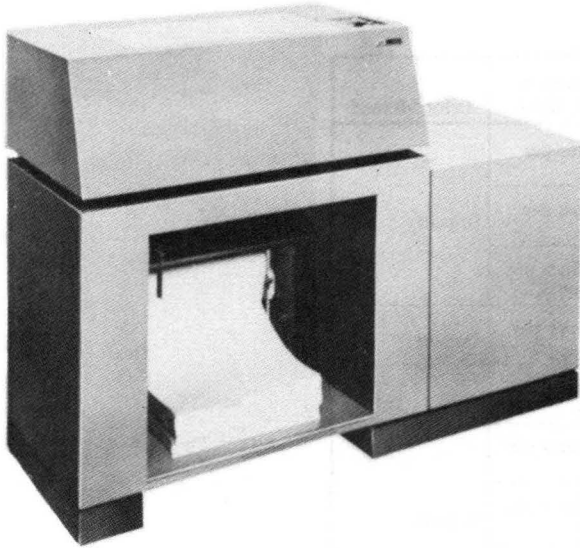

Figure 10-15. IBM 5203 Printer Model 3

Special Features

The following features can be ordered through the IBM sales representative to expand or customize the user's operation. The list of features may not be complete and more may be available. For more information about features, see the IBM sales representative.

Interchangeable Train Cartridge, Additional

The interchangeable train cartridge, additional feature supplies an additional operator changeable train cartridge that contains from 48 to 120 different characters.

Print Positions, 24, 12, and 36 Additional

The print positions, 24, 12, and 36 additional feature increases the number of print positions from 96 to 120, from 120 to 132, and from 96 to 132.

Universal Character Set Attachment

The universal character set attachment feature is needed if any interchangeable train cartridge with more than 48 different characters is used.

5213 Printer Model 1

The 5213 Printer Model 1 (Figure 10-16) can operate as a table-mounted console printer for IBM processors.

The highlights of the 5213 follow.

Attachment to a Processor

The 5213 attaches to an IBM processor through an integrated printer attachment.

Printer Characteristics

The 5213 uses a 62-character set and prints serially at 85 characters per second. The maximum print line is 132 positions at 10 characters per inch, with line spacing of 6 lines per inch.

Forms

The 5213 uses continuous forms that are pin-fed and margin-punched. The individual documents that make up the continuous forms can range from 76 to 356 mm (3 to 14 in.) in length; document width is 352 mm (13-7/8 in.) from left to right of the margin-punched centers. Multiple-part forms can be printed, having a maximum thickness of 0.457 mm (0.018 in.).

Forms Control

The 5213 has a pin-feed platen and a high-speed carrier-return. It also has single-space forms indexing under program control.

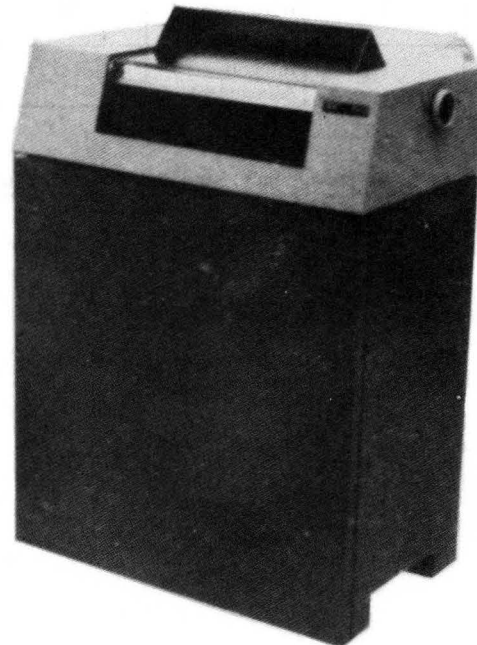

Figure 10-16. IBM 5213 Printer Model 1

Data Comparison Table

Figure 10-17 gives a comparison of data for the printers mentioned in this chapter.

I/O Device	Model	Control Unit	Number of Print Positions	Maximum Print Speed	Print Method
1403	2	2821	132	600 lines per minute	Impact
	7		120	600 lines per minute	
	N1		132	1,100 lines per minute	
1443	N1	Internal	120	240* lines per minute	Impact
3203	1	Integrated	132	600 lines per minute	Impact
	2	Integrated	132	1,200 lines per minute	
	3	3770	132	1,000 lines per minute	
	4	Integrated Attachment	132	1,200 lines per minute	
	5	Internal	132	1,200 lines per minute	
3211	1	3811	132	2,000 lines per minute	Impact
3262	1, 2, 3	Integrated Attachment	132	650 lines per minute	Impact
	11, 12, 13		132	325 lines per minute	
3800	1	Internal	204**	20,040***	Nonimpact, electro-photographic, laser
5203	3	Integrated Attachment	96	300 lines per minute	Impact
5213	1	Integrated Attachment	132	85 characters per second	Impact, serial, matrix
* 1443 Model N1 with 52-character set ** 204 positions at 15 characters per inch ***3800 with forms length of 279 mm (11 in.) and 12 lines per inch					

Figure 10-17. Comparison Data for Printers

Chapter 11. Punched Card Devices

The following devices operate on either 80- or 96-column cards (Figure 11-1). The punched card can be used to enter and retrieve data from a processor. It can also be used for storing data. Payroll checks are one of the practical applications of these devices. See Figure 11-11 at the end of this chapter for a comparison of the characteristics of punched card devices.

Some of these devices have buffers which give them an advantage over the devices that do not. The buffer is a storage used to compensate for a difference in rate of flow of data, or time of occurrence of events, when transferring data from one device to another.

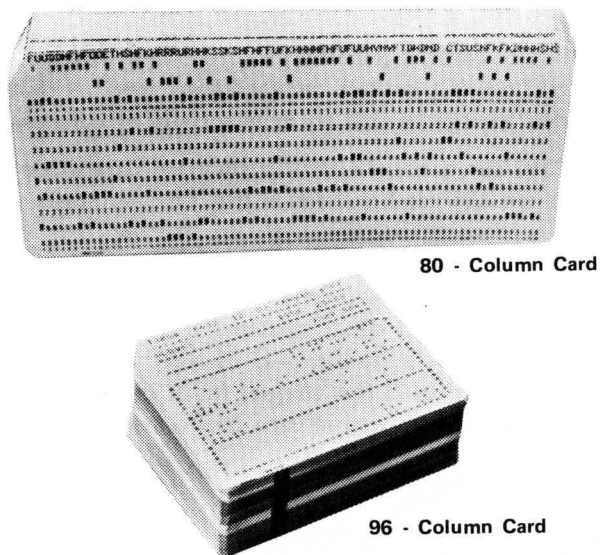

Figure 11-1. 80- and 96-Column Cards

1442 Card Read Punch Model N1

The 1442 reads and punches the 80-column card. It uses a single common card path for reading and punching, and reads and punches cards serially by card column. Serial card feeding, past a read station and then a punch station, makes it possible for the program to read data from a card and then punch data (such as the results of a calculation) into the same card during a single card pass. The appearance of the unit is similar to that of the 1442 Model N2 shown in Figure 11-2.

The highlights of the 1442 follow.

Speed

The Model N1 reads or punches cards at the following maximum rates:

- Reads 400 cards per minute
- Punches 160 card columns per second

Punching speed varies with the location of the last column punched. Interspersed blank columns between fields are considered punched columns. In terms of cards per minute, the rated speed for punching columns 1 through 10 is 265; for punching columns 1 through 80 it is 91.

Attachment to a Processor

No external control unit is needed; the control circuits are inside the 1442. The 1442 Model N1 attaches through a control unit position to a system channel. It does not have a buffer.

Hopper and Stackers

The read hopper holds 1200 cards. Card movement is from the hopper to the read station, to the punch station, then to one of the two stackers (pockets). The stackers hold 1300 cards each, and cards can be removed by the operator from either stacker without stopping the machine.

Read and Punch Mode

There are two modes of reading and punching cards, as described below. Data mode 1 is the normal mode of operation while data mode 2 needs a special feature called card image.

Data Mode 1: In data mode 1, the Model N1 can read and punch the 256 different combinations of holes needed by the extended binary-coded decimal interchange code (EBCDIC). For the 256 combinations, multiple punches in a single card column are needed; however, no more than one punch is permitted in rows 1 through 7. (Rows 12, 11, 0, 8, and 9 permit 32 possible combinations, which, multiplied by the eight possibilities in rows 1 through 7, equal the needed 256.) For multiple punches in rows 1 through 7, the card image special feature is needed.

Data Mode 2: Operations that use the card image feature are in data mode 2, which is the card image or column binary mode. The card image feature permits the low-order six bits of bytes read from the

processor to be punched alternately into the upper six and lower six rows of a card, enabling 160 such truncated bytes to be placed in the card. In a read operation, the information is read column by column and transmitted to the processor byte by byte, the two high-order bits (0 and 1) being set to zero.

Special Features

The following feature can be ordered through the IBM sales representative to expand and customize the user's operation. More features may be available. For more information about features, see the IBM sales representative.

Card Image

The card image feature permits processing of cards with multiple punches in rows 1 through 7 of a single column.

1442 Card Punch Model N2

The 1442 Model N2 (Figure 11-2) can be connected to an IBM processor to supply the card punching function only. Punching operations, speeds, internal controls, punching in data mode 2, and all other features related to punching are the same as those of the 1442 Card Read Punch Model N1, except that the Model N2 has only one 1300-card stacker.



Figure 11-2. IBM 1442 Card Punch Model N2

2501 Card Reader Models B1 and B2

The 2501 is a punched-card input device for an IBM processor. Model B1 can be used for primary card input or as a console reader. Model B2 can be

used for primary card input, often with the 2520 Card Punch Model B2 for maximum card-processing speeds.

The highlights of the 2501 follow.

Card-Reading Speed

The two models of the 2501 (Figure 11-3) are externally the same, except that the maximum card-reading rate of the Model B1 is 600 per minute; that of Model B2 is 1000 per minute.

Attachment to a Processor

No external control unit is needed; the control circuits are inside the device. The 2501 needs a control unit position on a system channel. The 2501 does not have a buffer.

Reading Operation

Reading of cards is done by photocells that convert the light passing through punched holes into electrical energy. Cards are read serially by column.

The 2501 can read EBCDIC in standard data mode 1. For the 256 combinations in EBCDIC, multiple punches in a single card column are needed; however, no more than one punch is permitted in rows 1 through 7. For multiple punches in rows 1 through 7, the card image special feature is needed. See "Data Mode 2" in the 1442 Model N1 description earlier in this chapter for a description of the reading operation in card image mode.

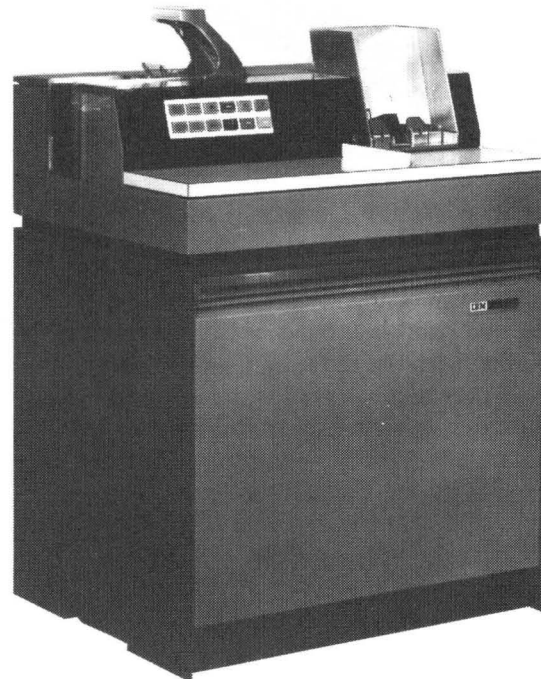

Figure 11-3. IBM 2501 Card Reader

Hopper and Stacker

The feed hopper has a 1200-card capacity, and cards can be removed from the single 1300-card stacker by the operator without stopping the reader.

Special Features

The following feature can be ordered through the IBM sale representative to expand or customize the user's operation. More features may be available. For more information about features, see the IBM sales representative.

Card Image

The card image feature permits processing of cards with multiple punches in rows 1 through 7 of a single column.

2520 Card Read Punch Model B1

The 2520 Card Read Punch Model B1 (Figure 11-4) is a combined punched-card input and output unit for IBM processors.

The highlights of the 2520 Model B1 follow.

Card-Processing Speed

The 2520 Model B1 reads and punches cards at a maximum rate of 500 per minute.

Reading Operation

Operation of the 2520 Model B1 is the same as for the 1442 Model N1 or 2501 with respect to reading cards serially by column. Cards move past a read station and then past a punch station. Prepunched cards can be fed through the punch station without a special feature. As in the 2501, cards are read by photocells that convert the light passing through punched holes into electrical energy. The reading operations do not go through a buffer.

Punching Operation

The punching operation of the 2520 differs from that of the 1442; punching is parallel by row instead of serially by column. Each card is fed in parallel and read serially while the preceding card, its axis turned 90 degrees, is passing by the punch station (Figure 11-5). The 2520 punching operations go through a buffer.

Attachment to a Processor

No external control unit is needed; the control circuits are inside the device. The 2520 needs a control unit position on a system channel.

Read and Punch Modes

The 2520 can read and punch EBCDIC in standard data mode 1. For the 256 combinations in EBCDIC, multiple punches in a single card column are needed; however, no more than one punch is permitted in rows 1 through 7. For multiple punches in rows 1 through 7, the card image special feature is needed. See "Data Mode 2" in the 1442 Model N1 description earlier in this chapter for a description of the reading and punching operations in card image mode.

Hopper and Stackers

The feed hopper has a 1200-card capacity. There are two stackers. The operator can remove cards from both 1300-card stackers while the machine is running.

Special Features

The following feature can be ordered through the IBM sale representative to expand or customize the user's operation. More features may be available. For more information about features, see the IBM sales representative.

Card Image

The card image feature permits punching of cards with multiple punches in rows 1 through 7 of a single column.

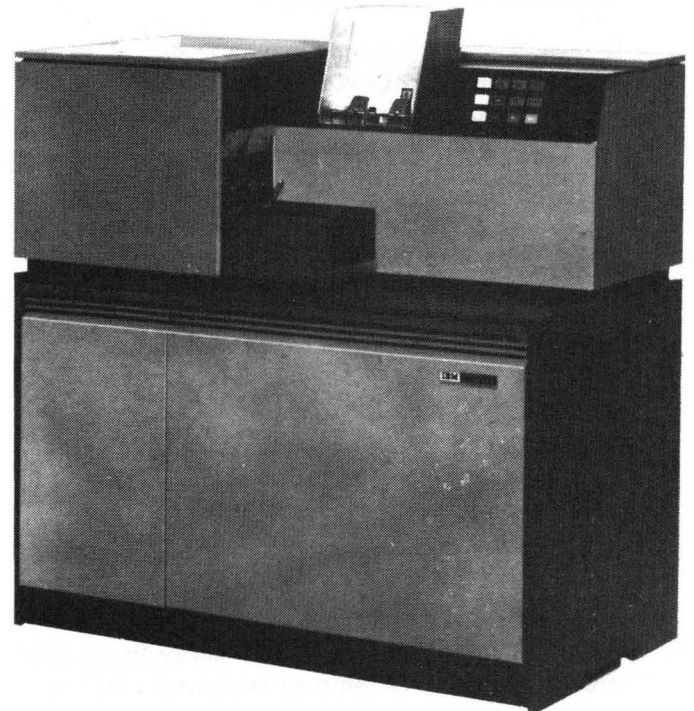

Figure 11-4. IBM 2520 Card Read Punch Model B1

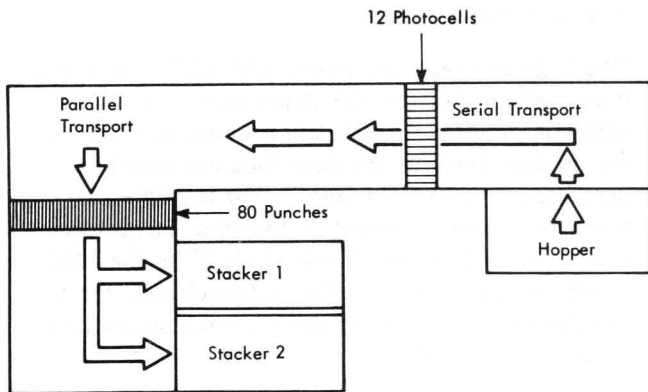

Figure 11-5. Card Path in the 2520 Card Read Punch Model B1

2520 Card Punch Models B2 and B3

The 2520 Card Punch Model B2 or B3 can be connected to an IBM processor to supply the punching function only.

The highlights of the 2520 follow.

Card-Punching Speed

Models B2 and B3 are externally the same (and the same as the 2520 Model B1 shown in Figure 11-4), except that the maximum card-punching rate of Model B2 is 500 per minute; that of Model B3 is 300 per minute.

Similarities to the 2520 Model B1

Internal controls, punching in data mode 2, the punching speed of Model B2, and all other features related to punching are the same as those of the 2520 Card Read Punch Model B1.

Special Features

The following feature can be ordered through the IBM sales representative to expand or customize the user's operation. For more information about this feature, see the IBM sales representative.

Card Image

The card image feature permits punching of cards with multiple punches in rows 1 through 7 of a single column by suspending validity checking.

2540 Card Read Punch Model 1

The 2540 Card Read Punch (Figure 11-6) is an input and output, 80-column card device for an IBM processor. The 2540 can read and punch EBCDIC.

The highlights of the 2540 follow.

Card-Processing Speed

The 2540 reads cards at a maximum rate of 1000 per minute, and punches cards at a maximum rate of 300 per minute. The card reading and punching facilities are separate entities, and can take place simultaneously.

Hoppers and Stackers

The read hopper, with its file feed, holds 3100 cards. The punch hopper holds 1350 cards. Five 1350-card stackers are located between the read and punch ends of the 2540; three stackers can be used in reading and three in punching. The center stacker can be fed with either punched or read cards, but should be reserved for one or the other during a run. The operator can remove cards from any pocket without stopping the machine.

Attachment to a Processor

The 2540 is controlled and attached to the channel by a 2821 Control Unit. (See "2821 Control Unit Models 1, 2, 3, 5, and 6," described under Chapter 10.)

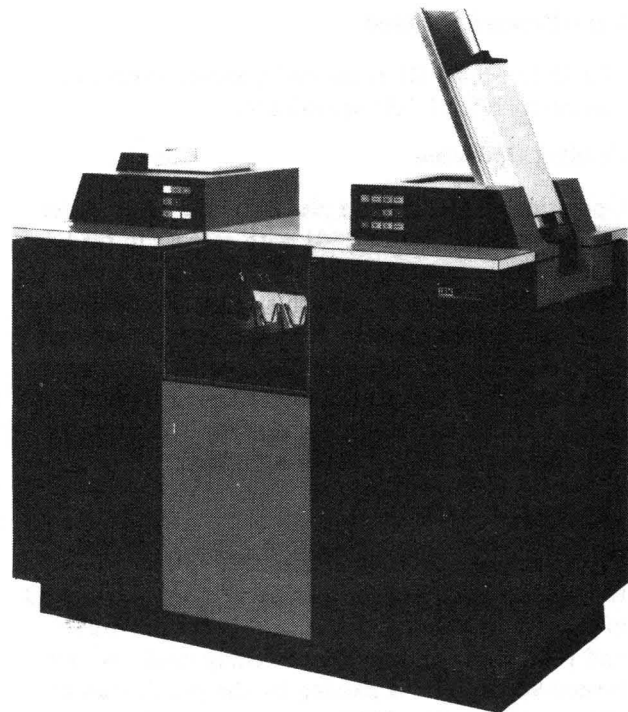

Figure 11-6. IBM 2540 Card Read Punch

Special Features

The following features can be ordered through the IBM sales representative to expand or customize the user's operation. The list of features may not be

complete and more may be available. For more information about features, see the IBM sales representative.

Punch Feed Read

The punch feed read feature permits the 2540 to punch output data into the same card from which input data was read. Column binary cards cannot be read in the punch feed. Unless this feature is installed, only blank cards can be fed through the punch facility.

Two Channel Switch Adapter

The two channel switch adapter feature permits the read and punch feed of the 2540 to be reset independently. This is needed if the 2540 is to be used with a 2821 that has a two channel switch feature installed.

51-Column Interchangeable Read Feed

The 51-column interchangeable read feed feature permits feeding either 51-column cards or standard 80-column cards in the read feed of the machine. The 51 columns are equal to columns 15 through 65 of an 80-column card. (51-column cards can be postal money orders, installment payments, inventory cards, for example, a detached 51-column stub from an 80-column card.) Installation of this feature permanently reduces the maximum card-reading speed to 800 cards per minute. The first two read pockets are modified so that the operator can adjust for either an 80- or 51-column

operation. During the time that the pockets are set for 51-column cards, the capacity of the two pockets is reduced to 800 cards each and 80-column cards cannot be fed.

2560 Multi-Function Card Machine Models A1 and A2

The 2560 Multi-Function Card Machine (Figure 11-7) supplies the combined functions of a card reader, card punch, and card collator for an IBM processor. The 2560 permits cards to be collated, gangpunched, reproduced, summary punched, and classified in a single pass, under program control.

There are two models of the 2560:

- Model A1 reads 500 cards per minute from either of two hoppers, punches at 160 columns per second, prints at 140 columns per second, and has five stackers.
- Model A2 reads at 310 cards per minute from either of two hoppers, punches at 120 columns per second, and has four stackers.

The highlights of the 2560 follow.

Attachment to a Processor

The 2560 attaches to an IBM processor through an integrated attachment.



Figure 11-7. IBM 2560 Multi-Function Card Machine

Functional Units

Both models have two 1200-card hoppers (primary and secondary), a read station, a punch station, and four or five 1300-card stackers.

Read and Punch Operations

Cards from either the primary or secondary hopper can be read, punched, and fed into any of the stackers. While in the read station, cards are checked for data validity, off-register punching, and correct alignment. The output per minute varies with the number of columns punched per card. For example, the output rates for Models A1 and A2 vary from 91 and 65 cards per minute respectively when column 80 is the last column punched, to 260 and 173 cards per minute respectively when punching stops at column 10.

Special Features

The following feature can be ordered through the IBM sales representative to expand or customize the user's operation. For more information about this feature, see the IBM sales representative.

Card Print

The card print feature (Model A1 only) supplies two, four, or six printing heads for serial printing as the card moves through the print station. Each printing head can be adjusted by hand to print in any one of 25 line positions not occupied by another head. Line positions are above the 12-punch position, on each row of punch positions, between the rows of punch positions, and below the 9-punch position.

Each printing head can print 62 different characters plus a blank, as transmitted from storage. Character spacing is 10 to the inch, and each line can be 64 characters long. Printing extends from approximately column 2 to column 75.

Printing speed is 140 characters per second, regardless of the number of lines printed. Six hundred 64-character lines per minute (100 cards per minute) can be printed if six lines are printed on each card; this time includes card movement and registration.

The card print feature permits cards to be printed (interpreted) in the same pass with other operations.

3504 Card Reader Models A1 and A2

The 3504 Card Reader supplies an 80-column, punched-card, input unit for an IBM processor.

It is available in two models:

- Model A1 reads 800 cards per minute.
- Model A2 reads 1200 cards per minute.

The highlights of the 3504 follow.

Functional Units

The 3504 Card Reader (Figure 11-8) is a high-speed device, that has 3000-card file feed and two 1750-card nonprogrammable stackers.

Attachment to a Processor

The 3504 attaches to an IBM processor through an integrated attachment.

Error-Recovery Support

The 3504 needs less error-recovery support than I/O devices such as the 2540 Card Read Punch, because many of the functions performed by the program support are already performed by the 3504 (for example, automatic feed retry).

The 3504 also has error-retry capabilities: It retries cards that fail to feed on the first try, and signals a hopper misfeed if subsequent retry operations are unsuccessful.

Operator Panel

The 3504 has a recovery-oriented operator panel. The indicators on the panel show the precise action to be performed for all normal stops and most error stops, or they direct the operator to a corrective procedure. Operating keys are located in the same general area for ease of control.

Read Column Eliminate

The read column eliminate capability gives the user, under program control, the ability to suppress the reading of selected card columns and substitutes blanks in these columns in the buffer.

Read and Validity Checks

Card reading in a 3504 is serially by column. The card read is checked for invalid codes or open-punched card scores. Machine checks are also made for off-punched or mispositioned cards.

Special Features

The following features can be ordered through the IBM sales representative to expand and customize the user's operation. The list of features may not be complete and more may be available. For more information about features, see the IBM sales representative.

51/80-Column Interchangeable Read Feed

The 51/80-column interchangeable read feed feature gives the attachments necessary to feed and read 51-column cards.

Optical Mark Read

The optical mark read feature permits the 3504 to read up to 40 columns of marked data. Pencil-marked, machine-printed, nonreflective-marked, and punched data can be read from a card.

Selective Stacker

The selective stacker feature supplies a third stacker (second logical stacker), which permits time-independent card selection under program control.

3505 Card Reader Models B1 and B2

The 3505 Card Reader Models B1 and B2 (Figure 11-8) is an 80-column, punched-card, input device for an IBM processor. It is a high-speed, fully buffered, card reader, containing its own control unit.

The 3505 is available in two models:

- Model B1 has a rated card speed of 800 cards per minute.
- Model B2 has a rated card speed of 1200 cards per minute.

The highlights of the 3505 follow.

Attachment to a Processor

The 3505 needs a control unit position on a system channel.

File Feed and Stackers

Both models of the 3505 have a 3000-card capacity file feed and two 1750-card capacity stackers.

Control Unit

The control unit with buffers, housed within the 3505:

- Contains its own microprocessor and resident programs (microcode) for error detection and recovery assistance
- Keeps a log of recent errors (especially helpful in device maintenance)
- Prevents channel overrun
- Permits card data to be transferred in burst mode

Error Recovery Support

The 3505 needs less error-recovery support than other I/O devices such as the 2540 Card Read Punch, because many of the functions performed by the program support are already performed by the 3505 (for example, automatic feed retry).

The 3505 has error-retry capabilities: It retries cards that fail to feed on the first try, and signals a hopper misfeed if subsequent retry operations are unsuccessful.

Operator Panel

The 3505 has a recovery-oriented operator panel. The indicators on the panel show the precise action to be performed for all normal stops and most error stops, or they direct the operator to a corrective procedure. Operating keys are located in the same general area for ease of control.

Read Column Eliminate

The read column eliminate capability gives the user, under program control, the ability to suppress the reading of selected card columns and substitutes blanks in these columns in the buffer.

Read and Validity Checks

Card reading in a 3505 is serially by column. The card read is checked for invalid codes or open-punched card scores. Machine checks are also made for off-punched or mispositioned cards.



Figure 11-8. IBM 3504 or 3505 Card Reader

Special Features

The following features can be ordered through the IBM sales representative to expand or customize the user's operation. The list of features may not be complete and more may be available. For more information about features, see the IBM sales representative.

Optical Mark Read

The optical mark read feature permits the 3505 to read up to 40 columns of marked data. Pencil-marked, machine-printed, nonreflective-marked, and punched data can be read from a card.

Selective Stacker

The selective stacker feature supplies a third stacker (second logical stacker), which permits time-independent card selection under program control.

3525 Card Print Control

The 3525 card print control feature supplies the control necessary for the basic card print feature installed on the 3525.

3525 Punch Adapter

The 3525 punch adapter feature permits attachment of the 3525 Card Punch, without its card read feature.

3525 Read Punch Adapter

The 3525 read punch adapter feature permits attachment of the 3525 Card Punch that has the card read feature installed.

51/80-Column Interchangeable Read Feed

The 51/80-column interchangeable read feed feature permits feeding either 51-column cards or standard 80-column cards in the read feed of the machine. The 51 columns are equal to columns 15 through 65 of an 80-column card.

3525 Card Punch Models P1, P2, and P3

The 3525 Card Punch (Figure 11-9) is an 80-column, punched-card, output device. When equipped with the appropriate special features, it can read and print as well as punch 80-column cards in a single pass through the machine.

The 3525 has three models:

- Model P1 has a rated speed of 100 cards per minute.
- Model P2 has a rated speed of 200 cards per minute.
- Model P3 has a rated speed of 300 cards per minute.

The highlights of the 3525 follow.

Attachment to a Processor

The 3525 attaches to an IBM processor through the 3505 or through an integrated attachment. It needs a control unit position on a system channel.

Functional Units

The 3525 has a 1200-card capacity hopper and two 1200-card capacity stacker.

Error-Recovery Support

The 3525 needs less error-recovery support than other I/O devices such as the 2540 Card Read Punch, because many of the functions performed by the program support are already performed by the 3525 (for example, automatic punch retry).

On recognizing a card with a punch error, the 3525 sends that card to an error stacker for later examination and retries correct punching.

Operator Panel

The 3525 has a recovery-oriented operator panel. The indicators on the panel show the precise action to be performed for all normal stops and most error stops, or they direct the operator to a corrective procedure. Operating keys are located in the same general area for ease of control.

Punch Checking

The 3525 checks card punching by monitoring the movement of all 80 punches. A card in which a punching error is sensed is automatically directed to a dedicated, 200-card capacity error stacker and followed by two automatic punching retry operations. Either the extended binary-coded decimal interchange code or card image can be punched.



Figure 11-9. IBM 3525 Card Punch

Special Features

The following features can be ordered through the IBM sales representative to expand or customize the user's operation. The list of features may not be complete and more may be available. For more information about features, see the IBM sales representative.

Card Read

The card read feature supplies an optical hole-sensing station ahead of the punch station. The cards are read parallel by row. This feature permits the 3525 to read 3504 and 3505 program cards and execute the program. The read column eliminate capability is standard with this feature and gives the ability, under program control, to suppress the reading of selected card columns.

Multiline Card Print

The multiline card print feature gives the ability to print, under program control, on any or all of the 25 printing lines on a card.

Two-Line Card Print

The two-line card print feature is the same in function as the multiline card print, with the exception that printing is limited to lines 1 and 3. Maximum speed in cards per minute, when printing, varies with the machine model only.

5425 Multi-Function Card Unit Models A1 and A2

The 5425 Multi-Function Card Unit (Figure 11-10) is a 96-column punched-card device for an IBM processor. It can function as a card reader, card punch, collator, and interpreter. The consolidation of these functions into one unit reduces card handling and the overall time to complete a job. In a single pass and under program control, the 5425 permits 96-column cards (Figure 11-1) to be collated, gangpunched, reproduced, summary-punched, printed, and classified. It also sorts cards, using a multiple pass method under program control.

Externally, both models of the 5425 look the same, and both have two 2000-card hoppers, a read station, a punch station, a print station, and four 600-card stackers; the exceptions are:

- Model A1 reads 250 cards per minute, punches 60 cards per minute, and prints 60 cards per minute.
- Model A2 reads 500 cards per minute, punches 120 cards per minute, and prints 120 cards per minute.

These print rates are for the first, second, and third lines, but they are reduced if the fourth line is printed.

The highlights of the 5425 follow.

Attachment to a Processor

The 5425 attaches to an IBM processor through an integrated attachment.

Card Path

The primary and secondary hoppers feed cards through the read station into wait stations. From the wait stations, the cards pass through the punch station and the print station, and move into a selected stacker.

Printing

At the print station, up to four lines (with as many as 32 characters per line) can be printed, using characters from the standard 64-character set.

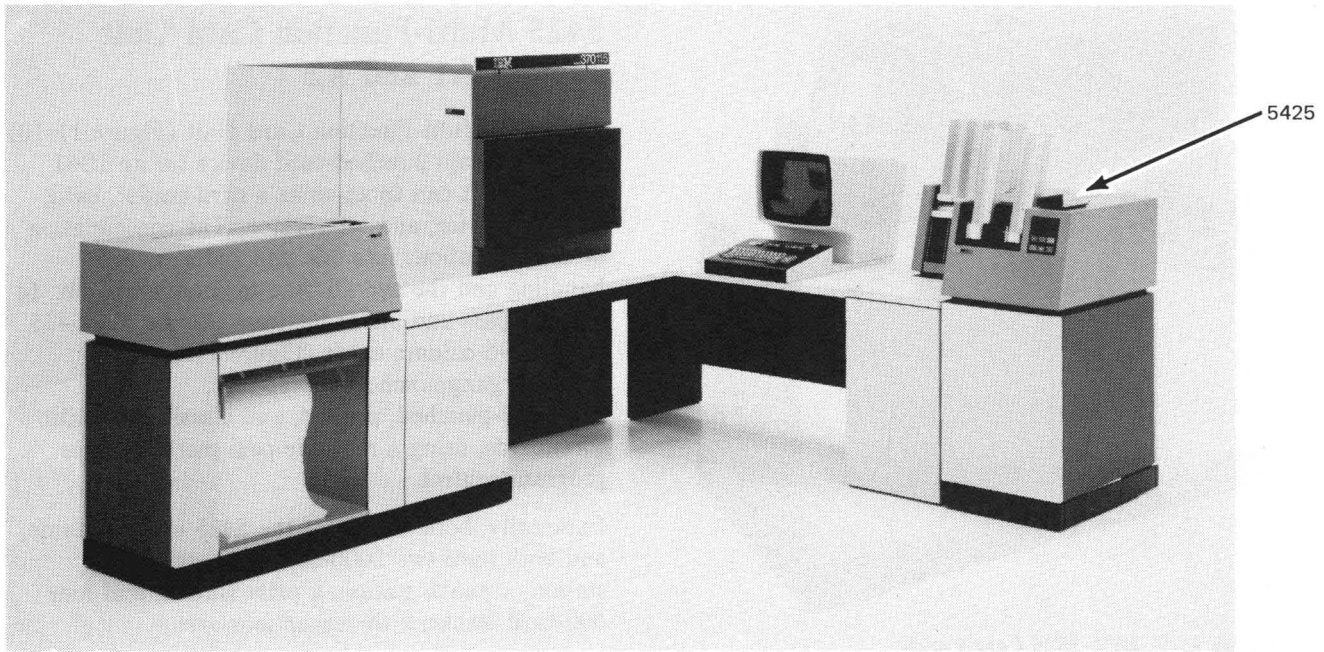

Figure 11-10. IBM 5425 Multi-Function Card Unit with System/370 Model 115

Data Comparison Table

Figure 11-11 gives a comparison of data for the card devices mentioned in this chapter.

Card Unit	Model	Read Speed (cards per minute)	Punch Speed	Read and Punch Same Card in One Pass	Self-Contained Control Unit	Buffers
1442	N1	400	160 cc/s (see Note 3)	yes	yes	none
1442	N2	—	160 cc/s (see Note 3)	—	yes	none
2501	B1	600	—	—	yes	none
2501	B2	1,000	—	—	yes	none
2520	B1	500	500 c/m	yes	yes	punch
2520	B2	—	500 c/m	—	yes	punch
2520	B3	—	300 c/m	—	yes	punch
2540	1	1,000 (see Note 1)	300 c/m	yes	no	read, punch
2560	A1	500	160 cc/s (see Note 4)	yes	no	none
2560	A2	310	120 cc/s (see Note 5)	yes	no	none
3504	A1	800	—	—	no	read
3504	A2	1,200	—	—	no	read
3505	B1	800	—	—	yes	read
3505	B2	1,200	—	—	yes	read
3525	P1	100 (see Note 2)	100 c/m	yes	no	read, punch, print
3525	P2	200 (see Note 2)	200 c/m	yes	no	read, punch, print
3525	P3	300 (see Note 2)	300 c/m	yes	no	read, punch, print
5425	A1	250	60 c/m	yes	no	none
5425	A2	500	120 c/m	yes	no	none

Notes:

- 800 if the 51/80-column interchangeable read feed feature is installed.
- With the card read feature installed.
- 265 cards per minute if the unit punches columns 1 through 10; 91 cards per minute if it punches all 80 columns.
- 260 cards per minute if the unit punches columns 1 through 10; 91 cards per minute if it punches all 80 columns.
- 173 cards per minute if the unit punches columns 1 through 10; 65 cards per minute if it punches all 80 columns.

Legend:
cc/s = card columns per second
c/m = cards per minute

Figure 11-11. Comparison Data for Card Devices

Chapter 12. Punched Tape Devices

The punched tape devices use paper tape to enter data into a processor. The tape can be 11/16-inch (five-track telegraphic code), 1-inch (eight-track code), or 7/8-inch (six- and seven-track codes) wide.

2671 Paper Tape Reader

The 2671 Paper Tape Reader (Figure 12-1) is an input unit for an IBM processor. It is especially designed for data communication, source recording, scientific data processing, and data gathering.

The highlights of the 2671 follow.

Read Operation

The 2671 photo-electrically reads strips of 5-, 6-, 7-, or 8-channel paper tape at a rate of up to 1000 characters per second. After acceleration time (approximately 8 milliseconds), the data rate reaches 1000 characters per second for strips. With spooling facilities, this rate can vary between 500 and 1000 characters per second, as determined by the length of a record.

Tape width is 17.5 mm (11/16 in.) (for five-track telegraphic code), 22.2 mm (7/8 in.) (six- and seven-track codes), or 1 inch (25.4 mm) (eight-track code).

The basic 2671 reads strips of paper tape from 229 mm to 6.10 m (9 in. to 20 ft) in length, including a 152.4 mm (6 in.) leader and 76 mm (3 in.) trailer. Tape code translation is under program control.

Operator Panel

Various switches on the 2671 panel aid operator functions and contribute to program efficiency. Examples are: end-of-record indications, parity checking (odd, even, or none), track suppression, and transmission or nontransmission to the processor of indications about deleted positions on tape.

Attachment to a Processor

The 2671 and the 2822 Paper Tape Reader Control (Figure 12-1) are usually attached to an IBM processor through a byte multiplexer channel, but they can be attached to another channel on some processors.

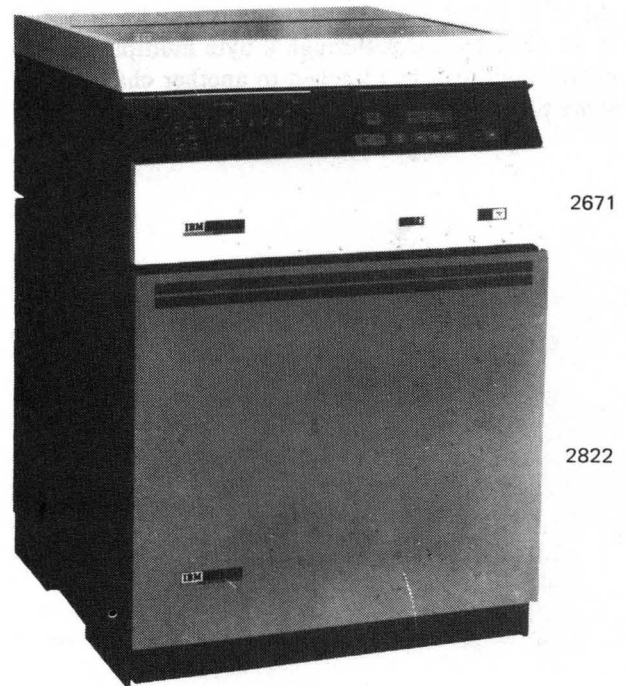

Figure 12-1. IBM 2671 Paper Tape Reader and IBM 2822 Paper Tape Reader Control

Special Features

The following features can be ordered through the IBM sales representative to expand or customize the user's operation. The list of features may not be complete and more may be available. For more information about features, see the IBM sales representative.

Center Roll Feeding

Spooling facilities are optional. The center roll feeding feature permits the 2671 to feed tape from the center of 266.7 mm (10.5 in.) rolls.

Supply Option

The supply option feature permits the 2671 to feed tape from a 266.7 mm (10.5 in.) reel (tape is fed from the outside of the reel).

Take-Up Option

The take-up option feature permits the 2671 to rewind tape on 266.7 mm (10.5 in.) reels.

2822 Paper Tape Reader Control

The 2822 Paper Tape Reader is the control unit for the 2671 Paper Tape Reader and is usually attached to an IBM processor through a byte multiplexer channel, but can be attached to another channel on some processors.

Functional Units

The 2822 supplies status and data information from the 2671 to the processor. It also checks for parity and signals the end of record and the end of tape.

Chapter 13. Systems

The systems described in this chapter interact with IBM processors to pass data from or to the system through the processor's channel or integrated attachment.

3250 Graphics Display System

The 3250 Graphics Display System (Figure 13-1) supplies interactive graphics capabilities for its host system. Graphic and alphanumeric information is displayed on a cathode-ray tube. Two types of keyboard and a light pen can be installed to permit the operator to interact with the displayed image and the host system, and to update stored data. Figure 13-4 illustrates the configuration of a 3250 System. Further introductory information and the details of attachment to a host system are contained in *An Introduction to the IBM 3250 Graphics Display System*.

Interactive computer graphics are used in a large and still growing variety of applications. Some of the most complex and highly developed applications are found in the automotive and aerospace industries, in which complete geometric definitions of products are specified through interactive graphic displays linked to powerful processors. Other industries that use interactive computer graphics include shipbuilding, electronics, architecture, and general mechanical engineering.

A key characteristic of these applications is the large amount of operator-initiated interactions with the system through input devices and the displayed graphic information. Rapid interaction with large amount of graphic and alphanumeric data is the normal mode of operation.

Several logically distinct and important functions contribute to the value of an application:

- Entering and editing data
- Updating and controlling changes
- Modeling geometric designs
- Sending data to other functions

The importance of these functions varies from one application to another. In some applications, such as integrated circuit layout or precision mapping, data entry and editing are important because large amount of precise data must be accurately generated. In other applications, such as computer-aided design engineering, change control can be important.

The highlights of the 3250 follow.

Image Display

Information can be presented graphically (graphs or maps) and alphanumerically (descriptive data). The

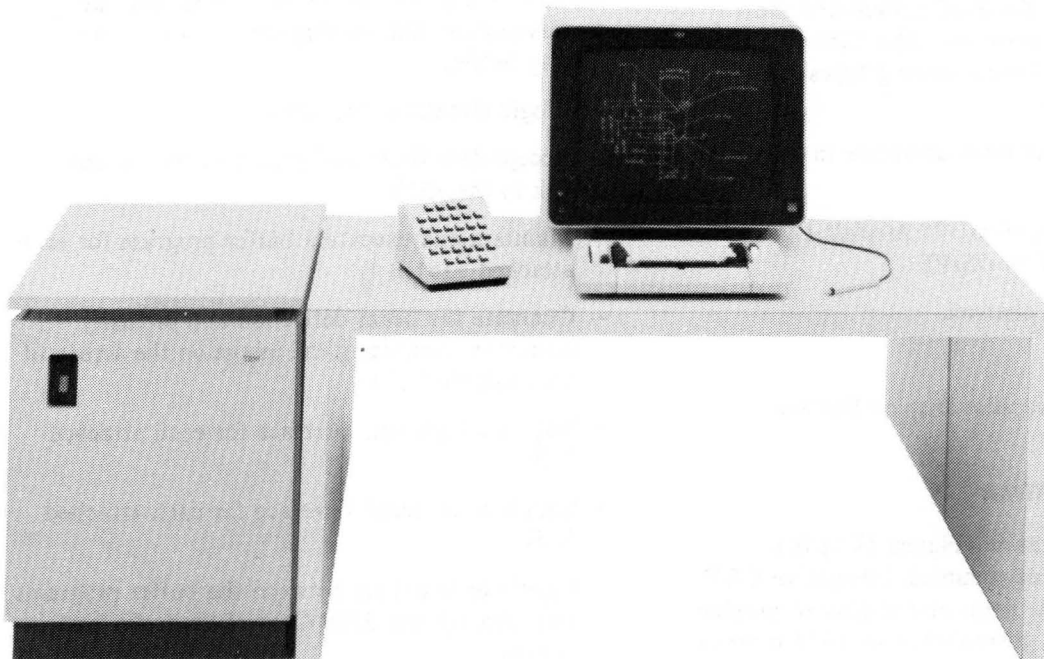

Figure 13-1. IBM 3250 Graphics Display System

images appear as a series of points, lines, and characters, and can be readily modified by the entry of additional information. Lines are displayed in one of four types of lines: solid, dotted, dashed, or dot-dashed. Each element of the image can be displayed at one of eight programmable intensity levels.

2250 Program Compatibility

The 3250 is generally upward compatible from the 2250 Graphic Display Unit Model 3. Valid programs written for the 2250 can be used on the 3250 without change, with the following minor exceptions:

- The 3250 supports one cursor per display station.
- Some earlier undefined orders have a defined function in the 3250.
- Lowercase characters are displayed as lowercase by the 3250.
- The 3250 does not have Program Function Keyboard overlay sense switches.
- The 3250 shares display buffers with a maximum of two display stations.
- Undefined characters in 3250 text strings are treated as blanks or nulls.

Channel Attachment

The 3250 Graphics Display System attaches to a host system through an I/O channel (Figure 13-4). This attachment gives two-way communication between the units of the 3250 system and the graphics application program. The 3250 system can be attached to any of the following types of I/O channel:

- Byte multiplexer channel operating in burst mode.

Note: *The IBM System/370 Models 115 and 125 are not supported by OS/VS.*

- Block multiplexer channel.
- Selector channel.

Units of the 3250 Graphics Display System components follow.

3251 Display Station

The 3251 Display Station (Figure 13-2) is a free-standing, table-top-mounted, interactive CRT display station for the input and display of graphic and alphanumeric data generated in an IBM processor. The display station can have an alphanumeric

keyboard, a program function keyboard, and a light pen through the installation of special features.

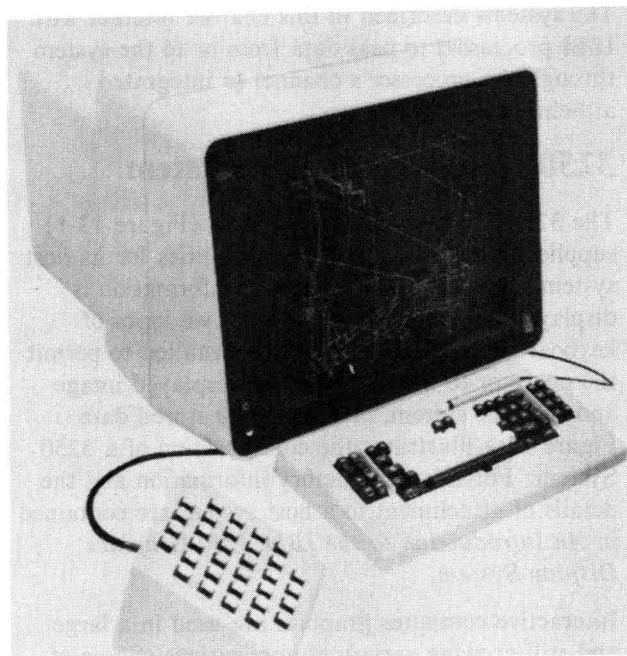

Figure 13-2. IBM 3251 Display Station

3255 Display Control Unit

The 3255 Display Control Unit (Figure 13-3) is a free-standing, floor-mounted unit that supplies common controls and attachments for one or two 3251. The 3255 has a 32,768-byte user-programmable display buffer that is shared by the attached 3251s. If the 3250 uses only one display station, that display can use the entire display buffer.

The logic circuits in the 3255:

- Accept data from, and pass data to, the serial link to the 3258
- Maintain and execute a buffer program for each attached 3251
- Generate the beam deflection and intensity signals for producing the image on the screen of each attached 3251
- Supply a light pen interface for each attached 3251
- Supply a keyboard interface for each attached 3251
- Supply an interface between the buffer programs and, through the 3258 Control Unit, the host system

Display Buffer: In the 3255, a 32,768 byte buffer is available to the buffer programs controlling the attached 3251s. Buffer programs are created and updated by the application program in the host system. The programs are then sent to the 3255 through the 3258 and the serial link. The functions of the buffer program are to generate the display image and to monitor the keyboards and light pen to accept operator actions.

The buffer programs consist of graphic orders, graphic and alphanumeric data, and control orders, which control:

- Regeneration of the displayed image
- The sensitivity of the displayed image to a light pen operation
- Data entry from the alphanumeric keyboard

3258 Control Unit

The 3258 Control Unit (Figure 13-3) is a free-standing, floor-mounted unit that attaches a 3250 System to a standard System/370 block multiplexer, selector, or byte multiplexer (burst mode) channel interface. The 3258 supports a burst mode data rate of up to 250,000 bytes per second, when the rate is not limited by the channel data rate.

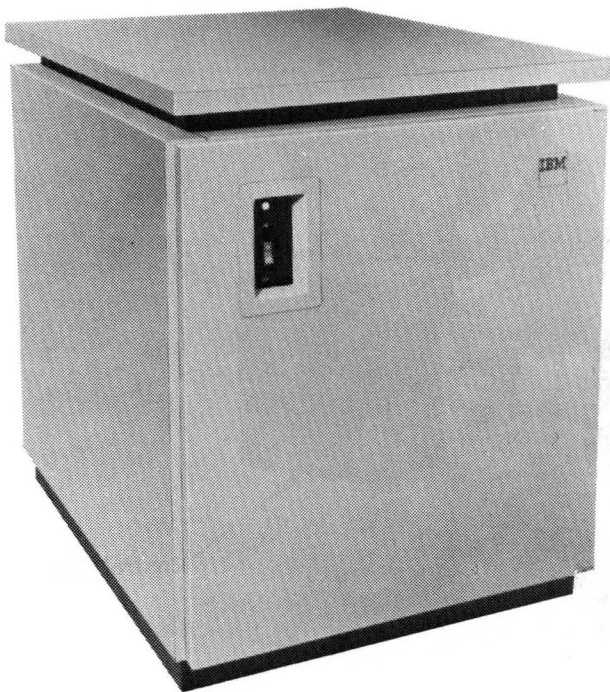

Figure 13-3. IBM 3255 Display Control Unit or IBM 3258 Control Unit

The 3258 is a channel-attached control unit that supplies an interface between the connected 3255 Display Control and the channel of the host system. Up to four 3255 Display Control Units can be attached to the 3258 through individual coaxial links of 1 megabit per second. These links can be up to 1525 m (5000 ft) in length (longer by request for price quotation [RPQ]) for local attachment. In addition, RPQs are available that permit remote connection of 3255s to a 3258 through communication systems. These systems permit display stations to be placed far from the central data-processing complex.

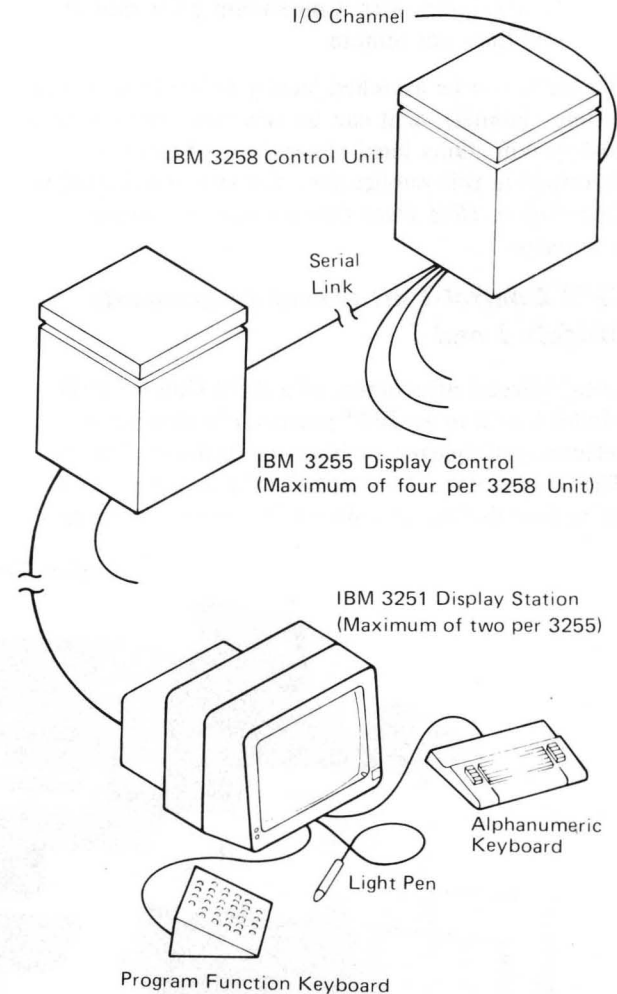

Figure 13-4. Simplified Configuration of a 3250 System

3270 Information Display System

The 3270 Information Display System (Figure 13-5) is composed of units and features selected from a family of display products. A combination of products can be selected and tailored to meet the needs of most alphanumeric and graphic display applications.

The highlights of the 3270 follow.

System Configuration

The 3270 Information Display System has configuration flexibility. It consists of a control unit and a cluster of up to 32 units, which can include:

- Display stations, whose display capabilities vary from 480 to 3564 characters
- Two types of printers:
 - Matrix printers with a maximum print rate of 120 characters per second
 - Line printers with a maximum print rate of 400 lines per minute

The 3270 can be attached locally (directly to a host system channel), or it can be attached remotely to a host system. Only local channel attachment is described in this publication. Remote attachment is described in *IBM Data Communication Device Summary*.

3272 Control Unit (Local Attachment) Models 1 and 2

Local (direct) attachment of a 3272 Control Unit Model 1 or 2 to an IBM processor is through a selector, multiplexer, or block multiplexer channel. The 3272 Control Unit permits the attachment of up to four devices at a data transfer rate of up to

650,000 characters per second. With special features installed, it can control the operation of up to 32 attached units.

Model 1 has a 480-character buffer capacity; Model 2 has a 1920-character buffer capacity.

3274 Control Unit Models 1A, 1B, and 1D

The 3274 cluster control unit can control up to 32 display stations and printers. Three models supply local channel attachment:

- Model 1A attaches to the processor through a selector, multiplexer, or block multiplexer channel for local (SNA version) mode of operation.
- Models 1B and 1D attach to the processor through a selector, multiplexer, or block multiplexer channel for local 3272 version (non-SNA) mode of operation.

Customized System Diskette: As part of the 3274 installation procedure, a customized system diskette is generated. The generation process is done by the customer at installation time by inserting diskettes in the 3274 and keying in system configuration parameters at a 3278 or 3279 display station attached to the 3274. The customized system diskette can be duplicated, or it can be regenerated to reflect configuration data that is changed.

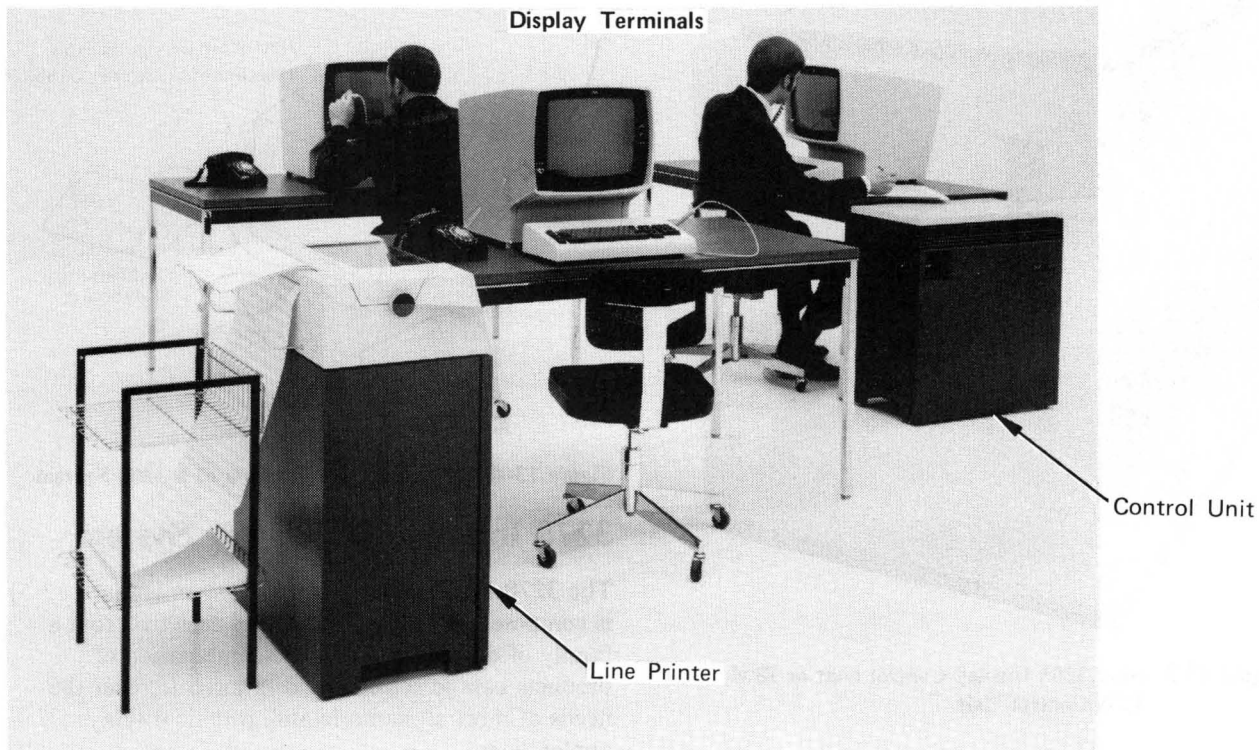

Figure 13-5. IBM 3270 Information Display System—Line Printer, Display Terminals, and Control Unit

Types of Terminal Adapters: Terminals that can attach to the 3274 are attached to two types of terminal adapters: Type A and Type B. The Type A adapter can attach Category A terminals, and the Type B can attach Category B terminals, as follows:

- Category A Terminals: 3278 Display Stations, 3279 Color Display Stations, 3287 Printer, and 3289 Line Printers
- Category B Terminals: 3277 Display Stations, 3284 Printers, 3286 Printers, 3287 Printers, and 3288 Line Printers

3277 Display Station Models 1 and 2

The 3277 Display Station is a cathode-ray tube display station used in clusters with a control unit for displaying alphanumeric data, and for entering and retrieving data. This display station (Figure 13-6) can display up to 1920 characters per screen display. The 3277 attaches up to 610 m (2000 ft) cable length from the control unit.

Models 1 and 2 have the following characteristics:

- Model 1 displays 480 characters and attaches to a 3272 Control Unit (all models) or to a 3274 Control Unit (all models) with a Type B terminal adapter installed.
- Model 2 displays 1920 characters and attaches to a 3272 Control Unit Model 2, or to a 3274 Control Unit (all models) with a Type B terminal adapter installed.

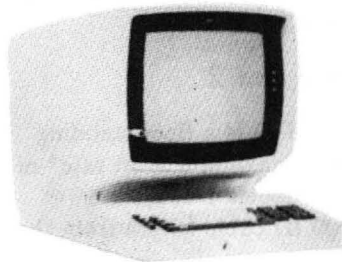

Figure 13-6. IBM 3277 Display Station Model 2

3278 Display Station Models 1 through 5

The 3278 Display Station (Figure 13-7) displays up to 3564 characters per screen display. An operator information area is supplied at the bottom of the screen, in which operator messages can be displayed

to indicate certain conditions. The 3278 attaches up to 1500 m (4920 ft) cable length from the 3272 or 3274 Control Units.

The 3278 has five models:

- Model 1 displays 960 characters (12 lines of 80 characters).
- Model 2 displays 1920 characters (24 lines of 80 characters).
- Model 3 displays 2560 characters (32 lines of 80 characters)
- Model 4 displays 3440 characters (43 lines of 80 characters).
- Model 5 displays 3564 characters (27 lines of 132 characters).

When it operates in 3277-compatible format, the 3278 Model 1 displays 480 characters (40 characters per line), and Models 2, 3, 4, and 5 display 1920 characters (80 characters per line).

Control Unit Attachment: Only Models 1, 2, 3, and 4 can attach to Type A terminal adapters on all models of the 3274 Control Unit. Model 5 can attach only to Type A terminal adapters on the 3274 Models 1A and 1D.

Programmed Symbols (PS): The 3278 (except Models 1 and 5), when attached to a 3274 Model 1A or 1D with Configuration Support C, can support programmed symbols (PS) and graphics.

Extended Highlighting: The 3278, when attached to a 3274 Model 1A or 1D with Configuration Support C, can support extended highlighting (underscore, blink, and reverse video).

Switch Control Unit: The 3278 can be equipped with the switch control unit feature, which permits changing the display station between two control units.

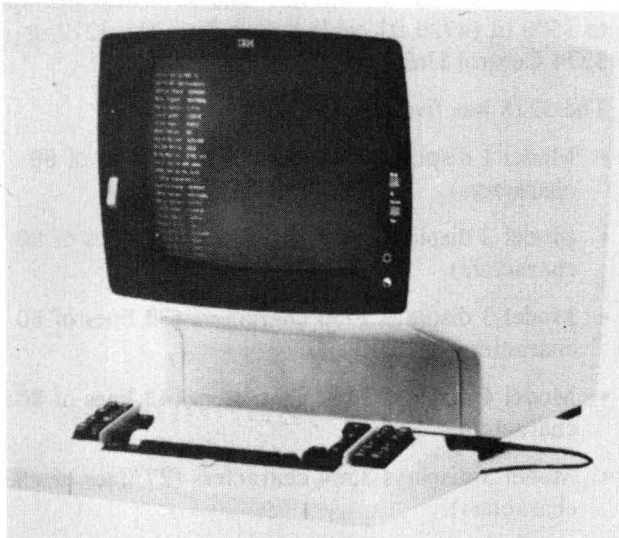

Figure 13-7. IBM 3278 Display Station

3279 Color Display Station Models 2A, 2B, 3A, and 3B

The 3279 Color Display Station (Figure 13-8) displays up to 2560 characters per screen display. An operator information area is supplied at the bottom of the screen, in which operator messages can be displayed to indicate certain conditions.

The 3279 is available in four models:

- Models 2A and 2B display 1920 characters (24 lines of 80 characters).
- Models 3A and 3B display 2560 characters (32 lines of 80 characters).

When it operates in 3277-compatible format, the 3279 displays 1920 characters (80 characters per line).

Switch Control Unit: The 3279 can be equipped with the switch control unit feature, which permits the display station to be controlled by either of two control units.

Control Unit Attachment: The 3279 attaches to the 3274 Control Unit Models 1A, 1B, and 1D for base color (four-color on a field basis) operation. It attaches up to 1500 m (4920 ft) cable length from the 3274. The 3279 Models 2B and 3B, when attached to a 3274 Model 1A or 1D with Configuration Support C, can support the following:

- Extended color (seven-color on a character or field basis) operation
- Extended highlighting (underscore, blink, and reverse video)
- Programmed symbols (PS) and graphics

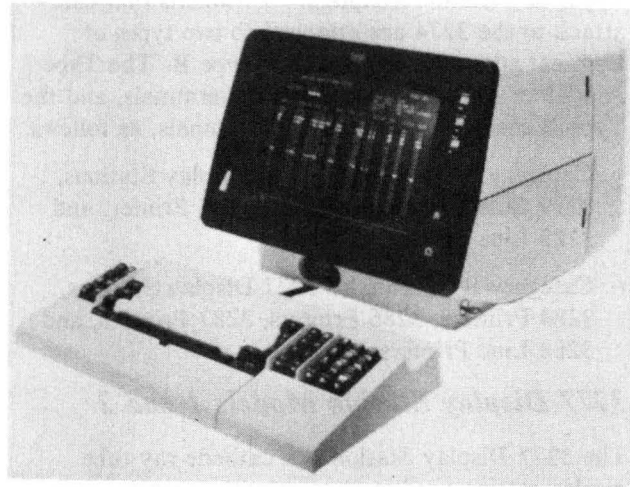

Figure 13-8. IBM 3279 Color Display Station

3284 Printer Models 1 and 2

The 3284 Printer (Figure 13-9) is a floor-standing matrix printer with a maximum print rate* of 40 characters per second. Models 1 and 2 can attach up to 610 m (2000 ft) cable length from the control unit.

Models 1 and 2 have the following characteristics:

- Model 1 has a 480-character buffer capacity and attaches to a 3272 Control Unit (all models) or to a 3274 Control Unit (all models) with a Type B terminal adapter installed.
- Model 2 has a 1920-character buffer capacity and attaches to a 3272 Control Unit Model 2 or to a 3274 Control Unit (all models) with a Type B terminal adapter installed.

3286 Printer Models 1 and 2

The 3286 Printer (Figure 13-9) is a floor-standing serial matrix printer with a maximum print rate* of 66 characters per second. Models 1 and 2 can attach up to 610 m (2,000 ft) cable length from the control unit.

Models 1 and 2 have the following characteristics:

- Model 1 has a 480-character buffer capacity and attaches to a 3272 Control Unit (all models) or to a 3274 Control Unit (all models) with a Type B terminal adapter.

*Actual printer throughput varies with the operational and system characteristics. Factors such as control-unit configuration, line-transmission rate, output format, buffer sizes, character set, and program-application processing must be considered in determining throughput.

- Model 2 has a 1920-character buffer capacity and attaches to a 3272 Control Unit Model 2 or to a 3274 Control Unit (all models) with a Type B terminal adapter installed.

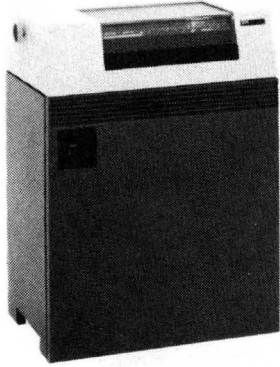

Figure 13-9. IBM 3284 Models 1 and 2 or IBM 3286 Printer Models 1 and 2

3287 Printer Models 1, 1C, 2, and 2C

The 3287 Printer (Figure 13-10) is a table-top matrix printer with bidirectional printing capability.

The four models indicate the print rate* and color capabilities, as follows:

- Model 1 has a maximum print rate of 80 characters per second and prints in monochrome mode.
- Model 2 has a maximum print rate of 120 characters per second and prints in monochrome mode.
- Model 1C has a maximum print rate of 80 characters per second when printing in monochrome mode. It can also print in four-color mode.
- Model 2C has a maximum print rate of 120 characters per second when printing in monochrome mode. It can also print in four-color mode.

Models 1, 1C, 2, and 2C have a 1968-character buffer capacity. An additional 2048 bytes of buffer is available for printouts of 2560, 3440, or 3564 characters.

Printed Output in Four-Color Mode: The throughput of the 3287 Models 1C and 2C may be reduced when they print in color mode, because the print head must make a separate pass for each color used on a given line. Character positions 1 through 120 can print in four-color or monochrome mode; character positions 121 through 132 can print only in black.

Control Unit Attachment: The 3287 attaches to either the 3272 or 3274 Control Unit. It attaches up to 1500 m (4920 ft) cable length from the 3274 Type A terminal adapter, or up to 610 m (2000 ft) cable length from the 3272 Control Unit or 3274 Type B terminal adapter, as follows:

- The 3287 Models 1 and 2 attach to either a Type A or Type B terminal adapter on the 3274 Control Unit, based upon the 3287 attachment feature selected. The 3287 Models 1C and 2C attach only to a Type A terminal adapter.
- The 3287, when attached to a 3274 Model 1A or 1D with Configuration Support C, supports extended highlighting (underscore only) and programmed symbols (PS) and graphics.
Note: The application used may also reduce the throughput of the 3287 when the 3287 prints using PS.
- The 3287 Models 1C and 2C, when attached to a 3274 Model 1A or 1D with Configuration Support C, supports four-color mode printing on a character or field basis.

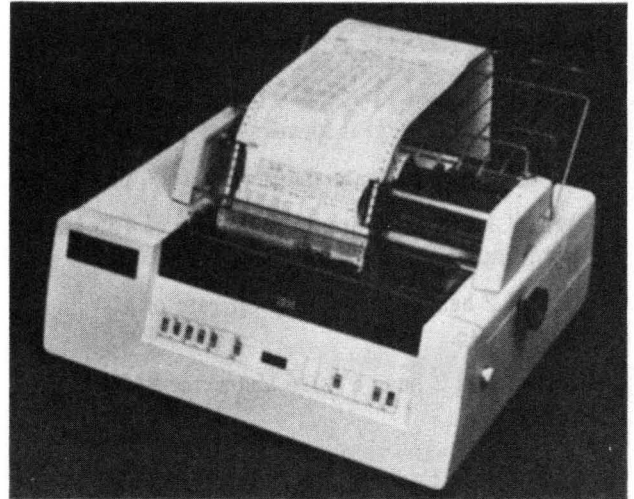

Figure 13-10. IBM 3287 Printer

3288 Line Printer Model 2

The 3288 Line Printer (Figure 13-11) is a floor-standing line printer with a maximum print rate* of 120 lines per minute. The print rate is up to 80 lines per minute when the text print feature is installed.

*Actual printer throughput varies with the operational and system characteristics. Factors such as control-unit configuration, line-transmission rate, output format, buffer sizes, character set, and program-application processing must be considered in determining throughput.

Control Unit Attachment: The 3288 Model 2 has a 1920-character buffer capacity and attaches to a 3272 Control Unit Model 2 or to a 3274 Control Unit (all models) with a Type B terminal adapter installed. It attaches up to 610 m (2000 ft) cable length from the control unit.

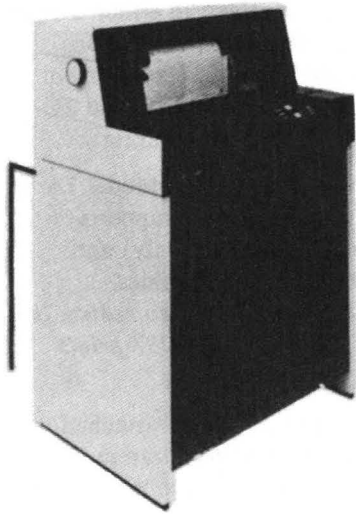

Figure 13-11. IBM 3288 Line Printer Model 2

3289 Line Printer Models 1 and 2

The 3289 (Figure 13-12) is a floor-standing line printer with an integral forms stand/stacker.

The two models indicate the print rates*, as follows:

- Model 1 has a maximum print rate of 155 lines per minute.
- Model 2 has a maximum print rate of 400 lines per minute.

Models 1 and 2 have a 4016-character buffer capacity.

Control Unit Attachment: The 3289 attaches to the 3274 Control Unit (Type A terminal adapter only). It attaches up to 1500 m (4920 ft) cable length from the 3274.



Figure 13-12. IBM 3289 Line Printer

Special Features

The following features can be ordered through the IBM sales representative to expand or customize the user's operation. The list of features may not be complete and more may be available. For more information about features, see the IBM sales representative.

APL and Text

The APL and text feature is available to the 3278 Display Station Models 1 through 5; to the 3279 Color Display Station Models 2B and 3B; and to the 3278 Printer Models 1 and 2 when they are attached to the 3274 Control Unit Models 1A and 1D.

Color Display

The color display feature supports the 3279 Color Display Station and the 3287 Printer Models 1C and 2C.

Data Analysis—APL Feature

The data analysis—APL feature supplies the user with an interactive APL or text capability.

Data Security Features

Data security features, such as security keylock and operator identification card reader or magnetic slot reader, permit the entering of data from badges, ID cards, and other magnetic striped plastic cards.

*Actual printer throughput varies with the operational and system characteristics. Factors such as control-unit configuration, line-transmission rate, output format, buffer sizes, character set, and program-application processing must be considered in determining throughput.

Extended Highlighting

The extended highlighting feature (underscore, blink, and reverse video) is available to the 3278 Display Station and to the 3279 Color Display Station.

Keyboards

Typewriter, data entry, APL, text, attribute select, overlay, and operator console keyboards are available.

Magnetic Slot Reader and Magnetic Hand Scanner

The magnetic slot reader and magnetic hand scanner features permit the entry of magnetically encoded data into the system.

Programmed Symbols (PS) and Graphic

The programmed symbols (PS) and graphic features are available to the 3278 Display Station (except Models 1 and 5); to the 3279 Color Display Station; and to the 3287 Printer. The programmed symbols feature permits the customer to define, store, have access to, display, and print symbols and special characters.

Selector Light Pen

The selector light pen feature supplies a hand-held, pen-like device that permits an operator of a display station to select fields of data from the display screen for input to the host system.

For details about configurations and features, see Chapter 2 of *IBM 3270 Information Display System Configurator*.

3730 Distributed Office Communication System

The 3730 Distributed Office Communication System is a distributed text processing system built around the 3791 Controller Models 11C, 12A, or 12B. The system supplies functions for document creation, editing, storage, retrieval, and printing. It can operate as a stand-alone system, as a host-attached system, or as a concurrent 3730-3790 system. The concurrent 3730-3790 system can operate as a stand-alone unit or attached to a host system.

The major components of the 3730 follow.

3732 Text Display Station

The 3732 Text Display Station (Figure 13-13) includes a 1920-character display and special feature keyboard. The display is a 15-inch (diagonal) cathode-ray tube that supplies 24 lines of 80 characters each. The top and bottom lines are reserved for system use, which leaves 22 lines available for text entry. The keyboard contains a central text-entry section that is similar in layout to a typewriter keyboard. In addition, the keyboard contains 29 function and control keys.

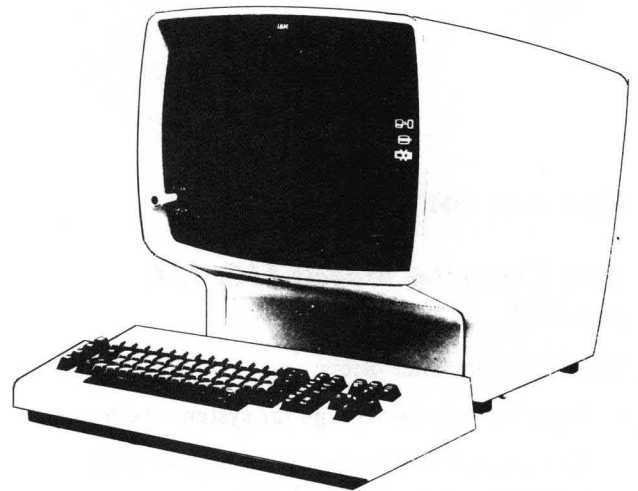

Figure 13-13. IBM 3732 Text Display Station

3736 Printer

The 3736 Printer (Figure 13-14) is a bidirectional, serial-impact printer that prints on single sheets (cut forms) or on continuous forms. It has the following characteristics:

- Printing of up to 55 characters per second
- Printing at 6 lines per inch (when using single-line spacing)
- Interchangeable 96-character print wheels, with four available type styles



Figure 13-14. IBM 3736 Printer

3791 Controller Models 11C, 12A, and 12B

The 3791 Controller offers:

- Logic and control storage for system operation
- Nonremovable disks for the storage of 3730 documents, programs, and data
- Facilities for using removable diskettes for initial installation, document archiving, and backup applications
- A line printer as a special feature (Figure 13-15)

The 3791 can be connected in one of two ways to a host system:

- Directly (locally), using a 3791 local channel attachment feature on a byte or block multiplexer channel.
- Remotely, using the 3791 SDLC communications feature on a 3704 or 3705 Communications Controller, or a communication adapter on a 4331 Processor. Communication can be over switched or nonswitched lines at up to 9600 bits per second.

Line Printer: The line printer, a special feature on the 3791, prints on continuous forms with a spacing of 6 lines per inch. Printing speeds are shown in Figure 13-18.

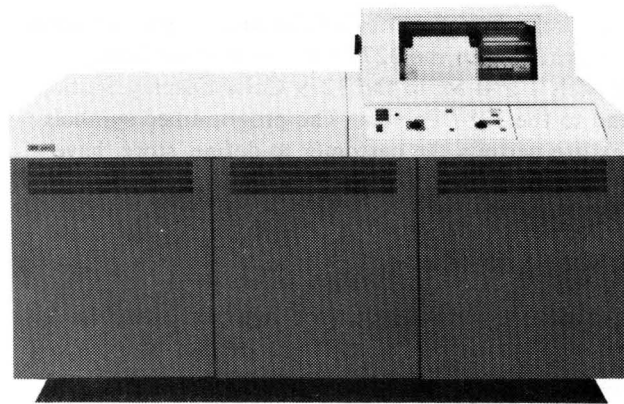

Figure 13-15. IBM 3791 Controller with Line Printer Feature

3790 Communication System

The 3790 Communication System (Figure 13-16) is an operator-oriented system that consists of a 3791 Controller and its attached operator stations and

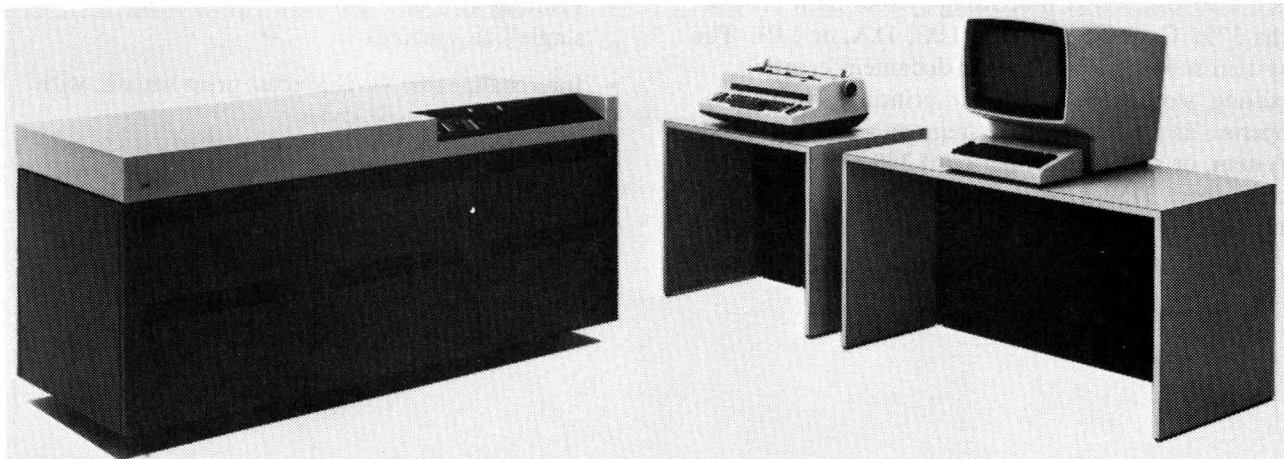

Figure 13-16. IBM 3790 Communication System

auxiliary control units. The operator stations can be keyboard-printers, keyboard-displays, or a combination of these devices.

Following is a description of the 3790 system units.

3791 Controller Models 1C, 2A, and 2B

The 3791 Controller (Figure 13-15), equipped with the local channel attachment, attaches directly to a host system's byte multiplexer or block multiplexer channel. The 3790 system performs functions specified by programs that are sent to the 3791 Controller from the host system. These programs permit the 3790 to operate without supervision from, or interaction with, the host system, except when data or programs are exchanged between systems. The controller contains:

- Control storage for supporting features, functions, and operator stations.
- Diskette storage for packed transmission data and for backup of application data sets.
- Disk storage for 3790 programs, transaction records, and application data sets. Based on the model, the 3791 can have 3.9 to 26.9 million bytes of storage.

The 3791 Controller has either a local or a remote attachment to a host system and can have two special features:

- One line printer with 80 or 132 print positions and speeds of 155 or 410 lines per minute (see Figure 13-18)
- One 3411 Magnetic Tape Unit Model 1, to which no other units can be attached

3792 Auxiliary Control Unit

The 3792 Auxiliary Control Unit (Figure 13-17), which can be placed up to 610 m (2,000 ft) from the 3791 Controller, adds operator stations in the system (some of which can be remote from the 3790 site) and offers:

- The capability for attaching up to four 3793 Keyboard-Printers
- A line printer as a special feature
- Special features for communicating with 2741 Communications Terminals
- A security keylock special feature that controls power to the 3792

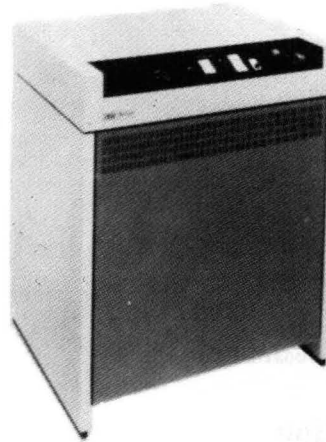

Figure 13-17. IBM 3792 Auxiliary Control Unit

Attachment Available On	Print Positions	Speed (lines per minute)	Characters in the Set
3791, 3792	80* or 132*	155	48
	80* or 132*	120	64
	80* or 132**	80	96
3791	80* or 132*	40	128
	132***	410	48
	132***	300	64
	132***	230	96
	132***	160	128

* Line Printer - 80 print positions (155 lpm) special feature
 ** Line Printer - 132 print positions (155 lpm) special feature
 ***Line Printer - 132 print positions (410 lpm) special feature

Figure 13-18. Print Rates of the Line Printer Attachment to the 3791 and 3792

3793 Keyboard-Printer

The 3793 Keyboard-Printer (Figure 13-19) is a data-entry operator station that can be attached to the 3791 or to the 3792 to supply printed output. The 3793 is similar in outward appearance to a Selectric typewriter. The 3793 has a friction-feed platen, with a pin-feed platen available as a special feature. The maximum print line is 130 print positions at 10 characters per inch; spacing is 6 lines per inch.

The 3793 keyboard is similar to a normal office typewriter keyboard and includes control keys, operator guidance indicators, and system indicators. Also included on the keyboard is a 10-key arrangement of dual-function keys that can be used for entering numeric data. A special feature supplies a power-line keylock for security.



Figure 13-19. IBM 3793 Keyboard-Printer

3790 Communication System—Miscellaneous Equipment

The following equipment can attach to the 3790 through the 3791 Controller or the 3792 Auxiliary Control Unit.

2741 Communication Terminal

The 2741 Communication Terminal (Figure 13-20) is a Selectric typewriter terminal that satisfies special system applications in which one-terminal-per-line operations are needed.



Figure 13-20. IBM 2741 Communication Terminal

3277 Display Station Models 1 and 2

The 3277 Display Station attaches to the 3791 to supply a CRT display and a 63-character set keyboard. See “3277 Display Station Models 1 and 2” in Chapter 5 for more information.

3284 Printer Models 1 and 2

Models 1 and 2 of the 3284 Printer attach to the 3791 to obtain hard-copy output at 6 lines per inch on continuous fanfold paper.

See “3270 Information Display System” earlier in this chapter for more information on the 3284.

3286 Printer Models 1 and 2

Models 1 and 2 of the 3286 Printer (Figure 13-9) attach to the 3791 to obtain hard-copy output at 6 lines per inch on continuous fanfold paper.

See “3270 Information Display System” for more information.

3288 Line Printer Model 2

Model 2 of the 3288 Line Printer (Figure 13-11) attaches to the 3791 to obtain hard-copy output at 6 lines per inch on continuous fanfold paper.

See “3270 Information Display System” for more information.

3790 Communication System/Data Entry Configuration

The 3790 Communication System/Data Entry Configuration is designed for production keying of transcriptive data using the 3760 Key Entry Station, and for payment-transaction processing using the 3762 Payment Transaction Processor. It cannot be used with any other 3790 configuration.

The 3760 and 3762 stations, described below, attach to the 3791 Controller Model 1C, 2A, or 2B.

3760 Key Entry Station Models 1, 2, and 3

The 3760 Key Entry Station (Figure 13-21) has a keyboard and a display panel for each operator station. Any task that does not need document processing can be done on a 3760 as well as on a 3762 station. The 3760 has three models:

- Model 1 has two keyboards, two displays, a direct connection to a power source, and a cable connection to the 3791 Controller.
- Model 2 has two keyboards, two displays, and must be attached to a Model 1 for power and control. Up to two Model 2s can attach to a Model 1.
- Model 3 has one keyboard, one display, a direct connection to the power source, and cable connections to up to four 3791 Controllers. When a Model 3 is attached to more than one controller, only one connection can be used at a time.



Figure 13-21. IBM 3760 Key Entry Station

3762 Payment Transaction Processor

The 3762 Payment Transaction Processor (Figure 13-22) consists of two operating stations housed in a single physical unit. Each station includes a keyboard, a document entry slot, a display panel, two document pockets, a document path, and optionally, a journal tape print device. Each document path includes an optical-character recognition reader and can optionally include an inscriber, audit trail printer, and endorser. The 3762 has a direct connection to a power source and a cable connection to the 3791 Controller.

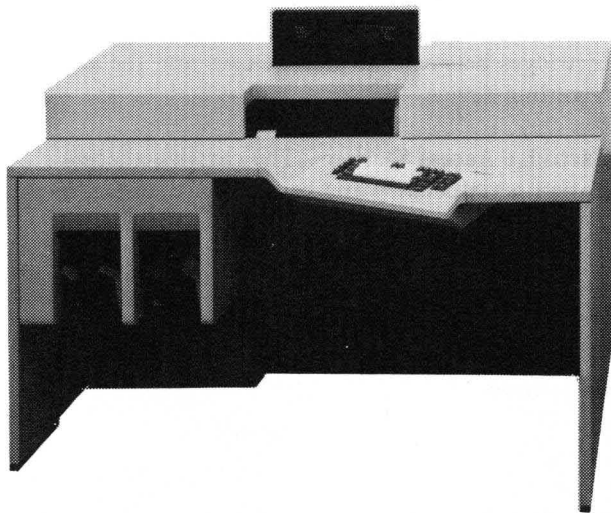

Figure 13-22. IBM 3762 Payment Transaction Processor

Restrictions

The maximum number of units that can be attached to a 3791 Controller is specified by the controller's eight ports. One cable can be attached to each of these ports. Therefore, the maximum number of 3762s or, in a combined system of 3762s, 3760 Model 1's, and 3760 Model 3s that can be attached is eight (16 operator positions or 15, if one 3760

Model 3 is included). To expand the number of operator stations in a combined system, 3760 Model 2s can be attached to the 3760 Model 1's (up to a maximum of 24 operator positions).

3850 Mass Storage System

The 3850 Mass Storage System (Figure 13-23) gives low-cost mass storage for as many as 472,000 million bytes of data under the control of a virtual-storage IBM processor. Direct-access device utilization is improved because only active data occupies direct-access device space. The 3850 combines many of the advantages of tape and disk systems.

The highlights of the 3850 follow.

Models

The 3851 Mass Storage Facility has 20 models. They differ in the number of mass storage controls, data recording devices, data recording controls, and cartridge cells they contain, as shown in Figure 13-24.

The smallest model contains a cartridge entry frame that consists of one cartridge access station, two data recording devices, one data recording control, and 706 cartridge cells. Larger models, in addition to the cartridge entry frame, can have up to three extension frames. Extension frames supply additional data recording devices, data recording controls, and cartridge cells. A *storage* extension frame contains 1338 cartridge cells; a *data* extension frame contains 1338 cartridge cells, two data recording devices, and one data recording control.

The first character of the model designation specifies the number of mass storage controls: A for one mass storage control and B for two. The second character (0, 1, 2, or 3) specifies the number of storage extension frames, and the third character (1, 2, 3, or 4) specifies the combination of cartridge entry frames and data extension frames. The sum of the second and third characters cannot exceed 4.

Either one or two Model-A Mass Storage Facilities, or one Model-B Mass Storage Facility, can be attached to a System/370 to become a part of the Mass Storage System. Two Model A's may be configured to permit a capacity of up to 472,000 million bytes.

Operation

Data under control of the 3850 Mass Storage System is stored on data cartridges. When data is

requested, it is moved online from the cartridges to direct access storage devices (DASD) in a process called staging. After data has been staged, the processor has access to it as if it were on a 3330-type DASD. After the data is no longer needed and if it has been modified, it will be moved back onto the data cartridge in a process called destaging.

Attachment to a Processor

Each mass storage control in the 3851 Mass Storage Facility attaches to a control unit position on a processor's byte or block multiplexer channel.

The following are the logical units of the Mass Storage System (Figure 13-25).

3851 Mass Storage Facility

The 3851 Mass Storage Facility supplies the large capacity storage and control facility for attachment to a virtual-storage IBM processor. A description of Mass Storage Facility functional units follow.

Mass Storage Control: The mass storage control coordinates the operation of the 3850 Mass Storage System, which includes the following:

- Accepting requests for data from the processor
- Maintaining an inventory of data cartridges stored in the 3851 to determine the location of data needed
- Allocating space on DASD for data to be staged
- Allocating a data recording device

- Instructing the accessor to move the data cartridge from its cell to the data recording device
- Initiating and monitoring the staging operation
- Performing error recovery procedures that include alternate-path-retry operation and device reallocation for the staging operation
- Performing the destaging operation when the data is no longer needed

Storage Cells for Data Cartridges: A mass storage volume has two data cartridges. Data cartridges reside in cartridge storage cells. Because all cartridges under control of the mass storage control are physically resident in the 3851 Mass Storage Facility, the amount of floor space needed for storage is greatly reduced.

Data Recording Devices and their Associated Data

Recording Controls: Each cartridge can store approximately 50.2 million bytes of data. Two cartridges equal the capacity of one 3336 Disk Pack Model 1. Data is written on and read from the cartridge by a data recording device and its associated data recording control.

Accessors and Accessor Controls: Two accessors and their associated accessor controls move the data cartridges between the storage cells and the data recording device.

Cartridge Access Station: The cartridge access station permits entry and removal of data cartridges.

3851 Mass Storage Facility
Models A1, B1

System/370 Model 158

3330 Disk Storage

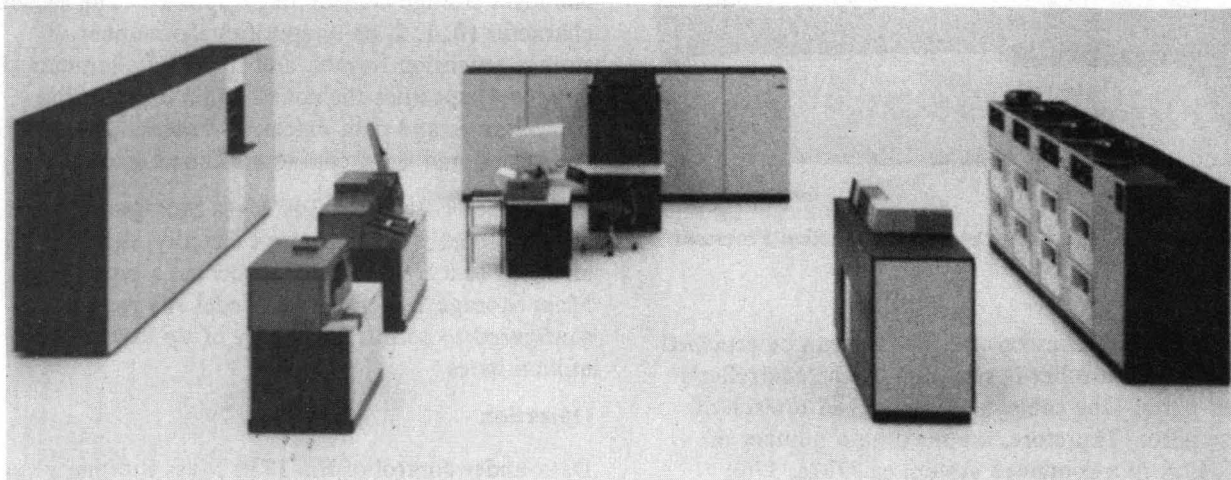

Figure 13-23. IBM 3850 Mass Storage System with 3851 Mass Storage Facility, System/370 Model 158, and 3330 Disk Storage

Mass Storage Facility Models*	Number of Data Recording Devices	Number of Data Recording Controls	Maximum Number of Cartridges**	Maximum Usable Capacity (10 ⁹ Bytes)
A01, B01	2	1	706	35.3
A02, B02	4	2	2044	102.2
A03, B03	6	3	3382	169.1
A04, B04	8	4	4720	236.0
A11, B11	2	1	2044	102.2
A12, B12	4	2	3382	169.1
A13, B13	6	3	4720	236.0
A21, B21	2	1	3382	169.1
A22, B22	4	2	4720	236.0
A31, B31	2	1	4720	236.0
<p>*Model A's contain one mass storage control, Model B's contain two.</p> <p>**This is the maximum number of cartridges, cells, or both in each Mass Storage Facility. Of this number, however, nine cartridge cells are reserved in each model: six for FE maintenance, two for misplaced cartridges, and one for the accessor.</p>				

Figure 13-24. Characteristics of the IBM 3851 Mass Storage Facility Models

Staging Adapter

The staging adapter performs all the staging and destaging operations, and permits the processor to access the staged data. The staging adapter can be either a 3830 Storage Control Model 3 or an Integrated Storage Control with the Staging Adapter (ISCSA) feature on a System/370 Model

158 or 168. Data is normally staged to 3330 or 3333 disk units. The 3350 staging feature is available on a 3830 Model 3 to permit staging data to 3350 disk units. With this feature installed, only 3350 disk units can be attached to that 3830. This feature is not available on an integrated storage control.

Direct Access Storage Devices

The direct access storage device (DASD) portion of the Mass Storage System has either 3333 Disk Storage and Controls Model 1 or 11 and 3330 Disk Storage Model 1, 2, or 11, or 3350 Direct Access Storage Models A2, A2F, B2, B2F, C2, or C2f units. The 3330/3333 and 3350 storage units make data available to an IBM processor for processing.

Disk Storage Configuration

The 3330 and 3350 Disk Storage series configuration varies with the 3851 configuration. A maximum of thirty-two 3330 drives can be attached to a 3830 Model 3 or to each path of the integrated storage controls of processors with the staging adapter feature. For 3330 Models 1 and 2, sixteen of these drives can be used as staging drives for the Mass Storage System. The additional disk drives are used for standard DASD operations. For 3330 Model 11, a maximum of eight drives can be used as staging drives. 3350 drives used for staging are configured the same as 3330 Model 11 drives but cannot be connected to the ISCSA. Access to the 3350 drives is in 3330 Model 11 mode.

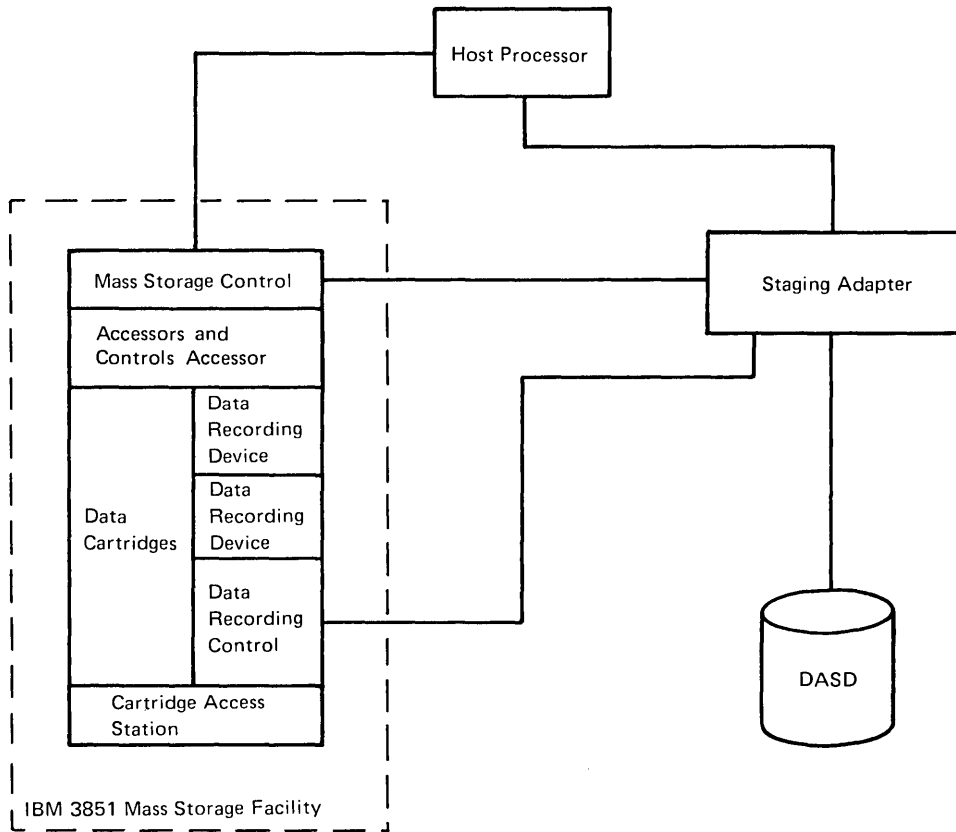

Figure 13-25. Logical Units of the Mass Storage System

Appendix A. I/O Attachment Data

IBM input/output (I/O) devices and systems for local operation with IBM processors operate through one control unit position (two are needed for the 3851 Mass Storage Facility Model Bs on an IBM channel, or through an integrated adapter on the processor. The control unit function can be part of the I/O device, part of the system, part of the integrated adapter on the processor, or a physically separate device.

Figure A-1 lists the I/O devices and systems and their method of attachment arranged by category. For further information about their attachment capabilities to IBM processors, see the input/output configurator for a specific processor.

I/O Device, Control Unit, or System	Model	Means of Attachment to Channel or Adapter	
Audio Communication Devices	7770 Audio Response Unit*	3	Direct
Auxiliary Processors	3838 Array Processor	1 through 3	Direct
Direct Access Storage Devices and Control Units	2305 Fixed Head Storage	2	2835 Model 2
	2835 Storage Control	2	Direct
	3310 Direct Access Storage	A1, A2	Direct
		B1, B2	3310 Model A2
	3330 Disk Storage	1, 2	3333 Models 1 and 11
		11	3333 Models 1 and 11
	3333 Disk Storage and Control	1	Direct 3830 Model 2 3830 Model 3 3880
		11	Direct 3830 Model 2 3830 Model 3 3880
	3340 Direct Access Storage Facility	A2	Direct 3830 Model 2 3880
		B1, B2	3340 Model A2
	3344 Direct Access Storage	B2, B2F	3340 Model A2
	3350 Direct Access Storage	A2, A2F	Direct 3830 Model 2 3830 Model 3 3880
		B2, B2F C2, C2F	3350 Model A2 3350 Model A2F
	3370 Direct Access Storage	A1	Direct 3880
B1		3370 Model A1	
3830 Storage Control	2, 3	Direct	
3880 Storage Control	1	Direct	
Diskette Input/Output Devices	3540 Diskette Input/Output Unit	B1, B2	Direct

*For attachment to a channel for operation with one or more attached inquiry terminals.

Figure A-1 (Part 1 of 3). Attachment Data for Local I/O Equipment

I/O Device, Control Unit, or System	Model	Means of Attachment to Channel or Adapter
Display Devices and Control Units	3251 Display Station	1 3255 Model 1 3258 Model 1
	3255 Display Control	1 3258 Model 1
	3258 Control Unit	1 Direct
	3272 Control Unit	1, 2 Direct
	3277 Display Station	1, 2 3272 Models 1 and 2
	3279 Color Display Station	2A, 2B, 3A, 3B 3274 Models 1A, 1B, and 1D
	3732 Text Display Station	N/A Direct
	8775 Display Terminal	1, 2 Direct or Data Link
11, 12 Data Link		
Magnetic Character Reading Devices	1255 Magnetic Character Reader	1 through 3 Direct
	1419 Magnetic Character Reader	1 through 5 Direct
	3890 Document Processor	A1 through B6 Direct
Magnetic Tape Devices and Control Units	3410 Magnetic Tape Unit	1 through 3 3411 Models 1 through 3
	3411 Magnetic Tape and Control	1 through 3 Direct
	3420 Magnetic Tape Unit	3, 5 3803 Models 1 through 3
		7 3803 Models 1 and 2
		4, 6, 8 3803 Model 2
	3803 Tape Control	1 through 3 Direct
8809 Magnetic Tape Unit	1A, 1B, 2, 3 8809 Models 1A and 1B	
Optical Readers	1287 Optical Reader	1 through 4 Direct
		5 Direct
	1288 Optical Page Reader	1 Direct
	3881 Optical Mark Reader	1 Direct
	3886 Optical Character Reader	1 Direct
Printer-Keyboards and Consoles	3215 Console Printer-Keyboard	1 Direct
Printer and Control Units	1403 Printer	2, 7, N1 2821 Models 1, 2, 3, and 5 Direct
	1443 Printer	N1 Direct
	2821 Control Unit	1, 2, 3, 5, and 6 Direct
	3203 Printer	1, 2, 4 Direct
	3211 Printer	1 3811 Model 1
	3213 Console Printer	1 Direct
	3262 Line Printer	1, 11 Direct
		2, 12 System Loop
		3, 13 3274 Models 1A, 1B, and 1D
	3284 Printer	1, 2 3272 Models 1 and 2
	3286 Printer	1, 2 3272 Models 1 and 2
	3287 Printer	1, 2 Direct
	3288 Line Printer	2 3272 Model 2
	3736 Printer	N/A Direct
	3800 Printing Subsystem	1 Direct
	3811 Printer Control Unit	1 Direct
	5203 Printer	3 Direct
5213 Printer	1 Direct	

Figure A-1 (Part 2 of 3). Attachment Data for Local I/O Equipment

I/O Device, Control Unit, or System	Model	Means of Attachment to Channel or Adapter	
Punched Card Devices	1442 Card Read Punch	N1, N2	Direct
	2501 Card Reader	B1, B2	Direct
	2520 Card Read Punch	B1	Direct
	2520 Card Punch	B2, B3	Direct
	2540 Card Read Punch	1	2821 Models 1, 5, and 6
	2560 Multi-Function Card Machine	A1	Direct
		A2	Direct
	3504 Card Reader	A1, A2	Direct
	3505 Card Reader	B1, B2	Direct
	3525 Card Punch	P1 through P3	3505 Models B1 and B2 Direct
5425 Multi-Function Card Unit	A1, A2	Direct	
Punched Tape Devices and Control Units	2671 Paper Tape Reader	1	2822 Model 1
	2822 Paper Tape Reader Control	1	Direct
Systems	3250 Graphics Display System	N/A	3258
	3270 Information Display System	N/A	3272 Models 1 and 2
	3272 Control Unit	1, 2	Direct
	3730 Distributed Office Communications System	N/A	3791 Models 11C, 12A, and 13B
	3790 Communication System	N/A	3791 Models 1A, 1B, 1C, 2A, and 2B
	3791 Controller	1A, 1B, 1C, 2A, 2B, 11C, 12A, 12B	Direct
		N/A	3851 Models A01, A02, A03, A04, A11, A12, A13, A21, A22, A23, A31, B01, B02, B03, B04, B11, B12, B13, A21, A22, A31
	3851 Mass Storage Facility	A01, A02, A03, A04, A11, A12, A13, A21, A22, A23, A31, B01, B02, B03, B04, B11, B12, B13, B21, B22, B23, B31, B1 through B4	3830 Model 3 Direct

Figure A-1 (Part 3 of 3). Attachment Data for Local I/O Equipment

Glossary and Abbreviations

This glossary includes definitions developed by the American National Standards Institute (ANSI) and the International Organization for Standardization (ISO). This material is reproduced from the *American National Dictionary for Information Processing*, copyright 1977 by the Computer and Business Equipment Manufacturers Association, copies of which may be purchased from the American National Standards Institute, 1430 Broadway, New York, New York 10018. ANSI definitions are preceded by an asterisk (*).

The following terms are defined as they are used in this publication. If you do not find the term you are looking for, see the *IBM Data Processing Glossary*.

A/FE: Americas/Far East.

***alphameric:** Synonym for alphanumeric. Pertaining to a character set that contains letters, digits, and usually other characters, such as punctuation marks.

***BCD:** Binary coded decimal notation.

***Binary coded decimal notation:** (ISO) A binary-coded notation in which each of the decimal digits is represented by a binary numeral, e.g., in binary-coded decimal notation that uses the weights 8-4-2-1, the number "twenty three" is represented by 0010 0011 (compare its representation 10111 in the pure binary numeration system). Synonymous with binary-coded decimal code, binary-coded decimal representation, coded decimal notation.

bits per second: In serial transmission, the instantaneous bit speed with which a device or channel transmits a character.

block multiplexer channel: A multiplexer channel that interleaves blocks of data.

BPI: Bytes per inch.

bps: Bits per second.

***buffer:** A routine or storage used to compensate for a difference in rate of flow of data, or time of occurrence of events, when transferring data from one device to another.

burst mode: A mode in which data is transmitted by means of burst transmission.

byte multiplexer channel: A multiplexer channel that interleaves bytes of data.

***channel:** A path along which signals can be sent, for example, data channel, output channel.

common-use sizes: A set of paper form sizes used on the IBM 3800 Printing Subsystem that have been selected as those most commonly used throughout the world.

***console:** A part of a computer used for communication between the operator or maintenance engineer and the computer.

cpi: Characters per inch.

CRT: Cathode-ray tube.

cryptographic: Pertaining to equipment that transforms data to mask its actual meaning to an unauthorized user.

customer set up products: IBM products such as the 3767 Communication Terminal and 3770 Data Communication System which can be installed by the customer.

DASD: Direct access storage device.

data density: On magnetic tape, the number of bytes per inch.

data mode 1: On 80-column punched card devices, the standard code used is EBCDIC or data mode 1. This code uses eight binary positions for each character format, plus a position for parity checking. 256 characters can be coded, including both uppercase and lowercase alphabetic characters, a wide range or special characters, and many control characters that are meaningful to some input/output devices.

data mode 2: This feature is also known as column binary and card image. It enables the reader to suspend validity checking for column binary data.

data transfer rate (effective): (SCI) In data communication the average number of bits, characters, or blocks per unit time transferred from a data source and accepted as valid by a data link. The data transfer rate is usually expressed in bits, characters, or blocks per second, minute, or hour.

DDA: Direct disk attachment.

diskette: A thin, flexible magnetic disk and a semi-rigid protective jacket, in which the disk is permanently enclosed. Synonymous with flexible disk.

DPCX: Distributed processing control executive.

DPPX: Distributed processing programming executive.

dual density: A feature that permits a program to use a tape unit in either 800 or 1600 bytes per inch recording.

EBCDIC: Extended binary-coded decimal interchange code.

extended binary-coded decimal interchange code: A set of 256 characters, each represented by eight bits.

***form overlay:** Synonym for form flash. (SC1) A projected pattern such as a report form, grid, or map used as background for a display image.

GAM: Graphics access method.

***gangpunch:** To punch identical hole patterns into each punch card of a card deck.

GCR: Group coded recording.

GPS: Graphic programming services.

graphic programming services: In OS/360 and OS/VS, a number of services provided for use in designing and executing programs that communicate with a user at a display station.

graphics access method: A facility that supports IBM display devices through the use of graphic programming services (GPS) and the graphic subroutine package (GSP).

group coded recording: Group coded recording is synonymous with 6250 bits per inch recording. In contrast with phase encoded recording, non-return-to-zero change-on-ones recording.

GSP: Graphic subroutine package.

host system: The data processing system to which a communication system is connected and with which the system can communicate.

IBG: Interblock gap.

IFA: Integrated file adapter.

***input/output:** (ISO) Pertaining to a device or to a channel that may be involved in an input process, and, at a different time, in an output process.

Integrated file adapter: An adapter that permits connection of multiple disk storage devices to a processing unit.

interblock gap: (ISO) The space between two consecutive blocks on a data medium.

ISCSA: Integrated storage control with the staging adapter.

K-byte: Each K-byte equals 1,024 bytes and refers to storage capacity.

***loop:** In data communication, an electrical path connecting a station and a channel.

lpm: Lines per minute.

magnetic character recognition: The character recognition of characters printed with ink that contain particles of a magnetic material. Contrast with optical character recognition.

maintenance device: The maintenance device is a primary maintenance tool for some IBM products. It is programmable, small, and lightweight. It consists of two units, the keyboard display unit and the basic unit, connected to each other by a cable.

MD: Maintenance device.

MICR: (ISO) Magnetic ink character recognition.

microprocessor: A processing unit, or part of a processing unit, that consists of microcode.

MP: Multiprocessor.

MSS: Mass Storage System.

multiplexer channel: A channel designed to operate with a number of I/O devices simultaneously. Several I/O devices can transfer records at the same time by interleaving items of data.

multiprocessor: A system consisting of two or more processing units (or ALUs, or processors) that can communicate without manual intervention.

MVS: Multiple virtual storage. An alternate name for OS/VS2, release 2.

nondestructive cursor: On a CRT display device, a cursor that can be moved within a display surface without changing or destroying the data displayed on the screen.

non-return-to-zero change-on-ones recording: (ISO) Nonreturn-to-reference recording of binary digits such that the ones are represented by a change in the condition of magnetization, and the zeros are represented by the absence of a change. This method is called (mark) recording because only the one or mark signals are explicitly recorded. Synonymous with non-return-to-zero (mark) recording, NRZ(M).

NRZI: Non-return-to-zero change-on-ones recording.

OCR: Optical character recognition.

optical character recognition: (ISO) character recognition that uses optical means to identify graphic characters. Contrast with magnetic ink character recognition.

OS/VS1: A virtual storage operating system that is an extension of the IBM System/360 Operating System that supports multiprogramming with a fixed number of tasks (OS/MFT).

OS/VS2: A virtual storage operating system that is an extension of the IBM System/360 Operating System that supports multiprogramming with a variable number of tasks (OS/MVT).

PE: Phase encoding.

phase encoding: Synonym for phase modulation recording. (ISO) A method of recording on magnetic tape in which each storage cell is divided into two regions which are magnetized in opposite senses; the sequence of these senses indicates whether the binary character represented is zero or one.

read/write head: (ISO) A magnetic head capable of reading and writing.

remote: In data communication, pertaining to devices that are connected to a data processing system through a data link.

***reproduce:** Synonym for duplicate. (ISO) To copy from a source to a destination that has the same physical form as the source, e.g., to punch new punched cards with the same pattern of holes as an original punched card.

rotational delay: In a rotating storage device, the time period between the request and the positioning of the desired record under the read head.

rotational position sensing: A feature that permits a disk storage device to disconnect from a block multiplexer channel (or its equivalent), allowing the channel to service other devices on the channel during positional delay.

SCP: System control programming.

SDLC: Synchronous data link control.

selector channel: An I/O channel designed to operate with only one I/O device at a time. Once the I/O device is selected, a complete record is transferred one byte at a time. Contrast with block multiplexer channel, multiplexer channel.

SNA: Systems network architecture.

summary punch: (ISO) A card punch that may be connected to another device, such as a tabulator, to enter data that was calculated or summarized by the other device.

system control programming: IBM-supplied programming that is fundamental to the operation and maintenance of the system. It serves as an interface with program products and user programs and is available without additional charge.

systems network architecture: The total description of the logical structure, formats, protocols, and operational sequences for transmitting information units through the communication system. Communication system functions are separated into three discrete areas: the application layer, the function management layer, and the transmission subsystem layer. The structure of SNA allows the ultimate origins and destinations of information—that is, the end users—to be independent of, and unaffected by, the specific communication-system services and facilities used for information exchange.

throughput: (ISO) A measure of the amount of work performed by a computer system over a given period of time, for example, jobs per day.

universal character set: A printer feature that permits the use of a variety of character arrays.

using system: In a teleprocessing environment, the remote system that is operating the I/O devices at the remote site.

virtual storage: (ISO) The concept of storage space that may be regarded as addressable main storage by the user of a computer system in which virtual addresses are assigned to real addresses. The size of virtual storage is limited by the addressing scheme of the computing system and by the amount of auxiliary storage available, and not by the actual number of main storage locations.

51-column card: A punch card that has been altered to be equivalent to the 80-column card but includes only column 15 through 65. The remainder of the card is missing.

80-column card: Synonym for Hollerith card. A punch card characterized by 80 columns and 12 rows of punch positions.

96-column card: A punch card characterized by 32 columns and 22 rows. The top four rows are for printing and the other 18 rows are for punching. The punch rows of the card are divided into three strips of 32 columns and 6 rows. It is possible to print 128 characters and to punch 96 positions on a card.

Index

The entries in this index are shown as they appear in the text of the book, that is, capitalized words are capitalized in text, lowercase words are lowercase in text, etc.

attachment data for local I/O equipment A-1
audio communication device 1-1
auxiliary processor 2-1

card print

2560 11-5
3525 11-8
5425 11-9

card punch

1442 11-1,11-2
2520 11-3,11-4
2540 11-4
2560 11-5
3525 11-8
5425 11-9

card read

1442 11-1
2501 11-2
2520 11-3
2540 11-4
2560 11-5
3504 11-6
3505 11-6
5425 11-9

card read punch

1442 11-1
2520 11-3
2540 11-4
2560 11-5
5425 11-9

check sorter

1255 6-1
1419 6-2
3890 6-4

color print 13-7

communication system, 3790 13-10,13-12

console printer 9-1

3215 9-1

control unit

2835 3-1
3255 5-1,13-2
3258 5-1,13-3
3272 5-2,13-4
3274 5-2,13-4
3333 3-6
3411 7-1
3791 13-10,13-11
3792 13-11
3803 7-4
3811 10-12
3830 3-2
3880 3-3

cryptographic unit, 3848 2-2

data cartridge 13-13

data mode 1 11-1

data mode 2 11-2

direct access storage device 3-1

2305 3-5
3310 3-5
3330 3-6
3333 3-6
3340 3-7

3344 3-7

3350 3-8

3370 3-9

disk pack

3336 3-6

3348 3-7

disk storage control

2835 3-1

3830 3-2

3880 3-3

disk storage unit

2305 3-5

3310 3-5

3330 3-6

3333 3-6

3340 3-7

3344 3-7

3350 3-8

3370 3-9

diskette input/output device, 3540 4-1

display control

3255 5-1,13-2

3258 5-1,13-3

3272 5-2,13-4

3274 5-2,13-4

display device

3251 5-1,13-2

3277 5-2,13-5,13-12

3278 5-3,13-5

3279 5-5,13-6

3732 13-9

8775 5-6

display system

3250 13-1

3270 13-3

Distributed Processing Control Executive 5-8

Distributed Processing Programming Executive 5-8

document reader

1255 6-1

1287 8-1

1288 8-2

1419 6-2

3881 8-4

3886 8-5

3890 6-4

document sorter

1255 6-1

1419 6-2

3890 6-4

EBCDIC 11-14

fixed head feature 3-8

fixed head storage, 2305 3-5

font

Farrington Selfchek 7B 8-2

IBM 1428 8-2

NCR Optical 8-2

OCR-A 8-2

Graphic Programming Services 5-2

graphics display system, 3250 13-1

group coded recording 7-3

information display system, 3270 13-3

I/O (input/output), attachment data for local equipment A-1

Katakana 5-2

light pen 5-1,5-2,5-3,5-5,5-6,5-8,13-1

line printer
 1403 10-1
 1443 10-3
 3203 10-4
 3211 10-5
 3262 10-6
 3288 13-5
 3289 13-5
 5203 10-12

magnetic character reader
 1255 6-1
 1419 6-2

magnetic slot reader 5-7

magnetic tape device 7-1

magnetic tape unit
 3410 7-1
 3411 7-1
 3420 7-2
 8809 7-5

mass storage facility, 3851 13-13,13-14

mass storage system, 3850 13-13

monochrome print 13-7

multi-function card machine
 2560 11-5
 5425 11-9

NRZI (non-return-to-zero change-on-ones recording) 7-2,7-3,7-4

one-half inch magnetic tape 7-1

Operator Identification Card Reader 5-3

optical reader 8-1
 1287 8-1
 1288 8-2
 3881 8-4
 3886 8-5

page printer, 3800 10-9

page reader
 1287 8-1
 1288 8-2
 3881 8-4
 3886 8-5

paper tape device
 2671 12-1
 2822 12-2

PE (phase encoded recording) 7-2

Personalization/Key Entry Unit 2-2

printer
 1403 10-1
 1443 10-3
 3203 10-4
 3211 10-5
 3215 9-1
 3262 10-6
 3284 13-6,13-12
 3286 13-6,13-12
 3287 13-7
 3288 13-7,13-12
 3289 13-8
 3736 13-9
 3791 13-10,13-11
 3800 10-9
 5203 10-12

printer control unit
 2821 10-3
 3811 10-12

printer-keyboard 9-1
 3215 9-1

punch card
 51-column 6-4,11-5
 80-column 11-1,11-4
 96-column 11-1,11-9

punched card device
 1442 11-1
 2501 11-2
 2520 11-3
 2540 11-4
 2560 11-5
 3504 11-6
 3505 11-7
 3525 11-8
 5425 11-9

punched tape device 12-1
 2671 12-1
 2822 12-2

Security Keylock 5-3,5-5,5-7

selector light pen 5-3,5-5,5-6,5-8,13-1

serial printer
 3215 9-1
 3284 13-6,13-12
 3286 13-6,13-12
 3287 13-7
 3736 13-9

system
 3250 13-1
 3270 13-3
 3730 13-9
 3790 13-10,13-12
 3850 13-13

table

Attachment Data for Local I/O Equipment (Appendix A) A-1

Characteristics of Models of the 3851 Mass Storage Facility Models A1 to A4 and B1 to B4 (Figure 13-24) 13-15

Comparison Data for Card Devices (Figure 11-11) 11-11

Comparison Data for Magnetic Character Readers (Figure 6-7) 6-5

Comparison Data for Optical Readers (Figure 8-7) 8-6

Comparison Data for Printers (Figure 10-17) 10-14

Comparison of Capacities for Disk Storage (Figure 3-14) 3-13

Comparison of Characteristics for Disk Storage (Figure 3-13) 3-12

Comparison of Characteristics for Magnetic Tape Devices (Figure 7-5) 7-7

Comparison of Characteristics for Storage Controls (Figure 3-12) 3-12

Comparison of Features for Storage Controls and Disk Storage (Figure 3-11) 3-11

Comparison of Performance for Disk Storage (Figure 3-15) 3-13

Fonts
 Letters, and Symbols Read by the 1287 (Figure 8-2) 8-2
 Letters, and Symbols Read by the 3886 Model 1 (Figure 8-6) 8-5
 Print Rates of the Line Printer attachment to the 3791 and 3792 (Figure 13-18) 13-11
 3800 Print Speed Ranges (Figure 10-13) 10-10

tape, magnetic 7-1

tape control unit		3272 Control Unit	5-2,13-4
3411	7-1	3274 Control Unit	5-2,13-4
3803	7-4	3277 Display Station	5-2,13-5,13-12
tape unit		3278 Display Station	5-3,13-5
3410	7-1	3279 Color Display Station	5-5,13-6
3411	7-1	3284 Printer	13-6,13-12
3420	7-2	3286 Printer	13-6,13-12
8809	7-5	3287 Printer	13-7
terminal		3288 Line Printer	13-7,13-12
3251	5-1,13-2	3289 Line Printer	13-8
3277	5-2,13-5,13-12	3310 Direct Access Storage	3-5
3278	5-3,13-5	3330 Disk Storage	3-6
3279	5-5,13-6	3333 Disk Storage and Control	3-6
3732	13-9	3336 Disk Pack	3-6
8775	5-6	3340 Direct Access Storage Facility	3-7
train cartridge		3344 Direct Access Storage	3-7
1416	10-1,10-4	3348 Disk Module	3-7
3216	10-5	3350 Direct Access Storage	3-8
two channel switch - pair feature	3-4	3350 Staging Feature	3-3
two channel switch feature	3-2,7-5,10-12	3370 Direct Access Storage	3-9
		3410 Magnetic Tape Unit	7-1
		3411 Magnetic Tape Unit and Control	7-1
		3420 Magnetic Tape Unit	7-2
		3504 Card Reader	11-6
		3505 Card Reader	11-7
		3525 Card Punch	11-8
		3540 Diskette Input/Output Unit	4-1
		3730 Distributed Office Communication System	13-9
		3732 Text Display Station	13-9
		3736 Printer	13-9
		3760 Key Entry Station	13-12
		3762 Payment Transaction Processor	13-13
		3790 Communication System	13-10,13-12
		3791 Controller	13-10,13-11
		3792 Auxiliary Control Unit	13-11
		3793 Keyboard - Printer	13-11
		3800 Printer Subsystem	10-9
		3803 Tape Control	7-4
		3811 Printer Control Unit	10-12
		3830 Storage Control	3-2
		3838 Array Processor	2-1
		3848 Cryptographic Unit Model 1	2-2
		3850 Mass Storage System	13-13
		3851 Mass Storage Facility	13-13,13-14
		3880 Storage Control	3-3
		3881 Optical Mark Reader	8-4
		3886 Optical Character Reader	8-5
		3890 Document Processor	6-4
		5203 Printer	10-12
		5213 Printer	9-1
		5425 Multi-Function Card Unit	11-9
		7770 Audio Response Unit	1-1
		8775 Display Terminal	5-6
		8809 Magnetic Tape Unit	7-5
		96-column punched-card device, 5425	11-9
1255 Magnetic Character Reader	6-1		
1287 Optical Reader	8-1		
1288 Optical Page Reader	8-2		
1403 Printer	10-1		
1416 Interchangeable Train Cartridge	10-1		
1419 Magnetic Character Reader	6-2		
1428 font	8-2		
1442 Card Punch	11-2		
1442 Card Read Punch	11-1		
1443 Printer	10-3		
2305 Fixed Head Storage	3-5		
2501 Card Reader	11-2		
2520 Card Punch	11-4		
2520 Card Read Punch	11-3		
2540 Card Read Punch	11-4		
2560 Multi-Function Card Machine	11-5		
2671 Paper Tape Reader	12-1		
2741 Communications Terminal	13-12		
2821 Control Unit	10-3		
2822 Paper Tape Reader Control	12-2		
2835 Storage Control	3-1		
2880 Block Multiplexer Channel	2-2		
3203 Printer	10-4		
3211 Printer	10-5		
3215 Console Printer-Keyboard	9-1		
3216 Interchangeable Train Cartridge	10-5		
3250 Graphics Display System	13-1		
3251 Display Station	5-1,13-2		
3255 Display Control	5-1,13-2		
3258 Control Unit	5-1,13-3		
3262 Line Printer	10-6		
3270 Information Display System	13-3		

This manual is part of a library that serves as a reference source for systems analysts, programmers, and operators of IBM systems. This form may be used to communicate your views about this publication. They will be sent to the author's department for whatever review and action, if any, is deemed appropriate. Comments may be written in your own language; use of English is not required.

IBM may use or distribute any of the information you supply in any way it believes appropriate without incurring any obligation whatever. You may, of course, continue to use the information you supply.

Note: *Copies of IBM publications are not stocked at the location to which this form is addressed. Please direct any requests for copies of publications, or for assistance in using your IBM system, to your IBM representative or the IBM branch office serving your locality.*

Comments:

Reader's Comment Form

Fold and tape

Please Do Not Staple

Fold and tape

Attention: Information Development
Department 61C

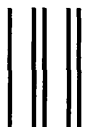

NO POSTAGE
NECESSARY IF
MAILED IN THE
UNITED STATES

BUSINESS REPLY MAIL
FIRST CLASS PERMIT NO. 40 ARMONK, NEW YORK

POSTAGE WILL BE PAID BY ADDRESSEE

International Business Machines Corporation
General Products Division
P. O. Box 27155
Tucson, Arizona 85726

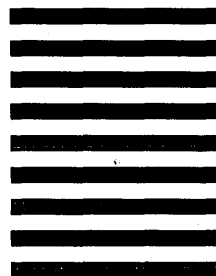

IBM Input/Output Device Summary Printed in U.S.A. GA32-0039-1

Fold and tape

Please Do Not Staple

Fold and tape



International Business Machines Corporation
Data Processing Division
1133 Westchester Avenue, White Plains, N.Y. 10604

IBM World Trade Americas/Far East Corporation
Town of Mount Pleasant, Route 9, North Tarrytown, N.Y., U.S.A. 10591

IBM World Trade Europe/Middle East/Africa Corporation
360 Hamilton Avenue, White Plains, N.Y., U.S.A. 10601

GA32-0039-1

IBM Input/Output Device Summary Printed in U.S.A. GA32-0039-1



International Business Machines Corporation
Data Processing Division
1133 Westchester Avenue, White Plains, N.Y. 10604

IBM World Trade Americas/Far East Corporation
Town of Mount Pleasant, Route 9, North Tarrytown, N.Y., U.S.A. 10591

IBM World Trade Europe/Middle East/Africa Corporation
360 Hamilton Avenue, White Plains, N.Y., U.S.A. 10601