

GA27-2890-4
File No. S360/S370/S3-09

Systems

**IBM 3270
Information Display System
3278 Display Station
Operator's Guide**

IBM

GA27-2890-4
File No. S360/S370/S3-09

Systems

**IBM 3270
Information Display System
3278 Display Station
Operator's Guide**

IBM

Fifth Edition (February 1984)

This is a reprint of GA27-2890-3 incorporating changes released in the following Technical Newsletters:

GN31-1259 (dated 14 November 1980)

GN31-1428 (dated 29 April 1983)

Changes are periodically made to the information herein; before using this publication, refer to the latest *IBM System/360 Bibliography*, GA22-6822 and the *IBM System/370 and 4300 Processors Bibliography*, GC20-0001, for the editions that are applicable and current.

References in this publication to IBM products, programs, or services do not imply that IBM intends to make these available in all countries in which IBM operates.

Publications are not stocked at the address given below. Requests for copies of IBM publications should be made to your IBM representative or to the IBM branch office serving your locality.

A form for readers' comments has been provided at the back of this publication. If the form has been removed, address comments to IBM Corporation, Department 52Q, Neighborhood Road, Kingston, N.Y. 12401. IBM may use or distribute whatever information you supply in any way it believes appropriate without incurring any obligation to you.

© Copyright International Business Machines Corporation 1978, 1979, 1980

Preface

This guide is written for persons who will be operating the IBM 3278 Display Station attached to a 3274 Control Unit or to a 3276 Control Unit Display Station. If your 3278 Display Station is attached to a control unit or to an adapter other than a 3274 or a 3276, some operations and/or indicators may be different from those described in this guide. The operator should refer to the appropriate appendix for a description of these differences.

For information about the operation of the 3274 Control Unit, the 3276 Control Unit Display Station, the 3287 Printer, and the 3289 Line Printer, refer to the following publications:

- *IBM 3270 Information Display System: 3274 Control Unit Operator's Guide*, GA23-0023
- *IBM 3270 Information Display System: 3276 Control Unit Display Station Operator's Guide*, GA18-2040
- *IBM 3287 Printer Operator's Guide*, GA27-3150
- *IBM 3289 Line Printer Operator's Guide*, GA27-3147

For information about the setup of the 3274 Model 1C, 3276, 3278, 3287, and 3289, refer to the following documents:

- *IBM 3270 Information Display System: 3274 Control Unit Planning, Setup, and Customizing Guide*, GA27-2827

- *IBM 3270 Information Display System: 3276 Control Unit Display Station Planning and Setup Guide*, GA18-2041
- *IBM 3274 Control Unit Model 1C Setup Instructions*, GA27-2855
- *IBM 3276 Control Unit Display Station Setup Instructions*, GA18-2017
- *IBM 3278 Display Station Setup Instructions*, GA27-2838
- *IBM 3287 Printer Setup Instructions*, GA27-3152
- *IBM 3289 Line Printer Setup Instructions*, GA27-3140

The keyboards illustrated in this manual are U.S. and Canadian French keyboards. For information concerning other keyboard languages, refer to *IBM 3270 Information Display System: Character Set Reference*, GA27-2837.

While IBM makes available many basic functions, the user chooses those he will utilize and in what manner. It is the responsibility of the user to establish and maintain appropriate operating procedures for the equipment.

Some of the units, devices, options, and features described in this manual may not be available in every locale. Ask your local IBM marketing representative for information about product availability.

Contents

Chapter 1. Introduction	1-1
First Words to the Operator	1-3
Data Processing	1-4
The Data Processing System	1-4
Chapter 2. Controls and Indicators	2-1
3278 Quick Reference	2-2
Introduction to 3278 Operation	2-6
3278 Operator Controls	2-8
The Display Image	2-11
Cursor	2-15
Cursor Wrap	2-16
3278 Operator Panel Lights	2-18
Operator Information Area	2-19
Cleaning Procedures	2-28
Chapter 3. Keyboards	3-1
Introduction	3-3
Typewriter Keyboard	3-7
Data Entry Keyboard	3-17
Similar Keys on Typewriter and Data Entry Keyboards	3-25
Attribute Select Keyboards	3-46
Chapter 4. Features for the 3278	4-1
Selector Light Pen Feature	4-3
Magnetic Slot Reader and Magnetic Hand Scanner Accessories	4-6
Security Keylock Feature	4-9
Audible Alarm Feature	4-10
Numeric Lock Feature	4-11
3278 Switch Control Unit Feature	4-12
3278 APL/Text Feature	4-13
X.21 Switched Networks Feature	4-28
Chapter 5. Important Differences between the 3275/3277 and the 3278	5-1
Introduction	5-3
Screen Character Capacities	5-4
3278 Operator Controls	5-5
3278 Display Image	5-7
3278 Operator Information Area	5-8
3278 Keyboards	5-9
Selector Light Pen Feature	5-16
Magnetic Slot Reader Accessory	5-16
Appendix A. Sample Problem Report Form	A-1
Appendix B. 3278 Display Station Attached to a 4331 Processor	B-1
Index	X-1

Figures

- 1-1. All data processing systems have Input, Processing and Output sections. 1-5
- 2-1. IBM 3278 Display Station 2-7
- 2-2. When the horizontal bar and the Ready indicator appear, your display station is warmed up and ready to operate. 2-8
- 2-3. The image on your screen might look like this. 2-12
- 2-4. Bank checks have a standard arrangement. 2-12
- 2-5. The normal cursor looks like an underscore. 2-15
- 2-6. The alternate cursor is a reversed character image. 2-16
- 2-7. The cursor wraps when you move it off any edge of the display area. 2-17
- 2-8. 3278 Operator Panel Lights 2-18
- 2-9. Operator Information Area Layout 2-19
- 3-1. 3278 Problem Determination Guide Access 3-4
- 3-2. Typewriter Keyboard 3-5
- 3-3. Data Entry Keyboard 3-5
- 3-4. Data Entry-Keypunch Layout Keyboard 3-5
- 3-5. Attribute Select Typewriter Keyboard 3-6
- 3-6. Attribute Select Typewriter/APL Keyboard 3-6
- 3-7. Attribute Select Overlay Keyboard 3-6
- 3-8. Typamatic (Repeat-Action) Keys 3-8
- 3-9. Alphabet Keys 3-9
- 3-10. Numeric Keys 3-10
- 3-11. Some symbols are located on numeric keys. 3-11
- 3-12. Some keys contain only symbols and punctuation marks. 3-12
- 3-13. PF1–PF12 Keys 3-14
- 3-14. Typamatic (Repeat-Action) Keys 3-18
- 3-15. Alphabet Keys 3-20
- 3-16. Symbol and Punctuation Mark Keys 3-21
- 3-17. Program Function (PF) Keys 3-24
- 3-18. Spacebar 3-25
- 3-19. Cursor Control Keys 3-25
- 3-20. New Line Key Operations 3-27
- 3-21. Tab Key Operations 3-28
- 3-22. Back Tab Key Operation 3-29
- 3-23. CURSR SEL Key Selectable Fields 3-33
- 3-24. Use the Insert key to insert missing information. 3-41
- 3-25. Insert Mode Example 3-42
- 3-26. Canadian-French Dead Keys (Typewriter Keyboard) 3-44
- 3-27. Canadian-French Dead Keys (Data Entry Keyboard) 3-44
- 3-28. Attribute Select Keys PF1–PF12 3-48
- 3-29. Attribute Select Keys PF13–PF24 3-49
- 4-1. 3278 Selector Light Pen 4-3
- 4-2. When the selector light pen is being used, correct positioning of the tip of the pen is important. 4-3
- 4-3. Designator characters tell you about the data on your screen. 4-4
- 4-4. Magnetic Slot Reader 4-6
- 4-5. Magnetic Hand Scanner 4-6
- 4-6. Only authorized operators may use a display station that has a security keylock. 4-9
- 4-7. Control Unit Selector Switch 4-12
- 4-8. APL/Text Character Set 4-14
- 4-9. Typewriter/APL Keyboard 4-15
- 4-10. Graphic Characters Entered by the Typewriter/APL Keyboard (2 Parts) 4-17
- 4-11. Typewriter/Text Keyboard 4-20
- 4-12. Graphic Characters Entered by the Typewriter/Text Keyboard (2 Parts) 4-22
- 5-1. IBM 3278 Display Station 5-3
- 5-2. 3278 Operator Controls and Lights 5-5
- 5-3. The alternate cursor is a reversed character image. 5-7
- 5-4. 3278 Typewriter Keyboard 5-9
- 5-5. 3278 Data Entry Keyboard 5-9
- 5-6. Data Entry Keypunch Layout Keyboard 5-10
- 5-7. 3278 Problem Determination Guide Access 5-10
- 5-8. Canadian French Dead Keys 5-13

Chapter 1. Introduction

Contents	1-1
First Words to the Operator	1-3
Data Processing	1-4
The Data Processing System	1-4
Input Section	1-6
Processing Section	1-6
Output Section	1-7

First Words to the Operator

This Operator's Guide provides operating instructions and operating tips for the IBM 3278 Display Station.

As a 3278 Display Station operator, you may operate a keyboard, an operator identification card reader, a magnetic slot reader, a magnetic hand scanner, a personal computer, or a selector light pen, depending on the equipment needs of your organization. The purpose of this manual is to help you prepare for these various operating tasks.

Readers of this manual need no previous knowledge of host systems, display system equipment, or data processing. General background information is provided to introduce you to data processing and host systems. If you have no experience in this area, begin by reading the "Data Processing" and "The Data Processing System" sections of this chapter.

The other chapters of this manual discuss in detail the operator controls, indicators, keys, and typical operating procedures for the 3278 Display Station.

The 3278 controls and indicators are discussed in Chapter 2.

Instructions for keyboard use are given in Chapter 3.

Instructions for using the selector light pen, security keylock, magnetic slot reader, magnetic hand scanner, and other 3278 features are given in Chapter 4.

Instructions for using the IBM 3270 Personal Computer Attachment are given in the *IBM Personal Computer 3270 Attachment User's Guide*.

If you are an experienced 3275 or 3277 operator and you are interested in the differences between the 3275/3277 and the 3278, refer to Chapter 5.

If you are interested in the operation of an IBM 3274 Control Unit, refer to the *IBM 3270 Information Display System: 3274 Control Unit Operator's Guide*, GA23-0023.

If you are interested in the operation of an IBM 3276 Control Unit Display Station, refer to the *IBM 3270 Information Display System: 3276 Control Unit Display Station Operator's Guide*, GA18-2040-0.

Data Processing

Following is a brief description of data processing and of the part you and your display system equipment play in the data processing of your organization.

First, you must understand that the "data" in "data processing" refers to all the information or records required by your organization to conduct its business. This is a lot of information to think about, so, for our discussion, let us consider only the data required for payroll administration, a common part of all business. The data (information) required to perform this function includes the names of all employees, the number of hours each employee worked, his or her rate of pay, the number of overtime hours he or she worked (if any), the amount of money to be withheld, and all other facts needed to pay everyone the correct amount.

The "processing" in "data processing" refers to all the work involved in accomplishing a particular data processing job. In a data processing "payroll" job, the processing involves providing the host system with the required data, determining (with the data) each employee's paycheck amount, printing all the checks, and updating the records.

Putting the two together, then, data processing is the performance of jobs or tasks by processing the required data.

Although data processing has always been a major part of running an organization, it has not always been called data processing. Before the development of the data processing system, almost all processing of data was done by hand. Today, most of it is done by data processing systems and in much less time than before.

The Data Processing System

You will be operating a machine that is part of your organization's data processing system. To give you some knowledge of the other machines in that system, we will now examine the different groups of machines that make up a typical data processing system. The points discussed will hold true even though some of the machines that are mentioned may not be included in all data processing systems.

Regardless of the information to be processed or the equipment used, all data processing systems can be divided into the three basic sections shown in Figure 1-1: input, processing, and output.

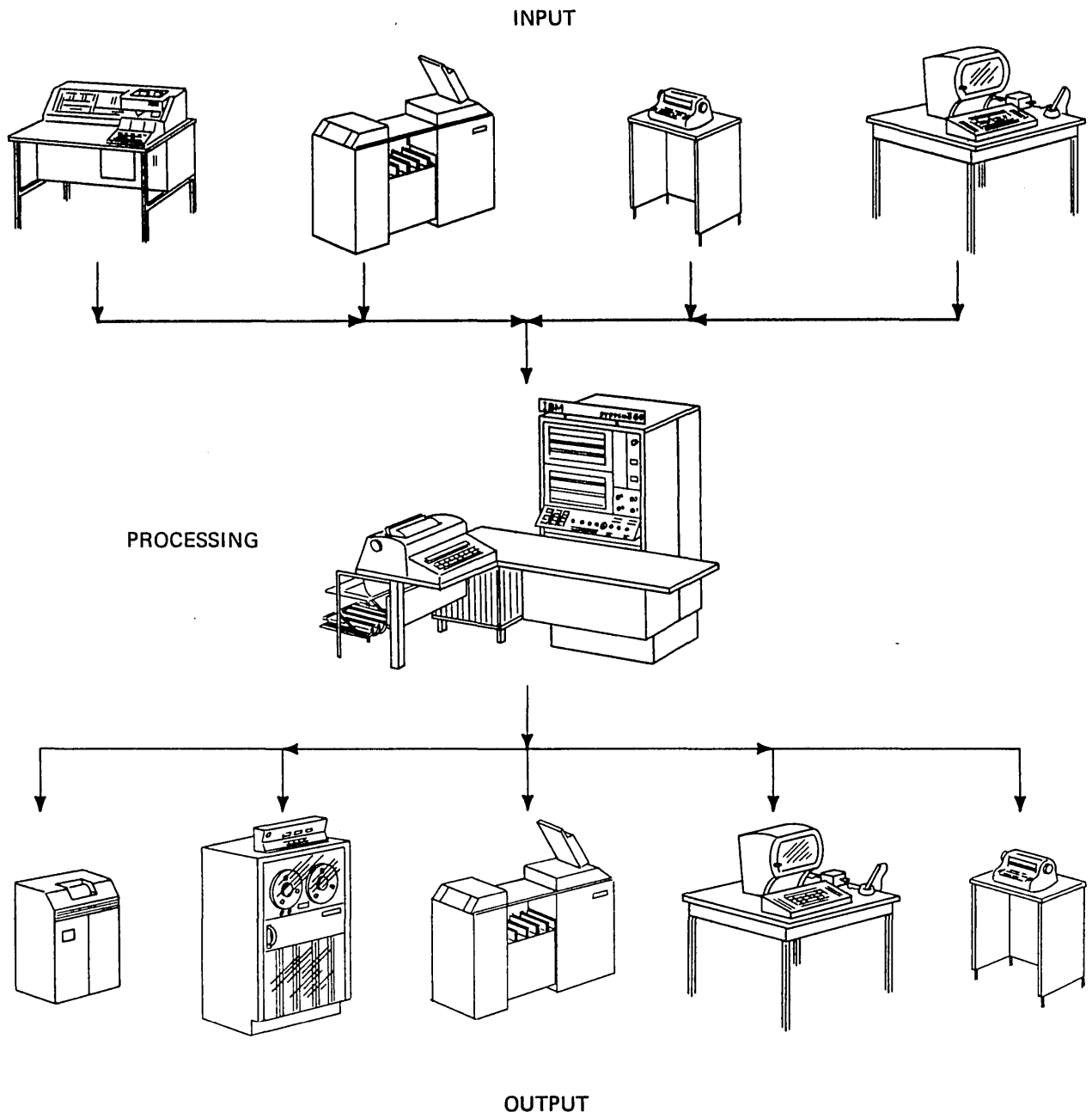

Figure 1-1. All data processing systems have Input, Processing, and Output sections.

Input Section

An input machine is any machine that provides for entry of outside data (information) into the host system. This definition can be used to determine if a machine is part of the input section of a data processing system. Input machines may be located at the host system site or at remote locations where they communicate with the host system over telephone lines.

Most of the data needed to perform a job is produced by people. As a result, it is handwritten or typed on one kind of form or another. A host system cannot process this data. These forms are the source of the input data to be entered into the host system. Thus, the data at this point is called source data.

Part of the job of the machines in the input section of a data processing system is the translation of the source data into a form that the host system can understand. These machines translate the source data and record it in the host system's language; also, and perhaps most important, they enter it into the data processing system. As you type from the source documents, you and your 3270 display station will be performing this type of work. Note that the selector light pen, operator identification card reader, and magnetic slot reader are also input devices which assist you in communicating with the host system.

The importance of the input section in a data processing system cannot be stressed enough. You may be the best typist in the world, but, if you are given inaccurate information to type, your completed typing will not be of much value. The same is true of any data processing system. The best host system in the world can produce results (output) of value only with accurate input data.

The machines that make up the input section, though small compared with some of those in the processing section, are vital to the success of the data processing system. Key punches and card readers, typewriter terminals, and display stations are some types of input machines.

Processing Section

The host system site, as you might guess, is where the host system is located. Once the system has all the information it needs for the intended job, the required work must be performed. This is done at the host system site by the group of machines that make up the processing section of a data processing system.

Several types of machines at the host system site process the data. Working together, they are used to sort the data, test it, perform computations on it, and otherwise use it to accomplish the assigned job.

Note that we said these machines are used to process data. The host system program uses the host system's capabilities.

Although a host system is a group of machines capable of doing many jobs, its actions must be directed. The machines and the program are two separate things; however, they must work together to form an operating data processing system. One can do nothing without the other. The program operates within the host system and directs the machines in the host system to accomplish the assigned job.

Output Section

After the work has been completed, the results must be made available. This is done by the machines that make up the output section of a data processing system.

Output from a data processing system can be in various forms. Printers, tape drives, card punches, and display stations are only a few examples of output machines; the most widely used is the printer. Printers can provide printed checks for payroll jobs, printed bills for customer billing jobs, printed reports, or any number of other types of output for all kinds of jobs.

Chapter 2. Controls and Indicators

Contents	2-1	High-Intensity Data	2-14
3278 Quick Reference	2-2	Protected Data	2-14
Introduction to 3278 Operation	2-6	Nondisplay Fields	2-15
3278 Operator Controls	2-8	Cursor	2-15
On/Off (I/O) Switch	2-8	Cursor Wrap	2-16
☼ Brightness Control	2-9	3278 Operator Panel Lights	2-18
● Contrast Control	2-9	Operator Information Area	2-19
⚡ Audible Alarm Volume Control	2-9	Readiness and System Connection	2-20
Normal/Test Switch	2-10	Do Not Enter (Input Inhibited)	2-21
Dual Case/Mono Case (A,a/A) Switch	2-10	Reminders	2-26
Video Test Switch	2-10	Shifts and Modes	2-27
The Display Image	2-11	Highlighting	2-27
Fields and Formatted Displays	2-13	Printer Status	2-28
Input Fields	2-13	Cleaning Procedures	2-29
Numeric Fields	2-14		

3278 Quick Reference

Switches, Controls, and Lights

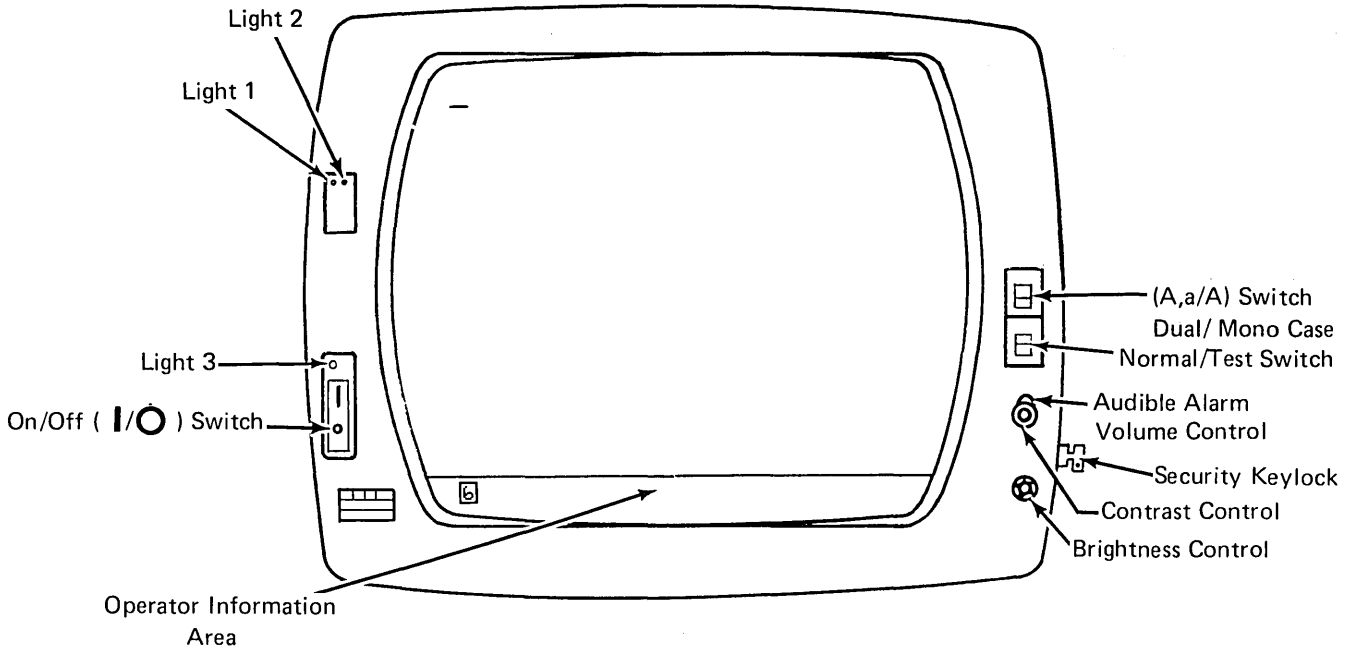

Operator Information Area Layout

Readiness and System Connection	Do Not Enter (Input Inhibited)	Reminders	Shifts and Modes Programmed Symbols Selection Highlighting	Printer Status
---------------------------------	--------------------------------	-----------	--	----------------

Operator Information Area Symbols and Messages

Note: For a 3278 not attached to a 3274 or to a 3276, these symbols and messages and/or their meanings may be different from those described here. Refer to the appropriate appendix for a description of these differences.

• Readiness and System Connection Symbols

- Location 1 — Means the 3274 () or 3276 () Control Unit is working (ready).
- Location 2 — Means the control unit is connected (online) to the host system under rules A () or rules B ().
- Location 3 — Your display station is working with your job (application program).
- Location 3 — Your display station is connected to the system operator (control program).
- Location 3 — Your display station is connected to the host system but is not connected to your application program or the control program.
- Locations 3–6 TEST — Your display station is in Test Mode.

3278 Quick Reference

• Do Not Enter (Input Inhibited) Messages

- X — Time is required for the host system to perform a function. Wait.
- X ?+ — Press RESET; then try the operation again.
- X SYSTEM — The host system has locked your keyboard. Look for a message. Wait or RESET.
- X — Go elsewhere on the screen to take that action. RESET. Move the cursor or take other action.
- X > — You have tried to insert more data than this field can hold. RESET. Correct the entry.
- X NUM — You should enter only numerals in this field. RESET. Then enter only numerals.
- X #? — Only certain numerals can be entered here. RESET.
- X -f — The function you requested is not available.
- X nn
and
 nnn — Your display station is not operating properly. RESET. If problem persists, refer to the display station or control unit Problem Determination Guide to determine the appropriate action.
- X nn
and
 nnn — There is a problem with the communication line between the control unit and the host system. RESET. If problem persists, refer to the display station or control unit Problem Determination Guide to determine the appropriate action.
- X PROGnn
and
PROGnnn — The control unit detected a programming error in the data it received from the host system. RESET. If problem persists, refer to the display station or control unit Problem Determination Guide to determine the appropriate action.
- X — The printer connected to your display station is busy. If is displayed on the right, the printer is busy printing your work. Wait for the operation to finish, or press DEV CNCL to cancel a pending print operation. (If the print operation has started, the operation cannot be canceled by the DEV CNCL key.)
- X — Same as above except more time is anticipated before your operation is accepted.
- X — The printer assigned to your display station is not working. If is displayed on the right, the printer stopped while printing your work. Wait or press DEV CNCL to cancel the print operation.
- X — You are not authorized to do that function. RESET.
- X — Security keylock is off. Keyboard can be unlocked only by key.
- X — That magnetic stripe card cannot be used in this operation. RESET. Try a different card, or request help.
- X +? }
X ^+? }
X ^+? }
X ^+? }
X ,+? } — You have entered an invalid accent and character combination. RESET. Then rekey both the accent and the character. (Canadian French keyboard only.)
- X -S — The symbol key you pressed is not available. RESET.
- X — A message from the control operator was received and rejected. RESET
- X -f — The application program will not allow you to make that selection.
- X 2% — Your display station is not configured for that selection.

• Reminders

- nn
and
 nnn — The communication link connecting your control unit to the host system is producing errors.
- Reserved for future use. Ignore.

• Shifts and Modes Messages

- Programmed Symbols Selection
 - SD — No Programmed Symbols Selected
 - PSA — Programmed Symbols — Set A
 - PSB — Programmed Symbols — Set B
 - PSC — Programmed Symbols — Set C
 - PSD — Programmed Symbols — Set D
 - PSE — Programmed Symbols — Set E
 - PSF — Programmed Symbols — Set F
 - * — You have selected a Programmed Symbol Set
 - * — Field Inherit for Programmed Symbols

*If neither symbol is present, the selection you made is not available at your display station.

3278 Quick Reference

- NUM — The keyboard is in Numeric Mode. Only 0 through 9, period (.), minus (-), and DUP will be accepted.
- APL — The keyboard is in APL Mode.
- TEXT — The keyboard is in TEXT Mode.
- ⇧ — The keyboard is in upshift.
- ^ — The display station is in Insert Mode.
- ALPHA — The keyboard is in Alpha Shift (Data Entry Keyboard only)

— Character Highlighting

- a — Normal character selected
- ⦿ — Blinking character selected
- — Reverse character selected
- Ⓐ — Underscore character selected
- ▶ — Field inherit for character highlighting
- ⚡ — You have selected a Programmed Symbol Set.

• Printer Status Messages

- _ _ — When you are changing the Printer ID/Class, the two numerals you key are displayed in the underlined locations of the message.
- nnn — Your display station is authorized to use Printer ID/Class nn.
- nnn — The selected printer is printing your work.
- ▶nnn — The printer stopped while printing your work.
- ?? — Your printer assignment has changed.

KEYBOARD

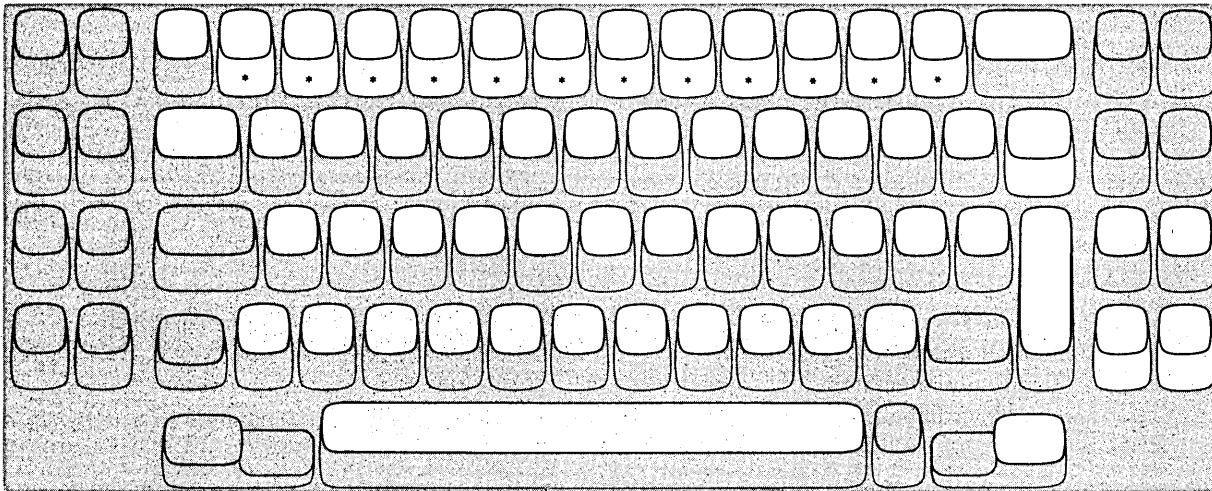

*Typewriter keyboard only.

The keys highlighted above are typamatic keys. This means that they have the ability to repeat their character or function when held down. They are:

All Alphabetic, Numeric, Symbol, and Punctuation Mark Keys, and the following keys:

- Tab
- ↵ New Line
- ⇧ Back Tab
- ⌂ Home
- ← Backspace
- ↑ Move cursor up
- ↓ Move cursor down
- ← Move cursor left
- ⇐ Double-speed move cursor left
- Move cursor right

3278 Quick Reference

- Double-speed move cursor right
- SKIP (Same as Tab)
- Spacebar
- ENTER
- PF1-PF12
- RESET (Data Entry - Keypunch Layout Keyboard)

Some of the function keys are:

CURSR SEL	Selects fields for processing. Cursor must be in a field that your application has designated for cursor selection.
CLEAR	Erases display and signals the host system that a clear action occurred.
ERASE INPUT	Erases all input fields and moves the cursor to the first input character position on the screen.
ERASE EOF	Erases the input field from the cursor to the end of the field. The cursor does not move.
CURSR BLINK	Causes cursor to blink or not blink.
ALT CURSR	Selects between the two forms of cursor (underline and reverse character image).
□-□	Print key. Sends data from the display station to the selected printer.
IDENT	Signals that the next two numbers will be the selected printer ID code. The ID is displayed in the Operator Information Area. The IDENT key is also used to display the new ID when your printer assignment is changed.
⏏	Turns the keyboard clicker on or off.
TEST	Used to run special problem determination functions. Refer to your display station's Problem Determination Guide.
DEV CNCL	Cancels a pending print request to the printer.
⏏	Insert key. Allows character insertion in an input field. To end Insert Mode, press RESET.
⏏	Delete key. Deletes the character at the cursor position in an input field.

How-to-Do References:

- Insert character(s) into a displayed area - see ⏏ key description in Chapter 3.
- Remove (delete) character(s) from a displayed area - see ⏏ key description in Chapter 3.
- Enter alphabetic character(s) into a Numeric field - see "Numeric Lock Feature" in Chapter 4.
- Select a selectable field with the CURSR SEL key - see CURSR SEL key description in Chapter 3.
- Request or change the printer ID - see IDENT key description in Chapter 3.
- Cause the information on your screen to be printed - see □-□ key description in Chapter 3.
- Cause the cursor to blink on and off - see CURSR BLINK key description in Chapter 3.
- Select the alternate cursor - see ALT CURSR key description in Chapter 3.
- Cancel a print operation - see DEV CNCL key description in Chapter 3.
- Turn the keyboard clicker on or off - see ⏏ key description in Chapter 3.
- Use a selector light pen - see "Selector Light Pen Feature" in Chapter 4.
- Use a magnetic slot reader or a magnetic hand scanner - see "Magnetic Slot Reader and Magnetic Hand Scanner Accessories" in Chapter 4.
- Adjust the audible alarm volume - see "Audible Alarm Feature" in Chapter 4.
- Use highlighting
 - character reversal - see "Attribute Selection Keys" in Chapter 3.
 - character blinking - see "Attribute Selection Keys" in Chapter 3.
 - character underscoring - see "Attribute Selection Keys" in Chapter 3.
- Use the programmed symbol set selection keys - see "Attribute Selection Keys" in Chapter 3.
- Use the Field Inherit Keys - see "Attribute Selection Keys" in Chapter 3.

Something Is Wrong

<i>Is this it?</i>	<i>Have you tried this?</i>
Display station will not turn on.	Make sure the power cord is plugged into the wall outlet.
No clicks when keys are pressed.	Is Do Not Enter (X) symbol on? RESET key turns it off.
	Is Do Not Enter (X) symbol off? Check condition of Click (⏏) key.

For more information on troubles, refer to the *3278 Problem Determination Guide*.

Introduction to 3278 Operation

If possible, sit at a display station as you read this part of the manual so that you can use the switches and keys as you read about them. If your display station has a keyboard attached and if some point is not clear as you read, pause for a moment to press the key and watch the result. Keep in mind, however, that the purpose of some of the keys is to notify the host system that your display station needs service by the program. Pressing any of these keys when the host system is ready interrupts the program. In case you do not have a keyboard provided with your display station, you will only be required to make initial adjustments to the display station (as explained in this section).

The IBM 3278 Display Station is shown in Figure 2-1.

Your 3278 Display Station will have one of the following six screen formats: 480 characters (12 lines of 40 characters each), 960 characters (12 lines of 80 characters each), 1920 characters (24 lines of 80 characters each), 2560 characters (32 lines of 80 characters each), 3440 characters (43 lines of 80 characters each), or 3564 characters (27 lines of 132 characters each).

If your organization uses both 3275/3277 and 3278 Display Stations, you may work with programs that use both groups of display stations. These programs can format the screen of your 3278 in the same way that they format a 3275 or 3277 screen. The 3275 and the 3277, however, have 480- and 1920-character screen formats.

To enable the 3275/3277 programs to use both groups of display stations, the 960-character 3278 can be formatted as a 480-character display (12 lines of 40 characters each) and the 2560-, 3440-, and 3564-character 3278s can be formatted as 1920-character displays (24 lines of 80 characters each). Some programs may use the large format, and other programs may use the smaller format. Therefore, if you use a 960-, 2560-, 3440-, or 3564-character 3278, the display station may switch between the large format and the smaller format for different transactions.

3278 Operator Controls

On/Off (| / O) Switch

Press the top portion () of the On/Off switch shown at the right to turn on your display station. Light 3 and Light 1 (see Figure 2-2) should have turned on when you pressed the On/Off switch. A delay of a few seconds allows the machine to warm up. After this delay, (1) Light 2 turns on, (2) a short horizontal bar (cursor) appears in the upper-left portion of the screen under the first position in line 1, (3) a horizontal line appears across the lower portion of the screen, and (4) a Ready symbol (see 3278 Quick Reference, Readiness and System Connection Symbols) appears in the lower-left portion of the screen (Operator Information Area). See Figure 2-2.



If your display station has the Security Keylock feature (described in Chapter 4) and the keylock is locked, the  (Security Key) symbol appears at the bottom of the screen to tell you to insert the security key and turn off the lock (turn key clockwise). When you leave your display station, turn on the lock (turn key counterclockwise) and remove the key.

Note: The keylock turns 90° (vertical to horizontal position) when you turn the key.

When you are ready to turn off your display station, press the bottom portion () of the On/Off switch.

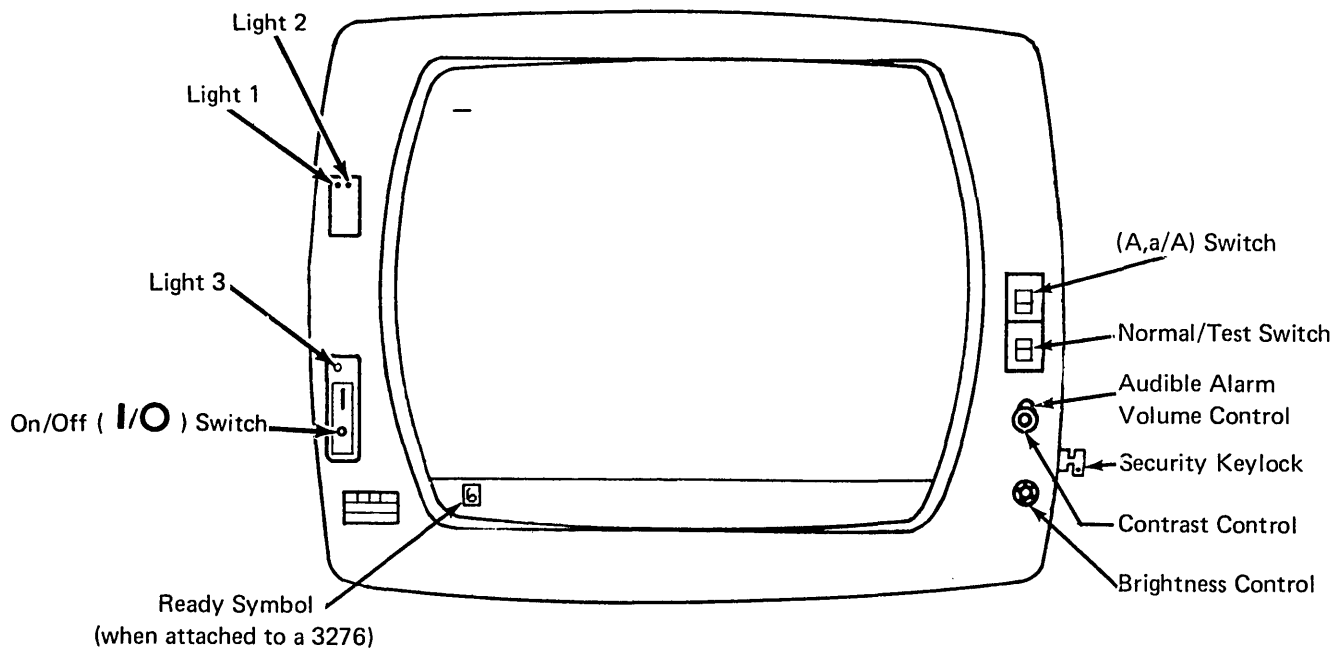



Figure 2-2. When the horizontal bar and the Ready indicator appear, your display station is warmed up and ready to operate.



Brightness Control

You can adjust the brightness of the characters displayed on the screen by turning the brightness control  knob to the left or to the right. Turning it to the right makes the display image brighter; to the left, dimmer. Experiment with this control until you find the setting that is most convenient and comfortable for your viewing.

This control also has a test position. When the control knob is turned fully clockwise beyond the first stop and held, the screen becomes very bright.

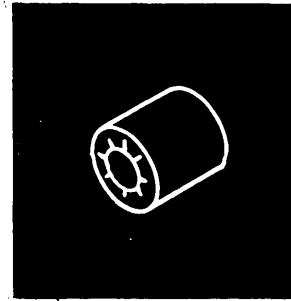

Contrast Control

The contrast control  is another aid in adjusting your display for comfortable viewing. If your organization uses two intensity levels to display characters (explained later in this chapter under the heading "High Intensity Data"), the contrast control varies the difference between these two levels. You may have to experiment with this control until you find the contrast level that satisfies you.

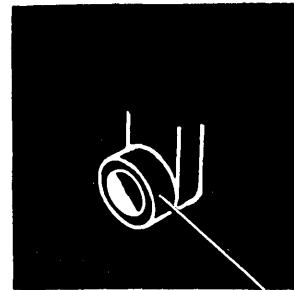

Audible Alarm Volume Control

If your display station has the Audible Alarm feature (described in Chapter 4) installed, the volume control  for the audible alarm is located at the outside of and behind the screen contrast control. Turning this control clockwise will increase the sound level; turning the control counterclockwise will decrease the sound level. If you want to test or adjust the audible alarm, refer to the Audible Alarm feature description in Chapter 4.

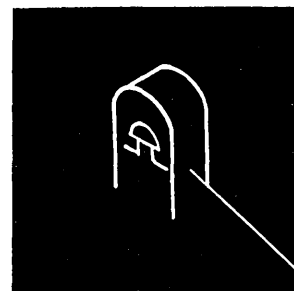

Normal/Test Switch

When you are operating the display station, this switch will be in the Normal position.

You will use the Test position of this switch when you have a problem with the machine and you perform the problem determination procedures. When you place the switch in the Test position, you can perform the tests that are described in Section 3 of the *3278 Problem Determination Guide*.



Dual Case/Mono Case (A,a/A) Switch

You can use this switch to cause your display station to display (1) only uppercase alphabetic characters or (2) both uppercase and lowercase characters. To select only uppercase characters, set the switch to *A*; to select uppercase and lowercase characters, set the switch to *A,a*.



However, the position of this switch does not determine whether uppercase or lowercase alphabetic characters are sent to the host system. For example, if the switch is set to *A* and you enter a lowercase *e* character, an uppercase *E* character is displayed on the screen; however, when the character is sent to the host system, the code for a lowercase *e* character is sent.

Video Test Switch

If your display station has the IBM 3270 Personal Computer Attachment installed, the Video Test switch is located in a panel on the back of the display. This switch does not affect the display and can be in any position during display operation.

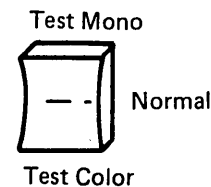

You will use the Test Mono and Test Color positions of the switch when you have a display station problem and are performing problem determination.

The Display Image

To make your display station ready for operation, perform the following:

Note: *If the display station screen is dirty, refer to “Cleaning Procedures” at the end of this chapter.*

1. Use the On/Off (/) switch to turn the display station on.
2. If the display station has the Security Keylock feature, insert the security key into the lock and turn the key clockwise. (Refer to Chapter 4 for a description of the Security Keylock feature.)
3. Adjust the brightness and contrast controls.
4. If the display station has the Audible Alarm feature, adjust the audible alarm volume control by using the procedure in the Chapter 4 Audible Alarm feature description.

If your display station has a keyboard, skip over the next paragraph and continue reading this section.

If your 3278 does not have a keyboard, selector light pen, magnetic slot reader, or magnetic hand scanner attached, operation is controlled by the program, and you may monitor information displayed on the screen. If your 3278 does not have a keyboard, selector light pen, magnetic slot reader, or magnetic hand scanner, you should now read about the lights and the Operator Information Area on your 3278, starting with “3278 Operator Panel Lights.” If your 3278 does not have a keyboard, but does have a selector light pen, a magnetic slot reader, or a magnetic hand scanner, read about the lights and the Operator Information Area, starting with “3278 Operator Panel Lights,” and then refer to Chapter 4 for a description of selector light pen or magnetic slot read operation.

Before we talk about the keyboard, there are some things you should know about your display screen.

As we have said before, the 3278 Display Station can be used by many different organizations, all with very different kinds of jobs to be done. Even within one organization, there are many different applications for 3278 displays. Today’s host systems are capable of processing many different jobs at the same time. Therefore, it is possible that you could be working on one job while the operator next to you is doing completely different and unrelated work. The images on your two screens would probably be completely different.

Figure 2-3 is a typical display image; you will be referred to this image in some of the discussions that follow. Keep in mind that this example is only one of many possible display images. Your organization may not even require this type of image. The references made to it, however, apply to all images.

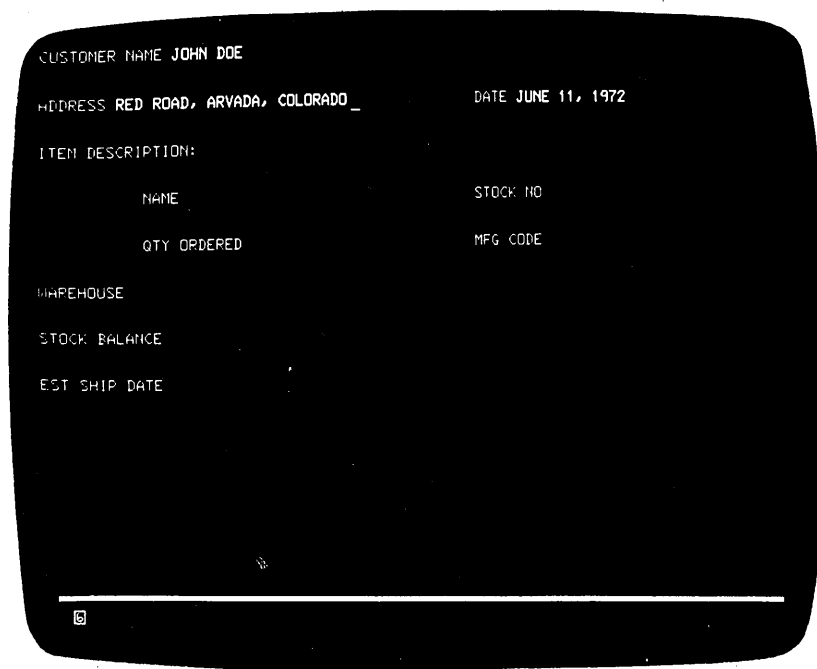

Figure 2-3. The image on your screen might look like this.

As you can see, the display image looks much like information typed on a sheet of paper. Notice, too, that the organization and content of this form are no different from the organization and content of handwritten and hand-processed documents. The same type of information is always recorded in the same areas. This is true of all documents, as can be seen by examining the arrangement of a standard bank check (Figure 2-4).

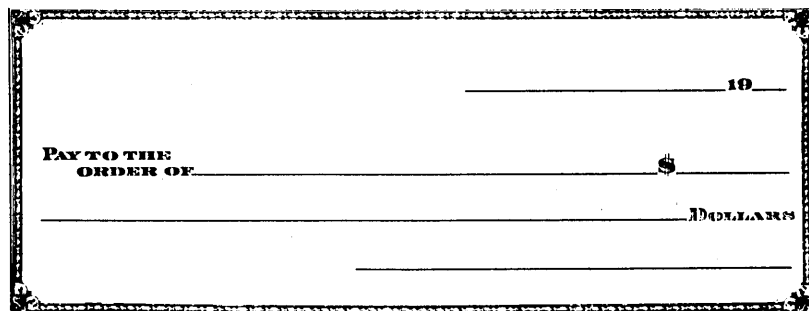

Figure 2-4. Bank checks have a standard arrangement .

The upper-right portion is usually reserved for the date. The center is for the name of the party to whom the check is made payable and the amount of the check. The lower-right portion usually contains the space for the signature of the person writing the check.

Fields and Formatted Displays

The various areas of bank checks that always contain the same type of information are called “fields” in data-processing language, for example, the “date” field or the “signature” field. Most documents to be entered into a host system will be organized by fields.

This practice of standardizing the arrangement of data originated because the person using the information could do his or her job much faster knowing that one type of data would appear at the same location on every document.

When a display station screen is divided into fields, it makes working with the display station quicker and easier for both the display station operator and the host system program. The application program divides the screen into fields and establishes the rules as to what each field will contain. The program then knows that the same type of information will always be displayed in the same location. Knowing this, the program can process the data from the screen much more quickly. The operator can also perform his or her job more efficiently having this information.

When a screen is divided into fields, it is known as a formatted screen. A screen that the program has not divided into fields is known as an unformatted screen. Each job that you work on could use a different format or none at all; therefore, you may be working with both formatted and unformatted screens.

Input Fields

You may see two types of fields on your screen. One is primarily used by the program to send you messages, instructions, and headings; you cannot key data into this type of field. All of your entries will be into the other type. For this reason, in the remainder of this manual, fields that you can key data into will be referred to as input fields. Each application program user’s guide should tell you which are the input fields for that particular job.

Once a field is assigned to one type of data in a job, those character positions should not be used for other data items in that job. For example, one field on the screen in Figure 2-3 is called “STOCK NO”. That is the only type of information you will key into it. You will not, for instance, key the digits of an MFG CODE number into the STOCK NO field. (Otherwise, the display station keyboard may stop functioning or a message may appear on the screen telling you of the error.)

There is no rule stating that fields must always be a certain length or that there will always be the same number of fields on the screen. The length of a field is normally arrived at by determining, from the type of information that will be entered in the field, the longest possible length of one entry. In many cases, this is known. For example, all Stock numbers could be the same length, 9 digits; therefore, the field for Stock numbers is 9 character spaces long. When the maximum length is not known, as in a field marked for customer name, maximum length must be estimated by some method, and the field length must be set from that estimate.

The number and names of fields that you will see on your screen will depend on the job you are doing and the application program that is operating in the host system.

Numeric Fields

Fields that normally contain only numbers (Stock number, manufacturer's code number, etc.) are known as Numeric fields. Such fields are used in organizations whose jobs are largely of the data-entry type.

Entry of numeric data is made possible by use of a Data Entry keyboard (described in Chapter 3). When your screen is formatted by your user's program, the Data Entry keyboard automatically shifts to Upshift Mode and the $\hat{\uparrow}$ (upshift) symbol appears in the Operator Information Area when the cursor enters a numeric field. (If the Numeric Lock feature is installed in your keyboard, the NUM shift symbol appears in the Operator Information Area instead of the $\hat{\uparrow}$ symbol.) Therefore, if you have a Data Entry keyboard, numeric fields help to increase your operating speed.

If you are using a Typewriter or Data Entry keyboard that has the Numeric Lock feature installed, the NUM shift message appears in the Operator Information Area when the cursor enters a Numeric field. When this occurs, the only keys that you can key into the Numeric field are the digits 0 through 9, period (.), minus (-), and the DUP key. Pressing any other key that can enter a displayable character turns on the Do Not Enter - Numeric Data Only (\times \nrightarrow NUM) message in the Operator Information Area and disables your keyboard (keyboard either starts or stops clicking). For additional information concerning the Numeric Lock feature, refer to Chapter 4.

The user's program guide for the program that you are working with should designate which the numeric fields are.

Figure 2-5 shows two other features of the 3278 that you can expect to see often. The more apparent of these is called "High-Intensity Data."

High-Intensity Data

This feature of the 3278 allows the display of fields (selected by the application program) at a brighter than normal intensity. Use of this feature makes the high-intensity fields stand out from the other fields displayed on the screen. Many companies make effective use of this feature by displaying the field names at normal intensity and the operator-keyed data at high intensity.

Protected Data

Not quite so obvious in the example in Figure 2-5 are the protected fields. They are the fields displayed at low intensity. We mentioned before that, in most jobs, there will be some areas on the screen where you will not be able to type. You will not be able to change field names (titles), for instance. In Figure 2-5, STOCK NO is a field name and would probably be a protected field.

The protected-data feature aids your operation because you do not have to worry about making a mistake and destroying part of the data on your screen. A \times \leftarrow \rightarrow (Go Elsewhere) message will come on in the Operator Information Area (bottom of screen) if you attempt to change (type over, erase, insert, or delete characters) any data in a protected field.

The blank field directly following "STOCK NO" is the unprotected stock number input field. You would key stock numbers from your source document into this field.

The user's program guide for the program that you are working with should designate which fields on the screen contain protected data and which are your input fields.

Nondisplay Fields

This feature of the 3278 allows the program to cause the information in a field to be nondisplayable. An example of the use of a nondisplay field is using such a field for entry of your operator identification when you log on your display station. When you enter your operator identification into the nondisplay field, your operator identification remains secret, because it is not displayed on the screen.

The user's program guide for the program that you are working with should designate which fields on the screen are nondisplay fields.

Cursor

The cursor operation is an important operation for you to understand when you are working with the display image. You will find that the flexibility of the cursor makes operating a 3278 easier and more enjoyable than operating a typewriter or a keypunch. For example, moving the cursor is easier and faster than repositioning the carriage of a typewriter or transporting the card in a keypunch.

Two types of cursors can be displayed on the screen of a 3278: the normal cursor and the alternate cursor. The normal cursor appears on the screen as an underline to the character position in which it is located (Figure 2-5).

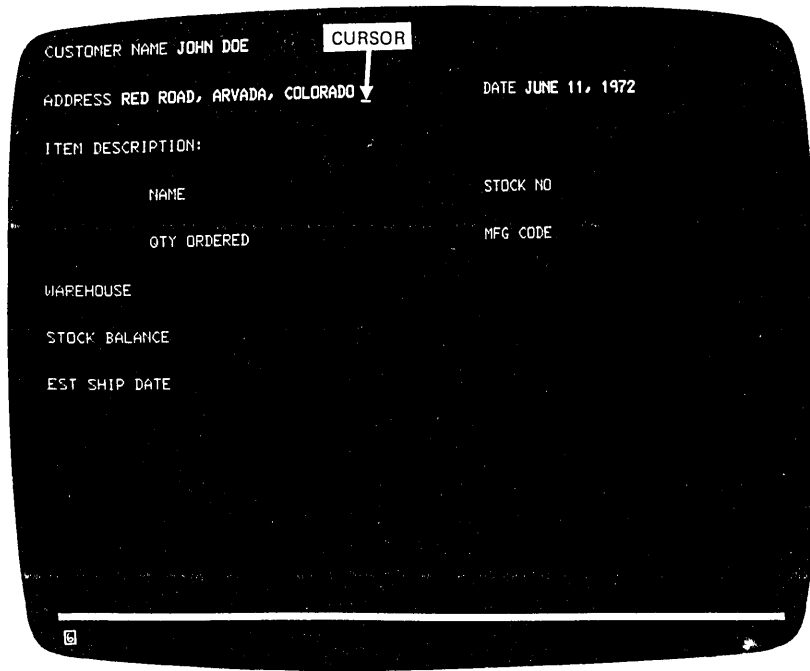

Figure 2-5. The normal cursor looks like an underscore.

The alternate cursor is a reverse image of the character that is located in the same character position as the cursor (Figure 2-6). By using the ALT CURSR and CURSR BLINK keys (described in the keyboard sections), you can select either type of cursor and you can also make the cursor blink on and off continuously.

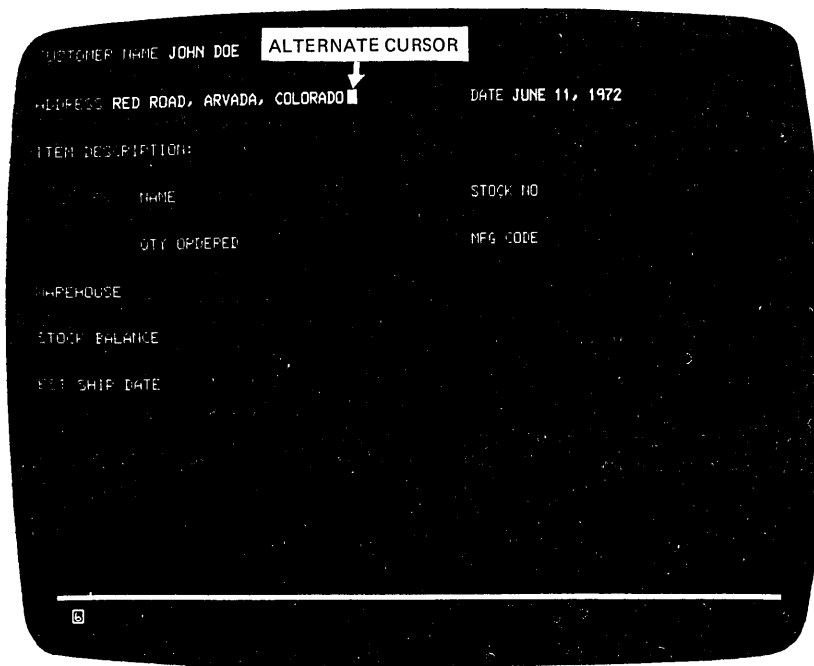

Figure 2-6. The alternate cursor is a reversed character image .

The cursor marks the position on the screen that the next character entered from the keyboard will occupy. It may be moved about freely on the screen, by use of certain keyboard keys, without interfering with other characters. You will also notice, when entering characters from the keyboard, that the cursor moves to the next available character position as each character is entered (except for Canadian French keyboard Dead Keys, as explained in the keyboard sections).

You may see the cursor apparently changing locations by itself. It can be moved about on your screen by the program, and when the cursor appears to be moving by itself the program is repositioning it for you.

Cursor Wrap

The cursor control keys are located on the keyboard and described in the keyboard sections. They move the cursor in either the horizontal (left or right) or vertical (up or down) direction on the display station screen; the ← and → (horizontal positioning) keys and the ↑ and ↓ (vertical positioning) keys move the cursor one position at a time; the ←← and →→ (double-speed horizontal positioning) keys move the cursor two positions at a time. If you hold down the key that moves the cursor to the right, the cursor will move off the right side of the line and will reappear one line lower on the left side. This is called cursor wrap. In effect, the cursor wraps around behind the screen. It also wraps when moved to the left, and it will reappear one line higher on the right side. See Figure 2-7.

Cursor wrap also occurs when the cursor is moved up or down. Notice that, in these cases, the cursor reappears in the same vertical position (on the opposite side of the image) that it occupied before moving off the screen; there is no shift left or right. In the examples in Figure 2-7, pressing and holding the indicated keys when the cursor is located at A moves the cursor to B.

Because your 3278 may use two different screen formats (see “Introduction to 3278 Operation,” earlier in this chapter), keep in mind that the cursor wraps (1) horizontally at the first (left) and last (right) character positions of the line and (2) vertically at the top and bottom lines, not at the left and right or top and bottom of the screen. In other words, the cursor wraps at the edge of the display area for the format being used, not at the edge of the screen.

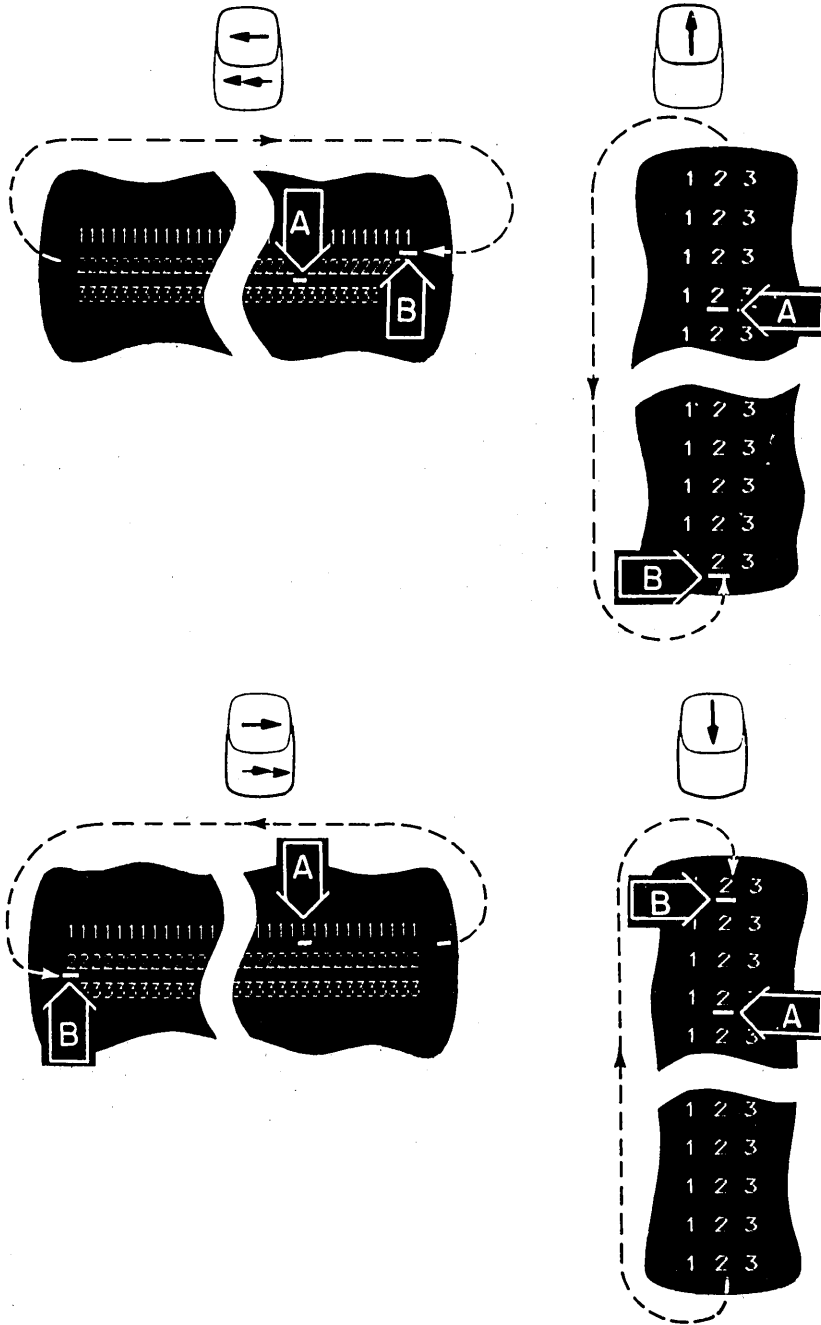

Figure 2-7. The cursor wraps when you move it off any edge of the display area.

3278 Operator Panel Lights

The 3278 Operator Panel is shown in Figure 2-8.

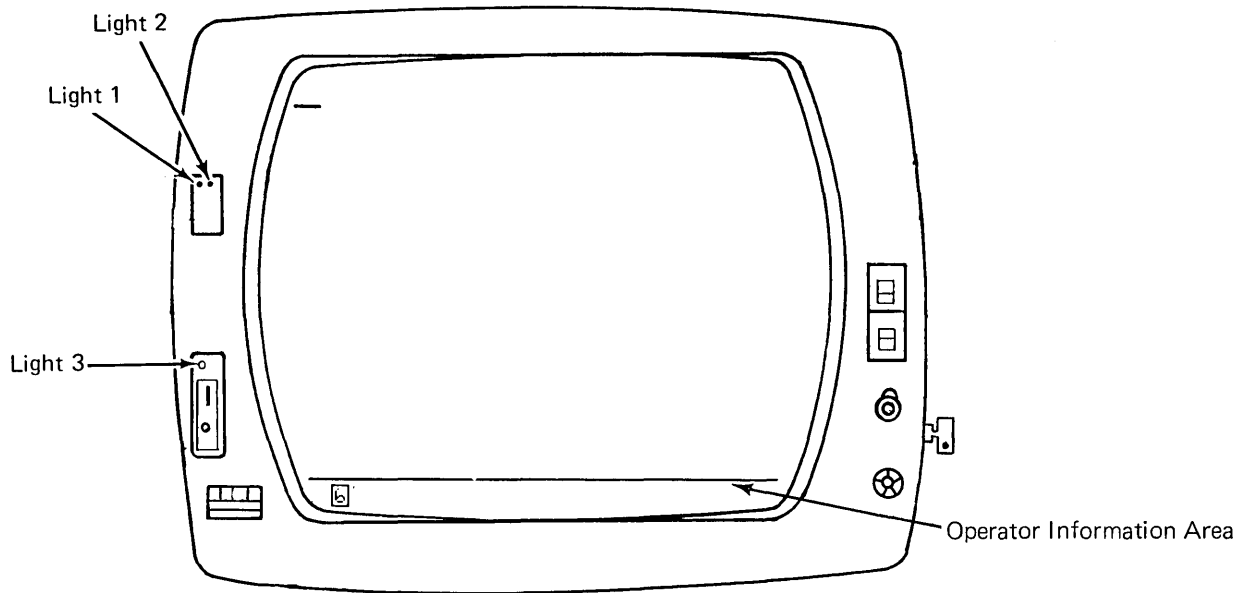

Figure 2-8. 3278 Operator Panel Lights

Light 3

Light 3, when lit, tells you that the display station is on. It will light when you turn the On/Off (I / O) switch to the On (II) position.

Light 1

Light 1, when lit, tells you that the machine hardware is ready. It will light when you turn the On/Off (I / O) switch to the On (II) position.

Light 2

Light 2, when lit, tells you that the display image is ready. It will light a few seconds after you turn the On/Off (I / O) switch to the On (II) position.

Operator Information Area

The Operator Information Area is the bottom line of your display screen; this area is separated from the rest of the display area by a horizontal line. The Operator Information Area is used to display operating and status messages that are associated with your display station operation. These messages are displayed as symbols, words, and numerals. For example:

- ✕ means Do Not Enter (Input Inhibited)
- ⊙ means time is required
- represents a display or printer unit
- ✕ signifies a malfunction, not working
- signifies a connection

Messages may be composed of groups of symbols which are read from left to right. For example:

- ✕ ⊙ means Do Not Enter because time is needed for the host system to perform a function.
- ✕ ✕ means Do Not Enter because your display station is not operating properly (Machine Check).
- □ ⊙ means your display station is connected to printer 06.
- ✕ □ ✕ means Do Not Enter because the printer connected to your display station is not working.

The operating and status messages are grouped into five categories, displayed in five different portions of the Operator Information Area as shown in Figure 2-9.

Note: For a 3278 not attached to a 3274 or to a 3276, these symbols and/or their meanings might be different from those described here. Refer to the appropriate appendix for a description of these differences.

Readiness and System Connection	Do Not Enter (Input Inhibited)	Reminders	Shifts and Modes Programmed Symbols Selection Highlighting	Printer Status
------------------------------------	-----------------------------------	-----------	--	----------------

Figure 2-9. Operator Information Area Layout

Readiness and System Connection

The Readiness and System Connection symbols, displayed in the Operator Information Area, are used either singly or in combinations to indicate the readiness status of your display station, control unit, and host system.

☐ and ☐ (Control Unit Ready Symbols)

A ☐ or a ☐ symbol appears in the Operator Information Area when the control unit that your display station is connected to is ready for operation.

If your 3278 display station is in Normal mode (Normal/Text switch set to Normal) and:

- is connected to a 3274, the ☐ symbol appears on your screen when the 3274 is ready for operation.
- is connected to a 3276, the ☐ symbol appears on your screen when the 3276 is ready for operation.

Ⓐ and Ⓑ (Online Symbols)

A Ready symbol must be displayed on your screen before an Ⓐ or a Ⓑ (Online) symbol can be displayed. The Online symbols, displayed in the Operator Information Area, are used to tell you that your display station is connected (online) to the host system.

If your display station is attached and online to the control unit, the Ⓐ or Ⓑ is displayed to tell you which of two sets of rules governs your transactions with the host system. Certain keyboard functions and the meanings of some Operator Information Area symbols differ depending upon which set of rules is governing. In those cases you will be referred to the Ⓐ or Ⓑ symbol displayed in the Operator Information Area.

The online Ⓐ symbol turns off when you perform any action at your display station that requires a response from the host system. When the host system responds, the Ⓐ symbol turns on again. Whether or not this off/on action is apparent depends upon how busy the host system is and how quickly it responds.

■ , ☒ , ☑ , and TEST

The ■ , ☒ , ☑ and the TEST message, displayed in the Operator Information Area, are used to tell you that:

- - Your display station is connected to your job (application program).
 - ☒ - Your display station is connected to the system operator (control program).
 - ☑ - Your display station is connected to the host system but not to your job or system operator.
- TEST - Your display station is in Test Mode as described in Section 4 of the Problem Determination Guide.

Do Not Enter (Input Inhibited)

The **✕** (Do Not Enter) symbol tells you that your display station will not accept input from your keyboard, selector light pen, magnetic slot reader, or magnetic hand scanner. Additional symbols are always displayed to the right of the **✕**, in the Operator Information Area, to define why your input devices are disabled.

There is no mechanical keyboard lock associated with preventing the use of the keyboard, such as there is on keypunch keyboards. That is, when input is disabled, the keys on your keyboard are not physically locked in one position; you can still press them down normally.



Your keyboard contains a clicker that causes a click when you press the keys. You can turn the click off or on by using the Click () key on your keyboard (described in the keyboard sections). When you have the clicker turned on, the absence of the click indicates that the keyboard is disabled; when you have the clicker turned off, the presence of the click indicates that the keyboard is disabled.

The reasons why Do Not Enter comes on are discussed in the descriptions that follow. Each description also tells you how to turn off the Do Not Enter message and restore your keyboard (when possible).

✕ - Time

This message tells you that the host system needs time to perform the function you requested. You must wait for the function to be completed.

✕ ?+ - What? (Try Again)

All, or part, of the last operation you tried was not accepted by the display station. Check your display screen to make sure the operation you want to perform is correct, press the RESET key to restore your keyboard, and try the operation again. If the ALT, , or  key was involved, press that key again and press the RESET key. Do not key in any more data while the **✕** symbol is displayed. If an IDENT key operation was in progress, it was canceled. Press RESET, and restart the IDENT key operation.

✕ SYSTEM- System Lock

This message means the host system has disabled your keyboard after processing your entry. The host system may send you a message on your display screen explaining the reason for disabling your keyboard. You may (1) wait for the host system to restore your keyboard or (2) press the RESET key to restore your keyboard.

✘ ←↔→ - Go Elsewhere

This message appears if you try to take an action in the wrong location, such as:

- To enter, insert, erase, or delete a character when the cursor is in a protected field.
- To read a magnetic stripe when the cursor is in a protected field.
- To perform a cursor select operation when the cursor is not in a valid cursor select field (refer to CURSR SEL key description in the keyboard sections).

Press the RESET key to restore your keyboard; then move the cursor to another location or take a different action.

✘ 𐄂> - Too Much Data

This message appears if you try to enter more data into a field than it can hold. Press the RESET key to restore your keyboard; then correct the entry.

✘ 𐄂NUM - Numeric Data Only

This message appears if you try to enter a non-numeric character (other than 0-9, .., -, or DUP) into a numeric field. Press the RESET key to restore your keyboard; then enter numeric data. To override the numeric control, use ↑ or ↓ (↓ key is present on Data Entry keyboards only).

✘ 𐄂#? - What Number?











This message tells you that only certain numbers can be entered for the operation you are performing. For example, this message is displayed when you:

- Enter an invalid Printer ID or Printer Class during a print operation (refer to IDENT key description in the keyboard sections)
- Make an error when your display station is in test mode (follow test instructions in the Problem Determination Guide)

Press the RESET key to restore your keyboard; then enter the correct number.

✘ -f - Minus Function

This message means the function (operation) that you requested is not available. Press the RESET key. Check the Operator Information Area for other symbols to determine if the function is permanently or temporarily unavailable; for example:

- If  or  is displayed, the function (except IDENT) is permanently unavailable. Press the RESET key to restore your keyboard; then take other action.
- If  or  is displayed, the CURSR SEL, ATTN, PA, and PF keys and transmission to the host system via selector pen, magnetic slot reader, and magnetic hand scanner are inappropriate at this time. Press the RESET key to restore your keyboard; then take other action.
- If  or  is displayed, the CURSR SEL, ENTER, ATTN, PA, and PF keys and transmission to the host system via selector pen, magnetic slot reader, and magnetic hand scanner are inappropriate at this time. Press the RESET key to restore your keyboard; then take other action.
- If  is displayed and CURSR BLINK does not work, the , IDENT, CURSR BLINK, and ALT CURSR keys are permanently unavailable. Press the RESET key to restore your keyboard; then take other action.
- If TEST is displayed, press the RESET key to restore your keyboard; and follow exactly the instructions in Section 4 of the Problem Determination Guide.
- If  is displayed and none of the above symbol combinations are displayed, the function is temporarily unavailable. Press the RESET key to restore your keyboard, check the screen, and try the function again.
- If none of the above is displayed, the IDENT function is temporarily unavailable while  is displayed (printer is printing). Wait until printer finishes, or press the RESET key and take other action.

✘ nn or ✘ -Machine Check

This message means your display station is not working properly. The error number, nn or nnn, defines the type of Machine Check. Press the RESET key to restore your keyboard, and continue. If the problem persists, refer to your Problem Determination Guide to determine the appropriate action.

✘ or ✘ -Communication Check

This message means there is a problem with the communication line between the control unit and the host system. The error number, nn or nnn, defines the type of Communication Check. Press the RESET key to restore your keyboard, and continue. If the problem persists, refer to your Problem Determination Guide to determine the appropriate action.

✘ PROGnn or ✘ PROGnnn - Program Check

This message means the control unit detected a programming error in the data it received from the host system. The error number, nn or nnn, defines the type of Program Check. Press the RESET key to restore your keyboard, and continue. If the problem persists, refer to your Problem Determination Guide to determine the appropriate action.

✘ □-□-□-□ - Printer Busy

The ✘ □-□-□-□ message means the printer connected to your display station is busy and cannot perform the print operation you requested. If □-■ is displayed in the Printer Status Message Area to the right, the printer is busy performing your own print operation; if □-□ is displayed in the Printer Status Message Area, the printer is busy performing an operation for another display station or the host system.

If you initiated the print operation by using the □-□ key, you can either (1) wait for the print operation to finish or (2) press the DEV CNCL key to cancel the operation. If you cancel the operation and □-□ is displayed you may be able to select another printer using the IDENT procedure and restart the print operation by using the □-□ key.

If the print operation was initiated by the host system (via a PA key, the ENTER key, etc.), you can cancel the print operation by pressing the DEV CNCL key. However, if the host system initiates the same print operation again, you should either (1) wait for the print operation to finish or (2) wait for the host system to restore your keyboard.

The RESET key has no effect when this message is displayed.

✘ □-□-□-□-□ - Printer Very Busy

This message means the same thing as the ✘ □-□-□-□ (Printer Busy) message, except that more time is anticipated before your print operation is accepted.

✘ □-□-□-□-□-□ - Printer Not Working

The ✘ □-□-□-□-□-□ message means the printer connected to your display station is not working (out of order, unplugged, out of paper, etc.) and cannot perform the print operation you requested. Therefore, your print request was canceled.

If you initiated the print operation by using the □-□ key, you should press the DEV CNCL key to restore the keyboard. Your print request was canceled. You may then select a different printer using the IDENT procedure, try to restore the failing printer, or take other action.

If □-■ is displayed in the Printer Status Message Area to the right, the printer stopped working while printing your own last print operation.

If the print operation was initiated by the host system (via a PA key, the ENTER key, etc.), you can cancel the print operation by pressing the DEV CNCL key. The RESET key has no effect when this message is displayed.

✘ 𐄂✘ - Operator Not Authorized

This message means that your display station is not authorized to do the requested printer-related function. Press the RESET key to restore the keyboard. Appropriate follow-on action depends upon the key you used and upon what appears in the printer assignment positions on the right side of the Operator Information Area.

1. After the Print (𐄂𐄂) key:

- If 𐄂𐄂?? is displayed, you should press RESET and then use the IDENT key to cause your new assignment to be displayed before you request a print.
- If nothing is displayed and a 𐄂 is not displayed in the Operator Information Area, you are not authorized to print at all. Press the RESET key to restore the keyboard and take other action.
- If nothing is displayed and a 𐄂 is displayed in the Operator Information Area, you have no automatic authorization. Press the RESET key to restore the keyboard. If a printer is available, you can establish an assignment by using the IDENT key, plus two valid numerals.
- If 𐄂𐄂nn is displayed, there is an error [mismatch?] in the authorization matrix (for example, the printer's buffer is too small for your display size, or Device "nn" is really a display, not a printer). Press the RESET key to restore the keyboard. Request assistance, use the IDENT function to select a different printer, or take other action.

2. After the IDENT key plus two numerals:

You are not authorized for the printer you specified. Press the RESET key to restore the keyboard; then start the IDENT procedure again or take other action.

3. Immediately after the IDENT key:

You are not authorized to print at all (a 𐄂 is not displayed in the Operator Information Area and nothing in printer assignment columns). Press the RESET key to restore the keyboard, and take other action.

✘ 𐄂 - Security Key

This message means the security keylock on your display station is off. Turn the key clockwise.

✘ 𐄂? - Questionable Card

This message appears during a magnetic slot reader or magnetic hand scanner operation if the magnetic stripe card cannot be used. Press the RESET key to restore your keyboard; then try another card or request help.

✘ 𐄂'+?, ✘ 𐄂`+?, ✘ 𐄂''+?, ✘ 𐄂^+?, ✘ 𐄂,+?

Accent Plus What? (Canadian French Keyboard Only)

This message means you have entered an invalid accent and character combination so the accent has become a stand-alone character. Press the RESET key to restore your keyboard; then re-key both the accent and the letter. See the Dead Key descriptions in the keyboard section.

Valid accent and character combinations are:

``aAeEüU
`eE
~aAeEïïöôûÛ
~eEïïüÜ
.çÇ

X -S - Minus Symbol

This message means the symbol you keyed is not recognized by the control unit. Press the RESET key to restore your keyboard.

X □←☒ A message from the control operator (☒) was received and rejected. Press the RESET key to restore your keyboard.

X -f fX This message means that you tried to change the PS or highlighting selection when the host program would not allow it. The keyboard becomes locked as a result. Pressing the RESET key will restore the keyboard.

X ⌘2% This message means that you tried to select a PS or highlighting when the necessary hardware was not present in the display station. Pressing the RESET key will restore the keyboard.

X ⌘— Operator Communication Check

This message appears when the operator presses an X.21 function key under the wrong conditions; for example, the DIAL key is pressed in the local mode.

Reminders

The reminder messages are displayed in the Operator Information Area. They are reminders that a condition occurred.

↘_nn and ↘_nnn Communication

This message means that the communication link that connects your control unit to the host system is producing errors. It is a reminder that you may be unable to communicate with the host system. The error number, nn or nnn, defines the type of communication problem. This message remains displayed until your control unit determines the communication link is working properly.

□←☒ Reserved for future use (appears with **X □←☒** message). Ignore this symbol.

X.21 Switched Network

The following messages may not appear on all 3278s.

— Call Ready

This message is used when your terminal has the X.21 Switched Networks feature installed; it appears when the terminal is ready to call and to be called.

—_ Nnnn or nn Call Ready with Call Progress Signal

If your terminal has the X.21 Switched Networks capability, this message appears when it is ready to call and to be called with the status code (nn) that is known as the Call Progress Signal (CPS). The CPS is a signal that the network sends back to the terminal to indicate the status of the network or of the host system. When the network connection has been established, the In-Use symbol (N) is displayed.

Dial In (Dialing-Originating Display)

This message appears on the display station at which the DIAL key is pressed and shows that the terminal is waiting for the dial digit number to be keyed in. On other display stations, the Dial In () message will appear at the same time.



Dial In (Other Than Dialing Originating Display)

This message appears on display stations other than the one originating the dial-in. When this message appears, the dial digit number cannot be entered at the keyboard.

Outgoing Call in Process

This message appears after (1) the DIRECT key is pressed or (2) the dial digit number is keyed in and the ENTER key is then pressed. The message means that the terminal is calling the host system.

Outgoing Call in Process with Call Progress Signal

This message appears when the status code ( or ) is sent back from the network while an outgoing call is in process; for example, when the host system is in the manual-answer mode,  N01 appears in the Operator Information Area.

Incoming Call in Process

This message appears when the terminal is being called from the host system.

Disconnect in Process



This message appears when the terminal is in the process of disconnecting from the network after receiving the disconnect command or after the DISC key has been pressed.

Local

This message appears when the terminal is in the local mode. When the LOCAL key is pressed, the terminal cannot communicate. For the terminal to communicate, the COMM key must be pressed.

Programmed Symbols



When one of the Programmed Symbol sets (available only when your display station has the Programmed Symbol Set feature installed) is used, the appropriate symbol set indicator will appear in the Operator Information Area. The symbol set indicators are PSA, PSB, PSC, PSD, PSE, and PSF. When any of the above symbol sets are indicated and PS selection keys are available, selectability will be shown in the Operator Information Area, following the programmed symbol, as follows:

-  operator selection is permitted and was made by pressing a Programmed Symbol key.
-  operator selection is permitted and was made by a Field Inherit key. Or, selection was made by the host program.
-  operator selection was not permitted; selection was made by the host.

Shifts and Modes

The shifts and modes messages displayed in the Operator Information Area, tell you what shift and mode your keyboard is using at the time.

NUM - Numeric

This message is used when your display station has the Numeric Lock feature (described in Chapter 4) installed. NUM appears when the cursor is located in a numeric field and your display station is in Numeric Mode. The only keys that are valid in Numeric Mode are 0 through 9, period (.), minus (-), and DUP. To override the numeric control, use  or  ( key is present on Data Entry keyboards only). Refer to the keyboard section, also.

ALPHA - Alpha

This message is used when your display station is in Alpha Mode. The Alpha key () , present on Data Entry Keyboards only, is nonlocking (must be held down to stay in Alpha Mode).

APL - APL

This message is used when your display station (1) has the APL/Text feature (described in Chapter 4) installed and (2) is equipped with a Typewriter/APL keyboard. APL appears when you place the keyboard in APL Mode by pressing the APL ON/OFF key while pressing and holding the ALT key; the APL message disappears when you place the keyboard in Non-APL Mode (normal) by pressing the APL ON/OFF key a second time while pressing and holding the ALT key. It also disappears under certain conditions, when you have selected a Programmed Symbol set.





TEXT - TEXT

This message is used when your display station (1) has the APL/Text feature (described in Chapter 4) installed and (2) is equipped with a Typewriter/Text keyboard. TEXT appears when you place the keyboard in Text Mode by pressing the TEXT ON/OFF key; the TEXT message disappears when you place the keyboard in Non-Text Mode (normal) by pressing the TEXT ON/OFF key a second time. It also disappears (under certain conditions) when you have selected a Programmed Symbol set.

- UP



The  symbol appears when (1) you place your keyboard in the upshift condition or (2) the cursor is located in an upshift (“numeric”) field when you are using a Data Entry keyboard that does not have the Numeric Lock feature.

- Insert

The  symbol appears when you place your display station in Insert Mode by pressing the  key. (For a description of Insert Mode, refer to the  key descriptions in the keyboard sections.) The  symbol turns off when you take your display station out of Insert Mode.

Highlighting

The highlighting attribute messages that appear in the Operator Information Area, if your display station has the extended highlighting feature installed, are as follows:

- Character Reversal — 
- Character Blink — 
- Character Underscore — 
- No character attributes employed — **a**

Although the PF15, 18, 21, and 24 keys indicate a choice of colors, there are no color options on the 3278 Display Station. When any of the above highlighting attributes are indicated and highlighting is available, selectability will be shown in the Operator Information Area following the selected attribute message, as follows:

- ⌘ operator selection is permitted and was made by depressing a Programmed Symbol key.
- operator selection is permitted and was made by a Field Inherit key. Or, selection was made by the host program.
- ⊞ operator selection was not permitted; selection was made by the host.

Printer Status

The Printer Status messages displayed in the Operator Information Area, are used during print operations to tell you where the print operation is performed and inform you of the progress of the print operation.

□□_ - Printer Selection

The □□_ message appears when you press the IDENT key to enter a new printer assignment. When □□_ appears the cursor disappears until the IDENT key operation is completed. The next two numbers you enter appear in the two underlined locations of the message. After you enter a valid printer ID or class, the cursor reappears. See IDENT key in the keyboard section.

□□nn - Printer Assignment

This message tells you that your display station is authorized to use printer number nn. Numbers 01 through 31 identify individual printers. Numbers 70 through 85 identify "classes" of printers.

If nothing is displayed in the Operator Information Area, you have no printer assignment. If the 3278 is attached to a 3276 Control Unit Display Station, you may use the IDENT procedure (see IDENT key in the keyboard section) to enter the printer number of an available printer; otherwise, you cannot print.

□■nn - Printer Printing

This message tells you the assigned printer is printing your work.

□■nn - Printer Failure

This message tells you the selected printer failed while printing your work. See

✕ □■ - Printer Not Working.

□□?? Assignment Pending

This means that your printer assignment has changed. If you press the IDENT key, your new printer assignment is displayed.

Cleaning Procedures

To clean the display station screen, use one of the following cleaning procedures (after turning off the 3278):

- Using Water Only - wipe the screen with a damp soft cloth; then dry the screen with a clean soft cloth.
- Using Water and Detergent - wash the screen with a clean soft cloth, rinse with a damp soft cloth, and dry with a soft cloth.
- Using an Ammonia-Based Glass Cleaner - apply the cleaner with a clean soft cloth; then dry the screen with a clean soft cloth.

Caution: Do NOT use acid solutions or abrasive products such as cleansers or scouring pads, because these products will damage the display station screen's anti-reflective coating.

To clean the covers, use warm water and a mild detergent.

Use isopropyl alcohol to clean haze and grime off the selector light-pen lens.

Chapter 3. Keyboards

Contents	3-1
Introduction	3-3
Typewriter Keyboard	3-7
Introduction	3-7
Typamatic (Repeat-Action) Keys	3-8
Shift (↑) and Lock (🔒) Keys	3-8
ALT (Shift) Key	3-9
Alphabet Keys	3-9
Numeric Keys	3-10
Symbol and Punctuation Mark Keys	3-10
DUP Key	3-13
FIELD MARK Key	3-13
PA1 and PA2 Keys	3-14
PF1–PF12 Keys	3-14
PF13–PF24 Keys	3-15
Data Entry Keyboard	3-17
Introduction	3-17
Typamatic (Repeat-Action) Keys	3-18
Numeric Shift (⬆) Key	3-19
Numeric Lock (🔒) Key	3-19
Alpha (↓) Key	3-19
ALT (Shift) Key	3-20
Alphabet Keys	3-20
Numeric Keys	3-21
Symbol and Punctuation Mark Keys	3-21
DUP Key	3-22
FIELD MARK Key	3-22
PA1, PA2, and PA3 Keys	3-23
PF1–PF10 Keys	3-24
Blank Keys (in Numeric Mode)	3-24
Similar Keys on Typewriter and Data Entry Keyboards	3-25
Introduction	3-25
Spacebar	3-25
Cursor Control Keys	3-25
Moving the Cursor to the Beginning of a Field	3-26
New Line Key	3-26
Tab Key	3-28
Skip Key (Data Entry Keyboard Only)	3-28
Back Tab Key	3-29
Home (⏪) Key	3-30
Moving the Cursor One or Two Character Spaces	3-30
Horizontal Positioning Keys	3-30
Double-Speed Horizontal Positioning Keys	3-30
Vertical Positioning Keys	3-31
Backspace Key	3-31
ATTN Key	3-32
SYS REQ Key	3-32
CURSR SEL Key	3-33
CLEAR Key	3-34
ERASE INPUT Key	3-35
ERASE EOF Key	3-35
CURSR BLINK Key	3-36
ALT CURSR Key	3-36
Print (🖨) Key	3-37
IDENT Key	3-38
Click (🖱) Key	3-39
TEST Key	3-39
RESET Key	3-40
DEV CNCL Key	3-40
Insert (⌨) Key	3-41
Delete (🗑) Key	3-43
ENTER Key	3-43
Dead Keys (Canadian-French Keyboard Only)	3-44
Attribute Select Keyboards	3-46
Introduction	3-46
Attribute Select Typewriter Keyboard	3-46
Attribute Select Typewriter/APL Keyboard	3-46
Attribute Select Overlay Keyboard	3-46
Attribute Selection Keys	3-47
Highlighting Selection Keys	3-47
Programmed Symbol Set Selection Keys	3-47
Field Inherit Keys	3-48

Introduction

Having a keyboard as part of a 3278 Display Station is optional. To the operators of most 3278 Display Stations, the keyboard will be their main contact with the display station and, through it, with the host system.

The keyboard controls the display station and provides a means of signaling the program. It is through the keyboard that you display data on the display screen.

The 3278 operates like a typewriter. Without looking at your keyboard, you can easily find the home row keys. The F and J keys on typewriter keyboards have deeper than normal depressions on the key face. On data entry keyboards, the three numeric keys on the home row (4, 5, and 6) have this deeper depression.

Typing on the keyboard prints the characters on the screen instead of on paper. This is an improvement when you have to correct typing errors. Just move the cursor to the error, and key in the correct character. You can check anything you have keyed except functions and nondisplay fields because the document is always visible.

Your keyboard contains a clicker that causes a click when you press the keys. You can turn the click off or on by using the Click () key on your keyboard. It is important to know that generally:

- When you have the clicker turned on, the click tells you that the keyboard is operational and that the data you are keying is being accepted. In this case, absence of the click indicates that the keyboard is disabled.
- When you have the clicker turned off, the absence of the click tells you that the keyboard is operational and that the data you are keying is being accepted. In this case, the presence of the click indicates that the keyboard is disabled.

Therefore, by being aware of the clicking, or of its absence, you can tell when the operation of your keyboard is not normal. When operation is not normal, your display station Operator Information Area symbols aid you in correcting the problem.

Note: *For a 3278 not attached to a 3274 or to a 3276, the functions of some of these keys may be different from those described here. Refer to the appropriate appendix for a description of those differences.*

Your keyboard also contains your display station's Problem Determination Guide. To access the Guide, press the latch shown in Figure 3-1; the access panel will spring open. Whenever you have a problem with your display station, refer to the Problem Determination Guide to determine the appropriate action. In addition to problem determination procedures, the Problem Determination Guide contains descriptions of the display station switches, keyboard functions, and Operator Information Area symbols.

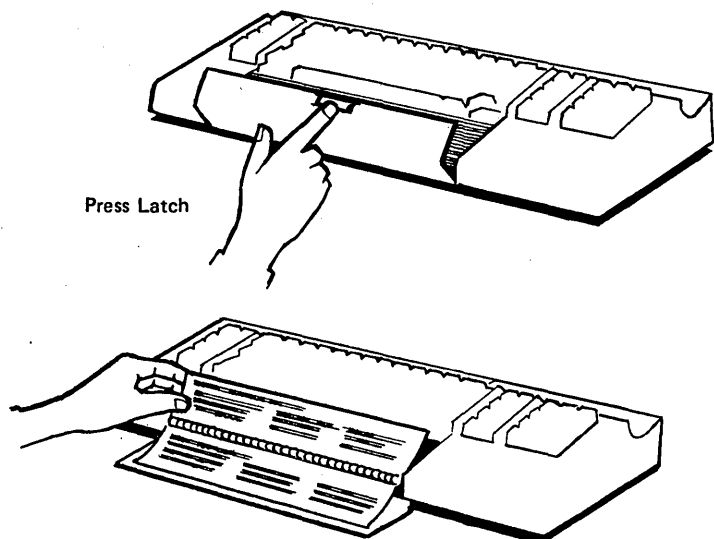

Figure 3-1. 3278 Problem Determination Guide Access

Three types of keyboards can be attached to the 3278 Display Stations:

- The Typewriter keyboard (Figure 3-2), which resembles a typewriter keyboard
- Two Data Entry keyboards -
 - The Data Entry keyboard (Figure 3-3), which provides the basic data entry type of keyboard
 - The Data Entry-Keypunch Layout keyboard (Figure 3-4), which has the same keys as the IBM keypunch (024-026-029-129) keyboard
- Attribute Select Keyboards
 - The Attribute Select Typewriter keyboard (Figure 3-5)
 - The Attribute Select Overlay keyboard (Figure 3-6)
 - The Attribute Select Typewriter/APL keyboard (Figure 3-7)

Note: *The Typewriter/APL and Typewriter/Text keyboards are described in Chapter 4.*

The main difference that you will notice between the Typewriter and Data Entry keyboards is the location of the numeric keys. On the Typewriter keyboard, the numeric keys are all on the top row of keys. On the Data Entry keyboard, the numeric keys are placed on all four rows around the right-side keys.

If you are familiar with any of these keyboards, you already know what most of the keys do. The remainder of this chapter has three subdivisions: the first two describe the keys that are different on the Typewriter and Data Entry keyboards, respectively; the third describes the keys that are similar on the two types of keyboards. Turn to the heading that applies to your keyboard.

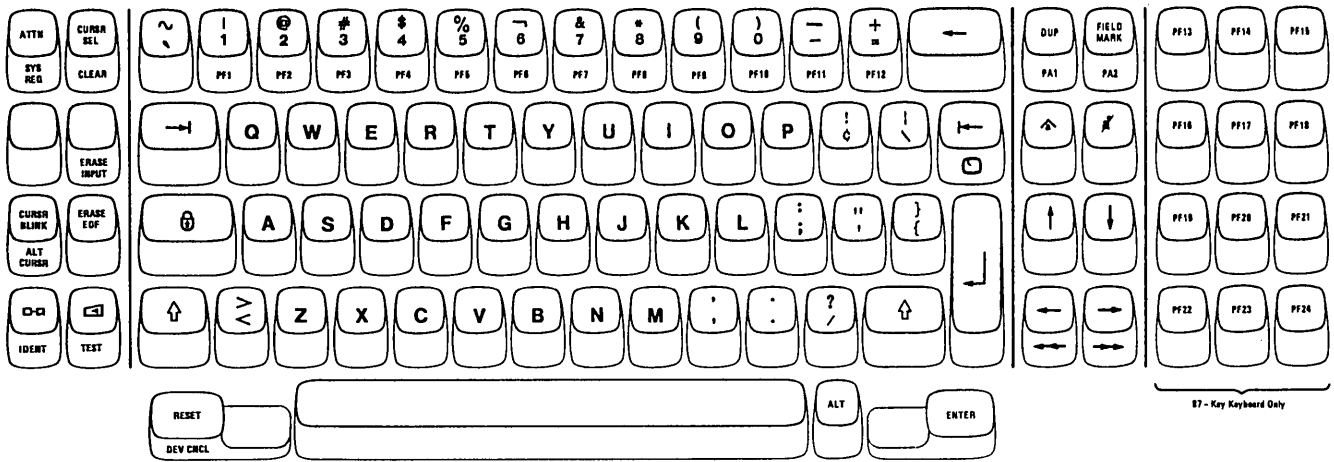

Figure 3-2. Typewriter Keyboard

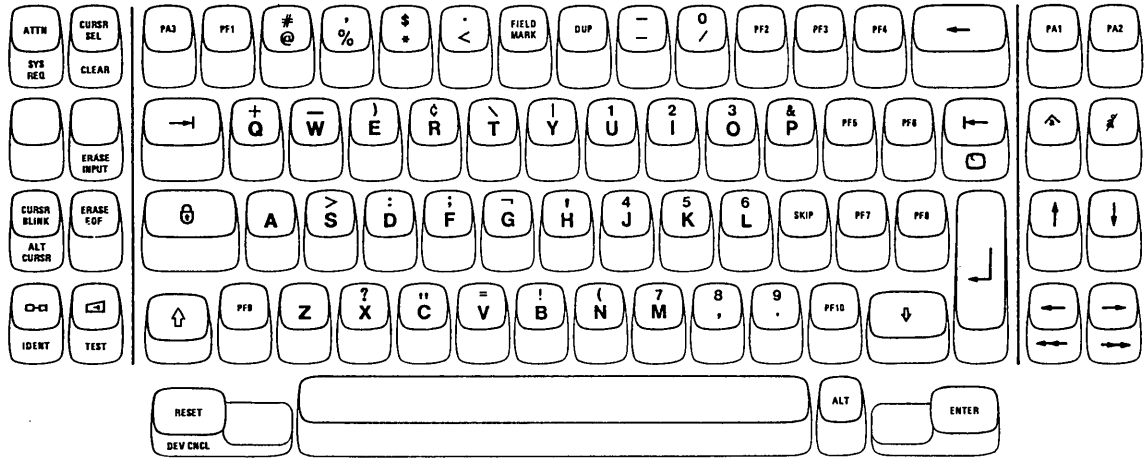

Figure 3-3. Data Entry Keyboard (See Note)

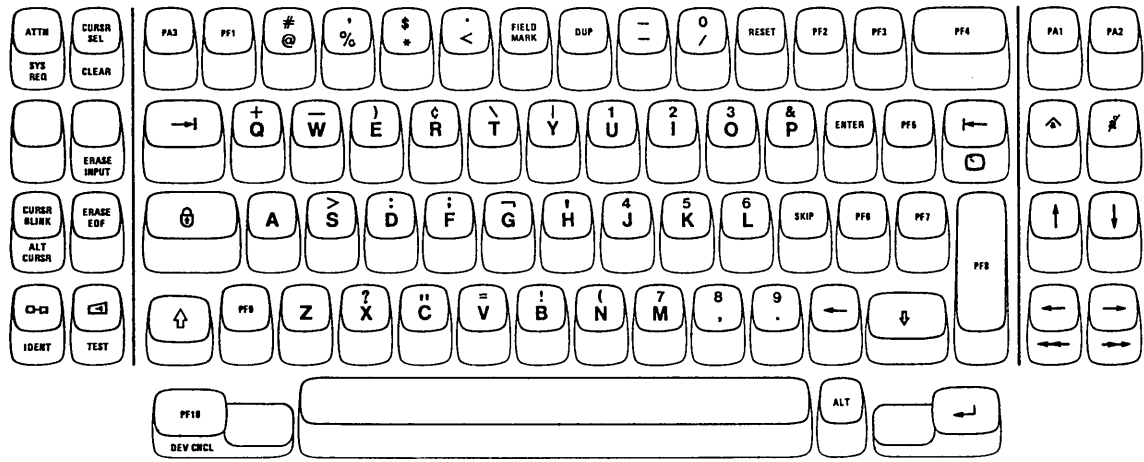

Figure 3-4. Data Entry-Keypunch Layout Keyboard (See Note)

Note: Check the positions of the RESET, ENTER, New Line, Backspace, PF2 through PF8, and PF10 keys to determine which type of Data Entry keyboard is attached to your display station.

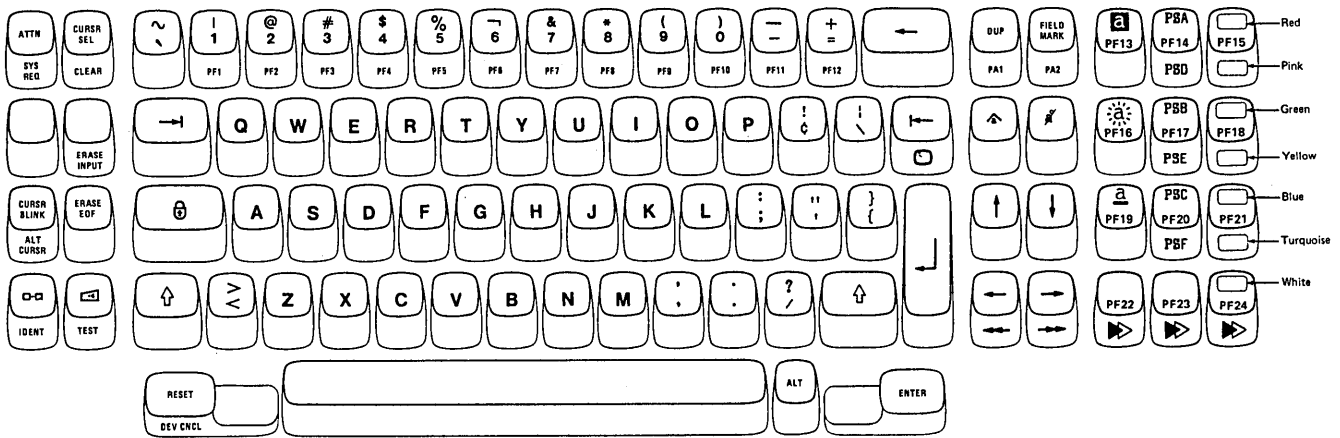

Figure 3-5. Attribute Select Typewriter Keyboard

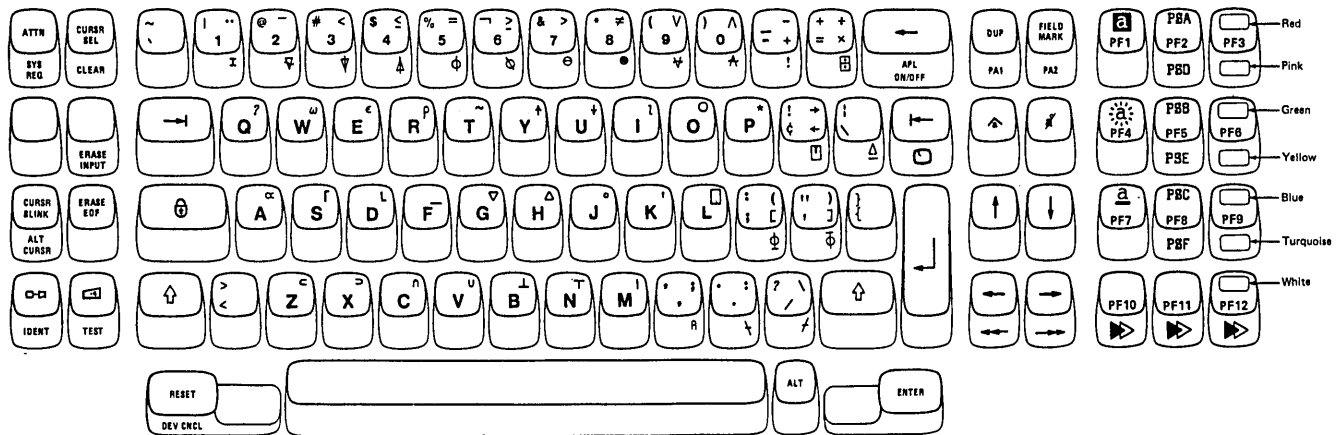

Figure 3-6. Attribute Select Typewriter/APL Keyboard

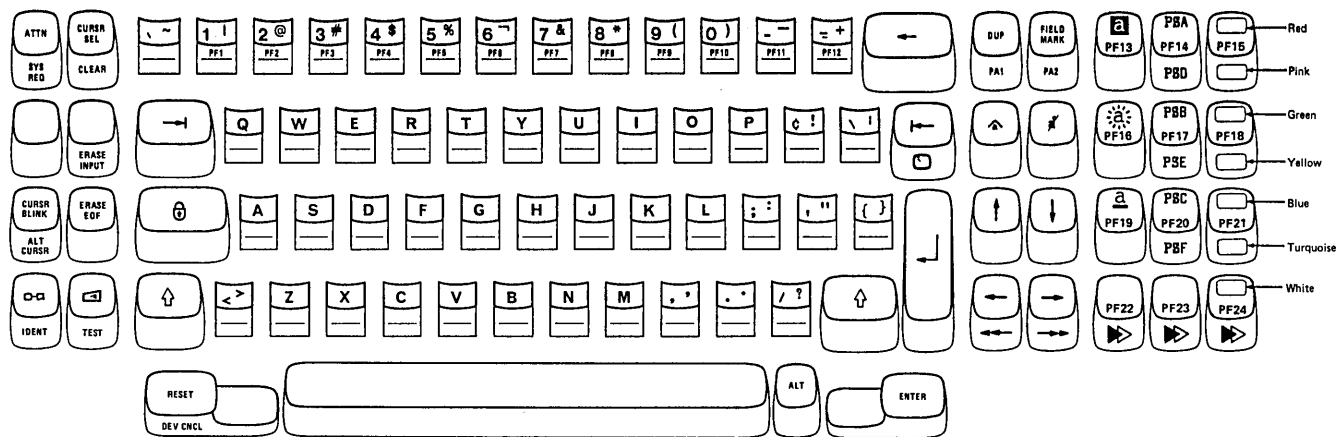

Figure 3-7. Attribute Select Overlay Keyboard





Typewriter Keyboard

Introduction

The 3278 Typewriter keyboard resembles a typewriter keyboard in appearance and key layout. In fact, most of the keys do the same thing as the keys of the same name on a typewriter keyboard.

Many different types of organizations will use the Typewriter keyboard, and each one has unique needs and, possibly, special character requirements. IBM provides many versions of the Typewriter keyboard in an attempt to meet the needs of everyone who uses 3278 Display Stations. Differences between the versions are small, and they affect only a few special symbols. All symbols are defined under the heading “Symbol and Punctuation Mark Keys.” The only other difference in versions is that your keyboard may or may not have 12 additional keys, PF13–PF24, located to the right of the normal typewriter keys. These keys are discussed under the heading “PF13–PF24 Keys.”

The characters that can be entered and displayed consist of 26 uppercase and 26 lowercase alphabetic characters, 10 numeric characters, and 32 symbols and punctuation marks. The keyboard also contains the keys that are required to format and enter an input message. Operation of any of the character keys causes the character indicated on the key to be displayed on the screen in the position marked by the cursor.

Keys that have two characters on their faces can display either of them, depending upon the operation of the Shift and Lock ( ) keys. The lower character displays when the character key is pressed and the keyboard is in the unshifted mode (the Shift  key not depressed). To display the upper character, you must hold the Shift () key down while pressing the character key or press and release the Lock () key before pressing the character key.

Some of the keys have a function name or symbol on the front of them. These keys are called alternate function keys. To cause the function on an alternate function key to be performed, press and hold the Alternate Shift (ALT) key down and press the desired alternate function key.

After reading this section, turn to “Similar Keys on Typewriter and Data Entry Keyboards,” in this chapter, for descriptions of other keys that are on a Typewriter keyboard.

Typamatic (Repeat-Action) Keys

Most of the keys are called typamatic keys. This means that they have the ability to repeat their characters or their function automatically if held down. The keys that have this capability are shown in Figure 3-8.

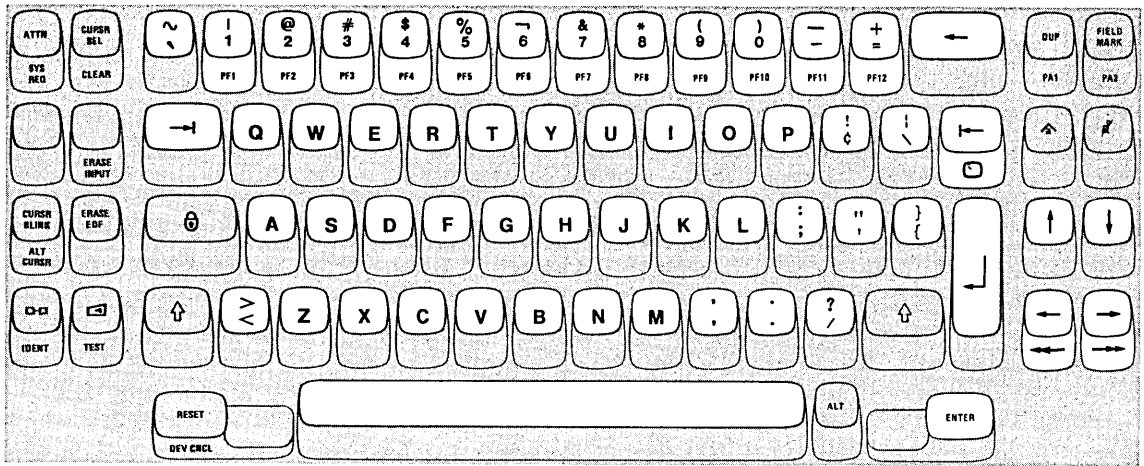

Figure 3-8. Typamatic (Repeat-Action) Keys

The discussion of each key also mentions the typamatic capability if it applies.

Shift (↑) and Lock (🔒) Keys

The Shift (↑) and Lock (🔒) keys operate like those on a typewriter keyboard. When either the left or the right Shift key is pressed, the upper symbols shown on the dual character keys will display when their respective keys are pressed.

When either Shift key is pressed when an alphabet key is pressed, the uppercase character is displayed; if no Shift key is pressed when an alphabet key is pressed, the lowercase character is displayed (if the *A,a/A* switch is set to *A,a*). If the *A,a/A* switch is set to *A*, only uppercase alphabet characters are displayed, but the program recognizes the difference between uppercase and lowercase alphabetic characters. The Shift keys are nonlocking and must be held down.

Pressing the Lock (🔒) key locks the keyboard in a shifted (uppercase) condition. When the Lock key is used, you do not have to hold the Shift key down, and both hands are free for typing. Press either Shift key when you are ready to return the keyboard to the unshifted (lowercase) condition. This releases the lock.

When the Numeric Lock feature (described in Chapter 4) is installed on the Typewriter keyboard, the Numeric Lock feature can be overridden to enter all uppercase characters and symbols by pressing and holding the Shift (↑) key and pressing the desired character/symbol key(s). However, the lock (🔒) key does not override the Numeric Lock feature.

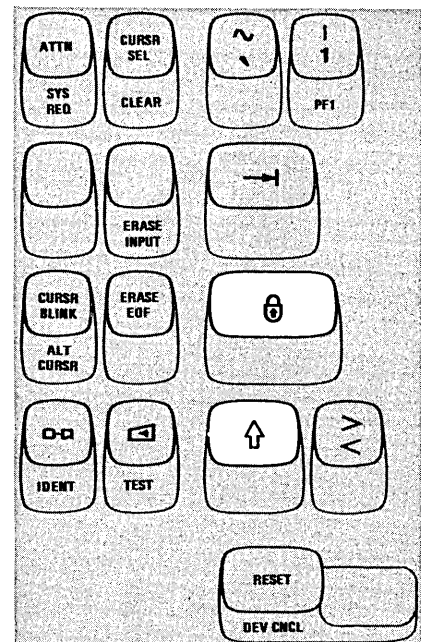

ALT (Shift) Key

The ALT (Alternate) Shift key is used to enable the alternate function keys. The alternate function keys are the keys that have a function name or a symbol on the front of them: SYS REQ, CLEAR, ERASE INPUT, ALT CURSR, IDENT, TEST, DEV CNCL, PA1, PA2, PF1 through PF12, Double-Speed Horizontal Positioning (←← and →→), and  (Home). To cause the function on an alternate function key to be performed, you must press and hold the ALT key down and press the desired alternate function key.

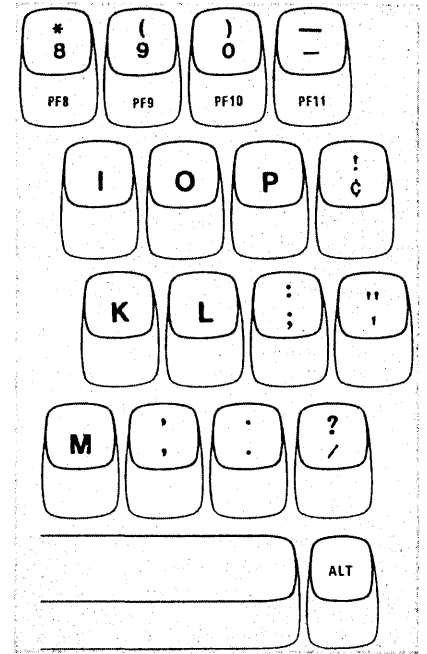

Alphabet Keys

The characters on the faces of the Alphabet keys (Figure 3-9) are displayed as uppercase (capital) letters when the keys are used in conjunction with the Shift (↑) and Lock (Ⓛ) keys. When the Alphabet keys are used without the Shift or Lock keys, the letters are displayed as lowercase letters (if the A,a/A switch is set to A,a). All the Alphabet keys are typamatic if held down.

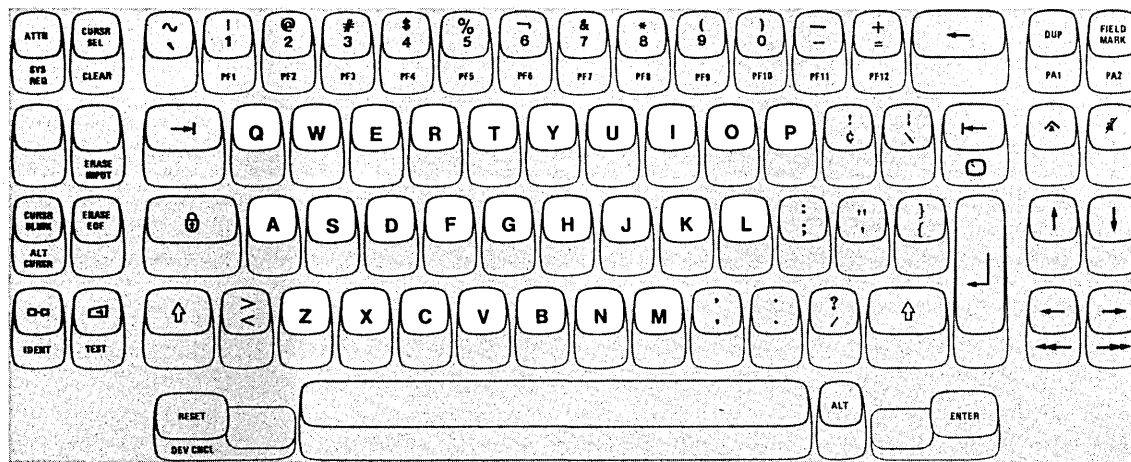

Figure 3-9. Alphabet Keys

Numeric Keys

When pressed with no shift, each of the Numeric keys (Figure 3-10) displays the digit shown on the lower half of the key. When operated with the Shift key held down, each key displays the symbol shown on the upper half of its face. When operated with the ALT key held down, the keys become PF1 through PF10. All the numeric keys are typamatic if held down.

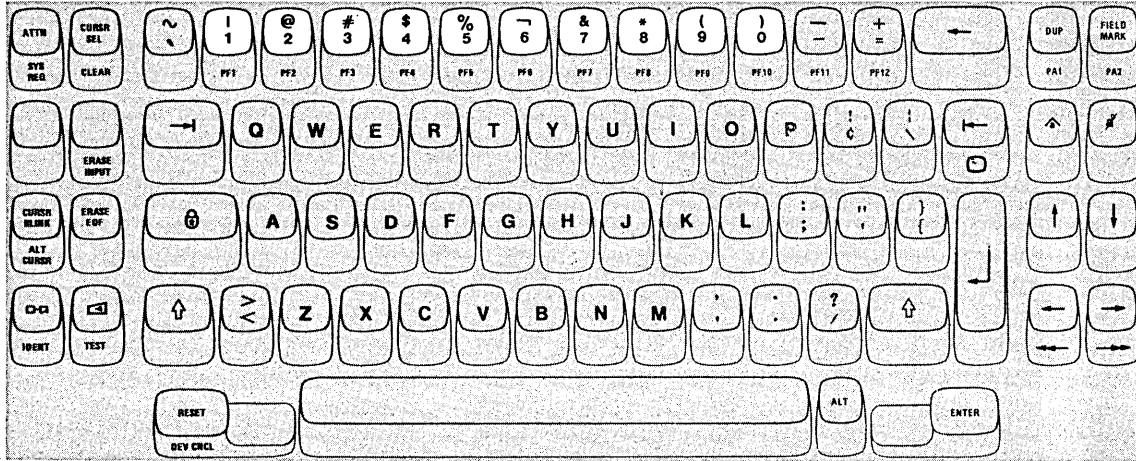
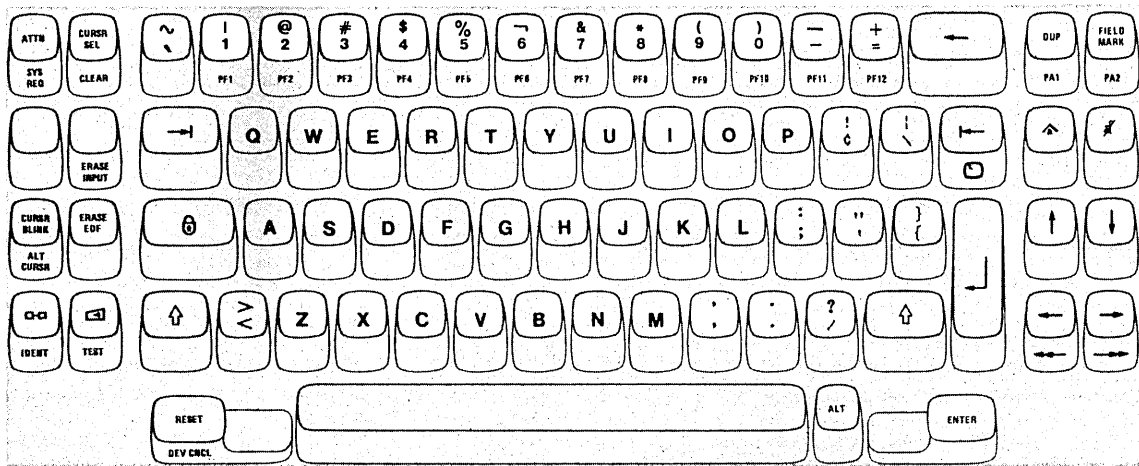

Figure 3-10. Numeric Keys

Symbol and Punctuation Mark Keys

These characters are divided into two groups because of their physical locations. The first group contains the symbols that are located on the upper part of the keys that have the numerals 1 through 0 on the lower half. The second group contains those characters located on keys that have two symbols on them. The symbol that appears on the upper half of a key requires pressing the Shift key or the Lock key to display it. Figures 3-11 and 3-12 show the locations of all symbols and give the name of each symbol. All the symbol and punctuation mark keys are typamatic if held down.



Numeric Key

- 1 } See Note
- 1 }
- 2
- 3
- 4
- 5
- 6 } See Note
- 6 }
- 7
- 8
- 9
- 0

Upper Half of Numeric Key

- | = logical OR, vertical bar
- ! = exclamation point
- @ = at sign
- # = number sign
- \$ = dollar sign
- % = percent sign
- = logical NOT sign
- ^ = circumflex, caret
- & = ampersand
- * = asterisk
- (= left parenthesis
-) = right parenthesis

Note: The exclamation point and circumflex (caret) are not illustrated, but are present on the 3278 ASCII Typewriter keyboard in place of the logical OR (vertical bar) and logical NOT sign.

Figure 3-11. Some symbols are located on numeric keys.

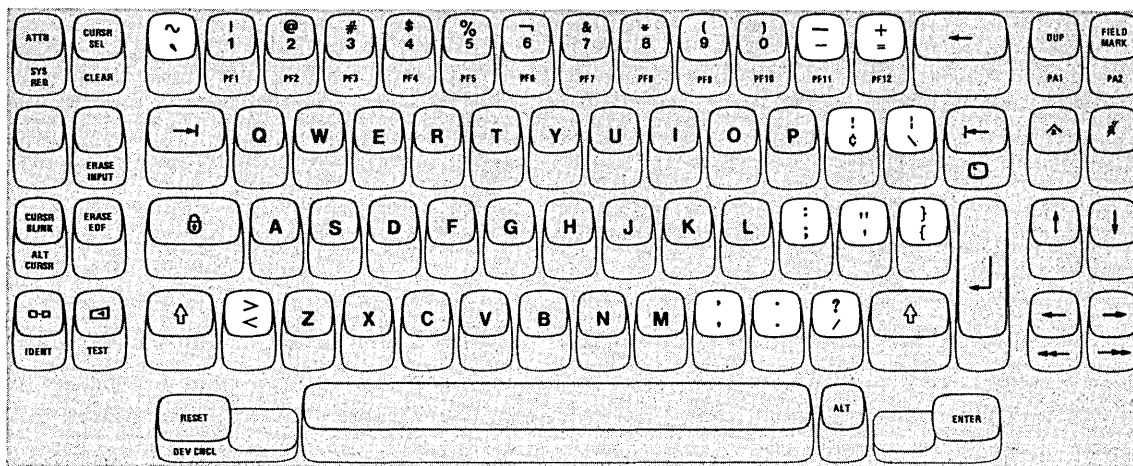

Lower Symbol

- ` = grave accent
- = minus sign
- = = equals sign
- ¢ = cent sign (See Note)
- \ = back slash
- ;
- ' = apostrophe
- { = left brace
- < = less than sign
- , = comma (lowercase)
- . = period (lowercase)
- / = slash

Upper Symbol

- ~ = tilde
- _ = underscore
- + = plus sign
- ! = exclamation point (See Note)
- | = broken vertical bar
- :
- " = quotation mark
- } = right brace
- > = greater than sign
- , = comma (uppercase)
- . = period (uppercase)
- ? = question mark

Note: The opening and closing brackets [] are not illustrated, but are present on the 3278 ASCII Typewriter keyboard in place of the exclamation point and cent sign.

Figure 3-12. Some keys contain only symbols and punctuation marks.

DUP Key

Pressing the DUP key displays an overscored asterisk ($\bar{*}$) when the *A,a/A* switch is set to *A,a*; when the *A,a/A* switch is set to *A*, only the asterisk is displayed. Also, as a result, the cursor advances to the first character location of the next input field.

The DUP operation is intended to provide you with a fast method of filling in the information that is the same for every document (such as the date). The DUP key causes a special code to be sent to the host system which tells the program that a duplication operation is needed. The program you are working with, however, determines the use of the DUP key. To verify its use, ask the appropriate person in your organization about its use or refer to the appropriate user's program guide.

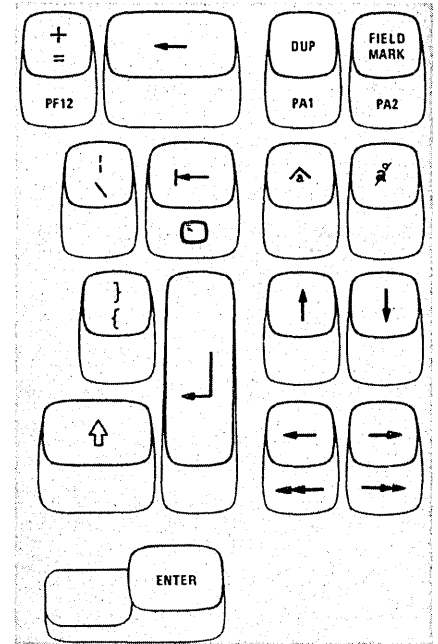

FIELD MARK Key

Pressing the FIELD MARK key displays an overscored semicolon ($\bar{;}$) when the *A,a/A* switch is set to *A,a*; when the *A,a/A* switch is set to *A*, only the semicolon is displayed. The FIELD MARK key is used when operating with an unformatted display to indicate the end of a field to the program.

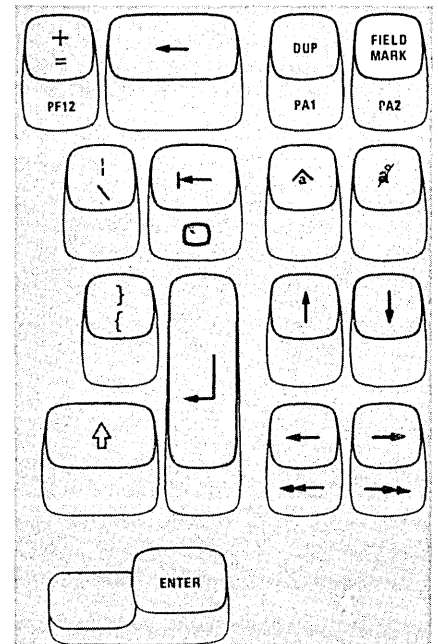

PA1 and PA2 Keys

PA1 and PA2 are Program Access (PA) keys, and they perform the function that their name implies; that is, they provide a means of signaling the program or communicating with it. The PA1 and PA2 keys are alternate function keys and can only be used when the ALT key is held down. While your display station is signaling the program, the Do Not Enter - Time (X ⌚) message appears in the Operator Information Area, disabling your keyboard. Most programs, when replying to these keys, turn off the Time message. However, this is up to the program. The program that is operating in the host system at the time also determines how these keys are used. If you are not familiar with the use of the PA1 and PA2 keys, ask the appropriate person in your organization about the use of PA1 and PA2 or refer to the appropriate user's program guide.

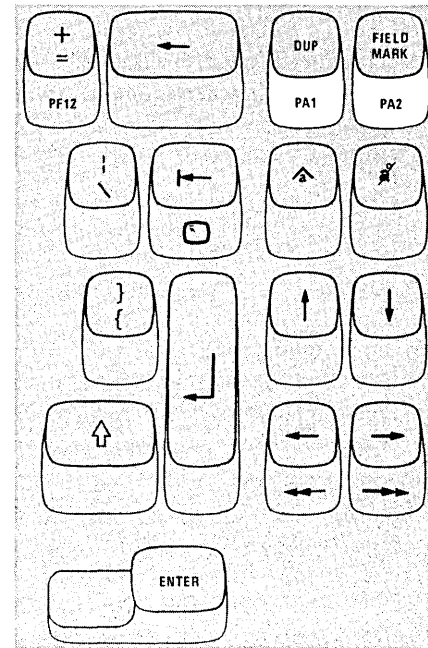

PF1–PF12 Keys

Application programs can assign programmable functions to the Program Function (PF) keys. On the 75-key Typewriter keyboard there are 12 PF keys on the front of the top row keys (Figure 3-13). The PF1 through PF12 keys are alternate function keys and can be activated only while the ALT key is held down.

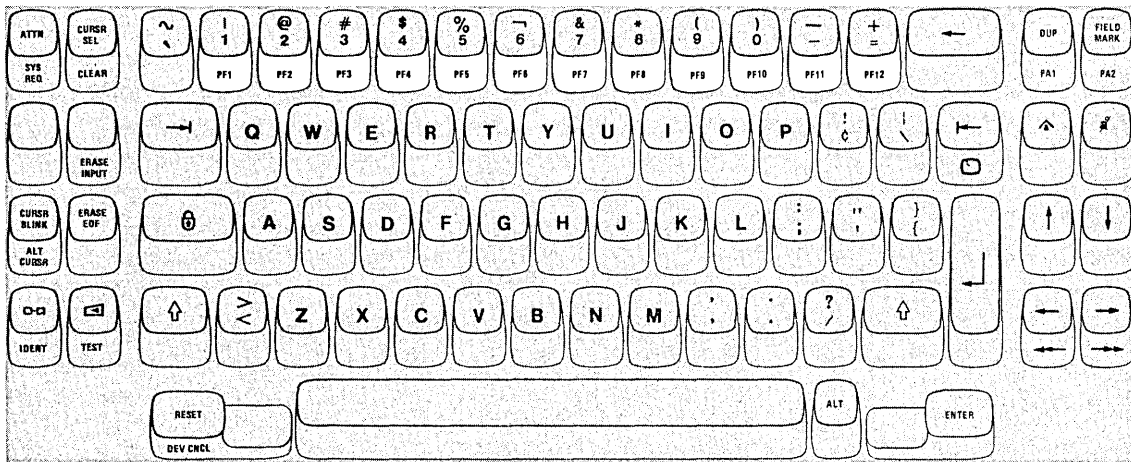

Figure 3-13. PF1–PF12 Keys

Application programs can define the action that occurs when any one of the PF keys is pressed. By doing this, each program can tailor the keyboard to fit its specific needs. This adds flexibility to the 3278 keyboards and makes them more powerful input devices. One program might replace the document on the screen with a different one whenever PF1 is pressed with the ALT key held down. When you are working with a different program, pressing PF1 and ALT might be a signal that you have keyed in all the source data that you have available.

To determine the use of each PF key and the action it causes, ask the appropriate person in your organization how the PF keys are used or refer to the appropriate user's program guide.

Note: *The PF keys are typamatic when held down; however, it is recommended that you do not use the PF key typamatic capability, because the results are unpredictable.*

PF13–PF24 Keys

The PF13 through PF24 are keys that your keyboard may or may not have. They serve the same function as the PF1 through PF12 keys. However, they are not alternate function keys, and you do not use the ALT key when you press them.

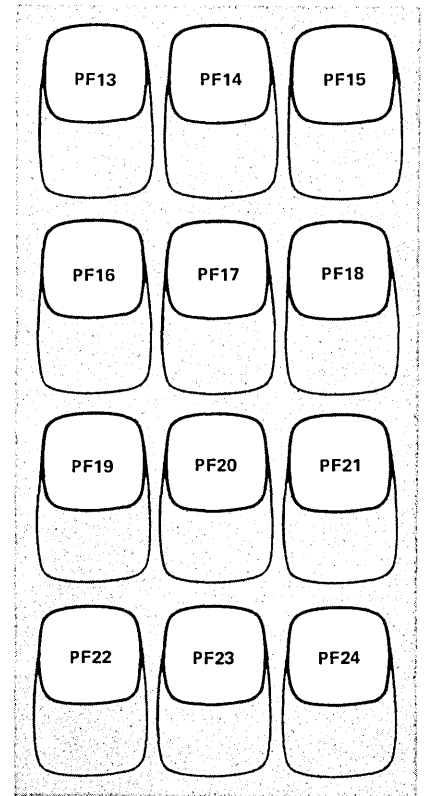



Data Entry Keyboard

Introduction

Only the basic Data Entry keyboard (Figure 3-3) is discussed in this section. Both types of Data Entry keyboards (basic Data Entry configuration/Data Entry Keypunch Layout) contain the same keys. Some of the keys are at different locations; however, the functions performed are identical on both keyboards.

The Data Entry keyboard combines the features of the typewriter keyboard with those of the familiar keypunch keyboard. The alphabet keys are arranged according to the typewriter touch system, and a group of the right-hand keys serves two purposes, for digits as well as letters. These keys are arranged like the corresponding keys on a keypunch keyboard. A three-finger touch system for the numeric keys can be used from the normal home position of the alphabetic keyboard. The touch system for the 10 numeric keys is: index finger for the 1, 4, and 7; middle finger for the 2, 5, and 8; and ring finger for the 0, 3, 6, and 9.

All other keys that have two characters on the key face also have two purposes. The character displayed is determined by whether the keyboard is in Alphabetic Mode or Numeric Mode when the key is pressed. Alphabetic Mode is the normal state of the keyboard, and the lower character on the key face displays when you press the key with the keyboard in this mode. To display the upper character, you must shift the keyboard into Numeric Mode. This is done by pressing the Numeric Shift key () or the Numeric Lock () key. A more detailed discussion of these keys is presented later.

Some of the keys have a function name or symbol on the front of them. These keys are called alternate function keys. To perform the functions on the front of these keys you must shift the keyboard into Alternate Mode and then press the alternate function key. To do this, press and hold down the ALT (Alternate Shift) key, then press the desired alternate function key.

Whenever the cursor enters a program-defined numeric input field on your screen, the display station will automatically shift the keyboard into Numeric Mode. Without shifting your hands from the home position or pressing any keys to shift modes, you can key a numeric field with the right hand only. While keying in the numeric field, your left hand is free for document handling if it is required. After you have keyed your input digits into the field, and as the cursor leaves the numeric field, the keyboard shifts back to Alphabetic Mode. This permits you to key an alphabetic field with both hands.

You may encounter situations where the cursor has entered a program-defined numeric input field (thereby placing the keyboard in Numeric Mode) and you must enter one or more alphabetic characters. The Alpha (↓) shift key is provided to enable you to enter alphabetic characters into a program-defined numeric input field. To enter alphabetic characters when the keyboard is in Numeric Mode, press and hold the Alpha shift key, and then key in the desired alphabetic character or characters.

After reading this section, turn to “Similar Keys on Typewriter and Data Entry Keyboards,” in this chapter, for descriptions of other keys on the Data Entry keyboard.

Typamatic (Repeat-Action) Keys

Most of the keys are called typamatic keys. This means that they have the ability to repeat their characters or their function automatically if held down. The keys that have this capability are shown in Figure 3-14. The discussion of each key also mentions the typamatic capability if it applies.

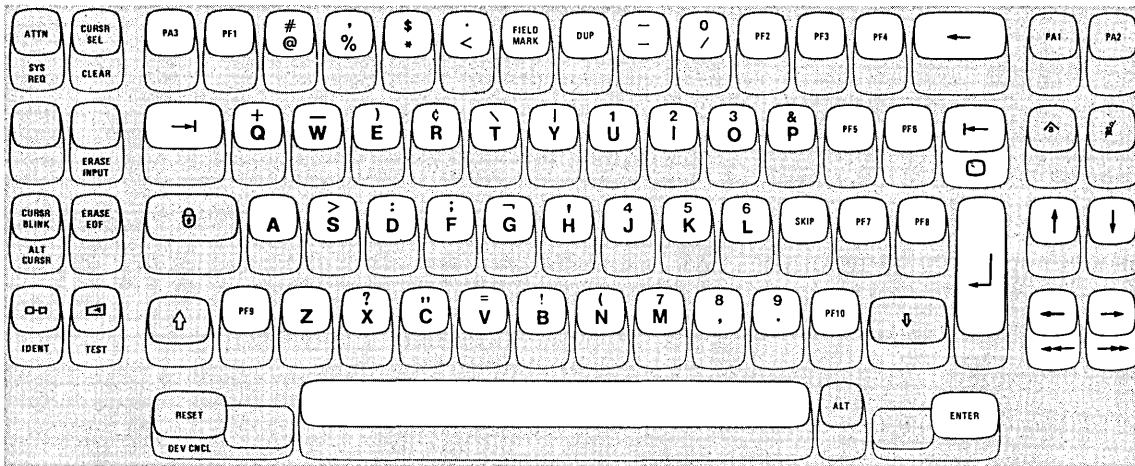

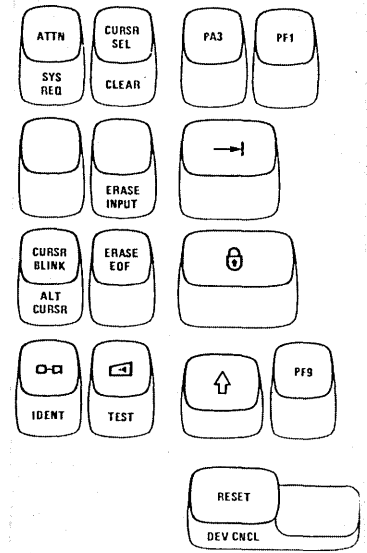



Figure 3-14. Typamatic (Repeat-Action) Keys

Numeric Shift () Key

Pressing the Numeric Shift () key shifts the keyboard into Numeric Mode for as long as the key is held down. Numeric Mode causes the top character shown on each key to be displayed when that key is pressed. The Numeric Shift key is nonlocking and must be held down. This key overrides the Numeric Lock feature (if installed).



Numeric Lock () Key

Press the Numeric Lock () key when it is necessary to shift the keyboard into Numeric Mode and it is not convenient to hold the Numeric Shift () key down while completing your operation. The keyboard remains locked until you press the Numeric Lock key again. At that time, it shifts back to Alphabetic Mode. This key does not override the Numeric Lock feature (if installed).

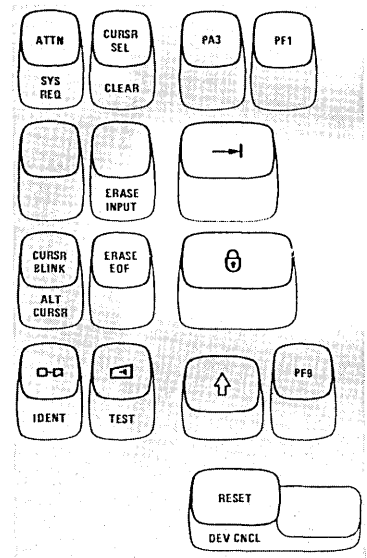

Alpha () Key

You will remember that, when the cursor enters a numeric field on a formatted screen, the keyboard automatically shifts to Numeric Mode. When one or more alpha characters must be keyed, and when the cursor is located in a numeric field on a formatted screen, press the Alpha key to shift the keyboard into Alphabetic Mode. The Alpha key is nonlocking and must be held down.

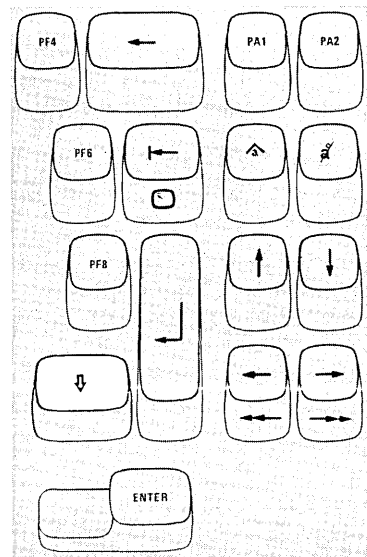

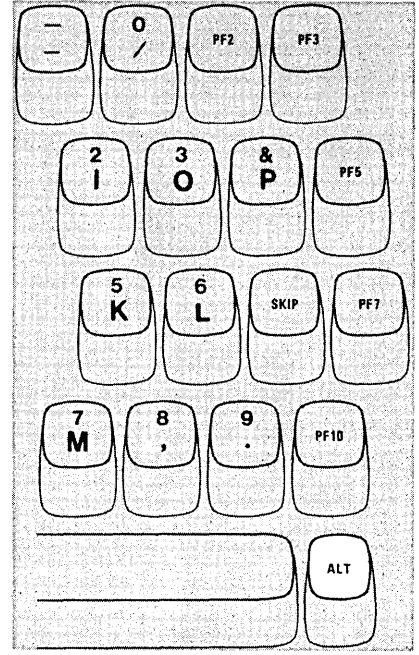

ALT (Shift) Key

The ALT (Alternate) Shift key is used to enable the alternate function keys. The alternate function keys are the keys that have a function name or a symbol on the front of them: SYS REQ, CLEAR, ERASE INPUT, ALT CURSR, IDENT, TEST, DEV CNCL, Double-Speed Horizontal Positioning (←← and →→), and  (Home). To cause the function on an alternate function key to be performed, you must press and hold the ALT key down and press the desired alternate function key.



Alphabet Keys

All but two of the Alphabet keys (A and Z) are dual-character keys. (See Figure 3-15.) The alpha character (on the lower half of the key face) will display when the key is pressed while the keyboard is in Alphabetic Mode (its normal mode). When pressed while the keyboard is in Numeric Mode, each of these keys displays the digit or symbol on the upper half of the key face. Remember that the keyboard is in Numeric Mode (1) when the Numeric Shift () key is being held down, (2) when the Numeric Lock () key has been pressed once, or (3) whenever the cursor is in a formatted numeric field. All alphabetic characters are always displayed as capital letters. All the Alphabetic keys are typamatic if held down.

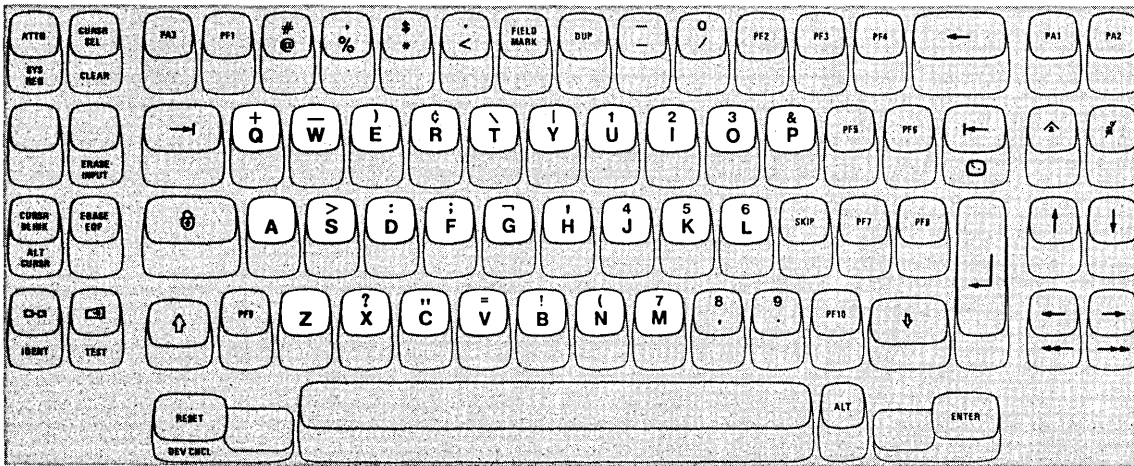
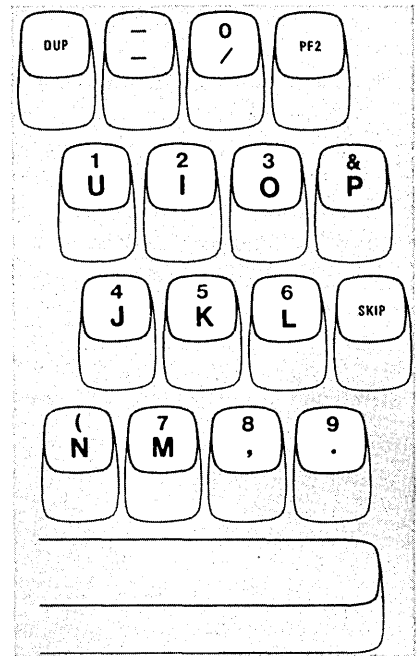

Figure 3-15. Alphabet Keys

Numeric Keys

Pressing any Numeric key displays the digit on the upper half of its key face when the keyboard is in Numeric Mode. The character on the lower half of the key face is displayed when the key is pressed while the keyboard is in Alphabetic Mode.

Remember that the normal mode of your keyboard is Alphabetic Mode. The keyboard automatically shifts to Numeric Mode when your screen is formatted and the cursor enters a numeric field. At all other times, you must press the Numeric Shift or the Numeric Lock keys to shift to Numeric Mode.



Symbol and Punctuation Mark Keys

The locations of the 25 keys that contain symbols and punctuation marks are shown in Figure 3-16. You must press the Numeric Shift key, along with the symbol key, to display the symbol that appears on the upper half of the key face.

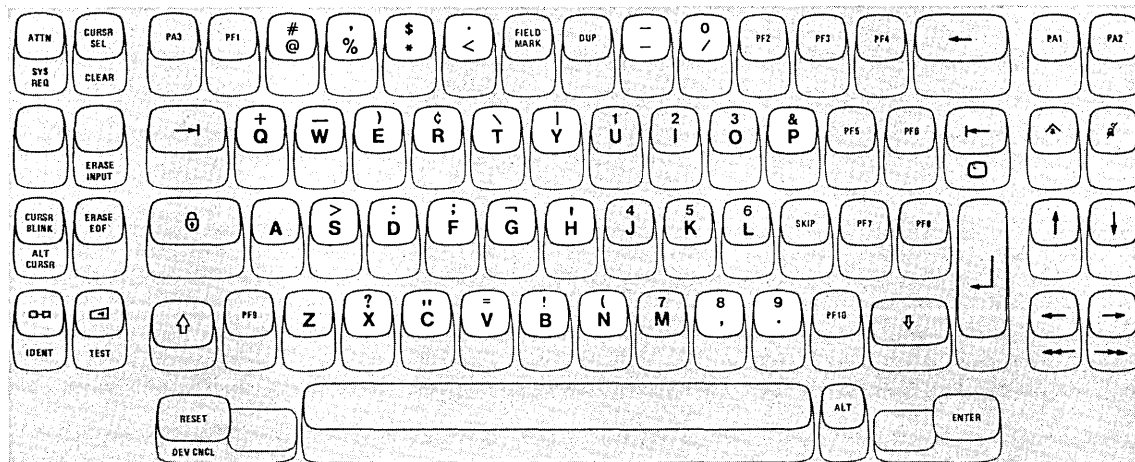

- | | | |
|---------------------------------------|-----------------------|-------------------------|
| @ = at sign | / = slash | ; = semicolon |
| # = number sign | + = plus sign | ¬ = logical NOT |
| % = percent sign | _ = underscore | ' = apostrophe |
| , = comma (upper case) |) = right parenthesis | ? = question mark |
| * = asterisk | ^ = cent sign | " = quotation mark |
| \$ = dollar sign | \ = back slash | = = equals sign |
| < = less than sign | = vertical bar | ! = exclamation mark |
| . = period (upper case) | & = ampersand | (= left parenthesis |
| - = minus sign (upper and lower case) | > = greater than sign | , = comma (lower case) |
| | : = colon | . = period (lower case) |

Figure 3-16. Symbol and Punctuation Mark Keys

DUP Key

Pressing the DUP key displays an overscored asterisk ($\bar{*}$) when the *A,a/A* switch is set to *A,a*; when the *A,a/A* switch is set to *A*, only the asterisk is displayed. Also, as a result, the cursor advances to the first character location of the next input field.

The DUP operation is intended to provide you with a fast method of filling in the information that is the same for every document (such as the date). The DUP key causes a special code to be sent to the host system which tells the program that a duplication operation is needed. The program you are working with, however, determines the use of the DUP key. To verify its use, ask the appropriate person in your organization about its use or refer to the appropriate user's program guide.

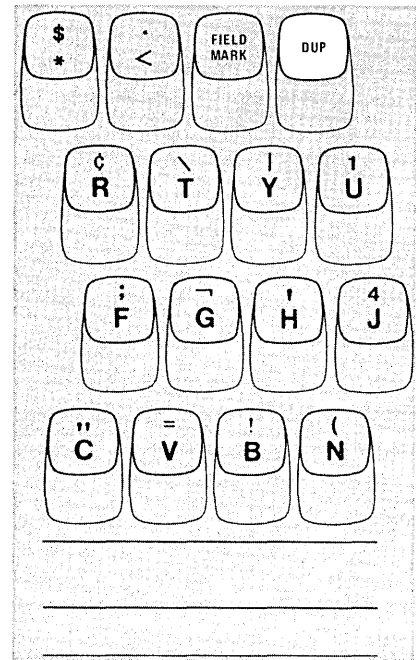

FIELD MARK Key

Pressing the FIELD MARK key displays an overscored semicolon ($\bar{;}$) when the *A,a/A* switch is set to *A,a*; when the *A,a/A* switch is set to *A*, only the semicolon is displayed. The FIELD MARK key is used when operating with an unformatted display to indicate the end of a field to the program.

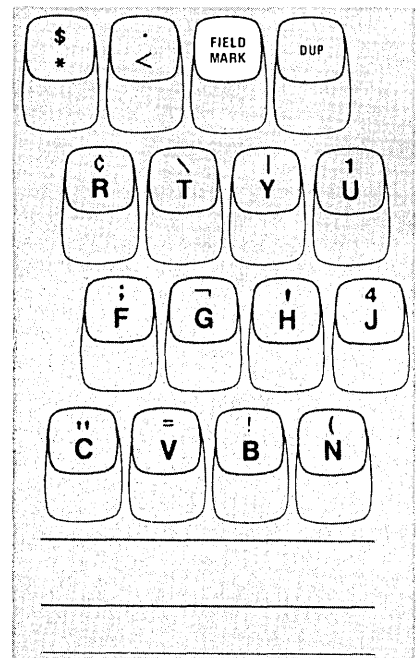

PA1, PA2, and PA3 Keys

PA1, PA2, and PA3 are Program Access (PA) keys, and they perform the function that their name implies; that is, they provide a means of signaling the program or communicating with it. While your display station is signaling the program, the Do Not Enter - Time (X) message appears in the Operator Information Area, disabling your keyboard. Most programs, when replying to these keys, turn off the Time message. However, this is up to the program. The program that is operating in the host system at the time also determines how these keys are used. If you are not familiar with the use of the PA keys, ask the appropriate person in your organization about the use of the PA keys or refer to the appropriate user's program guide.

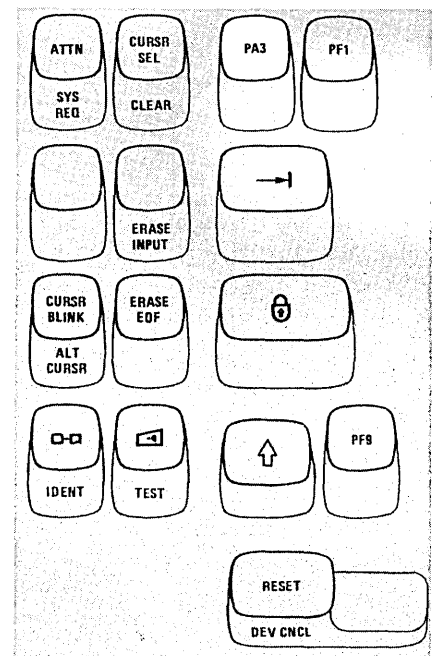
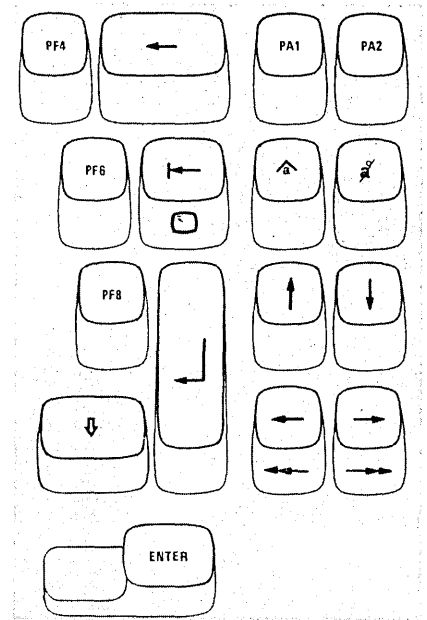

PF1–PF10 Keys

Application programs can assign programmable functions to the Program Function (PF) keys. On the Data Entry keyboards there are 10PF keys (Figure 3-17).

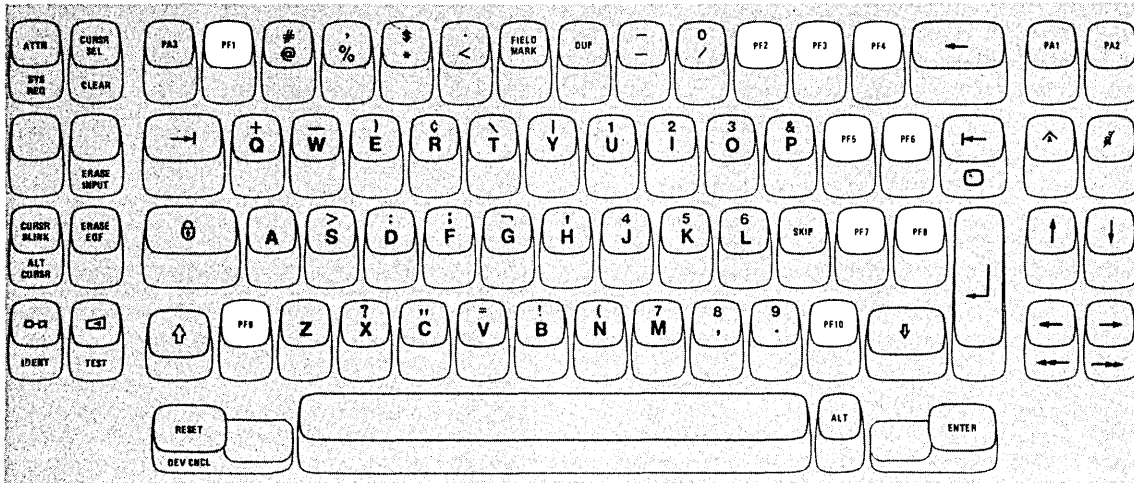

Figure 3-17. Program Function (PF) Keys

Application programs can define the action that occurs when any one of the PF keys is pressed. By doing this, each program can tailor the keyboard to fit its specific needs. This adds flexibility to the keyboards and makes them more powerful input devices. One program might replace the document on the screen with a different one whenever PF1 is pressed. When you are working with a different program, pressing PF1 might be a signal that you have keyed in all the source data that you have available.

To determine the use of each PF key and the action it causes, ask the appropriate person in your organization how the PF keys are used or refer to the appropriate user's program guide.

Note: *The PF keys are typamatic when held down; however, it is recommended that you do not use the PF key typamatic capability, because the results are unpredictable.*

Blank Keys (in Numeric Mode)

When the keyboard of a 3278 connected to a 3274 is in Numeric Mode and the cursor is in an input field, the A and Z keys generate a space when pressed. The top portion of these keys is blank.

On a 3278 connected to a 3276, the A and Z keys are ignored when the keyboard is in Numeric Mode; pressing either key when in Numeric Mode does not cause the cursor to move.

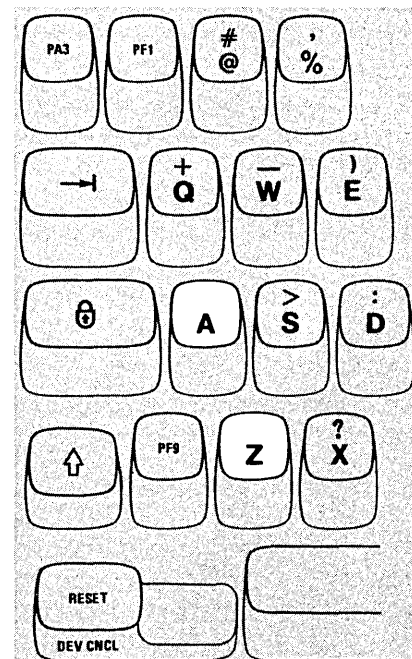

Similar Keys on Typewriter and Data Entry Keyboards

Introduction

Many of the keys on the Typewriter and Data Entry keyboards have similar locations and functions. The remainder of this chapter describes these keys.

Spacebar

On the 3278, unlike a typewriter or a keypunch, a space is considered an actual character that occupies a position on the screen. When the Spacebar (Figure 3-18) is pressed, a space is entered on the screen and replaces whatever character is present in that position (even if that character is not displayed on the screen; for example, a character in a nondisplay field). For this reason, the Spacebar should not be used to position the cursor. The Spacebar is typamatic if held down.

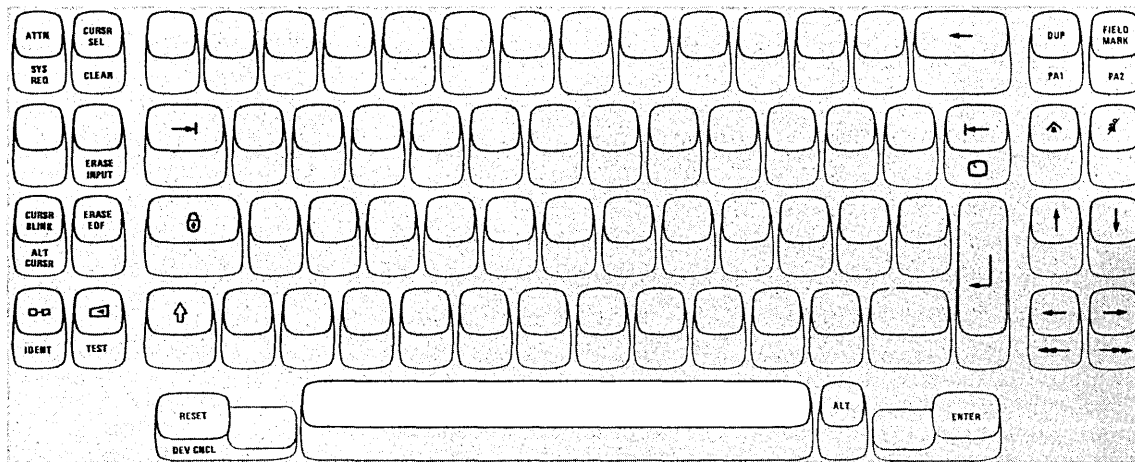

Figure 3-18. Spacebar

Cursor Control Keys

These keys have a common function. They provide a means of positioning the cursor without affecting any of the information already on the screen. See Figure 3-19.

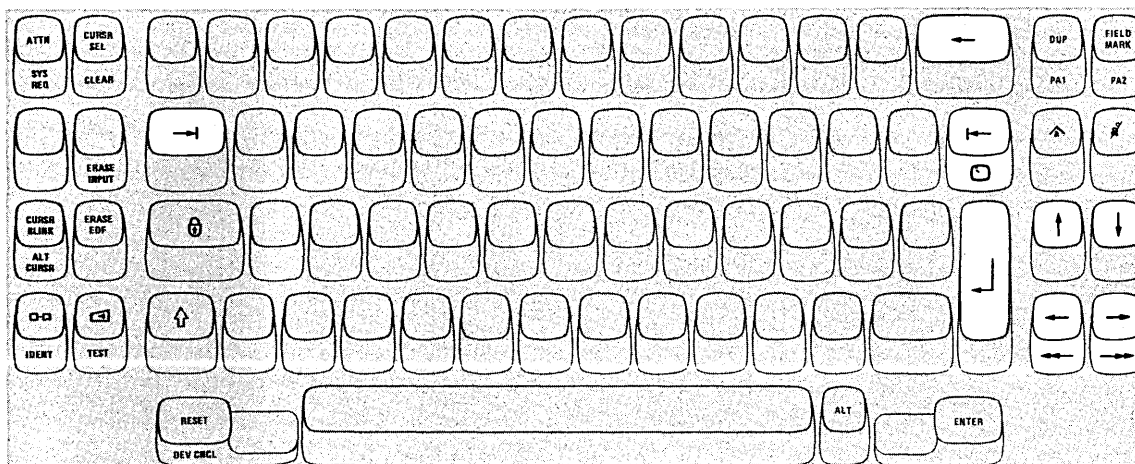

Figure 3-19. Cursor Control Keys

Because the position of the cursor determines where the next character you key is entered, it is important to know how to move the cursor to any location on the screen. Also, you will want to be able to move the cursor around quickly to correct any errors you detect while working.

These keys are divided into two types:

1. Those that move the cursor to the first character location in an input field.
2. Those that move the cursor one or two character positions at a time.

Moving the Cursor to the Beginning of a Field

New Line Key. The New Line key moves the cursor to the first input character location of the next line in which you can type. This new cursor location depends on the existing data displayed and on the screen format.

When the New Line key is pressed, there are five possible new cursor locations where you may begin entering data:

1. If the screen is unformatted, the cursor is moved to *the first position in the next line*.
2. If the screen is formatted, the cursor moves to one of three locations as described in the following examples (the New Line key is pressed when the cursor is located at A in Figure 3-20; then, the cursor moves to location B):
 - a. *A character position within the next line*, as shown in the top example in Figure 3-20. In this case, the cursor is placed in the first input character location past the protected field called "ITEM DESCRIPTION:".
 - b. *The first character position in the next line*, as shown in the middle example of Figure 3-20. In this case, no protected field or character is present at the first character position in the next line; therefore, the cursor is positioned at the left margin in the next line.
 - c. *A character position on the first new line available*. It may happen that the first new line contains all protected fields. Therefore, the cursor must keep searching until a new line is found that contains an input field.
3. *If all character positions on the screen are protected, the cursor is repositioned to the first location on line 1.*

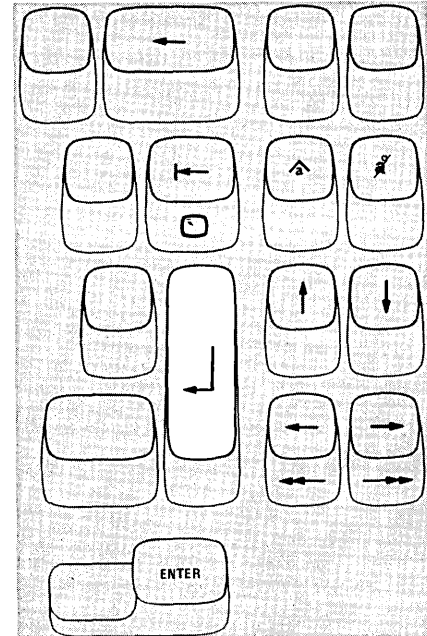

The New Line key is typamatic and moves the cursor quickly from line to line.

CUSTOMER NAME JOHN DOE
ADDRESS RED ROAD, ARVADA, COLORADO
DATE JUNE 11, 1972
ITEM DESCRIPTION:

NAME STOCK NO
QTY ORDERED MFG CODE
REHOUSE

STOCK BALANCE
EST SHIP DATE

☐

Figure 3-20. New Line Key Operations

Back Tab Key. The Back Tab key moves the cursor back to the first character position in an input field. In the top example in Figure 3-22, when Back Tab is pressed, the cursor moves from the end of the ADDRESS field (location A) to the first character location in that field, the R in RED.

If the cursor is already in the first character position of an input field, and if you press the Back Tab key, the cursor will then move back to the first character position of the preceding input field. This case is shown in the lower example in Figure 3-22. When the operator was about to enter the "MFG CODE" at location A, it was noticed that the "QTY ORDERED" entry was missing. Therefore, the operator pressed Back Tab, which moved the cursor back to the first character position of the QTY ORDERED field.

Pressing the Back Tab key moves the cursor to the first location on line 1 if the screen is not formatted or if there are no input fields. Back Tab also is typematic, allowing you to move the cursor quickly from field to field.

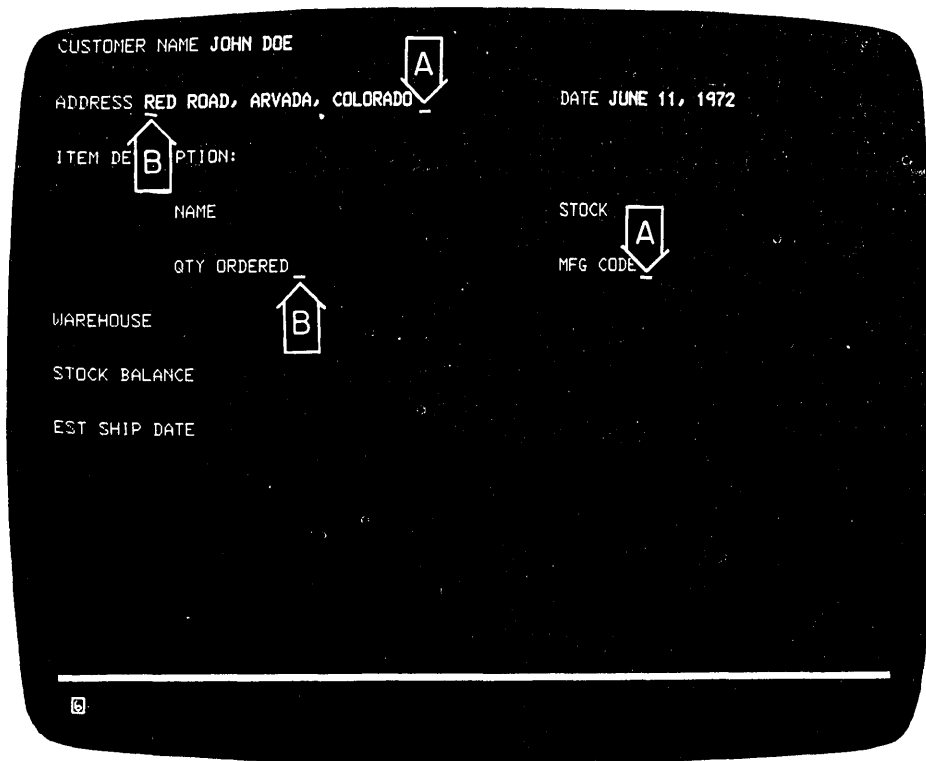
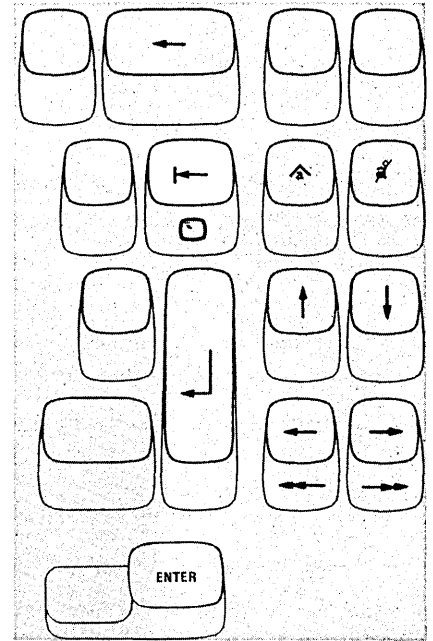
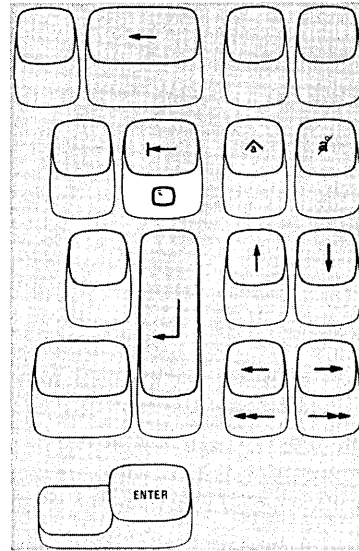

Figure 3-22. Back Tab Key Operation

Home (⌘) Key. Pressing the Home (⌘) key while holding the ALT key down moves the cursor to the first input character location on your screen. If your screen is unformatted or if there are no input fields, pressing the Home key moves the cursor to the first location on line 1. The Home key is typamatic if held down.



Moving the Cursor One or Two Character Spaces

Horizontal Positioning Keys. Pressing either of the two horizontal positioning keys (right→or left←) moves the cursor in the direction of the arrow, one character position at a time. The keys are typamatic so that you can move the cursor any distance quickly with only one pressing of the key. If you hold down the key that moves the cursor to the right, the cursor moves off the right side of the screen and reappears one line lower on the left side (as explained in Chapter 2). The cursor also wraps when moved to the left and reappears one line higher on the right side of the screen.

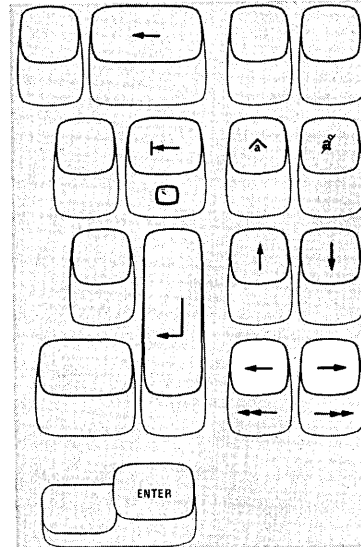

Double-Speed Horizontal Positioning Keys. Pressing either of the two double-speed horizontal positioning keys (right⇨or left⇦) while holding the ALT key down moves the cursor in the direction of the arrow, two character positions at a time. The keys are typamatic so that you can move the cursor at twice the speed of the normal horizontal positioning keys. When using these keys, the cursor wraps at the right and left sides of the screen in the same manner as when using the normal horizontal positioning keys.

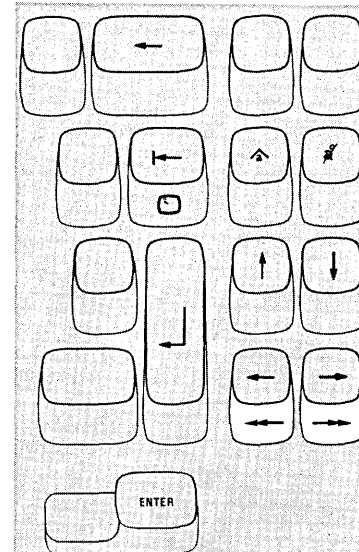

Vertical Positioning Keys. Operating the two vertical cursor positioning keys (up ↑ or down ↓) moves the cursor in the direction of the arrow, one line at a time. The keys are typamatic to allow you to move the cursor any number of lines quickly and with only one depression of the key. If a vertical positioning key is held down, cursor wrap occurs. In this case, the cursor reappears in the same character position, on the opposite edge (top or bottom line) of the screen that it occupied before moving off the screen.

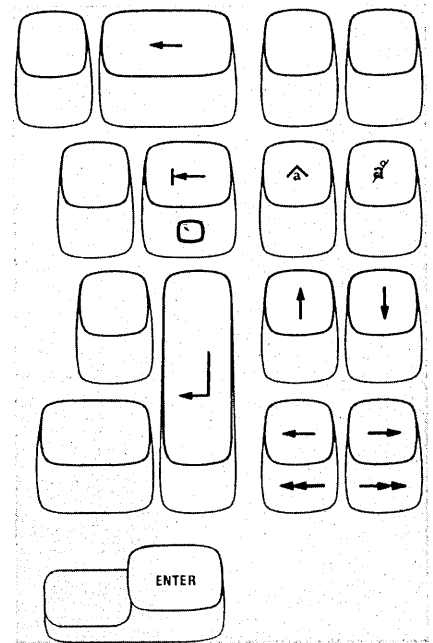

Backspace Key. Pressing the Backspace key moves the cursor one location to the left for each depression of the key. This key operates exactly like the horizontal (left) positioning key and also is typamatic. (This duplication of key function is provided for operator convenience.)

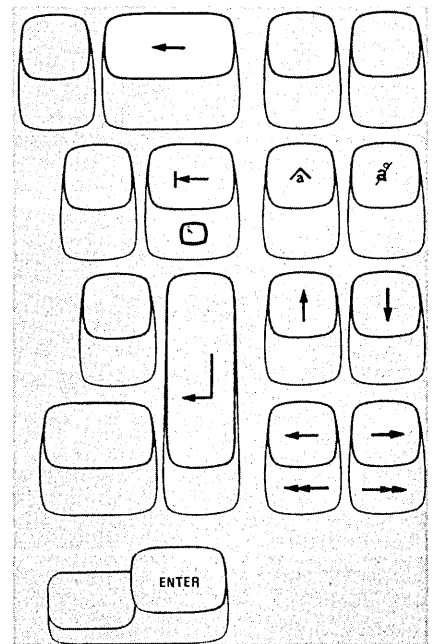

ATTN Key

The ATTN (Attention) key performs the function that its name implies; that is, it provides a means of getting the program's attention. The ATTN key is operative only when E is displayed in the Operator Information Area; if the ATTN key is pressed when A is displayed in the Operator Information Area, the Minus Function (X - f) message comes on in the Operator Information Area.

While your display station is signaling the program, the Time (X ⚙) message comes on in the Operator Information Area, disabling your keyboard. Most programs, when responding to this key, turn off the Time message. However, this is up to the program. The program that is operating in the host system at the time determines how the ATTN key is used. If you are not familiar with the program's response to an ATTN key depression, ask the appropriate person in your organization about the program's response or refer to the appropriate user's program guide.

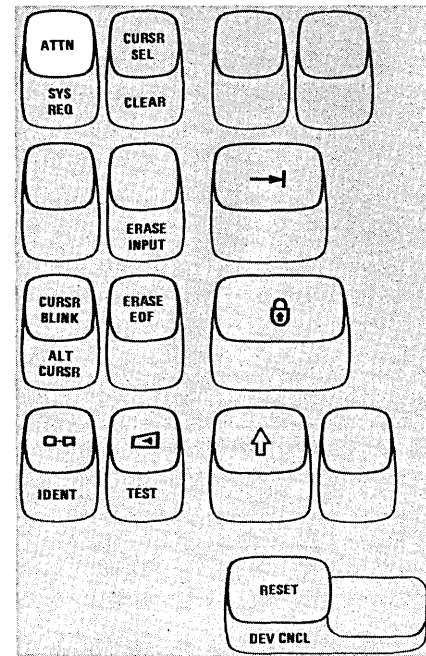

SYS REQ Key

The SYS REQ (System Request) key is an alternate function key and can be used only when you are holding the ALT key down. The function that this key performs depends upon whether an A or a E symbol is displayed in the Operator Information Area.

When the A symbol is displayed in the Operator Information Area, pressing the SYS REQ key (with the ALT key held down) sends a unique signal to the host system to tell the program that your display station may be failing and that you have keyed a test request message. If you are not familiar with the Request for Test procedures, ask the appropriate person in your organization about the procedures.

When the E symbol is displayed in the Operator Information Area, pressing the SYS REQ key (with the ALT key held down) (1) causes your display screen to be cleared and (2) switches your display station between application and control programs. Ask the appropriate person in your organization for an explanation of the use of the SYS REQ key when E is displayed or refer to the appropriate user's program guide.

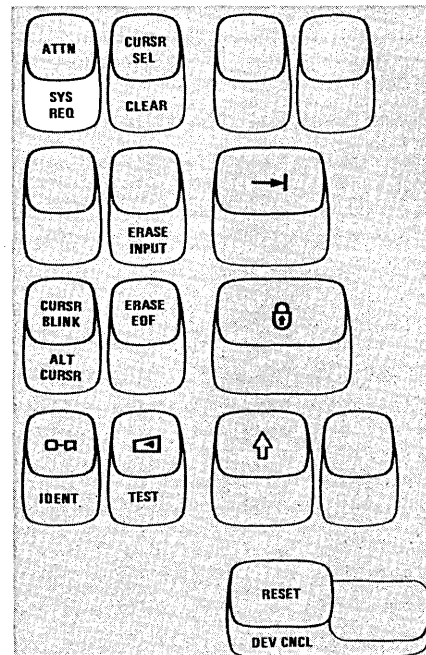

CURSR SEL Key

The CURSR SEL (Cursor Select) key provides the same function provided by the Selector Light Pen feature. In most applications for the CURSR SEL key a list or a table is displayed for you to select items from it. An example of a screen with selectable fields is shown in Figure 3-23.

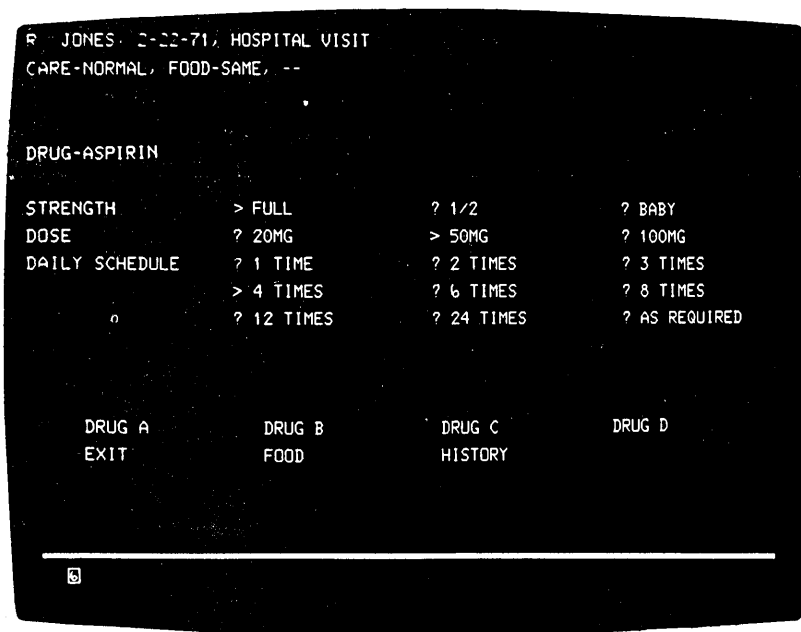
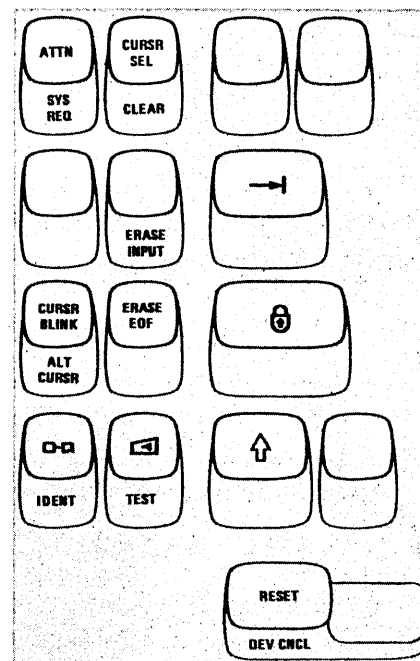

Figure 3-23. CURSR SEL Key Selectable Fields

There are two types of selectable fields that can be displayed on your screen: (1) selection fields and (2) attention fields. You will use the CURSR SEL key to (1) select items in selection fields and (2) notify the program of your selection by selecting an attention field.

The first character of each selectable field on your screen is called a designator character. The designator character for a selection field is either a question mark (?) or a greater-than sign (>); the designator character for an attention field is an ampersand character (&) or a blank position.

Initially, the designator characters in most of the selection fields on your screen will be question marks. To select an item (field), position the cursor within the selection field that you want to select; then press the CURSR SEL key. The question mark at the beginning of the selected field changes to a greater-than sign to indicate that the field has been selected.

If you select the wrong field, you can correct your mistake by selecting the field again with the CURSR SEL key. This changes the greater-than sign back to a question mark and deselects the field. The correct field can then be selected.

After you have completed your selections from the screen (more than one selection can be made), locate a selectable field (attention field) that has an ampersand character or a blank position for a designator character. Selecting the attention field turns on the Do Not Enter - Time (X) message and indicates to the program that you have completed your selections. The data you have selected can now be acted upon by the program.

The way you end a CURSR SEL operation depends on the program, and each job could be different. Always refer to the user's program guide for the program with which you are working for specific instructions.

CLEAR Key

Pressing the CLEAR key while holding the ALT key down (1) erases or blanks every character location on the screen except the Operator Information Area, (2) establishes an unformatted display, and (3) positions the cursor to the first location in line 1.

The CLEAR key does not change the keyboard shift status of your display station, but it removes the NUM message in the Operator Information Area if it is on. Also, if you are using a 960-, 2560-, 3440-, or 3564-character capacity display station that is formatted for the full screen capacity, pressing the CLEAR key may cause your display station to be unformatted as a 480- or 1920-character display.

When the CLEAR key is pressed, your display station signals the program, informing it that the CLEAR key has been pressed. While this signaling is taking place, the Do Not Enter - Time (X) message appears, disabling your keyboard. Most programs reply to the signal by turning off the Time message. This, however, is up to the program. Therefore, the Time message may remain on after a CLEAR key depression. If you are not familiar with the program's response to a CLEAR key depression, ask the appropriate person in your organization about the program's response or refer to the appropriate user's program guide.

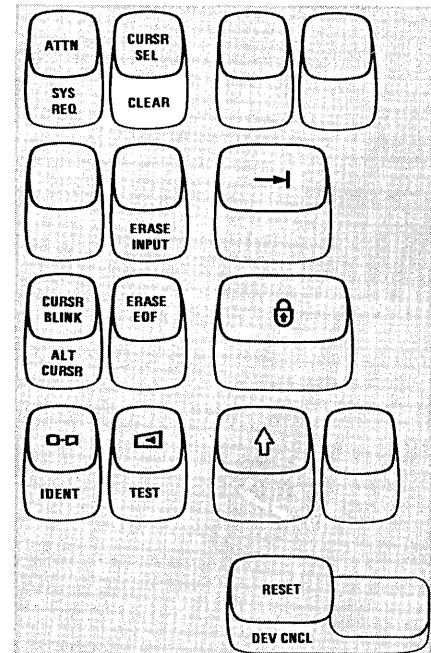

ERASE INPUT Key

Pressing the ERASE INPUT key while holding the ALT key down erases or blanks all input fields on your screen. If you have a permanently displayed document on the screen, and your job is to fill in the blanks, all those areas in which you can enter data are erased. The cursor also moves to the first character location in the first field in which you can begin keying data.

Pressing the ERASE INPUT key (with ALT) while working with a screen on which there are no input fields does not erase anything but moves the cursor to the first location on line 1.

Pressing the ERASE INPUT key (with ALT) while working with an unformatted screen erases all character locations and moves the cursor to the first location on line 1.

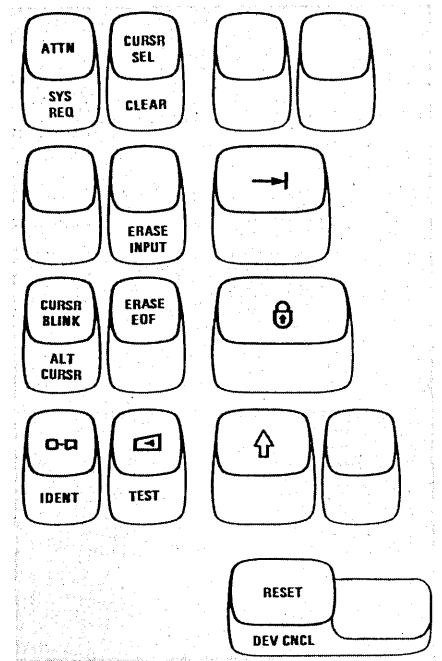

ERASE EOF Key

Pressing the ERASE EOF (Erase to End of Field) key erases or blanks character locations in the input field in which the cursor is located. All character locations from the cursor location to the end of the field are erased. The cursor, however, does not move. If your screen is unformatted, all character locations from the cursor to the last character location on the bottom line are erased.

A possible use of this key can be shown by assuming that you have entered wrong information when keying in a field. You could press the Back Tab key to return the cursor to the beginning of the field, press the ERASE EOF key to erase the incorrect information, and then key in the correct information.

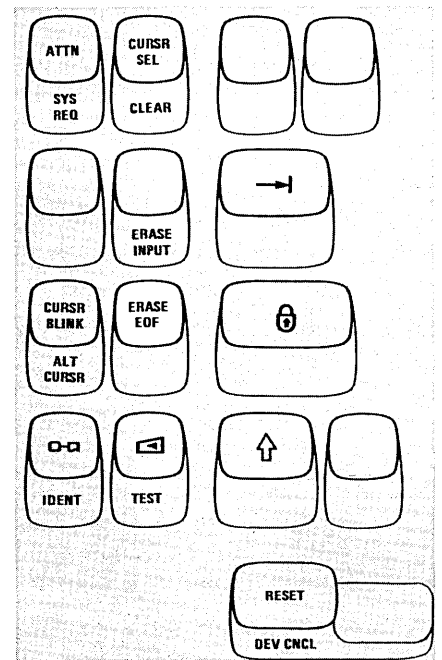

CURSR BLINK Key

The CURSR BLINK key enables you to control the blink function of your cursor. Pressing the CURSR BLINK key when the cursor on the screen is not blinking causes your cursor to blink on and off continuously. To stop the cursor blink, press the CURSR BLINK key again. The blink function operates with both the normal cursor (underline) and the alternate cursor (reverse character image).

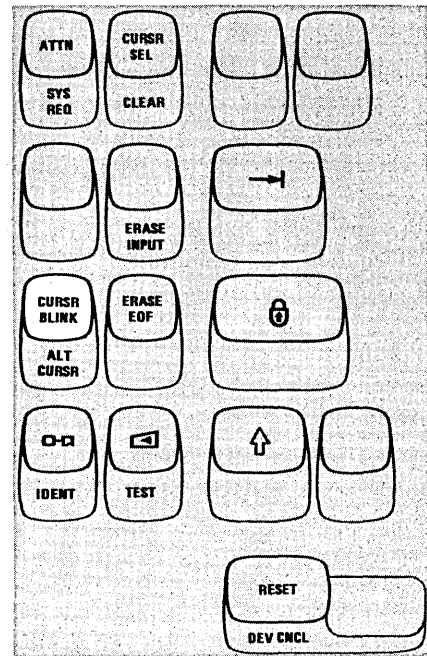

ALT CURSR Key

By using the ALT CURSR (Alternate Cursor) key with the ALT key you can control which type of cursor appears on your screen, the normal cursor or the alternate cursor (see Chapter 2). Pressing the ALT CURSR key (with ALT held down) when the normal cursor (underline) is on the screen replaces the normal cursor with the alternate cursor (reverse character image). To restore the normal cursor, press the ALT CURSR key (with ALT held down) again.

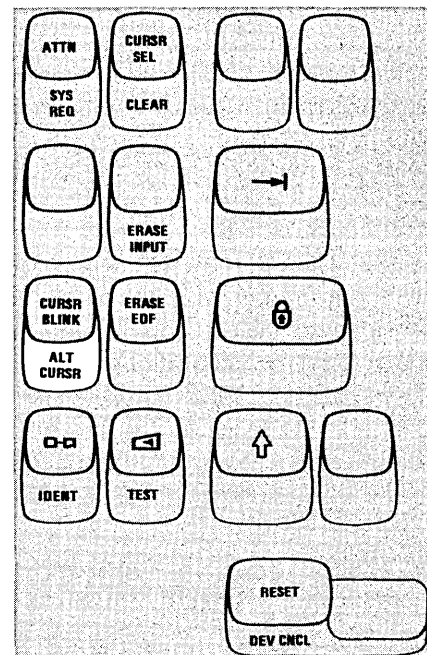

Print (P) Key

Pressing the Print (P) key causes the information on your screen to be printed on the printer assigned to your display station. The printer used is specified by the P-PP message on the right side of the Operator Information Area.

If a Printer Class was assigned to your display station at the time you pressed the Print key, the PP portion of the P-PP message in the Printer Status portion of the Operator Information Area changes from a Printer Class designation to the Printer ID of the printer being used. You can monitor the progress of the print operation by observing the Printer Status messages on your screen. When the printer begins your print operation, the P-PP message is replaced by a P-PP message. When the print operation is completed, the original P-PP message reappears.

If the printer is busy, one of the following Do Not Enter messages appears in the Operator Information Area after the Print key is pressed:

- ✘ P-PP The printer is busy and cannot perform your print operation.
- ✘ P-PP Means the same thing as the ✘ P-PP message, except more time is anticipated before your print request is accepted.

At this point you can either (1) wait for the print operation to be completed or (2) press and hold the ALT key and then press the DEV CNCL key to cancel the print operation and restore your keyboard. The RESET key has no effect when these messages are displayed.

If the printer is not working (out of order, unplugged, out of paper, etc.), a ✘ P-PP message appears in the Operator Information Area. This means the printer cannot perform your print operation and your print request has been canceled. At this point you should press and hold the ALT key and then press the DEV CNCL key to restore your keyboard. You may then either select a different printer or try to restore the failing printer. The RESET key has no effect when ✘ P-PP is displayed.

If the printer fails while printing your print request, (1) the P-PP message (on the right side of the Operator Information Area) changes to a P-PP message, (2) the Do Not Enter-Printer Not Working (✘ P-PP) message appears, and (3) your keyboard is disabled. To cancel the operation, remove the ✘ P-PP and P-PP messages, and restore your keyboard, press and hold the ALT key and then press the DEV CNCL key.

If you press the Print key when you are not authorized to perform a print operation, the Do No Enter-Operator Not Authorized (✘ P-PP) message appears. Press the RESET key to restore your keyboard; then refer to the Operator Not Authorized message description in Chapter 2 to determine the appropriate action.

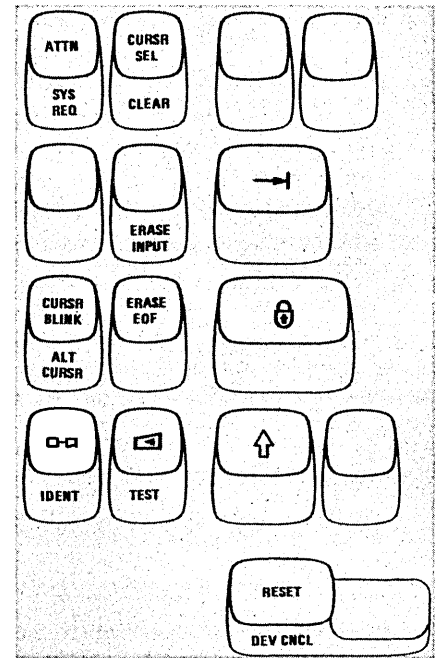

IDENT Key

The IDENT key is used with the ALT key to (1) either request or change the Printer ID/Printer Class for a print operation or (2) cause the existing printer authorization to be displayed (depending upon what is displayed in the Printer Status portion of the Operator Information Area). Depending upon your organization's operating procedures, you may specify printers by Printer IDs or Printer Classes.

A Printer ID number is the address assigned to a printer by the control unit. If your display station is connected to a 3276, the valid Printer ID numbers can be 01 through 07; if your display station is connected to a 3274, the valid Printer ID numbers can be 01 through 31.

Your organization may separate the printers connected to your control unit into Printer Classes. The valid Printer Class numbers are 70 through 85. The class of a printer may be based upon (1) its physical characteristics (speed, character set, type of forms used, etc.), (2) its physical location, (3) security, or (4) which operators are authorized to use it. For example, in a particular organization, Printer Class 75 may specify all printers capable of printing both uppercase and lowercase characters.

If a `□□nn` message is displayed in the Operator Information Area, it is replaced by a `□□__` message when you press the IDENT key (with the ALT key held down). You can now change the Printer ID/Printer Class for a print operation. When `□□__` appears the cursor disappears until the IDENT key operation is completed. You should now enter the two-character Printer ID or Printer Class number for your print operation; the Printer ID or Printer Class number appears in the two underlined locations of the `□□__` message.

If you enter an invalid Printer ID or Printer Class number, a `✕ ʘ#?` message appears. If `✕ ʘ#?` is displayed, press RESET and then try the IDENT key operation again, using the correct Printer ID or Printer Class number.

If you request a printer for which you are not authorized, a `✕ ʘ✕` message appears. If `✕ ʘ✕` is displayed, press RESET and then try the IDENT key operation again, using a different Printer ID or Printer Class.

If the host system changes your printer authorization, the `□□??` message is displayed in the Operator Information Area. In this case, pressing the IDENT key (with the ALT key held down) causes the `□□??` message to be replaced by a `□□nn` message that specifies your new printer assignment (in this case you do not enter two numerals).

If nothing is displayed in the Printer Status portion of the Operator Information Area, you can establish an assignment (if a printer is available) by pressing the IDENT key and entering a valid Printer ID.

If you are not familiar with your organization's use of Printer IDs/Printer Classes, ask the appropriate person in your organization for an explanation.

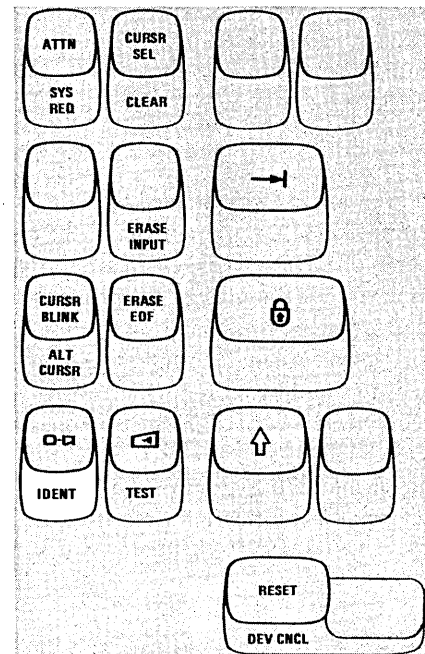

Click () Key

The Click () key enables you to turn the keyboard clicking sound on or off for normal operation. Pressing the Click key when the keyboard clicker is working causes the clicker to stop. Pressing the Click key a second time causes the clicker to operate.

It is important to know that generally:



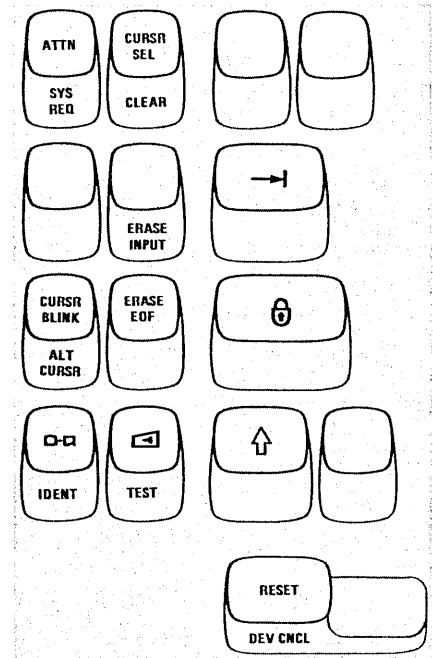

- When you have the clicker turned on, the click tells you the keyboard is operational and the data you are keying is being accepted. In this case, absence of the click indicates the keyboard is disabled.
- When you have the clicker turned off, the absence of the click tells you the keyboard is operational and the data you are keying is being accepted. In this case, the presence of the click indicates the keyboard is disabled.

Therefore, by being aware of the clicking, or of its absence, you can tell when the operation of your keyboard is not normal.



TEST Key

Pressing the TEST key when the ALT key is held down prepares your display station to run tests that reside in the control unit. When the TEST key is pressed with the ALT key held down the following actions occur:

1. The display screen is cleared.
2. The TEST message appears in the Operator Information Area.
3. All Do Not Enter () messages in the Operator Information Area are removed except , , and  (If any of these messages is displayed, the TEST key is inoperative.)

When your display station is in this Test mode, you can run the tests that are described in your *3278 Problem Determination Guide*. When you have finished running tests, press the TEST key (with ALT held down) again.

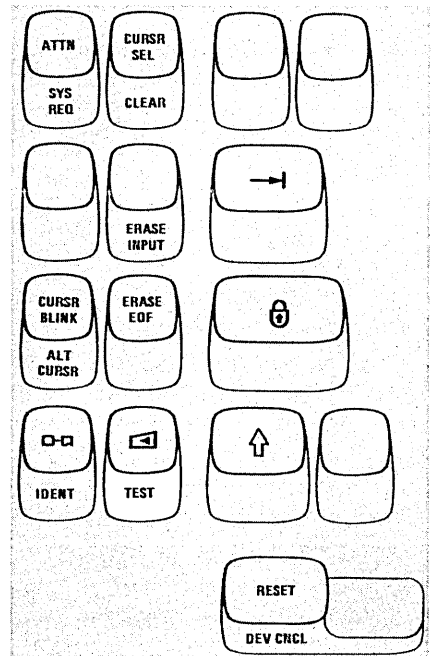

RESET Key

The RESET key is used to recover from Do Not Enter (X) conditions. Pressing the RESET key restores the keyboard and turns off the Do Not Enter message for all Do Not Enter conditions except X □□□, X □□□□, X □, X □□, and X □. (The RESET key has no effect when any of these messages are displayed.)

The RESET key will not operate when your display station is sending data to, or receiving data from, the host system.

Pressing the RESET key during an IDENT (Print Ident) key operation causes the IDENT key operation to end. The cursor reappears on the screen, and the old Printer ID or Printer Class number is displayed in the □□□□ message in the Operator Information Area.

The RESET key can be used to cancel a Dead Key operation, leaving a stand-alone accent at the cursor position.

The RESET key can also be used to terminate an Insert Mode operation.

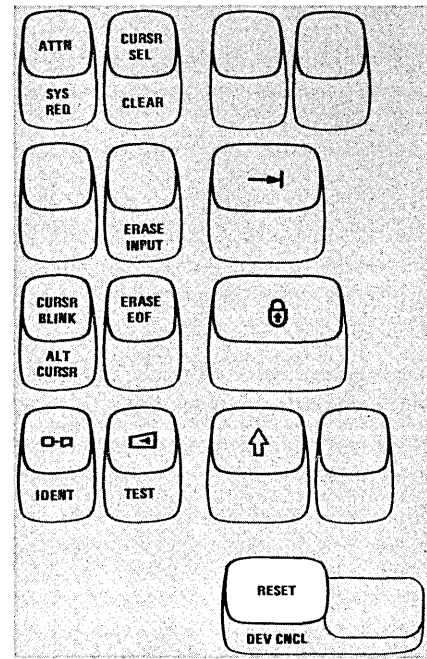

DEV CNCL Key

The DEV CNCL (Device Cancel) key, with ALT key held down, is used to recover from a Do Not Enter (X) condition that is caused by a Print(□□) key operation.

If you initiate an operation to a printer that is busy, a Do Not Enter-Printer Busy (X □□□ or X □□□□) message appears in the Operator Information Area. If you want to cancel the operation and restore the keyboard, press and hold the ALT key and then press the DEV CNCL key.

If you initiate an operation to a printer that is not working, a Do Not Enter-Printer Not Working (X □□) message appears and the operation is automatically canceled. To restore your keyboard, press and hold the ALT key and then press the DEV CNCL key.

If the printer failed while printing your print request, a Do Not Enter-Printer Not Working (X □□) message and a Printer Failure (□□□□) message appear in the Operator Information Area. To cancel the operation, remove the X □□ and □□□□ messages, and restore your keyboard, press and hold the ALT key and then press the DEV CNCL key.

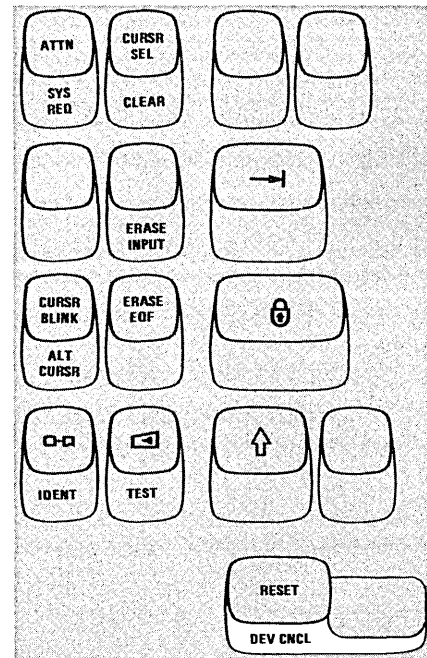

Insert (\wedge) Key

The purpose of the Insert (\wedge) key is to allow you to insert a character or characters into the middle of an input field without changing the characters that are already displayed there. Pressing the Insert key places the keyboard in the Insert Mode of operation. The Insert Mode symbol (\wedge) appears in the Operator Information Area to remind you that your keyboard is in Insert Mode.

All the keyboard control keys perform normally when in Insert Mode. Notice, however, that when any of the alphanumeric keys are pressed in Insert Mode the display station performs a unique operation. The examples in Figures 3-24 and 3-25 explain this operation.

In Figure 3-24, the information keyed into the ADDRESS field is incorrect. "RED ROAD, ARVADA, COLORADO" was keyed instead of "RED MAPLE ROAD, ARVADA, COLORADO".

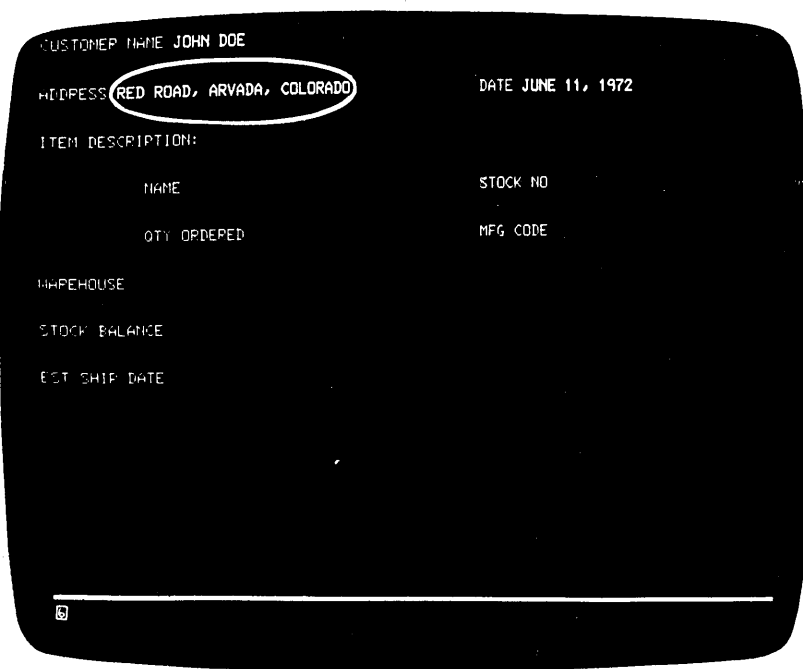
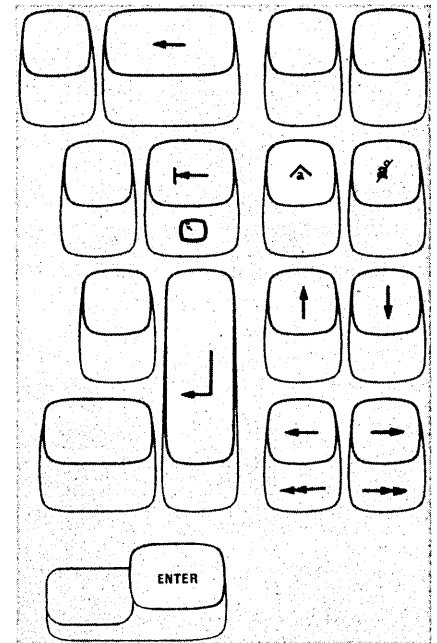

Figure 3-24. Use the Insert key to insert missing information.

To correct this error, using Insert Mode, you would move the cursor to the character position containing the R in the word ROAD.

RED ROAD, ARVADA, COLORADO

(This is the position where the word MAPLE should begin.)

Pressing the Insert key places the keyboard in Insert Mode. Now, keying of the word MAPLE, followed by one Spacebar depression, results in the sequence shown in Figure 3-25.

Key Pressed	Display
	ADDRESS: RED <u>R</u> OAD, ARVADA, COLORADO
M	ADDRESS: RED M <u>R</u> OAD, ARVADA, COLORADO
A	ADDRESS: RED MA <u>R</u> OAD, ARVADA, COLORADO
P	ADDRESS: RED MAP <u>R</u> OAD, ARVADA, COLORADO
L	ADDRESS: RED MAPL <u>R</u> OAD, ARVADA, COLORADO
E	ADDRESS: RED MAPLER <u>R</u> OAD, ARVADA, COLORADO
Space	ADDRESS: RED MAPLE <u>R</u> OAD, ARVADA, COLORADO

Figure 3-25. Insert Mode Example

The missing word has been inserted without disturbing the data following it. You may have noticed that, as characters are inserted, all characters to the right of the cursor are shifted into the blank positions to the right of the last displayed character. If you try to insert more characters than the field can hold, the Do Not Enter - Too Much Data (X 𐄂) message appears and your keyboard is disabled.

As a general rule, the number of characters you can insert into a field is limited to one character less than the number of blanks remaining in that field. For example, in Figure 3-24, the field titled "NAME" is 25 characters long, and the customer's name, "JOHN DOE", takes up 8 of those character positions. There are 17 blank positions remaining in the field; therefore, you could insert 16 additional characters.

If a field is a large one and covers more than one line, and if the situation calls for it, during the insert operation, characters will shift from the end of one line to the beginning of the next.

To return the keyboard to its normal mode of operation and turn off the Insert Mode indicator, press the RESET key or any key or device (selector light pen or magnetic slot reader) that causes communication with the host system (ENTER, PA Keys, PF Keys, etc.).

The correction made, you would now move the cursor to the next character position into which you want to enter data.

Delete () Key

Pressing the Delete () key when the cursor is located in an input field deletes the character occupying the position underlined by the cursor. It erases the character without leaving a blank. All characters in the field to the right of that position (and on the same line) are then shifted left one position. An example of its use is the case where you have incorrectly typed JUNNE 11, 1972, on the screen. To correct this error with the Delete key you would move the cursor to the position of the extra N with the cursor positioning key or the backspace key: JUNNE 11, 1972. Pressing the Delete key erases the N, and the characters to the right of it move left one space, resulting in: JUNE 11, 1972. The correction made, you would now move the cursor to the next character position into which you want to enter data.

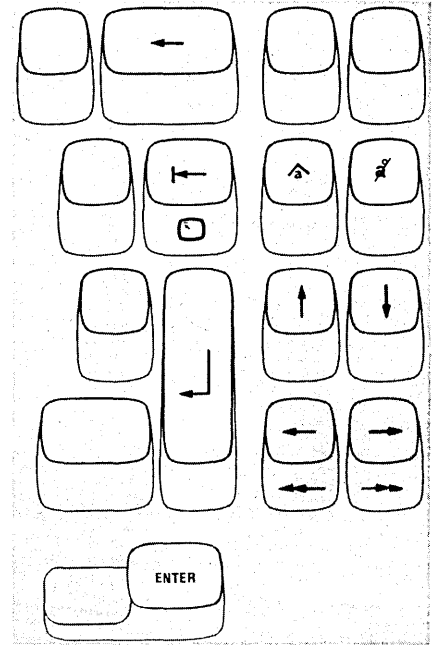

ENTER Key

Pressing the ENTER key tells the program that you have completed your message and are ready for the information on your screen to be entered into the host system. While your display station is signaling the program, the Do Not Enter - Time () message appears in the Operator Information Area, disabling your keyboard. Most programs, when acting on an ENTER key depression, turn off the Time message. However, this is up to the program. If you are not familiar with the program's response to an ENTER key depression, ask the appropriate person in your organization for an explanation of its use or refer to the appropriate user's program guide.

Note: *The ENTER key is typamatic when held down; however, it is recommended that you do not use this ENTER key typamatic capability, because the results are unpredictable.*

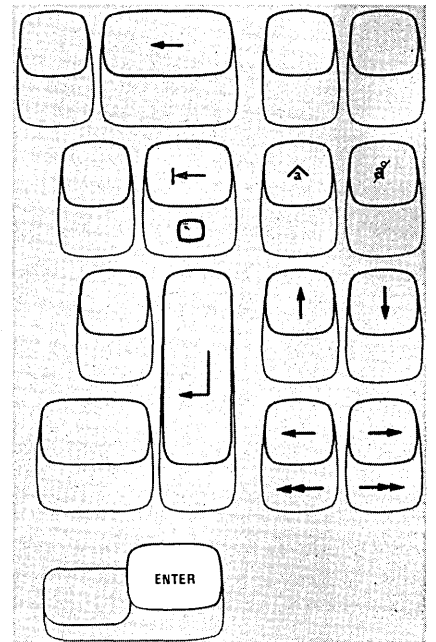

Dead Keys (Canadian-French Keyboard Only)

If you are using a Canadian-French keyboard (shown in Figures 3-26 and 3-27) the five accent keys (/, \ , ^ , ¨ , and) act as Dead Keys. Pressing a Dead Key causes the accent mark shown on the key to appear in the position designated by the cursor, but the cursor does not move. The letter that is to receive the accent must be keyed next. If the accent and letter combination is valid, the composite character (accent mark and letter) appears on the screen and the cursor moves to the next position. The composite character is treated as a single character by the display station.

The valid accent and character combinations are:

à â é è ê ë ï ï ò ó û ü ç
 À Â Ê Ë È É Î Ï Ò Ó Ù Ü Ç ` ^ ~

(Any accent plus a space to form a stand-alone accent character.)

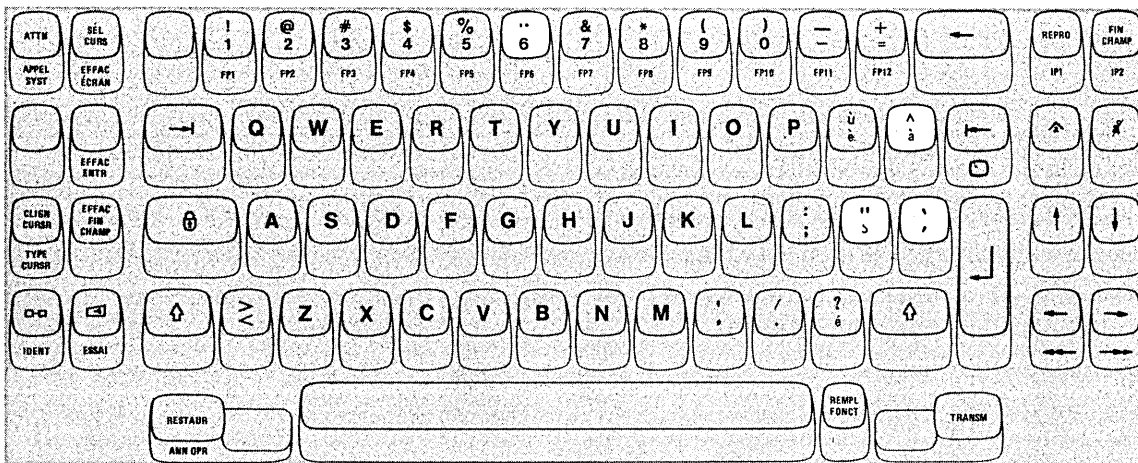

Figure 3-26. Canadian-French Dead Keys (Typewriter Keyboard)

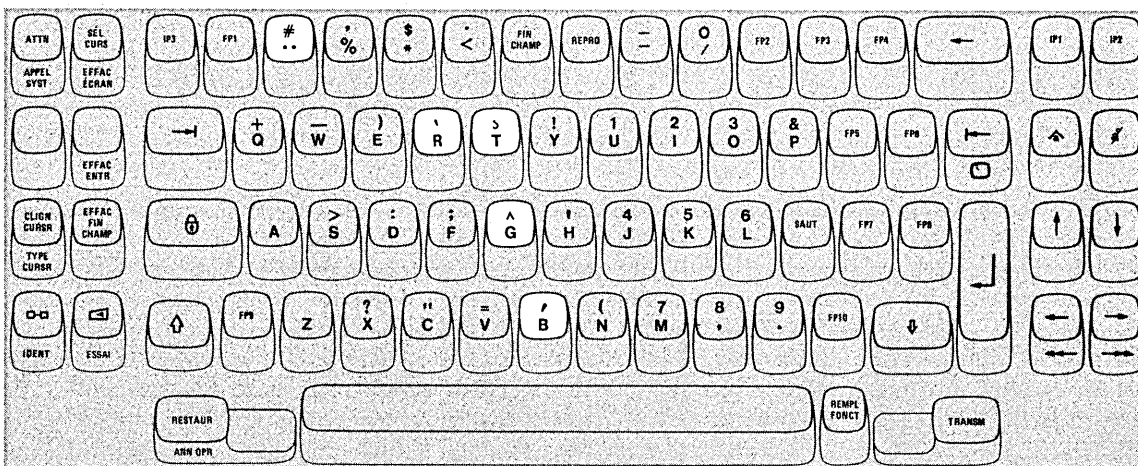

Figure 3-27. Canadian-French Dead Keys (Data Entry Keyboard)

If you key an incorrect accent, press the RESET key to cancel the Dead Key operation and then replace the accent (at the cursor location) with the correct accent.

If your second keystroke is not a valid letter or a space, a Do Not Enter - "Accent Plus What" (✖ 𐀀'+?, ✖ 𐀀`+?, ✖ 𐀀^+?, ✖ 𐀀''+?, or ✖ 𐀀,+?) message appears in the Operator Information Area, and a stand-alone accent is displayed at the cursor location. To recover from this error, press the RESET key and then rekey both the accent and a valid letter (or space).

If the Do Not Enter-What (✖ ?+) message appears in the Operator Information Area during a Dead Key operation, either (1) you have taken an illegal action or (2) the host system has interrupted your operation. Press the RESET key, check the contents of your screen, and then rekey the accent and the letter again.

By now you should be quite familiar with your display station. If there is any area that you are still not sure about, turn back and reread the section that discusses it. Press the key or keys in question, and watch the result. If you still have questions, now is the time to get them answered. Ask the appropriate person in your organization for an explanation.

Attribute Select Keyboards

Introduction

The Attribute Select keyboards consist of the following types:

- Attribute Select Typewriter keyboard
- Attribute Select Typewriter/APL keyboard
- Attribute Select Overlay keyboard

The Attribute Select keyboards will enable you to choose additional functions called Highlighting and Programmed Symbols. Highlighting offers you the following choices:

- Character Reversal (Reverse Video)
 - Allows you to reverse the color of a character with the color of the screen background. After the Select key is depressed, subsequent characters entered will be reversed.
- Character Blinking
 - When the Select Blink key is depressed, subsequent characters entered from the keyboard will blink.
- Character Underscoring
 - When underscore is selected, subsequent characters entered from the keyboard will be underlined.

The Programmed Symbol Set feature permits you to store, under program control, up to six character sets or fonts which are defined by your organization. These can be selected by program or by you (if your program allows you to and programmed symbols are installed) with the PF Keys.

Attribute Select Typewriter Keyboard

All the keys on the Attribute Select Typewriter keyboard (Figure 3-5), except the PF13–PF24 keys, perform the same functions and are located the same as on the Typewriter keyboard, described earlier in this chapter. PF13–PF24 keys are described later in this chapter under “Attribute Selection Keys.”

Attribute Select Typewriter/APL Keyboard

The Attribute Select Typewriter/APL keyboard (Figure 3-6) is exactly the same as the Typewriter/APL keyboard described in Chapter 4 except for the assignment of the PF1–PF12 keys. These keys are described later in this chapter under “Attribute Selection Keys.”

Attribute Select Overlay Keyboard

The Attribute Select Overlay keyboard (Figure 3-7) is similar in layout and operation to the Typewriter keyboard described earlier in this chapter. One difference is that this keyboard has special narrow keytops (in the 48-key data section only) which allow your organization to use its own specially marked overlays. These overlays are used to indicate the special font symbols associated with the keys whenever one of the Programmed Symbol sets is selected. These keys are described next under “Attribute Selection Keys.”

Attribute Selection Keys

The Attribute Selection keys are divided into three types:

- Highlighting selection keys
- Programmed Symbol Set Selection keys
- Field Inherit keys

Note: *Although some of the Attribute Selection keys indicate that you can select characters in various colors, there are no color choices on the 3278 Display Station. If you attempt to select colors on the 3278, the message X 2%% will appear in the Operator Information Area.*

For the following discussion of the Attribute Selection keys, refer to Figures 3-28 and 3-29.

Highlighting Selection Keys

Reverse Video Key. To select reverse video highlighting, first press the Shift key (**↑**) and hold it down while pressing the Reverse Video key.

The character entered will be highlighted by reversing the color of the character and its background. For example, a normal character of green on a black background will be displayed as a black character on a green background.

The highlighting indicators in the Operator Information Area will show: **■**

Blink Key. To select blink highlighting, first press the Shift key (**↑**) and hold it down while pressing the Blink key. The character entered will be highlighted by blinking on and off at the rate of approximately three times per second.

The highlighting indicators in the Operator Information Area will show: **⊠**

Underscore Key. To select underscore highlighting, first press the Shift key (**↑**) and hold it down while pressing the Underscore key. The character entered will be highlighted by an underscore beneath the character.

The highlighting indicators in the Operator Information Area will show: **a**

Programmed Symbol Set Selection Keys

These keys enable you to select from one of the programmed symbol sets. Pressing one of these selection keys causes any subsequent data entered from the keyboard to select a character from the appropriate symbol set.

To use the PSA, PSB, and PSC (upper symbol) keys, first press the Shift key (**↑**) and hold it down while pressing the appropriate key for the symbol set required. To use the PSD, PSE, and PSF (lower symbol) keys, first press the ALT key and hold it down while pressing the appropriate key for the required symbol set. The symbol set indicator in the Operator Information Area will be one of the following: PSA, PSB, PSC, PSD, PSE, or PSF. An S0 indicator appearing in the Operator Information Area means you did not select one of the programmed symbol set.

If you have made an invalid symbol set selection, the following message is displayed in the Operator Information Area: **✕ - f ✕**

Press the RESET key to restore the keyboard.

Field Inherit Keys

The Field Inherit keys permit you to return to field attributes after having used character attributes to enter data. With the two Field Inherit keys active on the 3278 you may remove your character attribute selection. See Figures 3-28 and 3-29. To use the Field Inherit keys, the ALT key must be pressed and held down while pressing the Field Inherit key.

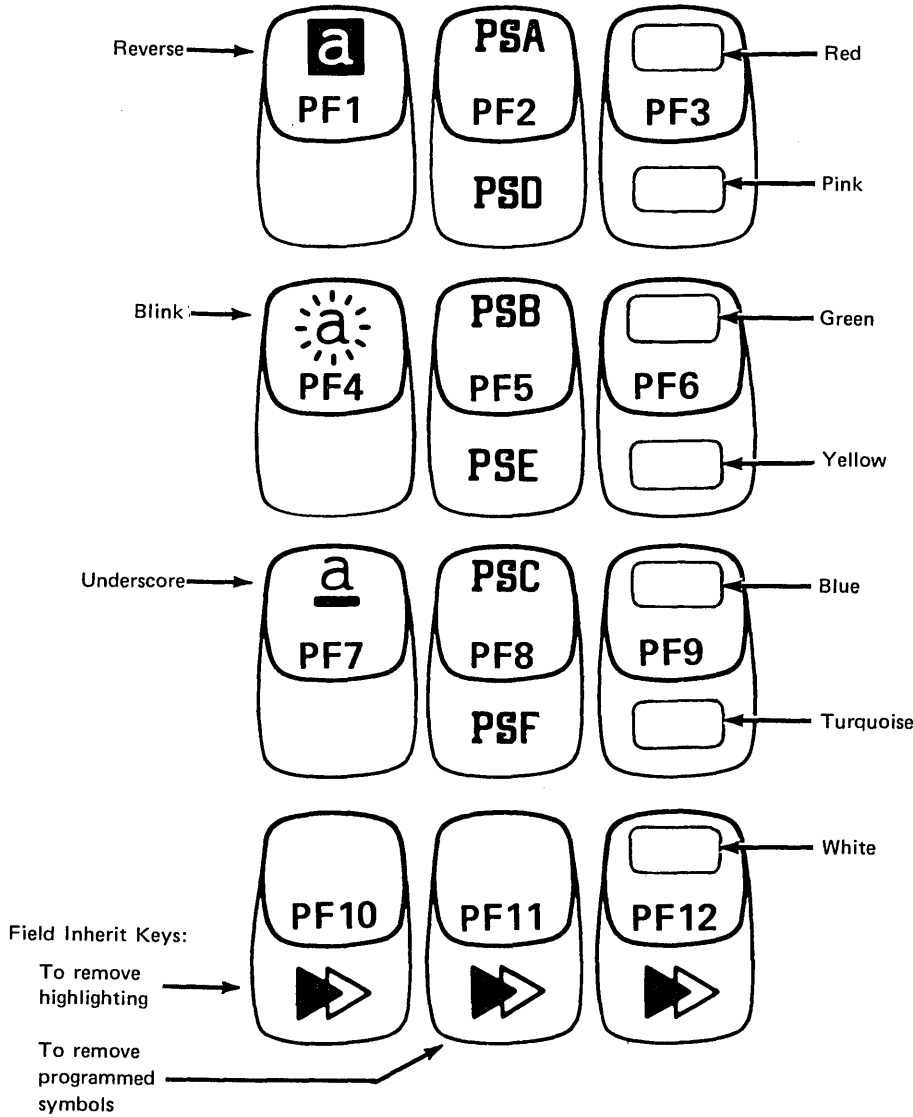

Figure 3-28. Attribute Select Keys PF1 – PF12

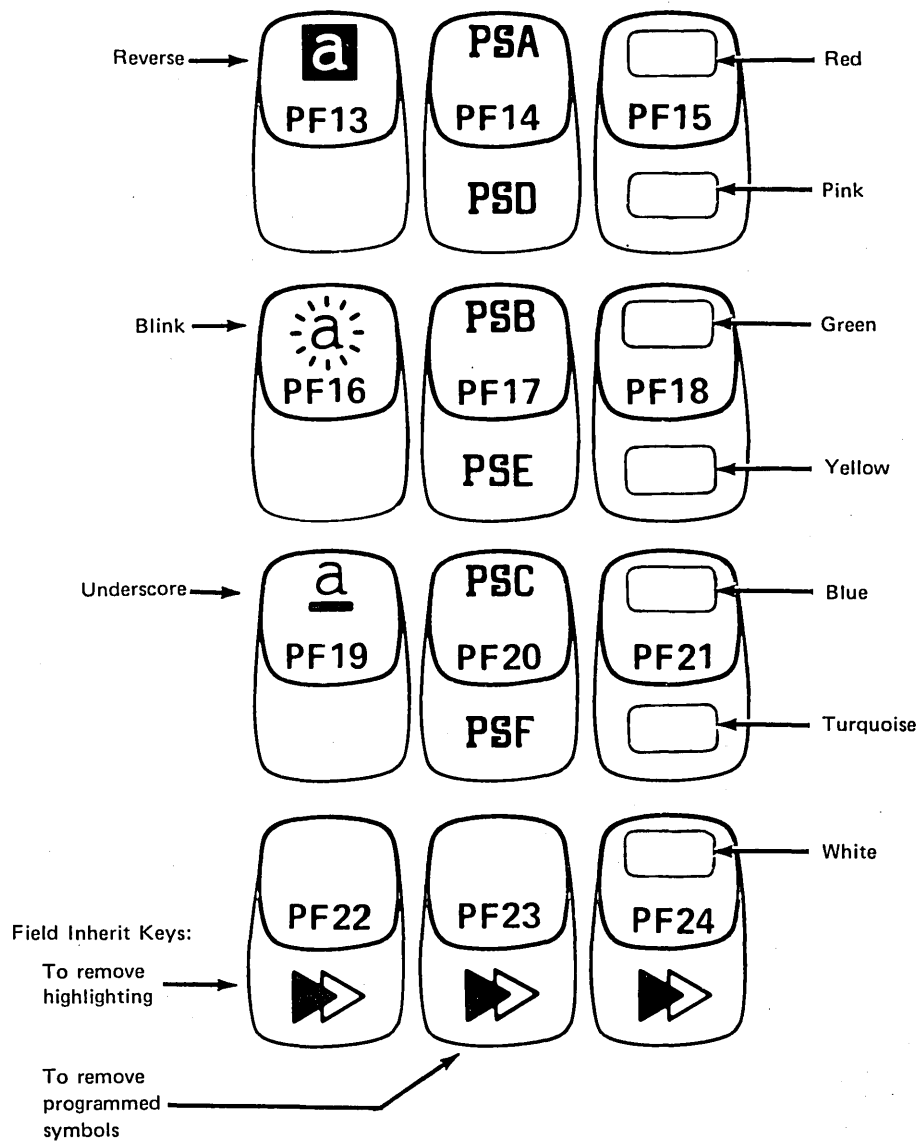

Figure 3-29. Attribute Select Keys PF13 – PF24

Chapter 4. Features for the 3278

Contents	4-1
Selector Light Pen Feature	4-3
How It Works	4-3
How It Is Used	4-4
Making Selections	4-4
Changing Selections	4-5
Magnetic Slot Reader and Magnetic Hand Scanner Accessories	4-6
Reader Lights and Buzzer Alarm	4-7
Magnetic Slot Reader or Magnetic Hand Scanner Operation	4-7
Security Keylock Feature	4-9
How It Is Used	4-9
Security Key Removal	4-10
Audible Alarm Feature	4-10
Numeric Lock Feature	4-11
3278 Switch Control Unit Feature	4-12
3278 APL/Text Feature	4-13
Typewriter/APL Keyboard	4-15
Typewriter/Text Keyboard	4-20

Selector Light Pen Feature

The selector light pen is a feature for a 3278 Display Station. You will usually use the selector light pen to select one entry of a list of options or items displayed on the screen. Figure 4-1 shows the selector light pen and the keyboard area in which you can place the light pen when not using it.

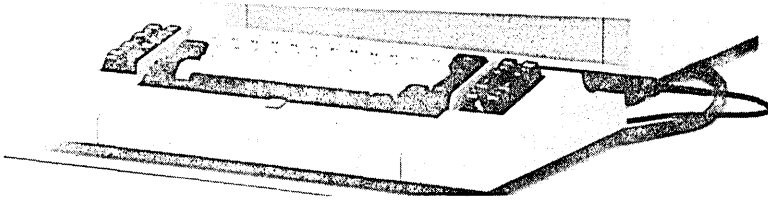

Figure 4-1. 3278 Selector Light Pen

How It Works

The point of the pen contains a device that can detect the light of a character on the screen. This device checks for the presence of a character only when a switch, also located in the point of the pen, is activated. The switch is spring-loaded and is activated by placing the point of the pen on the screen and pushing the barrel of the pen toward the screen (Figure 4-2).

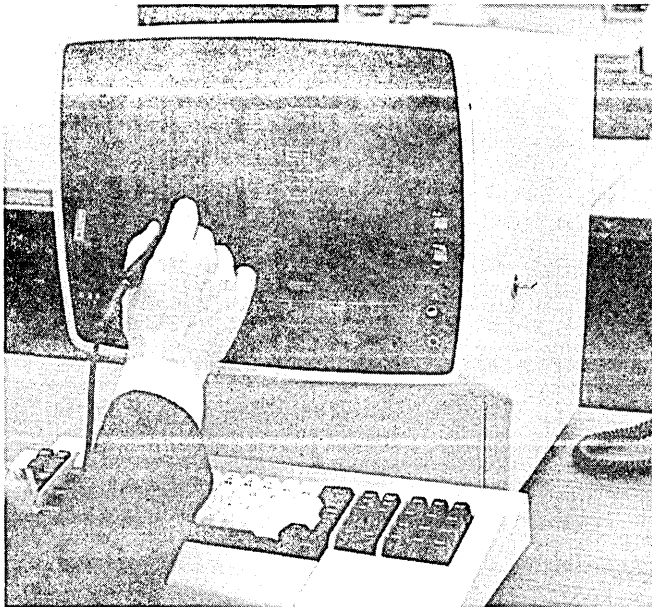

Figure 4-2. When the selector light pen is being used, correct positioning of the tip of the pen is important.

How It Is Used

In most applications for the selector light pen, a list or a table is displayed, and the operator selects items from it with the selector light pen. Although all applications are basically similar, a user's specific application could be unique. Ask the appropriate person in your organization to explain your organization's applications and the way you are to use your selector light pen.

There are two types of selectable fields that can be displayed on your screen: (1) selection fields and (2) attention fields. You will use the selector light pen to (1) select items in selection fields, and (2) notify the program of your selections by selecting an attention field.

The first character of each selectable field on your screen is called a designator character. The designator character for a selection field is either a question mark (?) or a greater-than sign (>); the designator character for an attention field is an ampersand (&) or a blank position. See Figure 4-3.

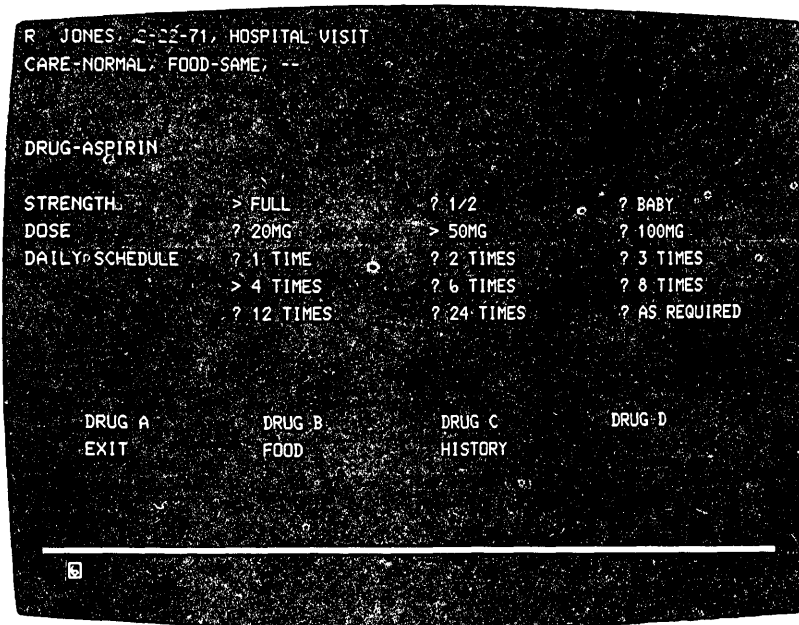

Figure 4-3. Designator characters tell you about the data on your screen.

Making Selections

To see more clearly which fields on your screen are light-pen-detectable, press the end of the selector light pen against the palm of your hand. This will cause lines to appear through all light-pen-detectable fields.

Initially, the designator characters (the first characters) of most detectable items on your screen will be question marks. To select an item, place the point of the pen directly over any character in that item and push the pen tip against the screen to detect it. The question mark at the beginning of that item changes to a greater-than sign to indicate that the item has been selected. Positioning the pen incorrectly (not directly over the intended character or over a character in another item) can cause the wrong item, or no item, to be selected. Therefore, you should always verify that the designator character has been changed after you have selected an item from your screen.

Changing Selections

If you select an incorrect item, you can correct your mistake by selecting a character from the incorrect item a second time with the selector light pen. This changes the greater-than sign back to a question mark and deselects the item. The correct item can then be selected.

After you have completed your selections from the screen (more than one selection can be made), locate a selectable field (Attention field) that has an ampersand character or a blank position for a designator character. Selecting the Attention field (the word EXIT in Figure 4-3) turns on the Do Not Enter - Time (✕ ⌚) message and indicates to the program that you have completed your selections. The data you have selected can now be acted upon by the program.

Remember, Figure 4-3 is only an example. The way you end a selector light pen operation depends on the program, and each job could be different. Always refer to the user's program guide for the program with which you are working for specific instructions.

Magnetic Slot Reader and Magnetic Hand Scanner Accessories

The magnetic slot reader and the magnetic hand scanner accessories are for 3278 Display Stations that are used to send coded messages to the host system. The magnetic slot reader (Figure 4-4) or the magnetic hand scanner (Figure 4-5) attaches to your display station through a cable. When your display station is equipped with a reader, you can send a coded message to the host system by passing a special magnetic striped card through the slot in the reader. With a hand scanner, you can send a coded message by passing the scanner over a magnetic stripe. You may be required to use a card reader or a hand scanner when, for example, you begin operating the display station.

A specially designed (coded) magnetic stripe card may also be used to update an account, request information about accounts, identify the person using the reader, or represent an account number. The code is contained on a magnetic stripe attached to the back of the card.

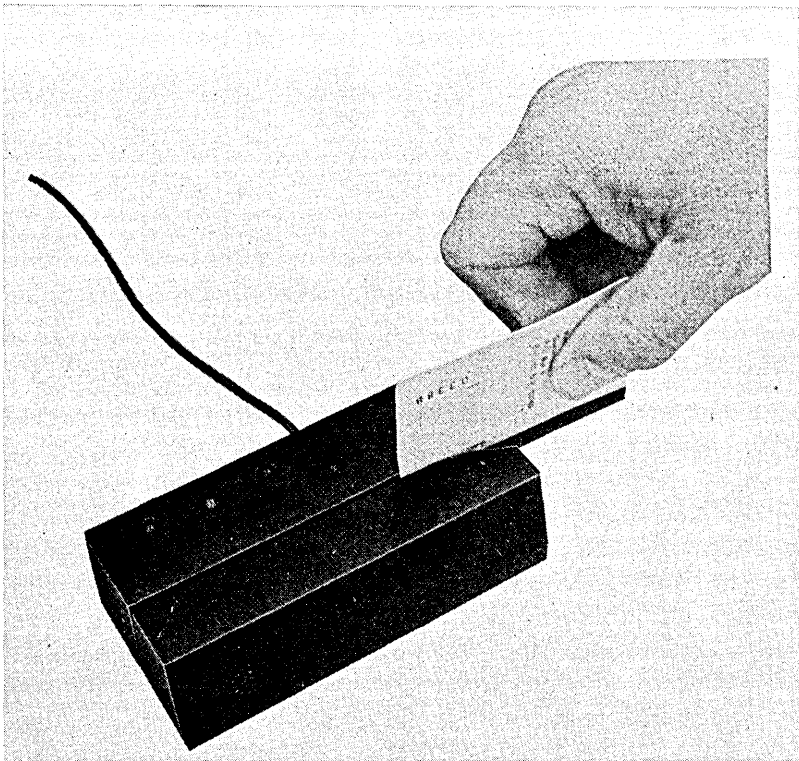

Figure 4-4. Magnetic Slot Reader

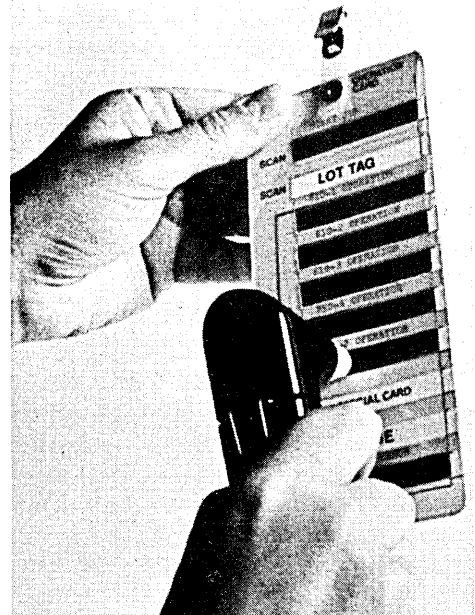

Figure 4-5. Magnetic Hand Scanner

Reader Lights and Buzzer Alarm

Both the magnetic slot reader and the magnetic hand scanner have three lights and a buzzer alarm; the three lights are colored green, yellow, and red. One of the three lights is on whenever your display station is powered on and the reader or scanner cable is connected to your display station.

The green light turns on when (1) the display station is turned on or (2) a coded message is successfully sent to the control unit. This light turns off during a card reader operation when you pass the card through the reader slot or pass the scanner over the card stripe. If the coded message on the card is successfully sent to the control unit, the green light turns on again. If the operation is unsuccessful, the red light turns on.

The yellow light turns on when the card is successfully read by the magnetic slot reader or the magnetic hand scanner and remains on until (1) the coded message on the magnetic stripe is successfully sent to the control unit or (2) an error in the transfer of the coded message to the control unit is detected. Subsequent read operations are ignored while the yellow indicator is on. If the operation is successful, the yellow light turns off and the green light turns on; if the operation is unsuccessful, the yellow light turns off when the red light turns on.

The red light turns on if an error occurs (1) while the card is read or (2) during the transfer of the coded message to the control unit.

The alarm buzzer on the reader or on the scanner produces a short tone (for about one quarter of a second) when the green light turns on and a long tone (about one second) when the red light turns on.

Magnetic Slot Reader or Magnetic Hand Scanner Operation

To operate the magnetic slot reader or the magnetic hand scanner:

1. Turn on the display station, or, if you are using the display station, complete the job you are presently working on.
2. Ask the appropriate person in your organization, or check the user's program guide, to determine where you should position the cursor in the input field to be used for the reader operation. Remember that, if the cursor is placed in a protected field, the coded message on the magnetic striped card will not be read into the host system.
3. For the magnetic slot reader, insert the magnetic striped card into the reader as shown in Figure 4-4 and pass the card through the slot in the reader.
4. For the magnetic hand scanner, pass the scanner over the magnetic stripe as shown in Figure 4-5. In some cases, the scanner can be passed over the card in either direction. Check with the proper person in your organization to see whether the magnetic stripe can be read in both directions.

If the card is read successfully, the green light on the reader turns back on, and the cursor moves to the character position that follows the position occupied by the last character read. The characters on the card may or may not be displayed on the screen.

If an error occurs while the card is being read, the red light on the reader turns on, and a Do Not Enter (**X**) message may appear in the Operator Information Area. If a Do Not Enter message is not displayed when an error occurs, try the card again. If a Do Not Enter message is displayed when an error occurs, note the meaning of the Do Not Enter message and take the appropriate action as described in the Operator Information Area section of Chapter 2.

If your display station does not have a keyboard, try to reset the red light and the Do Not Enter message by trying the card again or by trying a different card.

The following Do Not Enter messages are especially relevant when magnetic stripes are being read:

- X** 大田? The card or magnetic stripe cannot be used for the operation. Press the RESET key to reset the error.
- X** ←大→ The cursor is located in a protected field. Press the RESET key; then move the cursor to an input field.

Before trying the card reader or the scanner a second time, check that:

1. The host system has not interrupted the reader operation.
2. The cursor is positioned on the screen as stated in the user's program guide.
3. You are passing the card through the reader slot correctly.
4. You are passing the hand scanner over the magnetic stripe correctly.

If the failure is still present after the operation is required, obtain a different magnetic striped card and try again. If the failure still occurs, tell the appropriate person in your organization.

Security Keylock Feature

The Security Keylock feature (Figure 4-6) improves a user's data processing security. An organization using this feature has the ability to lock its 3278 Display Stations and allow only authorized operators (those issued keys) to operate them.

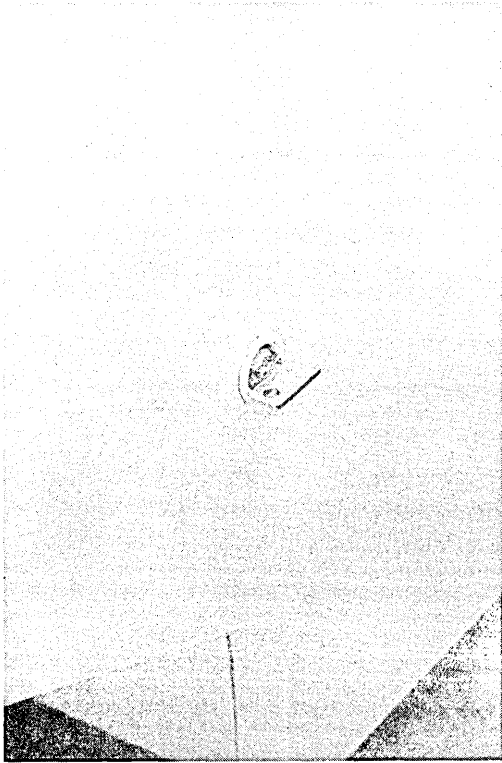



Figure 4-6. Only authorized operators may use a display station that has a security keylock.

How It Is Used

A display station with a security keylock installed cannot be operated until the key is inserted and turned clockwise.

Note: *The keylock turns 90° (vertical to horizontal position) when you turn the key.*

To prepare a display station equipped with a security keylock for operation, put the key in the lock and turn it clockwise; then, if the display station is turned off, press the top portion () of the On/Off switch. As soon as the cursor appears on the screen, you can begin work on your display station.

Security Key Removal

The key must remain in the lock as long as you wish to operate your display station. Also remember to remove the key if you are going to be away from your display station. The key cannot be removed while in the operating (turned clockwise) position, and turning it counterclockwise immediately blocks all entry, display, and retrieval of information and turns on the **X**  (Do Not Enter—Security Key) message in the Operator Information Area.

Audible Alarm Feature

3278 Display Stations can be equipped with an Audible Alarm feature that causes a high-pitched tone to sound for about one second when the alarm is activated.

The audible alarm always sounds when you enter a character into the next-to-last character position on your screen and the cursor moves to the last character position. This is normal operation. If you key another character after the cursor has wrapped, it is entered into the first character position on line 1 of your screen. In this situation, you would not want to key on line 1, because doing so would destroy the data already displayed there. In this case, the alarm is a warning to you.

The host system program that you are working with also can activate the alarm. To do so, it sends a signal to your display station. The user's guide for that program tells you if the audible alarm sounds and, if so, the different reasons for sounding it.

The volume of the audible alarm is adjustable. The adjustment control  is located at the outside of and behind the screen contrast control (see diagram to the right). Generally, you do not have to adjust the volume once it has been set for your operating environment.

To test the volume level, the next-to-last character position must be in an input field. If your display station does not have an input field in this area of the screen, check the application program user's guide or ask the appropriate person in your organization for instructions to obtain one. When you have an input field in this area of the screen, move the cursor and key in a character in the next-to-last position on the screen; then, listen to the level of the alarm. To check the sound level again, press the backspace key and, then, a character key. If the sound is not at the desired volume, adjust the alarm control and test the sound level again. When the volume setting is correct, press the ERASE INPUT key.

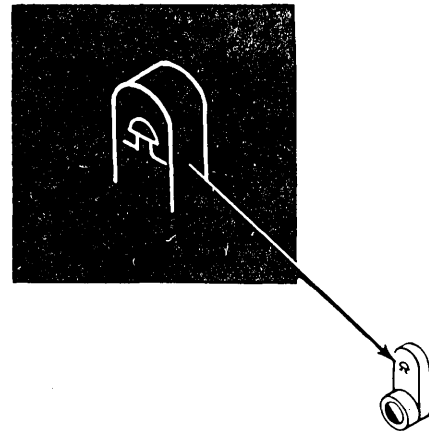

Numeric Lock Feature

When installed on a 3278 Typewriter keyboard or Data Entry keyboard, the Numeric Lock feature limits the characters that you can key into a field designated by the program as a Numeric field. This feature is provided as an aid for operators who rarely look at the screen.

When the cursor enters a Numeric field on your screen, your display station automatically shifts to Downshift Mode if you have a Typewriter keyboard (if the Typewriter keyboard does not have the Numeric Lock feature, nothing happens) or to Upshift Mode if you have a Data Entry keyboard (with or without the Numeric Lock feature installed). When this happens, if your keyboard has the Numeric Lock feature installed, (1) the Numeric (NUM) message appears in the Shifts and Modes portion of the Operator Information Area and (2) the only keys that you can key into the Numeric field are the digits 0 through 9, period (.), minus (-), and the DUP key. Pressing any other key that can enter a displayable character turns on the Do Not Enter - Numeric Data Only (X NUM) message in the Operator Information Area and disables your keyboard (keyboard clicker either starts or stops clicking). Therefore, if you key a non-numeric character into a Numeric field, you will realize your error without looking at the screen. Pressing the RESET key unlocks the keyboard and turns off the Do Not Enter message.

Note: *The Numeric Lock feature can be installed on the Typewriter/APL and Typewriter/Text keyboards.*

If you are using a Data Entry keyboard, you can override this feature and key any "locked out" character into the Numeric field. This is done by pressing the Numeric Shift (↑) key or the Alpha (↓) key, depending on the character to be keyed. For example, if a comma (,) must be keyed, press and hold the Numeric Shift key and then press the comma key. If an N must be keyed, press and hold the Alpha key and then press the N key. Using this method, you can enter "locked out" characters without error.

If you are using a Typewriter keyboard, you can override this feature and key any uppercase character or symbol into the Numeric field. This is done by pressing and holding the Shift (↑) key and then pressing the desired character/symbol key(s).

Note: *The Shift Lock (🔒) key cannot override the Numeric Lock feature.*

3278 Switch Control Unit Feature

The Switch Control Unit feature provides a switch (Figure 4-7) that enables you to connect your 3278 Display Station to either of two control units (designated CU1 and CU2). Your organization's operating procedures may have you switch from one control unit to the other to perform different tasks.

To switch from one control unit to another:

1. Set the Normal/Test switch on the 3278 to Test.
2. Set the Control Unit Selector switch to the position that selects the desired control unit (CU1 or CU2).
3. Return the Normal/Test switch on the 3278 to Normal.

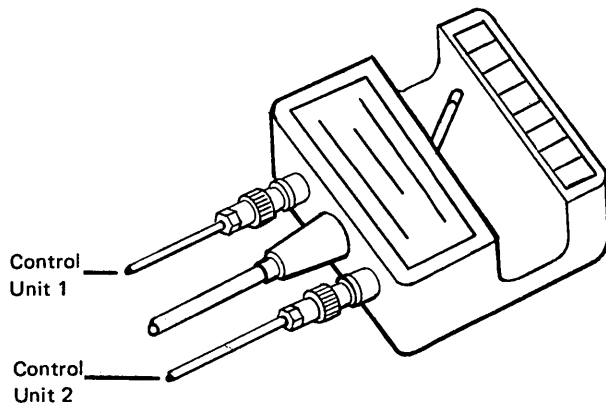

Figure 4-7. Control Unit Selector Switch

3278 APL/Text Feature

The 3278 APL/Text feature, the Extended Character Set Adapter feature (prerequisite feature for the APL/Text feature), and the appropriate Typewriter/APL or Typewriter/Text keyboard enable a 3278 operator to work with either APL or Text applications as well as with existing applications.

A 3278 that has the APL/Text feature installed can:

- Display the 222-character-plus-space APL/Text character set shown in Figure 4-8, *and*
- Be used to enter a 175-character-plus-space set of the APL/Text character set when equipped with the Typewriter/APL keyboard, *or*
- Be used to enter a 159-character-plus-space set of the APL/Text character set when equipped with the Typewriter/Text keyboard

The remainder of this section describes the operations of the Typewriter/APL and Typewriter/Text keyboards that are different from the normal Typewriter keyboard. If you are not familiar with the operation of the Typewriter keyboard, read the Typewriter Keyboard section in Chapter 3 before continuing with this section.

Typewriter/APL Keyboard

The Typewriter/APL keyboard (shown in Figure 4-9) is a typewriterlike keyboard with keys that contain APL characters in addition to the characters contained on the Typewriter keyboard (shown in Figure 3-2). All the APL characters are colored orange (on white keys).

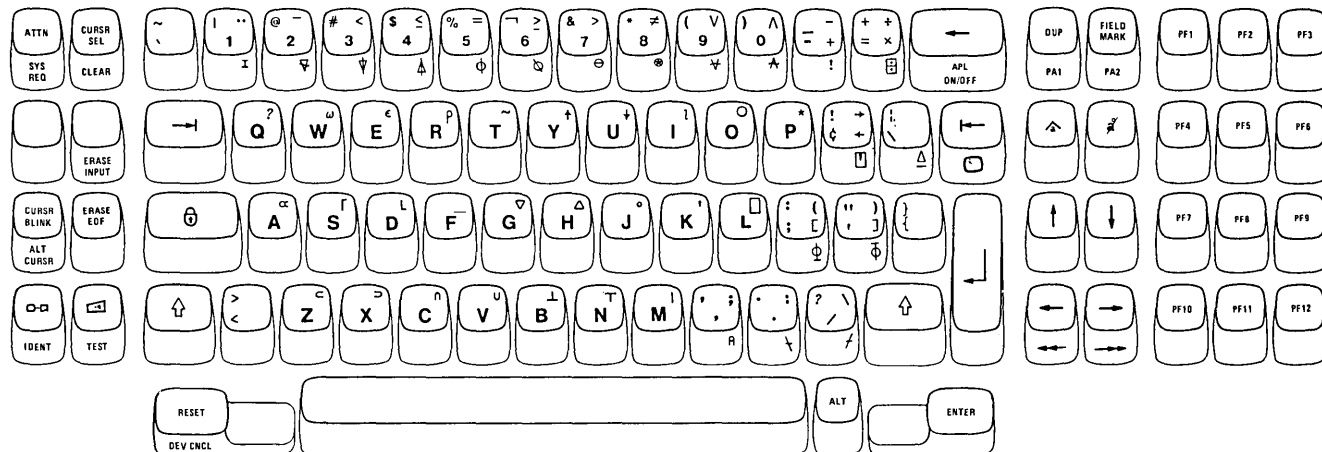

Figure 4-9. Typewriter/APL Keyboard

The Typewriter/APL keyboard key layout is similar to the key layout of the Typewriter keyboard except for the following differences:

- The PF1 through PF12 keys are located on the right side of the keyboard instead of on the front of the top row of keys.
- The PF13 through PF24 keys are not available on the Typewriter/APL keyboard.
- All symbols that are also on the Typewriter keyboard [except , (comma), . (period), and / (slash)] are located on the left side of the keytops instead of in the center of the keytops.
- APL symbols are located on the right side of the keytop and/or the front of some keys.
- APL ON/OFF is located on the front of the Backspace key (←).

When the display station is first turned on, the Typewriter/APL keyboard operates the same as the Typewriter keyboard. All lowercase and uppercase alphabetic characters, numeric digits, and symbols are entered in the same manner as on the Typewriter keyboard (see Figure 4-10).

APL ON/OFF Key

Pressing the APL ON/OFF key (with the ALT key held down) when the keyboard is in Non-APL Downshift Mode causes the keyboard to shift into APL Downshift Mode (APL shift message is displayed in the Operator Information Area); pressing the APL ON/OFF key (with the ALT key held down) when the keyboard is in Non-APL Upshift Mode causes the keyboard to shift into APL Upshift Mode [APL shift message and \uparrow (upshift) symbol are displayed in the Operator Information Area]. The keyboard is returned to Non-APL Mode by pressing the APL ON/OFF key (with ALT) again.

The Shift (\uparrow) and Lock (\mathbb{L}) keys operate the same in Non-APL Mode and APL Mode. To place the keyboard in APL Upshift Mode, (1) press and hold either of the Shift keys or (2) press the Lock key. When the keyboard is locked in APL Upshift Mode, press either Shift key when you are ready to return the keyboard to APL Downshift Mode.

APL Downshift Mode causes:

- The corresponding uppercase alphabet letter to be displayed when an Alphabet key is pressed.
- The corresponding numeric digit to be displayed when a Numeric key is pressed.
- The symbol on the lower center or the lower-right portion (if present) of the keytop to be displayed when a symbol key is pressed (see Figure 4-10).

APL Upshift Mode causes the symbol on the upper-right portion (if present) of the keytop to be displayed when the key is pressed (see Figure 4-10).

The ALT key is used in APL Mode to allow the entry of the APL Underscored Alphabetic characters and the APL Compound Symbols (located on the front of the Numeric and symbol keys).

Note: *The spacebar remains operational in ALT Mode. The characters that are entered in APL ALT Mode are shown in Figure 4-10. To enter any of these characters, (1) place the keyboard in APL Mode, (2) press and hold the ALT key, and (3) press the desired key.*

The Numeric Lock feature can be installed on the Typewriter/APL keyboard.

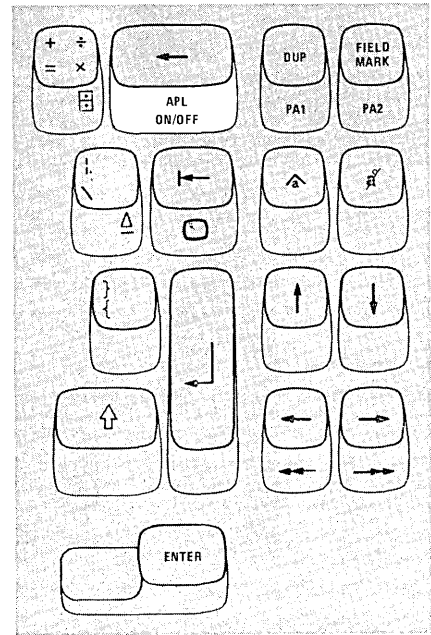

Non-APL Mode		APL Mode		
Downshift	Upshift	Downshift	Upshift	ALT-Shift
a	A	A	α (alpha)	<u>A</u>
b	B	B	⊥ (base)	<u>B</u>
c	C	C	∩ (cap)	<u>C</u>
d	D	D	⌊ (downstile)	<u>D</u>
e	E	E	∈ (epsilon)	<u>E</u>
f	F	F	⎵ (underbar)	<u>F</u>
g	G	G	∇ (del)	<u>G</u>
h	H	H	Δ (delta)	<u>H</u>
i	I	I	ι (iota)	<u>I</u>
j	J	J	∘ (null)	<u>J</u>
k	K	K	' (quote)	<u>K</u>
l	L	L	□ (quad)	<u>L</u>
m	M	M	⌈ (stile)	<u>M</u>
n	N	N	T (top)	<u>N</u>
o	O	O	∘ (circle)	<u>O</u>
p	P	P	* (star)	<u>P</u>
q	Q	Q	? (query)	<u>Q</u>
r	R	R	ρ (rho)	<u>R</u>
s	S	S	⌈ (upstile)	<u>S</u>
t	T	T	~ (tilde)	<u>T</u>
u	U	U	↓ (down)	<u>U</u>
v	V	V	∪ (cup)	<u>V</u>
w	W	W	ω (omega)	<u>W</u>
x	X	X	⊃ (close shoe)	<u>X</u>
y	Y	Y	↑ (up)	<u>Y</u>
z	Z	Z	⊂ (open shoe)	<u>Z</u>

Figure 4-10 (Part 1 of 2). Graphic Characters Entered by the Typewriter/APL Keyboard

Non-APL Mode		APL Mode		
Downshift	Upshift	Downshift	Upshift	ALT-Shift
1		1	¨ (dieresis)	⌈ (I beam)
2	@	2	¯ (overbar)	∇ (del tilde)
3	#	3	< (less)	∇ (del stile)
4	\$	4	≤ (not greater)	Δ (delta stile)
5	%	5	= (equal)	⊙ (circle stile)
6	┌	6	≥ (not less)	⊘ (circle slope)
7	&	7	> (greater)	⊖ (circle bar)
8	*	8	≠ (not equal)	⊗ (log)
9	(9	∨ (or)	∨ (nor)
0)	0	∧ (and)	∧ (nand)
\	~			
-	-	+ (plus)	- (bar)	⋅ (quote dot)
=	+	× (times)	÷ (divide)	⊞ (domino)
¢	!	← (left)	→ (right)	⌈ (quote quad)
\	⋮			Δ (delta underscore)
;	:	[(left bracket)	((open parenthesis)	⊖ (base null)
,	"] (right bracket)) (close parenthesis)	⊖ (top null)
{	}			
<	>			
,	,	,	;	⌈ (cap null)
.	.	.	:	∖ (slope bar)
/	?	/	\ (slope)	∖ (slash bar)

Figure 4-10 (Part 2 of 2). Graphic Characters Entered by the Typewriter/APL Keyboard

PF1 through PF12 Keys

The PF1 through PF12 keys on the Typewriter/APL keyboard are not Alternate Function keys, because they are located on the right side of the keyboard instead of on the front of the top row of keys. PF13 through PF24 keys are not available on the Typewriter/APL keyboard.

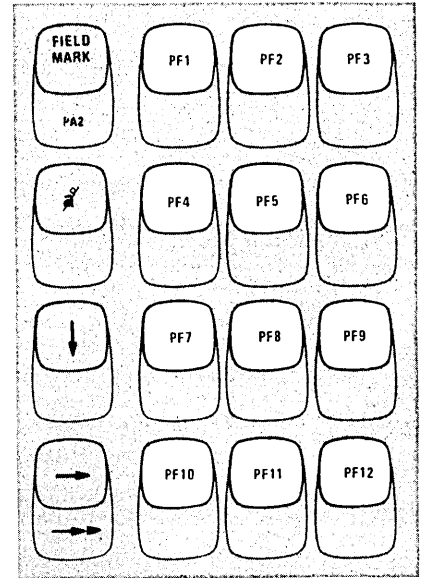

Typewriter/Text Keyboard

The Typewriter/Text keyboard (shown in Figure 4-11) is a typewriterlike keyboard with keys that contain Text characters in addition to the characters contained on the Typewriter keyboard (shown in Figure 3-2). All the Text characters are colored green (on white keys).

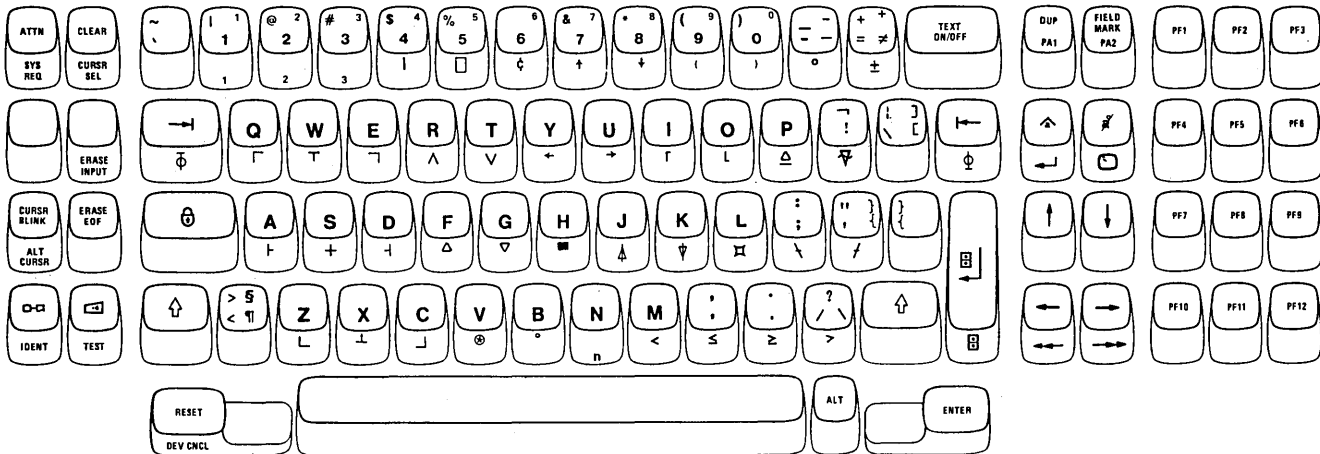

Figure 4-11. Typewriter/Text Keyboard

The Typewriter/Text keyboard key layout is similar to the key layout of the Typewriter keyboard except for the following differences:

- The PF1 through PF12 keys are located on the right side of the keyboard instead of on the front of the top row of keys.
- PF13 through PF24 keys are not available on the Typewriter/Text keyboard.
- The Backspace key (←) is replaced by a TEXT ON/OFF key [the move cursor left key (←) can be used to backspace the cursor].
- The ! (exclamation point), the ¢ (cent sign), and ¬ (logical not) symbols are moved to other locations.
- All symbols that are also on the Typewriter keyboard [except ¢ (cent sign), : (colon), ; (semicolon), , (comma), and . (period)] are located on the left side of the keytops instead of in the center of the keytops.
- Text symbols are located on the right side of the keytop and/or the front of some keys.
- The New Line (↵) and Home (⏠) keys are located on the front of the Insert (↵) and Delete (⏴) keys, respectively.
- PA1 and PA2 are located on the keytop instead of the key front.

When the display station is first turned on, the Typewriter/Text keyboard operates the same as the Typewriter keyboard. All lowercase and uppercase alphabetic characters, numeric digits, and symbols are entered in the same manner as on the Typewriter keyboard (see Figure 4-12).

The ALT key is used in Non-Text Mode to allow the entry of the Text symbols on the front of the keys. **Note:** *The spacebar remains operational in ALT Mode.*

The characters that are entered in Non-Text ALT Mode are shown in Figure 4-12. To enter any of these characters, (1) press and hold the ALT key and (2) press the desired key.

TEXT ON/OFF Key

Pressing the TEXT ON/OFF key when the keyboard is in Non-Text Downshift Mode causes the keyboard to shift into Text Downshift Mode (TEXT shift message is displayed in the Operator Information Area); pressing the TEXT ON/OFF key when the keyboard is in Non-Text Upshift Mode causes the keyboard to shift into Text Upshift Mode [TEXT shift message and ⤴ (upshift) symbol are displayed in the Operator Information Area]. The keyboard is returned to Non-Text Mode by pressing the TEXT ON/OFF key again.

The Shift (⤴) and Lock (🔒) keys operate the same in Non-Text Mode and Text Mode. To place the keyboard in Text Upshift Mode, (1) press and hold either of the Shift keys or (2) press the Lock key. When the keyboard is locked in Text Upshift Mode, press either Shift key when you are ready to return the keyboard to APL Downshift Mode.

Text Downshift Mode causes:

- The corresponding lowercase alphabet letter to be displayed when an Alphabet key is pressed.
- The corresponding numeric digit to be displayed when a Numeric key is pressed.
- The symbol on the lower center or the lower-right portion (if present) of the keytop to be displayed when a symbol key is pressed (see Figure 4-12).

Text Upshift Mode causes:

- The corresponding uppercase alphabet letter to be displayed when an Alphabet key is pressed.
- The symbol on the upper-center or the upper-right portion (if present) of the keytop to be displayed when a symbol key is pressed (see Figure 4-12).

The ALT key is used in Text Mode to allow the entry of symbols located on the front of the Alphabet, Numeric, Symbol, Tab (→|), Backtab (|←), and New Line (↵) keys.

Note: *The spacebar remains operational in ALT Mode. The characters that are entered in Text ALT Mode are shown in Figure 4-12. To enter any of these characters, (1) place the keyboard in Text Mode, (2) press and hold the ALT key, and (3) press the desired key.*

The Numeric Lock feature can be installed on the Typewriter/Text keyboard.

DUP and FIELD MARK Keys

The DUP and FIELD MARK functions on the Typewriter keyboard can be activated when the keyboard is in Downshift or Upshift Mode. On the Typewriter/Text keyboard, however, DUP and FIELD MARK can be activated only in Non-Text Upshift Mode and Text Upshift Mode.

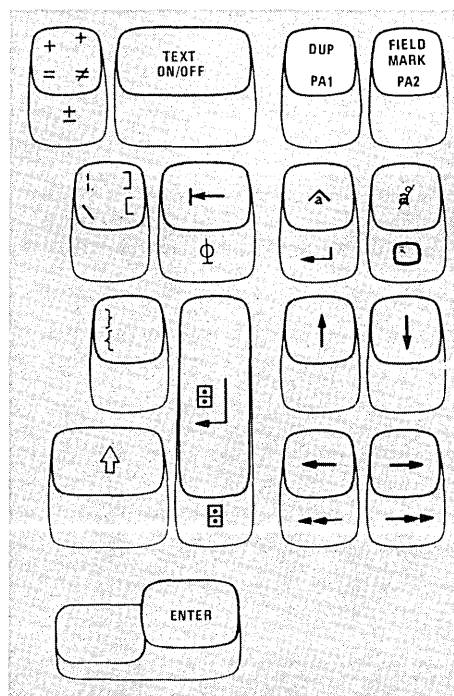
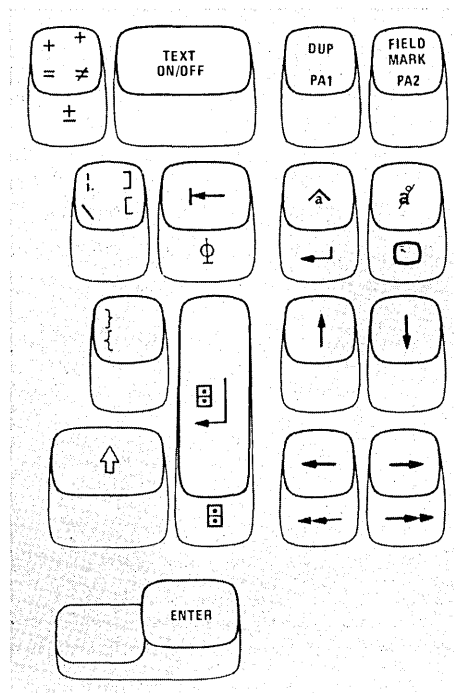

Non-Text Mode			Text Mode		
Downshift	Upshift	ALT-Shift	Downshift	Upshift	ALT-Shift
a	A	┌ (left junction)	a	A	┌ (left junction)
b	B	o (bullet)	b	B	o (bullet)
c	C	└ (lower right corner)	c	C	└ (lower right corner)
d	D	┐ (right junction)	d	D	┐ (right junction)
e	E	└ (upper right corner)	e	E	└ (upper right corner)
f	F	Δ (delta)	f	F	Δ (delta)
g	G	∇ (del)	g	G	∇ (del)
h	H	■ (histogram)	h	H	■ (histogram)
i	I	┌ (upstile)	i	I	┌ (upstile)
j	J	⋈ (delta stile)	j	J	⋈ (delta stile)
k	K	∇ (del stile)	k	K	∇ (del stile)
l	L	◊ (lozenge)	l	L	◊ (lozenge)
m	M	< (less)	m	M	< (less)
n	N	n (subscript)	n	N	n (subscript)
o	O	└ (downstile)	o	O	└ (downstile)
p	P	Δ (delta underscore)	p	P	Δ (delta underscore)
q	Q	┌ (upper left corner)	q	Q	┌ (upper left corner)
r	R	^ (and)	r	R	^ (and)
s	S	† (DA cross)	s	S	† (DA cross)
t	T	v (or)	t	T	v (or)
u	U	→ (right)	u	U	→ (right)
v	V	⊗ (log)	v	V	⊗ (log)
w	W	T (top junction)	w	W	T (top junction)
x	X	⊥ (bottom junction)	x	X	⊥ (bottom junction)
y	Y	← (left)	y	Y	← (left)
z	Z	└ (lower left corner)	z	Z	└ (lower left corner)

Figure 4-12 (Part 1 of 2). Graphic Characters Entered by the Typewriter/Text Keyboard

Non-Text Mode			Text Mode		
Downshift	Upshift	ALT-Shift	Downshift	Upshift	ALT-Shift
1		1	1	1	1
2	@	2 } (subscript)	2	2	2 } (subscript)
3	#	3 } (subscript)	3	3	3 } (subscript)
4	\$	(stile)	4	4	(stile)
5	%	□ (quad)	5	5 } (superscript)	□ (quad)
6		ç	6	6	ç
7	&	↑ (up)	7	7	↑ (up)
8	*	↓ (down)	8	8	↓ (down)
9	(((superscript)	9	9	((superscript)
0)) (superscript)	0	0) (superscript)
,	~				
-	-	° (degree)	- (extended dash)	- (superscript)	° (degree)
=	+	±	≠ (not equal)	+ (superscript)	±
:	:	∅ (del tilde)	: (quote dot)	∅	∅ (del tilde)
\	:	∕ (slope bar)	[]	∕ (slope bar)
;	:	∕ (slash bar)	;	:	∕ (slope bar)
,	“		{	}	∕ (slash bar)
{	}				
<	>		¶ (paragraph)	§	
,	,	≤ (not greater)	,	,	≤ (not greater)
.	.	≥ (not less)	.	.	≥ (not less)
/	?	> (greater)	\	?	> (greater)
→ (tab)	→ (tab)	⊖ (top null)	→ (tab)	→ (tab)	⊖ (top null)
← (backtab)	← (backtab)	⊖ (base null)	← (backtab)	← (backtab)	⊖ (base null)
⊞ (domino with auto New Line)	⊞ (domino with auto New Line)	⊞ (domino)	⊞ (domino with auto New Line)	⊞ (domino with auto New Line)	⊞ (domino)

Figure 4-12 (Part 2 of 2). Graphic Characters Entered by the Typewriter/Text Keyboard

PA1 and PA2 Keys

On the 3278 Typewriter/Text keyboard, PA1 and PA2 can be activated only in Non-Text Downshift Mode and Text Downshift Mode.

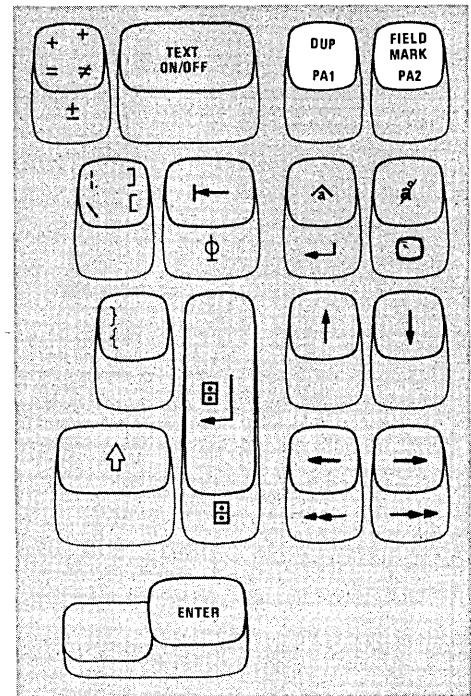

Tab Key

The Tab key operates normally in both Non-Text (Downshift and Upshift) Mode and Text (Downshift and Upshift) Mode. When the Tab key is pressed with the ALT key held down, the Φ symbol is displayed and tabbing is not done.

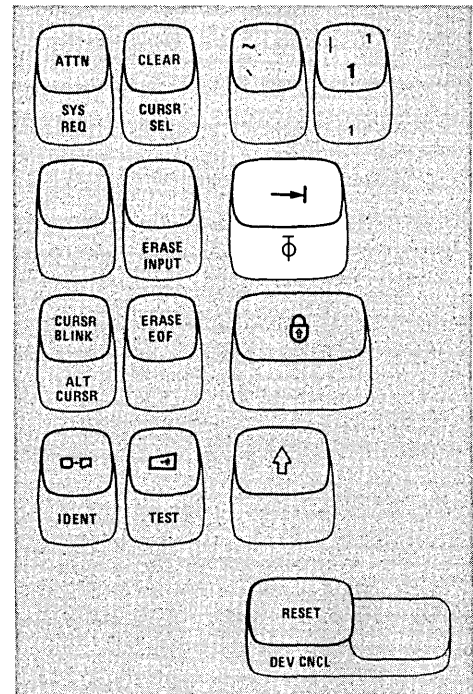

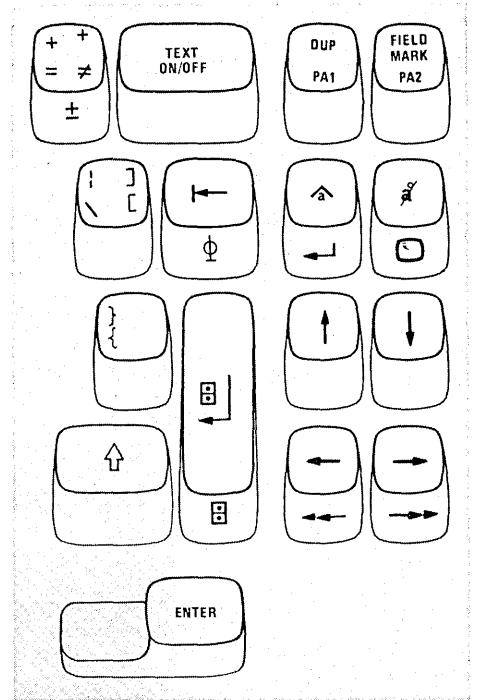

Back Tab Key

The Back Tab key operates normally in both Non-Text (Downshift and Upshift) Mode and Text (Downshift and Upshift) Mode. When the Back Tab key is pressed with the ALT key held down, the Φ symbol is displayed and back tabbing is not done.



Home () Key

The Home () key is located on the front of the Delete () key.
The Home function can be activated only when the ALT key is held down.

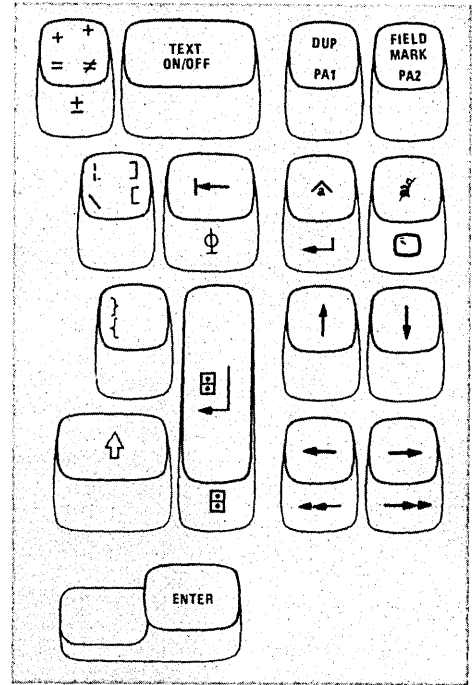

PF1 through PF12 Keys

The PF1 through PF12 keys on the Typewriter/Text keyboard are not Alternate Function keys, because they are located on the right side of the keyboard instead of on the front of the top row of keys. PF13 through PF24 keys are not available on the Typewriter/Text keyboard.

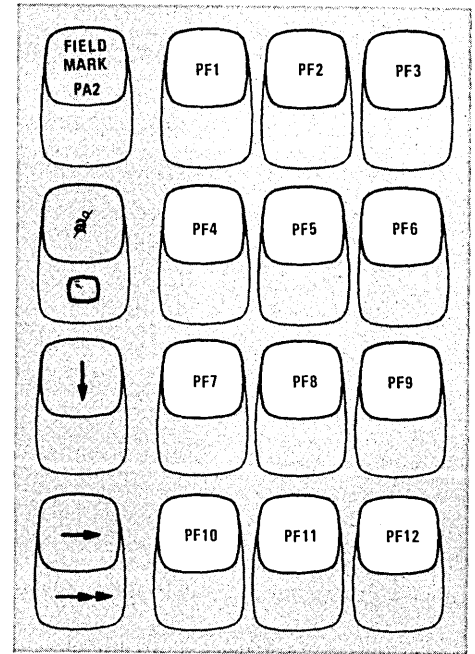





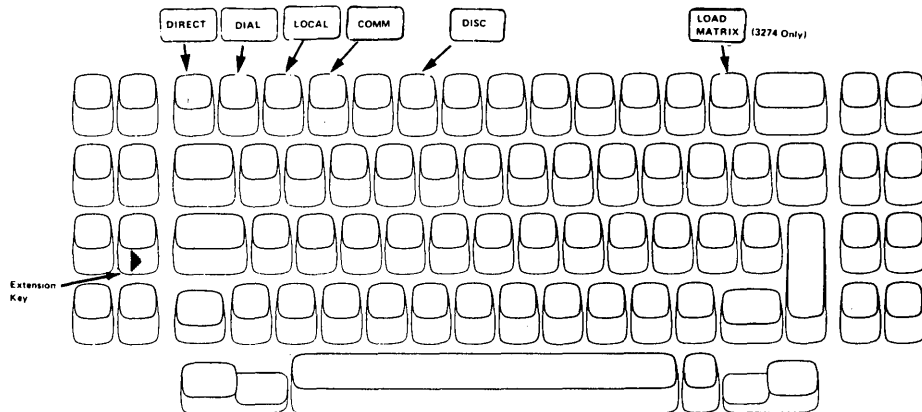

X.21 Switched Network Operating Procedures

For calling and associated operations with the X.21 Switched Networks feature installed, the keyboard attached to 3278s has uniquely defined X.21 keys, as shown below.



The functions of the keys are as follows:

- ▶ key (extension key) Pressing the ▶ key causes the terminal to go into the extension state. To activate the extension key, the ALT key must be pressed and held down while the extension key is pressed. The key enables the COMM, DIAL, DISC, DIRECT, LOAD MATRIX, or LOCAL key. (Displays ▶ in the Operator Information Area.)
- COMM key Pressing the COMM key causes the terminal to go into the call-ready state. (Displays  in the Operator Information Area.)
- DIAL key Pressing the DIAL key causes the terminal to go into the dial-in mode. (Displays  # ? in the Operator Information Area.)
- DIRECT key Pressing the DIRECT key causes the terminal to go into the direct-call mode. (Displays  in the Operator Information Area.)
- DISC key Pressing the DISC key causes the terminal to disconnect from the network and stops communications between the host system and the terminal. (Displays  in the Operator Information Area while disconnection is in process and  when it is finished.)
- LOCAL key When the terminal is in the call-ready state, pressing the LOCAL key causes it to go into the local mode. In this mode, the terminal cannot call or be called. (Displays  99 or 599 in the Operator Information Area.)
- LOAD MATRIX key (3274 only) Pressing the LOAD MATRIX key loads the printer authorization matrix.

Note: The preceding keys will not work in machine-check, security-key conditions.





Operating Procedure





The X.21 Switched Network operating procedures for display stations are described below. Details unique to your location, however, are not described. For example, operator identification codes, call-progress-signal codes, or operating instructions for attached non-IBM equipment are provided by the appropriate person in your organization.

Sending a Message to the Host System with the X.21 Switched Network Capability

1. The Ready symbol (**6** or **4**) should be displayed at the left of the Operator Information Area, indicating that the terminal is ready.



Make sure that one of the following symbols is also displayed in the Operator Information Area:

- a. Call Ready ()
- b. Call Ready with Communication Error Reminder ( nn or  5nn)
- c. Call Ready with Call Progress Signal ( Nnn)

If the Local mode symbol ( 99 or  599) is displayed, press and hold the ALT key while pressing the  key. Then press the COMM key. The Call Ready symbol () will be displayed.

Note: If Comm Check ( 33,557, or 561) is displayed, the following steps cannot be performed.



If your terminal is registered to Direct Call, go to step 3b.

2. If your terminal is registered to Full Address Call or Abbreviated Address Call, press the ALT key and the  key, then the DIAL key. The Dial In symbol ( # ?) will be displayed in the Operator Information Area, indicating that the operator may enter the dial number of the host system. The cursor is now at the home position.

- 3a. (Full Address Call or Abbreviated Address Call).

Key in the host system line number if your terminal is not registered to Abbreviated Address Call.

Key in the abbreviated line number [period (.) and two digits] if your terminal is registered to Abbreviated Address Call.

The number entered will be displayed at the top of the screen. Ensure that the number is the one for the host system with which you are communicating. Then, press the ENTER key. The Outgoing Call in Process symbol () will be displayed until the In Use symbol ( N) appears.

Go to step 4.

Notes:

1. Under some conditions, the Call Progress Signal symbol ( Nnn) will be displayed. The Call Progress Signal is from the X.21 network and indicates the status of the network or of the remote terminal. The meaning of the Call Progress Signal depends on the two digits (nn) after N in the Call Progress Signal symbol.

2. If no digit has been entered before the ENTER key is pressed or if any invalid characters are entered, the Wrong Number symbol (✕ ❸❹❺) and the Call Ready symbol (—) will be displayed.

Press the RESET key to return to step 2.

3. The area from the home position to column 31 is an unprotected area for entering the dial number. Areas other than this are protected. If the operator tries to enter a dial number in a protected area, the Wrong Place symbol (✕ ←❸→) is displayed. Press the RESET key to clear the symbol.

3b. (Direct Call Only).

Press the ► key and then the DIRECT key. The Outgoing Call in Process symbol (→—) should be displayed until the In Use symbol (N) appears.

Note: Under some conditions, the Call Progress Signal symbol (→—Nnn) will be displayed. The Call Progress Signal is from the X.21 network and indicates the status of the network or of the remote terminal. The meaning of the Call Progress Signal depends on the two digits (nn) after N in the Call Progress Signal symbol.

4. When the network connection is established, the Outgoing Call in Process symbol (→—) or the Outgoing Call in Process with Call Progress Signal symbol (→—Nnn) will disappear and the In Use symbol (N) will be displayed in the left section of the Operator Information Area.

Note: If you have trouble between steps 2 and 4, press the ► key while holding down ALT and then press the DISC key to return to step 1. If host communication does not begin within approximately 60 seconds after the In-Use symbol appears, the network connection ends automatically and the In-Use symbol disappears. (Host communication is indicated by the absence of a 5nn communication error, 505 or 521 reminder.) If this occurs, go back to step 1.

5. Your application may require you to perform a logon procedure before you can enter data. Perform the logon procedure if required.

6. Key in the message data, and press the ENTER key or the PF key specified for your application. When you have finished the message, go to step 7.

7. Note the formatted display or host system response on your screen.

If required, press the RESET key and continue keying the message data. Then press the ENTER or PF key when you have finished your message.

8. When the data transmission is finished, the network connection is disconnected by one of the following:



- a. Pressing of the ► and DISC keys.
- b. A Disconnect command from the host system.
- c. A Clear Indication signal from the network.
- d. An automatic timeout of the terminal.

While disconnection is in process, the In Use symbol (N) and the Disconnect in Process symbol (—) are present. They will disappear when disconnection is completed.





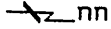
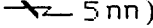
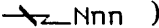
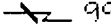





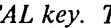
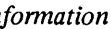

Note: For items b and c, the Clear Indication symbol (— 37 or 559) will be displayed.

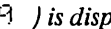
You are now free to send a new message or to receive a message from the host.

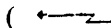
Receiving a Message from the Host System When the X.21 Switched Network Is Installed

1. When the host system operator wishes to send a message to a terminal, the message is received automatically and you do not have to be present if one of the following symbols is also displayed in the Operator Information Area:
 - a. Call Ready ()
 - b. Call Ready with Communication Error Reminder ( or )
 - c. Call Ready with Call Progress Signal ()If the local symbol () is displayed, press the  key, then the COMM key. The Call Ready symbol () will be displayed.

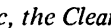
Notes:

1. If Comm Check ( 33, 557, or 561) is displayed, the following steps are not possible.
 2. If you need to reject a call from the host system, press the  key, and then the LOCAL key. The Local mode indicator ( or ) will be displayed in the Operator Information Area. Any incoming call from the host system while in local mode will be rejected.
 3. If the Local symbol ( or ) is displayed, press the  key, then the COMM key. The Call Ready symbol () will be displayed.
2. When the incoming call is in process, the Incoming Call in Process symbol () is displayed. When the network connection has been established, the In Use symbol () is displayed, and the Incoming Call in Process symbol will disappear.
 3. Your application may require you to perform a logon procedure before you can enter data. Perform the logon procedure if required.
 4. Key in the message data, and press the ENTER key or the PF key specified for your application.
 5. Note the formatted display or host-system response on your screen. If required, press the RESET key and continue keying message data. Press the ENTER or PF key when you have finished your message.
 6. When the data transmission is finished, the network is disconnected by:
 - a. Pressing of the  and DISC keys.
 - b. A Disconnect command from the host system.
 - c. A Clear Indication signal from the network.
 - d. An automatic timeout of the terminal.While disconnection is in process, the In Use symbol () and the Disconnect in Process symbol () are present. They will disappear when disconnection is completed.
Note: For items b and c, the Clear Indication symbol ( 37 or ) will be displayed.
 7. You are now free to send a new message or to receive a message from the host.

Chapter 5. Important Differences between the 3275/3277 and the 3278

Contents	5-1
Introduction	5-3
Screen Character Capacities	5-4
3278 Operator Controls	5-5
On/Off (I/O) Switch	5-5
☼ Brightness Control	5-6
● Contrast Control	5-6
🔊 Audible Alarm Volume Control	5-6
Normal/Test Switch	5-6
Dual Case/Mono Case (A, a/A) Switch	5-6
3278 Display Image	5-7
3278 Operator Information Area	5-8
3278 Keyboards	5-9
Problem Determination Guide Access Panel	5-10
Keyboard Clicker	5-11
Additional Keyboard Keys	5-11
Typamatic (Repeat-Action) Keys	5-14
Keys That Operate the Same on 3278 and 3275/3277	5-14
Keys That Operate Differently on 3278 and 3275/3277	5-14
Numeric Lock Feature	5-15
Selector Light Pen Feature	5-15
Magnetic Slot Reader Accessory	5-15

Introduction

This chapter is provided for experienced operators of the IBM 3275 and 3277 Display Stations who will be operating an IBM 3278 Display Station attached to a 3274 Control Unit or to a 3276 Control Unit Display Station. The two groups of machines are similar in operation, and only the differences in operation are described here. This chapter refers you to sections of Chapters 2, 3, and 4 for detailed descriptions of some of the 3278 indicators, switches, features, and keyboard operations. If your 3278 is not attached to a 3274 Control Unit or to a 3276 Control Unit Display Station, there may be differences other than those described here. Refer to the appropriate appendix for a description of those differences.

If possible, sit at a 3278 display as you read this chapter so that you can use the switches and keys as you read about them. If your display station has a keyboard attached and if some point is not clear as you read, pause for a moment to press the key and watch the result.

The IBM 3278 Display Station is shown in Figure 5-1. The 3278 (like a 3277) communicates with the host system through a control unit.

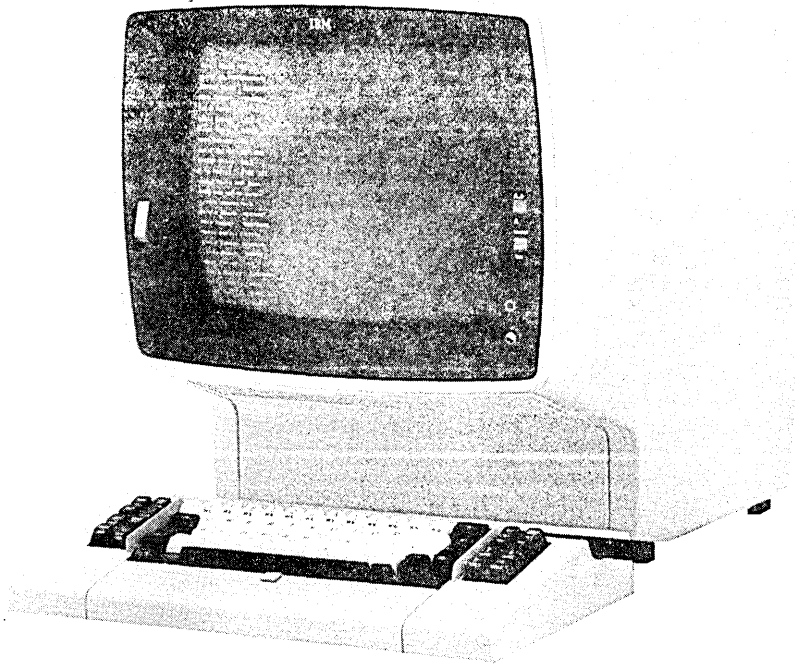

Figure 5-1. IBM 3278 Display Station

Screen Character Capacities

As you know, the 3275 and 3277 Display Stations can have either a large screen (1920-character capacity) or a small screen (480-character capacity). Your 3278 Display Station can have only one physical screen size, but six screen formats are available: 480 characters (12 lines of 40 characters each), 960 characters (12 lines of 80 characters each), 1920 characters (24 lines of 80 characters each), 2560 characters (32 lines of 80 characters each), 3440 characters (43 lines of 80 characters each), or 3564 characters (27 lines of 134 characters each).

If your organization uses both 3275/3277 and 3278 Display Stations, you may work with programs that use both groups of display stations. These programs can format the screen of your 3278 in the same way that they format a 3275 or 3277 screen.

To enable the 3275/3277 programs to use both groups of display stations:

- The 960-character 3278 can be formatted as a 480-character display.

- The 2560-, 3440-, and 3564-character 3278 can be formatted as 1920-character displays.

Some programs may use the large format, and other programs may use the smaller format. Therefore, if you use a 960-, 2560-, 3440-, or 3564-character 3278, the program may switch the screen format between the large format and the smaller format for different transactions.

3278 Operator Controls

On/Off (I / O) Switch

The 3278 On/Off (I / O) switch is separated from the brightness and contrast controls (see Figure 5-2). This reduces the possibility of accidentally turning the display station off. To turn the 3278 on, press the top portion  of the switch. Light 3 and Light 1 should turn on when you press the On/Off switch. After a delay of a few seconds, (1) Light 2 turns on, (2) the cursor appears in the first position of line 1, (3) a horizontal line appears across the lower portion of the screen, and (4) a Ready symbol (see Chapter 2) appears in the lower-left portion of the screen in an area called the Operator Information Area.

If your display station has the Security Keylock feature and the keylock is locked, the  symbol appears at the bottom of the screen in the Operator Information Area.

Note: The keylock turns 90° (vertical to horizontal position) when you turn the key.

When you are ready to turn off your display station, press the bottom portion  of the On/Off switch.

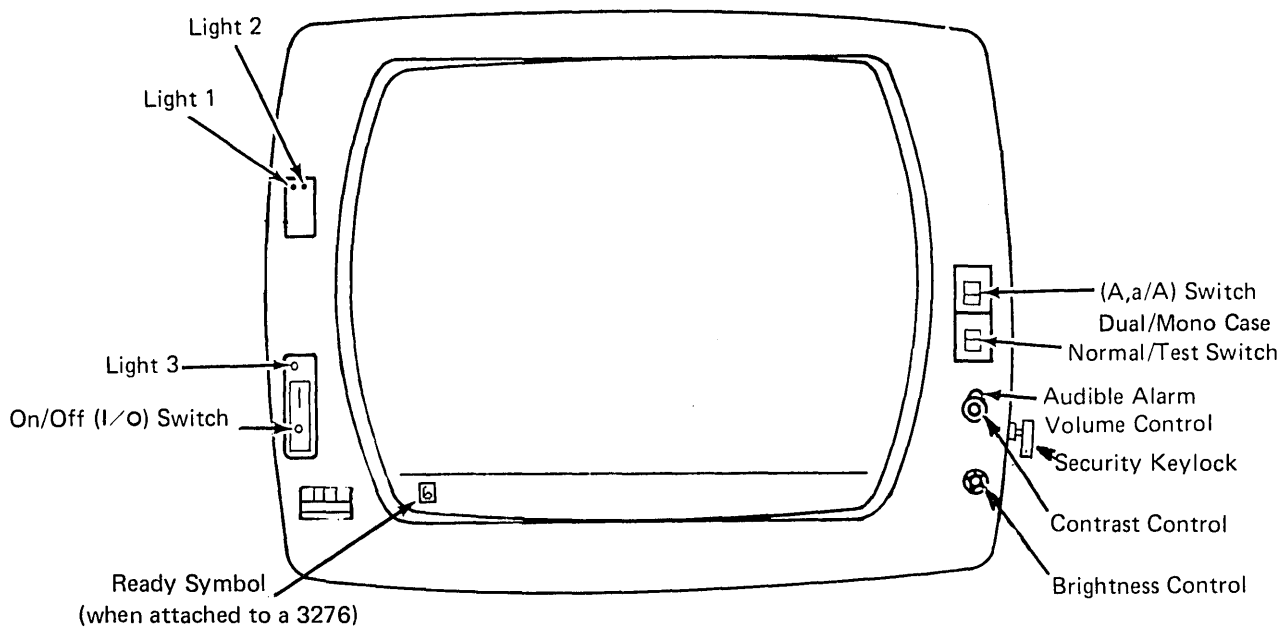

Figure 5-2. 3278 Operator Controls and Lights

Brightness Control

The brightness control knob (see Figure 5-2) serves the same function and operates in the same manner as the 3275/3277 brightness control. This control also has a test position. When the control knob is turned fully clockwise beyond the first stop and held, the screen becomes very bright.

Contrast Control

The contrast control knob (see Figure 5-2) serves the same function and operates in the same manner as the 3275/3277 contrast control.

Audible Alarm Volume Control

If your display station has the Audible Alarm feature installed, the volume control  for the audible alarm is located at the outside of and behind the screen contrast control (see Figure 5-2) instead of under the machine covers. Turning this control clockwise increases the sound level; turning the control counterclockwise decreases the sound level.

Normal/Test Switch

When you are operating the display station, this switch is in the Normal position (see Figure 5-2).

You use the Test position of this switch when you have a problem with the machine and you perform the problem determination procedures. When you place the switch in the Test position, you can perform the tests described in Section 3 of the *3278 Problem Determination Guide*.

Dual Case/Mono Case (A, a/A) Switch

The 3278 Display Stations can display both uppercase and lowercase alphabetic characters. You can use the A, a/A switch (see Figure 5-2) to display (1) only uppercase alphabetic characters or (2) both uppercase and lowercase characters. To select only uppercase characters, set the switch to A; to select uppercase and lowercase characters, set the switch to A, a.

The position of this switch does not determine whether uppercase or lowercase alphabetic symbols are sent to the host system. For example, if the switch is set to A and you enter a lowercase e character, an uppercase E is displayed on the screen; however, when the character is sent to the host system, the code for a lowercase e character is sent.

3278 Display Image

Display image characteristics such as input fields, numeric fields, high-intensity data, protected data, nondisplay fields, and cursor operation are the same on 3278 and 3275/3277 displays. However, there are display image differences, as follows:

- There are two types of cursors that can be displayed on the screen of a 3278: the normal cursor and the alternate cursor. The normal cursor appears on the screen as the same cursor used by the 3275 and 3277.

The alternate cursor is a reverse image of the character that is located in the same character position as the cursor (Figure 5-3). By using the ALT CURSR and CURSR BLINK keys (described in the Chapter 3 keyboard sections) you select either type of cursor and you can also make the cursor blink on and off continuously.

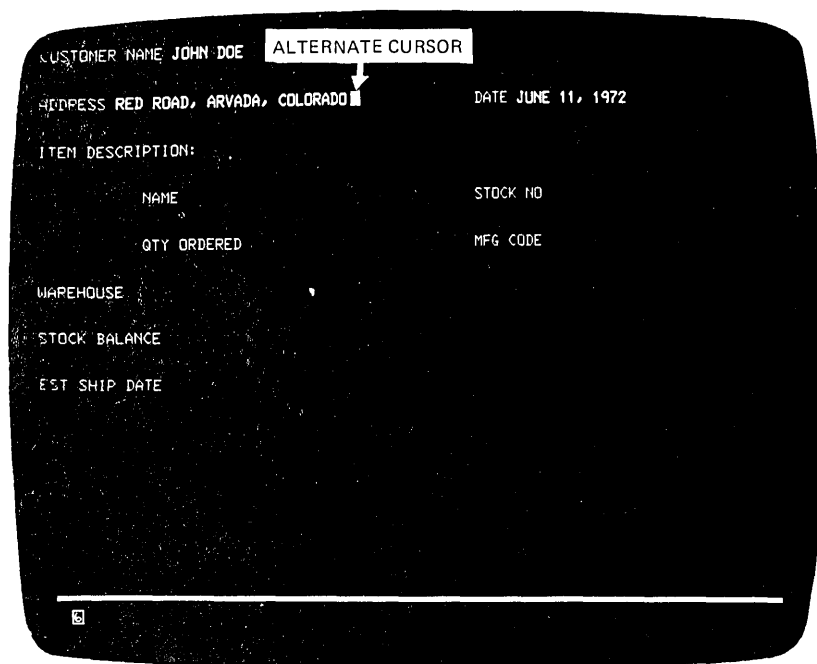

Figure 5-3. The alternate cursor is a reversed character image.

- Cursor wrap works the same way on the 3278 as it does on the 3275/3277. However, since your 3278 may use two different screen formats, keep in mind that the cursor wraps (1) horizontally at the first (left) and last (right) positions on the line and (2) vertically at the top and bottom lines, not at the left and right or top and bottom of the screen.
- When the program updates the screen on the 3275 and 3277, the display image blinks off and then on during the update. This blinking does not occur when a 3278 display image is updated.

If the control unit detects a communication line problem or a program error (when A is displayed in the Operator Information Area) while updating your screen, the update operation is stopped and the screen is restored to its original contents. If the error persists, successive retry operations may be seen in this manner on the screen.

- The New Line (NL), End Message (EM), and Form Feed (FF) order codes are displayed as 5, 9, and < respectively on 3275 and 3277 displays, but are not displayed on the 3278.
- The Duplicate and Field Mark characters are displayed as an asterisk (*) and semicolon (;), respectively, on 3275 and 3277 displays. The 3278 displays the Duplicate and Field Mark characters as an overscored asterisk (¯*) and overscored semicolon (¯;), respectively, when the A,a/A switch is set to A,a; when the A,a/A switch is set to A, only the asterisk or semicolon is displayed.
- When a 3275 or 3277 Operator ID Card Reader operation is performed, the cursor moves across the screen as the card is read.

When a 3278 Magnetic Slot Reader operation is performed, the cursor will not move until the control unit processes all the card characters. When the control unit is finished, and no error occurred, the cursor is moved to the character position beyond the last character read in; if an error occurred, the cursor is moved to the character position occupied by the last character read in.

3278 Operator Information Area

The 3275 and 3277 System Available, Insert Mode, and Input Inhibited indicators are not present on the 3278. Instead of these indicators the 3278 has an Operator Information Area in which symbols, words, and numerals are used to display operating and status messages. The Operator Information Area and the messages displayed in this area are described in Chapter 2.

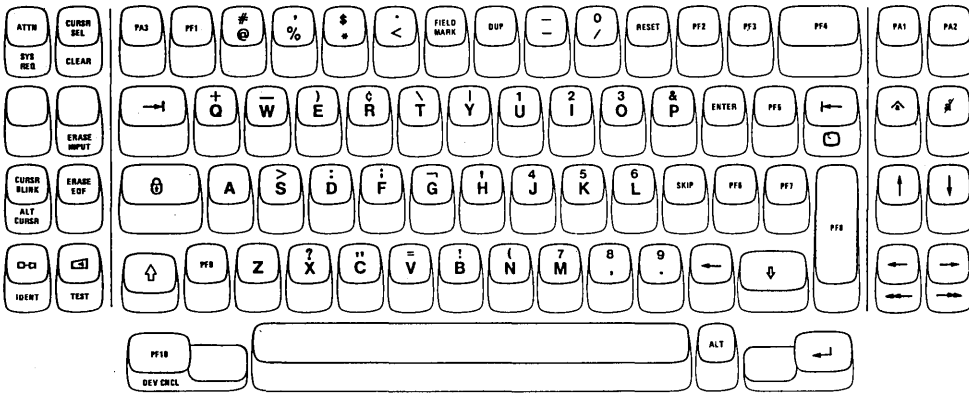

Figure 5-6. Data Entry Keypunch Layout Keyboard

Problem Determination Guide Access Panel

The 3278 keyboards contain the display station's Problem Determination Guide. To access the Guide, press the latch shown in Figure 5-7; the access panel will spring open. Whenever you have a problem with your display station, refer to the Problem Determination Guide to determine the appropriate action.

In addition to the problem determination procedures, the Problem Determination Guide contains descriptions of:

- The symbols on the keyboard keys
- The Operator Information Area messages
- The display station switches and lights

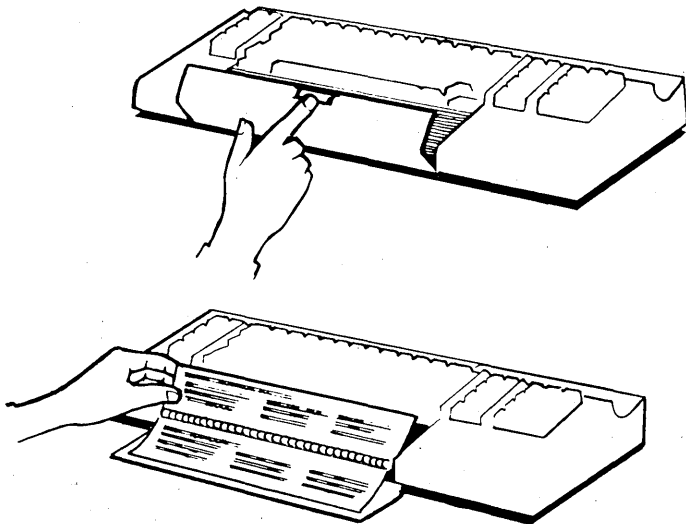



Figure 5-7: 3278 Problem Determination Guide Access

Keyboard Clicker



The 3278 keyboards, like the 3275 and 3277 keyboards, have a clicker that clicks when you press the keys. However, the 3278 keyboards do not have a clicker volume control, but you can turn the click off or on by using the Click () key on the keyboard. It is important to know that generally:

- When you have the clicker turned on, absence of the click indicates that the keyboard is disabled.
- When you have the clicker turned off, the presence of the click indicates that the keyboard is disabled.

Additional Keyboard Keys

The keys that are unique to the 3278 keyboards are briefly described next. For detailed descriptions of each of these keys, refer to the keyboard sections in Chapter 3.

ALT (Shift) Key

The ALT (Alternate) Shift key enables the alternate function keys. The alternate function keys are the keys that have a function name or symbol on the front of them: SYS REQ, CLEAR, ERASE INPUT, ALT CURSR, IDENT, TEST, DEV CNCL, PA1 and PA2 (Typewriter keyboard), PF1 through PF12 (Typewriter keyboard), Double-Speed Horizontal Positioning ( and ), and  (Home). To cause the function on one of these keys to be performed, press and hold the ALT key down and then press the desired key.

Additional PF Keys

The 3278 75-key Typewriter keyboard has 12 Program Function (PF) keys. Twelve additional PF keys (PF13 through PF24) are available with an 87-key Typewriter keyboard.

The 3278 Data Entry keyboards have 10 PF keys, whereas the 3275 and 3277 Data Entry keyboards have 5.

Additional Symbol and Punctuation Mark Keys

The 3278 Typewriter keyboard has 32 symbol and punctuation mark keys, whereas the 3275 and 3277 have 26. Also, some of the special symbol keys are located in different places.

ATTN Key

The ATTN (Attention) key performs the function that its name implies; that is, it provides a means of getting the program's attention. Depending upon the programming of your 3270 system, the ATTN key may or may not be operative. To determine how this key operates, refer to the appropriate user's program guide.

SYS REQ Key

As determined by the programming for your 3270 system, the SYS REQ (System Request) key (when used with the ALT key) may perform the function that the TEST REQ key performed, or it may clear your display screen and switch your display station between application and control programs. For more information about SYS REQ key operation, refer to the SYS REQ key description under the heading "Similar Keys on Typewriter and Data Entry Keyboards," in Chapter 3.

CURSR SEL Key

The CURSR SEL (Cursor Select) key provides the same function provided by the Selector Light Pen feature. To select a field, (1) position the cursor within the desired selection field and then (2) press the CURSR SEL key.

The 3278 has two attention field designators: ampersand (&) and a blank position. The selection field designator characters (? and) are the same as those used by the 3275 and 3277.

CURSR BLINK Key

The CURSR BLINK (Cursor Blink) key enables you to control the blink function of your cursor (normal or alternate).

Pressing the CURSR BLINK key when the cursor on your screen is not blinking causes your cursor to blink on and off continuously. To stop the cursor blink, press the CURSR BLINK key again.

ALT CURSR Key

The ALT CURSR (Alternate Cursor) key, when used with the ALT key, enables you to select either the normal cursor or the alternate cursor.

Pressing the ALT CURSR key (with ALT held down) when the normal cursor is on the screen replaces the normal cursor with the alternate cursor. To restore the normal cursor, press the ALT CURSR key (with ALT) again.

Print () Key

Pressing the Print () key causes the information on your screen to be printed on the printer you select by using the IDENT key. For a detailed description of this key, refer to the Print key description under the heading "Similar Keys on Typewriter and Data Entry Keyboards," in Chapter 3.

IDENT Key















The IDENT (Print ID) key is used with the ALT key to request a printer for a print operation. For a detailed description of this key, refer to the IDENT key description under the heading "Similar Keys on Typewriter and Data Entry Keyboards," in Chapter 3.

Typamatic (Repeat-Action) Keys

On the 3275 and 3277 keyboards, only the cursor move and space keys are typamatic; on the 3278 keyboards, all Alphabetic, Numeric, Symbol, Punctuation Mark, Cursor Move, Spacebar, ENTER, and PF1 through PF12 (PF1 through PF10 for Data Entry Keyboards) keys are typamatic.

Keys That Operate the Same on 3278 and 3275/3277



The following keys operate the same on 3278 keyboards as the corresponding keys on 3275 and 3277 keyboards:

- Shift () keys (SHIFT on 3275/3277)
- Lock () key (LOCK on 3275/3277)
- Numeric Shift () key (NUMERIC on 3275/3277)
- Numeric Lock () key (NUM LOCK on 3275/3277)
- Alpha () key (ALPHA on 3275/3277)
- Spacebar
- New Line () key
- SKIP key
- Tab () key
- Back Tab () key
- Horizontal Positioning ( and ) keys
- Vertical Positioning ( and ) keys
- Backspace () key
- CLEAR key (with ALT)
- ERASE INPUT key (with ALT)
- ERASE EOF key
- PA1 and PA2 (with ALT) on Typewriter keyboards
- PA1, PA2, and PA3 on Data Entry keyboards
- Delete () key (DEL on 3275/3277)
- Insert () key (INS MODE on 3275/3277)
- ENTER key
- PF keys (with ALT for PF1-PF12 on Typewriter keyboards)

Keys That Operate Differently on 3278 and 3275/3277

The following keys operate similarly on both the 3278 keyboards and on the 3275/3277 keyboards; therefore, only the differences are described.

Alphabet Keys

The characters on the faces of the Alphabet keys are displayed as uppercase (capital) letters when the keys are used in conjunction with the Shift () and Lock () keys. When the Alphabet keys are used without the Shift or Lock keys, the letters are displayed as lowercase letters (if the *A,a/A* switch is set to *A,a*). In addition, all the Alphabet keys have typamatic capability.

Numeric Keys

The Numeric keys on 3278 keyboards have typamatic capability.

Symbol and Punctuation Mark Keys

The Symbol and Punctuation Mark keys on 3278 keyboards have typamatic capability.

DUP (Duplicate) Key

Pressing the DUP key displays an overscored asterisk () when the *A,a/A* switch is set to *A,a*; when the *A,a/A* switch is set to *A*, only the asterisk is displayed.

FIELD MARK Key

Pressing the FIELD MARK key displays an overscored semicolon ($\overline{;}$) when the *A,a/A* switch is set to *A,a*; when the switch is set to *A*, only the semicolon is displayed.

Insert (\curvearrowright) Key

On the 3275 and 3277 Display Stations, only the RESET key can return the display station to normal operation after being in Insert Mode. On 3278 Display Stations, pressing RESET or any key that causes communication with the host system will return the display station to normal after being in Insert Mode.

Numeric Lock Feature

The 3275/3277 Numeric Lock feature cannot be overridden if the display station has a Typewriter keyboard. However, the 3278 Numeric Lock feature can be overridden by the Typewriter keyboard to enter all uppercase characters and symbols. This is accomplished by pressing and holding the Shift (\uparrow) key and then pressing the desired uppercase character/symbol key(s).

Selector Light Pen Feature

The 3278 and 3275/3277 Selector Light Pen features operate the same except that the 3278 has two attention field designator characters, whereas the 3275 and 3277 have one attention field designator character. Both groups of machines have blank position attention field designators; the 3278 also uses an ampersand (&) designator character.

For additional information about the 3278 Selector Light Pen feature, refer to Chapter 4.

Magnetic Slot Reader Accessory

The Magnetic Slot Reader accessory operates differently than the 3275 and 3277 Operator Identification Card Reader feature. For a description of the 3278 Magnetic Slot Reader accessory, refer to Chapter 4.

Appendix A. Sample Problem Report Form

IBM 3276/3278/3279 Problem Report Form

Unit Identification	_____
Unit Location	_____
Unit Type 3276 3278 3279 (circle one)	_____
Unit Serial Number	_____
Telephone Number	_____
Date and Time	_____
Reported by	_____

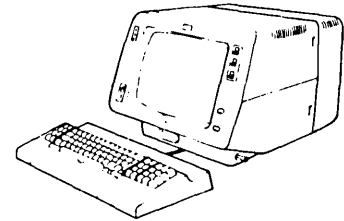
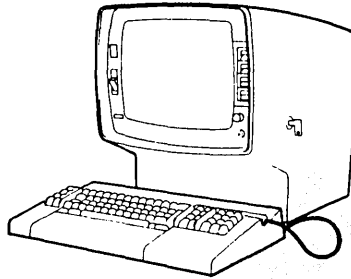

1 Record the step number where you detected the failure:

Step Number: _____

2 Circle all of the following symbols that are displayed in the Operator Information Area of the failing display station(s):

Note: If not a or a , record the symbol.

Subsystem Ready _____ or or _____

Host Connection _____ or

If one of these three symbols is displayed, insert the 2- or 3-digit code following the symbol.

}	Communication Problem _____ <input type="checkbox"/>	_____
	Display Station Problem _____ <input type="checkbox"/>	_____
	Program Error _____ PROG	_____

3 If the display station is a 3278 or 3279, go to step 6; if the display station is a 3276, continue.

4 Are all attached terminals failing?

If "NO" is checked, identify all the failing terminals:

YES NO

5 Write an "X" in each circle below for each light that was on when the error occurred.

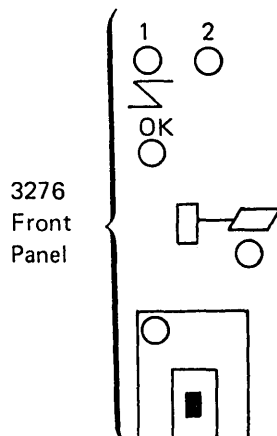

Inside of
3276 Control
Drawer

}	System Check	Machine Check	Test
	<input type="checkbox"/>	<input type="checkbox"/>	<input type="checkbox"/>

(See other side)

6 If the keyboard is failing, fill in the appropriate section below. On the keyboard diagram, write an X in the appropriate location for each key that failed.

- | | |
|---|---|
| <input type="checkbox"/> All keys fail. | <input type="checkbox"/> All PF keys fail. |
| <input type="checkbox"/> All character keys fail. | <input type="checkbox"/> Extended-keyboard failure. |

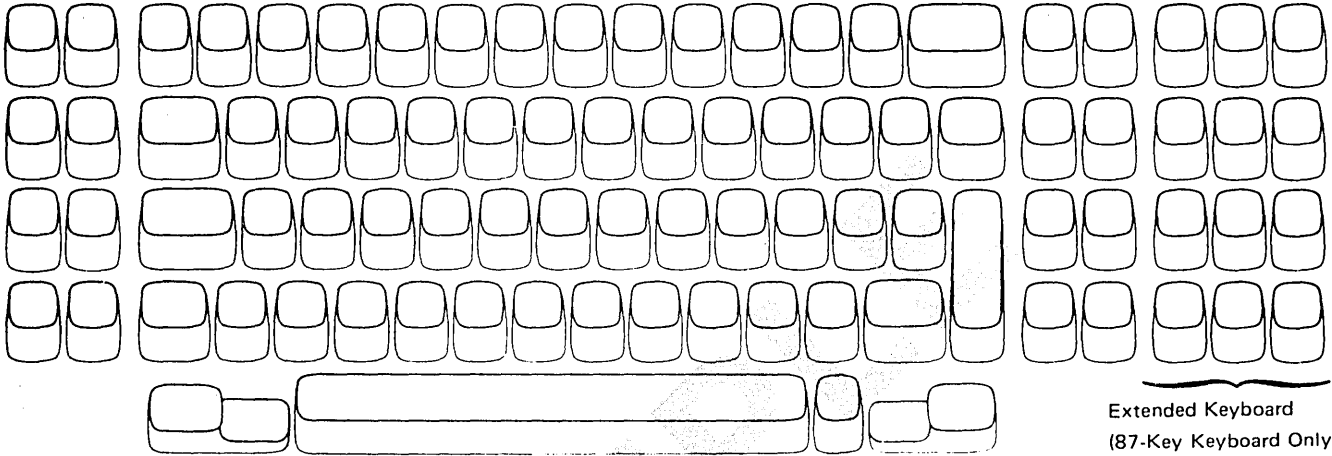

7 If this display station is a 3279, note with an X which front panel lights are on.

- 1 ○
- 2 ○
- 3 ○

8 After completing this form, follow your organization's procedure for reporting problems and save this form for the service representative.

It is possible that this material may contain reference to, or information about, IBM products (machines and programs), programming, or services that are not announced in your country. Such references or information must not be construed to mean that IBM intends to announce such IBM products, programming, or services in your country.

Address comments to IBM Corporation, Department 52Q, Neighborhood Road, Kingston, N.Y. 12401. IBM may use or distribute any of the information you supply in any way it believes appropriate without incurring any obligation whatever. You may, of course, continue to use the information you supply.

Printed in the U.S.A. GX23-0201-3 1/80

© Copyright International Business Machines Corporation 1978, 1979, 1980

Appendix B. 3278 Display Station Attached to a 4331 Processor

This appendix describes the different symbols and operations that will occur when the 3278 is attached to a 4331 processor instead of to a 3274 Control Unit or a 3276 Control Unit Display Station.

Operator Information Area Symbols and Messages

Readiness and System Connection Symbols

The ready symbol \bar{I} will appear in location 1 of the Operator Information Area to indicate the 4331 processor is working.

Do Not Enter (Input Inhibited) Messages

X C-F is the minus function symbol. This message means that the function (operation) that you requested is not available. Press RESET to restore your keyboard; then take other action.

Keyboards

CLICK () Key

The CLICK () key is not operative when a 3278 is attached to a 4331. The clicker will normally be on. A click tells you that the keyboard is operational and that the data you are keying in is being accepted. The absence of a click indicates that the keyboard is disabled.

Additional Keys

The following keys are not operative when a 3278 is attached to a 4331 processor:

- ATTN
- PRINT ()
- IDENT
- DEV CNCL
- CURSR SEL

If one of these keys is pressed, the minus function (**X** C-F) message will appear in the Operator Information Area.

Index

- Alpha message 2-27
- Alpha Shift key 3-19
- Alphabet keys* 3-9, 3-20
- ALT CURSR key 3-36
- ALT key 3-9, 3-20, 3-32
- ALT Shift key* 3-9, 3-20
- alternate cursor 2-15
- APL/Text feature 4-13
- ATTN key 3-32
- Attribute Selection keys
 - Field Inherit keys 3-47
 - highlighting selection keys 3-47
 - Programmed Symbol Set selection keys 3-47
- Attribute Select Overlay keyboard 3-4, 3-6, 3-46
- Attribute Select Typewriter/APL keyboard 3-4, 3-6, 3-46
- Attribute Select Typewriter keyboard 3-4, 3-6, 3-46
- Audible Alarm feature 4-10
- audible alarm volume control 2-9, 4-10

- Back Tab key 3-29
- Backspace key 3-31
- blank keys in Numeric Mode 3-24
- Blink key 3-47
- brightness control 2-9

- card reader operation 4-7
- character highlighting
 - character blinking 2-4, 2-27, 3-46, 3-47
 - character reversal 2-4, 2-27, 3-46, 3-47
 - character underscoring 2-4, 2-27, 3-46, 3-47
- characters
 - adjusting brightness 2-9
 - adjusting contrast 2-9
 - APL 4-17
 - deleting 3-43
 - inserting 3-41
 - Text 4-22
- cleaning procedures 2-28
- CLEAR key 3-34
- clearing the screen (*see* CLEAR key)
- Click key 3-39
- color(s) 2-28, 3-47
- contrast control 2-9
- Control Unit Selector switch 4-12
- controls/switches, discussion 2-8
- cursor 2-15
- cursor, moving (*see* Cursor Control keys)
- cursor, positioning (*see* Cursor Control keys)
- cursor, program control of 2-16
- Cursor Control keys 3-25
- cursor wrap 2-16
- CURSR BLINK key 3-36
- CURSR SEL key 3-33

- data, protected 2-14
- Data Entry keyboard 3-17
- data processing 1-4
- data processing system 1-4
- Dead Keys 3-44
- Delete key 3-43
- deleting characters (*see* Delete key)
- designator characters 4-4
- DEV CNCL key 3-40
- disabled keyboard (*see* Do Not Enter messages)

- display image 2-11
- Do Not Enter messages 2-21
- Dual Case/Mono Case switch 2-10
- DUP key* 3-13, 3-22

- ending a field (*see* FIELD MARK key)
- ENTER key 3-43
- ERASE EOF key 3-35
- ERASE INPUT key 3-35
- erasing input fields (*see* ERASE INPUT key)
- extended highlighting feature 2-27

- features, optional
 - APL/Text 4-13
 - audible alarm 4-10
 - Numeric Lock 4-11
 - Security Keylock 4-9
 - Selector Light Pen 4-3
 - Switch Control Unit 4-12
- Field Inherit key(s) 2-28, 3-47
- FIELD MARK key* 3-13, 3-22
- fields
 - definition 2-13
 - high-intensity 2-14
 - input 2-13
 - nondisplay 2-15
 - numeric 2-14
 - protected 2-14
- formatted display 2-13

- high-intensity data 2-14
- highlighting 2-2, 2-27
- highlighting selection keys 3-47
- horizontal positioning keys 3-30
- how to
 - adjust brightness of characters 2-9
 - adjust contrast of characters 2-9
 - adjust volume of audible alarm 2-9, 4-10
 - cancel a print operation 3-40
 - clear the screen 3-34
 - delete a character 3-43
 - determine your keyboard type 3-5
 - erase all input fields 3-35
 - erase an input field 3-35
 - insert a character 3-41
 - locate information in this book 1-1
 - move cursor 3-26
 - select a printer 3-38
 - start a print operation 3-38
 - turn power on/off 2-8
 - turn the keyboard clicker on/off 3-39
 - unlock keyboard 3-40
 - use audible alarm 4-10
 - use control unit selector switch 4-12
 - use Numeric Lock 2-14
 - use Security Keylock 4-9
 - use Selector Light Pen 4-4

*This subject is discussed in each 3278 keyboard section. Refer to the page that applies to your keyboard: the first reference is to the Typewriter keyboard; the second, to the Data Entry keyboard.

IBM 3270 Personal Computer Attachment 1-3

IDENT key 3-38

indicators

Light 1 2-18

Light 2 2-18

Light 3 2-18

input fields 2-13

input machines 1-6

input section 1-6

Insert key 3-41

inserting characters (see Insert key)

keyboard

APL 4-15

Attribute Select Overlay keyboard 3-4, 3-6, 3-46

Attribute Select Typewriter/APL keyboard 3-4, 3-6, 3-46

Attribute Select Typewriter keyboard 3-4, 3-6, 3-46

Data Entry 3-17

Data Entry Keypunch layout 3-5

disabled (see Do Not Enter messages)

keying sound 3-3

Text 4-20

type, how to determine 3-5

Typewriter 3-7

Typewriter APL 4-15

Typewriter Text 4-20

keyboards, introduction to 3-3

keys (see individual key name)

length of fields 2-17

locked keyboard (see Do Not Enter messages)

magnetic hand scanner 4-6

magnetic slot reader 4-6

moving the cursor one character space 3-30

moving the cursor to the beginning of a field 3-26

New Line key 3-26

nondisplay fields 2-15, 3-3

numeric field 2-14

Numeric keys* 3-10, 3-21

Numeric Lock feature 3-8, 4-11

Numeric Lock key 3-19

Numeric (Shift) key 3-19

Operator Information Area 2-20

operator panel 2-6 through 2-10

Operator Problem Report Forms A-1

output machines 1-7

output section 1-7

PA keys

PA1* 3-14, 3-23

PA2* 3-14, 3-23

PA3* None, 3-23

personal computer 1-3

PF keys

PF1-PF10 3-24

PF11-PF12 3-14

PF13-PF24 3-7, 3-15

positioning the cursor (see Cursor Control keys)

Power switch 2-8

Print key 3-37

Printer Status Messages 2-22

Problem Report Forms A-1

Processing Section 1-6

Program Access keys (see PA keys)

Program Function keys (see PF keys)

Programmed Symbols 2-26

Programmed Symbol key 2-26, 2-28

Programmed Symbol Set selection keys 3-47

Programmed Symbols Selection 2-2, 2-3, 2-19

Programmed Symbol Set(s) 2-26, 2-27, 3-46

protected data 2-14

quick reference 2-2 through 2-5

readiness and system connection messages 2-20

RESET key 3-40

reverse video 3-46, 3-47

Reverse video key 3-47

Security Keylock

removal 4-9

use of 4-9

Selector Light Pen

changing selections 4-5

how it is used 4-4

how it works 4-3

making selections 4-4

Shift key 3-47

Shift/Lock keys* 3-8, 3-19

Shifts and Modes messages 2-27

SKIP key 3-28

Spacebar 3-25

Switch Control Unit feature 4-12

switches/controls 2-6 through 2-10

Symbol and Punctuation Mark keys* 3-10, 3-21

SYS REQ key 3-32

Tab key 3-28

TEST key 3-39

Text feature 4-13

turning power on/off 2-8

typamatic keys* 3-8, 3-18

Typewriter/APL keyboard 4-15

Typewriter/Text keyboard 4-20

Typewriter keyboard 3-7

underscore key 3-47

vertical positioning keys 3-31

Video Test Switch 2-10

*This subject is discussed in each 3278 keyboard section. Refer to the page that applies to your keyboard: the first reference is to the Typewriter keyboard; the second, to the Data Entry keyboard.

IBM 3270 Information Display System
3278 Display Station
Operator's Guide

READER'S
COMMENT
FORM

Order No. GA27-2890-4

This manual is part of a library that serves as a reference source for systems analysts, programmers, and operators of IBM systems. This form may be used to communicate your views about this publication. They will be sent to the author's department for whatever review and action, if any, is deemed appropriate. Comments may be written in your own language; use of English is not required.

IBM may use or distribute any of the information you supply in any way it believes appropriate without incurring any obligation whatever. You may, of course, continue to use the information you supply.

Note: Copies of IBM publications are not stocked at the location to which this form is addressed. Please direct any requests for copies of publications, or for assistance in using your IBM system, to your IBM representative or to the IBM branch office serving your locality.

How did you use this publication?

- | | | | |
|--------------------------|-------------------------------------|--------------------------|------------------------|
| <input type="checkbox"/> | As an introduction | <input type="checkbox"/> | As a text (student) |
| <input type="checkbox"/> | As a reference manual | <input type="checkbox"/> | As a text (instructor) |
| <input type="checkbox"/> | For another purpose (explain) _____ | | |

Is there anything you especially like or dislike about the organization, presentation, or writing in this manual? Helpful comments include general usefulness of the book; possible additions, deletions, and clarifications; specific errors and omissions.

Page Number:

Comment:

What is your occupation? _____

Newsletter number of latest Technical Newsletter (if any) concerning this publication: _____

If you wish a reply, give your name and address:

IBM branch office serving you _____

Thank you for your cooperation. No postage stamp necessary if mailed in the U.S.A. (Elsewhere, an IBM office or representative will be happy to forward your comments or you may mail directly to the address in the Edition Notice on the back of the title page.)

Note: Staples can cause problems with automated mail sorting equipment.
Please use pressure sensitive or other gummed tape to seal this form.

Reader's Comment Form

IBM 3270 Information Display System 3278 Display Station Operator's Guide (File No. S360/S370/S3-09) Printed in U.S.A. GA27-2890-4

Fold and tape

Please Do Not Staple

Fold and tape



NO POSTAGE
NECESSARY
IF MAILED
IN THE
UNITED STATES

BUSINESS REPLY MAIL
FIRST CLASS PERMIT NO. 40 ARMONK, N.Y.

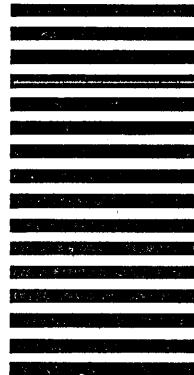

POSTAGE WILL BE PAID BY ADDRESSEE:

International Business Machines Corporation
Department 52Q
Neighborhood Road
Kingston, New York 12401

Fold and tape

Please Do Not Staple

Fold and tape



IBM 3270 Information Display System 3278 Display Station Operator's Guide (File No. S360/S370/S3-09) Printed in U.S.A. GA27-2890-4

