

GA23-0065-3
File No. S360/S370/S3/4300/8100-09

Systems

**IBM 3270
Information Display System**

**3274 Control Unit
Customizing Guide**

Configuration Support D

Validation Number 33

Models 31 and 51
with 192K of Storage
(Feature 3650)

Models 41 and 61

IBM

GA23-0061-1
File No. S360/S370/S3/4300/8100-09

Systems

**IBM 3270
Information Display System**

**3274 Control Unit
Description and
Programmer's Guide**

IBM

Warning: This equipment generates, uses, and can radiate radio frequency energy and if not installed and used in accordance with the instructions manual, may cause interference to radio communications. It has been tested and found to comply with the limits for a Class A computing device pursuant to Subpart J of Part 15 of FCC Rules, which are designed to provide reasonable protection against such interference when operated in a commercial environment. Operation of this equipment in a residential area is likely to cause interference in which case the user at his own expense will be required to take whatever measures may be required to correct the interference.

This warning is also applicable to all attaching units produced for use in the USA that have been manufactured after December 31, 1980. A notice of compliance has been affixed within the customer access area of all affected units.

Second Edition (January 1984)

This revision obsoletes GA23-0061-0 and its associated Technical Newsletters, GN31-1318 and GN31-1135. This revision also incorporates three supplements to GA23-0061-0: form numbers GA23-0136-0, GA23-0137-0, and GA23-0171-0.

Changes are made periodically to the information herein; before using this publication in connection with the operation of the IBM 3270 Information Display System, consult the latest *IBM System/360 Bibliography*, GA22-6822, or *IBM System/370 and 4300 Processors Bibliography*, GC20-0001, for the editions that are applicable and current.

References in this publication to IBM products, programs, or services do not imply that IBM intends to make these available in all countries in which IBM operates. Any reference to an IBM program product in this publication is not intended to state or imply that only IBM's program product may be used. Any functionally equivalent program may be used instead.

Publications are not stocked at the address given below; requests for IBM publications should be made to your IBM representative or to the IBM branch office serving your locality.

A form for readers' comments is provided at the back of this publication. If the form has been removed, address comments to IBM Corporation, Department 52Q, Neighborhood Road, Kingston, N.Y. 12401. IBM may use or distribute whatever information you supply in any way it believes appropriate without incurring any obligation to you.

Preface

This publication provides system level reference material related to the functional and programming characteristics of the IBM 3274 Control Unit and attached terminals.

The following 3270 display system machines are referred to in this publication:

IBM 3274 Control Unit Models 1A, 1B, 1C, 1D, 21A, 21B, 21C, 21D, 31A, 31C, 31D, 41A, 41C, 41D, 51C, and 61C

IBM 3277 Display Station Models 1 and 2

IBM 3278 Display Station Models 1, 2, 3, 4, and 5

IBM 3279 Color Display Station Models 2A, 2B, 2X, 3A, 3B, 3X, S2A, S2B, and S3G

IBM 3270 Personal Computer Attachment

IBM 3270 Personal Computer

IBM 3290 Information Panel Display Station

IBM 3178 Display Station

IBM 3230 Printer Model 2

IBM 3262 Printer Models 3 and 13

IBM 3268 Printer Model 2

IBM 3287 Printer Models 1, 1C, 2, and 2C

IBM 3289 Line Printer Models 1 and 2

IBM 3284 Printer Models 1 and 2

IBM 3286 Printer Models 1 and 2

IBM 3288 Line Printer Model 2

IBM 3299 Terminal Multiplexer Adapter

IBM 4250 Printer

IBM 5210 Printer Models G1 and G2

The full complement of IBM 3270 Information Display System machines is identified in the introductory publication *An Introduction to the IBM 3270 Information Display System*, GA27-2739.

Other publications containing 3274-related information such as site preparation or customizing are identified at the end of this Preface. Publications dealing

directly with the referenced terminals that attach to the 3274, and other aspects of the 3270 Information Display System, are identified in the *Library User's Guide* (see end of Preface).

Note: This publication does not discuss the operations of the various 3274 Control Unit models when a function offered as an RPQ item has been installed in the subsystem. RPQ items are accompanied by their own documentation.

Installation of an RPQ item may alter the 3274 functions discussed in this publication and, in addition, affect the operation of future subsystem functions that may be added.

Organization of This Publication

The first two chapters deal with the 3274 models, host attachments, the 3274 interpretation and execution of the commands and orders contained in the 3270 data stream, and the characteristics of the previously referenced 3270 system terminals when attached to the 3274 Control Unit.

The next three chapters address the functioning of the 3274 and attached devices when locally attached to the host system (A, B, and D units), when remotely attached to the host system using BSC (bisynchronous communication protocol) for communication (C units), or remotely attached to the host system using SNA/SDLC protocols for communication (C units).

Chapters 6 and 7 provide programming examples of the 3270 data stream including use of programmed symbols, color capabilities, and highlighting of fields on the display screen. Suggestions for handling terminal operator input and development routines for encoding and decoding messages from the displays are also discussed.

Chapter 8 describes the Response Time Monitor and the 3274 SNA alert functions, including operator procedures.

Appendixes are provided that deal with the following topics:

- 3274 Error Status Indicator Code Interpretation, and Log and Test Facilities
- Operator Information Area Indicators
- Keys and Keyboards
- APL/Text Feature
- Katakana Feature
- Encrypt/Decrypt Feature
- RECFMS Formats
- Selector Light Pen and Magnetic Stripe Reading Device
- X.21 Switched Network Adapter Feature
- Compression of Symbol Definition Bit Strings.

Following the appendixes are:

- A list of abbreviations used in this manual
- A glossary of terms used
- An index.

Related Publications

The following publications supplement the information contained in this publication:

IBM 3270 Information Display System

3274 Control Unit Planning, Setup, and Customizing Guide, GA27-2827

This publication is used to install Configuration Support levels A, B, C, and T, as appropriate, in 3274 Control Unit Models 1A, 1B, 1C, 1D, 21A, 21B, 21C, 21D, 31A, 31C, 31D, and 51C.

3274 Control Unit Customizing Guide—Configuration Support P, GA23-0176

This publication is used to install Configuration Support P in 3274 Control Unit Models 1C, 31C, and 51C.

3274 Control Unit Customizing Guide, GA23-0065

This publication is used to install Configuration Support level D in 3274 Control Unit Models 31A, 31C, 31D, and 51C equipped with the two-sided diskette drive, and 3274 Control Unit Models 41A, 41C, 41D, and 61C.

Data Stream Programmer's Reference, GA23-0059

This publication provides detailed architectural discussions of 3270 data stream elements.

3274 Control Unit Operator's Guide, GA23-0023

The *3270 Information Display System Reference Summary, GX20-1878*, contains summary listings of the status and sense codes, error codes, and other reference data discussed in this publication.

Publications describing the printers and displays attaching to the 3274, the 3270 data stream, the use of color, highlighting, and programmed symbols, operating and problem determination procedures, and programming information, are listed in *IBM 3270 Information Display System, Library User's Guide, GA23-0058*.

Information concerning the Multiuse Communications Loop, used to attach 3270 devices to 8100 Information Systems, is contained in:

IBM 8100 Information System: Communications, Loop, and Display/Printer Attachment Description, GA27-2883

IBM Multiuse Communications Loop Planning Guide, GA23-0038

IBM Multiuse Communications Loop Installation Guide, GA23-0039

The two Multiuse Communication Loop publications cited above and the following IBM 4300 Processor publications provide information concerning attachment of the 3274-51C to the 4331 Processor via the 4331 Loop Adapter:

IBM 4300 Processors Summary and Input/Output and Data Communications Configurator, GA33-1523

IBM 4331 Processor Functional Characteristics and Processor Complex Configurator, GA33-1526

3270 equipment attached to the 4331 Processor via the loop adapter appears to the 4331 as though it were locally channel-attached.

Contents

Chapter 1. Control Units and the 3270 Data Stream	1-1
Display System Components	1-2
Data Flow	1-3
Interface Codes	1-4
SNA Interface Codes	1-4
BSC Interface Codes	1-11
Device Addressing	1-11
Data Stream	1-12
3270 Data Stream Function	1-13
Commands/Structured Fields	1-13
Orders	1-14
Attributes	1-15
Write Commands	1-16
12/14-Bit Addressing	1-16
Write Command	1-16
Erase/Write Command	1-18
Erase/Write Alternate Command	1-19
Write, Erase/Write, and Erase/Write Alternate Commands (LU Type 3)	1-23
Write Structured Field (WSF) Command, Function Management Header 1 (FMH1), and Structured Field Functions	1-24
WSF Command	1-25
Function Management Header 1 (FMH1)	1-25
Structured Field Functions	1-26
SCS Data Structured Field (SCS Data)	1-35
Read Partition (Query) Structured Field	1-35
Orders and Attributes	1-36
Orders	1-36
Start Field (SF) Order	1-36
Set Buffer Address (SBA) Order	1-37
Insert Cursor (IC) Order	1-38
Program Tab (PT) Order	1-38
Repeat to Address (RA) Order	1-39
Erase Unprotected to Address (EUA) Order	1-39
Structured Field and Attribute Processing Orders	1-40
Read Commands	1-43
Read Buffer Command	1-44
Read Modified Command	1-45
Read Modified Operation	1-45
Short Read	1-48
Test Request Read	1-48
Read Modified All Command	1-49
Query Reply Structured Field	1-49
Query Reply (Color) Structured Field	1-50
Query Reply (Extended Highlighting) Structured Field	1-51
Query Reply (Usable Area) Structured Field	1-52
Query Reply (Reply Mode) Structured Field	1-54
Query Reply (Symbol Sets) Structured Field	1-54
Query Reply (IBM 3270 Personal Computer Attachment) Structured Field	1-56
Query Reply (Implicit Partition) Structured Field	1-56
Inbound Transmissions	1-58
Inbound Operation Device Characteristic (INOP)	1-58
Read States	1-58
Host Acknowledgments	1-61
Processing of Read Commands	1-61
Processing of Read Partition-Query Structured Fields	1-64
Control Commands	1-65
Copy Command	1-65
Structured Field and Attribute Processing Considerations for Copy	1-69
Select Command (3274 B Units)	1-69
Select Read Modified (RM) Command (3274 D Units)	1-70
Select Read Buffer (RB) Command (3274 D Units)	1-70
Select Read Modified from Position (RMP) Command (3274 D Units)	1-70
Select Read Buffer from Position (RBP) Command (3274 D Units)	1-71
Select WRT Command (3274 D Units)	1-71
Erase All Unprotected Command	1-71
No Operation Command (3274 B and D Units)	1-72

- Sense Command (3274 B and D Units) 1-72
- Sense ID Command (3274 B and D Units) 1-72
- Miscellaneous Operations 1-73
 - Test Request Function 1-73
 - Use of BSC Line Discipline 1-73
 - Text Transmission 1-73
 - Screen Update Protected Message 1-74
 - Responses 1-74
 - Error Handling 1-74
 - Character Sets 1-74
 - Use of SNA Protocol 1-75
 - Non-SNA Local Control Unit Differences 1-75
 - Operation Checks 1-75
 - Buffer Updates 1-75
 - Security Keylock 1-76

Chapter 2. Terminals 2-1

- Display Stations 2-1
 - Display Images 2-1
 - Display Fields 2-2
- Attributes 2-5
 - Field Attributes 2-6
 - Field Attribute Character 2-6
 - Automatic Skip 2-7
 - Base Color Mode 2-8
 - Extended Attributes 2-8
 - Extended Highlighting (Attribute Type X'41') 2-9
 - Extended Color (Attribute Type X'42') 2-9
 - Symbol Set (Attribute Type X'43') 2-10
- Programmed Symbols 2-11
 - Single-Plane Symbol Sets 2-13
 - Triple-Plane Symbol Sets 2-13
 - Secondary Colors 2-14
 - Defining a Triple-Plane Symbol 2-14
 - Reverse Video and Triple-Plane Symbols 2-16
- Unit and Model-Dependent Differences (Displays) 2-16
 - Keyboard Types 2-16
 - Keyboard Program Function Keys 2-17
 - Display Screen Size 2-17
 - Key Operation 2-17
 - Insert Mode 2-17
 - Typematic Keys 2-17
 - Numeric Shift Key 2-17
 - Screen Update 2-17
 - Display of New Line (NL), End of Message (EM), and Forms Feed (FF) Orders 2-18
 - Display of Duplicate (DUP) and Field Mark (FM) Characters 2-18
 - Operator Indicators and Symbols 2-18
 - Uppercase and Lowercase Character Display 2-18
- Security Keylock 2-18
- Printers 2-19
 - Print Line Formatting 2-20
 - Printer Orders (3270 Data Stream Mode) 2-22
 - New Line (NL) and End of Message (EM) (All Printers) 2-22
 - Forms Feed (FF) (3230, 3262, 3268, 3287, 3288, and 3289) 2-22
 - Suppress Index (SI) (3288) 2-22
 - Carriage Return (CR) (3230, 3262, 3268, 3287, and 3289 Printers) 2-23
 - Printer Operations (3270 Data Stream Mode) 2-23
 - Page Length Control/VFC Operations 2-23
 - SCS Operations 2-25
 - SCS Control Codes 2-25
 - Program Attention (PA) and Cancel Print Switches 2-29
 - Print Format Control 2-30
 - Local Copy Function 2-30
 - Screen Capture Function (3278 with IBM 3270 Personal Computer Attachment) 2-31
 - 3274 Printer Authorization Matrix 2-31
 - 3274 Local Copy Operation 2-41
 - Host-Initiated Local Copy Using SNA/SDLC 2-45
 - Local Copy Performed without SNA Protocol 2-47
 - Mono/Dual Case Control 2-48
 - Format Control during Shared Printer Operations 2-48

- Error Conditions 2-50
- Unit and Model-Dependent Differences (Printers) 2-51
 - Buffer Size 2-51
 - Uppercase and Lowercase Printouts 2-51
 - New Line (NL) and End of Message (EM) Orders 2-52
 - New Line (NL) at Maximum Print Position plus One Character 2-52
 - Duplicate (DUP) and Field Mark (FM) Character 2-52
 - Split Vertical Bar (|) Character 2-52

Chapter 3. Local Operations (3274 B and D Units) 3-1

- Non-SNA Local Operations 3-1
- 3274/3290 Operations 3-1
- Interface Operations (3274/Channel) 3-1
 - Selection 3-2
 - Command Initiation 3-2
 - Chaining 3-3
 - Status 3-4
 - Initial Status 3-5
 - Ending Status 3-7
 - Asynchronous Status 3-7
- Error-Recovery Procedures 3-11
 - 3274 B and D Unit Device-Detected Errors 3-11
 - Referenced Error-Recovery Procedures 3-11
 - Channel-Detected Errors 3-12

Chapter 4. Remote Operations—BSC 4-1

- Introduction 4-1
 - Code Structures 4-1
 - Channel Program Concepts 4-1
 - Text Blocking 4-1
 - Related Publications 4-2
- Multipoint (Nonswitched Line) Data Link Control 4-2
 - 3274 Modes of Operation 4-3
 - Control Mode 4-3
 - Text Mode 4-3
 - Transparent-Monitor Mode 4-3
 - Transparent Mode 4-4
 - Redundancy Checking 4-6
 - Data-Link Control Characters 4-7
 - Pad 4-7
 - SYN (Synchronous Idle) 4-7
 - DLE (Data Link Escape) 4-8
 - ACK 0 (Even Acknowledge) 4-8
 - ACK 1 (Odd Acknowledge) 4-8
 - NAK (Negative Acknowledgment) 4-8
 - ENQ (Enquiry) 4-8
 - WACK (Wait before Transmit) 4-9
 - RVI (Reverse Interrupt) 4-9
 - STX (Start of Text) 4-9
 - SOH (Start of Heading) 4-9
 - ETB (End of Transmission Block) 4-9
 - ETX (End of Text) 4-10
 - EOT (End of Transmission) 4-10
 - ITB (End of Intermediate Transmission Block) 4-10
 - ESC (Escape) 4-10
 - TTD (Temporary Text Delay) 4-10
- Operational Sequences (Nonswitched Line) 4-11
 - Remote Chaining of 3270 Commands 4-11
 - General and Specific Poll Sequences 4-12
 - Selection Addressing Sequence 4-13
 - Write-Type and Control-Type Command Sequences 4-19
 - Read-Type Command Sequences 4-21
 - Status and Sense (S/S) Bytes 4-23
- Error Recovery Procedures 4-23
 - Supplementary Procedures 4-29
 - EOT to a Text Block 4-29
 - Errors Detected During a Specific or General Poll Sequence 4-29
 - RVI to Selection Addressing Sequence 4-29

Chapter 5. SNA/SDLC Communication	5-1
Transmission Formats	5-1
Session Components	5-2
SNA Sessions	5-2
SSCP-PU Session	5-3
SSCP-Secondary LU Session	5-3
LU-LU Session	5-3
Initiating an LU-LU Session	5-3
Terminating an LU-LU Session	5-5
Transmission Header	5-5
EFI=1	5-6
EFI=0	5-7
SNA Commands	5-7
Commands Supported	5-7
Command Description	5-7
Activate Physical Unit (ACTPU)	5-7
Deactivate Physical Unit (DACTPU)	5-7
Activate Logical Unit (ACTLU)	5-8
Deactivate Logical Unit (DACTLU)	5-8
Notify	5-9
Bind	5-10
Unbind	5-13
Clear	5-13
Start Data Traffic (SDT)	5-14
Cancel	5-14
Chase	5-14
Bid	5-15
Signal	5-15
LU Status (LUSTAT)	5-16
Ready to Receive (RTR)	5-16
REQMS	5-16
REFMS	5-16
Shutdown	5-17
Shutdown Complete	5-17
FM Data	5-17
Pacing	5-20
Pacing (LU Type 1)	5-20
Pacing (LU Types 2 and 3)	5-21
SNA Responses	5-21
Summary of SNA Commands	5-22
Sample SNA Command Sequences	5-23
Session Processing States	5-23
Data Traffic (Reset/Active) State	5-23
Contention (CONT) State	5-24
Send (SEND) State	5-24
Receive (RCV) State	5-27
ERP1 State	5-29
Bracket States	5-29
Between Bracket (BETB) State	5-30
Pending Begin Bracket (PEND.BB) State	5-30
In Bracket (INB) State	5-30
3274 Bracket State Errors	5-30
RU Lengths	5-30
Outbound to the 3274	5-30
Inbound from the 3274	5-31
Segmenting Description	5-31
Segmenting Outbound	5-32
Segmenting Inbound	5-32
3274 Errors	5-33
Data Link	5-33
LU-LU Session Error Reporting	5-33
Sessions	5-34
Setting the Screen Size	5-35
Operation in SSCP-SLU Session	5-36
SSCP-SLU Contention Operation	5-36
Nonerror Operation	5-36
Error Operation	5-36
Outbound Message Handling	5-36
Inbound Message Handling	5-37
System Logon (3277 Attached to 3274)	5-37

System Logon (Category A Devices)	5-38
System Logoff (3277 Attached to 3274)	5-39
System Logoff (Category A Devices)	5-39
SNA Printer Control	5-39
Local Operations (3274 A Units)	5-41
Interface Operations	5-41
Selection	5-41
Command Initiation	5-41
Chaining	5-42
Commands	5-42
Write Command	5-42
Read Command	5-43
No Operation Command	5-43
Sense Command	5-43
Control Command	5-43
Write Break Command	5-45
Write Start 0 Command	5-45
Read Start 0 Command	5-45
Write Start 1 Command	5-45
Read Start 1 Command	5-46
Restart Reset Command	5-46
Sense ID Command	5-46
Test I/O Command	5-46
Status and Sense Definitions	5-46
Description	5-46
Initial Status	5-46
Ending Status	5-47
Asynchronous Status	5-50
Error Recovery Procedures	5-50
3274-A-Unit-Detected Errors	5-50
Referenced Error Recovery Procedures	5-51
Channel-Detected Errors	5-51
Typical CCW Sequences	5-52
Read CCW Sequence	5-52
Write CCW Sequence	5-52
Write-Read Sequence	5-53
CCW—Error Recovery Procedures	5-54
Remote Operations — SDLC	5-56
SDLC Transmission Frames	5-56
Response Modes	5-56
Control Field	5-57
Supervisory Commands	5-57
Nonsequenced Commands and Responses	5-58
Terminal Identification and Addressing	5-59
Terminal ID	5-59
SDLC Station Address	5-59
Information (I) Frame	5-59
Sequence Error Recovery Procedures	5-59
Abort Function	5-60
Timeout Controls	5-60
Auto-Disconnection (Models 51C and 61C)	5-60
SNA Reference Data	5-61
Bind Default	5-61
Bind Check	5-62
SNA Sense Codes	5-63
Logical Unit Status (LUSTAT)	5-67
Error Recovery Procedures	5-70

Chapter 6. Screen Design 6-1

Introduction	6-1
Field Concept	6-1
What Attributes May Be Assigned to a Field	6-2
Protection	6-2
Color	6-3
Extended Highlighting	6-3
Character Content	6-3
Visibility and Detectability	6-5
Transmission	6-5
Attribute Processing	6-6
Example of Field Definition	6-8

- Planning the Panel 6-12
 - Using the Panel Layout Sheet 6-12
 - An Example of Laying Out a Panel 6-13
 - Adding Orders to the Panel Layout Sheets 6-15
- Coding the Panel 6-19
 - Using the Repeat to Address Order 6-35
 - Using the Write Control Character (WCC) 6-35
 - An Example of a Sequence of Panels 6-37
- Analyzing Input Data 6-42
 - The Operator's Response 6-42
 - Attention Identifier (AID) 6-43
 - Input Data 6-43
 - SBA Codes 6-44
 - Program Attention (PA) Keys 6-44
 - Program Function (PF) Keys 6-45
- Selector Pen and Cursor Select Input and Output 6-45
 - Selector Field Format 6-45
 - Designator Characters 6-45
- The Relationship of One Data Stream to Another 6-47
- Modifying Existing Panels 6-48
- Using Erase Unprotected to Address (EUA) 6-51
- Using Erase All Unprotected (EAU) Command 6-52
- Repetitive Output 6-55
- Using the Program Tab (PT) 6-55
- Defining a Character 6-56
- Using Structured Fields 6-57
 - Load Programmed Symbols 6-60
 - Triple Planes 6-61

Chapter 7. Screen Management 7-1

- Decoding and Generating Data Streams 7-2
 - Decoding Read Modified Input Data Stream 7-2
 - Nonselector Pen or Noncursor Select Data Streams 7-3
 - Immediate Selector Pen or Cursor Select Data Stream 7-7
 - Mixed Read Modified Input Data Streams 7-9
 - Building Output Data Streams 7-9
 - Static Data Streams 7-9
 - Semidynamic Output Streams 7-12
 - Dynamic Output Streams 7-12
 - Large Screen Size 7-13
 - 3274 Copy Function 7-14

Chapter 8. The Response Time Monitor (RTM) and 3274 SNA Alert Functions 8-1

- The Response Time Monitor Function 8-1
 - 3274 and Host Requirements 8-1
 - Supported Devices 8-2
 - RTM and Response Time Definitions 8-2
 - RTM Logs 8-3
 - RTM Log Display Format 8-4
 - Last Transaction Time Indicator 8-5
 - Customizing 8-6
 - RTM Host Interface 8-7
 - Solicited RTM Information 8-8
 - Unsolicited RTM Information 8-9
 - Negative Responses 8-10
 - Distributed Function Device Interface 8-10
 - Host Request and 3274 Response Formats 8-11
 - Host Request Format 8-11
 - 3274 Responses Format 8-16
- The 3274 SNA Alert Function 8-19
 - NPDA Background Information 8-20
 - 3274 and Host Requirements 8-22
 - SNA Host Support 8-22
 - Network Problem Determination Application (NPDA) 8-23
 - Reportable Errors 8-25
 - Operator-Generated Alert Messages 8-28
 - Priority Queuing of Alerts within the 3274 8-30
 - Negative Responses 8-30
 - Product-Instance ID Vector Support 8-31

- Customizing 8-31
- Alert Message Formats 8-31
- 3274 Error Code Definitions 8-46
- Operator Procedures 8-51
 - Displaying RTM Data 8-51
 - Displaying the RTM Log 8-51
 - Resetting the RTM Log 8-53
 - Displaying the Last Transaction Time Indicator 8-54
 - Sending Operator-Generated Alert Messages 8-54

Appendix A. 3274 Error Indication, Log and Test Facility A-1

- 8 4 2 1 Indicator A-3
 - IML Diagnostics Mode A-4
 - 3274 Operational Mode A-5
 - 3290 Downstream Loading Operational Mode A-5
- 3274 Error Indicators and Codes A-7
 - Error Codes A-8
- Error Code Supplemental Information A-42
 - DCB Logical Terminal Extension A-44
- 3274 Log and Test Facility A-45
 - Test 0: Communication Path and Display Test A-46
 - Procedure for Requesting Test 0 A-47
 - 3274 Test 1: Device and Adapter Logs A-47
 - Resetting Device and Adapter Logs (Test 4) A-48
 - 3274 Test 1 Device Logs A-48
 - 3274 Test 1 Host Adapter Logs A-50
 - 3274 Model C (BSC) Test A0/1 A-51
 - 3274 Model C (SDLC) Test A0/1 A-53
 - 3274 Model A (LCA) Test A0/1 A-55
 - 3274 Model B (LHA) Test A0/1 A-56
 - 3274 Model D (SLHA) Test A0/1 A-57
 - A0/1 Test Mode Extension for X.25 Function A-58
 - X.25 Function Counter Explanations A-61
 - Type A Adapter Test A1/1 A-65
 - Feature Adapter Test A2/1 A-66
 - Controller Error Data Test A3/1 A-67
 - Test 2: Configuration Data A-67
 - Test 3: Status Summary Display A-79
 - Example 1 (Configuration Support A) A-79
 - Example 2 (Configuration Support B, C, D, or T) A-80
 - Example 3 (Configuration Support P or Configuration Support D with the X.25 Packet Switched Network Function Installed) A-81
 - Test 4: Reset Test 1 Logs A-82
 - Test 6: Device Control Block (DCB) A-82
 - DCB (Device Control Block) Test AA/6 (AA= Port Address, 00-31) A-84
 - A Test: Sending Operator-Generated Alert Messages A-86
 - B Test: Device Address Assignment Table Display A-86
- X.25 Function: Cause and Diagnostic Code Indicators and Diagnostic Code Modifiers A-87
 - Cause Fields Received from the DCE A-88
 - Diagnostic Code Fields Received from the DCE A-88
 - Diagnostic Code Fields Generated by an IBM (SNA) DTE A-88

Appendix B. Operator Information Area Symbols (3278, 3279) B-1

Appendix C. Keys and Keyboards C-1

- Keyboard Operations C-1
 - Cursor C-1
 - Keyboards C-2
 - Key Functions C-2
 - Character-Oriented Keys C-3
 - Field-Oriented Keys C-4
 - ERASE EOF (Erase to End of Field) Key C-4
 - ERASE INPUT Key C-5
 - INS (Insert) MODE Key (3277) a , (Insert Mode) Key (3178, 3278, or 3279) C-5
 - DEL (Delete) Key (3277), Delete Key (3178, 3278, or 3279) C-6
 - RESET Key C-6
 - DUP (Duplicate) Key C-6
 - FM (Field Mark) Key C-7
 - Program Attention Keys C-7

- SHIFT Key (3178, 3277, 3278, or 3279) C-9
- LOCK Key (3178, 3277, 3278, or 3279) C-9
- NUM Key (3178, 3277, 3278, or 3279) C-9
- NUM LOCK Key (3178, 3277, 3278, or 3279) C-9
- ALPHA Key (3178, 3277, 3278, or 3279) C-9
- CURSR SEL (Cursor Select) Key C-10
- ATTN (Attention) Key C-10
- CURSR (Cursor) BLINK Key C-11
- ALT CURSR (Alternate Cursor) Key C-11
- TEST Key C-11
- Click Key C-11
- Print Key C-11
- IDENT Key C-12
- Dead Keys, Canadian-French and Canadian Bilingual Keyboards C-12
 - Dead-Key Operations with Programmed Symbols C-13
- Attribute-Select Keys C-14
 - Extended Highlighting C-15
 - Symbol Set C-15
 - Extended Color C-16
- Numeric Lock Feature Operation C-16
- Keyboard Disabled (INPUT INHIBITED Indicator Is On) C-17

Appendix D. APL/Text Feature D-1

- APL/Text and Text Print Data Streams D-2
- 3274 APL/Text and Text Print Customizing Options D-2
- 3278-1, -2, -3, -4, and -5 or 3279-2B and -3B APL/Text D-2
 - APL Keyboards D-9
 - 87- and 88-Key Typewriter/APL Keyboards D-9
 - 88-Key Katakana Typewriter/APL Keyboard D-10
 - APL Keyboard World Trade Considerations D-10
 - 87-Key Typewriter/Text Keyboard D-11
- 3287-1 and -2 with APL/Text D-12
- 3289-1 and -2 with Text Print D-12
- BSC Copy Command D-13
- Local Copy D-13

Appendix E. Katakana Feature E-1

- Interface Codes E-1
- Keyboard Shift Operations E-3
- LATIN SHIFT and KANA SHIFT Keys—3277 E-3
 - Katakana Shift Keys—3178, 3278, and 3279 E-4

Appendix F. Encrypt/Decrypt Feature F-1

- Encrypt/Decrypt Products F-1
 - IBM Programmed Cryptographic Facility Program Product F-1
 - ACF/VTAM Encrypt/Decrypt Feature F-1
 - 3274/3276 Encrypt/Decrypt Feature F-2
- Establishing Cryptographic Sessions F-3
 - Bind Command Processing F-3
 - Installing the Secondary LU Key in the 3274 F-4
 - Terminal Master Key Verification for the 3274 F-4

Appendix G. Request Formatted Maintenance Statistics (RECFMS) Formats G-1

- REQMS Request Type 1—Link Test Statistics G-1
- REQMS Request Type 2—Summary Counters G-1
- REQMS Request Type 3—Communication Adapter Data Error Counts G-2
- REQMS Request Type 5—3274 Configuration Information (Configuration Support A, B, T, and P) G-3
- REQMS Request Type 5—3274 Configuration Information (Configuration Support C and D) G-4

Appendix H. Selector-Light-Pen and Magnetic-Stripe Reading Device Operations H-1

- Selector-Light-Pen Operations H-1
 - Selector-Light-Pen Field Format H-2
 - Designator Characters H-2
- Magnetic-Stripe Reading Devices H-4
 - Magnetic Slot Reader and Magnetic Hand Scanner H-7
 - Numeric and Alphanumeric Character Sets H-8
 - Capacities H-12

- SSCP-LU Session H-19
- MSR/MHS Operator Indicators and Alarm H-20
- Test Cards H-21
- Operator Identification Card Reader and Magnetic Slot Reader H-21
 - 3277-Compatible Numeric Character Set H-23
 - Magnetic-Stripe Format (OICR/MSR) H-23
 - Operational Differences because of Screen Format H-24
 - Error Conditions (OICR/MSR) H-24
 - OICR/MSR Validity Tests H-28
 - MSR Operator Indicators and Alarm H-29

Appendix I. X.21 Switched Network Adapter Feature (3274 Models 51C and 61C) I-1

- X.21 Functions I-1
- X.21 Inquiry Facility I-2
- X.21 Keys and Indicators I-2
 - The Keys I-2
 - The Indicators I-4
- X.21 Operations I-4
 - Extension Mode I-4
 - Ready State I-5
 - Dial In State I-5
 - Outgoing Call in Process State I-7
 - Ready-for-Data and Data Transfer States I-7
 - Disconnection-in-Process State I-8
 - Incoming Call State I-8
 - Controlled-Not-Ready State I-8
 - Call Progress Signals I-9
 - Call Progress Signal Handling I-9
- Registration/Cancellation Facility I-10
- Error Conditions I-10
- Inquiry Facility I-10

Appendix J. Compression of Symbol Definition Bit Strings J-1

- Character Cell Division J-1
- The Compression Process J-2
- The Comparison Rules and Header Bits J-3
- Creating the Compressed Bit String J-4
- Examples of the Compression Algorithm in Use J-5
 - Example of Algorithm Using Comparison Rule 1 J-5
 - Example of Algorithm Using Comparison Rule 2 J-6
 - Example of Algorithm Using Comparison Rule 3 J-7

List of Abbreviations X-1

Glossary X-7

Index X-11

Figures

- 1-1. United States EBCDIC I/O Interface Code for 3274 Control Units with Category B Terminals Attached 1-5
- 1-2. United States EBCDIC I/O Interface Code for 3274 Units and Attached Category A Terminals 1-6
- 1-3. Matrix for Hyphenation and Negative Responses—3274 Control Unit 1-7
- 1-4. United States ASCII I/O Interface Code for 3274 C Units and Attached Category B Terminals 1-8
- 1-5. United States ASCII I/O Interface Code for 3274 Units and Attached Category A Terminals 1-9
- 1-6. Control Character I/O Codes 1-10
- 1-7. Example of 3274 Control Unit Address Assignments 1-12
- 1-8. Command Codes 1-14
- 1-9. Write Control Character (WCC) 1-18
- 1-10. Reset Matrix 1-19
- 1-11. LU Type 2 Screen Size Bind Format 1-21
- 1-12. LU Type 3 Buffer Size Bind Format 1-24
- 1-13. Buffer Control Orders and Order Codes 1-37
- 1-14. Attribute Defaults 1-43
- 1-15. Attention ID (AID) Configurations 1-46
- 1-16. Read State Transitions 1-59
- 1-17. Copy Control Characters (CCC) 1-66
- 1-18. Buffer Transfers for 3274 C Unit Copy Command Operations 1-68
- 1-19. Sense Bit Description—3274 B and D Units 1-73
 - 2-1. Buffer Location and Display Screen Character Position Relationships 2-2
 - 2-2. Buffer Addressing Layouts for 480-, 960-, 1920-, 2560-, 3440-, and 3564-Character Terminals 2-3
 - 2-3. Example of Formatted Display 2-5
 - 2-4. Extended Attributes—A Conceptual View 2-6
 - 2-5. Field-Attribute Character Bit Assignment 2-7
 - 2-6. Colors Derived from Field Attributes 2-8
 - 2-7. Size of Character Position 2-12
 - 2-8. Conceptual View of Programmed Symbol Set 2-12
 - 2-9. Color Combinations 2-14
 - 2-10. A Triple-Plane Symbol 2-15
 - 2-11. Reverse Video Highlighting of Triple-Plane Symbols 2-16
 - 2-12. Relationship between Buffer Data and Printed Data 2-21
- 3-1. 3274 B and D Unit Device Addressing, 16 or Fewer Devices per Control Unit 3-2
- 3-2. 3274 B and D Unit Device Addressing, 17 or More Devices per Control Unit 3-3
- 3-3. Status Byte Bit Assignments for 3274 B and D Units 3-5
- 3-4. Initial Status and Sense Conditions for 3274 B and D Units 3-6
- 3-5. Ending Status and Sense Conditions for 3274 B and D Units 3-8
- 3-6. Asynchronous Status and Sense Conditions for 3274 B and D Units 3-9
- 4-1. General Poll and Specific Poll, Sequence/Response Diagram 4-14
- 4-2. Remote Control Unit and Device Addressing 4-16
- 4-3. 3274 Message Response to Polling or Read Modified Command 4-17
- 4-4. Selection Addressing, Sequence/Response Diagram 4-18
- 4-5. Write-Type and Control-Type Commands, Sequence/Response Diagram 4-20
- 4-6. Read-Type Command, Sequence/Response Diagram 4-22
- 4-7. Remote Status and Sense Byte Definitions—BSC 4-24
- 4-8. Remote Error Status and Sense Responses—BSC 4-25
- 4-9. Remote 3274 BSC Status and Sense Conditions 4-27
- 5-1. Establishing a Session with a 3274 5-4
- 5-2. Device Addressing for SNA Terminals 5-6
- 5-3. SNA Commands Supported by the 3274 5-8
- 5-4. Bind Command Session Parameters 5-11
- 5-5. Summary of SNA Commands Received 5-22
- 5-6. Summary of SNA Commands Sent 5-22
- 5-7. Bracket/Chain—LU Type 2 Initiated (without Contention) 5-23
- 5-8. Bracket/Chain—Host Initiated (without Contention) 5-24
- 5-9. Bracket/Chain—Host/SLU Contention 5-25
- 5-10. Signal from Host 5-26
- 5-11. Shutdown/Shutdown Complete 5-27
- 5-12. Cancel, SLU Type 2 Sending 5-28
- 5-13. RTR—LU Type 1 or LU Type 3 Send 5-29
- 5-14. State Diagram for Session Ownership of Device 5-35
- 5-15. 3274 Logical Subsystem 5-40

- 5-16. 3274 A Unit Local Command Codes 5-42
- 5-17. Status Bit Assignments for 3274 A Units 5-47
- 5-18. Sense Bit Assignments for 3274 A Units 5-48
- 5-19. Initial Status and Sense Conditions for 3274 A Units 5-48
- 5-20. Ending Status and Sense Conditions for 3274 A Units 5-49
- 5-21. Asynchronous Status and Sense Conditions for 3274 A Units 5-51
- 5-22. Bind Parameter Checking 5-62
- 5-23. Summary Table of LUSTATs 5-69
 - 6-1. Example of Four Fields and Attribute Bytes 6-2
 - 6-2. Results of Keyboard and Field Combinations 6-4
 - 6-3. Model for Field Attributes and Extended Field Attributes, A Conceptual View 6-7
 - 6-4. Relationship of Character and Extended Field Attributes 6-7
 - 6-5. Character Attribute Override 6-8
 - 6-6. Example of Attribute Specification 6-8
 - 6-7. Block-Diagramming a Sequence of Panels 6-12
 - 6-8. Sign-On Panel as Written Out on Layout Sheet 6-13
 - 6-9. Panel Layout, Including Attribute and Cursor Positions 6-14
 - 6-10. Laying Out Field Attributes 6-16
 - 6-11. Text Items on Panel Layout Sheet 6-17
 - 6-12. Attributes 6-18
 - 6-13. Attribute Default Values 6-18
 - 6-14. Completed Order and Attribute Information, No SFAP Capability 6-20
 - 6-15. Completed Order and Attribute Information for Extended Field and Character Attribute Capability 6-21
 - 6-16. Completed Orders and Attribute Information for an Extended Color Display 6-22
 - 6-17. Buffer Control Orders and Order Codes 6-23
 - 6-18. Sign-On Procedure Panel with Buffer Addresses 6-25
 - 6-19. Attribute Combinations in Hexadecimal 6-26
 - 6-20. Assembler Language Statements for Sign-On Panel 6-34
 - 6-21. An Example of the RA Order 6-36
 - 6-22. WCC Hexadecimal Codes 6-37
 - 6-23. Panel 1 of an Accounts Receivable Application 6-38
 - 6-24. Panel 2, Showing the Results of a Search on a Customer Name 6-39
 - 6-25. Panel 3, Showing the Customer's Open Invoices 6-39
 - 6-26. Panel 4, Showing Use of the Calculator 6-40
 - 6-27. Panel 5, Showing Selection of Invoices after Using the Calculator 6-41
 - 6-28. Panel 6, Showing New Balance after Posting 6-42
 - 6-29. Sign-On Panel with Operator's Input 6-43
 - 6-30. Input Data Sequence 6-43
 - 6-31. Definition of Field for Selector Pen Operation 6-46
 - 6-32. Sample Panel for Selector Pen or Cursor Select Detection 6-47
 - 6-33. Modifying an Existing Panel, Basic Panel 6-48
 - 6-34. Existing Panel with Error Message 6-49
 - 6-35. Panel Layout Changes for Error Message (Keyed to Text) 6-50
 - 6-36. Error Message Panel with Serial Number Field Erased 6-51
 - 6-37. Example of EUA Use 6-52
 - 6-38. Sign-On Panel with Three Erased Fields 6-53
 - 6-39. Erasing Multiple Fields with EUA 6-53
 - 6-40. Example of Data Entry Panel 6-54
 - 6-41. Data Entry Panel with Entered Data 6-54
 - 6-42. Employee Data Panel 6-55
 - 6-43. Panel Defined with Program Tab 6-57
 - 6-44. Character Definition for a 9 × 16 Display Matrix 6-58
 - 6-45. Character Definition for a 10 × 8 Printer Matrix 6-59
 - 6-46. Structured Fields 6-59
 - 6-47. Structured Field Data Stream to Load a Box 'A' for a 9 × 16 Display Matrix 6-60
 - 6-48. Structured Field Data Stream to Load a Box 'A' for a 10 × 8 Printer Matrix 6-61
 - 6-49. Programmed Symbol Sets 6-62
 - 6-50. Character Definition of a Multicolor Symbol 6-63
- 7-1. Relationship of Screen Management to Telecommunications Management and Application Program 7-1
- 7-2. Table of Requirements 7-5
- 7-3. Example of Selector Pen Panel 7-8
- 7-4. Sample Mapping Table 7-8
- 8-1. Counters and Boundaries 8-2
- 8-2. Display of an RTM Log 8-4
- 8-3. TH, RH, and RU Definitions for the Host Request 8-12
- 8-4. TH, RH, and RU Definitions for the 3274 Response (Solicited and Unsolicited) 8-17
- 8-5. Concepts of Alert Generation 8-21
- 8-6. SNA Host Connection 8-22

- 8-7. An Example of Alert Generation and Display 8-24
- 8-8. TH, RH, and RU Definitions for Control Unit Errors 8-35
- 8-9. TH, RH, and RU Definitions for Device Hardware Errors 8-37
- 8-10. TH, RH, and RU Definitions for Application Program Checks 8-40
- 8-11. TH, RH, and RU Definitions for Operator-Generated Alerts 8-43
- 8-12. 3274 Error Code Definitions 8-47
- 8-13. RU Quick-Reference Table 8-51
- 8-14. Representative Panel for the RTM Log Display 8-52
- 8-15. The LTTI Trigger Key 8-55
- 8-16. Skeleton Alert Message Panel 8-55
 - A-1. Indicator Code — Log Area Correlation A-43
 - A-2. Diagnostic Code Modifiers A-88
 - A-3. Cause Fields Received from the DCE A-89
 - A-4. Diagnostic Code Fields Received from the DCE A-90
 - A-5. Diagnostic Code Fields Generated by an IBM (SNA) DTE A-91
- C-1. Attribute Select Keys C-14
- D-1. Diagram of APL/Text Devices D-1
- D-2. APL/Text Feature, 1-Byte I/O Interface Codes (3274/3278/3279/3287) D-3
- D-3. APL/Text Feature, 2-Byte I/O Interface Codes (3274/3278/3279/3287) D-4
- D-4. National Use Differences I/O Interface Code (3274/3278/3279/3287) D-5
- D-5. Katakana/APL 1-Byte I/O Interface Codes (3274/3278/3279/3287) D-6
- D-6. Katakana/APL 2-Byte I/O Interface Codes (3274/3278/3279/3287) D-7
- D-7. 3289 Text Print Feature I/O Interface Codes D-8
- D-8. 87-Key Typewriter/APL Keyboard D-9
- D-9. 88-Key Katakana Typewriter/APL Keyboard D-10
- D-10. 87-Key Typewriter/Text Keyboard D-11
- E-1. Japanese Katakana EBCDIC I/O Interface Code for 3274 Control Units with 3277, 3284, 3286, 3287 (with 3271/3272 Attachment Feature), and 3288 Terminals Attached E-1
- E-2. Japanese Katakana EBCDIC I/O Interface Code for 3274 Control Units with 3178, 3262, 3278, 3279, 3287 (with 3274/3276 Attachment Feature), and 3289 Terminals Attached E-2
- H-1. Selector Light Pen H-1
- H-2. Sample Display Screen for Selector-Light-Pen Operations H-4
- H-3. Attachment of Magnetic Reading Devices to 3270 System Units H-5
- H-4. Magnetic Slot Reader (3278 and 3279 Attachments) H-5
- H-5. Magnetic Hand Scanner (3278 and 3279 Attachments) H-6
- H-6. Operator Identification Card Reader (3277 Attachment) H-7
- H-7. Numeric Character Set Used with Magnetic Slot Reader and Magnetic Hand Scanner Attached to a 3278 or 3279 Connected to a 3274 Control Unit H-9
- H-8. Alphameric Character Set Used with Magnetic Slot Reader and Magnetic Hand Scanner Attached to a 3278 or 3279 Connected to a 3274 Control Unit H-10
- H-9. Magnetic-Stripe Capacities When Using the Numeric and Alphameric Character Sets H-12
- H-10. Magnetic-Stripe Format (MSR and MHS Using Numeric and Alphameric Character Sets) H-12
- H-11. Operation of the Display with an Unformatted Screen (MSR or MHS Using Numeric or Alphameric Character Set) H-15
- H-12. Operation of the Display with a Formatted Screen (MSR or MHS Using Numeric or Alphameric Character Set), Example 1 H-16
- H-13. Operation of the Display with a Formatted Screen (MSR or MHS Using Numeric or Alphameric Character Set), Example 2 H-17
- H-14. 3277-Compatible Numeric-Character Set Used with Operator Identification Card Reader and Magnetic Slot Reader H-22
- H-15. Magnetic-Stripe Format (OICR and MSR Using 3277-Compatible Numeric Character Set) H-23
- H-16. Operation of the Display with an Unformatted Screen (OICR or MSR Using 3277-Compatible Numeric Character Set) H-25
- H-17. Operation of the Display with a Formatted Screen (OICR or MSR Using 3277-Compatible Numeric Character Set), Example 1 H-26
- H-18. Operation of the Display with a Formatted Screen (OICR or MSR Using 3277-Compatible Numeric Character Set), Example 2 H-27
- I-1. X.21 Feature Keys I-3
- I-2. Control Unit/Terminal Responses in Dial-In State I-7
- J-1. Type 1 Data Format—An Example of Pattern Encoded J-3
- J-2. Example of Compression Algorithm Using Comparison Rule 1 J-5
- J-3. Example of Compression Algorithm Using Comparison Rule 2 J-6
- J-4. Example of Compression Algorithm Using Comparison Rule 3 J-7

Chapter 1. Control Units and the 3270 Data Stream

The 3274 Control Unit (Model 1A, 1B, 1C, 1D, 21A, 21B, 21C, 21D, 31A, 31C, 31D, 41A, 41C, 41D, 51C, and 61C) is one of the basic components of the 3270 Information Display System, a family of products that can be tailored to meet the needs of a wide range of display applications.

The 3270 system offers the user a wide selection of components and configurations. Also available are a large variety of features which improve performance, provide additional operational capability, and permit expansion of the display system.

Models of the 3274 can be selected to form 3270 system configurations attachable to System/360, System/370, System/3, 4300 Processor, and 8100 Information System configurations as host systems. (See *An Introduction to the IBM 3270 Information Display System, GA27-2739*, for possible system combinations and control unit/device combinations.)

The 3274 Control Unit can attach locally or remotely to a host system. 3274 units employ binary synchronous communication (BSC) or synchronous data link control (SDLC) transmission disciplines in remote operations.

Terminology Used in This Book: The number of different 3274 Control Unit models and the number of attachable devices require that some naming conventions be established so that control units and devices can be referred to in a concise manner. The assumptions and naming conventions adopted throughout this publication are:

- The 3274 Models bearing the same letter designations (for example, Models 31A, 41A, and 1A) support the same terminals, terminal configurations, and functions with the following exceptions:
 - Models with the number 21 have less control storage than models with the numbers 1, 31, and 41 and do not support some of the terminal features or feature combinations available on the other models.
 - Models 41A, 41C, 41D, and 61C do not support Category B devices (see below).
- The terms “A units,” “B units,” “C units,” and “D units” are used as convenient abbreviations for all model numbers suffixed by the same letter (for example, 3274 Models 1A, 21A, 31A, and 41A are referred to as A units).

When needed, explicit model numbers are used.

- Attachable devices are grouped by the type of adapter they require (A or B). The groupings are:

Category A Devices

IBM 3270 Personal Computer
3178 Display Station
3230 Printer Model 2
3262 Line Printer Models 3 and 13
3268 Printer Model 2
3278 Display Station, all models
IBM 3278 Display Station with IBM 3270 Personal Computer Attachment
3279 Color Display Station, all models
3287 Printer, Models 1, 1C, 2, 2C
3289 Line Printer, Models 1 and 2
3290 Information Panel Display Station
4250 Printer
5210 Printer Models G01 and G02

Category B Devices

3277 Display Station
3284 Printer Models 1 and 2
3286 Printer Models 1 and 2
3287 Printer (with 3271/3272 Attachment Feature)
3288 Line Printer Model 2

Display System Components

The 3270 Information Display System has three basic components: a control unit, a display station, and a printer.

The control unit provides for the 3270 system's attachment to a data processing system and directs the operation of attached display stations and printers, except for those devices such as the 3290 Information Panel Display Station that interpret the data stream and execute the functions called for independently of the 3274. When such devices are attached to the 3274, the control unit essentially passes the outbound data stream to the addressed device and transmits, upon request, an inbound data stream prepared by the device.

The display station provides image display of data transmitted from the host system. A display station with an attached keyboard enables the user to enter, modify, or delete data on the display, and to cause the revised data to be returned to the host system for storage or additional processing.

The printer provides printed copy of data displayed at a display station or transmitted from the host system.

When not executing a command operation, the control units continually perform an internal poll of all attached devices. Internal polling is performed to determine the current device status and whether the device has an I/O pending condition.

The current status of each device indicates to the control unit whether the device is available, ready, or busy. This information is recorded in the associated device adapter in the control unit.

Additionally, when the host program addresses a specific device, the control unit stops the sequential polling and polls the addressed device to obtain its latest status. If conditions permit, the control unit communicates solely with that device until the operation is completed. At that time, sequential polling is resumed.

Data Flow

The 3274 Control Unit models can operate in local or remote configurations:

- The 3274 A units operate as channel-attached local units using SNA protocols (see Chapter 5).
- The 3274 B and D units operate as channel-attached local units using the host processor channel program (see Chapter 3).
- The 3274 C units operate as remote units using SNA/SDLC or BSC disciplines (see Chapters 4 and 5).

In the SNA/SDLC environment, attached displays function as LU type 2. The data stream chain for a write-type command, for example, consists of the command code, buffer orders, and display data.

Category A printers attached to a 3274, or the 3288 printer attached to a 3274, can also function in BSC or SNA/SDLC protocol. When operating in SNA/SDLC, the Category A printers function as LU type 3. When SCS is installed in Category A printers, the printer functions as an LU type 1. The Category A printers can also operate as local copy devices; that is, data may be sent to a printer(s) from a display station attached to the same 3274, which functions in either BSC or SNA/SDLC disciplines.

The instantaneous rate at which data is transferred between main storage of the data processing system and a device attached to the 3270 system depends on the information-transfer capability of the channel, whether data or command codes are transferred, and whether a local or remote 3270 system is attached.

In a local configuration, the control unit provides information to, and accepts information from, the channel at an instantaneous byte rate established by the channel or control unit, whichever is the slower. For the 3274 B and D units, the instantaneous data transfer rate for write operations is a maximum of 650,000 bytes per second and for read operations is a maximum of 400,000 bytes per second. With the 3274 A units (SNA operation), the maximum data transfer rate is 100,000 bytes per second; however, if 3277s are attached, continuous overrun conditions may exist. To remove these conditions, the maximum data transfer rate reduces to 20,000 bytes per second without significantly degrading subsystem performance.

When a remotely attached 3270 system is in operation, the rate at which data is transferred between the data processing system's main storage and the control unit depends on the type of transmission control unit and on the modems and communication facilities used. The 3270 system accepts data from, and provides it to, the transmission control unit/communication facility at the byte rate established by the transmission control unit/communication facility.

All command operations that direct movement of data to and from the 3270 system result in transfer of data between the control unit and a device buffer. When commands are not being performed, the control unit and the device buffer interact asynchronously, and the last image displayed by a previous command is continuously regenerated at a visible rate.

Interface Codes

Data, commands, and orders transmitted between the control unit and the host system are in the form of interface codes. Two different codes are used in the United States: extended binary-coded decimal interchange code (EBCDIC) and American National Standard Code for Information Interchange (ASCII). The EBCDIC codes are also used in the World Trade countries (ASCII is available only in the U.S.); refer to *IBM 3270 Information Display System: Character Set Reference*, GA27-2837, for details.

Figures 1-1 and 1-2 show the United States EBCDIC interface codes for several control unit/device combinations. Figure 1-3 indicates the actions taken by the 3274 Control Unit in response to various interface code points. Figures 1-4 and 1-5 show the United States ASCII codes. Figure 1-6 shows the control character codes. Refer to Appendix E for the Katakana codes.

ASCII uses 7 of a byte's 8 bits for information, allowing addressing of 128 code points per byte. The high-order ASCII bit is always zero. EBCDIC uses all 8 bits for information, allowing addressing of 256 code points per byte.

EBCDIC and ASCII explicitly define an information interchange code (ICC) and implicitly specify unique character sets. See the *Character Set Reference* manual.

SNA Interface Codes

With SDLC, the 3274 Control Unit operates with EBCDIC or an alternate, which is usually ASCII.

The alternate code is selectable as a feature during customizing. The 3274 physical unit (PU) cannot support multiple alternate codes concurrently. The Alternate Code feature:

- Defines the available alternate ICC.
- Defines the character set for all associated LU2 terminals.
- Allows only typewriter keyboards.
- Should not be used with an LU using the SNA character string (SCS).

The characteristics of LU-LU sessions are established by the SNA Bind RU. The Bind indicates which, if any, alternate code will be allowed for the ICC. The LUs must agree on an alternate code before one can be used.

The Request Header Code Select Indicator (RH CSI) indicates the alternate or EBCDIC ICC for the FMD RU. All host-bound FMD RUs will use alternate code when permitted by the bind and will have their RH CSIs set.

Bits 4567	Hex 1	00				01				10				11				Bits 0,1
		00	01	10	11	00	01	10	11	00	01	10	11	00	01	10	11	2,3
		0	1	2	3	4	5	6	7	8	9	A	B	C	D	E	F	Hex 0
0000	0	NUL				SP	&											0
0001	1		SBA				/			a	j				A	J		1
0010	2		EUA							b	k	s			B	K	S	2
0011	3		IC							c	l	t			C	L	T	3
0100	4									d	m	u			D	M	U	4
0101	5	PT	NL							e	n	v			E	N	V	5
0110	6									f	o	w			F	O	W	6
0111	7									g	p	x			G	P	X	7
1000	8									h	q	y			H	Q	Y	8
1001	9		EM							i	r	z			I	R	Z	9
1010	A					ç	ı	ı										
1011	B					.	\$.	#									
1100	C	FF	DUP		RA	<	*	%	@									
1101	D		SF			()	_	'									
1110	E		FM			+	.	>	=									
1111	F						⌋	>	"									

Notes:

- Character code assignments other than those shown within all outlined areas of this chart are undefined. If an undefined character code is programmed, the character that will be displayed or printed is not specified. The character displayed by the 3277 for a given undefined character code may be different for other devices. IBM reserves the right to change at any time the character displayed for an undefined character code.
- Lowercase alphabetic characters (shown within the dotted outlined area) are displayed or printed as uppercase characters, unless the terminal has dual-case capability.
- NL, EM, FF, DUP, and FM control characters are displayed or printed as 5 9 < * and ; characters, respectively, except by printers under format control, in which case NL and EM do not result in the printing of a character, and by printers successfully executing FF, in which case < is not printed.
- Bits 0 and 1 are assigned for the following characters: AID, attribute, write control (WCC), copy control (CCC), CU and device address, buffer address, sense, and status. Bits 0 and 1 are assigned so that each character can be represented by a graphic character within the solid outlined areas of the chart. See Figure 1-6.
- This table also applies for Belgian, French, and Italian mono-case I/O interface codes and graphics.
- The ' character (hex 6A) is not displayed and is printed by the 3287 and 3288 only.
- For BSC data-link control characters, see Chapter 4.

Figure 1-1. United States EBCDIC I/O Interface Code for 3274 Control Units with Category B Terminals Attached

Hex 1 Bits 4567	00				01				10				11				Bits 0,1
	00	01	10	11	00	01	10	11	00	01	10	11	00	01	10	11	← 2,3
	0	1	2	3	4	5	6	7	8	9	A	B	C	D	E	F	← Hex 0
0000	0	NUL			SP	&							()	\	0	
0001	1		SBA			/		a	j	~			A	J		1	
0010	2		EUA					b	k	s			B	K	S	2	
0011	3		IC					c	l	t			C	L	T	3	
0100	4							d	m	u			D	M	U	4	
0101	5	PT	NL					e	n	v			E	N	V	5	
0110	6							f	o	w			F	O	W	6	
0111	7							g	p	x			G	P	X	7	
1000	8	GE		SA				h	q	y			H	Q	Y	8	
1001	9		EM	SFE				'	i	r	z		I	R	Z	9	
1010	A				¿	!		:									
1011	B				.	\$.	#									
1100	C	FF	DUP	MF	RA	<	*	%	@								
1101	D	CR	SF		()	-	'									
1110	E		FM		+	;	>	=									
1111	F					^	?	"								EO	

Notes:

- Character code assignments other than those shown within all outlined areas of this chart are undefined. If an undefined character code is programmed, the character that will be displayed or printed is a hyphen (-); hex code 60 will be returned on a subsequent read operation. For control units with Configuration Support C installed, undefined control codes from X'00' to X'3F' cause a negative response (SNA) or an Op Chk (BSC). IBM reserves the right to change at any time the character displayed or printed and the I/O interface code returned for an undefined character code. See Figure 1-3.
- CR, NL, EM, and FF control characters are displayed and printed as blank characters. The DUP and FM control characters are displayed as ¶ and ¶, respectively, and are displayed and printed as * and ; when operating in mono-case mode.
- Bits 0 and 1 are assigned for the following characters: AID, attribute, write control (WCC), copy control (CCC), CU and device address, buffer address, sense, and status. Bits 0 and 1 are assigned so that each character can be represented by a graphic character within the solid outlined areas of the chart. See Figure 1-6.
- For BSC data-link control characters, see Chapter 4. For the SCS control codes associated with the SNA Character String feature on Category A printers, see Chapter 2.
- When operating in mono-case mode, the lowercase alphabetic characters are displayed or printed as uppercase characters.
- When 3277, 3284, 3286, 3287 (with the 3271/3272 Attachment feature), and 3288 terminals are attached to a 3274 Control Unit, the codes of characters: ` ~ { } and \ will be accepted and returned, but they will generally be displayed or printed as different graphics for the various language specify features.
When the CR control character is directed to one of these terminals, CR will be displayed or printed as > (on mono-case terminals), and no CR function will be executed; hex code 0D will be returned on a subsequent read operation.

Figure 1-2. United States EBCDIC I/O Interface Code for 3274 Units and Attached Category A Terminals

Controller With	Display or Printer	
	Without ECSA ¹	With ECSA ¹
Configuration Support A and B; codepoints <i>not</i> preceded by X'08'	All unsupported control codepoints or unsupported graphic codepoints are replaced with hyphen codepoints in the data buffer.	
Configuration Support B; codepoints X'nn' preceded by X'08'	X'08nn' is replaced by a single hyphen codepoint in the data buffer.	For X'nn' equal to all control codepoints and unsupported APL codepoints, X'08nn' is replaced by a hyphen codepoint in the data buffer.
Configuration Support C; codepoints <i>not</i> preceded by X'08'	<p>For Category A displays: (1) a hyphen codepoint replaces codepoints CE, CF, DD², DE, DF², ED, EE, EF, and FE in the data buffer, (2) a negative response is given to control codepoints in the range X'00' to X'3F' and X'FF' except for codepoints 00, 05, 08, 0C, 0D, 11, 12, 13, 15, 19, 1C, 1D, 1E, and 3C, and (3) graphic codepoints X'40' to 'FE', except as noted above, are stored in the data buffer and returned in subsequent read operations.</p> <p>For Category B displays: (1) Unsupported graphic codepoints in the range X'40' to X'FE' are replaced with a hyphen codepoint in the data buffer, and (2) a negative response is given as described above for Category A.</p>	<p>A negative response is given to unsupported control codepoints in the range X'00' to X'3F'.</p> <p>All codepoints in the range X'40' to X'FE' plus X'3F' and X'FF' are stored in the data buffer and returned in subsequent read operations.</p>
Configuration Support C; codepoints X'nn' preceded by X'08'	For X'nn' equal to X'00' through X'3F' or X'FF', a negative response is returned.	
	For X'nn' equal to X'40' through X'FE', X'08nn' is replaced by a single hyphen codepoint in the data buffer.	For X'nn' equal to all unsupported APL codepoints, X'08nn' is replaced by a single hyphen codepoint in the data buffer.

¹ Extended character set adapter

² FD for Canadian French Bilingual, not DD

FD for Swiss-French, not DD

6C for Swiss-German, not DF

6C for French AZERTY (105), not DF

Figure 1-3. Matrix for Hyphenation and Negative Responses – 3274 Control Unit

		Hex 1							
		000	001	010	011	100	101	110	111
Bits 4321	Hex 0	0	1	2	3	4	5	6	7
0000	0	NUL		SP	0	@	P		p
0001	1		SBA	!	1	A	Q	a	q
0010	2		EUA	"	2	B	R	b	r
0011	3		IC	#	3	C	S	c	s
0100	4		RA	\$	4	D	T	d	t
0101	5			%	5	E	U	e	u
0110	6			&	6	F	V	f	v
0111	7			'	7	G	W	g	w
1000	8			(8	H	X	h	x
1001	9	PT	EM)	9	I	Y	i	y
1010	A	NL		*		J	Z	j	z
1011	B			+		K	[k	
1100	C	FF	DUP			L		l	
1101	D		SF		-	M]	m	
1110	E		FM		.	N	^	n	
1111	F			>		O		o	

Notes:

1. Character code assignments other than those shown within all outlined areas of this chart are undefined. If an undefined character code is programmed, the character that will be displayed or printed and the I/O interface code returned on a subsequent read operation are not specified. The character displayed or printed by these terminals for a given undefined character code may be different for other terminals. IBM reserves the right to change at any time the character displayed or printed and the I/O interface code returned for an undefined character code.
2. Lowercase alphabetic characters (shown within the dotted outlined area) are converted to uppercase by the display station or printer and displayed or printed as uppercase characters.
3. NL, EM, FF, DUP, and FM control characters are displayed or printed as 5 9 < * and ; characters, respectively, except by printers under format control, in which case NL and EM do not result in the printing of a character, and by printers successfully executing FF, in which case < is not printed.
4. AID, attribute, write control (WCC), copy control (CCC), CU and device address, buffer address, sense, and status characters are assigned as specified in Figure 1-6 so that each character can be represented by a graphic character within the solid outlined portion of this chart.
5. ASCII A option displays and prints | and ~ for interface codes 21 and 5E (hex), respectively. ASCII B option displays and prints ! and ^ for codes 21 and 5E (hex), respectively.
6. For BBSC data-link control characters, see Chapter 4.

Figure 1-4. United States ASCII I/O Interface Code for 3274 C Units and Attached Category B Terminals

		Hex 1								Bits
		000	001	010	011	100	101	110	111	7, 6, 5
		0	1	2	3	4	5	6	7	Hex 0
Bits	4321									
0000	0	NUL		SP	0	@	P	*	p	
0001	1		SBA	!	1	A	Q	a	q	
0010	2		EUA	"	2	B	R	b	r	
0011	3		IC	#	3	C	S	c	s	
0100	4		RA	\$	4	D	T	d	t	
0101	5			%	5	E	U	e	u	
0110	6			&	6	F	V	f	v	
0111	7			'	7	G	W	g	w	
1000	8			(8	H	X	h	x	
1001	9	PT	EM)	9	I	Y	i	y	
1010	A	NL		*	:	J	Z	j	z	
1011	B			+	;	K	[k	}	
1100	C	FF	DUP	'	<	L	\	l		
1101	D	CR	SF	-	=	M]	m	}	
1110	E		FM	.	>	N	^	n	~	
1111	F			/	?	O	_	o		

Notes:

1. Character code assignments other than those shown within all outlined areas of this chart are undefined. If an undefined character code is programmed, the character that will be displayed or printed is a hyphen (-); code 2D will be returned on a subsequent read operation. IBM reserves the right to change at any time the character displayed or printed and the I/O interface code returned for an undefined character code.
2. CR, NL, EM, and FF control characters are displayed and printed as blank characters. The DUP and FM control characters are displayed as * and ; respectively, and are displayed and printed as * and ; when operating in mono-case mode.
3. AID, attribute, write control (WCC), copy control (CCC), CU and device address, buffer address, sense, and status characters are assigned as specified in Figure 1-6 so that each character can be represented by a graphic character within the solid outlined portion of this chart.
4. For BSC data-link control characters, see Chapter 4.
5. When operating in mono-case mode, the lowercase alphabetic characters are displayed or printed as uppercase characters.
6. When 3277, 3284, 3286, 3287 (with the 3271/3272 Attachment feature), and 3288 terminals are attached to a 3274 Control Unit, the characters { ` ~ { } } and \ are displayed or printed as \ ' - () and \ respectively; codes 7C, 60, 7E, 7B, 7D, and 5C will be returned on a subsequent read operation. When the CR control character is directed to one of these terminals, CR will be displayed or printed as > (on mono-case terminals), and no CR function will be executed; code 0D will be returned on a subsequent read operation.

Figure 1-5. United States ASCII I/O Interface Code for 3274 Units and Attached Category A Terminals

Bits 2-7	Graphic	EBCDIC	ASCII
00 0000	SP	40	20
00 0001	A	C1	41
00 0010	B	C2	42
00 0011	C	C3	43
00 0100	D	C4	44
00 0101	E	C5	45
00 0110	F	C6	46
00 0111	G	C7	47
00 1000	H	C8	48
00 1001	I	C9	49
00 1010	{	4A	-
		-	5B
00 1011		4B	2E
00 1100	<	4C	3C
00 1101	(4D	28
00 1110	+	4E	2B
00 1111	{	4F	-
	!	-	21
01 0000	&	50	26
01 0001	J	D1	4A
01 0010	K	D2	4B
01 0011	L	D3	4C
01 0100	M	D4	4D
01 0101	N	D5	4E
01 0110	O	D6	4F
01 0111	P	D7	50
01 1000	Q	D8	51
01 1001	R	D9	52
01 1010	{	5A	-
	}	-	5D
01 1011	\$	5B	24
01 1100	*	5C	2A
01 1101)	5D	29
01 1110	;	5E	3B
01 1111	{	5F	-
	/	-	5E

Bits 2-7	Graphic	EBCDIC	ASCII
10 0000	-	60	2D
10 0001	/	61	2F
10 0010	S	E2	53
10 0011	T	E3	54
10 0100	U	E4	55
10 0101	V	E5	56
10 0110	W	E6	57
10 0111	X	E7	58
10 1000	Y	E8	59
10 1001	Z	E9	5A
10 1010	{ (EBCDIC)	6A	7C
10 1011	,	6B	2C
10 1100	%	6C	25
10 1101	-	6D	5F
10 1110	>	6E	3E
10 1111	?	6F	3F
11 0000	0	F0	30
11 0001	1	F1	31
11 0010	2	F2	32
11 0011	3	F3	33
11 0100	4	F4	34
11 0101	5	F5	35
11 0110	6	F6	36
11 0111	7	F7	37
11 1000	8	F8	38
11 1001	9	F9	39
11 1010	:	7A	3A
11 1011	#	7B	23
11 1100	@	7C	40
11 1101	'	7D	27
11 1110	=	7E	3D
11 1111	"	7F	22

Note: The characters above are used as attribute, AID, write control (WCC), copy control (CCC), CU and device address, and buffer address. They are also used as status and sense except when operating in BSC. When any of these characters is transmitted to the program, the CU assigns the appropriate EBCDIC code. If transmission is in ASCII, the CU translates the EBCDIC code to ASCII code prior to transmission.

To use this table to determine the hex code transmitted for an address or control character, first determine the values of bits 2-7. Select this bit configuration from the "Bits 2-7" column. The hex code that will be transmitted (either in EBCDIC or in ASCII) is to the right of the bit configuration.

Use this table also to determine equivalent EBCDIC and ASCII hex codes and their associated graphic characters. See Figure 1-4, Note 5, for ASCII A and B graphic character difference for ASCII codes 21 and 5E (hex).

Graphic characters for the United States I/O interface codes are shown. Graphic characters might differ for particular World Trade I/O interface codes. Refer to IBM 3270 Information Display System: Character Set Reference, GA27-2837, for possible graphic differences when these codes are used.

Figure 1-6. Control Character I/O Codes

The alternate code character set is supported only for typewriter keyboards. The differences between the EBCDIC and ASCII keyboard layouts are noted below; four keys are involved, and the coding points associated with each are in parentheses:

Key Shift	Keytop Symbol	
	EBCDIC	ASCII
Up	Bar (X'4F')	Exclamation point (X'21')
Up	<i>Not</i> sign (X'5F')	Circumflex (X'5E')
Up	Exclamation point (X'5A')	Right bracket (X'5D')
Down	Cent sign (X'4A')	Left bracket (X'5B')

Code structures pertain only to the data portion of information in an SDLC data stream. All but the SNA LU-LU function management data request unit (FMD RU) is considered bit-significant control information and is not subject to graphic representation.

BSC Interface Codes

The BSC interface codes are described under "Redundancy Checking" and "Data-Link Control Characters," in Chapter 4.

Device Addressing

Addresses for devices on 3274 control units are based on the port to which they are attached. The port sockets are numbered, and device adapters are attached in accordance with requirements detailed in the following publications:

- *IBM 3274 Control Unit Planning, Setup and Customizing Guide*, GA27-2827, for all models using Configuration Support levels A, B, C, and T.
- *IBM 3274 Control Unit Customizing Guide*, GA23-0065, for all models using Configuration Support level D.

Note: Addressing when the IBM 3299 Terminal Multiplexer or an IBM 3290 Information Panel Display Station using Logical Terminal Addressing is attached to the 3274 is discussed in the *Customizing Guide*, GA23-0065.

The 32 addresses available for each 3274 (12 for Model 51C, 16 for 61C) are assigned sequentially to the ports, beginning at the bottom adapter; if no device is attached to a port, the address for that port is reserved even though unused. All category A ports are attached at the bottom of the control unit and receive sequential addresses, starting with 00 in non-SNA and 02 in SNA systems. Type B ports are attached above the A ports and are assigned sequential addresses, starting after the last type A port address. Type A addresses are reserved in blocks of 8 (each type A adapter has 8 ports on it); type B addresses are reserved in blocks of 4.

Figure 1-7 illustrates 3274 Control Unit address assignments.

Port Number	Type of Device Attached	Address	
		SNA	Non-SNA
A0	A	02	00
A1	A	03	01
A2	A	04	02
A3	A	05	03
A4	None	06	04
A5	None	07	05
A6	None	08	06
A7	None	09	07
A8	A	10	08
A9	A	11	09
A10	A	12	10
A11	A	13	11
A12	A	14	12
A13	A	15	13
A14	None	16	14
A15	A	17	15
B0	B	18	16
B1	B	19	17
B2	None	20	18
B3	None	21	19
B4	B	22	20
B5	B	23	21
B6	None	24	22
B7	None	25	23

Note: Regardless of the type of host attachment, the 3274 Printer Authorization Matrix requires all port addresses of each type to be based on a 0 origin.

Figure 1-7. Example of 3274 Control Unit Address Assignments

Data Stream

The 3270 data stream consists of application data, commands/structured field functions, and orders which are transmitted between the control unit and the host system. Control information, which governs the movement of the data stream, is also transmitted.

Data transfer commands are issued to initiate such operations as the total or partial writing, reading, and erasing of data in a selected terminal character buffer. Control commands initiate control unit and/or terminal operations not involved with data transfer (except for status information). Structured field functions (data transfer or control) are used for such operations as loading a programmed symbol set and querying a terminal as to its characteristics; for example, character buffer capacity. Orders can be included in write data streams either alone or intermixed with display and print data.

Two types of orders are available — buffer control orders and printer format orders. Buffer control orders are interpreted and executed as they are received by the control unit, and are used to position, define, modify, assign attributes on a field and character basis, and format data being written to a display character buffer; to erase selected unprotected data in the buffer; and to reposition the

cursor. Printer formatting orders are initially stored in the printer character buffer as data and are interpreted and executed by the printer logic when encountered in the print operation.

The balance of this chapter consists of 3270 data stream description.

3270 Data Stream Function

The 3270 data stream — outbound — can consist of commands, structured fields, write control characters (WCC) if appropriate, orders, character data, and the parameters needed by a control command. Inbound data streams (read operations) consist of orders and character data or requested sense and control information.

The command or structured field type-code defines the operation to be performed.

Commands/Structured Fields

The operations which may be specified include:

- Write to the character buffer
- Erase and then Write to the character buffer
- Erase and then Write to the Alternate size character buffer
- Read the entire character buffer
- Read only the Modified data from the character buffer (some exceptions)
- Read All the Modified data from the character buffer (no exceptions)
- Erase All the Unprotected data from the character buffer
- Copy the content of character buffer A to character buffer B. (3274 C units, BSC only.)
- Select a terminal and initiate terminal character buffer to control unit buffer transfer of all data, modified data only, or data from position in preparation for a Read Buffer, Read Modified or a Write operation (3274 B and D units).
- Perform No functional Operation, retrieve pending status (3274 B and D units).
- Sense further definition of the Unit Check condition (3274 B and D units).
- Sense the Control Unit Identification (3274 B and D units).

When the Structured Field and Attribute Processing Option is installed in the control unit, the following structured field functions are available:

- Write Structured Field (WSF); a write-type command indicating that structured fields follow.
- 3270 DS; a structured field function used to combine 3270 write-type commands and the COPY command (BSC) with other structured field functions in a single transmission to devices supporting structured field and attribute processing.
- ERASE/RESET; a structured field function used to set the buffers of devices capable of default or alternate size operation to either the default or alternate size and clear the buffer.
- Load Programmed Symbols; a structured field function used to load symbol definition data into loadable terminal storage.
- Set Reply Mode; a structured field function used to define the format of inbound data streams generated by Read command operations.

- Read Partition-Query; a structured field function used to query a terminal as to its characteristics.
- Query Reply; a structured field function containing the terminal characteristics requested by Read Partition-Query.
- SCS Data; a structured field function used to transmit an SCS data stream to a printer in an LU Type 1 session when other structured fields are also in the transmission.

Command codes, including the WSF command, are shown in Figure 1-8.

Command	3274 B and D Units	3274 A and C Units		Graphic
	EBCDIC Hex	EBCDIC Hex	ASCII Hex	
Copy ¹	NA	F7	37	7
Erase All Unprotected	0F	6F	3F	?
Erase/Write	05	F5	35	5
Erase/Write Alternate	0D	7E	3D	=
Read Buffer	02	F2	32	2
Read Modified	06	F6	36	6
Read Modified All	NA	6E	3E	:
Write	01	F1	31	1
No Operation	03	NA	NA	NA
Select ²	0B	NA	NA	NA
Select RM ³	0B	NA	NA	NA
Select RB ³	1B	NA	NA	NA
Select RMP ³	2B	NA	NA	NA
Select RBP ³	3B	NA	NA	NA
Select WRT ³	4B	NA	NA	NA
Sense	04	NA	NA	NA
Sense ID	E4	NA	NA	NA
Write Structured Field ³	11	NA	NA	NA
Write Structured Field	NA	F3	NA	NA

¹ Applicable to 3274 C units (BSC) only.

² Applicable to 3274 B and D units

³ Applicable to 3274 D units

Figure 1-8. Command Codes

Orders

The outbound data stream can contain orders directing the formatting of a display terminal buffer or the formatting of a printer operation. For a discussion of the printer formatting orders (NL, EM, FF, SI, and CR), refer to Chapter 2.

Orders that can be included in the 3270 data stream are described below:

The Set Buffer Address (SBA) order is followed by two address characters, and sets a pointer called the *current buffer address* (CBA). Subsequent data characters will be stored in the character buffer in a sequential fashion beginning at the CBA. As each character is stored, the CBA is updated to point to the next character location in the character buffer.

The Start Field (SF) order indicates that the next character in the data stream is to be interpreted as a field attribute character. It will therefore be stored in the character buffer in a unique fashion so that the hardware will interpret it as a field attribute and not as a data character.

The Insert Cursor (IC) order causes the cursor to be displayed at the screen location associated with CBA.

The Program Tab (PT) order will cause the CBA to be set to the first data character position in the next unprotected field in the buffer. Under certain circumstances it will also cause nulls to be inserted into the character buffer from this new CBA to the end of the field.

The Repeat to Address (RA) order is followed by 2 character buffer address bytes and a character to be repeated. That character will be replicated through the character buffer up to, but not including, the specified buffer address.

The Erase Unprotected to Address (EUA) order is followed by 2 character buffer address bytes and causes nulls to be inserted in all unprotected buffer locations starting at the CBA and up to, but not including, the specified stop address.

When the Structured Field and Attribute Processing option is installed in the control unit, the following orders are available for use with appropriately configured terminals:

The Start Field Extended (SFE) order is followed by a 1-byte count indicating the number of attribute type and value *pairs* which follows. The specified number of attribute type and value pairs follows the count.

The Modify Field (MF) order allows specified extended field attributes to be modified without having to respecify all the attributes in the field. The structure of the Modify Field order is identical to that of the Start Field Extended order, having a 1-byte *count* field followed by the specified number of attribute type and value pairs.

The Set Attribute (SA) order provides the ability to associate attributes with individual characters rather than with fields. In this case, only a *single* attribute type and value pair follows the order, and the count field is absent. Once a character attribute has been established using this order, it applies to all subsequent characters in the transmission, until a new character attribute value of *the same type* is established with another Set Attribute order. Character attribute values are reset to their defaults at the beginning of each transmission. The character attributes specified with Set Attribute orders override the same attribute type settings specified with the SFE or MF orders applying to the fields in which the characters are stored.

Attributes

Four attribute types can be specified in the orders included in the 3270 data stream: field, color, extended highlighting, and symbol set. All four can be assigned to fields and three of the four can be assigned to individual characters.

The color, extended highlighting, and symbol set attribute types may be applied to characters as well as fields. Values accompany the attribute type designation, specifying, for instance, red for the color attribute, or protected, numeric for the field attribute. Refer to Chapter 2 for a discussion of attributes.

Write Commands

Two write-type commands, Write and Erase/Write, are used to load, format, and selectively erase device buffer data. These commands can also initiate certain device operations such as starting the printer, resetting the keyboard, and sounding the audible alarm. Write and erase/write operations are identical except that Erase/Write causes complete erasure of the device buffer before the write operation is started. Thus, Erase/Write is used to load the buffer with completely new data, whereas Write can be used to modify existing buffer data.

A third write-type command, Erase/Write Alternate, performs the erase/write function for 3178, 3278, and 3279 displays and 3287 and 3289 printers. It is also used to switch the display or printer into large screen or expanded print capacity mode. The Erase/Write Alternate command is valid when sent to the 3274.

12/14-Bit Addressing

Twelve- or 14-bit buffer addressing is allowed in an outbound data stream. (Inbound data streams always use 12-bit addressing.) Definition of 12- or 14-bit buffer addressing is as follows:

Bits 0 and 1 of the first address byte following an SBA, RA, or EUA order are considered flag bits and have the following significance:

- = 00 — 14-bit binary address follows
- = 01 — 12-bit coded address follows
- = 10 — Reserved
- = 11 — 12-bit coded address follows

When the flag bits are 00, the next 14 bits (the remainder of the current byte (6 bits) and 8 bits of the next byte) are considered a buffer address in binary form. No address translation is necessary. Receipt of a buffer address beginning with the flag bits 10 will cause a negative response (X'1005') or an Op Chk when the 3274 has configuration support C installed.

Write Command

The bytes received by the 3274 for Write command operation consist of a command code, a write control character (WCC), and orders and/or data. Remotely attached 3274 control units also receive appropriate data link control framing. The sequence of bytes is as follows:

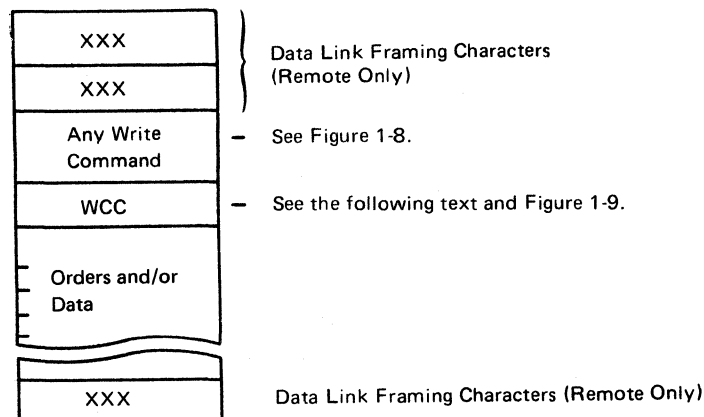

The minimum data stream following a Write command is a 1-byte WCC. This is ensured because the byte count field of the write channel control word (CCW) must be set to a minimum of 1 when attached to the 3274 Model 1B or 1D, or else the command code is not sent. The minimum Write command data stream to a remote 3270 consists of framing characters (for example, in BSC, STX, ESC, and ETX) and the command code. To be meaningful, a WCC byte should follow the command code; if the BSC data link control character ETX follows the command code, an all-zero default WCC byte is generated by the control unit, and command execution is ended normally. An order or display/print data byte that immediately follows the command code is interpreted as a WCC by the control unit.

The WCC byte format is as follows:

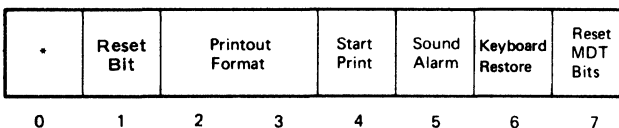

*Determined by the configuration of bits 2 through 7. See Figure 1-9.

Figure 1-9 describes the function of each WCC bit. When the WCC specifies an operation that does not apply to the selected device (for example, if the Sound Alarm bit is set and the selected device does not have the Audible Alarm feature), the specified operation is ignored. When the WCC byte is followed by order or display/print data bytes, only the Reset MDT Bits function, if specified, is performed before the write operation; any other WCC function is deferred until all data is written and all orders are performed.

Orders and buffer data can follow the WCC character. (Orders are described later in this chapter, following the "Write Commands" description.) Buffer data can be written into any specified location of the buffer without erasing or modifying data in the other buffer locations. Data characters are stored in successive buffer locations until an order is encountered in the data stream which alters the buffer address, or until all the data has been entered. During the write operation, the buffer address is advanced one location as each character is stored.

The buffer location where data entry starts depends upon the following considerations:

1. The starting location may be specified by an SBA order that follows the WCC. (This order is described later in this chapter under "Orders.")
2. The starting location will be the buffer address containing the cursor if the Write command is not chained or if it is chained from a Copy, Select, Erase All Unprotected, No Operation, or Sense command.
3. The starting location will be the current buffer address if the Write command is chained from a Read or another Write command.

The formatting and placement of write data and the modification of existing buffer data are described under "Orders."

Bit	Explanation
0	Determined by the contents of bits 2 through 7 as shown in Figure 1-6.
1	WCC reset bit. When set to 1, resets the functions denoted in Figure 1-10.
2,3	Define the printout format, as follows: = 00 – The NL, EM, and CR ¹ orders in the data stream determine print line length. Provides a 132-print position line when the orders are not present. = 01 – Specifies 40-character print line. = 10 – Specifies 64-character print line. = 11 – Specifies 80-character print line.
4	Start Printer bit. When set to 1, initiates a printout operation at completion of the write operation.
5	The Sound Alarm bit. When set to 1, sounds the audible alarm at the selected device at the end of the operation if that device has an audible alarm.
6	The Keyboard Restore bit. When set to 1, restores operation of the keyboard by resetting the INPUT INHIBITED indicator on 3277 displays, and the System Lock or Wait symbol on Category A displays. It also resets the AID byte at the termination of the I/O command.
7	Reset MDT bits. When set to 1, all MDT bits in the selected devices' existing buffer data are reset before any data is written or orders are executed.

¹ The CR order is applicable to the 3262, 3287 and 3289 printers only.

Figure 1-9. Write Control Character (WCC)

Programming Notes:

1. If the commands are being chained, the Write or Erase/Write command with the Start Print WCC bit set must be the last command in the chain. If not:
 - a. Local control units abort the Write or Erase/Write command that specifies Start Print.
 - b. Remote control units perform the print operation and abort the next command.
2. The Printout Format bits are honored only if the Start Print bit is set in the same WCC.
3. In remote operations, if a Write command that includes data is chained from a previous Write command, an SBA order should immediately follow the WCC to define the starting location at which data entry is to start; this permits recovery in case of an error condition that requires retransmission of that data.

Programming Restriction: A Write command should not be chained from an Erase All Unprotected command. If it is, the operation is undefined.

Erase/Write Command

Execution of the Erase/Write command performs two operations: an erase operation and a write operation. The erase operation clears the entire device buffer to nulls, positions the cursor to character location 0, and resets the buffer address to 0.

Erase/Write then performs the write and WCC operations in the same manner as a Write command. If no WCC is sent, the Erase/Write command will not erase the buffer.

Keyboard Actions or Data Stream States	Reply Mode	Color, Extended Highlighting, PS		INOP	Programmed Symbols		Base Color Override Bit
		Selection	Indicator		Symbol-Set ID	Content	
Clear key (SSCP)	R	R	1	R	NC	NC	R
Clear key (unowned)	R	R	1	R	NC	NC	R
Clear key (LULU)	R	R	1	R	NC	NC	R
System request key SSCP (unowned)	R	R	1	R	NC	NC	R
System request key SSCP (LULU)	R	R	1	R	NC	NC	R
System request key unowned (SSCP)	R	R	1	R	NC	NC	R
Receipt of RU (SSCP)	R	R	1	R	NC	NC	R
System request key LULU (SSCP)	R	R	1	R	NC	NC	R
TEST key "ENTER"	2	R	1	R	NC	NC	R
TEST key "EXIT"	R	R	1	R	NC	NC	R
WCC Reset in EW/EWA	R	R	1	R	NC	NC	R
Power on	R	R	R	R	R	R	R
SNA Clear (LULU)	NC	NC	NC	NC	NC	NC	NC
SNA ACTLU (SSCP-owned)	NC	NC	NC	NC	NC	NC	NC
SNA DACTLU	NC	NC	NC	NC	NC	NC	NC
SNA ACTLU (unowned)	NC	NC	NC	NC	NC	NC	NC
UNBIND	NC	NC	NC	NC	NC	NC	NC
BIND	R	R	R	R	NC	NC	R
Set Reply Mode	3	NC	1	NC	NC	NC	4
SA, SFE, MF	NC	NC	NC	NC	NC	NC	5
082B (external viewpoint)	R	R	R	R	NC	NC	R
CD/EB WRITE acknowledgment	NC	NC	NC	R	NC	NC	NC

R = Reset (to default value) NC = No change

Notes:

1. Display exactly those attribute selection indicators that are honored as a result of the Reply mode.
2. Allow all attribute key selections during test.
3. Inbound Reply mode changed to the mode described in the structured field.
4. If the Reply mode indicates color as an acceptable operator selection, then the color-override bit is set.
5. If SA, SFE, or MF reference color, then the color-override bit is set.

Figure 1-10. Reset Matrix

An Erase/Write command can also return a display or printer to the default screen size or character print capacity (as next described under "Erase/Write Alternate Command").

Erase/Write Alternate Command

The 3178, 3278, and 3279 displays and 3287 and 3289 printers with a capacity of 960 characters can function as 480-character devices; 1920-, 2560-, 3440-, and 3564-character (3278 Model 5, 3287, and 3289 attached to 3274 A, C, and D units only) displays and printers can function as 1920-character devices. Thus, application programs written for 3277 displays and for 3284, 3286, and 3288 printers can be used without modification of screen or print format for 3178, 3278, or 3279 displays and for 3287 and 3289 printers.

For the 3274 B, C, or D units, a unique instruction is required from the application program to enable a display or printer to function at greater than 480- or 1920-default-character capacity. The Erase/Write Alternate command is used to switch Category A display screen size or printer capacity to the alternate size indicated by the display model number or specified for the printer as follows:

3178 Model	3278 Model	3279 Model	3287 and 3289 Model	Default Character Capacity	Alternate Character Capacity
	1	—	1, 2	480	960
C1, C2	2	2A, 2B	1, 2	1920	1920
	3	3A, 3B	1, 2	1920	2560
	4	—	1, 2	1920	3440
	5	—	1, 2	1920	3564

The Erase/Write Alternate command also operates as an Erase/Write command. Once the display or printer is placed in alternate mode, operation continues in alternate mode until the operator presses the CLEAR, SYS REQ (SNA only), or TEST key or until an Erase/Write command is received, the SNA session is unbound, power fails at the control unit, display, or printer, or, in locally attached 3270 systems, a system reset sequence occurs. Only these conditions return the display or printer to the default-value screen-size or character print capacity. For the 3274 B, C, or D units, the Erase/Write Alternate and Erase/Write commands are used to switch a display screen size, or a print capacity to alternate size, or vice versa, according to Bind parameter definition.

When in emulation mode, and with the display not in an LU-LU session, the operator may set the display to its maximum size by pressing the CLEAR key.

A Category A display operating as an LU type 2 requires the format shown in Figure 1-11 as part of the Bind operation.

Byte 24 determines the screen size for both the base and the extended LU type 2. Only 480- and 1920-character displays are supported in the base LU type 2, which corresponds to the 3277 Models 1 and 2. The Bind format must specify the extended LU type 2 for larger screen sizes. The base LU type 2 screen size is in effect during the entire session when coded in byte 24. Bytes 20 through 23 are ignored in this case. The 3277s attached to the 3274 are always in base LU type 2 Bind format. Any I/O device that has base LU type 2 Bind format can accept an Erase/Write Alternate command, but it is executed as an Erase/Write command.

When bits 1 through 7 of byte 24 are coded b'0000000', the device assumes the 3277 default size defined for that model display. Buffer wrap occurs as if the device were physically a 3277 Model 1 or 2 display. If an Erase/Write Alternate command is received while bound, it is processed as a normal Erase/Write

Byte	Bit	Model	Content	Description
20	0-7	1	X'01' - X'0C'	Default number of rows 1-12
		2	X'01' - X'18'	1-24
		3	X'01' - X'20'	1-32
		4	X'01' - X'2B'	1-43
		5	X'01' - X'1B'	1-27
21	0-7	1	X'28'	Default number of columns 40
		1-5	X'50'	80
		5	X'84'	132
22	0-7	1	X'01' - X'0C'	Alternate number of rows 1-12
		2	X'01' - X'18'	1-24
		3	X'01' - X'20'	1-32
		4	X'01' - X'2B'	1-43
		5	X'01' - X'1B'	1-27
23	0-7	1	X'28'	Alternate number of columns 40
		1-5	X'50'	80
		5	X'84'	132
24	0-7	All	Reserved	Session screen size reserved
	0	1-5	b'000 0000'	Base default (12 x 40 or 24 x 80)
	1-7	1	b'000 0001'	Base Model 1 default (12 x 40)
		2-5	b'000 0010'	Base Model 2 default (24 x 80)
	1-5	1-5	b'111 1110'	Extended default (size specified in bytes 20 and 21)
		1-5	b'111 1111'	Extended alternate (size specified in bytes 22 and 23)
<p>Note: Row values outside these ranges and column values other than those listed cause the Bind to be rejected with X'0821'.</p>				

Figure 1-11. LU Type 2 Screen Size Bind Format

command. No state change occurs within the display. Default screen sizes are as follows:

3178 Model	3278 Model	3279 Model	Default Screen Size Assumed with Byte 24 = b'0000000'
C1, C2	1	—	480 (12 x 40)
	2	2A, 2B	1920 (24 x 80)
	3	3A, 3B	1920 (24 x 80)
	4	—	1920 (24 x 80)
	5	—	1920 (24 x 80)

Only a Model 1 display can be bound as b'0000001', a base LU type 2 with a 12 x 40 character screen. This coding of the Bind image is rejected with X'0821' on Models 2, 3, 4, and 5.

A Model 2, 3, 4, and 5 display can be bound as b'0000010', a Base LU type 2 with a 24 x 80 character screen. This Bind format, if used for a Model 1 display, causes the Bind to be rejected with X'0821'.

When operating with a screen size of 480 characters, sequential buffer addresses map to the 12 x 40 screen format in row major order. When operating in other screen sizes, sequential buffer addresses map to the defined screen format in row major order.

Byte 24 must be coded X'7E' or X'7F' to use displays in large-screen mode (2560, 3440, and 3564 characters) during the LU-LU session.

When bits 1 through 7 of byte 24 are coded X'7E', the screen size of the device is defined in bytes 20 and 21 of the Bind image, and bytes 22 and 23 are ignored. The device operates with the defined screen size during the entire session. An Erase/Write Alternate command is accepted by the device but is interpreted as an Erase/Write command. No state change occurs, and the screen size remains as defined in bytes 20 and 21 of the Bind image. Valid codings of bytes 20 and 21 are as follows:

		Model 1	Model 2	Model 3	Model 4	Model 5
Byte 20	Hex	≤ X'0C'	≤ X'18'	≤ X'20'	≤ X'2B'	≤ X'1B'
	Row	≤ 12	≤ 24	≤ 32	≤ 43	≤ 27
Byte 21	Hex	X'28' X'50'	X'50'	X'50'	X'50'	X'50' X'84'
	Col	40 80	80	80	80	80 132

If the Bind specifies an invalid number of columns, or if the number of rows is greater than the maximum row specified (above) for each model, the Bind will be rejected. Buffer wrap will occur at the end of the row specified in byte 20.

When bits 1 through 7 of byte 24 are coded b'0111111', a dynamic switch can be made during the session between a default screen size and an alternate screen size. When byte 24 is coded in this way, bytes 20 through 23 define the default and alternate screen sizes.

Valid codings of these bytes are as follows:

		Model 1	Model 2	Model 3	Model 4	Model 5
Bytes 20 and 22	Hex	≤ X'0C'	≤ X'18'	≤ X'20'	≤ X'2B'	≤ X'1B'
	Row	≤ 12	≤ 24	≤ 32	≤ 43	≤ 27
Bytes 21 and 23	Hex	X'28' X'50'	X'50'	X'50'	X'50'	X'50' X'84'
	Col	40 80	80	80	80	80 132

The Bind is rejected if an invalid number of columns is coded in the Bind image or if the number of rows is greater than the maximum row value shown for each model (above). When in alternate-size mode, the display will wrap at the end of the row specified in byte 22 of the Bind image. When in default-size mode, the screen will wrap at the end of the row specified in byte 20 of the Bind image.

Once the Bind has taken place, the display is cleared and set to the default screen size and format. Request/Response Units (RUs) that contain SBA, RA, or EUA orders with addresses out of the range of the default screen size are rejected with -RSP (1005) (address out of range) response. Data will wrap at the default screen boundary whether input by the operator or from the outbound data stream, and wrapping will occur at the default screen boundary as defined for all other 3270 operations (for example, Erase All Unprotected, Read Buffer).

The Erase/Write Alternate command dynamically switches the display to the specified alternate screen size. Note that, on a Model 2 display, the Erase/Write Alternate command performs no meaningful function.

If bound to dynamically switch, the device assumes the characteristics of a display with the alternate screen size, upon receipt of an Erase/Write Alternate command. RUs that contain SBA, RA, or EUA orders that have addresses out of the range of the valid alternate screen size are rejected with -RSP (1005) (address out of range).

Write, Erase/Write, and Erase/Write Alternate Commands (LU Type 3)

Both 3287 and 3289 printers can operate as LU type 3, and extended LU type 3. Commands and orders used by LU type 2 are applicable to LU type 3 and extended LU type 3 except for the read-type commands: Read Buffer, Read Modified, and Read Modified All. Read-type commands are rejected with -RSP (1003) (invalid command code).

LU type 3 operations are directed by write-type commands. As specified in the Bind, printers that function as base LU type 3 operate as 480- or 1920-character devices, and printers that function as extended LU type 3 operate with alternate buffer sizes of 960, 1920, 2560, 3440, or 3564 characters, or the full physical buffer. The alternate size is established by an Erase/Write Alternate command, and the default size is established by an Erase/Write command. Loss of power at the printer or the control unit or unbinding the session returns the printer to the default buffer size.

The WCC for LU type 3 and extended LU type 3 is shown in Figure 1-11. The function of bits 2, 3 (Printout Format), 5 (Sound Alarm), and 7 (Reset MDT bits) is the same as for LU type 2. When bit 4 (Start Print) is set to 1, the printer buffer content is printed after completion of the data transfer. Otherwise, printing does not occur after completion of the data transfer.

Buffered printers that operate as LU type 3 employ the format shown in Figure 1-12 as part of the Bind operation.

Byte 24 establishes the buffer size for both base and extended LU type 3 operations. The base LU type 3 operation supports a 480- or 1920-character buffer only, using the Erase/Write command. To use larger printer buffer sizes, the Bind must specify Extended LU type 3 operation.

The Erase/Write Alternate command is accepted in base LU type 3, but it is processed as an Erase/Write command. No state change occurs. All 3287s and 3289s can be bound with b'0000001' or b'0000010'.

When bits 1 through 7 of byte 24 are coded b'0000000', the entire print buffer can be used, regardless of size. Buffer wrap occurs at the end of the physical buffer. An Erase/Write Alternate command is processed as a normal Erase/Write command. No state change occurs.

When coded b'1111110', byte 24 indicates extended LU type 3 operation with the buffer size coded in bytes 20 and 21. Buffer size switching is not allowed. Bytes 22 and 23 are ignored. When an Erase/Write Alternate command is encountered in the data stream, it is interpreted as a normal Erase/Write command.

Byte	Bit	Content	Description
19	0-7	Reserved	
20	0-7	X'0C' X'18' X'1B' X'20' X'2B'	Default number of rows 12 24 27 32 43
21	0-7	X'28' X'50' X'84'	Default number of columns 40 80 132
22	0-7	X'0C' X'18' X'1B' X'20' X2B'	Alternate number of rows 12 24 27 32 43
23	0-7	X'50' X'84'	Alternate number of columns 80 132
24	0 1-7	Reserved Session Buffer Size b'0000000' b'0000001' b'0000010' b'1111110' b'1111111'	Extended LU3 uses all available buffer space. No size is specified. Base LU3, 12 x 40 Base LU3, 24 x 80 Extended LU3 static buffer size is defined in bytes 20, 21. Extended LU, alternate sizes are indicated in bytes 22, 23.
All other values are reserved and cause the Bind to be rejected with X'0821'.			

Figure 1-12. LU Type 3 Buffer Size Bind Format

When byte 24 is coded b'1111111', bytes 22 and 23 are inspected to determine the maximum alternate buffer size to be used during the session; for example, a Bind for 32 rows of 80 characters each permits the use of programs written for 960-, 1920-, and 2560-character buffer sizes. (If programs written for 132-character columns are used, byte 22 must be interpreted differently.) This assumes that programs do not depend upon buffer address wrap during write operations.

If the printer cannot support the required buffer size, the Bind is rejected with a -RSP (0821) response parameter error. A 3287 with a basic 2K buffer cannot, for example, accept an LU 3 Bind specifying a 2560-character buffer. The 3274 supports any column count within the constraints of the above row/column product. The row/column product determines the print buffer wrap point. Print control is managed by the WCC and not by the Bind parameter values.

Write Structured Field (WSF) Command, Function Management Header 1 (FMH1), and Structured Field Functions

For 3270 systems in the SNA/SDLC environment (LU Types 2 and 3 sessions), the BSC environment, and locally attached systems, the WSF command and its associated structured field functions provide the mechanism for:

- Combining eligible 3270 commands and structured field functions in a single transmission to terminals supporting SFAP (3270DS structured field).

- Loading symbol definition data into a specified terminal storage (Load Programmed Symbols structured field).
- Querying a terminal as to its characteristics (Read Partition-Query structured field).
- Setting default or alternate buffer sizes.
- Specifying the type of inbound transmission wanted, and allowing/disallowing operator selection of color, extended highlighting, and symbol-set characteristics for keyed-in data (Set Reply Mode structured field).

For LU type 1 sessions, a Function Management Header Type 1 (FMH1) and structured field functions (Load Programmed Symbols, Read Partition-Query, SCS Data) provide the mechanism for support of the Structured Field and Attribute Processing (SFAP) option in an SCS data stream.

WSF Command

The WSF command must be the first item in any structured-field transmission. The length field of the first structured field follows immediately. An exception is the D unit where the length field is the first item.

Command chaining involving the WSF command is not allowed, except after a Select Write (WRT) command.

In processing a structured-field transmission, the 3274, except for the Read Partition-Query structured field, does not check for multiple transmissions of a specific structured-field type. When the same type of structured field appears more than once in the transmission, the last occurrence of the field sets the values used.

A WSF transmission does not change printer allocations.

If a WSF transmission is sent to a controller and device not configured or featured for structured-field and attribute processing, an Op Chk or negative response (X'1003') is returned.

Function Management Header 1 (FMH1)

To direct a structured field data stream to a printer in LU type 1 session, an FMH1 is used, rather than the WSF command, to indicate the beginning of a structured field data stream. The format header indicator in the Bind command (byte 6, bit 1) must specify function management header included. The FMH1 format accepted by the 3274 is X'0601000B6000'. A data stream, with a properly specified Bind command (byte 6 bit 1 set to 1) and an FMH1 in the format just described, directed to a printer equipped for SFAP support, will be accepted by the 3274. For other printers, the Bind with byte 6 bit 1 set 1 will be rejected with sense code X'0821'.

A data stream containing a Bind with byte 6 bit 1 set to 0 and an FMH1 is rejected with sense code X'400F'.

Structured Field Functions

Structured fields, whether outbound or inbound, have the following general format: length—type—parameters and data.

The length-field value includes the 2 bytes of the length field. A length-field value of zero causes the structured field to be treated as the last structured field in the transmission.

The type field identifies the purpose of the structured field, and the parameters and data that follow are variable, depending on the structured-field type.

3270DS Structured Field. The 3270DS structured field is used to transmit Write, Erase/Write, Erase/Write Alternate, Erase All Unprotected, or BSC Copy commands as part of a 3270 structured field data stream containing other structured field functions (for example, the LPS structured field).

The 3274 Control Unit Models 1 and 31A, C, and D and 51C support the 3270DS structured field when Configuration Support C is installed.

Each 3270DS structured field encountered in the data stream is processed to completion before operations are started on a succeeding structured field.

A format description and explanatory notes for the 3270DS structured field follow.

Byte	Bit	Content	Meaning
0, 1	—	X'nnnn'	Length of structured field
2	—	X'40'	3270DS identifier
3 ¹	—	X'00'	Mandatory; checked. Any other value is rejected with SNA sense code X'1005' or non-SNA Op Chk.
4 ¹	—	—	3270 command codes. Byte 4 values are checked. Any value other than those shown results in rejection with SNA sense code X'1003' or non-SNA Op Chk. Error checking for the 3270 command specified is the same as for the command when not enclosed in a structured field.
		X'F1'	Write

¹ If bytes 3 and 4 are missing, an SNA sense code of X'1005' or a non-SNA Op Chk. is returned.

Byte	Bit	Content	Meaning
		X'F5'	Erase/Write ²
		X'7E'	Erase/Write Alternate ²
		X'6F'	Erase All Unprotected
		X'F7'	Copy (BSC) ³
5	—	X'nn'	Byte 5 contains the Write Control Character (WCC) ⁴ for the Write command (X'F1', X'F5', X'7E'), or the Copy Control Character (CCC) for the BSC Copy command (X'F7').
6	—	X'nn'	The "From" address for the BSC Copy command; or the start of 3270 data stream order and data associated with the Write commands.
7-n	—	X'nn...'	Orders and data continued (Write commands)

² If no WCC is defined, no erasing or resetting occurs.

³ See page 1-28

⁴ See page 1-28

The BSC Copy command must meet the following requirements to be valid in a 3270DS structured field. An Op Chk will be returned if they are not met.

- The communications must be BSC.
- The 3270DS structured field carrying the BSC Copy command must be the last structured field in the transmission.

The same rules apply to the BSC Copy command in the 3270DS structured field as cited for the command when used in a nonstructured field 3270 data stream.

If the 3270DS structured field carrying the BSC Copy command is sent to an SNA configured controller, SNA sense code X'1003' is returned.

When a data stream contains multiple 3270DS structured fields, and thereby multiple WCCs, the WCC functions will be executed as defined below.

RESET	Executed in each structured field as it is encountered.
START PRINT	Executed at the end of the transmission, after the write operation has been completed. Only the last structured field in the transmission may have a WCC that specifies Start Print. If the Start Print bit is set in any of the other structured fields, the WSF will be rejected with SNA sense code X'1001' (RU Data error) or non-SNA Op Chk.
SOUND ALARM	Executed for each structured field at the end of the operation specified for the structured field.
KEYBOARD RESTORE	Examined for each structured field and noted if set to restore. The keyboard will be unlocked if the WCC byte in one of the 3270DS structured fields was set to unlock. The keyboard will not be unlocked until the end of transmission is processed.
RESET MDT	Executed for each structured field containing a Write command, prior to writing any data or executing any orders in the data stream. The bit is ignored on an Erase/Write or Erase/Write Alternate command.

ERASE/RESET Structured Field. This outbound structured field can be used to set the buffers of devices capable of default or alternate buffer size operation to either the default or alternate size, for example, in the case of a 3278 display (Model 4) either 1920-character capacity or 3440-character capacity.

Execution of the function sets the buffer to the specified size and leaves the device in its base or power-on state.

The format of the ERASE/RESET structured field is:

Byte	Bit	Content	Meaning
0-1	—	X'0004'	Length of structured field
2	—	X'03'	ERASE/RESET identifier
3	0	b'0'	Set buffer to default size
		b'1'	Set buffer to alternate size
	1-7	Reserved	Must be set to b'0000000'. If not, negative response X'1003' (SNA) or an Op Chk (BSC) is returned.

Load Programmed Symbols Structured Field. This structured field is used to load symbol definition data into loadable terminal storage. (The *Color and Programmed Symbols* publication, GA33-3056, describes Programmed Symbols capability, applications, and programming support.)

Terminals configured to support Programmed Symbols can have up to six loadable storages (IDs of X'02' to X'07', correlating to the attribute selection keys PS-A to PS-F).

To accommodate multiple colors within a single-character location, some of the loadable terminal storages are provided with three primary color planes. Storage X'05' on the 3287 Models 1C and 2C and storages X'04', X'05', and X'07' (PS-C, PS-D, and PS-F) on the 3279 Models 2A and 3A are triple-plane storages.

The storage ID and a unique symbol-set ID [Coded Graphic Local Identifier (CGLI)] are specified in the structured field, and the controller logic keeps track of the association. When the symbol set ID shows up in SA, SFE, or MF orders as a Programmed Symbols attribute value, the symbol set is accessed in the specified storage.

A Programmed Symbol set contains up to 190 symbol definitions and a space code point (X'40'). Code points X'41' to X'FE' correlate to the 190 possible symbols. Note that not all code points can be invoked from a keyboard, only those permitted by the keyboard/language combination installed.

The skip suppression facility (specified in byte 3, bit 2) provides for suppression of the vertical spacing between character cells. If specified, skip suppression is applied any time the symbol set ID appears as an attribute value, effective with the next row of cells. Suppression is by row; that is, the symbol set ID of the symbol set specifying suppression must appear as an attribute value in each row if skip suppression is wanted. Specification of another symbol set with skip suppression off, or default to the base character set, normally stops skip suppression with the next row. However, when the base character set is selected by default and the change occurs when the field attribute and extended field attribute are associated with the first character position in a row, skip suppression will not turn off until the next line plus one.

Note: Skip suppression is available on the 3278 Model 2, the 3279 Model 2B, and the 3287 Models 1C and 2C.

This structured field has a basic and extended form, as follows. The basic form consists of a 7-byte header (bytes 0–6) and n bytes of symbol definition data. The extended form consists of an up to 6-byte extension to the basic header (bytes 7–12) that provides additional information associated with copy operations and color, followed by n bytes of symbol definition data.

Byte	Bit	Content	Meaning
0, 1	—	X'nnnn'	Length of structured field, including extension if present.
2	—	X'06'	LPS structured field identifier.

Byte	Bit	Content	Meaning
3	0	b'0'	Basic format. No extension present.
		b'1'	Format extension present. (Bytes 7–12.)
	1	b'0'	Do not clear the specified terminal storage (byte 6) prior to loading. This enables symbol definitions to be added to an existing set.
		b'1'	Clear the specified terminal storage (byte 6) before loading the symbol definitions in this structured field. The entire storage is cleared of any existing symbol definitions. If this PS set is part of a triple-plane set, only the plane(s) indicated in byte 12 (extension) is(are) cleared.
	2	b'0'	Skip suppression off. Normal row spacing (vertical) in effect.
		b'1'	Skip suppression on. The next row will be positioned adjacent to the current row, with no spacing (vertical) between rows.
	3	b'0'	Must be b'0'. Other values are rejected with negative response (X'1003') or Op Chk.
	4–7	X'1'	<p>The symbol definition data in this is display type 1; each symbol definition specifies the dot pattern to be displayed in a 9-dot-wide-by-16-dot-deep block matrix. The definition consists of 18 bytes of data, the first two bytes defining a 16-bit vertical slice of the matrix (left side) and the following 16 bytes representing sixteen 8-bit horizontal slices (top to bottom) of the matrix.</p> <p>Definitions for the 9 x 16 block matrix are always assumed. When the display uses only a 9 x 12 block matrix, the last four bits of the 16-bit vertical slice and the last four 8-bit slices are ignored.</p>
		X'2'	Display type 2. Display type 2 is the Display type 1 definitions in compressed form. See Appendix K for compression discussion.

Byte	Bit	Content	Meaning
		X'5'	The symbol definition data is printer type 5. Each symbol definition specifies the dot pattern to be displayed in a 10-dot-wide-by-8-dot-deep block matrix. The definition consists of 10 bytes of data, each representing an 8-bit vertical slice of the matrix. Bit 1 of byte 1 represents the upper-left dot in the matrix. Byte 10 represents the right-hand side of the matrix.
		X'6'	Printer type 6. Printer type 6 is the printer type 5 definitions in compressed form. The 3274 Control Unit, with Configuration Support C, will decompress the data for LU type 3 devices. See Appendix K for compression discussion. Values other than X'1', X'2', X'5', or X'6' in bits 4-7 are not accepted. A negative response (X'1003') or Op Chk results.
4	—	X'nn'	Programmed Symbol set identifier; valid values are X'40' to X'EF'. The controller associates this ID with the terminal storage ID specified in byte 6. This ID is used in SFE, MF, and SA orders as a Programmed Symbol attribute value. An X'FF' in this byte causes the control unit to mark the storage specified in byte 6 as "free" and effectively blocks any further reference to the symbol set. Invalid values cause a negative response (X'1003') or Op Chk.
5	—	X'nn'	X'nn' is an EBCDIC I/O interface code point in the range X'41' to X'FE. Invalid code points cause a negative response (X'1005') or Op Chk. The code point correlates with a symbol-definition data slot in the Loadable terminal storage, and the symbol definitions are loaded into slots correlated with contiguous EBCDIC code points, starting with the slot pointed to by X'nn'. Loading continues until (1) a positive response indicates that loading ended on a matrix boundary or (2) a negative response indicates that loading did not end on a matrix

Byte	Bit	Content	Meaning
			boundary, that code point X'FE' has been overrun, or that algorithm conditions for decompression were not met.
6	—	X'nn'	Loadable terminal storage ID in the range X'02' to X'07'. These values equate with the PS attribute selection keys PS-A through PS-F, respectively. Invalid IDs or a valid ID not loaded causes a negative response (X'084C') or Op Chk. Symbol definition data follows this byte unless extended form LPS.
7	—	X'nn'	Length specification for extended form, including this length parameter itself. If X'nn' is X'00' or a value greater than X'06', a negative response (X'1005') or Op Chk is returned. Bytes 7 through 12 compose the LPS extension, and the parameters may be progressively included by specifying the appropriate length. Omitted parameters are equated to X'00', and the effect is the same as receiving a byte containing X'00'.
8	0	b'0'	All dots available for display or printing.
		b'1'	Fewer than all dots may be displayed or printed.
	1	b'0'	For a local copy operation, the ID of this symbol set (byte 4) is compared with symbol-set IDs in the printer. If there is a match, the copy is performed using the corresponding symbol set in the printer. If there is no match, the characters of the interface code in the printer's read-only storage are used.
		b'1'	Symbol set IDs are not compared. Characters from the interface code in the printer's read-only storage are used.
2	b'0'	This symbol set is keyboard-selectable. The PS key corresponding to the storage specified in byte 6 is enabled.	

Byte	Bit	Content	Meaning
		b'1'	This symbol set is not keyboard-selectable; it is intended for output only. The PS selection key cannot be enabled while this storage and the specified symbol set (byte 4) are associated.
	3–7	b'00000'	If bits 3–7 are not zero, a negative response (X'1003') or Op Chk is returned.
9, 10	—	X'nn'	Bytes 9 and 10 are the horizontal (9) and vertical (10) dot specification for the block matrix size of symbols in the set. If specified, byte 9 must be X'0A' for printers and X'09' for displays, and byte 10 must be X'08' for printers and X'10' for displays. These values are assumed if bytes 9 and 10 are not specified or are set to zero. A negative response (X'1005') or an Op Chk is returned for values other than the above.
11	—	X'00'	If not X'00', a negative response (X'1003') or Op Chk is returned.
12	0–4	b'00000'	Must be 0. Other values cause a negative response (X'1003') or Op Chk.
	5–7	b'000'	When loading triple-plane terminal storages, b'000' causes the symbol definitions for each code point to be loaded in all three planes.
		b'001'	Load the symbol definitions in the blue plane.
		b'010'	Load the symbol definitions in the red plane.
		b'100'	Load the symbol definitions in the green plane.
			Any other values in bits 5–7 cause a negative response (X'084C') or Op Chk. Symbol definition data follows this byte.

Set Reply Mode Structured Field. This structured field defines the format of inbound data streams generated in response to Read commands and specifies the character attributes (Color, Extended Highlighting, Programmed Symbols) that the operator may select for keyed data. Three inbound data stream formats can be set: field mode, extended field mode, and character mode. Character mode also controls operator selection of character attributes.

SF, SBA orders, field attributes, characters, and the graphic escape code (X'08') may be included in inbound field mode transmissions.

SFE, SBA orders, field attributes, extended field attributes, characters, and the graphic escape code (X'08') may be included in inbound extended field mode transmissions.

SFE, SBA, SA orders, field attributes, extended field attributes, character attributes, and the graphic escape code (X'08') may be included in inbound character mode transmissions.

The graphic escape code (X'08') is returned with a character (all modes) when the Programmed Symbols character attribute value indicates that the APL/Text storage contains the definition of the character.

The SRM structured field consists of a length specification, an identifier, a reply mode specification, and, if character mode is specified, attribute type specifications. Length is a minimum of 5 bytes. Byte and bit content and meaning are as follows:

Byte	Bit	Content	Meaning
0, 1	—	X'0000' or X'0005' to X'nnnn'	Length of structure.
2	—	X'09'	Set Reply Mode identifier.
3	—	X'00'	Reserved, must be zero. Other values result in negative response (X'1005') or Op Chk.
4	—	X'00'	Field mode.
		X'01'	Extended Field mode.
		X'02'	Character mode.
			Other values result in negative response (X'1003') or Op Chk.

Byte	Bit	Content	Meaning
5-7	—	X'nn' or X'nnnn' or X'nnnnnn'	Attribute list for character mode. Bytes 5-7 are effective only if X'02' was specified in byte 4. Any, or all, of the character attribute types — Color, Extended Highlighting, Programmed Symbols — may be listed. Values are: X'41' - Extended Highlighting X'42' - Color X'43' - Programmed Symbols Other values result in negative response (X'1003') or Op Chk.

SCS Data Structured Field (SCS Data)

The SCS Data structured field allows an SCS printer data stream to be included in the same chain of RUs as the other structured fields (Read Partition-Query, Load Programmed Symbols) that can be directed to a printer in an LU type 1 session.

The SCS print stream must be sent via SCS Data if any of the other structured fields are included in the transmission.

The syntax is:

Byte	Content	Meaning
0, 1	X'nnnn'	Length of structured field. If X'0000', indicates last or only structured field in transmission.
2	X'41'	SCS Data identifier.
3	X'00'	Mandatory. Any other value results in rejection and sense code X'1005' is returned.
4-n	data	The SCS printer data stream.

Read Partition (Query) Structured Field

The Read Partition (Query) structured field provides the mechanism for a host application program to inquire as to the color, highlighting, usable area, reply modes, and symbol-set characteristics of a terminal and to receive a reply. This field is valid only in outbound data streams and must be the only or last structured field in a Write Structured Field (WSF) transmission. The format of the Read Partition structured field is as follows:

Byte	Bit	Content	Meaning
0-1	—	X'0000' or X'0005'	Length field
2	—	X'01'	Structured field type
3	—	X'FF'	Mandatory
4	—	X'02'	Identifies this structured field as a query

If bytes 3 and 4 do not exist or bytes exist after byte 4, an Op Chk or sense code X'1005' is returned. If byte 3 does not contain X'FF' or byte 4 does not contain X'02', an Op Chk or sense code X'1003' is returned. If the SNA outbound chain does not contain a change direction indicator (CD) or *does* contain an end bracket indicator (EB), the chain is rejected with negative response X'0829'.

The response by the controller to the query is the transmission of a series of structured fields that describe the characteristics of the addressed terminal. Response is immediate when SDLC/SNA protocols are being used; response is given when the terminal is polled if BSC protocol is being used, and, in the case of the 3274 D units, when a Read Modified CCW is received.

When Read Partition-Query is received by a 3274 D unit as the last structured field in a WSF transmission, the 3274 control unit returns a status of DE and terminates the operation. The Time indicator in the Operator Information Area is turned on, and the keyboard is locked to prevent operator interference with the query reply. The keyboard is unlocked upon receipt of a Write type command with the keyboard restore bit set.

If Read Partition-Query is not the last structured field in the WSF transmission, or, if there is an error in the WSF data, a 3274 D unit terminates the operation with status of DE, UC and sets the operation check bit in the sense byte.

Following acceptance of the Read Partition-Query structured field, a 3274 D unit generates an asynchronous status of attention, requesting the host to issue a Read Modified command to obtain the query reply.

Orders and Attributes

Orders

Orders can be included in Write, Erase/Write, or Erase/Write Alternate command data streams, either alone or intermixed with display or print data. Two types of orders are available: printout format orders and buffer control orders. Printout format orders are initially stored in the buffer as data and are subsequently executed only during a print operation (see Chapter 2).

The following paragraphs describe buffer control orders, which are executed as they are received in the write data stream by the 3274; these orders are not stored in the buffer. Six buffer control orders (see Figure 1-13) are provided to position, define, and format data being written into the buffer, to erase selected unprotected data in the buffer, and to reposition the cursor; three buffer control orders are provided for managing the Color, Extended Highlighting, and Programmed Symbols attributes for fields and characters when the SFAP option is installed. Refer to "Structured Field and Attribute Processing Orders" discussed later in this section.

Start Field (SF) Order

This order notifies the control unit that the next byte in the write data stream is an attribute character. (The attribute character is described in Figure 2-5.) The control unit then stores the next byte (the attribute character) at the current buffer address. As the attribute character is stored, the control unit sets a control bit at that address; this bit identifies the byte as an attribute character during subsequent program or device operations with the buffer data.

Order Sequence	Byte 1 (Order Code)		Byte 2	Byte 3	Byte 4
	EBCDIC (Hex)	ASCII (Hex)			
Start Field (SF)	1D	1D	Attribute Character ¹		
Set Buffer Address (SBA)	11	11	1st Address Byte ³	2nd Address Byte ³	
Insert Cursor (IC)	13	13			
Program Tab (PT)	05	09			
Repeat to Address (RA)	3C	14	1st Address Byte ³	2nd Address Byte ²	Character to Be Repeated
Erase Unprotected to Address (EUA)	12	12	1st Address Byte ³	2nd Address Byte ²	

Notes:

1. Figure 2-5 shows attribute byte.
2. Appendix J lists the 2-byte code for each possible address. To be a valid address:
 - a. If the default size is used in BSC mode, the maximum buffer addresses are:
 - 3277-1, 3278-1: 479
 - 3277-2; 3278-2, -3, -4, -5; 3279-2, -3: 1919
 - 3178 C1, C2
 - b. If the alternate size is used in BSC mode, the maximum buffer addresses are specified by the device model number:
 - Model 1: 959
 - Model 2: 1919
 - Model 3: 2559
 - Model 4: 3439
 - Model 5: 3563
 - c. If the SNA/SDLC mode is used, the maximum default size and alternate size are the display size minus 1. The display size is defined in the Bind parameter.

Figure 1-13. Buffer Control Orders and Order Codes

When received by control units and terminals supporting the extended field attributes, the SF order causes the default value (X'00') for the Color, Extended Highlighting, and Programmed Symbols attribute types to be set in the extended field attribute buffer.

Note: The byte immediately following the SF order in the data stream is always stored as an attribute character, even when the byte is intended as an order or an alphanumeric data character.

During execution of a Read Buffer command, the control unit automatically inserts SF order codes in the read data stream immediately before each attribute character. This permits identification of the attribute characters by the program and also permits correct storage of attribute characters in the buffer if the read data is used for subsequent write operations.

Set Buffer Address (SBA) Order

This 3-byte order specifies a new buffer address from which write operations are to start or continue. Set Buffer Address orders can be used to write data into various areas of the buffer. An SBA order can also precede another order in the

data stream to specify the starting address for a PT, RA, SA, or EUA order; to specify the address at which an attribute byte is to be stored by an SF, or SFE order or modified by an MF order; or to specify the address at which the cursor is to be repositioned by an IC order.

If the SBA order specifies an invalid address (for example, greater than 479 for a 3277 Model 1 or 1919 for a 3277 Model 2), the write operation is terminated at this point.

When a Read Modified command is executed and an attribute character (initially sent to the device by writing an SF order) is detected with the MDT bit set, the CU inserts, in place of the attribute, an SBA code followed by the 2-byte buffer address of the first character in the modified field (attribute address + 1). This permits identification by the control unit of fields that are modified. When a Read Modified command is executed in a remote unit, this 3-byte sequence is always sent in the same text block. Remote units do not split this sequence between two successive blocks.

Insert Cursor (IC) Order

This order repositions the cursor to the location specified by the current buffer address. Execution of this order does not change the current buffer address. For example, if IC is issued when the current buffer address is 160 and the cursor is at location 80, the cursor is moved from location 80 and inserted at location 160. The current buffer address at the end of this operation would remain 160.

Program Tab (PT) Order

The PT order advances the current buffer address to the address of the first buffer location following the next unprotected attribute byte. If the PT is issued when the current buffer address is the location of an attribute byte of an unprotected field, the buffer address advances to the next location of that field (one location). In addition, if the PT order in the write data stream does not follow a control command, order, or order sequence such as WCC, IC, or RA (3-character sequence), nulls are inserted in the buffer from the current buffer address to the end of the field, regardless of the value of bit 2 (protected/unprotected) of the attribute character for the field. Whenever a character position is set to null by the PT order, the default value (X'00') for the Color, Extended Highlighting, and Programmed Symbols attribute types is set in the character attribute buffer. When the PT order follows a control command, order, or order sequence, the buffer content is not modified for that field.

The PT order stops its search at the last location in the buffer. If an attribute character for an unprotected field is not found by this point, the buffer address is set to location 0. (If the PT order finds an attribute character for an unprotected field in the last buffer location, the buffer address is also set to zero.)

To continue the search for an unprotected field, a second PT order must be issued immediately following the first one. Since the current buffer address was reset to 0 by the first PT order, the second PT order begins its search at buffer location 0. If the previous PT order was still inserting nulls in each character location when it terminated at the last buffer location, the new PT order will continue to insert nulls from buffer location 0 to the end of the current field.

Repeat to Address (RA) Order

The RA order stores a specified alphanumeric or null character in all buffer locations, starting at the current buffer address and ending at (but not including) the specified stop address. This stop address and the character to be repeated are identified by the three bytes immediately following the RA order in the write data stream, as follows:

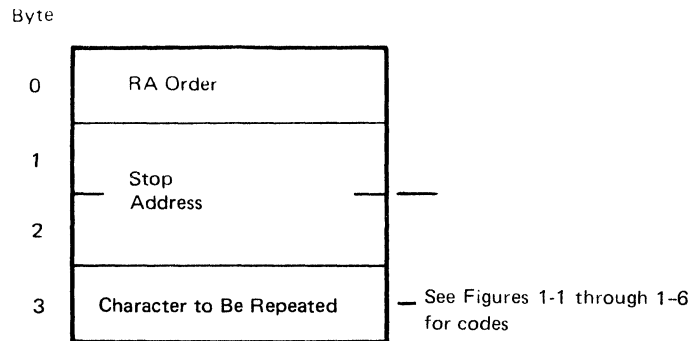

The third character following the RA order is always interpreted as the character that will be repeated. If an invalid stop address is specified, the write operation is terminated at this point without storing the character, and error status is generated. When Color, Extended Highlighting, or Programmed Symbols attributes are specified for the character, the attribute values are entered into the character attribute buffer as each repeated character is written in the data buffer.

When the stop address is lower than the current buffer address, the RA operation wraps from the bottom row of the buffer to the top row. When the stop address equals the current address, the specified character is stored in all buffer locations.

Attribute characters will be overwritten by the RA order if they occur before the RA order stop address.

Erase Unprotected to Address (EUA) Order

The EUA order inserts nulls in all unprotected buffer character locations, starting at the current buffer address and ending at, but not including, the specified stop address. This stop address is specified by 2 address bytes which immediately follow the EUA order in the write data stream. If an invalid address is specified, the write operation is terminated at this point and error status is generated. Whenever a character position is set to null by the EUA order, the default value (X'00') for the Color, Extended Highlighting, and Programmed Symbols attribute types is set in the character attribute buffer.

When the stop address is lower than the current buffer address, the EUA operation wraps from the bottom row of the buffer to the top row. When the stop address equals the current address, all unprotected character locations in the buffer are erased.

Attribute characters are not affected by the EUA order.

Structured Field and Attribute Processing Orders

Three orders—Start Field Extended (SFE), Modify Field (MF), and Set Attribute (SA)—are used to manage the Color, Extended Highlighting, and Programmed Symbols attributes for fields and individual characters. (Field attributes—protection, display, character type, etc.—can also be controlled by SFE and MF.) The SFE and MF orders are used to define and alter attributes as they apply to whole fields; the SA order sets the Color, Extended Highlighting, and Programmed Symbols attributes as they apply to individual characters. All three orders make use of a “type value” pair (2 bytes) to define the type of attribute (field, Color, Extended Highlighting, Programmed Symbols) and the setting. (Attribute types and values are discussed later on.) These orders can be included in Write, Erase/Write, or Erase/Write Alternate command data streams, alone or intermixed with display and print data.

Start Field Extended (SFE) Order. The Start Field Extended (SFE) order (hex code 29) is used to define the start of a field and to assign field, Color, Extended Highlighting, and Programmed Symbols attributes to the field.

The format of the order is “X’29’—number of type/value pairs-type-value-type-value . . . type-value”. The first byte after the order specifies the number of type/value pairs following; *type* is any of the 4 attribute types that can be specified; and *value* is the setting for the type.

Any permissible attribute type not specifically defined in the order has its value set to binary zeros. When specified more than once in the SFE order, the *last occurrence* of an attribute type and value determines the setting. If the number of type/value pairs is specified as zero, all attribute types are set to their default values.

Attribute values that are unknown or cannot be maintained and returned inbound are rejected with an Op Chk in non-SNA protocol, or, for Color and Extended Highlighting in SNA protocol, a negative response of X’1003’, or, for Programmed Symbols, X’0863’.

This order causes a field attribute byte to be generated at the current buffer position.

Modify Field (MF) Order. The Modify Field (MF) order (hex code 2C) is used to selectively change field, Color, Extended Highlighting, and Programmed Symbols attributes at the current buffer address. The current buffer address must be that of a field attribute byte; otherwise, the order is rejected with an Op Chk in non-SNA protocol, or a negative response of X’1005’ for SNA protocol. Only the attribute types specified in the order are changed.

The format of the order is “X'2C'—number of type/value pairs-type-value-type-value . . . type-value”. The first byte after the order specifies the number of type/value pairs following; *type* is one of the four attribute types specifiable in the MF order; and *value* is the setting for the type. (See “Attribute Types and Values.”)

At the completion of order processing, the current buffer address is incremented by 1.

If the number of type/value pairs is specified as zero, no change is made to any of the attributes and the current buffer address is incremented by 1. However, the current buffer address must still be that of a field attribute.

When specified more than once in an MF order, the *last occurrence* of an attribute type and value determines the setting.

Attribute values that are unknown or cannot be maintained and returned inbound are rejected with an Op Chk in non-SNA protocol, or, for Color and Extended Highlighting in SNA protocol, a negative response of X'1003', or, for Programmed Symbols, X'0863'.

Set Attribute (SA) Order. The Set Attribute (SA) order (hex code 28) is used to change the Color, Extended Highlighting, or Programmed Symbols attributes applicable to the character at the current buffer address, or to set these attribute types to their default value. Attributes set for the character at the current buffer address are applied to the current and subsequent characters in the data stream until another SA order is encountered or the attributes are reset by a write type command or power-on-reset. Color, Extended Highlighting, and Programmed Symbols attributes set at the character level override the same attributes set at the field level.

The format of the order is “X'28'-type-value” (3 bytes). *Type* is one of the four attribute types specifiable in the SA order, and *value* is the setting for the type. (See “Attribute Types and Values.”) If more than one attribute type is to be changed, more than one SA order can precede the character in the data stream.

An Erase/Write or Erase/Write Alternate command resets the data buffer to nulls and each attribute associated with the nulled characters to its default value.

An SA order is generated and inserted in the inbound data stream only when the *attribute value* of an attribute type that has been specified in the Set Reply Mode structured field changes. The assumption is made that the Color, Extended Highlighting, and Programmed Symbols attribute types are all set to their default values at the beginning of the inbound transmission. The first SA order generated will be for the first attribute not equal to its default value. (See “Set Reply Mode Structured Field” in the discussion of the Write Structured Field command.)

Attribute values that are unknown or cannot be maintained and returned inbound are rejected with an Op Chk in non-SNA protocol, or, for Color and Extended Highlighting in SNA protocol, a negative response of X'1003', or, for Programmed Symbols in SNA protocol, a negative response of X'0863'.

Attribute Types and Values. The following attribute types and values are used in the Start Field Extended, Modify Field, and Set Attribute orders. Type codes other than those given here are rejected with an Op Chk (non-SNA) or a negative response of X'1003' (SNA).

Attribute Type	Code	SFE, MF Orders	SA Order
Character Attribute reset	X'00'	—	x
Field Attribute	X'C0'	x	—
Extended Highlighting	X'41'	x	x
Color	X'42'	x	x
Programmed Symbols	X'43'	x	x

The x indicates that the type code is valid when used in the order.

Valid attribute values for each code are as follows:

Type Code	Values	Result
X'00'	X'00'	This is the only valid setting for this attribute type. This type/value pair is used only with the SA order. All character attributes specifiable in SA order are set to default value.
X'C0'		The codes appearing here are determined by the field attributes desired. See Figure 2-5 for a breakdown of the field attribute byte.
X'41'	X'00' X'F1' X'F2' X'F4'	Default. See Figure 1-14. Blink Reverse video Underscore
X'42'	X'00' X'F1' X'F2' X'F3' X'F4' X'F5' X'F6' X'F7'	Default. See Figure 1-14. Blue Red Pink Green Turquoise Yellow White for 3279, black for 3287, multicolor for triple plane symbol
X'43'	X'00' X'40' X'EF' X'F1'	Default. See Figure 1-14. Valid range for symbol-set IDs assigned in the Load Programmed Symbols structured field. Symbol-set ID for the APL/Text symbol set in terminal storage ID X'01'. This is the only non-loadable symbol set supported, and this attribute value may only be used in the SA order. If X'F1' is received in an SFE or MF order, an Op Chk or negative response of X'1005' is returned.

Attribute Defaults: Default conditions for the attribute types field (Color, Extended Highlighting, and Programmed Symbols) are described in Figure 1-14.

Attribute Type	Default Condition		
	Field Attribute	Character Attribute	
		Screen	
		Formatted	Unformatted
Field	Unprotected, A/N, display, non-detectable, MDT bit off	Not applicable	Not applicable
Color	3279 ¹ 3278 – green 3287 – black ²	Inherit field color	3279 ¹ – green 3278 – green 3287 – black ²
Extended Highlighting	None	Inherit field highlight	None
Programmed Symbols	Nonloadable character set in read-only storage.	Inherit field specified Programmed Symbol	Nonloadable character set in read-only storage.

¹ If the base color switch is set to color and the data stream contains any attribute type-color (X'42') specification, or the Set Reply Mode (SRM) function has set character mode with color as the reply mode, then the base color switch setting is overridden, and the field default display color is green (white if the field is intensified). (See the reset matrix in Figure 1-10 for the actions that cancel the override of the base color switch.)

² If feature 9136 is installed – green

Figure 1-14. Attribute Defaults

The Color, Extended Highlighting, and Programmed Symbol set attributes always assume the default condition when code X'00'. Character attributes assume the field setting (if defined); otherwise, the character attributes are as noted above for field attribute default.

Read Commands

Three read-type commands are executed by the 3274. Read Buffer, Read Modified, and Read Modified All. Read Buffer causes the entire buffer contents of the addressed terminal to be read into main storage. The operation initiated by Read Modified is determined by display station operator actions. The information read during execution of Read Modified or Read Modified All could consist of fields of data modified by keyboard operations, data entered by magnetic reading devices, buffer addresses, or data of selector light-pen or CURSR SEL fields, or the code of a Program Function or Program Access key.

In remote BSC configurations, reading is normally accomplished by a General or Specific Poll sequence. In local configurations, an operator action that requires program interaction causes an attention interruption; the program would respond to this attention interruption with a read command. In remote, the 3274 cannot generate attention interruption. Instead, the host program should issue poll

sequences periodically. Upon receipt of a poll sequence, the 3274 BSC control unit initiates one of three operations:

1. If status and sense information is pending, this information is sent to the TCU.
2. If an operator action has occurred that requires reading by the program, and status and sense information is not pending, a control-unit-generated Read Modified command operation is performed.
3. If no operator action has occurred and status and sense information is not pending, the control unit sends End of Transmission (EOT) to the TCU, terminating the operation.

Programming Note: Unsolicited read commands are not recommended because the information read by these commands may be incomplete.

During a read-buffer or read-modified operation, when BSC line discipline is used, a SUB character (3F in EBCDIC, 1A in ASCII) is sent in place of any byte that has bad parity. Also, a Data Check sense condition is recorded. Normal transmission of the read data then continues until the usual ending point. At that time, the operation ends as follows: (1) in local, Unit Check is sent in the ending status byte; (2) in remote, the transmission is terminated with ENQ in place of ETX or ETB.

Read Buffer Command

Execution of the Read Buffer command causes all data in the addressed device buffer, from the buffer location at which reading starts through the last buffer location, to be transferred to main storage. This command is provided primarily for diagnostic purposes. The transfer of data begins:

1. From buffer address 0 if the Read Buffer command is unchained. Certain 3270 emulators also begin data transfer from buffer address 0 if the Read Buffer command is chained from a Sense, Select, No Operation, or Copy command.
2. From the current buffer address if the Read Buffer command is chained. Certain 3270 emulators only begin data transfer from the current buffer address if the Read Buffer command is chained from a Write, Erase/Write, Read Modified, or another Read Buffer command. Regardless of where the transfer of data begins, data transfer from the buffer will terminate when the last character location in the buffer has been transferred, or before the last character location has been transferred as follows: (1) in local configurations, when the channel byte count reaches 0 (in this case, the buffer address after termination is undefined); or (2) in remote configurations, when the last character of a text block has been transferred (described in Chapters 4 and 5).

The transferred data stream begins with a 3-character read heading consisting of the AID character followed by a 2-character cursor address. The contents of all buffer locations are transferred, including nulls. Start Field or Start Field Extended (SF, SFE) orders are inserted by the control unit to identify the beginning of each field.

The possible Attention Identification (AID) byte configurations are shown in Figure 1-15. An AID configuration other than 60 or E8 is set when the operator at the selected display station has performed an operation that requires program intervention. These operations are (1) pressing a Program Function or Program Access key, (2) reading a magnetic stripe, or (3) detecting on an attention field with the selector light pen or CURSR SEL key. The attribute character is shown in Figure 2-5.

Read Modified Command

Read Modified initiates one of three operations, as determined by operator actions at the display station: (1) Read Modified, (2) Short Read, or (3) Test or System Request Read. Figure 1-15 lists the operator actions and the resulting Read Modified command operation initiated by each action. Read Modified commands normally are not used for remote configurations since polling initiates a control-unit-generated read-modified operation if AID is generated and if status is not pending.

A major feature of Read Modified command operations is null suppression. The device buffer is cleared to all nulls when the operator turns power on or presses the CLEAR key, or when the erase portion of an Erase/Write command is executed at the selected device. Also, selected portions of a buffer can be cleared to nulls by the Erase All Unprotected command and certain orders. During Read Modified command operations, null codes are not sent.

Read Modified Operation

During a Read Modified command, if an AID other than selector-light-pen attention, the CURSR SEL key, a PA key, or the CLEAR key is generated, all fields that have been modified by a keyboard, the selector light pen, the CURSR SEL key, or the reading of a magnetic stripe are transferred to the program. All nulls are suppressed during data transfer and thus are not included in the read data stream. As a field is modified by the operator, the modified data tag (MDT) bit is set in the attribute byte for that field. Then, when a read-modified operation is performed, successive attribute bytes are examined for a set MDT bit. When the bit is found, the data in the associated field is read (with nulls suppressed) before the next attribute byte is examined.

The first 3 bytes of the read data stream are always the AID code (Figure 1-15) and the 2-byte cursor address; these bytes are called the "read heading."

AID	Hex Character (EBCDIC)	Hex Character (ASCII)	Graphic Character	Read Modified Command Operation	Resultant Transfer to CPU
No AID generated (Display or Display Station)	60	2D	—	Rd Mod (Unsolicited Read or Read Modified from Host)	If performing a remote polling operation, no read operation occurs; otherwise, field addresses and text in the modified fields are transferred.
No AID generated (Printer)	E8	59	Y	Rd Mod	
ENTER key and & (Selector-Light-Pen Attention)	7D	27	'	Rd Mod	AID code and cursor address, followed by an SBA order, attribute address +1, and text for each modified field. Nulls are suppressed.
PF 1 key	F1	31	1	Rd Mod	
PF 2 key	F2	32	2	Rd Mod	
PF 3 key	F3	33	3	Rd Mod	
PF 4 key	F4	34	4	Rd Mod	
PF 5 key	F5	35	5	Rd Mod	
PF 6 key	F6	36	6	Rd Mod	
PF 7 key	F7	37	7	Rd Mod	
PF 8 key	F8	38	8	Rd Mod	
PF 9 key	F9	39	9	Rd Mod	
PF 10 key	7A	3A	:	Rd Mod	
PF 11 key	7B	23	#	Rd Mod	
PF 12 key	7C	40	@	Rd Mod	
PF 13 key	C1	41	A	Rd Mod	
PF 14 key	C2	42	B	Rd Mod	
PF 15 key	C3	43	C	Rd Mod	
PF 16 key	C4	44	D	Rd Mod	
PF 17 key	C5	45	E	Rd Mod	
PF 18 key	C6	46	F	Rd Mod	
PF 19 key	C7	47	G	Rd Mod	
PF 20 key	C8	48	H	Rd Mod	
PF 21 key	C9	49	I	Rd Mod	
PF 22 key	4A	5B	¢	Rd Mod	
PF 23 key	4B	2E	•	Rd Mod	
PF 24 key	4C	3C	<	Rd Mod	
Operator Identification Card Reader	E6	57	W	Rd Mod	
Magnetic Slot Reader and Magnetic Hand Scanner	E7	58	X	Rd Mod	
Selector-Light-Pen Attention space null	7E	3D	=	Rd Mod	AID code, cursor address, and field addresses only; no data.
PA 1 key	6C	25	%	Short Rd	AID code only.
PA 2 (CNCL) key	6E	3E	>	Short Rd	
PA 3 key	6B	2C	,	Short Rd	
CLEAR key	6D	5F	—	Short Rd	
TEST REQ and SYS REQ keys	F0	30	0	Tst Req Rd	A test request message. AID transferred on Read Buffer only.

Note: Graphic characters for the United States I/O interface codes are shown. If a World Trade country I/O interface code is used, refer to IBM 3270 Information Display System: Character Set Reference, GA27-2837, for possible graphic character differences.

Figure 1-15. Attention ID (AID) Configurations

Following the read heading is the alphanumeric data of each modified field. The data for each field is preceded in the data stream by a Set Buffer Address (SBA) order code followed by the 2-byte buffer address of the first character position in that field (the attribute address + 1). Thus, the read data stream when data has been modified is as follows:

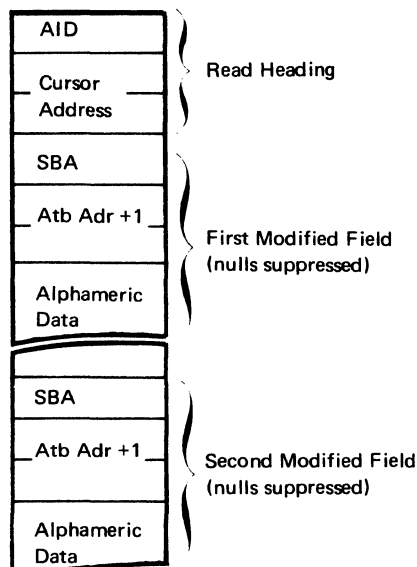

If a space or null selector-light-pen AID is generated, at a 3277 display, fields are not transferred to main storage during the read-modified operation. Instead, when a set MDT bit is found (indicating selector-light-pen and/or keyboard activity), only the Read Heading, the SBA order code, and the attribute address + 1 are transferred.

Note that if fields are modified by the keyboard but completion of the modification is signaled by a selector-light-pen-attention operation on other than ampersand character-designator fields, a resulting read-modified operation will read only the address of the modified fields, not the modified data. A Read Modified All command can be used to obtain both the address of, and the data in, each field that has the MDT bit set to 1.

The buffer location at which the search begins for attribute bytes that define modified fields is a function of command chaining. This location is:

1. Buffer address 0 if the Read Modified command is unchained or is chained from a Copy, Select, Sense, or No Operation command.
2. The current address if the Read Modified command is chained from a Write, Erase/Write, Read Modified, Read Modified All, or Read Buffer command.

The search for modified-field attribute bytes ends when the last buffer location is checked.

The transfer of read data is terminated as follows:

1. If the last modified field is wrapped from the last buffer (for example, 479 or 1919) to the first location, the operation is terminated after all data in the field is transferred (nulls are suppressed). The buffer address at the end of the operation is the address of the next attribute byte in the buffer. For

example, if a modified field extends from address 1900 (the attribute byte) to address 79 (wrapped field), the data from address 1901 through 79 is transferred (nulls are suppressed); in this case, the read operation is terminated with the buffer address set to 80 (the attribute byte of the next field).

2. If the buffer does not contain a wrapped modified field, and if the channel byte count has not reached zero (local operation only), the modified data stream is terminated when the last modified field is transferred; at the end of the operation, the buffer address is set to 0.
3. During 3274 B and D unit operations, if the channel byte count reaches zero before all modified data is transferred, read operations are terminated and the remaining modified data is not transferred. The buffer address after termination is undefined.

If the buffer is formatted (contains fields) but none of the fields have been modified, the read data stream consists of the 3-byte read heading only.

If the buffer is unformatted (contains no fields), the read data stream consists of the 3-byte read heading followed by all alphameric data in the buffer (nulls are suppressed), even when part or all of the data has not been modified. Since an unformatted buffer contains no attribute bytes, no SBA codes with associated addresses or address characters are included in the data stream, and the modification of data cannot be determined. Data transfer starts at address 0, regardless of command chaining, and continues to the end of the buffer. At the end of the operation, the buffer address is set to 0. This read operation can also be terminated by the channel byte count reaching zero before all data is read; in this case, the buffer address after termination is undefined.

Short Read

The Read Modified command causes a short read operation if the CLEAR, CNCL, or a PA key has been pressed at the selected device. During the Short Read operation, only an AID byte is transferred to main storage. This AID byte identifies the key that was pressed.

Test Request Read

This description applies only to units not using SNA protocol. The Read Modified command causes a Test Request Read operation if the TEST REQ (3277) or SYS REQ (3178, 3278, and 3279) key has been pressed at the selected device. The Test Request Read data stream sent to main storage is as follows:

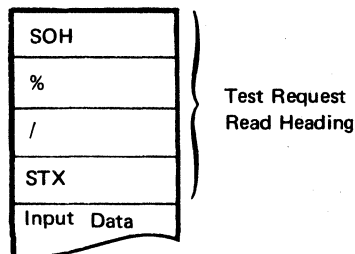

The Test Request Read heading is generated by the control unit. The remainder of the data stream is the same as described previously for read-modified operations, excluding the 3-byte read heading (AID and cursor address). If the

buffer is unformatted, all alphameric data in the buffer is included in the data stream (nulls are suppressed), starting at address 0. If the buffer is formatted, each attribute byte is examined for a set MDT bit. Each time a set MDT bit is found, the alphameric data in the field associated with that bit is sent to main storage (nulls are suppressed); if no MDT bits are set, the read data stream consists of the Test Request Read heading only. The buffer location at which the search for MDT bits begins and the transfer of data ends is the same as described for read-modified operations.

Test Request Read function usage is determined by the access method. Normally, the operator would (1) clear the display, (2) enter test request data in a predefined format, and then (3) press the TEST REQ or SYS REQ key.

Read Modified All Command

The Read Modified All command is used with the 3274 A and C units operating in SNA/SDLC protocol. This command operates like a Read Modified command except that both addresses and data from all modified fields are sent to the host, regardless of the AID byte generated. The Read Modified All command is not generated by the control unit in response to a poll sequence. It must be sent by the host.

Query Reply Structured Field

The response by the control unit to the Read Partition-Query function is the transmission of a series of structured fields indicating the field and character attributes, the screen or page size and characteristics, the symbol sets, the reply modes or features available on the addressed terminal. Up to seven structured fields can be transmitted: color, highlighting, usable area, reply mode, symbol set, IBM 3270 Personal Computer Attachment, and Implicit Partition. Since each structured field contains its own unique identification *the order in which the fields are transmitted is not important*. An example follows. After the example the individual structured fields are discussed.

The data stream sent in response to a Read Partition-Query structured field for a control unit with a device having an EAB is:

Query Reply	Function
X'88' or X'0601008B6000'	AID (X'0601008B6000' is the Function Management Header Type 1 (FMH1) required to transmit the Query Reply structured field inbound from a printer in an LU type 1 session.)
X'00168186Z008 (16 Z bytes)'	Color
X'000F818704 (8 Z bytes)'	Highlighting
X'00178181Z100 (17 Z bytes)'	Usable area
X'00078188000102'	Reply mode
X'00008185B000 (7 Z bytes)'	Character sets
X'03'	Number of bytes in descriptor
X'000000'	ROS 0
X'0100F1' (if present)	ROS 1 (ROS=Read-only storage)
X'02ZZtt' (if present)	RWS 2-PSA (RWS=Read/Write storage)
X'03ZZtt' (if present)	RWS 3-PSB
X'04ZZtt' (if present)	RWS 4-PSC

Query Reply	Function
X'05ZZtt' (if present)	RWS 5-PSD
X'06ZZtt' (if present)	RWS 6-PSE
X'07ZZtt' (if present)	RWS 7-PSF
X'000681930800'	IBM 3270 Personal Computer Attachment
X'001181A60000 (11 Z bytes)'	Implicit Partition

Where:

Z is a variable of the structured field that depends upon the device that is attached to the control unit.

tt is the symbol set ID for sets that have been host loaded. It is returned as X'FF' if the set is not loaded.

If a device has ECSA and ROS or RWS is not present in a ROS or RWS location, the descriptor for that location is not returned.

A Query Reply inbound data stream consists of AID byte X'88', or the FMH1 noted above, defining what follows as an inbound structured field data stream, followed by the structured fields. Each structured field is of the general format: length—type—data.

Note: Query Reply is the only structured field transmission sent inbound from a printer in LU type 1 or type 3 session.

Query Reply (Color) Structured Field

This Query Reply structured field indicates the color attribute values recognized by the addressed terminal and returned in an inbound data stream. Eight pairs of bytes, one pair for each of the possible color attribute values, are returned to the host. The first byte of a pair contains the color attribute value accepted; the second byte contains the same value if that color is supported by the terminal, or the default color attribute value (X'00') if it is not. There is one exception: the second byte of the pair defining the default color attribute for the terminal indicates the default color that will be supported.

The format of the Query Reply (Color) structured field is as follows:

Byte	Bit	Content	Meaning
0, 1	—	X'0016'	Length
2	—	X'81'	Query Reply structured field ID
3	—	X'86'	Identifies this query reply as color
4	0	b'0'	Reserved
	1	b'0'	Printer only; black ribbon not loaded
		b'1'	Printer only; black ribbon loaded
	2—7	b'000000'	Reserved
5	—	X'08'	Number of color pairs
6—21	(Terminal-dependent; see following.)		

Byte	Possible Attribute Value	2nd Byte			Full Color
		3178, 3278	3230, 3262, 3268, 3287-1,-2	3287-1C,-2C	
6, 7	X'00'	X'F4'	X'F7'	X'F7'	X'F4'
8, 9	X'F1'	X'00'	X'00'	X'F1'	X'F1'
10, 11	X'F2'	X'00'	X'00'	X'F2'	X'F2'
12, 13	X'F3'	X'00'	X'00'	X'00'	X'F3'
14, 15	X'F4'	X'00'	X'00'	X'F4'	X'F4'
16, 17	X'F5'	X'00'	X'00'	X'00'	X'F5'
18, 19	X'F6'	X'00'	X'00'	X'00'	X'F6'
20, 21	X'F7'	X'00'	X'00'	X'F7'	X'F7'

As an example, the following Query Reply (Color) structured field might be transmitted for a 3287 Model 1C and 2C printer:

X'00168186000800F7F1F1F2F2F300F4F4F500F600F7F7'

Query Reply (Extended Highlighting) Structured Field

This Query Reply structured field indicates the highlighting attribute values recognized by the addressed terminal and returned in an inbound data stream. Four pairs of bytes, one pair for each of the possible highlighting attribute values, are returned to the host. The first byte of a pair contains the highlighting attribute value accepted; the second byte contains the same value if that highlighting attribute is supported by the terminal or the default highlighting attribute value (X'00') if it is not. There is one exception: the second byte of the pair defining the default highlighting attribute support indicates the default highlighting that will be supported.

The format of the Query Reply (Extended Highlighting) structured field is as follows:

Byte	Content	Meaning
0, 1	X'0000' or X'000D'	Length of structure
2	X'81'	Query reply identifier
3	X'87'	Identifies this query reply as highlighting
4	X'04'	Number of highlighting pairs
5-12	(Terminal-dependent; see following. Note: <i>Possible highlighting attribute values are X'00'—default, X'F0'—normal, X'F1'—blink, X'F2'—reverse video, X'F4'—underscore.</i>)	

Byte	1st Byte		2nd Byte		
	Possible Attribute Value	3178	3278	3230, 3262, 3268, 3287-1,-2,-1C,-2C	3279
5, 6	X'00'	X'F0'	X'F0'	X'F0'	X'F0'
7, 8	X'F1'	X'00'	X'F1'	X'00'	X'F1'
9, 10	X'F2'	X'00'	X'F2'	X'00'	X'F2'
11, 12	X'F4'	X'00'	X'F4'	X'F4'	X'F4'

Query Reply (Usable Area) Structured Field

This Query Reply structured field indicates the size and characteristics of the screen or page of the addressed terminal. Screen or page size is expressed as width of usable area in characters (columns or print positions) and depth of usable area in characters (rows or print lines). [For a printer, the values returned correspond to the maximum print position (MPP) and maximum print line supported by the hardware, *not to the current settings if operator-specifiable.*]

The default size of the dot matrix block within which a character is presented is also defined.

The format of the Query Reply (Usable Area) structured field is as follows:

Byte	Bit	Content	Meaning
0, 1	—	X'0017'	Length of this structure
2	—	X'81'	Query reply identifier
3	—	X'81'	Identifies this query reply as "usable area".
4	0, 1	b'00'	Reserved
		b'0'	3270DS structured field supported
	b'1'	3270DS structured field not supported	
	3	b'0'	Not a hard-copy device
		b'1'	A hard-copy device
	4—7	b'0001'	14-bit addressing allowed
	4—7	b'1111'	If reply is from a device operating in LU type 1 mode.
5	—	X'00'	Reserved
6, 7	—	—	Width of usable area in characters (dot matrix blocks)
		X'50'	3178-C1,-C2, 3278-2,-3,-4
		X'50'	3279-2,-3
		X'84'	3230, 3262, 3268, 3278-5, 3287
8, 9	—	—	Depth of usable area in characters (dot matrix blocks)
		X'18'	3178-C1,-C2, 3278-2
		X'20'	3278-3
		X'2B'	3278-4
		X'1B'	3278-5
		X'18'	3279-2
		X'20'	3279-3
		X'66'	3287
X'7F'	3230, 3262, 3268		

Byte	Bit	Content	Meaning
10	—	X'00'	Unit of measure is the inch for distance between dots given for X and Y directions in bytes 11–14 and 15–18.
11–14	—	—	Dot spacing in the X (horizontal) direction, expressed as a fraction; 2-byte numerator/2-byte denominator; and measured in the units defined in byte 10.
		X'00000000'	3262
		X'00020089'	3178-C1,-C2, 3278-2,-3,-4
		X'00010071'	3278-5
		X'000A02E5'	3279-2,-3
		X'00010064'	3268
		X'000100A0'	3230
		X'00010064'	3287
15–18	—	—	Dot spacing in the Y (vertical) direction, expressed as a fraction; 2-byte numerator/2-byte denominator; and measured in the units defined in byte 10.
		X'00000000'	3262
		X'00020085'	3178-C1,-C2, 3278-2,-3,-4,-5
		X'0002006F'	3279-2,-3
		X'00010040'	3268
		X'000100A0'	3230
		X'0002008C'	3287
19	—	—	Default width of dot matrix block, in dots
		X'00'	3262
		X'09'	3178-C1,-C2, 3278-2,-3,-4,-5
		X'09'	3279-2,-3
		X'0A'	3268, 3287
		X'0C'	3230
20	—	—	Default depth of dot matrix block, in dots
		X'00'	3262
		X'10'	3178-C1,-C2, 3278-2,-3
		X'0C'	3278-4,-5
		X'0C'	3279-2,-3
		X'08'	3268, 3287
		X'12'	3230
21, 22	—	—	Character buffer size, in bytes. Buffer size is not reported for devices operating in LU type 1 mode.
		X'0780'	3178-C1,-C2, 3278-2 (1920)
		X'0A00'	3278-3 (2560)
		X'0D70'	3278-4 (3440)
		X'0DEC'	3278-5 (3564)
		X'0780'	3279-2 (1920)
		X'0A00'	3279-3 (2560)

Byte	Bit	Content	Meaning
		X'/nnnn'	3230, 3262, 3268, 3287—Dependent on installed buffer size (2K or 4K). Equivalent to display sizes except when byte 24 of an LU type 3 Bind command is set to X'00'. Wrap points for the physical buffer are then given as follows: 2K buffer — X'07B0' (1968) 4K buffer — X'0EB0' (3760) with PS feature installed 4K buffer — X'0FB0' (4016) no PS feature

Query Reply (Reply Mode) Structured Field

This Query Reply structured field indicates the form of inbound data stream that the addressed terminal supports.

The format is as follows:

Byte	Bit	Content	Meaning
0, 1	—	X'0007'	Length
2	—	X'81'	Query reply identifier
3	—	X'88'	Identifies this Query reply as "reply mode".
4	—	X'00'	Indicates that the terminal supports Field Mode inbound data streams.
5	—	X'01'	Indicates that the terminal supports Extended Field Mode data streams.
6	—	X'02'	Indicates that the terminal supports Character Mode data streams.

Query Reply (Symbol Sets) Structured Field

This Query Reply structured field indicates the number and kind of symbol sets (both user-defined and IBM-defined Programmed Symbol sets present in the terminal. The terminal storage ID is given as well as an indication of whether it is associated with a symbol set. The structured field consists of a 12-byte base and up to eight 3-byte storage descriptors, one for each storage area present in the terminal.

The format of the Query Reply (Symbol Sets) structured field is as follows:

Byte	Bit	Content	Meaning
0, 1	—	X'nnnn'	Length—includes any 3-byte symbol set descriptors present
2	—	X'81'	Query reply identifier
3	—	X'85'	Identifies this query reply as "symbol sets".

Byte	Bit	Content	Meaning
4	0	b'1'	Graphic escape supported
		b'0'	Graphic escape not supported
	1	b'0'	Reserved
		b'0'	Load Programmed Symbols structured field <i>not</i> supported
		b'1'	Load Programmed Symbols structured field supported
	3	b'0'	Load Programmed Symbols structured field extension <i>not</i> supported
		b'1'	Load Programmed Symbols structured field extension supported
	4	b'0'	Reserved
	5-7	b'000'	Reserved
5	—	X'00'	Reserved
6	—	—	Default dot matrix block width
		X'00'	3262
		X'0A'	3268, 3287
		X'0C'	3230
		—	Default dot matrix block width
7	—	X'09'	Display
		—	Default dot matrix block depth
		X'00'	3262
		X'08'	3268, 3287
		X'12'	3230
8-11	—	X'10'	Display
		X'40000000'	Display supports load PS data format type 1. (Will be X'60000000' if the 3274 has been customized to support decompression.)
		X'04000000'	Printer supports load PS data format type 5. (Will be X'06000000' if the 3274 has been customized to support decompression.)
12	—	X'03'	Length of each symbol-set descriptor which follows.

Descriptors (One or more descriptors follow byte 12; a descriptor defines one terminal storage and symbol-set characteristics.)

Byte	Bit	Content	Meaning
0	—		Terminal storage identification: X'00' to X'07'
		X'00'	Read-only storage containing I/O interface code symbol set.
		X'01'	Read-only storage containing APL/Text symbol set if feature present
		X'02' to X'07'	Host loadable terminal storages for Programmed Symbol sets. These storages are specified in the Load PS structured field.
1	0	b'0'	Read-only storage
		b'1'	Loadable terminal storage
	1	b'0'	Single-plane storage
		b'1'	Triple-plane storage
		b'0'	Symbols are accessed using a 1-byte code.

Byte	Bit	Content	Meaning
	3	b'0'	Comparison of the symbol set ID of the symbol set loaded in this storage with the symbol set ID(s) of sets loaded in the printer is allowed (copy operations).
		b'1'	Comparison is not allowed.
	4—7	b'0000'	Reserved
2		X'nn'	Symbol set ID. The ID is currently associated with the terminal storage ID contained in byte 0. Value range is X'40' through X'EF' for valid symbol ID. A value of X'FF' indicates that the storage is not associated with any symbol set.

Query Reply (IBM 3270 Personal Computer Attachment) Structured Field

The format of the 3270/PCAF Query Reply, indicating that the Personal Computer Attachment is present on the device, is:

Byte	Content	Meaning
0—1	X'0006'	Length
2	X'81'	Query reply ID
3	X'93'	Identifies this query reply as IBM 3270 Personal Computer Attachment.
4—5	X'0800'	Maximum size (bytes) of an individual file transfer message (2048 bytes).

The IBM 3270 Personal Computer Attachment can also be attached to a device without an EAB. The following Query Reply would be sent in response to the Read Partition-Query structured field:

Query Reply	Function
X'88'	AID
X'00178181Z100 (17 Z bytes)'	Usable area
X'000681930800'	IBM 3270 Personal Computer Attachment

Where:

Z is a variable of the structured field that depends upon the device that is attached to the control unit.

Query Reply (Implicit Partition) Structured Field

The Implicit Partition Query Reply structured field defines unique implicit partition characteristics.

Implicit Partition Default and Alternate Sizes:

- For SNA, the default and alternate sizes returned in this reply are those established at BIND.
- For non-SNA, the default and alternate sizes returned in this reply are those in effect at the time the reply is generated.

Format:

Byte	Content	Meaning
0-1	X'0011'	Length of structured field
2	X'81'	Query reply
3	X'A6'	Implicit partition
4-5	X'0000'	Reserved

Self-defining parameters follow:

Implicit partition sizes for display devices — 3278 and 3279 stations:

Byte	Content	Meaning
0	X'0B'	Parameter length
1	X'01'	Implicit partition sizes
2	X'00'	Reserved
3-4	WD	Width of default implicit partition size in cells
5-6	HD	Height of default implicit partition size in cells
7-8	WA	Width of alternate implicit partition size in cells
9-10	HA	Height of alternate implicit partition size in cells

The above elements of the Implicit Partition Query Reply structured field are generated and sent inbound in reply to a Query directed to any display device.

Implicit partition sizes for printer devices:

Byte	Content	Meaning
0	X'0B	Parameter length
1	X'03'	Implicit partition sizes
2	X'00'	Reserved
3-6	DPBS	Default printer buffer size in cells
7-10	APBS	Alternate printer buffer size in cells

The above elements of the Implicit Partition Query Reply structured field are generated and sent inbound in reply to a Query directed to any SNA LU type 3 or any non-SNA printer device.

The buffer size defines the following printer buffer restrictions:

1. The maximum linear character buffer address that can be explicitly specified in 3270 orders. (This maximum buffer address is one less than the buffer size in character cells.)
2. The wrapping point for the transmitted data. If the implied address for data being loaded into the character buffer exceeds the maximum address allowed by buffer size, then the implied address is reset to zero and loading continues from the first buffer location.

Note: For a BIND command with byte 24=0, the buffer sizes are decremented by 256 bytes if the printer has the Programmed Symbols (PS) feature.

Inbound Transmissions

Inbound transmissions result from an operator “enter” action, a host-initiated (unsolicited) read request, or a host retry of an inbound transmission.

An operator “enter” action is one that causes an attention identifier (AID) to be transmitted inbound. The host program responds with a read request. The host program must acknowledge the inbound transmission before a new inbound operation can be performed. (See “Host Acknowledgments” following.)

A host-initiated read operation is an inbound transmission not caused by an operator “enter” action. No host acknowledgment is required before a new inbound transmission can occur.

Host retry is a retransmission of the last unacknowledged inbound transmission from the device. The host must acknowledge reception of an inbound transmission before a “new” inbound transmission can take place. A host retry transmission does not cause read state transitions (read states are discussed following) and is not considered a “new” inbound transmission requiring host acknowledgment. Host retry occurs until a host acknowledgment takes place.

The type of inbound transmission is either a Query Reply structured field (the response to the Read Partition-Query structured field discussed earlier in this chapter), or data from the device buffer (for example, modified fields of the display image). An inbound operation device characteristic (INOP), set by the controller, defines the type.

Inbound Operation Device Characteristic (INOP)

The device characteristic INOP determines the operation to be performed when data is transmitted inbound on a retry transmission in SNA, BSC, or Local Attachment environments, or when the device is in a data pending state in a Local Attachment environment.

INOP is set by any of the following:

- An operator “enter” action sets INOP to Read Modified.
- Reception of a Read Partition-Query structured field sets INOP to Query.
- Host acknowledgment of an inbound transmission sets INOP to Read Modified.

INOP and the seven read states discussed next are used in the description of read command processing later in this chapter.

Read States

While powered on, a device is in one of seven states with respect to read operations. The three primary states are: Normal, Data Pending, and Retry. The data pending and retry states have three substates: Enter, Read, and Stacked Enter. The events that cause transitions between the states are shown in Figure 1-16, Parts A and B.

Events \ Read States	Normal ①	Retry	
		Enter⑤	Read⑥
"Enter" Action	⑤	R	R
Read Command	①	⑤	⑥
Read Partition-Query	⑥	R	⑥
Host Acknowledgment	—	①	①

Part A. SNA Environment – Read State Transitions

Events \ Read States	Normal ①	Data Pending			Retry		
		Enter②	Read③	Stacked Enter④	Enter⑤	Read⑥	Stacked Enter⑦
"Enter" Action	②	R	R	R	R	R	R
Read Command (BSC)	①	①	①	①	⑤	⑥	⑦
Read Command Local Attachment	①	⑤	⑥	⑦	⑤	⑥	⑦
Read Partition-Query	③	④	—	—	④	③	④
Poll (BSC)	—	⑤	⑥	⑦	—	—	—
Host Acknowledgment	—	①	①	②	①	①	②
Reset Key	—	①	—	—	①	—	—

Part B. BSC and Local Attachment (Non-SNA) Environment – Read State Transitions

Key: ① = Next state entered. Same state indicated means no transition.
 R = Reject, no state transition.
 — = No action, no state transition.

Figure 1-16. Read State Transitions

Normal Read State. A device is in Normal read state when powered on, or prior to initiation of a new read operation, or after use of the Reset key in certain instances (see Figure 1-16).

When in Normal read state, an operator "enter" action or the reception of a Read Partition-Query structured field causes the device to prepare to generate the inbound data stream and to go into a Data Pending state if in a BSC or Local Attachment environment, or to transmit the data and go into a Retry state if in a SNA environment.

In all environments, a host-initiated read operation causes the data to be transmitted with no state transitions occurring. The device remains in Normal read state.

Data Pending States. There are three data pending states:

- Data Pending Enter: the device state after an operator "enter" action occurred.
- Data Pending Read: the device state after reception of a Read-Partition-Query structured field.

- **Data Pending Stacked Enter:** the device state after a Read Partition-Query structured field was received while the device was in Data Pending Enter read state or Retry Enter read state (the enter data is stacked).

A Poll (BSC) or a read command (Local Attachment) received while the device is in a data pending state causes the data to be transmitted and the device to be placed in the corresponding Retry state. (See Figure 1-16, Part B.)

In an SNA environment, the data pending states do not occur. An “enter” action or reception of a Read Partition-Query structured field causes the data to be transmitted directly and the device to be placed in Retry state. (See Figure 1-16, Part A.)

Retry States. There are three retry states:

- **Retry Enter:** the device state after “enter” data was transmitted to the host.
- **Retry Read:** the device state after Query Reply data was transmitted to the host.
- **Retry Stacked Enter:** the device state after “enter” data was stacked (non-SNA environment only) and the Query Reply data has been transmitted to the host.

While in a retry state, the last inbound transmission can be retried by means of a Read Modified command.

A host acknowledgment causes the device to revert from a retry state to the normal read state, or, in the case of Retry Stacked Enter, to the Data Pending Stacked Enter read state.

Figure 1-16 shows the read states and the events that affect them.

With reference to Figure 1-16, the indicators displayed in the Operator Information Area of a display are as follows:

State	Indicator
①	No indicator or System Lock indicator
②	Time indicator (BSC) or System Lock indicator (Local Attachment)
③	Time indicator
④	Time indicator
⑤	System Lock (BSC and Local Attachment) Time indicator (SNA)
⑥	Time indicator
⑦	Time indicator

Host Acknowledgments

After inbound transmissions resulting from operator “enter” actions, or after transmission of the reply to a Read Partition-Query, the transmission must be acknowledged before a new inbound operation can be performed.

For inbound transmissions generated by operator “enter” actions, the following are host acknowledgments:

- An outbound transmission containing a Write, Erase/Write, or Erase/Write Alternate command followed by a WCC with the keyboard restore bit set to 1, or an Erase All Unprotected command.
- In a BSC or Local Attachment (non-SNA) environment, any write transmission when the device is in Data Pending Enter read state.
- In a BSC environment, a Copy command.
- In an SNA environment, any outbound transmission that, after processing, leaves the SLU in Send state or Contention state. These transmissions include null RUs carrying a CD or EB indicator.

For inbound Query Reply transmissions, the acknowledgment is:

- Any valid outbound data stream transmission other than a read command. For purposes of Query Reply acknowledgment, write commands without a write control character (WCC) are considered an acknowledgment. The reception of a Write Structured Field command is also an acknowledgment.

Host acknowledgment resets INOP to Read Modified.

Processing of Read Commands

Read commands (Read Modified, Read Modified All, Read Buffer) are processed as follows.

SNA Environment

1. If any of the following conditions pertains, the read command is rejected:
 - a. The SLU is not in SNA Receive (RCV) or Contention (CONT) state.
 - b. The chain that contains the RU does not specify CD.
 - c. The chain that contains the RU specifies EB.

Otherwise, step 2 or 3 is performed.

2. If the device is in Normal read state, then data is transmitted inbound as defined by:
 - a. The command
 - b. The AID (Read Modified command only)
 - c. The reply Mode (see “Set Reply Mode” earlier in this chapter)

The device remains in the Normal read state if the read operation was host-initiated. The device is placed in Retry state if the transmission was generated by an "enter" action or reception of a Read Partition-Query structured field.

3. If the device is in a Retry state, then a "retry" is performed as follows:
 - a. If the command is Read Modified and INOP specifies Query, then the appropriate query replies are transmitted.
 - b. If the command is Read Modified and INOP specifies Read Modified, then data is transmitted as specified by:
 - 1) The Read Modified command
 - 2) The AID
 - 3) The reply mode
 - c. If the command is Read Modified All or Read Buffer, then data is transmitted as defined by:
 - 1) The command
 - 2) The reply mode

The device remains in the retry state until a host acknowledgment causes a transition to the Normal read state.

BSC or Local Attachment Environment

1. If the device is in Normal read state in a BSC or Local Attachment environment, then:
 - a. Data is transmitted inbound as defined by:
 - 1) The command (Read Modified, Read Buffer)
 - 2) The AID (Read Modified command only)
 - 3) The reply mode

The device remains in Normal read state.
2. If the device is in a Data Pending state in a BSC environment, then data is transmitted as defined by:
 - a. The command
 - b. The AID (Read Modified command only)
 - c. The reply mode

The device is placed in Normal read state.

3. If the device is in a Data Pending state in a Local Attachment environment, then:
 - a. If the command is Read Modified and INOP specifies Query, the appropriate query replies are transmitted.
 - b. If the command is Read Modified and INOP specifies Read Modified, then data is transmitted as defined by:
 - 1) The Read Modified command
 - 2) The AID
 - 3) The reply mode
 - c. If the command is Read Buffer, then data is transmitted as defined by:
 - 1) The command
 - 2) The reply mode

For items a, b, and c, the device is placed in the corresponding Retry state (Enter, Read, Stacked Enter).

4. If the device is in a Retry state in a BSC or Local Attachment environment, then a "retry" is performed as follows:
 - a. If the command is Read Modified and INOP specifies Query, then the appropriate query replies are transmitted inbound.
 - b. If the command is Read Modified and INOP specifies Read Modified, then data is transmitted as defined by:
 - 1) The Read Modified command
 - 2) The AID
 - 3) The reply mode
 - c. If the command is Read Buffer, then data is transmitted as defined by:
 - 1) The command
 - 2) The reply mode

For items a, b, and c, the device remains in the retry state.

Processing of Read Partition-Query Structured Fields

Read Partition-Query and the Query Reply are processed as follows.

SNA Environment

1. If any of the following conditions pertains, the Read Partition (Query) is rejected.
 - a. The SLU is in a Retry state.
 - b. The SLU is not in SNA RCV or CONT state.
 - c. The Read Partition is not the last structured field in the RU chain.
 - d. The chain containing the RU does not specify CD or specifies EB.
 - e. Byte 3 of the query is not X'FF'.

Otherwise, steps 2 through 6 are performed.

2. The Time indicator is displayed.
3. INOP is set to Query.
4. The data is transmitted inbound.
5. The SLU is placed in RCV state.
6. The SLU is placed in Retry Read state.

BSC or Local Attachment Environment

1. If the device is in Normal Read state, then:
 - a. The Time indicator is displayed.
 - b. INOP is set to Query.
 - c. For BSC:
 - 1) The device prepares to generate the required inbound data stream.
 - 2) The device is placed in Data Pending Read state.
 - 3) A later Poll causes the data to be transmitted and the device to be placed in Retry Read state.
 - d. For Local Attachment (non-SNA):
 - 1) A channel attention occurs.
 - 2) The device is placed in Data Pending Read state.

- 3) A later read command causes the data to be transmitted and the device to be placed in Retry Read state.
2. If the device is in Data Pending Enter state or Retry Enter state, then:
 - a. The outstanding enter data is stacked.
 - b. The X-Clock condition remains in effect.
 - c. INOP is set to Query.
 - d. For BSC:
 - 1) The device prepares to generate the required inbound data stream.
 - 2) The device is placed in Data Pending Stacked Enter state.
 - 3) A later Poll causes the Query Reply data to be transmitted inbound and the device to be placed in Retry Stacked Enter state.
 - e. For Local Attachment (non-SNA):
 - 1) A channel attention occurs.
 - 2) The device is placed in Data Pending Stacked Enter state.
 - 3) A later read modified command causes the data to be transmitted and the device to be placed in Retry Stacked Enter.

Control Commands

Control commands initiate certain control unit and/or device operations not involved with the transfer of data (other than status). Four control-type commands are executed by the 3274: Copy, Select, Erase All Unprotected, and No Operation. Not all control commands are valid for all models. The applicable control units are identified within the description of each control command.

Copy Command

The 3274 C units support the Copy command when operating with BSC protocol. These units do not support the Copy command when operating with SNA/SDLC protocol; however, a local copy function is provided (see Chapter 2).

Note: The Copy command is not recognized by the 3290 Information Panel Display Station. To obtain a printed copy of information displayed on the 3290 screen "Local Copy" must have been specified at 3274 customization and the appropriate entries made in the Printer Authorization Matrix.

Copy is used to transfer buffer data from one device to another device attached to the same control unit. The selected device is the "to" device, the one to which buffer data will be transferred. The "from" device, the source of the buffer data to be copied, is identified in the second of two bytes that follow the Copy command code; the first byte, called the copy control character (CCC), identifies the type of data to be copied. The CCC can also, at the "to" device, start print operations, specify the printout format for those operations, and, when the device is a display station, sound the audible alarm.

The Copy data stream is as follows:

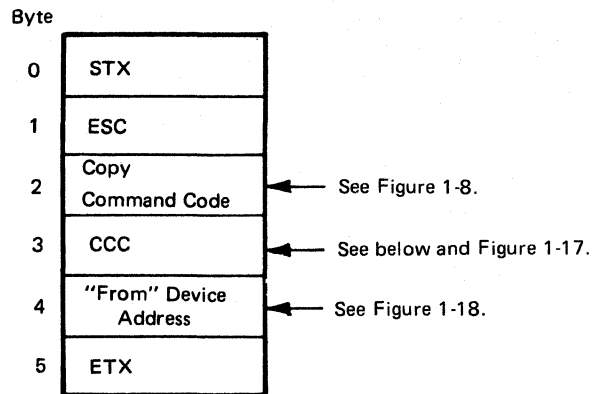

The CCC-byte format is as follows:

.	1	Printout Format	Start Print	Sound Alarm	Type of Data to Be Copied
0	1	2	3	4	5
		6	7		

*Determined by the configuration of bits 2 through 7. See Figure 1-6.

Figure 1-17 describes the function of each CCC bit. A CCC and address byte must always follow the command code; if they do not, the control unit aborts the command and generates error status.

Bit	Explanation
0,1	Determined by the contents of bits 2 through 7 as shown in Figure 1-6.
2, 3	Define the printout format as follows: = 00 – The NL, EM, and CR ¹ orders in the data stream determine print line length. Provides a 132-print position line when the orders are not present. = 01 – Specifies a 40-character print line. = 10 – Specifies a 64-character print line. = 11 – Specifies an 80-character print line.
4	The Start Print bit. When set to 1, initiates a printout operation at the "to" device after buffer transfers are completed.
5	The Sound Alarm bit. When set to 1, sounds the audible alarm at the "to" device after buffer transfers are completed if that device has an audible alarm.
6, 7	Define the type of data to be copied as follows: = 00 – Only attribute characters are copied. = 01 – Attribute characters and unprotected alphanumeric fields (including nulls) are copied. Nulls are transferred for the alphanumeric characters not copied from the protected fields. = 10 – All attribute characters and protected alphanumeric fields (including nulls) are copied. Nulls are transferred for the alphanumeric characters not copied from the unprotected fields. = 11 – The entire contents of the storage buffer (including nulls) are copied.

¹ The CR order is applicable to the 3262, 3287 (3274 Attachment) and 3289 Printers only.

Figure 1-17. Copy Control Characters (CCC)

Copy command operations are similar to Write command operations. After the control unit, for example, accepts the Copy data stream, it initiates the transfer of all bytes from the "from" device buffer to the control unit buffer. Upon completion of this transfer, the control unit inserts nulls in all character locations that do *not* contain the type of data specified by CCC bits 6 and 7. The updated control unit buffer contents are then transferred to the selected ("to") device. At

the completion of Copy command operations, the cursor is in the same character location at the "to" device as it was at the "from" device at the start of operations.

The "from" device buffer can be "locked" (made incapable of being copied) by writing a protected/alphanumeric attribute byte (bit 2=1 and 3=0) in address 0 (with BSC only).

The Copy command can specify as the "from" device the same device that is selected (the "to" device). This procedure provides a means of programming selective device buffer "erase" operations as specified by CCC bits 6 and 7. In this case, the device buffer contents are transferred to the control unit, nulls are inserted as determined by the CCC, and the resulting buffer contents are transferred back to the same device buffer.

When the buffer size of the "from" device is smaller than, or equal in size to, the buffer size of the "to" device, screen size switching occurs as listed in Figure 1-18. Invalid transfers are also indicated. The buffer of the "to" device is, in effect, cleared before the copy is performed. The same rules apply for copy-operation transfers to printer buffers.

Programming Notes:

1. Copy should not be chained from a Write, Erase/Write Alternate, Erase/Write Unprotected, or Erase All Unprotected command, since it will copy the data as modified by the Write or Erase command.
2. If the CCC Start Print bit is set and commands are being chained, Copy should be the last command of the chain. If not, the control unit aborts the subsequent command.
3. Copy can be executed from a smaller buffer size to a larger buffer size, but an attempt to copy from a larger to a smaller buffer size will cause an Operation Check.
4. An Operation Check will occur if copying from an APL device in APL mode to a device that does not have the APL feature installed.

When the "to" device is a 3288 equipped with the Text Print feature, a restricted character set applies, as shown in Figure D-10. A printout of a display station buffer containing the remaining characters of the 3288 120-character set, not included in the 3288 restricted character set, may be obtained by sending the contents of the display buffer to the host system. When the host receives data from a 3277 to be printed on a 3288, it translates the character codes received into codes that are applicable to the 3288 before transmission to the printer.

To	3277-1 480	3277-2 1920	3278-1 960	3278-1 480	3278-2 3279 1920	3278-2 3279 2560	3278-3 1920	3278-4 3440	3278-4 1920	3278-5 3564	3278-5 1920
From											
3277-1 480	o	•	v	o	•	•	•	•	•	•	•
3277-2 1920	—	o	—	—	o	v	o	v	o	v	o
3278-1 960	—	•	o	A	•	•	•	•	•	•	•
3278-1 480	o	•	v	o	•	•	•	•	•	•	•
3278-2, 3279 1920	—	o	—	—	o	v	o	v	o	v	o
3278-2, 3279 2560	—	—	—	—	—	o	A	•	A ¹	•	A ²
3278-3 1920	—	o	—	—	o	v	o	v	o	v	o
3278-4 3440	—	—	—	—	—	—	—	o	A	•	A ³
3278-4 1920	—	o	—	—	o	v	o	v	o	v	o
3278-5 3564	—	—	—	—	—	—	—	—	—	o	A
3278-5 1920	—	o	—	—	o	v	o	v	o	v	o

Legend:

- o Transfer allowed, no change in screen state required.
- Transfer not allowed, Operation Check returned to host.
- Transfer allowed, no change in screen state (appearance on "from" and "to" device may differ).
- A Transfer allowed, screen state changes to alternate size.
- v Transfer allowed, screen state changes to default size.

Notes:

- ¹The 3440 screen does not have a 2560 mode; therefore, the screen size is set to 3440.
- ²The 3564 screen does not have a 2560 mode; therefore, the screen size is set to 3564. The format is changed from 80 to 132 columns.
- ³The 3564 screen does not have a 3440 mode; therefore, the screen size is set to 3564. The format is changed from 80 to 132 columns.

Figure 1-18. Buffer Transfers for 3274 C Unit Copy Command Operations

Structured Field and Attribute Processing Considerations for Copy

If the Copy command references a “from” device that has *not* received the SFE, SA, or MF orders or the GE control code (X'08') since the last buffer clear (for example, EW, EWA commands), a copy action takes place. If the “from” device does have the extended functions in use, the Copy command is rejected with OC and US status (indicating a locked buffer) unless all of the following conditions are met:

1. The “from” device is a display.
2. The destination device is a printer.
3. The source device does not have a protected alphanumeric attribute in the first position.
4. The Copy Control Character has bits 4 (Start Print), 6, and 7 (Copy Entire Buffer) set to 1.

If these conditions are met, an attempt is made to produce a local copy. (See also the “Local Copy Function” in Chapter 2.)

Select Command (3274 B Units)

Select is an immediate command. The 3274 D units treat the Select command as a Select RM command (both the Select command and the Select RM command use the X'0B' command code). The Select command is invalid for all other 3274 control units. The 3274 B units execute a Select command by performing a device-to-control-unit buffer transfer. If not preceded by a Select command, this same buffer-transfer operation is performed as part of an initial (unchained) Write, Read Modified, or Read Buffer command.

The advantages of Select command usage are realized when a 3274 B unit is attached to a block multiplexer channel or to a byte multiplexer channel operating in forced Burst mode for the complete data transfer. Upon receipt of Select, the control unit sends Channel End as initial status to the channel. This frees a block multiplexer channel to perform other operations. Upon successful completion of the buffer transfer, the control unit sends Device End status asynchronously to the channel. Upon receipt of this status by the channel, a chain operation to the desired command (Write, Read Modified, or Read Buffer) must be initiated for effective use of the Select command. Note that device-to-control-unit buffer transfer time is not part of the execution time for this command.

At the conclusion of the command following the Select command, the control unit again issues Device End status. At this point, the channel may chain to another command of the same type or it may disconnect. If a chaining operation is performed, another Select command is unnecessary since the addressed device buffer contents are already in the 3274 B unit buffer.

Thus, the Select command is used to separate the device-to-control-unit buffer transfer operation portion of a Write, Read Modified, or Read Buffer command from the actual execution of the command. By doing so, the channel can use the buffer transfer time for other operations.

Select Read Modified (RM) Command (3274 D Units)

Select RM is an immediate command. It is used in place of the Select command (used by the 3274 B units) when a read-modified operation is to be executed.

The Select RM command causes a different operation in the 3274 D units than that caused by the Select command for the 3274 B units. The 3274 B units execute a Select command by performing a device-to-control-unit buffer transfer. If not preceded by a Select command, this same buffer-transfer operation is performed as part of an initial (unchained) Write, Read Modified, or Read Buffer command.

The 3274 D units execute a Select RM command by preparing for a read-modified operation; that is, the terminal buffer is searched for any modified fields, and the input data stream is built. This could result in an AID only (Short Read), test-request-read, or a read-modified data stream. If the command following the Select RM command (chained) is a Write command, the input data is not used. The write data stream is received by the 3274 D units and processed to the terminal. If the Write command is a WCC, SBA xx only, and then chained to a Read Buffer or a Read Modified command, the input data stream that had been prepared is not used, and the appropriate data stream is prepared upon receipt of the Read Buffer or Read Modified command. If the command following the Select RM is Read Buffer, the input data is not used, a read-buffer operation is performed, and the data is sent to the host.

The Select RM command is used to separate the device-to-3274-D-unit read-modified preparation from the channel operation to decrease channel use by the 3274 D units.

Note: The successful use of the Prepare to Read select commands on the 3274 D units requires that appropriate code be included in the access methods of the host operating system. Host operating system "sysgen" manuals indicate the operating system sysgen macros that are a prerequisite.

Select Read Buffer (RB) Command (3274 D Units)

Select RB is an immediate command. It replaces the Select command used by the 3274 B units when a read-buffer operation is to be executed.

The 3274 D units execute a Select RB command by preparing for a read-buffer operation; that is, a device-to-control-unit buffer transfer is performed and a read-buffer data stream is built. When the data stream is completed, Device End is sent to the host. If the command chained to the select RB command is not a Read Buffer, the command will not be accepted, and CE, DE, UC, OC will be sent to the host.

Select Read Modified from Position (RMP) Command (3274 D Units)

Select RMP is an immediate command. A Select RMP command is executed by recording the read-modified condition and returning Device End.

The commands following the Select RMP command should be a chained Write command followed by a chained Read Modified command. [The Write Command contains only four bytes (WCC, SBA xx) to set the buffer address.] If the sequence is other than as described, the command will not be accepted, and CE, DE, UC, OC will be sent to the host.

Upon receipt of the Write command, the 3274 D units will perform the read modified from position preparation, and return Device End to the host when the data stream is completed. The RM command is then executed.

Select Read Buffer from Position (RBP) Command (3274 D Units)

Select RBP is an immediate command. A Select RBP command is executed by recording the read-buffer condition and returning Device End.

The commands following the Select RBP command should be a chained Write command followed by a chained Read Buffer command. [The Write command contains only four bytes (WCC, SBA xx) to set the buffer address.] If the sequence is other than as described, the command will not be accepted, and CE, DE, UC, OC will be sent to the host.

Upon receipt of the Write command, the 3274 D units will perform the read buffer from position preparation, and return Device End to the host when the data stream is completed. The Read Buffer command is then executed.

Select WRT Command (3274 D Units)

Select WRT is an immediate command. A Select WRT command is executed by returning Device End to the host. If the chained command following the Select WRT is not a Write or Write Structured Field (WSF) command, CE, DE, UC, OC will be sent to the host.

Erase All Unprotected Command

This command performs five functions at the addressed device:

1. Clears all unprotected buffer character locations to nulls.
2. Resets to 0 the MDT bit for each unprotected field.
3. Unlocks the keyboard when either the System Lock or the Wait symbol is displayed on the 3178, 3278, or 3279. The Erase All Unprotected command always unlocks the keyboard attached to the 3277.
4. Resets the AID byte.
5. Repositions the cursor to the first character location in the first unprotected field of the buffer. If no unprotected fields exist, the cursor is positioned to buffer location 0.

In local configurations, Erase All Unprotected is an immediate type command. Upon acceptance of this command, the 3274 B or D units go “busy” and send Channel End initial status to the channel. Upon successful completion of this command, the control unit sends Device End status asynchronously to the channel and then goes “not busy.”

Programming Restriction: Erase All Unprotected should not be chained to a Write, Erase/Write, Erase/Write Alternate, Copy, or another Erase All Unprotected command. If it is, the resulting operation is not defined.

No Operation Command (3274 B and D Units)

The No Operation command performs no function operation in the control unit, but may be used to retrieve pending status. No Operation is an immediate command; therefore, Channel End and Device End normally will be presented as initial status unless pending status or a busy condition exists.

Sense Command (3274 B and D Units)

The Sense command should be issued in response to Unit Check status for further definition of the Unit Check condition. The control unit responds to a Sense command by sending 1 byte of sense data to the channel and resets the sense register when the Device End (DE) for the command is accepted by the channel.

All other commands to the same address, except a No Operation or a Test I/O "command" (command code of X'00'), reset the sense register immediately when the command is issued. Sense commands issued to an address other than the one for which sense data is pending are responded to with a Busy and Status Modifier (B, SM) initial status indication, and the sense register is not reset. Sense should be issued following receipt of Unit Check status to ensure that valid sense information is retrieved.

The sense byte configuration is as follows:

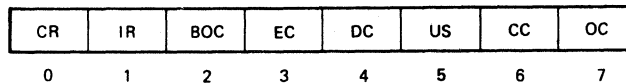

Figure 1-19 summarizes the significance of each sense bit. The various sense and status bit combinations are described in Figures 4-5, 4-6, and 4-7.

Sense ID Command (3274 B and D Units)

The Sense ID command requests data transfer to the host. Four bytes of data are sent as follows:

3274 B and D Units

Byte 0	FF	FF
Bytes 1, 2	3274	3274
Byte 3	1B	1D

Sense ID is honored when the 3274 B or D units are in one of the following states:

- Power on
- IML completed
- Online
- Not busy
- No outstanding status to be presented

Bit	Name	Significance
0	Command Reject (CR)	Set if the 3274 B or D units have received an invalid command; the valid commands are listed in Figure 1-8.
1	Intervention Required (IR)	Set if a command, other than Sense, was addressed to a device that is unavailable or is in the "not ready" condition.
2	Bus Out Check (BOC)	Set if the B or D units have detected bad parity on any command or data byte received from the channel.
3	Equipment Check (EC)	Set if: (1) the 3274 B or D units have asynchronously detected a parity check on data received from a device in response to an internal poll for attention status (the internal poll is tried twice before EC is set), (2) a printer error occurs. If this is a device-detected condition, Unit Specify is also set.
4	Data Check (DC)	Set if: (1) the 3274 B or D units or a device have detected bad parity on data transferred internally or between the control unit and a device during command operations, (2) a 3277, 3178, 3278, or 3279 has detected a cursor check, or (3) a device has detected a buffer check. If this is a device-detected condition, Unit Specify is also set.
5	Unit Specify (US)	Set if the sense bits resulted from a device-detected error.
6	Control Check (CC)	Set when the 3274 B or D units have detected a timeout condition. (The addressed device fails to perform a specified operation or respond within a specified period of time.)
7	Operation Check (OC)	Set when the 3274 B or D units have received a valid command or order that they cannot execute, as follows: <ol style="list-style-type: none"> 1. SBA, RA, or EUA order specifies an invalid buffer address. 2. Write data stream ends before all required bytes of SBA, RA, EUA, or SF order sequence are received. 3. Write, Erase/Write, or Erase/Write Alternate with Start Print bit set in WCC is chained to the next command; the print operation is suppressed. 4. The 3274 B units received a Write type command with the WCC equal to X'88'. 5. The 3274 D units received a command chained to a Select RB, Select RBP, Select RMP, or Select WRT command other than was expected; or the byte count of a Write command after RBP or RMP was not equal to 4.

Figure 1-19. Sense Bit Description—3274 B and D Units

Miscellaneous Operations

Test Request Function

The Test Request function is available for all 3270 systems. The Test Request message sent to the host (SOH%/STX) is invoked from the keyboard. The TEST REQ key is used on keyboards attached to the 3277s, and the SYS REQ key is used on keyboards attached to 3278 and 3279 displays. Systems using 3274s must operate in Compatibility mode to perform the Test Request function. The TEST key provided on 3178, 3278, and 3279 displays is used to invoke internal 3274 tests.

Use of BSC Line Discipline

Text Transmission

Buffer Transfers. The 3274 sends a positive response before transfer of the device buffer to the control unit. If an error occurs, the 3274 provides a positive response to the selection sequence and indicates the error with Data Check and Unit Specify status.

Partial Message Transfer. The 3274 allows parts of messages to be transmitted to the host before all data is moved from the 3178, 3278, or 3279 to the control unit. If a terminating condition prevents completion of data transfer from the 3278 or 3279 to the control unit after inbound link transmission has started, the control unit sends STX . . . SUB ENQ. The control unit responds to specific polling with Device Check (DC) and Unit Specify (US). A selection sequence with a write-type command is accepted. A selection sequence with a read-type command is rejected with DC and US.

Limited Conversational Text Mode. The 3274 can operate in Limited Conversational Text mode. If the host transmits a text block following receipt of a text transmission that ends in ETB, the 3274 initiates a timeout and sends ENQ.

Screen Update Protected Message

If a protected message is sent to a 3178 or 3278 display, the first message byte sent must be the protected attribute.

To ensure data security when nondisplayable data is sent to a 3278 display, a nondisplay attribute byte must be sent before new nondisplayable data is sent. When a screen image is being partially changed, care must be taken not to overwrite a nondisplay attribute in the current image. In general, the Erase/Write command is recommended if the current image contains a protected message.

Responses

RVI. The 3274 initiates a timeout if RVI is received in response to RVI.

Responses While Performing Concurrent Terminal Tests. While performing concurrent terminal tests, the 3274 responds to the host with EOT if messages are received, with RVI if a selection sequence is received, and with IR (Intervention Required) in reply to a Specific Poll. No response is sent by the control unit to a General Poll. While individual device tests are performed, the device remains in a busy state for a relatively long period of time.

Error Handling

Unrecoverable Errors. If a nonretryable error occurs in a 3178, 3278, or 3279 buffer, or if an error is detected in a transfer of data from the 3274 to the 3178, 3278, or 3279, the buffer is cleared, and the host is informed of the error by Device Check and Unit Specify status but is not informed of the clear operation.

Responses to Invalid Sequences. The sequence "SOH, ESC, Write command, WCC, . . . STX . . . ETX" is valid.

If the host selects the 3274 and issues a Read Modified command, the control unit transmits a single block of text ending with ETX and expects to receive an acknowledgment from the host (under BSC rules governing Limited Conversational mode). If the host makes an error by beginning a new command sequence starting with STX, then the control unit replies with ENQ.

Character Sets

Character sets that provide 94 characters (excluding space and null) are designed for various languages. They are available for the 3178, 3278, and 3279 displays and for 3262, 3287 and 3289 printers. Character sets available for the 3277

display and for the 3284, 3286, and 3288 printers contain 88 characters (excluding space and null). Unique character sets used in World Trade countries are available for the 3178, 3278, 3279, 3287, and 3289 units.

Units that employ the 96-character character set can display or print either mono-case or dual-case alphabetic characters.

The split vertical bar (|) character, hex 6A, was available only for the 3288. Character code 6A is now available as the (|) character on 3178, 3278, 3279, 3287, and 3289 units installed in the United States, and as a series of unique characters selected for use in World Trade character sets.

When the 3277 display is attached to the 3274, six character codes are provided which are also valid for the 3178, 3278, or 3279 display when attached to the 3274, but the characters displayed are different. A comparison of the displayed U.S. EBCDIC characters is as follows:

Code	C0	D0	E0	6A	A1	79
3277	()			-	.
3178/ 3278/ 3279	{	}	\		~	'

Refer to *IBM 3270 Information Display System: Character Set Reference*, GA27-2837, for a detailed comparison of character sets in all languages supported by the 3270 system.

Care must be exercised when communicating between 3178, 3277, 3278, and 3279 displays attached to a 3274. For example, if information is entered at a 3278 or 3279 within brackets such as {AA} and transferred to the 3277 where it is modified and then returned to the 3178, 3278, or 3279 as {BBB}, the 3277 operator must use the Insert Mode function instead of direct keying to modify the information. Otherwise, the reply will be displayed on the 3178, 3278, or 3279 as {BBB}.

Use of SNA Protocol

The 3274 functions as PU type 2 using SNA protocol.

Non-SNA Local Control Unit Differences

Operation Checks

The 3274 D units do not Op Check a WCC = X'88' during a Write command. The 3274 B units do Op Check a WCC = X'88'.

The 3274 B units report certain operation-check conditions as *ending status*. The 3274 D units do not execute the data stream as it is received from the channel and, therefore, report these conditions as *asynchronous status*.

Buffer Updates

The 3274 B units bring the device buffer into the control unit, update it, and return it to the device; the 3274 D units update the device buffer directly. If a Bus Out Check (BOC) or Operation Check (OC) is detected, the 3274 B units do not update the device buffer. The 3274 D units may change part of the device buffer prior to detecting the BOC or OC.

Because the 3274 D units have updated a portion of the device buffer, a Write command can be retried only if new fields have not been created in the buffer portion which has been cleared by a Program Tab or Erase Unprotected to Address Order. This applies only to BOC since OC is a nonrecoverable program error.

Security Keylock

The 3274 sends Device End only when the key is turned from the locked to the unlocked position if the host attempted to select the terminal while it was locked.

Chapter 2. Terminals

This chapter describes the function of the display stations and printers (other than the 3290 Information Panel Display Station, the IBM 3270 Personal Computer Attachment, and the IBM 3270 Personal Computer) that can attach to the 3274 Control Units. For more detailed information on display images, refer to Chapter 6, "Screen Design." For more device-specific information, refer to the Operator's Guides for the displays and printers.

Display Stations

Display Images

Display stations for the 3270 system are buffered displays. Data displayed on the screen is stored in coded form in a display buffer; the buffer contains as many locations as there are character positions on the screen. The data may be loaded from the host system by the application program or from a keyboard attached to the display station. Figure 2-1 illustrates the concept of a buffered display.

The display image contains a fixed number of horizontal rows, with a fixed number of character positions in each row. Depending upon the capacity of the screen, the number of rows and characters is as follows:

480-character display	12 rows of 40 characters
960-character display	12 rows of 80 characters
1920-character display	24 rows of 80 characters
2560-character display	32 rows of 80 characters
3440-character display	43 rows of 80 characters
3564-character display	27 rows of 132 characters

There is a fixed relationship between each location in the display buffer and each character position on the display screen. Buffer addresses start from 0, for the character position at the left of the top row, and proceed sequentially along the rows and down the screen to the character position at the right of the bottom row (for example, an image with 960 character positions has buffer addresses from 0 to 959). Figure 2-2 shows the addresses of the first and last character positions in each row, depending upon the available screen capacity.

Each location in the buffer contains 1 byte of storage; codes loaded into the buffer are 2-digit hexadecimal codes. Write commands are used to load the display buffer locations with the code needed to display the required data on the display screen (see Chapter 1). Defined codes that are displayed as alphameric characters are shown in Figures 1-1 through 1-5.

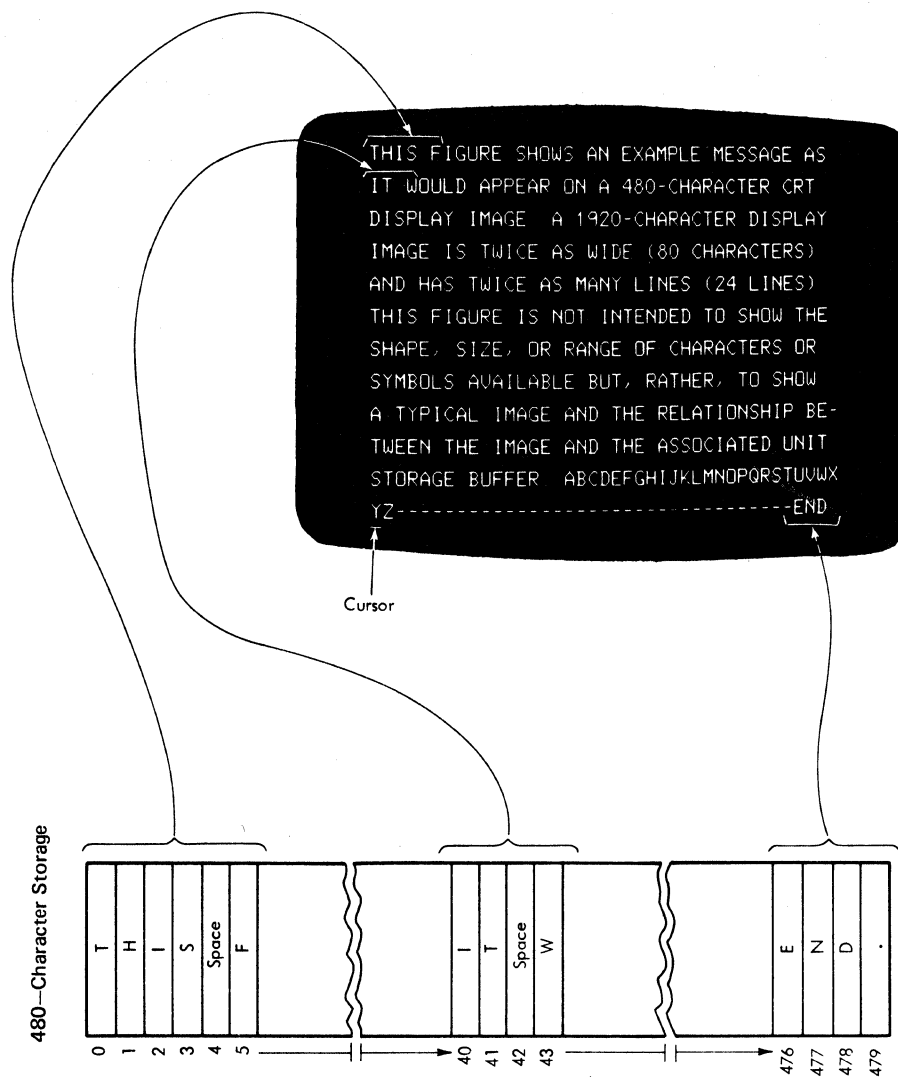

Figure 2-1. Buffer Location and Display Screen Character Position Relationships

Display images may be formatted or unformatted:

- **Formatted Display.** A formatted display is one that has separate fields defined by the program. The first character position in each field contains a control character that defines the characteristics of the field. See "Field Attributes," later in this chapter, for a description of the control character.
- **Unformatted Display.** An unformatted display is one that has no defined fields. An operator may input data into any position on the screen; to access the data, the program must issue a read command for the entire display buffer.

Display Fields

A formatted display contains display fields defined by the program. These fields consist of blocks of character positions bounded by control characters. The control character at the start of a field is set by the program to determine the characteristics of the field; this character contains the field attributes. (For details, see "Attributes," later in this chapter.) Fields containing character

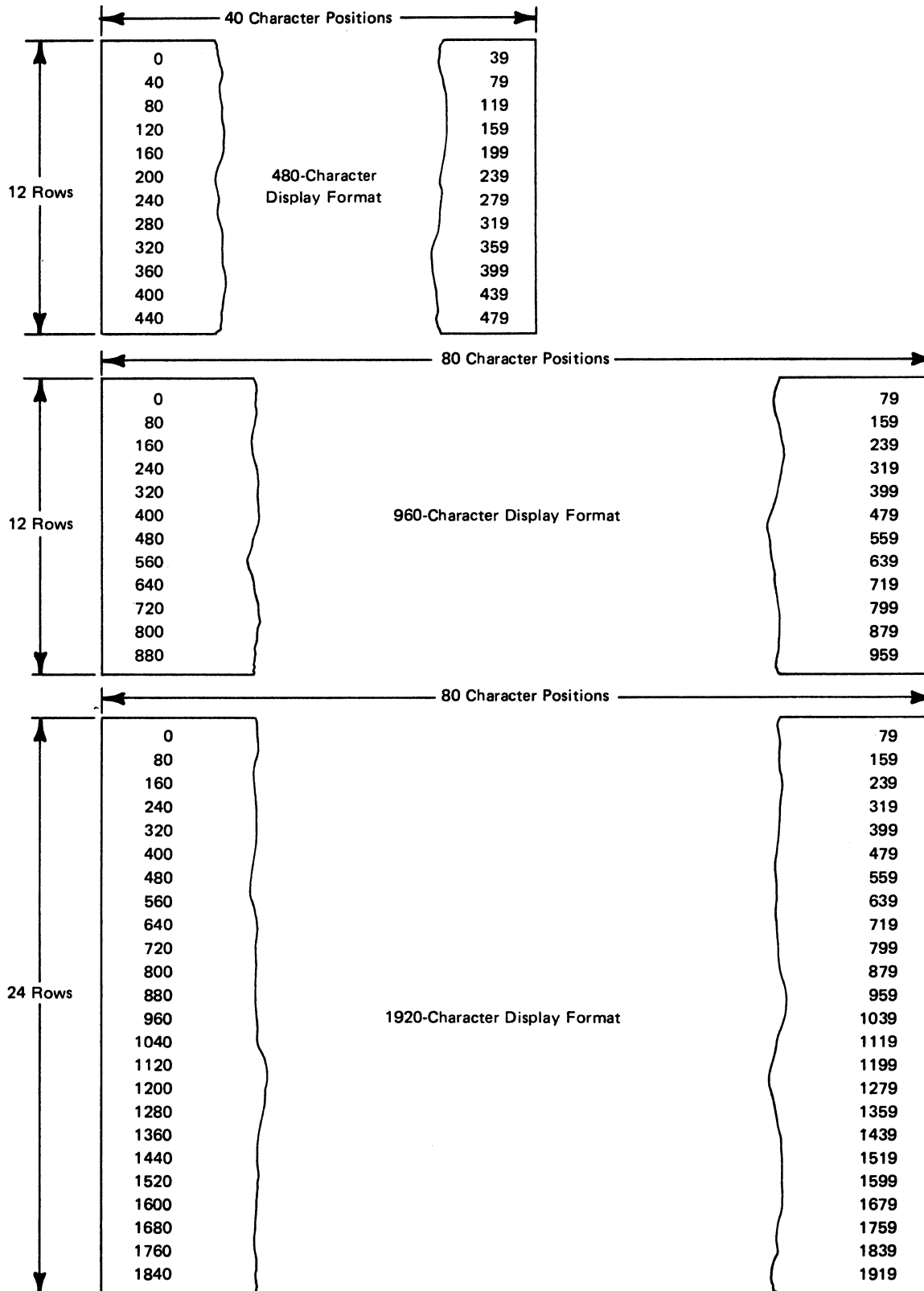

Note: See Appendix B for hexadecimal equivalents.

Figure 2-2 (Part 1 of 2). Buffer Addressing Layouts for 480-, 960-, 1920-, 2560-, 3440-, and 3564-Character Terminals

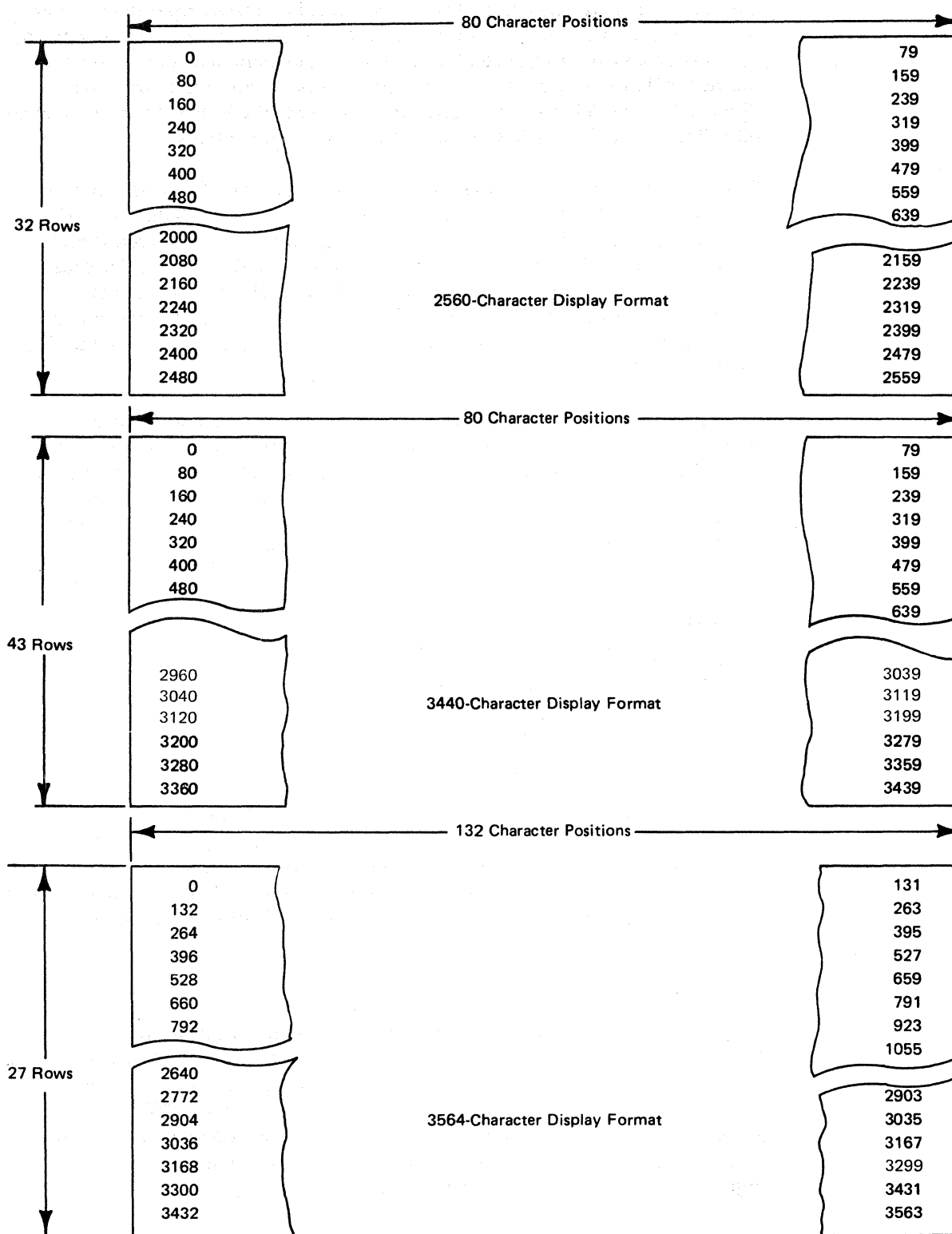

Figure 2-2 (Part 2 of 2). Buffer Addressing Layouts for 480-, 960-, 1920-, 2560-, 3440-, and 3564-Character Terminals

positions on more than one row “wrap” from the last character position on one row to the first character position on the next row. A field may wrap the screen; if the first character position on the screen does not contain a control character, the last field on the screen wraps from the last character position to the first. (Some field-oriented operations are terminated early if the field wraps the screen; this effect is noted in the descriptions of the specific operations.)

Display fields simplify operations both for the operator and for the programmer. Headings can be displayed to prompt the operator as to the data that should be entered, and the program can identify fields that contain entered data without reading the entire display buffer. When data is being entered into a formatted display, the presence of a control character acts as a tab stop; pressing the tab key advances the cursor from its current position to the first character position in the next unprotected field. (An unprotected field is one that accepts data input from the keyboard.)

The example in Figure 2-3 illustrates the versatility of formatted displays. In this example, the solid characters represent the displayed form of characters stored in the buffer. The dotted squares represent the character positions corresponding to control characters at the start of each field. The dotted characters represent fields of data that are stored in the buffer but that have been defined by the program as nondisplayable, that is, not to be displayed to the operator.

```
□NAME :□ JOHN B DOE
□SALARY □ 1 2 3 2 3
□JOB TITLE :□ WRITER
□PHONE # :□ 383-7628
```

Figure 2-3. Example of Formatted Display

To define the start of a field, the program may issue a Write command transferring a Set Buffer Address (SBA) order and a Start Field (SF) order to the display; the specified buffer address is selected, and the control character specified by the SF order is loaded into the addressed location. Only the start of a field is defined; starting a field ends the previous field at the character position prior to the new control character.

Attributes

All display stations for the 3270 system may be programmed with formatted fields. The control character at the start of each field contains the field attributes. Attributes contained in this character apply to all the data contained in the field; for example, the attribute character for the field containing PHONE # in Figure 2-3 might define the field as protected to ensure that the operator does not enter data into that field, and the field containing 383-7628 might be defined as unprotected to allow the data to be changed.

Display stations that support the Structured Field and Attribute Processing option, such as the 3279 Models 2B and 3B, are capable of handling extended attributes. The extended attributes increase the number of characteristics that can be defined. Extended attributes may be applied to a field and to individual characters within the field. Extended attributes may also be applied to individual characters in an unformatted display.

Extended attributes do not occupy positions in the display buffer. Conceptually, three additional buffers are provided for the extended attributes. Each buffer has the same number of locations and the same address map as the display buffer. Figure 2-4 shows the concept of four parallel buffers.

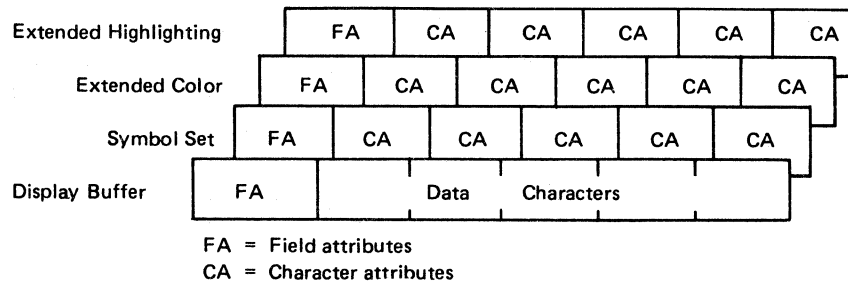

Figure 2-4. Extended Attributes – A Conceptual View

Field Attributes

The field-attribute character occupies the first character position of each display field in a formatted display; the corresponding character position on the display screen is always blank. This 8-bit attribute character is loaded by a Start Field or Start Field Extended (attribute type X'CO') order to (1) define the start of a field and (2) assign characteristics to the field. Bit positions in the character are significant to the display; the value assigned to each bit or group of bits controls whether a specific attribute is applied.

Field Attribute Character

Figure 2-5 shows the significance of bits in the field-attribute character. Characteristics set by the field-attribute character are:

- **Protected/Unprotected:** An operator cannot enter data into or modify the content of a protected field. Input fields that require data from the operator must be unprotected.
- **Alphameric/Numeric:** In an unprotected input field, alphameric/numeric defines the type of data that an operator can enter into the field. This attribute has special meaning for protected fields, data entry keyboards, and the Numeric Lock feature.
- **Nondisplay/Display/Intensified:** Data contained in the field is either not displayed, displayed at normal intensity, or displayed at high intensity. The 3279 does not support two levels of intensity; if no extended attribute is defined, nonintensified fields and intensified fields are displayed in different colors. (The actual colors are determined by the position of the Base Color switch and the value of the Protected/Unprotected attribute.)

Programming Note: Refer to Appendix H for the use of intensified field attributes when formatting selector-light-pen-detectable fields.

- **Detectable/Nondetectable:** Displayed data in a detectable field can be detected by the selector light pen. (The detectable field must contain a designator character as described under "Selector-Light-Pen Operations" in Appendix H.)

Attribute character bit assignments are summarized as follows:

X	X	U/P	A/N	D/SPD	Reserved	MDT	
0	1	2	3	4	5	6	7
EBCDIC Bit		Field Description					
0, 1		- Value determined by contents of bits 2-7. See Figure 1-8 for hexadecimal values.					
2		- 0 = Unprotected 1 = Protected					
3		- 0 = Alphameric 1 = Numeric (causes automatic upshift of data entry keyboard)					
		Note: Bits 2 and 3 equal to 11 causes an automatic skip. See text.					
4, 5		- 00 = Display/not selector-light-pen detectable. 01 = Display/selector-light-pen detectable. 10 = Intensified display/selector-light-pen detectable. 11 = Nondisplay, nonprint, nondetectable.					
6		- Reserved.					
7		- Modified Data Tag (MDT); identifies modified fields during Read Modified command operations. 0 = Field has not been modified. 1 = Field has been modified by the operator. Can also be set by program in data stream.					

Figure 2-5. Field Attribute Character Bit Assignment

Field attributes are protected against input from the keyboard; however, bit 7 (Modified Data Tag) is set to 1 when the operator enters data into the field defined by the attributes. Attribute characters are not protected against operation of the CLEAR key; pressing the CLEAR key erases all locations in the display buffer.

Automatic Skip

Upon entry of a character into the last character location of an unprotected data field, the cursor is repositioned according to the attribute character describing the next field.

If the field attribute character defines the next field as (1) alphameric and either unprotected or protected, or (2) numeric and unprotected, the cursor skips the attribute character and is positioned to the first character location in that field.

If the field attribute character defines the field as numeric and protected, the cursor automatically skips that field and is positioned to the first character location of the next unprotected field.

Base Color Mode

The 3279 uses the field attributes for the additional purpose of controlling color.

Models 2A and 3A of the 3279 always decode the field attributes to assign a color to each display field. If the operator sets the Base Color switch to base color (oooo), then the fields are colored in one of four colors—red, blue, green, or white—depending upon the protect and intensify bits. If the operator sets the Base Color switch to monochrome (oo), all data is displayed in green except for intensified fields; intensified data is displayed in white. The particular attributes examined are the protect and intensify attributes. Figure 2-6 shows how the value of these attributes determines the color of characters displayed in a field.

Field Attribute	Attribute Bit				Base Color Switch	
	2	3	4	5	oo	oooo
Unprotected, normal intensity	0	X	0	X	Green	Green
Unprotected, intensified	0	X	1	0	White	Red
Protected, normal intensity	1	X	0	X	Green	Blue
Protected, intensified	1	X	1	0	White	White

Figure 2-6. Colors Derived from Field Attributes

Models 2B and 3B support extended color. When extended color is used, the Base Color switch is disabled. However, if extended colors are not used by the application program, these models display base color or monochrome mode in the same way as Models 2A and 3A. See “Extended Color Attributes” later in this chapter for more information.

Note: The integrity of the unprotected/protected attribute is preserved; the operator can enter data only into an unprotected field.

Extended Attributes

Additional characteristics may be assigned to display fields and to individual character positions within the fields when the display station supports the 3270 Structured Field and Attribute Processing option. The extensions to the field attributes are:

- Extended Highlighting (blink, reverse video, underscore)
- Color (blue, red, pink, green, turquoise, yellow, white)
- Programmed Symbols (the character code in the display buffer is used to address a Programmed Symbol set)

Note: Extended attributes are ignored if “nondisplay” is set in the field attribute.

When a character is displayed in a formatted field, the character attributes corresponding to the display buffer location are examined to determine the extended attributes of the character. If any of the character attributes contain X'00', that particular attribute is “inherited” from the extended field attribute.

The application program may assign character attributes to an unformatted display. Because there are no extended field attributes, however, the defaults for

Extended Highlighting and Programmed Symbol set are *none* and *base character set*. Setting the extended color character attribute to X'00' in an unformatted display causes the color to default to green.

Extended field attributes are protected against input from the keyboard. Input data from the keyboard is always assigned character attributes of X'00' if the operator does not select specific attributes. Enabling operator selection is a function of the reply mode set by a Write Structured Field command.

The orders used by the program to load or change extended attributes are Start Field Extended, Modify Field, and Set Attribute. Orders and commands are described in Chapter 1.

Extended Highlighting (Attribute Type X'41')

Extended Highlighting offers three ways in which a character or a field can be highlighted: blink, reverse video, underscore. The valid codes for Extended Highlighting are:

- X'00' — Select default (see Note 1)
- X'F1' — Blink
- X'F2' — Reverse video (see Note 2)
- X'F4' — Underscore

Notes:

1. Default depends upon whether the display is formatted or unformatted:
 - a. Formatted: X'00' in the character attribute causes that attribute to be inherited from the extended field attribute. X'00' in both the character attribute and the extended field attribute causes display without highlighting.
 - b. Unformatted: X'00' in the character attribute causes display without highlighting.
2. Refer to "Triple-Plane Symbol Sets" later in this chapter for the effect of reverse video on symbols defined with more than one color in a single-character position.
3. If the operator selects "cursor blink" or "reverse cursor," the cursor attribute interacts with the Extended Highlighting attribute (see "Cursor" in Appendix C).

Extended Color (Attribute Type X'42')

Extended Color is available only on 3279 Models 2B and 3B attached to a 3274 Control Unit equipped for structured field and attribute processing. For compatibility of programming between color and monochrome, this attribute may be sent to a similarly attached 3278 Model 1, 2, 3, 4, or 5 when the 3278 is equipped with the Extended Character Set Adapter feature.

Extended Color offers seven colors that can be defined for individual characters within a field or for complete fields. The valid codes for the Extended Color attribute are:

- X'00' — Select default (see Note 1)
- X'F1' — Blue
- X'F2' — Red
- X'F3' — Pink
- X'F4' — Green
- X'F5' — Turquoise
- X'F6' — Yellow
- X'F7' — Neutral—white (see Note 2)

Notes:

1. Default for an unformatted display is always green.

On a formatted display, a character attribute of X'00' causes a default to the extended field attribute. When the extended field attribute also contains X'00', the display of base colors by 3279 Models 2B and 3B is suppressed if attribute type X'42' (Extended Color attribute) is used in the data stream following:

- a. Erase/Write or Erase/Write Alternate command.
- b. Set Reply Mode structured field function.

When the display of base colors is suppressed, default is white for data in an intensified field and green for all other data. (See Chapter 1 for details of commands and orders.)

Base color is reenabled by either (1) an Erase/Write or Erase/Write Alternate command with bit 1 of the WCC set to 1 or (2) the operator's pressing the Clear, Sys Req, or TEST key. Colors displayed when base color is enabled depend upon the field attributes and on the setting of the Base Color switch. (See "Base Color Mode," earlier in this chapter.)

2. X'F7' as a character attribute or "inherited" from the extended field attribute causes the character to be displayed white except when a triple-plane symbol set is used. (See "Triple-Plane Symbol Set," later in this chapter.)

Symbol Set (Attribute Type X'43')

The Programmed Symbols features PS-2 and PS-4 use the character code from the display buffer as an address to access a symbol set. (For details, see "Programmed Symbol Sets," later in this chapter.) Symbol sets are selected by the symbol set attribute. Valid codes for this attribute are:

- X'00' — Select default (see Note 1)
- X'40' — Range of valid identities for symbol sets (see Note 2)
through
X'EE'
- X'F1' — Select APL/Text character set (see Note 3)

Notes:

1. Default depends upon whether the display is formatted or unformatted:
 - a. Formatted: X'00' in the character attribute causes that attribute to be inherited from the extended field attribute. X'00' in both the character attribute and the extended field attribute selects the base character set.
 - b. Unformatted: X'00' in the character attribute selects the base character set.
2. The identity assigned to a symbol set is determined by the programmer; it is a valid identity only when the symbols have been loaded.
3. X'F1' cannot be used in the extended field attribute. This value is supported only if the APL/Text character set is present. If used it is rejected.

Programmed Symbols

A programmed symbol (PS) is a special character or graphic component that is loaded by the application program into a symbol set in the device. Each symbol set contains 190 symbol locations; each location contains a pattern of binary bits equivalent to the dot pattern contained in each character position on the display screen. To define a symbol, the application program sets only those bits in a location that relates to the active dots needed to display the symbol.

Symbol sets are either single-plane or triple-plane. Triple-plane sets are not available on monochrome displays. The advantage of a triple-plane set is that it allows more than one color to be used in a single character position. The following symbol sets are available at each PS address:

PS Address	3278 Models 2, 3, and 4	3279 Models 2B and 3B
A	Single plane	Single plane
B	Single plane	Single plane
C	Single plane	Triple plane
D	Single plane	Triple plane
E	Single plane	Single plane
F	Single plane	Triple plane

Characters displayed are a pattern of active dots. Each character position on the screen is addressed by the display as a matrix of dots. Characters of the base character set are defined within the display station as a pattern of active dots in this matrix. The number of dots in the matrix and the size of the matrix vary between display stations. Figure 2-7 illustrates the character position as defined for the 3279 Models 2B and 3B and lists the parameters used by the 3278 Models 2, 3, and 4.

When displaying a character from the base character set, the display station reads an EBCDIC code from the display buffer. This EBCDIC code is used to address the base character set, and the addressed location contains the pattern of points needed to display the character. However, if the character attributes define or "inherit" a symbol set, then the character code addresses a location in the symbol set.

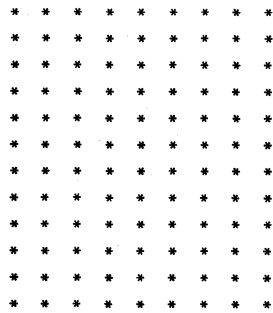

	3278-2, -3	3278-4	3279
Width, dots	9	9	9
Height, dots	16	12	12
Spacing between dots:			
Vertical	0.38 mm (0.015 inch)	0.38 mm (0.015 inch)	0.46 mm (0.018 inch)
Horizontal	0.37 mm (0.0145 inch)	0.37 mm (0.0145 inch)	0.34 mm (0.0135 inch)

Figure 2-7. Size of Character Position

Take, for example, an application that displays a histogram. This application would require a symbol set containing "fill" patterns. Location X'81' in the symbol set might then contain a cross hatch fill pattern. In this example, X'81' in two locations in the display buffer might fetch two different patterns of active dots; from the base character set, X'81' would fetch character *a*, and from the symbol set, X'81' would fetch the cross-hatch pattern. Figure 2-8 illustrates this example; the figure assumes that symbol set Y has been loaded.

```

Display Buffer | X'81' | X'81' |
Symbol Set    | base  | Y      |

```

Base Character Set	Symbol Set Y
-----	x--x--x--
-----	-x--x--x--
-----	--x--x--x--
-----	x--x--x--
--xxxx--	-x--x--x--
-----x--	--x--x--x--
--xxxxx--	x--x--x--
-x-----x--	-x--x--x--
--xxxxx--	--x--x--x--
-----x--	x--x--x--
-----	-x--x--x--
-----	--x--x--x--

Figure 2-8. Conceptual View of Programmed Symbols Set

Symbol sets are loaded by the program issuing a Write Structured Field command. Data sent to the display by the Write Structured Field command includes (1) the number of the set being loaded, (2) the 1-character identity assigned to the set, (3) a starting address for the load, and (4) the data that defines the required symbol or set of symbols. Valid addresses for location in each symbol set range from X'41' through X'FE'. Loading of a set starts at the location specified in the Write Structured Field command and progresses sequentially until all data has been transferred to the set. For details, refer to "WSF Command, FMH1, and Structured Fields" in Chapter 1.

Single-Plane Symbol Sets

A single-plane symbol set has no inherent color characteristic and is available for both monochrome and color displays. On color displays, symbols from a single-plane set are displayed in the color defined in the character attribute or the extended field attribute. If the extended color attribute is X'00' in both the character attribute and the extended field attribute, the symbol is displayed in the default color (white for data or symbols in an intensified field and green for all other data and symbols).

Triple-Plane Symbol Sets

In certain applications, it may be necessary to display more than one color within a single character position. For example, the Programmed Symbols feature may be used to display three lines: one red, one blue, and one yellow. These lines may cross at certain points, and the area of the crossing point is significantly smaller than the area of a single character position. If multiple colors could not be displayed within a character position, the point of intersection might appear as follows:

```

- - - - - r - - - - -
- - - - - r - - - - -
- - - - - r - - - - -
b b b b b b b b r r r r r r r r b b b b b b b b
- - - - - r - - - - -
- - - - - r - - - - -
- - - - - r - - - - -
Y Y Y Y Y Y Y Y r r r r r r r r Y Y Y Y Y Y Y Y
- - - - - r - - - - -
- - - - - r - - - - -
```

Legend:

- r = red
- b = blue
- y = yellow
- = blank

The Programmed Symbols feature overcomes this difficulty by allowing the user to define symbols that contain more than one color; these symbols are stored in a triple-plane symbol set. Triple-plane symbol sets contain a separate plane for each primary color: red, blue, and green. Corresponding locations in each plane may be loaded with a different pattern of active bits. Addressing a location in a triple-plane symbol set fetches the bit patterns from each plane at that location; the three patterns form the symbol displayed. The symbol is displayed in the character position related to the display buffer location that contains the code used to address the symbol set.

If the extended color attribute is X'F7' when a triple-plane set is addressed for a symbol, the pattern from each plane is displayed in the primary color for the plane, that is, red, blue, or green. To obtain pink, yellow, turquoise, and white, the same dot is made active in more than one plane. The combinations of the primary colors are described below under "Secondary Colors."

If a color is defined in the character attribute or inherited from the extended field attribute, all three patterns are displayed in the defined color. If no extended color attribute is defined, the default is white for symbols in intensified fields and green for symbols in all other fields.

Triple-plane sets may be used as single-plane sets. If the program loads a triple-plane set without defining it as such, the same symbol is loaded into each plane. Loading a triple-plane set as a single-plane set causes the symbol to take on the color characteristics of a single-plane set.

Secondary Colors

Secondary colors are obtained by mixing red, blue, and green. The secondary colors are pink, yellow, turquoise, and white. When a pattern of bits from a triple-plane symbol set is displayed with the extended color attribute of X'F7', if the same bit is active in more than one plane, the active primary colors combine to produce secondary colors. See Figure 2-9 for the combinations of primary colors.

Primary Colors			
Red	Blue	Green	Video
No	No	No	No display
No	No	Yes	Green
No	Yes	No	Blue
No	Yes	Yes	Turquoise
Yes	No	No	Red
Yes	No	Yes	Yellow
Yes	Yes	No	Pink
Yes	Yes	Yes	White

Figure 2-9. Color Combinations

Defining a Triple-Plane Symbol

A typical example of a symbol that requires a triple plane occurs where the application program displays a graph with lines in different colors. At the point where two or more lines cross, each line needs to hold its color in the same character position as another line. The application programmer should also be aware of color mixing that might occur at the point common to several lines.

Take, for example, the instance where two horizontal lines, one blue and one yellow, are cut by a red vertical line. The active dots at the character position might appear as shown in Figure 2-10.

```

- - - - r - - - -
- - - - r - - - -
- - - - r - - - -
b b b b r b b b b
- - - - r - - - -
- - - - r - - - -
- - - - r - - - -
Y Y Y Y r Y Y Y Y
- - - - r - - - -
- - - - r - - - -
- - - - r - - - -

```

Red Plane

Blue Plane

Green Plane

```

- - - - r - - - -      - - - - - - - - - -      - - - - - - - - - -
- - - - r - - - -      - - - - - - - - - -      - - - - - - - - - -
- - - - r - - - -      - - - - - - - - - -      - - - - - - - - - -
- - - - r - - - -      b b b b - b b b b      - - - - - - - - - -
- - - - r - - - -      - - - - - - - - - -      - - - - - - - - - -
- - - - r - - - -      - - - - - - - - - -      - - - - - - - - - -
- - - - r - - - -      - - - - - - - - - -      - - - - - - - - - -
- - - - r - - - -      - - - - - - - - - -      - - - - - - - - - -
r r r r r r r r r r      - - - - - - - - - -      g g g g - g g g g
- - - - r - - - -      - - - - - - - - - -      - - - - - - - - - -
- - - - r - - - -      - - - - - - - - - -      - - - - - - - - - -
- - - - r - - - -      - - - - - - - - - -      - - - - - - - - - -

```

Legend:

- b = active blue bit
- g = active green bit
- r = active red bit
- y = yellow (red = green)

Note: The symbol extends to the edges of the character position, thus allowing the lines to continue without interruption into the adjacent character positions.

Figure 2-10. A Triple-Plane Symbol

Note: If the triple-plane example shown in Figure 2-10 were displayed with any color attribute other than X'F7' (neutral), the three planes would be displayed in one character position using the defined color; an attribute of X'00' for a triple-plane set always defaults to white for symbols in an intensified field and to green for symbols in all other fields. For example, if the symbol previously described were displayed with a color attribute of X'F5' (turquoise), the symbol would be displayed as:

```

- - - - t - - - -
- - - - t - - - -
- - - - t - - - -
t t t t t t t t t
- - - - t - - - -
- - - - t - - - -
- - - - t - - - -
t t t t t t t t t
- - - - t - - - -
- - - - t - - - -
- - - - t - - - -

```

Legend:

- t = turquoise

Reverse Video and Triple-Plane Symbols

When reverse video is the Extended Highlighting attribute for a triple-plane symbol, the inactive primary colors for each point are made active and the active primary colors are made inactive. Figure 2-11 shows the effect of reversing the primary colors.

Primary Colors			Normal Video	Reverse Video
Red	Blue	Green		
No	No	No	No display	White
No	No	Yes	Green	Pink
No	Yes	No	Blue	Yellow
No	Yes	Yes	Turquoise	Red
Yes	No	No	Red	Turquoise
Yes	No	Yes	Yellow	Blue
Yes	Yes	No	Pink	Green
Yes	Yes	Yes	White	No display

Figure 2-11. Reverse Video Highlighting of Triple-Plane Symbols

For example, specifying reverse video for the triple-plane symbol used in this chapter has the following result:

<u>Normal Video</u>	<u>Reverse Video</u>
- - - - r - - - -	w w w w t w w w w
- - - - r - - - -	w w w w t w w w w
- - - - r - - - -	w w w w t w w w w
b b b b r b b b b	Y Y Y Y t Y Y Y Y
- - - - r - - - -	w w w w t w w w w
- - - - r - - - -	w w w w t w w w w
- - - - r - - - -	w w w w t w w w w
- - - - r - - - -	w w w w t w w w w
Y Y Y Y r Y Y Y Y	b b b b t b b b b
- - - - r - - - -	w w w w t w w w w
- - - - r - - - -	w w w w t w w w w
- - - - r - - - -	w w w w t w w w w

Legend:

b = blue
g = green
r = red
t = turquoise
w = white
y = yellow

Unit and Model-Dependent Differences (Displays)

This section describes model-dependent differences that affect display and keyboard operations.

Keyboard Types

Typewriter and data entry type keyboards can be attached to 3178, 3277, 3278, and 3279 displays. The operator console keyboard can be attached to 3277 displays only.

Keyboard Program Function Keys

Typewriter and operator console keyboards attached to the 3277 have a maximum of 12 program-function (PF) keys. The data entry and data entry (keypunch-layout) keyboards attached to the 3277 displays have five PF keys. A maximum of 24 PF keys are available on the typewriter keyboard attached to the 3178, 3278, and 3279 displays; and 10 PF keys are provided on the data entry and data entry keypunch-layout keyboards used with the 3178, 3278, and 3279 units.

Display Screen Size

The 3277 has model-dependent screen sizes of 480 or 1920 characters. The 3278 and 3279 displays have model-dependent screen sizes of 960, 1920, 2560, 3440, or 3564 characters. In addition, 960-character displays can function as 480-character displays, and 2560-, 3440-, and 3564-character units can function as 1920-character displays. The 3178 screen size is 1920 characters.

Programs written for one screen size can be used without change on other screen sizes that have the same width (that is, 40 or 80 characters) and a greater number of lines, provided that (1) a protected field-attribute character follows the last position on the screen that contains data and (2) the program does not depend on data wrap.

Key Operation

Insert Mode

On keyboards attached to the 3277 displays, the RESET key is used to return the keyboard to normal operation after an insert-mode (INS MODE) operation. To return a keyboard attached to the 3178, 3278, or 3279 display to normal operation, any key that causes I/O communication can also be used.

Typematic Keys

The cursor move and space keys are typematic on the keyboards attached to the 3277 displays. On keyboards attached to 3178, 3278, and 3279 displays, the ENTER key and alphameric keys (in addition to the cursor move and space keys) are typematic.

Numeric Shift Key

When the Numeric Shift key on a data entry keyboard attached to the 3277 display is used with a key that does not have an upper shift symbol (@, #, D), a blank character is inserted in the buffer. When the same operation is performed using the Numeric Shift key on a data entry keyboard attached to the 3178, 3278, or 3279 display, a no-shift character is placed in the buffer.

Screen Update

On 3277 displays, the entire image is removed from the screen when the screen content is changed. This action causes a blank screen (referred to as "blink") prior to display of a new image. When the content of a 3178, 3278, or 3279 is changed, the entire image is not removed. Display stations attached to a 3274 using SNA/SDLC protocol update the display image in character blocks of up to 256 bytes. As the screen on a display attached to a BSC 3274 is updated, if a

communication line or program error is detected during execution of a Write command, the update operation is stopped and the previous image is restored. If the error persists, successive retry operations will be noted at the display station.

Display of New Line (NL), End of Message (EM), and Forms Feed (FF) Orders

The NL, EM, and FF order codes are displayed as 5, 9, and < respectively on a 3277, but are not displayed on 3178, 3278, and 3279 units.

Display of Duplicate (DUP) and Field Mark (FM) Characters

The DUP and FM characters are displayed as * and ; on 3277 displays, and on 3178, 3278, and 3279 displays when the Dual Case/Mono Case switch is in the Mono Case position. On 3178, 3278, and 3279 displays, the same symbols appear with an overscore added (*, ;) when the Dual Case/Mono Case switch is in the Dual Case position or always appear with an overscore when the displays have the Extended Character Set Adapter installed and are attached to a 3274 with Configuration Support C installed.

Operator Indicators and Symbols

The 3277 has three operator indicator lights, located on the right side of the display tube. The 3178 and 3278 Models 2, 3, 4, and 5 and 3279 units can display up to 80 Operator Information Area symbols across the bottom row of the display image; the 3278 Model 1 units can display up to 64 Operator Information Area symbols.

Uppercase and Lowercase Character Display

The 3277 displays uppercase alphabetic characters. The 3178, 3278, and 3279 units display lowercase and uppercase character codes received from the host unless the Dual Case/Mono Case switch is placed in the Mono Case position, which results in an uppercase character display.

Uppercase and lowercase codes are transmitted between the host and the 3178, 3278, or 3279 display.

Security Keylock

The Security Keylock is a security-enhancement special feature that provides a key-controlled lock for 3277, 3278, and 3279 displays. The Security Keylock is standard on 3178 displays. When the key is in the "off" position or is removed from the display station, the message buffer is "locked," which prevents entry, modification, and display of data. The display station is unavailable to programmed read or write operations and to operator inputs such as keyboard entry, card reader entry, and selector-light-pen operations.

Programmed attempts to access display stations that have the key turned off or removed from the lock result in responses being returned to the CPU by the control unit. Responses are device- and operation-dependent, as summarized in the following table:

Device Attachment	Operation	Response
3274 B and D Units	All	UC, IR Status and Sense
3274 C Units (BSC)	Specific Poll	IR Status and Sense
	General Poll	EOT
	Selection Addressing Sequence	RVI
3274 A and C Units (SNA/SDLC)	Normal Flow Requests	3278/3279 IR (Negative Response 0802) 3277 Power Off (Negative Response 0831)

Printers

Printers for the 3270 Information Display System provide a printed copy of information that is displayed at a display station or of information written from the host program. Printed data appears in the same alphanumeric characters and symbols that appear on a display, and printouts can be formatted the same way a display is formatted. Cursor information is ignored by the printer.

The following printers are available for attachment to the 3274 control units:

- The 3230 Printer Model 2, an electromatrix printer supporting 3270 Data Stream and SNA Character String (SCS) modes of controlling printer formatting.
- The 3262 Models 3 and 13, a line printer supporting 3270 Data Stream and SNA Character String (SCS) modes of controlling printer formatting.
- The 3268 Printer Model 2, a matrix printer supporting 3270 Data Stream and SNA Character String (SCS) modes of controlling printer formatting.
- The 3284 Models 1 and 2, a matrix printer supporting the 3270 Data Stream mode of controlling printer formatting.
- The 3286 Models 1 and 2, a matrix printer supporting the 3270 Data Stream mode of controlling printer formatting.
- The 3287 Models 1, 2, 1C, and 2C, a matrix printer supporting 3270 Data Stream and SNA Character String (SCS) modes of controlling printer formatting; the C models are capable of supporting the Color, Extended Highlighting, and Programmed Symbols functions of the Structured Field and Attribute Processing customization option of the 3274 control units. Extended Highlighting and Programmed Symbols are supported on Models 1 and 2.

- The 3288 Models 1 and 2, a line printer supporting the 3270 Data Stream mode of controlling printer formatting.
- The 3289 Models 1 and 2, a line printer supporting the 3270 Data Stream and SNA Character String (SCS) modes of controlling printer formatting.

The relationship between the printer buffer and a printout is shown in Figure 2-12.

Full descriptions of the 3230, 3262, 3268, 3287, and 3289 printers are contained in the following publications:

IBM 3230 Printer Model 2 Product Description, GA24-3759

IBM 3262 Line Printer Models 3 and 13 Component Description, GA24-3741

IBM 3268 Printer Model 2 Description, GA27-3268

IBM 3287 Printer Models 1 and 2 Component Description, GA27-3153

IBM 3287 Printer Models 1C and 2C Component Description, GA27-3229

IBM 3289 Line Printer Component Description, GA27-3176

Print Line Formatting

Printout operations are specified by a Write command or a Copy command (3274 C units using BSC only) addressed to the printer. The print line format in which the data is to be printed from the buffer can be specified as part of the command in one of three printer formats. These formats define the print line length: 40, 64, or 80 character positions per line. If a format is not specified, the print line length is determined by platen length on 3284 and 3286 printers, while the print line length is 132 character positions on the 3262, 3287, 3288, and 3289 printers. Print line length (maximum presentation line—MPL) can be set to values less than 132 character positions by the operator on the 3230, 3262, 3268, 3287, and 3289 printers.

When the 3278 or 3279 Print key is used to initiate a printout, or when the 3274 SNA host copy operation, described later under "Local Copy Function," is executed, the print line length will be the same as that of the source display. Print line length formats are specified below:

Operation	Command	Addressed Terminal	Format Specification
Host Write (except SCS)	Write	Printer	WCC bits 2 and 3
BSC Host Copy	Copy	Printer	CCC bits 2 and 3
SNA Host Copy	Write	Display	Same as display
PRINT key	NA	NA	Same as display

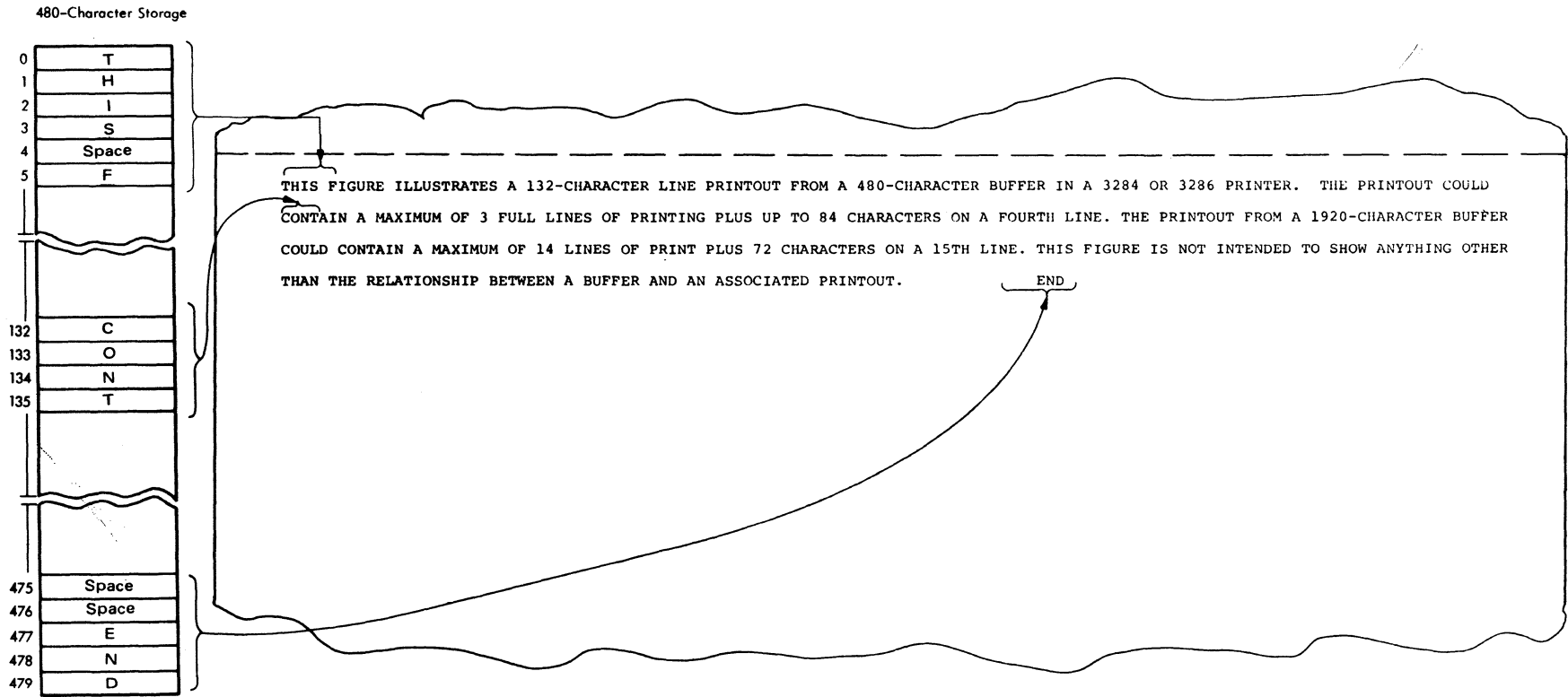

Figure 2-12. Relationship between Buffer Data and Printed Data

Printer Orders (3270 Data Stream Mode)

Printer orders are transferred as part of the data stream from the application program and stored in the buffer as data.

Programming Note: Devices without the Extended Character Set Adapter (ECSA) feature support 182 characters in the base character set; devices with the ECSA feature support 191 characters in the base character set. If characters from the 191-character set that are not supported by the 182-character set are directed to a device without the ECSA feature, then that device may interpret certain of these unsupported characters as control codes.

Some PS symbols may contain code points that coincide with those of control functions. If these symbols are directed to a device without the PS feature, that device will interpret these symbols as control codes.

New Line (NL) and End of Message (EM) (All Printers)

The NL order is executed only when encountered during an unformatted printout; that is, a printout that does not have a line-length format specified. When an NL order is encountered in the buffer, the printer performs an NL function. If no NL order is encountered before the printer reaches the end of a line (as determined by the maximum print position), the printer automatically performs an NL function and continues printing. If an NL order is encountered at one character position past the maximum print position, the 3230, 3268, 3284, 3286, 3287, and 3288 printers will perform two NL functions; the 3262 and 3289 printers will perform one NL function.

The NL order is not executed when located in a nondisplay/nonprint field; it is treated as an alphanumeric character and printed as a space. In addition, the NL order is not executed when encountered during formatted printout. Instead, it is printed by the 3284, 3286, 3287, and 3288 printers as the graphic "5," and by the 3230, 3262, 3268, 3287, and 3289 printers as a space character.

The EM order is executed only when encountered during an unformatted printout. The EM order is not executed when located in a nondisplay/nonprint field; it is treated as an alphanumeric character and printed as a space. In addition, the EM order is not executed when encountered during a formatted printout. Instead, it is printed by the 3284, 3286, 3287, and 3288 printers as the graphic "9," and by the 3230, 3262, 3268, 3287, and 3289 printers as a space character.

Forms Feed (FF) (3230, 3262, 3268, 3287, 3288, and 3289)

Valid Forms Feed (FF) orders are executed by the 3230, 3262, 3268, 3287, 3288, and 3289 printers during either formatted or unformatted printouts. (The FF order is described under "Page Length Control/VFC Operations.") When a valid FF order is encountered in the first print position of a line, the print form indexes to a predetermined print line on the next form.

Suppress Index (SI) (3288)

The Suppress Index order is effective only when the 3288 is attached to 3271 or 3272 Control Units. See the *3271 Control Unit/3272 Control Unit/3275 Display Station Description and Programmer's Guide*, GA23-0060.

Carriage Return (CR) (3230, 3262, 3268, 3287, and 3289 Printers)

When the Carriage Return (CR) order code is found in the data stream, the next print position will be the leftmost character position on the current print line. CR orders are not executed when they occur in nonprint fields and when the printout is formatted (printer format bits in the WCC indicate a line length). In both cases, the CR order is printed as a space character.

Printer Operations (3270 Data Stream Mode)

When the WCC Start Print bit is set to 1, the printout starts after the control-unit-to-printer-buffer transfer is completed.

During a formatted print operation, data characters in the printer buffer are scanned one line at a time before they are printed. A line feed is executed after each line is printed. If a line contains only space characters (one or more), line feed is performed to cause a blank line in the printout. When null characters, attribute characters, or alphameric characters in nonprint fields are encountered, they are treated as follows:

- If embedded in a print line, they are printed as spaces.
- If they constitute an entire line, they are ignored and the line feed is not performed; as a result, a blank line does not appear in the printout, and the data is compressed vertically one line.

During an unformatted operation, buffer data printout begins at buffer location 0 and continues until the last position of the buffer is printed or until a valid EM character is encountered. Each print line is left-justified. At the end of each printout, a final line feed is executed so that the printer is ready to start the next printout. When the print-terminating EM order appears in the first print position of the print line, a final line feed is not executed because the printer is already positioned at the left margin for the next printout.

Page Length Control/VFC Operations

The ability to index forms vertically under program control to a predetermined print line is provided by the Page Length Control function for the 3262 and 3287 printers, by the Vertical Forms Control (VFC) specify feature for the 3288, and as part of the basic 3289 functional capability. Special inks and preprinted forms containing index marks are not required to make this feature operational.

When a valid Forms Feed (FF) order is encountered in the buffer during a printout, the form skips to a predetermined line. Printing begins on the predetermined line; the first print position (the buffer location containing the FF character) is printed as a space character. Printing and skipping continue until the printout is terminated. The printer is "busy" while printing and skipping.

There is no limit on the number of FF orders that can be included in the printer buffer or on the frequency of their occurrence. However, for an FF order to be considered valid and thus initiate skipping, FF characters must be placed in buffer locations corresponding to the first position of a print line in a field designated either print or nonprint. This can be accomplished by placing the FF character (1) in the first character after the WCC in a write, erase/write, or erase/write alternate data stream to the printer or (2) after a valid NL or CR order.

When an FF character is placed in the first character position of any print line (for example, in character position 41 in a buffer with a printout format of 40 characters per line specified, or in character position 133 in a buffer for an unformatted printout), the form skips to line 1, position 2.

An FF order in any other position (than the above) in the printer buffer is considered invalid; the skip operation is not executed, and the FF character prints as a "<" character on the 3288 or as a space character on the 3262, 3287, or 3289, except when the FF order is located in a nonprint field. The "<" character prints during either formatted or unformatted printouts. When an FF order is sent to a 3288 that does not have the VFC feature installed, or if the skip operation is not executed, the FF character is printed as a "<" character. A valid FF order prints as a space character:

During a print operation, if a valid FF order is encountered when the form is located at the predetermined skip stop line (the first print line of each form) of a 3230, 3262, 3268, or 3288, the skip operation will be executed, and a blank form will result. The 3287 and 3289 will not skip a blank form.

Programming Note: Placing the FF order at the end of a print buffer is not recommended. When a valid FF order is placed at the end of a print buffer and is followed by an EM order, the 3262, 3287, 3288, and the 3289 printers will stop printing and skip to line 2 of the next form.

Before beginning Page Length Control/VFC operations, forms must be loaded in the printer and aligned to the print line where skipping should stop and printing begin. If the forms are not aligned properly while initially being loaded, all forms will be misaligned. The 3287 and 3288 Page Length Control/VFC circuitry synchronizes with the skip stop line on the form as the cover is closed and the printer goes from not ready to ready. If the cover must be raised or if a not-ready condition occurs, the form must be checked to ensure that the skip stop line is in the proper position before reclosing the cover.

The two Selector Switches must be set to the number corresponding to the total number of print lines from one skip stop to the next for each Page Length Control/VFC application. There can be up to 99 lines between successive skip stop lines. When uniform length forms are used, the setting for the switches is computed by multiplying the forms length in inches by the lines-per-inch setting, either 6 lines per inch for the 3288, or 6 or 8 lines per inch for the 3262, 3287, and 3289 printers. (For example, when 11-inch forms are installed on the 3288, the switches should be set at 66.)

Programming Notes:

1. If an NL order and an FF order appear on the last line of a 3288 printout and VFC is installed, FF is suppressed and the printer will not skip a full form. If this condition occurs on a 3262, 3287, or 3289 printer, subsequent printing will begin on a new form.
2. The Page Length Control function on the 3287 printer is synchronized when power is applied or when the FF switch is pressed.

SCS Operations

The SCS control codes provide printed page format control. They also can set modes of operation, define data to be used in a unique way, and allow communication between a terminal operator and an application program.

The SCS data stream consists of a sequential string of control and data characters. When the SCS DATA structured field is supported, it may be used to carry the SCS data stream.

SCS Control Codes

SCS control codes are honored by the 3262, 3287, and 3289 printers when operating as LU type 1 attached to the 3274. These printers, using SCS support, can perform a variety of page-editing functions. The SCS control codes follow:

Code	EBCDIC (Hex)	Name
BS	16	Back Space
BEL	2F	Bell Function
CR	0D	Carriage Return
ENP	14	Enable Presentation
FF	0C	Forms Feed
GE	08	Graphic Escape
HT	05	Horizontal Tab
INP	24	Inhibit Presentation
IRS	1E	Interchange-Record Separator
LF	25	Line Feed
NL	15	New Line
SA	28	Set Attribute
SHF	2BC1	Set Horizontal Format
SLD	2BC6	Set Line Density
SVF	2BC2	Set Vertical Format
TRN	35	Transparent
VCS	04XX	Vertical Channel Select
VT	0B	Vertical Tab

Note: To ensure format integrity, any change in print format should be followed by the appropriate synchronizing event (CR, NL, FF, etc.).

The SCS control codes are defined as follows:

Back Space (BS): a format control that moves the print position horizontally one position to the left. If the print position is at column 1, the function is inoperative. Left margin settings are ignored.

Carriage Return (CR): a format control that moves the print position horizontally to the left margin on the same line. If the print position is already at the left margin, the function is inoperative.

Enable Presentation (ENP): a formatting control character used to enable the printing of keyboard input data on the presentation space. This code performs no function on the LU type 1 device, but it is accepted without error response and without affecting format.

Form Feed (FF): a format control that moves the print position to the top and left margin of the next form. If the maximum presentation line (MPL) value has not been set and there is no default value, the MPL defaults to 1, and the print position moves to the left margin of the next line.

Horizontal Tab (HT): a format control that moves the print position horizontally to the next tab stop setting. Horizontal tab stop values are set by using the Set Horizontal Format (SHF) function. If there are no horizontal tab stops set to the right of the current print position, the horizontal tab function results in a space.

Programming Note: Horizontal tab placed after the MPP will cause a space in the first print position on the next line.

Inhibit Presentation (INP): a format control character used to inhibit the printing of keyboard input data. This code performs no function on the LU type 1 device, but it is accepted without error response and without affecting format.

Interrecord Separator (IRS): a separator character, normally used on the LU-SSCP session. If received on an LU-LU session, the IRS defaults to a New Line (NL) function.

Line Feed (LF): a format control that moves the print position vertically down to the next line.

New Line (NL): a format control that moves the print position to the left margin and vertically down to the next line. NL is functionally equivalent to CR followed by LF.

Set Horizontal Format (SHF): a data-defining control used to set the horizontal format controls. These include left and right margins and horizontal tab stops. A 1-byte binary count follows the SHF code that indicates the number of bytes to the end of the SHF string, including the count byte. The first 3 bytes following the count byte define the maximum presentation position (MPP), the left margin (LM), and the right margin (RM), respectively. Tab stop settings follow the right margin position. All values are expressed as 1-byte binary numbers.

The minimum SHF sequence is 1 byte long, which sets the horizontal format controls to their default conditions. The SHF sequence is:

(SHF)(cnt)(MPP)(LM)(RM)(T1)(T2)...(Tn)

This value is used to define a line length less than, or equal to, the maximum print position. The MPP default value is the maximum print position (132) or the value set up by the printer operator (3262 and 3289).

Programming Note: If the MPP is set to a value greater than the physical page width, data may be lost (for example, printing on the platen or print head jams at the right margin).

LM specifies the column value of the leftmost print position. The LM also serves as the first horizontal tab stop. Valid LM values are less than, or equal to, the MPP. The LM default value is 1.

RM is not used in printing operations.

T1...Tn are horizontal tab stop settings. The tab stops do not have to be in order. Valid tab stop values are equal to or less than MPP.

Set Line Density (SLD): specifies the distance to be moved for single-line vertical spacing, as in LF or NL. A 2-byte parameter follows the SLD control code. The first byte, a count field, can be either X'01' or X'02'. A count field of X'01' with no parameter byte will set default print density. The sequence can also be '1BC60200', which will set default value to 6 lines per inch. The second byte specifies the distance in standard typographic points (one point = 1/72 inch). For example, a value of 12 points indicates 6 lines per inch. LPI/Point Values are as follows:

LPI	3 ¹	4 ¹	6	8
Point Values	24 ¹	18 ¹	12	9

¹3289 only

Programming Note: If the SLD is changed without a corresponding change in the MPL (and vice versa), printing may occur on the form fold.

When the logical unit controlling a 3287 or 3289 receives an LU type 1 Bind, the 3287 or 3289 will default to a line density of 6 lines per inch.

Density values not implemented are rejected with a negative response of X'1005', parameter error. Line densities defined for the 3287 and 3289 printers are as follows:

LPI	6	8	4 ¹	3 ¹
SLD	12	9	18 ¹	24 ¹

¹3289 only

Set Line Density (SLD) - 3262: SLD sets the number of print lines per inch by specifying the distance to be moved for single-line vertical spacing, as in LF or NL. This function changes values that were previously set during printer initialization or by pressing the CHANGE LPI key on the operator's panel.

A 2-byte parameter follows the SLD control code. The first byte, a count field, may be either X'01' or X'02'. The second byte, a line density parameter (lpi), specifies the distance to be moved for single-line vertical spacing. This value may be X'18' (for 3 lpi), X'12' (for 4 lpi), X'0C' (for 6 lpi), or X'09' (for 8 lpi).

A count field or X'01' with no following line density parameter byte sets the default print line density to the current operator panel setting (either 6 or 8 lpi). A count field of X'11' (host system default) also sets line density to 6 lpi.

The following examples show how to use the SLD function:

2BC60218 = 3 lpi

2BC60212 = 4 lpi

2BC60209 = 8 lpi

2BC6020C = 6 lpi

2BC601 = default to op panel setting

If no SLD value is specified, the printer uses the operator-selected value.

Set Vertical Format (SVF): sets vertical format controls, including the maximum presentation line (MPL), top margin (TM), bottom margin (BM), and vertical tab stops. A 1-byte count field follows the SVF character to indicate the number of bytes, including the count byte, in the SVF string.

The first three values following the count in an SVF string are the maximum presentation line, the top margin, and the bottom margin, in that order. A zero for any of these values results in the function assuming the default value. Vertical tab stop values follow the bottom margin. All values are expressed as 1-byte binary numbers.

The SVF sequence is:

(SVF)(cnt)(MPL)(TM)(BM)(T1)...(Tn)

MPL defines the page depth. All values between 0 and 102 (3287) and 0 and 127 (3289) are valid. A page depth defined by the SVF takes precedence over the device default value. The MPL default value for the 3287 is 1; the MPL default value for the 3289 is 1 or the contents of the Selector switch. If the Selector switch is set to 00 and power is turned on, the MPL defaults to 1; if the Selector switch is set to 00 and the Reset switch is pressed, the MPL remains unchanged.

Programming Note: If the MPL is set to a value greater than the physical page length, printing may occur on the form fold.

TM specifies the line value used as the top representation line on the page. The top margin is also the first vertical tab stop. Valid TMs are equal to, or less than, MPL. The default TM value is 1.

After the TM is initialized, the TM should not be changed because a TM change requires operator intervention to align the physical page. The printer cannot detect physical line 1; therefore, it is assumed the operator has aligned physical line 1 to the printer's logical line 1. If a printer must be used in an intermixed SCS/non-SCS environment, the operator should always set the physical page line 1 at the first line to be printed and the TM should always be set to a value of 1.

BM specifies the line value that, if exceeded, causes an automatic skip to a new page. BM must be greater than, or equal to, TM, and less than, or equal to, the MPL. The default BM value is the MPL value.

Transparent (TRN): a data-definition character which provides for the transmission of data in transparent mode. A 1-byte binary value follows the TRN code which specifies the number of bytes of transparent data to follow. The length does not include the length byte. Transparent data is user-defined and is not scanned for SCS control. Valid graphics are printed. Invalid graphics are printed as hyphens (-).

Vertical Channel Select (VCS): is a device control code that allows selection of one of 12 vertical channels to control vertical format. The first character of the code is the select code, followed by a function value which selects the appropriate channel. When necessary, printers default the VCS code to an LF function. The 3287 always executes LF. The 3262 or 3289 skips to the channel, as specified by VCS.

Vertical Tab (VT): a format control that moves the print position vertically down to the next vertical tab stop setting. Vertical tab stops are set by using the Set Vertical Format (SVF) function. If there are no vertical tab stops below the current print position, the VT function results in an LF function.

Graphic Escape (GE): a character selection code that immediately precedes a codepoint and is used to indicate that the character to be displayed or printed is to be selected from the character set stored in ROS 1. (The base character set for the machine is stored in ROS 0.)

Set Attribute (SA): an attribute defining code used to associate the color, extended highlighting, and programmed symbols attribute types with a character or string of characters. The SA code can also reset the attributes defined for a character or string of characters to those of the field in which the character(s) appear. (See Chapter 1.)

Program Attention (PA) and Cancel Print Switches

The PA1/PA2 and Cancel Print switches are provided when SCS is installed on 3262, 3287, and 3289 printers (SCS is always installed on the 3289) attached to the 3274 via the type A adapter. These switches allow the operator to communicate with the host system in SCS mode, and are used with the Hold Print/Enable Print switch. Operator- or host-initiated operations can be performed.

Cancel Print. The Cancel Print switch causes the printer to terminate the current print operation. Portions of a chain that have not been passed to the printer are purged by the control unit.

Cancel print is meaningful when the printer is printing SCS data or waiting for the next data in a chaining operation. If the Cancel Print switch is pressed and the printer is not processing SCS print data, an invalid switch operation is indicated at the printer. The control unit is not made aware of this condition.

PA1/PA2. The PA1/PA2 switch causes an attention to be sent to the control unit. The status indicator on the printer will indicate acceptance of the code, and printing is resumed if it was in progress prior to the PA switch sequence. The two-digit code is then cleared from the status indicator.

The operator may then initiate another PA switch selection if the previous selection is overwritten. PA switch information is not stacked within the subsystem.

The control unit of an SCS printer transmits the PA switch codes to the PLU as FM data, as follows (note that there is a blank between APAK and the PA switch code digits):

PA Switch	Text String Transmitted
1	APAK 01

If the printer is not in SCS mode (for example, performing a local copy operation), an invalid switch operation is indicated, and no PA switch sequence can be initiated.

Print Format Control

The format of the printed data is determined by the following parameters:

Maximum Presentation Position (MPP)

Maximum Presentation Line (MPL)

Lines per Inch (LPI)

Single/Doublespace

Mono/Dual Case

The 3262 and 3289 allow the operator to change the machine default values of these parameters. They can be set by the host or control unit in SCS and non-SCS print modes. See the 3289 or 3262 Component Description manuals for detail.

When the 3287 is operating in SCS mode, the operator can change the machine default of only Single/Doublespace. The default values are MPP = 132, MPL = 1, LPI = 6, and Mono/Dual Case = Dual.

Local Copy Function

In addition to processing the BSC Copy command in remote control units (3274 C units and 51C BSC), the 3274 units provide a local copy function which allows direct data transfer from a display station to a printer(s) attached to the same control unit. The local copy function is directed by the 3274 *printer authorization matrix*. The printer authorization matrix must be loaded into the control unit.

The local copy function can be operator- or host-initiated. For operator-initiated copy, the operator uses the Print key on a keyboard attached to a 3178, 3278, or 3279 to initiate a local copy request. The local copy request is serviced by a printer selected under control of the print-control matrix.

In SNA models (3274 A and C units or 51C (SDLC)), host-initiated local copy requests are initiated by issuing a write-type command with the WCC Print Bit set to 1. Printer selection and servicing of the local copy request proceed in much the same way as for operator-initiated local copy requests.

Do not attempt to copy graphics dependent on more than one character position for their presentation. If the graphic data cannot be accessed by a single code point, the printout will be inaccurate because of the differing block matrix sizes

and dot densities between display and printer. Also, attempting to copy to a printer not featured for Programmed Symbol operation, or not containing a matching symbol set (with the one in the display station), results in default to the I/O interface character set installed in the printer.

Screen Capture Function (3278 with IBM 3270 Personal Computer Attachment)

The objective of the screen capture function is to transfer the data visible on the 3278 screen to the IBM 3270 Personal Computer Attachment for printing on the personal computer printer or for recording on the personal computer diskette. Screen capture is effective only in host mode.

Screen capture is initiated by pressing of the Print key on the keyboard. The printer ID must be defined as 99. 99 indicates that the selected printer is the personal computer. If the printer ID is not 99, a normal local copy operation occurs.

3274 Printer Authorization Matrix

The 3274 printer authorization matrix is either sent from the host per operator request or specified during 3274 customizing. The matrix defines the operating characteristics of the printers attached to the control unit. (For details on specifying the matrix from a terminal, refer to the *IBM 3270 Information Display System: 3274 Control Unit Planning, Setup, and Customizing Guide*, GA27-2827.) In this regard, the matrix serves a threefold purpose:

1. **Establish Printer Mode.** A printer may be reserved for exclusive use of either the host or the local copy function. A third mode allows a sharing between these two functions.
2. **Assign Print "Classes."** A print "class" is a way of grouping printers for use by local copy. A local copy request directed to a "class" is then serviced by one of the printers assigned to that group.
3. **Define Source Device Lists.** The source device list specifies which displays may use any given printer for local copy. Note that all displays for a printer must be attached to the same adapter type as the printer. For example, a category A printer can have only category A displays in its source device list.

Printer Modes. A printer may be in one of three modes, specified in the printer authorization matrix as local, system, or shared mode. Each printer on the 3274 is defaulted to system mode until a matrix is loaded. Printers that are specified as being in shared or local mode then become available for local copy use.

Local Mode. A printer in local mode may be used for local copy functions regardless of host attachment or communication protocol. This means that displays within the cluster may contend for use of printers but the host may not. The printer is not available for direct print operations from the host.

A local copy operation involves the transfer of data from the display buffer to the printer buffer and the subsequent printing of that data. A local copy may be initiated by an operator using the Print key on a 3178, 3278, or 3279 attached to a 3274 or by the host when the display is operating in SNA/SDLC. (The Start Print bit in the WCC of a Write command to the source display initiates the host copy operation.)

The response to a Copy command or a direct print request(s) from the host to a printer when in local mode is Intervention Required (IR). Also, a printer in local mode cannot validly be specified as a "from" BSC device in a Copy command. An I/O operation addressed to a printer in local mode when attached to a 3274-1B or -1D results in Control Check (CC). Subsequent operations cause Intervention Required. The control unit sends Device End (DE) when the printer is returned to either shared or system mode.

In SNA/SDLC, an LU type 1 or 3 bind request to a printer is rejected with a negative response of X'0801' (printer not assigned) when the printer has been put into local mode.

System Mode. A printer in system mode is entirely under host (system) control. This is the default mode each printer assumes when no matrix has been loaded. The printer cannot be used for operator-initiated local copy requests. The printer is likewise not available for host-initiated copy operations when using SNA/SDLC. However, when operating with BSC discipline, the printer may honor a BSC Copy command when it is in system mode. The BSC Copy command, directed to the "to" device, specifies the "from" device as a command parameter and does not use the printer authorization matrix. Host-directed printing is described under "3274 Local Copy Operation."

Shared Mode. In shared mode, both host-directed printing operations and local copy operations are permitted on the same printer. When in system mode, the printer is protected from local copies; in local mode, the printer is protected from host-initiated operations. However, when in shared mode, the subsystem does not guarantee this type of integrity. The user must assume the responsibility for integrity of his printed data by "installation rules" and proper programming practices when using a printer in shared mode. In BSC, an operator-initiated local copy operation to a printer in shared mode is not executed if the printer has status pending from a previous host-directed print operation. General or Specific polling will clear the printer status and free the printer for local copy usage.

In SNA/SDLC, a printer designated as being in shared mode in the printer authorization matrix may be used for local copy under the following conditions:

- When the printer is not in session with a primary logical unit (PLU) in the host
- When Between Bracket Printer Sharing has been specified in the customizing procedure (sequence number 213) and the printer is not in bracket state with a PLU in the host.

Printer Class Structure. The printer authorization matrix provides the ability to assign a printer to a class. The definition of a class of printers is made by the customer, and may be based on type, character subset, type of forms mounted, location, etc. For example, in a particular installation class, "72" may have been defined as referring to all printers with yellow paper. Thus, an operator may select an authorized printer on the basis of these characteristics rather than by address. When multiple printers are assigned to a class, improved copy throughput can be obtained.

The printer authorization matrix allows a maximum of 16 printer classes to be defined in each subsystem. A display operator may select a printer by class by using the IDENT key (ALT key depressed) and keying in a number ranging from

70 through 85 corresponding with one of the 16 classes. With this type of operation, the control unit selects an authorized printer in the class to service the copy. In any configuration, a single printer may be in one or several classes, or not in a class. Several printers may be members of a single class.

Source Device Lists. Each printer may be restricted as to which displays it may accept local copies from. Note that the control unit restricts local copy operations to devices on the same adapter (type A or type B). Any given printer may be permitted to process copies from some, all, or none of the displays on the same adapter. Even if configured in the source device list, local copy from a type B display to a type A printer (and vice versa) is not allowed.

When a local copy is directed to a print class, the printer selected will be one that is attached to the same adapter and that is authorized to accept copies from the requesting display. Not all printers assigned to a particular class may be authorized for the same subset of display terminals.

Matrix Structure. The 3274 printer authorization matrix defines how display stations (source devices) may use printers (destination devices) attached to the same control unit for the purpose of printing a local copy request.

The printer authorization matrix is structured as a two-dimensional array with each device in the cluster represented by a destination device descriptor with the following format:

Printer Port Address	Mode	Class	Source Device List
----------------------	------	-------	--------------------

Printer Port Address is the first field of the descriptor. A decimal address from 01 to 31 for the 3274 allows printers to be attached to any port on the control unit, except port 0. Addresses are sequential by adapter.

Mode defines the printer to be in local, system, or shared mode.

Class is the third field of the descriptor, and provides the ability to group printers into classes. This field is bit-coded, one bit for each of 16 classes, so that a single printer may be in more than one class. Valid classes are designated 70 through 85 inclusive. Coding a 1 under the appropriate class allows the printer to accept copies from displays selecting that class, provided it is authorized by the source device list.

Source Device List is a bit-coded field that specifies which displays (D) are authorized and configured to use the printer (P) associated with this device descriptor. Each bit position is associated with a port number on the cluster. Coding a 1 under a given display port address allows the printer to service copies from that display.

Note: The class and source device list must be changed from binary representation to hexadecimal for entry during customizing.

Consider an example in which ports 0 through 9 of a 3274 have terminals attached as follows:

```

Port Number   0 1 2 3 4 5 6 7 8 9
Terminal      D D P P D D P P D D
  
```

With the following matrix:

Printer			
Attached to Port with Address	Mode	Class 70 71 72 73...	Source Device List
			Port No: 0 1 2 3 4 5 6 7 8 9 Terminal: D D P P D D P P D D
02	Local	0 0 0 0 ...	1 0 X X 0 0 X X 0 0 ...
03	Shared	0 1 0 0 ...	0 1 X X 1 0 X X 0 0 ...
06	Local	0 1 0 0 ...	0 1 X X 1 0 X X 1 1 ...
07	System	0 0 0 0 ...	0 0 X X 0 0 X X 0 0 ...

X = Reserved, set to 0.

In this example, the display at port 0 may copy only to the printer on port 2. This printer is not addressable by class (class = all zeros). The displays on ports 1 and 4 are authorized to use either the printer on port 3 or the printer on port 6, while the displays on ports 8 and 9 are authorized to use only the latter. The printer on port 3 may also be used by the host. If selected by address, the addressed printer is logically connected to the display for local copy operations. If addressed by class, all printers in the class are logically connected to the display for local copy operations. In a class environment, printers in the class are selected on a most-available basis.

The display at port 5 is not authorized to use a printer as a local copy device. Also, the printer at port 7 is in system mode and therefore reserved for exclusive use by the system. It is not available to any displays for local copy operations, even if there is an authorized display in the source device list.

It is important to note that source devices are associated with destination devices, not with classes. Thus several printers may be defined to be in class 75, but a particular display may only be authorized for some subset, or even for none of the printers in that class. When class identification is displayed in the indicator row of the display, copying is performed only to authorized printers in that class.

Note: When defining the printer authorization matrix, it is desirable to match the capabilities of the destination printers with those of the source display, especially the capabilities for APL/Text handling and support of the Extended Highlighting, Color, and Programmed Symbols functions. If the print buffer is at least as large as the display buffer, a copy request will be honored, but, if the other capabilities do not match, a degradation of the printout may result, depending upon the contents of the display buffer when the copy request is honored.

Loading the Matrix. The 3274 printer authorization matrix is required to perform local copy operations between category A terminals. Local copy operations are

not permitted between category B terminals attached to a 3274. However, host-initiated copy may be performed by presetting a PF key on the category B terminal. If no matrix is loaded, the default condition for the cluster is that all printers are in System mode, and local copy operations are not possible except with the BSC Copy command. The matrix is loaded by one of the following procedures:

- The matrix may be defined during the customizing process. If so, the matrix is automatically loaded whenever IML is performed on the system diskette. See the *IBM 3270 Information Display System: 3274 Control Unit Planning, Setup, and Customizing Guide, GA27-2827*.
- The operator initiates loading of a printer authorization matrix as follows:
 1. The display operator initiates a transaction with a host program responsible for defining, managing, and loading the printer authorization matrix. This transaction may, through appropriate interaction with the operator, define a new printer authorization matrix, retrieve a previously defined matrix from host storage, or redefine an existing matrix.
 2. The host program then transmits the matrix data to the display attached to port 0 as normal application data in a data stream, causing it to be stored in the display buffer as normal character data.
 3. The operator holds down ALT and presses the Erase to End of Field key (EOF), causing the buffer to be scanned one row at a time from top to bottom. As each row is processed, the configuration data is stored in internal form in the control unit.

If the control unit is a 3274-51C with the X.21 Switched Network Adapter feature installed, buffer scanning is initiated by using the ALT key, the X.21 extension key, and the Host Load Matrix key as follows:

1. Simultaneously pressing the ALT and X.21 extension key
2. Then pressing the Host Load Matrix key

During the loading process, the Time symbol is displayed in the Operator Information Area and the keyboard is locked. If the load is successful, the Time symbol is turned off and the keyboard unlocks. The cursor appears in column 1 of the row containing the end-of-matrix attribute sequence. The operator can then return to normal activity. Local printing can take place according to the authorization established in the matrix. When the load process is completed, configuration data cannot be retrieved from the control unit for presentation back to the operator or the host.

If the loading process is unsuccessful, the Program Check symbol is displayed and the keyboard remains locked. The cursor appears in column 1 of the row containing the error. The operator can reset the keyboard and resume operation. Only those device descriptors that have been processed take effect. Recovery procedures are the responsibility of the application program. It is a host program responsibility to ensure that correct matrix data is loaded. If invalid data is loaded, unexpected results may occur when the matrix is used by the subsystem. Loading of the matrix will terminate abnormally only when there is a Program

Check. A display must be operating in 80-column format to properly load a matrix. If a matrix load is attempted, and the display is in 40-column mode, a Program Check will occur.

Screen Format. When the operator initiates the load operation from the keyboard, the printer authorization matrix must appear in the buffer as shown below:

Rows 1,2 — Reserved
 3 — Header
 4-4N — Destination Device Descriptors
 N+1 — Trailer

The first two lines of the display are reserved for the host program to display descriptive information to the display operator. These positions are not scanned during the load process.

Header. There must be a sequential string of four attribute characters, beginning at the first character position on the third row of the display, as follows:

Hex		Graphic	Definition
EBCDIC	ASCII		
60	2D	—	Protected
C1	41	A	Unprotected, MDT = 1
D4	4D	M	Unprotected, Numeric, Detectable
60	2D	—	Protected

This 4-byte sequence uniquely identifies the buffer data that follows as print authorization data. If the sequence does not appear exactly as shown, a Program Check occurs and the loading process is terminated. The remainder of the third row is not scanned.

Device Descriptors. Subsequent rows of the display contain the destination device descriptors. One descriptor is contained in a row. The format of each descriptor is as follows:

Col 1	Cols 2, 3	Col 4	Cols 5—20	Cols 21—52
Protected Attribute - 1 byte	Address of Printer - 2 bytes	Printer Mode - 1 byte	Print Class - 16 bytes	Source Device List - 32 bytes

The protected attribute (EBCDIC X'60' or ASCII X'2D') defines the next 51 bytes as a destination device descriptor. If it does not appear in the first column of the row, a Program Check occurs and the loading process is terminated at this point.

The 2 bytes immediately following the attribute character provide the character-coded decimal address of the printer being described. For example, the printer at port 03 is identified by the character data "03", X'FOF3'. Addresses

are validated at the time the matrix is loaded to ensure that addresses are within the range of the number of devices configured on the control unit. A Program Check is indicated if an invalid device address is specified.

Printer mode is expressed as follows, as a 1-character field:

Mode	Hex		
	EBCDIC	ASCII	Graphic
Local	D3	4C	L
System	E2	53	S
Shared	D1	4A	J

Any other coding of this byte results in the printer being defined to be in system mode. There is no validation of this byte during loading of the matrix. If there is a conflict between the mode definition and the coding of the source device list, the mode byte takes precedence.

The next 16 characters define the printer classes that are applicable to the device. By appropriate coding of this field, a device can be defined for multiple classes. Each character in this field is defined to be a character-coded digit, representing one entry in the class field of the device descriptor:

Display Column:	5 6 7 8 9 10 11 12 13 14 15 16 17 18 19 20
Class:	70 71 72 73 74 75 76 77 78 79 80 81 82 83 84 85

The character 1, X'F1', in one of these character positions defines the device being described as a member of the class associated with the corresponding position in the class field of the device descriptor. The character 0, X'F0', or any other character in this position, means that the device is not in the associated class.

The source device list is a 32-byte field. Source devices authorized for printers are character-coded. The character "1", X'F1', in any character location, specifies the associated device as an authorized source device for the destination device being defined. The character 0, X'F0', or any other value in this location, indicates that the associated device is not a valid source device:

Display Column:	21 22 23 24 25 26 27 28 29 30 31 32 . . . 52
Device Address:	00 01 02 03 04 05 06 07 08 09 10 11 . . . 31

Each descriptor takes 52 bytes, including the attribute byte; thus, each row contains 52 bytes of significant information. Other data on the row is not scanned during the load process. The first descriptor begins at row 4 column 2, the second at row 5 column 1, etc.

Trailer. The end of the matrix is signaled by the following sequence of four attribute bytes, beginning in the first column of the row following the last valid destination device descriptor:

Hex		Graphic	Definition
EBCDIC	ASCII		
60	2D	—	Protected
C5	45	E	Unprotected, MDT = 1, Detectable
D5	4E	N	Unprotected, Numeric, MDT = 1, Detectable
C4	44	D	Unprotected, Detectable

Scanning of the buffer terminates at this point; the configuration data and each device descriptor are stored in the control unit. If a descriptor has been previously loaded for a particular destination device, it is replaced by the one being loaded. An existing descriptor, not replaced, is in effect for local copy operations. There is no global reset other than power off on the control unit. Only a Program Check causes termination of the load process prior to completion. If the configuration data is not valid, for example, if a display is selected as a destination device, there is no notification of this condition to either the operator or the application program. However, when a local copy operation is attempted, it will not be performed.

Programming Note: If a printer authorization matrix is constructed using multiple Write commands, the WCC bit setting must not specify reset MDT bit 7 = 1.

Mode Transitions. When a new printer authorization matrix is loaded into the 3274, unsatisfied print requests may still be queued. These print requests may have been made using destination device descriptors which were modified by the loading process. When new device descriptors are loaded into the subsystem, outstanding print requests are satisfied (if possible) based on the new configuration matrix. If the print requests cannot be satisfied, they are purged from the queue.

If a destination device changes from local to system mode, a bind to the printer LU is allowed, and any local copy requests queued for the printer are purged from the queue. When initiated by an operator using the Print key, the Busy symbol on the requesting display changes to Operator Unauthorized. When initiated by the host using the Start Print bit in the WCC, a negative response of X'0801', printer not available, is sent to the PLU. Any printing actually in process is completed. If a device changes from system to local mode, subsequent transmissions to the SLU are responded to with X'0801', printer not available. If the printer is not in session, the transition to local mode is immediate. When changed from shared to system mode, the transition is immediate if the printer is in session with a host PLU. If the printer LU is not in session when the change is made, a session may be bound to the printer LU. However, any outstanding print requests are purged from the print queue. When initiated by the operator with the Print key, the Busy symbol is replaced with the Operator Unauthorized symbol. (Refer to Appendix B for symbol descriptions.) When initiated by the host with the Start Print bit in the WCC, a negative response of X'0801' is generated to the host request. When changing from local to shared mode, and from system to shared mode, the transition is immediate.

3274 Printer Status Symbols. The following conditions determine which printer status symbols appear in the Operator Information Area when the printer authorization matrix is loaded from the host:

1. After the matrix is updated, the Printer Assignment symbol is checked on each display station. If the current assignment symbol is still valid, i.e., the printer or printer class is authorized for use by the display operator, the symbol is not changed. If the assignment is not valid, but the display operator is authorized to use other printers, the Printer Assignment symbol is changed to What Printer symbol. If there are no printers in the system authorized for use by the display station, the Printer Assignment symbol does not appear.
2. If the Printer Assignment symbol is not displayed when the matrix is loaded, and there are printers authorized for the display station, the Printer Assignment symbol then appears. The nn value is assigned as the first (lowest address) printer authorized for the display station. If there are no authorized printers for the display station, the symbol will not appear.
3. The priority of the printer status symbols, from lowest to highest, is as follows:
 - a. No display
 - b. □-□?? What Printer
 - c. □-□nn Printer Assignment
 - d. □-□__ Assign Printer
 - e. □-■nn Printer Printing
 - f. □-■nn Printer Failure

Thus, if Printer Assignment or Printer Failure is displayed while the matrix is loaded, the symbol will not change until the condition causing the current indication is cleared, as for example, when the printing operation is completed. The new printer status symbol is then displayed.

4. Writing the What Printer symbol to a display, or removing the Printer Assignment symbol, will terminate the print ID sequence if the operator has been entering a print ID during the load process. The cursor will be visible, and there will be no inhibit conditions.
5. If operator-initiated print requests are queued and a new matrix is loaded, the symbols will change (as previously described). If there is no change in assignment, the queued requests will be processed normally. However, if the Printer Assignment symbol is not displayed or is changed to the What Printer symbol by the load process, the Operator Unauthorized symbol is displayed, the print request is removed from the queue, and the keyboard is locked. Pressing the RESET key will unlock the keyboard. If the queued request was host-initiated, the keyboard remains locked, the Time symbol is displayed, the request is removed from the queue, and a negative response of X'0801', printer not assigned, is sent to the PLU.

6. If the Print key is pressed while the What Printer symbol is displayed or while no Printer Assignment symbol is displayed, the Operator Unauthorized symbol will be displayed and the keyboard will be locked. RESET will unlock the keyboard.
7. If the IDENT key is pressed while the What Printer symbol is displayed, the Printer Assignment symbol will appear. The first (lowest number) print class of the first (lowest address) printer authorized for use by the display is indicated by nn.
8. If the IDENT key is pressed while no Printer Assignment symbol is displayed, the Operator Unauthorized symbol is displayed and the keyboard is locked. RESET will unlock the keyboard.
9. If power is removed from a display station after the matrix is loaded, and there are printers authorized for use by the display station, the Printer Assignment symbol will be displayed as described previously in condition 2.

Changes that can occur to the printer status symbols are summarized as follows:

If the Current Printer Status Symbol is:	And the New Matrix Specifies:	Then the New Symbol Is:
<input type="checkbox"/> - <input type="checkbox"/> nn <input type="checkbox"/> - <input checked="" type="checkbox"/> nn <input type="checkbox"/> - <input checked="" type="checkbox"/> nn	nn is still authorized.	<input type="checkbox"/> - <input type="checkbox"/> nn
<input type="checkbox"/> - <input type="checkbox"/> nn <input type="checkbox"/> - <input checked="" type="checkbox"/> nn <input type="checkbox"/> - <input checked="" type="checkbox"/> nn	nn is no longer authorized, but there are authorized printers for the display station.	<input type="checkbox"/> - <input type="checkbox"/> ??
<input type="checkbox"/> - <input type="checkbox"/> nn <input type="checkbox"/> - <input checked="" type="checkbox"/> nn <input type="checkbox"/> - <input checked="" type="checkbox"/> nn	nn is no longer authorized, and there are no authorized printers for the display station.	blank
<input type="checkbox"/> - <input type="checkbox"/> ??	An authorized printer exists for this display station.	<input type="checkbox"/> - <input type="checkbox"/> ??
blank	Authorized printers exist for the display station.	<input type="checkbox"/> - <input type="checkbox"/> nn
<input type="checkbox"/> - <input type="checkbox"/> ?? or blank	No authorized printers exist for the display station.	blank

Print and IDENT key operations are summarized as follows:

If the Current Printer Status Symbol Is:	And the Following Key Is Operated:	Then:
□-□?? or blank	Print	Operator Unauthorized is displayed, and the keyboard is locked.
□-□??	IDENT	The control unit will make assignment and display □-□nn .
blank	IDENT	Operator Unauthorized is displayed, and the keyboard is locked.
□-□nn	Print	Print request is processed as described under "Operator-Initiated Copy."
□-□nn	IDENT	□-□ is displayed and print ID mode is entered.

3274 Local Copy Operation

The operator initiates a local copy function using the Print key on the keyboard of a 3178, 3278, or 3279 attached to a 3274, or, in SNA/SDLC, the PLU initiates a local copy operation by sending a write-type command to the display, with the Start Print bit turned on in the WCC. The host-initiated local copy function may be initiated with the BSC Copy command directed to the "to" device (as described under "Copy Command" in Chapter 1).

The responses to local print requests are discussed in the following paragraphs. These responses depend upon the availability of printers within a selected print class. When a selected print class contains two or more printers, and no printers are immediately available, the system response to the print request is based on the most available printer(s) in the selected print class. Categories of unavailability, in order from most to least available, are:

1. Busy executing a display printout for another SLU.
2. An Intervention Required condition exists.
3. Allocated as LU1 or LU3, in session with a PLU.
4. A permanent error situation.

Printer Selection. With the exception of the BSC Copy command, the printer authorization matrix is used to direct local copy data from a display to an associated printer (as described previously).

Consider the following example of printer selection:

Printer			
Attached to Port with Address	Mode	Class 70 71 72 73...	Source Device List
			Port 0 1 2 3 4 5 6 7 Terminal: D D P P D D P D
02	Lo	0 1 0 0 ...	1 1 X X 0 0 X 0
03	Lo	0 0 1 0 ...	1 1 X X 0 0 X 0
06	Lo	0 0 1 0 ...	0 0 X X 1 1 X 0

The displays at ports 0 and 1 can copy to the printer at ports 2 and 3. The displays at ports 4 and 5 can copy only to the printer at port 6, and the display at port 7 cannot copy to any printer.

The class connections are shown in the Operator Information Area of each display. In this example, the indicators are:

Displays at ports 0 and 1—71

Displays at ports 4 and 5—72

No connection is shown in the Operator Information Area of display 7.

If the printer at port 2 is not a member of class 71 or any other class, the symbols on the display at ports 0 and 1 show the destination address 02, even though these displays are also authorized for using the printer at port 3 with membership in class 72. In other words, a display is always connected to the authorized printer at the port with the lowest address. The display symbol shows the class number (lowest) if the printer has membership in one or more classes, or the destination address if the printer is not a member of any class.

When a display is connected to a class, as shown on its symbol, the most available printer with lowest destination address is selected if there is more than one most-available printer with membership in that class.

When the display symbol shows a printer port address, only one printer is connected. The print request is executed on that printer when it is, or becomes, available. The display terminal operator may connect to another authorized printer by using the IDENT key.

If an application program requires a certain printer for copy output, the application program may begin a session by prompting the operator to select a certain printer class by transmitting a message, such as:

“Select Print Class 79”

The operator can then make the appropriate selection.

Local print data from a display station is always directed to an authorized printer in the “connected” printer class whether the copy is initiated by the operator or by the PLU. With the IDENT key on a 3178, 3278, or 3279 attached to a 3274,

the display operator may alter this defined connection from the display keyboard. A new print class may be selected by pressing the IDENT key and keying in a two-digit identification number (ID) between 70 and 85. The class selected by the operator then appears in the Operator Information Area of the display. The print class ID, keyed in using the IDENT key, selects a valid print class by comparisons with the class fields in the authorized device descriptors of the printer authorization matrix. At least one destination device in the class must have the source display in its source list for the class ID to be valid because copy operations are performed only on printers that have the source display in their source device list. The display operator may also select an authorized printer by pressing IDENT and keying in the port address of the desired printer.

If the specified print ID is not authorized, that is, the matrix does not permit the display to copy to the selected device or members of a selected class, then the Input Inhibited Operator Unauthorized symbol is displayed. If the selected print ID is not in the matrix, the Input Inhibited What Number symbol is displayed. In both cases, the print ID routine is exited, and the keyboard is locked. The operator may press RESET and retry the print ID sequence. The display connection indicator reflects the connection prior to the initiation of the print ID sequence. If the selected print class or printer is authorized and valid for this display, the connection indicator changes to indicate the new connection, and print ID mode is exited.

When in print ID mode, the following rules apply:

1. The RESET key and other keys that cause a reset operate normally and cause the print ID mode to be terminated.
2. The ATTN key, DEV CNCL key, security keylock, and unsolicited host write operate normally; however, a 3274 print ID mode is terminated.
3. Other keys that normally function during a keyboard inhibit condition function while in print ID mode without causing an exit.
4. All other keys that are not honored during a keyboard inhibit condition cause the Input Inhibited What symbol to be displayed and print ID mode to be terminated.
5. The unlock condition of the IDENT key is governed by the same rules as a normal data key.

Operator-Initiated Copy. With the printer authorization matrix loaded in the 3274, the operator may initiate a local copy operation by pressing the Print key on the display keyboard. The Print key is active in an SNA environment under the following conditions:

1. No session has been established (prior to receipt of ACTLU, or after receipt of DACTLU).
2. Session owner is "Unowned."
3. The terminal is in Test mode, and the keyboard is unlocked.
4. Session owner is the SSCP, and the keyboard is unlocked.
5. Session owner is the PLU, the keyboard is unlocked, and the SLU is not in receive state.

The Print key is active in a BSC environment whenever the Time symbol is not displayed.

If the specified print class or printer address is valid but the printer or all printers in the print class are busy doing local copy operations for other displays, the Input Inhibited Printer Busy (short term) symbol is displayed. If the printer or all printers in the class are busy because they are "in brackets" (SNA) or "have status pending" (BSC) with a host application, which is only possible when the printer is in shared mode, the Printer Very Busy (long term) symbol is displayed. In either case, the request is then queued, and the keyboard is locked until the copy can be performed or the operator cancels the print request. Note that the Printer Busy (short term) symbol is displayed if the operator presses Print while the Printer Printing symbol is being displayed, even if other printers in the assigned print class are available. The operator can wait until a printer becomes available to perform the copy function. The RESET key has no effect while a print request is on the queue; however, the operator can cancel the local copy request by pressing the DEV CNCL key (while the request is on the queue). This turns off the Input Inhibited symbol, unlocks the keyboard, and dequeues the print request. The operator is then free to perform another task.

If the print class or printer address is valid but the printer or all printers in the selected class are not functional, then the Input Inhibited Printer Not Working symbol is displayed and the keyboard is locked. The operator must depress the DEV CNCL key to continue. This action turns off the Input Inhibited symbol and unlocks the keyboard. The print request is not queued. The operator may then choose an alternate action. When the Printer Not Working symbol has been turned on as a result of an operator-initiated copy request, this symbol, and an associated Printer Failure symbol, if displayed, will be turned off by receipt of any outbound FM data request.

If the operator attempts to print again, and the selected print class is still not operational, the Input Inhibited Printer Not Working symbol reappears. Some operator action, for example, loading paper in the printer, may be required to clear a not-functional condition. If no valid print class or printer is defined for this display (no connection indicator) and the Print key is depressed, the Input Inhibited Operator Unauthorized symbol is displayed and the keyboard is locked. The indicators remain on until the operator presses the RESET key.

When a valid printer is selected, and the display-to-printer buffer transfer begins, the display keyboard is locked and the Printer Busy symbol remains displayed. This symbol remains on and the keyboard remains locked until the buffer transfer is completed successfully. When this occurs, the keyboard unlocks, and the Printer Printing symbol replaces the connection symbol during the print operation. The Printer Printing symbol always indicates the actual device address of the selected printer. Once the actual printing operation is complete, the Printer Printing symbol is replaced by the original printer assignment symbol.

If the printer stops during a local copy operation (out of paper, paper jam, etc; a data check on the printer does not fall in this category), the Printer Malfunction symbol replaces the Printer Printing symbol and the print is terminated. The keyboard locks and the Printer Not Working symbol is also displayed, calling the operator's attention to the failure. The Printer Failure symbol always specifies the failing printer, not the print class. In this state, the DEV CNCL key will remove both of the symbols from the display.

Operator-Unauthorized Condition. If the display cannot perform the copy operation because the most-available printer does not have a large enough buffer,

11/14/56

the operator will be alerted by an inhibit condition with the Operator Unauthorized symbol. This may occur, for example, when the operator attempts to copy to a 1920-character buffer printer from a 3440-character display.

The Operator Unauthorized symbol is also displayed if the indicated selection turns out to be a display rather than a printer. This may occur when an invalid device descriptor gets loaded in the matrix.

Host Interference with Operator Copy (SNA). Once the display operator has initiated a local copy operation, any outbound FM data request will be rejected with a busy indication, X'082D', during the time that the operator request is queued or the buffer is being transferred, and an outbound FM data request is received for display. Once the buffer transfer has been completed, the display is free to receive outbound FM data requests. If a negative response has been sent because of this condition, an LUSTAT of X'0001D000' will be sent at the completion of the buffer transfer to notify the host that the busy condition no longer exists. FM data may be written into the display buffer as soon as the buffer transfer is complete.

If the host is in session with the printer, the local copy operation will not change the selected size of the printer buffer as set by the host session.

Host-Initiated Local Copy Using SNA/SDLC

The host application program may initiate a local copy function in an SNA environment by sending to the display station a write-type command with the Start Print bit in the WCC turned on. (The copy function under SNA ignores WCC bits 2 and 3.) The control unit performs the local copy function as required, using the print class or printer assigned to the display and displayed in the Operator Information Area. When a write-type command is sent to the display with the Start Print bit on, the display first interprets the orders and data in the write data stream and updates the display buffer. During this time, the Input Inhibited Time symbol is displayed. Once the buffer write is completed, the control unit attempts to use the printer(s) it assigned to the display. The Time symbol remains on while the copy operation takes place. Once the buffer transfer is completed, the Printer Printing symbol replaces the Printer Assignment symbol. The Printer Printing symbol always shows the specific terminal address of the printer actually doing the print operation.

The keyboard remains locked, regardless of keyboard Restore, until the print operation is completed. When the print operation is completed, the keyboard unlocks according to the keyboard Restore in the WCC. The Time symbol is removed, and the Assignment symbol replaces the Printer Printing symbol.

To perform the host-initiated local copy described above, the host program must send a write-type command with the Start Print bit turned on in the WCC as an RQD chain or an RQE, CD, EB chain. Otherwise, the synchronization may be lost or the request rejected with response X'0843'.

Printer Busy Condition. If, after performing the display buffer update operation, the control unit finds that the connected printer or all printers in the selected print class are busy with other local copy operations, the print request will be queued; the Time symbol remains on; the Printer Busy symbol is not displayed. The DEV CNCL key will not function on queued host-initiated requests.

On a 3274 configured for between bracket printer sharing, if the selected printer or all printers in the selected class are found to be "in" brackets with the PLU, the copy operation is refused. After the write operation is complete, the control unit will respond negatively to the print request with X'0807', printer busy. When between bracket printer sharing, the 3274 will not hold the printer if a release condition occurs after the 0807 or 082E response and before the LUSTAT is sent.

Once a print request has been refused with "printer busy," the SLU sends an LUSTAT of '0001B000' to the PLU when a printer becomes available. (Only one LUSTAT is returned per SLU, regardless of the number of times the PLU may have requested a local print operation.)

The PLU may choose not to wait for the LUSTAT but to continue with other display work. Even though the SLU is taken out of the ERP.1 state by the PLU, it is still bound to send in the LUSTAT at the first opportunity when the printer becomes available.

The 3274 will not hold the printer after sending an '0001B000' LUSTAT when configured for between session printer sharing. If between bracket printer sharing is selected, the 3274 will broadcast LUSTATs for all displays it can service. The printer is then held until each of those displays has provided a release by one of the following:

- Receiving an FM data request. If start print is specified, it is processed prior to releasing the printer.
- Display powers off or a permanent error is detected on the display.
- Clear, Unbind, DACTLU, or ACTLU is received.
- DACTPU/ACTPU is received.

Printer Not Assigned Condition. If a printer is not assigned to the SLU at the time it is selected, the control unit responds to the write type command with negative response (0801) "printer not assigned."

On a 3274 configured for between session printer sharing, if the selected printer or all printers in the selected class are busy because they are "in" session with a host application, the print request is refused. After the write operation is completed, the control unit will respond negatively to the print request with X'0801', printer not assigned.

"Printer not assigned" will also be sent to the PLU when a copy request is made and the selected printer cannot perform the copy because of a feature mismatch between the display device and the printer.

In all cases mentioned above, once the negative response has been sent to the host, the 3274 enters the ERP.1 state.

Printer Not Functional Condition. If the most-available printer is not functional at the time the printer is selected, the Printer Not Working symbol replaces the Time symbol. The Write command is responded to with negative response (082E) intervention required or negative response (082F) permanent printer error. The display LU goes into the ERP.1 state as defined for printer busy. When intervention-required is returned, recovery may require operator action, e.g.,

loading forms. When the intervention-required condition has been cleared, the control unit will generate an LUSTAT 0001B000 to the PLU in session with the display. After receiving the LUSTAT, the PLU may reinitiate the copy request by sending a Write command with the Start Print bit in the WCC and with no data.

If the operator operates the DEV CNCL key while the Printer Not Working symbol is being displayed, the Printer Not Working symbol is replaced by the Time symbol.

If the PLU transmits any FM data request to the display and the Printer Not Working symbol has not been cleared, the FM data request will remove the Printer Not Working symbol and, if displayed, an associated Printer Failure symbol, and may take the SLU out of the ERP.1 state.

No LUSTAT is required when 082F (permanent error) is sent as a response to the Write command.

If the printer malfunctions during the print operation, both the Printer Not Working and the Printer Failure symbols are displayed. The print operation terminates, and the Write command is responded to with negative response (082E) or negative response (082F). The keyboard remains locked and the system waits for some recovery action as defined above. If another device is available in the same printer class, the 3274 may generate the LUSTAT immediately.

Note that any FM data requests from the PLU will clear a Printer Not Working symbol. This requires careful planning by an installation in the use of host- and operator-initiated printing.

Local Copy Performed without SNA Protocol

In a BSC environment, host-initiated local copy is initiated through use of the Copy command (remote only). The description of operator indicators under "Host-Initiated Local Copy using SNA/SDLC" does not apply to the Copy command. Operator-initiated copy in a non-SNA subsystem is the same as defined under "Operator-Initiated Copy."

When a printer or class of printers is in shared mode, the contention between host and local copy use of the printers is resolved according to the following procedure:

1. If, during processing of an operator-initiated copy operation, the host sends a selection addressing sequence to the printer, the control unit will respond with an RVI and set Intervention Required. When the local copy queue no longer exists and the printer becomes available, Device End (DE) is sent in response to a poll (remote) or as asynchronous sense/status (local) to signal that the printer is available.
2. To provide security in systems that operate in a non-SNA environment, the printer buffer is cleared after successful operator-initiated local copy operations are completed. A read buffer or read modified operation will not return the contents of a printer buffer just used in a local copy operation by another display operator.
3. A host program may use several messages to load a buffer with data to be printed or for temporary data storage. Once the program initiates loading of

the buffer, operator-initiated local copy operations cannot be performed until print operation is completed, or until there is a permanent error. An operator-initiated print request via the Print key during this period is queued, and the Device Very Busy symbol is displayed. The host system should issue an Erase/Write command with the Start Print bit "on" to release the printer for local print operations.

4. The host application program can use the printer when there are no operator-initiated local copy requests outstanding. If it is required that the host have sole ownership of the printer for data integrity or performance considerations, the printer should be designated as a system mode printer in the printer authorization matrix.
5. If the printer authorization matrix is changed during normal operation, the transitions are made as described under "Mode Transitions."
6. If a host transmission to the display is received while an operator-initiated copy request is queued, the host transmission will be accepted and written to the display. No change will be made to the status of the operator-initiated copy. If the copy is queued and buffer transfer has not taken place, the new screen will be copied. If buffer transfer has started before arrival of the host transmission to the display, the transfer will be completed before writing to the display. In this case, the old screen will be copied.
7. Each time the local copy queue is completed, a Device End will be transmitted to the CPU by the 3274, thereby signaling that the printer is available. The printer buffer is set to the default size after each copy queue is completed.

Mono/Dual Case Control

When power is applied, the 3262 and the 3289 are automatically activated to print the dual-case character set; the 3287 is activated to print mono case.

In dual-case operation, the alphabetic character codes sent by the host determine whether uppercase or lowercase characters are printed, provided that the print belt has the dual-case character set. In mono-case operation, the lowercase alphabetic character codes print equivalent uppercase characters.

The Change Case switch can be pressed to change the print case on the 3262, 3287, and 3289. However, when operating with LU1 printers in SNA, the data character codes and the print belt character set determine whether mono- or dual-case characters are printed, regardless of the Change Case switch setting.

In a BSC environment, when using the Copy command to transfer data from a display to a printer, the setting of the Change Case switch on the "from" display determines mono or dual case in the "to" printer. When the Copy command transfers data from a display or a printer to a display, the Change Case switch on the "to" display determines whether mono or dual case is displayed.

Format Control during Shared Printer Operations

When shared printers respond to uncoordinated print requests, control of the horizontal and vertical print position format is governed by the operating mode(s) and the format selected.

In BSC or 3274 B or D unit printer operations, sharing occurs on a buffer load basis, between local copy requests and host-initiated printer output, by means of write-type or Copy commands. When using SNA protocol, local copy requests for display buffer data originating from an LU2 session may share a printer with either LU3 or LU1 host output. Sharing of LU2 and LU3 devices is comparable to BSC or 3274 B or D unit operation.

In BSC, 3274 B or D unit, and SNA printer operations when performing local copy, the entire buffer contents, including nulls, attribute, and buffer control characters of a "from" display or a "from" printer (non-SNA only), can be transferred to a printer buffer.

During formatted print operations, the data is scanned a line at a time. If a line contains one or more data characters (including Space, NL, EM, and CR) in a display/print field, the line is printed and a line feed is performed. To produce a blank line, at least one Space character must be present.

A valid FF character is executed regardless of the attribute of the field, except for the 3262 and 3289-1 and -2. These printers do not execute or print any characters in a nonprint field, including the FF character. If the FF character is invalid, it is not executed and prints as a blank in a field that is not defined as nondisplay/nonprint.

If a line contains only nulls, attribute characters, or alphanumeric characters (including Space, NL, EM, FF, or CR) in a nonprint/nondisplay field, no line is printed and no line feed is performed. A screen facsimile can be obtained only by inserting at least one space character in the blank lines.

In BSC, 3274 B or D unit, and SNA LU3 printer operations when directly printing from the host, the identical procedure is followed as described above once data has been loaded in the buffer and the print operation is started. Thus, when a print operation is completed, a line feed will have been automatically performed after printing of the last line (blank or not). Therefore, the next buffer load of data, regardless of the source, starts printing on the next line, ignores the previous horizontal position, and is contiguous with the previous output except for blank lines as provided in either or both buffer data.

A valid FF control character in the data at either the beginning or end of a form (one or more buffer loads) ensures synchronization of the forms with the data. Interleaving of a local copy operation within a host output print operation using VFC will usually cause local copy to be printed on part of a completed form or cause at least one form to be misprinted. This may best be avoided by configuring the printer in system mode, thus excluding its use for local copy.

In BSC, and 3274 B or D unit unformatted print operations, the completed print operation terminates at a new line position. Thus, the next print operation is also contiguous with the previous output except for possible blank lines as specified in the data. (SNA LU type 1 devices do not perform unformatted printouts.)

When operating as an SNA LU type 1 device, an automatic LF, NL, etc., is not sent at the end of a bracket or a session. Therefore, the print position may be one position to the right of the last printed character. The first printed line resulting from a local copy operation performed with an LU2 device is printed on the line that is currently available. Overprinting may occur if the first line is not specified

as a blank line. When the local copy operation is completed, the LU1 session resumes with a new bracket at the horizontal print established by the preceding LU1 bracket.

Error Conditions

Four error conditions may be encountered at the printers. In each of the following cases, when an error is detected, the program is notified.

Not Ready. A printer is defined as not ready when it is out of paper, its cover is open, or it is mechanically disabled (unable to advance to its proper position). When a 3284 or 3286 printer mechanism experiences a "printer hang" condition (see Glossary) during a printout, the printer will stay busy with an Equipment Check (EC) present. For 15 seconds, the mechanism will automatically attempt to recover. If the recovery attempt is successful, the printer will return to the ready condition. If the recovery attempt is not successful after 15 seconds, the printer will become not ready, as indicated by Intervention Required (IR) status.

A 3262 displays an error code in the status indicator. The operator may be able to clear the error condition and continue printing.

If a printer (not the 3289) is not ready at the start of a printout, or if it becomes not ready during a printout operation, the print operation terminates. Error status is sent to the channel once when the condition occurs during a printout and, then, again each time a printout is initiated.

When the 3287 detects other than parity errors, the Check indicator lights, and the associated error code is displayed in the two-digit Status indicator. The operator may be able to correct the error and continue operation.

Character Generator or Sync Check Errors. The characters printed are a function of the character generator or character belt installed. When an incorrectly formed character is printed during a printout (not the 3287 or 3289), no attempt is made to substitute or alter the character. When the printout operation is completed, a new line function is executed and an X is printed (feature-dependent). A sync check error occurs when a character belt hammer is out of sync.

Parity Error. If a parity error is detected on a character about to be printed, the graphic X (3284, 3286, 3288) or an error graphic (*prx10T,L*) (3287) is printed in place of the character with incorrect parity. The buffer continues printing until all printable characters have been printed. The printer prints a graphic X. The isolated X character (specify feature on the 3287 and 3288) serves to indicate the detection of the parity error.

An **✕** (an X overprinted with an O) prints in place of an incorrect character on a 3262. An **✕** also prints in the left margin of the next line.

Command-Chaining. In local operations, if any command is chained to a command that initiates a print operation, an error condition occurs: no printout is performed, the command is aborted, and the system channel is notified of the error. In remote operations, if command chaining is attempted, error status is sent to the system channel but the printout is completed.

Unit and Model-Dependent Differences (Printers)

Following are the model-dependent differences between printer units that affect printer operations. (Refer also to the 3262, 3287, and 3289 Component Description publications.)

Buffer Size

The buffer size of the 3284, 3286, and 3288 is model-dependent. Model 1 units contain 480 characters, and Model 2 units contain 1920 characters.

The basic 3287 (all models) contains a 2K-character buffer, which can be expanded to 4K characters. The 3289 (all models) contains a 4K-character buffer. However, the number of characters that can be effectively accessed corresponds to the buffer size specified for the printer.

The 3287 and 3289 buffer size is specified as 960, 1920, 2560, 3440, or 3564 bytes. Additional space remaining in the buffer is available for SCS operation, if required. The 3262 has 8K bytes of buffer storage.

During an erase/write operation to a 3284, 3286, or 3288, the full 480- or 1920-character buffer is erased. When an Erase/Write command is sent to the 3287 or 3289, the buffer is erased up to the specified default size (480 or 1920 characters). The Set Buffer Address (SBA) order, when sent to the 3274, is valid if the address specified is less than the effective buffer size.

A data or attribute wrap operation to buffer position zero occurs when data characters are addressed beyond the effective end of the buffer. The last effective position in the buffer is the default buffer size when operating in SNA/SDLC protocol.

Uppercase and Lowercase Printouts

The 3284, 3286, and 3288 print uppercase alphabetic characters unless the Extended Character Set feature is installed (which provides additional characters, including lowercase).

Printouts in either uppercase or lowercase characters may be obtained from the 3287 and 3289 printers, depending upon the setting of the 3287 and 3289 Change Case switch, and the command or print operation in process. During execution of an Erase/Write or Erase/Write Alternate command, the printer switch setting determines the character case, and the previous request is erased. During a Copy command or local print operation, the character case is determined by the setting of the Mono/Dual switch on the "from" display.

Note: For 3289, the 94-character belt is the only belt that has lowercase characters. On the 3262, only the 96-character band (US EBCDIC) has lowercase characters.

While performing a Write command or buffer reprint operation, the previous print case request is honored. Change Case switch settings are ineffective during transmission of the SCS data stream to a 3262, 3287, or 3289 (SCS is always dual case). The proper character code points must be used to ensure that the correct printout occurs.

New Line (NL) and End of Message (EM) Orders

NL and EM orders are printed as 5 and 9 respectively on 3284, 3286, and 3288 printers and are printed as space characters on 3262, 3287, and 3289 printers when attached to 3274 control units.

New Line (NL) at Maximum Print Position plus One Character

When the 3289 printer encounters an NL character one character position past the line length (maximum print position), it performs a single new-line function. The 3284, 3286, 3287, and 3288 printers perform two new-line functions.

Duplicate (DUP) and Field Mark (FM) Character

DUP and FM characters are printed as ; and * respectively on 3284, 3286, 3287, 3288, and 3289 printers.

Split Vertical Bar (|) Character

The Split Vertical Bar (|) character, hex 6A, is available on the 3262 (96-character set band), 3287, 3288, and 3289 printers (and also 3178, 3278, and 3279 displays).

Chapter 3. Local Operations (3274 B and D Units)

The 3274 non-SNA locally attached control units are the 3274 Models 1B, 1D, 21B, 21D, 31D, and 41D. (The 3274 Models 1A, 21A, 31A, and 41A operate with SNA protocol and are discussed in Chapter 5.)

See *An Introduction to the IBM 3270 Information Display System, GA27-2739*, for the host-system, control-unit, attached-device combinations that support local operations.

Non-SNA Local Operations

The 3274 B and D units can attach to a selector channel, to a byte multiplexer channel, or to a block multiplexer channel, each through the I/O interface. When the units are attached to a byte multiplexer channel, operations can be in forced-burst mode or in single-byte-multiplex mode. The channel, in turn, is attached to main storage and to the central processing unit (CPU).

Note: In the following text, the term “control unit” refers to the 3274 B and D units unless otherwise indicated.

The channel program controls all control unit operations by transmitting information across the I/O interface. This information consists of (1) an address byte, which selects one control unit and one device (display or printer) attached to the control unit; (2) command bytes, which specify the type of operation to be performed by the control unit for that device; (3) data bytes, which either are stored in the control unit buffer for ultimate use by the selected device as display or printout data or are decoded as orders and used by the control unit for formatting the buffer; and (4) various control signals. Status bytes, which are automatically generated by the control unit, inform the channel program (1) of the general condition of the control unit and selected device at various stages of command operations and (2) of unique conditions of the control unit and any attached device when command operations are not in progress.

3274/3290 Operations

The 3274 D control units and the 3290 Information Panel Display Station interact in a different manner than the 3274 control units and other Category A displays. Because the 3290 is capable of interpreting the 3270 data stream, the 3274 D units basically “pass through” the outbound data stream (host to 3290) for 3290 processing. Likewise, the 3290 prepares the inbound data stream and then notifies the 3274 and requests that it perform an inbound transmission.

Interface Operations (3274/Channel)

Local interface operations are summarized in the following paragraphs and are described in detail in the *IBM System/370 Principles of Operations* manual, GA22-7000. The CPU program initiates control unit operations with a Start I/O instruction. This instruction identifies the I/O control unit and device (in this case, the control unit and a display or printer) and causes the channel to fetch a channel address word (CAW) from a fixed location in main storage. The CAW designates the storage protection key and the location in main storage from which the channel subsequently fetches the first channel command word (CCW). The CCW specifies the command to be executed and the number and address, in main storage, of any bytes to be transmitted.

Selection

The channel attempts to select the control unit and an attached device by sending a unique address byte to the control unit (and to all other control units attached to the same channel or subchannel). When a control unit has 16 or fewer devices attached, the first four bits of the address byte specify the control unit address and the last four bits of the address byte specify the device address (Figure 3-1). Up to 32 devices can attach to control units that have even-numbered addresses; these addresses are coded as shown in Figure 3-2. Note that no more than 16 devices can be attached to a control unit that has an odd-numbered address. Device address must always be assigned sequentially, starting with address 0. However, no priority is given to particular device address.

When a control unit recognizes both addresses, it logically connects to the channel and responds to the selection by returning the address byte to the channel.

Control Unit No.	8-bit Local Address Byte		Device No.	4 5 6 7 (XXXX)
	Control Unit	Device		
	0 1 2 3	4 5 6 7		
0	0 0 0 0	XXXX	0	0 0 0 0
1	0 0 0 1	XXXX	1	0 0 0 1
2	0 0 1 0	XXXX	2	0 0 1 0
3	0 0 1 1	XXXX	3	0 0 1 1
4	0 1 0 0	XXXX	4	0 1 0 0
5	0 1 0 1	XXXX	5	0 1 0 1
6	0 1 1 0	XXXX	6	0 1 1 0
7	0 1 1 1	XXXX	7	0 1 1 1
8	1 0 0 0	XXXX	8	1 0 0 0
9	1 0 0 1	XXXX	9	1 0 0 1
10	1 0 1 0	XXXX	10	1 0 1 0
11	1 0 1 1	XXXX	11	1 0 1 1
12	1 1 0 0	XXXX	12	1 1 0 0
13	1 1 0 1	XXXX	13	1 1 0 1
14	1 1 1 0	XXXX	14	1 1 1 0
15	1 1 1 1	XXXX	15	1 1 1 1

Figure 3-1. 3274 B and D Unit Device Addressing, 16 or Fewer Devices per Control Unit

Command Initiation

Command operations by the control unit start when the control unit and a device are successfully selected. When a command is to be executed by the control unit (not by the channel alone), the channel sends the command code (CCW bits 0 – 7) to the control unit.

When execution of the command involves a transfer of data (such as Write or Read Modified), the control unit responds to the command with a status byte (called “initial” status) indicating whether it can execute the command. If the command can be executed, the channel is set up to respond automatically to service requests from the control unit, and the control unit assumes further control of the operation. Command operation can be terminated by the control unit or

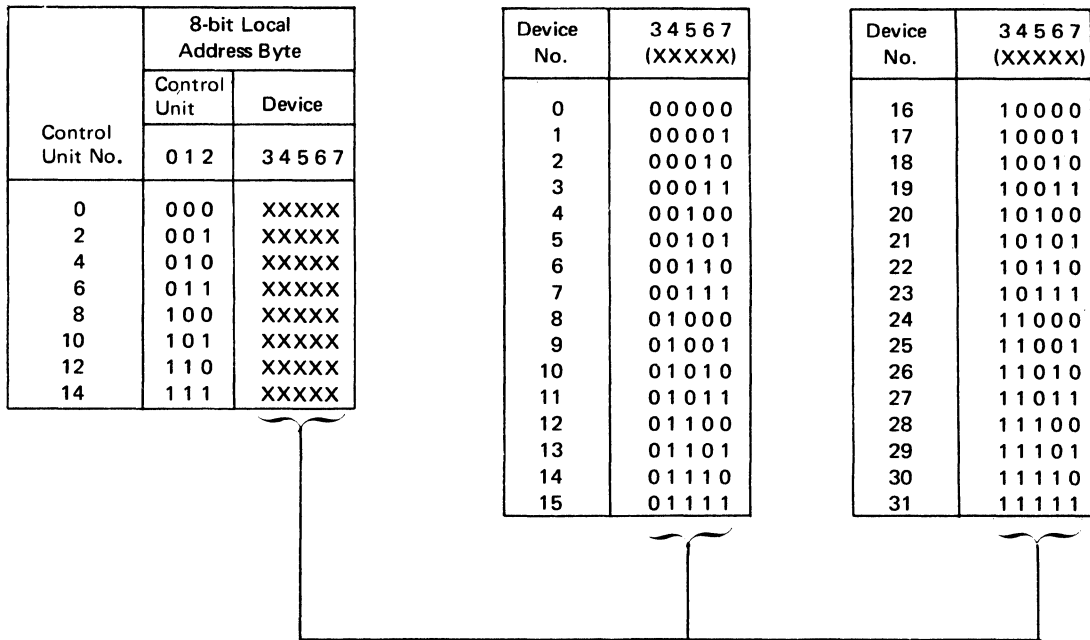

Note: Control Unit Nos. 1, 3, 5, 7, 9, 11, 13, and 15 cannot be assigned when attached devices are assigned Device No. 16 or greater.

Figure 3-2. 3274 B and D Unit Device Addressing, 17 or More Devices per Control Unit

when the channel byte count reaches 0. At this time, the control unit sends the channel a second status byte (called “ending” status) which indicates whether the command operation was successfully performed.

When the function of the 3270 command does not involve the transfer of data (such as EAU), it is called an “immediate” command. The resulting control unit operation depends on the particular command, as follows. If the command is No Operation, ending status and initial status are combined to indicate to the channel that the control unit has completed execution of the command. If the command is Select or Erase All Unprotected, which initiates certain control unit and device operations, the initial status from the control unit is such that block and byte multiplexer channels are released to perform other operations (selector channels remain logically connected to the control unit). When command execution is completed by the control unit and selected device (and regains selection if attached to a block or byte multiplexer channel), the control unit sends ending status to the channel, indicating whether the command was successfully performed.

Chaining

When the channel has completed the operations specified by a CCW, it can continue the activity initiated by the Start I/O by fetching a new CCW, thereby starting execution of another command. The fetching of this new CCW is called “command chaining”, and the CCWs belonging to such a sequence are said to be chained. All CCWs in a chain apply to the control unit and device specified by the Start I/O instruction.

Either of two types of chaining can be specified by the current CCW (bits 32 and 33): data chaining or command chaining. During data chaining (current CCW bit 32=1), the new CCW fetched by the channel defines a new main storage area

(data address) for the current command. During command chaining (current CCW bit 33=1), the new CCW specifies a new command and a data address for that new command.

Thus, when command chaining is used, the control unit is selected following the Start I/O instruction when the channel receives the first CCW in the chain that involves operations with the control unit. The control unit is dedicated to one CCW string until final Channel End time or until operations are abnormally terminated. Programming restrictions that must be observed when command chaining is used are described in Chapter 1.

Status

The control unit generates a status byte to inform the channel of certain control unit and device conditions. This status byte can be generated synchronously (while the control unit is selected and performing a command operation with the channel) or asynchronously (while the control unit is not selected).

Synchronous status is passed to the channel as both both "initial" and "ending" status to a command. Initial status reflects the condition of the selected device and/or control unit upon receipt of a command, and indicates to the channel whether the command can be executed. Ending status reflects the condition of the control unit and selected device after all channel/3270 interface operations of a nonimmediate command are completed. Asynchronous status reflects (1) ending status for an immediate command other than No Operation, (2) a second ending status for a Write, Erase/ Write, Erase/Write Alternate command, indicating that the control-unit-to-device buffer transfer is completed, or (3) an equipment condition or operator action not associated with command execution (an attention).

Figure 3-3 describes each bit of the status byte. Status is reset by the control unit once it has been accepted by the channel.

Figures 3-4, 3-5, and 3-6 list the initial, ending, and asynchronous status and sense bit combinations, respectively. The abbreviations used in these figures are as follows:

- **Status Bits**

- B - Busy
- CE - Channel End
- DE - Device End
- SM - Status Modifier
- UE - Unit Exception
- UC - Unit Check

- **Sense Bits**

- BOC - Bus Out Check
- CC - Control Check
- CR - Command Reject
- DC - Data Check
- EC - Equipment Check
- IR - Intervention Required
- OC - Operation Check
- US - Unit Specify

Bit	Name	Condition
0	Attention (A)	Indicates a request for service from an attached display device. Program should respond by issuing a Read Modified command (chained from a Select command if block or byte multiplexer channel) to the display device requesting attention. Attention bit is also set with Unit Check bit as result of asynchronously detected equipment malfunction; in this case, program should respond by issuing a Sense command.
1	Status Modifier (SM)	Is set, with Busy bit, in initial status byte to indicate that there is pending status for a device other than the one selected.
2	Control Unit End (CUE)	Is set following a busy condition, after pending status is cleared or when control unit is no longer busy, to indicate that control unit is now not busy and is free to accept a new command or pass a transmission to the 3290.
3	Busy (B)	Is set alone in initial status byte when addressed device is busy because it is performing a print operation or an Erase All Unprotected command. Set with SM when addressed control unit is busy. When the channel addresses a device other than the one that is busy and control unit is not busy, addressed device becomes selected and the command is honored. Busy bit is also set with pending status if addressed device has such status; if pending status is for a device other than the one addressed. Busy with Status Modifier is set.
4	Channel End (CE)	Indicates channel data transfer operations are completed. Is set alone (1) in initial status for Select or Erase All Unprotected command, or (2) as ending status for Write, Erase/Write, or Erase/Write Alternate command; in all cases, Device End status is sent asynchronously when device operations (command execution, control-unit-to-device-buffer transfer, or 3290 command execution) are completed. Is set with Device End, to indicate that control unit and device operations (except printing) are completed (1) in initial status for No Operation command, (2) in ending status for Read Buffer, Read Modified, or Sense command, or (3) asynchronously if only Channel End status was pending and the device operation is completed before the channel accepts status. Is set with Device End and Unit Exception in initial status for Read or Write command if addressed device is busy executing another command.
5	Device End (DE)	Indicates that control unit and device have completed all command operations and are free to execute another command. Is set (1) in initial status for No Operation command, (2) in ending status for Read Buffer, Read Modified, or Sense command, and (3) in asynchronous status for Write, Erase/Write, Erase/Write Alternate, Select, or Erase All Unprotected command, or a 3290 powering on.
6	Unit Check (UC)	Is set when an irregular program or equipment condition is detected by control unit or the device. Program should always respond to Unit Check status by issuing a Sense command for further definition of condition.
7	Unit Exception (UE)	Is set in ending status (synchronous or asynchronous) when control unit has attempted to execute a command but has found, after initial status was returned, that addressed device was busy.

Figure 3-3. Status Byte Bit Assignments for 3274 B and D Units

Initial Status

Initial status is generated by the control unit in response to initial selection, by the channel, of the control unit and an attached device. During the initial selection sequence, the status byte is sent to the channel after the control unit receives a command.

Figure 3-4 shows the possible initial status bit configurations. An all-zero status byte is sent when a nonimmediate command is accepted for execution by the control unit; it is also sent in response to Test I/O if other status is not pending. The Unit Check bit is set if the command is not accepted by the control unit, because of a program or equipment error.

Status ¹ (Hex)	Sense (Hex)	Display	Printer	Error Recovery Procedure	Condition
All Zeros (00)		X	X		Normal status for any command other than No Operation, Select, or Erase All Unprotected.
CE (08)		X	X		Normal status for a Select or Erase All Unprotected command.
CE, DE (0C)		X	X		Normal status for a No Operation command.
UC (02)	BOC (20)	X	X	1	A parity check was detected on the command byte.
UC (02)	IR (40)	X	X	2	A command other than Sense was addressed to a device that the control unit has recorded as "unavailable" or "not ready".
UC (02)	CR (80)	X	X	3	An invalid command was issued to control unit.
B (10)		X	X		Response to a command addressed to a device which is being serviced by the control unit or which is completing a previously issued command.
B, SM (50)		X	X		Response to a command addressed to a device other than device whose status is pending or device being serviced by the control unit.

¹ If an SIOF is executed by the channel, unchained initial status becomes ending status.

Figure 3-4. Initial Status and Sense Conditions for 3274 B and D Units

Initial status to immediate commands is as follows. For No Operation, Channel End and Device End are both set to indicate completion of the command. For Select and Erase All Unprotected, which do not involve data transfer between the channel and the control unit, Channel End is set. This frees a block or byte multiplexer channel for other operations while the command is being executed. When command execution is completed, ending status is presented asynchronously.

If a Start I/O Fast Release (SIOF) is executed by the channel, then unchained initial status becomes ending status. (See *System/370 Principles of Operation*, GA22-7000.)

When status is pending (a previous status byte is awaiting transfer to the channel), the pending status byte, with the Busy bit set, is sent to the channel in response to any command (not to a Test I/O instruction), and that command is not accepted by the control unit. For Test I/O, the pending status byte is presented without the Busy bit set. If the pending status is for a device other than the one selected during the initial command sequence, only Busy, Status Modifier (B, SM) is presented to the channel and the pending status is retained at the control unit.

Ending Status

When the control unit completes channel operations for a nonimmediate command, it sends an ending status byte to the channel, freeing the channel for other operations. This status byte always relates to the command operation that has been executed. The normal ending status byte for a Read Buffer, Read Modified, or Sense command will have only the Channel End and Device End bits set, indicating that the command has been executed. Normal ending status for a Write, Erase/Write, or Erase/Write Alternate command is Channel End alone. When the control-unit-to-device buffer transfer is completed, ending the command operation, Device End status is sent to the channel as asynchronous status. Any error condition associated with the operation just executed will cause additional status bits to be set. Figure 3-5 shows the possible ending status bit configurations. Ending status causes an I/O interruption unless chaining is specified.

When the control unit has pending status, it attempts to gain selection of the channel asynchronously to pass this status. It is passed to the channel either when selection is accomplished or as initial status for the next command (with the Busy bit set), whichever occurs first.

Asynchronous Status

Asynchronous status reflects: (1) the ending status of an "immediate" command other than No Operation; (2) the second ending status for a Write, Erase/Write, or Erase/Write Alternate command, indicating that all command-initiated operations are completed; (3) an action by the device operator that requires program intervention (attention status); or (4) a control unit or attached device equipment malfunction. Figure 3-6 shows the possible asynchronous status bit configurations.

When an asynchronous status condition occurs, the control unit attempts to gain selection by the channel (this is a hardware function), and passes this status to the channel when selection is accomplished. This status is called "pending" status until selection is accomplished. If the channel issues a command before retrieving this pending status, the pending status is returned, with the Busy bit set, in place of initial status for the command; in this case, the command is not executed, unless it is a Test I/O instruction.

When an asynchronous condition occurs at a device while the control unit is performing command operations with another device, the asynchronous status remains pending until the control unit completes the current command operation, returns ending status to the channel, and becomes not busy. The control unit then retrieves the pending status from the device and attempts to present it to the channel in the same manner as other asynchronous statuses.

Some other conditions of multiple status that can occur are not covered here. These conditions can be caused by multiple error conditions occurring simultaneously.

Status (Hex)	Sense (Hex)	Display	Printer	Error Recovery Procedure	Condition
CE ¹ (08)		X	X		Sent at end of data stream on Write, Write Structured Field, Erase/Write, or Erase/Write Alternate command.
CE, DE ^{1,2} (0C)		X	X		Sent at end of data stream on a Read Buffer, Read Modified, or Sense command or when channel byte count goes to zero on a Read Modified or Read Buffer command.
CE, DE, UC ² (0E)	BOC (20)	X	X	10	The control unit detected a parity error on a character in data stream of a Write, Write Structured Field, Erase/Write, or Erase/Write Alternate command. ³
CE, DE, UC ^{1,2} (0E)	DC, US (0C)	X	X	1	Addressed device detected to parity or cursor check during a Write, Write Structured Field, Read Buffer, or Read Modified command. Also, the control unit may disable the device because of error. (UC, IR is reported on the retry since the device requires a Power On Reset to be reenabled.)
CE, DE, UC ^{1,2} (0E)	DC (08)	X	X	1	The control unit detected a cursor or parity check during receipt of data stream on a Write, Write Structured Field, Erase/Write Alternate, or Erase/Write command.
CE, DE, UC ^{1,2} (0E)	DC (08)	X	X	10	The control unit detected a cursor or parity check during transmission of data stream on a Read Buffer or Read Modified command.
CE, DE, UC ^{1,2} (0E)	CC (02)	X	X	10	Addressed device failed to respond in a specified period of time to an Erase/Write, or Erase/Write alternate command, or an unchained Read Buffer, Read Modified, Write, or Write Structured Field command, or the device security key was in the off position. When attached to a 3274 B unit, the addressed device was found to be in test mode or assigned as a local copy device. (UC, IR will be reported on a subsequent operation. The addressed 3290 is not available, or is doing local copy.
CE, DE, UC ² (0E)	OC (01)	X	X	3	The 3274 B unit received an invalid buffer address in data stream of a Write, Erase/Write, or Erase/Write Alternate command, or data stream ended before providing all characters required for an SBA, RA, SF, or EUA order on a Write, Erase/Write, or Erase/Write Alternate command. Also, when receiving a write type command with a WCC = X'88'. 3274 D Units Only: An incorrect Select command chain sequence was received.
CE, DE, UE ^{1,2} (0D)		X	X	9	The control unit attempted to perform a Read Buffer, Read Modified, Write, Write Structured Field, Erase/Write, or Erase/Write Alternate command but found, after returning initial status, that the addressed device was "busy".

¹ Occurs if a Start IO Fast Release (SIOF) is executed by the channel for Select, Erase All Unprotected, or No Operation.

² If this status is stacked by the channel, CUE could be generated and combined with it before the stacked status is accepted by the channel.

³ A 3274 D unit updates the device buffer as it processes the data stream. A 3274 B unit does not change the device buffer until after the total data stream has been processed.

Figure 3-5. Ending Status and Sense Conditions for 3274 B and D Units

Status ¹ (Hex)	Sense (Hex)	Display	Printer	Error Recovery Procedure	Condition
A (80)		X			An attention-generating action (e.g., program access key has been pressed) was performed by the operator, or an inbound data stream has been prepared by the 3290 and is ready for transmission.
DE (04)		X	X		<p>The control unit-to-device buffer transfer is completed on a Write, Write Structured Field, Erase/Write, or Erase/Write Alternate command which did not start a printer, or the 3290 has completed processing a Write-type command.</p> <p>The device becomes "not busy" after completing an Erase All Unprotected command or the printer becomes "not busy" after completing a printout.</p> <p>The device-to-control unit buffer transfer is completed on a Select command, or the 3290 has completed preparation of a Read Modified (RM) data stream in response to a Select command.</p> <p>An attention-generating action (for example, a program access key was pressed) was performed by the operator after a Unit Exception, or Busy, condition had been reported to the host.</p> <p>A device changes from "not available" to "available" or from "not ready" to "ready".</p> <p>A device becomes "not busy" after having previously sent Unit Exception when the control unit attempted to execute a command with the device when it was "busy".</p> <p>Powering-on the 3274 causes each active 3290 logical terminal to present DE to the channel.</p> <p>Powering-on the 3290 or exiting from Test or Setup mode while the 3274 is on causes each active logical terminal to present DE to the channel.</p>
A, DE (84)		X			An attention-generating action was performed by the operator after a Unit Exception status (that is, a busy condition) had been reported to the host.
A, UC (82)	DC, US (0C)	X	X	1	An idle device detected a parity check or cursor check in its buffer, or an idle device on a 3274 has been disabled because of control-unit-detected errors. (UC, IR may be reported on the next retry since the device requires a Power On Reset.)
A, DE, UC (86)	IR (40)		X	6	The addressed printer became Not Ready (out of paper or cover open) before completion of a print operation.
DE, UC (06)	IR (40)		X	6	A command attempting to start a printer found it Not Ready.
A, DE, UC (86)	IR, EC, US (54)		X	6	A printer became mechanically disabled during a printout and an automatic recovery was not successful, the printer CARRIAGE MOTOR POWER switch was off, or the switch fuse was blown.
DE, UC (06)	IR, EC, US (54)		X	6	A command attempted to start a print operation, but the printer CARRIAGE MOTOR POWER switch was off.
A, DE, UC (86)	EC, US (14)		X	7	A printer character generator or sync check error occurred, or the printer became mechanically disabled during printout, but restored itself.

Figure 3-6 (Part 1 of 2). Asynchronous Status and Sense Conditions for 3274 B and D Units

Status ¹ (Hex)	Sense (Hex)	Display	Printer	Error Recovery Procedure	Condition
DE, UC (06)	DC (08)	X	X	10	During a Select, Erase/Write, or Erase/Write Alternate command the control unit (1) detected a parity or cursor error, or (2) detected a parity check on data received from the addressed device in response to an internal poll during a command.
DE, UC (06)	DC (08)	X	X	1	During a Write or Write Structured Field command, the control unit (1) detected a parity or cursor error, or (2) detected a parity check on data received from the addressed device in response to an internal poll during a command.
DE, UC (06)	DC, US (0C)	X	X	1	The addressed device detected a parity or cursor check while executing a Select, Write, Write Structured Field, Erase/Write, Erase/Write Alternate, or Erase All Unprotected command. Also, the control unit may disable the device because of error. (UC, IR is reported on the retry since the device requires a Power On Reset to be reenabled.)
DE, UC (06)	OC (01) ²	X	X	3	<p>A Write, Erase/Write, Write Structured Field, or Erase/Write Alternate command containing a WCC with a Start Print bit is chained to a subsequent command, or a WSF command was chained to a subsequent command.</p> <p>The 3274 D unit or 3290 received an invalid buffer address in data stream of Write-type command, or data stream ended before providing all characters required for an SBA, RA, SF, or EUA order on a Write-type command. A portion of the device buffer may have been changed.³</p> <p>The 3274 D unit or 3290 received an incorrect Select command chain sequence.</p>
DE, UC (06)	CC (02)	X	X	10	The addressed device failed to respond in a specified period of time to a Select, Write, Erase/Write, Erase/Write Alternate, or Erase All Unprotected command, a display was in test mode, the device's security key was in the off position, or a printer was assigned as a local copy device. (UC, IR will be reported on a subsequent operation.) The addressed 3290 was not available for a control-type command or was performing a local copy operation.
DE, UE (05)		X		9	The control unit attempted to perform a Select or Erase All Unprotected command, but found, after returning initial status, that the addressed device was busy.
CUE (20)		X	X		The control unit had been addressed while busy, but is now not busy and is free to accept a new command.

¹ If this asynchronous status is attacked by the channel, an asynchronous CUE could be generated and combined with it before the stacked status is accepted by the channel.

² The 3274 B units set OC upon receipt of a WCC = X'88'; the 3274 D units do not set OC upon receipt of a WCC = X'88'.

³ A 3274 D unit updates the device buffer as it processes the data stream. A 3274 B unit does not change the device buffer until the total data stream has been processed.

Figure 3-6 (Part 2 of 2). Asynchronous Status and Sense Conditions for 3274 B and D Units

Error-Recovery Procedures

3274 B and D Unit Device-Detected Errors

Error conditions detected by the control unit or by an attached device are indicated to the program by Unit Check status. The program must respond to this status by using a Sense command for further definition of the condition. If a Sense command is not performed and the sense conditions still exist, the control unit will not honor any other interrupts from the devices. Subsequent recovery operations are then determined by the combined configurations of Unit Check status bits and associated sense bits.

Referenced Error-Recovery Procedures

The recovery procedures referenced in the Error Recovery Procedure column of Figures 3-4, 3-5, and 3-6 are as follows:

1. Reconstruct the entire buffer image and retry the failing chain of commands. The sequence of commands used to reconstruct this image should start with an Erase/Write command (or Erase/Write Alternate on a 3274). However, if the failing command is a Write Structured Field command, do not issue Erase/Write, just retry the Write Structured Field command. If, after two retries, the problem is not corrected, follow procedure 4.
2. The error indicates the device is "unavailable." Request and wait for operator intervention to "ready" the device; then, upon receipt of DE status, retry the chain of commands.
3. A nonrecoverable program error has occurred. Examine the data stream to locate the problem.
4. Request maintenance for the device that is giving trouble. After the repair, reconstruct the buffer image, starting with an Erase/Write command (or Erase/Write Alternate).
5. Record the error for future reference, and continue with the program. This error occurred while the control unit was "idle" and is not indicative of a data error.
6. The error indicates the printer is out of paper, has the cover open, or has a disabled print mechanism. Request operator intervention to "ready" the printer; then, upon receipt of DE status, retry the print operation by issuing a Write command with the proper WCC and no data stream. (There is no data error; the data is still intact in the device buffer and can be reused.) If this procedure is unsuccessful, follow procedure 1.
7. The error occurred during a printout and indicates either a character generator or sync check error or a disabled print mechanism. There is no buffer data error. The proper error recovery procedure is application-dependent, since the user may or may not want a new printout. Because the buffer contents are still good, procedure 6 may be followed.
8. A data error occurred at the device during a printout. This indicates a data error at the device; procedure 1 should be followed.

9. A device is busy, but the control unit was not informed of this in time to respond with Busy status in the initial-status byte. A DE status will be generated asynchronously when the device becomes not busy. After the DE is received, retry the chain of commands that was being executed when the Unit Exception (UE) status was received.
10. Retry the failing chain of commands. If, after two retries, the problem is not corrected, follow procedure 1. A Write command to a 3274 D unit can be retried if new fields have not been created in the buffer portion which has been cleared by a Program Tab or Erase Unprotected to Address order.

Channel-Detected Errors

Errors detected by the channel are indicated to the program by the channel status byte in the channel status word (CSW). If the channel status byte indicates a Channel Control Check, an Interface Control Check, or a Channel Data Check, the recommended error-recovery procedure is to retry the chain of commands. If the problem is not corrected after three retries, request maintenance for the channel that is giving trouble.

Programming Note: System/370 Models 155 and 158 may also present a machine check interrupt prior to the CSW store. When an IBM operating system is used, this machine check interrupt (HIR) is not seen by the I/O Supervisor (IOS) or by the device-dependent error-recovery procedures.

Chapter 4. Remote Operations—BSC

Introduction

When using Binary Synchronous Communications (BSC) operating mode, the 3274 C units communicate with the host program via an IBM 2701, 2703, 3704, 3705, or an equivalent Integrated Communications Adapter (hereafter called "TCU") and with appropriate data sets as specified for the control unit. (Hereafter, the term "3274" encompasses the 3274 C units in BSC mode.)

The 3274 uses BSC procedures over duplex or half-duplex facilities (nonswitched or privately owned); these communications use the Multipoint Data Link mode of operation only.

Code Structures

Each 3274 can operate with one of two code structures: EBCDIC or ASCII. The choice of code depends on the application, but, for system compatibility, must be the same for all units on a particular communications line.

Channel Program Concepts

In remote configurations, the TCU becomes the intermediary between the 3274 and the channel program. As such, the TCU, not the 3274, executes channel commands and initiates I/O interrupts. At the start of each I/O operation involving the TCU, the Start I/O instruction addresses the TCU and a communications line attached to that TCU; it does not address an individual remote control unit on that line. Subsequent CCWs in the channel program initiate TCU operations; they specify TCU commands, not 3274 commands.

Selection of a 3274 and all subsequent command operations are specified by character sequences in TCU Write CCW data streams. Write CCW data to the TCU communications line selected by Start I/O can contain: (1) address bytes to select a control unit on that line; (2) the code of a command (such as Erase/Write or Write) to initiate a control unit operation; or (3) orders and/or display/print data for the control unit buffer. In addition, this write data will contain the appropriate data-link control characters. Thus, all characters sent by the TCU to a 3274, with the exception of SYN, pad, and BCC characters, originate from the data stream of a Write CCW addressed to the TCU.

Programming Note: All Write commands should be set for CCW chaining to a Read command when a response is expected. (This prevents a loss of data received by the TCU in response to Write command operations.) An exception to this requirement is when the Write command is used to issue EOT to the 3274.

Text Blocking

The 3274 performs inbound text blocking. Each block of data can contain a maximum of 256 text characters. Of that total, each block contains the STX and ETB (or ETX) data-link control characters. Two address bytes (CU poll address and device address) precede the read heading in the first block only and are included in the 256-character total. The last block of a message is terminated with ETX, which is also included in the 256-character total.

Programming Note: If the automatic polling facility (Auto Poll) is used by the TCU, the Auto Poll index byte adds 1 byte to the text block created by the 3274.

Block check characters (BCCs) are transmitted as the last characters of a data stream. (See "Redundancy Checking," later in this chapter.) BCC is not counted as text, because it follows the ETX and ETB data link characters. Upon successful comparison of the received BCC with the accumulated BCC, the program should respond with ACK to read the next block of text; each subsequent block is preceded by STX to initiate BCC accumulation by the TCU.

Text blocking does not disjoin the three-byte SBA order sequence (SBA code and two-byte field address) generated during execution of a Read Modified command. Therefore, the last characters of a block ending with an SBA sequence would be ... SBA, Address, Address, ETB (or ETX).

Related Publications

Readers who are unfamiliar with the binary synchronous method of communications should review the following publications, as applicable:

- *General Information—Binary Synchronous Communications*, GA27-3004
- *IBM 2701 Data Adapter Unit Component Description*, GA22-6864 (especially the section that describes Synchronous Data Adapter—Type II)
- *IBM 2703 Transmission Control Components Description*, GA27-2703 (especially the section on BSC capabilities)
- *Introduction to the IBM 3704 and 3705 Communications Controller*, GA27-3051

Multipoint (Nonswitched Line) Data Link Control

Each 3274 can operate on a nonswitched communications line with multiple stations. Time-sharing of the line is accomplished by interleaving transmissions between the TCU and all units on the line. A 3274 operates multidropped on the same line with other properly featured units, such as other 3270 units, IBM 2770s, and IBM 2780s.

The TCU is the *control station* of the multipoint, centralized network. All units attached by communications lines to the TCU are called *tributary stations*. The control station is the focal point of the network and maintains, under program control, an orderly flow of network traffic by initiating all data transfers. The control station is either the transmitter or receiver of every communication.

3274 Modes of Operation

In a multipoint environment, the 3274 is always in one of four modes of operation: control mode, text mode, transparent-monitor mode, or transparent mode.

Control Mode

The 3274 enters control mode whenever it transmits or receives a valid EOT sequence. While in control mode, the unselected 3274 monitors the communications line for the following:

- A valid selection or poll addressing sequence, by which the 3274 will become selected for entry into text mode.
- A DLE-STX sequence, placing the 3274 in transparent-monitor mode.

Text Mode

Once a 3274 is successfully selected, it enters text mode. In text mode, the 3274 is either a master station or a slave station, as is the TCU. This status depends on the operation being performed. The station that is transmitting a message is called the *master station*; the station that is receiving and acknowledging the message is called the *slave station*.

The 3274 becomes the master station (and the TCU the slave station) once it sends STX to the TCU while executing a Read command or a poll operation. As the master station, it can (1) transmit text messages and (2) transmit ENQ to request a reply or retransmission from the TCU. After transmission of the message is completed, the 3274 returns to control mode.

The 3274 becomes the slave station (and the TCU the master station) when executing a write-type command. As a slave station, it responds appropriately to master-station (TCU) transmissions.

Transparent-Monitor Mode

Transparent-monitor mode is provided with EBCDIC 3274s only. It permits the transmission of data in any of the 256 possible EBCDIC bit patterns between the TCU and another unit on the same communications line with the 3274. This data may be independent of the selected transmission code (EBCDIC). Examples of such format-independent data are packed-decimal data, programs (both source and object), core images, and other binary data. Thus, link control characters within this data will not inadvertently initiate a 3274 operation.

When an EBCDIC 3274 decodes a DLE STX sequence while in control mode, it enters transparent-monitor mode. While in this mode, the 3274 disregards *all* data configurations that may appear on the communications line except for (1) a transparent text sync sequence (DLE SYN) or (2) a transparent text-terminating sequence (DLE ITB, DLE ETX, DLE ETB, or DLE ENQ). The 3274 leaves transparent-monitor mode and returns to control mode (1) if a transparent text sync sequence is not received within any 3-second period or (2) if a transparent text-terminating sequence is decoded.

Transparent Mode

The 3274 provides transparent-mode transmission support (inbound and outbound) for the displays and printers that use the Extended Highlighting, Color, or Programmed Symbols function. Any data link control characters transmitted while the control unit is in transparent mode must be preceded by a DLE to be recognized as control functions. The control functions used are:

- DLE STX—Initiates transparent mode for the following text.
- DLE ETB—Terminates a block of transparent text, returns the link to normal mode, and calls for a reply.
- DLE ETX—Terminates the transparent text, returns the link to normal mode, and calls for a reply.
- DLE SYN—Used to maintain synchronization, or as a time-fill sequence for transparent mode.
- DLE ENQ—Indicates “disregard this block of transparent data” and returns the link to normal mode.
- DLE DLE—Used to transmit DLE as data when a bit pattern equivalent to DLE appears in the transparent text. One DLE is disregarded; the other is treated as data.
- DLE ITB—Terminates an intermediate block of transparent text, returns the data link to normal mode, and does not call for a reply. The BCC character follows DLE ITB.

The boundaries of transparent data are determined by the DLE STX and by the DLE ITB, DLE ETB, or DLE ETX control functions, which initiate and terminate the transparent mode of operation. The controller and the displays or printers that support the Extended Highlighting, Color, and Programmed Symbols functions can accept data in transparent mode at any time; acceptance is not related to the use of the Extended Highlighting, Color, or Programmed Symbols functions.

For outbound transparent text transmissions:

- Order splitting is permitted with a DLE ETB, meaning that the next block is a continuation of the text.
- DLE ETX processing is the same as in nontransparent mode; each block must start with a command sequence.
- On a teleprocessing line error, after a return of NAK by the 3274, either a retransmission of the block or an EOT is expected from the sender.
- When a program error is found in the data, or a device error occurs during the processing of a block, the 3274 returns an EOT.
- NAK is returned by the 3274 when a transmission has DLE ETX or DLE ETB missing.

Note: Block size is to be limited to 3,000 bytes in a Write Structured Field (WSF) transmission containing the LPS structured field. In addition, the maximum

number of LPS structured fields that can safely fit in the 3274 buffer space is 90. This applies to displays and printers. Exceeding this limit may cause the 3274 to overflow its checkpoint buffers. When this overflow is detected by the control unit, an op-check results.

In a WSF transmission to a 3278 Display Station/IBM 3270 Personal Computer Attachment terminal, the total length of one transmission should be held to 2,048 bytes or less.

Inbound Transparent Transmissions: The 3274 C units transmit inbound data in transparent mode only if:

- The inbound reply mode is extended field
- The inbound reply mode is character
- The inbound data stream includes structured fields.

Transparent Text Blocking (Outbound): The following example illustrates the sequence expected during outbound blocking.

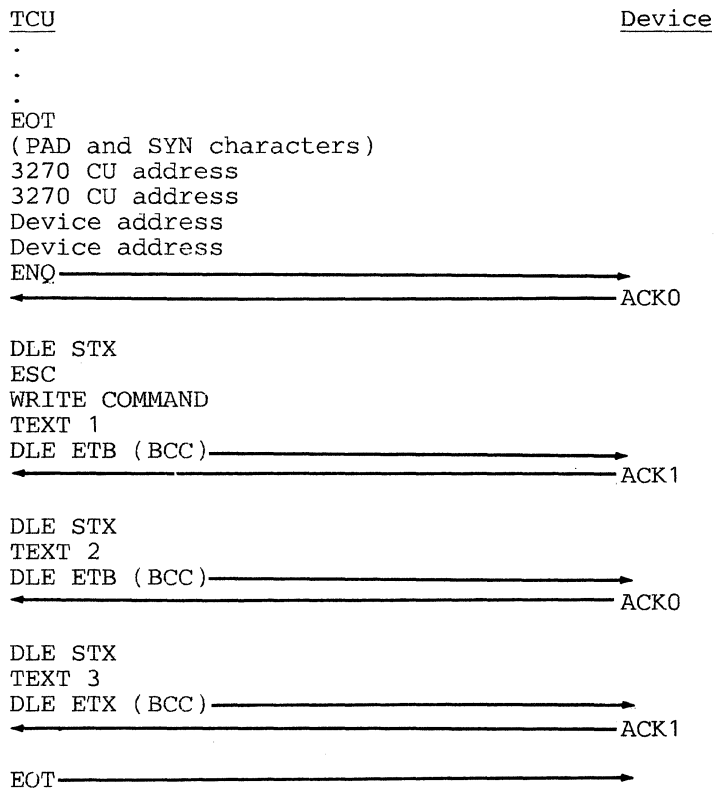

Order sequences may be split in the blocking process. For example, one block may end with:

SBA
DLE ETB (BCC)

and the next block continue with:

DLE STX
ADDRESS
ADDRESS

Outside of transparent mode, ETB is treated as an ETX function. If the transmission for TEXT 2 in the example had omitted the DLE prefix, ETB would have been treated as ETX and the transmission acknowledged, but the transmission for TEXT 3—not beginning with a command—would have been treated as an error.

If the outbound blocked transmission contains a read command, the ETB is treated as ETX. The read data stream is transmitted.

If a text block other than the first in the transmission contains a command, the second command sequence (ESC, CMMD) is treated as data. The device is in transparent mode, expecting a text block, and is not checking for a command sequence in the incoming transmission.

When a text block is expected, and another BSC control sequence, such as RVI or WACK, is received, the device ignores it. The effect is a timeout at the TCU.

Redundancy Checking

A redundancy check is performed on the following communications line data:

1. 3274 command-sequence characters (including the write data of a Write, Erase/Write, or Erase/Write Alternate command).
2. Data transmitted to the TCU in response to a read-type command or to a polling sequence.

A block check character (BCC) is accumulated for each block of data at both the TCU and the 3274. If EBCDIC code is used, a 2-byte BCC is generated (cyclic redundancy check accumulation); if ASCII code is used, a 1-byte BCC is generated (longitudinal redundancy check accumulation).

BCC accumulation is initiated by, but does not include, the first STX or SOH framing character. All characters following this STX or SOH, up to and including the end-of-block character (ETB or ETX), are part of the accumulation. Following the ETB or ETX character, the transmitting unit transmits its BCC character(s). The receiving unit then compares this character(s) with the BCC it has accumulated. If the redundancy accumulations are different, a transmission error has occurred.

When the 3274 is the receiving unit and detects a BCC error, it responds to the transmission by sending NAK to the TCU. When the TCU is the receiving unit, it will set Unit Check in the ending status for the TCU command being executed when the BCC error was detected; also, it will set Data Check in the sense byte.

Note: BCC characters are removed from the data stream when received for comparison by the TCU or by the 3274; they are not stored in main storage or in the 3274 buffer.

In both EBCDIC and ASCII, transmission formats (data link controls) are rigidly screened so that communication is orderly and accurate. Improper transmissions are ignored or rejected to avoid the acceptance of faulty messages. Received or transmitted data blocks are counted odd-even-odd-even, etc., by both the transmitter and receiver (by means of ACK 0's and ACK 1's), and their counts must agree at each block-check point.

Data-Link Control Characters

Two types of characters are transmitted between the TCU and the 3274: CU data-link control characters and 3274 message data. Data-link control characters are used for such purposes as message framing, acknowledgment that received message data was valid or invalid, and identification of the start- or end-of-text transmission. Data-link control characters are used (singly or in sequences) by the TCU (under program control) and by the 3274 to establish and control all data link operations in an orderly fashion. The 3274 message data consists of all address, command, order, and display/print characters sent to the 3274 and of all buffer data, AID bytes, and status/sense bytes read from the 3274. Data-link control characters are described individually in the following paragraphs and are described with 3274 message data later in this chapter (under "Operational Sequences").

The data-link control characters, with their EBCDIC or ASCII codes, are as follows:

<u>Data-Link Control Character</u>	<u>EBCDIC (Hex)</u>	<u>ASCII (Hex)</u>
ACK 0 (2 bytes)	1070	1030
ACK 1 (2 bytes)	1061	1031
DLE	10	10
ENQ	2D	05
EOT	37	04
ESC	27	1B
ETB	26	17
ETX	03	03
ITB	1F	1F
NAK	3D	15
RVI (2 bytes)	107C	103C
SOH	01	01
STX	02	02
SYN	32	16
TTD	022D	0205
WACK	106B	103B

All control characters transmitted by the TCU (except pad and SYN) are issued by the channel program as part of a TCU Write CCW data stream. All control characters transmitted to the TCU are generated by the control unit; a Read command to the TCU is used to store these characters (except pad and SYN) into main storage for subsequent analysis by the access method.

Pad

Pad characters, leading and trailing, are generated by TCU or 3274 hardware to ensure complete transmission or reception of the first and last significant character of each transmission.

SYN (Synchronous Idle)

Two consecutive SYN characters are generated by TCU or 3274 hardware to establish character synchronization. The TCU can also embed SYN characters in text for time-fill to maintain synchronization; the 3274 discards these SYN characters (does not store them in the buffer).

DLE (Data Link Escape)

DLE is always the first byte in the following 2-byte control characters: ACK 0, ACK 1, WACK, and RVI. DLE is also used as the first character in several 2-character sequences that are used in transparent-monitor mode (described earlier in this chapter under "Transparent Monitor Mode").

ACK 0 (Even Acknowledge)

ACK 0 is a 2-byte character, as follows:

- EBCDIC: 1070 (hex)
- ASCII: 1030 (hex)

ACK 0 is transmitted by the 3274 after a successful selection addressing (not poll) sequence to indicate to the TCU that the 3274 is ready to accept transmission. ACK 0 is also transmitted by the 3274 or by the TCU upon receipt and validation of an even-numbered (second, fourth, etc.) text block.

ACK 1 (Odd Acknowledge)

ACK 1 is a 2-byte character, as follows:

- EBCDIC: 1061 (hex)
- ASCII: 1031 (hex)

ACK 1 is transmitted by the 3274 or TCU upon receipt and validation of an odd-numbered (first, third, etc.) text block.

NAK (Negative Acknowledgment)

NAK is transmitted by the 3274 in response to a TCU text transmission that (1) terminates with ENQ, (2) has ENQ embedded in text, (3) has invalid BCC, (4) contains a TTD sequence (STX ENQ), or (5) has ETX missing.

When NAK is received by the 3274 in response to a text transmission, the 3274 retransmits the last block of text.

Programming Note: The TCU should be programmed to respond with NAK to an ENQ (that ends a text block) from the 3274; this NAK causes the 3274 to send EOT and retain the status for error recovery.

ENQ (Enquiry)

The 3274 transmits ENQ (1) to request a reply from the TCU following a 3-second timeout, (2) to request retransmission of the previous reply from the TCU, or (3) as the last character of a text message in which a data check was detected by the 3274. (See "Programming Note" above.)

When the 3274 receives ENQ in response to a transmission, the last 3274 transmission to the TCU is repeated. The 3274 responds with NAK when ENQ is received (1) as the last character of a TCU-aborted text transmission, (2) embedded in text, or (3) as part of a TTD sequence (STX ENQ).

To be addressed successfully, the 3274 must receive ENQ as the last character of a polling or selection addressing sequence.

WACK (Wait before Transmit)

WACK is a 2-byte character, as follows:

- EBCDIC: 106B (hex)
- ASCII: 103B (hex)

WACK is generated by the 3274 (1) in response to a selection addressing (not poll) sequence when a printer or a 3277 attached to the 3274 is busy, and (2) in response to a Write or Copy command text transmission when the Start Printer bit is set in the WCC or CCC. The 3274 responds with ENQ to a WACK from the TCU.

RVI (Reverse Interrupt)

RVI is a 2-byte character as follows:

- EBCDIC: 107C (hex)
- ASCII: 103C (hex)

RVI is generated by the 3274 in response to an attempted selection (not poll) by the TCU when the 3274 has a status and sense message to be transmitted. Whenever the 3274 accepts RVI from the TCU, the 3274 responds with EOT and resets all pending status and sense information. The 3274 accepts RVI in place of ACK 0 or ACK 1 and then only when they would have been valid. If RVI is received at the 3274 in response to RVI, a timeout occurs at the 3274.

STX (Start of Text)

The 3274 receives STX as the first character of a command or TTD sequence. The STX causes the 3274 to clear its BCC and start accumulating a new BCC (STX is not included in the accumulation). Subsequent STX (and SOH) characters are included in the BCC accumulation. STX is transmitted by the 3274 to the TCU as the first character of a read-data text block except in a status or test-request message; this STX causes the TCU to start accumulating a new BCC (STX is not included in the accumulation).

The first character in status and test-request messages is SOH, with STX following two header characters. With a message of this type, the TCU starts BCC accumulation upon receipt of the first SOH; the subsequent STX character is included in the BCC accumulation.

SOH (Start of Heading)

The 3274 generates SOH in a 3-character heading sequence that identifies the accompanying data as a status message (SOH, %, R, STX, ---) or as a test-request message (SOH, %, /, STX, data ---). The TCU starts BCC accumulation upon receipt of SOH (SOH is not included in the accumulation).

ETB (End of Transmission Block)

During a message transfer operation, ETB informs the receiving unit that BCC follows. The 3274 treats ETB as though it were ETX by checking BCC and then generating the appropriate response; the 3274 does not accept conventionally blocked outbound text.

ETX (End of Text)

During a message transfer operation, ETX informs the receiving unit that BCC follows. The 3274 transmits ETX at the end of the last (or only) block of a text message. Then, upon successful comparison of the received BCC with the accumulated BCC, the program should respond with ACK to the 3274. If the BCC comparison is unsuccessful, the TCU interrupts the program (Channel End, Device End, and Unit Check status, with Data Check set in the sense byte); the program should respond with NAK to the 3274. Receipt of ETX by the 3274 initiates a BCC comparison, causes a line turnaround, and causes generation of an appropriate response to the TCU.

EOT (End of Transmission)

EOT is transmitted by the 3274 (1) when the 3274 is a slave station and is unable to perform an operation requested by the TCU; (2) when the 3274 is a master station, as normal termination of a read operation; (3) when the 3274 has completed General Poll operations with each attached device; or (4) as an answer to RVI sent by the TCU. Line synchronization is dropped, and the 3274 is returned to control mode. Note that the program can also issue EOT to the 3274 in order to drop line synchronization and return the 3274 to control mode. EOT does not reset status and sense in the 3274; therefore, it should not be sent as a response to a status message.

Following receipt of a valid selection addressing sequence, if an error occurs during buffer transfer, the 3274 will provide a positive response to the selection sequence and internally set DC and US status. EOT is sent in response to the following 3270 command or poll.

ITB (End of Intermediate Transmission Block)

The 3274 does not accept conventionally blocked text. However, to coexist on a BSC multipoint line on which ITB may be used, the 3274 includes the ITB and associated BCC in its own BCC accumulation but then removes them from the data stream so that they are not stored in the buffer. The 3274 does not perform a BCC comparison at that time, but continues the receive operations until ETB or ETX is decoded.

ESC (Escape)

ESC must precede the command code in each command-sequence data stream transmitted to the 3274, as follows: STX, ESC, CMD, ---. The 3274 does not generate ESC.

TTD (Temporary Text Delay)

TTD is a two-character sequence: STX ENQ. The 3274 responds to TTD by transmitting NAK to the TCU. The 3274 does not generate TTD. TTD may also be used by the master station to terminate an operation (that is, initiate a forward abort). The 3274 (slave station) will always respond with a NAK, expecting the master station to transmit EOT. In this case, the slave station interprets this sequence as a controlled forward abort rather than an end of transmission.

Operational Sequences (Nonswitched Line)

The following paragraphs describe the various data and control sequences that can be performed with the 3274 operating on a nonswitched line. These sequences are divided into four categories:

1. Specific and General Poll
2. Selection addressing
3. Write and control type commands
4. Read-type commands

The description of each category is associated with a Sequence/Response Diagram, which shows (1) all 3274 responses to program-generated transmissions by the TCU and (2) normal program-handling of 3274 transmissions. These diagrams show the I/O supervisor/access method as examining each 3274 response to determine which operation to initiate next; however, for specific applications, additional use of command chaining in the channel programs may be desirable.

A selection addressing sequence selects a 3274 and an attached device for subsequent command operations. Polling sequences are selection sequences used specifically to obtain pending status at a device. Either a Specific Poll sequence requesting status from a particular device or a General Poll sequence sent to all devices may be executed.

Remote Chaining of 3270 Commands

For remote operations, 3270 command codes are included in the data stream of a Write CCW to the TCU. Remote chaining of 3270 commands is defined as the transmission of more than one command sequence to a 3274 following a single selection addressing or poll sequence. This chaining normally is accomplished with separate Write CCWs in the channel program. For example, the channel program could (1) write selection addressing sequence and read the response for evaluation by the I/O supervisor/access method, (2) write a 3270 Write command and text block and read the 3274 response for evaluation, and then (3) write a 3270 Write command followed by a second text block and read the 3274 response for evaluation.

The program may chain 3270 commands following a selection addressing sequence provided that the BSC rules governing limited conversational mode are observed. (Refer to *General Information Binary Synchronous Communications*, GA27-3004.) The 3274 permits any valid command to be chained following a poll sequence; however, Read Buffer or Read Modified should not be chained because the BSC rules for limited conversational mode (a maximum of two consecutive data transfers without an intervening ACK) will be violated.

Any 3270 command (except Erase All Unprotected) may be chained from a Write, Erase/Write, Erase/Write Alternate, or Copy command. However, if the Write, Erase/Write, Erase/Write Alternate, or Copy command has started a print operation, the 3274 will abort the subsequent chained command (the print operation is completed normally).

General and Specific Poll Sequences

When a General or Specific Poll sequence is issued (Figure 4-1), one of three possible results occurs:

1. If status and sense information is pending with or without an AID present, a status and sense message is generated.
2. If status and sense information is not pending and an AID is present, a Read Modified command is executed.
3. If there is no status or sense information or *no* AID pending, an EOT response is generated.

Figure 4-9 lists the conditions under which status and sense messages are transmitted.

Control unit and device address bytes transmitted for the General and Specific Poll sequences are as follows:

1. General Poll Address byte sequence:
3274 Poll Address
3274 Poll Address (See Figure 4-2.)
7F (EBCDIC) or 22 (ASCII) Used in place of the two
7F (EBCDIC) or 22 (ASCII) device-address bytes.
2. Specific Poll address byte sequence:
3274 Poll Address
3274 Poll Address (See Figure 4-2.)
Device Address
Device Address

The selected 3274 remains selected at the completion of a poll operation so that the program can issue a Write, Erase/Write, Erase/ Write Alternate, Copy, or EAU command without reselecting the 3274 and the device; command operations will be with (1) the device that was selected by Specific Poll or (2) the device from which a response was last received during the General Poll operation. Selection is dropped when the 3274 transmits EOT; the 3274 transmits EOT when the 3274 has no pending status or messages, or after it receives NAK from the TCU in response to a message that ends with ENQ.

Specific Poll addresses the 3274 and one device to determine if status and sense information or a manually entered message is awaiting transfer to the TCU. The pending status and sense information or message is transferred automatically by the 3274 upon receipt of the Specific Poll addressing sequence.

When a General Poll addresses the 3274, each attached device is examined in the order in which the ENTER key was pressed. If a message is present, it is transferred to the TCU. Each message is accompanied by the address of the device from which it originated.

Upon completion of this transfer, an ACK response from the program causes the 3274 to continue the General Poll operation, either by transferring another block of a text message or by examining other attached devices for pending messages. The program could issue a command rather than ACK to the device from which the message was just received only after inbound blocks that end with ETX. The 3274 will ignore any commands that are sent in response to a block of data that ends with ETB. Once the 3274 has examined all attached devices and has

successfully transferred all pending messages, it generates EOT and returns to control mode. If the program wishes to terminate the General Poll, an RVI may be issued to the 3274, forcing an EOT response. A command issued rather than the ACK (after blocks that end with ETX) will also terminate the General Poll.

Figure 4-3 shows the message formats. Note that a device address is not provided in the heading of a Test Request message. An address must be manually entered by the operator as part of the text; this is because the operator may specify the address of another device for test operations with the program.

The status and sense bits are described later in this chapter under "Status and Sense (S/S) Bytes."

Selection Addressing Sequence

The selection addressing sequence (Figure 4-4) specifies a 3274 and an attached device in preparation for write-, control-, or read-type command sequences. It is similar in format to a Specific Poll sequence in that a 3274 address is sent, followed by a device address, but different I/O characters and hex codes are used to represent the 3274 address bytes. Column 1 in Figure 4-2 lists the characters and hex codes used to complete the selection addressing sequence. Comparative examples of 3274 and device address codes for General Poll, Specific Poll, and selection addressing sequences are shown at the bottom of Figure 4-2.

For the 3274, the selection addressing sequence performs a function similar to a local Select command in that it causes a device-to-control unit buffer transfer. The 3274 provides a positive response to a selection sequence before transfer of a device buffer to the 3274. If an error occurs during buffer transfer, following receipt of a valid selection addressing sequence, a positive response to the selection sequence is provided by the 3274, and DC and US status are internally set. EOT is sent in response to the following command.

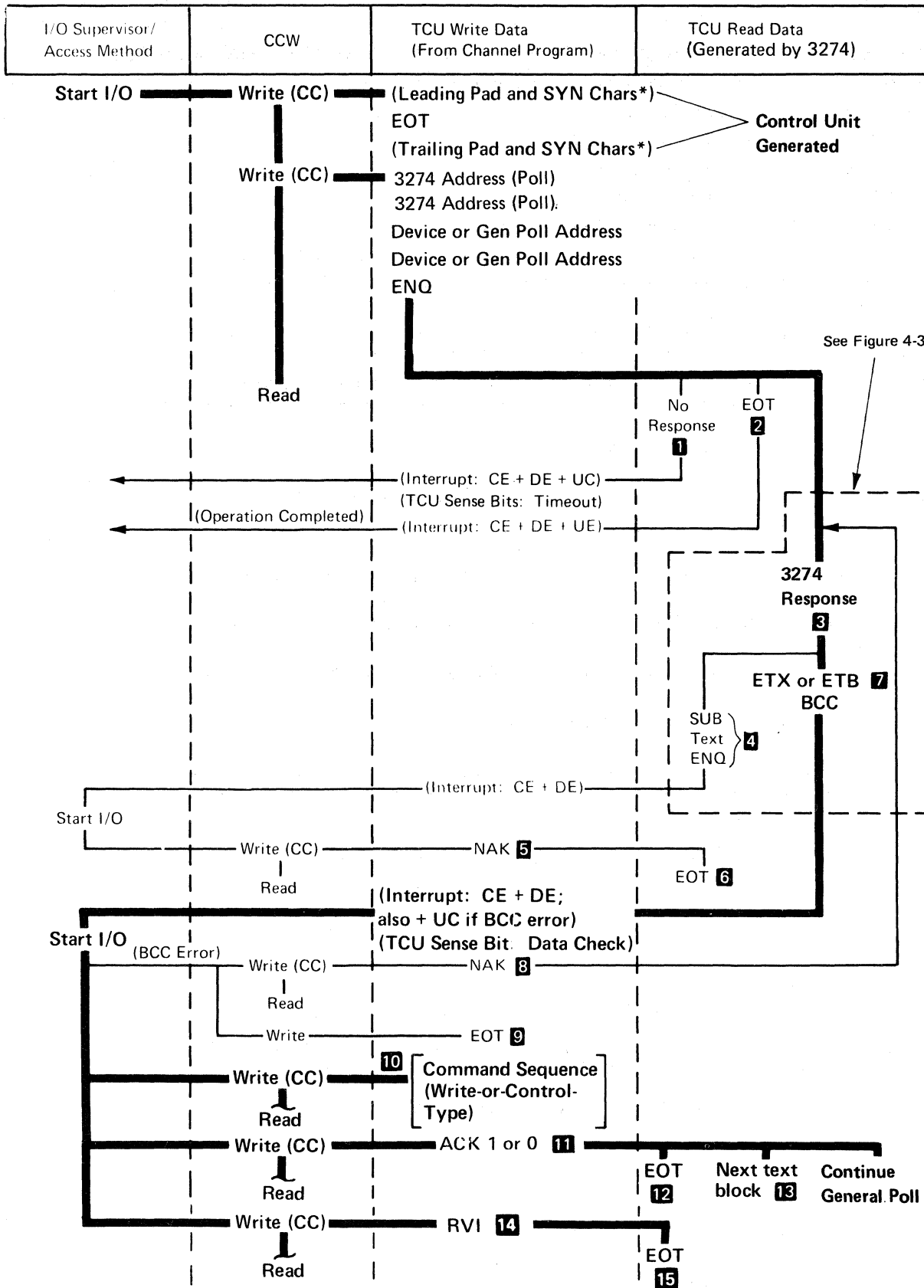

Figure 4-1 (Part 1 of 2). General Poll and Specific Poll, Sequence/Response Diagram

Notes:

- 1** The 3274 will fail to respond to the addressing or polling sequence, causing a TCU timeout, for any of the following reasons:
 - The 3274 is "unavailable" (has power off, is "offline", or is not attached).
 - Any character in the polling sequence is invalid.
 - The characters in the polling sequence are out of order.
 - The polling sequence is incomplete (less than seven characters).
 - The 3274 address is incorrect in the write data stream.
 - The addressed 3274 was left selected from the previous transmission.
- 2** There is no I/O pending nor pending status. For General Poll, the CU sends EOT only after polling all devices.
- 3** The device response is a function of the kind of device and its status. Types of responses include: Text, Status, and Test Request messages. (Refer to Figure 4-3.)

For General Poll, the search for a response starts at some random device address and continues sequentially (as long as ACKs are received in response to text transmissions) until all devices are given the opportunity to respond.
- 4** Upon detection of an internal parity check or a cursor check, the 3274 (1) substitutes the SUB character for the character in error, (2) records Data Check status, and (3) transmits an ENQ in place of ETX (or ETB) and BCC at the end of the text block. The General Poll process is stopped.
- 5** Mandatory program response to a text block terminated in ENQ.
- 6** Terminates the operation. The nature of the error (parity or cursor check) does not warrant a retry. This response indicates that status and sense information is stored. The status retrieval information included in Figure 4-6, Note 2, applies.
- 7** ETB is used to frame each block of a blocked text message, except the last block. ETX is used to frame the last block of a blocked text message.
- 8** BCC error has been detected. The program issues NAK to cause the 3274 to repeat its last transmission.
- 9** Response issued by the program to terminate the operation if the TCU is unsuccessful in receiving a valid BCC following "n" attempts by the 3274 to transmit the message. This response does not cause the 3274 to reset its sense/status information. Therefore, the same status message will be transmitted if a Specific Poll is immediately issued to the same device.
- 10** This transmission must be a write or control-type command sequence (described in Figure 4-5). A read-type command would violate BSC standards on limited conversational mode.

For General Poll, this transmission stops the polling operation. The General Poll must be reinitiated to ensure receipt of all pending device messages.
- 11** Positive acknowledgment. The text block has been successfully received by the TCU. The program issues ACK 1 in response to the first and all odd-numbered text blocks and issues ACK 0 in response to the second and all even-numbered text blocks.
- 12** Normal termination of a Specific or General Poll
- 13** The second and all succeeding text blocks are framed as the first except they do not include the 3274/device address sequence.
- 14** RVI to terminate polling sequence.
- 15** Termination of polling sequence on receipt of RVI.

LEGEND:

(CC) = Chain Command (CC) Flag in CCW is set to 1.

(Interrupt) = TCU-generated interrupt (CE = Channel End, DE = Device End, UE = Unit Exception, UC = Unit Check).

*Only the critical framing characters (sync pattern and pad) are shown. All other framing characters are also hardware-generated as required. See *SL General Information - Binary Synchronous Communications, GA27-3004*, for a complete description.

Figure 4-1 (Part 2 of 2). General Poll and Specific Poll, Sequence/Response Diagram

Column 1				
Use this column for:				
<ul style="list-style-type: none"> ● Device Selection, ● Specific Poll, ● General Poll, and ● Fixed Return Addresses 				
CU or Device Number	EBCDIC I/O Char.	EBCDIC Hex (Note 1)	ASCII I/O Char.	ASCII Hex
0	SP	40	SP	20
1	A	C1	A	41
2	B	C2	B	42
3	C	C3	C	43
4	D	C4	D	44
5	E	C5	E	45
6	F	C6	F	46
7	G	C7	G	47
8	H	C8	H	48
9	I	C9	I	49
10	¢	4A	[5B
11	.	4B	.	2E
12	<	4C	<	3C
13	(4D	(28
14	+	4E	+	2B
15	or !	4F	!	21
16	&	50	&	26
17	J	D1	J	4A
18	K	D2	K	4B
19	L	D3	L	4C
20	M	D4	M	4D
21	N	D5	N	4E
22	O	D6	O	4F
23	P	D7	P	50
24	Q	D8	Q	51
25	R	D9	R	52
26	!	5A]	5D
27	\$	5B	\$	24
28	*	5C	*	2A
29)	5D)	29
30	;	5E	;	3B
31	¬ or ^	5F	^	5E

Column 2				
Use this column for:				
<ul style="list-style-type: none"> ● 3274 Selection Addresses. ● Test Requests 				
CU Number	EBCDIC I/O Char.	EBCDIC Hex (Note 1)	ASCII I/O Char.	ASCII Hex
0	-	60	-	2D
1	/	61	/	2F
2	S	E2	S	53
3	T	E3	T	54
4	U	E4	U	55
5	V	E5	V	56
6	W	E6	W	57
7	X	E7	X	58
8	Y	E8	Y	59
9	Z	E9	Z	5A
10		6A		7C
11	,	6B	,	2C
12	%	6C	%	25
13	-	6D	-	5F
14	>	6E	>	3E
15	?	6F	?	3F
16	0	F0	0	30
17	1	F1	1	31
18	2	F2	2	32
19	3	F3	3	33
20	4	F4	4	34
21	5	F5	5	35
22	6	F6	6	36
23	7	F7	7	37
24	8	F8	8	38
25	9	F9	9	39
26	:	7A	:	3A
27	#	7B	#	23
28	@	7C	@	40
29	'	7D	'	27
30	=	7E	=	3D
31	" (Note 2)	7F	"	22

Examples:

3274 Addressing			
General Poll CU5	CU Address	EBCDIC	ASCII
		{ C5	45
Device Address	{ 7F	22	
	{ 7F	22	
Specific Poll Device 4 on CU5	CU Address	{ C5	45
	Device Address	{ C4	44
		{ C4	44
	Select Device 4 on CU5	CU Address	{ E5
Device Address		{ C4	44
		{ C4	44

Notes:

1. Graphic characters for the United States I/O interface codes are shown. Graphic characters for EBCDIC 4A, 5A, 5B, 7B, 7C, and 7F might differ for particular World Trade I/O interface codes. Refer to *IBM 3270 Information Display System: Character Set Reference*, GA27-2837, for possible graphic differences when these codes are used.
2. I/O character address ("") is used as the device address to specify a General Poll operation.

Figure 4-2. Remote Control Unit and Device Addressing

(Note: This figure is referenced in Figures 4-1 and 4-6.)

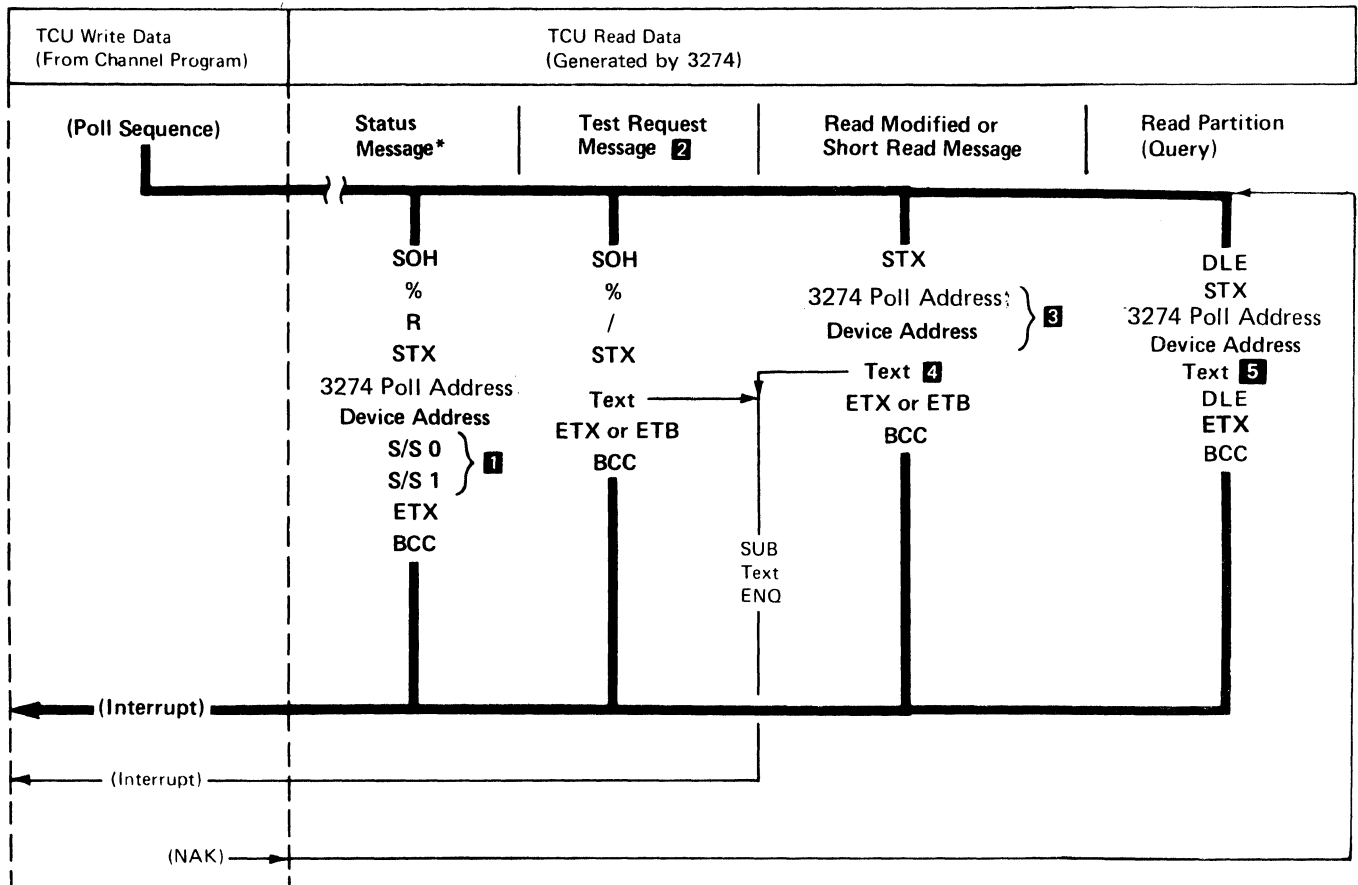

* Response to General Poll or Specific Poll only (not program-generated Read Modified command)

Notes:

- 1 A status message response is issued to a General or Specific Poll if (1) the 3274 has pending status (General Poll ignores Device Busy and device "unavailable" and, if the 3274 continues polling of next device), or (2) if error status develops during execution of the poll. Status and sense bit assignments are described in Figure 4-7.
- 2 A Test Request Message response is issued to a General or Specific Poll if a TEST REQ key is pressed at the keyboard of a polled 3277, or if a SYS REQ key is pressed at a 3178, 3278, or 3279 attached to a 3274.
- 3 This address is included only in the first block of a blocked text message.
- 4 The text portion of this message is the result of either a Read Modified or Short Read operation by the 3274. Figure 4-5 lists each operator action and the resulting read operation that will be performed.
- 5 The text portion of this message is the result of a Read Partition (Query) structured field function.

LEGEND:

(Interrupt) = TCU-generated interrupt.

Figure 4-3. 3274 Message Response to Polling or Read Modified Command

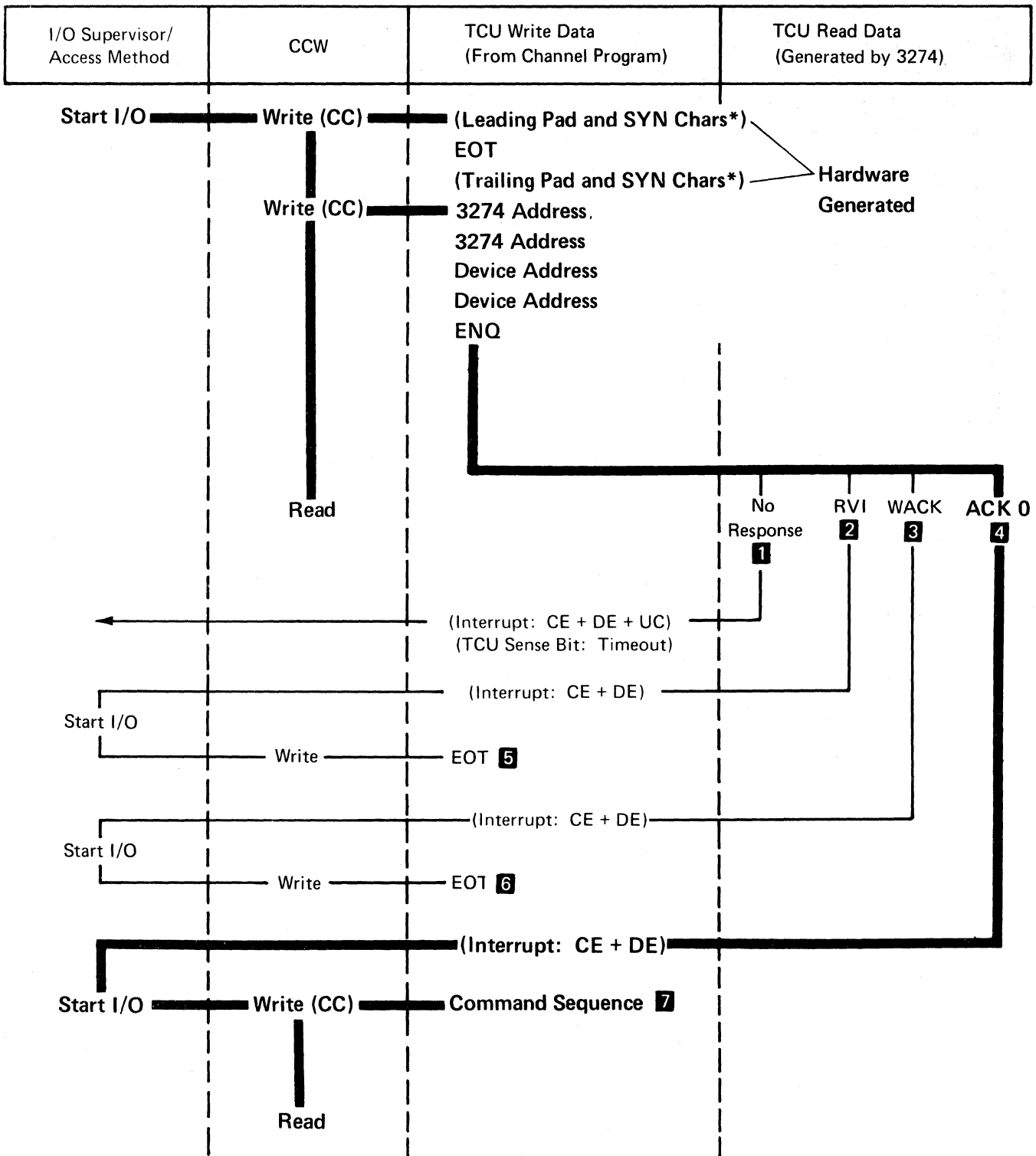

*Only the critical framing characters (sync pattern and pad) are shown. All other framing characters are also hardware-generated as required. See *SL General Information – Binary Synchronous Communications, GA27-3004*, for a complete description.

Figure 4-4 (Part 1 of 2). Selection Addressing, Sequence/Response Diagram

Notes:

- 1** The 3274 will fail to respond to the addressing or polling sequence causing a TCU timeout, for any of the following reasons:
 - The 3274 is "unavailable" (has power off, is "offline", or is not attached).
 - Any character in the polling sequence is invalid.
 - The characters in the polling sequence are out of order.
 - The polling sequence is incomplete (less than seven characters).
 - The 3274 address is incorrect in the write data stream.
 - The addressed 3274 was left selected from the previous transmission.
- 2** 3274: The addressed device has pending status (excluding Device Busy or Device End).
- 3** The addressed 3274 is busy. No S/S information is stored. An RVI response takes precedence over a WACK response.
- 4** The address has been successfully received, no status is pending.
- 5** Termination of attempted addressing sequence: Availability of valid status and sense information cannot be ensured unless a Specific Poll is issued to the responding device as the next addressing sequence issued to this 3274.
- 6** Termination of attempted addressing sequence.
- 7** Refer to Figure 4-5 or 4-6 for the desired command sequence.

LEGEND:

(CC) = Chain Command (CC) Flag in CCW is set to 1.

(Interrupt) = TCU-Generated interrupt (CE = Channel End, DE = Device End, and UC = Unit Check)

Figure 4-4 (Part 2 of 2). Selection Addressing, Sequence/Response Diagram

Write-Type and Control-Type Command Sequences

The program initiates a Write, Erase/Write, Erase/Write Alternate, Copy, or EAU operation (Figure 4-5) by first writing a command and, except for EAU, a data sequence to the selected 3274 and then reading the response. All write-type commands and Copy commands must be followed by a minimum of one data byte (the WCC or CCC byte). If the program reads a positive response (ACK) from the 3274, it can terminate the operation or continue with another command. The program can write blocks of text to the 3274 by initiating, after receipt of each ACK, a Write command sequence for each block to be written.

Write data is blocked to devices attached to a 3274 as follows: Each time the 3274 receives a selection addressing sequence, it begins to transfer the device buffer contents to the control unit buffer. As the Write command data is received by the control unit, updating occurs, and the result is asynchronously transferred to the buffer of the addressed device. The device buffer contents not affected by the write data stream remain unaltered in the device buffer. If the transmission of a block of data to the control unit is successful (ACK reply), a device-to-control-unit-buffer transfer is begun. If the transmission of a block of write data to the control unit is unsuccessful (e.g., NAK reply), the buffer contents previously stored in the control unit buffer are immediately transferred to the device buffer before another Write command is received. These contents include any previous text blocks that were written successfully. Thus, the 3274 can receive retransmission of the block that was unsuccessfully received.

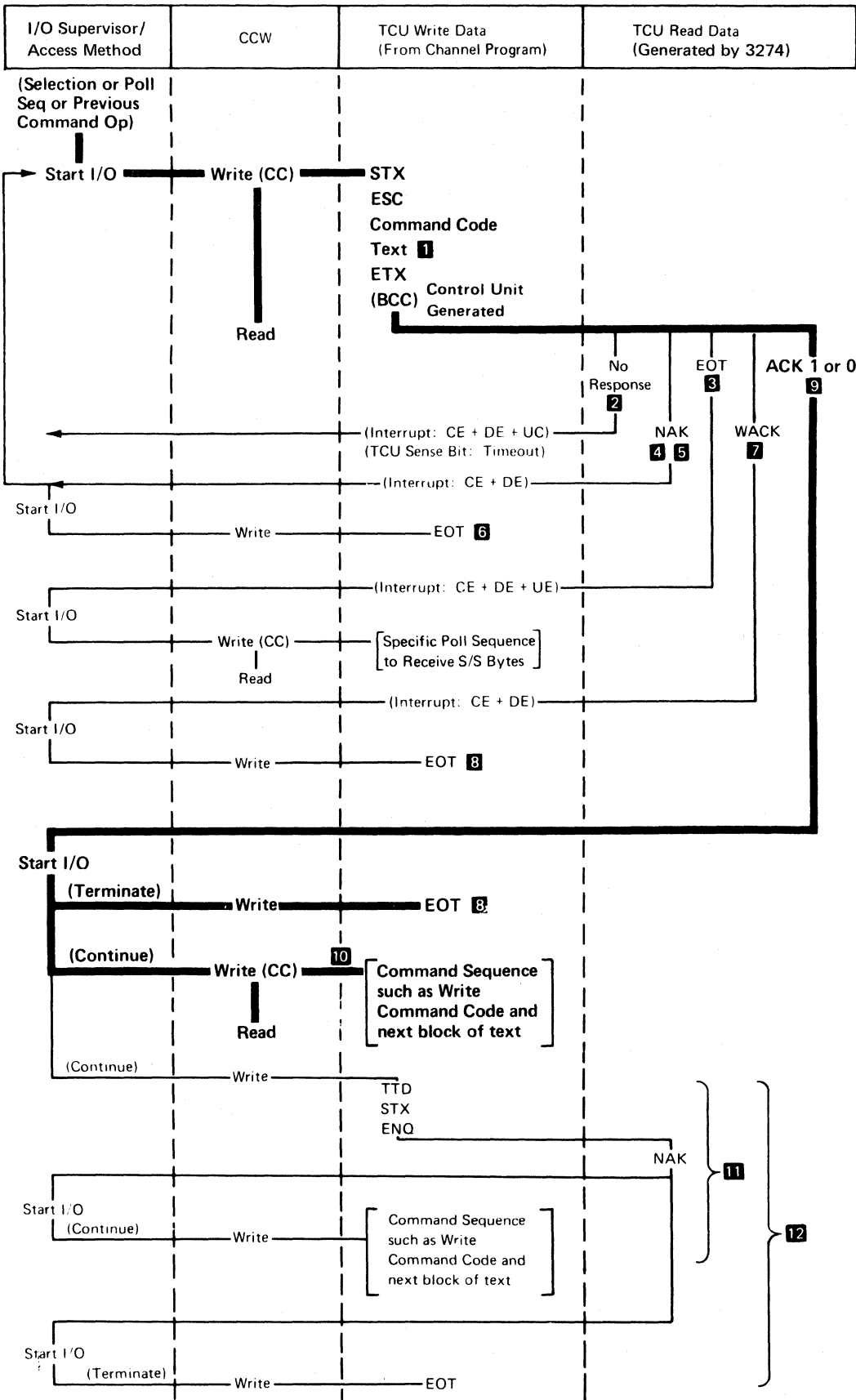

Figure 4-5 (Part 1 of 2). Write-Type and Control-Type Commands, Sequence/Response Diagram

Notes:

- 1** No text is transmitted on an EAU command transmission.
- 2** Command transmission was not successfully received because of invalid framing (STX missing). Causes a timeout at TCU.
- 3** The 3274 is unable to perform the operation indicated in the command transmission because of a busy/unavailable/not ready device.
- 4** If a transmission problem causes both a 3274 detected check condition and a BCC error, the BCC error takes precedence over all other check conditions, and a NAK is transmitted to the TCU.
- 5** BCC error or missing ETX has been detected. The NAK response requests the program to repeat its last transmission.
- 6** Response issued by the program to terminate the operation if the 3274 is unsuccessful in receiving a valid BCC following "n" attempts by the program to transmit the message.
- 7** If the Start Printer bit is set in the WCC or CCC, a WACK response indicates that the text transmission was successfully received but that the printer is now busy and an additional chained command cannot be accepted.
- 8** Normal termination of the operation by the program.
- 9** Command execution has been successfully completed.
- 10** Repeat the operation shown in this figure or in Figure 4-6 for the next command sequence.
- 11** Example of a Temporary Text Delay (TTD) sequence.
- 12** Example of terminating an operation using TTD (a forward abort sequence).

LEGEND:

(CC) = Chain Command (CC) Flag in CCW is set to 1.

(Interrupt) = TCU-generated interruption (CE = Channel End, DE = Device End, UE = Unit Exception, UC = Unit Check).

Figure 4-5 (Part 2 of 2). Write-Type and Control-Type Commands, Sequence/Response Diagram

Read-Type Command Sequences

Programming Note: Read Buffer is used primarily for diagnostic purposes, and Poll (General and Specific) is normally used in place of Read Modified for remote read operations.

The program initiates a read operation (Figure 4-6) by first writing a command sequence to the selected 3274 and then reading the response. If the 3274 responds with text followed by ETB, and if BCC comparison at the TCU is successful, the program should write ACK to retrieve the next block. This should continue until an error is detected or until a text block is followed by ETX. After ETX is received, the program should write ACK to the 3274 and then read the EOT reply. The three types of Read Modified message responses are shown in Figure 4-3.

The 3274 will retransmit text up to 15 times when NAK or an incorrect ACK is received or when ENQ is received in response to a conversational text reply to a Read command. The 3274 supports limited-conversational-text mode. If the host transmits a text block following receipt of a text transmission which ends in ETB, a timeout occurs at the 3274 and ENQ is sent to the host.

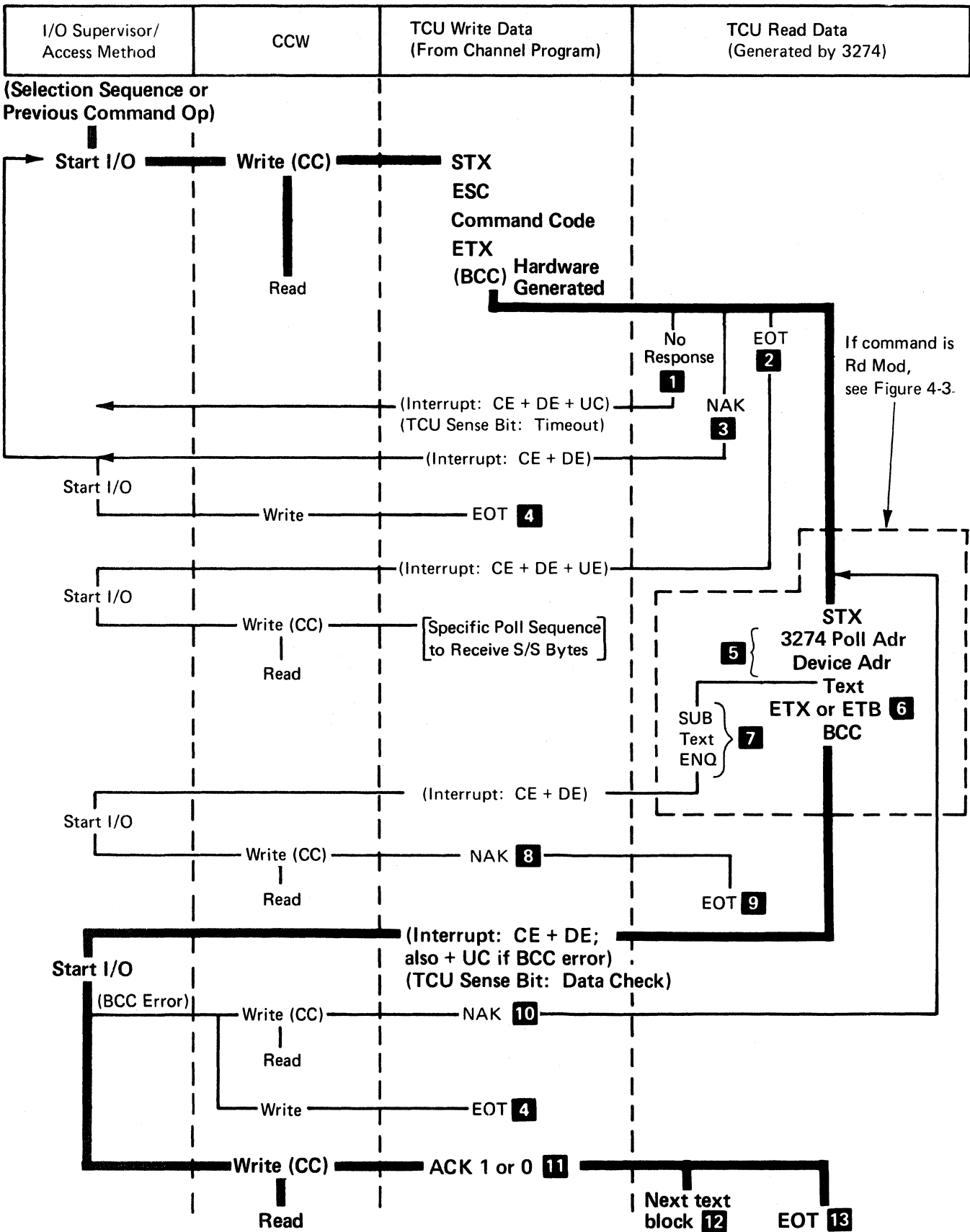

Figure 4-6 (Part 1 of 2). Read-Type Command, Sequence/Response Diagram

Notes:

- 1** Command transmission was not successfully received because of invalid framing (STX missing). Causes timeout at TCU.
- 2** The 3274 is unable to perform the operation indicated in the command transmission because of a busy/unavailable/not ready device or a 3274 detected check condition (receipt of an illegal command/order sequence, failure to decode a valid command, or an I/O interface "overrun"). The EOT response to a command transmission indicates that status information is stored in the 3274. To ensure retrieval of valid status, a Specific Poll must be issued to the device-responding EOT as the next addressing sequence issued to this 3274.
- 3** If a transmission problem causes both a 3274-detected check condition and a BCC error, the BCC error takes precedence over all other check conditions, and a NAK is transmitted to the TCU.
- 4** Response issued by the program to terminate the operation if the 3274 is unsuccessful in receiving a valid BCC following "n" attempts by the program to transmit the message.
- 5** This address sequence is included only in the first block of a blocked text message.
- 6** ETB is used to frame each block of a blocked text message, except for the last block. ETC is used to frame the last block of a blocked text message.
- 7** Upon detection of an internal parity check, the 3274 automatically substitutes the SUB character for the character in error. If a parity or cursor check is detected, ENQ is transmitted in place of ETX (or ETB) and BCC at the end of the text block and appropriate status and sense information is stored. This is also used by the 3274 if, after transmitting the first block, the transmission cannot be completed due to power being off at the terminal.
- 8** Mandatory program response to a text block terminated in ENQ.
- 9** Response to terminate the operation. The nature of the error (parity or cursor check) does not warrant a retry. This response indicates that appropriate status and sense information is stored. The status retrieval information included in Note 2 applies.
- 10** BCC error has been detected. The program issues NAK to cause the 3274 to repeat its last transmission.
- 11** Positive acknowledgment. The text block has been successfully received by the TCU. The program issues ACK 1 in response to the first and all odd-numbered text blocks and issues ACK 0 in response to the second and all even-numbered text blocks. This response to a text block terminated in ETX turns on the device SYSTEM AVAILABLE indicator.
- 12** The second and all succeeding text blocks are framed as the first except that they do not include the 3274/device address sequence.
- 13** Normal termination of the operation following transmission of the last text block.

LEGEND:

(CC) = Chain Command (CC) Flag in CCW is set to 1.

(Interrupt) = TCU-generated interrupt (CE = Channel End, DE = Device End, UE = Unit Exception, UC = Unit Check)

Figure 4-6 (Part 2 of 2). Read-Type Command, Sequence/Response Diagram

Status and Sense (S/S)Bytes

All remote status and sense conditions are combined into 2 bytes. These 2 bytes are always sent in a status message. In EBCDIC code, the bits are transmitted as indicated in Figure 4-7. If the sense bytes are transmitted in ASCII code, the EBCDIC code defined below is translated to ASCII before transmission.

Status and sense conditions are recorded by the 3274 for each device. These conditions may include busy or ready status or detected errors. Figure 4-8 shows how these status and sense conditions are interpreted for each error response transmitted by the 3274 in response to a poll sequence from the TCU.

Error Recovery Procedures

Errors detected at the 3274 are indicated to the system processor by the following responses: RVI, NAK, EOT, or sense/status information. The meaning of the responses depends upon their sequences, as defined in Figures 4-1 and 4-3 through 4-6.

An error in the 3178, 3278, or 3279 is reported once to a General Poll. The 3274 allows parts of messages to be transmitted to the host before all data is transferred from the 3178, 3278, or 3279 to the 3274. If a terminating condition prevents completion of data transfer from the 3178, 3278, or 3279 to the 3274 after

Bit No.	Bit Definition
	S/S Byte 0:
0	Dependent upon setting of bits 2-7.
1	Always a 1.
2	Reserved.
3	Reserved.
4	<p>Device Busy (DB) – This bit indicates that the addressed device (except the 3278 or 3279) is busy executing an operation or that a busy detection was previously made by a command or Specific Poll. The device is busy when it is executing an Erase All Unprotected command or a print operation, accepting data from the operator identification card reader, or performing various keyboard operations (ERASE INPUT, Backtab, and CLEAR).</p> <p>This bit is set with Operation Check when a Copy command is received which specifies a “busy” device with its “from” address.</p> <p>This bit is set with Unit Specify when a command is addressed to a busy device. This can occur by chaining a command to a Write, Erase/Write, Erase/Write Alternate, or Copy command which started a printer or by chaining a command to a Specific Poll addressed to a busy device.</p> <p>Note: DB is not returned for the 3278 or 3279 when executing an Erase All Unprotected command, accepting data from the MSR or MHS, or performing ERASE INPUT, Backtab, or CLEAR keyboard operations.</p>
5	<p>Unit Specify (US) – This bit is set if any S/S bit is set as a result of a device-detected error or if a command is addressed to a busy device.</p>
6	<p>Device End (DE) – This bit indicates that the addressed device has changed from unavailable to available and not ready to ready, or busy to not busy. This bit is included during a Specific or General Poll but is not considered pending status by a selection-addressing sequence.</p> <p>If a selection-addressing sequence detects that the addressed device has pending status and also detects one of the above status changes that warrants a Device End, then the Device End bit is set and preserved along with the other pending status, and an RVI response is made.</p>
7	Reserved.
	S/S Byte 1:
0	Dependent upon setting of bits 2-7.
1	Always a 1.
2	Command Reject (CR) – This bit is set upon receipt of an invalid 3270 command.
3	<p>Intervention Required (IR) – This bit is set if:</p> <ul style="list-style-type: none"> ● A Copy command contains a “from” address in its data stream which specifies an unavailable device. ● A command attempted to start a printer but found it not ready. The printout is suppressed. ● The 3274 receives a selection-addressing sequence or a Specific Poll sequence for a device which is unavailable or which became not ready during a printout. A General Poll sequence does not respond to the unavailable/not ready indication and proceeds to determine the state of the next device. ● The 3274 receives a command for a device which has been logged as unavailable or not ready.
4	Equipment Check (EC) – This bit indicates a printer character generator or sync check error occurred, the printer became mechanically disabled, or a 3274 detected bad parity from the device.
5	Data Check (DC) – This bit indicates a 3274 operation to a device was unsuccessful (i.e., the device was disabled with DC returned to the host; IR will be returned on subsequent retry by the host).
6	Reserved.
7	<p>Operation Check (OC) – This bit, when set alone, indicates one of the following:</p> <ul style="list-style-type: none"> ● Receipt of an illegal buffer address or of an incomplete order sequence on a Write, Erase/Write, or Erase/Write Alternate command. ● The device did not receive a CCC or a “from” address on a Copy command. ● Receipt of an invalid command sequence. (ESC is not received in the second data character position of the sequence.) ● The internal buffering capability is exceeded on a 3274. <p>This bit is set with Unit Specify to indicate that the “from” address on a Copy command specified a device with a “locked” buffer (the device data is secure).</p>

Figure 4-7. Remote Status and Sense Byte Definitions – BSC

Device Response	Command	S/S Explanation
RVI	Selection	<p>Outstanding Status — Pending information from a previous operation with the same device. (If the addressed device is busy, WACK is sent to the TCU instead of RVI, and no S/S bit is set.) Note: A selection-addressing sequence does not recognize a Device End as pending status. If there is no other pending status, it resets this bit and proceeds with the selection. If the addressed device has other pending status, Device End remains set with it, and the RVI response is made as usual.</p> <p>IR — The addressed device is unavailable.</p> <p>DE, EC, US — A character generator or syn check error has occurred, or the printer was mechanically disabled but the condition has been corrected. DE, EC, US is not sent by the 3287 or 3289.</p> <p>DE, IR — The addressed printer is out of paper, its power has been turned off, or its cover is open.</p> <p>DE, IR, EC, US — The addressed printer is mechanically disabled and cannot recover.</p> <p>DE, DC, US — A parity error is detected at the printer.</p> <p>DC, US — A parity check or cursor check is detected by the addressed device on the data it is sending to the control unit. For a 3274, an operation to a terminal was unsuccessful. The terminal was disabled and DC US returned to the host. On subsequent retry by the host, IR will be returned to the host.</p>
EOT	Read Commands	<p>CR — Invalid 3274 command is received.</p> <p>OC — Invalid command sequence (ESC is not in the second data character position), or data follows the command in the data stream received at the device.</p> <p>DB, US — The addressed device is busy. The command was chained to a Write, Erase/Write, Erase/Write Alternate, or Copy command which started a print, or it was chained to a Specific Poll.</p> <p>IR — A command is addressed to an unavailable device.</p> <p>DC — The 3274 is unable to complete a Read command operation after the first block has been sent to the host, because either there was an error in the terminal or the terminal was powered off after the first block was sent. A SUB character and an ENQ character are placed in the buffer. When the TCU responds NAK, the 3274 responds EOT.</p> <p>DC, US — A parity check or cursor check is detected by the addressed device on the data it is sending to the control unit. An operation to a terminal was unsuccessful. The terminal was disabled and DC US returned to the host. On subsequent retry by the host, IR will be returned to the host.</p>
EOT	Write Commands	<p>CR — An Invalid or illegal 3274 command is received.</p> <p>OC — An invalid command sequence (ESC is not in the second data position), an illegal buffer address or an incomplete order sequence is received, or a data byte was sent to the device during the Write command before the operation required by the previous data byte was completed.</p> <p>DC, US — The device detects a parity or cursor check on its buffer during the command operation. For a 3274, an operation to a terminal was unsuccessful. The terminal was disabled and DC US returned to the host. On subsequent retry by the host, IR will be returned to the host.</p> <p>DB, US — The addressed device is busy. The message is accepted but not stored in the 3274 buffer. The command is aborted.</p>
EOT	Copy Command	<p>DB, OC — The "from" device is busy. (The device is busy executing an operation, a printout, reading data from the operator identification card reader, or performing a keyboard operation.) The Copy command is aborted.</p> <p>IR, OC — The "from" device is not available.</p> <p>OC, US — The "from" device has a locked buffer.</p> <p>OC — The data stream contains other than 2 bytes (the CCC and the "from" address). The command is aborted.</p> <p>OC — The "from" device buffer is larger than the "to" device buffer.</p> <p>OC — The buffer of the "from" device (has APL/Text feature) contains APL/Text characters (entered since an Erase/Write or Erase/Write Alternate command or a CLEAR key operation) and the "to" device does not have the APL/Text feature.</p>

Figure 4-8 (Part 1 of 2). Remote Error Status and Sense Responses — BSC

Device Response	Command	S/S Explanation
EOT	Copy Command (cont)	DC, OC, US — Set when "from" device detects an internal parity or cursor check. For a 3274, an operation to a terminal was unsuccessful. The terminal was disabled and DC US returned to the host. On subsequent retry by the host, IR will be returned to the host. DB, US — The addressed "to" device is busy. DB, US, OC, DE — The addressed device becomes not busy before a Specific Poll is issued to retrieve the DB, US, OC status (described above).
EOT	Write, Erase/Write, Erase/Write Alternate, Copy Commands	IR — Addressed device is not available, or addressed printer is not ready.
EOT	Erase All Unprotected Command Specific and General Poll	OC — One or more data bytes followed the command (buffer overrun). DE, IR, EC, US — An unrecoverable mechanical failure is detected at the printer. DE, EC, US — A character generator or sync check error or a mechanical failure is detected at a 3284/3286/3288 printer but then recovered from. DC, US — A parity check or cursor check is detected by the addressed device on the data it is sending to the control unit. For a 3274, an operation to a terminal was unsuccessful. The terminal was disabled and DC US returned to the host. On subsequent retry by the host, IR will be returned to the host. DC — The 3274 is unable to complete a Read command operation after the first block has been sent to the host, because either there was an error in the terminal or the terminal was powered off after the first block was sent. A SUB character and an ENQ character are placed in the buffer. When the TCU responds NAK, the 3274 responds EOT. DE — The poll finds a device (1), previously recorded as busy, now not busy or, (2), previously recorded as unavailable <i>or</i> not ready, now available <i>and</i> ready. IR, DE — The poll finds a device, previously recorded as ready, available, and busy, now not ready and not busy, or the printer went not ready during a printout. DC, US, DE — A parity error is detected at printer.
	Specific Poll	DB — The addressed device is busy.
NAK	Read and Write Commands	NAK is transmitted by the 3274, when it detects a block check character (BCC) error on the TCU transmission. A BCC error has priority over all other detectable error conditions. If, for example, a BCC error and a parity error are detected during the same command transmission, the parity error condition is reset, and a NAK response is set by the 3274.

Figure 4-8 (Part 2 of 2). Remote Error Status and Sense Responses – BSC

inbound link transmission has started, the 3274 sends STX.....SUB ENQ. The 3274 responds to a Specific Poll with DC status. Following a selection addressing sequence, a write-type command is accepted but a read-type command is rejected and DC status is returned by the 3274.

When the host selects the 3274 and issues a Read Modified command, the 3274 transmits a single block of text followed by ETX. If the host makes an error by starting a new command sequence with STX, the 3274 responds with ENQ. If more than one text block is transmitted to the host, with ACK received from the host after each ETB, the host may respond to ETX on the last block, with a new command sequence beginning with STX, ESC.

Figure 4-9 lists the various error combinations of sense/status bits (with the exception of Device Busy (DB), which is not an error) and the recommended error recovery procedure for each combination. Supplementary procedures are also recommended. Although there are 256 possible combinations of status and sense bits, only a portion of this total is normally used. Combinations other than those listed may occur. For example, an unpredictable catastrophic hardware failure could induce an undefined combination of status and sense bits. Errors that occur at the "from" device during a Copy command are identified by an Operation Check (OC) sense bit in addition to the sense bit representing the detected error.

Sense/ Status Bits	Detected during 3274 Operation						Transmitted in Response to:		Error Recovery Procedure 3274
	Hex		Selection Addressing Sequence	Specific Poll Sequence	General Poll Sequence	A 3270 Command	Specific Poll	General Poll	
	EBCDIC	ASCII							
CR	40	60	20	2D			D, P		6
OC	40	C1	20	41			D, P		6
OC, US	C4	C1	44	41			D, P		13
IR	40	50	20	26	D, P	D, P	D, P		4
IR, OC	40	D1	20	4A			D, P		5
DC	40	C4	20	44	D, P	D, P	D, P	D, P	1
DC, US	C4	C4	44	44	D, P	D, P	D, P	D, P	2
DC, OC, US	C4	C5	44	45			D, P		3
DC, US, DE	C6	C4	46	44		P	P	P	8
IR, DE	C2	50	42	26		P	P	P	4
EC, US, DE	C6	C8	46	48		P	P	P	7**
IR, EC, US, DE	C6	D8	46	51		P	P	P	7
DB	C8	40	48	20	D, P	D, P		D, P	9
DB, US*	4C	40	3C	20			D, P	D, P	10
OC, DB*	C8	C1	48	41			D, P	D, P	11
DE	C2	40	42	20		D, P	D, P	D, P	None

Note: The attached device errors that are detected asynchronously do not cause a sense bit to set until the device is polled for status during a selection-addressing, Specific Poll, or General Poll sequence. Those error S/S bit combinations that contain DE were detected during a printout.

*The DB, US, and OC S/S bits will be combined if a Copy command is addressed to a busy "to" device and the command also specifies the "from" device the same as the "to" device.

**Occurs only if 3284, 3286, 3288 printers are attached.

LEGEND:

D – Display (3277, 3178, 3278, 3279)
P – Printer

Figure 4-9. Remote 3270 BSC Status and Sense Conditions

The error-recovery procedures recommended in Figure 4-9 are as follows:

1. Execute a new address selection addressing sequence and retransmit the message, starting with the command sequence that was being executed when the error occurred. If, after two retries, the operation is not successful, this should be considered as a nonrecoverable error. Follow supplementary procedure B after two retries.
2. Reconstruct the entire device buffer, if possible, and retry the failing chain of commands (within the BSC sequence of operations). The sequence of commands used to reconstruct the buffer should start with an Erase/Write or Erase/Write Alternate command. If the information in the screen buffer is such that it cannot, or need not, be reconstructed, the operation may still be

retried. If an unrecoverable 3178, 3278, or 3279 buffer error is detected, the entire buffer is cleared and the host system is informed of the error by receiving DC, US status but is not informed of the clear operation. If, after three retries, the operation is not successful, this should be considered as a nonrecoverable error. Follow supplementary procedure A.

Programming Note: A cursor check in the 3284 is indistinguishable from a second selection to a 3277 with a cursor check. A selection addressing sequence or poll sequence to another device on the same control unit should be attempted before flagging the control unit as inoperative. A successful sequence indicates that the CU is probably satisfactory, and the device requires manual intervention to reset it (for example, a 3277 with a nonrecoverable data check). An unsuccessful sequence indicates that the CU may be at fault and requires manual intervention to reset it.

3. The error occurred during execution of a Copy command. Execute procedure 2, except that it is the buffer of the "from" device specified by the Copy command that should be reconstructed. After three retries, follow supplementary procedure B.
4. The error indicates that the printer is out of paper, has its cover open, or has a disabled print mechanism; or it indicates that the device is unavailable. Request (or wait for) either the display or system operator to ready the device. Then, retry the printout by issuing a Write command with the proper WCC and no data stream. (There is no data error, and the data is still intact in the device buffer and can be reused.) Or, follow procedure 2.
5. The error indicates that the "from" device specified by a Copy command is unavailable. Note that the device address associated with the error status and sense information does not indicate the device that actually required "readying." The device that requires the corrective action is the device specified by the "from" address in the Copy command. When the device is determined and made "ready," follow procedure 1.
6. The operation should be tried up to six times. Continued failure implies an application programming problem, which can be detected by analyzing the failing write data stream.
7. The error occurred during a printout operation and indicates either a character-generator error or a disabled print mechanism. There is no data error. The proper error recovery procedure is application-dependent since the user may or may not want a new printout. If a new printout is required, follow procedure 4.
8. A data error occurred in the device buffer during a printout, and procedure 2 should be followed.
9. A Specific Poll detected that the addressed device is busy. Periodically issue a Specific Poll to pick up the Device End sense/status bit sent by the device when it becomes not-ready (unless this status change is detected on a selection addressing sequence).

10. Indicates that a command was erroneously addressed to a busy device. Periodically issue a General or Specific Poll to pick up the Device End sense/status bit sent by the device when it becomes not busy. Then follow procedure 1.
11. Indicates that, in attempting to execute a Copy command, the “from” device was found to be busy. Follow procedure 1 when the “from” device becomes not busy. Note that the device address associated with the status and sense message is the address of the “to” device and not that of the busy “from” device. The “from” device will transmit Device End via a Specific or General Poll when it becomes not busy.
12. An attempt was made to execute a Copy command, but access to the “from” device data was not authorized. The device address associated with the error sense/status bits is that of the copy “to” device.

Supplementary Procedures

- a. Request maintenance for the device that is giving trouble. After repair, reconstruct the screen buffer image. The sequence of commands used to reconstruct this image should start with an Erase/Write command. Retry the failing chain of commands according to the procedure that referred you to this supplementary procedure.
- b. The “from” device specified by the Copy command in the failing chain of commands (CCWs) is malfunctioning. The “from” device should be determined from the data-stream information, and maintenance should be requested for the device. After the repair, reconstruct the buffer image. The sequence of commands used to reconstruct this image should start with an Erase/Write command. Retry the failing chain of commands according to the procedure that referred you to this supplementary procedure.
- c. Same as procedure 1, except a new selection addressing sequence is not performed, and this message is transmitted as part of the present device selection.
- d. Same as procedure 1, except retransmit the entire failing chain of commands.

EOT to a Text Block

The recommended recovery procedure depends upon the type of detected error. A Specific Poll must be issued immediately following the EOT to obtain the error sense/status information. Then the recovery procedures referenced in Figure 4-9 should be executed.

Errors Detected During a Specific or General Poll Sequence

Any errors that result from execution of the poll sequence itself are contained in Figure 4-9, and those recovery procedures apply. The detected error bits are transmitted to the TCU in a Status Message during the poll sequence.

RVI to Selection Addressing Sequence

A Specific Poll must be issued immediately following the RVI to a selection addressing sequence to obtain the error sense/status information. Then the recovery procedures defined in Figure 4-9 should be followed.



Chapter 5. SNA/SDLC Communication

This chapter provides information to aid the system analyst and the system programmer in establishing the host-to-3274 communication, using Systems Network Architecture (SNA) protocols. A knowledge of the Network Control Program (NCP) and IBM access methods is assumed. The IBM access methods supporting SNA are VTAM, TCAM, and EXTM.

Additional information on SNA can be found in the *Systems Network Architecture Format and Protocol Reference Manual: Architecture Logic*, SC30-3112. Information to assist the host programmer in planning the use of SNA commands and access method macros can be found in the following publications:

VTAM:

ACF/VTAM Programming, SC27-0449

ACF/VTAM General Information, GC27-0608

TCAM:

TCAM Concepts and Application OS/VS, GC30-2049

TCAM Programmer's Guide OS/VS1, GC30-2054

TCAM Programmer's Guide OS/VS2, GC30-0241

EXTM Option of CICS/DOS/VS:

EXTM Version 1.0 General Information, GH20-1597

EXTM Version 2.0/3.0 General Information, GH20-1702

3790 Communication System:

Introduction to the IBM 3790 Communication System, GA27-2807

Network Control Program:

IBM 3704 and 3705 Communications Controller Network Control Program/VS Generation and Activities Guide and Reference Manual, GC30-3008

Transmission Formats

The host program and the 3274 communicate using half-duplex, flip-flop, send-receive protocols. When the host program or the 3274 is transmitting data, it assumes the role of the sending Logical Unit (LU). The LU to which the transmission is directed is the receiving LU. An LU is the logical entity that communicates on behalf of an end user (such as a terminal or application program). The term *outbound* refers to transmissions from the host to the 3274. The term *inbound* refers to transmissions from the 3274 to the host.

The portions of a transmission between the host and the 3274 that are discussed in this chapter are:

Request/Response Header (RH). This header describes the type of message being transmitted and contains indicators that control SNA protocols.

Request/Response Unit (RU). This contains the data or commands that flow in the transmission. (Note that occasional reference is made to a Null RU, that is, an RU that contains no data.)

Transmission Header (TH). This header contains format identification, mapping fields, and an expedited flow indicator.

The 3274 can communicate with the host system by means of a teleprocessing network that uses the synchronous data link control (SDLC) transmission format. The 3274 may also communicate using channel attachment to a host system. A description of SDLC transmission format is found in *IBM Synchronous Data Link Control General Information, GA27-3093*.

Session Components

Within SNA, communication takes place between LUs. For 3274 operation, the host always contains the Primary Logical Unit (PLU), and the 3274 contains the Secondary Logical Unit (SLU). The 3274 can have from 1 to 32 SLUs (addresses 2 through 33).

A set of logical connections, called *sessions*, is required to control the exchange of data and control information between the host program and a 3274 SLU. At the host system, the access method provides the System Services Control Point (SSCP) function for all sessions that are established with the 3274. The SSCP maintains information that allows a PLU to establish and maintain an LU-LU session with a specific 3274 LU.

SNA Sessions

The sessions that must exist between the host system and the 3274, for an access method application program and the 3274 to exchange information, are as follows:

SSCP-PU (access method—3274 Physical Unit (PU))

SSCP-PLU (access method—host program)

SSCP-SLU (access method—3274 SLU)

PLU-SLU (host program—3274 SLU) (referred to as LU-LU)

The following topics discuss the sessions individually and identify how they are established and terminated. The SNA commands that establish and terminate the sessions are identified. SNA commands are discussed in detail under "SNA Commands."

SSCP-PU Session

Before establishing the SSCP-PU (access method—3274 control unit) session, the physical transmission or channel connection to the host must be established. In locally attached systems, the Online/Offline switch must be placed in the Online position before communication can be established between the 3274 Model 1A and the host.

The SSCP-PU session must be established before establishing the SSCP-SLU or LU-LU sessions. When the access method network operator activates a specific 3274, the access method issues the Activate Physical Unit (ACTPU) command to the control unit. A predefined start procedure for the access method may also request the activation of specific 3274 control units. The SSCP-PU session is the first session established between the host system and the 3274.

The SSCP-PU session is terminated when the access method network operator deactivates the 3274. When all SSCP-LU sessions for the control unit have been terminated, the access method issues the Deactivate Physical Unit (DACTPU) command. When the 3274 returns a positive response to the DACTPU command, the SSCP-PU session is terminated.

In locally attached systems, the Online/Offline switch may be placed in the Offline position when the host communication function is terminated.

SSCP-Secondary LU Session

When the SSCP-PU session is established, an activate command may be issued to the access method to establish the SSCP-SLU session. The access method will issue an Activate Logical Unit (ACTLU) for the appropriate SLU or SLUs in the 3274. The SSCP-SLU session must be established before establishing the LU-LU session.

The SSCP-SLU session is terminated when the access method sends a Deactivate Logical Unit (DACTLU) command to the specified SLU. When the control unit returns a positive response to the DACTLU command, the SSCP-SLU session is terminated.

LU-LU Session

Initiating an LU-LU Session

Three types of LU-LU sessions are supported by the 3274. Further description of these sessions is provided later in this section. The LU-LU session types are:

- Type 1 — The device attached to the 3274 SLU is a printer, and the data stream is the SNA character string (SCS).
- Type 2 — The device attached to the 3274 SLU is a keyboard/display, and the data stream is in the 3270 data stream compatibility (DSC) mode format.
- Type 3 — The device attached to the 3274 SLU is a printer, and the data stream is in the 3270 DSC mode format.

The SNA Bind command is used to differentiate these types of sessions.

The command flow sequence required to establish a session is summarized in Figure 5-1. The command flow nomenclature is generalized, and access method specific macro names are not used. The example assumes that no sessions are active between the host and the 3274. The access method sends the ACTPU command to establish the SSCP-PU session **1**. ACTLU commands **2** are then sent to establish SSCP-PLU and SSCP-SLU sessions. The SSCP-PLU session can be established by the host application any time prior to logon. The network is now ready for LU-LU sessions to be established.

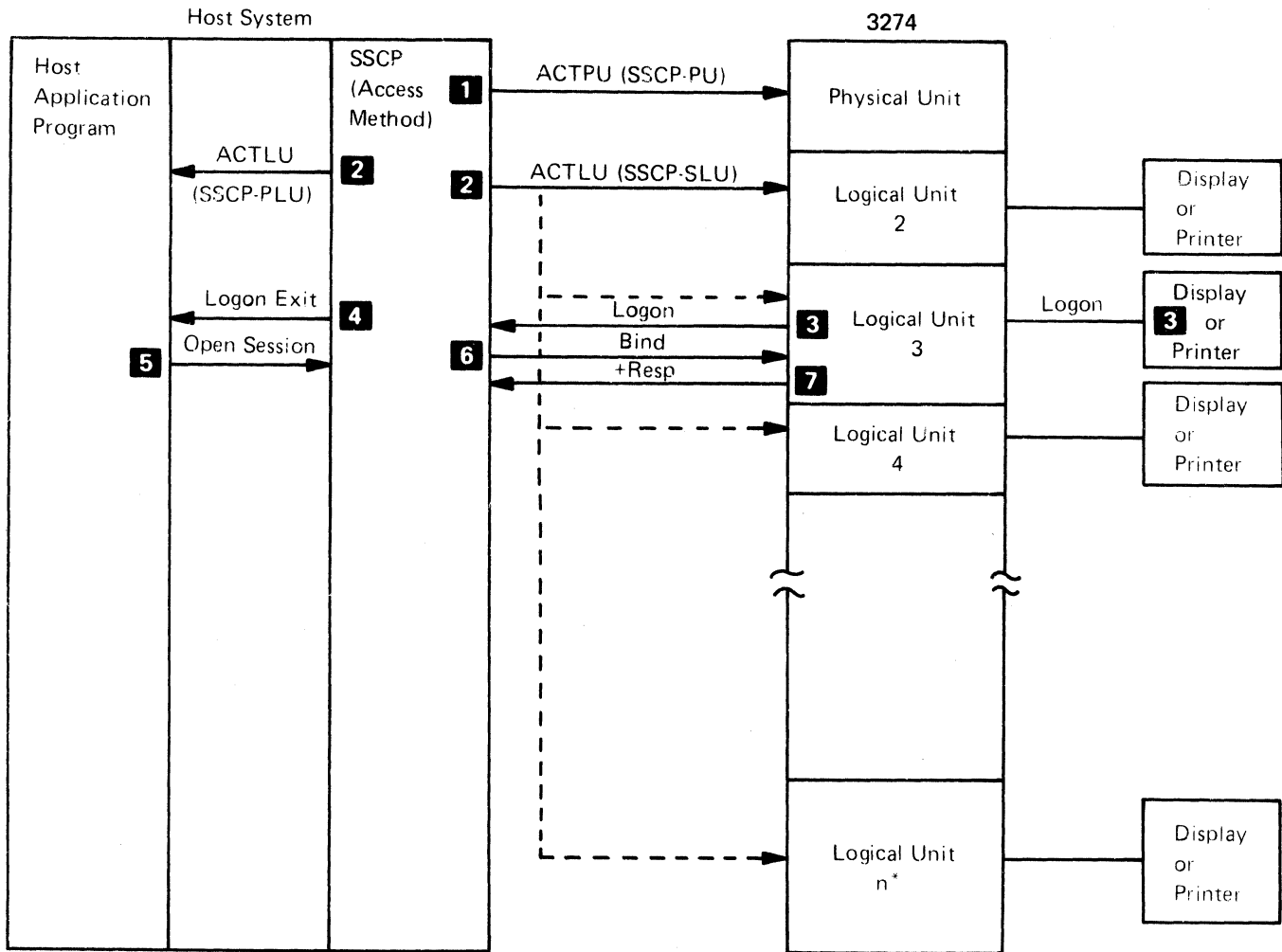

*The highest LU number for a 3274 is 33. (Note that LU1 is reserved.)

Figure 5-1. Establishing a Session with a 3274

An LU-LU session is started by the host application program when it issues the Bind request. The LU-LU session may be initiated by the host application program (for example, acquiring the terminal or by a simulated logon) or by the display terminal operator **3** (a character-coded logon). If a character coded logon is received by the access method, the access method translates the logon request and schedules a logon exit **4** for the PLU. After the PLU receives control at the logon exit, or when the PLU acquires a terminal, the PLU passes an open session request to the access method **5** which results in an SNA Bind **6** being passed to the SLU. The 3274 LU examines the session parameters of the Bind and, if they are acceptable, allows the session to be established by sending a positive response **7** to the Bind command. If the session parameters are not

acceptable, the 3274 LU rejects the Bind command by returning a negative response, indicating that the session parameters are invalid (sense code X'0821'). Also, if power is not on at the device, a negative sense code X'080A' or X'0845' is returned to the Bind. Bind is discussed later in this chapter.

After the Bind command has been accepted with a positive response, the host program can issue the Start Data Traffic command to allow data traffic to flow for the session.

The manner in which an LU-LU session may be initiated depends on the type of session being started. A type 1 or type 3 session must be initiated by the PLU. A type 2 session may be initiated by either the PLU or SLU.

Terminating an LU-LU Session

The PLU can terminate an LU-LU session by requesting that the SSCP close the session. The SSCP then sends the Unbind command to the secondary LU, and the LU-LU session is terminated.

Type 2 sessions can also be terminated by the display operator in either of two ways. The first method is to notify the PLU (where supported), on the LU-LU session, that termination is desired; the PLU then terminates the session. In the second method, the display operator changes from an LU-LU session to an SSCP-SLU session by using the System Request key (SYS REQ) and enters a logoff message. The SSCP then passes the logoff request to the PLU, if the logoff message is conditional, or issues the Unbind for the PLU if the logoff message is unconditional.

A PLU may close the session in an orderly fashion by issuing a Shutdown command. When the host program issues the Shutdown command, the 3274 returns the Shutdown Complete command after completing any outstanding operation and entering the between bracket state. Note that the PLU must close a bracket with end bracket before the Shutdown command is effective.

Transmission Header

The 3274 terminals support FID2 transmission headers (TH). The transmission header consists of 6 bytes:

TH0:	FID (Bits 0–3)	Format Identification
	MPF (Bits 4–5)	Mapping Field
	RES (Bit 6)	Reserved
	EFI (Bit 7)	Expedited Flow Indicator
TH1:	RES (Bits 0–7)	Reserved
TH2:	DAF' (Bits 0–7)	Destination Address Field (See Figure 5-2 and "Device Addressing" in Chapter 1)
TH3:	OAF' (Bits 0–7)	Origin Address Field
TH4,5:		Sequence Number on Normal, ID Number on expedited flow requests and responses

The 3274 handles transmission headers received on outbound requests as follows:

1. All reserved parameters are ignored on requests.
2. MPF—The 3274 supports outbound segmenting for FM data.
3. EFI—The expedited flow indicator identifies normal (0) or expedited (1) flow requests.

Device Number	Device Address Field							
	Bits: 0	1	2	3	4	5	6	7
PU	0	0	0	0	0	0	0	0
**	0	0	0	0	0	0	0	1
0	0	0	0	0	0	0	1	0
1	0	0	0	0	0	0	1	1
2	0	0	0	0	0	1	0	0
3	0	0	0	0	0	1	0	1
4	0	0	0	0	0	1	1	0
5	0	0	0	0	0	1	1	1
6	0	0	0	0	1	0	0	0
7	0	0	0	0	1	0	0	1
8	0	0	0	0	1	0	1	0
9	0	0	0	0	1	0	1	1
10	0	0	0	0	1	1	0	0
11	0	0	0	0	1	1	0	1
12	0	0	0	0	1	1	1	0
13	0	0	0	0	1	1	1	1
14	0	0	0	1	0	0	0	0
15	0	0	0	1	0	0	0	1
16	0	0	0	1	0	0	1	0
17	0	0	0	1	0	0	1	1
18	0	0	0	1	0	1	0	0
19	0	0	0	1	0	1	0	1
20	0	0	0	1	0	1	1	0
21	0	0	0	1	0	1	1	1
22	0	0	0	1	1	0	0	0
23	0	0	0	1	1	0	0	1
24	0	0	0	1	1	0	1	0
25	0	0	0	1	1	0	1	1
26	0	0	0	1	1	1	0	0
27	0	0	0	1	1	1	0	1
28	0	0	0	1	1	1	1	0
29	0	0	0	1	1	1	1	1
30	0	0	1	0	0	0	0	0
31	0	0	1	0	0	0	0	1

**Address reserved.

Figure 5-2. Device Addressing for SNA Terminals

EFI=1

The 3274 supports the following requests as outbound expedited flow requests:

RU Category	Request
SC	ACTPU, DACTPU, ACTLU, DACTLU, BIND, UNBIND, CLEAR, SDT
NC	Not supported
DFC	SIGNAL, SHUTDOWN
FMD	Not supported

When the 3274 receives any requests listed above with correct categories and EFI=1, they will be passed through for further processing.

EFI=0

The 3274 supports the following requests as outbound normal flow requests:

RU Category	Normal Request
SC	Not supported
NC	Not supported
DFC	Cancel, Bid, Chase, RTR
FMD on PLU-SLU	Any request
FMD on SSCP-SLU	Any in SCS format
FMD on SSCP-SPU	REQMS

When the 3274 receives any of the requests listed above associated with the correct categories and EFI=0, they will be passed through for further processing.

SNA Commands

SNA commands define a set of controls to establish and terminate sessions, and to assist in the management of host-to-3274 data flow and sessions.

Three types of SNA commands are discussed in the following topics:

- **Session Control (SC) commands**—These commands establish and terminate sessions in the network.
- **Data Flow Control (DFC) commands**—These commands control the flow of data in an LU-LU session.
- **Function Management Data (FMD) command**—This command is used to transfer data in the LU-LU session.

Commands Supported

The SNA commands supported by the 3274 are listed in Figure 5-3.

Command Description

Activate Physical Unit (ACTPU)

The ACTPU command is sent by the access method to establish the SSCP-PU session with a 3274 control unit. The SSCP-PU session is established when the 3274 returns a positive response to the ACTPU command.

The ACTPU command can be transmitted when the SSCP-SLU and LU-LU sessions are active; for example, when an NCP restart procedure occurs. When the 3274 receives the ACTPU command, all active sessions are terminated immediately (unless ACTPU ERP is specified). The 3274 returns a positive response to the ACTPU command, and the SSCP-PU session is reestablished.

Deactivate Physical Unit (DACTPU)

When the 3274 receives the DACTPU command, all LU-LU and SSCP-SLU sessions and the SSCP-PU session are terminated. If a command other than ACTPU is received after a positive response has been returned for the DACTPU command, the 3274 returns a negative response with sense data indicating PU not active (sense code X'8008').

SNA Command							
Name	Type	SSCP	PU	SSCP	SLU	PLU	SLU
		→	←	→	←	→	←
ACTPU	SC	X					
DACTPU	SC	X					
ACTLU	SC			X			
DACTLU	SC			X			
Bind	SC					X	
Unbind	SC					X	
SDT	SC					X	
Clear	SC					X	
Cancel	DFC					X	X
Chase	DFC					X	
LUSTAT	DFC						X
SHUTD	DFC					X	
SHUTC	DFC						X ¹
RTR	DFC						X ¹
Bid	DFC					X	
Signal	DFC					X	X ²
Data	FMD					X	
REQMS	FMD	X					
RECFMS	FMD		X				
Notify	FMD				X		
Alert	—		X				
RTM	—		X				

¹ Only SLU types 1 and 3 (3274 configured for 'between-bracket printer sharing').

² Only SLU types 1 and 2.

Figure 5-3. SNA Commands Supported by the 3274

Activate Logical Unit (ACTLU)

The ACTLU command is sent by the access method to establish the SSCP-SLU session with each 3274 control unit LU. The SSCP-SLU session is established when the 3274 returns a positive response to the ACTLU command. The SSCP-PU session must be established prior to the receipt of ACTLU to allow the 3274 to return a positive response to this command. If the 3274 receives a command other than ACTPU, ACTLU, DACTPU, or DACTLU before the SSCP-LU session is established, a negative response is returned with sense data indicating LU not active (sense code X'8009'). Note that the SLU is in the 3274 and that the session can be activated without a display or printer being powered on or attached.

When an SSCP-SLU session has been previously established and the 3274 receives an ACTLU command for that LU, any active session between that LU and a host program is terminated (unless ACTPU specifies ERP). The 3274 returns a positive response to the ACTLU command, and the SSCP-LU session is reestablished.

Deactivate Logical Unit (DACTLU)

Receipt of this command terminates the SSCP-SLU session. If an LU-LU session is established when the DACTLU command is received, the session is terminated. When the 3274 receives a command other than DACTPU, ACTPU, or ACTLU

after a positive response has been returned for the DACTLU command, a negative response is returned with sense data indicating SLU not active (sense code X'8009').

Notify

The 3274 supports the Notify command, when it flows from the secondary LU in the 3274 to the SSCP, for purposes of advising the SSCP of power on or off conditions at the device. The Notify command uses the same protocols and state changes, including keyboard control if device ownership is SSCP-SLU, as the character-coded requests. An inbound Notify may be sent while the device screen is in the unowned state; it does not cause a transition to the SSCP-SLU owned state.

The request is sent as follows:

TH0:	X'2C'	(Secondary-->Primary, normal)
TH1:	X'00'	
DAF':	X'00'	
OAF':	Address of LU sending Notify	
SNF:	X'0000'	
RH0:	X'0B'	(Request FMD, formatted, OC)
RH1:	X'80'	(DR1)
RH2:	X'00'	
RU0:	X'81'	Network Services
RU1:	X'06'	Session Service
RU2:	X'20'	Notify
RU3:	X'0C'	Vector key
RU4:	X'06'	Length
RU5:	b'0000 00x1'	
RU6-7:	X'0000'	LU-LU session limit
RU8-9:	X'0000'	LU-LU session count
RU10:	X'00'	Reserved

X = 0 Secondary LU is not enabled, power off.

X = 1 Secondary LU is enabled, power on.

The vector X'0C' is contained in the ACTLU positive response to notify the SSCP of device power on or off status at ACTLU time. While the SSCP-SLU session exists (that is, the ACTLU sequence has been processed, but a following DACTLU sequence has not, and an LU-LU session is not bound), any detected power on or off change by the device causes Notify to be sent to the SSCP. While an LU-LU session is bound, power on or off change notification is sent to the PLU by negative response and LUSTAT as already implemented. However, when an Unbind is received, the SLU checks the device power on or off status. If the status is power off, a Notify is sent to the SSCP at that time. Also, if an Unbind is generated by the 3274, a NOTIFY is sent to the SSCP.

The 3274 will also support a negative response of X'0845' to a BIND because of device power off. X'0845' will be the sense code in operation following IML for the control unit.

The 3274 will use the Positive/Negative response to Notify to determine whether the host can support queued initiates. If Notify receives a negative response, the

3274 will assume the SSCP does not support Notify and will set the sense code to X'080A' for a negative response to Bind for all LUs in the control unit. The negative response X'080A' will remain in effect until the control unit is powered off or re-IMLed or until a new ACTPU is received. Following the ACTPU for any of these conditions, the default response code of X'0845' is in effect.

For unformatted data flow on the SSCP-SLU session, a negative response from the SSCP will leave the SLU in receive state. This will cause a hang condition if a negative response (Notify) leaves the SLU in receive state. Therefore, the SLU will return to contention state irrespective of the value of the response.

Bind

This command is sent by the access method to request an LU-LU session between an application program and a 3274 SLU. The 3274 returns a positive response to establish the LU-LU session. When the session cannot be established, the 3274 returns a negative response with sense data that describes the reason the session was rejected.

The 3274 examines session parameters that are received with the Bind command. The values required depend on the type of session established. Figure 5-4 provides a detailed description of the session parameters that are sent with the Bind command.

When the SSCP-SLU session is established and the 3274 receives a command that flows in the LU-LU session other than the Bind, a negative response is returned with sense data indicating no session established (sense code X'8005').

If the device attached does not have power on or is physically detached from the 3274 cable port, a negative response is returned with sense data indicating power off (sense code X'080A').

When a LU-LU session exists, that is, one Bind has been accepted, and the 3274 receives a subsequent Bind command for the LU, a negative response is returned with sense data indicating session already exists (sense code X'0815') if the Bind sender address is the same as the session already found. A negative response indicating function active (sense code X'0805') is returned if the Bind sender address differs from the session already found.

Session parameters included in the Bind command RU define the protocols that govern the session. Figure 5-4 describes the contents of a Bind command RU that are supported by the 3274 and explains how the session parameters are used. A generalized setting for the access method logmode table is listed under "Bind Default" later in this chapter. Also listed (under "Bind Check") are the checks that the 3274 makes when the Bind command is received. Specific customer optimization or device features may require changes for each installation.

Also listed later in this chapter (under "Logical Unit Status") are the checks made by the 3274 for each logical unit type. Failure to properly specify the required session parameters results in rejection of the Bind command by the control unit because the session parameters are invalid (sense code X'0821').

Byte	Hex Value	Bit Setting	Meaning
0	31		Identifies this RU as a Bind command.
1	01		Bind type and format. The only Bind type supported is Hex 01.
2	03		Function management (FM) profile. Specifies that the data flow control commands and the request/response protocols that are to be used for this session conform to FM Profile 3.
3	03		Transmission services (TS) profile. Specifies that the 3274 conforms to TS Profile 3; that is, pacing and sequence numbers are used with normal flow transmission and that data traffic is controlled by the Clear and Start Data Traffic commands.
4			Primary LU Protocols.
		X	Chaining use: 0 The PLU can send only single-element chains. 1 The PLU can send single- or multiple-element chains.
		. X	Request mode selection: 0 Immediate request mode is used. Only one definite response can be outstanding at a time. That response must be received before the PLU can send another RU.
		. . XX	Chaining responses: 01 The PLU can only request exception-only responses. 10 The PLU can only request definite responses. 11 The PLU can request definite or exception-only responses.
	 00 . .	Reserved.
	 X .	Compression indicator: 0 Must be 0.
	 X	Send End Bracket Indicator (EB): 1 The PLU can send the EB.
5			Secondary LU Protocols.
		X	Chaining Use: 0 The 3274 can send only single-element chains. 1 The 3274 can send single- or multiple-element chains. Note: 0 or 1 for LU type 1 or 3. 1 for LU type 2.
		. X	Request mode selection: 0 Immediate request mode is used. The 3274 can issue a request for a single definite response. No further transmissions are sent until the 3274 receives the requested response.
		. . XX	Chaining responses: 01 The 3274 can only request exception-only responses. 10 The 3274 can only request definite responses. 11 The 3274 can request either definite or exception-only responses.
	 00 . .	Reserved.

Figure 5-4 (Part 1 of 3). Bind Command Session Parameters

Byte	Hex Value	Bit Setting	Meaning								
6	X.	Compression indicator: 0 The 3274 cannot send compressed data.								
	X	Send End Bracket indicator (EB): 0 The 3274 cannot send the EB.								
			Common Protocols.								
		0... ..	Reserved.								
		.X... ..	Function management (FM) header usage: 0 The PLU and the 3274 cannot exchange FM headers. 1 The PLU and the 3274 can exchange FM headers.								
		..X.	Brackets usage: 1 Bracketed session is used. Both the PLU and the 3274 must use bracket protocols.								
		...X	Bracket termination protocol: 1 Bracket termination rule 1 is used (refer to "Bracket Protocol" for a description of bracket termination rule 1).								
	 X...	Alternate Code selection: 0 Both the PLU and the 3274 must use EBCDIC. 1 Both the host program and the 3274 can use an alternate code. An example of an alternate code is ASCII.								
	000	Reserved.								
		7			Common Protocols.						
XX.	Normal Flow Send/Receive mode (selection): 10 This session uses half-duplex, flip-flop (HDX FF) transmissions. Refer to "Session Processing States."										
..X.	Recovery responsibility: 0 The PLU is responsible for error recovery.										
...X	Brackets first speaker: 0 The 3274 is always the first speaker.										
.... 000 .	Reserved.										
.... ..X	Contention resolution: 0 Contention (simultaneous transmissions from the host program and the 3274) is resolved in favor of the 3274.										
8		00xx xxxx	Secondary-to-primary LU pacing count. If set to zeros, pacing is not used.								
9		00xx xxxx	The primary-to-secondary pacing value defines the number of RUs that may be received by the 3274 before a pacing response must be returned to indicate readiness for another block of RUs. If set to zeros, pacing is not used. See "Pacing" for recommendations of pacing values.								
10	XX		Maximum RU size sent by the secondary LU. This value represents the largest RU that can be sent by the 3274. It is expressed as a mantissa (8 through F) and an exponent value of 2 by which the mantissa is multiplied. For example, when the mantissa is specified as 8 and the exponent of 2 is 5 (hex 85), the RU size represented is 256 bytes. Examples of mantissa and exponent values used by the 3274 are shown below with the RU size they represent: <div style="text-align: center;"> <table border="0"> <tr> <td>85=256</td> <td>86=512</td> <td>C6=768</td> <td>87=1024</td> </tr> <tr> <td>A7=1280</td> <td>C7=1536</td> <td>E7=1792</td> <td>88=2048</td> </tr> </table> </div>	85=256	86=512	C6=768	87=1024	A7=1280	C7=1536	E7=1792	88=2048
85=256	86=512	C6=768	87=1024								
A7=1280	C7=1536	E7=1792	88=2048								

Figure 5-4 (Part 2 of 3). Bind Command Session Parameters

Byte	Hex Value	Bit Setting	Meaning
			See "RU Lengths Supported" for detailed information about values supported by the 3274.
11	XX		Maximum RU size sent by the primary LU. This value represents the largest RU that can be sent by the PLU and is specified in the same format as for the secondary LU (byte 10). See "RU Lengths Supported" for detailed information about values supported by the 3274.
12, 13			Ignored by 3274.
For SLU Type 1:			
14	01		Type 1 print function using SCS data stream.
15-16	00		Reserved.
17	X	If set to b'1' the Read Partition-Query and Query Reply structured fields are supported by the secondary logical unit. Not checked by 3274, but will be accepted.
18	E1		Sent but not checked by the 3274 for LU type 1.
19	00		Reserved.
20-24			Not supported for LU type 1.
For SLU Types 2 and 3:			
14	02		Type 2 3270 data stream compatibility mode.
14	03		Type 3 3270 print function using 3270 data stream.
15	80	X.	If set to b'1' the Read Partition-Query and Query Reply structured fields are supported by the secondary logical unit. Not checked by 3274, but will be accepted.
16-19	00		Reserved.
20-24	XX		Refer to Figure 1-13 for LU type 2. Refer to Figure 1-14 for LU type 3.
For all SLU Types:			
25-K			Cryptography Options (Encrypt/Decrypt)
K+			Ignored

Figure 5-4 (Part 3 of 3). Bind Command Session Parameters

Unbind

Receipt of this command directs the 3274 to terminate the LU-LU session between a host program and a 3274 SLU. The LU-LU session is terminated when the 3274 returns a positive response to the Unbind command.

Clear

Receipt of the Clear command causes the 3274 to enforce the data-traffic-reset state upon the LU-LU session. Clear also causes the 3274 to initialize all inbound and outbound transmission buffers. When data-traffic-reset state is activated for an LU-LU session, only the following commands are valid for that session: Clear, Unbind, and Start Data Traffic (SDT).

Start Data Traffic (SDT)

This command allows data traffic to flow during an LU-LU session. The SDT command must be issued after a Bind command has established the LU-LU session. It is also sent after Clear to complete a session resynchronization sequence with the 3274. SDT is valid only when the data-traffic-reset state is active for an LU-LU session.

To complete a session resynchronization sequence, the host program must request transmission of the SDT command from the access method.

Cancel

When received, normal SNA use of this command directs the receiver to discard all elements of the chained transmission being received. However, the 3274 processes data RUs to the display or printer as they are received without waiting until end-of-chain. Therefore, the Cancel command serves to provide a proper termination for an otherwise incomplete chain. A Cancel command received between chains only affects the 3274 state controlled by the change direction (CD) and end bracket (EB) bit settings carried in the RH with the Cancel command. Processing of a chained transmission is terminated when the Cancel command is received. EB or CD may be sent with the command.

When a chained transmission is in progress and the 3274 returns a negative response to an element of that chain, the PLU should terminate that chained transmission and issue the Cancel command if the last chain element has not already been sent to the 3274.

When sent by the 3274 type 2 SLU, the Cancel command directs the PLU to stop processing a chained transmission and to discard all elements of the chain that are currently being received. The Cancel command is substituted for the end of the chain if a 3178, 3278, or 3279 failure or operator action prevents transfer of all data from the display to the 3274.

When the PLU returns a negative response for an element of a chain, the following will happen:

- *For a 3274 when inbound pacing is not used*, the entire chain will be transmitted before the PLU response is examined. Cancel will not be sent.
- *For a 3274 when inbound pacing is used*, the negative response from the PLU will be examined only if the 3274 must look for a pacing response. If the negative response is examined, the 3274 will send Cancel and will not transmit the remaining elements in the chain. If the negative response is not examined, the entire chain will be transmitted and Cancel will not be sent.

In either case, the PLU should discard all elements of a chained transmission after sending a negative response.

Chase

Chase is used to confirm that all preceding requests have passed through the network and have been processed. When this command is received, the 3274 returns a positive response to the PLU, indicating all previous chains have been processed.

The PLU should complete or cancel the current chained transmission before issuing the Chase command. When a chained transmission is sent with exception-only responses requested, the Chase command can be used to verify that all responses for that chain have been received. The EB or CD indicators can be issued with the Chase command.

Bid

The Bid command is sent by the PLU to a 3274 SLU to request permission to begin a bracket. The use of Bid avoids long chains of data using transmission time and then being discarded because the SLU won bracket contention. If the Bid is accepted by the SLU, a positive response is returned and the SLU goes to begin-bracket-pending state and waits for the request containing BB.

A 3274 SLU that is configured for between-bracket printer sharing can reject a Bid command by winning bracket contention for the following reasons:

1. LU Type 2

- The 3274 is already in Bracket (INB), and a PLU protocol error exists. The sense code returned is X'0813'.
- The operator has initiated an inbound data stream carrying Begin Bracket (BB). The sense code returned is X'0813'.
- An operator has started to enter data on the screen but has not initiated an inbound data stream. The sense code returned is X'081B'.

2. LU Type 1 or 3

- The SLU is already INB, and a host program protocol error exists. The sense code is X'0813'.
- A printer attached to the 3274 is busy doing a local copy operation. The sense code returned is X'0814'. The 3274 will send the Ready to Receive (RTR) command to the host program when the printer becomes not-busy and a BB can be accepted by the secondary LU. This applies to the 3274 only when configured for between-bracket printer sharing.

Signal

The PLU can send the Signal command to the 3274 SLU to request the Change Direction (CD) indicator. The SLU will complete any chained transmissions in progress and send the CD to the PLU. A request with CD but no data (a Null-RU) will be sent if the SLU is in send state but has not started transmitting. If the SLU is already in receive state, BETB, or ERP1 state (see "Session States"), the Signal is positively responded to but no SLU action is taken.

The 3274 will send the Signal command (X'00010000') when the terminal operator presses the keyboard ATTN key or, for an LU type 1, either of the printer PA switches. The command is expedited and has no effect on SLU states. Once Signal has been sent by an SLU, pressing the ATTN or PA keys will not cause a second Signal until the 3274 has received a response to the first Signal.

LU Status (LUSTAT)

The 3274 SLU sends the LUSTAT command to notify the PLU that a processing error has been detected or that a change in the operational status of a device has occurred. A 4-byte status code is sent by the 3274 SLU to describe the error condition or the device status change.

For LUSTAT codes and conditions that determine which LUSTAT is sent, refer to "Logical Unit Status" later in this chapter.

Ready to Receive (RTR)

A 3274 type 1 or 3 SLU sends this command to indicate when a previously rejected bracket (with sense code X'0814') can be initiated by the host program. The RTR command is allowed only when the session is ready to receive a new bracket. This applies to the 3274 only when configured for between-bracket printer sharing.

When the RTR command is sent and a positive response is received from the host program, the printer LU enters begin-bracket-pending state and expects the host program to begin a bracket.

REQMS

The Request Maintenance Statistics (REQMS) command is sent by the SSCP to a 3274 when the Network Determination Aid Processor (NDAP) requests PU performance statistics. Four types of requests can be made:

- Type 1 Link Test Statistics
- Type 2 Summary Counters
- Type 3 Communication Adapter Data Error Counts
- Type 5 3274 Configuration Information

The state of the RESET/NO-RESET indicator in the REQMS request determines whether the log area where the transmitted maintenance statistics are stored is cleared.

An REQMS request that cannot be executed by the 3274 is rejected with a negative response; an accepted REQMS request receives a positive response and the requested statistics (formatted as RECFMS) as an inbound message.

RECFMS

Record Formatted Maintenance Statistics (RECFMS) is sent by the 3274 to the SSCP in response to an REQMS command (the 3274 will not send unsolicited RECFMS requests to the host). The RECFMS maintenance statistics are recorded at the host by the Network Communications Control Facility (NCCF).

When the 3274 accepts an REQMS request, it transmits the maintenance statistics requested. If the REQMS specified "RESET," the error log area referenced by the REQMS is reset by the 3274 after the RECFMS is transmitted, otherwise, the error log area is not reset.

For descriptions of the RECFMS responses, refer to Appendix G.

Shutdown

The PLU sends the Shutdown command. Receipt of this command directs the 3274 SLU to prepare for a session termination sequence. The 3274 returns a positive response to the PLU, but data-transfer sequences are not inhibited.

The Shutdown command causes the session to enter shutdown-complete-pending state. The pending state is maintained until the SLU completes normal flow processing and goes between bracket (BETB). The SLU then sends the Shutdown Complete command to the PLU.

Shutdown Complete

This command is sent by the 3274 after the Shutdown command has been received from the host program and an End Bracket has caused the SLU to go to BETB state.

When the Shutdown Complete command is sent to the PLU, the session enters shutdown state. When shutdown state is active, no data transmissions can be sent to the PLU; the PLU, however, may continue to send data to the 3274.

The PLU may either terminate the session using Unbind when the Shutdown Complete command is received from the 3274, or use Shutdown as a means of quiescing traffic. Exit from Shutdown Complete requires a Clear and SDT if the command is used as a quiesce function.

FM Data

This command is used to transfer data in the LU-LU or SSCP-LU session. It may only be sent in LU-LU session when data traffic is allowed (SDT has been issued and received a positive response).

When communicating with a 3274 SLU, the following FM data protocols are used:

Bracket: Bracket Protocol is used to delimit a series of related inbound and outbound FM data request units (RUs); for example, all the RUs required to complete a transaction.

Chaining: Chaining logically connects one or more RUs from a single LU; for example, all RUs required to complete a display image.

Change Direction: Change direction informs the receiving LU that the sending LU has completed transmission and expects the next transmission to be from the receiving LU; for example, the PLU has transmitted a complete form image and expects the next transmission to be from the display operator when the blank fields in the form image are filled in.

Bracket Protocol. The 3274 provides a bracket protocol to delimit a series of related inbound and outbound requests. A bracket may consist of one input and one output, many sets of inputs and outputs, or a series of requests flowing in a single direction. The Begin Bracket (BB) and End Bracket (EB) indicators are used to delimit a bracket. References are made to bracket states (BETB and INB); these states are described under "Bracket States."

A bracket is initiated when the Begin Bracket indicator (BB) is accepted by the primary or secondary LU. The bracket is usually ended when the End Bracket

indicator (EB) is received by the secondary LU. The specific conditions that end a bracket are defined by SNA bracket termination rule 1 (see below). Two commands, Bid and Ready to Receive (RTR), are implemented to further define the initiation of a bracketed session. These commands are described under "SNA Commands."

The following protocols apply for 3274 bracket processing.

For sessions with type 2 SLUs, the SLU may begin a bracket any time the session is between brackets. The PLU may request permission to begin a bracket using Bid. If the SLU returns a positive response, the PLU may begin a bracket. If the SLU returns a negative response, the PLU must wait for the next BB from the SLU.

For type 1 and 3 sessions, the PLU may begin a bracket any time the session is between brackets (the only time the SLU will begin a bracket is when the operator presses the PA key). The PLU may start a bracket by sending a transmission that contains BB or by sending Bid, waiting for a positive response, and then sending a transmission that contains BB.

The PLU may attempt to initiate a bracket by simply sending a transmission with BB. If a contention situation exists (the SLU begins a bracket before receiving BB from the PLU), the SLU returns a negative response to the PLU's transmission and then discards all portions of the chain from the PLU. The SLU assumes that its transmission will be accepted by the PLU.

If a Bid or BB from the PLU is rejected, the 3274 will do the following:

- For a session with a type 2 SLU, the SLU sends BB when it next has data to send. The PLU may return its data when it receives Change Direction (CD).
- For a type 1 or 3 session with a 3274 configured for between-session printer sharing, the SLU will not reject the PLU's Bid or BB unless a protocol error is detected. The PLU should restart the transaction.
- For a type 1 or 3 session with a 3274 configured for between-bracket printer sharing, the SLU will only reject the PLU's Bid or BB if the printer is performing a local print function or when a protocol error is detected. When the local print is completed, the SLU will send RTR.

The host program can end a bracket. The 3274 cannot end a bracket. Bracket protocol establishes the following restrictions on beginning and ending brackets:

1. BB and EB cannot be sent with response RUs.
2. The EB cannot be sent with the Bid or RTR command. All other normal flow DFC commands can end the bracket.
3. All outbound chains that begin a bracket but do not carry EB must be sent with definite response requested.

The 3274 supports bracket termination rule 1 as follows:

1. When EB is received and the last element of a chain requires definite response, the 3274 will enter between-bracket state (BETB) from in-bracket state (INB) after +RSP to the chain or stay INB after -RSP.
2. When EB is received and the last element of a chain requires exception response, the 3274 will enter BETB from INB immediately.

The 3274 ignores the BB bit on all outbound requests except FM data, and ignores EB on all outbound requests except FM data and DFC commands Cancel and Chase.

Chaining Protocol Definition. A data chain is a complete unit of data that originates at a single LU. Data RU chaining provides a method of logically defining a complete unit of data regardless of whether the data is transmitted as a single RU or as a series of consecutive RUs. Each RU is associated with only one chain. An individual RU may be the beginning, middle, ending, or only (both beginning and ending) RU in the chain; the chaining indicators, Begin Chain (BC) and End Chain (EC), are contained in the request header. The following are definitions of each type of RU in a chain:

First in Chain (FIC)	Identifies an RU that begins a chained transmission (RH=BC∩EC).
Middle in Chain (MIC)	Is transmitted with all RUs following the BC transmission, with the exception of the last RU in that chain (RH=∩BC∩EC).
Last in Chain (LIC)	Identifies the RU that completes a chained transmission (RH=EC∩BC).
Only in Chain (OIC)	Both the BC and EC indicators are included to indicate a transmission that consists of a single RU. That RU is termed a single-element chain (RH=BCEC).

A chain is correct if the RUs consist of:

1. FIC, LIC; or
2. FIC, MIC, ..., LIC; or
3. OIC.

Any other sequence of chaining indicators will cause a chaining error.

Chaining Operations. When the 3274 receives a chain with chaining indicators in an improper sequence (for example, FIC, MIC, FIC), a negative response, with sense data indicating a chaining error (sense code X'2002'), is returned to the host program. The 3274 purges the chain, ignoring subsequent elements of that chain until a data RU with the LIC or a Cancel command is received. Receipt of an OIC data RU terminates the purging of a chain; the OIC message is also purged. Sending RUs having chaining indicators in the sequence FIC, MIC, OIC is a violation of chaining protocol. In this case, when the 3274 receives the OIC

transmission, the chaining error is detected, the OIC transmission is purged, purging of chain elements is stopped, and a negative response is sent for the OIC transmission. The 3274 is now ready to normally process the next chain.

Change Direction. The 3274 uses a half-duplex, flip-flop (HDX-FF) mode to transfer normal flow data. Only one of the two LUs in the session may send at a given time. The flip-flop protocol demands that, when one LU is sending, the other must be prepared to receive. Therefore, the two states of send and receive (RCV) exist on each end of the session.

A bit in the request header, called the Change Direction (CD) indicator, is used to keep the two end-point LUs in synchronization. Each time an LU accepts this CD in a request, it means it is that LU's turn to send. Each time an LU sends the CD in a request, that LU must then be prepared to receive. The 3274 always sends CD with LIC or OIC in an FMD RH. Exceptions may occur following negative responses. See "ERP1" state.

Pacing

Inbound and Outbound pacing is supported by the 3274. Pacing is used as a tuning parameter for the system. Usage comments are included here; however, control is under the user's discretion at NCP or equivalent definition time.

The pacing count (N) determines the number of normal flow request RUs that can flow before a pacing response is required to allow the next group of N RUs to continue. A special response designated as Isolated Pacing Response (IPR) is used to return the pacing response if a response to the outbound request is not required at the time the pacing response is required. The 3274 will indicate readiness with a pacing response as soon as printer buffers become available after receiving the pacing request. Thus, the number of normal flow RUs allowed in the network due to pacing is up to $2N-1$. RUs may vary in length as specified in the Bind parameter.

Pacing (LU Type 1)

For the 3274, device dependencies exist because the printer is slower than the displays. Care must be exercised in the use of pacing and/or definite response protocol so that waiting RUs and/or chains are not stacked in the 3274 link buffers.

Within a chain, the 3274 transfers RUs from the link buffer pool to the printer buffer as they are received. The pacing parameter is then used to ensure that there is adequate printer buffer space so that the link buffer pool does not fill and restrict data flow to the keyboard displays or other printers.

During the transmission of multiple chains, interaction occurs between pacing and the type of response requested. When a definite response is requested, a response for a chain must be received by the PLU before it can send the next chain. When exception response is requested, the PLU may send any number of consecutive chains without waiting for a response. Therefore, a definite response enforces a type of pacing.

When OIC RUs are used that are less than, or equal to, 256 bytes, it is redundant to specify both pacing and definite response; unnecessary network traffic will

occur if both are specified. The 3274 will not accept a pacing count of zero. When chains with multiple RUs are used, pacing is necessary even though definite response is requested.

During the transmission of multiple chains, the 3274 uses printer buffers as an extension of the link buffer pool. Pacing is based on the total buffer capacity.

If the 3274 SLU type 1 receives more normal flow requests than it is guaranteed by using the outbound pacing mechanism, and the printer buffer does not have enough space left to store the outbound data, a RSP using sense code X'0801' will be returned. The 3274 will respond to the chain in process of being printed and clear any remaining unprocessed chains from the printer, including the chain causing the error. A chain SNF error is likely to occur if additional chains are sent prior to a CLEAR for the 3274.

Pacing (LU Types 2 and 3)

For LU type 2, the 3274 will generally operate faster than the link, and pacing is not required for the controllers.

For LU type 3, the definite response required when the WCC Start Print bit is set is an effective alternative to pacing.

In telecommunication networks where RUs are processed through more than one communication controller (for example, a 3704 and a 3790 or two 3705s), outbound pacing may be required for type 2 and 3 LUs to prevent data traffic congestion in these controllers.

Inbound pacing is supported by the 3274. Usage in a tree-structured network may not be required. Usage in large telecommunication networks may require inbound pacing to prevent congestion at communication controllers in the network.

SNA Responses

The RH contains indicators that describe the type of response given: Definite Response 1 (DR1) or Definite Response 2 (DR2). The RH also contains an Exception Response (EX) indication that is used when describing the response protocol. Definite response protocol (DR1 EX or DR2 EX) specifies that a response, either positive or negative, must be given. Exception response protocol (DR1 EX or DR2 EX) specifies that only a negative response may, or need be, returned.

The only definite response type requested by the 3274 is Definite Response 1 (DR1). The response protocol requested by the 3274 (definite response and/or exception response) is defined in the Bind.

The 3274 will respond to message from the host with any requested response type (DR1, DR2, or both). The 3274 supports definite response or exception response protocols.

No distinction is made (within this chapter) between the specific response types. The term "positive response" indicates successful receipt of a command or data RU. The term "negative response" indicates that the receiving LU detected an error, which is reported to the sending LU.

Summary of SNA Commands

Figure 5-5 summarizes the validity of SNA commands received by the 3274 relative to the sessions (SSCP-PU, SSCP-LU, and LU-LU) to two LU-LU session processing states (data traffic reset and in brackets). Figure 5-6 shows the same for SNA commands sent by the 3274.

SNA Command Received	SSCP-PU Session Active	SSCP-LU Session Active	LU-LU Session Active	LU-LU Session Processing States			
				Data Traffic Reset		In Bracket	
				On	Off	On	Off
ACTLU	R	E	T				
ACTPU	E	T	T				
DACTLU	R	T	T				
DACTPU	R,T	T	T				
Bind			E, I	X			X
Unbind			R, T				
Cancel			R		R		
Chase			R			R	
Clear			R	X			X
SDT			R	R	X		
Signal			R		R		
Shutdown			R		R		
FM Data			R		R	R	
REQMS	R						

Legend:

- R - Required state for this command to be valid.
- I - Command invalid if in this processing state.
- E - Command establishes this session.
- T - Command terminates this session.
- X - Command sets the processing state to the indicated status.

Figure 5-5. Summary of SNA Commands Received

SNA Command Sent	SSCP-PU Session Active	SSCP-LU Session Active	LU-LU Session Active	LU-LU Session Processing States			
				Data Traffic Reset		In Bracket	
				On	Off	On	Off
LUSTAT			R		R		
Signal			R		R		
Cancel			R		R	R	
Ready to REC			R		R		R
Shutdown Complete			R		R		R
FM Data			R		R	R	
RECFMS	R		R				
Notify		R					

Legend:

- R - Required state for this command to be valid.

Figure 5-6. Summary of SNA Commands Sent

Sample SNA Command Sequences

Figures 5-7 through 5-13 illustrate the use of SNA commands. Responses to commands are not shown unless the response is a necessary part of the example.

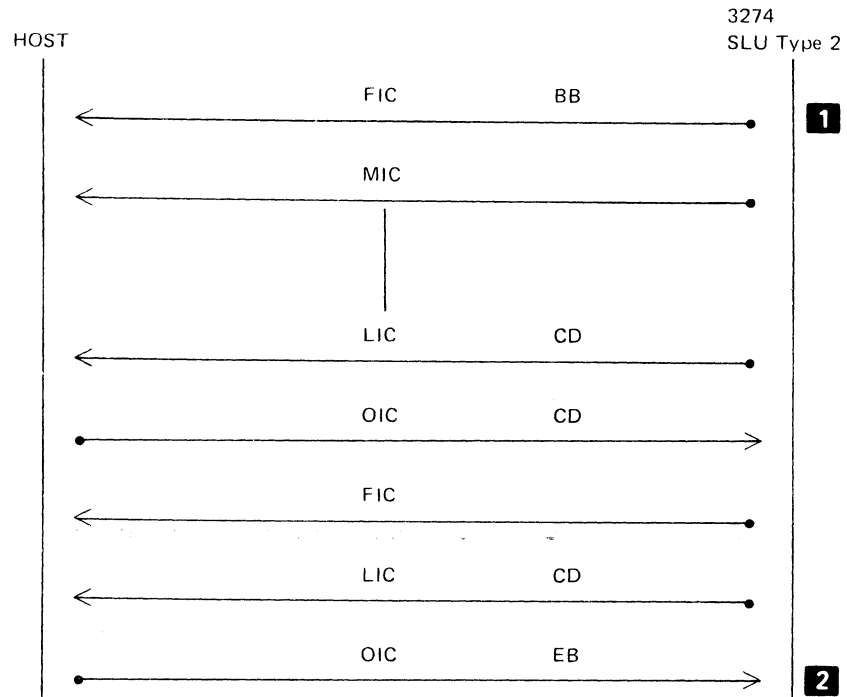

- 1** Initial conditions: Session established and both ends in contention-between-bracket state. SLU type 2 initiates a bracket and sends a chain as a result, for example, of Enter key depression.
- 2** After the required exchange of chains is completed, the host ends the 'unit of work' by sending EB (an LU type 2 cannot send EB). The EB chain may contain data: for example, a write to the screen; or it may be a Null RU chain, that is, only RHs.

Figure 5-7. Bracket/Chain—LU Type 2 Initiated (without Contention)

Session Processing States

The 3274 controls the processing of SNA commands, responses, and user data transmissions with a set of session states. Some of these states are defined by SNA and others are unique 3274 definitions that cause SNA state transitions. When the 3274 receives the Clear or Bind command, all 3274 session states are reset.

This section describes the processing states used by the 3274. When several states relate to a common processing function such as bracket or chain processing, they are described under a common heading. The remaining processing states are described individually.

Data Traffic (Reset/Active) State

Reset of all SNA LU-LU states in the 3274 is assured by entering data-traffic-reset state. This state is entered when a Bind or Clear command is received from the PLU. When data-traffic-reset state is turned off by SDT, the state is referred to as data traffic active.

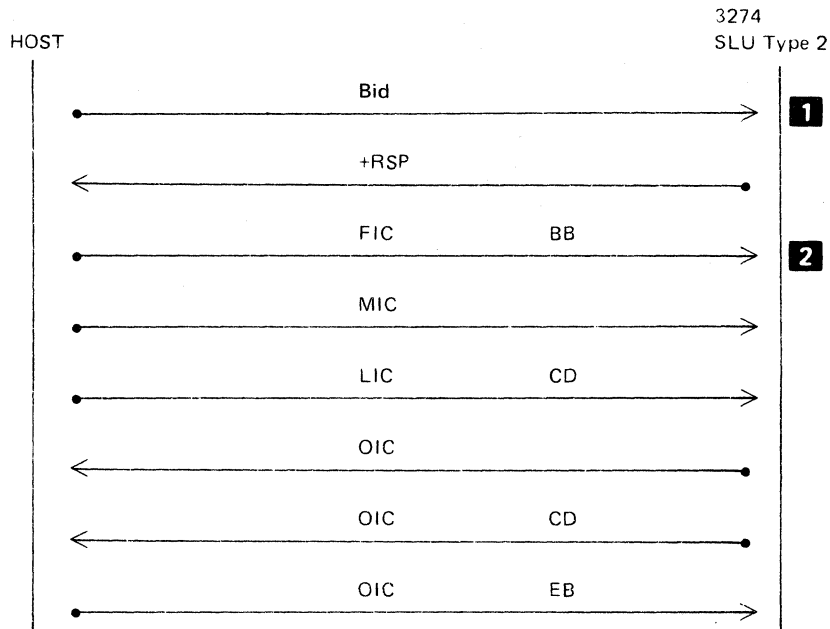

- 1** Initial conditions: Session established and both ends in contention between bracket state. Host sends Bid to indicate intention to begin a bracket.
- 2** The +RSP was SLU type 2, go ahead to the host. The host initiated the 'unit of work' with BB. **Note:** The host has the option of going directly to **2**, that is, skipping the Bid. However, there is a possibility of Bid rejection (Figure 5-9), which would result in resending the data associated with **2**.

Figure 5-8. Bracket/Chain – Host Initiated (without Contention)

When in data-traffic-reset state for any LU-LU session, the 3274 SLU cannot transmit data or commands to the host program. The host can send only session-recovery and session-termination commands when in this state. The 3274 accepts only data RUs for an LU-LU session during data-traffic-active state.

When in data-traffic-reset state and a data RU or a command other than SDT or Unbind is received from the host program, the 3274 returns a negative response with system sense data indicating that data traffic is inactive (sense code X'2005'). No other state, except contention, can exist when the SLU is in data-traffic-reset state.

Contention (CONT) State

The contention state on the LU-LU session exists only between brackets. In this state, the LU resources are not allocated. All associated I/O devices are enabled and the SLU can accept data from either the terminal or the host, whichever occurs first. The first arrival triggers a change to send or receive state.

For the SSCP-SLU session, contention state exists between the successful completion of all chains.

Send (SEND) State

The send state is common to both contention and HDX FF modes of operation.

In send state, the 3274 LU resources are allocated for inbound (to the primary) operations. Internally, there are two subdivisions of the send state. These are referred to as send --xmit (send-not-transmit) and send-xmit (send-transmit).

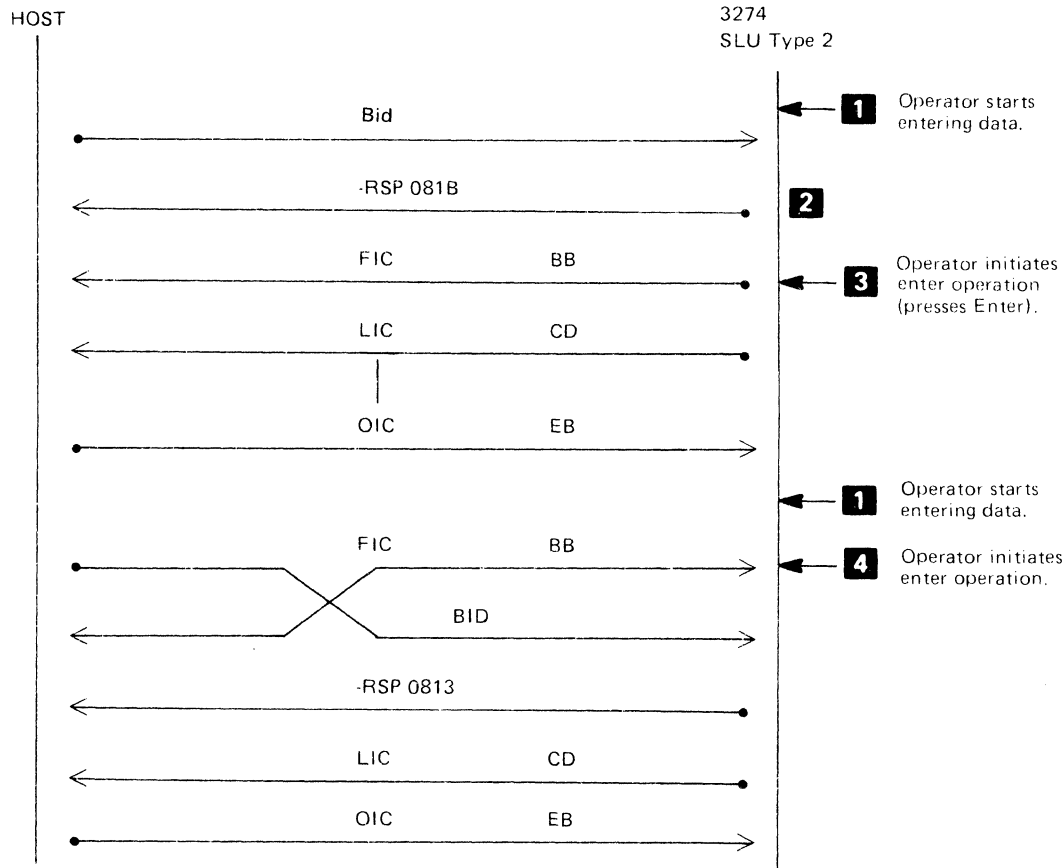

- 1** Initial conditions: Session established and both ends are in between-bracket state. The first operator keystroke puts the type 2 SLU in the send (but not transmitting) state. The type 2 SLU remains in BETB state.
- 2** The type 2 SLU will reject a Bid (or BB) with 081B. Receiver in transmit mode.
- 3** The operator initiates an enter operation; for example, he presses the ENTER key. The type 2 SLU begins a bracket and transmits the operator-entered data.
- 4** When the operator presses the ENTER key, type 2 SLU goes to in-bracket (INB) state. Type 2 SLU begins a bracket and starts sending data. The host end has sent a Bid (or BB) before the type 2 SLU first chain element was received. The type 2 SLU rejects the Bid (or BB) with 0813. The sense code differs from **2** because the bracket check is made before the HDX state check. In **2**, the bracket check was good.

Figure 5-9. Bracket/Chain – Host/SLU Contention

Send --.xmit exists while the control unit is entering data from a keyboard, MSR, or selector light pen into the device buffers. The state is entered from contention by the first keystroke capable of changing data on the display, or by initial input from the type 2 SLU MSR or selector light pen or the type 1 SLU PA key. The state is maintained until exited to send-xmit by an action causing the data to be sent inbound, generally the ENTER key. The transition from send --.xmit to send-xmit also causes the transition to in-bracket (INB) state when leaving contention. The transition always causes the keyboard to be locked and the Input Inhibit (3178, 3277, 3278, and 3279) and Wait (3178, 3278, 3279) indicators to be turned on. When in-bracket, send --.xmit is entered from receive state or ERP1 state after successfully processing an outbound chain carrying CD but not EB.

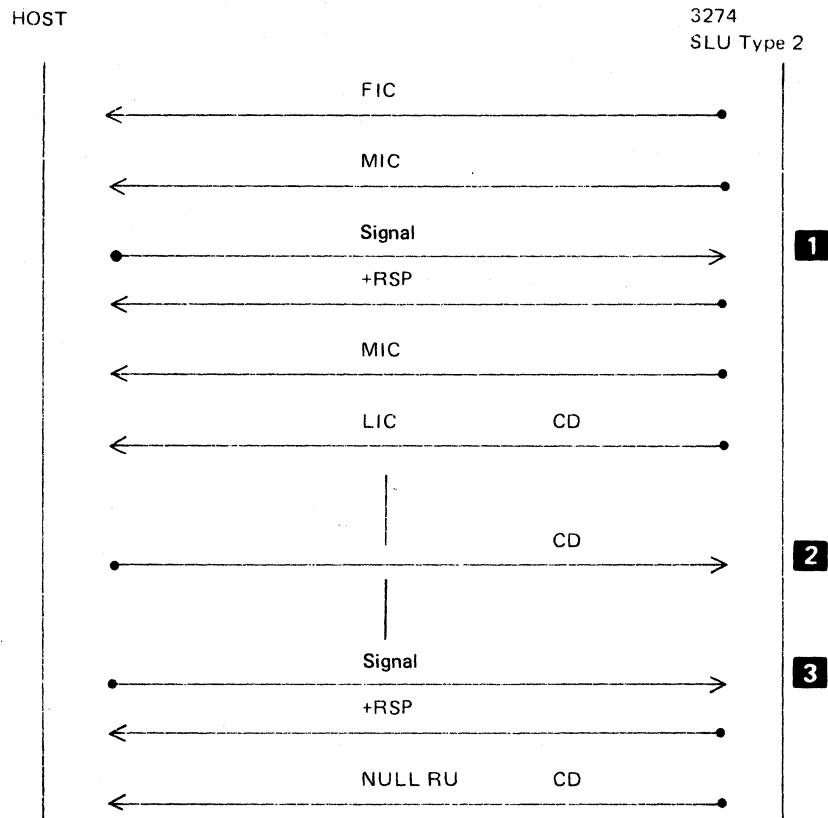

- 1** The SLU type 2 receives Signal while sending. The +RSP is returned to acknowledge receipt of Signal. The Signal is effectively treated as a NO-OP, and the SLU completes sending of the chain. The SLU type 2 always sends CD with the end of a data chain.
- 2** CD allows the SLU to send. The operator starts keying in data.
- 3** Before the operator initiates sending of data, for example, presses the ENTER key, the host sends Signal. The SLU sends +RSP to Signal, locks the keyboard, and sends CD.

Figure 5-10. Signal from Host

The type 2 SLU keyboard does not automatically unlock when the send state is entered from either receive state or ERP1 state. The keyboard is unlocked only if:

- A previous WCC specified keyboard restore, or
- The SLU is in send state and the terminal operator presses the RESET key.

After going from contention to send --.xmit state, any normal outbound requests received on that session will be discarded and a negative response "Receiver in Transmit Mode" with sense code X'081B' will be sent. Once INB, any normal outbound requests received on that session (FMD with BB or Bid) while in send state will be discarded and a negative response 'Bracket Bid Reject' with sense code X'0813' will be sent. Neither of these responses causes any state change in the 3274 or 3276 SLU. If INB and in send state, a request received that does not carry BB will be rejected by the 3274 with sense code X'2004'.

During send-xmit state, the data is being transferred from the device buffer to the PLU. Except for a possible LUSTAT, all normal flow chains on the LU-LU session will carry the CD. The transition out of send-xmit depends upon the response type carried with the inbound request. If a definite response is

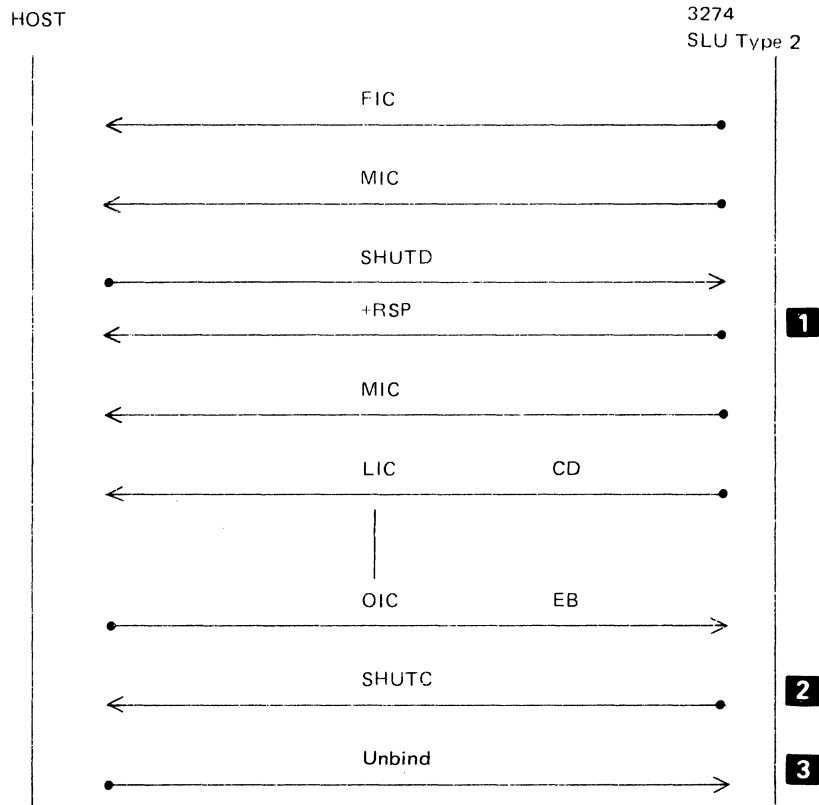

- 1** The SLU type 2 is alerted that the host wants to shut down. However, a synchronizing EB must be received before effecting shutdown.
- 2** The SLU goes into shutdown; that is, inbound normal flow (including Signal) is inhibited.
- 3** The host terminates the session. (*Note: The host could clear the condition and continue by sending Clear, SDT instead of terminating the session.*)

Figure 5-11. Shutdown/Shutdown Complete

requested, the transition from send-xmit to receive takes place after the response to the inbound request is returned to the 3274. If an exception response is requested, the transition from send to receive takes place as soon as the end-of-chain has been successfully transferred to the transmission link.

The SSCP-SLU session operates in definite-response mode only. Therefore, the transition is from send-xmit to contention upon the receipt of a positive response, or send-xmit to receive if a negative response is returned.

Receive (RCV) State

The receive state is common to both contention and HDX-FF modes of operation. In this state, the 3274 LU resources are allocated for outbound (from the PLU) operations.

When RCV state is active, inbound normal flow requests cannot be sent. Responses, as requested, and control commands of the expedited flow can be sent inbound.

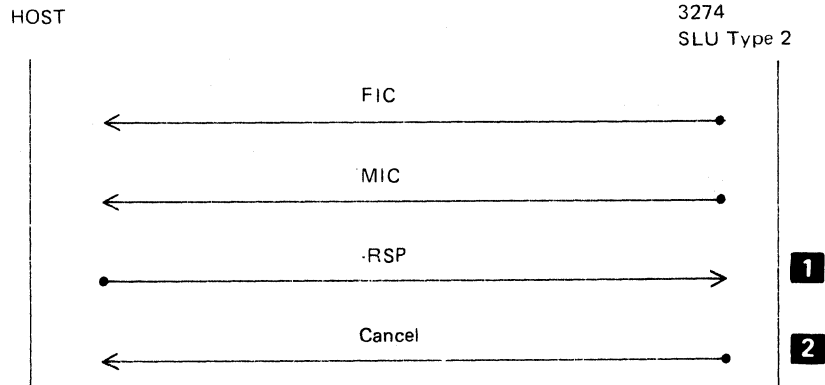

- 1** The type 2 SLU receives -RSP to a chain element. **Note:** Normally, the 3274 will not examine any response until the entire chain has been sent and will therefore not send Cancel as the result of receiving a -RSP. However, when inbound pacing is in effect, responses are examined when the SLU must receive a pacing response before continuing transmission. A -RSP will then be detected and cause Cancel to be sent.
- 2** The type 2 SLU sends Cancel to direct the host to discard the chain elements already received. The SLU goes to receive state, waiting for host recovery action.

Figure 5-12. Cancel, SLU Type 2 Sending

Input devices may be activated by a WCC character that specifies Keyboard Restore. However, an attempt to send data to the PLU by an operator, by using the selector light pen or MSR, or by pressing the ENTER, PA, or CURSR SEL key will not be allowed.

Normal flow traffic from the PLU is passed to the device when it is in receive state. This is allowed to halt local device operations by causing the keyboard to be locked and the Input Inhibited and Wait indicators to be turned on. A request with a WCC containing the Keyboard Restore bit set to zero is treated as a NO-OP for the keyboard states; that is, if the keyboard was unlocked before the write, it will remain unlocked after a successful write. If the keyboard was locked before the write, it will remain locked after the write.

For the LU-LU session, receive state is entered from contention state if an outbound normal flow message is accepted for processing. It is entered from send-xmit after receiving a response from an inbound request carrying CD and definite response, or after successfully transferring the chain to the data link when the request carries CD and exception response. For the SSCP-LU session, receive state is entered from contention if an outbound normal flow message is accepted for processing. It is entered from send-xmit if a negative response is received for an inbound request.

For the LU-LU session, receive state is changed to send --.xmit after successfully processing a last-of-chain carrying the CD. Receive state is changed to contention state after successfully processing and responding to a chain carrying EB, or after receiving a chain carrying EB which carries exception response requested. Receive state is changed to ERP1 state if any negative response except X'0813', X'0814', or X'081B' is returned to the outbound request.

For the SSCP-SLU session, receive state is changed to contention after returning the response to the outbound request.

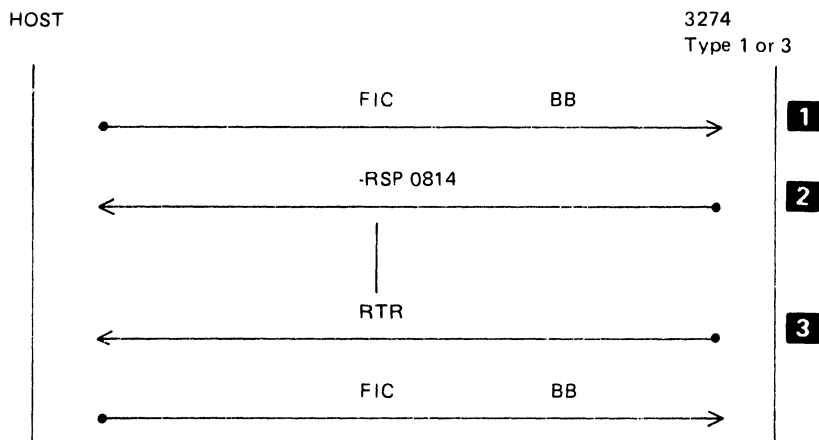

- 1** The printer associated with the SLU type 1 or 3 is not available because a local copy is being done. Consequently, the SLU type 1 or 3 cannot honor the host BB (or Bid).
- 2** The SLU type 1 or 3 rejects BB (or Bid) with -RSP X'0814' (Bracket Reject, RTR to follow).
- 3** The printer becomes available, and SLU type 1 or 3 send RTR to indicate to the host that a bracket may be started.

Figure 5-13. RTR—LU Type 1 or LU Type 3 Send

ERP1 State

ERP1 is a special state created to allow for error recovery protocols. The PLU is always responsible for error recovery; therefore, the SLU state structure generally is awaiting an outbound request to correct the error condition. However, there are times when the SLU must first recover and notify the PLU of its recovery by use of LUSTAT command before the PLU can take action. Thus, the SLU ERP1 state allows a form of contention mode within brackets. This state has the characteristic of being able to receive any request, but only sending LUSTATs.

When an LUSTAT flows inbound, the SLU remains in ERP1 state. This allows successive LUSTATs to flow without requiring the general exchange of CD between each LUSTAT. LUSTAT does not request change direction when sent while in ERP1 state.

ERP1 state is entered by an SLU after responding with any negative response except X'0813', X'0814', and X'081B'. If the negative response does not change the state to between- brackets (BETB), the transition to ERP1 takes place at end-of-chain.

ERP1 state is changed by accepting an outbound chain carrying CD. Following processing of the CD bit, the transition is made to Send state.

When in ERP1 state, the keyboard is locked, except for the SYS REQ, ATTN, and TEST REQ keys.

Bracket States

The 3274 has three major states associated with bracket protocols: between bracket (BETB), in bracket (INB), and pending begin bracket (PEND.BB). These states are used to ensure synchronization of traffic between the PLU and the SLU. Transitions between these states are controlled by the BB and EB bits and by the Bid command.

Between Bracket (BETB) State

BETB state exists when the PLU and SLU are in contention to begin a bracket. This is the state entered after the SDT command is accepted. When the Bid or BB is accepted from the PLU or sent by the SLU, BETB state ends. If the host program cancels the chain containing the Begin Bracket, or if the SLU sends negative response for the chain containing the Bid or BB, the 3274 returns to BETB state. BETB state is normally assumed when an EB has been processed successfully.

When a chain carrying both BB and EB is being processed, BETB state is not changed.

The 3274 sets BB on the first RU transmitted when the control unit enters INB from BETB.

BETB is terminated and INB is entered when the first (or only) element of a chain with BB bit on is ready to be transmitted; that is, an ENTER, PA, PF, or other attention key is pressed.

Pending Begin Bracket (PEND.BB) State

In the PEND.BB state, the 3274 is waiting for a bracket to be begun by the host system. The 3274 has either returned a positive response to a Bid command or has received a positive response to a Ready to Receive command. When the host program attempts to begin a bracket and the 3274 is in PEND.BB state, the 3274 will not reject the bracket with sense code X'0813' or X'0814'.

In Bracket (INB) State

INB state is entered when the 3274 receives a BB without the EB or when the 3274 begins a bracket. INB state is maintained by the 3274 until the positive definite response to the EB chain is returned to the host or until the 3274 receives the last element of the EB chain when exception response is requested.

3274 Bracket State Errors

Error codes generated for bracket error conditions are as follows. The bracket state conditions remain unchanged after sending the error code.

State \ Command	Chase &EB	Chase &-EB	Bid	Cancel &EB	Cancel &-EB	FMD &BB	FMD &-BB
BETB	2003	—	—	2003	—	—	2003
INB	—	—	0813	—	—	0813	—
PEND.BB	2003	—	—	2003	—	—	2003

RU Lengths

Outbound to the 3274

The maximum RU length that a PLU is permitted to send is defined in byte 11 of Bind. The 3274 accepts a maximum RU size within the following constraints. Note that where multiple constraints apply, the maximum RU size is limited to the smallest size calculated by applying each constraint.

For 3274 channel attachment: The maximum RU size received must be less than or equal to 1536 bytes. Byte 11 of Bind (PLU max send size) is not checked. A negative response with sense code X'1002' (RU length error) will occur if the PLU transmits an FM data RU greater than 1536 bytes.

For a type 1 SLU in a 3274: The following formula applies:

$$\text{MRU} \leq \left(\frac{\text{BUFF} - 336}{\text{PC}} \right) - 11$$

where:

MRU is the smallest multiple of 256, more than or equal to the maximum RU size specified in byte 11 of the Bind.

PC is the pacing count specified in byte 9 of the Bind.

BUFF is the device buffer size.

A Bind reject with sense code X'0821' will occur if the Bind specifications do not meet these limits.

For type 2 and 3 SLUs in a teleprocessing-attached 3274: There are no 3274 restrictions.

Inbound from the 3274

The 3274 accepts only a 'Multiple Element Chains' Bind for inbound operation. The maximum RU size can be controlled by the PLU through byte 10 of the Bind request. For the 3274, the RU size transmitted inbound is limited by the lesser of two values: the value in byte 10 or 1024. If the value of byte 10 is greater than the 3274 capabilities, the Bind will be accepted, but the actual RU size will be limited to device capabilities.

The minimum value that may be specified by byte 10 of the Bind request is 64 bytes for the 3274. If lesser values are specified, the Bind will be rejected with a negative response, sense code X'0821'.

Segmenting Description

RUs sent to network terminals are often larger than acceptable for optimum transfer of data by the link connecting the terminal to the network. Therefore, a Basic Information Unit (BIU) consisting of RH and RU may be divided into smaller elements, called *segments*, that are transmitted over the link. The 3274 supports inbound and outbound segmenting on the LU-LU session except when attached to a local channel.

The segment elements are defined as follows. The First in Segment (FIS) element is equated to Begin-BIU, not End-BIU. The Last in Segment (LIS) element equates to End-BIU, not Begin BIU. The Middle in Segment (MIS) equates to not Begin-BIU, not End-BIU. An Only in Segment (OIS) contains the entire BIU.

Sequencing of segments is in the correct order if the sequence consists of:

1. FIS, LIS
2. FIS, MIS, . . . , LIS
3. OIS

Segmenting Outbound

Errors due to improper sequencing of the segment elements will cause the 3274 to enter normal disconnect mode. This action does not permit sending a negative response to the PLU. The 3274 will also deactivate the Physical Unit and all Logical Units and turn on the Communication Check indicator on all 3278s and 3279s. See Appendix B.

The 3274 passes segment elements through for processing and immediate display or printing when the terminal is attached using a Terminal Adapter Type A (for example, a 3278). The segments are collected and processed in the 3274 on an RU basis when the terminal is attached using a Terminal Adapter Type B (for example, a 3277).

The maximum size for segment elements (the NCP MAX DATA SIZE parameter) delivered to the 3274 must not exceed 256 bytes of data plus 6 Transmission Header (TH) bytes and 3 Request/Response Header (RH) bytes for the FIS or OIS. The maximum size for MIS or LIS must not exceed 256 bytes of data plus 6 bytes of TH. If the segment elements exceed 256 bytes, a 3274 featured with the high-performance communications adapter will reject the segment element by not incrementing the link count and discarding the frame information. Continuous rejection of a segment element that is too long is expected to cause a retry failure in the communication controller, and results in a station inoperative disconnect by that node. A 3274 featured with the common communications adapter will return a Frame Reject for this condition.

The Communication Check indicator showing buffer overflow is turned on for all operational 3178, 3278, or 3279 displays connected to the 3274 when the control unit detects buffer overflow.

When the 3274 is connected to NCP, it is recommended that the NCP buffer size be set for one of the following byte sizes:

Optimum: 64, 128, or 256 bytes.

Second Choice: 84, 124, 248, or 252 bytes.

Segmenting Inbound

Segmenting inbound is supported by the 3274 on the LU-LU session under the following conditions:

1. When maximum RU size is specified as 256 or less and accepted at Bind time, no segmenting is used by the 3274.
2. When maximum RU size is specified as greater than 256, the RUs are segmented into segment elements containing 256 data bytes each for FIS or MIS, provided sufficient data is transmitted to cause segmenting.

Note: For the 3274 A units, inbound segmenting is determined by Bind, byte 10, and buffer size established at connection time.

When the Bind maximum RU size is greater than 256 bytes, considerations other than maximum RU size and amount of data to be transmitted may determine the actual RU length (\leq Max RU size) that is sent. The 3274 will never send an RU having more than 1024 bytes.

Programming Note: The 3274 may interleave a response between the inbound segment element of an RU.

3274 Errors

Data Link

For data link control, action is as discussed in *IBM Synchronous Data Link Control General Information*, GA27-3093. Unique action is that the Set Normal Response Mode command causes the 3274 to reset from an Activated Physical Unit to a Deactivated Physical Unit. All sessions must be restarted by the sequence starting with ACTPU.

A segmenting error will not be reported by an SNA negative response, but will cause the 3274 to go to normal-disconnect mode and do an internal DACTPU.

LU-LU Session Error Reporting

A protocol has been established for the reporting of transmission and processing errors during sessions. When the host program or the 3274 SLU is the receiving LU, errors are reported by turning a negative response to the sending LU, with descriptive sense data included.

The format of the 4-byte sense data RU, sent with a negative response, is as follows:

0	1	2 and 3
System Major Code	Sense Modifier	User Sense

Byte 0 of the sense data RU is bit-encoded to reflect one of six transmission error categories, as follows:

Byte 0 in Hex	Major Code
'80'	Path Error
'40'	RH Error
'20'	State Error
'10'	Request Error
'08'	Request Reject
'00'	User-Defined Error

Byte 1 of the sense data RU is a binary modifier that further defines the error condition. The modifier encoding is unique to each major code.

Bytes 2 and 3 are zeros for all negative responses sent by the 3274. The section "SNA Sense Codes" later in this chapter defines the modifier encoding for each major code of system sense data that is issued by the 3274.

Note that the 3274 will not examine the sense data in a negative response from the host. All negative responses on the LU-LU session cause the 3274 to enter RCV state and await further action by the host.

Sessions

Three sessions exist for the 3274 when operating with SNA protocols. These sessions are: SSCP-PU, SSCP-SLU, and LU-LU (PLU-SLU). The three sessions can exist simultaneously. The SSCP-SLU and LU-LU sessions may wish to use the display simultaneously.

An interactive protocol is used with the 3274, in which, at any given time, only one of the sessions is defined as the device (display screen, keyboard, and data buffer) owner. During ownership, any attempts by the nonowner session to send FM data is rejected.

The state diagram (Figure 5-14) shows the transfer of device ownership between the SSCP-SLU and the LU-LU session. Prior to ACTLU, or following DACTLU, no session can own a device. Local operations initiated by the TEST key are not defined as sessions.

Device ownership is indicated to the operator by symbols in column 3 of the Operator Information Area. (Refer to Appendix B for a detailed explanation of Operator Information Area symbols.) Prior to ACTLU or following DACTLU, this column is blank. ACTLU causes the Unowned symbol to appear.

After ACTLU is received, the SYS REQ key (or equivalent 3277 function) may be used by the operator to control which session owns the device. When the LU-LU session is not bound and the Unowned symbol appears in column 3, the SYS REQ key, or an RU from the SSCP, transfers device ownership to the SSCP-SLU session. At this time the System Operator symbol appears in column 3. The operator can then communicate with the SSCP.

If the attached device is a printer or a display without a keyboard, an FM data request to the SLU from the SSCP while in the unowned state will be rejected with category not supported sense code X'1007'.

When a Bind command is received and positively responded to, ownership is transferred immediately from the SSCP-SLU session, or the unowned state, to the LU-LU session, and the My Job symbol appears in column 3. Note that Bind commands may be PLU-initiated without operator logon.

The SYS REQ key is also used to transfer ownership from the LU-LU session to the SSCP-SLU session. This transfer of ownership interrupts communications taking place during the LU-LU session without waiting for completion of outbound chains. Inbound chains will complete unless a test is made for a pacing response. As long as the LU-LU session remains bound, another depression of

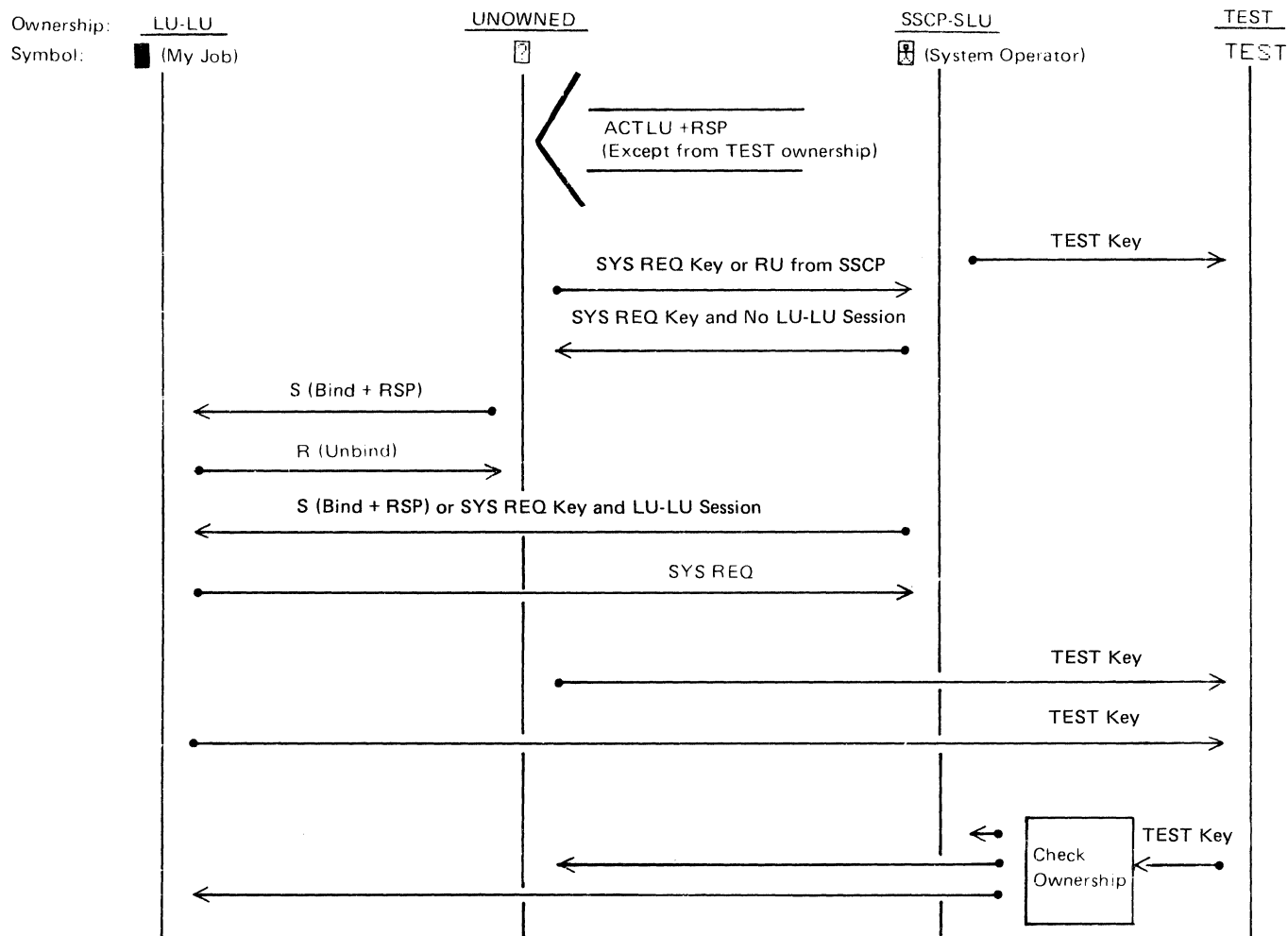

Figure 5-14. State Diagram for Session Ownership of Device

the SYS REQ key will cause ownership transfer back to the LU-LU session. Note that if the LU-LU session is not bound, the SYS REQ key will cause ownership transfer to the unowned state.

Pressing the TEST key causes the device to go into or leave the test ownership state. This state removes the device from the SLU and makes it unavailable to either the SSCP or PLU. If the PLU sends an FM request, the SLU sends RSP X'082D'. If the SSCP sends an FM request, the SLU sends RSP X'081B'. These responses assume that all other requirements for an active session have been met. When leaving the test state, a check is made for SSCP or PLU device ownership. Return will be to the session whose ownership is indicated by the check or to the unowned state if neither the PLU nor SSCP is the owner.

Setting the Screen Size

When ownership changes, the screen size may change. When changing from the unowned state to SSCP-SLU ownership, the screen size is set to the maximum physical size. When the screen enters the unowned or test state, the initial screen size is the size set by the previous owner; pressing the CLEAR key will set the screen to the maximum physical size. Operation and control of the screen size when the owner is the LU-LU session is discussed under "Erase/Write Alternate command" in Chapter 1.

Pressing the SYS REQ key causes the screen to be cleared. The screen also is cleared by the transfer of ownership from unowned to SSCP-owned when this state transfer is caused by an outbound RU from the SSCP.

Operation in SSCP-SLU Session

The following paragraphs describe the operational characteristics of the 3274 when exchanging display data on the SSCP-SLU session.

SSCP-SLU Contention Operation

The 3274 supports FM profile 0. Immediate control and immediate response are followed, and all requests are treated as definite requests.

HDX-contention is implemented, and a normal flow request must be processed and acknowledged by a response before an opposite-direction normal flow request can be accepted or processed.

The 3274 SLU is in contention state whenever SSCP-SLU session ownership mode is entered by use of the SYS REQ key.

Nonerror Operation

For nonerror operation, the receipt of a positive response, or transmission of the response, initiates the transition to contention state. The transition from contention to receive state is initiated by the recognition of an outbound request. The transition from contention to send-not-xmit is made when the first data key pressed is accepted. [Refer to "Send (SEND) State."] The transition to send-xmit is made when the ENTER key is accepted.

The keyboard is controlled by state conditions. It is unlocked when in contention or send-not-xmit, and locked when in receive or send-xmit. The operative keys that are locked or unlocked are the same as for the LU-LU session.

Error Operation

When a normal flow request has been transmitted inbound and a negative response is received, the SLU goes into receive state and waits for an outbound request from the SSCP.

When the 3274 SLU detects a temporary or permanent error condition while in send or contention state, the SLU goes into contention state. The SSCP is not notified of the error.

When a normal flow request is received but cannot be accepted because of error or a not-available condition, the SLU goes into contention state following the negative response.

Outbound Message Handling

The SSCP may send messages to a display when the SSCP-SLU session owns the display. The messages are byte strings consisting of SCS control codes and SSCP-supported graphic codes. There is an outbound limit of 1,536 bytes of data. The only valid SCS control codes are NL and, when the APL/Text feature is installed, the Graphic Escape character. NULL, IFS, and IRS are treated as graphics and displayed as blank, *, and ; respectively. Any other binary

combination in the SCS data stream will be treated as if it is a graphic. The characters appearing on the screen for code points other than supported graphics are unpredictable.

Each message from the SSCP is displayed at the current cursor address. When the 3274 receives an NL control code in the SSCP message, it will insert nulls in the character positions remaining in the display line being written and position the cursor at the leftmost position of the next line. Characters following the NL code are displayed beginning at the new cursor position. The message wraps to the top of the screen if the last line on the screen is written and additional characters remain in the message.

After displaying the data in the received chain, the 3274 places the cursor in the position next to the last character if NL does not follow. If the message is ended by NL, the remainder of the line is set to nulls, and the cursor appears in the first character position of the next line. This cursor position address is called the initial cursor address and is stored to identify the starting position of the operator's display input data.

Inbound Message Handling

When the System Operator symbol is displayed, an operator can enter the message bound for the SSCP from the character position occupied by the cursor.

After entering a message, the operator must press the ENTER key to initiate transmission of the inbound message to the SSCP. Pressing other PA keys has no effect, except for the CLEAR key. Data transmission does not occur. If other PA or PF keys are depressed, Input Inhibited and Minus Function symbols are turned on. Pressing the CLEAR key causes the display screen to be cleared, and the initial cursor address is reset. The ERASE INPUT and ERASE EOF keys operate as defined under "Key Functions" in Appendix C.

Chains sent on the SSCP-SLU session are OIC, and have a maximum RU length of 256 bytes. The 3274 will send the data (excluding nulls) contained in the first 256 screen character positions including and following the cursor address, or to the end of screen, whichever occurs first.

System Logon (3277 Attached to 3274)

The 3277 does not have the session ownership symbols that are present on Category A devices. Therefore, when an operator starts to use a 3277 that may have been used previously and left in an unknown session ownership, the following sequence of operations may be necessary to determine session ownership:

1. Check the display screen to see if messages exist which indicate that the terminal is already in an LU-LU session and that, therefore, system logon is not required.
2. If logon is required, press the TEST REQ key and then the CLEAR key. The SYSTEM AVAILABLE light should turn on (if it was off), and the INPUT INHIBITED light should be off. If the SYSTEM AVAILABLE light does not turn on, repeat the TEST REQ key, CLEAR key sequence. If the SYSTEM AVAILABLE light still does not turn on, the terminal is not connected to the system.

Key in the character-coded logon request and press the ENTER key. The SYSTEM AVAILABLE light will turn off.

Wait for the SYSTEM AVAILABLE light to turn back on. This indicates that the 3274 has received a positive response to the inbound message.

3. Acceptance of the Bind command does not cause a change in the SYSTEM AVAILABLE light, and therefore a message should be sent from the PLU to notify the operator that the LU-LU session has been established.

System Logon (Category A Devices)

By means of the logon sequences, the terminal operator requests that a session be established with a PLU. The logon sequence is as follows:

1. The terminal operator checks the symbol displayed in column 3 of the Operator Information Area. If the My Job symbol is displayed, the terminal is already connected to a PLU, and system logon is not required.
2.
 - a. If the Unowned symbol is displayed, the terminal operator presses the SYS REQ key to enter the SSCP-SLU owned session and then keys in a character-coded logon request in a syntax defined by the installation. The operator presses the ENTER key, and the logon message is sent to SSCP.
 - b. If the System Operator symbol is displayed, the display station is already owned by the SSCP-SLU session. In this case, the operator performs step 2a, except the SYS REQ key is not pressed.
3. SSCP receives the logon request and sends a positive response (X SYSTEM disappears).
4. SSCP may send a message, such as a prompting or error message, if necessary. When the 3274 receives this message, it sends a +RSP if accepted for display, or RSP X'081B' if device ownership has been transferred to the LU-LU session.
5. A successful logon causes the My Job symbol to appear. An error message leaves the System Operator symbol displayed; the operator may retry, starting with step 2b.

Note: An SSCP-SLU message confirming LOGON should not be used since this may arrive after the Bind command and confuse the operator by displaying the Message Received symbol.

System Logoff (3277 Attached to 3274)

This system logoff sequence is similar to that described below for Category A devices except that the two-key sequence of TEST REQ key followed by the CLEAR key is used in place of the SYS REQ key.

System Logoff (Category A Devices)

By performing the logoff sequence, the terminal operator requests the SSCP to terminate a session with the PLU. The logoff sequence is as follows:

1. The terminal operator presses the SYS REQ key to enter the SSCP-SLU owned session and keys in a character-coded logoff request in a syntax defined by the installation. When the operator presses the ENTER key, the logoff message is sent to SSCP.
2. SSCP receives the logoff request and sends a DR response.
3. SSCP may send a message. When the 3274 receives the message, it sends a +RSP if accepted for display, or RSP X'081B' if device ownership has been transferred.

SNA Printer Control

The following paragraphs describe the structure of the SNA session and the SNA control for printer operations. Details and constraints of subsystem operation are described under "3274 Local Copy Function" in Chapter 2.

Figure 5-15 shows a typical example of a logical subsystem and the point at which contention for the printer occurs.

Printers attached to the 3274 can be configured to operate in one of the three following modes:

1. **System Mode**—The printer is logically coupled with a type 1 or 3 SLU as the principal device; the SLU is in direct session with the PLU. The SLU type is selected at the time the session is bound (the Bind command) and remains the same throughout the session. In this mode, the printer cannot be used for local copy functions.
2. **Local Mode**—The printer may be used by one or more type 2 SLUs as a subsidiary device for local copy functions. A copy request may be initiated by the SLU's PLU (WCC with Start Print=1) or by the operator using the Print key. In this mode, the printer cannot be used by a type 1 or 3 SLU; a Bind request for the SLU associated with the printer will be rejected with sense code X'0801'.
3. **Shared Mode**—Both the SLU type 2 and the SLU type 1 or 3 may compete for use of the printer. The printer is used by the SLU type 1 or 3 as a principal device and by the SLU type 2 as a subsidiary device. Depending upon proper customizing, sharing may be done between brackets or between sessions.

Between-Bracket Printer Sharing: When in shared mode, printer contention is allowed to occur between brackets. When the printer's SLU enters BETB state (or if a session does not exist), the printer is available for either a local copy from an SLU type 2 or an SLU type 1 or 3 bracket, whichever occurs

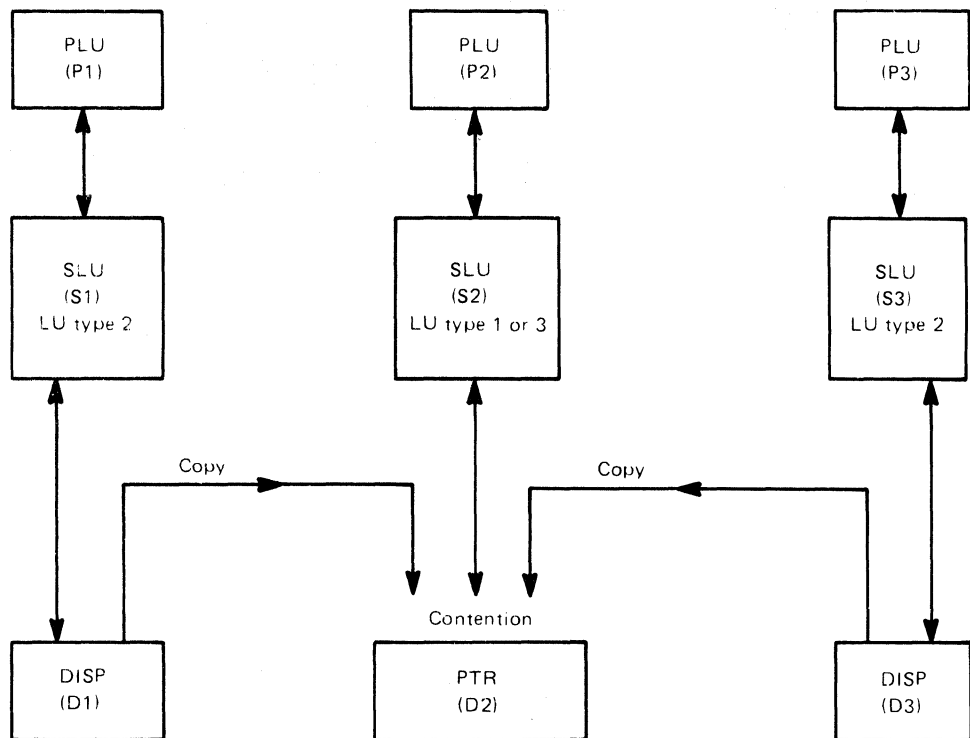

P1,P2,P3 : PLUs at the host.

S1,S3 : SLUs in the 3274 operating as LU type 2.

S2 : SLU in the 3274 operating as LU type 1 or LU type 3.

D1,D3 : Display device controlled by S1 and S3, respectively.

D2 : Printer device controlled by S2 or copied to from D1 or D3

Figure 5-15. 3274 Logical Subsystem

first. If a local copy function is being performed for either a single SLU type 2 or a queue of SLU type 2 requests, a BB request for the type 1 or 3 SLU will be rejected with sense code X'0814' (Bracket Reject, RTR to Follow). When all local copies are completed, the type 1 or 3 SLU acquires the printer and sends RTR to the PLU. If the type 1 or 3 SLU is in-bracket, the printer is not available for local copy functions. (See the description of the copy function for details.)

Between Session Sharing: When in shared mode, the 3274 allows a printer to be used for local copy only when the printer is not being used in an SLU type 1 or 3 session. If a printer is being used for local copy and a Bind is received to initiate a type 1 or 3 session, the 3274 allows the local copy in progress to complete and then sends a positive response to the PLU. All queued local copy requests will either be processed by an alternate printer or rejected with sense code X'0801' (No Printer Configured). This type of sharing biases the printer availability in favor of the type 1 or 3 SLU session.

Local Operations (3274 A Units)

The 3274 A units are 3790-compatible using data stream compatibility (DSC) mode of operation. They attach to a System/370 using a selector, multiplexer, or block multiplexer channel via the standard I/O interface. When attached to a byte multiplexer channel, operation will be in 2-byte multiplex mode.

The channel program controls all 3274 A unit operations by transmitting information across the I/O interface. This information consists of: (1) an address byte, which selects one control unit, (2) a command byte, which specifies the type of operation to be performed, (3) a link header, (4) SNA data, and (5) various control signals. Status bytes, which are automatically generated, inform the channel of the general and unique conditions of the 3274 A units when command operations are not in progress.

Interface Operations

Local interface operations for the 3274 A units are summarized in the following paragraphs and are described in detail in the *IBM System/370 Principles of Operations* manual, Form GA22-7000, and the *IBM System/360 and System/370 I/O Interface Channel to Control Unit Original Equipment Manufacturers' Information* manual, Form GA22-6974. The CPU program initiates operations with a Start I/O instruction. This instruction identifies the I/O control unit and causes the channel to fetch a channel address word (CAW) from a fixed location in main storage. The CAW designates the storage protection key and the location in main storage from which the channel subsequently fetches the first channel command word (CCW). The CCW specifies the command to be executed and number and address, in main storage, of any bytes to be transmitted.

Any one of 256 terminal addresses (0–255) may be assigned.

Selection

The channel attempts to select a 3274 A unit by placing a unique address byte on the channel or subchannel. When the addressed 3274 A unit recognizes its address, it logically connects to the channel and responds to the selection by returning the address to the channel. 3274 A units are single-address control units and device addressing is accomplished via SNA protocol.

Command Initiation

Command operations start when a 3274 A unit is successfully selected. When a command is to be executed by the control unit (not by the channel alone), the channel sends the command code (CCW bits 0–7) to the 3274 A unit.

When execution of the command involves a transfer of data (such as write or read operation), the 3274 A unit responds to the command with a status byte called "initial" status, which indicates when it can execute the command. If the command can be executed, the channel responds automatically to service requests from the control unit, and the control unit assumes further control of the operation. Command operation can be terminated by the control unit or by the channel when the channel byte count reaches zero. At this time, the control unit sends the channel a second status byte, called "ending" status, which indicates whether the command operation was successfully performed.

Chaining

When the channel has completed the operations specified by a CCW, it can continue the activity initiated by the Start I/O by fetching a new CCW, thereby starting execution of another command. Fetching of this new CCW is called "command chaining," and the CCWs which belong to such a sequence are said to be chained. All CCWs in a chain apply to the control unit specified by the Start I/O instruction. Multiple devices may be specified through SNA protocol.

Either of two types of chaining can be specified by the current CCW (bits 32 and 33): data chaining or command chaining. During data chaining (current CCW bit 32=1), the new CCW fetched by the channel defines a new main storage area, the data address, for the current command. Data chaining is transparent to the control unit. During command chaining (current CCW bit 33=1), the new CCW specifies a new command and a data address for that new command.

The control unit is totally dedicated to one CCW string until final Channel End time or until operations are abnormally terminated.

Commands

The commands and orders discussed in Chapter 1 are contained in the SNA data stream. The commands listed in Figure 5-16 are the command codes (CCW bits 0-7) the channel sends to the control unit.

Command	Code
Write	01
Read	02
No Operation (NOP)	03
Sense	04
Control	05
Write Break	09
Write Start 0	31
Read Start 0	32
Write Start 1	51
Read Start 1	52
Restart Reset	93
Sense ID	E4
Test I/O	00

Figure 5-16. 3274 A Unit Local Command Codes

Write Command

The Write command requests data transfer from the host. A minimum of 4 bytes, called the *Link Header*, must be transmitted in the following specific format:

- Link Header consisting of:
 - Data Count Field (2 bytes)
 - Bytes 0 and 1 must contain the total byte count of the record which is being transferred.

- Byte 2 is reserved.
- Byte 3 contains the Function code. A value of X'00' is used for normal data transfer.
- SNA Data
 - TH (FID2), RH, and RU

Read Command

The Read command requests data transfer to the host. The format of the data is:

- Link Header ¹ consisting of:
 - Data Count Field (2 bytes)
 - Reserved (1 byte)
 - Function code (1 byte). A value of X'00' is used for normal data transfer.
 - Pad Characters (*n* bytes)
- SNA Data
 - TH (FID2), RH, and RU

¹ The size of the Link Header is determined by the Connect. (Refer to "Control Command" below.)

No Operation Command

The No Operation command does not transfer data. Ending status to this command does not reflect any change within the control unit. Normal System/370 usage inserts No Operation (NOP) in a CCW string for possible later dynamic program modification, or as a standalone command for checking availability of the channel path to the control unit. Additionally, the NOP command may be used as the ending command in the Read CCW, Write CCW, and the Write-Read CCW sequences.

Sense Command

The Sense command is normally issued after Unit Check status has been presented to the host, and requests 2 bytes of sense data. The sense bits are predictable and meaningful only after presentation of Unit Check status. The sense bits are retained for reading until a command other than Sense, Test I/O, or NOP is accepted.

Control Command

The Control command provides two functions to the 3274 A units: Connect and Disconnect.

Connect Function. The Host Physical Unit Services issues a Control command (05) to send initialization parameters to the 3274 A units.

The data stream consists of the following 10 bytes:

Byte	0	1	2	3	4	5	6	7	8	9
Content	Length		Res	Func Code	Numbers of Host Buffers		Size of Host Buffers		S to P Link-Header Size	

Length = X'000A'

Total number of bytes (including length)

Reserved = X'00'

Not used

Function Code = X'01'

Connect function code

Number of Host Buffers

The number of buffers contained in each host Read channel program. Used to determine the maximum number of Basic Transmission Units (BTUs) that may be sent to the host with CCW string.

Size of Host Buffers

The total number of bytes that may be sent with each Read CCW (i.e., buffer). The total length is the sum of the Path Information Unit and Secondary to Primary (S-to-P) Link Header, including pad characters.

Secondary-to-Primary Link Header Size

Specifies the total length of the S-to-P Link Header. This length consists of the 4-byte fixed portion of the Link Header plus 'n' pad characters. All S to P PIUs are preceded by 4+n bytes.

The 3274 A unit determines that these parameters are acceptable when the size of the host buffer is large enough to accommodate the Link Header (LH), the Pad, the Transmission Header (TH), the Request Header (RH), and at least 64 bytes of data (RU), and the host buffer is an even number of bytes.

Rejection of the Connect function code will be a status of DE, UC to the next command received by the control unit. The sense byte will contain NI (not initialized). Sense Command Reject (CR) may also be set according to the type of command received.

Receipt of a connect function code while already connected will result in the control unit disconnecting and then reconnecting using the new initialization parameters.

Disconnect Function. The Host Physical Unit Services issues a Control command (05) that sends a Disconnect function. The NI sense bit will be set.

The contents of the 4-byte* data stream are:

Byte	0	1	2	3
Content	Length		Reserved	Function Code

Length = X'0004'

Total number of bytes

Reserved = X'00'

Not used

Function Code = X'02'

Disconnect function code

* The data stream can be larger than 4 bytes but only 4 bytes are used and the rest are ignored. The number of bytes sent must agree with the length in the data count field.

Write Break Command

This command must be used as the last Write command in all Write CCW sequences. If only one write CCW is to be issued, it must be the Write Break command. This command includes all the functions shown for the Write command.

Write Start 0 Command

All SNA data from the host is sent by a Write CCW sequence. A Write Start command initializes the sequence. No data is transferred for this command. It attempts to set the Write Start indicator which is used as a reference for data sent from the host.

All data from the host in a chained command CCW string is under the envelope of a preceding Write Start 0 command. The data is considered valid (i.e., no need for retransmission) when the control unit receives a Write Start 1 command. "New" data is transmitted only when the Write Start 1 command is accepted by the control unit.

Note that "new" data is transmitted when a Restart Reset immediately precedes a Write Start 0. The Write Start command attempts to change the Write Start indicator state. The indicator is not changed if the command is not accepted, or Unit Exception (UE) is part of the ending status.

Read Start 0 Command

All SNA data is received by the host via a Read CCW sequence, which is initialized by a Read Start command. This sequence will be considered fully complete by the 3274 A unit upon receipt of a subsequent alternate Read Start command. "New" data is transmitted when a Restart Reset command immediately precedes a Read Start 0 command. No data is transferred for this command.

Write Start 1 Command

This command is similar to the Write Start 0 command. It attempts to change the Write Start indicator from the alternate setting of the Write Start 0 command. In other respects, the two commands are the same. Note that "old" data is retransmitted when a Restart Reset command immediately precedes a Write Start 1 command.

Read Start 1 Command

This command complements the Read Start 0 command. Previous ("old") data is retransmitted when this command follows a Restart Reset command.

Restart Reset Command

Data is not transferred with this command. Restart Reset is used to reset the Read Start and Write Start indicators to logical zero. Previously transmitted data is subject to retry if the Restart Reset command is followed by a Read Start 1 command or a Write Start 1 command (improper usage may result in duplicate or lost data). Ending status does not reflect the inability to transfer data to or from the control unit.

Sense ID Command

This command requests data transfer to the host. Four bytes of data are sent as follows:

Byte 0—FF, Byte 1,2—3274, Byte 3—1A

The Sense ID command is honored when the 3274 A unit is in one of the following states:

- Power On
- IML Completed
- On Line
- Not Busy
- No outstanding status to be presented

Test I/O Command

This command transfers no data. It is never coded in a CCW. It originates from a Test I/O instruction or from channel hardware not under program control. A Test I/O command will clear outstanding status in the 3274 A unit.

Status and Sense Definitions

Description

The 3274 A units generate a status byte to inform the channel of certain control unit conditions. This status byte can be generated synchronously (when the control unit is selected and performing a command operation with the channel) or asynchronously (while the control unit is not selected). Figure 5-17 describes status bits. Figure 5-18 describes the sense bits.

Initial Status

Initial status is generated by the 3274 A units in response to the initial selection and command sequence. The status byte is sent to the channel after the 3274 A unit receives the command.

Figure 5-19 shows the possible initial status bit configurations. An all-zero status byte is sent when a command is accepted for execution by the control unit.

Bit	Name	Condition
0	Attention (A)	Indicates an inbound message has been readied for transmission to the host. The host should respond by issuing a Read CCW sequence.
1	Status Modifier (SM)	Indicates to the host that the control unit is ready to receive data from the host or set in response to Write Break command, as a request for a Read. Also set with Busy (see below) when control unit is busy.
2	Control Unit End (CUE)	Is set following a busy condition, after pending status is cleared or when control unit is no longer busy, to indicate that the control unit is now not busy and is free to accept a new command.
3	Busy (B)	Is set in initial status byte with the Status Modifier (SM) when the addressed control unit is busy. The control unit uses this sequence when it cannot respond to the normal channel initiated selection sequence. See CUE above for the reset of the busy state.
4	Channel End (CE)	Indicates channel data transfer operations are completed. No error unless Unit Check (UC) is included.
5	Device End (DE)	Indicates that the control unit is ready to receive a new command.
6	Unit Check (UC)	Is set when an invalid program or equipment condition is detected by the control unit or the device. The program should always respond to Unit Check status by issuing a Sense command for further definition of condition.
7	Unit Exception (UE)	Indicates that no data is available for a successive (following) read.

Figure 5-17. Status Bit Assignments for 3274 A Units

Ending Status

When the control unit completes channel operations for a command, it sends an ending status byte to the channel, freeing the channel for other operations. This status byte always relates to the command operation that has been executed. The normal ending status byte for a read-type command or sense-type command will have only the Channel End and Device End bits set, indicating that the command has been executed. Normal ending status for a write-type command is Channel End alone. When the control unit-to-device buffer transfer is completed, ending the command operation, Device End status is sent to the channel as asynchronous status. Any error condition associated with the operation just executed will cause additional status bits to be set. Figure 5-20 shows the possible ending status bit configurations. Ending status causes an I/O interruption unless command chaining is specified.

When the control unit has pending status, it attempts to gain selection of the channel asynchronously to pass this status. It is passed to the channel either when selection is accomplished or as initial status of a Start I/O (with the Busy bit set), whichever occurs first.

Bit	Name	Condition
0	(CR) Command Reject	Set if the 3274 A unit has received an invalid command. It is also set if the Not Initialized bit is set and a Restart Reset, Read Start 0/1, Write Start 0/1, Read, Write or Write Break command is received.
1	Intervention Required (IR)	Not used.
2	(BOC) Bus Out Check	Set if the 3274 A unit has detected bad parity on any command or data byte received from the channel.
3	(EC) Equipment Check	Set in response to any command if a control unit parity check has occurred, or if a control unit I/O error has been detected during a Control, Read, Write, or Write Break command.
4	(DC) Data Check	Set in response to a Control, Write or Write Break command along with Data Length Check (DLC) (refer to DLC) or to a Read command if the byte count specified in the host's Read command was not large enough to transfer all data associated with the control unit's buffer.
6	(NI) Not Initialized	Set when the 3274 A unit has not been initialized via an acceptable Connect function via a Control command.
8	(DLC) Data Length Check	Set in response to a Control, Write, or Write Break command if fewer than 4 bytes have not been transferred as the data count field or the count in the data count field does not equal the total byte count received.
12	(PCM) Parity Check Modifier	See Figure 5-20, Ending Status and Sense Conditions.
13	(PC1) Parity Check 1	See Figure 5-20, Ending Status and Sense Conditions.
14	(PC2) Parity Check 2	See Figure 5-20, Ending Status and Sense Conditions.
15	(MC) Machine Check	Set with Equipment Check to indicate that an internal 3274 A unit error occurred.

Note: Sense bits 5, 7, 10, and 11 are not used.

Figure 5-18. Sense Bit Assignments for 3274 A Units

Status ¹	Sense	ERP ²	Condition
All Zeros			Normal status for all commands.
B,SM			Response to a command when the control unit cannot respond to a normal channel-initiated selection sequence.
B,'x'			Pending status

¹ If a Start I/O Fast Release (SIOF) is executed by the channel, unchained initial status becomes ending status.

² Refer to "Referenced Error Recovery Procedures."

Figure 5-19. Initial Status and Sense Conditions for 3274 A Units

Status ¹ (hex)	Sense (hex)	ERP ²	Condition
CE (08)			Sent at end of data stream on a Control, Write, Read or Write Break command.
CE,DE ¹ (0C)			Sent at end of data stream on all valid commands except Control, Write, Read and Write Break.
CE,DE,UE ¹ (0D)			Sent in response to: <ol style="list-style-type: none"> 1. A Control Write, Write Break, or Write Start 0/1 command because of insufficient buffer space at the time of the request. The command and its associated data transfer (if any) are rejected. 2. Read command if there is no new data available at this time for a subsequent Read in this CCW sequence. All available data has been transferred to the host. 3. Read Start 0/1 command if there is no data available for transfer to the host in response to this request.
CE,DE,UE,A ¹ (8D)			Sent in response to: <ol style="list-style-type: none"> 1. A Control, Write, Write Break, or Write Start 0/1 command because of insufficient buffer space at the time of the request. The command and its associated data transfer, if any, are rejected. In addition, a Read CCW sequence is requested. 2. Read Start 0/1 command as a warning. Its purpose is to notify the host that an unsolicited Read CCW sequence was issued. The command was rejected. However, data is available for transmission to the host. 3. Read command in which all data for a block has been transmitted to the host; therefore, a new Read CCW sequence is requested. Note that a new Read CCW sequence is necessary to release the buffers for re-use.
CE,DE,UC (0E)	CR,NI (8200)	2	Sent in response to a Restart Reset, Read Start 0/1, Write Start 0/1, Read, Write, or Write Break command if the control unit is not initialized.
CE,DE,UC (0E)	CR (8000)	1	An invalid command was issued to the control unit.
CE,DE,UC (0E)	BOC,PC2 (2002)	1	The control unit detected a parity error at command time or on data transfer from the host.
CE,DE,UC (0E)	BOC,PC1,PC2 (2006)	1	The control unit detected a channel parity error during a Write command.

Figure 5-20 (Part 1 of 2). Ending Status and Sense Conditions for 3274 A Units

Status ¹ (hex)	Sense (hex)	ERP ²	Condition
CE,DE,UC (0E)	EC,PC1 (1004)	1	Detection of a control unit parity error during a Write command.
CE,DE,UC (0E)	EC,PC1,PCM (100C)	1	Detection of a control unit parity error during a Read command.
CE,DE,UC (0E)	EC,PC2 (1002)	1	Detection of a channel parity error during a Read command.
CE,DE,UC (0E)	EC,MC (1001)	1	Detection of an internal error during a Write or Read command.
CE,DE,UC (0E)	DC (0800)	1	The byte count specified in the host's Read command was not large enough to transfer all data associated with the control unit buffer.
CE,DE,UC (0E)	DC,DLC (0880)	1	Set in response to a Control, Write, or Write Break command if a minimum of four bytes have not been transferred or if the count in the data-count field did not equal the total byte count received.

¹ If this status is stacked by the channel, CUE could be generated and combined with it before the stacked status is accepted by the channel.

² See "Referenced Error Recovery Procedures."

Figure 5-20 (Part 2 of 2). Ending Status and Sense Conditions for 3274 A Units

Asynchronous Status

Asynchronous status reflects: (1) the second ending status for a Control, Read, Write and Write Break command, indicating that all command-initiated operations are completed; (2) a request for the host to initiate a Read CCW sequence; (3) that the control unit now has buffers available for a Write CCW sequence; or (4) whether the control unit is initialized or not initialized. Figure 5-21 shows the possible asynchronous status conditions.

When an asynchronous status condition occurs, the control unit attempts to gain selection by the channel, and passes this status to the channel when selection is accomplished. This status is called "pending" status until selection is accomplished. If the channel issues a command before retrieving this pending status, the pending status is returned, with the Busy bit set, in place of initial status for the command; in this case, the command is not executed.

There are other conditions of multiple status that can occur which are not covered here. These conditions can be caused by multiple error conditions occurring simultaneously.

Error Recovery Procedures

3274-A-Unit-Detected Errors

Error conditions detected by the 3274 A units are indicated to the program by Unit Check status. The program must respond to this status by using a Sense command for further definition of the condition.

Device-detected errors are reported via SNA. See "SNA Sense Codes" at the end of this chapter.

Status ¹	Sense	ERP ²	Condition
A			The control unit requests the host to initiate a Read CCW sequence.
DE			The control unit is ready to communicate with the host. In the case of a Control, Read, Write, or Write Break command, this is normal ending status. For Control, Write, or Write Break, all data associated with the command has been transferred; transfer was terminated by the channel. For Read, all data available for this command has been transferred. However, more data is available for a subsequent Read. A NOP command at the end of a Read CCW sequence is a special case. If this is seen by the host, it indicates incompatibility between the host and the 3274 A unit. The number of Read CCWs in the host is less than the number expected by the 3274 A unit as a result of the connect function.
DE,SM			The status, when presented in response to the Write Break command, should not be seen by the host program. The channel will utilize this status to skip a CCW. (See Write CCW sequence.) The status is also presented asynchronously to indicate a buffer available (See Write Start 0/1 Commands).
DE,SM,A			Indicates that the control unit requires a Read CCW sequence.
DE,UC	NI	2	The control unit has successfully enabled the interface to the host and the not initialized bit is on.

¹ If this status is stacked by the channel, CUE could be generated and combined with it before the stacked status is accepted by the channel.

² See "Referenced Error Recovery Procedures."

Figure 5-21. Asynchronous Status and Sense Conditions for 3274 A Units

Referenced Error Recovery Procedures

The recovery procedures in the Error Recovery Procedure (ERP) column of Figures 5-19, 5-20, and 5-21 are as follows:

1. Issue a message containing the address of the channel and unit, the CSW, the sense data, and the CCW executed. If the first CCW of the chain is a valid Start command, begin retry from that point. If the failure is continuous, notify the operator.
2. Issue an initializing control command.

Channel-Detected Errors

Errors detected by the channel are indicated to the program by the channel status byte in the CSW. If the channel status byte indicates a Channel Control Check, an Interface Control Check, or a Channel Data Check, the recommended error recovery procedure is to retry the chain of commands. If the channel status byte indicates a Channel Program Check, a Protection Check, or an Incorrect Length (should not occur), the recommended error recovery procedure is to terminate the task. A program error has probably occurred.

Typical CCW Sequences

The following CCW sequence is recommended for support of the 3274 A units.

Read CCW Sequence

The commands used in the Read CCW sequence are Read Start 0/1, Read, and NOP. All Read CCW sequences must start with a Read Start 0/1 command and are initiated only on the request of 3274 A units.

An example of a possible Read CCW sequence follows:

Read Start 0	CC
Read	CC,SLI
Read	CC,SLI
Read	CC,SLI
Read	CC,SLI
NOP	

Note: The number of Read CCWs should equal the number of buffers specified in the Connect function.

The NOP as shown above is recommended. The control unit will signal CE,DE as ending status to the NOP. Normally, the data should be depleted before the NOP command is reached. Ending status to the last Read CCW used will be CE,DE,UE(A).

Whenever the host issues the next Read CCW sequence, it must start with the alternate Read Start command, which in this case would be Read Start 1. However, if the sequence is restarted with its original Read Start command, in this case Read Start 0, the control unit interprets this to mean that an error has occurred and presents the data again.

Write CCW Sequence

When the host has been notified that the control unit has buffers available, it may at any time issue a Write CCW sequence.

The commands used in Write CCW sequences are Write Start 0/1, Write, Write Break, and NOP.

Every Write CCW sequence must start with a Write Start 0/1 command. Command chaining into a Write Start command should only be from a NOP or Restart Reset command. The last write command should be a Write Break command, which in turn should be followed by two NOP commands or by an NOP and a Read CCW sequence.

An example of a possible Write CCW sequence follows:

Write Start 0	CC
Write	CC,SLI
Write	CC,SLI
Write	CC,SLI
Write Break	CC,SLI
NOP	
NOP	

Two NOP commands are necessary at the end of this CCW chain because the ending sequence will depend upon the availability of data for transmission to the host. If no data is to be transmitted, DE is signaled to the Write Break command. As a result, the channel command chains into the first NOP command. However, if data is to be transmitted, the ending status signaled to the Write Break command will be DE, SM. The channel will then skip the first NOP command and command chain to the second NOP command, thereby ending the CCW sequence. If this skip to the second NOP command occurs, the host must remember that a Read CCW sequence is "owed" to the control unit, and that the unit will not request the Read with an asynchronous attention interrupt. However, it will respond with DE, SM to all Write Break commands until all data has been correctly transmitted.

Note: If the host issues a Write CCW sequence starting with the original Write Start command, in this example -Write Start 0, the control unit interprets this to mean that an error has occurred and starts taking in the data, discarding it, and counting the Write commands received until the count matches its saved CCW counter. Any data subsequently received will then be treated as new data.

Write-Read Sequence

This sequence is used for reducing host activity and clearing buffers in the control unit as rapidly as possible. It consists of the previous two sequences combined. It is a Write CCW sequence which at the option of the control unit may continue into a Read CCW sequence if data is available for transmission to the host. The method used is to signal SM with the DE for the Write Break command. The SM causes the channel to skip the NOP CCW and to continue into the Read CCW sequence.

If there is no data available to transmit to the host, the SM will not be signaled in the ending status. The channel will then command chain from the Write Break command into the NOP command, thereby ending the CCW sequence.

An example of a possible Write-Read CCW sequence follows:

Write Start 0	CC
Write	CC,SLI
Write	CC,SLI
Write	CC,SLI
Write Break	CC,SLI
NOP	
Read Start 0	CC
Read	CC,SLI
Read	CC,SLI
Read	CC,SLI
Read	CC,SLI
Read	CC,SLI
NOP	

Notes:

1. The number of Read CCWs should equal the number of buffers specified in the Connect function.
2. If due to error the CCW chain is broken in the section containing the Write CCWs, then the entire CCW chain must be re-sent by the host. If an error occurs in the read portion of the CCWs, only the Read CCW sequence should be re-sent.

CCW—Error Recovery Procedures

The error recovery procedures have been outlined in preceding paragraphs. The following paragraphs describe those procedures. Commands involved are those shown in the Write, Read, and Write-Read CCW sequences. The actual retry must be from the first CCW in the write or read sequence, which must be a Write Start or a Read Start command or may be reinitialized by a Restart Reset command.

After a 3274 A unit has received the Control command containing a valid Connect function, it expects the first host Write CCW sequence to begin with a Write Start 0, and the first host Read CCW sequence to begin with a Read Start 0. Upon receipt of a new Write Start or Read Start command, the control unit complements its appropriate switch, which remembers which Write or Read Start command is due next. In error situations, the CCW sequences reissued by the host must not be changed, and retry must be from the appropriate Read or Write Start command or from a Restart Reset command.

In error-free operation, Read CCW sequences should not be issued by the host unless solicited by Attention, or by Status Modifier in response to the Write Break command.

When an error occurs in the data transfer, recovery is controlled by proper use of the following five commands, as appropriate, in a Read or Write CCW sequence:

Read Start 0
Read Start 1
Write Start 0

Write Start 1
Restart Reset

Read Start 0/1 Commands. One of these commands initializes the Read CCW sequence. It reads old or new data. To read new data, Attention or Status Modifier must have been presented or the Read Start command will end with CE,DE,UE. The normal ending status is CE,DE, which allows the Read Start to be command-chained to a Read command(s).

Reissuing a Read CCW sequence without changing the Read Start command will result in rereading previously transmitted data, whether or not an error occurred. The read operation need not have been solicited by the control unit.

The expected Read Start indicator in the control unit is changed only if the response to the Read Start command was CE,DE and if the Read Start command received was the expected one. Thus, the host should change its Read Start CCW only after successful completion of its Read CCW sequence. Successful completion is signaled by DE,UE to one of the Read CCWs.

Write Start 0/1 Commands. One of these commands initializes the Write CCW sequence. It indicates whether the host is transmitting old or new data. The normal ending status is CE,DE, which allows the Write Start command to be command-chained to a Write or Write Break command. The ending status of CE,DE,UE indicates a buffer depletion condition (no buffers available to receive the data from the host). The host must stop sending data and await a buffer available signal (DE,SM).

When the host receives the Buffer Available signal, it may resume data transmission, starting with the CCW that was rejected with the UE status. However, the CCW chain may be handled as if an error has occurred and the host may resend the complete Write CCW sequence starting with the unmodified Write Start command initially used. Whenever the host does start a Write CCW sequence with the same Write Start command as previously used, the control unit will then discard the data from a number of Write commands until the count of discarded records equals its previous count of the number of records accepted. Subsequent data will then be treated as new data.

The expected Write Start indicator in the control unit is changed only if the response to the Write Start command was CE,DE, and if the Write Start command received was the expected one. Thus, the host should change its write start indicator only after completion is signaled with DE or DE,SM as ending status to the Write Break command.

Restart Reset Command. This command may be used to resynchronize channel transfers after any host failure, provided the control unit has not been re-IMLed. This command sets the indicators to expect Write Start 0 and Read Start 0 as the next starting CCW for transmitting new data. Thus, Write Start 1 and Read Start 1 may be used to retry the last transmitted records. The host may then continue normal transmission by using the Write Start 0 and Read Start 0 commands for all new transmissions.

If Read Start 0 is used first, then any old data is destroyed, and only new data, if available, may be read. If Read Start 1 is used first, then the last data transmitted

to the host is to be retried. Therefore, any portion of data already processed by the host should be skipped after a reread, and any portion of data not processed before the error is lost if Read Start 0 is used first.

To continue write data transfers after a Restart Reset command is issued, the host may use either Write Start command. If Write Start 1 is used, the last Write CCW sequence as its associated data should be used. Then any record which was successfully processed under the last accepted Write Start command will be skipped by the control unit. If Write Start 0 is used first, then the accepted record count in the control unit is reset and all records now sent by the host will be processed as new data.

The host must be aware of these possibilities and use the proper Read Start and Write Start command to avoid lost or duplicate data.

Remote Operations – SDLC

SDLC Transmission Frames

SDLC transmission frames are composed of a series of 8-bit binary-coded bytes which contain addressing, data, control, and checking information. Transmission between the controller and the 3274 takes place according to a predefined frame format which consists of the following sequence of bytes:

Flag (F) Sequence	1 byte
Secondary Station Address (A)	1 byte
Control (C) Field	1 byte
Information (I) Field	Up to 256 bytes of message data, preceded by header information
Frame Check Sequence (FCS)	2 bytes
Flag (F) Sequence	1 byte

Bit synchronization preceding transmission of an initial flag and following a line turnaround is achieved by transmission of 16 zero bits after the Clear to Send signal is turned on and the NRZI encoder (when used) is enabled.

When sending or receiving over an SDLC link, these units operate in modulo-8 mode—that is, up to seven frames at a time.

For a detailed description of the SDLC frame format, refer to *IBM Synchronous Data Link Control General Information, GA27-3093*. Support of the frame sequence, flag byte, address byte, and frame check sequence bytes conforms to the referenced document.

Response Modes

The 3274 functions in two link operating modes: normal response mode (NRM) and normal disconnect mode (NDM). In NRM, the 3274 can initiate transmission only as a result of receiving a frame from the communications controller which contains the P bit set to 1. Single or multiple frames may be

sent. The last frame (or a single frame) transmitted by the 3274 in response to a command received with the P bit set to 1 must have the F bit set to 1. When the 3274 has completed a transmission, a new transmission cannot be initiated until a subsequent frame is received from the communications controller which contains the P bit set to 1. A response transmission initiated by the 3274, which requires acknowledgment from the communications controller, is repeated each time the communications controller polls until the acknowledgment is received. There is no limit to the number of transmissions. Responses that require acknowledgment from the communications controller are I frames, FRMR, and RR when transmitted with the F bit set to 0, to report clearing of a busy condition.

When in NDM, the 3274 cannot accept or transmit I or supervisory (S) frames. Nonsequenced responses are not transmitted unless the 3274 is solicited to reply. Invalid or nonimplemented commands received in NDM cause the 3274 to transmit a DM response at the next response opportunity. DM can be retransmitted until an SNRM or DISC command is received. Command reject conditions are not present in NDM.

The following paragraphs describe the 3274 support of the control and information fields.

Control Field

The control field designates the frames as supervisory (S), nonsequenced (NS), or information (I).

Supervisory Commands

The 3274 supports only the supervisory commands Receive Ready (RR) and Receive Not Ready (RNR).

The C-field formats are as follows:

RR	Nr	P/F	00	01
	012	3	45	67
RNR	Nr	P/F	01	01
	012	3	45	67

The 3274 will transmit RNR when it cannot accept further data from the link.

When the reported RNR condition is cleared, the control unit will transmit an I frame or RR with the F bit on after a frame with the P bit on is received.

If the 3274 has received an RNR, an I frame will not be transmitted until an RR or I frame with the poll bit on is received.

The transmission or receipt of an NS frame does not indicate the RNR condition has cleared.

Nonsequenced Commands and Responses

The following nonsequenced commands and responses are supported by the 3274:

Command/Response	C-Field	Hex Code
Set Normal Response Mode (SNRM) Command	1 0 0 P 0 0 1 1 0 1 2 3 4 5 6 7	93
Disconnect (DISC) Command	0 1 0 P 0 0 1 1 0 1 2 3 4 5 6 7	53
Unnumbered Acknowledgment (UA) Response	0 1 1 F 0 0 1 1 0 1 2 3 4 5 6 7	73
Disconnect Mode (DM) Response	0 0 0 F 1 1 1 1 0 1 2 3 4 5 6 7	1F
Frame Reject (FRMR) Response	1 0 0 F 0 1 1 1 0 1 2 3 4 5 6 7	97
Test Command/Response	1 1 1 P/F 0 0 1 1 0 1 2 3 4 5 6 7	F3
Exchange Station ID Command/Response	1 0 1 P/F 1 1 1 1 0 1 2 3 4 5 6 7	BF

The SNRM command sets the 3274 in NRM. Receipt of SNRM causes the 3274 to deactivate the physical unit if it is in active state. The On-Line and Ownership symbols are turned off.

The DISC command sets the 3274 in NDM.

The UA response is sent by the 3274 to acknowledge receipt and acceptance of the SNRM and DISC commands.

The Test command is used to initiate one round-trip transmission of test data both in NRM and NDM. The 3274 will return the Test response without data if buffering is not available to hold the complete test data, or with data if buffering is available.

The Disconnect Mode (DM) response is sent by the 3274 in normal disconnect mode (NDM) to request on-line status. DM is sent in response to any command except Test and XID. DM is sent in response to the SNRM command when the 3274 cannot enter NRM.

The FRMR response is implemented by the 3274 as described in GA27-3093. The FRMR will be sent in response to any poll until an SNRM or DISC is received to reset the control unit.

The XID command and response contains additional data beyond the C byte. The 3274 responds to the XID command in NRM or NDM, except when an FRMR condition exists, in which case the FRMR response takes precedence over

XID. The additional data of the XID response consists of 48 bits (except for the Multi-Use Communications Loop that has a variable length XID), defined as follows:

Bits	Meaning
0–3	ID format B'0000'
4–7	PU type B'0010'
8–15	Self-description X'00'
16–27	X'017'
28–47	Terminal ID

Bits 28–47 are a unique terminal ID. (See following.)

Terminal Identification and Addressing

Terminal ID

The 3274 has a unique, 5-character identification that is selected at customization time.

SDLC Station Address

The SDLC station address is a 1-byte address that must be selected by the customer at setup time.

For details, refer to *IBM 3270 Information Display System: 3274 Control Unit Planning, Setup, and Customizing Guide*, GA27-2827. An SDLC station address of either X'00' or X'FF' should not be assigned.

Information (I) Frame

The information frame is used to transmit message data. When transmitted, the I frame contains a maximum of 256 bytes of RU message data preceded by 6 bytes of transmission header (TH) and, optionally, three bytes of request/response header (RH). For further information, refer to "Segmenting Description" in this chapter.

Sequence Error Recovery Procedures

A sequence error occurs when the 3274 receives an I frame with an incorrect Ns sequence count and valid FCS bytes. The 3274 does not accept the I frame that caused the sequence error and rejects all following I frames until an I frame is received which contains the correct Ns value, at which time the sequence error condition is reset.

The 3274 transmits I frames in the sequence indicated by the last Nr count received, which may include retransmission of previously transmitted I frames that have not been acknowledged.

All I frames are transmitted in contiguous sequence according to the Ns value within the constraints of the modulo count.

Abort Function

The abort function is used by the communications controller or by the 3274 when a frame being transmitted is to be discarded. The abort function is performed by transmitting eight contiguous 1 bits without zero insertion at the earliest possible time following recognition of an abort situation. No FCS is transmitted. When, for example, the 3274 receives seven contiguous 1 bits, it discards the aborted frame. The 3274 employs the abort function when an equipment malfunction occurs that causes an erroneous transmission.

Timeout Controls

When the 3274 is attached point to point or multipoint and does not recognize any valid outbound frame for 20 to 25 seconds, a nonproductive timeout occurs. The timeout causes the 3274 to set the Communication Check symbol on all attached 3278s. The timer is reset to zero every time the 3274 detects a valid outbound frame. The Communication Check symbol is turned off when a valid frame is received by the station.

If a condition of no line activity is detected by the 3274 for 20 to 25 seconds, the Communication Check symbol is set on all attached 3278s. The indicator will be turned off when a valid frame is received.

Auto-Disconnection (Models 51C and 61C)

Auto-disconnection is the result of the control unit's detecting the absence of any communication for 60 seconds. 3274 Model 51C and 61C support is as follows:

Modem	Configuration	Auto-Disconnection
Integrated Modem	Switched	
	Manual Answer	No
	Auto Answer	Yes
	SNBU Manual Answer	No ¹
	SNBU Auto Answer	Yes ¹
	Leased	No
External Modem	Switched	Yes ^{1 2}
	Leased	No

¹ When the control unit is operating with an SNBU modem, receipt of an SDLC DISC command will not cause automatic disconnection from the line; it *will* cause the control unit to quiesce and all active sessions to be deactivated.

² Automatic disconnection is supported, but the line will not be physically disconnected when a CDT coupler, or its equivalent, is used between the modem and the line.

SNA Reference Data

Bind Default

The following is suggested as a setting for the access method logmode table for LU type 1:

Byte	Binary Bits	Byte	Binary Bits
	0123 4567		0123 4567
0	0011 0001	9	0000 0001
1	0000 0001	10	1000 0101
2	0000 0011	11	1000 0111
3	0000 0011	12,13	0000 0000
4	1011 0001	14	0000 0001
5	1001 0000	15-17	0000 0000
6	0011 0000	18	1110 0001
7	1000 0000	19-26	0000 0000
8	0000 0000		

The suggested settings for LU type 2 are the same as for LU type 1 except for:

Byte	Binary Bits
—	0123 4567
9	0000 0000
10	1000 0111
14	0000 0010
18	0000 0000
24	0000 0001 Model 1
24	0000 0010 Model 2

The suggested settings for LU type 3 are the same as for LU type 1 except for:

Byte	Binary Bits
—	0123 4567
9	0000 0000
14	0000 0011
18	0000 0000

Bind Check

The Bind parameters sent to the 3274 will be checked as shown in Figure 5-22.

Byte	Bit	LU Type 1		LU Type 2		LU Type 3	
		Check	Reject if	Check	Reject if	Check	Reject if
1	0-3	C	¬ X'0'	C	¬ X'0'	C	¬ X'0'
	4-7	C	¬ X'1'	C	¬ X'1'	C	¬ X'1'
2, 3		C	¬ X'03'	C	¬ X'03'	C	¬ X'03'
4	0	NC		NC		NC	
	1	C	B'1'	C	B'1'	C	B'1'
	2, 3	C	B'00'	C	B'00'	C	B'00'
							B'01'
	4,5	NC		NC		NC	
	6	C	B'1'	C	B'1'	C	B'1'
	7	C	B'0'	C	B'0'	C	B'0'
5	0	NC		C	B'0'	NC	
	1	NC		NC		NC	
	2, 3	C save	B'00'	C save	B'00'	C save	B'00'
	4-7	NC		NC		NC	
6	0	NC		NC		NC	
	1	C	B'1'	C	B'1'	C	B'1'
	2	C	B'0'	C	B'0'	C	B'0'
	3	C	B'0'	C	B'0'	C	B'0'
	4	C	**	C	**	C	**
	5-7	NC		NC		NC	
7	0,1	C	¬ B'10'	C	¬ B'10'	C	¬ B'10'
	2	C	B'1'	C	B'1'	C	B'1'
	3	C	B'1'	C	B'1'	C	B'1'
	4-7	NC		NC		NC	
8		NC		NC		NC	
9	0,1	NC		NC		NC	
	2-7	C	X'00'	NC		NC	
10	0-7	C		C		NC	
11		C		NC		NC	
12,13		NC		NC		NC	
14		C	¬ correct device	C	¬ correct device	C	¬ correct device
15-19		NC		NC		NC	
20-23		NC		C*		C*	
24		NC		C save		C save Device Dep	
25		NC		NC		NC	
26†		C	¬ X'00'	C	¬ X'00'	C	¬ X'00'
(27-35 All bytes ignored)							

Notes:

- † Bytes 26-35 are reserved for the Encrypt/Decrypt feature.
- * If byte 24 bits 4-7 has X'E' or X'F', these bytes are checked.
- ** Feature dependent.

- C - Check
- NC - No check
- B - Bit
- ¬ - Logical Not

Figure 5-22. Bind Parameter Checking

SNA Sense Codes

Each major error code has modifiers for further description in sense byte 1. The modifier codes supported and the controller or terminal condition causing the negative response to be returned are described below.

Path Error X'80'

X'04'—Unrecognized DAF'

Controller does not have a terminal adapter for the DAF address.

X'05'—NO SESSION

- A Bind has not been received or accepted.
- A request other than Bind is sent to an SLU which has already accepted a Bind, and the OAF' is not X'00' or the OAF in the accepted Bind.

X'08'—PU NOT Active

The 3274 has not received or accepted an ACTPU, or a control condition caused an internally generated DACTPU.

X'09'—LU NOT Active

The 3274 has not received or accepted an ACTLU, or a control condition caused an internally generated DACTLU.

X'0F'—Invalid Address Combination

A request was addressed to the PU (DAF'=X'00'), and the OAF was not SSCP (OAF'=X'00').

RH Error X'40'

X'06'—Exception Response Not Allowed

LIC carried exception response when Bind specified definite response.

X'07'—Definite Response Not Allowed

LIC carried definite response when Bind specified exception response or LIC carried definite response.

X'0A'—No-Response Not Allowed

A chain element did not have DR1, DR2, or the exception bit set to 1.

X'0F'—Format Indicator Not Allowed

An FM request received by the 3274 indicated formatted header included.

State Error X'20'

X'01'—Sequence Number Error

The sequence number of the normal flow request did not match the number expected.

X'02'—Chaining Error

Chain elements were out of protocol sequence.

X'03'—Bracket State Error

A bracket state error occurred.

X'04'—Direction Error

A normal flow without begin bracket was received while the 3274 was in send state.

X'05'—Data Traffic Reset

An FM or DFC request was received before an SDT was received or accepted.

X'09'—Session control protocol violation (Encrypt/Decrypt feature)

An FM request was received prior to a valid CRV.

Request Error X'10'**X'02'—RU Length Error**

Message length > 1536 bytes (3274-1A only). RU size exceeds Bind specification (LUT1 only).

X'03'—Function Not Supported

- Unsupported Session Control Request
- Unsupported Data Flow Control Request
- Signal Code is not X'00010000'
- Network Control Request
- FM Data Stream
- Invalid Command
 - Data Following a Read, RM, RMA, or EAU command
 - For LU type 3, any Read, RM, or RMA command
- Unsupported FM Data, SSCP --> SPU

X'05'—Parameter Error

Invalid address following SBA, RA, or EUA order (SBA, RA, or EUA order without parameters), or SCS parameter error.

X'07'—Category Not Supported

- An FMD request from the SSCP was directed to a printer.
- An unsupported network service message received.
- An unsupported FM Data command received.

Request Reject X'08'

X'01'—Resource Not Available

- LU type 2, a printer is not allowed by the authorization matrix.
- For LU type 1 or 3, Bind reject because printer is authorized for local mode only.
- For LU type 1, outbound pacing algorithm is overrun.

X'02'—Intervention Required (on principal device).

- For LU type 2, security keylock is turned off.
- For LU type 1 or 3, printer condition such as end of form, paper jam, printer cover up, or hold time out.

X'05'—Session Limit Exceeded

A Bind was received whose OAF' differs from the PLU already bound.

X'07'—Subsidiary Device Temporarily Not Available

For LU type 2, a printer to be copied to is in bracket on an LU type 1 or 3 session, or an operator has depressed DEV CNCL key.

X'0A'—Permission Rejected

Display or printer power is off. The SSCP will not be notified when the device powers on.

X'0C'—Procedure Not Supported

An unsupported REQMS type request was received.

X'11'—Break

Sent on LU type 1 when the operator depresses the printer Hold Print Key followed by Cancel key, if a chain has not completed printing.

X'13'—Bracket Bid Reject—(No RTR)

- Returned by LU types 1 and 2 to a BID or BID with Begin Bracket if the display has won contention and started a bracket.
- Returned by all LU types when a BID or Begin Bracket was received and INB state already exists. This may be a protocol error.

X'14'—Bracket Bid Reject—(RTR to follow).

For LU type 1 or 3, the printer is busy doing local copy from a display. RTR will be returned when the printer becomes not busy with local copy.

X'15'—Function Active

- Bind reject if the same OAF' already has an accepted Bind to the SLU.
- REQMS request is in process.

X'1B'—Receiver in Transmit Mode

- The SLU is between bracket, but a data key has been depressed.
- An FM message was received from the SSCP while the display was owned by the PLU-SLU session or is in test mode.
- An SSCP FM message is rejected if local copy is taking place while the SSCP-SLU session owns the display.

X'1C'—Request Not Executable

The 3274 has a nonrecoverable error.

X'21'—Invalid Session Parameters

Bind parameters do not match the 3274 Bind checks.

X'29'—Change Direction Required

A 3270 read-type command was received without a Change Direction or with an End Bracket.

X'2A'—Presentation Space Altered, Request Executed

An LU type 2 3277 attached to a 3274 has a reset keyboard, and tried to enter while in receive state.

X'2B'—Presentation Space Integrity Lost

- A temporary error has occurred; for example, parity check in device.
- An operator has cleared the display by switching to SSCP-SLU session or test mode and returned to PLU-SLU session.

X'2D'—SLU Busy

- LU type 2 display is owned by SSCP-SLU session or test mode.
- LU type 2 display is busy doing an operator-initiated local copy.
- LU type 2 3277 attached to 3274 is busy with a Back Tab.

X'2E'—Intervention Required at Subsidiary Device

For LU type 2, a printer being copied to from a host-initiated print has intervention-required type error. Refer X'0802'. Printer power off or not attached to the controller is included in this category.

X'2F'—Request Not Executable Because of LU Subsidiary Device.

For LU type 2, a printer being copied to has a nonrecoverable error.

X'31'—LU Component Disconnected

This response is returned if the device attached to the 3274 cannot be contacted by a device poll. This is due to device power off, cable detached from the controller port, or connecting cable broken.

X'43'—Required Function Manager Synchronization Not Supplied

For LU type 2 or 3 chains having the print bit on, must be definite response or exception response chain must carry CD.

X'45'—Permission Rejected

Display or printer power is off. The SSCP will be notified when the device powers on.

X'4A'—Presentation Space Altered, Request Not Executed

Refer to X'2A'.

X'4C'—Resource Not Configured

X'63'—Symbol Set Not Loaded

X'71'—Read State Error

Logical Unit Status (LUSTAT)

LUSTAT provides a means for the SLU to report exception conditions or status when the SLU is not in receive state (a negative response is used when the SLU is in receive state). The following are the CD settings that accompany LUSTAT and the state changes, if any, that occur:

SLU State When LUSTAT Sent	CD Setting	State Change
BETB	CD may be set	None
ERP1	CD not set	None
Send	CD set for principal device	to Receive
	CD not set for subsidiary device	None

Inbound LUSTATs are sent with exception response by the 3274.

Programming Note: An LUSTAT showing power off sent while in send state carries CD. An LUSTAT that shows power on cannot be sent until the PLU causes an SLU state change to (S, *R).

The following status codes will be used by the 3274 to send information to the PLU, on the PLU-SLU session:

Value	Explanation
X'0001Z000'*	Device now available; presentation space not destroyed.
X'00020000'	Device has received CD, but has no input mechanism.
X'081C2000'	Component Failure; Permanent Error.
X'082B0000'	Device available; presentation space integrity lost.
X'08310000'	Principal device is powered off or disconnected.
X'0801Z000'*	Printer has been removed from configured status.

* Where Z specifies whether the status refers to the principal or subsidiary device. (Refer to "SNA Printer Control" for a description of principal and subsidiary devices.) The value of Z is defined as follows:

LU type 1 Principal (printer)	Z = 0
LU type 2 Principal (display)	Z = D
LU type 2 Subsidiary (printer)	Z = B
LU type 3 Principal (printer)	Z = 0

The priority of these status codes, in low to high order, is assigned as:

X'0002', X'0001', X'082B', X'0831', X'0801', X'081C'

The 3274 will send the highest level of priority status when an opportunity allows its transmission.

Definition: (S, *R) = Send state, ERP1 state, or BETB state.

The upper section of Figure 5-23 shows the LUSTAT codes that are returned to clear the negative response condition listed in the left column. The lower section lists the LUSTAT codes that are used to report an SLU error condition instead of a negative response. The X's show the sessions that use the code points.

LUSTAT is used as follows:

For all LU types, when the 3274 has sent -RSP with X'0802' or X'082E' and this condition is reset, LUSTAT with X'0001P000' will be sent, where the value P is X'0' for LU type 1 or 3, X'D' for LU type 2 principal (display), and X'B' for LU type 2 subsidiary device (printer).

If the presentation integrity is lost while an X'0802' condition exists, LUSTAT with X'082B0000' will be sent instead of X'0001P000' when the X'0802' condition is reset.

For LU type 2, when the 3274 SLU has sent -RSP with secondary component not available (X'0807') and this condition is reset, LUSTAT with X'0001B000' will be sent.

For all LU types supported by the 3274, the LUSTAT X'00020000' will be sent to the PLU when the 3274 accepts a normal flow request carrying CD, but no input components (keyboard, light pen, MSR, etc.) are attached to the device.

For all LU types, LUSTAT with X'082B0000' will be sent to the PLU when the 3274 SLU detects presentation integrity lost (for example, regeneration buffer parity error), and is in (S, *R) state for the 3274.

For LU type 2, when the 3274 has sent -RSP (Device Busy) (X'082D') to a PLU request because of session ownership change from PLU to SSCP or TEST, LUSTAT with X'082B0000' will be sent to the PLU when returning to PLU-SLU session.

For LU type 2, when the -RSP (Device Busy) (X'082D') has been returned from the 3274 for a Back Tab busy condition, the LUSTAT X'0001D000' component now available to the PLU will be sent when the busy condition clears.

LUSTAT Returned

Negative Response Code	LU Type			
	T1	T2	T3	SSCP
0802	00010000 082B0000 081C0000 08310000	0001D000 082B0000 081CD000 08310000	00010000 082B0000 081C0000 08310000	NA
0807	NA	0001B000 0801B000 081CB000 081CD000	NA	NA
082D	NA	0001D000 082B0000 081CD000	NA	NA
082E	NA	0001B000 0801B000 081CB000 081CD000	NA	NA
0831	082B0000 081C0000	082B0000 081CD000	082B0000 081C0000	NA NA

Sent By

LUSTAT	LU Type		
	T1	T2	T3
SEND BETB ERP.1			
00020000	X	X	X
081C0000	X		X
081CB000		X	
081CD000		X	
082B0000	X	X	X
08310000	X	X	X
0801B000		X	

Figure 5-23. Summary Table of LUSTATs

For LU type 2, when the 3274 has sent -RSP (Device Busy) (X'082D') to a PLU because the SLU is busy executing a local copy, the 3274 sends LUSTAT X'0001D000' component now available to the PLU when the busy condition clears.

For all LU types, if a principal device is powered off or unplugged from the controller port and a session exists which is in (S, *R) state, LUSTAT X'08310000' will be sent to the PLU.

For all LU types, when a principal device has sent -RSP or LUSTAT X'0831000' and then power is restored, LUSTAT with X'082B0000' will be sent to the PLU.

For all LU types, if the 3274 finds a permanent error in the principal device and is in (S, *R) state, LUSTAT with X'081CP000' will be sent to the PLU. The value of P is the same as previously defined.

For LU type 2, if the 3274 finds a permanent error in the subsidiary device and is in (S, *R) state, the worsening of the previous condition will not be reported. Instead, LUSTAT X'0001B000' will be sent, and the next outbound request will be rejected with the proper sense code.

For LU type 2, if the 3274 finds the subsidiary device has been configured from local or shared mode to system mode, LUSTAT X'0001B000' will be sent if an LUSTAT is owed. The next outbound request will be rejected with the proper sense code.

Error Recovery Procedures

The following sense codes are returned by a negative response or an LUSTAT. Suggested recovery procedures are indicated for each error code and must be evaluated for the needs of each user.

Negative Response Codes:

Error Code	Recovery Procedures Notes
Path errors X'80xx'	1
RH errors X'40xx'	2
State errors X'20xx'	2,3
Request errors X'10xx'	2,21
Request Reject: X'08xx'	

Hex 'xx'	LU Type 1	LU Type 2	LU Type 3	
01	5	5 or 6	5	
02	8	7	8	
05	4	4	4	
07	NA	7	NA	
0A	4	4	4	
11	9	NA	NA	
13	10,11	10,11	10,11	
14	12	NA	12	
15	4	4	4	
1B	NA	13	NA	See Recovery Note(s) indicated.
1C	3,4	3,4	3,4	
21	1	1	1	
29	3,4	3,4	3,4	
2A	NA	14	NA	
2B	16	16	16	
2D	NA	7	NA	
2E	NA	7	NA	
2F	NA	17	NA	
31	7	7,18	7	
43	NA	7,19	7,19	
45	1	1	1	

LUSTAT Sense Codes:

Hex Code	Recovery Procedure Notes
0001 0000	9a
0001 B000	9a
0001 D000	9a
0002 0000	21
082B 0000	16
081C 0000	3
081C B000	17
081C D000	3
0831 0000	7,18,20
0801 B000	6,17

Recovery Notes:

1. No recovery action can be taken until the 'xx' condition reported is corrected.
2. Unbind and correct program code.
3. Retry the operation up to three times by sending Clear, SDT, and starting traffic at a program check-point restart. Terminate the operation if the retries are not successful.
4. No recovery; look for an alternate terminal or terminate the operation.
5. Unbind, and look for an alternate terminal or terminate the operation.
6. Read the display, and save for later printout.
7. Wait for LUSTAT; recovery based on LUSTAT code.
8. Wait for LUSTAT; retransmit chain.
9. User options:
 - a. Resend chain.
 - b. Send next chain.
 - c. Send query to printer operator for PA key response.
10. Check the input queue for inbound data with BB and CD.
11. Protocol error occurred. Retry without BID or BB.
12. Wait for RTR to begin bracket.
13.
 - a. Check the input queue, and wait for data.
 - b. Send SIGNAL to get CD.

14. Retry with CD and not EB.
15. User options:
 - a. Send Null or comment RU with CD to give control to operator.
 - b. Send Read Modified command with CD to obtain display AIDS and modified data.
 - c. Reformat display from check-point restart.
16. Reformat display or printer from check-point restart.
17. Retry the operation up to three times by use of Write command and WCC with Start Print bit set to 1. An alternate printer may become available.
18. Unbind to force user identification by entering new logon.
19. Retry with correct bit settings.
20. When received, the user must be sure the secondary logical unit is in ERP1 or send state, to allow sending the LUSTAT which indicates a power-on condition.
21. Program dependent:
 - a. If input is required from terminal, unbind and select an alternate terminal.
 - b. If input is not required, data output may continue. CD should be suppressed.

Chapter 6. Screen Design

Introduction

To use whatever you have created for display or printing, your information must be communicated to a 3270 device by means of the 3270 data stream, which is made up of structured fields, commands, control characters, orders, attributes, and data.

Structured fields provide another format for sending information to a display or printer.

Commands control such things as whether you write to or read from a display and whether the screen is erased before new data is written.

Control characters are used with certain commands to perform such functions as sounding the audible alarm, formatting the printer, and restoring or enabling the keyboard.

Orders are instructions written to the 3270 to tell the display unit how to format your panel.

Attributes determine the characteristics of the fields and characters within a field.

Data is the information you are displaying or printing.

The 3270 data stream is based upon the presence of a mapped character buffer in the device. There is a fixed one-to-one relationship between each character storage location in the buffer and each character position on the display. For instance, consider a display, for which the display screen is composed of 12 rows of 40 columns each. Row 1 maps to the first 40 character storage positions in the character buffer, row 2 maps to the second 40 character storage positions, and so on. This sequence is the same whether the display is 12 rows and 40 columns or up to 27 rows of 132 columns.

When an Erase/Write command is transmitted to the device, the character buffer is first cleared to nulls (X'00') and subsequent text is written into the character buffer sequentially. The format of the data stream is as follows:

Write Command	WCC	Orders and Text
------------------	-----	-----------------

Field Concept

People dealing with information see it as a collection of individual elements. For example, what we know about John Smith's employment may be a collection of individual elements: his name, serial number, location, and date of hire. The size of the element is the amount of data required to convey useful information. You do not think of J and O and H and N as useful individually, but collectively, as the name JOHN. You do not think of JOHNSMITH963981BOSTON070262 as being useful collectively, but see the elements individually: name: JOHN SMITH, serial number: 963981, location: BOSTON, date of hire: 07/02/62.

Each data element has its own characteristics. In this example, the serial number is six numeric digits and varies from employee to employee. The word *NAME* is 4 characters, is alphabetic, is all uppercase, and does not change. When people record these elements of data on paper, they take on such additional characteristics as position (where on the sheet of paper the item is written), color (what ink or medium is used), size of the letters, and writing style.

In the past, when information was handled by a data processing device, it was generally handled as an artificial entity called a record. The contents and characteristics of a record were primarily determined by device requirements, and little or no attention was given to the individual information elements. Data processing users had to adjust their thought pattern to conform to the machine requirements.

The IBM 3270 Information Display System recognizes that people deal with individual units of information. The system, which is designed to conform to human needs and requirements, and enables you to deal with data by individual elements or *fields*, each with its own characteristics.

You may describe data to the 3270 on a field or character basis and specify the characteristics or *attributes* of each individual field or character. The 3270 then provides program and data control based on your individual field and character definitions.

What Attributes May Be Assigned to a Field

Besides length, which is controlled by the position of field attributes, you may specify the following additional characteristics with the attributes.

Protection

A field is either protected or unprotected. When it is protected, the operator cannot enter or modify data in any location within that field.

In an unprotected field, the operator can enter characters or can delete or modify characters that are already there. Headings, labels, titles, and formats are commonly specified as protected. Any field in which the 3270 operator should enter or modify data must be specified as unprotected.

In Figure 6-1, *NAME:* would most likely be specified as protected. JOHN B DOE would be specified as protected if it was written by the application program and is to remain unchanged. If JOHN B DOE is to be entered or modified by the operator, the attribute 2 must specify unprotected.

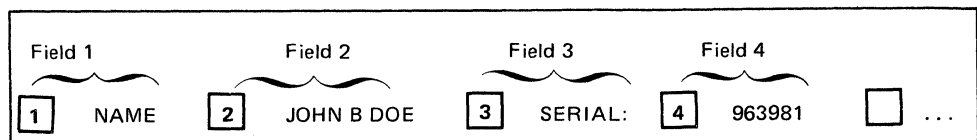

Figure 6-1. Example of Four Fields and Attribute Bytes

Color

If the device has the capability of displaying or printing in color, then the fields or individual characters may be defined in four or seven colors, depending on whether the device has base-color or extended-color capability.

- Base Color - Terminals with base color can display or print fields in one of four colors, depending on the definition of the field by the field-intensify/field-protection bits in the field attribute character. Base color can be produced on color displays using existing 3270 programs.
- Extended Color - Terminals with extended color capability can display or print fields or characters in one of seven colors or characters in multicolors. The colors available in extended color are white, red, blue, green, pink, yellow, and turquoise. Extended colors for color displays and printers are defined as follows:

Color Displayed on 3279	Color Printed on 3287 Models 1C and 2C
White	Black or green
Red	Red
Blue	Blue
Green	Green or black
Pink	Black
Yellow	Black
Turquoise	Black

Note: The printing of black or green, as shown, depends upon the Base Color (black or green) specify feature selected.

Extended Highlighting

If the display has the capability of interpreting the extended field and character attributes, then Extended Highlighting attributes (blink, reverse video, and underscore) can be applied to entire fields or to individual characters. In Figure 6-1, the unprotected fields could be underscored to highlight them as operator input areas.

For printers with the ability to interpret these extended attributes, only the underscore attribute can be applied to whole fields or to individual characters.

Character Content

A field is either alphameric, numeric, or user-defined symbols. An operator can enter alphameric, numeric, special characters, or user-defined symbols in an alphameric field.

The numeric attribute is more complex; it depends upon whether the numeric Lock feature is present and which keyboard is attached to the display. Figure 6-2 shows what characters may be entered with various combinations of keyboards and field types.

Keyboard Type	Keyboard Numeric Lock	Shift Key Pressed	Field Type	Protected	Resulting Characters		
					In Buffer	Displayed On Screen	Read Into Storage
Typewriter	No	No	Alpha or Numeric	No	Lowercase	Uppercase	Lowercase
Typewriter	No	Yes	Alpha or Numeric	No	Uppercase	Uppercase	Uppercase
Typewriter	Yes	No	Alpha	No	Lowercase	Uppercase	Lowercase
Typewriter	Yes	Yes	Alpha	No	Uppercase	Uppercase	Uppercase
Typewriter	Yes	No	Numeric	No	Can only enter 0–9, period, and minus sign; any other characters lock keyboard.		
Typewriter	Yes	Yes	Numeric	No	Can only press dup key; any other action locks keyboard (3277). Shift key overrides on 3278 and 3279. See Numeric Lock discussion in Appendix C.		
Data Entry	No	—	Alpha	No	Alpha keys produce uppercase alpha characters. Numeric shift key produces numeric characters. Alpha shift key has no effect.		
Data Entry	No	—	Numeric	No	Numeric shift key has no effect. Alpha shift key overrides numeric specification and allows alpha character entry.		
Data Entry	Yes	—	Alpha	No	Alpha keys produce uppercase alpha characters. Numeric shift allows numeric character entry. Alpha shift key has no effect.		
Data Entry	Yes	—	Numeric	No	Can only enter 0–9, period, dup, and minus sign. Any other characters lock all keys except for RESET key. Numeric shift key allows numeric character entry. Alpha shift key allows alpha character entry.		

Figure 6-2. Results of Keyboard and Field Combinations

Visibility and Detectability

A field is either displayable or nondisplayable. When it is displayable and contains characters, those characters are visible to the operator. When it is nondisplayable, any characters within that field are not visible to the operator. The nondisplayable attribute is useful for entering classified or security information at a display unit that is in public view.

To maintain security, make sure that programs:

- Send a nondisplay attribute byte prior to sending the intended new nondisplayable data to preclude its momentary appearance on the screen.
- Do not overwrite a field attribute of nondisplay for the currently displayed image when partially changing field formats.

All characters within a displayable field can be displayed at regular brightness, at a high intensity, in color, with Extended Highlighting (blink, reverse video, or underscore), so that they stand out among regular display fields. Blink, reverse video, underscore, color, or high intensity can be used to call attention to error conditions or to emphasize protected fields or format fields. When used on a color display, high intensity causes the field or character to be displayed in white. However, if the color property is defined, it will override the high-intensity property.

High intensity on a monochrome display results in the field or character so defined to be displayed at a brighter level than those defined as regular intensity.

Throughout this document, in discussions on highlighting fields for better operator recognition and performance, remember that, if the device has the capability of interpreting the structured fields and attribute processing functions, then color, reverse video, blink, or underscore may be used to highlight fields or characters for display. Color and/or underscore can be used to highlight printer output. On 3278 displays, only Extended Highlighting and high intensity can be used. On 3178 displays, only high intensity can be used. Normal intensity or underscore may be used for all input fields, so that the terminal operator can tell at a glance which fields require operator action.

You should not specify unprotected fields as high intensity since such fields may become selector-pen-detectable (if this feature is installed) if the operator enters a question mark, ampersand, or blank as the first input character. Fields are specified as either detectable or nondetectable. When a field is detectable, it can be used for selector-pen operations. A nondetectable field location cannot be detected by the selector-pen or cursor select. It is good practice to designate all detectable fields as protected to prevent the operator from changing the content of the sensitive field.

Transmission

The fields that have been entered or modified by the operator are sent to the application program by a Read Modified operation. The 3270 keeps track of such modifications and uses that information to select data to send to the application program. If you wish to pass a field into the computer regardless of modification, you may assign the "modified" or "modified data tag" (MDT) property. However, you should note that the operator can change the MDT property unless you also assign the protected property.

You can decide which combination of attributes you want within the limitations specified. Certain attribute combinations produce additional characteristics. For example, the numeric (limiting keyboard use) and protected (eliminating keyboard use) attributes seem contradictory, but, when specified together, automatically skip the cursor past the field.

You should also be aware that the application program is not limited by attributes. The application program can, for example, place alphabetic information in a field defined as numeric, or protected, or both. The operator does not have such liberty.

If you do not specify any combination of attributes, a field is assumed to have the following attributes:

- Alphameric
- Unprotected
- Displayable (at regular brightness)
- Nondetectable by the selector pen or cursor select
- Not modified
- Color - If used as a character attribute, it defaults to the defined extended field attribute. If used as an extended field attribute, it defaults to the color defined in the Query Reply structured field.
- Nonloadable character set (the character set shipped with the device).
- Extended Highlighting - If used as a character attribute, it defaults to the defined extended field attribute. If used as an extended field attribute, it defaults to the defined extended highlighting defined in the Query Reply structured field.

The field attribute in the 3270 data stream uses a single nondisplayed and protected character position on the screen and serves as a visual separation between successive fields.

Attribute Processing

The model for attribute processing is shown in Figure 6-3. Each device has a character buffer and an attribute buffer (for extended field and character attributes). For each character in the character buffer, there is an associated position in the attribute buffer. Where a position in the character buffer is occupied by a field attribute, the corresponding position in the attribute buffer is interpreted by the hardware as an extended field attribute. Where it is a graphic or control character, the associated position in the attribute buffer is interpreted as a character attribute. The extended field and character attributes do not occupy a position in the character buffer, but instead are in a related position in the attribute buffer. The extended field and character attributes do not occupy a position on the display surface nor do they print.

If an extended field attribute, such as underscore is used, then the relationship between character and field attributes is as shown in Figure 6-4. Remember that

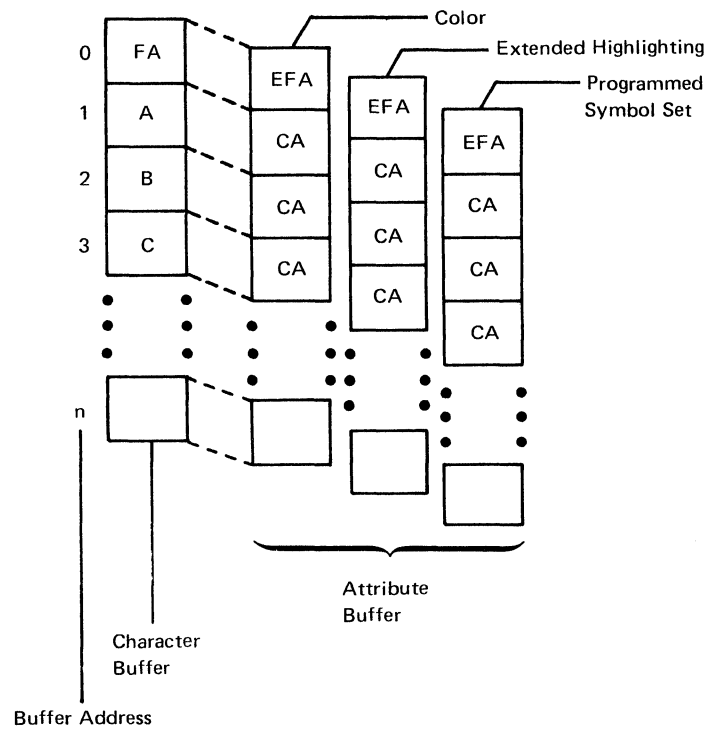
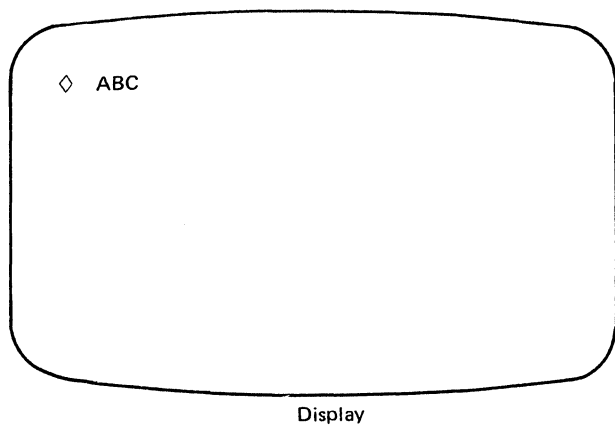

FA = Field Attribute
 CA = Character Attribute
 EFA = Extended Field Attribute

Figure 6-3. Model for Field Attributes and Extended Field Attributes, A Conceptual View

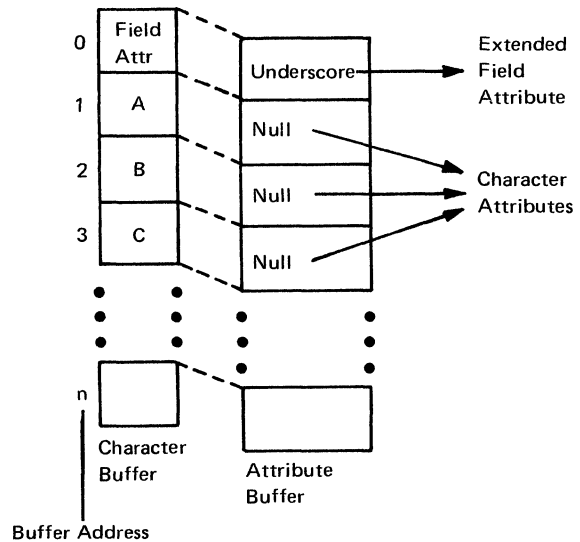
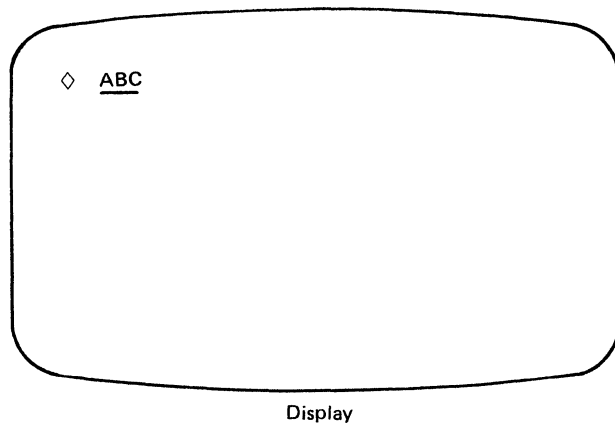
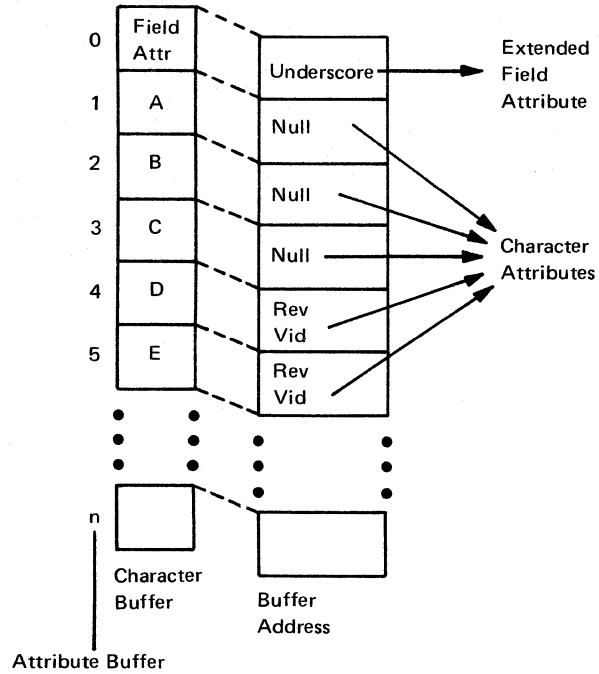
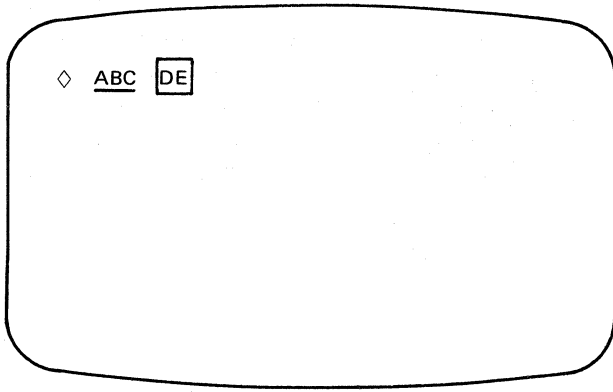

Figure 6-4. Relationship of Character and Extended Field Attributes

the position in the attribute buffer associated with a field attribute character is interpreted as an extended field attribute, and those positions associated with the graphic characters are interpreted as character attributes.

When the character attributes associated with characters in a field are not defined (X'00'), the characters are displayed with the attributes specified for the field. As seen in Figure 6-5, when the character attributes are defined (not X'00'), then the characters are displayed with the attributes specified for the character, overriding the field attributes specified.



□ — Indicates reverse video

Figure 6-5. Character Attribute Override

Example of Field Definition

A typical sign-on procedure illustrates how you might define fields. Figure 6-6 illustrates a simple procedure in which the application program requests the operator to provide his name, location, and serial number.

Field 1: SIGN-ON PROCEDURE:

This field is a heading which the operator should not be able to alter. It is unnecessary for the words SIGN-ON PROCEDURE to be returned to the computer when the ENTER key is pressed. This field should be protected, alphameric, displayed at normal intensity, not detectable by the selector pen or cursor select, and not modified. All default attributes can be assumed, except that you must specify this field as protected.

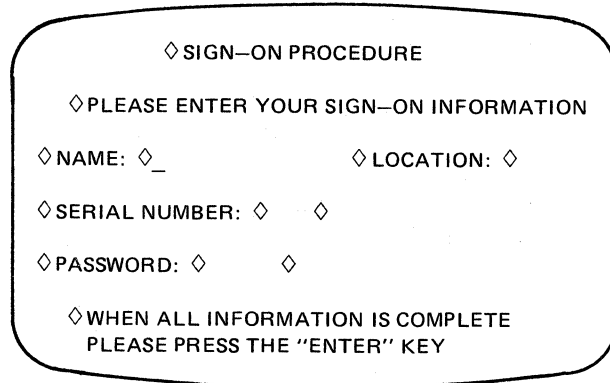

Figure 6-6. Example of Attribute Specification

Field 2: PLEASE ENTER ... INFORMATION

You should specify this field as protected. Remember that the characteristics of a field are determined by the field attribute at the beginning of the field. Field 1 and Field 2 have identical attributes and are adjacent to each other. You may choose to define them separately and use two field attributes, or you may choose to omit the field attribute at the beginning of Field 2. In the latter case the two headings combine to become a single field of greater length.

Field 3: NAME:

This field should be protected, alphameric, not modified, and not detectable by the selector pen. The heading could be displayed at high intensity. Specify the protected and high-intensity attributes (the two deviations from the default attributes).

Field 4: The Area Following NAME:

The null area following NAME: is an input area for the operator and must therefore be unprotected. The display marks this field as modified if anything is entered into it, so you should not specify the modified attribute. The default attributes (alphameric, unprotected, displayable at normal intensity, not detectable by the selector pen or cursor select, and not modified) apply. Use a default attribute at the beginning of this field.

The maximum number of characters the operator can enter is determined by the length of this field. The length is equivalent to the number of nulls, or available positions on the screen, between the field attribute for Field 4 and the field attribute for Field 5.

Field 5: LOCATION:

The field attribute for this field is the same as that specified for Field 3; protected and high intensity should be specified. This field attribute prevents the operator from keying a name longer than the maximum length desired. If the name is shorter than the maximum field size, the operator presses the TAB key when the name is complete. The TAB automatically skips the cursor past protected fields, such as this one, and stops at the first character position in which data can be entered (the next unprotected field). In this example, the cursor would be positioned for entry of location. If the operator attempts to key too many characters (a name greater than 17 characters in the example), the cursor is positioned under this attribute for the 18th character. The next keystroke attempts to destroy this field attribute but fails to do so because field attributes are protected. The keyboard is inhibited, the clicker shuts off, and the "input inhibited" indicator is turned on. The operator's attention is assured since this condition requires pressing the RESET key to continue.

If the field attribute for this field were omitted, the word LOCATION: would become part of Field 4 and would be normal intensity and unprotected. This is undesirable since the operator could continue entering name information beyond the desired maximum length and could modify the heading information by entering data in the screen locations occupied by LOCATION:.

Field 6: The Area Following LOCATION:

This field is for operator input and therefore must be unprotected. The rest of the default attribute values apply and so a default attribute may be used. You need specify only that a field is to begin following LOCATION: This field ends with the field attribute at the beginning of Field 7, which determines the length of the field.

Field 7: SERIAL NUMBER:

This field, like NAME: and LOCATION:, should be specified as protected and high intensity. This also limits the location field length to 5 characters. Note that if field 6, the input field for location, were defined as always being a 5-character code, Field 7, SERIAL NUMBER:, could be defined as auto-skip to save the operator from having to press TAB after filling in the location code.

Field 8: The Area Following SERIAL NUMBER:

The null area following SERIAL NUMBER: is an input area for the operator and must be unprotected. It should also be specified as numeric so that if the operator tries to enter alphabetic data in the field (and the keyboard has the Numeric Lock feature), the keyboard inhibits entry of the incorrect character, the keyboard clicker shuts off, and the DO NOT ENTER (X) indicator appears to notify the operator of the error. The improper character does not appear on the screen, and the correct digit may be entered after the operator presses the RESET key.

The serial number in the example always contains a fixed number of digits and is the last field entered. The maximum length of the field is determined by the location of the field attribute for the next field. But the next field in the example is too far away (PASSWORD).

By placing an additional field attribute following input Field 8, the operator cannot enter a serial number that is too long.

Field 9: The Area Between the Additional Attribute Described in Field 8 and PASSWORD:

By definition, the additional field attribute you used to delimit the serial number field begins a new field. The protected attribute alone is sufficient for this field, and this attribute limits length for the serial number field. Normally, however, protected (output) fields that follow fixed-length input fields should be defined as protected and numeric. The protected and numeric field attribute defines a field as auto-skip. Auto-skip automatically positions the cursor at the location following the field attribute for the next unprotected field, which is the next place you want to key data. This technique saves keystrokes for the operator. When the operator keys the last character of the preceding fixed-length field, the cursor normally enters the next field, which may be protected. But since the next field is auto-skip, the cursor skips this intervening protected field, and automatically positions itself for entry of the next field, without an extra keystroke.

Field 10: PASSWORD:

This would be exactly like the serial number field, protected and intensified.

Field 11: The Input Field for PASSWORD:

This, like the input field for serial number, should be unprotected and numeric. But, one additional characteristic should be added, that of non-display. This allows the operator to input his or her password without anyone in the area being able to read it since it will not be visible on the display surface, thereby allowing for security. Again you would place an additional field attribute following input Field 11 to ensure that the number entered would be of proper length.

This additional length check is used here because this is the last field to be entered. If you had another field to enter after PASSWORD:, it might be more advantageous to omit this length check, as explained in Field 9.

Field 12: The Area Between the Additional Attribute Described in Field 11 and WHEN ... COMPLETE.

This field should be protected since it is not an operator input area. The rest of the default values apply.

Field 13: WHEN ALL ... KEY.

This field is a heading which the operator should not be allowed to change. It need not be high intensity and thus it may be defined as protected only. Field 13 does not automatically terminate when the last screen position is reached. The field definition continues from the bottom right screen position to the upper left screen position until the next field attribute is reached. This is called "wraparound." Keep this in mind, particularly if you define the last field on a screen as unprotected!

Since items 13 and 1 are adjacent to each other (by wraparound) and all have the same attributes, they may be combined into a single field by the omission of field attributes before WHEN and SIGN-ON. The result is a single protected field beginning after the input area for password, wrapping around the screen, and terminating either at PLEASE or at NAME if Fields 1 and 2 have been previously combined.

Combining fields in the above manner may be convenient but may cause confusion and error if you change the screen layout later. It is a better practice to specify separate fields in all cases.

The panel is completely formatted when the fields are positioned, the field attributes are all defined, and the cursor is placed. You must now begin the transition from the visual image, or human-oriented panel, to the detailed data necessary for the 3270 to implement your panel design.

Planning the Panel

You can think of a panel as a single display screen image created by your program. After an application program has been defined, the information that will be passed between the program and the terminal operator must be defined. This information can be thought of as output panels and input responses to panels. Usually, you will be able to approximate the sequence of the panels needed. The exact sequence of output panels often depends on the input responses to them.

Assuming you have a good understanding of the type of application program (such as data entry, order entry, or inquiry) and the kind of information that must be exchanged and processed (such as customer name, invoices, and check amounts), you can consider which panels come first. Suppose the first panel required is a sign-on panel, as shown in Figure 6-7. After sign-on, the next panel might allow the terminal operator to choose one of several different applications or procedures that he would use. But what if the name or word entered was not an authorized sign-on? Another panel might tell the terminal operator about this and ask him to reenter a sign-on name. Figure 6-7 illustrates a technique, sometimes called "block diagramming," that may help in laying out a sequence of panels.

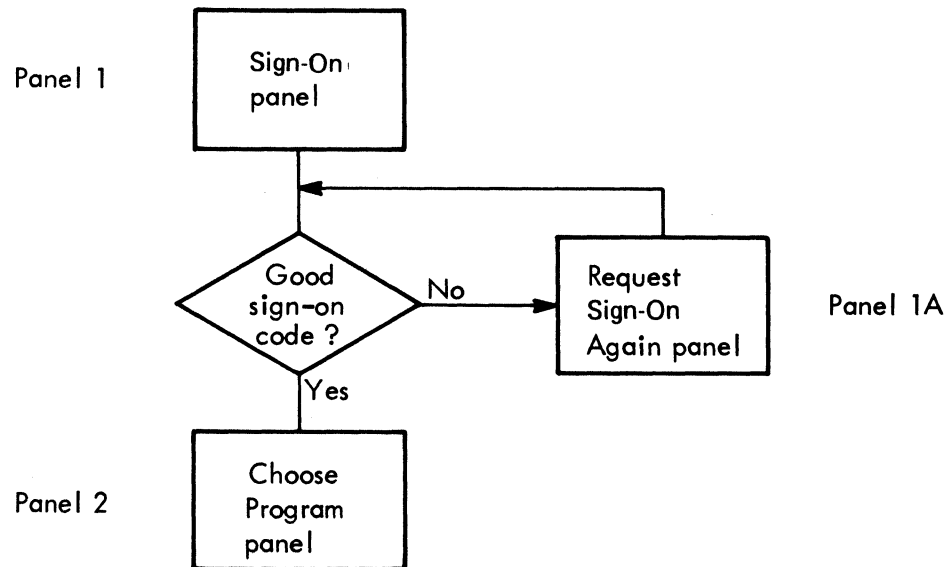

Figure 6-7. Block-Diagramming a Sequence of Panels

Using the Panel Layout Sheet

After block-diagramming the panels in the application or procedure, you are ready to decide on the exact contents of each panel: the fields that will be in the panel, what attributes each field will have, and what words will be displayed in the panel. This can be done on graph paper. The *IBM 3270 Information Display System Layout Sheet*, GX27-2951 or GX27-0014, is useful for layout.

One of these sheets can be used for each panel. After laying out a sequence of panels, you have a collection of panel layout sheets. Using the information on

these sheets and the block diagram showing the relationship between panels, the program can be written to send the panels to a terminal and handle an operator's response to them.

An Example of Laying Out a Panel

To lay out a panel, consider the sign-on panel shown in Figure 6-6. You might jot down on a piece of paper the information required for the panel, or you might write it directly on the panel layout sheet. Figure 6-8 shows what the panel part of the layout sheet might look like after you put the text you wanted for your sign-on panel on the layout sheet. A 1920-character display is shown here.



**3270 Information Display System
Layout Sheet**

Panel ID _____ Subject _____

Job No. _____ Sheet _____

Originated by _____ Date _____ of _____

		COLUMN																																																																															
		1-10	11-20	21-30	31-40	41-50	51-60	61-70	71-80																																																																								
01																																																																																	
02		SIGN-ON PROCEDURE																																																																															
03																																																																																	
04		PLEASE ENTER YOUR SIGN-ON INFORMATION																																																																															
05																																																																																	
06																																																																																	
07																																																																																	
08																																																																																	
09		NAME: _____																																								LOCATION: _____																																							
10																																																																																	
11																																																																																	
12																																																																																	
13		SERIAL NUMBER: _____																																																																															
14																																																																																	
15																																																																																	
16		PASSWORD: _____																																																																															
17																																																																																	
18																																																																																	
19		WHEN ALL INFORMATION IS COMPLETE																																																																															
20																																																																																	
21		PLEASE PRESS THE "ENTER" KEY																																																																															
22																																																																																	

Figure 6-8. Sign-On Panel as Written Out on Layout Sheet

Now that you have written out what you want the terminal operator to see, you can define as fields the separate items of displayed text and spaces you are allowing for operator input. Remember that a field is always preceded by a field attribute. The field attribute occupies a space on the panel even though it appears as a blank space to the operator. Before deciding the attributes of a field, insert some character such as A on the layout sheet to indicate the space for the field attribute. As you get used to creating panels, you may want to enter the A at the same time you are laying out the text. You should also show the cursor location on the panel layout sheet to indicate to the operator where to start his response. The cursor position can be indicated by an underscore () under the space where

you want it to appear, or you might enclose the space or characters in a rectangle. After the indications for field attributes and the cursor position have been added, the sign-on panel appears as shown in Figure 6-9.



3270 Information Display System
Layout Sheet

Panel ID _____ Subject _____
 Job No. _____ Sheet _____
 Originated by _____ Date _____ of _____

ROW	COLUMN																																																																															
	1-10	11-20	21-30	31-40	41-50	51-60	61-70	71-80																																																																								
01																																																																																
02	SIGN-ON PROCEDURE																																																																															
03																																																																																
04	PLEASE ENTER YOUR SIGN-ON INFORMATION																																																																															
05																																																																																
06																																																																																
07																																																																																
08																																																																																
09	NAME: <input type="text"/>										LOCATION: <input type="text"/>																																																																					
10																																																																																
11																																																																																
12																																																																																
13	SERIAL NUMBER: <input type="text"/>																																																																															
14																																																																																
15																																																																																
16	PASSWORD: <input type="text"/>																																																																															
17																																																																																
18																																																																																
19	WHEN ALL INFORMATION IS COMPLETE																																																																															
20																																																																																
21	PLEASE PRESS THE "ENTER" KEY																																																																															
22																																																																																

Figure 6-9. Panel Layout, Including Attribute and Cursor Positions

You could have designed the panel as one long field (or even no field at all), but if you did you would not be taking advantage of the 3270's capabilities. If you designate various items on the panel as fields, each field can have different attributes, as discussed in "What Attributes May Be Assigned to a Field."

For example, you might want the fields NAME:, LOCATION:, and SERIAL NUMBER: to have high intensity to focus the operator's attention on them, because these fields indicate where the operator enters information. You might want to protect the fields other than the operator input fields so that the operator could not erase them; the operator input fields following NAME:, LOCATION:, SERIAL NUMBER:, and PASSWORD: should be unprotected so the operator can type in information. The operator input field following SERIAL NUMBER: and PASSWORD: can be numeric to allow some work station editing; the operator would not be allowed to accidentally enter an alphabetic character. Field length can be defined by beginning a new field where you want the previous field to end (in some cases, this new field serves only to give a length attribute to a previous field).

Having decided on these attributes, you can use the columns on the back of the layout sheet to record the locations and attributes of the fields you have created. Your recording in these columns might appear as in Figure 6-10.

The use of these columns depends on whether the panel designer also codes the panels or only designs them. The information now on the layout sheet can be used to write a line of code that, when sent to the display, displays your panel with its specified field characteristics.

Adding Orders to the Panel Layout Sheets

The back of the panel layout sheet is used for writing the panel orders. The headings indicate what the columns should contain.

The first six columns, as shown in Figure 6-11, identify items in the text, their addresses, and the orders required to format them. The column headings are explained below:

- **Item:** Refers to any part of the panel that requires one or more orders to the control unit to format it. There are 14 items in the sign-on panel:
 1. **SIGN-ON PROCEDURE**
 2. **PLEASE ENTER YOUR SIGN-ON INFORMATION**
 3. **NAME:**
 4. **Input field**
 5. **LOCATION:**
 6. **Input field**
 7. **SERIAL NUMBER:**
 8. **Input field**
 9. **Field to limit size of serial number input**
 10. **PASSWORD**
 11. **Input field**
 12. **Field to limit the size of the password field**
 13. **WHEN ALL INFORMATION IS COMPLETE**
 14. **PLEASE PRESS THE ENTER KEY**

Since each field requires an SF or SFE order, there are always at least as many items as fields. There are more items than fields when, for example, the SBA order is used to space over unused positions within a single large field, as in Item 14.

Item	Display Printer		Buffer Address		Orders	Prot	No.
	Row	Col	Dec	Hex			
1	2	30			SBA SF ATT		
2	4	20			SBA SF ATT		
3	9	10			SBA SF ATT		
4	9	16			SF ATT IC		
5	9	41			SBA SF ATT		
6	9	51			SF ATT		
		9	80		SBA SF ATT		
7	13	10			SBA SF ATT		
8	13	25			SF ATT		
9	13	32			SBA SF ATT		
10	16	10			SBA SF ATT		
11	16	20			SF ATT		
12	16	27			SBA SF ATT		
13	19	15			SBA SF ATT		
14	21	16			SBA		

Figure 6-10. Laying Out Field Attributes

Item	Display Printer		Buffer Address		Orders
	Row	Col	Dec	Hex	

Figure 6-11. Text Items on Panel Layout Sheet

- Row, Col: Contain the starting location (row, column) address of each item.
- Dec, Hex: Are for a different addressing format which you do not need if you use the row, column addressing format. Therefore, you may use these columns for any notes to yourself or leave them blank.
- Orders: Contains the orders (described in Chapter 1) you are writing, such as SBA, SF, SFE, and so forth.

As shown in Figure 6-12, the columns under the heading Attribute provide the field or character attributes that can be defined. The programmer checks the appropriate columns of the attributes he is changing from the default values. The meaning of abbreviations used in Figure 6-12 follows:

- Prot: Protected
- No.: Numeric
- High Int: High intensity
- Sel Det: Selector-pen-detectable or cursor selectable
- Non-Disp Prt: Not displayed not printed at printer
- MDT On: Modified data tag on
- Yel: Yellow
- Turq: Turquoise
- Rev Vid: Reverse video
- PS Set: Programmed symbol set
- PSA through PSF: Programmed symbol set A through Programmed symbol set F (they correspond to Read/Write storage buffers 02 through 07)

Attribute

Prot	No	High Int	Sel Det	Non- Disp Prt	MDT On	Color							Highlight			PS Set													
						Red	Yel	Blue	Pink	Turq	Green	White	Rev Vid	Blink	Under- score	PSA	PSB	PSC	PSD	PSE	PSF								

Figure 6-12. Attributes

At the bottom of the columns (Figure 6-13) are the defaults automatically applied if you do not specify attributes. You must, however, specify a hexadecimal order value for the default attributes, as discussed under "Coding the Panel." The field attribute default values are:

- Unpr: Unprotected
- A/N: Alphameric (alphabetic and numeric)
- Norm: Displayed at regular brightness
- Non: Not detectable by the selector pen or cursor select
- Norm: Displayed (at regular brightness)
- Off: Not modified

Unpr	A/N	Norm	Non	Norm	Off	Green							Note 1			Note 2														
Defaults						Defaults																								

Figure 6-13. Attribute Default Values

Defaults for the extended field and character attributes are:

Notes 1 & 3 (Extended Highlighting) - When used as a character attribute, the default assumes the characteristics of the extended field attribute. When used as an extended field attribute, the default assumes the characteristics defined in the Query Reply structured field.

Notes 1 & 3 (Color) - When used as a character attribute, the default assumes the characteristics of the extended field attribute. When used as an extended field attribute, it defaults to the color specified in the Query Reply structured field.

Notes 1 & 2 (PS Set) - When used as a character attribute, the default assumes the characteristics of the extended field attribute. When used as an extended field attribute, the default is the character nonloadable character set installed in the device in buffer X'00'.

You are now ready to add the required orders to the panel layout form. This may require that you rewrite the back of the form if it was originally prepared without regard to orders or if insufficient space was allowed. The completed layout sheet containing all the orders are shown in the following figures:

- Figure 6-14 lists the orders for a display with no structured field and attribute processing capabilities; that is, it only has field attribute processing capabilities.
- Figure 6-15 lists the orders for a monochrome or base color display that can process extended field and character attributes. It can interpret Extended Highlighting and Programmed Symbols along with field attributes.
- Figure 6-16 lists the orders for an extended color display. It can interpret Extended Highlighting, Programmed Symbols, Color, and field attributes.

These layout sheets contain all the orders and attributes to be sent with the sign-on panel. The hexadecimal order values are discussed under "Coding the Panel" and are shown in Figure 6-17. Each item on the panel has been assigned an item number to help correlate the text with its associated orders. The sign-on panel will be designed for 1920-character screen capacity displays.

Coding the Panel

To write a panel in assembler language so that it can be part of the application program, you must transfer the panel's text and orders to the appropriate programming coding sheet or any other form you find suitable.

On the coding sheet (and in your program), a panel is represented by a series of programming statements, each with a name to which your program can refer. In the following example, SIGNPANL is the name of the sign-on panel. When the application program wants to send the sign-on panel to a display unit, it issues an Erase/Write or Erase/Write Alternate command and designates SIGNPANL as the panel for display.

The display orders must be written in the programming statements using the hexadecimal codes listed in Figure 6-17. Thus, SF is represented by 1D, SBA by 11, IC by 13, SFE by 29, SA by 28, and so on. In the following discussion, three statements are shown per item, identified by (1), (2), and (3) and are to be interpreted as follows:

- (1) = for a display using field attributes.
- (2) = for a display with the capability to interpret extended field and field attributes.
- (3) = for a display with extended color capability.

Each part of each order must be written in hexadecimal, including the attribute byte that follows the SF order and the buffer address that follows the SBA order.

Item	Display Printer		Buffer Address		Orders	Prot	No.	High Int	Sel Det	Non-Disp Prt	MDT On
	Row	Col	Dec	Hex							
1	2	30			SBA						
					SF	ATT	✓				
2	4	20			SBA						
					SF	ATT	✓				
3	9	10			SBA						
					SF	ATT	✓	✓			
4	9	16			SF	ATT					
					IC						
5	9	41			SBA						
					SF	ATT	✓	✓			
6	9	51			SF	ATT					
	9	80			SBA						
					SF	ATT					
7	13	10			SBA						
					SF	ATT	✓	✓			
8	13	25			SF	ATT		✓			
9	13	32			SBA						
					SF	ATT	✓	✓			
10	16	10			SBA						
					SF	ATT	✓	✓			
11	16	20			SF	ATT	✓			✓	
12	16	27			SBA						
					SF	ATT	✓				
13	19	15			SBA						
					SF	ATT	✓				
14	21	16			SBA						

Figure 6-14. Completed Order and Attribute Information, No SFAP Capability

Attribute

Item	Display Printer		Buffer Address		Orders	Prot	No.	High Int	Sel Det	Non-Disp Prt	MDT On	Color							Ex. Highlighting			PS Set																																
	Row	Col	Dec	Hex								Red	Yel	Blue	Pink	Turq	Green	White	Rev Vid	Blink	Under-score	PSA	PSB	PSC	PSD	PSE																												
1	2	30			SBA SFE ATT	✓																																																
2	4	20			SBA SFE ATT	✓																																																
3	9	16			SBA SFE ATT	✓		✓																																														
4	9	16			SFE ATT IC																			✓																														
5	9	41			SBA SFE ATT	✓		✓																																														
6	9	51			SFE ATT																			✓																														
	9	80			SBA SFE ATT																																																	
7	13	10			SBA SFE ATT	✓		✓																																														
8	13	25			SFE ATT			✓															✓																															
9	13	32			SBA SFE ATT	✓		✓																																														
10	16	18			SBA SFE ATT	✓		✓																																														
11	16	20			SFE ATT			✓			✓																																											
12	16	27			SBA SFE ATT	✓																																																
13	19	15			SBA SFE ATT	✓																																																
14	21	16			SBA																																																	

Figure 6-15. Completed Order and Attribute Information for Extended Field and Character Attribute Capability

Order Sequence Order	Byte 1 (Order Code)		Byte 2	Byte 3	Byte 4	Byte n	Byte n+1
	EBCDIC Hex	ASCII Hex					
Start Field (SF)	1D	1D	Attribute				
Set Buffer Address (SBA)	11	11	Address	Address			
Insert Cursor (IC)	13	13					
Program Tab (PT)	05	09					
Repeat To Address (RA)	3C	14	Address	Address	Char. ¹		
Erase Unprotected to Address (FUA)	12	12	Address	Address			
Set Attribute (SA)	28	NA	Attr type	Attr value			
Start Field Extended (SFE)	29	NA	Number of pairs	Attr type 1	Attr value 1	Attr type n	Attr value n
Modify Field (MF)	2C	NA	Number of pairs	Attr type 1	Attr value 1	Attr type n	Attr value n

¹ When graphic escape is used in the RA order, the fourth byte will be the graphic escape character and the fifth byte will be the character to be repeated.

Figure 6-17. Buffer Control Orders and Order Codes

Item 1. SIGN-ON PROCEDURE.

Begin coding the first item on the panel layout sheet: the title, SIGN-ON PROCEDURE. Start with the orders for the panel text which must precede the text itself so that the control unit knows what to do with the text. To write this title, you must tell the control unit:

- Where the title is displayed on the panel. The SBA order will be used to set the buffer address location to row 2 (R2) and column 30 (C30).
- That this location is the start of a field. The Start Field (SF) order tells the control unit that the location contains a field attribute and not a text character. The field attribute defines the properties of this field up to the next field attribute encountered. In this case, the field is protected. The remaining properties of the field are default attributes and do not have to be defined. For displays with extended field and character attributes, Extended Highlighting and Color properties will be defined as indicated in Figures 6-15 and 6-16.

The first order for the title is the SBA order. Figure 6-17 shows that the SBA hexadecimal code is 11, so this code is used in the program statement. Figure 6-17 also shows that the SBA order must be accompanied by 2 bytes of address information. This address is also in hexadecimal.

Now refer to Appendix J for the address row 2 (R2) and column 30 (C30) that must follow the SBA order. The EBCDIC address is C16D and it follows the SBA code in the programming statement. This address should also be recorded on the layout sheet in the Buffer Address Hex column for future reference. If you prefer, you may look up all of the addresses and record them in a similar manner before writing the programming statements. See Figure 6-18 for an example.

The next order for the title is the SF order, which is followed by the field attribute. Attribute definitions are shown in Figure 6-19.

The SF code (1D), and the attribute code (60), are read from Figure 6-17 and 6-19 respectively and added to the programming statement. The data stream would be coded as follows:

(1)	SBA (11)	Address (C1)	Address (6D)	Order (1D)	Attribute (60)	S	I	G	N	-	O	N
-----	-------------	-----------------	-----------------	---------------	-------------------	---	---	---	---	---	---	---

P	R	O	C	E	D	U	R	E
---	---	---	---	---	---	---	---	---

(2)	SBA (11)	Address (C1)	Address (6D)	Order (SFE) (29)	No. of Attribute Pairs (01)	A/T (FA) (C0)	A/V (60)
-----	-------------	-----------------	-----------------	------------------------	-----------------------------------	---------------------	-------------

S	I	G	N	-	O	N	P	R	O	C	E	D	U	R	E
---	---	---	---	---	---	---	---	---	---	---	---	---	---	---	---

(3)	SBA (11)	Address (C1)	Address (6D)	Order (SFE) (29)	No. of Attribute Pairs (02)	A/T (FA) (C0)	A/V (60)
-----	-------------	-----------------	-----------------	------------------------	-----------------------------------	---------------------	-------------

A/T (Color) (42)	A/V (Red) (F2)	S	I	G	N	-	O	N	P	R	O	C	E	D	U	R	E
------------------------	----------------------	---	---	---	---	---	---	---	---	---	---	---	---	---	---	---	---

Item	Display Printer		Buffer Address		Orders
	Row	Col	Dec	Hex	
1	2	30		C16D	SBA SF ATT
2	4	20		C7C3	SBA SF ATT
3	9	10		4AC9	SBA SF ATT
4	9	16		4A4F	SF ATT IC
5	9	41		4AEB	SBA SF ATT
6	9	51			SF ATT
	9	80		4B4F	SBA SF ATT
7	13	10		4FC9	SBA SF ATT
8	13	05			SF ATT
9	13	32		4F5F	SBA SF ATT
10	16	10		D2F9	SBA SF ATT
11	16	20			SF ATT
12	16	27		D34A	SBA SF ATT
13	19	15		D66E	SBA SF ATT
14	21	16		D94F	SBA

Figure 6-18. Sign-on Procedure Panel with Buffer Addresses

Field Attribute Bit Definitions

ATTRIBUTE						Hex
Prot	A/N	MDT ON	High Intens	Sel Det	Non Disp PRT	
U		Y				40
U				Y		C1
U		Y			Y	C4
U				Y		C5
U		Y	H	Y		C8
U			H	Y		C9
U		Y	-	-	Y	4C
U			-	-	Y	4D
U	N	Y				50
U	N			Y		D1
U	N	Y		Y		D4
U	N			Y		D5
U	N	Y	H	Y		D8
U	N		H	Y		D9
U	N	Y	-	-	Y	5C
U	N		-	-	Y	5D
P		Y				60
P				Y		E1
P		Y		Y		E4
P				Y		E5
P		Y	H	Y		E8
P			H	Y		E9
P		Y	-	-	Y	6C
P			-	-	Y	6D
P	S	Y				F0
P	S			Y		F1
P	S	Y		Y		F4
P	S			Y		F5
P	S	Y	H	Y		F8
P	S		H	Y		F9
P	S	Y	-	-	Y	7C
P	S		-	-	Y	7D

S = Skip Y = Yes
 U = Unprotected H = High
 P = Protected N = Numeric

Extended Field Attribute Types and Values

Type Code	Setting	Result
X'00'	X'00'	This is the only valid setting for this attribute type. This type/value pair is used only with the SA order. All character attributes specifiable in SA order are set to default value.
X'00'		The codes appearing here are determined by the field attributes desired.
X'41'	X'00' X'F1' X'F2' X'F4'	Default. Blink Reverse video Underscore
X'42'	X'00' X'F1' X'F2' X'F3' X'F4' X'F5' X'F6' X'F7'	Default. Blue Red Pink Green Turquoise Yellow White for 3279, black for 3287
X'43'	X'00' X'40' X'EF' X'F1'	Default. Valid range for symbol-set IDs assigned in the Load Programmed Symbols structured field. Symbol-set ID for the APL/Text symbol set in terminal storage ID X'01'. This is the only nonloadable symbol set supported, and this attribute value may only be used in the SA order. IF X'F1' is received in an SFE or MF order, an Op Chk or negative response of X'1005' is returned.

Figure 6-19. Attribute Combinations in Hexadecimal

Note: The meanings for the abbreviations used in these and the following data stream format examples are:

SBA = Set Buffer Address
 Addr = Address
 Attr = Attribute
 A/T = Attribute type
 A/V = Attribute value
 # Pairs = Number of attribute type/value pairs
 Prot = protected
 HI = High intensity
 Ex Hi = Extended Highlighting
 SF = Start Field
 SFE = Start Field Extended
 FA = Field Attribute
 IC = Insert cursor

Each item contained in the block is one byte of the data in the program.

Item 2. PLEASE ENTER YOUR SIGN-ON INFORMATION

To write this information, the control unit must know only where the text is located. Therefore, you must use an SBA instruction followed by the address for R4, C20. This is also the beginning of a protected field, so you should include an SF order and a protected attribute.

The code for this field, except for the address, is identical to the code for field 1 SIGN-ON PROCEDURE and will not be repeated here.

Item 3. NAME:

As with Item 2, the location where the text is to be displayed must be identified. Write an SBA order followed by the EBCDIC buffer address X'hex 4AC9'. This is the beginning of a protected, high-intensity field. For a color display, it would be protected and yellow. The data stream would be coded as follows:

(1)	SBA	Address	Address	Order	Attribute	N	A	M	E	:
	(11)	(4A)	(C9)	(SF) (1D)	(E8)					

(2)	SBA	Address	Address	Order	No. of	A/T	A/V	N	A	M	E	:
	(11)	(4A)	(C9)	(SFE) (29)	Pairs (01)	(FA) (C0)	(E8)					

(3)	SBA	Address	Address	Order	No. of	A/T	A/V	A/T	~~~~~			
	(11)	(4A)	(C9)	(SFE) (29)	Pairs (02)	(FA) (C0)	(E8)	Color (42)				

~~~~~	A/V	N	A	M	E	:
	Yellow (F6)					



**Item 4. Input Field for Operator's Name.**

Since this item immediately follows Item 3, the control unit already knows the correct address. Therefore, there is no reason to issue an SBA order. Item 4 is the start of a new field, however, so you must issue an SF order to instruct the display to expect a field attribute next. The field attribute defines the input field as unprotected (U), alphameric (A), normal intensity, not detectable by selector pen, and no MDT on. Because these are the default attributes, you do not have to check anything in the attribute definition columns. However, for the terminals that interpret extended field and character attributes, the underscore property will be added.

The cursor should follow the field attribute to indicate where the operator should begin to enter information. The Insert Cursor (IC) order displays the cursor at this current buffer address. After the display has stored the field attribute in location R9, C16, the new current address is R9, C17; this is the place where the cursor appears on the panel.

To code an input field that contains no text, such as the input field for NAME:, write just one programming statement that contains the orders for that field. The "hex" values are:

- (1) X'1D4013'
- (2) X'2902C04041F413'
- (3) X'2902C04041F413'

The data stream would be coded as follows:

(1)

Order SF (1D)	Attribute (40)	Order IC (13)
---------------------	-------------------	---------------------

(2)

Order SFE (29)	#Pairs (02)	A/T FA (C0)	A/V (40)	A/T EX HI (41)	A/V (F4)	Order IC (13)
----------------------	----------------	-------------------	-------------	----------------------	-------------	---------------------

(3)

Order SFE (29)	#Pairs (02)	A/T FA (C0)	A/V (40)	A/T EX HI (41)	A/V (F4)	Order IC (13)
----------------------	----------------	-------------------	-------------	----------------------	-------------	---------------------

**Item 5. LOCATION**

The control unit must have two orders for this item which (1) give the starting buffer address (SBA) of the field as R9, C41, and (2) indicate that it is the start of a new field (SF) or (SFE), that it is protected, has high intensity, and for a color display is yellow. The "hex" values are:

- (1) X'114AE81DE8'
- (2) X'114AE82901C0E8'
- (3) X'114AE82902C0E842F6'

The data stream would be coded as follows:

(1)	Order SBA (11)	Addr (4A)	Addr (E8)	Order SF (1D)	Attr (E8)	L	O	C	A	T	I	O	N	:
-----	----------------------	--------------	--------------	---------------------	--------------	---	---	---	---	---	---	---	---	---

(2)	Order SBA (11)	Addr (4A)	Addr (E8)	Order SFE (29)	# Pairs (01)	A/T FA (C0)	A/V (E8)	
-----	----------------------	--------------	--------------	----------------------	-----------------	-------------------	-------------	--

L O C A T I O N :

(3)	Order SBA (11)	Addr (4A)	Addr (E8)	Order SFE (29)	# Pairs (02)	A/T (C0)	A/V (E8)	A/T (42)	A/V (F6)
-----	----------------------	--------------	--------------	----------------------	-----------------	-------------	-------------	-------------	-------------

L O C A T I O N :

**Note:** The previous examples show how the text follows in the data stream to be coded. Hereafter only the word "Text" will be used rather than the actual words.

#### Item 6. Input Field for Operator's Location Code

This item immediately follows the text of the last item so there is no need to set the buffer address. Write only the SF order to indicate the start of a new unprotected field, and use default attributes.

For the extended field attribute terminals, the Extended Highlighting property of underscore will be used. Therefore, the following precaution should be taken. If the field is not terminated by an additional SBA order at location column 80, the underscore property would wrap the line and continue until the next SF or SFE order is encountered. Since only the field for operator input should be underscored, terminate the field at the proper location using the proper orders. The "hex" values are:

- (1) X'1D40114B4F1D60'
- (2) X'2902C04041F4114B4F2901C060'
- (3) X'2902C04041F4114B4F2901C060'

The data stream would be coded as follows:

(1)

Order SF (1D)	Attr (40)	Order SBA (11)	Addr (4B)	Addr (4F)	Order SF (1D)	Addr (60)
------------------	--------------	-------------------	--------------	--------------	------------------	--------------

(2)

Order SFE (29)	# Pairs (02)	A/T FA (C0)	A/V (40)	A/T Ex Hi (41)	A/V (F4)	Order SBA (11)	Addr (4B)	Addr (4F)
-------------------	-----------------	-------------------	-------------	----------------------	-------------	-------------------	--------------	--------------

Order SFE (29)	# Pairs FA (01)	A/T (C0)	A/V (60)
-------------------	-----------------------	-------------	-------------

(3)

Order SFE (29)	# Pairs (02)	A/T FA (C0)	A/V (40)	A/T Ex Hi (41)	A/V (F4)	Order SBA (11)	Addr (4B)	Addr (4F)
-------------------	-----------------	-------------------	-------------	----------------------	-------------	-------------------	--------------	--------------

Order SFE (29)	# Pairs FA (01)	A/T (C0)	A/V (60)
-------------------	-----------------------	-------------	-------------

Note that, with the SFE order, if the field attributes are all defaults as in the case above of (C0,40), only the extended field attributes need be coded. The X'C040' need not be coded since these defaults will be assumed by the display.

**Item 7. SERIAL NUMBER**

This field requires an SBA order to location R13, C10 and an SF or SFE order to begin a new field. The attributes are specified the same as that for Item 5 except the color will now be pink. The "hex" values are:

- (1) X'114FC91DE8, text "SERIAL NUMBER:"
- (2) X'114FC92901C0E8, text "SERIAL NUMBER:"
- (3) X'114FC92902C0E842F3, text "SERIAL NUMBER:"

The data stream would be coded as follows:

(1)	Order SBA (11)	Addr (4F)	Addr (C9)	Order SF (1D)	Attr (E8)	Text
-----	----------------------	--------------	--------------	---------------------	--------------	------

(2)	Order SBA (11)	Addr (4F)	Addr (C9)	Order SFE (29)	# Pairs (01)	A/T FA (C0)	A/V (E8)	Text
-----	----------------------	--------------	--------------	----------------------	-----------------	-------------------	-------------	------

(3)	Order SBA (11)	Addr (4F)	Addr (C9)	Order SFE (29)	# Pairs (02)	A/T FA (C0)	A/V (E8)	A/T Color (42)
-----	----------------------	--------------	--------------	----------------------	-----------------	-------------------	-------------	----------------------

A/V (F3)	Text
-------------	------

Item 8. Input Field for Serial Number.

Because the field attribute for this input field immediately follows the last character of the previous field, an SBA is not required. The attribute is numeric; for the terminals that can interpret extended field and character attributes, it will also have the Extended Highlighting property of blink. The "hex" values are:

- (1) X'1D50'
- (2) X'2902C05041F1'
- (3) X'2902C05041F1'

The data stream would be coded as follows:

(1)	Order SF (1D)	Attribute (50)
-----	---------------------	-------------------

(2)	Order SFE (29)	# Pairs (02)	A/T FA (C0)	A/V (50)	A/T Ex Hi (41)	A/V (F1)
-----	----------------------	-----------------	-------------------	-------------	----------------------	-------------

(3)	Order SFE (29)	# Pairs (02)	A/T FA (C0)	A/V (50)	A/T Ex Hi (41)	A/V (F1)
-----	----------------------	-----------------	-------------------	-------------	----------------------	-------------

**Item 9. An Extra Field Created to Limit the Size of the Serial Number Input Field**

This field follows the input field and is protected and numeric. This field is an auto skip field which will place the cursor at the next location for operator input, the password input field. An SBA is required for location R13, C32, for proper placement of the attribute. The "hex" values are:

- (1) X'114F5F1DF0'
- (2) X'114F5F2901C0F0'
- (3) X'114F5F2901C060'

The data stream would be coded as follows:

(1)

Order SBA (11)	Addr (4F)	Addr (5F)	Order SF (1D)	Attribute (F0)
----------------------	--------------	--------------	---------------------	-------------------

(2)

Order SBA (11)	Addr (4F)	Addr (5F)	Order SFE (29)	# Pairs (01)	A/T FA (C0)	A/V (F0)
----------------------	--------------	--------------	----------------------	-----------------	-------------------	-------------

- (3) Same as (2).

**Note:** The previous format examples are representative of all those for the sign-on panel fields. The following item explanations will not show formats unless there are differences.

**Item 10. PASSWORD**

The control unit must have two orders for this item: an SBA order that gives the starting address of R16, C10 and an SF or SFE order to indicate that it is the start of a new field. The field attribute defines a protected and intensified field. The "hex" values are:

- (1) X'11D2F91DE8'
- (2) X'11D2F92901C0E8'
- (3) X'11D2F92901C0E8'

**Item 11. Input Field for Password**

Because the field attribute for this input field immediately follows the last character of the previous field, an SBA order is not required. The attribute is numeric and nondisplayable. The "hex" values are:

- (1) X'1D5C'
- (2) X'2901C05C'
- (3) same as (2).

Item 12. Extra Field

This is another extra field created to limit the size of the password, identical to the field to limit the size of the serial number. This follows an input field and is protected only. An SBA is required for location R16, C27, for proper placement of the field attribute byte. The "hex" values are:

- (1) X'11D34A1D60'
- (2) X'11D34A2901C060'
- (3) same as (2).

Item 13. "WHEN ALL INFORMATION IS COMPLETE"

The control unit must have two orders for this item: an SBA order that gives the starting address of R19, C16 and an SF or SFE order to indicate that it is the start of a new field. The field attribute defines a protected field, and the rest of the field attributes take the default value. For the color display, the color turquoise is an added property. The "hex" values are:

- (1) X'11D66E1D60'
- (2) X'11D66E2901C060'
- (3) X'11D66E2902C06042F5'

Following each of the above statements in the program would be the text "WHEN ALL INFORMATION IS COMPLETE".

Item 14. "PLEASE PRESS THE "ENTER" KEY".

All of the words from "WHEN ALL ....." through "KEY" could have been treated as a single item, but the proper amount of blank spaces would have to be sent between "COMPLETE" and "PLEASE" to position "PLEASE" properly at R21, C16. It is easier and less chance for error to use the three characters required for the SBA order and its associated address, breaking the field into two items, to position "PLEASE" at R21, C16. The "hex" values are the same for (1), (2), and (3): X'11D94F' followed by the text "PLEASE PRESS THE "ENTER" KEY."

Each item from the panel layout sheet is coded in this fashion. Figure 6-20 shows the assembler language code required to display the sign-on panel for a display with no SFAP capability and for an extended color display. Except for one control character, it consists entirely of the panel text, preceded by the display orders for that text.

The SIGN-ON panel is now complete and can be sent to the display unit by the application program.

## SIGNPANL (NO EXTENDED ATTRIBUTES)

JOHN DOE

11/11/83

1 1

```

SIGNPANL DC X\F5' ERASE/WRITE
DC X\C7' WCC
DC X\11C16E1D60' SBA R2C31 ATT P
DC C\SIGN-ON PROCEDURE'
DC X\11C4C41D60' SBA R4C21 ATT P
DC C\PLEASE ENTER YOUR SIGN-ON INFORMATION'
DC X\114A4A1DE8' SBA R9C11 ATT P HI-INT
DC C\NAME:'
DC X\1D4013' ATT U CURSOR
DC X\114AE91DE8' SBA R9C42 ATT P HI-INT
DC C\LOCATION:' ATT U
DC X\1D40'
DC X\114F4A1DE8' SBA R13C11 ATT P HI-INT.
DC C\SERIAL NUMBER:'
DC X\1D50' ATT U NUM
DC X\114FSF1D60' SBA R13C32 ATT P
DC X\11D27A1DE8' SBA R16C11 ATT P HI-INT.
DC C\PASSWORD:'
DC X\1D5C' ATT U NUM NON-DISPLAY
DC X\11D34A1D60' SBA R16C27 ATT P
DC X\11D66F1D60' SBA R19C16 ATT P
DC C\WHEN ALL INFORMATION IS COMPLETE'
DC X\11D94F' SBA R21C16
DC C\PLEASE PRESS THE "ENTER" KEY'

```

## SIGNPANL (7 COLOR DISPLAY)

JOHN DOE

11/11/83

1 1

```

SIGNPANL DC X\F5' ERASE/WRITE
DC X\C7' WCC
DC X\11C16E2902C06042F2' SBA R2C31 ATT P RED
DC C\SIGN-ON PROCEDURE'
DC X\11C4C42902C06042F2' SBA R4C21 ATT P RED
DC C\PLEASE ENTER YOUR SIGN-ON INFORMATION'
DC X\114A4A2902C0E842F6' SBA R9C11 ATT P YELLOW
DC C\NAME:'
DC X\2902C04041F413' ATT U CRSOR UND-SCORE
DC X\114AE92902C0E842F6' SBA R9C42 ATT P YELLOW
DC C\LOCATION:'
DC X\2902C04041F4' ATT U UNDERSCORE
DC X\114B4F1DF0' SBA R9C80 ATT P NUM
DC X\114F4A2902C0E842F3' SBA R13C11 ATT P PINK
DC C\SERIAL NUMBER:'
DC X\2902C05041F1' ATT U NUMERIC BLINK
DC X\114F5F2901C060' SBA R13C32 ATT P
DC X\11D27A2901C0E8' SBA R16C11 ATT P HI-INT.
DC C\PASSWORD:'
DC X\2901C05C' ATT NON-DISP. NUM U
DC X\11D34A2901C060' SBA R16C27 ATT P
DC X\11D66F2902C06042F5' SBA R19C16 ATT P TORQUOISE
DC C\WHEN ALL INFORMATION IS COMPLETE'
DC X\11D94F' SBA R21C16
DC C\PLEASE PRESS THE "ENTRY" KEY'

```

Figure 6-20. Assembler Language Statements for Sign-On Panel

## Using the Repeat to Address Order

The Repeat to Address (RA) order stores a specified alphanumeric or null character in buffer locations, starting at the current buffer address and ending at (but not including) the specified stop address. The specified stop address then becomes the current buffer address.

RA is 3C in hexadecimal. RA can repeat null characters and can erase selected parts of the screen. You may also use it to repeat any other character. To put a row of asterisks under the last title in the sign-on panel, after the DC statement for "PLEASE PRESS THE ENTER KEY", you specify an SBA for R22, C1. The RA order should repeat the asterisk character to location R1, C1 (the address after the last *). This is noted on the layout form as shown in Figure 6-21.

The order in the example is coded as:

```
DC X'3C4040'  
DC C'*'
```

If you want to delete a field already on the screen, repeat the "null" character.

## Using the Write Control Character (WCC)

The control unit to which the display unit is attached uses the orders to format the panel. One control character for the control unit must be included following the write commands for every panel you write: the Write Control Character (WCC). However, no WCC is required between a Write Structured Field command and a structured field. The WCC is a hexadecimal code that provides control information for the control unit and defines printer information for printing panels. The other information in the WCC specifies:

- Whether to sound the audible alarm. The audible alarm is an optional display unit and printer feature that sounds a tone at the display unit upon program request. You can request this function by selecting the appropriate WCC hexadecimal code. If this feature is not installed on a display unit, the request is ignored.
- Whether to restore the keyboard at the end of your panel operation. If this option is requested, the keyboard, which locks when the operator completes a panel operation, is automatically unlocked when the program has finished processing the operator's input. Keyboard restoration means the operator does not have to press the RESET key.

You might not want to unlock the keyboard after each panel is displayed. For example, if you plan to write out another panel before you want to accept input, locking the keyboard prevents the operator from entering data before it is needed. Also, after writing an incorrect panel, you may want to force the operator to press the RESET key to make sure you have gained his attention.

- Whether to reset the modified data tag (MDT). If this option is specified, the field attributes of all modified fields are reset. This function resets all input fields to their original (unmodified) status when an operation is completed so they are ready for the next operation.



Item	Display Printer		Buffer Address		Orders
	Row	Col	Dec	Hex	
1	2	30		C16D	SBA SF ATT
2	4	20		C7C3	SBA SF ATT
3	9	10		4A69	SBA SF ATT
4	9	16		4A4F	SF ATT IC
5	9	41		4AEB	SBA SF ATT
6	9	51			SF ATT
	9	80		4B4F	SBA SF ATT
7	13	10		4FC9	SBA SF ATT
8	13	05			SF ATT
9	13	32		4A5F	SBA SF ATT
10	16	10		D2F9	SBA SF ATT
11	16	20			SF ATT
12	16	27		D37A	SBA SF ATT
13	19	15		D66E	SBA SF ATT
14	21	16		D94F	SBA
15	23	01		5B60	RA *

Figure 6-21. An Example of the RA Order

Each panel written to a display unit or printer must begin with the WCC to identify whether these functions are requested.

The hexadecimal code for each possible WCC combination is shown in Figure 6-22. See the *IBM 3270 Data Stream Programmer's Reference* manual, GA23-0059 for more information on the WCC.

WCCs for the Display

Start Printer	Sound Audible Alarm	Restore Keyboard	Reset MDTs	Code This Hex Value
No	Yes	Yes	Yes	C7
No	Yes	Yes	No	C6
No	Yes	No	Yes	C5
No	Yes	No	No	C4
No	No	Yes	Yes	C3
No	No	Yes	No	C2
No	No	No	Yes	C1
No	No	No	No	40

WCCs for the Printer

Start Printer	Sound Audible Alarm	Restore Keyboard	Reset MDTs	Code This Hex Value If You Want			
				NL and EM Codes Honored	40-Char. Line	64-Char. Line	80-Char. Line
Yes	Yes	Yes	Yes	4F	5F	6F	7F
Yes	Yes	Yes	No	4E	5E	6E	7E
Yes	Yes	No	Yes	4D	5D	6D	7D
Yes	Yes	No	No	4C	5C	6C	7C
Yes	No	Yes	Yes	4B	5B	6B	7B
Yes	No	Yes	No	4A	5A	6A	7A
Yes	No	No	Yes	C9	D9	E9	F9
Yes	No	No	No	C8	D8	E8	F8

Figure 6-22. WCC Hexadecimal Codes

## An Example of a Sequence of Panels

Assume you are given the assignment of designing the panels for an accounts receivable application. You are to create the panels that will allow a terminal operator to post a customer payment against his unpaid invoices. The terminal operator will be sitting at a 3270 work station, removing checks and invoice copies from envelopes. If the invoice copies are returned with the check, the terminal operator will for each invoice enter the customer number, payment, and invoice number. If the invoice copies are not returned, the terminal operator will have to find the customer number based on the customer name and then decide which open invoices to apply the payment against. It will be helpful if the operator has some way of adding various open invoices to find a combination that totals the payment.

The 1920-character panels that follow show one possible solution. The first panel in the application is shown in Figure 6-23. If the invoice copies come with the check, the terminal operator can enter the customer number, amount, and invoice number, and press the ENTER key.

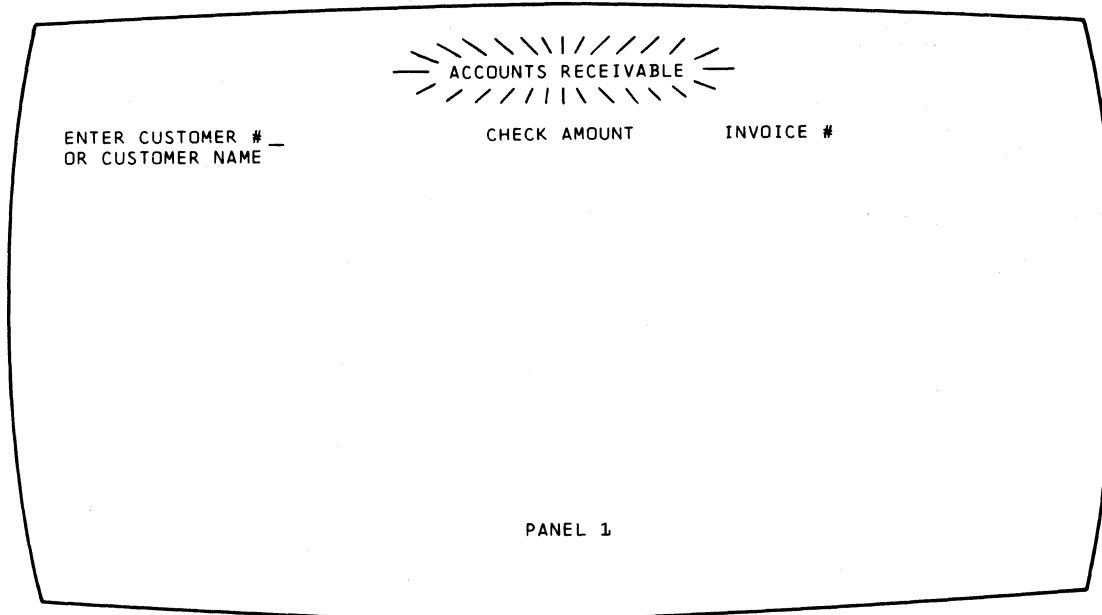

Figure 6-23. Panel 1 of an Accounts Receivable Application

This posts the payment against the specified invoice. The terminal operator can then post the next payment and so forth; as long as the customer number and invoice number are known, only Panel 1 is displayed.

If, however, no invoice is returned and the customer number is not known, the customer name can be entered. The name need not be the complete name of the company; it can be the first name of the company. In our example, the check says only CAPITOL so that is what the operator enters. When the name has been entered, the terminal operator presses the ENTER key. The customer number is missing, so Panel 2 is displayed.

Panel 2, shown in Figure 6-24, shows all customers and customer numbers phonetically similar to the name entered in response to Panel 1. Item numbers in Panel 2 allow the terminal operator to select one by using the corresponding Program Function (PF) key (see "Program Function Keys" later in this chapter).

As a result of terminal operator response to Panel 2, Panel 3 (shown in Figure 6-25) displays all open invoices for the identified customer. The terminal operator can now use the selector pen or cursor select to specify the open invoices to which the payment applies. He does this by touching the selector pen to the question mark adjacent to each desired invoice number or by positioning the cursor in the invoice number field and processing the cursor select keys; selection is verified immediately by the question mark changing to a > character. To post the payment against the selected invoice numbers, the operator can select APPLY. If, however, the operator cannot easily tell the invoices to which the payment is applied, he can select CALC instead of APPLY.

ITEM	CUST #	NAME/ADDRESS	ITEM	CUST #	NAME/ADDRESS
1	0010341	CAPITAL AVIATION 711 HILLSBOROUGH ST. RALEIGH, N.C. 27611	5	0052693	CAPITOL ELECTRIC 56 STATE ST. MONTPELIER, VT. 05602
2	0028472	CAPITOL BAKERIES 1800 MAIN ST. COLUMBIA, S.C. 29201	6	0084362	CAPITOL FEATHER CO. 899 LOGAN ST. DENVER, COLO. 80217
3	0034020	CAPITOL COLA CORP 1439 PEACHTREE ST. NE ATLANTA, GA. 30309	7	0048729	CAPITAL GLASS CO. 121 STATE ST. ALBANY, N.Y. 12201
4	0041938	CAPITAL DRUG CO. 201 NORTH 9TH ST. RICHMOND, VA. 23219	8	0038492	CAPITOL HOLDING CO. 1609 SHOAL CREEK B AUSTIN, TEXAS 78701

PANEL 2

Figure 6-24. Panel 2, Showing the Results of a Search on a Customer Name

ACCOUNTS RECEIVABLE

CUST #	NAME	INVOICE #	DATE	(D)	GROSS	NET
0028472	CAPITOL BAKERIES	? A984632	11/01/82		\$182.50	\$182.50
		? B000312	12/05/82		\$778.00	\$778.00
CHK AMT	\$4,000.00	? B000418	12/07/82		\$98.50	\$98.50
TOT DUE	\$5,358.40	? B000964	12/11/82		\$1,250.00	\$1,250.00
		? B001200	12/21/82		\$682.40	\$682.40
		? B001439	12/25/82		\$395.00	\$395.00
		? B001800	01/11/83	*	\$1,029.75	\$1,009.15
		? B002015	01/15/83	*	\$982.50	\$962.85

MANUAL      APPLY  
CALC        NEXT

PANEL 3

Figure 6-25. Panel 3, Showing the Customer's Open Invoices

Selecting CALC displays Panel 4 (Figure 6-26); this is the same as Panel 3 except that ACCOUNTS RECEIVABLE, which was high intensity in Panel 3, is now normal intensity in Panel 4. A new line with CALCULATOR in high intensity indicates the screen mode and explains the functions of the PF keys. The terminal operator can now use the lower right quadrant of the screen as a *scratch pad* to figure out a combination of open invoices that will total the payment check. This use of one part of the screen for a separate function is sometimes called a *split-screen capability*.

ACCOUNTS RECEIVABLE							
CUST #	NAME		INVOICE #	DATE	(D)	GROSS	NET
0028472	CAPITOL BAKERIES	?	A984632	11/01/82		\$182.50	\$182.50
		>	B000312	12/05/82		\$778.00	\$778.00
CHK AMT	\$4,000.00	?	B000418	12/07/82		\$98.50	\$98.50
TOT DUE	\$5,358.40	>	B000964	12/11/82		\$1,250.00	\$1,250.00
		?	B001200	12/21/82		\$682.40	\$682.40
		?	B001439	12/25/82		\$395.00	\$395.00
		>	B001800	01/11/83	*	\$1,029.75	\$1,009.15
		>	B002015	01/15/83	*	\$982.50	\$962.85

MANUAL	APPLY	CALCULATOR PF1= + PF2= - PF3= CLEAR PF4= RET				
CALC	NEXT					

	\$778.00	.00
	\$1,250.00	
	\$1,009.15	
	\$962.85	

PANEL 4

Figure 6-26. Panel 4, Showing Use of the Calculator

The calculator could be programmed a number of different ways. It could, as our example illustrates, show in one column in the CALCULATOR quadrant all invoice numbers selected (shown with > in Figure 6-26) prior to selecting CALC and in another column show any balance remaining from the check amount after subtracting the selected invoice numbers. In Figure 6-26, Panel 4 is shown as it would appear if the terminal operator had first selected four invoice numbers and then selected CALC. In this example, the selected invoices equal the check amount so .00 is shown as the balance after subtracting the selected invoices.

Panel 4 shows that the CALCULATOR could also allow the operator to key in amounts and to add or subtract them from the check amount (pressing PF1 in our example adds keyed-in amounts; PF2 subtracts one keyed-in amount from another). To start over at any point, the operator can press PF3 to clear the calculator quadrant. In our example, the selected invoices equal the check amount, so they can now be posted. But first the terminal operator must leave the CALCULATOR routine by pressing PF4 (RETURN). This displays Panel 5, shown in Figure 6-27.

Panel 5 is the same as Panel 4 except that, with the operator having signaled completion of the CALCULATOR, the word now appears in normal intensity and ACCOUNTS RECEIVABLE once again appears in high intensity. The terminal operator can now, using the selector pen or cursor select, select the invoices against which to apply the payment and then select APPLY to post the payment.

ACCOUNTS RECEIVABLE						
CUST #	NAME	INVOICE #	DATE	(D)	GROSS	NET
0028472	CAPITOL BAKERIES	? A984632	11/01/82		\$182.50	\$182.50
		> B000312	12/05/82		\$778.00	\$778.00
CHK AMT	\$4,000.00	? B000418	12/07/82		\$98.50	\$98.50
TOT DUE	\$5,358.40	> B000964	12/11/82		\$1,250.00	\$1,250.00
		? B001200	12/21/82		\$682.40	\$682.40
		? B001439	12/25/82		\$395.00	\$395.00
		> B001800	01/11/83	*	\$1,029.75	\$1,009.15
		> B002015	01/15/83	*	\$982.50	\$962.85

MANUAL	APPLY					
CALC	NEXT	CALCULATOR	PF1= +	PF2= -	PF3= CLEAR	PF4= RET

	\$778.00	.00
	\$1,250.00	
	\$1,009.15	
	\$962.85	

PANEL 5

Figure 6-27. Panel 5, Showing Selection of Invoices after Using the Calculator

Panel 6 (in Figure 6-28) shows the ACCOUNTS RECEIVABLE file for the customer after posting the payment, with the new balance and the total amount applied. To continue to the next customer, the operator selects NEXT and returns to Panel 1.

Not all the 3270's possibilities are shown in these six panels, and not all users will have the selector pen or cursor select; this example was designed to show only what panels are and how the 3270 can be used.

Note that, in the above example, the terminal operator does not see as many panels as the programmer must create; not all panels necessarily appear to the operator in any given application. What the programmer regards as separate panels may appear to the terminal operator as one changing panel.

In the above example, a number of additional panels or variations to the panels shown would be required. For example, if the terminal operator presses an invalid PF key, a variation of the panel would be required to send a message to the operator over the panel presently at his display. In programming panels that are variations of one main panel, it may be useful to assign panel designations (for example, Panel 4A, 4B, and so forth) for variations of Panel 4.

ACCOUNTS RECEIVABLE						
CUST #	NAME	INVOICE #	DATE	(D)	GROSS	NET
0028472	CAPITOL BAKERIES	? A984632	11/01/82		\$182.50	\$182.50
CHK AMT	\$4,000.00	? B000418	12/07/82		\$98.50	\$98.50
TOT DUE	\$5,358.40	? B001200	12/21/82		\$682.40	\$682.40
NEW BAL	\$1,358.40	? B001439	12/25/82		\$395.00	\$395.00
SEL INV	\$4,000.00					
MANUAL	APPLY					
CALC	NEXT					

PANEL 6

Figure 6-28. Panel 6, Showing New Balance after Posting

## Analyzing Input Data

### *The Operator's Response*

When a sign-on panel is displayed, the operator responds by entering name, location, and serial number as shown in Figure 6-29. As the operator keys this information, the entered data characters are stored in the display unit's buffer and are displayed as part of the panel. Data that is entered in a nondisplayable field is stored in the buffer, but does not appear on the panel.

When the operator finishes entering the requested data, he indicates the end of this operation by pressing the ENTER key, which causes an automatic Read Modified command execution and sends the following information to your program:

- An attention code to identify that the ENTER key was pressed.
- The address of the cursor's location.
- The start buffer address code to identify the next 2 characters as addresses.
- The starting addresses of every modified field, followed by the data in the modified fields.

Figure 6-30 shows this sequence of input data, which is explained below.

```

SIGN-ON PROCEDURE

PLEASE ENTER YOUR SIGN-ON INFORMATION

NAME: JOHN SMITH      LOCATION: BOSTN
SERIAL NUMBER: 963981

WHEN ALL INFORMATION IS COMPLETE
YOU MAY PRESS THE ENTER KEY

```

Figure 6-29. Sign-On Panel with Operator's Input

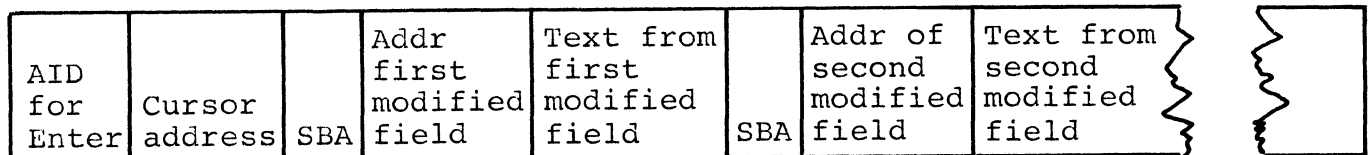

Figure 6-30. Input Data Sequence

### Attention Identifier (AID)

The Attention Identifier (AID) is a hexadecimal code. By identifying this code, your program can determine in which of several possible ways the operator contacted the program and determine what request is being made. For example, pressing the ENTER key requests "Please enter this data."

For a Read Modified, the AID code is followed by the cursor address, which is the hexadecimal code for the row and column location of the cursor when the operator contacted your program.

### Input Data

All the modified fields from the panel follow the AID code and the cursor address. A modified field is any field whose field attribute has the MDT on. A modified field can be one that was modified by the operator or one that was defined by you in your program with the MDT on in its field attribute.

When any character location in an input field is modified by the operator, the MDT in the field attribute for that field is automatically turned on. An input field is not necessarily a modified field. If the operator made no entry in the SERIAL field, for example, only his name, location, and the date would be sent as modified fields to your program.

The display unit sends all the data in a modified field except nulls. When an operator finishes an operation, the display unit reads through the buffer for every field attribute whose code indicates its MDT is on. Each time one is found, the display unit provides an SBA code and the starting address (the field attribute's address plus one) of the modified field. The SBA code identifies to your program that an address follows. It is the same X'11' code that you coded in your panel to identify the starting locations of the panel's text.



## SBA Codes

SBA codes identify the incoming data by cross-referencing it to the correct input field.

For the sign-on panel, your program knows that row 6, column 8 (X'C34F') is the start of the name input field. When it receives the first SBA code (X'11'), it checks the address that follows to see if it is (X'C34F'). If it is, your program knows the text that follows it (until the next SBA code) is the operator's name and can process the input accordingly.

The first part of the input from the sign-on panel is as follows:

7D	C4	C6	11	C3	4F	J	O	H	N	S	M	I	T	H	...
----	----	----	----	----	----	---	---	---	---	---	---	---	---	---	-----

The hexadecimal codes are:

- 7D: The AID code for the ENTER key
- C4C6: The cursor address R7, C23. The cursor is at the next character location after the entered serial number.
- 11: The SBA order code which tells the program that the next 2 characters are addresses. (See Figure 6-17.)
- C34F: The location (R6, C8) where the following text is located on the panel.
- JOHN SMITH ...: The first modified field containing the operator's name.

## Program Attention (PA) Keys

Each 3270 keyboard has at least one program attention (PA) key that the operator can use to request program attention without sending any input data.

The AID codes for the PA keys are shown under a separate heading in Figure 1-15, because they are not followed by input data even though there may be modified fields on the panel when a PA key is pressed. All four short read codes consist of just the AID code.

Your program should use these keys for operator requests for immediate action such as trouble alerts or requests for termination. For example, the assignment of several PA keys might be:

- PA1: Terminate current application
- PA2: Return to starting (master) panel
- PA3: Explain system message

## ***Program Function (PF) Keys***

Program function (PF) keys are a keyboard feature. Your program defines the function that each key requests when it is pressed by the operator.

There is a separate AID code for each PF key so that your program can quickly identify which key was pressed and consequently which function was requested. When a PF key is pressed, all modified fields on the panel and their addresses are sent with the AID code and cursor address, the same as the ENTER key. For this reason, a PF key can be a valuable time-saving device for the operator. For example, the assignment of several PF keys might be:

PF1: Return to previous panel

PF2: Clear (without using data) and repeat current panel

PF3: Set up next panel

PF4: Page forward

PF5: Page backward

PF6: Return to page 1

## **Selector Pen and Cursor Select Input and Output**

Positioning data for selector pen (optional feature) or cursor select (basic feature on the 3278 and 3279) use and setting the attribute characters are the same as for any other type of data, but the select function has additional data-stream requirements.

### ***Selector Field Format***

A field for selector pen operations must be defined as shown in Figure 6-31. The cursor select does not require the three-part character that must precede the selector pen field, although it can be present. Also, the cursor selection can be on any character in the field.

The field attribute, the designator character (described in the next section), and displayed alphanumeric characters must be on the same line. If the field is longer than one line, only those characters on the same line as the field attribute can be detected by the selector.

### ***Designator Characters***

Designator characters define three types of selector fields: selection and two types of attention. Each type of field performs a different operation.

The selection field is defined by a question mark (?) designator character. When the selector pen detects a selection field, the MDT bit in the field attribute for that field is set in the display buffer. Also, the designator character is automatically changed on the screen to a greater-than (>) sign to provide a visible indication to the operator that the detection was successful. If a mistake was made and the operator again detects on that same field, the > reverts to a ? and the MDT is reset. The first type of attention field is defined by a space or null designator character. Probing an attention field or selecting it with the cursor is similar to using an ENTER key. The input information is released to be read by the

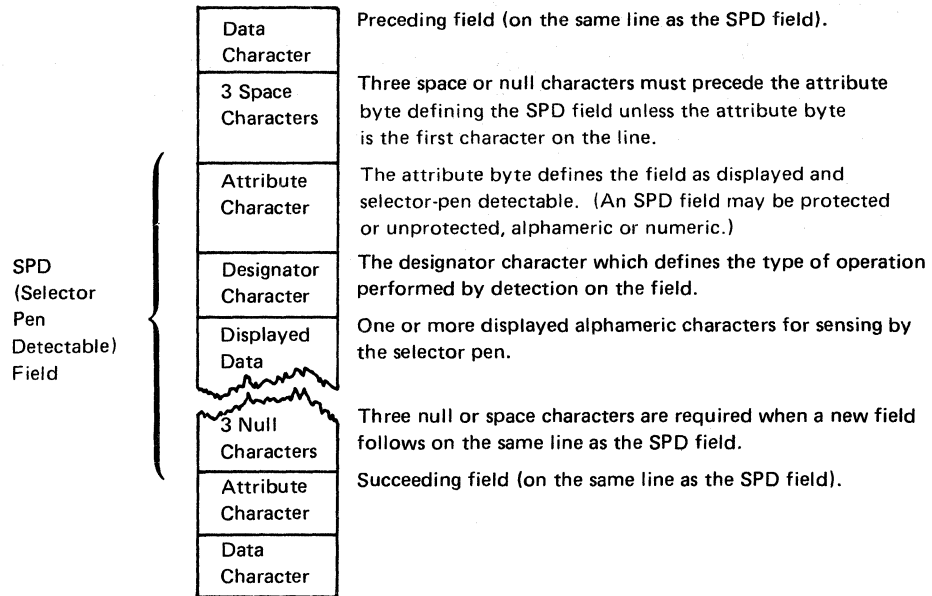

Figure 6-31. Definition of Field for Selector Pen Operation

application program when it is ready to do so. The second type of attention field is the ampersand (&) with the 3274. Probing this field causes the program to issue a Read Modified command and obtain both the address and data of each field.

Figure 6-32 shows a sample selector pen panel that illustrates some of the special input and output data stream considerations.

For output, an Erase/Write creates the panel. In the WCC, you enable input and optionally reset the MDTs. Next you specify an SBA sequence to get you to R1, C7, followed by an SF or SFE with a protected attribute.

This should be followed by the heading "PICK ... COLUMN" and another SBA to R3, C9. Then specify an SF order, followed by a protected (detectable fields may be protected) and detectable attribute. Next you need the designator "?" followed by "RED":

C	O	L	U	M	N	S	R3	C9	S	P	?	R	E	D
						B			F	+				
						A				D				

An SBA after "RED" to R3, C25, provides more than the three required null characters and positions the SF or SFE field attribute, and designator for "2 DOOR". This type of sequence is repeated for the remaining fields to location R7, C28. The designator here must be a null or a blank so that probing or selecting by the cursor causes the "ENTER" field to release the selection to the application program.

As the operator uses the selector pen or cursor select, the program correlates the address of each selector-pen-detectable field with the data associated with it.

To combine selector-pen or cursor-select-detectable input with keyboard or cursor select input, use the keyboard to release the data to the application program by pressing the ENTER key or a PF key. Use of the selector pen or cursor select to

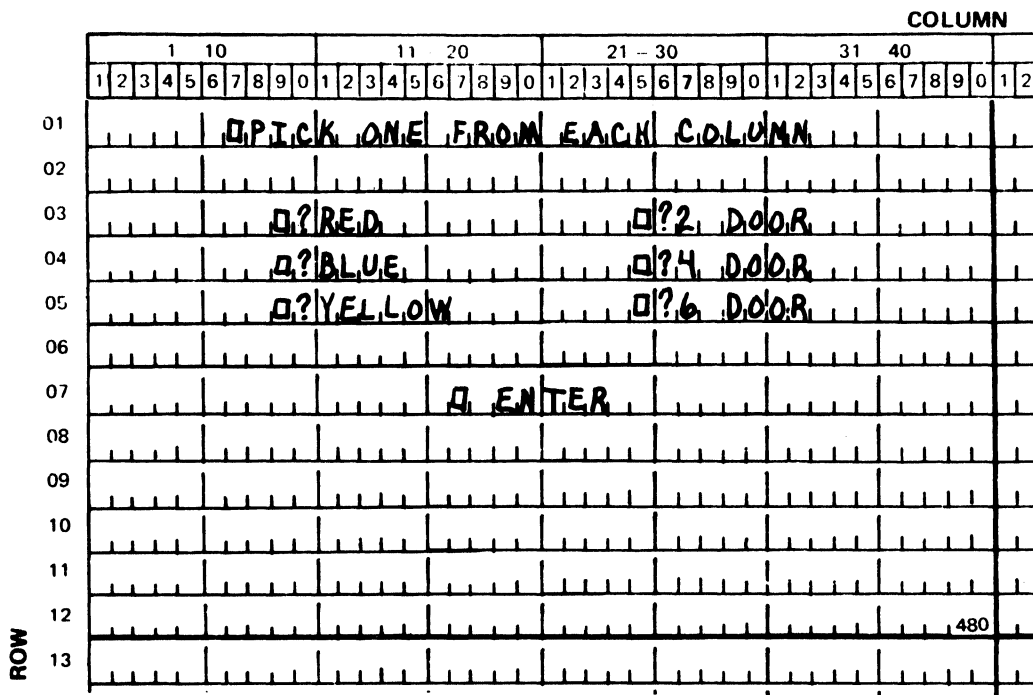

Figure 6-32. Sample Panel for Selector Pen or Cursor Select Detection

release the data, such as by selecting "ENTER" in our example, transmits only the addresses of the fields in which the MDT was set unless you are using a 3274 control unit, in which case the address and data are transmitted.

In the example, if you pick RED and 4 DOOR, the symbolic input would appear as follows:

Pen							
A	Cursor	S			S		
I	ADDR	B	R3	C10	B	R4	C26
D		A			A		

Shortening transmissions by eliminating unnecessary data requires some caution. If you design a panel requiring both pen selection and keyboard entry, do not put an attention designator (space or null) on the panel. An attention designator after keyboard entry transmits only the address of the keyboard input field and causes the loss of its contents. Not having an attention designator on the panel assures you that an ENTER or PF key will be used, and the modified field contents will be transmitted (and the words "RED" and "4 DOOR" in the example).

### The Relationship of One Data Stream to Another

The examples used so far have assumed that you started with a blank screen and that you built the entire panel into your data stream with Erase or Write commands. This approach may lead to tedious work and lengthy data streams, which you can avoid if the panel you wish to display differs only slightly from the one that is presently displayed. The following discussion deals with modification of existing data streams.

## Modifying Existing Panels

Suppose the displayed panel is the sign-on panel in the previous sections. If the operator keys an invalid serial number, you may wish to notify him of his error and request reentry of the serial number field only. You could create a new error message panel, write it to the display, require that the operator acknowledge its receipt, create a special serial number entry panel, write it, and finally read the corrected serial number. A better way might be to use the existing sign-on panel.

After the operator has keyed the data and it has been read into the computer, the screen appears as shown in Figure 6-33. You would like the screen to look like Figure 6-34. Most of the information you want displayed is already there. An Erase/Write or Erase/Write Alternate command would clear the screen and require writing a data stream containing all the information for the new panel. You could use a Write command which modifies existing data in the 3270's buffer.

		COLUMN																																														
		1 - 10										11 - 20										21 - 30										31 - 40																
		1	2	3	4	5	6	7	8	9	0	1	2	3	4	5	6	7	8	9	0	1	2	3	4	5	6	7	8	9	0	1	2	3	4	5	6	7	8	9	0	1	2					
01																																																
02																																																
03																																																
04																																																
05																																																
06																																																
07																																																
08																																																
09																																																
10																																																
11																																																
12																																																
13																																																

Figure 6-33. Modifying an Existing Panel, Basic Panel

To change the panel in Figure 6-33 to look like Figure 6-34:

1. Position the cursor at R7, C17.
2. Replace the message beginning at R10, C5 with the error message.
3. Change the attribute at R10, C4 to high intensity for the error message.

		COLUMN																																																						
		1 - 10										11 - 20										21 - 30										31 - 40																								
		1	2	3	4	5	6	7	8	9	0	1	2	3	4	5	6	7	8	9	0	1	2	3	4	5	6	7	8	9	0	1	2	3	4	5	6	7	8	9	0	1	2													
01																																																								
02																																																								
03																																																								
04																																																								
05																																																								
06																																																								
07																																																								
08																																																								
09																																																								
10																																																								
11																																																								
12																																																								
13																																																								

Figure 6-34. Existing Panel with Error Message

To make these changes, the right side of your panel layout for the error panel might (in abbreviated form) look like Figure 6-35:

- Item 1.        Repositions the cursor to R7, C17.
- Item 2.        Changes the attribute at R10, C4 to protected and high intensity.

**Note:** If the designer of the sign-on panel had combined the original field at this location with the previous field, with the field "SIGN-ON PROCEDURE," and with the following field by omitting the attributes at R10, C4; R2, C11; and R4, C2, the result would be undesirable. The attribute placed at R10, C4 would begin a new field. This would not affect the preceding field but, by wraparound, would cause "SIGN-ON PROCEDURE" and "PLEASE ... INFORMATION" to be high intensity even though they were neither intended to be so, nor were they rewritten. For this reason you should adhere closely to the "Field Concept" and not combine fields unless necessary for efficiency; if you must combine fields, be very careful to avoid undesired results.

- Item 3.        Repositions the data flow to correctly place the second line of the error message. 3 characters are used instead of 6 null characters.
- Item 4.        Repositions the data flow for the third line of the error message.

Since there are two different types of Write commands for the 3274, you must tell the I/O portion of your program which type to use for the data stream. You may want to indicate the type you want in a comment in the data stream. It is

Item	Display Printer		Buffer Address		Orders	Prot	No.	High Int	Sel Det	Non-Disp Prt	MDT On
	Row	Col	Dec	Hex							
1	07	17			SBA						
2	10	04			IC SBA SF						
			"LINE 1		OF ERROR MESSAGE"						
3	11	05			SBA						
			"LINE 2		OF ERROR MESSAGE"						
4	12	05			SBA						
			"LINE 3		OF ERROR MESSAGE"						

Figure 6-35. Panel Layout Changes for Error Message (Keyed to Text)

suggested that you establish some convention for indicating command selection by discussing it at your installation with the people responsible for the I/O portion of the program.

In Figure 6-33, assume that the operator now keys "9" and presses the ENTER key. The "9" corrects the original entry error and the serial number field now reads "963981". What goes into the application program? The prior discussion of input data streams shows the basic format, but which fields can you expect? You know that the serial number input field will be received in its entirety, since keying the "9" caused the display to turn on the MDT for this field, and any field which has been modified is transmitted in its entirety (except nulls).

The input field MDTs for NAME, LOCATION, and SERIAL NUMBER were all turned on by the data entered into those fields in the sign-on panel. While an Erase/Write or Erase/Write Alternate resets all MDTs, a Write does not; therefore, if you do not reset them, all three input fields are returned to the application program. Because not all of them have changed, all three should not return to the application program. You may specify in the WCC that all MDTs in the device are reset "off" or "not modified" (you should do so here).

You may also want to sound the audible alarm, if you have one, with the error panel. A WCC to reset the keyboard, reset all MDTs, and sound the alarm is defined as DC X'C7' (see Figure 6-22). You can now use the Write command to change the sign-on panel into the error message panel.

**Warning:** As you have seen, the Write command allows you to modify an existing screen image while retaining all or a portion of the information already displayed. With the Write command, you can treat the 3270 as a typewriter-type terminal and write your panel line by line or field by field. Using multiple Write commands to create a panel, while technically possible, may create problems.

The operator might start keying data into the panel before you have finished writing it all to the screen. You can prevent this problem by not enabling the keyboard until the last Write in the series.

Using successive Write commands to accomplish what one Write command can do is an inefficient use of the communication line on remote 3270s and unnecessary I/O overhead on local 3270s.

Wherever possible, use a single Write command to avoid the inconveniences noted above.

### Using Erase Unprotected to Address (EUA)

The error panel shown in Figure 6-34 displayed the erroneous serial number. All the operator had to do was to key over the incorrect digits. This may sometimes be confusing. You might instead want to erase only the serial number input field as shown in Figure 6-36.

		COLUMN																																																							
		1 10										11 20										21 - 30										31 - 40																									
		1	2	3	4	5	6	7	8	9	0	1	2	3	4	5	6	7	8	9	0	1	2	3	4	5	6	7	8	9	0	1	2	3	4	5	6	7	8	9	0	1	2														
01																																																									
02																																																									
03																																																									
04																																																									
05																																																									
06																																																									
07																																																									
08																																																									
09																																																									
10																																																									
11																																																									
12																																																									
13																																																									

Figure 6-36. Error Message Panel with Serial Number Field Erased

Begin again with the desired WCC. Place the cursor at R7, C17 with an SBA to R7, C17, followed by an IC order. To erase what was entered in the serial number input field, use the EUA order, (watch the sequence of these letters so you do not confuse them with EAU, which is discussed next). EUA inserts nulls (erases all unprotected positions) from the current buffer address up to, but not including, the specified stop address. It will also set any character attributes of the nulled characters to X'00'.

The specified stop address then becomes the current buffer address. The format of the order is similar to an SBA; the code for the order itself (X'12' for EUA) is immediately followed by a row and column address.

At the first position to be erased (a result of prior operation), you should include an EUA order. For a terminating address, you may use R7, C23 (the first position after the last to be erased). There is a better stop address, however. Since EUA erases only unprotected fields, and since the field beginning at R7, C23 is protected, it can be included in the range covered by the EUA. If R10, C4 is used as the stop address, nothing additional is erased, but you can then write the next attribute without using an SBA, saving three characters of transmission (see Figure 6-37). The current buffer address is the stop address. Any data or SF order that follows go into the buffer at this address.



Item	Display Printer		Buffer Address		Orders	Prot	No.	High Int	Sel Det	Non-Disp Prt	MDT On
	Row	Col	Dec	Hex							
1	07	17			SBA						
					IC						
	10	04			EUA						
2					SF ATT	✓		✓			
	"LINE 1 OF ERROR MESSAGE"										
					.						
					.						
					.						

Figure 6-37. Example of EUA Use

EUA erases all unprotected fields within its range and can erase multiple fields. Suppose you wanted all three input fields erased on the error panel, as shown in Figure 6-38. First place the cursor at R7, C17, then "back up" with an SBA to R6, C8 (the name input field) before issuing the EUA to R10, C4 (see Figure 6-39).

You could have started at R6, C8 with an SBA to R6, C8, followed by the EUA to R10, C4. However, sometime later in the data stream you would have had to "back up," probably with an SBA to insert the cursor.

### Using Erase All Unprotected (EAU) Command

In the preceding example, you wanted to erase all unprotected data, reposition the cursor, and add some new titles to the sign-on panel to make it an error panel. The EAU command:

- Clears all unprotected character locations and associated character attributes to nulls.
- Resets MDTs in all unprotected fields.
- Unlocks the keyboard.
- Resets the AID.
- Repositions the cursor to the first character of the first unprotected field.

This command appears to do what you want (it even does what the WCC would have done), but it does not write any data to the screen. You could issue an EAU command before the Write command. Then you would just write the new titles in their proper positions. You have then issued two commands to create one panel. What, then, is EAU for? It logically resets the panel for repetitive input using the same panel. Do not use EAU to change panels.

ROW	COLUMN																																									
	1 10										11 20										21 30										31 40											
	1	2	3	4	5	6	7	8	9	0	1	2	3	4	5	6	7	8	9	0	1	2	3	4	5	6	7	8	9	0	1	2	3	4	5	6	7	8	9	0	1	2
01																																										
02																																										
03																																										
04																																										
05																																										
06																																										
07																																										
08																																										
09																																										
10																																										
11																																										
12																																										
13																																										480

Figure 6-38. Sign-On Panel with Three Erased Fields

Item	Display Printer		Buffer Address		Orders	Prot	No.	High Int	Sel Det	Non-Disp Prt	MDT On
	Row	Col	Dec	Hex							
01	07	17			SBA						
					IC						
	06	08			SBA						
	10	04			EVA						
					SF	ATT	✓		✓		
					.						
					.						
					.						

Figure 6-39. Erasing Multiple Fields with EUA

*Data Entry Example:* You can use the EAU command to change a sign-on panel slightly and make it a data entry panel. Then the operator just keys in NAME, LOCATION, and SERIAL NUMBER for the first employee. If an error is made, an error panel is shown. If there is no error, you may want to clear the input, reset the MDTs, unlock the keyboard, and reposition the cursor. The data entry panel might appear as shown in Figure 6-40.

The operator keys JOHN SMITH, presses TAB, keys BOSTN, presses TAB, keys 963981, and presses ENTER (Figure 6-41). You simply send the 3270 an EAU command to unlock the keyboard. The operator then sees the same panel as in Figure 6-40 and may now key data for the next employee. You have used your knowledge of what is already displayed to arrive at the next panel or to re-create the present panel.

ROW	COLUMN																																								
	1 10										11 20										21 30										31 40										
	1	2	3	4	5	6	7	8	9	0	1	2	3	4	5	6	7	8	9	0	1	2	3	4	5	6	7	8	9	0	1	2	3	4	5	6	7	8	9	0	1
01																																									
02																																									
03																																									
04																																									
05																																									
06																																									
07																																									
08																																									
09																																									
10																																									
11																																									
12																																									480
13																																									

Figure 6-40. Example of Data Entry Panel

ROW	COLUMN																																								
	1 10										11 20										21 30										31 40										
	1	2	3	4	5	6	7	8	9	0	1	2	3	4	5	6	7	8	9	0	1	2	3	4	5	6	7	8	9	0	1	2	3	4	5	6	7	8	9	0	1
01																																									
02																																									
03																																									
04																																									
05																																									
06																																									
07																																									
08																																									
09																																									
10																																									
11																																									
12																																									480
13																																									

Figure 6-41. Data Entry Panel with Entered Data

## Repetitive Output

In the data entry example, you used one panel repetitively for input of employee information. You can reverse the requirement and design an employee data screen. For this example, assume the application is inquiry with "browsing" capability. Assume also that the operator has previously used another panel to request the information for employee number 963981. The display might appear as shown in Figure 6-42.

		COLUMN																																																														
		1 10										11 20										21 30										31 40																																
		1	2	3	4	5	6	7	8	9	0	1	2	3	4	5	6	7	8	9	0	1	2	3	4	5	6	7	8	9	0	1	2	3	4	5	6	7	8	9	0	1	2																					
01																																																																
02																																																																
03																																																																
04																																																																
05																																																																
06																																																																
07																																																																
08																																																																
09																																																																
10																																																																
11																																																																
12																																																																
13																																																																

Figure 6-42. Employee Data Panel

At the bottom of the panel, the operator is instructed to use the PA1 key to see the next employee page, probably number 963982. The PA2 key is assigned to page backwards. Remember, PA keys are assigned by the program. Program attention keys cause a short transmission; they do not even transmit the contents of changed fields. For an inquiry and browsing application, there should be no input. The PA key assures there is no input even if the operator changes one of the unprotected fields, so its use is preferred to the ENTER or PF keys.

## Using the Program Tab (PT)

The input fields in the previous examples are output fields in this example. You could designate them as protected, but if you did, you could not use another 3270 function called Program Tab. The Program Tab (PT) order advances the current buffer address to the address of the first character location of the next unprotected field. When the PT order immediately follows an alphanumeric or null character (not another order) in the WRITE data stream (other than the character specified by the Repeat to Address order, which is discussed earlier), it also inserts nulls in all the character positions from the current buffer address to the end of the current field. The PT order can be used to page through the employee data file.

When ready to view the information for the next employee, press the PA1 key. Since you want to modify only the present panel, not erase it or blank the

unprotected fields, you request a WRITE command with a WCC to unlock the keyboard. Because you are not sure of the present buffer address, you might begin with an SBA order to R6, C8 followed by the next employee name from the disk file - JOE AMES. Because this name contains fewer characters than JOHN SMITH, the screen would look like this if you did not clear the remainder of the field:

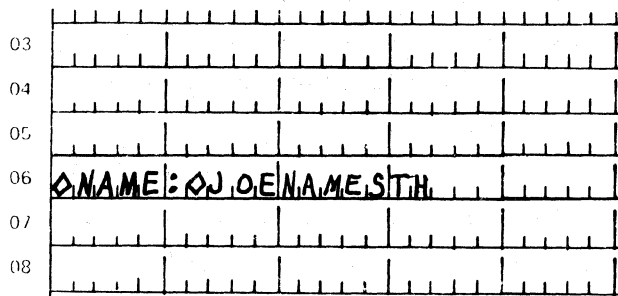

You must also place the location code at location R6, C36. You could use blanks after the name and an SBA sequence, or EUA with its associated address. Use PT instead. Insert a PT order after the "S" in "AMES". The single PT order clears the remainder of the unprotected name field to nulls and positions for the location code. PT should also follow the location code to position for the serial number. The data stream might look like this:

W	S	R	C	J	C	E	A	M	E	S	P	K	N	G	S	T	P	9	3	9	8	2
C	B	6	3	6	3	6	3	6	3	6	3	6	3	6	3	6	3	6	3	6	3	6
C	A																					

The screen would appear as shown in Figure 6-43.

## Defining a Character

All 3270 terminals have a nonloadable character set installed in the device. A second nonloadable character set is present if the machine has the APL/TEXT capability. Application programs use the characters or symbols in these sets as they are; they cannot alter or add to them.

Along with the nonloadable character sets found in the 3270, the 3270 data stream allows for the storage and accessing of up to six character sets by using the Programmed Symbols feature. These character sets are user-defined and can be altered whenever required. Each character set can have up to 190 graphic symbols. They are loaded under program control and may be used by the display operator by accessing the appropriate code points. The user may use the full character cell to design a character or symbol, allowing for a high degree of flexibility in the choice of graphic symbols, which can be used for the display and printing of diagrams, curves, graphs and special fonts, such as bold face and mathematical symbols, in addition to other special symbols.

On the 3178, 3278, and 3279 display stations, each character is represented by a pattern of dots selected from a character cell. The 3178s and the 3278 Models 2 and 3 have character cells of 9 dots horizontally by 16 dots vertically, while the 3278 Model 4 and all 3279 models have character cells of 9 dots horizontally and 12 dots vertically. On the 3287 printers, each character is represented by a pattern of dots selected from a character cell of 10 dots horizontally by 8 dots

ROW	COLUMN																																							
	1 - 10										11 - 20										21 - 30										31 - 40									
	1	2	3	4	5	6	7	8	9	0	1	2	3	4	5	6	7	8	9	0	1	2	3	4	5	6	7	8	9	0	1	2	3	4	5	6	7	8	9	0
01																																								
02																																								
03																																								
04																																								
05																																								
06																																								
07																																								
08																																								
09																																								
10																																								
11																																								
12																																								
13																																								

Figure 6-43. Panel Defined with Program Tab

vertically. Characters are normally represented by predefined patterns accessed by codes in the data stream, sent to the terminal, which represent code points for selecting the character from the character set.

To define a character, the byte value for the character cell must be put into the data stream by the use of bytes M-N of the Load Programmed Symbols structured field. A 10 x 8 character cell is composed of 80 dots and a 9 x 16 character cell is composed of 144 dots. By slicing the character cell into bytes, 8 dots to a byte, characters can be formed. If each dot is a bit, then turning it on (1) allows this dot to display or print, as the case may be. By considering the slices as bit strings, turning each dot on (1) or off (0) gives a hex representation which determines what is printed or displayed. Consider the example of the box "A" in Figure 6-44. Figure 6-44 shows the slicing of the character cell and its bit string hexadecimal representation for a display 9 x 16 character cell. Figure 6-45 shows the same for a 10 x 8 printer character cell.

## Using Structured Fields

As pointed out earlier, the 3270 data stream is a formatted data stream. To provide additional controls and transmit various data types other than character, it was necessary to define a new data structure in the data stream. This is termed "structured fields."

In the 3270 data stream, structured fields are introduced with the Write Structured Field (WSF) command. This command does not contain explicit control information as the other 3270 commands do. It simply means, "Here is data in a structured field format."

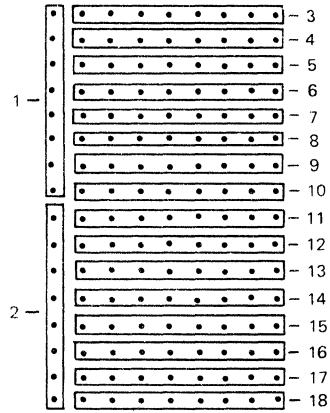
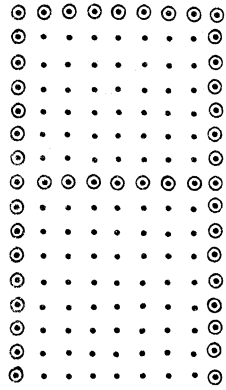

1. 11111111 = X'FF'
2. 11111111 = X'FF'
3. 11111111 = X'FF'
4. 00000001 = X'01'
5. 00000001 = X'01'
6. 00000001 = X'01'
7. 00000001 = X'01'
8. 00000001 = X'01'
9. 00000001 = X'01'
10. 11111111 = X'FF'
11. 00000001 = X'01'
12. 00000001 = X'01'
13. 00000001 = X'01'
14. 00000001 = X'01'
15. 00000001 = X'01'
16. 00000001 = X'01'
17. 00000001 = X'01'
18. 00000001 = X'01'

Figure 6-44. Character Definition for a 9 x 16 Display Matrix

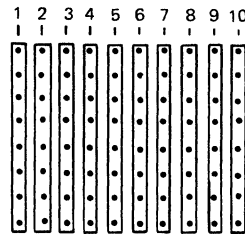
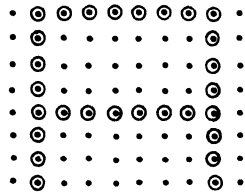

1. 00000000 = X'00'
2. 11111111 = X'FF'
3. 10001000 = X'88'
4. 10001000 = X'88'
5. 10001000 = X'88'
6. 10001000 = X'88'
7. 10001000 = X'88'
8. 10001000 = X'88'
9. 11111111 = X'FF'
10. 00000000 = X'00'

Figure 6-45. Character Definition for a 10 x 8 Printer Matrix

Following the WSF command, all data in the transmission must be in structured field format. A structured field transmission has the form shown in Figure 6-46.

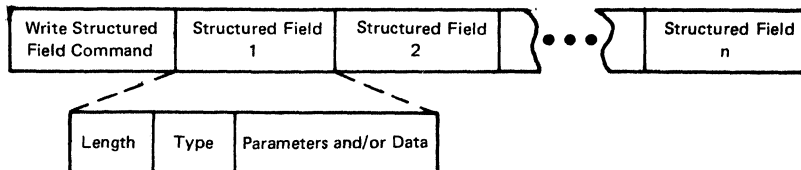

Figure 6-46. Structured Fields

The structured field syntax permits variable-length data and controls to be encoded in such a way that a device that is processing the data stream sequentially can decompose a sequence of fields into its component fields without having to scan every byte. Each structured field contains a 2-byte-length field. This indicates the length of the field (including the length bytes), in effect, pointing to the next structured field in the transmission. Next follows a 1-byte type field, and then parameters and data in the format defined by the type code. If the value specified in the length field is zero, this structured field is treated as the last structured field in the transmission. The type field in the structured field identifies the purpose of the field.



## Load Programmed Symbols

The Load Programmed Symbols (Load PS) structured field is one type of structured field defined as an outbound control function. It is used to load character definition data into the device. This structured field causes characters and symbols to be loaded into contiguous addressable slots in the read/write storage buffers. If no data is transmitted with this structured field, the operation is executed as specified in the parameters field of the structured field and no data is loaded. This allows the characteristics of the character set to be changed without altering the contents of the character set.

As an example of structured field usage, consider the loading of the box "A" from Figures 6-44 and 6-45 into a Programmed Symbol buffer area. Figures 6-47 and 6-48 show the structured field for loading this symbol into the device.

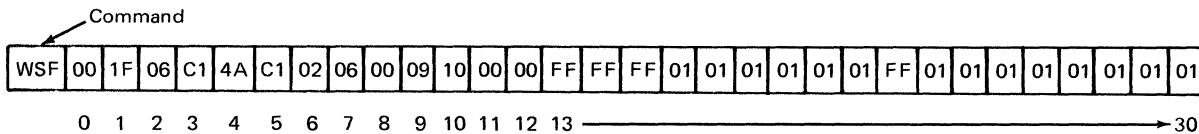

Byte	Content	Meaning
Command	WSF	Write Structured Field command.
0	00	Length
1	1F	
2	06	Load P's type of structured field.
3	C1	Extended form; clear PS storage, skip suppression off, Type 1 data format.
4	4A	LCID of character set.
5	C1	Beginning code point for the character set.
6	02	Use PS storage buffer number 2.
7	06	There are 6 bytes to the extended form.
8	00	All points available, no LCID compare and the PS set is keyboard selectable.
9	09	Number of X-units in the character cell (9).
10	10	Number of Y-units in the character cell (16).
11	00	Reserved, must be zero.
12	00	It is a single plane symbol.
13 – 30		These bytes define the box "A" in Figure 6-44.

Figure 6-47. Structured Field Data Stream to Load a Box 'A' for a 9x16 Display Matrix

Now suppose we wanted to use the 3270 data stream to display the box "A" after the Load PS structured field loaded it into the device. How is this done? It can be accessed by using the attribute type, character set, and the attribute value which is the LCID for the character set containing the "A".

The LCID is assigned to the character set in the Load PS structured field. This LCID is used in the extended attributes when one wants to access the character sets loaded in the device. The Load PS structured field also gave the starting code point for the character set. With this information, the character set can be accessed by the application program or by the operator. We can access the box "A" by using the above information. In the program we would write a DC statement as follows:

```
DC X'114040290241F1434A'
DC X'C1'
```

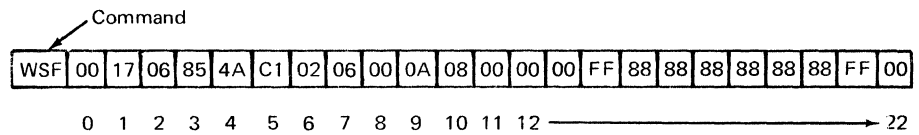

Byte	Content	Meaning
Command	WSF	Write Structured Field command
0	00	Length
1	17	
2	06	Load P's structured field type
3	85	Extended form; do not clear PS storage, Type 5 data format (loading from left to right)
4	4A	LCID of character set
5	C1	Beginning code point for the character set
6	02	Use P's storage buffer number 2.
7	06	There are 6 bytes to the extended form.
8	00	All points are available, no LCID compare, the PS set is keyboard selectable.
9	0A	Number of X-Units in the character cell (10).
10	08	Number of Y-units in the character cell (8).
11	00	Reserved, must be zero.
12 - 22		These bytes define the box "A" in Figure 6-45.

Figure 6-48. Structured Field Data Stream to Load a Box 'A' for a 10x8 Printer Matrix

This is:

- 11 an SBA order
- 40 row 1
- 40 column 1
- 29 an SFE order
- 02 2 attribute type-value pairs
- 41 attribute type of extended highlighting
- F1 attribute value of blink
- 43 attribute type of character set
- 4A the local character set ID (LCID) of the character set
- C1 the code point for the "A"

Figure 6-49 portrays the above process. If we had both nonloadable and loadable character sets in our device, what would be displayed when our data stream was interpreted? Well, if our data stream contained the LCID for the nonloadable character set, what would be displayed would be from the nonloadable character set, PS0 here. If the LCID was from our loadable character set (4A), what would be displayed for the codepoint (C1) would be from character set 4A. If no character set was defined in the 3270 data stream, then what would be displayed would be from the default character set, a nonloadable character set installed and shipped with the device. In this example, let our loadable character set 4A be equal to Programmed Symbol set B (PSB), Read/Write Storage 03.

### Triple Planes

There may be a need, in certain circumstances, to be able to display or print in more than one color within a single character position. A Programmed Symbols set enables the user to define symbols in more than one color. This is called a triple-plane set. A triple-plane Programmed Symbols set occupies three times the normal amount of storage for each defined character, arranged in three planes, each representing one of the three primary colors: red, blue, and green. By defining only a portion of the total symbol in each color plane, the user can obtain

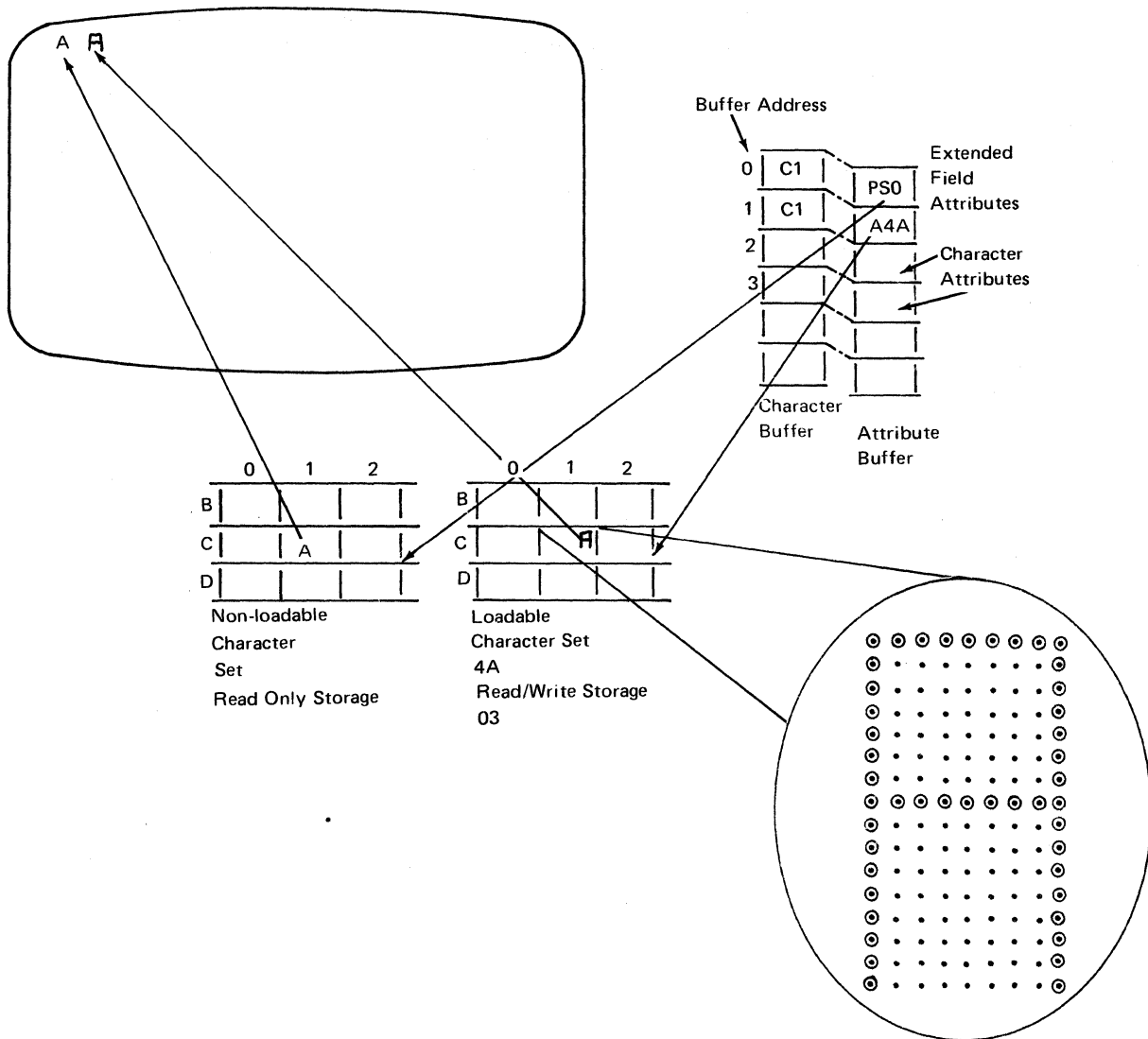
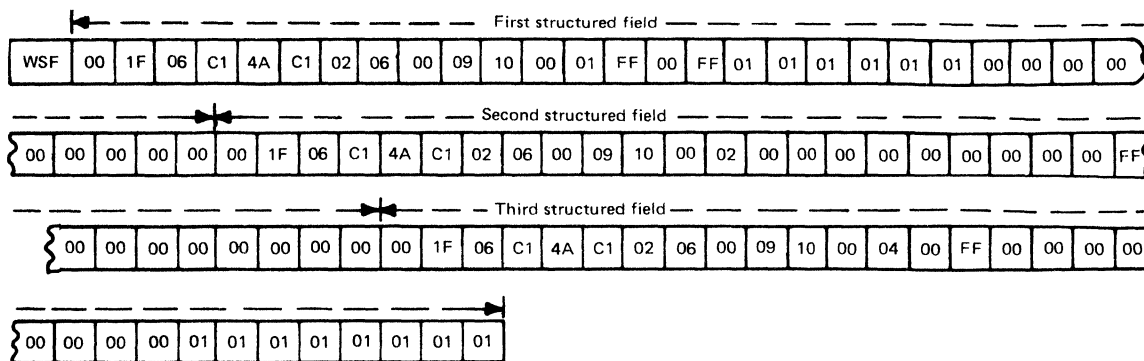

Figure 6-49. Programmed Symbol Sets

a whole symbol in more than one color. When multicolored symbols are required, the appropriate patterns must be defined in the three primary colors, loaded using the Load PS structured field, and referenced for use with a X'F7' color attribute type.

Consider again the box "A" example. To load this symbol in three colors, the structured field of Figure 6-50 would be used and, if referenced properly for display or printing, the symbol would print or display as indicated.



This data stream would result in the character's being displayed as shown below.

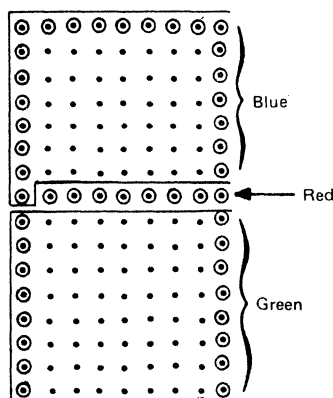

Figure 6-50. Character Definition of a Multicolor Symbol

A multicolored symbol could appear in various ways when displayed or printed:

- If a symbol defined in a triple-plane set is displayed or printed with the color attribute X'F7', the pattern defined in each color plan is presented in that color. When part of a whole symbol appears in more than one color plane, the colors combine as follows:

Plane in Which Dot Is Defined	Color of Dot	
	3279	3287 Printer
Red	Red	Red
Blue	Blue	Blue
Green	Green	Green
Red and blue	Pink	Black
Red and green	Yellow	Black
Blue and green	Turquoise	Black
All three	White	Black

- If a symbol defined in a triple-plane set is displayed or printed with an explicit color attribute other than X'F7' (for example, red), the whole symbol as defined by combining all three planes is displayed in the specified color (red).
- If a symbol defined in a triple-plane set is displayed or printed without any color attribute, the whole symbol appears in monochrome in the same way as any character.

Unless the user loads the three planes in a triple-plane symbol set separately, the system loads the same pattern into all three planes. Thereafter, the triple-plane set behaves (for any character that has the same pattern in all three planes) exactly as if it were a single-plane set. Consequently, a triple-plan set can always be used as if it were a single-plane set.

## Chapter 7. Screen Management

A screen management program module is a set of subroutines physically separate from application programs and from the telecommunications management program module of an online 3270 system. Figure 7-1 illustrates this relationship.

Support functions in a screen management program may reduce the amount of detail work required by the application programs, and effectively use the features of the 3270. The separation of screen management from the other programs also allows screen management to be modified with little or no impact on application programs or on the telecommunications management programs.

Screen management might include:

- Decoding input data streams.
- Dynamic building of output data streams.
- Generating multiple I/O requests to the Line Control Module based upon a single request from an application program (that is, WRITE then READ).
- Automatic paging; the application program passes multiple pages to screen management, which asks the line control module to write a particular page to a display, depending on the display operator's request.
- Automatic copying (providing a hard copy of a display image).

The BSC COPY function supports data movement between any types of device attached to the same control unit: display to display, display to printer, printer to display, and printer to printer. To prevent copying information from an unauthorized device, the control unit provides a program-controlled copy-lock for devices attached to it. If the first position of a device buffer contains a field attribute character with the protected option, the control unit rejects any attempt to copy from that device.

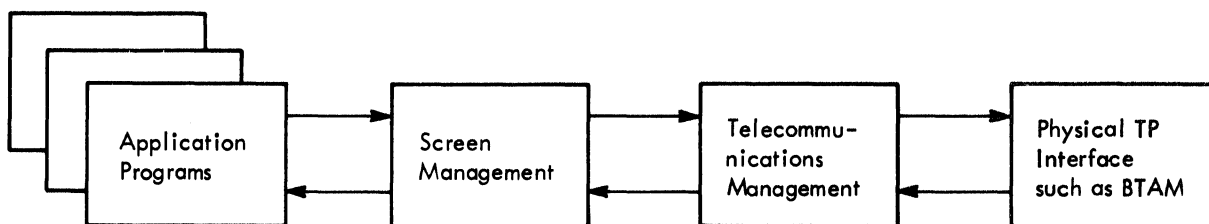

Figure 7-1. Relationship of Screen Management to Telecommunications Management and Application Program

## Decoding and Generating Data Streams

The data streams sent between application programs and the 3270 contain unique orders that request particular operations by the 3270 displays and printers. Generalized subroutines can be written to assist the application programmer's interface with the 3270 system, and an interface can be built to simplify online programs.

This chapter discusses several approaches to developing a screen management module whose functions can be used by the application programmer to prepare output data streams and to decode input data streams. The approaches demonstrate how some 3270 device-dependent considerations can be removed from the application programmer's responsibility. The different techniques for 3270 input or output data stream manipulation can be used in various combinations to suit the needs of the installation.

This discussion assumes that the device management routines (line control) make the local and remote 3270 transparent to the application program. Therefore, discussion of data streams in this chapter ignores all header data in the input stream up to and including the AID character and all header data in the output stream up to but not including the Write Control Character (WCC).

### *Decoding Read Modified Input Data Stream*

A Read Modified command for a display station with a formatted screen (a screen with at least one attribute character defined) produces a data stream consisting of the data from each field whose modified data tag has been turned on (either by program control or by data entered in the field). Each transmitted data field is preceded by the 3270 buffer address where that data is located on the display. The order of the fields transmitted from the screen is from left to right for each line, starting at the top of the screen and ending at the bottom of the screen. All null characters in a transmitted field are stripped out by the control unit during transmission.

The data stream, ignoring the header information up to and including the AID character, appears as:

S	A	A		S	A	A	
B	1	2	DATA	B	1	2	. . . .
A				A			

If the data entered in a field is of variable length or if a field can be skipped by the terminal operator, the data from a particular field on a given panel can appear in a different location within the data stream for each set of operator input. A Read Modified command produces a variable-length data stream of fixed-length fields and variable-length fields concatenated together.

Each 2-character screen address in the data stream is immediately preceded by a Set Buffer Address (SBA) order. The detection of each SBA order in the data stream identifies the next two characters in the stream as a 3270 screen address and also indicates the end of the preceding data field. The System/360 and System/370 Translate and Test instruction (TRT) can be used to scan the data stream and to stop at each main storage address containing an SBA order. If the

detected main storage address of the current SBA order is known, the following calculations can be performed for a given data stream:

```
SBA( 1 ), ADD( 1A ), ADD( 1B ), DATA FIELD( 1 ),
SBA( 2 ), ADD( 2A ), ADD( 2B ), DATA FIELD( 2 ),
SBA( 3 ),
```

The numbers in parentheses are used as subscripts to provide unique identification:

- The length of data field(1) = [Address of SBA(2) - Address of SBA (1)] -3.
- The 2-character 3270 screen address of data field(1) can be found at the address of SBA(1) +1.
- The length of data field(2) = [Address of SBA(3) - Address of SBA (2)] -3.
- The 2-character screen address of data field(2) can be found at the address of SBA(2) +1.

The 2-character 3270 screen address as it appears in the input stream does not provide a direct decimal or binary numeric value that can be used to calculate the relative position in the 3270 buffer from which the data was read. However, you can use the following routine to convert the 3270 address as it appears in the input data stream to a binary value which directly indicates the position (relative to zero) of the data in the 3270 buffer.

Assume that R3 contains the address of SBA(1) and that R4 and R5 are work registers. R5 will contain the result at the end of the routine.

```
ADDCNVRT EQU *
SR R4, R4 CLEAR WORK REG
SR R5, R5 CLEAR WORK REG
IC R4, 0(R3) GET FIRST ADDRESS CHAR (ADD ( 1A ))
N R4, = F'63' TURN OFF ALL BITS EXCEPT LAST SIX
IC R5, 1(R3) GET SECOND ADDRESS CHAR (ADD ( 1B ))
N R5, = F'63' TURN OFF ALL BITS EXCEPT LAST SIX
SLL R4, 6 SHIFT FIRST ADDRESS SIX BITS
TO THE LEFT
AR R5, R4 ADD THE RESULTS TOGETHER
```

By using the above technique, several approaches may be developed to a general purpose subroutine that decodes the variable field length data stream for the application program, and returns the data in a more easily processed format.

### Nonselector Pen or Noncursor Select Data Streams

**Display Buffer Image Technique:** By using the Read Buffer command, you can use the display buffer image technique to return to the application program a main storage buffer area the same size as the display buffer (480, 960, 1920, 2560, 3440, 3564). The data read from the display is placed in the same relative position in the main storage buffer as it occupied in the display buffer, with all other positions in the returned buffer cleared to spaces.

For this technique, use the TRT instruction and the 3270 address conversion routine. You must know the relative locations in the display buffer where data can be entered by the operator, so that the decoded buffer can be processed when



returned by the mapping subroutine. The completed layout sheet for the panel in which the operator enters data will give you the required addresses relative to the respective buffers.

Using the image technique, all data received from the 3270 is left-justified in its respective fields. This has no effect on fixed-length fields, variable-length alphanumeric fields (which are normally left-justified), or omitted input fields. However, you must be aware of variable-length numeric fields where the operator can omit leading zeros.

Although the image technique requires little main storage for the mapping subroutine, main storage can be wasted if the routine returns a complete buffer with little data. To help overcome this problem, the decoding routine can pass back to the application program, a field at the beginning of the buffer. The field indicates the total length of the buffer, which allows the decoding routine to use a buffer area just large enough to accommodate the relative address of the last data field read.

**Mapping from a Table of Requirements:** This mapping technique requires a table assembly for each unique input panel that the mapping subroutine decodes for the application program. The table provides information to the subroutine so that the input data stream in one main storage buffer can be decoded a field at a time and moved to a specified relative offset in another main storage buffer (the target buffer) according to the directions assembled in the table. The preassembled table could be used to specify the following information to the mapping subroutines:

1. The 3270 buffer address preceding each field, which could be read from a particular panel. This is the buffer address as it appears in the data stream which corresponds to the first data position in a field, not to the buffer location of the field attribute byte that defines the field. Any data fields in the 3270 input stream that do not have a matching buffer address in the table would be ignored by the typical mapping routine using the table approach.
2. An offset relative to zero that provides the starting position of each field in the target buffer. This information allows the application programmer to order the fields in the target buffer in a sequence that may or may not agree with the field sequence in the transmitted data stream.
3. A value that indicates the maximum length of each field in the target buffer. This information allows the mapping routine to truncate data stream fields that are too long for the target fields. The maximum field length value is also required if the mapping routine supports right-justification of fields during mapping.
4. A flag byte consisting of bit switches that could indicate:
  - Whether left justification with low-order blank padding is requested.
  - Whether right justification with high-order zero fill is requested.
  - Whether the field should be translated to ensure uppercase characters only.

- Any additional functions the installation wishes to implement in the mapping routine.

Figure 7-2 shows some typical logical contents of the table. The order of the elements within each table entry is optional.

TABLE	DS 0H	
ENTRY 1	DC X'40D4'	ACTUAL 3270 ADDRESS FOR POS 20
	DC H'10'	RELATIVE OFFSET IN TARGET BUFFER
	DC HL1'5'	MAX FIELD LENGTH OF TARGET FIELD
	DC X'80'	RIGHT JUSTIFY, NO TRANSLATE FLAG
ENTRY 2	DC X'40E8'	ACTUAL 3270 ADDRESS FOR POS 40
	DC H'0'	RELATIVE OFFSET IN TARGET BUFFER
	DC HL1'10'	MAX FIELD LENGTH OF TARGET FIELD
	DC X'40'	LEFT JUSTIFY, TRANSLATE FLAG
ENTRY 3	DC X'C1C6'	ACTUAL 3270 ADDRESS FOR POS 70
	DC H'15'	RELATIVE OFFSET IN TARGET BUFFER
	DC HL1'6'	MAX FIELD LENGTH OF TARGET FIELD
	DC X'00'	LEFT JUSTIFY, NO TRANSLATE FLAG
ENDOLIST	DC X'FF'	END OF LIST INDICATOR

**Note:** 3270 buffer addresses in the table are shown relative to buffer location zero; relative offsets in the target buffer are shown relative to zero.

Figure 7-2. Table of Requirements

Assume that you map the following input data stream in hexadecimal using the sample table in Figure 7-2:

1140D4F1F2F31140E8818283848511C1C6E385A7A3

The following target buffer, also in hexadecimal, would be returned to the application program:

C1C2C3C4C54040404040F0F0F1F2F3E385A7A34040

This approach to mapping makes the application program's input processing routine device-independent.

Instead of the mapping table, you could write a macro instruction to prepare the table; the macro would convert written requests into the proper machine language constants.

A typical format for a macro instruction to build the sample table shown in Figure 7-2 might be:

```
MAP      NAME=TABLE,MODEL=2
MAP      ADD=(1,21),OFFSET=11,MAXL=5,JUST=RIGHT
MAP      ADD=(1,41),OFFSET=1,MAXL=10,JUST=LEFT,TRAN=YES
MAP      ADD=(1,71),OFFSET=16,MAXL=6,JUST=LEFT
```

**Note:** The ADD parameter specifies the 3270 buffer in row and column notation relative to one. For example, buffer position zero equals row 1, column 1. The offset values are expressed relative to one. The macro instruction can have default options; for example, if JUST=RIGHT is not specified, JUST=LEFT can be assumed.

The following example shows the logic flow for a table-driven input mapping technique:

1. Find the 3270 buffer address of a data field to be processed in the input data stream, using the TRT instruction.
2. Determine the length of the data field in the data stream using the techniques previously discussed.
3. Search the table of requirements, using the 3270 buffer address found in step 1 as a search argument to find a matching entry.
4. Add the offset value from the entry found in the table to the starting address of the main storage map buffer, to produce the main storage address of the start of the receiving field.
5. If the length of the data field determined in step 2 is greater than the maximum field length value in the entry found in the table, go to step 10.
6. Check the flag byte in the entry found in the table. If left justification is requested, go to step 10. Otherwise proceed to step 7 for right justification.
7. Move zoned decimal zeros to the receiving field, using the field starting address determined in step 4. Use the maximum field length value in the entry found in the table as the length for the move.
8. Develop a new main storage address for the start of the receiving field to accommodate the request for right justification. The right-justified starting address for the receiving field equals (the field starting address determined in step 4 + maximum field length value in the entry found in the table) - length of the data field in the data stream found in step 2.
9. Move the data field from the data stream to the main storage address developed in step 8, using the length of the data in the data stream determined in step 2. Return to the start of this routine to find the next data field in the data stream.
10. Move blanks to the receiving field, using the starting address of the field as determined in step 4. Use the maximum field length value in the entry found in the table as the length for the move.
11. Move the data field from the data stream to the receiving field, using the field address determined in step 4. Use the length of the data in the data stream (determined in step 2) as the length for the move.
12. Check the flag byte in the entry found in the table to determine if uppercase translation is requested. If it is not requested, return to the start of this routine to find the next data field in the data stream.
13. Translate the data in the receiving field to uppercase, then return to the start of this routine to find the next data field in the data stream. The translation can be done in two ways:
  - Use the TRANSLATE instruction with the translation table built to convert lowercase alphabetic characters to uppercase.

- Use the OR instruction to place blanks in the field. This will change the DUP and FM characters. The FM appears as a semicolon (;) on the screen, but appears in the data stream as X'1E'. It will be converted to a true ; (X'5E'). The DUP appears as an asterisk (*) on the screen, but appears in the data stream as X'1C'. It will be converted to a true * (X'5C').

### Immediate Selector Pen or Cursor Select Data Stream

When a Read Modified command is executed for a display station as a result of an immediate detection by the selector pen or cursor select, the resulting data stream consists of address strings that identify which fields on the screen have the modified data tag set; the 3274 Control Unit also transmits the modified data if the proper designator character is used.

The data stream, ignoring the header information up to and including the AID character, appears as:

S	A	A	S	A	A	
B	1	2	B	1	2	.
A			A			.

If the operator keys into a field and an immediate selector field is selected, the keyed data is not transmitted. However, if keyed data is entered by the operator, delayed selector fields are selected, and the ENTER key or a PF key is pressed; then the address and data for all fields, whether selected or keyed, are included in the data stream.

You can use a subroutine to free the application program from determining which fields were selected on a panel. A table can be built that consists of the 3270 buffer addresses, giving the location of each selectable field on a panel. The mapping routine can then compare the addresses in the table, and return to the application program a list of indicators that identify the selected fields.

The list of indicators can be returned to the application program. A string of one-position fields can be used, and each position can indicate with a unique character that a field was selected. The first position in the returned list can be marked if a field in the data stream has the same address as the first element in the address table; the second position in the returned list can be marked if a field in the data stream has the same address as the second element in the address table. The application program can then determine which relative positions in the list have been marked to determine which fields have been selected by the operator.

Because the input from a display using selector pen or cursor select detection is a series of fixed-length addresses, the mapping routine can analyze the input stream and decode it.

For example, using the selector panel illustration in Figure 7-3, assume that the operator has selected the delayed-detectable fields located at row 5, column 10 and row 3, column 26 and the immediate-detectable field located at row 7, column 18. The input data stream transmitted in hexadecimal from the display would be:

11C1E911C2E911C4C1

ROW	COLUMN																																							
	1 - 10										11 - 20										21 - 30										31 - 40									
	1	2	3	4	5	6	7	8	9	0	1	2	3	4	5	6	7	8	9	0	1	2	3	4	5	6	7	8	9	0	1	2	3	4	5	6	7	8	9	0
01	PICK ONE FROM EACH COLUMN																																							
02																																								
03	0?RED																				0?2 DOLOR																			
04	0?BLUE																				0?4 DOLOR																			
05	0?YELLOW																				0?6 DOLOR																			
06																																								
07	0 ENTER																																							
08																																								
09																																								
10																																								
11																																								
12																																							480	
13																																								

Figure 7-3. Example of Selector Pen Panel

Using the sample table in Figure 7-4, the mapping routine returns a list in hexadecimal to the application program:

406F40406F406F

SELTABLE	EQU *	FOR MODEL 1 DISPLAY
DC	X'C1D9'	ROW 3 COL 10
DC	X'C1E9'	ROW 3 COL 26
DC	X'C2C1'	ROW 4 COL 10
DC	X'C2D1'	ROW 4 COL 26
DC	X'C2E9'	ROW 5 COL 10
DC	X'C2F9'	ROW 5 COL 26
DC	X'C4C1'	ROW 7 COL 18
DC	X'FF'	TABLE STOP INDICATOR

**Note:** The 3270 addresses used in the above table correspond to the buffer position of the Selector Pen designator character in a field, not to the location of the field attribute character which defines the field.

Figure 7-4. Sample Mapping Table

This list indicates that the 2nd, 5th, and 7th fields were selected. Note that the addresses of the selected fields appear in the datastream in the same sequence that the fields appear in the display buffer. When a selector pen panel is designed by columns, the address of the field selected from the first column may not occur before the address of the field selected from the second column in the input data stream.

You can write a macro instruction similar to the one used to build the table in Figure 7-2 to build the selector pen table:

```
MAP      NAME=SELTABLE,MODEL=1
MAP      ADD=( 3, 10 )
MAP      ADD=( 3, 26 )
MAP      ADD=( 4, 10 )
. . .
```

### **Mixed Read Modified Input Data Streams**

When some keyed input and some delayed selector pen or cursor select detection occur in a panel during the same input operation from a display, you can use the table-driven mapping technique for nonselector-pen or cursor select panels. Specify the table elements so that all delayed selector fields have a maximum length of one character. The mapping routine places the first character from the appropriate data stream field into the target field. The first character in a delayed selector field that has been selected is always a (>); that is, X'6E'. The application program can examine the target buffer for that character in the proper target field to determine whether the field has been selected.

### **Building Output Data Streams**

The 3270 requires specific bit patterns for order sequences, control characters, and buffer addressing. The data streams can be prepared in several different ways. A data stream to build a static panel (a panel which will always be displayed in exactly the same manner) can be assembled in an application program as a set of data constants. A semidynamic panel, which may occasionally be modified or added to, can have the static portion assembled in the application program and have the program dynamically modify or add to the data stream. A data stream for a dynamic panel (a panel with a high degree of change) must be created or assembled as a unit at execution. This section discusses how to reduce the considerations of device-dependency required to support static, semidynamic, and dynamic output data streams.

### **Static Data Streams**

You can write macro instructions to simplify the preparation of static data streams for the 3270. One approach is to write a set of macro instructions in which each macro instruction prepares a single order sequence. Another approach is to write one macro instruction that can prepare all types of order sequences, but prepares only one sequence for each execution of the macro instruction in a program.

A sample macro instruction of the first type might be:

```
$MOD MODEL = 1, 2, 3, 4, 5
```

This macro instruction sets a global value so that the specified model number is used until another \$MOD macro instruction is encountered. The model number is required to correctly calculate 3270 buffer addresses. The buffer address X'C2D5' represents column 4, row 30, for a Model 1 display, and column 2, row 70, for a Model 2 display.

The following are also examples of the first type of macro instruction:

\$SBA (1,10) generates the SBA order sequence X'1140C9'

\$SF (PROT,NUM,SKIP,MDT,HI,DET,NONDISP) generates an SF order (X'1D') followed by the appropriate attribute character defined by the options selected in parentheses. Notice that if PROT is not specified, unprotected is assumed; if numeric is not specified, alphameric is assumed.

\$RA (1,10,'*') generates the RA order sequence X'3C40C95C'.

\$EUA (1,10) generates an EUA order sequence X'1240C9'.

\$WCC (RESET,RESTORE,ALARM,PRINT,40CHAR,64CHAR,80CHAR,NLEM) generates the proper WCC, depending on the options selected in parentheses.

\$CCC (PRINT,40CHAR,64CHAR,80CHAR,ALARM,ATT,UNPROT,PROT,ALL) generates the proper copy control character (CCC), depending on the options selected in parentheses. (The CCC identifies the type of data to be copied.)

\$IC generates X'13'

\$KBD KEYBOARD - APL or Text Used with the Data Analysis feature to identify the keyboard providing 3277-2 display input.

\$SI generates the Suppress Index character, valid for the 3288-2 or 3289 printer. Other printers receive | (the or bar) in place of the Suppress Index character.

After you have defined the macro instruction, the data stream required to build the sign-on panel shown in Figure 6-8 could be created as follows:

```
SIGN-ON  $MOD  MODEL=1
          $WCC  ( RESET,RESTORE )
          $SBA  ( 2,11 )
          $SF   ( PROT )
          DC    C'SIGN-ON PROCEDURE'
          $SBA  ( 4,2 )
          $SF   ( PROT )
          DC    C'PLEASE ENTER YOUR SIGN-ON INFORMATION'
          $SBA  ( 6,1 )
          $SF   ( PROT,HI )
          DC    C'NAME: '
          $SF
          $IC
          $SBA  ( 6,25 )
          $SF   ( PROT,HI )
          DC    C'LOCATION: '
          $SF
          $SBA  ( 7,1 )
          $SF   ( PROT,HI )
          DC    C'SERIAL NUMBER: '
          $SF   ( NUM )
          $SBA  ( 7,23 )
          $SF   ( PROT )
          $SBA  ( 10,4 )
          $SF   ( PROT )
          DC    C'WHEN ALL ... ENTER KEY'
```

You could also write the second type of instruction, a single 3270 data stream macro instruction, which might have the format:

<symbol>	\$MAC	op-type ,(attributes) ,(row,column) <,character> ,MODEL=	1 2 3 4
----------	-------	----------------------------------------------------------	------------------

**symbol**

specifies a symbol that refers to the data stream.

**op-type**

specifies the type of screen control operation to generate. Valid values are: SF, SBA, IC, RA, EUA, WCC, and CCC.

**(row,column)**

specifies the row (1 to 43) and column (1 to 132) where the operation starts or ends (depending on the op-type). This parameter is required for op-types SBA, RA, and EUA.

**(attributes)**

indicates attributes or control bits for SF, WCC, and CCC.

Some valid values for SF are: PROT, SKIP, NUM, MDT, HI, DET, NONDISP.

Some valid values for WCC are: RESET, RESTORE, ALARM, PRINT, 40CHAR, 64CHAR, 80CHAR, NLEM.

Some valid values for CCC are: PRINT, 40CHAR, 64CHAR, 80CHAR, ALARM, ATT, UNPROT, PROT, ALL.

**character**

specifies the character used in the RA function.

**MODEL=**

indicates the model of 3270. This model number is used to calculate the buffer address. This parameter is specified only once in the first macro instruction of a data stream series or whenever the data stream to be generated is for a different model than the preceding series. Model numbers 3 and 4 can be specified only for the 3278 Display Station.



After you have defined the macro instruction, the data stream required to create the sign-on panel shown in Figure 6-8 could be as follows:

```
SIGN-ON  $MAC  WCC,(RESET,RESTORE),MODEL=1
          $MAC  SBA,(2,11)
          $MAC  SF,(PROT)
          DC    C'SIGN-ON PROCEDURE'
          $MAC  SBA,(4,2)
          $MAC  SF,(PROT)
          DC    C'PLEASE ENTER YOUR SIGN-ON INFORMATION'
          $MAC  SBA,(6,1)
          $MAC  SF,(PROT,HI)
          DC    C'NAME:'
          $MAC  SF
          $MAC  IC
          $MAC  SBA,(6,25)
          $MAC  SF,(PROT,HI)
          DC    C'LOCATION:'
          $MAC  SF
          $MAC  SBA,(7,1)
          $MAC  SF,(PROT,HI)
          DC    C'SERIAL NUMBER:'
          $MAC  SF,(NUM)
          $MAC  SBA,(7,23)
          $MAC  SF(PROT)
          $MAC  SBA,(10,4)
          $MAC  SF,(PROT)
          DC    C'WHEN ALL ... ENTER KEY'
```

These two types of macro instructions can generate either a total static data stream or static sections of data streams that can be dynamically assembled at execution by the application program.

### ***Semidynamic Output Streams***

A semidynamic panel requires some dynamic modification. Perhaps an error message must be written to a particular part of the panel and the cursor must be moved to the input field in which an error was detected during editing. The application program can concatenate preassembled static data stream segments into the program, such as field error messages. The same macro instructions that build static data streams can build partial static streams. As the input from a panel is edited, the standard error message for each field can be assembled in the output buffer, thus allowing multiple brief messages to be sent to the display in one operation.

You may have to change one or two attribute characters from high intensity to low intensity and erase the unprotected fields on a display. For example, an error message segment may have changed a field to high intensity to call the operator's attention to the field; the operator has recognized the error and reentered the correct information. The display must now be made ready for the next input on the panel. Concatenate the order stream segments to change the attribute characters and use the Erase Unprotected to Address (EUA) order to restore the panel; do not transmit all the data and orders to completely refresh the panel.

### ***Dynamic Output Streams***

It may become physically impossible to hold in main storage all possible output data and order stream combinations that could occur during execution of an application. To eliminate the need for storage, you can incorporate a subroutine into screen management to accept parameters from an application program, to decode the parameters and to create the data stream. You can also write for the

application program a macro instruction that builds a parameter list in line from entries you specify in the macro instruction, and then branches to the screen management routine to build the required orders and data in the buffer area.

The macro instruction could appear as follows:

```
$BUILD ADD=ADDFIELD,ATT=(R3),DATA=(R4),LEN=(R5)
```

The ADDFIELD contains the 3270 buffer address in either row-column format, binary offset, or 3270 address form. R3 contains the address of the attribute byte, R4 contains the address of the data to be entered in the field, and R5 contains the length of the data. The attribute character parameter is optional.

The subroutine could convert row and column buffer addresses relative to one to decimal offsets relative to zero with the following formula:

```
Model 1 Buffer:      ((R-1)X40)+(C-1)
Models 2, 3, 4 Buffer: ((R-1)X80)+(C-1)
```

If the row and column buffer addresses relative to one are in two single-byte areas in binary, the conversion to binary offsets relative to zero can be coded as follows:

```
SR      R3,R3
IC      R3,COLUMN
BCTR    R3,0
SR      R4,R4
IC      R4,ROW
BCTR    R4,0
MH      R4,=H'40' USE VALUE OF 80 FOR MODEL 2
AR      R4,R3  RESULT IN R4
```

The following subroutine converts a binary halfword that represents the offset relative to zero of a position in a 3270 buffer to an equivalent 2-character 3270 address. R3 is a work register, and R4 points to the binary halfword to be converted. The converted result is found at ANSWER.

```
LH      R3,0(R4)
STC     R3,ANSWER+1
SRL     R3,6
STC     R3,ANSWER
NI      ANSWER+1,X'3F'
TR      ANSWER(2),TAB
.
.
.
ANSWER DC X'0000'
TAB    DC X'40C1C2C3C4C5C6C7C8C9A4B'
       DC X'4C4D4E4F50D1D2D3D4D5D6D7'
       DC X'D8D95A5B5C5D5E5F6061E2E3'
       DC X'E4E5E6E7E8E96A6B6C6D6E6F'
       DC X'F0F1F2F3F4F5F6F7F8F97A'
       DC X'7B7C7D7E7F'
```

### ***Large Screen Size***

Application programs written for systems that use 480- or 1920-character screen size will run on large screen displays. Terminals with large screen capacity (960, 2560, 3440, and 3564 characters) will automatically default to smaller screen size

unless the large screen size has been specified explicitly by the application program. The Erase Write Alternate command is used to switch a display into large screen mode.

Since buffer address wrapping is screen size dependent, application programs should not depend on buffer wrap during write operations. Also, field attributes must be appropriately placed to delimit the end of the screen image.

### ***3274 Copy Function***

The 3274 Control Units operating in BSC mode can only process the Copy command. However, the 3274 can also handle the local copy function as follows:

1. Local copy can be initiated by using the Print key and the print authorization matrix. A local copy involves the transfer of data directly from the display buffer to the printer buffer and its subsequent printing.
2. The host can initiate a copy via the print authorization matrix by setting the start-print bit in the WCC of a write command.

Refer to "Local Copy Function" in Chapter 2.

## Chapter 8. The Response Time Monitor (RTM) and 3274 SNA Alert Functions

### The Response Time Monitor Function

As networks become larger and more complex, many installations are having more and more difficulty effectively managing them. When components within these networks change due to installation of such functions as automatic switching from a telephone line to a satellite link, a new routing table, or a new version of software in one of the nodes, a display station operator may notice a significant improvement or degradation in response time. When response time increases and a complaint is registered with the network management desk at the host, the network manager has no way of verifying the problem.

The objective of the 3274 Response Time Monitor (RTM) function is to provide a means for the installation to manage the network by differentiating between a good and a bad response time as well as a response time that is questionable. The RTM function accurately measures and records the transaction times of inbound host attention (AID) operations from display stations that communicate with the host. Depending on how the 3274 is customized, the RTM function allows the RTM information to be obtained either by a network management application in the host, by a subsystem display station operator, or both.

### 3274 and Host Requirements

The RTM function is supported by 3274 microcode Configuration Support C and D only. The function requires microcode support in the control unit and a hardware timer adapter card (installed in the control unit) that can be read by this microcode. *Note that the distributed function device interface is supported by Configuration Support D only.* (An example of a distributed function device is the 3290 Information Panel.)

The RTM function is available on 3274 Control Unit Models 31A, C, and D; 41A, C, and D; 51C; and 61C. Configuration Support D also requires a 2-sided diskette and 192K bytes of storage. Note that for BSC and for non-SNA local channels, no host interface is available and therefore RTM operates in the 3274 subsystem only.

The timer adapter card provides a time-base generator that increments a 16-bit counter every 25 milliseconds. This furnishes the microcode with about a 27-minute interval with which to measure the host's response to AID-generating keys and other operator actions such as a selector-pen-immediate detect or an MSR/MHS auto-enter operation. The timer adapter card also provides a 16-bit register for the alert function that is *not* reset when the control unit is IMLed. The register is reset, however, when the 3274 is powered off.

No specific host support is required. RTM has a host interface for SNA communications. Although IBM does not provide host support programming at this time, it is IBM's intent to provide host programming support for the IBM 3274 Response Time Monitor function. When introduced, the support will be an offering that will run on the IBM System/370, 4300, 303X, and 308X products. It will collect response time data from the 3274 in SNA mode and will display that information to network operations personnel. Further information on the availability of this package will be provided at a later date.

No host programming is required to use the 3274 Response Time Monitor function for 3270 subsystem display of response times.

## Supported Devices

The RTM function measures response times for all attached 3178, 3277, 3278, and 3279 display devices. Because printers are output devices only, RTM statistics are not kept for them.

A distributed function device *interface* is also supported. This allows response time measurement for devices that process their own data streams (distributed function devices such as the 3290 Information Panel).

## RTM and Response Time Definitions

When the RTM function is customized in the 3274, a series of five counters (Figure 8-1) is allocated for each configured device or logical terminal representing intervals of time into which the various response times are mapped. During the customizing process, up to four counters may be set up by specifying the maximum times, or boundaries, associated with each. If a response time is less than or equal to a particular boundary, the counter associated with that boundary is incremented at the end of the transaction. If not, the next boundary value is checked. If the response time does not fit within any of the boundaries, then it is mapped into the fifth, or overflow, counter. Should any one of the four boundaries be specified as the maximum, the counter associated with that boundary becomes the overflow counter and subsequent counters are ignored. By specifying boundary values properly, a customer is able to obtain a distribution of his network responses for each logical terminal.

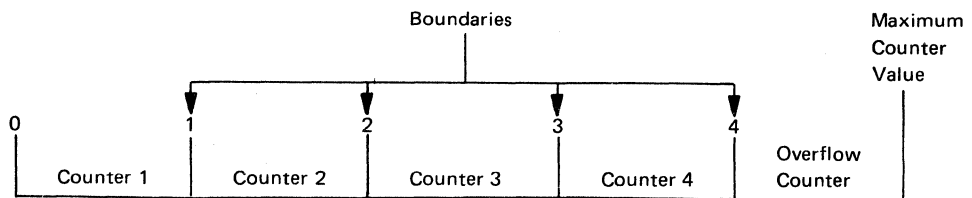

Figure 8-1. Counters and Boundaries

Boundaries must be specified in order of increasing magnitude. The maximum boundary value is 27 minutes, 18.3 seconds. The maximum counter value is 65,535. The counter will not wrap around when this value is reached. If any of the boundaries is set to the maximum boundary value, the counter associated with it becomes the overflow counter. The customizing default boundaries are 1, 2, 5, and 10 seconds.

The total response time is also kept for each logical terminal. Each time a counter (including the overflow counter) is incremented, the corresponding transaction time is added to a total-time register for that device. By dividing this total time by the total number of transactions, the average response time may be calculated. This average response time is available only through the host application; it is not displayable by the 3270 subsystem.

Response time is measured from recognition of the inbound AID request in the 3274 until the end of the transaction. The end-of-transaction parameter is defined for all devices when the 3274 is customized. When the 3274 is attached via an SNA protocol, response time is measured on the LU-LU flow only; none is measured for the SSCP-LU session.

The end-of-transaction parameter may be defined as one of the following:

- **FIRST CHARACTER:** The measurement is terminated when the first character of the next outbound message is written to the device. Note that this character can be (1) an EAU, E/W, E/WA command, (2) an EUA or SBA order, (3) a Load PS or Erase Reset function, (4) reset MDT, or (5) actual data for the device buffer. Note also that a Write with no data terminates the RTM measurement. The foregoing are examples of outbound communication that could possibly be expected to modify the contents of the presentation space.
- **KEYBOARD USABLE:** The measurement is terminated when the next outbound operation (other than READ) to that device contains a WCC or EAU command and the operation has been processed by the 3274. The operator is then able to use the keyboard.
- **CD/EB:** This definition is only valid in an SNA environment. The measurement is terminated upon receipt of a Change Direction (CD) or End Bracket (EB) which puts the device into send or contention state, respectively. This is usually equivalent to a "time-to-last-character."

**Notes:**

1. EB and CD received in an exception or definite response request cause measurement to be terminated on LIC (last in chain).
2. CD with a Read does not stop the timer.

## ***RTM Logs***

Display stations that may display RTM logs are the 3178, 3278, and 3279 display stations.

Via customizing, viewing of RTM logs by the display station operator may be specified as (1) no ports, (2) port 0 only, or (3) all ports. The operator is able to view the entire RTM log when an authorized display station is in test mode.

*Display or reset of RTM logs is not available on distributed function devices.*

The operator of an authorized display station can retrieve and display the RTM logs of all configured devices. See "Operator Procedures" in this chapter for a description of the procedure.

A hard copy of the display may be obtained by use of the Local Copy function.

When the host interface is not customized in the 3274, the operator of an authorized display station can reset the RTM logs of all configured devices. See "Operator Procedures" in this chapter for a description of the procedure. All log information is reset except the customized boundaries, the customized RTM definitions, any pending transaction status, and the last transaction time. (If the RTM-started flag is set, the response time for that transaction will still be measured.) *The RTM logs can be reset at any time during their display.*

## RTM Log Display Format

RTM log information is displayed as in the example shown in Figure 8-2. The entire screen is protected and the second line is displayed in high intensity.

```

A4/1                               @ = 000
@ DEF  CTR#1  BDY#1  CTR#2  BDY#2  CTR#3  BDY#3  CTR#4  BDY#4  OV
00  1      10    0.5 11,415   1.0   316   5.0   21  1:00.0   6
01p 1      0     0.5 0        1.0    0    5.0    0  1:00.0   0
02 ? 1     651   0.5 0        1.0    0    5.0    0  1:00.0 14,458
03  2     215   0.5 512    1.0    56   5.0    0  1:00.0   1

04i 1 *    31    1.0 11     2.0 4,371  5.0    4  10.0    2
05_ 1      0     0.5 0        1.0    0    5.0    0  1:00.0   0
06 *3      1     1.0 61     2.0    4    3.0    0   4.0    45
07 *1 * 1,415  0.5 890    1.0   323  5.0    0  1:00.0 1,381
  
```

**Note:** The example shows representative information for the first eight logical terminals. Each time the ENTER (or PA1) key is pressed, the next group of eight terminals is displayed. The heading, @ = XXX, in the top center of the display corresponds to the first logical terminal number in the group currently being displayed (000, 008, etc.).

An * is displayed in the DEF column when a definition is changed by the host. In the example, the definitions of logical terminals 06 and 07 were changed.

Also, an * is displayed in the CTR#1 column if any of the *boundaries* are changed by the host. In the example, one or more boundaries were changed for logical terminals 04 and 07.

### Abbreviations and Definitions of Symbols

CTR = counter  
 BDY = boundary  
 @ = device or logical terminal  
 OV = overflow  
 p = printer (No statistics are kept for printers.)  
 i = distributed function device  
 _ = never powered on (No statistics are kept.)  
 * = parameter set by the host. An * preceding the response time definition indicates that the definition has been changed by the host. An * following the definition indicates that the boundary values have been changed by the host.  
 ? = RTM disabled by host, or by customizing, for this device  
 DEF = response time definition:  
     1 = time to first character on screen  
     2 = time to keyboard usable by operator  
     3 = time to CD (Change Direction)/EB(End Bracket)  
 CTR#1 = first counter (response time = 0 up to BDY #1 value)  
 BDY#1 = first boundary in minutes and seconds  
 CTR#2 = second counter (response time greater than BDY #1 up to BDY #2 value)  
 BDY#2 = second boundary in minutes and seconds  
 CTR#3 = third counter (response time greater than BDY #2 up to BDY #3 value)  
 BDY#3 = third boundary in minutes and seconds  
 CTR#4 = fourth counter (response time greater than BDY #3 up to BDY #4 value)  
 BDY#4 = fourth boundary in minutes and seconds  
 OV = overflow (response exceeds last boundary value)

Note that displayed boundaries are rounded to the nearest tenth of a second.

**Figure 8-2. Display of an RTM Log**

## Last Transaction Time Indicator

Display stations that can display the last transaction time indicator (LTTI) are the 3178, 3278, 3279, and 3290 display stations.

The last transaction time indicator may be displayed by the operator at an authorized display station by performing the procedure given in "Operator Procedures." (A display station can be authorized by customizing or by the host.)

For each transaction, the LTTI is displayed in one of two formats. The format depends on the transaction time measured; less than 1 minute, or more than 1 minute. The LTTI is displayed in locations 21–27 of the operator information area and appears as either:

clock: ss.s —  :00.0 — when the transaction time is less than 1 minute.

clock mm:ss —  00:00 — when the transaction time is 1 minute or more.

ss = seconds, .s = tenths of a second; mm = minutes.

**Once enabled, the last transaction time indicator is updated each time the operator performs a host attention (AID) operation.** Updating continues until the last transaction time indicator is erased by one of the following actions:

- The device (or control unit) is powered off.
- The operator repeats the steps described under the heading "Displaying the Last Transaction Time Indicator."

If the host revokes authorization of the last transaction time indicator after it has been enabled by the operator, the indicator continues to be displayed until the next host attention operation from that logical terminal. At that point, the clock symbol remains displayed but the time is erased from the screen. The last transaction time indicator (the clock symbol and time) will again be displayed when authorized by the host.

If the host revokes authority and then reinstates it before a host attention operation is performed from that logical terminal, the indicator will remain active.

When the ability to display the last transaction time indicator is revoked by the host and the operator performs the sequence described in "Operator Procedures," the clock symbol is erased. If the operator performs the sequence while unauthorized, only the clock and the colon (  ) are displayed in the operator information area.

If the host reauthorizes the last transaction time indicator after it is erased by the operator, there is no indication at the display station that authority has been reinstated.

If a communication check occurs, the last transaction time indicator is replaced by the communications reminder indicator. When communications are again established, the communications reminder indicator is erased, and the last transaction time indicator is again displayed.



## Customizing

Customizing support is required for the RTM feature. During customizing of the 3274 Control Unit, panels are displayed to permit the customizer to specify various RTM feature parameters. The customizer must enter the following RTM information:

1. **How RTM is configured.** Possible responses are:

- RTM is not configured.
- RTM is configured, with *no* host support (SNA and non-SNA). On port 0 only, the operator is authorized to: (1) display RTM log information in test mode and (2) display the last transaction time indicator. The authorized operator may also reset the RTM data via the A4/4 test.
- RTM is configured with *no* host support (SNA and non-SNA). On all ports, the operator is authorized to: (1) display RTM log information in test mode and (2) display the last transaction time indicator. All operators may reset the RTM data via the A4/4 test.
- RTM is configured *with* host support (SNA only). No subsystem display of RTM log information or last transaction time indicator is authorized.
- RTM is configured *with* host support (SNA only). On port 0 only, the operator is authorized to: (1) display RTM log information in test mode and (2) display the last transaction time indicator.
- RTM is configured *with* host support (SNA only). On all ports, the operator is authorized to: (1) display RTM log information in test mode and (2) display the last transaction time indicator.

**Note:** Authorization to display RTM log information given by the latter three responses may be altered by the host at any time. These responses are applicable to SNA networks only.

2. **How RTM is defined.** Possible responses are:

- Time from host attention key until the first character is displayed on the screen.
- Time from host attention key until the keyboard is usable by the operator.
- Time from host attention key until receipt of Change Direction (CD) or End Bracket (EB) (SNA only).

The first parameter (How RTM is configured) specifies where the system performance data will be displayed. The second parameter (How RTM is defined) specifies what is to be timed by the RTM feature.

3. **Status flag field.** This is an 8-position flag field that is displayed only when host support is configured. The customizer must specify the status he wishes to set. The format is:

WWWWWWWW

where:

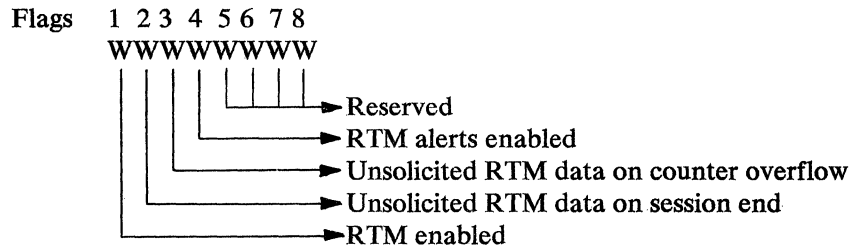

**Notes:**

1. If no host interface is customized, the status flag field is not displayed. Flags 1 and 4 are defaulted on in each RTM log for each device. Positions 5, 6, 7, and 8 are reserved at this time.
2. If you customize for the host interface and let the defaults for the status flag field stand (the defaults are all functions off), RTM statistics will *not* be kept for any device until a host application enables the RTM function.
4. **Boundaries.** The customizer must specify the boundary values. There are four of these boundaries and the format of each is:

mm:ss.s

where:

mm:ss.s = response time boundaries in minutes and seconds at tenth-of-a-second intervals up to a maximum of 27 minutes 18.3 seconds.

The four boundaries will initially be set to the default values of 1.0, 2.0, 5.0, and 10.0 seconds. The customer may accept the default values or enter his own boundaries. These values must appear in ascending order. No boundary may exceed the maximum of 27 minutes 18.3 seconds. If less than four boundary values are defined, definition must begin with the first boundary. At least one boundary must be defined.

The customized values are applicable to all devices attached to the control unit unless changed by the host.

See the appropriate 3274 customizing guide for procedures.

(See the paragraph concerning host support under the heading "3274 and Host Requirements" at the beginning of this chapter.)

### ***RTM Host Interface***

Using the request/response unit (RU) formats given at the end of this section, an SNA host application program can communicate with the RTM feature in the 3274 and can solicit RTM information from:

- One logical unit (LU)
- All LUs
- All LUs with nonzero RTM data

The host application program can reset the RTM logs. Also, the host application program may change the parameters affecting collection of RTM information by updating the following on a one-or-all LU basis.

- Set RTM boundaries
- Set RTM definition code
- Enable/disable subsystem display of RTM logs and last transaction time indicator
- Activate/deactivate RTM data collection
- Return unsolicited data when a session ends
- Return unsolicited data when a counter overflows
- Activate/deactivate RTM alerts when an RTM counter overflows

Note that an ACTPU/DACTPU will set the potential lost data flag in the 3274 response RU, but will *not* cause the control unit to revert to the customizing defaults for RTM parameters.

#### **Solicited RTM Information**

When the 3274 Control Unit is customized to support the host interface for RTM information and a request is made to the 3274 on an SSCP-PU session via a host request containing an RTM major vector, the 3274 examines the request. If the request is accepted, a positive response is returned to the host. If the host request does not solicit any data, the 3274 considers the request completed after sending the positive response and updating the appropriate RTM logs, and reverts to contention state.

If the host request is soliciting information, one or more 3274 responses are then returned to the host as the solicited response(s). Each of these responses contain data pertinent to a specific LU attached to the 3274. If the reset bit is included in the request, the RTM data for that LU is reset upon transmission of the record. This reset function includes the RTM counters (including overflow) and the total transaction time. It excludes the last transaction time and any pending transaction time. If the host gives a negative response, the counter information is lost.

If an outbound request is intended for a specific LU, it must contain an SNA address list with one element providing the 3274 with the local address of the LU. Each inbound request contains an SNA address list with two elements: the first element provides the local address of the SLU; the second element provides the local address of the associated PLU. Inclusion of local addresses in the inbound RUs allows the host RTM application program to correlate response time data with the associated PLU and SLU session pair. Translation of the addresses into 8-byte EBCDIC names is the responsibility of one or more upstream nodes.

A session correlation vector is also returned with the RTM data that is unique to each session pertaining to a specific 3274. This allows a host application program to determine the appropriate session pair *after* that session has been unbound, provided that the application program was able to determine the session identity previously.

The RTM data is only collected when a device is in an LU-LU session. When unsolicited RTM transmission on UNBIND is not supported, the data associated with each logical terminal may pertain to multiple LU-LU sessions. Should multiple session data be present, a flag is set in the appropriate RTM log indicating this. The flag is reset when the RTM data is sent inbound. Note that the session correlation number is updated upon acceptance of each BIND for that LU.

Should a counter-overflow occur, collection of RTM data for that logical terminal is suspended until the RTM data is reset. This is done when a host request is received from the host for that terminal (or all terminals) containing a Reset vector or when a request is received that changes the boundaries or definition for that LU, or when data is sent unsolicited to the host.

When the host requests RTM data from a specific LU whose RTM data is zero, all the RTM data is returned for that device. The no-data flag is not set. This provides the host application program with the ability to determine the actual parameters associated with a given LU, regardless of the data contained in its RTM log.

When the host requests only nonzero RTM data from all LUs, only those LUs with nonzero RTM data will respond, except for the last LU which will respond regardless of its RTM data content.

While a request unit (RU) is in process, additional REQMS or RTM requests are rejected by the 3274 until a positive or negative response is received for the transmitted RU. Also, if the 3274 is busy processing an unsolicited alert or RTM response, the PU is in send state and any requests from the host are rejected until the unsolicited operation is completed and a response is received for the transmitted responses.

### **Unsolicited RTM Information**

Besides allowing solicited information to flow on the SSCP-PU session, the 3274 may be customized, or enabled by the host, to transmit unsolicited RTM information when UNBIND is processed for an LU-LU session or when an RTM counter overflows. When one of these conditions occurs, the associated RTM information is scheduled within the 3274 for transmission to the host RTM application program on the SSCP-PU flow. Once transmitted, the data for that logical terminal is reset.

If the transmission was caused by an RTM counter overflow, a flag is set in the RTM data to indicate the potential loss of data. If the transmission was caused by an UNBIND and another BIND is accepted for that logical terminal before the RTM information can be transmitted, additional responses are discarded until the RTM data is transmitted. The session correlation vector is updated after the RTM information is transmitted. A potential loss of data because of the new BIND is indicated in the next RTM transmission (not the transmission just sent).

Should a solicited response be pending when a session unbinds or a counter overflows, flags will be set in the RU to indicate the multiple reasons for returning data, and only *one* RU will flow. Data will be reset upon transmission, regardless of whether the reset bit was included in the host RTM request.

## Negative Responses

The following negative responses may be returned in response to a host RTM request:

**1003 Negative Response.** An NS (network services) header was received but it was neither REQMS nor RTM. The request is rejected and error recovery is the responsibility of the sender.

**1007 Negative Response.** An invalid NS header or unsupported NS category was received. The request is rejected and error recovery is the responsibility of the sender.

**0815 Negative Response.** Another REQMS or RTM request was in process in the 3274 when this request was received. The request is rejected and error recovery is the responsibility of the sender.

**081B Negative Response.** A host RTM was received while the 3274 was in send state processing an unsolicited RU. The request is rejected and error recovery is the responsibility of the sender.

**0835 Negative Response.** An invalid parameter was contained in the host request. Two bytes of user sense data are included in the response indicating the byte in the request that caused the rejection. If more than one byte is invalid, only the position of the first byte that is determined to be invalid is returned.

The response has the form 0835 00XX, where XX is the position of the byte in the request that caused the rejection by the 3274. Note that XX will vary depending on the inclusion of optional subvectors within the RU.

Only certain checks will be performed by the 3274. Others are considered "sender" checks and indeterminate results will occur if they are received. See "Host Request and 3274 Response Formats" for the bytes that are checked by the 3274.

## ***Distributed Function Device Interface***

The 3274 provides an interface for distributed function devices to support the RTM function. However, since such devices are responsible for their own keystroke and datastream processing, RTM support is also required in these devices.

When a distributed function device indicates that one or more of its logical terminals is online to the host, the 3274 issues a command indicating the RTM definition and the authorization to display the last transaction time indicator to *each* of these active logical terminals.

When an operator initiates a host attention operation on one of these logical terminals, the device sends status to the 3274, indicating that the 3274 should start an RTM measurement. After processing the resulting data stream, the device sends additional status to the 3274, indicating that the RTM measurement should be completed. The 3274 then updates its RTM log for that logical terminal and responds with the last transaction time for the operation, if so authorized. If the operator has enabled the last transaction time indicator for that logical terminal, the device then displays this time.

Each time a host request is received from the host application program that alters the definition or authority to display the last transaction time indicator for a particular logical terminal, the 3274 notifies the distributed function device of the change. The 3274 also provides status to each distributed function device (as well as the 3nn indicator), if the RTM adapter in the 3274 is no longer functioning properly.

### ***Host Request and 3274 Response Formats***

This section contains the SNA transmission header (TH)/request header (RH)/request unit (RU) formats for the host request and the solicited and unsolicited 3274 responses.

#### **Host Request Format**

The basic format of the host request is as follows:

TH  
RH  
RU  
    RTM Header  
    Length to End of RU  
    RTM Request Control Vector  
        SNA Address List (if required)  
        Target LU (if required)  
    RTM Request Vector  
    RTM Control Vector (optional)

Figure 8-3 shows the TH, RH, and RU definitions for the host request format.

Byte	Bit	Value	Meaning
TH0	0-3	X'2'	FID
	4-5	B'--'	MPF (segment)
	6	B'0'	Reserved
	7	B'0'	EFI
TH1	-	X'00'	
TH2		X'00'	DAF'
TH3		X'00'	OAF'
TH4, 5		X'0000'	SNF
RHO	0	B'0'	Request
	1-2	B'00'	FMD
	3	B'0'	Reserved
	4	B'1'	Format indicator
	5	B'0'	Sense data included
	6-7	B'11'	Chain state indicator
RH1	0	B'1'	Definite response 1
	1	B'0'	Reserved
	2	B'0'	Definite response 2
	3	B'0'	ERI
	4-5	B'00'	Reserved
	6	B'0'	QRI
	7	B'0'	PI
	RH2	-	X'00'
RU0	-	X'41'	RTM header
RU1	-	X'03'	
RU2	-	X'8D'	
RU3 RU4		X'0000'	Ignored (may be nonzero but not to be used)
RU5	0	B'0'	Reserved
	1	B'0'	Reserved
	2	B'0'	Ignored
	3	B'0'	Ignored
	4-7	-	PRID
RU6		-	PRID
RU7	0	B'0'	Reserved
	1	B'0'	Last RU
	2	B'0'	First RU
	3	B'--'	SNA address list indicator: 0 = No vector 1 = Vector describes specific LU
	4-7	B'0000'	Reserved
RU8	0	B'0'	No concatenation
	1-7	B'000 0000'	Remaining length of this RU
RU9	0-7	X'--'	
RU10 RU11		X'8080'	Code point for RTM major vector
RU12		X'0A'	Length of SNA address list if RU7 bit 3 = 1
RU13		X'04'	Code point SNA address list
RU14		X'01'	Number of TAFs

Figure 8-3 (Part 1 of 3). TH, RH, and RU Definitions for the Host Request

Byte	Bit	Value	Meaning
RU15 thru RU20 RU21		X'0000 0000 0000 aa'	Target address: 7 bytes aa = local destination address (DAF')
RU22		X'04'	Length of RTM request vector
RU23		X'92'	RTM request vector key
RU24	0 1 2 3 4 5-7	B'-' B'-' B'-' B'-' B'-' B'000'	0 = No reset 1 = Reset data upon reply transmission (or immediately if no reply is expected) 1 = Retrieve data/status for all LUs with nonzero counts 1 = Retrieve data/status for all LUs 1 = Retrieve data/status only of target LU 0 = Apply RTM control vectors to LU specified in SNA address vector 1 = Apply to all LUs Reserved
RU25		X'00'	Reserved
RU26		X'...'	Length of RTM control vector
RU27		X'94'	RTM control vector key
RU28          RU29	0 1 2 3 4 5 6 7 0 1-7	B'-' B'-' B'-' B'0' B'-' B'-' B'0' B'-' B'-' '0000000'	STATUS/PARAMETER CHANGE 1 = Activate/deactivate status 1 = Unsolicited on session end 1 = Unsolicited on counter o'flo 1 = Unsolicited on time interval 1 = RTM definition code 1 = RTM boundaries 1 = Unsolicited on BIND 1 = Subsystem display enable/disable 1 = Activate/deactivate RTM alert Reserved
RU30          RU31	0 1 2 3 4 5 6 7 0 1-7	B'-' B'-' B'-' B'0' B'-' B'-' B'0' B'-' B'-' '0000000'	STATUS INDICATORS 1 = Activate RTM; 0 = Deactivate RTM 1 = Unsol on session end; 0 = No 1 = Unsol on counter o'flo; 0 = No 1 = Unsolicited on time interval 1 = RTM definition to be set; 0 = No 1 = RTM boundaries to be set; 0 = No 1 = Unsolicited on BIND 1 = Enable subsystem display; 0 = Disable subsystem display 1 = Activate RTM alerts; 0 = Deact. Reserved
RU32		X'00'	Reserved
RU33		X'xx'	Ignore (Unsol in time interval)
RU34		X'00' X'01' X'02' X'03'	RTM DEFINITION Reserved First character on screen Keyboard usable CD/EB Other code points reserved

Figure 8-3 (Part 2 of 3). TH, RH, and RU Definitions for the Host Request



Byte	Bit	Value	Meaning
RU35		X'00'	RTM time increment = 100 msec.
RU36 thru RU41		X'00'	Reserved
RU42	0-3 4-7	B'0000' B'0----	Reserved Number of boundaries (1-4)
RU43 RU44		X'----	Boundary, if appropriate (Must be in increasing value)
RU45 RU46		X'----	Boundary, if appropriate
RU47 RU48		X'----	Boundary, if appropriate
RU49 RU50		X'----	Boundary, if appropriate

Figure 8-3 (Part 3 of 3). TH, RH, and RU Definitions for the Host Request

**Abbreviations Used in Figures 8-3 and 8-4**

ACTPU	Activate Physical Unit
CD	Change Direction
DAF'	Destination address field prime (local address of SLU)
deact	Deactivate
EB	End Bracket
EFI	Expedited flow indicator
ERI	Exception response indicator
FID	Format identification
FM	Function management
FMD	Function management data
LU	Logical unit
MPF	Mapping field
OAF'	Origin address field prime (local address of PLU)
o'flo	Overflow
PI	Pacing indicator
PLU	Primary logical unit
PRID	Procedure-related identifier
PU	Physical unit
QRI	Queued response indicator
RECFMS	Record Formatted Maintenance Statistics
REQMS	Request Maintenance Statistics
resp	Response
RH	Request/response header
RTM	Response Time Monitor
RU	Request/response unit
SLU	Secondary logical unit
SNA	Systems Network Architecture
SNF	Sequence number field
sol	Solicited
SSCP	System services control point
TAF	Target address field
TH	Transmission header
TS	Transmission services
unsol	Unsolicited
vect	Vector

Bytes checked by the 3274 in the host request (Figure 8-3) are as follows:

Bytes	Negative Response	Potential Problem
0-1	1007	Request contained an invalid network services (NS) header.
2	1003	Not an REQMS/RTM request.
7	0835	Only bit 3, SNA address list present, can be set.
9	0835	Invalid remaining length.
10-11	0835	Unsupported major vector.
12	0835	Invalid length for SNA address list.
13	0835	Byte 7, bit 3, indicated that an SNA address list is included when, in fact, it is not.
14	0835	More than one TAF.
15-20	0835	Reserved. All bits must be off.
21	0835	Invalid target address.
22	0835	Invalid subvector length.
23	0835	Invalid or unsupported subvector.
24	0835	Bits 3 or 4 specify a target LU, but the request does not contain a local address. Bits 5-7 are reserved and must be off.
25	0835	Reserved. All bits must be off.
26	0835	Invalid subvector length.
27	0835	Invalid or unsupported subvector.
28	0835	If bits 3 or 6 are set, bit 5 indicates setting RTM boundaries, but byte 42, number of boundaries, is missing.
29	0835	If bit 0 is set and alert is not customized, or if bits 1-7 are set.
30	0835	If bits 3 or 6 are set.
31	0835	If bit 0 is set and alert is not customized, or if bits 1-7 are set.
32	0835	Reserved. All bits must be off.
34	0835	Unsupported RTM definition (RU30 bit 4 = 1).
35	0835	Unsupported RTM time increment.
36-41	0835	Reserved. All bits must be off.
42	0835	Invalid number of boundaries or bits 0-3 are reserved and must be off.
43-50	0835	Boundary was greater than 3FFF or bytes are not in ascending order.

Note that the byte positions contained in the 0835 negative responses assume the presence of an SNA address list and therefore, if one is not present, byte positions will be adjusted accordingly.

#### Notes for Figure 8-3:

- The 3274 SSCP-PU session is defined as FM profile 0 and TS profile 1 (half-duplex definite response). Should the 3274 transmit an inbound message, it will wait for a response (positive or negative) before transmitting or receiving additional messages on that session. If a response is somehow lost by the network, no other SSCP-PU activity will be possible without first receiving an ACTPU. Data may be lost during recovery.

- Because of the characteristics of the SSCP-PU session, the 3274 defaults to contention state. Should an alert, 3274 RTM response, or RECFMS be queued for inbound transmission, the 3274 will go into send state and reject all outbound messages on that session until that message is transmitted and a response is received. Error recovery is the responsibility of the upstream node.
- If the 3274 receives a host request with RU28 bits 3 or 6, RU29 bits 1–7, or the corresponding bits in RU30–31, it will reject the request.
- RU-33 is ignored.
- All other bytes are considered “sender checks” and indeterminate results will occur if there are problems within them.
- RTM statistics are only accumulated for devices while they are in LU-LU sessions (SNA only).
- The RTM control vector key (X'94') and RTM request vector key (X'92') are applied immediately if no inbound RUs are to flow. Otherwise, they are applied after the requested data for each LU has been transmitted, not after the response has been received. The current data is reset if RU24 bit 0=1 in the request vector key. In addition, if boundaries or the definitions are changed without requesting the current data, the data is reset.
- If unsolicited-on-UNBIND or counter-overflow is enabled either by the host RTM application program or as a 3274 customizing option, the RTM data for each LU is reset upon transmission.
- If unsolicited-on-UNBIND is not enabled, the RTM counters are not reset upon receipt of a BIND. It is a host RTM program responsibility to solicit the RTM data before the counters overflow.
- The 3274 requires that the RTM request vector key (X'92') precede the optional RTM control vector key (X'94'). If a host request is received with the RTM control vector key first, the host request is rejected.

### 3274 Responses Format

The basic format of the 3274 solicited and unsolicited response is as follows:

```

TH
RH
RU
  RTM Header
  Length to End of RU
  RTM Data Reply Vector
    SNA Address List
    Target LU
    PLU Associated with Target LU
    Data Reset Flag Vector (if required)
    RTM Status Response Vector
    Relative Time Vector
    RTM Data Vector (if required)

```

Figure 8-4 shows the SNA TH, RH, and RU definitions for the solicited and unsolicited 3274 response.

Byte	Bit	Value	Meaning
TH0	0-3	X'2'	FID
	4-5	B'--'	MPF (segment)
	6	B'0'	Reserved
	7	B'0'	EFI
TH1	-	X'00'	
TH2		X'00'	DAF'
TH3		X'00'	OAF'
TH4, 5		X'0000'	SNF
RH0	0	B'0'	Request
	1-2	B'00'	FMD
	3	B'0'	Reserved
	4	B'1'	Format indicator
	5	B'0'	Sense data included
	6-7	B'11'	Chain state indicator
RH1	0	B'1'	Definite response 1
	1	B'0'	Reserved
	2	B'0'	Definite response 2
	3	B'0'	ERI
	4-5	B'00'	Reserved
	6	B'0'	QRI
	7	B'0'	PI
RH2	-	X'00'	Not applicable
RU0	-	X'41'	RTM header
RU1	-	X'03'	
RU2	-	X'8D'	
RU3, 4		X'0000'	Ignored
RU5	0	B'0'	Reserved
	1	B'0'	Reserved
	2	B'0'	Ignored
	3	B'0'	Ignored
RU6	4-7	B'----'	PRID from request (000 if unsolicited)
		X'--'	
RU7	0	B'-'	0 = Unsolicited; 1 = Solicited
	1	B'-'	0 = Last; 1 = Not last
	2	B'-'	0 = First; 1 = Not first
	3	B'1'	SNA address list included
	4-7	B'0000'	Reserved
RU8	0	B'0'	No concatenation
RU9	1-7	X'000 0000'	Remaining length of this RU
		X'25'	No DATA or RESET vectors
		X'27'	No DATA vector but RESET vector
		X'46'	DATA vector but no RESET vector
		X'48'	DATA and RESET vectors
RU10, 11		X'0080'	Code point for RTM data reply
RU12		X'11'	Length of SNA address list
RU13		X'04'	Code point SNA address list
RU14		X'02'	Number of TAFs
RU15 thru RU21 RU22 thru RU28		X'4000 0000 0000 aa' X'0000 0000 0000 pp'	TARGET ADDRESSES SLU local address: 7 bytes (40 = PLU follows)  aa = local destination address (DAF') PLU local address associated with above SLU address (OAF'): 7 bytes pp = OAF'

Figure 8-4 (Part 1 of 3). TH, RH, and RU Definitions for the 3274 Response (Solicited and Unsolicited)

Byte	Bit	Value	Meaning
RU29		X'09'	Length RTM status response vector
RU30		X'91'	RTM status response vector key
RU31	0 1 2  3 4  5-7	B'0' B'-' B'-'  B'-' B'-'  B'000'	<b>RESPONSE CODES</b> Reserved 0 = Data included; 1 = No data 1 = Specific RTM request for this LU, but RTM for this LU is not active 1 = First response for current LU-LU session 1 = BIND for new session received while in solicited mode only. Session data is combined. Reserved
RU32	0 1 2 3-7	B'-' B'-' B'0' B'00000'	<b>REASON FOR UNSOLICITED RESPONSE</b> 1 = Session end 1 = Counter overflow 1 = Time interval expired Reserved
RU33	0 1  2 3  4  5-7	B'0' B'-'  B'-' B'-'  B'-'  B'000'	<b>RESP CODE – POTENTIAL DATA LOSS</b> Reserved 1 = Counter overflowed All counters for LU frozen 1 = Control unit IMLed/ACTPU-Cold 1 = New session before data sent Potential loss of new data 1 = RTM definition/boundaries set without soliciting data; all old data lost. Reserved
RU34	0 1 2 3 4 5 6 7	B'-' B'-' B'-' B'0' B'-' B'-' B'0' B'-'	<b>STATUS INDICATORS</b> 1 = RTM active; 0 = RTM inactive 1 = Unsol on session end 1 = Unsol on counter overflow 1 = Unsol on time interval 1 = RTM definition set by host 1 = RTM boundaries set by host 1 = Unsolicited on BIND 1 = Subsystem display of logs enabled
RU35	0 1-7	B'-' '0000000'	1 = RTM alerts active Reserved
RU36 RU37		X'rraa'	Session Correlation Number rr = Number assigned at BIND by 3274 and incremented for each subsequent BIND for that LU: 00-FF with wrap. aa = LU subsystem address
RU38		X'07'	Length of relative time vector
RU39		X'42'	Code point for relative time vector
RU40		X'EF'	Sequence number; not time
RU41 RU42 RU43 RU44		X'-----' X'-----'	Sequence number Starts at 0000 0000 at IML; incremented for each record sent indicating order of transmission
RU45		X'21'	Length of RTM data vector
RU46		X'93'	RTM data vector
RU47		X'00' X'01' X'02' X'03'	<b>RTM DEFINITION</b> Reserved First character on screen Keyboard usable CD/EB Other code points reserved

Figure 8-4 (Part 2 of 3). TH, RH, and RU Definitions for the 3274 Response (Solicited and Unsolicited)

Byte	Bit	Value	Meaning
RU48		X '00'	RTM time increment = 100 msec.
RU49 RU50		X '00' X '00'	Reserved Reserved
RU51 RU52		X '0000'	Time interval from last data in seconds
RU53	0-3 4-7	X '4' X '-'	Number of boundaries returned Number of valid boundaries: 1-4
RU54, 55		X'----'	Boundary 1
RU56, 57		X'----'	Boundary 2
RU58, 59		X'----'	Boundary 3
RU60, 61		X'----'	Boundary 4
RU62, 63		X'----'	Counter 1
RU64, 65		X'----'	Counter 2
RU66, 67		X'----'	Counter 3
RU68, 69		X'----'	Counter 4
RU70, 71		X'----'	Overflow counter
RU72 RU73 RU74 RU75		X'----' X'----'	Total response time Includes time for all counters including overflow
RU76, 77		X'----'	Last transaction time
RU78		X '02'	Length of data reset flag
RU79		X '45'	Data reset flag vector key

Figure 8-4 (Part 3 of 3). TH, RH, and RU Definitions for the 3274 Response (Solicited and Unsolicited)

## The 3274 SNA Alert Function

The 3274 SNA alert function provides problem determination information, collected by the 3274 Control Unit or entered by an operator, to the Network Problem Determination Application (NPDA). NPDA is an IBM-written and owned application program that runs under control of the Network Communication Control Facility (NCCF) at the host computer.

There are four categories of events that result in the generation of problem determination information (alert messages) that are transmitted to the host (NPDA) by the 3274 Control Unit:

- Control unit errors
- Attached device errors
- Application program checks
- Operator-generated alert messages that call attention to situations not normally encountered.

The balance of this section provides background information on NPDA operation and 3274 model and configuration support requirements, host support requirements, and 3274 SNA alert function operational details.

## ***NPDA Background Information***

Version 3 of the Network Problem Determination Application (NPDA) provides the network user with problem determination information. This information is generated at resources (for example, programs and devices such as the 3274 Control Unit) that are both remote-attached and channel-attached to the host system. The problem determination information issued to the host consists of:

- Statistics, defined in NPDA as records of traffic and recoverable error counts that have been collected at certain resources and reported to the host system.
- Events, defined in NPDA as some unusual situation detected at the resource and reported to the host system. These reported situations are not necessarily errors or other undesirable incidents, but generally indicate the need for some form of attention or intervention. The event data is sent to the host system for NPDA both to store in its data base and to analyze to determine whether to issue and record an alert.
- Alerts, defined in NPDA as high-priority events that warrant immediate attention. They are directed to the Network Communication Control Facility (NCCF) operator or the NPDA operator.

**Note:** The current host alert support does not identify the source of alert messages below the physical unit (PU) level, e.g., the 3274. Therefore, all alert messages for a 3274 and attached devices will be stored in the NPDA data base under the 3274 name.

Alert generation is depicted in Figure 8-5, which shows the data flow through the NPDA statistical and alert processing functions. Statistical data received by NPDA is directed to a statistical processor and compared to a user-established error-to-traffic ratio. If it is found to be greater than the established threshold value, a performance event record is created, provided that the comparison process has been enabled by the user. The original statistical record is entered in the data base.

The performance event record is then processed by the alert processor (before entry into the data base) and an alert record **A** is formatted. This newly-generated alert record is directed to the NCCF operator and is also entered into the data base, provided that user-defined criteria (filters) have been met. (A filter is an NPDA facility that allows the user to prevent certain data from being recorded or from being viewed on a display. A filter can also be used to generate alert data from an event.)

Alerts are also generated from selected event data records. Figure 8-5 shows an event being processed by the alert processor (before entry into the data base) and the creation of an alert record **B** to be directed to the NCCF operator and entered into the NPDA data base.

The statistical records that supply error-to-traffic data and the event records that become alerts remain on the data base in their original form.

Alerts are stored in the NPDA data base and displayed (at the host) to the user in a reverse-chronological listing that may be viewed on several displays. Alert data is not organized by resource; records are presented only in reverse-chronological order.

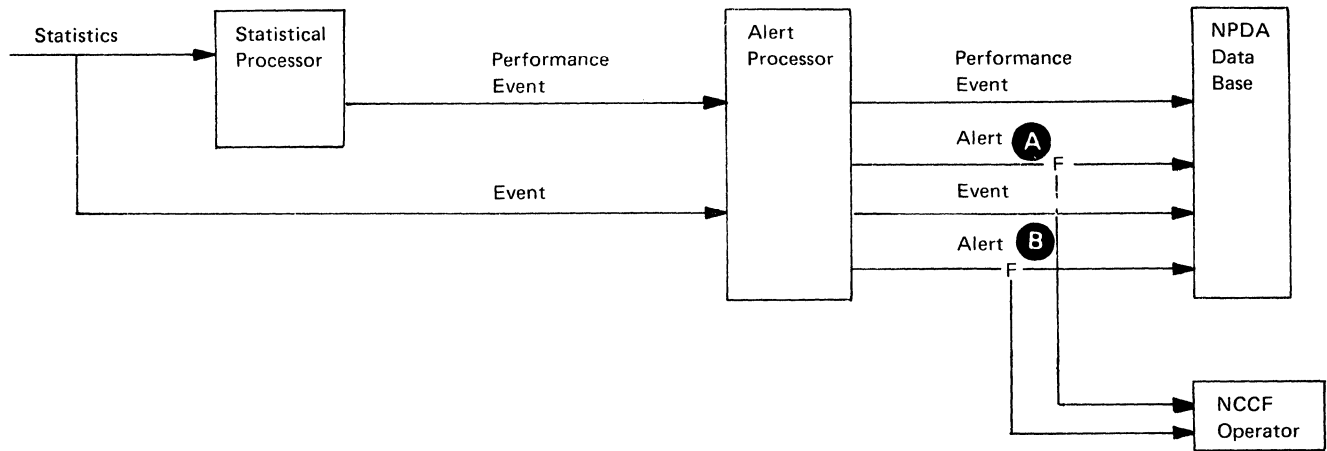

F = filter

**Figure 8-5. Concepts of Alert Generation**

Alert data can be retrieved from the data base for display by:

- Entering commands that retrieve specific types of alert displays
- Following an alert/event tracking sequence of displays that finally leads to a single event on the resource that caused the alert.

Alert data may be displayed in various presentations. The presentations pertinent to the 3274 alert function are described under the heading “Network Problem Determination Application (NPDA).” The alert data that is displayed to the NCCF or NPDA operator is determined by the filters specified by the display operator. Filters allow control of the flow of data from the resources to the data base and from the data base to the display. An NPDA user may not want to view all the data stored in the NPDA data base. By selective filtering, only alert data about specific terminals may be passed on to the display operator.

For more detailed background information on NPDA functions, see the following manuals:

*Network Problem Determination Application:*

*User’s Guide, SC34-2112*

*Installation, SC34-2117*

*Messages and Codes, SC34-2115*

*Recommended Action Guide, SC34-2113*

*How To Use Guide, SC34-2108*



## 3274 and Host Requirements

The alert function is available on channel-attached 3274 Models 1A, 31A, and 41A, and on remote-attached 3274 Models 1C, 31C, 41C, 51C, and 61C using SDLC protocol. All current device configurations are supported with the exception that distributed function devices (such as the 3290 Information Panel) do not support operator-generated alerts. (These devices do not support controller RAS tests.)

Version 3, Release 1 of the Network Problem Determination Application is required at the host.

3274 Configuration Support C or D is required.

The alert function does not require any hardware changes. However, if the Response Time Monitor (RTM) feature timer adapter card is installed in the 3274 Control Unit (not installable in Models 1A and 1C), the alert function is enhanced, permitting the detection of performance throughput degradation because of noisy coaxial cable and for microcode-detected catastrophic errors in the control unit. In the latter case, as long as the 3274 is not powered off, a subsequent IML will cause the 3274 to interrogate a 16-bit problem determination register on the RTM timer adapter card and generate an alert based on the information stored in the register.

## SNA Host Support

The SSCP-PU session is used to send alert data to the host (Figure 8-6). The alert information flows through the network to the access method and on through the Network Communication Control Facility (NCCF) to the Network Problem Determination Application (NPDA) program. NPDA maintains a data base of alert information based on filters currently in effect for devices throughout the network and allows customers to perform problem determination and failure isolation.

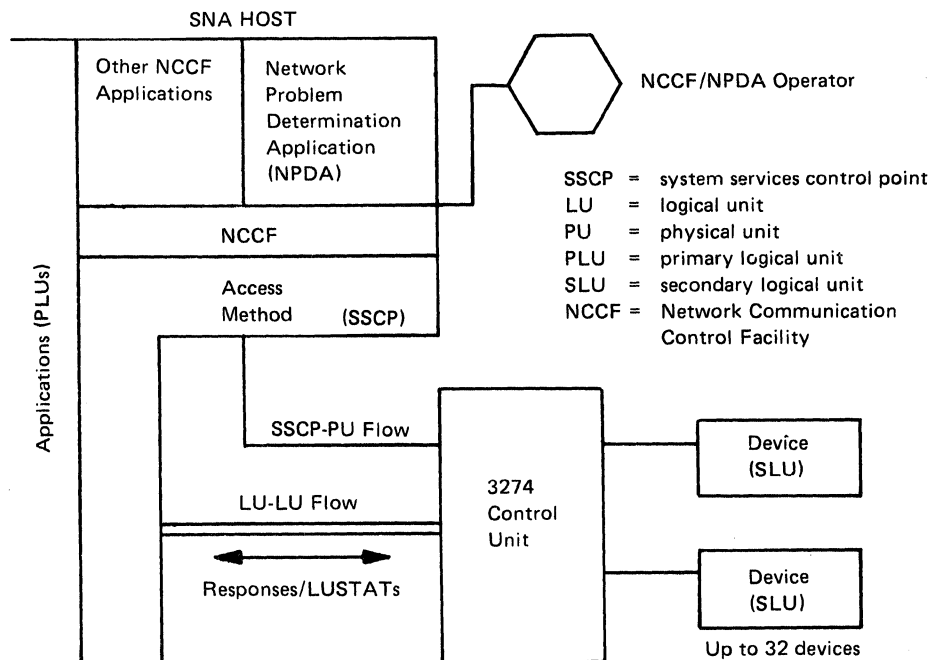

Figure 8-6. SNA Host Connection

## ***Network Problem Determination Application (NPDA)***

Alert messages transmitted by 3274s flow through NCCF into NPDA for additions to the NPDA data base or are displayed to an NPDA operator depending on the filters specified by that operator. Some of the information provided in the alert message can be used by a customer engineer (CE) to help determine field replaceable unit (FRU) isolation.

NPDA permits multiple display operators to view alert data. Further, NPDA permits each operator to specify, using filters, the alert data he wishes to monitor. Thus, a large network can have several people each monitoring selected portions of the network.

The example in Figure 8-7 shows that NPDA uses three basic screen presentations to aid the customer and CE in problem determination. These are as follows:

- Alert dynamic display

This display shows a reverse-chronological history of the alerts (the latest alert is at the top) of all elements or of a specific node that have been received most recently by NPDA and have met the filter requirements designated by a particular operator. Each alert occupies a line entry and specifies the date and time the alert was received and recorded in the data base, the originator's name and type, and a canned alert description of the potential problem. Included in the description is a probable cause statement. Other screens are selected from an input line on this display.

- Recommended action display

This display lists the possible reasons for a specific error condition. The most likely causes of the error condition are listed under three major categories: user-caused, install-caused, and failure-caused. Within each category the actions are shown in the most practical sequence of execution from the user's viewpoint. Each recommended user action in the display is preceded by a reference in the form 'Dxxx', where D indicates *documentation* and xxx is an *identifying number*. These references are listed in *Network Problem Determination Application: Recommended Action Guide*, SC34-2113. This manual contains additional information about each recommended action following the reference number. The user must consult this manual for a brief description of each action, a list of the different tools, service aids, etc., that apply to the action, and a reference to documents that provide detailed information about the action.

- Event detail display

This display shows a detailed description of the alert message and is primarily intended to provide a program support representative (PSR) or CE with additional information. It shows a hierarchy of resource names and types showing the path through the network to the alert originator. It also shows several modifiers provided by the originator explaining the type, general and specific causes, a user-action code, and the device's block ID. The display also provides for up to three 8-character qualifiers that can be used by the

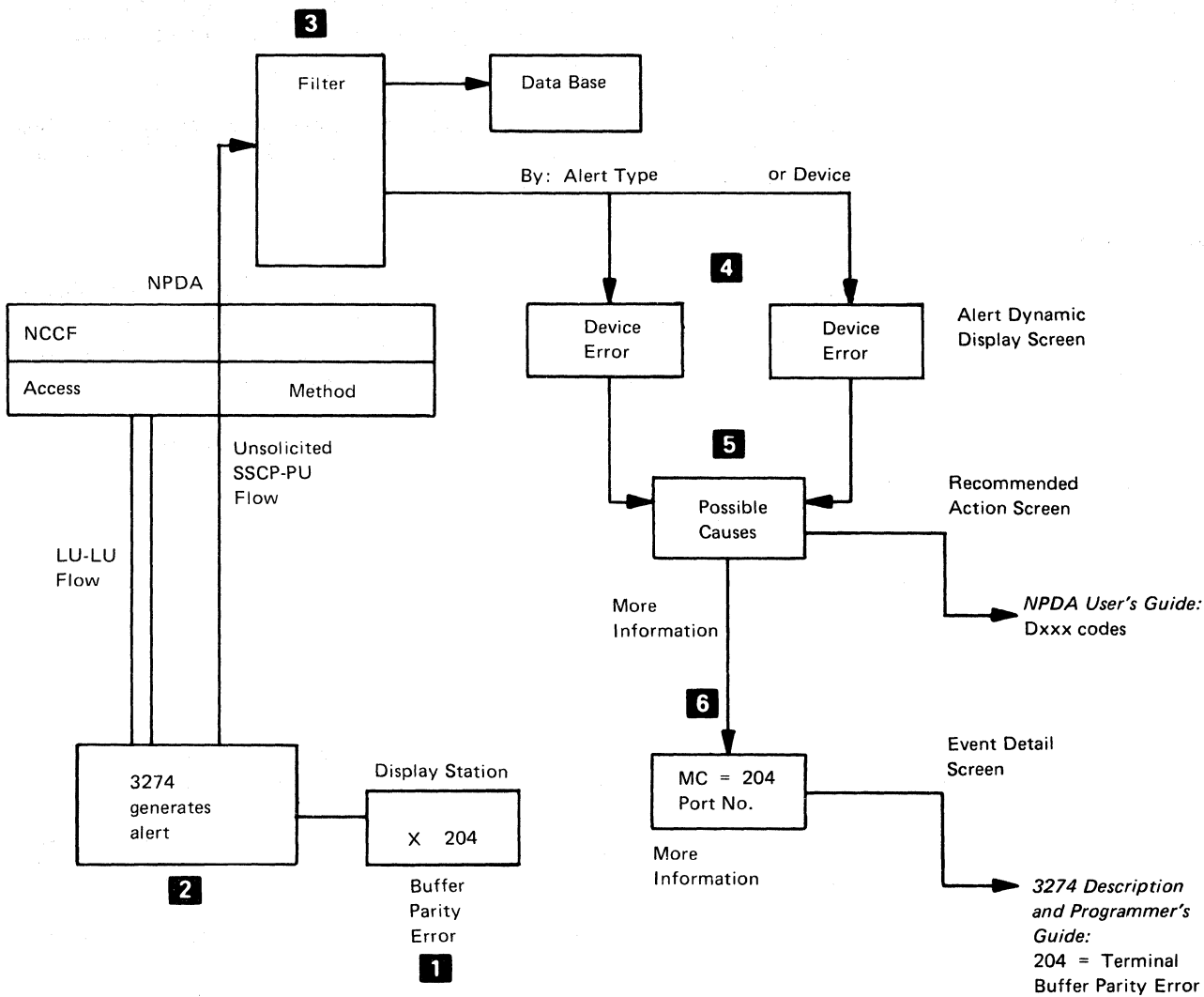

- 1** The 3274 detects a buffer parity error in the display station.
- 2** The 3274 generates an alert and sends it to host.
- 3** NPDA filters the alert. NPDA has filters by alert type:
  - What the operator sees
  - What is recorded in the data base
- 4** Alerts are displayed on the NPDA operator's display in reverse-chronological order on the dynamic display screen.
- 5** If more information is desired, the operator calls out the recommended action screen and consults the *NPDA User's Guide* to find the meaning of the Dxxx code.
- 6** If still more detailed information is desired, the operator calls out the event detail screen and consults the *3274 Description and Programmer's Guide* to find the meaning of X 204.

Figure 8-7. An Example of Alert Generation and Display

originator to further explain the problem. Finally, the display provides the ability to transmit a three-line text message from the originating physical unit (PU) to the NPDA operator.

Specific recommended action and event detail displays are selected for display to the NPDA operator based on the device type (for example, 3274) and the user-action code contained within the alert.

## ***Reportable Errors***

In normal operation, the 3274 causes three-digit error codes (*nnn*) to be displayed in the operator information area of the display screen. These codes follow the machine check, program check, and communication check symbols. These codes further define the error conditions indicated by the error symbols.

The first digit of the *nnn* error code indicates the type of error that occurred, as follows:

<b>Error Code</b>	<b>Type of Error</b>
<i>2nn, 3nn, 6nn</i>	Machine check
<i>4nn, 7nn</i>	Program check
<i>5nn</i>	Communication check

For example, a communication check symbol followed by an *nnn* code of 520 indicates that the communication line has experienced a nonproductive timeout.

**Note:** The *6nn* and *7nn* codes are reported only by distributed function devices. An example of a distributed function device is the 3290 Data Panel.

The 3274 will try to send alerts for all errors that have not affected the integrity of the host adapter, the control unit, the storage, or the microcode itself. A *permanent* error disables a device or causes the loss of a critical resource. A *temporary* error is one that is recoverable with some loss in productivity and one that may cause the loss of a noncritical resource. A *performance* alert is one that exceeds a predetermined threshold but does not disable a device. Mismatches between the hardware and the microcode are considered installation problems. Certain *5nn* communication check numbers are returned *after* the communication line is re-established and are considered delay-recovered. Response time alerts are sent when a Response Time Monitor (RTM) counter overflows and that device is allowed to send RTM alerts.

The intent is to send alerts based on the error codes generated by the 3274 Control Unit and attached terminals and to let NPDA-filtering decide which alerts are significant.

NPDA supports the following alert parameters: alert type, general cause, specific component, and the accompanying description/user-action and detail text reference codes from the 3274.

### Alert Type

X'01'	Permanent error
X'02'	Temporary error
X'03'	Performance
X'0A'	Terminal operator input
X'0C'	Installation consistency problem
X'0D'	Operational/procedural (program check)
X'0F'	Delayed-recovered

### General Cause

X'01'	Hardware or microcode
X'02'	Software (user programmable)
X'03'	Communications
X'06'	Media (diskette)
X'07'	Hardware or software
X'09'	Operator
X'0C'	Microcode
X'0D'	SNA-level protocol
X'0F'	Unknown
X'11'	Operator error (Unbind Session)
X'12'	Customizing

### Specific Cause

X'0001'	Base processor (microcode)
X'0004'	Main storage
X'0006'	Printer
X'0009'	Keyboard
X'000A'	Selector pen
X'000B'	Magnetic slot reader/magnetic hand scanner
X'000C'	Display or printer
X'000D'	Display
X'000E'	Remote product
X'0012'	Communication line adapter
X'0014'	Local-channel adapter
X'0016'	Direct-attached adapter
X'001B'	Line-customer (coaxial cable)
X'0056'	Application program check
X'0062'	DASD device (includes media)
X'006D'	Response Time Monitor feature timer adapter
X'006E'	Encryption/decryption adapter
X'006F'	Outboard-user processor (Personal Computer)
X'00FF'	Unknown

### Description/User-Action Code

X'FE01'	Customizing error
X'FE02'	Permanent device error
X'FE03'	Temporary device error
X'FE04'	Permanent error (device or coaxial cable)
X'FE05'	Temporary device error (keyboard)
X'FE06'	Temporary device error (selector pen)
X'FE07'	Permanent device error (color convergence or battery)
X'FE08'	Permanent device-control unit interface sync error

### Description/User-Action Code (Continued)

X'FE09'	RPQ error (undetermined)
X'FE0A'	Temporary error direct-attach adapter
X'FE0B'	Permanent error direct-attach adapter
X'FE0C'	Permanent error (crypto adapter or battery)
X'FE0D'	Permanent error DASD hardware
X'FE0E'	Permanent error disk media
X'FE0F'	Application program check
X'FE10'	Temporary error - device reported
X'FE11'	Permanent error - device reported
X'FE12'	Permanent device reported application program check
X'FE13'	Customizing error (control unit)
X'FE14'	Permanent error. Device failed to report operation complete
X'FE15'	Temporary possible lost status
X'FE16'	Permanent Response Time Monitor feature adapter error
X'FE17'	Permanent crypto adapter error
X'FE18'	Temporary device power off in session
X'FE19'	Permanent Kanji memory error
X'FE1A'	Permanent PC hardware error
X'FE1B'	Permanent PC hardware/software error
X'FE1C'	Permanent PC software error
X'FE1D'	Permanent intelligent device interface error
X'FE20'	Operator-generated alert screen 01
X'FE21'	Operator-generated alert screen 02
X'FE22'	Operator-generated alert screen 03
X'FE23'	Operator-generated alert screen 04
X'FE24'	Operator-generated alert screen 05
X'FE25'	Operator-generated alert screen 06
X'FE26'	Operator-generated alert screen 07
X'FE27'	Operator-generated alert screen 08
X'FE28'	Operator-generated alert screen 09
X'FE29'	Operator-generated alert screen 10
X'FE2A'	Operator-generated alert screen 11
X'FE2B'	Operator-generated alert screen 12
X'FE2C'	Operator-generated alert screen 13
X'FE2D'	Operator-generated alert screen 14
X'FE2E'	Operator-generated alert screen 15
X'FE2F'	Operator-generated alert screen 16
X'FE30'	Operator-generated alert screen 17
X'FE31'	Operator-generated alert screen 18
X'FE32'	Operator-generated alert screen 19
X'FE33'	Operator-generated alert screen 20
X'FE34'	Delayed alert host communication adapter
X'FE35'	Delayed alert control unit error
X'FE36'	Delayed alert memory error
X'FE37'	Coaxial cable error threshold
X'FE38'	ECC error threshold
X'FE39'	Response Time Monitor counter overflow
X'FE3A'	Delayed alert 5nn (nonlocal attach)
X'FE3B'	Delayed alert microcode
X'FE3C'	Delayed alert local channel adapter
X'FE3D'	Delayed alert 5nn (local channel)
X'FE3E'	Delayed alert DCA
X'FD3F'	Spare

### Detail Text Reference Code*

X'FE01'	Q1: nnn	Q2:	Q3:
X'FE02'	Q1: nnn	Q2: port number	Q3:
X'FE03'	Q1: nnn	Q2: LU number	Q3:
X'FE04'	Q1: nnn	Q2: port number	Q3: device ID
X'FE05'	Q1: nnn	Q2: LU number	Q3: device ID
X'FE06'	Q1: nnn	Q2: 8 4 2 1 indicators code	
X'FE07'	Q1, Q2, and Q3 are customer-defined		
X'FE08'	Q1:	Q2: port number	Q3:
X'FE09'	Q1:	Q2: 8 4 2 1 indicators code	Q3:
X'FE0A'	Q1:	Q2: LU number	Q3:

DASD = direct access storage device

DCA = device cluster adapter (Type A adapter)

ECC = error checking and correction

LU = logical unit

PC = Personal Computer

Q = qualifier

* NPDA Version 3 Release 1 generates 3274 alert messages using the 3274 description/user-action code only. The 3274 also includes a detail text reference code, which NPDA is currently ignoring. There is no correlation between these two codes.

### Operator-Generated Alert Messages

**Note:** The procedure for sending an operator-generated alert message to the host is presented in "Operator Procedures."

Display stations from which operator-generated alert messages can be sent are the 3178, 3278, and 3279.

Via a customizing parameter, all display station operators, the operator on port 0 only, or *no* operators may be authorized to request an alert message panel while the display is in 3274 test mode. When properly filled in, the information on the panel is transmitted as part of an alert Network Management Vector Transport (NMVT) inbound request to the host.

Included in these alert messages are the installation-specified user-action code, a 120-character (maximum length) text message, and up to three 8-digit qualifiers.

The user-action code (01–20 decimal, required) correlates with one of up to 20 product-unique panels that can be defined in the NPDA data base as part of the host SYSGEN process.

Once the alert message is received by NPDA, the user-action code is used to correlate the message with one of the product-unique panels defined in NPDA, and the message is mapped into the panel. The text message and qualifiers allow the operator to pass such things as a 3274 *nnn* code, a port number, telephone number, etc. as well as a text message to the NPDA operator.





If other than the basic characters have been entered from the keyboard, the input-inhibited and what? symbols are displayed. The screen must be cleared before characters can be re-entered.

If a communication check is detected, the input-inhibited and communication-reminder symbols, followed by a 5nn number, are displayed.

### ***Priority Queuing of Alerts within the 3274***

The 3274 Control Unit queues one alert for each attached device. If an error occurs in a device that causes an alert to be queued and a second and more serious error (one of higher priority) occurs in that device, the second error will replace the first error in the queue and the first error will be lost. However, if the second error is of equal or lower priority, the second error will be lost. See Figure 8-12 for a tabulation of alert priorities.

Except for temporary errors, as soon as an alert for a specific device is transmitted to the host, additional alerts for that device may be queued. The rate of acceptance of errors into the queue is determined primarily by the host response time on the SSCP-PU flow. When a condition occurs that causes a temporary alert, an attempt is made to queue that alert according to the above algorithm. However, if a subsequent temporary error occurs, an alert will not be generated until the operator has reset the input-inhibited condition caused by the previous alert. Thus the frequency of temporary alerts is restricted by keying the alert generation to the rate at which the operator can reset the keyboard.

### ***Negative Responses***

The following inbound negative responses from the 3274 may be returned in response to a REQMS or NMVT request. These responses are not unique to alert but are included here for reference.

**1003 Negative Response.** (1) Invalid length, or (2) An NS (network services) header was received, but it was neither REQMS nor NMVT. The request is rejected and error recovery is the responsibility of the sender.

**1007 Negative Response.** An invalid NS header or unsupported NS category was received. The request is rejected and error recovery is the responsibility of the sender.

**080C Negative Response.** A valid REQMS or NMVT request was received, but the REQMS or NMVT type parameter is not supported by the 3274. The request is rejected and error recovery is the responsibility of the sender.

**0815 Negative Response.** Another REQMS or NMVT request was in process in the 3274 when this request was received. The request is rejected and error recovery is the responsibility of the sender.

**081B Negative Response.** An NMVT or REQMS request was received when the 3274 was in send state processing an unsolicited RU. The request is rejected and error recovery is the responsibility of the sender.

## ***Product-Instance ID Vector Support***

As shown in Figures 8-8 through 8-11, the 3274 supports the following fields in the NMVT product-instance ID vector:

### **For the 3274:**

- Machine type: 3274 in EBCDIC
- Model: XXX in EBCDIC
- Plant of manufacture: X'0000' (to indicate unknown)
- Serial number: 00XXXXXX in EBCDIC*

* XXXXX is the response to customizing question 215, Physical Unit ID (PUID), which is supposed to be a unique number within the network and may consist only of alphanumeric characters 0 through 9 and A through F. (These are the only valid alphanumeric characters that may be entered during the customizing procedure.)

### **For attached devices:**

- Machine type: 0000 in EBCDIC
- Plant of manufacture: X'0000' (to indicate unknown)
- Serial number: X'00000000 000000' (to indicate unknown)

## ***Customizing***

Customizing support is required for the alert function. During customizing of the 3274 Control Unit, the customizer is asked one question regarding alert to which he may respond with one of four possible answers:

- No alerts
- No operator-generated alerts
- Operator-generated alerts on port 0 only
- Operator-generated alerts on all ports.

See the appropriate 3274 customizing guide.

## ***Alert Message Formats***

There are four categories of problems that result in the generation of alert messages: control unit error, device hardware error, applications program check, and operator-generated alert. Each category requires the generation of an alert message in a specific NMVT format. The four formats are shown immediately below. Then, Figures 8-8 through 8-11 show the TH/RH/RU definitions for each category in detail. Notes for all four figures follow.

### Control Unit Error

TH

RH

RU

NMVT Header

Length to End of RU

Alert Vector

Product-Set ID Vector

PU Product Vector

PID - PU

PID Subvector

Basic Alert Vector

Detail Qualifier Vector (blank, *2nn*, *3nn*, or *5nn*)

Detail Qualifier Vector*

Relative Time Vector

* Status of 8 4 2 1 indicators (LEDs) on the 3274 operator's panel when the 3274 is not operational.

See Figure 8-8 for details.

### Device Hardware Error

TH RH RU

NMVT Header

Length to End of RU

Alert Vector

SNA Address List

SLU

Product-Set ID Vector

PU Product Vector

PID - PU

PID Subvector

Product-Set ID Vector

LU Product Vector

PID - SLU

PID Subvector

Basic Alert Vector

Detail Qualifier Vector (blank, *2nn*, or *6nn*)

Detail Qualifier Vector (Port)

Detail Qualifier Vector (Device type)

Relative Time Vector

See Figure 8-9 for details.

### **Application Program Check**

TH RH RU  
NMVT Header  
Length to End of RU  
Alert Vector  
SNA Address List  
SLU  
PLU  
Product-Set ID Vector  
PU Product Vector  
PID - PU  
PID Subvector  
Product-Set ID Vector  
LU Product Vector  
PID - SLU  
PID Subvector  
Basic Alert Vector  
Detail Qualifier Vector (4nn or 7nn)  
Detail Qualifier Vector (LU)  
Detail Qualifier Vector (Device type)  
Relative Time Vector

See Figure 8-10 for details.

### **Operator-Generated Alert**

TH RH RU  
NMVT Header  
Length to End of RU  
Alert Vector  
SNA Address List  
SLU  
Product-Set ID Vector  
PU Product Vector  
PID - PU  
PID Subvector  
Basic Alert Vector  
Text Vector  
Detail Qualifier Vector  
Detail Qualifier Vector  
Detail Qualifier Vector  
Relative Time Vector

See Figure 8-11 for details.

**Abbreviations Used in Figures 8-8 through 8-11**

ACTPU	Activate Physical Unit
DAF'	Destination address field prime
EFI	Expedited flow indicator
ERI	Exception response indicator
FID	Format identification
FM	Function management
FMD	Function management data
ID	Identification
IML	Initial Microprogram Load
LED	Light-emitting diode
LU	Logical unit
MPF	Mapping field
N/A	Not applicable
NMVT	Network Management Vector Transport
NPDA	Network Problem Determination Application
OAF'	Origin address field prime
PAC	Program authorized credentials
PID	Product-set ID
PLU	Primary logical unit
PRID	Procedure-related identifier
PU	Physical unit
QRI	Queued response indicator
RECFMS	Record Formatted Maintenance Statistics
REQMS	Request Maintenance Statistics
RH	Request/response header
RU	Request/response unit
SLU	Secondary logical unit
SNA	Systems Network Architecture
SNF	Sequence number field
SSCP	System services control point
TAF	Target address field
TH	Transmission header
TS	Transmission services

### Control Unit Error

Byte	Bit	Value	Meaning
TH0	0-3	X'2'	FID
	4-5	B'--'	MPF (segment)
	6	B'0'	Reserved
	7	B'0'	EFI
TH1	-	X'00'	
TH2		X'00'	DAF'
TH3		X'00'	OAF'
TH4,5		X'0000'	SNF
RH0	0	B'0'	Request
	1-2	B'00'	FMD
	3	B'0'	Reserved
	4	B'1'	Format indicator
	5	B'0'	Sense data included
	6-7	B'11'	Chain state indicator
RH1	0	B'1'	Definite response 1
	1	B'0'	Reserved
	2	B'0'	Definite response 2
	3	B'0'	ERI
	4-5	B'00'	Reserved
	6	B'0'	QRI
RH2	-	X'00'	Not applicable
RU0	-	X'41'	NMVT
RU1	-	X'03'	
RU2	-	X'8D'	
RU3 RU4		X'0000'	Reserved (May be nonzero but not to be used.)
RU5 RU6		X'0000'	PRID when solicited
RU7	0	B'0'	Unsolicited
	1	B'0'	Last or only
	2	B'0'	First or only
	3	B'0'	No SNA address list included
	4-7	B'0000'	Reserved
RU8	0	B'0'	No concatenation
RU9	1-7	B'000 0000'	Remaining length of this RU
	0-7	X'3A'	
RU10 RU11		X'0000'	Code point for alert
RU12		X'19'	Length of product-set ID vector
RU13		X'10'	Product-set ID vector - PU
RU14		X'F1'	PU product vector
RU15		X'16'	Length of subvector
RU16		X'11'	PID subvector
RU17		X'01'	IBM machine
RU18		X'13'	Length of product-instance ID vector
RU19		X'00'	Product-instance ID vector
RU20		X'12'	Format of product-instance ID vector

Figure 8-8 (Part 1 of 2). TH, RH, and RU Definitions for Control Unit Errors

Byte	Bit	Value	Meaning
RU21		X'F3'	Machine type: 3274
RU22		X'F2'	
RU23		X'F7'	
RU24		X'F4'	
RU25		X' '	Model number in EBCDIC
RU26		X' '	
RU27		X' '	
RU28 RU29		X'0000'	Plant of manufacture (Zero if unknown)
RU30 RU31		X'F0F0'	Leading serial number digits
RU32		X' '	Operator-customized machine serial number in EBCDIC.
RU33		X' '	
RU34		X' '	
RU35		X' '	
RU36		X' '	
RU37		X'0E'	Length of basic alert vector
RU38		X'91'	Basic alert vector
RU39	0-3 4-7	X'0' X'0'	Alert classification: IBM product: Initiating component IBM product: Target component
RU40		X'--'	Alert type
RU41		X'--'	General cause code
RU42 RU43		X'00--'	Specific component code
RU44 RU45		X'FE--'	Alert description code
RU46 RU47		X'FE--'	User-action code
RU48 RU49		X'FE--'	Detail text reference code
RU50		X'00'	Alert repetition count
RU51		X'05'	Length of detail qualifier 1
RU52		X'A0'	Detail qualifier 1 – EBCDIC
RU53		X'F--'	2nn or 3nn machine check number or 5nn communication check number (Use X'404040' if not applicable)
RU54		X'F--'	
RU55		X'F--'	
RU56		X'03'	Length of detail qualifier 2
RU57		X'A0'	Detail qualifier 2 – EBCDIC
RU58		X'F--'	8421 indicator (LED) value (Use X'40' if not applicable.)
RU59		X'07'	Length of relative-time vector
RU60		X'42'	Code point for relative-time vector
RU61		X'EF'	Sequence number; not time
RU62 RU63 RU64 RU65		X'--' X'--' X'--' X'--'	Sequential number: Starts at 0000 0000 at IML. Incremented for each record sent.

Figure 8-8 (Part 2 of 2). TH, RH, and RU Definitions for Control Unit Errors

### Device Hardware Error

Byte	Bit	Value	Meaning
TH0	0-3	X'2'	FID
	4-5	B'--'	MPF (segment)
	6	B'0'	Reserved
	7	B'0'	EFI
TH1	-	X'00'	
TH2		X'00'	DAF'
TH3		X'00'	OAF'
TH4,5		X'0000'	SNF
RH0	0	B'0'	Request
	1-2	B'00'	FMD
	3	B'0'	Reserved
	4	B'1'	Format indicator
	5	B'0'	Sense data included
	6-7	B'11'	Chain state indicator
RH1	0	B'1'	Definite response 1
	1	B'0'	Reserved
	2	B'0'	Definite response 2
	3	B'0'	ERI
	4-5	B'00'	Reserved
	6	B'0'	QRI
RH2	-	X'00'	Not applicable
RU0	-	X'41'	NMVT
RU1	-	X'03'	
RU2	-	X'8D'	
RU3 RU4		X'0000'	Ignored
RU5 RU6		X'0000'	PRID when solicited
RU7	0	B'0'	Unsolicited
	1	B'0'	Last or only
	2	B'0'	First or only
	3	B'1'	SNA address list included
	4-7	B'0000'	Reserved
RU8	0	B'0'	No concatenation
RU9	1-7	B'000 0000'	Remaining length of this RU
	0-7	X'5F'	
RU10 RU11		X'0000'	Code point for alert
RU12		X'0A'	Length of SNA address list
RU13		X'04'	Code point SNA address list
RU14		X'01'	Number of TAFs
RU15 thru RU20 RU21		X'0000 0000 0000 aa'	Target address (source): SLU local address: 7 bytes  aa = LU local address
RU22		X'19'	Length of product-set ID vector
RU23		X'10'	Product-set ID vector - PU
RU24		X'F1'	PU product vector
RU25		X'16'	Length of subvector
RU26		X'11'	PID subvector

Figure 8-9 (Part 1 of 3). TH, RH, and RU Definitions for Device Hardware Errors



Byte	Bit	Value	Meaning
RU27		X'01'	IBM machine
RU28		X'13'	Length of product-instance ID vector
RU29		X'00'	Product-instance ID vector
RU30		X'12'	Format of product-instance ID vector
RU31		X'F3'	Machine Type: 3274
RU32		X'F2'	
RU33		X'F7'	
RU34		X'F4'	
RU35		X' '	Model number in EBCDIC
RU36		X' '	
RU37		X' '	
RU38 RU39		X'0000'	Plant of manufacture (Zero if unknown)
RU40 RU41		X'F0F0'	Leading serial number digits
RU42		X' '	Operator-customized machine serial number in EBCDIC.
RU43		X' '	
RU44		X' '	
RU45		X' '	
RU46		X' '	
RU47		X'16'	Length of product-set ID vector
RU48		X'10'	Product-set ID vector - LU
RU49		X'F3'	LU product vector
RU50		X'13'	Length of subvector
RU51		X'11'	PID subvector
RU52		X'03'	IBM or non-IBM machine
RU53		X'10'	Length of product-instance ID vector
RU54		X'00'	Product-instance ID vector
RU55		X'10'	Format of product-instance ID vector
RU56		X'F0'	Machine type (Zero if unknown)
RU57		X'F0'	
RU58		X'F0'	
RU59		X'F0'	
RU60 RU61		X'0000'	Plant of manufacture (Zero if unknown)
RU62		X'00'	Serial number (Zero if unknown)
RU63		X'00'	
RU64		X'00'	
RU65		X'00'	
RU66		X'00'	
RU67		X'00'	
RU68		X'00'	
RU69		X'0E'	Length of basic alert vector
RU70		X'91'	Basic alert vector

Figure 8-9 (Part 2 of 3). TH, RH, and RU Definitions for Device Hardware Errors

Byte	Bit	Value	Meaning
RU71	0-3 4-7	X'0' X'3'	Alert classification: IBM product: Initiating component Unknown product: Target component
RU72		X'--'	Alert type
RU73		X'--'	General cause code
RU74 RU75		X'00--'	Specific component code
RU76 RU77		X'FE--'	Alert description code
RU78 RU79		X'FE--'	User-action code
RU80 RU81		X'FE--'	Detail text reference code
RU82		X'00'	Alert repetition count
RU83		X'05'	Length of detail qualifier 1
RU84		X'A0'	Detail qualifier 1 - EBCDIC
RU85 RU86 RU87		X'F-' X'F-' X'F-'	2nn or 3nn machine check number or 5nn communication check number (Use X'404040' if not applicable)
RU88		X'04'	Length of detail qualifier 2
RU89		X'A0'	Detail qualifier 2 - EBCDIC
RU90 RU91		X'F-' X'--'	Port number 00-1F
RU92		X'04'	Length of detail qualifier 3
RU93		X'A0'	Detail qualifier 3 - EBCDIC
RU94 RU95		X'F-' X'F-'	Device type (Use X'4040' if unknown.)
RU96		X'07'	Length of relative-time vector
RU97		X'42'	Code point for relative-time vector
RU98		X'EF'	Sequence number; not time
RU99 RU100 RU101 RU102		X'--' X'--' X'--' X'--'	Sequential number: Starts at 0000 0000 at IML. Incremented for each record sent.

Figure 8-9 (Part 3 of 3). TH, RH, and RU Definitions for Device Hardware Errors

### Application Program Check

Byte	Bit	Value	Meaning
TH0	0-3	X'2'	FID
	4-5	B'--'	MPF (segment)
	6	B'0'	Reserved
	7	B'0'	EFI
TH1	-	X'00'	
TH2		X'00'	DAF'
TH3		X'00'	OAF'
TH4,5		X'0000'	SNF
RH0	0	B'0'	Request
	1-2	B'00'	FMD
	3	B'0'	Reserved
	4	B'1'	Format indicator
	5	B'0'	Sense data included
	6-7	B'11'	Chain state indicator
RH1	0	B'1'	Definite response 1
	1	B'0'	Reserved
	2	B'0'	Definite response 2
	3	B'0'	ERI
	4-5	B'00'	Reserved
	6	B'0'	QRI
RH2	-	X'00'	Not applicable
RU0	-	X'41'	NMVT
RU1	-	X'03'	
RU2	-	X'8D'	
RU3 RU4		X'0000'	Ignored
RU5 RU6		X'0000'	PRID when solicited
RU7	0	B'0'	Unsolicited
	1	B'0'	Last or only
	2	B'0'	First or only
	3	B'1'	SNA address list included
	4-7	B'0000'	Reserved
RU8	0	B'0'	No concatenation
RU9	1-7	B'000 0000'	Remaining length of this RU
	0-7	X'66'	
RU10 RU11		X'0000'	Code point for alert
RU12		X'11'	Length of SNA address list
RU13		X'04'	Code point SNA address list
RU14		X'02'	Number of TAFs
RU15 thru RU20 RU21		X'4000 0000 0000 aa'	Target addresses: SLU local address: 7 bytes (40=PLU follows) -- aa = 02- . . . is LU local address
RU22 thru RU27 RU28		X'0000 0000 0000 pp'	PLU local address: 7 bytes -- pp = OAF' from LU BIND
RU29		X'19'	Length of product-set ID vector
RU30		X'10'	Product-set ID vector - PU
RU31		X'F1'	PU product vector

Figure 8-10 (Part 1 of 3). TH, RH, and RU Definitions for Application Program Checks

Byte	Bit	Value	Meaning
RU32		X'16'	Length of subvector
RU33		X'11'	PID subvector
RU34		X'01'	IBM machine
RU35		X'13'	Length of product-instance ID vector
RU36		X'00'	Product-instance ID vector
RU37		X'12'	Format of product-instance ID vector
RU38		X'F3'	Machine type: 3274
RU39		X'F2'	
RU40		X'F7'	
RU41		X'F4'	
RU42		X' '	Model number in EBCDIC
RU43		X' '	
RU44		X' '	
RU45 RU46		X'0000'	Plant of manufacture (Zero if unknown)
RU47 RU48		X'F0F0'	Leading serial number digits
RU49		X' '	Operator-customized machine serial number in EBCDIC.
RU50		X' '	
RU51		X' '	
RU52		X' '	
RU53		X' '	
RU54		X'16'	Length of product-set ID vector
RU55		X'10'	Product-set ID vector - LU
RU56		X'F3'	LU product vector
RU57		X'13'	Length of subvector
RU58		X'11'	PID subvector
RU59		X'03'	IBM or non-IBM machine
RU60		X'10'	Length of product-instance ID vector
RU61		X'00'	Product-instance ID vector
RU62		X'10'	Format of product-instance ID vector
RU63		X'F0'	Machine type (Zero if unknown)
RU64		X'F0'	
RU65		X'F0'	
RU66		X'F0'	
RU67 RU68		X'0000'	Plant of manufacture (Zero if unknown)
RU69		X'00'	Serial number (Zero if unknown)
RU70		X'00'	
RU71		X'00'	
RU72		X'00'	
RU73		X'00'	
RU74		X'00'	
RU75		X'00'	
RU76		X'0E'	Length of basic alert vector

Figure 8-10 (Part 2 of 3). TH, RH, and RU Definitions for Application Program Checks

Byte	Bit	Value	Meaning
RU77		X'91'	Basic alert vector
RU78	0-3 4-7	X'0' X'3'	Alert classification: IBM product: Initiating component Unknown product: Target component
RU79		X'--'	Alert type
RU80		X'--'	General cause code
RU81 RU82		X'00--'	Specific component code
RU83 RU84		X'FE--'	Alert description code
RU85 RU86		X'FE--'	User-action code
RU87 RU88		X'FE--'	Detail text reference code
RU89		X'00'	Alert repetition count
RU90		X'05'	Length of detail qualifier 1
RU91		X'A0'	Detail qualifier 1 - EBCDIC
RU92 RU93 RU94		X'F-' X'F-' X'F-'	4nn or 7nn program check
RU95		X'04'	Length of detail qualifier 2
RU96		X'A0'	Detail qualifier 2 - EBCDIC
RU97 RU98		X'F-' X'F-'	LU number hex 02-81
RU99		X'04'	Length of detail qualifier 3
RU100		X'A0'	Detail qualifier 3 - EBCDIC
RU101 RU102		X'F-' X'F-'	Device type (Use X'4040' if not applicable; X'F0F0' if 3290.)
RU103		X'07'	Length of relative-time vector
RU104		X'42'	Code point for relative-time vector
RU105		X'EF'	Sequence number; not time
RU106 RU107 RU108 RU109		X'--' X'--' X'--' X'--'	Sequential number: Starts at 0000 0000 at IML. Incremented for each record sent.

Figure 8-10 (Part 3 of 3). TH, RH, and RU Definitions for Application Program Checks

### Operator-Generated Alert

Byte	Bit	Value	Meaning
TH0	0-3	X'2'	FID
	4-5	B'--'	MPF (segment)
	6	B'0'	Reserved
	7	B'0'	EFI
TH1	-	X'00'	
TH2		X'00'	DAF'
TH3		X'00'	OAF'
TH4,5		X'0000'	SNF
RH0	0	B'0'	Request
	1-2	B'00'	FMD
	3	B'0'	Reserved
	4	B'1'	Format indicator
	5	B'0'	Sense data included
	6-7	B'11'	Chain state indicator
RH1	0	B'1'	Definite response 1
	1	B'0'	Reserved
	2	B'0'	Definite response 2
	3	B'0'	ERI
	4-5	B'00'	Reserved
	6	B'0'	QRI
RH2	-	X'00'	Not applicable
RU0	-	X'41'	NMVT
RU1	-	X'03'	
RU2	-	X'8D'	
RU3 RU4		X'0000'	Ignored
RU5 RU6		X'0000'	PRID when solicited
RU7	0	B'0'	Unsolicited
	1	B'0'	Last or only
	2	B'0'	First or only
	3	B'1'	SNA address list included
	4-7	B'0000'	Reserved
RU8	0	B'0'	No concatenation
RU9	1-7	B'000 0000'	Remaining length of this RU
	0-7	X'D4'	
RU10 RU11		X'0000'	Code point for alert
RU12		X'0A'	Length of SNA address list
RU13		X'04'	Code point SNA address list
RU14		X'01'	Number of TAFs
RU15 thru RU20 RU21		X'0000 0000 0000 aa'	Target address (source): SLU local address: 7 bytes  aa = LU local address
RU22		X'19'	Length of product-set ID vector
RU23		X'10'	Product-set ID vector - PU
RU24		X'F1'	PU product vector
RU25		X'16'	Length of subvector
RU26		X'11'	PID subvector

Figure 8-11 (Part 1 of 3). TH, RH, and RU Definitions for Operator-Generated Alerts

Byte	Bit	Value	Meaning
RU27		X'01'	IBM machine
RU28		X'13'	Length of product-instance ID vector
RU29		X'00'	Product-instance ID vector
RU30		X'12'	Format of product-instance ID vector
RU31		X'F3'	Machine type: 3274
RU32		X'F2'	
RU33		X'F7'	
RU34		X'F4'	
RU35		X' '	Model number in EBCDIC
RU36		X' '	
RU37		X' '	
RU38 RU39		X'0000'	Plant of manufacture (Zero if unknown)
RU40 RU41		X'F0F0'	Leading serial number digits
RU42		X' '	Operator-customized machine serial number in EBCDIC.
RU43		X' '	
RU44		X' '	
RU45		X' '	
RU46		X' '	
RU47		X'0E'	Length of basic alert vector
RU48		X'91'	Basic alert vector
RU49	0-3 4-7	X'0' X'3'	Alert classification: IBM product: Initiating product Unknown product: Target component
RU50		X'--'	Alert type
RU51		X'--'	General cause code
RU52 RU53		X'00--'	Specific component code
RU54 RU55		X'FE--'	Alert description code
RU56 RU57		X'FE--'	User-action code
RU58 RU59		X'FE--'	Detail text reference code
RU60		X'00'	Alert repetition count
RU61		X'7A'	Length of text vector
RU62		X'00'	Text vector ID
RU63- RU182		X'.....'	120-byte operator input (Text message in EBCDIC format)
RU183		X'0A'	Length of detail qualifier 1
RU184		X'A0'	Detail qualifier 1 - EBCDIC
RU185- RU192		X'.....'	8-byte operator input (Text message in EBCDIC format)
RU193		X'0A'	Length of detail qualifier 2
RU194		X'A0'	Detail qualifier 2 - EBCDIC
RU195- RU202		X'.....'	8-byte operator input (Text message in EBCDIC format)

Figure 8-11 (Part 2 of 3). TH, RH, and RU Definitions for Operator-Generated Alerts

Byte	Bit	Value	Meaning
RU203		X'0A'	Length of detail qualifier 3
RU204		X'A0'	Detail qualifier 3 - EBCDIC
RU205- RU212		X'.....'	8-byte operator input (Text message in EBCDIC format)
RU213		X'07'	Length of relative-time vector
RU214		X'42'	Code point for relative-time vector
RU215		X'EF'	Sequence number; not time
RU216 RU217 RU218 RU219		X'--' X'--' X'--' X'--'	Sequential number: Starts at 0000 0000 at IML. Incremented for each record sent.

**Figure 8-11 (Part 3 of 3). TH, RH, and RU Definitions for Operator-Generated Alerts**

**Notes for Figures 8-8 through 8-11:**

- The 3274 SSCP-PU session is defined as FM profile 0 and TS profile 1 (half-duplex definite response). Should the 3274 transmit a message inbound, it will wait for a response (positive or negative) before transmitting or receiving additional messages on that session. If a response is somehow lost by the network, no other SSCP-PU activity will be possible without first receiving an ACTPU. Data may be lost during recovery.
- Because of the characteristics of the SSCP-PU session, the control unit defaults to contention state. Should an alert message, or RECFMS be queued for inbound transmission, the 3274 will go into send state and reject all outbound messages on that session until that message is transmitted and a response is received. Error recovery is the responsibility of the upstream node.
- When an alert condition is detected by the 3274, that event will be scheduled to be sent inbound to NPDA. Only one such event can be scheduled for the control unit, or each physical device attached to the control unit, at a time. If a second event occurs from an already scheduled device, the more serious event will be sent. For example, if a temporary error is queued for transmission and a permanent error occurs, the permanent error will replace the temporary error in the queue and the latter error will be lost. If a permanent error is queued and another permanent error occurs, the second permanent error is lost.
- The SNA address list will be included with all device hardware, application program checks, and operator-generated alerts. If the address list cannot be translated by the appropriate network components, it is a host responsibility to handle the data.
- With operator-generated alerts, the LU originating the message will not be in LU-LU session. As stated above, it is the responsibility of the appropriate network components to handle the SNA address list and assure that the message is received by NPDA.
- Only one operator-generated alert can be scheduled in the 3274 at a time. If a second operator attempts to send an alert, that request will be denied. Once an alert is scheduled for inbound transmission and the RU is built, that



operator's screen will be cleared. Note that if a communication check occurs while the operator-generated alert is being transmitted, all or part of that message may be lost, depending on network recovery procedures. The operator will not be notified about the success or failure of the message when this happens as it is beyond the capabilities of the 3274 to determine it. Once an operator-generated alert is transmitted to NPDA, another authorized operator may send an alert message.

- With operator-generated alerts, RUs 63 through 182 contain an operator-keyed text message. This message may contain nulls and NPDA must be capable of including these nulls in the message displayed on the detail screen.

### **3274 Error Code Definitions**

Figure 8-12 lists the 3274 error code definitions. It shows some of the detail information that the 3274 assembles and sends to the host and that the NPDA operator may see on the event detail screen. By referring to the appropriate figure (Figure 8-8, 8-9, 8-10, or 8-11) called out in the column headed "Fmt," you may see how the alert message for that particular error will be assembled.

The meanings of the column headings and other notations in Figure 8-12 are:

Code	3274 Error Code (nnn code). The error codes are listed in the left-hand column.
Pr	Priority. This number (0–7) refers to the internal priority scheme that the 3274 uses to schedule the sending of alerts to the host. Zero is the minimum and 7 is the maximum priority.
Type	Alert Type. (The alert types are listed in "Reportable Errors.")
Gen	General Cause Code. (See "Reportable Errors.")
Spec	Specific Component Code. (See "Reportable Errors.")
DES/UA	Description/User-Action Code. (See "Reportable Errors.")
DTR	Alert Detail Text Reference Code. (See "Reportable Errors.")
Fmt	Format. This column refers to Figures 8-8, 8-9, 8-10, and 8-11 that show the TH, RH, and RU definitions corresponding to the type of problem: control unit error, device hardware error, application program check, or operator-generated alert, respectively. Figure 8-8 shows a control unit error with two qualifiers. Qualifier 3 is not sent to the host. Figure 8-9 shows a device hardware error with three qualifiers and an SLU local address (for the device). Figure 8-10 shows an application program check with three qualifiers and both an SLU and a PLU local address. Figure 8-11 shows an operator-generated alert.
Q1	Detail Qualifier 1 (except for operator-generated alerts) contains the nnn code.
Q2	Detail Qualifier 2.

Code	Pr	Type	Gen	Spec	DES/UA	DTR	Fmt	Q1	Q2	Q3	NPDA Message
2%%	3	0C	12	00FF	FE01	FE02	9	2nn	Port	--	Customizing Error: User
202 204 207 211 223 274 277 279	6	01	01	000C	FE02	FE02	9	2nn	Port	--	Device Error: Device
203	3	02	01	000D	FE03	FE02	9	2nn	Port	--	Device Error: Device
204 208 211 277	3	02	01	000C	FE03	FE02	9	2nn	Port	--	Device Error: Device
206 207	6	01	01	000D	FE03	FE02	9	2nn	Port	--	Device Error: Device
209 278	6	01	01	000C	FE04	FE02	9	2nn	Port	-	Device Error: Cable/Device/Control Unit
212	3	02	01	0009	FE05	FE02	9	2nn	Port	--	Device Error: Keyboard/Display
222	3	02	01	000A	FE06	FE02	9	2nn	Port	--	Device Error: Selector Pen/Host Program/Display
224	3	02	01	000B	FE03	FE02	9	2nn	Port	--	Device Error: Device
225 229	6	01	01	000D	FE03	FE02	9	2nn	Port	--	Device Error: Device
226 227	6	01	01	000D	FE04	FE02	9	2nn	Port	--	Device Error: Cable/Device/Control Unit
228	6	01	01	000D	FE07	FE02	9	2nn	Port	--	Device Error: Battery/Device
229	3	02	01	000D	FE03	FE02	9	2nn	Port	--	Device Error: Device
231 232 275 276	6	01	01	0006	FE02	FE02	9	2nn	Port	--	Device Error: Device
232 276	3	02	01	0006	FE03	FE02	9	2nn	Port	--	Device Error: Device
235	6	01	01	006F	FE1A	FE02	9	2nn	Port	--	Device Error: Device
236	6	01	07	006F	FE1B	FE02	9	2nn	Port	--	Timeout: Program/Device
237 238	6	01	02	006F	FE1C	FE02	9	2nn	Port	--	Message Error: Program
240 242	6	01	01	000C	FE1D	FE04	9	2nn	Port	ID	Device Error: Device
241	6	01	07	000C	FE08	FE02	9	2nn	Port	--	Device Error: Program/Device/Control Unit
243	6	01	0F	00FF	FE14	FE04	9	2nn	Port	ID	Device Error: Host Program/Device
263- 269	3	02	01	00FF	FE09	FE02	9	2nn	Port	--	RPO Error: Undetermined
263- 269	6	01	01	00FF	FE09	FE02	9	2nn	Port	--	RPO Error: Undetermined
270 271 273	6	01	01	0016	FE0B	FE01	8	2nn	--	N/S	Control Unit Error: Direct-Attached Adapter
272 292 294 295 297	3	02	01	0016	FE0A	FE01	8	2nn	--	N/S	Control Unit Error: Direct-Attached Adapter

Figure 8-12 (Part 1 of 4). 3274 Error Code Definitions

Code	Pr	Type	Gen	Spec	DES/UA	DTR	Fmt	Q1	Q2	Q3	NPDA Message
292 294- 299	6	0F	01	0016	FE3E	FE06	8	2nn	8421	N/S	Delayed Alert: Direct-Attached Adapter
293	3	0C	12	00FF	FE13	FE01	8	2nn	--	N/S	Customizing Error: User
296 298 299	3	02	01	00FF	FE15	FE01	8	2nn	--	N/S	Lost Device Status
381	6	0F	0C	0001	FE3B	FE06	8	3nn	8421	N/S	Delayed Alert: Control Unit
382	6	01	06	006D	FE16	FE01	8	3nn	--	N/S	Control Unit Error: Timer
386 389	6	01	01	0062	FE0D	FE01	8	3nn	--	N/S	Control Unit Error: DASD
387 388	6	01	06	0062	FE0E	FE01	8	3nn	--	N/S	Control Unit Error: DASD Media
390	6	0F	01	0004	FE36	FE06	8	3nn	8421	N/S	Delayed Alert: Control Unit
391	6	0F	01	0001	FE35	FE06	8	3nn	8421	N/S	Delayed Alert: Control Unit
392- 395	6	01	01	0004	FE19	FE06	8	3nn	8421	N/S	Kanji Memory Error: Control Unit
397 399	6	01	01	006E	FE17	FE01	8	3nn	--	N/S	Control Unit Error: Encryption/Decryption
398	6	01	01	006E	FE0C	FE01	8	3nn	--	N/S	Control Unit Error: Battery/Encryption/Decryption
401- 404 411- 414 420- 423 430- 434 439- 445 450- 458 468 470- 475	4	0D	0D	0056	FE0F	FE03	10	4nn	LU	--	SNA Data Stream Error: Host Program
601- 629 631 634 637- 699	3	02	01	000E	FE10	FE04	9	6nn	Port	ID	Device-Detected Error: Device
601- 629 631 634 637- 699	6	01	01	000E	FE11	FE04	9	6nn	Port	ID	Device-Detected Error: Device
701- 799	4	0D	0D	0056	FE12	FE05	10	7nn	LU	ID	SNA Data Stream Error: Host Program

Figure 8-12 (Part 2 of 4). 3274 Error Code Definitions

Non-Channel											
Code	Pr	Type	Gen	Spec	DES/UA	DTR	Fmt	Q1	Q2	Q3	NPDA Message
320 321 326 330- 336	6	0F	01	0012	FE34	FE06	8	3nn	8421	N/S	Delayed Alert: Communications Adapter
501 502 504 515 519- 522 525 527- 530 555 556 558- 561 565	5	0F	03	00FF	FE3A	FE01	8	5nn	--	N/S	Delayed Alert: Host Link Communications
Channel											
Code	Pr	Type	Gen	Spec	DES/UA	DTR	Fmt	Q1	Q2	Q3	NPDA Message
340- 342	6	0F	01	0014	FE3C	FE06	8	3nn	8421	N/S	Delayed Alert: Channel Adapter
501 511- 514 541 543- 550	5	0F	03	00FF	FE3D	FE01	8	5nn	--	N/S	Delayed Alert: Local Communications
Coaxial Cable Threshold											
Code	Pr	Type	Gen	Spec	DES/UA	DTR	Fmt	Q1	Q2	Q3	NPDA Message
---	4	03	01	001B	FE37	FE08	9	--	Port	--	Coaxial Cable Threshold: Coaxial Cable
Memory Error (ECC) Threshold											
Code	Pr	Type	Gen	Spec	DES/UA	DTR	Fmt	Q1	Q2	Q3	NPDA Message
---	4	03	01	0004	FE38	FE09	8	--	8421	N/S	Memory Error Threshold: Control Unit
RTM Counter Overflow											
Code	Pr	Type	Gen	Spec	DES/UA	DTR	Fmt	Q1	Q2	Q3	NPDA Message
---	3	0C	12	00FF	FE39	FE0A	9	--	LU	--	Counter Overflow: User

Figure 8-12 (Part 3 of 4). 3274 Error Code Definitions

Operator-Generated Alert											
Code	Pr	Type	Gen	Spec	DES/UA	DTR	Fmt	Q1	Q2	Q3	NPDA Message
---	5	0A	09	00FF	FE20	FE07	11	op	op	op	<b>Note:</b> All NPDA messages are customer-defined.
---	5	0A	09	00FF	FE21	FE07	11	op	op	op	
---	5	0A	09	00FF	FE22	FE07	11	op	op	op	
---	5	0A	09	00FF	FE23	FE07	11	op	op	op	
---	5	0A	09	00FF	FE24	FE07	11	op	op	op	
---	5	0A	09	00FF	FE25	FE07	11	op	op	op	
---	5	0A	09	00FF	FE26	FE07	11	op	op	op	
---	5	0A	09	00FF	FE27	FE07	11	op	op	op	
---	5	0A	09	00FF	FE28	FE07	11	op	op	op	
---	5	0A	09	00FF	FE29	FE07	11	op	op	op	
---	5	0A	09	00FF	FE2A	FE07	11	op	op	op	
---	5	0A	09	00FF	FE2B	FE07	11	op	op	op	
---	5	0A	09	00FF	FE2C	FE07	11	op	op	op	
---	5	0A	09	00FF	FE2D	FE07	11	op	op	op	
---	5	0A	09	00FF	FE2E	FE07	11	op	op	op	
---	5	0A	09	00FF	FE2F	FE07	11	op	op	op	
---	5	0A	09	00FF	FE30	FE07	11	op	op	op	
---	5	0A	09	00FF	FE31	FE07	11	op	op	op	
---	5	0A	09	00FF	FE32	FE07	11	op	op	op	
---	5	0A	09	00FF	FE33	FE07	11	op	op	op	

Figure 8-12 (Part 4 of 4). 3274 Error Code Definitions

- Q3** Detail Qualifier 3. Not sent to the host for control unit errors (Figure 8-8).
- NPDA Msg** This is the message seen by the NPDA operator on the dynamic alert screen.
- Port** The 3274 port number in hex (00–1F).
- ID** This is the 3290 Information Panel identifier.
- 8421** Refers to the 8 4 2 1 indicators (LEDs) on the 3274 operator's panel.
- LU** This is the secondary logical unit ID in hexadecimal (local address).
- Blanks. This indicates that the qualifier is not applicable to this error.
- N/S** Not sent. This means that the qualifier is not sent to the host.

Figure 8-13 is a quick-reference table to help you find the RUs in Figures 8-8 through 8-11 that are associated with specific alert information in each of the problem categories.

Alert Information	Control Unit Error (Figure 8)	Device Hardware Error (Figure 9)	Application Program Check (Figure 10)	Operator-Generated Alert (Figure 11)
Alert Type	40	72	79	50
General Cause Code	41	73	80	51
Specific Component Code	42, 43	74, 75	81, 82	52, 53
Alert Description/ User-action Code	44, 45/ 46, 47	76, 77/ 78, 79	83, 84/ 85, 86	54, 55/ 56, 57
Detail Text Reference Code	48, 49	80, 81	87, 88	58, 59
Qualifier 1	52	84	91	185–192
Qualifier 2	57	89	96	195–202
Qualifier 3	Not sent	93	100	205–212

Figure 8-13. RU Quick-Reference Table

## Operator Procedures

This section provides the step-by-step procedures for displaying the RTM logs and last transaction time indicator (LTTI) for sending operator-generated alert messages.

### Displaying RTM Data

Authorized display stations can display two kinds of RTM data; the RTM log and the RTM last transaction time indicator (LTTI). Display stations are authorized at customization time, or, if host support is present, display station authorization may be set by the host program. Also, when a host interface is *not* present, an authorized display station can be used to reset the RTM log data.

**Note:** The 3277 Display Station cannot display or reset the RTM log or display the LTTI. The 3290 Information Panel cannot display or reset the RTM log.

### Displaying the RTM Log

The procedure for displaying the RTM log is:

1. Press the TEST key, placing the display station in test mode.
2. Key in A4/1 and press the ENTER or PA1 key. A panel is displayed, showing the logs for the first eight logical terminals associated with the control unit. See Figure 8-14.

#### Notes for Step 2:

- If the control unit is not customized for RTM when A4/1 is entered, the “What Number” symbol ( X †# ? ) is displayed in the operator information area.
- If A4/1 is entered at an unauthorized display station, the input-inhibited, minus-function, and operator-unauthorized symbols ( X -f †X ) are displayed in the operator information area.

```

A4/1
@ = 000
@ DEF CTR#1 BDY#1 CTR#2 BDY#2 CTR#3 BDY#3 CTR#4 BDY#4 OV
00 1 10 0.5 11,415 1.0 316 5.0 21 1:00.0 6
01p 1 0 0.5 0 1.0 0 5.0 0 1:00.0 0
02 ? 1 651 0.5 0 1.0 0 5.0 0 1:00.0 14,458
03 *2 215 0.5 512 1.0 56 5.0 0 1:00.0 1

04i 1 * 31 1.0 11 2.0 4,371 5.0 4 10.0 2
05_ 1 0 0.5 0 1.0 0 5.0 0 1:00.0 0
06 *3 * 1 1.0 61 2.0 4 3.0 0 4.0 45
07 1 1,415 0.5 890 1.0 323 5.0 0 1:00.0 1,381

```

The entire screen is protected and the column headings are displayed at high intensity. This example shows representative information for the first eight logical terminals.

The heading @ = nnn at top center shows the first logical terminal number in the group currently being displayed, in this case 000 to 007.

**Abbreviations and definitions of symbols:**

CTR = counter  
 BDY = boundary  
 @ = device or logical terminal  
 OV = overflow  
 p = printer (No statistics are kept for printers.)  
 i = pass-through device  
 _ = never powered on (No statistics are kept.)  
 * = parameter set by host. An * preceding the response time definition indicates that the definition has been changed by the host. An * following the definition indicates that the boundary values have been changed by the host.  
 ? = RTM disabled by host for this device  
 DEF = response time definition:  
 1 = time to first character on screen  
 2 = time to keyboard usable by operator  
 3 = time to CD(Change Direction)/EB(End Bracket)  
 CTR#1 = first counter (response time = 0 up to BDY #1 value)  
 BDY #1 = first boundary in minutes and seconds  
 CTR#2 = second counter (response time greater than BDY #1 up to BDY #2 value)  
 BDY #2 = second boundary in minutes and seconds  
 CTR#3 = third counter (response time greater than BDY #2 up to BDY #3 value)  
 BDY #3 = third boundary in minutes and seconds  
 CTR#4 = fourth counter (response time greater than BDY #3 up to BDY #4 value)  
 BDY #4 = fourth boundary in minutes and seconds  
 OV = overflow (response exceeds last boundary value)

**Figure 8-14. Representative Panel for the RTM Log Display**

3. Press the ENTER or PA1 key again. A panel displaying the logs of the second eight terminals will appear. Use the ENTER or PA1 keys to continue paging through the RTM log.
4. Pressing the ENTER or PA1 key after the last group of logs has been displayed causes the input-inhibited and minus-function symbols ( X - f ) to be displayed in the operator information area.

**Note for Step 4:** To page through the log again you must clear the screen (press the CLEAR key) and repeat steps 2, 3, and 4.

5. Press the TEST key to exit test mode. The screen will be cleared. (Note: You can exit test mode at any point in this procedure.) Any RTM log information present is cleared from the screen.

A printed copy of any of the RTM log panels on display can be obtained by use of the Local Copy function of the 3274 control unit.

### Resetting the RTM Log

The RTM log can be reset from an authorized display station *only* when *no* host interface is defined for RTM. (When host support for RTM is present, only the host can reset the RTM log.) The individual logs for all configured logical terminals will be reset, except for:

1. The information entered at customization time (time boundaries, display authorization, measurement definition).
2. Any pending transaction status. (If the RTM-started flag is set, the response time for that transaction will still be measured.)

The procedure for resetting the RTM log is:

1. Press the TEST key, placing the display station in test mode.
2. Key in A4/4 and press the ENTER or PA1 key. A4/4 will be displayed in the upper-left corner of the screen.

#### Notes for Step 2:

- If the control unit is not customized for RTM when A4/4 is entered, the "What Number" symbol ( X ʘ# ? ) is displayed in the operator information area.
  - If A4/4 is entered at an unauthorized display station, the input-inhibited, minus-function, and operator-unauthorized symbols ( X-f ʘX ) are displayed in the operator information area.
3. When the logs have been reset, a plus sign (+) will appear immediately to the right of A4/4 as in A4/4+.
  4. Press the TEST key to exit test mode.



If you are displaying the RTM log and want to reset the log, you must:

- a. Clear the screen by pressing the CLEAR key. The cursor will appear in the upper-left corner of the screen.
- b. Key in A4/4, starting at the cursor position. Press the ENTER or PA1 key.
- c. Steps 3 and 4 of the reset procedure above now apply.

### Displaying the Last Transaction Time Indicator

The last transaction time indicator (LTTI) is displayed in the operator information area of an authorized display station. The LTTI is displayed as a clock symbol followed by numbers representing minutes and seconds, or as a clock symbol followed by numbers representing seconds and tenths of seconds:

⌚:10:02 represents ten minutes and two seconds

⌚:11.3 represents eleven and three tenths seconds

Note that the colon separates minutes and seconds; the period separates seconds and tenths of seconds.

Use the following procedure to display the LTTI:

1. While pressing the ALT key, press the ERASE EOF key, placing the display station in extension mode. The Extension mode indicator ( ▶ ) will be displayed in the operator information area.

**Note for Step 1:** If extension mode support is not present, pressing the ERASE EOF key has no effect. RTM is not supported.

2. Press the LTTI trigger key indicated in Figure 8-15 for the keyboard you are using. The LTTI will appear in the operator information area in one of the formats previously discussed.

#### Notes for Step 2:

- If the control unit is not customized for RTM when the LTTI trigger key is pressed, the input-inhibited and "What?" symbols ( ✕ + ? ) are displayed in the operator information area.
- If the display station is unauthorized, the clock symbol and colon ( ⌚ : ) are displayed in the operator information area with *no* time indicated.

To erase the LTTI from the operator information area, place the display in extension mode and press the LTTI trigger key again.

### *Sending Operator-Generated Alert Messages*

Requests can be made from authorized display stations for the display of an operator-generated alert message in skeleton form. When filled in with installation-developed information (a 3274 error code, a port number, etc.) and an installation-specified user-action code, the message is then transmitted inbound to the host. See Figure 8-16.



The procedure for sending operator-generated alert messages is as follows:

1. Press the TEST key, placing the display station in test mode.
2. Key in /A and press the ENTER or PA1 key; the panel shown in Figure 8-16 will appear on the screen.

**Note for Step 2:** If the display station is unauthorized, the input-inhibited, minus-function, and operator-unauthorized symbols ( X-f X ) are displayed in the operator information area.

3. Fill in the message with the information specified by your installation. *The user-action code is required.* See Figure 8-16.

**Notes for Step 3:**

- Use only characters from the base character set (do not enter message information while the keyboard is in APL mode, TEXT mode, etc.) *and* do not enter characters with extended attributes.
  - If other than characters from the base character set have been entered from the keyboard, the input-inhibited and “What?” symbols ( X?+ ) are displayed in the operator information area. To re-enter the information, you must clear the screen (CLEAR key) and request the operator-generated message panel again by keying in /A and pressing the ENTER or PA1 key.
4. After filling in the panel, press the ENTER or PA1 key to initiate transmission of the message.

**Notes for Step 4:**

- The user-action code is checked after the message is presented for transmission. If invalid, the input-inhibited and “What?” symbols ( X?+ ) are displayed. To enter a correct code, you must follow the procedure given in the “Notes for Step 3” concerning the re-entering of information.
- After transmission the display screen is cleared.
- If a communication check is detected, the input-inhibited and communication-reminder symbols, followed by a 5nn are displayed.
- Only one operator-generated alert message can be pending transmission at a time. For example, several authorized display station operators may request an alert screen concurrently. Once an operator fills the panel with the required user-action code and any optional information, and presses the ENTER or PA1 key, that message is queued for transmission, provided there is no operator-generated alert message already pending. If a second operator attempts to enter an alert message before the first message has been transmitted to the host, entry of the second message is inhibited, and the input-inhibited and minus-function symbols are displayed. The second operator’s panel is *not* cleared from the screen, and by pressing the RESET key and re-entering the message the second operator may try again.

## Appendix A. 3274 Error Indication, Log and Test Facility

The 3274 Error Indication, Log and Test Facility records and displays control-unit-detected failure information and can (on demand) display control unit and device-related information useful in managing a 3270 subsystem. The major components of this facility are:

The 8 4 2 1 indicator on the 3274 control panel that signals control unit status and failure information. See "The 8 4 2 1 Indicator."

The communication check (X~~---~~), machine check (X~~---~~), and program check (X PROG) indicators displayed in the operator information area of Category A displays. These indicators are usually accompanied by three-digit error codes often referred to as nnn codes. See "3274 Error Indicators and Codes (nnn Codes)."

Log and Test facilities that display failure and subsystem information on demand. See "3274 Log and Test Facility."

X.25 Function cause and diagnostic indicators (two-digit error codes) that are displayed with the X.25 Call Ready indicator or the X.25 Communication Reminder indicator. See "X.25 Function: Cause and Diagnostic Code Indicators and Diagnostic Code Modifiers."

The Response Time Monitor (RTM) and 3274 SNA alert functions. See Chapter 8.

Detailed problem determination information is provided in the *3274 Problem Determination Guide*, GA27-2850.

The Maintenance Concept Manuals (MCMs) for the 3274 Model 51C, 52C, 61C, and 63C (SY27-2528) and the 3274 Model 1, 21, 31, and 41 control units (SY27-2512) also provide additional information.

IBM also supplies a Control Unit Problem Report form that may be of assistance. A sample of this form is shown at the end of this appendix.



## 8 4 2 1 Indicator

There are four lights, labeled 8 4 2 1, on the 3274 control panel.

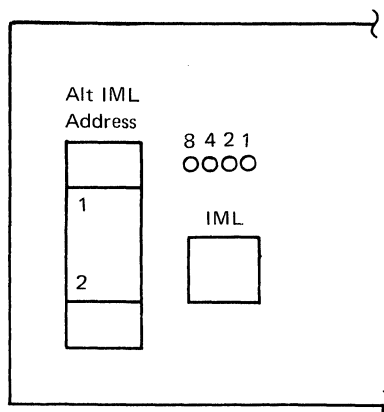

When the IML button is pressed, a test of these lights is performed (they should all be turned on). When the IML button is released (or when the 3274 is initially powered on) the 3274 IML procedure is initiated.

The first part of this IML procedure consists of running a series of tests in the 3274 called IML diagnostics. The purpose of these tests is to assure that the hardware components of the 3274 are functioning properly. These tests use the 8 4 2 1 indicator to show what portion of the diagnostic sequence is currently being run in the controller. If a failure is detected during this diagnostic sequence, the 8 4 2 1 value indicates where in the 3274 the failure exists. Normally, when a failure is detected the 8 4 2 1 indicator blinks.

Successful completion of the IML diagnostic sequence is indicated by all of the 8 4 2 1 lights being turned on. The completion of the IML diagnostic sequence initiates the loading of the 3274 operational microcode, or, depending on the diskette inserted, various other functions (for example, customizing).

Successful completion of this loading process turns the 8 4 2 1 lights off and initializes the function that was loaded. The IML sequence should normally be completed in less than 2.5 minutes. The time varies depending on the 3274 model, the configuration support level, and the customization options selected.

After the full IML process has been completed, the 8 4 2 1 indicator is used to convey operational status and failure information. The status and failure information for functions other than the normal 3274 operational microcode operation (for example, 3274 customizing) is described in the documentation provided for that particular function.

The 8 4 2 1 indicator is used by the 3274 operational microcode to convey either unrecoverable (hung 3274) failure information or status information. In the case of intermittent, unrecoverable 3274 failures, the failure code in the 8 4 2 1 indicator serves as a primary source of repair information for the IBM FE. The recording of the 8 4 2 1 value is useful, in all cases, if repair action is required.

The following material describes the meanings of the 8 4 2 1 indicator for both the IML diagnostics and normal operation.

8 4 2 1 Value

8	4	2	1
X	X	X	X

Each number (X) in the 8 4 2 1 value is either a 0 (light off) or a 1 (light on).

### ***IML Diagnostics Mode***

*8 4 2 1 Value:* 0000, 0001, 0011 thru 1000, 1010

*Indication:* Error

*Cause:* 3274 hardware failure

*Action Recommended:* Retry the IML sequence. If the failure persists, record the 8 4 2 1 value and notify the IBM FE.

*8 4 2 1 Value:* 0010

*Indication:* Error

*Cause:* Diskette failure or diskette adapter failure.

*Action Recommended:* Verify that the proper diskette is inserted in the 3274. If it is, try a backup diskette if available. Retry the IML sequence. If the failure persists, record the 8 4 2 1 value and notify the IBM FE.

*8 4 2 1 Value:* 1001

*Indication:* Error

*Cause:* 3274 Encrypt/Decrypt Adapter failure

*Action Recommended:* Retry the IML sequence. If the failure persists, record the 8 4 2 1 value and notify the IBM FE. Your security administrator must reload the master key after repair. See the *3274 Operator's Guide*.

*8 4 2 1 Value:* 1101

*Indication:* Status

*Cause:* Uncustomized system diskette

*Action Recommended:* Refer to the appropriate 3274 customizing guide for information on how to customize a system diskette.

*8 4 2 1 Value:* 1111

*Indication:* Error

*Cause:* Operational microcode did not load properly.

*Action Recommended:* Try a spare system diskette. Retry the IML sequence. If the failure persists, record the 8 4 2 1 value and notify the IBM FE.

**3274 Operational Mode**

*8 4 2 1 Value:* 0001 thru 1111

*Indication:* Error

*Cause:* 3274 hardware failure

*Action Recommended:* Re-IML. If the failure persists, record the 8 4 2 1 value and notify the IBM FE.

*8 4 2 1 Value:* Alternating 1000/0001, 1000/0010, 1000/0011, 1000/0100, or 1000/0101

*Indication:* Error

*Cause:* Type A Adapter failure

*Action Recommended:* Re-IML. If the failure persists, record the 8 4 2 1 value and notify the IBM FE.

**3290 Downstream Loading Operational Mode**

*8 4 2 1 Value:* Alternating 1111/0001

*Indication:* Status

*Cause:* Diskette not ready or invalid diskette

*Action Recommended:* Insert the proper diskette in the diskette drive.

*8 4 2 1 Value:* Alternating 1111/1100

*Indication:* Status/error

*Cause:* Defective diskette

*Action Recommended:* Insert a spare diskette. If the failure persists, notify the IBM FE.





## 3274 Error Indicators and Codes

The following symbols appear in the operator information area of the display terminal and have the following meanings.

### Communication Reminder ( )

A condition exists in the communication network that is inhibiting communications with the host.

### Communication Check ( )

A operation to the host was attempted when a communication reminder was being displayed. Use the Reset key to unlock the keyboard, and retry the operation when the communication reminder is turned off.







### Machine Check ( )

Hardware errors internal to the 3274 subsystem (3274 or its attached devices) occurred and the controller could not recover.

### Program Check ( X PROG )

An SNA protocol error or a data stream error was detected in the data received from the host.

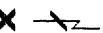
Each of the symbols also has a three-digit suffix associated with it to further describe the error. This three-digit error code is commonly referred to as an nnn number. The numbers are also broken down by a range of values, into general categories. A detailed description of errors, arranged by number, follows.

Indicator	Error Suffix	Associated Failure
	201-269	Device failure (attached to Type A adapter)
	270-279	Category B adapter or attached device failure
	290-299	Category A adapter failure
	301-399	3274 hardware failure
	401-499	Program checks
	501-599	Communication checks
	601-699 ¹	Distributed-function-device-detected hardware error ²
	701-799 ¹	Distributed-function-device-detected program check ²

¹ Refer to the documentation provided with the particular distributed function device for details concerning these error codes.

² 3290 Information Panel

**Error Codes**

2%%

**Machine Check:** The circumstances and times when the 2%% error code is displayed are as follows:

1. 2%% is displayed when the display is powered on and a keyboard mismatch exists.
2. 2%% is displayed when an attempt is made to use the Structured Field and Attribute Processing feature (Color, Programmed Symbols, Highlighting) or the APL/Text feature, and the feature itself, or a prerequisite feature, is not installed in the display.

Reasons and examples follow:

- **Keyboard Mismatch (Power-On Time)**

2%% is displayed when microcode support for the attached keyboard has not been configured, that is, has not been installed in the controller microcode via customization of the system diskette. As an example, only typewriter keyboard support was configured (customization question 131) but the attached keyboard is a Data Entry keyboard.

- **Operational Mismatches (Attempted-Use Time)**

The controller microcode has been configured for the Structured Field and Attribute Processing feature or the APL/Text feature, but the physical feature itself, or a prerequisite feature on which it depends, is not installed in the device. Following are examples:

- 2%% is displayed when a PS set selection key is pressed and the PS feature is not present on the device.
- 2%% is displayed when an APL or Text key function is requested and no ECSA feature is installed in the device. **Note:** *Applicable only with microcode configurations that do not support SFAP.*
- 2%% is displayed when a Color selection key is pressed and the display is not a color display.
- 2%% is displayed when a Programmed Symbol, Color, or Extended Highlighting selection key is pressed and the ECSA feature is not present on the device.
- 2%% is displayed when status is received from an invalid address on the device feature bus.

**8 4 2 1 Indicator:** Off

**Indicator displayed:** ✕ 2%%

**Recovery:** Verify that the customizing procedure specified the proper keyboard/feature support. Press RESET to restore the keyboard.

**Sense codes:** None

**Applicable to:** 3278 or 3279 keyboard or feature

- 202**                    **Machine Check:** Internal terminal error  
**8 4 2 1 Indicator:** Off  
**Indicator displayed:** ✕    ≈ 202  
**Recovery:** At the affected terminal, switch the Normal/Test switch from Normal to Test and back again (or switch the power Off, then On).  
**Sense codes:**  
                  Non-SNA: DC/US  
                  SNA:       081C  
**Applicable to:** Type A terminal
- 203**                    **Machine Check:** Terminal feature circuitry failure  
**8 4 2 1 Indicator:** Off  
**Indicator displayed:** ✕    ≈ 203  
**Recovery:** Press RESET and retry the operation.  
**Sense codes:** None  
**Applicable to:** Feature
- 204**                    **Machine Check:** Terminal buffer parity error  
**8 4 2 1 Indicator:** Off  
**Indicator displayed:** ✕    ≈ 204  
**Recovery:**  
1. Host recovery  
2. If control unit recovery is unsuccessful, switch the Normal/Test switch from Normal to Test and back again (or switch the power Off, then On).  
**Sense codes:**  
1. The control unit clears the terminal buffer and sets sense:  
                  Non-SNA: DC/US  
                  SNA:       081C  
2. If internal recovery is unsuccessful, the terminal is disabled:  
                  Non-SNA: DC/US  
                  SNA:       081C  
**Applicable to:** Type A terminal
- 205**                    **Machine Check:** An operation was attempted on an inoperative or unsupported terminal feature.  
**8 4 2 1 Indicator:** Off  
**Indicator displayed:** ✕    ≈ 205  
**Recovery:** Press RESET and retry the operation. (Verify that the customizing procedure specified the failing feature.)  
**Sense codes:** None  
**Applicable to:** Feature
- 206**                    **Machine Check:** Feature did not initialize properly  
**8 4 2 1 Indicator:** Off  
**Indicator displayed:** ✕    ≈ 206  
**Recovery:** Press RESET and continue.  
**Sense codes:** None  
**Applicable to:** Feature

- 207**                    **Machine Check:** The terminal failed to respond to the control unit.  
**8 4 2 1 Indicator:** Off  
**Indicator displayed:** ✕    207  
**Recovery:** At the affected terminal, switch the Normal/Test switch from Normal to Test and back again (or switch the power Off, then On).  
**Sense codes:**  
                   Non-SNA: DC/US  
                   SNA:       081C  
**Applicable to:** Type A terminal
- 208**                    **Machine Check:** Invalid terminal response to control unit  
**8 4 2 1 Indicator:** Off  
**Indicator displayed:** ✕    208  
**Recovery:** Press RESET and retry the operation.  
**Sense codes:** None  
**Applicable to:** Type A terminal
- 209**                    **Machine Check:** Control unit-to-terminal communication failure  
**8 4 2 1 Indicator:** Off  
**Indicator displayed:** ✕    209  
**Recovery:** At the affected terminal, switch the Normal/Test switch from Normal to Test and back again (or switch the power Off, then On). Check the coaxial connection for looseness.  
**Sense codes:**  
                   Non-SNA: DC/US  
                   SNA:       081C  
**Applicable to:** Type A adapter; Type A terminal
- 210**                    **Machine Check:** Keyboard type is not supported  
**8 4 2 1 Indicator:** Off  
**Indicator displayed:** ✕    210  
**Recovery:** Verify that the customizing procedure specified that this keyboard type was attached to the subsystem.  
**Sense codes:** None  
**Applicable to:** Type A terminal; feature
- 211**                    **Machine Check:** Invalid terminal response to control unit  
**8 4 2 1 Indicator:** Off  
**Indicator displayed:** ✕    211  
**Recovery:** Press RESET and retry the operation.  
**Sense codes:** None  
**Applicable to:** Type A terminal
- 212**                    **Machine Check:** An invalid keystroke was received from this display.  
**8 4 2 1 Indicator:** Off  
**Indicator displayed:** ✕    212  
**Recovery:** Press RESET and retry the operation.  
**Sense codes:** None  
**Applicable to:** Type A terminal; keyboard

- 222**                    **Machine Check:** Selector pen error  
**8 4 2 1 Indicator:** Off  
**Indicator displayed:** ✕    222  
**Recovery:** Press RESET and retry the operation. If no keyboard, retry the operation.  
**Sense codes:** None  
**Applicable to:** Type A terminal; feature
- 223**                    **Machine Check:** ECSA adapter buffer parity error  
**8 4 2 1 Indicator:** Off  
**Indicator displayed:** ✕    223  
**Recovery:**  
1. Host recovery. Press RESET to continue.  
2. If control unit recovery is unsuccessful, switch the Normal/Test switch from Normal to Test and back again (or switch the power Off, then On).  
**Sense codes:**  
1. The control unit clears the terminal buffer:  
    Non-SNA: DC/US  
    SNA:        082B  
2. If internal recovery is unsuccessful, the terminal is disabled:  
    Non-SNA: DC/US  
    SNA:        081C  
**Applicable to:** Feature
- 224**                    **Machine Check:** MSR or MHS error  
**8 4 2 1 Indicator:** Off  
**Indicator displayed:** ✕    224  
**Recovery:** Press RESET and retry the operation. If no keyboard, retry the operation.  
**Sense codes:** None  
**Applicable to:** Type A terminal; feature
- 225**                    **Machine Check:** ECSA adapter error  
**8 4 2 1 Indicator:** Off  
**Indicator displayed:** ✕    225  
**Recovery:**  
1. Press RESET and retry the operation.  
2. At the affected terminal, switch the Normal/Test switch from Normal to Test and back again (or switch the power Off, then On).  
**Sense codes:** If the display is disabled:  
    Non-SNA: DC/US  
    SNA:        081C  
**Applicable to:** Feature

- 226, 227**      **Machine Check:** Transmission error communicating with ECS feature  
**8 4 2 1 Indicator:** Off  
**Indicator displayed:** ✕    226, 227  
**Recovery:** At the disabled terminal, switch the Normal/Test switch from Normal to Test and back again (or switch the power Off, then On).  
**Sense codes:**  
                 Non-SNA:    DC/US  
                 SNA:            081C  
**Applicable to:** Feature (3278 or 3279)
- 228**            **Machine Check:** Battery has failed or color convergence hardware has failed  
**8 4 2 1 Indicator:** Off  
**Indicator displayed:** ✕    228  
**Recovery:**  
 1. If the keyboard can be reset, the battery has failed. The *3279 Problem Determination Guide* explains how to replace it.  
 2. If the keyboard cannot be reset, the color convergence hardware has failed. At the terminal, switch the Normal/Test switch from Normal to Test and back again (or switch the power Off, then On).  
**Sense codes:** If terminal is disabled:  
                 Non-SNA:    DC/US  
                 SNA:            081C  
**Applicable to:** 3279
- 229**            **Machine Check:** Color convergence hardware storage failed, either during a power-on sequence or a Test 7 execution.  
**8 4 2 1 Indicator:** Off  
**Indicator displayed:** None  
**Recovery:** At the affected terminal, switch the Normal/Test switch from Normal to Test and back again (or switch the power Off, then On).  
**Sense codes:** None  
**Applicable to:** 3279
- 231**            **Machine Check:** An unrecoverable printer error has occurred.  
**8 4 2 1 Indicator:** Off  
**Indicator displayed:** None  
**Recovery:** See the printer's *Problem Determination Guide*.  
**Sense codes:**  
                 Non-SNA:    EC/IR/US  
                 SNA:            081C  
**Applicable to:** Type A terminal and printer
- 234**            **Machine Check:** The ECS adapter does not have the required ROS.  
**8 4 2 1 Indicator:** Off  
**Indicator displayed:** ✕    234  
**Recovery:** Required ROS must be installed.  
**Sense codes:** None  
**Applicable to:** Type A terminal

- 235**            **Machine Check:** Adapter status or Personal Computer Attachment queue error  
**8 4 2 1 Indicator:** Off  
**Indicator displayed:** ✕    235  
**Recovery:** Power-on reset restores the keyboard.  
**Sense codes:**  
                Non-SNA: DC/US  
                SNA: 081C  
**Applicable to:** 3270 Personal Computer Attachment
- 236**            **Machine Check:** Deferred (asynchronous) ending status was not returned.  
**8 4 2 1 Indicator:** Off  
**Indicator displayed:** ✕    236  
**Recovery:** Power-on reset restores the keyboard.  
**Sense codes:**  
                Non-SNA: DC/US  
                SNA: 081C  
**Applicable to:** 3270 Personal Computer Attachment
- 237**            **Machine Check:** 3274/Personal Computer Attachment protocol error  
**8 4 2 1 Indicator:** Off  
**Indicator displayed:** ✕    237  
**Recovery:** Power-on reset restores the keyboard.  
**Sense codes:**  
                Non-SNA: DC/US  
                SNA: 081C  
**Applicable to:** 3270 Personal Computer Attachment
- 238**            **Machine Check:** Inbound message too long  
**8 4 2 1 Indicator:** Off  
**Indicator displayed:** ✕    238  
**Recovery:** Power-on reset restores the keyboard.  
**Sense codes:**  
                Non-SNA: DC/US  
                SNA: 081C  
**Applicable to:** 3270 Personal Computer Attachment
- 240**            **Machine Check:** 3290/3274 interface error  
**8 4 2 1 Indicator:** Off  
**Indicator displayed:** ✕    240  
**Recovery:** Power-on reset restores the device.  
**Sense codes:**  
                Non-SNA: DC/US  
                SNA: 081C  
**Applicable to:** 3290 Information Panel



- 241**            **Machine Check:** 3274/3290 interface error  
**8 4 2 1 Indicator:** Off  
**Indicator displayed:** X    241  
**Recovery:** Power-on reset restores the device.  
**Sense codes:**  
                  Non-SNA: DC/US  
                  SNA: 081C  
**Applicable to:** 3290 Information Panel
- 242**            **Machine Check:** 3290 permanent error  
**8 4 2 1 Indicator:** Off  
**Indicator displayed:** X    242  
**Recovery:** Power-on reset restores the device.  
**Sense codes:**  
                  Non-SNA: DC/US  
                  SNA: 081C  
**Applicable to:** 3290 Information Panel
- 243**            **Machine Check:** Deferred (asynchronous) ending status was  
not returned.  
**8 4 2 1 Indicator:** Off  
**Indicator displayed:** X    243  
**Recovery:** Power-on reset restores the device.  
**Sense codes:**  
                  Non-SNA: DC/US  
                  SNA: 081C  
**Applicable to:** 3290 Information Panel
- 270, 271**        **Machine Check:** An unrecoverable terminal error  
**8 4 2 1 Indicator:** 1010  
**Indicator displayed:** None  
**Recovery:** Re-IML; perform host recovery if required.  
**Sense codes:** None  
**Applicable to:** Type B adapter
- 272**            **Machine Check:** The terminal request was not serviced by the  
control unit.  
**8 4 2 1 Indicator:** 1010  
**Indicator displayed:** None  
**Recovery:** Host recovery  
**Sense codes:**  
                  Non-SNA: DC/US  
                  SNA: 082B  
**Applicable to:** Type B adapter
- 273**            **Machine Check:** An unrecoverable terminal error  
**8 4 2 1 Indicator:** 1010  
**Indicator displayed:** None  
**Recovery:** Re-IML; perform host recovery if required.  
**Sense codes:** None  
**Applicable to:** Type B adapter

- 274**            **Machine Check:** A terminal busy condition does not clear.  
**8 4 2 1 Indicator:** Off  
**Indicator displayed:** None  
**Recovery:** At the affected terminal, switch the power Off, then On.  
**Sense codes:**  
                   Non-SNA: DC/US  
                   SNA: 081C  
**Applicable to:** Type B terminal
- 275**            **Machine Check:** The affected printer indicates equipment check and not ready condition.  
**8 4 2 1 Indicator:** Off  
**Indicator displayed:** None  
**Recovery:** Operator recovery; follow locally established procedures.  
**Sense codes:**  
                   Non-SNA: EC/IR/US  
                   SNA: 081C  
**Applicable to:** Type B printer
- 276**            **Machine Check:** The affected printer indicates equipment check. (Character generator error or sync check)  
**8 4 2 1 Indicator:** Off  
**Indicator displayed:** None  
**Recovery:** Host recovery  
**Sense codes:**  
                   Non-SNA: EC/US  
                   SNA: 082B  
**Applicable to:** Type B printer
- 277**            **Machine Check:** A terminal buffer parity error has occurred.  
**8 4 2 1 Indicator:** Off  
**Indicator displayed:** None  
**Recovery:** Host recovery. If host recovery is unsuccessful, switch power Off, then On.  
**Sense codes:**  
                   Non-SNA: DC/US  
                   SNA: 082B  
 If internal recovery is unsuccessful, terminal is disabled:  
                   Non-SNA: DC/US  
                   SNA: 081C  
**Applicable to:** Type B terminal
- 278**            **Machine Check:** A control unit-to-terminal communication problem  
**8 4 2 1 Indicator:** Off  
**Indicator displayed:** None  
**Recovery:** At the affected terminal, switch the power Off, then On.  
**Sense codes:**  
                   Non-SNA: DC/US  
                   SNA: 081C  
**Applicable to:** Type B adapter; Type B terminal

- 279**            **Machine Check:** Internal terminal error  
**8 4 2 1 Indicator:** Off  
**Indicator displayed:** None  
**Recovery:** At the affected terminal, switch the power Off, then On.  
**Sense codes:**  
                Non-SNA: DC/US  
                SNA: 081C  
**Applicable to:** Type B terminal
- 292**            **Machine Check:** Adapter failure; terminal status may have been lost.  
**8 4 2 1 Indicator:** Off  
**Indicator displayed:** ✕    292  
**Recovery:** Press RESET and retry the operation.  
**Sense codes:** None  
**Applicable to:** Type A adapter
- 293**            **Machine Check:** The control unit has received input from a terminal port that is not in the configuration table.  
**8 4 2 1 Indicator:** Off  
**Indicator displayed:** ✕    293  
**Recovery:** Press RESET and retry the operation. (Verify that the number of Type A terminals attached agrees with the number specified during the customizing procedure.)  
**Sense codes:** None  
**Applicable to:** Type A adapter
- 294, 295**        **Machine Check:** Adapter failure; terminal status may have been lost.  
**8 4 2 1 Indicator:** Off  
**Indicator displayed:** ✕    294, 295  
**Recovery:** Press RESET and retry the operation.  
**Sense codes:** None  
**Applicable to:** Type A adapter
- 296**            **Machine Check:** Adapter failure; terminal status may have been lost.  
**8 4 2 1 Indicator:** Off  
**Indicator displayed:** ✕    296  
**Recovery:** Press RESET and retry the operation.  
**Sense codes:** None  
**Applicable to:** Type A adapter
- 297**            **Machine Check:** Adapter failure or unisolated terminal failure  
**8 4 2 1 Indicator:** Off  
**Indicator displayed:** ✕    297  
**Recovery:** Press RESET and retry the operation.  
**Sense codes:** None  
**Applicable to:** Type A adapter

- 298, 299**      **Machine Check:** Adapter failure; terminal status may have been lost.  
**8 4 2 1 Indicator:** Off  
**Indicator displayed:** X    298, 299  
**Recovery:** Press RESET and retry the operation.  
**Sense codes:** None  
**Applicable to:** Type A adapter
- 310, 311**      **Machine Check:** A host communication adapter has failed.  
**8 4 2 1 Indicator:** 1001  
**Indicator displayed:** X    310, 311  
**Recovery:** Re-IML; perform host recovery if required.  
**Sense codes:** None  
**Applicable to:** Model 1C — BSC
- 320, 321**      **Machine Check:** A host communication adapter has failed.  
**8 4 2 1 Indicator:** 1001  
**Indicator displayed:** X    320, 321  
**Recovery:** Re-IML; perform host recovery if required.  
**Sense codes:** None  
**Applicable to:** Model 1C — SDLC; Model 51C — SDLC
- 326**            **Machine Check:** A host adapter has failed.  
**8 4 2 1 Indicator:** 1001  
**Indicator displayed:** X    326  
**Recovery:** Re-IML; perform host recovery if required.  
**Sense codes:** None  
**Applicable to:** Model 51C; X21 switched
- 330, 331**      **Machine Check:** A host communication adapter has failed.  
**8 4 2 1 Indicator:** 1001  
**Indicator displayed:** X    330, 331  
**Recovery:** Record the nnn and 8 4 2 1 values; re-IML; if problems persist, notify the IBM service representative.  
**Sense codes:** None  
**Applicable to:** All C models — SDLC; all C models — X.25
- 332, 333**      **Machine Check:** A host adapter has failed. (332 = HPCA wrap failure; 333 = LSA wrap failure)  
**8 4 2 1 Indicator:** 1001  
**Indicator displayed:** X    332, 333  
**Recovery:** Re-IML; perform host recovery if required.  
**Sense codes:** None  
**Applicable to:** Model 51C; Multiuse Communication Loop
- 334**            **Machine Check:** Three SHUTOFF commands have been received from the host; or an LSC hardware failure has occurred.  
**8 4 2 1 Indicator:** 1001  
**Indicator displayed:** X    334  
**Recovery:** Same as 332, 333.  
**Sense codes:** None  
**Applicable to:** Model 51C; Multiuse Communication Loop

- 335, 336**      **Machine Check:** A host adapter has failed. (335 = LSA failure; 336 = LSC wrap failure)  
**8 4 2 1 Indicator:** 1001  
**Indicator displayed:** ✕    ☒ 335, 336  
**Recovery:** Same as 332, 333.  
**Sense codes:** None  
**Applicable to:** Model 51C; Multiuse Communication Loop
- 340–342**      **Machine Check:** A host communication adapter has failed.  
**8 4 2 1 Indicator:** 1001  
**Indicator displayed:** ✕    ☒ 340, 341, 342  
**Recovery:** Re-IML; perform host recovery if required.  
**Sense codes:** None  
**Applicable to:** Model 1A
- 350–353**      **Machine Check:** A host communication adapter has failed.  
**8 4 2 1 Indicator:** 1001  
**Indicator displayed:** ✕    ☒ 350, 351, 352, 353  
**Recovery:** Re-IML; perform host recovery if required.  
**Sense codes:** None  
**Applicable to:** Model 1B
- 354**            **Machine Check:** The number of terminals specified during customization exceeds the number specified in the adapter address jumpers.  
**8 4 2 1 Indicator:** 1001  
**Indicator displayed:** ✕    ☒ 354  
**Recovery:** Verify that the number of terminals specified during customization does not exceed the number of addresses jumpered on the adapter.  
**Sense codes:** None  
**Applicable to:** Model 1B
- 355**            **Machine Check:** A host communication adapter has failed.  
**8 4 2 1 Indicator:** Off  
**Indicator displayed:** ✕    ☒ 355  
**Recovery:** Host recovery. Press RESET to restore the keyboard.  
**Sense codes:** DC  
**Applicable to:** Model 1B
- 356**            **Machine Check:** A host communication adapter has failed.  
**8 4 2 1 Indicator:** Off  
**Indicator displayed:** ✕    ☒ 356  
**Recovery:** Re-IML; perform host recovery if required.  
**Sense codes:** DC  
**Applicable to:** Model 1B
- 357**            **Machine Check:** A host communication adapter has failed.  
**8 4 2 1 Indicator:** 1001  
**Indicator displayed:** ✕    ☒ 357  
**Recovery:** Re-IML; perform host recovery if required.  
**Sense codes:** None  
**Applicable to:** Model 1B

- 360, 361**      **Machine Check:** A host communication adapter has failed.  
**8 4 2 1 Indicator:** 1001  
**Indicator displayed:** X    360, 361  
**Recovery:** Re-IML; perform host recovery if required.  
**Sense codes:** DC  
**Applicable to:** Model 1D
- 362**            **Machine Check:** A control unit failure occurred during an I/O operation.  
**8 4 2 1 Indicator:** Off  
**Indicator displayed:** X    362  
**Recovery:** Host recovery. Press RESET to restore the keyboard.  
**Sense codes:** DC  
**Applicable to:** Model 1D
- 363**            **Machine Check:** A host communication adapter has failed.  
**8 4 2 1 Indicator:** 1001  
**Indicator displayed:** X    363  
**Recovery:** Re-IML; perform host recovery if required.  
**Sense codes:** DC  
**Applicable to:** Model 1D
- 364**            **Machine Check:** A control unit failure occurred during an I/O operation.  
**8 4 2 1 Indicator:** Off  
**Indicator displayed:** X    364  
**Recovery:** Host recovery. Press RESET to restore the keyboard.  
**Sense codes:** DC  
**Applicable to:** Model 1D
- 381**            **Machine Check:** Unrecoverable control logic error  
**8 4 2 1 Indicator:** 0010  
**Indicator displayed:** X    381  
**Recovery:** Record the nnn and 8 4 2 1 values; re-IML; if problems persist, notify the IBM service representative.  
**Sense codes:** None  
**Applicable to:** All 3274 models
- 390**            **Machine Check:** A storage parity error has occurred.  
**8 4 2 1 Indicator:** 0001 or 0011-0111  
**Indicator displayed:** X    390  
**Recovery:** Re-IML; perform host recovery if required.  
**Sense codes:** None  
**Applicable to:** All 3274 models
- 391**            **Machine Check:** A control unit logic failure  
**8 4 2 1 Indicator:** 0010 or 1101  
**Indicator displayed:** X    391  
**Recovery:** Re-IML; perform host recovery if required.  
**Sense codes:** None  
**Applicable to:** All 3274 models

- 392-395**      **Machine Check:** Kanji font card 1(392), 2(393), 3(394), or 4(395) contains an unusable character font.  
**8 4 2 1 Indicator:** 0111  
**Indicator displayed:** X    392, 393, 394, 395  
**Recovery:** Press RESET and retry the operation. If this is unacceptable, re-IML the 3274 and reload the fonts. Perform host recovery, if necessary.  
**Sense codes:** None  
**Applicable to:** Model 52C Kanji
- 397**            **Machine Check:** An unrecoverable Encrypt/Decrypt I/O error has occurred. The adapter is disabled.  
**8 4 2 1 Indicator:** 1110  
**Indicator displayed:** X    397  
**Recovery:** *Non-cryptographic sessions may still be run. Press RESET and use local logon/logoff procedures.*  
**Sense codes:** 0848  
**Applicable to:** Encrypt/Decrypt
- 398**            **Machine Check:** A master key parity error was received and recovery attempts were unsuccessful.  
**8 4 2 1 Indicator:** Off  
**Indicator displayed:** X    398  
**Recovery:** Refer to the master key entry and verification procedure in the *Operator's Guide*. If master key verification fails, replace the battery and enter the master key.  
*Non-cryptographic sessions may still be run. Press RESET and use local logon/logoff procedures.*  
**Sense codes:** 0848  
**Applicable to:** Encrypt/Decrypt
- 399**            **Machine Check:** An unrecoverable Encrypt/Decrypt failure has occurred. The adapter is disabled.  
**8 4 2 1 Indicator:** Off  
**Indicator displayed:** None  
**Recovery:** *Non-cryptographic session may still be run. Press RESET and use local logon/logoff procedures.*  
**Sense codes:** 0848  
**Applicable to:** Encrypt/Decrypt
- 401**            **Program Check:** Invalid command received; or SFE, MF, SA with invalid alias.  
**8 4 2 1 Indicator:** Off  
**Indicator displayed:** X PROG 401  
**Recovery:** Press RESET to reset the program check indicator and retry the operation. Call the host-support programmer if the problem persists, since it is probably a data stream error.  
**Sense codes:**  
     Invalid command received:  
         Non-SNA: CR/OP  
         SNA: 1003  
     SFE, MF, SA with invalid alias:  
         SNA: 0863  
**Applicable to:** All 3274 models

- 402**                    **Program Check:** An invalid (out of range) address was received following an SBA, RA, or EUA order; or an MF order addressed a nonfield attribute location.  
**8 4 2 1 Indicator:** Off  
**Indicator displayed:** X PROG 402  
**Recovery:** Press RESET to reset the program check indicator and retry the operation. Call the host-support programmer if the problem persists, since it is probably a data stream error.  
**Sense codes:**  
     Invalid address following SBA, RA, or EUA order:  
         Non-SNA: CR/OP  
         SNA: 1005  
     MF order address problem:  
         SNA: 0863  
**Applicable to:** A, C, and D models
- 403**                    **Program Check:** Data stream containing:  
 (1) Data following a Rd, Rd Mod, or EAU command was received; or  
 (2) Invalid parameter following an SFE, MF, or SA order; or  
 (3) A GE or RA order was received with invalid parameters.  
**8 4 2 1 Indicator:** Off  
**Indicator displayed:** X PROG 403  
**Recovery:** Press RESET to reset the program check indicator and retry the operation. Call the host-support programmer if the problem persists, since it is probably a data stream error.  
**Sense codes:**  
     Non-SNA: OC  
     SNA: 1003  
**Applicable to:** A, C, and D models
- 404**                    **Program Check:** The data stream ended before all required bytes on an SBA, RA, EUA, SF, SFE, MF, or SA order were received.  
**8 4 2 1 Indicator:** Off  
**Indicator displayed:** X PROG 404  
**Recovery:** Press RESET to reset the program check indicator and retry the operation. Call the host-support programmer if the problem persists, since it is probably a data stream error.  
**Sense codes:**  
     Non-SNA: OC  
     SNA: 1005  
**Applicable to:** A, C, and D models
- 405**                    **Program Check:** An invalid copy command was received.  
**8 4 2 1 Indicator:** Off  
**Indicator displayed:** X PROG 405  
**Recovery:** Press RESET to reset the program check indicator and retry the operation. Call the host-support programmer if the problem persists, since it is probably a data stream error.  
**Sense codes:** OC  
**Applicable to:** C models — BSC



- 406**                    **Program Check:** An invalid command sequence was received.  
**8 4 2 1 Indicator:** Off  
**Indicator displayed:** X PROG 406  
**Recovery:** Press RESET to reset the program check indicator and retry the operation. Call the host-support programmer if the problem persists, since it is probably a data stream error.  
**Sense codes:** OC  
**Applicable to:** C models — BSC; D models
- 407**                    **Program Check:** A valid command or order that was received cannot be executed because:  
(1) SBA, Ra, or EUA order specifies an invalid address; or  
(2) Write data stream ends before all the required bytes of SBA, RA, EUA, or SF order sequence are received; or  
(3) Write, E/W, EWA with Start Print bit set in WCC is chained to the next command; the print operation is suppressed.  
**8 4 2 1 Indicator:** Off  
**Indicator displayed:** X PROG 407  
**Recovery:** Press RESET to reset the program check indicator and retry the operation. Call the host-support programmer if the problem persists, since it is probably a data stream error.  
**Sense codes:** OC  
**Applicable to:** B models
- 408**                    **Program Check:** There is a line buffer overflow.  
**8 4 2 1 Indicator:** Off  
**Indicator displayed:** X PROG 408  
**Recovery:** Press RESET to reset the program check indicator and retry the operation. Call the host-support programmer if the problem persists, since it is probably a data stream error.  
**Sense codes:** OC  
**Applicable to:** C models — BSC
- 410**                    **Program Check:** An RU greater than 1,536 bytes was received.  
**8 4 2 1 Indicator:** Off  
**Indicator displayed:** X PROG 410  
**Recovery:** Press RESET to reset the program check indicator and retry the operation. If the problem persists, it is probably a data stream error. Call the host-support programmer.  
**Sense codes:** 1002  
**Applicable to:** A models
- 411**                    **Program Check:** The LU1 RU received was longer than in the Bind specification.  
**8 4 2 1 Indicator:** Off  
**Indicator displayed:** X PROG 411  
**Recovery:** Press RESET to reset the program check indicator and retry the operation. If the problem persists, it is probably a data stream error. Call the host-support programmer.  
**Sense codes:** 1002  
**Applicable to:** SNA

- 412**            **Program Check:** The LU1 RU received was shorter than the Bind specification.  
**8 4 2 1 Indicator:** Off  
**Indicator displayed:** X PROG 412  
**Recovery:** Press RESET to reset the program check indicator and retry the operation. If the problem persists, it is probably a data stream error. Call the host-support programmer.  
**Sense codes:** 1002  
**Applicable to:** SNA
- 413**            **Program Check:** The attempted function is not supported.  
**8 4 2 1 Indicator:** Off  
**Indicator displayed:** X PROG 413  
**Recovery:** Press RESET to reset the program check indicator and retry the operation. If the problem persists, it is probably a data stream error. Call the host-support programmer.  
**Sense codes:** 1003  
**Applicable to:** SNA
- 414**            **Program Check:** A bad pool count or a non-module-8 RU has been received during a cryptographic session.  
**8 4 2 1 Indicator:** Off  
**Indicator displayed:** X PROG 414  
**Recovery:** Press RESET to reset the program check indicator and retry the operation. If the problem persists, it is probably a data stream error. Call the host-support programmer.  
**Sense codes:** 1003  
**Applicable to:** Encrypt/Decrypt
- 420**            **Program Check:** The LIC carried an exception response when Bind specified a definite response.  
**8 4 2 1 Indicator:** Off  
**Indicator displayed:** X PROG 420  
**Recovery:** Press RESET to reset the program check indicator and retry the operation. If the problem persists, it is probably a data stream error. Call the host-support programmer.  
**Sense codes:** 4006  
**Applicable to:** SNA
- 421**            **Program Check:** The LIC carried a definite response when Bind specified an exception response.  
**8 4 2 1 Indicator:** Off  
**Indicator displayed:** X PROG 421  
**Recovery:** Press RESET to reset the program check indicator and retry the operation. If the problem persists, it is probably a data stream error. Call the host-support programmer.  
**Sense codes:** 4007  
**Applicable to:** SNA

- 422**            **Program Check:** A NO response is not allowed.  
**8 4 2 1 Indicator:** Off  
**Indicator displayed:** X PROG 422  
**Recovery:** Press RESET to reset the program check indicator and retry the operation. If the problem persists, it is probably a data stream error. Call the host-support programmer.  
**Sense codes:** 400A  
**Applicable to:** SNA
- 423**            **Program Check:** The format indicator (FI) bit is not allowed.  
**8 4 2 1 Indicator:** Off  
**Indicator displayed:** X PROG 423  
**Recovery:** Press RESET to reset the program check indicator and retry the operation. If the problem persists, it is probably a data stream error. Call the host-support programmer.  
**Sense codes:** 400F  
**Applicable to:** SNA
- 430**            **Program Check:** A sequence number error  
**8 4 2 1 Indicator:** Off  
**Indicator displayed:** X PROG 430  
**Recovery:** Press RESET to reset the program check indicator and retry the operation. If the problem persists, it is probably a data stream error. Call the host-support programmer.  
**Sense codes:** 2001  
**Applicable to:** SNA
- 431**            **Program Check:** A chaining error  
**8 4 2 1 Indicator:** Off  
**Indicator displayed:** X PROG 431  
**Recovery:** Press RESET to reset the program check indicator and retry the operation. If the problem persists, it is probably a data stream error. Call the host-support programmer.  
**Sense codes:** 2002  
**Applicable to:** SNA
- 432**            **Program Check:** Bracket error  
**8 4 2 1 Indicator:** Off  
**Indicator displayed:** X PROG 432  
**Recovery:** Press RESET to reset the program check indicator and retry the operation. If the problem persists, it is probably a data stream error. Call the host-support programmer.  
**Sense codes:** 2003  
**Applicable to:** SNA
- 433**            **Program Check:** Data Traffic Reset  
**8 4 2 1 Indicator:** Off  
**Indicator displayed:** X PROG 433  
**Recovery:** Press RESET to reset the program check indicator and retry the operation. If the problem persists, it is probably a data stream error. Call the host-support programmer.  
**Sense codes:** 2005  
**Applicable to:** SNA

- 434**                    **Program Check:** A direction error  
**8 4 2 1 Indicator:** Off  
**Indicator displayed:** X PROG 434  
**Recovery:** Press RESET to reset the program check indicator and retry the operation. If the problem persists, it is probably a data stream error. Call the host-support programmer.  
**Sense codes:** 2004  
**Applicable to:** SNA
- 439**                    **Program Check:** FM data was received prior to a valid CRV.  
**8 4 2 1 Indicator:** Off  
**Indicator displayed:** X PROG 439  
**Recovery:** Press RESET to reset the program check indicator and retry the operation. If the problem persists, it is probably a data stream error. Call the host-support programmer.  
**Sense codes:** 1001  
**Applicable to:** Encrypt/Decrypt
- 440**                    **Program Check:** The session limit was exceeded.  
**8 4 2 1 Indicator:** Off  
**Indicator displayed:** None  
**Recovery:** Press RESET to reset the program check indicator and retry the operation. If the problem persists, it is probably a data stream error. Call the host-support programmer.  
**Sense codes:** 0805  
**Applicable to:** SNA
- 441**                    **Program Check:** Bracket Bid Reject (No RTR)  
**8 4 2 1 Indicator:** Off  
**Indicator displayed:** None  
**Recovery:** Press RESET to reset the program check indicator and retry the operation. If the problem persists, it is probably a data stream error. Call the host-support programmer.  
**Sense codes:** 0813  
**Applicable to:** SNA
- 441**                    **Program Check:** Receiver is in transmit mode  
**8 4 2 1 Indicator:** Off  
**Indicator displayed:** None  
**Recovery:** Press RESET to reset the program check indicator and retry the operation. If the problem persists, it is probably a data stream error. Call the host-support programmer.  
**Sense codes:** 081B  
**Applicable to:** SNA
- 442**                    **Program Check:** Request not executable  
**8 4 2 1 Indicator:** Off  
**Indicator displayed:** X PROG 442  
**Recovery:** Press RESET to reset the program check indicator and retry the operation. If the problem persists, it is probably a data stream error. Call the host-support programmer.  
**Sense codes:** 081C  
**Applicable to:** SNA

- 443**                    **Program Check:** Change Direction is required.  
**8 4 2 1 Indicator:** Off  
**Indicator displayed:** X PROG 443  
**Recovery:** Press RESET to reset the program check indicator and retry the operation. If the problem persists, it is probably a data stream error. Call the host-support programmer.  
**Sense codes:** 0829  
**Applicable to:** SNA
- 444**                    **Program Check:** Session already bound  
**8 4 2 1 Indicator:** Off  
**Indicator displayed:** None  
**Recovery:** Press RESET to reset the program check indicator and retry the operation. If the problem persists, it is probably a data stream error. Call the host-support programmer.  
**Sense codes:** 0815  
**Applicable to:** SNA
- 445**                    **Program Check:** ACTLU is not equal to COLP or Erp.  
**8 4 2 1 Indicator:** Off  
**Indicator displayed:** X PROG 445  
**Recovery:** Press RESET to reset the program check indicator and retry the operation. If the problem persists, it is probably a data stream error. Call the host-support programmer.  
**Sense codes:** 0821  
**Applicable to:** SNA
- 450–458**              **Program Check:** Bind Reject; Bind parameters do not match.  
Bind checks:  
450 = Profile error  
451 = Primary protocol error  
452 = Secondary protocol error  
453 = Common protocol error  
454 = Screen size specification error  
455 = LU profile error  
456 = LU1 error  
457 = Bind for cryptography was specified when the feature was not present; or a CRV was received in CRV invalid state.  
458 = Master cryptography key mismatch between the host and control unit; see the *Planning and Setup Guide*.  
**8 4 2 1 Indicator:** Off  
**Indicator displayed:** X PROG 450–458  
**Recovery:** Press RESET to reset the program check indicator and retry the operation. If the problem persists, it is probably a data stream error. Call the host-support programmer.  
**Sense codes:** 0821  
**Applicable to:** SNA

- 460**            **Program Check:** Control unit detected an invalid printer authorization matrix.  
**8 4 2 1 Indicator:** Off  
**Indicator displayed:** X PROG 460  
**Recovery:** Press RESET to reset the program check indicator and retry the operation. If the problem persists, it is probably a data stream error. Call the host-support programmer.  
**Sense codes:** None  
**Applicable to:** Printers
- 462**            **Program Check:** Printer detected an error in the LU1 data stream.  
**8 4 2 1 Indicator:** Off  
**Indicator displayed:** X PROG 462  
**Recovery:** Host recovery  
**Sense codes:** Sense set by printer  
**Applicable to:** SNA Printers
- 468**            **Program Check:** Printer detected an error in the LU1 data stream.  
**8 4 2 1 Indicator:** Off  
**Indicator displayed:** None  
**Recovery:** Call the host-support programmer if problem persists, since it is probably a data stream error.  
**Sense codes:** Sense set by printer:  
           1003 – function not supported  
           1005 – currently supported in base code  
           084C – illegal PS selection  
           0863 – illegal alias selection  
           1008 – invalid FMH  
**Applicable to:** SNA
- 470**            **Program Check:** Unsupported code point <X'40' decoded, or X'3F' or X'FF' sent to non-ECSA device.  
**8 4 2 1 Indicator:** Off  
**Indicator displayed:** X PROG 470  
**Recovery:** Press RESET to reset the program check indicator and retry the operation. Call the host-support programmer if the problem persists, since it is probably a data stream error.  
**Sense codes:**  
           Non-SNA: OC  
           SNA:        1003  
**Applicable to:** Extended data stream

**471**

**Program Check:** Extended data stream function cannot be executed:

1. Unsupported structured field type
2. Device without ECSA feature
3. Invalid load format addressed to terminal PS storage
4. Invalid mode in Set Reply mode
5. Invalid operation in Read Partition (not Query)
6. Symbol set ID out of valid range
7. Invalid X or Y value for Load PS structured field
8. Section ID not supported (byte 11 not equal to 0)
9. Invalid length structured field
10. Invalid partition ID
11. Invalid EBCDIC code point
12. Invalid reserved bits received in the data stream
13. (BSC only) Buffer overflow; more than 3K bytes of uncompressed PS data received

See "Error Code Supplemental Information" for additional problem determination information.

**8 4 2 1 Indicator:** Off

**Indicator displayed:** X PROG 471

**Recovery:** Press RESET to reset the program check indicator and retry the operation. Call the host-support programmer if the problem persists, since it is probably a data stream error.

**Sense codes:**

- Non-SNA: OC
- SNA: for 1-6, 8, 12, and 13:  
1003
- for 7 and 9-11:  
1005

**Applicable to:** Extended data stream

**472**

**Program Check:** Improper command sequence from host caused a read structured field state error.

**8 4 2 1 Indicator:** Off

**Indicator displayed:** X PROG 472

**Recovery:** Press RESET to reset the program check indicator and retry the operation. Call the host-support programmer if the problem persists, since it is probably a data stream error.

**Sense codes:**

- Non-SNA: OC
- SNA: 0871

**Applicable to:** Extended data stream

- 473**                    **Program Check:**
1. ECSA adapter present, but terminal storage was addressed that was not physically present.
  2. A color plane operation was attempted to terminal storage with no color plane.
  3. The color plane operation was invalid.
  4. Specified terminal storage ID was outside supported range. See "Error Code Supplemental Information" for additional problem determination information.
- 8 4 2 1 Indicator:** None  
**Indicator displayed:** X PROG 473  
**Recovery:** Press RESET to reset the program check indicator and retry the operation. Call the host-support programmer if the problem persists, since it is probably a data stream error.  
**Sense codes:**  
                   Non-SNA: OC  
                   SNA: 084C  
**Applicable to:** Extended data stream
- 474**                    **Program Check:** No extended DCB was customized for this device.
- 8 4 2 1 Indicator:** Off  
**Indicator displayed:** X PROG 474  
**Recovery:** Log on to an application that does not require extended function, or perform the customizing process for the extended DCB for this device and re-IML.  
**Sense codes:**  
                   Non-SNA: OC  
                   SNA: 1003  
**Applicable to:** Extended data stream
- 475**                    **Program Check:** WCC had the START PRINT bit set, but was not the last structured field.
- 8 4 2 1 Indicator:** Off  
**Indicator displayed:** None  
**Recovery:** Call host-support programmer if problem persists, since it is probably a data stream error.  
**Sense codes:** None  
**Applicable to:** Extended data stream
- 498**                    **Program Check:** Negative response received
- 8 4 2 1 Indicator:** Off  
**Indicator displayed:** X PROG 498  
**Recovery:** Press RESET to reset the program check indicator and retry the operation. Call the host-support programmer if the problem persists.  
**Sense codes:** None  
**Applicable to:** SNA



- 499**                    **Program Check:** Exception request  
**8 4 2 1 Indicator:** Off  
**Indicator displayed:** X PROG 499  
**Recovery:** Press RESET to reset the program check indicator and retry the operation. Call the host-support programmer if the problem persists.  
**Sense codes:** None  
**Applicable to:** SNA
- 501**                    **Communication Check:** Manual OFFLINE switch in the OFFLINE position  
**8 4 2 1 Indicator:** None  
**Indicator displayed:** X ~~→~~ 501  
**Recovery:** At the control unit, place the switch in the ONLINE position.  
**Sense codes:** None  
**Applicable to:** Models 1A, 1B, 1D
- 501**                    **Communication Check:** Local/Comm switch set to Local  
**8 4 2 1 Indicator:** Off  
**Indicator displayed:** X ~~→~~ 501  
**Recovery:** At the control unit, switch the Local/Comm switch to Comm.  
**Sense codes:** None  
**Applicable to:** Model 51C; Multiuse Communications Loop
- 501**                    **Communication Check:** Data Set Ready line dropped  
**8 4 2 1 Indicator:** Off  
**Indicator displayed:** X ~~→~~ 501  
**Recovery:** Check modem. Press RESET and retry operation.  
**Sense codes:** None  
**Applicable to:** C models — SDLC, and X.25
- 502**                    **Communication Check:** Clear to send not present  
**8 4 2 1 Indicator:** Off  
**Indicator displayed:** X ~~→~~ 502  
**Recovery:** Check modem. Press RESET key and retry the operation.  
**Sense codes:** None  
**Applicable to:** C models — SDLC, and X.25
- 503**                    **Communication Check:** A selective reset sequence was received.  
**8 4 2 1 Indicator:** Off  
**Indicator displayed:** X ~~→~~ 503  
**Recovery:** Press RESET and retry the operation.  
**Sense codes:** None  
**Applicable to:** Models 1B and 1D

- 504**            **Communication Check:** The control unit is disconnected from the line, due to: (1) IML; (2) DISC from network; (3) control unit detected errors; (4) operator action.  
**8 4 2 1 Indicator:** Off  
**Indicator displayed:** ~~X~~ → 504  
**Recovery:** A new connection is required.  
**Sense codes:** None  
**Applicable to:** Models 1C and 51C — SDLC
- 504**            **Communication Check:** DISC received  
**8 4 2 1 Indicator:** Off  
**Indicator displayed:** ~~X~~ → 504  
**Recovery:** 3274 is attempting to reopen the link; if the problem persists, verify the proper operation of the X.25 network.  
**Sense codes:** None  
**Applicable to:** All C models — X.25
- 505**            **Communication Check:** The initial state of the control unit on a Disconnect command was received.  
**8 4 2 1 Indicator:** Off  
**Indicator displayed:** ~~X~~ → 505  
**Recovery:** Host recovery requires an SNRM command. Press the RESET key and retry the operation.  
**Sense codes:** None  
**Applicable to:** Models 1C and 51C — SDLC
- 505**            **Communication Check:** Initial state of control unit; a Disconnect command or a System Reset was received.  
**8 4 2 1 Indicator:** Off  
**Indicator displayed:** ~~X~~ → 505  
**Recovery:** Host recovery; requires a connect sequence. Press RESET and retry the operation.  
**Sense codes:** None  
**Applicable to:** Model 1A
- 505**            **Communication Check:** System Reset was received.  
**8 4 2 1 Indicator:** Off  
**Indicator displayed:** ~~X~~ → 505  
**Recovery:** Host recovery; the first I/O operation other than TIO or Sense will clear the Communication Reminder. Press RESET and retry the operation.  
**Sense codes:** None  
**Applicable to:** Model 1B, 1D
- 505**            **Communication Check:** Initial state of control unit; a DISC command has been received, or beaconing has been completed.  
**8 4 2 1 Indicator:** Off  
**Indicator displayed:** ~~X~~ → 505  
**Recovery:** Host recovery; an SNRM command is required. Press RESET and retry the operation.  
**Sense codes:** None  
**Applicable to:** Model 51C; Multiuse Communications Loop

- 505**                    **Communication Check:** CONTACT required  
**8 4 2 1 Indicator:** Off  
**Indicator displayed:** ✕ → 505  
**Recovery:** None. This is normal at startup. If the 505 is displayed for a long time, notify the system operator.  
**Sense codes:** None  
**Applicable to:** All C models — X.25
- 506**                    **Communication Check:** Waiting for DCE Ready  
**8 4 2 1 Indicator:** Off  
**Indicator displayed:** ✕ → 506  
**Recovery:** None. This is normal at startup. If the 506 is displayed for a long time, validate the proper operation of the X.25 network.  
**Sense codes:** None  
**Applicable to:** All C models — X.25
- 507**                    **Communication Check:** No RLSD for a 4-second period  
**8 4 2 1 Indicator:** Off  
**Indicator displayed:** ✕ → 507  
**Recovery:** Host recovery. If 507 remains in the communication reminder area, check for a ✕ → 3nn keyboard inhibit and refer to that error description.  
**Sense codes:** None  
**Applicable to:** Model 51C; Multiuse Communications Loop
- 508**                    **Communication Check:** A CNFG command was received that specified Set Monitor code.  
**8 4 2 1 Indicator:** Off  
**Indicator displayed:** ✕ → 508  
**Recovery:** A CNFG command that specifies CLEAR or RESET is received from the host.  
**Sense codes:** None  
**Applicable to:** Model 51C; Multiuse Communications Loop
- 509**                    **Communication Check:** A CNFG command was received that specified Suppress Loop Carrier mode.  
**8 4 2 1 Indicator:** Off  
**Indicator displayed:** ✕ → 509  
**Recovery:** A CNFG command that specifies CLEAR or RESET is received from the host.  
**Sense codes:** None  
**Applicable to:** Model 51C; Multiuse Communications Loop
- 510**                    **Communication Check:** The PU is not active.  
**8 4 2 1 Indicator:** Off  
**Indicator displayed:** ✕ → 510  
**Recovery:** Host recovery; ACTPU is required.  
**Sense codes:** Off  
**Applicable to:** SNA

- 511**                    **Communication Check:** Disconnect command was received when PU was active.  
**8 4 2 1 Indicator:** Off  
**Indicator displayed:** ✕ ~~→~~ 511  
**Recovery:** Host recovery; Connect is required.  
**Sense codes:** None  
**Applicable to:** Model 1A
- 512**                    **Communication Check:** Connect command was received when PU was already connected.  
**8 4 2 1 Indicator:** Off  
**Indicator displayed:** None  
**Recovery:** Host recovery; ACTPU is required.  
**Sense codes:** Off  
**Applicable to:** Model 1A
- 513**                    **Communication Check:** Channel not available  
**8 4 2 1 Indicator:** Off  
**Indicator displayed:** ✕ ~~→~~ 513  
**Recovery:** If an outgoing call was attempted, retry. If no outgoing call was attempted, wait for the network to retry. If 513 is displayed for a long time or if there are many retries, validate the proper operation of the X.25 network.  
**Sense codes:** None  
**Applicable to:** All C models — X.25
- 514**                    **Communication Check:** Connect error caused by:  
(1) Specification of a buffer with odd-number length  
(2) Specification of a buffer of insufficient length  
**8 4 2 1 Indicator:** Off  
**Indicator displayed:** None  
**Recovery:** Host recovery; valid connect is required. See “Connect Function,” under “Control Command,” in Chapter 5.  
**Sense codes:** None  
**Applicable to:** Model 1A
- 515**                    **Communication Check:** During the monitoring of “RLSD,” a “no RLSD” condition was detected and wrap tests were run successfully.  
**8 4 2 1 Indicator:** Off  
**Indicator displayed:** ✕ ~~→~~ 515  
**Recovery:** Receipt of more than 51% RLSD samples will cause the station to stop beaconing. SNRM is required. (See 505.)  
**Sense codes:** None  
**Applicable to:** Model 51C; Multiuse Communications Loop
- 517**                    **Communication Check:** DCE not available/open timeout  
**8 4 2 1 Indicator:** Off  
**Indicator displayed:** ✕ ~~→~~ 517  
**Recovery:** The 3274 is retrying. Wait, and if the problem persists, verify the proper operation of the X.25 network.  
**Sense codes:** None  
**Applicable to:** All C models — X.25

- 518**                    **Communication Check:** A segment with improperly sequenced TH MPF bits was received.  
**8 4 2 1 Indicator:** Off  
**Indicator displayed:** ~~X~~ → 518  
**Recovery:** Host recovery; SNRM is required.  
**Sense codes:** None  
**Applicable to:** Models 1C and 51C — SDLC
- 519**                    **Communication Check:** A message larger than the control unit buffer was received.  
**8 4 2 1 Indicator:** Off  
**Indicator displayed:** ~~X~~ → 519  
**Recovery:** Host recovery; check NCP SYSGEN parameters if the condition persists.  
**Sense codes:** None  
**Applicable to:** Models 1C and 51C — SDLC
- 520**                    **Communication Check:** A nonproductive timeout was caused when:  
(1) A valid frame was not received in the past 20–25 seconds; or  
(2) The communication line is hung at a space or a valid data character.  
**8 4 2 1 Indicator:** Off  
**Indicator displayed:** ~~X~~ → 520  
**Recovery:** Verify the operational status of the communication network. Reset upon receipt of a valid frame or a frame containing a poll.  
**Sense codes:** None  
**Applicable to:** Models 1C and 51C — SDLC
- 520**                    **Communication Check:** Receive timeout  
**8 4 2 1 Indicator:** Off  
**Indicator displayed:** ~~X~~ → 520  
**Recovery:** The 3274 is waiting for the X.25 network to recover, or, if trying to open the link, is itself trying to recover. Wait. If the problem persists, verify the proper operation of the X.25 network.  
**Sense codes:** None  
**Applicable to:** All C models — X.25
- 521**                    **Communication Check:** No Flag characters on the line in the past 20–25 seconds. On a switched network, three successive occurrences of an idle timeout will cause the station to disconnect.  
**8 4 2 1 Indicator:** Off  
**Indicator displayed:** ~~X~~ → 521  
**Recovery:** Verify the operational status of the communication network. Reset upon receipt of a valid frame or a frame containing a poll.  
**Sense codes:** None  
**Applicable to:** Models 1C and 51C — SDLC

- 522**                    **Communication Check:** The control unit's Read Control Block overflowed. The line may be hung at a space or valid data character.  
**8 4 2 1 Indicator:** Off  
**Indicator displayed:** ✕ → 522  
**Recovery:** Verify the operational status of the communication network. Reset by receipt of a valid frame or a frame containing a poll.  
**Sense codes:** None  
**Applicable to:** Model 51C; Multiuse Communications Loop
- 525**                    **Communication Check:** A connection problem on the communications link prevents establishing or reestablishing host communication. (Set by receipt of 20 Write retries, 20 ROLs, 20 CRs, 20 XIDs, or 20 HSAs.)  
**8 4 2 1 Indicator:** Off  
**Indicator displayed:** ✕ → 525  
**Recovery:** Verify the operational status of the communication network.  
**Sense codes:** None  
**Applicable to:** Models 1C and 51C — SDLC
- 525**                    **Communication Check:** A connection problem on the communications link prevents establishing or reestablishing host communication. (Set by receipt of 20 Write retries, 20 ROLs, 20 CRs, 20 XIDs, or 20 HSAs.)  
**8 4 2 1 Indicator:** Off  
**Indicator displayed:** ✕ → 525  
**Recovery:** Verify the operational status of the communication network. If there were wrap-test failures, an IML is required. If the wrap tests were successful, an SNRM is required.  
**Sense codes:** None  
**Applicable to:** Model 51C; Multiuse Communications Loop
- 527**                    **Communication Check:** Write timeout caused by clocking problem or missing CTs.  
**8 4 2 1 Indicator:** Off  
**Indicator displayed:** ✕ → 527  
**Recovery:** Verify the operational status of the network; re-IML.  
**Sense codes:** None  
**Applicable to:** Model 51C; Multiuse Communications Loop
- 528**                    **Communication Check:** Command Reject caused by:  
(1) Detection of an NR sequence error; or  
(2) Receipt of a command that has no data field defined; or  
(3) Receipt of an invalid command.  
**8 4 2 1 Indicator:** Off  
**Indicator displayed:** ✕ → 528  
**Recovery:** Host recovery; SNRM is required. Verify proper 370X parameters if condition persists.  
**Sense codes:** None  
**Applicable to:** Models 1C and 51C — SDLC

- 529**                    **Communication Check:** Abnormal response from the modem  
**8 4 2 1 Indicator:** Off  
**Indicator displayed:** ✕ → 529  
**Recovery:** Check modem. Host recovery; SNRM is required.  
**Sense codes:** None  
**Applicable to:** Models 1C and 51C — SDLC
- 529**                    **Communication Check:** DCE error  
**8 4 2 1 Indicator:** Off  
**Indicator displayed:** ✕ → 529  
**Recovery:** The 3274 is closed and is attempting to re-open the X.25 link. If link and circuit are re-opened, recovery is the responsibility of the host. If the problem persists, try to isolate the problem and contact the appropriate service representative.  
**Sense codes:** None  
**Applicable to:** All C models — X.25
- 530**                    **Communication Check:** Write timeout caused because:  
(1) Modem clocking is missing; or  
(2) CTS has dropped.  
**8 4 2 1 Indicator:** Off  
**Indicator displayed:** ✕ → 530  
**Recovery:** Check modem. Host recovery. In SDLC, SNRM is required.  
**Sense codes:** None  
**Applicable to:** Models 1C and 51C
- 530**                    **Communication Check:** Write Timeout  
**8 4 2 1 Indicator:** Off  
**Indicator displayed:** ✕ → 530  
**Recovery:** The 3274 is closed and is attempting to re-open the X.25 link. Host recovery is required. If the problem persists, try to isolate the problem and contact the appropriate service representative.  
**Sense codes:** None  
**Applicable to:** All C models — X.25
- 531**                    **Communication Check:** Control unit has sent a NAK response because:  
(1) A BCC error was detected; or  
(2) Three seconds elapsed during a read operation without receipt of SYN, ETX, or ETB; or  
(3) A forward abort (ENQ in text) was received; or  
(4) A Temporary Text Delay sequence (STX ENQ) was received.  
**8 4 2 1 Indicator:** Off  
**Indicator displayed:** ✕ → 531  
**Recovery:** Host recovery. Host should retransmit the last transmission. Also resets the Communication Reminder symbol.  
**Sense codes:** None  
**Applicable to:** Models 1C and 51C — BSC

- 532**                    **Communication Check:** Approximately 20 seconds have elapsed without the detection of SYN characters on the line.  
**8 4 2 1 Indicator:** Off  
**Indicator displayed:** ✕ ~~→~~ 532  
**Recovery:** Verify the operational status of the communication network. Host recovery. A valid Poll or selection-addressing sequence is required. Also resets the Communication Reminder symbol.  
**Sense codes:** None  
**Applicable to:** Models 1C and 51C — BSC
- 533**                    **Communication Check:** The control unit did not receive ETX or ETB with the last block of text transmitted by the host. The host has sent ENQ to the control unit.  
**8 4 2 1 Indicator:** Off  
**Indicator displayed:** ✕ ~~→~~ 533  
**Recovery:** Host recovery. Host should retransmit the last transmission sent that preceded ENQ. Also resets the Communication Reminder symbol.  
**Sense codes:** None  
**Applicable to:** Models 1C and 51C — BSC
- 534**                    **Communication Check:**  
(1) The control unit did not receive a response to its last block sent, and sent ENQ 15 times.  
(2) The control unit has acknowledged a selecting sequence, or Text block, and has waited 45 seconds without detecting synchronization (PAD and SYNs).  
**8 4 2 1 Indicator:** Off  
**Indicator displayed:** ✕ ~~→~~ 534  
**Recovery:** Host recovery. A valid Poll or selection-addressing is required. Also resets the Communication Reminder symbol.  
**Sense codes:** None  
**Applicable to:** Models 1C and 51C — BSC
- 535**                    **Communication Check:** The control unit received 15 consecutive NAKs to its last transmission.  
**8 4 2 1 Indicator:** Off  
**Indicator displayed:** ✕ ~~→~~ 535  
**Recovery:** Host recovery. A valid Poll or selection-addressing is required. Also resets the Communication Reminder symbol.  
**Sense codes:** None  
**Applicable to:** Models 1C and 51C — BSC
- 536**                    **Communication Check:** The control unit received 15 consecutive ACK0s instead of ACK1s or vice versa.  
**8 4 2 1 Indicator:** Off  
**Indicator displayed:** ✕ ~~→~~ 536  
**Recovery:** Host recovery. A valid Poll or selection-addressing is required. Also resets Communication Reminder symbol.  
**Sense codes:** None  
**Applicable to:** Models 1C and 51C — BSC



- 537**                    **Communication Check:** Call Timeout  
**8 4 2 1 Indicator:** Off  
**Indicator displayed:** ~~X~~ → 537  
**Recovery:** The COMM key may be used to reset the nnn. If in Call Ready state, the call may be retried via a DIAL key sequence. If the problem persists, verify the proper operation of the X.25 network.  
**Sense codes:** None  
**Applicable to:** All C models — X.25
- 538**                    **Communication Check:** Packet Timeout  
**8 4 2 1 Indicator:** Off  
**Indicator displayed:** ~~X~~ → 538  
**Recovery:** The 3274 is waiting for the X.25 network to recover; or if it is attempting to open the link, the 3274 is itself trying to recover. Wait. If the problem persists, verify the proper operation of the X.25 network.  
**Sense codes:** None  
**Applicable to:** All C models — X.25
- 539**                    **Communication Check:** Bad network termination  
**8 4 2 1 Indicator:** Off  
**Indicator displayed:** ~~X~~ → 539  
**Recovery:** The 3274 is waiting for the X.25 network to recover; or if it is attempting to open the link, the 3274 is itself trying to recover. Wait. If the problem persists, verify the proper operation of the X.25 network.  
**Sense codes:** None  
**Applicable to:** All C models — X.25
- 540**                    **Communication Check:** A Restart Reset, Read Start, Write Start, or Write Break command was received while the control unit was not initialized.  
**8 4 2 1 Indicator:** Off  
**Indicator displayed:** None  
**Recovery:** Host recovery. A Connect command is required.  
**Sense codes:** 8200¹  
**Applicable to:** Model 1A
- 541**                    **Communication Check:** An invalid command was received.  
**8 4 2 1 Indicator:** Off  
**Indicator displayed:** None  
**Recovery:** Host recovery. Verify the host SYSGEN for proper device-type.  
**Sense codes:** 8000¹  
**Applicable to:** Model 1A

---

¹ These sense codes are transmitted by 3274 Model 1A in response to a sense command. Do not confuse them with SNA sense codes.

- 543**                    **Communication Check:** A channel parity error occurred during selection.  
**8 4 2 1 Indicator:** Off  
**Indicator displayed:** None  
**Recovery:** Host recovery  
**Sense codes:** 2002¹  
**Applicable to:** Model 1A
- 544**                    **Communication Check:** A channel parity error occurred during a host write operation.  
**8 4 2 1 Indicator:** Off  
**Indicator displayed:** None  
**Recovery:** Host recovery  
**Sense codes:** 2006¹  
**Applicable to:** Model 1A
- 545**                    **Communication Check:** A control unit parity error occurred during a host write operation.  
**8 4 2 1 Indicator:** Off  
**Indicator displayed:** None  
**Recovery:** Host recovery  
**Sense codes:** 1002¹  
**Applicable to:** Model 1A
- 546**                    **Communication Check:** A control unit parity error occurred during a host read operation.  
**8 4 2 1 Indicator:** 0001 or 0011–0111  
**Indicator displayed:** None  
**Recovery:** Host recovery  
**Sense codes:** 1006¹  
**Applicable to:** Model 1A
- 547**                    **Communication Check:** A channel parity error occurred during a host read operation.  
**8 4 2 1 Indicator:** 1001  
**Indicator displayed:** None  
**Recovery:** Host recovery  
**Sense codes:** 1002¹  
**Applicable to:** Model 1A
- 548**                    **Communication Check:** A control unit error occurred during an I/O operation.  
**8 4 2 1 Indicator:** 1001 or 1011  
**Indicator displayed:** None  
**Recovery:** Host recovery  
**Sense codes:** 1001¹  
**Applicable to:** Model 1A

---

¹ These sense codes are transmitted by 3274 Model 1A in response to a sense command. Do not confuse them with SNA sense codes.

- 549**                    **Communication Check:** The byte count specified in the host's Read command was insufficient to transfer all associated data from the control unit buffer.  
**8 4 2 1 Indicator:** Off  
**Indicator displayed:** None  
**Recovery:** Host recovery  
**Sense codes:** 0800¹  
**Applicable to:** Model 1A
- 550**                    **Communication Check:** The count in the link header did not equal the byte count received.  
**8 4 2 1 Indicator:** Off  
**Indicator displayed:** None  
**Recovery:** Host recovery  
**Sense codes:** 0800¹  
**Applicable to:** Model 1A
- 551**                    **Communication Check:** The control unit detected bad parity on a command or data byte it received.  
**8 4 2 1 Indicator:** Off  
**Indicator displayed:** ✕ → 551  
**Recovery:** Host recovery  
**Sense codes:** 20¹  
**Applicable to:** Models 1B and 1D
- 555**                    **Communication Check:** Format error on a network CPS or line ID.  
**8 4 2 1 Indicator:** Off  
**Indicator displayed:** ✕ → 555  
**Recovery:** Press the Comm key.  
**Sense codes:** None  
**Applicable to:** X.21 switched
- 556**                    **Communication Check:** X.21 network timeout has been detected.  
**8 4 2 1 Indicator:** Off  
**Indicator displayed:** ✕ → 556  
**Recovery:** Press the Comm key.  
**Sense codes:** None  
**Applicable to:** X.21 switched
- 557**                    **Communication Check:** Network not ready  
**8 4 2 1 Indicator:** Off  
**Indicator displayed:** ✕ → 557  
**Recovery:** If the error persists, network recovery may be needed.  
**Sense codes:** None  
**Applicable to:** X.21 switched

---

¹ These sense codes are transmitted by 3274 Model 1A in response to a sense command. Do not confuse them with SNA sense codes.

- 558**                    **Communication Check:** Lost data  
**8 4 2 1 Indicator:** Off  
**Indicator displayed:** ✕ ~~→~~ 558  
**Recovery:** Press the Comm key.  
**Sense codes:** None  
**Applicable to:** X.21 switched
- 559**                    **Communication Check:** DCE cleared; the network or host has disabled communications.  
**8 4 2 1 Indicator:** Off  
**Indicator displayed:** ✕ ~~→~~ 559  
**Recovery:** The host or operator initiates a call.  
**Sense codes:** None  
**Applicable to:** X.21 switched
- 560**                    **Communication Check:**  
(1) Not +/Bel received while monitoring for incoming call; or  
(2) Proceed to Select not received while dialing.  
**8 4 2 1 Indicator:** Off  
**Indicator displayed:** ✕ ~~→~~ 560  
**Recovery:** The host or operator initiates a call.  
**Sense codes:** None  
**Applicable to:** X.21 switched
- 561**                    **Communication Check:** A CLR Timeout was detected during a "clearing sequence."  
**8 4 2 1 Indicator:** Off  
**Indicator displayed:** ✕ ~~→~~ 561  
**Recovery:** If the error persists, network recovery may be required.  
**Sense codes:** None  
**Applicable to:** X.21 switched
- 562**                    **Communication Check:** Compare error. A signal mismatch on the 3274 driver receiver.  
**8 4 2 1 Indicator:** Off  
**Indicator displayed:** ✕ ~~→~~ 562  
**Recovery:** Press the Comm key.  
**Sense codes:** None  
**Applicable to:** X.21 switched
- 565**                    **Communication Check:** An invalid operation was caused by an unknown network failure.  
**8 4 2 1 Indicator:** Off  
**Indicator displayed:** ✕ ~~→~~ 565  
**Recovery:** Press the Comm key.  
**Sense codes:** None  
**Applicable to:** X.21 switched

**590**                    **Communication Check:** 3290 no poll received  
**8 4 2 1 Indicator:** Off  
**Indicator displayed:** X → 590  
**Recovery:** Perform a power-on reset at the 3290 and observe whether the device returns to normal operation. Check the physical coaxial connections between the 3290 and the 3274. Check the control unit 8 4 2 1 indicators. Display the 3290's device log in the 3274 to see whether the 3274 has detected a coaxial problem.  
**Sense codes:**  
                   Non-SNA: DC/US  
                   SNA:       081C  
**Applicable to:** 3290 Information Panel

**599**                    **Communication Check:** Local mode. An operator pressed the Local key on an attached 3278/3279.  
**8 4 2 1 Indicator:** Off  
**Indicator displayed:** X → 599  
**Recovery:** Press the Comm key to return to Call Ready state.  
**Sense codes:** None  
**Applicable to:** X.21 switched, X.25

### Error Code Supplemental Information

Complementing the PROG 4nn indicator codes, bytes X'170-174' of the extended DCB are used as a log area for additional information. The extended DCB is created during customization for devices supporting Structured Field and Attribute Processing (SFAP).

Bytes X'170', X'171' contain the displacement in hex to the byte in the Write Structured Field that was found to be in error. (The WSF command = byte 1.) Bytes X'172', X'173' contain the displacement into the particular structured field (SF) where the error was detected. Byte X'174' contains the SF type of the SF that contained the error.

Figure A-1 correlates the 4nn numbers, the values found in bytes X'172-174', the SNA sense code, and a description of the error. OP check is the sense set for local attachment (non-SNA) and BSC in all cases.

Bytes X'170-174' may be displayed in the following manner. Enter Test Mode by pressing the Alt and Test keys. Select the DCB in question by typing in AA/6; AA is the coaxial port number in question (00-31). (If the device being used for the test is the port in question, /6 will suffice.) Press the ENTER key. The display should now contain:

```

Line 1 AA/6 (Same as input)

Line 2 00

Line 3 XXXX XXXX XXXX XXXX XXXX XXXX XXXX XXXX

Line 4 XXXX XXXX XXXX XXXX XXXX XXXX XXXX XXXX

Line 5 XXXX XXXX XXXX XXXX XXXX XXXX XXXX XXXX

Line 6 XXXX XXXX XXXX XXXX XXXX XXXX XXXX XXXX

```

4nn	Bytes X'172-174'	Sense	Error Description (See Note)
471	0003 XX XX = any value but 01, 06, or 09	1003	Unsupported SF type
471	----	1003	WSF command sent to a device without an ECSA feature
471	0004 06	1003	Invalid load format addressed to terminal PS storage
471	000A 06	1005	Invalid horizontal (X) value for LPS SF
	000B 06	1005	Invalid vertical (Y) value for LPS SF
471	000C 06	1003	Byte 11 is not equal to 0 in LPS SF
471	0001 XX XX = 01, 06, or 09	1005	Invalid length SF
471	0004 09	1005	Byte 3 not 0 in SRM SF
471	0005 09	1003	Invalid Mode in SRM SF
471	0005 01	1003	Byte 4 is not X'02' in Read Partition-Query SF
471	0005 06	1003	Symbol set ID out of legal range
471	0006 06	1005	Invalid EBCDIC code point
471	000D 06	1003	Bits 0-4 of Byte 12 in LPS SF not 0
471	0009 06	1003	Bits 3-7 of byte 8 in LPS not 0
471	0002 06	Op Chk	(BSC only) Greater than 3K of uncompressed LPS data received
471	0004 01	1003	Byte 3 not X'FF' in Read Partition-Query SF
473	0007 06	084C	ECSA present but addressed RWS in device not physically present
473	000D 06	084C	Color plane invalid

**Note:** As part of overall SFAP problem determination, the usage of the following functions should be kept in mind. If the device in question does not have an extended DCB (not enough allocated during customization), the DCB display procedure (described above) inhibits the keyboard with the minus function indicator on the fourth pressing of the PA1 or Enter Key. If the device does not have an ECSA feature, Test 8 (Enter test mode, type in /8, press Enter) inhibits the keyboard with a wrong number indicator. This is also true if SFAP is not configured. If SFAP is not configured, the above nnn numbers do not appear.

Figure A-1. Indicator Code – Log Area Correlation

Where:

00 = The displacement from the start of the control block (in hex, the low-order digit is dropped) of the portion of the control block currently being displayed.

XXXX = Hex representation of the portion of the control block currently being displayed.

Press the PA1 or ENTER key five times. Line 2 should change to 04, 08, 0C, 10, and then 14. The low-order digit being dropped, the values are really X'40', X'80', X'C0', X'100', and X'140'. X'170-174' are the first 5 bytes on line 6.

**Note:** Values exceeding X'0C' on line 2 appear only if an extended DCB (for this device) is present.

### DCB Logical Terminal Extension

DCBs for devices that support "logical terminals" such as the 3290 Information Panel Display Station will have, following the four pages of extended DCB information (10 to 1C on line 2), information concerning the logical terminals (if any) that are associated with the device.

The logical terminal information is accessed by pressing the ENTER key until X0 appears on line 2. Line 3 will now display 20 bytes of data concerning the first logical terminal associated with the device. Pressing ENTER again (X1 appears on line 2) will cause a 20 byte display of data for the second logical terminal. Up to five displays may be accessed; line 2 will change from X0 to X1, to X2, to X3, to X4 as the ENTER key is pressed.

The screen will appear as follows:

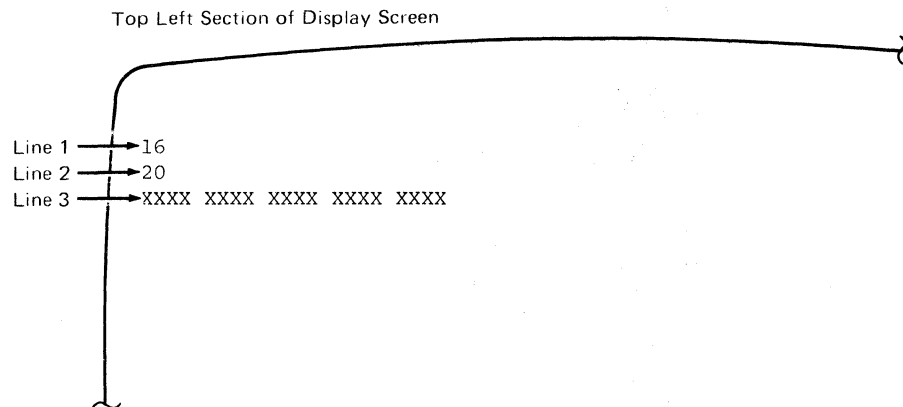

where xxxx xxxx . . . represents the 20 bytes of data (x = 1 byte). From left to right, the data is interpreted as follows:

Byte	Meaning
0	The address of the logical terminal
1	ACTLU type—ERP or cold
2	ACTLU and Bind status
3	Bracket and chaining status of logical terminal
4-5	Segmenting information
6-7	Format ID (FID) and transmission header (TH) information
8	Destination address (DAF)
9	Origin address (OAF)
10-11	Receive sequence number
12-13	Bytes 0 and 1 of the request header (RH)
14	Byte 2 of the RH
15-19	Reserved

## 3274 Log and Test Facility

The 3274 control units have a log and test facility that records failure information in 3274 storage and allows the display of subsystem status, device control blocks, configuration data, and error counters. Much of this information may be of value as an aid to problem determination and management of a network. This data is available (via test mode) on any 3178/3278/3279 display attached to the 3274 control unit. The information obtained is displayed on the screen and, if desired, hardcopy may be obtained by initiating the local copy function.

The data displayed by the 3274 test facility falls into two general categories: configuration data and error logs. The configuration data contains information about the physical configuration, microcode EC data, RPQ data, status displays, and the device control blocks for all configured devices.

The error logs include error event information and statistical counters. They record the most recent error event information and count the number of errors of a given type that have occurred. The error logs include individual device logs for all configured devices, type A/type B adapter error logs, host adapter logs, 3274 control logic logs, and summary logs for the 3274 subsystem. The error logs are reset to zero whenever the 3274 is powered on or IMLed. The 3274 subsystem also provides the capability for the 3178/3278/3279 operator to dynamically reset any desired log to zero. This facility may prove useful when trying to find intermittent errors or counting the number of errors that occurred within a specific time period (workshift, hour, day, etc.).

The output of the test commands are presented to the requestor in a hexadecimal dump format with little formatting of fields. The documentation on the interpretation of this information is in the *3274 Control Unit Maintenance Concepts Manuals*, SY27-2512 and SY27-2528. These FE manuals are shipped with the 3274 control unit. The accompanying charts have been prepared to highlight the more useful data available. However, this document is not intended to be a replacement for the *Maintenance Concepts Manuals*. A summary of the information in the *Maintenance Concepts Manuals* is available in reference card form: *3274 Subsystem CE Reference Summary*, SX23-0207.

The test facility is entered by pressing and holding the ALT key and then pressing the TEST key. Successful entry into test mode is indicated by the presence of the word "TEST" in the operator information area. The test facility is exited by again pressing the ALT and TEST keys. A display that is in test mode will be "unavailable" to host applications. The host application is notified of exit from test mode via LUSTATUS of 082B (SNA) or asynchronous status of DE (non-SNA).

The following is a brief introduction to certain of the available test facilities:

- Test 0 — Checks and identifies the communication path between the 3274 control unit and its attached devices.
- Test 1 — Displays error statistics for displays, printers, adapters and control logic.
- Test 2 — Displays configuration information.



- Test 3 – Displays the status (off, on, disabled) of all configured devices and summary counters.
- Test 4 – Resets error logs.
- Test 6 – Displays information in device control blocks.
- Test A – Sends operator-generated alert messages.
- Test B – Displays the device address assignment table.

**Note:** Test 7 and Test 8 are also available for Color Convergence and Programmed Symbols, Highlighting, and Color Testing of 3279 displays, but are not covered here. Details are available in the devices' problem determination guides.

The following Keyboard Inhibit, "Do Not Enter," conditions can be set as a result of actions taken while making a test request.

<b>Indicator Displayed</b>	<b>Probable Cause</b>
X-f (minus function)	An aid generating action other than the ENTER or PA1 key was initiated while in test mode (PA2, PF keys, MSR operation, or a selector pen, or cursor select operation in a immediate detect field in Test 0).
	In a test that supports paging with the PA1 or ENTER key, no further paging is allowed.
X ？# ? (what number)	An unsupported test request syntax was found starting in column 0 when the ENTER key was pressed (unsupported test number).

### ***Test 0: Communication Path and Display Test***

Test 0 performs the following functions:

- Causes a test pattern to be returned from the control unit to the requesting display.
- The test pattern sent allows the testing of high intensity, nondisplay, various key functions, selector pen, MSR, and audible alarm.
- Indicates the origin (port number) of the request.
- Tests the four-color function and override switch (3279).

## Procedure for Requesting Test 0

Press and hold ALT, and then press TEST to enter test mode. Ensure the cursor is at location zero (0). Enter a slash (/). Press the ENTER key. The following pattern will appear on the screen if the test is successful.

Top Left Section of Display Screen

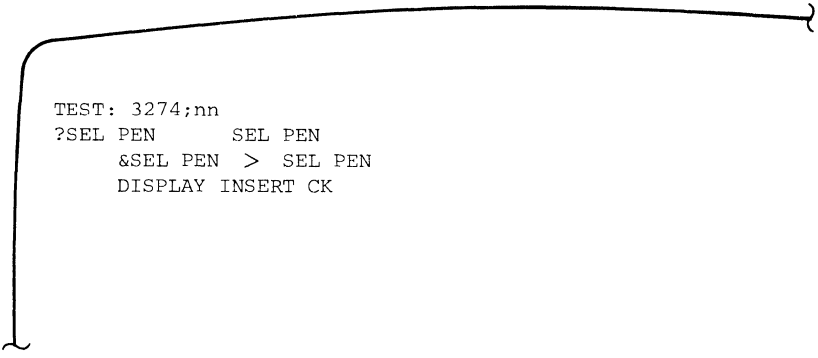

```
TEST: 3274;nn
?SEL PEN      SEL PEN
&SEL PEN > SEL PEN
DISPLAY INSERT CK
```

nn = The port number of the terminal that requested the test.

Use the *IBM Display Station Problem Determination Guide* to run the tests with the above test pattern. To exit test mode, press and hold ALT and then press TEST.

## 3274 Test 1: Device and Adapter Logs

Through the use of the Test 1 facilities a variety of device and adapter error log and statistical counter information can be displayed (and printed with local copy).

To obtain Test 1 information, press and hold the ALT key, then press the TEST key to enter test mode. Then enter the request as described below.

While in test mode, subsequent requests may be made by clearing the screen (using the ALT and CLEAR keys) and entering the next request.

The following is a brief description of the format and function of the various Test 1 requests:

- 00/1 to 31/1    – Displays specified device logs for the coaxial port specified (00–31).
- A0/1           – Displays host adapter/attachment logs. The information displayed is dependent on the host adapter/attachment installed.
- A1/1           – Displays Type A adapter logs.
- A2/1           – Displays feature adapter logs.
- A3/1           – Displays 3274 control logic error logs.

The following sections detail pertinent information that may be obtained from the control unit and device logs. Due to the volume and complexity of error data logged, not all of it is documented here. An attempt was made, however, to illustrate the more useful error information. Certain of the error data available to the user with this test is also available to the host site network operator through the functions of NPDA (by means of the 3274 SNA alert function). The information available to NPDA is control unit level summary information, while information obtained through the use of the Test 1 facility is also at the device level.

The error logs may be used for statistical purposes and for problem determination. A 3274 site may wish to monitor error counts for indications of problems detected by, or within, the subsystem. The tracking of error trends within the subsystem may enable the site to pinpoint potential problems before they become serious enough to affect the availability of that portion of the network. The logs may also be used for some basic problem determination. For example, if a port is indicating a high number of coaxial errors, the problem may possibly be resolved by tightening the coaxial cable, thereby saving a service call.

#### Resetting Device and Adapter Logs (Test 4)

In order to track intermittent problems or to record the number of errors within a specific time period the error logs can be reset without powering off or re-IMLing. Test 4 accomplishes this.

Enter:

nn/4 to reset logs for device (port) specified. (nn = 00 to 31.)  
 A0/4 to reset host adapter logs  
 A1/4 to reset Type A adapter logs  
 A2/4 to reset feature adapter logs  
 A3/4 to reset 3274 control logic logs

#### 3274 Test 1 Device Logs

The device logs are of a format similar to that shown in the example below. Distributed function device logs on configurations that support distributed function devices will display additional data on lines 2 and 3.

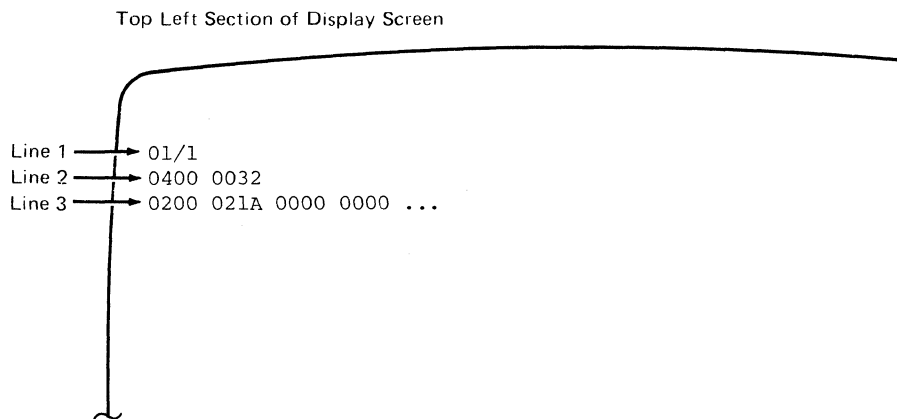

Line 1 is the test request message as input.

Line 2 contains error event data.

Byte	Meaning
00	Last two digits of the most recent 200 error
01	Last two digits of the most recent 300 error
02	Last two digits of the most recent 400 error
03	Last two digits of the most recent 500 error
04	Last two digits of the most recent distributed-function-device-detected 6nn machine check
05	Last two digits of the most recent distributed-function-device-detected 7nn program check

Refer to “3274 Error Indicators and Codes (nnn Codes)” for nnn code explanations.

**Note:** Use the nnn code logged for the device for initial analysis. If no 2nn code is logged (location 0 = 00), the error was recovered by the 3274.

Line 3 contains coaxial and device error counters.

Byte	Meaning
00	Coaxial timeouts. This counter is incremented when the 3274 sends data or commands to the device and does not receive a response in a predetermined period of time.
01	Coaxial parity error. This counter is incremented when the 3274 detects a parity error in data received from the device.
02	Normal power off. This counter indicates the number of times the device failed to respond to a poll retry sequence (device powered off). Counter 1 or 2 is incremented on the first failure to receive a poll sequence response; 32 successive poll sequence retries then follow. If all retries are unsuccessful, the control logic assumes that the device is powered off and then increments the counter.
03	Device checks. The device attached has detected a buffer parity error and has returned device check status to the 3274. See nnn code 204 (type A devices) or 277 (type B devices).
04	3278/3279 or Type A Printer: Error status was returned from a device that indicates a device failure. Refer to 2nn in error event data.  Type B Printer: The printer reported a synchronization or equipment check. Refer to nnn = 276 in “3274 Indicators and Codes (nnn Codes).”

Byte	Meaning
05	3278/3279: Status was returned to the controller that indicates a feature failure.  Distributed Function Device: Interface synchronization error.  Type A Printer: The printer reported an equipment check. Refer to nnn = 231 in "3274 Indicators and Codes (nnn Codes)."  Type B Printer: The printer reported itself disabled equipment check. Refer to nnn = 275 in "3274 Indicators and Codes (nnn Codes)."
06/07	Not applicable
08-0B	Distributed-function-device-unique error counters. (See appropriate maintenance documentation for the device in question.) These bytes are not displayed for other than distributed function devices.

In the above example, the log was retrieved for coaxial port number 1. The last 200 series nnn number for this port was a 204 (device check). No 300 or 400 errors were recorded. The most recent 500 series error was 532 (BSC line idle).

Line 3 shows two coaxial timeouts, two device power offs and hex 1A (26 decimal) device checks were counted. (Note that a 2%% will display as a EE in the 2nn area.)

### 3274 Test 1 Host Adapter Logs

Host logs are retrieved via an A0/1 Test request. The general format is shown in the following example:

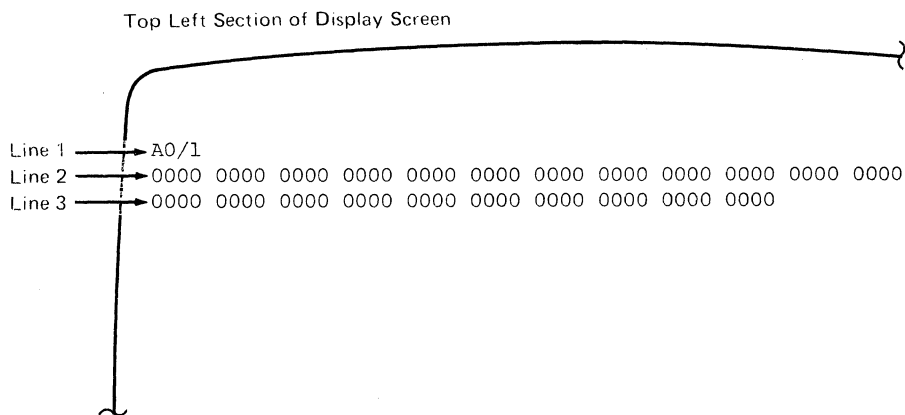

Line 1 is the test request message as input from the keyboard.

Line 2 is event data logged for certain host failures. This data is analyzed by the 3274 microcode when a failure occurs. The analysis results in an increment to a statistical counter (see Line 3) or the generation of a 300 or 500 machine check or program check indicator.

Line 3 contains a series of one byte statistical counters that record the number of times a particular event was detected. The counters increment to X'FF' (256) and do not wrap. X'FF' in a counter indicates 256 or more of that class of error have been encountered.

### 3274 Model C (BSC) Test A0/1

#### Common Communications Adapter Log (CCA)

Line	Byte	Meaning	nnn Code
2	0	Last two digits of the most recent 500 error for which the adapter provides detailed failure status.	
	01-09	Detailed internal hardware status of failure.	
3	00	NAK Sent: The number of times the 3274 sent a NAK response because: 1. A BCC error was detected, or 2. Three seconds elapsed during a read operation without receipt of SYN EXT, or ETB, or 3. A forward abort (ENQ in text) was received, or 4. A temporary text delay sequence (STX ENQ) was received. (A communication link error.)	531
	01	NAK Received: The number of times the 3274 received a NAK response from the host. The text block is transmitted by the 3274. (A communication link error.)	
	02	ENQ Received: The number of times the 3274 did not receive ETX or ETB with the last block of text transmitted by the host. The host has sent ENQ to the CU. (A communication link error.)	533
	03	15 Timeouts: The number of times the 3274 did not receive a response to its last block sent, and has sent ENQ 15 times. (The communication link has become inactive.)	534
	04	15 NAKs received: The number of times the 3274 received 15 consecutive NAKs to its last transmission. (A communication link error.)	535

Line	Byte	Meaning	nnn Code
3 (cont.)	05	15 Wrong ACKs: The number of times the 3274 received 15 consecutive ACK0s instead of ACK 1s, or vice versa.	536
	06	Underruns/Overruns: The number of times the 3274 was not ready to transmit a byte of data (underrun) or was not ready to receive a byte of data from the device (overrun). (An internal 3274 exception condition.)	
	07	Write Timeout: The number of times the 3274 detected Write Timeout. Write Timeout is caused by: 1. Modern clocking missing, or 2. CTS has dropped from the modem. (A modem error.)	530
	08	DCE Error: The number of times the 3274 has detected the loss of Data Set Ready (DSR) from the modem (DCE). (A modem error.)	501
	09	Line Buffer Overflow: The number of times the 3274 detected an internal buffer overflow condition. (An internal 3274 exception condition.)	408

## 3274 Model C (SDLC) Test A0/1

Line	Byte	Meaning	nnn Code
2	00	Last two digits of the most recent 500 error for which the adapter provides detailed failure status.	
	01–07 (CCA) 01–23 (HPCA)	Detailed internal hardware status of failure.	
3		Bytes 00–10 are the same counters as returned via REQM3 type 3 bytes 18–28.	
	00	Nonproductive Timeout: The number of times the 3274 encountered no valid SDLC frames that contain either a valid FCS or a valid address for a period of 20 seconds. (The line is active but the control unit is not being addressed.)	520
	01	Idle Line Timeout: The number of times no valid flag characters were detected by the 3274 on the host link for 20 seconds. (The communication link was not active or was hung.)	521
	02	Write Retry: The number of times a previously transmitted I-frame was not received by the host. The 3274 will retransmit the same I-frame. (A communication link error.)	
	03	Overrun: The number of times the 3274 was not able to receive a byte of data from the communication line. (An internal 3274 exception condition.)	
	04	Underrun: The number of times the 3274 was not able to provide data to the communication line in the proper time. (An internal 3274 exception condition.)	



Line	Byte	Meaning	nnn Code
3 (cont.)	05	Connection Problem: The number of times a connection problem was encountered on the communication link that prevented the 3274 establishing or reestablishing host communication. (Set by receipt of 20 Write retries, 20 ROLs, 20 CRs, 20 XIDs, or 20 NSAs.)	525
	06	FCS Error: The number of messages received by the 3274 that had an invalid checksum (CRC). (A communication link error.)	
	07	Primary Abort: The number of times the 3274 detected an abnormal termination of a message by the remote master station. (A network error.)	
	08	Command Reject: The number of SDLC commands rejected by the 3274. They are caused by: 1. Detection of an NR sequence error, 2. Receipt of a command that has no data field defined, or 3. Receipt of an invalid command. (A network error.)	528
	09	DCE Error: The number of times the 3274 detected an abnormal response from its modem. (Modem errors.)	529
	0A	Write Time Out: The number of write timeouts detected by the 3274. Write timeout caused by: 1. Modem clocking missing or, 2. CTS has dropped from the modem while the 3274 was transmitting.	530
	0B	Count Exceeded/Wrong Length Message: The number of times that a message was received from the host that was larger than the 3274's buffers. (A network error.)	519
	0C	Secondary Busy: The number of times an RNR response has been sent to the primary station because the 3274 does not have sufficient outbound (receive) buffers.	

Line	Byte	Meaning	nnn Code
3 (cont.)	0D	No RLSD (MCL only): The number of times that the 3274 detected the loss of RLSD (carrier) on the MCL for at least a four-second period.	507

## 3274 Model A (LCA) Test A0/1

Line	Byte	Meaning	nnn Code																																																
2	00	Last two digits of the most recent 500 nnn number for sense data.	540-550																																																
	01	Internal operation data.																																																	
	02-03	Last sense data sent to host.																																																	
	04-09	Internal hardware status information.																																																	
3	00-0A	The number of times sense data is sent to the host.																																																	
		<table border="1"> <thead> <tr> <th>Byte</th> <th>Sense</th> <th>Meaning</th> <th>nnn Code</th> </tr> </thead> <tbody> <tr> <td>00</td> <td>8200</td> <td>Command Reject not initialized</td> <td>540</td> </tr> <tr> <td>01</td> <td>8000</td> <td>Command Reject</td> <td>541</td> </tr> <tr> <td>02</td> <td>0200</td> <td>Not initialized</td> <td>505</td> </tr> <tr> <td>03</td> <td>2002</td> <td>Bus Out Check, Parity Check #2</td> <td>543</td> </tr> <tr> <td>04</td> <td>2006</td> <td>Bus Out Check, Parity Check #16 #2</td> <td>544</td> </tr> <tr> <td>05</td> <td>1004</td> <td>Equipment Check, Parity Check #1</td> <td>545</td> </tr> <tr> <td>06</td> <td>1000</td> <td>Equipment Check, Parity Check #1 and modify</td> <td>546</td> </tr> <tr> <td>07</td> <td>1002</td> <td>Equipment Check, Parity Check #2</td> <td>547</td> </tr> <tr> <td>08</td> <td>1001</td> <td>Equipment Check Controller Machine Check</td> <td>548</td> </tr> <tr> <td>09</td> <td>0800</td> <td>Data Check</td> <td>549</td> </tr> <tr> <td>10</td> <td>0880</td> <td>Data Check, Length Check</td> <td>550</td> </tr> </tbody> </table>		Byte	Sense	Meaning	nnn Code	00	8200	Command Reject not initialized	540	01	8000	Command Reject	541	02	0200	Not initialized	505	03	2002	Bus Out Check, Parity Check #2	543	04	2006	Bus Out Check, Parity Check #16 #2	544	05	1004	Equipment Check, Parity Check #1	545	06	1000	Equipment Check, Parity Check #1 and modify	546	07	1002	Equipment Check, Parity Check #2	547	08	1001	Equipment Check Controller Machine Check	548	09	0800	Data Check	549	10	0880	Data Check, Length Check	550
		Byte		Sense	Meaning	nnn Code																																													
		00		8200	Command Reject not initialized	540																																													
		01		8000	Command Reject	541																																													
		02		0200	Not initialized	505																																													
		03		2002	Bus Out Check, Parity Check #2	543																																													
		04		2006	Bus Out Check, Parity Check #16 #2	544																																													
		05		1004	Equipment Check, Parity Check #1	545																																													
		06		1000	Equipment Check, Parity Check #1 and modify	546																																													
		07		1002	Equipment Check, Parity Check #2	547																																													
	08	1001	Equipment Check Controller Machine Check	548																																															
09	0800	Data Check	549																																																
10	0880	Data Check, Length Check	550																																																
0B	The number of times a Connect was received from the host when the controller was already connected.	512																																																	

Line	Byte	Meaning	nnn Code
3 (cont.)	0C	The number of times a Disconnect was received from the host when the PU was active.	511
	0D	The number of times an RU larger than 1536 bytes was sent to the 3274.	410
	0E	The number of times a Connect was rejected because of improper data content.	514
	0F	The number of times the host requested a retransmission of data on the channel.	

## 3274 Model B (LHA) Test A0/1

Line	Byte	Meaning	nnn Code
2	00	Last two digits of 300 machine check number. If 00, the error logged was not a machine check.	
	01	Not used.	
	02	Sense sent to host on last error.	
	03-05	Detailed internal status information.	
	05-17	Not used.	
3	00	Bus Out Check: The number of channel parity errors detected by the 3274.	551
	01-04	Internal, recoverable adapter I/O failures.	01 = 351 02 = 355 03 = 356

## 3274 Model D (SLHA) Test A0/1

Line	Byte	Meaning	nnn Code
2	00	Last two digits of the most recent 300 machine check number. If 00, the error logged was not a machine check (see sense and status bytes 06–07).	
	01	Device (port) address at time of error.	
	02–05	Internal adapter status at time of failure.	
	06–07	Sense and status sent to host at time of error.	
	08–0A	Internal microcode status at time of failure.	
3	00	Command Reject: The number of invalid channel commands seen by the adapter. The 3274 returned sense of command reject.	401
	01	OP Check: The count of the host data stream errors detected by the 3274. The 3274 returned sense of op check to the host.	various 4XX errors
	02	Adapter Parity Error: The number of 3274 adapter parity errors. The 3274 returned sense of Data Check.	364
	03	Bus Out Check: The number of times the 3274 detected bad parity on the channel and returned sense of Bus Out Check to the host.	551
	04–05	Internal, recoverable adapter hardware errors.	04 = 362

**A0/1 Test Mode Extension for X.25 Function**

The following describes the format of the host adapter error log display when the control unit is connected to the host via a packet switched data network. The control unit (the DTE) is connected to the network DCE via the X.25 interface. The error log is displayed by entering an A0/1 Test request message.

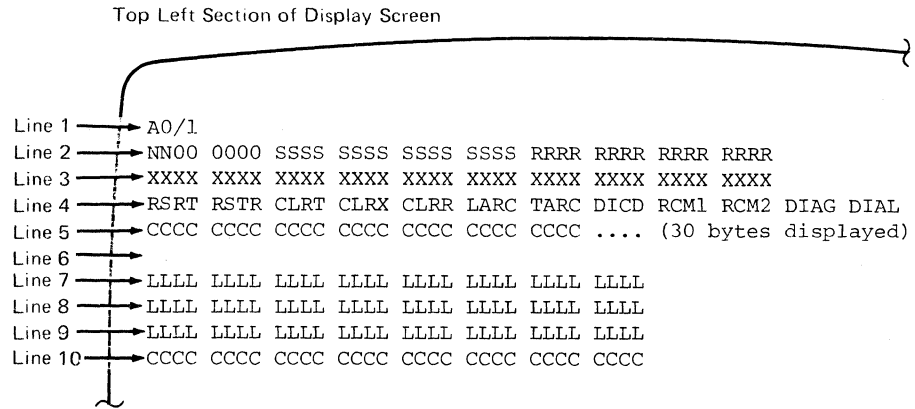

Line 1: Name of test.

- Line 2:    NN = Communication Reminder 5NN that is associated with the error  
           00 = Always zero for X.25  
           SS = Adapter sense bytes (identical to the first eight bytes of HPCA sense)  
           RR = Reserved

Line 3: HPCA counters. These are 1-byte counters in which XX represents the value counted in hexadecimal. The counter values range from 00–FF and do not wrap.

HPCA Ctr	Map via CAC adapter return code (ARC)
1	Reserved
2	Reserved
3	Reserved
4	Reserved
5	Reserved
6	Retries exceeded maximum limit
7	Reserved
8	Reserved
9	FRMR transmitted
10	DCE hardware error
11	Write timeout
12	Invalid status
13	Adapter machine check
14	Reserved

Line 4:	RSRT	=	Cause and diagnostic codes for the last restart packet transmitted by the 3274.
	RSTR	=	Cause and diagnostic codes for the last restart packet received by the 3274.
	CLRT	=	Diagnostic code modifier and diagnostic codes for the last clear or reset packet transmitted by the 3274.
	CLR X	=	Extension for cause and diagnostic codes for the last clear or reset packet sent by 3274.
	CLRR	=	Cause and diagnostic codes for the last clear or reset packet received by the 3274.
	LARC	=	Last ARC for which error logging occurred.
	TARC	=	Last bad termination ARC (nnn = 539).
	DICD	=	Reason code for the last packet discarded event.
	RCM1	=	Reason code modifier for additional information on an FRMR sent or received.
	RCM2	=	Reason code modifier for additional information on an FRMR sent or received.
	DIAG +	=	Information field from the last diagnostic packet
	DIAL	=	received by the 3274.

Line 5: X.25 auxiliary counters. These are 1-byte counters in which XX represents the value counted in hexadecimal. The counter values range from 00–FF and do not wrap.

Aux Ctr	Value
Link Level	
1	SABM received
2	FRMR received
3	DISC received
4	DCE not available
5	Unexpected UA received
6	Send sequence number not sequencing
7	Restart sent
8	Restart received
9	Reserved
10	Reserved
11	Reserved
Circuit Level	
12	Reset packets sent
13	Reset packets received
14	Clear packets sent
15	Clear packets received
16	Call timeouts
17	Call-connected truncated
18	Call parameter changes
19	Packets discarded
20	Packet timeouts
21	Contacts received
22	Discontacts received
23	Channel inoperative or no channel available
24	Channel in invalid state
25	Diagnostic packets received
26–30	Reserved

Line 6 is a blank line.

Lines 7–10: X.25 statistical counters. These are half-word counters where:

LLLL = Counters for link-level events (8 per line)  
 RRRR = Reserved  
 CCCC = Counters for circuit-level events (8 per line)

The values of the LLLL and CCCC counters range from 0000–FFFF and do not wrap.

Line 7: Link-level events.

Diag Ctr	Value
1	I-frames sent
2	I-frames received
3	RR-frames sent
4	RR-frames received
5	RNR-frames sent
6	RNR-frames received
7	REJ-frames sent
8	REJ-frames received

Line 8: Link-level events (cont.).

Diag Ctr	Value
9	Retries on transmit
10	FCS errors on receive
11	Receive errors
12	CS underruns
13	Receive buffer overruns
14	Receive control block overruns
15	Aborts
16	CS overruns

Line 9: Link-level events (cont.).

Diag Ctr	Value
17	Receive timeouts
18	Reserved
19	Call attempts
20	Call completions
21–24	Reserved

Line 10: Circuit-level events.

Diag Ctr	Value
25	Data packets sent
26	Data packets received
27	RR packets sent
28	RR packets received
29	Reserved
30	RNR packets received
31	Interrupt packets sent
32	Interrupt packets received

## X.25 Function Counter Explanations

Following is a list of the counters associated specifically with the X.25 function. They include HPCA counters, X.25 auxiliary counters (both link level and circuit level), and X.25 statistical counters (both link level and circuit level). They are listed by counter number; counters not listed are reserved.

**Note:** CCDD = cause and diagnostic codes.

### HPCA Counters

- |            |                                                                                                                                                                                                                                             |
|------------|---------------------------------------------------------------------------------------------------------------------------------------------------------------------------------------------------------------------------------------------|
| Counter 6  | RETRIES EXCEEDED LIMIT: A link level error condition exists that has not been cleared by retries. The link and circuit have been stopped and a restart attempted.                                                                           |
| Counter 9  | FRMR TRANSMITTED: An FRMR has been sent by the 3274 due to an error in a received I-frame. A DISC has been sent. The link and circuit have been stopped and a restart attempted (nnn = 539).                                                |
| Counter 10 | DCE HARDWARE ERROR: Data Set Ready (nnn = 501) or Clear-to-Send (nnn = 502) from the DCE have been interrupted, or another DCE abnormal condition (nnn = 529) was detected. The link and circuit have been stopped and a restart attempted. |
| Counter 11 | WRITE TIMEOUT: Clocking from the DCE has been interrupted. The link and circuit have been stopped and a restart attempted (nnn = 530).                                                                                                      |
| Counter 12 | INVALID STATUS: A 3274 communication adapter problem has been encountered (nnn = 331).                                                                                                                                                      |
| Counter 13 | ADAPTER MACHINE CHECK: A 3274 communication adapter problem has been encountered (nnn = 330).                                                                                                                                               |

### X.25 Auxiliary Counters (Link Level)

- |           |                                                                                                                                                                           |
|-----------|---------------------------------------------------------------------------------------------------------------------------------------------------------------------------|
| Counter 1 | SABM RECEIVED: A valid SABM link-level command was received from the DCE after normal initiation sequences. The 3274 has sent a DISC and terminated the link (nnn = 539). |
| Counter 2 | FRMR RECEIVED: An FRMR has been received. A DISC has been sent. The link and circuit have been stopped and a restart attempted (nnn = 539).                               |
| Counter 3 | DISC RECEIVED: A DISC has been received. A UA response has been sent. The link and circuit have been stopped and a restart attempted (nnn = 504).                         |
| Counter 4 | DCE NOT AVAILABLE: A DM has been received in response to an SABM, indicating that the DCE is not ready to communicate. A restart is attempted (nnn = 517).                |



- Counter 5 UNEXPECTED UA: A UA response has been received. A DISC has been sent. The link and circuit have been stopped and a restart attempted (nnn = 539).
- Counter 6 SEND SEQUENCE NUMBER NOT SEQUENCING: Multiple I-frames have been received with the same send sequence number. The link and circuit have been stopped and a restart attempted (nnn = 539).
- Counter 7 RESTART SENT: A restart packet has been sent due to an error. The link and circuit have been stopped and restarted. Analyze the diagnostic code in the event log to determine the cause. X.25 Communication Check Reminder indicator ( R CCDD) is displayed.
- Counter 8 RESTART RECEIVED: A packet-level restart has been received. The link and circuit have been stopped and a restart attempted. Analyze the cause and diagnostic codes in the event log to determine the cause. X.25 Communication Check Reminder indicator ( N CCDD) is displayed.

#### X.25 Auxiliary Counters (Circuit Level)

- Counter 12 RESET SENT: A reset packet has been sent due to an error. The circuit has been stopped and restarted. Analyze the diagnostic code in the event log to determine the cause. X.25 Communication Check Reminder indicator ( M CCDD) is displayed.
- Counter 13 RESET RECEIVED: A reset packet has been received. The circuit has been stopped. Analyze the cause and diagnostic codes in the event log to determine the cause. X.25 Communication Check Reminder indicator ( Q CCDD) is displayed.
- Counter 14 CLEAR SENT: A clear packet has been sent due to an error. The circuit has been stopped and restarted. Analyze the diagnostic code in the event log to determine the cause. X.25 Communication Check Reminder indicator ( L CCDD) is displayed.
- Counter 15 CLEAR RECEIVED: A clear packet has been received. The circuit has been stopped. Analyze the cause and diagnostic codes in the event log to determine the cause. X.25 Communication Check Reminder indicator ( P CCDD) is displayed.
- Counter 16 CALL TIMEOUT: The response to a Call Request packet has not been received within the time specified. An attempt is made to restart the circuit (nnn = 537).
- Counter 17 CALL CONNECT TRUNCATED: A Call Request packet has been received that is larger than the buffer reserved for the packet.

- Counter 18      **CALL PARAMETER CHANGE:** This condition is posted on completion of an open circuit for an SVC if the flow control negotiation parameters received in the Call Connected packet are different from those entered during customizing or via the Dial screen.
- Counter 19      **PACKET DISCARDED:** A packet has been discarded. Analyze the diagnostic code field in the event log to determine the reason.
- Counter 20      **PACKET LEVEL TIMEOUT:** 200 seconds have elapsed without receiving a response to a Clear, Reset, or Restart packet. The circuit and link have been stopped (nnn = 538).
- Counter 21      **CONTACT RECEIVED:** A LLC Contact packet has been received.
- Counter 22      **DISCONTACT RECEIVED:** A LLC Discontact packet has been received (nnn = 504).
- Counter 23      **CHANNEL INOPERATIVE:** The PVC channel is inoperative due to a timeout. The circuit is stopped (nnn = 513), *or* **NO CHANNEL AVAILABLE:** No channel is available for the outgoing call (nnn = 513).
- Counter 24      **CHANNEL IN INVALID STATE:** An Incoming Call packet has been received and the 3274 was not in the proper state. The circuit is stopped (nnn = 513).
- Counter 25      **DIAGNOSTIC PACKET RECEIVED:** A Diagnostic packet was received. Analyze the diagnostic code and explanation field in the event log to determine the cause.

#### **X.25 Statistical Counters (Link Level)**

- Counter 1      **I-FRAMES SENT:** The number of I-frames sent by the 3274.
- Counter 2      **I-FRAMES RECEIVED:** The number of I-frames received by the 3274.
- Counter 3      **RR-FRAMES SENT:** The number of RR-frames sent by the 3274.
- Counter 4      **RR-FRAMES RECEIVED:** The number of RR-frames received by the 3274.
- Counter 5      **RNR-FRAMES SENT:** The number of RNR-frames sent by the 3274.
- Counter 6      **RNR-FRAMES RECEIVED:** The number of RNR-frames received by the 3274.
- Counter 7      **REJ-FRAMES SENT:** The number of REJ-frames sent by the 3274.

- Counter 8      **REJ-FRAMES RECEIVED:** The number of REJ-frames received by the 3274.
- Counter 9      **RETRIES ON TRANSMIT:** The number of I-frames that had to be retransmitted by the 3274 due to Nr mismatches.
- Counter 10     **FCS ERRORS ON RECEIVE:** The number of I-frames received by the 3274 Frame Check Sequence errors.
- Counter 11     **RECEIVE ERRORS:** The number of receive errors detected by the 3274.
- Counter 12     **CYCLE STEAL UNDERRUNS:** The number of cycle underruns detected by the 3274. This is an internal exception condition and is retried by the 3274.
- Counter 13     **RECEIVE BUFFER OVERRUNS:** The number of receive buffer overruns detected by the 3274. This is an internal exception condition and is retried by the 3274.
- Counter 14     **RECEIVE CONTROL BLOCK OVERRUNS:** The number of receive control block overruns detected by the 3274. This is an internal exception condition and is retried by the 3274.
- Counter 15     **ABORTS:** The number of aborts detected by the 3274.
- Counter 16     **CS OVERRUNS:** The number of CS overruns detected by the 3274. This is an internal exception condition and is retried by the 3274.
- Counter 17     **RECEIVE TIMEOUTS:** A valid frame has not been received within the time specified. The link and circuit have been stopped and a restart attempted (nnn = 520).
- Counter 19     **CALL ATTEMPTS:** The number of call attempts counted by the 3274.
- Counter 20     **CALL COMPLETIONS:** The number of call completions counted by the 3274.

#### **X.25 Statistical Counters (Circuit Level)**

- Counter 25     **DATA PACKETS SENT:** The number of data packets sent by the 3274.
- Counter 26     **DATA PACKETS RECEIVED:** The number of data packets received by the 3274.
- Counter 27     **RR PACKETS SENT:** The number of RR packets sent by the 3274.
- Counter 28     **RR PACKETS RECEIVED:** The number of RR packets received by the 3274.

- Counter 30 RNR PACKETS RECEIVED: The number of RNR packets received by the 3274.
- Counter 31 INTERRUPT PACKETS SENT: The number of interrupt packets sent by the 3274.
- Counter 32 INTERRUPT PACKETS RECEIVED: The number of interrupt packets received by the 3274.

### Type A Adapter Test A1/1

Line	Byte	Meaning	nnn Code
2	00	Last two digits of last Type A adapter failure.	292-299
	01	Not applicable.	
	02-03	Internal adapter status at time of error.	
3	00	Type A adapter failure count.	292
	01	The number of times that input was received from a coaxial port that was not configured.	293
	02-07	Counts of various Type A adapter failures.	294-299

## Feature Adapter Test A2/1

Line	Byte	Meaning	nnn Code
2	00	Last two digits of Type B adapter number.	270-273
	01-03	Internal error status from Type B adapter.	
	04-07	Last two digits of Kanji font storage parity error for cards 1, 2, 3, and 4 respectively.	392-395
	08	Last two digits of Encrypt/Decrypt Adapter 3nn number.	397-399
	09	Internal error status from Encrypt/Decrypt Adapter.	
	0A	Last two digits of diskette adapter machine check number.	386-389
	0B-0D	Internal diskette status information.	
	0E	Response Time Monitor machine check number.	
	0F	Response Time Monitor status at time of last machine check.	
3	00	The number of Type B adapter I/O errors.	
	01	The number of Type B adapter overruns.	
	02	The number of interrupts from unconfigured Type B adapter device addresses.	
	03	Not used.	
	04-07	The number of Kanji font storage parity errors.	
	08	The number of Encrypt/Decrypt key parity errors.	
	09	The number of Encrypt/Decrypt Adapter errors.	
	0A	Diskette adapter hardware errors.	389
	0B	Diskette media errors.	387, 388
	0C	Unrecoverable diskette overrun errors.	386
	0D	Not applicable.	
	0E	Response Time Monitor adapter errors.	
	0F	Not applicable.	

## Controller Error Data Test A3/1

Line	Byte	Meaning	nnn Code
2	00 ¹	The number of internal cycle share I/O failures.	Not applicable
	01 ¹	The number of 3274 storage parity errors.	
	02 ¹	The number of 3274 errors.	
	03	Not used.	
	04 ¹	The number of host adapter I/O errors.	
	05 ¹	The number of Type A adapter I/O errors.	
	06 ²	The number of Type B adapter I/O errors.	
	07 ²	The number of Encrypt/Decrypt Adapter I/O errors.	
	08	Diskette adapter I/O errors.	
	09	Response Time Monitor I/O errors.	

- ¹ The counts reflect recoverable errors. If the errors are not recoverable, the 8 4 2 1 indicator is lit, the control unit is disabled, and an IML is required.
- ² The counts reflect the number of recoverable errors. If the errors are not recoverable, the 8 4 2 1 indicator is lit and the adapter is disabled. While the remainder of the control unit remains operational, an IML is required to reinitialize the adapter.

**Test 2: Configuration Data**

The configuration data obtained from Test 2 is the result of the 3274 customizing process. The following table describes the more commonly required information in the order that the information appears on the display. Also included is an indication of the customization question associated with the particular data. Refer to the *3274 Customizing Guides* (GA27-2827 or GA23-0065 as appropriate).

The format of the configuration data charts is as follows:

Column 1, **Information Provided:** The definition of the data at the location indicated in Column 2.

Column 2, **Location:** Describes the location in hexadecimal of the desired data.

Column 3, **Hex Digits or Bit Setting:** Describes the pertinent bit settings or hexadecimal values.

Column 4, **Meaning:** Describes the meaning of the particular bit settings or describes the contents of the data location.

Column 5, **Page/Line/Byte**: The information will help you to find the byte under discussion.

- *Page* indicates the value that should appear in display Line 2 if you are in the proper block of configuration data for the byte in question.
- *Line* indicates which line of the four lines of data being displayed contains the byte you are looking for.
- *Byte* is the displacement of the byte in question from the start of the line. There are 16 bytes (00 to 0F hex) per line.

Column 6, **Customization Question**: Indicates which customizing question, number, and value caused the results.

When, in test mode, the /2 is typed (starting at location 0 on the display) and the ENTER key is pressed, a display similar to the following example will appear on the screen. Lines 3–6 each represent 16 bytes of data, displayed in hexadecimal.

Top Left Section of Display Screen

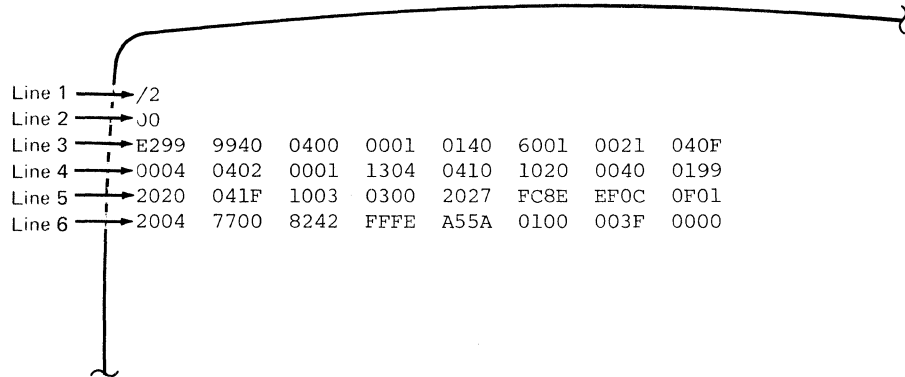

By pressing the ENTER key, the next 64 bytes of the configuration table will be displayed. Line 2 indicates the starting location of the first byte displayed. (The last (0) digit is dropped.)

Top Left Section of Display Screen

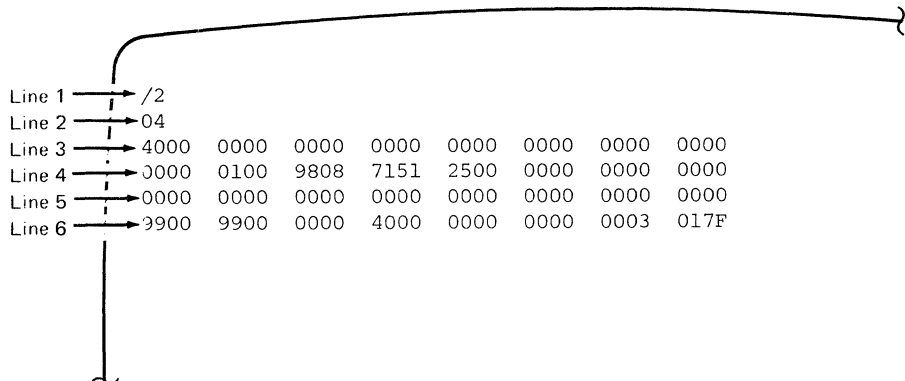

The amount of configuration data displayed depends on the configuration support level of the 3274 microcode that is installed. In all cases, if more information is available to be displayed, the ENTER key will display the next 64 bytes. If there is no more information to be displayed, pressing the ENTER key will cause the keyboard to be inhibited. (X-f will be displayed in the operator information area.) Line 2 will serve as an indication of location of the first byte displayed on Line 3. For example, if Line 2 contains 08, the location in the table of the first byte displayed on Line 3 is hex 80.



Information Provided	Location	Hex Dig./Bit Setting	Meaning	Page/ Line/ Byte	Customization Question
Diskette type identifier	00 See note 1.	D3 D4 D9 E2 E4 E6	Language Feature RPO System Dump Load	00/03/00	N/A
Diskette level IDs	01 02 03	nn nn nn	Feature System Language	00/03/01 00/03/02 00/03/03	N/A
3274 model number and communication adapter type	04	01 02 04 08 21 24 28 A4 41 42 44 48 84	1A-LCA 1B-LHA 1C-CCA/HPCA 1D-SLHA 41A LCA 41C CCA/HPCA 41D SLHA 61C CCA/HPCA 21A-31A-LCA 21B-LHA 21C/31C-CCA/HPCA 21D/31D-SLHA 51C CCA/HPCA	00/03/04	151
3274-A models	05	nn	3274 Channel address	00/03/05	201=nn
3274-C models, line code	07	01	EBCDIC	00/03/07	321=0, or 121=02
		02	ASCII		321=1, or 121=02
3274-C models, line control mode	08	01	BSC	00/03/08	331=0
		02	SDLC		331=1
3274-C models, BSC address	09	nn	3274 BSC poll address	00/03/09	Derived from 301; location 1D contains 301's response
3274-C models, selection address	0A	nn	BSC	00/03/0A	Derived from 301; location 1D contains 301's response
			SDLC		302 = nn
Miscellaneous option selection	0B	01	CCA	00/03/0B	351 = 0
		02	HPCA		351 = 1
		04	Encrypt/Decrypt		352 = 1
		08	Individual port assign		116 = 1
		10	Printer polled host		305 = 1

Information Provided	Location	Hex Dig./Bit Setting	Meaning	Page/ Line/ Byte	Customization Question
3274-C models, remote attachment options	0C	00	CCITT V.35 or external modem interface	00/03/0C	343 = 0
		01	Wrappable modem		311 = 1
		02	DDSA adapter		343 = 1
		04	X.21 leased		343 = 2
		08	Integrated modem >1200 BPS		343 = B
		10	X.21 switched		343 = 3
		20	MCL loop		343 = A
		40	EMI		343 = 4
		80	Integrated modem 1200 BPS		343 = 5,6,7,8,9 Refer to location 41 for specific response data
3274-C models, communication options	0D	01	Omit answer tone	00/03/0D	345 = 1
		02	Permanent RTS		value=0 if 317 = 1 =0 if 314 or 342 = 0
		04	Half speed		318 = 1
		08	SNBU (select standby)		317 = 1
		10	Special RTS (BSC from selection till EOT)		value=0 if 314 = 0 and 342 = 1
		20	Leased line		value=0 if 343 = 3,4, or 6 =0 if 343 = 0 and 317 = 1 value = 1 all other cases
		40	NRZI (SDLC) or internal clocking (BSC)		313 = 1
		80	WT DCE switched network		310 = 1
Storage expansion	13	01	Installed	00/04/03	113
		02	Not installed		
		80	Storage Expansion Feature, Mod. 21, 31, 51		
		40	Storage Expansion Feature, Mod. 41, 61		
Request to send control	14	00	Input from question 342	00/04/04	342 = 0
		01			342 = 1

Information Provided	Location	Hex Dig./Bit Setting	Meaning	Page/Line/Byte	Customization Question
3274 optional features selection	15	01	3289 text print control	00/04/05	145 = 1
		02	Between bracket sharing		213 = 1
		04	IBM Personal Computer Attachment		114 = 1
		40	1063 auto entry MSR		141 = D
		80	1063 MSR		141 = C or D
	16	01	No SCS printer support	00/04/06	211 = 0
		02	No host load PAM support		143 = 0
		04	No local copy support		147 = 0
		10	MSR support bit set on (1) (no MSR)		141 = A
			Bit set off (0) (MSR-numeric)		141 = B
Number of Category B devices installed	19	nn	Answer to question 111	00/04/09	111 = nn
Number of Category A devices installed	1A	nn	Answer to question 112	00/04/0A	112 = nn
		00			CS-D 116 = 1
Total number of Category A and Type B devices installed	1B	nn	111+112, maximum of 32	00/04/0B	111,112
Modem and connection options	1C	01	Loop attach only high-speed rate	00/04/0C	347 = 1
Control unit number	1D	nn	Answer to 301	00/04/0D	301 = nn
Language Code	1E	nn	Answer to 121	00/04/0E	121 = nn
Extended Function Store	1F	nn	First 2 digits of answer to 113	00/04/0F	113 = nnxx
Actual number of Type A ports supported	20	nn	Number of Type A device control blocks assigned by the 3274	00/05/00	See note 2.
Total number of ports supported	21	nn	Total number of device control blocks assigned by the 3274	00/05/01	Derived from 112+111 (To find the actual starting address for the first Type B port subtract the value of location 20 from value of location 21.)

Information Provided	Location	Hex Dig./Bit Setting	Meaning	Page/Line/Byte	Customization Question
Keyboard types	23	01	Typewriter	00/05/03	131 = 1
		02	Data Entry		132 = 1
		04	Data Entry 11		133 = 1
		08	APL		134 = 1
		10	Text		135 = 1
ECSA adapter (configs. that support SFAP data stream processing)	24	nn	Number of terminals with ECSA installed	00/05/04	See note 4.
SFAP data stream support options (configs. that support SFAP data stream processing)	25	01	Color terminals	00/05/05	161 = 1
		02	PS terminals installed		164 = 1 (CS-A,-B,-C,-T) 160 = 1 (CS-D)
	26	01	SFAP data stream supported	00/05/06	162 = 1 (CS-A,-B,-C,-T) 160 = 1 (CS-D)
		02	Decompression supported		165 = 1
X.21 switched retry time	27	nn	Value input by 361 response	00/05/07	361 = nn
X.21 switched keys supported	3D	xx (SDLC)  01 (BSC)	Hex representation of question 362 binary input (SDLC)	00/06/0D	Example: 362 = 0010 1000 xx = 28 176 = 1 (BSC)
X.21 switched retries	3E	nn	Same value as input in question 360	00/06/0E	360 = nn
X.21 switched retry timings	3F	01 = 0.1 02 = 0.2 04 = 0.4 08 = 0.8 10 = 1.6 20 = 3.2 40 = 6.4 80 = 12.8	Same value as input in 361	00/06/0F	361 = nn
Diskette zapped indicator	40	Not 0	Indicates diskette has been "zapped" with a fix.	04/03/00	
38LS responses	41	00 80 40 20 10 08	No 38LS Installed 38LS Feat. 5500 38LS Feat. 5501 38LS Feat. 5502 38LS Feat. 5507 38LS Feat. 5508	04/03/01	343 = 5 343 = 6 343 = 7 343 = 8 343 = 9

Information Provided	Location	Hex Dig./Bit Setting	Meaning	Page/ Line/ Byte	Customization Question
Patch IDs	42-51		Each 1-byte field contains a patch ID. 00 indicates no patch.	04/03/02 to 04/04/01	011,012, 013
Number of RPQ diskette installed	52	nn	Number input in question 031 (0-3)	04/04/02	031 = nn
RPQ information	54-58	See note 5.	RPQ 1	04/04/04 to 08	N/A
	59-5D		RPQ 2	04/4/09 to 0D	
	5E-62		RPQ 3	04/04/0E to 04/05/02	
Physical unit ID	67-69	nnnnnn	Input to question 215	04/05/07 to 09	215=nnnnn
3290 attachment options	6A	80 20 10	3290 attached 3290 dump completed ok MIS address defined	04/05/0A	
Copied version of diskette	6B	C3	Diskette was created via Copy RPQ 8K1071.	04/05/0B	
EC Levels  <i>Note: All EC Levels are expressed as release level and A suffix. For example Release 43.1 will display as 4301.</i>	70,71	nn nn	Feature Diskette level and suffix	04/06/00 to 01	N/A
	72,73	nn nn	System Diskette level and suffix	04/06/02 to 03	N/A
	74,75	nn nn	Language Diskette level and suffix	04/06/04 to 05	N/A
RPQ Information  <i>Note: The configuration Support Flags at the right indicate the 3274 Configuration Support Level for which the RPQ was released. Any mismatch between this setting and the Microcode Configuration Support Level (appears on the system disk) should be validated with your IBM Sales Representative for proper support.</i>	76	0XXXXXXXX	RPQ1 If the high order bit of the first byte = 0 this byte contains RPQ EC Level.	N/A	04/6/06
		1XXXXXXXX	If the high order bit of the first byte = 1 the byte listed has the meaning listed below and the second byte 77 = 00.		
		C000	Configuration Support D		
		8400	Configuration Support C		
	8800	Configuration Support T			
	8200	Configuration Support B			
	8100	Configuration Support A			
77	nn	If high order bit of byte 76 = 0 RPQ1 Level Suffix		04/6/07	
78	xx	RPQ2 (same as byte 76)		04/6/08	
79	nn	RPQ2 Level Suffix		04/6/09	
7A	xx	RPQ3 (same as byte 76)		04/6/0A	
7B	nn	RPQ3 Level Suffix		04/6/0B	
Magnetic Reader Type	7C	00 01 02 03	None Numeric 3270 Compatible Alphameric (Auto Entry for non-display data) Alphameric (Auto Entry for all data)	04/6/0C	141 = A 141 = B 141 = C  141 = D
Attribute select keyboards (only valid for configuration Support Levels that support SFAP Data Stream Processing)	7D	00	No attribute select keyboards supported	04/6/0D	166 = A
		01	Attribute Select keyboards - w/o numeric lock		166 = B
		02	Attribute select keyboards with numeric lock.		166 = C

Information Provided	Location	Hex Dig./Bit Setting	Meaning	Page/Line/Byte	Customization Question
Alert Function Requested	8A	00	No Alert Function	05/3/0A	220 = 0
		01	Alert Without Test Alert Capability		220 = 1
		02	Alert With Test Alert On Port 0 Only		220 = 2
		03	Alert With Test Alert On All Ports		220 = 3
X.25 Non-Standard Packet Size	8B (high order nibble)	0 1 2 3	64 Byte Packet 128 Byte Packet 256 Byte Packet 512 Byte Packet	08/3/0A	434
Load Diskette	90	xx	Load Diskette EC Number	08/4/00	N/A
EC + Suffix Number	91	xx	Load Diskette Suffix Number	08/4/01	N/A
3290 RPO ID Number	92-96	XXXXXXXXXX	Ten digits	08/4/02-06	N/A
MIS Definition (Configuration Support T only)	97	xx	First port with MIS	08/4/07	171
	98	xx	Number of ports with two Logical Terminals	08/4/08	171
	99	xx	Number of ports with three Logical Terminals	08/4/09	171
	9A	xx	Number of ports with four Logical Terminals	08/4/0A	171
	9B	xx	Number of ports with five Logical Terminals	08/5/0B	171
3290 RPO Options	9C-9D	xxxx	Defined by 3290	04/5/0C-0D	N/A
3290 Features and Functions	9F	80	Enable 3290 Local Copy	04/5/0E	173 = 1XXX XXXX = X1XX XXXX  = XX1X XXXX
		40	Auto Form Feed before Local Copy		
		20	Auto Form Feed after Local Copy		
Physical and logical devices	A1	xx	Number of physical and logical devices defined on the 3274	08/5/01	171+112 if CS-T 111+117 if CS-D
Number of MIS	A2	xx	Number of logical terminal extensions	08/5/02	171 if CS-T 111+117 if CS-D
3290 Keypad Selection	A3	00	Default keypad (based on national language).	08/5/03	139=0
		01	24-key numeric		139=1
		02	25-key numeric with comma on key 4		139=2
		03	25-key numeric with decimal point on key 4		139=3
		07	Program Function Keypad		139=7
Optional code selection	A4	80 40 20	Clear key Unsupported control codes Clicker option	08/5/04	125 = 1XXX XXXX 125 = X1XX XXXX 125 = XX1X XXXX

Information Provided	Location	Hex Dig./Bit Setting	Meaning	Page/Line/Byte	Customization Question
X.25 incoming call options	A6	XXXX XX1X XXXX X1XX XXXX 1XXX  XXX1 XXXX  X11X XXXX 00  01  11   1XXX XXXX	Negotiate throughput class. Validate CID on incoming packets. Accept packets that include negative window size facility. Accept packets that include negative packet size facility. If bit positions designated 11 equal: Do not accept calls with reverse charge facility. Accept calls with reverse charge facility if reverse charge requested. Accept calls with reverse charge facility and either reverse charge requested or NOT reverse charge accepted. Validate calling DTE address.	08/5/06	420
X.25 outgoing call options	A7	XXXX XX1X  XXXX X1XX  XXXX 1XXX  XXX1 XXXX  X11X XXXX 00  01  11 1XXX XXXX	Include throughput class facility in call request packet. Include CID in the call user data field of call user packet. Include window size facility field in call request packet. Include packet size facility field in call request packet. If bit positions designated 11 equal: Do not include reverse call facility in call request packet. Request reverse charge via reverse charge facility. Invalid. Supply calling DTE address in call request packet.	08/5/07	421
X.25 negotiate packet size	A8 (high-order nibble)	0 1 2 3	64-byte packet 128-byte packet 256-byte packet 512-byte packet	08/5/08	432
X.25 packet sequence numbering	A8 (low-order nibble)	0 1	Modulo 8 Modulo 128	08/5/08	431
X.25 negotiate window size	A9	01-07 01-11	Range for Modulo 8 Range for Modulo 128	08/5/09	432
X.25 throughput class	AA (high-order nibble)	3 4 5 6 7 8 9 A B C	75 bps 150 bps 300 bps 600 bps 1200 bps 2400 bps 4800 bps 9600 bps 19200 bps 48000 bps	08/5/0A	440
X.25 K-maximum out	AA (low-order nibble)	1-7	Maximum number of link level I-frames that the 3274 will transmit prior to waiting for acknowledgment	08/5/0A	433

Information Provided	Location	Hex Dig./Bit Setting	Meaning	Page/Line/Byte	Customization Question
X.25 recognized private operating agency (RPOA)	AC-AD	0000 thru 9999	Used to select intermediate network to be used between two public networks	08/5/0C 08/5/0D	442
X.25 keyboard support	AE	XXXX XX1X 0 1 XXXX X1XX 0 1 XXXX 1XXX 0 1 XX11 XXXX 00 01 1X 11XX XXXX 00 01 1X	If bit position designated 1 equals: Take appropriate action — DISC (SVC) or LOCAL (PVC) key off only if no LUs active. DISC (SVC) or LOCAL (PVC) key (disconnect or local mode). If bit position designated 1 equals: Display all fields on dial screen. Display only HNAD on dial screen. If bit position designated 1 equals: X.25 keys supported on port 0 only. X.25 keys supported on all ports. If bit positions designated 1 equal: X.25 LOCAL and COMM keys are not supported on 3274. X.25 LOCAL and COMM keys are supported on port 0. X.25 LOCAL and COMM keys are supported per XXXX 1XXX bit above. If bit positions designated 1 equal: X.25 DISC key not supported on 3274. X.25 DISC key supported on port 0. X.25 DISC key supported per XXXX 1XXX bit above.	08/5/0E	443
X.25 network type	AF	00 02 03	CCITT recommended network that has announced IBM support. X.25 connection is to UKPSS or TELENET. DDP-X.	08/5/0F	400
RPQ parameter list	B0-BF	16X 'FF'	Specific information is supplied with the RPQ.	08/6/00-0F	033
Type A port assignment table	C0-CF	16 Hex Bytes	32 hex digits are displayed, one for each possible port	0C-3/00-0F	112 = 00 116 = 1 117 = Port-by-port assignment (Configuration Support "D" only)
Response Time Monitor support	D0	00 01 02 03 04 05	Not configured Configured — No host support display from port 0 only (SNA only) Configured — No host support display from all ports (SNA only) Configured — Host support no subsystem display (SNA only) Configured — Host support display from port 0 only (SNA only) Configured — Host support display from all ports (SNA only)	0C/4/00	127 X = 0 127 X = 1 127 X = 2 127 X = 3 127 X = 4 127 X = 5



Information Provided	Location	Hex Dig./Bit Setting	Meaning	Page/ Line/ Byte	Customization Question
Response Time Monitor definition	D1	00	Not defined	0C/4/00	127 Y = 0
		01	Host attention key to first character on screen		127 Y = 1
		02	Host attention key to keyboard usable		127 Y = 2
		03	Host attention key to change direction or end bracket (SNA only)		127 Y = 3
Response Time Monitor	D2-D3	Minutes, Seconds, Tenths of Seconds, mm/ss/s	First time boundary	0C/4/02-03	128 B1 (Line 2)
	D4-D5		Second time boundary	0C/4/04-05	128 B2 (Line 3)
	D6-D7		Third time boundary	0C/4/06-07	238 B3 (Line 4)
	D8-D9		Fourth time boundary	0C/4/08-09	128 B4 (Line 5)
Response Time Monitor options (Note: D0 above must equal 3, 4, or 5 for this field to be displayed)	DA	80	Response Time Monitor enabled	0C/4/0A	128 F1 (Line 1) 1XXX XXXX
		40	Unsolicited on Session End		128 F1 (Line 1) X1XX XXXX
		20	Unsolicited on Counter Overflow		128 F1 (Line 1) XX1X XXXX
		10	RTM alerts enabled		128 F1 (Line 1) XXX1 XXXX
X.25 logical link control	DB (high-order nibble)	0 1	QLLC PSH	0C/4/0B	403
X.25 circuit type	DB (low-order nibble)	1 2 4 8	Permanent virtual circuit Incoming call only Outgoing call only Two-way call	0C/4/0B	401
X.25 host DTE network address (HNAD)	DC-E3		15 packed decimal digits or spaces (16th position always set to F)	0C/4/0C through 0C/5/03	410 – digits (0–9, blanks or nulls)
X.25 3274 DTE network address (LNAD)	E4-EB		15 packed decimal digits or spaces (16th position always set to F)	0C/5/04 through 0C/5/0B	411 – digits (0–9, blanks or nulls)
X.25 logical channel ID	EC-ED	0000-4095	Channel ID for the circuit specified in byte DB (low-order nibble) earlier in this table	0C/5/0C and 0C/5/0D	402 input = 000 thru FFF
X.25 link level transmit timeout (Tp)	EE-EF	0000-2540	Number of 0.1 second intervals	0C/5/0E and 0C/5/0F	450 – Input example: 30 seconds = 300 x 0.1, value entered = 300

**Notes:**

- On Test 2 only E2 or E6 is displayed.
- CS-A, -B, -C, -D, -T, -P; derived from 112. CS-D; if 116 = 1, then derived from 117.
- 131-135 CS-A, -B, -C, -T, -P only. CS-D; derived from 121.
- CS-A, -B, -C, -T, -P; 163 = nnn. CS-D; if 160 = 1 and 116 = 0, then derived from 112. If 116 = 1, then derived from 117.
- The RPQ information fields differ between CS-A, -B, -C, -T and CS-D. For CS-A, -B, -C, -T the 10 hexadecimal digits in each field are interpreted as follows: The first three digits represent the last three digits of the RPQ number. The next seven digits represent the media assembly bill of materials assigned by manufacturing. For example: RPQ 8K0980 with a bill of materials number of 5675103 would display as 9805 6751 03.

For CS-D the 10 hexadecimal digits of each field are interpreted as follows: The first four digits represent the last four digits of the RPQ number. The next six digits represent the 6-digit engineering change (EC) number associated with the release of the RPQ. (Each time the same RPQ is released (updated) it gets a new EC number.) For example: RPQ 8K0980, EC 123456 would display as 0980 1234 56.

### Test 3: Status Summary Display

This test is used to obtain statistics and configuration information about the control unit and its attached devices. You request this test by placing the terminal in test mode and keying in /3. The resulting display will vary depending on the level of configuration support (A, B, C, D, T, or P) installed in the control unit and whether the control unit is customized for X.25 packet switched network operation or not.

Example 1 shows the display when configuration support A is installed; Example 2 shows the display when configuration support B, C, D, or T is installed; and Example 3 shows the display when configuration support P or configuration support D customized for X.25 operation is installed. The information is displayed in the upper left area of the screen.

#### Example 1 (Configuration Support A)

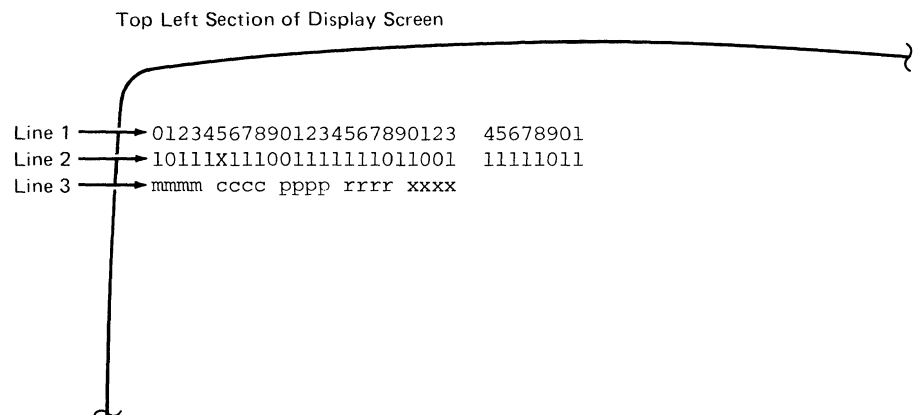

Line 1: Low-order digit of the port addresses configured on the 3274. When a Type B adapter is attached, the last (highest) Type A port and the first (lowest) Type B port are separated by two spaces on lines 1 and 2. The example shows 24 Type A terminals and eight Type B terminals.

Line 2: Status of each terminal by port address, where:

- 1 = terminal powered on
- 0 = terminal recognized as powered off (by 3274)
- X = unconfigured port
- _ = terminal disabled due to error

Line 3: Ten bytes of summarized statistical information, as follows:

- mmm m = summary count of 3274-detected machine checks
- ccc c = summary count of communication checks
- ppp p = summary count of program checks
- rrr r = summary count of SDLC Test commands received
- xxx x = summary count of SDLC Test commands successfully transmitted

**Example 2 (Configuration Support B, C, D, or T)**

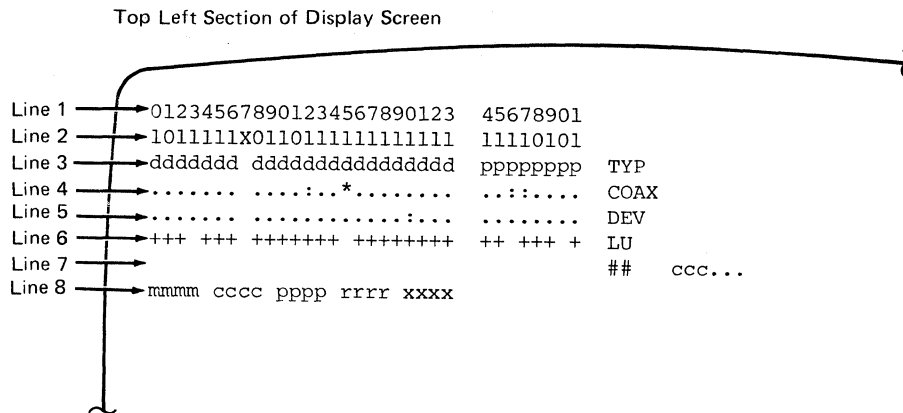

Line 1: See Example 1.

Line 2: See Example 1.

Line 3: Type of terminal attached, where:

- d = display
- p = printer
- i = distributed function terminal
- = terminal was not initialized

Line 4: Summary of possible coaxial cable errors by port address, where:

- . = no errors
- : = 1 to 9 errors
- | = 10 to 19 errors
- * = 20 or more errors

**Note:** This summary is the result of coaxial errors, time-outs, and terminal power-offs. (See Test 1, line 3, bytes 00, 01, 02.) (Byte 00 + Byte 01 - Byte 02.)

Line 5: Summary of terminal errors by port address, where:

- . = no errors
- : = 1 to 9 errors
- | = 10 to 19 errors
- * = 20 or more errors

**Note:** This summary is the sum of counters in the device logs at Byte 03 and higher. (See Test 1, line 3, bytes 03 +.)

Line 6: Terminals that have sessions bound, where:

- + = session bound
- blank = no session bound

**Note:** This entire line, including the label "LU" is blank when operating in a non-SNA mode.

Line 7: Display of X.21 connection, where:

- ## 0000 = direct call
- ## ---- = incoming call
- ## ccc. . . = number dialed by operator (up to 32 characters)

**Note:** This entire line including the label “##” is blank when the X.21 Switched communication feature is not installed.

Line 8: See Example 1.

**Example 3 (Configuration Support P or Configuration Support D with the X.25 Packet Switched Network Function Installed)**

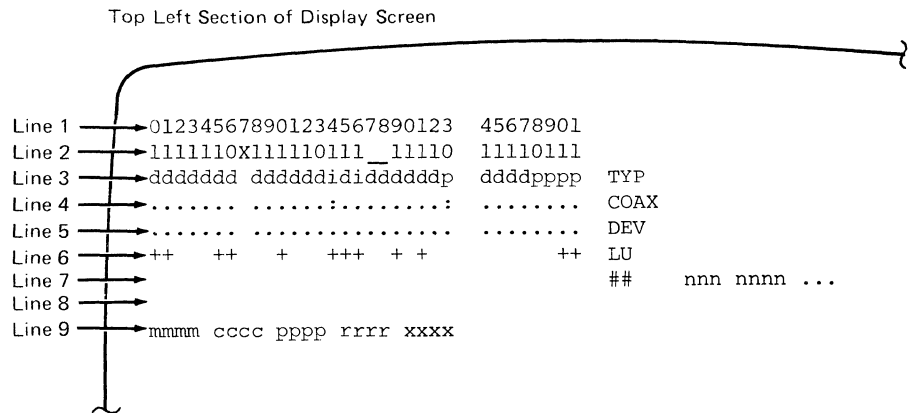

Line 1: See Example 1.

Line 2: See Example 1.

Line 3: See Example 2.

Line 4: See Example 2.

Line 5: See Example 2.

Line 6: See Example 2. (Always present with X.25 operation.)

Line 7:

--> nnn nnnn . . . (15 characters). Indicates an outgoing call operation is performed. The 15 characters are the host DTE address. (X.25 switched virtual circuit.)

<-- nnn nnnn . . . (15 characters). Indicates an incoming call in session. The 15 characters are the host DTE address. (X.25 switched virtual circuit.)

<-- (blank) (no characters). Indicates an incoming call performed. No calling address (host DTE address) was provided in the Call Request packet.

The intent of line 7 is to allow the user to tell what host the control unit is currently connected to (if Call Ready is displayed), or was connected to (if Call Ready is not displayed).

Line 8: Blank.

Line 9: mmmm, cccc, and pppp are as explained in Example 1; rrrr = summary count of XTEST packets received; xxxx = summary count of XTEST packets transmitted.

**Test 4: Reset Test 1 Logs**

See the introduction to Test 1.

**Test 6: Device Control Block (DCB)**

The device control blocks contain common subsystem information pertaining to the devices, device features, and device status. Test 6, as illustrated below, will indicate whether the device attached to the port in question has identified itself as a display or printer, the screen size being used, keyboard type attached, or features attached.

To request the display of the DCB for a particular port, the following procedure should be followed. Enter test mode (press the TEST key while pressing the ALT key). Select the DCB in question by keying in XX/6 (4 characters). XX signifies the port in question and should be 00 to 31. (If the device being used to request the test is the port in question, keying /6 (two characters) will suffice. Press the ENTER key.

Also, if the Multiple Interactive Screen capability is configured, this test will display all the logical terminal (LT) extension areas for this DCB. One line of 20 bytes (10 halfwords) is displayed for each LT. Pressing the ENTER or PA1 key will page to the next LT extended area. Line 2 shows the LT number, X0, X1, etc.

The display should now appear similar to the example below:

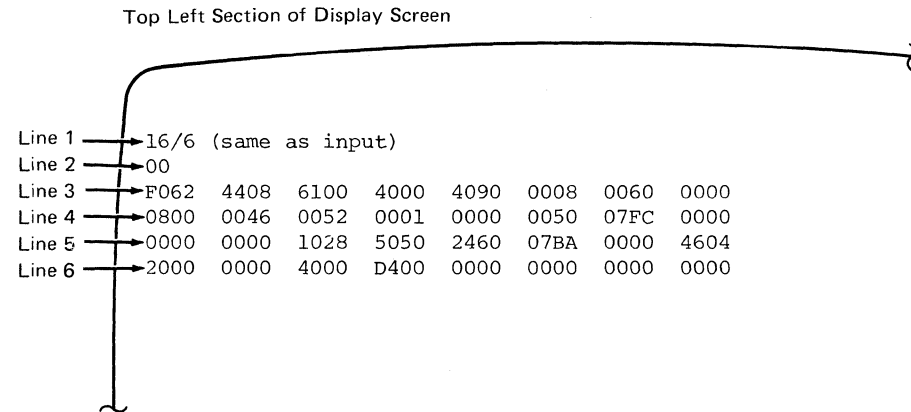

Line 1 is the same as the request input.

Line 2 indicates the displacement from the start of the control block in hexadecimal (the last (0) digit is dropped).

Lines 3–6 contain the hexadecimal representation of the 64 bytes currently being displayed. (The last byte in Line 6 represents location 3F.)

The ENTER or PA1 key can be used to page to subsequent 64 byte areas of the DCB. (The base DCB contains 256 bytes (4 pages.) The extended DCB (for 7 Color, PS, Extended Highlighting, etc.) contains 512 bytes. Line 2 should change to 04, 08, 0C (and if extended DCB 10, 14, 18, 1C) for each depression of the PA1 or ENTER key. The above values for Line 2 represent locations for the first byte on Line 3 of X'40', X'80', X'C0', X'100', X'140', X'180', and X'1C0' respectively. Attempts to page beyond the range of the DCB selected will result in the keyboard being inhibited and X-f displayed in the operator information area.

The format of the DCB charts is as follows:

Column 1, **Information Provided:** The definition of the data at the location indicated in Column 2.

Column 2, **Location:** The location (in hexadecimal) in the DCB of the desired data.

Column 3, **Hex Digits or Bit Setting:** The value of the data in question.

Column 4, **Meaning:** The significance of the particular value or bit setting.

Column 5, **Page/Line/Byte:** This line may serve as an aid to help find the particular byte in question.

- *Page* indicates the value that should appear in display Line 2 as the ENTER or PA1 key is pressed.
- *Line* indicates which of the 4 lines of data should be referenced (Lines 3–6 on the DCB display).
- *Byte* is the displacement of the byte from the start of the subject line (00–0F).

**DCB (Device Control Block) Test AA/6 (AA= Port Address, 00-31)**

Information Provided	Location	Hex Dig./Bit Setting	Meaning	Page/ Line/ Byte	
Model Number of Attached Device	02 Bits 0-2	001 010 011 111 110	Model 1 Model 2 Model 3 Model 4 Model 5	00/3/02	
Features supported by the 3274 and reported as available by the device attached to the port requested. (See also bytes 25, 95, 96, 97.)	02 Bits 3-4	00	Typewriter, APL or Text Keyboard	00/3/02	
		01	Data Entry Keyboard		
		10	Distributed function device		
		11	Printer		
	Bit 5	1	Keyboard Attached		
	Bit 6	1	Type B Device		
	Bit 7	1	Numeric Lock		
Features supported by the 3274 and reported as available by the device attached to the port requested. (See also bytes 25, 95, 96, 97.) (Same as byte 2.)	03 Bit 0	1	Katakana Keyboard	00/3/03	
	Bit 1	1	SCS Feature (Printer)		
	Bit 2	1	Text Keyboard		
	Bit 3	1	3289 TN Text (Printer)		
	Bit 4	1	APL Keyboard		
	Bit 5	1	Extended Function Keyboard		
Features supported by the 3274 and reported as available by the device attached to the port requested. (See also bytes 25, 95, 96, 97.) (Same as byte 2.)	04 Bit 1	1	Security Key	00/3/04	
	Bit 2	1	Selector-light-pen		
	Bit 4	1	MSR		
	Bit 7	1	ECS Adapter		
ID Read from PS Feature	05 Bit 3	1	Color	00/3/05	
	25		Valid only for 3274 configurations that supports SFAP DATA Stream		
		Bit 2	1		ROS Present
		Bit 3	1		APL SWITCH in APL Position
		Bit 4	1		APL Feature Present
Bits 5-6	00 01 10 11	No PSs on Device 2 PSs on Device 4 PSs on Device 6 PSs on Device			
Printer authorization displays authorized to use the printer attached to the port	76, 77	X-X	Bit map for ports 0-15. Ones in this field indicate ports authorized to use this printer	04/6/06-0B	
	78, 79	X-X	Bit map for ports 16-31. Ones in this field indicate ports authorized to use this printer.		
Printer classes assigned to the printer on this port	7A, 7B	X-X X-X	1 in one or more bits (0-15) represents printer classes (70-85) assigned to this printer.		

Information Provided	Location	Hex Dig./Bit Setting	Meaning	Page/Line/Byte
Actual features identified to the controller by the device. (Any bit set here that does not have a corresponding bit in bytes 02-05 above will result in a ✕ 2%% at power on time.)	95		For display (for printer see below)	08/04/05
	Bits 0-3	0000	Reserved	
		0001	APL Keyboard with Numeric Lock	
		0010	Text Keyboard with Numeric Lock	
		0011	Typewriter Keyboard with Numeric Lock	
		0100	Typewriter, Attribute Select Keyboards (Numeric Lock, as specified in customizing question number 166, will be reflected in bit 7 at location 2.)	
		0101	APL Keyboard	
		0110	Text Keyboard	
		0111	APL Attribute Select Keyboard (Numeric Lock, as specified in customizing question number 166, will be reflected in bit 7 at location 2.)	
		1000	Data Entry 2 Keyboard with Numeric Lock	
		1001	Data Entry 1 Keyboard with Numeric Lock	
		1010	Typewriter Keyboard with Numeric Lock	
		1011	Reserved	
		1100	Data Entry 2 Keyboard	
	1101	Data Entry 1 Keyboard		
	1110	Typewriter		
	1111	No Keyboard		
	001	Model 1		
	Bit 4-6	010	Model 2	
		011	Model 3	
100		Reserved		
101		Reserved		
110		Model 5		
111		Model 4		
Bit 7	0			
95		(Printer)	08/04/05	
Bit 0	1	ECS Feature Present		
Bit 1	1	APL Feature Present		
Bit 2	1			
Bit 3	3			
Bits 4-6	000-111	See bits 4-6, Display.		
Bit 7	1	For Printer		
96		(Display)	08/04/06	
Bit 1	1	Security Key		
Bit 2	1	Selector Light Pen		
Bit 4	1	Magnetic Slot Reader		
Bit 7	1	ECS Adapter		
97			08/04/07	
Bit 3	1	Color		
Screen Size (In SNA set by host Bind.)	DC-DD		Default Screen Size	0C/4/0C-0D
	DE-DF		Alternate Screen Size	0C/4/0E-0F



**A Test: Sending Operator-Generated Alert Messages**

The procedure for sending an operator-generated alert message is given in Chapter 8.

**B Test: Device Address Assignment Table Display**

This test displays, for each port on the controller, the number of addressable terminals (physical and logical) associated with the port; the primary address for the port; and the range of secondary addresses (if any) associated with the primary address. Category A and B adapters are shown.

This test requires 22 lines on the screen (there is no paging for additional data) and must be requested from a display device with 24 row screen capacity or greater.

The data for Category A adapter ports is presented in four groups, eight ports to a group (A00 to A07, A08 to A15, . . . ) with four lines required for each port, as follows:

Line 1:	A00	A01	.....	A07
Line 2:	X	X		X
Line 3:	XX	XX		XX
Line 4:	XX-XX	XX-XX		XX-XX

Three more groups, A08 to A15, A16 to A23, and A24 to A31 follow.

Each line carries the following meaning:

- Line 1 = device address (port number)
- Line 2 = number of interactive screens
- Line 3 = primary address
- Line 4 = range of secondary addresses (if any)

The data for Category B adapter ports is presented following the Category A presentation and consists of two lines displaying the data for all 16 possible Category B ports. The format is:

Line 1:	B00	B01	B02	.....	B15
Line 2:	XX	XX	XX		XX

where:

- Line 1 = device address (port number)
- Line 2 = primary address

## X.25 Function: Cause and Diagnostic Code Indicators and Diagnostic Code Modifiers

Cause and diagnostic code indicators, and diagnostic code modifiers are displayed to the operator in conjunction with the Call Ready or X.25 Communication Reminder indicators to aid in problem determination for an abnormal disconnection or rejection of an incoming call by the 3274.

The two indicators:

- XCCDD Call Ready with cause and diagnostic codes
- XCCDD X.25 Communication Reminder with cause and diagnostic codes

appear in the operator information area of the display.

Cause and diagnostic codes are displayed with the Call Ready indicator when cause or diagnostic codes are received by or transmitted from the 3274 due to an error condition. They are not displayed when the 3274 operator causes a normal disconnect via the DISC key function. Cause and diagnostic codes are also displayed with the X.25 Communication Reminder indicator and indicate the cause and diagnostic codes from a restart packet transmitted by or received from the 3274.

Diagnostic code modifiers are displayed with a diagnostic code when the 3274 has sent a clear packet rejecting an incoming call.

**Note:** These codes are the CCITT-recommended, and IBM-architected, codes. However, these codes may not apply, nor be common to, all networks.

XCCDD are defined as follows:

- X This field may have the following values and meanings:
  - P = The 3274 received a clear packet.
  - Q = The 3274 received a reset packet.
  - R = The 3274 received a restart packet.
  - L = The 3274 sent a clear packet.
  - M = The 3274 sent a reset packet.
  - N = The 3274 sent a restart packet.
- CC = Cause code received when X = P, Q, or R.  
 = Diagnostic code modifier when X = L. The diagnostic code modifier is supplied by the 3274 to give additional problem determination information about why the 3274 rejected an incoming call. This modifier is displayed and logged but is not included in the clear packet sent by the 3274. See values in Figure A-2.
- DD = Diagnostic code sent or received.

Diagnostic Code Modifier	Reason
00	No additional information is provided. See the diagnostic code.
01	Calling DTE address is expected, but none is included.
02	Calling DTE address does not match customized value.
03	Facilities other than RPOA are included when customizing indicates that none is expected.
04	Reserved.
05*	Packet facility is included, but is not customized.
06	Incoming CUG does not match customized value.
07	Call requests reverse charging, but function is not customized.
08	Call requests reverse charging not requested, but function is not customized.
09*	Call included window size facility, but window size facility is not customized.
10	CID is to be validated, but none is included in Call Request packet.
11	CID is included, but it does not match the customized value.
12	Protocol ID is not included.
13	Protocol ID is incorrect.
14	CUG facility is customized, but is not included in Call Request packet.
15	Throughput class facility customized, but not included.
16	Reserved.
17	Reverse charge facility customized, but not included.

*Customized = either customized value or value entered via dial screen.

Figure A-2. Diagnostic Code Modifiers

### ***Cause Fields Received from the DCE***

Figure A-3 lists the cause fields received from the DCE.

### ***Diagnostic Code Fields Received from the DCE***

Figure A-4 lists the diagnostic code fields received from the DCE.

### ***Diagnostic Code Fields Generated by an IBM (SNA) DTE***

Figure A-5 lists the diagnostic code fields generated by an IBM (SNA) DTE.

<b>Clear Indication Packet</b>	<b>Hex Code</b>
DTE originated ¹	00
Number busy	01
Out of order	09
Remote procedure error	11
Reverse charging acceptance not subscribed	19
Incompatible destination	21
Fast select acceptance not subscribed	29
Invalid facility request	03
Access barred	0B
Local procedure error	13
Network congestion	05
Not obtainable	0D
RPOA out of order	15
<b>Reset Indication Packet</b>	
DTE originated ¹	00
Out of order ²	01
Remote procedure error	03
Local procedure error	05
Network congestion	07
Remote DTE operational ²	09
Network operational ²	0F
Incompatible destination	11
<b>Restart Indication Packet</b>	
Local procedure error	01
Network congestion	03
Network operational	07

¹When the cause field is hex 00, the diagnostic code field has been passed through the network from the remote DTE's original Clear Request, Reset Request, or Restart Request packet. The diagnostic code is then as listed in Figure A-5, provided the remote DTE is an IBM (SNA) DTE.

²Applicable to permanent virtual circuits only.

Figure A-3. Cause Fields Received from the DCE

Diagnostic Code Field	Hex Code
No additional information	00
Invalid P(S)	01
Invalid P(R)	02
Packet type invalid – general	10
For state: R1	11
R2	12
R3	13
P1	14
P2	15
P3	16
P4	17
P5	18
P6	19
P7	1A
D1	1B
D2	1C
D3	1D
Packet not allowed – general	20
Unidentifiable	21
Call on one-way logical channel	22
Invalid packet type on PVC	23
Packet on unassigned logical channel	24
Reject not subscribed to	25
Packet too short	26
Packet too long	27
Invalid GFI	28
Restart with nonzero GFI	29
Packet type incompatible with facility	2A
Unauthorized interrupt confirmation	2B
Unauthorized interrupt	2C
Timer expired – general	30
Incoming call	31
Clear indication	32
Reset indication	33
Restart indication	34
Call setup problem – general	40
Facility code not allowed	41
Facility parameter not allowed	42
Invalid called-address	43
Invalid calling-address	44
Call clearing problem – general	50
Nonzero address lengths field	51
Nonzero facility lengths field	52

Figure A-4. Diagnostic Code Fields Received from the DCE

Diagnostic Code Field	Hex Code
Normal initialization or termination	00
Invalid LLC type	0C
Invalid packet type - general	10
For state: R1	11
R2	12
R3	13
P1	14
P2	15
P3	16
P4	17
P5	18
P6	19
P7	1A
D1	1B
D2	1C
D3	1D
DCE timer expired - general	20
Incoming call	21
Clear indication	22
Reset indication	23
Restart indication	24
DTE timer expired - general	30
Call request	31
Clear request	32
Reset request	33
Restart request	34
QLLC error - general	50
Undefined C-field	51
Unexpected C-field	52
Missing I-field	53
Undefined I-field	54
I-field too long	55
QFRMR received	56
Invalid QLLC header	57
Data received in nondata state	58
Timeout condition	59
PSH error - general	60
Sequence error	61
PS header too short	62
PSH format invalid	63
Command undefined	64
Invalid PSH protocol	65
Data received in nondata state	66
Timeout condition	69

Figure A-5 (Part 1 of 2). Diagnostic Code Fields Generated by an IBM (SNA) DTE

Diagnostic Code Field	Hex Code
Packet not allowed	A0
Invalid M-bit packet sequence	A1
Invalid packet type received	A2
Invalid packet on PVC	A3
Unassigned logical channel number	A4
Diagnostic packet received	A5
Packet too short	A6
Packet too long	A7
Invalid GFI	A8
Not identifiable	A9
Not supported	AA
Invalid P(S)	AB
Invalid P(R)	AC
Invalid 'D' bit received	AD
Invalid 'Q' bit received	AE
CAC-specific codes	C0
Termination pending	C1
Channel inoperative	C2
Unauthorized interrupt confirmation	C3
Unauthorized interrupt request	C4
PVC resource not available	C5
Resources - general	D0
Buffers depleted	D1
PIU too long	D2
Local procedure error - general	E0
Packet received with LC not equal to 0	E1
Restart or diagnostic packet received with LC not equal to 0	E2
Incoming call received on wrong LC	E3
Facility not subscribed	E4
Invalid packet for LC equal to 0	E5
Facility parameters not supported	E6
Facility not supported	E7
Unexpected calling DTE	E8
Invalid 'D' bit request	E9
Reset indication on virtual call	EA
Invalid protocol identifier	EB
Connection identifier mismatch	EC
Remote procedure error - general	F0

**Note:** The CAC uses this list of diagnostic codes regardless of the type of circuit (i.e., SNA-to-SNA (QLLC or PSH).

**Figure A-5 (Part 2 of 2). Diagnostic Code Fields Generated by an IBM (SNA) DTE**

**Sample of 3274 Control Unit Problem Report Form**

**IBM[®] 3274 Control Unit  
Problem Report Form**

Please fill out this form before requesting service.

1. Are all attached terminals failing? YES NO  
If "NO" is checked, please identify all failing terminals:

2. Check any of the following symbols that are displayed in the operator information area of any failing display station:

Subsystem Ready _____  4

Host Connection _____ A or B

If one of these three symbols is displayed, please insert the 3-digit code following the symbol.

Communication Problem ~~✓~~ _____  
Machine Check Problem  _____  
Program Error _____ PROG _____

3a. Record the status of the 8 4 2 1 indicators before initializing the 3274. (Check which indicators are on; if all are off, check "All Off.")

8 4 2 1  
○ ○ ○ ○  
All Off

3b. If the 3274 has the Loop Attachment, record the status of the Loop Indicators (check which indicators are on).

~~✓~~ External Machine  
OK Check Check  
○ ○ ○

4. Do all the 8 4 2 1 indicators light while the IML pushbutton is pressed and held? (If the 3274 is attached to a loop, the Line Ready, External, and Machine Check indicators should also light.) YES NO

5. Record the status of the 8 4 2 1 indicators after initializing the 3274. (Check which indicators are on; if all are off, check "All Off.")

8 4 2 1  
○ ○ ○ ○  
All Off

When requesting service, please report which of the indicators (step 5) are on. Never Flashed

6. Comments (record any other symptom): _____  
_____  
_____

Address comments concerning this form to IBM Corporation, Department 52Q, Neighborhood Road, Kingston, New York 12401.

Printed in U.S.A. GX23-0203-1





## Appendix B. Operator Information Area Symbols (3278, 3279)

### Readiness and System Connection Symbols (Locations 1 through 7)

Symbol	Name	Explanation
Ⓜ	3274 Ready	<p>The appropriate ready symbol is displayed in location 1 of the Operator Information Area when the 3274 to which the display is attached is ready (functional), and the display is ready.</p>
<u>A</u> <u>B</u>	Online A Online B	<p>The Online <i>A</i> and Online <i>B</i> symbols govern transactions with the host system. Certain keyboard functions and the meaning of some Operator Information Area symbols differ depending upon which set of rules is applicable.</p> <p><i>Online A.</i> The control unit is connected to the system under <i>A</i> rules. The <i>A</i> symbol appears in remote systems using BSC protocol, and in locally attached non-SNA systems. It is turned on by receipt of the following commands: Write, Erase/Write, Erase All Unprotected, Copy, Read Modified, and Read Buffer.</p> <p>The <i>A</i> symbol is turned off when:</p> <ol style="list-style-type: none"><li>1. An operator action causes host communication.</li><li>2. The display station is turned off.</li><li>3. The Normal/Test switch is placed in Test, or the TEST key is pressed to place the 3274 in test mode.</li></ol> <p><i>Online B.</i> The control unit is connected to the system under <i>B</i> rules. The <i>B</i> symbol appears in systems that use SNA protocol. It is turned on by completion of an ACTPU/ACTLU command sequence, and is turned off by execution of DACTPU or DACTLU, including an internal DACTPU sequence, and when the Normal/Test switch is placed in Test or the TEST key is pressed.</p>

Symbol	Name	Explanation
■	My Job	<p>The display station is connected to the operator's application program. This symbol is displayed in position 3. It appears in systems that use BSC or SNA protocol, or in locally attached non-SNA systems.</p> <p>In systems using BSC or locally attached non-SNA systems, it is turned on with the <i>A</i> symbol, and is turned off when power is removed, and when the Normal/Test switch is placed in Test. When using SNA protocol, it is turned on when the operator's application session owns the screen.</p>
⊠	System Operator	<p>This symbol is used with SNA protocol and indicates that the system operator (SSCP Control Program) session owns the display screen. Except for the ENTER key, the Program Attention keys are not functional when this symbol is displayed.</p>
⊡	Unowned	<p>The display station is connected to the system (using SNA only), but not to the operator's application program or to the system operator (control program). The SYS REQ key is used if LOGON is required. This symbol is displayed in position 3.</p>
TEST	Test	<p>The display station is in test mode. Test mode is initiated or terminated by pressing the TEST key while holding the ALT key. TEST is displayed in locations 3 through 6. Test procedures are described in the <i>IBM 3270 Information Display System: 3278 Display Station Problem Determination Guide, GA27-2639</i>, and the <i>IBM 3270 Information Display System: 3279 Display Station Problem Determination Guide, GA33-3051</i>.</p>

Symbol	Name	Explanation
N	In-Use Indicator (3274-51C; X.21 Switched Network Adapter feature)	Data transfer is taking place between the control unit and the host system. The In-Use indicator is displayed on all attached 3278 and 3279s when the control unit has entered the X.21 data transfer state.  The X.21 disconnect key (▶ DISC) is the only key honored in the data transfer state. Pressing the ▶ DISC key disconnects the line and causes the Disconnection-in-Process indicator to be displayed, followed by the Call Ready indicator when the process is complete.

**Do Not Enter (Input Inhibited), Locations 9 through 17:** All these symbols contain an "X" in position 9 (do not enter), combined with other symbols in positions 11 through 17, which define why input is disabled. The keyboard does not lock mechanically, but a change in state of the keyboard clicker (on to off, or off to on) indicates that the keyboard is disabled.

The following keys are not disabled: RESET, SYS REQ, ATTN, TEST, DEV CNCL, shift keys, ALT CURSR, CURSR BLINK, and Click keys.



Also, during an unsolicited write or during buffer transfer while executing a BSC Copy command, a limited number of keystrokes will be accepted for processing, and input is not disabled. The 3274 will queue up to four keystrokes, and, if the queue capacity is not exceeded, will process the input normally when the host restores the keyboard. If the capacity of the queue is exceeded, all queued keystrokes will be discarded and the What symbol is displayed.

RESET will remove the input disabled condition and restore the keyboard except when the following symbols are displayed: Time, Printer Busy, Printer Very Busy, Printer Not Working, and Security Key.

For a 3278 or 3279 display without a keyboard, a selector-light-pen or MSR operation will remove the same input disabled conditions as the RESET key. A selector-light-pen or MSR operation will not cause a reset on a 3278 or 3279 display that has a keyboard attached.

Symbol	Name	Explanation
X 	Time	<p>Time is required for the system to perform a function. This symbol is displayed due to:</p> <ol style="list-style-type: none"> <li>1. Line protocol requirements.</li> <li>2. A keyboard that has been locked by the host; for example, during a host-initiated print operation.</li> <li>3. Internal processing constraints of the control unit, such as loading of the printer authorization matrix from a 3278 or 3279 Display Station into a 3274.</li> </ol> <p>When operating with SNA protocol, the keyboard will be restored and the Time symbol is removed by a WCC which contains the keyboard restore bit set to 1.</p> <p>If a "Change Direction" was also received, the 3274 will enter send state. However, if a CD was not received, the session will remain in receive state when the WCC contains the Keyboard Restore bit set to 1.</p> <p>In this state, all keys can be used except the Program Attention and Print keys. Use of a Program Attention key will result in display of the Minus Function symbol. If a WCC which contains a Keyboard Restore bit set is not received, display of the Time symbol is determined by whether the CD has been received, as follows:</p> <ol style="list-style-type: none"> <li>1. If CD has not been received, the session will remain in receive state and the Time symbol remains displayed with keyboard locked.</li> <li>2. If CD has been received, the 3274 will enter send state; and, if the keyboard was unlocked prior to receipt of the command, the Time symbol is removed and the keyboard is restored. Otherwise, the Time symbol is replaced by the System Lock symbol.</li> </ol>

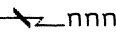
Symbol	Name	Explanation
		<p>If End Bracket is received, the Time symbol is removed, the session enters contention state, and the keyboard is restored regardless of the WCC setting.</p> <p>When using BSC protocol or locally attached non-SNA systems, the keyboard will be unlocked, and the Time symbol removed, if the WCC keyboard restore bit is on, or if the keyboard had been unlocked prior to receipt of the command. Otherwise, Time will be replaced by the System Lock symbol.</p>
X SYSTEM	System Lock	<p>The program has disabled the keyboard following an entry. The operator may receive a message and then press Reset to restore the keyboard. In systems that use SNA protocol, the System Lock symbol appears when the application program has replied to the last message sent by the operator and is requesting the operator to send the next message. At this time, however, the host has not unlocked the keyboard. (The Keyboard Restore bit is not set in any WCC that follows the last message from the operator.)</p> <p>When the System Lock symbol appears in BSC systems, or in locally attached non-SNA systems, the host is notified of the last AID generated.</p>
X 3nn	nnn Machine Check	<p>The display station is not working properly. The symbol is accompanied by three digits, nnn, (3278 or 3279 attached to 3274), which define the probable cause of the problem. Recovery procedures depend upon the type of error.</p> <p>Refer to Appendix A for a description of the machine check codes. Machine check symbols are almost always reset by the operator using the RESET, SYS REQ (SNA only), or TEST keys. If the 3278 or 3279 does not have a keyboard, a selector lightpen, an MSR, or an MHS can be used to reset the Machine Check symbol.</p>

Symbol	Name	Explanation
✕  nnn	Communication Check	An attempt was made to cause host communication or to use the MSR, MHS, or selector light pen that causes host communication, and a communication link error was detected while the Communications Reminder is displayed. Data cannot be sent. The RESET, TEST, or SYS REQ (SNA) key should be pressed. This symbol is accompanied by up to three digits, nnn (3278 or 3279 attached to 3274), which define the probable cause of the problem. (The Communication Reminder symbol is displayed as long as the condition exists.) Refer to Appendix A for a description of the communication-check codes.
✕  	Operator Communication Check (3274-51C.X.21 Switched Network Adapter Feature)	The operator has requested an X.21 function that is currently prohibited. See Appendix I.
✕ PROGnnn	Program Check	A programming error was detected in the data received by the control unit. RESET should be pressed, and the operation should be retried. This symbol is accompanied by up to three digits, nnn, (3278 or 3279 attached to 3274), which define the probable cause of the problem. Refer to Appendix A for a description of the program-check codes.
✕ ?+	What?	The last input was not accepted. The What symbol appears when: <ol style="list-style-type: none"> <li>1. Keystrokes are being queued during unsolicited write or buffer transfer, and the capacity of the queue is exceeded. (The queue is not processed in this case.)</li> <li>2. ATTN or SYS REQ was pressed while inbound processing was queued for the device.</li> <li>3. ATTN, SYS REQ, or TEST was pressed during a Time condition which was caused by internal processing constraints of the 3274.</li> <li>4. The operator continued to key while the Time, Printer Busy, or Printer Not Working symbol was displayed.</li> </ol>

Symbol	Name	Explanation
		<p>5. Two conflicting operations have been attempted "simultaneously" with one operation not serviced. (For example, CLEAR and selector light pen.)</p> <p>6. A dead key operation has been aborted, and a standalone accent created at the cursor location.</p> <p>7. Print ID mode has been aborted. The RESET key restores the keyboard.</p>

This indicator is also displayed under additional indicators for X.21 switched feature operation (refer to Appendix I).

Because of uncertainty about what was accepted, the operator should check the contents of the screen before repeating the operation. In addition:

1. If ALT or a shift key was used, press the key again and then press RESET and retry the operation.
2. When retrying SYS REQ or ATTN, repeated use of these keys may be necessary if inbound processing is queued.

**X -f** Minus Function

A currently unavailable function was requested. RESET should be pressed to restore the keyboard. Conditions that cause a Minus Function are:

1. Use of an ATTN, PF, or PA key while in SSCP session or in the "unowned state," or prior to ACTLU. Also use of the Enter key in the "unowned state" or prior to ACTLU.
2. Use of SYS REQ prior to receipt of ACTLU in SNA.
3. Any of the following actions in receive state with the keyboard unlocked: Print and all AID generating keys.
4. Use of ATTN while operating with remote systems that use BSC or local non-SNA systems.
5. Use of SYS REQ, ATTN, and any PA or PF key that is not specified for test mode.



Symbol	Name	Explanation
		<p>6. When invoking concurrent test 0, the control terminal is not the test terminal, and the latter is either in session (SNA) or has the Time indicator on in systems that use BSC or in local non-SNA systems.</p> <p>7. When using the IDENT key during a printing operation.</p> <p>8. MSR/MHS in "receive state" or in "unowned state."</p> <p>9. MSR in SSCP-LU session with 3277-compatible 10-character set.</p>

The security key is turned off and no operator input.

<b>X -f</b>	<b>⌘</b>	<b>Minus Function Operator Unauthorized</b>
-------------	----------	---------------------------------------------

This symbol means that the display operator has tried to change the Programmed Symbols, Color, or Extended Highlighting attributes when disallowed by the host program. The keyboard is locked as a result. Pressing the Reset key restores the keyboard.





The indicator is also displayed when a Programmed Symbols terminal storage is referenced (PS-A—PS-F attribute keys) but the storage has no symbol set currently associated with it, or the symbol set is marked not keyboard-selectable.

<b>X</b>	<b>⌘</b>	<b>Security Key</b>
----------	----------	---------------------

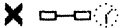
The security key is turned off and no operator input can be accepted. When the key is turned on, this symbol disappears, but any other pre-existing do-not-enter condition may then be displayed.

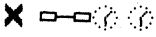
RESET does not remove the Security Key symbol. The Shift, ALT CURSR, CURSR BLINK, and Click keys, and associated symbols, and all other noninput disabled symbols will function when the Security Key symbol is displayed. The Security Key has priority over other input disabled symbols except when machine checks prevent communication between the control unit and the terminal.

Symbol	Name	Explanation
	Printer Not Working	<p>The printer assigned to the display station is not functioning, and no other printers in the class are available. If this symbol appears after the Print key was pressed, and if the Printer Failure symbol is not displayed, the printer assigned to the display (or the most available printer in the class) is not functional. The print request is cancelled, and the DEV CNCL key should be pressed to restore the keyboard. (RESET has no effect.) Restoration of the printer will not automatically remove the Printer Not Working symbol. If the Printer Failure symbol is displayed in the printer status area, the printer stopped during the last print operation. If the print operation was initiated by the Print key, DEV CNCL should be pressed to restore the keyboard. The display terminal indicator may precede a comparable indicator on the printer by as much as 2 minutes.</p> <p>The Printer Not Working symbol may also appear for a host-initiated print operation. Operators are not instructed to use DEV CNCL, but, if used, the the Printer Not Working symbol is replaced with the Time symbol, and the host must continue the operation. Subsequent receipt of outbound FM data will remove the Printer Not Working symbol.</p>
	Printer Busy	<p>The printer assigned to the display station is busy. The operator may either wait for the printer to become available or press the DEV CNCL key. For print requests initiated by the Print key, DEV CNCL will cancel the request, remove the Device Busy symbol, and restore the keyboard.</p> <p>For host-initiated requests, DEV CNCL will cause Device Busy to be replaced by the Wait symbol, and a negative response will be sent to the host. If the Print key was used, it may be possible to select another printer.</p>

Symbol	Name	Explanation
	Printer Very Busy	<p>This symbol applies only to operator-initiated requests via the Print key and means the same as Printer Busy except that more time than usual is anticipated before the print request is accepted. It is displayed when the requested printer is allocated to the host as follows:</p> <ol style="list-style-type: none"> <li>1. If  B is displayed, the printer is currently "in bracket" with a host PLU.</li> <li>2. If  A is displayed, a host Write, Erase/Write, or Copy command has been addressed to the printer, and the print operation has not yet been started by the host (via a command with the Start Print bit on in the WCC).</li> </ol>
	Operator Unauthorized	<p>This symbol means that the operator has requested a printer for which the terminal or attached device is not authorized. RESET should be pressed to restore the keyboard.</p> <p>This symbol appears when:</p> <ol style="list-style-type: none"> <li>1. The Print key is pressed while the Printer Assignment columns of the Operator Information Area show no printer assignment or show question marks.</li> <li>2. The IDENT key is pressed on a 3278 or 3279 attached to a 3274 when there is no printer assignment.</li> <li>3. During a print ID sequence, the operator enters a number which is in the printer authorization matrix, but is not authorized for the display.</li> <li>4. During a local print operation initiated by the Print key, the "printer" assigned is really a display. This can occur if an invalid device description is loaded into the printer authorization matrix.</li> <li>5. The print buffer is unable to store the contents of a display buffer (for example, when the display buffer is too large) during an operator-initiated local copy operation.</li> </ol>

Symbol	Name	Explanation
✕ ←→	Go Elsewhere	<p>An action has been attempted which is invalid for the display screen location. RESET should be pressed, and either the cursor should be moved or some other action taken.</p> <p>The Go Elsewhere symbol appears when:</p> <ol style="list-style-type: none"> <li>1. An attempt has been made to enter, insert, erase, or delete a character when the cursor is in a protected field or at an attribute location.</li> <li>2. An attempt has been made to use the CURSR SEL key while the cursor is not in a cursor select or selector-light-pen field.</li> <li>3. An attempt has been made to enter MSR/MHS data outside the operator input area during an SSCP-LU session when the 3274 is configured for the numeric and alphameric character sets.</li> </ol>
✕ >	More Than	<p>This symbol means that the operator has attempted to enter too much information into a field. RESET should be pressed to restore the keyboard, and the operation should be retried and the entry corrected.</p>
✕ NUM	Numeric	<p>This symbol appears when the Numeric Lock feature is installed. A non-numeric entry was made at a display screen location reserved for numeric information. RESET should be pressed to restore the keyboard, and the operation should be retried.</p>
✕ #?	What Number	<p>The operator has entered a number which is unacceptable at the display screen location. This message appears when a selected print ID is not numeric or is not in the matrix, or an incorrect entry is made in test mode. (Refer to description of IDENT key in Appendix C for further information.) RESET should be pressed to restore the keyboard and to make the correct entry.</p>

Symbol	Name	Explanation
✕ 𐀀	Questionable Card	The operator tried to read an inappropriate magnetic stripe card. RESET should be pressed and the correct MSR card should be used. If a keyboard is not available, repeat the operation using a valid MSR card. This symbol will also appear if the End of Inquiry (EOI) character is present on the magnetic card. Cards with EOI are applicable to the operator identification card reader for the 3277 only.
✕ 𐀁+?	Accent Plus What	These messages indicate that an invalid dead key/character key combination was entered (Canadian French keyboard only). RESET should be pressed to restore the keyboard, and a valid dead key/character key combination should be entered. Valid combinations are as follows:
✕ 𐀂+?		
✕ 𐀃+?		
✕ 𐀄+?		
✕ 𐀅+?		
✕ 𐀆+?		
✕ 𐀇	Minus Symbol	The symbol keyed is not available. The RESET key should be pressed to restore the keyboard.

‘ a A e E u U

’ e E

^ a A e E i i o O u U

¨ e E i i u U

ç ç ç

For further information, refer to “Dead Keys, Canadian French Keyboards” in Appendix C.

#### Reminders (Locations 21 through 27)

→_nnn	Communication Reminder	The communication link connecting the control unit to the system is producing errors. Refer to Appendix A for a description of the error codes.
-------	------------------------	-------------------------------------------------------------------------------------------------------------------------------------------------

The Communication Reminder appears when:

1. The control unit detects a permanent error condition in the connection to the host. (Attempts to retry have ceased.) In this case, the reminder symbol is sent to all terminals attached to the control unit.

Symbol	Name	Explanation
		2. In BSC mode, a line error is detected which results in the original contents of the screen being restored and a request for retransmission made to the host. In this case, the reminder symbol is sent only to the affected terminal.
—	Call Ready ¹	<p>The 3274 is in X.21 Ready state.² This indicator appears when the terminal is powered on and whenever the control unit is in Ready state.² Dial operations or an incoming call are accepted.</p> <p>The ▶ DIAL, ▶ DIRECT, ▶ LOCAL, TEST, and Other² keys are accepted.</p> <p>The ▶ DISC and ▶ COMM keys are ignored.</p> <p>Keys that produce an AID signal are rejected with display of the minus function indicator (X-f).</p>
—Nnn	Call Ready ¹ with Call Progress Signal	<p>A call has been placed but the connection has not been completed for the reason indicated by nn. (See Appendix I for nn code interpretation.)</p> <p>Keys, except ▶ DISC and ▶ COMM, are treated as for Call Ready.</p> <p>The ▶ DISC and ▶ COMM keys are accepted and clear the call progress code. The control unit returns to Ready state².</p>
—#?	Dial-In ¹	<p>This indicator is displayed at the terminal originating the call when the ▶ DIAL key is pressed. The control unit is waiting for the operator to key in the dial digits.</p> <p>—## is displayed at other terminals connected to the same control unit as the originating terminal.</p>

Symbol	Name	Explanation
		<p>At the originating terminal:            The ▶ DIAL, ▶ DIRECT, ▶ LOCAL, ▶ DISC, TEST, and Other² keys are accepted; the AID keys CLEAR and ENTER are accepted (all others are rejected with minus function (X-f) displayed), and the COMM key is ignored.</p> <p>At other terminals:            The ▶ DISC, TEST, and Other² keys are accepted; the ▶ DIAL, ▶ DIRECT, and ▶ LOCAL keys are rejected with the operator communication check indicator (X*z) displayed.</p> <p>The ▶ COMM key is ignored, and AID keys are rejected with the minus function indicator (X-f) displayed.</p>
→z	Outgoing Call ¹ in Process	<p>This indicator is displayed when the operator presses the ENTER key after keying in the dial digits. If no dial digits have been entered, the ENTER key is rejected and the What Number? indicator (X*#?) and Call Ready¹ indicator (z) are displayed.</p> <p>The ▶ DISC, TEST, and Other² keys are accepted.</p> <p>The ▶ DIRECT, ▶ DIAL, and ▶ LOCAL keys are rejected with the Operator Communication check indicator (X*→z) displayed.</p> <p>The ▶ COMM key is ignored, and AID keys are rejected with the minus function indicator (X-f) displayed.</p>
→znnn	Outgoing Call ¹ in Process with Call Progress Signal	<p>The outgoing call is in process and connection is not being made for the reason indicated by nnn. (See Appendix A for nnn code interpretation.) If the connection cannot be made, the control unit returns to ready state² and the Call Ready with Call Progress Signal indicator is displayed.</p>

Symbol	Name	Explanation
		<p>The ▶ DISC, TEST, and Other² keys are accepted; the ▶ DIRECT, ▶ DIAL, and ▶ LOCAL keys are rejected with the Operator Communication Check indicator (X<del>z</del>-z) displayed.</p> <p>The ▶ COMM key is ignored, and AID keys are rejected with the minus function indicator (X-f) displayed.</p>
	Incoming Call ¹ in Process	<p>This indicator appears when the control unit has been addressed by the network and is processing an incoming call. When the connection is completed, the Incoming Call in Process indicator is turned off and the In-use indicator (N) is displayed.</p> <p>The ▶ DISC, TEST, and Other² keys are accepted; the ▶ DIRECT, ▶ DIAL, and ▶ LOCAL keys are rejected with the Operator Communication check indicator (X<del>z</del>-z) displayed; the ▶ COMM key is ignored, and the AID keys are rejected with the minus function (X-f) indicator displayed.</p>
	Disconnect in Process ¹	<p>This indicator is displayed when the ▶ DISC key is pressed or a disconnect command or timeout condition causes the connection to be broken.</p> <p>The TEST and Other² keys are accepted; the ▶ DIRECT, ▶ DIAL, and ▶ LOCAL keys are rejected with the Operator Communication check indicator displayed; the ▶ DISC and ▶ COMM keys are ignored, and the AID keys are rejected with the minus function (X-f) indicator displayed.</p>
	Local ¹	<p>This indicator is displayed when the ▶ LOCAL key is pressed. The control unit is offline to the network, in the X.21 Controlled-Not-Ready state.²</p> <p>Incoming and outgoing calls are inhibited.</p> <p>Pressing the ▶ COMM key restores the control unit to ready state.²</p>



Symbol	Name	Explanation
		The ▶ COMM, TEST, and Other keys are accepted; the ▶ LOCAL key is ignored; and the ▶ DIRECT, ▶ DIAL, and ▶ DISC keys are rejected with the Operator Communication Check indicator (X [‡] -) displayed.
		The AID keys are rejected with the minus function indicator (X-f) displayed.

The following notes apply to the indicators discussed in the Communication Reminder area:

**Notes:**

1. 3274-51C with the X.21 Switched Network Adapter feature.
2. See Appendix I for definitions of X.21 states and Other keys, and details concerning the X.21 feature.

**Programmed Symbols (Locations 31 through 34)**

The symbol set indicators, locations 31 through 33, show the symbol set that will be addressed for a displayable character or symbol in response to the next character entered at the keyboard. A supplementary indicator in location 34 is present if the application program allows the operator to select a PS character attribute for character positions in the current field.

S0	Base character set	The base character set is addressed for a displayable character when the operator presses a character key.
PSA through PSF	Symbol set A through symbol set F	The EBCDIC code for characters entered at the keyboard will be used to address the indicated symbol set for a displayable character.

**Supplementary Indicator:**

None		The operator is not allowed to select a symbol set.
‡		The current character set or symbol set was selected by the operator.
▶		The current character set or symbol set is determined by the extended field attribute; either (1) operator selection is allowed, but no selection has been made, or (2) the operator has selected field inherit.

Symbol	Name	Explanation
--------	------	-------------

**Shifts and Modes (Locations 32 through 41):**

**Note:** Display stations that support the Extended Data Stream feature use locations 36 through 44 for Shifts and Modes and the insert-mode symbol transfers to location 52.

NUM	Numeric	The Numeric Lock feature is installed and the keyboard is in numeric shift, which allows use of the 0 through 9 keys, and the decimal sign, minus (-), and DUP keys only. (The comma replaces the decimal sign in certain World Trade languages.)
↑	Upshift	The keyboard is in upshift.
^	Insert	The keyboard is in insert mode. A character may be inserted at the cursor location. Characters beyond the cursor position move to make room for the inserted character.
APL		The keyboard is in APL mode.
TEXT		The keyboard is in test mode.
▶	X.21 Extension Mode Entered	This indicator is displayed when the X.21 extension key is pressed to enable use of the X.21 modifier keys.  All keyboard status indicators such as KANA, APL, TEXT, UPSHIFT, etc., are reset.  When in extension mode: <ol style="list-style-type: none"> <li>1. The RESET key operates normally but does not reset extension mode.</li> <li>2. The ALT key is ignored.</li> <li>3. If any key other than the X.21 modifier keys, the ALT key, or the RESET key is pressed, the Retry indicator is displayed and extension mode is reset.</li> <li>4. Pressing the extension key will reset extension mode.</li> </ol>

Symbol	Name	Explanation
--------	------	-------------

### Extended Highlighting (Locations 46 and 47)

The Extended Highlighting indicators in locations 46 and 47 show how the next character entered at the keyboard will be highlighted on the display screen; any symbol in location 46 confirms that the operator is allowed to select an extended highlighting character attribute for character positions in the current field.

None		The operator is not allowed to select extended highlighting.
a	Normal	Normal condition. No extended highlighting in effect.
▣	Reverse Video	Character highlighting by reversing the light intensity between the character and its background.
⋮	Blink	Character highlighting by blinking on and off at regular intervals.
<u>a</u>	Underscore	Character highlighting by underscore.

### Supplementary Indicator

⚡		The current extended highlighting attribute was selected by the operator.
▶		The current extended highlighting is determined by the extended field attribute; either (1) operator selection is allowed, but no selection has been made, or (2) the operator has selected field inherit.

### Extended Color (Locations 49 and 50)

The color indicators in locations 49 and 50 show the color that will be used to display the next character entered at the keyboard; any indication in location 49 confirms that the operator is allowed to select an extended color character attribute for character positions in the current field.

None		The operator is not allowed to select extended color.
■	Extended color	The color of the symbol is the color used to display the next character at the keyboard.
0	Default	The color is green or white by default.

### Supplementary Indicator

⚡		The current extended color attribute was selected by the operator.
---	--	--------------------------------------------------------------------

Symbol	Name	Explanation
▶		The current extended color is determined by the extended field attribute; either (1) operator selection is allowed, but no selection has been made, or (2) the operator has selected field inherit.

#### Printer Status (Locations 60 through 64)

□-□nn	Printer Assignment	The display station is authorized to use printer address number nn. Individual printers may be assigned address numbers 1 through 31 when attached to the 3274. Valid print classes are designated 70 through 85 for the 3274.
□-□??	What Printer	The printer IDENT has changed. Pressing the IDENT key causes display of a new printer assignment.
□-■nn	Printer Printing	The printer identified by nn is printing information from the display station.
□-□nn	Printer Failure	The printer identified by nn has stopped while printing information from the display station. This symbol will remain on until: <ol style="list-style-type: none"> <li>1. The condition is cleared following operator intervention.</li> <li>2. The operator uses DEV CNCL following a printer-not-functional condition.</li> <li>3. Receipt of outbound FM data.</li> </ol>
□-□_ _	Assign Printer	When the operator changes the assigned printer using the IDENT key, the two numbers appear in the assignment columns replacing the underlines.
	(nothing displayed)	If a display is attached to a 3274 (☒ displayed in location 1), printing cannot take place. The operator may be able to assign a printer using the IDENT key.



## Appendix C. Keys and Keyboards

### Keyboard Operations

Keyboards, which may be attached to a 3270 display, enable the operator to change, edit, or create character displays except within fields defined by attribute characters as protected from keyboard operations by the program. As messages are being composed or modified by keyboard operations, the changes are inserted in the buffer and then displayed. When the operator completes an operation and presses the ENTER or an AID generating key, an I/O pending interruption occurs.

**Note:** Keyboards attached to 3278 IBM Personal Computer Attachment units function as normal 3278 keyboards when the unit is in host mode. For keyboard characteristics when the unit is in personal-computer mode, see the appropriate publications.

### *Cursor*

A special symbol, called a *cursor*, is displayed on the display screen to indicate where the next character entered from the keyboard will be stored. The cursor on 3277 displays appears as an underscore under a character. On 3178, 3278, and 3279 displays, the cursor may appear as an underscore, as a blinking underscore, or as a rectangular or blinking rectangular symbol imposed over a character. The character within the rectangular cursor remains visible. The operator may change the cursor from an underscore to a rectangular symbol, or vice versa, by pressing the Alternate Cursor (ALT CURSR) key. The same operator may cause either type cursor to blink by using the Cursor Blink (CURSR BLINK) key. When the cursor is displayed under one character in a line of characters, that character can be changed or deleted by keyboard action. Also, if the cursor is displayed under (or within) a position without a display character, a character can be inserted in that position by keyboard action.

One, and only one, cursor must always be in the display buffer. A cursor check occurs when the display station circuitry detects no cursor or more than one cursor in the buffer. When the display is turned on, the cursor is automatically generated and displayed in the first location on the screen. The cursor can be repositioned by the keyboard operator and also by the program. The cursor is not affected by field attributes or by the Security Keylock special feature; it is displayed even when positioned in a nondisplayed/nonprint field and when the Security Keylock special feature (if installed) is turned off.

On the 3178, 3278, and 3279, the normal cursor is an underscore and the alternative cursor is a reverse image of the character in the character position containing the cursor.

On the 3278 and 3279, cursor blink and reverse cursor interact with the Extended Highlighting attributes. The combinations are as follows:

	Extended Highlighting Attribute		
	Reverse	Blink	Underscore
Normal cursor	Reverse character, normal cursor	Character blink, normal cursor	No underscore, normal cursor
Normal cursor with blink	Reverse character, cursor blink	Character blink, and cursor blink	Underscore alternating with normal cursor
Reverse cursor	Normal character cursor displayed as line of dots	Solid character alternating with reverse character	Reverse character with normal underscore

## **Keyboards**

Six types of keyboards are available: typewriter, data entry, data entry keypunch layout, operator console, APL, and text keyboards. All keyboards have special symbol keys and control keys for entering data. The type of keyboard determines the characters and symbols that can be transmitted from the system for the display image.

Variations in keyboards include 66-key and 78-key versions for the 3277 and 75-key and 87-key versions for the 3178, 3278, and 3279. The 66-key/75-key keyboards provide all the basic operator keys. The 78-key/87-key keyboards provide expanded operator-to-program message flexibility with 12 additional keys that may be defined to fit the requirements of the application program. Refer to *3270 Information Display System: Character Set Reference, GA27-2837*, for key layouts and nomenclature.

Typewriter and APL 87-key and 88-key keyboards are available with extended function for the 12 program function keys on the right-hand side of the keyboard. The added functions are by operator selection of the extended attributes (Extended Highlighting, Programmed Symbol set, and Color). The 87-key and 88-key typewriter keyboard with attribute selection is also available as an overlay keyboard; the 48 character keys in the typewriter section of the keyboard have narrow keytops, and blank overlays are available for the user to mark up special characters or symbols assigned to these keys when using Programmed Symbols. Overlay keyboards are available only for displays with the PS feature.

## **Key Functions**

Alphabetic characters on typewriter or operator console keyboards attached to 3270 displays can be entered into the display buffer in either uppercase or lowercase code, depending upon the position of the Shift key. Alphabetic characters in the buffer (upper- or lowercase codes) are displayed as uppercase characters on 3277 displays. On 3178, 3278, and 3279 displays, they are displayed as all uppercase or upper- and lowercase characters, as determined by the setting of the Dual Case/Mono Case switch. The shift keys on the Katakana keyboards operate differently from the keys described here; refer to Appendix E for details.

Keyboard entry of an alphanumeric character into the display buffer occurs at the cursor location, provided the cursor is located in an alphanumeric character location within an unprotected data field. (An attempt to enter an alphanumeric character into a protected data field or into an attribute character location is blocked.)

On displays that support extended attributes, the character attributes for each character position are normally set to X'00' when the operator enters data into that position. If the program allows attribute-selection, the character attributes for each character position are set to X'00' if the operator has not selected a specific attribute for the input data.

Successful keyboard entry of the alphanumeric character causes the cursor to advance to the next character location within the unprotected data field.

**Note:** The following descriptions of key functions are applicable to all keyboards, except where noted. In some cases, descriptions of key functions contain SNA protocol terms, references to local copy operations, or Operator Information Area symbols. For a detailed description of these topics, refer to "Local Copy Function" in Chapter 2, to Chapter 5, "SNA/SDLC Communication," or to Appendix B, "Operator Information Area Symbols." Operator Information Area symbols referred to as "Input Inhibit" symbols in this chapter are designated as "Do Not Enter" symbols in Appendix B.

The ALT key must be held to activate functions shown on the front of keys on the 3178-, 3278-, and 3279-attached keyboards. These functions are SYS REQ, CLEAR, ERASE INPUT, IDENT, TEST, DEV CNCL, PF1-PF12, PA1, PA2, ALT CURSR, and HOME. The ALT key is also used with the ▶▶ (Right) and ◀◀ (Left) key to move the cursor two locations at a time instead of one. Using the ALT key with a key that has no associated function produces no effect.

## Character-Oriented Keys

A cluster of four keys (located to the right of the main keyboard) moves the cursor one location at a time into any character location. These are ↑ (Up), ↓ (Down), → (Right), and ← (Left). A fifth key, the Backspace key,¹ occupies its normal position on the keyboard. It performs the same functions as the move-cursor-left key. The cursor may be moved into any character location, including unprotected and protected alphanumeric character and field attribute character locations, through the use of these keys. Operation of these keys does not affect the MDT bit. The ↑ (Up), ↓ (Down), → (Right), and ← (Left) keys move the cursor one location at a time. When the ALT (Alternate) key is pressed and held, the ▶▶ (Right) and ◀◀ (Left) key will move the cursor two locations at a time.

These keys are all capable of causing the cursor to wrap. Horizontal wrap always involves a vertical movement; the cursor repositions to the next or preceding row of characters. Vertical wrap due to operation of the Up or Down keys involves no horizontal movement; the cursor stays in the same character column.

These keys all have typematic operation at a repeat rate of approximately 10 operations per second. (When a typematic key is fully pressed, its function is repeated as long as the key is held pressed.)

---

¹ The APL and Text Keyboard features applicable to 3277-2 displays modify this key function; see Appendix D.



## Field-Oriented Keys

Any of four keys moves the cursor to the first position in a field on a formatted screen. All four key operations can cause the cursor to wrap from the end of the last line on the display and to continue at the beginning of the top line. Operation of these keys, described below, does not affect the MDT bit:

→ (Tab) Key — Moves the cursor to the first character location of the next unprotected data field. In a display with no unprotected fields, the cursor is repositioned to character location 0. The Tab key has typematic capability at a repeat rate of approximately 10 operations per second.

← (Backtab) Key² — When the cursor is located in the field attribute character position or the first alphameric character location of an unprotected data field or in any character location of a protected data field, this key moves the cursor to the first alphameric character location of the first preceding unprotected data field.² When the cursor is located in any alphameric character location of an unprotected data field other than the first location, this key moves the cursor to the first alphameric character location of that field. In a display with no unprotected fields, the cursor is repositioned to character location 0. The Backtab key on keyboards attached to 3178, 3278, and 3279 units has typematic capability.

↵ (New Line) Key² — Moves the cursor to the first unprotected character location of the next line. If the display has no unprotected data fields, the cursor is repositioned to character location 0. If the display contains no fields, the cursor is repositioned to the first character position of the next line. The New Line key has typematic capability at a rate of approximately 10 operations per second.

← (Home) Key — Moves the cursor to the first unprotected character position on a 3178, 3278, or 3279 display screen.

## ERASE EOF (Erase to End of Field) Key

If the cursor is located in an alphameric character location in an unprotected data field, this key clears the character location occupied by the cursor and all remaining character locations to the right in that field to nulls. The character attributes for all the erased characters are set to X'00'. The operation can wrap from the end of the last line on the display to the end of the field. The cursor does not move as a result of operating this key, and the MDT bit is set to 1.

Operation of this key when the cursor is located in an attribute character location or is within a protected data field causes an input-inhibit condition and disables the keyboard; no character locations are cleared, the cursor is not moved, and the MDT bit is not set.

---

² The APL and Text Keyboard features applicable to 3277-2 displays modify this key function; see Appendix D.

## ERASE INPUT Key

This key clears all unprotected character locations to nulls, resets the MDT bit to 0 in unprotected fields, and repositions the cursor to the first unprotected character location on the screen. The character attributes for all the erased characters are set to X'00'.

On 3178, 3278, and 3279 displays, the Alternate (ALT) key must be pressed and held first.

In a buffer with only protected data fields, no character locations are cleared and the cursor is repositioned to character location 0.

If the display contains no field, the entire buffer is cleared to nulls and the cursor is repositioned to location 0.

## INS (Insert) MODE Key (3277) $\Delta$ , (Insert Mode) Key (3178, 3278, or 3279)

The INS MODE key on 3277-attached keyboards and the Insert Mode key on 3178-, 3278-, or 3279-attached keyboards place the keyboard in an insert mode of operation. INSERT MODE is indicated on 3277 displays, and the Insert symbol is displayed in the Operator Information Area on the 3178, 3278, or 3279 display screen.

If the cursor is located in an unprotected data field having a null character either in the character location identified by the cursor or in any character location in the field beyond the cursor, operation of an alphameric key causes that alphameric character to be entered at the cursor and the MDT bit to be set to 1. The character formerly occupying the cursor location and all remaining characters within the field (except for null characters or characters to the right of null characters) will be shifted one character location to the right. If the location identified by the cursor location at the time of the insert operation is a null, no character shifting occurs.

After all null characters at or beyond the cursor location in the field have been overwritten, or if there were no null characters, operation of an alphameric key causes the keyboard to become disabled. Field-attribute characters and extended field attributes are not shifted as part of the insert operation. On displays that support extended attributes, the character attributes are shifted with the characters. The character attributes for inserted characters are set to X'00', except where the application program allows attribute-selection and the operator has selected specific attributes.

If more than one row of characters is contained within the field, a character occupying the last character location in the row is shifted into the first character location of the next row.

Operation of an alphameric key while in insert mode when the cursor is located in a field-attribute character location or is within a protected data field disables the keyboard; no character locations are cleared, the cursor is not moved, and the MDT bit is not set.

Operation of the RESET key on 3277 displays returns the keyboard to normal mode.

On 3178, 3278, and 3279 displays, operation of the RESET key, ENTER key, or any other key that causes host communication returns the keyboard to normal mode. Operation of the selector light pen or the CURSR SEL (Cursor Select) key also returns the keyboard to normal mode.

#### **DEL (Delete) Key (3277), Delete Key (3178, 3278, or 3279)**

If the cursor is located in an alphameric character location in an unprotected field, operation of the DEL key (3277) or Delete key (3178, 3278, or 3279) deletes the character from the character location identified by the cursor and sets the MDT bit to 1 (if not previously set). The cursor does not move. All remaining characters in the unprotected field, to the right of the cursor and on the same row, shift one character location to the left. If the display supports extended attributes, the character attributes for the deleted character are deleted and the other character attributes are shifted left; the character attributes of vacated character positions are set to X'00'. Vacated character locations at the end of the row are filled with nulls. If the unprotected field encompasses more than one row, characters in rows other than the row identified by the cursor are not affected.

Operation of this key when the cursor is located in a field-attribute character location or is within a protected data field disables the keyboard; no character locations are cleared, the cursor is not moved, and the MDT bit is not set.

#### **RESET Key**

The RESET key is used to recover from an inhibited keyboard operation that has resulted in a disabled keyboard. When a keyboard is disabled, no other keyboard operations are honored. The RESET key will not reset a disabled keyboard when a command is being executed for the device to which the keyboard is attached, or when a parity error or cursor check is detected in the device buffer.

On 3178, 3278, and 3279 displays, when a keyboard is disabled, symbols are displayed on the bottom row of the screen. Pressing RESET restores the keyboard or other input devices, except for Printer Busy, Printer Very Busy, Printer Not Working, Time, or Security Key input-inhibited conditions. Pressing RESET once resets multiple input-inhibited conditions.

When operating in BSC after an AID generating key is pressed, the RESET key will be ignored during the period from poll to the end of a transmission to the host. Prior to the poll, a RESET action will cancel both the AID code and I/O pending. After transmission to the host is ended, RESET will reset the AID code.

RESET causes print ID mode to terminate. The cursor then reappears, and the old printer ID is displayed in the indicator row.

#### **DUP (Duplicate) Key**

Operation of this key causes a unique character code to be entered into the display buffer, a Tab key operation to be performed, and the MDT bit to be set to 1. The DUP key is provided on all keyboard types except operator console. The DUP character provides a means of informing the application program that a "duplicate" operation is indicated for the rest of the field in which it is located. The DUP character is transferred as a DUP code when the data is read from the display to the program. No duplicate operation is performed at the 3270. The DUP character, when stored in a device buffer, is displayed as an asterisk (*) on

3277 displays and on 3178, 3278, and 3279 displays using mono-case mode, and is printed as an asterisk (*) on a printer. On 3178, 3278, and 3279 displays using dual-case mode, DUP is displayed as an asterisk with an overscore ( ¯* ).

Pressing the DUP key does not affect the current status of extended attributes, and PS selection has no effect on a DUP character.

Operation of this key when the cursor is located in field-attribute character location or is within a protected data field disables the keyboard; no character locations are cleared, the cursor is not moved, and the MDT bit is not set.

### **FM (Field Mark) Key**

Operation of this key causes a unique character code to be entered into the display buffer and the MDT bit to be set to 1. The field mark character provides a means of informing the application program of the end of a field in an unformatted buffer or a subfield in a formatted buffer. The field mark character is transferred as an FM code when the data is read from the display to the program. The field mark character, when stored in a device buffer, is displayed as a semicolon (;) on 3277 displays and on 3178, 3278, and 3279 displays using mono-case mode, and is printed as an asterisk (*) on a printer. On 3178, 3278, and 3279 displays using dual-case mode, FM is displayed as a semicolon with an overscore ( ¯; ). The Field Mark key is not provided on operator console type keyboards.

Pressing the FM key does not affect the current status of extended attributes, and the PS selection has no effect on an FM character.

Operating this key when the cursor is located in a field-attribute character location or within a protected data field disables the keyboard; no character locations are cleared, the cursor is not moved, and the MDT bit is not set.

### **Program Attention Keys**

These keys solicit program action by causing an I/O pending to occur at the display terminal. The program is notified of the interruption by an Attention status indication in locally attached systems and by responding to a poll in remotely attached systems. An Attention Identification (AID) character is generated at the time of the interruption to identify which key caused the interruption, but the MDT bit is not affected.

The program attention keys for 3277 displays are CLEAR, ENTER, CNCL (cancel), TEST REQ, all Program Function (PF) keys, and the Program Access (PA) keys. Operation of the CLEAR key also causes the entire display buffer to be cleared to nulls, positions the cursor to character location 0, and causes all MDT bits to be reset. Operation of any program attention key disables the keyboard, lights the INPUT INHIBITED indicator, and extinguishes the SYSTEM AVAILABLE indicator.

The program attention keys for the 3178, 3278, and 3279 displays are CLEAR, ENTER, the Program Function (PF) keys, and the Program Access (PA) keys. The use of a PA or PF key during a System Services Control Point (SSCP) session results in an input-inhibited condition. Refer to "Keyboard Disabled (INPUT INHIBITED Indicator Is On)," later in this appendix. On 3178, 3278, and 3279

displays, the operation of the CLEAR key also clears the display screen of all data to nulls (except the indicator row), sets all extended attributes to X'00', and positions the cursor at location 0,0 on the display.

It does not change shift status except that it will remove the NUM symbol, if displayed. It does not perform a reset function. If an alternate screen size has been selected, the CLEAR key will reset the screen to the default size. When SNA/SDLC is used, the action of the CLEAR key depends upon the type of session. In 3270 BSC, the CLEAR key AID code is sent to the host. When SNA/SDLC is used, the CLEAR key AID code is sent to the host when CLEAR is pressed while in the LU-LU session. While in test mode, the CLEAR key does not cause an AID to be sent to the host.

**Note:** Not all program attention keys are available on each type of 3270 keyboard.

**TEST REQ Key.** The TEST REQ key on 3275 and 3277 keyboards is used to perform the Test Request function (if installed).

**SYS (System) REQ Key.** When the 3274 operates in remote SNA/SDLC, the operator can use the SYS REQ key for SSCP-SLU and PLU-SLU session switch procedures. SYS REQ also simultaneously initiates keyboard reset and clear functions. SYS REQ performs these functions despite the presence of input-inhibited conditions except (1) when inbound processing is queued for the display station, in which case the Input Inhibited What symbol appears, and (2) when Printer Busy, Printer Very Busy, or Printer Not Working is displayed, which results in no response when SYS REQ is pressed. (Inbound processing queue is the time from when an AID generating key is pressed until regeneration to the line buffer transfer has been completed.)

When a 3277 is attached to a 3274 which is operating with SNA protocol, the SYS REQ key function is obtained by using the two-key sequence TEST REQ key followed by the CLEAR key.

In BSC and 3274 B and D unit local operation, the SYS REQ key performs the test-request function. The automatic reset function is not available. Refer to "Test Request Read" under "Read Modified Command" in Chapter 1.

The ALT key must be pressed and held while the SYS REQ is pressed.

**DEV CNCL (Device Cancel) Key.** The operator may use DEV CNCL to cancel a current outstanding print request to a 3262, 3287, or 3289 if input is inhibited because of a Printer Busy or Printer Very Busy condition. A request initiated by the Print key is dequeued, and the keyboard is restored. A host print request is dequeued, and a negative response is sent to the host. The Printer Busy symbol is replaced by the Time symbol.

DEV CNCL is also used to remove Device Not Functional conditions (printer failure, printer not working). Any coexisting malfunction-while-printing symbol is also removed.

Following use of the Print key, the keyboard is restored. After a host-initiated print, the Printer Not Working symbol is replaced by the Time symbol.

During other input-inhibited conditions, DEV CNCL causes no response, except that it is queued or detected (with subsequent indication) during certain Time conditions in other situations. Use of DEV CNCL in other situations results in no indication.

The ALT key must be pressed and held while the DEV CNCL key is pressed to cancel a request and restore the keyboard.

Use of DEV CNCL during a print ID operation at the 3274 causes the operation to terminate. The cursor reappears, and the previous printed ID is displayed in the Operator Information Area near the bottom of the screen.

#### **SHIFT Key (3178, 3277, 3278, or 3279)**



Shift keys perform the upshift function. When the typewriter keyboard becomes ready initially, only characters located on the bottom position of the keytops can be entered from the keyboard. By pressing and holding the Shift key, characters shown on the top position of the keytops can be entered. On 3178, 3278, and 3279 displays, the shift “up” state is indicated to the operator in the Operator Information Area on the display screen. Pressing the Shift key will reset the Lock key.

#### **LOCK Key (3178, 3277, 3278, or 3279)**



The Lock key fixes upshift character selection. The Lock key is deactivated by pressing the Shift key. When the Shift key on a 3178, 3278, and 3279 typewriter keyboard is used, the shift state is indicated to the operator in the Operator Information Area on the display screen.

#### **NUM Key (3178, 3277, 3278, or 3279)**



The Numeric (NUM) key on the 3277 data entry and data entry keypunch layout keyboards and the Numeric key on the equivalent 3178, 3278, and 3279 keyboards are used to perform the upshift function, equivalent to the Shift keys on the typewriter keyboards. The “up” shift state is indicated to the operator in the Operator Information Area on the display screen.

#### **NUM LOCK Key (3178, 3277, 3278, or 3279)**



The Numeric Lock (NUM LOCK) key on the data entry and data entry keypunch layout keyboards used with the 3277 displays and the Numeric Lock key on the data entry and data entry keypunch layout keyboards used with 3178, 3278, and 3279 displays fix the upshifted character selection, but will not disable the Numeric Lock feature.

#### **ALPHA Key (3178, 3277, 3278, or 3279)**



When the data entry or data entry keypunch layout keyboards have been programmed for nonalpha shift, characters shown on the bottom of the keytops can be selected by holding the ALPHA key (3277 display keyboards) or the Alpha key (3178, 3278, and 3279 display keyboards) and entering the desired characters. When power is applied, the keyboard is in lowercase alpha mode.

## **CURSR SEL (Cursor Select) Key**

The CURSR SEL key on 3178, 3278, and 3279 keyboards allows the selector-light-pen-detection function to be performed from the keyboard. The CURSR SEL key may be used on any field defined as a selector-light-pen-detectable field (as described under "Selector-Light-Pen Operations"). However, a cursor-select field does not require the space or null character padding constraints associated with the selector-light-pen-detectable field, and cursor-select can occur within the field on a line different from that of the attribute that describes the field.

Cursor-select operations may be immediate or deferred (as defined for selector-light-pen fields).

The field used for cursor-select operation may also be defined in the following format:

- Basic attribute character as defined for selector light pen.
- Designator character as defined for selector light pen.
- Data character(s) Optional.
- Basic attribute character Next field.

This format is not applicable when using the selector light pen. When defining a cursor-select field, the attribute character may not be located in the last line of the display with the designator character in the first line.

## **ATTN (Attention) Key**

The ATTN key on the 3178, 3278, and 3279 keyboards is operable in SNA/SDLC in an SNA LU-LU session, with the following exceptions:

1. When inbound processing is queued for the display.
2. When in Shutdown condition.
3. When in Data Traffic Reset state.
4. When a second or successive ATTN which occurs prior to completion of processing for the first ATTN is ignored (with no indication).

When a 3277 is attached to a 3274 which is operating with SNA protocol, the ATTN key function is obtained by using the two key sequences, TEST REQ key followed by the PA1 key.

Use of ATTN in any session except LU-LU causes an Input Inhibit Minus Function.

The ATTN key is inoperative in BSC and will cause an Input Inhibit Minus Function when pressed.

When operating with a 3274 in SNA/SDLC, use of ATTN during a print ID operation causes the print ID operation to terminate; the cursor reappears, and the previous printer ID is displayed in the Operator Information Area.

### **CURSR (Cursor) BLINK Key**

Pressing the CURSR BLINK key causes the cursor (either the bar or the rectangular cursor) to blink. Activating the key again causes the blinking to stop. This key function is available on keyboards attached to the 3178, 3278, or 3279.

### **ALT CURSR (Alternate Cursor) Key**

Pressing the ALT CURSR key while holding the ALT key changes the cursor display. The underlined type of cursor is changed to a rectangular cursor. Conversely, the rectangular cursor is changed to the underlined type cursor by activating the ALT CURSR key. This key function is available on keyboards attached to the 3178, 3278, or 3279.

### **TEST Key**

The TEST key on the 3178, 3278, or 3279 keyboard is used to invoke test functions resident in the 3274. Pressing the TEST key (while holding ALT key) clears and resets the display screen, and the test mode indication turns on, despite any input-inhibited conditions, with the following exceptions: if Printer Busy, Printer Very Busy, or Printer Not Working is displayed, or if the security key is locked, use of TEST results in no response. The control unit places the device to be tested in test mode, and the operator identifies the test function desired. The operator terminates test mode by pressing the TEST key again.

When the 3274 uses SNA/SDLC, the control unit enters test ownership state.

When the 3274 operates in remote BSC mode, Intervention Required is generated if a command is received for the display when in test mode. The 3274 B and D units, in this case, generate Control Check and Intervention Required. When test mode terminates normally, status with Device End is generated.

The test function, described for 3178, 3278, and 3279 displays, does not apply to 3277 displays attached to the 3274.

### **Click Key**

A clicking sound may be produced as keys are pressed on keyboards attached to 3178, 3278, and 3279 displays. The clicking sound is controlled by operating conditions such as input inhibit. For example, if the clicking sound is enabled and an input-inhibited condition occurs, the key click is then disabled, and vice versa. By pressing the Click key, the operator can activate the clicking sound if it has been turned off or can prevent clicking if it has been activated.

### **Print Key**

The Print key is used to initiate a local copy function from a keyboard attached to a 3178, 3278, or 3279 display.



## **IDENT Key**

The IDENT key is used to assign a printer or printer class, while performing a local copy function. (The ALT key must be simultaneously pressed to activate the IDENT key.) When the IDENT key is pressed, the cursor disappears from the screen, and the Printer Assignment symbol appears with two underlined characters in the “nn” position. The operator may then enter the ID in the “nn” position. (Display stations with one of the PS features always select the base character set for the printer ID; if a symbol set is active when the IDENT key is pressed, it is suppressed and then made active again at the end of the printer ID sequence.)

If the specified printer is not authorized (that is, the matrix does not permit the display to copy to the selected device or class of devices), the keyboard is locked and the Input Inhibited Operator Unauthorized symbol is displayed. If the print ID is not in the matrix, the keyboard is locked and the Input Inhibited What Number symbol is displayed. The contents of the printer status field are displayed for the input-inhibited condition, the cursor appears, and the keyboard is locked. The operator must reset and then retry the print ID sequence.

If the selected print class or printer is valid and authorized for this display, the connection indicator will change to indicate the new connection, and print ID mode is terminated. The cursor reappears, and the keyboard remains unlocked.

When in print ID mode, the following rules apply:

1. Numeric information is displayed at the “nn” position in the indicator row. Each character is then checked for validity.
2. The RESET key and other keys or functions that cause a reset operate normally and cause print ID mode to be terminated. The cursor reappears, and the contents of the printer status field are displayed.
3. The ATTN and DEV CNCL keys, the security key, and unsolicited host read and write operations cause the print ID mode to terminate. The cursor reappears, and the contents of the printer status field are displayed in the indicator row.
4. Other keys that function during a keyboard inhibit condition also function while in print ID mode without causing termination.
5. All other keys that are not honored during keyboard inhibit conditions cause the Input Inhibit What symbol to be displayed and terminate print ID mode. In this case, the cursor reappears and the contents of the printer status field are displayed in the indicator row.

## ***Dead Keys, Canadian-French and Canadian Bilingual Keyboards***

On Canadian-French and Canadian Bilingual keyboards, pressing the accent keys causes the individual accents to appear on the display, but the cursor does not move. These accent keys are referred to as “dead keys.” A subsequent character that receives the accent must be keyed next. If the subsequent character is valid, a unique composite character is formed. Refer to the *IBM 3270 Character Set Reference* manual, GA27-2837, for keyboard layouts, I/O codes, and identification of valid accent characters.

Pressing an accent key places the keyboard in dead-key mode, until a valid second key is pressed. When the second character of a dead-key sequence is invalid, only the Shift, DEV CNCL, ALT, Click, and ALT CURSR keys, the Dual Case/Mono Case switch, and the security key are operational. Use of ATTN, in this case, causes the Input Inhibited Minus symbol to appear. Use of any other key terminates the operation and causes an Input Inhibited Accent Plus What symbol to appear on the screen.

The selector light pen and the magnetic slot reader (MSR) do not function while in a dead-key sequence. If used, they cause the dead-key sequence to be aborted, and the keyboard is inhibited, with the What symbol displayed.

All other nonkeyboard-related functions that occur during a dead-key sequence are performed normally. If performance of the function causes the dead-key sequence to be aborted, the keyboard is inhibited and the What symbol is displayed after the function has been performed.

In all of these conditions, the dead-key sequence is aborted, and only an accent is displayed at the cursor position. The operator must reset and rekey both the accent and the valid character.

### Dead-Key Operations with Programmed Symbols

Dead-key operations when the keyboard is selecting code points in a Programmed Symbol set in loadable storage do not cause a composite character to be displayed. Instead, the character at a third code point is selected. The following chart specifies the resulting code point selected when the indicated combinations are keyed:

First Key	Second Key													
	81	C1	85	C5	89	C9	96	D6	A4	E4	83	C3	40	Other Space Key
Circumflex X'5F'	42	62	52	72	56	76	CB	EB	DB	FB				5F
Grave accent X'79'	4A	64	DO	74					6A	FD				79
Trema X'A1'			53	73	57	77			DC	FC				A1
Acute accent X'5A'			CO	71										5A
Cedilla X'EO'											48	68		EO

All code points are given in EBCDIC, and the hyphen (-) indicates that an input-inhibit-invalid dead-key combination indicator will be displayed if the combination indicated is keyed.

Code points shown are transmitted to the host as part of an inbound transmission.

## Attribute-Select Keys

Displays that support the 3270 Structured Field and Attribute Processing option also support the attribute-select keyboards (overlay keyboards include the attribute-select function). The 12 program-function keys at the right of the keyboard, in conjunction with the shift and ALT keys, are used to select extended character attributes that are to be assigned to each character entered from the keyboard. These keys are shown in Figure C-1, and their action explained following the figure.

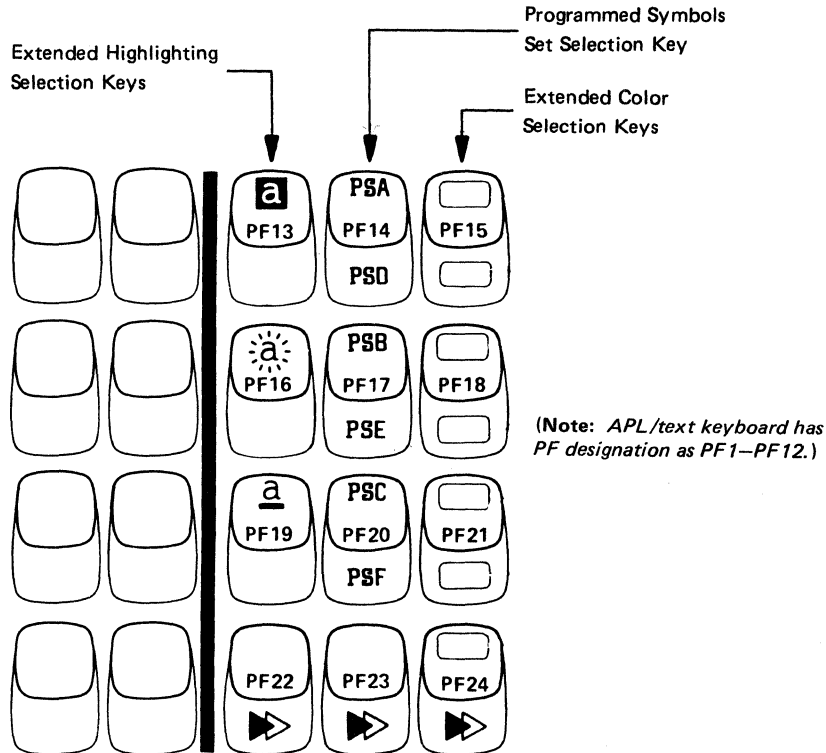

Figure C-1. Attribute Select Keys

Operator selection of extended attributes is restricted to character attributes; extended field attributes are protected against operator input. Character attributes of X'00' are assigned to characters entered, except when the program allows the operator to select attributes and the operator has made a selection. Where a selection has been made, the same attribute assignment is made for each character entered from the keyboard until the operator makes another selection for that attribute-type or until the Set Reply Mode is changed to disable selection. The types of attribute that the operator is allowed to select must be explicitly defined by the application program in the Set Reply Mode function of a Write Structured Field command; if the operator is to select symbol sets, then the Load Programmed Symbols function must also define the set as operator-selectable. When attribute selection is allowed, the Operator Information Area shows which extended attribute is valid for selection and the current status of that attribute. A "field inherit" key (▶) is provided for each type of extended attribute; the operator uses this key to cancel a selected attribute and to cause default to the extended field attribute.

When data is entered from the keyboard, the character attributes related to the location of the data entered into the buffer are updated. If attribute selection is allowed and the operator has selected specific attributes, the code of each selected attribute is loaded into the character attributes. For each type of extended attribute, if selection is not allowed and canceled, the character attribute is set to X'00'.

### Extended Highlighting



With uppercase shift, this key selects reverse video as the Extended Highlighting character attribute.



With uppercase shift, this key selects character blink as the Extended Highlighting character attribute.

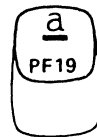

With uppercase shift, this key selects character underscore as the Extended Highlighting character attribute.



With ALT shift, this key sets "field inherit" as the Extended Highlighting attribute.

### Symbol Set

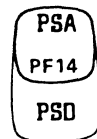

PSA through PSF, with the required shift (uppercase or alternate, depending upon the position of the legend on the key), select the symbol-set character attribute.

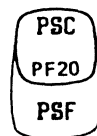
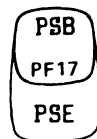

With ALT shift, this key sets "field inherit" as the symbol-set attribute.

## Extended Color



The color codes, with the required shift (uppercase or alternate, depending upon the position of the code on the key), select the extended-color character attribute.

With ALT shift, this key sets "field inherit" as the extended-color character attribute.

## Numeric Lock Feature Operation

When the Numeric Lock feature is installed, the characters (0–9), decimal sign, minus sign (-), and DUP may be entered by the operator in a field identified in the field-attribute byte as numeric and unprotected. MSR/MHS input is also accepted. Operating any other key that can enter a displayable character causes an input-inhibited condition. In addition, the NUM symbol lights on the 3178, 3278, and 3279 displays. Operating the RESET key enables the keyboard (if disabled), and the INPUT INHIBITED light (3277) or NUM symbol (3178, 3278, 3279) goes out. The nondisplay/nonprint attribute bits 4 and 5 and MDT bit 7 operate normally.

The Numeric Lock feature can be overridden as follows:

1. On a data entry keyboard, any character can be entered by pressing (and holding) the Numeric Shift key or the Alpha Key, depending upon the character to be keyed, and then pressing the desired key(s).
2. On a typewriter keyboard, any uppercase character or symbol can be entered by pressing (and holding) the Shift key and then pressing the desired key(s).
3. On an APL or a text keyboard, any non-APL or non-Text uppercase character or symbol can be entered by pressing (and holding) the Shift key and then pressing the desired key(s); also, any APL or Text uppercase or ALT-Shift character can be entered by placing the keyboard in APL mode or Text mode (pressing APL ON/OFF with ALT or TEXT ON/OFF with ALT), pressing (and holding) the Shift key or the ALT key (depending upon the character to be keyed), and then pressing the desired key(s).

**Note:** For devices with attribute-select or overlay keyboards, numeric lock for those keyboards is set by an option taken during customizing. The option taken applies to all devices with attribute-select and overlay keyboards; if numeric lock is set off, all these devices have numeric lock off.

On a 3277 typewriter or operator console keyboard, the characters that can be entered in the field identified in the attribute byte as numeric and unprotected are (0–9), decimal sign, and minus sign (-); in addition, on 3277 typewriter keyboards, when the SHIFT or the LOCK key is operated, the DUP character may be entered by the operator.

### ***Keyboard Disabled (INPUT INHIBITED Indicator Is On)***

When INPUT INHIBITED is on (3277 displays), the keyboard and other input devices are disabled. In cases caused by operator key action, the input-inhibited condition can be cleared by using the RESET key unless one of the following conditions coexists:

1. A command is being executed for a device to which the keyboard is attached.
2. A magnetic card read operation is in progress. (OICR operation.)
3. A parity error or cursor check is detected in a terminal buffer. (The INPUT INHIBITED indicator will be off as long as the RESET key is pressed, but will turn on when the RESET key is released.)
4. The security keylock is in the off position. (This condition is cleared by turning on the security keylock.)

The following conditions can be cleared by using the RESET key on all keyboards (attached to 3178, 3277, 3278, and 3279 displays):

1. A Program Attention key operation prior to initiation of a command for a device with an attached keyboard.
2. A selector-light-pen attention operation prior to initiation of a command for a device with an attached keyboard.
3. An input-inhibited condition the operator initiated by pressing an alphameric key not included in the numeric key grouping when the Numeric Lock special feature is installed.
4. An attempt by the operator to change the data displayed in a protected display field. (The CLEAR key can also be used in this case, which places nulls in all buffer positions and turns on the INPUT INHIBITED indicator. INPUT INHIBITED can then be turned off by pressing the RESET key prior to initiation of a command for a device with an attached keyboard.)

INPUT INHIBITED is turned on by:

1. Operation of a Program Attention key.
2. A selector-light-pen attention that caused an I/O interruption or that resulted in an operator error.

3. A magnetic slot reader (MSR) or magnetic hand scanner (MHS) operation that caused an I/O interruption. (3278, 3279 only.)
4. Turning the security key to the off position when the Security Keylock feature is installed, when power is applied initially.
5. A system-initiated I/O operation addressed to that unit.
6. Operation of any alphameric key or of the DUP, FIELD MARK, ERASE EOF, or DEL key, when the cursor is in a protected field.
7. Operation of any alphameric key not included in the numeric key grouping when the cursor is in a numeric field, without simultaneously operating either the Alpha or Numeric shift key on a data entry keyboard or the Shift key on a typewriter keyboard, when the Numeric Lock feature is installed on a keyboard.
8. Copying of data in the refresh buffer to another terminal.
9. The occurrence of a Machine Check, Program Check, or Communications Check.
10. The terminal's being in receive state under SNA protocol.

INPUT INHIBITED is turned off by:

1. On 3277 displays: receipt and execution of a WCC with the Keyboard Restore bit on. On 3178, 3278, and 3279 displays: receipt and execution of a WCC with the Keyboard Restore bit on when the System Lock or Time symbol is displayed.
2. On 3277 displays: receipt and execution of an Erase All Unprotected command. On 3178, 3278, and 3279 displays: receipt and execution of an Erase All Unprotected command when the System Lock or Time symbol is displayed.
3. Turning of the security key to the on position (if the INPUT INHIBITED indicator was turned on because the security key was in the off position).
4. Operation of the RESET (except as noted under "Reset Key"), TEST, or SYS REQ keys in BSC or 3274 B or D unit local operation.
5. Depression of the DEV CNCL key after receipt of a Printer Not Working symbol.
6. Termination of a Time condition.

An I/O operation that leaves the 3274 in a send state but does not unlock the keyboard can be cleared by using the RESET key on the 3178-, 3278-, or 3279-attached keyboards. When INPUT INHIBITED is on, on a 3178, 3278, or 3279 display, manual input to the unit from the keyboard or selector light pen is inhibited, except for use of the Shift, ALT CURSR, CURSR BLINK, and Click keys.

INPUT INHIBITED is cleared by a reset action from the control unit or the operator. During an unsolicited write operation or during a buffer transfer when the 3274 is executing a Copy command in BSC, keystrokes are accepted for processing. The 3274 will queue up to four keystrokes and, if the queue capacity is not exceeded, will process the input after the host restores the keyboard.

If the queue capacity is exceeded, all queued keystrokes are discarded, and the What symbol is displayed. The What symbol is also indicated if input is attempted during Time symbol conditions or during Printer Busy or Printer Not Working input-inhibited conditions.

If the input-inhibited condition is caused by a Machine Check, only an operator reset action can reset the device (if it can be reset). Only an operator reset action will reset a device that shows a Communication or Program Check condition. The Communications Check inhibit symbol does not reappear unless it is reencountered by pressing a host communication key on the display keyboard.





## Appendix D. APL/Text Feature

The APL and text processing capabilities of the IBM 3270 Information Display System are available on the devices shown in Figure D-1 when attached to an appropriately customized 3274 A, C, or D unit. These devices must be equipped with the appropriate APL/text and Extended Character Set Adapter or Text Print features.

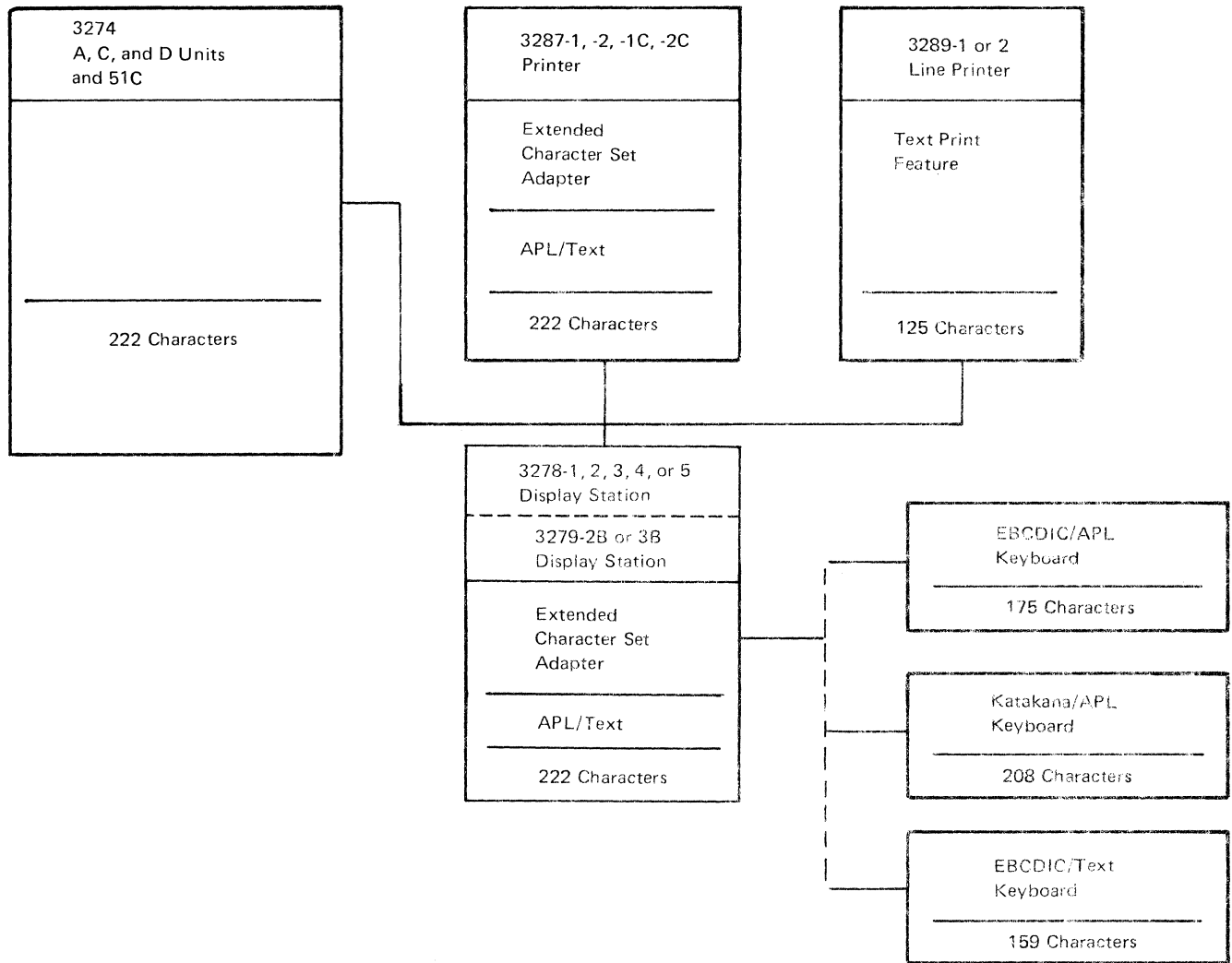

Figure D-1. Diagram of APL/Text Devices

## **APL/Text and Test Print Data Streams**

The I/O interface codes used by the APL/text customized 3274, the 3278 and 3287 with APL/text and Extended Character Set Adapter features, and the 3279 Models 2B and 3B are shown in Figures D-2 and D-3; codes used with Katakana/APL and Extended Character Set Adapter features are shown in Figures D-5 and D-6. Figure D-4 shows National Use differences for the I/O interface code. The I/O interface codes used by the 3289 text print customized 3274 and the 3289 with the Text Print feature are shown in Figure D-7. The 3278/3279/3287 APL/text and the 3289 text print I/O interface codes do not affect the operation of any 3274 data stream commands, orders, or control characters. All 3278/3279/3287 APL-specific characters are specified by 2-byte sequences; each 2-byte sequence consists of a Graphic Escape (hex '08') control character followed by a character code.

The 3274 APL/text data streams:

- Contain 94 EBCDIC characters (plus space).
- Specify all APL- and text-specific characters by using a 2-byte sequence consisting of a hex 08 control character followed by a character code.
- Contain 10 graphic plot characters.

The 3274 text print data streams:

- Contain 93 U.S. English set characters (plus space).
- Use different interchange codes to specify some text-specific characters.

### **3274 APL/Text and Text Print Customizing Options**

The 3274 APL/text customizing option for the 3278, 3279, and 3287 APL/Text and Extended Character Set Adapter features and the 3289 text print customizing option for the 3289 Text Print feature are accomplished with extensions of the configuration code on the 3274 system diskette. The APL/text and 3289 text print configuration code is selectable as part of the 3274 customizing process, provided the 3274 control storage size is adequate.

The 3274 APL/text and 3289 text print customizing options require that EBCDIC be specified when customizing the 3274, and cannot be specified for the 3274 B units (the 3274 D units must be used for local non-SNA attachment).

### **3278-1, -2, -3, -4, and -5 or 3279-2B and -3B APL/Text**

The APL/Text special feature, the Extended Character Set Adapter special feature (prerequisite for the APL/Text feature), and the appropriate APL or text keyboard enable a 3278 or 3279 operator to interact with either APL or text applications as well as existing applications.

Bits 4567		00				01				10				11				Bits 0,1 2,3 Hex 0		
		00	01	10	11	00	01	10	11	00	01	10	11	00	01	10	11			
		0	1	2	3	4	5	6	7	8	9	A	B	C	D	E	F			
0000	0					SP	&	-									<b>12</b>	<b>13</b>	<b>14</b>	0
0001	1							/	É	a	j	<b>11</b>					A	J		1
0010	2					À	Ê	À	Ê	b	k	s					B	K	Ş	2
0011	3						ë		Ë	c	l	t					C	L	T	3
0100	4							À	Ê	d	m	u					D	M	U	4
0101	5									e	n	v					E	N	V	5
0110	6					Ì		Ì		f	o	w					F	O	W	6
0111	7					Ï		Ï		g	p	x					G	P	X	7
1000	8					ç		Ç		h	q	y					H	Q	Y	8
1001	9								<b>7</b>	i	r	z					I	R	Z	9
1010	A					<b>1</b>	<b>3</b>	<b>6</b>	:											
1011	B					.	<b>4</b>	.	<b>8</b>							À	Ù	Ò	Û	
1100	C					<	*	%	<b>9</b>								ü		Û	
1101	D					(	)	-	'											ù
1110	E					+	;	>	=											
1111	F					<b>2</b>	<b>5</b>	?	<b>10</b>											

Notes:

**1** through **14** are the National use differences. They are shown in Figure D-4.



 = Canadian French characters.

1. No control characters are shown in this chart.
2. All codes can be entered from the keyboard.
3. Character code assignments other than those shown within all outlined areas of this chart are undefined. If an undefined character code is programmed, the character that will be displayed or printed is a hyphen (hex 60); also, a hex 60 will be returned on a subsequent read operation. (For control units with Configuration Support C installed, undefined control codes (X'00' to X'3F') cause a negative response (SNA) or an Op Chk (BSC). The character displayed or printed for an undefined character code is unpredictable.) The character displayed or printed for a given undefined character code may be different for other devices. IBM reserves the right to change at any time the character displayed or printed for any undefined character code.
4. NL (hex 15), EM (hex 19), FF (hex 0C), and NUL (hex 00) are not displayed or printed. The DUP (hex 1C) and FM (hex 1E) control characters on dual case terminals are displayed as * and ; respectively, and are printed as * and ;.
5. DUP (hex 1C) and FM (hex 1E) control characters on mono case terminals are displayed as * and ; respectively, and are printed as * and ;.

Figure D-2. APL/Text Feature, 1-Byte I/O Interface Codes (3274/3278/3279/3287)

Hex 1	Hex 0	00				01				10				11			
		00	01	10	11	00	01	10	11	00	01	10	11	00	01	10	11
		0	1	2	3	4	5	6	7	8	9	A	B	C	D	E	F
0000	0									~	□	-	α	{	}		⊙
0001	1					<u>A</u>	<u>J</u>		Λ			°	e	(	)	1	1
0010	2					<u>B</u>	<u>K</u>	<u>S</u>	..	-	-	-	ι	+	-	2	2
0011	3					<u>C</u>	<u>L</u>	<u>T</u>			-	•	ρ	■	+	3	3
0100	4					<u>D</u>	<u>M</u>	<u>U</u>			-	n	ω	L	┘		4
0101	5					<u>E</u>	<u>N</u>	<u>V</u>			-			┌	┐		5
0110	6					<u>F</u>	<u>O</u>	<u>W</u>					x	└	├		6
0111	7					<u>G</u>	<u>P</u>	<u>X</u>					\	┆	T		7
1000	8					<u>H</u>	<u>Q</u>	<u>Y</u>	V				÷	§	¶		8
1001	9					<u>I</u>	<u>R</u>	<u>Z</u>									9
1010	A									↑	▷	∩	∇	☆	I	/	
1011	B									↓	◁	∪	Δ	∞	!	∖	▽
1100	C									≤	≡	⊥	T		ψ		△
1101	D									┌	○	[	]	φ	⋈	e	⊕
1110	E									L	±	≥	≠		▣	▤	⊖
1111	F									→	←	◦		φ	⊖	⊖	

Notes:

-  Subscripts
-  Superscripts

1. These codes, preceded by a hex 08 control character, transmit the graphics shown.
2. No control characters are shown in this chart.
3. All codes within the solid outlined areas of this chart can be entered from the keyboard; the 10 graphic plot characters within the dashed outlined area cannot be entered from the keyboard.
4. Character code assignments other than those shown within all outlined areas of this chart are undefined. If an undefined character code is programmed, the character that will be displayed or printed is a hyphen (hex 60); also, a hex 60 will be returned on a subsequent read operation. The character displayed or printed for a given undefined character code may be different for other devices. IBM reserves the right to change at any time the character displayed or printed for any undefined character code.

Figure D-3. APL/Text Feature, 2-Byte I/O Interface Codes (3274/3278/3279/3287)

Character Set	Code Key (Note 1)													
	EBCDIC	1	2	3	4	5	6	7	8	9	10	11	12	13
English (US)	4A	4F	5A	5B	5F	6A	79	7B	7C	7F	A1	C0	D0	E0
Austrian/German	Ä	ı	Ü	Ş	^	ö	'	#	Ş	"	β	ä	ü	Ö
Austrian/German (Alternate)	ö	ı	ü	Ü	ı	β	'	Ä	Ö	ä				
Danish/Norwegian	#	ı	ı	Ä	^	φ	'	Æ	φ	"	ü	æ	ä	\
Danish/Norwegian (Alternate)	φ	ı	ä	Ä	ı			Æ	φ	æ				
Finnish/Swedish	Ş	ı	ı	Ä	^	ö	é	Ä	Ö	"	ü	ä	â	É
Finnish/Swedish (Alternate)	ö	ı	ä	Ä	ı			Ä	Ö	ä				
French	°	ı	Ş	Ş	^	ú	'	£	á	"	ı	e	è	ç
Italian	°	ı	é	Ş	^	ó	ú	£	Ş	"	ı	á	è	ç
Portuguese (Note 2)	ı	ı	ı	Ş	^	õ	'	Ä	Ö	"	ç	ã	'	Ç
Spanish	ı	ı	ı	Pts	ı	ñ	'	Ñ	@	"	ı	{	}	\
Spanish (Alternate)	¢	ı	ı	Pts	ı	ı	'	Ñ	@	ñ				
English (UK)	Ş	ı	ı	£	ı	ı	'	#	@	"	ı	{	}	\
Belgian	ı	ı	ı	Ş	^	ú	'	#	á	"	ı	é	è	ç
Brazilian/Portuguese	É	ı	Ş	Ç	^	ç	ã	Ö	Ä	"	ı	õ	é	\
Japanese (English)	£	ı	ı	¥	ı	ı	'	#	@	"	ı	{	}	Ş
Spanish Speaking	ı	ı	ı	Ş	ı	ñ	'	Ñ	@	"	ı	{	}	\
Canadian (French)	ä	ı	'	Ş	^	ú	'	#	@	"	ı	é	è	ç
International	ı	ı	ı	Ş	^	ı	'	#	@	"	ı	{	}	\

**Notes:**

1. See Figure D-2 for code points.
2. Portugal
  - a. Host system to control unit -4C or EO is Ç
  - b. Control unit to host system -EO is Ç
  - c. Control unit to host system -4C (<) is removed.

Figure D-4. National Use Differences I/O Interface Code (3274/3278/3279/3287)

Bits 4567	Hex 1 ↓	00				01				10				11				Hex 0	
		00	01	10	11	00	01	10	11	00	01	10	11	00	01	10	11		
		0	1	2	3	4	5	6	7	8	9	A	B	C	D	E	F		
0000	0					SP	&	-			ソ					\$	0		
0001	1					。	エ	/			ア	タ	-			A	J		1
0010	2					「	オ				イ	チ	へ			B	K	S	2
0011	3					」	ヤ				ウ	ツ	ホ			C	L	T	3
0100	4					、	ユ				エ	テ	マ			D	M	U	4
0101	5					・	ヨ				オ	ト	ミ			E	N	V	5
0110	6					ヲ	ッ				カ	ナ	ム			F	O	W	6
0111	7					ア					キ	ニ	メ			G	P	X	7
1000	8					イ	-				ク	ヌ	モ			H	Q	Y	8
1001	9					ウ					ケ	ネ	ヤ			I	R	Z	9
1010	A					£	!		:		コ	ノ	ユ	レ					
1011	B					.	¥	,	#					□					
1100	C					<	*	%	@		サ			ヨ	ワ				
1101	D					(	)	_	'		シ	ハ	ラ	ン					
1110	E					+	;	>	=		ス	ヒ	リ	”					
1111	F						←	?	"		セ	フ	ル	°					



Notes:

1. No control characters are shown in this chart.
2. All codes can be entered from the keyboard.
3. Character code assignments other than those shown within all outlined areas of this chart are undefined. If an undefined character code is programmed, the character that will be displayed or printed is a hyphen (hex 60); also, a hex 60 will be returned on a subsequent read operation. The character displayed or printed for a given undefined character code may be different for other devices. IBM reserves the right to change at any time the character displayed or printed for any undefined character code.
4. NL (hex 15), EM (hex 19), FF (hex 0C), and NUL (hex 00) are not displayed or printed. The DUP (hex 1C) and FM (hex 1E) control characters on dual case terminals are displayed as * and ; respectively, and are printed as * and ;.
5. DUP (hex 1C) and FM (hex 1E) control characters on mono case terminals are displayed as * and ; respectively, and are printed as * and ;.

Figure D-5. Katakana/APL 1-Byte I/O Interface Codes (3274/3278/3279/3287)

Hex 1 Bits 4567		00				01				10				11				Bits 0,1
		00	01	10	11	00	01	10	11	00	01	10	11	00	01	10	11	←2,3
		0	1	2	3	4	5	6	7	8	9	A	B	C	D	E	F	Hex 0
0000	0									~	□	-	α	{	}		⊙	
0001	1					<u>A</u>	<u>J</u>		Λ			°	ε	(	)	1	1	
0010	2					<u>B</u>	<u>K</u>	<u>S</u>	..	—	—	—	ι	+	-	2	2	
0011	3					<u>C</u>	<u>L</u>	<u>T</u>			—	•	ρ	■	+	3	3	
0100	4					<u>D</u>	<u>M</u>	<u>U</u>			—	n	ω	L	┘		4	
0101	5					<u>E</u>	<u>N</u>	<u>V</u>			—			┌	┐		5	
0110	6					<u>F</u>	<u>O</u>	<u>W</u>					x	┌	┐		6	
0111	7					<u>G</u>	<u>P</u>	<u>X</u>					\	┌	┐		7	
1000	8					<u>H</u>	<u>Q</u>	<u>Y</u>	v				÷	§	¶		8	
1001	9					<u>I</u>	<u>R</u>	<u>Z</u>									9	
1010	A											↑	▷	∩	∇	⋄	∕	
1011	B											↓	◁	∪	Δ	⋄	∖	
1100	C											≤	≡	⊥	T		△	
1101	D											┌	○	[	]	φ	⊕	
1110	E											L	±	≥	≠		⊕	
1111	F											→	←	◦		φ	⊕	

Notes:

-  Subscripts
-  Superscripts

1. These codes, preceded by a hex 08 control character, transmit the graphics shown.
2. No control characters are shown in this chart.
3. All codes within the solid outlined areas of this chart can be entered from the keyboard; the 10 graphic plot characters within the dashed outlined area cannot be entered from the keyboard.
4. Character code assignments other than those shown within all outlined areas of this chart are undefined. If an undefined character code is programmed, the character that will be displayed or printed is a hyphen (hex 60); also, a hex 60 will be returned on a subsequent read operation. For control units with Configuration Support C installed, undefined control codes from X'00' to X'3F' cause a negative response (SNA) or an Op Chk (BSC). The character displayed or printed for a given undefined character code may be different for other devices. IBM reserves the right to change at any time the character displayed or printed for any undefined character code.

Figure D-6. Katakana/APL 2-Byte I/O Interface Codes (3274/3278/3279/3287)



Bits 4567		00				01				10				11				Bits
		00		01		10		11		00		01		10		11		0,1
		0	1	2	3	4	5	6	7	8	9	A	B	C	D	E	F	←2,3
Hex 1		Hex 0																
0000	0					SP	&	-				-	0	{	}	\	0	
0001	1						/			a	j	~ ^o	1	A	J		1	
0010	2									b	k	s	2	B	K	S	2	
0011	3									c	l	t	3	C	L	T	3	
0100	4									d	m	u	4	D	M	U	4	
0101	5									e	n	v	5	E	N	V	5	
0110	6									f	o	w	6	F	O	W	6	
0111	7									g	p	x	7	G	P	X	7	
1000	8									h	q	y	8	H	Q	Y	8	
1001	9								'	i	r	z	9	I	R	Z	9	
1010	A					c	!	!	:									
1011	B					.	\$	.	#	{	}	L	J					
1100	C					<	*	%	@	≤	≠	Γ	∟					
1101	D	CR				(	)	-	'	(	)	[	]					
1110	E					+	;	>	=	+	±	≥	≠					
1111	F						┘	?	"	+	■	●	-					

Notes:



Superscripts

1. No control characters except CR (hex 0D) are shown in this chart. The CR control character provides the capability to inhibit line advance after a line of characters is printed.
2. Character code hex A1 causes a ^o (degree) character to print when the 3289 text print belt is installed and a ~ (tilde) character to print when a U.S. English 3289 print belt is installed.
3. Character code assignments other than those shown within the outlined areas of this chart are undefined. If an undefined character code is programmed, the character that will be printed is a hyphen (hex 60); also, a hex 60 will be returned on a subsequent read operation. IBM reserves the right to change at any time the character printed for an undefined character code.
4. NL (hex 15), EM (hex 19), FF (hex 0C), and NUL (hex 00) are not printed. The DUP (hex 1C) and FM (hex 1E) control characters are printed as * and ; respectively.

Figure D-7. 3289 Text Print Feature I/O Interface Codes

## APL Keyboards

The 3278/3279 APL keyboards are typewriter-like keyboards with keys that contain both APL and the featured-language characters. The APL characters are colored orange (on white keys). The PF1 through PF12 keys on the APL keyboards are located on the right side of the keyboard instead of on the front of the top row of keys as on non-APL keyboards; PF13 through PF24 keys are not available on APL keyboards. The Numeric Lock feature is available for all APL keyboards.

### 87- and 88-Key Typewriter/APL Keyboards

The 87-key typewriter/APL (U.S. English) keyboard is shown in Figure D-8 (the Japanese English typewriter/APL keyboard has 88 keys). This keyboard is available in all 3278/3279 keyboard languages.

The typewriter/APL keyboard enables a 3278/3279 operator to enter the 81 APL-specific characters as well as the 94-character-plus-space EBCDIC dual-case character set. The following characters can be entered:

With APL "off" - 94 EBCDIC characters plus space  
 With APL "on" - 81 APL-specific characters plus:  
     10 numerics (0 through 9)  
     26 uppercase alphabet characters  
     16 invariant symbols (excluding & and %)

When the display station is first turned on, the typewriter/APL keyboard operates like the 75-key typewriter keyboard without APL, with the exception of the PF1-PF12 keys. Pressing the APL ON/OFF key (with the ALT key held down) causes the keyboard to enter APL mode (the letters APL display in the Operator Information Area); in this mode the APL characters on the right half of the keys may be entered (the Shift, Lock, and ALT keys are used to select the desired character on a key). The keyboard is returned to normal (non-APL) mode by pressing the APL ON/OFF key again.

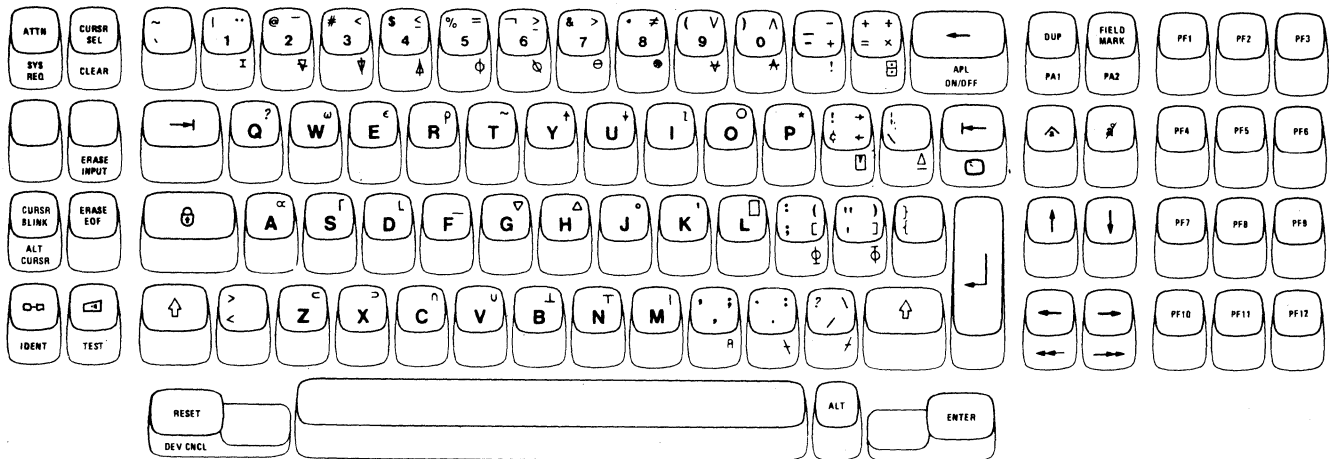

Figure D-8. 87-Key Typewriter/APL Keyboard

**88-Key Katakana Typewriter/APL Keyboard**

The 88-key Katakana typewriter/APL keyboard (available for IBM World Trade Americas/Far East only) is shown in Figure D-9.

The Katakana typewriter/APL keyboard enables a 3278/3279 operator to enter the 81 APL-specific characters as well as the 127-plus-space Japanese Katakana character set. The following characters can be entered:

- With APL "off" - 127-character Japanese Katakana set plus space
- With APL "on" - 81 APL-specific characters plus:
  - 10 numerics (0 through 9)
  - 26 uppercase alphabet characters
  - 16 invariant symbols (excluding & and %)

When the display station is first turned on, the Katakana typewriter/APL keyboard operates like the 88-key Katakana typewriter keyboard without APL, with the exception of the PF1 through PF12 keys. Momentarily pressing the APL ON/OFF key (with the ALT key held down) places the keyboard in APL downshift mode (the letters APL display in the Operator Information Area). APL upshift characters can be entered either by pressing and holding either ↑ (upshift) key or by pressing the Ⓛ (Lock) key; when the keyboard is locked in APL upshift mode, pressing either key returns the keyboard to APL downshift mode. The APL characters on the right front of keys can be entered by pressing and holding the ALT key. The keyboard is returned to non-APL mode (ALPHA downshift) by pressing the APL ON/OFF key again.

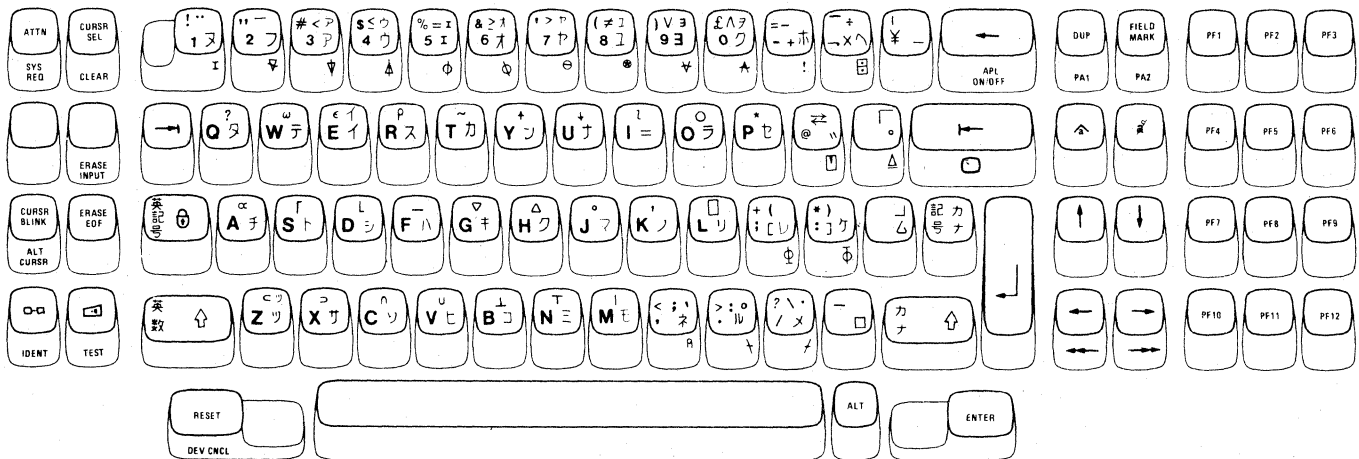

**Figure D-9. 88-Key Katakana Typewriter/APL Keyboard**

**APL Keyboard World Trade Considerations**

The APL programming support does not support certain Canadian-French and Katakana characters on the Canadian-French and Katakana typewriter/APL keyboards. The unsupported Canadian-French characters are all those enterable by a dead-key sequence except à, é, and u. The unsupported Katakana characters are those with I/O interface codes that are not included in the 94-character-plus-space EBCDIC character set. However, the 3274 control units do not block these unsupported codes when they are sent inbound to the host system.

## 87-Key Typewriter/Text Keyboard

The 87-key typewriter/text keyboard (shown in Figure D-10) is a typewriter-like keyboard with keys that contain both U.S. English and text-specific characters. This keyboard is available for U.S. English only (the text keyboard is not available in IBM Europe/Middle East/Africa countries).

The text-specific characters are colored green (on white keys). The PF1–PF12 keys on the typewriter/text keyboard are located on the right side of the keyboard instead of on the front of the top row of keys as on nontext keyboards; PF13–PF24 are not available on the typewriter/text keyboard.

The 3278/3279 operator can use the typewriter/text keyboard to enter the 65 text-specific characters as well as the 94-character- plus-space U.S. English character set. The following characters can be entered:

With Text "off" - 94 U.S. English characters plus space  
 With Text "on" - 65 text-specific characters plus:  
     10 numerics (0 through 9)  
     26 uppercase alphabet characters  
     26 lowercase alphabet characters  
     9 symbols (. < ; , > ? : ! ~)

When the display station is first turned on, the typewriter/text keyboard operates similarly to the 75-key typewriter keyboard without text, with the exception of the PF1 through PF12 keys. Pressing the TEXT ON/OFF key causes the keyboard to enter text mode (the letters TEXT display in the Operator Information Area); in this mode the text characters on the right half of the keys may be entered (the Shift, Lock, and ALT keys are used to select the desired character on a key). The keyboard is returned to normal (non-text) mode by pressing the TEXT ON/OFF key again.

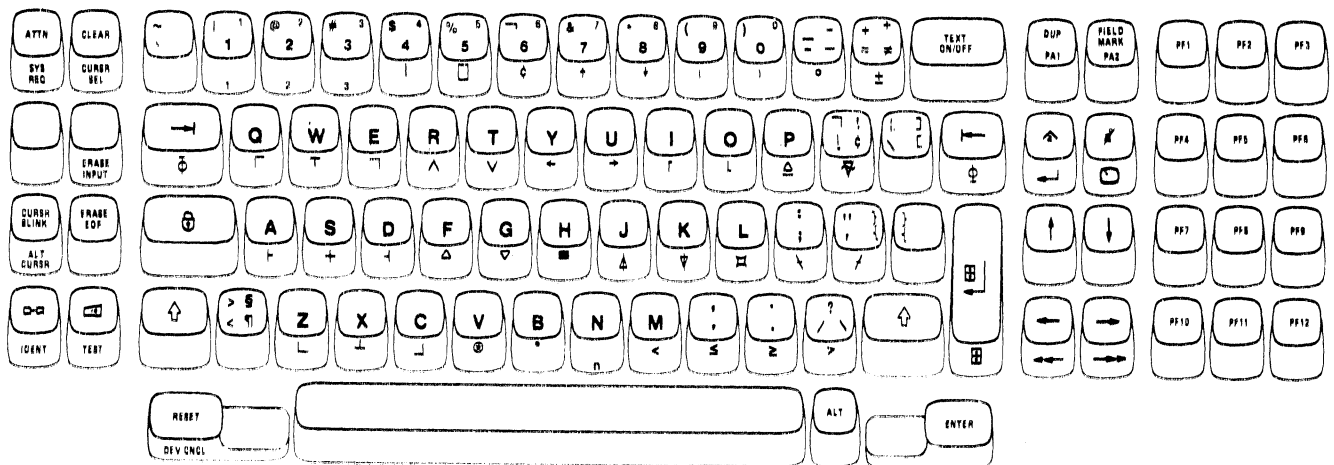

Figure D-10. 87-Key Typewriter/Text Keyboard

### 3287-1 and -2 with APL/Text

The 3287 APL/Text special feature and its prerequisite Extended Character Set Adapter special feature enable the 3287 to print the following characters:

- 94 EBCDIC characters plus space
- 81 APL-specific characters
- 37 text-unique characters
- 10 graphic plot characters

### 3289-1 and -2 with Text Print

The 3289 Text Print special feature (not available in IBM Europe/ Middle East/Africa countries) enables the 3289, when equipped with the text print belt, to print the following characters:

- 93 U.S. English characters plus space

**Note:** This 93-character U.S. English set is identical to the normal 94-character U.S. English set except the tilde ( ~ ) symbol is not included.

- 32 TN characters

A 3289 with the Text Print feature can operate with the 125-character text print belt on a 48-, 64-, or 94-character U.S. English print belt at the following maximum speeds in lines per minute (lpm):

- With the 125-character text print belt installed
  - Model 1 = 40 lpm
  - Model 2 = 160 lpm
- With the 48-, 64-, and 94-character print belts respectively
  - Model 1 = 155 lpm, 120 lpm, 80 lpm
  - Model 2 = 400 lpm, 300 lpm, 230 lpm

**Note:** Actual printer throughput depends upon operational and system characteristics. Maximum print speed may be affected by such factors as communication line speed, control unit load, character set, and application program.

Local or host-initiated copy operations from a 3278/3279 to a 3289, with or without the text Print feature installed, are limited to the normal 3274/3278/3279/3287/3289 94-character U.S. English set.

## **BSC Copy Command**

For control units operating under BSC, if APL- or text-specific characters reside in the device buffer, a copy operation initiated by the BSC Copy command will be allowed only to another ECSA featured device. If the "to" device is not equipped with an ECSA feature, an operation check will be returned to the host.

## **Local Copy**

A local copy from an ECSA featured display with APL/text characters on the screen will print correctly on an ECSA-featured 3287 printer with APL ROS installed. Local copy from an ECSA-featured display with APL/text characters on the screen will be allowed to print on a non-ECSA-featured 3287 printer. The standard EBCDIC character set will print correctly, but APL/text-specific characters will print as EBCDIC characters or hyphens.

10/10/2010



# Appendix E. Katakana Feature

This appendix contains Katakana unique information interface codes and the keyboard shift operations.

## Interface Codes

Figures E-1 and E-2 show the Japanese Katakana EBCDIC interface codes for several control unit/device combinations.

		00				01				10				11				Bits
		00	01	10	11	00	01	10	11	00	01	10	11	00	01	10	11	0,1
Hex 1	Bits 4567	0	1	2	3	4	5	6	7	8	9	A	B	C	D	E	F	2,3
		Hex 0																
0000	0	NUL				SP	&	-			ソ					\$	0	
0001	1		SBA			。	ゝ	/		ア	タ			A	J		1	
0010	2		EUA			フ	オ			イ	フ	ハ		B	K	S	2	
0011	3		IC			レ	ハ			ウ	ツ	ニ		C	L	T	3	
0100	4					、	ユ			イ	テ	マ		D	M	U	4	
0101	5	PT	NL			・	ヨ			オ	ト	ニ		E	N	V	5	
0110	6					ヲ	ツ			カ	ナ	ニ		F	O	W	6	
0111	7					ア				キ	ニ	メ		G	P	X	7	
1000	8					イ	-			ク	ヌ	エ		H	Q	Y	8	
1001	9		EM			ウ				ア	マ	ハ		I	R	Z	9	
1010	A									コ	ノ	ニ	レ					
1011	B						¥	.	#									
1100	C		DUP		RA	<	*	%	@	ナ		ヨ	ク					
1101	D		SF			(	)	_	'	シ	ハ	ラ	ン					
1110	E		FM			+	:	>	=	ス	ヒ	リ	”					
1111	F				SUB		フ	フ		ヒ	フ	フ	°					

**Notes:**

- Character code assignments other than those shown within all outlined areas of this chart are undefined. If an undefined character code is programmed, the character that will be displayed or printed is not specified. The character displayed by the 3277 for a given undefined character code may be different for other devices. IBM reserves the right to change at any time the character displayed for an undefined character code.
- Hex codes 4A, 5A, 6A, and 7F are used for CU addressing, device addressing, buffer addressing, and control purposes (for example, WCC and CCC), but have no associated graphic characters.
- The DUP and FM control characters are displayed or printed as * and ; respectively.
- For 3277, 3284, 3286, 3287 (with the 3271/3272 Attachment feature), and 3288 terminals attached to a 3274 Control Unit, the NL and EM control characters occupy one character position in the buffer, display or print as · and 9, are never executed, even by printers not operating under Format Control, and are transmitted as hex 45 and F9 to the host on a subsequent read operation.
- For AID, attribute, write control (WCC), copy control (CCC), CU and device address, buffer address, sense and status characters, bits 0 and 1 are assigned so that each character can be represented by a graphic character.
- The SUB control character (hex 3F) is not supported for terminals attached to a 3274 Control Unit.
- For BSC data-link control characters, see Chapter 4.

Figure E-1. Japanese Katakana EBCDIC I/O Interface Code for 3274 Control Units with 3277, 3284, 3286, 3287 (with 3271/3272 Attachment Feature), and 3288 Terminals Attached



		00				01				10				11				Bits 0,1
Hex 1		00	01	10	11	00	01	10	11	00	01	10	11	00	01	10	11	Bits 2,3
Bits 4567	Hex 0	0	1	2	3	4	5	6	7	8	9	A	B	C	D	E	F	Hex 0
0000	0	NUL				SP	&	-		ソ						\$	0	
0001	1		SBA			。	エ	/		ア	タ	-		A	J		1	
0010	2		EUA			「	オ			イ	チ	ハ		B	K	S	2	
0011	3		IC			」	ホ			ウ	ツ	ホ		C	L	T	3	
0100	4					、	ユ			イ	チ	マ		D	M	U	4	
0101	5	PT	NL			・	ヨ			オ	ト	ニ		E	N	V	5	
0110	6					ヲ	ツ			カ	ナ	ム		F	O	W	6	
0111	7					ア				キ	ニ	メ		G	P	X	7	
1000	8	GE				イ	-			ク	ヌ	モ		H	Q	Y	8	
1001	9		EM			ウ				ケ	ネ	ト		I	R	Z	9	
1010	A					£	!			コ	ノ	ユ	レ					
1011	B						¥		#				ロ					
1100	C	FF	DUP		RA	<	*	%	@	サ		ヨ	ク					
1101	D	CR	SF			(	)	_	'	シ	ハ	ラ	ン					
1110	E		FM			+	:	>	=	ス	ヒ	リ	”					
1111	F						~	?	"	ヒ	フ	ロ	°					

**Notes:**

- Character code assignments other than those shown within all outlined areas of this chart are undefined. If an undefined character code is programmed, the character that will be displayed or printed is a hyphen (-); hex code 60 will be returned on a subsequent read operation. For control units with Configuration Support C installed, undefined control codes from X'00' to X'3F' cause a negative response (SNA) or an Op Chk (BSC). IBM reserves the right to change at any time the character displayed for an undefined character code.
- CR, NL, EM, and FF control characters are displayed or printed as blank characters. The DUP and FM control characters are displayed as * and ; respectively.
- Hex code 6A is used for CU addressing, device addressing, buffer addressing, and control purposes (for example, WCC and CCC), but has no associated graphic character.
- For AID, attribute, write control (WCC), copy control (CCC), CU and device address, buffer address, sense, and status characters, bits 0 and 1 are assigned so that each character can be represented by a graphic character.
- For BSC data-link control characters, see Chapter 4. For the SCS control codes associated with the SNA Character String feature on 3287 (with the 3274/3276 Attachment feature) and 3289 printers, see Chapter 2.
- For 3277, 3284, 3286, 3287 (with the 3271/72 Attachment feature), and 3288 terminals attached to a 3274 Control Unit, when graphic characters £ ! " and - (hex 4A, 5A, 7F, and A1) are programmed, they display or print a # \ ' (apostrophe) and ~ respectively; on a subsequent read operation, they will be returned as hex 7B, 4F, 7D, and 5F respectively. Furthermore, when control characters NL, EM, FF, and CR are programmed, they are not executed, occupy a single-character position in the buffer, and display or print as 9 < and > respectively; hex codes 45, F9, 4C, and 6E will be returned respectively on a subsequent read operation.

Figure E-2. Japanese Katakana EBCDIC I/O Interface Code for 3274 Control Units with 3262, 3278, 3279, 3287 (with 3274/3276 Attachment Feature), and 3289 Terminals Attached

## Keyboard Shift Operations

The Katakana keyboards shift operations are different from the other EBCDIC keyboards described in Appendix C. The following paragraphs discuss the unique keys and operations.

### LATIN SHIFT and KANA SHIFT Keys—3277

To place the keyboard in the lower shift of either Latin or Katakana (Kana) mode, press and release the desired mode shift key. This enables the characters on the lower portion of each character key to be generated. Holding the shift key depressed while operating the character keys causes the upper-shift characters of the selected mode to be generated.

In addition, a single depression of the Lock key locks the keyboard in the upper shift of the selected mode. A second depression of the Lock key returns the keyboard to the lower shift of the selected mode.

With two exceptions, once a mode is selected, the keyboard remains in that mode until the operator changes the mode by operating the Alternate Shift key. These exceptions are:

1. When power is initially applied, the keyboard is automatically placed in Latin mode.
2. (Data entry keyboards only) — When the cursor enters a numeric field, the data entry keyboard is automatically placed in upper-shift Latin mode. Only 0–9, minus (-), decimal sign, and DUP may be entered when in this mode.

While the cursor remains in the numeric field, the upper-shift Latin mode can be overridden, one character at a time, by depressing the appropriate shift key as follows:

**Upper-shift Kana mode** — While holding the KANA SHIFT key depressed, press the selected character key.

**Lower-shift Kana mode** — Press and release the KANA SHIFT key; then press the selected character key.

**Upper-shift Latin mode** — While holding the LATIN SHIFT key depressed, press the selected character key. This permits keying in upper-shift Latin mode characters other than 0–9, minus (-), decimal sign, and DUP.

**Lower-shift Latin mode** — Press and release the LATIN SHIFT key; then press the selected character key.

In all cases, when the selected character has been entered and the key (or keys) has been released, the keyboard returns to upper-shift Latin mode.

When the cursor leaves the numeric field, the keyboard returns to lower shift of the most recent Latin or Kana mode used by the operator. This is independent of whether the last mode was caused by an override by the operator or by the mode being used just prior to entry of the cursor into the numeric field.

## Katakana Shift Keys—3178, 3278, and 3279

Four shifts [upper and lower left (UL and LL) and upper and lower right (UR and LR)] on the Katakana keyboards are used with the 3178, 3278, and 3279 displays:

Shift	Typewriter Keyboard	Data Entry Keyboard	Operator Message
UL	英記号 Alpha Symbol	英数字 Alpha Symbol Numeric	ALPHA ↑
LL	英数 Alphameric	英字 Alpha	ALPHA
UR	カナ記号 KANA Symbol	カナ記号 KANA Symbol	カナ ↑
LR	カナ Katakana	カナ Katakana	カナ

The characters associated with each shift level are shown in the corresponding position of the key tops. In normal operation, the appropriate shift key is pressed and released to enter the required shift level; the keyboard remains in that shift level until another is selected. However, in a programmed numeric field (program attribute), the keyboard is automatically set to the upper left (UL) shift, and all characters for that shift are valid, unless a keyboard with the Numeric Lock feature is being used. The Numeric Lock feature limits the entries to 0–9, minus (-), decimal sign, and DUP. This automatic UL shift may be overridden by pressing and holding the desired shift key; releasing the shift key returns the keyboard to the UL shift.

Holding a shift key when leaving the programmed numeric field causes the keyboard to enter and remain in that shift level until another shift key is pressed.

On a data entry or data entry (keypunch layout) keyboard, the Numeric Lock feature is disabled while the Alpha, Numeric, Latin Shift, Lock, or upper left shift (3278) key is operated.

On a 3277 typewriter or operator console keyboard, the characters that can be entered in the field identified in the attribute byte as numeric and unprotected are (0–9), decimal sign, and minus sign (-); in addition, on 3277 typewriter keyboards, when the Shift, Latin Shift, or Lock Key is operated, the DUP character may be entered by the operator.

## **Appendix F. Encrypt/Decrypt Feature**

### **Encrypt/Decrypt Products**

The IBM Cryptographic Subsystem is a combination hardware and programming implementation of cryptography for data security. It consists of the following separate products:

- IBM Programmed Cryptographic Facility Program Product (OS/VS1 and OS/VS2 MVS only).
- ACF/VTAM (Level 3.0 or higher) Encrypt/Decrypt feature.
- 3274/3276 Encrypt/Decrypt feature.

The first two products reside at the host processor; the third resides in the control unit.

#### ***IBM Programmed Cryptographic Facility Program Product***

This product contains the following functions: encrypt/decrypt, key generation, and key management. The encrypt/decrypt function is an IBM programmed implementation of the Federal Data Encryption Standard (DES) algorithm as published by the National Bureau of Standards in January 1977 and adopted as the United States Federal Information Processing Standard (FIPS 46) in July 1977.

The other functions of the IBM Programmed Cryptographic Facility generate new keys upon request and in general manage all the keys used throughout the network. Under the IBM key management concept, since the enciphering algorithm is published, protection is derived from keeping the keys secret.

#### ***ACF/VTAM Encrypt/Decrypt Feature***

This feature provides cryptographic support in ACF/VTAM by:

- Allowing the specification of a physical cryptographic feature on a Logical Unit (LU) basis.
- Being an interface with the Programmed Cryptographic Facility Program Product for enciphering and deciphering messages and key management.
- Supporting cryptographic changes to SNA.

## 3274/3276 Encrypt/Decrypt Feature

This feature provides hardware implementation of the DES algorithm for encrypting and decrypting data on a TP line. For 3274 installation, it is applicable to the 3274 C Models operating in SNA/SDLC mode. When used with the ACF/VTAM Encrypt/Decrypt feature described above, data transmitted via the transmission subsystem can be safeguarded through cryptography from modification, disclosure, or both. Installed in the control unit with SDLC line control, this feature provides encrypt/decrypt services for up to 32 attached terminals. Included in the feature are:

- A single secondary LU key (terminal master key) storage element and logic to perform enciphering and deciphering operations for secondary LUs by block-chaining.
- A cryptographic diskette to be used when initially installing or changing the terminal master key in the 3274.
- A security keylock located in the customer access area of the control units.
- A mercury battery, IBM PN 1743456, to sustain the terminal master key when the control unit power is off.

When the Encrypt/Decrypt feature is used in conjunction with other IBM Cryptographic Subsystem products and is operating in an SNA/SDLC environment, data may be transmitted between the control unit and the host computer in a form that precludes accidental or intentional disclosure; neither can the data be modified without detection.

In SNA terminology, communication occurs between network nodes (application programs and terminals), each node being an LU. Data may be transmitted between the host computer (the primary LU) and a terminal attached to the control unit (the secondary LU) once the LUs have established an LU-LU session. When the cryptographic function is *not* used, the data is transmitted in the clear, that is, not enciphered. When the cryptographic function *is* used, the data is enciphered, thus permitting the end-users to communicate the data between the LUs in a secure manner.

It is important to note that only the data transmitted via the transmission subsystem between the host computer and the control unit may be protected by cryptography. Data passing between the control unit and its attached terminals (display stations and printers) is not enciphered.

Two types of cryptographic LU-LU sessions may be established: *required cryptographic* and *selective cryptographic* sessions. In the first type, all data transmitted between the host computer and the control unit is enciphered during the LU-LU session. In the second type, data is enciphered at the option of the application program; thus, enciphering of data can be selected or suppressed by the host LU, but not by the control unit LU.

## Establishing Cryptographic Sessions

Before a cryptographic session can be established, the ACF/VTAM Encrypt/Decrypt feature must recognize a request for a cryptographic session and determine the cryptographic capability of the host processor and the control unit. The ACF/VTAM Encrypt/Decrypt feature calls the IBM Programmed Cryptographic Facility Program Product to generate a *cryptographic session key* in two versions. The first version is enciphered under the *host master key* and is stored in the host processor. From this first version, the program product produces a second version enciphered under the *secondary LU key*. The secondary LU key is a *key encrypting key* associated with the secondary LU and is used to protect the cryptographic session key during transmission to the secondary LU. The cryptographic session key is used to encipher and decipher data that will be transmitted between the primary and secondary LUs once a cryptographic session has been established.

To establish a cryptographic session, the host processor transmits the enciphered cryptographic session key to the control unit as part of the Bind command. The control unit can decipher the session key, since the secondary LU key is known (having previously been installed in the control unit by a security officer).

### ***Bind Command Processing***

In addition to storing the encrypted session key, the control unit takes part in the following cryptographic protocol:

- A pseudo-random value (N) is encrypted under the just-received session key (KS), and this 8-byte quantity EKS(N) is sent to the host as part of the Bind response.
- A valid host will decrypt EKS(N), invert 4 bytes of N, re-encipher the value, and send this 8-byte quantity EKS(N) to the control unit as part of the crypto verification (CRV) command.

The control unit decrypts EKS(N), inverts N, and compares this value N with the original N. If the values are identical, a positive response is sent to the host, and the conditions of a cryptographic protocol have been met. This cryptographic protocol serves two purposes:

1. It verifies that both host and control unit are using the same data encrypting key (KS).
2. It validates the host's cryptographic capability, thus preventing an active wiretapper from using the control unit to decipher captured enciphered data.

The following chart illustrates how the cryptographic protocol fits in with the SNA commands which invoke and terminate a cryptographic session:

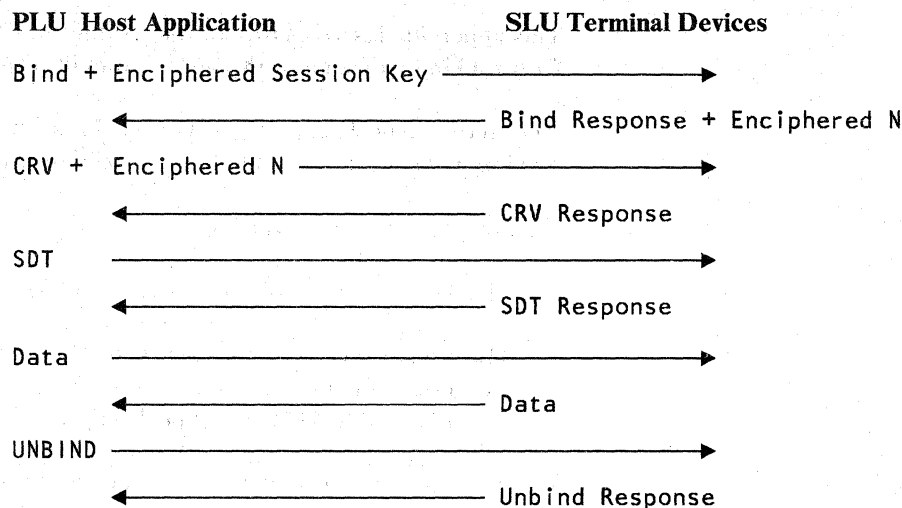

### ***Installing the Secondary LU Key in the 3274***

A copy of the secondary LU key (the *terminal master key*) must be installed in the 3274. The procedure to install this key should be performed by someone in a position of trust, such as a security officer. The key can only be entered from the keyboard of a 3178 or 3278 attached to port A0 of the 3274. To reduce the possibility of exposing the terminal master key prior to installing the key, the procedure requires that the customized system diskette be removed from the 3274 and replaced by the cryptographic diskette. A physical key is then inserted and rotated in a security keylock located inside the customer access area of the 3274. The terminal master key is entered, together with the control unit identification, from the 3178, 3278, or 3279 keyboard. At no time is the terminal master key displayed on the display station screen. Once the terminal master key has been installed in the 3274, the security key is removed from the security keylock, and the cryptographic diskette is replaced by the customized system diskette.

### ***Terminal Master Key Verification for the 3274***

Once the terminal master key has been installed in the 3274, the 3274 generates a verification pattern based on the terminal master key. Each terminal master key generates a unique verification pattern. To verify that the correct terminal master key is installed in the 3274, the cryptographic diskette is inserted in the 3274. By interrogating the 3274 from the 3178, 3278, or 3279 (attached to port A0 of the 3274), the display station operator can check that the terminal master key is correct. This verification procedure can be performed by any operator without compromising the security of the Encrypt/Decrypt feature.

**Note:** The characters entered for the terminal master key are hexadecimal characters. Each byte of the key-variable, consisting of two of these hexadecimal characters, must have odd parity. This means that the number of 1 bits in that byte of the key-variable must be odd.

## Appendix G. Request Formatted Maintenance Statistics (RECFMS) Formats

This appendix describes the formats of the four RECFMS responses the 3274 Control Unit can send to the host system in response to an REQMS command.

Counters in type 1, 2, and 3 responses do not wrap when they exceed their maximum value; they maintain the maximum value.

The log areas are reset when:

- The 3274 is turned off (types 1, 2, and 3).
- The concurrent test, section 4, Error Log Erase, is executed for the 3274 Common Communications Adapter/High-Performance Communications Adapter (CCA/HPCA) (type 3 only).
- The execution of RECFMS is completed normally as the response to an REQMS with a "RESET" request (types 1, 2, and 3).

### REQMS Request Type 1—Link Test Statistics

Bytes 14, 15 = Number of times the Test command was received.

Bytes 16, 17 = Number of times the Test response was transmitted.

### REQMS Request Type 2—Summary Counters

Byte 14 = Mask bits of the summary counters supported. All supported counters, including those containing zero count, are sent to the host by RECFMS.

Bit 0 = 1 = Machine Check.

Bit 1 = 1 = Communication Check.

Bit 2 = 1 = Program Check.

Bits 3–7 = Reserved.

Bytes 15, 16 = Reserved.

Bytes 17, 18 = Machine Check Summary Counter.

Bytes 19, 20 = Communication Check Summary Counter.

Bytes 21, 22 = Program Check Summary Counter.



## REQMS Request Type 3—Communication Adapter Data Error Counts

- Byte 14 = Adapter Type.
- X'01' = CCA Link Adapter.
  - X'02' = HPCA Link Adapter.
  - X'04' = Local Channel Adapter (LCA).
  - X'05'–X'FF' = Reserved.
- Byte 15 = Mask bits of the Communication Adapter Error Counters supported. All supported counters, including those containing zero count, are sent to the host by RECFMS.
- Bit 0 = 1 = Nonproductive Timeout.
  - Bit 1 = 1 = Idle Timeout. (Not valid for loop.)
  - Bit 2 = 1 = Write Retry.
  - Bit 3 = 1 = Overrun.
  - Bit 4 = 1 = Underrun.
  - Bit 5 = 1 = Connection Problem.
  - Bit 6 = 1 = FCS Error.
  - Bit 7 = 1 = Primary Abort.
- Byte 16 = Mask bits of the Communication Adapter Error Counters supported. All supported counters, including those containing zero count, are sent to the host by RECMS.
- Bit 0 = 1 = Command Reject.
  - Bit 1 = 1 = DCE Error.
  - Bit 2 = 1 = Write Timeout.
  - Bits 3–7 = Reserved.
- Byte 17 = Reserved.
- Byte 18 = Nonproductive Timeout Counter (CCA, HPCA); Command Reject, Not Initialized (LCA).
- Byte 19 = Idle Timeout Counter (Not valid for loop)(CCA, HPCA); Command Reject (LCA).
- Byte 20 = Write Retry Counter (CCA, HPCA); Not Initialized (LCA).
- Byte 21 = Overrun Counter (CCA, HPCA); Bus Outcheck, Parity Check 2 (LCA).
- Byte 22 = Underrun Counter (CCA, HPCA); Bus Outcheck, Parity Check 1 and 2 (LCA).
- Byte 23 = Connection Problem Counter (CCA, HPCA); Equipment Check, Parity Check 1 (LCA).
- Byte 24 = FCS Error Counter (CCA, HPCA); Equipment Check, Parity Check 1 and Parity Shift Modify (LCA).

- Byte 25 = Primary Abort Counter (CCA, HPCA); Equipment Check, Parity Check 2 (LCA).
- Byte 26 = Command Reject Counter (CCA, HPCA); Equipment Check, Control Unit Machine Check (LCA).
- Byte 27 = DCE Error Counter (CCA, HPCA); Data Check (LCA).
- Byte 28 = Write Timeout Counter (CCA, HPCA); Data Check, Length Check (LCA).
- Byte 29 = Connect Received and Already Connected (LCA).
- Byte 30 = Disconnect Received and PU Is Active (LCA).
- Byte 31 = Response Unit Length Error (LCA).
- Byte 32 = Connect Error; Connect Rejected (LCA).
- Byte 33 = Read Start Old Received (LCA).

**REQMS Request Type 5–3274 Configuration Information (Configuration Support A, B, T, and P)**

- Byte 14 = Always X'00'.
- Bytes 15–30 = Installed Patch ID Values.
- Byte 31 = Number of RPQs Installed on the 3274.
- Byte 32 = Reserved.
- Bytes 33–37 = RPQ 1 ID.
- Bytes 38–42 = RPQ 2 ID.
- Bytes 43–47 = RPQ 3 ID.
- Bytes 48–50 = Control Values for Suffix Numbers.
- Byte 61 = Feature Disk Level.
- Byte 62 = Feature Disk Suffix.
- Byte 63 = System Disk Level.
- Byte 64 = System Disk Suffix.
- Byte 65 = Language Disk Level.
- Byte 66 = Language Disk Suffix.
- Byte 67 = RPQ 1 Disk Level.
- Byte 68 = RPQ 1 Disk Suffix.

Byte 69 = RPQ 2 Disk Level.  
 Byte 70 = RPQ 2 Disk Suffix.  
 Byte 71 = RPQ 3 Disk Level.  
 Byte 72 = RPQ 3 Disk Suffix.

**REQMS Request Type 5-3274 Configuration Information (Configuration Support C and D)**

Byte	Value	Meaning
14	X'01'	Always X'01'
15		Disk ID Type
	C'S'	System Diskette
	C'K'	Kanji Diskette
	C'W'	Distributed Function Device Load Diskette
16		Feature Disk Level Identifier
17		System Disk Level Identifier
18		Language Disk Level Identifier
19		Host Attach Mode
	X'84'	CCA/HPCA Model 51C
	X'A4'	CCA/HPCA Model 61C/63C
	X'41'	LCA Model 31A
	X'44'	CCA/HPCA Model 31C
	X'21'	LCA Model 41A/43A
	X'24'	CCA/HPCA Model 41C
20		LCA Channel Address
21		LCA Channel Options
	X'01'	Cycle Share Nonchaining Jumper Installed
22		Line Control Code
	X'01'	EBCDIC
	X'02'	ASCII
23		Line Control Discipline
	X'02'	SDLC
24		Reserved for BSC
25		SDLC Polling Address
26		Miscellaneous Options
	X'01'	CCA Installed
	X'02'	HPCA Installed
	X'04'	Cryptography Installed
	X'10'	Reserved for BSC
27		HPCA/CCA Adapter Options
	X'80'	38LS Installed
	X'40'	EMI Switched
	X'20'	RLOOP (LSA) Attached
	X'10'	X.21 Switched Modem Installed
	X'08'	Integrated Modem Installed
	X'04'	X.21 Leased Modem Installed
	X'02'	DDSA Installed
	X'01'	Ext Modem Wrappable

Byte	Value	Meaning
28		Miscellaneous Telecommunication Options
	X'80'	WT Extended Switched Modem
	X'40'	NRZI or Internal Clock
	X'20'	Nonswitched Line
	X'10'	RTS from STX to EOT
	X'08'	SNBU
	X'04'	Half-Speed Transmission
	X'02'	Perm RTS (Multidrop Networks)
X'01'	Omit Answer Tone	
29		Volume 0 Storage Card 1
	X'08'	64K
	X'04'	32K
30		Volume 0 Storage Card 2 or Volume 1 Storage Card 1
	X'00'	Not Installed
	X'08'	64K
	X'04'	32K
	X'02'	16K
	X'01'	8K
31		Volume 0 Storage Card 3 or Volume 1 Storage Card 2
	X'00'	Not Installed
	X'04'	32K
	X'02'	16K
	X'01'	8K
32		Volume 1 Storage Card 1 or Volume 2 Storage Card
	X'00'	Not Installed
	X'08'	64K
	X'04'	32K
	X'02'	16K
	X'01'	8K
33		Volume 1 Storage Card 2 or Volume 3 Storage Card
	X'00'	Not Installed
	X'80'	192K Font
	X'40'	64K Font
	X'20'	256K Font
	X'10'	128K Font
	X'08'	64K
	X'04'	32K
	X'02'	16K
	X'01'	8K
34		Extended Storage Feature Installed
	X'80'	Models 31 or 51 Installed
	X'40'	Models 41 or 61 Installed
	X'02'	Model 1 Installed
	X'01'	Not Installed
35		Customizing Response Storage
	X'01'	Sequence 342 Response (4-Wire RTS Control)

Byte	Value	Meaning
36		Optional Code Selections
	X'80'	10/63 MSR
	X'40'	10/63 MSR Auto Enter
	X'08'	Entry Assist
	X'02'	BBS
	X'01'	3289 Text Print Control Present
37		Optional Code Selections
	X'10'	Magnetic Reader Control Not Present
	X'04'	Local Copy Not Present
	X'02'	Host Loadable PAM Not Present
	X'01'	SCS Printer Support Not Present
38		Type B (ANR) Adapter Driver/Receiver Cards
	X'00'	Not Installed
	X'04'	4 Cards = 16 Ports
	X'03'	3 Cards = 12 Ports
	X'02'	2 Cards = 8 Ports
	X'01'	1 Card = 4 Ports
39		Type A (DCA) Adapter Driver/Receiver Cards
	X'08'	4 Cards = 32 Ports
	X'06'	3 Cards = 24 Ports
	X'04'	2 Cards = 16 Ports
	X'02'	1 Card = 8 Ports
40		Number of Type B (ANR) Devices (Question 111)
41		Number of Type A (DCA) Devices (Question 112)
42		Total Number of Devices Configured
43		Modem Connection Options
	X'01'	High-Speed RLOOP Operation
44		Reserved for BSC
45		Language Code (Question 121)
46		Customizing Question 113 Response
47		DCA Device Control Block Count (Question 112)
48		Total Device Control Block Count (Questions 111 and 112)
49		PAM Entry Count
50		Keyboard Codes
	X'10'	Text (Question 135) (C Only)
	X'08'	APL (Question 134) (C Only)
	X'04'	Data Entry — Keypunch Layout (Question 133) (C Only)
	X'02'	Data Entry (Question 132) (C Only)
	X'01'	Typewriter (Question 131) (C Only)
51		Number of Extended Device Control Blocks
52		Extended Data Stream Display Codes
	X'02'	Programmed Symbols Supported
	X'01'	Color Convergence Supported
53		Extended Data Stream Controller Codes
	X'02'	Decompression Supported
	X'01'	3270 Extended Data Stream Supported
54		Reserved for Customizing
55-56	X'2-2-'	Disk Validation Number (-- = Number)
57-58		Module Load Size — Volume 0
59-60		Module Load Size — Volume 1
61-62		Reserved for Customizing

Byte	Value	Meaning
63-64		Reserved for Customizing
65-66		Reserved for Customizing
67-68		Reserved for Customizing
69-70		Volume 0 RAM Size (FFFE=64K)
71-72		Volume 1 RAM Size (FFFE=64K)
73-74	X'A55A'	Valid Disk Marker
75		Code/Data Volume Indicator
	X'80'	Requested Volume Swap
	X'01'	Data in Volume 0
	X'00'	Code in Volume 0
76		X.21 Switched Keys Support for All Terminals (Not Set Means Port 0 Only)
	X'80'	Direct Key
	X'40'	Dial Key
	X'20'	Local/Comm Key
	X'10'	Disconnect Key
	X'08'	Extension Key
	X'04'	Reserved
	X'02'	DCE Supports Direct Call
	X'01'	DCE Supports Address Call
77		Number of Retries when Number Can Be Redialed (X.21)
78		Time between Retries for X.21.S (Question 361)
	X'80'	12.8 Seconds
	X'40'	6.4 Seconds
	X'20'	3.2 Seconds
	X'10'	1.6 Seconds
	X'08'	0.8 Seconds
	X'04'	0.4 Seconds
	X'02'	0.2 Seconds
	X'01'	0.1 Seconds
79		Reserved for Engineering
80		38LS Responses (Customizing Question 343)
	X'80'	Feature 5500 (343=5)
	X'40'	Feature 5501 (343=6)
	X'20'	Feature 5502 (343=7)
	X'10'	Feature 5507 (343=8)
	X'08'	Feature 5508 (343=9)
81-96		Installed Patch ID Values
97		Number of RPQs Applied (Customizing Question 031)
98-102		RPQ 1
	X'---'	Last 3 Digits of RPQ Number
	X'-----'	Bill of Material Number of RPQ
103-107		RPQ 2
	X'---'	Last 3 Digits of RPQ Number
	X'-----'	Bill of Material Number of RPQ
108-112		RPQ 3
	X'---'	Last 3 Digits of RPQ Number
	X'-----'	Bill of Material Number of RPQ
113		Feature Disk Suffix
114		System Disk Suffix

Byte	Value	Meaning
115		Language Disk Suffix
116		Reserved
117-119		XID (Customizing Question 215)
	X'0-----'	XID Assigned by Customer
120		Distributed Function Terminal Support Indicators
	X'80'	Support Included (Customizing Question 170)
	X'40'	Reserved for Customizing
	X'20'	3274 Core Image Transferred to Load Disk
	X'10'	Multiple Interactive Screens (MIS) Supported
121		Copy RPQ Indicator
	C'C'	Disk Created from Disk Copy RPQ
122-125		Spare
126		Feature Disk Active Level
127		Feature Disk Active Suffix
128		System Disk Active Level
129		System Disk Active Suffix
130		Language Disk Active Level
131		Language Disk Active Level
		RPQ Compatibility Indicators
132		RPQ 1 Compatibility
	X'80'	Following Flags Valid
	X'40'	Compatible with Configuration Support D or Above
	X'08'	Compatible with Configuration Support T
	X'04'	Compatible with Configuration Support C
	X'02'	Compatible with Configuration Support B
	X'01'	Compatible with Configuration Support A
133		Release Level for Above RPQ
134		RPQ 2 Compatibility
	X'80'	Following Flags Valid
	X'40'	Compatible with Configuration Support D or Above
	X'08'	Compatible with Configuration Support T
	X'04'	Compatible with Configuration Support C
	X'02'	Compatible with Configuration Support B
	X'01'	Compatible with Configuration Support A
135		Release Level for Above RPQ
136		RPQ 3 Compatibility
	X'80'	Following Flags Valid
	X'40'	Compatible with Configuration Support D or Above
	X'08'	Compatible with Configuration Support T
	X'04'	Compatible with Configuration Support C
	X'02'	Compatible with Configuration Support B
	X'01'	Compatible with Configuration Support A
137		Release Level for Above RPQ
138		Reserved
139		Advanced Function Keyboards (Customizing Question 166)
	X'02'	Numeric Lock Installed on Advanced Function Keyboards
	X'01'	Advanced Function Keyboards Supported
140-141		Load Module Size for Volume 2

Byte	Value	Meaning
142–143		Load Module Size for Volume 3
144–145		Reserved for Customizing
146–147		Reserved for Customizing
148–149		Volume 2 RAM Size (FFFE=64K)
150–151		Volume 3 RAM Size
152–157		Spare
		EC Levels Follow (Distributed Function Terminals)
158		Load Disk EC Level
159		Load Disk Suffix Level
160–164		RPQ Number (10 Digits)
		Multiple Interactive Screens (MIS) Allocation
165		Starting Port Number of MIS Devices
166		Number of Ports with 2 Logical Terminals
167		Number of Ports with 3 Logical Terminals
168		Number of Ports with 4 Logical Terminals
169		Number of Ports with 5 Logical Terminals
170–171		Reserved for RPQ Code
172		Reserved
173		3290 Device Local Copy Emulation (Question 173)
	X'80'	CR at MMP+1 (0=Standard/1=Feature)
	X'40'	NL at MMP+1 (0=Standard/1=Feature)
	X'20'	FF within Print Buffer (0=Standard/1=Feature)
	X'10'	FF at End of Print Buffer (0=Standard/1=Feature)
	X'08'	Null Suppression (0=Standard/1=Feature)
	X'04'	FF Position (0=Standard/1=Feature)
	X'02'	Auto Position after Print (0=Standard/1=Feature)
	X'01'	Base Color A or B (0=Standard/1=Feature)
174		Reserved
175		Number of Entries in Host Address Table (MIS)
176		Number of Logical Terminals to Link
177		Keypad Selection (Question 139)
	X'00'	Default Keypad
	X'01'	US Calculator Keypad
	X'02'	WT Calculator Keypad 1
	X'03'	WT Calculator Keypad 2
	X'04'	US Data Entry Keypad
	X'05'	WT Data Entry Keypad 1
	X'06'	WT Data Entry Keypad 2
	X'07'	P.F. Keypad
178		Embedded RPQ Features (Customizing Question 125)
	X'80'	Clear Key (Formerly RPQ 8K0978)
	X'40'	Unsupported Control Codes (Formerly RPQ 8K0980)
	X'20'	Clicker Default to OFF
179		Model Extension Field (Question 151 Extension)
	X'80'	Kanji Response (Model 43A or 63C)
180–189		Reserved
190–205	X'F . . F'	RPQ Parameter List (Customizing Question 033)
206–255		Reserved





# Appendix H. Selector-Light-Pen and Magnetic-Stripe Reading Device Operations

## Selector-Light-Pen Operations

The selector light pen, shown in Figure H-1, is a light-sensitive pen that can detect the light emitted from characters displayed on the 3277, 3278, or 3279 displays. With the selector light pen, the operator can select from a list or table of displayed items and can then cause those selections to be passed to the application program.

The selector light pen is operated by pressing the tip of the pen against the screen on fields programmed for selector-light-pen operations.



Figure H-1. Selector Light Pen

## Selector-Light-Pen Field Format

A field that is to be used for selector-light-pen operations must be defined in the following format:

SPD (Selector Pen Detectable) Field Format	Data Character	Preceding field (on the same line as the SPD field).
	3 Space or Null Characters	Three space or null characters must precede the field-attribute character defining the SPD field unless the attribute character is the first character on the line.
	Field Attribute Character	The field-attribute character defines the field as displayed and selector-light-pen-detectable. (An SPD field may be protected or unprotected, alphameric or numeric.)
	Designator Character	The designator character which defines the type of operation that will be performed by detection on this field.
	Displayed Data	One or more displayed alphameric characters for sensing by the selector light pen.
	3 Space or Null Characters	Three space or null characters are required when a new field follows on the same line as the SPD field.
	Field Attribute Character	Succeeding field (on the same line as the SPD field).
	Data Character	

The field-attribute character, the designator character, and displayed alphameric characters must be on the same line. If the field extends beyond one line, only those characters on the same line as the attribute character can be detected by the selector light pen. A maximum of 6 detectable fields in the 3277-1, a maximum of 12 detectable fields in the 3277-2, or 3278-1, -2, -3, -4, or 3279, or a maximum of 15 detectable fields in the 3278-5 may precede the last detectable field on any given line.

## Designator Characters

Designator characters are used to define two types of selector light pen fields: selection fields and attention fields. Each type of field performs a different selector-light-pen operation.

The selection field is defined by a question mark (?) designator character. When the selector light pen detects on a selection field, the MDT bit in the field-attribute character for that field is set (1) in the display buffer. Also, the designator character is automatically changed on the screen to a greater than (>)

sign to provide a visible indication to the operator that the detection was successful. If a mistake was made and the operator again detects on that same field, the > changes to a ? and the MDT bit for that field is reset (0).

The attention field is defined by a space or null designator character. A detection on an attention field causes an I/O pending (attention) at the display. This I/O pending indicates to the program that the selector-light-pen operation has been completed. The program may then issue a Read Modified command to obtain the address of each field that was selected or modified by the operator.

A second type of attention field (for 3278 and 3279 displays) is defined by an ampersand (&) designator character. A selector-light-pen detection on a field containing an ampersand designator sets the MDT bit and causes an ENTER key I/O pending condition at the 3274. The display responds to a poll or Read Modified command, and both the address and the data in each field that was modified by the operator are returned to the application program.

#### **Programming Notes:**

1. The application programmer should be aware that both normal intensity and high-intensity unprotected fields can be modified by the display station operator to become selector-light-pen-detectable fields.
2. Use of the Selector Light Pen feature without the ampersand (&) designator character is anticipated to be such that the program will correlate the address of each SPD field with the data associated with it. Therefore, to minimize TP line loading, channel loading, and buffer size requirements, only the address of selector-light-pen-detected fields are required to be sent to the application program; the field data is not included.
3. Users who wish to combine selector-light-pen-detect input with keyboard input must use the keyboard or the ampersand designator character to generate the I/O pending. Use of the selector light pen on a space or null designator field or on an attention field to generate the I/O pending will result in transmission of only the addresses of the fields in which the MDT bit was set.

Figure H-2 shows a sample display with fields defined for selector-light-pen operation. In this sample, "FULL", "50MG", and "4 TIMES" are all preceded by > designator characters to indicate that they were selected by the operator. When the operator detects on the word "EXIT", which has no displayed designator character, an I/O pending occurs and the program obtains the addresses of the three selected fields.

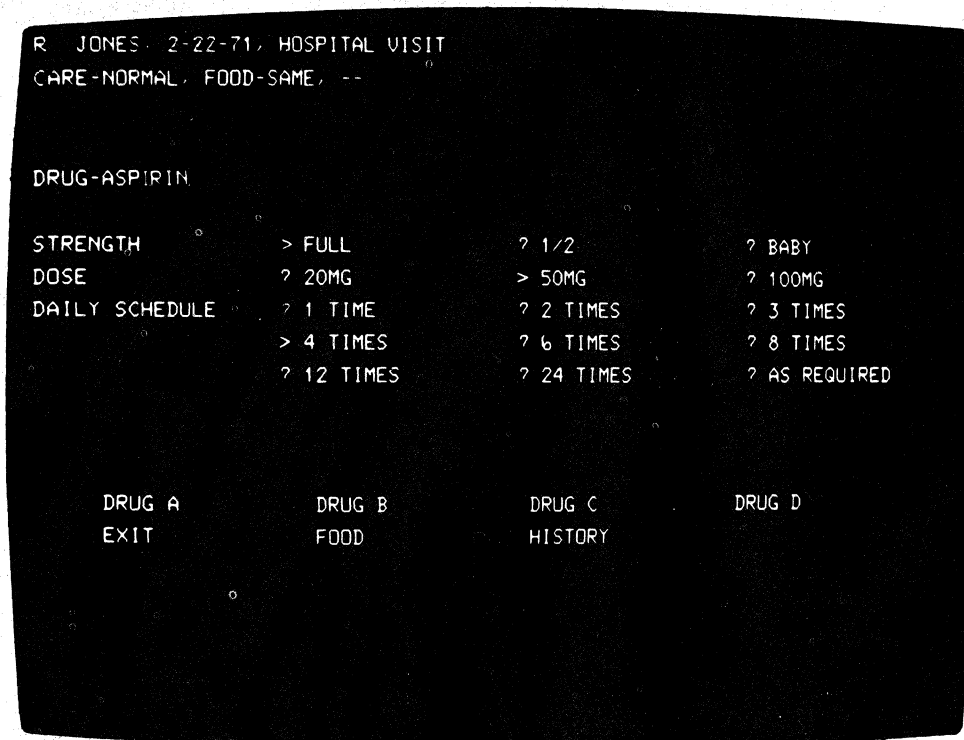
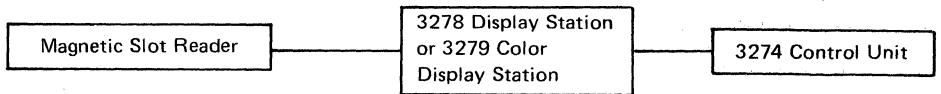

Figure H-2. Sample Display Screen for Selector-Light Pen Operations

## Magnetic-Stripe Reading Devices

Three magnetic-stripe reading devices are provided for the 3270 system (Figure H-3):

- **Magnetic slot reader (Figure H-4):** When attached to a 3278 or 3279 Display Station that is connected to a properly configured 3274 Control Unit, this device reads either the 3277-compatible numeric character set shown in Figure H-14 or the numeric and alphameric character sets shown in Figures H-7 and H-8, respectively.
- **Magnetic hand scanner (Figure H-5):** When attached to a 3278 or 3279 Display Station that is connected to a properly customized 3274 Control Unit, this hand-held device reads the numeric and alphameric character sets shown in Figures H-7 and H-8, respectively.
- **Operator identification card reader (Figure H-6):** When attached to a 3277 Display Station, this device reads the 3277-compatible numeric character set shown in Figure H-14.



Reads character set shown in Figure H-14 or numeric and alphameric character sets shown in Figures H-7 and H-8, respectively. The 3274 must be customized appropriately.

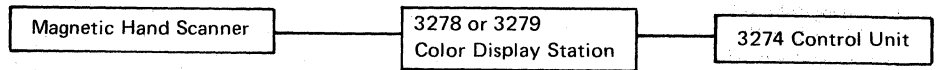

Reads numeric and alphameric character sets shown in Figures H-7 and H-8, respectively. The 3274 must be customized appropriately.

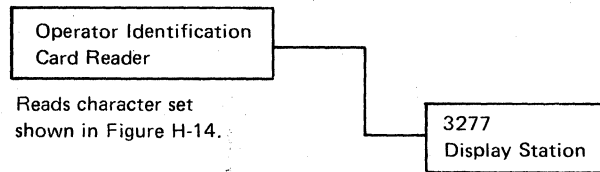

Reads character set shown in Figure H-14.

**Figure H-3. Attachment of Magnetic Reading Devices to 3270 System Units**

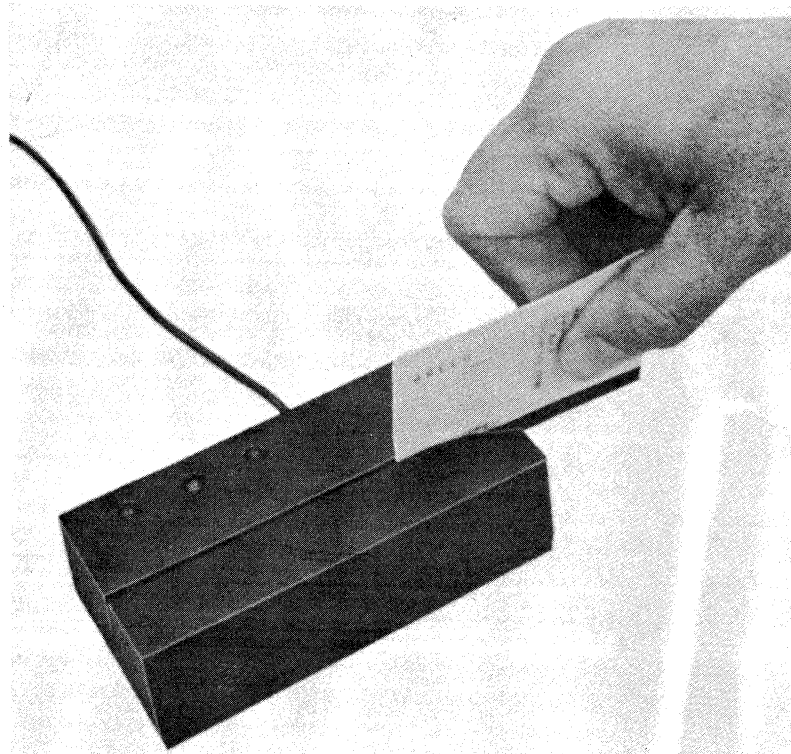

**Figure H-4. Magnetic Slot Reader (3278 and 3279 Attachments)**





Figure H-6. Operator Identification Card Reader (3277 Attachment)

### ***Magnetic Slot Reader and Magnetic Hand Scanner***

The magnetic slot reader (MSR) and the magnetic hand scanner (MHS), each attached by a cable to a 3278 or 3279 that is, in turn, connected to a properly customized 3274 (Figure H-3), read information encoded on magnetic-stripped documents. The MSR reads the magnetic stripe as the document, such as a card or badge, is passed through the reader's slot. The MHS, on the other hand, reads the magnetic stripe as the scanner is passed over the document, such as a label affixed to a shelf, carton, or other object. The MHS reads in both forward and reverse directions. Both devices can read the numeric and alphanumeric character sets described below.

Note that the numeric character set (described following), although similar, is *not* the same as the 3277-compatible numeric character set shown in Figure H-14 and described under "Operator Identification Card Reader and Magnetic Slot Reader." The MSR can read all three character sets, that is, the 3277-compatible numeric, numeric, and alphanumeric character sets shown in Figures H-14, H-7, and H-8, respectively. The MHS, however, can read only the numeric and alphanumeric character sets shown in Figures H-7 and H-8.

Which character set, or sets, is to be read by the MSR or MHS is specified in the 3274 customizing procedure. Either the 3277-compatible numeric character set (Figure H-14) or the numeric and alphanumeric character sets (Figures H-7 and H-8) are specified. Note that this specification affects attached 3278s or 3279s



only; it has no effect on the operation of 3277s that are also attached to the 3274. The 3277s continue to use the 3277-compatible numeric character set of Figure H-14.

Both devices may be used to log on and off in SNA mode (both LU-LU and SSCP-LU sessions) or in non-SNA mode.

### Numeric and Alphameric Character Sets

When the numeric and alphameric character sets (Figures H-7 and H-8) are specified, the header character of the magnetic-stripe record identifies which of the two character sets (numeric or alphameric) is recorded on the magnetic stripe. Note that when these character sets are used, protection, nondisplay, and nonprint of the recorded information are not automatic as when the 3277-compatible numeric character set (Figure H-14) is used. Protection, nondisplay, and nonprint are functions of the header character of the magnetic-stripe record. It continues to be the user's responsibility to provide data protection through proper encoding of the magnetic-stripe record and also to provide control over unauthorized access.

The numeric character set shown in Figure H-7 comprises 10 numeric characters plus space and control characters. Each character consists of a 4-bit code plus an odd parity bit.

The alphameric character set shown in Figure H-8 comprises 10 numeric, 26 alphabetic, and 27 graphic characters, plus space and control characters. Each of the nonnumeric characters is composed of 2 hex characters, with each hex character consisting of 4 bits plus a parity bit. Looking at this as a *paired* 4-bit code, the letter *M*, for example, is recorded as hex D-4, with the hex D being recorded first. In the alphameric character set, each numeric character is composed of a single hex character consisting of a 4-bit code, and, therefore, 2 numeric characters can be recorded in this paired 4-bit code structure.

Consequently, when this alphameric character set is being used, either there must be an even number of numeric characters in any contiguous string of numeric characters or, if an odd number of numeric characters are recorded, a filler character (hex A) must be added following the odd-numbered numeric character to preserve the paired 4-bit code structure.

Examples:

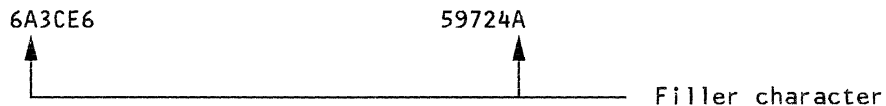

For both the numeric and the alphameric character sets, hex characters are recorded low-order bit first ( $2^0 2^1 2^2 2^3 P$ ). (See Figures H-7 and H-8.)

Character	Bit Pattern <span style="float: right;">Direction of Recording →</span>					Hex Code	I/O Interface Code Sent to Host			
	2 ⁰	2 ¹	2 ²	2 ³	P		EBCDIC	ASCII	SSCP	
Data	0	0	0	0	1	0	F0	30	F0	
	1	1	0	0	0	1	F1	31	F1	
	2	0	1	0	0	2	F2	32	F2	
	3	1	1	0	0	1	F3	33	F3	
	4	0	0	1	0	0	F4	34	F4	
	5	1	0	1	0	1	F5	35	F5	
	6	0	1	1	0	1	F6	36	F6	
	7	1	1	1	0	0	F7	37	F7	
	8	0	0	0	1	0	F8	38	F8	
	9	1	0	0	1	1	F9	39	F9	
Space character	1	0	1	1	0	D	40	20	40	
Control	Secure data (Note 1)	0	1	0	1	1	A	Not sent	Not sent	X'0450' SSR (Note 6)
	Start Sentinel (SS); Reverse Start Sentinel (Note 2)	1	1	0	1	0	B	Not sent	Not sent	Not sent
	Reserved (Note 3)	0	0	1	1	1	C	Not sent	Not sent	Not sent
	(See Note 4)	0	1	1	1	0	E	Not sent	Not sent	Not sent
	End Sentinel (ES) (Note 5)	1	1	1	1	1	F	Not sent	Not sent	X'1E' IRS (Note 6)

**Notes:**

1. Hex A, immediately after Start Sentinel (SS), indicates that the data section is secure (protected, nondisplay, and nonprint). Hex A is an error if it appears in the data section.
2. Hex B appearing anywhere but as SS or RSS is an error.
3. Hex C is an error if it appears in the data section.
4. Hex E identifies a 2-character sequence as a control code when located in the second character position of the data section. This control code is not supported by the 3274 and is an error.
5. Hex F is the End Sentinel character. If it is inadvertently included in the data section, it will terminate reading of the data section and the following character will be read as the LRC character.
6. SSR (Secure String Record) and IRS (Interrecord Separator) are sent to SSCP as a bracket for the MSR/MHS data.

The Questionable Card symbol is displayed in the Operator Information Area, and the red light on the magnetic slot reader or on the magnetic hand scanner is turned on for all above error conditions except an LRC error, which turns on the red light only.

**Figure H-7. Numeric Character Set Used with Magnetic Slot Reader and Magnetic Hand Scanner Attached to a 3278 or 3279 Connected to a 3274 Control Unit**

Character	Bit Pattern					Direction of Recording					Hex Code	I/O Interface Code Sent to Host		
	2 ⁰	2 ¹	2 ²	2 ³	P	2 ⁰	2 ¹	2 ²	2 ³	P		EBCDIC	ASCII	SSCP
0	0	0	0	0	1						0	F0	30	Same I/O Codes as EBCDIC
1	1	0	0	0	0						1	F1	31	
2	0	1	0	0	0						2	F2	32	
3	1	1	0	0	1						3	F3	33	
4	0	0	1	0	0						4	F4	34	
5	1	0	1	0	1						5	F5	35	
6	0	1	1	0	1						6	F6	36	
7	1	1	1	0	0						7	F7	37	
8	0	0	0	1	0						8	F8	38	
9	1	0	0	1	1						9	F9	39	
A	0	0	1	1	1	1	0	0	0	0	C1	C1	41	
B						0	1	0	0	0	C2	C2	42	
C						1	1	0	0	1	C3	C3	43	
D						0	0	1	0	0	C4	C4	44	
E						1	0	1	0	1	C5	C5	45	
F						0	1	1	0	1	C6	C6	46	
G						1	1	1	0	0	C7	C7	47	
H						0	0	0	1	0	C8	C8	48	
I	0	0	1	1	1	1	0	0	1	1	C9	C9	49	
J	1	0	1	1	0	1	0	0	0	0	D1	D1	4A	
K						0	1	0	0	0	D2	D2	4B	
L						1	1	0	0	1	D3	D3	4C	
M						0	0	1	0	0	D4	D4	4D	
N						1	0	1	0	1	D5	D5	4E	
O						0	1	1	0	1	D6	D6	4F	
P						1	1	1	0	0	D7	D7	50	
Q						0	0	0	1	0	D8	D8	51	
R	1	0	1	1	0	1	0	0	1	1	D9	D9	52	
S	0	1	1	1	0	0	1	0	0	0	E2	E2	53	
T						1	1	0	0	1	E3	E3	54	
U						0	0	1	0	0	E4	E4	55	
V						1	0	1	0	1	E5	E5	56	
W						0	1	1	0	1	E6	E6	57	
X						1	1	1	0	0	E7	E7	58	
Y						0	0	0	1	0	E8	E8	59	
Z	0	1	1	1	0	1	0	0	1	1	E9	E9	5A	
{ (EBCDIC);(ASCII)	0	0	0	0	1	0	0	1	1	1	0C	4A*	5B	
! (EBCDIC);(ASCII)	1	0	0	0	0						1C	5A*	5D	
:	1	1	0	0	1						3C	7A	3A	
<	0	0	1	0	0						4C	4C	3C	
*	1	0	1	0	1						5C	5C	2A	
%	0	1	1	0	1						6C	6C	25	
@	1	1	1	0	0	0	0	1	1	1	7C	7C*	40	
.	0	0	0	0	1	1	0	1	1	0	0D	4B	2E	
\$	1	0	0	0	0						1D	5B*	24	
,	0	1	0	0	0						2D	6B	2C	
#	1	1	0	0	1						3D	7B*	23	
(	0	0	1	0	0						4D	4D	28	
)	1	0	1	0	1						5D	5D	29	
_	0	1	1	0	1						6D	6D	5F	
'	1	1	1	0	0	1	0	1	1	0	7D	7D	27	
(EBCDIC)														
(ASCII)	0	0	0	0	1	0	1	1	1	0	0E	4F*	21	
~ (EBCDIC)														
~ (ASCII)	1	0	0	0	0						1E	5F*	5E	
>	0	1	0	0	0						2E	6F	3F	
?	1	1	0	0	1						3E	7F*	22	
:	0	0	1	0	0						4E	4E	2B	
+	1	0	1	0	1						5E	5E	3B	
;	0	1	1	0	1						6E	6E	3E	
>	1	1	1	0	0	0	1	1	1	0	7E	7E	3D	
=	0	1	1	1	0	0	0	0	0	1	E0	E0*	5C	
/	0	1	1	1	0	1	0	0	0	0	E1	61	2F	
&	1	0	1	1	0	0	1	0	1	1	DA	50	26	
.	0	1	1	1	0	0	1	0	1	1	EA	60	2D	
SP	0	0	1	1	1	0	1	0	1	1	CA	40	20	

Figure H-8 (Part 1 of 2). Alphameric Character Set Used with Magnetic Slot Reader and Magnetic Hand Scanner Attached to a 3278 or 3279 Display Station That Is Connected to a 3274 Control Unit

Character	Bit Pattern					Direction of Recording →					Hex Code	I/O Interface Code Sent to Host			
	2 ⁰	2 ¹	2 ²	2 ³	P	2 ⁰	2 ¹	2 ²	2 ³	P		EBCDIC	ASCII	SSCP	
Control	Secure Data; Filler (Note 1)	0	1	0	1	1						A	Not sent	Not sent	X'0450' SSR (Note 6)
	Start Sentinel (SS); Reverse Start Sentinel (RSS) (Note 2)	1	1	0	1	0						B	Not sent	Not sent	Not sent
	(See Note 3)	0	0	1	1	1						C	Not sent	Not sent	Not sent
	Test record (Note 4)	0	1	1	1	0	0	1	1	1	0	EE	Not sent	Not sent	Not sent
	End Sentinel (Note 5)											F	Not sent	Not sent	X'1E' IRS (Note 6)

**Notes:**

1. Hex A, when located in the first hex character position of the header (that is, immediately following the Start Sentinel (SS) character), indicates that the data section is secure (protected, nondisplay, nonprint). When located in the second hex character position of the header (following hex C), it is recognized as a filler character. It is also recognized as a filler character in the data section when it is the last hex character following a single numeric character or an odd number of consecutive numeric characters.
2. Hex B appearing anywhere but as SS or RSS is an error.
3. Hex C indicates the alphameric character set when located in the first or second hex character position of the header, that is, immediately following the SS character.
4. The hex EE sequence denotes a Test record. The Test card is encoded with hex CAEE in the header and first two hex positions of the data section indicating the alphameric character set, nonsecure data. The 3274 will treat the Test card as a data card. The hex EE will be discarded and the data record displayed. No Auto Enter is performed; however, the data may be sent to the host by pressing the ENTER key, a PF key, or Cursor Select key, by a selector light pen, or by another MSR/MHS Auto Enter operation.
5. Hex F is the End Sentinel character. If it is inadvertently included in the data section, it will terminate reading of the data section and the following character will be read as the LRC character.
6. SSR (Secure String Record) and IRS (Interrecord Separator) are sent to SSCP as a bracket for MSR/MHS data.

The Questionable Card symbol is displayed in the Operator Information Area, and the red light on the MSR or on the MHS hand scanner is turned on for all above error conditions except an LRC error, which turns on the red light only.

*The characters shown for EBCDIC codes 4A, 5A, 7C, 5B, 7B, 4F, 5F, 7F, and E0 are U.S. EBCDIC. For National Use differences, see IBM 3270 Information Display System: Character Set Reference, GA27-2837.

**Figure H-8 (Part 2 of 2). Alphameric Character Set Used with Magnetic Slot Reader and Magnetic Hand Scanner Attached to a 3278 or 3279 Connected to a 3274 Control Unit**

## Capacities

When the numeric or alphanumeric character sets are being used, the magnetic-stripe capacities are as shown in Figure H-9.

MSR/MHS	Minimum Number of Hex codes between Start Sentinel and End Sentinel Characters	Maximum Number of characters between Start Sentinel and End Sentinel Characters	Bit Density in Bits per Millimeter and (Bits per Inch)
Numeric Character Set	7	37	3 (75)
	7	118	5 (127)
Alphanumeric Character Set ¹	7	37 numerics	3 (75)
	7	18 nonnumerics	3 (75)
	7	118 numerics	5 (128)
	7	59 nonnumerics	5 (128)
	7	37 numerics	8.3 ² (210 ² )
	7	18 nonnumerics	8.3 ² (210 ² )

**Note:** Encoding across the full-width of the magnetic stripe is recommended for the MSR and is required for the MHS.

¹ 1 hex code = 1 numeric character

² 2 hex codes = 1 nonnumeric character or 2 numeric characters

Maximums shown are for *all*-numeric or *all*-nonnumeric characters. If a combination of numeric and nonnumeric characters is recorded, the total number of hex codes must not exceed the numeric character maximum. For example: At 75 bpi, a combination of 20 numeric and 10 nonnumeric characters is permissible.

² MSR only

Figure H-9. Magnetic-Stripe Capacities When Using the Numeric and Alphanumeric Character Sets

## Magnetic-Stripe Format

The format shown in Figure H-10 is used to record the numeric and alphanumeric character sets.

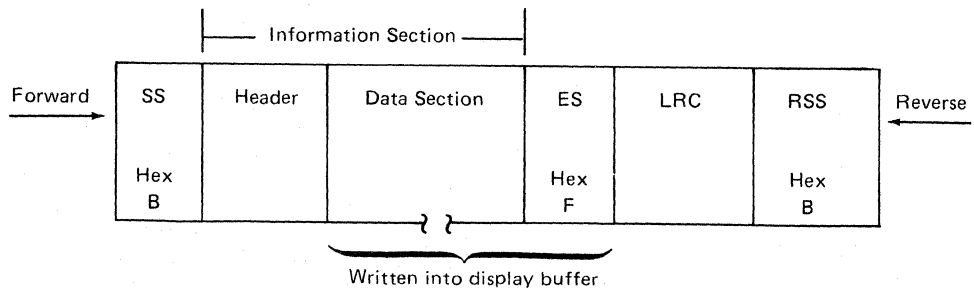

SS = Start Sentinel

ES = End Sentinel

LRC = Longitudinal Redundancy Check

RSS = Reverse Start Sentinel

Figure H-10. Magnetic-Stripe Format (MSR and MHS Using Numeric and Alphanumeric Character Sets)

When reading in the forward direction, Start Sentinel (SS; hex B) identifies the beginning of the information section and End Sentinel (ES; hex F) identifies the end of the information section. The LRC character is located after the End Sentinel and is calculated beginning with the Start Sentinel and ending with the End Sentinel characters. The Reverse Start Sentinel (RSS; hex B) character is not included in this calculation. When the magnetic stripe is read in the reverse direction, as can be done with the MHS, the Reverse Start Sentinel is read before the LRC, but is not included in the LRC calculation.

The information section consists of the header and the data section. The header (1) specifies whether the data section is protected or nonprotected and (2) identifies the specific character set (numeric character set or alphameric character set) used in the data section. When the data section is protected, it will not be displayed or printed. Regardless of the character set used, a secure data section is specified when hex A immediately follows the Start Sentinel character, as BA, in the Header. Conversely, if the hex character immediately following the Start Sentinel character is not hex A, the data section is unprotected and may be displayed or printed.

The header identifies the character set as follows:

- For nonsecure data, if a numeric character (0—9) or the space character (hex D) immediately follows the Start Sentinel character (hex B), the numeric character set is specified.

Examples: B327454 ..... BD327454 .....

First character  
of data section

If hex C immediately follows the Start Sentinel character (hex C is in the first hex character position of the header), the alphameric character set is specified. (In this case, hex A, in the second hex character position of the header, is the filler character.)

Example: BCA32D6E5 .....

- For secure data, if the character immediately following hex A (denoting secure data) is a numeric character or the space character (hex D), the numeric character set is specified.

Examples: BA327454 ..... BAD327454 .....

First character  
of data section

If the character immediately following hex A is hex C (hex C is in the second hex character position of the header), the alphameric character set is specified.

Example: BAC32D6E5 .....

## Operational Differences because of Screen Format in SNA Mode (LU-LU Session) or Non-SNA Mode

Differences occur in the handling of MSR/MHS data because of screen formatting, whether the data is secure or nonsecure. The descriptions that follow are concerned with non-SNA mode and LU-LU sessions in SNA mode. (For a description of operation in SSCP-LU sessions, see "SSCP-LU Session.")

**Secure Data.** Whether operating in non-SNA mode or SNA mode, the processing of secure MSR/MHS data always formats the screen by generating a field-attribute character at the current cursor position. When the screen is unformatted (that is, is without attribute characters or fields), an MSR/MHS read operation results in an inbound data stream as shown in Figure H-11.

A formatted screen has at least one field-attribute character defined at initial presentation. This may be the only attribute character, as in the instruction sequence ENTER ID; or many attributes may be required, as, for example, in the instruction sequence NAME, TITLE, ID DEVICE.

Two fields (new data field and previous data field), with the MDT bits set, are sent to the application program, because the 3278 and 3279 treat all information from the MSR/MHS as data until after the information is written into the buffer. Also, the MDT bit is set in the MSR/MHS attribute byte that was initiated when the data was entered. The following examples indicate the processing of secure MSR/MHS data with a formatted screen.

**Example 1:** When the MSR/MHS field is set up by the application program as an unprotected field containing instruction information (ENTER ID, in the example), the inbound data stream is as shown in Figure H-12.

**Example 2:** When the screen is formatted and the MSR/MHS field is set up by the application program as an unprotected field, with the cursor directly following an unprotected field-attribute character, the data stream is as shown in Figure H-13.

**Nonsecure Data.** When nonsecure data is read by the MSR or MHS, no field-attribute character is generated. When the screen is unformatted, the data is displayed. When the screen is formatted and the cursor is located in an unprotected display field, the MSR/MHS data is also displayed. The MSR/MHS data may be sent upstream by means of the ENTER key, a PF key, a CURSR SEL key, the selector light pen, a secure MSR/MHS read operation, or when the 3274 is configured for the Auto-Enter option.

**Note:** The Auto-Enter option is intended for situations when the MSR/MHS operator cannot be at the display keyboard. Successful writing of the MSR/MHS data into the display buffer automatically initiates an inbound data stream with the ENTER key AID code (hex 7D).

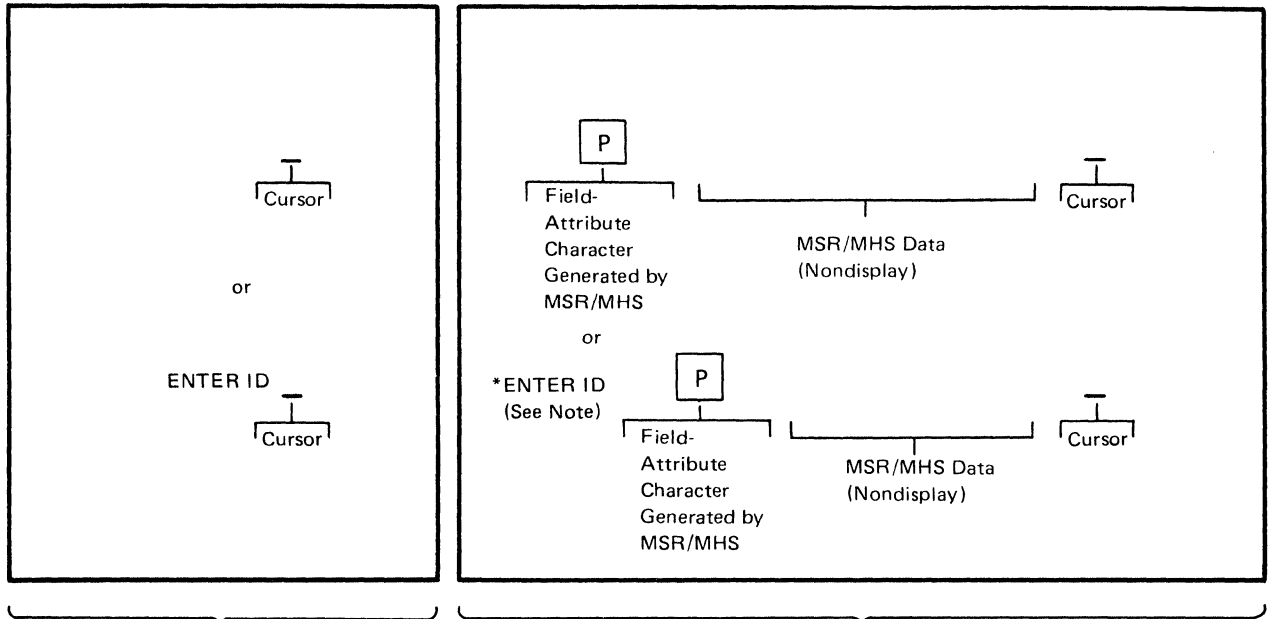

Display screen before MSR/MHS data is entered.

Display screen after MSR/MHS data is entered.

**Note:** The ENTER ID is not displayed because it is within a nondisplay field, defined by the MSR/MHS-generated field-attribute character.

Inbound Data Stream

AID
Cursor Address
SBA
Start of Data Address
Data

Set to indicate MSR/MHS input.

Address of the cursor upon completion of the MSR/MHS read operation.

Set Buffer Address.

Address of the first data character following the field-attribute character.

The MSR/MHS data followed by any additional information present in the display buffer. The additional information can be initiated by the application program as ENTER ID (as shown in the example) or entered by the operator before the MSR/MHS read operation is started.

Note that with an unformatted screen the MSR/MHS data is the first data sent to the application program in the data stream.

**U** = Unprotected field-attribute character

**P** = Protected field-attribute character

Figure H-11. Operation of the Display with an Unformatted Screen (MSR or MHS Using Numeric or Alphameric Character Set)



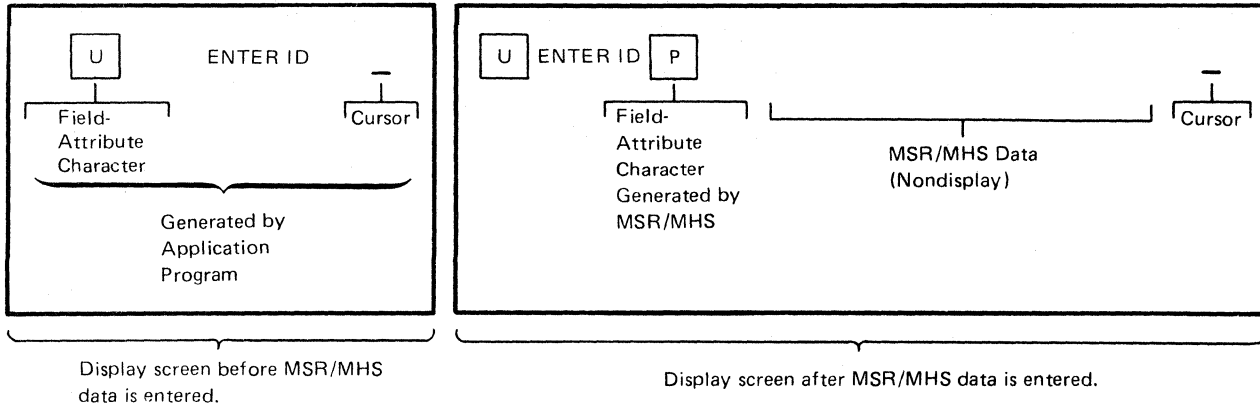

Inbound Data Stream

AID
Cursor Address
SBA
Start of Data Address
Data
SBA
Start of Data Address
Data

Set to indicate MSR/MHS input.

Address of the cursor upon completion of the MSR/MHS read operation.

Set Buffer Address.

Address of the unprotected (U) field-attribute character + 1.  
ENTER ID, in the example above.

Set Buffer Address.

Address of the protected field-attribute character + 1. In this case, the address of the first data character from the MSR/MHS following the MSR/MHS-generated field-attribute character.

The MSR/MHS data (and any data between the cursor and the next field-attribute character).

**U** = Unprotected field-attribute character

**P** = Protected field-attribute character

Figure H-12. Operation of the Display with a Formatted Screen (MSR or MHS Using Numeric or Alphameric Character Set), Example 1

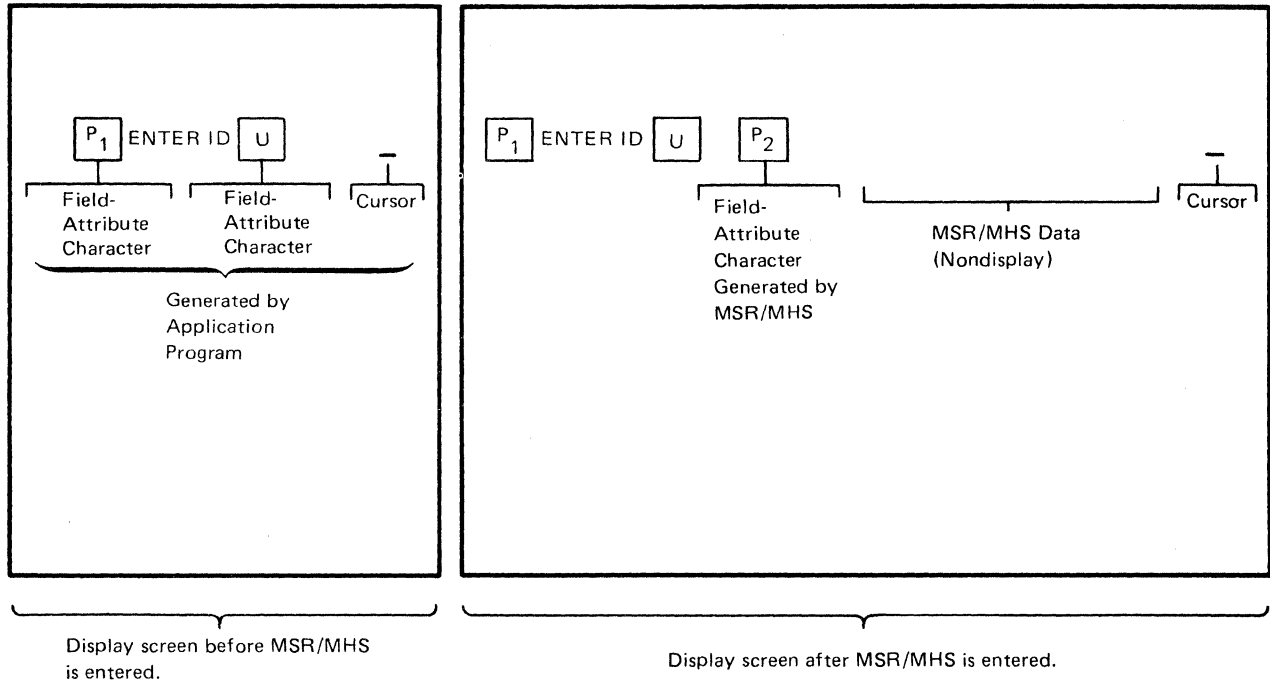

**U** = Unprotected field-attribute character  
**P** = Protected field-attribute character

**Note:** Rules for positioning modified data on formatted screens apply. The position of MSR/MHS data in the inbound data stream depends on the field position in the format.

Inbound Data Stream

AID	Set to indicate MSR/MHS input.
Cursor Address	Address of cursor upon completion of MSR/MHS read operation.
SBA	Set Buffer Address.
Start of Data Address	Address of the unprotected (U) field-attribute character + 1. In the example above, it will be the address of the P ₂ field-attribute character.
SBA	Set Buffer Address.
Start of Data Address	Address of the P ₂ field-attribute character + 1. In this case, the address of the first data character from the MSR/MHS following the MSR/MHS-generated field-attribute character.
Data	The MSR/MHS data (and any data between the cursor and the next field-attribute character).

Figure H-13. Operation of the Display with a Formatted Screen (MSR or MHS Using Numeric or Alphameric Character Set), Example 2

**Error Conditions.** Data is not written into the display buffer if any of the following error conditions exist when the magnetic stripe is read by the MSR or the MHS:

- The cursor is located in a protected field.
- The cursor is located in an attribute character location.
- The display is busy performing another operation.
- The field is too small to contain the MSR/MHS data.

### MSR/MHS Validity Tests

The proper use of the MSR/MHS as a secure data-entry device requires that the application program perform certain validity tests. The following guidelines are recommended for proper operation:

1. No field should be accepted as secure data input unless the AID byte (EBCDIC E7; ASCII 58) is set.
2. For application-formatted displays, the application program must know, on the basis of the hardware operation previously performed, the location of the field defined to receive the secure data and the exact location of the entered data. The use of the cursor address present in the data stream, in combination with the AID byte to ensure secure input, is an additional technique that can be used to ensure the integrity of the data. For unformatted displays, the secure data is always presented as the first data entry in the input record to the application program.
3. For application-formatted displays, it is advisable to terminate the secure data field with another attribute byte.
4. No ES (End Sentinel) or LRC character is included in the inbound data stream. Receipt of the AID byte (EBCDIC E7; ASCII 58) ensures valid MSR/MHS secure data.
5. The header information is not included in the inbound data stream. The application program should be prepared to accept the alphameric and special characters shown in Figures H-7 and H-8.
6. If the MSR/MHS field is to be reused, the application program must remove the hardware-generated attribute character and MSR/MHS input data. The location of this attribute character can be derived from the inbound data stream by using one less than the start-of-data address preceding the MSR/MHS data. Additionally, the cursor is located one position beyond the end of the MSR/MHS data field.
7. Data from all fields having the MDT bit set are included in the inbound data stream when the MSR/MHS data is retrieved in response to the MSR/MHS-generated I/O pending.
8. The cursor must be moved out of the MSR/MHS-generated field before further keyboard activity is permitted.

9. If the application program desired to call attention to a particular MSR/MHS secure input, it is recommended that a message be written to the screen and that the WCC include the Sound Alarm bit.
10. A test card, PN 1742659, is delivered with each 3278 Magnetic Reader Control feature. The test card data placed in the display buffer is as follows:

0123456789987654321001234567

Care should be taken that the card is not accidentally auto-entered. The display should be placed in test mode to avoid auto-entering magnetic-stripe information to the host.

### SSCP-LU Session

The display screen is unformatted in an SSCP-LU session. When the display keyboard is unlocked, the current cursor position, that is, the "initial cursor position," identifies the beginning of the operator input area. When using a 3278 or 3279 attached to a 3274, in order for data to be sent to the SSCP, the operator must restrict data entry (both keyboard and magnetic data) to this position and to the following 255 screen positions, or to the last character position of the screen, whichever occurs first. Care should be taken in using the cursor move keys (including Tab, Backtab, and New Line) or the operator may inadvertently enter data outside the operator input area. Pressing the CLEAR key repositions the cursor to the first screen location and defines this location as the new initial cursor position. Because the screen is also cleared, other data may be lost.

When the 3274 is customized for the numeric and alphameric character sets, the MSR/MHS devices may be used for secure logon in the SSCP-LU session. MSR/MHS input is restricted to the operator input area. If MSR/MHS input is attempted outside this area, the data is rejected.

When the MSR/MHS data is secure, a protected nondisplay field-attribute character is generated followed by the MSR/MHS secure data. An unprotected display field-attribute character is then generated following the data. This permits additional keyboard or MSR/MHS data to be written into the display buffer. No Auto-Enter operation is performed. When the ENTER key is pressed, the information is sent to the SSCP. MSR/MHS secure data is bracketed by the SSR and IRS control codes. No SBAs are generated, and no field-attribute characters are sent to the SSCP. Upon transmission to the SSCP, MSR/MHS secure data and associated attribute characters are removed from the operator input area of the screen.

**Differences in Operation of ERASE INPUT and ERASE EOF Keys.** Because MSR/MHS secure data may be present on the screen, the ERASE INPUT and ERASE EOF (End of Field) keys perform differently. The ERASE INPUT key erases the entire display buffer contents, including the field-attribute characters generated in conjunction with the MSR/MHS read operation. The cursor is repositioned to the first screen location, but the operator input area remains unchanged.

The ERASE EOF key erases all information from the current cursor position to the end of the screen, including the MSR/MHS data and associated attribute characters. If the cursor is located within an MSR/MHS secure data field, the entire field is erased, including the associated attribute characters.

**Error Conditions.** Data is not written into the display buffer if any of the following error conditions exist when the magnetic stripe is read by the MSR or the MHS:

- The display is busy performing another operation.
- An MSR/MHS read operation is attempted outside the operator input area.
- An attempt is made to overlay other MSR/MHS secure data.
- The keyboard is already locked.

**Notes:**

1. In an SSCP-LU session, the inbound RU is limited to 256 bytes of data. Therefore, when an APL/Text-unique keyboard is being used, care must be taken when keying in APL/Text-unique characters not to exceed the 256-byte limit. Each APL/Text-unique character displayed on the screen generates a 2-byte Graphic Escape sequence to be sent to the SSCP and thus may truncate the information sent to the SSCP.
2. If a Graphic Escape character with its associated data byte exceeds the 256-byte limit of the inbound RU, neither the Graphic Escape character nor its associated data byte will be included in the inbound RU.
3. Because of the APL/Text Graphic Escape character sequence, the IRS control code may be omitted from the inbound RU. This is an error, and the SSCP should send an error message to the operator.
4. MSR/MHS secure data is sent to the SSCP bracketed by the SSR and IRS control codes. No ES (End Sentinel) or LRC characters are included in this data stream, and receipt of IRS ensures data validity.

**MSR/MHS Operator Indicators and Alarm**

The MSR and the MHS each contain three operator indicators and a buzzer. The indicators are color-coded green, yellow, and red. When all indicators are off, power has not been applied to the MSR/MHS.

**Green Indicator On:** Indicates that the MSR/MHS is ready to read a magnetic stripe. This indicator is turned on when:

1. The 3278 or 3279 is turned on.
2. The 3278 or 3279 Test/Normal switch is operated.
3. The 3274 IML pushbutton is pressed.
4. The MSR/MHS data has been successfully transferred to the host if this is an Auto-Enter operation; the data has been successfully written into the 3278 or 3279 buffer if this is not an Auto-Enter operation.

**Yellow Indicator On:** This indicator is turned on when the magnetic stripe has been read successfully by the MSR/MHS. Subsequent read operations are ignored while the yellow indicator is on. The yellow indicator is turned off when either the red or the green indicator is turned on.

Red Indicator On: Indicates that the MSR/MHS data is rejected. The red indicator is turned on when:

1. Invalid magnetic-stripe information (for example, invalid character, LRC error, parity error) is detected by the MSR/MHS hardware.
2. The keyboard is already locked. The operator should check the symbols in the display's Operator Information Area and take the appropriate action.
3. An unsuccessful read operation is detected. The keyboard is locked.

The red indicator is turned off when the yellow indicator is turned on.

The buzzer on the MSR/MHS gives a short tone (one-quarter second) when the green indicator turns on and a longer tone (one second) when the red indicator turns on.

### Test Cards

A test card, PN 1742659, is delivered with each 3278 or 3279 Magnetic Reader Control feature. The test card data written into the display buffer is as follows:

0123456789987654321001234567

Care should be taken that the character string is not accidentally sent to the application program.

The test card supplied with the IBM 3630 Plant Communication System may also be used, provided that the 3274 has been customized to use the numeric and alphameric character sets. This test card is encoded with CAEE in the header and first two hex positions of the data section, indicating an alphameric character set and nonsecure data. The 3274 will accept this test card as a data card, strip off the EE, and display the data following the EE. Auto Enter is not performed; that is, the data is not automatically sent to the host.

If the magnetic stripe of either of the above test cards is read successfully, the MSR/MHS green light is turned on. If the 3278 or 3279 is in test mode, the Do Not Enter and Minus Function symbols are displayed in the Operator Information Area. If the magnetic stripe is not read successfully, the red light is turned on and the Do Not Enter symbol may be displayed in the Operator Information Area.

**Note:** The operator identification card reader test card is rejected. The Do Not Enter and Questionable Card symbols are displayed, and the red light is turned on.

### ***Operator Identification Card Reader and Magnetic Slot Reader***

The operator identification card reader (OICR), which is attached by a cable to a 3277 (Figure H-6), reads data, such as a unique operator ID number, encoded on a magnetic-striped card. As the card is inserted into the reader, the ID number is read from the magnetic stripe and written into the display buffer, in nondisplay mode and at the location specified by the cursor. The ID number, therefore, is not displayed on the screen. An I/O pending is generated at the display to inform the program that the ID number can be retrieved and transferred to main storage.

With the 3277-compatible numeric character set, plus control characters (described below and shown in Figure H-14), the maximum number of characters that can be read is 40 characters at 3 bits per millimeter (75 bits per inch). This number includes the SOR, LRC, and either EOR or EOI characters.

Character	Bit Pattern					Hex Code	I/O Interface Code (Note 5)	
	2 ⁰	2 ¹	2 ²	2 ³	P		EBCDIC	ASCII
Data	0	0	0	0	1	0	F0	30
	1	1	0	0	0	1	F1	31
	2	0	1	0	0	2	F2	32
	3	1	1	0	0	3	F3	33
	4	0	0	1	0	4	F4	34
	5	1	0	1	0	5	F5	35
	6	0	1	1	0	6	F6	36
	7	1	1	1	0	7	F7	37
	8	0	0	0	1	8	F8	38
	9	1	0	0	1	9	F9	39
Control	(Special - See Note 1)	0	1	0	1	A	7A	3A
	SOR, SS, or RSS (Note 2)	1	1	0	1	B	7B	23
	EOI (Note 3)	0	0	1	1	C	7C	40
	Field Separator	1	0	1	1	D	7D	27
	(Unassigned)	0	1	1	1	E	7E	3D
	EOR or ES (Note 4)	1	1	1	1	F	7F	22

**Notes:**

1. This character is reserved for operator identification only and must be located in the first data character position.
2. OICR: SOR (Start of Record)  
MSR: SS (Start Sentinel); RSS (Reverse Start Sentinel).
3. EOI (End of Inquiry) may also be used as a termination character on the Operator Identification Card Reader (3277 display). This code is treated as an error by the MSR (3278 and 3279 displays). The card is rejected, and the MSR red light is turned on.
4. OICR: EOR (End of Record)  
MSR: ES (End Sentinel).
5. Programmers use only the four least-significant bits of the I/O interface code.

**Figure H-14. 3277-Compatible Numeric-Character Set Used with Operator Identification Card Reader and Magnetic Slot Reader**

The magnetic slot reader (MSR), which is attached by cable to a 3278 or 3279 connected to a appropriately configured 3274, reads information encoded on magnetic-striped cards such as job tickets, operator ID badges, and both large and small credit cards. The recorded information is read from the stripe as the operator passes the card through the slot of the reader. The data is written into the display buffer at the location specified by the cursor, but is not displayed on the screen. If the device supports the Structured Field and Attribute Processing option, the extended attribute buffer is updated. After the information is read, an I/O pending is generated at the display to inform the program that the data can be retrieved and transferred to main storage.

With the 3277-compatible numeric character set (Figure H-14), the maximum number of characters that can be read is:

- 40 characters at 3 bits per millimeter (75 bits per inch) and at 8.3 bits per millimeter (210 bits per inch)
- 100 characters at 5 bits per millimeter (128 bits per inch)

**Note:** A minimum of seven characters must be encoded between the Start Sentinel and End Sentinel characters.

The 3277-compatible numeric character set may be used to log on and log off in SNA mode (LU-LU session only; *not SSCP-LU session*) or in a non-SNA mode.

### 3277-Compatible Numeric Character Set

The 3277-compatible numeric character set (Figure H-14) comprises 10 numeric characters plus a Field Separator and control characters. Each character consists of a 4-bit pattern plus an odd-parity bit. This bit pattern is recorded with the low-order bit recorded first. A longitudinal redundancy check (LRC) character is placed at the end and is protected by an odd-parity bit of its own.

Characters are recorded, low-order bit first, beginning at the left side of the magnetic stripe when the stripe is at the bottom of the card or badge as you face the magnetic material. The characters are read in one direction only.

### Magnetic-Stripe Format (OICR/MSR)

The format used on the magnetic stripe is in the sequence shown in Figure H-15. When the SOR character is read from the magnetic stripe, a field-attribute character is entered automatically into the cursor-identified location of the buffer (provided the cursor is at an unprotected character location). This attribute character defines the following data field as protected, alphameric, and nondisplay or nonprint. As the data characters are read into the buffer, they are stored starting at the first character location after the field-attribute character. As each data character is stored in the buffer, the cursor advances one buffer location. The cursor advancement is all the operator sees on the display screen when using the operator identification card reader. When the operator uses the magnetic slot reader, the cursor does not move as the card is passed through the slot, but is repositioned after the card has been read.

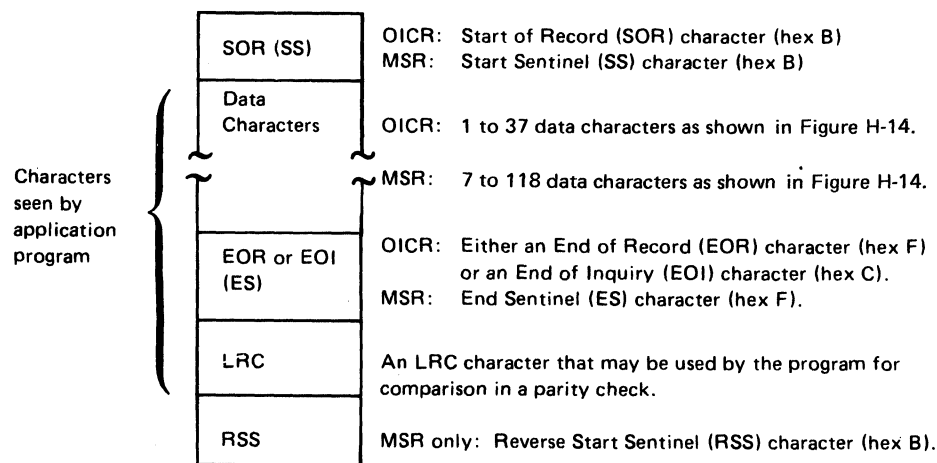

Figure H-15. Magnetic-Stripe Format (OICR and MSR Using 3277-Compatible Numeric Character Set)



## Operational Differences because of Screen Format

When the character set of Figure H-14 is being used with the operator identification card reader (OICR) or the magnetic slot reader (MSR), differences exist in the content of the data stream sent to the application program, depending upon whether the display screen is unformatted or formatted.

When an unformatted screen (that is, a screen without attribute characters or fields) is being used, the operation of the display results in an inbound data stream as shown in Figure H-16.

The reader operation formats the screen by the automatic generation of the field-attribute character at the cursor position by the reader. A formatted screen has at least one field-attribute character defined at initial presentation. This may be the only field-attribute character, as in the instruction sequence ENTER ID; or one or more attributes may be required, as, for example, in the instruction sequence NAME, TITLE, ID CARD READER.

The operations of the 3277 with the OICR, or of the 3278 and 3279 with the MSR, are identical when formatted screens are used.

Two fields (new data field and previous data field), with the MDT bits set, are sent to the application program because the displays treat all information from the reader as data until after the information is written into the display buffer. Also, the MDT bit is set in the reader-generated field-attribute character that was initiated when the data was entered.

The following examples are included to help clarify operation of the reader with a formatted screen:

Example 1: If the OICR/MSR field is set up by the application program as an unprotected field and contains instruction information, the inbound data stream is as shown in Figure H-17.

Example 2: When the OICR/MSR field is set up by the application program as an unprotected field, with the cursor directly following an unprotected field-attribute character, the inbound data stream is as shown in Figure H-18.

## Error Conditions (OICR/MSR)

OICR/MSR data will not be written into the display buffer if any of the following error conditions exist when the magnetic stripe is read:

- The SOR (OICR) or SS (MSR) character is not successfully connected to a field-attribute in the display buffer.
- The cursor is located in a protected field.
- The cursor is located in a field-attribute character location.
- The display is busy performing another operation.

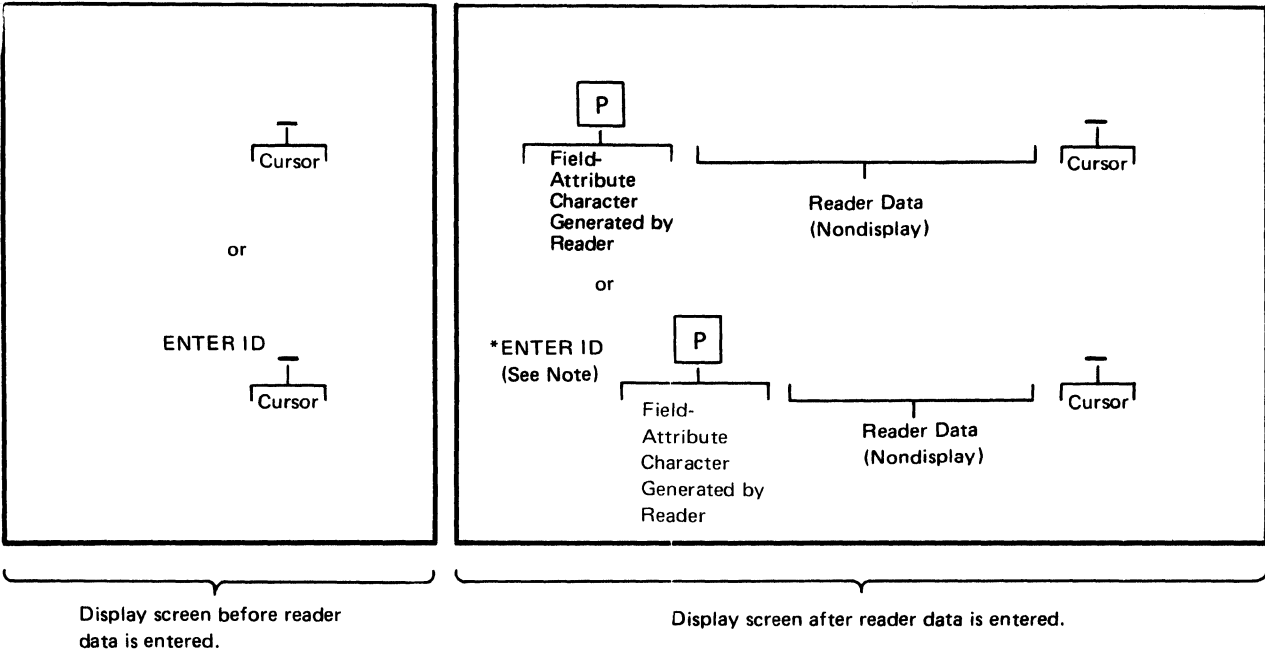

**Note:** The ENTER ID is not displayed because it is within a nondisplay field, defined by the reader attribute character.

**P** = Protected field-attribute character

Inbound Data Stream

AID
Cursor Address
SBA
Start of Data Address
Data

Set to indicate input from a magnetic-stripe reading device.

Address of the cursor upon completion of the reader operation.

Set Buffer Address.

Address of the first data character following the field-attribute character.

The reader data followed by any additional information present in the display buffer. The additional information can be initiated by the application program as ENTER ID (as shown in the example) or entered by the operator before the reader operation is started.

Note that with an unformatted screen the reader data is the first text in the data stream sent to the application program.

Figure H-16. Operation of the Display with an Unformatted Screen (OICR or MSR Using 3277-Compatible Numeric Character Set)

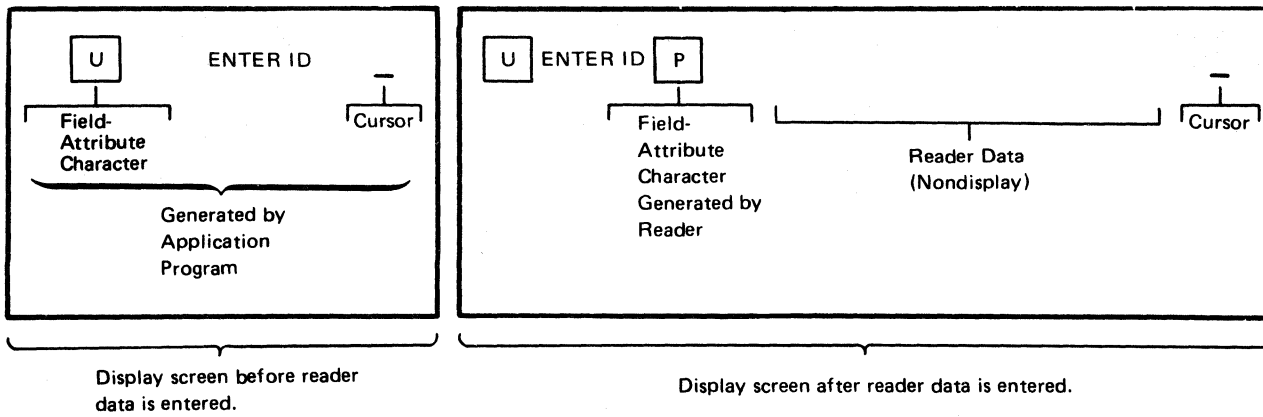

Inbound Data Stream

AID
Cursor Address
SBA
Start of Data Address
Data
SBA
Start of Data Address
Data

Set to indicate input from a magnetic-stripe reading device.

Address of the cursor upon completion of the reader operation.

Set Buffer Address.

Address of the unprotected (U) field-attribute character + 1.

ENTER ID, in the example above.

Set Buffer Address.

Address of the protected field-attribute character +1. In this case, the address of the first data character from the reader following the protected field-attribute character.

The reader data (and any data between the cursor and the next field-attribute character).

**U** = Unprotected field-attribute character

**P** = Protected field-attribute character

Figure H-17. Operation of the Display with a Formatted Screen (OICR or MSR Using 3277-Compatible Numeric Set), Example 1

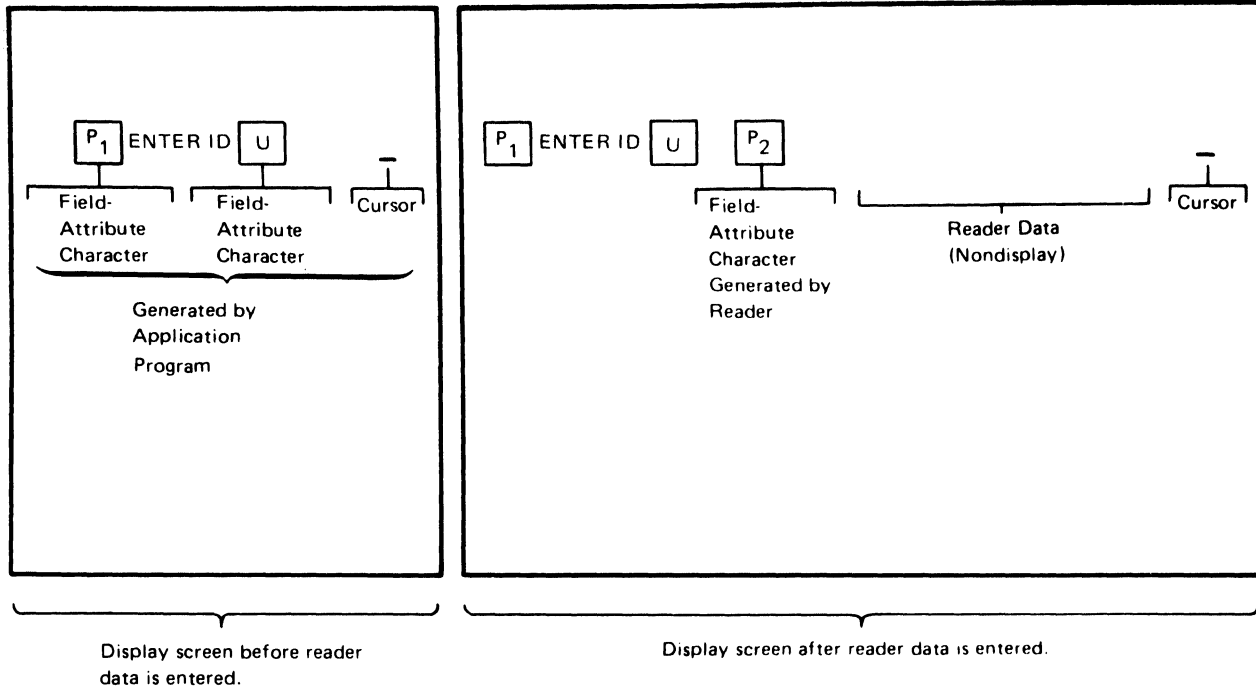

**U** = Unprotected field-attribute character  
**P** = Protected field-attribute character

**Note:** Rules for positioning modified data on formatted screens apply. The position of reader data in the inbound data stream depends on the field position in the format.

Inbound Data Stream

AID	Set to indicate input from magnetic-stripe reading device.
Cursor Address	Address of cursor upon completion of reader operation.
SBA	Set Buffer Address.
Start of Data Address	Address of the unprotected (U) field-attribute character + 1. In the example above, it will be the address of the P ₂ field-attribute character.
SBA	Set Buffer Address.
Start of Data Address	Address of the P ₂ field-attribute character + 1. In this case, the address of the first data character from the reader following the P ₂ field-attribute character.
Data	The reader data (and any data between the cursor and the next field-attribute character).

Figure H-18. Operation of the Display with a Formatted Screen (OICR or MSR Using 3277-Compatible Numeric Character Set), Example 2

## OICR/MSR Validity Tests

The proper use of the OICR or MSR as an identification and data-entry device requires that the application program perform certain validity tests. The following guidelines are recommended for proper operation:

1. No field should be accepted as reader input unless the reader AID code is set.
2. For preformatted displays, the application program must know the location of the field defined to receive the reader data and the exact location of the entered data, based upon the hardware operation that was previously defined. The use of the cursor address present in the inbound data stream, in combination with the AID byte to ensure reader input, is an additional technique that can be used to ensure the integrity of the data. For unformatted displays, the reader data is always presented as the first data entry in the input record to the application program.
3. For preformatted displays, it is advisable to terminate the reader data field with another attribute byte.
4. Upon completion of the reader operation, the application program should check for the presence of the EOI/EOR character (OICR) or the ES character (MSR). Absence of this character means the reader data has not been transferred successfully.
5. Upon completion of the reader operation and a successful check for the EOI/EOR (ES) character, the LRC character may be used for a parity check to ensure integrity of the data.

Because of the makeup of the 3277-compatible numeric character set codes (4 bits plus parity bit), only the right-hand 4 bits are of concern. The application program should set up a 1-byte field initialized to X'0B'. This is the SOR (SS) character, which is not included in the inbound data stream but which is used to compute the LRC. As each character is checked for validity, it is exclusively ORed into this field. This operation should include the EOR/EOI (ES) character and the LRC, resulting in the byte containing zero. If the byte is nonzero, it means the result of the check on the data characters, including EOR/EOI (ES), does not equal the LRC, and a parity error has occurred.

6. If the reader input field is to be reused, the application program must remove the hardware-generated field-attribute character and reader input data. The location of this character can be derived from the inbound data stream by using one less than the start of the data address preceding the input data. Additionally, the cursor is located one position beyond the end of the reader data field.

The card field may be reused if more than one card input is required or if the original attempt was unsuccessful and the application program desires to retry the operation.

7. Text for all fields having the MDT bit set is transferred to main storage when the reader data is retrieved in response to the reader-generated I/O pending.

8. The cursor must be moved out of the reader-generated field before further keyboard activity is allowed.
9. A test card is delivered with each OICR and is available for system validation. The test card data (in 4-bit code) written into the display buffer is as follows:

BB1234567890123456789012345678955ABDEF7

A test card, PN 1742659, is delivered with each 3278 Magnetic Reader Control feature. The test card data placed in the display buffer is as follows:

0123456789987654321001234567F4

Care should be taken that these cards are not accidentally auto-entered. The display should be placed in test mode to avoid auto-entering magnetic-stripe information to the host.

#### **MSR Operator Indicators and Alarm**

Refer to "MSR/MHS Operator Indicators and Alarm".

1950



## Appendix I. X.21 Switched Network Adapter Feature (3274 Models 51C and 61C)

The X.21 switched feature, installed in the 3274-51C or -61C and appropriately configured (see the *3274 Control Unit Customizing Guide*, GA23-0065), enables a display operator, using a display's keyboard, to connect the control unit and attached terminals to a host system via the public switched network. The feature provides an adapter and appropriate control code for interfacing the 51C or 61C with Data-Circuit Terminating Equipment (DCE) in the public switched network.

Communication with the host is conducted using SNA/SDLC protocols, and line speeds of 2400, 4800, and 9600 bps in a digital switched network are supported.

The *IBM 3270 Information Display System Feature Description*, GA23-0113, and *IBM 3270 Information Display System Configurator*, GA27-2849, list the prerequisite or mutually exclusive features associated with the X.21 feature.

### X.21 Functions

The subset of X.21 functions supported by the 3274-51C or -61C is:

- Address Call, including Abbreviated Call and Closed User Group Call
- Direct Call
- Automatic Answering
- Call Progress Signals
- Controlled Not-Ready state
- Registration/Cancellation Facility

**Address Call.** A host system can be "dialed" using the keyboard to enter its public switched network address.

- **Abbreviated Address Call.** A host system can be "dialed" using an abbreviated network address.
- **Closed User Group Call.** The number of 3270 systems and host systems that may connect to each other can be limited. "Dialing" of a network number not included in the "dialer's" user group results in an "access barred" condition.

**Direct Call.** A host system connection is established without entering its network address. The address must have been predefined to the network.

**Automatic Answering.** An incoming call from a host system is automatically "answered" by the control unit. Operator action is not required to complete the connection.

**Call Progress Signals.** Call Progress signals from the network are interpreted and displayed by the control unit. They report on the status of outgoing calls (and also indicate results of operations with the Registration/Cancellation Facility).



**Controlled-Not-Ready State.** Control unit is disconnected from network. Incoming calls are not accepted and a call progress signal to this effect is returned to the caller. Outgoing calls, dialed or direct, cannot be initiated. The control unit can perform offline functions.

**Registration/Cancellation Facility.** Abbreviated network addresses, and IDs for members of a closed user group, are registered and canceled (with the network) using this facility.

## X.21 Inquiry Facility

The 3274-51C and -61C support of X.21 switched network operations includes a facility with which an operator can query the control unit about the status of each terminal attached to it, and obtain the address of the currently connected host. (See "Inquiry Facility" at the end of this appendix for a detailed presentation.)

## X.21 Keys and Indicators

The X.21 functions are invoked by operator actions at the keyboard (and incoming calls), and the status of the control unit with respect to X.21 functions is signaled to the operator via indicators in the Operator Information Area of the display. (This Appendix does not detail operator actions. See the appropriate Operator's Guides for such information.)

The keyboard/display attached to port 0 of the control unit has access to the full complement of X.21 functions. The other terminals (as a group) are assigned function ranging from the full complement to lockout when the 3274 is customized.

### *The Keys*

Seven keys on the 3278/3279 keyboards are affected when the X.21 feature is installed in the control unit. See Figure I-1. Six of these keys are associated with the X.21 function; the seventh, the LOAD MATRIX key, inherits the load printer matrix function normally assigned to the key labeled "Extension Key" in Figure I-1. when the X.21 feature is not installed. This key is effective *only* on the keyboard at port 0 (see "Printers" in Chapter 2).

The six X.21 function keys consist of a "shift" key—the X.21 Extension key (▶) —and five control keys: Direct Call key (▶ DIRECT), Dial Call key (▶ DIAL), Local key (▶ LOCAL), Communication key (▶ COMM), and Disconnect key (▶ DISC).

To activate any of the X.21 control keys (and the ▶ LOAD MATRIX key), the sequence is: press and hold the ALT key (present on all keyboards), press the X.21 extension key (▶), release the ALT and ▶ keys, and press the desired control key. (Decals are provided to mark the keys; the decals are shown in parentheses above.)

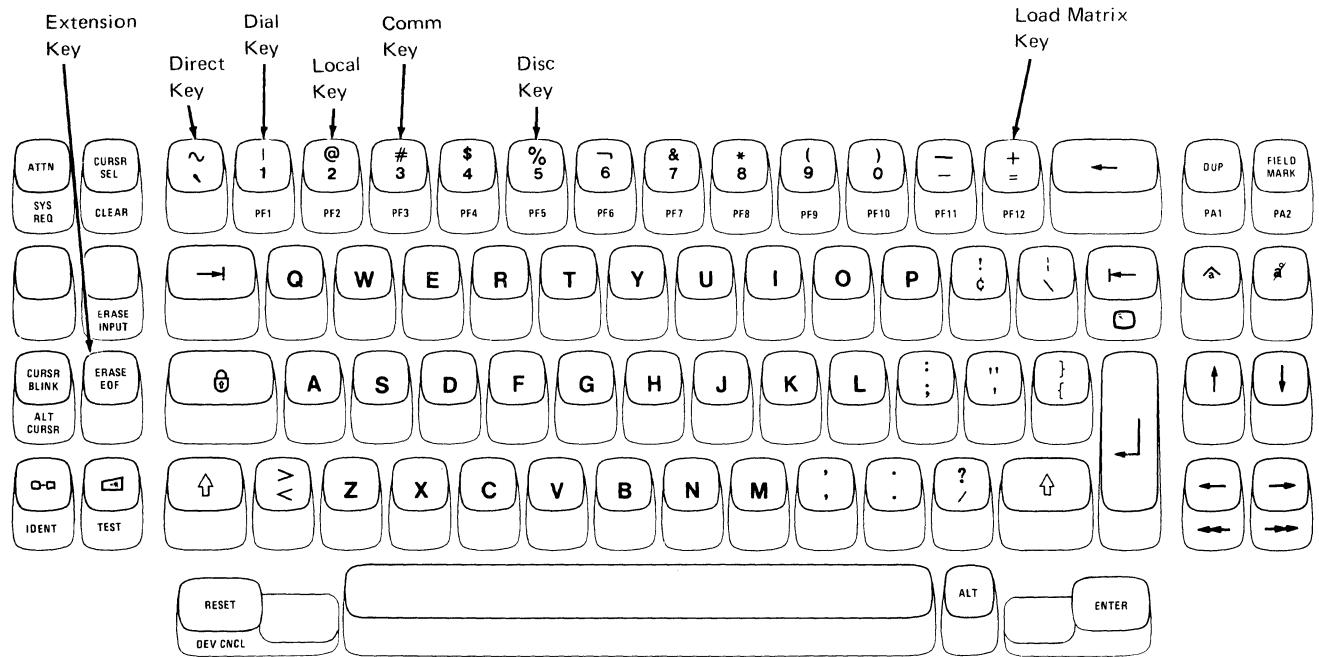

3278, 3279 Keyboards

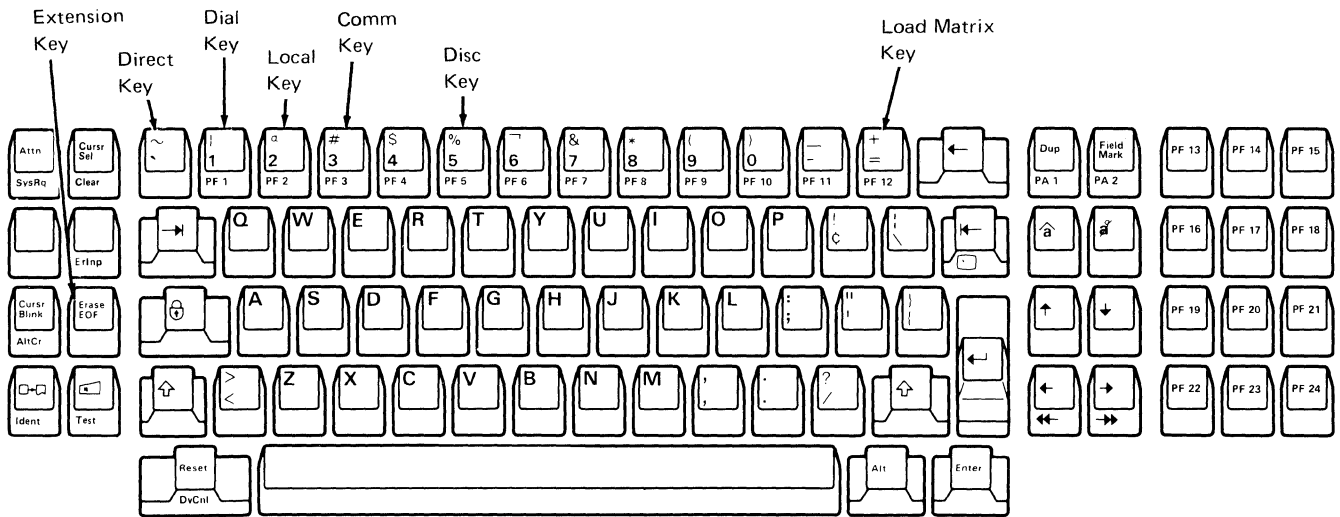

3178 Keyboards

Figure I-1. X.21 Feature Keys

## The Indicators

X.21 indicators are displayed in the Readiness and System Connection, Do Not Enter, Reminder, and Shifts and Modes areas of the Operator Information Area. They reflect the state of the control unit with respect to X.21 operations. When the X.21 indicators are accompanied by a Call Progress signal (Nnn), the signal is conveying information about a network operation (Call Progress signals are listed later in this appendix).

The following indicators are displayed in the Reminder area:

Call Ready —  
Call Ready with Call Progress signal — Nnn  
Dial In (Dialing terminal) — # ?  
Dial In (other terminals, same control unit) — ##  
Outgoing Call in Process  
Outgoing Call in Process with Call Progress signal ← Nnn  
Incoming Call in Process ←  
Disconnect in Process —  
Local ← 599 (Communication Reminder with status code 599.)

The following indicator is displayed in the Do Not Enter area:

Operator Communication Check ✕ —

The following indicator is displayed in the Readiness and System Connection area:

In-use N

The following indicator is displayed in the Shifts and Modes area:

Extension mode ▶

The X.21 indicators appear alone or in conjunction with other Operator Information Area indicators. In the topic that follows, "X.21 Operations", the X.21 indicators are related to the keyboard actions or control unit states that cause them to be displayed.

## X.21 Operations

X.21 switched network operations are initiated and tracked using the keys and indicators just described. The "state" that the control unit is in controls which key functions are applicable at any given time. The keyboard must be in extension mode for any X.21 control key to be active.

### Extension Mode

The keyboard is placed in extension mode by pressing the ALT key and the extension key (▶), unless the security keylock is off, or if a TEST mode or machine check condition is present. The keyboard remains in extension mode until one of the X.21 control keys is pressed or a reset action occurs.

If any other than the X.21 control keys, ALT key, and the RESET key is pressed, the Retry indicator is displayed and the extension mode is reset. When extension mode is reset, the status indicator previously active will again be displayed.

While in extension mode:

1. Pressing the extension key resets extension mode.
2. The reset key operates normally and does not reset extension mode.
3. If pressed, the ALT key is ignored.

### ***Ready State***

When the control unit is in X.21 Ready state, the Call Ready indicator is displayed, and the ▶ (extension), ▶ DIAL, ▶ DIRECT, and ▶ LOCAL keys or an incoming call are responded to.

The Ready state is entered when:

- a. Power is brought up on the control unit.
- b. The ▶ COMM key is pressed while the control unit is in local mode.
- c. When a Dial In state is ended by use of the ▶ DISC key.
- d. The line is disconnected normally (▶ DISC key or ▶ DISC command).
- e. An outgoing call is rejected by the network. The Call Ready indicator with Call Progress signals is displayed. The ▶ DISC or ▶ COMM keys will clear the Call Progress signal.
- f. The line is disconnected by an error, or an error occurs in the connection process. The Communication Error indicator is displayed (overrides the Call Ready indicator). Pressing the ▶ COMM key will restore the Call Ready indicator.

### ***Dial In State***

Pressing the ▶ DIAL key causes the control unit to exit the ready state, to turn off the Call Ready and Extension mode indicators, to and display the Dial In (dialing terminal) indicator at the dialing terminal and the Dial In (other terminal) indicator on the other terminals.

The Dial Call key initiates a keyboard reset and screen clear operation; positions the cursor at the home position, selects the character set in ROS X'00', and resets the Highlighting Color (3279) and Programmed Symbols indicators to the default indications. If the terminal is in a Wait, Device Busy, Device Very Busy, Device Not Functional, or Security Key off condition, the Dial Call key has no effect and extension mode is exited.

The control unit accepts call requests (Dial Call key or Direct Call key pressed) from the terminals on a first-come basis. Once a given terminal has entered a dial request, an attempt to enter a dial request or to change the Dial In state (except for ▶ DISC) by another terminal is rejected. (The keyboard is inhibited and the Operator Communication Check indicator is displayed.) Test Mode entered on another terminal is allowed and will not affect the Dial In state.

While in Dial In state:

- a. At the dialing terminal: The ▶ DIAL, ▶ DIRECT, ▶ LOCAL, ▶ DISC, TEST, CLEAR, ENTER, and Other keys are accepted, the ▶ COMM key is ignored, and AID producing keys (except for CLEAR and ENTER) are rejected with the minus function indicator displayed.
- b. At the other terminals: The ▶ DIAL, ▶ DIRECT, and ▶ LOCAL keys are rejected with an operator communication check displayed. The ▶ DISC, TEST and Other keys are accepted, the ▶ COMM key is ignored, and AID producing keys are rejected with the minus function indicator displayed.
- c. Using the TEST key at the dial-originating terminal aborts the Dial In state.
- d. When dialing, as address digits are entered they are displayed in an unprotected area extending from the home position to column 31 of the screen—the Dial In area. The remainder of the screen is protected, and the Go Elsewhere indicator will be displayed if an attempt is made to enter a digit in the protected area.
- e. Null and blank characters in the Dial In area will be ignored.
- f. If no digit has been entered before the ENTER key is pressed, the ENTER key is rejected and the What? and Call Ready indicators are displayed.
- g. Pressing the CLEAR key clears the Dial In area. (No AID signal is sent.)
- h. Pressing the ENTER key after entering the dial digits causes the outgoing Call in Process indicator to replace the Dial In indicator, and the ▶ DIAL, ▶ DIRECT, and ▶ LOCAL keys are disabled. (However, if the dial digits are incorrect or invalid, the What? indicator is displayed and Dial In state is reset to the Call Ready state.
- i. The ▶ DIAL and ▶ DISC keys in Dial In state clear the screen; the former does not reset the Dial In state; the latter resets the Dial In state to Call Ready state. The ▶ DISC, TEST, and Other keys are accepted; the ▶ COMM key is ignored; and all AID producing keys are rejected with the minus function indicator displayed.

See Figure I-2 for a Dial In state summary.

Action Taken	Response and Operator Information Area Indicator Displayed	
	Dialing Terminal	Other Terminals
Dial Call (► DIAL key)	Accepted Z#?	Rejected X $\frac{f}{Z}$ Z Z##
Direct Call (► DIRECT key) Enter Outgoing Call-in-Process state	Accepted ¬Z	Rejected X $\frac{f}{Z}$ Z Z##
Take offline enter Controlled-not- Ready state (► LOCAL key)	Accepted ¬Z599	Rejected X $\frac{f}{Z}$ Z Z##
Cancel Controlled- not-Ready state (► COMM key)	Ignored Z#?	Ignored Z#?
Disconnect Line (► DISC key) Enter Call Ready State	Accepted Z	Accepted Z
TEST key Enter TEST mode	Accepted TEST Abort dial in	Accepted TEST Z##
ENTER key Enter Outgoing Call-in-Process state	Accepted ¬Z	Rejected X-f Z##
CLEAR key	Accepted clears Dial-In area Z#?	Accepted clears screen Z##
PA, PF, ATTN, SYS REQ keys	Rejected X-f Z#?	Rejected X-f Z##

Figure I-2. Control Unit/Terminal Responses in Dial-In State

### ***Outgoing Call in Process State***

Outgoing Call in Process state is entered via the Dial In state (pressing ENTER after entering the dial digits) or directly from the Ready state when the Direct Call key is used. The Call Ready indicator is replaced with the Outgoing Call in Process indicator and the same keys are enabled/disabled as noted in item h under Dial In state. Call Progress signals may be displayed along with the Outgoing Call-in-Process indicator. (See "Call Progress Signals" later in this appendix.)

### ***Ready-for-Data and Data Transfer States***

After line connection has been made but before any sessions with the host have been established (SNA ACTPU/ACTLU sequence), the Outgoing Call-in-Process indicator is turned off and the In-Use indicator is displayed in the Readiness and System Connection area. After session(s) have been established, the Online indicator is also displayed in the same area.

While in the Ready-for-Data and Data Transfer states:

1. The AID producing keys, TEST, ▶ DISC, and Other keys are accepted.
2. The ▶ DIAL, ▶ DIRECT, and ▶ LOCAL keys are rejected with the Operator Communication Check indicator displayed.
3. The ▶ COMM key is ignored.

### ***Disconnection-in-Process State***

Disconnection-in-Process state is entered when the DISC key is pressed or a disconnect command or timeout condition causes the line connection to be broken. The Disconnection-in-Process indicator is displayed until disconnection is complete when the Call Ready indicator is displayed and the control unit returns to Ready state.

While in the Disconnect-in-Process state:

1. TEST and Other keys are accepted.
2. The ▶ DIAL, ▶ DIRECT, and ▶ LOCAL keys are rejected with the Operator Communication Check indicator displayed.
3. The AID producing keys are rejected with the minus function indicator displayed.

The screen will not be cleared. All session-related indicators including the Online indicator, Ownership, System Lock, etc., are cleared.

### ***Incoming Call State***

Incoming Call state is entered from Ready state. The Call Ready indicator is replaced with the Incoming Call-in-Process indicator, and, when the connection is completed, the In-Use indicator is displayed. After session establishment, the Online indicator is also displayed.

While in Incoming Call state:

1. The ▶ DISC, TEST and Other keys are accepted.
2. The ▶ DIAL, ▶ DIRECT, and ▶ LOCAL keys are rejected with the Operator Communication Check indicator displayed.
3. The ▶ COMM key is ignored.
4. AID producing keys are rejected with the minus function indicator displayed.

### ***Controlled-Not-Ready State***

Controlled-Not-Ready state is entered from the Ready state when the ▶ LOCAL key is pressed. All incoming calls and outgoing call requests are rejected. The Call Ready indicator is replaced with the Communication Reminder indicator accompanied by a status code of 599.

The ▶ COMM key is used to restore the control unit to Ready state.

While in Controlled-Not-Ready state:

1. The ▶ COMM, TEST, and Other keys are accepted.
2. The ▶ DIAL, ▶ DIRECT, ▶ DISC keys are rejected with the Operator Communication Check indicator displayed.
3. The AID producing keys are rejected with the minus function indicator displayed.

### ***Call Progress Signals***

The Call Progress signals, two digit codes displayed with the Call Ready and Outgoing Call-In-Process indicators, are public switched network originated. They provide information to the control unit and operator concerning outgoing call requests and registration/cancellation operations.

When displayed with the Call Ready indicator, Call Progress signals indicate that:

1. The call request just made has failed and the line is disconnected. The network reason for the failure is specified by the specific signal.
2. The registration/cancellation operation just attempted succeeded or failed.

When displayed with the Outgoing Call-In-Process indicator, Call Progress signals indicate the network status of the call. No operator action should be taken until either the In-Use indicator appears (call successful) or the Call Ready indicator with Call Progress signals appears (call unsuccessful).

### **Call Progress Signal Handling**

The following are the CCITT-defined Call Progress signals for public switched networks:

01 Terminal called	45 Controlled-not-ready
02 Redirected call	46 Uncontrolled-not-ready
03 Connect when free	47 DCE power off
20 No connection	48 Invalid facility request
21 Number busy	49 Network fault in local loop
22 Procedure error	51 Call information service
23 Transmission error	52 Incompatible user
41 Access barred	61 Network congestion
42 Changed number	71 L.T. network congestion
43 Not obtainable	72 RPOA out of order
44 Out of order	81 Registration/cancellation confirmed



Call Progress signals are handled by the control unit according to category, as follows:

Category 1—0x signals: Wait for 1 minute, return to Call Ready state if not successful.

Category 2—2x,6x signals: Retry. The number of retries and the time interval (3 to 20 seconds) between retries is specified at control unit customization.

Category 3—4x,5x,7x,8x: Go to Call Ready state immediately.

Call Progress signals displayed with the Call Ready indicator are cleared by use of the Dial call, Direct call, Disconnect, Local, or Communication key or by receipt of an incoming call.

## Registration/Cancellation Facility

This facility is used to register (with the network) or cancel abbreviated address call sequences or the addresses of the members comprising the closed user group.

To use the Registration/Cancellation Facility, the control unit is placed in Dial In state (the ► DIAL key) and a sequence of numbers indicating the type of registration/cancellation wanted and the specifics is then entered. The exact sequence and content will vary between public switched networks. After completion of a registration/cancellation request, the Call Ready indicator will be displayed with a Call Progress signal indicating success or failure of the request.

## Error Conditions

When the Communication Reminder indicator with 3274 error status code is displayed during X.21 operations, the state of the connection can be determined by the In Use indicator. See Appendix A for status code interpretation. If the call is to be retried, the ► COMM key will reset the Communication Reminder indicator. Appendix A should also be referred to for machine-check indicator interpretation and handling.

## Inquiry Facility

Concurrent test 3 of the subsystem log and test facility provides X.21-related information when the X.21 feature is installed on the 3274-51C or -61C.

Test 3 is invoked by:

1. Pressing and holding the ALT key, and pressing the TEST REQ key.
2. Releasing the ALT and TEST REQ keys.
3. Keying in /3 (slash three).
4. Pressing the ENTER key.

The following eight lines of information will be displayed:

Line 1 01234567 89...

The digits represent the low-order digit of the 3274 port address. Type B ports are always noted following Type A ports; if a Type B port is attached the last (highest) Type A port and the first (lowest) Type B port are separated by two blanks.

Line 2 1, 0, or a - (hyphen) under each position in line 1.

1 indicates the terminal is powered on.  
0 indicates the terminal is powered off (or that no terminal is attached to the port).  
- indicates that the terminal is disabled due to an error detected at the control unit.

Line 3 d, p, i, or a __ (underscore) under each position in line 1 followed by the letters TYP.

d indicates the terminal is a display.  
p indicates the terminal is a printer.  
i indicates a terminal other than a display or printer.  
__ indicates the terminal has never been powered on (or that no terminal is attached to the port).

Line 4 . (period), : (colon), | (vertical bar), or a * (asterisk) under each position in line 1 followed by the letters COAX.

. indicates no coax cable errors recorded.  
: indicates 1 to 9 coax cable errors recorded.  
| indicates 10 to 19 coax cable errors recorded.  
* indicates 20 or more coax cable errors recorded.

Line 5 . (period), : (colon), | (vertical bar), or a * (asterisk) under each position in line 1 followed by the letters DEV.

. indicates no terminal errors recorded.  
: indicates 1 to 9 terminal errors recorded.  
| indicates 10 to 19 terminal errors recorded.  
* indicates 20 or more terminal errors recorded.

Line 6 + or a blank under each position in line 1 followed by the letters LU.

+ indicates that the terminal is in session with the host.  
blank indicates that the terminal is not in session with the host.

Line 7 ## is displayed directly under the letters LU in line 6 followed by one of the following:

- a. The host access (the dialed number) to which the control unit is currently connected.
- b. Four zero digits (0000) if the current connection was made via the ▶ DIRECT key.
- c. Four hyphens (----) if the control unit's current status is "incoming call in process" or the connection has been made by an incoming call.

Line 8 MMMM CCCC PPPP RRRR XXXX

MMMM is a summary count of 3274 detected machine checks.  
CCCC is a summary count of communication checks.  
PPPP is a summary count of program checks.  
RRRR is a summary count of SDLC Test commands received.  
XXXX is a summary count of SDLC Test commands successfully transmitted.

An example follows:

Line	Contents
1	01234567 (No Type B adapter)
2	101111-1
3	ddddpppp TYP
4	.....*: COAX
5	.....: DEV
6	+ ++ + LU
7	## 0466443
8	0000 0001 0000 0000 0000

## Appendix J. Compression of Symbol Definition Bit Strings

Symbol definition bit strings can be transmitted by the LPS structured field function in uncompressed or compressed form. The 3274 control units (Configuration Support C or D installed) can expand the compressed symbol definitions into the full dot pattern required by the display or printer.

An uncompressed symbol definition requires either 18 bytes of data (display) or 10 bytes of data (printer) to be transmitted. Compression, as described in this appendix, is a method for reducing the number of bytes (bits) transmitted.

An uncompressed symbol definition is created by dividing the character cell within which a symbol is formed into bytes (slices) as shown in the next section. The symbol is defined by encoding the bits (dots) in each byte (slice) as a B'1' if the dot is to be "on", and a B'0' if off. The dot pattern representing the symbol is thus formed. Byte (slice) 1 is understood to represent the leftmost upper 8 dots in the display matrix or the leftmost 8 dots in the printer matrix. The string of 144 bits (display) or 80 bits (printer) thus encoded represents the uncompressed symbol definition. A comparison process, comparing digits (4 bits) in the uncompressed bit string to reference digits selected from the same bit string, is used to compress the data.

### Character Cell Division

The character cell for a display or printer character position is divided into slices as shown following. A slice corresponds to a byte, the bits to dots.

Bits	0		Slice 3								
	1	S	0	1	2	3	4	5	6	7	Bits
	2	l	5								
	3	i	6								
	4	c	7								
	5	e	8								
	6	1	9								
	7		10								
	0	S	11								
	1	l	12								
	2	i	13								
	3	c	14								
	4	e	15								
	5	2	16								
	6		17								
	7		18								

Display (9 x 16)

Bits	0									
	1	S								
	2	l								
	3	i								
	4	c								
	5	e								
	6	1	2	3	4	5	6	7	8	9
	7									

Printer (10 x 8)

Once the character cell has been sliced in an appropriate manner, the slices can be thought of as forming a data string, beginning with slice 1, the zero bit in each slice at the left.

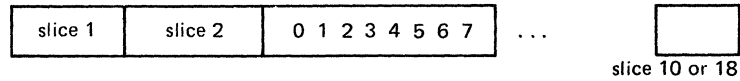

As noted, each group of 4 bits is termed a digit. The bit string forming the symbol definition is compressed by comparing each digit with the corresponding digit in a preceding slice, or zero, and the compressed bit string is generated according to the matches and mismatches that occur in the comparison process.

## The Compression Process

In creating a Type 2 (display) or Type 6 (printer) compressed bit string for an individual symbol, an algorithm based on one of four comparison rules is used. So that the 3274 can subsequently expand the compressed string, a *header* (of 1 to 4 bits) is used at the start of each symbol definition to signal which of the four comparison rules was used in the compression.

The compressed bit strings for all the symbols being defined are concatenated without regard for byte boundaries, and then *terminator bits* are added to make the total bit string fit into an integral number of bytes.

To summarize so far, Type 2 or Type 6 data defining a full set of symbols in a Load Programmed Symbols structured field function looks like this:

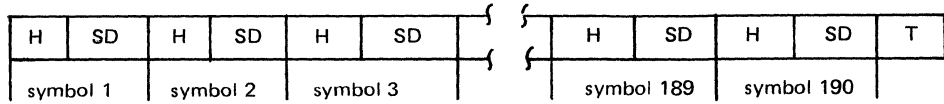

- H = header bit(s)
- SD = symbol-definition bits
- T = terminator bits

The following material describes comparison rules and header bits, creating the compressed bit string, terminator bits, and examples of compressing the symbol-definition bit string for the symbol in Figure J-1.

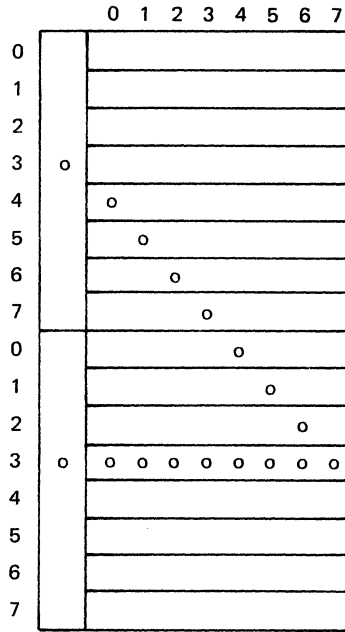

In Type 1 data format, the dot pattern for this example symbol would be transmitted in 18 bytes having the following values:

- Slice 1: B'00010000' = X'10'
- Slice 2: B'00010000' = X'10'
- Slice 3: B'00000000' = X'00'
- Slice 4: B'00000000' = X'00'
- Slice 5: B'00000000' = X'00'
- Slice 6: B'00000000' = X'00'
- Slice 7: B'10000000' = X'80'
- Slice 8: B'01000000' = X'40'
- Slice 9: B'00100000' = X'20'
- Slice 10: B'00010000' = X'10'
- Slice 11: B'00001000' = X'08'
- Slice 12: B'00000100' = X'04'
- Slice 13: B'00000010' = X'02'
- Slice 14: B'11111111' = X'FF'
- Slice 15: B'00000000' = X'00'
- Slice 16: B'00000000' = X'00'
- Slice 17: B'00000000' = X'00'
- Slice 18: B'00000000' = X'00'

Figure J-1. Type 1 Data Format – An Example Dot Pattern Encoded

## The Comparison Rules and Header Bits

The four comparison rules that follow are used in creating a compressed symbol-definition bit string from a Type 1 (display) or 5 (printer) uncompressed symbol-definition bit string. Encoding the results of the comparison is discussed under “Creating the Compressed Bit String.”

- Comparison Rule 1 (Header bit = B'0')

Each digit is compared with a digit consisting of zero bits.

- Comparison Rule 2 (Header bits = B'10')

Each digit is compared with the corresponding digit in the previous slice; for example, the first digit of slice 2 is compared with the first digit of slice 1, the second digit of slice 2 with the second digit of slice 1, the first digit of slice 3 with the first digit of slice 2, and so on. Since slice 1 has no previous slice, compare each digit of slice 1 to a zero digit.

- Comparison Rule 3 (Header bits = B'110')

Each digit is compared with the corresponding digit in the next-to-previous slice; for example, the first digit of slice 3 is compared to the first digit of slice 1, the second digit of slice 3 with the second digit of slice 1, the first digit of slice 4 with the first digit of slice 2, and so on. Since slices 1 and 2 have no next-to-previous slice, compare each digit of slices 1 and 2 to a zero digit.

- Comparison Rule 4 (Header bits = B'1110')

No comparison required. A blank symbol. The symbol definition consisted of zero bits only.

## Creating the Compressed Bit String

The digit comparisons are encoded by taking the digits 4 at a time (2 slices—the slice-pair referred to in following discussions) and comparing them to their corresponding digits in a reference slice-pair that you have created (following the comparison rules). Because the digits are compared 4 at a time, it is convenient to regard the 18 slices of the type 1 data string or the 10 slices of a type 5 data string symbol definition as being made up of 9 or 5 slice-pairs. The digits of the slice-pairs are compressed as follows:

- Step 1

Compare the first Type 1 or 5 slice-pair with the reference slice-pair.

- Step 1A

When the two slice-pairs are identical, put a *0* bit in the symbol-definition bit string, and repeat step 1 for the next slice-pair.

- Step 1B

When the two slice-pairs are not identical, put a *1* bit in the symbol-definition bit string, and proceed to step 2.

- Step 2

Compare, in turn, each digit in the Type 1 or 5 slice-pair with the corresponding digit in the reference slice-pair.

- Step 2A

For each digit that matches (that is, the digits being compared are the same), put a *0* bit in the symbol-definition bit string.

- Step 2B

For each digit that does not match (that is, the digits being compared are not the same), put a *1* bit in the symbol-definition bit string *followed by a copy of the 4 bits of the nonmatching digit from the Type 1 or 5 slice-pair*.

- Step 3

Repeat steps 1 and 2 in a similar manner through to the ninth slice-pair of a Type 1 string or the fifth slice-pair of a Type 5 string.

When the bit strings for all the symbols have been created and concatenated, the Type 2 or Type 6 data string is completed with 1 bits to make up an integral number of bytes. *There must be at least 4 of these terminator 1 bits—even if they spill over into a further byte.* The number of 1 bits required thus ranges from 4 (minimum) to 11 (maximum).

## Examples of the Compression Algorithm in Use

The following three examples show how a Type 1 data string for a particular symbol is compressed into a Type 2 data string. In these examples, the symbol whose Type 1 data string being compressed is the one shown in Figure J-1. Here is the data string for that symbol, presented as nine slice-pairs:

Slice-pair 1: X'1010'  
 Slice-pair 2: X'0000'  
 Slice-pair 3: X'0000'  
 Slice-pair 4: X'8040'  
 Slice-pair 5: X'2010'  
 Slice-pair 6: X'0804'  
 Slice-pair 7: X'02FF'  
 Slice-pair 8: X'0000'  
 Slice-pair 9: X'0000'

For the particular symbol used in these examples, comparison rule 1 yields the shortest bit string; for any other symbol, however, the comparison rule that yields the shortest bit string depends on the symbol's particular dot pattern.

### Example of Algorithm Using Comparison Rule 1

Slice-pairs being compared according to Rule 1:		Step 1: Compare slice-pairs. For a match, generate B'0'. For a mismatch, generate B'1', and do step 2.			
Reference slice-pair	Type 1 slice-pair	Step 2: Compare digits. For a match, generate B'0'. For a mismatch, generate B'1' followed by a copy of the bits in the nonmatching Type 1 digit.			
		Digit 1	Digit 2	Digit 3	Digit 4
X'0000'	X'1010'	1	1 0001	0	1 0001 0
X'0000'	X'0000'	0			
X'0000'	X'0000'	0			
X'0000'	X'8040'	1	1 1000	0	1 0100 0
X'0000'	X'2010'	1	1 0010	0	1 0001 0
X'0000'	X'0804'	1	0	1 1000	0 1 0100
X'0000'	X'02FF'	1	0	1 0010	1 1111 1 1111
X'0000'	X'0000'	0			
X'0000'	X'0000'	0			

Figure J-2. Example of Compression Algorithm Using Comparison Rule 1

With Comparison Rule 1, the header is B'0' and the symbol-definition bit string is created by comparing each Type 1 slice-pair with an all-zeros reference slice-pair as shown in Figure J-2. The resultant bit string, including the header, is thus:

```
0110 0010 1000 1000 1110 0001 0100 0110 0100 1000 1010 1100
0010 1001 0100 1011 1111 1111 00
```

Note that the original Type 1 bit string of 144 bits is compressed to 74 bits.



## Example of Algorithm Using Comparison Rule 2

Slice-pairs being compared according to Rule 2:		Step 1: Compare slice-pairs. For a match, generate B'0'. For a mismatch, generate B'1', and do step 2.			
Reference slice-pair	Type 1 slice-pair	Step 2: Compare digits. For a match, generate B'0'. For a mismatch, generate B'1' followed by a copy of the bits in the nonmatching Type 1 digit.			
		Digit 1	Digit 2	Digit 3	Digit 4
X'0010'	X'1010'	1	1 0001	0	0
X'1000'	X'0000'	1	1 0000	0	0
X'0000'	X'0000'	0			
X'0080'	X'8040'	1	1 1000	0	1 0100
X'4020'	X'2010'	1	1 0010	0	1 0001
X'1008'	X'0804'	1	1 0000	1 1000	0
X'0402'	X'02FF'	1	0	1 0010	1 1111
X'FF00'	X'0000'	1	1 0000	1 0000	0
X'0000'	X'0000'	0			

Figure J-3. Example of Compression Algorithm Using Comparison Rule 2

With Comparison Rule 2, the header is B'10', and the symbol-definition bit string is created by comparing each Type 1 slice-pair with a reference slice-pair composed of the previous slices as shown in Figure J-3. The resultant bit string, including the header, is thus:

```
1011 0001 0001 1000 0000 0111 0000 1010 0011 0010 0100 0101
1000 0110 0001 0100 1010 0101 1111 1111 1110 0001 0000 000
```

Note that the original Type 1 bit string of 144 bits is compressed to 95 bits.

### Example of Algorithm Using Comparison Rule 3

Slice-pairs being compared according to Rule 3:		Step 1: Compare slice-pairs. For a match, generate B'0'. For a mismatch, generate B'1', and do step 2.			
Reference slice-pair	Type 1 slice-pair	Step 2: Compare digits. For a match, generate B'0'. For a mismatch, generate B'1' followed by a copy of the bits in the nonmatching Type 1 hexadecimal digit.			
		Digit 1	Digit 2	Digit 3	Digit 4
X'0000'	X'1010'	1	1 0001	0	1 0001 0
X'1010'	X'0000'	1	1 0000	0	1 0000 0
X'0000'	X'0000'	0			
X'0000'	X'8040'	1	1 1000	0	1 0100 0
X'8040'	X'2010'	1	1 0010	0	1 0001 0
X'2010'	X'0804'	1	1 0000	1 1000	1 0000 1 0100
X'0804'	X'02FF'	1	0	1 0010	1 1111 1 1111
X'02FF'	X'0000'	1	0	1 0000	1 0000 1 0000
X'0000'	X'0000'	0			

Figure J-4. Example of Compression Algorithm Using Comparison Rule 3

With Comparison Rule 3, the header is B'110' and the symbol-definition bit string is created by comparing each Type 1 slice-pair with a reference slice-pair composed of the next-to-previous slices as shown in Figure J-4. The *resultant bit string*, including the header, is thus:

```

1101 1000 1010 0010 1100 0001 0000 0011 1000 0101 0001 1001
0010 0010 1100 0011 0001 0000 1010 0101 0010 1111 1111 1110
1000 0100 0010 0000
    
```

Note that the original Type 1 bit string of 144 bits is compressed to 112 bits.

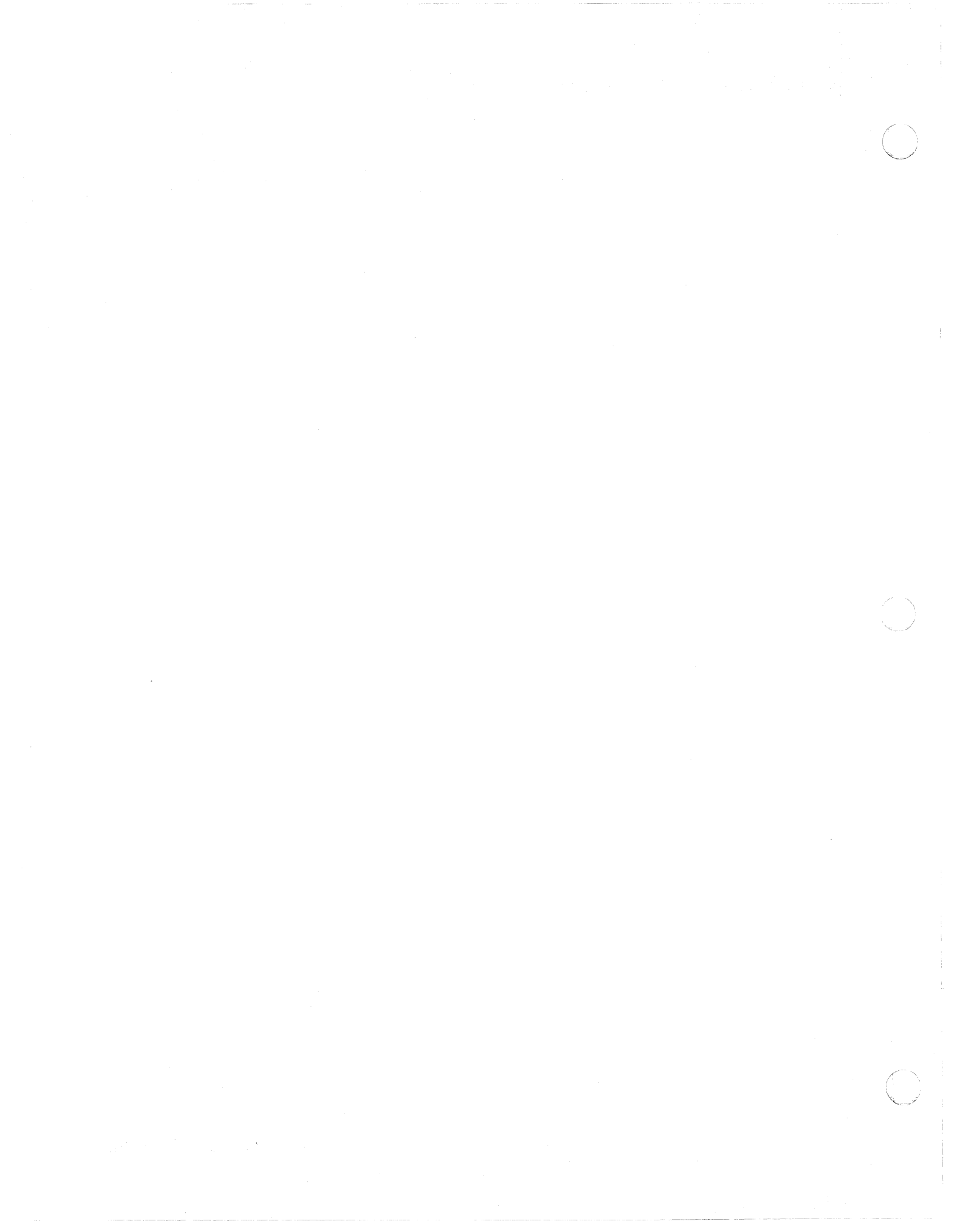

## List of Abbreviations

### A

**A.** Attention  
**ACK.** Positive acknowledge  
**ACTLU.** Activate Logical Unit  
**ACTPU.** Activate Physical Unit  
**AID.** Attention Identification  
**ALT.** Alternate  
**A/N.** Alphanumeric  
**APL.** A programming language  
**ARC.** Adapter return code  
**ASCII.** American National Standard Code for Information Interchange  
**async.** Asynchronous  
**atb.** Attribute  
**ATTN.** Attention

### B

**B.** Busy  
**BB.** Begin bracket  
**BCC.** Block check character  
**BETB.** Between-bracket state  
**BIU.** Basic information unit  
**BOC.** Bus-out check  
**bps.** Bits per second  
**BSC.** Binary synchronous communication

### C

**C.** Column  
**C&D.** Cause and diagnostic (codes)  
**CAC.** Common adapter code  
**CAW.** Channel address word  
**CC.** Control check, Chain Command (flag)  
**CCC.** Copy control character  
**CCITT.** International Telegraph and Telephone Consultative Committee  
**CCW.** Channel control word

**CID.** Connection identifier  
**CD.** Change direction  
**CE.** Channel End  
**char.** Character  
**cmd.** Command  
**CNCL.** Cancel  
**CNM.** Communication network management  
**COAX.** Coaxial (cable)  
**COMM.** Communication  
**cps.** Characters per second  
**CPU.** Central processing unit  
**CR.** Command Reject  
**CRT.** Cathode-ray tube  
**CRV.** Cryptographic Session Verification  
**CSW.** Channel status word  
**ctl.** Control  
**ctr.** Counter  
**CTS.** Clear to Send  
**CU.** Control unit  
**CUE.** Control Unit End  
**CUG.** Closed user group

### D

**D.** Display  
**DAA.** Data access arrangement  
**DAF^o.** Destination address field prime (local address of SLU)  
**DB.** Device Busy  
**DC.** Data Check  
**DCE.** Data-Circuit Terminating Equipment  
**DDSA.** Digital Data Service Adapter  
**DE.** Device End  
**deact.** Deactivate  
**dec.** Decimal  
**DEL.** Delete

**DEV.** Device

**DISC.** Disconnect

**DLE.** Data link escape

**DM.** Disconnect mode

**DPKT.** Default packet (size)

**DR.** Definite response

**DSR.** Data set ready

**DTE.** Data terminal equipment

**DWND.** Default window (size)

**DUP.** Duplicate

## **E**

**EAU.** Erase All Unprotected

**EB.** End brackets

**EBCDIC.** Extended Binary-Coded Decimal Interchange Code

**EC.** Equipment Check, engineering change

**ECSA.** Extended Character Set Adapter

**EFL.** Expedited flow indicator

**EIA.** Electronic Industries Association

**EM.** End of message

**ENP.** Enable Presentation

**ENQ.** Enquiry

**EOF.** End of Field

**EOI.** End of Inquiry

**EOR.** End of Record

**EOT.** End of Transmission

**EPSN.** Extended packet sequence numbering

**ERI.** Exception response indicator

**ERP.** Error recovery procedure(s)

**ESC.** Escape

**ETB.** End of Transmission Block

**ETX.** End of Text

**EUA.** Erase Unprotected to Address

**E/W.** Erase/Write

**EX.** Exception (response)

## **F**

**FCS.** Frame checking sequence

**FF.** Forms feed

**FID.** Format identifier

**FIE.** Function interpret error

**FM.** Field mark, function management

**FMD.** Function management data

**FMH.** Function management header

**FRMR.** Frame reject response

## **G**

**GFI.** General format identifier

**GP.** General Poll

## **H**

**HDLC.** High-Level Data Link Control

**Hex.** Hexadecimal

**HNAD.** Host network (DTE) address

**HPCA.** High Performance Communication Adapter

**HT.** Horizontal Tab

**Hz.** Hertz

## **I**

**I.** Information (format)

**IC.** Insert Cursor

**ID.** Identification, identifier

**ident.** Identification

**IML.** Initial machine load, initial microprogram load

**Ind.** Indicator

**INS.** Insert

**IOPT.** Incoming call option

**IOS.** Input/Output Supervisor

**IR.** Intervention Required

**IRS.** Interrecord separator

**ITB.** End of intermediate transmission block

**K****KANA.** Katakana**kbd.** Keyboard**L****LAPB.** Link access procedure balanced**LC.** Logical channel**LCID.** Logical channel identifier**LED.** Light emitting diode**LF.** Line feed**LIC.** Last in chain**LLC.** Logical link control**LNA.** Logical network address**LRC.** Longitudinal redundancy check**LU.** Logical unit**LU/SSCP.** Logical unit/system services control point**M****MCL.** Multiuse Communication Loop**MDT.** Modified data tag**MHS.** Magnetic hand scanner**MPF.** Mapping field**MPP.** Maximum presentation position**MSR.** Magnetic slot reader**N****NA or N/A.** Not applicable**NAK.** Negative acknowledge**NIA.** Network Interface Adapter**NCP.** Network control program**NL.** New Line**NMVT.** Network Management Vector Transport**NOLLC.** No logical link control**NOP.** No operation**NPDA.** Network Problem Determination Application**NPKT.** Negotiated packet (size)**NRZ.** Non-return-to-zero (recording)**NS.** Nonsequenced (format)**NUL.** Null**NUM.** Numeric**NWND.** Negotiated window (size)**O****OAF⁹.** Origin address field prime**OC.** Operation Check**OCIR.** Operator Identification Card Reader**o'flo.** Overflow**P****P.** Printer, protected**PA.** Program access**PAC.** Program authorized credentials**PCKT.** Packet**PF.** Program function**PI.** Pacing indicator**PID.** Product-set ID**PIU.** Path information unit**PLU.** Primary logical unit**PRID.** Procedure-related identifier**PS.** Programmed Symbols, physical services**PSDN.** Packet switched data network**PSH.** Physical services header**PSI.** Primary to secondary indicator**PSWD.** Password**PT.** Program Tab**PU.** Physical unit**PVC.** Permanent virtual circuit**Q****QFRMR.** Qualified frame reject response**QLLC.** Qualified logical link control**QRI.** Queued response indicator**QSM.** Qualified set mode**R****R.** Row**RA.** Repeat to Address

**RB.** Read Buffer  
**RBM.** Read Buffer Modified  
**Rd Mod.** Read Modified  
**RECFMS.** Record Formatted Maintenance Statistics  
**Req.** Request  
**REQMS.** Request Maintenance Statistics  
**resp.** Response  
**RH.** Request/response header  
**RM.** Read Modified  
**RNR.** Request not ready, receive not ready  
**RPOA.** Recognized private operating agency  
**RP-Q.** Read Partition-Query  
**R/R.** Request/response  
**RR.** Request ready, receive ready  
**RSP.** Response  
**RTM.** Response Time Monitor  
**RTS.** Request to send  
**RU.** Request/response unit  
**RVI.** Reverse interrupt

**S**

**S.** Sequenced (format)  
**SA.** Selection addressing  
**SABM.** Set Asynchronous Balance Mode (command)  
**SARM.** Set Asynchronous Response Mode  
**SBA.** Set Buffer Address  
**SCS.** SNA character string  
**SDLC.** Synchronous Data Link Control  
**SF.** Start field  
**SHF.** Set Horizontal Format  
**SI.** Suppress Index  
**SIOF.** Start I/O Fast Release  
**SLU.** Secondary logical unit  
**SM.** Status modifier  
**SNA.** Systems Network Architecture  
**SNBU.** Switched network backup

**SNF.** Sequence number field  
**SNRM.** Set Normal Response Mode  
**SOH.** Start of heading  
**sol.** Solicited  
**SOR.** Start of record  
**SP.** Space, Specific Poll  
**SPD.** Selector pen detect  
**SRM.** Set Reply Mode  
**S/S.** Status and sense  
**SSCP.** System services control point  
**SSR.** Secure string record  
**STX.** Start of text  
**SUB.** Substitute  
**SVC.** Switched virtual circuit  
**SVF.** Set Vertical Format  
**sw.** Switch  
**SYN.** Synchronous idle  
**SYSREQ.** System request

**T**

**TAF.** Target address field  
**TC.** Transmission check  
**TCLS.** Throughput class  
**TCU.** Transmission control unit  
**TH.** Transmission header  
**TS.** Transmission services  
**TTD.** Temporary text delay

**U**

**U.** Unprotected  
**UA.** Unnumbered acknowledgment  
**UC.** Unit check  
**UE.** Unit exception  
**UKPSS.** United Kingdom Packet Switching Service  
**unsol.** Unsolicited  
**US.** Unit Specify

**V**

**V.** Volts

**vect.** Vector

**VFC.** Vertical forms control

**VTAM.** Virtual Telecommunications Access Method

**W**

**WACK.** Wait before transmit

**WCC.** Write control character

**WNDO.** Window

**WSF.** Write Structured Field





# Glossary

The terms in this glossary are defined here as they apply to the 3270 Information Display System.

## A

**access method.** A technique for moving data between main storage and input/output devices.

**AID.** See *attention identifier*.

**alphanumeric field.** A field that may contain any alphabetic, numeric, or special characters.

**alternate character set.** A character set, located in the terminal, from which characters are obtained for display and printing by using the graphic escape character in the data stream.

**alternate cursor.** An image reversal of each dot in the character cell at the cursor position.

**attention.** An I/O interruption generated asynchronously by a display station, usually as the result of an action taken by the operator of the device.

**attention identification (AID).** A code that the terminal sends in the inbound data stream to identify the operator action or structured field function that caused the data stream to be sent to the application program. An AID is always sent as the first byte of the inbound data stream. Structured fields in the data stream may also contain an AID.

**attribute.** A characteristic.

**attribute select keyboard.** A keyboard that enables the operator, when permitted by the program, to change the character attributes of the keyed-in character.

**attribute type.** A code that identifies the characteristics from which the associated set of attribute values can be selected. See also *extended color*, *extended highlighting*, and *character set*.

**attribute value.** A code immediately following the attribute type in the data stream that specifies a particular characteristic from the set defined by the attribute type.

**audible alarm.** A special feature that sounds a short, audible tone automatically when a character is entered from the keyboard into the next-to-last character position on the screen. The tone can also be sounded under program control.

**automatic polling.** (1) A hardware feature of a telecommunications unit that processes a polling list, polling the terminals in order and handling negative responses to polling without interrupting the central processing unit. At the end of the list, polling is automatically begun again at the beginning of the list. Synonymous with *autopoll*. (2) See also *polling*.

**automatic skip.** After entry of a character into the last character position of an unprotected display field, automatic repositioning of the cursor from a protected and numeric field to the first character position of the next unprotected display field.

**autopoll.** Same as *automatic polling*.

**auto-skip.** Same as *automatic skip*.

## B

**base color.** The capability to display or print all characters in a field, in one of four colors, on a color terminal by using combinations of the field protection and the field intensify bits of the field attribute.

**Binary Synchronous Communications (BSC).** Data transmission in which character synchronism is controlled by timing signals generated at the sending and receiving stations.

**blink.** An extended highlighting attribute value (for emphasis) of a field or character.

**block matrix.** The total array of dots that can be used to describe a graphic character for a 3270 display or printer.

**bracket.** In VTAM, an exchange of data between an application program and a logical unit which accomplishes some task.

**BSC.** See *Binary Synchronous Communications*.

**buffer address.** The address of a location in the buffer at which one character can be stored.

## C

**CCC.** See *copy control character*.

**category A terminals.** Terminals that can be attached to type A adapters. For example the 3278 and 3279 Displays, the 3287 Models 1, 2, 1C and 2C, the 3262 Models 3 and 13, and the 3289 Models 1 and 2 Printers.

**category B terminals.** Terminals that can be attached to type B adapters. For example the 3277 Display, the 3284, 3286, 3287 Models 1 and 2, and 3288 Printers.

**character attribute.** The properties of a character with respect to its color, highlighting, and character set. See also *extended field attribute*.

**character buffer.** The read/write storage used by a partition for storing character or graphic data for display or printing on a terminal.

**character position.** A location on the screen at which one character can be displayed; also, an addressed location in the buffer at which one character can be stored.

**character set.** (1) A defined collection of characters in a loadable or nonloadable set selected by means of a local character set identifier. (2) An attribute type in the extended field and character attributes. (3) An attribute passed between session partners in the Start Field Extended, Modify Field, and Set Attribute orders.

**clear indicator.** In VTAM, a SESSIONC indicator sent by one node to another that prevents the exchange of messages and responses.

**cluster control unit.** (1) A device that can control the input/output operations of more than one device. A remote cluster control unit can be attached to a host CPU only via a communications controller. A cluster control unit may be controlled by a program stored and executed in the unit, or it may be controlled entirely by hardware. (2) See also *communications controller*.

**command.** An instruction that directs a control unit or device to perform an operation or a set of operations.

**communications controller.** (1) A type of communication control unit whose operations are controlled by a program stored and executed in the unit. Examples are the IBM 3704 and 3705 Communications Controllers. (2) See also *cluster control unit*.

**control character.** A character used in conjunction with a Write command to specify that a control unit is to perform a particular operation.

**control codes.** The hexadecimal values hex 00 through hex 3F, and hex FF in the 3270 data stream.

**conventional 3270.** A locally attached 3270 terminal or a remotely attached 3270 terminal that uses the BSC line discipline.

**copy control character (CCC).** A character used in conjunction with the Copy command to specify the type of data to be copied.

**copy operation.** An operation that copies the contents of the buffer from one display station or printer to another display station or printer attached to the same control unit.

**cursor.** A unique symbol that identifies a character position in a screen display, usually the character position at which the next character to be entered from the keyboard will be displayed.

## D

**data stream.** All data transmitted through a channel in a single read or write operation to a display station or printer.

**data transfer.** In telecommunications, the sending of data from one node to another.

**data transfer mode.** A set of facilities (including the macro instructions needed to use them) that enable the application program to communicate with terminals.

**definite response 1.** In VTAM, a response that indicates whether its associated message was successfully forwarded to its final destination (such as the display screen of an output device).

**definite response 2.** In VTAM, a response that indicates that the node sending the response has accepted recovery responsibility for the associated message.

**designator character.** A character that immediately follows the attribute character in a selector-pen-detectable field. The designator character controls whether a detect on the field will or will not cause an attention. For a nonattention-producing field, the designator character also determines whether the modified data tag for the field is to be set or reset as the result of a selector-pen detect.

**detectable.** An attribute of a display field; determines whether the field can be sensed by the selector pen.

**display field.** A group of consecutive characters (in the buffer) that starts with an attribute character (defining the characteristics of the field) and contains one or more alphanumeric characters. The field continues to, but does not include, the next attribute character.

**dot.** One point in a printer or display block matrix.

## E

**Erase All Unprotected (EAU) command.** A command that clears all unprotected fields to nulls, resets modified data tags in all unprotected fields, unlocks the keyboard, resets the attention identifier, and repositions the cursor to the first character of the first unprotected field.

**Erase Unprotected to Address (EUA) order.** An order that erases all unprotected positions (inserts nulls) from the current buffer address up to, but not including, the specified stop address.

**Extended Attribute Buffer (EAB).** A buffer for storing extended field attributes and character attributes.

**extended color.** (1) A capability that allows color terminals to display or print fields or characters in colors using extended field and character attributes. (2) An attribute type in the extended field attribute and character attribute.

**extended field attribute.** Additional field definition to the field attribute that controls defining additional properties such as color, highlighting, character set, and field validation. The extended field attribute is altered by information passed in the Start Field Extended and Modify Field orders.

**extended highlighting.** (1) A function that provides blink, reverse video, and underscore for emphasizing fields or characters on devices supporting extended field attributes and character attributes. (2) An attribute type in the extended field attribute and character attribute. (3) An attribute passed between session partners in the Start Field Extended, Modify Field, and Set Attribute orders.

## F

**field.** See *display field*.

**field attribute.** A control character stored in the character buffer in the first character position of a field. For those devices supporting the 3270 data stream, a field attribute defines protected/unprotected, alphanumeric/numeric, detectable/nondetectable, display/nondisplay, intensity, and modified data tag (MDT).

**field inherit.** A bit setting in the character attribute which defaults the character properties to the extended field attributes or device default if the buffer is unformatted.

**FME response.** See *definite response 1*.

**formatted display.** A screen display in which a display field, or fields, has been defined as a result of storing at least one attribute character in the display buffer.

## G

**general polling.** (1) An input technique for remote 3270 devices in which special invitation characters are sent to a device control unit instructing that control unit to begin transmission from all devices ready to enter data. (2) See also *polling* and *specific polling*.

## I

**Insert Cursor (IC) order.** An order that displays the cursor at the current buffer address.

**intensified display.** An attribute of a display field; causes data in that field to be displayed at a brighter level than other data displayed on the screen.

## L

**leased line.** See *nonswitched line*.

**line control characters.** Characters that regulate the transmission of data over a line; for example, delimiting messages, checking for transmission errors, and indicating whether a station has data to send or is ready to receive data.

**local.** Pertaining to the direct attachment of devices by channels to a host CPU. Contrast with *remote*.

**logical unit.** The combination of programming and hardware of a teleprocessing subsystem that comprises a terminal for VTAM.

## M

**MDT.** See *modified data tag*.

**modified data tag (MDT).** A bit in the attribute character of a display field, which, when set, causes that field to be transferred to the channel during a read-modified operation. The modified data tag may be set by a keyboard input to the field, a selector-pen detection in the field, a card read-in operation, or program control. The modified data tag may be reset by a selector-pen detection in the field, program control, or ERASE INPUT key.

**Modify Field (MF).** An order that allows specified field attributes to be modified.

## N

**nonswitched line.** A connection between a remote 3270 unit and a computer that does not have to be established by dialing.

## O

**order code.** A code that may be included in the write data stream transmitted for a display station or printer; provides additional formatting or definition of the write data.

**order sequence.** A sequence in the data stream that starts with an order code and includes a character address and/or data characters related to the order code.

**outgoing group.** In systems with TCAM, that section of a message handler that manipulates outgoing messages after they have been removed from their destination queues.

## P

**polling.** A technique by which each of the terminals sharing a communications line is periodically interrogated to determine whether it requires servicing.

**Prepare to Read (PTR).** A command for a local 3274-1D that allows the terminal to know the next program action.

**program attention key.** Any key on the keyboard that solicits program action by generating an I/O interruption. The keys are the CLEAR key, ENTER key, TEST REQ key, CNCL key, program function keys, and program access keys. Each program attention key is associated with a unique attention identification (AID) character.

**program function (PF) key.** A program attention key that may be defined to solicit program action that usually requires data to be read from the buffer of the display station. If a Read Modified command is issued in response to the program function key interruption, the attention identifier (AID) and all display fields in which the modified data tags are set are transferred to the program.

**Program Tab (PT) order.** An order that advances the current buffer address to the address of the first character location of the next unprotected field.

**Programmable Symbols (PS).** Customer-defined symbols, a maximum of 190 symbols to a programmed symbol set.

**protected field.** A display field for which the display operator cannot use the keyboard or operator identification card reader to enter, modify, or erase data.

## R

**remote.** Pertaining to the attachment of devices to a central computer through a communication control unit. Contrast with *local*.

**Repeat to Address (RA) order.** An order that stores a specified alphanumeric or null character in up to 480 buffer locations, starting at the current buffer address and ending at, but not including, the specified stop address.

**RRN response.** See *definition response 2*.

## S

**SDLC.** Synchronous data link control.

**selector pen.** A pen-like instrument that may be attached to the display station as a special feature. When pointed at a detectable portion of an image and then activated, the selector pen senses the presence of light at a display field and produces a selector-pen detect.

**selector-pen detect.** The sensing by the selector pen of the presence of light from data in a display field that has the detectable attribute. Depending on the designator character of that display field, the detection and location information is identified on the screen (and stored in the buffer) or may produce an interrupt that is transmitted to the CPU.

**SESSIONC indicators.** In VTAM, indicators that can be sent from one node to another without using SEND or RECEIVE macro instructions. SDT, clear, and STSN are SESSIONC indicators. All SESSIONC indicators are sent with a SESSIONC macro instruction.

**Set Attribute (SA) order.** An order that associates attributes in the EAB with individual characters.

**Set Buffer Address (SBA) order.** An order that sets the buffer address to a specified location.

**specific polling.** (1) A polling technique that sends invitation characters to a device to find out whether the device is ready to enter data. (2) See also *general polling* and *polling*.

**Start Field (SF) order.** An order that indicates a specified location which contains an attribute byte and not a text character.

**Start Field Extended (SFE) order.** An order that generates an extended field attribute in the EAB and at the current buffer location.

**Structured Field.** A data stream format that permits variable-length data and controls to be parsed into its components without having to scan every byte.

**Suppress Index (SI) order.** An order that generates the suppress index character, valid only for the 3288-2 printer. This character inhibits a line index to allow overprinting.

**switched line.** A communication line in which the connection between the computer and a remote terminal is established by dialing.

## T

**telecommunications network.** In a telecommunication system, the combination of all terminals and other telecommunication devices and the lines that connect them.

**terminal.** (1) A point in a system or communication network at which data can either enter or leave.  
(2) Any device capable of sending and receiving information over a communication channel.

**terminal-initiated logon.** A logon request that originates from the terminal.

## U

**unformatted display.** A screen display in which no attribute character (and, therefore, no display field) has been defined.

**unprotected field.** A display field for which the display station operator can manually enter, modify, or erase data.

## W

**WCC.** See *write control character*.

**wraparound.** The continuation of an operation (for example, a read operation or a cursor movement operation) from the last character position in a buffer to the first character position in the buffer.

**write control character (WCC).** A character used in conjunction with a Write command to specify that a particular operation, or combination of operations, is to be performed at a display station or printer.

**Write Structured Field (WSF) command.** A command used for processing structured fields.

## 3

**3270 data stream.** A coded character data stream.

# Index

## A

abbreviations M-1  
abort function 5-60  
ACF/VTAM Encrypt/Decrypt feature F-1  
ACK 0 (Even Acknowledge) 4-8  
ACK 1 (Odd Acknowledge) 4-8  
activate logical unit 5-3, 5-4  
activate physical unit 5-3, 5-4  
ACTLU 5-3-5-9  
ACTPU 5-3-5-9  
address byte (local operation) 3-1  
AID configurations 1-42 (Fig. 1-15)  
alert  
    alert generation 8-24  
    alert parameters 8-26  
    application program check message 8-33  
    control unit error message 8-32  
    customizing 8-31  
    device hardware error message 8-32  
    error code definitions 8-46  
    host requirements 8-22  
    message formats 8-31  
    negative responses 8-30  
    Network Problem Determination Application (NPDA) 8-23  
    operator-generated alert messages 8-28  
        procedure for sending 8-54  
    queuing 8-30  
    reportable errors 8-25  
    SNA host support 8-22  
    SNA alert function 8-19  
    3274 requirements 8-22  
alphameric attribute C-6  
alternate cursor C-1  
APL keyboards D-9  
APL/Text Feature (Appendix D) D-1-D-13  
APL/Text I/O interface codes D-3, D-4  
APL/Text National Use differences D-5  
asynchronous status 3-9, 5-50, 5-51  
attribute character bit assignments 2-7 (Fig.2-5)  
attribute characters 2-6  
attribute defaults 1-43  
attribute select keys C-14  
attribute types and values 1-42  
attributes 1-15, 1-42, 1-43  
automatic polling 4-2

## B

Base Color 2-6, 2-8  
Base Color switch 2-6, 2-8  
BCC (see block check character)  
between bracket sharing 5-39  
Between Bracket state 5-30  
Between Brackets state 5-29, 5-30  
Bid 5-15  
Binary Synchronous Communication (see BSC)  
Bind 5-10-5-13  
Bind check 5-62  
Bind command processing with Encrypt/Decrypt F-3  
Bind default 5-61  
block check character 4-2  
blocking write data 4-17  
bracket/chain — host-initiated 5-24  
bracket/chain — host/SLU contention 5-25  
bracket/chain — LU Type 2 5-23

bracket protocol 5-17-5-19  
Bracket state errors 5-30  
Bracket states 5-29  
BSC (Binary Synchronous Communication)  
    Copy command with APL/Text D-13  
    line discipline 1-73  
    remote operations 4-1  
buffer addressing for terminals 2-1-2-4  
buffer addressing (12/14 bit) 1-16  
buffer data relationship to printed data 2-21  
buffer size (printers) 2-51

## C

Cancel 5-14, 5-28  
Cancel Print switch 2-29  
Carriage Return (CR) 2-23  
CAW 3-1  
CCW 3-1, 4-1, 4-11  
CCW error recovery 5-54  
Chaining 5-19, 5-20  
chaining of commands (local operation) 3-3  
change direction 5-20  
channel commands 5-45 (Fig. 5-16)  
channel-detected errors 3-12  
channel-detected errors (SNA) 5-51  
channel programs 3-1  
character display attribute 2-5  
character generator error 2-50  
character set differences 1-74, 1-75  
channel program (BSC) 4-1  
Chase 5-14  
Clear 5-13  
code structures for BSC operations 4-1  
color attribute type 2-9, 2-10  
command-chaining error conditions 2-52  
command codes 1-14 (Fig. 1-8)  
command flow (SNA) 5-4  
command initiation (local operation) 3-2  
command sequences 4-10, 4-11  
commands 1-13, 1-14  
contention for printer use 2-47  
contention state 5-24  
control character I/O codes 1-10 (Fig. 1-6)  
control commands 1-65  
control mode (BSC) 4-3  
copy buffer transfers 1-65-1-68  
Copy command 1-65  
copy control character (CCC) 1-65, 1-66  
copy data stream 1-66  
cursor C-1  
customizing options with APL/Text D-2

## D

DACTLU 5-8  
DACTPU 5-3, 5-7  
DAF 5-5  
data flow 1-3  
data link control characters 4-6, 4-7  
data link errors 5-33  
Data Pending states 1-59  
data streams 1-12  
data traffic state 5-29  
data transfer 1-3  
deactivate logical unit (DACTLU) 5-3, 5-7

deactivate physical unit (DACTPU) 5-3, 5-7  
Dead-Key operations C-13  
deciphering messages F-1  
definite responses 5-21  
DES algorithm F-1  
designator characters H-2, H-3  
device addressing 1-11  
device addressing for SNA terminals 5-6  
device-detected errors 3-11  
disconnect 5-62  
display buffer addresses 2-3, 2-4  
display fields 2-2  
displays, model differences 2-16  
DUP character 2-18

## E

enciphering messages with Encrypt/Decrypt F-1  
Encrypt/Decrypt F-1  
ending status 3-7, 5-49-5-50  
ending status bit configurations 3-8 (Fig.3-5)  
EOT to a text block 4-30  
Erase All Unprotected command 1-59, 1-65  
Erase Unprotected to Address order 1-15, 1-36  
Erase/Write command 1-18, 1-19  
ERP1 state 5-29  
error recovery procedures  
    3274-1B, -1D 3-11  
    remote BSC 4-27-4-30  
    SNA 5-70  
error recovery protocols 5-29  
errors detected (remote BSC) 4-30  
establishing cryptographic sessions F-3  
ETB 4-2  
ETX 4-2  
exchange station ID 5-58  
extended attributes 2-5, 2-8  
extended color 2-9, 2-10  
extended highlighting 2-9

## F

field attribute character 2-6, 2-7  
field attribute type 2-6, 2-7  
FM character 2-18  
FM data 5-17  
format control with shared printers 2-48  
formatted display images 2-2, 2-5  
forms feed (FF) 2-18, 2-22  
Function Management Header 1 1-25

## G

General Poll sequences 4-11-4-16

## H

host acknowledgment 1-61  
host-initiated local copy with SNA/SDLC 2-45  
host interference with operator copy 2-45  
host retry 1-58

## I

In Bracket state 5-30  
inbound message handling 5-37  
Inbound Transparent Transmission 4-4  
Inbound Transmissions 1-58  
indicator codes A-3-A-43  
information (I) frame 5-59

## X-12

initial status 5-46  
INOP 1-58  
Insert Cursor order 1-15, 1-38  
Integrated Communications Adapter 4-1  
interface codes 1-4-1-10 (Figs. 1-3-1-6)  
interface operations (local) 3-1

## K

### Katakana

interface codes E-1, E-2  
I/O interface codes for APL/Text D-6, D-7  
shift keys (3278) E-4  
shift operations E-3  
unique information E-3  
key functions (Appendix C) C-1-C-19  
key generation, encrypt/decrypt F-1  
key management, encrypt/decrypt F-1  
keyboard functions C-2, C-3  
keyboard types C-2

## L

line formatting 2-20  
Link Test Statistics (RECFMS) G-1  
Load Programmed Symbols (LPS) 1-26  
loading printer matrix 2-34-2-36  
local attachment 3-1  
local control units (non-SNA) 3-1  
local copy function 2-30  
local copy function with BSC 2-41  
local copy with APL/Text D-13  
local operations (non-SNA) 3-1  
logical unit status (LUSTAT) 5-67  
LU status (LUSTAT) 5-16  
LU type 1 5-20  
LU type 2 5-21  
LU type 2 screen size Bind 1-21  
LU type 3 1-23, 5-21  
LU type 3 Bind format 1-24  
LU-LU error reporting 5-33  
LU-LU sessions, types of 5-3  
LUSTAT 5-67  
LUSTAT inbound 5-29

## M

magnetic hand scanner (MHS) H-4-H-21  
magnetic slot reader (MSR) H-4-H-21  
magnetic-stripe reading devices H-4-H-6  
master station 4-3  
matrix structure 2-33  
message handling 5-36, 5-37  
message response 4-16 (Fig. 4-3)  
MF order 1-15, 1-40  
mode transitions 2-38  
Modify Field (MF) order 1-15, 1-40, 1-41  
multipoint data link mode 4-1

## N

NAK (negative acknowledge) 4-8  
National Use differences for APL/Text D-5  
New Line (NL) 2-22, 2-52  
No Operation command 1-65, 1-72  
nonsequenced acknowledgment 5-58  
nonswitched line data link control 6-2  
Normal Read state 1-59  
Numeric Lock feature C-16

## O

OAF 5-6  
operational sequences (BSC) 4-10  
operator identification card reader H-21  
operator-initiated copy 2-43  
operator symbols (Appendix B) B-1-B-19  
Orders 1-14, 1-36-1-41  
outbound message handling 5-36

## P

pacing 5-20  
page length control 2-23  
Pending Begin Bracket state 5-29, 5-30  
PLU (primary logical unit) 5-2  
poll sequences 4-11  
primary logical unit 5-2  
print classes 2-33, 2-34  
Print key 2-43, 2-44  
print line length 2-20  
Printer Authorization Matrix 2-31-2-42  
Printer Authorization Matrix structure 2-33-2-36  
printer class structure 2-32  
printer control (SNA) 5-39  
printer error conditions 2-50  
printer formatting 2-30  
printer local mode 2-31  
printer matrix  
  defining 2-32, 2-33  
  device descriptors 2-36  
  loading 2-34  
  screen format 2-36  
printer model-dependent differences 2-51  
printer Mono/Dual Case control 2-48  
Printer mode 2-31  
Printer Not Assigned condition 2-46  
Printer Not Functional condition 2-46  
printer orders 2-22  
printer selection 2-41  
printer shared mode 2-32  
Printer Status symbols 2-39  
printer System mode 2-32  
printer types 2-19  
printer operations 2-23, 2-25  
Program Attention switch 2-31  
Program Tab order 1-15, 1-38  
programmed cryptographic facility F-1  
programmed symbol set 2-11  
protected attribute 2-6, 2-7  
protected messages 1-74

## Q

Query Reply Structured Fields 1-49-1-58

## R

RCV (receive) state 5-27  
Read Buffer command 1-44  
Read CCW sequence 5-52  
Read Command processing 1-61  
read heading 1-45  
Read Modified command 1-45  
Read Modified All command 1-49  
Read Partition-Query processing 1-59  
Read states 1-58  
Read State transitions 1-59  
Read type command sequences 4-21-4-26  
Ready to Receive (RTR) 5-16

Receive state 5-27  
recovery from error conditions A-3-A-43  
redundancy checking 4-6  
remote chaining (BSC) 4-11  
remote control unit and device addressing 4-14, 4-15  
remote operations  
  BSC 4-1  
  BSC channel programs 4-1  
  SDLC 5-56  
Repeat to Address order 1-15, 1-39  
request/response  
  header 5-2  
  unit 5-2  
required cryptographic sessions F-2  
Reset/Active state 5-23  
Response Time Monitor (RTM)  
  boundary definition 8-2  
  customizing 8-6  
  counter definition 8-2  
  devices supported 8-2  
  distributed function device interface 8-10  
  end-of-transaction definition 8-3  
  host interface 8-7  
  host request format 8-11  
  host requirements 8-1  
  last transaction time indicator (LTTI) 8-5  
  log display 8-3  
    log display procedure 8-51  
  log format 8-4  
  log reset 8-3  
    log reset procedure 8-53  
  LTTI 8-5  
  LTTI display procedure 8-54  
  LTTI formats 8-5  
  negative responses 8-10  
  response time definition 8-2  
  RTM definition 8-7  
  solicited data 8-8  
  unsolicited data 8-9  
  3274 requirements 8-1  
  3274 response format 8-16  
Restart Reset command 5-55  
Retry States 1-60  
reverse video 2-16  
RH (request/response header) 5-2  
RTR 5-16  
RU category 5-6  
RU lengths 5-30  
RU (request/response unit) 5-2  
RVI to selection addressing sequence 4-30

## S

SA order 1-15, 1-41  
screen size, setting 5-35  
SCS (SNA character string) control codes 2-25  
SCS Data structured field 1-35  
SDLC station address 5-59  
SDT 5-14  
Secondary colors 2-14  
secondary logical units 5-2  
secondary LU key F-2, F-3  
Security keylock 1-76, 2-18  
segmenting  
  inbound 5-32  
  outbound 5-32  
Select command 1-65, 1-69-1-71  
Select RB command 1-70  
Select RBP command 1-71  
Select RM command 1-70



- Select RMP command 1-70
- Select WRT command 1-71
- selecting control units 3-1
- selecting print classes 2-31-2-33
- selection addressing 4-17, 4-18
- selection addressing sequence 4-17
- Selection (local ops) 3-2
- selective cryptographic sessions F-2
- selector-light-pen operations H-1
- Send state 5-24
- sense bit description 1-73
- sense bits, abbreviations for 5-48
- sense codes (SNA) 5-63
- Sense command 1-72
- Sense conditions 5-48 (Fig. 5-19)
- Sense ID command 1-72
- sequence error recovery procedures 5-59
- session processing states 5-23
- Set Attribute (SA) order 1-15, 1-41
- Set Buffer Address order 1-14, 1-37
- Set Normal Response 5-58
- setting screen size 1-19-1-25
- SF order 1-15, 1-36
- SFE order 1-15, 1-40
- shared mode 7-39
- short read 1-48
- Shutdown 5-17
- Shutdown command 5-8
- Shutdown Complete 5-17
- Signal 5-15
- signal from host 5-26 (Fig. 5-10)
- Single-plane symbol set 2-14
- slave station 4-3
- SLU 5-2
- SNA
  - Bind command 5-10
  - character string for printers 2-19, 2-26-2-31
  - commands 5-8 (Fig. 5-3)
  - commands received 5-22 (Fig. 5-5)
  - commands sent 5-22 (Fig. 5-6)
  - commands, types of 5-7-5-20
  - local control units 3-1
  - printer control 5-39
  - reference data 5-61
  - responses 5-21
  - sense codes 5-63
  - sessions 5-2
- source device list 2-35
- Specific Poll sequence 4-11, 4-12, 4-14
- split vertical (|) character 2-52
- SRM structured field 1-34, 1-35
- SSCP 5-2-5-4
- SSCP-PU session 5-3
- SSCP-Secondary LU session 5-3
- SSCP-SLU contention 5-36
- start data traffic 5-14
- Start Field Extended (SFE) order 1-15, 1-40
- Start Field order 1-15, 1-36
- Start I/O Fast Release 3-8
- Status and Sense bytes 4-21, 4-24, 4-25
- Status and Sense conditions (Remote BSC) 4-28
- status bits, abbreviations for 3-4
- Status byte generation 3-4, 3-5
- Status Indicator Codes (Appendix A) A-3-A-43

- Structured Field functions 1-26-1-28
- Structured Field orders 1-40
- SUB character 1-44
- Summary Counters (RECFMS) G-1
- Suppress Index (SI) 2-22
- symbol set attribute type 2-10
- sync check error 2-50
- system logoff 5-39
- system logon 5-38
- System mode 2-32, 5-39
- System Services Control Point (SSCP) 5-3

## T

- tab key C-4
- terminal ID 5-59
- terminal identification and addressing 5-59
- terminal master key F-4
- terminal master key verification F-4
- terminating LU-LU session 5-5
- test command/response 5-58
- test request function 1-73
- test request read 1-48
- test request read heading 1-48
- text blocking 4-1, 4-5
- text mode 4-3
- text print
  - data streams (APL/Text) D-2
  - I/O interface codes D-8
- TH (transmission header) 5-2
- timeout controls 5-60
- transmission formats, SNA/SDLC 5-1, 5-2
- transmission header 5-2, 5-5
- transparent mode 4-3
- transparent monitor mode 4-3
- tributary stations 4-2
- triple-plane symbol set 2-13
- type 1 LU-LU session 5-3
- type 2 LU-LU session 5-3
- type 3 LU-LU session 5-3
- typewriter/APL keyboard D-9
- typewriter/text keyboard D-11

## U

- Unbind 5-13
- unformatted displays 2-2
- usable area 1-52
- uppercase and lowercase printouts 2-51

## V

- Vertical Forms Control (VFC) 2-23

## W

- Write Control Character (WCC) 1-16, 1-17
- World Trade considerations for APL keyboard D-10
- Write CCW sequence 5-52
- Write commands 1-16-1-25
- Write commands (LU type 3) 1-23
- Write-type command sequences 4-17-4-21
- WSF Command 1-24, 1-25

## X

XID 5-58, 5-59  
X.21 Host Load Matrix key 2-35  
X.21 Switched Network Adapter feature  
  Call Progress signals I-9  
  control unit/terminal responses I-7  
  Dial-In state I-5  
  extension mode I-4  
  functions I-1

inquiry facility I-10  
keys and indicators I-2, I-3  
Ready state I-5

## Numerals

87-key typewriter/APL keyboard D-9  
87-key typewriter/text keyboard D-11  
88-key Katakana typewriter/APL keyboard D-10



IBM 3270 Information Display System  
3274 Control Unit  
Description and Programmer's Guide

READER'S  
COMMENT  
FORM

Order No. GA23-0061-1

This manual is part of a library that serves as a reference source for systems analysts, programmers, and operators of IBM systems. This form may be used to communicate your views about this publication. They will be sent to the author's department for whatever review and action, if any, are deemed appropriate. Comments may be written in your own language; use of English is not required.

IBM may use or distribute any of the information you supply in any way it believes appropriate without incurring any obligation whatever. You may, of course, continue to use the information you supply.

Note: Copies of IBM publications are not stocked at the location to which this form is addressed. Please direct any requests for copies of publications, or for assistance in using your IBM system, to your IBM representative or to the IBM branch office serving your locality.

How did you use this publication?

- |                          |                                     |                          |                        |
|--------------------------|-------------------------------------|--------------------------|------------------------|
| <input type="checkbox"/> | As an introduction                  | <input type="checkbox"/> | As a text (student)    |
| <input type="checkbox"/> | As a reference manual               | <input type="checkbox"/> | As a text (instructor) |
| <input type="checkbox"/> | For another purpose (explain) _____ |                          |                        |

Is there anything you especially like or dislike about the organization, presentation, or writing in this manual? Helpful comments include general usefulness of the book; possible additions, deletions, and clarifications; specific errors and omissions.

Page Number:

Comment:

Note: Staples can cause problems with automated mail sorting equipment.  
Please use pressure sensitive or other gummed tape to seal this form.

What is your occupation? _____

Newsletter number of latest Technical Newsletter (if any) concerning this publication: _____

If you wish a reply, give your name and address:

IBM branch office serving you _____

Thank you for your cooperation. No postage stamp necessary if mailed in the U.S.A. (Elsewhere, an IBM office or representative will be happy to forward your comments or you may mail directly to the address in the Edition Notice on the back of the title page.)

Reader's Comment Form

Cut or Fold Along Line

Fold and tape

Please Do Not Staple

Fold and tape



NO POSTAGE  
NECESSARY  
IF MAILED  
IN THE  
UNITED STATES

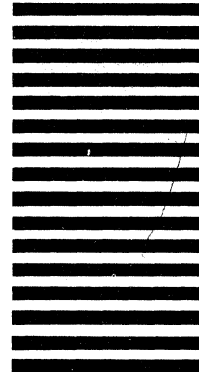

**BUSINESS REPLY MAIL**  
FIRST CLASS PERMIT NO. 40 ARMONK, N.Y.

POSTAGE WILL BE PAID BY ADDRESSEE:

International Business Machines Corporation  
Department 52Q  
Neighborhood Road  
Kingston, New York 12401

Fold and tape

Please Do Not Staple

Fold and tape

IBM 3270 IDS 3274 Control Unit Description and Programmer's Guide (File No. S360/S370/S3/4300/8100-09) Printed in U.S.A. GA23-0061-1

