

IBM 3178 Display Station Operator Reference Guide

**GA18-2128-3
File No. 3270/4300-09**

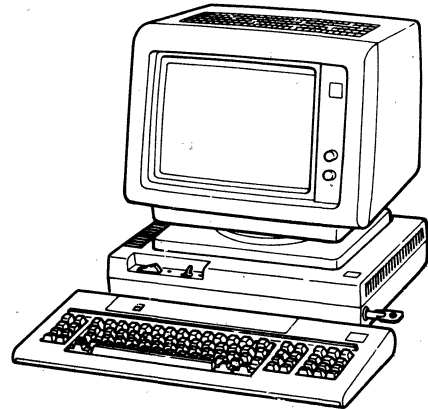

Fourth Edition (January 1984)

This revision obsoletes GA18-2128-2. This revision incorporates information about Model C4 in the "Keyboard Key Functions," and "Customer Problem Analysis and Resolution" sections. Changed pages are marked with vertical bar at left margin.

Changes are made periodically to the information herein; any such changes will be reported in subsequent revisions or Technical Newsletters.

References in this publication to IBM products, programs, or services do not imply that IBM intends to make these available in all countries in which IBM operates. Any reference to an IBM program product in this

© Copyright International Business Machines Corporation 1982, 1983, 1984

publication is not intended to state or imply that only IBM's program product may be used. Any functionally equivalent program may be used instead.

Publications are not stocked at the address given below. Requests for IBM publications should be made to your IBM representative or to the IBM branch office serving your locality.

A form for readers' comments is provided at the back of this publication. If the form has been removed, comments may be addressed to IBM Corporation, Department 812J, 1133 Westchester Avenue, White Plains, New York 10604. U.S.A. IBM may use or distribute whatever information you supply in any way it believes appropriate without incurring any obligation to you.

How to Use This Guide

This guide is divided into four parts: "Setup and Preparation," "Operator Reference Information" (ORI), "Customer Problem Analysis and Resolution" (CPAR), and "Packing Instructions." "Setup and Preparation" helps you to complete your station installation. The ORI has three sections: "Keyboard Key Functions," "Video Element Procedures" and "Operator Messages." The CPAR helps you to isolate the failing element. "Packing Instructions" guides you through packing the failing element for repair.

Each part or section is identified by a black tab at the bottom edge of the page.



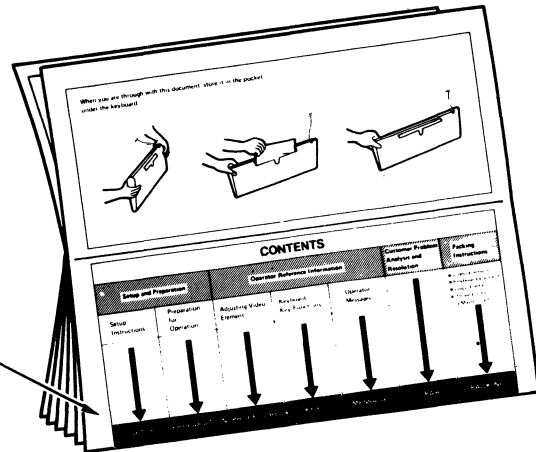



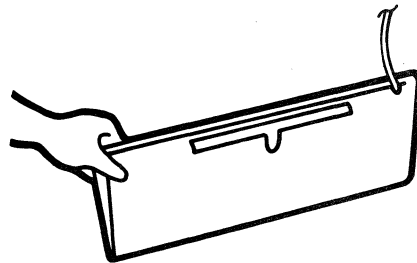
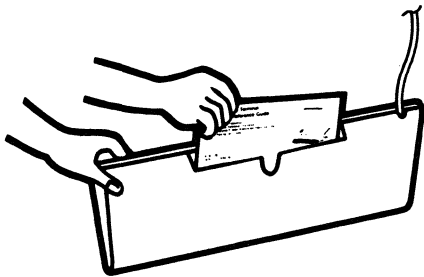
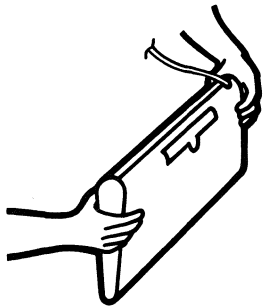

1. From "CONTENTS," find the part or section you want.
2. Follow the arrow to the black tab at the bottom edge of the page. Next, leaf through the guide until you find the same black tab.
3. If you encounter any problem with your display station, refer to "Customer Problem Analysis and Resolution (CPAR)."



When you are through with this document, store it in the pocket under the keyboard.



CONTENTS

Setup and Preparation		Operator Reference Information			Customer Problem Analysis and Resolution	Packing Instructions
Setup Instructions	Preparation for Operation	Adjusting Video Element	Keyboard Key Functions	Operator Messages		<ul style="list-style-type: none">• Video Element• Keyboard Element• Logic Element• Three Elements in a Master Carton 
						SETUP
					CPAR	PACKING
			KEYS	MESSAGES		

Setup and Preparation

Setup Instructions

- 1 Check that all the parts shown below are included in the package.

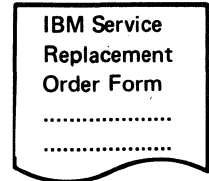
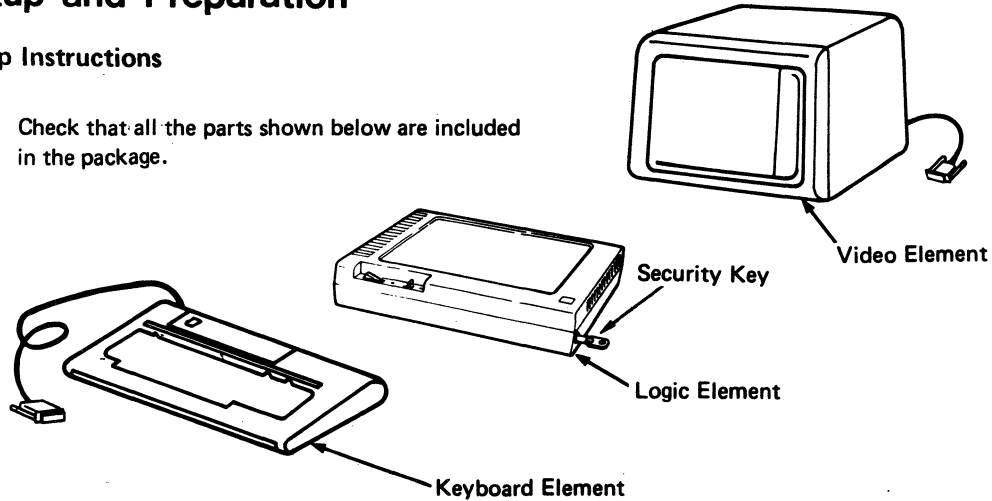



Power Cable

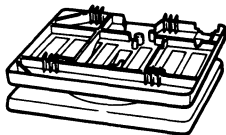

Video Element Stand

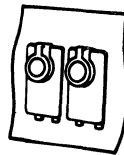

Foot Assembly
(IBM part number 5641297)

- Notes:**
1. Save all packaging material for use if service is required.
 2. The video element stand is not covered by the IBM maintenance agreement. You may purchase replacements from the local FE branch office parts station in the U.S. and from your IBM sales representative in the Americas and Far Eastern countries.
 3. Check that the security key is in the keylock of the logic element.
 4. It is your responsibility to record the key identification number at setup time in case the keys are lost and replacement may be needed.

2

Place the keyboard upside down and attach the feet according to the following illustrations.

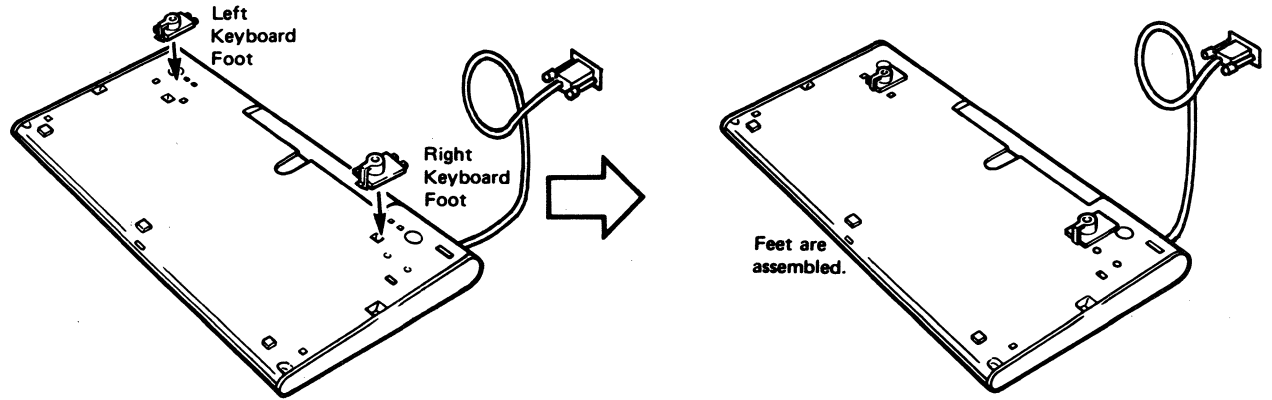

Assembling the left keyboard foot

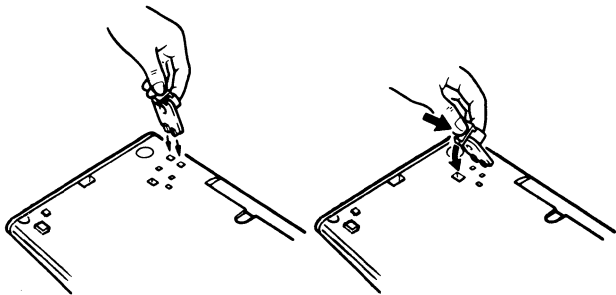

Assembling the right keyboard foot

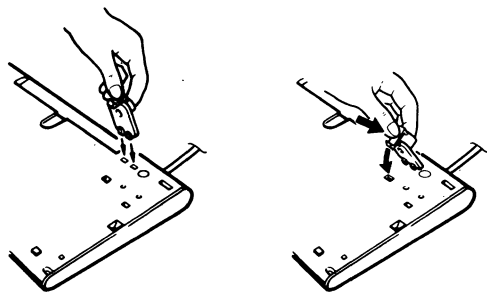

3

Place the video element on its top.

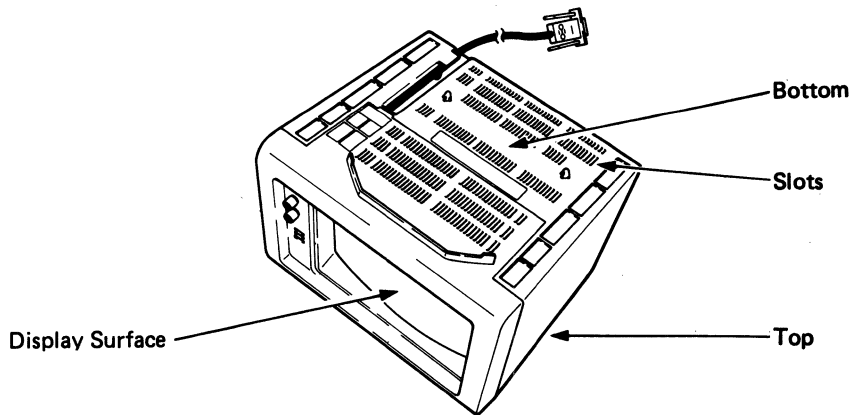

Caution:

**Canadian Standard Association (CSA)
Certification requires that the video element
stand be attached to the video element. This
CSA Certification is void if the stand is not
installed or if it is removed after installation.**

4

Set the stopper of the stand to either position shown.

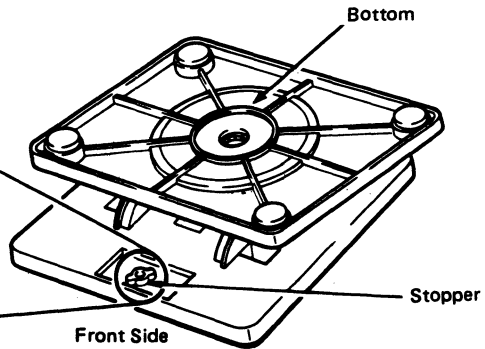
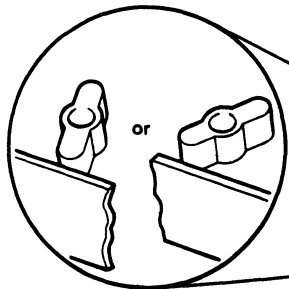

5 Insert the left three rear hooks of the stand in the slots of the video element

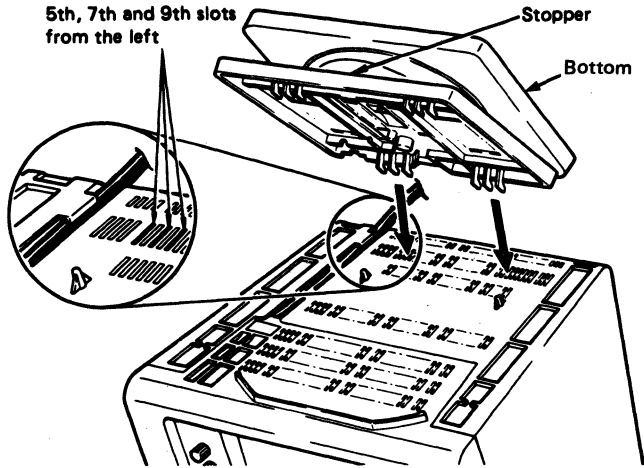

6

Pull the stand toward you until it stops.

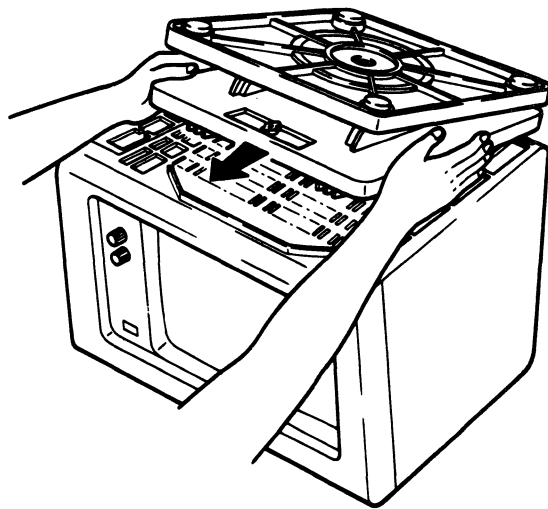

7

Slowly lower the front of the stand so that the front hooks of the stand enter the front slots of the video element.

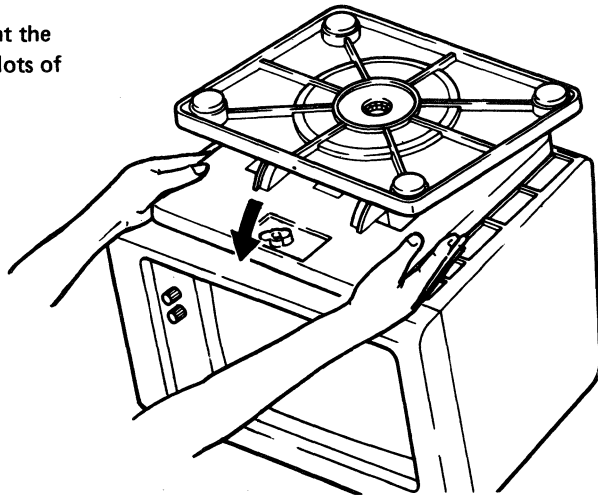

8

Lock the stand in place by turning the stopper of the stand clockwise or counterclockwise until it clicks.

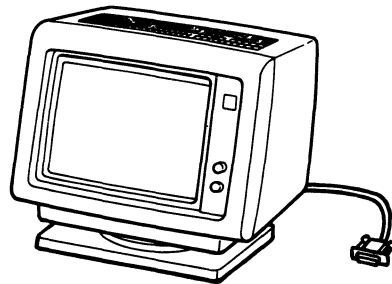
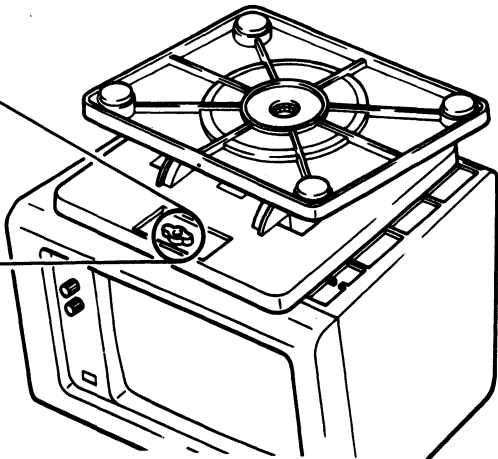
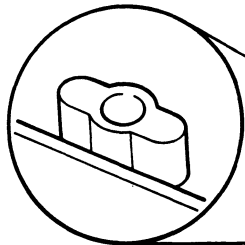

9

Lift the video element and place it in the recessed area of the logic element.

Note: Ensure that the logic element is on a flat surface.

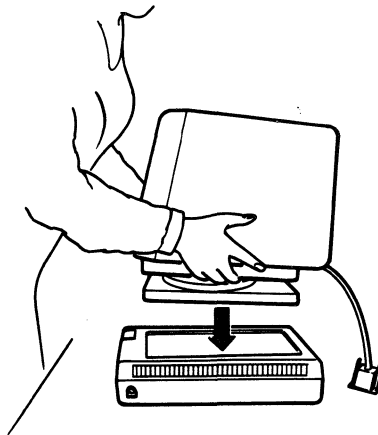

10

Connect the video element's connector to the video port (2) of the logic element.

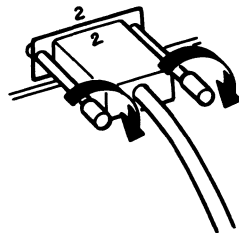
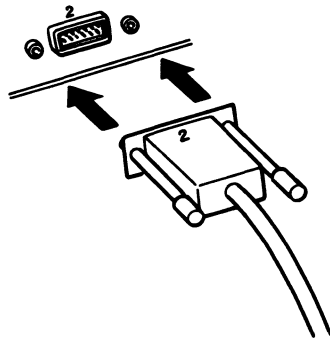
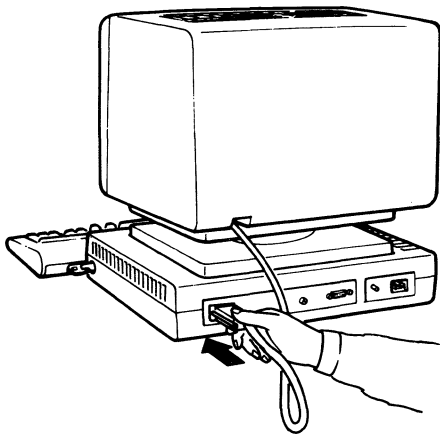

11

Connect the keyboard element's connector to the keyboard port (5) of the logic element.

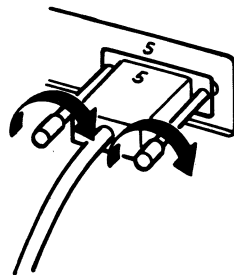
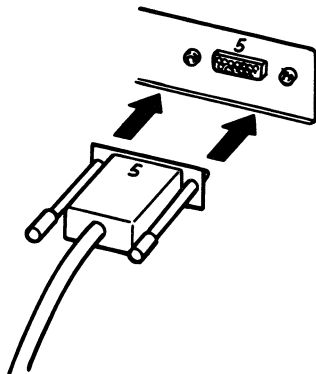
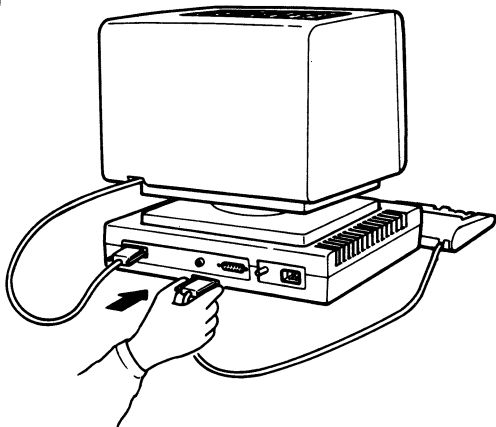

12

Connect the coaxial cable to its connector (4) on the logic element.

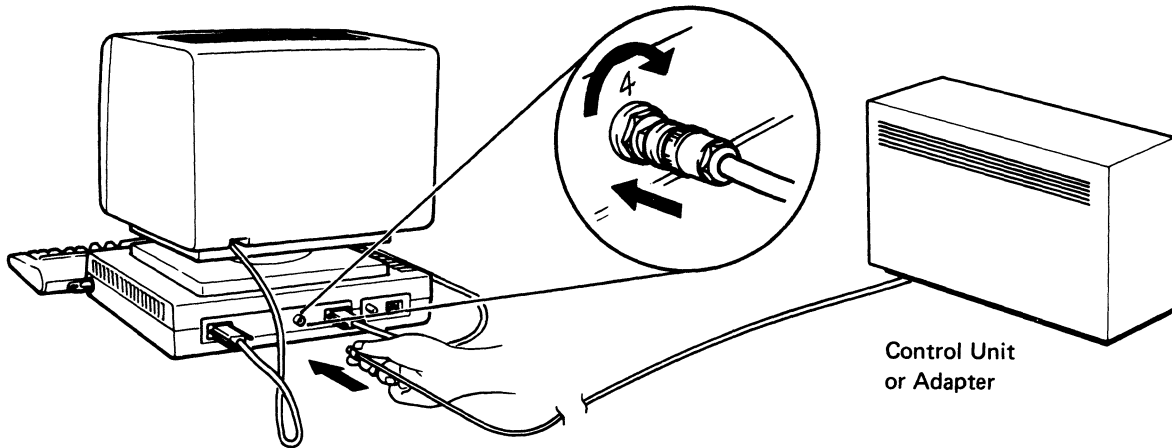

13

Ensure that the Power On/Off (I/O) switch is set to Off (O).

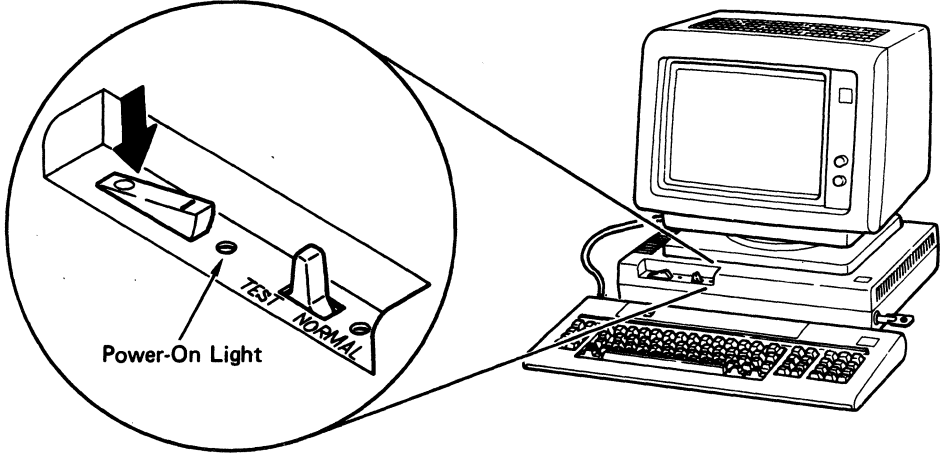

14

Push the power cable completely into the plug of the logic element. Then plug the power cable into the power outlet.

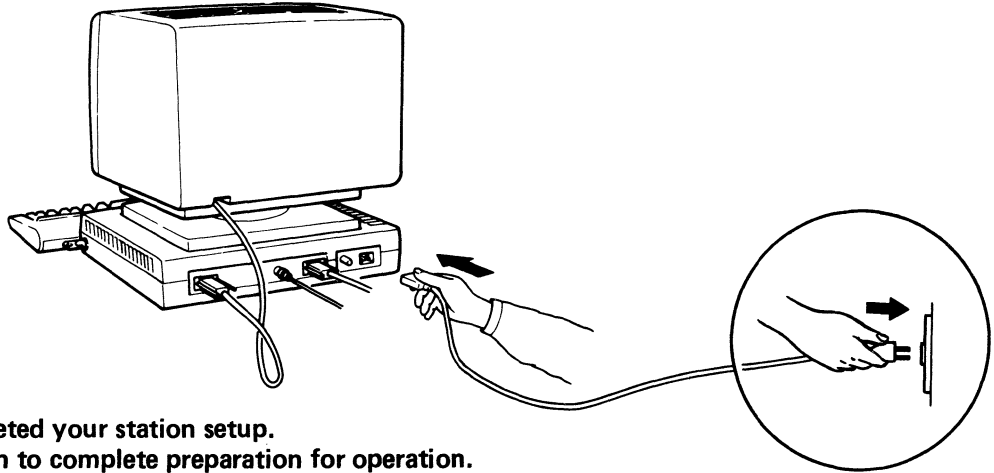

You have now completed your station setup.
Go to the next section to complete preparation for operation.

Preparation for Operation

Become familiar with the location of each switch, light, control, etc., as shown below.

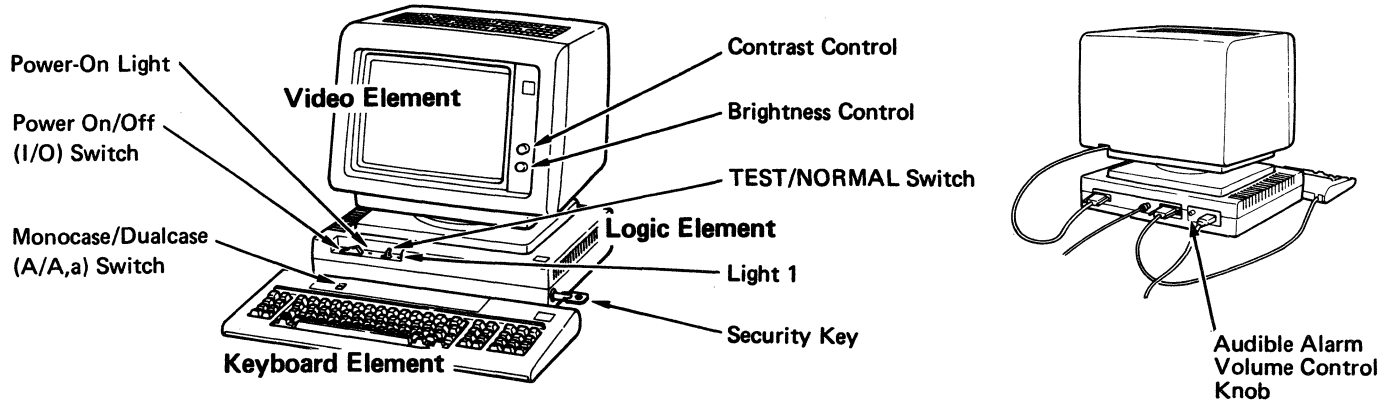

Warning:

- Do not insert any objects in the adjusting holes **1**. These holes are for the use of trained service personnel only.
- Do not lean on the video element. It could be dislodged from the top of the logic element.

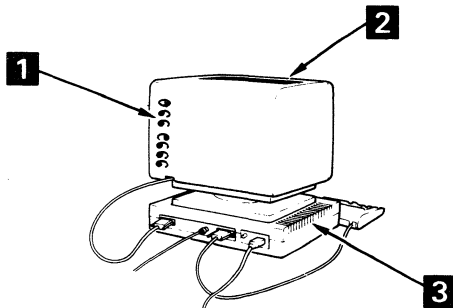

- Do not cover the cooling slots **2** at the top of the video element and **3** at both sides of the logic element.
- Do not try to open this **4**. It does not open.
- For cleaning the display surface **5**, use a clean, soft, dry cloth. If cleaning is not enough, use a moist, clean, soft cloth and dry with a clean, soft cloth. Do not use a wet cloth or a chemical cleaner.

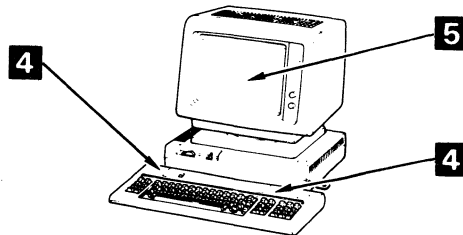

Preparation for Operation

- 1** Check that the security key is in the fully clockwise position.
If the key is not fully clockwise, push it in and turn it.

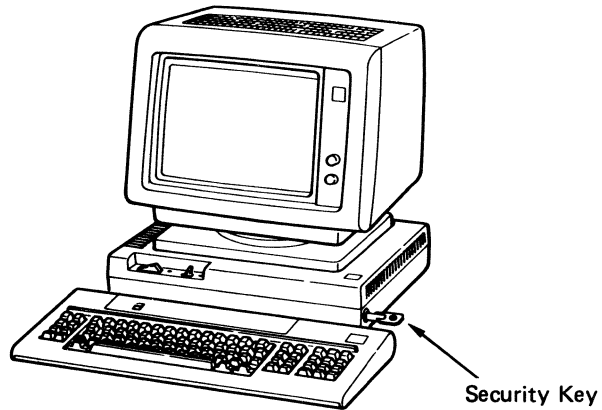

Note: If you have a problem at any step, refer to the CPAR part of this guide.



CPAR

2

Set the Power On/Off (I/O) switch to On.

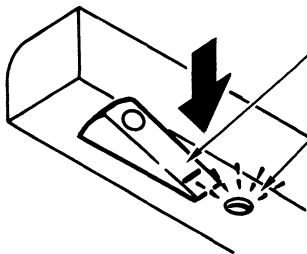

Power On/Off (I/O) Switch: Pressing "I" Power on
Pressing "O" Power off

Power-On Light: Lights when the power is on.

Notes:

1. A quick power-off and power-on sequence may cause a machine malfunction. If this happens, set the Power On/Off (I/O) switch to Off, wait several seconds, then set it back to On.
2. A bright glow will momentarily appear on the display surface whenever power is switched off. This is normal.

- 3** Turn the Brightness and Contrast Control knobs fully clockwise. Then, turn the Brightness Control knob counterclockwise until the patterns of lines on the display screen disappear.

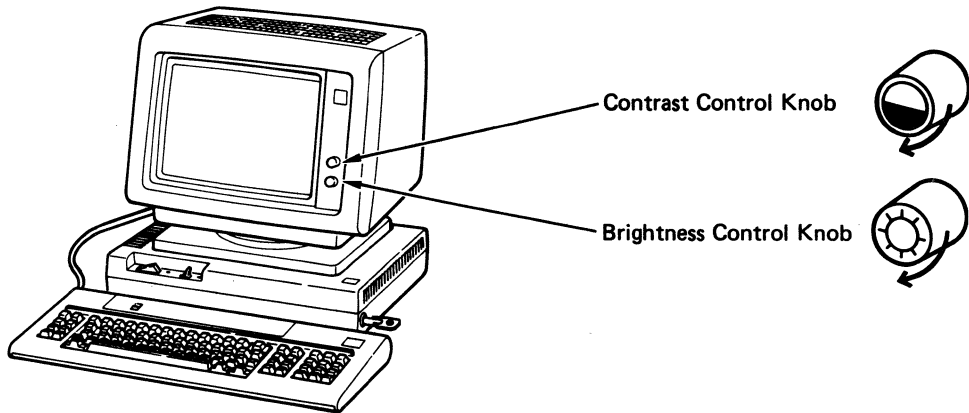

4

Turn the Audible Alarm Volume Control knob at the rear of the logic element fully clockwise. Then, set the TEST/NORMAL switch on the front of the logic element to TEST. The test pattern should appear on the display surface, Light 1 on the logic element should blink, and the audible alarm should sound briefly.

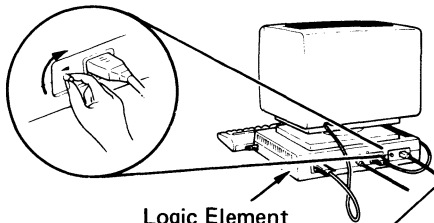

Logic Element

TEST/NORMAL Switch: For normal communications, this switch is set to NORMAL. When the switch is set to TEST, the self-testing program checks the station functions.

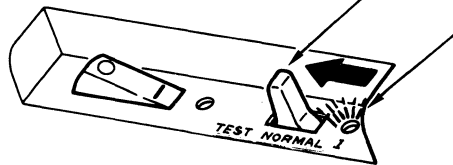

Light 1: Blinks when the TEST/NORMAL switch is set to TEST. Stays on or blinks when the switch is set to NORMAL and the station is connected to the controller.

5

Adjust the volume of the audible alarm.

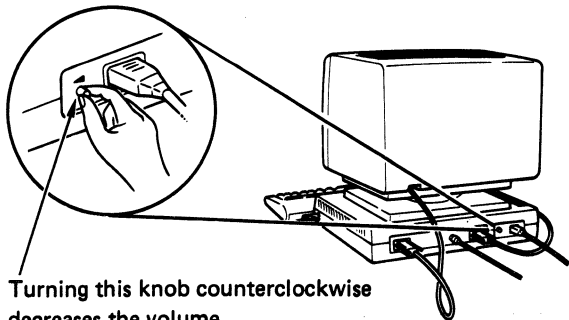

To check the volume, set the TEST/NORMAL switch to **NORMAL**, then to **TEST**. The audible alarm will sound once.

6

Set the TEST/NORMAL switch to NORMAL and ensure that Light 1 stays on or blinks. On the keyboard, press and hold the Alt key; while holding the Alt key, press the Test key. Let both keys up. Now, press the / key; then, press the Enter key. The following test pattern is displayed in the upper-left corner of the screen.

This test pattern is not displayed when attached to IBM 4701 controller. "4700" will be displayed in the lower left corner of the screen.

```
TEST: CCCC;NN
?SEL PEN    SEL PEN
  &SEL PEN   >SEL PEN
  DISPLAY   INSERT CK  _
```

Legend:

CCCC: Identifies the control unit/adaptor to which the IBM 3178 is attached.

If you are using the IBM 4321 or IBM 4331, you will see only I instead of CCCC.

NN: Is the port number of the requesting terminal.

7 If the second line in step 6 is not highlighted, adjust the contrast with the Contrast Control knob.

Contrast Control
Counterclockwise Dimmer

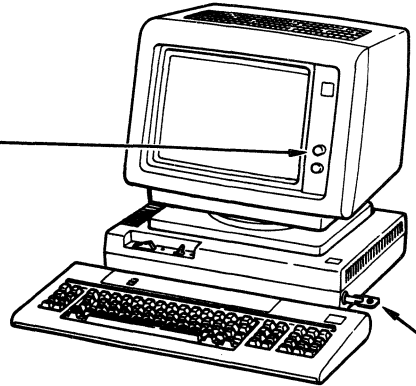

Security Key

Note: If you turn the security key to off (counterclockwise), the test pattern shown in step 6 disappears, and **X** appears in the operator information area.

8

Set the TEST/NORMAL switch to TEST, and the Monocase/Dualcase (A/A,a) switch to the Dualcase position (A,a).

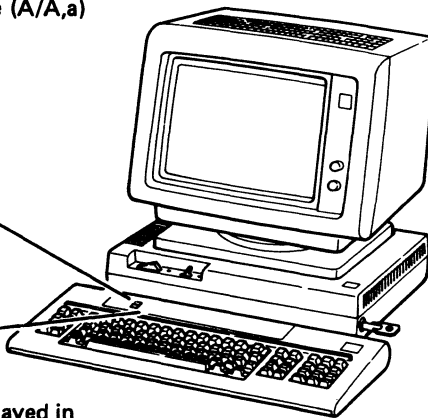
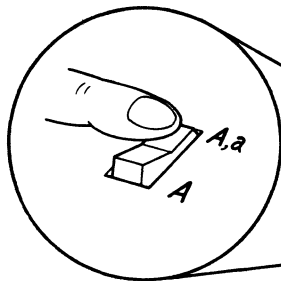

Note: When the switch is set to Monocase (A), all characters are displayed in uppercase only. When set to Dualcase (A,a), characters are displayed in uppercase or lowercase.

10

Set the TEST/NORMAL switch to NORMAL to begin operation. Light 1 should stay on or blink.

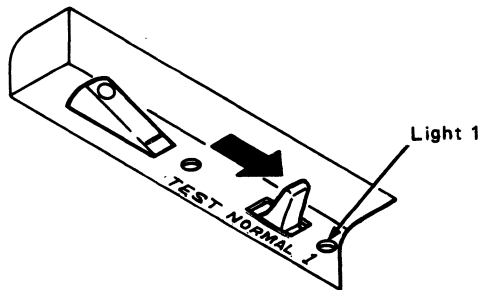

You have now completed preparation for operation.

(Intentionally left blank)

Adjusting the Video Element

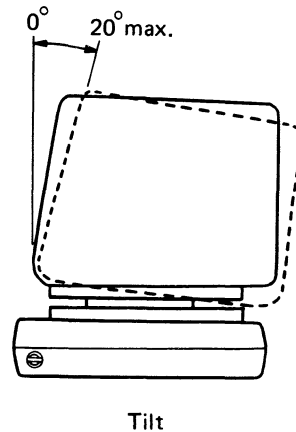
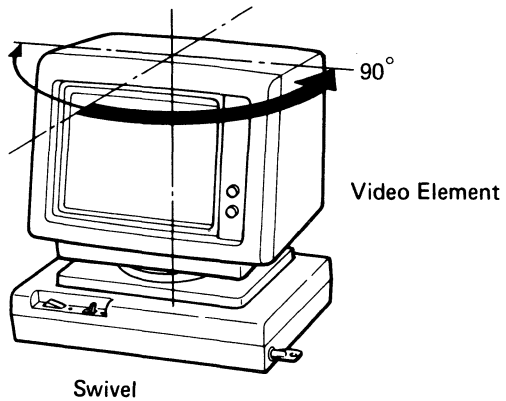

Keyboard Key Functions

The following are the description of typical keyboard key functions of the IBM 3178 when attached to the IBM 3274 Control Unit, IBM 3276 Control Unit Display Station, and IBM 4321/4331 processor through a Display/Printer Adapter.

When attached to the IBM 4701 Controller, refer to *IBM 4700 Finance Communication System Principles of Operation*, GC31-2029, for supported keyboard functions.

Three types of keyboards are available: a 75-key data-entry keyboard and two 87-key typewriter keyboards. The following pages show the layouts for these three types of keyboards.

Alternate Function Keys

Some keys have printing on the front. These keys are called alternate function keys.

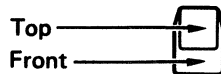

Alternate Shift Key

To activate an alternate function, you must hold the Alt key down and press the desired key.

Keyboard Function Keys

75-Key Keyboard (for Model C1)

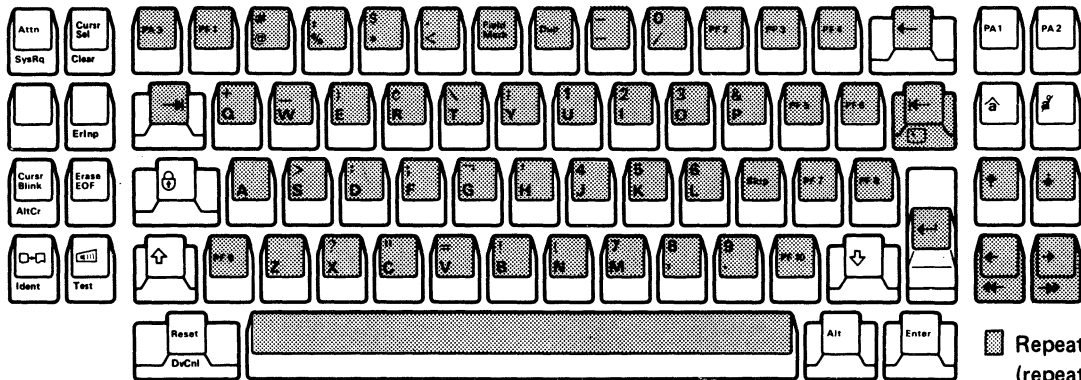

■ Repeat-action keys
(repeat characters or
functions when held
down)

87-Key Keyboard (for Model C2)

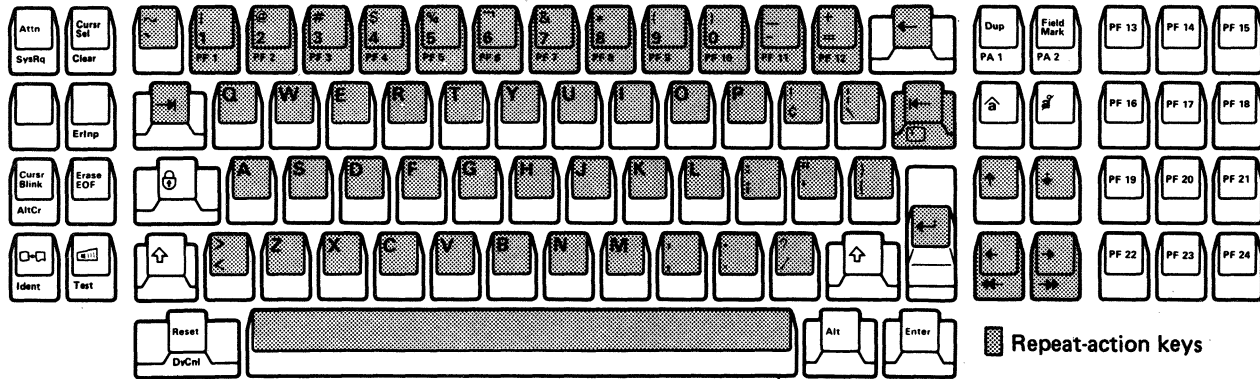

87-Key Keyboard (for Model C3)

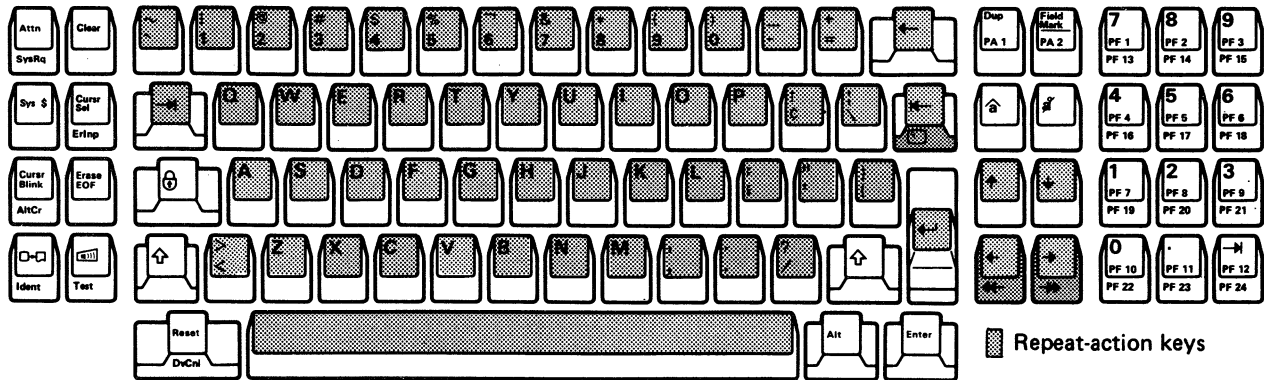

87-Key Keyboard (for Model C4)

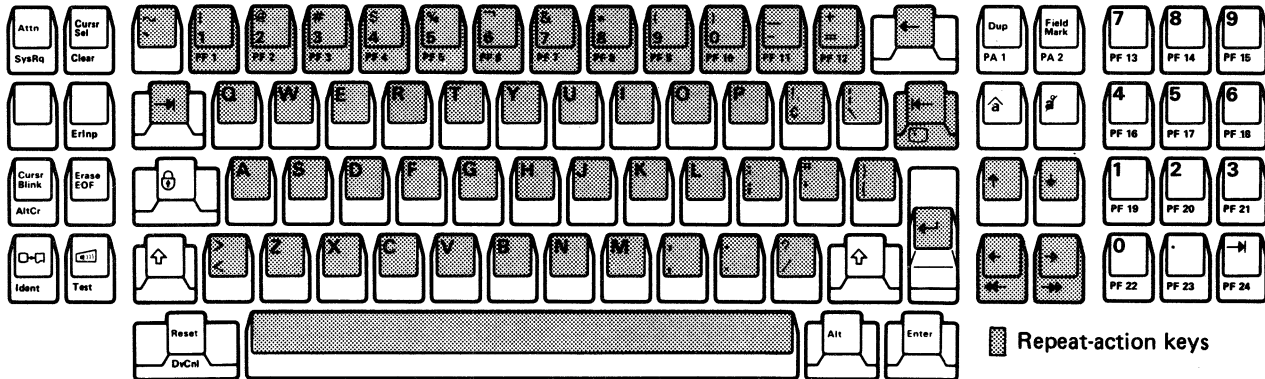

Cursor Control Keys



New Line Key

Moves the cursor to the first character position of the next input line.



Tab Key

Moves the cursor to the first character position of the next unprotected field.



Back Tab Key

Moves the cursor back to the first character position of an input field. If this key is pressed when the cursor is at the first character position of an input field, the cursor moves back to the first character position of the preceding unprotected field.



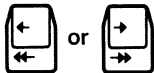

Home Key

Moves the cursor to the first input position of the display.



Horizontal-Positioning Keys

Moves the cursor one character position in the direction of the arrow. If you hold down the key that moves the cursor to the right, the cursor moves off the right side of the display surface and reappears one line lower on the left side. If moved to the left, the cursor moves off the left side of the display surface and reappears one line higher on the right side. These keys cause the cursor to wrap. If the  key is pressed, the cursor moves to the first position of the first line after it reaches the last column of the bottom line. If the  key is pressed, the cursor moves to the last position of the bottom line after it reaches the first column of the first line.

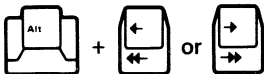

Double-Speed Horizontal-Positioning Keys

The functions are the same as the Horizontal-Positioning keys except that the cursor moves two character positions at a time.

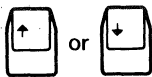

Vertical-Positioning Keys

Moves the cursor one line in the direction of the arrow. If a key is held down, the cursor moves off at the top or bottom edge and reappears in the same column at the opposite edge of the display surface.



Backspace Key

Moves the cursor one character position to the left. This key operates the same as the Horizontal-Positioning (Left) key.

Attention Key



Causes an interruption of the operation in process. The key is operative only when E is displayed in the operator information area (see "Operator Messages"). The function of the key is determined by the application program.

System Request Key



The action caused by pressing this key depends on whether A or B is displayed in the operator information area (see "Operator Messages"). When A is displayed, a test-request message is sent to the host. When B is displayed, the action is dependent upon the application program.

Cursor Select Key



Keyboard for
Models C1, C2, and C4



Keyboard for
Model C3

Enables you to select items from a list or table. There are two types of selectable fields: selection and attention. This key is used to (1) pick items from selection fields and (2) notify the program of your choice by selecting an attention field. The first character of each selectable field is called the designator character. Most of the designator characters for selection fields are question marks; for attention fields, an ampersand (&) or a space. To select an item, position the cursor within the selection field, then, press Cursr Sel. The question mark changes to a greater-than (>) symbol, and you can select an attention field. ✕ appears in the operator information area to indicate that the host system is completing selections.

Note: If you choose the wrong selection field, select the field again with the Cursr Sel key. This changes the > symbol back to a ?, and you can select the correct field.

Clear Key

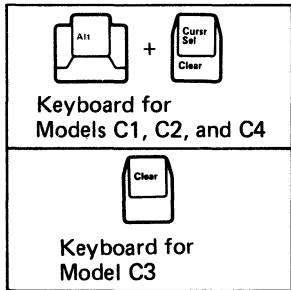

Clears all characters on the display surface.  appears in the operator information area (see "Operator Messages"), but most application programs turn off the indication instantly.

Erase Input Key

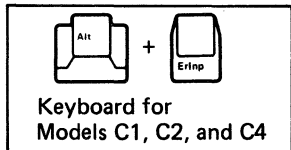

In an unformatted display, erases all characters on the display surface. In a formatted display, erases all characters in unprotected fields.

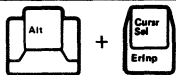

Keyboard for
Model C3

Erase EOF Key



In an unformatted display, erases all characters from the cursor position to the last character position of the bottom line. In a formatted display, erases all characters in a field, from the cursor position to the end of the field.

Sys \$ Key



Causes a dollar sign to be entered at the cursor location without using the shift key.
(This key applies to Model C3 only.)

Cursor Blink Key



Controls the blinking feature of the cursor. Pressing the key when the cursor is not blinking causes it to blink, and when the cursor is blinking, causes it to stop blinking.

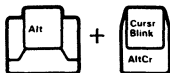

Alternate Cursor Key





Changes the normal cursor (underline) to the block cursor. To restore the normal cursor, press the key again.

Print Key

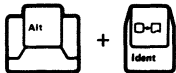

Sends the entire display image to the printer.  , followed by the printer identification (ID), appears in the operator information area (see "Operator Messages"). When printing starts, this symbol is replaced with  , followed by the printer ID. When printing is complete,  reappears.

Printer ID Key

Enables you to request or change the printer ID or printer class.  appears in the operator information area (see "Operator Messages"). The printer ID or printer class number appears in the underlined portion of the message as you enter it.

Click Key

Enables you to turn the keyboard clicking sound on or off.
Each time the key is pressed, the clicking sound turns on if off, or off if on.

It is important to know that if the clicker is on and a Do-Not-Enter condition occurs, you hear no sound until the condition is reset. Likewise, if the clicker is off and an input-inhibited condition occurs, you do hear a sound until the condition is reset.

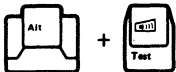
Test Key

Used when you find a problem. Refer to the CPAR (step 11).

Reset Key

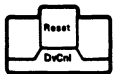

This key is used to:

1. Recover from a Do-Not-Enter condition (see "Operator Messages").
2. End an invalid Ident key operation.
3. End an insert mode operation.

Device Cancel Key

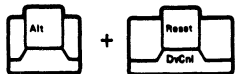

Cancels a pending print operation.

Duplicate Key



75-Key Keyboard

Causes the DUP character code (displayed as * or $\bar{*}$) to be entered into the display buffer and a Tab key operation to be performed. The DUP character provides a means of informing the application program that a duplicate operation is indicated for the field in which it is located.



87-Key Keyboard
for Models C2 and C4

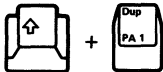

87-Key Keyboard
for Model C3

Field Mark Key



75-Key Keyboard

Causes the field mark character code (displayed as ; or ¯) to be entered into the display buffer. The field mark character provides a means of informing the application program of the end of a field.



87-Key Keyboard
for Models C2 and C4



87-Key Keyboard
for Model C3

Field Mark Key (Continued)

Causes the field mark character code (displayed as ; or $\bar{}$) to be entered into the display buffer. The field mark character provides a means of informing the application program of the end of a field.

Program Access Key



75-Key Keyboard

Sends special signals to the host. The function of this key is dependent upon application programs.

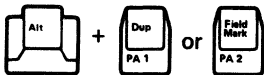

87-Key Keyboard
for Models C2 and C4

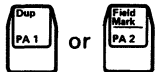

87-Key Keyboard
for Model C3

Insert Key



Enables you to insert characters at the cursor position of an input field and all the characters to the right on the same line shift one character position to the right. \wedge appears in the operator information area (see "Operator Messages") to indicate that the keyboard is in the insert mode. To leave the insert mode, press the Reset key. If you try to insert more characters than the field can hold, $\times \rightarrow$ appears in the operator information area (see "Operator Messages") and the keyboard becomes inoperative. To recover from this condition, press the Reset key.

Delete Key



Deletes the character at the cursor position of an input field. All characters to the right and on the same line shift one character position to the left.

Enter Key



Sends the data to the host.  appears in the operator information area (see "Operator Messages"), but most application programs turn this off instantly.

Skip Key



Moves the cursor to the first character location of the next unprotected field. The function of this key is dependent upon application programs (75-key keyboard).

Program Function Keys

75-Key Keyboard (for Model C1)

Ten Program Function (PF) keys are arranged around the alphabetic keys. The function of each PF key is determined by the application program.

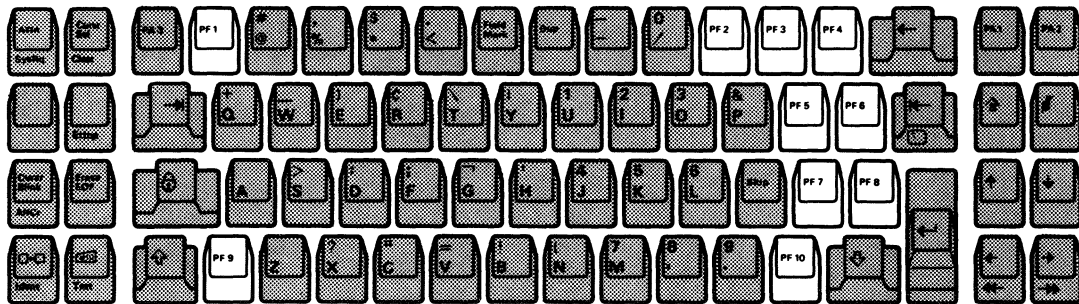

Program Function Keys (Continued)

87-Key Keyboard (for Model C2)

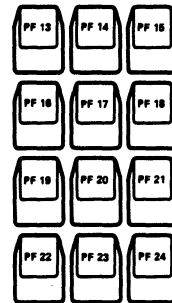

The function of each PF key is determined by the application program.
The keys, PF1 through PF12, are alternate-shift function keys.
(Alt key must be held down when these keys are pressed.)

Note: PF1 through PF12 are repeat-action keys; however, you should not use this capability, because the results are unpredictable.

Program Function Keys (Continued)

87-Key Keyboard (for Model C3)

The function of each PF key is determined by the application program. PF1 through PF12 operate in lower shift, while PF13 through PF24 are alternate-shift function keys. The PF keys (PF1 through PF12) operate as a numeric keypad when in upper shift.

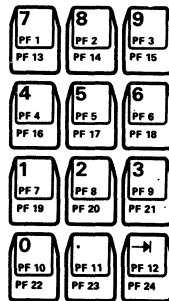

Program Function Keys (Continued)

87-Key Keyboard (for Model C4)



The function of each PF key is determined by the application program. The keys, PF1 through PF24, are alternate-shift function keys. (Alt key must be held down when these keys are pressed.)

Note: PF1 through PF12 are repeat-action keys; however, you should not use this capability, because the results are unpredictable.



Information about the X.25 Network Operation

Obtain the "X.25 Keyboard Labels and Installation Procedures" (GX23-0285), and attach the labels to your IBM 3178 keyboard.

The following example shows the position of the six X.25 keyboard labels.

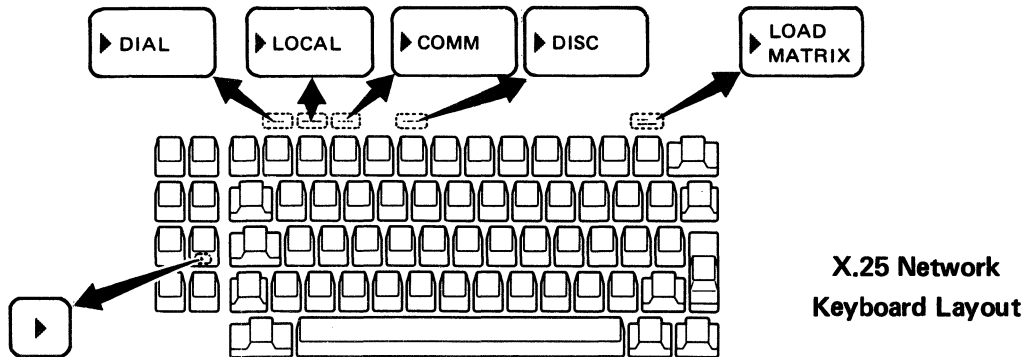

Control Keys

Extension Mode Key



Enables you to enter extension mode for X.25 Network operation. An extension mode symbol (▶) will appear on line 25.

Disconnect Key

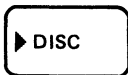

Causes the control unit to disconnect from the network and enter the call ready state (for SVC operations only).

Local Key

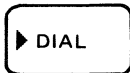

Disconnects the control unit from the network (⚡ 599 will appear on line 25) and places the machine in local mode (for SVC and PVC operations).

Dial Key

Displays the dial mode display screen. You can change the values on the screen if required. The new values will be effective after pressing the Enter key.

```
HNAD = @123 123 789  @
CID   = @32740000@
NPKT  = @1@
NWND  = @02@
RPOA  = @1898@
CUG   = @32@
QLLC  = @1@
TCLS  = @9@
DPKT  = @1@
DWDD  = @02@
OOPT  = @00000000@
IOPT  = @00000000@
I/O   = @0@
```

Dial mode
display screen



Legend (@ @: indicates an entry field.)

HNAD : DTE address (up to 15 characters, 0-9, only)
CID : Network password (up to 8 characters; 0-9, A-F)
NPKT : Packet size to be negotiated (0=64; 1=128; 2=256; 3=512)
NWND : Packet window size to be negotiated (01-07 for modulo 8; 01-11 for modulo 128)
RPOA : Recognized private operating agency (0001-9999)
CUG : Closed user group (01-99)
QLLC : Qualified logical link control or physical service header (PSH LLC) (0 PSH; 1 QLCC)
TCLS : Through Class Value (3-C)
DPKT : Default packet size if TCLS is not specified. The value of this field is set during customization.
DWDD : Default window size if TCLS is not specified. This field is set during customization.
OOPT : Override outgoing call options (0 or 1)
IOPT : Override incoming call options (0 or 1)
I/O : If customized for two-way call (0=dial screen data is used to initiate an outgoing call; 1=store changed values to be used on an incoming call or a future outgoing call). If customized for a one-way call (0=dial screen data is used to initiate an outgoing call; 1=store changed values to validate the next incoming call).

Communication Key



This key is used for either switched virtual circuit (SVC) or permanent virtual circuit (PVC) operations. For SVC operations, pressing this key changes the control unit from local mode to the call ready state. For PVC operations, pressing this key initiates reopening of the link and circuit.

Note: The SVC may be thought of as a point-to-point switched line. The PVC may be thought of as a point-to-point SDLC leased line.

(Intentionally left blank)

Operator Messages

When Attached to Control Unit/Adapter (IBM 3274, IBM 3276, and IBM 4321/4331 with Display/Printer Adapter)

Operating and status messages appear in the operator information area, which is the bottom line of the display surface and is separated from the rest of the display area by a horizontal line.

When the IBM 3178 is attached to the IBM 4701 Controller, refer to *IBM Finance Communication System Component Descriptions*, GC31-2030, for operator messages.











The messages are grouped into five categories and are displayed in different locations of the area, as follows:

①	②	③	④	⑤
Readiness and System Connection	Do-Not-Enter	Reminders	Shifts and Modes	Printer Status
1 6	9 17	21 27	37 41	60 64

There are some differences between the operator messages for the IBM 3178 attached to the IBM 3274 and IBM 3276, and those for the IBM 3178 attached to the IBM 4321 and IBM 4331. The following messages are typical operator messages in both cases.

Messages for the IBM 3178 attached to the IBM 3274 and IBM 3276

- Readiness and System Connection Symbols (Positions 1 through 6)

- Position 1  and  — Means the IBM 3274 () or IBM 3276 () control unit is working (ready).
- Position 2  and  — Means the control unit is connected (online) to the host system under rule A () or rule B ().
- Position 3  — Your display station is working with your job (application program).
- Position 3  — Your display station is connected to the system operator (control program).
- Position 3  — Your display station is connected to the host system but is not connected to your application program or to the control program.
- Position 3-6 TEST — Your display station is in test mode.

- Do-Not-Enter (Input-Inhibited) Messages (Positions 9-17)

-  — Time is required for the host system to perform a function. Wait.

X?+

XSYSTEM

X←→

X→

X-S

XNUM

X#?

X○

X-f

Xnn

and

Xnnn

Xnn

and

Xnnn

- What? Input not understood. Check screen. Press the Reset key and try the operation again.
- The host system has locked your keyboard. Look for a message. Wait or press the Reset key.
- Go elsewhere on the screen to take that action. Press the Reset key.
Move the cursor or take another action.
- You have tried to insert more data than this field can hold. Press the Reset key. Correct the entry.
- The symbol keyed is not available. The Reset key should be pressed to restore the keyboard.
- Numeric Data Only. You should enter only numerals in this field. Press the Reset key and enter a numeral.
- Only certain numerals can be entered here. Press the Reset key.
- Security key is off. Keyboard can be unlocked only by the key.
- The function you requested is not available. Press the Reset key.
- Your display station is not operating properly. Press the Reset key and re-try. If the problem persists, notify your supervisor of this message, including the numbers, for further action. (n is a digit, 0 through 9.)
- There is a problem with the communication line between the control unit and the host system. Press the Reset key and re-try. If the problem persists, notify your supervisor of this message, including the numbers, for further action. (n is a digit, 0 through 9.)

XPROG nn
and
XPROG nnn

— The control unit detected a programming error in the data it received from the host system. Press the Reset key and re-try. If the problem persists, notify your supervisor of this message, including the numbers, for further action. (n is digit, 0 through 9.)

X□□⊙

— The printer connected to your display station is busy. If □—■ is displayed on the right, the printer is busy printing your job. Wait for the operation to finish, or press the DvCnl key to cancel a pending print operation. (If the print operation has started, the operation cannot be canceled by the Dv Cnl key.)

X□□⊙⊙

— Same as preceding, except more time is anticipated before your operation is accepted.

X□—■

— The printer assigned to your display station is not working. If □—■ is displayed on the right, the printer stopped while printing your job. Wait or press the DvCnl key to cancel the print operation.

X⊗⊗

— You are not authorized to do that function. Press the Reset key.

X□←⊗

— A message from the control operator was received and rejected. Press the Reset key.

● Reminders (Positions 21-27)

↔— nn

and

↔— nnn

— The communication link connecting your control unit to the host system is producing errors. Notify your supervisor of this message, including the numbers, for further action (n is digit, 0 through 9.)

□←⊗

— Reserved for future use. Ignore.

- Shifts and Modes Messages (Positions 37-41)



- ↑ — The keyboard is in upshift.
- ^ — The IBM 3178 is in insert mode.
- NUM — The keyboard is in numeric shift.

- Printer Status Messages (Positions 60-64)









- __ — When you are changing the Printer ID/Class, the two numerals you enter are displayed in the underlined portions of the message.
- nn — Your IBM 3178 is authorized to use Printer ID/Class nn.
- nn — The selected printer is printing your job.
- ▣nn — The printer stopped while printing your job.
- ?? — Your printer assignment has changed.

Messages for the IBM 3178 attached to the IBM 4321 and IBM 4331

● Readiness and System Connection Symbols (Positions 1 through 6)

- Position 1 I — Means the IBM 4321 or IBM 4331 Processor (I) is working (ready).
Position 2  — Means the Display/Printer Adapter is connected to the system under rule A ().
Position 3-6 TEST — Your display station is in test mode.





● Do-Not-Enter (Input-Inhibited) Messages (Positions 9-17)

-  — Time is required for the system to perform a function. Wait.
 — What? Input not understood. Check screen. Press the Reset key and try the operation again.
 — Go elsewhere on the screen to take that action. Press the Reset key.
Move the cursor or take another action.
 — You have tried to insert more data than this field can hold. Press the Reset key. Correct the entry.
 — The function you requested is not available. Press the Reset key.
 — Security key is off. Keyboard can be unlocked only by the key.
 — The symbol keyed is not available. The Reset key should be pressed to restore the keyboard.
 — Numeric Data Only. You should enter only numerals in this field. Press the Reset key and enter a numeral.

- Shifts and Modes Messages (Positions 37-41)

- ↑ — The keyboard is in upshift.
- ^ — The IBM 3178 is in insert mode.
- NUM — The keyboard is in numeric shift.

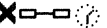
- Printer Status Messages (Positions 60-64)

-  — When you are changing the Printer ID/Class, the two numerals you enter are displayed in the underlined portions of the message.
-  — Your IBM 3178 is authorized to use Printer ID/Class nn.
-  — The printer is printing your job.
-  — The printer connected to your display station is busy. Wait for the operation to finish, or press the DvCnl key to cancel a pending print operation. (Once the print operation has started, the operation cannot be cancelled by the DvCnl key.)
-  — The printer assigned to your display station is not working. Wait or press the DvCnl key to cancel the print operation.

(Intentionally left blank)

Messages for the IBM 3178 attached to the IBM 3274 customized for the X.25 Network.

- **Readiness and System Connection Symbol (Position 1-6).**

N — The control unit is connected to a host system through the network.

- **Do-Not-Enter (Input-Inhibited) Messages (Positions 9-17)**

X  — An X.25 Network function key was pressed under improper conditions. Press Reset and verify the sequence.

X  — The control unit has detected a network error. The nnn error code is developed by the control unit.

- **Reminders (Positions 21-27)**

 — The control unit is ready to call or be called by the host system.

- Z#? — Your IBM 3178 is in dial-in mode. You can modify the dial mode screen if desired.
Press the Enter key in order for the control unit to start the dial-in sequence with the host system.
- Z## — Another terminal is in dial-in mode. You cannot initiate any action at your IBM 3178.
- Z — The control unit is calling the host system.
- ←Z — The control unit is being called by the host system.
- Z⊙ — The control unit is being disconnected from the network.
- ↘Z 599 — The control unit is in local mode. Press the COMM key to establish the call ready state for SVC operations or to establish the communication state for PVC operations.

— XCCDD

- The control unit is ready to call the host system or to be called by the host system.
The X.25 Network C and D codes are determined by the network and are defined as follows:

X = The control unit action.

When x =	the control unit
L	Sent a CLEAR packet
M	Sent a RESET packet
N	Sent a RESTART packet
P	Received a CLEAR packet
Q	Received a RESET packet
R	Received a RESTART packet

CC = Cause code received when X = P, Q or R.

Diagnostic code modifier when X = L.

SS = Diagnostic code sent or received.

- **Shifts and Modes (Position 37-41)**

- ▶ — The keyboard is in extension mode and the keys with the symbol (▶) are enabled.

(Intentionally left blank)

Customer Problem Analysis and Resolution (CPAR)

How to Use CPAR

1. Start at "Quick Check!", then follow the instructions in the shaded area of each page until the problem you are having is described.
2. Follow the instructions in the white area to determine which of the three replaceable elements is failing.

FINISH appears when the problem no longer exists in your station, or when the problem may be external to the station.

3. How to replace a failing element is explained in steps 15, 16 and 17:
15 – Video Element
16 – Keyboard Element
17 – Logic Element

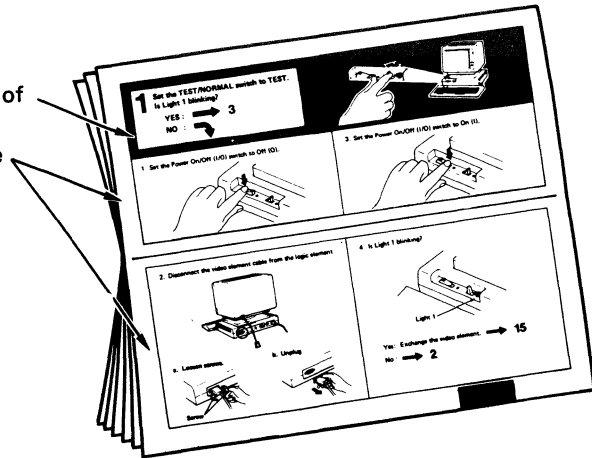

IBM 3178 Service Offerings

On-Site Assistance

On-site assistance by a customer engineer is available, on a billable-hourly (per-call) basis for the performance of CPAR and the replacement of the failing element with a user-owned spare (if available). The customer engineer will aid you in performing CPAR procedures.

In addition to on-site assistance, IBM provides the following service options for the IBM 3178 in the U.S.

Customer Carry-In Repair: You may either deliver the failing element to an IBM Service/Exchange Center or package the failing element and ship it to an IBM Service/Exchange Center for repair.

Customer Carry-In Exchange: You may deliver the failing element to an IBM Service Exchange Center for exchange.

Customer On-Site Exchange: IBM sends a replacement element to your site, using a courier or parcel service.

IBM On-Site Exchange: IBM brings a replacement element to your site, installs and tests it.

The service offerings in the Americas (other than the U.S.) and Far Eastern countries may differ by country; contact your IBM representative for additional information.

Requests for service should be directed to the National Support Center by dialing toll-free 800-428-2569 in the continental U.S. and Puerto Rico; Hawaii and Alaska customers may call collect to 312-986-7541.

Note: An element returned by the designated IBM location as "No Trouble Found" should be tested as soon as practical. If the original problem still exists, it is probably external to the IBM 3178. However, perform problem determination again, and if you still consider the problem to be in the IBM 3178, we recommend that you return all three elements to the designated IBM location with all the information you obtained about the problem.

Quick Check !

Match your problem to one of the following symptoms or operator information area indications, and perform the actions indicated.

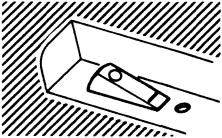
Symptom or Operator Information Area Indication	First Action	Follow-Up Action
<p>Power-On light is not on.</p> 	<p>Be sure that:</p> <ol style="list-style-type: none"> 1. Power On/Off (I/O) switch is set to On (I). 2. Power at the outlet is available. 3. The power plug is firmly connected to the logic element and the outlet. 	<p>If same symptom, exchange the logic element → 17</p>
<p>Audible Alarm Sounds continuously</p>	<p>Set the Power On/Off (I/O) switch to Off (O), then On (I).</p>	<p>If same symptom, exchange the logic element → 17</p>

Light 1 stays off.

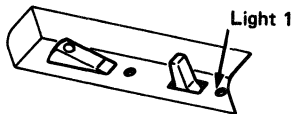

Be sure that:

1. TEST/NORMAL switch is set to NORMAL.
2. Your station is connected to the control unit/adapter.



If other stations under the same control unit/adapter are not working, the problem is most likely external to the IBM 3178. If they are working, the problem may be in the logic element or in the cable from the control unit/adapter. Report the problem to your supervisor.



Turn the security key fully clockwise. If you have lost the security keys but have recorded the security key identification, you can order spare keys by sending a letter of authorization, including the key identification, to IBM. If you do not have the identification, the logic element must be returned to IBM for replacement of the lock and keys.

If same symptom, exchange the logic element → 17

Symptom or Operator Information Area Indication	First Action	Follow-Up Action
<p align="center">If your station is connected to an IBM 4321, IBM 4331, or IBM 4700, go to step 1. If connected to either an IBM 3274 or IBM 3276, do the following.</p>		
<p>X 2%% X 73</p>	<ol style="list-style-type: none"> 1. Ensure that the keyboard cable is firmly connected to the logic element. 2. Set the TEST/NORMAL switch to TEST. 3. Press the Reset key, then the J key. 	<p>Is the terminal ID* displayed in the first position of the operator information area? Yes: Report the problem to your supervisor. No: → 1</p> <p>* Terminal ID: u for 75-Key Data-Entry Keyboard (Model C1) E for 87-Key Typewriter Keyboard (Models C2 and C4) : for 87-Key Typewriter Keyboard (Model C3)</p> <p>Note: To determine which keyboard you are using, refer to the keyboard layouts in "Keyboard Key Functions."</p>

<p> X nn or X nnn or X nn , nnn - nnn (n is digit, 0 through 9.) </p>	<ol style="list-style-type: none"> 1. Press the Reset key and re-try the operation that failed. 2. If the same symptom recurs, check if other stations under the same control unit/adapter are working. 	<ol style="list-style-type: none"> 1. If other stations are working:  1 2. If other stations are not working, notify your supervisor of this symbol, including the numbers, for further problem determination.
<p> X — nn or X — nnn (n is digit, 0 through 9.) </p>	<p>Press the Reset key and re-try the operation that failed.</p>	<p>If same symptom, notify your supervisor of this symbol, including the numbers, for further problem determination.</p>
<p> XPROG nn or XPROG nnn (n is digit, 0 through 9.) </p>	<p>Report the problem to your supervisor.</p>	
<p>Any other symptom?</p>	<p>Press the Reset key and re-try the operation.</p>	<p>If same symptom:  1</p>

1 Set the TEST/NORMAL switch to TEST.
Is Light 1 blinking?

YES :  **3**

NO : 

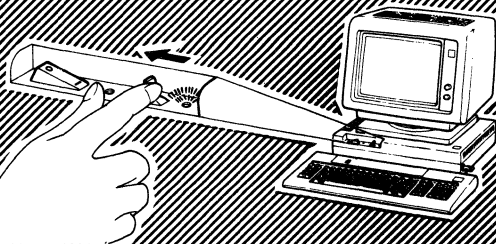

1. Set the Power On/Off (I/O) switch to Off (O).

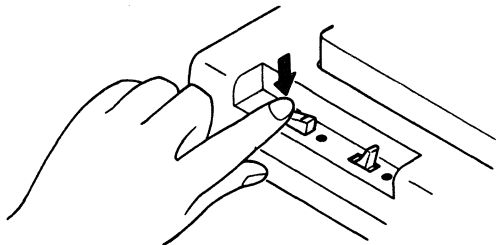

3. Set the Power On/Off (I/O) switch to On (I).

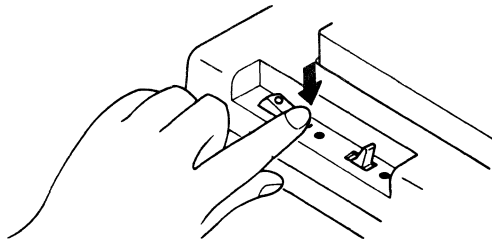

2. Disconnect the video element cable from the logic element.

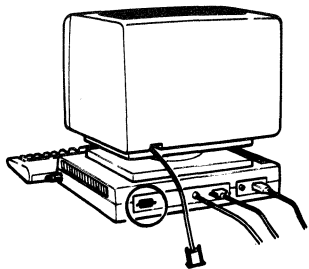

a. Loosen screws.

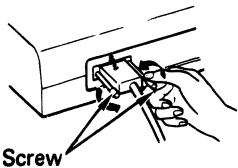

b. Unplug.

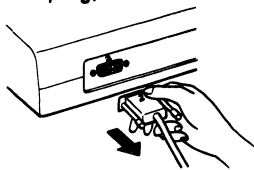

4. Is Light 1 blinking?

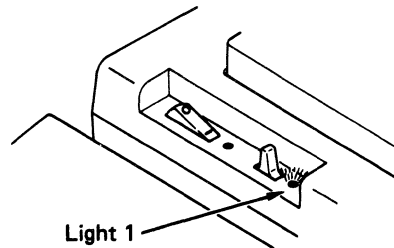

Yes: Exchange the video element → 15

No : → 2

2 Perform the following procedures.

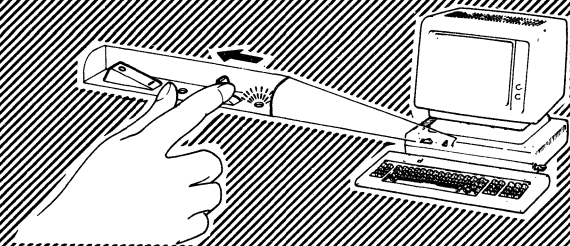

1. Set the Power On/Off (I/O) switch to Off (O).

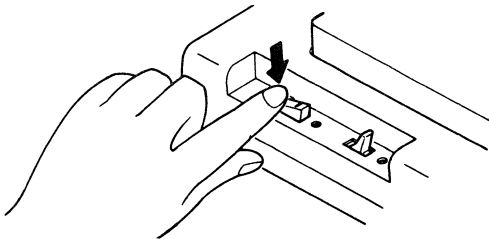

3. Set the Power On/Off (I/O) switch to On (I).

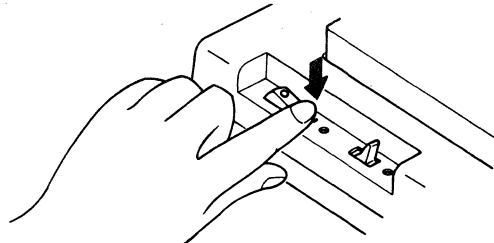

2. Disconnect the keyboard element cable from the logic element.

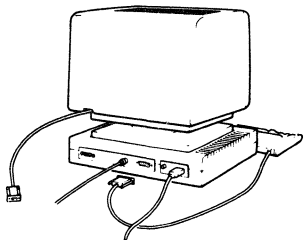

a. Loosen screws.

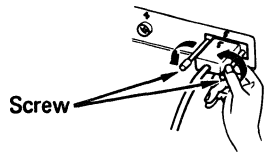

b. Unplug.

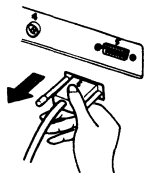

4. Is Light 1 blinking?

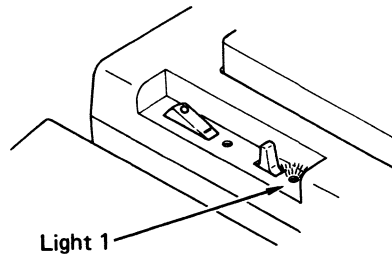

Yes: Exchange the keyboard element → 16

No : Exchange the logic element → 17

3 Is the display surface completely dark or green with no horizontal line and no characters?

NO :  4

YES : 

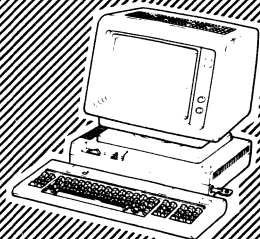

1. Set the Power On/Off (I/O) switch to Off (O).

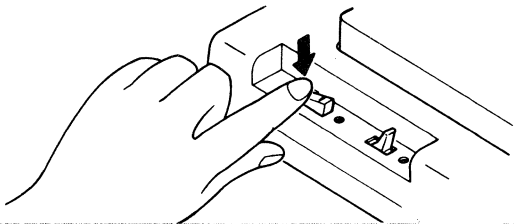

3. Set the Power On/Off (I/O) switch to On (I).

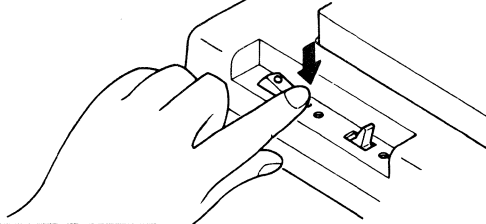

2. Disconnect, then reconnect the video element cable (at the rear of the logic element) as follows:

a. Loosen screws.

Note: Do not remove the thumbscrews from the connector.

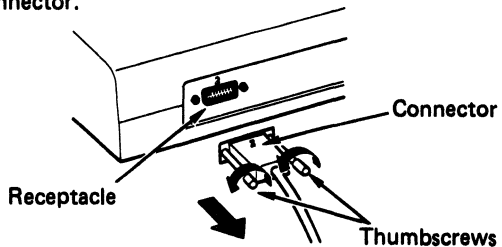

- b. Pull the connector from the receptacle.
c. Push the connector back into the receptacle.
d. Tighten screws.

4. Turn Contrast Control and Brightness Control knobs fully clockwise.

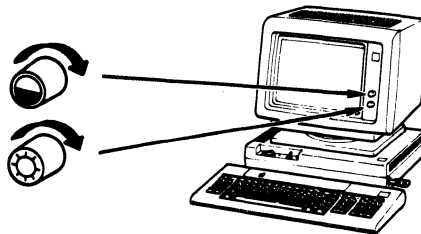

5. Is the display surface still completely dark or green with no horizontal line and no characters?

Yes: Exchange the video element → **15**

No : Adjust the Brightness Control for comfortable viewing, then resume normal operation. **FINISH**

4 Do you have one or more of the following problems?

NO:  **5**

YES: Exchange the video element  **15**

- Display is moving vertically or horizontally (drifting).

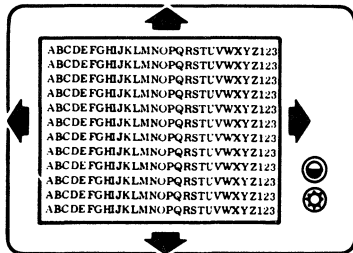

- Display is out of focus.

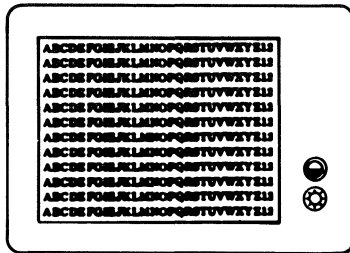

- Display lines across screen do not disappear when the Brightness Control is at minimum.

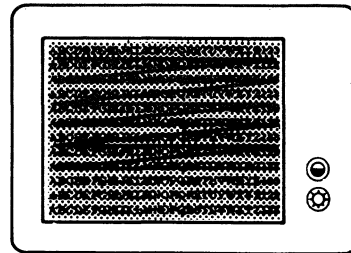

- The Brightness Control does not control the amount of light on the display surface.

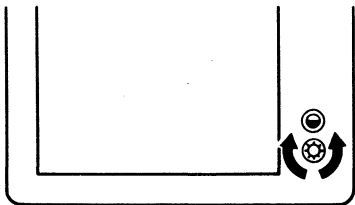

- Display area has shrunken (or expanded) significantly.

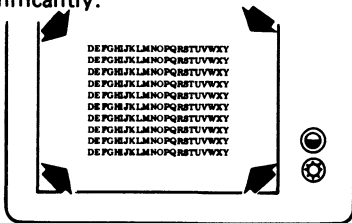

- Display area is tilted.

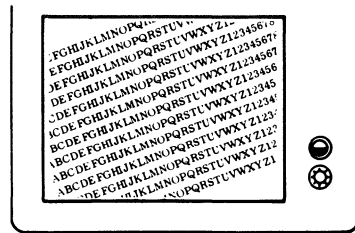

- Display is too dark at the maximum contrast and brightness levels.

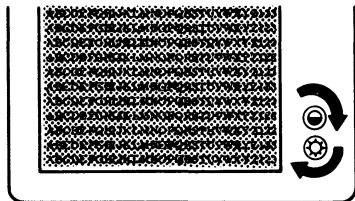

- Single horizontal line appears in the wrong position.

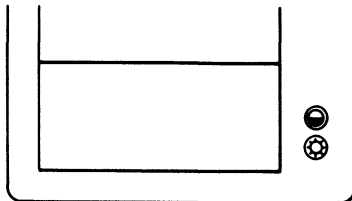

- Display size changes significantly when the Brightness Control is adjusted.

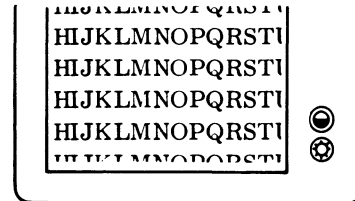

1. Set the Power On/Off (I/O) switch to Off (O).

2. Disconnect the keyboard element cable from the receptacle 5.

a. Loosen screws.

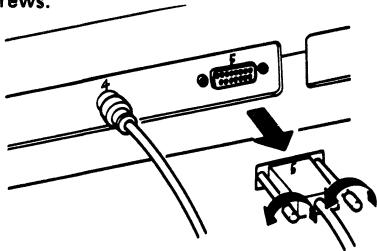

Note: Do not remove thumbscrews from the connector.

b. Unplug.

3. Set the Power On/Off (I/O) switch to On (I).

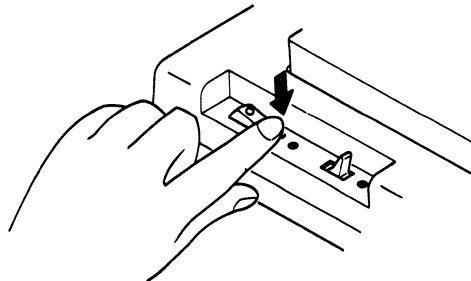

4. Go to step 6.

- 7** Set the Monocase/Dualcase switch to Dualcase. Press each key (except Reset) and check for any keyboard-to-display problems. Compare the characters displayed with those shown in the following keyboard diagram (the characters of some key tops in the diagram are different from your actual key-top characters). Do you have any keyboard-to-display problems?

NO:



8

YES:

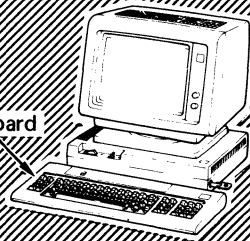

Keyboard

**Notes:**

1. The cursor moves to the next character position with each keystroke.
2. Do not hold down any key long enough to cause repeat action.
3. The keys shown with a bold line cause a double-character entry; the first when the key is pressed and the second when it is released.

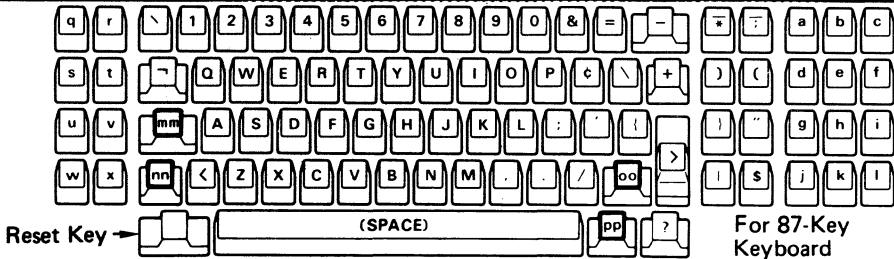

Do you have any of the following problems with the keyboard?

No: → 8

Yes: Take the action indicated.

Type of Problem	Action
<p>Cursor</p> <ul style="list-style-type: none">● Cursor does not advance with a keystroke.● Wrong cursor positioning occurs. <p>Character Display</p> <ul style="list-style-type: none">● Characters are simultaneously displayed on multiple lines with one keystroke.● Character is displayed, but not at the cursor position.	<p>Exchange the logic element → 17</p>
<p>Click</p> <ul style="list-style-type: none">● Some keys do not click. Note: mm, nn, oo and pp keys should not click. <p>Character Display</p> <ul style="list-style-type: none">● Some characters are not displayed with a keystroke.● Pressing a specific key causes the same wrong character to appear.● A keyboard-to-display failure other than the preceding occurs.	<ol style="list-style-type: none">1. Set the Power On/Off (I/O) switch to Off (O).2. Set the Power On/Off (I/O) switch to On (I) and re-try the keyboard-to-display operation.3. If the same problem exists, exchange the keyboard element → 16

8 Press the Reset key, then the J key. Is the terminal ID (u, E, or :) displayed in the first position of the operator information area?

u for 75-key data-entry keyboard (Model C1)

| E for 87-key typewriter keyboard (Models C2 and C4)

: for 87-key typewriter keyboard (Model C3)

YES: → 9

NO: ↘

Note: To determine which keyboard you are using, refer to the keyboard layouts in "Keyboard Key Functions."

Exchange the keyboard element → 16

Dividing Line

Terminal ID

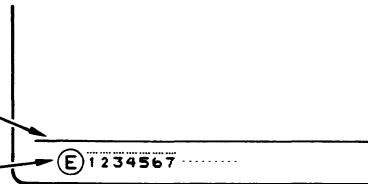

9

Set the TEST/NORMAL switch to NORMAL.
Does the test pattern disappear from the display surface?

YES:  **10**

NO: 

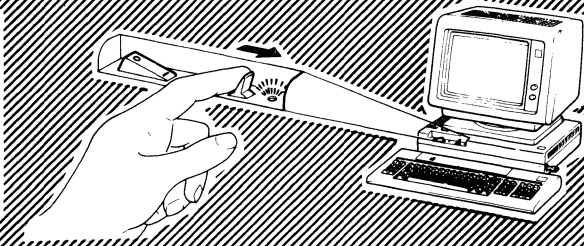

Exchange the logic element.  **17**

10 Is the control unit/adapter Ready symbol **4**, **6**, **4700**, or **I** displayed in the first position of the operator information area?

YES:  **11**

NO: 

Ensure that the communication cable is securely connected to the communication port of the logic element.

If a Ready symbol is not displayed, go to step 13.

If displayed, resume normal operation. **FINISH**

(Intentionally left blank)

11

When your IBM 3178 is attached to the IBM 4701 Controller, go to step 13. When your IBM 3178 is attached to an IBM 3274, IBM 3276, or IBM 4321/4331, press and hold the Alt key; then, press the Test key. Release both keys. Press the / key, and then the Enter key.

Note: If the What symbol (X?+) appears in the operator information area, press the Reset key and continue the process.

Is the following test pattern displayed?

```

TEST: CCCC;NN
?SEL PEN    SEL PEN
&SEL PEN    >SEL PEN
DISPLAY    INSERT CK  _
  
```

Legend:

CCCC: Identifies the control unit/adaptor to which the IBM 3178 is attached.

NN : Is the port number of the requesting station.

No :  **13**

Yes: 

Is the 2nd line of the test pattern highlighted?

Yes:  **12**

No : 

Adjust the contrast and brightness with the Contrast and Brightness Control knobs.

Did the above test pattern appear this time?

Yes: Resume normal operation **FINISH**

No : Exchange the video element  **15**

Contrast Control
Counterclockwise Dimmer



Brightness Control
Counterclockwise Dimmer



12

Move the cursor under the C of CK in the fourth line of the test pattern.

Press the  (Insert) key and  (numeric) key.

Did you hear a click sound?

NO: Exchange the keyboard element  **16**

YES: 

```
TEST: CCCC;NN
?SEL PEN      SEL PEN
&SEL PEN      >SEL PEN
DISPLAY INSERT CK _
```



Do the following in sequence:

1. Press the click key and then the  key.

Did you hear a click sound?

Yes: Exchange the keyboard element  **16**

No: 

2. Press the  key and ensure that the display surface is the same as this. 

Is the display the same?

No:  **13**

Yes:  **14**

```
TEST: CCCC;NN
?SEL PEN      SEL PEN
&SEL PEN      >SEL PEN
DISPLAY INSERT 12CK
```

13

Are other stations connected to the same control unit/adapter working?

YES: Exchange the logic element:  17

NO: 

The problem is most likely external to the IBM 3178.
Report this problem to your supervisor.

14

Press the Reset key. Press and hold the Alt key; then, press the Test key. Start normal operations. Are you having a problem communicating with the control unit/adaptor?

NO:  Continue operations.

YES: 

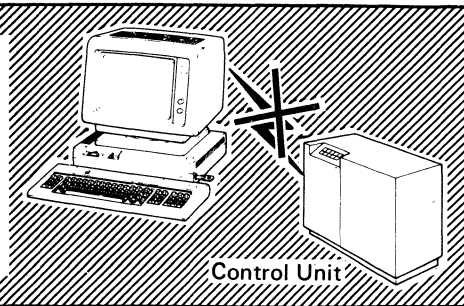

The problem is most likely external to the IBM 3178. Report the problem to your supervisor.

If you have a spare logic element, you can confirm this by swapping the logic element with the spare.  **17**

If you are still unable to resolve the problem, call:

In the continental U.S. and Puerto Rico . . (800)-428-2569 (toll-free)

In Hawaii and Alaska (312)-986-7451 (collect)

15 Video Element Removal and Replacement

If you need IBM service, swap the failing element with a spare (if available) to verify the failure and then call the appropriate number in step 14 of this CPAR.

Before shipment, remove the video element stand from the video element | (see steps 4 through 8 of "Setup Instructions" in this guide).

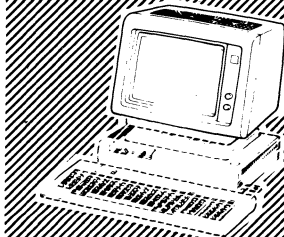

1. Set the Power On/Off (I/O) switch to Off (O).

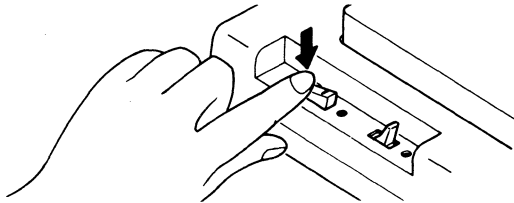

5. Attach the video element stand to the new video element | (see steps 4 through 8 of "Setup Instructions" in this guide).

6. Place the video element assembly on the logic element.

2. Unplug the power cord.



3. Disconnect the video element cable from receptacle 2.
(Do not remove thumbscrews from the connector.)
(Omit this step if the connector has already been removed.)

a. Loosen screws.

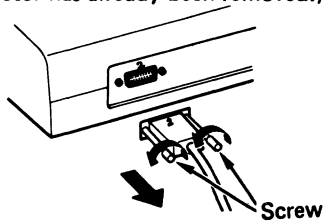

b. Unplug.

4. Remove the video element stand from the failing video element
(see steps 4 through 8 of "Setup Instructions" in this guide).

7. Connect the cable of the new video element.

a. Connect.

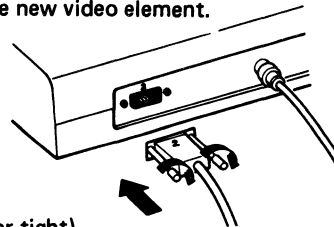

b. Tighten screws (finger tight).

8. Plug the power cable into the power outlet.

9. Set the Power On/Off (I/O) switch to On (I) and verify that the station operates normally.

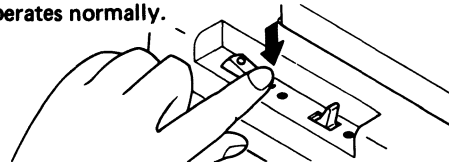

16 Keyboard Element Removal and Replacement

If you need IBM service, swap the failing element with a spare (if available) to verify the failure and then call the appropriate number in step 14 of this CPAR.

Before shipment, remove the keyboard foot assembly (see step 2 of "Setup Instructions" in this guide) and the X.25 Network labels from the keyboard element, if used.

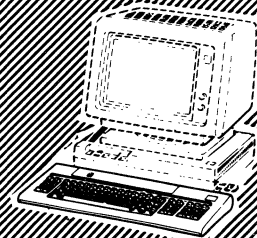

1. Set the Power On/Off (I/O) switch to Off (O).

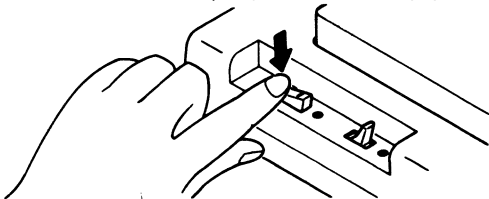

4. Exchange the failing keyboard element with a good one.

5. Connect the keyboard element cable of the new element to the logic element.

- a. Connect.

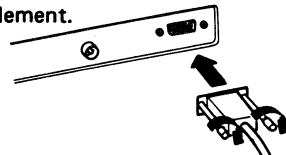

- b. Tighten screws (finger tight).

2. Unplug the power cord.



3. Disconnect the keyboard element cable from receptacle 5.
(Do not remove thumbscrews from the connector.)
(Omit this step if the connector has already been removed.)

a. Loosen screws.

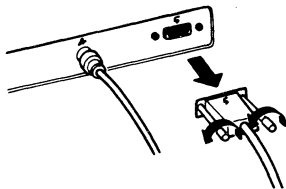

b. Unplug.

6. Plug the power cable into the power outlet.

7. Set the Power On/Off (I/O) switch to On (I) and verify that the station operates normally.

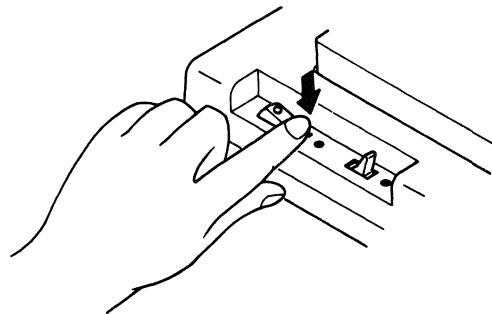

17 Logic Element Removal and Replacement

If you need IBM service, swap the failing element with a spare (if available) to verify the failure and then call the toll-free number in step 14 of this CPAR. When you receive IBM maintenance service, send the security keys together with the logic element.

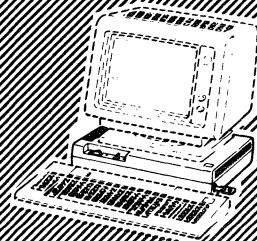

1. Set the Power On/Off (I/O) switch to Off (O).

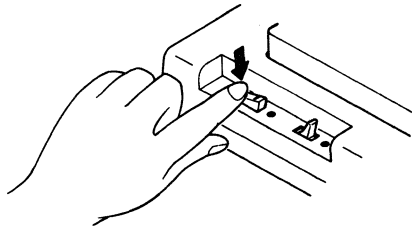

4. Exchange the failing logic element.

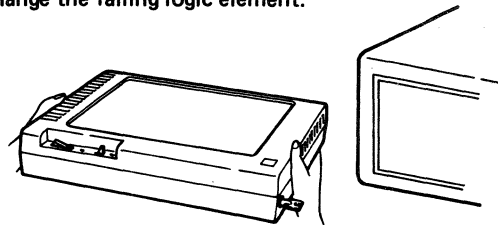

2. Unplug the power cord.



3. Loosen the screws on all the cables at the rear of the logic element and disconnect them. Power cord should not be disconnected.

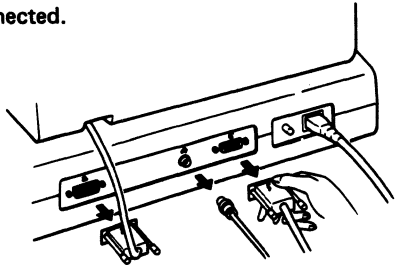

5. Connect to the logic element all cables disconnected in step 3.

6. Plug the power cable into the power outlet.

7. Set the Power On/Off (I/O) switch to On (I) and verify that the station operates normally.

8. Set audible alarm to the desired volume.

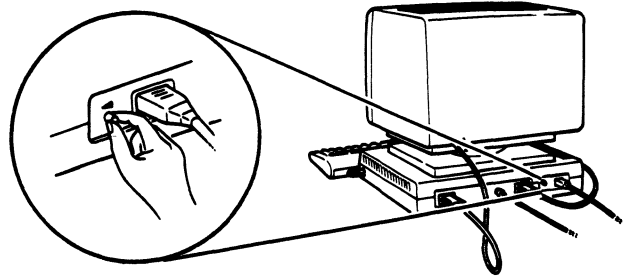

Video Element

The failing element should be packed using the original or equivalent packaging material and returned to IBM for repair or replacement.

Note: Be sure to remove all accessories before returning the failed element.

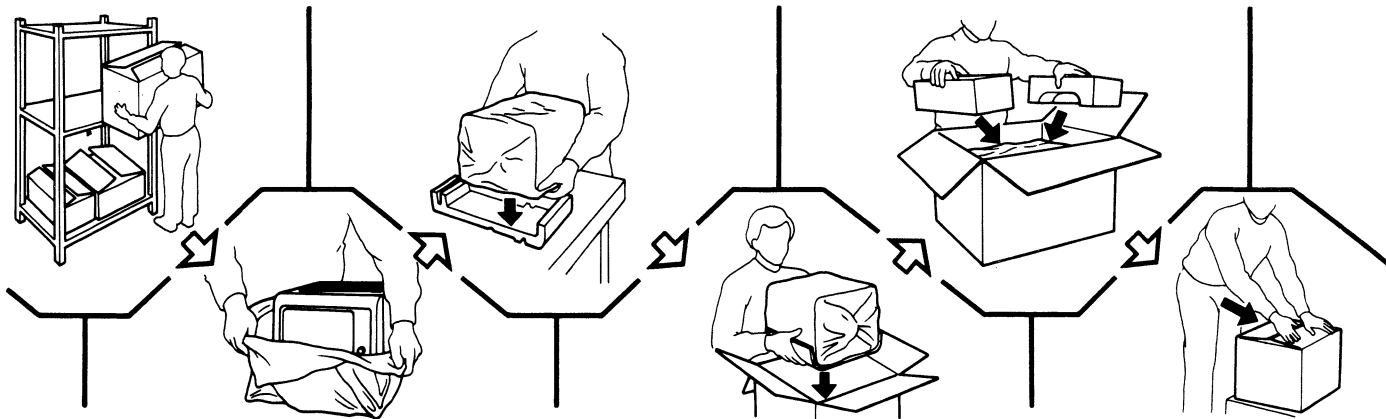

Keyboard Element

The failing element should be packed using the original or equivalent packaging material and returned to IBM for repair or replacement.

Note: Be sure to remove all accessories before returning the failed element.

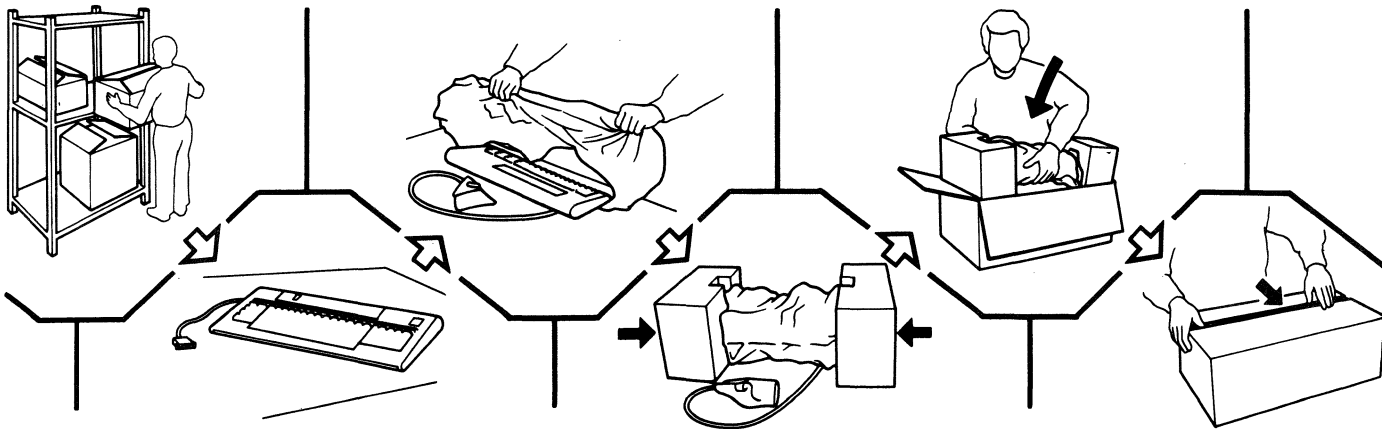

Logic Element

The failing element, both security keys (one inserted in the keylock of the logic element), and the power cord should be packed using the original or equivalent packing material and returned to IBM for repair or replacement.

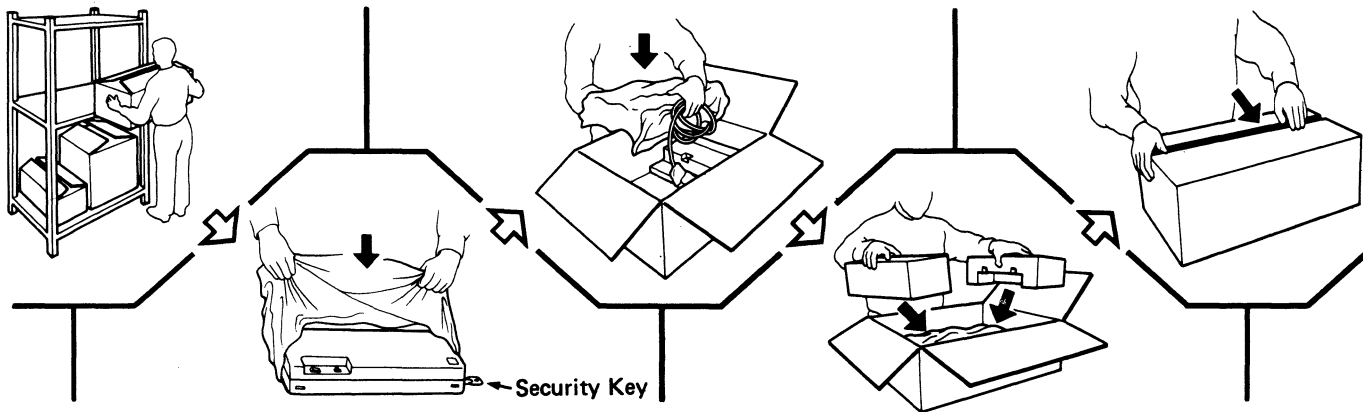

Three Elements in a Master Carton

If all three units must be returned to IBM for repair or replacement, pack them in one master carton.

Note: Be sure to remove all accessories before returning the failed element.

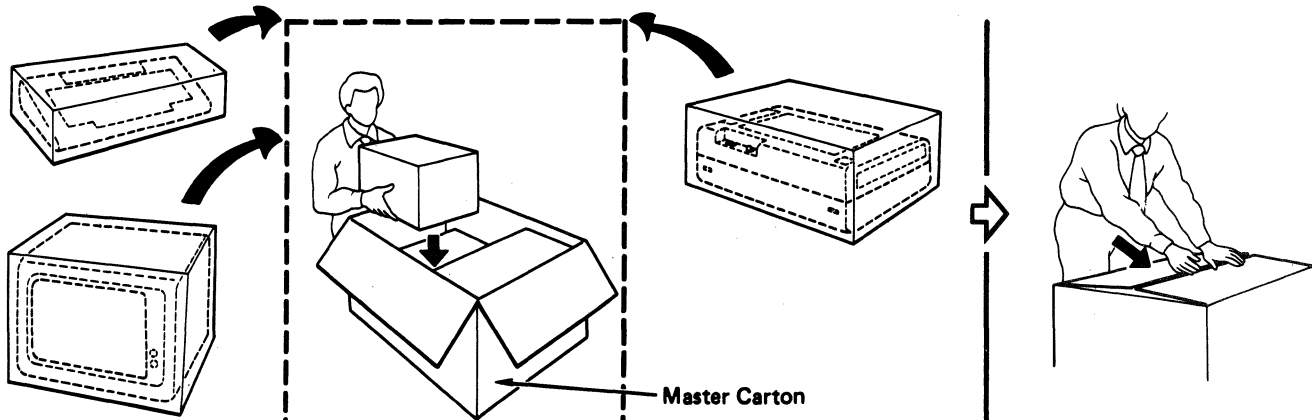

**IBM 3178 Display Station
Operator Reference Guide**

GA18-2128-3

**READER'S
COMMENT
FORM**

You may use this form to communicate your comments about this publication, its organization, or subject matter, with the understanding that IBM may use or distribute whatever information you supply in any way it believes appropriate without incurring any obligation to you. Your comments will be sent to the author's department for whatever review and action, if any, are deemed appropriate.

	Yes	No*
Did you find this booklet useful?		
Were the instructions clear?		
Were the instructions accurate?		
Is the level of detail appropriate?		
Is the booklet well organized?		
Is the size of the booklet appropriate?		

*** (please explain)**

What do you most like about this booklet?

What improvement should be made to this booklet?

If you would like a reply, please enter your name and address below:

Thank you for your cooperation. Reply is not necessary if mailed in the U.S.A.

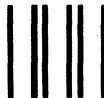

NO POSTAGE
NECESSARY
IF MAILED
IN THE
UNITED STATES

BUSINESS REPLY MAIL

FIRST CLASS PERMIT NO. 40 ARMONK, N.Y. U.S.A.

POSTAGE WILL BE PAID BY ADDRESSEE:

International Business Machines Corporation
Department 812J
1133 Westchester Avenue
White Plains, New York 10604

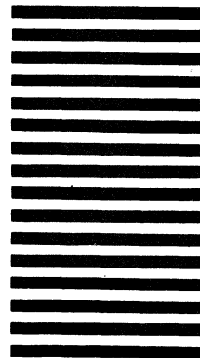

IBM 3178 Display Station Operator Reference Guide GA18-2128-3



Printed in U.S.A.