

HP 9000 Series 200 Computers
Model 220

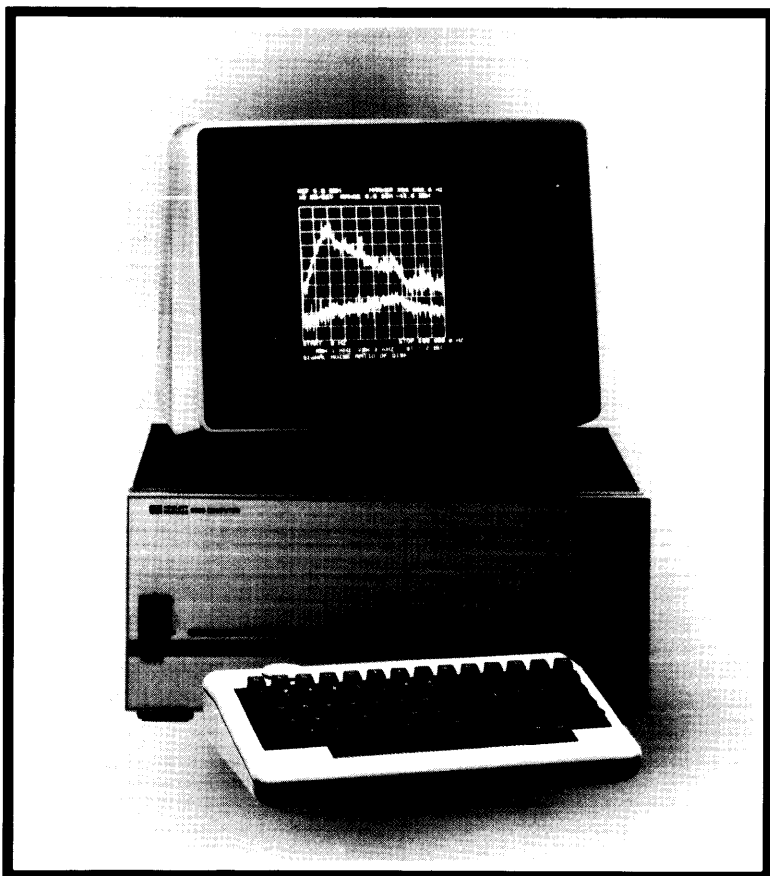

Installation Guide



Installation Guide

for the HP 9000 Series 200 Model 220 Computers

Manual Part No. 09920-90001

© Copyright 1984, Hewlett-Packard Company.

This document contains proprietary information which is protected by copyright. All rights are reserved. No part of this document may be photocopied, reproduced or translated to another language without the prior written consent of Hewlett-Packard Company. The information contained in this document is subject to change without notice.

Use of this manual and flexible disc(s) or tape cartridge(s) supplied for this pack is restricted to this product only. Additional copies of the programs can be made for security and back-up purposes only. Resale of the programs in their present form or with alterations, is expressly prohibited.

Restricted Rights Legend

Use, duplication, or disclosure by the Government is subject to restrictions as set forth in paragraph (b)(3)(B) of the Rights in Technical Data and Software clause in DAR 7-104.9(a).

© Copyright 1980, Bell Telephone Laboratories, Inc.

© Copyright 1979, 1980, The Regents of the University of California.

This software and documentation is based in part on the Fourth Berkeley Software Distribution under license from the Regents of the University of California.

We acknowledge the following individuals and institutions for their role in its development:

© Copyright 1979, The Regents of the University of Colorado, a body corporate.

This document has been reproduced and modified with the permission of the Regents of the University of Colorado, a body corporate.



Hewlett-Packard Company

3404 East Harmony Road, Fort Collins, Colorado 80525

Printing History

New editions of this manual will incorporate all material updated since the previous edition. Update packages may be issued between editions and contain replacement and additional pages to be merged into the manual by the user. Each updated page will be indicated by a revision date at the bottom of the page. A vertical bar in the margin indicates the changes on each page. Note that pages which are rearranged due to changes on a previous page are not considered revised.

The manual printing date and part number indicate its current edition. The printing date changes when a new edition is printed. (Minor corrections and updates which are incorporated at reprint do not cause the date to change.) The manual part number changes when extensive technical changes are incorporated.

August 1984...First Edition

October 1984...Updated for FCC Statement

November 1984...First Edition with update

Warranty Statement

Hewlett-Packard products are warranted against defects in materials and workmanship. For Hewlett-Packard computer system products sold in the U.S.A. and Canada, this warranty applies for ninety (90) days from the date of shipment.* Hewlett-Packard will, at its option, repair or replace equipment which proves to be defective during the warranty period. This warranty includes labor, parts, and surface travel costs, if any. Equipment returned to Hewlett-Packard for repair must be shipped freight prepaid. Repairs necessitated by misuse of the equipment, or by hardware, software, or interfacing not provided by Hewlett-Packard are not covered by this warranty.

HP warrants that its software and firmware designated by HP for use with a CPU will execute its programming instructions when properly installed on that CPU. HP does not warrant that the operation of the CPU, software, or firmware will be uninterrupted or error free.

NO OTHER WARRANTY IS EXPRESSED OR IMPLIED, INCLUDING BUT NOT LIMITED TO, THE IMPLIED WARRANTY OF MERCHANTABILITY AND FITNESS FOR A PARTICULAR PURPOSE. HEWLETT-PACKARD SHALL NOT BE LIABLE FOR CONSEQUENTIAL DAMAGES.

HP 9000 Series 200

For the HP 9000 Series 200 family, the following special requirements apply. The Model 216 computer comes with a 90-day Return-to-HP warranty during which time HP will repair your Model 216, however, the computer must be shipped to an HP Repair Center.

All other Series 200 computers come with a 90-Day On-Site warranty during which time HP will travel to your site and repair any defects. The following minimum configuration of equipment is necessary to run the appropriate HP diagnostic programs: 1) 1/2 Mbyte RAM; 2) HP-compatible 3 1/2" or 5 1/4" disc drive for loading system functional tests, or a system install device for HP-UX installations; 3) system console consisting of a keyboard and video display to allow interaction with the CPU and to report the results of the diagnostics.

To order or to obtain additional information on HP support services and service contracts, call the HP Support Services Telemarketing Center at (800) 835-4747 or your local HP Sales and Support office.

* For other countries, contact your local Sales and Support Office to determine warranty terms.

Table of Contents

Chapter 1 - Introduction

Banish Your Fears	1
How This Guide Is Organized.....	2
Computer Fundamentals.....	4

Chapter 2 - Installing Your Computer

Position Your Computer.....	10
Check the Line Voltage Selector Switch	11
Check the Fuse	12
Connect the Power Cord	13
Turn On Your Computer	14

Chapter 3 - Installing Accessories

Introduction	16
Installing Accessories.....	17
Configure and Install Memory Cards.....	18
Configure and Install Other Non-Interface Accessories	20
Configure and Install Interfaces	22

Chapter 4 - Installing Your Keyboard and Monitor

Installing Your Keyboard.....	26
Installing Your Monitor	27

Chapter 5 - Installing HP-IB Peripherals 29

Chapter 6 - Installing Non-HP-IB Peripherals..... 35

Chapter 7 - Reading The Self-Test

Self-Test Messages.....	38
Status Messages.....	39
Error Messages.....	40
Self-Test Beeper	41
Boot ROM Errors.....	41
Running an Extended Memory Test	42
What To Do When Errors Occur	42
Where To Get Help.....	42
Boot ROM Error Messages	43
Where To Go Next	43

Chapter 8 - Setting Up For HP-UX

Installing Your Computer	46
Installing Accessories	46
Memory Requirements	46
DMA Controller	46
HP 98625A High-speed Disc Interface	46
HP 98624A HP-IB Interface(s)	47
HP 98626A Asynchronous Serial Interface	48
HP 98628A Datacomm Interface.....	48
HP 98644A HP Serial Interface	48
Installing Your Keyboard and Monitor.....	53
If You Use a Keyboard and Monitor....	53
If You Use a Terminal.....	54
Installing HP-IB Peripherals	55
Installing Non-HP-IB Peripherals	58
Datacomm Cables.....	58
Connecting Terminals.....	59
Terminal Baud Rate Settings	61
Terminal Configuration.....	62

Reference

Keyboard/HP-IB Interface Switches	65
Memory Concepts	67
Memory Terms	67
Setting the Switches	67
Interfacing Concepts	68
Internal HP-IB Interface	68
The Select Code	69
HP-IB Concepts	70
The Controller	72
The Talkers	73
The Listeners	73
Bus Addresses	73
HP-IB Considerations for HP-UX	74
HP-IB Description	74
Overview of Parameters	75
Example Systems	79
HP-IB Configuration Restrictions	82
Data Communications Concepts	91
What is the Data Communications Interface?	91
Datacomm Fundamentals	92
Cable Connections	96
 Glossary	 101
 Index	 105

Figures

Installation Highlights	8
Position the Computer to Allow Free Air Flow	10
Voltage Selector Switch	11
Fuse and Fuse Holder	12
Connecting the Power Cord	13
Turning On Your Computer	14
Accessory Slots	16
Removing the Accessory Slot Covers	18
Inserting a Memory Card	19
Seating a Memory Card	19
Removing the Accessory Slot Covers	20
Inserting an Accessory	21
Seating an Accessory	21
Removing the Accessory Slot Covers	23
Inserting an Interface	23
Seating an Interface	24
Keyboard/HP-IB Interface Video Interface Switch	26
Plugging Keyboard Cable into Keyboard/HP-IB Interface	27
Example of HP-IB Address Switches	30
Connecting the HP-IB Cable to the Internal Bus Socket	32
“Chaining” HP-IB Connections	32
Stacking HP-IB Connectors	33
Typical Power-up Display	38
Configuring the HP 98625A High-speed Disc Interface for HP-UX	46
Configuring the HP 98624A HP-IB Interface for HP-UX	47
HP 98626A Asynchronous Serial Interface	50
HP 98628A Datacomm Interface	51
HP 98644A HP Serial Interface	52
Configuring the Keyboard/HP-IB Interface for HP-UX	53
Example of a Directly Connected Terminal	59
Example of a Modem-connected Terminal	61

Keyboard/HP-IB Interface Configuration Switches	66
Internal HP-IB Interface	69
Selecting an Interface	69
Communication on the HP-IB	71
Example of a Small Single-user System	79
Example of an Expanded Single-user System	80
Example of a Small Multi-user System	81
Example of an Expanded Multi-user System	87
Parallel Transmission	92
Serial Transmission	93
Indistinguishable Characters	93
Distinguishable Character	94
Transmission Rate Problem	94
DTE Cable with Male Connector	96
DCE Cable with Female Connector	96
Connecting Your Computer to a Modem	97
Connecting Your Computer to Another Computer	98
Connecting Your Computer to a DCE Peripheral	98
Connecting Your Computer to a DTE Peripheral	99

Tables

Available Power Cords	13
Available HP-IB Cables	31
Boot ROM Error Messages	43
HP-UX Select Codes	48
HP-IB Bus Address Assignments for HP-UX	57
Terminal Configuration Settings	63
Datacomm Configuration Settings	63
Available HP-IB Bus Addresses	76
Assignment of Shared Sets of I/O Resources by Bus Address	78

**FEDERAL COMMUNICATIONS COMMISSION
RADIO FREQUENCY INTERFERENCE
STATEMENT (U.S.A. ONLY)**

The Federal Communications Commission (in Subpart J of Part 15, Docket 20780) has specified that the following notice be brought to the attention of the users of this product.

Warning: This equipment generates, uses, and can radiate radio frequency energy and if not installed and used in accordance with the instructions manual, may cause interference to radio communications. It has been tested and found to comply with the limits for a Class A computing device pursuant to Subpart J of Part 15 of FCC Rules, which are designed to provide reasonable protection against such interference when operated in a commercial environment. Operation of this equipment in a residential area is likely to cause interference in which case the user at his own expense will be required to take whatever measures may be required to correct the interference.

Introduction

Chapter

1

Banish Your Fears

Your new computer has just arrived. You're looking for some easy instructions to get it set up and running, and you've turned to this guide for help. You've come to the right place.

Before you proceed, we want to address a few preconceptions you may have about computer documentation. Yes, we know that you may be less than enthusiastic about reading this guide. You're concerned that you'll have to read for hours before you can finally put the book down and actually *do something* with your computer. Or perhaps you're afraid that we'll presume you have a Ph.D. in electrical engineering, give you a schematic of the computer, and tell you to figure it out for yourself.

Forget it. That's not going to happen here. This guide tells you how to put your computer system together and turn it on. When you're done with this manual, you'll be ready to load and use your operating system or applications program.

How This Guide Is Organized

This guide has eight chapters. Please read the first seven in order, performing the installation procedures as you go. You will use Chapter 8 only if you have an HP-UX computer.

Chapter 1 – Introduction. Tells you how your installation guide is organized. “Computer Fundamentals” introduces you to computer technology and terminology.

Chapter 2 – Installing Your Computer. Tells you how to install the computer.

Chapter 3 – Installing Accessories. Tells you how to configure and install accessories. Accessories are memory cards, interfaces, and other enhancements.

Chapter 4 – Installing Your Keyboard and Monitor. Tells you how to connect your keyboard and monitor to the computer. If you do not have a keyboard and monitor, skip these procedures.

Chapter 5 – Installing HP-IB Peripherals. Tells you how to set up your HP-IB peripheral devices and connect them to your computer.

Chapter 6 – Installing Non-HP-IB Peripherals. Tells you how to set up and install data communications equipment and other non-HP-IB peripherals.

Chapter 7 – Reading The Self-Test. Tells you how to turn on your computer system and read and interpret the self-test messages.

Chapter 8 – Setting Up For HP-UX. Tells you the hardware installation requirements that are specific to HP-UX. You are referred to this chapter from other chapters when you need to set up for HP-UX. If you will not use the HP-UX operating system, ignore this chapter.

Reference. Contains information that you don't necessarily need for installation, but that may be valuable for reference or tutorial purposes. You are referred to this section from the body of the guide where appropriate. The Reference section contains the following information:

- Keyboard/HP-IB Interface Switches
- Memory Concepts
- Interfacing Concepts
- HP-IB Concepts
- HP-IB Considerations for HP-UX
- Data Communications Concepts

Glossary. Contains definitions of terms used in this guide.

Index. Contains an alphabetical list of the subjects in this guide and the corresponding pages where the subjects are discussed.

If you already are familiar with computer systems and terminology, skip the next section and go on to Chapter 2.

Computer Fundamentals

If you think computer technology is intimidating and cannot be understood, and if all of that computer jargon sounds like pure gobbledygook to you, read on—this section is for you. In just a few minutes you'll be able to talk computers with the best of them.

The next few paragraphs will put your computer into a more human perspective. We will argue that computers have the same basic design as people, except that computers have much lower I.Q.s and don't complain as much about doing repetitive, mundane tasks. We'll start at the center of your computer and work our way out.

The **processor** is the command center of the computer, just as the brain is your command center. This tiny chip contains thousands of circuits, like the nerve fibers of the brain. Each circuit performs one specific operation at near light speed.

Just because the processor runs close to the speed of light and is capable of many great operations, don't assume it's intelligent. The processor is a very docile creature; it never had an original thought in its life. It does exactly as it's told, and if it's told nothing, it does nothing. In order to make the processor do something worthwhile, you must give it a set of instructions called a **program**. It's the program (also called **software**) that makes the processor perform complicated calculations, plot graphics, and do all of the other marvelous things that we associate with computers.

People have programs too, of course. When someone gives another person directions for getting to his house, he's giving that person a sort of "program". Of course, if this person forgets the directions, he's not going to get very far. The same is true for computers. Fortunately, both computers and people have a **memory** that they can store their programs in.

There are two types of computer memory: **Random Access Memory** or **RAM**, and **Read-Only Memory** or **ROM** (computer folks love to make acronyms of everything, but you'll get used to it).

RAM is similar to a human being's short-term memory. You can commit a program to memory, remember it a short time later when you need it, and then erase (forget) it when you're through. When the computer's power is turned off, everything stored in RAM is erased.

ROM is a different story, akin to a person's long-term memory. This is where the computer stores the experiences that it can't afford to forget, not even when the power is turned off. Once something is committed to ROM at the factory, it can be recalled but never erased. Since ROM is not re-programmable like RAM, it's more expensive and is used for only the most essential programs.

One of these essential programs is the set of instructions that wake the computer up when its power is turned on. When a human being gets up in the morning, he has a set of automatic responses that tell him how to open his eyes, get out of bed, take a shower and eat breakfast. In your computer, the equivalent instructions are called the **booting program** and they are stored in a special place called the **Boot ROM**. Note that because RAM is erased when the power is turned off, the booting program must be stored in ROM.

So now the computer can function. It has a memory to store programs and data and it has a processor to execute the programs and process the data. But how can the computer communicate with us mortals, who are waiting anxiously for the results? Right now it can't, so **peripheral devices** must be added.

Peripheral devices (or **peripherals**, for short) are the computer's communication link to the outside world, much as a person's ears and mouth are his communication devices. There are two main classes of peripherals, although some devices fall into both classes. **Input devices** accept information from the outside world and give it to the processor. In people, input devices include ears and eyes; in computers, they include keyboards and disc drives. **Output devices** accept information from the processor and give it to the outside world. A person's vocal chords are an output device, as are a monitor (also called a CRT), disc drive, and printer.

The **disc drive** is a very important peripheral device and is worth a closer look. One problem computers face is how to get programs into memory where the processor can get to them. One way is to type a program in line-by-line at the keyboard every time you want to run it, but that would be tedious. Or all programs could be stored in ROM, but that would be expensive. Clearly, the best way is to store programs on some kind of inexpensive media, and then design a device to transfer the programs from the media into memory. The media most often used today is the disc, and the device that drives the disc is, naturally, the disc drive.

The disc drive is very much like a record player, except that it records data and programs instead of music. The disc drive rotates the disc, and waits for the processor to ask for a program. When the request comes through, the disc drive finds the desired program on the disc and copies it into memory.

One last problem: What happens when a person's ears send him messages in Greek and his brain does all his thinking in Hebrew? The usual solution is to hire an interpreter to moderate the conversation, one who speaks both Greek and Hebrew.

Surprisingly, this situation also occurs in computers. When a peripheral device is designed to communicate differently from the processor it's connected to, an **interface** is used to do the interpreting. The interface (interpreter) intercepts messages from the processor and translates them into the language the peripheral understands, and vice versa.

That's enough information to get you started. More specialized topics will be covered in the chapters to come. If you have a problem understanding a term, refer to the Glossary at the back of this guide. Now move on to Chapter 2.

Table of Contents

Chapter 2 - Installing Your Computer

Position Your Computer	10
Check the Line Voltage Selector Switch	11
Check the Fuse	12
Connect the Power Cord	13
Turn On Your Computer	14

Chapter 3 - Installing Accessories

Introduction	16
Installing Accessories	17
Configure and Install Memory Cards	18
Configure and Install Other Non-Interface Accessories	20
Configure and Install Interfaces	22

Chapter 4 - Installing Your Keyboard and Monitor

Installing Your Keyboard	26
Installing Your Monitor	27

Power Switch - This is the switch you use to turn power on and off. A green indicator in the switch lights when power is on. Never plug or unplug the computer with power turned on.

Voltage Selector Switch - The computer is designed to run at either 90-125 Vac or 195-250 Vac. The line frequency range is 48-66 Hz.

Accessory Slots - Remove the accessory slot covers to install memory cards, interface cards, and other accessories (Chapter 3).

Keyboard/HP-IB Interface - This interface provides connections for the keyboard and monitor (Chapter 4) and for HP-IB peripherals (Chapter 5).

Power Socket - The power socket is especially designed for an HP power cord. The power cord is shipped in the carton this guide came in.

Fuse - A properly rated fuse must be installed for your computer to run safely. The correct fuse rating depends on the input voltage.

Fan - The computer has a small built-in fan to keep the machine cool. The fan should always be running when the computer is on.

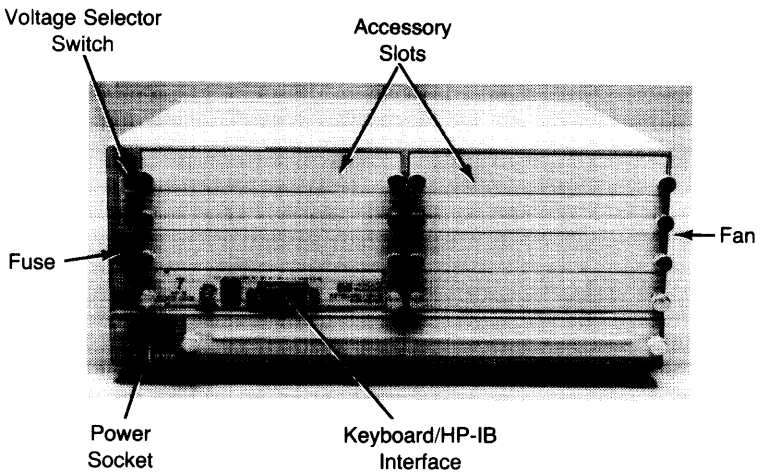
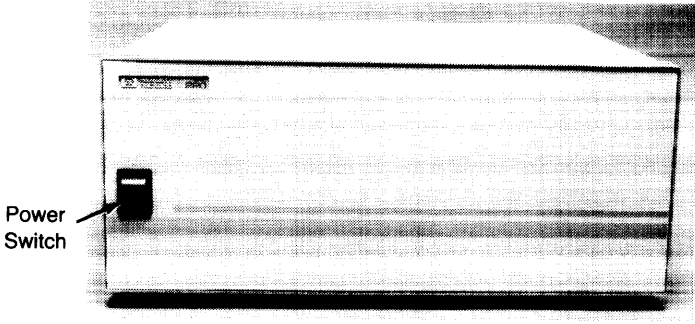

Installing Your Computer

Chapter

2

Note

Pull out the photo foldout on the facing page and familiarize yourself with the computer parts. Find each part on your own computer as you look over the list. Leave the foldout open so you can refer to it as you install your computer.

This chapter tells you how to:

- Position your computer.
- Check the line voltage selector switch.
- Check the fuse.
- Connect the power cord.
- Turn on your computer.

Position Your Computer

Place your computer on any convenient surface. Position it so there is at least 6 cm (2.5 inches) of clearance on the left side. The fan draws cooling air into the left side near the back and exhausts the air at the left side near the front. Ensure that there is an unrestricted supply of cool air to the intake holes.

Allow at least 15 cm (6 inches) of clearance at the back of the computer for cable connections. If pressure is exerted against the computer-end of these cables, the connectors could be damaged. No top, bottom, or right side clearance is required.

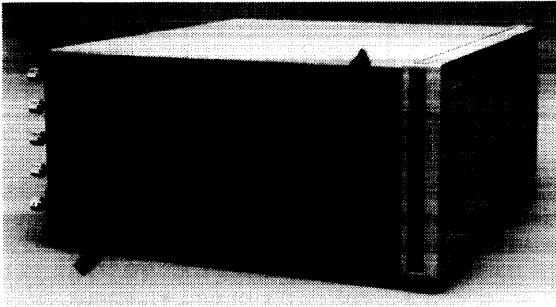

Position the Computer to Allow Free Air Flow

Check the Line Voltage Selector Switch

Ensure that the line voltage selector switch at the upper left corner of the rear panel is set to the correct position. If the local line voltage is between 90 and 125 volts, slide the switch **up**. If the voltage is between 195 and 250 volts, slide the switch **down**.

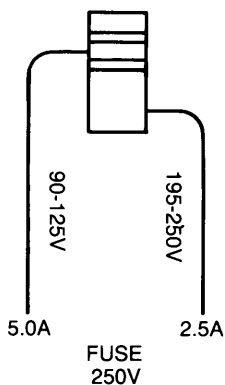

Voltage Selector Switch

CAUTION

THE COMPUTER CAN BE DAMAGED IF SET FOR THE LOWER VOLTAGE RANGE AND PLUGGED INTO A HIGHER VOLTAGE.

Check the Fuse

WARNING

DO NOT CHECK OR CHANGE THE FUSE UNLESS POWER IS DISCONNECTED FROM THE COMPUTER.

To remove the fuse holder, press in on it and turn it counterclockwise. If your line voltage selector switch is set for 90-125V, ensure you have a 5-amp fuse; if your switch is set for 195-250V, ensure you have a 2.5-amp fuse. The fuse must be rated for 250V.

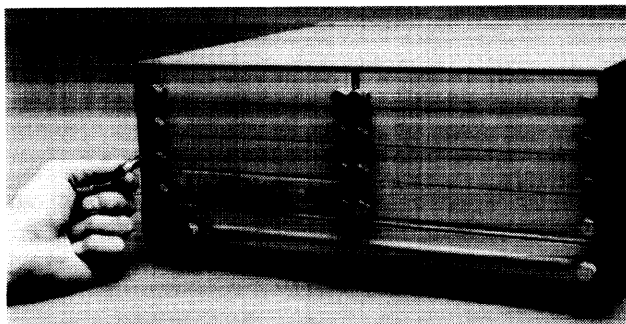

Fuse and Fuse Holder

If you need a replacement fuse, use the correct fuse from your Accessories Kit or contact the nearest HP Sales and Support Office.



USE CORRECT VOLTAGE SETTING
AND FUSE - SEE MANUAL

UTILISER TENSION ET FUSIBLE
APPROPRIÉS - C.F. MANUAL

BENUTZEN SIE KORREKTE SPANNUNGSEIN-
STELLUNG UND SICHERUNG - SIEHE MANUAL

USE A JUSTE DE VOLTAGE Y FUSIBLE
CORRECTO - VEA MANUAL

Connect the Power Cord

Ensure that the power switch on the front of the computer is set to the off (0) position.

Connect the power cord to the ~AC LINE socket at the lower left corner of the rear panel. Connect the other end of the power cord to your power outlet.

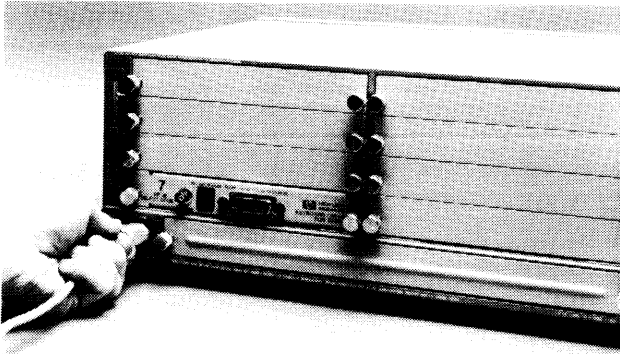

Connecting the Power Cord

WARNING

IF A REPLACEMENT POWER CORD IS NEEDED, MAKE SURE YOU ORDER AN HP POWER CORD THAT IS IDENTICAL TO THE ORIGINAL. OTHERWISE, ELECTRICAL SHOCK OR EQUIPMENT DAMAGE MAY RESULT.

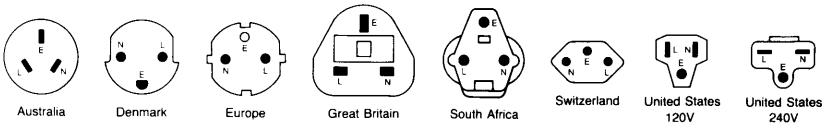

Country	Part Number	Opt.	Voltage
Australia	8120-1369	901	250V, 6A
Denmark	8120-2956	912	250V, 6A
Europe	8120-1689	902	250V, 6A
Great Britain	8120-1351	900	250V, 6A
South Africa	8120-4211	917	250V, 10A
Switzerland	8120-2104	906	250V, 6A
United States	8120-1378	903	120V, 10A
United States	8120-0698	904	240V, 10A

Power cords supplied by HP have polarities matched to the power-input socket on the computer:

- L = Line or Active Conductor (also called "live" or "hot")
- N = Neutral or Identified Conductor
- E = Earth or Safety Ground

NOTE: Plugs are viewed from connector end. Shape of molded plug may vary within country.

Available Power Cords

Turn On Your Computer

Press the power switch on the front of your computer to the on (1) position. The switch should light (green), and the fan should operate. **If the fan runs and the indicator is on, you have successfully installed your computer; turn off the computer and go on to Chapter 3.** Otherwise, continue here.

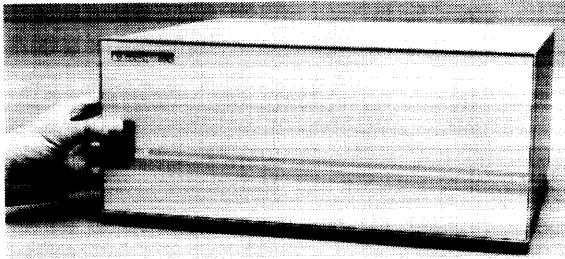

Turning On Your Computer

Problem?

If your computer does not turn on, check the following:

1. Is the power switch on the front of the computer set to the on (1) position?
2. Is the power cord firmly plugged into the computer's power socket and into the power outlet?
3. Is power present at the power outlet?

If you answered "yes" to all three questions, replace the fuse and try again to turn on your computer. If it still doesn't turn on, call your HP Service Representative.

Installing Accessories

Chapter

3

Accessories are devices that plug into your computer's accessory slots. They include memory cards, interfaces, and other enhancements. This chapter tells you how to install accessories in your computer. You will also find pointers to Chapter 8 for specific HP-UX configurations. This chapter has the following sections:

Introduction - Provides general information on your accessory slots and helps you plan accessory installation.

Installing Accessories - Tells you how to configure and install memory cards, interfaces, and other accessories.

Note

For additional information on accessories, refer to "Memory Concepts" and "Interfacing Concepts" in the Reference section at the back of this guide.

Introduction

Your computer has 16 accessory slots as shown in the following illustration. The Keyboard/HP-IB Interface occupies slot 8.

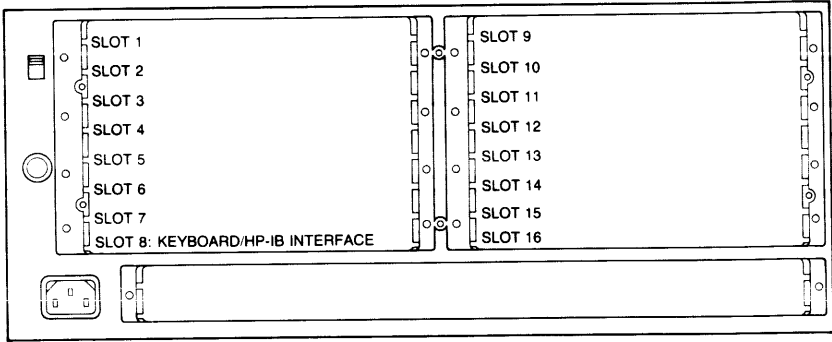

Interfaces with attached cover plates must be installed in even-numbered slots.
All other accessories can be installed in any available slot.

Accessory Slots

If you have additional accessories to install, continue with “Installing Accessories”; otherwise, go on to Chapter 4.

Installing Accessories

CAUTION

SWITCH OFF THE COMPUTER BEFORE INSTALLING AN ACCESSORY. PLUGGING OR UNPLUGGING A CARD WITH THE POWER ON CAN DAMAGE THE CARD AND THE COMPUTER.

MOST ACCESSORIES CONTAIN COMPONENTS THAT ARE SENSITIVE TO DAMAGE FROM ELECTROSTATIC DISCHARGE. WHENEVER YOU REMOVE, INSTALL, OR HANDLE AN ACCESSORY, HOLD IT BY ITS EXTRAC-TORS, EDGES, OR COVER PLATE. DO NOT TOUCH ITS ELECTRICAL COMPONENTS, TRACES, OR EDGE CON-NECTORS.

USE PROTECTIVE MEASURES INCLUDING ANTI-STATIC WORKSTATIONS AND PERSONNEL GROUNDING DE-VICES, IF POSSIBLE. BE ESPECIALLY CAREFUL WHEN WORKING IN CARPETED AREAS.

Your first step is to determine what accessories you are going to install and where you are going to install them. Interfaces with attached cover plates must be installed in even-numbered slots. All other accessories can be installed in any available slot. An odd-numbered slot covered by an inter-face cover plate is an available slot—except in the case of the HP 98204 Composite Video Interface with graphics option, which is a two-card inter-face and occupies two slots.

Use the preceding illustration by writing in the accessory types next to the slots as you assign them. Remember that an interface must occupy an even-numbered slot.

Note

If you have more accessories than slots, you must use an HP 9888A Bus Expander which provides an additional 15 slots.

If you use an expander, install the HP 98625A High-speed Disc Interface, HP 98620B DMA Controller, HP 98255A EPROM Interface, and as many memory cards as possible in the **compu-ter's** accessory slots.

Configure and Install Memory Cards

HP-UX Note!

If you are going to run HP-UX on your computer, you need at least three HP 98256A 256K RAM cards or one HP 98257A 1M RAM card.

If you are going to install memory cards, continue here; otherwise, skip ahead to “Configure and Install Other Non-Interface Accessories” or “Configure and Install Interfaces”.

You can have up to 15 memory cards (or a maximum of 7.68 mbytes) in your computer. All can be HP 98256A 256K byte cards, all HP 98257A 1M byte cards, or any combination of the two.

First, remove the accessory slot covers by turning the thumbscrews counterclockwise.

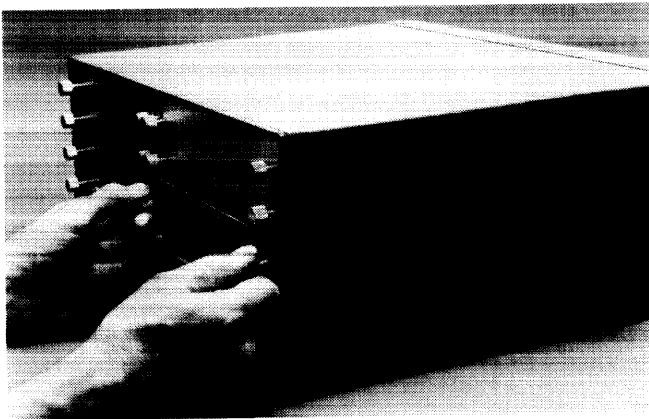

Removing the Accessory Slot Covers

Then, set the address switches on your memory cards as described in the Installation Note that came with the card.

Finally, slide each memory card into its pre-assigned accessory slot, component-side up. Push the card firmly into place with its extractors until they are flush with the back of the computer.

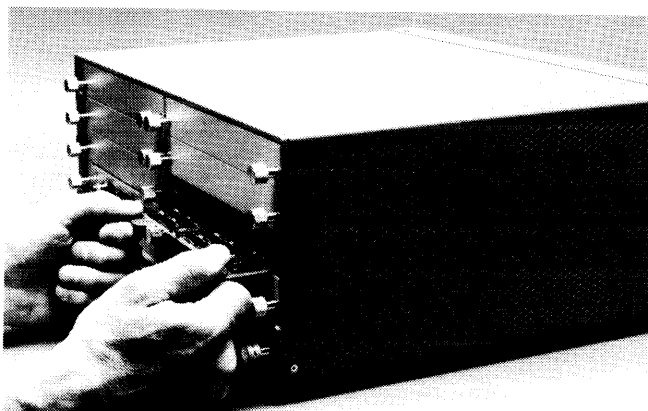

Inserting a Memory Card

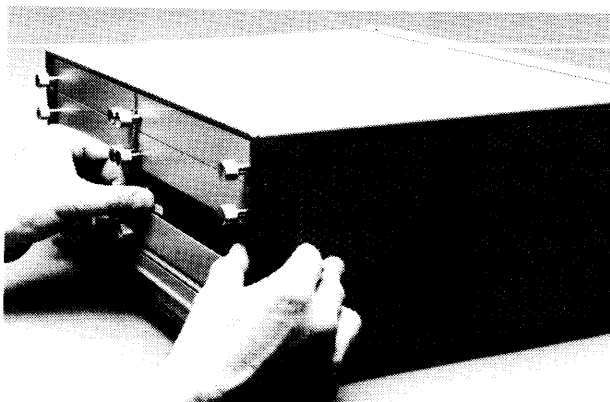

Seating a Memory Card

If you've installed all your accessories, replace the accessory slot covers and go on to Chapter 4; otherwise, continue here.

Configure and Install Other Non-Interface Accessories

HP-UX Note!

If you are going to run HP-UX on your computer, you need an HP 98620B DMA Controller.

If you are installing accessories other than memory cards and interfaces, continue here; otherwise, skip ahead to “Configure and Install Interfaces”.

Configure your other non-interface accessories according to their installation manuals.

Remove the accessory slot covers by turning the thumbscrews counterclockwise.

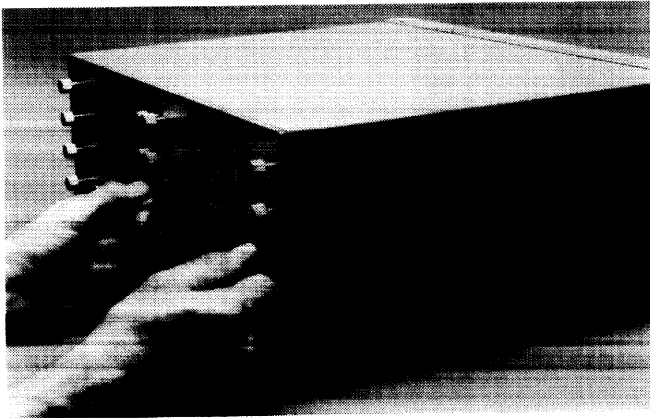

Removing the Accessory Slot Covers

Slide each accessory into its pre-assigned accessory slot component-side up. Use the extractors to push the accessory firmly into place. When the accessory is inserted properly, the extractors should rest flush with the back of the computer.

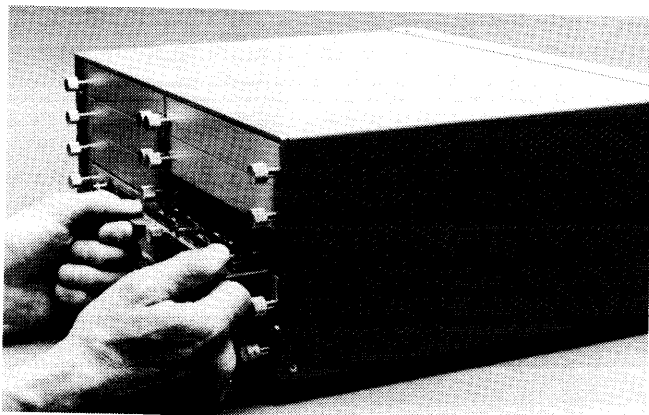

Inserting an Accessory

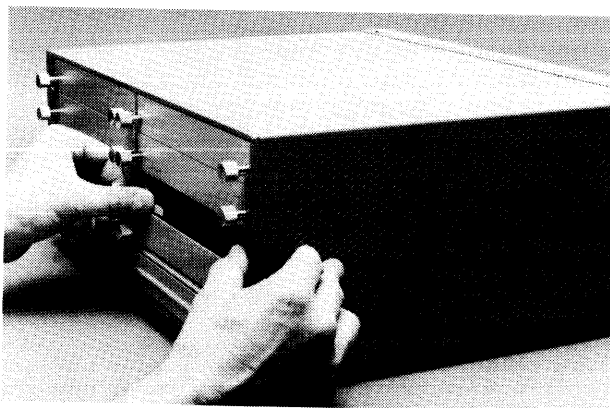

Seating an Accessory

If you've installed all your accessories, replace the accessory slot covers and go on to Chapter 4; otherwise, continue here.

Configure and Install Interfaces

HP-UX Note!

If you are going to run HP-UX on your computer, you must have an HP 98625A High-speed Disc Interface. You may also have an HP 98624A HP-IB Interface, an HP 98626A Asynchronous Serial Interface, an HP 98628A Datacomm Interface, and/or an HP 98644A HP Serial Interface. You must configure these interfaces specifically for HP-UX. Refer to Chapter 8, under the heading "Installing Accessories", for configuration procedures for these interfaces.

Remove the interface from its anti-static envelope. Some interfaces have a factory-set select code prominently marked on the cover plate. The factory-set select code usually will not conflict with your other interfaces.

Each interface has a group of switches for setting the select code. Refer to the interface's installation manual to locate the select code switches. Check the select code switches on the interface card and reset if necessary.

Keep in mind the following restrictions:

- Don't use select codes 0 through 6. They are reserved by the system.
- Don't use select code 7. It's reserved for the internal HP-IB built into the Keyboard/HP-IB Interface.
- When using HP-UX, don't use select codes 8, 9, and 14 except as described in Chapter 8.

Set any other switches which may be on the interface. These switches control various functions on the interface. Refer to the installation manual for instructions on setting these switches before you insert the card into your computer.

Remove the accessory slot covers by turning the thumbscrews counterclockwise.

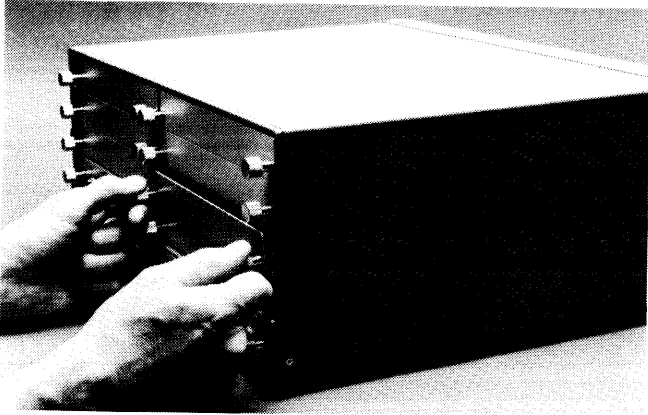

Removing the Accessory Slot Covers

Insert the interface card into its pre-assigned accessory slot and tighten the thumbscrews until the interface cover plate is flush with the back of the computer.

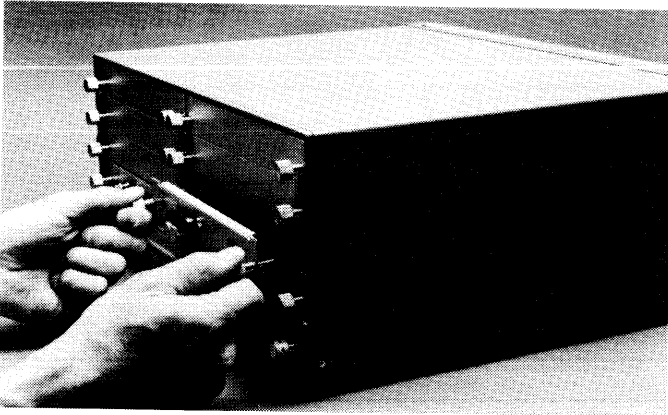

Inserting an Interface

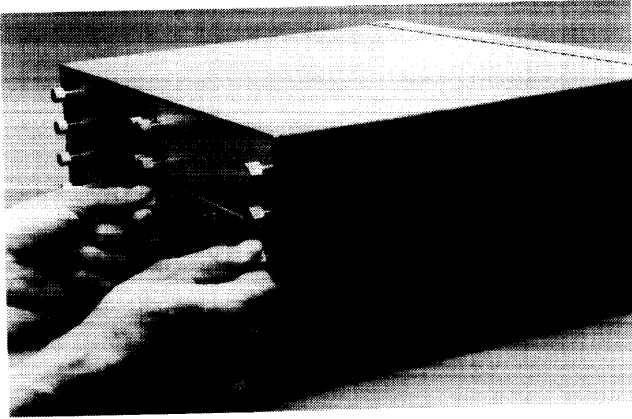

Seating an Interface

Repeat the above procedure for each interface you're installing. Your computer can accommodate up to eight interfaces. If you want additional interface capacity, contact your HP Sales Representative about the HP 9888A Bus Expander.

You've now installed your accessories. Replace the accessory slot covers and go on to Chapter 4.

Installing Your Keyboard and Monitor

Chapter

4

HP-UX Note!

If you are installing an HP-UX system, install your system console (keyboard and monitor, or terminal) according to the instructions in Chapter 8 under the heading "Installing Your Keyboard and Monitor". Then continue with Chapter 5.

This chapter describes how to install your keyboard and monitor. It is assumed you have an HP 98203A or HP 98203B keyboard. If you don't have a keyboard and monitor, skip to Chapter 5.

CAUTION

TURN OFF YOUR COMPUTER BEFORE INSTALLING THE
KEYBOARD AND MONITOR.

Installing Your Keyboard

1. Ensure that your computer is turned off.
2. Ensure that the Video Interface switch on the Keyboard/HP-IB Interface is set to the Installed position.

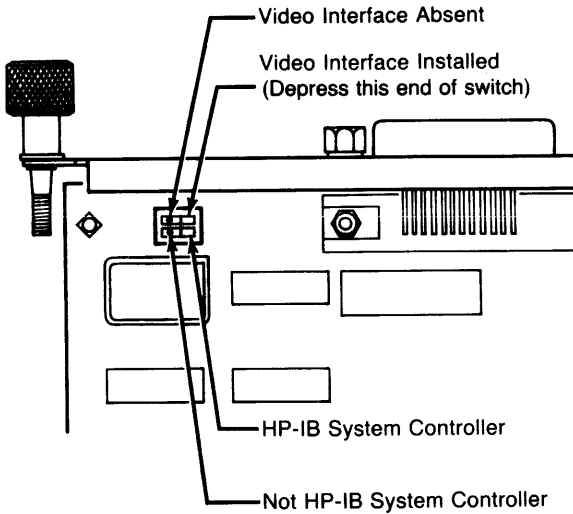

Keyboard/HP-IB Interface Video Interface Switch

3. Plug the coiled cable into the back of the keyboard (HP 98203B only; the HP 98203A has an attached cable).
4. Plug the free end of the coiled cable into the Keyboard/HP-IB Interface. If the coiled cable is too short, either substitute the keyboard extension cable for the coiled cable or use both the coiled cable and the keyboard extension cable interconnected by the double-female receptacle block.

Note

Refer to the Installation Note that came with your keyboard if you need additional information.

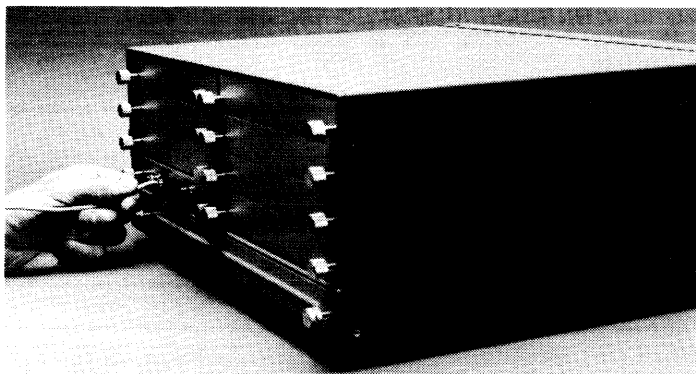

Plugging Keyboard Cable into Keyboard/HP-IB Interface

Installing Your Monitor

1. Ensure that the switches on the HP 98204 Composite Video Interface are set according to the Installation Note that came with the interface.
2. Set up and install your monitor according to the instructions that came with the monitor.

The video cable connects to the HP 98204 Composite Video Interface.

The audio cable, if used, connects to the Keyboard/HP-IB Interface.

If you are going to install HP-IB peripherals, continue with Chapter 5; if you do not have HP-IB peripherals but will install other peripheral devices, skip to Chapter 6; otherwise, go on to Chapter 7.

Table of Contents

Chapter 5 - Installing HP-IB Peripherals 29

Chapter 6 - Installing Non-HP-IB Peripherals. 35

Installing HP-IB Peripherals

Chapter

5

The HP-IB interface is a standard, simple, multiple-device interface. The HP-IB interface allows you to connect most HP disc drives, printers, plotters, and graphics tablets that are supported on your computer. And because you can connect up to 14 peripherals to a single HP-IB, this interface satisfies most peripheral interfacing needs.

Your computer has an internal HP-IB interface built into the Keyboard/HP-IB Interface installed in accessory slot 8. Select code 7 is assigned to that interface.

This chapter describes how to connect peripheral devices to the HP-IB interface. To find out if your peripheral conforms to the HP-IB standard, look for the letters "HP-IB" near the socket on the device, or consult the manual that came with the device.

Note

For additional information on the HP-IB, refer to "Interfacing Concepts" and "HP-IB Concepts" in the Reference section at the back of this guide.

HP-UX Note!

If you are installing an HP-UX system, you will configure at least two HP-IB buses: a system bus and an internal bus. You may also configure one or more external HP-IB buses. You must configure the HP-IB buses and HP-IB peripheral device addresses specifically for HP-UX. The HP 98625A High-speed Disc Interface drives the system bus. Refer to Chapter 8, under the heading "Installing HP-IB Peripherals", for more information before continuing. Refer to "HP-IB Considerations for HP-UX" in the Reference section at the back of this guide for additional information.

The internal HP-IB interface drives the internal bus; its connector is on the Keyboard/HP-IB Interface installed in accessory slot 8. The HP 98624A HP-IB Interface drives the external bus. Up to 14 peripheral devices can be interconnected on each bus.

Configure and install the buses in this order: 1) system (if HP-UX), 2) internal, 3) external(s), if any. Perform the following procedures for **each** HP-IB bus that you are configuring.

1. Install your HP-IB peripheral devices in their normal operating position, connect their power cables, and run their stand-alone self-tests. Refer to the installation instructions that came with each device.
2. Turn off all the peripheral devices. Then turn off the computer.
3. Set the address switches on each peripheral device to a unique address. Most HP-IB peripherals have a set of address switches next to the HP-IB socket (see the following example). If you cannot locate or understand the switches, refer to the peripheral device's installation manual.

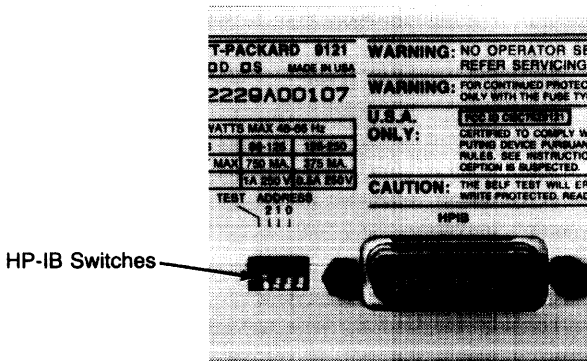

Example of HP-IB Address Switches

If you have only one device of each type connected to your computer (e.g., one printer, one disc drive and one plotter), you probably won't need to alter the factory-set addresses.¹ Change the bus address only if two peripherals are set to the same address.

¹ The flexible disc drive in the HP 9133 and 9135 devices is set at the factory to address 1. Since all HP printers are also shipped with address 1, you must change the primary address of either the flexible disc drive or the printer.

The factory address settings for common peripherals are shown below.

Peripheral Type	Factory Address Setting	Switch Settings
		2 1 0 or 4 2 1
HP-IB Disc Drives	0	0 0 0
HP-IB Printers	1	0 1 0
HP-IB Plotters	5	1 0 1
HP-IB Graphics Tablet	6	1 1 0

4. Select a peripheral device to attach directly to the computer.
5. Press the HP-IB cable plug into your peripheral's HP-IB socket and secure the connection with the thumbscrews. The plug and socket fit together in only one way, so if you're having difficulty making the connection, rotate the plug 180° and try again.

Note

A 2-metre cable is supplied with the computer. Additional cables are available from Hewlett-Packard. Call your HP Sales Representative for details.

Length	Part Number
0.3 metre	92220R
0.5 metre	10833D
1.0 metre	10833A
2.0 metres	10833B
4.0 metres	10833C
6.0 metres	5060-9459
8.0 metres	5060-9460

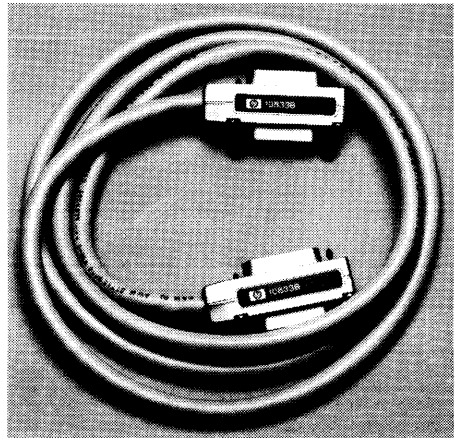

Available HP-IB Cables

6. Connect the other end of the HP-IB cable to the HP-IB socket on the computer (HP-IB socket on the Keyboard/HP-IB Interface for the internal bus, HP 98625A socket for the system bus, or HP 98624A socket for the external bus). Tighten the connector screws.

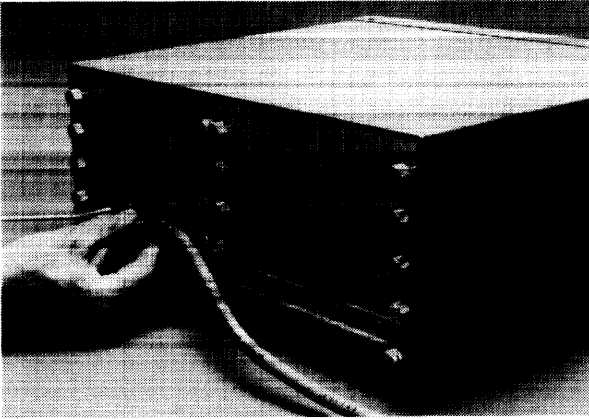

Connecting the HP-IB Cable to the Internal Bus Socket

7. Interconnect all the other peripheral devices to the bus with HP-IB cables subject to the following guidelines:

- You can interconnect up to 14 peripheral devices on one bus system.
- You can interconnect your peripherals any way you want as long as there is an unbroken link between each peripheral and the computer.

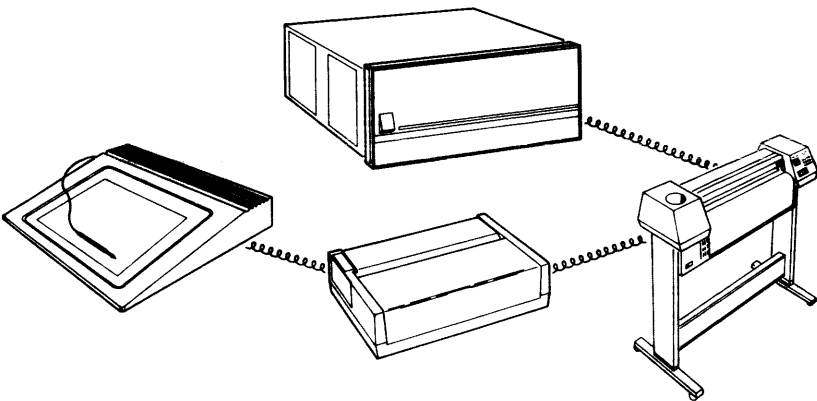

"Chaining" HP-IB Connections

- You can connect more than one HP-IB cable to the same connector in piggyback fashion. However, do not stack more than three connectors on one device, as the weight of the connectors could damage the device socket.

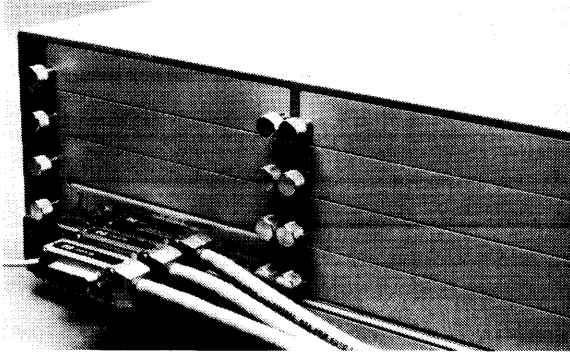

Stacking HP-IB Connectors

- The total length of cable in one bus must be less than or equal to two metres times the number of devices connected together (the interface card is counted as one device). However, the total length of cable must not exceed 20 metres.

For example, a system containing six devices (including the interface) can be connected together with cables that have a total length less than or equal to 12 metres (six devices \times 2m/device = 12 metres). The individual lengths of cable can be distributed in any manner desired as long as the total length does not exceed the allowed maximum and there are no more than 4 metres of cable between devices. If more than 10 devices are to be connected together, cables shorter than two metres must be used between some of the devices to keep the total cable length less than 20 metres.

Repeat steps 1 through 7 for each bus you are configuring.

If you're going to install other peripherals, continue with Chapter 6; otherwise, skip to Chapter 7.

Installing Non-HP-IB Peripherals

Chapter

6

The data communications interfaces allow you to connect your computer to modems, terminals, other computers, and many low-cost peripherals that conform to the characteristics of these interfaces.

HP-UX Note!

If you're installing an HP-UX computer, refer to Chapter 8, under the heading "Installing Non-HP-IB Peripherals" for HP-UX-specific guidelines.

You configured and installed any required interfaces as described in Chapter 3. Now install the peripheral devices and connect them to the interfaces according to the manuals which came with the peripherals.

Note

For additional information on data communications, refer to "Interfacing Concepts" and "Data Communications Concepts" in the Reference section at the back of this guide.

When you've completed installation of non-HP-IB peripherals, go on to Chapter 7.

Table of Contents

Chapter 7 - Reading The Self-Test

Self-Test Messages.	38
Status Messages.	39
Error Messages.	40
Self-Test Beeper	41
Boot ROM Errors.	41
Running an Extended Memory Test	42
What To Do When Errors Occur	42
Where To Get Help	42
Boot ROM Error Messages	43
Where To Go Next	43

Reading The Self-Test

Chapter

7

Computers can be valuable time-savers, but only if they are operating reliably. If a problem goes undetected and your computer fails in the middle of a job, data can be lost and hours of work wasted.

Your computer minimizes this risk by performing a self-test every time you turn it on. In this way, most problems are caught before you start to work, sparing you the frustration of a mid-session failure.

In this chapter, we describe how to interpret the self-test messages and suggest what you should do in case of a failure.

Note

If you do not see a display when you perform the following procedure, first ensure that your monitor is correctly installed (Chapter 4) and is operating. Then, **TURN OFF THE COMPUTER**, check your memory card switch settings (Chapter 3), and ensure the cards are firmly seated in their accessory slots.

Self-Test Messages

Turn on your computer or press the reset key on your keyboard if it is already on (**RESET** on the HP 98203B keyboard; **RST** on the HP 98203A keyboard). If you have one or more operating systems on-line, tap the space bar a couple times after the word `Keyboard` appears. This inhibits the computer from loading a system.

Notice the messages appearing along the left-hand side of the screen. Compare your display to the following one. Adjust your monitor if necessary. Your display and the following display should be very similar. (Boot ROM 3.0 does not display `MC680XX Processor`.)

```
9920      (serial no.)
Copyright 1984,
Hewlett-Packard Company,
All Rights Reserved.
```

```
BOOTROM 4.0
MC680XX Processor
Keyboard
Graphics
HP-IB
655200 Bytes
```

```
SEARCHING FOR A SYSTEM (ENTER To Pause)
RESET To Power-Up
```

Typical Power-up Display

The lines under the `BOOTROM 4.0` message tell you that each major component in your computer has just been tested. If the component passed the test, a **status message** is displayed; if the component failed the test, an **error message** will appear.

Status Messages

Usually, each component will pass its test and only status messages will be displayed. The first three status messages, `MC680XX Processor`, `Keyboard`, and `Graphics`, tell you that the processor, keyboard, and the screen's graphics display, respectively, are working properly. Remember that boot ROM 3.0 does not display `MC680XX Processor`.

The next message reports that your computer's built-in `HP-IB` interface is functional. If you added another interface to your computer, its product number and select code would be listed also.

Note

If you have boot ROM 3.0 and an HP 98644A interface, the boot ROM reports the interface as an HP 98626A interface.

The final status message in the self-test list (`655200 Bytes`) shows that memory has passed its test. While the memory test is in progress, the message:

TESTING MEMORY

appears at the bottom of the screen. Press the reset key if you want to re-start the self-test and see this message. When the memory test is finished, the number of bytes of RAM is reported in the self-test list (e.g., `655200 Bytes`).

Check Your Memory

Each HP 98256A card in your system provides 262,144 bytes of memory. Each HP 98257A card provides 1,048,576 bytes. If you have an HP 9920A or an HP 9920S, you have an additional 131,072 bytes. Determine the total memory in your system and subtract 160 bytes. Your result and the display should match. If they do not match, **TURN OFF THE COMPUTER**, check your memory card switch settings (Chapter 3), and ensure the cards are firmly seated in their accessory slots.

If your display indicates a successful self-test, skip to the last paragraph of this chapter; otherwise, continue reading for information on self-test errors.

Error Messages

If a component fails its test, an error message is displayed in place of the usual status message. There are several types of error messages; we'll discuss a few of them here and list the rest in the Boot ROM Error Messages list which follow in this chapter.

Some failures occur because the computer can't find a component that it expects to see. In this case, it reports that component missing. For example:

```
Keyboard Missing
```

This message doesn't mean that the keyboard is physically missing; it means that the computer couldn't find the electronic components that control the keyboard. You might also get the message:

```
Keyboard Failed
```

This means that the computer found the keyboard's electronics, but it wasn't happy with what it found. Both of these messages indicate a problem that an HP Service Representative should look at.

After displaying an error message, the computer moves on to the next component in the self-test list. After all components are tested, the computer looks for a program or language to load, or displays the message:

```
WAITING 1 MINUTE (ENTER To Abort Wait)
```

This message tells you that the computer found at least one error and it's giving you a minute to read the error message(s) on the screen. You can press **ENTER** to terminate the waiting period.

Self-Test Beeper

In addition to displaying an error and waiting a minute, the self-test sounds a pattern of beeps. It is actually sending an error message to a service person. If this error pattern is sounded, check the display for an error message. Refer to the Boot ROM Error Messages list at the back of this chapter. If the message indicates something you cannot correct, or if the display is not working, you should call HP for service. Your Service Representative may ask you to restart the self-test so he can listen to the error code sounded.

After the error pattern has sounded, the computer searches for a system to load. If you want to cancel the one-minute delay and the beeps, you can press **ENTER**. The computer will then display any operating systems found and wait for you to specify which system you want loaded.

Boot ROM Errors

If the computer detects a problem with the boot ROM, it displays the message:

```
CONTINUE AT OWN RISK (ENTER To Continue)
```

The computer will do nothing further until you press the **ENTER** key. Your computer is somewhat unpredictable in this state and could alter the programs that you want to load from a disc. Therefore, if you decide to continue, make sure you have extra copies of any discs or programs that the computer might access.

Running an Extended Memory Test

If you wish to run a more complete test of all RAM in the computer, turn on the computer or press the reset key. Press these keys simultaneously while the computer is self-testing:



When the Configure menu appears, press:



That will restart the self-test and run a longer RAM test. This test may catch intermittent problems not seen by the power-up self-test.

What To Do When Errors Occur

Very few self-test errors are serious enough to require immediate service. When an error is reported, always run the self-test again and see if the error is repeated.

If the same error is reported a second time, look up the message in the appropriate Boot ROM Error Messages list which follows. You can often correct the problem yourself. Make the recommended adjustment and run the self-test again. If the same error is reported, or if the error message you get doesn't appear in the Boot ROM Error Messages list, call your HP Service Representative for help.

Where To Get Help

When your computer develops a problem that you cannot correct yourself, call your HP Service Representative. Refer to the Sales and Support Offices list which was packed with your computer.

Boot ROM Error Messages

This section lists error messages which might occur during self-test. We have tried to anticipate some errors you might receive that indicate a hardware misconfiguration rather than a failure. If you still receive the error after making the recommended adjustment, it means that there is a real problem; call HP for service.

Error Message	Description and Recovery Action
WAITING 1 MINUTE	The self-test found a failure. After evaluating the message, either press ENTER to begin the booting process or call HP for service.
RAM FAILED ABOVE xxxxxx	A memory failure has occurred. Call HP for service.
RAM GONE ABOVE xxxxxx	The computer couldn't find RAM. Either the address switches on a RAM card are not set correctly or the memory has failed. Check the switches (refer to Chapter 3). Call HP for service if the error is repeated after another powerup.
HP-IB Failed	Either more than half of the devices on the HP-IB interface are turned OFF or a device on the HP-IB has failed the self-test. First turn each device on or disconnect it. Then run the self-test again. If the message is repeated, call for service.
CONTINUE AT OWN RISK	Errors detected in the boot ROM. Press ENTER to continue the self-test. Ensure you have a copy of every file the computer may access. If the error persists, call HP for service.
UNEXPECTED USE OF xxxxxx	Indicates system failure. Call HP for service.

Where To Go Next

You have completed installation of your computer hardware. You are now ready to load software into your computer so you can do useful work. Now find the beginning manual that describes your operating system, language system, or applications program. It tells you how to load and start using your software. It may be called a *User's Guide* or it may have another name, depending on the software you will use.

Table of Contents

Chapter 8 - Setting Up For HP-UX

Installing Your Computer	46
Installing Accessories	46
Memory Requirements	46
DMA Controller	46
HP 98625A High-speed Disc Interface	46
HP 98624A HP-IB Interface(s)	47
HP 98626A Asynchronous Serial Interface	48
HP 98628A Datacomm Interface	48
HP 98644A HP Serial Interface	48
Installing Your Keyboard and Monitor	53
If You Use a Keyboard and Monitor... ..	53
If You Use a Terminal... ..	54
Installing HP-IB Peripherals	55
Installing Non-HP-IB Peripherals	58
Datacomm Cables	58
Connecting Terminals	59
Terminal Baud Rate Settings	61
Terminal Configuration	62

Setting Up For HP-UX

Chapter

8

HP-UX Note!

If you intend to load and use the HP-UX operating system, this chapter is for you! Keep reading!

If you will not use HP-UX, ignore this chapter.

The HP-UX operating system requires a specific computer system configuration. Therefore, you must install your computer system to satisfy the HP-UX requirements.

The topics in this chapter are organized in the same order as the installation sequence (Chapters 2 through 6), and the headings correspond to the chapter titles. As you install your system according to Chapters 2 through 6, you are referred to this chapter for HP-UX installation information and procedures.

REMEMBER!

DO NOT PERFORM THE PROCEDURES IN THIS CHAPTER UNTIL YOU'RE REFERRED TO THIS CHAPTER FROM OTHER CHAPTERS IN THE MANUAL.

You need the following hardware to load and run the HP-UX operating system:

- HP 9920U or HP 9920T Computer
- System console (keyboard and monitor, or terminal)
- System console interface
- Three HP 98256A 256K RAM cards or one HP 98257A 1M RAM card
- HP 98620B DMA Controller
- HP 98625A High-speed Disc Interface (for system bus)
- HP 7908, 7911, 7912, or 7914 Disc Drive, with cartridge tape drive (single-controller)

Installing Your Computer

Install your HP-UX computer as described in Chapter 2.

Installing Accessories

Accessories include additional memory cards, other non-interface accessories like the DMA controller, and all interfaces.

Memory Requirements

You need at least three HP 98256A 256K RAM cards or one HP 98257A 1M RAM card for HP-UX. Set the address configuration switches and install the cards as described in Chapter 3.

DMA Controller

You need an HP 98620B DMA Controller when using HP-UX. Install the DMA controller as described in Chapter 3.

HP 98625A High-speed Disc Interface

1. Set switches on your HP 98625A card as follows (see illustration):
 - a. Set Select Code switch to select code 14. Set Segments 4 and 0 to "0"; set Segments 3, 2, and 1 to "1".
 - b. Set Interrupt Level switch to interrupt level 4. Set Segment 1 to "0"; set Segment 0 to "1".

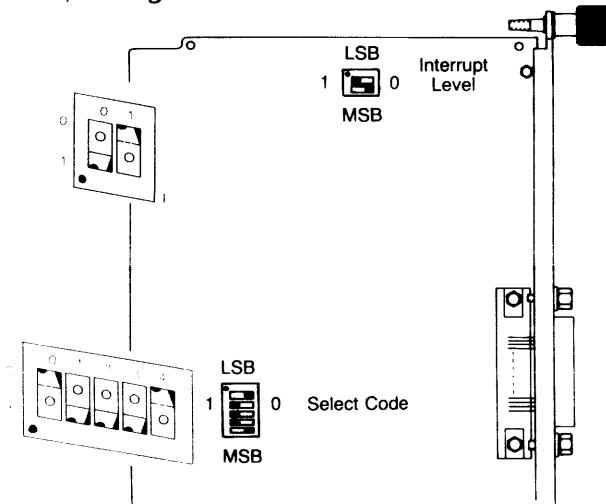

Configuring the HP 98625A High-speed Disc Interface for HP-UX

2. Install the HP 98625A interface card in your computer as described in Chapter 3.

HP 98624A HP-IB Interface(s)

1. Set switches on your HP 98624A card(s) as follows (see illustration):
 - a. Set Select Code switch (U1) to select code 8 (for the first HP 98624A) or select code 9 (for the second HP 98624A, if used). For select code 8, set switch Segments 4, 2, 1, and 0 to "0", and Segment 3 to "1". For select code 9, set switch Segments 4, 2, and 1 to "0", and Segments 3 and 0 to "1".
 - b. Set Interrupt Level switch (U2) to interrupt level 3 by setting both switch segments to "0".
 - c. Set Address/System Controller switch (U17) to address 21 by setting Segments 4, 2, and 0 to "1", and Segments 3 and 1 to "0".
 - d. Set Address/System Controller switch (U17) to System Controller position by setting Segment 5 to "1".

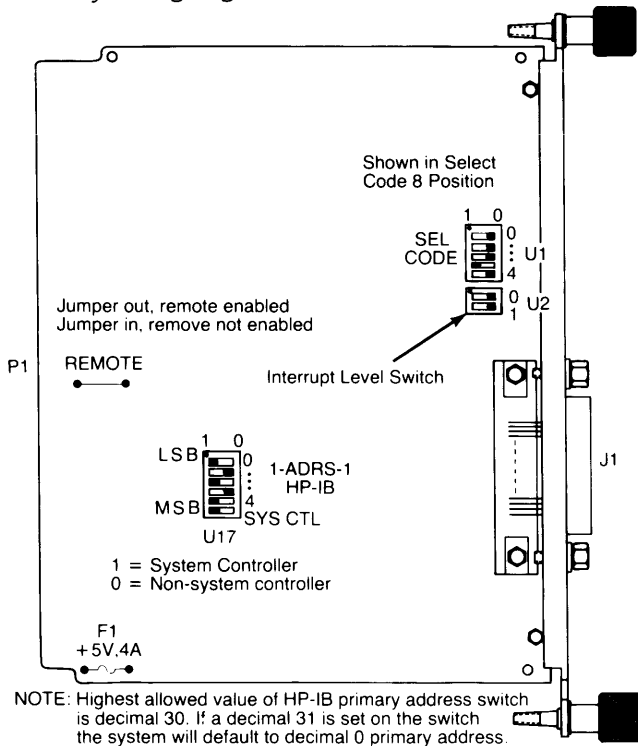

Configuring the HP 98624A HP-IB Interface for HP-UX

2. Install the HP 98624A interface(s) in your computer as described in Chapter 3.

HP 98626A Asynchronous Serial Interface

HP 98628A Datacomm Interface

HP 98644A HP Serial Interface

A terminal or remote computer is connected to the computer system through an HP 98626A Asynchronous Serial Interface, an HP 98628A Datacomm Interface, or an HP 98644A HP Serial Interface, each of which supports the RS-232C datacomm standard. One interface is required for each terminal or remote computer, and each interface must be set to a unique select code. You can use any interface as the system console interface.

Note

If you are **installing HP-UX** via a terminal, you **must** use a terminal connected to the HP 98626A Asynchronous Serial Interface. You cannot install HP-UX via the HP 98628A or HP 98644A interfaces.

You can set the datacomm interface to any unused select code as shown in the following table. Select codes 0-9 and 14 have been used or are reserved.

HP-UX Select Codes

Select Code	Switch	Select Code	Switch
	43210 (98626/8)		43210 (98626/8)
	12345 (98644)		12345 (98644)
0-9, 14	Do not use	21	10101
10	01010	22	10110
11	01011	23	10111
12	01100	24	11000
13	01101	25	11001
15	01111	26	11010
16	10000	27	11011
17	10001	28	11100
18	10010	29	11101
19	10011	30	11110
20	10100	31	11111

HP 98626A Asynchronous Serial Interface

1. Set the switches on your HP 98626A interface exactly as shown in the following illustration, with these considerations:
 - a. Set the select code switches to the desired select code (see preceding table). Select code 11 is set in the illustration as an example.
 - b. Remove the remote keyboard jumper if you are using the HP 98626A as the system console interface.
 - c. The baud rate set switches (U1) are shown in the normal HP-UX default of 9600 bauds.
 - d. The line control switches (U2) are shown selecting these normal HP-UX defaults: 7 bits per character, 1 stop bit, even parity. Bits 6 and 7 set the handshake type. XON/XOFF (shown) is required if you are installing HP-UX via this card and if you have boot ROM 4.0.
 - e. The modem line switches (U3) should be set to the CONNECT position if your interface is connected to a modem. If the interface is connected directly to a terminal, set the switches to the ALWAYS ON position.

Refer to the HP 98626A Installation Manual that came with the interface for more information.

2. Install the HP 98626A interface in your computer as described in Chapter 3.

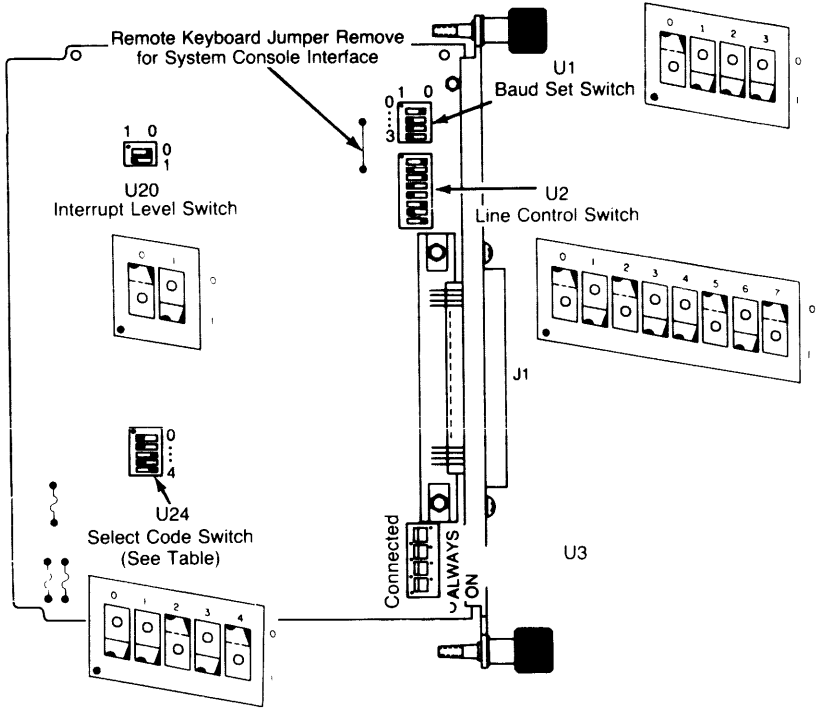

Bit 6	Bit 7	Handshake Type
0	0	ENQ/ACK
1	0	XON/XOFF
0	1	None
1	1	None

HP 98626A Asynchronous Serial Interface

HP 98628A Datacomm Interface

1. Set the switches on your HP 98628A interface exactly as shown in the following illustration, with these considerations:
 - a. Set the select code switches to the desired select code (see preceding table). Select code 20 is set in the illustration as an example.
 - b. Set the remote keyboard switch to position 0 if you are using the HP 98628A as the system console interface.

- c. Default switches 7 and 6 select bits per character and parity type. Normal HP-UX default settings are shown in the illustration: 7 bits per character, even parity.
- d. Default switches 5 and 4 configure hardware handshake. Set the switches as shown if you have a direct connection with no modems. Set switch 4 to the opposite position if you are using a modem connection.
- e. Default switches 3, 2, and 1 set the baud rate and are shown set to 9600 bauds. If your datacomm line has a different speed, change the settings to match the speed.

Refer to the HP 98628A Installation Manual that came with the interface for more information.

2. Install the HP 98628A interface in your computer as described in Chapter 3.

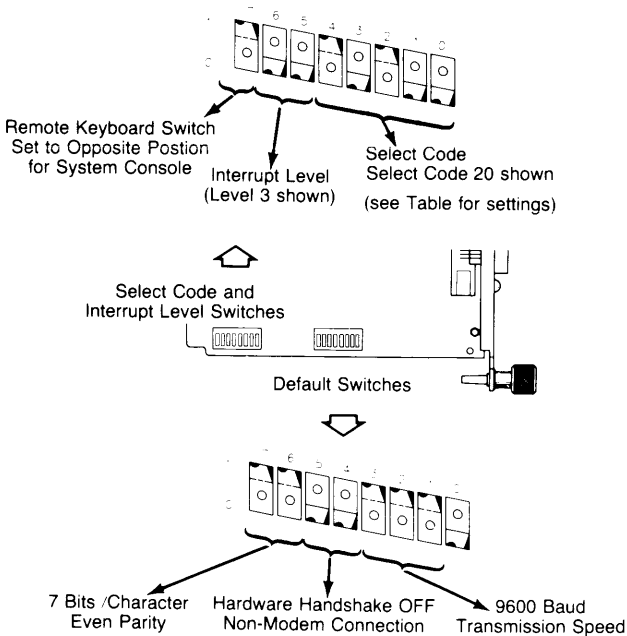

HP 98628A Datacomm Interface

HP 98644A HP Serial Interface

1. Set the switches on your HP 98644A interface exactly as shown in the following illustration, with these considerations:
 - a. Set the select code switches to the desired select code (see preceding table). Select code 25 is set in the illustration as an example.
 - b. Remove the **REMOTE** jumper if you are using the HP 98644A as the system console interface.
 - c. The **626 OPT** jumper enables the interface to be compatible with various operating systems and their versions. Add or delete the jumper according to instructions in the HP 98644A Installation Manual.

Refer to the HP 98644A Installation Manual that came with the interface for more information.

2. Install the HP 98644A interface in your computer as described in Chapter 3.

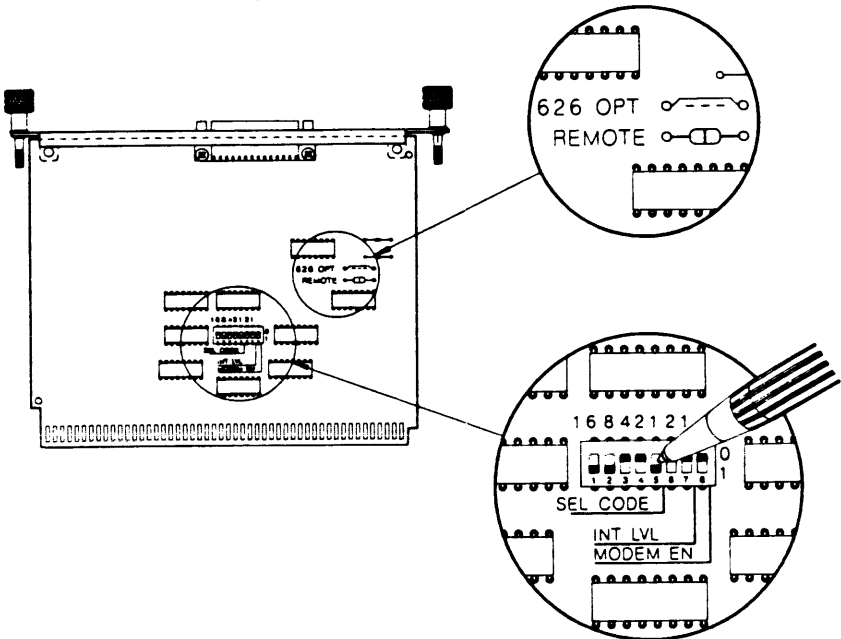

HP 98644A HP Serial Interface

Installing Your Keyboard and Monitor

Your HP-UX system requires that you install a system console. The system console may consist of a keyboard and monitor or it may be a terminal. Installation procedures for both possibilities are provided below. Follow the procedure appropriate for your system.

If You Use a Keyboard and Monitor...

You need an HP 98203B keyboard and a video monitor. The keyboard plugs into the Keyboard/HP-IB Interface; the monitor requires an HP 98204 Composite Video Interface.

1. Ensure the Keyboard/HP-IB Interface switches are set to the Video Interface Installed and HP-IB System Controller positions.

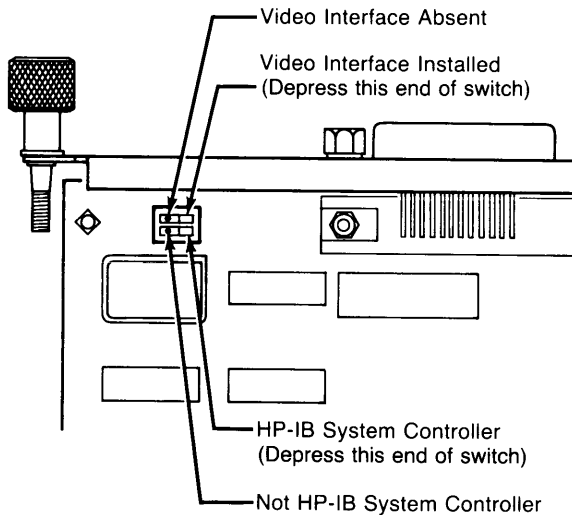

Configuring the Keyboard/HP-IB Interface for HP-UX

2. Ensure the switches on the HP 98204 Composite Video Interface are set according to the installation note that came with the card.
3. Plug one end of the retractable cord into the back of the keyboard; plug the other end into the connector on the Keyboard/HP-IB Interface. If the retractable cord is not long enough, use the extension cord instead, or use both cords interconnected by the receptacle block.

4. Set up and configure the monitor. Connect the power cord to the monitor. Plug the other end of the cord into a properly grounded outlet.
5. Plug the video cable to the video connector on the HP 98204 Composite Video Interface. Plug the other end of the video cable to the video input connector on the monitor.
6. Plug the audio cable to the audio connector on the Keyboard/HP-IB Interface. Plug the other end of the audio cable to the audio input connector on the monitor.

If You Use a Terminal...

You need a supported HP terminal and an HP 98626A Asynchronous Serial Interface, HP 98628A Datacomm Interface, or HP 98644A HP Serial Interface. To install HP-UX, you must use the HP 98626A.

1. Configure the interface as described previously in this chapter.
2. Install the interface in your computer as described in Chapter 3.
3. Configure your terminal as described in the terminal's installation manual and HP-UX manuals.
4. Connect your terminal to the interface as described in Chapter 6.

Installing HP-IB Peripherals

Note

Refer to “HP-IB Considerations for HP-UX” in the Reference section at the back of this guide for additional information, if needed.

You need two HP-IB buses for HP-UX: an internal bus and a system bus. A third bus, the external bus, is optional.

The internal bus is defined by the internal HP-IB interface which is built into the Keyboard/HP-IB Interface installed in accessory slot 8. The HP-IB connector on the interface allows you to connect the internal bus to peripheral devices. For HP-UX, the internal HP-IB interface must be set to be the system controller by setting a switch on the Keyboard/HP-IB Interface. This is described in the Reference section at the back of this guide.

The system bus is defined by the HP 98625A High-speed Disc Interface which you installed earlier in the accessory card cage. Your HP-UX operating system requires a dedicated CS/80-type disc drive which stores the HP-UX file system. This dedicated disc drive is also called the “root” device. It must be an HP 7908, 7911, 7912, or 7914 disc drive with cartridge tape drive. The “root” device resides on the system bus.

The optional external bus provides additional HP-IB capability. Each external bus is controlled by an HP 98624A HP-IB Interface.

When installing your HP-IB peripherals (Chapter 5), set the HP-IB bus addresses and install the peripherals as follows. Also refer to the HP-IB Bus Address Assignments table which follows the procedure for a summary of the procedure.

1. Set the root CS/80 disc drive switches to HP-IB bus address 0. Connect the root drive HP-IB disc connector to the system bus (HP 98625A High-speed Disc Interface) with an HP-IB cable.
2. If your root CS/80 device has dual controllers, set the HP-IB tape address switches to HP-IB bus address 1. Connect the HP-IB tape connector to the system bus. **You cannot install HP-UX from a dual-controller CS/80 device.**

3. Set and install additional CS/80 disc drives as follows:

- Drive 1: Internal Bus Address 0
- Drive 2: System Bus Address 6
- Drive 3: System Bus Address 7

4. Set and install non-CS/80 disc drives as follows:

- Drive 1: Internal Bus Address 3
- Drive 2: Internal Bus Address 4
- Drive 3: Internal Bus Address 0 (See Note)
- Drive 4: System Bus Address 3 (See Note)
- Drive 5: System Bus Address 4 (See Note)
- Drive 6: System Bus Address 5 (See Note)

Note

Use only if Internal Bus Address 0 was not already assigned to an additional CS/80 drive (Step 3). Otherwise, set Drive 3 to System Bus Address 3, Drive 4 to System Bus Address 4, and Drive 5 to System Bus Address 5.

Do not connect the HP 9135, HP 82901, or HP 82902 drives to the system bus. Connect these drives to an external bus.

5. Set the system line printer to bus address 1, and install the printer on the internal bus.
6. Set the 9-track tape drive to bus address 2, and install the drive on the internal bus.
7. Install additional line printers at internal bus addresses 5, 6, and 7; or at external bus addresses 1 through 4 (HP 98624A HP-IB Interface). Do not connect printers on same bus with plotters/tablets, if possible.
8. Install plotters/tablets at unused internal bus addresses 1, 5, 6, and 7; or at external bus addresses 1 through 7. Do not connect plotters/tablets with printers, if possible.
9. Check all assignments to ensure that two or more devices are not assigned to the same bus address for each bus.

HP-IB Bus Address Assignments for HP-UX

HP-IB Device	Bus Address		
	System	Internal	External
System CS/80 Disc	0		
System Tape Drive (if dual-controller device)	1		
Add'l CS/80 Disc #1		0	
Add'l CS/80 Disc #2	6		
Add'l CS/80 Disc #3	7		
Non-CS/80 Disc #1		3	
Non-CS/80 Disc #2		4	
Non-CS/80 Disc #3		0 (a)	
Non-CS/80 Disc #4	3 (b)		
Non-CS/80 Disc #5	4 (b)		
Non-CS/80 Disc #6	5 (b)		
9-Track Tape Drive		2	
System Line Printer		1	
Add'l Line Printer(s)		5,6,7 (c)	1-4 (c)
Plotter(s)/Tablet(s)		1,5,6,7 (c)	1-7 (c)

- (a) Use only if there is no additional CS/80 Disc #1. Otherwise, use system bus address 3 for non-CS/80 Disc #3, and so on.
- (b) Do not connect the HP 9135, HP 82901, or HP 82902 to the system bus. Connect these drives to an external bus.
- (c) Connect plotters/tablets to any **unused** bus addresses, as indicated. Do not connect plotters/tablets and printers on same bus, if possible.

Installing Non-HP-IB Peripherals

This section explains how to connect your computer to terminals and other HP-UX computer systems. Guidelines for configuring terminals are also provided in this section. Before you attempt to make these connections, all interfaces must be installed in the computer.

Datacomm Cables

Datacomm cables generally fall into one of three categories.

- DTE (Data Terminal Equipment) cables connect an RS-232C interface to other RS-232C devices. DTE cables are configured so that the terminal or computer connected to the cable behaves electrically like a terminal when connected to a mating cable or device. The Series 200 DTE cable is available as an option with the HP 98626 Asynchronous Serial Interface, the HP 98628A Datacomm Interface, or the HP 98644A HP Serial Interface, or it can be ordered separately (HP Part No. 5061-4215). The cable is fitted with a male RS-232C connector that mates directly with any RS-232C modem or with an RS-232C DCE cable or modem eliminator extension cable.
- DCE (Data Communication Equipment) cables, sometimes called modem eliminator cables, contain internal cross-wiring to make the HP 98626 Asynchronous Serial Interface, the HP 98628A Datacomm Interface, or the HP 98644A HP Serial Interface electrically resemble a modem when connected to a DTE cable. This enables you to directly connect an HP-UX computer to a terminal (or computer equipped with terminal emulator software). The DCE cable is available as an option with the interface, or it can be ordered separately (HP Part No. 5061-4216). The DCE cable cannot be used for direct connections between two HP-UX computers in a network.
- Extension cables are used in direct connections to lengthen the distance between the computer and a terminal, or between computers in a network. They are usually wired straight through such that each pin on one connector is connected to the mating pin on the connector at the other end. However, some extension cables are wired as modem eliminator cables such that they can mate with a DTE cable at both ends. The modem eliminator cable is cross-wired to provide the necessary signal routing for proper link behavior.

Extension cables are terminated by a male and a female connector. Modem eliminator cables have female connectors at both ends.

Connecting Terminals

Terminal connections are straight-forward. Whether you are connecting a relatively simple terminal with few enhancements or a large powerful computer running sophisticated terminal emulator software, you are concerned with essentially two types of connections:

Direct Connections

When terminals are located near the computer, direct links can be used, subject to certain interface signal expectations. In most cases, a DCE cable is used with the computer interface for direct connections to terminals in the system. Here is a typical direct connection:

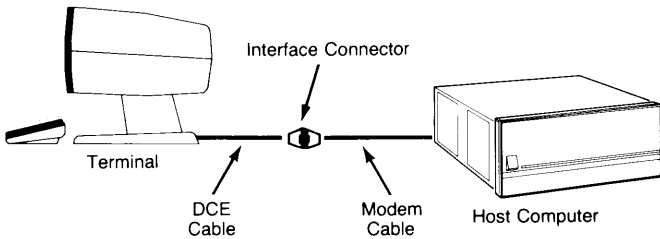

Example of a Directly Connected Terminal

When connecting terminals to the HP-UX computer, the following guidelines are important. They apply equally to terminals and Series 200 computers running terminal emulator software.

- The terminal's modem cable must provide an RTS (request to send) signal to the datacomm or serial interface DCD (data carrier detect) input. The DCE cable connects RTS to the interface DCD (data carrier detect) input. This requirement is met when the modem cable supplied with the terminal is connected directly to the Series 200 DCE cable. If the combined length of the two cables is not sufficient to span the distance between the terminal and the computer, use an industry standard RS-232C extension cable that extends at least pins 1, 2, 3, 4, 7, and 8 pin-for-pin from the male connector at one end to the female connector at the other end. The DCE cable also returns the computer interface's RTS output to the terminal's modem cable DCD input.

Note

Always use industry standard cables or cables supplied with HP products for all system interconnection. If you need special adapters for specific needs, use a pair of connectors bolted together with cross-wiring readily accessible. This technique prevents confusion that can occur when troubleshooting a system that uses unmarked non-standard cables.

- You can also connect the terminal and computer using two DTE (modem) cables and an intermediate modem eliminator extension cable. The terminal's modem cable and the interface DTE cable are both equipped with male connectors having a DTE pin configuration. The modem eliminator cable provides the cross-wiring that makes each device look like a modem to the other device.
- For direct connections, set the **datacomm interface** hardware default switches to non-modem connection, hardware handshake off. If you are using a **serial interface**, set the modem line switches to their "always on" (not connected) positions.
- Connections to computers equipped with terminal emulator software are treated the same as terminal connections.

Modem Connections

If you are using modems to connect terminals to your computer, both devices must be connected to a suitable modem. Be sure the two modems on each link are compatible with each other, have RS-232C interface connectors (unless the modem plugs directly onto the interface), and can support the required baud rate. Contact your HP Sales and Service Office if you need assistance in selecting modems. Connect the modem to the telephone line or other wire link, following the instructions in the modem installation manual. Connect the DTE modem cable between the datacomm or serial interface on your computer and the modem, then engage the retainers so the connectors cannot inadvertently come apart. Use the same technique to connect Series 200 Terminal Emulator computers to a modem. Install terminal modem cables as instructed in the terminal installation manual. The following illustration shows a modem connection between the computer and a terminal.

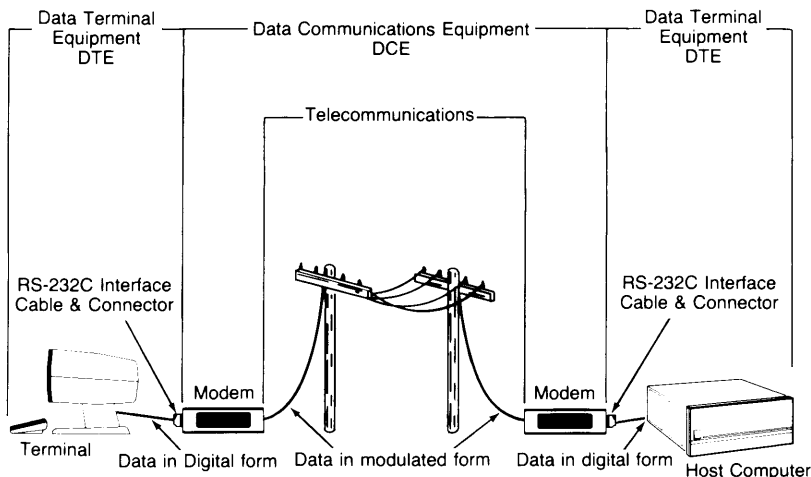

Example of a Modem-connected Terminal

Note that when using modem connections, hardware handshake must be active. Be sure that the serial interface modem line switches are in their “connected” (not “always on”) positions. The modem lines are used to control and verify the interaction between the computer and modem during message transfers. They are not directly related to the data being transferred. Data transfer handshaking between computers is handled as part of the data messages. The modem line switches are explained previously in this chapter under “Installing Accessories”.

Terminal Baud Rate Settings

Before a given terminal can communicate with the system computer, its baud rate must be configured to match system expectations. Baud rates are defined by the System Administrator at system configuration. Contact the System Administrator to determine the correct baud rate setting for the terminal being installed. Computer interface baud rate settings, except for the system console, are overridden by HP-UX, and are not important. Consult the terminal or terminal emulator manual for the required procedure when setting the terminal’s baud rate.

Terminal Configuration

After terminals are installed, they must be correctly configured before they can successfully communicate with the HP-UX computer. Several parameters affect the terminal's interaction with the computer. They include, among other factors, baud rate, character format (bits per character, stop bits, and parity), and terminal pacing. Terminal settings must exactly match the configuration of the HP-UX operating system for each terminal being connected to the system.

Some user terminal configuration requirements are defined during HP-UX operating system installation or reconfiguration, while others are permanently defined by HP-UX. The following list shows the parameters that are permanently established by HP-UX. For other parameters (such as baud rate), contact the System Administrator for information about what configuration settings are appropriate for the terminal(s) being installed.

Two sets of parameters apply during configuration. The first set applies to the terminal directly, while the second set applies to the datacomm link. Some of the parameters listed here may not be configurable options on some supported terminal models. If that is the case for supported terminals in your installation, the unconfigurable parameters are handled correctly by the terminal. Configuration parameters that are available on your terminal, but not listed here are not of interest to HP-UX, so you can use any value that fits your needs.

Parameters are listed here. Refer to the terminal manual for the meaning of each parameter and how to set it up.

Terminal Configuration Settings

Parameter	Setting
Tab = Spaces:	NO
RETURN Def:	Carriage Return (no line-feed)
RETURN = ENTER:	NO
LocalEcho:	OFF
CapsLock:	OFF
StartCol:	1
ASCII 8 Bits:	NO
XmitFnctn (Strap A):	NO
SPOW (Strap B):	NO
InhEolWrp (Strap C):	NO
InhHndShk (Strap G):	YES
InhDC2 (Strap H):	YES

Datcomm Configuration Settings

Parameter	Setting
Parity:	EVEN
DataBits:	7
Clk:	INT
StopBits:	1
EnqAck:	NO
TR(CD):	HI
ChkParity:	NO
RecvPace:	Xon/Xoff
SRRXmit:	NO
RR(CF)Recv:	NO
XmitPace:	Xon/Xoff
SRRInvert:	NO
CS(CB)Xmit:	NO

Table of Contents

Reference

Keyboard/HP-IB Interface Switches	65
Memory Concepts	67
Memory Terms	67
Setting the Switches	67
Interfacing Concepts	68
Internal HP-IB Interface	68
The Select Code	69
HP-IB Concepts	70
The Controller	72
The Talkers	73
The Listeners	73
Bus Addresses	73
HP-IB Considerations for HP-UX	74
HP-IB Description	74
Overview of Parameters	75
Example Systems	79
HP-IB Configuration Restrictions	82
Data Communications Concepts	91
What is the Data Communications Interface?	91
Datacomm Fundamentals	92
Cable Connections	96
Glossary	101

Reference

Keyboard/HP-IB Interface Switches

The Keyboard/HP-IB Interface has two switches:

- HP-IB System Controller/Not HP-IB System Controller (factory default setting is HP-IB System Controller)

With the switch in the HP-IB System Controller position, the computer has the most control over the devices connected to the internal HP-IB. For HP-UX systems and for most other systems you will use the factory default setting of HP-IB System Controller. If you don't have an HP-UX system and you wish to designate another device as the system controller on the internal HP-IB bus, you must set the switch to the Not HP-IB System Controller position.

- Video Interface Installed/Video Interface Absent (factory default setting is Video Interface Installed)

The card provides a CRT memory timing signal when no external CRT has been installed by placing this switch in the Video Interface Absent position. For all HP-UX systems and for most other systems, you will have an external CRT (either a local monitor or remote terminal), and the switch should be in the Video Interface Installed position. If no external CRT is connected to your computer, set the switch to the Video Interface Absent position.

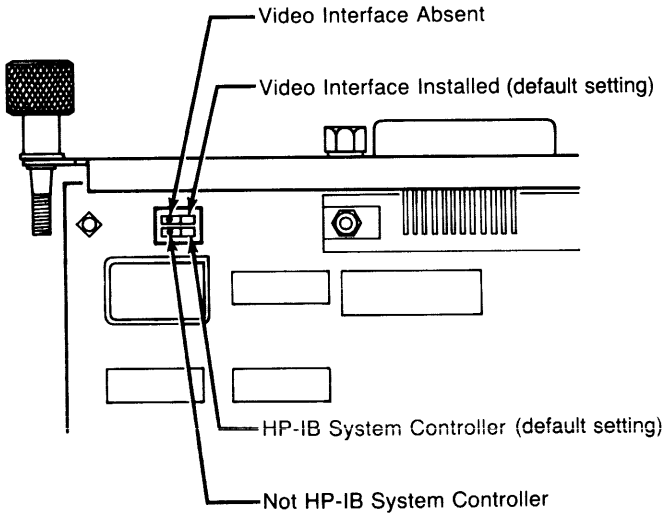

Keyboard/HP-IB Interface Configuration Switches

Memory Concepts

There are many ways to use your computer, and some applications require more random access memory (RAM) than others. Some programs can run by themselves; for them, a minimum amount of memory may be sufficient. Others may require a language system in order to run; these programs require a larger memory. The size of your computer's memory can be increased by installing plug-in RAM cards in the accessory slots.

Memory Terms

There are a few common terms associated with memory that you should be familiar with. You've probably heard these terms before, but since some of them have several interpretations, we define them now as they relate to your computer.

Byte. This is the unit of memory used on your computer. The byte is simply one location in memory, capable of storing one letter.

K bytes. Since the size of memory can be so large, often reaching several thousand bytes, the "K" convention was adopted to make memory sizes easier to express. "K" is nothing more than a multiplier with the value 1 024.

M bytes. M bytes, like K bytes, expresses memory size. "M" is a multiplier with the value 1 048 576.

Address. Each byte in memory has a unique identifying number called an address. Whenever the processor wants to access a particular byte in memory, it uses the byte's address to find it. If you think of memory as a large city with each byte representing one house, then any house (byte) in the city (memory) can be found by looking up its street (memory) address.

Setting the Switches

When you install an HP 98256A RAM card in your computer, you increase the size of its RAM by 256K bytes. This is like adding a new subdivision of 262 144 houses to a city. When you install an HP 98257A card, you increase computer memory by 1M byte (1 048 576 bytes, or houses).

When you build a new house in a city, you must assign it a street address. The same is true for a new byte of RAM; you must give it an address before the processor can recognize it. This is done with address switches.

Each 256K and 1M plug-in RAM card has a group of switches that set the address of the first byte on the card. The 256K card has six switches, and the 1M card has four switches. With the address of the first byte set, all other bytes on the card are assigned addresses automatically. Each RAM card must be set to a unique starting address using the switches on the card.

The switches on plug-in RAM cards must be set so that there are no “addressing gaps” in the memory. If you follow the procedures for configuring memory which are given in Chapter 3, you will have no problem with “addressing gaps”.

Interfacing Concepts

HP makes several plug-in interfaces for your computer, making it possible to connect it to virtually any peripheral device. Up to seven plug-in interfaces can be installed directly into your computer, in addition to the Keyboard/HP-IB Interface. To install more than seven interfaces, you need an HP 9888A Bus Expander.

The interface acts as an interpreter between your computer and a peripheral. Often the computer speaks one language and a peripheral device speaks another, so *direct* communication between the two is impossible. The interface's role is to mediate this conversation, translating messages from the computer's language into the peripheral's language and vice versa.

Interfaces allow computers to be more general purpose. Rather than wiring or programming a computer to speak every conceivable peripheral language, it's much easier (and less expensive) to simply plug in the specific interface card needed for the peripheral you want to connect.

Internal HP-IB Interface

Your computer has an internal HP-IB interface built into the Keyboard/HP-IB Interface. The HP-IB interface is a standard, simple, multiple-device interface. The HP-IB interface allows you to connect most HP disc drives, printers, plotters, and graphics tablets that are supported on your computer. And because you can connect up to 14 peripherals to a single HP-IB, this interface satisfies most peripheral interfacing needs.

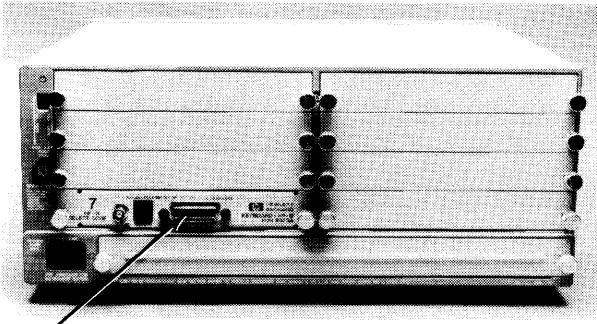

Internal HP-IB

Internal HP-IB Interface

The Select Code

Since every interface is different, there is no general set of installation instructions that applies to all of them. Refer to the installation instructions that came with your interface for details. However, there is one parameter which must be set on every interface you install. It's called the **select code**.

Suppose your computer contains two interfaces, and each interface is connected to a peripheral device, say a printer and a disc drive. The computer wants the printer to print something, so how does it select which interface (and thus which peripheral) it wants to send information to?

The answer is it selects the interface by specifying its select code. The select code is similar to a memory address, but instead of uniquely identifying a location in memory, it specifies an interface. Thus no two interfaces can have the same select code. One way to illustrate this idea is shown here.

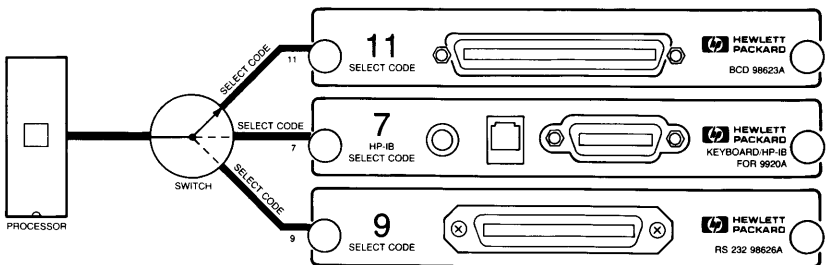

Selecting an Interface

Think of the select code as a switching station through which all communication between the processor and the interfaces must pass. A single track leads from the processor to this switching station where it divides into several tracks, one to each interface in the computer.

When the processor wants to “talk” to a particular peripheral, it sets the switching station to the select code of the peripheral’s interface. Then information can only travel along the track that directly connects the processor with the desired device.

The select code of the internal HP-IB interface built into the Keyboard/HP-IB Interface is set to 7. The select codes of all plug-in interfaces are set with switches, similar to those used to address plug-in RAM cards. Each interface card is set at the factory to a unique select code. If this setting does not conflict with the select codes of your other interfaces, simply leave the switches as they are; otherwise change them to an unused value.

HP-IB Concepts

In 1975, the Institute of Electrical and Electronic Engineers (IEEE) decided the interfacing situation was getting out of hand. Interfaces were springing up everywhere, each designed to optimize communication between a specific computer and a specific peripheral device. Unless this situation was contained, eventually every peripheral would require its own specialized interface.

The result was IEEE Standard 488-1975: the IEEE Standard Digital Interface for Programmable Instrumentation. This version was revised in 1978 into its current form, IEEE Std 488-1978. Hewlett-Packard’s version of the IEEE Std 488-1978 is the HP-IB, which stands for Hewlett-Packard Interface Bus.

The HP-IB is a bus. A bus is nothing more than a bundle of parallel wires over which several devices can communicate. Where most interfaces can support only a single peripheral, the bus architecture of the HP-IB allows up to 14 devices to be connected. This makes efficient use of resources, but requires some additional management if things are to run smoothly. Fortunately, the HP-IB manages itself; virtually all you have to do is connect your peripherals to it and let the bus do the rest.

Think of the bus as a party line shared by several telephones. If everyone wanted to talk at once, the messages would be garbled and no one could understand anything. The HP-IB avoids this situation by assigning roles to its devices. Any device capable of receiving information from the bus is called a **listener**. Any device able to send information over the bus is called a **talker**. Any device capable of regulating the bus (usually a computer) is called a **controller**. Each role is described in more detail in the following paragraphs.

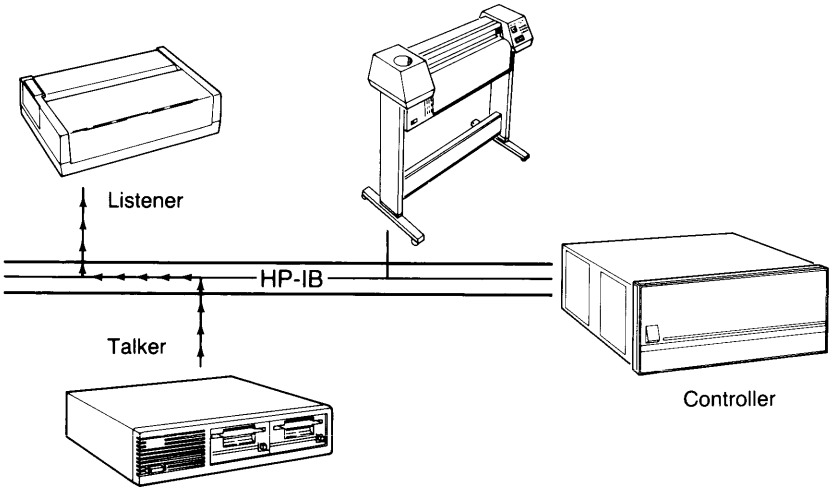

Communication on the HP-IB

The Controller

The party line approach is simple and efficient, but can quickly turn to chaos if everyone tries to talk at once. Obviously, someone has to take command of the bus and decide who should talk and who should listen. On the party line, this person is the operator. On the HP-IB, it is the controller.

The controller is usually the computer itself. It takes requests to talk from the peripherals on the bus and decides which ones will be honored immediately and which ones will have to wait. As on the party line, if an emergency request comes through, it will take priority over casual gossip.

The computer is set at the factory to be the system controller on the internal HP-IB. The **system controller** has the most control over other devices on the HP-IB. If you wish to designate another device as the system controller, you can set the computer to not automatically be the system controller by changing a switch setting. The system controller switch is located on the Keyboard/HP-IB Interface. Refer to "Keyboard/HP-IB Interface Switches", earlier in this Reference section, for specifics.

CAUTION

SWITCH THE COMPUTER OFF BEFORE REMOVING CARDS OR CHANGING THE SYSTEM CONTROLLER SWITCH. OTHERWISE, THE COMPUTER COULD BE DAMAGED.

On optional HP-IB interface cards, the system controller status is determined by a switch setting. See the HP-IB installation note supplied with the card for further details.

The Talkers

To prevent messages from becoming garbled, the operator allows only one person to talk at a time. On the bus, computers, disc drives, and other input devices are called talkers. When a talker wants to transfer some information, it sends a request to talk to the controller and specifies which device(s) it wants to talk to. When the request is honored, the talker takes control of the bus and begins transmitting the information. All peripherals not designated as active listeners can't receive the information—the controller, in effect, tells them to hang up.

The Listeners

Several people can listen at once on a party line. Disc drives, printers, plotters and other output devices are called listeners on the bus. Listeners just wait around for someone to call them. When the call comes, they signal that they are ready to listen, and then wait intently for the information to come.

Bus Addresses

Everyone must have a phone number on a party line. Without it, the operator could not specify who should talk, who should listen, and who should hang up. For the same reason, every device is given a unique **address** on the bus. The address is usually set with switches located next to the HP-IB socket of each device. The controller uses the address to selectively access individual peripherals on the bus.

Note

When your computer is set to system controller, its primary address is 21. Otherwise, its address is 20.

HP-IB Considerations for HP-UX

This subsection discusses the underlying principles involved in planning allocation of HP-IB interface and interface bus resources so that your HP-UX system can operate at or near optimum efficiency. If you are installing a small system with only a few peripherals, this information can help you get the job done with minimal knowledge and without extensive study. On the other hand, if you are working with a larger, more complex system where issues that are unimportant in smaller installations can bottleneck system performance, this subsection also provides the knowledge you need to optimize your system. Some of the optimization information will be used during planning and installation, and also later after the system is in use. Also note that how you configure the hardware directly affects operating system loading and configuration procedures.

HP-IB Description

The Hewlett-Packard Interface Bus (HP-IB) is an interfacing technique that enables a single interface to communicate with several peripherals through a single string of cables. It is electrically similar to the IEEE-488 interface standard. Your computer supports three bus types; the first two are required, while the third is optional, depending on system needs:

- The HP 98625 High-speed **Disc Interface** drives the **system bus**. The system bus is used mainly for system resources such as CS/80 hard disc drives and other fast devices.
- The **Keyboard/HP-IB Interface** is used to drive the **internal bus**. The internal bus connects to general system peripherals (such as the system printer), user-oriented rather than system-oriented mass storage devices (such as flexible disc drives for storing user data), and other peripherals.
- The HP 98624 **HP-IB Interface** is used for **external bus** needs. One or two interfaces can be installed, depending on system requirements. Used mainly to improve overall performance in larger systems, external buses are best suited to interactive devices such as graphics input tablets, digitizers, or plotters. An external bus can also relieve congestion on the internal bus by handling peripherals that tend to monopolize bus resources when they share a bus with other or higher-priority devices.

Communicating With HP-IB Devices

HP-IB devices are accessed through a combination of parameters:

- **Select code** identifies which interface in the computer is used for data transfers in or out.
- **Bus address** identifies which peripheral connected to the selected interface is to be accessed.
- The **I/O resources** (device drivers, buffers, and related elements) that correspond to a given device class are selected by use of software commands. There are several HP-IB device classes, each with a corresponding class of I/O resources. I/O resources must be matched to the speed, device characteristics, and system demands presented by each device or device class. Devices must also be matched to the capabilities and characteristics of the available interface buses. These combinations of requirements determine what resources and peripherals can be connected to a given bus. Selecting one of the two bus types that are available to each device is based on compatibility of the device with other devices sharing the same bus, and on overall system efficiency considerations.

Overview of Parameters

This section provides a cursory overview of bus configuration parameters and their relationship to software and system resources. These topics are then expanded later in this chapter with examples and in-depth discussion.

Selecting An Interface Bus

Except for small, straight-forward systems, bus selection for each HP-IB peripheral can be relatively complex because of the interactive nature of the hardware involved. In short, there are three bus types, and up to four buses in a system. Each peripheral in the system can be used on either of two out of the three bus types, but never on all three. Thus, for any given device you can select either of two bus types according to your individual system needs. Which bus you select can affect overall system performance, so it is important to make the correct selection. Bus selection depends on the device class and the function of the device in the overall system as explained later in this chapter. Several examples are also provided to help you understand how to assign buses in your system.

Assigning Bus Addresses

The following guidelines apply when assigning bus addresses:

- Each peripheral must occupy a **unique** address on the bus where it is used. Other devices in the system can occupy an identical bus address, provided they are not connected to the same bus and interface.
- Only specified HP-UX-compatible bus addresses can be used; if you use addresses other than those specified, the peripheral cannot be accessed by HP-UX.
- Allowable addresses vary, depending on which bus is used for a given device. The following table lists the values that are compatible with the HP-UX operating system.

Available HP-IB Bus Addresses

HP-IB Device Class	System Bus Addresses	Internal Bus Addresses	External Bus Addresses
CS/80 Discs:			
Root Device	0 only	none	none
Other CS/80 Drives	6 or 7	0 only	none
Non-CS/80 Discs	3, 4, or 5	0, 3, or 4	none
9-track Tape Drive	2 only	2 only	none
Line Printers (with or without graphics)	none	1, 5, 6, or 7	1 thru 4
Plotters/Tables	none	1, 5, 6, or 7	1 thru 7

When determining which interface to use for a given HP-IB device, you must consider device speed, how much demand the device places on bus resources, the level of use relative to other devices that use the same interface, and level of use relative to other devices (if any) that share the same set of I/O resources.

The operating system root mass storage device must be placed on the system bus at bus address 00. Other devices can be set to other addresses as discussed in this chapter.

Using Defaults to Simplify Configuration

For relatively simple systems, the following guidelines can be used to obtain reasonable, if not optimum, performance:

- Place the system root mass storage device on the system bus at address 00.
- Set the system printer to address 01 on the internal bus.
- Set the 9-track tape to bus address 02 on the internal or system bus. If the tape drive is connected to the system bus, it will slow down disc swaps (degrading system performance) when the tape drive is in use. If use is relatively infrequent, the overall performance loss is not significant.
- Avoid putting flexible discs on the system bus.
- Non-CS/80 hard discs should be placed on the internal bus, but can be used on the system bus when the internal bus becomes congested. Do not use HP 9135 disc drives (which also have a 5¼-inch flexible disc drive) on the system bus.

Resources and their assignment to device classes are discussed later in this chapter. Except for root disc device and system printer, bus address assignment is related to individual system requirements and system optimization.

I/O Resources

HP-IB I/O Resources include buffer space and other elements necessary to support I/O operations with a given HP-IB device. Each HP-IB peripheral device in the system is allocated a set of resources based on device characteristics and operating system definition. In some cases a given device has a dedicated set of resources that exist for that device only. In other cases, a given set of resources is shared between devices when certain conditions exist. In general, all devices except line printers and 9-track tape drives have dedicated I/O resources assigned for each drive in the system. On the other hand, 9-track tape drives, and printers use sets of resources that may or may not be shared, depending on bus address assignments and bus selection.

Shared sets of resources are assigned on the basis of bus address only; not on the basis of which bus is being used. Therefore, if two devices in the same HP-IB device class **reside on the same bus or on separate buses at dissimilar addresses**, they **do not share the same set of resources** even though both use a shared (or, perhaps more properly, a sharable) set of resources.

The following table lists shared sets of resources and identifies which set for each device class is assigned to given bus addresses for each bus. External bus 1 connects to the HP 98624 HP-IB Interface on select code 8. External bus 2 connects to an identical interface on select code 9.

Assignment of Shared Sets of I/O Resources by Bus Address

Device Class	Set	Bus Address		
		System Bus	Internal Bus	External Bus 1 or 2
9-track Tape	A	2	2	none
Line Printer	B	none	1	1
	C	none	5	2
	D	none	6	3
	E	none	7	4

Forced Serial Operations

When two or more devices share a common set of I/O resources, or when they reside on a common bus, simultaneous I/O operations to those devices must be handled serially because buses and resources cannot execute two or more conflicting tasks simultaneously.

Without a lengthy discussion of operating system theory and HP-IB protocol, in short, here is how serial operations are handled on shared buses and through shared sets of resources:

- I/O operations to devices residing on the same bus are handled serially on an operation basis. An operation usually consists of transferring a line or block of data, a set or series of commands, or some similar entity.
- I/O operations to devices that share a common set of I/O resources are handled in much the same way as devices sharing a bus. Shared buffers and other resources are allocated at the beginning of each operation or sequence of operations, then released upon completion of the transfer. How much data is handled before releasing resources is determined by software.
- When line printers are driven through line printer class resources (the usual method), serial operation is handled on a job basis. That is, when a user initiates an output sequence to a printer, all other users are locked out from using the allocated set of resources until the sequence is finished and the resources are released. When the resources are released, they become available to the next pending sequence of operations, if any exist. Thus, if one printer is using a set of

resources that are shared with two other printers, the other printers are held off (stopped) during the time the active printer has use of the shared set of resources.

If you have two 9-track tape drives, they share one set of tape drive resources. If the resources have been allocated to one drive to support an operation currently in progress, any transfer requests to or from the second drive are held off until the resources are released.

You can avoid I/O resource availability conflicts by placing all system printers (up to four printers) on dissimilar bus addresses. You can avoid bus availability conflicts by placing each printer on a different bus (up to three printers). Unless your system is larger than usual, you will probably experience little difficulty due to resource or bus conflicts if you follow the guidelines presented in this subsection.

Example Systems

HP-IB peripherals must be configured to match the requirements of the HP-UX operating system before they can be used in your system. To help you understand the ramifications of various configuration options, let's look at some example systems that vary in complexity and illustrate basic principles.

Simple Single-user System

Consider the following system that supports a single user. It has a single CS/80 disc drive with its own built-in back-up tape drive that shares the disc controller. A line printer provides system hardcopy output. There are no other peripherals in the system.

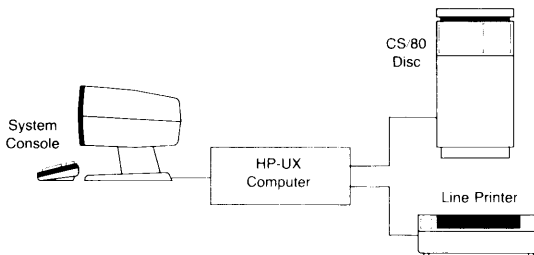

Example of a Small Single-user System

In this case, configuration is very simple. The CS/80 disc drive connects to the system bus. As indicated earlier, the disc drive bus address switches must be set to **system bus** address 00; the printer to **internal bus** address 01. The system bus interface is set to select code 14, interrupt level 4 at installation; and the internal bus interface has no select code or interrupt level switches; so HP-IB configuration is now complete.

Expanded Single-user System

Consider the same system, but add a flexible disc drive for removable data storage, a plotter and graphics tablet for graphics work, and a 9-track tape drive for transporting data to other systems:

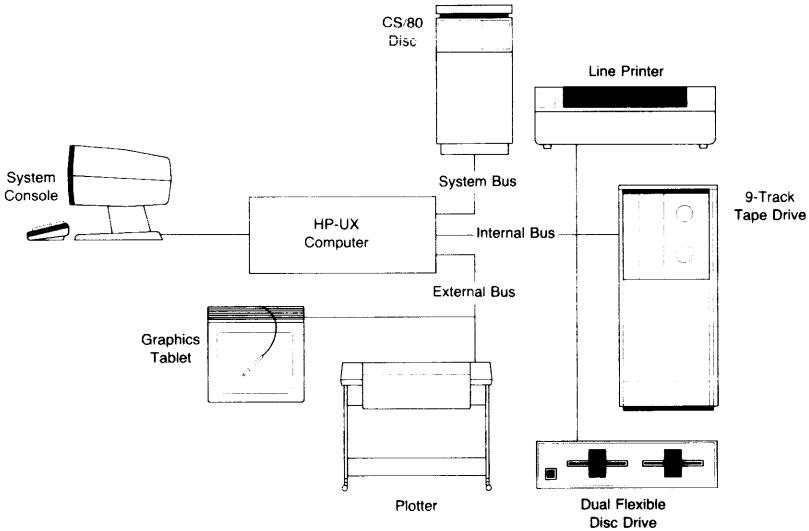

Example of an Expanded Single-user System

In this case, system performance and overall efficiency from the user's point of view can be significantly affected by the selection of buses for various peripherals. Some devices are restricted in terms of which bus and interface can be used, while others have more flexibility.

The CS/80 system disc **must** be run on the **system bus** because it contains the swap space that is used by the memory management system, and must be readily available. On the other hand, the drivers for the system printer and graphics peripherals cannot be used with the high-speed disc interface (besides, the graphics and printing devices would tend to monopolize the bus, severely reducing disc swap efficiency). Therefore, they are placed on the internal bus, or on an external bus where they interfere even less. The two remaining devices: the flexible disc drive and 9-track tape drive, can be operated on either the system bus or on the internal bus. Neither can be run on an external bus (note that certain flexible disc models cannot be used on the system bus). In general, mass storage devices with removable media (flexible disc and tape drives) are placed on the internal bus to maximize the response efficiency of the system bus to system needs. Configuring bus addresses for peripherals in larger systems is related to performance optimization. System optimization is discussed later in this subsection.

Simple Multi-user System

Let's expand the simple single-user system to a multiple user system and add a flexible disc drive to provide a removable media option for system users. Here is how the system looks now:

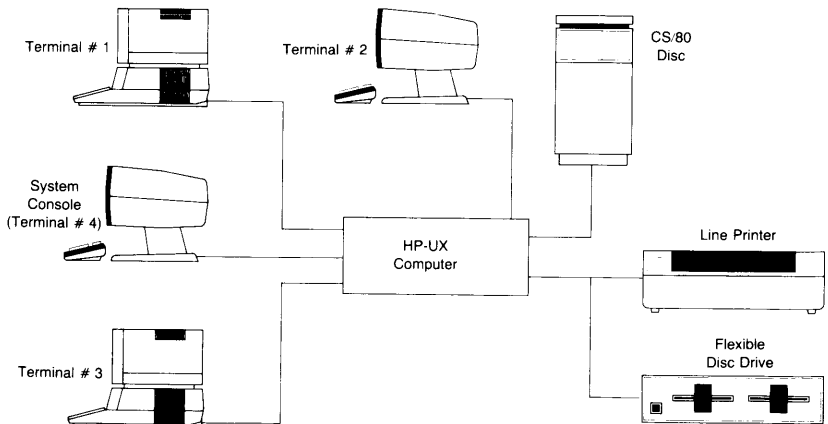

Example of a Small Multi-user System

In this example, we have added four user terminals, one of which is also the System Console. As in the single-user example, the CS/80 disc **must** reside at address 00 on the **system bus**. The system printer is on the **internal bus** at address 01. In the interest of maintaining good overall performance, the flexible disc drive is installed on the internal bus (even though the system bus does support some flexible disc drives) to minimize system bus congestion. The drive is placed on the internal bus at address 0, 3, or 4. Which address you select for the drive does not affect performance.

Now that you have been introduced to single-user and small multi-user systems, let's discuss some of the details. Larger multi-user systems are discussed later after introducing the concepts of system optimization and other factors that are more closely related to larger systems.

HP-IB Configuration Restrictions

The operating characteristics of each HP-IB peripheral in the system, combined with the electrical characteristics of given interface models, place inherent restrictions on system configuration and layout. These restrictions are related to the number of devices that can be connected to a given bus, the maximum combined cable length for that bus, and compatibility of the peripherals that compete for available bus resources.

Initial System Installation

When you install the HP-UX operating system for the first time, the root device for installation *must* be a CS/80 disc drive with a *shared controller option* and an HP 88140 Cartridge Tape Drive. The controller must be set at bus address 0, and must be installed on the system bus whose interface must be at select code 14. The system bus requires an HP 98625 High-speed Disc Interface. After system installation, the root device must still be a CS/80 disc drive, but you can use a dual-controller tape option, or operate without the tape option. System configuration must reflect the installed hardware configuration before you can successfully use HP-UX. CS/80 disc drives that can be used for initial system installation include: HP 7908P, HP 7911P, HP 7912P, HP 7914P, and HP 7914TD with required options.

System Bus

The system bus is intended for system operations such as memory swapping and storing system programs. User devices that reside on the system bus tend to congest the bus and slow down system operations, thus degrading performance for other users. Total cable length for the system bus

is limited to the **lesser** of 1 metre per equivalent load on the bus or 10 metres. The interface presents 7 equivalent loads, allowing up to 7 metres plus 1 metre per device connected to the bus. The bus can accommodate up to 11 equivalent loads (four peripheral devices plus interface).

Thus, for a single peripheral you can use up to 8 metres of cable; for 2 devices you can use 9 metres, and for 3 or 4 devices up to 10 metres. Do not connect more than four peripherals to the system bus, even though the software supports additional bus addresses. Don't forget that some devices (such as 9-track tape drives) present two equivalent loads to the bus and must be counted as two devices.

Some devices are not compatible with the system bus, while other devices deliver their best performance when connected to the system bus. The following guidelines define device connections to the system bus:

- No more than 4 peripheral devices can be connected to the system bus (hardware limit) even though 7 bus addresses are supported.
- The system root volume (a CS/80 disc drive) must reside at bus address 0 at all times. The interface must be at select code 14, hardware interrupt level 4. If the system root device has a cartridge tape drive with a **separate** controller, place the tape drive at any other unused CS/80 system bus address, or on the internal bus at a CS/80 bus address. Don't forget that the root CS/80 drive must use a single controller for both disc and tape when the HP-UX is initially installed. After HP-UX is installed and configured, you can substitute a dual (separate) controller disc and tape drive option.
- If you install a second CS/80 disc drive for storing user data and programs, you may find some performance advantages if the second drive is connected to the internal bus instead of the system bus. Any CS/80 drives beyond the second must be connected to the system bus.
- HP 8290x and HP 9135 Disc Drives which have 5¼-inch flexible disc drives are not compatible with the system bus, and so must be used on the internal bus instead. All other disc drives listed in the supported peripherals list can be used on the system bus.
- 9-track tape drives can be connected to the system bus or internal bus. Which bus is selected depends on individual needs. The HP 7971 presents two equivalent loads to the bus, and must be treated as two devices. This reduces the capacity of the system bus to one other CS/80 or other disc drive besides the root device.
- Do not connect printers to the system bus.

Internal Bus

The internal bus is used for system output peripherals, user mass storage devices when you want to minimize system bus congestion, and for other peripherals that cannot operate on the system bus. Normal HP-IB limitations apply to this bus. You can connect up to 14 devices besides the interface to the bus, and line length can total 2 metres per device (including the interface as one device) provided you do not exceed the maximum bus limit of 20 metres. Software supports only eight bus addresses, limiting practical bus configuration to eight peripherals and 18 metres of cable.

If you install a CS/80 disc drive or a 9-track tape drive on the internal bus, bus configuration guidelines change. The internal bus must then be treated as a high-speed bus where up to 15 devices can be connected to the bus (the internal interface counts as one device), but only one metre of cable is allowed per device (or equivalent load) up to a maximum of 15 metres. Thus if the internal bus has only one CS/80 disc and no other devices connected, only 2 metres of cable can be used. If you connect an HP 7971 to the internal bus, but no CS/80 devices are connected, the bus is treated as a high-speed bus and the high-speed cable length restriction applies. The HP 7971 presents two equivalent loads to the bus, and must be counted as two devices when calculating bus capacity and cable length. When the internal bus is configured for high-speed operation, the software configuration limit of eight bus addresses limits you to eight peripherals and nine metres of cable.

Any device that can be used on the system bus or on an external bus can also be used on the internal bus. However, several restrictions should be observed:

- Since only eight bus addresses are supported for the internal bus, only eight peripherals can be used on the bus.
- Avoid placing printers and plotters together on the same bus. Plotters tend to monopolize the bus with a corresponding reduction in printer speed. If simultaneous use of printers and plotters is expected to be infrequent, the conflict is less significant. If you have both printers and plotters on your system, when practical, place them on separate buses, using an external bus for plotters.

- When you use graphics input tablets for data entry or digitizing, avoid placing them on the internal bus because they tend to monopolize bus resources. Place them on external buses, especially on multi-user systems. If you must use plotters and graphics tablets on the same external bus, this is usually preferable over placing graphics devices on the same bus with printers. When it is practical to do so, you can improve efficiency and performance by selecting bus addresses such that no two line printers share the same set of I/O resources, because sharing bus resources is generally more efficient than sharing I/O resources.

External Bus

One or two external buses can be installed to relieve congestion on the internal bus, thus improving overall system performance and response. Configuration limits are the same as for the internal bus: up to 15 devices including the interface, and up to two metres of cable per device or 20 metres, whichever is less. Since no CS/80 or other fast devices are allowed on the external bus, no special limits apply.

Any device, other than mass storage peripherals, that is included in the supported peripherals list can be used on either external bus. There are no other restrictions outside the limit of eight bus addresses supported by software. Maximum cable length is again 2 metres per device (including the interface) or a maximum of 18 metres.

Optimizing HP-IB Performance in Larger Systems

As system complexity increases with the addition of more HP-IB peripherals, several interrelated factors become important, especially as they begin to affect overall system efficiency. The previous discussions of device classes and shared I/O resources is a helpful background for understanding the relationship between system hardware and some of the operating system software.

The system allocates **dedicated** resources (such as buffer space and other items that vary with each driver) for data transfers to and from all peripherals except line printers and 9-track tape drives. **Shared sets** of resources are allocated for printers and 9-track tape drives. Which shared set of resources gets allocated to a given printer is determined by the device class and what bus address the device occupies. There is only one set of resources for 9-track tapes that is assigned to bus address 2.

For example, consider a simple system where the only peripheral besides the system disc is a line printer with graphics capability. In a typical operation, one of the system users selects the smart line-printer driver to output text to the printer which resides at internal bus address 01. The intelligent printer driver understands how to manage line lengths and other parameters related to line printing, and allocates a predetermined set of resources. The operation is executed, and the printed text appears on the printer output. When the output job is finished, the I/O resources are released.

Later, the same user decides to output a set of graphics data to the same printer. Since the normal line printer driver does not know what to do with graphics data because the data format is different, the user selects the graphics driver (a general-purpose, device-independent driver) instead. The second driver allocates a second set of resources that are unrelated to the first set used by the other driver. Since the system is small and no other peripherals are present, the resources used in this scenario can be treated as if they were dedicated.

Now, let's expand the system, adding a second printer, but instead of placing it on the internal bus with the other printer where it competes for bus resources, let's put it on an external bus.

In the single-printer example, where there were no other similar peripherals residing on any other bus in the system, the "shared" sets of resources used by the line printer and graphics drivers were, in effect, dedicated. In a larger system, bus addresses can be arranged so that a given set of resources can be treated as dedicated or shared, depending on how bus addresses for each peripheral in the system are configured.

As we expand from the previous example by adding a second line printer to an external bus, let's look at the effect of bus address on system operation. In the single-printer example, the system printer was using resource set B for line printing because it was at internal bus address 01. If we add the second printer, using an identical address on the external bus, the resource assignment table near the beginning of this subsection shows that the system will assign the same set of resources to the second printer. That forces the two devices to operate serially by job if used as a line printer device (resource set B), although they do not share resources when accessed as graphics devices.

Improved line printer performance is obtainable by changing the bus address of the second printer so it does not use the same set of resources as the first printer. Changing the second printer to external bus address 2, 3, or 4 allocates a non-conflicting set of resources so that operation of each device can be handled on demand, independent of the availability of I/O resources.

Let's use an example to illustrate how to optimize a system.

Expanded Multi-user System

Using the small multi-user system discussed earlier as a basis, let's expand to a more elaborate system used for graphics applications. Adding an HP 7580 Plotter, two HP 9111 Graphics Tablets (digitizers), a fast printer with graphics capability, and replacing the flexible disc with a 9-track tape drive yields the following system; again with four user terminals, one of which is the System Console:

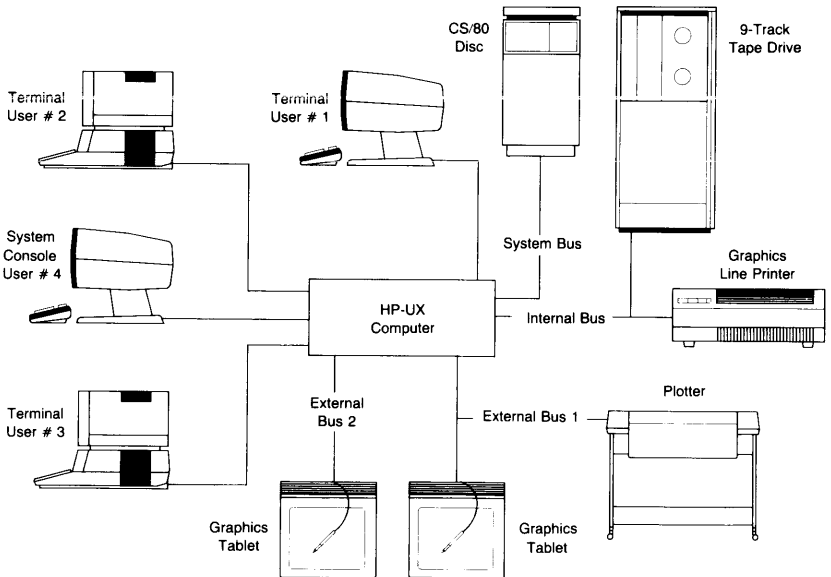

Example of an Expanded Multi-user System

Bus address assignment becomes much more complex in this case because of the potential effects of user interaction and peripheral demands on system resources. To keep things simple in the beginning, let's use the defaults built into the system at the time it was shipped:

- The CS/80 disc drive is installed on the system bus at address 0, and
- The system printer resides on the internal bus at address 01.

The table of available bus addresses earlier in this chapter lists the bus addresses that must be used for given device classes. Let's take each peripheral and determine where it could be installed, then consider advantages and disadvantages of different configurations.

Consider the following factors:

- The operating system uses the CS/80 disc quite heavily, especially as the number of users increases. Any intrusion on the efficiency of the system bus can have dramatic effects on system processing performance. Therefore, the general rule is: **avoid placing non-system resources on the system bus.**
- Printers, plotters, and digitizers (graphics input devices in general) tend to dominate the bus on which they reside. Since we have all three in this system, we need to consider the potential for conflict as we select bus addresses and location in the system.

As a general rule, digitizers and other devices that interact with humans during normal operation should be placed on a dedicated bus when possible. In this case, you might want to add two external buses to the system for use with digitizers, leaving most other peripherals to share the system and internal buses.

For good performance, **plotters and printers should not reside on the same bus** if they are to be used simultaneously. When they are used simultaneously on the same bus, they tend to congest the bus. For example, when a plotter is loading data from the computer, it totally dominates the bus, causing printers to stop completely until the transfer is finished. If simultaneous use of printers and plotters is infrequent, you should have little slow-down with regard to overall peripheral throughput.

The remaining peripherals pose some interesting problems. A system that includes two printers (one or both with graphics capability) sharing a bus with a plotter and 9-track tape is almost certain to lead to bus conflicts. Given the two graphics input devices, you will need four buses (a system bus, internal bus, and two external buses) if you expect reasonable performance.

If the 9-track tape drive is used infrequently, it can be placed on the system bus with only modest loss of overall performance, provided you can accept the accompanying degradation of system bus performance during tape operations. If tape use is heavier, your only alternate choice is to place the tape drive on the internal bus. In either case, the tape drive resides at bus address 02.

The preferred location for the system printer which may or may not have graphics capability is internal bus address 01. The second graphics printer could be placed on an external bus, but (as explained in the next paragraph) we're going to use the external buses for a plotter and the two graphics tablets, both of which tend to interfere with line printer operation and vice versa. Placing the second printer on the internal bus will probably yield better overall efficiency. Any available address, 5, 6, or 7 can be used without affecting performance, but let's use 5.

We are now left with the two graphics input devices and one plotter. The plotter should not reside on a common bus with even one, much less two printers, especially if they are used heavily as in a multi-user environment. The safest approach is to install the two external bus interfaces, and connect each graphics input device to a separate external bus. The graphics tablets, like the graphics printer on the internal bus, can reside at bus address 5, 6, or 7. Which address you choose does not affect overall performance. To maintain uniformity in assigning addresses, you may prefer to use identical addresses for both graphics tablets, and a different address for the plotter.

Optimization Guidelines

The following guidelines are presented to help you determine the best configuration for your system. In general, initial configuration is usually based on a “best guess” estimate of system use and needs after considering individual device operating characteristics. After the system is in use, some experimentation with configuration may expose a better combination. In short, there is no cut-and-dried method for optimizing a system without a history of actual use in real-world applications.

- In general, printers, plotters, and digitizers tend to monopolize bus resources. Therefore, performance usually improves when they are on separate buses; especially when they must operate simultaneously.
- Since disc swapping by the memory management system requires frequent use of the system bus, and using this bus for other operations can impede needed access, peripherals other than the root CS/80 disc drive should be placed on other buses when available.
- The HP 98625 High-speed Disc Interface is a high-performance (fast) device. Avoid placing slower devices on the system bus because they degrade overall performance.
- Do not exceed bus loading capacity or bus configuration limits (available bus addresses). HP-UX address limits prevent placing the maximum number of devices on a given bus, except for the system bus.
- Only eight devices are configurable on each internal or external bus due to software limits, making the 15-device hardware limit meaningless. Only four equivalent loads can be placed on the system bus due to electrical characteristics, even though more than four bus addresses are supported by software.
- For best performance, graphics input devices should be placed on a dedicated bus when it is practical to do so.
- When possible, avoid placing devices on bus addresses such that they compete for shared sets of I/O resources.
- There is a point at which bus congestion versus competition for shared resources becomes closely balanced, in which case choosing one option (increased bus congestion) versus the other (sharing resources) becomes an indeterminant tradeoff, and is therefore irrelevant.
- These guidelines do not imply that you can only place peripherals at non-competing addresses. Devices can be placed at any of the indicated supported addresses for each given device class. However, some performance advantages can be gained by judicious use of address assignments.

Data Communications Concepts

The rest of this section describes some guidelines for using the following data communications (datacomm) interfaces:

- HP 98626A Asynchronous Serial Interface
- HP 98628A Datacomm Interface
- HP 98644A HP Serial Interface
- HP 98691A Programmable Datacomm Interface

Because the datacomm interface is not standardized, each device you connect must be considered on an individual basis. For information about programming the data communications interface, refer to the appropriate operating system or programming language manual.

What is the Data Communications Interface?

Technically speaking, the data communications interface conforms to the RS-232C electrical standard adopted by the Electronic Industries Association (EIA). RS-232C defines the electrical characteristics of an interface between a piece of data terminal equipment (**DTE**) and a piece of data communications equipment (**DCE**). For most applications, the piece of data terminal equipment is your computer, and the piece of data communications equipment is a modem.

Non-technically speaking, the data communications interface allows you to use your computer like a terminal to send information to, and receive information from, another computer. The connection between your computer and the other computer may be direct if the distance between them is short, or it may be over telephone lines if the distance is long. When telephone lines are used, the data communications interface is used to connect your computer to a **modem**. The modem encodes computer data into a form suitable for transmission over telephone lines, and decodes signals received from the telephone line back into a computer-readable form.

The data communications interface can also be used to connect a variety of low-cost peripherals to your computer. However, because the interface was not actually designed with this purpose in mind, the cable connection between the computer and the peripheral may require an adapter cable or some cross-wiring.

Datacomm Fundamentals

All information can be represented as words and numbers. Words and numbers can be represented by characters (letters and numerals). The message HELLO is represented with the four alphabetic characters "H", "E", "L" and "O," while the number 10 is represented by the numeric characters "1" and "0."

Since computers store and process information, they must be able to store and process characters. In your computer, characters are encoded into a pattern of ones and zeroes before they are stored. For example, the letter H looks like this when it is stored in the computer:

H → 01001000

Each binary digit (i.e., a "1" or a "0") of the encoded character is called a **bit**. The entire set of bits for a character is a byte. The codes for the rest of the bytes in HELLO are:

E → 01000101

L → 01001100

O → 01001111

If we wanted to send the message HELLO to another computer, the best way would be to have eight parallel wires running between the computers, one for each bit of a character. Then transmissions could occur one character at a time:

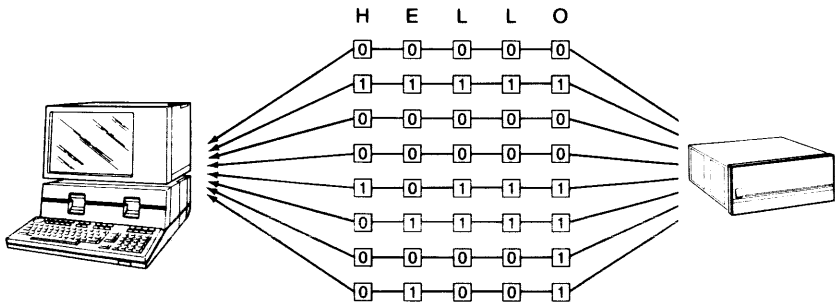

Parallel Transmission

This is, in fact, how the HP-IB works. But telephone lines don't have parallel wires, they only have one. So each character will have to be disassembled and sent over the wire one bit at a time, then reassembled by the receiver. This is called **serial** transmission. The transmission of the character "H" would look like this:

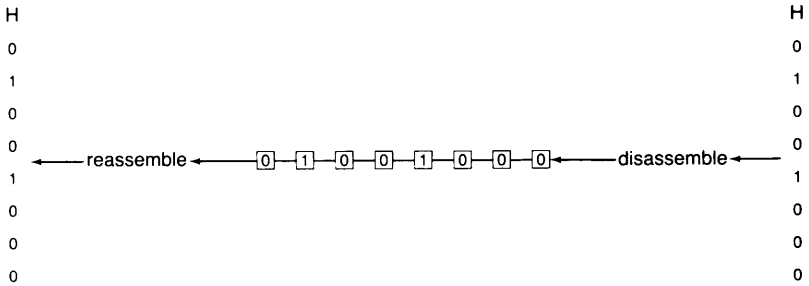

Serial Transmission

The preceding illustration shows the transmission of a single character. But what happens when several characters are transmitted, one after the other? The line would just be one long string of ones and zeroes. How can the receiver tell where one character ends and another begins?

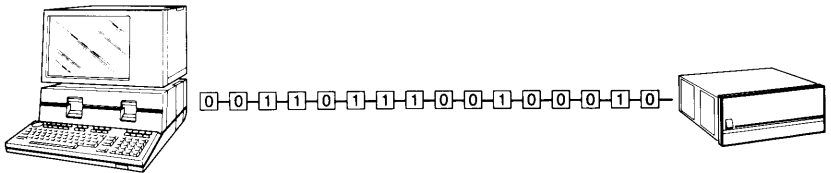

Indistinguishable Characters

First of all, the sender and receiver must agree on how many bits there are in a character. If the sender thinks there are eight bits in a character and the receiver thinks there are only five, the message will be garbled. If the sender and receiver agree that eight bits are needed to represent one character, then when the receiver finds the first bit, it knows that the following seven bits are part of the same character. But for the transmission to work, there must be a way for the receiver to identify the first bit.

To solve this problem, special **start bits** and **stop bits** are sent before and after each character, respectively. There is always one start bit per character, and it signals the receiver that the next eight bits (or whatever number of bits was agreed upon) will represent a character. Either one or two stop bits follow each character to allow the receiver time to get ready for the next character. Both sender and receiver must agree on the number of stop bits to be used.

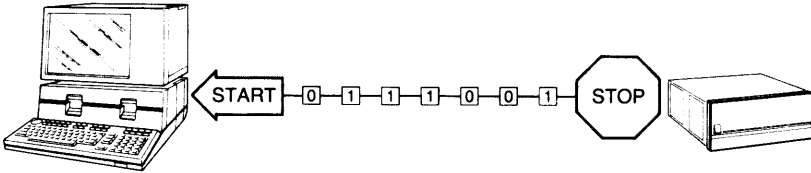

Distinguishable Character

Now the sender and receiver understand each other. They both use the same character coding format, and agree upon the character delimiters. Nothing can go wrong, right? Wrong. What would happen if the sender sends information to the receiver faster than the receiver can read it? Again, the transmission will be garbled.

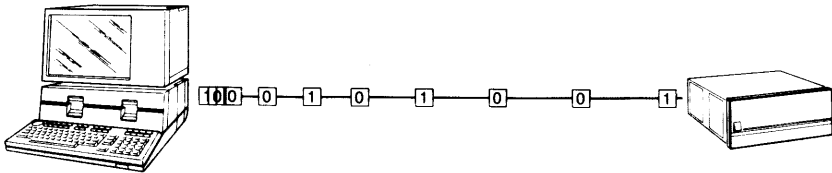

Transmission Rate Problem

The solution is to set the transmission rate of the sender to a level equal to or lower than the maximum rate at which the receiver can accept data. This rate is called the **baud rate**, and is simply the number of bits transmitted by the sender every second. Baud rates can range from 50 to 19 200 bits per second.

One final note. Even when everything between the sender and the receiver is set correctly, errors in transmission will occasionally occur. It would be nice if the receiver could detect these errors and ask the sender to retransmit the garbled information. This is possible by adding an extra bit to each character, called a **parity bit**. The value of the parity bit depends on the parity type that the sender and receiver agree upon.

Odd parity will set the parity bit so that the total number of ones in the character (including the parity bit) is an odd number. For example, if odd parity is used, the parity bit for the letter H will be set to one in order to make the total number of ones in the character odd.

H	Parity Bit
01001000	1

Total number of ones in character = 3 (odd parity)

Even parity sets the parity bit so that the total number of ones in the character is even. Using even parity, the parity bit for the letter H would be zero.

H	Parity Bit
01001000	0

Total number of ones in character = 2 (even parity)

Other parity schemes are available that always set the parity bit the same, either to one or to zero.

If the sender and receiver agree to use *odd* parity, and a character is received containing an *even* number of ones, then an error has occurred in the transmission of that character. The receiver can detect this and ask to have the character retransmitted.

Cable Connections

Assuming you've set the switches on your interface card and installed the card in your computer (Chapter 3), you can now physically interconnect the device and interface with a cable.

Two cables are available. The DTE (Data Terminal Equipment) cable has a 25-pin **male** connector on one end, and a 50-pin connector on the other. The 50-pin connector plugs into the data communications interface installed in your computer, while the 25-pin male connector plugs into the other type of cable: the DCE (Data Communication Equipment) cable. The DCE cable has a 25-pin **female** connector to match the DTE male connector, and also has a 50-pin connector for connecting to your computer.

The following photos show the DTE and DCE connectors. The plastic housing around your connectors may differ, but the pin configuration will be the same.

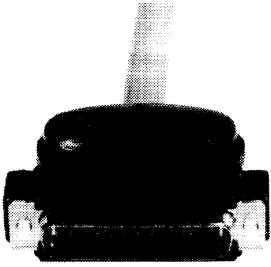

DTE Cable with Male Connector

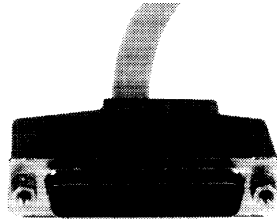

DCE Cable with Female Connector

The type of cable you need for your computer depends on the type of device you are connecting to it. Therefore, no cable is included with your computer. Order separately as needed by part numbers 5061-4215 (male) and 5061-4216 (female). Some guidelines are given below.

Connecting a Modem

Most modems are considered data communication equipment and should come equipped with a female (DCE) cable or socket. Your computer, therefore, is playing the role of the data terminal equipment, and should use a male (DTE) cable.

Connect the 50-pin connector of the DTE cable to the data communications socket on your installed interface. Connect the 25-pin male connector on the other end of the DTE cable to the female (DCE) connector supplied with the modem. Secure the connection with the fasteners.

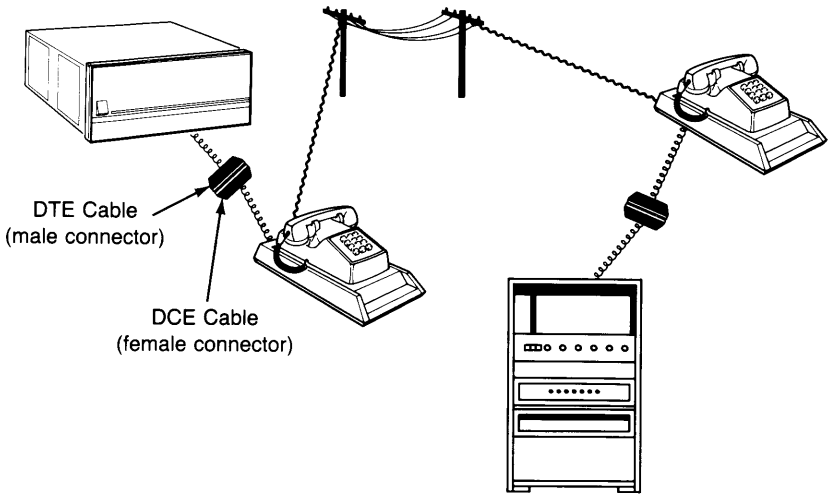

Connecting Your Computer to a Modem

Connecting Another Computer or Terminal

When connecting your computer back-to-back with another computer or terminal, you will normally use a DCE cable. The other computer or terminal will generally have the DTE cable or socket attached to it.

Connect the 50-pin connector of the DCE cable to the data communications socket on your installed interface. Connect the 25-pin female connector on the other end of the DCE cable to the male (DTE) connector attached to the other computer or terminal. Secure the connection with the fasteners.

If, for some reason, the other computer is equipped with a female (DCE) connector, use the male (DTE) cable for your computer. The important thing to remember when connecting two computers directly is that one must have a male cable and the other must have a female cable.

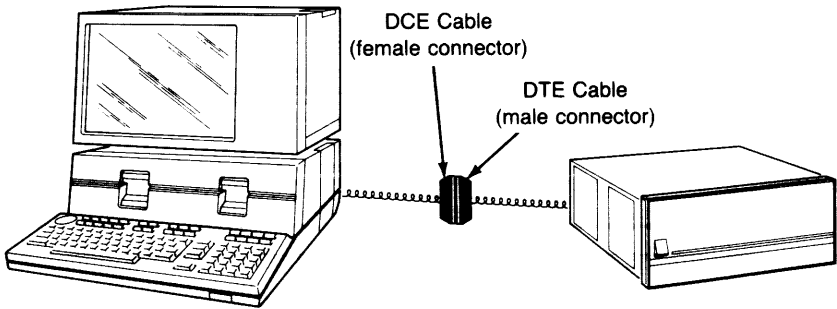

Connecting Your Computer to Another Computer

Connecting RS-232C Peripherals With DCE Connectors

If your peripheral has a female DCE connector, you should be able to connect it directly to your installed interface using a male DTE cable. The only problem might be that the peripheral requires signals not provided by the interface. Not all of the pin functions defined in the EIA Std RS-232C interface are available on your interface.

Connect the 50-pin connector of the DTE cable to the data communications socket on your installed interface. Connect the 25-pin male connector on the other end of the DTE cable to the female (DCE) connector supplied with the peripheral. Secure the connection with the fasteners.

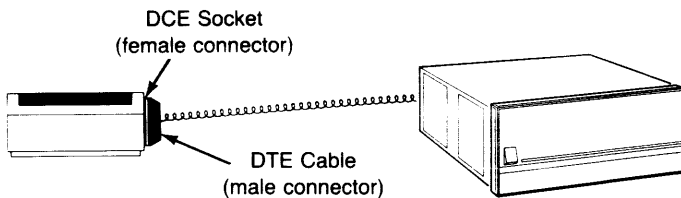

Connecting Your Computer to a DCE Peripheral

Connecting RS-232C Peripherals With DTE Connectors

Line printers and other peripheral devices that use the data communications interface are frequently *wired* as DTE but have a *female* connector instead of the usual male. This means that if you use a male (DTE) cable to connect to the *female* DTE device connector, no communication can take place because the signal paths are incompatible.

To get around this problem, use an adapter cable with male connectors at both ends. The adapter cable effectively converts the peripheral's female DTE connector into the common male DTE connector. Then you can run a female DCE cable from the interface to the adapter cable.

Several adapter cables are available to solve problems like the one discussed above. Contact your HP Sales Representative for advice on selecting an adapter cable.

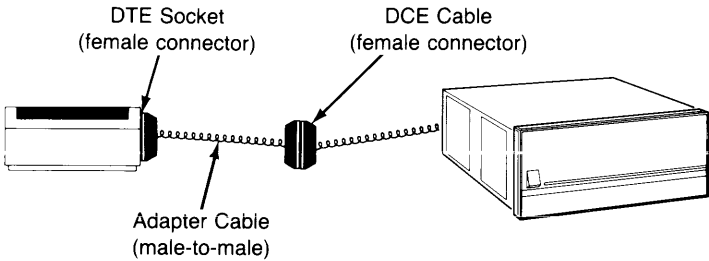

Connecting Your Computer to a DTE Peripheral

Glossary

- Baud Rate:** The number of bits transmitted each second during a serial transmission.
- Bit:** A binary digit (1 or 0).
- Boot ROM:** The boot ROM stores instructions that tell the computer how to run its self-test and then search for a system program.
- Bus Address:** A number that identifies the location of a device on the HP-IB; also called primary address.
- Byte:** The unit of memory used on your computer. One byte equals eight bits and is generally equivalent to one character, like "A".
- Character Code:** A numeric code which is used to represent a character inside the computer.
- Controller:** An device capable of regulating the communication among devices on the HP-IB.
- CRT:** The computer's monitor (cathode ray tube).
- Cursor:** The blinking underline character that marks the position on the screen where the next character will be typed.
- Disc:** Similar to a phonograph record, except that it stores programs and data instead of music.
- Disc Drive:** An input/output device that transfers programs and data between a disc and the computer's memory.
- Hardware:** All of the electrical and mechanical components of the computer.
- Input/Output:** Anything relating to the exchange of information between the computer and its peripherals.

Input Device: A peripheral device which transfers programs and data into the computer. Common input devices include keyboards, disc drives, and graphics tablets.

Interface: The interface makes the computer and a peripheral mechanically and electronically compatible. It is the “interpreter” of the system, making communication possible between the computer and its peripherals.

K bytes: 1 024 bytes.

Language System: A large program which performs all of the functions of a system program, plus supports a programming language like BASIC or Pascal.

Language-dependent Program: A program which requires a language system in order to run. Language-dependent programs are always loaded into memory *after* a language system has been booted.

Listener: Any peripheral device capable of *receiving* information on the HP-IB.

M bytes: 1 048 576 bytes.

Memory: The area of the computer where programs and data are stored. The processor cannot run a program unless it is in memory.

Memory Address: A number which uniquely identifies one byte of memory.

Modem: A peripheral device that allows computer signals to be sent and received over telephone lines; used with the data communications interfaces.

Output Device: A peripheral device which accepts information from the computer for storage or display purposes. Common output devices include computer screens, disc drives, printers and plotters.

- Parity Bit:** A bit that is appended to a character code for detecting errors during transmission.
- Peripheral Devices:** Devices that allow the computer to communicate with the outside world. See “Input Device” and “Output Device.”
- Primary Address:** See Bus Address.
- Processor:** This is the “brain” of the computer that runs programs and regulates most other computer functions.
- Program:** A set of instructions that tell the processor how to perform a particular task. Most programs are written in a high-level programming language like BASIC or Pascal.
- RAM:** Random Access Memory. This is erasable program memory. Programs and data are usually copied into RAM from a disc drive or other mass storage device, executed by the processor, and then erased from RAM. When the power is turned off, RAM is erased.
- ROM:** Read-Only Memory. This is permanent program memory, used primarily for storing essential programs. Programs in ROM are never erased, so ROM is not reusable.
- Select Code:** A number which uniquely identifies an interface. The processor uses the select code to select which interface will be used in a data transfer operation.
- Serial Transmission:** Transmission of data one bit at a time over a single wire.
- Software:** A synonym for program.
- Start Bit:** A bit used to mark the beginning of a character in a serial transmission.
- Stop Bit:** A bit used to mark the end of a character in a serial transmission.

System Program: A program which handles all of the overhead functions of computing, such as defining the keyboard, managing the peripherals, refreshing the display, etc. When the computer is turned on and passes its self-test, it immediately begins searching for a system program to boot.

Stand-alone Program: A program that has a “built-in” system program and can run without any underlying language support.

Talker: Any peripheral device capable of *sending* information over the HP-IB.

Subject Index

a

Accessory slots	8, 16, 17
Address:	
HP-IB bus	30, 31, 73, 75, 76
HP-UX HP-IB bus	56, 57
memory	67, 68
Airflow, computer.	10
Assignments, accessory slot.	17
Audio cable	27, 54

b

Baud rate	61, 94
Beeper, self-test	41
Boot ROM:	
error messages.	43
errors	41
general	5, 38, 39
Bootling program	5
Bus:	
address, HP-IB.	73, 75, 76
address, HP-UX HP-IB	56, 57
external	29, 30, 32, 55, 74, 85
HP-IB.	70
internal	29, 30, 32, 55, 74, 84, 88
system	29, 30, 32, 45, 55, 74, 77, 82, 88
Byte	67

C

Cable length, HP-IB	33, 83, 84, 85
Cable:	
audio	27, 54
keyboard	26, 27
video	27, 54
Cables:	
data communications equipment (DCE)	58, 59, 96, 97, 98, 99
data terminal equipment (DTE)	58, 96, 97, 98, 99
extension	58
HP-IB	31, 32, 33
modem eliminator	58
Cautions	17
Chaining HP-IB connections	32
Code, select	22, 29, 69, 70, 75
Computer cooling	10
Computer positioning	10
Connectors, HP-IB	33
Console, system	45, 53
Controller	71, 72, 73
Cooling, computer	10
Cord, power	13
CS/80-type disc drive	55, 56, 74, 79, 82, 83, 84, 85, 88, 90

d

Data communications equipment	91
Data communications equipment cables	58, 96, 97, 98, 99
Data terminal equipment	91
Data terminal equipment cables	58, 96, 97, 98, 99
Datacomm configuration settings	63
Datacomm interface	60
DCE	91
DCE cables	58, 59, 96, 97, 98, 99
Disc drive	5
DTE	91
DTE cables	58, 96, 97, 98, 99

e

Error message	38, 40
Error messages, boot ROM	43
Errors, boot ROM	41
Even parity	95
Example system	79, 80, 87
Extension cables	58
External bus	29, 30, 32, 55, 74, 85

f

Fan	8
Fuse	8, 12

g

Guide organization	2
--------------------------	---

h

HP 7908 Disc Drive	45, 55, 82
HP 7911 Disc Drive	45, 55, 82
HP 7912 Disc Drive	45, 55, 82
HP 7914 Disc Drive	45, 55, 82
HP 7971 Tape Drive	83, 84
HP 82901 Disc Drive	56, 57
HP 82902 Disc Drive	56, 57
HP 8290x Disc Drive	83
HP 9135 Disc Drive	56, 57, 77, 83
HP 98203A Keyboard	25, 38
HP 98203B Keyboard	25, 38, 53
HP 98204A Composite Video Interface	17, 27, 53, 54
HP 98255A EPROM Interface	17
HP 98256A 256K RAM	18, 39, 45, 46, 67
HP 98257A 1M RAM	18, 39, 45, 46, 67
HP 98620B DMA Controller	17, 20, 45, 46

HP 98624A HP-IB Interface	22, 29, 32, 47, 55, 56, 74, 78
HP 98625A High-speed Disc Interface	17, 22, 29, 32, 45, 46, 55, 74, 82, 90
HP 98626A Asynchronous Serial Interface	22, 39, 48, 49, 50, 54, 58, 91
HP 98628A Datacomm Interface	22, 48, 50, 54, 58, 91
HP 98644A HP Serial Interface	22, 39, 48, 52, 54, 58, 91
HP 98691A Programmable Datacomm Interface	91
HP 9888A Bus Expander	17, 24, 68
HP 9920A Computer	39
HP 9920S Computer	39
HP 9920T Computer	45
HP 9920U Computer	45
HP-IB:	
bus addresses	30, 31, 70, 73, 75, 76
bus addresses, HP-UX	56, 57
buses	29, 30, 55
cable lengths	33, 83, 84, 85
cables	31, 32, 33
chaining connections	32
connectors	33
internal interface	68, 70
HP-UX:	
HP-IB bus addresses	56, 57
notes	18, 20, 22, 25, 29, 35, 45
select codes	48
system installation	48, 82

i

I/O resources	75, 77, 78, 79, 85, 86, 90
IEEE Standard 488-1975	70
IEEE Standard 488-1978	70
Input devices	5
Installation, HP-UX system	48, 82
Interface	6
Internal bus	29, 30, 32, 55, 74, 84, 88
Internal HP-IB interface	68, 70
Interrupt level switch	46, 47

k

K bytes	67
Keyboard cable	26, 27
Keyboard, HP 98203A	38
Keyboard, HP 98203B	38, 53
Keyboard/HP-IB Interface	8, 16, 22, 26, 27, 29, 32, 53, 54, 55, 65, 66, 68, 72, 74

l

Listener	71, 73
----------------	--------

m

M bytes	67
Memory:	
address	67
address switches	68
extended test	42
general	4, 39, 45, 46, 47
Messages:	
boot ROM error	43
error	38, 40
status	38, 39
Modem	60, 61, 91, 96
Modem eliminator cables	58

O

Odd parity	95
Organization, guide	2
Output devices	5

p

Parallel transmission	92
Parity bit	95
Peripherals	5
Power cord	13
Power socket	8
Power switch	8, 14
Power troubleshooting	14
Processor	4
Program	4
Program, booting	5

r

RAM:	
address switches	68
general	4, 39, 45, 46, 47
test	42
Random access memory	4, 39, 67
Read-only memory	4
ROM:	
boot, error messages	43
boot, errors	41
boot, general	38, 39, 5
general	4
Root device	55, 77
RS-232C	48, 58, 59, 60, 91, 98,99

S

Select code	22, 29, 69, 70, 75
Select code switch	46, 47
Select codes, HP-UX	48
Self-test	37
Self-test beeper	41
Serial interface	60
Serial transmission	93
Slots, accessory	16, 8
Socket, power	8
Software	4
Stacking HP-IB connectors	33
Start bit	94
Status message	38, 39
Stop bit	94
Switch:	
address/system controller	47
interrupt level	46, 47
power	8, 14
select code	46, 47
system controller	53, 65
video interface	26, 53, 65
voltage selector	8, 11
Switches:	
HP-IB address	30
Keyboard/HP-IB Interface	65
memory address	68
System:	
bus	29, 30, 32, 45, 55, 74, 77, 82, 88
console	45, 53
console interface	49, 50
controller	72, 73
controller switch	53, 65
examples	79, 80, 87

t

Talker	71, 73
Terminal:	
configuration settings	63
emulator	60
general	61, 62, 63
Test, extended memory	42
Transmission:	
parallel	92
rate	94
serial	93

v

Ventilation, computer	10
Video cable	27, 54
Video interface switch	26, 53, 65
Voltage selector switch	8, 11