

INTRODUCTION

The HP 64000 Logic Development System Selection and Configuration Guide is not intended as a substitute for the Technical Data Sheets of 64000 System products; nor is it to serve as an installation guide. The HP64000 Configuration Guide was designed to aid both the knowledgeable and less familiar users in selecting the appropriate HP64000 products required to satisfy specific microprocessor development needs. For applications information and a broader overview of the system, HP64000 Concept Brochures are recommended.

New Section 3, the "Hosted Development Systems," gives a good overview of the HP64000 networking capabilities and the component parts which comprise the hosted environment. This new section also functions as a selection guide, but is NOT intended to provide information for configuring an HP9000, Series 500 or 200 computers. For specific configuration information, you should consult the "HP 9000 Series 500 Configuration Information and Order Guide", Pub. No. 09050-90050, or the "HP 9000 Series 200 Configuration Information and Order Guide", Pub. No. 09800-90020.

For those readers familiar with the HP64000, who need only product number information and/or compatibility issues addressed, the "Quick Reference," Section 2, is provided.

It is recommended that less familiar users read the Introductory Chapter first, to gain a policy, guide structure, and system numbering overview, and then to refer to those chapters of interest. Ordering forms are provided in Section 15 to aid those unfamiliar with configuration to put together an order consistent with Logic System Division ordering policies.

GUIDE STRUCTURE

This Configuration Guide basically addresses (1) HP64000 System products in a stand-alone or cluster mode, and (2) the Logic Development System networked to mainframe computers and other terminals, providing even more computing power and larger design teams. Hosted Systems are addressed in Section 3. Software for the Hosted Development environment is addressed separately in Section 11, "Software," and Section 13, "Support Services." Available Hosted software is also tabled in the "Quick Reference" Section.

Chapters which discuss subsystems, 64XXS products, specifically Emulation, Internal Analysis, State Analysis, Timing Analysis, and Prom Programming are divided into two parts. The first part of these chapters discusses subsystems, and gives information pertinent for first-time orders. Reference to the second half of these chapters discusses components and information required when expanding an existing system. The chapters were organized to represent the flow of putting a HP64000 system together. Chapter 3 covers Development Stations, chapter 4 covers Emulation and Memory Subsystems, and the new Microprogram Development Subsystem, followed by chapters devoted to Internal Analysis/High-Level Language Analysis, State and Timing Analysis. The last chapter devoted to 'station products' is PROM Programming. Then a section entitled "Multi Module Configurations" details card and cabling issues to both clarify factory systemizing procedures, and provide guidance to configurations when expanding an existing system. The ensuing chapters then cover topics considered once the features and analysis products for each station have been considered i.e. Software, Accessories, and Support Services. The last two chapters are provided to ensure all Configuration Requirements (power and card slot) have been satisfied, and Ordering procedures are understood.

DEFINITIONS

Throughout this guide, terms are used to refer to aspects of the HP64000 product. Some of these are defined below:

DEVELOPMENT STATION : The HP64000 station; model numbers 64100A, and 64110A.

PERIPHERALS : Components attached to the system bus other than the HP64000 stations; i.e., disc drives and printers.

CLUSTER : More than one development station sharing common peripherals such as a disc or printer.

HOSTED DEVELOPMENT SYSTEMS : A cluster of HP64000 stations connected to a host mainframe computer and other terminals, whereby microprocessor-based design can be done on the HP64000 cluster stations, on the host computer, or terminals can be used to remotely control the HP 64000 stations for emulation and analysis procedures.

CARD : A printed circuit board assembly which plugs into a 64100A or 64110A Development Station.

SUBSYSTEM : A collection of interdependent hardware and software which performs a specific function. For example : A 64156S Option 012 is an Emulation Memory Subsystem which consists of a Memory Control Card, a 128K Byte Memory Board, and an interconnecting Memory Bus all in one package.

CONFIGURATION GUIDELINES

Throughout this Guide, guidelines are offered, where appropriate to specific sections. General guidelines that apply to many sections are discussed here. Three key areas to understand involve:

- o Software,
- o Cables,
- o Development Station Power and Slot Requirements.

SOFTWARE

All hardware-DEPENDENT software is included in the purchase of hardware (i.e., 64xxxx model numbers). Hardware INDEPENDENT software products, which must be purchased separately, consist of the Operating System, Assembler/Linkers, and Compilers.

Purchase of a software product entitles a customer to use that product on one HP 64000 Logic Development Cluster, where a cluster is defined as a group of up to six stations sharing a common hard disc.

It is possible for any software product to be modified or enhanced at any time by Hewlett-Packard. A new revision of one software product may render it incompatible with an earlier revision of any other software product used on that system. For this reason, a Software Subscription Service is offered to HP customers. Customers subscribing to this maintenance service are always assured of having compatible software. Compatibility is not guaranteed unless a customer is a subscriber. Consult your local HP Field Engineer for assistance in determining if your software is the latest revision. See Support Services, Section 13 for more information.

CABLES

Cables necessary to connect boards within a particular subsystem (e.g. 64600S) are included with the subsystem order. Cables that connect between two or more subsystems must be ordered where necessary. Specifically these cables are the 64960A Emulation/Memory Bus Cable which interconnects the Emulator, Emulation Memory, and Internal Analyzers, and the 64964A Intermodule Bus which synchronizes measurements between analysis subsystems. Although these cables must be ordered, they are offered AT NO CHARGE when ordered with 64000 products. To order separately, they may be purchased with their 8 or 10-digit part number from Hewlett Packard Corporate Parts Center, (found on page 9-11).

Throughout this Guide, cables are illustrated differently to distinguish between "must order," interconnecting cables, and subsystem cables. In the diagrams of card configurations, cables drawn as solid black lines are interconnecting and must be ordered. Those cables which are outlined are included with the product when the product is ordered as a 64XXS subsystem.

To order the appropriate cable option (which indicates the size or number of positions on the cable) consult the chapter/s which cover the products you have selected for a given development station. The section entitled, Multi Module Configurations illustrates how the factory will put together subsystems ordered within a station (if ordered correctly), and thus the cable option (number of positions) required for a given application.

When modifying or expanding an existing subsystem, e.g., adding individual cards, the appropriate cabling must be ordered to insure correct cabling sizes are obtained for the expanded subsystem.

DEVELOPMENT STATION POWER AND SLOT REQUIREMENTS

The HP 64000 System allows great flexibility in configuring different Measurement Systems together in a development station. However, it is always necessary to consult Section 14 on "Configuration Requirements", to ensure that the available power supply currents and card cage slots are not exceeded.

NUMBERING FORMAT

All 64000 product model numbers are of two basic formats: (1) 64XXXYZ, where XXX are always numeric characters used to distinguish the particular products and YZ are always alpha characters used to indicate one of the following:

First Alpha Suffix:

Y = S Denotes subsystem, where the subsystem is made up of other 64XXSY products.

Second Alpha Suffix:

Z = F Denotes software product, for which the transfer media is 5 1/4 inch Flexible Disc.

Z = R Denotes Right to Reproduce an -AF or software product.

Z = X Denotes One-Time Update (with complete manual).

(2) 64XXXYZ+Nnn, where YZ are always alpha characters; N always represents an alpha character and "nn" always represents numeric characters, such as:

NUMBERING FORMAT (continued)

Suffix Additions:

- N = +S Denotes Software Materials Subscription service.
- N = +W Right to Reproduce SMS products.
- n = + 43 Denotes media type for operating system.
- n = + 00 Denotes all other 64000 software products for either Software Materials Subscription service or Rights to Reproduce SMS products.

For Example :

- 64203S is a subsystem composed of a collection of hardware and/or software products.
- 64100AF is the software product required to operate the 64000 system.
- 64100AR is the Right to Reproduce product for 64100AF
- 64100AF+S43 is the Software Materials Subscription for the operating system
- 64XXXXA+S00 is the Software Materials Subscription for all other 64000 system products (except operating system).
- 64100AF+W00 is the Right to Reproduce product for the 64100AF+S43 or any 64XXXXA+S00 product.

Subsystems, 64XXXS, are provided for ordering and configuration convenience. Rather than specifying several distinct hardware or software products and connecting cables, the entire package is obtained with one number. For subsystem breakdown information, see the Quick Reference Section. Where options exist to alter or expand the basic capability of the subsystem, they are shown as option numbers to that subsystem. Options always add or subtract in material list and price from the base product to which they are options.

NUMBERING SYSTEM

Following is a breakdown of the 64000 System Numbering scheme. The product line is 64XXX in which XXX is:

- 001-099: Mainframe Options
- 100-149: Mainframes
- 150-169: Emulation Memory and Controllers
- 190-299: Emulation Modules
- 300-350: Internal Analyzers
- 500-530: PROM Programmers
- 600-620: Timing Analysis
- 620-629: State Analysis
- 630 : State Probes
- 650-799: State Preprocessors
- 810-830: Compilers
- 840-859: Assemblers
- 930-939: Special Support Services
- 940-959: Field Installed Mainframe Options
- 960-965: Cables
- 980-999: Manual Sets

QUICK REFERENCE

MICROPROCESSOR SUPPORT

	MICRO-PROCESSOR	HOST COMPUTER SOFTWARE*			HP 64000 SYSTEM					
		ASSEMBLER LINKER SYSTEM	PASCAL LANGUAGE SYSTEM	"C" LANGUAGE SYSTEM	CROSS ASSEMBLER	PASCAL CROSS COMPILER	"C" CROSS COMPILER	EMU-LATOR	STATE ANALY. INTRF. MODULE	HIGH-LEVEL SW ANALY.
16 BIT	68000	Y	Y	Y	Y	Y	Y	Y	Y	Y
	68000 PGA	Y	Y	Y	Y	Y	Y	Y	N	Y
	68008	Y	Y	Y	Y	Y	Y	Y	Y	****
	68010	Y	Y	Y	Y	Y	Y	Y	Y	Y
	68010 PGA	Y	Y	Y	Y	Y	Y	Y	N	Y
	8086/87/C86	Y	Y	Y	Y	Y	Y	Y	Y	Y
	8088/87/C88	Y	Y	Y	Y	Y	Y	Y	Y	Y
	Z8001	Y	Y	Y	Y	Y	Y	Y	Y	N
	Z8002	Y	Y	Y	Y	Y	Y	Y	Y	N
	900/9989	Y	N	N	Y	N	N	UD	UD	N
	70116/108	Y	Y	Y	Y	Y	Y	Y	N	N
	80186	Y	Y	Y	Y	Y	Y	Y	Y	Y
	80188	Y	Y	Y	Y	Y	Y	Y	Y	Y
	80286	Y**	Y***	Y***	Y**	Y***	Y***	Y	Y	N
	9450	Y	N	N	Y	N	N	Y	UD	N
TMS32010	Y	N	N	Y	N	N	Y	N	N	
8 BIT	Z80	Y	Y	Y	Y	Y	Y	Y	Y	UD
	8080	Y	Y	Y	Y	Y	Y	Y	Y	Y
	8085	Y	Y	Y	Y	Y	Y	Y	Y	Y
	6301V/03R	Y	Y*	Y*	Y	Y*	Y*	Y	N	Y
	6800	Y	Y	Y	Y	Y	Y	Y	Y	Y
	6801/03	Y	Y	Y	Y	Y	Y	Y	Y	Y
	6802/08	Y	Y	Y	Y	Y	Y	Y	Y	Y
	6805/R/U	Y	N	N	Y	N	N	Y	N	N
	6805P	Y	N	N	Y	N	N	Y	N	N
	146805G2/E2	Y	N	N	Y	N	N	Y	N	N
	6809	Y	Y	Y	Y	Y	Y	Y	Y	Y
	6809E	Y	Y	Y	Y	Y	Y	Y	Y	Y
	8048	Y	N	N	Y	N	N	Y	N	N
	8035/39/49	Y	N	N	Y	N	N	Y	N	N
	8051	Y	N	N	Y	N	N	Y	N	N
	NCS800	Y	Y	Y	Y	Y	Y	Y	Y	Y
	6502	Y	N	N	Y	N	N	UD	UD	N
	Z8	N	N	N	Y	N	N	N	N	N
1000L	N	N	N	Y	N	N	N	N	N	
1802	N	N	N	Y	N	N	UD	UD	N	
FB(3800/70)	N	N	N	Y	N	N	N	N	N	
8021	Y	N	N	Y	N	N	N	N	N	
UD	Y	N	N	Y	N	N	Y	Y		
ROM							Y			

"Y" = HP 64000 PRODUCT AVAILABLE

"N" = NO PRODUCT AVAILABLE AT THIS TIME

"UD" = USER-DEFINABLE PRODUCT AVAILABLE

* - SUPPORTED WITH 6800 CODE

** - LIMITED CODE GENERATION IN VIRTUAL ADDRESS MODE

*** - CODE GENERATION IN REAL ADDRESS MODE ONLY

**** - HL SOFTWARE ANAL ONLY (NO REAL-TIME HL)

* HOST COMPUTER SYSTEMS ARE HP

9000/S500 WITH HP-UX, AND DEC VAX-11/730-750-780

WITH VMS

DEVELOPMENT STATIONS

MODEL	OPTIONS	TO ORDER SEPARATELY	DESCRIPTION	SOFTWARE	CABLING
64100A			10 SLOT LOGIC DEVELOPMENT STATION *	64100AF	2M HPIB CABLE INCLUDED
	OPT 041	64941A	SPECIFIES DUAL 5 1/4" FLEXIBLE DISC UNIT		
64110A			5 SLOT DEVELOPMENT STN INCLUDES FLEXIBLE DISC	64100AF	
	OPT 034	64034A	ACCESSORIES POUCH		

* PROM PROGRAMMER OPTION CAN BE ADDED TO 64100A, NOT 64110A

EMULATION AND MEMORY SYSTEMS

UP	EMULATION SUBSYSTEM	MEMORY SUBSYSTEM	BUS ANALYZER	CONTROL CARD *	POD *	CABLING
8080	64202S	64152S	64310A	64201A	64202A 64203A	64960A OPTIONS
8085	64203S			64211A	64212A 64213A	
6800	64212S			64214A	64215A 64216A	
6802,68802, 6808	64213S			64205A	64206A	
6809	64215S			AND/OR	64302A	
6809E	64216S	64223B	64221B 64221C			
6301V,6303, 63P01M MC68HC01	64206S	64223B	64224A 64225A			
8086,8087	64220S	64271B	64227B			
80C86	64220S, OPT. 001	64630S 64304A	64271B			
8088,8087	64221S		INCLUDED (1)		INCLUDED (1)	
80C88	64221S, OPT. 001		↓		↓	
80186***	64224S		64255A		64256A	
80188***	64225S		64263A		64264A	
80286	64227S	64271B	64286AA			
Z8001	64232S	64156S	64304A	64223B	64294A 64295A	
Z8002	64233S			64271B	64294A 64295A	
68000	64242S			64271B	64294A 64295A	
68010	64249S			64271B	64294A 64295A	
68000	64243AA			64271B	64294A 64295A	
68000 PGA	64243AB			64271B	64294A 64295A	
68008	64244AA			64271B	64294A 64295A	
68010	64245AA			64271B	64294A 64295A	
68010 PGA	64245AB			64271B	64294A 64295A	
6801,6803	64256S			64271B	64294A 64295A	
8051***	64264S	N/A	64302S AND/OR 64304A W/ 64620S	64271B	64272A	
F9450	64286SA			64197A	64192A 64193A 64194A 64195A	
70116	64294S			64271B	64253A	
70108	64295S			64261A(2)	64262A	
6805U/R	64192S			64271B	64285A	
6805P	64193S	64291A	64292A			
146805G2	64194S	64274A	64274B			
146805E2	64195S	64156S	64302S AND/OR 64304A W/ 64620S	64271B	64272A	
Z80,Z80A,B,H,L	64253S			64271B	64272A	
8048**/**	64262S	64156S	64302S AND/OR 64304A W/ 64620S	64271B	64272A	
TMS32010	64285S			64271B	64272A	
NSC800	64292S	64156S	64302S AND/OR 64304A W/ 64620S	64291A	64292A	
UDE	64274S			64274A	64274B	
ROM	64272S	64152/156S	64302S AND/OR 64304A W/ 64620S	64271B	64272A	

* THE EMULATION CONTROL CARD AND EMULATION POD MAY BE ORDERED INDIVIDUALLY OR AS A SUBSYSTEM (I.E. A 64252S CONSISTS OF A 64251A CONTROL CARD AND A 64252A POD).

** HAS TWO CONTROL CARDS WITH MEMORY INCLUDED.

*** EMULATORS TO WHICH CABLING EXCEPTIONS APPLY (SEE PAGE 4-4).

(1) EMULATION CONTROL CARD AND EMULATION POD ARE INCLUDED IN SUBSYSTEM, AND MAY NOT BE ORDERED INDIVIDUALLY.

EMULATION (continued)

ROM EMULATOR SUPPORTS:	INTEL 2764,2732,2716,2816,3636,2758,2808,2809, MOTOROLA 68764,68766,68732-01-1,MCM2532,MCM2716 HARRIS HN462532,HN462732,HN462716,HN48016 TI TMS2564,TMS2532,TMS2508-20
------------------------	---

MICROPROGRAM DEVELOPMENT SYSTEM

MODEL	MAINFRAME CNTRL. CARD	POD AND CABLES	WCS (KBYTES)
64276A	64276	YES	0
64276B	↓	YES	32
64276C	↓	YES	64

MEMORY SUBSYSTEMS

MEMORY SUB- SYSTEM	OPTIONS	SIZE (BYTES)	MEMORY BOARD	CONTROL CARD	MEMORY BUS CABLE
64152S		32K	64163A	64151A	64960A/OPTS (see below)
	OPT 011	64K	64162A		
64156S		32K	64163A	64155A	
	OPT 011	64K	64162A		
	OPT 012	128K	64161A		
	OPT 013	256K	(64161A) X 2		
	OPT 014	512K	(64161A) X 4		
	OPT 015	1024K	(64161A) X 8		

INTERNAL ANALYSIS

64302A	48-CHANNELS 24 ADDRESS BITS
64304A	60-CHANNELS(REQUIRES 64620S)
64310A	SOFTWARE PERFORMANCE ANALYZER
64330A	HIGH LEVEL SOFTWARE ANALYZER

EMULATION/MEMORY/INTERNAL and HLL ANALYSIS--CABLING

64960A				
		2-POSITION	OPT 010*	F1-R1 2-POSITION
	OPT 001	3-POSITION	OPT 011*	F2-R1 3-POSITION
	OPT 002	4-POSITION	OPT 012*	F3-R1 4-POSITION
	OPT 003	5-POSITION	OPT 013*	F1-R1 3-POSITION
	OPT 004	6-POSITION	OPT 014*	F2-R2 4-POSITION
	OPT 005	7-POSITION	OPT 015*	F3-R2 5-POSITION
	OPT 006	8-POSITION	OPT 016*	F1-R3 4-POSITION
	OPT 007	9-POSITION	OPT 017*	F2-R3 5-POSITION

NOTE: For cable part numbers, please refer to page 9-11.

LOGIC STATE ANALYSIS

LOGIC STATE/SOFTWARE ANALYZER

MODEL	OPTION	CHAN	ACQ. CARD	CONT CARD	CABLES/OPTIONS	OVERVIEW	
64620S		20	64623A	64621A ↓	64962A	YES	
	OPT 010	40	64622A			NO	
	OPT 011	60	64622A/23A			YES	
	OPT 012	80	(64622A)X2			OPT 001	NO
	OPT 013	100	(64622A)X2 64623A				YES
	OPT 014	120	(64622A)X3			OPT 002	NO
INTERFACE MODULE ONLY 60 CHANNELS. IF MORE PROBING DESIRED, MUST USE GENERAL PURPOSE PROBES.							

GENERAL PURPOSE PROBES

MODEL	OPTION	CHAN	DATA PROBES	CLOCK PROBES
64630S		20	64635A	64636A
	OPT 010	40	(64635A) X 2	
	OPT 011	60	(64635A) X 3	
	OPT 012	80	(64635A) X 4	
	OPT 013	100	(64635A) X 5	
	OPT 014	120	(64635A) X 6	

GENERAL PURPOSE PREPROCESSOR

64650A	UP TO 60 CHANNELS
--------	-------------------

EMULATION BUS PREPROCESSOR

64304A	UP TO 60 CHANNELS
--------	-------------------

MICROPROCESSOR INTERFACE

uP	PREPROCESSOR	INTERFACE MODULE	CH REQ	
8086/8088	64650A ↓	64653A	60	
8085		64655A	40	
80186/188		64658A	60	
80286		64657A	60	
68000/010		64674A	60	
6809/09E		64671A	40	
6800/02		64672B	40	
68008		64673A	60	
Z8001		64680A	60	
Z8002		64681A	40	
Z80		64683A	40	
NSC800		64690A	40	
UDI			64651B	OPT 010 OPT 011 OPT 012

25 MHz LOGIC STATE/SOFTWARE ANALYZER

MODEL	OPTION	CHAN	ACQ. CARD	DATA PROBES	CNTRL CARD	CLOCK PROBE
64320S		30	64322A	(64324A)X3	64321A ↓	64325A ↓
	OPT 010	60	(64322A)X2	(64234A)X6		
	OPT 011	90	64322A)X3	(64324A)X9		

LOGIC TIMING ANALYSIS

LOGIC TIMING ANALYZER

HIGH-SPEED TIMING/STATE SUBSYSTEM		CHANNELS	ACQUISITION CARDS	CONTROL CARD	DATA PROBE	CLOCK PROBE	DELAY POD	BUS CABLE	
64610S		8	64602A	64601B	64604A	64605A	64606A	64693A	
	OPT 016	16	2-64602A		2-64604A		2-64606A		OPT 001
	OPT 024	24	3-64602A		3-64604A		3-64606A		OPT 002
	OPT 032	32	4-64602A		4-64604A		4-64606A		OPT 003
TIMING-ONLY SUBSYSTEM									
64610S	OPT 001	8	64602A	64601B	64604A	---	---	64693A	
	OPT 002	16	2-64602A		2-64604A		---		OPT 001
	OPT 003	24	3-64602A		3-64604A		---		OPT 002
	OPT 004	32	4-64602A		4-64604A		---		OPT 003

CABLING

CABLES		DESCRIPTION
64962A		2-POSITION STATE BUS CABLE
	OPT 001	3-POSITION
	OPT 002	4-POSITION
64963A		2-POSITION TIMING BUS CABLE
	OPT 001	3-POSITION
	OPT 002	4-POSITION BUS BOARD IN LIEU OF 64963A
	OPT 003	5-POSITION BUS BOARD IN LIEU OF 64963A
64964A		2-POSITION INTERMODULE BUS CABLE
	OPT 001	4-POSITION
	OPT 002	6-POSITION
	OPT 003	8-POSITION
	OPT 004	3-POSITION
	OPT 005	5-POSITION
	OPT 006	7-POSITION

INTERMODULE BUS EXTENDER

MODEL NO.	DESCRIPTION
64303A	INTERMODULE BUS EXTENDER

PROM PROGRAMMING

PROM FAMILY	PROM	SUBSYSTEM MODEL NO.S MODULE AND CONTROL CD	MODULE NO.S (FOR ADD ONS)	CONTROL CARD
INTEL 2716	2716/2758, TI TMS 2516/2532 <u>NATIONAL 27C16</u>	64500S	64502A	64501A
HARRIS	HM 7640/7641 HM 7640 AR/7641 AR HM 7608 HM 7680/7681 HM 7680R/7681R HM 7680P/7681P HM 7680RP/7681RP	OPT 011	64504A	
SIGNETICS	825 140/141/180/ 181/190/191 8252708	OPT 012	64505A	
2708/2704	2704/2708	OPT 013	64507A	
INTEL 2732	2732/2732A/ NAT 27C32	OPT 015	64509A	
INTEL 8748	8748/41/42/49/ 48H/49H	OPT 016	64510B	
INTEL 8755A	8755	OPT 017	64513A	
MOTOROLA 68764	68764	OPT 018	64514A	
MOTOROLA 68701	MOTOROLA 68701-1, 68A701/68B701	OPT 020	64517A	
INTEL 8751	8751	OPT 022	64520A	
INTEL 2764	INTEL 2764A, 27128A, 27256 HITACHI: 27128, SEEQ 5143, NEC 27128	OPT 023	64515C	

PERIPHERALS

DISC DRIVES

MODEL NO.	SIZE	FAMILY	DESCRIPTION	HP-IB CABLE	
9134D	14.5MB	SM. FOOTPRINT	DISC WITH HP-IB	NOT INCLUDED	
9134H	20MB		DISC WITH HP-IB INTERFACE		
7907A	41MB	CS/80	20.5 FIXED/REMOVABLE DISC WITH HP-IB INTERFACE AND 8" DISC CARTRIDGE	1 METER	
7911P	28.1MB		DISC AND CARTRIDGE	1 METER	
7912P	65.6MB		TAPE DRIVE WITH	1 METER	
7914P	132.1MB		HP-IB INTERFACE	1 METER	
OPT 015			220/240 V 50 HZ OP		
OPT 140		DELETE CART. TAPE DRIVE			
7941A	24MB	CS/80	DISC WITHOUT CARTRIDGE TAPE DRIVE AND WITH HP-IB INTERFACE	1 METER	
7945A	55MB			1 METER	
7942A	24MB	SMALL FOOTPRINT	DISC WITH CARTRIDGE TAPE DRIVE AND WITH HP-IB INTERFACE	1 METER	
7946A	55MB		230 V/50 HZ OP		
OPT 015			DELETES HP-IB		
OPT 055					
7908M	19.6MB	AMIGO	MASTER (M) AND SLAVE(S) REMOVABLE DISC DRIVE		
7920M	50MB				
7925M	120MB				
7925S			230 V/50 HZ OP		
OPT 015			ADDS REQUIRED 12745A HP-IB INTERFACE	2 METERS	
OPT 102*			CHANGES CABLE LENGTHS ON SLAVE UNITS		
OPT 001					
9144A	67MB	CS/80 COMPATIBLE	STAND-ALONE 1/4" TAPE DRIVE**	NOT INCLUDED	

* MUST BE SPECIFIED WITH ORDER; HP-IB INTERFACE

** MUST BE USED WITH A CS/80 DISC DRIVE ONLY

PRINTERS

MODEL NO	OPTION	DESCRIPTION	CABLING
2563A	OPTION 015 OPTION 016 OPTION 017 OPTION 110 OPTION 115 OPTION 115 OPTION 068 OPTION 264*	300 LPM DOT MATRIX IMPACT 220V 50/60 HZ 180 50/60 HZ 240V 50/60 HZ SOUND COVER AND STATIC SUPPRESSOR PASSIVE STACKER (PEDESTAL STAND) SERVICE DOCUMENTATION THREE SERIES 300 LP RIBBONS 64000 BUS CONFIGURATION	HP-IB CABLES NOT INCLUDED
2673A		120 CPS DOT MATRIX THERMAL	HP-IB CABLES NOT INCLUDED
2932A	OPTION 046*	9 X 12 DOT MATRIX IMPACT OFFICE WITH HP-IB INTERFACE	
2934A	OPTION 046*	9 X 12 DOT MATRIX IMPACT OFFICE WITH HP-IB INTERFACE	

* MUST BE SPECIFIED WITH ORDER; HP-IB INTERFACE.
TO USE PRINTERS GRAPHICS CAPABILITIES, THE STATION MUST BE CONFIGURED WITH 64050A GRAPHICS OUTPUT CARD.

PRINTER ACCESSORIES

MODEL NO.	DESCRIPTION
92171G	PAPER CATCHER FOR TABLE TOP
92214P	PRINTER STAND
92154B	PRINT HEAD
92155L	3 RIBBON PACK

SOFTWARE -- HP 64000 SYSTEM

CROSS ASSEMBLERS/ LINKERS	MICROPROCESSORS
64840AF	INTEL 8080,8085
64841AF	MOT 6800,6801,6802,6803,6808;FITJ 8861;HIT 6301,6303
64842AF	ZILOG Z80,NSC800
64843AF	6501,6502,6503,6504,6505,6511,6512,6514
64844AF	MOTOROLA 6805,6809,6809E
64845AF	MOTOROLA 68000,68008,68010
64846AF	INTEL 8048/49,8022/21,8035/39,8040/41/42,8741/48/49
64847AF	TI 9900,9980,9981,9985,9989,9940,99105A,99110A
64848AF	RCA 1802
64849AF	F8/3870
64850AF	ZILOG Z8
64851AF	USER DEFINABLE
64852AF	HP1000L
64853AF	INTEL 8086,8087,8088,8089,80186,80188,80286*;NECV20/30
64854AF	ZILOG Z8001/2
64855AF	INTEL 8051
64857A	MIL-STD-1750A (FAIRCHILD 9450)
64858A	TMS 320
64860A	INTEL 8096
64861A	USER-DEFINABLE MICROASSEMBLER (MICROPROGRAM-BASED DESIGNS)

PASCAL CROSS COMPILER	MICROPROCESSORS
64811AF	MOTOROLA 6800,6801,6802,6803,6808,HIT 6301 (6800 CODE)
64823A	ZILOG Z80,NSC800
64813AF	MOTOROLA 6809,6809E
64814AF	INTEL 8086,8088,80186,80188,80286**
64815AF	MOTOROLA 68000,68008,68010
64816AF	ZILOG Z8001/2
64817AF	HOST PASCAL (HP 64000 STATION ONLY COMPILER)
64825A	INTEL 8080/85

C CROSS COMPILER	MICROPROCESSORS
64818AF	INTEL 8086,8088,80186,80188,80286**
64819AF	MOTOROLA 68000,68008,68010
64820AF	ZILOG Z8001,Z8002
64821AF	MOTOROLA 6800,6801,6802,6803,6808,HIT 6301 (6800 CODE)
64822AF	MOTOROLA 6809,6809E
64824A	ZILOG Z80 AND NSC800
64826A	8085/8080

* LIMITED CODE GENERATION IN VIRTUAL ADDRESS MODE.

** CODE GENERATION IN REAL ADDRESS MODE ONLY.

NOTE: For Software update information, see Support Services section, page 13-1.

SOFTWARE -- HOSTED DEVELOPMENT SYSTEM

ASSEMBLERS/LINKER SYSTEM				MICROPROCESORS
64840S	OPT. 001	OPT. 002	OPT.3 003	INTEL 8080/8085
64841S	(NOTE 1)	(NOTE 2)	(NOTE 3)	NOT 6800,6801,6802,6803,6808,FITJ 8861,HIT 6301,6303
64842S	↓	↓	↓	ZILOG Z80 AND NSC 800
64843S				ROCK 6501,6502,6503,6504,6505,6511,6512,6514
64844S				MOT 6805,6809/6809E
64845S				MOT 68000,68008,68010
64846S				INTEL 8048,8049,8749,8021,8022,8035,8039,8041,8042,8741
64847S				TI 990,9980,9985,9989,9940,99105A,99110A
64851S				USER-DEFINABLE
64853S				INTEL 8086,8088,8089,80186,80188,80286*;NECV20/30
64854S				ZILOG Z8001,Z8002
64855S				INTEL 8051
64857S				MIL-STD/750A (FAIRCHILD 9450)
64858S				TI TMS320
64860S				INTEL 8096

PASCAL LANGUAGE SYSTEM				MICROPROCESORS
64811S	OPT. 001	OPT. 002	OPT.3 003	MOT 6800,6801,6802,6803,6808,HIG 6301 (ALL 6800 CODE)
64813S	(NOTE 1)	(NOTE 2)	(NOTE 3)	MOT 6809,6809E
64814S	↓	↓	↓	INTEL 8086,8088,80186,80188,80286**
64815S				MOT 68000,68008,68010
64816S				ZILOG Z8001,Z8002
64823S				ZILOG Z80 AND NSC800
64825S				INTEL 8080,8085

C LANGUAGE SYSTEM				MICROPROCESORS
64821S	OPT. 001	OPT. 002	OPT.3 003	MOT 6800,6801,6802,6803,6808,HIT 6301 (ALL 6800 CODE)
64822S	(NOTE 1)	(NOTE 2)	(NOTE 3)	MOT 6809,6809E
64818S	↓	↓	↓	INTEL 8086,8088,80186,80188,80286**
64819S				MOT 68000,68008,68010
64820S				ZILOB Z8001,Z8002
64824S				ZILOG Z80 AND NSC800
64826S				INTEL 8080,8085

* LIMITED CODE GENERATION IN VIRTUAL ADDRESS MODE

** CODE GENERATION IN REAL ADDRESS MODE ONLY

NOTE 1 FOR HP 9000, SERIES 500 WITH HP-UX

NOTE 2 FOR HP 9000, SERIES 200 WITH HP-UX

NOTE 3 FOR DEC VAX SERIES COMPUTERS WITH VMS

(NOTE: For Software update information, see Support Services section, page 13-1.)

HOSTED DEVELOPMENT SYSTEM SOFTWARE

MODEL NO.	DESCRIPTION
64880A	HP-UX 9000 SERIES 500 COMPUTER SYSTEM (SUPPLIED ON DC-150 CARTRIDGE TAPE)
64881A	HP-UX 9000 SERIES 200 COMPUTER SYSTEM (SUPPLIED ON DC-150 CARTRIDGE TAPE)
64882A	DIGITAL EQUIPMENT CORPORATION VAX COMPUTER WITH VMS OPERATION SYSTEM (SUPPLIED ON 1600 BPI 9 TRACK MAGNETIC TAPE)

NOTE: VAX and VMS are trademarks of the Digital Equipment Corporation.

HARDWARE COMPATIBILITY

U.S. MANUFACTURED PRODUCTS

DUE TO THE CONTINUAL UPGRADES TO BOTH THE HARDWARE AND SOFTWARE FOR THE 64000 SYSTEM, COMPATIBILITY ISSUES MUST BE ADDRESSED WHEN CONSIDERING THE PURCHASE OF A PRODUCT TO FUNCTION WITH AN EXISTING 64000 SYSTEM

IF A PRODUCT IS NOT DISCUSSED BELOW, NO COMPATIBILITY ISSUES EXIST AT THIS TIME. THIS TABLE IS REPRESENTATIVE OF US MANUFACTURED PRODUCTS ONLY

64100A	DISCS CS/80		PRINTER	MEMORY		POWER SUPPLY	GRAPHICS
MAINFRAME SERIAL NUMBERS:	7908,7911, 7912,7914	7907,7941/ 42/45/46, 9134D/H	2673A	EXPANSION (64032A)	FLOPPY ROMS (64941A)	400 WATT	OUTPUT BOARD 64050A
2033A AND BELOW							IS NOT COM- PATIBLE #
2121A AND BELOW						MUST HAVE NEW MOTHER BOARD #	
2125A AND BELOW	MUST HAVE FIRMWARE VERSION C OR ABOVE *		MUST HAVE FIRMWARE VERSION C OR ABOVE *				
2149A ** AND BELOW			MUST HAVE FIRMWARE VERSION D OR ABOVE *		MUST HAVE ROMS RETRO- FITTED TO BE COMP W/ FLOPPIES *		
2212A AND BELOW		MUST HAVE FIRMWARE VERSION D OR ABOVE *		NEEDS 64032A MEM. EXP. TO COMPILE			
64110A 2240A AND BELOW				NEEDS 64032 MEM. EXPANSION TO COMPILE			

* PLEASE REFER TO SERVICE NOTE HP64000-2 FOR FURTHER DETAILS.

PLEASE CONSULT YOUR LOCAL HP FIELD OR CUSTOMER ENGINEER FOR UPGRADE PATH.

** SERIAL NO. 2210A AND ABOVE HAVE COMPATIBLE ROMS.

NOTE: Refer to the Firmware Chart on the next page for contents and enhancements.

HARDWARE COMPATIBILITY (continued)

64100A DEVELOPMENT STATION FIRMWARE

FIRMWARE VERSION	PROM PART NUMBER	NEW FEATURE OR DEFECT FIXES (CPU Board Number)
A	1818-1107	ORIGINAL RELEASE (CPU BD #64100-66508)
	1818-1108	
	1818-1024	
	1818-1025	
B	1818-1107	FIXES BOOT FROM CASSETTE PROBLEM AND ADDS ABILITY TO USE 37203A BUS EXTENDER (64100-66525)
	1818-1108	
	1818-1373	
	1818-1374	
C	1818-1107	ADDS ABILITY TO SUPPORT CS/80 DISC 7908/11/12/14 (64100-66525)
	1818-1108	
	1818-1815	
	1818-1816	
D	64100-80020 thru 64100-80027	ADDS ABILITY TO SUPPORT THE 64941A FLOPPY DISC SYSTEM, AND THE 9134D AND 9134XV (64100-66521)
E	64100-80028 64100-80029	NO CHANGES FROM VERSION D. THE IDENTICAL FIRMWARE IS STORED IN TWO PROMS INSTEAD OF EIGHT (64100-66532)

EUROPEAN MANUFACTURED PRODUCTS

BOARD REVISION	DESCRIPTION	MFGD FROM SERIAL # ON
64100-62602	400 WATT POWER SUPPLY	2150G00479
64100-66526	"HEAVY COPPER" MOTHERBOARD	2150G00479
64100-66519	DISPLAY CONTROL BOARD W/TOP TAB	2134G00359
64100-66530	DISPL CTRL BD W/MEMORY EXPANSION	2312G01009
1818-1815/16	FIRMWARE FOR CS/80 DISCS	2134G00404
64100-80020..27	EXCEPT 2134G00407, 410, AND 412 FIRMWARE FOR 9134 SUPPORT	2328G01209

PLEASE NOTE, THAT NOT EACH OF THESE CHANGES INVOLVED A CHANGE OF THE SERIAL PREFIX, FOR INSTANCE WITH THE CHANGE TO THE CS/80 COMPATIBLE FIRMWARE. SO NOTE THE ACTUAL SERIAL # RATHER THAN ONLY THE PREFIXES.

JAPANESE MANUFACTURED PRODUCTS

All upgrade information for Japanese Manufactured Products are the same as the US with the exception of the 64032 Host Memory Expansion. Japanese manufactured mainframes of 2212J00351 and above have the integral host memory expansion installed as standard equipment on the display controller board. Thus, those mainframes with serial numbers below that number must have the 64032A to compile Host languages.

HP64000 DEVELOPMENT STATIONS

Two development stations are available for the 64000 System. The 64100A is a 10-card slot station typically suited for a lab environment. The option available with the 64100A is the 041 Dual Flexible Disc Drives. The 64110A is a portable station with 5-card slots. The 64110A has integral dual 5 1/4" flexible disc drives installed as standard equipment. Another distinction is that the 64110A does not support the PROM Programming option, the 64100A does. Any combination of the two stations may be configured in a cluster with a bus disc. In each cluster, at least one development station must have a Dual Flexible Disc Drive to load system software.

All 64100A's delivered since January 1982 have a 400W power supply; the 64110A has a 250W power supply. Before selecting a station, ensure that card cage slots and power supply capacity will support the subsystems to be installed. Refer to Configuration Requirements section for information to assist with these calculations.

The options available for each development station (041 for the 64100A, and 034 for the 64110A) may be selected directly as options when ordering a 64100A or 64110A, or they may be ordered separately by individual product number at a later date.

The HP 64100AF Operating System for the HP 64000 Logic Development System provides a softkey-oriented environment for a user to edit source files, assemble, compile and link micro-processor code and analyze the code with emulators, state and timing products. The 64100AF Operating System software provides the capabilities to link up to six HP 64000 Logic Development Stations, a shared system disc and a printer. If a printer is not on the system bus, a seventh station may be added to the cluster at the printer's address. (See station restrictions when the cluster is used in a hosted development environment.) The software will allow use of a single station in stand-alone mode. Modules of the HP 64100AF Operating System software include a file management system, an editor, control of the measurement system, and terminal mode software. One HP 64100AF Operating System software is required per each one to seven-station cluster.

LOGIC DEVELOPMENT STATIONS

MODEL NO.	PART NO.*	DESCRIPTION	OPERATING SYSTEM SOFTWARE
64100A		LOGIC DEVELOPMENT STATION (10 CARD SLOTS)	64100AF
OPTION 041	64941A	INCLUDES DUAL 5 1/4 " FLEXIBLE DISC UNIT	
64110A		LOGIC DEVELOPMENT STATION (5 CARD SLOTS). INCLUDES INTEGRATED DUAL 5 1/4" FLEXIBLE DISC UNIT	64100AF
OPTION 034	64034A	ACCESSORIES POUCH USED AS STORAGE FOR PROBES, CABLES; DISCETTES; ETC., IN TRANSPORTATION APPLICATIONS	

* Part Number is used to order option only when adding these features to an existing development station.

HP 64000 DEVELOPMENT STATIONS, CONT'D

Please Note:

- o One Operating System Software, 64100AF, is required per cluster.
- o Each 64100A or 64110A comes with a two-meter HP-IB connecting cable.
- o The 64110A is not compatible with the PROM Programming subsystem.
- o Include the World Country Code to assure proper power cord is shipped with station.
- o The 64032A 16K Word Memory expansion module is necessary for only those development stations with serial prefixes of 2212A or lower. (This is for customers intending to utilize Pascal or C compilers on that station.)

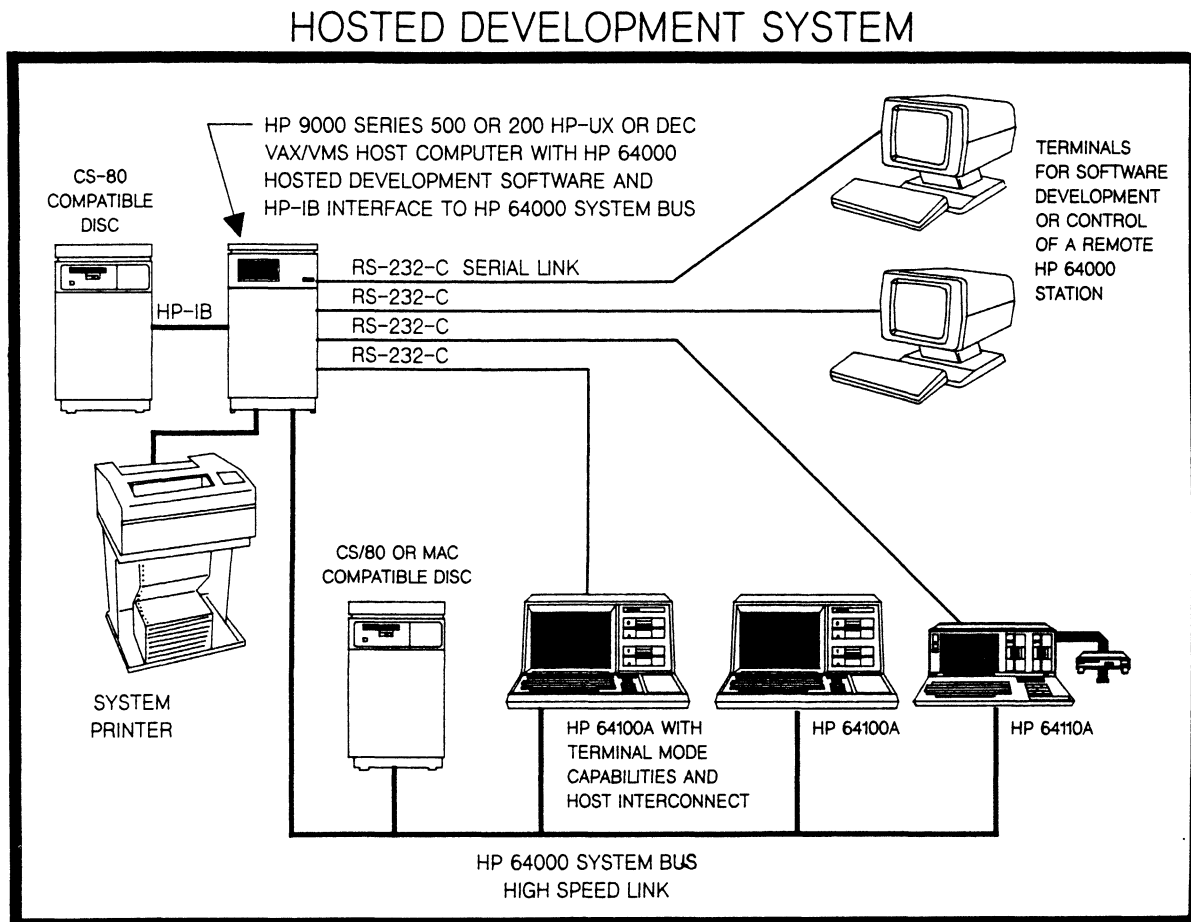

HOSTED DEVELOPMENT SYSTEMS

INTRODUCTION

HP 64000 system clusters can be used with a host computer. Microprocessor software development can take place on either the HP 64000 cluster or the host computer. Terminals on the host computer can be used to develop software or to remotely control an HP 64000 station for emulation and analysis. This application of the HP 64000 is termed a Hosted Development System. See the accompanying figure.

HP 64000 Microprocessor Development Systems can be connected to three series of host computers. The HP 64000 stations can be connected via RS-232 links; the HP 64000 system bus can be connected to the host computer via an HP-IB link. Multiple HP 64000 system bus clusters can be connected to a host computer.

Software developed on the host computer can be transmitted to the HP 64000 cluster's hard disc. Likewise, software developed on an HP 64000 station can be transmitted to the host computer's hard disc. This software can be assembled, linked or compiled on either the host computer or the HP 64000 system. The resulting absolute code and symbol tables can then be used in the HP 64000 emulation and analysis products. Additionally, terminals connected to the host computer can control an HP 64000 station by communicating through the host computer over RS-232 serial links.

Three host computers are currently supported in this environment:

- HP 9000 Series 500 with an HP-UX* operating system.
- HP 9000 Series 200 with an HP-UX operating system.
- Digital Equipment Corporation VAX** Series Computers (11/730, 11/750 and 11/780) with a VMS operating system.

NOTE: The HP 9000 Series 200 does not support High Speed Link configurations.

HOSTED DEVELOPMENT SYSTEM SOFTWARE

To use the HP 64000 System with a host computer, the proper Hosted Development System Software must be ordered. Hosted Development System Software is application software usable in HP-UX or VMS operating systems for HP 64000 Logic System Development applications. All the utilities to support High Speed Link and RS-232 communications, file transfers, and remote control of an HP 64000 system from a host computer are included.

* HP-UX is Hewlett-Packard's implementation of UNIX. UNIX is a trademark of AT&T Bell Laboratories.

** VAX and VMS are trademarks of the Digital Equipment Corporation.

HOSTED SOFTWARE, CONT'D

The following Hosted Development System software is needed for use in any of the three hosted computers:

MODEL NO.	DESCRIPTION
64880A	HP-UX 9000 SERIES 500 COMPUTER SYSTEM SOFTWARE; SUPPLIED ON DC-150 CARTRIDGE TAPE.
64881A	HP-UX 9000 SERIES 200 COMPUTER SYSTEM SOFTWARE; SUPPLIED ON DC-150 CARTRIDGE TAPE.
64882A	DIGITAL EQUIPMENT CORPORATION VAX COMPUTER WITH VMS OPERATING SYSTEM SOFTWARE; SUPPLIED ON 1600 BPI 9-TRACK MAGNETIC TAPE.

Refer to Section 11 on HP 64000 Software in this Configuration Guide to determine the necessary cross-assemblers, linkers and cross-compilers needed for use in the host computer. Refer also to Section 11 for information on the Right-to-Reproduce and the One-Time updates available for the above software.

HOSTED DEVELOPMENT SYSTEM - COMPUTERS

This section contains details on the three supported computers, their software, and available options. Please refer to the appropriate configuration guides to properly configure HP-series computers. (Use "HP 9000 Series 500 Configuration Information and Order Guide", Pub.No. 09050-90050, or "HP 9000 Series 200 Configuration Information and Order Guide", Pub.No. 09800-90020.) The HP 64000 Configuration Guide is not intended to be a substitute for configuring an HP 9000.

NOTE: In ordering a Hosted Development System with an HP 9000 Series 200 or Series 500 Computer, be sure to include all HP 9000 products and peripherals as a subitem to the HP 64000S System Reference Number.

For information on Digital Equipment Corporation VAX-Series computers, refer to the end of this section.

The HP 9000 Series 500 and Series 200 computers, when operating with HP-UX, require an HP-IB interface for at least one supported CS/80 disc and 1/4-inch data cartridge drive; an additional HP-IB interface is required for each HP 64000 High Speed Link (Series 500 only). The HP 9000 system disc is not the same disc that is required on the HP 64000 system bus; the HP 64000 system bus will also require a disc (CS/80 or MAC protocol) for operation as a cluster and for use in a Hosted Development System.

NOTE: The HP 7910A, 7925M/S, 9134A, 9134B, 9134XV, and 9134D Discs are not supported as an HP 64000 cluster system disc when the cluster is used in a Hosted Development System environment with a High Speed Link.

HOSTED SYSTEMS, CONT'D

In Hosted Development environments, the host computer occupies one address of the HP 64000 System cluster (address 7). Up to 5 stations can be supported on a system bus cluster when the cluster is used in a Hosted Development System. One station must have a dual flexible disc drive to load HP 64000 system software.

NOTE: An HP 64000 station operating in a stand alone mode is not supported for use in a Hosted Development System with a High Speed Link.

Several interface products will be required for the supported computers to use the HP 64000 Hosted Development System. For each HP 64000 station used in terminal mode, a serial interface must be provided in the host computer. For each HP 64000 cluster using the High Speed Link capabilities, a dedicated HP-IB Interface must be provided in the host computer.

NOTE: Only five HP 64000 stations can be attached to a single host HP-IB interface.

Multiple clusters of HP 64000 stations may be put on an HP 9000 Series 500. Up to 4 five-station clusters are supported on the HP 9000 Series 500. For a single cluster, one CPU in the HP 9000 is required; for two to four clusters, two CPUs, or more, are required in the HP 9000 Series 500.

OPERATING SYSTEM VERSION REQUIREMENTS

The Hosted Development System products are dependent upon proper versions of the operating systems in both the host computer and the HP 64000. For the HP 64000, the currently supported version of the HP 64100AF Operating System will be required for use in the Hosted Development System. For the HP 9000 Series 500, Version 4.0 HP-UX is required. For the HP 9000 Series 200, Version 2.1 HP-UX is required. As changes are made to HP-UX, Hosted Development software will be released as soon as possible to operate with the current HP-UX version. For VAX computers, VMS Version 3.7 is required. As new versions of VMS are announced by Digital Equipment Corporation, the old version of VMS will be supported for a reasonable time period. During this time period, the Hosted Development products will be updated to accommodate changes made to the newer version of VMS.

REMOTE CONTROL AND TRANSFER

Terminals can communicate with the HP 64000 stations through the host computer via an RS-232 serial connection. The terminal must have a 24-line display. The 24-line terminals supported by the HP 9000 Series 200 or 500 are recommended for use in remote control of the HP 64000. HP terminals that emulate DEC products, VT 100-series* terminals from DEC, or ANSI standard terminals with keypad can be used on a VAX computer for remote HP 64000 station control. Other terminals may work, but the feature set may be limited.

* VT is a trademark of the Digital Equipment Corporation

REMOTE CONTROL AND TRANSFER, CONT'D

Certain restrictions and limitations apply when using remote control in the Hosted Development System:

- An HP 64000 station cannot remotely control another HP 64000 station through the host computer.
- A graphics terminal used in remote control mode cannot be used to display timing diagrams; histograms can be displayed. To view a timing diagram, use an HP 64000 station directly.
- No functions dealing with HP 64000 cluster's printer can be used by the remote terminal.
- Any function that uses the RS-232 connection of the remotely controlled HP 64000 station cannot be accessed, (e.g., terminal, copy to RS-232, RS-232 SIM I/O, or RS-232 Host Pascal access).
- Prompting for command file parameters is not available on the remote terminal.
- During remote control, the HP 64000 station's keyboard is locked out except for the reset, shift, and control keys. The station may be enabled or disabled for remote control use.
- On the HP 9000 Series 200, remote control ports must be set to 2400 baud.

File transfers from one hard disc to another (host computer's or the HP 64000's) can be done on any HP 64000 station operating in terminal mode. These transfers can be over an RS-232 link or the HP-IB High Speed Link. A terminal can initiate file transfers by accessing an HP 64000 station in remote mode or via a transfer command using the High Speed Link.

INTERCONNECTION TO THE HOST COMPUTER

The HP 64000 stations can be connected to any of the supported host computers via RS-232 serial links for terminal mode operations; this connection is necessary for remote control of an HP 64000 station from a terminal. The HP 64000 system bus can be connected to the HP 9000 Series 500 or VAX computers via an HP-IB (IEEE-488) link for high speed file transfers. This connection may be extended beyond standard HP-IB lengths by using HP 37203A HP-IB Extenders. Extended distances are 250 meters over coax or 1000 meters via a fiber optic link.

HP 9000/500 COMPUTER SYSTEMS

INTRODUCTION

In this section, the HP 9000 Series 500 Computer operating with HP-UX is detailed. This section is not intended to replace the current issue of the HP 9000 Series 500 Configuration Information and Order Guide. This section is intended to provide guidelines for using the HP 9000 Series 500 in an HP 64000 Hosted Development System. Several items to keep in mind when configuring the HP 9000 Series 500 are also provided.

The HP 9000 Series 500 is available in four system packages: integrated (Model 520), rack enclosure (Model 530), desk height cabinet (Model 540), or modular HP Design Plus enclosure (Model 550). (Model 550 includes a built-in HP-IB interface.) Bundled systems are available that include interfaces, additional memory, and software. Each of these models has a 12-card slot Memory Processor Bus (MPB) used for CPUs (up to three), I/O Processors (up to 3; up to 2 for the Model 550), RAM (up to 10 Mbytes), and Display Station Buffer boards (Model 550 only). Each model also has an eight card slot I/O bus for adding interfaces to peripherals. The I/O bus is expandable to two additional eight card slot units (only one additional for Model 550).

The remaining sections provide guidelines in configuring the HP 9000 Series 500 in a Hosted Development Environment:

HOSTED DEVELOPMENT ON THE HP 9000 SERIES 500:

Hosting the HP 64000 onto the HP 9000 Series 500 has certain guidelines to keep in mind.

- Each HP 64000 cluster, attached via a High Speed Link, must be used with a separate HP-IB Interface (27110A/B). Five stations are the maximum per cluster.
- Only one cluster with a High Speed Link is supported on any one CPU system, regardless of memory configuration.
- At least 2 Mbytes of memory are required for any High Speed Link configuration.
- The HP 9000 Series 500 guidelines for RAM memory and disc space based on number of users must be followed in all cases. See the current HP 9000 Series 500 Configuration Guide. Typically, the general rule is .2 Mbytes of RAM and 5 Mbytes of disc space for each user.
- The performance curves found in the HP 9000 Series 500 Technical Data Supplement (HP P/N 5953-9276) should be consulted to determine optimal configurations of CPUs and memory.
- For RS-232 serial connections to the HP 64000 stations the 8-channel MUX (HP 27130B) or the Asynchronous Serial Interface (HP 27128A) is recommended.

CONFIGURATION STEPS (HP 9000/500)

To configure a Hosted Development System, follow these steps:

- o Determine the number of users, terminals and HP 64000 stations.
- o Choose the cross-languages and application software to be executed on the HP 9000.
- o Determine the number of CPUs, main memory, and disc space to accommodate users and their applications.
- o Select the packaging enclosure and determine if a bundled configuration would be more economical.
- o Select the necessary interfaces, terminals, peripherals, cabling and and verify compatibility with the HP 9000.
- o Select the necessary HP 64000 stations, peripherals, software, and feature boards.
- o Determine the training, consulting, and support services needed to maintain the system.

MINIMUM HOSTED DEVELOPMENT SYSTEM

The following is a minimum basic system for Hosted Development on the HP 9000 Series 500 using a High Speed Link:

- Any HP 9000 Series 500 computer with Option 500 (single CPU)
- One of the following system console capabilities (this terminal can remotely control the HP 64000 station):
 - Model 520 built-in keyboard and display
 - 98700H Graphics Display Station (Model 550 only)
 - An RS-232 interface (27128A) and a supported terminal with cables
- 2.0 Mbytes of HP 9000 RAM memory (97047A or 97046A)
- One CS/80 or SS/80 disc with at least 24 Mbytes of memory and 18 I/Os per second for HP 9000 Series 500 (7945A is suggested for a single user and 791XP for multiple users)
- One CS/80 1/4" cartridge tape drive for software installation, either built into the disc or a 9144A for HP 9000 Series 500
- Two HP-IB interfaces (27110A), one for the system disc and one for the High Speed Link on the HP 9000 Series 500 (Note: A minimum system could actually not include a High Speed Link to the host; the HP 64000 stations could operate in transfer and remote control over RS-232 connections only.)
- A 27128A asynchronous interface for the HP 64000 terminal interface and cabling (may use 27130A/B MUX for this and system console)

MINIMUM HOSTED SYSTEM, CONT'D (HP 9000/500)

- 97080C or 97089C Option 022 HP-UX Language System for 16 users
- HP 64100A Option 041 Station with Dual Floppy Drives or HP 64110A station
- Any supported HP 64000 system disc
- HP 64100AF operating system software on 5 1/4" floppy
- HP 648XXS Option 001 cross language or assembler software
- HP 64880A Hosted Development System Software on 1/4" cartridge tape
- Appropriate training, consulting and support services

ORDERING INFORMATION:

All of the following HP 9000 Series 500 products and compatible peripherals are listed for use under the HP 64000S Reference Number. Be certain to use the System Reference number to distinguish an HP 64000 Hosted Development System order from other HP 9000 system orders. For computer accessories, media and cables consult the Computer Users Catalog (5953-2450).

NOTE

The U.S. Department of Commerce (DOC) has classified HP Series 500 computer mainframes and 97043A/B CPU boards as critical technology under Section 1565A of its export regulations. Reshipment to some countries is prohibited and others require an export license. Contact the DOC Office of Export Administration for details.

HP 9000 SERIES 500 COMPUTER

MODEL	DESCRIPTION
9020A	Model 520 workstation with standard color CRT display
9020B	Model 520 workstation with monochrome CRT display
9020C	Model 520 workstation with high performance color CRT
9030A	Model 530 box computer in rack mount unit
9040A	Model 540 box computer in stand alone unit
9050A	Model 550 modular enclosure unit
Opt 500	First CPU (at least one is required)
Opt 600	One additional CPU
Opt 700	Two additional CPUs
Opt 247	Additional 512 kbyte RAM boards
Opt 248	Replace standard RAM with four 1.0 Mbyte boards
Opt 246	Additional 1.0 Mbyte boards

All HP 9000 Series 500 Models include 512 Kbytes RAM and a single I/O Processor. Additional bundled systems, I/O Processors, and options are available for the above models. Consult "HP 9000 Series 500 Configuration and Order

ORDERING INFORMATION, CONT'D (HP 9000/500)

Guide" for complete details on these models and assistance in configuring these computers. Note: Each HP 9000 Series 500 requires a CS/80 Disc and a 1/4-inch cartridge tape drive and HP-IB interface.

HP 9000 SERIES 500 INTERFACE PRODUCTS

MODEL	DESCRIPTION
27110B	HP-IB (IEEE 488-1978) Interface; one required for CS/80 system disc and one required for HP 64000 High-speed Link Interface
27128A	Single channel asynchronous serial interface (RS-232)
27130B	Eight channel asynchronous terminal multiplexer interface
27140A	Six channel asynchronous modem multiplexer interface
97098A	I/O expander for use with additional I/O Processors
37203A	HP-IB extender; extended distances are 250 feet with coax and 1000 feet with fiber optic cable for HP 64000 High-speed Link use.

Additional interface products are available for the HP 9000 Series 500. Consult the "HP 9000 Series 500 Configuration Information and Order Guide" for complete details on these models, aid in configuring these interface products, as well as compatible peripherals information (disc drives, tape drives, printers, terminals, etc.).

HP-UX 4.0 OPERATING SYSTEM SOFTWARE

MODEL	DESCRIPTION
97080C	HP-UX for Model 520, 16-users
97078C	HP-UX for Model 520, 32-users
97089C	HP-UX for Models 530/540/550, 16-users
97088C	HP-UX for Models 530/540/550, 32-users

One operating system software product is required for each HP 9000 Series 500 computer. The 16- or 32-user systems are recommended for use in the Hosted Development System. (Order Option 022 to receive software on 1/4-inch cartridge tape.)

SAMPLE HOSTED DEVELOPMENT ORDER

The following is a Hosted Development System order for a four user system with a four terminals (including system console) and two HP 64000 stations for 68000 software development.

<u>QUANTITY</u>	<u>PRODUCT/OPT</u>	<u>DESCRIPTION</u>
1	64000S	HP 64000 System Reference Number
1	9050A	Model 550 System (internal HP-IB, 512 Kbytes and one I/OP standard)
3	Opt 247	Additional 512 Kbyte RAM (2.0 Mbytes total)
1	Opt 500	Single CPU
1	97089B	16-user HP-UX
1	Opt 022	Software on 1/4" tape cartridge
2	27110B	HP-IB Interfaces for sys disc and High Speed Link
1	27130B	8 channel Asynchronous Multiplexer (MUX) for 4 terminals and 2 HP 64000 station connections
1	Opt 550	Mounting bracket for 92211R Model 550 cabinet
1	7914P	132 Mbyte Disc with built-in 1/4" cartridge tape drive, HP-IB, and 1 meter HP-IB cable for HP 9000 Series 500 system
1	2934A	200 cps printer
1	Opt 046	HP-IB interface (use Model 550 built-in HP-IB interface and cable)
1	92214P	Printer stand
4	2392A	Alpha display terminals
4	Opt 301	5 meter modem cable for MUX (40242M)
2	64100A	Logic Development Station
2	Opt 041	Dual Flexible Disc Drives
1	64100AF	Operating System Software on 5 1/4" discs
1	7942A	24 Mbyte disc with built-in 1/4" cartridge tape drive, HP-IB, and 1 meter HP-IB cable for HP 64000 cluster
1	64880A	Hosted Development System software for the HP 9000 Series 500 on 1/4" cartridge tape
1	64819S	68000 C language system
1	Opt 001	For use on HP 9000 Series 500 and HP 64000; compilers and assemblers supplied on 1/4" cartridge tape and 5 1/4" floppy discs
2	13242N	5 meter cable for 64000 stations to MUX
4	35128A	Introduction to HP-UX course (for 4 users)
1	35129A	HP-UX System Administration course
3	35022B	Start-up consulting for three days
12	97089B+T22	AMS for multi-user HP-UX, updates provided on 1/4" cartridge tape
12	50954A+S00	SMS for multi-user NS/9000
2	64100A+24D	HP 64000 System concepts and measurements (training for other 2 team members; 2 bundled with stations)
1	64100AF+S43	SMS for HP 64000 operating system software
1	64880A+S22	SMS for Hosted Development SW on HP 9000/500
1	64819S+S00	SMS for C 68000 Cross language software
1	Opt 001	SMS for HP 9000 Series 500
2	88140LC	67 Mbyte, 600 ft. data cartridge (box of 5)
1	92155LC	Ribbons for 2934A printer (box of 3)
1	92157A	Fanfold blank printer paper
1	92190A	5 1/4" floppy discs (box of 10)

HP 9000/200 COMPUTER SYSTEMS

INTRODUCTION

In this section, the HP 9000 Series 200 Computer operating with HP-UX is detailed. This section is not intended to replace the current issue of the HP 9000 Series 200 Configuration Information and Order Guide. This section is intended to provide guidelines for using the HP 9000 Series 200 in an HP 64000 Hosted Development System. Several items to keep in mind when configuring the HP 9000 Series 200 are also provided.

The HP 9000 Series 200 is available in two system packages for use with HP-UX and HP 64881A Hosted Development System Software: Model 220 (9920U and 9920T) and Model 236 (9836T and 9836CU.) Additionally, Model 226, 9836A/S and 9836C/CS may be upgraded to HP-UX capability. Model 220 is rack mountable, requires an external display, and has 16 backplane slots. Model 236 is a desktop unit that has an integrated keyboard, display (color or monochrome), and 8 backplane slots. These card slots can be used for I/O cards which consume the lower of each pair of backplane slots and cover the other, or RAM cards which use one slot. The backplane slots can be extended by the HP 9888A bus extender; this unit provides 16 slots and consumes one.

The remaining sections provide guidelines in configuring the HP 9000 Series 200 in a Hosted Development Environment:

HOSTED DEVELOPMENT ON THE HP 9000 SERIES 200:

Hosting the HP 64000 onto the HP 9000 Series 200 has certain guidelines to keep in mind.

- The High Speed Link feature found on the HP 9000 Series 500 and VAX product is not available on the HP 9000 Series 200 computer.
- At least 1 Mbyte of RAM memory is required.
- The HP 9000 Series 200 guidelines for RAM memory and disc space based on number of users must be followed in all cases. See the current HP 9000 Series 200 Configuration Guide.
- The performance curves found in the HP 9000 Series 200 Technical Data Supplement should be consulted to determine optimal configurations of the computer and memory.
- For RS-232 serial connections to the HP 64000 stations, either the 98626A or 98628A Asynchronous Serial Interface cards are recommended.

CONFIGURATION STEPS (HP 9000/200)

To configure a Hosted Development System, follow these steps:

- o Determine the number of users, terminals and HP 64000 stations.
- o Choose the cross-languages and application software to be executed on the HP 9000 Series 200.
- o Determine the amount of main memory, and disc space to accommodate the users and their applications.
- o Select the packaging enclosure and determine if a bundled configuration would be more economical.
- o Select the necessary interfaces, terminals, peripherals, cabling and verify compatibility with the HP 9000 Series 200.
- o Select the necessary HP 64000 stations, peripherals, software, and feature boards.
- o Determine the training, consulting, and support services needed to maintain the system.

MINIMUM HOSTED DEVELOPMENT SYSTEM

The following is a minimum basic system for Hosted Development on the HP 9000 Series 200:

- One of the following Series 200 computers:
 - 9920U, 9920T
 - 9836T, 9836U, 9836CT, 9836CU
- One of the following system console capabilities (this terminal can remotely control the HP 64000 station):
 - Model 236 built-in keyboard and display
 - 09920-66533 or 09920-66534 Keyboard/HP-IB interface, 98203B large U.S. keyboard, 98204A Video Output card and 82912A or 82913A CRT monitor (Model 220 only)
 - An 98626A RS-232 interface and a supported terminal with cables
- 1 Mbyte of HP 9000 RAM memory (98256A or 98257A)
- One CS/80 or SS/80 disc with at least 24 Mbytes of memory and 18 I/Os per second for HP 9000 (7946A is suggested for a single user and 791XP for multiple users) and with built-in 1/4" tape cartridge drive
- One built-in HP-IB interface. A Model 220 computer must have a supplied 09920-66533 or 09920-66534 Keyboard/HP-IB interface installed even though a 98203B keyboard is not required.
- One HP-IB interface (98625A) for the HP-UX system disc

MINIMUM HOSTED SYSTEM, CONT'D (HP 9000/200)

- One 98620B DMA card; HP-UX does not support the 98620A
- A 98626A or 98628A Asynchronous Interface for the HP 64000 terminal interface and cabling
- 98680A Option 022 HP-UX Language System for 16 users
- HP 64100A Option 041 Station with Dual Floppy Drives or HP 64110A station
- Any supported HP 64000 system disc
- HP 64100AF operating system software on 5 1/4" floppy
- HP 648XXS Option 002 cross language or assembler software
- HP 64881A Hosted Development System Software on 1/4" cartridge tape
- Appropriate training, consulting and support services

ORDERING INFORMATION:

All of the following HP 9000 Series 200 products and compatible peripherals are listed for use under the HP 64000S Reference Number. Be certain to use the System Reference number to distinguish an HP 64000 Hosted Development System order from other HP 9000 system orders. For computer accessories, media and cables consult the Computer Users Catalog (5953-2450).

HP 9000 SERIES 200 COMPUTER

MODEL	DESCRIPTION
9920U	Model 220 Basic Computer with 09920-66534 keyboard/HP-IB interface; 15 backplane slots available.
9836U	Model 236 Desktop Computer with built-in HP-IB, keyboard and 12" CRT; 8 backplane slots available.
9836CU	Model 236 Desktop Computer with built-in HP-IB, keyboard and 12" color CRT; 8 backplane slots available.

Additional bundled systems and options are available for the HP 9000 Series 200 models (previous page). For HP-UX operation, the computer must have a 98620B DMA card and CS/80 Disc with built-in 1/4 inch tape cartridge drive on a 98625A HP-IB Disc interface. Consult "HP 9000 Series 200 Configuration and Order Guide" for complete details on these models and assistance in configuring these computers.

ORDERING INFORMATION, CONT'D (HP 9000/200)

HP 9000 SERIES 200 INTERFACE PRODUCTS

MODEL	DESCRIPTION
98256A	256 KBYTE RAM CARD
98257A	1.0 MBYTE RAM CARD
98620B	DIRECT MEMORY ACCESS (DMA) CONTROLLER CARD
98624A	HP-IB INTERFACE (STANDARD SPEED)
98624A	DISC INTERFACE (HIGH SPEED HP-IB)
98626A	RS-232C SERIAL INTERFACE
98628A	DATA COMM INTERFACE
9888A	SERIES 200 HP-D10 BUS EXPANDER

Additional products and options are available for HP 9000 Series 200. Consult "HP 9000 Series 200 Configuration Information and Order Guide" for complete details on those models, aid in configuring these interface products, as well as compatible peripherals information (disc drives, tape drives, printers, terminals, etc.).

HP-UX 2.1 OPERATING SYSTEM SOFTWARE

MODEL	DESCRIPTION
98680A OPT 022	HP-UX MULTI-USER OPERATING SYSTEM SOFTWARE ON CS/80 1/6" TAPE CARTRIDGE

One operating system software product is required for each HP 9000 Series 200 computer. The multi-user system is recommended for use in the Hosted Development System.

SAMPLE HOSTED DEVELOPMENT ORDER

The following is a Hosted Development System order for a four-user system with four terminals (including system console) and two HP 64000 stations for 68000 software development.

<u>QUANTITY</u>	<u>PRODUCT/OPT</u>	<u>DESCRIPTION</u>
1	64000S	HP 64000 System Reference Number
1	9920U	Model 220 base computer
1	98625A	HP-IB interface for disc
6	98626A	Asynchronous interface for console
6	Opt 002	Provides DCE cable
2	98257A	1.0 Mbyte RAM card
1	98620B	Dual channel DMA controller card
1	98680A	HP-UX Multi-user operating system
1	Opt 022	Software supplied on 1/4" cartridge tape
1	7914P	132 Mbyte Disc with built-in 1/4" cartridge tape drive, HP-IB, and 1 meter HP-IB cable for HP 9000 Series 200
1	2934A	200 cps printer
1	Opt 046	HP-IB interface (use 09920-66534 interface supplied with Model 220)
1	10833A	1 meter HP-IB cable for printer
1	92214P	Printer stand
4	2392A	Alpha display terminals
4	Opt 301	5 meter modem cable for DCE cable
2	64100A	Logic Development Station
2	Opt 041	Dual Flexible Disc Drives
1	64100AF	Operating System Software on 5 1/4" disc
1	7942A	24 Mbyte disc with built-in 1/4" cartridge tape drive, HP-IB, and 1 meter HP-IB cable for HP 64000 cluster
1	64881A	Hosted Development System software for the HP 9000 Series 200 on 1/4" cartridge tape
1	64819S	68000 C language system
1	Opt 002	For use on HP 9000 Series 200 and HP 64000; compilers and assemblers supplied on 1/4" cartridge tape and 5 1/4" floppy discs
4	35128A	Introduction to HP-UX course (for 4 users)
1	35073A	HP-UX System Administration course
1	35032B	Start-up consulting for one day
12	98680A+T00	AMS for multi-user HP-UX
12	98680A+S22	SMS for multi-user HP-UX updates provided on 1/4" cartridge tape
2	64100+24D	HP 64000 System concepts and measurements (training for other 2 team members; 2 bundled with stations)
1	64100AF+S43	SMS for HP 64000 operating system software
1	64881A+S22	SMS for Hosted Development Software
1	64819S+S00	SMS for C 68000 Cross language software
1	Opt 002	SMS for HP 9000 Series 200
2	88140LC	67 Mbyte, 600 ft. data cartridge (box of 5)
1	92155L	Ribbons for 2934A printer (box of 3)
1	92157A	Fanfold blank printer paper
1	92190A	5 1/4" floppy discs (box of 10)

DIGITAL EQUIPMENT CORPORATION --

VAX SERIES COMPUTERS

In the VAX Series computers, the 11/730, 11/750 and 11/780 models are supported in the HP 64000 Hosted Development System environment. The user must have VMS operating system version 3.7 to operate with the Hosted Development System. As new versions of VMS are announced by Digital Equipment Corporation, the old version of VMS will be supported for a reasonable time period. During this time period the Hosted Development products will be updated to accommodate changes made to the newer version of VMS. The VAX user must install the Hosted Development Software onto the VAX computer system. The user must also install, on the VAX UNIBUS, the HP 64000/VAX High Speed Interface (HP 64070A) to interface with the HP 64000 system bus for High Speed Link use. The VAX user may have to install additional RS-232 ports in the VAX series computer to use the serial link capabilities of the Hosted Development System.

Similarly, the user may need to install additional memory and other Digital Equipment Corporation products needed for optimum performance in the HP 64000 Hosted Development Environment. For assistance in this selection process and for more detailed information, refer to performance information in the Hosted Development System Technical Data Supplements for the VAX Computers.

In using the HP 64000 stations in terminal mode to the VAX computer, the stations emulate a DEC VT 52 terminal. Terminals on the VAX computer can access an HP 64000 station; these terminals can be HP terminals that emulate DEC products, DEC VT 100-series, or an ANSI standard terminal with a keypad. Other terminals may work, but features may be limited. One or more HP 64000 clusters can be placed on the VAX computer; each cluster requires an HP 64070A interface on the VAX UNIBUS. The VAX computer must have its own system disc; each HP 64000 cluster must have a system disc (CS/80 or MAC protocol).

MODEL	DESCRIPTION
64070A	HP 64000/VAX HIGH SPEED INTERFACE FOR USE ON THE VAX UNIBUS

NOTE: DEC, VAX, VMS, VT and UNIBUS are trademarks of Digital Equipment Corporation.

EMULATION AND MEMORY SYSTEMS

NOTE: The Microprogram Development subsystem follows "Emulation and Memory Systems" in this Section 4.

The Emulation Measurement System consists of four hardware components (as well as all Emulation Software):

- o Emulation Subsystem,
- o Emulation Memory Subsystem,
- o Internal Analyzer, (next chapter)
- o Emulation/Memory Bus Cable, (which interconnects all of the above).

Emulation memory is optional for certain Emulators and required for others. The 8048 and 6805 emulators, model numbers 64262S, and 64192S/193S respectively, contain their own memory and thus emulation memory need not be purchased separately. For full trace and debug capability, an Internal Analyzer is required with the Emulator. The 64302A is an Emulation Bus Analyzer, and is compatible with all Emulators. The 64310A Software Performance Analyzer is optionally available for emulators except for the 64272S ROM Emulator. To utilize the analysis capabilities of the 64620S Logic State/Software Analyzer with an emulator, the 64304A Emulation Bus Preprocessor is available. For more information on Internal Analyzers see next section.

Illustrated below are the typical decision elements in configuring an Emulation Measurement System. The diagram below also graphically depicts the hardware elements of a "subsystem".

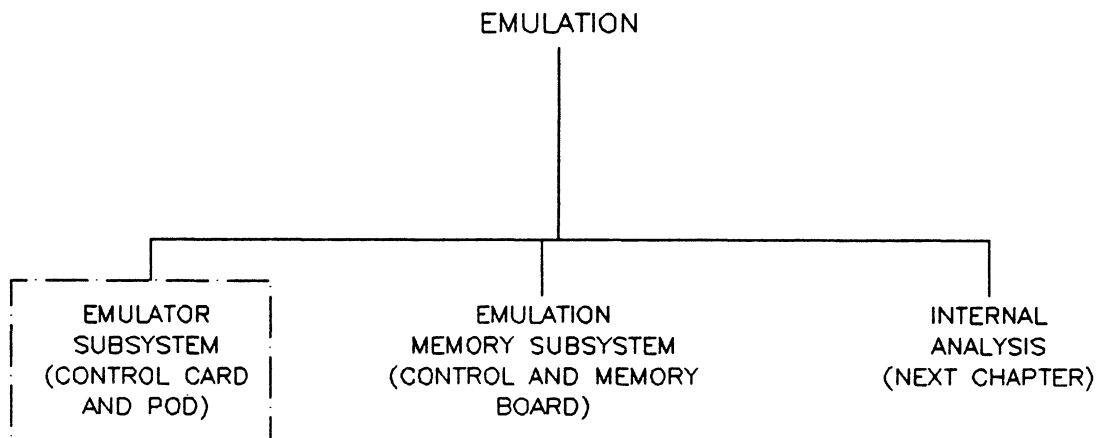

PLEASE NOTE: An Emulation Measurement System that includes Memory and/or any Internal Analyzers is incomplete without TWO Emulation Bus Cables, (64960A), which must be ordered separately.

EMULATION REQUIREMENTS

Some emulators require the purchase of an Assembler/Linker to allow the emulation monitor to be used. It is recommended that all emulators be accompanied with an Assembler/Linker (see Emulation Requirements Table). The corresponding Assembler/Linker for the processor is ordered separately from the Software Translators Section.

EMULATOR MODEL NUMBER	MICRO- PROCESSOR SUPPORTED	EMULATION MEMORY		ASSEMBLER/LINKER	
		REQUIRED	COMPATIBLE TYPE	REQUIRED	COMPATIBLE TYPE
64192S	6805U/R	N/A	N/A	NO	64844AF
64193S	6805P	N/A	N/A	NO	64844AF
64194S	146805G2	N/A	N/A	NO	64844AF
64195S	146805E2	NO	N/A	NO	64844AF
64202S	8080	NO	64152S	NO	64840AF
64203S	8085	NO	64152S	NO	64840AF
64206S	6301V/6303R	YES	64156S	NO	64841AF
64212S	6800	NO	64152S	NO	64841AF
64213S	6802	NO	64152S	NO	64841AF
64215S	6809	NO	64152S	NO	64844AF
64216S	6809E	NO	64152S	NO	64844AF
64220S	8086/8087	YES	64156S	YES	64853AF
64220S,OPT. 001	80C86	YES	64156S	YES	64853AF
64221S	8088/8087	YES	64156S	YES	64853AF
64221S,OPT. 001	80C88	YES	64156S	YES	64853AF
64224S	80186	YES	64156S	YES	64853AF
64225S	80188	YES	64156S	YES	64853AF
64227S	80286	YES	64156S	YES	64853AF
64232S	Z8001	YES	64156S	YES	64854AF
64233S	Z8002	YES	64156S	YES	64854AF
64242S	68000	YES	64156S	YES	64845AF
64243AA	68000	YES	64156S	YES	64845AF
64243AB	68000 PGA	YES	64156S	YES	64845AF
64244AA	68008	YES	64156S	YES	64845AF
64245AA	68010	YES	64156S	YES	64845AF
64245AB	68010 PGA	YES	64156S	YES	64845AF
64249S	68010	YES	64156S	YES	64845AF
64253S	Z80A,B,H,L	NO	N/A	NO	64842AF
64256S	6801/03	YES	64156S	NO	64841AF
64262S	8048	N/A	N/A	NO	64846AF
64264S	8051	YES	64156S	YES	64855AF
64272S	ROM	YES	64156S		N/A
64274S	USER- DEFINABLE EMULATOR	YES	64156S	YES	*
64285S	TMS32010	NO	N/A	YES	64858AF
64286SA	F9450	YES	64156S	NO	64857A
64292S	NSC800	NO	64156S	NO	64842AF
64294S	70116	YES	64156S	YES	64853AF
64295S	70108	YES	64156S	YES	64853AF

* ASSEMBLER FOR THE PROCESSOR BEING EMULATED BY USER-DEFINABLE EMULATOR OR 64651 USER-DEFINABLE ASSEMBLER IS REQUIRED.

CABLING INFORMATION

An HP64000 subsystem contains cabling required within the subsystem. Cabling which interconnects subsystems must be ordered. Specifically, these are the two Emulation Bus Cables and the Intermodule Bus Cable.

The connection between the Emulator Control Card, the Memory Control Card, and any Internal Analyzers, is made via TWO 64960A Emulation Bus Cables/options. The options correspond to the size or number of positions on the bus. To determine the appropriate option for your application, first select the specific elements of your Emulation Measurement System (Emulator, Memory, Internal Analyzers).

CASE NO.	IS EMULATION MEMORY A PART OF THIS CONFIGURATION?				IS AN EMULATION BUS ANALYZER (64302A) PART OF THIS CONFIGURATION?	
	IS THE SOFTWARE PERFORMANCE ANALYZER (64310A) PART OF THIS CONFIGURATION?	IS AN EMULATION BUS PREPROCESSOR (64304A) PART OF THIS CONFIGURATION?	NUMBER OF POSITIONS REQUIRED FOR THE EMULATION BUS CABLE (64960A)	64960A OPTION NO.		
0	NO	NO	NO	NO	NO CABLE REQUIRED	N/A
1	NO	NO	NO	YES	2-POSITION	NO OPTION
2	NO	NO	YES	NO	2-POSITION	NO OPTION
3	NO	NO	YES	YES	3-POSITION	001
4	NO	YES	NO	NO	2-POSITION	NO OPTION
5	NO	YES	NO	YES	3-POSITION	001
6	NO	YES	YES	NO	3-POSITION	001
7	NO	YES	YES	YES	4-POSITION	002
8	YES	NO	NO	NO	2-POSITION	NO OPTION
9	YES	NO	NO	YES	3-POSITION	001
10	YES	NO	YES	NO	3-POSITION	001
11	YES	NO	YES	YES	4-POSITION	002
12	YES	YES	NO	NO	3-POSITION	001
13	YES	YES	NO	YES	4-POSITION	002
14	YES	YES	YES	NO	4-POSITION	002
15	YES	YES	YES	YES	5-POSITION	003

CABLING INFORMATION, CONTINUED

The table on page 4-3 determines the number of positions needed in most cases. Generally each emulation subsystem requires the use of two Bus Cables. The number of positions required on the two Emulation Bus Cables is two, plus the number of Internal Analyzers.

EXCEPTIONS to the general rule is the **HP 64262S (8048) Emulator**, as well as the following **Split-Bus Emulators**:

HP 64262S (8048)	HP 64221S (8088/87)	HP 64245AA (68010)
HP 64224S (80186)	HP 64221S,	HP 64245AB (68010 PGA)
HP 64225S (80188)	Opt.001 (80C88)	HP 64294S (70116)
HP 64220S (8086/87)	HP 64243AA (68000)	HP 64295S (70108)
HP 64220S,	HP 64243AB (68000 PGA)	
Opt.001 (80C86)	HP 64244AA (68008)	

These require one position, plus the number of Internal Analyzers on both emulation bus cables.

The **HP 64264S (8051) Split-Bus Emulator** is yet another exception. Only the middle connector of this Emulator (from the emulation control card to the memory control card) is split bus, requiring a bus cable of one position, plus the number of Internal Analyzers. The second bus cable requires two positions, plus the number of Internal Analyzers.

The following table illustrates which cables to order for the number of positions needed:

EMULATION/MEMORY BUS CABLES

MODEL NO.	DESCRIPTION
64960A	EMULATION/MEMORY BUS CABLE; 2-POSITION
OPTION 001	REPLACE WITH 3-POSITION CABLE
OPTION 002	REPLACE WITH 4-POSITION CABLE
OPTION 003	REPLACE WITH 5-POSITION CABLE
OPTION 004	REPLACE WITH 6-POSITION CABLE
OPTION 005	REPLACE WITH 7-POSITION CABLE
OPTION 006	REPLACE WITH 8-POSITION CABLE
OPTION 007	REPLACE WITH 9-POSITION CABLE

DUAL EMULATION WITH TWO SPLIT-BUS EMULATORS

The Rear split-bus emulator requires special emulation bus cabling (HP 64960A, **OPTIONS 10 through 17**; See **Page 5-7** for cabling illustration and information. These new cable options skip two board positions between two of the connectors.)

If the rear Split-bus Emulator is either an HP 64224S or 64225S, the number of connectors required on both bus cables is the number of Internal Analyzers, plus the number of memory boards, minus one board (for the Front connectors), plus one Rear connector for the Emulation Control card.

CABLING INFORMATION, CONTINUED

If the rear Split-bus Emulator is the 8051, two different bus cables are again required. As an example, the following illustration shows that one bus cable is a two-position cable, skipping both memory cards, (Option No. 10), and the other bus cable is a Front-1; Rear-2 (three-position) Option No. 13 cable to access that part of the memory control card without split-bus cable.

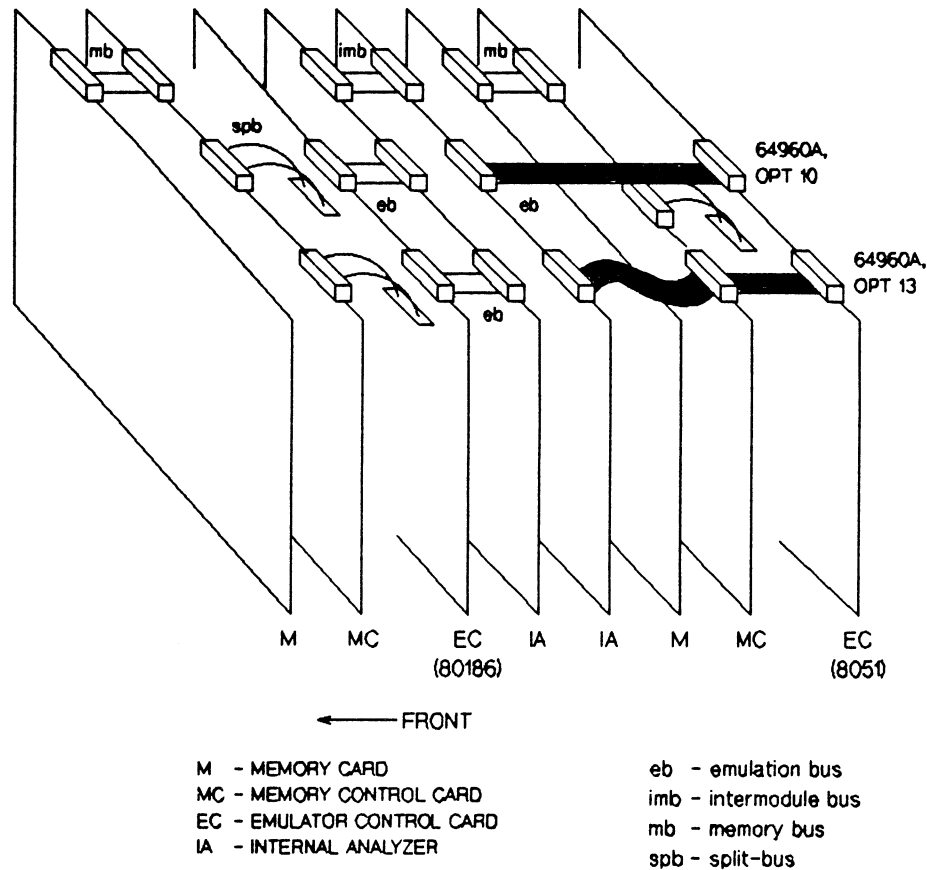

EMULATOR SUBSYSTEM

An Emulator Subsystem consists of all the required hardware and software for a particular microprocessor emulator; specifically an: **Emulator Control Card, Emulator Pod, and Emulator Software**. Some emulators use the same Control Card. If a second emulator is used (nonconcurrently) the user need only purchase an additional emulator pod in order to emulate a second microprocessor (see Table below for compatibility).

EMULATOR SUBSYSTEM, CONT'D.

EMULATOR SUBSYSTEM

MODEL NO.	SUPPORTS	ALSO SUPPORTS	HARDWARE COMPONENTS	
			CONTROL BD.	POD
64192S	6805U/R	6805R2,6805R3,6805R5,6805U2, 6805U3,6805U5	64197A	64192A
64193S	6805P	6805P2,6805P3,6805P4,6805P5	64197A	64193A
64194S	146805G2		64197A	64194A
64195S	146805E2		64197A	64195A
64202S	8080		64201A	64202A
64203S	8085		64201A	64203A
64206S	6301V/6303R	63P01M,MC68HC01	64205A	64206A
64212S	6800	6800,68A00,68B00	64211A	64212A
64213S	6802	6802,6808,68B02	64211A	64213A
64215S	6809	6809,68B09,65809	64214A	64215A
64216S	6809E	6809E,68A09E,68B09E	64214A	64216A
64220S	8086/8087(1)		64223B	64220B
64220S, OPT. 001	80C86(1)		64223B	64220C
64221S	8088/8087(1)		64223B	64221B
64221S, OPT. 001	80C88(1)		64223B	64221C
64224S	80186(1)		64223B	64224A
64225S	80188		64223B	64225A
64227S	80286(1)		64271A	64226B
64232S	Z8001(2)		64271A	64232A
64233S	Z8002(2)		64271A	64233A
64242S	68000(3)		64271A	64242A
64243AA	68000(3)		INCLUDED*	INCLUDED*
64243AB	68000 PGA(3)		↓	↓
64244AA	68008(3)		64271A	64249A
64245AA	68010(3)		64271B	64253A
64245AB	68010 PGA(3)		64255A	64256A
64249S	68010(3)		64261A	64262A
64253S	Z80	Z80A,B,H,L	64263A	64264A
64256S	6801/6803		64271A	64272A
64262S	8048	8035,8039,8048,8049	64274A	64274B
64264S	8051	8751/8031	64271B	64285A
64272S	ROM		64271B	64286AA
64274S	USER-DEFINABLE(5)		64291A	64292A
64285S	TMS32010		64223B	64294A
64286SA	F9450(4)		64223B	64295A
64292S	NSC800			
64294S	70116(1)			
64295S	70108(1)			

- (1) REQUIRES 64853AF ASSEMBLER/LINKER
- (2) REQUIRES 64854AF ASSEMBLER/LINKER
- (3) REQUIRES 64845AF ASSEMBLER/LINKER
- (4) REQUIRES 64857A ASSEMBLER/LINKER
- (5) REQUIRES COMPATIBLE ASSEMBLER/LINKER
- (6) PROVIDES ONLY LIMITED SUPPORT

*COMPONENTS INCLUDED WITH SUBSYSTEM AND MAY NOT BE ORDERED INDIVIDUALLY.

EMULATION MEMORY

Two Emulation Memory Subsystems are available. The 64152S for 8 bit processors and the 64156S for 16 bit processors. The appropriate subsystem is selected according to which Emulation Subsystem it supports (refer to Emulation Memory Compatibility Table). Each Memory Subsystem consists of:

- o An Emulation Memory Control Card,
- o One or more Memory Cards,
- o An Interconnecting Memory Bus Cable.

To order, select the appropriate Emulation Memory Subsystem, 64152S or 64156S, with desired memory size specified as an option. Only one memory option may be specified per 6415XS subsystem.

EMULATION MEMORY SUBSYSTEMS

SUBSYSTEM	SIZE	COMPATIBLE EMULATOR TYPE
64152S	32K	MOST 8 BIT EMULATORS,* (SEE EXCEPTIONS BELOW)
OPT 011	64K	
64156S	32K	ALL 16 BIT EMULATORS, THE UDE (64274S) AND THESE 8 BIT EMULATORS: 6801/6803 (64256S) 8051 (64264S) NSC800 (64292S)
OPT 011	64K	
OPT 012	128K	
OPT 013	256K	
OPT 014	512K	
OPT 015	1024K	

* 8048, 6805WR, 6805P, AND Z80 EMULATORS HAVE RESIDENT EMULATION MEMORY.

EMULATOR AND MEMORY COMPONENTS

In this section, hardware information is presented to help the current user of an Emulation Measurement System reconfigure installed equipment. The required software is included in the purchase of the hardware.

EMULATOR COMPONENTS Emulator hardware contains a control card (two in the case of the 64262S) and an emulator pod. The emulator may occupy any available card slot in a development station. To reconfigure an existing Emulator Subsystem, select additional hardware products from the following table. Note that certain control cards are common to several emulator pods. In these cases, emulation capability for an additional microprocessor is obtained by selecting the appropriate pod. **EMULATION/MEMORY BUS CABLES MUST BE ORDERED SEPARATELY.** Information on cables follows.

EMULATOR COMPONENT COMPATIBILITY

MICRO-PROCESSOR	EMULATOR SUBSYSTEM	EMULATOR POD	EMULATOR CONTROL CARD
6805U/R	64192S	64192A	64197A
6805P	64193S	64193A	64197A
146805G2	64194S	64194A	64197A
146805E2	64195S	64195A	64197A
8080	64202S	64202A	64201A
8085	64203S	64203A	64201A
6301V/6303R	64206S	64205A	64206A
6800	64212S	64212A	64211A
6802	64213S	64213A	64211A
6809	64215S	64215A	64214A
6809E	64216S	64216A	64214A
8086/8087	64220S	64220B	64223B
80C86	64220S,OPT. 001	64220C	64223B
8088/8087	64221S	64221B	64223B
80C88	64221S,OPT. 001	64221C	64223B
80186	64224S	64224A	64223B
80188	64225S	64225A	64223B
80286	64227S	64227B	64271B
Z8001	64232S	64232A	64271B
Z8002	64233S	64233A	64271B
68000	64242S	64242A	64271B
68000	64243AA	INCLD.*	INCLD.*
68000 PGA	64243AB		
68008	64244AA	↓	↓
68010	64245AA		
68010 PGA	64245AB		
68010	64249S	64249A	64271B
Z80	64253S	64253A	64271B
6801/6803	64256S	64256A	64255A
8048	64262S	64262A	64261A(2)
8051	64264S	64264A	64263A
ROM	64272S	64272A	64271B
USER-DEFINABLE	64274S	64274B	64274A
TMS32010	64285S	64285A	64271B
F9450	64286SA	64286AA	64271B
NSC800	64292S	64291A	64292A
70116	64294S	64294A	64223B
70108	64295S	64295A	64223B

*NOTE: These components are included with the Emulator subsystem and MAY NOT be ordered individually.

EMULATION MEMORY COMPONENTS

In this section, information is presented to help the current user of an Emulation Measurement System to add or expand an Emulation Memory Subsystem.

The Emulation Memory Subsystem is composed of an Emulation Memory Control card and from one to eight Memory cards. (The maximum for the 64151A Control card is one Memory card, the maximum for the 64155A is eight). The Emulation Memory Subsystem may occupy any available slots in the development station card cage.

To reconfigure an existing Emulation Memory Subsystem, select extra hardware products from the following table. To purchase a complete Emulation Memory Subsystem, refer to the first half of this Section for ordering and compatibility information.

EMULATION MEMORY HARDWARE PRODUCTS

MODEL NO.	DESCRIPTION
64151A	EMULATION MEMORY CONTROL CARD
64155A	WIDE-ADDRESS EMULATION MEMORY CONTROL CARD
64161A	128K-BYTE EMULATION MEMORY CARD
64162A	64K-BYTE EMULATION MEMORY CARD
64163A	32K-BYTE EMULATION MEMORY CARD

NOTE: 64161A, 64162A AND 64163A CAN BE MIXED IN THE SAME STATION WITH THE 64155A MEMORY CONTROL CARD.

The 64151A Narrow Memory Controller is used with most 8-bit emulators. It is compatible with both 6415X and 6416X series memory boards, but is limited to 64K bytes of addressing.

The 64155A Wide Memory Controller is used with all 16-bit plus the 8-bit 64256S 6801/03 emulator. The 64155A Wide Memory Controller has 1M byte addressing capability if the board is revision 66502 or above, or has been upgraded, otherwise the 64155A has 128K byte addressing capability. All 6415X boards are compatible with the 64155A. The 6416X boards however, are compatible with only the 66502 and above versions.

Mixing 6415X and 6416X Memory Boards is possible, remember, however that with the 64151A Controller a maximum of 64K bytes addressing capability is available. With the 64155A Controller, if more than 128K bytes is being addressed, a 6416X Memory Board **MUST** be in an adjacent card slot. If less than 128K bytes is being addressed a 6416X **MUST NOT** be in an adjacent card slot.

CABLING INFORMATION

Cards within the Emulation Memory Subsystem are connected by the 64960A Emulation/Memory Bus Cable. The Emulation/Memory Bus Cable is supplied with an Emulation Memory Subsystem. When purchasing additional Memory Cards to change the memory size, a Memory Bus Cable is required. Select the appropriate cable to correspond to the number of cards in the Memory Subsystem. Refer to previous page for Emulation/Memory Bus Cable Table.

Illustrated below is the use of the Emulation/Memory Bus Cable as a Memory Bus in both a 64152S Memory Subsystem, and a 64156S Memory Subsystem.

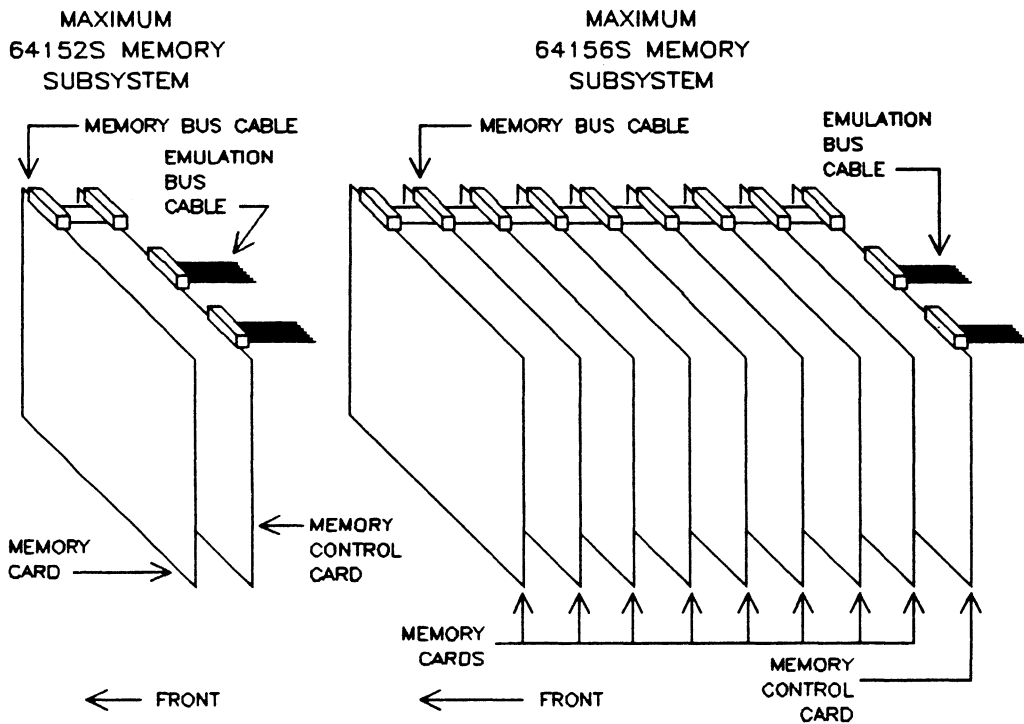

Illustrated below is a sample configuration of an Emulation Measurement System with one Internal Analyzer, and two Memory Boards. This is the configuration implemented by the factory if these subsystems are ordered on the same order section as a development station.

EMULATION, MEMORY, AND INTERNAL ANALYSIS
EXAMPLE CONFIGURATION

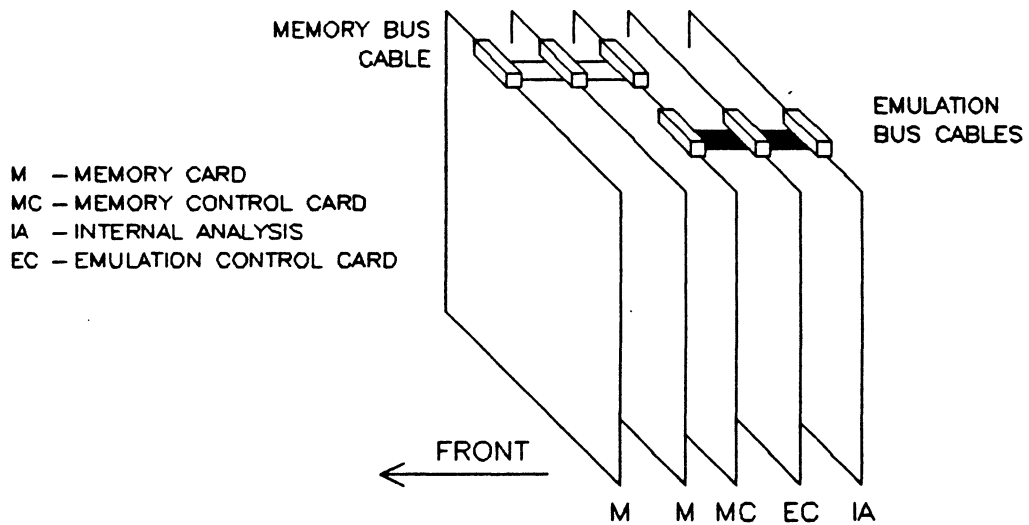

(NOTE: The darkened or solid-line cables interconnect subsystems and must always be ordered, the outlined cables are included as part of a subsystem.)

NOTE: On the previous page, TWO 3-position Emulation Bus Cables are required, these would always be ordered separately. The Memory Bus Cable would be included in the Subsystem. If, however, this Memory system was an expanded system, for example an upgrade from a 64152S 32K byte memory system to a 64K byte memory system, 32K byte board would have been added. In this case a 3-position Memory Bus Cable would have to be ordered.

EMULATION BUS CABLE

The 64960A Emulation/Memory Bus Cables are available in 2-,3-,4-,5-,6-,7-,8-,9- connector sizes. These sizes meet the needs of connecting Emulator Control Cards to Memory Control Cards and any analyzers, as well as the interconnection between the Memory Control Card and the Memory Boards.

The Emulation-Memory-Analyzer bus requires two 64960A Emulation Bus cables. The number of positions required is selected based upon the four parameters shown in the following table:

EMULATION/MEMORY BUS CABLES

MODEL NO.	DESCRIPTION
64960A	EMULATION/MEMORY BUS CABLE; 2-POSITION
OPTION 001	REPLACE WITH 3-POSITION CABLE
OPTION 002	REPLACE WITH 4-POSITION CABLE
OPTION 003	REPLACE WITH 5-POSITION CABLE
OPTION 004	REPLACE WITH 6-POSITION CABLE
OPTION 005	REPLACE WITH 7-POSITION CABLE
OPTION 006	REPLACE WITH 8-POSITION CABLE
OPTION 007	REPLACE WITH 9-POSITION CABLE

INTERMODULE BUS

For interactive measurements with other modules (such as Logic Timing Analysis, Logic State Analysis), or other Internal Analyzers, the Intermodule Bus (IMB) is implemented via an Intermodule Bus Cable. IMB cables must always be ordered separately. For more information see Multimodule Configurations, Section 9.

THIRD PARTY EMULATORS

When the emulation pod and software is supplied by a third party, the HP 64000 user must use the third party emulator pod with the HP 64274A UDE Control Card. The third party supplier will not supply the emulation system software, so the HP 64000 user must also purchase the HP 64274C Third Party Emulation Software.

MICROPROGRAM DEVELOPMENT SUBSYSTEM

In this section, HP 64000 hardware requirements for the Microprogram Development Subsystem are outlined. The Microprogram Development Subsystem is included in the Emulation Section of the Configuration Guide because this subsystem extends the range of processor support offered by the HP 64000. The subsystem supports software and hardware development for a wide variety of microprogrammable-based designs.

The Microprogram Development Subsystem consists of following components:

- * Run Control (HP 64276A/B/C)
- * Writable Control Store (HP 64275A)
- * 25 MHz Logic State/Software Analyzer (HP 64320S)
- * User-definable Microassembler/Linker (HP 64861A)

RUN CONTROL

The basic Microprogram Development Subsystem component is Run Control which consists of an external Run Control pod, cables, and a HP 64276 mainframe Run Control card. The external pod has a Run Control card, a self test card, various cable assemblies, and space for two memory cards.

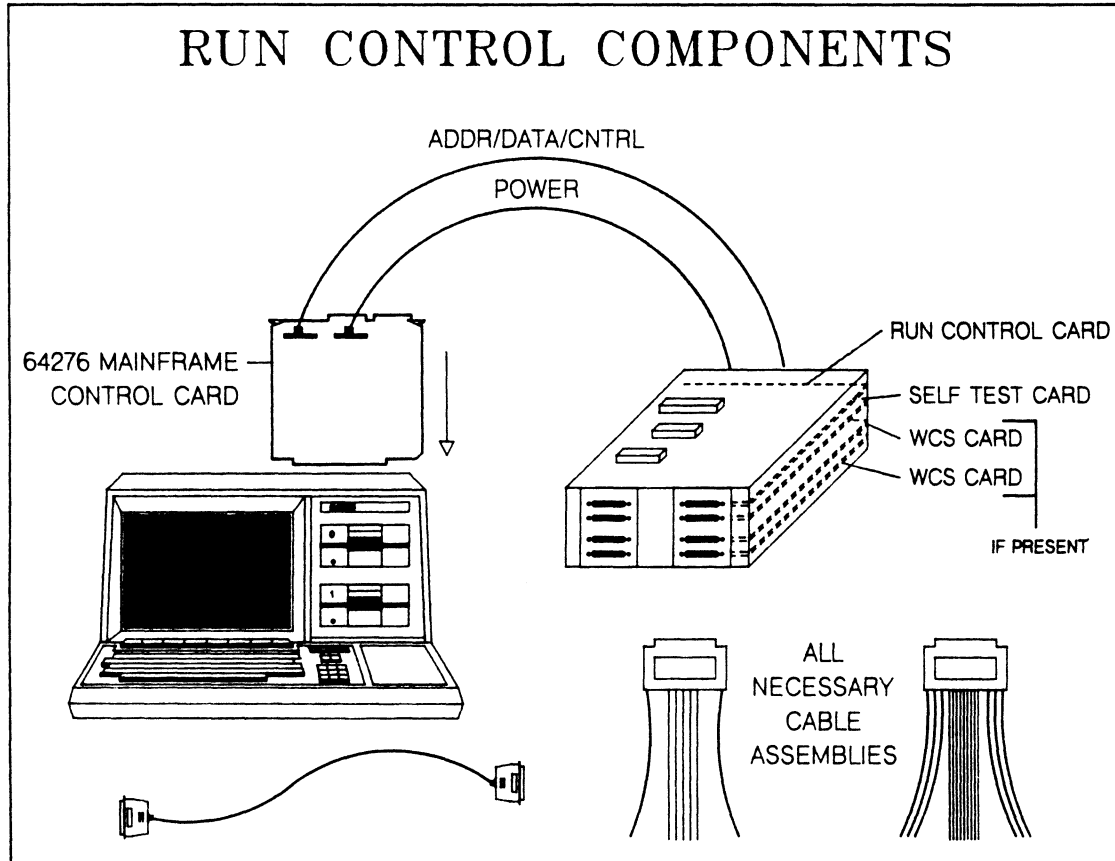

RUN CONTROL, CONTINUED

The minimum Run Control order (HP 64276A) does not include any memory; however, up to two 32k memory cards (HP 64275A) may be added.

CONFIGURATION REQUIREMENT: There is no configuration requirement for the HP 64276 mainframe Run Control card; it may go in any available card slot.

WRITABLE CONTROL STORE (WCS)

The WCS is the memory for the Microprogram Development Subsystem and it resides in the Run Control pod. Each WCS card contains 32 kbytes of memory that can be software configured as follows: (bytes wide by words deep) 16 by 16k, 32 by 8k, or 64 by 4k. If both WCS cards are present, the resultant memory configurations are: (bytes wide by words deep) 16 by 32k*, 32 by 16k, 64 by 8k, or 128 by 4k.

* WCS array of 16 by 32k requires a special cable for connection to the target. This cable is supplied with the HP 64276C and the HP 64275A.

There are three different options when ordering Run Control. It can have no WCS (HP 64276A), 32 kbytes of WCS (HP 64276B), or 64 kbytes of WCS (HP 64276C). WCS that is initially ordered with the Run Control module will be installed by the factory. The table below summarizes the initial ordering configurations of the Run Control module and WCS sizes.

MODEL	MAINFRAME CNTRL. CARD	POD AND CABLES	WCS (KBYTES)
64276A	64276	YES	0
64276B	↓	YES	32
64276C	↓	YES	64

A stand alone WCS board is available for those customers wishing to expand their WCS array or use it as a spare. The HP 64275A is a 32 kbyte WCS board that includes all cable assemblies needed to connect to the user's target system. All hardware needed to install the WCS board in the Run Control pod is also added, (please NOTE some disassembly is required).

USER-DEFINED WCS

For those customers opting to use their own WCS, the HP 64277A user-defined WCS control board was designed. The HP 64277A provides the means of connecting the target system WCS to the HP 64276 Microprogram Development Subsystem. Use of the HP 64277A user-defined WCS control card requires that a HP 64276 Run Control module also be used in the system (ie. stand alone HP 64277A use is not supported). To connect the HP 64277A to the target WCS, a cable terminated with a 50-pin AMP connector is supplied. Cable termination for the HP 64277A is defined in the operating manual.

If the HP 64277A user-defined WCS control card is used in conjunction with the HP 64276B or HP 64276C, the WCS that is associated with the Run Control pod is ignored.

USER-DEFINED WCS, CONT'D.

CONFIGURATION REQUIREMENT :

User-Defined WCS and Run Control: The configuration requirement for the HP 64277A user-defined WCS control card is that it must go immediately after the HP 64276 control card.

USER WCS CONTROL CONFIGURATION

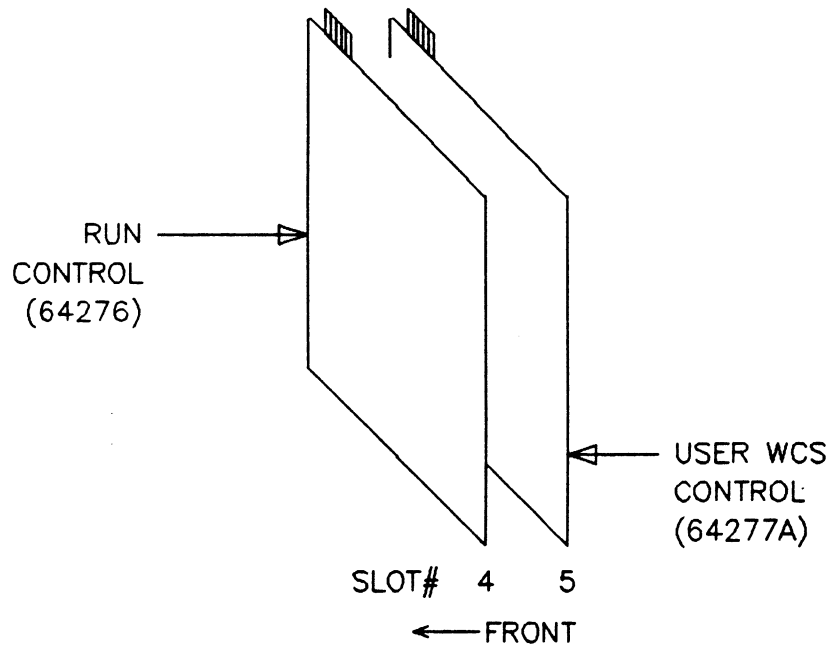

25 MHz LOGIC STATE/SOFTWARE ANALYZER

The HP 64320S 25 MHz Logic State/Software Analyzer adds high-speed, real-time, nonintrusive software analysis to the HP 64000 Logic Development System. This analyzer was made specifically for use in the Microprogram Development Subsystem; however, it can be used as a stand alone, general purpose logic state/software analyzer.

Since the 25 MHz Analyzer is an integral part of the Microprogram Development Subsystem, it is supplied with general purpose probes that plug into the HP 64276 Run Control pod. This connection allows the 25 MHz Analyzer to use the signals acquired by the Run Control pod without the need of double probing the target system.

For specific information about the 25 MHz Logic State/Software Analyzer, see Section 6, "Logic State Analysis", in this Guide.

CONFIGURATION REQUIREMENTS :

25 MHz State and Run Control: n the 25 MHz State Analyzer is used in conjunction with the HP 64276 Run Control module, the HP 64276 Run Control mainframe card must go immediately in front of the 25 MHz State Analyzer's control board, the following illustrates this configuration.

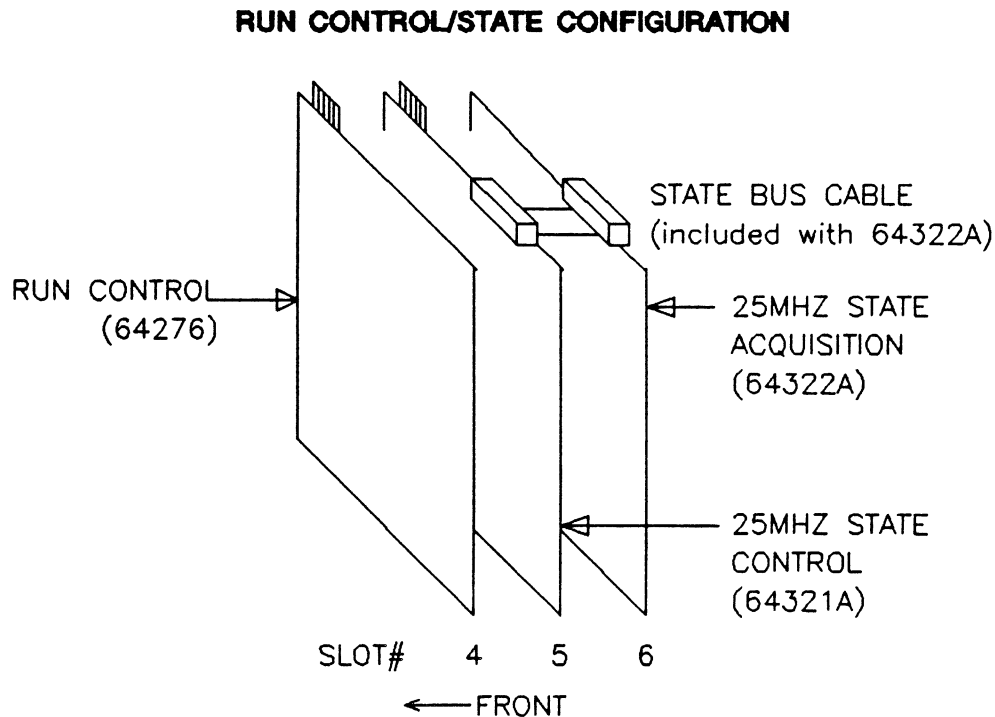

25 MHz LOGIC STATE/SOFTWARE ANALYZER, CONT'D.

25 MHz State, Run Control, and User-defined WCS: The configuration requirement for using the HP 64320S 25 MHz State Analyzer, the HP 64276-Run Control module, and the HP 64277A user-defined WCS is as follows: the HP 64276 control card must be in the lowest card slot (not necessarily the lowest available slot); the HP 64277A user-defined WCS control card must go in the next higher card slot; and the HP 64320S must go in the next higher card slot after the HP 64277A (figure 5). In addition, the individual cards of the HP 64320S state analyzer must follow the requirements specified in the logic state analysis section.

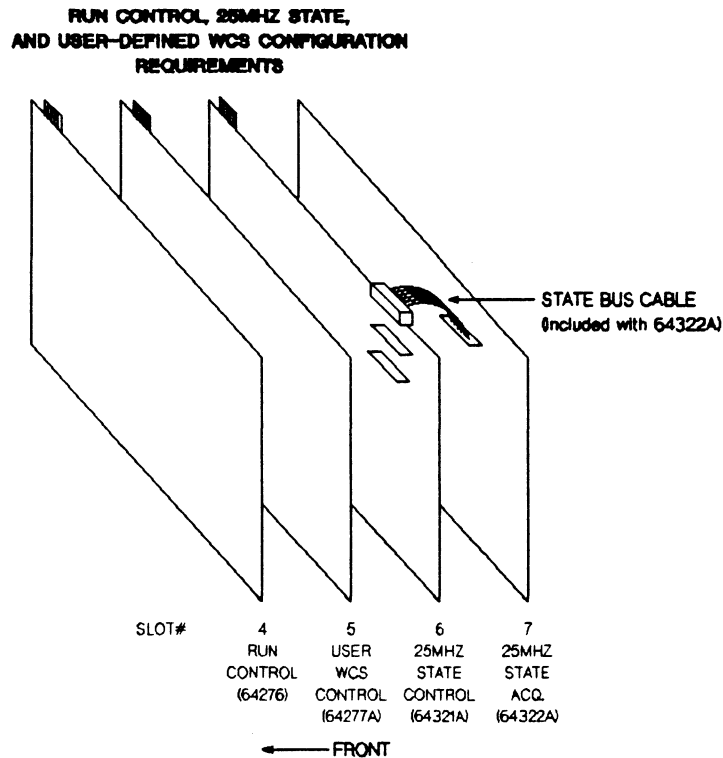

NOTE: the memory expansion board (HP 64032A) is required for use of the HP 64276 and/or the HP 64320S in any HP 64100/110 station with a Serial Number Prefix less than 2309A. The necessary memory is standard on workstations with higher Serial numbers.

MICROASSEMBLER/LINKER

The HP 64861A Microassembler provides a user-defined microinstruction assembler. The Microassembler can be used in a hosted (HP-UX 9000 series 500/200 or VAX-VMS) environment or with a stand alone HP 64000. Currently, the Microassembler software is structured such that the assembler definition must be done on a HP 64000. The definition can then be uploaded to the host computer, if desired, for actual microprogram development on the host. Also, by using the HP User-Definable Microassembler, the source code display feature on the HP 64320S State Analyzer can be utilized.

INTERNAL ANALYSIS HIGH-LEVEL LANGUAGE ANALYSIS

There are five internal logic analysis capabilities available. These products are used directly with an emulator, and for purposes of distinction, are discussed separately in the Internal Analysis section:

INTERNAL ANALYSIS

MODEL NO.	DESCRIPTION
64302A 64304A	48-CHANNEL EMULATION BUS (INTERNAL) LOGIC ANALYZER CARD EMULATION BUS PREPROCESSOR, USED WITH 64620S STATE/SOFTWARE ANALYZER
64310A	SOFTWARE PERFORMANCE ANALYZER
6433XX	HIGH-LEVEL SOFTWARE ANALYZER, USED WITH EMULATION SUBSYSTEM AND 64302A
64340A	REAL-TIME, HIGH-LEVEL SOFTWARE ANALYZER

Each Internal Analyzer can be used with any other internal analyzer, and any combination of internal analyzers can be used together, (assuming the card slots are available). The exception: When the HP 6433XX Analyzer is running, no other analyzer can make measurements.

EMULATION BUS ANALYSIS:

The HP 64302A EMULATION BUS (INTERNAL) LOGIC ANALYZER

This is a single card and is compatible with all emulators.

The HP 64304A EMULATION BUS PREPROCESSOR

This product interfaces the 64620S Logic State/Software Analyzer with Emulator, except the 64272S ROM Emulator. Component parts of this product are the EBPP card and its operating software. Inverse Assemblers are provided with the supported emulators to give mnemonic display of the processor instruction set. When using the 64620S and 64304A to probe a user-definable emulator, the 64856AF User-Definable Inverse Assembly Language software may be used to create an inverse assembler for the particular microprocessor being emulated. To order, first select the desired 64620S subsystem, then the 64304A. Note: the 64620S must be ordered with the appropriate option to meet the "Minimum Configuration Requirement" for the corresponding specific emulator shown in the following table:

INTERNAL / HLL ANALYSIS, CONT'D

MINIMUM CHANNEL REQUIREMENTS FOR 64620S

EMULATOR MODEL NO.	DESCRIPTION	MINIMUM CHANNEL CONFIGURATION REQUIREMENT	EMULATOR MODEL NO.	DESCRIPTION	MINIMUM CHANNEL CONFIGURATION REQUIREMENT
64192S,64193S	6805U/R,6805P	40	64221/OPT 001	8088,87/80C88	40
64264S	8051	60	64227S	80286	60
64202S	8080	40	64232S	Z8001	60
64203S	8085	40	64233S	Z8002	60
64212S,64213S	6800,6802/08	40	64242S	68000	60
64215S,64216S	6809,6809E	40	64249S	68010	60
64222S	8086	60	64252S	Z80	40
64220/OPT 001	8086,87/80C86	60	64256S	6801/6803	40
64224S	80186	60	64262S	8048	40
64225S	80188	40	64274S	USER DEFINABLE	40/60
64226S	8088	40	64292S	NSC800	40

SOFTWARE PERFORMANCE ANALYSIS

The 64310A Software Performance Analyzer is used with any emulator, except the 64272S ROM version, for software characterization, testing, debugging, and optimization. The 64310A can be used with other 64000 Analyzers for interactive analysis (see Section 9). The 64310A is composed of a single card and the operating software.

EMULATION BUS CABLING INFORMATION

The 64302A/304A/310A are all single cards that must connect via TWO Emulation/Memory Bus Cables (64960A) to the Emulator Control Card and the Memory Control Card. The correct cable option selected is a function of the number of positions needed, which is configuration dependent. The factory systemizing requirement is (as a general rule) the number of Control Cards (Emulation and Memory), plus the number of Internal Analyzers in a given system. Exceptions to this rule are the HP 64262 (8048) Emulator and all Split-Bus Emulators (see Page 4-4 for details on these exceptions).

EMULATION BUS CABLING, CONT'D

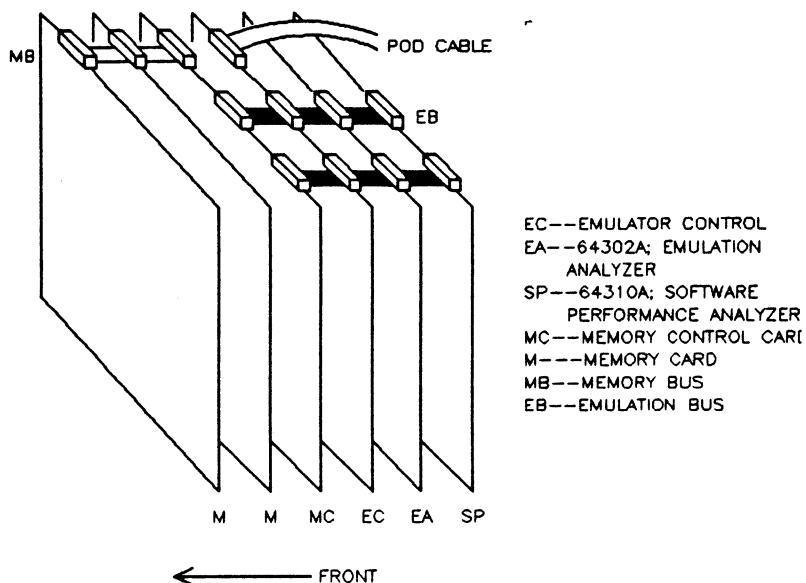

NOTE: The Emulation Bus Preprocessor should always go behind the Emulation Control board. Outlined cables are included in a subsystem; solid cables interconnect subsystems and must always be ordered separately.

INTERMODULE BUS

Interactive measurements between Internal Analyzers or Internal and External Analyzers is accomplished through the use of the 64964A InterModule Bus. (Refer to Section 9 "Multi-module Configurations" for details and illustrations of IMB.)

For ease of cabling, the factory places the 64302A AND 64310A in adjacent card slots; thus, the number of positions required on the IMB is simply the number of analyzers; in this case, two positions. (See illustration on page 9-5.)

The IMB is a connection between analyzers only. When a 64304A Emulation Bus Preprocessor is present, interactive measurements are accomplished with the IMB through the 64620S Logic/State Software Analyzer. The number of positions on the IMB cable is then dependent on the placement of the 64620S within the station. (See illustration on page 9-6.)

See the following table for the appropriate IMB option selection:

INTERMODULE BUS

MODEL NO.	DESCRIPTION
64964A	INTERMODULE BUS CABLE, 2-POSITION
OPTION 001	REPLACE WITH 4-POSITION
OPTION 002	REPLACE WITH 6-POSITION
OPTION 003	REPLACE WITH 8-POSITION
OPTION 004	REPLACE WITH 3-POSITION
OPTION 005	REPLACE WITH 5-POSITION
OPTION 006	REPLACE WITH 7-POSITION

HIGH-LEVEL SOFTWARE ANALYSIS:

Two series of High-Level Software Analyzers are available: The HP 6433XX High-Level Software Analyzers, and the HP 64340 Real-Time, High-Level Software Analyzer. Both series are powerful debug and test tools for programs written in C and Pascal for specific microprocessors.

Basic differences between the two HLL Software Analyzers are:

HP 6433XX HIGH-LEVEL SOFTWARE ANALYZERS -

are not subsystems, they are software products only, which require an HP 64000 Emulator Subsystem, and a HP 64302A 48-Channel Emulation Bus Analyzer.

Cables are not a consideration.

HP 6434XX REAL-TIME, HIGH-LEVEL SOFTWARE ANALYZER -

is both a hardware and software package that operates with a corresponding emulator subsystem. The hardware consists of:

- 64340A CPU Board
- 64340A Control Board
- 64340A Acquisition Board

and occupies three (3) option slots in the Logic Development Station. In addition, a 64341XX Software product **MUST** be ordered for the target microprocessor (see table on the following page).

The 64340A CPU, Control, and Acquisition cards (in that order) should be placed behind the emulation card set and immediately before the other analyzers. See the configuration diagrams beginning on page 5-8. Exception: The Emulation Bus Preprocessor (64304A), if used with the 64620S State/Software Analyzer, must still be placed next to the emulator, followed by the 64340A.

Cables (the HP 64960A Emulation Bus) are a significant factor and vary with each configuration. Please refer to the following cable section.

HIGH-LEVEL SOFTWARE ANALYSIS, CONT'D

MODEL #	DESCRIPTION	<u>REQUIRES</u>			
		EMULATION	INTERNAL ANALYZER	COMPILER	OTHER
6433XX	High-Level Software Analyzers				
64331A	for 68000 uPs	64242S	64302A ↓	* Use the appropriate C or Pascal Compiler (current rev.)	HP 64032A Memory Expansion Module required for only those Logic Development Stations with a Serial Prefix Number UNDER 2309A. ↓
64332A	for 8086 uPs	64222S			
64332B	for 8086/C86 uPs	64220S, 64220S OPT 001			
64333A	for 8088 uPs	64226S			
64333B	for 8088/C88 uPs	64221S, 64221S OPT 001			
64334A	for 68010 uPs	64249S			
64335A	for 80186 uPs	64224S			
64336A	for 80188 uPs	64225S			
64340A***	Real-Time, High-Level SW Analyzer				
SOFTWARE PRODS:					
64341AA	for 8086/C86 uPs	64220S, 64220S OPT 001	NO ↓	* Use the appropriate C or Pascal Compiler (current rev.)	Two Emulation Bus Cables No. 64960A (with appropriate number of positions) are required. **
64341BA	for 68000 uPs	64242S			
64341CA	for 8088/C88 uPs	64221S, 64221S OPT 001			
64341DA	for 80186 uPs	64224S			
64341EA	for 68010 uPs	64249S			
64341FA	for 80188 uPs	64225S			

* When using hosted development compilers, data base must be built on the 64000 Logic Development Station.

** A 6415XS Emulation Memory System must also be present in the workstation.

*** Requires a 64341XA Software Product.

HIGH-LEVEL LANGUAGE ANALYSIS, CONT'D

HP 64340A CABLING

OPTION NUMBERS 10 through 17 have been added to the 64960A Emulation/Memory Bus Cable selections, to accommodate the complexity of new configuration considerations with the HP 64340A. **Two 64960A cables are still required.** These new cables connect the emulation control card to the 64340A Acquisition card, skipping two positions to clear the 64340 CPU card and the Control card.

The 64960A cable Options are dependent on the number of positions needed for data communications between the emulator, the 64340, internal and/or external analyzers.

NOTE : All HP 64960 Emulation Bus Cables must be ordered separately, in quantities of two.

If additional 64960A cables are needed, they can be ordered through the Corporate Parts Center, under the following HP part numbers:





CABLE PART NUMBERS:

64960A OPT.NO.	HP PART NUMBER
010	64960-61609
011	64960-61610
012	64960-61611
013	64960-61612
014	64960-61613
015	64960-61614
016	64960-61615
017	64960-61616

HIGH-LEVEL SOFTWARE ANALYSIS, CONT'D

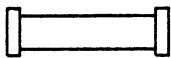
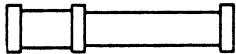
The table below is a checklist for the type of HP 64960 Bus Cables needed for particular configurations, and the corresponding Option numbers to be ordered for the selected configuration:

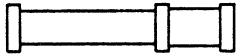
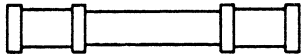
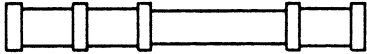
64340A CONFIGURATIONS

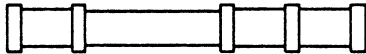
ALL CABLES SKIP TWO POSITIONS			RT-HL	EBPP	Split	# of
64960A	front	rear	64340A	64304A	EBUS	Int Anl
opt #						
10			yes	no	yes	1
11			yes	yes	yes	2
12			yes	yes	no	2
13			yes	no	yes	2
14			yes	yes	yes	3
15			yes	no	no	2
16			yes	yes	no	3
17			yes	no	yes	3

REMINDER: An appropriate Intermodule Bus cable must be ordered.

The following illustrates cabling of the HP 64340A with and without the Emulation Bus Preprocessor, and with and without split-bus emulation in various configurations.

HIGH-LEVEL SOFTWARE ANALYSIS, CONT'D

HP 64340A WITHOUT EBPP / NON-SPLIT BUS EMULATION

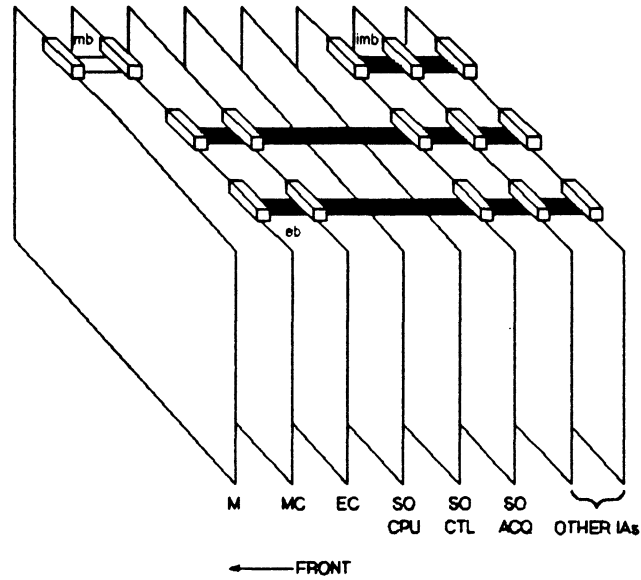

HP 64340A WITH EBPP / NON-SPLIT BUS EMULATION

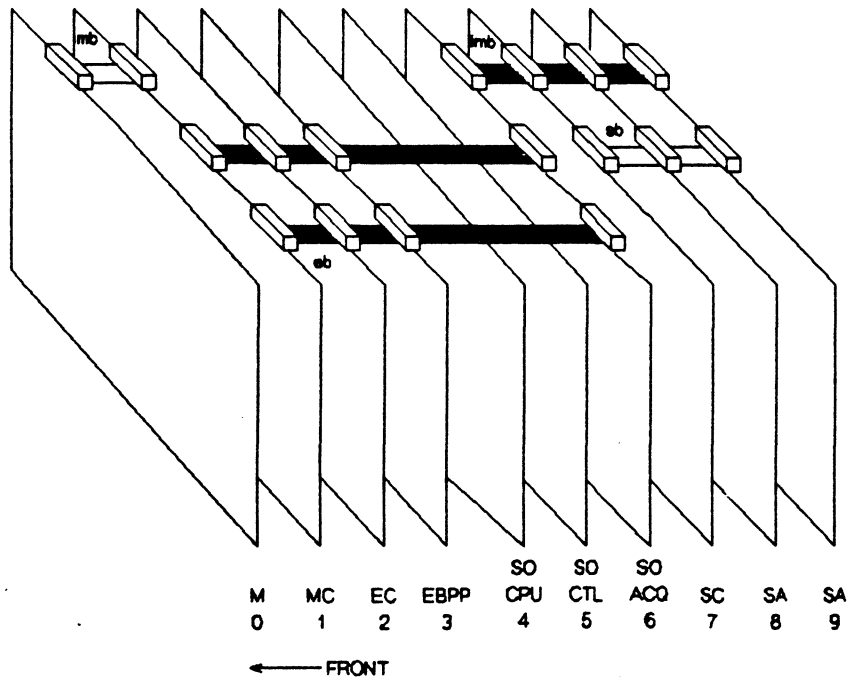

M - MEMORY CARD
 MC - MEMORY CONTROL CARD
 EC - EMULATION CONTROL CARD
 EBPP - EMULATION BUS PREPROCESSOR
 IA - INTERNAL ANALYZER
 SO - HP 64340A HILL ANALYZER
 SC - STATE CONTROL CARD
 SA - STATE ACQUISITION CARD

mb - memory bus
 imb - intermodule bus
 eb - emulation/memory bus
 sb - state bus

HIGH-LEVEL SOFTWARE ANALYSIS, CONT'D

HP 64340A WITHOUT EBPP / SPLIT BUS EMULATION

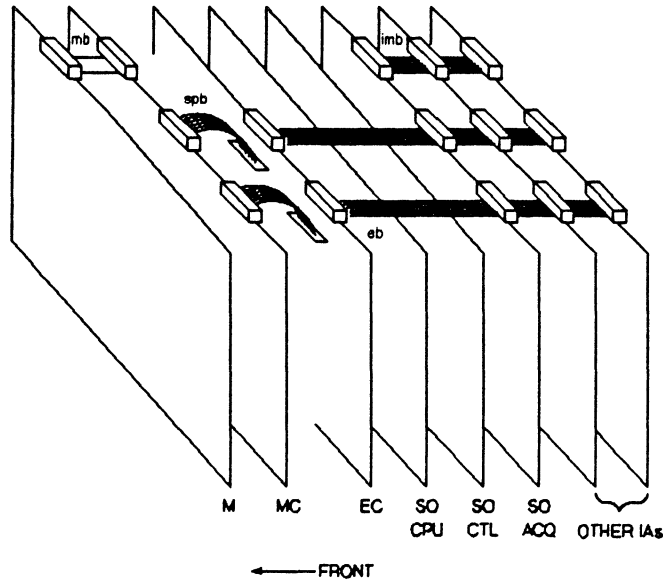

HP 64340A WITH EBPP / SPLIT BUS EMULATION

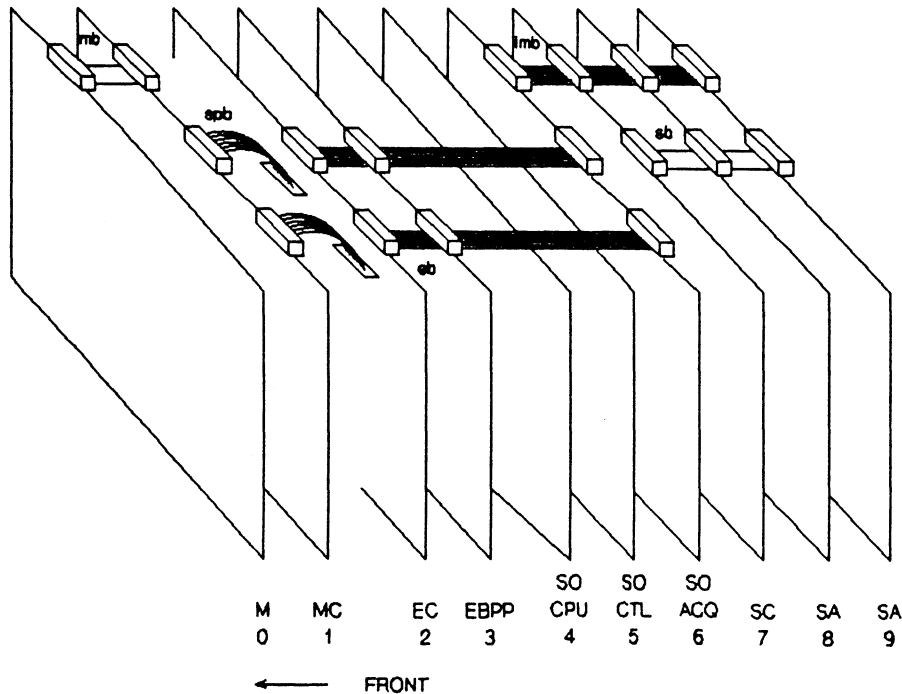

- M - MEMORY CARD
- MC - MEMORY CONTROL CARD
- EC - EMULATION CONTROL CARD
- EBPP - EMULATION BUS PREPROCESSOR
- SO - HP 64340A HLL ANALYZER
- SC - STATE CONTROL CARD
- SA - STATE ACQUISITION CARD

- mb - memory bus
- imb - intermodule bus
- eb - emulation/memory bus
- sb - state bus
- spb - split bus

LOGIC STATE ANALYSIS

The Logic State/Software Analysis Measurement System provides general purpose as well as processor-specific probing capability. Modular architecture allows adding input channels and modifying the probing configuration. There are four types of hardware available in this measurement system:

- o Logic State/Software Analyzer Subsystem, plus
- o General Purpose Logic State Probe set,
- o General Purpose Preprocessor with Processor Specific Interface Modules, or
- o Emulation Bus Preprocessor.

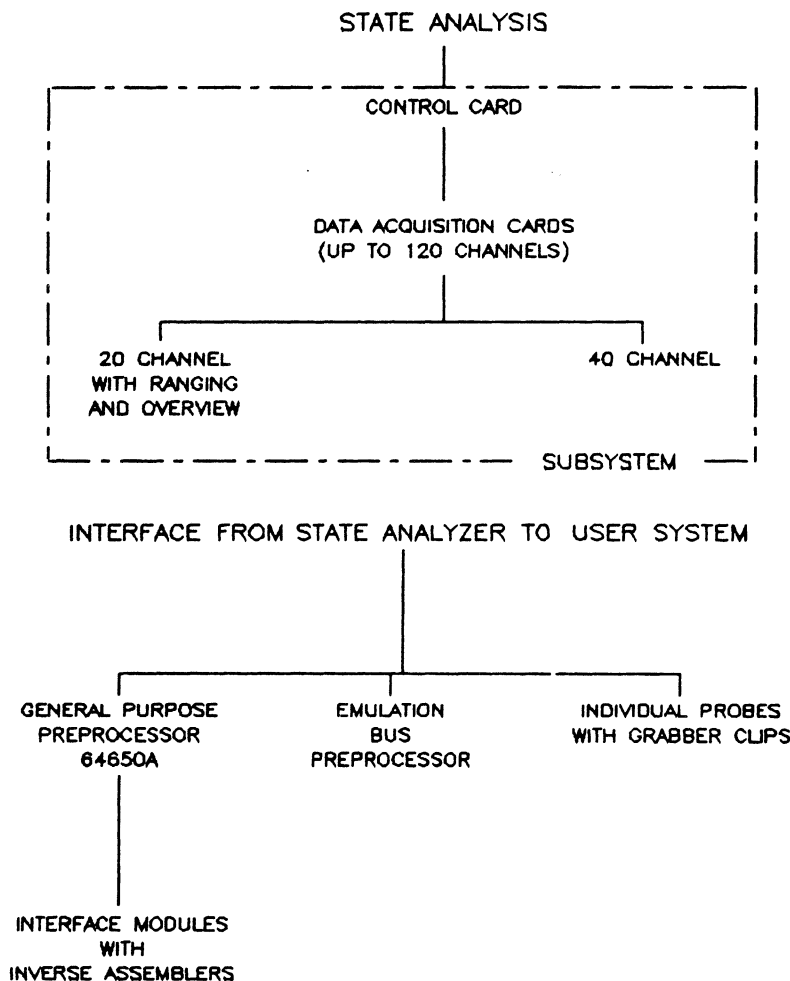

Illustrated above are the hardware components which comprise the 64620S Logic State/Software Analyzer subsystem. The probing scheme must then be chosen from the 64630S General Purpose Probes, the 64650A General Purpose Preprocessor with Interface Modules and Inverse Assemblers, or the 64304A Emulation Bus Preprocessor.

The overview capability and number of input channels are determined by the card set selected. Probing is matched to the environment in which the analyzer is to be used. For general purpose probing, a General Purpose Probe Set may be chosen which provides the same number of input channels as the analysis card set. Processor-specific probing is provided by a General Purpose Preprocessor with the appropriate Interface Module installed. Combinations of processor-specific and general purpose probing, combinations of Emulation System and general purpose probing, and Emulation Bus analysis via the 64304A Emulation Bus Preprocessor, are possible. In selecting components for a Logic State Analysis System, the factors to be considered are:

- o Measurement features required,
- o Number of input channels needed,
- o The most appropriate probing scheme for the application

LOGIC STATE/SOFTWARE ANALYZER

In configuring a 64620S Logic State/Software Analyzer, the basic set of measurement features is defined by the card set and related software that is supplied on flexible disc. Combinations of 20-channel and 40-channel data acquisition cards provide from 20 to 120 input data channels. Refer to the table below.

There are two basic modes of operation, conventional trace listing and the overview mode. Overview mode is used for performance analysis applications, and is included on the 20-channel data acquisition card only.

LOGIC STATE/SOFTWARE ANALYZER

OPTION NO.	CHANNELS	NO. OF 40-CHANNEL CARDS	NO. OF 20 CHANNEL CARDS	AVAILABILITY OF OVERVIEW
64620S*	20	0	1	YES
010	40	1	0	NO
011	60	1	1	YES
012	80	2	0	NO
013	100	2	1	YES
014	120	3	0	NO

* ONLY ONE OPTION MAY BE SPECIFIED PER SUBSYSTEM

CHANNEL REQUIREMENTS

	40 CHANNEL CARD	20 CHANNEL CARD WITH OVERVIEW
20 CHANNELS	-	1
40 CHANNELS	1	-
60 CHANNELS	1	1
80 CHANNELS	2	-
100 CHANNELS	2	1
120 CHANNELS	3	-

GENERAL PURPOSE LOGIC STATE PROBES

When General Purpose probing is desired, one clock probe and the proper number of data probes are required. NOTE: 64630S General Purpose Logic State Probes are not required with a 64304A Emulation Bus Preprocessor or 64650A General Purpose Preprocessor.

GENERAL PURPOSE PROBES

MODEL NO.	DESCRIPTION
64630S	GENERAL PURPOSE PROBE SET; INCLUDES ONE 8-CHANNEL CLOCK PROBE, AND ONE 20-CHANNEL DATA PROBE.
*OPT 010	EXPAND TO 40 DATA CHANNELS
011	EXPAND TO 60 DATA CHANNELS
012	EXPAND TO 80 DATA CHANNELS
013	EXPAND TO 100 DATA CHANNELS
014	EXPAND TO 120 DATA CHANNELS

* ONLY ONE OPTION MAY BE SPECIFIED PER SUBSYSTEM

GENERAL PURPOSE PREPROCESSOR

For processor-specific analysis, the 64650A General Purpose Preprocessor with the appropriate Interface Module offers the convenience of simple probing and inverse assembly of selected 8-bit and 16-bit processor instruction sets. The Interface Module includes a simple probe which fits on the processor chip and contains all the bus signal routing and clock signals required for capturing valid data. The processor-specific interface module contains an Inverse Assembler for mnemonic display of the processor instruction set and a configuration file to format the Logic State/Software Analyzer as required for analysis.

The 64651B Wire Wrap Interface Kit is available for interface applications not presently supported with processor-specific interfaces. The 64651B provides a wire-wrap printed circuit board and connectors for applications consisting of only wire routing to the 64650A General Purpose Preprocessor. For interfaces requiring active circuitry, option 001 provides the necessary hardware for implementation. Three cabling options are available for probing the target system. The 64856AF User-Definable Inverse Assembly Language software can be used to create an inverse assembler for a specific microprocessor or bus.

To order, select the desired 64620S subsystem and 64650A General Purpose Preprocessor. Then select the Interface Module and Inverse Assembler for the specific microprocessor.

MODEL NO.	DESCRIPTION
64650A	GENERAL PURPOSE PREPROCESSOR

INTERFACE MODULES

PREPROCESSOR INTERFACE KIT MODEL NO	MICROPROCESSOR SUPPORTED	MINIMUM CHANNEL CONFIGURATION
64651B*	WW IFC	40
64653A	8086/8088	60
64655A	8085	40
64657A	80286	60
64658A	80186/80188	60
64671A	6809/6809E	40
64672B	6800/6802	40
64673A	68008	60
64674A	68000/68010	60
64680A	Z8001	60
64681A	Z8001	40
64683A	Z80	40
64690A	NSC800	40

* CONFIGURATION AND CABLING OPTIONS ARE AVAILABLE FOR THE 64651B WIRE WRAP INTERFACE KIT.

64651B OPT. 001	ADD MICROPROCESSOR INTERFACE KIT
OPT. 010	ADD CABLE WITH CONNECTOR FOR 40 PIN DIP
OPT. 011	ADD CABLE WITH CONNECTOR FOR 48 PIN DIP
OPT. 012	ADD CABLE WITH CONNECTOR FOR 64 PIN DIP

Note that the 64620S Logic State Analyzer must be ordered with the appropriate option to obtain the number of channels in the "Minimum Channel Count" column corresponding to the specific interface module in the table shown. The maximum configuration for any preprocessor is 60 channels. Channels may be required for a minimum configuration, but not actually be used by the preprocessor. Additional acquisition cards may be ordered for general purpose probing up to a maximum of 120 channels in the same subsystem. Inverse assemblers are supplied with the interface modules on 5 1/4" flexible disc.

EMULATION BUS PREPROCESSOR

For powerful trace and debug capability in the emulation environment, the 64620S Logic State Analyzer subsystem can directly probe the emulation bus through the 64304A Emulation Bus Preprocessor. The 64304A may replace or be used with a 64302A Emulation Bus Logic Analyzer Card. The 64304A can be used with any Emulation Subsystem, except the 64272S ROM Emulator. Inverse Assemblers are provided with the supported emulators to give mnemonic display of the processor instruction set. A configuration file to automatically format the 64620S is also provided.

For automatic configuration of the 64620S, or if an Internal Analyzer is present, the 64304A must be installed in the next higher slot after its Emulation Control Board. The Internal Analyzer should be installed next to the Preprocessor Board for easier cable connection. For a configuration diagram, see page 9-6.

When using the 64620S and 64304A to probe a user-definable emulator, the 64856AF User-Definable Inverse Assembly Language software may be used to create an inverse assembler for the particular microprocessor being emulated.

To order, first select the desired 64620S subsystem, then the 64304A. Note the 64620S must be ordered with the appropriate option to obtain the number of channels in the "Minimum Configuration Requirement" corresponding to the specific emulator in the table shown.

EMULATION BUS PREPROCESSOR

MODEL NO.	DESCRIPTION
64304A	EMULATION BUS PREPROCESSOR

MINIMUM CHANNEL REQUIREMENTS FOR 64620S

EMULATOR MODEL NO.	DESCRIPTION	MINIMUM CHANNEL CONFIGURATION REQUIREMENT	EMULATOR MODEL NO.	DESCRIPTION	MINIMUM CHANNEL CONFIGURATION REQUIREMENT
64192S,64193S	6805U/R,6805P	40	64221/OPT 001	8088,87/80C88	40
64264S	8051	60	64227S	80286	60
64202S	8080	40	64232S	Z8001	60
64203S	8085	40	64233S	Z8002	60
64212S,64213S	6800,6802/08	40	64242S	68000	60
64215S,64216S	6809,6809E	40	64249S	68010	60
64222S	8086	60	64252S	Z80	40
64220/OPT 001	8086,87/80C86	60	64256S	6801/6803	40
64224S	80186	60	64262S	8048	40
64225S	80188	40	64274S	USER DEFINABLE	40/60
64226S	8088	40	64292S	NSC800	40

LOGIC STATE/SOFTWARE ANALYZER COMPONENTS

In this section, hardware configuration information is presented to help the current user of a Logic State/Software Analyzer expand equipment to a larger, more powerful configuration.

The 64620S Logic State/Software Analyzer card set is composed of a Control Card and up to three Data Acquisition Cards. There are 20-channel and 40-channel data acquisition cards. Various combinations of these cards produce analyzer configurations with input channel capacities ranging from 20 to 120 input data channels. If more than one 20-channel acquisition card is configured per state analyzer subsystem only one of them will perform the overview function. The others will operate as simple 20 channel boards and their overview capability will not be available.

State Analyzer cards are installed in the development station card cage according to the following rules:

- o The Control Card must be in the lowest numbered slot of the subsystem.
- o The 40-channel Cards must be the next higher numbered slots of the subsystem.
- o The 20-channel Card must be in the highest numbered slot of the subsystem.

As shown in the diagram below:

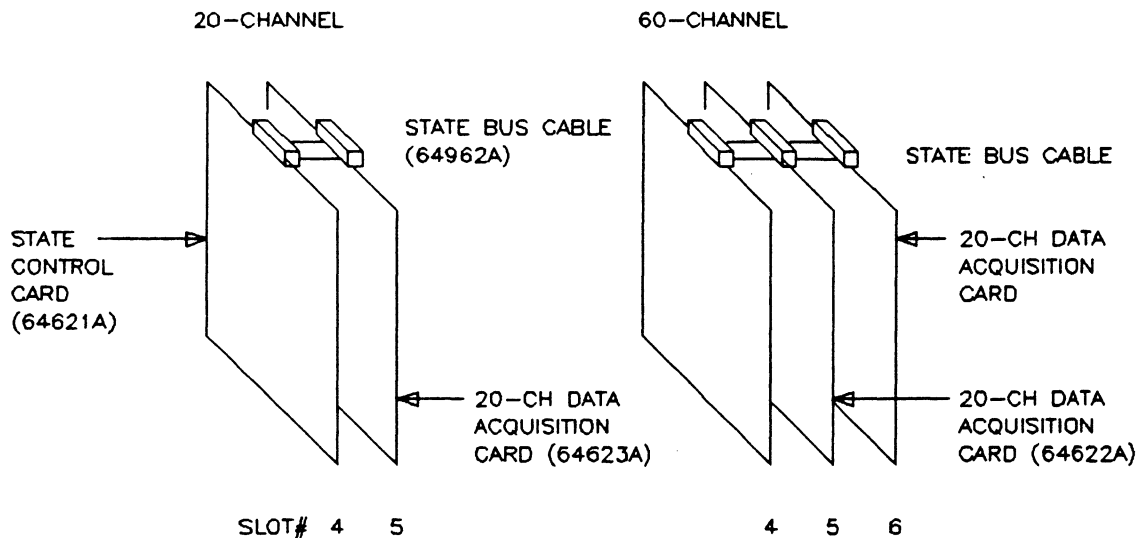

For general purpose probing, one 8-channel clock probe is required for each analyzer, and as many 20-channel data probes as needed to match the inputs of the data acquisition card configuration.

The following tables show the data acquisition cards which make up the different channel size Logic State/Software Analyzer Subsystem. For general purpose probing, the number of data probes required per acquisition card is shown.

CHANNEL CONFIGURATION REQUIREMENTS

	CONTROL CARD 64621A	40-CHANNEL DATA ACQUISITION CARD 64622A	20-CHANNEL DATA ACQUISITION CARD 64623A	NUMBER OF DATA PROBES REQUIRED FOR GENERAL PURPOSE PROBING
20 CHANNEL	1	0	1	1
40 CHANNEL	1	1	0	2
60 CHANNEL	1	1	1	3
80 CHANNEL	1	2	0	4
100 CHANNEL	1	2	1	5
120 CHANNEL	1	3	0	6

NOTE: ONE AND ONLY ONE CLOCK PROBE IS REQUIRED FOR ALL ANALYZER CONFIGURATIONS.

To expand an existing Logic State/Software Analyzer, select extra cards from the following table.

LOGIC STATE/SOFTWARE ANALYZER CARDS

MODEL NO.	DESCRIPTION
*64621A	LOGIC STATE/SOFTWARE ANALYZER CONTROL CARD
64622A	40-CHANNEL LOGIC STATE/SOFTWARE ANALYZER DATA ACQUISITION CARD
64623A	20-CHANNEL LOGIC STATE/SOFTWARE ANALYZER DATA ACQUISITION CARD WITH OVERVIEW

* ONLY ONE 64621A LOGIC STATE/SOFTWARE ANALYZER CONTROL CARD CAN BE CONNECTED TO A SINGLE LOGIC STATE/SOFTWARE ANALYZER

For extra probes refer to the following table to match the added data acquisition cards.

LOGIC STATE/SOFTWARE ANALYZER PROBES

MODEL NO.	DESCRIPTION
64635A	20-CHANNEL LOGIC STATE/SOFTWARE ANALYZER DATA PROBE
*64636A	8-CHANNEL LOGIC STATE/SOFTWARE ANALYZER CLOCK PROBE

*Only one 64636A 8-channel Logic State/Software Analyzer clock probe can be connected to a single Logic State/Software Analyzer.

Refer to the General Purpose Preprocessors and Interface Module tables in the Measurement Systems section for a selection of products available for processor-specific interfaces.

CABLING INFORMATION

STATE BUS

Cards for the Logic State/Software Analyzer are interconnected by a cable called the State Analysis Bus Cable. This cable connects all cards within one analysis subsystem.

The State Bus cable is supplied when the analyzer is purchased as a 64620S Logic State/Software Analysis Subsystem. When cards are purchased individually, a State Bus cable of the correct size must be separately ordered. The correct cable size is determined from the following diagram:

Each vertical line represents a card position, and, thus, a connector position on the cable.

CABLE SIZE REQUIREMENTS

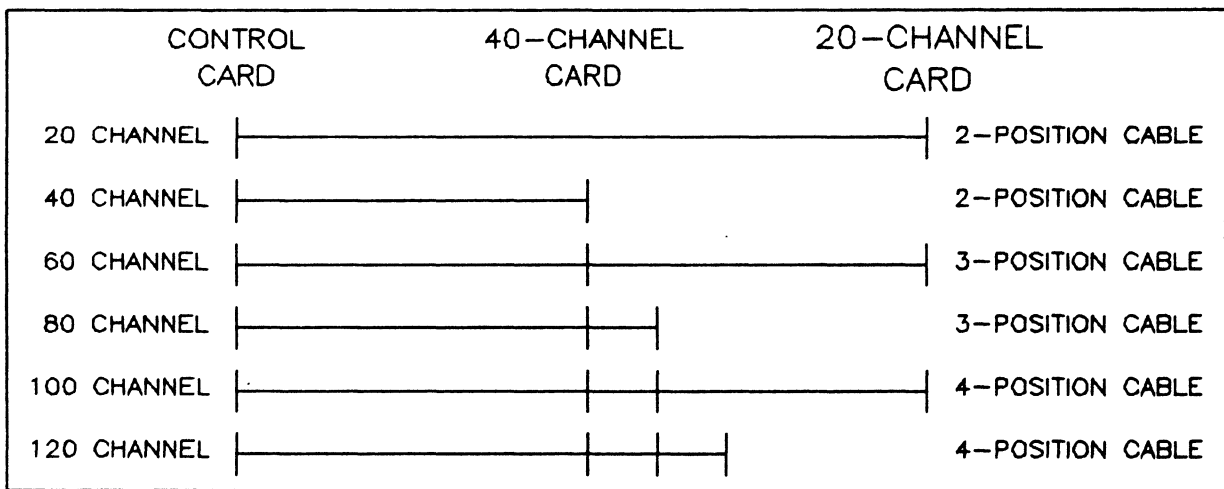

The appropriate cable model number can be obtained using the following table.

STATE BUS CABLE

MODEL NO.	DESCRIPTION
64962A	STATE BUS CABLE, 2-POSITION
OPTION 001	REPLACE 2-POSITION CABLE WITH 3-POSITION
OPTION 002	REPLACE 2-POSITION CABLE WITH 4-POSITION CABLE

INTERMODULE BUS

For interactive measurements with other modules, such as another Logic State/Software Analyzer (64620S), 64600S Timing Analyzer, 64302A Emulation Bus Analyzer, or a 64310A Software Performance Analyzer, the Intermodule Bus (IMB) is implemented via an Intermodule Bus Cable (64964A). THIS CABLE MUST BE SPECIFIED IN ALL CASES. When a user expands a system to accommodate a new measurement system, a new IMB cable may have to be ordered.

All Logic State/Software Analyzer cards have an edge for the IMB cable, however, only the connector on the control board is functional. The connectors on the data acquisition cards only provide mechanical support to the IMB cable. The following examples include some possible configurations and the required IMB cables:

MULTI-STATE ANALYZER CABLING

CONFIGURATION EXAMPLE	SLOT NO.	0	1	2	3	4	5	6	7	8	
60 CH/40 CH											
	CARD TYPE		c	d	d	c	d				
											4-POSITION CABLE
60 CH/40 CH/60 CH											
	CARD TYPE		c	d	d	c	d	c	d	d	
			c - Control Card d - Data Acquisition Card								

The following table can be used to order the required cable:

INTERMODULE BUS

MODEL NO.	DESCRIPTION
64964A	INTERMODULE BUS CABLE, 2-POSITION
OPTION 001	REPLACE WITH 4-POSITION
OPTION 002	REPLACE WITH 6-POSITION
OPTION 003	REPLACE WITH 8-POSITION
OPTION 004	REPLACE WITH 3-POSITION
OPTION 005	REPLACE WITH 5-POSITION
OPTION 006	REPLACE WITH 7-POSITION

25 MHz LOGIC STATE/ SOFTWARE ANALYZER

The HP 64320S 25 MHz Logic State/Software Analyzer adds high-speed, real-time, nonintrusive software analysis to the HP 64000 Logic Development System. This analyzer was made specifically for use in the Microprogram Development Subsystem; however, it can be used as a stand alone, general purpose logic state/software analyzer.

Since the 25 MHz analyzer is an integral part of the Microprogram Development Subsystem, it is supplied with general purpose probes that plug into the HP 64276 Run Control pod. This connection allows the 25 MHz Analyzer to use the signals acquired by the Run Control pod without the need of double probing the target system.

The 25 MHz Logic State/Software Analyzer can be ordered with 30, 60, or 90 input data channels (i.e., HP 64320S, Option 010, or Option 011). The components of the 25 MHz State Analyzer are as follows: a control card

- o HP 64321A Control Card
- o HP 64322A Data Acquisition Card
(one, two, or three cards)*
- o HP 64325A Clock Probe
- o Cables and Interfaces

***NOTE:** Each data acquisition card has three, 10-channel data acquisition probes (HP 64324A).

25 MHz LOGIC STATE/SOFTWARE ANALYZER

MODEL	OPTION	CHAN	ACQ. CARD	DATA PROBES	CNTRL CARD	CLOCK PROBE
64320S		30	64322A	(64324A)X3	64321A	64325A
	OPT 010	60	(64322A)X2	(64234A)X6	↓	↓
	OPT 011	90	64322A)X3	(64324A)X9	↓	↓

One point which needs to be elaborated upon is the way the data acquisition probes connect to the data acquisition cards. The correct ordering scheme is to connect the probes in order (i.e., 1 thru 9), starting with the front data acquisition card and connecting the data probes from right to left. The Illustration on the next page shows this ordering scheme.

25MHz LOGIC STATE/SOFTWARE ANALYZER, CONT'D.

To use the 25 MHz State Analyzer interactively with other analysis and emulation subsystems in the HP 64000, the correct intermodule bus (IMB) cable must be used. IMB information can be found in Section 9 of this Guide.

NOTE: the memory expansion board (HP 64032A) is required for use of the HP 64276 and/or the HP 64320S in any HP 64100/ 64110 station with a serial number prefix less than 2309A. The necessary memory is standard on workstations with higher serial numbers.

CONFIGURATION REQUIREMENTS : The configuration requirement for the HP 64320S 25 MHz Logic State/Software Analyzer is that the HP 64321A control board go in the lowest numbered slot of those used by the 25 MHz analyzer. In addition, the HP 64322A data acquisition cards must go in the next consecutive higher numbered slots. This 25 MHz Analyzer configuration is shown in the illustration below.

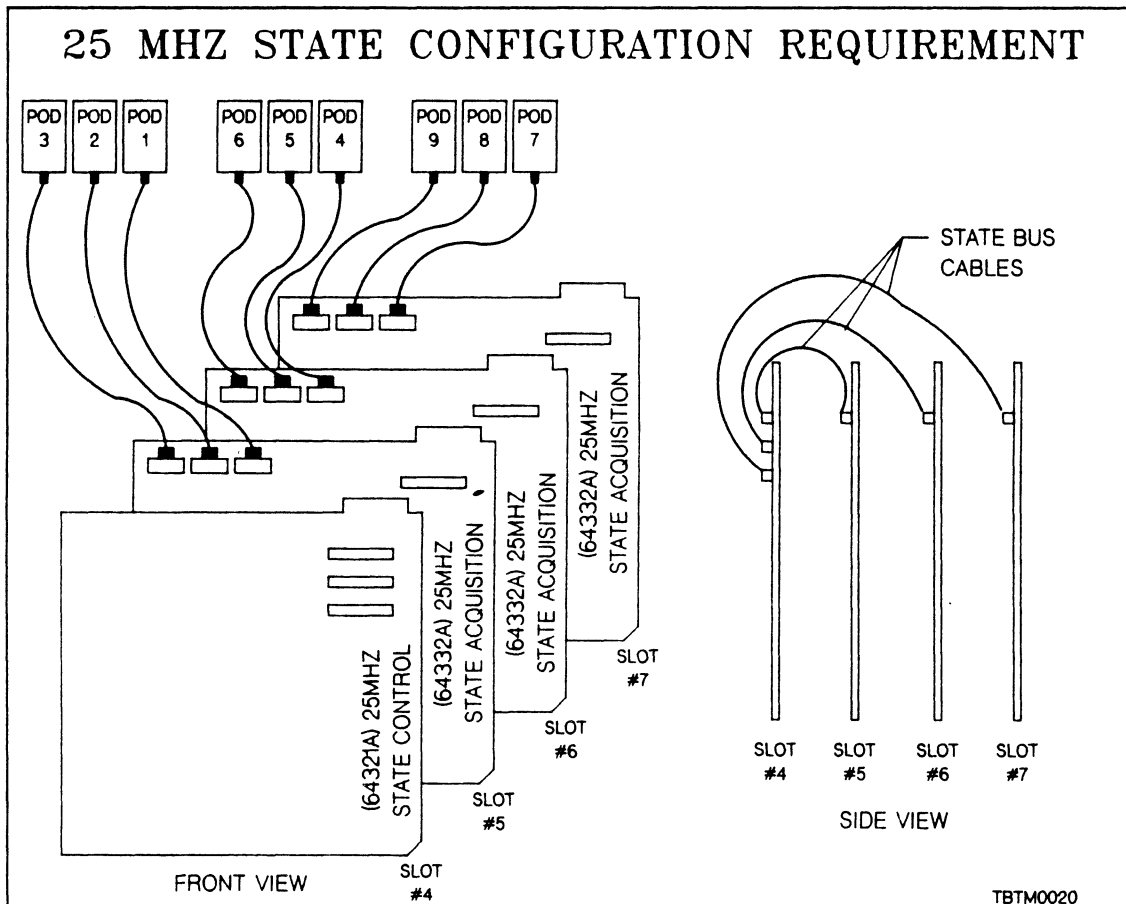

LOGIC HIGH-SPEED TIMING/STATE ANALYSIS

The Logic High-Speed Timing/State Analysis Measurement System consists of:

- o A Timing/State Analyzer Card set
- o Data Probes,
- o Clock Probes
- o Timing/State Bus cable,
- o Delay Pods
- o Optional Graphics Output Card.

A High-Speed Timing/State Analyzer subsystem includes the card set, delay pods, probes and cables, and the timing bus cable. If components such as the Timing/State Analyzer Control Card and Data Acquisition Cards are ordered separately or the system is being expanded, then the Timing/State Bus cable must be specified.

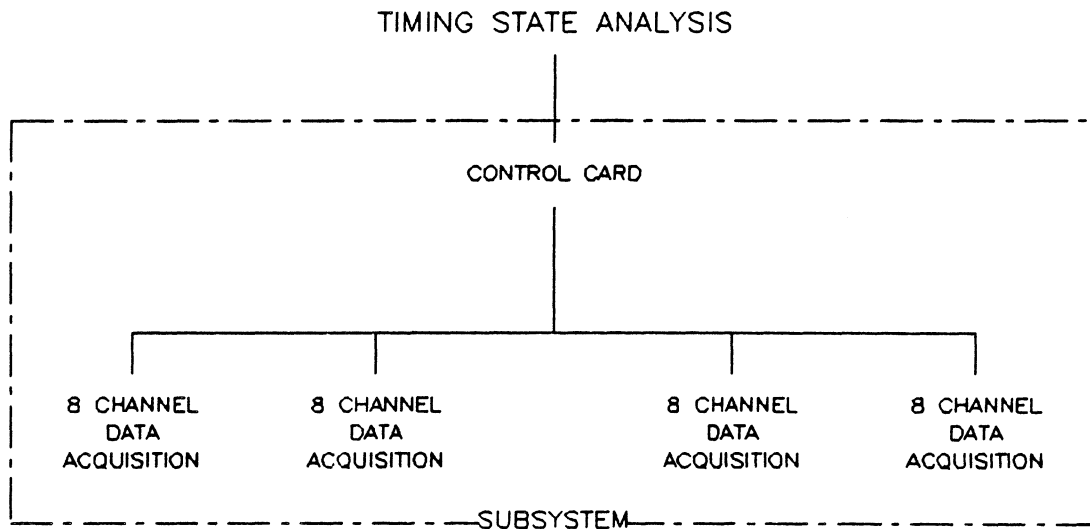

The hardware components of a 64610S Logic Timing/State Analyzer subsystem are illustrated above.

LOGIC TIMING/STATE ANALYSIS SUBSYSTEMS

High-Speed Logic Timing/State Analysis Subsystems can be configured from 8 to 32 input data channels. One to four 8-channel data acquisition cards are used as shown in the table below. These configurations allow all basic modes of operation. Probes are an integral part of the hardware set.

HIGH-SPEED TIMING/STATE ANALYZER

MODEL NO.	DESCRIPTION	CHANNELS	NUMBER OF 8-CHANNEL CARDS
64610S	200 MHz TIMING/STATE ANALYSIS SUBSYSTEM	8	1
OPT 016	200 MHz TIMING/STATE ANALYSIS SUBSYSTEM	16	2
OPT 024	200 MHz TIMING/STATE ANALYSIS SUBSYSTEM	24	3
OPT 032	200 MHz TIMING/STATE ANALYSIS SUBSYSTEM	32	4
OPT 001	200 MHz TIMING ANALYSIS SUBSYSTEM	8	1
OPT 002	200 MHz TIMING ANALYSIS SUBSYSTEM	16	2
OPT 003	200 MHz TIMING ANALYSIS SUBSYSTEM	24	3
OPT 004	200 MHz TIMING ANALYSIS SUBSYSTEM	32	4
OPT 005	UPGRADE 64000S (8 CHANNELS) TO STATE CAPABILITY	(ADDS DELAY POD AND CLOCK PROBE, AND NEW CONTROL BOARD.)	
OPT 006	UPGRADE 64000S (16 CHANNELS) TO STATE CAPABILITY		

GRAPHICS OUTPUT

An optional high resolution Graphics Output Card, the 64050A, is available for use with a graphics output of the timing analyzer. This allows printing of the timing waveform output from the graphics printer exactly as it appears on the screen.

GRAPHICS

MODEL NO.	DESCRIPTION
64050A	OPTIONAL GRAPHICS OUTPUT CARD

The Graphics Output Card does not require any special cabling considerations.

LOGIC TIMING/STATE ANALYZER COMPONENTS

In this section, hardware configuration information is presented to help the current user of a 64610S Logic Timing/State Analyzer expand a measurement system.

The Logic Timing/State Analyzer Subsystem contains a Control Card and up to four 8-channel Data Acquisition Cards. The cards are installed in the development station card cage according to the following rules:

- o In 8-channel systems the Control Card must be in the higher numbered slot of the subsystem. mainframe slots, and one Data Acquisition Card in the higher mainframe slot.
- o In 16-channel systems the Control Card should be between both Data Acquisition cards.
- o In 24-channel systems the Control Card must have two Data Acquisition Cards in the lower mainframe slots, and one Data Acquisition Card in the higher mainframe slot.
- o In 32-channel systems Control Card must have two Data Acquisition Cards in lower mainframe slots, and two Data Acquisition Cards in higher mainframe slots.

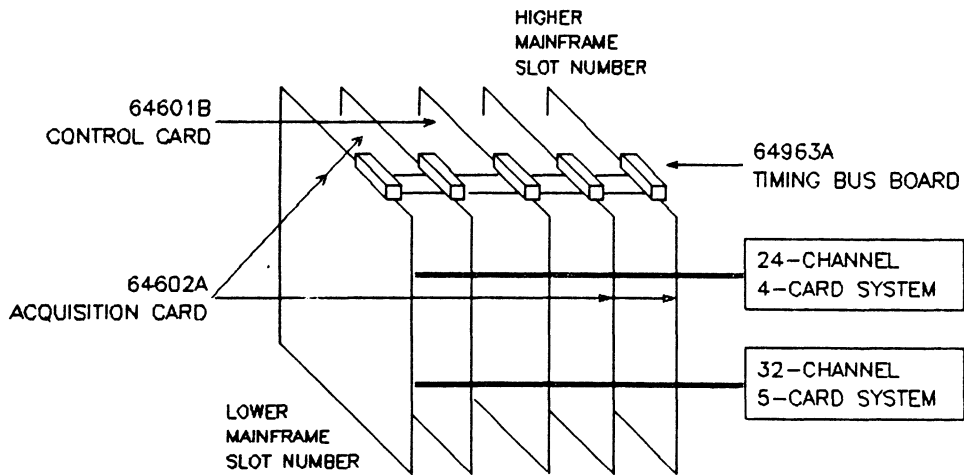
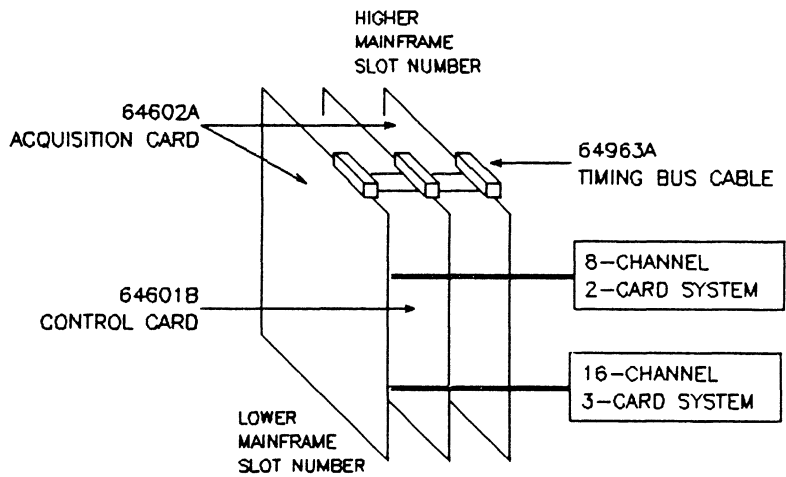

LOGIC TIMING/STATE ANALYZER COMPONENTS, CONT'D

The following table shows the component parts for each specific Timing or Timing/State Analyzer configuration, and the respective 64610S Option numbers.

CONFIGURATION	NEW TIMING/STATE ANALYZER				NEW TIMING ANALYZER			
	8- CHAN	16- CHAN	24- CHAN	32- CHAN	8- CHAN	16- CHAN	24- CHAN	32- CHAN
MODEL 64610S/	NO OPT.	OPT. 016	OPT. 024	OPT. 032	OPT. 001	OPT. 002	OPT. 003	OPT. 004
<u>COMPONENTS</u>								
64601B-CONTROL CARD	1	1	1	1	1	1	1	1
64602A-ACQUISITION CARD	1	2	3	4	1	2	3	4
64604A-DATA PROBE & CABLE	1	2	3	4	1	2	3	4
64605A-CLOCK PROBE & CABLE	1	1	1	1	-	-	-	-
64606A-DELAY POD	1	2	3	4	-	-	-	-
64963A-2-POSITION BUS CABLE	1	-	-	-	1	-	-	-
64963A (OPT.001) 3-POSITION BUS CABLE		1	-	-		1	-	-
64963A (OPT.002) 4-POSITION BUS BOARD			1	-			1	-
64963A (OPT.003) 5-POSITION BUS BOARD				1				1
SOFTWARE	1	1	1	1	1	1	1	1

To expand or upgrade an existing Timing or Timing/State Analyzer, use the following table to select the right components and subsystem options.

NOTE: System calibration is required when updating a system by replacing the HP 64601A with an HP 64601B Control Card. When upgrading for State analysis capabilities, the HP 64602A Acquisition Card in the present system also requires calibration. Please refer to Service Note number 64601B-1 for calibration procedures.

INDIVIDUAL COAXIAL CLOCK CABLES PART NUMBERS/DESCRIPTIONS

64600-61604... 4 Inch	64600-60608...12 Inch	64600-60618...18 Inch
64600-64606... 8 Inch	64600-60617...14 Inch	64600-60612...20 Inch
64600-60616...10 Inch	64600-60610...16 Inch	64600-60614...24 Inch

TIMING/STATE ANALYZER COMPONENT MATRIX

WANT →	8-CHAN TIME	16-CHAN TIME	24-CHAN TIME	32-CHAN TIME	8-CHAN STATE	16-CHAN STATE	24-CHAN STATE	32-CHAN STATE
8-CHAN TIME 64600		1-64602A/001 1-64963A/001 1-64604A	1-64601B 2-64602A/001 1-64963A/002 2-64604A	1-64601B 3-64602A/001 1-64963A/003 3-64604A	1-64610S/005	1-64610S/006 1-64602A 1-64604A 1-64963A/001	2-CLOCK CABLES 1-64606A 1-64610S/016 1-64963A/002	3-CLOCK CABLES 1-64606A 1-64610S/024 1-64963A/003
16-CHAN TIME 64600			1-64601B 1-64602A/001 1-64963A/002 3-64604A	1-64601B 1-64602A/001 1-64963A/003 4-64604A	1-64610S/005	1-64610S/006	1-64610S 1-64963A/002 2-CLOCK CABLES 2-64606A	2-64606A 1-64610S/016 1-64963A/003 2-CLOCK CABLES
8-CHAN TIME 64600		1-64602A 1-64604A 1-64963A/001	2-64602A 2-64604A 1-64963A/002	3-64602A 3-64604A 1-64963A/003	1-64605A 1-64606A	1-64602A 1-64604A 1-64605A 2-64606A 1-64963A/001	2-64602A 2-64604A 1-64605A 3-64606A 1-64963A/002	3-64602A 3-64604A 1-64605A 4-64606A 1-64963A/003
16-CHAN TIME 64610			1-64602A 1-64604A 1-64963A/002	2-64602A 2-64604A 1-64963A/003	1-64605A 1-64606A	1-64605A 2-64606A	1-64602A 1-64604A 1-64605A 3-64606A 1-64932A/002	2-64602A 2-64604A 1-64605A 4-64606A 1-64963A/003
24-CHAN TIME 64610				1-64602A 1-64604A 1-64963A/003	1-64605A 1-64606A	1-64605A 2-64606A	1-64605A 3-64606A	1-64602A 1-64604A 1-64605A 4-64606A 1-64963A/003
32-CHAN TIME 64610					1-64605A 1-64606A	1-64605A 2-64606A	1-64605A 3-64606A	1-64605A 4-64606A
8-CHAN STATE		1-64602A 1-64604A 1-64963A/001	2-64602A 2-64604A 1-64963A/002	3-64602A 3-64604A 1-64963A/003		1-64602A 1-64604A 1-64606A 1-64963A/001	2-64602A 2-64604A 2-64606A 1-64963A/002	3-64602A 3-64604A 3-64606A 1-64963A/003
16-CHAN STATE			1-64602A 1-64604A 1-64963A/002	2-64602A 2-64604A 1-64963A/003			1-64602A 1-64604A 1-64606A 1-64963A/002	2-64602A 2-64604A 2-64606A 1-64963A/003
24-CHAN STATE				1-64602A 1-64604A 1-64963A/003				1-64602A 1-64604A 1-64606A 1-64963A/003
32-CHAN STATE								

58 JULY 7-5 1985

↑
HAVE

GRAPHICS OUTPUT CARD

An optional high resolution Graphics Output card (64050A) is available for use with a graphics printer to provide graphics output of the timing analyzer.

This product is not compatible with mainframes manufactured before 1981. To verify compatibility, check mainframe serial numbers. The serial number prefix must be 2120A and above if manufactured in the US, or 2120J and above if manufactured in Japan. If manufactured in Germany, serial numbers should be 66100-66530 and above.

GRAPHICS

MODEL NO.	DESCRIPTION
64050A	OPTIONAL GRAPHICS OUTPUT CARD

The Graphics Output Card must be placed behind the display controller (slot 0). All necessary cables are included on the board and do not need to be ordered.

CABLING INFORMATION

TIMING BUS

Cards for the Timing Analyzer Subsystem are connected by a cable called the Timing/State Bus Cable. There is a cable available for each configuration:

- o 2-position cable for the 8-channel analyzer
- o 3-position cable for the 16-channel analyzer
- o 4-position Bus board for the 24-channel analyzer
- o 5-position Bus board for the 32-channel analyzer

The appropriate cable can be selected from the following table:

TIMING BUS CABLE

MODEL NO.	DESCRIPTION
64963A	TIMING BUS CABLE, 2-POSITION
OPTION 001	REPLACE WITH 3-POSITION CABLE
OPTION 002	4-POSITION TIMING BUS BOARD
OPTION 003	5-POSITION TIMING BUS BOARD

INTERMODULE BUS

For interactive measurements with other modules, such as another Logic Timing/State Analyzer, a Logic State Analyzer, Emulation Bus Analyzer, or Emulation Bus Preprocessor, the Intermodule Bus (IMB) is implemented via a Intermodule Bus Cable. An IMB Cable must always be ordered separately. When a user expands the system to accommodate a new measurement system, more positions may be needed and thus a new cable may need to be ordered.

Both the control and the data acquisition cards have an edge connector for the IMB cable, however, only the connector on the control card is functional. The connectors on the data acquisition cards only provide mechanical support to the IMB cable.

The following examples include some possible configurations and the required IMB cables.

CONFIGURATION EXAMPLE	SLOT #	0	1	2	3	4	5	6	7	8	
8 CH/16 CH											3-POSITION CABLE
	CARD TYPE		d	c	d	c	d				
16 CH/16 CH											4-POSITION CABLE
	CARD TYPE		d	c	d	d	c	d			
16 CH/8 CH/16 CH											6-POSITION CABLE
	CARD TYPE		d	c	d	d	c	d	c	d	
c - Control Card d - Data Acquisition Card											

INTERMODULE BUS

MODEL NO.	DESCRIPTION
64964A	INTERMODULE BUS CABLE, 2-POSITION
OPTION 001	REPLACE WITH 4-POSITION
OPTION 002	REPLACE WITH 6-POSITION
OPTION 003	REPLACE WITH 8-POSITION
OPTION 004	REPLACE WITH 3-POSITION
OPTION 005	REPLACE WITH 5-POSITION
OPTION 006	REPLACE WITH 7-POSITION

PROM PROGRAMMING

The PROM programming option is available only with the 64100A development station and is not available with the 64110A. A single PROM Programmer Control Card is used in combination with many PROM Modules for various PROM families. The 64500S PROM Programmer Subsystem consists of:

- * The 64501A Control Card;
- * The 64502A Programmer Module (required for performance verification, also programs Intel 2716 and TI2516);
- * A PROM specific Module, and
- * The appropriate software.

The hardware subsystem components are illustrated above. The control card and the 64502A Module are required as they contain self-test circuits for the PROM Programmer. Options to the 64500S PROM Programmer add additional Modules to provide programming capability for various PROMs. All necessary cabling is included in the PROM subsystem. For information relevant when expanding an existing system, see Page 8-3.

PROM PROGRAMMER SUBSYSTEM

MODEL NO.	DESCRIPTION	PROGRAMS
64500S	PROM PROGRAMMER SUBSYSTEM; INCLUDES INTEL 2716 PROM MODULE FOR SELF TEST	INTEL 2716/2758, TI TMS2516/2532 NATIONAL 27C16
OPT 011 (NOTE 1)	ADDS HARRIS HM76XX SERIES PROM MODULE.	HARRIS HM 7640/7641, HM 7640AR/7641AR, HM 7608, HM 7680/7681, HM 7680R/7681R, HM 7680P/7681P, HM 7680RP/7681RP
OPTION 012	ADDS SIGNETICS 82S SERIES PROM MODULE.	SIGNETICS 82S140/141/180/181/190/191, 82S22
OPTION 013	ADDS 2704/B PROM MODULE.	INTEL, TI, AMD, MOTOROLA 2704/2708
OPTION 015	ADDS INTEL 2732/32A PROM MODULE.	INTEL 2732/32A, NATIONAL 27C32
OPTION 016	ADDS INTEL 8748 PROM MODULE.	INTEL 8748/41A, 8748H, 8749H, 8742
OPTION 017	ADDS INTEL 8755A PROM MODULE.	INTEL 8755A
OPTION 018	ADDS MOTOROLA 68764/66 PROM MODULE.	MOTOROLA 68764, 68766, 687L64
OPTION 023	ADDS 2764/27128/27256 MODULE.(NOTE 2)	INTEL 2764, 27256, 2764A, 27128A, 27256, TI 2564, AMP, AM27128, AM 27256, HITACHI: 27128, NEC 27128
OPTION 020	ADDS MOT MC68701 MODULE.	MOT MC68701, MC68701-1, MC68A701, MC68B701
OPTION 022	ADDS INTEL 8751 MODULE.	INTEL 8751
OPTION 023	ADDS INTEL 2764	INTEL 2764, 27128, 27256

NOTE 1: See next page for same list of Modules with their five digit product number.

NOTE 2: The INTEL-igent programming algorithm is also supported by this module with the software revision 2329 and above.

PROM PROGRAMMER COMPONENTS

In this section, hardware configuration information is presented to help the current user of a PROM Programmer Subsystem expand programming capability.

The PROM Programmer subsystem is composed of a PROM Module, a Control Card, and software. The Control Card may be installed in the first available 64100A Development Station card slot toward the front.

For expansion of an existing PROM Programmer Subsystem, use the table below to select modules. Always consult your HP Field Engineer to determine if updated PROM Programmer Software is required. The latest revision software is required with the purchase of a new PROM programmer module for support reasons.

The PROM Programmer Control Card connects to each module via a special cable (Part No. 8120-4336) that is supplied with each PROM Programmer Subsystem and each 64501A Control Card. No additional cables are required when purchasing modules for a PROM Subsystem.

PROM PROGRAMMER HARDWARE PRODUCTS

MODEL NO.	DESCRIPTION	PROGRAMS
64501A	PROM PROGRAMMER CONTROL CARD.	
64502A	INTEL 2716 PROM MODULE. INCLUDES SELF TEST CIRCUITRY	INTEL 2716/2758 TI TMS2516/2532 NATIONAL 27C16
64504A	HARRIS HM76XX SERIES PROM MODULE	HARRIS HM7608,7640/41, 7640AR/41AR,7680/81, 7680R/81R,7680P/81P, 7680PR/81PR
64505A	SIGNETICS 82S SERIES PROM MODULE.	SIGNETICS 82S140/141/ 180/181/190,191,82S2708
64507A	2704/8 PROM MODULE.	INTEL, TI, AMD, MOTOROLA 2704/2708
64509A	INTEL 2732/32A PROM MODULE.	INTEL 2732/32A, NATIONAL 27C32
64510B	INTEL 8748 PROM MODULE.	INTEL 8748/41A,8741H, 8749H,8748
64513A	INTEL 8755A PROM MODULE	INTEL 8755A
64514A	MOTOROLA 68764/66 PROM MODULE	MOTOROLA 68764,68766, 68L764
64515C	2764/27128/27256 PROM MODULE.	INTEL 2764,2764A,27128 27128A,27256,AMD AM27128,AM27256,HITACHI 27128,NEC 27128, TI2564
64516A	27512/27513 PROM MODULE.	INTEL 27512,27513, AMD 27512
64517A	MOTOROLA MC68701 PROM MODULE	MOT MC68701,MC68701-1 MC68A701,MC68B701
64520A	INTEL 8751 PROM MODULE	INTEL 8751,8751H

MULTIMODULE CONFIGURATIONS

The following pages provide diagrams to clarify cabling and card placement issues when interactive measurements and analysis are desired between modules or subsystems within a development station. The following interactive configurations are documented in this section: Interactive is defined as the coordination of measurements between modules.

- o Dual Emulation Subsystems
- o Dual Logic State Subsystems
- o Dual Logic Timing Subsystems
- o Emulation and Multi Internal Analyzers
- o Emulation and Logic State Analysis
- o Emulation and Logic Timing Analysis
- o Logic State and Logic Timing Analysis
- o Emulation, State, and Timing Analysis

Interactive Emulation implies an Internal Analyzer, as the Internal Analyzer in an Emulation Measurement System is the element which interacts with other modules, not the Emulator itself.

Please note that the configurations illustrated in this chapter are the configurations implemented in the factory. When modules are ordered on the same order section as a development station they are placed in the development station and cabled this way before shipment.

Also included in this chapter is general cabling information and the 64303A Intermodule Bus Extender.

NOTE: The cable selection tables correspond with configuration diagrams in this chapter. Cabling needs are configuration dependent. If your configuration differs from the diagrams shown here, so will your cabling requirements.

INTERACTIVE DUAL EMULATION

The configuration below represents the only possible configuration in dual emulation cases which involve the 8051, 80186, and/or 80188 emulators (Models 64264S, 64224S, and 64225S). If the 64303A IMB Extender is to be included it must be placed between the two analysis boards and thus requires an extra position on the IMB Cable.

PLEASE NOTE: IN ALL ILLUSTRATIONS THROUGHOUT THIS GUIDE, THOSE CABLES WHICH ARE PART OF A SUBSYSTEM ARE OUTLINED TO INDICATE THEY ARE INCLUDED IN THE SUBSYSTEM. THOSE CABLES WHICH INTERCONNECT SUBSYSTEMS ARE DARKENED TO ILLUSTRATE THAT THEY MUST BE ORDERED SEPARATELY.

INTERACTIVE DUAL EMULATION (Continued)

- M - MEMORY CARD
- MC - MEMORY CONTROL CARD
- EC - EMULATOR CONTROL CARD
- IA - INTERNAL ANALYZER
- mb - memory bus
- imb - intermodule bus
- tb - timing bus
- eb - emulation bus

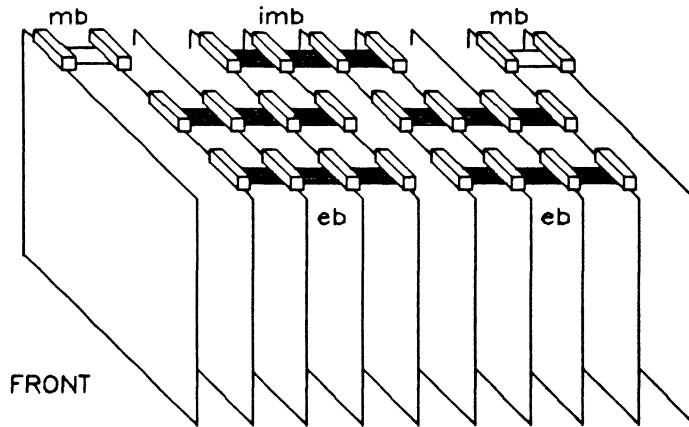
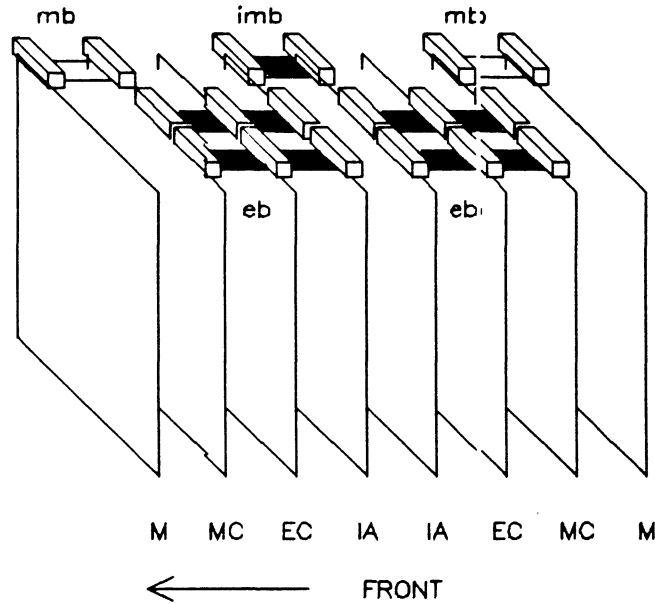

0	1	2	3	4	5	6	7	8	9	SLOT NUMBER
M	MC	EC	EA	SP	SP	EA	EC	MC	M	BOARD TYPE

- EC - Emulation Control Card
- EA - Emulation Bus Analyzer Card
- MC - Memory Control Card
- M - Emulation Memory Card
- SP - Software Performance Analyzer Card
- imb - Intermodule Bus
- eb - Emulation Bus
- mb - Emulation Memory Bus

INTERACTIVE DUAL STATE ANALYSIS

For interactive measurements with any other modules, such as another 64620S Logic State/Software Analyzer, the Intermodule Bus is implemented through a 64964A IMB cable. This cable must always be ordered separately, whereas all intra subsystem cabling is included in the subsystem.

All Logic State/Software Analyzer cards have an edge for the IMB cable, however, only the connector on the control board is functional. The connectors on the data acquisition cards only provide mechanical support to the IMB cable. The following examples include some possible configurations and the required IMB cables:

MULTI-STATE ANALYZER CABLING

CONFIGURATION	SLOT NO.	0	1	2	3	4	5	6	7	8
EXAMPLE										
60 CH/40 CH	CARD TYPE									
60 CH/40 CH/60 CH	CARD TYPE									
c - Control Card										
d - Data Acquisition Card										



The following table can be used to order the required cable:

INTERACTIVE DUAL TIMING ANALYSIS

For interactive measurements with other modules, such as another Logic Timing or High-Speed Timing/State Analyzer, the Intermodule Bus (IMB) is implemented via an 64964A IMB Cable. An IMB cable must always be ordered separately.

Both the control and the data acquisition cards have an edge connector for the IMB cable, however, only the connector on the control card is functional. The connectors on the data acquisition cards only provide mechanical support to the IMB cable.

The following examples include some possible configurations and the required IMB cables.

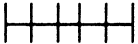
CONFIGURATION EXAMPLE	SLOT #	0 1 2 3 4 5 6 7 8	
8 CH/16 CH			3-POSITION CABLE
	CARD TYPE	d c d c d	
16 CH/16 CH			4-POSITION CABLE
	CARD TYPE	d c d d c d	
16 CH/8 CH/16 CH			6-POSITION CABLE
	CARD TYPE	d c d d c d c d	
c - Control Card d - Data Acquisition Card			

Note that in the first example a 3-position cable would be sufficient. However, a 4-position cable is the next largest cable size available. The extra cable position reaches the next data card and plugs into it mechanically for cable support. See table below to select the appropriate cable for your application.

INTERMODULE BUS

MODEL NO.	DESCRIPTION
64964A	INTERMODULE BUS CABLE, 2-POSITION
OPTION 001	REPLACE WITH 4-POSITION
OPTION 002	REPLACE WITH 6-POSITION
OPTION 003	REPLACE WITH 8-POSITION
OPTION 004	REPLACE WITH 3-POSITION
OPTION 005	REPLACE WITH 5-POSITION
OPTION 006	REPLACE WITH 7-POSITION

EMULATION AND INTERACTIVE MULTI INTERNAL ANALYZERS

Interactive measurements between the 64302A Emulation Bus Analyzer and the 64310A Software Performance Analyzer can be realized through the use of the 64964A Intermodule Bus (IMB). The 64304A Emulation Bus Preprocessor is an Internal Analyzer which interfaces between the State Analysis subsystem and the Emulator and does not interact with other modules. The 6433XX High-Level Software Analyzers are also Internal Analyzers; however, these are software-only products and can only interact with other modules through the 64302A. Details on the 6434XX Real-time, High-Level Software Analyzers are covered in Section 5.

All analysis cards should be placed in adjacent card slots, this will keep IMB cable position requirements at a minimum. The correct Intermodule Bus cable may be selected by referencing the table below.

INTERMODULE BUS REQUIREMENTS

SOFTWARE PERFORMANCE ANALYZERS	EMULATION BUS ANALYZERS	EMULATION SUBSYSTEMS	NUMBER OF POSITIONS NECESSARY
0	1	1	NO IMB CABLE NECESSARY
1	0	1	NO IMB CABLE NECESSARY
1	1	1	2-POSITION
2	0	1	2-POSITION
2	1	1	4-POSITION
0	1	2	NO IMB CABLE NECESSARY
0	2	2	2-POSITION
1	0	2	NO IMB CABLE NECESSARY
2	0	2	2-POSITION
1	1	2	2-POSITION
2	1	2	4-POSITION
1	2	2	4-POSITION
2	2	2	4-POSITION

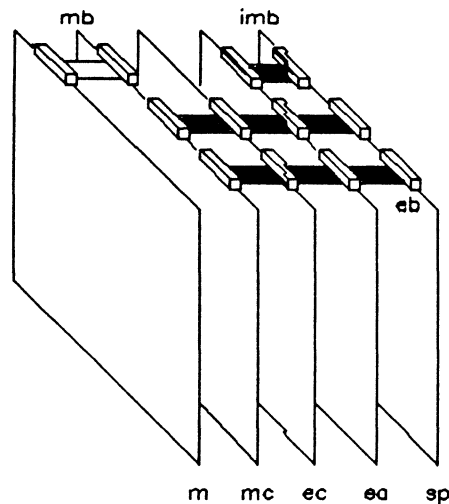

EC-Emulator Control Card
 MC-Memory Control Card
 M-Memory Board
 EA-64302A Emulation Bus Analyzer
 SP-64310A Software Performance

irnb-intermodule bus cable
 eb-emulation bus cable
 mb-memory bus cable

The illustration above contains one emulator with a memory subsystem and two Internal Analyzers. Two four-position emulator bus cables, and one two-position IMB cable is required. (NOTE: Solid black cables interconnect subsystems and must always be ordered; outlined cables are included in the subsystem.)

EMULATION AND INTERACTIVE LOGIC STATE ANALYSIS

The configuration below represents an Emulator with one Internal Analyzer and a 64620S Logic State/Software Subsystem which employs external probing. If an 64304A Emulation Bus Preprocessor were used to probe the Emulation Bus, as well as provide the interface between the Emulator and the State system, the card would be placed in the same position as the Internal Analyzer; however, an IMB cable would not be needed.

If the 64304A were used together with an Internal Analyzer, the 64304A must be placed in the next higher slot after the Emulation Control Card to provide proper configuration of the 64620s. The State Analyzer would then be installed next to the 64304A (in the next higher slot) for easier cable connection.

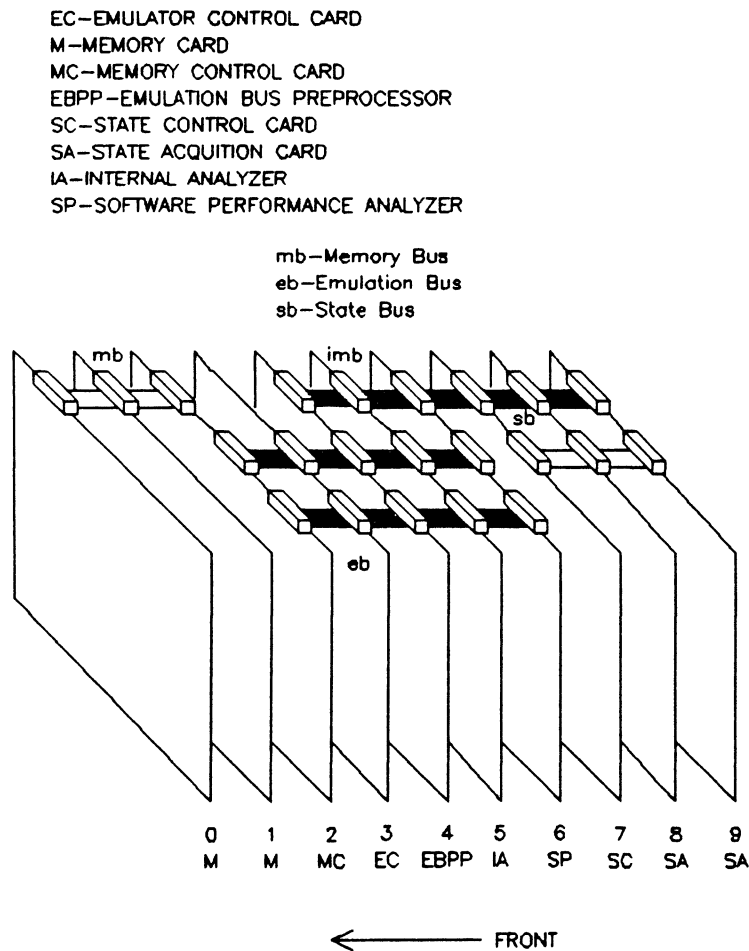

Illustrated above is an Emulation Measurement System (Emulator, Memory, Internal Analysis and Software Performance Analysis, with a 60-channel State Subsystem.

EMULATION AND INTERACTIVE LOGIC TIMING ANALYSIS (16 channels)

Illustrated below is a 16-channel Timing Subsystem interacting with an Emulation Measurement System.

- | | |
|-----------------------------|----------------------------|
| mb - memory bus cable | M - Memory Card |
| imb - intermodule bus cable | MC - Memory Control Card |
| eb - emulation bus cable | EC - Emulator Control Card |
| tb - timing bus cable | IA - Internal Analyzer |
| | DA - Data Acquisition Card |
| | TC - Timing Control Card |
| | DA - Data Acquisition Card |

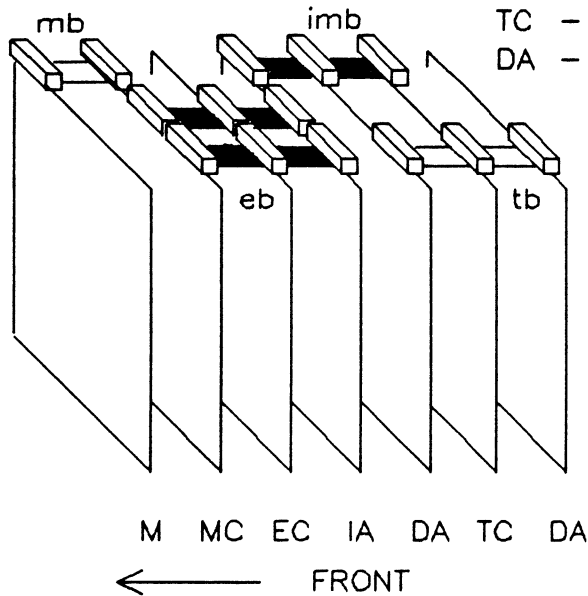

NOTE 1: In this configuration, only a three position IMB cable is needed; however, a 4-position cable is usable. The extra cable position reaches the next data card and plugs into it mechanically for cable support. See table on page 9-3 to select the appropriate option.

NOTE 2: Solid black cables interconnect subsystems and must always be ordered; outlined cables are included with the subsystem.

INTERACTIVE LOGIC STATE AND LOGIC TIMING ANALYSIS

Interactive measurements between two or three subsystems of both Logic State/Software Analysis and Logic Timing Analysis are possible. Remember that the Logic Timing Control Card must be in the highest numbered slot of an 8-channel subsystem, and between the Timing Acquisition Cards in a 16-channel subsystem. Also remember that the Logic State Control Card must be in the lowest numbered slot of its subsystem. The correct Intermodule Bus Cable may be selected with the aid of the following diagram and table.

The illustration below is a 16-channel Logic Timing subsystem connected to a 60-channel State Software Analysis subsystem and a 40-channel Logic State/Software Analysis subsystem. A 6-position Intermodule Bus Cable is necessary.

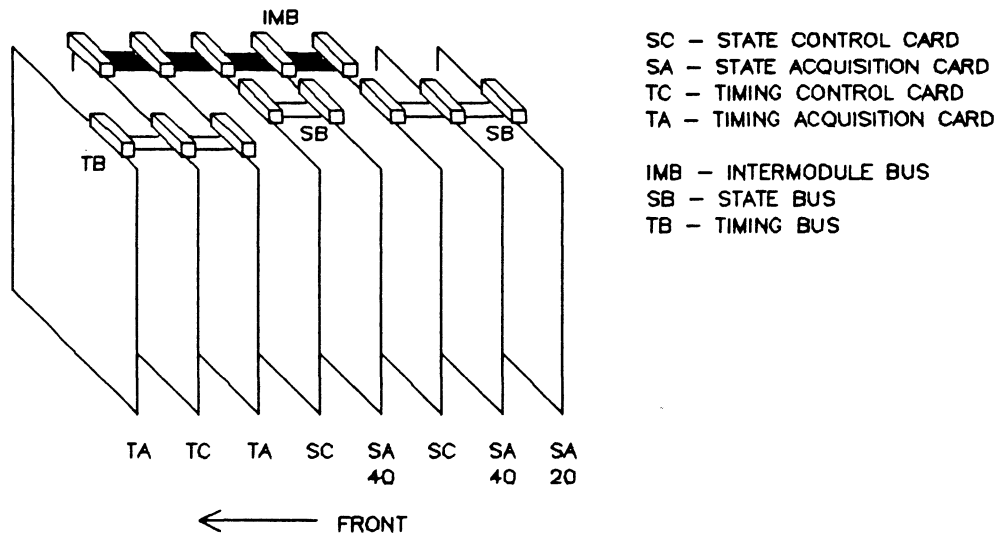

(NOTE: Solid black cables interconnect subsystems and must always be ordered; outlined cables are included with the subsystem.)

CHANNEL/INTERMODULE BUS REQUIREMENTS

8-CH TIME	16-CH TIME	STATE	INTERMODULE BUS CABLE SIZE
1	0	1	2-POSITION
0	1	1	3-POSITION
2	0	1	4-POSITION
0	2	1	6-POSITION
1	1	1	5-POSITION
1	0	2	NOTE A
0	1	2	NOTE B

NOTE A: DETERMINE THE TOTAL NUMBER OF CARDS IN THE SMALLEST LOGIC STATE/SOFTWARE SUBSYSTEM AND ADD TWO. ORDER A CABLE WITH POSITIONS EQUAL TO OR GREATER THAN THIS SUM.

NOTE B: DETERMINE THE TOTAL NUMBER OF CARDS IN THE SMALLEST LOGIC STATE/SOFTWARE SUBSYSTEM AND ADD THREE. ORDER A CABLE WITH POSITIONS EQUAL TO OR GREATER THAN THIS SUM.

INTERACTIVE EMULATION, LOGIC STATE, AND LOGIC TIMING ANALYSIS

Interactive measurements between one or two emulator subsystems and Logic Analysis is possible. Remember that the Logic Timing Control Card must be in the highest numbered slot of an 8-channel subsystem, and between the Timing Acquisition Cards in a 16-channel subsystem; and that the Logic State/Software Analysis Control Card must be in the lowest numbered slot of its subsystem. The correct Intermodule Bus Cable may be selected with the aid of the table below.

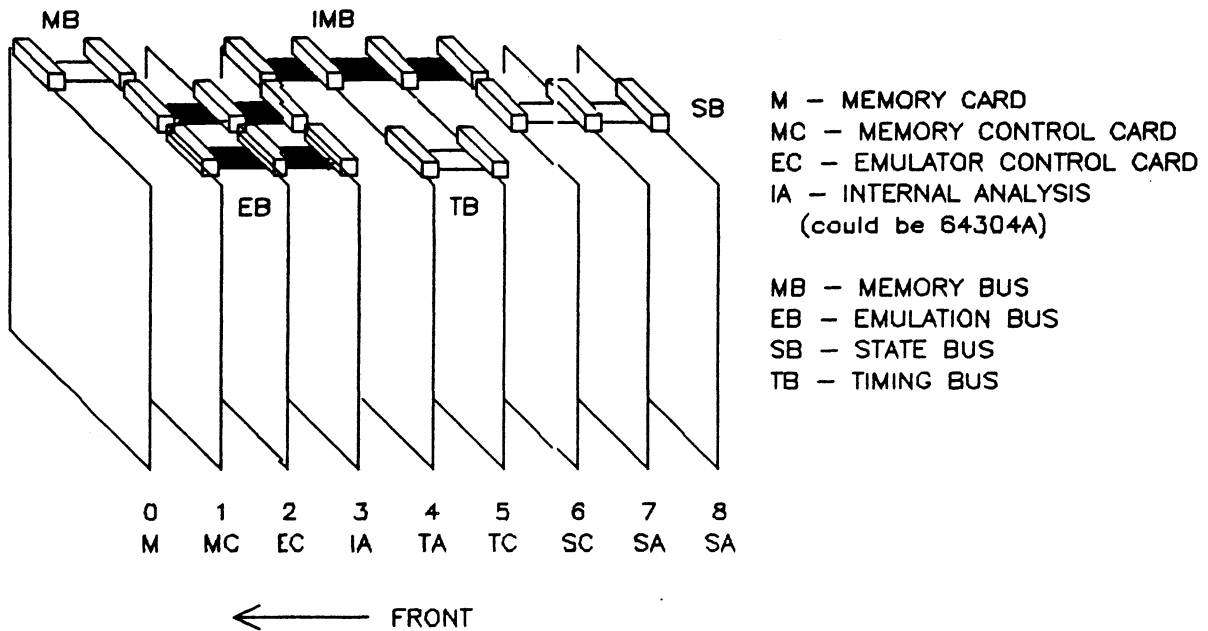

(NOTE: Solid black cables interconnect subsystems and must always be ordered; outlined cables are included with the subsystem.)

To synchronize measurements with an 64304A Emulation Bus Preprocessor as the Internal Analyzer, the configuration would be the same but without an IMB cable.

INTERMODULE BUS SELECTION

8-CH TIME	16-CH TIME	STATE	INTERNAL ANALYZER	INTERMODULE BUS CABLE SIZE
1	0	0	1	3-POSITION
0	1	0	1	3-POSITION
0	0	1	1	2-POSITION
1	0	1	1	4-POSITION
0	1	1	1	5-POSITION
1	1	0	1	5-POSITION
0	0	2	1	NOTE A
0	1	0	2	4-POSITION
1	0	0	2	4-POSITION
0	0	1	2	3-POSITION

NOTE A: DETERMINE THE TOTAL NUMBER OF CARDS IN THE LOGIC STATE SUBSYSTEM AND (THE SMALLER IF TWO SUBSYSTEMS IN STATION) ADD TWO. ORDER A CABLE WITH POSITIONS EQUAL TO OR GREATER THAN THIS SUM.

INTERMODULE BUS EXTENDER

The Intermodule Bus Extender, or 64303A IMB Extender is a single card that enables the consolidation of two or more stations into one interactive measurement system. Each 64000 station in this multi-station measurement system that will be receiving IMB signals must include an IMB Extender to take advantage of shared resources between stations.

The IMB Extender is connected to the other cards in the station through the internal 64964A IMB Cable. Thus an extra position on the IMB cable is required for the 64303A IMB Extender. The 64303A can be placed in any slot in the station, however the factory places the IMB Extender next to the Internal Analyzers in a station for ease of cabling.

The connection between stations is made using standard 50 ohm coax cables attached to the BNC connectors at the back of each station. If more than two stations are to be included in the measurement system, 50 ohm T connectors must be used. These cables may be a maximum of 30 meters in length. (HP has a 112 cm., (48 in) cable, part no. 11170C available). The number of coax cables needed, from one to four, will vary depending on measurement complexity. To determine the appropriate number for your application, consult the IMB Extender data sheet, part no. 5953-9232.

The diagram below illustrates a two-station configuration.

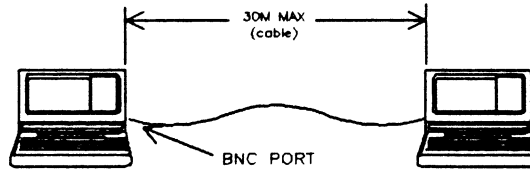

EXAMPLE OF AN IN-STATION CONFIGURATION

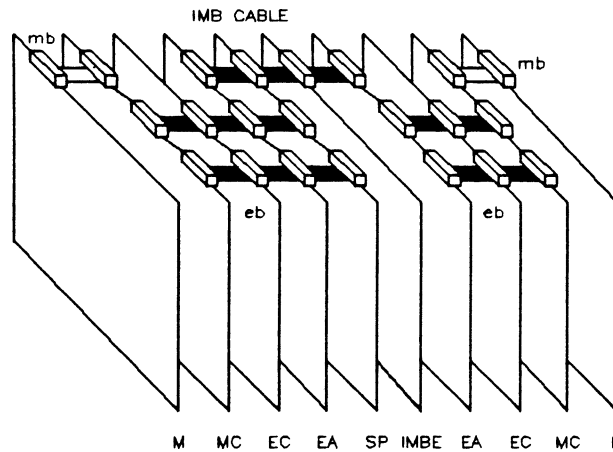

M-EMULATION MEMORY CARD
 MC-MEMORY CONTROL CARD
 EC-EMULATION CONTROL CARD

EA-EMULATION BUS ANALYZER CARD
 SP-SOFTWARE PERFORMANCE ANALYZER
 IMBE-IMB EXTENDER CARD

← FRONT

The illustration above is a dual emulation and card placement configuration with an IMB Extender. Note that the IMB Cable must connect to both the IMB Extender and any Internal Analyzer card.

CABLE PRODUCTS

CABLE PRODUCTS SUMMARY

MODEL NO.	DESCRIPTION	PART NUMBER
64960A	EMULATION/MEMORY BUS CABLE; 2-POSITION CABLE	64960-61601
* OPTION 001	REPLACE 2-POSITION WITH 3-POSITION	64960-61602
OPTION 002	REPLACE 2-POSITION WITH 4-POSITION	64960-61603
OPTION 003	REPLACE 2-POSITION WITH 5-POSITION	64960-61604
OPTION 004	REPLACE 2-POSITION WITH 6-POSITION	64960-61605
OPTION 005	REPLACE 2-POSITION WITH 7-POSITION	64960-61606
OPTION 006	REPLACE 2-POSITION WITH 8-POSITION	64960-61607
OPTION 007	REPLACE 2-POSITION WITH 9-POSITION	64960-61608
64962A	STATE ANALYSIS BUS CABLE; 2-POSITION CABLE	8120-4086
* OPTION 001	REPLACE 2-POSITION WITH 3-POSITION	8120-4087
OPTION 002	REPLACE 2-POSITION WITH 4-POSITION	8120-4088
64963A	TIMING ANALYSIS BUS CABLE; 2-POSITION	8120-4094
OPTION 001	REPLACE 2-POSITION WITH 3-POSITION	8120-4093
OPTION 002	REPLACE 2-POSITION WITH 4-POSITION	64600-66502
OPTION 003	REPLACE 2-POSITION WITH 5-POSITION	64600-66503
64964A	INTERMODULE BUS CABLE; 2-POSITION	8120-4089
* OPTION 001	REPLACE 2-POSITION WITH 4-POSITION	8120-4090
OPTION 002	REPLACE 2-POSITION WITH 6-POSITION	8120-4091
OPTION 003	REPLACE 2-POSITION WITH 8-POSITION	8120-4092
OPTION 004	REPLACE 2-POSITION WITH 3-POSITION	64964-61601
OPTION 005	REPLACE 2-POSITION WITH 5-POSITION	64964-61602
OPTION 006	REPLACE 2-POSITION WITH 7-POSITION	64964-61603

* ONLY ONE OPTION MAY BE SPECIFIED PER PRODUCT

** THE CABLE PART NUMBER MUST BE USED WHEN ORDERING CABLES SEPARATLY THROUGH CORPORATE PARTS CENTER. THESE CABLES ARE NOT UNDER LOGIC SYSTEMS NO CHARGE POLICY.

HP-IB CABLES

Each HP 64000 Development Station and the 7908P Disc Drive come with a two-meter HP-IB cable. The 7911P, 7912P, and 7914P Disc Drives come with a one-meter HP-IB cable. A 64000 System Printer is not supplied with an HP-IB cable. For customers requiring special configurations or for installation of a system printer with a bus disc which does not include a cable (see specific disc description), additional HP-IB cables may be ordered in lengths from one-half to four meters. The maximum allowable HP-IB cable length for a clustered 64000 System installation is twenty meters total (no specific limits between devices with the exception of certain printer configurations, see printer section). If only a single hard disc and development station is connected, then the maximum cable length is eighteen meters.

HP-IB cables can be connected end to end. For different lengths other than those listed below please contact your local HP Field Engineer.

HP-IB CABLES

MODEL NO.	PART NO.	DESCRIPTION
10833A	8120-3445	1-METRE HP-IB CABLE, SHIELDED
10833B	8120-3446	2-METRE HP-IB CABLE, SHIELDED
10833C	8120-3447	4-METRE HP-IB CABLE, SHIELDED
10833D	8120-3444	0.5-METRE HP-IB CABLE, SHIELDED

RS-232 C CABLES

Two HP RS-232-C cables are listed in the following table. These cables satisfy the connection requirements of most RS-232-C devices connected to an HP 64000 Logic Development Station. However, since cabling requirements depend on device connections, it is recommended that an HP Field Engineer be consulted for assistance when configuring your system.

RS-232-C CABLES

MODEL NO.	DESCRIPTION
13242-60002	RS-232-C CABLE, 5 M (16.7 FT). MALE-TO-MALE STANDARD 25-PIN RS-232-C CONNECTORS. THE FOLLOWING PINS WIRED END-TO-END: 1 THRU 8, 12, 15, 17, 19, 20, 22, 23, 24
13242-60005	RS-232-C CABLE, 5 M (16.7 FT). MALE-TO-MALE STANDARD 25-PIN RS-232-C CONNECTORS. THE FOLLOWING PINS WIRED END-TO-END: 1, 2, 3, 7

CABLE CLAMPS

When installing LOGIC STATE or LOGIC TIMING ANALYSIS in a 64100A Development Station check to see whether the station is equipped with all emulation cable clamps at the rear of the card cage where cables exit to emulation and/or measurement pods. If all three cable clamps are bar clamps, then order two fuse clip type clamps, and install in place of the respective bar clamps.

CABLE CLAMP

PART NO.	DESCRIPTION
64100-01204	CABLE CLAMP ASSEMBLY

PERIPHERALS

DISC DRIVES

A 64000 System bus disc may be connected to one or more (up to six) development stations and a printer to form a shared data base cluster. Except in single, stand-alone station configurations, the cluster must be supported by a system disc.

The CS-80 protocol Winchester disc drives are available in two families: floor, pod-type units with casters, and integrated 1/4-inch streaming tape drives or small footprint, desktop units with or without 1/4-inch streaming tape drives. These Winchester discs may be mixed on the same cluster; however, each disc takes up one of the eight available System Bus addresses. Hence, the second and each subsequent disc requires giving up either a potential printer or a potential development station address.

The 7906M, 7920M, and 7925M discs, from HP's Multi-Access Controller (MAC) Family, use removable hard-disc media. Any of these discs may be mixed on a cluster; however they may not reside in the same cluster with CS-80 discs. The MAC discs may share the disc controller, so that only one System Bus address is used, thus allowing the maximum configuration of six stations and printer with up to eight disc drives. (For multiple MAC drives, consult your HP Field Engineer for special ordering instructions.)

When ordering any of the 64000 System disc drives, be certain to use the System Reference number: 64000S Logic Development System. The System Reference number is required to distinguish a 64000 System disc order from other HP disc orders. Include the disc as a sub-item to the 64000S reference number. HP-IB cables are supplied with all discs except the 9134D and 9134XV. For disc accessories, consult the HP Computer Users Catalogue and order from the Computer Supplies Division.

NOTE: All disc capacities are formatted capacities.

CS/80 DISC DRIVE FAMILY (SEE NOTE 1)

MODEL NO.	SIZE	DESCRIPTION (NOTE 2)	HP-IB CABLE
7911P	28.1 MB	DISC AND 1/4" CARTRIDGE TAPE DRIVE WITH HP-IB INTERFACE	1 METER
7912P	65.6 MB	DISC AND 1/4" CARTRIDGE TAPE DRIVE WITH HP-IB INTERFACE	1 METER
7914P	132.1 MB	DISC AND 1/4" CARTRIDGE TAPE DRIVE WITH HP-IB INTERFACE	1 METER
OPT 015		220/240V 50HZ OPERATION(FIELD CHANGE-ABLE TO 110/120V) SEE NOTE 2.	
OPT 140		DELETE CARTRIDGE TAPE DRIVE	

64000 SYSTEM DISC DRIVES (continued)

CS/80 SMALL FOOTPRINT DISC DRIVE (SEE NOTE 1)

MODEL NO.	SIZE	DESCRIPTION (NOTE 2)	HP-IB CABLE
7907A	41 MB	20.5 FIXED/20.5 REMOVABLE DISC WITH HP-IB INTERFACE AND 8" DISC CARTRIDGE	1 METER
7941A	24 MB	DISC WITH HP-IB INTERFACE	1 METER
7942A	24 MB	DISC AND 1/4" CARTRIDGE TAPE DRIVE WITH HP-IB INTERFACE	1 METER
7945A	55 MB	DISC WITH HP-IB INTERFACE	1 METER
7946A	55 MB	DISC AND 1/4" CARTRIDGE TAPE DRIVE WITH HP-IB INTERFACE	1 METER
9134D	14.5 MB	DISC WITH HP-IB INTERFACE	NOT INCL.
9134H	20 MB	DISC WITH HP-IB INTERFACE	NOT INCL.
OPT 015		SET SWITCH TO 230V	
OPT 005		DELETES HP-IB	
9144A	67 MB	STANDALONE 1/4" TAPE DRIVE (NOTE 3)	NOT INCL.

AMIGO DISC DRIVE FAMILY (SEE NOTE 1)

MODEL NO.	SIZE	DESCRIPTION (NOTE 2)	HP-IB CABLE
7906M	19.6 MB	MASTER DISC DRIVE (INCLUDES 13037C CONTROLLER); MUST ORDER OPT. 102.	
7906S	19.6 MB	SLAVE (ADD-ON) DISC DRIVE WITH DATA AND MULTI-UNIT CABLE INCLUDED.	
7920M	50 MB	MASTER DISC DRIVE (INCLUDES 13037C CONTROLLER); MUST ORDER OPT.102.	
7920S	50 MB	SLAVE (ADD-ON) DISC DRIVE WITH DATA AND MULTI-UNIT CABLE INCLUDED.	
7925M	120 MB	MASTER DISC DRIVE (INCLUDES 13037C CONTROLLER); MUST ORDER OPT. 102.	
7925S	120 MB	SLAVE (ADD-ON) DISC DRIVE WITH DATA AND MULTI-UNIT CABLE INCLUDED.	
OPT 015		230V/50HZ OPERATION FOR EITHER DISC (SEE NOTE 2.)	
OPT 102		ADDS 12745A HP-IB INTERFACE TO MASTER DISC; REQUIRED FOR 64000.	
OPT 001		CHANGES CABLE LENGTHS ON SLAVE UNITS FROM 5.5M (18 FT.) MULTI-UNIT AND 7.6M (25 FT.) DATA CABLES TO 12 FT. AND 10 FT. RESPECTIVELY.	2 METERS

NOTE 1: 64000S System Reference Number must precede all Disc Drive orders with Disc Drives appearing as a subitem.

NOTE 2: Disc Drive orders must indicate the destination country for the correct power cord to be included.

NOTE 3: The 9144 unit must be used with a CS/80 Disc Drive, only.

PRINTERS

Only a single printer may be configured on the System Bus; additional RS-232-C printers may be connected to individual development stations to provide local output (see restrictions).

Printers are not supplied with HP-IB cables; the cable supplied with the bus disc and/or development station may be used. In the case where a printer is connected to a bus disc which does not have a cable (see specific 64000 System printers description), a cable must be ordered separately (see Cable Products in Multi Module section).

When ordering any of the printers, be certain to use the System Reference number: 64000S Logic Development System. The System Reference number is required to distinguish a 64000 System printer order from other HP printer orders. Include the printer as a sub-item to the 64000S reference number.

An optional Graphics Output Card, 64050A, is required in the 64100A and 64110A stations to print the timing waveform diagrams on the printer exactly as it appears on the screen. Without this card the waveform diagram is printed vertically on the printer's pages.

(SEE NOTES 1 AND 2)

MODLE NO.	SPEED	DESCRIPTION (NOTE 3)	CHAR./LINE
2563A	300 LPM	5X13 DOT MATRIX, IMPACT GRAPHICS, LINE PRINTER WITH HP-IB; MUST ORDER OPT 264, HP-IB INTERFACE	132
OPT 015 OPT 016 OPT 017 OPT 264 OPT 068 OPT 110 OPT 112 OPT 115		220 VAC, 50/60 HZ 100 VAC,50/60 HZ 240 VAC, 50/60 HZ 64000 BUS CONFIGURATION THREE SERIES 300 LP RIBBONS SOUND ABATEMENT ATTACHMENT ENCLOSED PRINTER STAND PASSIVE PAPER STACKER FOR USE WITH OPT 112	
2932A	200 CPS, BI-DIR	9X12 DOT MATRIX, IMPACT, GRAPHICS OFFICE PRINTER (SEE ACCESSORIES BELOW); MUST ORDER OPT 046, HP-IB INTERFACE	136
2934A	200 CPS, BI-DIR	9X12 DOT MATRIX, IMPACT, GRAPHICS OFFICE PRINTER (SEE ACCESSORIES BELOW); MUST ORDER OPT 046,HP-IB INTERFACE	136
OPT 046		HP-IB INTERFACE FOR 2932 OR 2934A PRINTER, CABLE NOT INCLUDED; NOTE BUS CONFIGURATION	
2673A	120 CPS, BI-DIR	9X15 DOT MATRIX, THERMAL GRAPHICS PRINTER WITH HP-IB	80

NOTE: The 2563A Dot Matrix Impact Printer will not function in a stand-alone configuration.

2932A AND 2934A ACCESSORIES

(SEE NOTE 4)

MODEL NO.	DESCRIPTION
92171G	PAPER CATCHER FOR TABLE TOP
92214P	PRINTER STAND INCLUDING CABINET, PAPER CATCHER AND CASTERS
92154B	PRINT HEAD, AVERAGE LIFE OF 200 MILLION CHARACTERS
92155L	3 RIBBON PACK, AVERAGE RIBBON LIFE 10 MILLION CHARACTERS

NOTE 1: 64000S System Reference Number must precede all printer orders with the printer appearing as a sub-item.

NOTE 2: To use the printer's graphics capabilities the station must be configured with 64050A Graphics Output Card.

NOTE 3: Printer orders must indicate the destination country for the correct power cord to be included.

NOTE 4: Accessories shown for reference only; do not order with the 64000S System Reference Number; Order through Computer Supplies Division Computer Users Catalog.

SOFTWARE

HP 64000 LOGIC DEVELOPMENT SYSTEM

The HP 64000 Logic Development System, whether a stand-alone unit or a cluster configuration, supports a wide variety of software development functions. This section is divided into four categories:

- o Cross Assemblers
- o Cross Compilers
- o Right-to-Reproduce Products
- o One-Time Update Products

All 64000 System software may reside concurrently on the hard-disc in a cluster system. Stand-alone Development Stations allow software to be selectively configured onto flexible discs. Series of processors supported by the same assembler or compiler is explicitly stated.

CROSS-ASSEMBLERS Each assembler includes the required processor specific linker.

CROSS COMPILERS Pascal and C Language cross compilers for specific processors include the linker and run-time libraries. However, it is highly recommended that assembler for the specific microprocessor also be ordered to provide flexibility in software development.

In all cases a 64032A Host RAM expansion card or 64100A or 64110A with integral expanded memory (serial numbers prefix 2309A or greater) is required for compiler operation.

RIGHT TO REPRODUCE SOFTWARE For customers who own more than one HP 64000 system it is possible to order additional copies at a significant discount. The Right to Reproduce products are now available, namely as an -AR and a +W00 suffix product.

1. The Right to Reproduce products (-XR suffix, supplied by LSD) provides a customer with a license to make one copy of an HP 64000 software product for each additional 64000 cluster (six stations with a hard disc). For example, the Right to Reproduce product must be purchased if any -A, -XA, or -AF suffix product from the first cluster, is wanted to run on a second or any additional cluster.

2. The Software Materials Subscription (software updates service, supplied by ISD), suffix +S00 (except +S43 which designates the media type for the HP 64000 Operating System) also has a Right to Reproduce (+W00) associated with it. This +W00 suffix gives the user the right reproduce SMS products. See the following table. (For details on SMS please refer to Section 13.)

Included in the purchase of the Right-to-Reproduce products are the software manual, change sheets (if applicable), and a license describing aspects of the software usage.

ONE-TIME UPDATE PRODUCTS The One-Time Update products (-AX suffix) enable customers who have not subscribed to HP's Software Update Service to bring a system to a supported level on a product-by-product basis. Since LSD only supports the latest revision, this product is usually needed in order to install add-on products.

PRODUCT/SUFFIX	RIGHT TO REPRODUCE	ONE-TIME UPDATE
LSD 64xxxAF 64xxxA 64xxxS	64xxxAR 64xxxAR 64xxxAR	64xxxAX 64xxxAX 64xxxAX
ISD 64100AF+S43 64XXXXA+S00	64100AF+W00 64XXXXA+W00	----- -----

HP 64000 SOFTWARE, CONTINUED

CROSS ASSEMBLER SOFTWARE

MODEL NO. FLEX DISC	DESCRIPTION
64840AF	8080/8085 CROSS ASSEMBLER/LINKER
64841AF	6800 CROSS ASSEMBLER/LINKER SUPPORTS: 6800, 6801, 6802, 6803, 8861, 6301, 6303
64842AF	Z80 CROSS ASSEMBLER/LINKER SUPPORTS: Z80, NSC800
64843AF	6502 CROSS ASSEMBLER/LINKER SUPPORTS: 6501, 6502, 6503, 6504, 6505, 6511, 6512, 6514
64844AF	6805/6809 CROSS ASSEMBLER/LINKER
64845AF	68000 CROSS ASSEMBLER/LINKER SUPPORTS: 68000, 68008, 68010
64846AF	8048 FAMILY CROSS ASSEMBLER/LINKER SUPPORTS: 8048, 8049, 8748, 8749, 8021, 8022, 8035, 8039, 8040, 8041, 8042, 8741
64847AF	9900 CROSS ASSEMBLER/LINKER SUPPORTS: 9900, 9980, 9981, 9985, 9989, 9940, 99105A, 99110A
64848AF	1802 CROSS ASSEMBLER/LINKER
64849AF	F8/3870 CROSS ASSEMBLER/LINKER
64850AF	Z8 CROSS ASSEMBLER/LINKER
64851AF	USER-DEFINABLE CROSS ASSEMBLER/LINKER
64852AF	HP 1000L CROSS ASSEMBLER/LINKER
64853AF	8086 CROSS ASSEMBLER/LINKER SUPPORTS: 8086, 8087, 8088, 8089, 80186, 80188, V20/30, 80286*
64854AF	Z8000 CROSS ASSEMBLER/LINKER SUPPORTS: 8001, Z8002
64855AF	8051 CROSS ASSEMBLER/LINKER
64857A	CROSS ASSEMBLER/LINKER FOR MIL-STD-1750A INSTRUCTION SET ARCHITECTURE SUPPORTS F9450
64858A	TMS320 CROSS ASSEMBLER/LINKER
64861A	MICROASSEMBLER/LINKER
64860A	8096 CROSS ASSEMBLER/LINKER

* LIMITED CODE GENERATION IN VIRTUAL ADDRESS MODE.

HP 64000 SOFTWARE, CONTINUED

PASCAL/64000 CROSS COMPILER SOFTWARE

MODEL NO. FLEX DISC	DESCRIPTION
64811AF	6800 PASCAL CROSS COMPILER SUPPORTS: 6800, 6801, 8602, 8603, 6808, 6301 (ALL WITH 6800 CODE)
64813AF	6809 PASCAL CROSS COMPILER
64814AF	8086 PASCAL CROSS COMPILER SUPPORTS: 8086, 8088, 80186,80188, 80286**
64815AF	68000 PASCAL CROSS COMPILER SUPPORTS: 68000, 68008, 68010
64816AF	Z8000 PASCAL CROSS COMPILER SUPPORTS: Z8001, Z8002
64817AF	HOST PASCAL COMPILER
64823A	Z80 PASCAL CROSS COMPILER SUPPORTS: Z80, NSC800
64825A	8085 PASCAL CROSS COMPILER SUPPORTS: 8085, 8080

C/64000 CROSS COMPILER SOFTWARE

MODEL NO. FLEX DISC	DESCRIPTION
64818AF	8086 C CROSS COMPILER SUPPORTS: 8086, 8088, 80186, 80188, 80286**
64819AF	68000 C CROSS COMPILER SUPPORTS: 68000, 68008, 68010
64820AF	Z8000 C CROSS COMPILER SUPPORTS: Z8001, Z8002
64821AF	6800 C CROSS COMPILER SUPPORTS: 6800, 6801, 6802, 6803, 6808, 6301 (ALL WITH 6800 CODE)
64822AF	6809 C CROSS COMPILER
64824A	Z80 C CROSS COMPILER SUPPORT: Z80, NASC800
64826A	8085 C CROSS COMPILER SUPPORTS: 8085, 8080

** CODE GENERATION IN REAL ADDRESS MODE ONLY.

SOFTWARE

HOSTED DEVELOPMENT SYSTEMS

INTRODUCTION

The HP 64000 Logic Development System allows users to develop software for microprocessor-based applications on host computers. Currently supported host systems are the HP 9000 Series 500 computer with an HP-UX operating system, HP 9000 Series 200 with an HP-UX operating system, and the Digital Equipment Corporation, VAX Series computer with a VMS operating system. (Refer to Section 3, "Hosted Development Systems," for hardware details.)

The Hosted Development System Software is application software usable in HP-UX or VMS operating systems for HP 64000 Logic System Development applications. All the utilities to support communication, file transfers and remote control of a HP 64000 system from a host computer terminal are included.

HOSTED DEVELOPMENT SYSTEM SOFTWARE

MODEL NO.	DESCRIPTION
64880A	HP-UX 9000 SERIES 500 COMPUTER SYSTEM (SUPPLIED ON DC-150 CARTRIDGE TAPE)
64881A	HP-UX 9000 SERIES 200 COMPUTER SYSTEM (SUPPLIED ON DC-150 CARTRIDGE TAPE)
64882A	DIGITAL EQUIPMENT CORPORATION VAX COMPUTER WITH VMS OPERATION SYSTEM (SUPPLIED ON 1600 BPI 9 TRACK MAGNETIC TAPE)

PASCAL OR C LANGUAGE SYSTEM

The Pascal or C language system provides a complete high level programming language facility to develop software for a particular target microprocessor. Each language system consists of two compilers, two assemblers and two linkers - one of each running on the host computer system and the other operating on a 64000 workstation. (Note: The option is used to designate the host computer system.)

NOTE: VAX and VMS are trademarks of Digital Equipment Corporation.

PASCAL OR C LANGUAGE , CONTINUED

PASCAL LANGUAGE SYSTEM

MODEL NO.	DESCRIPTION	9000/ S500 HP-UX*	9000/ S200 HP-UX*	DEC/ VAX VMS**
64811S	6800 PASCAL LANGUAGE SYSTEM SUPPORTS 6800, 6801, 6802, 6803, 6808, 6301 (ALL WITH 6800 CODE).	OPTION 001	OPTION 002	OPTION 003
64813S	6809/6809E PASCAL LANGUAGE SYSTEM.	↓	↓	↓
64814S	8086 PASCAL LANGUAGE SYSTEM SUPPORTS 8086, 8088, 80186 AND 80188, 80286***.	↓	↓	↓
64815S	68000 PASCAL LANGUAGE SYSTEM SUPPORT 68000, 68008 AND 68010.	↓	↓	↓
64816S	Z8001 PASCAL LANGUAGE SYSTEM SUPPORTS Z8001 AND Z8002.	↓	↓	↓
64823S	Z80 PASCAL LANGUAGE SYSTEM SUPPORTS Z80 AND NSC800.	↓	↓	↓
64825S	8085 PASCAL LANGUAGE SYSTEM SUPPORTS 8080 AND 8085.	↓	↓	↓

* ALL SOFTWARE FOR THE 9000/S200 & S500 SUPPLIED ON DC-150 CARTRIDGE TAPE. ALL SOFTWARE FOR THE HP 64000 IS SUPPLIED ON 5 1/4" FLEXIBLE DISC.

** ALL SOFTWARE FOR VAX/VMS IS SUPPLIED ON 1600 BPI 9 TRACK MAGNETIC TAPE. ALL SOFTWARE FOR THE HP 64000 IS SUPPLIED ON 5 1/4" FLEXIBLE DISC.

*** CODE GENERATION IN REAL ADDRESS MODE ONLY.

C LANGUAGE SYSTEM

MODEL NO.	DESCRIPTION	9000/ S500 HP-UX*	9000/ S200 HP-UX*	DEC/ VAX VMS**
64821S	6800 C LANGUAGE SYSTEM SUPPORTS 6800, 6801, 6802, 6803, 6808, 6301 (ALL WITH 6800 CODE).	OPTION 001	OPTION 002	OPTION 003
64822S	6809/6809E C LANGUAGE SYSTEM.	↓	↓	↓
64818S	8086 C LANGUAGE SYSTEM SUPPORTS 8086, 8088, 80186, 80188 AND 80286***	↓	↓	↓
64819S	68000 C LANGUAGE SYSTEM SUPPORTS 68000, 68008 AND 68010.	↓	↓	↓
64820S	Z8001 C LANGUAGE SYSTEM SUPPORTS Z8001 AND Z8002.	↓	↓	↓
64824S	Z80 C LANGUAGE SYSTEM SUPPORTS Z80 AND NSC800.	↓	↓	↓
64826S	8085 C LANGUAGE SYSTEM SUPPORTS 8080 AND 8085.	↓	↓	↓

* ALL SOFTWARE FOR THE 9000/S200 & S500 SUPPLIED ON DC-150 CARTRIDGE TAPE ALL SOFTWARE FOR THE HP 64000 IS SUPPLIED ON 5 1/4" FLEXIBLE DISC.

** ALL SOFTWARE FOR VAX/VMS IS SUPPLIED ON 1600 BPI 9 TRACK MAGNETIC TAPE. ALL SOFTWARE FOR THE HP 64000 IS SUPPLIED ON 5 1/4" FLEXIBLE DISC.

*** CODE GENERATION IN REAL ADDRESS MODE ONLY.

ASSEMBLER/LINKER SYSTEM

The Assembler/Linker system provides a complete facility for assembly language software development. It may be used for target microprocessors that are not supported with a high level language or in situations where assembly code is desired. Two assembler/ linkers are supplied, one for the host computer system and one for the 64000 workstation. (Note: The option is used to designate the host computer system.)

ASSEMBLER/LINKER SYSTEM

MODEL NO.	DESCRIPTION	9000/ S500 HP-UX*	9000/ S200 HP-UX*	DEC/ VAX VMS**
64840S	8080 ASSEMBLER/LINKER SYSTEM SUPPORTS 8080 AND 8085.	OPTION 001	OPTION 002	OPTION 003
64841S	6800 ASSEMBLER/LINKER SYSTEM SUPPORTS 6800, 6801, 6802, 6803, 6301, 6303 AND 8861			
64842S	Z80 ASSEMBLER/LINKER SYSTEM SUPPORTS Z80 AND NSC800.			
64843S	6502 ASSEMBLER/LINKER SUPPORTS 6501, 6502, 6503, 6504, 6511, 6512 AND 6514.			
64844S	6805 ASSEMBLER/LINKER SYSTEM SUPPORTS 6805 AND 6809/6809E.			
64845S	68000 ASSEMBLER LINKER SYSTEM SUPPORTS 68000, 68008 AND 68010.			
64846S	8048 ASSEMBLER/LINKER SYSTEM SUPPORTS 8048, 8049, 8748, 8749, 8021, 8022, 8035, 8039, 8040, 8041, 8042, AND 8741.			
64847S	9900 ASSEMBLER/LINKER SYSTEM SUPPORTS 9900, 9980, 9981, 9985, 9989, 9940, 99105A AND 99110A.			
64851S	USER-DEFINABLE ASSEMBLER/LINKER SYSTEM.			
64853S	8086 ASSEMBLER/LINKER SYSTEM SUPPORTS 8086, 8087, 8088, 8089, 80186, 80188, 80286***, AND V20/30.			
64854S	Z8000 ASSEMBLER/LINKER SYSTEM SUPPORTS Z8001 AND Z8002.			
64855S	8051 ASSEMBLER/LINKER SYSTEM.			
64857S	MIL-STD-1750A ASSEMBLER/LINKER SUPPORTS F9450.			
64858S	TMS320 ASSEMBLER/LINKER SYSTEM.			
64860S	8096 ASSEMBLER/LINKER SYSTEM			

* ALL SOFTWARE FOR THE 9000/S200 & S500 SUPPLIED ON DC-150 CARTRIDGE TAPE. ALL SOFTWARE FOR THE HP 64000 IS SUPPLIED ON 5 1/4" FLEXIBLE DISC.

** ALL SOFTWARE FOR VAX/VMS IS SUPPLIED ON 1600 BPI 9 TRACK MAGNETIC TAPE. ALL SOFTWARE FOR THE HP 64000 IS SUPPLIED ON 5 1/4" FLEXIBLE DISC.

*** LIMITED CODE GENERATION IN VIRTUAL ADDRESS MODE

RIGHT TO REPRODUCE SOFTWARE

The Right To Reproduce products (-SR suffix) provide a customer with a license to make one copy of the software product for an additional host computer.

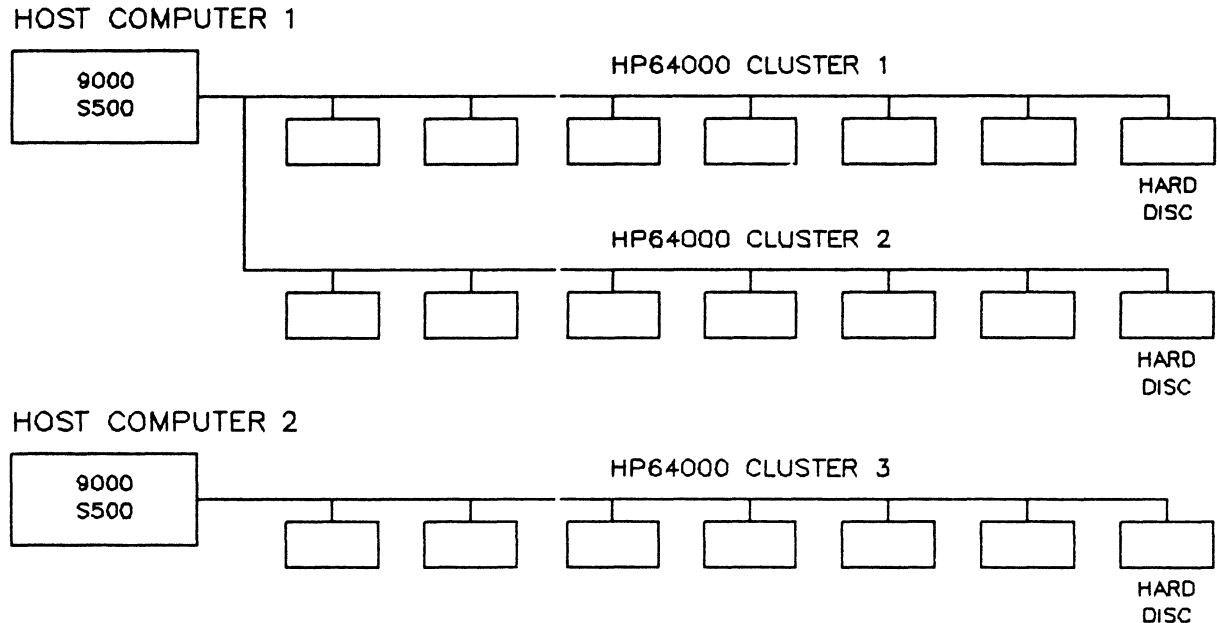

The Right To Reproduce product (-SR) must be purchased if an -S suffix product from Host Computer 1 will be used on Host Computer 2. Every additional hosted computer requires its own Right To Reproduce product.

The Right to Reproduce product (-AR) is also required if an -A or -AF suffix product from HP64000 Cluster 1 will be used in HP64000 Cluster 2 or HP64000 Cluster 3. The purchase of an -A/-AF/-S suffix product (except the Language Systems) entitles the customer to use the product on one cluster. The purchase of a language system (-S) entitles the customer to use the product on one host computer system and one cluster.

Two Right to Reproduce products (-AR) are required if the software from Cluster 1 will be used on Cluster 2 and Cluster 3, assuming the host computer system 2 does NOT have an -SR product of the software. Since the -S suffix Language System products include software which execute on both the host computer and the 64000 workstations, a single -SR right to reproduce product from Host Computer 1 would license software on both Host Computer 2 and HP64000 Cluster 3.

EXAMPLE :

64814SR with option 001

A license to use the Pascal Language System for the 8086/88/186/188 microprocessor family on another HP-UX 9000/S500 computer system and its HP64000 cluster.

The option is used to designate the host computer system.

ONE-TIME UPDATE PRODUCTS

The One-time Update products (-SX suffix) enable customers who have not subscribed to HP's software update service to bring a system to a supported condition on a product-by-product basis. Since LSD only supports the latest revision, this product is needed in order to install add-on products. For Software Materials Subscriptions (SMS) from ISD, specify 648XXS+S00 and the proper host computer option. SMS for 64880A, 64881A, and 64882A, add +S22 to the model number.

EXAMPLE :

64845SX with option 003

An update to the 68000/68008/68010 Assembler/Linker hosted on the VAX/VMS computer system.

The option is used to designate the host system.

PRODUCT/SUFFIX	RIGHT TO REPRODUCE	ONE-TIME UPDATE
LSD 64XXXS OPT 001	64XXSR OPT 001	64XXSX OPT 001
ISD 64XXXS+S00 OPT 001 OPT 002 OPT 003	64XXXS+W00 OPT 001 OPT 002 OPT 003	----- ----- ----- -----

NOTE: To order Software Materials Subscriptions (SMS) for host computer software, from Instrument Support Division, specify 648XXS+S00 and the proper host computer option. SMS for 64880A, 64881A, and 64882A, add +S22 to the model number.

ACCESSORIES

Commonly required accessories to complement the HP 64000 System are listed in this Guide. Additional parts such as other furniture, cables, media storage, disc packs, and printer expendables are available through the Hewlett-Packard Computer Users Catalog. (Part Number 5953-2450)

FURNITURE PRODUCTS

MODEL NO.	DESCRIPTION
64030A	<u>DEVELOPMENT STATION CART.</u> PROVIDES EXCELLENT MOBILITY FROM ONE LAB TO ANOTHER VIA HIGH QUALITY CASTORS. STORAGE SHELF PROVIDED BELOW TABLE-TOP. DIMENSIONS: HEIGHT: 660 mm (26 in.); WIDTH: 610 mm (24 in.); DEPTH: 762 mm (30 in.).
92170G	<u>WORK STATION TABLE.</u> STEEL TABLE DESIGNED TO COORDINATE WITH CS80 FAMILY DISCS; PROVIDES DURABLE WORK SURFACE FOR LAB ENVIRONMENT. DIMENSIONS: HEIGHT: 720 mm (28.3 in.); WIDTH: 930 mm (36.6 in.); DEPTH: 712 mm (28 in.).

MISCELLANEOUS PRODUCTS

9211-2663	<u>TRANSIT CASE FOR 64110A.</u> RUGGED PROTECTIVE OUTER SHELLS OF FIBERGLASS-REINFORCED PLASTIC, FOR USE WHEN 64110A MUST BE FREQUENTLY TRANSPORTED AND USED AWAY FROM LAB CONDITIONS. FOR FIELD INSTALLABLE CASTERS, ADDITIONALLY ORDER HP P/N 1490-0913.
10211A	<u>IC PROBE CLIP.</u> PROVIDES EASE OF CONNECTING THE 64600S TIMING ANALYZER TO AN IC OR MICROPROCESSOR.
64034A	ACCESSORY POUCH FOR 64110A STATIONS

MEDIA & MEDIA STORAGE PRODUCTS

MODEL NO.	DESCRIPTION
98200A	<u>BLANK TAPE CARTRIDGES.</u> CERTIFIED MINI DATA CARTRIDGES IN BOX OF 5, EACH WITH OWN PROTECTIVE PLASTIC CASE.
92190A	<u>BLANK FLEXIBLE DISCS.</u> 5-1/4 IN. DOUBLE SIDED FLEXIBLE DISCS IN BOX OF 10, EACH WITH OWN PROTECTIVE ENVELOPE.
88140LC	<u>PRECERTIFIED HIGH DENSITY DATA CARTRIDGE.</u> 600 FT (67 MBYTE) CARTRIDGE FOR USE WITH THE 7908P, 7911P AND 7912P DISC DRIVES. IN BOX OF 5, EACH WITH OWN PROTECTIVE PLASTIC BOX.
88140SC	<u>PRECERTIFIED HIGH DENSITY DATA CARTRIDGE.</u> 150 FT (16 MBYTE) CARTRIDGE FOR USE WITH THE 7908P, 7911P AND 7912P DISC DRIVES. IN BOX OF 5, EACH WITH OWN PROTECTIVE PLASTIC BOX.
HP P/N 64980-90906	<u>TAPE CARTRIDGE STORAGE BINDER.</u> PROVIDES STORAGE FOR UP TO 12 MINIDATA CARTRIDGES.
92194G	<u>PORTABLE ALBUM FILE FOR 5-1/4 IN. FLEXIBLE DISCS.</u> PROVIDES STORAGE FOR UP TO 20 DISCS IN A SNAP LOCK VINYL ALBUM.
9282-0989	<u>64000 SYSTEM 3-RING BINDER (2-1/2")</u>
9282-0987	<u>64000 SYSTEM 3-RING BINDER (1")</u>
12940A	9.8 MB FORMATTED DISC CARTRIDGE FOR 7906 M/S DISC
13394A	50 MB FORMATTED DISC PACK FOR 7920 M/S DISC
13356A	120 MB FORMATTED DISC PACK FOR 7925 M/S DISC

NOTE: For additional accessories consult the HP Computer Users Catalog.

EXTRA MANUALS

All 64000 System components except for 64000 System peripherals include the appropriate Operating and Service Manuals. 64000 System peripherals are shipped with operating manuals only. No special or separate model numbers are required.

Customers requiring extra manuals or peripherals service manuals may order by individual manual part number. For determining the appropriate 10-digit part number, refer to the latest Software Notification Bulletin (distributed quarterly to all receivers of the Software Subscription Service). Contact your local HP Field Engineer for assistance.

SUPPORT SERVICES

At each point in the lifecycle of an HP 64000 application, HP support can contribute to productivity. HP offers a total solution to HP 64000 support needs:

- o Application Support provides HP expertise to improve application productivity.
- o Software Support ensures system software is kept current.
- o Training Support imparts skills and knowledge to improve HP 64000 use and productivity.
- o Hardware Support helps to ensure maximum system up-time and low service costs.

APPLICATION SUPPORT

Two categories of applications support are available for the 64000 system. Instrument Application Services (IAS) provide the expertise of an HP Systems Engineer to conduct either specialized HP 64000 training or assist in evaluating or optimizing HP 64000 software applications. This support can be purchased by the day or at reduced rates for longer term needs.

Application, Development, and Implementation (AD&I) is a programming service provides the customer with HP systems expertise in the user definable capabilities of the HP 64000 system. AD&I is a task oriented service to help define customer needs and specify software to be developed by HP System Engineers. AD&I is subject to local availability.

SOFTWARE SUPPORT SERVICES

Software Materials Subscription (SMS) is HP's software support service for the HP 64000 supplied by the Software Distribution Center in California. SMS keeps the customer current with the latest developments in the software and documentation. By automatically providing software updates and enhancements, documentation revisions and changes, and the Software Status Bulletin and a user Newsletter, SMS helps customers use their development system more effectively.

SMS includes the following features:

- o Software Releases
(updates, revisions, enhancements)
- o Reference Manual Updates
- o Software Status Bulletins
- o User Newsletter

Since the support is priced for each individual software package, the total cost of the SMS service will depend on your customer's particular configuration. This structure helps ensure the lowest possible price for each customer.

All system software must be at the current release or revision level before HP will provide Software Materials Subscription. If the software is not current, users must purchase a one-time update for each software product that is out of date. These one-time updates are available from Logic Systems Division as 64xxxAX products.

In ordering software support, make sure that the customer orders support for each software product. Without total software coverage, we cannot ensure software compatibility.

To order SMS for a particular software product, specify the software product number with the suffix "+S00" added (SMS for the operating system is a "+S43" designation). For example:

64213S -- is a 6802 Emulator Subsystem.
64213A+S00 -- is Software Materials Subscription for the 6802 Emulator Subsystem.
64100AF+S43 -- is SMS for the 64100AF Operating System.

Although this example is the general rule, the following exceptions apply:

62474A--User Definable Emulator Subsys. 64274B+S00--SW Materials Subscription 64274BX--One-time update	64600S--8 Channel Timing Analyzer (including Opt. 010-16 Channels) 64601A+S00--SW Materials Subscription 64601AX--One-time update
64500S--PROM Programmer Subsystem (including all Options) 64501A+S00--SW Materials Subscription 64501AX--One-time update	64620S--20 Channel State/SW Analyzer (including all Options) 64621A+S00--SW Materials Subscription 64621AX--One-time update

Please Note: All HP 64000 software products ordered from ISD as Software Materials Subscription or Right to Reproduce products for SMS, end with the same suffix as the software product being supported, except for those emulator subsystems which end in A instead of the usual S suffix.

For information about ordering SMS for HP 64000 Hosted Development Systems, see the SMS Worksheet in the Ordering section and the SMS Field Training Manual.

HARDWARE SUPPORT

All 64000 Systems are backed by HP's commitment to providing quality hardware support. Factory trained professionals are available worldwide to provide installation, calibration, and service support of 64000 products.

INSTALLATION Installation of a systems, containing at least one hard disc is included in the price of the 64000 system. The customer is responsible for installing stand alone development stations or future optional expansions if they do not include a hard disc purchase. Service manuals containing installation procedures are shipped to the customer with the order.

WARRANTY All HP 64000 products are warranted for 90 days after installation, and will be repaired on the customer site (or replaced at HP's discretion at no charge to the customer if a failure occurs during that time).

REPAIR Extensive ROM based diagnostics exist for the development station host boards and local mass storage devices. Disc based diagnostics exist for the emulation and measurement system options. Diagnostics for the host disc drives exist on local mass storage media and are implemented using a development station.

The Exchange Repair Program (Blue Stripe) provides customers and the HP Customer Service Organization the ability to replace defective assemblies with restored assemblies at reduced cost. Restored assemblies are available through Corporate Parts Center (CPC) and Parts Center Europe (PCE) and are in Field Service Inventory (FSI) at some field offices.

Contracts for service on 64000 System hardware are encouraged for a variety of reasons. Advantages to the customer include specified response times, timely maintenance, known repair prices, priority response, preferential inventory stocking, etc. For further information, refer to the Instrumentation Basic System Maintenance Agreement data sheet, part number 5953-8201.

Hardware support is also available to customers who do not choose to sign a contractual agreement. HP offers repair and calibration services on an as-needed basis with a charge per incident. For those customers who choose to service their own equipment, HP offers a 64000 Service Training Class which is offered several times a year at both the Colorado Springs and Boeblingen, Germany manufacturing sites. In addition, customers can directly participate in the Bluestripe program and receive replacement assemblies.

For further information concerning hardware support, contact your local HP Sales Office.

CUSTOMER TRAINING

HP offers a wide selection of customer training courses designed to allow customers to become quickly productive with a new HP 64000 system, or to improve the productive use of an existing system.

A comprehensive offering of modular training classes allows each HP 64000 user to obtain training in those specific areas related to his application. Training courses are taught by HP Systems Engineers who are highly trained and experienced in the use of the HP 64000. The material is presented in lecture format reinforced by extensive hands-on lab exercises and practice. For more information on the courses below, consult the Instrument Training Course Catalog (publication number 5953-9608[D]), or contact your local HP Sales Representative.

HP MODEL NO.	TITLE
BASIC TRAINING: HP 64100A+24D	HP 64000 SYSTEM CONCEPTS AND MEASUREMENTS
APPLICATIONS: HP 64310A+24D HP 64600S+24D HP 646205+24D HP 64851A+24A	SOFTWARE PERFORMANCE ANALYSIS TRAINING ADVANCED TIMING/HARDWARE ANALYSIS TRAINING ADVANCED STATE/SOFTWARE ANALYSIS TRAINING USER DEFINABLE ASSEMBLER TRAINING
COMPILERS: HP 64810A+24D HP 64812A+24D HP 64814A+24D HP 64815A+24D HP 64817A+24D	HP 64000/PASCAL ON 8080/8085 MICROPROCESSORS HP 64000/PASCAL ON Z80 MICROPROCESSOR HP 64000/PASCAL ON 8086/8088 MICROPROCESSOR HP 64000/PASCAL ON 68000 MICROPROCESSOR HP 64000 SYSTEM (HOST) PASCAL PROGRAMMING COURSE

CONFIGURATION REQUIREMENTS

To ensure that the resources of the 64000 System are not exceeded, it is important to observe the following power and slot requirements as limitations when purchasing or adding to a system.

DEVELOPMENT STATION POWER AND SLOT REQUIREMENTS

Hardware subsystems installed in a 64000 Logic Development Station must not exceed the available current and card cage slots. To ensure that the hardware selected for a single station can be accommodated, use the following table.

In order to provide the most convenient use of this table, the numbers for currents and slots listed for an option represent the sum of the requirements of the base product (e.g., 64XXXS) and that of the particular option.

Add the requirements of the hardware for each of the three columns and check to determine that the available values for the selected station are not exceeded.

POWER AVAILABLE TO OPTION CARD SLOTS

MODEL NO.	DESCRIPTION	+5 V CUR.	-3/-5V CUR.	NO. OF SLOTS
64100A	LOGIC DEVELOPMENT STATION*	40.00	40.00	10
64110A	LOGIC DEVELOPMENT STATION	24.30	35.00	5
64100A	LOGIC DEVELOPMENT STATION S/N PREFIX 2136 AND BELOW	19.00	10.00	10

* POWER AVAILABLE TO OPTION CARD SLOTS

FOOTNOTES TO PAGES 4-2 and 4-3.

- #1 Only applicable for 64100A. Slots and Currents are accounted for in the 64110A (which always has Dual Flexible Discs installed)
- #2 Only available in 64100A. Difference between PROM modules is negligible. Therefore, options and individual modules are not listed.
- #3 Current requirements for Interface Kits are all equal and are included in Model 64650A total.
- #4 Obsolete products. Included for reference in add on orders.

REQUIRED CURRENTS & SLOTS FOR DEVELOPMENT STATION OPTIONS

MODEL NO.	DESCRIPTION	+5V CUR.	-3/-5V CUR.	NO. OF SLOTS
64032A	16K-WORD MEMORY EXPANSION	0.38	0.00	1
64050A	GRAPHICS OUTPUT CARD	1.20	0.00	1
64100A	LOGIC DEVELOPMENT STATION			
#4 OPT 040	TAPE CARTRIDGE UNIT	0.62	0.00	1
#1 OPT 041	DUAL 5-1/4 IN. FLEXIBLE DISC UNIT	2.00	0.00	1
#4 OPT 032	EXPAND HOST RAM BY 16K-WORDS	0.38	0.00	1
64110A	LOGIC DEVELOPMENT STATION			
OPT 032	EXPAND HOST RAM BY 16K-WORDS	0.38	0.00	
64151A	EMULATION MEMORY CONTROL BOARD	1.54	0.00	1
64155A	WIDE-ADDR EMUL MEM CNTRL CD	3.80	0.00	1
64161A	128K BYTE EMULATION MEMORY CARD	1.60	0.00	1
64162A	64K BYTE EMULATION MEMORY CARD	1.60	0.00	1
64163A	32K BYTE EMULATION MEMORY CARD	1.60	0.00	1
64192S	6805U/R EMULATOR SUBSYSTEM	2.30	0.00	1
64193S	6805P EMULATOR SUBSYSTEM	2.30	0.00	1
64194S	146805G EMULATOR SUBSYSTEM	2.30	0.00	1
64202S	8080 EMULATOR SUBSYSTEM	4.93	0.00	1
64203S	8085 EMULATOR SUBSYSTEM	5.46	0.00	1
64206S	6301V/6303R EMULATOR SUBSYSTEM	4.50	0.00	1
64212S	6800 EMULATION SUBSYSTEM	6.25	0.00	1
64213S	6802/08 EMULATION SUBSYSTEM	6.50	0.00	1
64215S	6809 EMULATION SUBSYSTEM	6.80	0.00	1
64216S	6809E EMULATION SUBSYSTEM	4.90	0.00	1
64222S	8086 EMULATOR SUBSYSTEM	6.20	0.00	1
64224S	80186 EMULATOR SUBSYSTEM	6.20	0.00	1
64225S	80188 EMULATOR SUBSYSTEM	6.20	0.00	1
64226S	8088 EMULATOR SUBSYSTEM	6.20	0.00	1
64232S	Z8001 EMULATOR SUBSYSTEM	6.10	0.00	1
64233S	Z8002 EMULATOR SUBSYSTEM	6.10	0.00	1
64242S	68000 EMULATOR SUBSYSTEM	6.10	0.00	1
64249S	68010 EMULATOR SUBSYSTEM	6.10	0.00	1
64253S	Z80 EMULATOR SUBSYSTEM	5.81	0.00	1
64256S	6801/03 EMULATOR SUBSYSTEM	8.40	0.00	2
64262S	8048 EMULATOR SUBSYSTEM	4.90	0.00	1
64264S	8051 EMULATOR SUBSYSTEM	3.00	0.00	1
64272S	ROM EMULATOR SUBSYSTEM	8.40	0.00	1
64274S	USER-DEFINABLE EMULATOR SUBSYS.	4.90	0.00	1
64276A	RUN CONTROL	1.30	2.10	1
64276B	RUN CONTROL WITH 32K WCS	4.80	2.10	1
64276C	RUN CONTROL WITH 64K WCS	8.30	2.10	1
64277A	USER WCS CONTROL	0.10	0.00	1
64292S	NSC800 EMULATOR SUBSYSTEM	5.40	0.00	1
64294S	70116 EMULATOR SUBSYSTEM	4.60	0.00	1
64295S	70108 EMULATOR SUBSYSTEM	4.60	0.00	1

REQUIRED CURRENTS & SLOTS FOR DEVELOPMENT STATION OPTIONS (cont)

MODEL NO.	DESCRIPTION	+5V CUR.	-3/-5V CUR.	NO. OF SLOTS
64300A	40-CH EMULATION ANALYZER	3.60	0.50	1
64302A	48-CH EMULATION ANALYZER	3.70	0.40	1
64303A	IMB EXTENDER	1.80	0.25	1
64304A	EMULATION BUS PREPROCESSOR	1.50	1.20	1
64310A	SOFTWARE PERFORMANCE ANALYZER	5.80	0.12	1
64320S	30-CH 25MHz STATE SYSTEM	3.10	9.90	2
OPT 010	60-CH 25MHz STATE SYSTEM	4.50	14.70	3
OPT 011	90-CH 25 MHz STATE SYSTEM	5.90	19.50	4
64321A	25 MHz STATE CONTROL BOARD	1.70	5.10	1
64322A	25 MHz STATE ACQUISITION BOARD	1.40	4.80	1
64340A	REAL-TIME, HLL SOFTWARE ANALYZER	12.4	1.20	3
#2 64500S	PROM PROGRAMMER SUBSYSTEM	1.12	0.00	1
64610S	HIGH SPEED TIMING/STATE ANALYSIS			
64601B	TIMING/STATE ANALYSIS CONTROL CARD	1.60	3.60	1
64602A	8-CHAN TIMING/STATE ACQUISITION CARD	3.60	3.30	1
64604A	8-CHAN TIMING/STATE DATA PROBES	0.04	0.24	0
64605A	TIMING/STATE CLOCK PROBE	0.04	0.08	0
64606A	TIMING/STATE DELAY POD	0.00	0.00	0
64620S	LOGIC STATE ANALYSIS; 20-CH WITH OVERVIEW	5.20	7.20	2
OPT 010	EXPAND TO 40-CHANNELS	7.00	6.30	2
OPT 011	EXPAND TO 60-CHANNELS W OVRW	10.40	8.80	3
OPT 012	EXPAND TO 80-CHANNELS	12.20	7.90	3
OPT 013	EXPAND TO 100-CHANNELS W OVERVW	15.60	10.40	4
OPT 014	EXPAND TO 120-CHANNELS	17.40	9.50	4
64621A	LOGIC STATE ANALYZER CNTRL CD	1.80	4.70	1
64622A	40-CHANNEL LOGIC STATE CARD	5.20	1.60	1
64623A	20-CHANNEL LOGIC STATE CARD	3.40	2.50	1
64630S	GP PROBE SET; CLOCK AND 20-CH	0.20	0.60	0
OPT 010	EXPAND TO 40-CHANNELS OF DATA	0.30	1.00	0
OPT 011	EXPAND TO 60-CHANNELS OF DATA	0.5	0.00	0
OPT 012	EXPAND TO 80-CHANNELS OF DATA	0.6	1.7	0
OPT 013	EXPAND TO 100-CHANNELS OF DATA	0.8	2.00	0
OPT 014	EXPAND TO 120-CHANNELS OF DATA	0.90	2.9	0
64635A	20-CHANNEL STATE DATA PROBE	0.14	0.35	0
64636A	STATE CLOCK PROBE	0.06	0.26	0
#3 64650A	GP PREPROCESSOR POD	1.80	2.60	0
#4 64940A	TAPE CARTRIDGE UNIT	0.62	0.00	1
#1 64941A	DUAL 5-1/4 IN. FLEXIBLE DISC UNIT	2.00	0.00	1

(SEE FOOTNOTES ON PAGE 4-1)

MAXIMUM CURRENT FOR DEVELOPMENT STATIONS & PERIPHERALS

MODEL NO.	DESCRIPTION	MAXIMUM CURRENT		HEAT OUTPUT
		110V/60Hz	220V/50Hz	
64100A	DEVELOPMENT STATION	7.2 A	3.6 A	710 kcal
64110A	DEVELOPMENT STATION	6.0 A	3.0 A	568 kcal
9134XV	14.5MB DISC	1.14 A	.57	107 kcal
7907A	41MB DISC DRIVE	1.14 A	.57	125 kcal
7911P	28MB DISC DRIVE	7.4 A	3.8 A	700 kcal
7912P	65MB DISC DRIVE	7.4 A	3.8 A	700 kcal
7914P	132MB DISC DRIVE			
7911P	28MB DISC W/OUT TAPE	7.0 A	3.5 A	662 kcal
OPTION 140	DELETE TAPE			
7912P	65MB DISC W/OUT TAPE	7.0 A	3.5 A	662 kcal
OPTION 140	DELETE TAPE			
7914P	132MB DISC W/OUT TAPE	7.4 A	4.3 A	700 kcal
OPTION 140	DELETE TAPE			
7941A	24MB DISC DRIVE W/OUT TAPE	.87 A	.48 A	222 btu/hr
7942A	24MB DISC DRIVE WITH TAPE	N/A	N/A	N/A
7945A	55MB DISC DRIVE W/OUT TAPE	.87 A	.48 A	222 btu/hr
7946A	55MB DISC DRIVE WITH TAPE	N/A	N/A	N/A
9134D	14.5MB DISC DRIVE W/OUT TAPE	1.14 A	.57	107 kcal
9134H	20MB DISC DRIVE	1.14 A	.57	107 kcal
9144A	STAND ALONE 1/4" TAPE DR.	1.14 A	.57	107 kcal
7906M	20MB DISC	8.0 A	4.5 A	757 kcal
OPTION 102	HP-IB			
7920M	50MB DISC	7.4 A	3.8 A	700 kcal
OPTION 102	HP-IB			
7925M	120MB DISC	6.7 A	3.5 A	633 kcal
OPTION 102	HP-IB			
2673A	120 CPS THERMAL GRAPHICS PRINTER	1.0 A	0.5 A	94.6 kcal
2932A	GRAPHICS OFFICE PRINTER	2.5 A	1.36 A	312 kcal
2934A	GRAPHICS OFFICE PRINTER	2.5 A	1.36 A	312 kcal
2563A	LINE PRINTER	5.0 A	2.73 A	624 kcal

SYSTEM REQUIREMENTS Maximum Current - 60Hz: Maximum Steady State Current (in amperes) required for unit at 110 Vac/ 60 Hz. Maximum Current - 50 Hz: Maximum Steady State Current (in amperes) required for unit at 220 Vac/ 50 Hz.