

SYSTEM INSTALLATION GUIDE

Addendum A

SUBJECT

Additions and changes to the System Installation Guide.

SPECIAL INSTRUCTIONS

This update, Order Number A78138957-202, is the first Addendum to A78138957-201, dated June 1988.

The attached pages are to be inserted into A78138957-201, as indicated in the collating instructions on the back of this cover. Change bars in the margins indicate technical additions and changes, and asterisks indicate deletions. These changes will be incorporated into the next revision to this manual.

NOTE:

Insert this cover following the manual cover to indicate the updating of the document with the first Addendum.

ORDER NUMBER

A78138957-202

September 1988

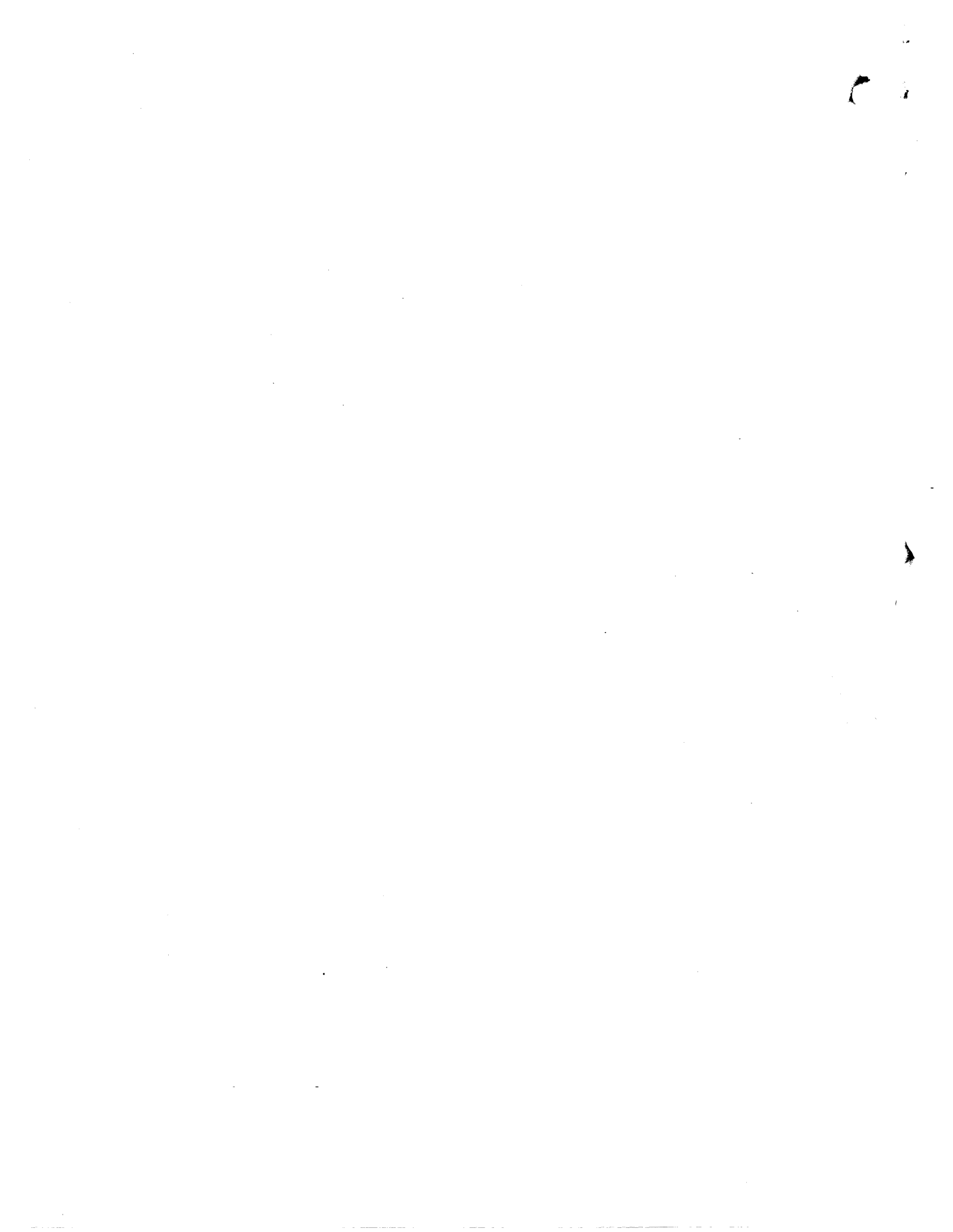

COLLATING INSTRUCTIONS

To update the last version of the manual, remove the old pages and insert the new pages, as follows:

<u>Remove</u>	<u>Insert</u>
vii through ix	vi through ix
	1.18-1 through 1.18-4
	1.30-1 through 1.30-4
1.31 through 1.34	1.31 through 1.34
	1.34-1, blank
1.37, 1.38	1.37, 1.38
1.45, 1.46	1.45, 1.46
1.47, 1.48	1.47, 1.47-1
	blank, 1.48
1.49 through 1.52	1.49 through 1.52
1.61, 1.62	1.61, 1.62
1.63, 1.64	1.63, 1.63-1
	blank, 1.64
3.3 through 3.14	3.3 through 3.14
3.17, 3.18	3.17, 3.17-1
	3.17-2, 3.17-3
	blank, 3.18
3.21 through 3.24	3.21 through 3.24

Remove

3.31, 3.32

3.37, 3.38

3.41, 3.42

4.1, 4.2

4.5, 4.6

4.11, 4.12

4.13 through 4.18

B.1 through B.4

Insert

3.31, 3.32

3.37, 3.38

3.41, 3.42

3.42-1, blank

4.1, 4.1-1

blank, 4.2

4.5, 4.6

4.11, 4.12

4.12-1, blank

4.13 through 4.18

B.1, B.2

B.3, B.3-1

blank, B.4

CONTENTS

	Page
SECTION I SYSTEM INSTALLATION	
Unpacking the Central Unit	1.2
Removing the Panels	1.7
Removing the Front Panel	1.8
Removing the Rear Panel	1.9
Removing the Top Panel	1.10
Description of the Central Unit	1.11
X-20	1.11
X-20E	1.15
X-20EF	1.18-1
X-20R	1.19
X-15	1.21
X-40	1.23
X-40E	1.27
X-40EF	1.30-1
Removing the Safety Devices	1.31
Linking the Peripherals	1.32
Installing the Peripherals	1.35
VIP72XX Personalization	1.36
VTU001X Personalization	1.37
VTU004X Personalization	1.38
VTU005X Personalization	1.39
HDS71XX Personalization	1.40
HDS74XX Personalization	1.42
Identifying the Interface and Cables Used to Connect the Peripherals to an SP0 or SP1 Board	1.45
Identifying the Interface and Cables Used to Connect the Peripherals to an SP2 Board	1.47-1
Identifying the Interface and Cables Used to Connect the Peripherals or another System to the LPO Board	1.48

CONTENTS (cont.)

	Page
Personalization of the Cable Connectors	1.53
Local Connection	1.54
Remote Connection	1.55
Local Connection with other Systems	1.56
Remote Connection with other Systems	1.59
Installing the Communication Lines	1.61
Linking the Line Cables to the System	1.64
Remounting the Panels	1.68
Remounting the Top Panel	1.69
Remounting the Front Panel	1.70
Attaching the Power Supply	1.71
SECTION II PRELIMINARY OPERATIONS	
System Test	2.2
Loading the System Test Diskette	2.3
Powering the System ON	2.5
Executing the System Test	2.6
SECTION III INSTALLING THE OPTIONAL MODULES	
Power Supply for the Additional Units	3.2
Installing an Additional Board	3.3
Identification of the Guides for Board Lodging	3.4
Installing a Board	3.5
Installing the Second Memory Expansion Board	3.7
Installing the Third Memory Expansion Board	3.9
Installing the Cache Board	3.11
Installing an SP0 or LP0 Board	3.13
Installing the SP1 Board	3.16
Installing the SP2 Board	3.17-1
Installing a VME Lan Board	3.18
Installing an SCI Board	3.22

CONTENTS (cont.)

	Page
Installing a VME Board for SMD Disks	3.25
Installing a VME Board for External Tape Units	3.33
Installing the EPROM on the SC1 Board	3.38
Replacing a Memory Board	3.39
Replacement of the Battery for SCX Board	3.40
Installing an Additional Disk Unit	3.41
Installing the Streamer Unit	3.51
Installing the Additional Power Supply	3.60
Installing the Emergency Battery (UPS)	3.66
SECTION IV INSTALLING THE EXPANSION UNIT	
Description of the Expansion Unit	4.2
Installing the Expansion Unit	4.4
Power Supply for the Unit	4.14
Installing the Additional Power Supply	4.15
Installing a Board	4.16
Installing the DCS1 or DCE1 board	4.18
Installing the Disk Units	4.21
APPENDIX A USE OF THE ANTISTATIC WRISTBAND	
APPENDIX B EARTHING OF THE LINE CABLES	



X-20EF

Main Cabinet:

- Standard components:

- **Diskette unit**
- **Disk unit with ESDI interface**
- **Central Processor board (CPF), where the main microprocessor is located**
- **System Controller board (SC1), which controls the system and the operator panel**
- **Station Processor (SP0, SP1 or SP2) or Line Processor board (LP0), for controlling asynchronous/synchronous lines for terminals and printers**
- **Memory Expansion boards MF4 or MF8 for 4 or 8 Mb of main memory respectively**
- **Disk Controller board DCE, for controlling disk, diskette and streamer units**
- **Fan**
- **Power supply**

- **Optional components which are provided upon request:**
 - **Cache board (CHF)**
 - **Two Memory Expansion boards MF4 or MF8 boards (4/8 Mb)**
 - **Three Station Processor boards (SP0, SP1 or SP2) or Line Processor boards (LP0); the SP0 and SP1 boards control eight asynchronous lines, the SP2 board controls 12 asynchronous lines and the LP0 board controls six synchronous/asynchronous lines**
 - **Termination board**
 - **The following boards can be inserted in the VME slots:**
 - LAN controller to create local networks**
 - Controller for removable disk units with SMD interfaces**
 - Controller for external tape units**
 - Two SP1 or SP2 boards**
 - **Two disk units**
 - **Streamer unit**
 - **Second power supply**

Additional Cabinet:

- **Four SPX or LP0 boards**
- **DCE board**
- **The following boards can be inserted in the VME slots:**
 - LAN controller to create local networks**
 - Controller for removable disk units with SMD interfaces**
 - Controller for external tape units**
 - Two SP1 boards**
- **3 disk units with ESDI interface**
- **Fan**
- **2 power supplies**

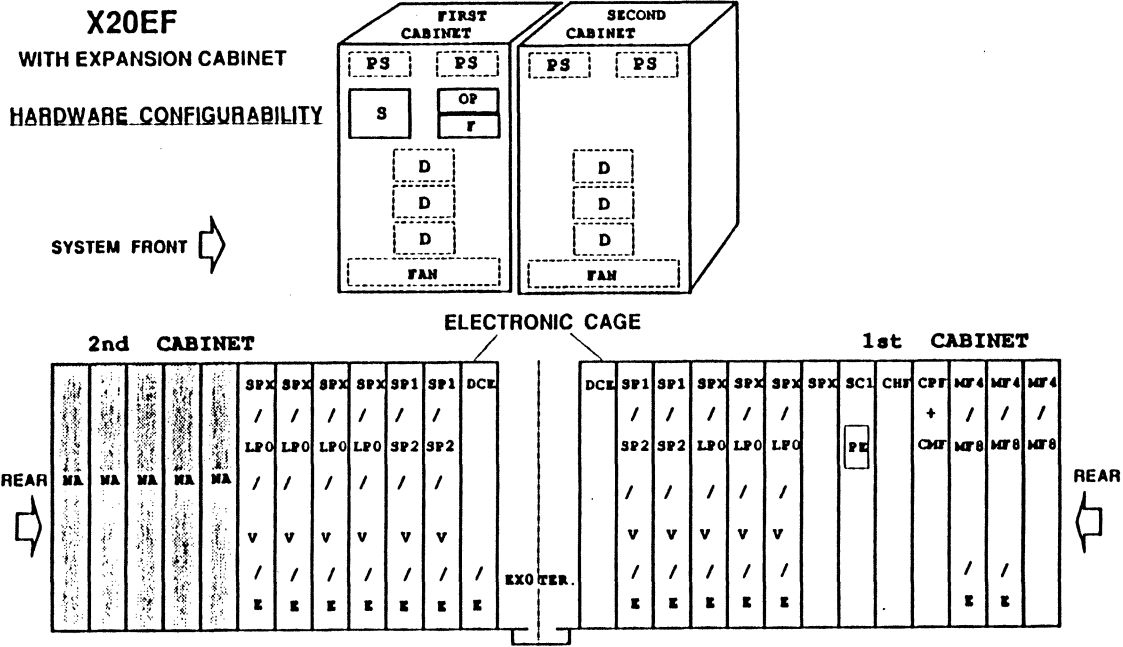

X-40EF

- Standard components:

First cabinet:

- **Diskette unit**
- **Disk unit**
- **Central Processor board (CPF), where the main microprocessor is located**
- **System Controller board (SC1) which controls the system and the operator panel**
- **Station Processor (SP0, SP1 or SP2) or Line Processor board (LP0), for controlling asynchronous/synchronous lines for terminals and printers**
- **Memory Expansion boards MF4 or MF8 for 4 or 8 Mb of main memory respectively**
- **Disk Controller board DCE, to control disk, diskette and streamer units**
- **Fan**
- **Power supplies**
- **Cache board (CHF)**
- **Termination board**

Second Cabinet:

- **Central Processor board (CPF), where the main microprocessor is located**
 - **Memory Expansion boards MF4 or MF8 for 4 or 8 Mb of main memory respectively**
 - **Fan**
 - **Power supplies**
 - **Cache board (CHF)**
- **Optional components for the first cabinet:**
- **Two Memory Expansion boards MF4 or MF8 boards (4/8 Mb)**
 - **Three Station Processor boards (SP0, SP1 or SP2) or Line Processor boards (LP0); the SP0 and SP1 boards control eight asynchronous lines, the SP2 board controls 12 asynchronous lines and the LP0 board controls six synchronous/asynchronous lines**
 - **The following boards can be inserted in the VME slots:**
 - LAN controller to create local networks**
 - Controller for removable disk units with SMD interfaces**
 - Controller for external tape units**
 - Two SP1 or SP2 boards**
 - **Two disk units**
 - **Streamer unit**

- **Optional components for the second cabinet:**
 - **Two Memory Expansion boards MF4 or MF8 boards (4/8 Mb)**
 - **Three Station Processor boards (SP0, SP1 or SP2) or Line Processor boards (LP0); the SP0 and SP1 boards control eight asynchronous lines, the SP2 board controls 12 asynchronous lines and the LP0 board controls six synchronous/asynchronous lines**
 - **DCE board**
 - **The following boards can be inserted in the VME slots:**
 - LAN controller to create local networks**
 - Controller for removable disk units with SMD interfaces**
 - Controller for external tape units**
 - Two SP1 or SP2 boards**
 - **Three disk units**

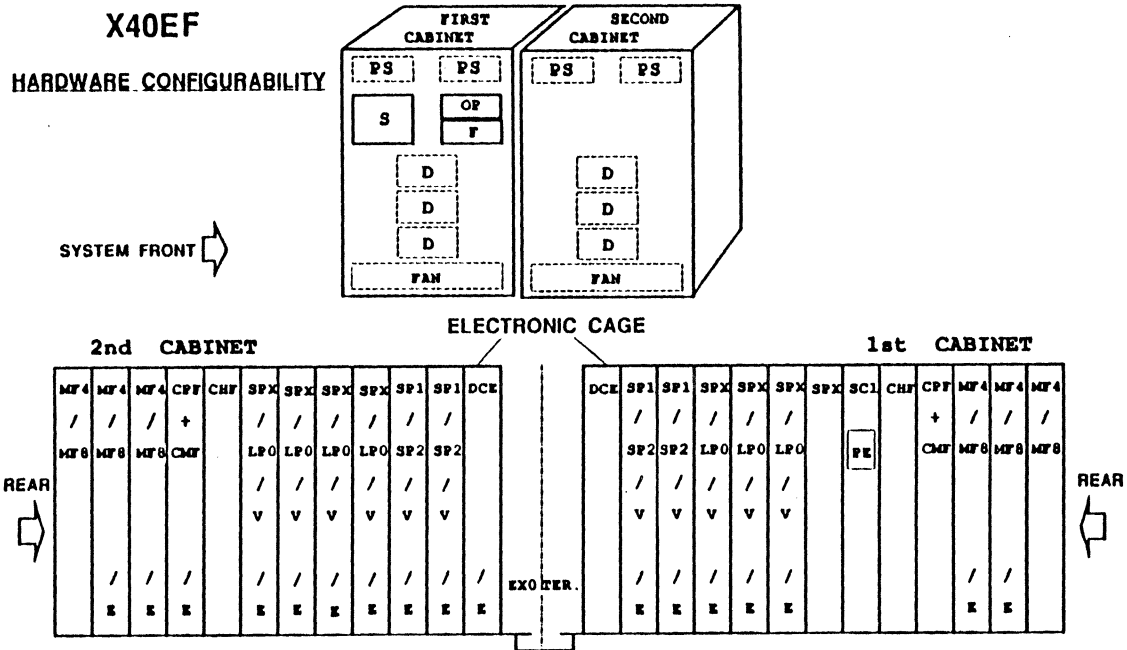

REMOVING THE SAFETY DEVICES

The removal of the safety devices on the central unit entails removing the protective card from the diskette unit. To perform this operation, carry out the instructions indicated on the following pages.

The diskette unit contains a protective card that prevents damage to the heads during transportation.

To remove the protective card it is necessary to unlock the shutter on the diskette unit. Position it to the right.

Keep the card in a safe place. If you ever need to move the system, the protection card must be reinserted in the diskette unit to prevent damage to the heads during transportation.

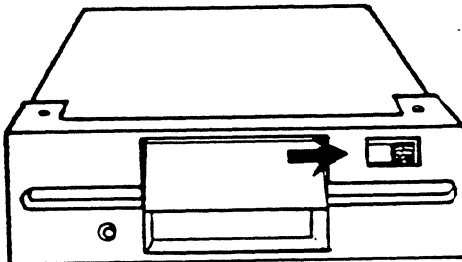

LINKING THE PERIPHERALS

Two types of board are used for linking the peripherals: Station Processor (SP0, SP1 or SP2) or Line Processor (LP0) boards. As indicated in the figure on the following pages, there are nine connectors on the SP0 and SP1 board, thirteen connectors on the SP2 board and six connectors on the LP0 board.

The SP0 or SP1 board contain the following elements:

- a connector for a printer with a CENTRONICS-IBM type parallel interface (the lower connector [PRINTER])
- eight 9 pin connectors for local connections linking asynchronous peripherals with RS232 or RS422 type interfaces for the SP0 board. The RS232 interface is only linked to the SP1 board.

The SP2 board contains the following elements:

- a connector for a printer with a CENTRONICS-IBM type parallel interface (the lower connector [PRINTER])
- twelve 9 pin micro-connectors for local or remote connection: 8 asynchronous lines for connection with RS232C or RS422A interface (the interface type is selected by means of the appropriate jumpers); 4 asynchronous lines for remote connection with RS232C interface.

The LP0 board includes the following elements:

- a connector for a printer with a CENTRONICS-IBM type parallel interface (the lower connector [PRINTER])
- two 9 pin connectors for local connections linking asynchronous peripherals with RS232 or RS422 type interfaces

- two 25 pin connectors for connections via modem linking synchronous or asynchronous peripherals with RS232 type interfaces
- two 15 pin connectors for local host/host connections at a speed of up to 100 Kbaud, involving synchronous or asynchronous peripherals with RS422 type interfaces.

The first communication board is usually an SP0, SP1 or an SP2, but, if requested, it can also be an LP0. In either case, the initializing work station must be connected to the highest connector on the first communication board in the system (the board in position 4).

The connection of a peripheral to the system requires the following operations:

- Installation
- Personalization
- Identification of the interface and the cables used for linking the peripheral to the system
- Installation of the communication lines from the system to the peripheral
- Connection of the line cables to the system
- Earthing of the line cables

If connecting the peripheral to the line 2 and 3 on the LP0 board (ttyx2 and ttyx3), it is necessary to personalize the line in order to effect a synchronous or asynchronous connection. See the paragraph "Installing an SP0 or LP0 board".

Each operation is described in detail in the relative subsection, except the final operation, which is in Appendix B. The operations described will be repeated for each peripheral connection.

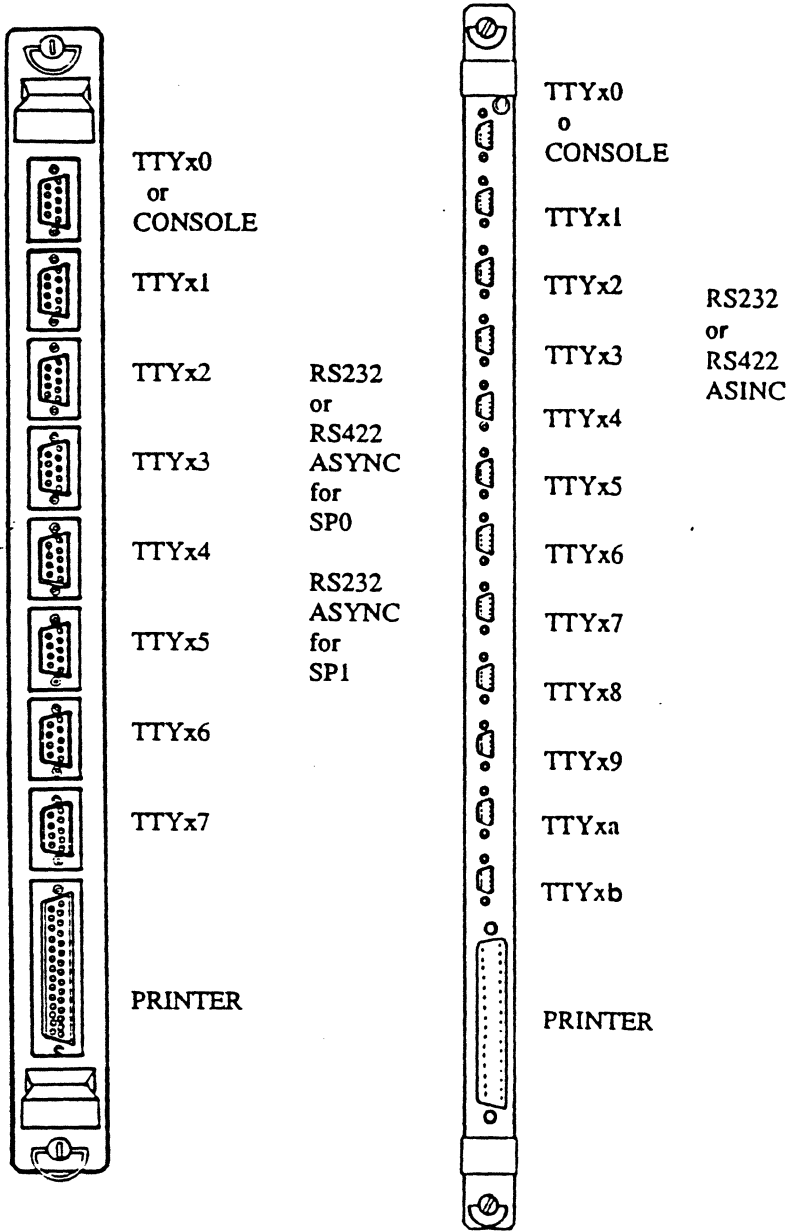

SP0 or SP1 board

SP2 board

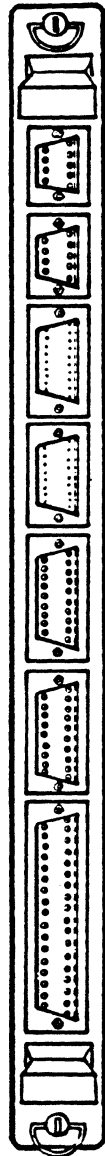

TTYx0 or CONSOLE	RS232 or RS422 ASYNC
TTYx1	ASYNC
TTYx2	RS422 SYNC/ ASYNC
TTYx3	
TTYx4	RS232 SYNC/ ASYNC
TTYx5	or RS422 ASYNC
PRINTER	

LPO board

THIS PAGE IS INTENTIONALLY LEFT BLANK

VTU001X Personalization

To display the personalization screen for the terminal, press the <SHIFT> and <SET UP> keys simultaneously, followed by <Enter menu>.

To personalize VTU001X terminals, consult the operating standards described in the relative installation manual. Perform the personalization procedure as follows. Modify the *BAUD RATE* and *HOST INTERFACE* values according to specific needs.

MONITOR CODE	OFF	A
AUTO LF/CR	OFF	B
BAUD RATE	9600	C
STOP BITS	1	D
PAR ENBL	ON	E
PAR SENSE	EVEN	F
DATA BITS	7	G
ECHO	ON	H
CURSOR TYPE	BLK	I
CURSOR BLINK	ON	J
MARGIN BELL	ON	K
STATUS LINE	ON	L
EOM CHAR	CR	M
XON/XOFF	ON	N
STX CHAR	ON	O
HOST INTERFACE	RS232	P
COUNTRY	USA	Q

At the end of the operation, press the <Control> and <s> keys simultaneously to save the new personalization.

VTU004X Personalization

To display the selection screen for the terminal, press the <Control> and <F1> keys simultaneously.

To personalize VTU004X terminals, consult the operating standards described in the relative installation manual. Perform the personalization procedure as follows. Modify the Baud Rate and Host Interface values according to specific needs:

SET-UP MODE

GENERAL PARAMETERS ASYNC MODE PRINTER PARAMETERS

Mode	ASYNC	Echo	ON	Penq lock	OFF
Display all	OFF	Char/text	CHAR	Print all	ON
72 Lines	ON	Flow Control	OFF	Printer type	ASYNC
Roll mode	ON	Termin.Char	EOT	Start char.	<CR+LF>
Tab. mode	DELAY	Interface	RS422	End char.	<CR+LF>
Space suppr.	ON	Parity enable	ON	Async speed	9600
CR+LF text	ON	Baud rate	9600		
Trasm. on Ret.	OFF				
Block transmit	OFF				
KB lockout	ON				
Drop DTR local	OFF				
Console mode	OFF				
Cursor format	BLOCK				
Cursor blink	ON				
National ver.	INT'L				

		<u>SYNC MODE</u>		<u>SET-UP COMMANDS</u>	
		Process before		Arrow down	next par.
		Quiesc frame		Arrow up	prev.par.
		Ack/Ack +TNB		Arrow right	next field
		4wire/2wire		Arrow left	prev.field
		Polling addr.		Key "S"	save data
				Key "Return"	exit

HISI VTU - Rev. XXX

Identifying the Interface and Cables Used to Connect a Peripheral to an SP0 or an SP1 Board

A printer with a CENTRONICS-IBM parallel interface and peripherals with RS232 and RS422 asynchronous interfaces can be connected to an SP0 or an SP1 board, which supports the RS232 interface only.

In order to support these interfaces, different types of cable have been developed.

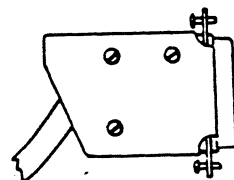
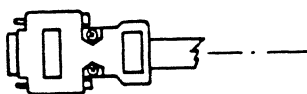

RS232 INTERFACE

The following cables are used for the system-peripheral connection:

Other markets

B78141032-001 (VCW0654)
B78141031-001 (VCW0655)

for the SP0 board

USA only

B78146276-001 (VCW0654U)
B87146275-001 (VCW0655U)

Other markets

B78144115-001 (VCW0666)
B78144116-001 (VCW0662)
B78144117-001 (VCW0663)

USA only

B78146298-001 (VCW0666U)
B78146299-001 (VCW0662U)
B78146300-001 (VCW0663U)

RS422 INTERFACE (SP0 only)

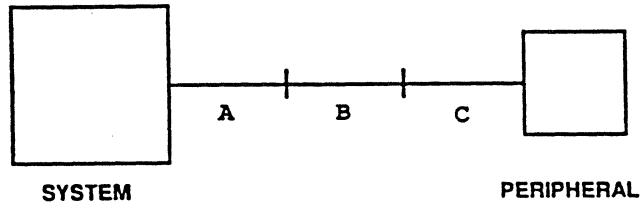

The following cables are available:

- a. B78141030-001
B78141035-001 (VCW0651)
B78141231-001

The type of cable used depends upon the connector on the host to which the cable is connected.

- b. extension cable (optional):

- 60146692-050 (VCW2605)
- 60146692-100 (VCW2606)
- 60146692-150 (VCW2611)
- 60146692-200 (VCW2607)
- 60146692-300 (VCW2612)
- 60146692-400 (VCW2613)

- c. cross cable:

- 60146685-010 (VCW2622)
- 60146685-025 (VCW2624)
- 60146685-050 (VCW2625)

CENTRONICS INTERFACE

The following cables can be used to connect a printer with the CENTRONICS-IBM parallel interface:

Other markets

B78141038-002 (VCW0601)
B78141038-001 (VCW0606)

USA only

B78146282-002 (VCW0601U)
B78146282-001 (VCW0601U)

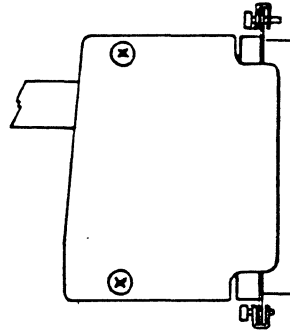
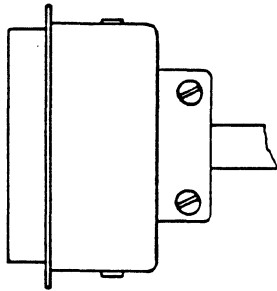

Identifying the Interface and Cables Used to Connect a Peripheral to an SP2 Board

A printer with a CENTRONICS-IBM parallel interface and peripherals with RS232 and RS422 asynchronous interfaces can be connected to an SP2 board.

The following cables are used for the different connections with the SP2 board.

RS422 INTERFACE

B78145149-001 (VCW0618)

B78145150-001 (VCW0619), cross cable

RS232 INTERFACE

B78144222-001 (VCW0615), remote connection

B78145755-001 (VCW0663), local connection (VIP terminal)

B78145754-001 (VCW0617), local connection (Tektronix terminal)

THIS PAGE IS INTENTIONALLY LEFT BLANK

Identifying the Interface and Cables Used to Connect the Peripherals or another System to the LP0 Board

A printer with a CENTRONICS-IBM parallel interface and peripherals with RS232 and RS422 asynchronous interfaces can be connected to an LP0 board.

Different types of cable have been developed to support these interfaces.

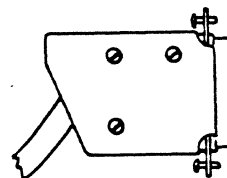
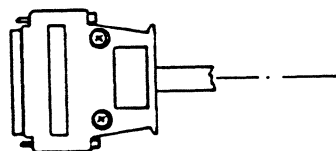
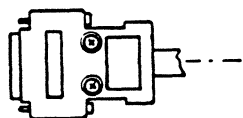
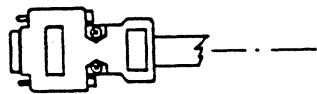

RS232 INTERFACE

The following cables are available for the system-peripheral connection:

Other markets

USA only:

B78141036-001 (VCW0653) B78146280-001 (VCW0653U)

for remote connection

Other markets:

USA only:

B78141037-001 (VCW0658)	B78146281-001 (VCW0658U)
B78141039-001 (VCW0659)	B78146283-001 (VCW0659U)
B78141032-001 (VCW0654)	B78146276-001 (VCW0654U)
B78141031-001 (VCW0655)	B78146275-001 (VCW0655U)

for local connection.

The following cables are provided for an asynchronous system-system connection:

- a. B78141030-001
B78141035-001
B78141231-001
(VCW0651)
B78141222-001
B78141232-001
B78141232-001

In order to make the connection to the host two cables are used (one from each group). This depends upon the connector on the host to which the cable is connected.

- b. extension cable:

- 60146692-050 (VCW2605)
- 60146692-100 (VCW2606)
- 60146692-150 (VCW2611)
- 60146692-200 (VCW2607)
- 60146692-300 (VCW2612)
- 60146692-400 (VCW2625)

c. cross cable:

60146685-010 (VCW2622)
60146685-025 (VCW2624)
60146685-050 (VCW2625)

The following cables are available for a synchronous system-system connection:

a. cross cable:

B78141033-001 (VCW066)

b. extension cable:

B78141034-002 (VCW0671)
B78141034-003 (VCW0672)
B78141233-001 (VCW0673)
B78141233-002 (VCW0674)

There are three cables which must be personalized to enable various connections.

Other markets:

B78141036-001 (VCW0653)
B78141037-001 (VCW0658)
B78141039-001 (VCW0674)

USA only:

B78146280-001 (VCW0653U)
remote connection
B78146281-001 (VCW0658U)
local connection
B78146283-001 (VCW0674U)
local connection

See the following paragraph for information regarding the personalization of these cables.

RS422A INTERFACE

System-Peripheral Connection

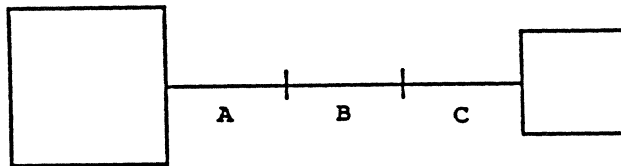

Cables available: **SYSTEM**

PERIPHERAL

- a. Use one of the three cables below, according to the connector with which the cable will be connected:

B78141030-001
B78141035-001 (VCW0651)
B78141231-001

- b. extension cable (optional):

60146692-050 (VCW2605)
60146692-100 (VCW2606)
60146692-150 (VCW2611)
60146692-200 (VCW2607)
60146692-300 (VCW2612)
60146692-400 (VCW2613)

- c. cross cable:

60146685-010 (VCW2622)
60146685-025 (VCW2624)
60146685-050 (VCW2625)

CENTRONICS-IBM INTERFACE

The following cables are provided to connect a printer with a CENTRONICS-IBM parallel interface:

Other markets:

B78141038-001 (VCW0601)

B78141038-002 (VCW0606)

USA only:

B78146282-001 (VCW0601U)

B78146282-002 (VCW0601U)

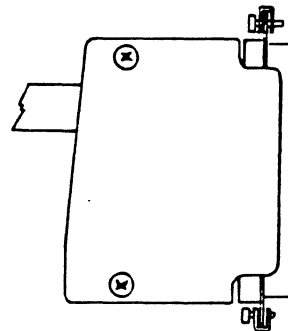
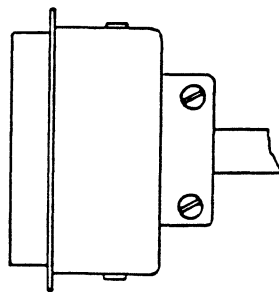

Installing the Communication Lines

As described in the previous paragraphs, RS422 or RS232 serial interface lines can be attached to the system.

With the RS422 line, the link between system and peripheral is always local. To link the peripheral to the system, use the cable supplied with the peripheral. If the cable is not long enough to cover the distance between the system and the peripheral, use one or more extension cables.

For RS232 lines, a link may be local or remote (via modem).

- if the link is local, a cable of maximum length 15 meters is supplied with the peripheral.
- if the link is remote, a modem must be attached to the system. In this case, the cable to link the modem is supplied with the modem itself.

The peripherals may be connected to two types of board: SP0, SP1 or SP2 and LP0.

NOTE

The LP0 and SP1 boards give the user the possibility of connecting a peripheral in remote or local mode, rather than in just local mode, as is the case with the SP0 and SP2 board.

In local mode, it makes no difference which board (SP0/SP1/LP0) is used. A peripheral may be connected to one of the connectors on the board. The peripheral has a symbolic name according to the connector that is used. The software uses this name to refer to the peripheral. Refer to the figure on the following page for information regarding the "connector position on the board/symbolic name" combinations. The symbol "x" corresponds to the logical position of the board:

Central unit:

board number 4	x = 0
board number 5	x = 1
board number 6	x = 2
board number 7	x = 3
board number 8	x = 8
board number 9	x = 9

Expansion unit:

board number 4	x = 4
board number 5	x = 5
board number 6	x = 6
board number 7	x = 7
board number 8	x = a
board number 9	x = b

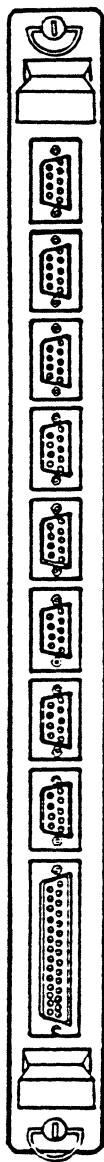

TTYx0
or
CONSOLE

TTYx1

TTYx2

TTYx3

TTYx4

TTYx5

TTYx6

TTYx7

PRINTER

SP0 or SP1 board



TTYx0
o
CONSOLE

TTYx1

TTYx2

TTYx3

TTYx4

TTYx5

TTYx6

TTYx7

TTYx8

TTYx9

TTYxa

TTYxb

PRINTER

RS232
or
RS422
ASINC

SP2 board

TTYx0
or
CONSOLE RS232
 or
 RS422
TTYx1 ASYNC

TTYx2
 RS422
 SYNC/
 ASYNC
TTYx3

TTYx4
 RS232
 SYNC/
 ASYNC
TTYx5 or
 RS422
 ASYNC

PRINTER

LPO board

THIS PAGE IS INTENTIONALLY LEFT BLANK

Linking the Line Cables to the System

Before linking a peripheral (workstation or printer) to the system, it is necessary to make sure that the peripheral has been installed correctly.

Note that:

- a printer with a CENTRONICS-IBM interface must be linked to the PRINTER connector.
- the console must be linked initially to the highest connector on the board in position 4 (LP0, SP0, SP1 or SP2).
- any other terminal with an RS232 or RS422 interface for local connection only must be connected to the first available 9 pin connector on the SP0, SP2, SP1 (RS232 only) or LP0 board (going from top to bottom).
- a terminal with an RS232 interface for remote connection must be connected to the first available 25 pin connector on the LP0 board or to the first available connector on the SP1 board.
- a terminal with an RS422 interface for high speed local connection must be connected to the first available 15 pin connector on the LP0 board.

To connect the line cable to the system:

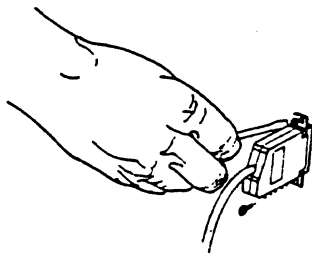

- A. Insert the peripheral cable plug into the appropriate connector of the board.
- B. Tighten the plug, using a small screwdriver if necessary, by turning the screws on the edges of the plug.

- connect the connector that was previously located in P2 to the free socket in the Back Panel.

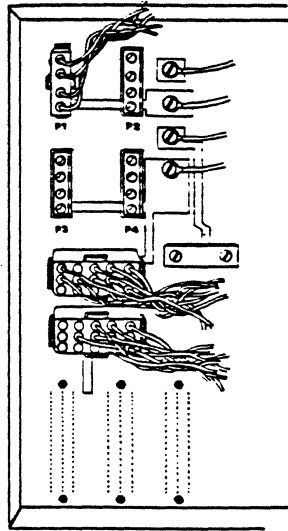

INSTALLING AN ADDITIONAL BOARD

The installation of a new board requires the following operations:

- identifying the position in which the board must be inserted
- installing the board
- connecting the necessary cables to the board

Identification of the Guides for Board Lodging

The following additional boards may be inserted in the central unit cage:

- two 2/4/8 Mb memory expansion boards
- a Cache board
- up to 3 SP0, SP1, SP2 or LP0 boards
- two VME boards
 - a Lan
 - a controller for an external tape unit
 - up to two controllers for removable disks
 - up to two SP1 or SP2 boards

Each board occupies a specific position in the central unit cage, and each position is labelled with a number or an acronym (see the figure on the following page). These labels are used for identification purposes.

If the label has not already been applied, it will be supplied with the board: locate the label corresponding to the position in which the board is to be installed and apply this label to the board.

The guides for the additional boards are occupied by dummy boards. The dummy board should only be removed from the guides when a real board is to be installed in that position. It is advisable to keep the dummy boards, as they must be reinserted in the relevant position if a board is temporarily removed.

Installing a Board

WARNING

- A. *The additional power unit must be already installed prior to installation of any of the following items:*

*CHX
SPX
LPO
VME*

- B. *The order in which memory expansion boards are installed depends on the capacity of each board. In fact, the boards must be installed in descending order. The board with the greatest capacity must always occupy position MEM1; the board with the next highest capacity MEM2; and the board with the lowest capacity MEM3.*
- C. *Do not open the packing box containing the boards before starting the procedure. Wait for the procedure to request its opening.*
- D. *Power the system off.*
- E. *Do not remove the power supply plug from the supply socket of the system.*
- F. *Remove the rear panel. Put on the antistatic wristband and insert its cable in one of the appropriate sockets in the central unit (see Appendix A).*

- G. When the various installations have been completed, remove the cable connected to the antistatic wristband and remount the rear panel.**

INSTALLING THE SECOND MEMORY EXPANSION BOARD

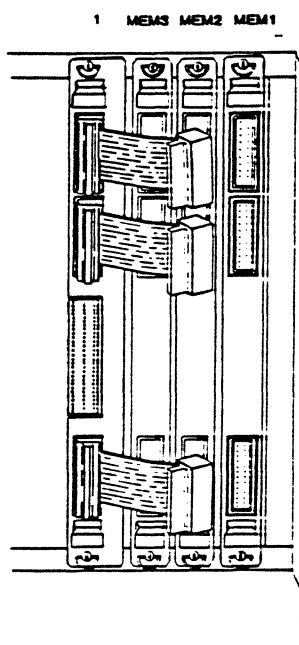

1. Remove the cables which connect the CPX board to the first memory expansion board on the system.

These cables must be replaced by cables with four connectors.

NOTE: The cables delivered with the X20EF and X40EF systems already have four connectors and it is therefore not necessary to replace them.

Do not change the positions of the three cables.

2. Remove the dummy board from the position MEM2 where the memory expansion board will be inserted.

11	10	9	8	7	6	5	4	3	2	1	MEM 3	MEM 2	MEM 1
EX0	DCS0	VME	VME	SPX3	SPX2	SPX1	SPX0	SCX	CHX0	CPX0	SE2	SE2	SE2
TER	DCE0	SP1	SP1	LP03	LP02	LP01	LP00				SE2	SE2	SE2
		SP2	SP2								SM4	SM4	SM4
											SM8	SM8	SM8
											MF4	MF4	MF4
											MF8	MF8	MF8

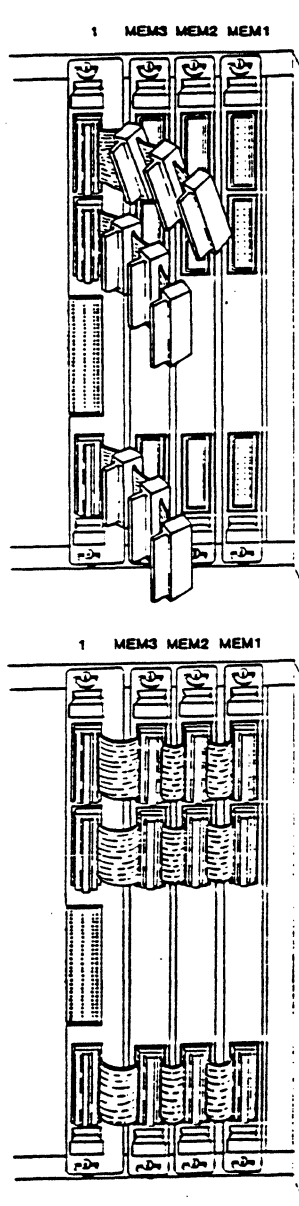

3. Locate the cables with four connectors:

- A. insert the connector at the end of the cable in the plug located at the top of the CPX board.
- B. insert connector 1 (the connector for the third board) in the plug located at the top of the MEM3 dummy board.
- C. insert connector 2 (the connector for the second board) in the plug located at the top of the MEM2 board.
- D. insert connector 1 (the connector for the first board) in the plug located at the top of the MEM1 board.

Perform these operations with the other two cables, connecting them to the intermediate and the low plugs on the boards.

INSTALLING THE THIRD MEMORY EXPANSION BOARD

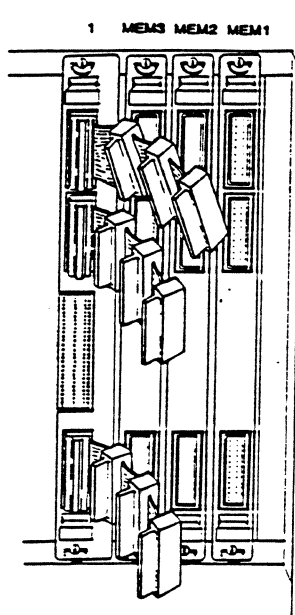

1. Disconnect the cables from the memory expansion board and from the MEM3 dummy board.

2. Remove the dummy board from the position MEM3 where the memory expansion board will be inserted.

11	10	9	8	7	6	5	4	3	2	1	MEM 3	MEM 2	MEM 1
EX0	DCS0	VME	VME	SPX3	SPX2	SPX1	SPX0	SCX	CHX0	CPX0	SE2	SE2	SE2
	o			o	o	o	o				o	o	o
TER	DCE0	SPT	SP1	LP03	LP02	LP01	LP00				SM4	SM4	SM4
		o	o								o	o	o
		SP2	SP2								SM8	SM8	SM8
											o	o	o
											MF4	MF4	MF4
											o	o	o
											MF8	MF8	MF8

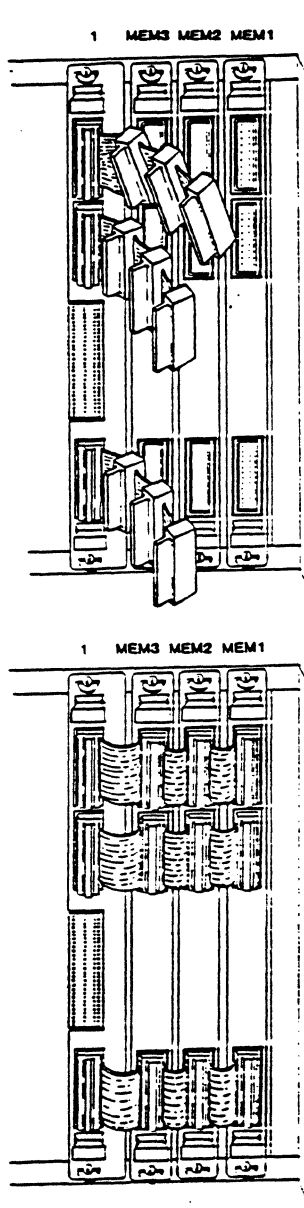

3. Insert connectors number 3 (the connectors for the MEM3 board) in the plug of the third memory board.

Insert the cables in the plugs on the other memory boards.

INSTALLING THE CACHE BOARD

- Using the figure, locate the position in which the board is to be inserted. Remove the dummy board currently inserted in that position.

11	10	9	8	7	6	5	4	3	2	1	MEM 3	MEM 2	MEM 1
EX0	DCS0 o	VME	VME	SPX3 o	SPX2 o	SPX1 o	SPX0 o	SCX	CHX0	CPX0	SE2 o	SE2 o	SE2 o
TER	DCE0	SP1 o SP2	SP1 o SP2	LP03	LP02	LP01	LP00				SM4 o SM8 o MF4 o MF8	SM4 o SM8 o MF4 o MF8	SM4 o SM8 o MF4 o MF8

- Unpack the board. Apply the label corresponding to the position in which the board is to be inserted. Establish the way by which the board is inserted in the cage (the board components must face towards the right) and insert the board in the appropriate position. Press down until the connectors on the rear side of the board lock into position.

Fasten the board to the system by turning the two wing nuts at the end of the board in a clockwise direction.

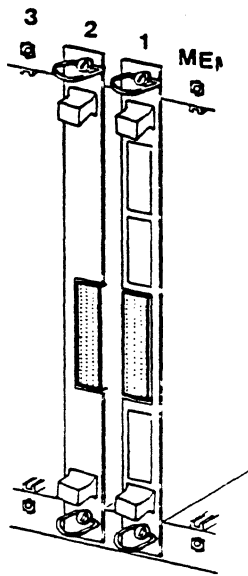

3. Locate the two identical sockets on the CHX (2) and CPX (1) boards.

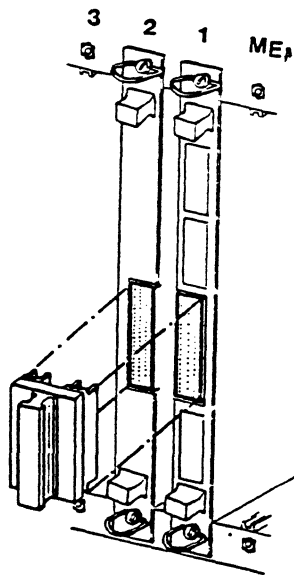

4. Insert the connector supplied with the cache board, as shown in the figure.

INSTALLING AN SP0 OR LP0 BOARD

- Using the figure, locate the position where the board will be inserted. Remove the dummy board currently inserted in that position.

11	10	9	8	7	6	5	4	3	2	1	MEM 3	MEM 2	MEM 1
EX0	DCS0 o	VME	VME	SPX3 o	SPX2 o	SPX1 o	SPX0 o	SCX	CHX0	CPX0	SE2 o	SE2 o	SE2 o
TER	DCE0	SP1 o SP2	SP1 o SP2	LP03	LP02	LP01	LP00				SM4 o	SM4 o	SM4 o
											SM8 o	SM8 o	SM8 o
											MF4 o	MF4 o	MF4 o
											MF8 o	MF8 o	MF8 o

- Unpack the board. Apply the label corresponding to the position where the board will be inserted.

- For LPO board, it is necessary to personalize lines 2 and 3, depending on whether the lines are to be used for synchronous or asynchronous connections. Locate the personalization pins and position the jumpers according to the following scheme:

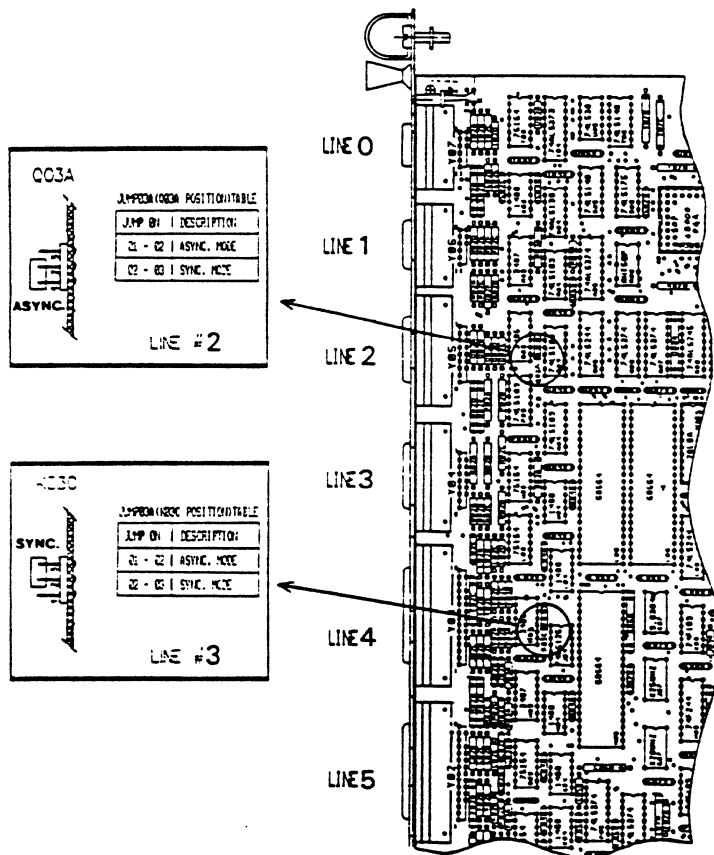

3. Follow the steps described in the paragraph *Installing an SP0 or LP0 board* to install the SP1 board.

The following table shows the maximum number of SP1 boards that can be inserted in a cabinet based upon the number of SP0 and LP0 boards already present.

LP0	SP0				
	0	1	2	3	4
0	6	5	3	1	0
1	5	3	1	0	NA
2	3	1	0	NA	NA
3	1	0	NA	NA	NA
4	0	NA	NA	NA	NA

NOTE

NA indicates that the configuration is not allowed.

INSTALLING THE SP2 BOARD

- Using the figure, locate the position where the board will be inserted. Remove the dummy board currently inserted in that position.

11	10	9	8	7	6	5	4	3	2	1	MEM 3	MEM 2	MEM 1
EX0	DCS0 o	VME	VME	SPX3 o	SPX2 o	SPX1 o	SPX0 o	SCX	CHX0	CPX0	SE2 o	SE2 o	SE2 o
TER	DCE0	SP1 o SP2	SP1 o SP2	LP03	LP02	LP01	LP00				SM4 o	SM4 o	SM4 o
											SM8 o	SM8 o	SM8 o
											MF4 o	MF4 o	MF4 o
											MF8 o	MF8 o	MF8 o

- Depending on the position in which the SP2 board is inserted, it is necessary to set the appropriate jumpers. With the help of the figure locate the personalization jumpers on the rear part of the board.

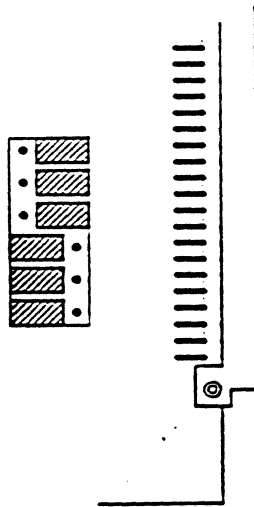

- Position the jumpers according to the following table:

main cabinet:

slot	S0	S1	S2	S3
4	off	off	off	on
5	off	off	off	on
6	off	off	off	on
7	off	off	off	on
8	on	on	on	off
9	off	on	on	off

expansion cabinet:

4	off	off	off	on
5	off	off	off	on
6	off	off	off	on
7	off	off	off	on
8	on	off	on	off
9	off	off	on	off

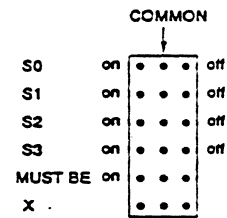

- For eight (the 4 connectors starting from the top and 4 connector above the Centronics connector) of the twelve connectors of the SP2 board it is possible to select the interface type RS232 or RS422. With help of the figure locate the jumpers.

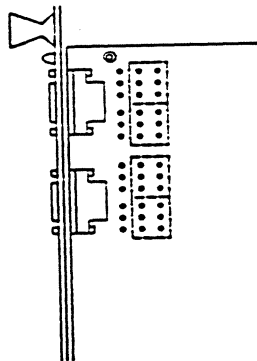

5. Select the RS232 or RS422 interface positioning the jumpers as shown in the figure.

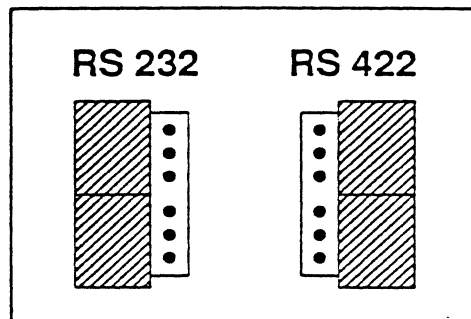

6. Follow the steps described in the paragraph *Installing an SP0 or LP0 board* to install the SP2 board.

THIS PAGE IS INTENTIONALLY LEFT BLANK

INSTALLING A VME LAN BOARD

- Using the figure, locate the position where the board is to be inserted. Remove the dummy board currently inserted in that position.

11	10	9	8	7	6	5	4	3	2	1	MEM 3	MEM 2	MEM 1
EX0	DCS0	VME	VME	SPX3	SPX2	SPX1	SPX0	SCX	CHX0	CPX0	SE2	SE2	SE2
	o			o	o	o	o				o	o	o
TER	DCE0	SP1	SP1	LP03	LP02	LP01	LP00				SM4	SM4	SM4
		o	o								o	o	o
		SP2	SP2								SM8	SM8	SM8
											o	o	o
											MF4	MF4	MF4
											o	o	o
											MF8	MF8	MF8
											o	o	o

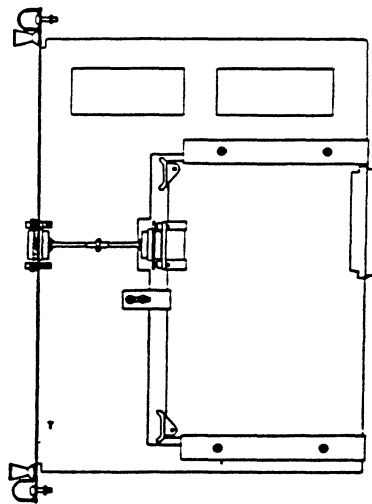

- Unpack the board. Apply the label corresponding to the position where the board will be inserted. Establish the way by which the board is inserted in the cage (the board components must face towards the right) and insert the board in the appropriate position. Press down until the connectors on the rear side of the board lock into position.

Fasten the board to the system by turning the two wing nuts at the end of the board in a clockwise direction.

INSTALLING AN SCI BOARD

- Using the figure, locate the SC0 board (n. 3). Disconnect the cables and remove the board.

11	10	9	8	7	6	5	4	3	2	1	MEM 3	MEM 2	MEM 1
EX0	DCS0 o	VME	VME	SPX3 o	SPX2 o	SPX1 o	SPX0 o	SCX	CHX0	CPX0	SE2 o	SE2 o	SE2 o
TER	DCE0	SP1 o SP2	SP1 o SP2	LP03	LP02	LP01	LP00				SM4 o	SM4 o	SM4 o
											SM8 o	SM8 o	SM8 o
											MF4 o	MF4 o	MF4 o
											MF8 o	MF8 o	MF8 o

- Unpack the board. If necessary, apply the label corresponding to the position in which the board will be inserted.

3. Locate the personalization microswitches used to connect with the emergency battery and personalize them according to the following instructions:

Microswitch A is used to enable or disable the battery time-out. To disable the battery, set it to the right position. In this case, if there is a power failure, the system will receive power from the battery, while sufficient charge remains.

To enable the time-out, microswitch A must be set to the left position and microswitch B must be set as follows:

- To the right if the operating system is UNIX (time-out value: 3.5 minutes);
- To the left if the operating system is PICK (Time-out value: 7 minutes).

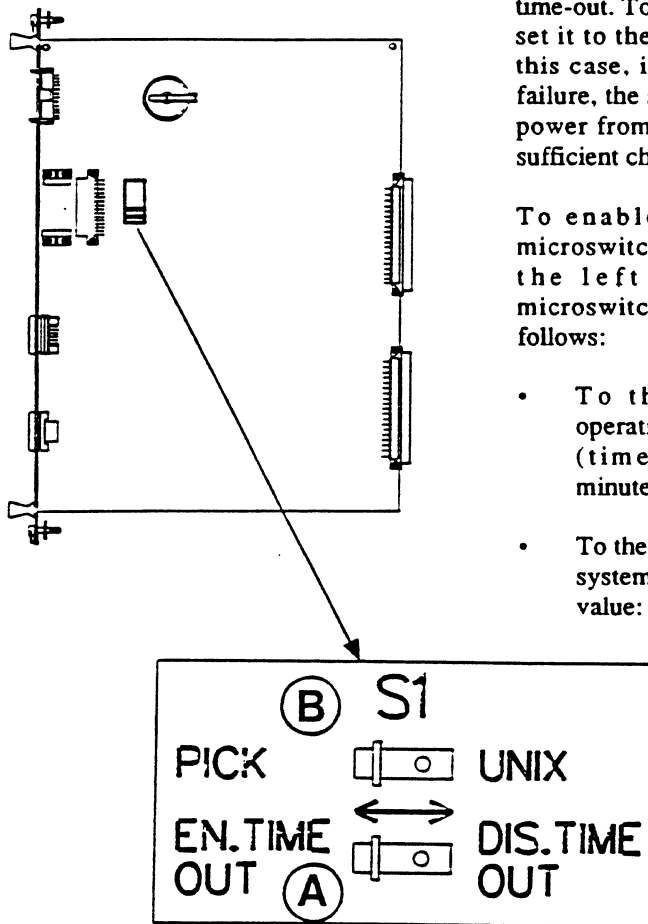

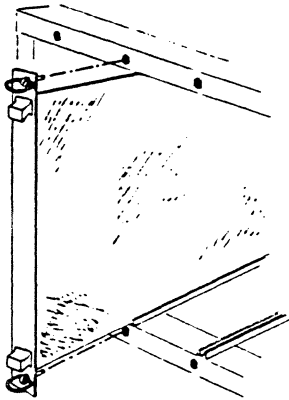

4. Establish the way by which the board is inserted into the cage (the board components must face towards the right) . Insert the board in position 3. Press down until the connectors on the rear side of the board lock into position .

Fasten the board to the system by turning the two wing nuts at the end of the board in a clockwise direction.

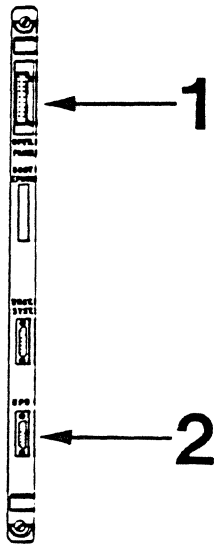

5. Identify the connectors located on the SC1 board:
 1. Cable for the operator panel.
 2. Cable for the emergency battery.

INSTALLING A VME BOARD FOR SMD DISKS

- Using the figure, locate the position where the board will be inserted. Remove the dummy board currently inserted in that position.

11	10	9	8	7	6	5	4	3	2	1	HIGH 3	HIGH 2	HIGH 1
EX0	DCS0 o	VME	VME	SPX3 o	SPX2 o	SPX1 o	SPX0 o	SCX	CHX0	CPX0	SE2 o	SE2 o	SE2 o
TER	DCE0	SP1 o SP2	SP1 o SP2	LP03	LP02	LP01	LP00				SM4 o SM8 o MF4 o MF8	SM4 o SM8 o MF4 o MF8	SM4 o SM8 o MF4 o MF8

- Unpack the board. Apply the label corresponding to the position where the board will be inserted.

11. Insert the resistance stoppers in the J04 and J05 connectors of the disk unit that was previously connected.

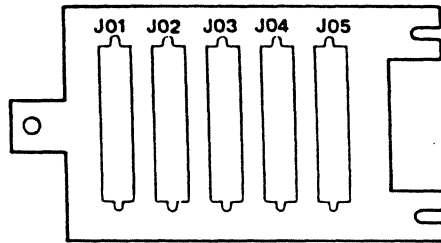

INSTALLING A VME BOARD FOR EXTERNAL TAPE UNITS

- Using the figure, locate the position where the board will be inserted. Remove the dummy board currently inserted in that position.

11	10	9	8	7	6	5	4	3	2	1	MEM 3	MEM 2	MEM 1
EX0	DCS0 o	VME	VME	SPX3 o	SPX2 o	SPX1 o	SPX0 o	SCX	CHX0	CPX0	SE2 o	SE2 o	SE2 o
TER	DCE0	SP1 o SP2	SP1 o SP2	LP03	LP02	LP01	LP00				SM4 o SM8 o MF4 o MF8	SM4 o SM8 o MF4 o MF8	SM4 o SM8 o MF4 o MF8

- Unpack the board. Apply the label corresponding to the position where the board will be inserted.

Installing the EPROM on the SCI Board



1. Using the figure locate the connector for the EPROM on the SCI board.

2. Insert the EPROM in the appropriate connector.

NOTE

The EPROM supports the DCE board.

The EPROM must be installed when the system contains more than 8 Station Processor or Line Processor boards.

The EPROM has been integrated on the SCI board for the X20EF and X40EF systems and it is therefore not necessary to install it.

Replacing a Memory Board

To replace one memory board of lesser capacity with another having a larger capacity. Follow the procedure indicated for installing additional memory boards.

Refer to the paragraphs *Installing a Board*.

Obviously, the board to be replaced must be located and removed. The order in which memory expansion boards are installed depends on the capacity of each board. In fact, the boards must be installed in descending order. The board with the greatest capacity must always occupy position MEM1; the board with the next highest capacity MEM2; and the board with the lowest capacity MEM3. Thus, when a board is replaced, install the boards in such a way that this order is maintained.

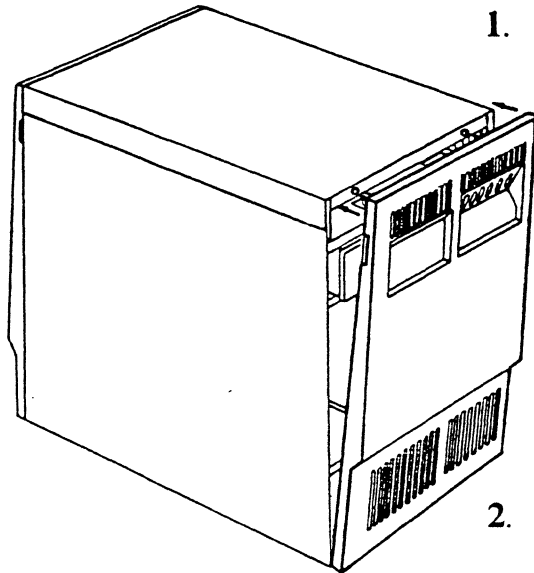

1. Remove the front panel of the central unit.

2. Put on the antistatic wristband.

Insert its cable in one of the appropriate sockets in the central unit. See Appendix A.

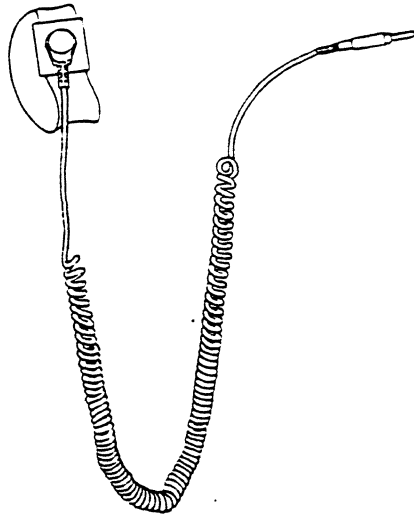

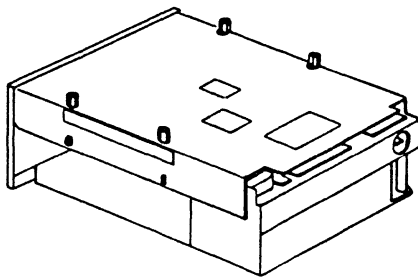

3. Unpack the disk unit and place it on a horizontal plane. Separate it from the surface with a piece of packing material.

Remove the resistance stopper shown in figure.

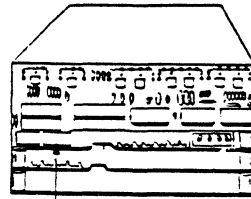

- 4a. Locate the disk personalization pins at the rear of the unit and position the jumper as follows:

- A. for the first additional disk unit (D02), position the jumper on the second pair of pins (from left to right).
- B. for the second additional disk (D03), position the jumper of the third pair of pins (from left to right).

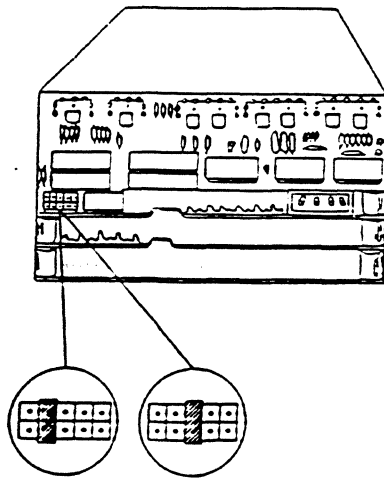

4b. For the Maxtor disk locate the personalization jumpers with help of the figure and position them as follows:

- A. for the first additional disk (D02) position the jumper on DS2.
- B. for the second additional disk (D03) position the jumper on DS3.

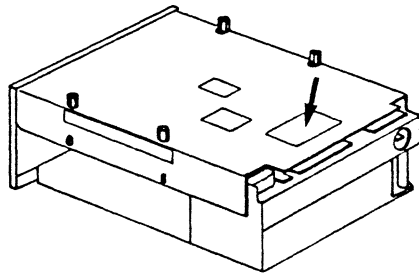

THIS PAGE IS INTENTIONALLY LEFT BLANK

Section IV

INSTALLING THE EXPANSION UNIT

This section contains the instructions necessary to perform the installation of the expansion unit and the optional units which may be inserted.

This section contains the following subsections:

- Description of the Expansion Unit
- Installing the Expansion Unit
- Power Supply for the Unit
- Installing the Additional Power Supply
- Installing a Board
- Installing the Disk Units

NOTE

If the system contains more than 8 Station Processor or Line Processor boards, it is necessary to install the portable EPROM on the SCI board. See "Installing the EPROM on the SCI Board".

The EPROM has been integrated on the SCI board for the X20EF and X40EF systems and it is therefore not necessary to install it.

THIS PAGE IS INTENTIONALLY LEFT BLANK

DESCRIPTION OF THE EXPANSION UNIT

The purpose of this subsection is to give a general description of the expansion unit. Each component is listed and its location in the unit is indicated.

The components are:

- Central Processor board (CPU), where the main microprocessor is located
- Cache board (CH0)
- Three 2, 4 or 8 Mb memory expansion boards
- Four Station Processor boards (SP0, SP1 or SP2) or Line Processor boards (LP0), to control eight asynchronous lines and six synchronous/asynchronous lines respectively
- Disk Controller board (DCS1 or DCE), to control disk units with ST506 and ESDI interface respectively
- Fan
- Two Power supplies
- Two VME boards of the following type:
 - LAN controller for creating local networks
 - Controller for removable disk units with SMD interfaces
 - Controller for external tape units
 - Two SP1 or SP2 boards

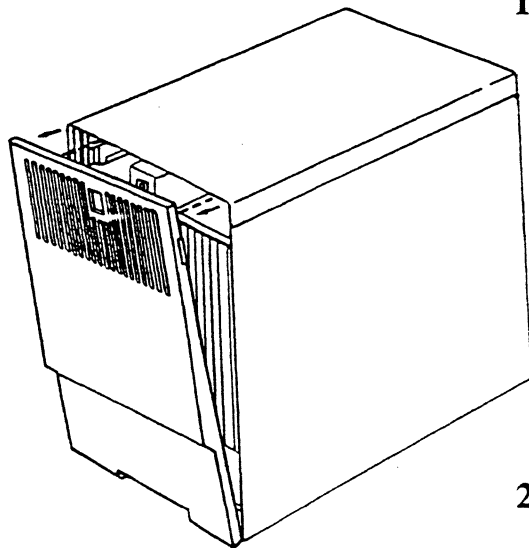

1. Remove the panels from the central unit and from the expansion unit.

2. Put on the antistatic wristband.

Insert its cable in one of the appropriate sockets in the central unit. See Appendix A.

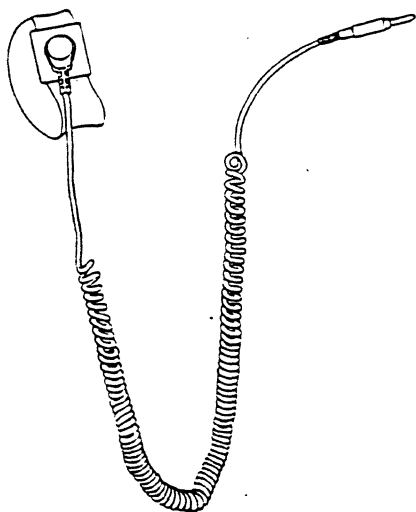

WARNING

On some systems, the small panel and the termination board are not supplied. In this case go to step 6.

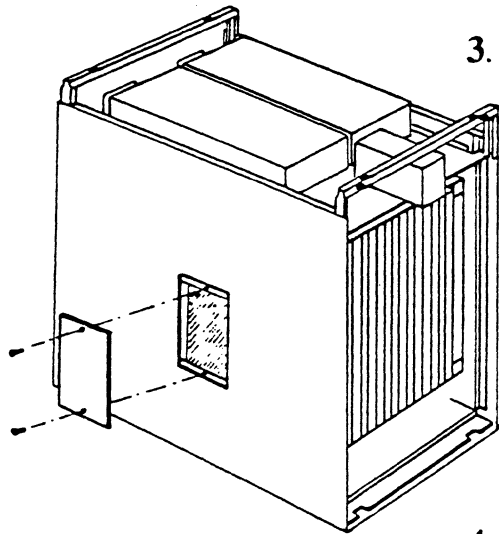

3. On the side of the central unit, there is a small panel. Unscrew the two screws on the side panel and remove the smaller panel.

4. Identify the termination board (number 11) inside the cage box.

1	2	3	1	2	4	5	6	7	8	9	10	11
SE2	SE2	SE2	CPX1	CHX1	SPX4	SPX5	SPX6	SPX7	VME	VME	DCS1	
o	o	o			o	o	o	o			o	
SM4	SM4	SM4			LP04	LP05	LP06	LP07	SP1	SP1	DCE1	
o	o	o							o	o		
SM8	SM8	SM8							SP2	SP2		
o	o	o										
MF4	MF4	MF4										
o	o	o										
MF8	MF8	MF8										

- 13.** Insert the upper plates as indicated in the figure.

Fasten the plates using the two longest screws which are provided.

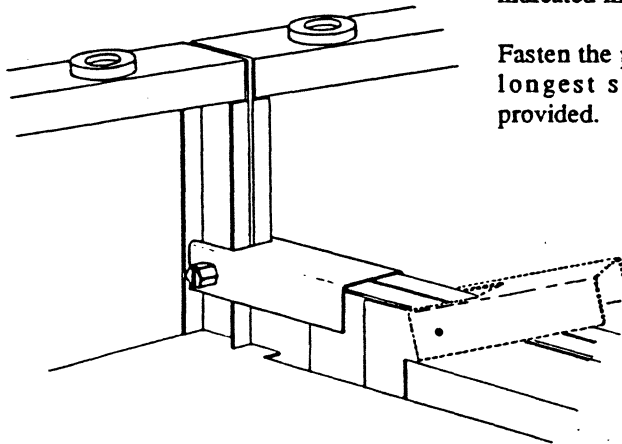

- 14.** Insert the lower plates as indicated in the figure.

Fasten the plates using the four shortest screws which are provided.

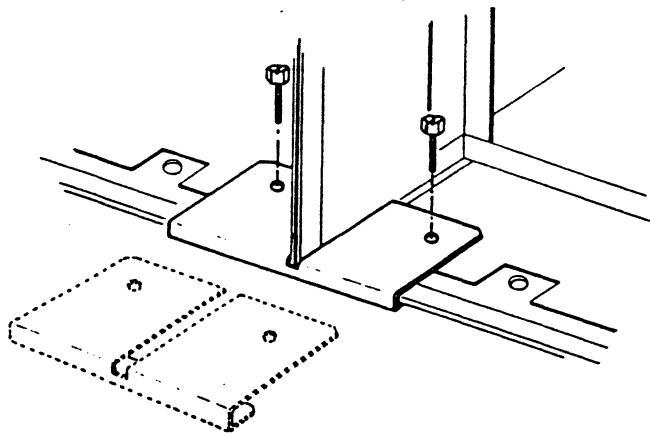

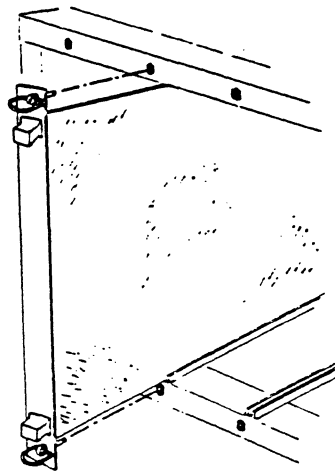

15. In the expansion unit, remove the three boards which are closest to the central unit (numbers 10, 9, 8).

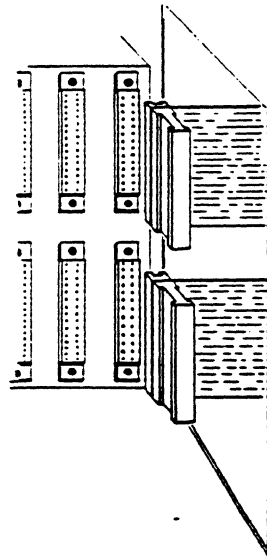

16a. Connect the free ends of the connectors to the corresponding plugs on the back panel of the expansion unit.

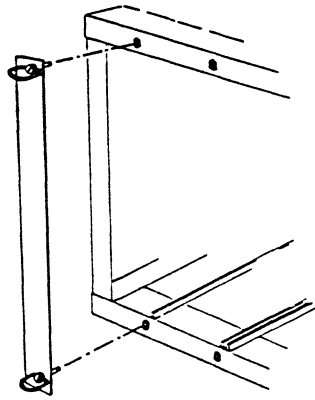

16b. Fix the metal covers in the rightmost position of the electronic cage in the expansion unit and the leftmost position of the electronic cage of the main cabinet .

THIS PAGE IS INTENTIONALLY LEFT BLANK

17. Reinsert any boards that have been previously removed .

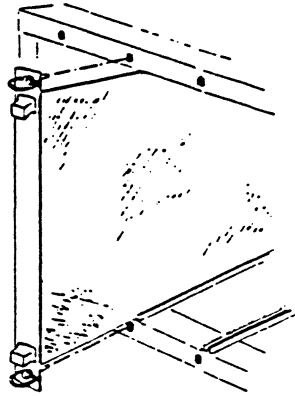

18. Remove the cable connected to the antistatic wristband.

Remount the panels.

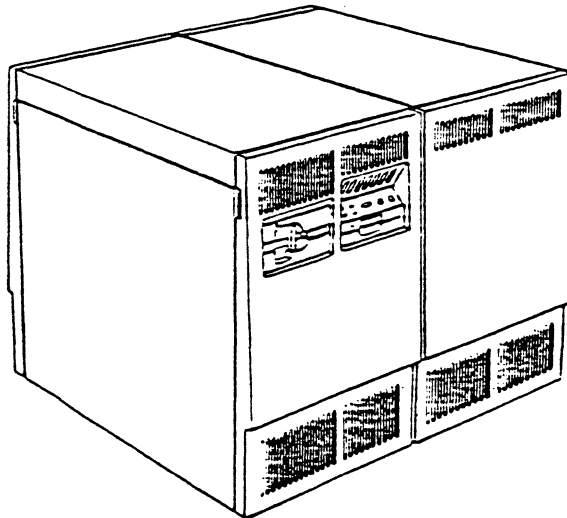

POWER SUPPLY FOR THE UNIT

This subsection lists only those items in the expansion unit that require the installation of the additional power supply. The additional power unit must already be installed prior to the installation of any of the following items:

- CHX board
- 2nd, 3rd e 4th SP0, SP1, SP2 or LP0 boards
- VME boards
- Third disk unit

The power cables are already connected to sockets P1, P2, P3 and P4 of the Back Panel. The power for sockets P1 and P2 comes from the first power supply, whereas the power for sockets P3 and P4 comes from the second power supply.

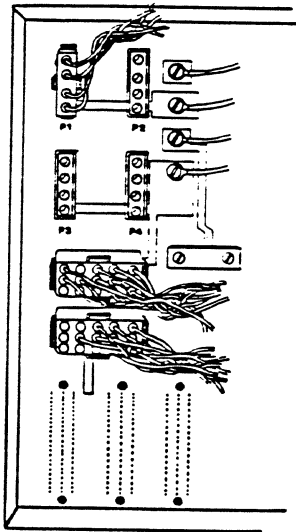

INSTALLING THE ADDITIONAL POWER SUPPLY

The operations required to install the additional power unit in the expansion unit are exactly the same as those described in the corresponding section regarding the central unit.

INSTALLING A BOARD

The position of the boards in the cage box of the expansion unit differs significantly from the position of by the boards in the central unit.

The boards are located in a mirror-image of the position they occupy in the central unit, as the figure below illustrates.

1 MEM	2 MEM	3 MEM	1	2	4	5	6	7	8	9	10	11
SE2	SE2	SE2	CPX1	CHX1	SPX4	SPX5	SPX6	SPX7	VME	VME	DCS1	
o	o	o			o	o	o	o			o	
SM4	SM4	SM4			LP04	LP05	LP06	LP07	SP1	SP1	DCE1	
o	o	o							o	o		
SM8	SM8	SM8							SP2	SP2		
o	o	o										
MF4	MF4	MF4										
o	o	o										
MF8	MF8	MF8										

It can be seen that the various boards which might be installed in the expansion unit correspond to those illustrated in the previous chapters. Therefore, the procedures to install the individual boards are identical to those regarding the installation in the central unit.

Because the system control board is not required in the expansion unit, there are less boards present than before.

The termination board, located in position 11 of the central unit, will never be in the corresponding position in the expansion unit, because this position is automatically taken by the connector which performs the connection between the two units.

The connection between the CPX and CH0 boards is performed with a larger jumper due to the difference in distance between the two boards.

If you want to insert an SP1 board into the expansion unit, set the switches according to the following table:

SLOT NUMBER	SWITCHES			
	S3	S2	S1	S0
4	ON	OFF	OFF	OFF
5	ON	OFF	OFF	OFF
6	ON	OFF	OFF	OFF
7	ON	OFF	OFF	OFF
8	OFF	ON	OFF	ON
9	OFF	ON	OFF	OFF

WARNING

The procedure for installing an additional board is very similar to the sequence of operations described in the chapter regarding the central unit. The installation procedure for the DCS or DCE disk controller board is described on the following pages, since one of these boards is always installed.

Installing the DCS1 or DCE1 board

- Using the figure, locate the position where the board will be inserted. Disconnect the cables connected to the dummy board. Warning: these cables must then be connected to the DCS1 or DCE1 board in the same order in which they were connected to the dummy board.

1 MCM	2 MCM	3 MCM	1	2	4	5	6	7	8	9	10	11
SE2	SE2	SE2	CPX1	CHX1	SPX4	SPX5	SPX6	SPX7	VME	VME	DCS1	
o	o	o			o	o	o	o			o	
SM4	SM4	SM4			LP04	LP05	LP06	LP07	SP1	SP1	DCE1	
o	o	o							o	o		
SMB	SMB	SMB							SP2	SP2		
o	o	o										
MF4	MF4	MF4										
o	o	o										
MF8	MF8	MF8										
o	o	o										

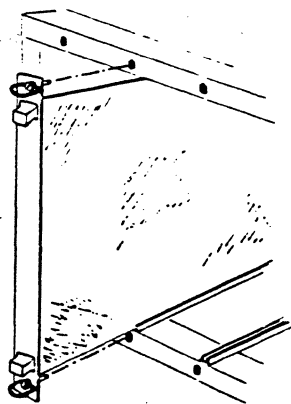

- Remove the dummy board currently occupying the position.

Appendix B

EARTHING THE LINE CABLES

This appendix contains the necessary instructions for grounding the line cables.

EARTHING THE LINE CABLES

The earthing device is made up of a two-part rack that is shaped to accommodate line cables connected to peripheral units or to other systems, and to allow contact between the copper sheathing around the cables and the system.

The racks, which are supplied together with the additional boards, may be of two different types, depending on the kind of board to which they are linked.

Up to four racks, arranged in two overlapping lines, may be installed, depending on the number of lines to be connected.

The cables must be set up for contact by removing a portion of the outer covering. They are then inserted in the rack, which is subsequently attached to the system.

With the help of the figure, establish which of the three segments of the covering must be removed. Note that if the cable is attached to one of the connectors in zone 1, the segments of covering to be removed are those furthest from the end of the cable itself. If the cable is to be connected in zone 2, the intermediate segment will be removed. Finally, if the cable is to be connected in zone 3, the segment nearest to the end of the cable will be removed.

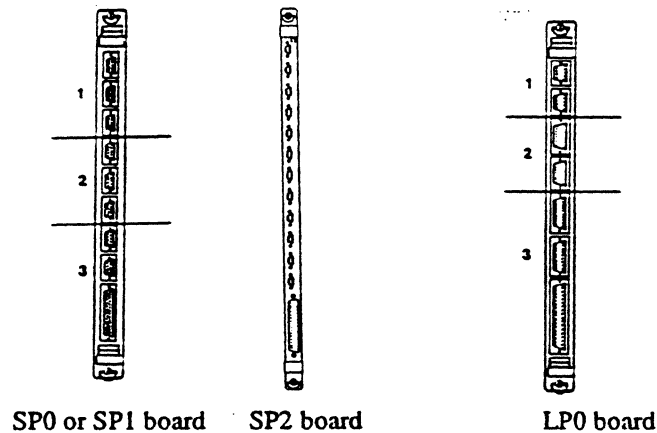

The rack illustrated in the figure is for the SP0 and SP1 board. The following hole types are visible for connection of the line cables:

- A. a hole for the printer cable with a CENTRONICS-IBM interface;
- B. a hole to accommodate a VME board cable;
- C. eight holes for the asynchronous line cables RS232 or RS422.

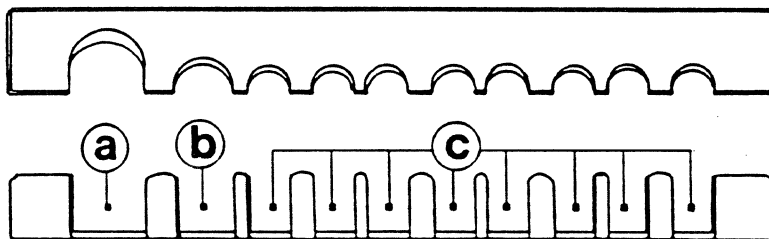

The rack in the next figure is for the LP0 or VME boards. The illustration shows the following hole types for the connection of the line cables:

- A. a hole for the printer cable with a CENTRONICS-IBM interface;
- B. four holes to accommodate the 25 pin cable connectors with an RS232 interface or the cables for a VME board;
- C. four holes for 9 or 15 pin cable connectors.

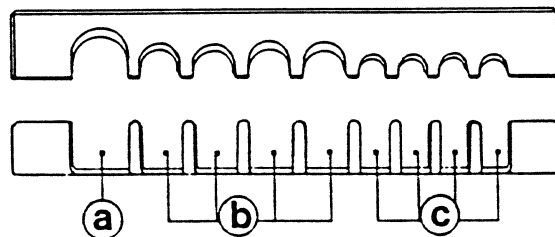

The rack in the next figure is for the SP2 boards. The illustration shows the following hole types for the connection of the line cables:

- A. a hole for the printer cable with a CENTRONICS-IBM interface:
- B. eighteen holes to accommodate the 9 pin cable connectors with RS232, RS422 or military standard interface

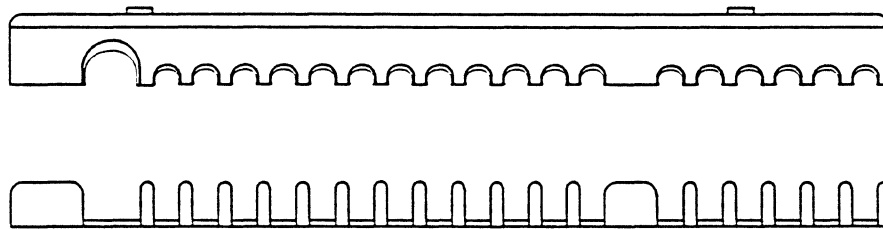

THIS PAGE IS INTENTIONALLY LEFT BLANK

The following table shows the correct sequence for the four racks to be installed in the system.

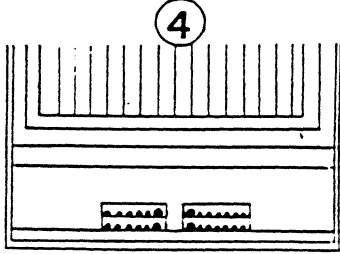
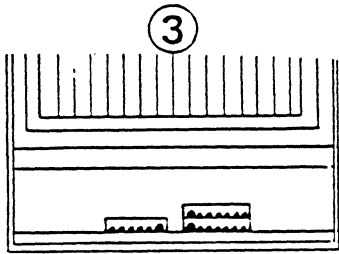
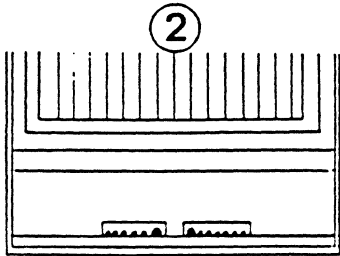
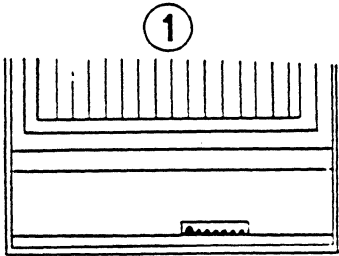

SYSTEM TESTING GUIDE

Addendum A

SUBJECT

Additions and changes to the System Testing Guide.

SPECIAL INSTRUCTIONS

This update, Order Number A78138958-202, is the first Addendum to A78138958-202, dated June 1988.

The attached pages are to be inserted into A78138958-201, as indicated in the collating instructions on the back of this cover. Change bars in the margins indicate technical additions and changes, and asterisks indicate deletions. These changes will be incorporated into the next revision to this manual.

NOTE:

Insert this cover following the manual cover to indicate the updating of the document with the first Addendum.

ORDER NUMBER

A78138958-202

September 1988



COLLATING INSTRUCTIONS

To update the last version of the manual, remove the old pages and insert the new pages, as follows:

<u>Remove</u>	<u>Insert</u>
1.1 through 1.6	1.1 through 1.6
2.3 through 2.6	2.3 through 2.6
2.11, 2.12	2.11, 2.12
2.19 through 2.22	2.19 through 2.22
2.25, 2.26	2.25, 2.26
2.27, 2.28	2.27, 2.27-1 blank, 2.28
2.49, 2.50	2.49, 2.50
2.55, 2.56	2.55, 2.56
3.41 through 3.44	3.41 through 3.44
3.45, 3.46	3.45, 3.45-1 blank, 3.46
3.49, 3.50	3.49, 3.49-1 blank, 3.50
3.51, 3.52	3.51, 3.52

Section I

INTRODUCTION

STRUCTURE OF THE GUIDE

This guide consists of six sections:

- "**Introduction**", which explains how to use the guide.
- "**Unit Tests**", which helps you to identify the faulty Customer Replaceable Unit, or CRU).
- "**Unit Replacement**", which tells you how to replace each CRU.
- "**Unit Return**", which tells you how to prepare a faulty unit for its return to the nearest "Service Center".
- "**Calling for Help**", which tells you how to contact the distributor.
- "**Cover Removal/Replacement**", which contains information that you should consult while using the first five sections.

Most sections contain procedures for performing hardware tests on various system units. Each procedure is made up of a number of different operations.

NOTES

- In this guide, variable values are indicated by three consecutive dots (...).
- In this guide, the square brackets indicate a range of values.
- The system contains units which, if faulty, can be replaced by the user. The following figure shows every Customer Replaceable Unit, or CRU.
- The messages that are displayed during execution of the tests are marked with a series of hyphens (- - -) if no response is necessary, and do not appear in the documentation.

CENTRAL UNIT

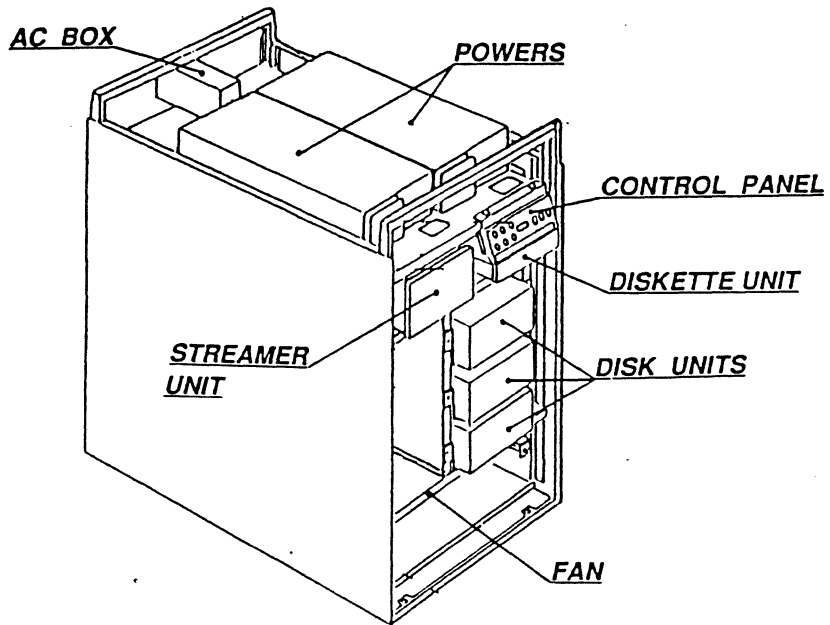

11	10	9	8	7	6	5	4	3	2	1	MEM 3	MEM 2	MEM 1
EX0	DCS0	VME	VME	SPX3	SPX2	SPX1	SPX0	SCX	CHX0	CPX0	SE2	SE2	SE2
	o			o	o	o	o				o	o	o
TER	DCE0	SP1	SP1	LP03	LP02	LP01	LP00				SM4	SM4	SM4
		o	o								o	o	o
		SP2	SP2								SM8	SM8	SM8
											o	o	o
											MF4	MF4	MF4
											o	o	o
											MF8	MF8	MF8
											o	o	o

EXPANSION UNIT

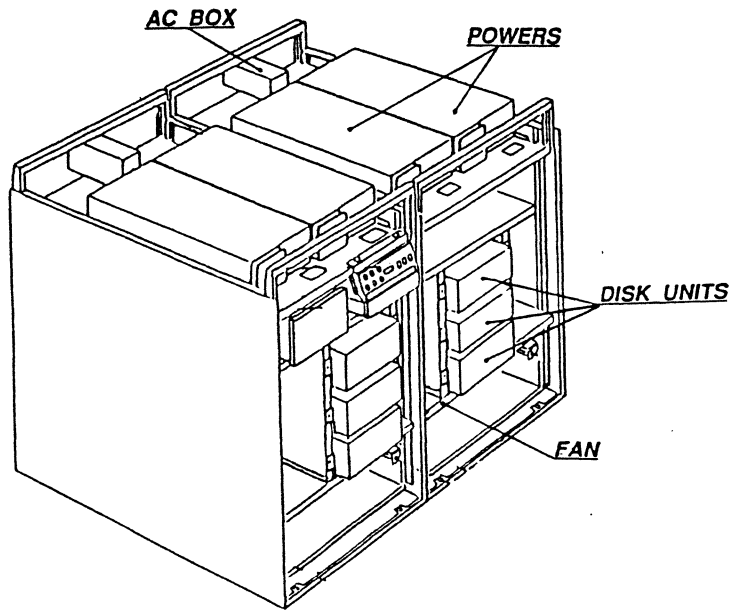

1 MEM	2 MEM	3 MEM	1	2	4	5	6	7	8	9	10	11
SE2	SE2	SE2	CPX1	CHX1	SPX4	SPX5	SPX6	SPX7	VME	VME	DCS1	
o	o	o			o	o	o	o			o	
SM4	SM4	SM4			LP04	LP05	LP06	LP07	SP1	SP1	DCE1	
o	o	o							o	o		
SM8	SM8	SM8							SP2	SP2		
o	o	o										
MF4	MF4	MF4										
o	o	o										
MF8	MF8	MF8										
o	o	o										

SYSTEM TESTING

The system testing process is performed in three distinct phases. Each test has a different testing level. The three phases are:

1. **START**, the resident test. During this phase the following units are checked to ensure that they are working correctly:
 - CPU Units
 - CHX Units
 - SPX Units
 - LPX Units
 - Memory Units
 - Disk Controller Units

This test is automatically performed at every system initialization. It requires no other operation. If faulty units are found, the control panel displays the values identifying these units.

2. **STAL**, the stand-alone test, i.e. without the operating system. During this phase the following units are checked to ensure that they are working correctly:
 - CPX Units
 - CHX Units
 - SCX Units
 - Memory Units
 - SPX Units
 - LPX Units
 - Disk Controller Units
 - Disk Units
 - Diskette Unit
 - Streamer Unit

The tests are performed using the DIAGX2 system test diskette supplied with the system.

3. *DIAG*, the test controlled by the operating system. During this phase, the following units are checked to ensure that they are working correctly:

- CPX Units
- CHX Units
- SCX Unit
- Memory Units
- SPX Units
- LPX Units
- Disk Controller Units
- Disk Units
- Diskette Unit
- Streamer Unit
- Tape Units
- VME BUS Units
- Printers
- Workstations
- The kernel of the operating system.

The tests are performed by initializing the system in normal mode from disk, or as a continuation of the *STAL* test.

6. Look at the console.

The following messages should be displayed:

```
*****
                STAL - DIAGNOSTIC SYSTEM
                REVISION .-.. ..
(c) COPYRIGHT Honeywell Bull Italia 1988
*****
```

Current date is: (y/n)?

If the date is correct, enter y. Otherwise, enter n: the following message is displayed:

Enter date (YYMMDDHHMMWX)
YY=year MM=month DD=day HH=hour MM=min. W=d/week
X=(0=am 1=pm)

Enter the date and press *RETURN*.

SELECT:

- a Full system test
(test performed from both diskette and disk)
- b Automatic system test
(test performed from diskette only)
- c Test of Unit CPU
- d Test of Unit SCX
- e Test of Unit Memory
- f Test of Unit CHX
- g Test of Unit Disk
- h Test of Unit Diskette
- i Test of Unit Streamer
- j Test of Unit SPX-LPX

Were the above messages displayed?

NO

YES

If one of these three messages is displayed: Continue.

*ERR : RISPOSTA NON RICEVUTA ENTRO 1 MINUTO
*ERR : REPLY NOT RECEIVED WITHIN 1 MINUTE

or

*ERR : RICEVUTO . . .
*ERR : RECEIVED . . .

or

*ERR: CAPITAL LETTERS RECEIVED...

Re-enter *dcba* and watch the console. Is the select screen displayed?

YES

NO

Continue.

Go to *Procedure C*, later in this section.

7. Choose the function you require by entering the appropriate letter, and continue.

SELECT:

- a Full system test
(test performed from both diskette and disk)
- b Automatic system test
(test performed from diskette only)
- c Test of Unit CPU
- d Test of Unit SCX
- e Test of Unit Memory
- f Test of Unit CHX
- g Test of Unit Disk
- h Test of Unit Diskette
- i Test of Unit Streamer
- j Test of Unit SPX-LPX

Go to the section identified by the letter you entered.

NOTES:

- For the "*Full system test*", selection a, "*Automatic system test*", selection b, and "*Test of Unit Streamer*", selection i, if a streamer unit is installed, a cartridge which does not contain any useful information must be inserted.
- If during the run of tests the message:

CPUX TRAP: ...

is displayed on the console, go to "*Procedure A - point 2*", later in this section.
- If you want to come out of the *STAL* testing phase, remove the diskette and proceed with normal work.

a. Full System Test

The following system configuration table will be displayed on the screen:

```
*****  
System configuration: ( (*) = Initializing Disk)  
MEMORY : ... Mb (...+...)  
CENTRAL HW : SCX0 CPU0 ...  
COMMUNICATION : ...  
: ...  
NETWORKING : ...  
DISK/TAPE CONTROLLER : ...  
DISK DEVICE : ...  
: ...  
TAPE DEVICE : ...
```

Press *RETURN* key to continue

where:

(...+...) is the capacity of the memory boards (first cabinet + additional cabinet)

... will take the value of the connected units. These values are shown in Table F on later in this section.

(*) This message is displayed only if the system is supplied with the unit indicated.

SELECT:

- a Full system test
(test performed from both diskette and disk)
- b Automatic system test
(test performed from diskette only)
- c Test of Unit CPU
- d Test of Unit SCX
- e Test of Unit Memory
- f Test of Unit CHX
- g Test of Unit Disk
- h Test of Unit Diskette
- i Test of Unit Streamer
- j Test of Unit SPX-LPX

NO

YES

Continue.

Select another operation or go to "Load from Disk", later in this section.

Is the following message displayed on the screen?

*ERR : CRU = . . .

NO

YES

Go to the beginning of "Unit Replacement", Section 3. Follow the instructions to replace the CRU indicated by the last Unit Test Message on the console.

Go to the beginning of "Unit Replacement", Section 3. Follow the instructions to replace the CRU indicated in the message.

c. Test of Unit CPU

The following message and the test evolution mask are displayed:

Test of Unit CPU (about 2 minutes)

Test Evolution Mask

The test recycles automatically.

Is the following message displayed?

*ERR : CRU = UNIT CPUx

where x is 0 or 1.

YES

Go to the beginning of "*Unit Replacement*", Section 3. Follow the instructions to replace the CPUx unit. See "*Replacing a Board*".

NO

Press < *B R E A K* > or the corresponding key sequence to stop the test. The selection menu is redisplayed. Select another operation from the list or go to "*Load from Disk*", later in this section.

i. Test of Unit Streamer

The following message and the test evolution mask are displayed on the screen:

Test of Unit Streamer (about 3 minutes)

Test Evolution Mask

The test recycles automatically.

Is the following message displayed?

*ERR : CRU = UNIT STREAMER

YES

NO

Go to the beginning of "*Unit Replacement*", Section 3, and follow the instructions to replace the streamer unit.

Press < *B R E A K* > or the corresponding key sequence to stop the test. The selection menu reappears. Select another operation from the list or go to "*Load from Disk*", later in this section.

j. Test of Unit SPX

The following message and the test evolution mask are displayed:

```
Test of Unit SPX                      (about 10 seconds)
                                     Test Evolution Mask
```

The test recycles automatically.

Is the following message displayed?

```
*ERR .... : CRU = UNIT SPX_x
```

where *x* is the number of the board.

YES

Go to the beginning of "*Unit Replacement*", Section 3, and follow the instructions to replace the SPX board identified by *x* (see "*Replacing a Board*").

NO

Press *<BREAK>* or the corresponding key sequence to stop the test. The selection menu is redisplayed. Select another operation from the list or go to "*Load from Disk*", later in this section.

j. Test of Unit LPX

The following message and the test evolution mask are displayed:

Test of Unit LPX (about 1 minute)

Test Evolution Mask

The test recycles automatically.
Is the following message displayed?

*ERR : CRU = UNIT LPX_x

where x is the number of the board.

YES

NO

Go to the beginning of "*Unit Replacement*", Section 3, and follow the instructions to replace the LPX board identified by x (see "*Replacing a board*").

Press *<BREAK>* or the corresponding key sequence to stop the test. The selection menu is redisplayed. Select another operation from the list or go to "*Load from Disk*", later in this section.

LOAD FROM DISK

1. Power on the console workstation and wait for the cursor to be displayed.
2. Check that the diskette unit is empty. If there is a diskette present remove it.
3. Press the POWER ON and RESET buttons on the control panel. Look at the console.

Does the following message appear within one minute?

```
System startup Version 2.1  
...
```

YES

NO

Continue.

Go to "*Procedure B*", later in this section.

a. System automatic test

The following messages will be displayed:

The selection run such tests sequence:

+----- DEFAULT TEST -----+

FLOPPY unit test
DISK 0 test
CPU test
FILE SYSTEM test

Do you want to insert other tests? (y/n)

If you press y the following messages will be displayed:

- Do you want to insert test for the other disk?
(y/n)

1	Disk 1
2	Disk 2
3	Disk 3
4	Disk 4
5	Disk 5
6	Disk 6

Insert the selection:

- Do you want to insert test for WORK STATION?
(y/n)

Do you want to insert test for work station of the
first board? (y/n)

If you press y the following messages will be displayed:

Digit the number of the station [0-b]

If you press `n` the following messages will be displayed:

```
[10-1b]:  
[20-2b]:  
[30-3b]:  
[40-4b]:  
[50-5b]:  
[60-6b]:  
[70-7b]:  
[80-8b]:  
[90-9b]:  
[a0-ab]:  
[b0-bb]:
```

Press the selection. See "*Appendix A-Table C*" in the "System Operations Guide".

- Do you want to insert test for the PRINTER? (y/n)
- Do you want to insert test for the STREAMER?
(y/n)
- Do you want to insert test for the TAPE? (y/n)

If you press `y` the following messages will be displayed:

```
0      Tape 0  
1      Tape 1  
2      Tape 2  
3      Tape 3
```

Insert your selection:

Press the selection and then the following messages will be displayed:

```
0  Tape x  Low Density  
1  Tape x  High Density
```

Select:

The following messages will be displayed after the previous questions and if you press **n** for the first question:

```
TEST EXECUTION TIME 3 MINUTES
MONITOR: ... processes created
          sgtst ----->
```

Are the following messages and the selection menu displayed at the end of the test?

```
... seconds from start
MONITOR: End test
```

YES

The test has not found any errors. If you are following these instructions because of a fault in the system, go to *"Calling for Help"*, Section 5. Otherwise continue.

NO

Is one of the messages contained in *"Table D"* displayed?

YES

Go to *"Calling for Help"*, Section 5.

NO

Go back to step 3 and make your selection suggested by the following considerations:

Is the message in either *Table A* or *B*?

NO

Choose "e" or "g".

YES

Choose "c" or "d".



b. CPU Test

The following messages are displayed:

```
TEST EXECUTION TIME 3 MINUTES  
MONITOR: ...processes created  
          sgtst ----->
```

Are the following messages and the selection menu displayed at the end of the test?

```
... seconds from start  
MONITOR: End test
```

NO

YES

Go to *"Calling for Help"*, Section 5.

No faults have been found in the part checked by the system. Select a different option.

TABLE F

<i>unit identifier</i>	<i>unit description</i>
SCX0	System Controller
BOOT	Portable EPROM
CPU0	Central Processor #0
CPU1	Central Processor #1
CHX0	Cache #0
CHX1	Cache #1
SP0_X	Station Processor #X
SP1_X	Station Processor #X
SP2_X	Station Processor #X
SR0_X	Station Processor #X
SR1_X	Station Processor #X
LP0_X	Line Processor #X
DCSX	Disk/Floppy Controller
DCEX	Disk/Floppy Controller
SCSX	Disk/Floppy Controller
ESDX	Disk Controller
RSDX	Disk Controller
TPE0	Tape Controller
LAN	Local Area Network Controller
D_DK0X	Disk Device #X
E_DK0X	Disk Device #X
R_DK0X	Disk Device #X
S_DKXX	Disk Device #X
D_ST00	Streamer Device
E_ST00	Streamer Device

TABLE G

Error Messages:

LAN capability not present

You must control the existence of the directory /net.

LAN capability not installed

You must control the existence of the file /usr/EXOS/lanstart and its content.

LAN daemon not running

Second LAN daemon UD not running

Second LAN daemon RWHOD not running

LAN daemon FTPD not running

LAN daemon RSHD not running

You must control the activate LAN processes (see *LAN manual*).

PROCEDURE D

unit not present

operations

D_DK00	Go to " <i>Unit Replacement</i> ", Section 3, and follow
D_DK01	the instructions to replace the unit indicated in the
D_DK02	message and the DCS0 board (see " <i>Replacing a</i>
D_ST00	<i>Board</i> ").
D_DK03	Go to " <i>Unit Replacement</i> ", Section 3, and follow
D_DK04	the instructions to replace the unit indicated in the
D_DK05	message and the DCS1 board (see " <i>Replacing a</i>
	<i>Board</i> ").
E_DK00	Go to " <i>Unit Replacement</i> ", Section 3, and follow
E_DK01	the instructions to replace the unit indicated in the
E_DK02	message and the ESD0 board (see " <i>Replacing a</i>
E_DK03	<i>Board</i> ").
E_DK00	Go to " <i>Unit Replacement</i> ", Section 3, and follow
E_DK01	the instructions to replace the unit indicated in the
E_DK02	message and the DCE0 board (see " <i>Replacing a</i>
E_ST00	<i>Board</i> ").
E_DK04	Go to " <i>Unit Replacement</i> ", Section 3, and follow
E_DK05	the instructions to replace the unit indicated in the
E_DK06	message and the ESD1 board (see " <i>Replacing a</i>
E_DK07	<i>Board</i> ").
E_DK03	Go to " <i>Unit Replacement</i> ", Section 3, and follow
E_DK04	the instructions to replace the unit indicated in the
E_DK05	message and the DCE1 board (see " <i>Replacing a</i>
	<i>Board</i> ").
R_DK00	Go to " <i>Calling for Help</i> ", Section 5.
R_DK01	

R_DK02
R_DK03

Go to "*Calling for Help*", Section 5.

TPE0

Go to "*Calling for Help*", Section 5.

ALL OTHER
UNITS

Go to the beginning of "*Unit Replacement*" Section 3, and follow the instructions to replace the unit not matching the effective system configuration.

REPLACING A BOARD

Removal

1. Using the diagram of the board cage, locate the board to be replaced. Disconnect the cables from the plugs on the board.

Central Unit

11	10	9	8	7	6	5	4	3	2	1	MEM 3	MEM 2	MEM 1
EXO	DCS0	VME	VME	SPX3	SPX2	SPX1	SPX0	SCX	CHX0	CPX0	SE2	SE2	SE2
	o			o	o	o	o				o	o	o
TER	DCE0	SP1	SP1	LP03	LP02	LP01	LP00				SM4	SM4	SM4
		o	o								o	o	o
		SP2	SP2								SM8	SM8	SM8
											o	o	o
											MF4	MF4	MF4
											o	o	o
											MF8	MF8	MF8
											o	o	o

Expansion Unit

1 MEM	2 MEM	3 MEM	1	2	4	5	6	7	8	9	10	11
SE2	SE2	SE2	CPX1	CHX1	SPX4	SPX5	SPX6	SPX7	VME	VME	DCS1	
o	o	o			o	o	o	o			o	
SM4	SM4	SM4			LP04	LP05	LP06	LP07	SP1	SP1	DCE1	
o	o	o							o	o		
SM8	SM8	SM8							SP2	SP2		
o	o	o										
MF4	MF4	MF4										
o	o	o										
MF8	MF8	MF8										
o	o	o										

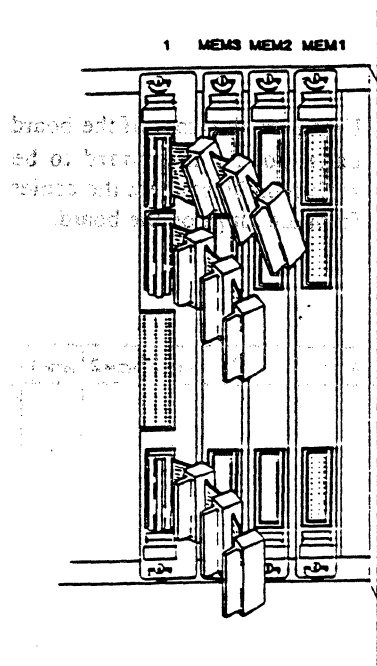

2. For the second or third memory expansion board, disconnect the 78139359-001 cable from the first memory expansion board, position MEM1, and the CPX, position 1.

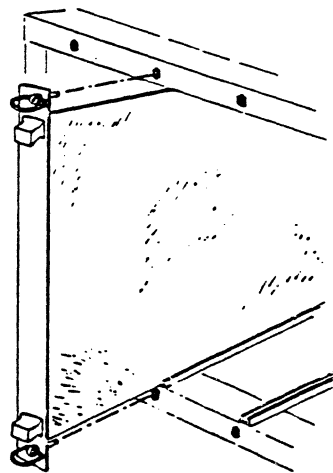

3. Locate the two ring bolts that attach the board to the system and unscrew them in an anti-clockwise direction. Remove the board from the system, handling it by the tabs at the edges.

If the board is not to be replaced immediately with a new board, insert a dummy board in the vacant position.

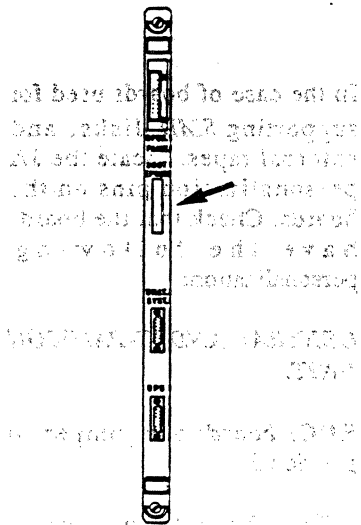

4. For SC1 boards with removable EPROM, remove the EPROM connected to the "BOOT EPROM" connector and keep it in a safe place. (It will later be reconnected to the new SC1 board.).

NOTE: This operation is not necessary for the SC1 board of the X20EF and X40EF systems.

Reinstallation

TO REINSTALL THE BOARD, REMOVE THE BOARD FROM THE RACK AND REINSTALL IT IN THE RACK. THE BOARD SHOULD BE REINSTALLED IN THE RACK IN THE SAME POSITION AS IT WAS REMOVED FROM THE RACK.

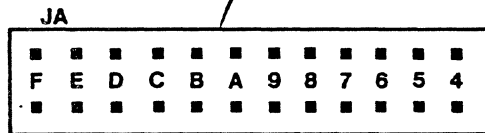
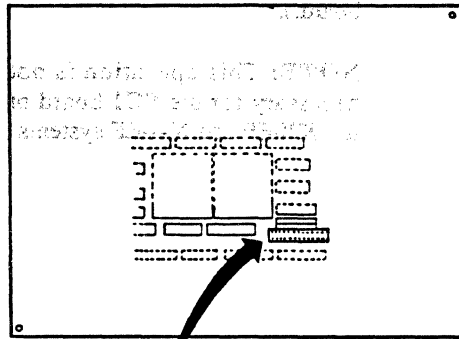

1. In the case of boards used for supporting *SMD* disks, and external tapes, locate the JA personalization pins on the boards. Check that the boards have the following personalization:

CENTRAL AND EXPANSION UNIT:

RDC1 board: one jumper in position 5

RDC2 board: jumpers in position 5 and 4

TAC board: one jumper in position 6

ai ti brood 192 in it s...
 necessary to select the interface
 type for the line card and the
 for connection from the

elsof stng) edit' gion d110
 to) anony n...
 eschmal sll mber o...
 edled -.../.../...

2. For LP0 board, it is necessary to personalize lines 2 and 3, depending on whether the lines are to be used for synchronous or asynchronous connections. Locate the personalization pins and position the jumpers according to the following scheme:

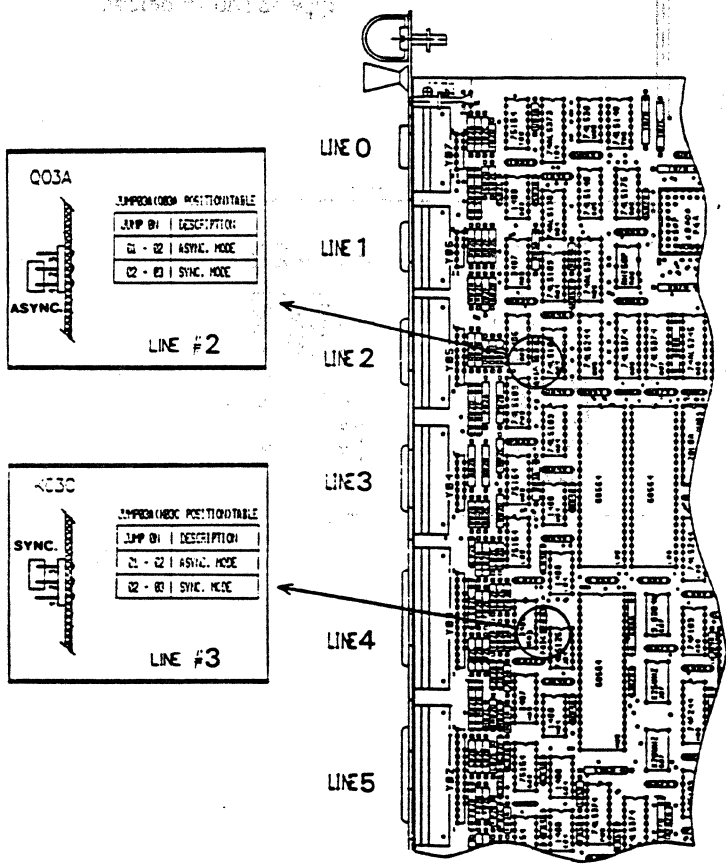

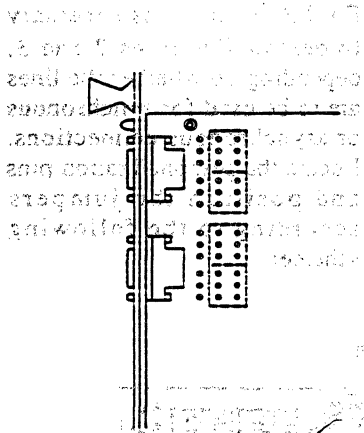

2.1 In case of an SP2 board it is necessary to select the interface type for the first four and the last four lines (starting from the top).

With help of the figure locate the personalization jumpers for the lines and select the interface type as shown below.

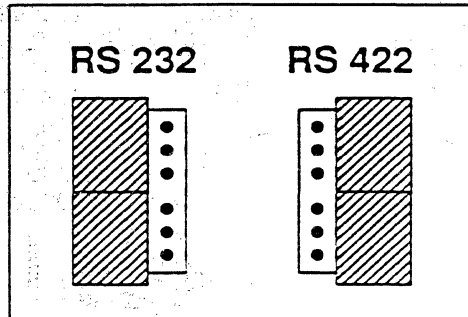

based on the...
as follows:

...the...
...the...
...the...
...the...

...the...
...the...
...the...
...the...
...the...

...the...
...the...
...the...
...the...

...the...
...the...
...the...

...the...
...the...
...the...

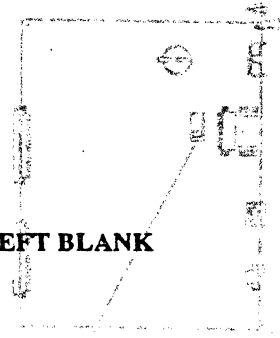

THIS PAGE IS INTENTIONALLY LEFT BLANK

3. In case of SCI board, personalize it as follows:

Locate the personalization microswitches used for the connection with the emergency battery (UPS) and personalize them according to the following instructions:

Microswitch A is used to enable or disable the battery time-out. To disable the battery, set it to the right position. In this case, if there is a power failure, the system will receive power from the battery, while sufficient charge remains.

To enable the time-out, microswitch A must be set to the left position and microswitch B must be set as follows:

- To the right if the operating system is UNIX (time-out value: 3.5 minutes);
- To the left if the operating system is PICK (time-out value: 7 minutes);

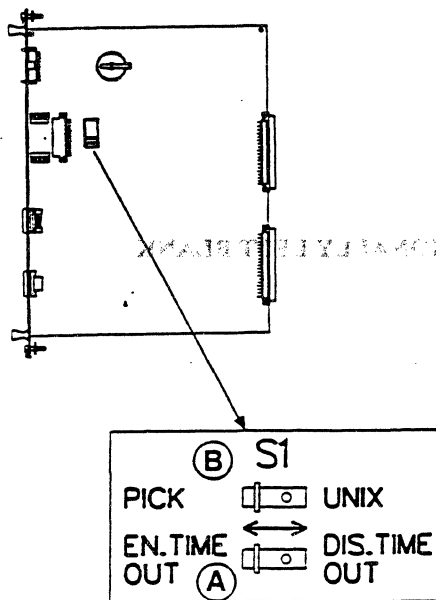

of the board is to be installed. If present, remove the dummy board.

5. Locate the position in which the board is to be installed. If present, remove the dummy board.



Central Unit

of the board is to be installed. If present, remove the dummy board.

11	10	9	8	7	6	5	4	3	2	1	MEM 3	MEM 2	MEM 1
EX0	DCS0	VME	VME	SPX3	SPX2	SPX1	SPX0	SCX	CHX0	CPX0	SE2	SE2	SE2
	o			o	o	o	o				o	o	o
TER	DCE0	SP1	SP1	LP03	LP02	LP01	LP00				SM4	SM4	SM4
		o	o								o	o	o
		SP2	SP2								SM8	SM8	SM8
											o	o	o
											MF4	MF4	MF4
											o	o	o
											MF8	MF8	MF8
											o	o	o

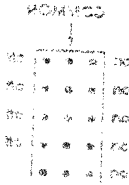

Expansion Unit

1 MEM	2 MEM	3 MEM	1	2	4	5	6	7	8	9	10	11
SE2	SE2	SE2	CPX1	CHX1	SPX4	SPX5	SPX6	SPX7	VME	VME	DCS1	
o	o	o			o	o	o	o			o	
SM4	SM4	SM4			LP04	LP05	LP06	LP07	SP1	SP1	DCE1	
o	o	o							o	o		
SM8	SM8	SM8							SP2	SP2		
o	o	o										
MF4	MF4	MF4										
o	o	o										
MF8	MF8	MF8										
o	o	o										

and down in both of the slots
 11. before the board is inserted
 you must set the appropriate jumpers

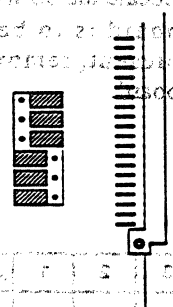

5.1 In case of an SP2 board it is necessary to set the appropriate jumpers according to the position in which the board is inserted.

With help of the figure locate the jumpers and set them according to the following table.

main cabinet:

slot	S0	S1	S2	S3
4	off	off	off	on
5	off	off	off	on
6	off	off	off	on
7	off	off	off	on
8	on	on	on	off
9	off	on	on	off

expansion cabinet:

slot	S0	S1	S2	S3
4	off	off	off	on
5	off	off	off	on
6	off	off	off	on
7	off	off	off	on
8	on	off	on	off
9	off	off	on	off

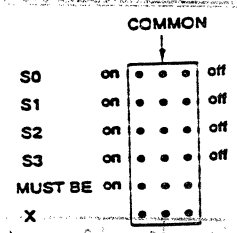

6. Insert the new board in the guides previously occupied by the old board. If present, remove the dummy board.

Fix the board in the system by turning the ring bolts in a clockwise direction.

THIS PAGE IS INTENTIONALLY LEFT BLANK

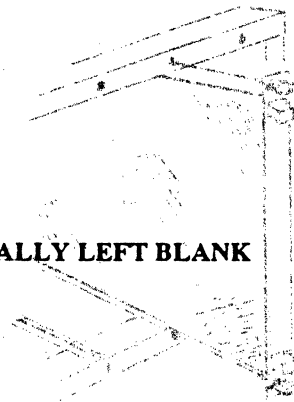

7. If necessary, identify the board that refers to the board of the board inside the system and attach a label with the number to the upper part of the board.

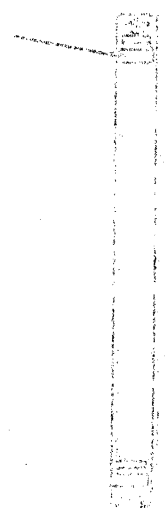

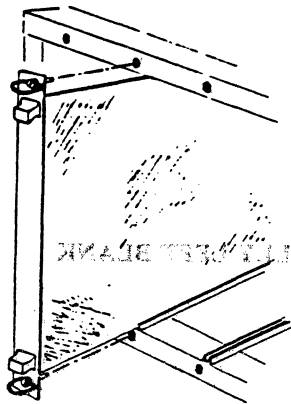

6. Insert the new board in the guides previously occupied by the old board. If present, remove the dummy board.

Fix the board to the system by turning the ring bolts in a clockwise direction.

THIS PAGE IS INTENTIONALLY LEFT BLANK

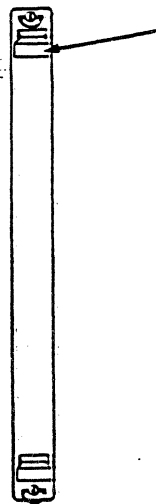

7. If necessary, identify the number that refers to the position of the board inside the system and attach a label with this number to the upper tab of the board.

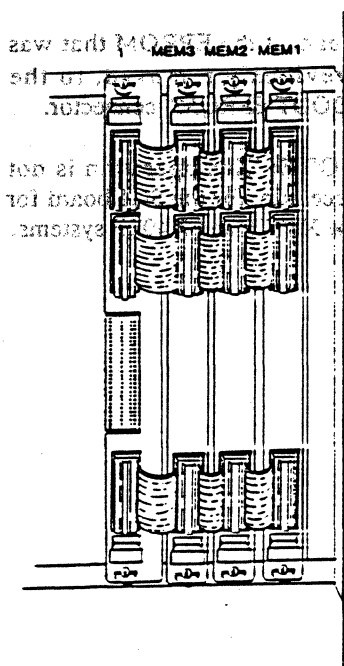

8. Connect the cables to the plugs on the board so that each plug with a given colour code corresponds to a socket with the same colour code.

9. If necessary, the three 7813959-001 cables should also be reconnected to the expansion boards or CPU, from which they were previously disconnected.

Connect the cables to the plugs on the board and on each plug with a given colour code corresponds to socket with the same colour code.



10. Connect the EPROM that was previously removed, to the "BOOT EPROM" connector.

NOTE: This operation is not necessary for the SC1 board for the X20EF and X40EF systems.

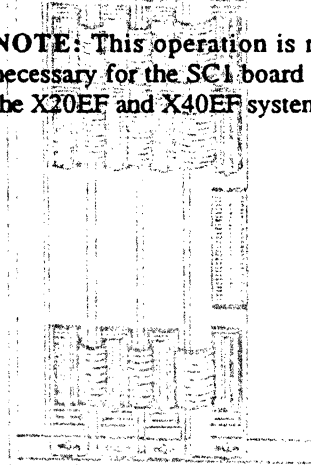

If necessary, the three 78109-001 cables should also be reconnected to the expansion boards or CPU from which they were previously disconnected.

