

Ernst Abt Group

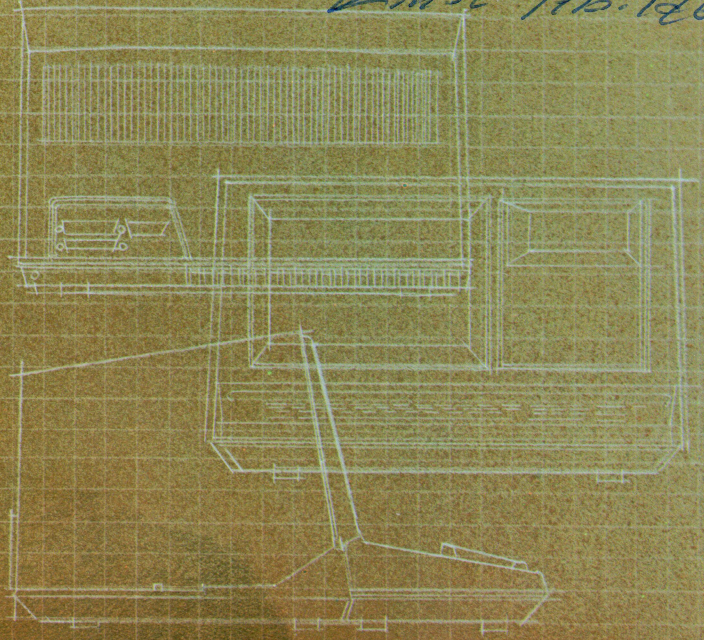

**A computer
designed
to adapt.**

Shirley

60k. Brüger

ca. 88.000,-



Datapoint 1800 Dispersed Processor

The Datapoint 1800 Dispersed Processor is a low cost, multi-function computer system designed to make businesses more efficient. Whether functioning as a stand-alone data processing system, as part of a wider, geographically-dispersed network, or as a member of an Attached Resource Computer™ system, the 1800 is an extremely flexible system that can meet a wide variety of business applications.

Versatile Hardware

The 1800 hardware components offer extensive capabilities in an easy to use form. With 60K bytes of user memory, the powerful 1800 processor allows for rapid program execution. Economical double density diskette storage can be expanded from the standard one million characters up to four million. The 1800 keyboard is laid out in the standard typewriter format to minimize operator training, and is detachable for further convenience. The 1800's large, easy to read video display screen can prompt operators with a wide range of visual cues. And the 1800 is compatible with nearly all Datapoint peripherals, including a wide variety of printers, magnetic tape units, and many others.

Comprehensive Software

Even the most advanced hardware is useless without equally advanced software; sophisticated 1800 software permits the fast and easy implementation of nearly any application. The 1800's complete library of both machine-and high-level programming languages includes Interactive COBOL, RPG, DATABUS® and Assembler.

The 1800 can accommodate both a business's present and future requirements through the Datapoint family approach to software. The common file structure of the 1800's powerful Disk Operating System means that all data files generated by the 1800 are fully compatible with all other systems in Datapoint's extensive line. Additionally, all 1800 programs may be executed, without modification, on any larger Datapoint system.

Extensive Communications

With its integral communications interface, the 1800 is a valuable member of nearly any network. For batch data processing tasks, the 1800 supports a variety of line disciplines through MTE, Datapoint's Multiple Terminal Emulator package. The 1800 may also submit batch jobs through the Datapoint Attached Support Processor (DASP), a complete communications and spooling system for IBM System/360-370 (and equivalent) mainframes.

Tasks requiring real-time communications with host mainframe computers, including such complex tasks as the updating of a remote database, can be completed quickly and easily with the MULTILINK™ feature of the DATABUS language. The 1800 can also participate in Datapoint-to-Datapoint

processing networks using the DATAPOLL® package. Through DATAPOLL, programs can be down-line loaded to allow central control of remote processing operations.

ARC System Operations

In addition to its stand-alone and networking capabilities, the 1800 may also participate in Attached Resource Computer systems. Linking nearly any number of Datapoint processors through compatible software and electronic interconnection, ARC™ systems provide virtually unlimited processing power, efficient use of resources, a database common to all system users, and a modular growth path without economic penalty.

As part of an ARC system, the 1800 has access to all system resources, including the common database, telecommunications links, and print spooling facilities. Since these resources are accessible to the 1800 regardless of their location within the system, expensive peripherals receive use proportionate to their cost. Only the addition of an ARC interface is necessary for the 1800 processor to operate as part of an ARC system; no hardware modification or software revision is required.

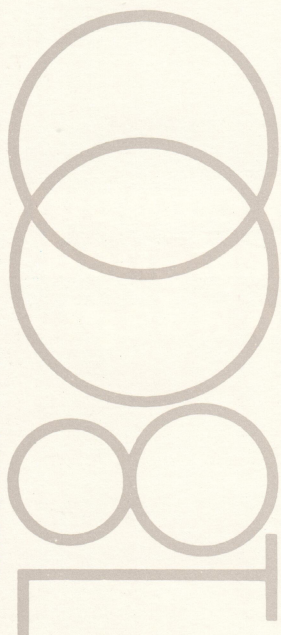





Video display screen

- Large, easy to read
- 80 columns by 24 rows
- Inverse video highlighting

Processor

- Advanced design
- 60K bytes of user memory
- 4K bytes of system memory
- Integral auto-answer communications interface

Keyboard

- Detachable for convenience
- Standard typewriter layout
- 11-key numeric pad
- Function and control keys

Diskette Storage

- Economical double density diskettes
- 1 to 4 million character capacity
- "Diskette in use" indicators
- Easy operation

Peripherals

- Line, belt, and character printers
- Magnetic tape units
- Modems and other peripherals

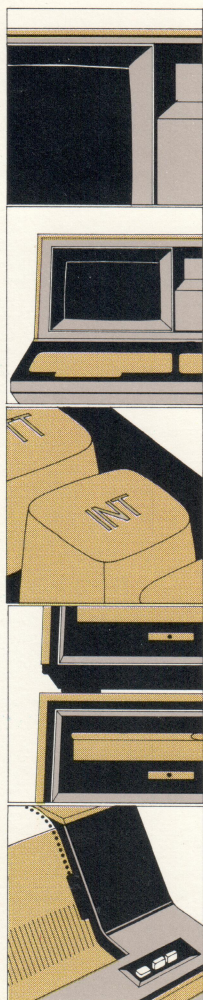

The Datapoint 1800 Dispersed Processor

A complete, low-cost computer system that can help make nearly any business more efficient.

Intelligent Data Entry

Providing complete capabilities for error-free data entry at those sites where data processing tasks originate:

- Interactive COBOL — an industry standard language tailored specifically to data entry and checking

- DATAFORM®—a two-level language including both forms generation and data checking capabilities
- DSGEN — a powerful forms generator that enables even untrained operators to implement a complete data entry system
- DATABUS — a high-level business language for applications requiring more extensive data checking features

Complete Business Data Processing

Facilitating information management requirements by presenting accurate data in a clear form whenever it is needed:

- COBOL — an industry standard business programming language with a wide range of applications
- RPG — a powerful business language oriented toward the production of reports, analyses, and summaries

- DATABUS — a popular high-level business language with upward compatibility among the Datapoint processors
- BASIC — a mathematically-oriented language for complex problem solving and computations
- ASSEMBLER — a machine level language for applications requiring precise instructions

Comprehensive Data Communications

Extending a full complement of powerful computing resources to those geographically-dispersed locations where business operations are conducted:

- 2780, 3780, RES, and HASP emulation for batch processing
- MULTILINK for real-time mainframe communications
- DATAPOLL for Datapoint-to-Datapoint networks
- TTY for data inquiry applications

To meet present and future needs

1800 hardware and software flexibility enables users to follow an orderly growth path free from economic penalty:

- Easily-upgraded diskette storage (from 1MB to 4MB)
- Comprehensive peripheral support capabilities
- Complete file compatibility
- Upward compatibility with other Datapoint systems
- Unlimited growth through the ARC system

The Datapoint 1800 Dispersed Processor

A system that's adapted to meet the needs of the business it serves, not the other way around.

ca. 29,500 - 34,500

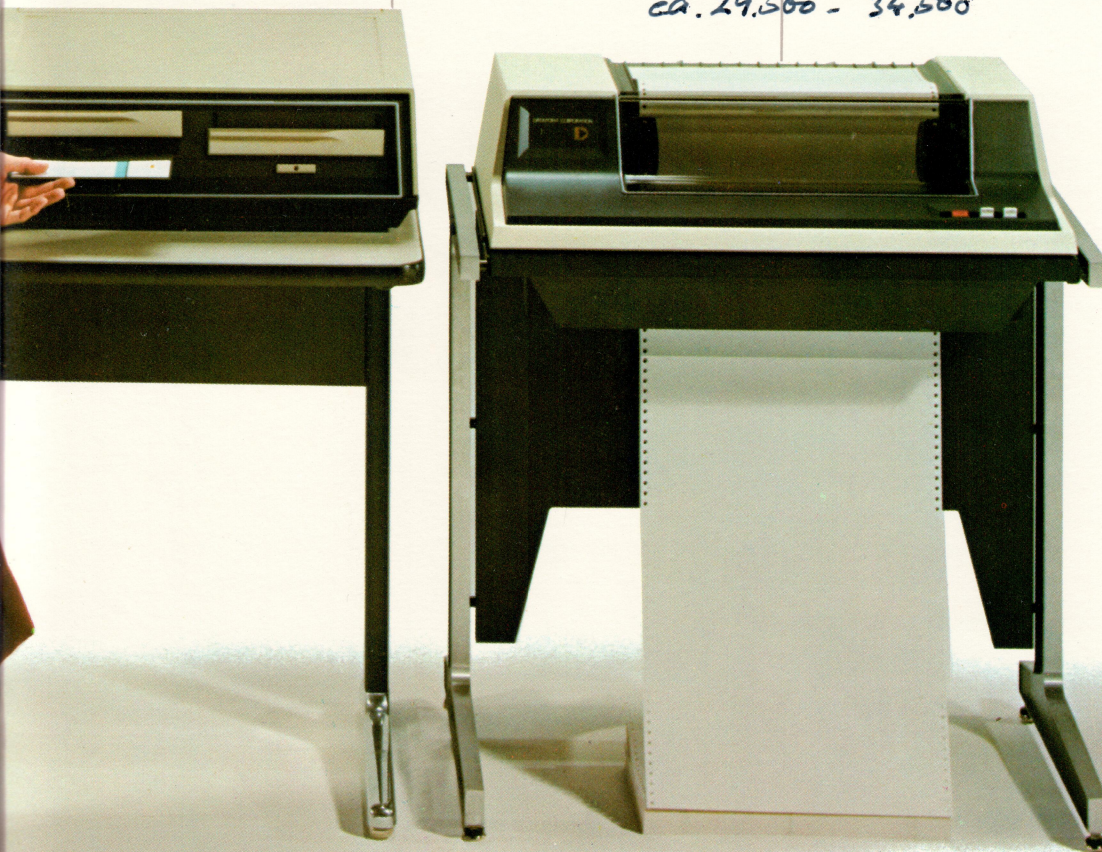

A Typical Application

The following example shows the 1800 Dispersed Processor, along with the Disk Operating System and Interactive COBOL, as a complete data processing system. Many other uses are possible; this typical application illustrates just one of the many different applications that can be accomplished with the 1800.

Using a program written in Interactive COBOL (part of which is shown below), an operator keys in sales orders. Following the forms displayed on the 1800's large screen, the operator simply fills in the blanks. The COBOL program performs many helpful operations, such as displaying the part description and the quantity available in response to the part number entry. Error checks incorporated into the program improve accuracy by alerting the operator to mistakes (such as entering letters in the numeric zip code field). The 1800 can display inverse video (dark characters on a light background) or signal in different audio tones to more effectively prompt an operator and so reduce costly errors.

```
FORMS SECTION.
01  HEADER
   LINE 5 VALUE "ADDRESS ENTRY".
01  PROMPTER
   LINE 5 VALUE "GO AHEAD" BLINK.
01  BLANKOUT
   BLANK SCREEN.
01  ADDRESS-IN LINE 1.
02  NAME
   03  FIRST-NAME          COLUMN 1
                               PIC X (10) INTO FIRST-NAME.
   03  LAST-NAME         COLUMN 11
                               PIC X (12) INTO LAST-NAME.
02  STREET.
   03  S-NUMBER          COLUMN 23
                               PIC 9 (5) INTO S-NUMBER.
   03  FILLER
```

Cobol Program

The COBOL program automatically writes the sales information to the 1800's diskettes. Using the SORT utility of the Disk Operating System, the operator organizes the information for processing. A batch-mode COBOL program is then used to generate invoices, bills of lading, and sales reports from the sales information. Through the 1800's programmable function keys, the operator selects a program's different options by simply pressing a key (different types of reports for different days of the week, for instance). The reports and other materials may be written to diskette for storage or printed on any of the wide variety of Datapoint printers compatible with the 1800 (or both).

With the CHAIN utility of DOS, data processing operations may be conducted accurately and reliably, without supervision. CHAIN allows nearly any number of programs to be executed as a result of a single command,

enabling the 1800 to be used for data entry during the day and for data processing at night. (The 1800 may be programmed to automatically resume processing data in the event of a power failure and subsequent return.)

The CHAIN utility is especially valuable for accomplishing tasks that require communications. The 1800, with its integral auto-answer communications interface, may participate in a wider, geographically-dispersed processing network. Sales information and summaries may be forwarded to a host computer in a variety of communications disciplines; the 1800 can also receive host computer output and automatically print the desired information. And these operations may be conducted at night, saving money by reducing telephone line charges as well as operator expenses.



INTELLIGENT DATA ENTRY

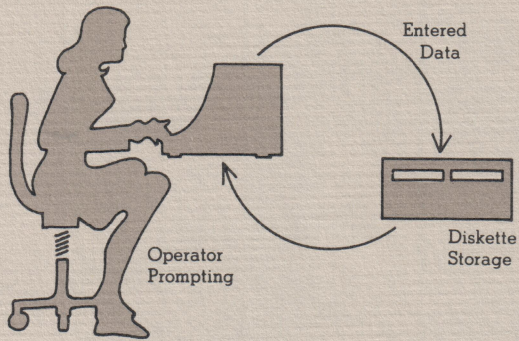

LOCAL DATA PROCESSING

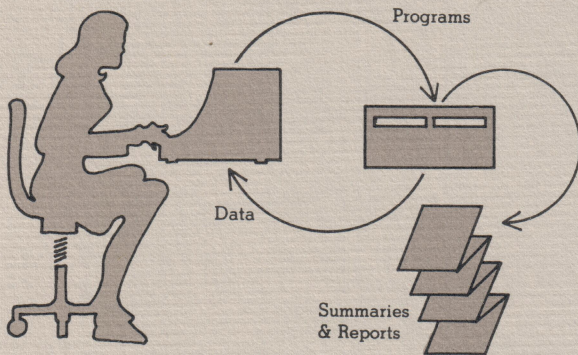

UNATTENDED COMMUNICATIONS

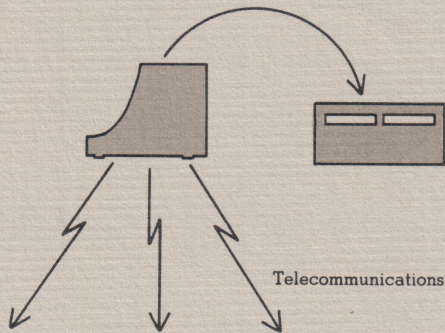

1800 ARC SYSTEM COMMUNICATIONS

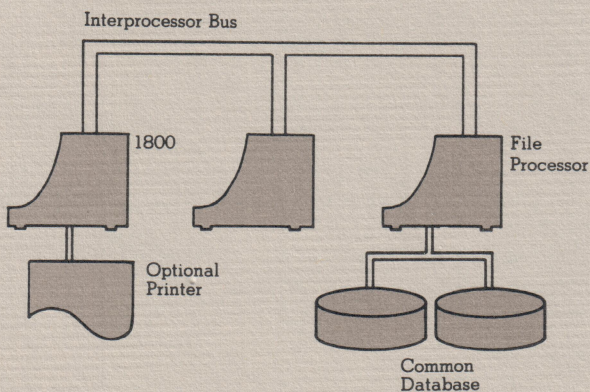

Processor:

Advanced design
Supports all 1800 operations (keyboard, screen, diskettes, other peripherals, and communications)
Programmable audio tones

Keyboard:

Detachable, 1 meter cable
Standard typewriter layout (55 keys)
11-key numeric pad
5 control keys
5 programmable function keys
Character repeat

Video Display

5 x 7.9 inch viewing area
80 columns by 24 rows (1920 character positions)
Upper and lower case
Regular and inverse video
5 x 7 dot matrix for high readability
Programmable display memory allows generation of 128 characters under program control
High speed character display

Diskette Units:*

Two drives per module
1 million characters per module
Up to 4 modules supported
Average access time: 83 milliseconds
Completely processor-controlled
"Diskette in use" indicators
*See the diskette listing in the Datapoint Equipment Catalog for more detailed information

Memory:

4K bytes of system memory (ROM)
60K bytes of user memory (RAM)

TECHNICAL SPECIFICATIONS

Functional Characteristics

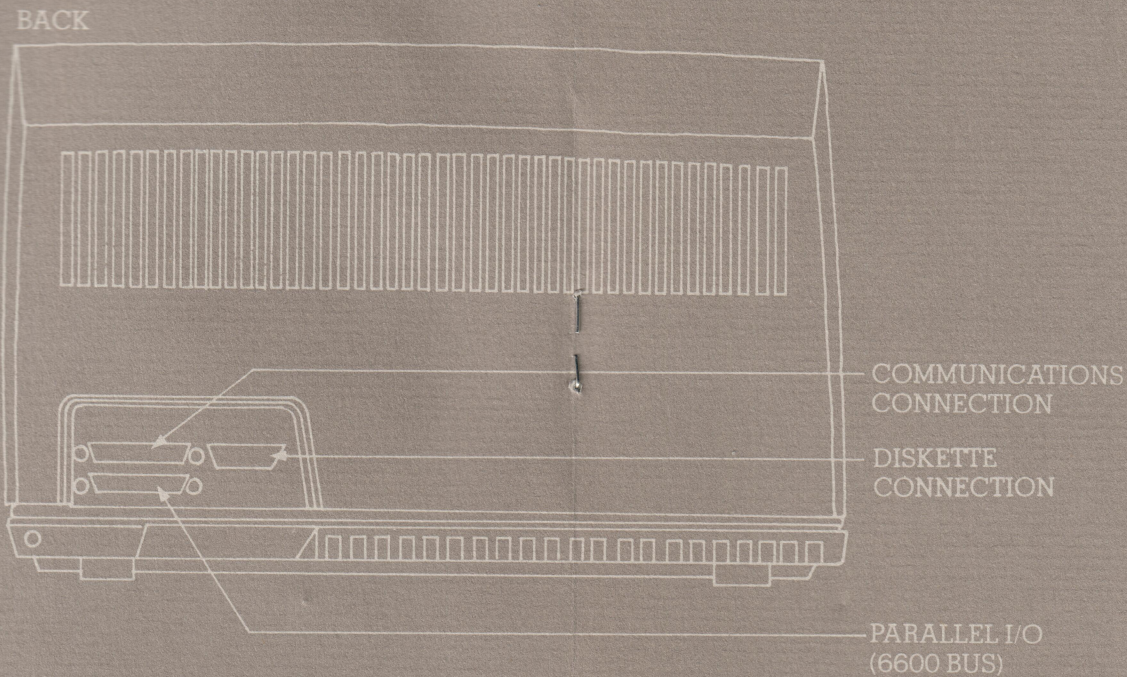
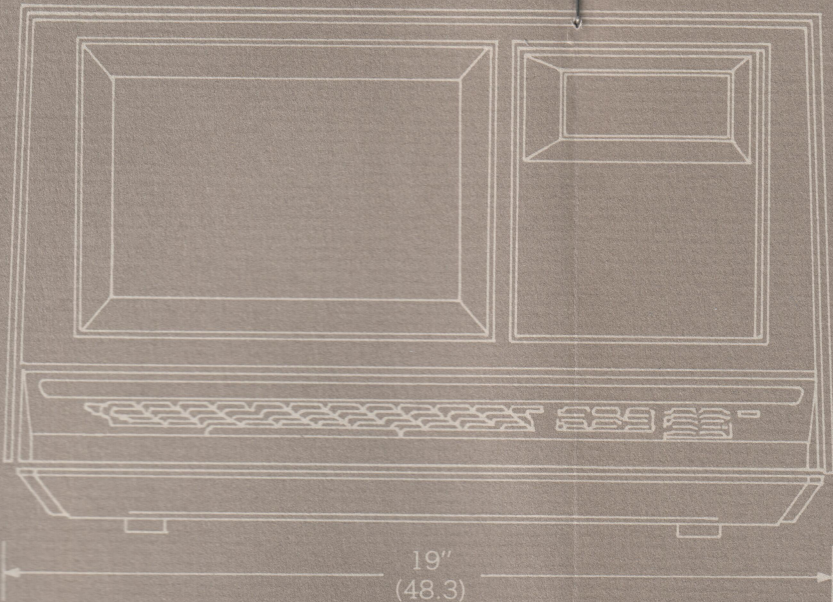
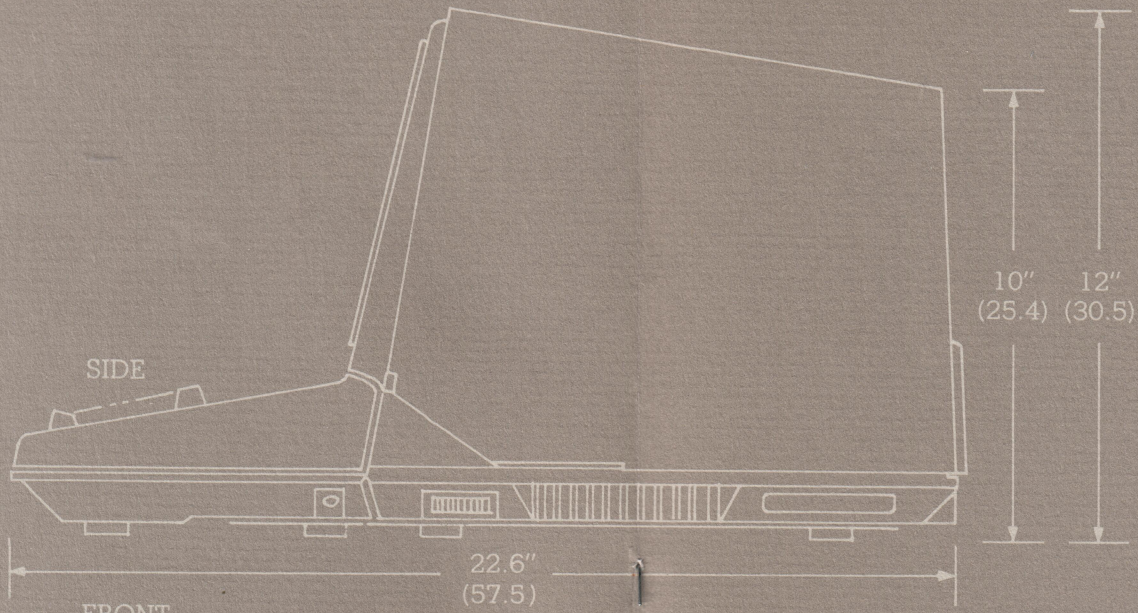

Processor:

Ad
Sup
dis
Pro

Keyboard:

Det
Star
11-
5 c
5 p
Cha

Video Display:

5 x
80
Up
Rec
5 x
Pro
cha
Hig

Diskette Unit:

Two
1 m
Up
Ave
Con
"Dis
*Se
Ca

Memory:

4K
60K

TOP

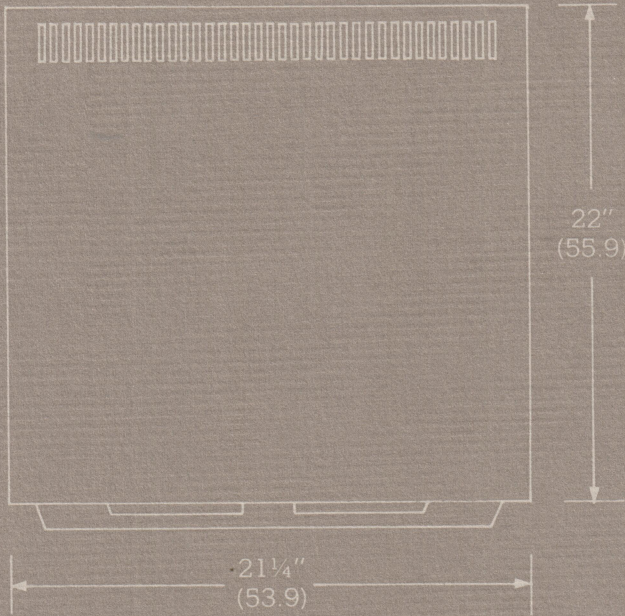

FRONT

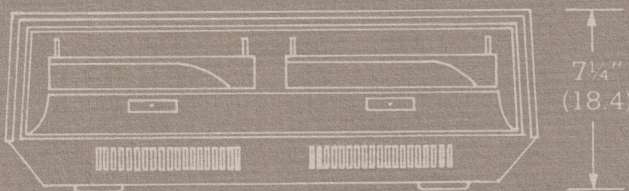

SIDE

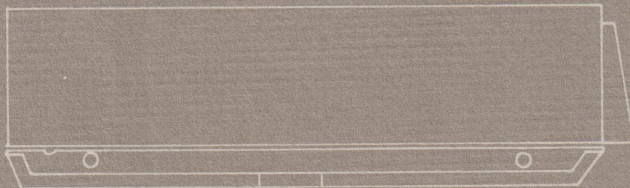

BACK



BACK (W/COVER)

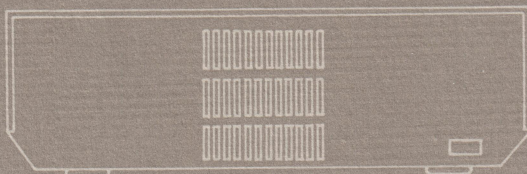

TECHNICAL SPECIFICATIONS

Physical Characteristics

*Pr. diskette station
ca. 30.000
m. 2 ambader.*

Equipment Dimensions

Processor

Width: 19 in. (48.3 cm)
Height: 12 in. (30.5 cm)
Depth: 22.6 in. (57.5 cm)
Weight: 50 lbs. (22.7 kg)

Diskette Module

Width: 21.25 in. (53.9 cm)
Height: 7.25 in. (18.7 cm)
Depth: 22 in. (55.9 cm)
Weight: 66 lbs. (30 kg)

Power Requirements:

115 or 230 VAC, 50 or 60 Hz

Environment:

50 to 100 degrees F
10 to 38 degrees C
20 to 90% relative humidity, non-condensing

Model Codes

1802 Datapoint 1800, 60K user memory,
one diskette module
1842 Datapoint diskette module
5163 230 VAC, 50 or 60 Hz Power Option

A computer designed to adapt.

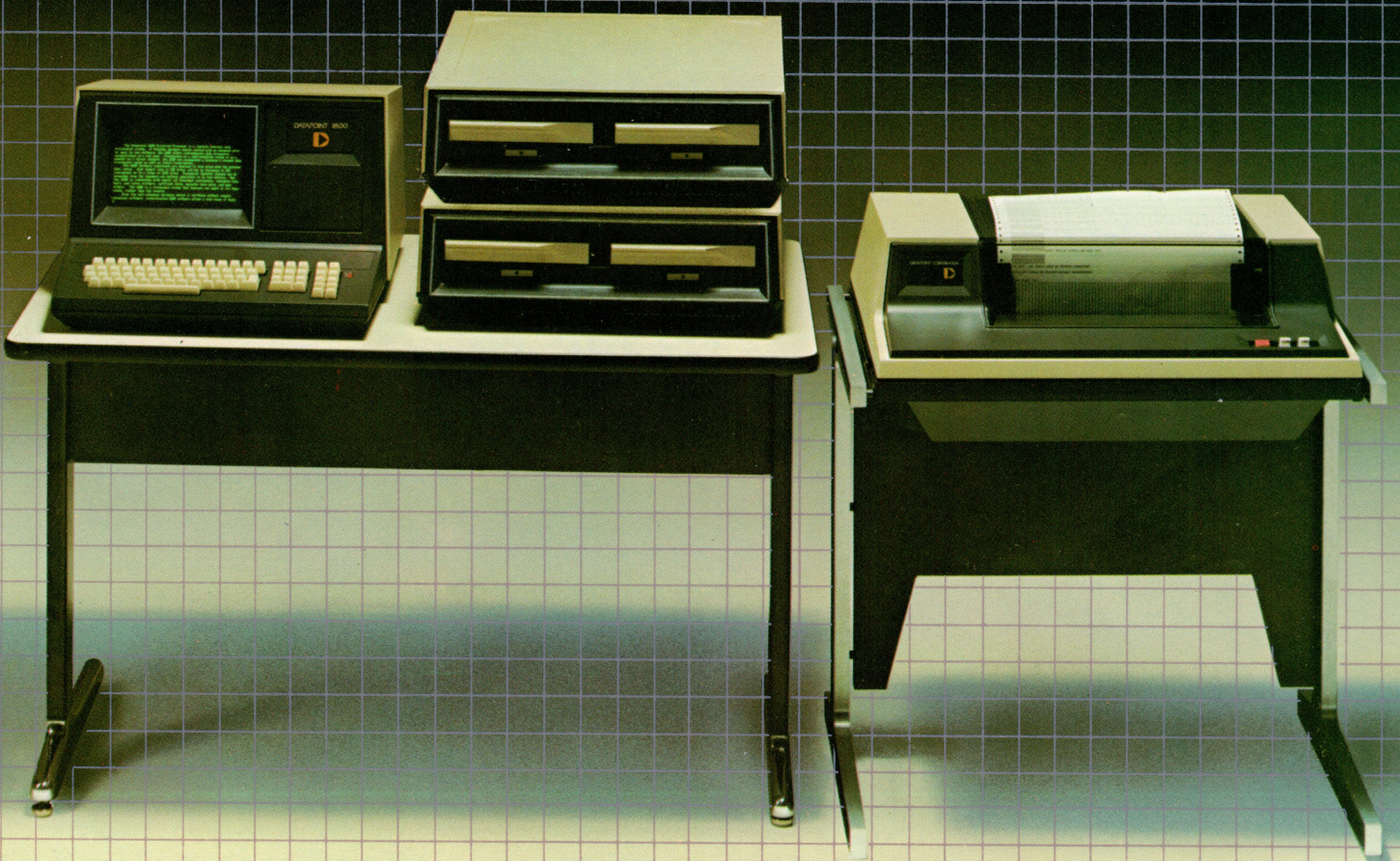

HOME OFFICE:
9725 Datapoint Drive
San Antonio, Texas 78284
(512) 699-7151

SALES OFFICES:

Albany/(518) 459-7781
Atlanta/(404) 325-2212
Boston/(617) 890-0440
Charlotte/(704) 527-5300
Chicago/(312) 298-1240
Cincinnati/(513) 984-5057
Cleveland/(216) 351-1775
Columbus/(614) 890-7686
Dallas/(214) 661-5536
Denver/(303) 321-8286
Des Moines/(515) 225-9070
Detroit/(313) 855-2900
East Hartford/(203) 289-9364
Greensboro/(919) 299-8401
Honolulu/(808) 833-2110
Houston/(713) 680-2200
Indianapolis/(317) 299-4253
Irvine/(714) 752-9073
Kansas City MO./(816) 474-2160
Louisville/(502) 893-2531
Los Angeles/(213) 385-0395
Memphis/(901) 761-3080
Miami/(305) 621-4335
Milwaukee/(414) 453-1425
Minneapolis/(612) 854-4054
Nashville/(615) 361-5981
New Orleans/(504) 831-8101
New York/(212) 971-9270
Oklahoma City/(405) 942-8714
Orlando/(305) 896-1940
Philadelphia/(215) 667-9477
Phoenix/(602) 265-3909
Pittsburgh/(412) 344-6800
Portland/(503) 644-5575
Richmond/(804) 353-3858
Rochester, N.Y./(716) 248-2616
San Antonio/(512) 734-8982
San Francisco/(415) 398-2888
Seattle/(206) 455-2044
Stamford/(203) 359-4175
St. Louis/(314) 878-6595
Tampa/(813) 879-8216
Toledo/(419) 474-5766
Tulsa/(918) 664-2295
Paramus, N.J./(201) 368-0070
Washington, D.C./(703) 841-7600

DATAPOINT CORPORATION



The leader in dispersed data processing™

INTERNATIONAL SALES OFFICES:

Australia/Sydney/(02) 922 3100
Austria/Vienna/(0222) 36 21 41
Belgium/Brussels/(02) 376 2030
Brazil/Rio de Janeiro/(021) 222 6795
Canada/Ontario/(416) 491 9606
Denmark/Copenhagen/(01) 10 53 66
England/London/(01) 903 6261
Finland/Helsinki/(90) 661 991
France/Paris/(01) 657 13 31
Germany/Hannover/(0511) 67971
Greece/Piraeus/ 412 3471
Holland/Rotterdam/(10) 21 62 44
Hong Kong/(5) 243 121
Iran/Tehran/ 831 035 39
Israel/Tel-Aviv/(03) 228 174
Italy/Milano/(02) 316 333
Japan/Tokyo/(03) 264 6131
New Zealand/Auckland/ 78 543
Norway/Oslo/(02) 35 75 80
The Phillippines/Makati Rizal/(02) 877 294
Singapore/915822
South Africa/Johannesburg/(11) 724 9301
Spain/Madrid/ 242 3905
Sweden/Hagersten/(8) 188 295
Switzerland/Zurich/(01) 54 56 46
Taiwan/Taipei/(02) 768 1114 5 6
Thailand/Bangkok/2825689
USA/Los Angeles, CA/(213) 475 9861
Venezuela/Caracas/ 213 386