

THE ALTO

From The Industrial Designer's Perspective

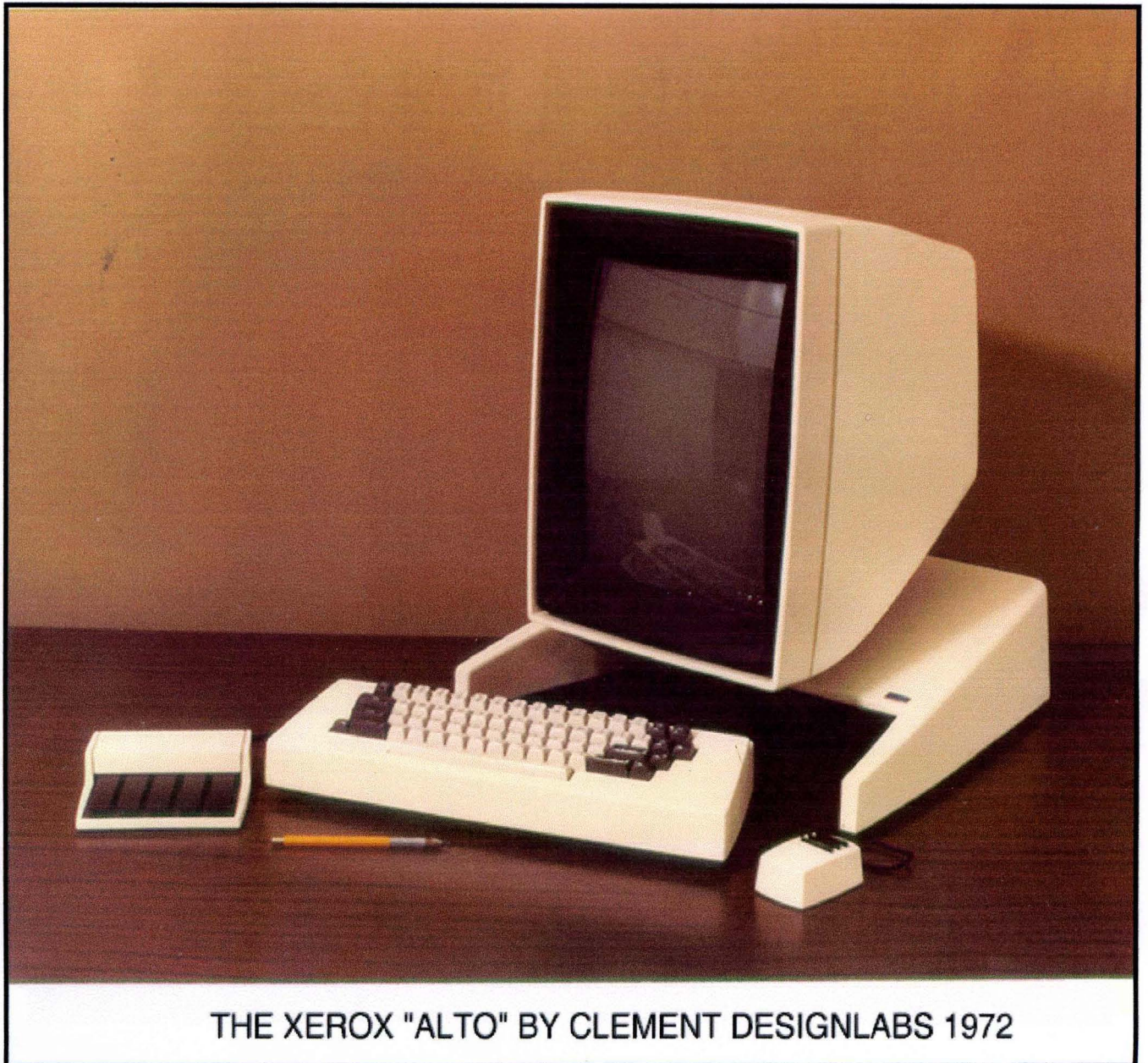

THE XEROX "ALTO" BY CLEMENT DESIGNLABS 1972

By Carl J. Clement

Dedicated to

Kenneth Strong Campbell

my friend and fellow product-designer,
whose devotion to Clement Designlabs
made this booklet possible.

PREFACE

CLEMENT DESIGNLABS

The business of Clement Designlabs is Product Development.

We are committed to a partnership with our clients in the creation of total-performance products; integrating technology, utility, and beauty to instill confidence and pride in our employees, in our clients, and in our clients' customers.

We are further committed to the application of our combined skills and energy to power these products through manufacture and into the marketplace *...on schedule and within budget.*

Although we provide a comprehensive Product Development service to our clients, their overriding requirement and perception of our service is that we improve their product image and therefore their corporate image. In order to attract clients we must ourselves project an image of excellence and elegance in every aspect of our business and in all of our communication with the public. Otherwise we are not credible, regardless of our capability.

CORPORATE OBJECTIVES

It is the policy of Clement Designlabs to interpret our commitments in the form of objectives which can be easily understood and accepted by all of our people, and to provide the latitude for each to work toward these objectives in a manner which he determines is most effective within his own area of responsibility and which is in harmony with his fellow employees:

OBJECTIVE 1: MAXIMIZE OUR LONG-TERM PROFIT

Without profit no other objective is achievable by any means.

Our profit is the measure of our contribution to society and of our efficiency in making that contribution. In a more immediate sense, our profit will be enhanced as we enhance our clients' profits and as we succeed in improving, simplifying, and standardizing our internal procedures on a continuing basis.

OBJECTIVE 2: SERVE OUR CLIENTS TIMELY EXCELLENCE

We exist as an organization to serve our clients. Once we have been retained by a client, we become in a large sense part of the client's organization, and we share his commitment to the success of the particular project at hand. The client has retained us because he believes we have skills which he either does not have or cannot apply in a timely manner. Because we are guiding him through a process which he may not understand, it is our responsibility to educate him as we go and to respond to unrealistic demands with professional courtesy, gentle persuasion ...and realistic alternatives. It is imperative that we communicate with our clients on a timely basis and in a manner which will assure them that they are highly valued by Clement Designlabs. A client can be lost by poor communication just as easily as by poor performance. Neither is acceptable. Without a continuously expanding base of satisfied clients confirming our record of outstanding professional performance and integrity, growth is impossible ...and even survival is unlikely.

Every person in every part of our organization must view his individual responsibility in context with this central purpose of serving our clients.

OBJECTIVE 3: FOCUS OUR EFFORT ON OUR STRENGTHS

Clement Designlabs has an outstanding record of excellence in Product Development and Manufacturing Services for client-companies ranging in size from new ventures to established corporations, and involving a wide variety of products. Our primary interest is in high-technology companies and products because of the character of our geographical location and because of the emerging industrial growth pattern of our country.

Due to our intimate involvement in the birth of many new ventures for more than three decades, we have acquired sufficient experience and knowledge to enable us to create new ventures of our own. We shall examine such opportunities as they are generated through the normal course of our Product Development Consulting activity and shall exploit those which are consistent with available capital and with our other objectives. Although such new ventures will be operated independently of our core Product Development Consulting activity, they are expected to contribute to the total growth of Clement Designlabs and to enhance the benefits to all of our employees.

OBJECTIVE 4: GROW

We must maintain a continuous and consistent pattern of growth for two basic reasons:

First, our primary field of interest, high technology, is expanding at an explosive rate, at least equal to that of any social force in recorded history. We are in the midst of this technological revolution which is having, and will continue to have for the foreseeable future, consequences perhaps greater than those of the great industrial revolution. We cannot merely sit and watch. To do so would be to lose market share and credibility as a dynamic, progressive Product Development organization. Moreover, we choose to be leaders in this adventure, rather than followers.

Second, we must attract the highest caliber persons available, those who are leaders in their own right and who are concerned about their own personal growth. Growth opportunities for our people can only flow from a planned and sustained pattern of growth of our company.

OBJECTIVE 5: ATTRACT THE BEST EMPLOYEES

To repeat, we shall attract the highest caliber persons available for all positions in the company.

We shall provide a stimulating and enjoyable atmosphere such as to encourage individual initiative and to instill a sense of pride and accomplishment in all of our people.

Financial rewards, benefits, security, advancement, and personal recognition will be commensurate with performance.

OBJECTIVE 6: MANAGE BY OBJECTIVE AND BY EXAMPLE

These Corporate Objectives will serve as a model for each supervisor to emulate in his particular area of responsibility. In most cases his specific Objectives and Procedures will be in documented form. In all cases they will be stated in such a manner as to be credible, understandable, acceptable, and further consistent with the spirit of the Corporate Objectives.

Certain procedures in our company have evolved from many years of experience in performing the same general type of work. At any given point in our growth they should be as efficient as we know how to make them. As each new person joins the company he is obligated to understand these procedures as they exist and to practice them until such time as he can improve upon them. In other words, established practice should always be regarded as the default mode ...comfortable to have around to fall back on, but always subject to improvement. An understanding of this policy will help to assure personal fulfillment and motivation throughout the organization, which in turn will help to perpetuate the professional, dynamic efficient company we all desire.

CARL J. CLEMENT

THE HISTORY OF THE XEROX ALTO

March 19, 2002, Los Altos Hills, California.

In June of 1972 Clement Designlabs received a request from Xerox PARC to participate in a competition with two other industrial design firms to design a device which they termed "a Replacement for the Pad and Pencil," to become part of Xerox' "Office of the Future" theme. I accepted, and was then introduced to Doug Engelbart at Stanford Research Institute (SRI), who had fashioned a "breadboard" of the device, the rudiments of what we now call a "desktop computer," a far cry from the behemoths of IBM and Control Data, etc. to which we had become accustomed. The central features of the device were a "mouse," a pictorial interface, later referred to as "GUI" (Graphical User Interface), and a 5-key binary mini-typewriter. We proceeded with the project, through analysis, concept drawings, foamcore mockup, and concluding with a hard model, the features of which were :

1) the first detachable keyboard, 2) the first tilt-and-swivel monitor, 3) the first 3-button mouse, and 4) the first compact combination of a "garageable" mouse, keyboard, and mini-typewriter, all characterized by the expected elegant appearance for which Clement Designlabs was renowned worldwide. Our project team included Ken Campbell, a seasoned engineer; Fred Stengel, one of my students at San Jose State University, and myself. Upon completion, I presented our model to our Xerox contacts, Bill English, Doug Fairbairn, Dave Liddle, and others working for Alan Kay, who reported to PARC Director George Pake, then later to John Seely Brown. Shortly thereafter we were advised that we had won the competition and accordingly were given the follow-on contract to proceed with the production-engineering phase.

Upon completing this assignment, we were commissioned by Xerox PARC to manufacture a pilot-run of 80 units (including computer/monitor, keyboard, mouse, and mini-typer), given that PARC had no manufacturing facilities of its own. We were to work with Rick Nevinger, purchasing manager, and Tony Ciuffini, development engineer at Xerox El Segundo, whose crew would then insert the electronics into our packages. The finished units were planned to be delivered to all Xerox divisions for use in an Alto-dependent interactive communication network. Lo, the product was so successful, even based upon crude prototype tooling, that Xerox gave us a number of serial contracts, each for low hundreds of units, totaling about 2000 units over a period of more than 10 years. Xerox hadn't followed through with the high level (injection-molded plastic and metal die-casting) tooling for the unexpectedly higher production levels, so in about 1976 I unilaterally upgraded the tooling somewhat, at Clement Designlabs' expense, cutting the cost by about 1/2 and increasing the concomitant profit, which I, also unilaterally, shared with Xerox.. Thereafter Clement Designlabs designed many other products for PARC, including a horizontal-format version of the original vertical-format Alto, a Japanese Kanji version of the Alto, a portable Alto, 9-micron IR item-gate touch screen masks for which we did the basic optical research and mfg., and the first scanner. One of our later modifications was the inclusion of a wire-cloth layer imbedded in the fibreglas housing to comply with the new US "Tempest" secrecy regulations to reduce the RF leakage containing the key-click information. One of our Alto units is retained in the Smithsonian Institute permanent collection.

It was during this period that Steve Jobs was allowed to tour the PARC facility, where he saw the Clement Designlabs product, which, according to John Seely Brown, Research Director of PARC, "took his breath away." Shockingly, Xerox allowed the product to go into public domain sans patent protection, meaning that the high-quantity manufacturing-design contract that Clement Designlabs had anticipated wasn't going to happen. Jobs then appropriated the technology and abandoned Apple's

"Apple 2" product lines, starting its first copy of the Xerox Alto, the Lisa, which was a dismal failure. Apple then recovered with its Macintosh. Meanwhile Bill Gates' Microsoft was working on its "Windows," a different adaptation of the Alto technology. Microsoft became the more successful company, largely because of Gates' open attitude, wherein he welcomed applications software from almost any source. Jobs then sued Microsoft (and Hewlett-Packard) for infringing on "Apple's copyright." As a former employee of Hewlett Packard, I offered myself as a witness for HP in the trial (copy enclosed), to refute Jobs' claim. During the later anti-trust trial, US v. Microsoft, my letter to Gates extolling the virtues of Microsoft's integrated "Office Suite," (copy enclosed) was entered as evidence into the trial.

Recently I became acquainted with John V. Titsworth, a former Xerox top management executive, who explained in his books, "Win Some, Lose Some" and "Entrepreneurs, Bureaucrats, and Enthusiastic Idiots" that the reason for Xerox not pursuing the Altos concept, but letting it go into public domain sans patent was that "computers" would have been inconsistent with the Xerox "copier" culture! Tragically for Xerox, they allowed others to harvest the results of the seeds they had sown, by abandoning what has come to be one of the most revolutionary and successful technologies of the 20th century.

In 1984 I retired and sold Clement Designlabs, which was still supplying Alto parts to Xerox, El Segundo as of 1986.

The documents in this booklets are only those essential to a brief but accurate accounting of the project, taken from Clement Designlabs #72-17 Job Book, which contains the detailed "warts and all" history of what we call the iterative process. Product development, for all of its scientific method and organization, can be a messy process --- in more ways than one. Not only are there unproductive side roads, back-tracking, and running in circles, but in this case, literally, some of the documents were so coffee-stained that they had to be rehabilitated through "Adobe Photoshop" in order to be presentable. Any errors in the recycling are assumed to be minimal and not damaging to the authenticity of this booklet as a vehicle for explaining the Alto project and the product development process at large.

My association with Xerox PARC was one of the most exhilarating and rewarding during my entire professional career. Never have I experienced a more creative and stimulating group of engineers. Recently, I made a new connection with Doug Fairbairn, my main contact at PARC, who remains active in the computer field. He is currently considering new applications for the now-ubiquitous and seemingly eternal Alto technology, some 30 years after the original work by the Xerox-Clement team!

Carl J. Clement
12785 Dianne Drive
Los Altos Hills, CA 94022

June 29, 1972

Mr. William K. English
Xerox Research
Hillview & Coyote Hill
Palo Alto, California

Dear Mr. English:

We are pleased that you are considering our assistance in the design of your new Office System.

We hope that you became aware during our first interview that our firm is devoted to product innovation and improvement in a total sense; we are enclosing a brochure of representative material to reaffirm this fact. Should our proposal prove acceptable, as we begin work on the project you will find that our designers and engineers apparently pay little attention to styling at the start. You can expect them to question many functional aspects, which you might take for granted, and to work side by side with your own engineers in an effort to discover and take advantage of all possibilities for maximizing the coupling efficiency between your System and the user. Cardboard and 2 x 4 geometry studies will be in abundance, and we plan at least one trip to SRI and/or other appropriate facilities.

Following our brief experiences with the equipment in your laboratories and our perusal of the Doug Engelbard article, we also are believers in the profound nature of the advances which your System can bring about. We share your feeling that a completely new concept is necessary, which will not only dramatize the essence of the System but which will relate it intimately with the user, or should we say, participant --- almost as an extension of himself.

You will notice that we have listed the various phases following Advanced Design, but without statement of fees, as we indicated would be the case. One item that might deserve additional explanation is #2 under Advanced Design: Design Layout drawings. If we continue through the entire program as planned, this item becomes unnecessary (inasmuch as we can communicate to ourselves more expediently than to others), saving the amount of \$1080. We shall quote on the Documentation Phase midway toward the end of the Advanced Design Phase, as the number and type of drawings become predictable. Although not so clearly identifiable, other similar savings are implicit in our continuity of effort throughout the final production and delivery of complete units.

We are pleased to propose as follows:

PRODUCT:

1. Office System, including:
 - a. CRT Display.
 - b. Keyboard.
 - c. Key Set.
 - d. Writing-Pointing Device (Mouse).
 - e. Horizontal Surface.

OBJECTIVES:

1. Manufacturing economy to be maximized, consistent with tooling amortization over pilot run of 32 units.
2. Human factors to be consistent with office environment and to maximize ease of operation and operator comfort.
3. Appearance to dramatize this new concept, to relate the devices to the user in an intimate "non-machine" fashion, and to maintain and promote the identity of Xerox as a manufacturer of innovative, high quality equipment.
4. Physical volume to be minimized, consistent with function.

PROCEDURE:

PHASE I. ANALYSIS & PRELIMINARY DESIGN (4 WKS)

- A. It will be your responsibility to supply:
 1. The following components (or drawings and specifications):
 - a. CRT Chassis.
 - b. Keyboard.
 - c. Key Set.
 - d. "Mouse".
 2. Product specifications.
 3. Operating instructions.
 4. Contact information on typical users.
 5. Marketing information as required to develop the design, including information on and photographs of similar equipment.
 6. Reproducible samples of your logotype.
 7. Statement of any preferences or exclusions not covered under objectives above, particularly as regards color.

B. During our analysis, we will:

1. Review your engineering specifications, drawings, and available hardware.
2. Analyze your human factors, environmental, servicing, and functional restraints.
3. Study appearance and features of similar equipment.
4. Consider materials and manufacturing methods appropriate to projected production quantities.
5. Consider approaches to minimizing physical volume, consistent with desired functional characteristics.

C. This analysis will be the basis for developing preliminary design specifications and design configurations, carried out in a series of loose sketches and/or 3-dimensional cardboard visualizations.

PHASE II. ADVANCED DESIGN (7 WKS)

Based upon evaluation of Phase I and review of all parameters under B above, we will develop a definitive representation of the System to be transmitted as follows:

1. Loose appearance sketches and/or cardboard visualizations as necessary.
2. Design layout drawings showing essential features of the design and critical exterior dimensions. The drawing will include notes of general specifications for materials, finishes, clearances, etc., required to make individual part drawings for production.
3. Clay model(s) for form study (non-deliverable).

PHASE III. FUNCTIONAL AND APPEARANCE MODELS (4 WKS)

1. To be faithful in appearance to production versions.
2. Will provide for mounting of operating electronics.
3. Will be fabricated from most appropriate and expedient materials for one-of-a-kind production.
4. Will be suitable for total operator involvement and subsequent evaluation.

William K. English
Page 4
June 29, 1972

PHASE IV. COLOR SCHEME (CONCURRENTLY)

Following analysis of present and potential products, a color scheme will be selected, consisting of 2 colors, plus quasi-black and bright metal. It will be transmitted as follows:

1. Preliminary (approximate chroma and value) colors on large chips for your evaluation and subsequent refinement.
2. Final colors to be lacquer-sprayed on appearance/functional models.
3. 6 standard sprayed paint panels of each color for vendor paint specification and quality control.

PHASE V. DOCUMENTATION (5 WKS)

Based upon the design achieved in Phase II, and in place of layout drawings under 2 above, we will provide documentation for fabrication and assembly of 32 units, including:

1. Individual part drawings.
2. Assembly drawings as needed.
3. Parts list.
4. Specifications.
5. Camera-ready art.

PHASE VI. PROTOTYPE: 2 UNITS (3 WKS. + VENDOR LEAD TIME)

1. To be fabricated using final production materials and processes, based upon documentation in Phase V.
2. All documentation to be updated following fabrication and assembly.
3. Includes all purchasing and vendor liaison.

PHASE VII. PRODUCTION RUN: 30 UNITS (6-8 WKS. + VENDOR LEAD TIME)

Same as above.

William K. English
Page 5
June 29, 1972

FEES & PAYMENT:

1. For the work outlined above, our fees are as follows:

Phase I	\$4340.
Phase II	6120.
Phase III & IV	2525.
Phases V - VII	to be quoted later.

2. Fees payable monthly.

3. Any additional work resulting from program modification by client billable at:

- a. \$30/hr. for conference/creative time.
- b. \$15/hr. for mechanical/drafting time.

SCHEDULE:

We can begin within 5 working days and complete all work within 26 weeks, contingent upon timely and accurate responses from Xerox personnel.

We look forward to working with you and your organization on what promises to be the most stimulating project we have seen to date.

Your endorsement hereon shall constitute an agreement between us.

Please return the signed copy.

Sincerely,

CJC:cc

Carl J. Clement

I accept this proposal and all terms herein.

(client company)

(authorized individual)

(date)

Terminal Packaging Guidelines for
Clement Laboratories

I. General

- A. All mounting holes should be pre-tapped. This includes mounting holes for keyset, keyboard, mouse, external device, and BNC connectors.
- B. One person should be capable of assembling or disassembling the terminal without aid.
- C. All screws shall be Phillips-head type.

II. Keyboard

- A. It should be easy to align the keyboard with the case. This means the keyboard should mount to the top rather than the base.
- B. The keyboard should be removable from the case without loosening or removing the connector mounting bracket.

III. Keyset

- A. The functional design^{and size} of the keyset should closely follow that of the SRI keyset. Especially, the switches should be rigidly mounted and the trip point should be externally adjustable.

IV. CRT housing

- A. The brightness, contrast, and volume controls shall be mounted to a non-removable portion of the chassis. They shall be mounted out of sight, probably under the CRT housing.
- B. The CRT itself shall be removable without dismounting any of the electronics.
- C. The T.V. printed circuit card shall be mounted in such a way as to assure easy access to the top side of the board for component replacement.
- D. Each major electrical component should be removable without moving any other component.
- E. The high voltage assembly shall be mounted in such a way that the rectifier assembly is at least 1 " away from any metal part.
- F. ^{LED WIRES} Hooks or holes should be provided on the bezel to attach the CRT grounding spring. The spring should go across the end of the tube opposite the high voltage part.

- G. The logic board shall be mounted in such a way as to make insertion and removal easy. No screws should be used if possible.
- H. There should be 1/4" clearance for components on the logic board.

V. Base unit

- A. The power supply unit should slide out the back of the base if possible. If this is not possible, it can drop out the bottom.
- B. The strain reliefs for the external cables shall be part of the power supply unit and thus remain with the power supply when it is removed. The same applies to the interior connector bulkhead.

C. POWER CORD SHOULD BE 3 WIRE TYPE.

These guidelines should not be interpreted as requirements. Any of them which add "significantly" to the cost of the unit are subject to change.

D. CONNECTOR ITT # 2DABIP TO BE
ADDED TO INSIDE & OUTSIDE OF
POWER SUPPLY

HUMAN FACTORS IDEAS

1. ~~SWIVEL~~ SPHERICAL ADJUSTMENT.
2. WHEELS ON CRT
3. SEMI-CIRCULAR TABLE
4. ADJUSTABLE GLARE HOOD
5. HEIGHT ADJUSTMENT - SCISSORS JACK, COUNTER WEIGHT, SCREW
6. STORE KEYBOARD UNDER CRT
7. BLACK TABLE TOP & KEYBOARD - TILT PLEX SHIELD DOWN.
8. LIFT MOUSE TO CENTER POINTER.

7/1/72

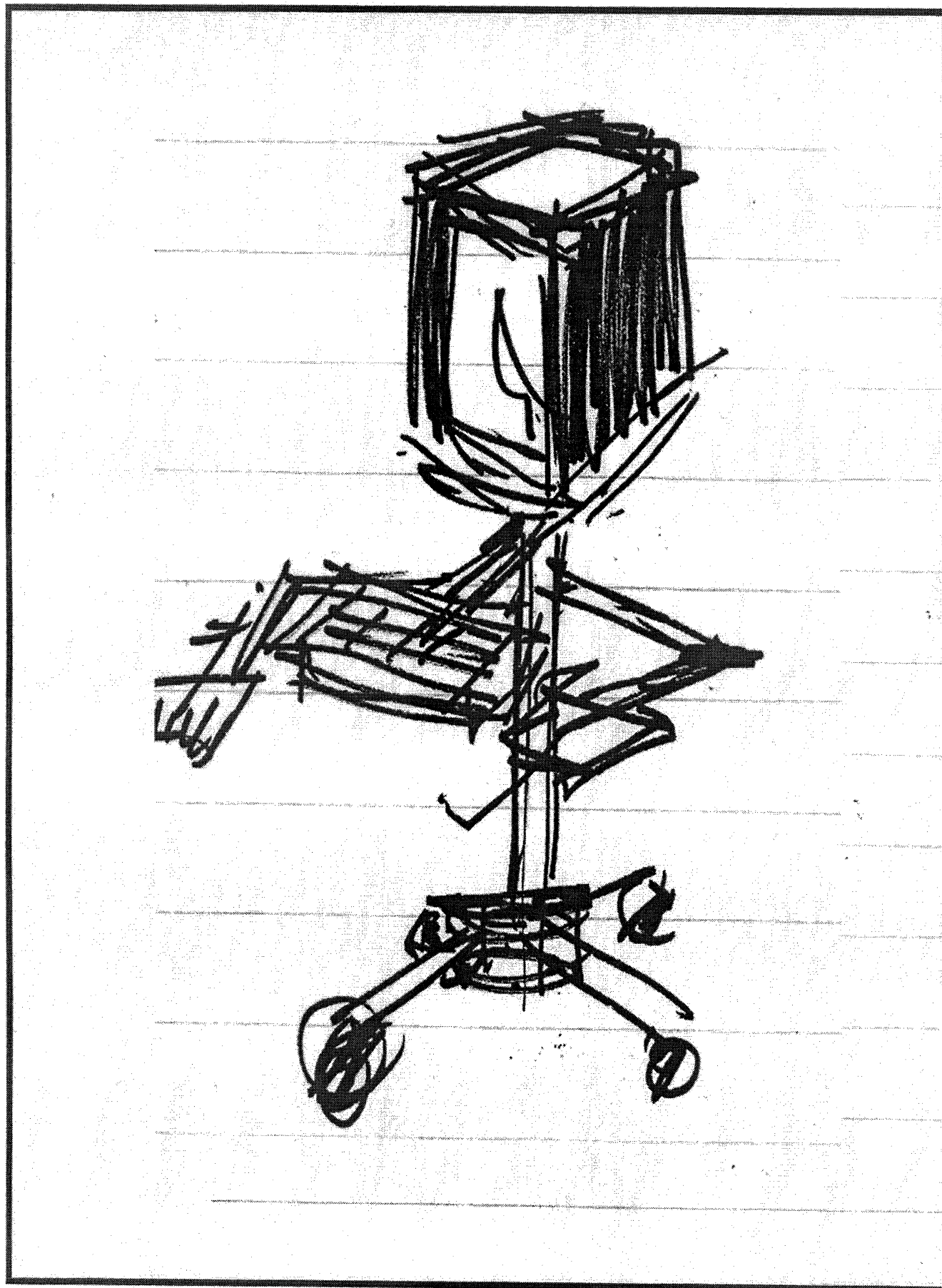

EARLY CONCEPTS: MEET MR. COMPUTER

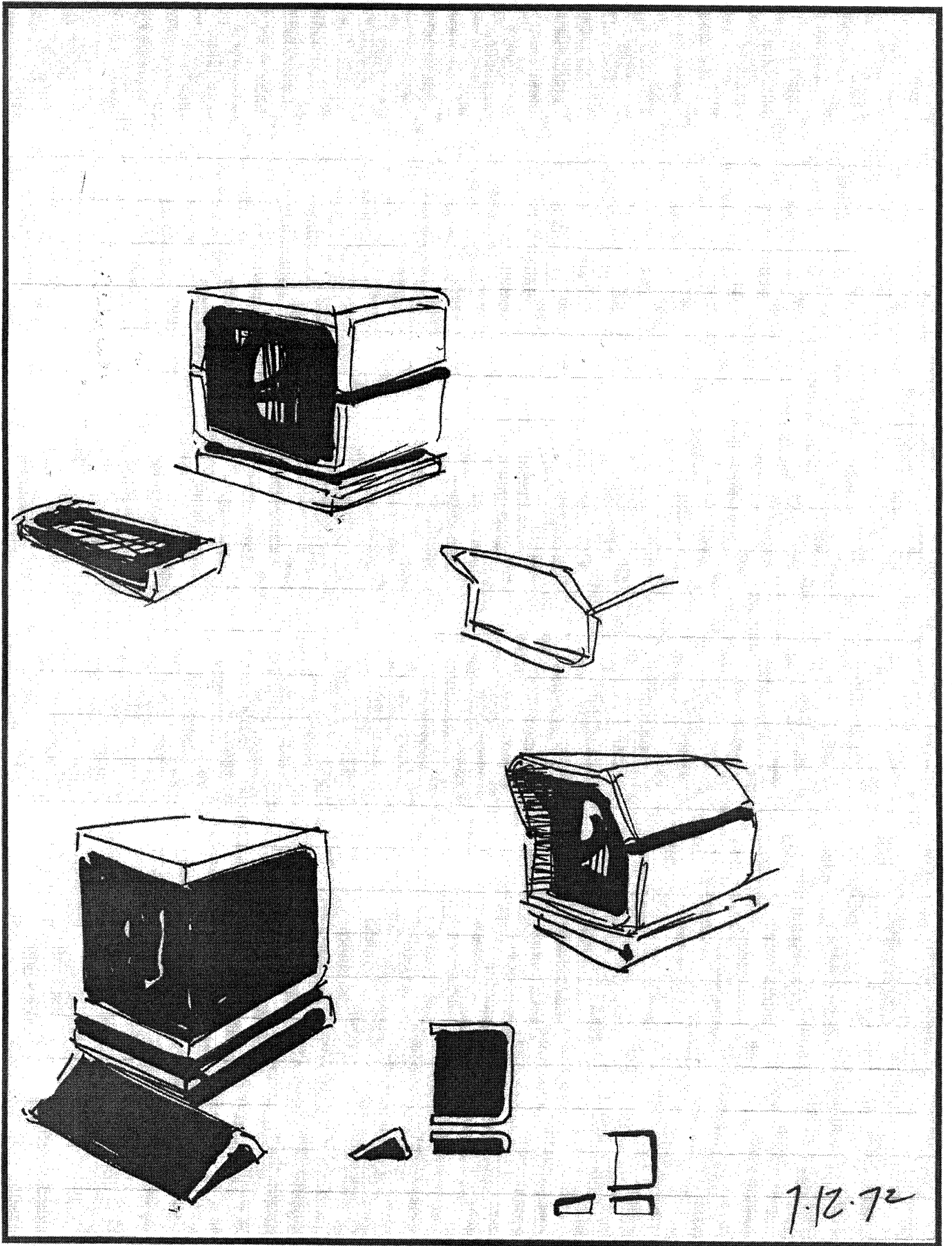

7.12.72

EARLY VARIATIONS ON A THEME

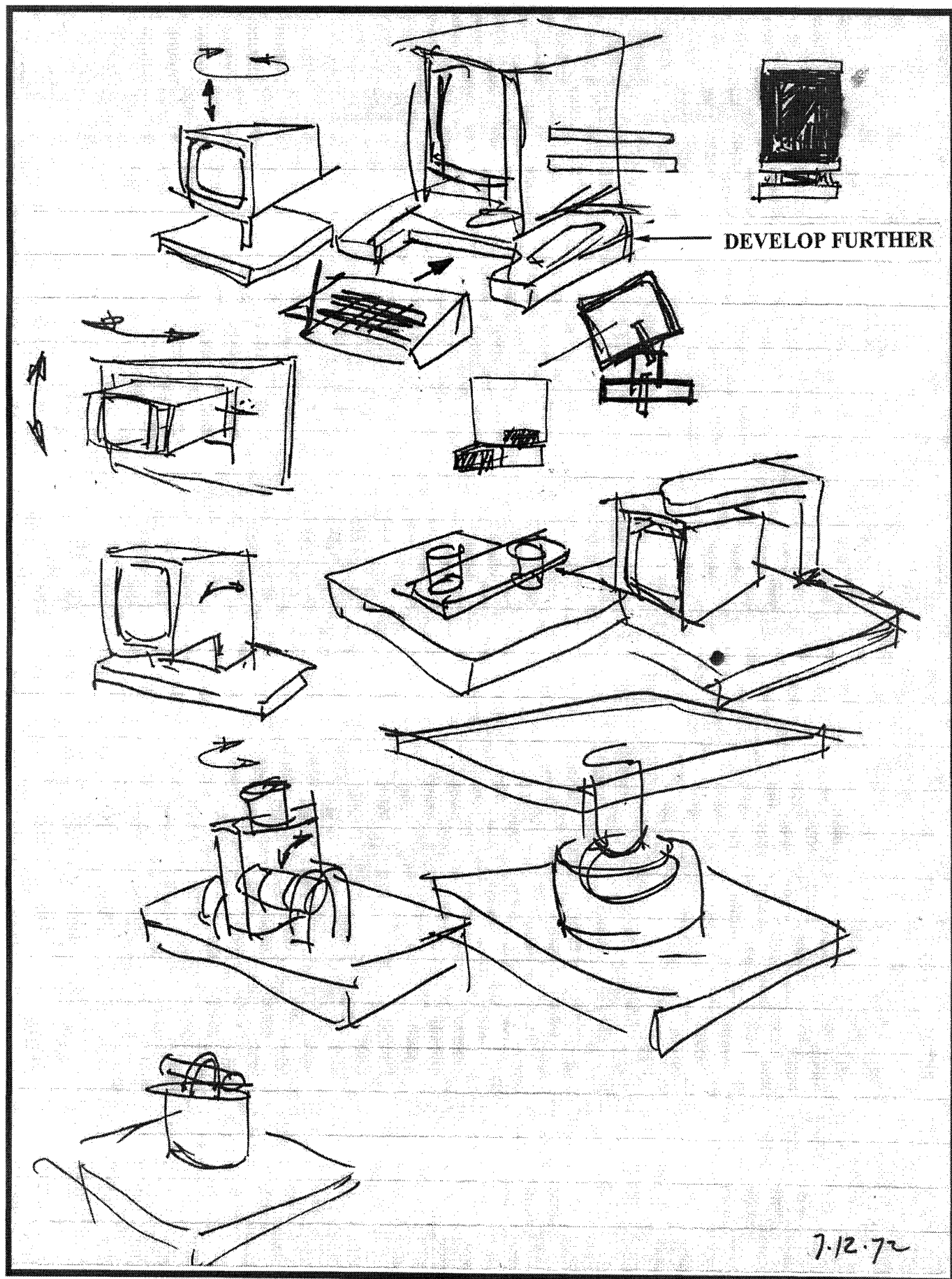

EARLY CONCEPTS; E PLURIBUS WHICH UNUM?

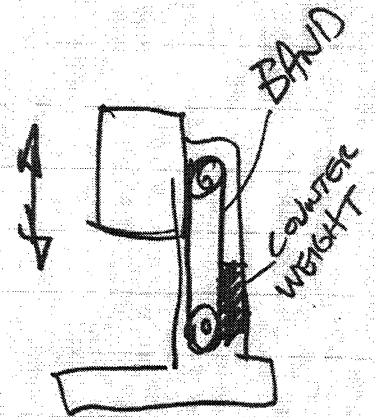
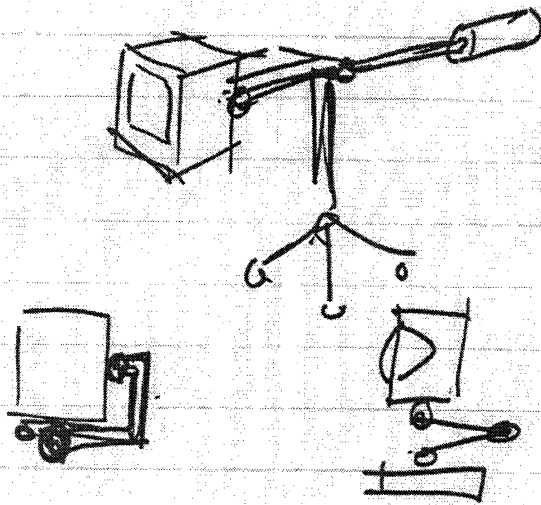
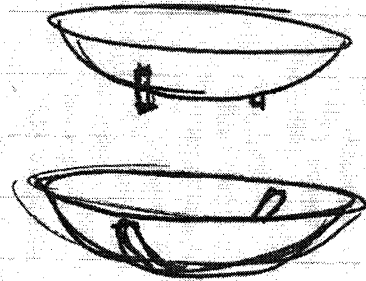
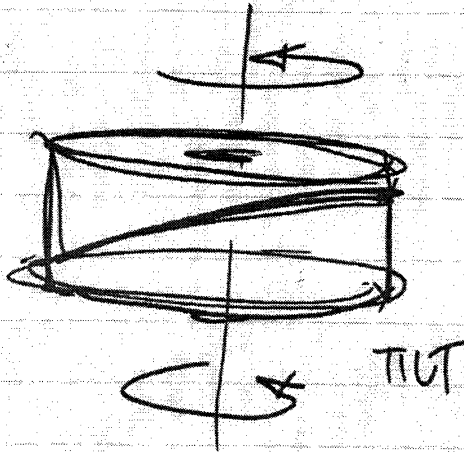
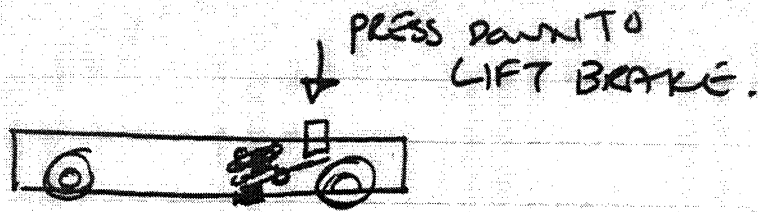

7.18.72

EARLY TILT/ROTATE: RUBE GOLDBERG TAKE NOTICE

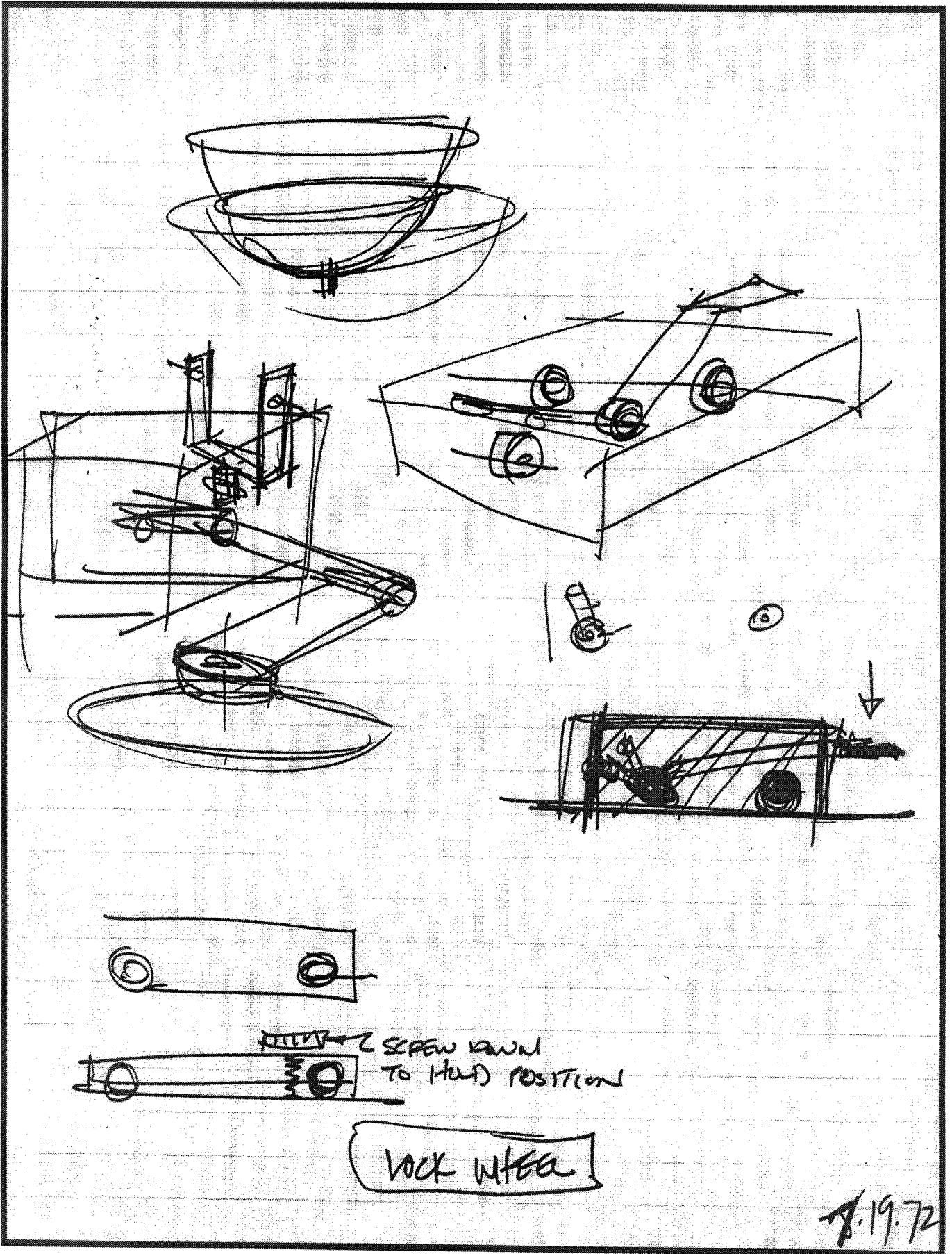

CHANGE YOUR TIRE, ANYONE?

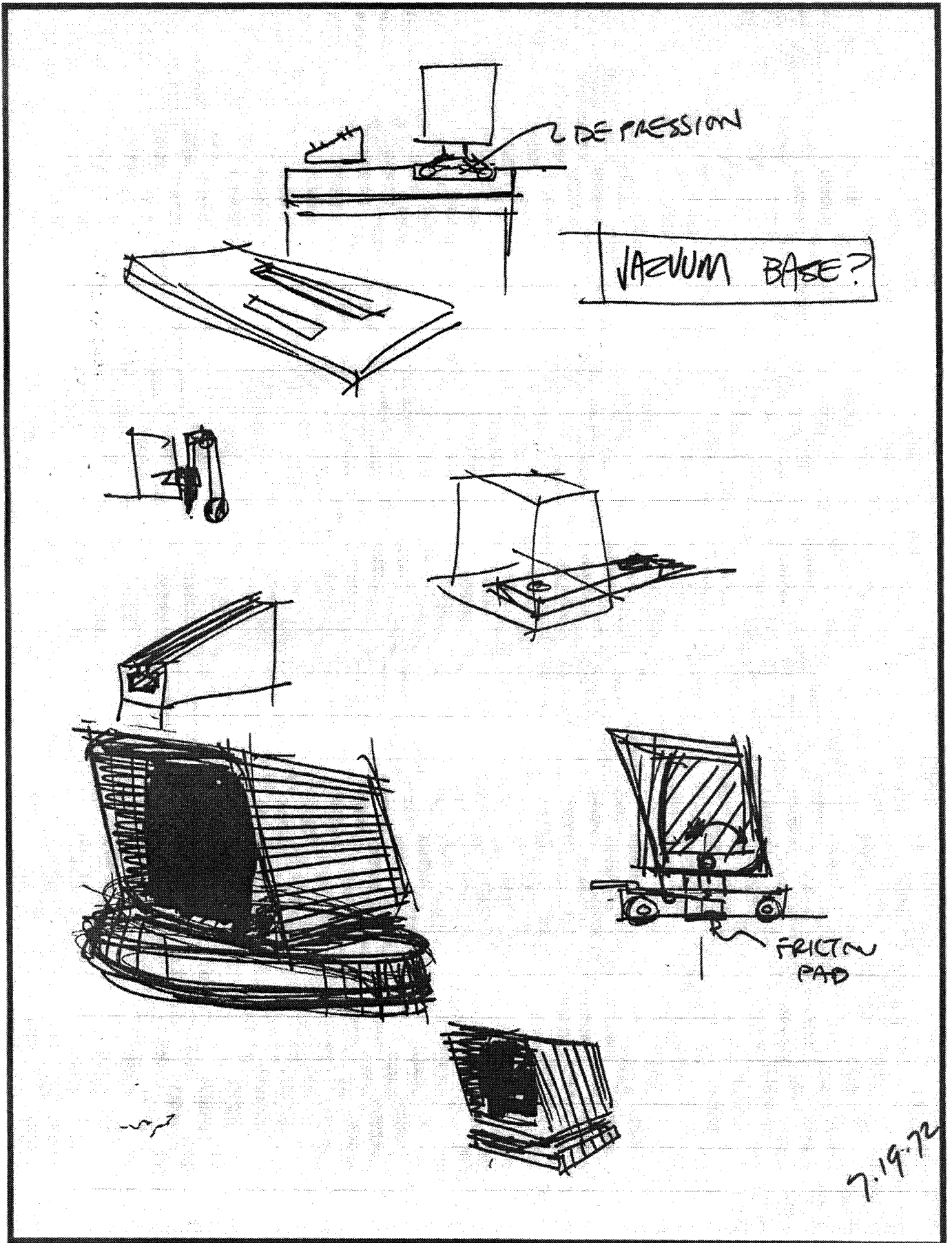

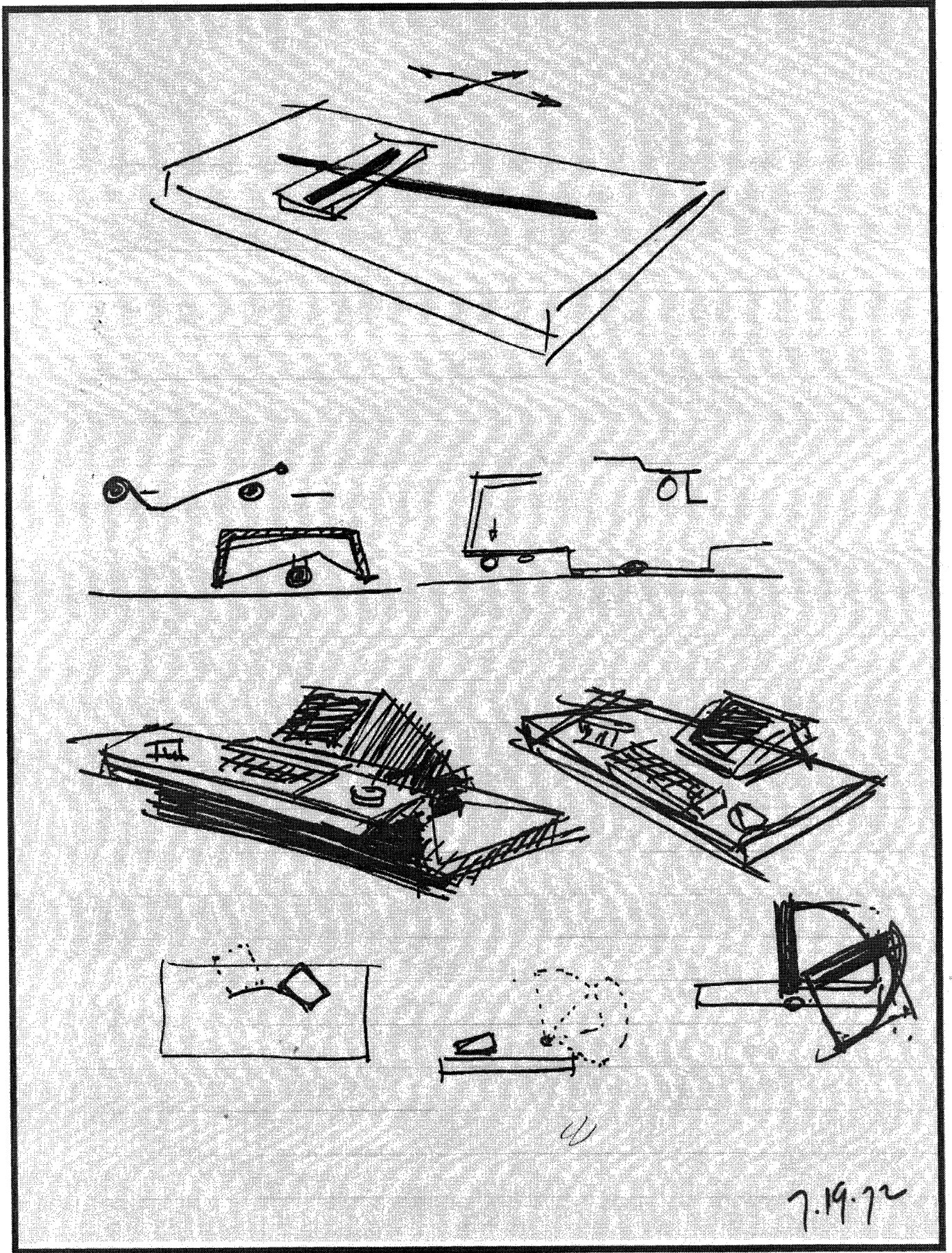

7.19.72

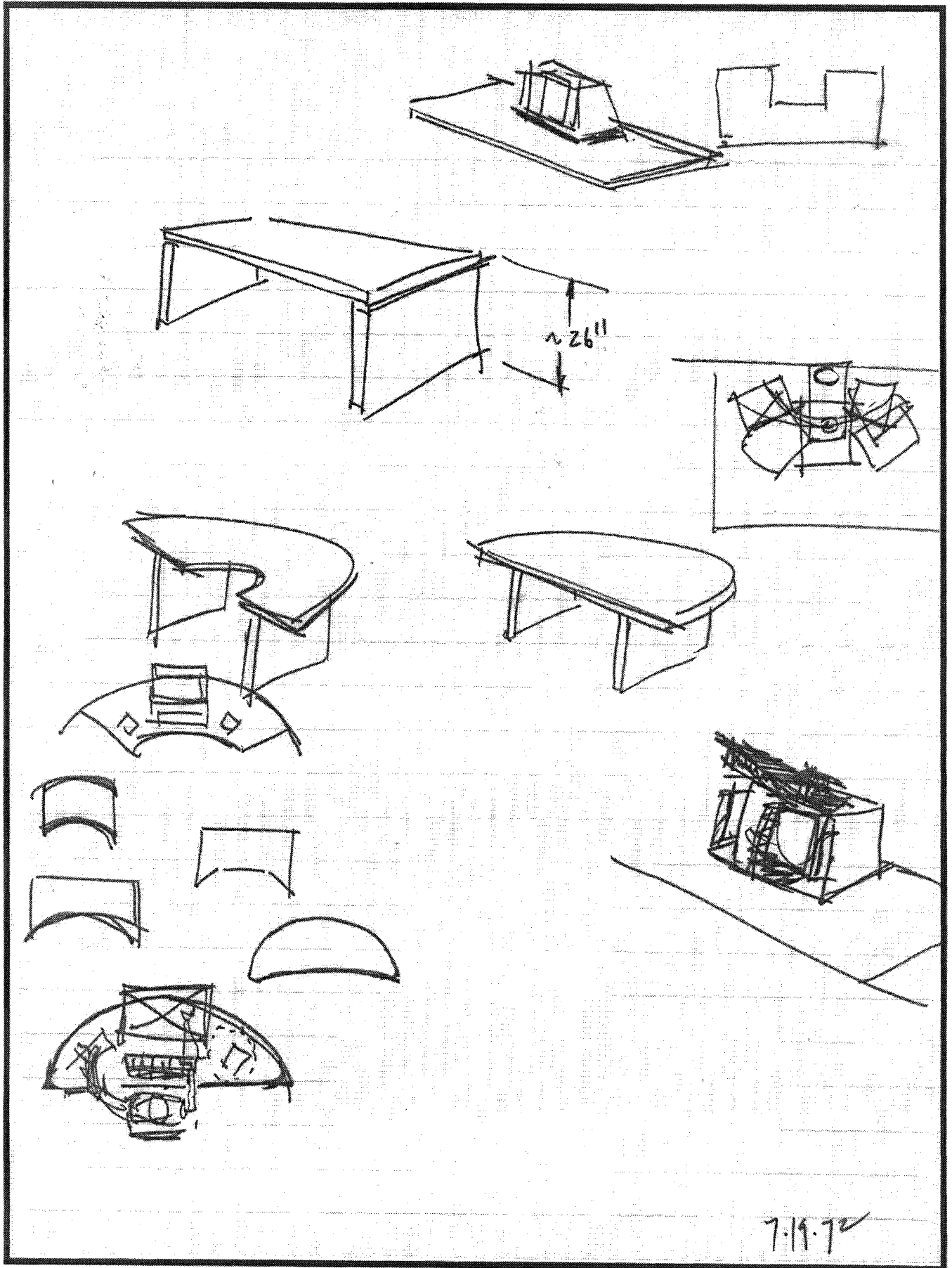

7.19.72

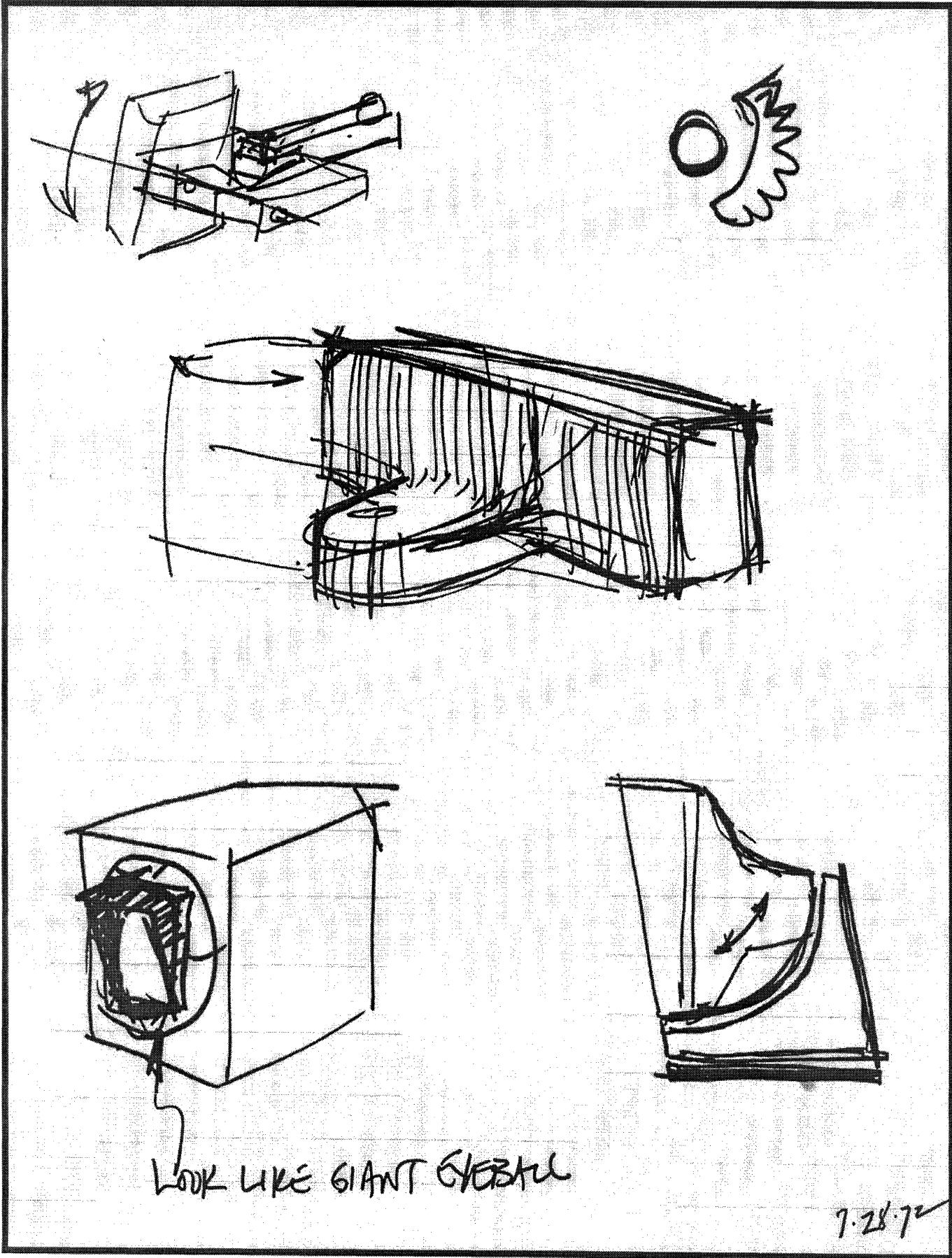

EARLY CONCEPTS: HERE'S LOOKING AT YOU, KID

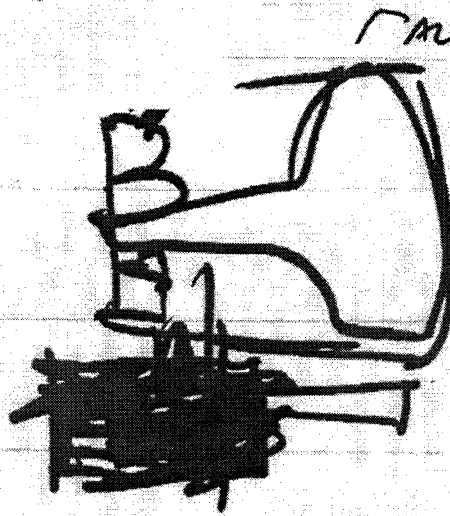
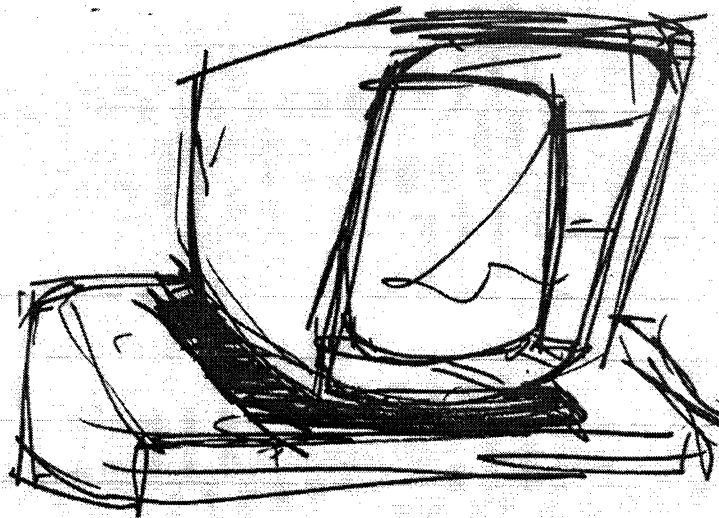

ALL HEAVY STUFF
IN REAR

SO COULD BE
ANTILEVERED
OFF BASE

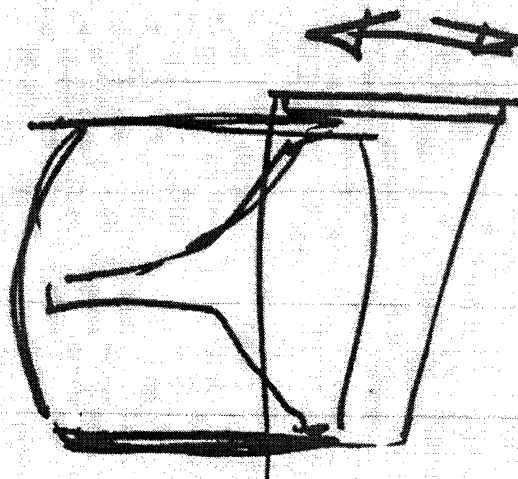

ADJUSTABLE OUTER HOOD?

7.28.72

**EARLY CONCEPT: BALANCING ACT
UNDER THE FLOODLIGHTS**

Client Communication

 CLEMENT LABORATORIES
INDUSTRIAL DESIGN • PRODUCT DEVELOPMENT

DATE

8.1.72

PROJECT

MEETING AT

PHONE CALL

CJC & NORMAN SEAL, DEPT OF HEALTH, EDUCATION, &

PARTICIPANTS

BUREAU OF RADIOLOGICAL HEALTH.

SUBJECT

"IF OUR COMPUTER OUTPUT WAS IN THE RANGE OF
10-18KV, WE HAVE NO PROBLEM."

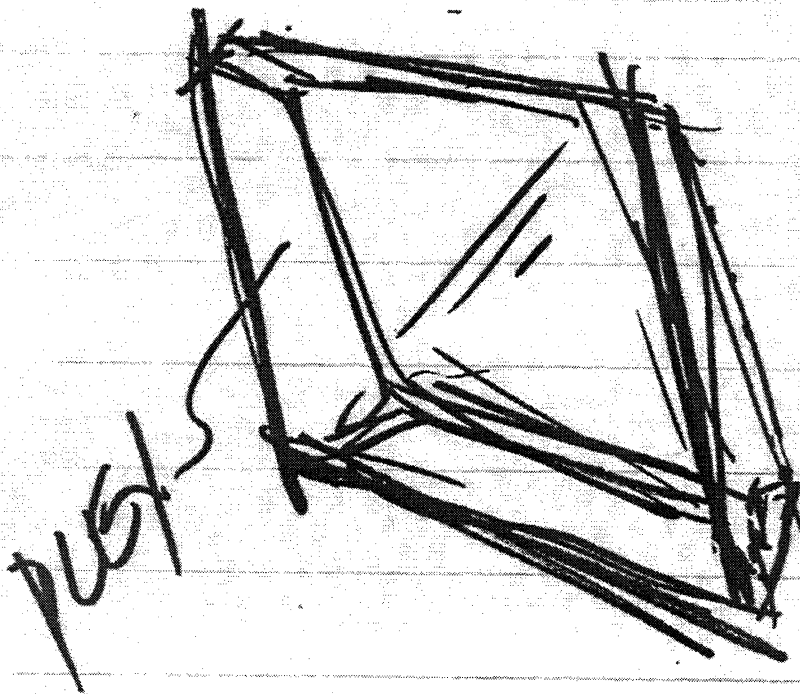
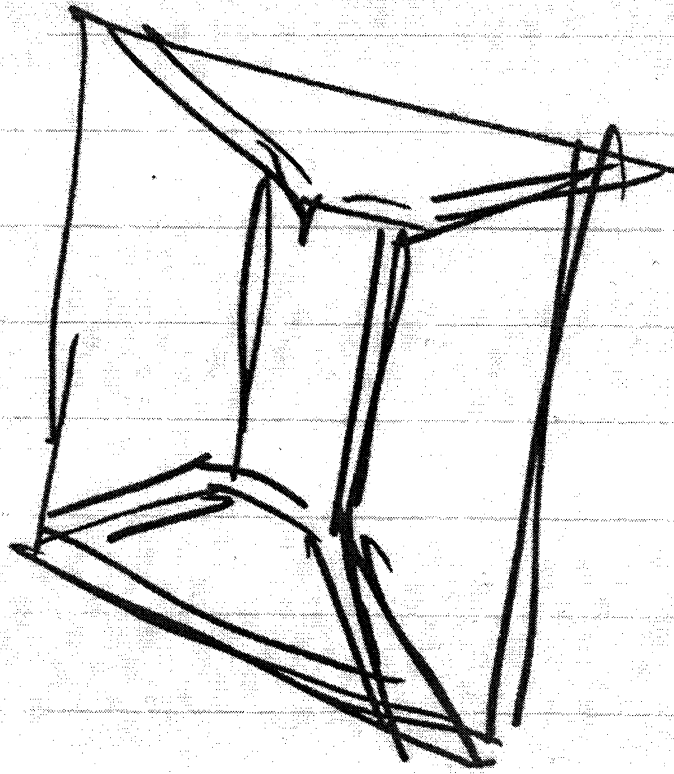

8.1.72

TAKE OFF YOUR MASK; IT'S NOT HALOWE'EN

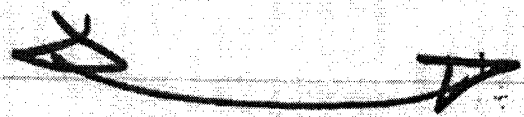
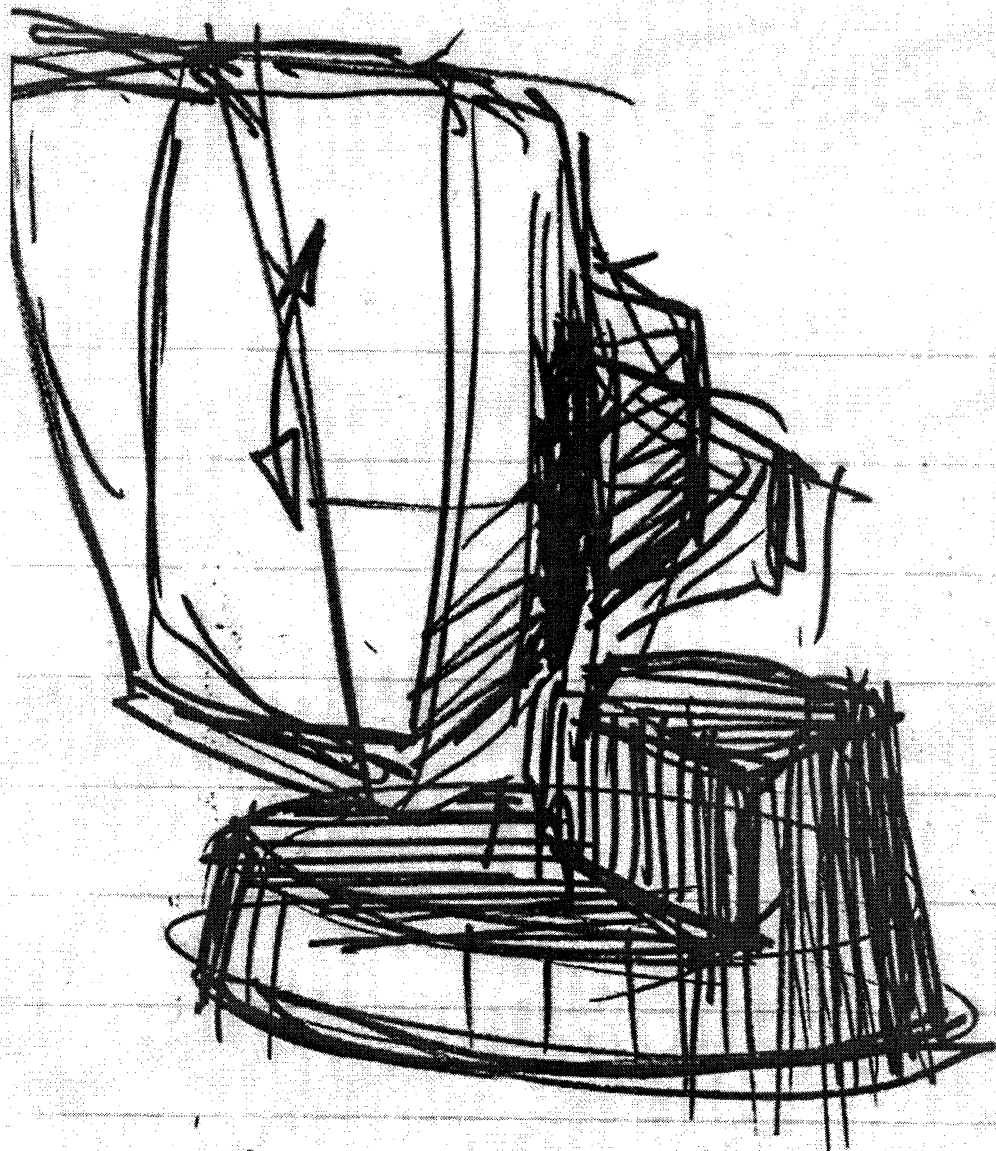

LAZY SUSAN BASE

8.1.72

EARLY CONCEPT: "IF YOU KNEW SUSIE"



OPTICAL COATING LABORATORY, INC.

2789 GIFFEN AVE. P.O. BOX 1599 SANTA ROSA, CALIFORNIA 95403 - TELETYPE 610-764-2081
TELEPHONE 707-545-8440

August 4, 1972

Mr. Carl Clement
Clement Laboratories
2560 Wyandotte Street
Mountain View, California 94040

Dear Mr. Clement

It was a pleasure talking with you the other day. Per our conversation, we are enclosing literature describing HEA[®], our multilayer antireflection coating.

HEA is an all-dielectric, multilayer, thin film coating which, when it is vacuum-deposited on the surfaces of glass and certain plastic substrates, will reduce reflections, increase transmission through the substrate, and sharpen the image of the object viewed through it.

Originally designed for use on instrument glasses in military aircraft, HEA is widely used in periscope, LLLTV, high resolution photographic and military sighting systems. All windows on U. S. manned spacecraft, except Mercury, have been coated with HEA. In 1968, use of the coating in the optical system of a special movie camera won an Oscar for OCLI for its technical contribution to the movie industry. A major manufacturer of high quality still cameras, under license from OCLI, coats all of its lenses with HEA.

As early as 1966, OCLI was depositing the coating directly on tube faces. Prior to that time, HEA was deposited on an implosion shield that was subsequently cemented to the tube face. On a production basis, coating deposition can be made on implosion shields and/or tubes with diagonal measurements up to 30". The length of the device can total 11". Larger sizes can be handled in special equipment. Enclosed are specifications for HEA on glass and certain plastic substrates, along with a sketch depicting various ways the coating is used for display purposes.

Under separate cover, we are sending you two samples of HEA on glass. One sample simulates the coating on the front surface of a CRT. The central portion of the glass disc is coated and the back side of the disc is painted. By reflecting light from the clear side, you can see the tremendous difference in reflecting glare from the coated and uncoated parts of the disc. The other sample demonstrates the properties of HEA when it is applied to both surfaces of glass, as it would be to a free-standing coverplate.

I hope the foregoing, the enclosure and the samples will give you an idea of the value of HEA and that we will hear from you.

Very truly yours,

L. S. Howerton, Sales Manager
Electronic Thin Films
Technical Products Division

LSH/LP
Enclosure

EXCELLENCE IN THIN FILMS

RESEARCH: BREAKING THE MIRROR IMAGE



HEA[®] COATINGS for DISPLAY DEVICES

will transform . . .

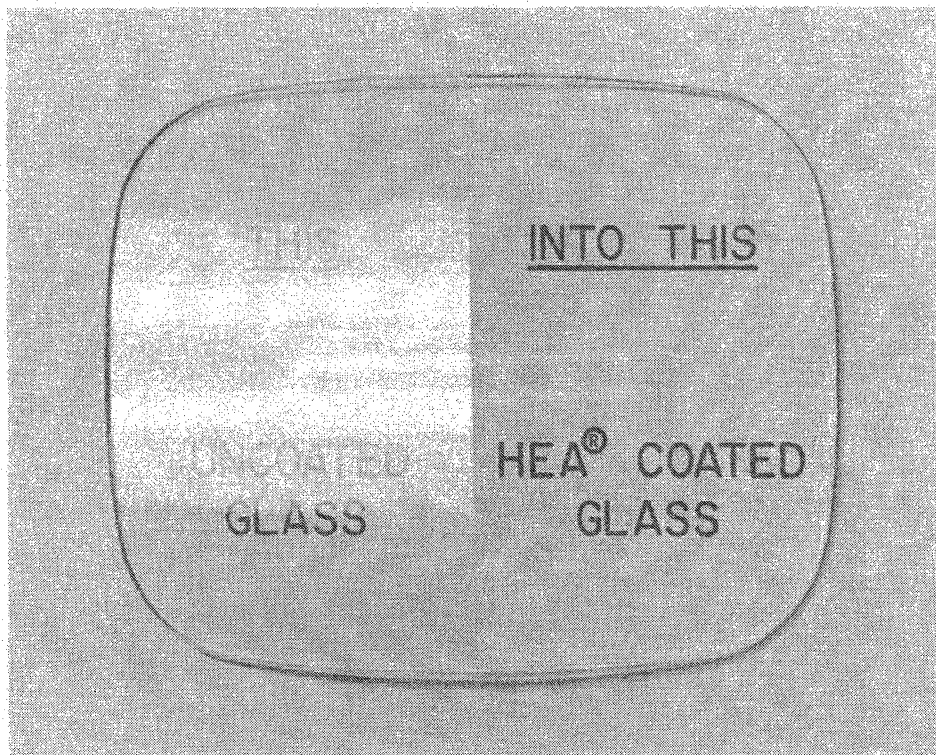

(Unretouched Photograph)

OCLI OPTICAL COATING LABORATORY, INC.
P.O. Box 1599, 2789 Giffen Avenue - Santa Rosa, California 95403 - Teletype 510-744-2083

NOW YOU SEE IT

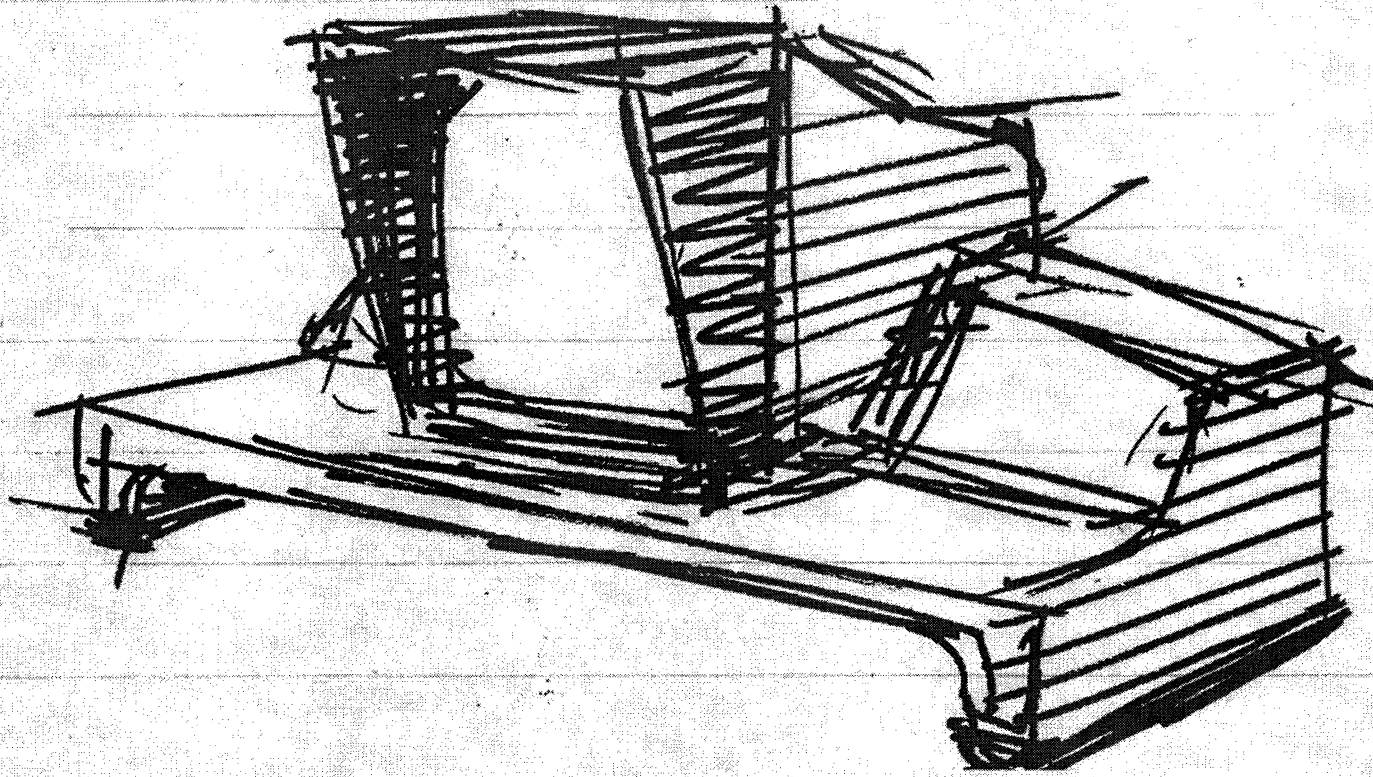

9.8.92

EARLY CONCEPT: A REAL STRETCH

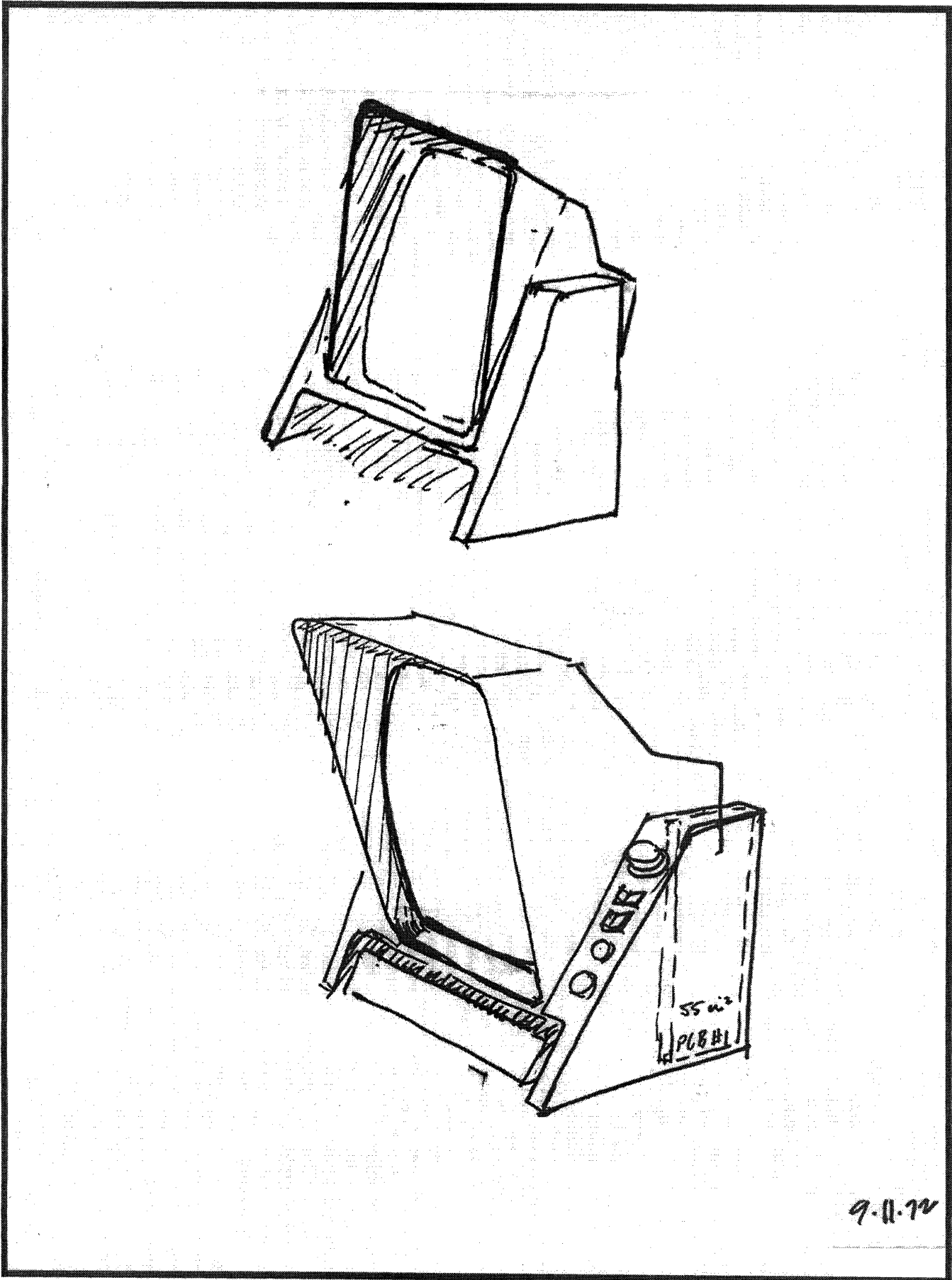

9.11.72

EARLY CONCEPT: A DIFFERENT SLANT

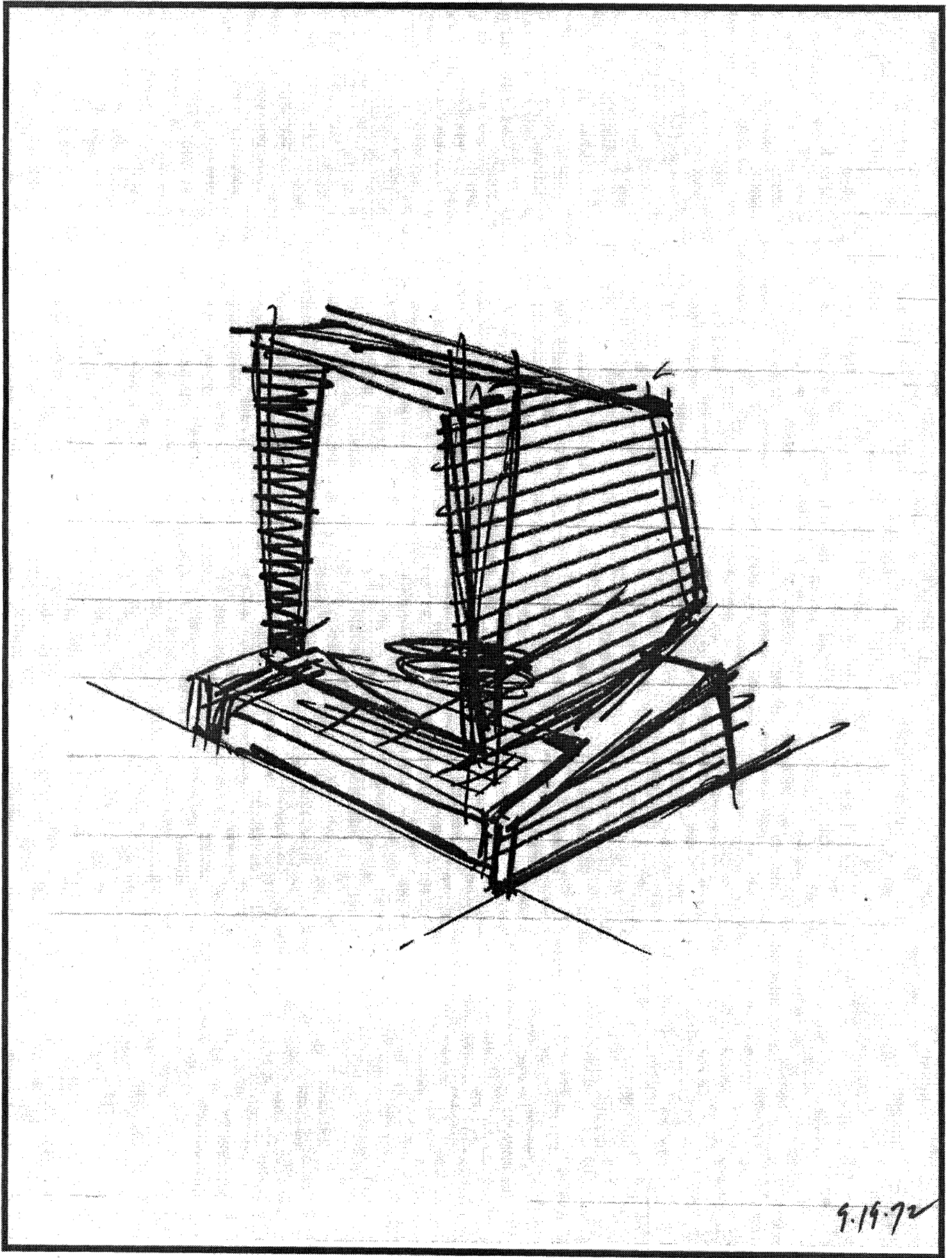

EARLY CONCEPT: GO FOR IT!

New **ECONO/MATE** Low Cost Modular Power Supplies

TECH-SER, INC.
1954-M OLD MIDDLEFIELD
MOUNTAIN VIEW, CA. 940 3
(415) 969-902



the

PIMIC

series

Built and Backed by the World's Largest Supplier of Quality Modular Power Supplies



POWER/MATE CORP.

514 S. RIVER STREET, HACKENSACK, NEW JERSEY 07601
PHONE: (201) 343-6294 TWX: (710) 990-5023

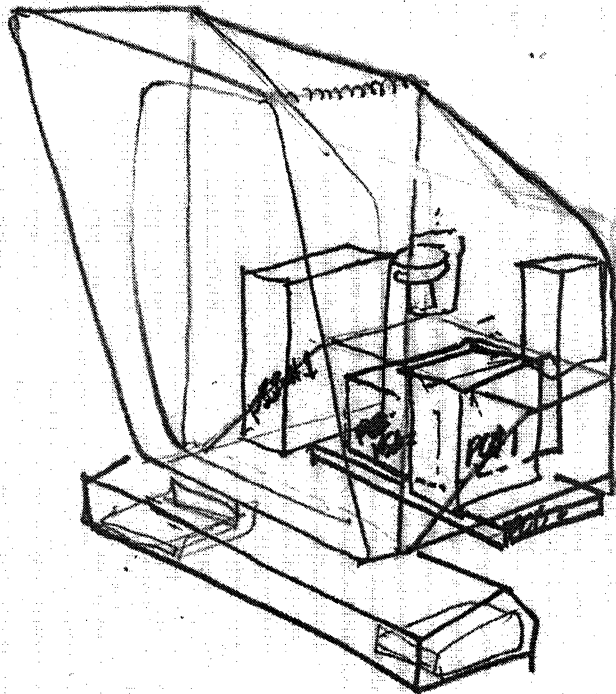
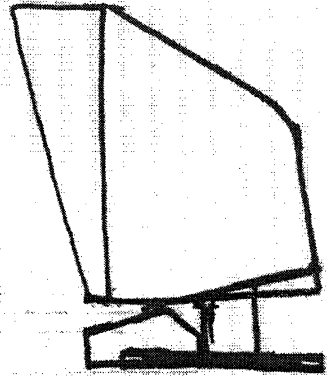
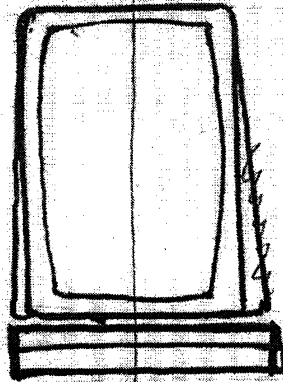

* NOTE:
SUBJECT TO
SPACE IN PACKAGE
WITH TUBE IN
PLACE

9-12-72

MAKING ROOM FOR THE GUTS

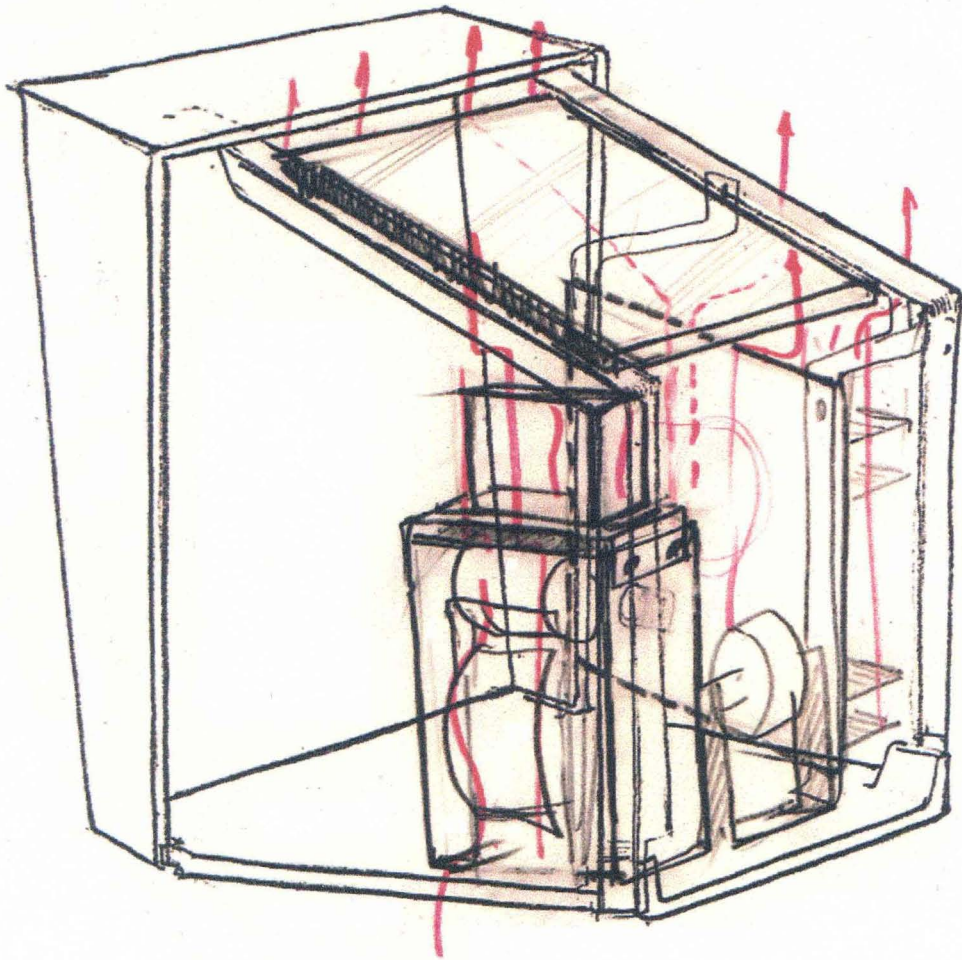

advant.

- ① low CG
- ② all parts exposed with enough room to resist in to tube
- ③ convenient mounting of top PC BOARD

disadvant.

- ① top board blocks heat flow
- ②

11/10/72

THERMAL STUDY

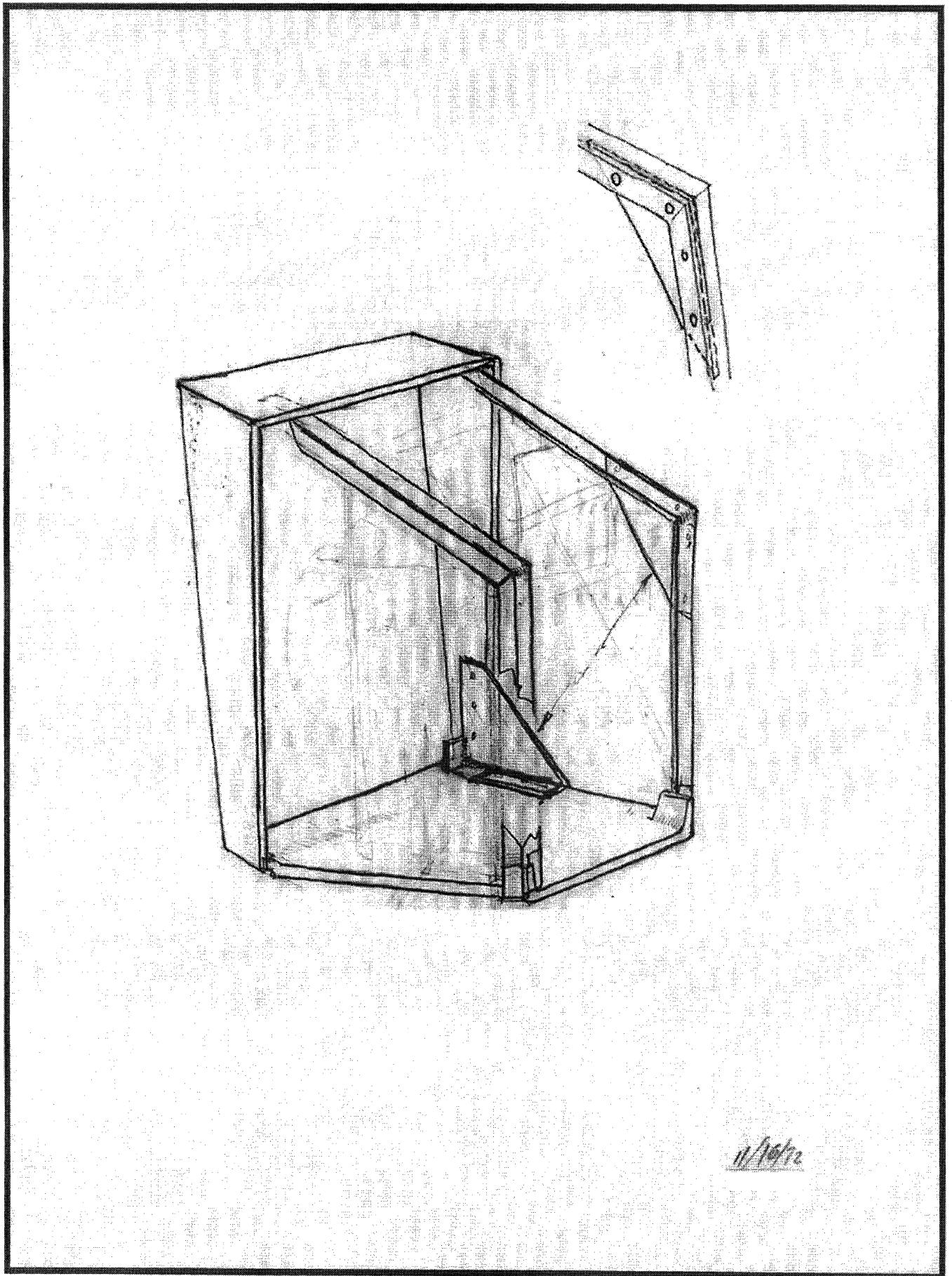

11/10/72

MONITOR BEZEL AND STRUCTURE

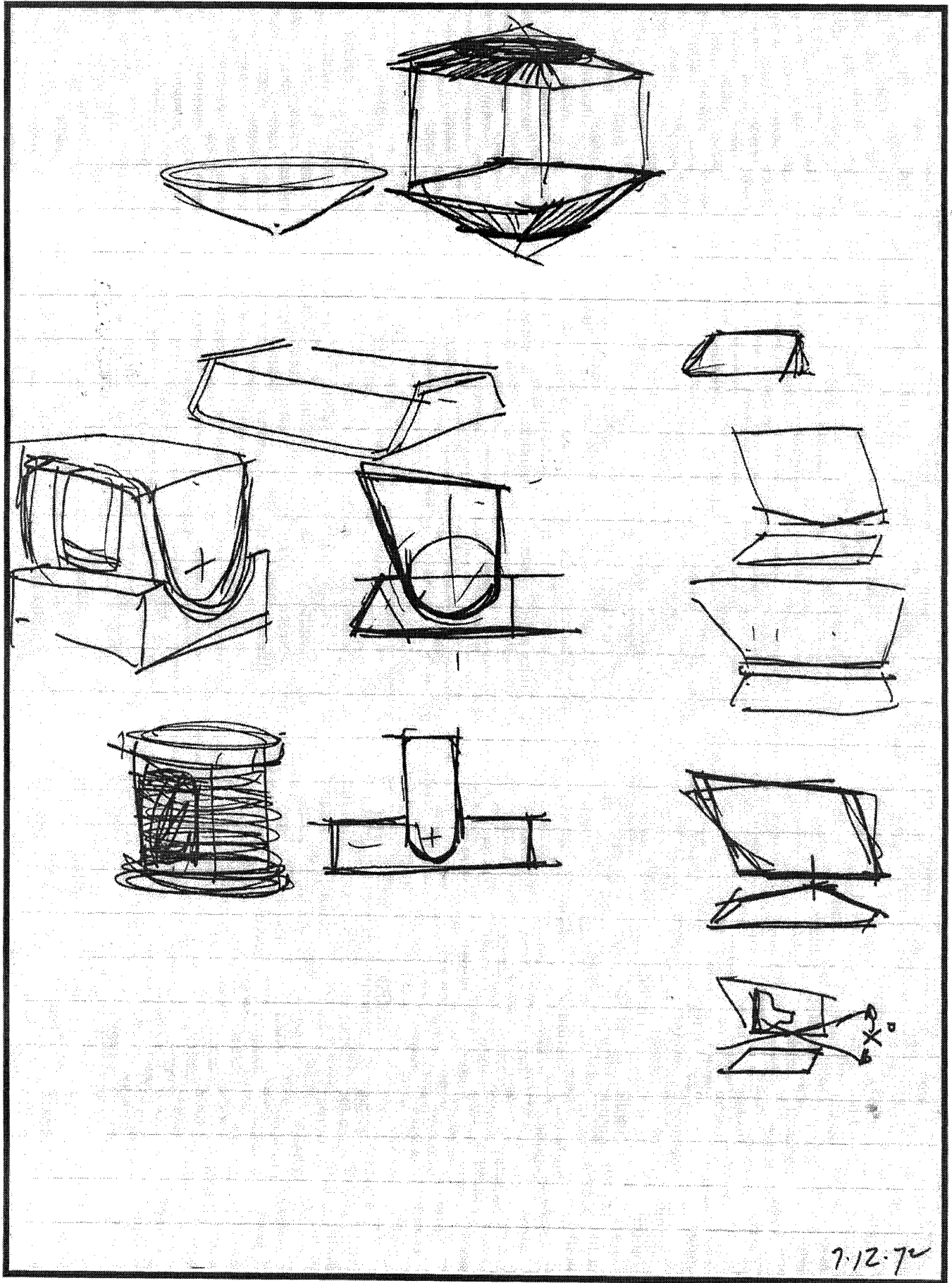

EARLY CONCEPTS: TILT METHODS

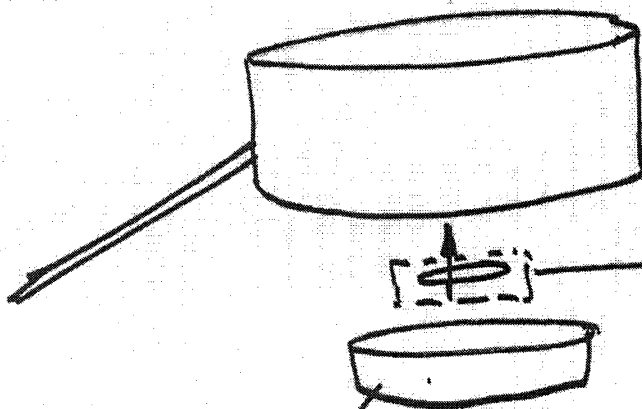
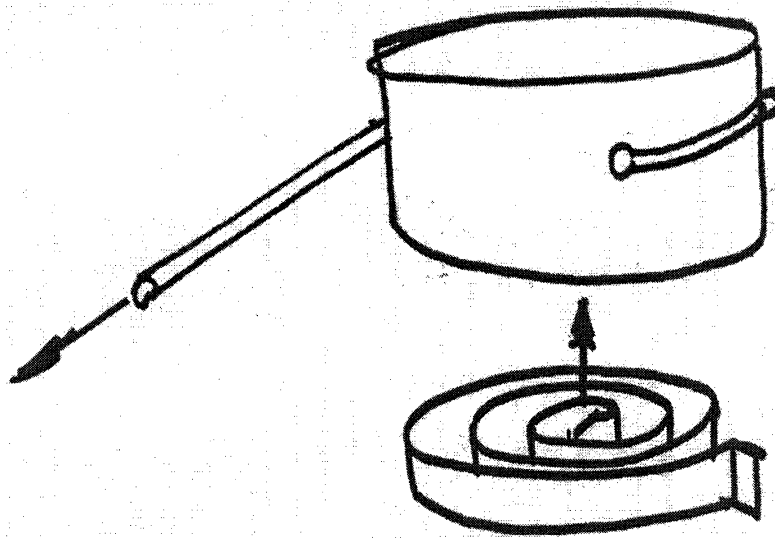

clutch may be necessary.

{ simple pen-like }
 solenoid type } ⇒ to REWIND PUSH
 motor } "STORE" BUTTON ON
 MACHINE TO REWIND.

9.12.72

SPRING-LOADED ROTATION

MOTORIZED TILT & SWIVEL

$$1" = \frac{64}{16} = 4 \quad \frac{256}{16} = 16$$

26 tooth gear

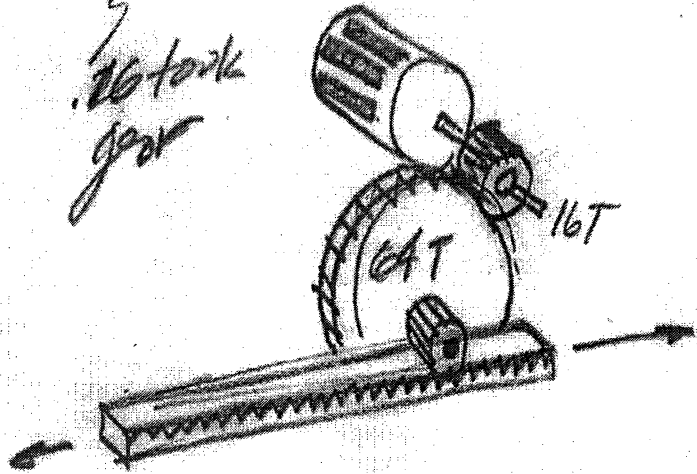
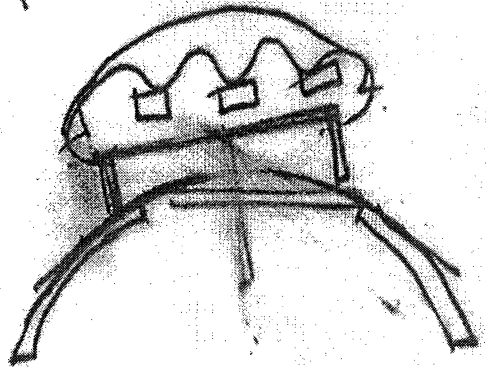

may not give fine enough control

9/22/12

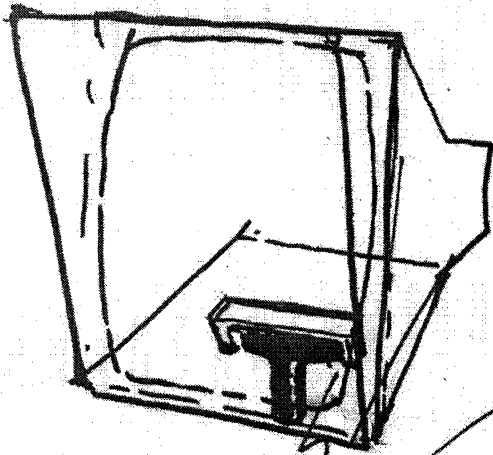

friction joint to hold tilt

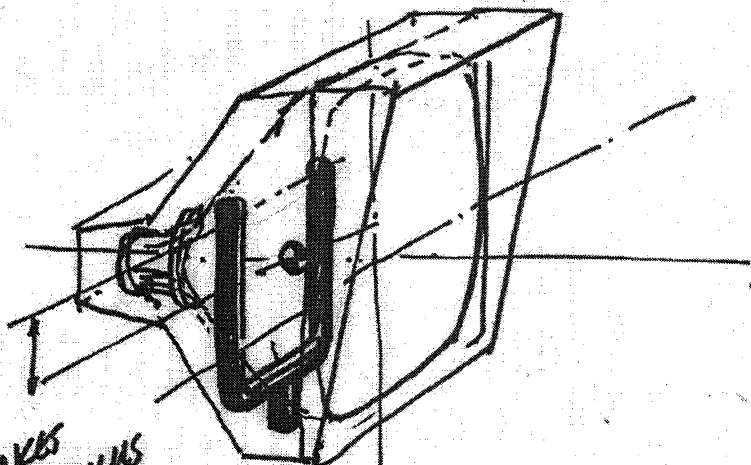

c.g.
 BELOW
 AXLE MAKES
 WEIGHT PENDULUM
 1. a small amount of
 this in conjunction with
 a friction joint may be
 good - could it make
 movement easier
 maybe joint need to be
 at c.g.

8.11.72
 1.12.72

ROTATION/TILT ON CENTER OF GRAVITY

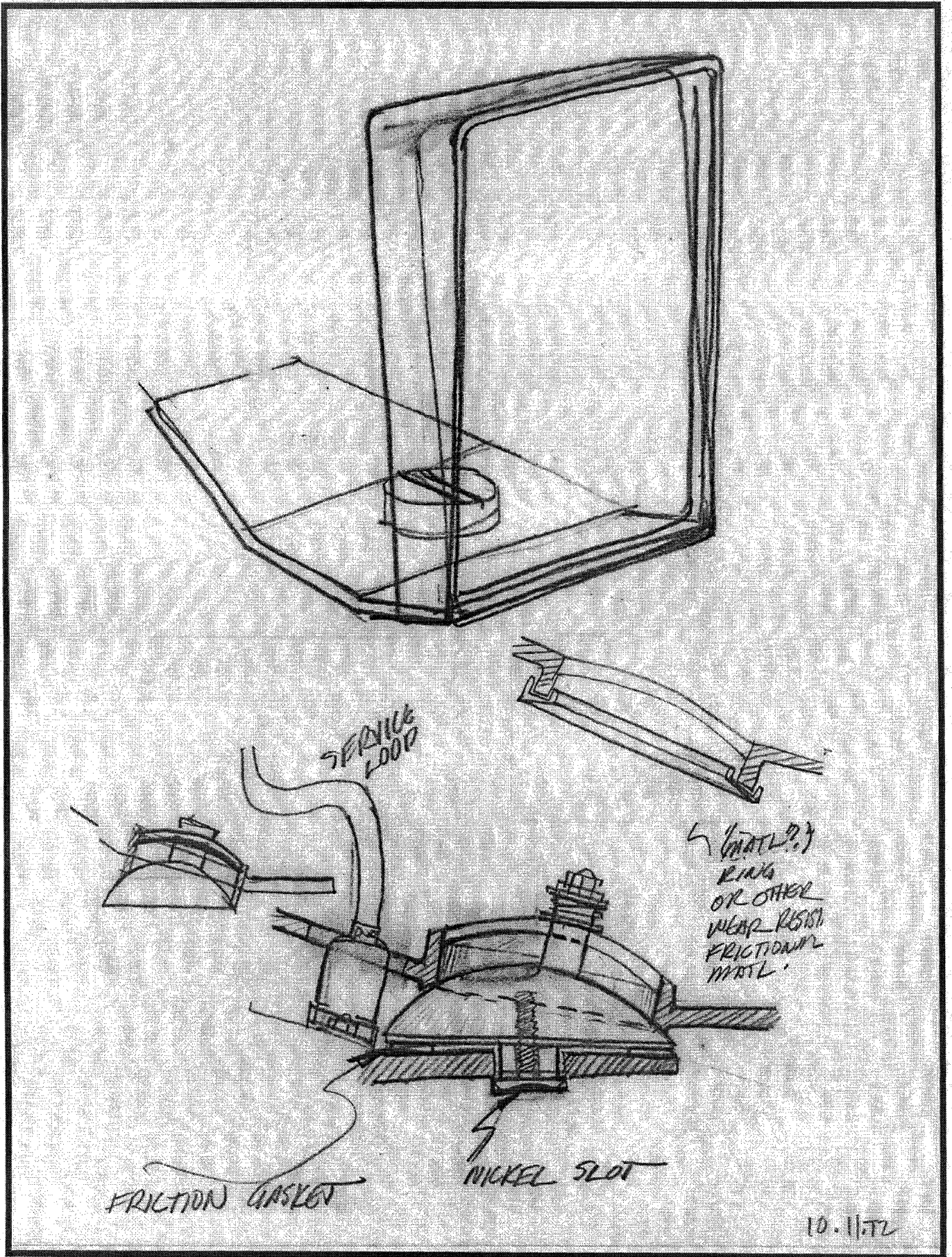

ROTOTILT: FITTING TO THE MONITOR

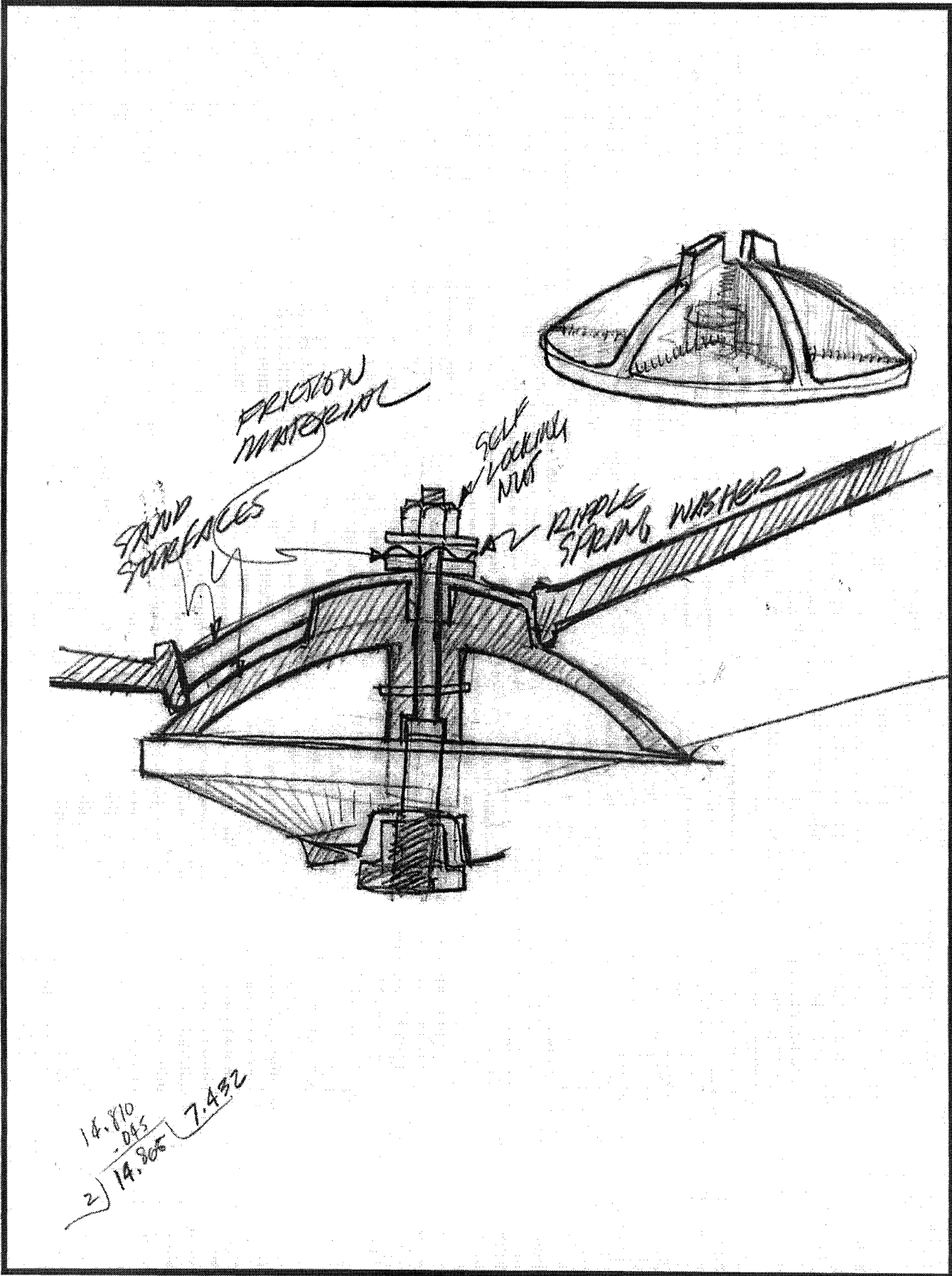

THE ROTILTER PRODUCTION DETAILS

XEROX

November 9, 1972

Mr. Carl Clement
Clement Laboratories
2560 Wyandotte
Mountain View, California 94040

Dear Carl,

Enclosed is a pictorial diagram of cable inter-connections for the terminal. You should not assume that the cables must run exactly as shown but it does give a picture of where signals originate and on what cables they are carried. Below is a word description of the function of each cable and the approximate size of the connector used with it.

- CABLE A: 7 twisted pair (22 AWG)
2 COAX
O.D. = $< 0.5"$
Connector: 19 PIN "Deutsch" 750 series - (see enclosed drawing) - Designated "CA" on drawing.
- Use: Runs between wall and terminal carrying audio on 3 T.P., data on 2 T.P. and video on coax. (2 T.P. are spare.)
- CABLE B: 35 single conductors (28 AWG)
2 single conductors (20 AWG)
O.D. = $\sim 0.24"$
Connector: 52 pin rectangular connector $\sim 2" \times \frac{1}{2}"$. The shell which encloses the plug part of the connector is $\sim 1"$ deep. Designated "CB" on drawing.
- Use: Carries keyboard, keyset, and mouse data between those devices and the interface board in the T.V. assembly. Note that it must also go through the power supply enclosure to pick up +5v, -12v, and GND for distribution to the keyboard, interface board, etc.
- CABLE C: 10 single conductors (30 AWG)
O.D. = $\sim 0.13"$
Connector: 19 pin rectangular connector $\sim 1" \times \frac{1}{2}"$. (We aren't set on this connector yet, but the

dimensions will remain about the same.
Designated "CC" on drawing.

Use: Carries data and power from mouse and keyset
to keyboard where the data enters cable "B".

I hope this information clarifies the situation and please feel free
to suggest variations which would ease the packaging problem.

Sincerely,

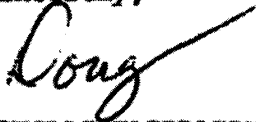
A handwritten signature in cursive script, appearing to read "Doug", written in dark ink.

DOUGLAS FAIRBAIRN

DF:cer

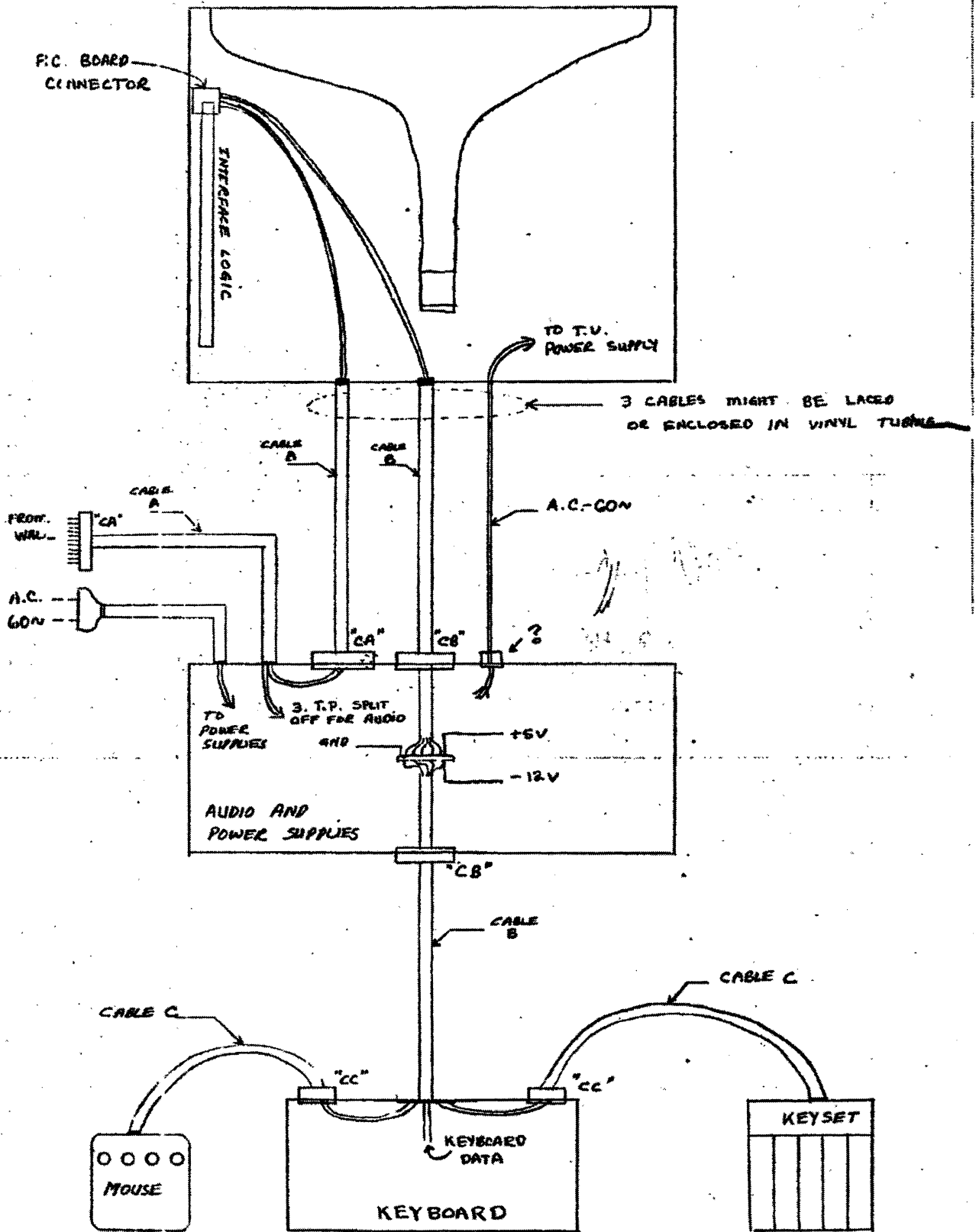

CABLE A: 7 TWISTED PAIR (#22)
2 COAX
O.D. \approx 0.5"

CABLE B: 35 SINGLE CONDUCTORS (#18)
2 SINGLE CONDUCTORS (#20)
C.D. \approx 0.24"

CABLE C: 10 SINGLE CONDUCTORS (#30)
O.D. \approx 0.13"

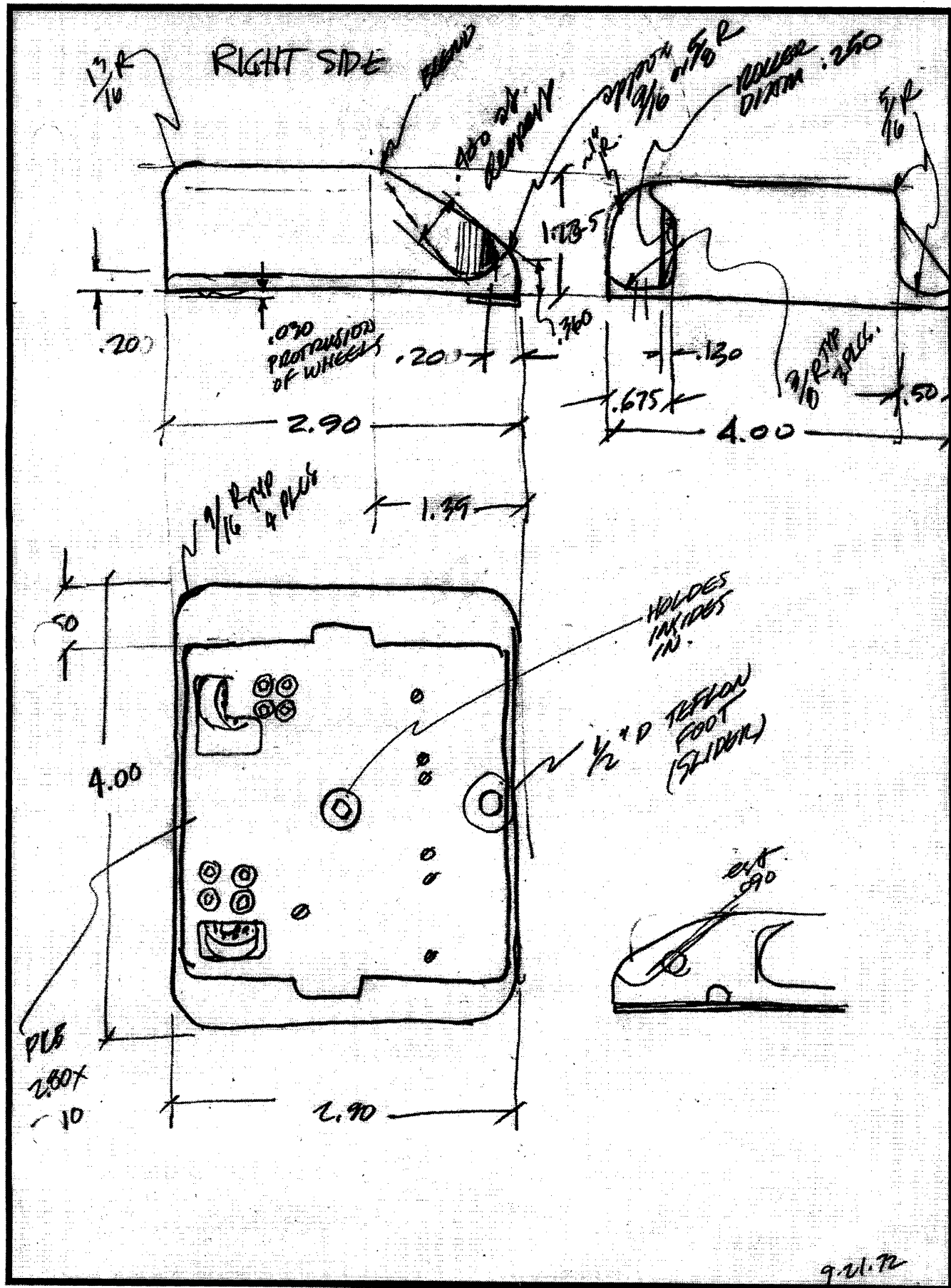

DEBUT OF THE MOUSE

KEY BOARD

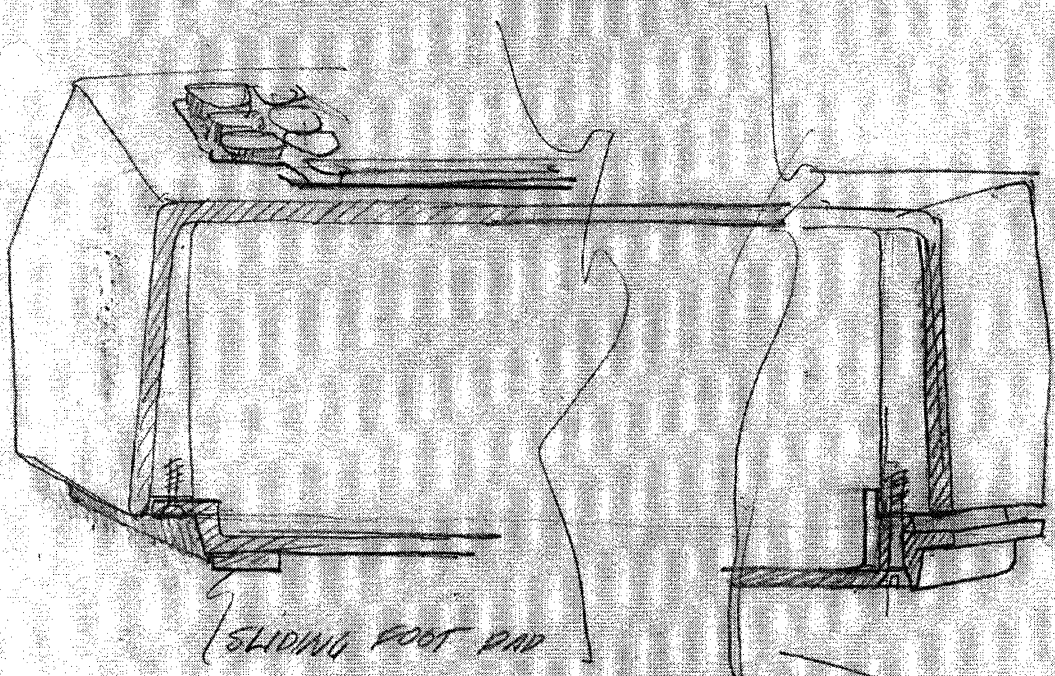

SLIDING FOOT PAD

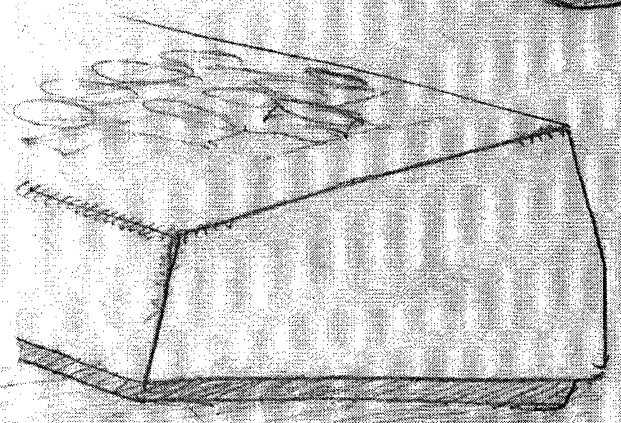
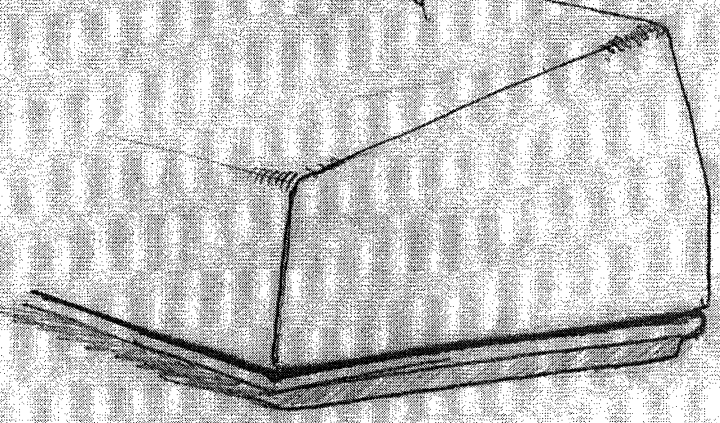

11/15/12

KEYBOARD STUDY

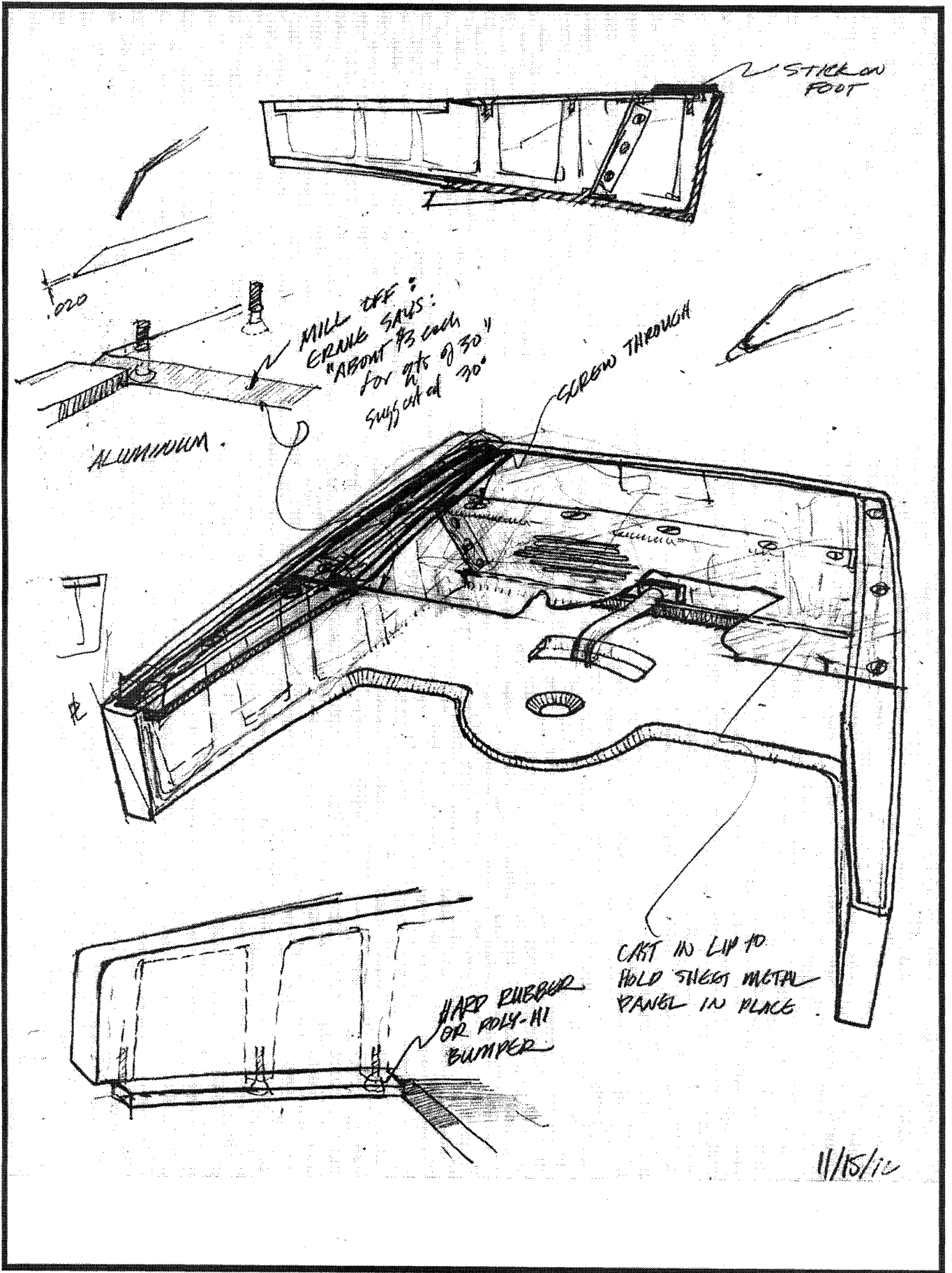

MANUFACTURING THE BASE

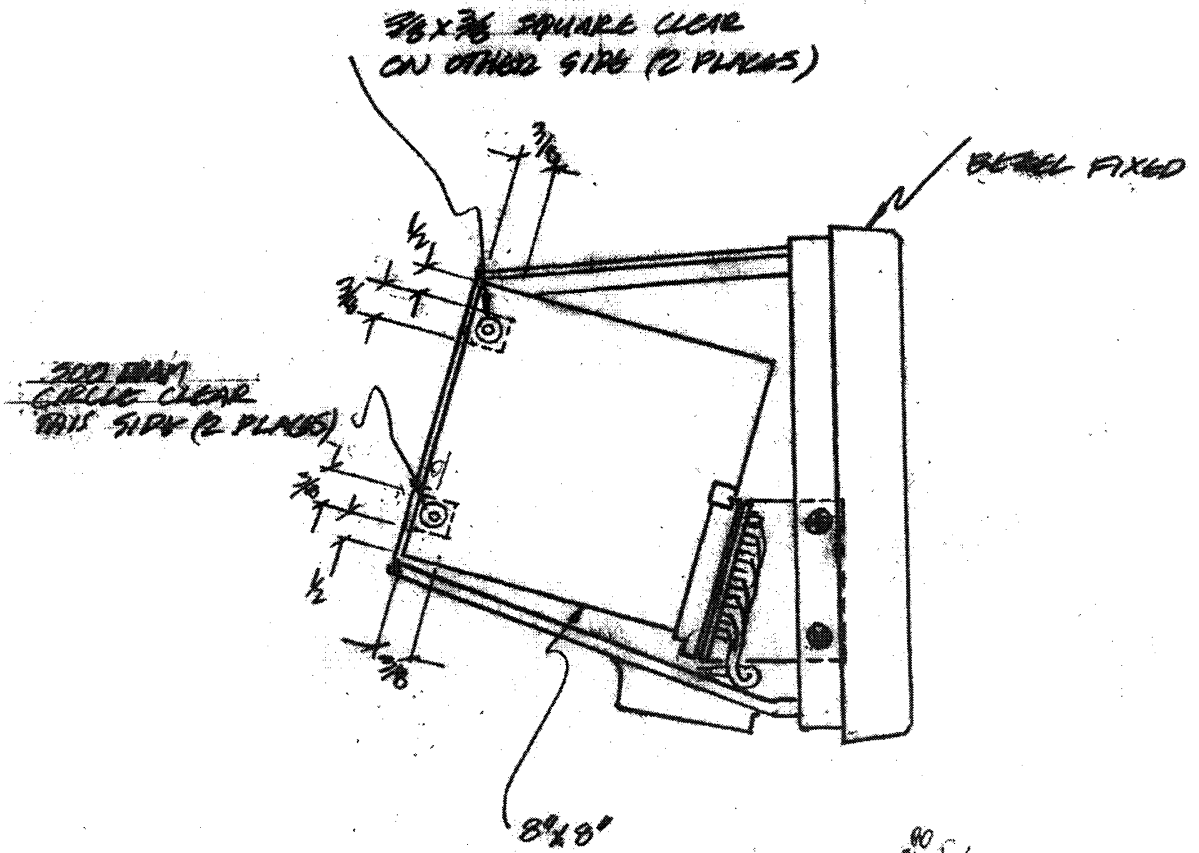

108
550
1089

SCALE: AS SHOWN
CLEMENT LABORATORIES
 2560 WYANDOTE ST.
 MENLO PARK, CALIF. 94040
 4.4.73

FASTENING DETAILS

Section 4/Subminiature Switches

Basic Types

2LM
5 amp rating

3LM
10 amp rating

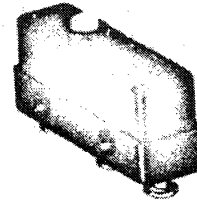

These long life SPDT subminiature switches provide reliable switching in limited space. Variations available include integral or auxiliary actuators, ratings to 10 amperes, silver or gold crossbar contacts and military approved types. Dimensions shown apply to all basic types.

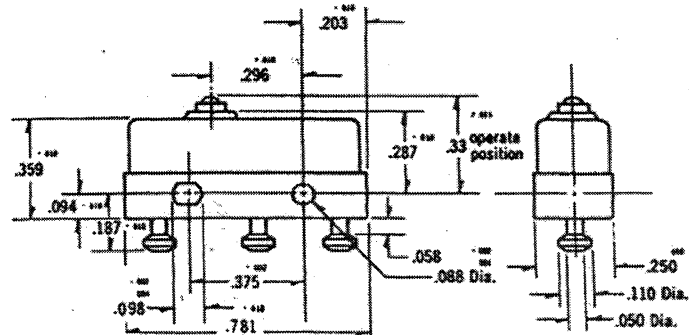
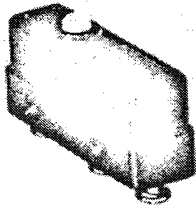

STYLE -C TURRET TERMINALS

ELECTRICAL RATINGS

VOLTS	LOAD	AMPERES			
		2LM	24LM	3LM	5LM
125 A.C.	RES. and IND.	5*	1	10*	5*
250 A.C.	RES. and IND.	5*		10*	5*
30 D.C.	RES. SEA LEVEL	5	1	5	5
30 D.C.	IND. SEA LEVEL	3	.5	3	3
30 D.C.	RES. 50,000 FT.	4	1	4	5
30 D.C.	IND. 50,000 FT.	2.5	.5	2.5	2.5
115 A.C.	LAMP				1.5
28 D.C.	LAMP				2.4

*UL and CSA listings

FORCE and MOVEMENT SPECIFICATIONS

	2LM	24LM	3LM	5LM
Operate force — ounces	5 Max.		6 Max.	5 Max.
Release force — ounces	1 Min.		1 Min.	2 Min.
Movement Differential — inches	.004 Max.		.004 Max.	.004 Max.
Pretravel — inches	.030 Max.		.030 Max.	.030 Max.
Overtravel — inches	.005 Min.		.005 Min.	.005 Min.

- 2LM-C** is a pin type switch and has a rating of 5A 250 VAC.
- 24LM-C** is a pin type switch with gold alloy crossbar contacts for use in low energy circuits.
- 3LM-C** is a pin type switch and has a rating of 10A 250 VAC.
- 5LM1-E** meets the requirements of MIL S 8805 and MS 25085-1
- 5LM1-D** meets the requirements of MIL S 8805 and MS 25085-2

OTHER TERMINALS AVAILABLE ON SPECIAL REQUEST

Other terminal styles which may be furnished are shown below. To order one of these types, the "C" in the catalog part number is replaced by the letter designating the desired style. (ex: Quick connect style "A" is described as 2LM-A)

STYLE -A QUICK CONNECT

Male solderless terminal that fits miniature, female quick connect terminals.

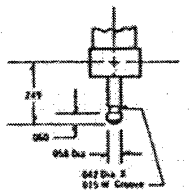

STYLE -D DOUBLE TURRET

Facilitates Solder, Wrap-around and Junction Joint Connections

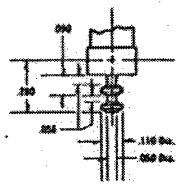

STYLE -E SOLDER

Wire is inserted in terminal hole for strong mechanical connection

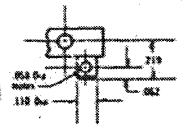



CLEMENT DESIGNLABS ASSEMBLY SHOP

EYE ON THE FUTURE

Xerox Palo Alto Research center develops cutting-edge technologies

By Tom Foremski
SPECIAL TO THE EXAMINER

IN LATE 1979, Steve Jobs and a handful of Apple Computer engineers visited Xerox's research center in the heart of Silicon Valley. At the time, Cupertino-based Apple was king of the personal computer market and IBM was nowhere to be seen. Yet what Jobs and his colleagues saw took their breath away.

They saw workstations with graphical user interfaces, icons and the mouse. "Why aren't you marketing this?" Jobs is reported to have asked. Back at Apple, Jobs set the company on a new course to

build a commercial product based on what he'd seen. This led first to the Apple Lisa, and then to the Macintosh computer.

The Xerox Palo Alto Research Center, or Parc, continues to work on cutting-edge technologies and its work could again shape the development of our computers and the way we use them.

Imagine a research center where more than 250 of the the top specialists in fields as diverse as anthropology, linguistics, psychology, nanotechnology and computer sciences mingle in a relaxed university campus setting. Xerox Parc, founded in 1970, is one of the most innovative computer research cen-

ters in the world.

Xerox Parc holds a special distinction in computer industry history. It was Xerox Parc that gave us much of our current computer technology, such as graphical user interfaces as seen in Microsoft Windows and Apple's Macintosh; the mouse, the laser printer, Ethernet local area networks and it was here that the Alto, the first personal computer, was developed in 1973.

Under the leadership of John Seely Brown, Xerox's chief scientist and director of Parc, Xerox is funding research and development of some of the most interesting ideas in the computer industry. Xerox won't disclose how much it invests in Parc.

"John Seely Brown, is one of our best technology visionaries," says Paul Saffo, a research fellow at the Institute for the Future, a Menlo Park-based technology think tank. "His work at Xerox Parc is producing some of the most innovative ideas around."

Brown, who has been at Parc since 1978, has directed the research center to work on ideas like ubiquitous computing, adaptive learning technology and to study the social aspects of how technology is used. Computer technologies, Brown believes, can help people cope with rapidly changing demands at home and at work.

This approach looks beyond new word processing and spreadsheet packages, beyond ever faster microprocessors and greater min-

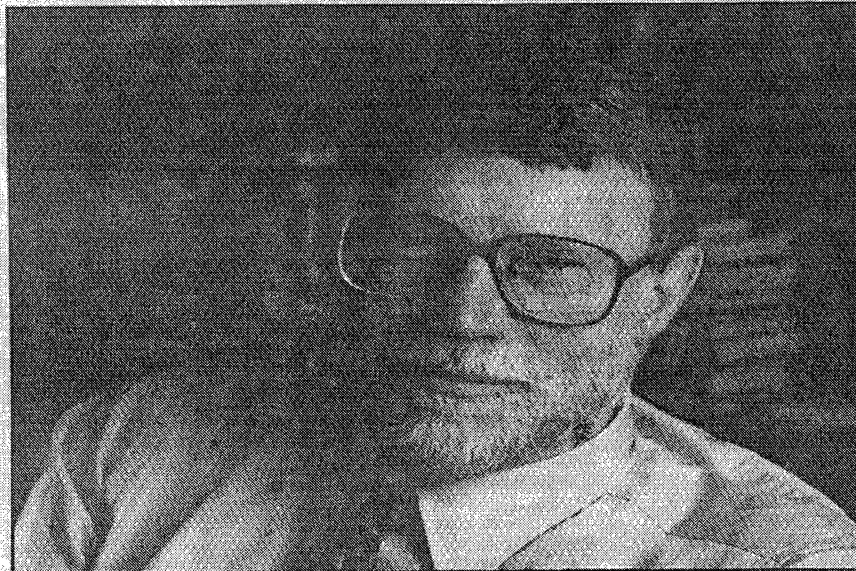

John Seely Brown, Xerox's chief scientist and director of its Parc research center, is considered a technology visionary

[See PARC, C-7]

Dr. John Seely Brown
Xerox Palo Alto Research Center
3333 Coyote Hill Road
Palo Alto. CA 94304

3/15/94

Dear Dr. Brown:

I read with great interest and fond memories the description in the 3/13/94 Examiner of the work that Parc has done for more two decades. As you may recall, it was my company, Clement Laboratories, that did the product design on your Alto, then went on to manufacture more than 2000 packages for your E1 Segundo division. We were introduced to the mouse-icon technology by Bill English and Doug Engelbart, circa 1971, at SRI .

My recollections of your innovative technology and brilliant, creative people parallel the Examiner article, and more.

Although I retired from Product Design Consulting in 1984, I have never quite lost the zest for "never leaving well enough alone," and the experience with the Alto confirmed me as an everlasting computer devotee. I am particularly interested in the description of your Liveboard, and its potential application as a product design interface. For a dozen or so years I've had the notion that the traditional drafting board still has some redeeming, if not endearing, features in this regard, and wondered whether the typical crt monitor, or mega liquid crystal display, and the drafting board could be combined in such a manner as to offer a more natural (to me, at least) and uni-focus device for such purpose. I had not thought about the networking feature, and for my single, retired-person use it wouldn't be necessary.

I should be most interested in any information you can provide on the Liveboard or similar products.

Congratulations on your longevity as a most creative research center.

Sincerely,

Carl J.Clement

25 March 2002

Carl Clement
Clement Designlabs
12785 Dianne Drive
Los Altos Hills, CA 94022

Dear Carl,

It's good to get connected with you again, after the nearly 30 years since we worked together on the many Xerox PARC products. I take great pride in the work we did and am glad you are making an effort to set the record straight.

One of the great things about PARC was the opportunity to work with so many outstanding people. I recently met my former boss, Bill English, who is now living in Marin and is spending a lot of time sailing on the Bay. Alan Kay recently sent me a note asking my opinion on the idea of resurrecting the NoteTaker (portable Alto) architecture in a modern form. Last summer I made a pitch to David Liddle, now a Venture Capitalist at US Venture Partners. Chuck Thacker, the father of the Alto, has been at Microsoft for many years. I recently ran into him and found that he was heading the design of the latest tablet PC.

Last week, I had dinner with Steve Purcell, one of the software engineers working for Alan Kay in the early 1970's. We both have sixth-grade daughters going to the same school in Mountain View! As part of their sixth grade computer science program, they used a program called Stagecast, authored by a company headed by Larry Tesler, a key Smalltalk and Alto software developer. A small world indeed!

So it seems quite timely that you found me at this time after all these years. Last April I wandered into the Computer exhibit section of the Smithsonian in Washington DC. My daughter accompanied me. I was a bit surprised and delighted to see the Alto with the workstation you designed sitting there in a prominent location. I got to tell her of the times your team and I spent working out the details of this elegant product. Remember at the time it was designed for the POLOS (PARC On-line Office System), which was the precursor of the Alto. When the Alto was born it quickly obsoleted the POLOS program, but it did adopt the workstation design you had done.

I believe your team also gets credit for the design of the NoteTaker packaging. This was far more challenging in that it was the first portable computer. Developed in 1978, it preceded by several years that other famous portable from Compaq. NoteTaker ran Smalltalk, used an 8086 processor and floppy disk, had voice input and output, a bit map screen with an integrated touch pad, and of course an Ethernet connection. A custom power supply and an integrated battery pack made it truly portable. It holds the mark of being the first personal computer booted and used on airplane (p. 327, Dealers of Lightning, by Michael E. Hiltzik). One of the NoteTaker computers is on permanent display at the Computer History Museum.

I was disappointed that Xerox didn't take the Alto or NoteTaker into high-volume manufacturing and marketing following your limited production runs. However, we can all take pride in its original concept and its evolution since Apple, Microsoft, Compaq and others picked up the pieces.

Sincerely,

Douglas G. Fairbairn

CARL J. CLEMENT

12785 Dianne Drive Los Altos Hills, CA 94022 Voice: (415) 948-0109 Fax: (415) 941-8173

Mr. William Gates, CEO & Chairman
Microsoft Corporation
Redmond, WA

COPY

11/17/97

Dear Mr. Gates:

I am one of your many customers. As the industrial designer who productized the first "icon-mouse" computer for Xerox in 1971, I feel somewhat competent to evaluate your products.

As you may know, perhaps the most important service an industrial designer provides is what we used to call "human engineering", now referred to as "user-friendliness". In the early days of electronic device development, it was common practice for Electrical Engineers to drive the process, to the point of shipping devices which could be operated only by other electrical engineers. It was at this point in history that I had the good fortune to be hired by the Hewlett-Packard Company as a draftsman. (The function of an industrial designer was unknown.)

Within a few months I found my niche. Along with improvements in cabinetry, my most important tasks became the elimination of the need for user cross-calculation of individual control panel functions and the virtual stamping out of tedious instruction manuals.

I later founded my own consultant industrial design firm, and I began to notice a curious thing: I had competition! But it was not necessarily from other industrial designers; it was in the form of a new activity by the electrical engineers themselves, called SOFTWARE! In time much of my own activity became designing bit-mapped CRT interfaces. During this period I had the further good fortune to meet Doug Engelbart at SRI, the father of the GUI and mouse. You know the computer development history from then on, including the fraudulent claims by Apple.

Having sold my company and propelled my last child through college, I have finally made it into retirement, based upon a Microsoft Excel spreadsheet I designed for the purpose. The integration of your many programs based upon a common theme now allows me to do easily all the things necessary to survival, nay, thrival, of a modern retired family: written communication, accurate tracking of health matters such as weight control, cardiac functions; financial planning and investing; etc. Lately, of course, I can also communicate easily with the entire world via your Internet Explorer. I can testify from experience that research by this method beats using a separate browser or "letting your fingers do the walking."

Such comfort would not have been possible without Microsoft integrated software. Keep up the good work. I am prepared to argue the point with Sun, or Oracle, or Netscape, or Janet Reno!

Yours very truly,

Carl J. Clement

enclosures

CLEMENT DESIGNLABS

12785 Dianne Drive Los Altos Hills, CA 94022 Voice: (650) 948-0109 Fax: (650) 941-8173

Mr. David Packard, Chairman
Hewlett-Packard Company
3000 Hanover Street
Palo Alto, CA 94304

5/24/91

Dear Dave,

From time to time I see the recurring story of the Apple-HP/Microsoft matter in the news, particularly HP's contention that Apple's copyright was fraudulently obtained.

A couple years ago I reminded your Bill Terry that we at Clement Designlabs did the productizing of the Xerox Alto, including the original mouse, then went on to produce about 2000 packages over a 10-year period. The project began with our proposal which had been requested and accepted by Bill English of Xerox PARC. We were then introduced to Doug Engelbart, the creator of the mouse-icon concept. As we proceeded with the project, our main contact was Doug Fairbairn, a bright young engineer with PARC.

My point is that I was a participant and a witness to all of this, starting in mid-1972, and I'm in a position to support your contention of fraud by Apple. Xerox, as it turned out, allowed the Alto concept to go into public domain, sans patent, then failed at a belated attempt to reclaim it.

Apple clearly appropriated the SRI-PARC technology for its Lisa and MacIntosh, then fraudulently claimed it as proprietary.

There are other witnesses to this authentic history, of course, but in case you need one, you can count on my help.

Warmest regards,

Carl

ABOUT THE AUTHOR

Carl J. Clement is widely recognized as one of the important pioneers of the California electronics and scientific industries.

Mr. Clement's influence on modern-day product design began as Corporate Design Director of the legendary Hewlett-Packard company from 1951 through 1963 and continued through his term as a Vice-President of Spectra-Physics, at that time a fledgling laser company. Both companies to this day sell Clement-designed products, some of which he designed more than 4 decades ago. Their imitators have been legion ever since.

During this period he concurrently taught product design at both Stanford and San Jose State Universities and was instrumental in changing the emphasis in industrial design education from a random cosmetic approach to a comprehensive system-oriented method, based upon a respect for the particular technological constraints on the one hand and the need for user-efficiency and aesthetic elegance on the other, all within a realistic manufacturing framework.

In the mid-sixties he assembled a team of industrial-designers and engineers educated in this new philosophy to serve the growing needs of Silicon Valley. During that period Clement Designlabs designed hundreds of highly profitable and elegant products for large established corporations, Nobel laureates, and new ventures throughout the US and Europe, having received scores of patents and awards for design excellence in the process. During his career, Mr. Clement designed products for a wide variety of fields; he would typically strap on climbing-spikes to reach the top of a utility pole one day, then don the obligatory cap, gown, and rubber gloves to witness an open-heart surgery on the next. His work has been displayed in the US, South America, and Europe, including a showing at the Louvre in Paris, France. His design of the first "mouse-icon" computer, the Xerox "Alto" is retained in the permanent collection of the Smithsonian Institute in Wash, DC, and in 1962 he received the Fortune Magazine Award for the Hewlett-Packard modular system, introduced in the 1961 IEEE New York trade show. Dave Packard, co-founder of Hewlett-Packard was quoted, "...our products had an elegance and finish which will be hard to duplicate. Carl Clement's new cabinet system was the hit of the show. In fact it was considered by many to be the most impressive contribution to the packaging of electronic instrumentation that has ever been made."

Mr. Clement is a founder of the San Francisco chapter of the Industrial Designers Society of America, having served as one of IDSA's early regional vice-presidents. He is also a Life Member of the Institute of Electrical and Electronic Engineers and has been active in the American Electronics Association (AEA) having spearheaded the Wescon Industrial Design Awards program for many years.

A native of Seattle, Washington, Mr. Clement is a graduate (1939) and member of the Hall of Fame of Broadway High School and a graduate of the University of Washington (1951). He also did Post-Graduate work at MIT and the University of Santa Clara. He served in the US Army Signal Corps during WWII as Radar and Signal Operations Officer in the US and European theaters.

He is a competent self-educated jazz-pianist and arranger, having been invited during his youth to join Lionel Hampton's jazz ensemble.