

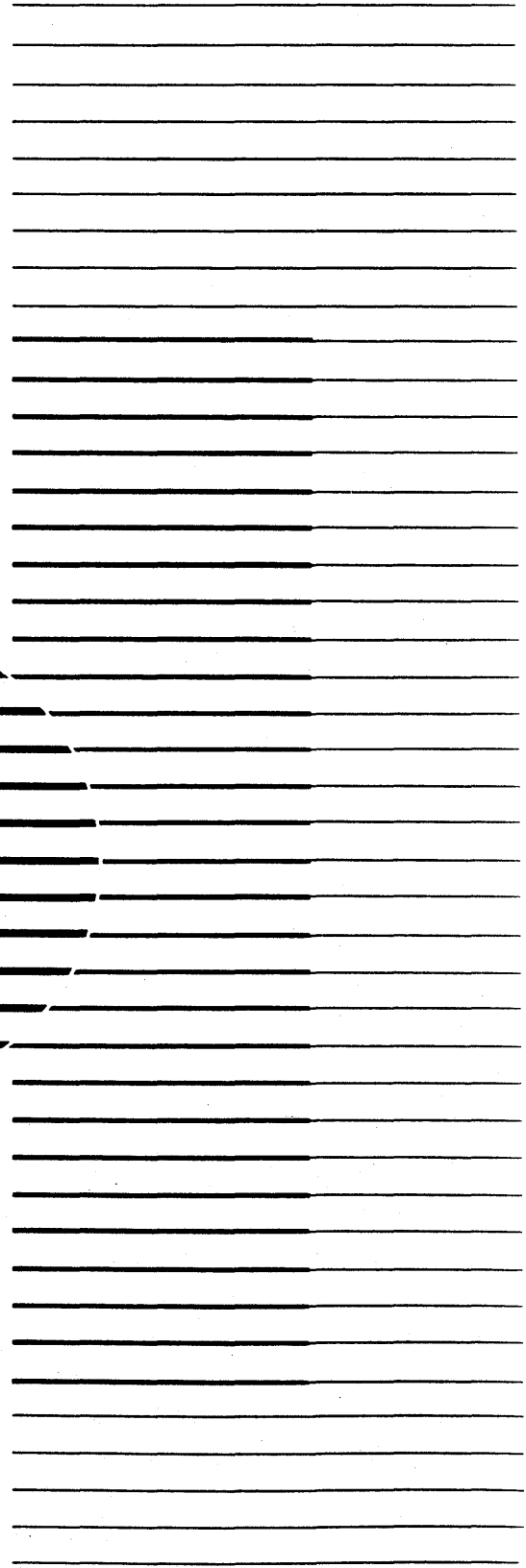

**adaptec, inc.**

**ACB-3530  
User's Manual**

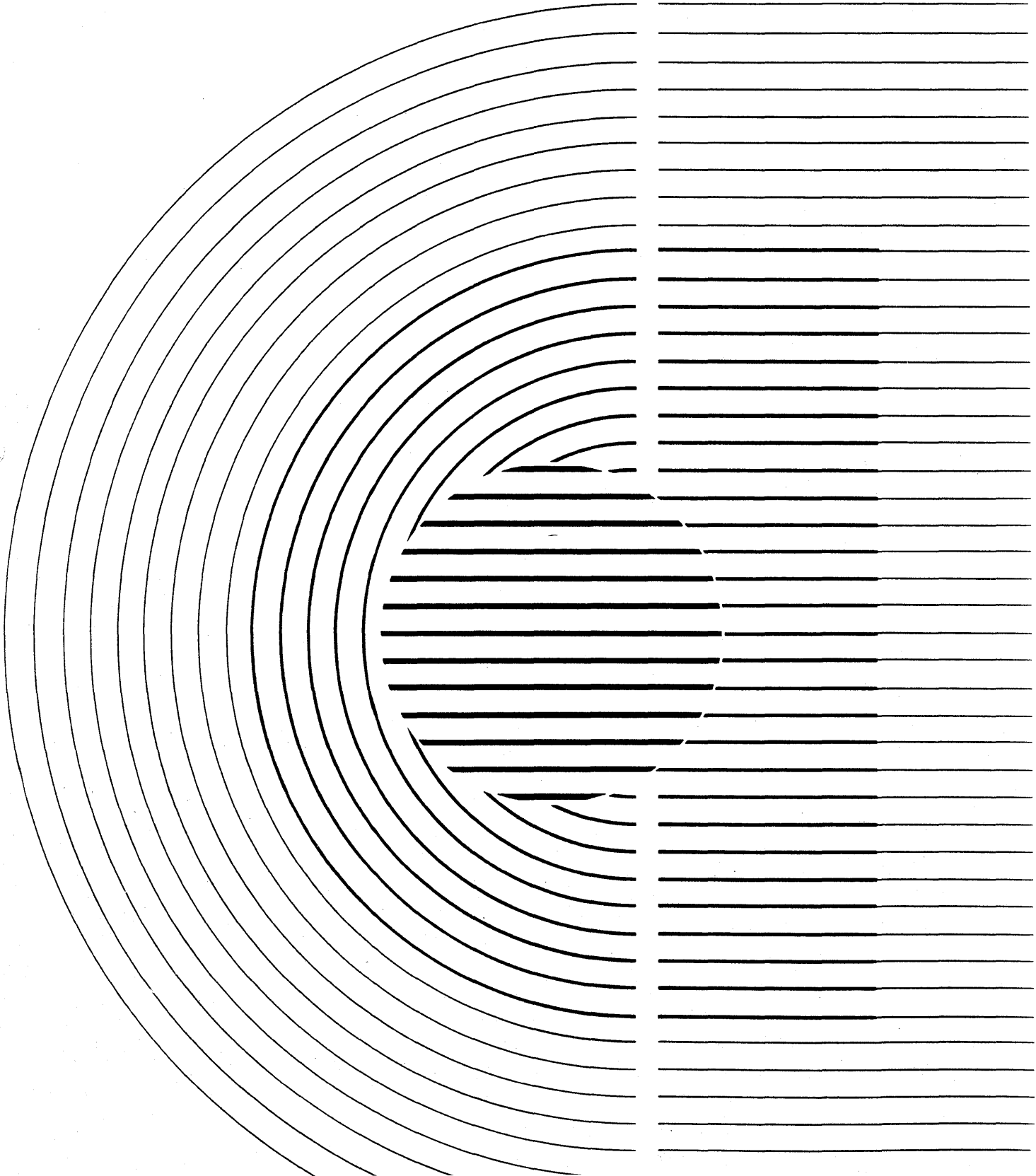

**ACB-3530 User's Manual**  
**1/4" Streaming Tape Controller**  
**SCSI to QIC-36**

June, 1985

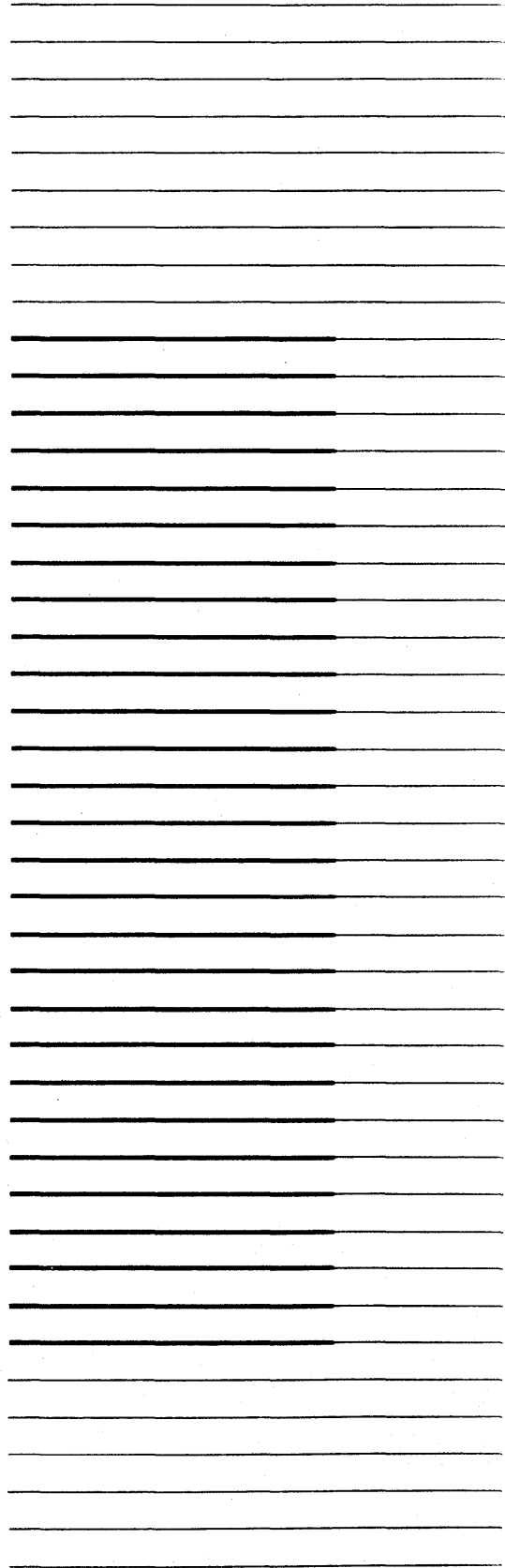

Additional copies of this manual may be obtained from:

Adaptec, Inc.  
Literature Dept.  
580 Cottonwood Drive  
Milpitas, Calif. 95035

The information contained in this manual is subject to change without notice.

No part of this document may be copied or reproduced in any form without prior written consent from Adaptec, Inc.

Adaptec, Inc., 580 Cottonwood Drive, Milpitas, California 95035

Copyright 1985

\$5.00

## TABLE OF CONTENTS

Ø	INTRODUCTION.....	1-1
	1.1 Feature Set.....	1-1
	1.2 Reference Documents.....	1-2
	1.3 Controller Board Layout.....	1-2
	1.4 Product Specification.....	1-4
	1.4.1 Physical Dimensions.....	1-4
	1.4.2 Power Requirements.....	1-4
	1.4.3 Environmental Requirements.....	1-4
Ø	THEORY OF OPERATION.....	2-1
	2.1 Architecture.....	2-1
	2.2 Microcode Structure.....	2-3
Ø	INSTALLATION.....	3-1
	3.1 Unpacking.....	3-1
	3.2 Preparation of Installation.....	3-1
	3.2.1 Mounting Considerations.....	3-1
	3.2.2 RF Considerations.....	3-2
	3.3 Cabling.....	3-2
	3.3.1 Power Connector, J2.....	3-3
	3.4 Configuration.....	3-3
	3.4.1 SCSI Bus Address.....	3-3
	3.4.2 4/9 Track Tape Drive.....	3-4
	3.4.3 SCSI Bus Parity.....	3-4

3.5	Powering.....	3-4
4.0	QIC-36 1/4" Streaming Tape Interface.....	4-1
4.1	Interface Signals.....	4-1
4.2	Block Format.....	4-3
4.2.1	File Marks.....	4-4
4-3	Track Layout.....	4-4
4-4	Tape Media Defect Handling.....	4-5
5.0	SCSI INTERFACE DESCRIPTION.....	5-1
5.1	General Description.....	5-1
5.2	Bus Signals.....	5-3
5.3	Bus Phases.....	5-5
5.3.1	Bus Free Phase.....	5-5
5.3.2	Arbitration Phase.....	5-5
5.3.3	Selection Phase.....	5-6
5.3.4	Reselection Phase.....	5-6
5.3.5	Information Transfer Phases.....	5-7
5.3.5.1	Command Phase.....	5-9
5.3.5.2	Data Phase.....	5-9
5.3.5.3	Status Phase.....	5-9
5.3.5.4	Message Phase.....	5-9
5.3.6	Bus Phase Sequencing.....	5-10
5.4	Bus Conditions.....	5-11
5.4.1	Attention Condition.....	5-11
5.4.2	Reset Condition.....	5-11

5.5	Bus Timing.....	5-11
5.6	Command Descriptor Block.....	5-15
5.7	Completion Status Byte.....	5-16
5.8	Message System.....	5-17
5.8.1	Message Description.....	5-17
Ø	Command Descriptions.....	6-1
6.1	Test Unit Ready Command.....	6-2
6.1.1	Possible Error States.....	6-2
6.2	Rewind Command.....	6-3
6.2.1	Possible Error States.....	6-3
6.3	Request Sense Command.....	6-4
6.3.1	Possible Error States.....	6-4
6.3.2	Unit Sense Information.....	6-5
6.3.3	Sense Keys.....	6-7
6.4	Read Block Limits Command.....	6-10
6.4.1	Possible Error States.....	6-11
6.5	Set Parameters Command.....	6-12
6.5.1	Possible Error States.....	6-13
6.6	Read Command.....	6-14
6.6.1	Possible Error States.....	6-15
6.7	Write Command.....	6-16
6.7.1	Forced Streaming.....	6-17
6.7.2	Encountering End of Media.....	6-18

6.7.3	Write Errors During Buffered Mode.....	6-18
6.7.4	Media Defect Handling.....	6-19
6.7.5	Possible Error States.....	6-19
6.8	Write File Mark Command.....	6-21
6.8.2	Possible Error States.....	6-22
6.9	Space Command.....	6-23
6.9.1	Possible Error States.....	6-25
6.10	Inquiry Command.....	6-26
6.10.1	Possible Error States.....	6-27
6.11	Verify Command.....	6-28
6.11.1	Possible Error States.....	6-29
6.12	Recover Buffer Data Command.....	6-30
6.12.1	Possible Error States.....	6-30
6.13	Mode Select Command.....	6-32
6.13.1	Possible Error States.....	6-34
6.14	Reserve Unit Command.....	6-35
6.14.1	Possible Error States.....	6-35
6.15	Release Unit Command.....	6-36
6.15.1	Possible Error States.....	6-36
6.16	Erase Command.....	6-37
6.16.1	Possible Error States.....	6-37
6.17	Mode Sense Command.....	6-39
6.17.1	Possible Error States.....	6-39

6.18 Load/Unload Unit Command.....	6-40
6.18.1 Possible Error States.....	6-41





## LIST OF TABLES

TABLE	TITLE	PAGE
3-2	Power Connector, J2, Pin Assignment	3-3
4-1	QIC-36, J1, Connector Pin Assignment	4-1
5-1	SCSI Connector, J3, Pin Assignment	5-3
5-2	Information Transfer Phases	5-7
5-3	SCSI Messages Supported by ACB-3530	5-7
6-1	ACB-3530 SCSI Command Set	6-1
6-2	ACB-3530 Sense Keys	6-8
6-3	Space Search Codes	6-23

## - - Errata - -

### ACB-3530 User's Manual

Parity is not implemented at this time.

QIC-11 compatibility is Read Only at this time.

## LIST OF FIGURES

FIG.	TITLE	PAGE
1-1	ACB-3530 Board Layout	1-3
2-1	ACB-3530 Block Diagram	2-2
2-2	ACB-3530 Controlling Firmware	2-3
3-1	ACB-3530 System Cabling	3-2
3-2	ACB-3530 Configuration Jumpers, J4	3-3
4-1	QIC-11 and QIC-24 Block Format	4-3
4-2	1/4" Tape Layout	4-4
5-1	Typical SCSI Configuration	5-2
5-2	REQ/ACK Handshake	5-8
5-3	SCSI Bus Phase Sequencing	5-10
5-4	SCSI Bus Timing	5-12/ 5-13/ 5-14
5-5	Class 0 CDB Supported by ACB-3530	5-15
5-6	Completion Status Byte	5-16
5-7	Identify Message	5-18
6-1	Test Unit Ready Command	6-2
6-2	Rewind Command	6-3
6-3	Request Sense Command	6-4
6-4	Sense Information	6-5
6-5	Read Block Limits Command	6-10

## LIST OF FIGURES (Con't)

IG.	TITLE	PAGE
-6	Read Block Limits Data Returned	6-10
-7	Set Parameters Command	6-12
-8	Read Command	6-14
-9	Write Command	6-16
-10	Write File Mark Command	6-21
-11	Space Command	6-23
-12	Inquiry Command	6-26
-13	Inquiry Data	6-27
-14	Verify Command	6-28
-15	Recover Buffer Data Command	6-30
-16	Mode Select Command	6-32
-17	Mode Select Configuration Data Block	6-33
-18	Reserve Unit Command	6-35
-19	Release Unit Command	6-36
-20	Erase Command	6-37
-21	Mode Sense Command	6-39
-22	Load/Unload Command	6-40



## 1.0 INTRODUCTION

---

The Adaptec ACB-3530 streaming tape controller board interfaces a 1/4" streaming tape drive using the QIC-36 interface to any host interface compatible with the ANSI X3T9.2 Small Computer System Interface (SCSI).

### 1.1 ACB-3530 FEATURE SET

- o FULL SCSI SPECIFICATION, REVISION 14B, COMPATIBILITY.  
Connects to any SCSI standard host adapter.
- o SCSI BUS ARBITRATION AND DISCONNECT/RECONNECT SUPPORT.  
Overlapped disk/tape operation capability with multitasking I/O subsystems.
- o BUFFERED WRITE AND IMMEDIATE COMMAND COMPLETION SUPPORT.  
Data buffering and immediate completion mode for streaming on systems that do not support SCSI bus disconnect/reconnect.
- o QIC-24 AND QIC-11 MEDIA FORMAT SUPPORT.  
Capable of reading and writing QIC-24 and QIC-11 format tapes.
- o 16 BIT CRC ON EACH RECORD AND SCSI BUS PARITY.  
Data integrity is assured by reading the data and checking CRC immediately after it is written. CRC is also checked on tape reads. In addition, SCSI bus parity is checked or generated on all bus transfers.
- o AUTOMATIC TAPE DEFECT HANDLING.  
Media defects detected by the controller from read after write will result in the data being rewritten in the next sequential block.
- o RESERVE/RELEASE.  
The tape drive can be reserved by an attached host to restrict other host accesses to the data.

## **1.2 REFERENCE DOCUMENTS**

- o ANSI X3T9.2, Small Computer System Interface Specification, Revision 14B
- o QIC-24 Specification: Proposed standard for data interchange on streaming 1/4" drives.
- o QIC-11 Specification: Proposed standard for data interchange on streaming 1/4" drives.
- o QIC-36 Specification: 1/4" Streaming tape drive basic interface.

## **1.3 ACB-3530 CONTROLLER BOARD LAYOUT**

The dimensions and component layout of the ACB-3530 is shown in Figure 1-1. This diagram is referred to later in the manual for the location of the interface connectors, bus terminators and configuration jumpers.

The outside board dimensions and mounting holes are designed to fit into the standard QIC-02 controller envelope. These dimensions are slightly narrower than the holes provided on most drives for mounting to a system chassis. Additional hardware (not provided) is required to use these mounting holes for the controller.

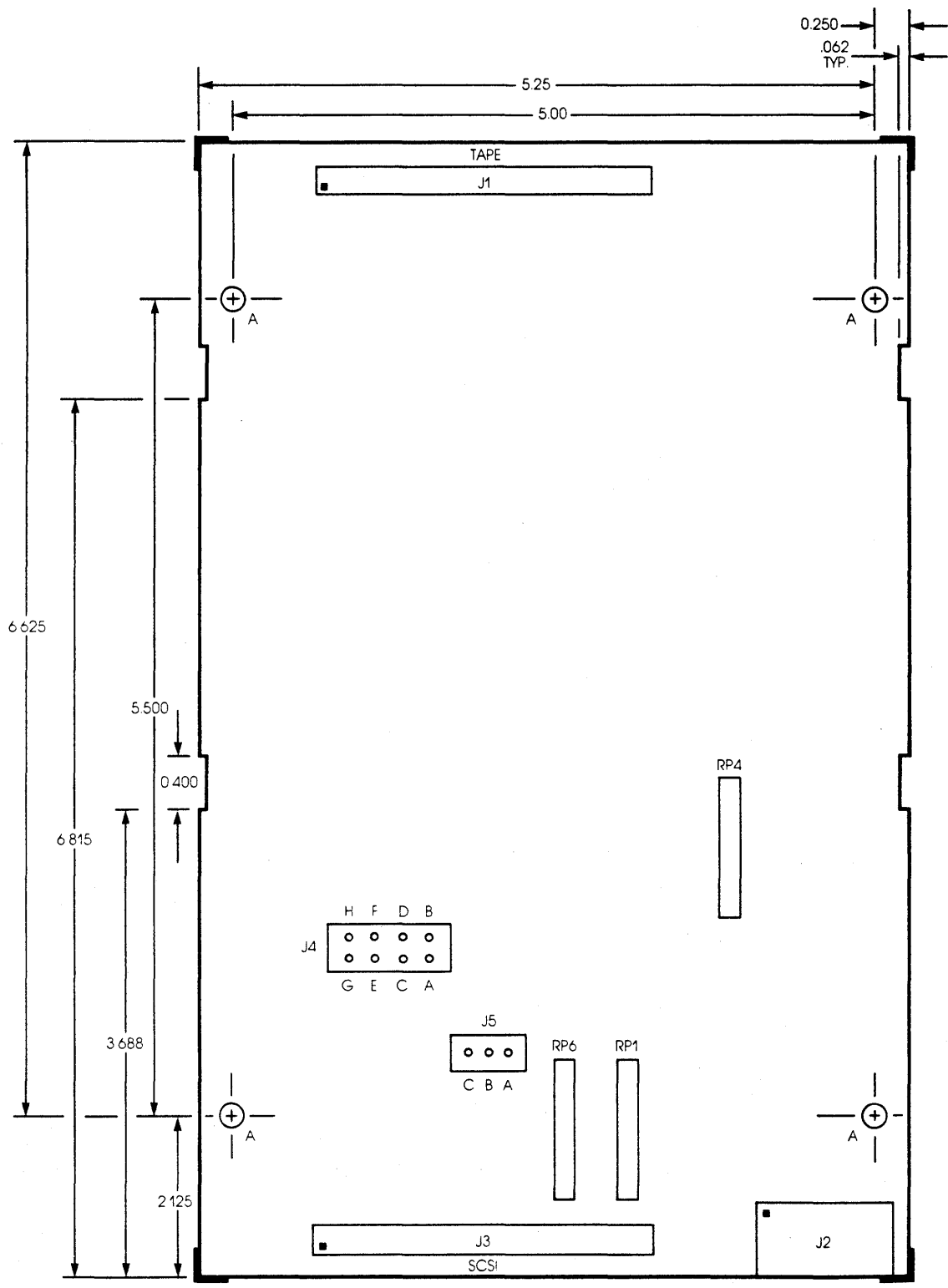

Figure 1-1. ACB-3530 Board Layout



## 1.4 PRODUCT SPECIFICATION

The ACB-3530 controller is designed to function under normal operating conditions for electronic components. The form factor is such that the controller can be mounted with the drive in most systems.

### 1.4.1 PHYSICAL DIMENSIONS

Length	8.75 inches (19.7 cm)
Width	5.50 inches (14.6 cm)
Height	.75 inches ( 1.9 cm)

### 1.5.2 POWER REQUIREMENTS

+5 VDC	± 5% at 1.8 Amps (max)
+12 VDC	± 10% at 100 mAmp (max)

### 1.5.3 ENVIRONMENTAL REQUIREMENTS

	<u>Operating</u>	<u>Storage</u>
Temperature (F/C)	32/0 to 131/55	-40/-40 to 167/75
Humidity (non-cond)	10 % to 95 %	10 % to 95 %
Altitude (feet)	Sea L. to 10,000	Sea L. to 20,000

Exhaust air flow may be required to keep the air on both sides of the board at or below the maximum operating temperature.

## 2.0 THEORY OF OPERATION

---

The ACB-3530 architecture is designed around the Adaptec controller chips; the AIC-010 and AIC-300. This architecture divides the controller into two basic components, a data path and a control path. A block diagram of the ACB-3530 is shown in Figure 2-1.

### 2.1 ACB-3530 ARCHITECTURE

The ACB-3530 data path carries data to and from the attached QIC-36 tape drive and host. Data is transferred in an asynchronous fashion from the host to/from the controller 8K dual ported buffer RAM. The buffer dual port addressing and port handshaking is controlled by the AIC-300. Odd bus parity is checked on data transferred into the buffer and generated on data transferred onto the SCSI bus. The dual ported buffer is designed to allow data to be written into one port (ie. from the host) as it is being read out from the other (ie. to the tape) in a FIFO fashion.

Data is transferred between the RAM buffer and the AIC-010 sequencer using synchronous timing to assure streaming operation. Data is converted into a serial NRZ data stream in the QIC-24 format by the AIC-010. The QIC-24 ID and data fields are then appended with CRC information. This NRZ data stream is encoded into the GCR encoding scheme and written onto the tape. As data is being written, the ACB-3530 is also performing a CRC check on the data and will rewrite blocks if any errors are detected.

An 8 bit microprocessor is used to initialize and monitor the status of the data path and serves as the main component of the control path. The microprocessor drives the SCSI control lines to sequence through the various bus phases and decodes all SCSI commands. The micro is further used in the SCSI interface to report all errors encountered and to transfer messages to the host.

The microprocessor also performs the main controlling functions on the QIC-36 interface. These include track select, motion control and cartridge status (in or out).

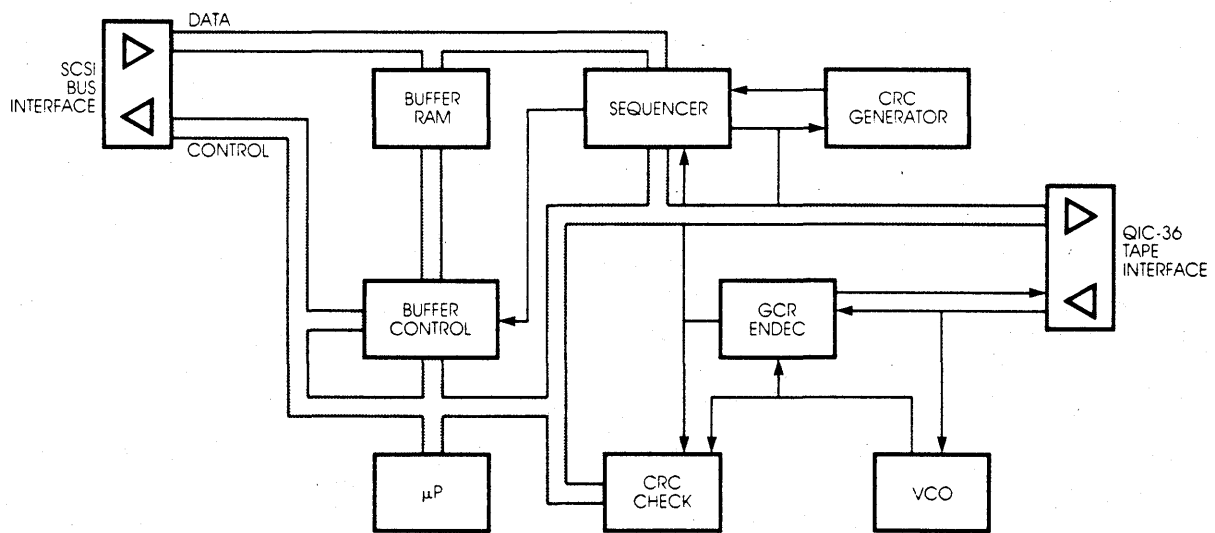

Figure 2-1. ACB-3530 Block Diagram

## 2.2 MICROCODE STRUCTURE

The controlling microcode for the ACB-3530 is preprogrammed in 16K of (Ep)ROM memory. This firmware contains all routines necessary to properly interface to the SCSI bus and the QIC-36 interface and to control the tape data path. Figure 2-2 contains a basic flow chart for the controller firmware.

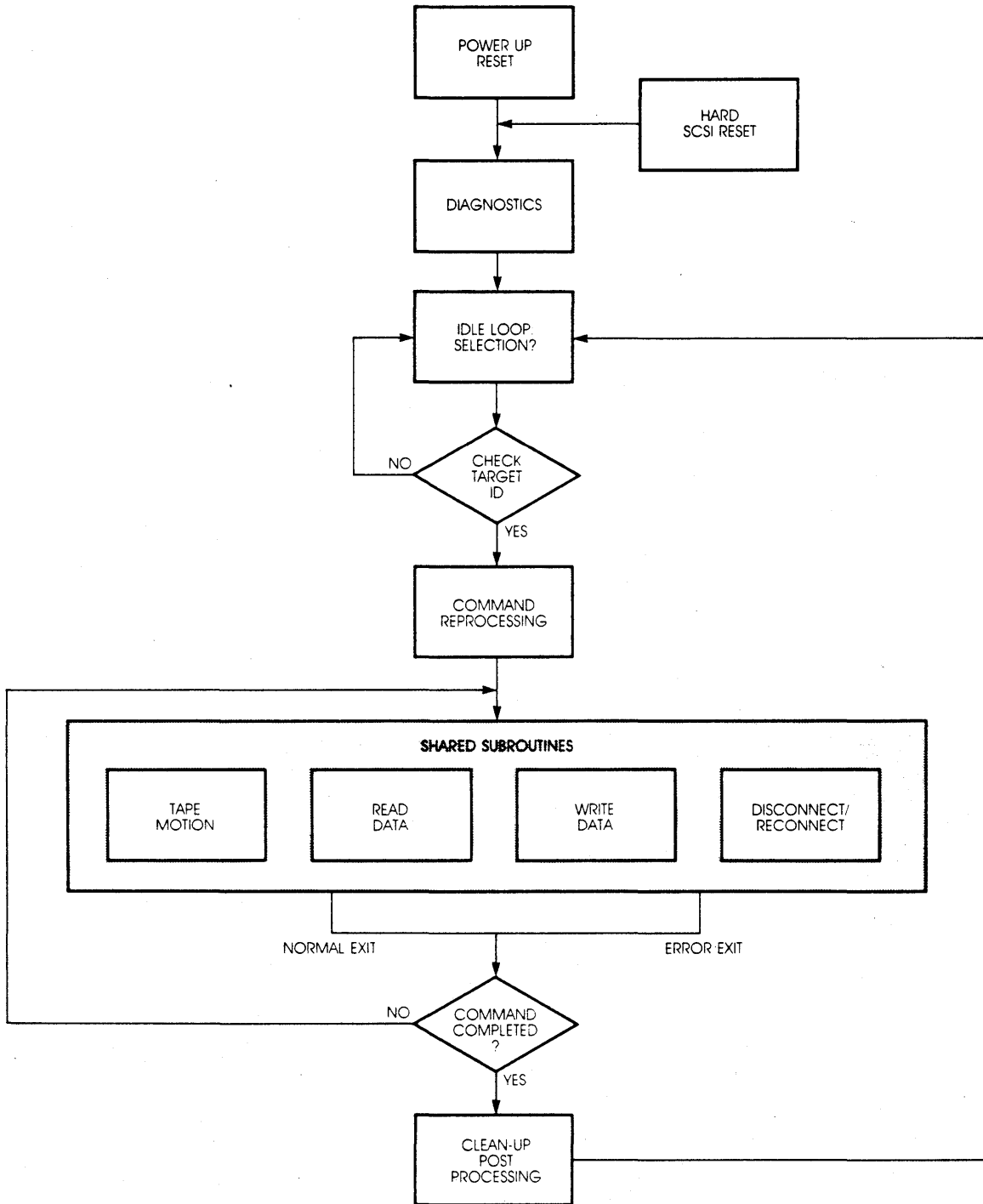

Figure 2-2. ACB-3530 Controlling Firmware.



### **3.0 INSTALLATION OF THE ACB-3530**

---

The ACB-3530 is designed to provide the performance and flexibility required to reliably operate a QIC-36 1/4" tape drive for streaming backup of system data. Some basic installation steps are required to assure proper board operation.

#### **3.1 UNPACKING**

The ACB-3530 is shipped in a protective carton with shock absorbing and static protection material completely surrounding the card. The carton should be examined for external damage as it is opened. The cards are physically inspected prior to packaging, any damage noted should be reported immediately.

**CAUTION-** All circuit boards containing VLSI circuitry have some sensitivity to electro-static discharge. The ACB-3530 is no exception. Proper handling precautions, including personnel and work surface grounding, should be taken to prevent circuit stress which can cause component failure.

#### **3.2 PERPARATION OF INSTALLATION AREA**

The ACB-3530 is generally designed into the physical host system or a peripheral subsystem. Proper attention should be given to the location of the ACB-3530 to assure the necessary ventilation, installation clearances and cabling paths are provided.

##### **3.2.1 MOUNTING CONSIDERATIONS**

The ACB-3530 can be physically mounted using the 4 mounting holes. These holes are in locations compatible with standard QIC-02 controllers for mounting onto the drive. The controller can also be mounted onto custom designed brackets for alternate mechanical requirements. Care must be taken, however, to consider the physical forces the system will be subject to. No conductive material should come in contact with the ACB-3530 PC card.

### 3.2.2 RF CONSIDERATIONS

The ACB-3530 and all other partially shielded electronic devices are sensitive to high power, high frequency or magnetic sources. The controller should be protected from such sources. In particular, unshielded switching power supplies should be physically isolated from all electronic boards and interconnecting cables. Additional cable shielding may be required in some environments.

### 3.3 ACB-3530 CABLING

The ACB-3530 is connected into the host system or subsystem using board connectors J1, J2 and J3. The connectors are used as follows:

- J1- 50 Pin QIC-36 Connector (Section 4.1)
- J2- 4 Pin Power Connector (Section 3.3.1)
- J3- 50 Pin SCSI Connector (Section 5.2)

Figure 3-1 shows proper system cabling. Take care to note pin 1 orientations of all connectors. These are easily found by locating the square solder pad on the solder side of the PC board.

Note: If the ACB-3530 is not the last controller on the SCSI bus, the SCSI terminators, RP1, RP2 and RP6 should be removed.

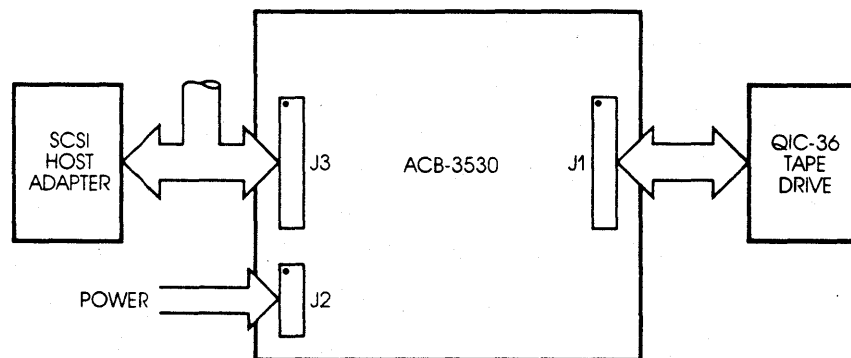

Figure 3-1. ACB-3530 System Cabling

### 3.3.1 ACB-3530 POWER CONNECTOR, J2

Figure 3-2 shows the pin assignments for power connector, J2. The suggested mating connector to J2 is AMP P/N1-480424-0 or equivalent.

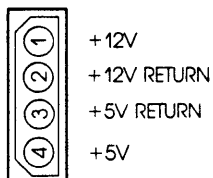

Figure 3-2. Power Connector, J2, Pin Assignments

### 3.4 ACB-3530 CONFIGURATION

The ACB-3530 requires a minimum of hardware setup. Four jumper pairs on header J4 configure the controller SCSI bus address and type of attached tape drive (optional). One jumper pair at J5 enables and disables SCSI bus parity.

The function of each jumper pair on J4 is shown in Table 3-1, sections 3.4.1 and 3.4.2 detail these functions.

Table 3-1 ACB-3530 Configuration Jumpers, J4

G	O	O	H	- SCSI Bus Address 2 <sup>0</sup>
E	O	O	F	- SCSI Bus Address 2 <sup>1</sup>
C	O	O	D	- SCSI Bus Address 2 <sup>2</sup>
A	O	O	B	- 4/9 Track Tape (optional)

#### 3.4.1 SCSI BUS ADDRESS

The installation of jumpers C-D, E-F and G-H set the address ID of the ACB-3530 on the SCSI bus. SCSI devices can have bus addresses of 0 to 7, however no two devices may have the same address. A jumper installed indicates a logical 1 bit address.



### 3.4.2 4/9 TRACK TAPE DRIVE (optional)

The installation of jumper A-B indicates whether the attached tape drive is a 4 or 9 track drive. This jumper is optional in that the Mode Select (15<sub>H</sub>) and Set Parameters (06<sub>H</sub>) command can also be used to indicate this. The A-B jumper installed corresponds to a 4 track tape drive.

### 3.4.3 SCSI BUS PARITY ENABLE

The installation of jumper, J5 in the A-B position, will enable the ACB-3530 to check odd bus parity on all data transferred from the host. This jumper in the B-C position will disable bus parity checking. If the attached host does not generate parity, parity must be disabled. The ACB-3530 will always generate odd parity on data transferred to the host.

### 3.5 POWERING ON THE ACB-3530

The ACB-3530, once properly cabled and configured, can be powered-on. Power should not be applied to the controller if activity is present on the attached SCSI bus. The electrical nature of the components typically used to drive this interface could interrupt bus activity.

Upon power-on, the controller will execute internal diagnostics checking the health of the major components of the controller. This self test lasts approximately 10 seconds, any attempt to access the controller during this period will result in an SCSI Busy status.

If a cartridge is installed in the attached drive at power-on, the controller will rewind it to BOT to prepare for read and write accesses.

If a cartridge is installed some time after power-on, it will be rewound by the controller upon insertion.

The controller will present a Busy status to any access attempts made during the power-on or cartridge insertion tape rewind.

## 4.0 QIC-36 1/4" STREAMING TAPE INTERFACE

The QIC-36 interface provides a low cost, high performance, standard interface for attaching a 1/4" streaming tape drive to intelligent controller/formatters. This sections describes the interface between the ACB-3530 and a QIC-36 tape drive.

### 4.1 QIC-36 INTERFACE SIGNALS

The QIC-36 interface is implemented through a 50 pin dual in-line header located at position J1 on the ACB-3530. The suggested mating connector is 3M P/N 3425-60XX, 3425-70XX or equivalent. Maximum cable length is 10 feet (3 meters).

The connector pins are numbered 1 to 50. All odd pins are signal returns and are connected to the controller board ground. Table 4-1 shows J1 pin assignments.

Table 4-1. QIC-36, J1, Connector Pin Assignments

				<u>Signal</u>	<u>Source</u>	<u>Description</u>
Return	1	o o	2	GO-	C	Tape Motion Enable
	3	o o	4	REV-	C	Tape Direction Control
	5	o o	6	TR3-	C	Track Select 2 <sup>3</sup>
	7	o o	8	TR2-	C	Track Select 2 <sup>2</sup>
	9	o o	10	TR1-	C	Track Select 2 <sup>1</sup>
	11	o o	12	TR0-	C	Track Select 2 <sup>0</sup>
	13	o o	14	RST-	C	Reset (Initialize Drive)
	15	o o	16	DS3-	C	Reserved (not used)
	17	o o	18	DS2-	C	Reserved (not used)
	19	o o	20	DS1-	C	Reserved (not used)
	21	o o	22	DS0-	C	Drive Select 0
	23	o o	24	HC-	C	High Write Current
	25	o o	26	RDP-	D	Read Data (Pulse Output)
	27	o o	28	UTH-	D	Upper Tape Position Code
	29	o o	30	LTH-	D	Lower Tape Position Code
	31	o o	32	SLD-	D	Drive Select Response
	33	o o	34	CIN-	D	Cartridge In Place
	35	o o	36	USF-	D	Unsafe (No Write Protect)
	37	o o	38	TCH-	D	Capstan Tachometer Pulse
	39	o o	40	WDA-	C	Write Data Signal -
	41	o o	42	WDA+	C	Write Data Signal +
	43	o o	44	TDH-	C	Threshold (35% Read Mrgn)
	45	o o	46	HSD-	C	High Speed Slew Select
	47	o o	48	WEN-	C	Write Enable
Return	49	o o	50	EEN-	C	Erase Enable

A detail of the QIC-36 interface signals follows:

Go (GO-): Assertion of GO- causes a start tape motion sequence in the direction specified by the state of REV-.

Reverse (REV-): Assertion of REV- will cause tape motion in the reverse direction if GO- is asserted. Deassertion of REV- will cause tape motion in the forward direction.

Track Select (TR0-, TR1-, TR2-, TR3-): Assertion of the track select signals will result in the selection of track 0 through 3, on a 4 track drive, or 0 through 8, on a 9 track drive. Track selection is made through binary assertion of these lines with TR0- the least significant.

Reset (RST-): Assertion RST- will cause the tape drive to reinitialize. This sequence differs between drive vendors.

Drive Select (DS0-)/ Drive Selected (SLD-): The assertion of DS0- selects the attached tape drive to allow all tape operations to proceed. The drive selected signal (SLD-) will be asserted by the drive in response to selection.

High Current (HC-): Assertion of HC- enables the tape drive to use a higher write current when writing to the drive.

Read Data Pulses (RDP-): Serial read data is passed to the controller as a pulse for every flux change. Since no read enable is required, Read Data Pulses will be present any time data passes under the tape read head and DS0- is asserted.

Upper Tape Hole (UTH-)/ Lower Tape Hole (LTH-): The UTH- and LTH- signals are generated by the drive to indicate some media status. The BOT, Load Point, Early Warning and EOT tape holes are encoded to produce an output code indicating specific positions of the tape.

Cartridge In (CIN-): The CIN- signal is asserted by the drive when a cartridge tape is fully installed and DS0- is asserted. The line is deasserted when the cartridge is removed.

Unsafe (USF-): The USF- signal is asserted by the drive to indicate that the installed cartridge is not write protected. This signal will be asserted when the write protect plug is in the unsafe position and DS0- is asserted.

**Tachometer Pulses (TCH-):** The tachometer pulses generated by the rotation of the capstan motor inform the controller when the tape is in motion and how fast. DS0- must be asserted for this signal to be valid.

**Write Data (WDA+, WDA-):** WDA line are differentially driven and contain tape write data from the controller. WEN- must be asserted prior to writing to the tape.

**Threshold (THD-):** Assertion of THD- invokes a 35% qualifying amplitude for the read signal. This is typically used to eliminate marginal tape recording areas.

**High Speed (HSD-):** Assertion of HSD- causes 30ips tape drive to operate at 90ips speed.

**Write Enable (WEN-):** Assertion of WEN- allows write data to be written to the tape.

**Erase Enable (EEN-):** Assertion of EEN- enables erase current to the full tape width erase head. DS0- and TR0- must also be asserted.

**4.2 BLOCK FORMAT**

The ACB-3530 is designed to read and write user data, control information and file marks in the QIC-24 and QIC-11 media formats. Both media format standards are supported with a 512 byte block size and are shown in Figure 4-1.

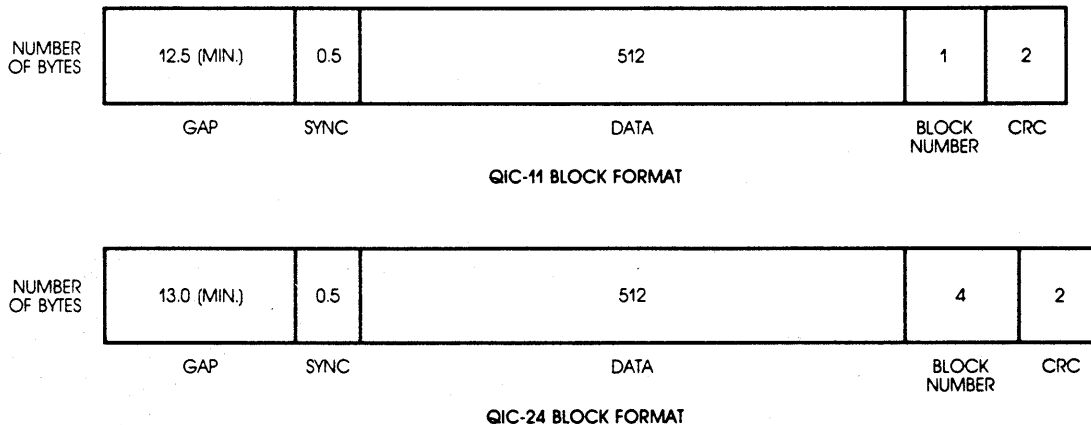

Figure 4-1. QIC-11 and QIC-24 Block Format

### 4.2.1 FILE MARKS

Data blocks can be used to create "marks" on the tape, typically between recorded files. File marks are written to the tape when specified by the host using a unique data pattern in the 512 byte data field. The host can then use file marks as boundaries for spacing and streaming reads.

### 4.3 TRACK LAYOUT

Data is read and written in a serpentine fashion between the tape early warning holes; Load point and Early warning. When the controller encounters the end of a track, the tape reverses direction and continues the read or write. Even numbered tracks are recorded while the tape is moving forward. Odd numbered tracks are recorded while the tape is moving backward. The controller reports an overflow state when the end of the last track is encountered (Early Warning). While writing on track 0, the tape erase head will be activated ahead of the write data. Figure 4-2 shows the layout of an entire 1/4" tape and the relative location of the tape positioning holes.

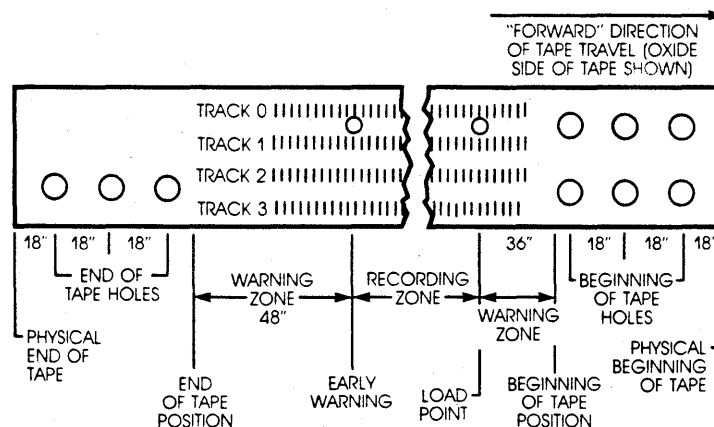

Figure 4-2. 1/4" Tape Layout

#### **4.4 TAPE MEDIA DEFECT HANDLING**

The ACB-3530 checks each block on the tape for good CRC as it is being written. However, since the tape read head trails the write head by about 300 bytes, the CRC results for a given block (block N) are not known until the next block write has begun. The controller, therefore, assumes that the previous block will check correctly and begins writing the next block as such.

If the CRC check should fail, typically due to a media defect, the ACB-3530 will complete the current block write (N+1) and then rewrite the previous block (N). This alternation between N and N+1 will continue until a successful CRC check of block N is achieved or 16 unsuccessful writes have been attempted. If block N were the last block to be written, it would be repeated until a good CRC check is made. This results in the last block of each write to be written at least twice.

This process is effective in that the ACB-3530 will not attempt to read N+1 until a valid read from block N is made.



## 5.0 SCSI INTERFACE DESCRIPTION

---

This section briefly describes the SCSI protocol implemented by the ACB-3530. The SCSI protocols are further defined in the ANSI X3T9.2 specification, revision 14B.

### 5.1 GENERAL DESCRIPTION OF SCSI

The SCSI is a device independent method of interfacing up to 8 host computers and peripheral devices. Device independence relates to the ability to communicate with a number of peripheral types without regard to the physical characteristics of the device (ie. # of tracks, tape capacity, etc).

The SCSI interface, based on the IBM block multiplexer I/O channel, provides optimum performance in host to host and host to peripheral communication. The SCSI is implemented through a 50 pin ribbon cable that is daisy chained to all attached hosts and peripheral controllers. The SCSI can support up to 8 devices. A single device, such as a disk controller, can support a number of peripherals. The daisy chained SCSI cable must be terminated at both ends. Figure 5-1 shows the ACB-3530 in a typical SCSI configuration.

Communication occurs across the bus in an Request/Acknowledge, asynchronous fashion. The asynchronous bandwidth of the SCSI bus is 15 Mbyte/sec maximum. When two devices communicate across the bus, the device initiating the command assumes an INITIATOR role, the other device required to execute the command is designated as the TARGET. Host computers are almost always INITIATORS, controllers are almost always TARGETS in SCSI transactions. Commands are transferred and executed across the bus using a number of bus "phases." The phases determine what type of information (command, data, status, etc.) is being transferred at any given time.

In order to execute a command, the INITIATOR (host) must first gain control of the SCSI bus, this is accomplished through arbitration. The host then selects the required controller: From this point on, the controller determines all bus phases and byte transfers. The host interface must make no assumption regarding the sequence of bus phases, as error conditions can cause the controller to change the bus state in the middle of command and data transfers.



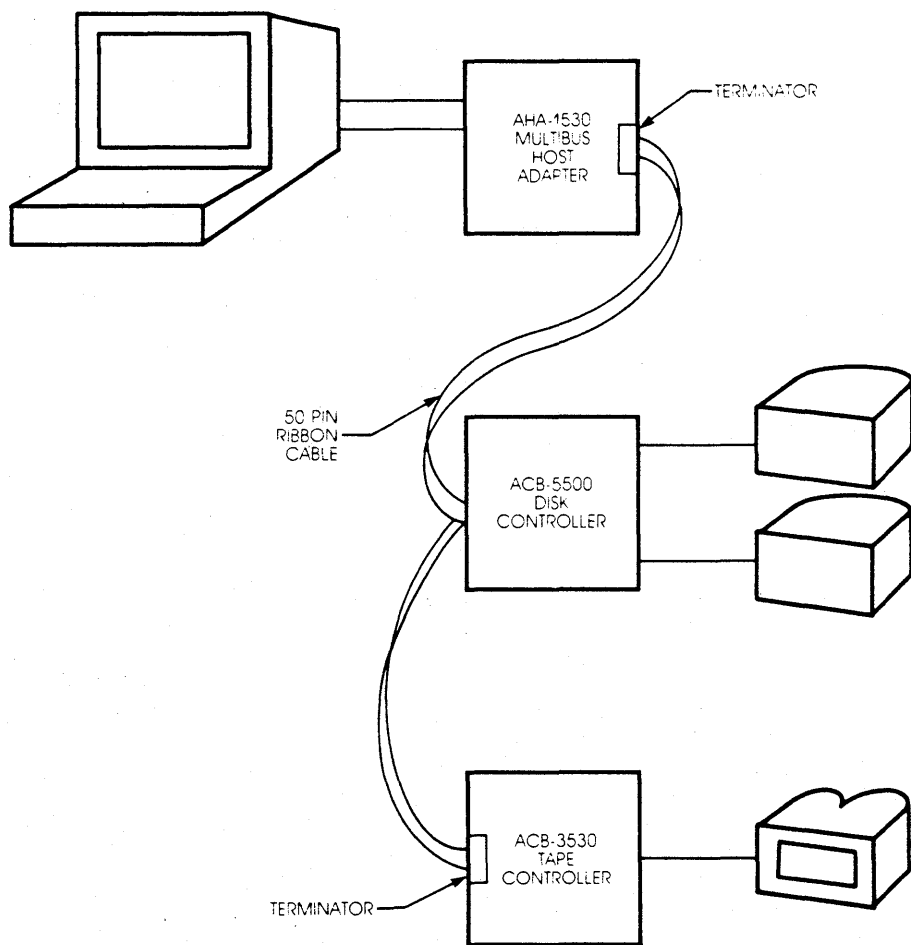

Figure 5-1. Typical SCSI Configuration

## 5.2 SCSI BUS SIGNALS

The SCSI bus contains 9 control signals, controlling the bus phase and all byte transfers, and 9 data signals. The interface is implemented using a 50 pin dual in-line header at location J3. All odd numbered pins are ground. The suggested mating connector is 3M P/N 3425-60XX, 3425-70XX or equivalent.

Table 5-1 shows the SCSI, J3, pin assignments.

Table 5-1. SCSI Connector, J3, Pin Assignments

				<u>Signal</u>	<u>Description</u>
Return	1	o o	2	DB0-	Data Bit 0
	3	o o	4	DB1-	Data Bit 1
	5	o o	6	DB2-	Data Bit 2
	7	o o	8	DB3-	Data bit 3
	9	o o	10	DB4-	Data Bit 4
	11	o o	12	DB5-	Data Bit 5
	13	o o	14	DB6-	Data Bit 6
	15	o o	16	DB7-	Data Bit 7
	17	o o	18	DBP-	SCSI Bus Parity Bit
	19	o o	20	GND	Ground
	21	o o	22	GND	Ground
Return	23	o o	24	GND	Ground
N/C	25	o o	26	TFWR	Bus Terminator Power
Return	27	o o	28	GND	Ground
	29	o o	30	GND	Ground
	31	o o	32	ATN-	Attention
	33	o o	34	GND	Ground
	35	o o	36	BSY-	Busy
	37	o o	38	ACK-	Acknowledge
	39	o o	40	RST-	Reset
	41	o o	42	MSG-	Message
	43	o o	44	SEL-	Select
	45	o o	46	C/D-	Control/Data
	47	o o	48	REQ-	Request
Return	49	o o	50	I/O-	Input/Output

A description of each signal is as follows:

**Busy (BSY-):** BSY- is an "or-tied" signal that indicates that the bus is in use. The ACB-3530 will assert busy upon being selected by an SCSI host.

**Select (SEL-):** SEL- is an "or-tied" signal that is used to select an SCSI device. The SEL- line can be used by a host to select a controller to initiate a command or by a controller to reselect a host to complete a command (see Section 5.3).

Input/Output (I/O-): I/O is driven by the controller to indicate the direction of information transfers on the SCSI bus relative to the host. Assertion of this signal, In, indicates a controller to host transfer. Out indicates a host to controller transfer.

Control/Data (C/D-): C/D- is driven by the controller to indicate whether a control or data byte is being transferred across the bus. The type of control information is indicated by the I/O line. Inbound, controller to INITATOR, control information is status. Outbound control information is commands. I/O also indicates the direction of data transfers.

Message (MSG-): MSG is driven by the controller to indicate a request to send or receive an SCSI message. This signal will be asserted when the controller desires to send a message or in response to the host asserting ATN-, indicating a host request to send a message.

Attention (ATN-): ATN- is driven by the host to indicate a request to transfer a message to the selected controller.

Request (REQ-): REQ- is driven by the controller to initiate the REQ/ACK asynchronous handshake of a byte of information to or from the host. The type of information is indicated by the C/D-, I/O- and MSG- signals.

Acknowledge (ACK-): ACK- is driven by the host to complete the REQ/ACK asynchronous handshake of a byte of information to or from the host.

Data Bits and Parity (DB0- to DB7-, DBP-): The SCSI contains an 8 bit parallel bus, plus odd parity. DB0- is the least significant.

### 5.3 SCSI BUS PHASES

The SCSI bus has eight distinct operational phases that are controlled by the ACB-3530 by the assertion of one or more of; C/D, I/O, MSG, SEL and BSY. The eight phases are:

- o Bus Free
- o Arbitration
- o Selection
- o Re-selection
- o Command \*
- o Data \*
- o Status \*
- o Message \*

\* Information transfer phases

In execution of SCSI operations, the bus will sequence through a number of these phases. When the bus is between phases, the BSY, SEL, REQ and ACK signals may not change. The C/D, I/O, MSG and data lines may change.

The following sections describe the sequence of events contained within each bus phase, refer to figure 5-2 and section 5.5 for relative bus timing.

#### 5.3.1 BUS FREE PHASE

The Bus Free phase, indicating that the bus is free and available for use is entered by the deassertion and passive release of all bus signals. At the completion of an SCSI operation, the active device(s) must deassert all bus signals within 800 nS of releasing BSY.

SCSI devices sense the Bus Free phase when SEL and BSY are deasserted and the Reset condition is not active

#### 5.3.2 ARBITRATION PHASE

The Arbitration phase allows one SCSI device to gain control of the bus in systems where more than one device may require the use of the bus. Systems with one host and SCSI devices that do not support reconnection may skip this phase by entering the Selection phase directly from Bus Free.

The sequence of arbitrating for the bus is as follows:

- 1) Wait for Bus Free phase: deassertion of both SEL and BSY.
- 2) After Bus Free is detected, the arbitrating device waits a minimum of 800 nS (bus free delay) to assert BSY and the data bit corresponding to the device's SCSI address ID.

- 3) The arbitrating device then looks on the data bus for an ID of higher priority. If no higher priority IDs are present, the device has won control of the bus. If higher priority IDs exist the device returns to step 1.
- 4) After winning arbitration, the device asserts SEL and enters the Selection or Reselection phase.

### 5.3.3 SELECTION PHASE

The Selection phase allows an INITIATOR (host) with control of the bus to select a TARGET (controller) to initiate an SCSI command.

The sequence for a host to select a controller is as follows:

- 1) To select a device in nonarbitrating systems, the host asserts the controller ID address bit and optionally asserts its own ID.

When selecting a device from the Arbitration phase, the host already has SEL asserted (along with BSY). The host asserts the controller ID and its own ID and then deasserts BSY.

- 2) On detecting the simultaneous condition of SEL and its own ID asserted, and I/O and BSY not asserted, the selected controller examines the data bus for the host ID and responds by asserting BSY.
- 3) The host then deasserts SEL and ID address data bits.

### 5.3.4 RESELECTION PHASE

The Reselection phase is used to re-establish a connection between a host and controller in order to continue a disconnected operation. This phase is entered from the Arbitration phase. Like the Selection phase, the SCSI device with control of the bus has both SEL and BSY asserted. The Reselection phase differs from the Selection phase by the assertion of I/O.

The sequence for a controller to reselect a host is as follows:

- 1) The controller asserts I/O and the data bits corresponding to its own ID address and the desired host ID address. The controller then deasserts BSY.
- 2) On detecting the simultaneous condition of SEL, I/O and its own ID asserted and BSY not asserted, the reselected host examines the data bus for the controller ID and responds by asserting BSY.

- 3) After detecting the assertion of BSY, the controller also drives BSY and then releases SEL and the ID address bits.
- 4) The host then deasserts BSY leaving the bus in the same state as at the completion of the Selection phase.

### 5.3.5 INFORMATION TRANSFER PHASES

The Command, Data, Status and Message phases are used to transfer data or control information across the data bus.

The C/D, I/O and MSG signals are used to differentiate the various information transfer phases. These signals are not considered valid unless REQ is asserted. Table 5-2 shows the bus phases related to the C/D, I/O and MSG signals.

Table 5-2. Information Transfer Phases

<u>Signal</u>			<u>Phase</u>	<u>Direction of Information Xfer</u>
<u>MSG</u>	<u>C/D</u>	<u>I/O</u>		
0	0	0	Data Out Phase	Host to ACB-3530
0	0	1	Data In Phase	ACB-3530 to host
0	1	0	Command Phase	Host to ACB-3530
0	1	1	Status Phase	ACB-3530 to Host
1	0	0	- Not Used	
1	0	1	- Not Used	
1	1	0	Message Out Phase	Host to ACB-3530
1	1	1	Message In Phase	ACB-3530 to Host

Note: "1" indicates signal assertion (SCSI bus signals are negative true)

The Information Transfer Phases use the REQ/ACK handshake to control data transfers. Each REQ/ACK allows the transfer of one byte of data. The handshake starts with the controller asserting the REQ signal, requesting a byte transfer. The host responds by reading or writing a byte of data from/to the bus and asserts ACK. The controller then deasserts REQ, causing the host to deassert ACK. See Figure 5-2.

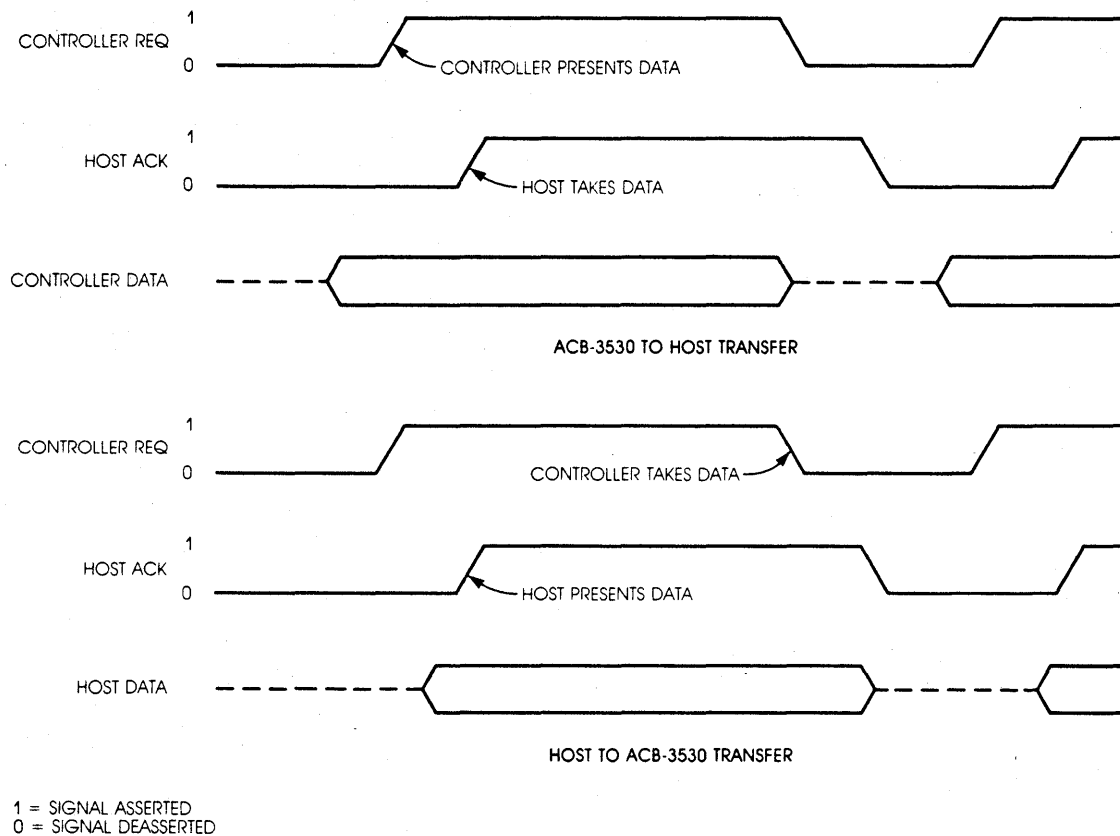

Figure 5-2. REQ/ACK Handshake

A controller to host data transfer (I/O asserted) occurs with the ACB-3530 placing data on the bus, assuring it is valid at the host interface, and asserting REQ. The host then reads the data and asserts ACK.

A host to controller transfer (I/O deasserted) occurs with the controller asserting REQ, requesting a byte of data from the host. The host places data on the bus, assuring it is valid at the controller interface, and asserts ACK.

The BSY signal remains asserted throughout the Information Transfer Phases.

#### 5.3.5.1 COMMAND PHASE

The Command phase is used by the ACB-3530 to obtain Command Descriptor Blocks (CDB) from the host. The sequence for a command transfer is as follows:

- 1) A host, in order to execute a command, arbitrates for the bus (if arbitrating system) and selects the ACB-3530.
- 2) The ACB-3530 becomes selected and places the bus in a Command phase with REQ asserted.
- 3) The command is passed, in a 6 byte block, to the ACB-3530 using the REQ/ACK handshake and begins execution.

Section 5.6 details the content of an SCSI Command Descriptor Block.

#### 5.3.5.2 DATA PHASE

The Data phase includes both Data In and Data Out. The Data In phase is used by the ACB-3530 to transfer tape data or control information (ie. error codes or configuration data) to the host. The Data Out phase is used by the host to transfer tape write data or control information to the ACB-3530.

The Data phase is typically entered after the Command phase and like command transfers, data is transferred using a REQ/ACK handshaking.

#### 5.3.5.3 STATUS PHASE

The Status phase is used by the ACB-3530 to inform the host of the state in which the last command completed. The controller can enter the Status phase at any time to indicate a detected error. If an error is detected during the 6 byte command transfer, the ACB-3530 will transfer all 6 bytes and then enter the Status phase. The controller will immediately invoke the Status phase if an error is encountered during a data transfer. Status information is transferred in a single byte from the controller to host. Section 5.7 details the SCSI status information.

#### 5.3.5.4 MESSAGE PHASE

The Message Phase includes both Message In and Message Out. The Message In phase is used by the ACB-3530 to transfer a control message to the host (ie. prepare to disconnect). The Message Out phase is used by the host to transfer a control message to the controller (ie. abort operation). In order to enter the Message Out phase the host must assert the ATN line which causes the controller to accept the message. Section 5.8 details the messages supported by the ACB-3530.



### 5.3.6 SCSI BUS PHASE SEQUENCING

The execution of commands typically consists of a number of SCSI bus phases. Figure 5-3 shows a typical sequence of bus phases.

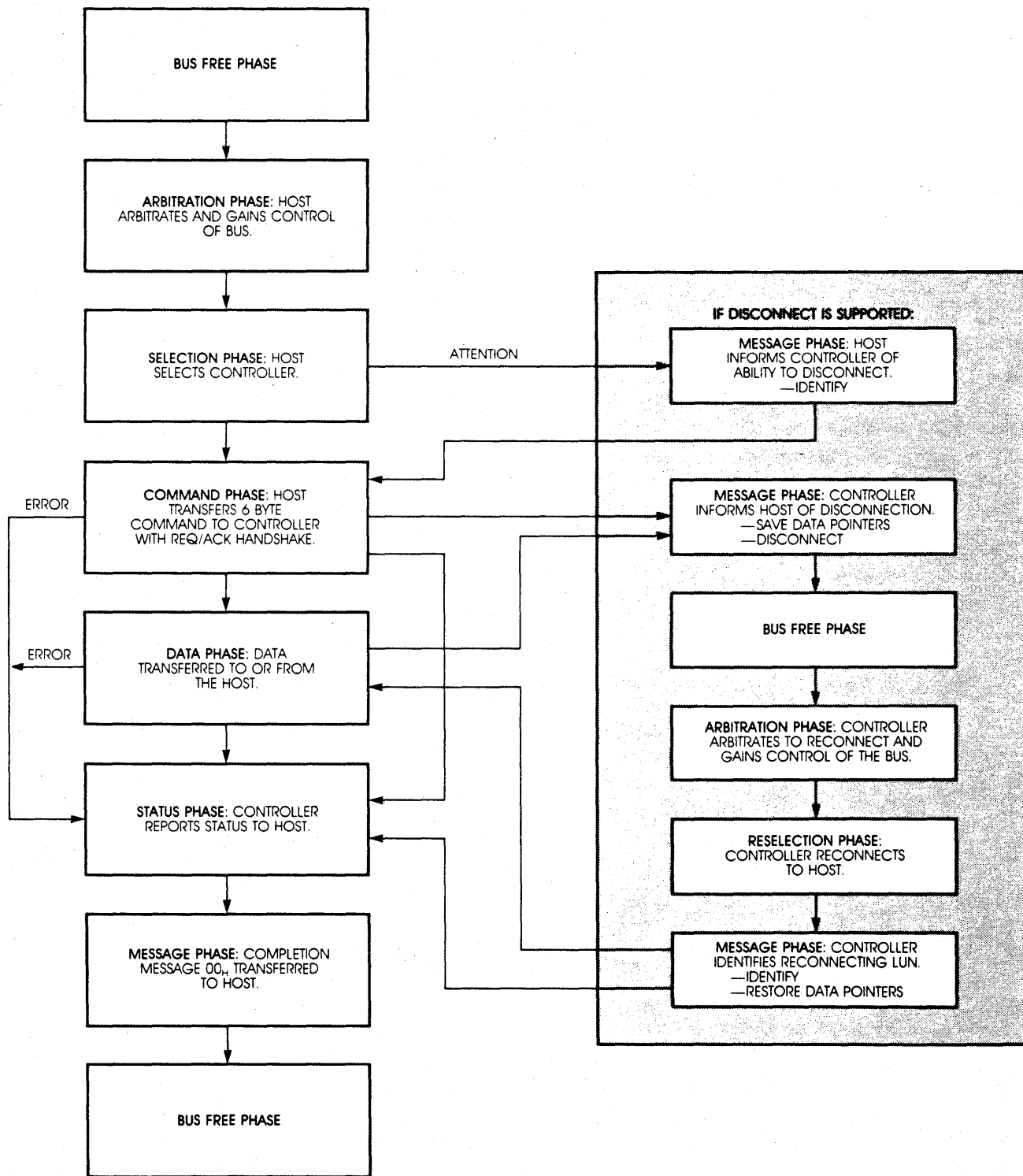

Figure 5-3. SCSI Bus Phase Sequencing

## **5.4 BUS CONDITIONS**

The SCSI bus has two conditions that can interrupt normal phase sequencing and initiate certain device activity. These are the Attention and Reset Condition.

### **5.4.1 ATTENTION CONDITION**

The Attention condition allows the host to signal the ACB-3530 of a waiting message. The ACB-3530 accesses the message by invoking a Message Out phase and handshaking the message from the host.

The host may create the Attention condition by asserting ATN at any time except during the Arbitration and Bus Free phase. When the message byte is to be transferred the host deasserts the ATN signal once the Message Out phase is entered.

The ACB-3530 may not be able to respond to the Attention condition immediately so the host must continue to support the other bus phases while ATN is asserted.

### **5.4.2 RESET CONDITION**

The Reset condition is used by the host to clear all devices from the SCSI bus. This condition is created by asserting the RST signal.

Reset can occur at any time and takes precedence over all other bus phases and conditions. On reset, all devices immediately deassert and passively release all bus signals, thus entering a Bus Free phase.

The RST signal must stay asserted for at least 25 uS, while asserted, no other bus signals can be assumed valid.

The ACB-3530 supports the SCSI "hard" reset mode. Upon reset, the ACB-3530 releases all bus signals and immediately clears any commands in process. The ACB-3530 will also rewind the tape to BOT.

The next command to the ACB-3530 after reset will result in a Check status. The Request Sense (15<sub>H</sub>) command will return a sense key Unit Attention (6).

## **5.5 SCSI BUS TIMING**

SCSI bus timing is shown in Figure 5-4. The SCSI specification can provide further timing detail if required.

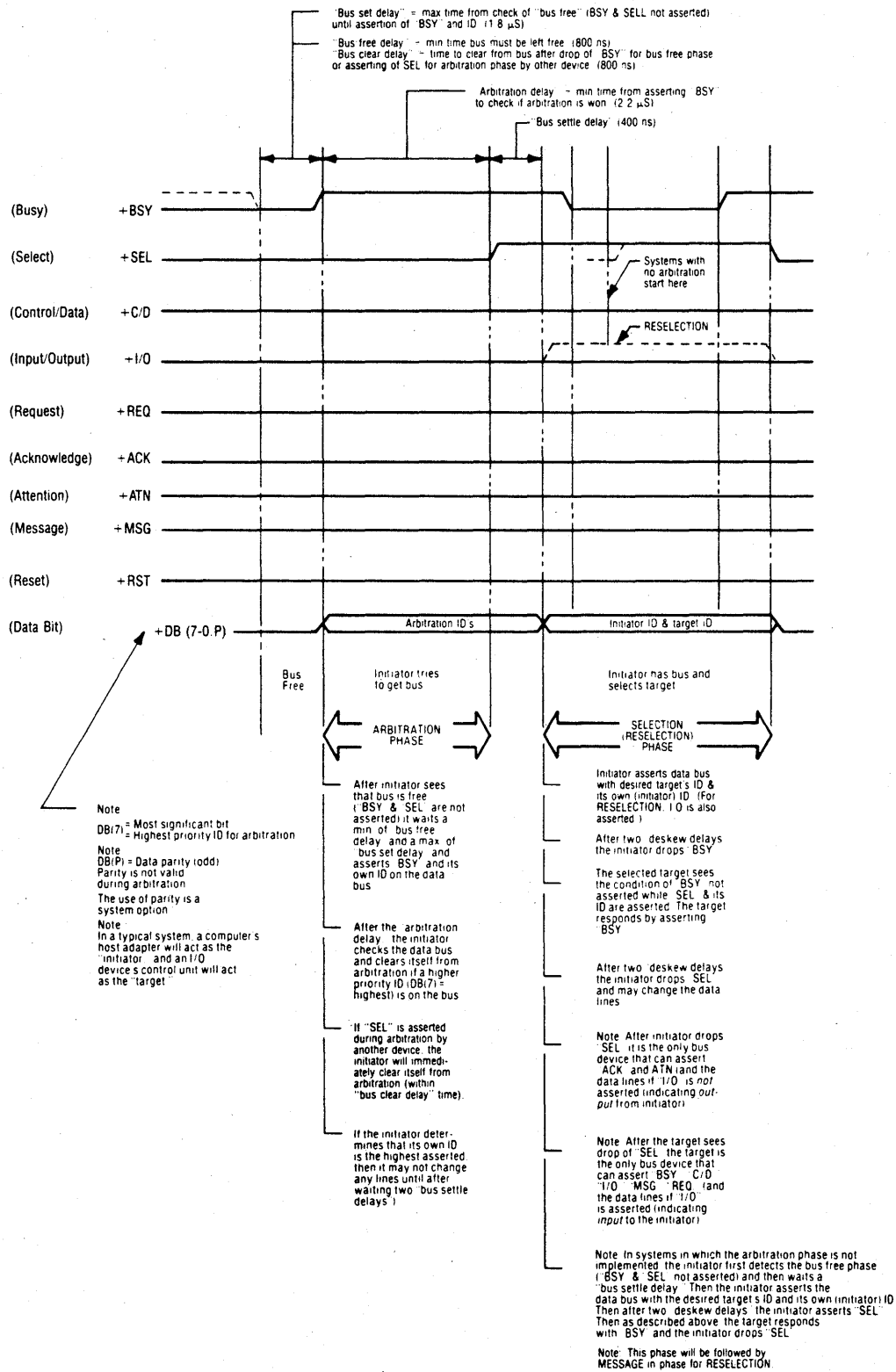

Figure 5-4. SCSI Bus Timing

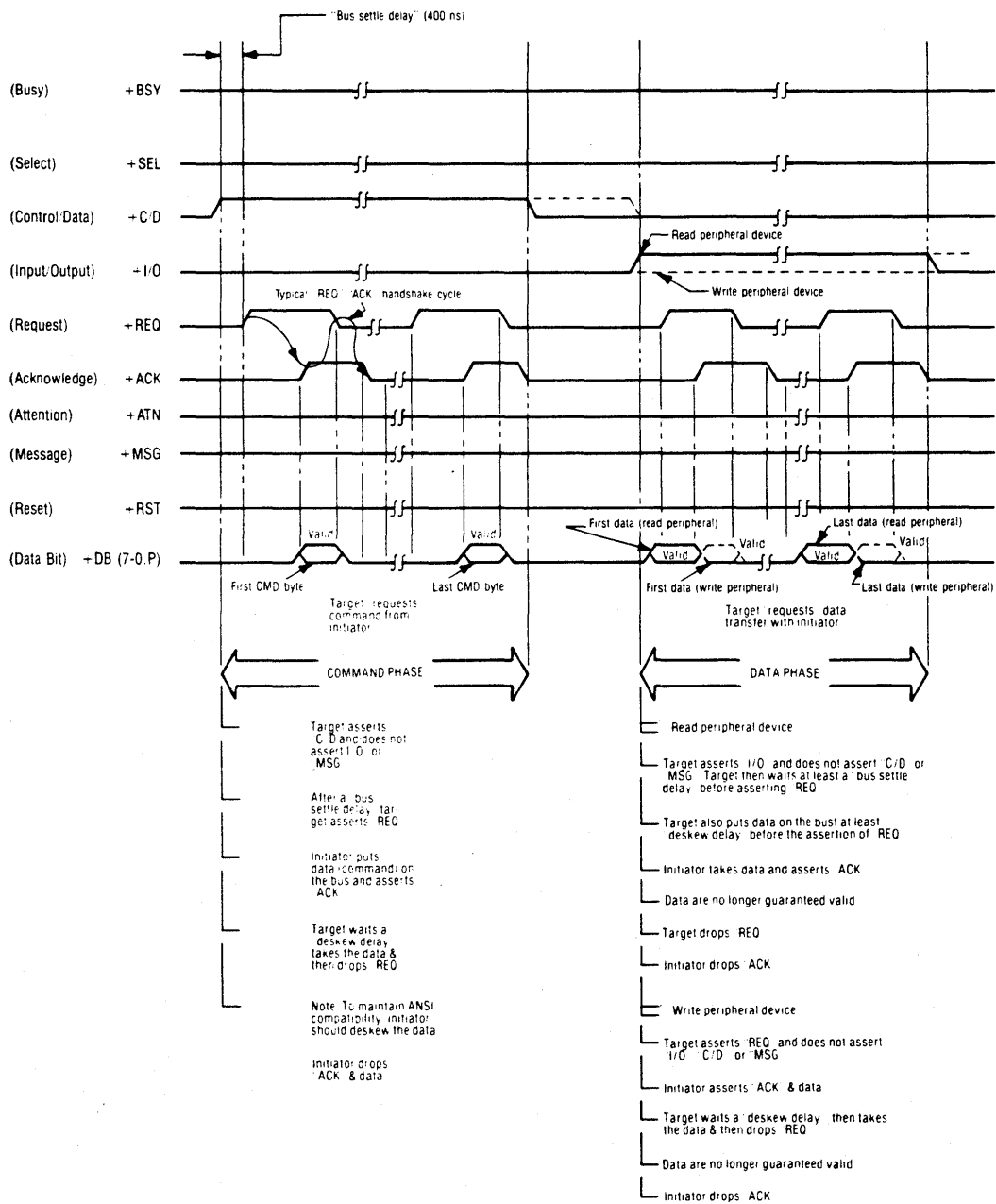

Figure 5-4. SCSI Bus Timing (con't)

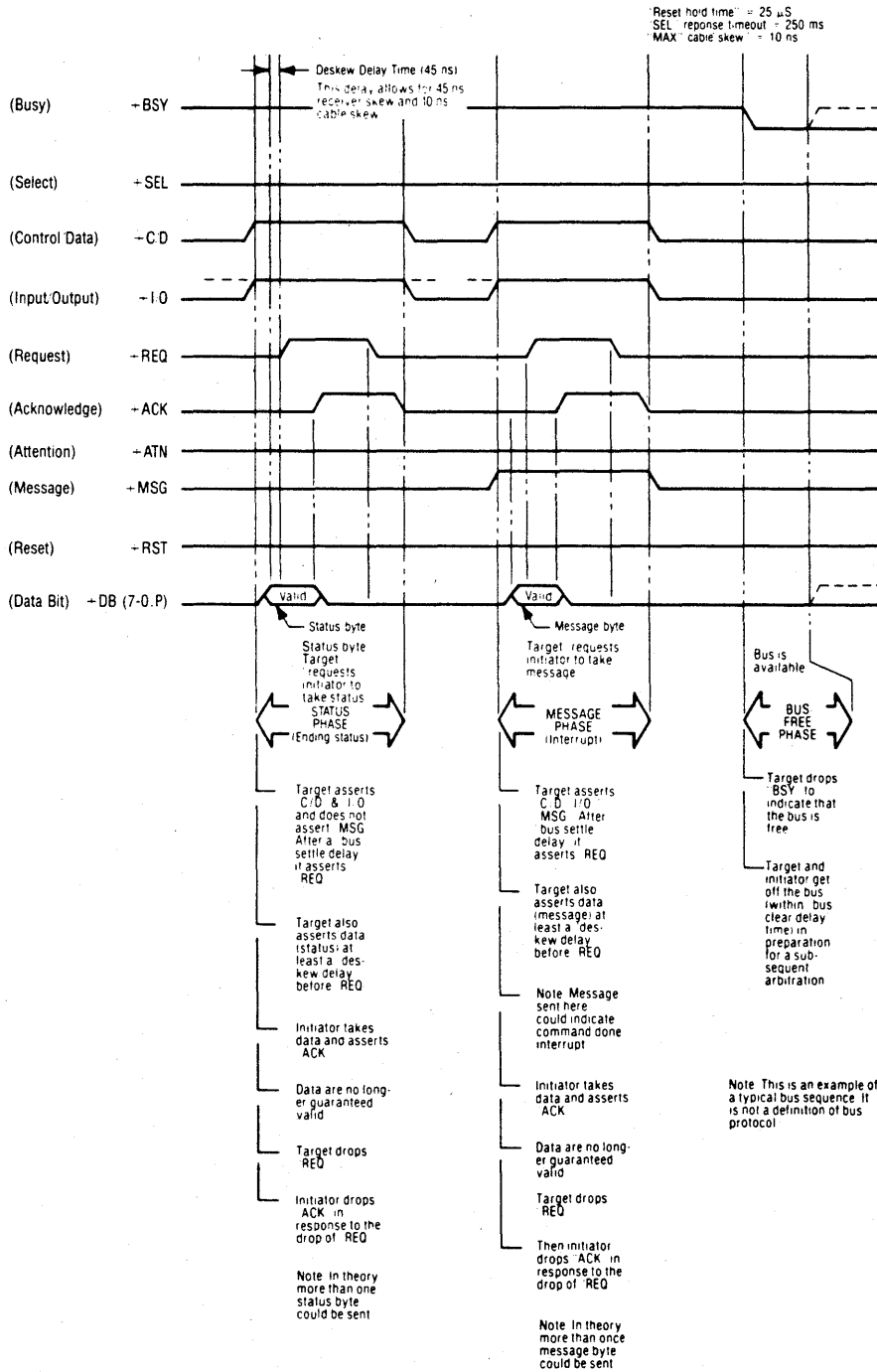

Figure 5-4. SCSI Bus Timing (con't)

## 5.6 COMMAND DESCRIPTOR BLOCK

Commands transferred from an SCSI host to the ACB-3530 are in the form of a 6 byte block. The command block, Command Descriptor Block (CDB), is a predefined format shown in Figure 5-. The CDB contains a command opcode, the peripheral device being addressed and the number of blocks to be accessed within that peripheral.

The ACB-3530 supports the SCSI class 0, 6 byte, command blocks.

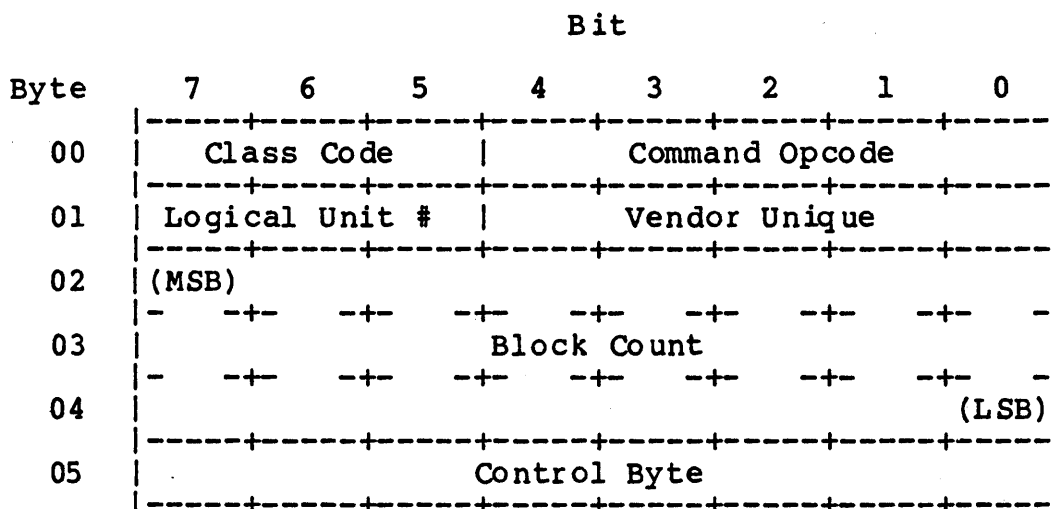

Figure 5-5. Class 0 CDB Supported by the ACB-3530

A description of each CDB field is as follows:

**Class Code:** The class codes defined by the SCSI specification are 0 through 7. The ACB-3530 supports only class 0, 6 byte, commands. This field must therefore always be zero.

**Command Opcode:** The command opcode indicates the command to be executed to the controller. The opcodes defined by the SCSI specification are 00<sub>H</sub> through 1F<sub>H</sub>. The commands supported by the ACB-3530 are detailed in Section 6.0.

**Logical Unit Number:** The logical unit number refers to the peripheral devices attached to the SCSI controller. SCSI allows for up to 8 peripherals (logical units), however, since the ACB-3530 only supports one QIC-36 tape drive, this field must always be logical unit number 0.

Block Count: The number of blocks field indicates the total number of consecutive blocks accessed. A data transfer will begin at the position of the tape and continue for the total number of blocks indicated.

Control Byte: The control byte is used to indicate SCSI linked commands and is used by some vendors for vendor unique features. Most ACB-3530 commands do not support any control byte extensions.

The definition of each field within the CDB can vary for each SCSI command. Refer to section 6.0 for the CDB for each command supported.

### 5.7      COMPLETION STATUS BYTE

A byte of status information is transferred from the controller to the host during the SCSI Status phase. The status phase is invoked at the completion of every command. If an error state is encountered during data transfers or command execution, the ACB-3530 will also invoke the Status phase. Errors encountered during a "buffered" write operation will be reported with the next command.

Figure 5-6 shows the Completion Status byte.

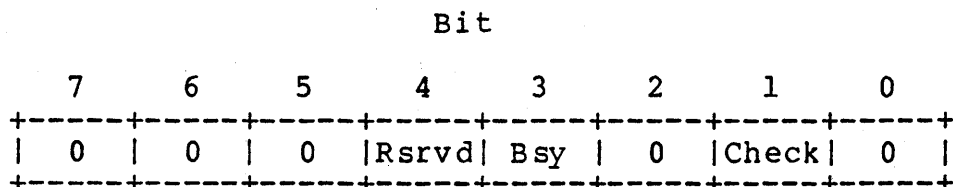

Figure 5-6. Completion Status Byte

A 00<sub>H</sub> status byte at the completion of a command indicates good status, or proper command completion. The ACB-3530 supports three additional status states: Busy, Check and Reservation Conflict. Bits 0,2,5,6 and 7 will always be set to zero. Bits 1,3 and 4 are described as follows:

Busy (bit 3): The controller is unable to accept the command because of the power-on self test in process or a previous command still in process, typically an immediate load/unload or rewind. This status will occur immediately after a 6 byte command is transferred.

Check (bit 1): An error condition prevented successful completion of the active command. The nature of the error can be obtained through the Request Sense command (03<sub>H</sub>). This status can occur at any time during the transfer and execution of a command.

Reservation Conflict (bit 4): A reservation conflict exists. When this bit is set with bit 3, Busy, the command issued is in conflict with an existing tape drive reservation. This status can be returned as a result of a tape access or a reservation request.

## 5.8 SCSI MESSAGE SYSTEM

The message system allows communication between an Initiator and an ACB-3530 for the purposes of physical path management. This section describes the messages supported by the ACB-3530.

### 5.8.1 SCSI MESSAGE DESCRIPTION

The ACB-3530 supports SCSI messages to allow disconnect/reconnect and provide communication between the host and controller.

Table 5-3 shows the messages supported by the ACB-3530.

Table 5-3. SCSI Messages Supported by the ACB-3530

<u>Code (in Hex)</u>	<u>Description</u>	<u>Direction</u>
00	Command Complete	In
02	Save Data Pointer	In
03	Restore Data Pointer	In
04	Disconnect	In
07	Message Reject	In Out
08	No Operation	Out
80 - FF	Identify	In Out

Command Complete (00<sub>H</sub>): The Command Complete message is sent by the ACB-3530 to indicate that the last command has terminated. This message will always follow a valid status byte. Immediately after this message the bus will be placed in the Bus Free phase.

Save Data Pointer (02<sub>H</sub>): The Save Data Pointer message is sent by the ACB-3530 to direct the host to save the active command execution state prior to disconnect. The host typically stores pointers to command, status and data areas of memory related to the disconnecting command.



Restore Data Pointers (03<sub>H</sub>): The Restore Data Pointers message is sent by the ACB-3530 to direct the host to restore the most recently saved pointers for logical unit indicated in the preceding Identify message to the active state.

Disconnect (04<sub>H</sub>): The Disconnect message is sent by the ACB-3530 to inform the host that the present physical path is going to be broken by disconnection. This message is always preceded by a Save Data Pointers message. Immediately after this message the bus will be placed in a Bus Free Phase.

Message Reject (07<sub>H</sub>): The Message Reject message can be sent from either the initiator or target to inform the other that the last message sent was either inappropriate or not implemented.

No Operation (08<sub>H</sub>): The No Operation message is used by the host to respond to the Message Out phase when there is no valid message to send.

Identify (80<sub>H</sub> to FF<sub>H</sub>): The Identify message is sent by either the host or controller to establish a physical path connection between the host and the ACB-3530 controller. The format of the Identify message is shown in figure 5-7.

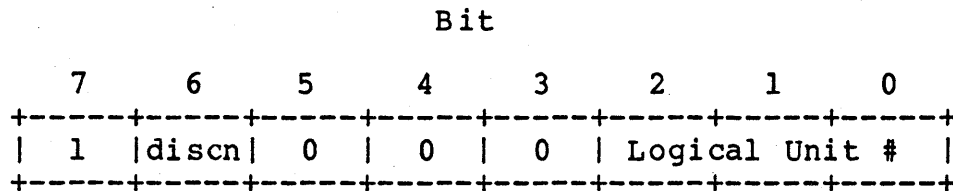

Figure 5-7. Identify Message

Disconnect (bit 6): This bit is set in a host to controller message indicating the host's ability to disconnect. This message is sent after controller selection.

Logical Unit Number (bits 0,1 and 2): The logical unit number is used to inform the host of the which logical unit attached to the controller is reconnecting. or to inform the controller which logical unit is being selected (if system is disconnecting).

## 6.0 Command Descriptions

---

This Section describes the command set implemented by the ACB-3530. This command set follows the ANSI X3T9.2, however, deviations do occur to support special Adaptec functions. Table 6-1 summarizes the implemented command set.

Table 6-1. ACB-3530 SCSI Command Set

<u>Command Opcode (in hex)</u>	<u>Command</u>	<u>Section</u>
00	Test Unit Ready	6.1
01	Rewind Tape (D)	6.2
03	Request Sense	6.3
05	Read Block Limits	6.4
06	Set Parameters	6.5
08	Read (D)	6.6
0A	Write (D)	6.7
10	Write File Mark (D)	6.8
11	Space (D)	6.9
12	Inquiry	6.10
13	Verify (D)	6.11
14	Recover Buffer Data	6.12
15	Mode Select	6.13
16	Reserve Unit	6.14
17	Release Unit	6.15
19	Erase (D)	6.16
1A	Mode Sense	6.17
1B	Load Unload Unit (D)	6.18

(D) Disconnecting commands

## 6.1 TEST UNIT READY COMMAND (00H)

This command returns the status of the attached tape drive. A good completion status, 00H status byte, indicates the drive is powered-on with cartridge inserted and ready for operation. Figure 6-1 shows the CDB for Test Unit Ready.

Byte	Bit							
	7	6	5	4	3	2	1	0
00	0	0	0	0	0	0	0	0
01	Logical Unit #			0	0	0	0	0
02	0	0	0	0	0	0	0	0
03	0	0	0	0	0	0	0	0
04	0	0	0	0	0	0	0	0
05	0	0	0	0	0	0	0	0

Figure 6-1. Test Unit Ready Command

### 6.1.1 POSSIBLE ERROR STATES

This command could return a Busy or Reservation Conflict status, see Section 5.7 for a description of possible causes.

If this command results in a Check status, the following error codes could be returned from a Request Sense (03H) command:

Sense Key:	Error:	Possible Cause:
2	Unit Not Ready	See Section 6.3.3
4	Hardware Error	See Section 6.3.3
6	Unit Attention	See Section 6.3.3

## 6.2 REWIND COMMAND (01H)

This command rewinds the cartridge tape to the beginning of tape (BOT). Figure 6-2 shows the CDB for the Rewind command.

	Bit							
Byte	7	6	5	4	3	2	1	0
00	0	0	0	0	0	0	0	1
01	Logical Unit #			0	0	0	0	Immed
02	0	0	0	0	0	0	0	0
03	0	0	0	0	0	0	0	0
04	0	0	0	0	0	0	0	0
05	0	0	0	0	0	0	0	0

Figure 6-2. Rewind Command

If the host does not support disconnect and the Immediate bit (byte 01, bit 00) is not set, this command will return a completion status at the end of the rewind process. If the Immediate bit is set, the ACB-3530 will return good completion status at the initiation of rewind. During the rewind, the controller will return a Busy status in response to all commands.

If the host has indicated the ability to disconnect (through the Identify message), the ACB-3530 will disconnect during the rewind process and reconnect to present ending status.

### 6.2.1 POSSIBLE ERROR STATES

This command could return a Busy or Reservation Conflict status, see Section 5.7 for a description of possible causes.

If this command results in a Check status, the following error codes could be returned from a Request Sense (03H) command:

Sense Key:	Error:	Possible Cause:
2	Unit Not Ready	See Section 6.3.3
4	Hardware Error	See Section 6.3.3
6	Unit Attention	See Section 6.3.3

### 6.3 REQUEST SENSE COMMAND (03H)

This command returns Unit Sense information for the specified logical unit. Unit sense can provide the host information regarding a Check status condition, tape access retries, buffer status and tape status. Sense information will be valid for the last Check status sent to the host. Sense data will be cleared upon receiving a subsequent command, from the host that received the Check status. Access attempts from other hosts will result in a Busy status until the Unit Sense information has been cleared. This command, therefore, should always follow a Check status. Figure 6-3 shows the CDB for the Request Sense command.

Byte	Bit							
	7	6	5	4	3	2	1	0
00	0	0	0	0	0	0	1	1
01	Logical Unit #			0	0	0	0	0
02	0	0	0	0	0	0	0	0
03	0	0	0	0	0	0	0	0
04	Number of Bytes							
05	0	0	0	0	0	0	0	0

Figure 6-3. Request Sense command

Number of Bytes (byte 04): This byte specifies the number of bytes allocated by the host for returned Unit Sense information. A value of 0 will default to 4 bytes; it is recommended that 16 bytes be allocated for sense data. The controller will return the exact number of bytes specified.

The sense information returned by this command is detailed in Section 6.3.2.

#### 6.3.1. POSSIBLE ERROR STATES

This command could result in a Busy status, see Section 5.7 for a description of the possible cause.

A Check status will not be returned in response to this command.

### 6.3.2 UNIT SENSE INFORMATION

Sense information returned as a result of the Request Sense command is in the SCSI extended sense format. The sense data will be valid for the Check status just presented to the host. Sense data will be cleared on any subsequent command from the host receiving a Check status. Figure 6-4 shows the format of the sense bytes returned by the ACB-3530.

Byte	Bit							
	7	6	5	4	3	2	1	0
00	Valid	1	1	1	0	0	0	0
01	0	0	0	0	0	0	0	0
02	Filmk	EOM	0	0	Sense Key			
03	(MSB)							
04	- +- +- +- +- +- +- +- -							
05	- +- +- - Block Count - +- +- -							
06								(LSB)
07	# of Additional Bytes (08)							
08	0	CNI	0	WRP	EOM	UDA	BNL	FIL
09	0	0	NDA	0	BOM	0	0	POR
0A	(MSB)							
0B	- +- +- Data Retries Counter +- +-							(LSB)
0C	(MSB)							
0D	- +- +- Underrun Counter +- +-							(LSB)
0E	Current Track							
0F	Blocks to Go Count							

Figure 6-4. Sense Information

Address Valid (Bit 7, Byte 00): This bit set indicates that the information contained in the Block Count bytes (03 - 06) is valid.

File Mark (Bit 7, Byte 02): This bit will be set to indicate that the last block processed was a file mark. Read, Verify and certain Space commands will terminate on a file mark.

End of Media (Bit 6, Byte 02): This bit will be set when the end of physical tape warning is encountered while accessing the last track of the tape.

Sense Key (Bits 0-3, Byte 02): The sense key contains the error code (if any) that caused the last Check status. A detail of possible error codes is contained in Section 6.3.3.

Block Count (Bytes 03-06): The block count contains the number of blocks not processed (written to tape) from all buffered and current commands. The use of block count will vary with the initial command issued. Refer to the individual command detail to determine the meaning of this field. The Block Count is only valid if the Valid bit is set.

The following information, contained in bytes 08 to 0F, provides additional error, controller state and drive state data.

Cartridge Not Inserted, CNI (Bit 6, Byte 08): This bit set indicates the tape cartridge is not inserted.

Write Protect, WRP (Bit 4, Byte 08): This bit set indicates the inserted drive is write protected, inhibiting tape writes.

End of Media, EOM (Bit 3, Byte 08): This bit is set to indicate the end of physical tape warning has been encountered. This bit is identical to bit 6, byte 02.

Unreadable Data Encountered, UDA (Bit 2, Byte 08): This bit set indicates that a block cannot be successfully read or written. The ACB-3530 will retry a read or write 16 times.

Block Not Located, BNL (Bit 1, Byte 08): This bit set indicates that the block the controller is attempting to access, N, cannot be found. This will be reported when blocks N+1 and N+2 are found and not N after 16 attempts. This error may occur during any tape access and when locating the last block on the tape for appending data.

File Mark Encountered, FIL (Bit 0, Byte 08): This bit set indicates that a file mark has been encountered. This bit is identical to bit 7, byte 02.

No Data Detected, NDA (Bit 5, Byte 09): This bit is set to indicate that a span of erased tape has been encountered.

Beginning of Media, BOM (Bit 3, Byte 09): This bit set indicates that the tape is positioned at the physical beginning of the media.

Power On Reset, POR (Bit 0, Byte 09): This bit set indicates that a power-on or SCSI reset has occurred clearing all reservations and commands in process. The sense key, Unit Attention (06) will always be reported with this bit.

Data Retries Counter (Bytes 0A-0B): The Data Retries Counter contains the number of blocks rewritten due to errors during a write operation. During a read operation this counter contains the number of soft and hard errors, causing tape reposition, encountered.

Underrun Counter (Bytes 0C-0D): The Underrun Counter contains the number of times a normal streaming operation was interrupted because of an underrun or overrun of data in the controller buffer.

Current Track (Byte 0E): The Current Track contains the track number, starting at 0, that the read and write heads are currently positioned over.

Blocks To Go (Byte 0F): The Blocks To Go contains the number of blocks that have been written into the buffer and not written to tape from previously completed and current write operations. This information can be used by the host to determine the status of a buffered write.

### 6.3.3 SENSE KEYS

The sense key returned in the Unit Sense information, indicates the error state causing the last Check status. Generally, the sense key should always be checked after a Check status to determine the nature of the operational failure.

The sense keys supported by the ACB-3530 are detailed in Table 6-2.



Table 6-2. ACB-3530 Sense Keys

<u>Sense Key</u>	<u>Error</u>
0	No Sense
1	Recovered Error
2	Device Not Ready
3	Media Error
4	Hardware Error
5	Illegal Request
6	Unit Attention
7	Data Protect
8	Blank Check
9	Not Used
A	Not Used
B	Aborted Command
C	Not Used
D	Volume Overflow
E	Not Used
F	Not Used

No Sense (0): No sense information available. The last command for this LUN was successful. File mark or EOM may have been encountered, the appropriate sense bits will be set.

Recoverable Error (1): The last tape access was successful after retries.

Not Ready (2): The addressed unit cannot be accessed. This can be caused by no cartridge inserted, no power applied to drive, or a faulty QIC-36 cable.

Media Error (3): The last tape access was unsuccessful. This is likely to due to a flaw in the media.

Hardware Error (4): The ACB-3530 detected an uncorrectable hardware error. This is generally caused by the lack of capstan tach pulses from the drive or a faulty QIC-36 cable.

Illegal Request (5): There is an illegal parameter in the CDB or parameter data last transferred to the controller. A Check status condition will be sent immediately after the invalid parameter data byte is transferred. If an illegal byte is contained in the command, a Check status will be reported after the entire CDB is transferred. .pa

Unit Attention (6): The tape cartridge has been changed (removed and reinserted) or a reset has occurred since the last command. This will be returned in response to the first command from each host after the condition is detected. These commands will result in a Check status and not be executed. If this sense key is a result of a device reset, power-on or SCSI, the POR sense bit will be set.

Data Protect (7): A write was attempted to a tape that is write protected.

Blank Check (8): The end of recorded media was encountered during a read. The host has attempted to read beyond the last recorded block number.

Aborted Command (B): The ACB-3530 aborted the command. The command should be reissued by the host.

Volume Overflow (D): A completed, buffered, write has reached the physical EOM before all the data was written to tape. A Recover Buffer Data command (14H) may be issued to recover the data in the buffer.

#### 6.4 READ BLOCK LIMITS COMMAND (05 H)

The Read Block Limits command returns the minimum and maximum block size currently written on the tape. The ACB-3530 supports only 512 byte, QIC-24 and QIC-11, formatted blocks. Both the minimum and maximum block size will equal 512 bytes. Figure 6-5 shows the CDB for the Read Block Limits command.

Byte	Bit							
	7	6	5	4	3	2	1	0
00	0	0	0	0	0	1	0	1
01	Logical Unit #			0	0	0	0	0
02	0	0	0	0	0	0	0	0
03	0	0	0	0	0	0	0	0
04	0	0	0	0	0	0	0	0
05	0	0	0	0	0	0	0	0

Figure 6-5. Read Block Limits Command

Figure 6-6 shows the data returned by the controller in response to this command.

Byte	Bit							
	7	6	5	4	3	2	1	0
00	0	0	0	0	0	0	0	0
01	(MSB)							
02	Maximum Block Length							
03	(LSB)							
04	(MSB)							
05	Minimum Block Length							
	(LSB)							

Figure 6-6. Read Block Limits Data Returned

### 6.4.1 POSSIBLE ERROR STATES

This command could return a Busy or Reservation Conflict status, see Section 5.7 for a description of possible causes.

If this command results in a Check status, the following error codes could be returned from a Request Sense (03H) command:

Sense Key:	Error:	Possible Cause:
2	Unit Not Ready	See Section 6.3.3
4	Hardware Error	See Section 6.3.3
6	Unit Attention	See Section 6.3.3

## 6.5 SET PARAMETERS COMMAND (06H)

The Set Parameters command allows the host to configure the controller to the attached drive and set specific parameters related to read and write operation. Some parameters specified by this command may also be established through the Mode Select command (15H). The controller will use the parameters contained in the last command issued (Set Parameters or Mode Select). Figure 6-7 shows the CDB for the Set Parameters command.

Byte	Bit							
	7	6	5	4	3	2	1	0
00	0	0	0	0	0	1	1	0
01	Logical Unit #				Drive Manufacturer			
02	Number of Tracks							
03	Minimum Block Transfer							
04	0	0	0	0	0	Extnd		fmt
05	0	0	0	0	0	0	0	0

Figure 6-7. Set Parameters Command

**Drive Manufacturer (Bits 0-4, Byte 01):** The characteristics of the capstan tachometer pulses from the tape drive can vary between drive manufacturers. The ACB-3530 can optimize up-to-speed performance when the drive manufacturer is specified. This field is set as follows:

Code:	Manufacturer:
0	Cipher 5 1/4"
1	Wangtec 5 1/4"
2	Archive 5 1/4"
3	300 mS QIC-36 Delay

**Number of Tracks (Byte 02):** This byte specifies the maximum track number supported by the tape drive. The track count begins at 0, therefore a nine track tape would be indicated with an 8 in the byte. This parameter replaces the number of tracks specified by the Mode Select command.

**Minimum Block Transfer (Byte 03):** This byte specifies the minimum number of 512 byte blocks to be transferred to the controller at any one time. This parameter replaces both read and write thresholds specified by the Mode Select command.

In disconnecting systems, this value will determine when the ACB-3530 disconnects and reconnects. The controller will disconnect after transferring the specified number of bytes and reconnect when space is available for this number of blocks. This value is ignored on the last transfer of a command if it is less than the specified minimum.

**Extend Mode (Bit2, Byte 04):** This bit set enables the ACB-3530 to perform extended write. In the extend mode the controller will continue streaming even is a buffer underrun occurs. The controller will continue to write the last block indefinitely until another block of data is available in the buffer, the end of the physical track is reached or a new command is issued. This parameter sets the forced streaming value of the Mode Select command to FF.

**QIC Format (Bit 0, Byte 04):** This bit specifies which QIC format the inserted cartridge utilizes. This bit set to 1 indicates a QIC-11 format, reset to 0 indicates QIC-24. This parameter sets the Density Code of the Mode Select command to 04, for QIC-11, or 05, for QIC-24.

#### 6.5.1 POSSIBLE ERROR STATES

This command could return a Busy or Reservation Conflict status, see Section 5.7 for a description of possible causes.

If this command results in a Check status, the following error codes could be returned from a Request Sense (03<sub>H</sub>) command:

Sense Key:	Error:	Possible Cause:
2	Unit Not Ready	See Section 6.3.3
5	Illegal Request	Minimum block transfer exceeds buffer size.
4	Hardware Error	See Section 6.3.3
6	Unit Attention	See Section 6.3.3

## 6.6 READ COMMAND (08H)

The Read command reads the specified blocks from the attached tape and transfers them to the requesting host. Figure 6-8 shows the CDB for the Read command.

Byte	Bit							
	7	6	5	4	3	2	1	0
00	0	0	0	0	1	0	0	0
01	Logical Unit #			0	0	0	0	1
02	(MSB)							
03	Block Count							
04	(LSB)							
05	0	0	0	0	0	0	0	0

Figure 6-8. Read Command

The reading will begin from the current tape position if the previous command left the tape at position for the read. This can be accomplished by a previous Read, Verify or Space command. Otherwise, the read must begin at BOT, indicated by the BOM bit in Unit Sense information (Section 6.3.2). This can be accomplished by a Rewind command. An attempt to execute a Read command when the above conditions are not met will result in a Check status and an Illegal Request (5) sense key. The read operation will terminate when all requested blocks are transferred, media or hardware errors occur or a file mark or recorded end of tape is encountered.

The ACB-3530 will attempt to cache data on all tape reads. A multiple block Read command will cause the controller to fill the 8K buffer with the next sequential blocks in anticipation of another read. This can be used to facilitate overlapped disk restore operations in non-disconnecting systems by executing a number of tape reads.

In a disconnecting system, the ACB-3530 will disconnect from the host when the buffer becomes empty, during the data transfer. The controller will reconnect when the the buffer has filled to a specified "threshold". This value is set by either the Set Parameters (06H) command, Minimum Number of Blocks byte or the Mode Select (15H) command, Read Threshold byte. A value of 0 in either of these bytes will default to 8 blocks, 4K of data.

A buffer overrun will occur if the host fails to empty the buffer fast enough. In the event of an overrun, the ACB-3530 will reposition the tape and wait for the buffer to become empty to resume reading. This sequence can take up to 2 seconds and can seriously degrade system performance. The host can monitor the frequency of data overruns through the Request Sense (03<sub>H</sub>) command, Underrun Counter.

The ACB-3530 will not transfer blocks containing errors to the host. Unrecoverable read errors will be reported to the host with a Check status and a Media Error (3) sense key. The suggested recovery is to space, 1 block, over the defective block and continue reading.

### 6.5.1 POSSIBLE ERROR STATES

This command could return a Busy or Reservation Conflict status, see Section 5.7 for a description of possible causes.

If this command results in a Check status, the following sense keys could be returned from a Request Sense (03<sub>H</sub>) command:

Sense Key:	Error:	Possible Cause:
0	No Sense	See Section 6.3.3
2	Unit Not Ready	See Section 6.3.3
3	Media Error	See Section 6.3.3
4	Hardware Error	See Section 6.3.3
5	Illegal Request	See Section 6.3.3 Check that bit 0, byte 01 is set. Previous command was a write type command.
6	Unit Attention	See Section 6.3.3
8	Blank Check	See section 6.3.3

The Data Error Counter will be incremented each time the tape must be repositioned to reread a bad block.

The Data Underrun Counter will be incremented each time the tape must be stopped to allow the host to empty the buffer.



## 6.7 WRITE COMMAND (0AH)

The Write command will transfer the specified number of blocks from the host and sequentially write them onto the attached tape. Figure 6-9 shows the CDB for the Write command.

Byte	Bit							
	7	6	5	4	3	2	1	0
00	0	0	0	0	1	0	1	0
01	Logical Unit #			0	0	0	0	1
02	(MSB)							
03	Block Count							
04	(LSB)							
05	0	0	0	0	0	0	0	0

Figure 6-9. Write Command

The write operation is initiated with the controller transferring the first block of data into the buffer at which point the write begins.

The writing will begin from the current tape position if the previous command left the tape at position for the write. This can be accomplished by a previous Write, Write File Mark or Space (to end of recorded media) command. Otherwise, the write must begin at BOT, indicated by the BOM bit in Unit Sense information (Section 6.3.2). This can be accomplished by a Rewind or Erase command. Any attempt to execute a Write command without the above conditions met will result in a Check status and an Illegal Request (5) sense key. The write operation will terminate when all requested blocks are transferred, media or hardware errors occur or physical end of tape (Section 6.7.2) is encountered.

The ACB-3530 supports two modes of write operation; buffered and non-buffered. The mode used is specified by the Mode Select (15<sub>H</sub>) command. The non-buffered mode will not present a completion status until all the blocks have been written to tape and verified. The buffered mode will present a completion status as the last block to be written has been transferred into the controller buffer.

The controller buffer is configured for 15 blocks of buffered write data.

The **buffered mode** is invoked through the Mode Select (15<sub>H</sub>) command. It has been implemented on the ACB-3530 to help facilitate streaming back-up in a non-disconnecting system. Once the host has filled the controller buffer and a completion status and message has been issued, the host has approximately 60-70mS to reissue the next sequential write operation. This time allows the host to obtain additional disk data. The next write will refill the buffer as space becomes available until the last block is transferred, when completion is again issued. If an error is encountered on writing buffered data for which a good completion status has already been issued, a Check status will be posted on the next tape access from the same host. See Section 6.7.3 for proper recovery.

The **non-buffered mode** is generally used with a disconnecting system. The ACB-3530 will disconnect from the host when the buffer becomes full. The controller will reconnect when the buffer is emptied to a specified "threshold". This value is set through the Set Parameters (06<sub>H</sub>) command, Minimum Number of Blocks byte or the Mode Select (15) command, Write Threshold byte. The parameters contained within the last of these two issued will be used. A value of 0 in either of these bytes will result in a default of 8 blocks, 4K of data. The controller will report a completion status when the last block has been written to tape and verified.

#### 6.7.1 FORCED STREAMING

The ACB-3530 will attempt to keep the tape streaming on all write operations if a buffer underrun occurs in the forced streaming mode. A buffer underrun occurs during a buffered or non-buffered write operation when the host is not capable of transferring the blocks specified by the Write command into the controller buffer fast enough to supply the tape write. In the event of a buffer underrun the ACB-3530 will continue to stream the tape by continuously rewriting the last block. This forced streaming will continue for a maximum of the number of blocks specified in the Mode Select, Forced Streaming byte or until the end of the track, if the Set Parameters, Extend bit is set. The parameters in the last of these two commands issued will be used. Once the next block is available in the buffer, the controller will resume the write operation.

### 6.7.2 ENCOUNTERING END OF MEDIA

The host will be informed of the end of media when the early warning is detected by the ACB-3530. The current block written will be completed and a Check status will be posted with the EOM bit set in Unit Sense information and a Volume Overflow (D) sense key. The Block Count will contain the number of blocks, for the current and all previous commands, not written to tape. In the buffered mode, the Check status will be posted with the next access to the tape from the same host. Buffered data, completed but not yet written to tape can be recovered as detailed in Section 6.7.3.

The tape will typically hold some additional number of blocks between early warning and the physical end of tape. If necessary, additional blocks or file marks can be written, one at a time, until the end of tape is reached. Multiple block writes will result in a Check status with an Illegal Request sense key. Single block writes will terminate with a Check status with the EOM bit set and a No Sense (0) sense key. The number of additional blocks written should not exceed 5. When a block write is interrupted by the physical EOM, a Check status will be posted with the EOM bit set and a Media Error (3) sense key. Since the interrupted block has not been verified it is not recoverable.

### 6.7.3 WRITE ERRORS DURING BUFFERED MODE

Recovering from errors encountered while writing data for which a good completion status has already been issued can be problematic. The ACB-3530 provides the host the capability to effectively recover from these errors. Upon encountering an error state, the controller will post a Check status. If write data from a write operation is currently being written into the buffer, the transfer will be interrupted with a Check status. If no subsequent command has been issued, a Check status will be posted with the next command from the same host. The related sense key will indicate the cause of the error state. Any attempts from another host to access the controller when an outstanding Check status is present, will result in a Busy status to that host.

Assuming that a subsequent command has transferred data into the buffer and is interrupted by a Check status, the host can determine which blocks have been written to tape and recover the data in the buffer.

To determine how many blocks have been written to the tape, the host should issue a Request Sense command to determine the Block Count. This value reports the number of blocks from the current and all previously buffered write commands that have not been written to tape. The Blocks to GO value (BYTE 0F) reflects the same information.

When the host determines the residue block count of the previous buffered and current commands, a Recover Buffer Data (14<sub>H</sub>) command can be used to read the buffer data back into the host. This command will return all bytes left in the buffer from the current and all previous commands. The number of blocks specified in the command should equal the number of blocks in the buffer to assure all buffered data will be recovered, however more than one command can be used to recover all of the data. If the number of blocks transferred is less than the number specified, the ACB-3530 will present a Check status with the EOM bit set and a No Sense (0) sense key when the last block available in the buffer has been transferred. The Block Count in the Unit Sense information contains the difference between the number of blocks specified and number recovered. See description of Recover Buffer Data command, Section 6.12, for further details.

Once the data has been recovered, a Write File Mark (10<sub>H</sub>) command is required to flush the buffer and resume normal write operations.

#### 6.7.4 MEDIA DEFECT HANDLING

The ACB-3530 checks each block on the tape for good CRC as it is being written. However, since the tape read head trails the write head by about 300 bytes, the CRC results for a given block (block N) are not known until after the next block write (N+1) has begun. The controller, therefore, assumes that the previous block will check correctly and begins writing the next block. A block will not be considered transferred to tape until a successful CRC check is completed.

If the CRC check should fail, typically due to a media defect, the ACB-3530 will complete the current block write (N+1) and then rewrite the previous block (N). This alternation between N and N+1 will continue until a successful CRC check of block N is achieved or 16 unsuccessful writes have been attempted. If block N were the last block to be written, it would be repeated until a good CRC check is made. This results in the last block of each write to be written at least twice. After 16 unsuccessful attempts, a Check status will be posted with a Media Error (3) sense key.

#### 6.7.5 POSSIBLE ERROR STATES

This command could return a Busy or Reservation Conflict status, see Section 5.7 for a description of possible causes.

If this command results in a Check status, the following sense keys could be returned from a Request Sense (03<sub>H</sub>) command:

Sense Key:	Error:	Possible Cause:
0	No Sense	See Section 6.3.3 Writing at EOM
2	Unit Not Ready	See Section 6.3.3
3	Media Error	See Section 6.3.3
5	Illegal Request	See Section 6.3.3 Check that bit 0, byte 01 is set. Previous command was a read type command.
4	Hardware Error	See Section 6.3.3
6	Unit Attention	See Section 6.3.3
7	Data Protect	See Section 6.3.3 Cartridge write protect.
D	Volume Overflow	See Section 6.3.3 Writing at EOM.

The Data Error Counter will be incremented for each block that must be rewritten due to a CRC error.

The Data Underrun Counter will be incremented each time the tape must be stopped to allow the host to fill the buffer.

## 6.8 Write File Mark Command (10H)

The Write File Mark command writes the specified number of file mark blocks to the tape, starting from the current tape position. File marks are used by the host for file management by partitioning areas of the tape with one or more sequential file marks. Figure 6-10 shows the CDB for the Write File Mark command.

		Bit							
Byte		7	6	5	4	3	2	1	0
00		0	0	0	1	0	0	0	0
01		Logical Unit #			0	0	0	0	0
02		0	0	0	0	0	0	0	0
03		0	0	0	0	0	0	0	0
04		File Mark Count							
05		0	0	0	0	0	0	0	0

Figure 6-10. Write File Mark command

The number of sequential file marks specified by the File Mark Count will be written to the tape. The file mark write will begin at the current tape position if the previous command left the tape at position for the write. This can be accomplished by a previous Write, Write File Mark or Space (to end of recorded media). Otherwise, the file mark write must begin at BOT, indicated by the BOM bit in Unit Sense information (Section 6.3.2). This can be accomplished by a Rewind or Erase command. Any attempt to execute a Write File Mark command without the above conditions met will result in a Check status and an Illegal Request (5) sense key. The write operation will terminate when all requested file mark blocks are transferred, media or hardware errors occur or physical end of tape (Section 6.6.2) is encountered.

A File Mark Count of 0 will result in no file marks to be written however, the command will not be completed until all buffered data from a previous Write command is transferred to tape. This may be used to insure that the last buffered write transfers to tape successfully.

In a disconnecting system, the ACB-3530 will disconnect on file mark writes. The controller will reconnect to present command completion.

### 6.8.2 POSSIBLE ERROR STATES

This command could return a Busy or Reservation Conflict status, see Section 5.7 for a description of possible causes.

If this command results in a Check status, the following sense keys could be returned from a Request Sense (03H) command:

Sense Key:	Error:	Possible Cause:
0	No Sense	See Section 6.3.3 Writing at EOM
2	Unit Not Ready	See Section 6.3.3
3	Media Error	See Section 6.3.3
5	Illegal Request	See Section 6.3.3 Previous command was a read type command.
4	Hardware Error	See Section 6.3.3
6	Unit Attention	See Section 6.3.3
7	Data Protect	See Section 6.3.3 Cartridge write protected.
D	Volume Overflow	See Section 6.3.3 Writing at EOM.

The Data Error Counter will be incremented for each file mark that must be rewritten due to a CRC error.

The Data Underrun Counter will be incremented once when tape repositions after the last file mark is written.

## 6.9 SPACE COMMAND (11H)

The Space command is used to change the physical location of the tape in either the forward or reverse direction. This command is the only command that can be used to place the tape at position for both a read and write operation. Figure 6-11 shows the CDB for the Space command.

Byte	Bit							
	7	6	5	4	3	2	1	0
00	0	0	0	1	0	0	0	1
01	Logical Unit #			0	0	0	Search Code	
02	(MSB)							
03				Space Count (N)				
04								(LSB)
05	0	0	0	0	0	0	0	0

Figure 6-11. Space command

The type of tape positioning is specified by the Search Code. The direction and amount of tape motion is specified by the Space Count value, N. A positive N will result in a forward motion, a negative N will result in a reverse motion. Negative N values are represented in 2's complement notation. A zero value will result in no tape motion.

The Space command allows the host to space across blocks, file marks or to the end of recorded media depending on the Search Code. The definition of each Search Code, 0 through 3, is shown in Table 6-3.

Table 6-3. Space Search Codes

<u>Search Code</u>	<u>Space Function</u>
0	Space Blocks
1	Space File Marks
2	Space Sequential File Marks
3	Space to End of Recorded Media



Search Code = 0: Space blocks. Space over N blocks, either forward or reverse depending on the sign of N. The space will terminate when the specified number of blocks have been passed, with a good completion. If EOT, BOT, a file mark, or end of recorded media is encountered, a Check status will be posted with the appropriate sense bits set.

A forward space will complete with the tape positioned at the end of the last block spaced or a file mark encountered.

A reverse space will complete with the tape positioned at the beginning of the last block spaced. The ACB-3530 does not search for file marks on a reverse space, any encountered will be treated as data blocks. Reverse spaces are limited to 128 blocks (Space Code = FFFF80<sub>H</sub>).

Search Code = 1: Space File Marks. Space over N file marks in forward direction, toward EOT (a space in the reverse direction will result in tape motion to BOT, no file marks will be found). The space will terminate when the specified number of file marks have been spaced with a good completion. If EOT, BOT or end of recorded media is encountered, a Check status will be posted with the appropriate sense bits set.

The space will complete with the tape positioned at the end of the last file mark spaced.

Search Code = 2: Space Sequential File Marks. Spaces the tape forward until the next occurrence of N sequential file marks. Only positive counts are supported. The space will terminate when the specified number of sequential file marks have been encountered with a good completion. If EOT or end of recorded media is encountered, a Check status will be posted with the appropriate sense bits set.

The space will complete with the tape positioned at the end of the last of the sequential file marks encountered.

Search Code = 3: Space to End of Recorded Media. Spaces the tape to the end of the recorded media. The tape is left in the position to append data to the last block written. The Space Count field is ignored.

A multiple block space operation will reread blocks with CRC errors until a good read is accomplished. Single block spaces will bypass CRC errors after 16 retries. This allows the host to space past bad blocks on prewritten tapes.

On systems that support disconnection, the ACB-3530 will disconnect during lengthy tape motion and reconnect to present completion status.

### 6.9.2 POSSIBLE ERROR STATES

This command could return a Busy or Reservation Conflict status, see Section 5.7 for a description of possible causes.

If this command results in a Check status, the following sense keys could be returned from a Request Sense (03H) command:

Sense Key:	Error:	Possible Cause:
0	No Sense	See Section 6.3.3 EOM encountered
2	Unit Not Ready	See Section 6.3.3
3	Media Error	See Section 6.3.3
5	Illegal Request	See Section 6.3.3
4	Hardware Error	See Section 6.3.3
6	Unit Attention	See Section 6.3.3
D	Volume Overflow	See Section 6.3.3 Spacing past BOT or EOT

The Data Error Counter will be incremented each time the tape must be repositioned to re-read a bad block.

The Data Underrun Counter will be incremented once when tape repositions after the last space.

## 6.10 INQUIRY COMMAND (12<sub>H</sub>)

The Inquiry command passes information regarding the controller and attached device type to support self configuring systems. The CDB for the Inquiry command is shown in figure 6-12.

Byte	Bit							
	7	6	5	4	3	2	1	0
00	0	0	0	1	0	0	1	0
01	Logical Unit #			0	0	0	0	0
02	0	0	0	0	0	0	0	0
03	0	0	0	0	0	0	0	0
04	Number of Blocks							
05	0	0	0	0	0	0	0	0

Figure 6-12. Inquiry Command

The number of bytes allocated by the host to be returned as Inquiry data is specified in block 04. A value of zero will result in no data transferred. The total number of bytes available is 18 (decimal). Figure 6-13 shows the returned Inquiry data.

The Inquiry data indicates:

Device Type Code=01	Sequential Access
Device Type Qualifier=80	Removable
ACB-3530 Firmware Rev.	Firmware rev. in X.Y
Number of Buffered Read Blocks	16 (decimal)
Number of Buffered Write Blocks	15 (decimal)
Adaptec Identifier	A-D-A-P-T-E-C in ASCII
Product Identifier	01 <sub>H</sub> indicates ACB-3530

Byte	Bit							
	7	6	5	4	3	2	1	0
00	Device Type Code (01)							
01	Device Type Qualifier (80)							
02	0	0	0	0	0	0	0	0
03	0	0	0	0	0	0	0	0
04	Number of Additional Bytes (0CH)							
05	0	0	0	0	0	0	0	0
06	ACB-3530 Firmware Revision Level							
07	0	0	0	0	0	0	0	0
08	Number of Buffered Read Blocks (10H)							
09	Number of Buffered Write Blocks (0FH)							
0A : : 10	Adaptec Inc. Identifier							
11	Product Identifier (01H)							

Figure 6-13. Inquiry Data

**6.10.1 POSSIBLE ERROR STATES**

This command could return a Busy or Reservation Conflict status, see Section 5.7 for a description of possible causes.

If this command results in a Check status, the following sense keys could be returned from a Request Sense (03H) command:

Sense Key:	Error:	Possible Cause:
4	Hardware Error	See Section 6.3.3
6	Unit Attention	See Section 6.3.3

## 6.11 VERIFY COMMAND (13H)

The Verify command performs a CRC check on the number of blocks specified. The controller only performs a CRC check, no data is transferred to the host. Figure 6-14 shows the CDB for the Verify command.

Byte	Bit							
	7	6	5	4	3	2	1	0
00	0	0	0	1	0	0	1	1
01	Logical Unit #			0	0	0	0	1
02	(MSB)							
03	Block Count							
04	(LSB)							
05	0	0	0	0	0	0	0	0

Figure 6-14. Verify command

The verify will begin from the current tape position if the previous command left the tape at position. This can be accomplished by a previous Read, Verify or Space command. Otherwise, the verify MUST begin at BOT, indicated by the BOM bit in Unit Sense information (Section 6.3.2). This can be accomplished by a Rewind command. An attempt to execute a Read command when the above conditions are not met will result in a Check status and an Illegal Request (5) sense key. The operation will terminate when all requested blocks are transferred, media or hardware errors occur or a file mark, recorded end of tape or physical end of tape is encountered.

The command will verify the CRC on one or more blocks on the tape starting next block from the current position. The verification will terminate when the specified number of blocks have been verified, a file mark is encountered or EOT is encountered. If termination occurs before the block count is reached, the Unit Sense information will contain the remaining number of blocks.

The controller will place the tape at the end of the last block verified or file mark encountered prior to completion.

### 6.11.1 POSSIBLE ERROR STATES

This command could return a Busy or Reservation Conflict status, see Section 5.7 for a description of possible causes.

If this command results in a Check status, the following sense keys could be returned from a Request Sense (03H) command:

Sense Key:	Error:	Possible Cause:
0	No Sense	See Section 6.3.3
2	Unit Not Ready	See Section 6.3.3
3	Media Error	See Section 6.3.3
5	Illegal Request	See Section 6.3.3 Check that bit 0, byte 01 is set. Previous command was a write type command.
4	Hardware Error	See Section 6.3.3
6	Unit Attention	See Section 6.3.3
7	Data Protect	See Section 6.3.3
D	Volume Overflow	See Section 6.3.3 Verifying at EOM.

The Data Error Counter will be incremented each time the tape must be repositioned to re-read a bad block.

The Data Underrun Counter will be incremented once when tape repositions after the last space.

## 6.12 RECOVER BUFFER DATA COMMAND (14H)

The Recover Buffer Data command is used to recover data left in the buffer as a result of an error occurring during a write operation. This command will return all buffer data from previously completed and current commands not yet written to tape and verified. Figure 6-15 shows the CDB for the Recover Buffer Data command.

Byte	Bit							
	7	6	5	4	3	2	1	0
00	0	0	0	1	0	1	0	0
01	Logical Unit #			0	0	0	0	1
02	(MSB)							
03	Block Count							
04	(LSB)							
05	0	0	0	0	0	0	0	0

Figure 6-15. Recover Buffer Data command

The data will be transferred in the order that it would have been written to tape.

The Block Count can be set to the maximum buffer size to assure all buffered data is recovered. If a smaller count is used, multiple Recover Buffer Data commands can be used. If the Block Count exceeds the number of blocks available, a Check Status will be posted with a No Sense (0) sense key. The EOM bit will be set and the Unit Sense information Block Count will contain the difference between the number of blocks specified and transferred.

### 6.12.1 POSSIBLE ERROR STATES

This command could return a Busy or Reservation Conflict status, see Section 5.7 for a description of possible causes.

If this command results in a Check status, the following sense keys could be returned from a Request Sense (03H) command:

Sense Key:	Error:	Possible Cause:
0	No Sense	See Section 6.3.3 Block Count exceeded data available (EOM bit set)
2	Unit Not Ready	See Section 6.3.3
5	Illegal Request	See Section 6.3.3 Check that bit 0, byte 01 is set.
6	Unit Attention	See Section 6.3.3 Spacing past BOT or EOT



### 6.13 MODE SELECT COMMAND (15H)

The Mode Select command is used by the host to configure the ACB-3530 for the desired operational parameters. Some parameters can also be specified by the Set Parameters (06H) command. The overlapping values will be used from the last command issued. Figure 6-16 shows the CDB for the Mode Select command.

Byte	Bit							
	7	6	5	4	3	2	1	0
00	0	0	0	1	0	1	0	1
01	Logical Unit #			0	0	0	0	0
02	0	0	0	0	0	0	0	0
03	0	0	0	0	0	0	0	0
04	Number of Bytes							
05	0	0	0	0	0	0	0	0

Figure 6-16. Mode Select command

The Number of Bytes specifies the number of bytes of configuration data to be sent to the controller. A minimum of 3 bytes must be sent for any meaningful data, however less than 3 is not an error state. It is recommended that the host provide 17 bytes of data for full configuration. Figure 6-17 shows the Mode Select configuration data block.

The Mode Select configuration data is defined as follows:

**Buffered Mode (bit 4, byte 02):** This bit set invokes the buffered mode of write operation. Good completion status and message will be transferred by the controller when the last byte of write data is transferred into the controller buffer. An error encountered will be posted with the next command. (See Section 6.7, Write command, for additional details)

**Density Code (byte 04):** This byte specifies the QIC format of the inserted tape. This can be overridden by the Set Parameters command. The density codes supported are:

Density Code:	00	QIC Format:	QIC-24 (default)
	04		QIC-11
	05		QIC-24

**Block Size (byte 0A-0B):** These bytes specify the formatted block size on the tape. This must be set to 512 (02,00H).

Byte	Bit							
	7	6	5	4	3	2	1	0
00	0	0	0	0	0	0	0	0
01	0	0	0	0	0	0	0	0
02	0	0	0	BufMd	0	0	0	0
03	Length of Extent Descriptor List (08H)							

#### Extent Descriptor List

04	Density Code							
05	0	0	0	0	0	0	0	0
06	0	0	0	0	0	0	0	0
07	0	0	0	0	0	0	0	0
08	0	0	0	0	0	0	0	0
09	0	0	0	0	0	0	0	0
0A	(MSB)							
0B	- +- +- +- Block Size - +- +- (LSB)							

#### Operational Mode Parameters

0C	Operational Code (04H)							
0D	Number of Tracks							
0E	Read Threshold							
0F	Write Threshold							
10	Forced Streaming Count							

Figure 6-17. Mode Select Configuration Data Block

The following fields define the operational mode of the ACB-3530:

**Number of Tracks (byte 0D):** This byte configures the controller to the number of tracks on the inserted tape. Track counts supported are 04 or 09, a value of 00 in this byte will default the controller to the configuration jumper A-B (see Section 3.4). This can be overridden by the Set Parameters command Number of Tracks value.

**Read Threshold (byte 0E):** This byte sets the buffer threshold for when the controller will reconnect on disconnecting read operations. The threshold value specifies the number of blocks that must be available to transfer to the host before reconnection. A read operation can buffer up to 16 blocks. A zero in this field will default to 8. A value greater than 16 will default to 15. This can be overridden by the Set Parameters command Minimum Number of Blocks value.

**Write Threshold (byte 0F):** This byte sets the buffer threshold for when the controller will reconnect on disconnecting write operations. The threshold value specifies the number of blocks that must be free in the buffer before the controller will reconnect and request write data. A write operation can buffer up to 15 blocks. A zero in this field will default to 8 blocks. A value greater than 15 will default to 14. This can be overridden by the Set Parameters command Minimum Number of Blocks value.

**Forced Streaming Count (byte 10):** This byte specifies the number of time the controller will rewrite the last block during a write operation in the event of a buffer underrun. A zero in this field will default to one block. A value of FF will result in a forced stream to the end of a track. An overriding Set Parameters command with the Extend bit set will set this field to FF.

#### 6.13.1 POSSIBLE ERROR STATES

This command could return a Busy or Reservation Conflict status, see Section 5.7 for a description of possible causes.

If this command results in a Check status, the following sense keys could be returned from a Request Sense (03<sub>H</sub>) command:

Sense Key:	Error:	Possible Cause:
2	Unit Not Ready	See Section 6.3.3
6	Unit Attention	See Section 6.3.3

## 6.14 RESERVE UNIT COMMAND (16H)

The Reserve Unit command will reserve the attached tape drive for the exclusive use of the requesting host. The reservation is released by a Release command (17H) or a power-on or SCSI reset. Figure 6-18 shows the CDB for the Reserve command.

	Bit							
Byte	7	6	5	4	3	2	1	0
00	0	0	0	1	0	1	1	0
01	Logical Unit #			0	0	0	0	0
02	0	0	0	0	0	0	0	0
03	0	0	0	0	0	0	0	0
04	0	0	0	0	0	0	0	0
05	0	0	0	0	0	0	0	0

Figure 6-18. Reserve Unit command

An attempted access to a drive with an active reservation from another host will result in a Reservation Conflict status.

### 6.14.1 POSSIBLE ERROR STATES

This command could return a Busy or Reservation Conflict status, see Section 5.7 for a description of possible causes.

If this command results in a Check status, the following sense keys could be returned from a Request Sense (03H) command:

Sense Key:	Error:	Possible Cause:
2	Unit Not Ready	See Section 6.3.3
6	Unit Attention	See Section 6.3.3

## 6.15 RELEASE UNIT COMMAND (17H)

The Release Unit command releases a drive reservation invoked by the same host. Figure 6-19 shows the CDB for the Release Unit command.

	Bit							
Byte	7	6	5	4	3	2	1	0
00	0	0	0	1	0	1	1	1
01	Logical Unit #			0	0	0	0	0
02	0	0	0	0	0	0	0	0
03	0	0	0	0	0	0	0	0
04	0	0	0	0	0	0	0	0
05	0	0	0	0	0	0	0	0

Figure 6-19. Release Unit Command

A Release Unit command to a drive that has an active reservation from another host will result in a Reservation Conflict status.

### 6.15.1 POSSIBLE ERROR STATES

This command could return a Busy or Reservation Conflict status, see Section 5.7 for a description of possible causes.

If this command results in a Check status, the following sense keys could be returned from a Request Sense (03H) command:

Sense Key:	Error:	Possible Cause:
2	Unit Not Ready	See Section 6.3.3
6	Unit Attention	See Section 6.3.3

## 6.16 ERASE COMMAND (19H)

The Erase command will erase the entire tape inserted. The drive erase head covers the entire tape, all tracks will be erased in one forward motion from the beginning of track 0 to the physical end of track 0. Figure 6-20 shows the CDB for the Erase command.

	Bit							
Byte	7	6	5	4	3	2	1	0
00	0	0	0	1	1	0	0	1
01	Logical Unit #			0	0	0	0	1
02	0	0	0	0	0	0	0	0
03	0	0	0	0	0	0	0	0
04	0	0	0	0	0	0	0	0
05	0	0	0	0	0	0	0	0

Figure 6-20. Erase Command

The erase operation must begin at BOT. An attempt to erase a tape not at BOT will result in a Check status with an Invalid Request sense key.

If the host has indicated the ability to disconnect (through the Identify message), the ACB-3530 will disconnect during the erase process and reconnect to present ending status.

### 6.16.1 POSSIBLE ERROR STATES

This command could return a Busy or Reservation Conflict status, see Section 5.7 for a description of possible causes.

If this command results in a Check status, the following sense keys could be returned from a Request Sense (03H) command:

Sense Key:	Error:	Possible Cause:
2	Unit Not Ready	See Section 6.3.3
4	Hardware Error	See Section 6.3.3
5	Illegal Request	See Section 6.3.3 Check that bit 0, byte 01 is set. Tape not at BOT
6	Unit Attention	See Section 6.3.3
7	Data Protect	See Section 6.3.3

## 6.17 MODE SENSE COMMAND (1AH)

The Mode Sense command will return the configuration parameters set by the Mode Select or Set Parameters command to the host. Figure 6-19 shows the CDB for the Mode Sense command.

Byte	Bit							
	7	6	5	4	3	2	1	0
00	0	0	0	1	1	0	1	0
01	Logical Unit #			0	0	0	0	0
02	0	0	0	0	0	0	0	0
03	0	0	0	0	0	0	0	0
04	Number of Bytes							
05	0	0	0	0	0	0	0	0

Figure 6-21. Mode Sense Command

The number of bytes specifies how many bytes will be returned by the controller. The format data returned is the same as the Mode Select Configuration Data (see Section 6.13, Mode Select command). The entire configuration data length is 17 blocks. If a Set Parameters command has been issued last, the overlapping parameters will reflect the Set Parameters values in the Mode Select value convention.

### 6.17.1 POSSIBLE ERROR STATES

This command could return a Busy or Reservation Conflict status, see Section 5.7 for a description of possible causes.

If this command results in a Check status, the following sense keys could be returned from a Request Sense (03<sub>H</sub>) command:

Sense Key:	Error:	Possible Cause:
2	Unit Not Ready	See Section 6.3.3
4	Hardware Error	See Section 6.3.3
6	Unit Attention	See Section 6.3.3



## 6.18 LOAD/UNLOAD UNIT COMMAND (1B<sub>H</sub>)

The Load/Unload command is used by the host to prepare the tape for insertion or removal. This command allows the host to place the tape at BOT or EOT and to retension the tape. Figure 6-20 shows the CDB for the Load/Unload command.

Byte	Bit							
	7	6	5	4	3	2	1	0
00	0	0	0	1	1	0	1	0
01	Logical Unit #			0	0	0	0	Immed
02	0	0	0	0	0	0	0	0
03	0	0	0	0	0	0	0	0
04	0	0	0	0	0	0	ReTen	Load
05	EOT	0	0	0	0	0	0	0

Figure 6-22. Load/Unload Command

The specific function of the Load/Unload command is determined by the Retension, Load and EOT bits. The definition of each function is as follows:

**Retension (bit 1, byte 04):** This bit set will cause the controller to retension the tape prior to any load or unload function. A tape retension consists of a rewind to BOT, motion to EOT and a rewind back to BOT. This is recommended prior to writing to a new or stored tape.

**Load = 1 (bit 0, byte 04):** This bit set indicates a load function. To properly initialize to inserted drives (without power-on reset), this function will cause the controller to position the tape at BOT and determine tape length for proper write current.

**Load = 0 (bit 0, byte 04):** This bit and the Retension bit cleared indicates an unload function. This function will cause the controller to position the tape at BOT or EOT (see EOT bit below)

**EOT = 1 (bit 7 byte 05):** This bit in an unload operation will result in the tape being positioned at EOT. This bit cleared will position the tape at BOT.

If the host does not support disconnect and the Immediate bit (byte 01, bit 00) is not set, this command will return a completion status at the end of the load/unload process. If the Immediate bit is set, the ACB-3530 will return good completion status at the initiation of load/unload. During the operation, the controller will return a Busy status in response all commands.

If the host has indicated the ability to disconnect (through the Identify message), the ACB-3530 will disconnect during tape motion and reconnect to present ending status.

#### 6.18.1 POSSIBLE ERROR STATES

This command could return a Busy or Reservation Conflict status, see Section 5.7 for a description of possible causes.

If this command results in a Check status, the following sense keys could be returned from a Request Sense (03H) command:

Sense Key:	Error:	Possible Cause:
2	Unit Not Ready	See Section 6.3.3
4	Hardware Error	See Section 6.3.3
6	Unit Attention	See Section 6.3.3



**adaptec, inc.**

580 Cottonwood Drive, Milpitas, California 95035 Telephone (408) 946-8600

400112-00/AB/SB/BOFORS Printed in U.S.A.