

AUGUST 1986

# Mini-Micro Systems

THE MAGAZINE FOR COMPUTER SYSTEMS INTEGRATION

A CAHNERS PUBLICATION

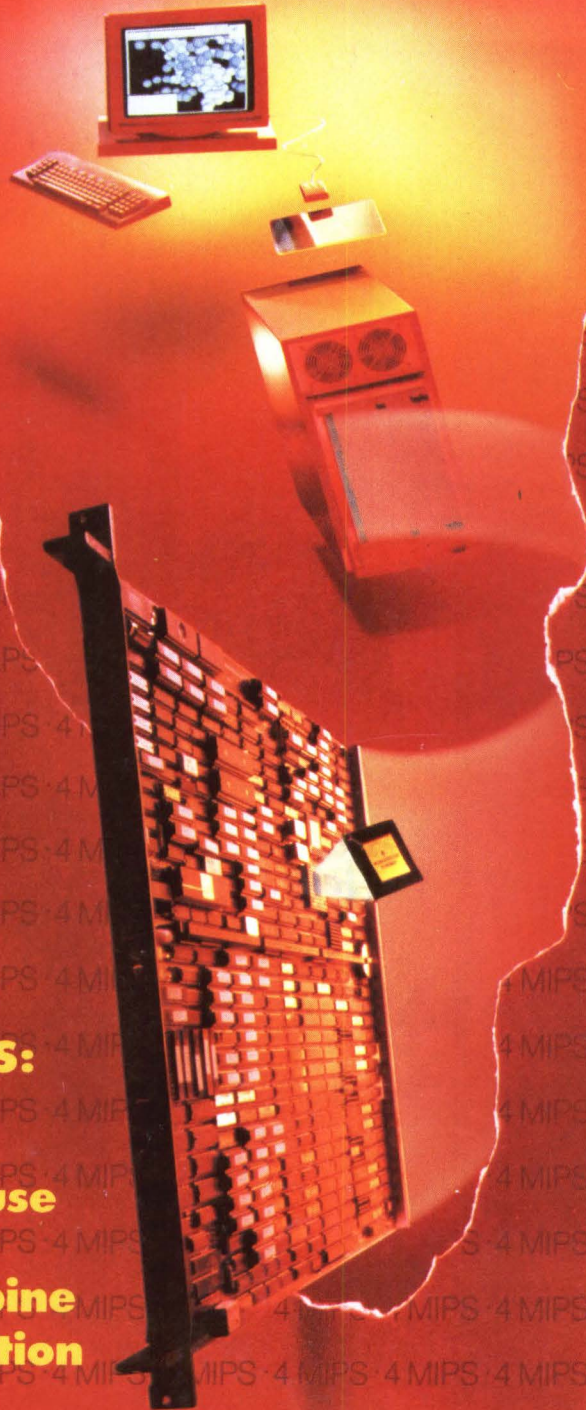

## SPECIAL REPORTS:

- **AI shapes up for mainstream use**

- **Compilers combine maturity, innovation**

- **Added functionality sparks STDbus rebirth**

- **Already potent PC/ATs gain power, versatility**

## Sun Microsystems doubles speed with 4-MIPS workstations

# HOW TO STAY ON TOP OF THE CHARTS.

One thing is certain. You have to present a quality image. And you have to maintain it with absolute consistency.

That's why you should look into the new Seiko Hardcopier. You can get a variety of output sizes. With strong vibrant colors and clear, sharp lines on both paper and transparency.

Plus you can get those copies in as little as 45 seconds each. For a lot less money than you thought possible.

The Seiko Hardcopier can make a hundred copies for you off-line. Because its frame buffer holds the image data

and frees your terminal. You just set the quantity you want and go on working.

You even get independent image control at the hardcopier. You can change colors without changing the image on the screen. And get hardcopy or overheads that look great even if the colors on the display aren't quite right for presentation purposes.

So make one phone call. We'll present you with the whole quality story. And make sure you have the hardcopier that will keep you on top of the charts.

Call Martin Nelson  
at (408) 943-9100  
today.

**SEIKO**   
INSTRUMENTS

© 1986 Seiko Instruments U.S.A., Inc.

CIRCLE NO. 1 ON INQUIRY CARD

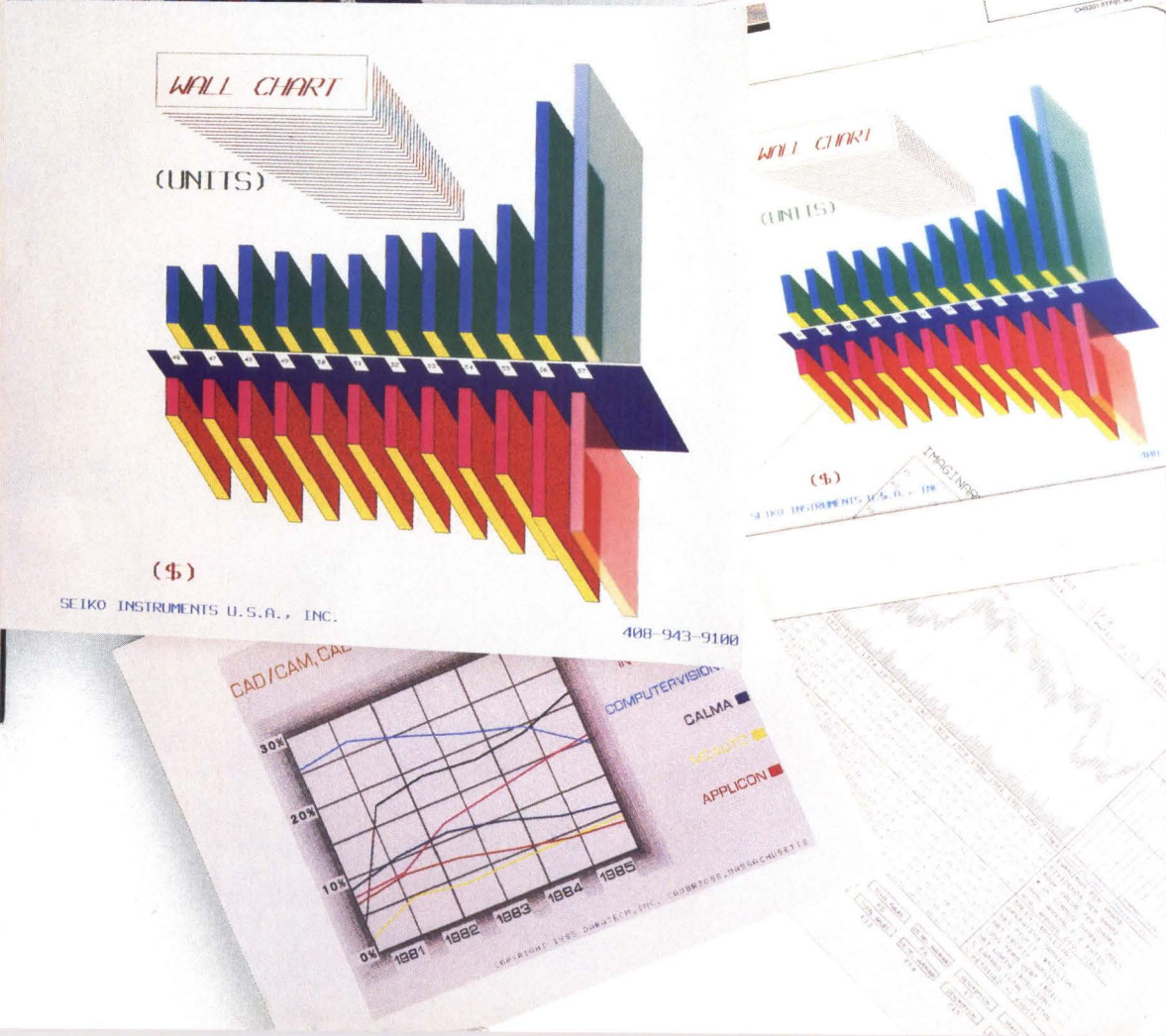
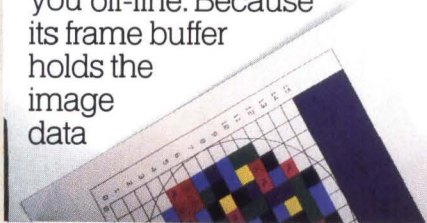
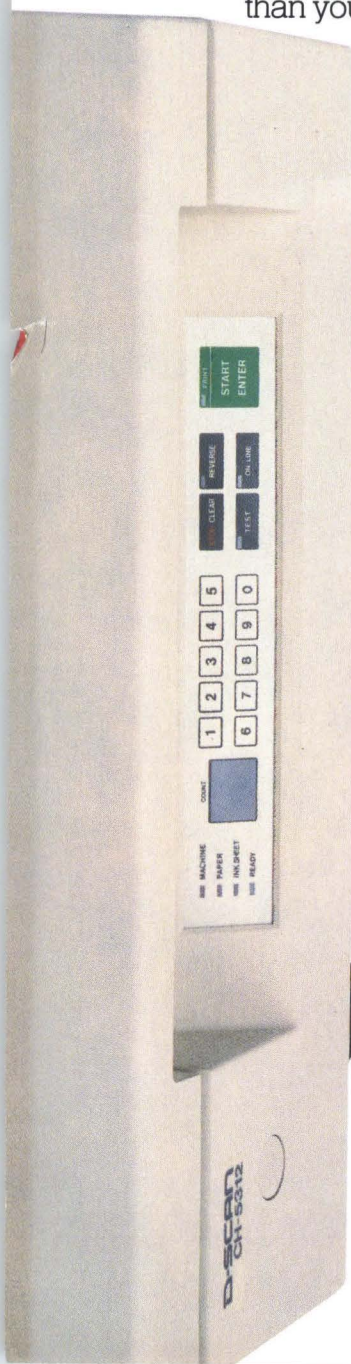

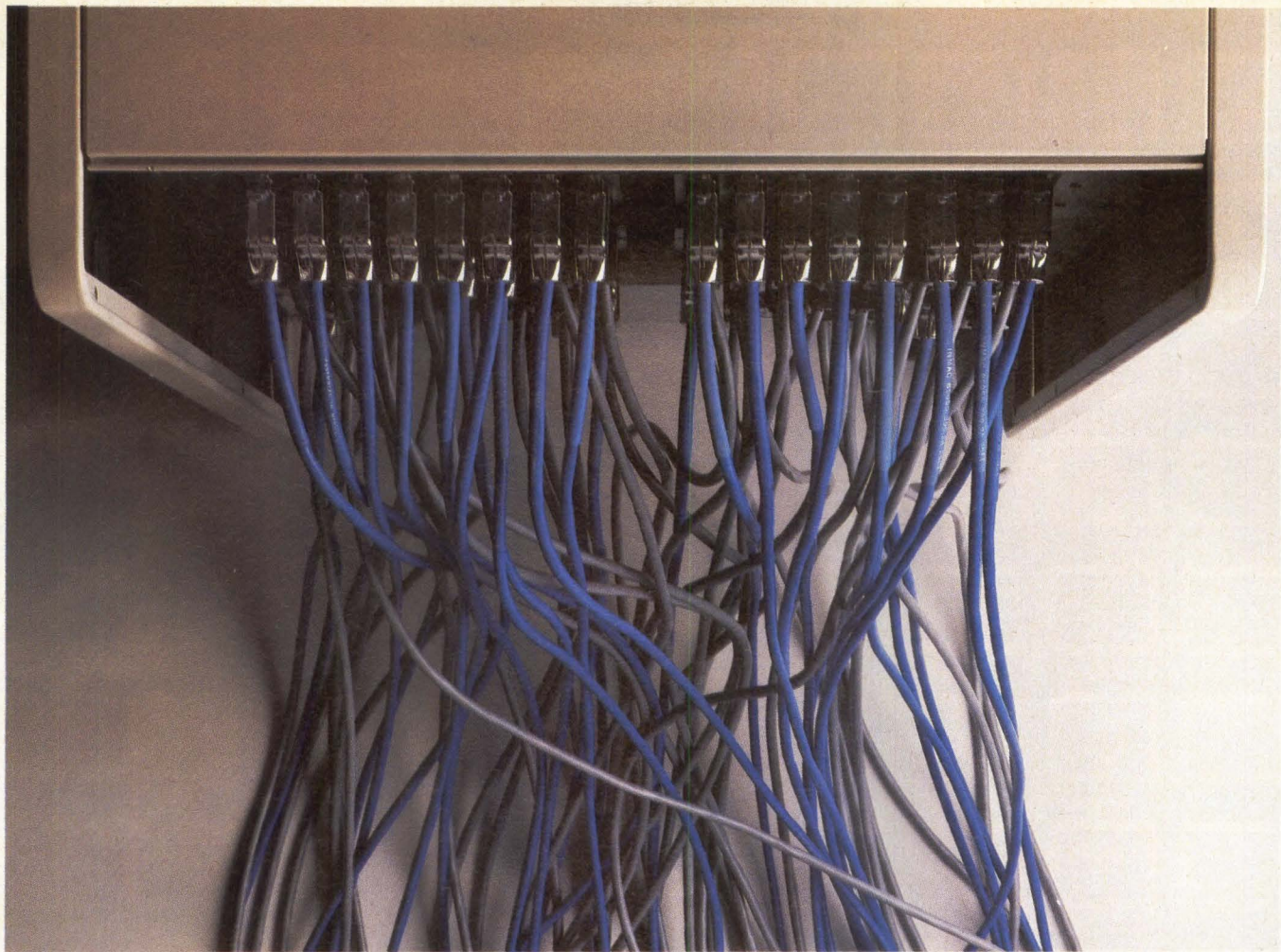

## How many more reasons do you need to Unplug your computer?

Until now, connecting 128 terminals to your computer meant one thing. A myriad of cards taking up precious space on the backplane. And accomplishing nothing but communications. All of which could frustrate almost any self-respecting system designer into hanging up his calculator.

Well, at Systech, we understand the serial communications problems of a multi-user system. So we developed The Unplug™ asynchronous distributed multiplexer that can be used with any Multibus®, VMEbus or Multibus® II system.

The Unplug can take those 128 connections off the back of the computer and turn them into just one. And presto, you've got all the expansion slots you need for more important things. Like disks. Streaming tapes. More CPU power. A synchronous communications processor. And your imagination.

You see, what we did was move part of the computer's operating system—the part devoted to managing traffic to and from the terminals—out of the computer and into The Unplug. Giving the host computer the freedom to concentrate on more important tasks.

We know it sounds simple. And the truth is, it is. In fact, you might wonder why no one thought of it before. Then again, no one else has our commitment to make your job easier. And a lot more gratifying.

Just give us a call at Systech to hook up with The Unplug. Then you can start figuring out what you want to add on next.

Instead of trying to figure out how to untangle all those wires.

Systech Corporation, 6465 Nancy Ridge Drive, San Diego, CA 92121, (619) 453-8970.

**CIRCLE NO. 2 ON INQUIRY CARD**

# The Unplug.

An outlet for your frustrations.

When you're ready to expand, you simply run one cable from the last Unplug to the next. And you've hooked up 8 new users, without ever opening the computer cabinet.

The Unplug is a trademark of Systech Corporation. Multibus is a registered trademark of Intel Corporation.

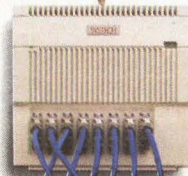
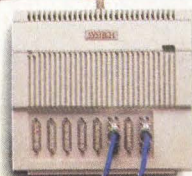

**SYSTECH**

© 1986 Systech Corporation.  
The Unplug patent pending.

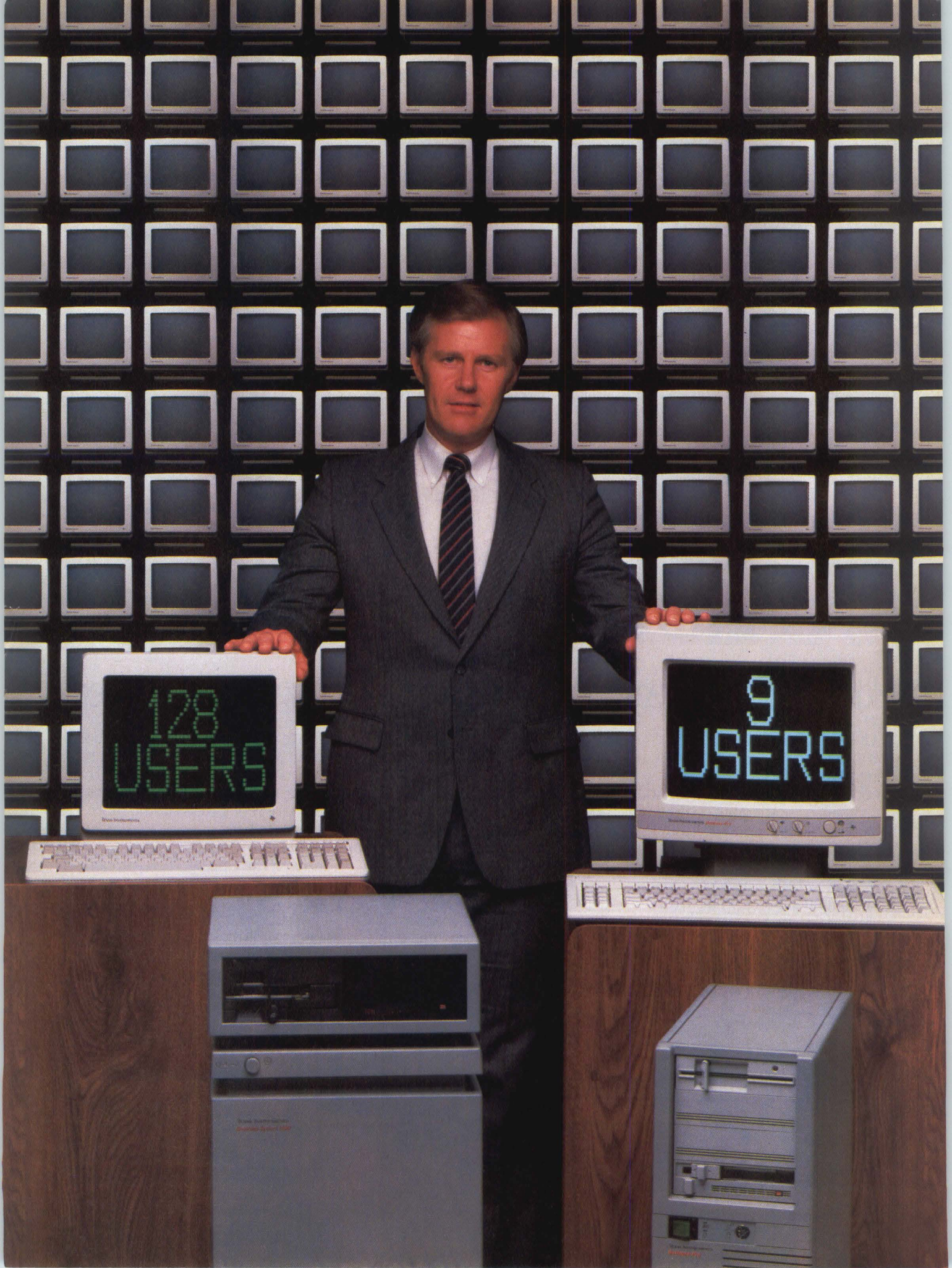

# For the VAR with multi-user environment problems, Texas Instruments has industry-standard answers.

Whether your multi-user system needs are low-end or high-end, TI provides commercially tuned operating systems derived from UNIX™ System V, and a common programming language for both.

Multi-user systems can present sizable problems to system designers: Configuration. Performance. Cost. Texas Instruments has solved these problems with the XENIX® V-based Business-Pro™ and TI System V derived from UNIX V on the Business System 1500.

**A common environment across the family.**

We preserved your end-user's software investment. An enhanced UNIX interface — TI Business Shell, a commercialized file system, and COBOL System V are supported on both the Business-Pro and the Business System 1500.

**The TI Business System 1500: High performance delivered to a larger number of users.**

The Business System 1000 Series Model 1500 provides exceptional expandability and processing power in a multiprocessor environment. With the multiprocessor design, increasing performance may be as simple as adding processor boards. The Business System 1500 can support up to 128 users. And through

the use of common peripherals, its connectivity and configuration flexibility meet the changing needs of most business applications.

**The XENIX V-based TI Business-Pro: Minicomputer power in a micro package.**

The Business-Pro was designed with multi-user capabilities in mind. The standard architecture features eight full-size and six half-size expansion slots and memory capacity up to 15 MB. The Business-Pro with XENIX V supports up to nine users. And now, many of the software features available on the Business System 1500 are offered for the Business-Pro, too.

The Business-Pro can also function as a high-performance, single-user workstation and network server. Under MS®-DOS, it offers software compatibility with both the TIPC™ and the IBM® Personal Computer AT™.

**The VAR's computer company: Ready today for tomorrow.**

Texas Instruments offers VARs the opportunity to step into the next generation of computing and artificial intelligence. We even offer VARs the ability to marry the advances of knowledge-based systems into traditional data processing applications.

Our portfolio of tools includes a broad range of software, hardware, training and support.

For today's needs, TI system peripherals include a wide array of VDTs, printers and customizable portable data terminals. We'll even help you convert your proprietary software to the new standards at the TI Migration Center in Austin, Texas. And in service and support, TI offers VAR-tailored maintenance agreements and a nationwide network of support offices.

The multi-user story here is simple. If you are a VAR with the desire to move to industry-standard multi-user operating systems, then we have the answers. Texas Instruments is the VAR's computer company.

For more information on TI's multi-user systems, call **1-800-527-3500.**



## TEXAS INSTRUMENTS



From left to right,  
TI Business System 1500 and TI Business-Pro.

TIPC and Business-Pro are trademarks of Texas Instruments Incorporated. IBM is a registered trademark and Personal Computer AT is a trademark of International Business Machines Corporation. MS and XENIX are registered trademarks of MicroSoft Corporation. UNIX is a trademark of Bell Laboratories. 31625 © 1986 TI

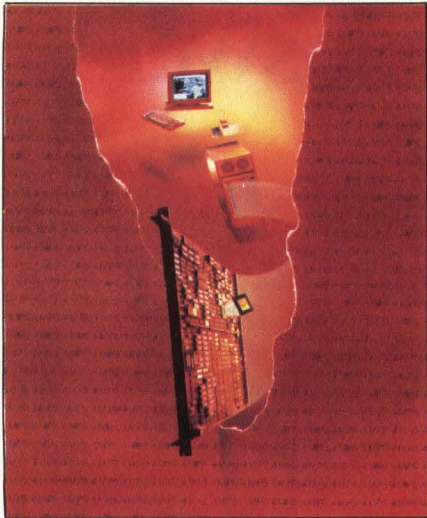

p. 25. . . . Sun introduces its 4-MIPS workstation. Art direction and design by Blankenship-Tavares. Courtesy of Sun Microsystems Inc.

## INTERPRETER

- Sun Microsystems doubles speed with 4-MIPS workstations . . . . .** 25  
"Its performance is higher by an order of magnitude"
- Parallel claims niche with low-end fault-tolerance . . . . .** 27  
The price drops to as low as \$21,000
- Chip makers boost PC graphics performance . . . . .** 33  
Intel, TI, Advanced Micro Devices push PCs beyond being super typewriters
- Bell Labs models parallel processor on neural networks . . . . .** 43  
The Big Brain may eventually operate like one

## \* EUROPEAN NEWS

- Britain, France collaborate on standard for Prolog . . . . .** E1  
May be "work item" for the ISO

\*Appearing in the European edition only

## \* DEC DIRECTIONS

(section begins opposite Page 110)

- ESDI disk drives enhance DEC computers . . . . .** D3  
Using an intelligent controller and ESDI disk drives, system integrators can configure higher capacity, more flexible mass-storage subsystems
- New Products . . . . .** D14

\*Appearing in issues of subscribers who have indicated having DEC computers

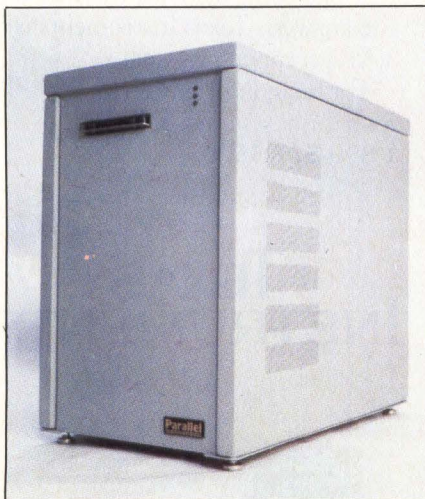

p. 27 . . . . . A low-end niche

Cahners Publishing Company • A Division of Reed Publishing USA • Specialized Business Magazines for Building and Construction • Electronics and Computers • Foodservice • Manufacturing • Book Publishing & Libraries • Medical/Health Care. MINI-MICRO SYSTEMS (ISSN 0364-9342) is published monthly with additional issues in February, April, June and November by Cahners Publishing Company, A Division of Reed Publishing USA, 275 Washington St., Newton, MA 02158. William M. Platt, President; Terrence M. McDermott, Executive Vice President; Jerry D. Neth, Vice President of Publishing Operations; J.J. Walsh, Financial Vice President/Magazine Division; Thomas J. Dellamaria, Vice President Production and Manufacturing; Terrence M. McDermott, Group Vice President. Copyright 1986 by Reed Publishing USA, a division of Reed Holdings Inc., Saul Goldweitz, Chairman; Ronald G. Segel, President and Chief Executive Officer. Circulation records are maintained at Cahners Pub-

INTEGRATION

FEATURES

**Feature Highlights** ..... 55

**AI shapes up for mainstream use** ..... 57  
Commercial AI is evolving, not exploding. But new platforms, standardized languages, lower prices and targeted applications are beginning to spur usage

**Compilers combine maturity, innovation** ..... 71  
Despite being one of the oldest software technologies, compilers continue to develop as software-development tools and as databases to monitor code modification

**Already potent PC/ATs gain power, versatility** ..... 81  
Manufacturers of PC/AT-compatibles are increasing clock speeds, adding higher capacity disks and providing alternative motherboards, as well as bringing out new chips and software

**Added functionality sparks STDbus rebirth** ..... 91  
New software, 16-bit transfers, CMOS technology, multiprocessor support and a wealth of I/O cards gird STDbus for the industrial-market battles of the future

**Product table...Single-board microcomputers** ..... 101



p. 57 ..... AI's evolution

DEPARTMENTS

Editorial Staff ..... 6

Editorial ..... 9

Breakpoints ..... 11

New Products ..... 119

Index to Advertisers ..... 135

Career Opportunities ..... 137

Mini-Micro Marketplace ..... 138



p. 91 ..... STDbus' future

lishing Co., 270 St. Paul St., Denver, CO 80206. Second class postage paid at Denver, CO 80202 and additional mailing offices. Postmaster: Send address changes to MINI-MICRO SYSTEMS, 270 St. Paul St., Denver, CO 80206. MINI-MICRO SYSTEMS is circulated without charge by name and title to U.S.- and Western European-based corporate and technical management, systems engineers and other personnel who meet qualification procedures. Available to others at the rate of \$65 per year in the United States; \$70 in Canada and Mexico; \$95 surface mail in all other countries; air mail surcharge, \$35 (16 issues). Special HANDBOOK issues, \$15. Single issues, \$5 in the United States; \$6 in Canada and Mexico; \$7 in all other countries.

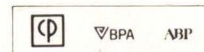

© 1986 by Cahners Publishing Company, Division of Reed Publishing USA. All rights reserved.

# Introducing the NEW "Tape Backup"

For Novell Networks and the new PC/AT (8MHz)

AIC proudly presents the first and only tape backup system that works with the NEW PC/AT (8MHz) and with most network systems. It is available in both internal and portable external unit for operation with both the PC/XT, PC/AT or compatibles.

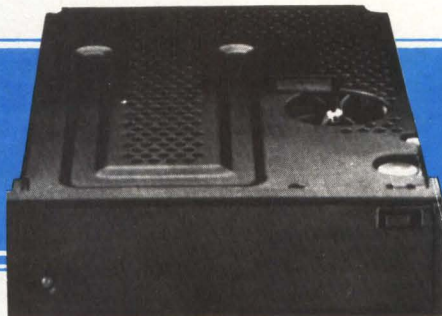

## QUALITY FEATURES:

- \* 1 Year Parts and Service Guarantee
- \* Automatically adjusts clock speed for the IBM PC/XT and the PC/AT
- \* Operates with most local area networks (IBM PCnet, AST PCnet ORCHID PCnet)
- \* Operates with clock speeds from 4 to 10 Mhz.
- \* Menu driven, command line or batch file operation
- \* Backup & restore individual files, groups of files, directories, partitions or complete hard disks
- \* Works with all brands and sizes of hard disks
- \* Uses standard 1/4 inch data cartridges
- \* Software configurable DMA channel, interrupt and I/O addresses
- \* Backup multiple volumes on single tape. Multiple tapes can be utilized for backing up larger hard disks
- \* Works with IBM PC/XT, AT&T, COMPAQ, ZENITH and most compatibles

## SPECIFICATIONS:

- \* Direct drive instead of belt driven tape drive
- \* Tape speed: 90 inches per second
- \* Data transfer rate: 5 Mb per minute
- \* Recording density: 10,000 FRPI
- \* Tape drive I/O interface: QIC 44 (QIC 36 available)
- \* Tape format: QIC 24
- \* Error detection: CRC error check
- \* Tape capacity: 60 Mb (600 ft. cartridge)
- \* Software configurable: DMA Channel (1-3), Interrupt Address (IRQ 2-7), I/O Address (330-33F Hex)

Speed, accuracy, quality engineering and construction, adds up to the very best backup that money can buy...Guaranteed!  
For additional information on this and other high quality AIC computer systems and products call.

**DEALER ENQUIRIES INVITED.**

IBM PC/TT, PC/AT, IBM PC network are trademarks of IBM Corporation.  
AT&T, COMPAQ and ZENITH are trademarks of respective Corporations.  
AST PC net are trademarks of AST Corp., and ORCHID PC net are trademarks of ORCHID Corp.



**Access Information Concepts, Inc.**  
"Tomorrows technology today"

**Eastern Office:**  
1372 Broadway, 17th Floor  
New York, NY 10018  
(212) 221-8764

**Western Office:**  
88 Glen Carran Circle  
Sparks, Nevada 89431  
(702) 356-2714

## STAFF

Vice President/Publisher  
**S. Henry Sacks**

Editor-in-Chief  
**George V. Kotelly**

Managing Editor  
**James F. Donohue**

Assistant Managing Editor  
**Bruce J. MacDonald**

Senior Editor: **David Simpson**

Western Editor: **Carl Warren**  
Irvine, (714) 851-9422

European Editor: **Keith Jones**  
London: (011-441-661-3040)

Associate Editor: **Frances T. Granville**

Associate Editor: **Lynn Haber**

Associate Editor/Research: **Frances C. Michalski**

Associate Western Editor: **Mike Seither**

San Jose, (408) 296-0868

Associate Editor: **Gregory Solman**

Associate Editor: **Michael Tucker**

Associate Editor: **Jesse Victor**

Assistant Editor/New Products: **Megan Nields**

Assistant Editor/Research: **Pamela Gorski**

## Contributing Editors

**Andrew Allison**

Mini/Micro Computer

Product and Market Consultant

**Raymond C. Freeman Jr.**

Freeman Associates

Special Features Editor: **Wendy Rauch-Hindin**

Dix Hills, N.Y.

(516) 667-7278

Washington, D.C.: **Stephen J. Shaw**

(202) 387-8666

**Gene R. Talsky**

Professional Marketing Management Inc.

**Edward Teja**

Freehold Corp.

## Editorial Production

Senior Copy Editor: **Arsene C. Davignon**

Production Editor: **Mary Anne Weeks**

## Editorial Services

**Lisa Kramer, Terri Gellegos**

Assistant to the Publisher: **Linda L. Lovett**

## Art Staff

Art Director: **Vicki Blake**

Assistant Art Director: **Cynthia McManus**

Director of Art Dept.: **Norm Graf**

## Production Staff

VP Production: **Wayne Hulitzky**

Director/Production: **John Sanders**

Supervisor: **William Tomaselli**

Production Manager: **Betsy Cooper**

Composition: **Diane Malone**

## Editorial Offices

**Boston:** 275 Washington St., Newton, MA 02158, (617)964-3030. **Irvine:** 2041 Business Center Dr., Suite 109, Irvine, CA 92715. **Los Angeles:** 12233 W. Olympic Blvd., Los Angeles, CA 90064. **San Jose:** 3031 Tisch Way, San Jose, CA 95128. **London:** PO. Box 37E, Worcester Park, Surrey, KT4 8RQ, England.

**Reprints** of Mini-Micro Systems articles are available on a custom printing basis at reasonable prices in quantities of 500 or more. For an exact quote, contact Katie Pyziak, Cahners Reprint Service, Cahners Plaza, 1350 E. Touhy Ave., Box 5080, Des Plaines, IL 60018. Phone (312)635-8800.



# EMULEX'S GROWING Q-BUS LINE. ENGINEERED TO FIT THE TIGHTEST BUDGET.

Emulex has the Q-Bus controller and communications products you need for **MicroVAX I and II, PDP-11, MicroPDP, and LSI-11**. We also offer both tape and disk packaged subsystems. All are packed with performance features, very attractively priced and software transparent to DEC operating systems.

## **WINCHESTER DISK CONTROLLERS** **ST506**

Our QD01/D dual-wide MSCP

controller interfaces two ST506 5¼" Winchester.

### **SMD**

The QD32 controller, functionally equivalent to DEC's KDA50, is a dual wide board which supports disk with transfer rates up to 2.5 MByte/sec.

### **ESDI**

The QD21 dual wide controller will interface two 10MHZ ESDI high capacity Winchester disks and emulate DEC's MSCP protocol.

## **COMBINATION CONTROLLERS**

Like the QD01/D, the DM01 supports two ST506 5¼" Winchester but (in addition) also supports two SA450 floppy drives, software compatible with DEC's RX50. For higher performance the DM02 will support two ESDI drives and two floppy disk drives. Both the DM01 and DM02 emulate MSCP for controlling the hard disks.

## **SCSI HOST ADAPTER**

The UC04 implements MSCP and supports the opticals via the SCSI connection.

## **TAPE PRODUCTS**

For ¼" tape backup our dual wide QT12 controller is compatible with QIC02 drives.

For ½" tape drives use the TC03. The TC03 supports NRZI/PE and GCR drives with speeds to 125 ips.

## **COMMUNICATIONS PRODUCTS**

Our CS02 single quad board supports 16 lines on PDP-11, MicroVAX and LSI-11, and is compatible with DEC's DHV11.

For larger line counts the CS01/H single-quad multiplexer is expandable from 16 lines to 64 lines for 50% or more savings per line.

To see how well Emulex fits your needs, call toll free 1-800-EMULEX3. In California, (714) 662-5600. Or write: Emulex Corporation, 3545 Harbor Boulevard, P.O. Box 6725, Costa Mesa, California 92626.



*The genuine alternative.*

**U.S. Regional Offices:** Anaheim, CA (714) 385-1685; Schaumburg IL (312) 490-0050; Roswell, GA (404) 587-3610; Nashua, NH (603) 882-6269. **International Offices:** Australia, Eastwood, N.S.W. (02) 858-4833; Canada, Mississauga, Ontario (416) 673-1211; France Montrouge (1) 735-7070; United Kingdom, Bracknell, Berkshire (334) 484234; West Germany, Munich (089) 304051.

Most products shown are stocked nationally by Hamilton/Avnet, Kierulff Electronics and MTI Systems Corp.

Q-Bus, LSI-11, PDP-11, MicroPDP, MicroVAX I, MicroVAX II, and DEC are trademarks of Digital Equipment Corporation.

**CIRCLE NO. 4 ON INQUIRY CARD**

BALANCE SHEET

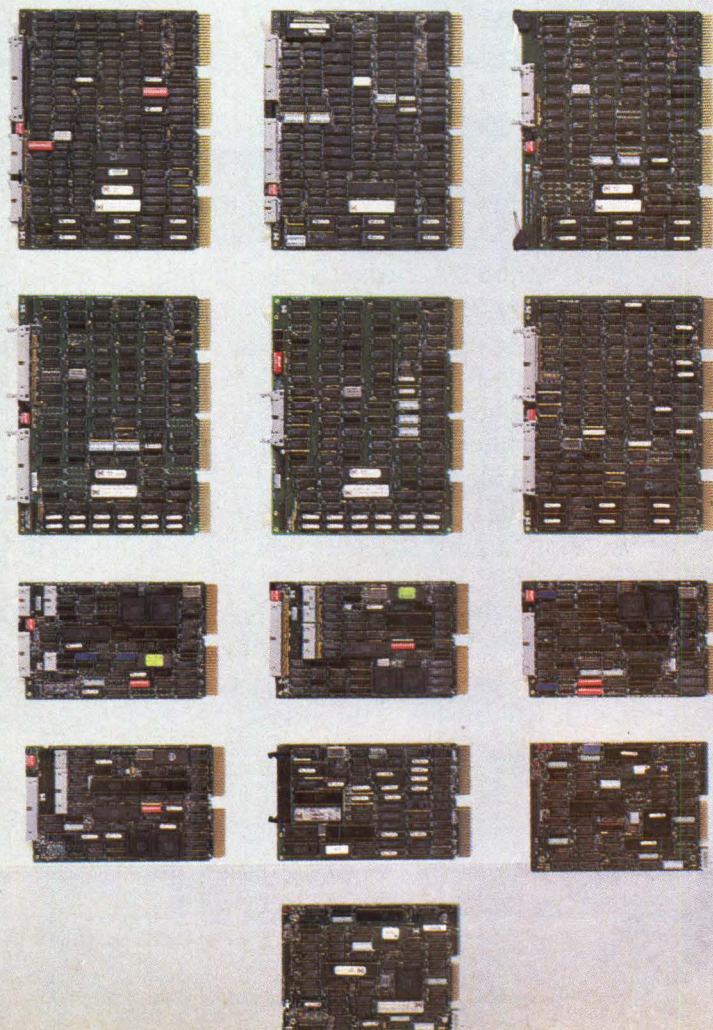

# THE TIME MACHINES



The Facit "C-line" includes the 400 cps, 15-color C7500 and the 250 cps, 7-color C5500

*The 400 cps report is finished. You press a button and the printer is ready for a single sheet, 15-color business graphics. Then you change to a multi-font NLQ printout from a second connected computer. At the same time, you also change the paper path for document-on-demand. Then you...*

The Facit C7500 and C5500 Matrix Printers not only handle a multitude of different applications. They permit instant switching from one application to another.

Printout options (including NLQ, multi-fonts and graphics), paper handling and all set-up parameters are changed in a matter of seconds using the "Yes" and "No" keys. Two entire parameter sets can even be pre-defined for instant selection.

All at the touch of a key.

IBM and Epson are reg. trademarks

## INSTANT PAPER LOADING AND SWITCHING

To save more time, paper loading is fully automatic with a choice of three different paper paths. This enables accurate feed of multi-part invoices and paper tear-off without losing a single form. You can even hold a continuous form in stand-by while cut-sheets are printed.

To facilitate easy integration in your system, both parallel and serial interfaces are provided as standard along with Epson FX/JX or IBM Graphics Printer emulation. You can use the pre-defined set-ups to alternate between different hosts, if required.

For a demonstration of how the Facit C7500 and C5500 boost the efficiency of your computer system, contact your nearest Facit representative. It will be a real timetrip.

# FACIT

Head Office: Facit AB, S 172 91 Sundbyberg, Sweden. Phone: 46 8 764 30 00. USA: Facit Inc. P.O. Box 334, Merrimack, NH 03054. Phone: (603) 424-8000

AUSTRALIA: EAI Electronics Associates Pty Ltd., 427-3322. AUSTRIA: Ericsson Information Systems GmbH, 0222-613 641. BELGIUM: Ericsson S.A., 02-243 82 11. CANADA: Facit Canada Inc., 416-821-9400. CYPRUS: LBM (Lillytos) Ltd 516 46 34. DENMARK: Facit A/S, 02-63 33 11. FINLAND: OY Facit, 90-420 21. FRANCE: Facit S.A., 1-4780 7117. GREAT BRITAIN: Facit 0634-40 20 80. GREECE: Computer Application Co. Ltd., 01-671 97 22. HONGKONG: Gilman & Co. Ltd., 5-893 00 22. ICELAND: Gisli J. Johnsen HF, 354-64 12 22. INDIA: Forbes Forbes Campbell & Co. Ltd., 22-20 48 081. IRELAND: Ericsson Information Systems Ltd., 75 30 93. ITALY: Facit Data Products S.p.A., 039-63 63 31. JAPAN: Electrolux (Japan) Ltd., 03-479-3411. KOREA: K.D.C. Corporation, 723-8555/8236. THE NETHERLANDS: Ericsson Information Systems BV, 03480-709 11. NEW ZEALAND: Northrop Instruments and Systems, 501-801, 501-219. NORWAY: Ericsson Information Systems A/S, 02-35 58 20. PORTUGAL: Regisconta Sarl, 1-56 00 91. SINGAPORE: Far East Office Eqpts Pte Ltd., 745 82 88. SPAIN: Facit, 91-457 90 81. SWEDEN: Ericsson Information Systems Sverige AB, 08-28 28 60. SWITZERLAND: Ericsson Information Systems AG, 01-391 97 11. WEST GERMANY: Ericsson Information Systems GmbH, 0211-61 090.

CIRCLE NO. 251 ON INQUIRY CARD

# EDITORIAL

## PROMISES AND PITFALLS OF 'HUMAN FRONTIERS'



It's called "Human Frontiers." It's visionary. It's improbable. It will probably fail. But, if it succeeds, even if only in part, it will remake the world.

Human Frontiers is the current name of an R&D program recently proposed by the Japanese Ministry of International Trade and Industry (MITI). Essentially, it involves a close investigation of the functions of living beings in the hope that those functions might be reproduced in machines. In the near term, the Japanese plan to use this research to produce superior AI software and improved medicine. In the long term, they are seriously discussing biochips, biomotors and the cloning of organs for transplant.

The program is going to be expensive. The Japanese are talking about spending \$5 billion just to get started. But, if the program achieves even a tenth of its stated goals, it would mean an industrial revolution. Leaving aside the biotechnical and medical aspects of the program, consider the effects on just the computer industry, if Frontiers were to make "biofabrication" a part of everyday engineering. In both this country and Japan, researchers have discussed designing electronics in which individual components would be assembled atom by atom via mechanisms similar to those used by biotech researchers to modify organic molecules. Success in perfecting such techniques could produce Turing machines with individual switches no larger than a single molecule.

Non-Japanese companies would share in Frontiers. In theory, the project is an open and international effort. In theory, foreign companies, universities and institutions would be invited, even encouraged, to join as full and equal partners.

But theory and practice are rarely the same thing. Above and beyond the question of whether they are serious about making the project an international and open effort (the Fifth Generation also was supposed to be "open"), the Japanese have been vague about how the program is to operate, and how its

results are to be conveyed to those who are not direct participants.

In short, even if the Japanese are acting with the best of intentions, the lack of clear-cut mechanisms to report on progress and developments is disturbing. There is a real chance that the West in general, and America in particular, might not benefit at all from Human Frontiers—simply because it would take too long for data to trickle down to the right groups. What's needed is an organization that could be an American, or Western, counterpart to the Human Frontiers administration in Japan. This organization would promote the program, help interested researchers gain access to resources and safeguard Western interests.

Within recent years, Congress has passed a series of bills making it legal for private companies to cooperate in applied research. The most famous of such R&D collaborations is, of course, the Microelectronics and Computer Corp., Austin, Texas, formed in response to the Japanese Fifth Generation effort. There are others, and their numbers are growing.

Suppose, then, that an American or Western association were to be formed of computer, biotech and electronics companies. Suppose further that it included those federal labs that were relevant. And suppose finally that it were to be funded as an RDLP. Would not such an organization be the best vehicle for American participation in the Frontiers program? American companies would thus have a direct channel into the program's results, have greater control over the kind of research that was done and possess any resulting technology, without having to perform an expensive transfer operation.

It seems to make a certain sense.

A handwritten signature in black ink that reads "Michael Tucker". The signature is fluid and cursive, with a long horizontal line extending to the right.

Michael Tucker  
Associate Editor

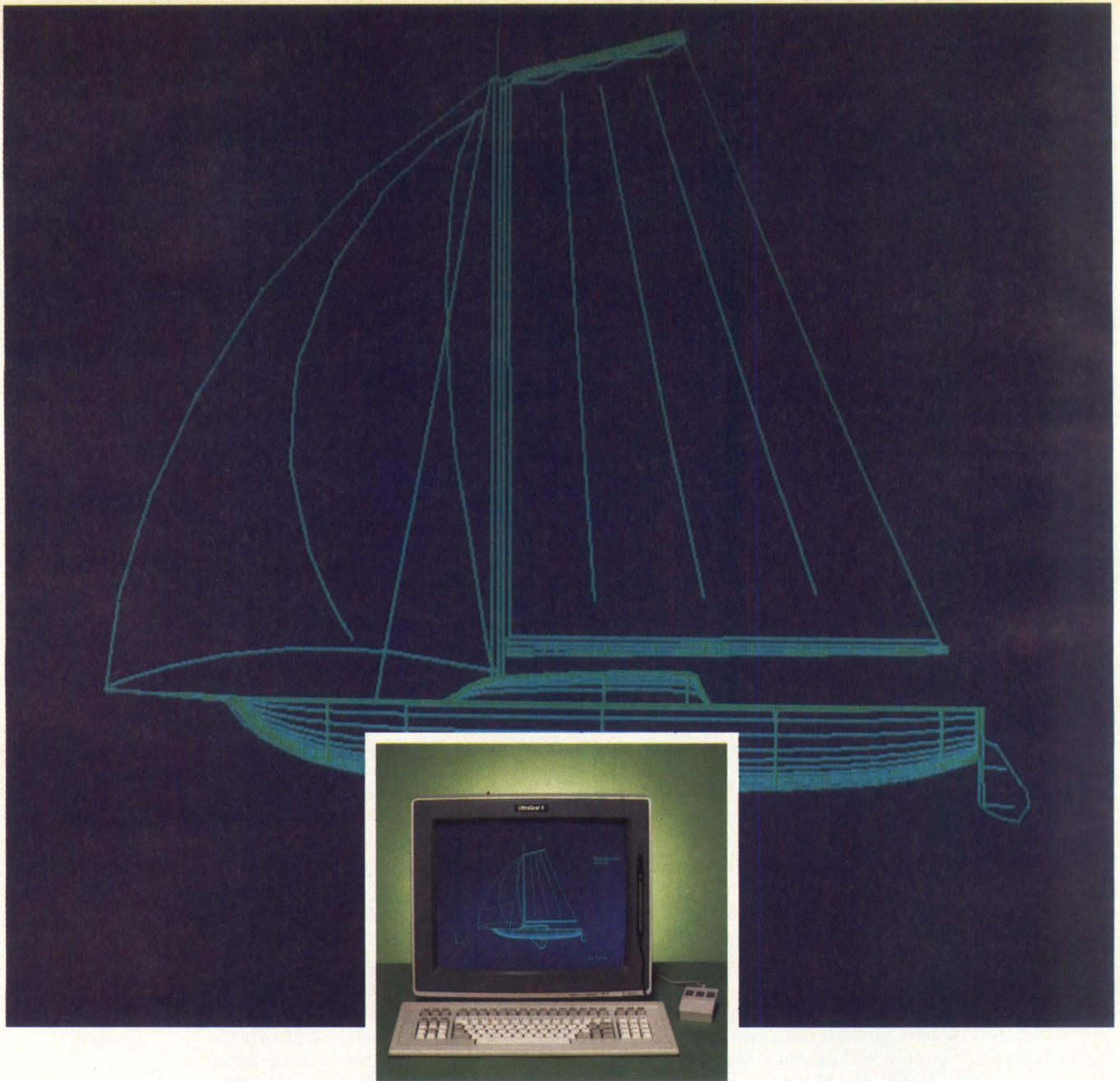

## Designing Is a Breeze with Lundy's New UltraGraf® II

No matter what business you're in, sluggish productivity could blow you—and your profits—away. But now, thanks to Lundy's new UltraGraf® II, there's an economical way to fight back. UltraGraf® II is an intelligent 3-D graphics workstation with features and functions that help you breeze through intricate designs.

### Exceptional Quality and Performance

What sets UltraGraf® II apart from other workstations in its price range is its exceptional quality and performance. That's because Lundy engineers have developed extremely efficient vector and hardware processors that permit fast, high resolution design. And unlike many

other workstations, UltraGraf® II is highly intelligent. So functions such as 3-D translation, rotation, and scaling are performed locally, increasing design speed even further while freeing your host. The result is fast, high quality design that helps keep rigid development schedules firmly on course.

A wide variety of options and accessories are available to help make graphics design as convenient as possible. And as with all Lundy products, UltraGraf® II is backed by our customer service and support network, one of the largest in the industry.

This combination of speed, intelligence, responsiveness, economy, options, accessories, service and support

make UltraGraf® II the ideal choice for mechanical design and drafting, architectural engineering, finite element analysis, robotics, and other applications that require high resolution display.

So don't let sluggish design productivity take the wind out of your sails. Fight back with UltraGraf® II.

Contact: Graphics Marketing,  
Lundy Electronics & Systems, Inc.  
1 Robert Lane, Glen Head, N.Y. 11545  
(516) 671-9000.



**LUNDY**

CIRCLE NO. 5 ON INQUIRY CARD

# BREAKPOINTS

## **DEC EXPANDS PDP FAMILY**

Digital Equipment Corp., Maynard, Mass., says its new low-end MicroPDP-11/53 has twice the performance of the MicroPDP-11/23 and is fully compatible with existing PDP-11 software. The RX33, DEC's first half-height 5¼-inch flexible disk drive, works on the system and provides up to 1.2M bytes of storage capacity per disk. Markets for the MicroPDP-11/23 include real-time process control, small business and communications. Availability begins this month with prices starting at \$9,270.

—Lynn Haber

## **IBM MAKES RT SMARTER**

Developers who expect IBM Corp. to introduce an Intel Corp. 80386-based machine may be surprised by how the 32-bit microprocessor will be used. According to an IBM source, the company has no plans for upgrading the AT; rather, they will use the 80386 as an I/O processor on the RT-Plus. This machine will use the 64-bit version of the processor used in the RT. IBM may not have settled on the 80386 as the processor of choice, however:

It is also exploring the Motorola Inc. MC68040, a 62-bit processor, to handle I/O chores. The reason: Intel is having difficulty manufacturing the 80386; quantity production isn't expected until 1987.—Carl Warren

## **INTERPHASE CONTROLLER TRIPLES VMEBUS THROUGHPUT**

Interphase Corp., Dallas, will begin shipping in October the V/SMD 4200 ("Cheetah") disk controller. The new product is a follow-on to the popular V/SMD 3200, but it differs in two key respects: It has a 128K-byte cache memory (the 3200 had 16K bytes) and uses the proprietary BUSpacket Interface, a new technology that permits VMEbus DMA throughput of 30M bytes per second. Until now, VMEbus controllers have been limited to a throughput of 5M to 10M bytes per second. The company says that the BUSpacket Interface technology will be the cornerstone of future controller products. It decouples bus activity from other controller activity through high-speed bus FIFOs and an asynchronous-state machine that controls VMEbus signalling.—Dave Simpson

## **SPEECH-TO-TEXT SYSTEM FOLLOWS NATURAL VOICE PATTERNS**

Speech Systems Inc., Tarzana, Calif., is talking up its speech-to-text development system, now available to OEMs. The breakthrough, according to the company, centers on a 100-bit-per-second phoneme-recognition engine that allows continuous speech in natural rhythms and stress patterns. Potential users enroll in the system by reading a phonetically rich script to create a vocal model; the process takes as little as 15 to 20 minutes. The system currently runs on machines from Digital Equipment Corp., Gould

Inc. and Sun Microsystems Inc. Development systems cost \$80,000 to \$100,000. The first OEM business application, called Talkwriter, is due in early 1987.—*Gregory Solman*

## **CROMEMCO MOVES TOWARD HIGH-END GRAPHICS**

Cromemco Inc. will introduce at SIGGRAPH in Dallas this month an expansion board that will give its new MC68020-based multiuser system, the CS420, real-time graphics capability. Priced at about \$4,000, a single 1024KTP graphics board uses dual-ported video RAM to create 256 colors at 8 bits per pixel. Using three boards, the system has access to a palette of 16 million colors at 24 bits per pixel. Cromemco, Mountain View, Calif., says the 64-user CS420 is the first system to use the 16.7-MHz version of Motorola Inc.'s MC68881 math coprocessor. An entry-level CS420 with 2M bytes of RAM and 140M bytes of mass storage costs \$27,995.

—*Mike Seither*

## **HEWLETT-PACKARD GETS RUGGED FOR FACTORY WORK**

Two blue-collar computer products—a personal computer and a terminal—that are rugged enough to survive on the factory floor will be available from Hewlett-Packard Co.'s Cupertino, Calif., Advanced Manufacturing Systems Operation. The personal computer is a rack-mountable version of HP's Vectra line of microcomputers, available next month. The terminal, the 9666A Operator Interface Unit, is designed for people who have little experience with computers. Available now, it operates at temperatures ranging from freezing to 131 F. Both are priced at about \$6,300. HP also is offering a factory cell-control system developed for General Motors Corp. in a price range of \$100,000 to \$150,000.—*Jim Donohue*

## **GENERAL ROBOTICS SUPERMICRO SUPPORTS 100 USERS**

The Super Python supermicrocomputer from General Robotics Corp., Hartford, Wis., uses the new National Semiconductor Corp. 32381, a floating-point coprocessor and the 32383 memory-management unit to support more than 100 users under AT&T Co.'s UNIX Version 5.2 or 5.3. Three to six Q-bus boards provide rigid-disk controllers with multiple caches supporting more than 2G bytes of storage, a high-speed multiplexer and half-inch tape and streaming tape backup. The \$19,950 basic CPU board has 16M bytes of RAM, expandable to 128M bytes.—*Jesse Victor*

## **VERSATEC EYES LOW END WITH DESKTOP COLOR PLOTTER**

Versatec Inc. has added a new technology to its bag of tricks for hard copy output. Known chiefly for its high-end electrostatic plotters, the Santa Clara, Calif., company moves into thermal-transfer devices with a desktop color plotter aimed at the PC marketplace. The Versaplotter, to be unveiled this month at the SIGGRAPH trade show in Dallas, prints at a resolution of 300 dots per inch on cut-sheet opaque paper or transparent film. The plotter produces 8½-by-11-inch pages in 45 seconds. Versatec has packaged the paper and film in cartridges to make loading and changing media easy. The product lists for \$8,950.—*Mike Seither*

# PERKIN-ELMER USERS:

## FAST

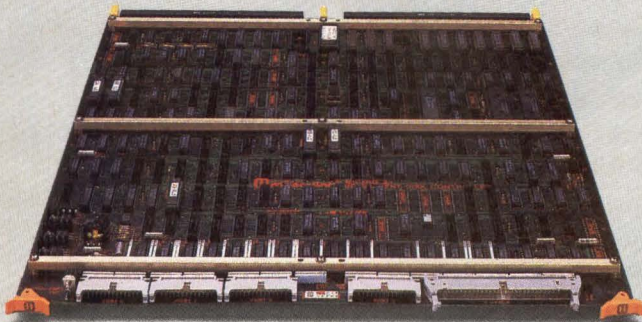

Error-Free Formatting, media compatible with IDC and MSM packs, and more.

Our **Solid State Disk** system offers ultimate performance — up to 20 times faster than conventional disks. No special drivers or software modifications are required for OS/32 or XELOS, so installation is easy. The SSD uses our standard 3200 series memory modules, supports up to 268MB, and can be dual ported.

The Macrolink **SCSI/Laser** disk interface gives you 1 gigabyte of removable media on-line storage. We've made Write-Once-Read-Mostly (WORM) optical technology available for your system today.

Call today for our catalog, and find out why OEMs and End Users make Macrolink

## BIGGEST

their first choice. Service and installation is available world-wide, and from Concurrent Computer.

Macrolink, Inc., 1500 N. Kellogg Drive,  
Anaheim, California 92807  
Phone (714) 777-8800  
TWX 910-591-1671.

## FASTER

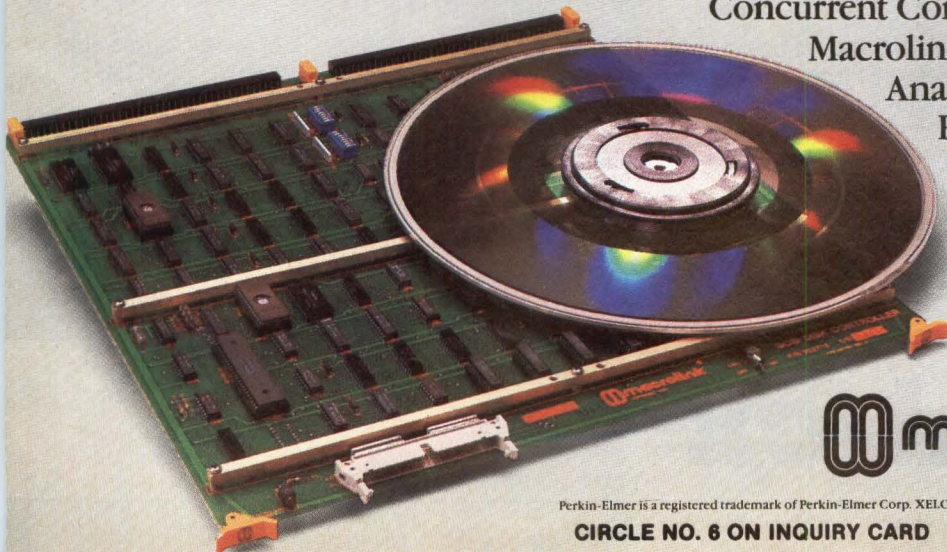
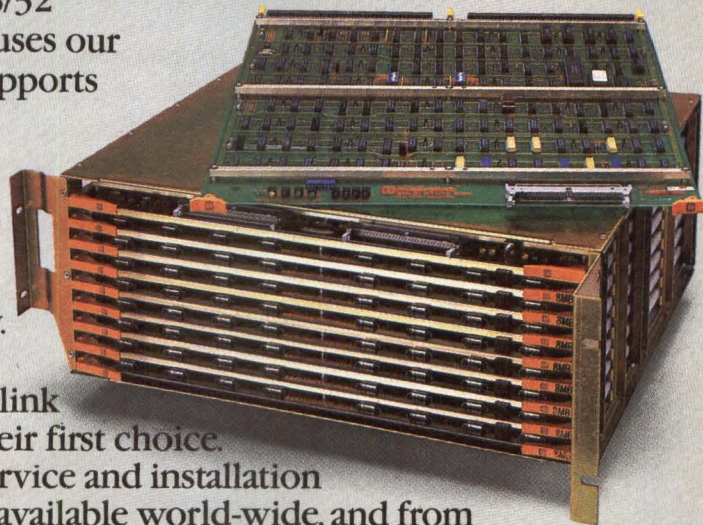

 macrolink® inc.

Perkin-Elmer is a registered trademark of Perkin-Elmer Corp. XELOS and Concurrent Computer are registered trademarks of Concurrent Computer

**CIRCLE NO. 6 ON INQUIRY CARD**

# FAST MicroVAX Graphics

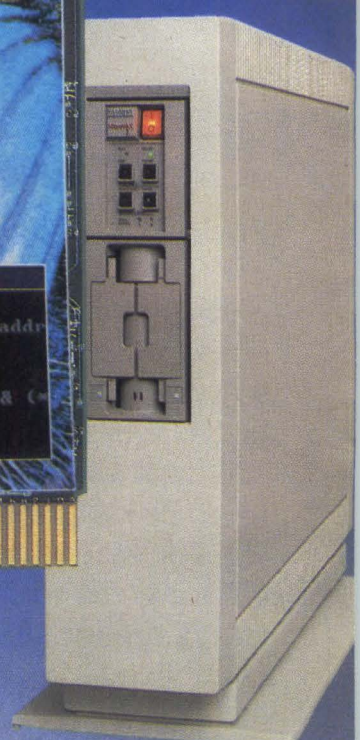
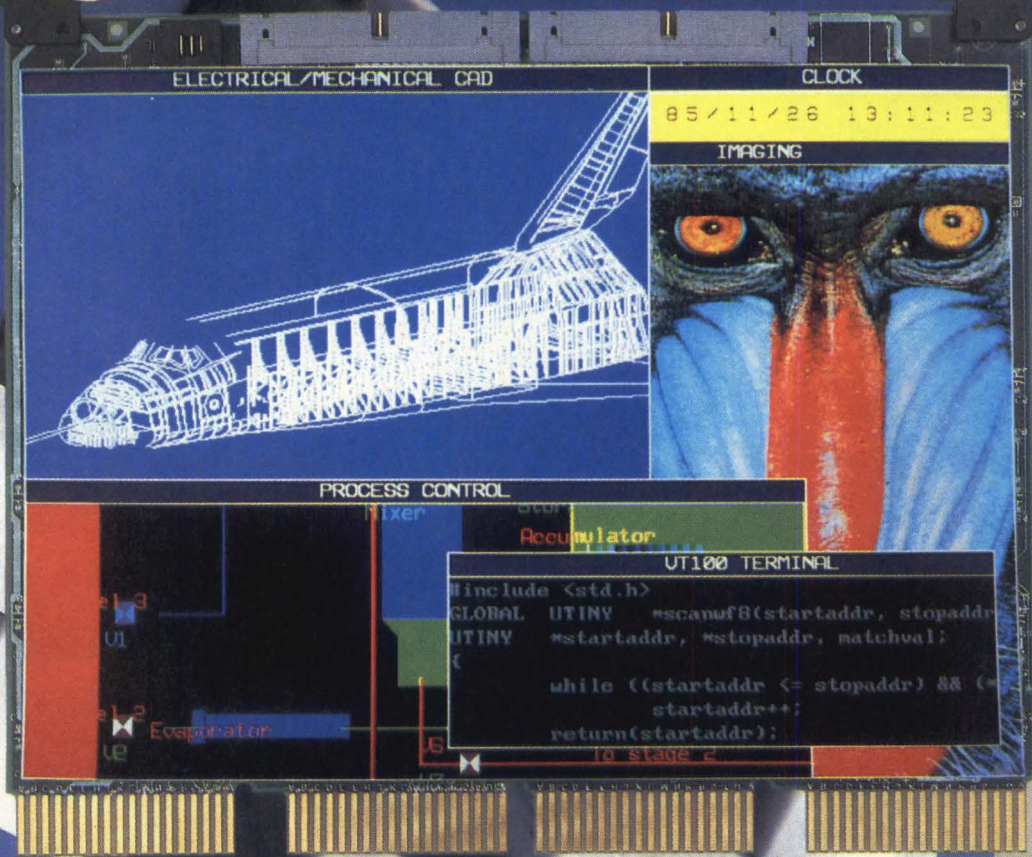

- 1280 x 1024 x 8 display (QG-1280)
- 640 x 480 x 8 display (QG-640)
- 35,000 vectors/second drawing speed

- 1 million pixels/second image load
- 3D accelerator SPACE MACHINE<sup>®</sup> option
- MicroVMS and RSX drivers

Matrox now offers two new intelligent color graphics boards for the Q-Bus. The QG-1280 and QG-640 provide the speed and resolution necessary to upgrade DEC's MicroVAX and PDP computers into Professional Graphics workstations.

The QG-1280 has a resolution of 1280 x 1024. The board's drawing speed of 35,000 vectors/second means complex pictures are displayed in under a second. For solid modelling applications, an optional 3D accelerator module complete with Z buffer provides fast hidden surface elimination and shading.

The QG-640 is the perfect solution for OEM's requiring the same performance but with less resolution; 640 x 480, at 50% less cost.

Unlike conventional graphics terminals the QG-1280 and QG-640 are directly accessible from the Q-Bus. There are no slow serial communication links. **You "see" results immediately.**

Let our new generation graphics boards "**speed up**" your workstation design — today.

**Call Toll Free: 1-800-361-4903**



# matrox

1055 St-Regis Blvd  
Dorval, Québec, Canada  
H9P 2T4  
Tel.: (514) 685-2630  
Tlx: 05-822798



**KEYBOARD AUTOMATICALLY CONFIGURES ITSELF TO DIFFERENT PCs**

Quimax Systems Inc., Sunnyvale, Calif., primarily known as a monitor manufacturer, has introduced its first keyboard for OEMs. The KM-5170 is compatible with the IBM Corp. PC and XT, which use different kinds of keyboards. An on-board microprocessor senses the difference in the PC's keyboard signals and automatically configures the keyboard for the proper machine. Quantity-one price is \$119.—*Mike Seither*

**THEOS ADDS MS-DOS TO MULTIUSER OPERATING SYSTEM**

Earlier this summer, Theos Software Corp., Lafayette, Calif., began shipping THEOS 286-V, a multiuser operating system for Intel Corp.'s 80286 microprocessor, the backbone of the IBM Corp. PC/AT and compatibles. Next month, 286-V users can expect a bonus—THEOS-DOS, a utility that sits on top of the operating system and allows MS-DOS programs to run in a multiuser environment. Theos says that, while the utility runs with most MS-DOS programs tested, it does not operate with software that is copy-protected or intended for intensive graphics. THEOS-DOS sells for \$250.—*Mike Seither*

**NOW APPEARING INSIDE THE PC/AT—A VECTOR SIGNAL PROCESSOR**

Zoran Corp., Santa Clara, Calif., has spent the last two years trying to condense vector signal-processor components from several boards onto a single chip. In an effort to acquaint system integrators with its products, Zoran has put the chips on an application-development board that fits into a single slot in the IBM Corp. PC/AT. Priced at \$3,000, the board and other tools are aimed at developers working on a variety of digital signal-processing applications, including medical imaging and satellite communications. A site license for Zoran's vector-processing simulation software costs \$15,000.—*Mike Seither*

**BRIDGE IMPLEMENTS TCP/IP PROTOCOLS ON BROADBAND LAN**

Bridge Communications Inc., Mountain View, Calif., introduced four high-speed broadband local area network products, including two server units that implement the Transmission Control Protocol/Internet Protocol (TCP/IP). The broadband family operates at 5M bits per second on 6-MHz broadband channels and permits the integration of multiple computing environments, including IBM Corp. and Digital Equipment Corp., through the TCP/IP-based servers, according to the company. The products include the CS/1B modular communications server, the MB/1 eight-port Ethernet-to-broadband bridge, the CR/5 channel modulator and the RFM/5 modem. Products are available 60 days after order.—*Lynn Haber*

**RICOH TESTS OPTICAL WATERS**

Primarily thought of as a printer supplier, Ricoh Systems Inc., San Jose, Calif., is testing the OEM optical waters with an 8-inch optical disk drive

dubbed the Model RO-8070 WL. The company claims that the write-once drive can store up to 700M bytes per side. Pricing and the formal introduction date haven't been announced but, expect it in late 1987.—*Carl Warren*

## **KYOCERA OFFERS LASER PRINTER WITH FULL EMULATION**

Kyocera OEM Sales, Cupertino, Calif., is offering the FBP-10 Compact Laser Printer for \$3,900. This printer includes 1M byte of internal RAM, 300-dot-per-inch resolution and 10 page-per-minute output. In addition, the printer emulates the Hewlett-Packard Co. LaserJet Plus, Epson America Inc. FX-80 dot-matrix printers and the Diablo Systems Inc. 630 daisy-wheel printer. A page-description language called PRESCRIBE comes as part of the controlling ROM code.—*Carl Warren*

## **COLOR LASER PRINTER EXPECTED BY FEBRUARY**

Shown only to a few observers at NCC this year was a \$4,000, 10-page-per-minute, four-color laser printer. The printer, manufactured by a major Japanese company, uses a small-computer systems interface (SCSI), provides emulation of all popular laser and dot-matrix printers and includes 64 built-in fonts. The company, which asked not to be identified, says it plans to introduce the printer in January 1987. Deliveries start the next month.—*Carl Warren*

## **TANDEM DEBUTS CHEAPER LOW-END FAULT-TOLERANT SYSTEM**

A year ago Tandem Computers Inc., Cupertino, Calif., decided to play in the low end of the transaction-processing field with its NonStop EXT fault-tolerant system. With a market apparently established for that class of machine, Tandem has doubled the performance and dropped the entry price by a third to \$82,500 for its new EXT10, rated at 4.3 transactions per second.—*Mike Seither*

**NOTES FROM OVERSEAS:** The worldwide telecommunications and information technology activities of **ITT Corp.** will fall under French control when the Paris-based **Compagnie Générale d'Électricité (CGE)** completes its planned acquisition of a majority holding. ITT will retain a 30 percent share. The government-owned CGE is the leading manufacturer of central office digital switches in France and is interested in ITT's European telephone exchange manufacturing and marketing activities.—*Keith Jones*

Competition for faster disk storage is coming from a new company. **Anamartic Ltd.**, Cambridge, England, says it will launch a semiconductor memory system with a capacity of 40M bytes by the end of the year. The memory will offer access speeds "thousands of times" faster than Winchester disk storage while offering compatibility with industry-standard disk drive interfaces, according to the company. Costs will be held down by building the system from complete wafers of integrated circuits, thus avoiding the expense of dividing the wafers into individual chips, packaging them and mounting them on printed-circuit boards.—*Keith Jones*



TEXAS  
INSTRUMENTS

---

**The VAR's computer company. By design.**

**Providing the right solution to the end-user is your product.  
Providing the right product to deliver your solution is ours.**

---



## Committed to your needs. Engineering to fill them.

That's the real story. Commitment to you and your market. From day one, our broad range of products, services and programs were designed and engineered to help you deliver better solutions. And we continue to do just that — engineering everything we offer so you can better fill the needs of your customers. Today, we have an installed base of over 100,000 minicomputers, 1,000,000 printers and terminals.

When it comes to understanding the Value-Added-Reseller marketplace, we're your computer company. By design.

### **Better software solutions need enhanced standards.**

We started with the industry standards, and then designed in the kind of performance enhancements and ease-of-use features that deliver far more than standard performance. For example, on our new, top-of-the-line Business System 1500, TI System V is our commercially "tuned" operating system derived from the standard — the UNIX™ System V operating system. TI System V supports COBOL, C, and Pascal programming languages. COBOL offers a common development environment and compatible features with XENIX® V on the entry-level Business-Pro™. This allows you to preserve your end-user's software investment over our entire System V product family.

Overall, TI System V-based computers offer commercial enhancements that provide a superior application development environment, while allowing you to enter the UNIX software mainstream market. For example, we've taken the best features from the user interface to our highly successful VAR-proven

DX10/DNOS minicomputer operating systems and created the TI Business Shell. This shell provides command entry with menus and prompt screens. Other TI commercial enhancements include: T-ISAM files; forced write-to-disk; record locking, an extent-based file system; a cursor-driven single-character command file manager; an on-line HELP system; sort/merge; software protection; multiple CPU load balancing; and a high-performance field-edit driver.

We also provide the COBOL System V enhanced programming language, which is supported on both the Business-Pro and the Business System 1500. This powerful language is derived from MicroFocus™ COBOL and provides an integrated set of COBOL programming tools which can dramatically increase productivity. This common development environment gives you a wide range of delivery configuration options without having to revise your existing applications software. COBOL System V also provides a powerful COBOL compiler which generates an intermediate interpretive code for fast compilations and debugging, or an optimized native code for production programs. Other COBOL System V features include: the ANIMATOR™ source-level COBOL debugger; selectable runtime environments; and an interactive forms designer. It is versatile, offering you unmatched programmer productivity and efficiency in designing flexible multi-user system solutions.

### **Hardware that works harder.**

Our enhanced standards are not limited to advanced software developments. Since multi-user system designs demand an extra measure of performance, we developed advanced architectures to handle customized con-

figurations of multiple processors, mass storage devices and communications options. And since you need the flexibility to move up or down the multi-user product family, our compact modular equipment designs offer standard features like front access for easy installation, expansion and maintenance, reduced cabling requirements, and plug compatibility with peripherals. This combination of state-of-the-art modular design and high-technology/high-performance microprocessors and coprocessors yields exceptional performance in a standard office environment, plus easy incremental expansion as needs grow.

### **Enhanced standards enhance value.**

We enhanced the software and hardware standards to deliver better performance and ease of use. You can develop better solutions for your customers, which means they get a higher return on their investment. You get lower application maintenance costs, easier system upgrades, and increased programmer productivity. And since your customers can easily add to their systems, their cost of ownership stays desirably low for a long, long time.

## Behind the TI product family is an even larger family.

On the cover of this piece is a "family portrait" of our products. Pictured below is a portrait of a different kind of family — a few of the people responsible for the research, design, development, testing, manufacture, quality control, marketing and sales, training, service and support of our VAR product line. All easy to work with, and all dedicated to one thing in particular. You. **Service programs designed for you and your customer.**

The Service Division of the Data Systems Group helps you meet the specific maintenance needs of your customers. We offer a wide variety of packaged options, or we can custom design a service package to fill precise needs. When you work with DSG Service, you receive the attention of some of the

most dedicated customer service representatives in the industry. Our highly skilled and professional technicians are available 24 hours a day, seven days a week, depending on the location and service level selected.

There are two service programs designed exclusively for Value-Added Resellers. Both programs recognize the need for your involvement in all aspects of your customer's business, including service. And each program offers financial benefits to you for assisting in your customer's service management.

The Group Maintenance Agreement (GMA) allows you to be the single point of contact for all of your customer's service needs, and provides you with a discount from the standard contract rates. If a service call is required, your phone call to TI, via our nationwide toll-free number, will initiate prompt and efficient service.

The Maintenance Agreement Preparation Program (MAPP) provides you with a finder's fee for signing your customers to a standard TI service contract. All of DSG's on-site service contracts may be provided under the GMA or MAPP programs.

If you choose to provide hardware service, we'll provide you with the best factory training available, detailed technical and maintenance manuals, and backup support from our own service department. Our TI Express program also provides ready availability of accessories, supplies and media for your systems and peripherals.

We believe that the service flexibility we offer is an important and integral part of the total sales solution you offer to your customers.



## The printer family: Establishing the standards of reliability.

TI's Omni 800™ Series printers are known for the standards they uphold — premium performance and industrial quality. Every TI printer is made to do its job very well, for a very long time, and with a very healthy return on investment.

Most of the options offered by competitors are standard features on many of our microprinter and system printer models. Features like letter quality and color printing, snap-in front-loading font cartridges, 10" and 16" carriage widths, graphics capabilities, and speed. And, of course, reliability. TI's renowned 810 printer has set standards of reliability in demanding applications for almost a decade. Based on the same architecture as the 810, the Model 880 printers are twice as fast and still offer correspondence printing, raster graphics, forms handling, and AT-class software compatibility.

The three members of our new OmniLaser™ printer family are the first of the second generation of laser printers and are the perfect answer to the shared-resource environment. They last up to 15 times as long as their first-generation counterparts and deliver the lowest cost per page in the industry. OmniLasers are destined to be the "810" of laser printers.



## Data terminals: Keeping the customer connected.

There's a TI data terminal to fit almost anyone's requirements, from heavy-duty desktop models to lightweight, portable units. In fact, we pioneered the development of portable data terminals and their markets. We set design standards with our introduction of the Silent 700™ Series, and continue to every time we add a product to the line. Today, the majority of this market belongs to us.

With TI portable data terminals, you can actually create whole new markets by customizing terminals to new user applications, or serve additional needs in your existing segments, because only TI terminals give you the flexibility of the Personal Application Cartridge. Application-specific cartridges can be developed with features and functions to help satisfy your customers' special communications, data entry and retrieval needs, such as remote sales automation, database inquiry or electronic mail.

The new TravelMate™ portable terminals feature an easy-to-read, 16-line, pop-up LCD screen with built-in editing capability. Their printer control keys allow selective printing. The TravelMates feature built-in communications capabilities and are available with either 300 or 300/1200 baud internal modems. And, one model was engineered specifically for direct connection to a customer's computer.

So when your customers tell you that they need to stay in touch with satellite offices, or that they need to supply a sales force with communications tools, or they need to access a remote database, you can tell them that TI's portable data terminals will keep them connected.



## Artificial Intelligence: Putting Knowledge Technologies™ to work.

TI offers a broad range of AI products and programs for VARs, from development tools like the Explorer™ system — our advanced Lisp environment workstation, to speech technology to our Knowledge Engineering Department, which can help you pinpoint and begin developing expert systems opportunities. The bottom line is this — AI and expert systems are an ideal opportunity for you to develop and offer new solutions to your existing customer base.

The Personal Consultant™ Plus software package provides an easy-to-use development shell with which you can quickly build an expert system on a Business-Pro or any IBM-compatible PC. You can supply your customers with expert systems that can perform diagnostic analysis, help make decisions and assist in complex problem solving. And the addition of expert systems to your product line can give you a sharper competitive edge because you can provide new solutions to your customer. TI's Knowledge Technologies™ products and services bring artificial intelligence know-how out of our labs and into the commercial computing world.



## TI support goes beyond dedicated service.

### Education and migration.

We offer you the services of our TI Education Center where you can learn all about our systems and how to configure them. Our TI Migration Center can help you convert your proprietary software to run on our new generation System V family. And we've even created a Knowledge Engineering Department to help you get started in artificial intelligence.

### Programs to help make sales happen.

Our vertical trade show program includes booths, demo equipment, literature, and professional Tiers to help you from start to finish. All available at no extra charge to you. This year alone, this important program gives our VARs excellent representation at over 125 shows.

Our solutions-oriented advertising emphasizes vertical markets and the benefits of VAR-TI teamwork. It runs in leading business and trade publications.

Our lead referral program gathers thousands of inquiries each month, qualifies the leads that apply to you, and sends them on to you for immediate action.

### The VAR's computer company: Committed to you and your solutions.

We've explained how we've engineered each of our products and services to help you deliver better solutions. Now take a good look at the company behind the products.

### Texas Instruments.

### The VAR's computer company. By design.

For more information on our VAR programs and products, call toll-free 1-800-527-3500.



# TEXAS INSTRUMENTS

Business-Pro, NuBus, Silent 700, TravelMate, Omni 800, OmniLaser, Personal Consultant, Knowledge Technologies, and Explorer are trademarks of Texas Instruments Incorporated. UNIX is a trademark of Bell Laboratories. XENIX is a registered trademark of MicroSoft Corporation. MicroFocus COBOL and ANIMATOR are trademarks of MicroFocus. IBM is a registered trademark, and Personal Computer AT is a trademark of International Business Machines Corporation.

Texas Instruments reserves the right to change its products and service offerings at any time without notice.

© 1986 TI 31604



## The Business-Pro: Minicomputer power in a micro package.

Designed specifically for low-end multi-user capabilities, the Business-Pro is an ideal VAR machine. The XENIX V-based Business-Pro supports up to nine users and can function as a network server in a PC LAN, supporting larger numbers of PCs and peripherals. As a stand-alone system, or connected to a high-end multi-user system like the Business System 1500, the Business-Pro provides high AT-class performance with unsurpassed expandability.

Its standard architecture features the 80286 16-bit CPU, 14 expansion slots (eight full-size and six half-size) on a standard AT bus structure and up to 15 MB memory capacity. The XENIX V-based Business-Pro enhanced standards include: a 120 MB disk drive, TI's low-cost 924 video display terminal, COBOL System V programming language, the TI Business Shell, the T-ISAM file system, and a conversion utility set for file transfer. The Business-Pro will run programs written for the IBM® Personal Computer AT™.

Overall, the Business-Pro brings increased speed, more memory, greater data storage, and greater ease of use to the delivery of both standard and advanced software solutions.



## The Business System 1500: High performance for high-end use.

The Business System 1500 combines enhanced industry standards and advanced technology in a high-performance system that can handle up to 128 users. You get the speed and power of the 68020 processor in an open architecture, giving you software compatibility within the TI System V family. And its 32-bit multiple-processor design provides performance capabilities previously available only on small mainframes, and at a much lower cost.

Ease of expandability and configuration flexibility were key design goals of the Business System 1500. This was achieved through a combination of multiprocessors and terminal concentrators, which allow for quick and easy upgrades. Its 68010-based intelligent terminal concentrators support clusters of up to 16 workstations and printers. As your customers' needs grow, upgrades are easily and efficiently handled by adding more processors, terminal concentrators, and of course, the necessary peripherals.

Its sophisticated task distribution architecture provides highly efficient sharing of the system's load and maximum use of available processing power. Each processor board has a minimum of 2 MB of dynamic random access memory, upgradeable to 4 MB. Its high-speed NuBus™ has a 37.5 MB transfer rate with a 100 ns clock period, making

it one of the fastest system buses available in the business computer marketplace.

You can customize disk subsystems with two types of mass storage controller boards, each with a 68010 microprocessor to help optimize peripheral control. The SCSI interface can support over 900 MB of storage with four mass storage enclosures containing a combination of hard-disk and streaming-tape devices. The SMD/SCSI mass storage controller board can extend storage to 3 GB, supporting larger and faster devices.

Summed up, its powerful 32-bit multiprocessor design delivers the performance you require for a broad range of commercial applications. Its modular hardware design and the long life expectancy of its architecture were engineered to allow you to expand the system in incremental stages to meet an organization's growing needs for years to come.





# One-Two Punch!

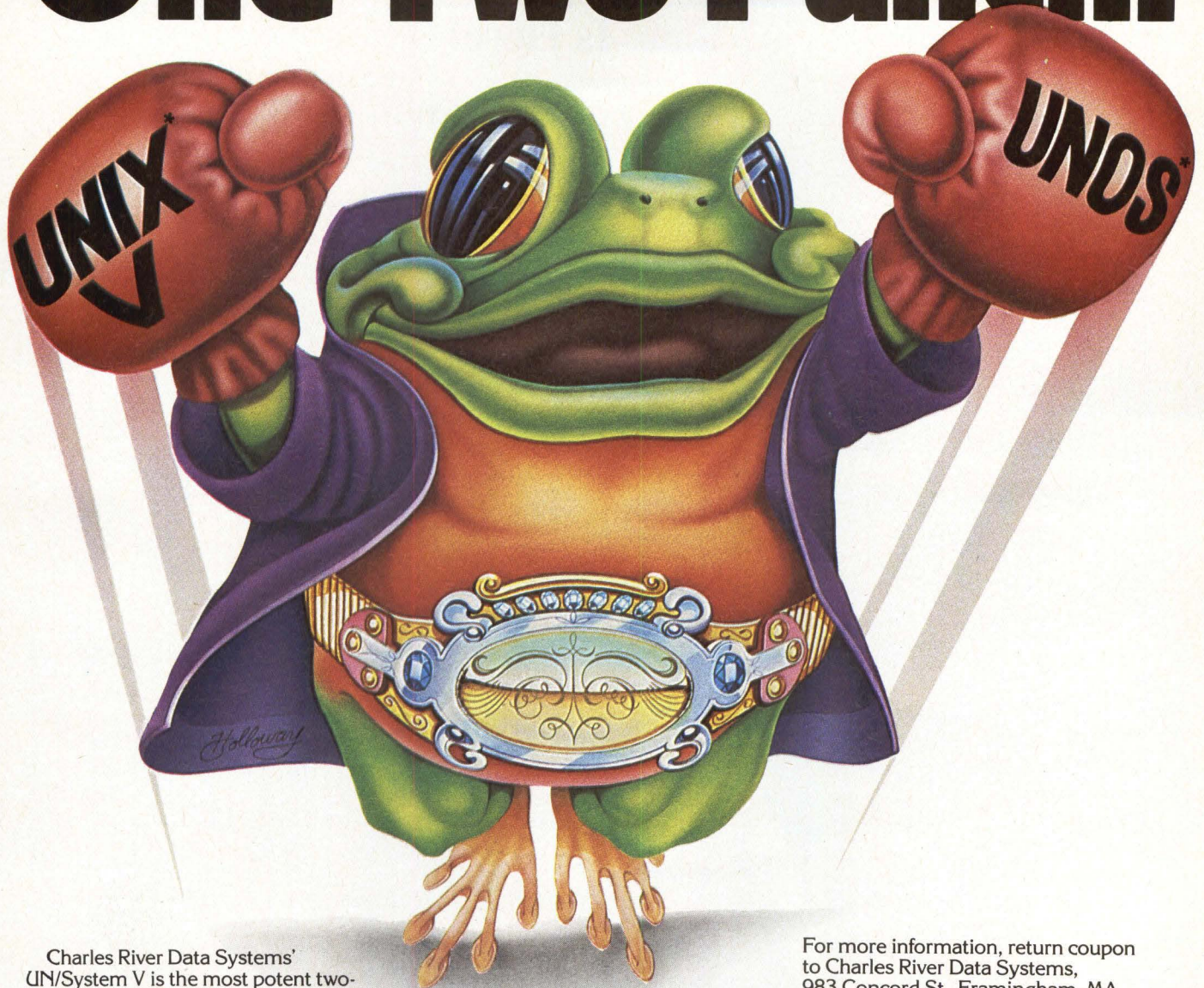

Charles River Data Systems' UN/System V is the most potent two-fisted combination of industry-standard functionality and powerful extensions in the UNIX ring today.

### Industry-Standard UNIX

On the one hand, UN/System V is derived from AT&T-licensed UNIX System V. So it gives you all you expect from the industry standard, including a full set of UNIX development tools, Bell license, Berkeley extensions, access to UNIX applications, and support for Fortran, RM/COBOL\*, Pascal, BASIC, and our own highly optimizing C compiler.

### Plus Extensions

At the same time, UN/System V offers a knockout bonus you can't get anywhere else: its UNOS kernel.

UNOS makes possible comprehensive real-time extensions, ISO/OSI

MAP-TOP local area networking, and unique distributed UNIX functions, including remote file access with record locking, remote execution, multi-system pipes, and virtual terminal support.

### Plus Heavyweight Hardware

UN/System V runs on the Universe family of computers, the undisputed supermicro price/performance champions.

Universe systems offer 68020 performance (2.5 to 3 MIPS), VME and VERSAbus configurations, up to 64-plus concurrent users, and a suite of languages and application tools including high-performance spread sheet, relational database, and an office automation package with word processor, list manager, and calendar.

For more information, return coupon to Charles River Data Systems, 983 Concord St., Framingham, MA 01701, or call (617) 626-1000, Telex 681-7373 CRDS (W).

- Send me technical information. MM8  
 Have a sales representative call.

Name \_\_\_\_\_

Company \_\_\_\_\_

Address \_\_\_\_\_

City \_\_\_\_\_ State \_\_\_\_\_ ZIP \_\_\_\_\_

Telephone \_\_\_\_\_

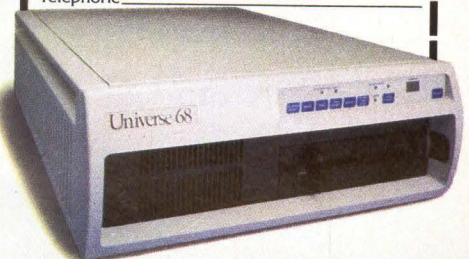

# CHARLES RIVER DATA SYSTEMS

\* UNOS is a trademark of Charles River Data Systems. UNIX is a trademark of AT&T Bell Laboratories. RM/COBOL is a trademark of Ryan McFarland.

CIRCLE NO. 8 ON INQUIRY CARD



Optotech, Inc.

## The 5¼ inch Optical Disk Drive Is Here!

### Optical Disk Drive 5984

- 200 megabytes on a removable cartridge.
- Fast access read and write.
- For PCs and minis.
- Extensive interface software.
- Available Now.

### The Preferred Solution For:

- Database—large, portable, indelible and updatable
- Online Mass Storage—integral backup
- Imaging—capacity with removability



Optotech, Inc.

770 Wooten Road  
Colorado Springs, CO 80915  
303.570.7500 Telex 592966

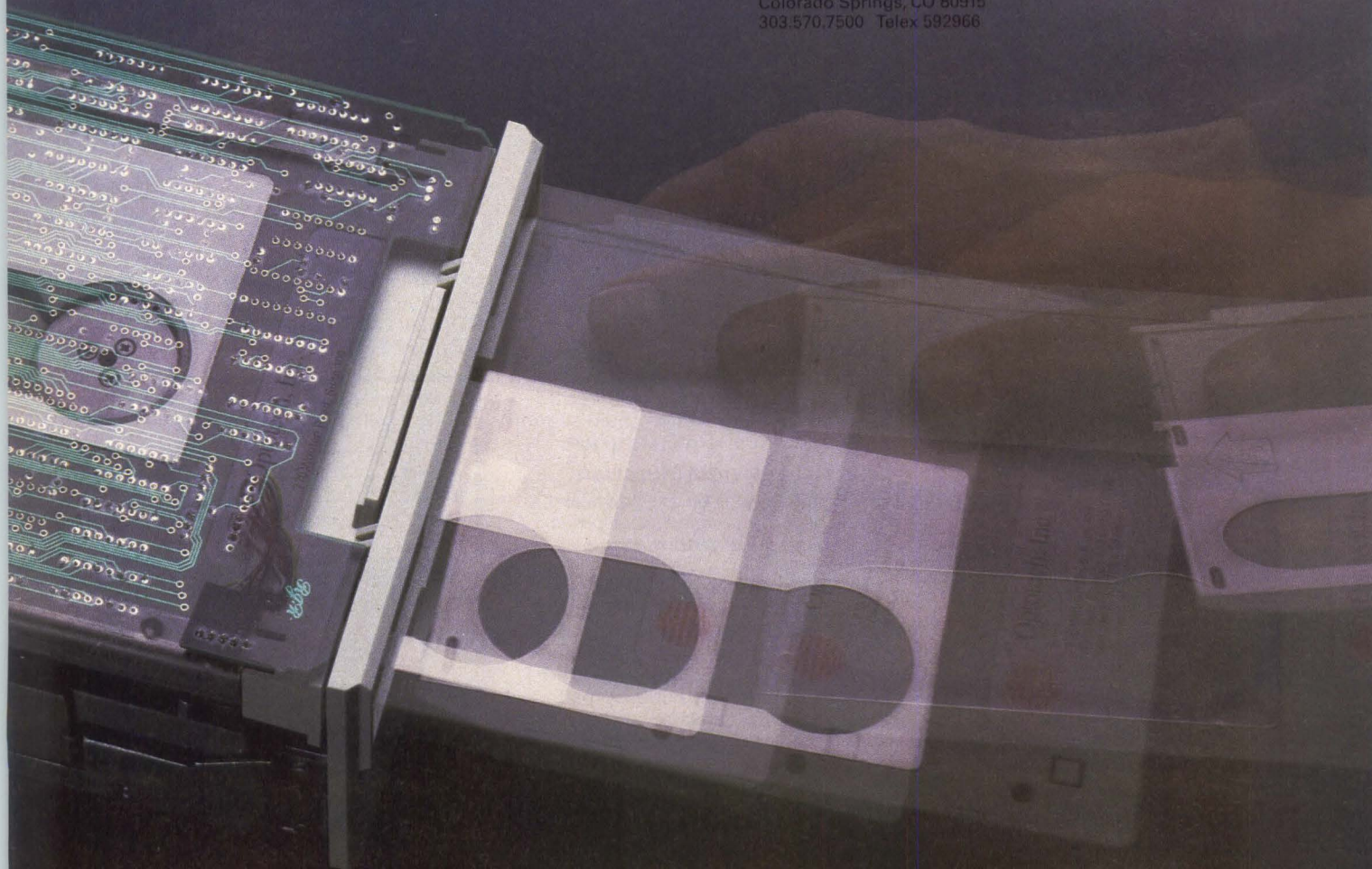

CIRCLE NO. 9 ON INQUIRY CARD

# INTERPRETER

## Sun Microsystems doubles speed with 4-MIPS workstations

**Mike Seither**

Associate Western Editor

The ante for players in the technical-workstation game has just been driven up in a big way. This month, Sun Microsystems Inc., Mountain View, Calif., brings to market the Sun-3/200, a powerful family of workstations that the company claims can operate at 4 million instructions per second (MIPS).

That's double the performance of any previous machine from Sun, or from its prime competitors, Apollo Computer Inc., Digital Equipment Corp. and IBM Corp.

"You can't compare it [the Sun-3/200] with IBM's RT PC or any of the others," says Dave Burdick, an analyst with Dataquest Inc., a San Jose, Calif., market-research company. "Its performance is higher by an order of magnitude. It's in the class of a DEC VAX 8600."

Although the VAX 8600 costs in excess of \$300,000, Sun plans to sell its new systems for \$55,000 to \$87,000.

Indeed, Sun is pitching the new computer as an alternative to DEC-like workhorses. "We believe the Sun-3/200 will take us into markets where workstations have never been before," says Sun product marketing director John Hime. "By that we mean supermini-class applications like finite-element modeling, real-time graphics and high-end computer-aided publishing."

Where does the power come from? Like its predecessor, the 2-MIPS Sun-3/160, the new workstation uses Motorola Inc.'s 32-bit MC68020 processor, which runs on a VMEbus system architecture. But Sun is using

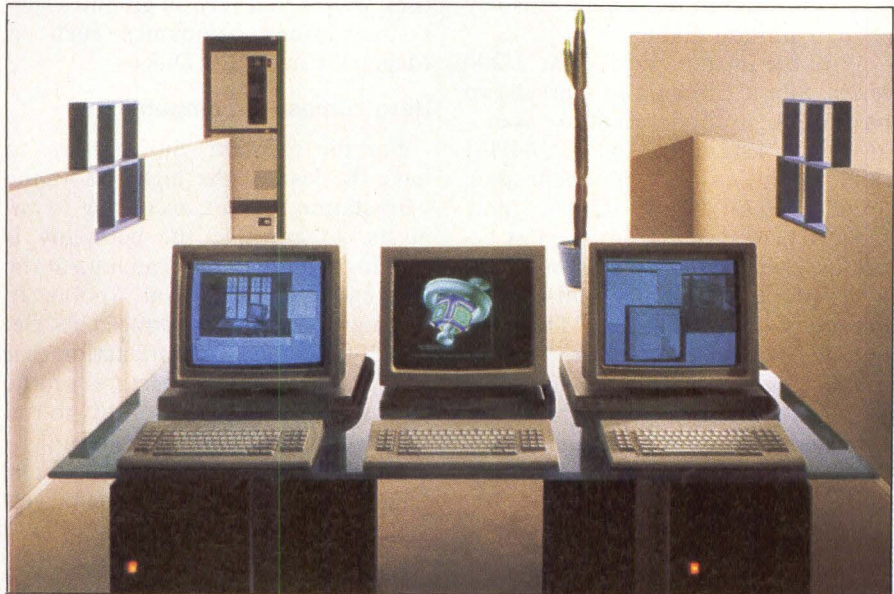

**The Sun-3/200 series** can be used as either standalone technical workstations or network servers for compute-intensive applications such as geophysical analysis, electrical CAD and artificial intelligence.

a different breed of the 68020, one with a clock rate of 25 MHz. In its previous machines, Sun relied on the 16-MHz version of the 68020.

Coupled with the faster 68020 is a 64K-byte virtual-address cache memory that the CPU can both read from and write to. The cache clips along at 120 nsec, allowing the CPU to run at its top speed. Thanks to the cache, the 68020 never spends more than 5 percent of its time waiting for data from main memory. Apollo also uses the 16-MHz chip in its newest high-end workstations, the DN570 and DN580, rated at 1.5 to 2 MIPS.

As it has done with earlier computers, Sun still integrates a Motorola MC68881 floating-point coprocessor with all its CPUs to perform scientific and engineering calculations. Sun's

\$4,900 proprietary Floating Point Accelerator (FPA), which connects to the CPU by a high-speed memory bus and triples the performance of the 68881, is available as an option.

In an April 1986 report from the Argonne National Laboratory in Argonne, Ill., the Sun-3/160 with the FPA was rated at 0.40 million (double-precision) floating-point operations a second (megaflops), using the LINPACK linear-equation benchmark. In the same test, an IBM 4381-11 was rated at 0.39 megaflops, followed by a DEC VAX 8600 at 0.38 megaflops.

Sun officials point to those figures to bolster their claim that Sun machines can compete with higher cost superminicomputers for floating-point performance. For the 3/200

workstations, Sun has fine tuned the FPA to increase its performance by 40 percent, says Hime.

But Sun is relying on more than MIPS and megaflops to gain a toe-hold in new graphics and publishing ventures. It is bringing out a 19-inch monochrome monitor with a resolution of 1,600 columns by 1,280 rows. That works out to more than 2 million pixels on the screen, or about twice the resolution of today's high-resolution monitors, which display about 1 million pixels.

With the introduction of the 3/200 series, Sun is bringing to market two basic configurations. First are stand-alone workstations: the 3/260HM (high-resolution monochrome), 3/260C (color) and 3/260G (gray scale). These systems, designed as 12-slot deskside pedestals, start with 8M bytes of main memory and can be expanded to 32M bytes. They are bundled with a companion pedestal that stores a 280M-byte Winchester with a storage module device interface and a quarter-inch tape drive. They can also operate as diskless nodes; sharing file and printer resources via Ethernet.

A high-resolution monochrome workstation with 8M bytes of main memory, Winchester and tape drives, two serial ports, Ethernet controller, keyboard and mouse sells for \$55,400. A comparably configured

color system costs about \$65,000.

Sun also offers the 3/200s as servers. The 3/280S, for instance, is configured as a 76-inch-high, rack-mounted file server with a 575M-byte Winchester, half-inch tape drive and 8M bytes of memory. It costs \$77,600. A similarly equipped terminal server for 16 users costs \$86,700. According to marketing director Hime, Sun plans to position its 3/260 workstations against two- and three-user VAXes that rely on graphics subsystems from companies such as Megatek Corp., San Diego.

**Here comes PC compatibility**

For the moment, Sun appears to have the lead at the high end of the workstation market, according to analysts. Meanwhile, the company is moving rapidly to play catch up at the low end with arch-rival Apollo. In February, Apollo introduced its Series 3000, a \$15,000 workstation that offers the open architecture of the IBM PC/AT bus and the ability to run those myriad MS-DOS programs.

Says Dataquest analyst Burdick: "The Series 3000 has been the biggest story of the year, and Sun has suffered because of it." The reason: Apollo offered two key criteria for "big-buy" accounts in the 3000—compatibility with the MS-DOS operating system and low-cost color.

Sun has countered in a variety of

ways. In June it introduced the SunIPC, a \$1,995, Intel Corp. 80286-based coprocessor board that allows Sun workstations to run MS-DOS applications in a window under the UNIX operating system. At the same time, Sun brought out PC-NFS, a software package that allows IBM PCs and compatibles to access files and peripherals over Sun's Network File System. In quantities of 100, PC-NFS sells for \$305; or for \$955 bundled with an Ethernet interface.

Sun's low-end strategy includes a color workstation, the 3/100, also unveiled this month. The three-slot VMEbus-based 3/100 can be configured as either a desktop or pedestal workstation. Standard equipment includes the 16.7-MHz 68020, the 68881, 4M bytes of main memory and a frame buffer with 10 planes of graphics.

At both the low end and high end, Sun appears to have its house in order, at least for the time being. But, according to industry observers, a new round of product introductions is due from IBM, DEC and Apollo. IBM is expected to increase the clock rate of its RT PC from 5.8 MHz to 20 MHz, increase its CPU bandwidth and improve floating-point performance. DEC may well bring out a more powerful MicroVAX based on its new B1 bus, or a desktop system built around the Q-bus. □

**Bringing the two worlds of UNIX together**

When it took the wraps off its newest workstations this month, Sun Microsystems Inc. also announced the first phase of a program to wed the two dominant "standards" of the UNIX operating system—that is, to find a common application interface for System V and Berkeley Version 4.2. Sun agreed last September to cooperate with AT&T Co. on the effort.

The Sun Operating System is based on UNIX 4.2, but customers have been clamoring for some System V compatibility. So, in the latest release of its operating system, Sun users will see some of that System V functionality, says Martha Vivoli, Sun's operating system product manager. Unlike other vendors who have implemented a dual port of both versions of UNIX, Sun is providing its users with a single environment by which to find many of the system calls, commands and routines of System V and UNIX 4.2.

Vivoli notes that although there are differences in the two versions of UNIX there are also similarities, which Sun is seeking to unify in one environment. For example, in release 3.2 of the Sun Operating System, there are 133 systems calls. Of those, 53 are the same for System V and UNIX 4.2, and users will be able to gain access to them from a single directory. The remaining calls—13 for System V and 67 for UNIX 4.2—can be stored in "user bins," or directories tailored to the needs of individual application writers, says Vivoli.

The primary System V features that Sun users can expect to see are interprocess communication, shared memory, semaphors and messages.

Current users will not have to change what they are doing, Vivoli adds. "If they don't need the System V stuff, they won't have to load it."

# Parallel claims niche with low-end fault-tolerance

**Mike Seither**

Associate Western Editor

Fault-tolerant computers, those systems designed to survive everything from power outages to internal component failures, have never come cheap. Fully configured models begin well above \$100,000. And they have appealed chiefly to large customers such as banks, stock exchanges, automobile manufacturers and retail chains for on-line transaction-processing applications.

But there are other "operational" markets—hotels, hospitals, government agencies, engineering departments and communications companies—where it's desirable to keep a system running in order to deliver services or products. The problem for system integrators has been that these users have been unable to justify the high cost of fault tolerance and have opted instead for traditional small computer systems.

Parallel Computers Inc., Santa Cruz, Calif., is taking aim at these markets with its new XR line of fault-tolerant machines, the UNIX-based 200XR, 400XR and 500XR. They cost, with OEM discounts, between \$21,000 and \$50,000.

## New niche beckons

Richard Eppel, Parallel's president, makes it clear that his company is not trying to play in the same league as Tandem Computers Inc., Stratus Computer Inc. or Tolerant Systems Inc., all of whom make fault-tolerant systems. Those companies offer high-end machines, and Eppel says he is content to let them fight it out for market share. Parallel, he explains, is bringing the basic functionality of those high-end systems down a notch or two.

"We think there's an opportunity to open up a market at a different price point and compete with supermicros," says Eppel.

The new XRs are cousins of the



Parallel 300, the company's first system that runs Parallel's version of UNIX. The Parallel 300, a 16-bit Motorola Inc. MC68010-based machine, has been available for two years and has sold for between \$60,000 and \$80,000.

With the 200XR leading the way, Parallel's strategy is to clash head-on with non-fault tolerant systems such as the 3068 from Altos Computer Systems, the MicroVAX II from Digital Equipment Corp. and the Tower from NCR Corp. Those systems have been instrumental in building a growing UNIX end-user market for commercial operations.

Parallel reasons that because its computers are designed around redundant hardware—dual CPUs, disk drives and uninterruptible power supplies—they offer a higher degree of reliability than do competing systems. And, says Eppel, that's a feature certain classes of customers will pay a premium for: perhaps 20 percent to 30 percent above the cost of a typical multiuser system.

Dave Moschella, an analyst with International Data Corp. (IDC), a Framingham, Mass., market-research company, agrees, saying that there are buyers who are willing to pay more to

**The 200XR from Parallel Computers features fault-tolerance in a desk-side pedestal. The MC68010 system can be upgraded in the field by replacing CPU and memory boards with 32-bit MC68020 versions.**

guarantee a higher degree of reliability for their small systems. Parallel, he adds, has carved out a unique niche for itself.

"No one else is building a redundant supermicro," says Moschella. "Parallel has the lead, and there is plenty of room for them to grow." This year the market for multiuser systems used in commercial operations is expected to exceed \$100 million, according to IDC.

## Safety in numbers

Parallel's XR line offers a wide range of performance and has been designed so that users can upgrade in the field from 16- to 32-bit processors as the need grows for more computing power. All systems are built around the company's basic redundant architecture.

Under that architecture, identical processors run the same stream of instructions, which are compared by a synchronization module. Periodically, synchronization calls embedded in the operating system verify that the two processors have executed the same set of instructions. If the two CPUs get out of synch, diagnostics locate and isolate the faulty processor. Meanwhile, processing continues on the remaining CPU.

To ensure the integrity of data going to mass storage, redundant controllers operate a pair of small computer system interface (SCSI) disk drives inside the main cabinet. All

**ANNOUNCING  
A MAJOR  
BREAKDOWN  
IN SOFTWARE  
DEVELOPMENT.**

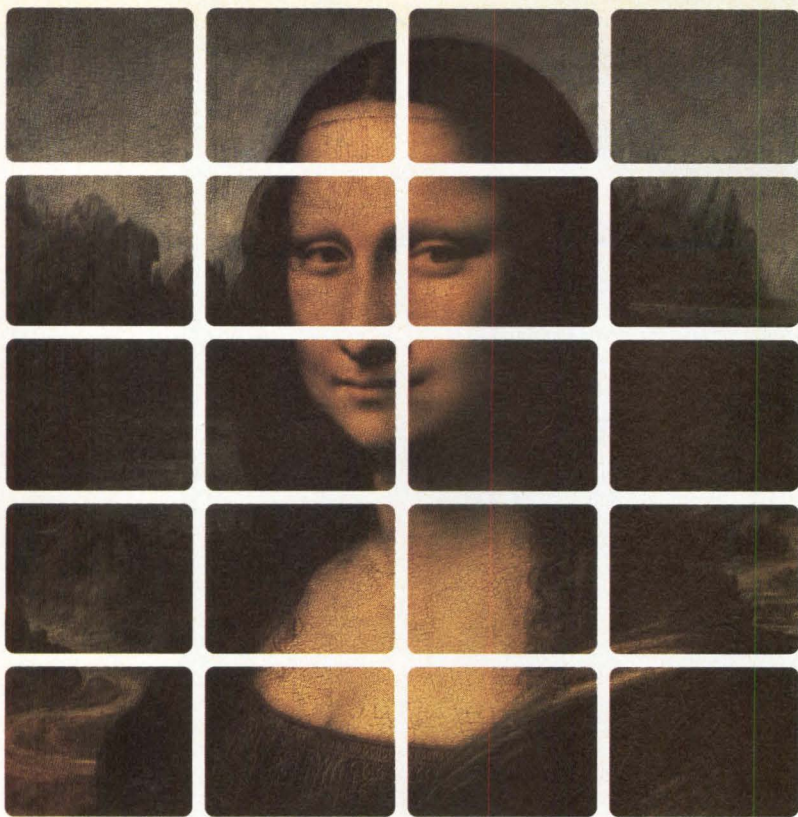

*A Pyramid system helps you break major microcomputer or embedded system programs into manageable parts, without letting you lose sight of the big picture.*

Developing a microcomputer mega-program these days is hardly what you'd call a day in the country. Programs for embedded systems aren't exactly a picnic, either.

They have to be broken into individual, manageable pieces.

Then the pieces put back together. In the right order, at the right time, without sacrificing anyone's productivity. Or sanity.

It's a real art.

And it requires plenty of resource.

Otherwise known as a Pyramid Technology system.

Dollar for dollar, nobody makes more development horsepower, or more flexibility, available to more developers, all at once, than we do.

Take our ISOPROCESSOR™ for instance. The ultimate 32-bit, RISC-based commercial computer.

It's one and a half times the speed of a VAX™ 8600, only two-thirds the cost, and runs all the popular UNIX®-based development software.

That's right. All.

Thanks to our dualPort™ OSx operating system. Itself an original.

OSx was the first combined implementation of both the Berkeley 4.2 BSD and AT&T System V UNIX standards.

It's a programming environment software vendors find irresistible. Which is why you have an overwhelming collection of tools to choose from.

IBM is a registered trademark of International Business Machines Corp. Macintosh is a trademark licensed to Apple Computer, Inc. VAX is a trademark of Digital Equipment Corp. UNIX is a registered trademark of AT&T Bell Laboratories, ISOPROCESSOR and dualPort are trademarks of Pyramid Technology Corp. ©1986 Pyramid Technology Corporation.

Tools like cross-assemblers and cross-compilers for all the popular microprocessor families. In all the popular development languages. Including C, Pascal and FORTRAN.

High-performance design packages that allow even the largest collection of programmers to test, time, analyze, debug, update, integrate and document their code as a team.

So they can finish before the product they're developing becomes obsolete. And the dollars they're consuming become obscure.

There are even two kinds of communications software available.

The computer-to-computer kind. For moving, massaging and sharing data. Say, between Macintoshes™, IBM® PCs, and a Pyramid host.

And the people-to-people kind. For writing, revising and sharing ideas. With the aid of our UNIX word-processing utilities.

But mere hardware and software aren't all we offer.

There's also our round-the-clock service and support. A boon for design teams that do their best work at three in the morning.

Plus an extensive training program.

A lifesaver for managers who need to get a dozen engineers up to speed by a week from tomorrow. Even so, why wait?

Before your next development effort is ready to come apart, write us at 1295 Charleston Road, P.O. Box 7295, Mountain View, CA 94039-7295.

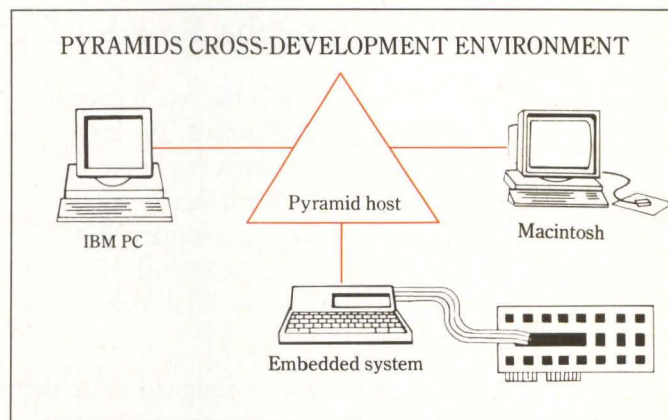

*Thanks to our open architecture, a Pyramid can play host to a variety of microprocessor environments. Including Macintoshes, IBM PCs, and just about any processor you can name for an embedded system. And our adherence to industry standards like UNIX and Ethernet, means you can add new resources without scrapping your existing equipment.*

Or, better yet, call us at 1-415-965-7200, Ext. 3450.

We'll do everything we can to help your project go to pieces.

**PYRAMID  
TECHNOLOGY**

The Shape of Performance.

CIRCLE NO. 10 ON INQUIRY CARD

# ALL IN ONE.



## Introducing the Freedom<sup>®</sup> ONE from Liberty Electronics

The Freedom ONE is the one terminal for all of your ASCII needs. With the Freedom ONE you don't pay more for advanced features. With the Freedom ONE you don't sacrifice features just because you pay less. At \$449 the Freedom ONE gives you the best of all worlds—in one terminal.

The Freedom ONE is designed to be there with all the features you need whatever your application. A 14-inch flat screen gives you the ultimate in crisp, clear characters in either 80 or 132 column display formats. Popular emulations like Freedom 200, WY-50, Viewpoint A2, TeleVideo 950, and ADM 31 let you fully utilize all

your existing applications programs. An adjustable height keyboard with 44 easy to program keys (88 with shift) lets you tailor the key layout and functions to your liking. Compact and attractive styling gives your workspace a state-of-the-art look with room to spare. These are just a few of the no-compromise, unbeatable features you get standard with the Freedom ONE.

For more information call Liberty Electronics today (415) 543-4353, and ask for it all. Ask for the ONE.

 **Liberty**  
We Make Terminals

CIRCLE NO. 11 ON INQUIRY CARD

Freedom is a registered trademark of Liberty Electronics WY-50 is a trademark of Wyse Technology ADM is a trademark of Lear Siegler, Inc. Viewpoint is a trademark of Applied Digital Data Systems, Inc. TeleVideo 950 is a trademark of TeleVideo Systems, Inc.



disk-writes are mirrored identically to both drives. If a media defect causes a read or write error on one of the drives, the operating system maps out a new block, fetches correct data from the other drive and replaces it so that copies exist on each drive. In the event that a controller or a drive fails, the system isolates the faulty device and sends later requests to the other twin.

The fault-tolerant machines' UNIX operating system has all the Berkeley Version 4.2 features, as well as some from System V, such as record locking and shared memory.

**No machine is an island**

Parallel has taken steps to keep its systems from becoming islands unto themselves. The company just announced, for instance, its support of Sun Microsystem Inc.'s Network File System protocol, which allows users to access files from a variety of different computers. In addition to its Ethernet connection, Parallel also markets the Advanced Communications Processor to handle user-defined protocols, as well as industry standards like CCITT's X.25 and X.29; and IBM Corp.'s Systems Network Architecture and 3270-3780.

Parallel's low-end 200XR is a desk-side pedestal that, like the earlier 300, operates on the MC68010 16-bit CPU. It can support up to 16 I/O ports and be configured with 2M bytes or 4M bytes of memory per processor. Mirrored 5¼-inch Winchester disk drives are available in unformatted capacities of 86M bytes or 172M bytes.

Parallel's mid-range machine, the 400XR, comes with the same packaging, memory and disk-drive configurations as the 200XR, but uses the 32-bit MC68020 processor. It also accommodates more users, offering up to 24 serial I/O ports using Parallel's standard eight-port I/O controllers, and 128 with Parallel's Distributed I/O Processor (DIOP).

Parallel developed the DIOP to solve the problem of physically connecting a tangle of devices to a desk-side computer cabinet. Available only on the 400XR and Parallel's high-end machine, the 500XR, a single DIOP

allows up to 128 peripherals to tie into the computer through one 2.5M-bit-per-second coaxial cable that functions as a token bus. Within 1,000 feet of the main cabinet, MC68000-based cluster controllers can hook into the coaxial cable. Each cluster controller multiplexes up to 16 devices onto the cable.

Parallel's top-of-the-line machine, the 500XR, can handle two DIOPs, allowing a maximum of 256 devices to tie into the system. The 500XR is basically an upgraded version of the Parallel 300, except that it uses 32-bit processors. Larger than the 200XR and 400XR, it comes in a 48- or 56-inch-high cabinet, depending on mass storage options—either mirrored 168M-byte or 344M-byte, 8-inch Winchesters.

According to marketing director Brian Knowles, the key to Parallel's strategy is to offer OEMs a wide latitude of systems that customers can upgrade when necessary. For exam-

ple, a low-end 200XR can be configured as a mid-range 400XR by simply replacing the 16-bit CPU and memory boards with 32-bit versions. The upgrade kit for such a conversion, with 2M bytes of main memory, costs \$9,900. For the same price, customers with the Parallel 300 can also upgrade to a 500XR by trading in the old boards.

Now poised with a full line of fault-tolerant systems, Parallel officials believe they have a winning combination of technology and products to capture new business. And they appear to have support. In addition to a recent round of financing that brought in more than \$7 million, Parallel recently licensed its technology to Ameritech Communications Inc., the Midwest regional Bell operating company based in Chicago.

Says IDC analyst Moschella: "The Ameritech deal is a vote of confidence in Parallel. It's pretty good evidence the technology works." □

Bus Specific Networks  
**NEW SOLUTION**

**Complete network solutions for the price of a single card.**

Entry level costs to networking are reduced by ICM's unique integration of the most common components of both file servers and network workstations. ICM's WS-286 contains all the common local area network components on one board—including ARCnet, SCSI, 1 MByte RAM, and 5 expansion slots. This greatly reduces system complexity, repair costs, and stock of multiple costly components.

The on-board SCSI controller provides easy interface to ICM's single-board disk and tape controller—so the WS-286 may be used as both a file server and inexpensive diskless workstation, supporting Novell and TurboDOS. It fits into standard IBM-XT enclosures without software or hardware modification. The 80286-based workstation operates at 10 MHz with no wait states when accessing on-board peripherals and RAM, while the expansion slots operate at 4.77 MHz to allow full XT expansion card compatibility.

Call ICM for more information and Reseller pricing.

PC, ARCNET, AND S-100 APPLICATIONS.

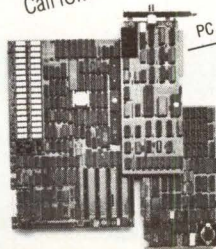

**ICM**

TOMORROW'S BREAKTHROUGHS TODAY

InterContinental Microsystems

4015 Leaverton Ct., Anaheim, CA 92807

Phone: (714) 630-0964

Telex: 821375 SUPPORT UD

Easylink 62562040 BBS (714) 632-8750

# TODAY IS THE BLACKEST DAY IN DOT MATRIX PRINTER HISTORY.

It would pay you to mark it on your calendar.

Because today is the day we introduce our new Pinwriter™ P5XL dot matrix printer. The only dot matrix printer available capable of producing the rich, black printing you associate with a letter-quality printer. Because it's the only one designed to use a multi-strike film ribbon — the same ribbon used in typewriters and letter-quality printers.

## A LITTLE BLACK MAGIC.

Actual line printed with the Pinwriter P5XL printer.

Black letter-quality printing is only the beginning. The Pinwriter P5XL printer can also use an optional ribbon to print in seven other colors. And it has the finest graphics resolution of any impact printer you can buy. Plus it's very fast and exceptionally quiet.

It's only natural that

the first dot matrix printer with true letter-quality printing should be an NEC. After all we make Spinwriter® letter-quality printers, the most popular line today, as well as the Pinwriter P5 dot matrix printer, the most advanced 24-pin printer.

The Pinwriter P5XL printer is part of the most extensive line of 24-pin printers available. You'll find a model designed to fit every need and budget. See them at your dealer or call 1-800-343-4418 (in MA 617-264-8635). Or write: NEC Information Systems, Dept. 1610, 1414 Massachusetts Ave., Boxborough, MA 01719.



**NEC PRINTERS. THEY ONLY STOP  
WHEN YOU WANT THEM TO.**

# NEC

NEC Information Systems, Inc.

**C&C** Computers and Communications  
© 1986 NEC Corp.

CIRCLE NO. 15 ON INQUIRY CARD

# Chip makers boost PC graphics performance

Lynn Haber, Associate Editor

New coprocessors that offload graphics functions from a personal computer's CPU are ushering in the next generation of personal computer graphics. Some analysts contend that these coprocessors, such as Intel Corp.'s 82786, will cut into sales of low-end specialized graphics workstations.

According to market research concern Dataquest Inc., San Jose, Calif., there were 1.5 million bit-mapped, graphics add-in cards installed on personal computers used in business last year. Lew Brentano, Dataquest's vice president for graphics industry service, expects that number to increase 70 percent per year, compounded, over the next few years.

By comparison, sales of standalone graphics terminals, beginning with an installed base of 100,000 units last year, are expected to grow only 20 percent per year over the same period.

"Depending upon implementation, these chips will improve performance three-to-10-times over the previous generation of products," Brentano says. He suggests that manufacturers of low-end graphics workstations may cut prices to compete.

Advanced Micro Devices Inc., Sunnyvale, Calif., and Texas Instruments Inc., Dallas, have joined Intel in selling graphics coprocessors.

Advanced Micro sells a special-purpose graphics coprocessor, the Am95C60 Quad Pixel Dataflow Manager. Texas Instruments Inc., Dallas, is developing the TMS34010, a general-purpose, 32-bit microprocessor with special graphics-processing hardware embedded in the instruction set. First shipments for both products are scheduled in the fourth quarter.

Intel's 82786 graphics coprocessor incorporates two independent on-chip processors—a graphics processor and a display processor—to

manipulate graphics and text while executing multiple windows. The chip also incorporates a bus interface unit, a dynamic RAM (DRAM) controller and supports the computer graphics interface (CGI) standard.

According to Intel, Santa Clara, Calif., the primary task of the graphics processor is to draw bit-mapped graphics. It claims the 82786 can draw graphics primitives such as points, lines, arcs, circles, rectangles, polygons and characters, in any of 256 colors. (The color details such as bits per pixel and exact color are programmable.)

Graphic coprocessors will aid in the adoption of industry software standards without compromising on performance, says Garth Wilson, gen-

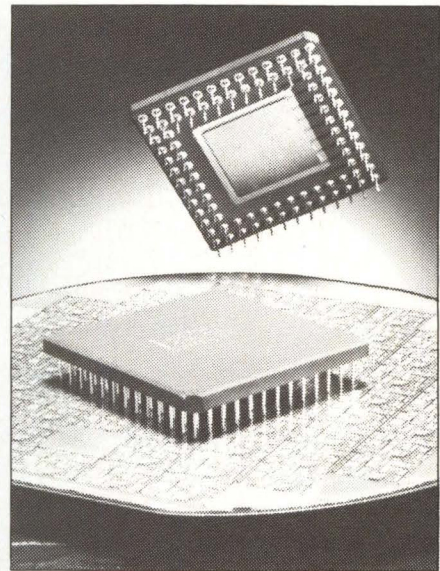

Intel's 82786 incorporates two on-chip processors—a graphics processor and a display processor—that operate concurrently. The 82786 also includes a bus interface unit and a DRAM controller.

Bus Specific Networks

# NEW FUTURE

**Finally PC-DOS capabilities on S-100 systems—a major breakthrough the noncompatibility barrier.**

For the first time, you can run monochrome PC-DOS and MS-DOS—including Lotus 123, Wordstar, and Sidekick—on your existing S-100 system. All with the brand new CPS-16F, a powerful single board network processor, only from ICM. It fits existing installations without a LAN hookup and has low entry requirements for TurboDOS Systems. The CPS/MS-1000 package (with 1000 opportunities) consists of the CPS-16F processor; M/STER—ICM's monochrome graphics PC-emulating terminal; PC-DOS; TurboDOS/PC; and ICM's exclusive MS-1000 software.

ICM brings PC-DOS to the S-100 industry. Call ICM for Reseller pricing on the CPS/MS-1000 package and info about our upcoming products.

PC, ARCNET, AND S-100 APPLICATIONS.

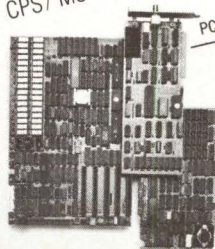

**ICM**

TOMORROW'S BREAKTHROUGHS TODAY  
**InterContinental Microsystems**  
 4015 Leaverton Ct., Anaheim, CA 92807  
 Phone: (714) 630-0964  
 Telex: 821375 SUPPORT UD  
 Easylink 62562040 BBS (714) 632-8750

# You can buy a Maxtor drive. Or you can wait.

Sure, plenty of companies have announced high-capacity 5¼-inch Winchester with more than 100 megabytes. And one of these days they'll be shipping in volume.

But Maxtor already is. And has been for over two years.

So if you need 5¼-inch Winchester with over 100 megabytes, don't wait.

You know who to call.

Maxtor Corporation, 150 River Oaks Parkway,  
San Jose, CA 95134, (408) 942-1700, TELEX 171074.

Sales Offices: Austin, (512) 345-2742; Boston, (617) 872-8556;  
Orange County, (714) 859-3100; San Jose, (408) 435-7884.

## Maxtor

CIRCLE NO. 16 ON INQUIRY CARD

RECEIVING



eral manager of graphics component operations at Intel. When standard interfaces are written into software, they are implemented with complex algorithms that execute slowly, resulting in performance loss, Wilson explains. Software vendors often bypass standards to gain better performance. But graphics coprocessors such as the 82786 implement key functions of the standards in hardware.

Dataquest's Brentano believes that the performance improvements made possible by these coprocessors are especially important for windowing and multitasking interfaces such as Digital Research Inc.'s GEM, IBM Corp.'s TopView and Microsoft Corp.'s Windows. He says that personal computers equipped with IBM's Enhanced Graphics Adapter (EGA) boards are too slow to handle the processing requirements needed to manipulate more than one window on a screen, while simultaneously handling the CPU's processing requirements, such as overhead and data management.

"The Intel and TI chips can handle windows on the order of five times faster than an EGA card," because the chips have windowing support built into the hardware, he contends.

Brentano adds that these chips provide better resolution and color capability than do EGA cards: "I think that, as a result of these coprocessors, people will move to color quicker than they might have otherwise, as these chips make the technology more affordable."

**Intel targets the office**

Intel's Wilson says that the 82786 chip is intended for the office market, where personal computer applications such as desktop publishing and high-performance graphics are expected to gain wide acceptance. He adds that the 82786 is also aimed at designers who use their personal computer workstations for computer-aided design (CAD) and computer-aided engineering (CAE).

Advanced Micro's Am95C60 is a graphics coprocessor that maintains, updates and displays information on four bit-mapped video planes. Ac-

ording to a company spokesman, two support chips—the AM8171/2 Video Data Assembly and the

Am8176 Video Clock Generator—were specifically designed to work with the Am95C60. Other members

**HOW THE CHIPS FALL**

Company/Product	Description
<b>Advanced Micro Devices</b> Am95C60 Quad Pixel Dataflow Manager	CMOS graphics coprocessor with a maximum clock speed of 20 MHz that can draw vectors up to 3.3 million pixels per second. The coprocessor can interface to an 8- or 16-bit bus. It supports the computer graphics interface (CGI) standard. Available in the fourth quarter. Pricing not available.
<b>Intel Corp.</b> 82786 graphics coprocessor	CHMOS graphics coprocessor that incorporates two on-chip processors—graphics and display—as well as a bus interface unit and a DRAM controller. Supports a maximum clock speed of 25 MHz and can display up to 256 colors simultaneously. The chip features hardware windows and supports CGI. Available at the end of this year. Priced at less than \$100 in quantities of 1,000.
<b>Texas Instruments Inc.</b> TMS34010 graphics system processor	General-purpose, 32-bit CPU capable of handling 6 million instructions per second; draw rate of up to 48 million pixels per second. Supported by a C language compiler, CGI and real-time emulation. Available at the end of the year. Priced at \$50 in quantities of 25,000.

Bus Specific Networks

**NEW SIZE**

**4-in-1 processor board.**  
 More compact, our new CPS-Q6A opens a myriad of new opportunities. Only from ICM. Combining four 8-bit network processors on a single board shrinks the bus space, uses 35% less power and costs less per processor. Designed to operate at 10 MHz, it offers S-100 users the highest degree of performance and system integration available in the market today!

ICM's CPS-216 is also available—with two 16-bit network processors operating at 8 MHz with 256K RAM each, all on a single board.  
 ICM provides the system integrator with the best price performance products possible. Call ICM for Reseller pricing on the CPS-Q6A and CPS-216 package and info about our upcoming products.

PC, ARCNET, AND S-100 APPLICATIONS.

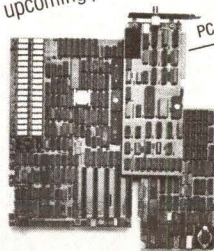

**ICM**

TOMORROW'S BREAKTHROUGHS TODAY  
**InterContinental Microsystems**  
 4015 Leaverton Ct., Anaheim, CA 92807  
 Phone: (714) 630-0964  
 Telex: 821375 SUPPORT UD  
 Easylink 62562040 BBS (714) 632-8750

2.45 MByte/sec  
transfer rate

# All SMD disk drives. One tester.

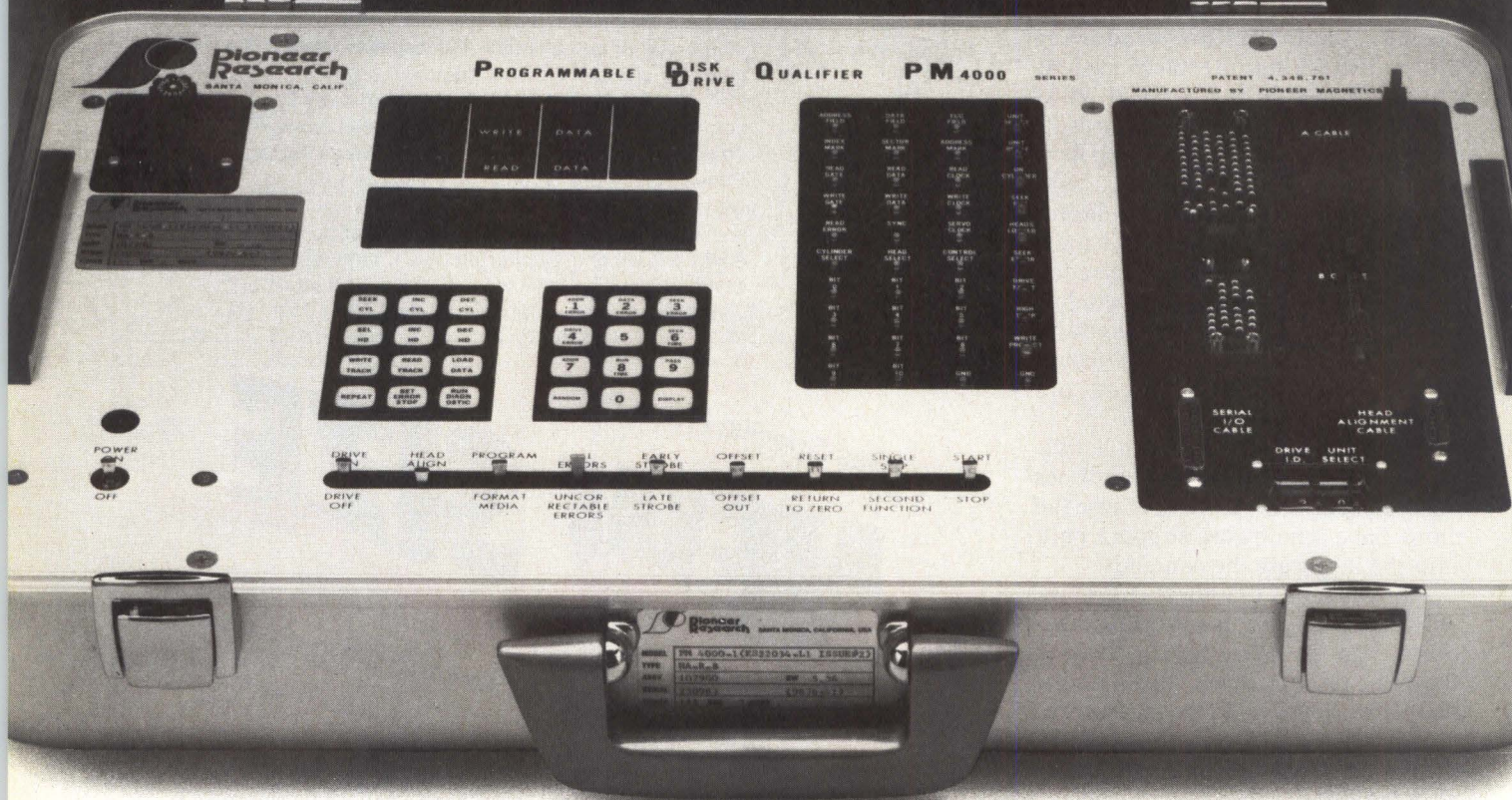

If you design, manufacture or service SMD-interface disk drives, take a good look at the picture in this ad. It's the only disk drive tester you'll ever need.

It's the advanced, high performance PM4000 Qualifier™ from Pioneer.

This programmable portable micro-computer-in-a-briefcase tests all drives with SMD interfaces. And it can test them at transfer rates in excess of 2.45 MB per second.

It will test today's Fujitsu M2361 or any CDC,™ Century Data, NEC, Toshiba, you name it.

#### One size tests all.

With the PM4000 Qualifier you can standardize all your company's testing needs on a single lightweight unit. Use it in development engineering, produc-

tion test, receiving, inspection, and field service.

The PM4000 monitors and diagnoses drive problems. And all the readouts are in English. It can format at 2.45 megabytes per second. Pinpoints errors to a specific media sector or byte. And can rerun tests continually to find intermittents in the output. It works with dedicated or embedded servos. Can be multiplexed to test four drives at once. And even operate remotely using a standard terminal and modem.

The PM4000 enables you to run up to six preprogrammed test sequences or enter your own test programs thru the

## The intelligent disk drive tester.

keyboard or RS 232C port. And you can input a custom set of drive parameters with no EPROMS to modify or boards to change.

#### The intelligent disk drive tester.

The PM4000 is so packed with advance features, it takes a six-page information piece to detail them all. Phone us toll free at 800 233-1745 (In CA, 800 848-1745) and we'll speed one off to you, without obligation, in the next morning's mail.

If you'd like to see a PM4000 Qualifier in person, call us. We'd be pleased to arrange a complete demonstration. The Pioneer PM4000. It's the only SMD drive tester you'll ever need.

 **Pioneer Research**

CIRCLE NO. 17 ON INQUIRY CARD

1745 Berkeley Street, Santa Monica, CA 90404,  
213 829-6751, TWX 910-343-6249.

# HOW TO BE IN 6 PLACES AT ONCE.

Only a Falco 500 Multi-Host Terminal can open windows onto all these worlds-today.

No other product in its class delivers productivity like the Falco 500 Multi-Host Terminal.

## 1. THE ANSI WORLD OF DEC MINICOMPUTERS.

Because no one can match its high-performance specs. Which are—in a word—*spectacular*.

For openers, take the Falco 500's multi-host capabilities. They let you communicate with separate computers through two bidirectional ports—*concurrently*. Ports that can be configured automatically



## 2. THE UNIX WORLD.

as RS232C or RS422. So

you can enter or retrieve data from any of the computer worlds shown here—plus hundreds of others. And switch between any of them with a single keystroke. *No other terminal today offers this kind of multi-host capability.* Period.

Then too, nobody does win.



## 3. THE REMOTE TELECOM WORLD.

mode, compatible with virtually all ANSI and ASCII terminal protocols. Plus its own set of 64 programmable function key levels. And its own segment of dedicated display memory. Meanwhile, the competition's only got split screens. No contest there, either.

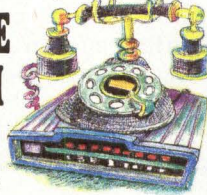

## 4. THE ELECTRONIC-MAIL WORLD.

Maybe you don't need to talk to this many applications from a single terminal—today.



But if you're getting ready to install multiple computers or replace single-function terminals—don't. Until you look at the Falco 500.

It's the only terminal that lets your operators be in six places at once—getting lots more work done. And the only one that doesn't mind if those places are ANSI- or ASCII-oriented; mainframe, mini or micro; or located in an office, factory or engineering lab. Plus the

## 5. THE LOCAL AREA NETWORK WORLD.

adaptability of the Falco 500 means you no longer need several terminals doing just one thing at a time. Because it does six things on one terminal—half a dozen on another.

To start opening windows today on a more productive,



## 6. THE ASCII WORLD OF SUPERMINIS AND MICROS.

multi-host world, contact your Falco distributor.

For the one nearest you, contact Falco Data Products, 1294 Hammerwood Avenue, Sunnyvale, CA 94089; (408) 745-7123. Toll-free (800) 835-8765.

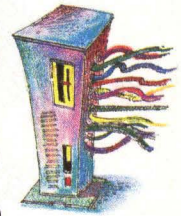

# FALCO 500

THE SPECTACULAR PRODUCTIVITY MACHINE.

of the display products family include an Enhanced Display Refresh Controller and a Graphics Color Palette. Targeted applications for the graphic coprocessor include personal computers, CAD and high-end video.

TI's TMS34010 offers users more flexibility and greater functionality than AMD's or Intel's coprocessors, a

TI spokesman says. But, because it's a general-purpose CPU, it requires the user to create additional software. Intel's Wilson contends, "The TI chip is more flexible but doesn't give the performance in graphics applications that you get from dedicated hardware."

According to TI, TMS34010 micro-

processor applications include those for personal computers, facsimile machines, laser printers, graphics terminals, workstations and desktop publishing systems.

**Strong third-party support**

TI reports that third-party support for its chip is being provided by Graphics Software System Inc. (GSS), Microsoft Corp. and Nova Graphics International Corp. GSS also supports the Intel chip.

GSS, Beaverton, Ore., recently announced the DGIS\*82786 ROM kit, a firmware product that provides a high-level programmer interface to Intel's 82786 graphics coprocessor. The product, which GSS will license this summer, is emerging from a two-year cooperative effort between GSS and Intel, according to GSS.

A spokesman for GSS contends that both Intel's and TI's chips have their pluses and minuses. "The Intel chip has a rich graphics-instruction set but doesn't cover CPU capabilities, whereas the TI chip is an all-in-one solution; but not everyone would want to write a program directly to the [TI] chip," he says. The TMS34010 is capable of being programmed in languages such as C and is supported by a software-and-hardware development environment, according to the company.

Vendors endorsing Intel's 82786 coprocessor include Microsoft, Nova, Ashton-Tate, Digital Research Inc., Lotus Development Corp. and Number Nine Computer Corp. According to Intel, these companies are developing applications-support software, board products and development tools.

Number Nine Computer, Cambridge, Mass., plans to introduce the Pepper Graphic System, a board-level product for business graphics that implements the 82786, as its first foray into the low-end business arena. According to Will Frentz, Number Nine executive vice president, the company's family of board-level graphics products has traditionally targeted high-end graphics markets such as CAE, desktop publishing, imaging and video production. □

# DO YOU WANT TO BE A HERO?



Solve your customers' problems. Fast. That's what makes you valuable. And brings them back to you.

Let us help.

Our cable assemblies are the finest available. All built to IBM specs. Every part we use is QPL. No substitutions of cheap components; no shortcuts in assembly. More than the years' experience has taught us there are no shortcuts to quality.

And our service? Fast. And helpful. If you know what you need, call us at 1-800-323-6604 and order it. If you don't, call us and ask. Either way, you can expect same day shipping of built-to-length assemblies.

And *you* get all the credit.



**NATIONAL  
ELECTRIC  
CABLE**

Cable Specialists for IBM Systems

1730 Elmhurst Road  
Elk Grove Village, Ill. 60007

Chicago (312) 593-8100  
Portland (503) 620-9400  
San Francisco (415) 785-1277  
Houston (713) 464-8555

**CALL TOLL FREE 1-800-323-6604**



# How your great UNIX™ application could make you a great IBM VAD.

If your company has written an outstanding multi-user application for UNIX-based systems, you could qualify to become an IBM Value Added Dealer.

Our recent introduction of the IBM RT Personal Computers has created a wealth of opportunities for potential VADs. The RT PC's innovative 32-bit RISC microprocessor has the power and speed to take full advantage of a rapidly expanding market—especially those customers with technical or professional needs.

The RT PC runs on AIX™, an IBM-enhanced UNIX that's easier to use, and lets you offer companies a powerful and compact system that can grow with their needs. By adding low-cost ASCII terminals such as the IBM 3161, you can tailor competitively priced systems for up to eight concurrent users. And, with the optional Intel 80286 coprocessor board, users can run many of their existing IBM PC programs.

In addition, you will gain all the advantages of being an IBM VAD. Our comprehensive dealer support

program, ProPlan, helps IBM dealers with marketing, training and promotions. IBM also has a wide range of professional management classes for VADs.

And, thanks to an online referencing system used by IBM's own sales force, we can refer prospects with special needs to VADs that have unique solutions.

The VAD program for the IBM RT PC is a great opportunity for companies with proven business records in innovative programming.

To find out how your company can share this opportunity, simply send in the coupon or call 1 800 IBM-8277, Ext. 96/R.



IBM Corporation	96-8/86
National Distribution Division	
Dept. K6E/R29C	
P.O. Box 76477	
Atlanta, GA 30358	
Please send me information about qualifying as an IBM RT PC VAD.	
Name _____	Title _____
Company _____	
Address _____	
City _____	State _____ Zip _____
Phone _____	

UNIX is a trademark of AT&T Bell Laboratories.  
AIX is a trademark of the International Business Machines Corporation.

© 1986 IBM Corporation

CIRCLE NO. 20 ON INQUIRY CARD

# The Thinking

*Looks for typeset-quality printing and demands perfection in text and graphics integration.*

*Requires extensive networking and strong emulator support to handle Sun, Apollo, DEC and IBM host environments.*

*Needs to wrap both CAE and document processing needs in one laser printing system.*

*Wants to protect his investment with a versatile system that is easily upgraded as his needs change.*

*Expects his system to stand up to heavy demands with advanced page management features like duplexing.*

*Requires printing systems that actually run at the rated speeds—even on original pages.*



# Printer's Man.

Who is The Thinking Printer's Man? At IMAGEN, we believe it's the kind of person who recognizes the advantages of dealing with the industry's leading manufacturer of laser printing systems. Someone who can appreciate our understanding of the workgroup environment's need to integrate text and graphics. In both high-volume *and* high-quality printing.

Six years ago, we perfected the technology that optimized laser printing. And at IMAGEN today, we build intelligent laser printing systems with an independent "brain" that allows them to do what they do best, and frees your host computer to do what it does best.

Our printing systems feature a dedicated image processor with three MC68000s that, along with our sophisticated page description languages, offers more flexibility than simple printer controllers can. Like clean text fonts and publication-quality graphics. Anywhere you want them on the page. The kind of quality that can turn documents that need to be read into ones that want to be read.

But our printing systems don't compromise quantity for quality.

For example, some suppliers claim their printers can deliver a certain number of pages per minute. But what they really

do is print multiple copies of the same original per minute. With IMAGEN's newest system, you can print 20 completely different pages in the same 60 seconds.

IMAGEN laser printing systems offer a variety of innovative page management features that handle automatic duplexing, page reversal, electronic collation and jam recovery. This, combined with the ability to print on 11 x 17-inch paper, allows you to produce as much high-volume, high-quality documentation as you want. With as much technical detail as you need. And all our printers can be connected through Ethernet and other networks.

So, if you'd like to learn more about our laser printing systems, call IMAGEN today at (800) 556-1234 extension 199 in the Continental U.S. In California, call 1-800-441-2345 extension 199.

Because it's time you have a printer that's nearly as smart as you.



**IMAGEN**  
INTELLIGENT PRINTING

CIRCLE NO. 21 ON INQUIRY CARD

Take a good long look at your performance and system integration needs. Now take a look at two Microbar Multibus™-based boards for the 68020—Multibus I and Multibus II.

Needless to say, we look very, very good.

Witness, for example, 32-bit performance on a single board. And you can have it *now*. Not next year or down the road, but right now (after all, we do understand the window of opportunity you're up against).

Nice enough, but there's more.

# 68020 Multibus Boards. Ready and waiting for design teams taking quantum leaps.

Like the 68020 with MMU, DMA and Floating Point capabilities. RAM, from 1MB to more than 4MB—all high-speed with dual-ported access. Two serial ports and a parallel port. We also provide UNIX™ System V and real-time operating systems ported to the CPU.

However, while the above is all great and wonderful, it is by no means the whole story.

Our boards deliver ideal performance of the microprocessor as well as thorough integration with the standard system bus architecture.

You'll also grow quite fond of the software portability, allowing existing 68000 software to be executed by the 68020—while more than doubling performance.

And lest we forget, the on-board architecture of our GPC68020 for Multibus I is compatible with your next-generation system's evolutionary path using our Multibus II MT68020 board.

So, when your team wants to go to town, call us in California at (800) 421-1752 or (800) 821-1011 within the Continental U.S.

We'll give you the Microbar muscle to move in quantum leaps.

 **MICROBAR  
SYSTEMS, INC.**  
785 Lucerne Drive, Sunnyvale, CA 94086  
*Your future system is our current project.*

CIRCLE NO. 22 ON INQUIRY CARD



™ UNIX is a trademark of AT&T  
™ Multibus is a trademark of Intel Corp.

# Bell Labs models parallel processor on neural networks

Jesse Victor, Associate Editor

Researchers in the microscience group at AT&T Bell Laboratories, Holmdel, N.J., have turned to a massively parallel, non-Von Neumann architecture—one that is similar in some respects to that of simple biological neural networks—to overcome the fundamental performance limitations of both conventional digital computers and submicron integrated circuits (ICs).

The group has developed experimental, "neural-network" processors whose fundamental elements are resistors, not transistors. Capable of functioning as either content-addressable memories or optimizers, these processors use a form of "fuzzy" logic to provide fast solutions to complex problems—in some cases much faster than digital computers.

"We are running out of steam on conventional computers," asserts Richard E. Howard, a member of the Bell Labs research group. "We have to look at something different. A biological processor proves that a different way of doing computing is possible. It gives us cues for another way to go."

Using electron-beam lithography and plasma etching, the Bell Labs researchers have fabricated a silicon, narrow-channel metal oxide semiconductor field-effect transistor (MOSFET) with features as small as 25 nm—only about a hundred atoms wide. But chips like these are so small, Howard contends, that they exhibit two kinds of quantum effects at near room temperature from the wave nature and discrete energy levels of the electrons in the circuit.

Microfabrication is not the problem, explains Howard. "We can do lithography 100 times smaller than conventional line widths and make complex devices with 0.02 micron lines. But, at this point, you are getting very close to fundamental limits to increasing chip density."

The fundamental limits involve

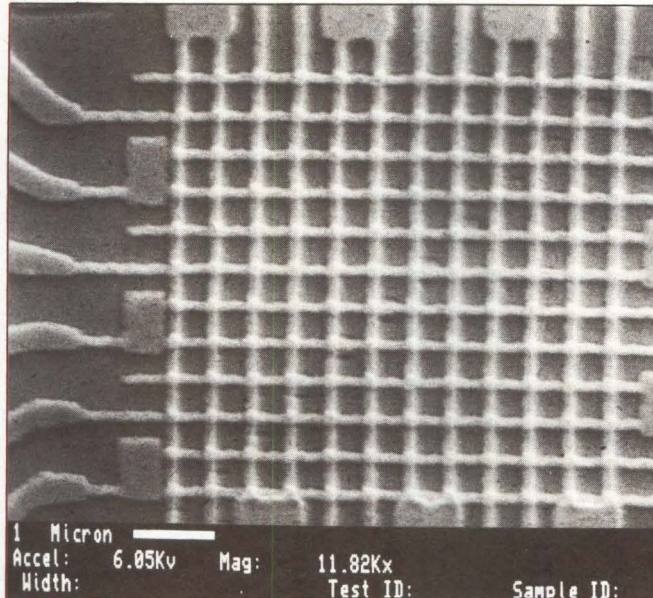

**Fabricated of amorphous silicon and tungsten wires, a 12-line-by-12-line resistive array for a neural-network processor packs 144 interconnects into an area 6 microns on a side using 0.1-micron line widths. Interconnect pads surrounding the grid lead to the off-chip amplifiers—essential elements of the neural-network processor.**

problems with thermal effects and discrete-switching effects—due to the few electrons in the circuit—and to the two kinds of quantum effects. One effect, associated with single electrons moving in and out of interface traps, causes wide swings in device conductivity, with device resistance fluctuating in factors of 30K ohms. The second effect, which results from interference between electron waves, also causes conductivity changes with variations in other parameters, such as gate voltage or magnetic-field strength.

Because of these effects, Howard warns, such submicron circuits do not behave like ordinary semiconductors. "We can predict the statistical distribution of these [conductivity] changes. But statistical distribution is not good enough when you are designing a circuit. Below 0.1 micron line widths, you have to talk about using completely different devices."

The Bell Labs group and other researchers have circumvented the limitations of submicron ICs by using massively parallel processors based on simple models of biological systems.

In biological neural systems, nerve cells (neurons) send pulses via nerve-fiber pathways (axons) to the inputs (dendrites) of other neurons, through synapses. In an electronic analog of a neural network, Howard says, the neurons are operational amplifiers and the synapses are resistors that determine how the output of one amplifier (an "axon") is connected through a capacitor to the input of another amplifier (a "dendrite").

Thus, the neural-network processor is basically an array of amplifiers with resistors at the crosspoints of a wire grid. The processor's operational states can be defined by a plot of potential energy or an energy "surface"; this in turn can be mathematically modeled as a function of the amplifiers' gain and of where the resistors are placed on the grid.

In operation, the processor, in effect, "rolls down hill" from higher to lower energy states until it reaches local valleys or pits in the energy surface: minimal or stable states where the neural-network's voltages are constant in time. These minimal voltages solve users' problems when the processor acts as an optimizer and

Alis® is an office software system with one very special benefit any businessman can relate to.

Freedom.

Freedom to choose the equipment that best meets your company's varied needs... even from different hardware vendors. Portable Alis gives you the independence to make future computer choices based on the things that matter, like function, support, and performance.

Freedom to run one superior office automation system company-wide, across equipment never before considered compatible.

Even the freedom to forget about office automation worries for a long time to come. Because Alis has advanced software technology and integration that are not only superior to anything available today, but also designed to meet office needs well into the 1990's.

That's why more than a dozen major international computer manufacturers are including it in their most advanced products.

If you've been feeling locked in by the choices in office automation, call John Butler, V.P. of Marketing, at (617) 870-0300. Freedom could be just a phone call away.

Alis combines text, spreadsheet, graphics and database in single, always editable documents  handles proportionally-spaced and multiple-size fonts WYSIWYG-style  provides automatic formatting of reports, letters, memos, etc.  sophisticated equation-solving spreadsheet  drawing and business graphics  personal and office databases  integrated electronic mail and meeting scheduling  multiple windows  supports graphic workstations and terminals.

\*Alis and Applix are registered trademarks of Applix, Inc.



*"I feel so locked in,"  
he cried in frustration.*

*"I have the key,"  
Alis smiled confidently.*

# Alis®

The office software system from APPLIX®

## Finally, some answers in Wonderland.

APPLIX, INC. 112 TURNPIKE ROAD, WESTBORO, MASSACHUSETTS 01581 (617) 870-0300

CIRCLE NO. 23 ON INQUIRY CARD

store data when the unit serves as a content-addressable memory.

Like a human brain, the network exhibits parallel-processing operation, very high density and extensive fault tolerance. Thus, damage to many of the connections, or loss of data in the network, will not significantly affect the processor's output.

"The processor basically functions as an analog computer with digital outputs," Howard observes. "It is a computer that guesses in a reasonably intelligent way. In a digital circuit, each transistor is important. In a neural-network processor, only the collective state of the network is significant."

The microscience group at Bell Labs has fabricated several 22-line-by-22-line-matrix neural-network chips using amorphous silicon and 2-micron line widths. One version—coupled with its off-chip amplifiers—can store four 22-bit words. A 512-line-by-512-line array, which can

**In this computer simulation of a neural-network processor acting as a content-addressable memory, the processor converges to a minimal voltage level (the bottom line) that recalls a full name and telephone number when only part of the name is entered.**

Time	Energy			
0	0.	john s		
0.20	-0.0784	john sdewirubneoimv	8109	
0.40	-0.8426	john sdewirtbnenimv	8129	
0.60	-0.8451	john sdewirtbnenimv	8129	
0.80	-0.8581	john sdewirt nenkmv	8128	
1.00	-0.9099	john sdewart denker	8128	
1.20	-0.9824	john stewart denker	8128	

Source: AT&T Bell Laboratories

store 128 512-bit words, has also been fabricated. It integrates all circuit elements, including CMOS amplifiers and multiplexers, on a 7-mm-by-7-mm chip.

"The advantage is that we can make the resistive elements as small as we wish," Howard comments. "For example, we've fabricated a 12-line-by-12-line tungsten-wire matrix chip,

without active elements, using 0.1-micron lines, which fits into a square 6 microns on a side—about the same size as a cell within a conventional dynamic RAM."

Because the synapses are in parallel, the resistor network is not power-hungry. A 4-mm-by-4-mm network dissipates only 0.5W.

Functioning as a content-address-

# POWER. FOR PEOPLE WHO KNOW HOW TO USE IT.



## Introducing the HK68/V20 68020 VME processor.

Features include the 68020 MPU, 1 to 4 MegaBytes of on-board DRAM, 68851 PMMU, 68881 Floating Point Coprocessor, one serial port and MVMX/32. UNIX™ and VRTX® supported. Compatible with other members of the HK68/V™ Family of Heurikon VME processors. And technical support you've come to depend on. Call 1-800-356-9602, Ext. 395 for more information. Heurikon Corporation, 3201 Latham Drive, Madison, WI 53713.

**HEURIKON** CORP.

UNIX is a trademark of AT&T Bell Laboratories, Inc.  
VRTX is a registered trademark of Hunter & Ready  
HK68/V is a trademark of Heurikon Corporation.

CIRCLE NO. 24 ON INQUIRY CARD

*The Convergent Principle Applied:*

# Our workstations let you

When searching for the perfect workstation, OEMs and VARs often find themselves faced with two choices: they can settle for systems that don't meet all their requirements or they can buy more system than they need.

NGEN<sup>®</sup> workstations eliminate those compromises by providing all the features you need on a modular basis. With NGEN, you combine only the precise modules that will make your great ideas work perfectly. You never get stuck with excess features or extra charges.

## FREEDOM OF CHOICE

We offer more than 30 NGEN modules, to which you

can add your own proprietary modules for specific applications. With over 1 million possible configurations, you can deliver the exact system your customers need.

You select the amount of RAM (from 256K to 4MB) and the amount of disk storage (from 10MB to 240MB). You can also choose among processors, graphic controllers and other innovative options. And all NGEN modules include a built-in network, so the great ideas you create can be shared with everyone else on the system.

Since all modules are interchangeable, when you upgrade one workstation, the old modules can be used at another.

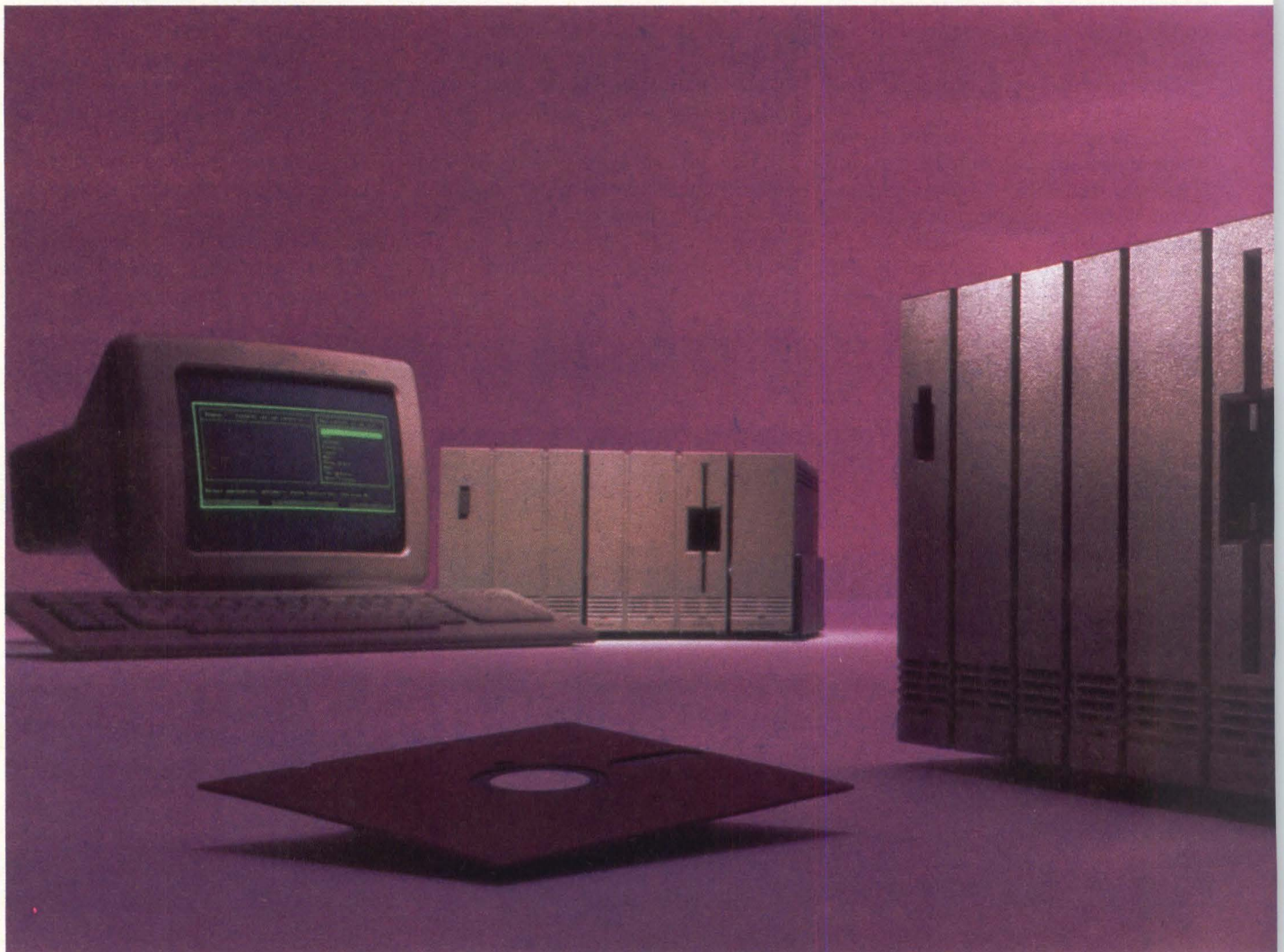

NGEN is a registered trademark of Convergent Technologies.

**CIRCLE NO. 25 ON INQUIRY CARD**



---

# expand on a great idea.

And the modules can be changed in seconds by the people who use them. Connecting or disconnecting modules requires neither training nor tools.

## FREEDOM TO GROW

NGEN workstations never become obsolete. As your needs change or new technologies emerge, new modules simply latch on to existing ones.

For example, one of our newest modules is a voice processor that allows you to add verbal comments to written documents. You can also use it for voice mail or other advanced voice applications.

The modular NGEN is backed by Convergent's commitment to excellence in engineering, craftsmanship in manufacturing and fast turn-around in high-volume production.

We'd like to show you how this convergence of thinking can work for you. Call us for more information at 800-538-8157, ext. 951 (in California call 800-672-3470, ext. 951; in Europe call 44-2404-4433). Or write us: Convergent Technologies, 2700 North First Street, P.O. Box 6685, San Jose, CA 95150-6685, Attention: Mail Stop 10-015.

That is, if flexible workstations that never become obsolete sound like a good idea to you.

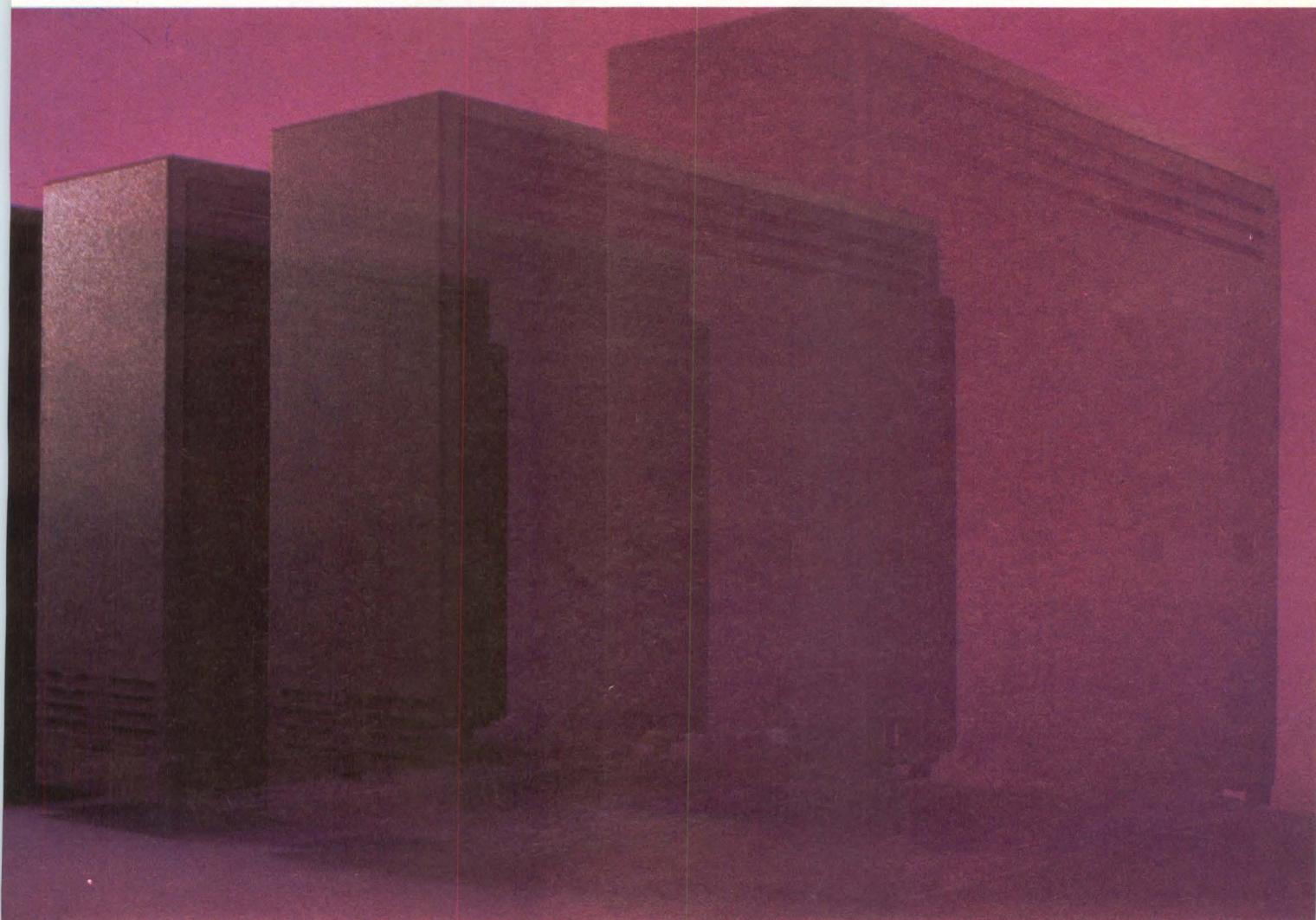

# Convergent

When great ideas converge, great products emerge.

# Presenting great bauds from Capetronic.

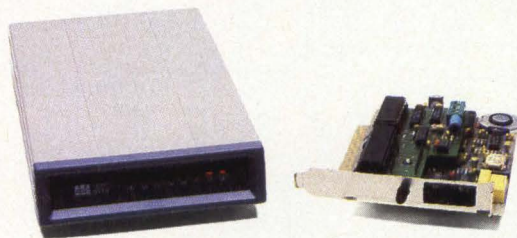
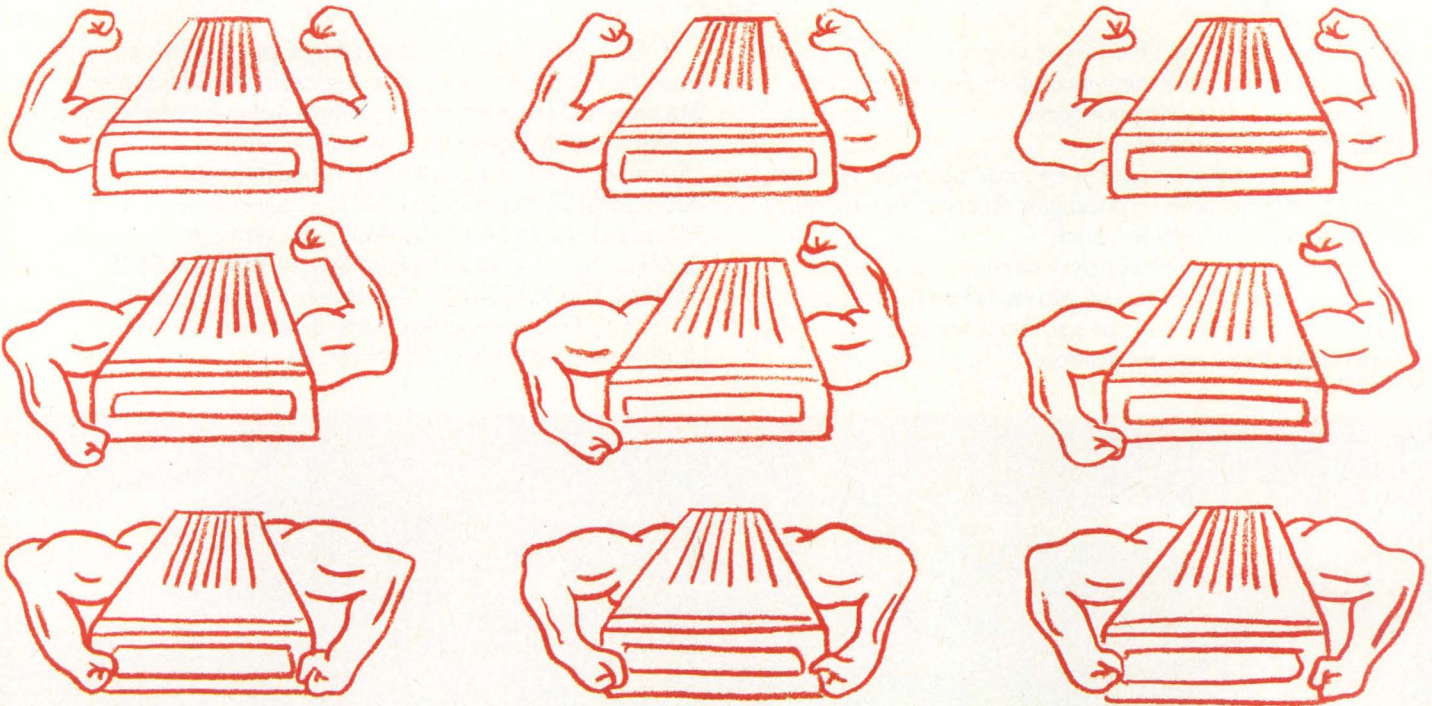

## The Capetronic modems from Hall-Mark.

Capetronic's new 1200/300 baud modems are available now from Hall-Mark, with features you just won't find in other comparably-priced modems:

- Auto-answer and auto-dial
- Programmable intelligent dialing
- Accessible time base
- Help commands
- Diagnostics
- Touch-tone and pulse dialing
- Built-in speaker with volume control
- Hayes command set compatible
- Multiple microprocessors

The 1200B card modem plugs into the IBM PC or XT as well as most compatibles and comes with a sophisticated communications package which provides for transfer of any type of text and binary files.

The 1200 stand-alone model comes with RS-232 interface for use with most personal computers.

Call Hall-Mark today for the new Capetronic modems. We've got them in stock right now in our 32 distribution centers nationwide, ready to ship to you.

### Alabama

Huntsville (205) 837-8700

### Arizona

Phoenix (602) 437-1200

### California

Bay Area (408) 946-0900

Orange County (714) 969-4700

Sacramento (916) 722-8600

San Diego (619) 268-1201

San Fernando Valley (818) 716-7300

West Los Angeles (213) 27-8400

### Colorado

Denver (303) 790-1662

### Connecticut

Connecticut (203) 269-0100

### Florida

Ft. Lauderdale (305) 971-9280

Orlando (305) 855-4020

Tampa Bay (813) 530-4543

### Georgia

Atlanta (404) 447-8000

### Illinois

Chicago (312) 860-3800

Indianapolis (317) 872-8875

### Kansas

Kansas City (913) 888-4747

### Maryland

Baltimore (301) 988-9800

### Massachusetts

Boston (617) 935-9777

### Minnesota

Minneapolis (612) 941-2600

### Missouri

St. Louis (314) 291-5350

### New Jersey

Fairfield (201) 575-4415

### New York

Long Island (516) 737-0600

### North Carolina

Raleigh (919) 872-0702

### Ohio

Cleveland (216) 349-4632

Southem Ohio (614) 888-3333

### Oklahoma

Tulsa (800) 231-0253

### Pennsylvania

Philadelphia (215) 355-7300

### Texas

Austin (512) 258-8848

Dallas (214) 553-4300

Houston (713) 781-6100

### Utah

Salt Lake City (801) 972-1008

### Wisconsin

Milwaukee (414) 797-7844



able memory, the 22-line-by-22-line matrix can store four 22-bit strings of data. The data, however, is not retrieved by conventional addresses but by the meaning of the entered bit string.

"Any piece of the data brings up the rest of it," Howard explains. "If you enter, say, a good guess of a person's name, with possibly a few wrong bits, the 22-line-by-22-line circuit will find the whole correct name in a few microseconds; the 512-line-by-512-line processor, in 100 nsec. The processors, in effect, settle down to the nearest word stored that matches what you put in."

There is a tradeoff between "error correction" capability and storage, Howard says. Storing four words, the circuit corrects all 2-bit errors and some as large as 8 bits. Storing only two words, it always corrects 4- or 5-bit errors and sometimes 10-bit errors.

### Voltages define problem

The neural-network processor is programmed using a computer and matrix algebra to design a resistor-network matrix and voltage states that correspond to the problem to be solved. When the processor operates as a content-addressable memory, some of the neuron voltages are set at levels representing data bits entered in the system. The network's final minimal voltage levels correspond to the data you want to recall.

John Hopfield, professor of biology and chemistry at the California Institute of Technology and a member of the Bell Labs staff, and David Tank, also a staff member, have simulated a neural-network processor's operational voltage levels using a Digital Equipment Corp. VAX-11/780 mini-computer in order to compute solutions to the traditional "travelling salesman" problem, which proves a time-consuming task for conventional digital computers.

The problem involves finding the shortest path between a fixed number of cities, visiting each city only once and then returning to the point of origin. To program the neural network, Howard says, one chooses net-

"I need a LAN that lets us communicate with other buildings—or other continents."

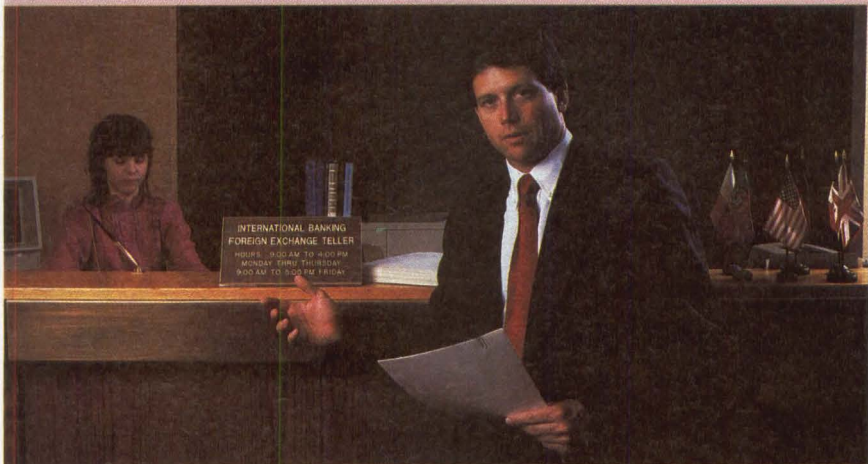

"I need 10-NET."

With 10-NET RS232 you can tie entire networks, or individual PCs to networks, via phone lines. 10-NET is your key to economical, easily installed PC communications, unsurpassed in speed and transparency.

Once you add up 10-NET advantages, you'll see why over 50,000 installations are already in place worldwide.

A phone call gets you the facts. Call:

**1-800-358-1010.**

In Ohio call 1-800-782-1010. Telex 650-2079125



Fox Research, Inc. • 7016 Corporate Way • Dayton, Ohio 45459  
10-NET is designed for use with IBM PCs, ATs and compatibles.



More than just talk.

CIRCLE NO. 27 ON INQUIRY CARD

# If you cherish your memories...



## FLEXSTAR DISK DRIVE TEST EQUIPMENT

**W**hen a disk drive fails, everyone loses: end user, dealer, distributor, VAR, systems integrator and, ultimately, the drive manufacturer.

FlexStar provides Total Disk Drive Support right down the line: sophisticated drive test equipment for everyone from the manufacturer to the service organization. Plus complete repair facilities.

If drive reliability is important to you, get Total Disk Drive Support from FlexStar: a thorough understanding of the needs of test equipment users backed by industry leading test equipment developed by an innovative technical staff.

**FS9000**- Designed for high volume drive testing with simultaneous, asynchronous testing of up to 32 ST506 type drives with either MFM or 2-7 RLL encode/decode schemes.

**FS6000**- A full length IBM PC card designed to test any SCSI bus, including arbitration, disconnect/reconnect and bus timing. It simulates an initiator or target device and measures all bus parameters in the Logic Analyzer

mode. The standard library supports the Common Command Set. Any vendor defined commands can be generated and stored in memory.

**FS2000**- A low cost, high volume intelligent burn-in system which tests ST506 (MFM/2-7 RLL), ESDI or SCSI interfaces. Provides error rate, seek error and media defect data. Allows user programmable window margin or no margin.

**FS5500**- A portable Winchester drive tester with full Analog/Digital and self-calibrating capability; tests any ST506 type drive (MFM or 2-7 RLL). Fully self-contained, it features a built-in printer and menu-driven software. External control is via RS232 bidirectional port.

**FS500**- A calibration tool for ST506 interface test equipment and ST506 controller characterization. Will introduce up to 15 bits of data error in the data stream and has 3 levels of accurate, repeatable bit shift. Programmable as a perfect, marginal or worst case disk drive.

**For further information on how FlexStar can support the quality of your drives call or write:**

*Total Disk  
Drive Support*

**FlexStar Corporation**  
606 Valley Way  
Milpitas, CA 95035-4138  
408/946-1445

TWX 510 601 5000  
FlexStar UD

# FlexStar

CIRCLE NO. 29 ON INQUIRY CARD

work elements so that the equation describing the processor's energy states corresponds to a "cost" function. This cost function increases the greater the distance the "salesman" travels, when a city is visited more than once and if a city is not visited at all.

"It is not known how to find the best solution to the problem," Howard notes. "For 30 cities, with  $10^{30}$  possible combinations of routes, the best known solution is described by a relative distance factor of 4.3. The neural-network processor simulation gives a solution of 5.07; and a neural-network processor designed to solve this problem should provide a solution in seconds—much faster than conventional digital computers. You may get a better solution with a VAX computer and a conventional algorithm, but you can get a very fast, okay solution with a neural network," he says.

Howard sees opportunities for further research in hierarchical arrays of neural-network processors—similar to the way biological vision systems are thought to function—as well as optically programmed networks and circuits that could "learn," reconfiguring themselves on the basis of experience.

"Finding the best set of resistors for a given problem is basically an optimization problem. We might use another neural network to solve it," Howard adds. "We would like to make the circuits completely programmable, more like electrically programmable ROMs than the basically masked ROMs we have now."

Howard also anticipates possible applications for the neural-network processor in pattern- and speech-recognition, signal processing and for a packet-switching network that contains the rules of how packets act within the system. However, he cautions that real-world applications are not around the corner.

"I would expect applications within 10 years, if the concept proves useful. We should know in a few years whether it is worthwhile to really push the development of this type of processor." □

"I need a LAN that lets users talk to our mainframe."



"I need 10-NET."

A distant mainframe is as near as the next room with a 10-NET LAN. Using a Hot Key gives single PCs, or entire networks, a transparent, instantaneous micro-to-mainframe link. Your 10-NET SNA Gateway provides 3270 SNA emulation, without the expense of a 3274 cluster controller.

Once you add up 10-NET advantages, you'll see why over 50,000 installations are already in place worldwide.

A phone call gets you the facts. Call:

**1-800-358-1010.**

In Ohio call 1-800-782-1010. Telex 650-2079125



Fox Research, Inc. • 7016 Corporate Way • Dayton, Ohio 45459

10-NET is designed for use with IBM PCs, ATs and compatibles.



More than just talk.

## IBM ASCII terminals:

# The case in black and white.

### Introducing a somewhat more colorful member of the family.

Meet the IBM 3164 ASCII Color Display Station.

It gives you eight foreground and eight background colors. On a 14" screen.

And because of its 8 x 16 character matrix, the 3164 gives you clear, crisp characters in color.

But is color any reason to buy IBM's 3164? It is, according to studies that indicate the use of color increases productivity, decreases errors and promotes user satisfaction.

Color, of course, is far from the sole reason for choosing the 3164. To appreciate the others, you should get to know the rest of our ASCII family.

### Emulation. Another side of the family.

Our ASCII terminals are designed to fit into existing systems. Even if the systems aren't ours.

Emulation Capability	
3161	IBM 3101 Model 881 ADDS Viewpoint* Hazeltine 1500* Lear Siegler ADM-3A* Lear Siegler ADM-5* TeleVideo 910*
3163	IBM 3101 Model 881 DEC VT 52* DEC VT 100* TeleVideo 950*
3164	IBM 3101 Model 881

For example, our basic ASCII Display Station, the IBM 3161, emulates up to six

Features	3161	3163	3164
Screen size	12"	12"	14"
Lines x characters	25x80	25x80	25x80
Character matrix	8x16	8x16	8x16
Double-sized characters	No	Yes	Yes
Line drawing characters	24	24	24
Vertical scroll	Jump	Jump/ Smooth	Jump/ Smooth
Definable function keys	24	24	24
Windowing	No	Yes	Yes
Partitioning	Horiz.	Vert./ Horiz.	Vert./ Horiz.
Characters in buffer	1920	7680	7680

terminals. And the advanced-function 3163 emulates a number of higher level ASCII data streams.

What's more, every one of our ASCII terminals can operate in its own function-rich native mode.

### Our family is flexible.

Our unique plug-in cartridges allow for considerable flexibility in your operation. For example, simply by switching cartridges you can shift a terminal from one data stream to another.

And, in many countries cartridges are also available that go beyond emulation to let you operate your ASCII terminals in several foreign languages. Appropriate foreign language keyboards are also offered.

### Enhanced ergonomics. Another family trait.

All our ASCII terminal keyboards have 102 keys. But that's not all they have in common. Every keyboard also has a low profile, gentle contour and typewriter touch.

And our keyboards have

programmable function and editing keys so they can be custom-tailored to fit your application needs. The 3163 and 3164 models also have redefinable and recappable keys.

Superior ergonomic design isn't confined to the key-

board, however. All three displays tilt and swivel for maximum user satisfaction. And, of course, by making the display easy to read, we made it easier on the eyes. In addition to the 8 x 16 character matrix, we gave it an advanced non-glare etched screen, cursors, and character and field attributes like blink, reverse video, under-scoring and dual intensity.

### High standards. Competitive prices.

Quantity discounts are offered, too. And financing is available through the IBM Credit Corporation. Best of all, each terminal comes with the quality, service and support you'd expect from IBM.

Contact your IBM marketing representative, or call 1 800 IBM-2468, Ext. KC/96, for the IBM Authorized Distributor nearest you. And we'll present more evidence in the case for IBM's ASCII terminals.

It may be all you need to color your view.

\*ADDS Viewpoint is a trademark of Applied Digital Data Systems, Inc.; Hazeltine 1500 is a trademark of Hazeltine Corp.; Lear Siegler ADM-3A/ADM-5 are trademarks of Lear Siegler, Inc.; TeleVideo 910/950 are trademarks of TeleVideo Systems, Inc.; DEC VT 52/VT 100 are trademarks of Digital Equipment Corporation.

# The case in color.

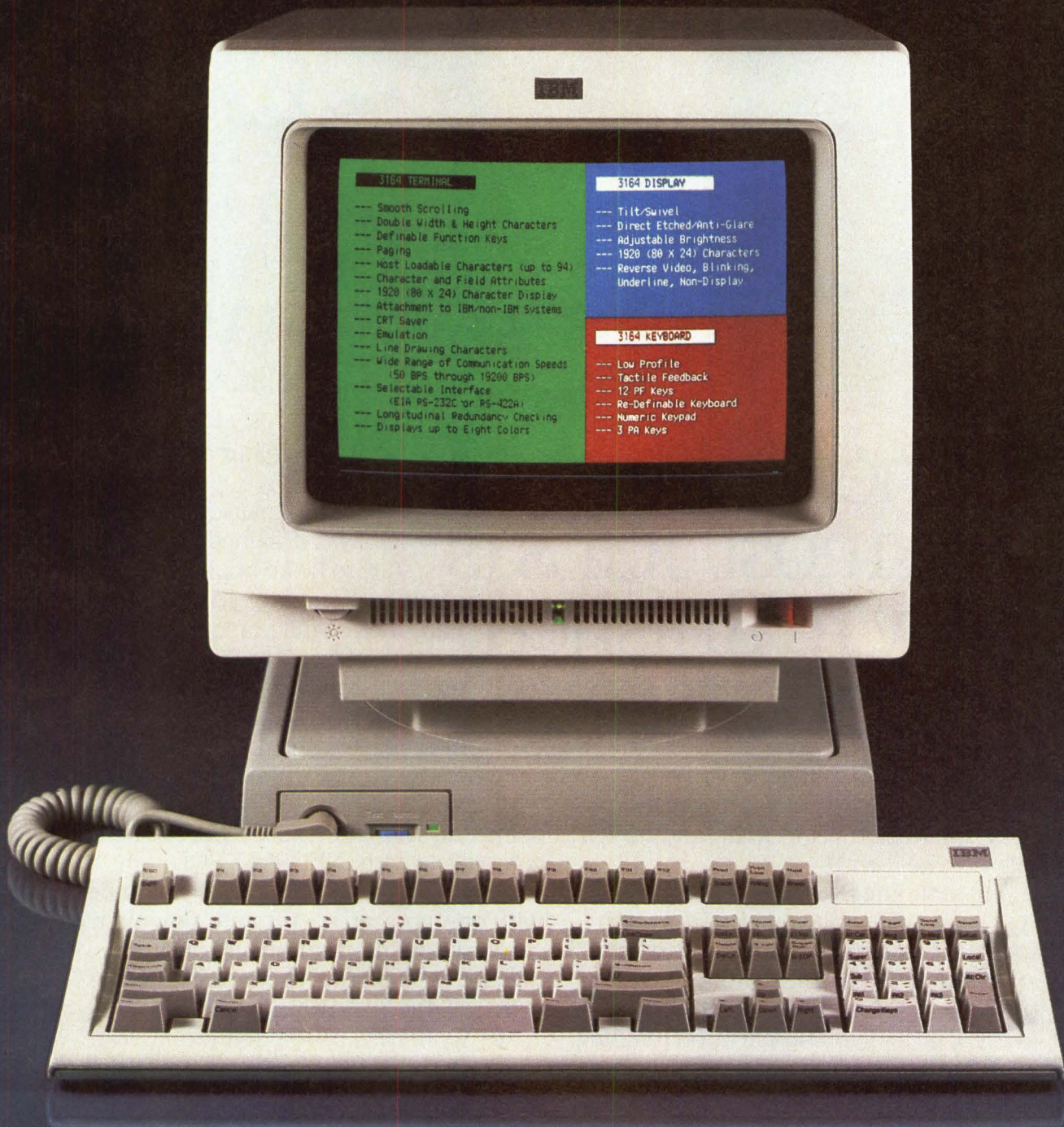

**3164 TERMINAL**

- Smooth Scrolling
- Double Width & Height Characters
- Definable Function Keys
- Paging
- Most Loadable Characters (up to 94)
- Character and Field Attributes
- 1920 (80 X 24) Character Display
- Attachment to IBM/non-IBM Systems
- CRT Saver
- Emulation
- Line Drawing Characters
- Wide Range of Communication Speeds (50 BPS through 19200 BPS)
- Selectable Interface (EIA RS-232C or RS-422A)
- Longitudinal Redundancy Checking
- Displays up to Eight Colors

**3164 DISPLAY**

- Tilt/Swivel
- Direct Etched/Anti-Glare
- Adjustable Brightness
- 1920 (80 X 24) Characters
- Reverse Video, Blinking, Underline, Non-Display

**3164 KEYBOARD**

- Low Profile
- Tactile Feedback
- 12 PF Keys
- Re-Definable Keyboard
- Numeric Keypad
- 3 PA Keys

CIRCLE NO. 30 ON INQUIRY CARD



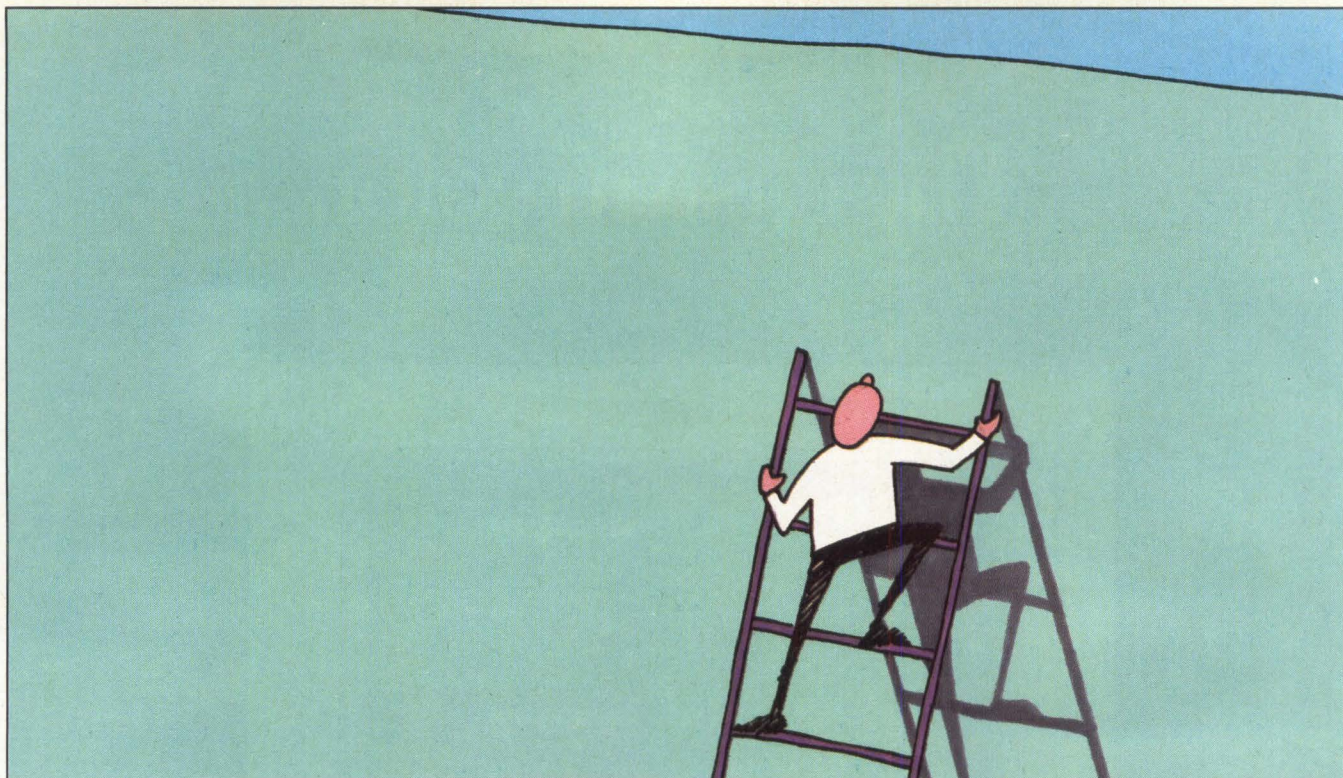

# The problem with most 4GLs is they're finished before you are.

And where does that leave you?

With the final, tricky ten percent of your application yet to write, and no 4GL left to write it with.

Introducing INFORMIX®4GL.

Never again will you have to switch to C or COBOL to truly customize your application. Instead, INFORMIX-4GL provides an all encompassing syntax for every aspect of your application building.

So once you're programming in INFORMIX-4GL, you never have to leave it. And considering all it can do, you may never want to.

Now, for instance, you can write in just ten to twenty pages of 4GL code, applica-

tions that would take hundreds of pages with C.

That's because INFORMIX-4GL was designed from the start to be an application building language. It's built around the full implementation of ANSI Standard SQL. And features Custom Screen Generation, Custom Menu Building and a built-in Report Writer.

What's more, INFORMIX-4GL works with UNIX™, MS™-DOS and Networked DOS operating systems. And, of course, it's compatible with INFORMIX-SQL—our popular, proven DBMS. So files you build with one, you can access with the other.

For more information and our free booklet, "A 20-Minute Guide to INFORMIX-4GL," call 415/322-4100.

Or write RDS, 4100 Bohannon Drive, Menlo Park, CA 94025.

And start taking your applications to even greater heights.



**RELATIONAL DATABASE SYSTEMS, INC.**

INFORMIX is a registered trademark of RDS. Other names identified by TM are tradenames and/or trademarks of their respective manufacturers.  
© 1986, Relational Database Systems, Inc.

**CIRCLE NO. 31 ON INQUIRY CARD**



# FEATURE HIGHLIGHTS

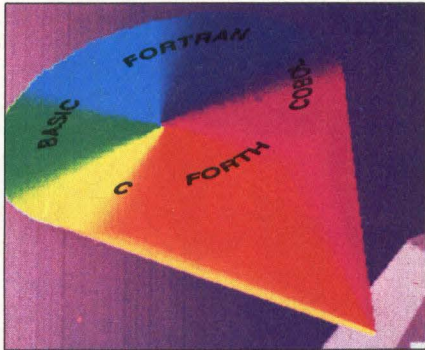

p. 71 ..... A dynamic technology



p. 81 ..... Adding to the AT

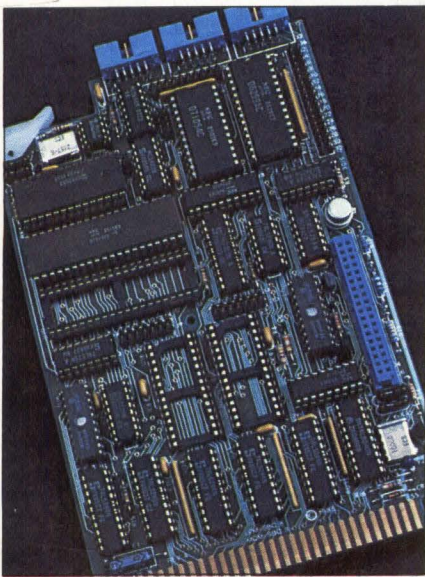

p. 91 ..... STDbus reborn

## **AI SHAPES UP FOR MAINSTREAM USE .....57**

Despite the hype and hoopla surrounding artificial intelligence, the technology continues to evolve at a normal pace. And now AI is stepping out of the research closet into the real-life world. The major forces behind AI's mainstream acceptance are new workstations, standardized languages such as Common LISP and Prolog, and affordable prices. Perhaps most importantly, system integrators and value-added resellers are developing precisely targeted AI applications. This article is the first of a two-part special report on artificial intelligence.

## **COMPILERS COMBINE MATURITY, INNOVATION ..71**

Although they rarely enjoy the limelight, compilers—programs that turn source code into machine language—remain a dynamic technology. Where they used to be mills that merely churned out binary code, compilers now often come with large assortments of integrated software-engineering tools, highly modular designs, interactive debugging facilities and even integrated databases to keep track of code modifications.

## **ALREADY POTENT PC/ATs GAIN POWER, VERSATILITY .....81**

If the original IBM PC/AT doesn't have enough bang-per-buck for your applications, take a look at what AT-compatible manufacturers are up to. Cranking up the capabilities of the AT and compatibles, vendors are offering faster machines, larger capacity rigid disk drives, add-in and add-on boards, expansion buses, alternative motherboards and new chips and software.

## **ADDED FUNCTIONALITY SPARKS STDBUS REBIRTH ..... 91**

The STDbus has long been the workhorse of the low-cost industrial-control market. But recently, the old standby has encountered increased competition from PC/AT, Multibus and VMEbus single-board computers. To meet the opposition, STDbus board vendors are upgrading in a variety of ways, including adding new 16- and 16/32-bit microprocessors, CMOS technology, multitasking and multiprocessing support and SCSI interfaces.

## **SINGLE-BOARD MICROCOMPUTERS Product Table ..... 101**

*Mini-Micro Systems'* annual survey of single-board microcomputers lists over 50 companies and more than 120 products. The table also identifies key characteristics, such as the CPU type, bus, operating system, software and programming language support, memory capacities, dimensions and price.



Too big.



Too noisy.



Too much.

# How to keep from buying the wrong UPS.

If you've been told a big, noisy, expensive uninterruptible power supply is the only way to really protect your power-based system from error or disaster, look again.

Yes, you do need a UPS.

But a UPS doesn't have to hog half your computer room, or put your staff—or your treasurer—into shock. Not when the UPS is from General Power Systems.

GPS is the pioneer in transistor-based UPSs with all the benefits that implies—small, quiet, cool, reliable, efficient. In fact, a GPS system is often half the size of another supply of comparable power. And because GPS manufactures the most complete line of UPSs on the market, we have what you need—on-line models from 500VA to 50KVA, and exceptionally small standby systems from 200VA to 2000VA with transition times as low as 2ms.

GPS systems have a low initial cost with many features, which are traditionally optional, included free. Plus, our extraordinary reliability, ease of use and service make the cost of ownership low.

So why buy the wrong UPS when the right one is as close as your telephone. Call GPS today. (800) 854-3469, in California (800) 824-8912, (714) 956-9321, Telex 182283. General Power Systems, 1400 North Baxter St., Anaheim, CA 92806-1201.



Now, UL Listed models  
1KVA-10KVA.

## GENERAL POWER SYSTEMS

A Division of ALS Corporation

CIRCLE NO. 32 ON INQUIRY CARD

# AI SHAPES UP FOR MAINSTREAM USE

Commercial AI is evolving, not exploding. But new platforms, standardized languages, lower prices and targeted applications are beginning to spur usage

**Wendy Rauch-Hindin**  
Special Features Editor

Perhaps because of hype, just a few years ago many people expected artificial intelligence (AI) to burst into the business scene. Now it is becoming the "in thing" to criticize AI for not developing a market fast enough.

The truth is that AI demonstrated commercial feasibility a few years back, but the time expectations were unrealistic. Solving the problems necessary to field a new technology is usually an evolutionary, not revolutionary, process.

Fielding a knowledge system depends on a

*Part II of Mini-Micro Systems' special report on artificial intelligence, to be published later this year, will cover AI software trends, integration with standard systems and knowledge-system tools.*

number of technical and non-technical factors. These include corporate-management attitudes, perceived risk, cost, training, hardware, language, portability, tools, integration with traditional hardware and software systems and the demonstration of application success stories.

One hardware barrier, related to risk and cost, is dissolving because major computer companies are entering the field. For example, Texas Instruments Inc. and Xerox Corp. are players in the LISP machine market. Apollo Computer Inc., Digital Equipment Corp., Hewlett-Packard Co., IBM Corp., Sun Microsystems Inc. and Tektronix Inc. have made AI a major focus. Of these, Apollo, HP, IBM, Sun, Tektronix and Xerox offer relatively inexpensive AI workstations. Some of these workstations are based on the Motorola Inc. MC68020 microprocessor—a processor that has become popular for AI. Intel Corp. has also designed features specifically suited to AI pro-

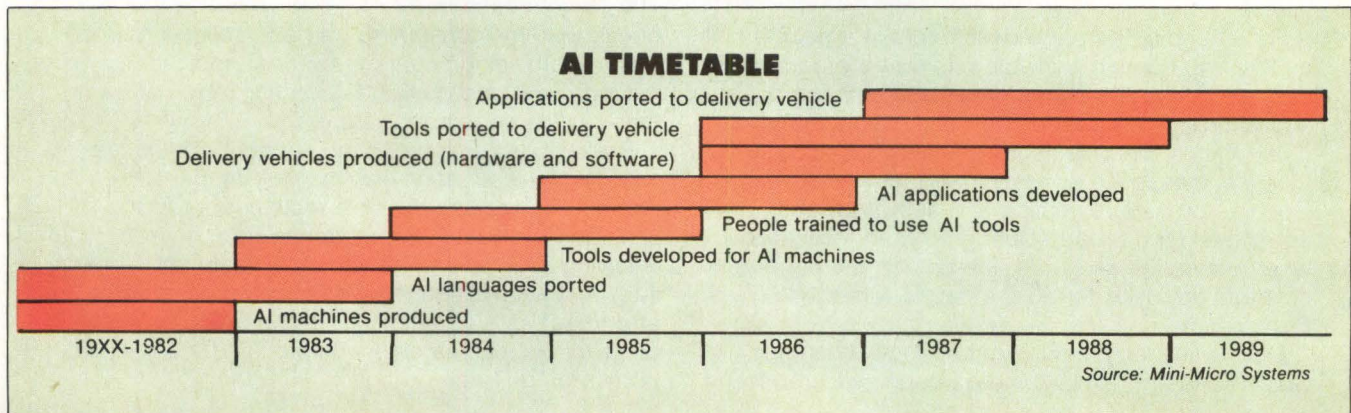

programming into its 80386 microprocessor, and it is working with third parties to develop an 80386-based machine that hosts Common LISP and Prolog environments as well as support the major knowledge-system development tools (see "The 386 enters the fray," below).

These may or may not be the most innovative companies. But most of them are large. And large companies, which are likely to be AI users, prefer to deal with other large, familiar companies. Management tends to feel that, if they go out on a limb and make a \$20,000 investment in an AI computer and have to write it off later, at least they haven't bought themselves an expensive white elephant. They can creep into AI sidewise, with inexpensive machines that are capable of doing substantial AI jobs and are from familiar vendors that, they feel, understand the tradition of service.

A key barrier to AI acceptance is programming languages. Most AI systems are programmed in LISP. A large number of LISP versions exist.

With an eye toward avoiding the incompatibility problems rampant in the computer industry, the major AI players banded together to standardize and support a version of LISP called Common LISP. An ANSI subcommittee is working on a formal standard. LISP experts in commercial companies, universities, government and research organizations are participating in the ANSI efforts. Common LISP is now appearing on all LISP machines and on some conventional computers.

Common LISP means AI portability with

minimal grief. If programmers write a large software package in Common LISP, and take reasonable care not to use too many machine-dependent features, they can salvage more than 90 percent of the code when they transport the program to other Common LISP machines.

Associated with the programming language obstacle is the lack of available programmers. However, many universities are teaching LISP and AI in their computer science courses. Several AI books for the non-researcher have been published. And programmers who want to learn LISP or Prolog—the other major AI language—can obtain these languages, with usable documentation, for PCs and compatibles.

One example is Golden Common LISP, an enhanced subset of Common LISP from Gold Hill Computers Inc., that includes a fairly complete LISP development system and an organized computerized LISP tutorial. Another example is the recently introduced Prolog compiler, from Borland International Inc., which includes an interactive development system and has the added attraction of a \$99.95 price tag. Digitalk Inc. has a comparable offering—language, graphical environment and readable documentation for a PC implementation of the object-oriented Smalltalk language.

A number of companies have designed large-scale AI toolkits for developing large knowledge systems on LISP machines, conventional computers and workstations. Increasingly, these companies are basing their tools on Common LISP, and some are translating the tools into C.

## The 386 enters the fray

Paging, dynamic memory management and "garbage collection" are three bottlenecks in LISP program execution. The Intel Corp. 80386 microprocessor is designed to attack them and speed AI performance.

For example, the page descriptors in a paging unit on the chip contain available bits that a programmer can use to classify pages on a page-by-page basis and to facilitate garbage collection (cleaning out old data). Pages typically might be classified according to their lifetimes, such as static (lives forever), dynamic (such as procedures called and activated) and ephemeral (short-lived). During program execution, when pages are allocated, the bits on the page descriptors are used to tag the pages with these classifications.

During any incremental garbage collection run, which frees up memory, the garbage collector scans

the page descriptor table to look for the most likely areas of memory that have become garbage. The trick is to scan the short-lived ephemeral objects 10 times before scanning any of the dynamic objects. The static area is never scanned. This scheme reduces the time-consuming garbage collection procedure by providing some hardware support for memory management and garbage collection, and narrowing the areas to search for garbage.

Besides garbage collection support, certain features in the instruction set, memory model and—particularly—the permissible register-addressing schemes allow fast access to and from memory when following LISP pointers across LISP data structures. Intel is now investigating a symbolic process accelerator to act as a coprocessor to the 80386. Among other things, such a chip would offload a significant portion of garbage collection from the CPU.

The combination of tools, academic training and available languages means that the supply of people who can develop knowledge systems is expanding. It is still smaller than the market needs. But engineers and application experts exist who can do the job, and people who are good conventional-application programmers are slowly being turned into good AI programmers.

All things considered, it is no longer hare-brained to suggest that a large, stable, conservative company use AI technology in its routine operations. So encouraging are the signs that Dataquest Inc., a San Jose, Calif., market-research concern, predicts that world purchases of AI hardware, software and services will grow from \$335 million last year to \$2.7 billion in 1990. Most of this market will be oriented toward large-scale knowledge systems.

The fastest growth will be in conventional computers purchased primarily for symbolic processing. Until now, most AI hardware and software has been purchased primarily for AI research, and most AI systems have been developed and run on LISP machines. Symbolics Inc. currently has the lion's share of the LISP-machine market. But commercialization of AI is likely to require the purchase of many LISP computers instead of just a few, and so cost will become a greater factor. The changing AI hardware requirements mean that by 1988 purchase of conventional computers dedicated to AI will outstrip LISP machine purchases. Many experts believe, however, that LISP machines will have a place in niche markets as specialized hardware.

### Approaches to AI

In AI, there are turnkey applications, vertical-market tools, generic application-development tools and AI-specific languages like LISP and Prolog. Knowledge systems are computer programs that contain people's opinions, experiences and judgements, all of which can change. Thus, it seems that a turnkey application would be difficult to build. However, there are some routine judgments and decisions that are made in certain types of application areas, like assessing a corporation's financial future. If the potential user agrees with the quality of knowledge in such a knowledge system, then a turnkey system is possible.

PlanPower, from Applied Expert Systems Inc. (APEX), is an example of a turnkey knowledge system. PlanPower performs comprehensive personal financial planning. It is designed for use by financial planners who can control it, interact with it or run it in an automated mode.



**Three artificial intelligence workstations** from Tektronix run Smalltalk, LISP and Prolog. They are the 4406 (foreground), 4405 (back left) and 4404 (back right).

A large system, PlanPower runs on Xerox LISP machines and uses a variety of AI techniques. It differs primarily in scope from a number of similar, but smaller, systems, including some which run on IBM PCs and compatibles. Its developers claim that PlanPower covers the details and analyses necessary for comprehensive financial planning. Most smaller systems bite off only a small part of the problem.

A subsidiary of APEX, APEX Advisory Services, provided the staff and expertise to source the knowledge for PlanPower. But the APEX subsidiary, itself a registered investment advisor, is also committed to servicing and supporting the knowledge base as knowledge changes or as new situations arise.

Turnkey systems are less likely to be found in manufacturing domains because factories are not generic. A compromise—customized turnkey systems—is finding favor for these domains. Such systems are essentially AI application-development tools that also contain some generic knowledge applicable to particular application domains.

Users can add the remaining knowledge that is specific to a company's problem. Generally, the user of such a system is a non-programmer and can add the specific knowledge by picking choices from a menu.

The best known examples are off-the-shelf knowledge-based simulation systems from IntelliCorp Inc. and Carnegie Group Inc., and Picon from LISP Machine Inc. (LMI). IntelliCorp's simulation system is built on top of the company's KEE package; Carnegie Group's is built on top of its Knowledge Craft package. They are visually oriented, frame-based systems that contain knowledge of components of a factory, networks or of other systems that

users want to model. The simulation system uses its knowledge of manufacturing to ask users about applications.

When the simulation system runs, it displays events and performs knowledge-based analyses of the simulation, compares alternative models, generates reports and recommends changes.

Picon is a similar type of semicustom vertical tool. The first version contains knowledge about process control plants; a second Picon version contains knowledge about discrete manufacturing and materials handling.

Picon users develop specific applications through a menu-driven, interactive graphics system and a schematic capture system. Engineers combine plant component icons to construct a schematic that represents their plant. Picon captures the component/icon information, its type and connections, and determines its relationship to the overall process or to the materials-handling system. Users can add further knowledge by selecting and combining words and phrases from a menu to form knowledge-system rules. Picon has been used to develop applications that are operational at Exxon Corp., Johnson Controls Inc., Leeds & Northrup Co. and Texaco Inc.

In the materials-handling area, Picon has been used to build an Automated Guided Vehicle (AGV) system in use at the Oak Ridge National Laboratory. Called Hermies II, the AGV not only carries and retrieves materials in hazardous environments, but also navigates and dodges obstacles and still figures out how

to reach its goal.

Another approach to building and using AI systems is through knowledge-system application-development tools. These tools are composed of a template to hold knowledge, an inference mechanism that reasons with the knowledge and an easy-to-use interface. Large-scale tools also support multiple ways to represent knowledge, multiple reasoning methods, a control mechanism to efficiently control the order of a consultation and an explanation facility, used more by developers debugging a system than by users.

Application-development tools can be used by application experts, but most often they are used by programmers and engineers. The most well known of the large-scale tools are S.I from Teknowledge Inc., KEE from IntelliCorp, ART from Inference Corp. and Knowledge Craft from Carnegie Group. These tools are similar, but different. For example, they vary in complexity and ease of use in the order listed, with S.I being the simplest to use and Knowledge Craft, at the high end, being the hardest. A variety of other knowledge-system tools exist for minicomputers, UNIX-based workstations and IBM PCs and compatibles.

Still another approach to developing knowledge systems is to develop the system in a low-level AI language like LISP, Prolog or even OPS5, which is a slightly higher level rule-based language. This requires much more programming and AI knowledge than does using an application-development tool. On the other

**SYMBOLIC PROCESSING MARKET SURGES AT 50 PERCENT PER YEAR**

**TOTAL WORLDWIDE REVENUES**

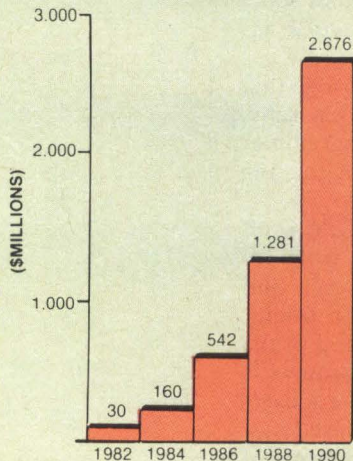

SOURCE: DATAQUEST INC.

(Worldwide revenues, \$ millions)

	% CAGR*							% Total market	
	1982	1984	1986	1988	1990	81-85	86-90	1985	1990
<b>Hardware:</b>									
Conventional hardware	14	37	143	403	953	72	61	24	36
Symbolic processors	9	70	185	389	736	159	41	40	28
Hardware subtotal	23	107	328	792	1,689	105	51	64	63
<b>Systems software:</b>									
System development tools	0	7	55	132	284	N/A	51	8	11
System processing languages	0	5	36	80	147	N/A	42	5	5
Natural language	0	11	29	69	141	N/A	49	5	5
Systems software subtotal	0	22	120	281	572	N/A	48	19	21
<b>Services:</b>									
Contract services	5	26	84	181	355	124	44	15	13
Education and training	2	5	10	27	60	58	55	2	2
Services subtotal	7	31	94	208	415	109	45	17	16

Note: Numbers may not total due to rounding

\* Compound annual growth rate

# To make the right protocol connections, don't get a board.

Each time you connect a PC or peripheral to your IBM System 34, 36 or 38, you face a dilemma. If you buy a board level protocol converter, you have to install it yourself — and use up a slot doing it. If you buy a multiport converter, you might be paying for ports you don't need.

That's why we're pleased to announce our one-port, portable Series III TWINAX protocol converter. Compact and affordable, it's perfect for communications applications that require a single local port.

Best of all, the Series III converter doesn't require technical expertise. Simply plug it in and it's ready to go. And it can be moved easily from device to device as your needs dictate.

The Series III TWINAX converter provides IBM System 3X connections for most devices, including printers, CRT's and microcomputers (such as IBM, Wang and Macintosh). It can be used with a low cost modem to give a remote device access to the 3X as well. And like our Series II multiport TWINAX converter, it incorporates three levels of internal diagnostics,

menu-driven programmability, printer passthrough, file transfer and 25th status line capabilities.

So now, you can take care of virtually all your single port protocol connections without getting a board. Call us today at 1-800/531-5167 (in

Texas, 512/836-8080) or write KMW Systems Corporation, 8307 Highway 71 West, Austin, Texas 78735.

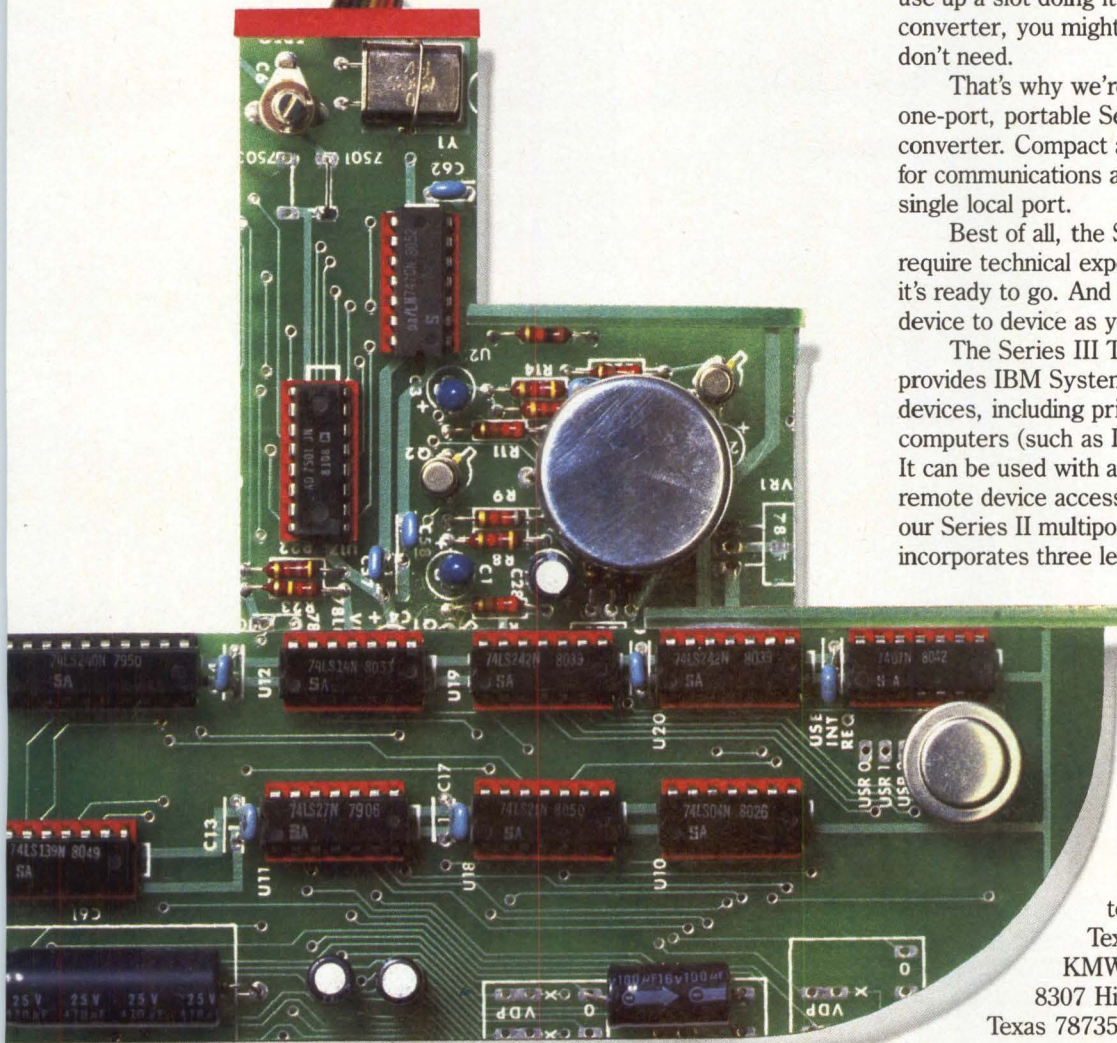

**KMW  
SYSTEMS  
CORPORATION**

*For the right connections*

Auscom is now a division of KMW Systems Corporation.

Registered trademarks: IBM, IBM System 3X, IBM System 34, 36, 38 — International Business Machines Corp.; Wang — Wang Laboratories, Inc.; Macintosh — Apple Computer, Inc.

CIRCLE NO. 33 ON INQUIRY CARD



# THE GREAT ESCAPE!

FROM IVORY TOWERS AND  
COLD COMPUTER ROOMS TO  
THE WARMTH OF YOUR OFFICE.

Artificial intelligence for business  
has arrived in a revolutionary new  
product . . . Guru.

At last, artificial intelligence designed especially for business! Guru brings together expert system capabilities of artificial intelligence, the productivity of familiar business computing tools and the ease of communicating with your computer using menus, commands or plain English. All available in a single, integrated program.

Guru works like human experts, considering uncertainties, reasoning through forward and backward chaining, asking for more information when needed, and explaining its recommendations.

Guru's expert system works hand-in-hand with all the familiar business computing tools like spreadsheets, statistical analysis, business graphics and a programming language, always available for both expert consultation and your everyday business computing needs.

Best of all, you won't need to learn LISP or PROLOG or buy fancy computers . . . Guru runs on your PC and communicates in plain English! Guru is artificial intelligence that means business.

For more information, call or write Micro Data Base Systems, Inc./Marketing & Sales, P.O. Box 248, Lafayette, IN, 47902, 317/463-2581, Telex 209147 ISE UR.

# GURU™

ARTIFICIAL INTELLIGENCE THAT MEANS BUSINESS.

mdbs is a registered trademark and Guru is a trademark of Micro Data Base Systems, Inc., P.O. Box 248, Lafayette, IN, 47902



CIRCLE NO. 34 ON INQUIRY CARD



hand, working in these languages provides the maximum amount of functionality.

IntelliCorp surveyed 50 of its customers in 1985 and asked them, in some detail, what they needed to deliver their applications. They found a spectrum of answers.

At one end of the spectrum were users who wanted to use the development system as a delivery system as well. These were mostly people whose applications were a moving target. They needed the use of the development machine so that, over time, they could continue to make significant modifications and add major new functionality rather than just perform normal maintenance. Many of these customers were in the scientific or real-time areas. Typically, they have a knowledge-based meteorological or pattern-recognition system. Generally, they did not need production quantities of either the system or of the AI computers.

The ability to develop programs incrementally was particularly valuable to these people. There are no metrics to measure productivity for incremental program development, but few people who have used it want to return to conventional methods.

At the other end of the spectrum were users who wanted applications embedded within existing software or hardware systems so they were invisible to the end users. The same two issues appeared in most survey answers: cost and integration with existing software. A third significant issue, the ability to run on existing hardware, relates both to cost and integration.

### Choosing run-time systems

There are five classes of hardware that can be used as run-time vehicles for knowledge systems: delivery versions of LISP machines, engineering workstations, RISC (reduced instruction set computers) machines, timesharing computers and personal computers. Run-time machines are usually characterized by features such as low cost, ease-of-use by non-programmers and maintenance support.

APEX cites low price and the national support provided by a large company as the reason for buying 1,000 run-time versions of the Xerox LISP machine to deliver PlanPower. The Xerox delivery machine, model 1185, sells for \$10,000; the 1186 development machine costs \$25,000. Xerox attributes its low price to economy of scale that stems from using the same hardware for its 1185 and 1186 LISP machines and its 6085 office products machines. The only differences are the microcode, which the 1185 and 1186 use to execute LISP instructions, and the machines' configurations.

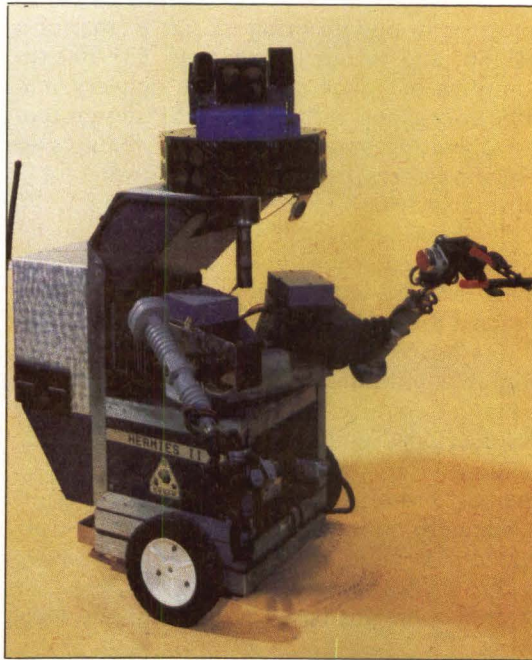

**An Automated Guided Vehicle (AGV), called Hermies II, was built using LISP Machines' Picon AI application-development software. The AGVs carry and retrieve materials in hazardous environments. They can also navigate and dodge obstacles.**

Because of this commonality, the 1185 and 1186 lack specialized LISP machine hardware, such as hardware memory tags and hardware assists for garbage collection. "Garbage" is obsolete data residing in main memory. Hardware memory tags provide hardware support for run-time data-type checking. Xerox does its run-time data-type checking in microcode.

Xerox says this design does not give its machines the fastest LISP-function execution speed. But real applications also involve I/O, graphics, windows, menus and moving things on the screen. Benchmarks tend to merely measure computational time for performing simple operations on data structures. The fast graphics of the 1185 and 1186 deliver zippy performance for real world applications.

Direct comparisons between LISP machines like the 1185 or 1186—or conventional workstations running Common LISP—and the TI, Symbolics, and LMI LISP machines are misleading. These latter LISP machines are bundled with expensive peripherals, including huge amounts of main memory, mass storage, digital signal processors and array boards. When these are added to the smaller scale LISP machines and workstations, price differences begin to fade. In any case, LISP machine prices are decreasing.

For example, earlier this year, Symbolics introduced a delivery version of its model 3600 LISP machine. The 3610 AE (Application Engine) uses VLSI semicustom, gate-array technology, and CMOS for low power consumption, to reduce the 3600's three-board

processor to one, to bring its size to that of a desktop, and to cut the price to \$31,500 (in quantities of 76 or more). The delivery machine goes along with a new LISP design tool and operating system, which has features to help developers package their software for a delivery system.

TI is looking toward commercial versions of its compact LISP machine, which is essentially a plug-in board-level version of the Explorer, its regular LISP machine. The central component of this board is a VLSI CMOS sub-2-micron chip that contains about 60 percent of the Explorer's circuits. The compact LISP machine was developed under contract for the Defense Advanced Research Projects Agency (DARPA). The first prototype, built for very high performance with military specifications, will be delivered next month.

This prototype will be followed by some lower cost designs based on the chip. To meet

cost goals, the chip's performance will probably be downgraded. The chip will be designed into a board-level LISP processor that can be used as an inexpensive standalone LISP machine or as a board that plugs into non-LISP machines.

TI estimates that the price of a commercial version of the compact LISP machine will be about \$25,000, for which the user gets the same performance, memory and mass storage as with today's Explorer. Initially, the LISP board aims at machines such as the TI Business Systems 1500—a multiuser UNIX-based minicomputer—and the TI Business Pro. The boards will also be available to other computer manufacturers. But the architecture and memory handling methods of a LISP processor and of a conventional computer are too different to allow the LISP boards to work directly as a plug-in board. TI believes that some customizing of the boards will be necessary for most computers.

Porting and customizing, however, take time.

## Companies mentioned in this article

### Apollo Computer Inc.

330 Billerica Road  
Chelmsford, Mass. 01824  
(617) 256-6600

Circle 316

### Applied Expert Systems Inc. (APEX)

5 Cambridge Center  
Cambridge, Mass. 02142  
(617) 492-7322

Circle 317

### Borland International Inc.

4585 Scotts Valley Drive  
Scotts Valley, Calif. 95066  
(408) 438-8400

Circle 318

### Carnegie Group Inc.

659 Commerce Court,  
Station Square  
Pittsburgh, Pa. 15219  
(412) 642-6900

Circle 319

### Data General Corp.

4400 Computer Drive  
Westboro, Mass. 01580

Circle 320

### Digital Equipment Corp.

146 Main St.  
Maynard, Mass. 01754  
(617) 897-5111

Circle 321

### Digitalk Inc.

5200 W. Century Blvd.  
Los Angeles, Calif. 90045  
(213) 645-1082

Circle 322

### Gold Hill Computers

163 Harvard St.  
Cambridge, Mass. 02139  
(617) 492-2071

Circle 323

### Hewlett-Packard Co.

3404 E. Harmony Road  
Fort Collins, Colo. 80525  
(303) 226-3800

Circle 324

### IBM Corp.

1133 Westchester Ave.  
White Plains, N.Y. 10604  
(914) 765-1900

Circle 325

### Inference Corp.

5300 W. Century Blvd.  
Los Angeles, Calif. 90045  
(213) 417-7997

Circle 326

### Intel Corp.

3065 Bowers Ave.  
Santa Clara, Calif. 95051  
(408) 987-8080

Circle 327

### IntelliCorp

1975 El Camino Real W.  
Mountain View, Calif.  
94040-2216

(415) 965-5500

Circle 328

### LISP Machine Inc.

6 Tech Drive  
Andover, Mass. 01810  
(617) 682-0500

Circle 329

### Lucid Inc.

707 Laurel St.  
Menlo Park, Calif. 94025  
(415) 329-8400

Circle 330

### MIPS Computer Systems

930 Arques Ave.  
Sunnyvale, Calif. 94086  
(408) 720-1700

Circle 331

### Motorola Inc.

Semiconductor  
Products Sector  
5005 E. McDowell Road  
Phoenix, Ariz. 85008  
(602) 244-7100

Circle 332

### National Semiconductor Corp.

2900 Semiconductor Drive  
Santa Clara, Calif. 95051  
(408) 721-5000

Circle 333

### Sun Microsystems Inc.

2550 Garcia Ave.  
Mountain View, Calif. 94043  
(415) 960-7310

Circle 334

### Symbolics Inc.

555 Virginia Road  
Concord, Mass. 01742  
(617) 259-3600

Circle 335

### Teknowledge Inc.

525 University Ave.  
Palo Alto, Calif. 94301  
(415) 424-0500

Circle 336

### Tektronix Inc.

P.O. Box 500  
Beaverton, Ore. 97077  
(503) 627-7111

Circle 337

### Texas Instruments Inc.

P.O. Box 809063  
Dallas, Texas 75240  
(214) 995-2011

Circle 338

### Xerox Corp.

250 North Halstead  
P.O. Box 7018  
Pasadena, Calif. 91190  
(818) 351-2351

Circle 339

**THE  
SECRET  
BEHIND  
THE PLOT.**

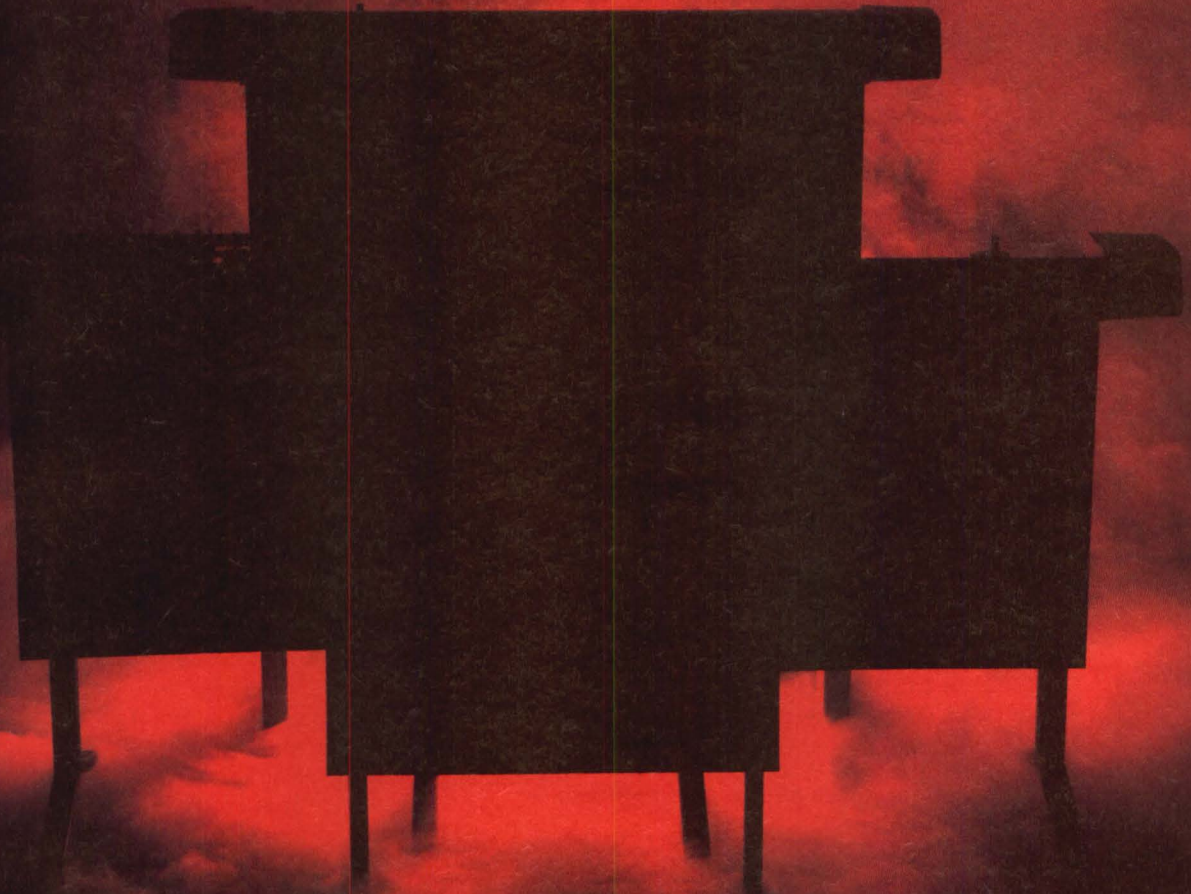

---

**RISC machines, which are considered a new AI delivery vehicle, are characterized by instructions that are designed to execute in one machine cycle.**

---

TI estimates it will be one to two years before the boards turn up in TI end-user environments, and two to three years before other companies have similar boards.

LMI espouses a different delivery-system strategy. For users who need the development machine as a delivery vehicle, LMI offers two-, three- and four-user LISP machines. Each user has a dedicated LISP processor. But the processors are in one cabinet. This approach divides the cost among users who share the cabinet, power supply and peripherals.

However, LMI maintains that many AI applications can be delivered on conventional machines. For those cases, LMI supports tools that allow the automatic port of applications to other machines, including DEC's VAX, IBM's PC/AT and Sun machines.

The viability of AI on time-shared minicomputers and mainframes is controversial. Time-shared machines that support AI include the VAX and MicroVAX, Data General Corp.'s Eclipse and DS series, and IBM 370s and 4300s. The DEC and DG machines run Common LISP and several standard AI application tools. The VAX also runs OPS5, a high-level rule-based language. IBM machines run their own LISP and an IBM AI tool called ESDE/VM (Expert System Development Environment/VM).

#### **Minicomputers as run-time systems**

The problem with AI on time-shared machines is other users. Experts say that neither the hardware nor the instruction sets of these machines were designed for LISP. Users say LISP on a time-shared machine is instantly visible to other users, and degrades the machine's performance. Developers at Delco Products did their initial knowledge-system development in the middle of the night so they could get a dedicated VAX. For reasons like these, many developers advocate LISP development on the MicroVAX or AI VAXstation, rather than the VAX.

Arnold Kraft, manager of solutions marketing for the intelligent-systems technologies group at DEC, says users running knowledge systems that only occasionally need to consult other files often opt for a standalone machine. But other customers have knowledge systems that access data from attached manufacturing systems. And the accesses in this environment are often as intensive as those in many MIS shops. These users frequently prefer to have the two systems coresident on the VAX.

Coresidency makes application integration and database access easier. It reduces file, disk,

and integrity maintenance problems. And some applications are served best by the VAX processors' I/O and data transfer rates.

Kraft claims that performance degradation problems due to VAX LISP may often be solved by adding more physical memory. Moreover, he points out that many VAX knowledge systems are written in OPS5. Kraft adds, "OPS5 is as invisible in a time-shared environment as FORTRAN." In addition, some knowledge-system development tools, such as S.1 and ART, have been translated to C.

#### **Engineering workstations serve AI**

Engineering workstations represent a major class of machines being touted for AI delivery. They are generally based on the Motorola 680X0 and Intel 80X86 families, the National Semiconductor Corp. NS32032, or on a proprietary RISC chip. The manufacturers include Apollo, HP, Sun Microsystems, Tektronix and IBM with the RT PC workstation. The machines run Common LISP, which gives them an entry to many of the standard AI application tools, and often Prolog. Tektronix workstations also run Smalltalk.

Unlike minicomputers, workstations are dedicated machines with graphical interfaces. They have the advantages of lower cost (\$20,000 to \$50,000) and compatibility with existing programs. The HP 300 series workstations, for example, run Common LISP as a process under HP-UX (HP's version of UNIX). From LISP, users can call HP-UX commands or software written in any UNIX-supported language, edit a Pascal program, spawn a Pascal compile and create programs that are hybrids of conventional and AI languages, without ever leaving the LISP editor.

Workstations had been deemed deficient because they were not microcoded for LISP execution. But now fast LISP compilers are being written for 32-bit workstations. Lucid Inc., for example, has written such compilers for several engineering workstations. Scott Fahlman, senior research scientist at Carnegie Mellon University reports that, with the Lucid compiler, the 68020-based Sun-3 performs considerably faster than the Symbolics 3600 on most of the benchmarks. He says Apollo machines will do as well.

There are some differences, however. To get maximum speed on the Sun machine, it is necessary to program carefully and to make sure of the declarations. Data type checking, which helps ensure program correctness, slows speed. In contrast, sloppy programs run just fine on Symbolics machines, which have hard-

# HOUSTON INSTRUMENT.

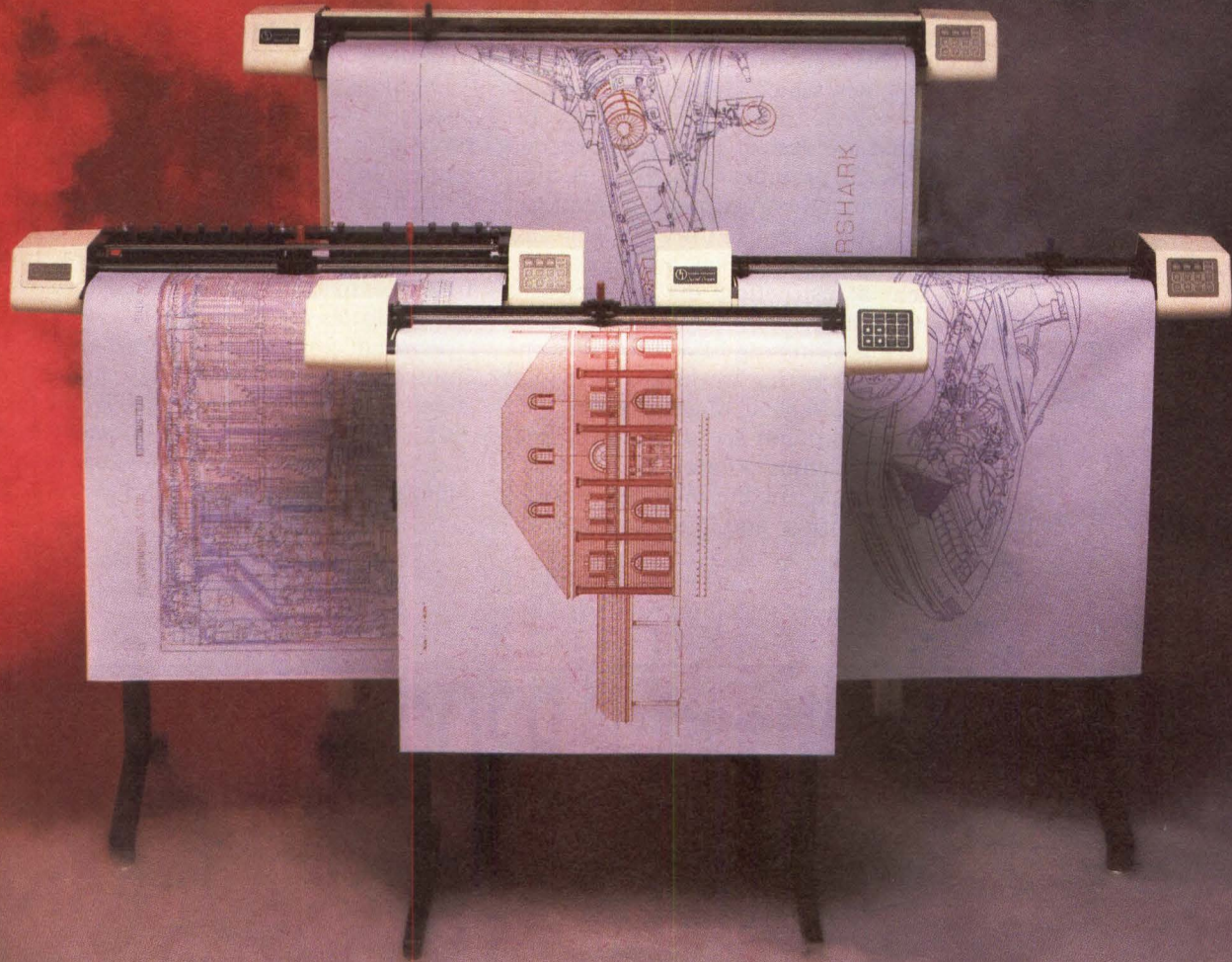

**D**iscover the secret behind the plot with Houston Instrument's line of low cost, high performance plotters.

Within HI's impressive line of plotters and digitizers, you'll find a full range of models suited for virtually any graphics or CAD application.

### Secrets in flexibility and quality.

Define your requirements. You'll find a plotter that's uniquely suited to your CAD system in Houston Instrument's lineup.

Choose from models with one, four, eight, even 14 pens. Select the types of pens and plotting media you need. Decide on format sizes—from A (8½ × 11 inches) through E (36 ×

48 inches). Whichever model you choose, your HI plotter will create accurate, crisp, colorful drawings.

### Secrets in performance and price.

With high MTBF ratings, your HI plotter excels in reliability. And, depending on the model you select, you'll experience plotting speeds up to 22 inches per second and resolutions ranging from .005 to .001 inch.

As you examine features, performance, and especially price, you'll quickly realize that Houston Instrument offers outstanding performance at an affordable price.

Regardless of the model you pick, you'll find hundreds of compatible software packages. And, by using

HI's popular DM/PL™ language, you can create your own custom software and be assured of upward compatibility with HI's entire line of plotters.

Discover more about the secret behind the plot. Call 800-531-5205 (512-835-0900 if in Texas) or write Houston Instrument, 8500 Cameron Road, Austin, TX 78753. In Europe, contact Houston Instrument, Belgium NV., Rochesterlaan 6, 8240 Gistel, Belgium. Tel.: 32-(0)59-277445, Tlx.: 846-81339.

**houston  
instrument™**

A Division of **AMETEK**

OEM discounts available. Houston Instrument and DM/PL are trademarks of AMETEK, Inc.

**CIRCLE NO. 35 ON INQUIRY CARD**

**Opinions  
about the  
value of PCs  
for AI  
applications  
are divided.**

ware support for run-time type checking. A way around this drawback is for programmers to use the run-time type checking on the Sun machine just for program development. When they are sure their code is correct, they can turn off the type checking and compile for speed.

RISC machines, which are considered a new AI delivery vehicle, are characterized by instructions that are designed to execute in one machine cycle. To provide this high instruction throughput, simple instructions are necessary, otherwise the computer can't decode them fast enough. Such throughput may not be possible for more general instructions that are typical of traditional machines.

RISC machines running LISP have the same problems as engineering workstations in that they cannot simultaneously achieve run-time checking and maximum speed. However, machines with RISC chips, a lot of memory and a good compiler may, in the long run, surpass both LISP machines and traditional workstations.

MIPS Computer Systems Inc. has a family of RISC-based products that illustrates what the

RISC future might hold. The RISC products include either VMEbus or Multibus CPU boards and a development system for building minicomputers, supermicrocomputers and workstations (MMS, May, Page 33). The MIPS computers will run Common LISP.

Opinions about the value of personal computers for AI applications are divided. The problem is that most serious AI programs require substantial memory. Programmers have written and fielded small, but useful, systems on personal computers. Personal computers also make inexpensive entry vehicles, front-end interfaces to host-based knowledge systems and good vehicles for learning AI.

Personal computers, however, are inherently limited because of their lack of memory. Their memory is even further limited by the fact that PCs do not support virtual-memory capabilities, which would allow them to use more main memory than they physically have. □

Interest Quotient (Circle One)  
High 483 Medium 484 Low 485

## Light Pens Ahead of the Competition



Yes, there can be a bar code reader in your customer's future, with Caere's new EASY-SCANNER™ 400 Series. Introducing the incredibly versatile lightweight scanner that's designed to fit your product's requirements as well as your budget.

This keyboard wedge with a light pen fits easily between your keyboard and terminal and inputs data 20 times faster than the quickest human hands. Plus it can autodiscriminate between several of the most popular bar codes.

Whether your application is manufacturing, healthcare or retail, the low-cost Caere EASY-SCANNER™ 400 Series is the one. It can be used with your IBM PC's and PC compatibles, ASCII and IBM terminals and point-of-sale systems.

Call Caere at 408-395-7000 and see how the Caere EASY-SCANNER™ 400 Series can put you light pens ahead of your competition.

*Volume discounts available to resellers*

Caere® Corporation  
100 Cooper Court  
Los Gatos, CA 95030  
408-395-7000  
TWX# 910-597-5391

**CAERE**  
CORPORATION

CIRCLE NO. 36 ON INQUIRY CARD

## PROGRAMMABLE COMMUNICATIONS TRANSLATOR

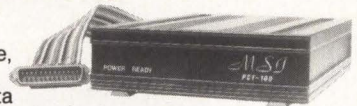

The PCT-100 is an in-line, user-programmable RS-232 protocol and data translator. It can provide a simple, inexpensive solution to your communications and compatibility problems.

- Terminal & Printer Emulation
- Baud Rate Conversion (50 through 19.2 kbaud)
- Handshake Translations (XON/XOFF, CTS/RTS, ENQ/ACK)
- Code Conversions (ASCII, Modified ASCII, EBCDIC)
- Bidirectional Manipulation of Data Strings, Bytes, Bits
- User-Programmable
- User Programs are Easily Implemented
- Built-in Compiler, Editor and Debugger
- Programs via any RS-232 ASCII Device
- Only \$495 (single unit quantities)
- User's Technical Manual \$25

**MSI**

**Method Systems Incorporated**

3511 Lost Nation Road  
Willoughby, Ohio 44094  
(216) 942-2100 or toll-free Sprint local  
number, then 666-0212

CIRCLE NO. 37 ON INQUIRY CARD

# Input Devices - The Solution is Through the Keyboard



In a world where the cost of memory, processing and output are decreasing, why doesn't the cost of input fall as well?

It can, with Key Tronic input solutions. By integrating the additional input devices *through* the keyboard, extensive hardware, software and firmware changes are minimized.

With this approach, input devices can easily be added to the system\*, the system's ports are available for other additional peripherals, and the clutter of cables and connections is reduced.

Key Tronic has pioneered this solution in the retail market and, as a result, integrated input devices are becoming widely accepted. Above all, it's available from a single source — Key Tronic, the world's largest independent manufacturer of full travel keyboards, with a complete line of integrated input devices.

Support your users more, improve your margins, and stay ahead of the competition with better and more complete solutions. Talk to your Key Tronic Representative today. We can help you design your input solution.

Pictured:

\*Some systems require minimal modifications.

- A. **Touch Pad** - a multi-purpose input device usable as a programmable function pad, mouse, fast cursor control device and digitizing tablet.
- B. **Speech Recognition** - natural, language independent command entry for hands free operation.
- C. **Bar Code** - integrated into a keyboard.
- D. **Mouse** - accurate pointing and selecting tool in a maintenance-free design.
- E. **OCR** - optical character recognition capability.

*“Feel the Key Tronic Touch”*

**key tronic**<sup>®</sup>  
The *Responsive Input Company*™

P. O. Box 14687 • Spokane, WA 99214 • USA  
(509) 928-8000 TWX 510 773-1885

CIRCLE NO. 38 ON INQUIRY CARD

# ALL THINGS ARE NOT CREATED VMEqual.



**V/SMD 3200  
SMD Disk Controller**

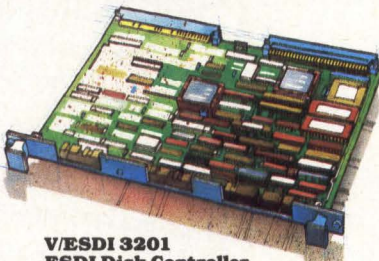

**V/ESDI 3201  
ESDI Disk Controller**

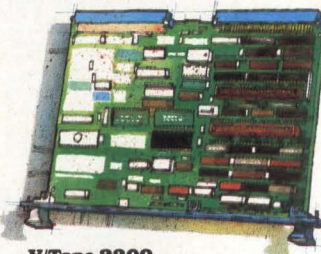

**V/Tape 3209  
1/2 Inch Tape Controller**

All VMEbus products are not created equal. In fact, we don't know of ANY that are equal to the Interphase® line of high-performance VMEbus controllers.

Interphase takes a family approach to VMEbus product development. Our system architecture and software features are compatible across the product line. This allows quicker development cycles and offers logical growth paths.

**V/SMD 3200 SMD Disk Controller**—is the industry's preeminent 32-bit SMD controller with more V/SMD 3200's installed today in VMEbus systems than any other similar product. It interfaces to any SMD or SMD-E drive with data rates up to 24 Mb/s, and adapts to your system environment through programmable system parameters.

Interphase's multitasking Virtual Buffer Architecture<sup>SM</sup> permits the V/SMD 3200 to move data with extraordinary speed and is the key to zero-latency operation. The on-board 68000 processor manages a pool of buffers and state machines, which allow it to immediately start moving data no matter where the head lands on the

track. It can transfer an entire track of data in one disk rotation and by pre-fetch caching, will continue to read and cache data even after it has finished transferring those requested. These cached sectors can then be transferred without an additional disk access.

**V/ESDI 3201 ESDI Disk Controller**—using the powerful Interphase Virtual Buffer Architecture, handles the latest high-speed 5 1/4" ESDI disk drives with hundreds of Megabyte capacities. A sister product to the V/SMD 3200 SMD disk controller, the V/ESDI 3201 is the logical migration path from SMD storage devices to a 5 1/4" form factor. Totally software compatible with the V/SMD 3200, the V/ESDI 3201 will "PLUG AND PLAY" with existing drivers to protect software investments for the future.

A 24 Mb/s disk drive front-end ensures complete compatibility with future higher speed drives.

**V/Tape 3209 1/2 Inch Tape Controller**—represents the Interphase commitment to design compatibility and ease of integration through its close-coupling with both V/SMD 3200

and V/ESDI 3201 disk controllers. It supports 8, PERTEC interface, 1/2" 9-track tape drives at speeds of 200 ips and above and is the perfect controller for start/stop or streaming applications.

An Interphase exclusive CacheFlow<sup>SM</sup> feature allows expensive drive performance with an inexpensive drive by eliminating the need for costly intelligence and large buffers. An on-board processor and 8K or optional 128K buffer create intelligent FIFOs that start moving data even before the tape is up to speed and keeps tape streaming. The V/Tape 3209 can run at up to 320 ips, at 6250 bpi, meaning that it will handle future tape drive advances.

#### **FIND OUT MORE**

Our family approach to these and other VMEbus products makes your task much easier. From peripheral controllers to system foundations, from our Design Assistance Group to our First Time User Program, no one is VMEqual to Interphase. To learn more about our products, our support or anything else, just call:

(214) 350-9000



**INTERPHASE**<sup>®</sup>  
corporation

2925 Merrell Road • Dallas, Texas 75229 • Telex: 9109976245 NASDAQ-NMS:INPH

Interphase International

93a New Street, Aylesbury, Bucks. HP20 2NY, England (0296)35661 Telex: 826715 AERO G

Interphase is a registered trademark of Interphase Corporation  
Virtual Buffer Architecture and CacheFlow are Service Marks of Interphase Corporation

CIRCLE NO. 39 ON INQUIRY CARD



# COMPILERS COMBINE MATURITY, INNOVATION

Despite being one of the oldest software technologies, compilers continue to develop as software-development tools and as databases to monitor code modification

**Michael Tucker**, Associate Editor

Compilers are almost 30 years old. Yet, despite their age, they are by no means a perfected or a static technology, and still less do they represent a static market. Increasingly, compilers for a host of languages resemble complete software-development environments. Where once compilers were little more than mills to churn out binary code, now they may come with large assortments of integrated software-engineering tools, highly modular designs, interactive debugging facilities and even integrated databases to keep track of code modifications.

Moreover, compiler vendors are adapting rapidly to the new realities of microcomputing. Instead of being relegated to a kind of mainframe ghetto, compilers can now fit easily into 32-bit workstations and personal computers. Compiler vendors see their products taking a starring role in remote software development: coding tasks performed by teams of programmers, each programmer at a workstation producing software for target machines ranging from supercomputers to embedded systems.

Even the most basic rules of the compiler business have begun to change. Where at one time compilers only randomly appeared on individual computers, now hardware makers include compilers as basic elements in their machines' design. Microprocessor vendors have begun to line up strategic alliances with compiler makers even before their own products come to market.

Compilers are programs that turn source

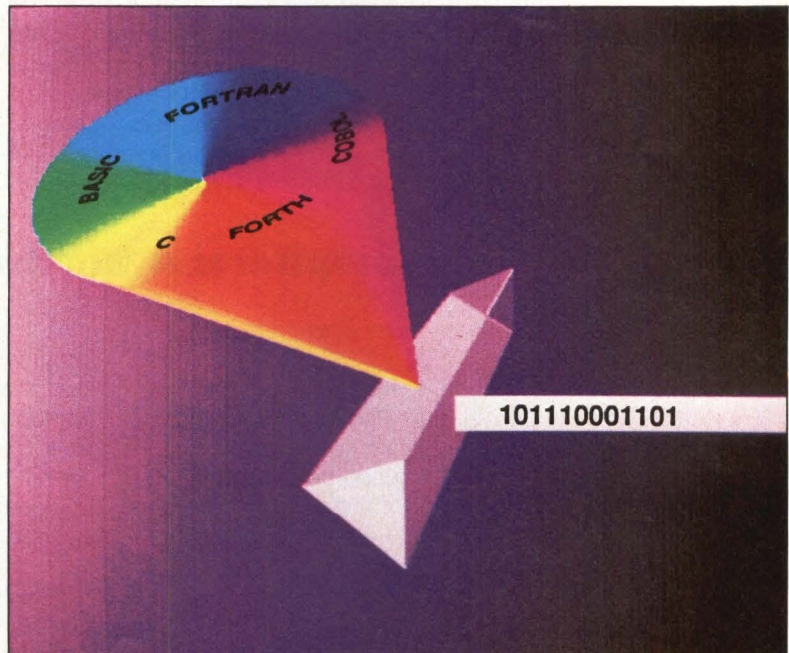

**Compilers** are software programs that turn high-level languages like COBOL and FORTRAN into machine code.

code—software written in such languages as BASIC, FORTRAN, C and FORTH, which humans can understand—into binary code, which machines can understand. They differ from, say, interpreters, in that they perform this translation in a single pass. This makes them very fast and very demanding of computer resources.

The first compilers appeared with some of the first commercial computers in the 1950s.

They've undergone considerable refinement since then, and some observers regard them as having reached the limits of their development potential. "We don't even follow them," says one market researcher. "When you've had a product around for 30 years or so, whatever big advances are going to be made have been made."

To a certain extent, the manufacturers themselves agree, though less for technical reasons than for marketing ones. "As languages mature," says John Hurd, vice president for marketing at compiler maker Language Processors Inc. (LPI), "it becomes less and less an issue of what features a compiler will have, as how closely it adheres to whatever standard has been set for the language." While compilation speed never really goes away as an issue, says Hurd, portability and standards gradually become more important.

However, if the technology of compilers tends to be fixed, the tools around them are not. Over the last decade, the business of compiler making has become the business of manufacturing software-development environments. LPI, for instance, markets compilers for several languages for computer systems based on UNIX and the Motorola Corp. MC68000 mi-

croprocessor. While Hurd may argue that the languages thus supported—LPI's COBOL, RPG II, Pascal, PL/1, BASIC, C and FORTRAN—are remarkable only in their conformance to standards, the underlying structure supporting the compilers is extremely unusual. The compilers are, in fact, merely modules within a much larger collection of code.

Each compiler sits on top of a code optimizer common to them all. The optimizer, in turn, is atop a common code generator. The code generator, which functions as the compilers' "back end" and their link to the computer, is the only part of the structure that isn't machine-independent. "What we have is basically seven different front ends," says Hurd. "These front ends, the compilers, are machine-independent. When we want to put our languages on a new computer, we just write a new back end and marry it to seven different compilers."

For programmers, this means software can be developed in several languages and then run as a single application—something which would be particularly useful in addressing vertical markets. For example, if developers wanted to sell an application to small engineering shops, they could write a program that would do computer aided design and computer aided

## Compilers: A hardware vendor's perspective

**Tom Miller**, Fairchild Semiconductor Corp.

Microprocessors that have evolved, often painfully, to the 32-bit level from 8- and 16-bit forebears are burdened with performance-limiting architectures. However, new precision instruction processors (PIP) bring superminicomputer performance to desktop machines. They do this through streamlined instruction sets tuned to architectures that foster concurrent operations in hardware. While only in their first generation, PIPs in advanced systems such as the IBM Corp. RT PC and the Hewlett-Packard Co. Spectrum have broken price, performance, power and size barriers that had seemed to permanently threaten the evolution of CPUs.

Not surprisingly, the most popular PIPs draw from both the commercial experience of supercomputer architecture and academia's research in reduced instruction set computers. Inputs from both worlds helped develop balanced architectures that meld intimately with appropriate high-level language (HLL) compilers and mate with operating systems like the de facto standard UNIX System V.

Fortunately, much of the software that OEMs need to port to high-performance PIPs has been written in

HLLs; and just about all ongoing software development is in HLLs. Though, of course, for time-critical operations there is usually some hand-crafted assembly-language code that can be returned after the port. To facilitate the switch to PIPs, system designers and integrators need high-quality development tools for generating new applications and for converting existing programs to run efficiently on the new-generation processors. Central to such tool sets are compilers. These translators join software written in easily produced, easily maintained HLLs to speedy hardware, resulting in efficient computing systems.

Compilers, of course, convert HLL instructions into machine code. This code can and does vary from compiler to compiler in two important aspects—program length (number of bytes) and execution speed (algorithm run time). The quality of the code it generates depends on the level of intelligence (the optimizing capabilities) programmed into the compiler. This intelligence handles five operations:

- Eliminating or reducing redundant jumps, unreachable code, run-time computation and so forth.
- Mapping data structures onto the memory hierarchy of the architecture. PIP class processors generally support main, cache and register memory levels.

manufacturing in C and bookkeeping in COBOL. The C and COBOL would be processed by their relative compilers and then, using tags provided by the programmers, linked into a single binary program at the code generator.

This also has advantages in team programming. An organization working on a large project requiring different capabilities in different modules of code could have individual programmers working at individual workstations in whatever language each was expert. The results could then be assembled and coordinated at some larger departmental machine.

To support both kinds of development, LPI is investing heavily in programmers' tools. The company currently markets LPI-Debug, an interactive source-level debugger that allows programmers to test code without having to reduce it to machine language.

Another compiler maker, Philon Inc., takes a very similar approach. Philon too produces compilers for 68000-based UNIX systems. Specifically, the company supports C, COBOL, BASIC, FORTRAN, RPG and Pascal. However, Philon is noted for the extraordinary speed of its product. The company can produce benchmarks showing that its products are

among the fastest on the market. For this reason, hardware vendors have been eager to put Philon compilers on their machines (the faster the compiler, the better a machine looks to would-be customers), and the company's products now run on over 30 different brands of computer.

Philon can give its customers the ability to work in several languages on the same project. The company's compilers are also modular in design. In fact, Philon argues that it was one of the first software vendors to successfully produce modular compilers. The compilers have a device-independent front end sitting atop a device-dependent back end. They are linked by Philon's proprietary intermediate code known as "Phi-code." The front end translates a programming language into Phi-code and then drops it to the back end, where it's turned into machine code.

Philon also offers a highly interactive, powerful debugger called "Phi-Analyzer." Like LPI's LPI-Debug, Phi-Analyzer could almost be sold as an interpreter. It allows programmers to test code and locate errors while performing development. Indeed, if there is a common theme to the compiler market of 1986, it's the emerging eminence of tools.

- Reorganizing compiled code in accord with system pipelining. Non-synchronized code sequences can force what would otherwise be pipelined processes to wait for the completion of a calculation.

- Parameter passing in subroutines. Allocating parameters to registers whose use is in turn controlled during subroutine execution saves many push/pop operations otherwise needed for calling and returning subroutines.

- Selecting cache strategy. PIPs, like their mainframe forebears, usually allow compilers to choose between copy-back and write-through modes or to bypass caching completely.

In addition to the compiler, advanced processor programmers must be supplied with quality run-time environments such as a library of FORTRAN computational subroutines. Here again, as in the compiler, a run-time library's quality is measured by code length and execution time of the routines. The library's completeness is critical.

Completing the support environment crowned by the HLL compiler are the system-development and debugging utilities provided by the operating system. These facilitate the code-verification process. Sort, Merge and comparison routines; HLL debuggers; and configuration managers are musts for programming

and for porting to and maintaining modern high-performance 32-bit processor-based systems. Here, the UNIX environment saves the day. Software developed in virtually any popular HLL ports easily to PIPs under UNIX, once the appropriate compilers are in place.

Developing the appropriate compiler for a particular PIP under UNIX is an exercise of the processor vendor's determination. UNIX is written in C. Most good third-party compilers, however, are written in Pascal. By generating dedicated code generators for the target processor, first the compilers and then the derived UNIX port can execute on the new system. With the UNIX "pcc" compiler, however, code generation is frequently not optimum. But, processor suppliers can choose compiler vendors such as Green Hills Software Inc., Glendale, Calif., whose packages for each HLL merge to a common intermediate format. With the Green Hills package, one optimization covers the C, FORTRAN and Pascal.

---

**Tom Miller** is the director of marketing for Fairchild Semiconductor Corp. He works particularly with the Clipper Chip.

---

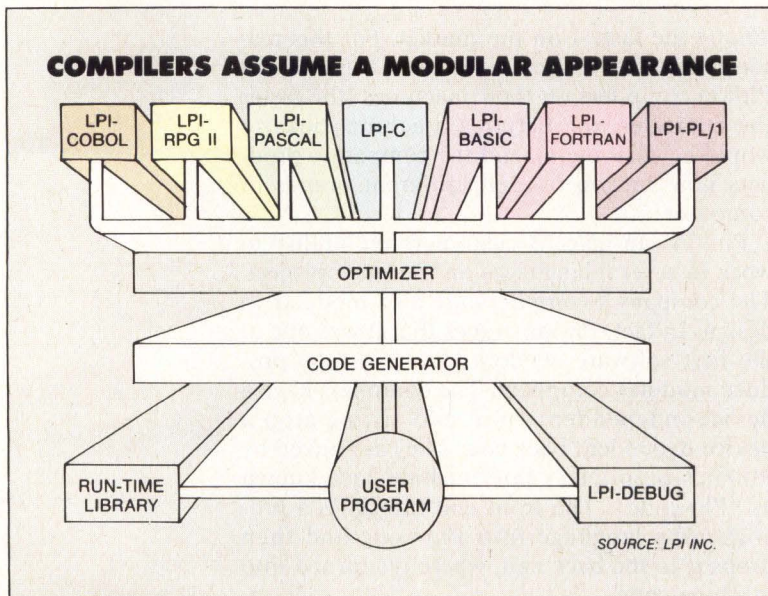

**The seven interlocking compilers** from *Language Processors Inc.* sit atop a common code generator. This means programmers can work with different languages in the same application.

Partly, the sudden dominance of software tools is the product of elementary market forces. Lattice Inc., for example, sells a selection of popular C compilers. Lattice has, however, recently brought out several tools to support those compilers. Steve Hersee, Lattice's vice president of marketing, says bluntly, "We're diversifying. We've been in this business long enough to know that any market can go down the drain."

In addition, compiler vendors are beginning to feel that software support and maintenance are part and parcel of software development. Ryan-McFarland Corp., for instance, is one of the leading names in compilers. Its FORTRAN and COBOL compilers have become very close to being standards. Recently, Ryan-McFarland began incorporating a debugger into its compiler. The company also has a licensed third-party software-vendor community of 300 members, most of whom are selling tools. "When you think of a language, you don't normally think of a debugger or linker," explains Chuck Runge, Ryan-McFarland's vice president of marketing. "But, for developers, such support software is very much an issue."

This trend shows up most clearly in the case of Ada—the programming language developed to the specifications of the Department of Defense in the late 1970s. Ada is a young and complex language, still struggling with quite basic issues of compiler technology. While FORTRAN and BASIC may have reached their development limits, Ada compilers are very much in their infancy. Only recently have any Ada compilers been validated by the DOD as being genuinely Ada. And they're still compar-

atively rare on microcomputers. Only in the last year have validated Ada compilers appeared on even the largest personal computers, such as the IBM Corp. PC/AT.

Gradually, however, Ada compilers are becoming more sophisticated. Telesoft released the first commercial Ada compiler in the early 1980s. It was, says Bruce Sherman, Telesoft's director of marketing, "Very bad. I'll admit that." However, this year Telesoft introduced Telegen 2, which the company calls an "Ada development system." It features a much-improved compiler. "It is truly one of the first second-generation Ada compilers," says Sherman. "We've spent three years taking care of the problems in the first one."

The rub in Telegen 2 is the software around the compiler. Ada is immensely capable, doing almost anything a programming language can do. In addition, because it is used by the civil government, the military and their contractors, it frequently shows up in vast projects, involving hundreds of programmers and hundreds of thousands or, even, millions of lines of code. The result is that Ada's single biggest problem is its own complexity. Projects get lost in themselves.

Telegen 2 addresses the problem with several tools, among them a complete database management system integrated directly with the compiler. "Ada encourages the use of separately compiled modules of code," explains Sherman. "The problem is in maintaining consistency among updates of those modules. In our compiler, we've included a library-management function, actually a complete database management system, specifically to let the programmer keep track of all those adjustments in the software."

**Enter embedded systems**

Another Ada vendor facing the same issues is Verdix Corp., whose presence in the compiler business is something of a surprise to Verdix itself. The company was formed in July 1982 with no intention of being involved with compilers. Verdix's founders were interested in making secure local area networks for military and government installations. "But, when they took a look at the commercial Ada compilers available, they found most of them were pretty awful," says Jack Crosby, Verdix's director of marketing. "So, they wrote one of their own."

The compiler they wrote, plus an extended collection of tools, is known as the Verdix Ada Development System (VADS). It includes the compiler itself, a symbolic debugger and assorted support software. VADS has been popu-

# HOW FAR DOES YOUR DRIVE SUPPLIER GO TO GIVE YOU AN EDGE?



9" Drives: 800 MB, or 520 MB sized for today's smaller superminis.

## NEC goes all the way to 800 MB.

NEC continues to expand the edges of disk drive technology farther and farther. So your computer systems can be more competitive.

Again we've edged out every other Winchester drive maker. One of our 9" Winchesters now has a capacity of 800 MB. Our other 9" Winchester has 520 MB. Our newest 8" has a capacity of 337 MB.

## We make you faster on your feet.

Capacity is not the only edge our large drives offer. They're also fast. Our 800 MB drive has a 2.4 MB/sec data transfer rate and a 15 ms. seek time.

And our 9" Winchesters use a special design that supports the spindle at both ends resulting in greater read/write accuracy.

## NEC drives are still going, after others fail.

Take our 8" Winchester. It has the longest MTBF in the industry. 24,000 POH. Which makes it two to three times as reliable as anybody else's.

Our 9" drives are also outstanding. With 20,000 POH. And the MTTR of our large drives is less than one hour.

## NEC keeps going for more.

NEC offers you one other important thing you need in a disk drive supplier. A solid future. Our experience in disk drive technology goes all the way back to 1959. And during the past 27 years we've added a stream of innovations in both design and manufacturing. So, we have the resources, the talent and the commitment to keep giving you an edge.

If your disk drive supplier doesn't go this far, isn't it time you called NEC. Call 1-800-343-4418 (in MA 617-264-8635). Or send us the coupon.

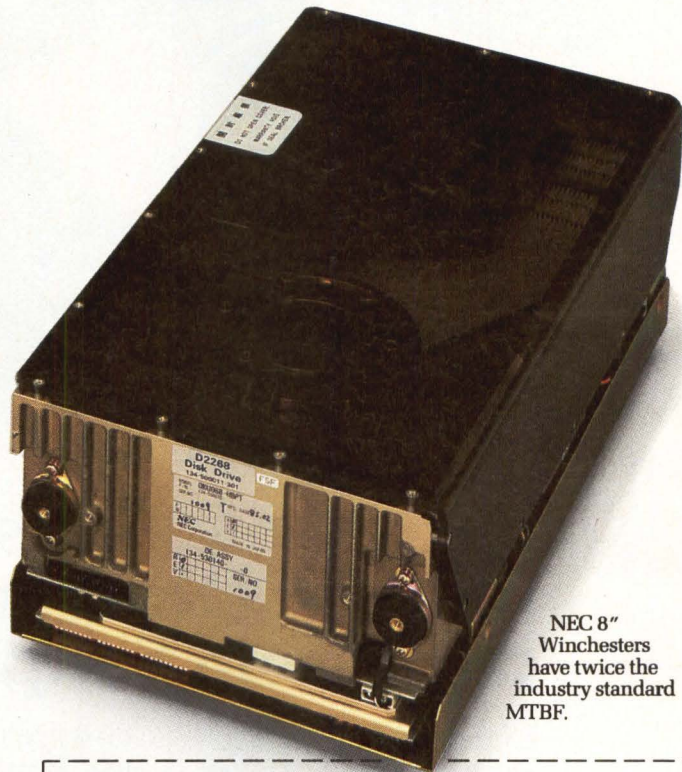

NEC 8" Winchesters have twice the industry standard MTBF.

- Please send me more information on NEC disk drives.
- Please have a salesperson call.

Name

Title

Company

Address

City

State  Zip

Tel (  )

NEC Information Systems, Inc.  
1414 Massachusetts Avenue  
Department 1610  
Boxborough, MA 01719

**C&C** Computers and Communications

**NEC**

NEC Information Systems, Inc.

mms 8 86



## The best communications tools for DEC computers come from Simpect.

### COMPUTERS

Our turnkey packages reduce communications loads for all DEC™ PDP, MicroVAX, VAX and VAXBI computers. Simpect products are compatible with Q-bus, UNIBUS and the new VAXBI bus from DEC.

### PROTOCOLS

We currently implement X.25 PPI, X.25 SVI, HDLC-LAPB, ADCCP-HDLC, ADCCP-NRM, DDCMP and SDLC protocols on our intelligent communications front-end processors, COM – FEPs. Our packages provide host connectivity to DEC and non-DEC computers.

### OPERATING SYSTEMS

RSX, MicroVMS, VMS, ULTRIX and the UNIX™ V operating system are supported.

### PERFORMANCE

Simpect intelligent COM – FEP packages let you compute and communicate – at the same time. Our packages deliver multiple high speed channels without using up your computing resources. On a MicroVAX II, a single COM – FEP with two X.25 channels operating at 64K bits/sec uses only 15% of the host CPU's time – leaving 85% available for primary processing functions.

To get more information on the best standard or custom communications tools for DEC computers, call Simpect today.

## **simpect**

Simpect Associates, Inc.  
9210 Sky Park Court  
San Diego, CA 92123  
619-565-1865

DEC, PDP, MicroVAX II, Q-bus, RSX, ULTRIX, UNIBUS, VAX, VAXBI and VMS are trademarks of Digital Equipment Corporation  
UNIX is a trademark of Bell Laboratories

**CIRCLE NO. 41 ON INQUIRY CARD**

lar on minicomputers and high-end microcomputers and, most recently, on workstations, such as the Digital Equipment Corp. MicroVAX II, the Harris Corp. MCX and the Sun Microsystems Inc. Sun-2 and Sun-3.

This is significant because it reflects a new reality of programming—the remote development of software. Increasingly, software vendors are producing their code on machines different from those on which it's meant to run. Instead, programmers are doing their work on 32-bit workstations, and then downloading their code to target systems that are either too big or too small to be their own development environments. These targets might be anything from supercomputers, whose time is just too expensive to waste in software development, to a toaster oven's 4-bit microcontroller, which simply hasn't got the brains for it.

Ada is tailor-made for both kinds of remote development. For one thing, it is so biased toward modular, structured programming that projects automatically break up into neat components, easily farmed out to the desktops of individual programmers. For another, Ada was originally meant for the military market, which is to say it was designed for embedded systems.

What has prevented the language from being more broadly used in remote development has been a lack of cross-compilers—that is, compilers on one machine that can produce binary code for another machine. This summer, Verdix announced it was working on just such an Ada cross-compiler, the "VADS/VAX VMS-

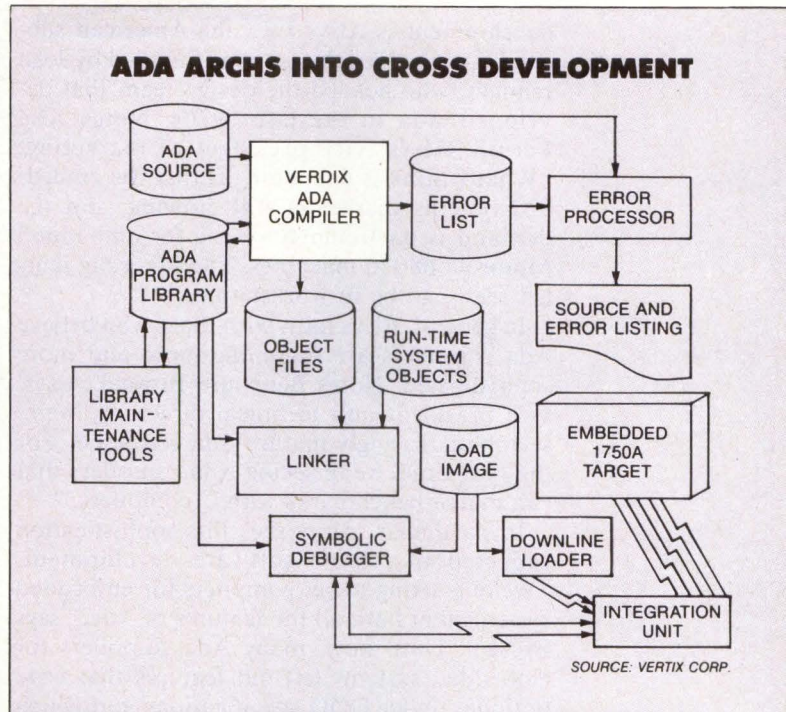

**An Ada cross development system** from Verdix; the VMS to MIL-STD-1750A cross compiler allows code developed on a DEC VAX to be downloaded to a 1750A processor.

to-1750A cross-compiler," meant to drop code from VADS running on a DEC VAX to the military-standard microprocessor, MIL-STD-1750A, currently produced by several vendors.

Another Ada compiler vendor eyeing remote

## Are compilers obsolete?

Meanwhile, at least for some applications, compilers are coming under pressure to go away and stop bothering everyone.

Compilers will, of course, always be with us—at least so long as programmers need a means of accessing computers at a level above machine code and below natural language. But, gradually, non-compileable fourth-generation languages (4GL) are making serious inroads wherever non-programmers develop their own applications. The production and refinement of 4GLs seems to be something of a growth industry.

The following are just a few of the 4GLs that have made news lately:

- **Accell**, from Unify Corp., Lake Oswego, Ore., is a combined 4GL and applications generator built on the Unify database manager for UNIX machines. Accell makes particular use of forms-based programming.

- **Informix-4GL**, from Relational Database Systems Inc., Menlo Park, Calif., is built on the company's UNIX-oriented database management system. Informix-4GL offers a quick and easy entrance to SQL-applications.

- **Progress**, from Data Language Corp., Billerica, Mass., is meant for MS-DOS-, XENIX- and UNIX-based machines. Progress provides a 4GL, a DBMS and associated support utilities for both programmers and non-programmers in the commercial field.

- **Smart\*Star**, from Signal Technologies Inc., Goleta, Calif., is a 4GL and applications generator for the Digital Equipment Corp. world. Smart\*Star allows developers to link 4GL applications with applications in standard third-generation languages, like COBOL.

- **Mach 1**, from Tominy Inc., Cincinnati, Ohio, is a 4GL for IBM machines. It is capable of producing code for the entire spectrum of IBM Corp. computers, from mainframes to the PC.

development is Alsys Inc., the American subsidiary of the French company founded by Jean Ichbiah, who headed the design team that developed Ada in the late 1970s. Notes José Leruth, Alsys' vice president of marketing, "What I think is happening is that the embedded-systems market is still growing, and the demand is particularly strong for embedded Motorola 68020 machines. The other big market seems to be in workstations."

In general, Alsys joins with those who believe Ada compilers are becoming more and more sophisticated. Notes Benjamin Brosgol, Alsys' vice president and technical director, "We're seeing increasingly mature Ada compilers. For the first time, we're seeing Ada compilers that can match benchmarks with C compilers."

In particular, Alsys sees this sophistication reflected in remote software development. "We're starting to get compilers for embedded systems that have all the features of Ada," says Brosgol. Until now, many Ada compilers for embedded systems left out features that were optional under DOD specifications, but which were also extremely useful.

And, Alsys is getting into the cross-compiler business. In September, the company announced an agreement with Hunter & Ready Inc., Palo Alto, Calif., makers of VRTX, a real-time operating system (RTOS) for embed-

ded applications. Under the terms of the agreement, the two companies will work together to produce a cross-compiler that will drop Alsys' Ada code from a DEC VAX or MicroVAX II to a 68020 running on VRTX.

**PCs play a role**

Like most compiler vendors, Alsys sees remote development on workstations as the wave of the future. "I think, very soon, the majority of programmers in the world will have workstations on their desk," says Alsys' Leruth. What is unusual is that among the workstations they see on those desks are IBM PCs, or at least PC/ATs, for which Alsys recently introduced an Ada compiler. "Increasingly, you are going to see the PC/AT used as a developmental environment," says Brosgol.

Pursuing that logic, a few compiler makers feel the ever-present PC, PC/XT, PC/AT and compatibles may be the best possible platform for remote but inexpensive software development. Forth Inc., for example, makes a PC-based compiler for the FORTH language, which is frequently used for real-time applications. The company recently introduced PolyFORTH ISD-4, a development environment for the PC consisting of the compiler, the PolyFORTH operating system, an editor and assorted utilities.

PolyFORTH ISD-4 is meant expressly for the embedded-systems world. "The glamour market for the last few years has been personal computer software," says Elizabeth Rather, president of Forth. "But if you really look at what's going on in industrial automation, and at the fact that you virtually can't buy a chair anymore without finding a microcontroller in it, then you realize embedded systems are a very, very important market."

The PolyFORTH operating system is an extremely fast RTOS that may be downloaded to an embedded system along with a completed application. Most development environments require that users do their programming on a fully featured, but relatively slow operating system, such as UNIX. They then must download the resulting code to a target processor running a real-time executive—that is, a small, streamlined, fast operating system that may have strikingly different features from the host operating system. "With PolyFORTH ISD-4," says Rather, "you do your development and your execution on the same software." □

**Companies mentioned in this article**

**Alsys Inc.**  
1432 Main St.  
Waltham, Mass. 02154  
(617) 890-0030  
**Circle 418**

**Forth Inc.**  
111 N. Sepulveda Blvd.  
Manhattan Beach, Calif. 90266  
(213) 372-8493  
**Circle 419**

**Language Processors Inc.**  
400-1 Totten Pond Road  
Waltham, Mass. 02154  
(617) 890-5633  
**Circle 420**

**Lattice Inc.**  
P.O. Box 3072  
Glen Ellyn, Ill. 60138  
(312) 858-7950  
**Circle 421**

**Philon**  
641 Avenue of the Americas  
New York, N.Y. 10011  
(212) 807-0303  
**Circle 422**

**Ryan-McFarland Corp.**  
609 Deep Valley Drive  
Rolling Hills Estates, Calif. 90474  
(213) 541-4828  
**Circle 423**

**Telesoft**  
10639 Roselle St.  
San Diego, Calif. 92121-1506  
(619) 457-2700  
**Circle 424**

**Verdix Corp.**  
Westgate Research Park  
7655 Old Springhouse Road  
McLean, Va. 22102  
(703) 448-1980  
**Circle 425**

Interest Quotient (Circle One)  
High 486 Medium 487 Low 488





OFFICE  
AUTOMATION

UNIX

MS-DOS

# All Together Now

## Office Automation

Looking for reliable UNIX™-based office automation? It's time you looked at Fortune, with a complete line of applications that all work together.

**Fortune:Word-Wang™**-like word processing, international languages, and the largest share of the UNIX word processing market.

**Multiplan®** for everything from number crunching to "what-if."

**Graphics**-create your own business presentations, based on GSS™ standards.

**Databases**-over 15 of the most popular available.

**Fortune:Windows**-cut and paste between eight applications, all together on a single screen.

**Communications**-to put you on-line with practically any local or remote system.

## UNIX-Based Systems

All this software runs on Fortune's high-performance, UNIX-based, multi-user supermicro—expandable, upgradeable, and remarkably easy to use. A single system can handle up to 32 users. And Fortune:Link connects up to 255 multi-user Fortune systems in a local area network. So that all the users in an office can share all the information, all the software, and all the peripherals—all the time.

## MS-DOS® Compatibility

If you have IBM® PCs® or compatibles, Fortune:Works puts them right into our network. And Fortune's UNIX Coprocessor card adds multi-user UNIX capability to your IBM PC. No need to choose between your existing investment and multi-user technology. Now they work together.

Vertical applications? Hundreds of UNIX-based software packages run on a Fortune. And MS-DOS compatibility means you can keep all your old favorites, too.

## It's All Yours

Fortune offers the ideal system for small to large businesses. Or even corporate America. And with five years' development and testing and 50,000 workstations installed worldwide, you know it works. With Fortune Systems, it's all together. Now.

For all the facts, send in this coupon today.

- Tell me how a Fortune reseller can have it all together.  
 Tell me how a Fortune user can get it all together. **mms 8 86**

Name \_\_\_\_\_

Company \_\_\_\_\_

Address \_\_\_\_\_

City \_\_\_\_\_ State \_\_\_\_\_ Zip \_\_\_\_\_

Phone \_\_\_\_\_ Ext \_\_\_\_\_

Fortune Systems, 300 Harbor Boulevard, Belmont, CA 94002 (415) 593-9000 Ext 35

UNIX is a trademark of AT&T Bell Laboratories, Wang is a trademark of Wang Laboratories, Inc., Multiplan and MS-DOS are registered trademarks of Microsoft Corp., GSS is a trademark of Graphics Software Systems, Inc., IBM and IBM PC are trademarks of International Business Machines, Corp.



## If you want to raise your sales, raise your hand. Create new markets with TI-Speech.™

TI-Speech offers you speech capabilities designed to give you a hand in opening the doors to untapped markets. With it, your system designs will be more innovative. You'll provide customers with better solutions, and have an opportunity to make more money.

Simply put, TI-Speech provides voice I/O for computer applications in a wide variety of fields. Applications include voice mail and telephone access to computers for businesses of any kind, robot-calling for telemarketing, hands-free data entry for

manufacturing, medicine and research and development. It can even act as a learning aid in computer-based training.

TI-Speech was designed with you in mind, too. Its handy, modular design means that you use only the hardware and software you need for your applications. And it's affordable. For under \$1,000, a plug-in option board delivers voice I/O capabilities on most IBM®-compatible PCs.

Chances are, you've been looking for new ways to expand your customer base. TI-Speech is an effective, cost-

efficient answer. Put it to work, and watch your business opportunities increase.

For an example of TI-Speech at work, call 1-512-250-4114. For more information on TI-Speech, call us toll-free at 1-800-527-3500.



# TEXAS INSTRUMENTS

TI-Speech is a trademark of Texas Instruments Incorporated.  
IBM is a registered trademark of International Business Machines Corporation.  
TI reserves the right to change its prices and product offerings at any time without notice.

31596  
© 1986 TI

# ALREADY POTENT PC/ATs GAIN POWER, VERSATILITY

Manufacturers of PC/AT-compatibles are increasing clock speeds, adding higher capacity disks and providing alternative motherboards, as well as bringing out new chips and software

**Carl Warren**, Western Editor

The IBM Corp. PC has evolved from the original, relatively slow pseudo-16-bit machine to a powerhouse system capable of supporting multiple displays and handling a veritable warehouse of peripherals. This more powerful architecture, dubbed Advanced Technology (AT) by IBM, provides true 16-bit data and address paths, and replaces the PC's Intel Corp. 8088 with the more powerful 80286 microprocessor.

But, as capable as the original PC/AT was, the demand for greater processing power made changes in the basic machine inevitable. IBM and PC-compatible manufacturers have thus beefed up the PC/AT into a machine for the multiuser environment and as a powerful single-user workstation that supports a variety of concurrent applications.

Indeed, the goal of IBM, and virtually all the manufacturers of PC/AT-compatible products, is to drive as many display devices and to handle as much information as possible. To this end, vendors offer faster machines, larger capacity rigid-disk drives, add-on and add-in boards and chassis, expansion buses, alternative motherboards and new chip sets and software.

To exploit the last ounce of processing power, IBM boosted the PC/AT clock rate to 8 MHz, and one vendor's version offers a 10-MHz clock—although 6 MHz or 8 MHz is still the norm for most implementations.

For example, Intelligent Data Systems Inc. (IDS) provides 4.77-MHz to 10-MHz speeds on its PC-286. But IDS has added more to its

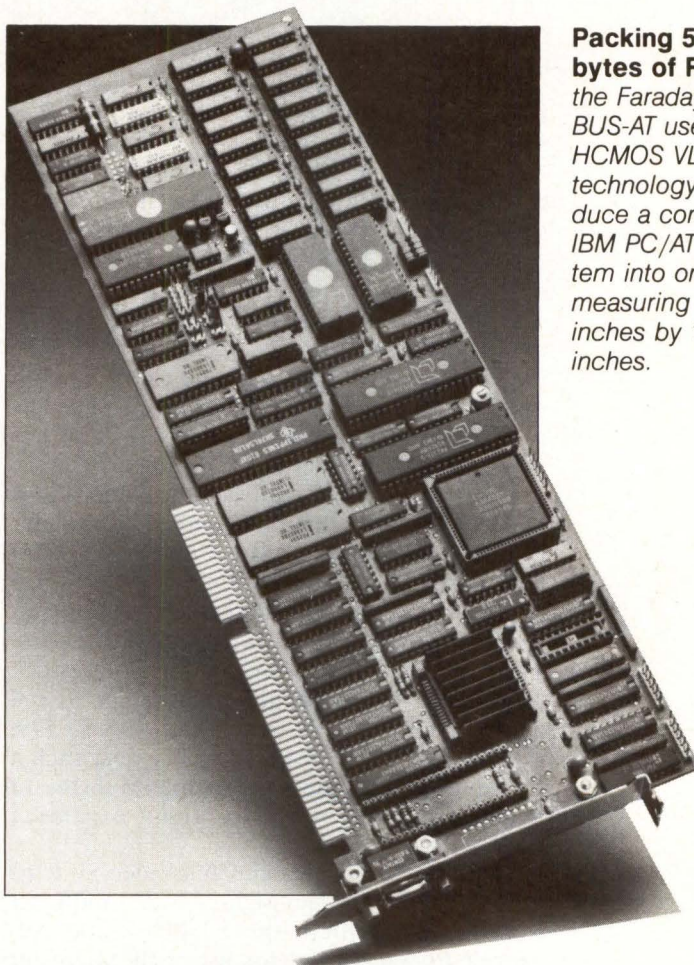

**Packing 512K bytes of RAM,** the Faraday BUS-AT uses HCMOS VLSI technology to reduce a complete IBM PC/AT system into one card measuring 4.8 inches by 13.2 inches.

machines than clock speed. Because the company also views the IBM PC/AT as being a powerful workstation engine, they include a large Winchester disk drive, which starts at 30M bytes in the \$3,360 basic model. To meet the

**Capable of functioning** as a stand-alone single-user system, or a file, print or communications server, TeleVideo's TeleCAT-286 serves as a multiuser UNIX engine.



need of large Winchesters for more power, IDS supplies a 200W supply.

Epson America Inc.'s Equity III PC/AT-compatible machine allows users to switch between 6 MHz and 8 MHz. It also provides up to 15.5M bytes of RAM with expansion cards and optional support for the Intel 80287 math coprocessor. Epson, however, isn't simply relying on sheer clock power. It provides a 200W switched power supply with the ability to hold up the system when AC power drops to as low as 90V, and a software setup system that lets users tailor the system's I/O to add peripherals.

The company that really set the standard for 80286-based systems is Compaq Computer Corp. The original IBM PC/AT has several limitations, including comparatively sluggish processing speed, and Compaq elected to overcome this limitation with its 8-MHz Deskpro. The company's goal, however, wasn't necessarily to sell a display engine, but rather to sell many single-user systems, and its \$3,599, 6-MHz, 80286-based Portable II is just such a machine. It can support up to 4M bytes of RAM, using one of its two 16-bit expansion slots.

Zenith Data Systems and TeleVideo Systems Inc. have also set their sights on the multiuser world. Zenith offers the \$3,499 Z-200 Advanced PC, suggested for use with Microsoft Corp.'s XENIX for multiuser functions. TeleVideo's TeleCAT-286 functions as a multiuser UNIX engine. It is capable of working as a single-user system, or as a file, printer or communications server driving many displays.

Kaypro Corp. is also getting on the AT-compatible bandwagon with the \$3,995 model 286i, which comes with a 30M-byte Winchester disk drive. It uses the same DOS 3.2 software as does the IBM PC-Convertible, and the company plans to eventually offer drives for 5¼- and 3½-inch disks.

#### Software in short supply

Full utilization of the power of the AT's 80286 processor, however, has been hampered by lack of software. Because the chip can address as much as 16M bytes of memory and integrates memory-management functions, associated software becomes complex, especially to accommodate protected-mode operation.

Protected mode, which makes use of the memory-management scheme, allows tasks to operate concurrently while preventing overlapping of application- or system-level software. George Alexi, Intel's microprocessor marketing manager, contends, however, that Digital Research Inc.'s Concurrent DOS-286 and Microsoft's XENIX are providing the tools necessary to ensure adequate use of the processor's capabilities.

The PC/AT and its look-alikes can run under a variety of operating systems including UNIX and its derivatives. Wyse Technology's \$4,199 WYSEpc 286, for example, which sports a 40M-byte Winchester disk drive, maximizes UNIX's abilities to run multiple terminals and to link up to other attached PCs. Wyse thus expects to see a growing use of dependent displays—nonintelligent terminals—connected to a departmental system like IBM's System/36 minicomputer via PC/AT clusters.

Structuring the use of the PC/AT around larger systems to drive as many display devices as possible is a concept endorsed by IBM. Connecting the company's three distinct architectures—the PC, the System/3X minicomputers and the System 370 mainframe—is thus a key issue, according to Allison Lowrie, manager of advanced information systems planning at IBM in Rochester, Minn.

Part of the challenge of PC/AT software is getting applications to run properly on the hardware—especially on the clones. To assist system integrators in this effort, Control-C Software Inc. has developed the Softcloning technique. It allows misbehaving IBM PC applications (such as those that make direct calls to ROM, the basic input/output system, the video memory or a screen controller) to run on systems that aren't totally compatible with the IBM PC or its derivatives. It also permits PC/AT vendors who want to increase the per-

formance or functionality of their version of the PC/AT architecture to do so, without their machines' losing the ability to run the large store of available applications.

Tatung Company of America Inc.'s model TCS-7000 is an engine capable of supporting applications such as computer-aided design. Aimed at OEMs, its prices depend on what you decide to add on. The company also makes an enhanced-graphics adapter board and the high-bandwidth display to support it.

Cordata Inc., on the other hand, offers VARs the ability to drive multiple displays with its ATD-8-Q40 \$6,995 desktop system. It also offers the ATP-8-Q single-user transportable workstation for \$2,995.

Along with adding power, PC/AT-compatible vendors are making the computers smaller by shrinking the box itself or by reducing the electronics to a board-level system.

Taking the latter approach, Datavue Technology Systems's model 8612 is packaged on a full-sized PC expansion card and uses the NEC Semiconductor Corp. V30 processor or an Intel 8086-1 chip operating at 10 MHz. The \$626 single-board computer includes 512K bytes of RAM and serves as the bus master.

Faraday Electronics is taking a similar approach with its BUS-AT. This board includes the Faraday FE3000 very large-scale integration (VLSI) chip that shrinks all the functions of an AT motherboard down to a 4.8-inch-by-13.2-inch configuration. The system is priced at \$1,195 for the 6-MHz version and \$1,395 for the 8-MHz model.

Although the board can slip into an open slot on an existing machine, Faraday expects that OEMs will consider it more for industry appli-



**Supporting up to 4M bytes of internal RAM memory, the Compaq Portable II uses a 6-MHz 80286 and operates as a single-user workstation.**

cations that are currently served by STDBus-level boards. With the BUS-AT, "you get a higher level of power, a wider range of software and more system flexibility than you do with boards designed for other buses," claims Faraday's vice president for marketing, Ron Mazza.

Faraday and Chips and Technologies Inc. are taking leading roles in shrinking the AT system. Both are squeezing the support electronics, comprising bus drives, real-time clocks, and memory managers, into gate arrays—an approach that frees up board real estate to designers who want to add interfaces or additional RAM.

Moreover, because the high-speed CMOS gate arrays take the place of about nine large-scale integrated (LSI) circuits and 11 small-scale integrated (SSI) circuits, overall power needs are reduced by about 2.5A. "This alone," says Ira J. Perlow, hardware product manager at Phoenix Technologies Ltd. in Norwood, Mass., "helps resolve power issues when porta-

## A look at the PC processor hierarchy

There are some major differences in the micro-processors used on the various IBM Corp. PC architectures. The PC's Intel Corp. 8088 chip is a 16-bit processor internally, but it masquerades as an 8-bit processor to the outside world. The processor's cousin, the 8086, on the other hand, is a full-fledged 16-bit device both internally and externally. The 8086 can operate as fast as 10 MHz and address 1M byte of memory.

Despite both chips' 16-bit capability, the original IBM PC implemented them on an 8-bit bus structure, thus limiting them to byte-wide transfers.

The 80286, also a 16-bit processor, is currently being shipped as a 10-MHz part; volume shipments of 12.5-MHz units are expected to start this fall. When

properly implemented on a 16-bit-wide bus, such as the PC/AT's, it manages up to 16M bytes of RAM and another 16M bytes of virtual memory.

The 32-bit 80386 processor sits at the top of the performance scale. Capable of addressing up to 4G bytes of physical memory, the 16-MHz part can manage another 64 terabytes of virtual memory.

Both the 80286 and 80386 integrate memory management and memory protection, which handle arrays of memory and implement concurrent, multitasking and multiuser functions.

"We developed the 80386 as a UNIX engine," says Intel's microprocessor-marketing manager, George Alexi. He sees the 80386 as being a good platform for the next generation of office-automation products.

bility is the goal."

The Chips and Technologies CS-8220 PC/AT-compatible chip set is priced at \$50 each in quantities of 1,000 and currently includes five chips. However, the company plans to soon add another array that picks up a real-time clock and peripheral drivers such as serial- and parallel-port support chips.

Similarly, Faraday Electronics' FE3000 integrates 53 components and shrinks the size of the AT motherboard by 62 percent. The device supports 6-, 8- and 10-MHz clock speeds with zero wait states and can accommodate 256K-bit and 1M-bit dynamic RAMs. The FE3000 is

priced at \$45 in quantities of 100.

Even though the 80286 microprocessor used on IBM's and other vendors' AT systems, offers a significant increase in computer power over the PC, companies such as Definicon Systems Inc. and Opus Systems are tackling yet more-demanding processing needs with 32-bit add-on subsystems.

Definicon claims its DSI-32 coprocessor board provides performance equivalent to that of the Digital Equipment Corp. VAX-11/750. Using the National Semiconductor Corp. NS32032 microprocessor, the NS32081 floating-point math processor and the NS32082

## Companies mentioned in this article

**AMQ Computer Corp.**  
Pruneyard Tower  
1901 S. Bascom Ave.  
Campbell, Calif. 95008  
(408) 559-0781  
**Circle 393**

**Avant Industries Inc.**  
9926 Pioneer Blvd.  
Santa Fe Springs, Calif.  
90670  
(213) 942-1277  
**Circle 394**

**Chips and Technologies Inc.**  
521 Cottonwood Drive  
Milpitas, Calif. 95035  
(408) 434-0600  
**Circle 395**

**Compaq Computer Corp.**  
20555 FM 149  
Houston, Texas 77070  
(713) 374-1560  
**Circle 396**

**Control-C Software Inc.**  
6441 S.W. Canyon Court  
Portland, Ore. 97221  
(503) 292-8842  
**Circle 397**

**Cordata Inc.**  
275 E. Hillcrest Drive  
Thousand Oaks, Calif. 91360  
(805) 495-5800  
**Circle 398**

**Datavue Technology Systems**  
4355 International Blvd.  
P.O. Box 2687  
Norcross, Ga. 30093  
(404) 564-5780  
**Circle 399**

**Definicon Systems Inc.**  
31324 Via Colinas  
Westlake Village, Calif.  
91362  
(818) 889-1646  
**Circle 400**

**Epson America Inc.**  
Computer Products Div.  
2780 Lomita Blvd.  
Torrance, Calif. 90505  
(213) 539-9140  
**Circle 390**

**Faraday Electronics**  
749 N. Mary Ave.  
Sunnyvale, Calif. 94086  
(408) 749-1900  
**Circle 401**

**First International Computer Inc.**  
201 Tung HWA N. Road  
Taipei, Taiwan  
(07) 154-4473  
Telex 23056 CHARLENE  
**Circle 402**

**Hewlett-Packard Co.**  
P.O. Box 10301  
Palo Alto, Calif. 94303  
(415) 857-1501  
**Circle 403**

**I-Bus Systems**  
9235 Chesapeake Drive  
San Diego, Calif. 92123  
(619) 569-0646  
**Circle 404**

**IBM Corp.**  
Information Systems Group  
900 King St.  
Rye Brook, N.Y. 10573  
(914) 934-4822  
**Circle 405**

**Intel Corp.,**  
3065 Bowers Ave.  
Santa Clara, Calif. 95051  
(408) 987-8080  
**Circle 406**

**Intelligent Data Systems Inc.**  
14932 Gwenchris Court  
Paramount, Calif. 90723  
(213) 633-5504  
**Circle 407**

**Kaypro Corp.**  
533 Stevens Ave.  
Solana Beach, Calif. 92075  
(619) 481-4300  
**Circle 391**

**King Yee Industries Co. Ltd.**  
10th Floor-2 No. 145  
Ta Tung 2nd Road  
Kaohsiung, Taiwan, R.O.C.  
(07) 201-3186-8  
Telex 72141 KING KHH  
**Circle 408**

**K.S. Brotherbox Co. Ltd.**  
P.O. Box 32-62  
Taipei, Taiwan, R.O.C.  
(02) 772-5785  
Telex 13264 KSBOX  
**Circle 409**

**Micro Computer Technologies**  
1745 21st St.  
Santa Monica, Calif. 90404  
(213) 829-3641  
**Circle 410**

**Micro Distribution Center**  
560 S. Murphy Ave.  
Sunnyvale, Calif. 94086  
(408) 730-6965  
**Circle 411**

**Opus Systems**  
20863 Stevens Creek  
Cupertino, Calif. 95014  
(408) 446-2110  
**Circle 412**

**Tatung Co. of America Inc.**  
Computer Products Division  
2850 El Presidio St.  
Long Beach, Calif. 90810  
(213) 637-2105  
**Circle 413**

**TeleVideo Systems Inc.**  
1170 Morse Ave.  
Sunnyvale, Calif. 94086  
(408) 745-7760  
**Circle 414**

**Tokyo Electric Co. Ltd.**  
Peripheral Equipment  
Sales Division  
1-14-10 Uchikanda,  
Chiyodaku  
Tokyo, 101, Japan  
(03) 292-1011  
**Circle 415**

**Wyse Technology**  
3571 N. First St.  
San Jose, Calif. 95134  
(408) 433-1000  
**Circle 416**

**Zenith Data Systems**  
1000 Milwaukee Ave.  
Glenview, Ill. 60025  
(312) 391-8949  
**Circle 417**

# A great little terminal any way you look at it.



## The Wyse WY-30. \$399.\*

Our approach to breaking the \$400 barrier in an ASCII terminal was not to strip down an existing design, but to create a streamlined, no-nonsense machine from the ground up. We incorporated some familiar features, like the exclusive keyboard design that's helped make our terminals best-sellers, worldwide. And we added a few neat twists to give you a new angle on comfort, any way you look at it.

A 14" flat screen increases viewing area and clarity for a crisp 80-column display. A sturdy Touch-Tilt mechanism puts just the right slant on the screen. An optional arm adjusts the screen height, and lets you tuck the keyboard out of the way underneath. Another optional base raises the terminal and swivels at a touch. And the adjustable keyboard puts 41 programmable functions at your fingertips, at whatever angle feels best.

Call toll-free or write, today, for more information.

Wyse is a registered trademark of Wyse Technology. WY-30 and the "V" shaped design are trademarks of Wyse Technology. © 1986 Wyse Technology. \*Price does not include optional arm pictured.

# WYSE

YOU NEVER REGRET A WYSE DECISION.



- Yes, please send me detailed information on the WY-30 and the entire Wyse product line.
- I'd like to see a demonstration of the WY-30.

MMS 8 86

Name \_\_\_\_\_ Title \_\_\_\_\_

Company \_\_\_\_\_ Phone \_\_\_\_\_

Address \_\_\_\_\_

City \_\_\_\_\_ State \_\_\_\_\_ Zip \_\_\_\_\_

Mail to: Wyse Technology, Attn: Marcom Dept. 30  
3571 N. First Street, San Jose, CA 95134

**Call 1-800-GET-WYSE**

**CIRCLE NO. 43 ON INQUIRY CARD**

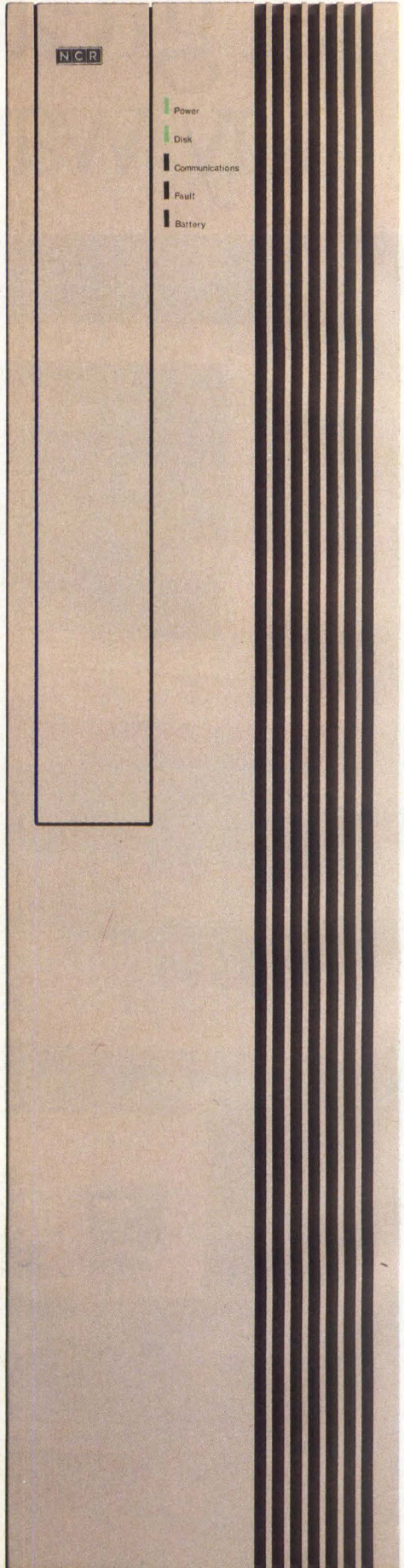
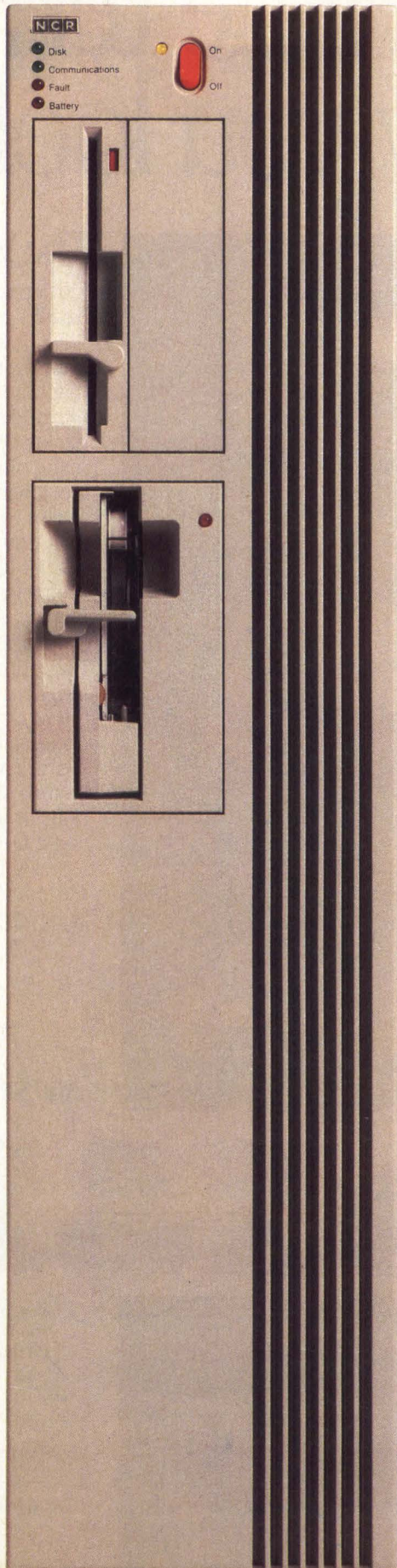
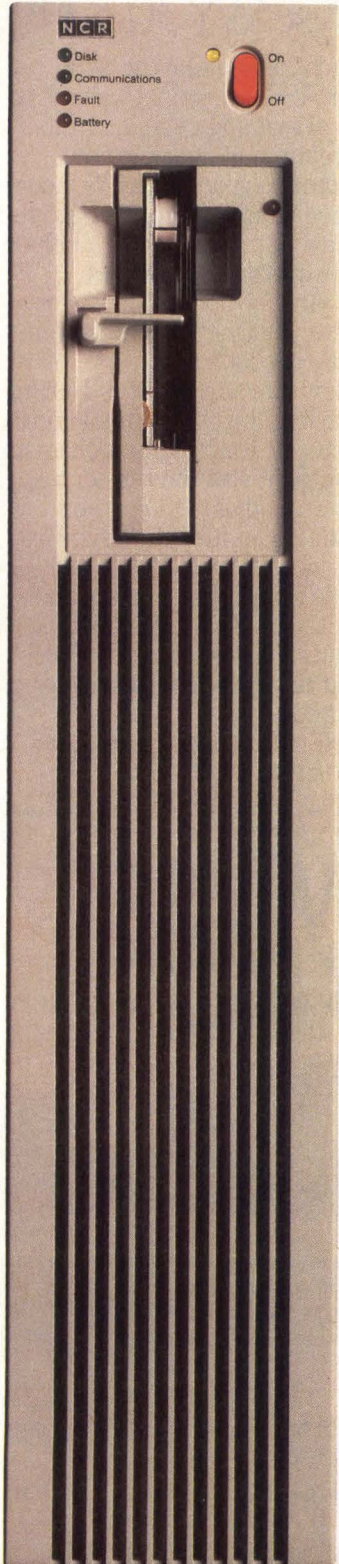



# TOWER<sup>3</sup>

Tower\* to the third power: MiniTower (1-8 users), Tower XP (1-16 users), and the new Tower 32 (1-32 users). Everything you've always loved about a Tower, in a size to fit any customer need.

NCR packs every Tower with all the features that have made us a power in the OEM market: a UNIX\* operating system that virtually never PANICs, extensive remote and in-service diagnostics, consistent error logging, power failure recovery, and much more.

And now, with the addition of the new Tower 32, you can offer your customers performance two to three times that of even the Tower XP. Memory capacity up to 16MB, with an amazing 14MB per program. SCSI (Small Computer Systems Interface) for large disk unit capacity. And connectivity for up to 32 users.

Compatibility between Towers means that as your customers grow, so can their Tower investment. MiniTower to Tower XP to Tower 32. With a minimum of software and support investment.

And, maximum profitability.

Plus, when you put the Tower family to work for any of your customers, you're putting the power of a \$4 billion corporation to work for you.

NCR product quality is unparalleled. We spend over a quarter of a billion dollars a year on R&D. Our nit-picking reliability fanatics subject every Tower to an unprecedented barrage of reliability tests. We maintain a standing army of 7,000 service representatives in 400 field locations nationwide. And more.

All to be sure that every Tower you sell lives up to our reputation. And yours.

**THE TOWERS.  
BUILT FOR SYSTEMS BUILDERS  
BY NIT-PICKING FANATICS.**



**CIRCLE NO. 44 ON INQUIRY CARD**

OEM Systems Division, NCR Corporation, U.S. Data Processing Group, USG-1, Dayton, OH 45479. Nationwide (800) CALL NCR.

Tower is a registered trademark of NCR Corp. UNIX is a trademark of AT&T. Specs subject to change. © 1985 NCR Corporation

memory-management unit, the board operates at a minimum clock rate of 10 MHz and includes 2M bytes of dual-ported RAM. According to Definicon, the system, which starts at \$1,495 depending on configuration, supports multiuser tasks under UNIX System V.

Opus Systems' president Ted Atlee likes to refer to his company's AT implementation, the Opus board, as a "personal mainframe." A multiuser and multitasking UNIX engine, the board costs about the same as the DSI-32 and uses the same processors. It operates at 10 MHz without wait states and treats all the on-board memory (up to 4M bytes) as being local to the National processor.

Although Atlee sees the board being used primarily with PC/AT-type architectures, the design is optimized for the PC/XT—an 8-bit bus machine. Thus transfers are done 1 byte at a time. However, Atlee says that, to improve performance, the board affords direct-memory access directly to an I/O device.

Other computer vendors take a different approach to PC/AT compatibility by providing board-level coprocessors that allow their machines to run MS-DOS applications. Hewlett-Packard Co.'s 80286-based coprocessor, interface card and software allow the company's HP 9000 Series of technical workstations to integrate MS-DOS applications under the multitasking HP-UX operating system.

Because a major trend with AT architectures is to pack most of the power on plug-in cards, there is an attendant need for backplane boards as well. One of the companies that is stepping forward to solve this problem is I-Bus Systems. It offers a PC/AT expansion chassis board as well as a rack-mount version. Both backplanes have 12 slots: one has three 16-bit slots and nine 8-bit slots; the other has 12 16-bit slots.

To ensure proper power distribution, I-Bus provides four sets of power connectors. Although IBM has elected not to terminate the PC/AT backplane bus, the I-Bus board can add active or passive termination.

Adding extra slots to the PC/AT backplane is also the motive behind Micro Computer Technologies' \$250 Expansion Box. It provides four slots, for a net gain of three: The host-adaptor board requires use of one of the main backplane slots.

#### **PC/AT systems that are inexpensive**

There are PC/AT compatibles awaiting cost-conscious buyers. For example, Micro Distribution Center offers a 640K motherboard that operates at 8 MHz for \$175. From Taiwan comes First International Computer Inc.'s

8-MHz 80186 system, dubbed the Turbo Leo, for less than \$500, depending on the options and configuration. K.S. Brotherbox Co. Ltd., also in Taiwan, offers the Kingtech 80286 machine and a full line of add-in boards for under \$2,000, depending on configurations and quantities. An American newcomer to the AT neighborhood, AMQ Computer Corp., offers its 8-MHz AMQ AT 286. With 2.7M bytes of RAM and a 20M-byte hard disk, the system costs \$3,995.

Other companies, such as Avant Industries Inc. of Santa Fe, Calif., King Yee Industries Co. Ltd. of Taiwan, and Tokyo Electric Co. Ltd., provide all the components to build IBM PC-compatible systems, including PC/AT compatibles. Parts range from graphics display cards to power supplies and keyboards. In fact, Tokyo Electric's FB-506-AT2 is offered as an OEM product complete with chassis, power supply, disk controllers and a complete choice of add-in cards.

Assembling your own PC/AT-compatible machine may have some pitfalls, however. VARs are cautioned to look closely at the workmanship and the quality of the material, because a cheap part may end up being an expensive problem.

#### **Vendors aim for 32-bit performance**

Although the 80286 microprocessor-based machines haven't gotten into full swing, computer developers are already eyeing the Intel 80386 processor to increase data transfers to 32 bits. Intel, in order to encourage development, has created an extension for the PC/AT bus that accommodates the 32-bit chip.

Trying to dam the stream of information leaks about Intel's so-called 386 Turbo enhancement, William Lattin, senior vice president for Intel's System Group, has put a "No Comment" sign on the desk of anyone who is even remotely associated with the design.

But members of the industry's Personal Computer Extended Technology (PCET) bus committee, which includes representatives from over 40 companies, are going beyond the Intel design in their deliberations. They expect to provide a short-range solution that allows the PC/AT to handle 32-bit memory mapping over its 16-bit bus and then to define a fully workable 32-bit design for later standards consideration. □

---

Interest Quotient (Circle One)  
High 489 Medium 490 Low 491

---



---

**Along with adding power, AT-compatible vendors are making the computers smaller by shrinking the box or reducing the electronics to a board-level system.**

---



PRESENTS

## SCSI FORUM / BOSTON '86

A comprehensive 3-day technical conference for system integrators and suppliers to discuss SCSI (Small Computer System Interface) issues, learn about the latest SCSI developments, and promote industry standardization.

**WHERE** The Hilton at Colonial, Route 128, Wakefield, Massachusetts

**WHEN** October 7 - 9, 1986

**TECHNICAL PROGRAM** The new Fall Technical Program, presented by the world's leading SCSI experts, consists of nine one and one-half hour Technical Sessions:

- What is SCSI and What Can It Do For Your System?
- SCSI Command Set Overview
- SCSI Common Command Set (CCS) Status
- High Performance SCSI Features
- Backup and the Copy Command
- SCSI Overhead Trade-offs
- Host Adapters
- SCSI Applications: PC's to Supermini's
- SCSI Test Issues

**EXHIBITORS PROGRAM**

• WORKSHOPS

The optional half-hour SCSI Exhibitors Workshops conducted by participating SCSI Suppliers provide an opportunity to interactively learn more about a particular SCSI product or supplier.

• RECEPTION

The Tuesday evening Exhibitors Reception provides an opportunity to see the latest SCSI products and talk to technical representatives from participating SCSI suppliers. A light buffet and cocktails will be served.

**SPONSORS**

- |                               |                                  |                                     |
|-------------------------------|----------------------------------|-------------------------------------|
| • Adaptec, Inc.               | • Micropolis                     | • Siemens Information Systems, Inc. |
| • Adaptive Data Systems, Inc. | • Mini-Micro Systems             | • System Surety Group               |
| • Control Data Corporation    | • NCR E & M                      | • Technology Forums                 |
| • Emulex Corporation          | • NCR Microelectronics           | • Western Digital                   |
| • ENDL Consulting             | • NSA/Hitachi                    | • Xebec Systems, Inc.               |
| • Fujitsu America, Inc.       | • Pertec Peripherals Corporation |                                     |
|                               | • Scientific Micro Systems, Inc. |                                     |

**REGISTRATION FEE** The Registration Fee of \$995 includes attendance at all scheduled functions, copies of the SCSI and CCS Specifications, Speaker Presentations, Continental Breakfast and Luncheon each day, a Welcome Reception, and the Exhibitors Reception.

---

**REGISTRATION FORM**

Please register me for the SCSI Forum. I have printed the following information as I want it to appear on my name tag and on the list of attendees:

**Name** \_\_\_\_\_

**Title** \_\_\_\_\_ **Phone** (\_\_\_\_) \_\_\_\_\_

**Company** \_\_\_\_\_

**Address** \_\_\_\_\_

- Please send information on exhibiting at the SCSI Forum.
- Please send information on the SCSI Source Guide, A Comprehensive Handbook on SCSI Hardware and Software Products.

SCSI Forum registrations cannot be accepted unless accompanied by full payment of \$995. Please make checks payable to "SCSI Forum" and mail with this registration form to:

**TECHNOLOGY FORUMS**  
3425 Pomona Blvd., Suite F • Pomona, CA 91768 • (714) 861-7300

**CIRCLE NO. 45 ON INQUIRY CARD**

# Introducing our 1,722 new data storage systems.

Our latest Multibus®, Q-Bus® and SCSI systems provide 12 to 280 megabytes of hard disk storage.\* With one or two 5¼" or 8" floppies. Plus streaming tape or removable cartridge backup. In just about any combination.

In short, you can virtually custom-design your own configuration.

Throughput of your whole system will be considerably improved by our non-interleaved data transfer. It's up to three times as fast as other systems.

And you'll save a backplane slot. Or two. All controller electronics are on one board that fits inside the system itself. You can even have a built-in 6 or 12-slot backplane to add your own CPU and other boards.

To combine all these functions, we developed a new high-scale integrated technology. Which means these systems are reliable as well as fast. They have the most sophisticated error-correction features available. Plus on-board diagnostics, formatting and backup utilities all controlled from a handy panel on the front of the case.

If you're installing your own drives, the controllers are also available separately for DEC MicroVAX®, LSI-11®, Intel Multibus and SCSI.

We think we've covered every requirement you might have. But if we haven't, let us know.

With 1,722 models already, what's one more?

Scientific Micro Systems,

339 N. Bernardo Avenue, Mountain View, CA 94043

Telephone (415) 964-5700 • Telex 184160.

## Scientific Micro Systems

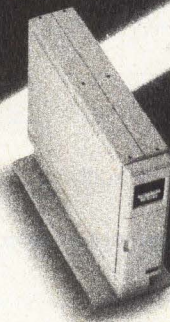
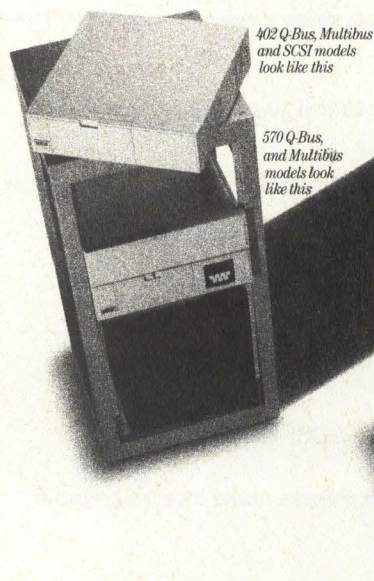

\*Soon up to 700 megabytes when we introduce systems with high-performance ESDI drives. But that's another few hundred models.

Branch Offices: U.S.—Eastern: (617) 246-2540 Southeastern: (919) 292-8072 Central: (312) 966-2711 Western: (206) 883-8303 Europe—West Germany TWX: 178-218-89 Telephone: 821-572095. Multibus is a registered trademark of Intel. Q-Bus, MicroVAX, and LSI-11 are registered trademarks of Digital Equipment Corp. ©1986 Scientific Micro Systems, Inc.

CIRCLE NO. 46 ON INQUIRY CARD

# ADDED FUNCTIONALITY SPARKS STDBUS REBIRTH

New software, 16-bit transfers, CMOS technology, multiprocessor support and a wealth of I/O cards gird STDbus for the industrial-market battles of the future

**Jesse Victor**, Associate Editor

Vendors of Standard Bus (STDbus) products are attempting to dispel what they regard as an unjustified image of a dormant 8-bit bus technology unsuited to the challenges of the '80s and '90s. In fact, this workhorse of the low-cost industrial-control market is alive and kicking. The 8-year-old bus has quietly and steadily added new 16- and 16/32-bit processors, advanced operating systems and programming languages, multitasking or multiprocessing support, CMOS single-board computers and I/O cards, small computer systems interfaces (SCSI), compatible rigid disks and semiconductor disk storage.

Armed with these enhancements—plus new 16-bit data-transfer and Intel Corp. 8088 microprocessor standards—STDbus vendors are vigorously working to protect the bus's large installed base of industrial applications against assaults by IBM Corp. PC and PC/AT bus single-board computers and VMEbus and Multibus products.

In addition, STDbus vendors are looking ahead to double-byte-wide memory boards and a new generation of networks to link STDbus systems both to one another and to single-board computers adhering to other bus standards. With all this activity, vendors are engaged in another crucial endeavor: pitching STD's advantages to system integrators and end users so that it can continue to win "design-ins" for industrial applications. Although it's a major-league bus in every way—with over 150 vendors, scores of single-board computers and more than 1,000 I/O cards—STDbus has

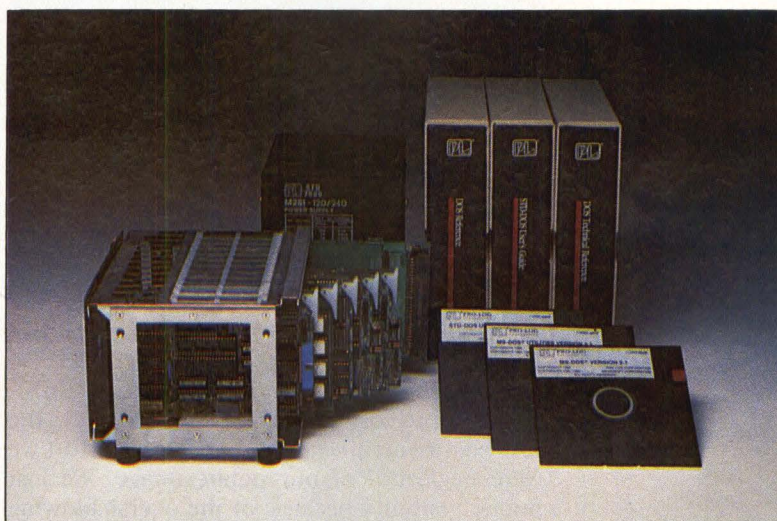

**The PS1.1 prototyping system** from Pro-Log furnishes a built-in editor and debugger, an 8088 CPU card with an RS232C port, two RAM disks, 384K bytes of system RAM and 128K bytes of ROM for the resident STD-DOS version of the MS-DOS 3.1 operating system.

lost its image in the glare of publicity given to "bus wars" between the glamorous, high-end buses.

"Originally, STDbus was an 8-bit single-processor bus relying mainly on the [Zilog Inc.] Z80 microprocessor, which limited it," asserts Paul Virgo, marketing manager at STDbus vendor Pro-Log Corp. "However, multiple-processor schemes using the 8088 CPU for real-time I/O-intensive applications, full 16-bit specifications, which allow processors on the bus like

**This CMOS 8088-based 16-bit single-board computer from WinSystems is typical of the increased processing power now appearing on the STDbus. On-board functions include an 8259A interrupt controller, three 16-bit counter/timers, an RS232/RS422 serial port and a watchdog timer.**

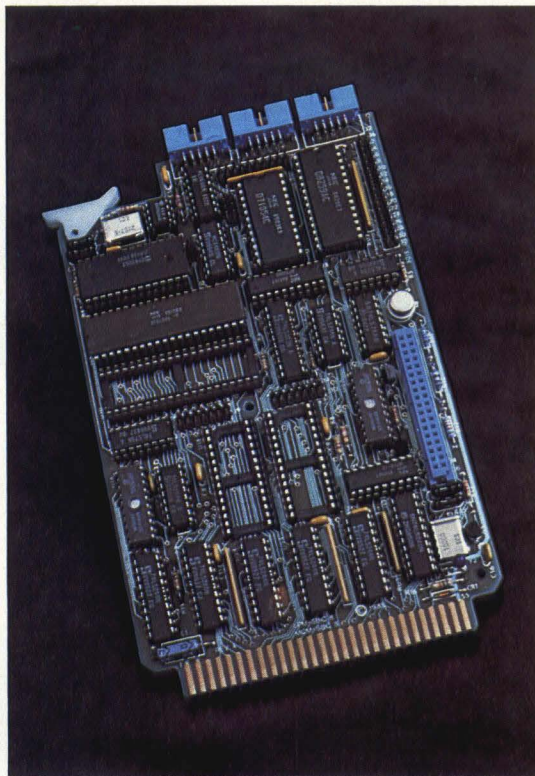

the [Intel] 80286 or the [Motorola Inc.] MC68000, and a full CMOS specification have geared the bus up to go forward into the 1990s."

"STDbus is here to stay," contends Jim Eckford, vice president of sales and marketing at Ziatech Corp., San Luis Obispo, Calif. "There is no cost-effective solution like it in the low-cost control-system marketplace. But we were neglectful of our public image. We lost public visibility because of the overshadowing publicity given to Multibus, VMEbus and the PC bus."

#### **Underestimates market share**

The bus's momentum has also been blunted, STDbus vendors charge, because market-research companies have consistently underestimated STDbus' market share, relative to other computer buses, for several reasons. For instance, since STDbus cards generally cost much less than VMEbus or Multibus boards, market-share figures based solely on shipment values make it appear as if the STDbus had a much smaller installed base than it does. Also, STDbus boards are unique in that a large number of them are user-designed and thus not counted by market-share estimates.

"STDbus is holding its own in design-ins; there's no question about it," asserts Chuck Cech, president of ElectroTech Marketing Con-

sultants, Monterey, Calif.

Cech says that, although STDbus product sales were essentially flat last year, the bus will show a 20 percent to 25 percent growth rate this year and at least a 20 percent growth rate through 1990. This year's total sales of boards and hardware support products such as card racks should reach \$65 million to \$75 million, he estimates.

Cech attributes the "revitalization" of the STDbus to the availability of both STD-DOS, the STDbus version of MS-DOS, and to the 8088 processor standard, but he sees the integration of more software as the key to future growth.

For its part, STD-DOS allows STDbus users to utilize IBM PC application software in industrial environments with the PC as a software-development machine on the bus.

"Industrial process-control people are reluctant to put IBM PC cards in the factory," claims Robert A. Burckle, vice president of WinSystems Inc. "[But.] with the 8088 on the bus, you can develop applications on a development machine or IBM PC and move them directly to a target application."

STDbus vendors Ziatech and Pro-Log follow different approaches to STD-DOS implementation. Ziatech's is based on IBM's PC-DOS; Pro-Log's, on Microsoft Inc.'s MS-DOS. Ziatech also offers STD Multi-DOS, an extension of PC-DOS comprising a multitasking virtual real-time executive (VRTX) kernel, a Virtual System Console, a global file system and the TRACER real-time debugger, developed by Hunter & Ready Inc. Both STD Multi-DOS and Ziatech's STD-DOS allow concurrent and independent operation of both the PC and the STD system and program development on either a PC or an STDbus computer. "The Multi-DOS multitasking kernel takes over the system and uses the resources of the PC as a background utility set," comments Eckford.

Pro-Log supplies the PS 1.1 STD-DOS prototyping system and three-card (OS 1.1) and two-card (OD 1.2) versions of its STD-DOS OEM system, all based on MS-DOS 3.1. The prototyping system furnishes a built-in editor and debugger, MS-DOS in ROM, an RS232C port, 8088 CPU card, plus semiconductor disk storage. In addition, the company's new STD LIB 1.1 library of initialization and driver routines permits application programs written in assembly language, BASIC or C to control STDbus I/O cards.

Software support by the STDbus is not confined to PC-DOS or MS-DOS or the BASIC offered by most vendors. Languages, develop-

ment systems and boards with resident high-level languages are proliferating on the bus, enabling programs to be developed on a PC or on a standalone module and downloaded for execution from ROM in the STDbus system.

“Sophisticated operating and development systems are appearing on STD that cut the costs of development by an order of magnitude,” asserts Eckford. “Our customers spend 10 times more on software than they do on hardware. If we can halve that, we have made a major contribution.”

FORTH language programs, which can execute code 50 times faster than BASIC programs, are supplied by several vendors. Ziotech, for example, offers STD PolyFORTH combining a multitasking operating system, the PolyFORTH high-level language, a PolyFORTH assembler for the 8088 CPU, an editor, database support, utilities and a math package for the 8087 coprocessor. The company also offers STD VRTX with a VRTX development system and the STD PDS IBM PC-based development system for its 8088 and

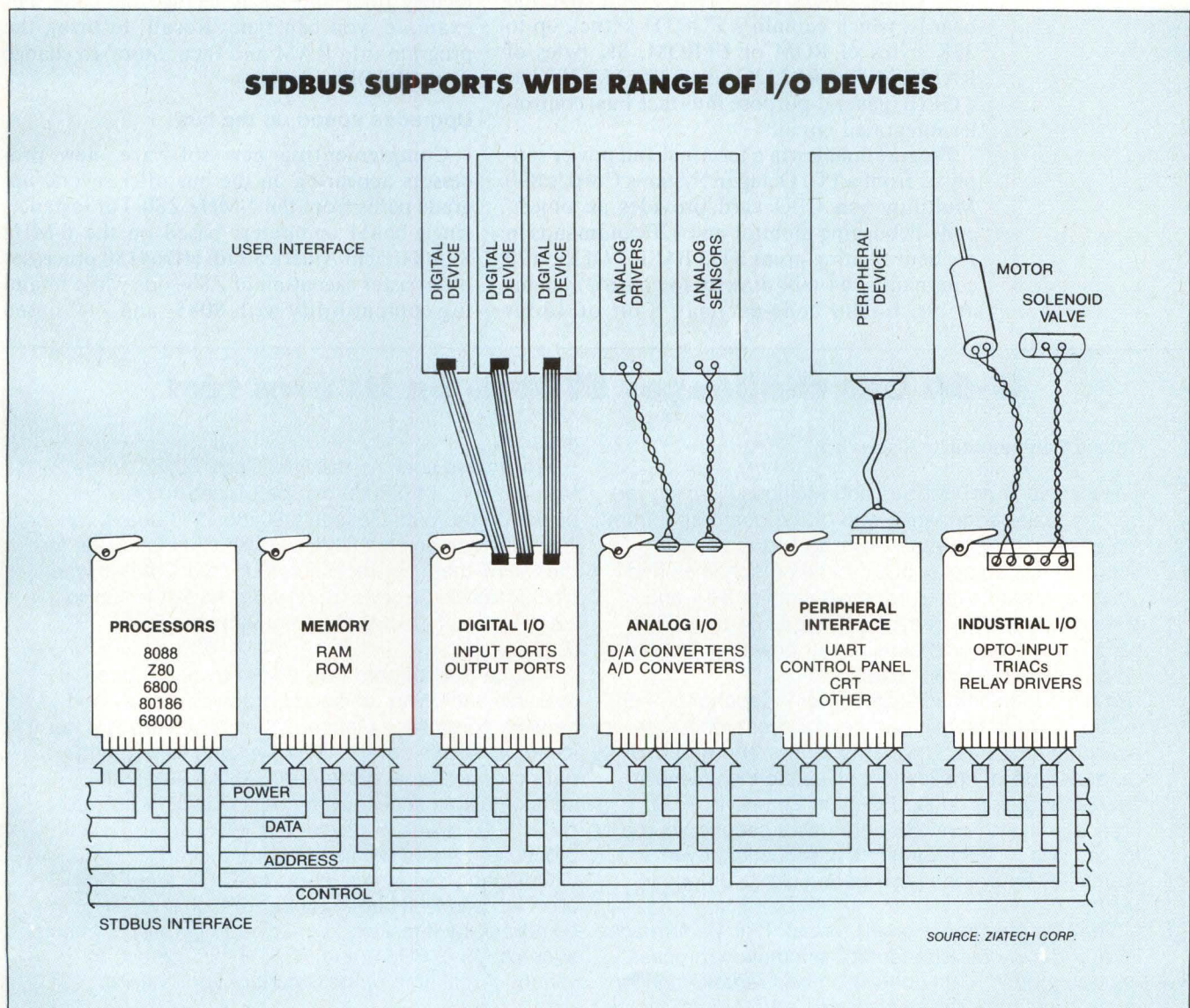

**A synchronous bus structure** using a 56-pin edge connector and separate buses for power, data, address and control signals, STDbus supports a wide variety of I/O cards for data acquisition, motor and valve control, robot guidance and other industrial applications. Analog

interfaces handle A/D and D/A converters and sensors; peripheral cards function with CRTs and UARTs; and industrial I/O connections control relays and valves through opto-isolated inputs and other inputs.

80188 computers.

Vesta Technology Inc.'s STD88 board provides a FORTH board with an editor in ROM, allowing software development via a terminal and a power supply or via a PC. HiTech Equipment Corp., San Diego, provides ForthCard, which also allows integrators to develop FORTH or alternative assembly language programs. The board includes an EPROM-EEPROM programmer (electrically programmable-erasable programmable ROM), development firmware and serial and parallel I/O. Finally, Mitchell Electronics, Athens, Ohio, offers the M/E200 and M/E300 boards, which contain a FORTH kernel, up to 32K bytes of ROM or EPROM, 8K bytes of RAM and dual RS232C ports. The M/E200 has a GPIB (general-purpose interface bus) controller integrated circuit.

Programmable via a terminal and power supply or from a PC, Octagon Systems Corp.'s 890 Multifunction CPU card provides an object-code-debugging monitor and 120 commands in resident floating-point STD BASIC. Of the 120 commands, 44 talk directly to control systems at bit, binary code-decimal, 8-bit or 16-bit

levels. Statistical and math functions are included, and special commands ease control tasks. "Tach," for example, enables the board to measure the revolutions per minute of a rotating shaft via an optical encoder.

John McKown, the Westminster, Colo., company's technical marketing manager, notes that ROM-based systems, such as the 890, have many advantages in factory-floor applications. "Our experience is that most users have to change the software frequently. If you are having a problem with your robot arm, for example, you can take a programmer out on the factory floor and easily change the code. For example, you can type 'Recall' to bring the program into RAM and then 'Store' to change your EPROM."

#### Upgrades speed up the bus

Complementing new software, new processors appearing on the bus offer several upgrade paths from the 4-MHz Z80. For instance, single-board computers based on the 6-MHz 8-bit Hitachi America Ltd. HD64180 processor offer faster execution of Z80 code while retaining compatibility with 8085- and Z80-based

## G-64 bus challenges STDbus on its own turf

**Cosma Pabouctsidis**, Gespac Inc.

Buses such as VMEbus and Multibus II, which target the high-performance end of the board spectrum, are usually implemented on large and expensive boards, have complex bus-arbitration schemes and often represent overkill for most simpler 8-bit and 16-bit applications. In contrast, the G-64 bus offers compact, simple, inexpensive but powerful, industrial-grade microcomputer boards.

A second-generation, processor-independent, non-multiplexed, 16-bit-microprocessor synchronous or asynchronous bus, G-64 aims for low-end and mid-range industrial applications. Gespac Inc., Geneva, Switzerland, first defined G-64 in Europe in 1979. France's Thompson-CSF acted as a second source for the bus in 1980. Since its introduction, over 250,000 G-64 boards have been sold to European users.

The bus's compact board format, high-performance level and low cost suit factory-automation, process-control, robotic, data-acquisition and remote-monitoring applications. The bus's Eurocard/DIN form factor is a worldwide standard supported by many card-cage manufacturers. G-64's pin-in-socket connector provides two points of contact on each pin in a virtually gas-sealed environment, making it corrosion-

resistant.

Processors such as the Intel Corp. 80286 or the Motorola Inc.. MC68000 can be utilized to their full power on the bus. Gespac's 80286 CPU board, for example, contains an 8-MHz 80286 CPU, a socket for the 80287 math coprocessor, four timers, a real-time clock/calendar, a serial port and a socket for up to 128K bytes of electrically programmable ROM (EPROM).

A large pool of hardware and software support is available, including advanced graphics display and network controllers. Gespac's GESNET-1A board, for instance, allows several G-64 systems to exchange data over a coaxial cable and CSMA/CA (carrier sense multiple access with collision avoidance) protocol at 800K bytes per second. CMOS and 32-bit-processor boards will soon be introduced.

Operating systems such as MS-DOS and CP/M allow access to a large number of high-level-language compilers. Multitasking kernels and operating systems such as OS-9, PDOS and FORTH suit the bus for a variety of real-time process-control applications.

---

**Cosma Pabouctsidis** is president of Gespac Inc., Mesa, Ariz.

---



# Let Telxon help you get the lead out of your integrated systems.

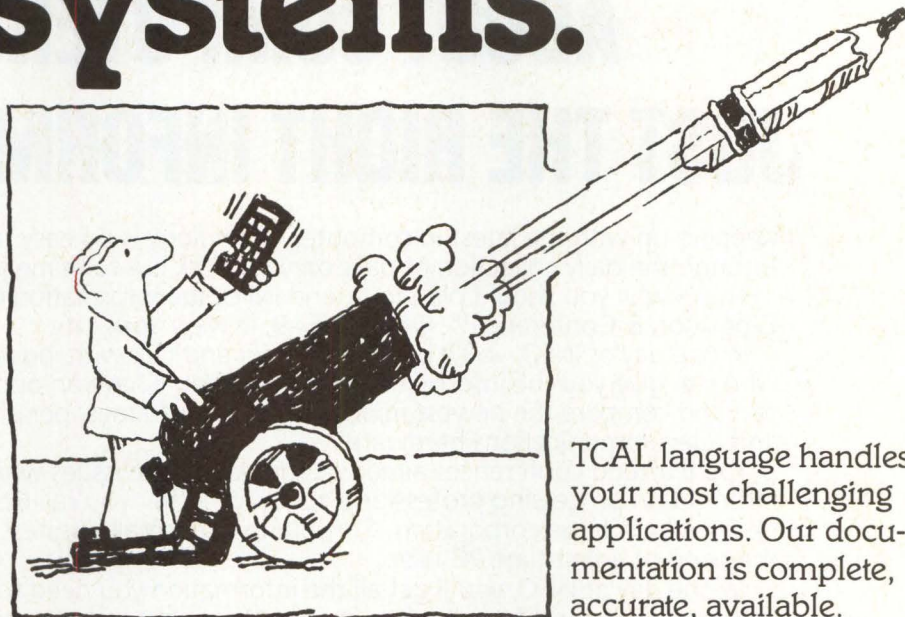

The better your integrated system, the greater the need for timely input.

Pencil and paper won't make it.

Telxon gives you the way to start data into your systems electronically.

Telxon Portable Tele-Transaction Computers (PTCs) mean accuracy as well as speed. They prompt. They edit. They transmit and receive machine-readable data — to and from micro, mini, or mainframe.

Consider the advantages. You can collect, process, store, transmit real-time data on the spot — where it originates — no matter how remote the location.

You'll like the way Telxon's Cobol-like

TCAL language handles your most challenging applications. Our documentation is complete, accurate, available.

Telxon's world leadership in handheld computers gives you the support and service you want — with 56 offices and a 24-hour hotline to back you up.

Do you know us?  
Call 800-321-2424 (in Ohio 800-222-3330) or write Telxon, 3330 W. Market St., Akron, Ohio 44313-3352.



Call or write for free video tape, "Telxon Portable Tele-Transaction Computers... The Systems Solution." Specify 3/4", 1/2" VHS or Beta.

## TELXON®

Think what we can help you do.

CIRCLE NO. 47 ON INQUIRY CARD

lah Optical Storage blah blah blah EGA blah blah blah k  
lah blah blah Broad Band blah blah blah Thrashing k  
lah ISAM TCAM VSAM blah blah blah Channel Programming bla  
i blah blah blah Fault Tolerance System blah blah blah bla  
OCR blah blah blah Error Correcting Codes  
ah blah blah VMS MVS blah blah Fifth Generation blah bla  
i blah Bubble Memory blah blah CD ROM blah blah blah bla

## YOU DON'T NEED MORE INFORMATION ABOUT COMPUTERS.

## JUST THE RIGHT INFORMATION.

Keeping up with the latest in computer technology is no easy task. Just sifting through the daily collection of data on your desk is a full-time job.

That's why you should plan to attend INFO, the Information Management Exposition & Conference™, October 6-9, in New York City.

In one day at INFO, you'll be able to meet and talk with industry experts who can give you the information you need. You'll have an opportunity to see, test and compare the newest minis, micros, mainframes, peripherals, software, and telecommunications hardware.

You'll attend conferences aimed at addressing the issues which face the information processing professional today. Whether you're integrating systems for a large corporation. Consulting with small businesses. Or holding the hand of a first-time PC user.

In one day at INFO, you'll get all the information you need to make informed decisions. For your free show admission, send coupon below or call Customer Services at **203-964-8287**.



**Information Management Exposition & Conference™**

October 6-9, 1986

Jacob K. Javits Convention Center  
New York City

### FREE SHOW ADMISSION

- Yes, I'd like to attend INFO. Please send me my Free Admissions Pass.
- I'm interested in attending the Conference. Please send me a full Conference Program.
- My company is interested in exhibiting. Please send details.

Name \_\_\_\_\_

Title \_\_\_\_\_

Company \_\_\_\_\_

Address \_\_\_\_\_

City \_\_\_\_\_ State \_\_\_\_\_ Zip \_\_\_\_\_

Clip and mail to: **INFO 86**, P.O. Box 597, Chester, NY 10918

P

## SINGLE-BOARD COMPUTERS

applications. They provide memory management for 512K-byte addressing, a high-speed multiply circuit and up to 25 percent faster throughput. WinSystems Inc. and the Cubit division of Proteus Industries, Mountain View, Calif., both offer NMOS (N-channel metal-oxide semiconductor) and CMOS versions of 64180 boards.

CMOS processor and I/O boards are emerging as important selling points for STDbus systems, enabling remote and factory-floor applications to take advantage of the technology's low power dissipation, wide operating temperature range (minus 40 C to 85 C) and high noise immunity.

"CMOS allows STDbus systems to be totally embedded in controllers," explains Pro-Log's Virgo. "We are well into providing a critical mass of support on the bus for CMOS systems. Ten or 12 vendors now offer five or six CMOS cards."

Most new STDbus 8088-based boards are implemented in CMOS or come in CMOS or NMOS versions. WinSystems' LPM-SBC-8 board, for example, uses a NEC America Inc. CMOS V20 processor, but is also available in an NMOS version. It packs three 16-bit counter/timers, an 8087 math coprocessor, an 8259A interrupt controller and a watchdog timer, which monitors and automatically reinitializes the system in the event of failure. It also has a power-fail-detect circuit, sockets for 128K bytes of EPROM or 64K of RAM, RS232C and RS422 ports, and an iSBX connector in a 4½-by-6½-inch card.

The 8-MHz 8810-C8 CMOS board from Systek also uses the V20 chip. Capable of addressing 1M byte of memory, the board includes three 16-bit programmable counter/timers, an interrupt controller, 48K bytes of memory, a serial interface with crystal-controlled baud rate, power-fail-detect circuitry and an iSBX expansion connector.

Pro-Log offers 12 CMOS boards in its 7000 Series, including four CPU and five I/O cards. The 80C88-processor-based 78C61 has an on-board interrupt vector generator, up to 136K bytes of memory and an I/O wait-state generator.

The STDbus 16-bit data-transfer standard provides up to 24 bits of addressing by multiplexing eight address lines on the data bus. It redefines only the infrequently used "Memex" signal on the bus, easing upgrades to 16-bit applications, and it clears the way for the emerging 80186, 80286 and 68000 processors that are generating the most excitement about the bus.

Several STDbus vendors, including WinSystems, Cubit, Miller Technology Inc., R.L.C. Enterprises and Ziotech, offer or will soon offer 16/32-bit processor boards.

WinSystems' 80186 board uses the NEC America V50 chip and is available in both CMOS and NMOS versions. It furnishes an 8259 interrupt controller, four direct-memory-access (DMA) channels, a real-time clock, battery backup and three 16-bit counter/timers. The company's MC68000-based CMOS board will be available by the end of the year.

Cubit's model 8500 8-MHz, 80186-based STDbus board sports one RS232 serial port and two 8-bit parallel ports controlled by an 8256 chip. Soft-emulator firmware supports software development and debugging via a PC. An iSBX connector allows the addition of the

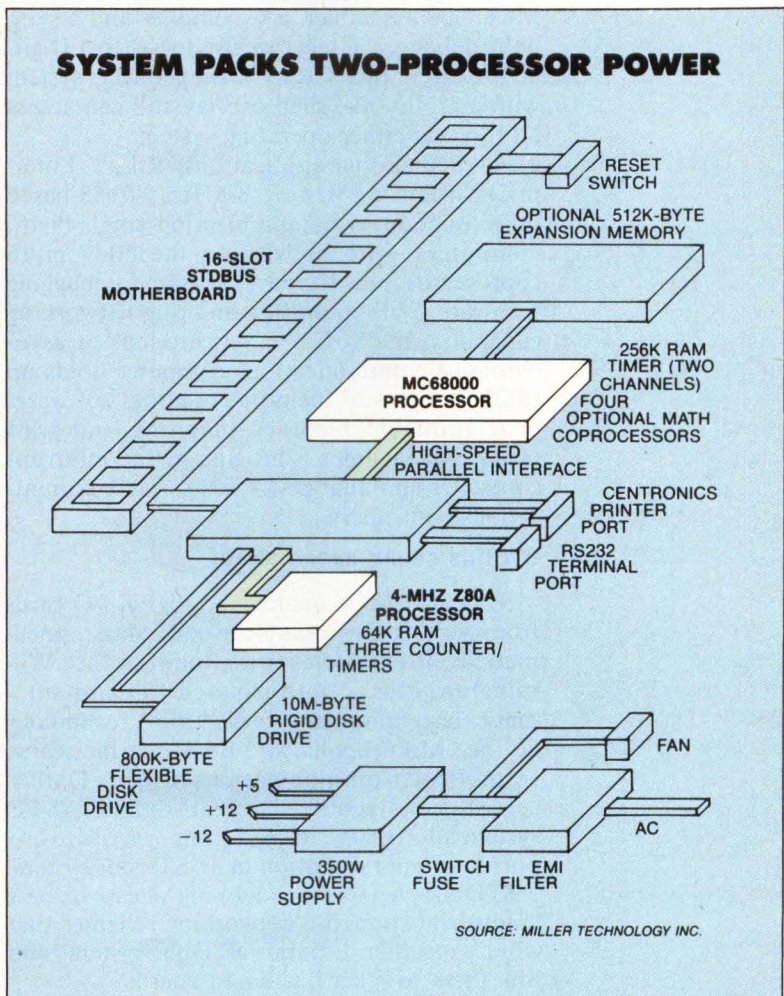

**Taking a different approach** to 16-bit upgrades, Miller Technology's MTI-1000 STDbus system board combines a Z80 processor and a 6-MHz 68000 coprocessor communicating via a high-speed parallel port.

---

**STD-DOS  
allows STDbus  
users to utilize  
IBM PC  
application  
software in  
industrial  
environments.**

---

model 3810 EPROM programmer and a serial-expansion board or the 3830 programmable interrupt-controller module. The 8087 math coprocessor can be added with the model 8590 board replacing the 80186 chip. Ziatech's CMOS 80186 board will debut in the third quarter.

Miller Technology takes a different approach to 16-bit upgrades with its MTI-1000 STDbus single-board computer. It combines a conventional Zilog Z80A with a 6-MHz 68000 coprocessor, communicating through a high-speed parallel port. The 68000 addresses its own memory, timer and arithmetic coprocessors on a 16-bit data, 24-bit address bus. The Z80 controls I/O mass storage and the STDbus controller.

Software support includes the CP/M 68K operating system for the 68000 with an MC68000 assembler, a C compiler and a symbolic debugger. Users can also toggle to a Digital Research Inc. CP/M 2.2 operating system with a UNIX-like shell overlay and can access all files via either operating system.

For demanding applications, R.L.C. Enterprises offers 5-MHz or 8-MHz, 80188-based multifunction or communication single-board computers, with or without the 8087 math coprocessor, plus support cards and debugging firmware. With multidrop and ring-networking capability, the SCC-188 synchronous or asynchronous communications computer holds up to 256K bytes of memory, provides software-programmable memory mapping and wait states and includes a programmable interrupt controller and dual DMA and serial communications controllers.

#### **STDbus seeks networking**

STDbus CMOS analog and digital I/O cards from Analog Devices, Norwood, Mass., pneumatic-control systems from Robitech Inc., Wilmington, Mass.; opto-isolated I/O and automatic test-equipment cards from Technology 80 Inc., Minneapolis, and LAN interface cards from Beal Communications Corp., Dallas, serve specialized needs. Beal's NETPC/STD system allows a PC to read from or write to any port or memory location in an STDbus system.

STDbus vendors are looking ahead to new "industrial-strength" networking schemes that will tie together disparate STDbus systems and link them to other bus-based boards.

"The next frontier is STDbus-compatible smart networks that will be able to handle program downloading and remote-file access," maintains Ziatech's Eckford. "Some kind of general-purpose, widely accepted networking is

very much in demand. The type of network is up in the air. The Manufacturing Automation Protocol (MAP) is too expensive and too much in flux right now. It is also overkill for the kinds of low-cost applications STDbus controllers perform."

The network that will become the standard, Eckford contends, will cost \$350 to \$400 a node, will be multidropped and will be environmentally robust. "It will be able to be strung around in a tough environment outdoors or in a factory. We are in a waiting mode with some intermediate approaches until IBM, Intel or some [other] major force comes forward with something that everyone salutes," Eckford adds.

STDbus vendors are confident that such added functionality on the bus, plus STD's traditional strengths—a small card, ruggedness, simplicity of design, low bus overhead, favorable cost/performance ratio and wealth of I/O cards—will enable it to weather the challenges of PC bus systems, Multibus, VMEbus and the emerging G-64 bus (see "G-64 challenges STDbus on its own turf," Page 94).

Although STDbus products are not competing directly against VMEbus and Multibus for high-end applications, the 32-bit buses are having an impact on the industrial-control market where, observes ElectroTech Marketing's Cech, "STDbus will move up to midrange applications through 16-bit systems. VMEbus and Multibus will retain the high-mid and the high-end portions."

The industry movement from 8-bit to 16-bit and, ultimately, to 32-bit applications will affect the sales of STDbus products, but the migration might be slower in the industrial than in the business arena. It may not be economical to link a fast 32-bit processor to an 8-bit analog-to-digital card for the relatively simple control applications that are STDbus' strong suit. In any case, STDbus vendors think they are well-positioned for demanding control tasks with the emerging 16/32-bit processors, 16-bit data transfers and multiprocessor implementations.

"Our motto is, 'Here today, here tomorrow,'" insists WinSystems' Burckle. "We serve people in the industrial environment with products that have life spans to 15 years. If I were an industrial-control person, I would be relieved to know that the STDbus has been around for awhile." □

---

Interest Quotient (Circle One)  
High 492 Medium 493 Low 494

---

# The wait is over. You can evaluate this 1/2" cartridge tape drive today.

## Fujitsu delivers products, not just promises.

It's here—a high-performance 1/2" cartridge tape drive, in a 5 1/4" form factor.

Fujitsu America has it. We're ready today with evaluation units. And we have a product that performs.

Our M2451A cartridge tape drive gives you up to 120 MB of formatted storage capacity. It runs in both streaming and start/stop modes, at streaming speeds of 75 and 50 ips, so it fits almost any application. Its ESDI interface assures easy, cost-effective system integration.

And for your SCSI system, the optional high-performance M1008A SCSI controller is now available.

Most importantly, these cartridge tape drives are already proven and working in systems today. And with second sources available for both drives and media, you can be sure of protecting your investment in this technology.

For more information about Fujitsu's 1/2" cartridge, or other tape drives, call (408) 946-8777. Or write Fujitsu America, Inc., Storage Products Division, 3055 Orchard Drive, San Jose, CA 95134-2017.

Fujitsu tape drives meet the quality standards and technical requirements that have made this one of the world's leading companies. That's leadership you can depend on to develop the technology you need. And deliver it.

**CIRCLE NO. 49 ON INQUIRY CARD**

**We're developing technology for you.**



**FUJITSU AMERICA**

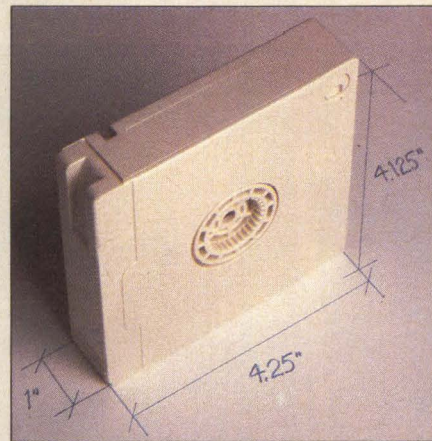

For data integrity and ease of use, fully enclosed 1/2" media is packed in a single reel, in a compact plastic enclosure.

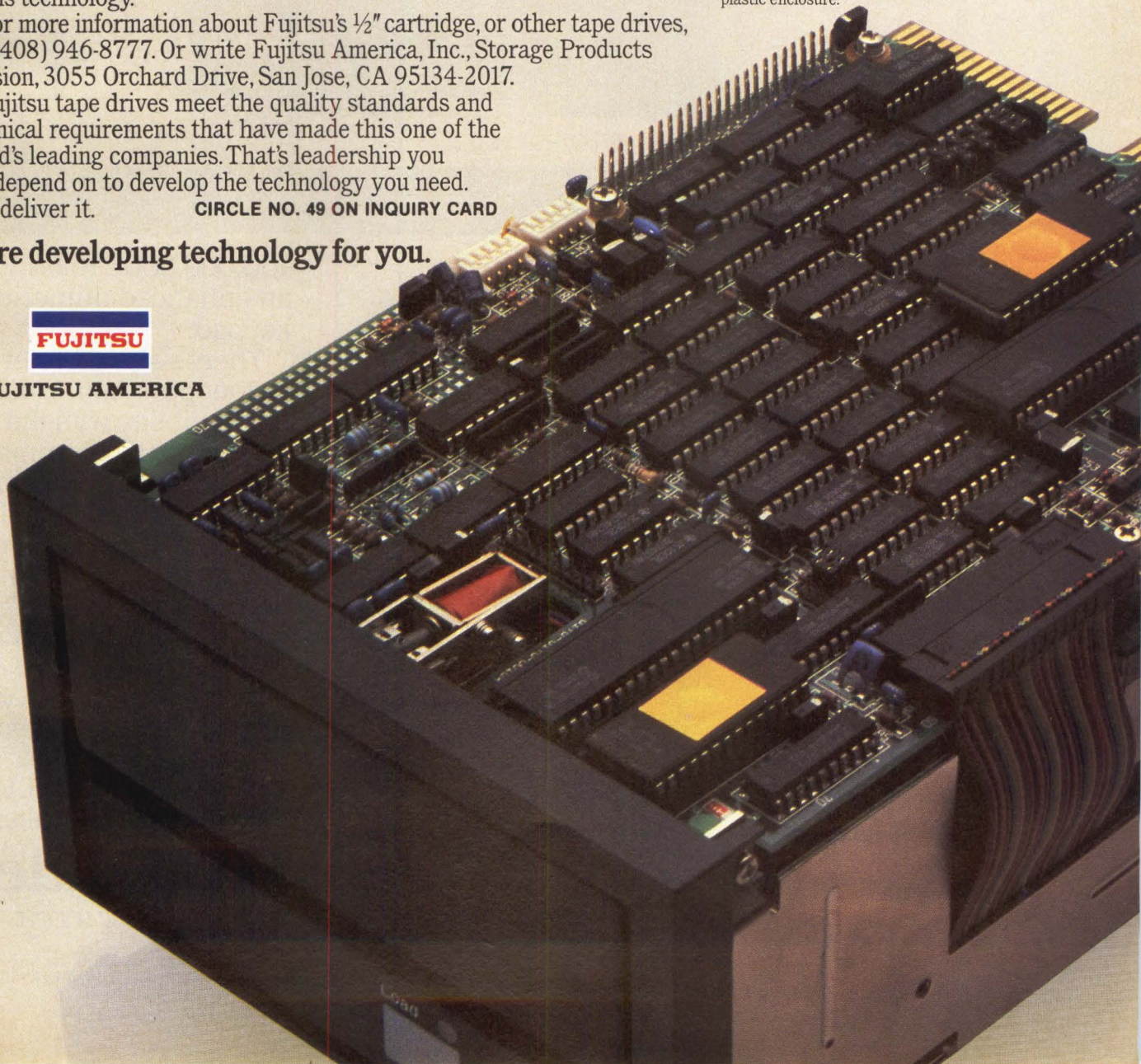

# The TeleVideo 905 terminal. What a difference \$10 makes.



Let's face it; there are a lot of \$399 terminals being sold these days. You get a basic box, a few tacked-on bells and whistles, and not a whole lot more.

But now there's the TeleVideo® 905. At \$409, it has a feature set so powerful, your customers

TELEVIDEO 905 VS. WYSE WY-30		
FEATURES	TELEVIDEO 905	WYSE WY-30
Individual programmable function keys	16	4
Tilt and swivel standard	Yes	No
High contrast super dark Matsushita screen	Yes	No
WordStar® mode	Yes	No
Full-size keyboard	Yes	No

100,000,000 strokes. Even an enhanced numeric keypad.

There's also a buffered printer port. And, of course, compatibility with the TeleVideo 925 command set, the most popular and widely emulated ASCII command set in the world.

If you'd like more information just get in touch with the nearest TeleVideo regional office listed below, and we'll give you the name of your nearest distributor.

The TeleVideo 905. What a difference \$10 makes.

 **TeleVideo®**  
Settle for more.

will think they're sitting at an expensive workstation.

For example, there's a sleekly designed monitor case with full tilt and swivel.

A full-size keyboard

with sculptured keycaps for smooth, comfortable typing. Sixteen non-volatile, programmable function keys. Keyswitches that have been tested to



TeleVideo Systems, Inc., 1170 Morse Avenue, Sunnyvale, CA 94088-3568, (408) 745-7760, Regional Offices: Northwest (408) 745-7760, Southwest (714) 476-0244, South Central (214) 550-1060, Southeast (404) 447-1231, Midwest (312) 397-5400, East (516) 496-4777, Northeast (617) 890-3282. AMSTERDAM: 31.2503.35444, PARIS: 33.1.4687.34.40, LONDON: 44.9905.6464.

©1986 TeleVideo Systems, Inc. WYSE is a trademark of Wyse Technology. WordStar is a registered trademark of MicroPro International Corporation.

**CIRCLE NO. 50 ON INQUIRY CARD**

# Single-board microcomputers

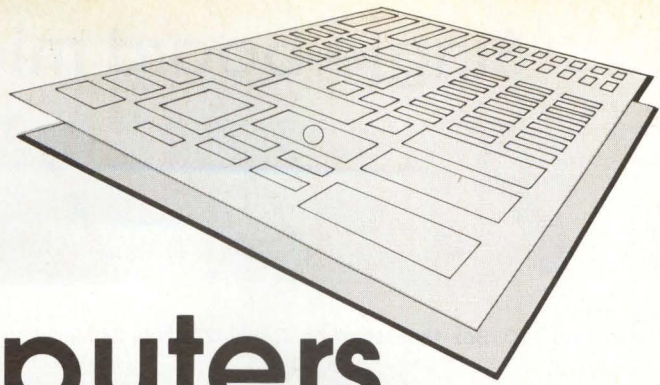

Company Model	CPU type (word size/bits)	Bus	Operating system	Software support	Programming languages supported	Memory/bytes RAM(ROM)	Dimensions (H x W x D/inches)	Price \$ (quantity)	Notes and features
<b>ALCYON CORP.</b> 5010 Shoreham Place, San Diego, CA 92122, (619) 587-1155 <span style="float: right;">Circle 340</span>									
A68 KPM	68000, 68010 (32)	Q-bus	REGULUS	debugger	C, FORTRAN, Pascal	512K (64K)	10.4 x 8.7		clock/calendar, memory management, four asynch communication ports
A68 VME	68000, 68010 (32)	VMEbus	REGULUS, pSOS	debugger, editor, graphics generators	C, FORTRAN, Pascal	1M (128K)	6.4 x 9.32		memory management, clock/calendar, two asynch serial communication ports
<b>ALLOY COMPUTER PRODUCTS INC.</b> 100 Pennsylvania Ave., Framingham, MA 01701, (617) 875-6100 <span style="float: right;">Circle 341</span>									
PC-PLUS	NEC V20 (16)		MS-DOS			512K (1M)		4,895(Q1)	math coprocessor
<b>AMPRO COMPUTERS INC.</b> 67 E. Evelyn Ave., Mountain View, CA 94041, (415) 962-0230 <span style="float: right;">Circle 342</span>									
Little Board	Z80A	SCSI	CP/M 2.2, Turbo-DOS, ZRDOS			64K (64K)	5.75 x 7.75 x 0.75	249(Q1)	two serial and one parallel port(s)
Little Board 186	80186	SCSI	Concurrent DOS, PC-DOS, Turbo-DOS			128K (1M)	5.75 x 7.75 x 0.75	549(Q1)	two serial and one parallel port(s)
<b>APPLIED BUSINESS COMPUTER CO.</b> 1509 N. Kraemer Blvd., Suite E, Anaheim, CA 92806, (714) 666-2604 <span style="float: right;">Circle 343</span>									
65-8	6502, 6809 (8)	EXORciser bus	ADOS	debugger, editor	Assembly, BASIC, FORTH	8K (24K)	6.5 x 9.75 x 0.5	295(Q1)	one RS232C port, battery backup
65-64	6502, 6809 (8)	EXORciser bus	ADOS	debugger, editor	Assembly, BASIC, FORTH	64K (64K)	6.5 x 9.75 x 0.5	325(Q1)	two RS232C ports, real-time clock, battery backup
<b>CENTRAL DATA CORP.</b> 1602 Newton Dr., Champaign, IL 61821, (217) 359-8010 <span style="float: right;">Circle 344</span>									
CD21/1680	68000 (8, 16)	Multibus	UNIX	UNIX boot monitor	C	(128K)	6.75 x 12 x 0.5	1,400(Q1); 975(Q100)	memory management, three programmable timers
CD21/8630	8086 (8, 16)	Multibus	RMX-86	system debugger, monitor	ASM-86, FORTRAN, Pascal, PL/M-86	128K-256K (4K-256K)	6.75 x 12 x 0.5	1,500-1,680(Q1); 1,000-1,125(Q100)	one serial I/O port
CD21/8635	8086 (8, 16)	Multibus	RMX-86	system debugger, monitor	ASM-86, FORTRAN, Pascal, PL/M-86	512K-1M (4K-256K)	6.75 x 12 x 0.5	1,740-2,135(Q1); 1,160-1,425(Q100)	one serial I/O port
<b>COMPUTER DYNAMICS INC.</b> 105 S. Main St., Greer, SC 29651, (803) 877-7471 <span style="float: right;">Circle 345</span>									
CPU-9	Z80, Z80A, Z80B, Z80H (8)	STD	CP/M-80, Turbo-DOS	debugger, monitor	Assembly, BASIC, C, FORTRAN, COBOL	64K (32K)	4.5 x 6.5 x 0.5	250(Q1); 200(Q100)	two serial and one Centronics parallel port(s), real-time clock, two timers, memory mapping

# Single-board microcomputers

Company Model	CPU type (word size/bits)	Bus	Operating system	Software support	Programming languages supported	Memory/bytes RAM(ROM)	Dimensions (H x W x D/inches)	Price \$ (quantity)	Notes and features
<b>DAVIDGE CORP.</b>									
292 E. Hwy. 246, P.O. Box 1869, Buellton, CA 93427, (805) 688-9598									
<b>Circle 346</b>									
DSB-4000	Z80A, Z80B (8)		CP/M-80			64K (4K)	0.5x10 x5.75	315(Q1); 235(Q100)	flexible disk controller, SASI port, up to four RS232C and one Centronics port(s), DMA
DSB-6000	Z80B (8)		CP/M-80			256K (32K)	0.5x10 x5.75	570(Q1); 415(Q100)	flexible disk controller, SASI port, two RS232C and one Centronics port(s), DMA
DSB-8000	HD64180 (8)		CP/M-80, MP/M-II			512K (64K)	0.5x10 x5.75	480(Q1); 375(Q100)	flexible disk controller, SCSI port, up to six RS232C and one Centronics port(s), DMA
<b>DIVERSIFIED TECHNOLOGY INC.</b>									
P.O. Box 748, Ridgeland, MS 39158, (601) 856-4142									
<b>Circle 347</b>									
CBC 86C/05	80C86 (16)	Multibus				16K (128K)	6.75x12 x0.5	1,395(Q1); 1,116(Q100)	one RS232C port, 24 parallel I/O lines, three 16-bit counter/timers
CBC 86C/14	80C86 (16)	Multibus				128K (128K)	6.75x12 x0.5	1,795(Q1); 1,436(Q100)	one RS232C port, 24 parallel I/O lines, three 16-bit counter/timers
CBC 88C/25	80C88 (8)	Multibus				16K (128K)	6.75x12 x0.5	1,095(Q1); 876(Q100)	one RS232C port, 24 parallel I/O lines, three 16-bit counter/timers
<b>DUAL SYSTEMS CORP.</b>									
2530 San Pablo Ave., Berkeley, CA 94702, (415) 549-3834									
<b>Circle 348</b>									
VIOP	68000 (16, 32)	VMEbus		downloading		512K (64K)	2.4x9.36 x0.8	1,495(Q1)	three interrupts
VMPU	68020, 68881 (32)	VMEbus	UNIX System V 2.2	downloading	BASIC, C, COBOL, FORTRAN, LISP	1M (32K)	2.4x9.36 x0.8	5,250(Q1)	battery-backed clock, mailbox interrupt
<b>FARADAY ELECTRONICS INC.</b>									
749 N. Mary Ave., Sunnyvale, CA 94086, (408) 749-1900									
<b>Circle 349</b>									
Bus AT	(16)	PC/AT bus	MS-DOS	debugger; editor; loader; character, graphics generators	BASIC, C, FORTH, Pascal	512K (64K)	13.5x4.8	1,190-1,325(Q1); 1,012-1,126(Q100)	two DMA controllers, 15 vectored interrupts, CMOS clock/calendar
Bus PC 256	8088 (8)	PC bus	MS-DOS	debugger; editor; loader; character, graphics generators	BASIC, C, FORTH, Pascal	256K (64K)	13.5x4.2	495(Q1); 421(Q100)	eight interrupts, one parallel port, coprocessor
CMOS Micro PC/256	80C88 (8)	PC bus	MS-DOS	debugger; editor; loader; character, graphics generators	BASIC, C, FORTH, Pascal	256K (64K)	6.2x4.2	550(Q1); 468(Q100)	eight interrupts, one serial port, coprocessor
<b>FORCE COMPUTERS INC.</b>									
727 University Ave., Los Gatos, CA 95030, (408) 354-3410									
<b>Circle 350</b>									
CPU-1/2/3	68000, 68010 (8, 16)	VMEbus	P-DOS, pSOS	assembler, disassembler, monitor	BASIC, C, FORTRAN 77, Pascal	512K/1M/128K (128K/32K/128K)	9.2x6.3 x0.8	1,295/1,895/2,195(Q1)	real-time clock, CPU-2: flexible drive controller, CPU-3: UNIX engine, MMU
CPU-5	68000, 68010 (8, 16)	VMEbus	P-DOS, pSOS	assembler, disassembler, monitor	BASIC, C, FORTRAN 77, Pascal	128K (25.6K)	9.2x6.3 x0.8		coprocessor, two RS232C ports
CPU-21	68020 (8, 16, 24, 32)	VMEbus	P-DOS	assembler, disassembler, monitor	BASIC, C, FORTRAN 77, Pascal	512K (512K)	9.2x6.3 x0.8	6,995(Q1)	coprocessor, two RS232C ports
<b>GENERAL MICRO SYSTEMS INC.</b>									
4740 Brooks St., Montclair, CA 91763, (714) 625-5475									
<b>Circle 351</b>									
GMS6506	6809, 6502 (8)	EXORbus	CP/M 2.2, OS9	debugger, loader, file manager	BASIC, C, FORTRAN	4K (32K)	9.75x6 x0.7	536(Q1); 429(Q100)	serial and parallel port



# Single-board microcomputers

Company Model	CPU type (word size/bits)	Bus	Operating system	Software support	Programming languages supported	Memory/bytes RAM(ROM)	Dimensions (H x W x D/inches)	Price \$ (quantity)	Notes and features
GMS6507	68008, 6809 (8)	EXORbus	CP/M 2.2, OS9	debugger, loader, file manager	BASIC, C, FORTRAN, Pascal	65K (65K)	9.75x6 x0.7	799(Q1); 539(Q100)	two serial and one parallel port(s)
GMS V06/V07	68010/68020 (16/32)	VMEbus	P-DOS, UNIFLEX	debugger, self-test, I/O drivers	BASIC, C, FORTRAN, Pascal	2M/512K (128K/128K)	9.2x6.3 x0.4	2,995/4,195(Q1); 2,396/3,356(Q100)	SCSI controller; battery-backed, real-time clock; coprocessor; two serial ports

## GESPAC INC.

100 W. Hoover, Suite 11, Mesa, AZ 85202, (602) 962-5559

Circle 352

MPU-4A	68000 (16)	G-64	CP/M-68, OS9	debugger, graphic plotter, loader, macro assembler, screen editor,	Extended BASIC, C, COBOL, FORTRAN 77, Pascal	16K (64K)	0.625x3.9 x6.3	395(Q1); 315(Q100)	three 16-bit timers, RS232C port
MPU-18	80286 (16)	G-64	MS-DOS	debugger	Extended BASIC, C, COBOL, FORTRAN, Pascal	(128K)	0.625x3.9 x6.3	1,350(Q1); 1,080(Q100)	coprocessor, RS232C port
SBS-5	8088 (8)	G-64	CP/M-88	assembler, editor, graphic plotter	CBASIC, PBASIC, C Compiler, COBOL, Pascal	64K (64K)	0.625x3.9 x6.3	595(Q1); 485(Q100)	two RS232C ports, multi-memory mapping, ten 8-bit and four 16-bit timers, real-time clock/calendar

## GIMIX INC.

1337 W. 37th Place, Chicago, IL 60609, (312) 927-5510

Circle 353

SBC-20	68020 (32)		OS9		BASIC, C, Pascal	1M		2,750(Q1)	battery-backed clock/calendar, MMU, floating point coprocessor
--------	------------	--	-----	--	------------------	----	--	-----------	--

## GOODSPEED SYSTEMS INC.

23 Main St., P.O. Box 29, East Haddam, CT 06423, (203) 873-1481

Circle 354

GS-32	32032 (32)		C-Executive, CP/M, UNIX	debugger, disassembler, editor, loader	BASIC, C, FORTRAN, Pascal	2K (16K)	1x15x13	5,500(Q1); 3,575(Q100)	SCSI port, six RS232C and one parallel port(s)
68020 UNI-SYSTEM	68020 (32)	VMEbus	Berkeley UNIX Version 4.2, UNIX System V	debugger, disassembler, editor, loader	BASIC, C, FORTRAN, Pascal	8K (128K)	1x14.4 x11.1	7,500(Q1); 6,000(Q100)	SCSI port, one RS422 and up to 16 RS232C port(s)

## GRANT TECHNOLOGY DIVISION OF COMPUTER PRODUCTS INC.

321 Billerica Rd., Chelmsford, MA 01824, (617) 256-8881

Circle 355

309	8X305 (8)	Q-bus				0.5K (4K)	8.9x5.2 x0.5	995(Q1); 696(Q100)	16 serial ports
312	68000 (16)	Q-bus				4K (16K)	8.9x5.2 x0.5	795(Q1); 556(Q100)	eight serial ports
1301	Z80H (8)	VMEbus				2K (8K)	10x6 x0.6	795(Q1); 556(Q100)	eight serial ports

## HEURIKON CORP.

3201 Latham Dr., Madison, WI 53713, (608) 271-8700

Circle 356

HK68/ME	68000 (16)	Multibus	VRTX		Ada, BASIC, C, COBOL, FORTRAN, Pascal	1M (128K)	12.2x6.88	1,395(Q1); 975(Q100)	two RS232C and RS422 ports, mailbox interrupt, six counter/timers
HK68/M10	68010 (16)	Multibus	UNIX System V 2.2, VRTX		Ada, BASIC, C, COBOL, FORTRAN, Pascal	1M (128K)	12.2x6.88	2,895(Q1); 2,000(Q100)	four RS232C and RS422 ports, mailbox interrupt, three counter/timers
HK68/V10	68010 (16)	VMEbus	UNIX System V 2.2, VRTX		Ada, BASIC, C, COBOL, FORTRAN, Pascal	1M (128K)	9.4x6.4	2,595(Q1); 1,800(Q100)	two RS232C and RS422 ports, mailbox interrupt, six counter/timers

## INDOCOMP INC.

5409 Perry Dr., P.O. Box 157, Drayton Plains, MI 48020, (313) 674-2294

Circle 357

68001/68011	68010 (16, 32)		MTOS-68K, MTOS-UX68K	application programs, debugger, editor	C, Pascal	128K (128K)	15x1.5 x9.5	942/2,894(Q1); 785/2,411(Q100)	
-------------	----------------	--	----------------------	--	-----------	-------------	-------------	--------------------------------	--

# Single-board microcomputers

Company Model	CPU type (word size/bits)	Bus	Operating system	Software support	Programming languages supported	Memory/bytes RAM(ROM)	Dimensions (H x W x D/inches)	Price \$ (quantity)	Notes and features
68021/ 68031	68010 (16, 32)		MTOS-68K, MTOS-UX68K	application programs, debugger, editor	C, Pascal	128K (128K)	15x1.5 x9.5	2,312/ 1,650(Q1); 1,927/ 1,375(Q100)	32 digital I/O lines/ eight serial ports
68041	69010 (16, 32)		MTOS-68K, MTOS-UX68K	application programs, debugger, editor	C, Pascal	128K (128K)	15x1.5 x9.5	2,100(Q1); 1,774(Q100)	40 digital I/O lines

## INNER ACCESS CORP.

3206 E. Laurel Creek Rd., Belmont, CA 94002, (415) 591-8295

Circle 358

68K-P	68000 (16)	S-100	AMOS/L, DOS, Mirage	debugger, editor	APL, BASIC, C, FORTRAN, FORTH, Pascal	32K	5x10 x0.5	695(Q1)	
-------	---------------	-------	------------------------	------------------	---	-----	--------------	---------	--

## INTEGRATED SOLUTIONS

1140 Ringwood Ct., San Jose, CA 95131, (408) 943-1902

Circle 359

V8/V16/ V24	68020 (32)	VMEbus	Berkeley UNIX Version 4.2	debugger; editor; loader; character, graphics generators	Assembly, C, FORTRAN, LISP, Pascal		25.5x9.5 x19.5/ 26.4x12.5 x28.4/ 62x21.5 x30		
----------------	---------------	--------	------------------------------	--	--	--	---	--	--

## INTERCONTINENTAL MICRO SYSTEMS CORP.

4015 Leaverton Ct., Anaheim, CA 92807, (714) 630-0964

Circle 360

CPS-B6A	Z80B (8)	S-100	Turbo-DOS	debugger; editor; loader; character, graphics generators	BASIC, C, FORTH, Pascal	64K-128K	5.5x10 x0.5	650-750(Q1); 422- 487(Q100)	interrupt controllers, two RS232C ports
CPS-16	8086 (16)	S-100	Turbo-DOS, MS-DOS	debugger; editor; loader; character, graphics generators	BASIC, C, FORTH, Pascal	256K	5.5x10 x0.5	995- 1,595(Q1); 646- 1,037(Q100)	interrupt controllers, two RS232C ports
NET-82	Z80A (8)	S-100	Turbo-DOS	debugger; editor; loader; character, graphics generators	BASIC, C, FORTH, Pascal	64K-128K (2K)	5.5x10 x0.5	600-700(Q1); 390- 455(Q100)	interrupt controllers, two RS232C ports

## IRONICS INC.

798 Cascadilla St., Ithaca, NY 14850, (607) 277-4060

Circle 361

IV-1600/ IV-1602	68010 (16, 32)	VMEbus	UNIX System V 2, pSOS, UNIFLEX	debugger, monitor		1M (320K/64K)		3,395/ 2,295(Q1)	
---------------------	-------------------	--------	-----------------------------------	-------------------	--	------------------	--	---------------------	--

## ISOTRON INC.

140 Sherman St., Fairfield, CT 06430, (203) 255-7443

Circle 362

712G	68010 (32)	VMEbus	UNIX System V, XENIX V compatible	UNIX/XENIX utilities	APL, C, COBOL, FORTRAN, Pascal, OSI BASIC	2M	1x15 x12	2,000(Q100)	two SCSI interfaces, four RS232C ports, battery- backed clock/calendar, floating point processor
------	---------------	--------	---	----------------------	--	----	-------------	-------------	---

## JF MICROSYSTEMS

3641 Frontier Rd., Pasco, WA 99301, (509) 297-4294

Circle 363

4188	8088 (16)	STD				2K (16K)	4.5x6.5 x0.4	400(Q1); 300(Q100)	four parallel ports, three timers, interrupt controller
8759	8088 (16)	STD	CP/M-86	debugger		(32K)	4.5x6.5 x0.4	500(Q1); 375(Q100)	memory and I/O mapping, three timers, interrupt controller
8800	8088 (16)	STD		debugger		(8K)	4.5x6.5 x0.4	250(Q1); 187(Q100)	

## LAMAR MICRO

2107 Artesia Blvd., Redondo Beach, CA 90278, (213) 374-1673

Circle 364

Super- kim	6502, 65C02 (8)	KIM-1	KIM-1	cross assembler	Assembly, BASIC, C	48K (16K)	11.5x11.5 x1	545(Q1); 345(Q100)	priority interrupts, eight counter/timers
---------------	-----------------------	-------	-------	-----------------	-----------------------	--------------	-----------------	-----------------------	--

## LAPOLE SYSTEMS INC.

Link Consulting Associates-New York, 575 5th Ave., New York, NY 10021 (212) 744-4423

Circle 365

LPU 68-K	68000 (16)	Multibus	CP/M-68K, OS9, REGULUS			512K (8K-128K)	12x6.76 x0.55	1,750- 1,950(Q1); 1,120- 1,250(Q100)	
----------	---------------	----------	---------------------------	--	--	-------------------	------------------	---	--

# Single-board microcomputers

Company Model	CPU type (word size/bits)	Bus	Operating system	Software support	Programming languages supported	Memory (bytes RAM/ROM)	Dimensions (H x W x D) (inches)	Price \$ (quantity)	Notes and features
---------------	---------------------------	-----	------------------	------------------	---------------------------------	------------------------	---------------------------------	---------------------	--------------------

## LITTLE MACHINES INC.

4241 Jutland Dr., Suite 103, San Diego, CA 92117, (619) 483-3606

Circle 366

DPX86/ME	80286, 80186 (16)	Multibus	RMX-286, VRTX 86, XENIX	RMX, XENIX utilities	BASIC, C, FORTRAN, Pascal	1M (384K)	6.75x12 x0.6	3,950(Q1); 2,370(Q100)	three serial and one parallel port(s)
----------	-------------------	----------	-------------------------	----------------------	---------------------------	-----------	--------------	------------------------	---------------------------------------

## MATROX ELECTRONIC SYSTEMS LTD.

1055 St. Regis Blvd., Dorval, Quebec, H9P 2T4, Canada, (514) 685-2630

Circle 367

MAP-2000	68020 (32)	Multibus		ROM monitor		256K (512K)	12x6.75 x0.5	2,995(Q1)	two serial ports
MBC-86/512	8086 (16)	Multibus		ROM monitor		512K (128K)	12x6.75 x0.5		one serial port, 24 programmable parallel lines
NAP-2000	32032 (32)	Multibus		ROM monitor		128K (512K)	12x6.75 x0.5	2,995(Q1)	two serial ports

## MICRO-AIDE INC.

685 Arrow Grand Circle, Covina, CA 91723, (818) 915-5502

Circle 368

80-0027	Z80 (8)	STD				128K (128K)	0.5x4.5 x6.5	250(Q1); 212(Q100)	CMOS version available
80-0033	6809E (8)	STD	OS9 compatible	monitor		128K (128K)	0.5x4.5 x6.5	300(Q1); 250(Q100)	one RS232C port, 16 I/O lines
80-0038	8088 (8)	STD		monitor		256K (256K)	0.5x4.5 x6.5	170(Q1); 144(Q100)	

## MILLER TECHNOLOGY INC.

647 N. Santa Cruz Ave., Los Gatos, CA 95030, (408) 395-2032

Circle 369

MCPU-800/MCPU-900	Z80A (8, 16)	STD	CP/M	monitor	BASIC, C	64K (32K/16K)	4.5x7 x0.5	645/795(Q1); 535/675(Q100)	memory mapping/flexible drive controller, counter/timer
-------------------	--------------	-----	------	---------	----------	---------------	------------	----------------------------	---

## MIZAR INC.

20 Yorkton Ct., St. Paul, MN 55117, (612) 224-8941

Circle 370

VME 7100	68000, 68010 (16)	VMEbus	CP/M-68K, P-DOS, polyFORTH, OS9-68K	debugger, monitor	BASIC, C, FORTH, FORTRAN 77, Pascal	512K (128K)	9.1x.54 x6.2	1,595-2,345(Q1); 1,215-1,785(Q100)	two RS232C and parallel ports, seven interrupts
VME 7120	68020 (32)	VMEbus	polyFORTH, P-DOS, OS9	debugger, monitor	BASIC, C, FORTH, FORTRAN 77, Pascal	1M (256K)	9.1x.54 x6.2	2,995(Q1); 2,280(Q100)	controller, seven interrupts, timer
VME 8115	68000, 68010 (16)	VMEbus	CP/M-86, polyFORTH, P-DOS, OS9-68K	debugger, monitor	BASIC, C, FORTH, FORTRAN 77	512K (128K)	3.9x0.54 x6.2	1,195-1,595(Q1); 910-1,215(Q100)	seven interrupts, two RS232C ports

## MODULAR COMPUTER SYSTEMS (MODCOMP)

1650 W. McNab Rd., Ft. Lauderdale, FL 33310, (305) 977-1823

Circle 371

CLASSIC	custom (16)	proprietary	MAX IV		C, COBOL, CORAL, FORTRAN, Pascal		1.25x14.5 x19.6	9,500(Q1)	
---------	-------------	-------------	--------	--	----------------------------------	--	-----------------	-----------	--

## MONOLITHIC SYSTEMS CORP.

84 Inverness Circle East, Englewood, CO 80112, (303) 790-7400

Circle 372

MSC8009	Z80A (8)	Multibus	CP/M, ZRDOS		Assembly, BASIC, C	64K (32K)	12x6.75 x0.5	1,219(Q1); 750(Q100)	two serial ports, CP/M engine
MSC8019	HD64180 (8)	Multibus	CP/M, ZRDOS		Assembly, BASIC, C	512K (128K)	12x6.75 x0.5	1,190(Q1); 790(Q100)	two serial and one SCSI port(s)
MSC8186	80186 (16)	Multibus	CP/M, iRMX, MS-DOS	SDM-186 debugger, monitor	Assembly, BASIC, C, FORTRAN, Pascal, PL/M	1M (256K)	12x6.75 x0.5	1,990(Q1); 1,200(Q100)	coprocessor, one serial port, 24 parallel I/O lines

## OMNIBYTE CORP.

245 W. Roosevelt Rd., Bldg. 1-5, West Chicago, IL 60185 (312) 231-6880

Circle 373

OB68-K1A	68000 (16)	Multibus	polyFORTH, IDRIS	Versabug, Macsbug	C, FORTH, FORTRAN 77, Pascal	32K, 128K, 512K, (up to 192K)	6.75x12 x0.062	1,250(Q1); 842(Q100)	two 16-bit parallel and two serial ports, three 16-bit timers
----------	------------	----------	------------------	-------------------	------------------------------	-------------------------------	----------------	----------------------	---

# Single-board microcomputers

Company Model	CPU type (word size/bits)	Bus	Operating system	Software support	Programming languages supported	Memory/bytes RAM (ROM)	Dimensions (H x W x D/inches)	Price \$ (quantity)	Notes and features
OB68K/MSBC1	68000, 68010 (16)	Multibus	polyFORTH, IDRIS		C, FORTH, FORTRAN 77, Pascal	256K/2M (256K)	6.75x12 x0.062	1,895(Q1); 1,232(Q100)	four serial ports, ISBX port, one 24-bit timer
VME-1	68000 (16)	VMEbus				4K-112K (8K-448K)	6.3x9.19 x0.062	995(Q1); 647(Q100)	two serial and two 8-bit parallel ports, one 16-bit and one 24-bit timer

## ONSET COMPUTER CORP.

199 Main St., North Falmouth, MA 02556, (617) 563-2267

Circle 374

CPU-801	NSC800 (8)	C-44	monitor			0.12K (6K)	5.25x4.5 x0.5	445(Q1); 350(Q100)	real-time clock, 22 I/O lines
CPU-8085	80C85 (8)	C-44	monitor			8K (8K)	5.25x4.5 x0.5	275(Q1); 200(Q100)	22 I/O lines
CPU-8088	80C88 (8)	C-44	monitor			0.25K (8K)	5.25x4.5 x0.5	550(Q1); 400(Q100)	real-time clock, 22 I/O lines

## PERFORMANCE TECHNOLOGIES INC.

300 Main St., East Rochester, NY 14445, (716) 586-6727

Circle 375

PT-VME-100	68010 (16, 32)	VMEbus	UNIX System V	debugger, loader	Ada, BASIC, C, COBOL, FORTRAN, Pascal	64K (64K)	9.2x0.8 x6.3	2,800(Q1); 2,000(Q100)	dual MMU, VME system controller
PT-VME-102	68010 (16, 32)	VMEbus	P-DOS	debugger, loader	BASIC, C, FORTRAN 77, Pascal	2M (256K)	9.2x0.8 x6.3	2,195(Q1); 1,700(Q100)	floating point processor, VME controller
PT-VME 103 PT-VBS 104	68010/68020 (16, 32/32)	VMEbus/ Versabus		debugger, loader		128K/64K (64K/128K)	9.2x0.8 x6.3 9.25x0.4 x14.5	2,950/ 6,500(Q1); 2,100/ 5,000(Q100)	floating point processor/two serial ports, real-time clock

## PERIPHERAL TECHNOLOGY

1480 Terrell Mill Rd., Suite 870, Marietta, GA 30067, (404) 984-0742

Circle 376

PT-68K-1	68008 (8, 16)		OS9-68K, STAR-DOS	assembler, debugger, editor	BASIC, C, Pascal	768K (64K)	8x5.75 x0.5	500(Q1); 350(Q100)	two serial and parallel ports, flexible disk controller, real-time clock
PT-69-3	6809 (8)		FLEX, OS9, STAR-DOS	assembler, debugger, editor	BASIC, C, Pascal	59K (4K)	6.5x5.5 x0.5	279(Q1); 185(Q100)	two serial and parallel ports, flexible disk controller, real-time clock
PT-69-5	6809 (8)		FLEX, OS9, STAR-DOS	assembler, debugger, editor	BASIC, C, Pascal	60K (4K)	7x5.75 x0.5	450(Q1); 325(Q100)	four serial and two parallel ports, flexible disk controller, real-time clock

## PERSONAL MICRO COMPUTERS INC.

275 Santa Ana Ct., Sunnyvale, CA 94086, (408) 737-8444

Circle 377

PC-101	Z80A (8)		CP/M 3.0		CBASIC	128K (4K)	11.65x5.7	325(Q1)	
--------	----------	--	----------	--	--------	-----------	-----------	---------	--

## PLESSEY MICROSYSTEMS

One Blue Hill Plaza, Pearl River, NY 10965, (914) 735-4661

Circle 378

PME 68-1B	68000, 68010 (16)	VMEbus	P-DOS, pSOS, VDOS	assembler, debugger	BASIC, C, FORTH, FORTRAN, IDEAL, Pascal	512K (128K)		1,037(Q1); 835(Q100)	battery-backed, real-time clock; three RS232C and one parallel port(s)
PME 68-2	68000, 68010 (16)	VMEbus	P-DOS, pSOS	assembler, debugger	BASIC, C, FORTRAN, Pascal	1M (64K)		1,609(Q1); 1,295(Q100)	one RS232C port, seven interrupts, flexible drive controller
PME 68-2D	68000, 68010 (16)	VMEbus	P-DOS, pSOS	assembler, debugger	BASIC, C, FORTRAN, Pascal	512K (64K)		1,188(Q1); 956(Q100)	one RS232C port, seven interrupts

## POWER SOLUTIONS INC.

25 Main St., P.O. Box 878, Kennebunk, ME 04043, (207) 985-2926

Circle 379

IOP-1	Z80A (8)	STD		line editor, cassette download	MBASIC	32K (24K)	11x13 x0.5	1,495(Q1); 1,125(Q100)	math coprocessor; two RS232C ports
-------	----------	-----	--	--------------------------------	--------	-----------	------------	------------------------	------------------------------------

The VME BUS and OS-9:

# Ultimate Software for the Ultimate Bus.

Modularity. Flexibility. High Performance. Future growth. These are probably the prime reasons you chose the VME bus. Why not use the same criteria when selecting your system software? That's why you should take a look at Microware's OS-9/68000 Operating System—it's the perfect match for the VME bus.

When you're working with VME you must have access to every part of the system. Unlike other operating systems that literally scream KEEP OUT!, OS-9's open architecture invites you to create, adapt, customize and expand. Thanks to its unique modular design, OS-9 naturally fits virtually any system, from simple ROM-based controllers up to large multiuser systems.

And that's just the beginning of the story. OS-9 gives you a complete UNIX-application compatible environment. It is multitasking, real time, and extremely fast. And if you're still not impressed, consider that a complete OS-9 executive and I/O driver package typically fits in less than 24K of RAM or ROM.

Software tools abound for OS-9, including outstanding Microware C, Basic, Fortran, and Pascal compilers. In addition, cross C compilers and cross assemblers are available for VAX systems under Unix or VMS. You can also plug in other advanced options, such as the GSS-DRIVERS™ Virtual Device Interface for industry-standard graphics support, or the OS-9 Network File Manager for high level, hardware-independent networking.

Designed for the most demanding OEM requirements, OS-9's performance and reliability has been proven in an incredible variety of applications. There's nothing like a track record as proof: to date, over 200 OEMs have shipped more than 100,000 OS-9-based systems.

Ask your VME system supplier about OS-9. Or you can install and evaluate OS-9 on **your own** custom system with a reasonably priced Microware PortPak™. Contact Microware today. We'll send you complete information about OS-9 and a list of quality manufacturers who offer off-the-shelf VME/OS-9 packages.



#### Microware Systems Corporation

1866 N.W. 114th Street • Des Moines, Iowa 50322  
Phone 515-224-1929 • Telex 910-520-2535

#### Microware Japan, Ltd.

41-19 Honcho 4-Chome, Funabashi City • Chiba 273,  
Japan • Phone 0474-22-1747 • Telex 298-3472

*Modular Hardware Deserves Modular Software*

**Micomaster Scandinavian AB**  
St. Persgatan 7  
Box 1309 S-751 43 Uppsala  
Sweden  
Telex: 76129 microma s  
Phone: 018-138595

**Dr. Rudolf Keil, GmbH**  
Porphyrrstrasse 15  
D-6905 Schriesheim  
West Germany  
Telex: 465025 keil d  
Phone: 06203-6741

**Elsoft AG**  
Bankstrasse 9  
CH-5432 Neuenhof  
Switzerland  
Telex: 57136 elso ch  
Phone: 056-862724

**Vivaway, Ltd.**  
36-38 John Street, Luton  
Bedfordshire LU1 2JE  
England  
Telex: 825115  
Phone: 0582-423425

**Microprocessor Consultants, Ltd.**  
16 Bandera Avenue  
Waga Waga, 2650  
NSW Australia  
Phone: (069) 312331

OS-9 is a trademark of Microware and Motorola. PortPak is a trademark of Microware. GSS-Drivers is a trademark of Graphic Software Systems, Inc. VAX and VMS are trademarks of DEC. Unix is a trademark of AT&T.

**CIRCLE NO. 51 ON INQUIRY CARD**

# Appearing on Screens Everywhere!



When you need a guy with powerful mainframe-to-micro connections, call *The Emulator* from Grafpoint.

It's no mystery why *The Emulator's* become an amazing success story. He's a master of disguise, and his software emulates Tektronix™ 4105/6/7/9 and DEC VT100™ terminals with surprising speed and resolution. He's cracked cases coast-to-coast. And he's the one with the

right connections when it comes to most popular PCs and associated boards.

If you're after a mirror-image for a lot less, look into TGRAF™ from Grafpoint. But don't ask how it's done. Only *The Emulator* really knows.



## GRAFPPOINT

4340 Stevens Creek Blvd., Suite 280,  
San Jose, CA 95129 (408) 249-7951

CIRCLE NO. 52 ON INQUIRY CARD

# Single-board microcomputers

Company Model	CPU type (word size/bits)	Bus	Operating system	Software support	Programming languages supported	Memory/bytes RAM(ROM)	Dimensions (H x W x D/inches)	Price \$ (quantity)	Notes and features
---------------	---------------------------	-----	------------------	------------------	---------------------------------	-----------------------	-------------------------------	---------------------	--------------------

## PRO-LOG CORP.

2560 Garden Rd., Monterey, CA 93940, (408) 646-3603

Circle 380

7806	Z80A (8)	STD		editor	BASIC interpreter	32K (128K)	4.5×6.5 ×0.5	345(Q1)	two serial ports, clock, two counter/timers, power reset circuit
7863	8088 (8)	STD	MS-DOS				4.5×6.5 ×0.5	395(Q1)	coprocessor, two serial ports, clock

## QUICKWARE ENGINEERING & DESIGN INC.

139 Brighton Ave., Suite 5, Allston, MA 02134, (617) 782-8330

Circle 381

QED 11/85 CPU	J-11 (16)	UNibus	RT-11, RSX-11, RSTS, UNIX	all DEC software	all PDP-11 languages		9×16 ×0.5	6,000(Q1); 4,000(Q100)	16K-byte cache memory, two serial lines, line clock
---------------	-----------	--------	---------------------------	------------------	----------------------	--	-----------	------------------------	---

## R.L.C. ENTERPRISES

1117 Hillview Dr., Milpitas, CA 95035, (408) 946-7471

Circle 382

SBC-188/ SBC-1885L	80188 (16)	STD	MS-DOS	debugger, symbolic monitor	Assembly, C, FORTRAN, Pascal, PL/M	96K (256K)	6.5×4.5 ×0.062	549(Q1); 357(Q100)	RS232C port, real-time clock, interrupt and DMA controller
SBC-100	Z80, Z80A (8)	STD	CP/M	debugger, monitor	Assembly, BASIC, C, FORTRAN	16K (16K)	6.5×4.5 ×0.062	249(Q1); 179(Q100)	real-time clock, two RS232C ports, parallel port

## SPURRIER PERIPHERALS CORP.

10513 LeMarie Dr., Cincinnati, OH 45241, (513) 563-2625

Circle 383

STD 68008	68008 (16, 32)	STD	CP/M-68K	debugger	BASIC, C, FORTRAN	128K	4.5×6.5	399(Q1); 349(Q100)	
STD 68020	68020 (32)		OS9	debugger	BASIC, C, FORTRAN	512K (32K)	10×10	7,000(Q1)	flexible and rigid drive controller
Z80-II	Z80 (8)	STD	CP/M	debugger	BASIC, C, FORTRAN	64K	4.5×6.5	379(Q1); 329(Q100)	serial port

## SYSTEK

1027 N. Kellogg St., Kennewick, WA 99336, (509) 735-1200

Circle 384

8810/ 8810-C	8088/ 80C88 (8, 16)	STD	CP/M-86, MS-DOS	debugger	BASIC, C, FORTH, Pascal	32K (48K)	4.5×6.5 ×0.5	395/475(Q1); 260/ 356(Q100)	interrupt controller, three 16-bit counters
8887	8088 (8, 16)	STD	CP/M-86, MS-DOS	debugger	BASIC, C, FORTH, Pascal	(64K)	4.5×6.5 ×0.5	425(Q1); 319(Q100)	coprocessor

## TELETEK ENTERPRISES INC.

4600 Pell Dr., Sacramento, CA 95838, (916) 920-4600

Circle 385

SBC 86/87	8086 (16)	S-100	CP/M-86, Turbo-DOS			512K (4K-64K)	5×10	1,770(Q1); 1,079(Q100)	two serial and parallel ports
System-master	Z80A (8)	S-100	CP/M, Turbo-DOS			64K (2K-8K)	5×10	795(Q1); 499(Q100)	flexible disk controller, two serial and one parallel port(s)
System-master II	Z80H (8)	S-100	Turbo-DOS			128K (2K-32K)	5×10	1,074(Q1); 754(Q100)	

## TEXAS INSTRUMENTS INC. (INDUSTRIAL SYSTEMS DIV.)

P.O. Box 1255, Johnson City, TN 37605-1255, (615) 461-2500

Circle 386

990/101-MB1	TMS 9900 (16)	TM 990	P-DOS	debugger, graphics	BASIC, FORTH, Pascal	4K (60K)	7.5×11	743(Q1)	two RS232C and one parallel port(s)
990/102-3	TMS 9900 (16)	TM 990	P-DOS	debugger, graphics	BASIC, Pascal	128K (16K)	7.5×11	1,125(Q1)	one RS232C port
990/103-1	TMS 99105 (16)	TM 990	P-DOS	debugger, graphics	BASIC, Pascal	64K (32K)	7.5×11	1,674(Q1)	two RS232C and one parallel port(s)

## VESTA TECHNOLOGY INC.

7100 W. 44th Ave., Suite 101, Wheatridge, CO 80033, (303) 422-8088

Circle 387

OEM 188	80188 (8, 16)	IBM PC bus	MS-DOS		MS-DOS languages	256K (64K)	7×8 ×0.5	329(Q1); 269(Q100)	disk controller, printer port
---------	---------------	------------	--------	--	------------------	------------	----------	--------------------	-------------------------------

# Single-board microcomputers

Company Model	CPU type (word size/bits)	Bus	Operating system	Software support	Programming languages supported	Memory/bytes RAM(ROM)	Dimensions (H x W x D/inches)	Price \$ (quantity)	Notes and features
SBC88	8088 (8, 16)				BASIC, FORTH	32K (32K)	5x6 x0.5	199(Q1); 139(Q100)	

## WAVE MATE INC.

14009 S. Crenshaw Blvd., Hawthorne, CA 90250, (213) 978-8600

Circle 388

Bullet 286	80286 (16)	IBM PC bus	Concurrent CP/M, PC-DOS, Pascal, SMC, UNIX	assembler, debugger, editor, linker	BASIC, C, COBOL, FORTRAN, Pascal, PL/1	1M (32K)	8.5x12 x0.75	995(Q1); 398(Q100)	custom bus controller
Bullet SBC	Z80A (8)	proprietary	CP/M 3.0, MP/M, THEOS 8			128K (16K)	8x10 x0.5	495(Q1); 198(Q100)	flexible disk controller, two RS232C ports
Super-bullet SBC	Z80A (8)	proprietary	CP/M 3.0, MP/M, THEOS 8	assembler, debugger, editor, linker	BASIC, C, COBOL, FORTRAN, Pascal, PL/1	256K (16K)	8x10 x0.5	795(Q1); 318(Q100)	flexible disk controller, four RS232C ports

## WINSYSTEMS INC.

P.O. Box 121361, Arlington, TX 76012, (817) 274-7553

Circle 389

MCM-CPU2A	Z80A (8)	STD, CMOS STD	CP/M	debugger, loader	BASIC, C, FORTH, Pascal	64K (64K)	4.5x6.5 x0.5	185(Q1)	four counter/timers
MCM-SBC3	Z80A (8)	STD, CMOS STD	CP/M	debugger, loader	BASIC, C, FORTH, Pascal	64K (64K)	4.5x6.5 x0.5	295(Q1)	two RS232C, RS422 ports; two 8-bit parallel I/O ports; four counter/timers
MCM-SBC5	HD64180 (8, 16)	STD, CMOS STD	CP/M	debugger, loader	BASIC, C, FORTH, Pascal	64K (128K)	4.5x6.5 x0.5	395(Q1)	four RS232C ports, two 16-bit timers

## LOW COST TERMINALS



The TransTerm® family of data terminals has the following common features:

• 5x7 Dot Matrix A/N LCD Display (upper and lower case) • Membrane Keyboard with audible key-click and embossed overlay • Standard RS-232 Serial ASCII Communications • Keyboard accessed setup features • Eight Baud Rates • Programmable function keys • Powered by Wall Plug-in Transformer (12 Vac) or external DC between 8-16 Volts • Low Power Consumption (less than 7.5 Watts) • Optional Networking with RS422 I/O • Optional Bar Code Wand input (Code 39) • Optional display backlight (5 & 6)

### TRANSTERM. 3

Two line 80 character display  
48 line buffer memory  
QWERTY KBD w/edit functions  
NiCd battery powered w/charger  
Optional Printer/Plotter  
Optional 300 baud modem/coupler  
Unit price \$499.

### TRANSTERM. 4

Eight line 40 character display  
50 line buffer memory  
6 x 4 Numeric/function keypad  
Unit price \$749.

### TRANSTERM. 5

Two line 24 character display  
Unit price \$249.

### TRANSTERM. 6

Two line 40 character display  
Unit price \$299.

### TRANSTERM. 7

Battery Powered  
56K Buffer memory  
Programmable prompting  
Clock/calendar time stamping  
Unit price \$399.

## The RPC50 does what your IBM PC AT® can, where your IBM PC AT can't!

The Allen-Bradley RPC50 is a transportable, Ruggedized Personal Computer System. It does the same things your IBM personal computer AT can do, but it can do them in harsh environments (0-50° ambient, 2.5G operating shock, 30G non-operating.)

- 80286 Processor
- 1 MB Internal RAM Memory
- 10 MB Hardened Hard Disk
- 3-1/2", 720 KB Microfloppy
- 9" High-Resolution (640 x 200 pixel) amber CRT
- Integral 5-1/4" external floppy connection
- Integral Serial and Parallel Ports
- \$6600 OEM Net Price



**TO ORDER, CALL OUR 24-HOUR RESPONSE CENTER, 1-800-346-6600, Ext. B540.** For further details contact Allen-Bradley, Industrial Computer Group, Commercial Services, 747 Alpha Drive, Cleveland, Ohio 44143.

IBM PC AT is a registered trademark of International Business Machines Corporation.



**ALLEN-BRADLEY**  
A Rockwell International Company

CIRCLE NO. 54 ON INQUIRY CARD

**COMPUTERWISE, INC.**

302 N. Winchester • Olathe, KS 66062 • (913) 829-0600 • TELEX 705337

CIRCLE NO. 53 ON INQUIRY CARD



## MicroPDP-11/53

### The Entry-Level 16-bit Q-bus Supermicrosystem

digital



The MicroPDP-11/53 is the entry-level, 16-bit supermicrosystem with an attractive price and performance combination that will meet the best of your computing requirements. The MicroPDP-11/53, with approximately twice the system performance of the MicroPDP-11/23, offers just the extra boost of power you may need to solve your realtime or multitasking problems.

At the center of the MicroPDP-11/53 is a 15-megahertz, J-11 single-board computer that contains 0.5 Mbytes of onboard memory. This computing engine can easily devote itself to your dedicated process control program or become a shared resource for your department's multiuser workload. Whatever the job, the MicroPDP-11/53 demonstrates superlative performance.

As is the standard with all PDP-11 systems, the MicroPDP-11/53 is fully compatible with the proven 16-bit PDP-11 architecture and the thousands of PDP-11 software tools and applications in existence today. Along with this compatibility is support for a wide variety of Q22-bus mass-storage devices and communications interfaces, including two new half-height disk drives. Its trim size is small enough to fit comfortably and quietly into your personal work area. And with DECnet and Ethernet networking capability, the MicroPDP-11/53 can send, share, and store files from other systems in your department or organization.

With improved performance at an appealing price, the MicroPDP-11/53 enhances 16-bit computing to help you meet your business goals. And better yet, Digital has it now.

*Literature  
Distribution*

*For additional copies of this  
information sheet write:  
PDP-11 ED-28903-41,  
200 Baker Avenue, Concord,  
Massachusetts 01742.*

*Current PDP-11 users: If you  
would like to be added to  
our PDP-11 mailing list  
please indicate the CPUs  
you are currently using  
on the back of your business  
card and send it to the  
above address.*



### Highlights

- Features a high-performance, single-board computer with 0.5 Mbytes of onboard memory.
- Allows for memory expansion for up to 4 Mbytes with parity MOS memory in increments of 0.5, 1, or 2 Mbytes.
- Has complete MicroPDP-11/73 instruction set, including the Extended Instruction Set (EIS) for compatibility with the full line of MicroPDP-11 processors.
- Includes floating-point instructions for increased instruction execution.
- Supports a comprehensive set of communications interfaces and mass-storage devices, including two new half-height disk drives.
- Supported by an extensive number of operating systems, high-level languages, development tools, and application packages.
- Easily integrates into networking environments or into local area networks with DECnet and Ethernet.

### The Single-board Computer—A First for MicroPDP-11 Systems

The MicroPDP-11/53 is based on the high-speed, 15-megahertz J-11 chip set. Accompanying this micro-processor on the same quad-height module is 0.5 Mbyte of dynamic RAM, parity MOS memory. This economical combination of CPU and onboard memory saves on module space and input power and, more importantly, increases the basic system performance to approximately twice that of the MicroPDP-11/23. The MicroPDP-11/53 single-board computer comprises:

- A J-11 chipset, including 16-bit I/O, addressing capability up to 4 Mbytes, maximum clock rate of 15 megahertz, and onboard memory management.
- Complete MicroPDP-11/73 instruction set, including floating-point instructions and the Extended Instruction Set (EIS).
- Q22-bus interface that supports block-mode DMA and up to 4 Mbytes of physical memory.
- One console serial-line unit and one printer serial-line unit.
- 32-Kbyte, erasable read-only memory (ROM) for bootstraps and diagnostics.

### Half-height Storage Can Increase Your Storage Capacity

The Q-bus links the MicroPDP-11/53 with a compatible set of mass-storage devices. Two new half-height disk drives, the RD31 and the RX33, are available for the first time on a super-microsystem. At half the height of their predecessors, their size allows more storage devices to be housed directly in the system chassis. There is now room for three integrated mass-

storage devices, as opposed to two full-height devices.

Offered as integrated storage devices, the RD31 is a 20-Mbyte Winchester fixed-disk subsystem, and the RX33 is a 1.2-Mbyte single-diskette subsystem. And the following full-height storage devices can be added externally to your MicroPDP-11/53:

- 71-Mbyte RD53 Winchester fixed-disk subsystem.
- 31-Mbyte RD52 Winchester fixed-disk subsystem.
- 95-Mbyte TK50 cartridge-tape subsystem.

The Q-bus also has a wealth of peripherals developed for it by Digital. You can select from a wide range of communications interfaces, videodisplay terminals, hardcopy terminals, and system printers.

### Flexible Packaging for Your Style of Working

The MicroPDP-11/53 is packaged in a trim, versatile enclosure that can fit underneath, beside, or on top of your desk. It is also available in a rack-mount model for cabinet integration. This package features an eight-slot backplane and space for three half-height storage devices or for two full-height storage devices. Ample space exists for memory and communications options and room for connecting as many as 26 I/O devices.

### Software That Is Proven and Available

The MicroPDP-11/53 runs Digital's leadership 16-bit operating systems.

These are proven operating systems that efficiently and effectively meet a variety of demands—from small, dedicated laboratory and industrial control systems to larger, multiuser information management systems.

Micro/RXS and Micro/RSTS are tailored specifically for the MicroPDP-11 family. Micro/RXS is a low-cost version of Digital's larger RSX-11M-PLUS. It combines the multiuser, realtime capability of RSX with refined commercial capabilities. And Micro/RSTS is a subset of the RSTS/E system that is a multiuser, timesharing system environment.

Also available is RT-11, a single-user, realtime system; RSX-11M-PLUS, RSX-11M, and RSX-11S, three multiuser, realtime systems; RSTS/E, a multiuser, timesharing system; CTS-300, for small business timesharing; ULTRIX-11, Digital's enhanced native-mode UNIX\* software; MicroPower/Pascal, an advanced development tool kit; and DSM-11, a multiuser operating system with high-performance, data management capability.

Digital's own layered software includes a wide variety of high-level languages and data management tools. Supported high-level languages include BASIC, C, COBOL, DIBOL-83, FORTRAN-77, FORTRAN IV, MUMPS,\* and Pascal. Data management tools include DATATRIEVE-11, a query report-writing and data-maintenance system; RMS-11, a record management system; and FMS-11, a forms management system.

And thousands of application software products already exist for the MicroPDP-11/53 in virtually every

I/O Distribution Panel Insert

Backplane

Signal Distribution Board

RD31

RX33

Control Panel

Q-Bus Modules

MicroPDP-11/53  
KDJ11-DA  
MSV11-Q  
RQDX3

Power Supply

Fans

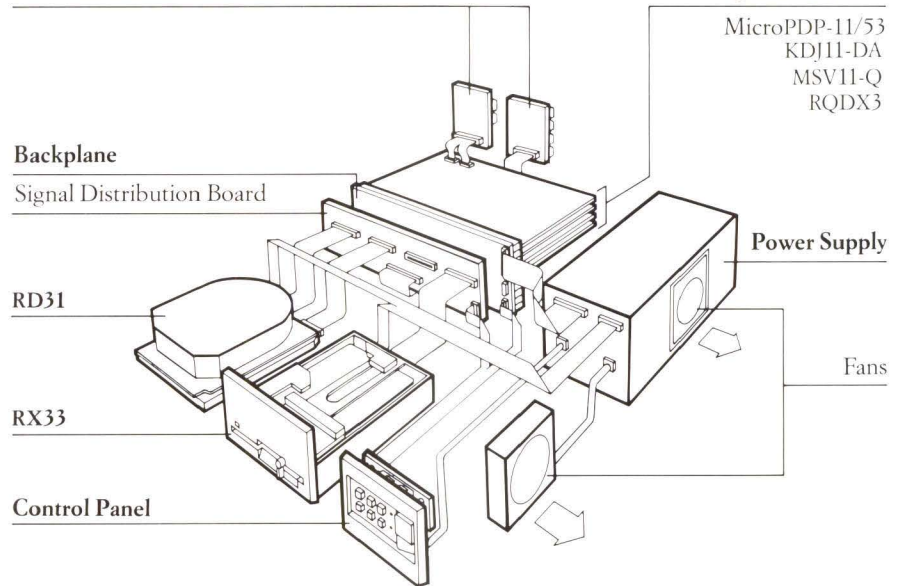

area of science, education, government, business, and industry. These products have been developed both by Digital and third-party software developers. Ask your sales representative for a copy of the *PDP-11 Software Source Book*, a guide to the more than 2,000 applications packages that are available today.

### **Tie Together Your System, Department, and Organization**

A wide variety of communications hardware and software is available to make the MicroPDP-11/53 supermicrosystem interface with the widest possible range of communications and networking applications. Digital's powerful DECnet software supports communications between Digital systems, and between Digital systems and other manufacturers' systems. The MicroPDP-11/53 is also supported

by Ethernet local area networking. Ethernet allows large amounts of data to be exchanged at high rates among various departments of an organization, within one building or within a complex of buildings.

### **Digital's Commitment To Service**

Like all of Digital's products, the MicroPDP-11/53 and its system software have been designed for reliability. And Digital's customer services organization is ready to provide quality support. Digital is the complete service vendor and has the products and tools to back its commitment to customer satisfaction.

### **If You Would Like To Know More**

Find out just what the MicroPDP-11/53 can do for you. Call your local Digital sales office, Digital OEM, or Authorized Digital Distributor for an indepth discussion of the MicroPDP-11/53 solution.



## Specifications

### Power Requirements

Line voltage	120 Vac	240 Vac
System power	4.4 amperes	2.2 amperes
Power source phasing	Single	Single
Voltage tolerance	90-128 VRMS	176-256 VRMS
Line frequency tolerance	47-63 Hz	47-63 Hz
Input power	345 watts	345 watts

### Operating Environment

Temperature range	15-32°C (59-90°F)
Relative humidity	20-80% noncondensing
Maximum operating altitude	2.4 km (8,000 ft)

### Physical Characteristics

Pedestal Model	
Height	62.2 cm (24.5 in)
Width	25.4 cm (10.0 in)
Depth	72.4 cm (28.5 in)
Weight	32 kg (70 lb)
Tabletop Model	
Height	15.2 cm (6.0 in)
Width	56.5 cm (22.25 in)
Depth	72.4 cm (28.5 in)
Weight	32 kg (70 lb)
Rackmount Model	
Height	13.3 cm (5.25 in)
Width	48.3 cm (19.0 in)
Depth	64.8 cm (25.5 in)
Weight	25 kg (55 lb)

Digital believes the information in this publication is accurate as of its publication date; such information is subject to change without notice. Digital is not responsible for any inadvertent errors.

The following are trademarks of Digital Equipment Corporation: CTS-300, DATATRIEVE-11, DEC, DECnet, DIBOL-83, the Digital logo, FMS-11, J-11, MicroPDP-11, MicroPower/Pascal, Q-bus, PDP-11, RMS-11, RSTS/E, RSX, RSX-11M, RSX-11M-PLUS, RSX-11S, RT-11, and ULTRIX-11.

\*Third-party trademarks: UNIX is a registered trademark of AT&T Bell Laboratories; MUMPS is a registered trademark of Massachusetts General Hospital.

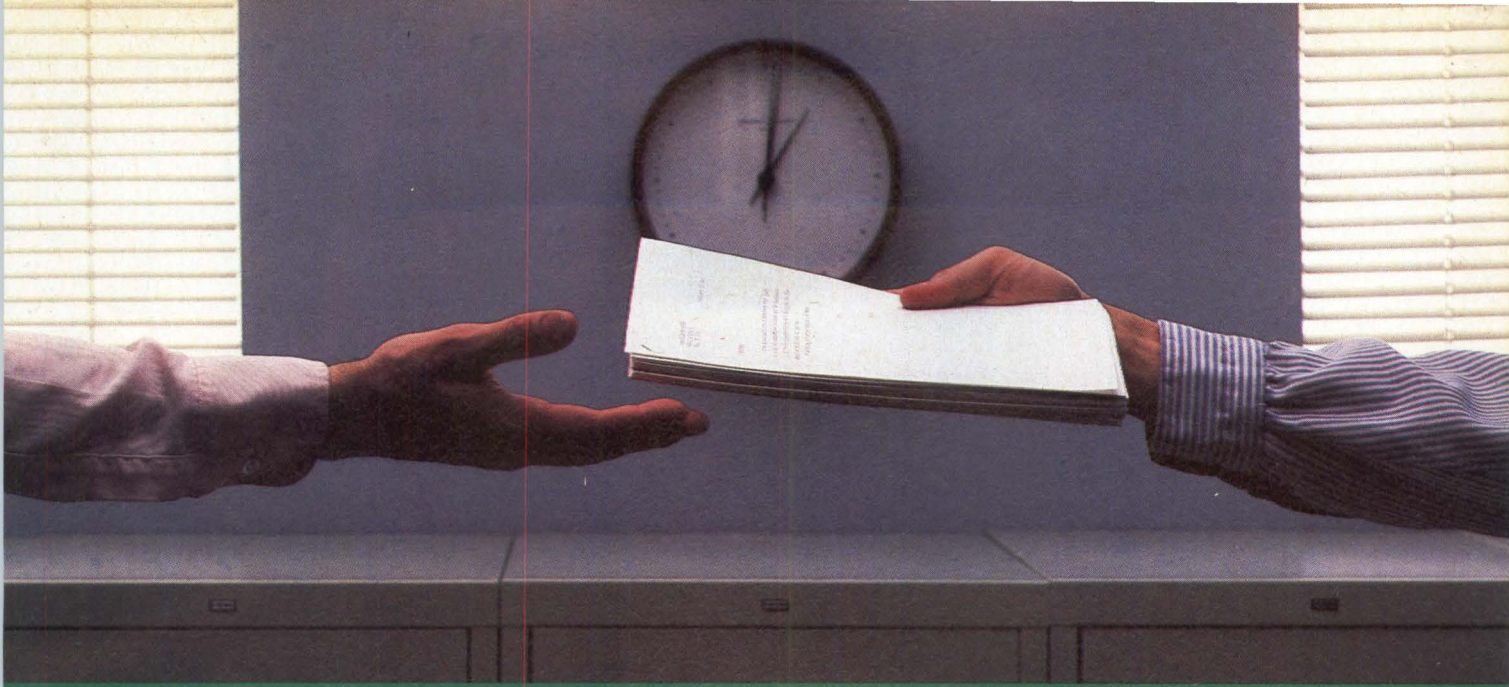

## 2400 bps modems: Do you Really need another speed?

- Is the shift from 300 to 1200 bps going to repeat itself at 2400 bps? The answer is both yes and no. There certainly are applications for 2400 bps asynch dial-up modems, but we shouldn't expect 1200 bps to die overnight.
- 2400 bps modems can improve throughput, thereby getting tasks done quicker and more economically. However, 1200 bps has become the virtual standard for professional dial-up communications, and most users are satisfied with it. So why consider a 2400 bps modem at all?
- One reason is flexibility. If the modem you select operates at all three speeds (300, 1200 & 2400) in accordance with accepted industry standards, it will serve virtually all dial-up applications now and in the foreseeable future.
- The modem you select should be the MultiModem224. It is Bell 212A and 103 compatible at 1200 and 300 bps, and CCITT V.22bis compatible at 2400. It is also 100% compatible with the Hayes command set, meaning that it will work with virtually all communications software packages, at all three speeds. Other features include both synchronous and asynchronous operation, full intelligence and a phone number memory.
- The MultiModem224 is available in both desktop and IBM PC™ internal card versions. (There is also a rack-mounted version for central sites.) And as a bonus, we provide free offers from ten of the most popular on-line information services, including CompuServe™, Dow Jones™ and The Source™.
- A 2400/1200/300 bps modem is just a plain good investment. Why not let the MultiModem224 provide your communications for both today and tomorrow?

For more information, call us toll-free at  
1-800-328-9717 (in Minnesota, call 1-612-631-3550).

CIRCLE NO. 66 ON INQUIRY CARD

**MultiTech**   
Systems

*The right answer every time.*

82 Second Ave. S.E., New Brighton, MN 55112 (612) 631-3550, TWX: 910-563-3610

**MultiTech**   
Systems

**MultiModem 224**  
2400/1200/300 BPS Intelligent Modem

1200  
300 Ans



**IN GERMANY, WE'D RATHER  
CREATE A LASTING IMPRESSION THAN  
RUSH PRODUCTION TO BE FIRST.**

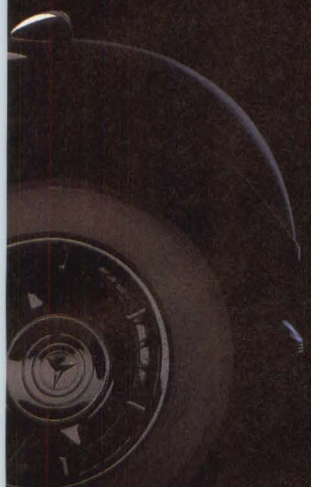

it through to a superior conclusion.

The result is not just an idle entry into the burgeoning class of 24-needle machines. But a printing plant that some have even suggested is overbuilt.

In contrast to hurriedly stamped frames of sheet metal, the superstructure of the MT330 is solid cast. All of which creates a more substantial, shock-absorbing work platform.

Likewise, the power train is a product of serious deliberation; a push-fed tractor driven by surge resistant DC motors.

Then our engineers went to work on the print head.

For increased speed and resolution, they staggered the 24-needle matrix into two perfect vertical-plane columns.

In addition, they developed a magnetic head assembly that actually requires less

power during printing. So long after our counterparts have overheated, or beaten themselves into obsolescence, the MT330 continues to spew out mountains of data.

Up to 10,000 pages per month at 300 characters per second.

Characters that remain crisp and dense from a ribbon rated at more than 15 million impressions.

So if it seems we were exceedingly patient in our introduction of the MT330, the results of German perfectionism are a justifiable reward.

To make your own evaluation, call us at 1-800-843-1347 for a demonstration.

We think you'll be suitably impressed. Particularly in the long run.

**MANNESMANN**  
*TALLY*

Call it a manifestation of German pride, but we took our time to introduce the MT330 for good reason: We wanted to think

# Leadership Is Being One Step Behind



Hot on the heels of the latest computer printer hardware.  
World leadership in replacement ribbons means consistently coming out with the caliber of ribbon product that sets the industry standard.  
When IBM introduced the Proprinter, Pelikan R&D was right behind them. Just like we were with Epson's LX-80 and Canon's AP-200. With top quality ribbons. Priced right.  
Keeping pace with hardware development is what keeps us on our toes. And one step ahead of the rest.



For Information: 1-800-251-1910 (in Tennessee call collect 615-790-6171)

**Pelikan**   
The first name. The last word.

CIRCLE NO. 68 ON INQUIRY CARD



# NEW PRODUCTS

## SYSTEMS

Megan Nields, Assistant Editor

### Business system suits IBM PC/AT

- 10 expansion slots
- 512K bytes of RAM
- 80286 processor

Supplying 10 expansion slots, the Business Partner 286 computer accommodates five IBM PC/AT-compatible and five IBM PC-compatible boards. The unit's 80286 microprocessor offers 512K bytes of RAM, expandable to 1M byte. It is available in two configurations. The system operates under MS-DOS 3.1 and GW BASIC. \$2,795 to \$2,995. **Panasonic Industrial Co.**, 1 Panasonic Way, Secaucus, N.J. 07094, (201) 348-7000.

Circle 301

### Supermicrocomputer features dual bus

- MC68000 processor
- 256K bytes of RAM
- 18 RS232C ports

Incorporating an MC68000 processor, the XF/300 supermicrocomputer features dual-bus architecture and 256K bytes of RAM. The system supplies 18 RS232C ports, 1M byte to 4M bytes of memory and up to 177M bytes of formatted disk storage. Options include a floating-point processor and an Ethernet data controller. \$14,000 and higher. **Concurrent Computer Corp.**, 197 Hance Ave., Tinton Falls, N.J. 07724, (201) 758-7000.

Circle 302

### Supermicro runs DOS, XENIX

- Four configurations
- 80286 processor
- 1.6M bytes of RAM

Available in four configurations, the XTRA XL supermicrocomputer runs both DOS and XENIX. The system utilizes an 80286 processor. It provides 640K bytes or 1.6M bytes of RAM, a 1.2M-byte flexible disk drive and a

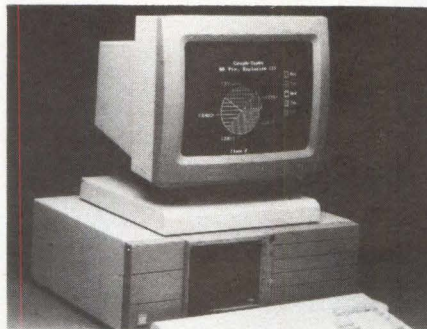

40M-byte or 72M-byte rigid disk drive. Disk storage is expandable to 144M bytes. The multiuser models include 60M bytes of streaming tape backup. \$5,299 to \$12,299. **ITT Information Systems**, 2350 Qume Drive, San Jose, Calif. 95131, (408) 945-8950.

Circle 303

### Personal computer suits IBM PC/AT

- 40M-byte disk drive
- 640K bytes of RAM
- Five internal slots

Compatible with the IBM PC/AT, the APC IV personal computer is geared toward CAD/CAM, engineering and data-processing applications. The unit provides a 40M-byte rigid disk drive, a 1.2M-byte flexible disk drive and five internal storage slots. It utilizes an 80286 microprocessor. Up to 640K bytes of RAM is standard. Features include a color monitor and two RS232C ports. \$5,045 and higher. **NEC Information Systems Inc.**, 1414 Massachusetts Ave., Boxborough, Mass. 01719, (617) 264-8000.

Circle 304

### Microcomputer suits OEMs

Addressing OEMs, the 32-bit Universe 2600 microcomputer is built around the 68000 microprocessor. It supports over 100 simultaneous users or 1,064 serial communication devices, 10M bytes of main memory and 1G

byte of disk storage. The system supplies 20 VMEbus-board slots for user configuration. A 4K-byte data and instruction cache enables it to execute 1.25 million instructions per second with no-wait states. The base configuration is equipped with a 45M-byte streaming tape unit, a 140M-byte Winchester disk drive and four serial ports. \$29,000 and higher. **Charles River Data Systems Inc.**, 983 Concord St., Framingham, Mass. 01701, (617) 626-1000.

Circle 305

### Computer achieves IBM compatibility

- 80286 processor
- 1M bytes of RAM
- Five-drive capacity

The AT286i is an IBM PC/AT-compatible computer equipped with an 80286 microprocessor. It provides 512K bytes to 1M byte of RAM, eight expansion slots, a five-drive capacity and a 1.2M-byte flexible disk drive. The unit runs all IBM PC, PC/XT and PC/AT software. MS-DOS 3.1 and GW BASIC 3.1 operating systems are provided. Options include an 80287 numeric coprocessor. \$2,995. **PGI Corp.**, 1635 W. 12th Place, Tempe, Ariz. 85281, (602) 967-1421.

Circle 306

### Computer offers 640K bytes of RAM

- 35M-byte disk drive
- IBM PC/AT compatible
- 80286 processor

The Tandy 3000 35MB HD computer offers 640K bytes of RAM, a 35M-byte rigid disk drive and a 1.2M-byte flexible disk drive. It is compatible with the IBM PC/AT. The unit utilizes an 80286 microprocessor operating at 8 MHz and 10 expansion card slots. Features include a serial/parallel adapter and a color monitor. \$4,499. **Tandy Corp./Radio Shack**, 1800 1 Tandy Center, Fort Worth, Texas. 76102, (817) 390-3700.

Circle 307

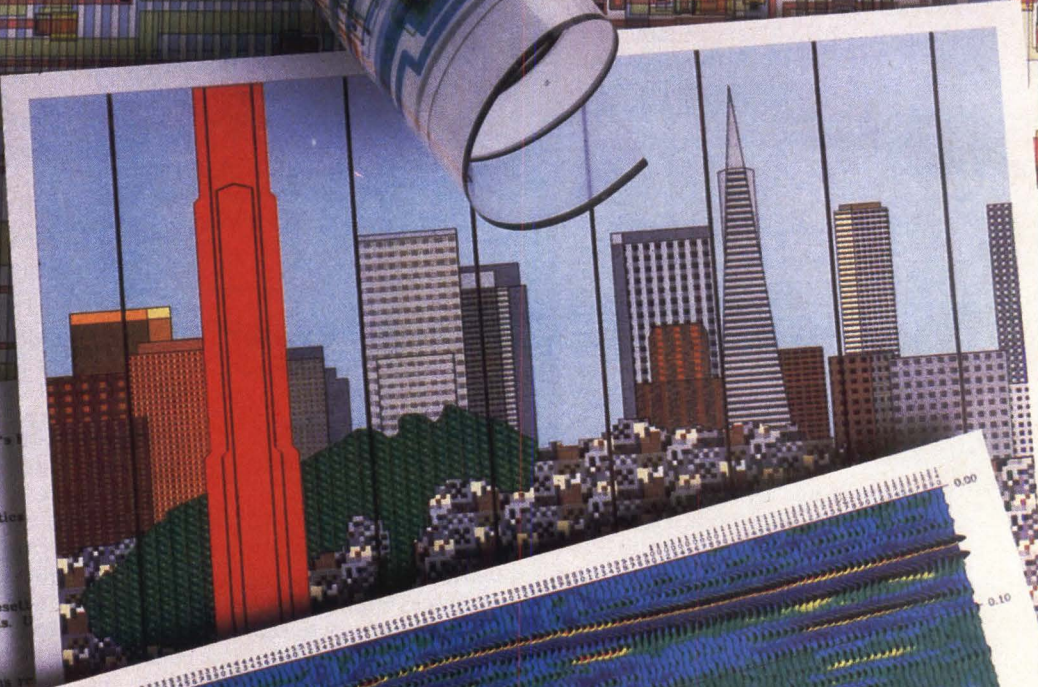
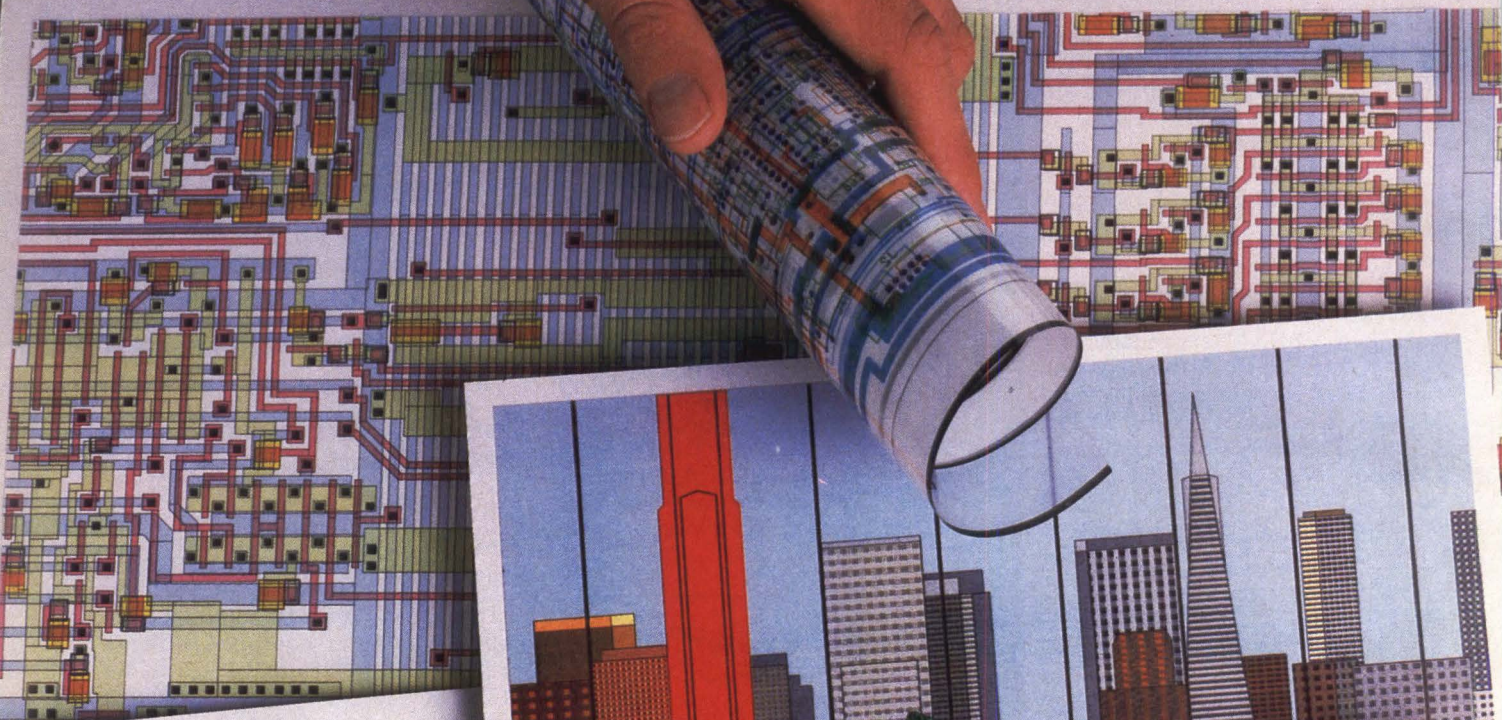
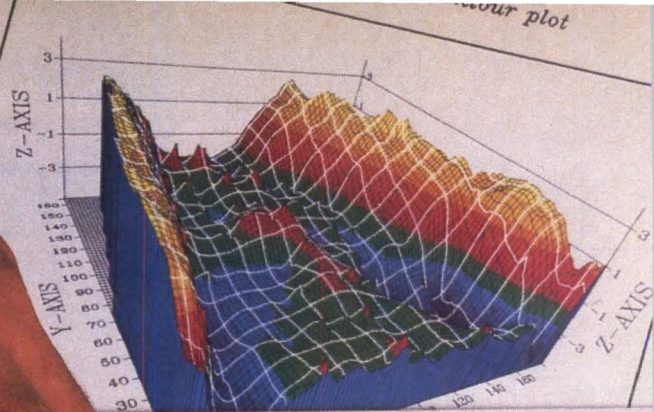

EQN(1) UNIX Programmer's

**NAME** eqn, neqn, checkeq - typeset mathematics

**SYNOPSIS**  
 eqn [-dxy] [-pn] [-sn] [-fn] [file] ...  
 checkeq [file] ...

**DESCRIPTION**  
 Eqn is a troff(1) preprocessor for typeset-  
 terns phototypesetter, neqn on terminals.  
 eqn file ... | troff  
 neqn file ... | nroff

If no files are specified, these programs  
 beginning with .EQ marks the start of a  
 marked by a line beginning with .EQ.  
 may be defined in macro packages. It is  
 possible to set two character sets for  
 between .EQ and .EN. The left set is  
 are turned off by 'delim off'. The right set  
 between .EQ and .EN is passed to troff.  
 The program checkeq reports errors in  
 pairs.

Tokens within eqn are separated by  
 quotes, tildes or circumflexes. In  
 ing, anywhere a single character  
 tion enclosed in braces may be used  
 the output, circumflex ~ half as many  
 Subscripts and superscripts are pro-  
 x sub i makes  $x_i$ , a sub i sup 2 pro-  
 $e^{x^2 y^2}$ .

Fractions are made with over: a over b  
 sqrt makes square roots: 1 over sqrt 2

The keywords from and to introduce  
 $\lim_{n \rightarrow \infty} x_i$  is made with lim from {n -> inf}

Left and right brackets, braces, etc., of  
 right: left [ x sup 2 + y sup 2 over alpha

The right clause is optional. Legal char-  
 brackets, bars, e and f for ceiling and floor  
 right-side-only bracket).

Vertical piles of things are made with pile.  
 above c] produces  $\begin{matrix} a \\ b \\ c \end{matrix}$ . There can be an arbi-

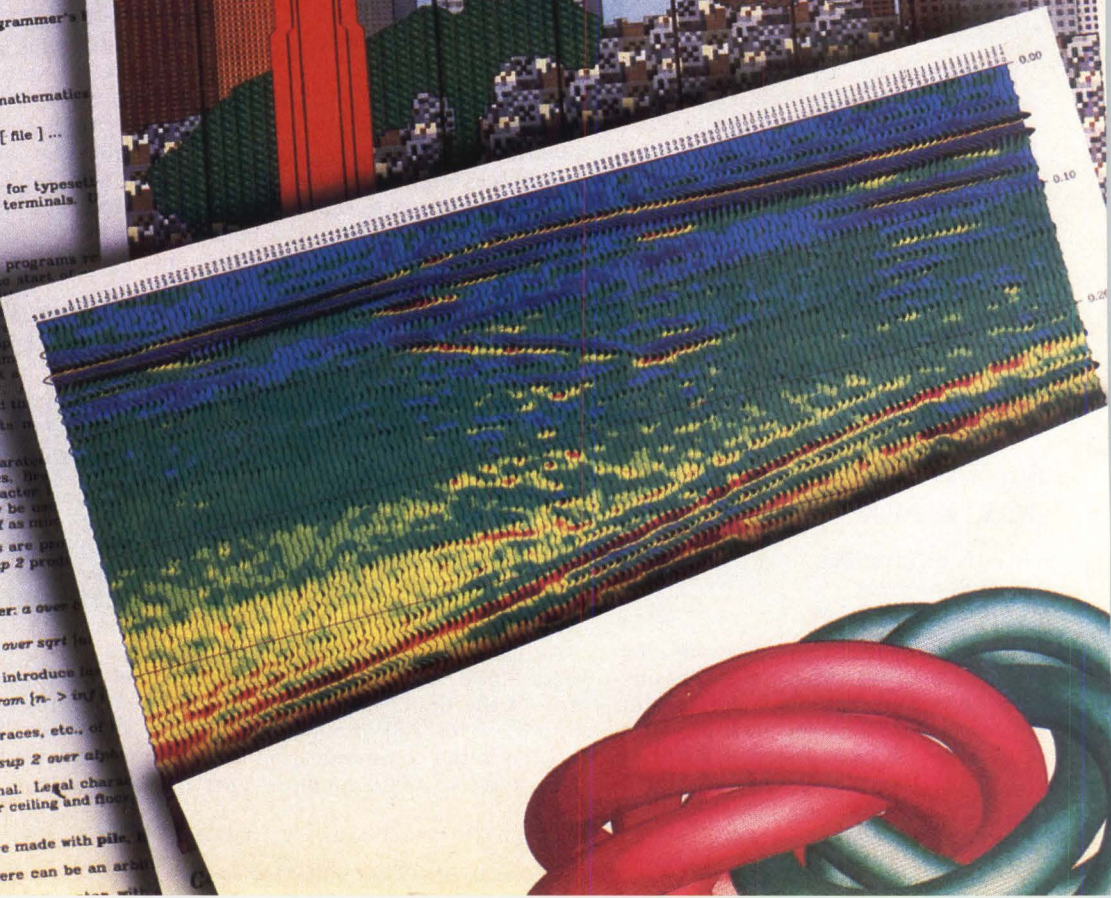

# VERSATEC SPECTRUM. THE WORLD'S MOST VERSATILE COLOR HARD COPY DEVICE.

The Versatec Spectrum electrostatic plotter/printer does it all. Plots A (11" x 8½") and B (11" x 17") page drawings. Plots in full color or black and white. Prints software listings, parts lists, reports, or other alphanumeric printing with a built-in character generator at 1000 lines per minute. Produces hard copies direct from monochrome or color displays with an optional video interface that includes a frame-buffer. And all at a lower cost per copy than other technologies.

Here is the trouble-free throughput you need. Plot. Print. Make copies from your local workstation. Use as a network plot server and for unattended remote applications. Only Versatec Spectrum automatically

handles any mix of A- and B-size, color and monochrome, graphics and text. No need for an operator to change donor rolls, pens, or input paper sizes. And you can run over 300 pages without changing paper. Interfaces and software are available for popular computers, workstations, and terminals.

Get support from the leader. Versatec, the leader in electrostatic plotting, assures customer satisfaction with worldwide service and supplies.

Discover Versatec Spectrum, the world's most versatile color hard copy device. For more information, circle the readers' service number, call toll-free 800/538-6477,\* or visit your nearby Versatec sales office.

**VERSATEC**  
A XEROX COMPANY

2710 Walsh Avenue  
Santa Clara, California 95051  
Telephone: (408) 988-2800  
TWX: 910-338-0243  
Telex: 334421

Versatec and Spectrum are trademarks of Versatec, Inc. Xerox is a trademark of Xerox Corporation.

\*In California, call toll-free 800/341-6060.

**It's a Versatec.**

See us at SIGGRAPH

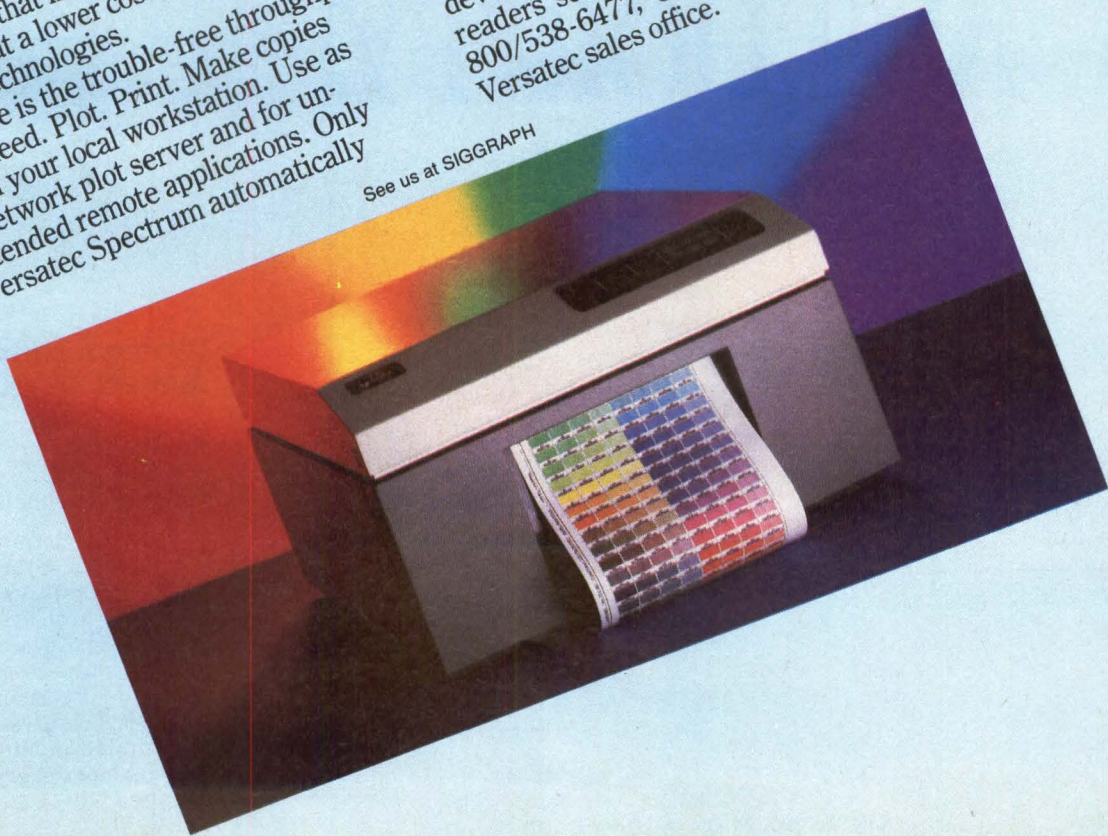

### Graphics monitor combines with card

The Definition 895 DU color graphics monitor and the Ultragraph 800 graphics-and-text card combine to execute personal computer-based CAD/CAM applications. The 14-inch monitor displays 800 by 400 pixels in 16 colors. Automatic mode selection al-

lows all IBM PC and compatible software to be run.

\$895, monitor. **Microvitec, Inc.**, 1943 Providence Court, Airport Perimeter Business Center, College Park, Ga. 30337, (404) 991-2246. **Circle 454**  
\$995, card. **Ultragraphics Corp.**, 37 S. Franklin St., Chagrin Falls, Ohio. 44022, (216) 247-6600.

**Circle 308**

### RGB monitor offers 16 colors

The CM 2000 RGB monitor displays a 640-dot-by-240-line resolution on a 13-inch screen. It features a 16-color chromatic mode. The unit is plug-compatible with the IBM PC, /XT and /AT. \$599. **C. Itoh Digital Products**, Suite 220, 19750 S. Vermont, Torrance, Calif. 90502, (213) 327-2110.

**Circle 309**

---

# FORTRAN FROM THE HIGHEST AUTHORITY.

Namely, RM/FORTRAN™ from Ryan-McFarland. It's nothing less than a mainframe FORTRAN compiler for a pc. It's also a full ANSI 77, complete with mainframe extensions and GSA-certified error-free at the highest level. And, thanks to our high optimizing compiler, it's the fastest pc FORTRAN you can buy. To do just that, call us at 213-541-4828.

Or write 609  
Deep Valley Dr.,  
Rolling Hills  
Estates, CA 90274.



**RYAN-McFARLAND**

**Masters of the Language.**

RM/FORTRAN is a trademark of Ryan-McFarland Corporation. ©1986 Ryan-McFarland Corp.

**CIRCLE NO. 71 ON INQUIRY CARD**

---

### Monitor suits OEMs, VARs

- 14-inch screen
- 256 by 256 dpi
- IBM PC compatible

Suiting OEMs and VARs, the Touch-Monitor 14 is the lowest priced monochrome touch screen monitor available. The unit is compatible with the IBM PC, PC/XT and PC/AT. It displays 256 by 256 dpi on a 14-inch screen. Analog ports and RS232C ports are standard. \$398. **Personal Touch**, 4320-290 Stevens Creek Blvd., San Jose, Calif. 95129, (408) 246-8822.

**Circle 310**



---

### Terminal suits IBM PC, PC/XT, PC/AT

- 14-inch screen
- 25 lines
- 80 or 132 columns

An ASCII terminal, the model 232 functions in either single IBM PC, PC/AT or multiuser PC/AT environments via host PC software. The unit displays 25 lines at either 80 or 132 columns on a 14-inch screen. It emulates IBM PC scan-codes and screen displays. Features include TeleVideo 925 emulation and a serial interface. \$649. **Ampex Corp.**, 401 Broadway, Redwood City, Calif. 94063-3199.

**Circle 311**

**We have 2400 feet to stick in the door.  
So you can put yours in the sand.**

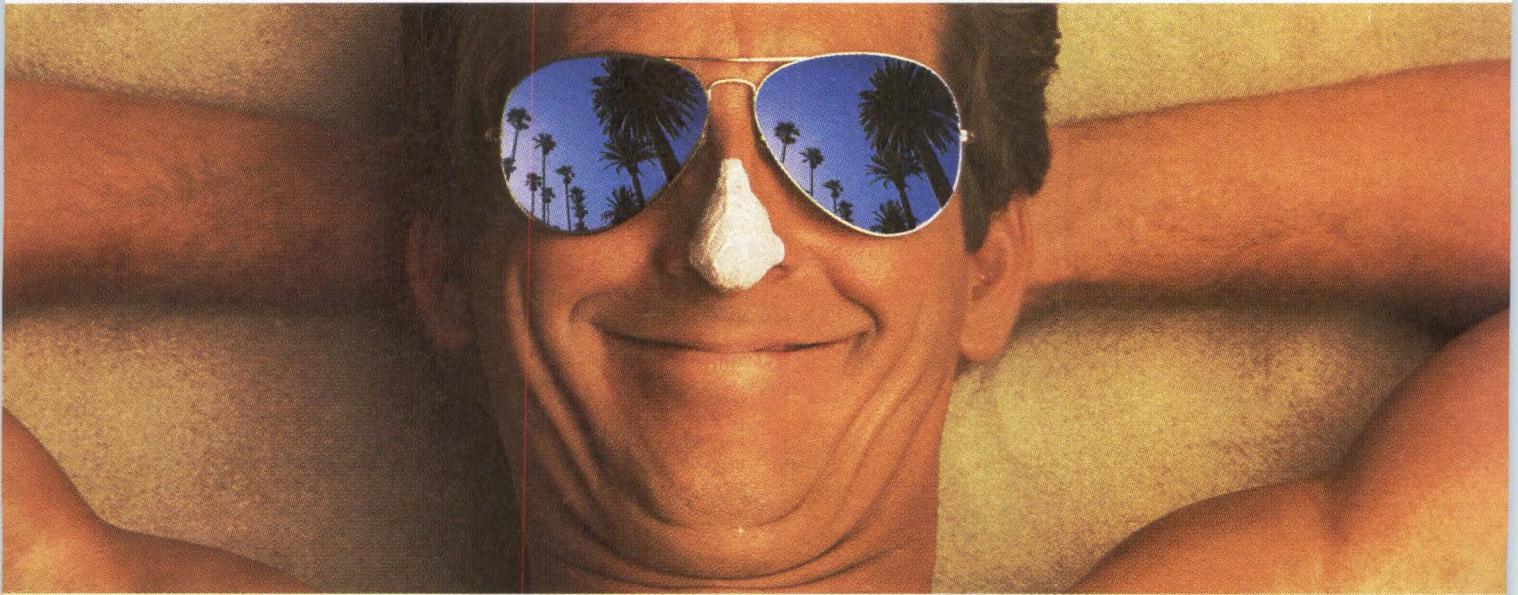

You've all been working around the clock on the new software. It's finished. It's terrific. And you're exhausted.

You really need a vacation. But, first you have to get out there and drum up business. Unless, of course, you'd rather Hewlett-Packard did the drumming for you.

Join our commercial Software Supplier program, and that's exactly what happens. Our worldwide sales force will go to work, opening doors you may never know existed.

Your side of the bargain is to write software to run on HP 3000 business computers. For any kind of business you choose. Then help us close the deals.

For this, we'll give you a bonus of up to 6% of the HP hardware price on any system sale leveraged by your software. That's on top of your full price to the customer.

The HP Program for Software Suppliers is full of nice incentives like this. To find out about all of them, send in the coupon for our brochure.

Pretty soon, you could be on your way somewhere they've never even heard of computers. While we take care of business.



### The HP Program for Software Suppliers

- Send me details of your commercial HP 3000 Software Supplier Program. Maybe we have been working too hard.  
 Have an HP representative call me.

Name/Title \_\_\_\_\_

Company \_\_\_\_\_

Address \_\_\_\_\_

City/State/Zip \_\_\_\_\_

Phone \_\_\_\_\_ Market \_\_\_\_\_

Mail to: Bob Hall, Hewlett-Packard, Dept. 694D  
10520 Ridgeview Court, Cupertino, CA 95014 ISO2604

Victory is the bottom line.



All year long you've been striving for it.  
Victory.

By outstriding the competition. Cultivating business relationships. Striking the money-making deals. Stretching toward the big reward.

COMDEX/Fall puts you in the midst of thousands of the computer industry's leaders—drawn to the main computer event of the year to see the latest and the best, to buy the fastest and most reliable, to learn from an array of conference sessions run by experts only COMDEX can provide.

COMDEX helps you seal your most profitable deals and lay the groundwork for new ones. And gives you a head start on the '87 race.

Because the finish line is the bottom line.

Call (617) 449-6600 now to reserve preferred exhibit space. Or write to:  
The Interface Group, Inc., 300 First Avenue, Needham, MA 02194.

**COMDEX® Fall '86**

Join The Winner's Circle.  
November 10-14, 1986, Las Vegas, Nevada

©1986 The Interface Group, Inc.

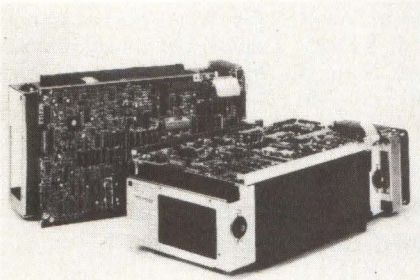

### Eight-inch Winchester holds 510M bytes

- SMD interface
- 18-msec access time
- 2.4M bytes per second

Utilizing an SMD interface, the MK-288FC 8-inch Winchester disk drive offers 510M bytes of memory. The device has an average access time of 18 msec and a data transfer rate of 2.4M bytes per second. Track capacity is 40,000 bytes per track. The unit accommodates eight disks. \$4,315. **Toshiba America Inc.**, Disk Products Division, 3910 Freedom Circle, #103, Santa Clara, Calif. 95054, (408) 727-3939.

Circle 312

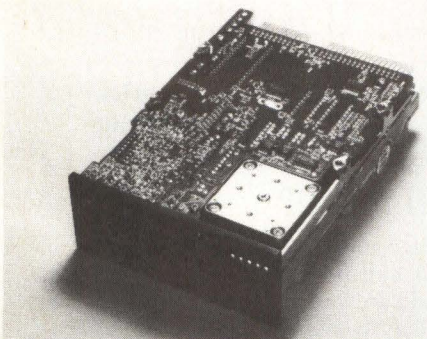

### OEMs targeted by 3½-inch drives

- 910 tpi
- 20M-byte capacity
- 69-msec access time

The HMD-710 and HMD-720 Winchester disk drives provide 10M bytes and 20M bytes of formatted storage capacity, respectively. The 3½-inch, half-height units are aimed at OEMs. Average access time is 69 msec and data transfer rate is 5M bps. The devices utilize an ST506/412 interface. Rotary positioning supports storage densities of

910 tpi. \$300 to \$400. **Epson America Inc.**, OEM Product Division, 23600 Telo Ave., Torrance, Calif. 90505, (213) 534-4500.

Circle 313

### Subsystem targets IBM PC and compatibles

- Two disk drives
- Host adapter cards
- 35-msec access time

The Bernoulli Box Plus combines two removable-cartridge 20M-byte disk drives with an 80M-byte formatted rigid disk drive in an external subsystem. The unit is compatible with the IBM PC. Fixed-disk hardware allows the rigid disk to store files larger than 32M bytes. Data access rate is 35 msec. Features include a SCSI interface, two host adapter cards and a file-management software package. \$5,995 to \$6,095. **Iomega Corp.**, 1821 W. 4000 South, Roy, Utah 84067, (801) 778-1000.

Circle 314

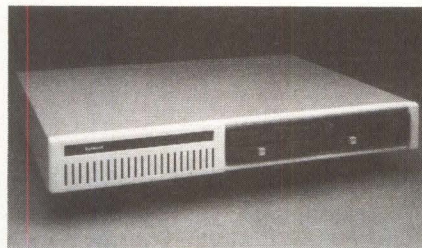

### Subsystems suit IBM PC, PC/XT, PC/AT

- Four models
- 7.5M-bps transfer rate
- 45M-byte fixed drive

The SQ1500 subsystem comes in four models. The single- and dual-drive configurations, models SQ15 and SQ15x15, feature 15M-byte removable rigid disk drives. The model SQ15x45 provides a 15M-byte removable and a 45M-byte fixed drive; the SQ45x45 offers dual 45M-byte fixed drives. Data transfer rate is 7.5M bps. Features include a chassis, a controller and utility software. The units are geared toward OEMs and system integrators. \$2,499 to \$3,695. **SyQuest Technology**, 47923 Warm Springs Blvd., Fremont, Calif. 94539, (415) 490-7511.

Circle 315

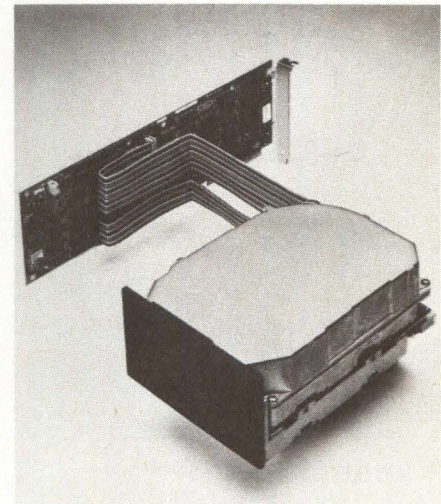

### Subsystem includes tape controller

- IBM compatible
- 70M-byte capacity
- 28-msec access time

The Matched Pair Winchester disk drive subsystem is available in 40M-byte or 70M-byte capacities with an average access time of 28 msec. The IBM PC- and PC/XT-compatible systems incorporate the SC6000 Turbo Controller to control up to two self-booting rigid disk drives. A 1-to-1 interleave-factor ratio is used. \$250, Turbo Controller; \$1,795 to \$2,995, Matched Pair. **Sysgen Inc.**, 47853 Warm Springs Blvd., Fremont, Calif. 94539, (415) 490-6770.

Circle 457

### Optical disk subsystem targets VARs

- IBM PC compatible
- SCSI controller
- 1G byte of storage

A write-once optical disk drive subsystem, the Optitem 1000/S suits the IBM PC, PC/XT, PC/AT and compatibles operating under DOS 3.0 or 3.1. The 12-inch unit provides 1G byte of storage, a SCSI-standard controller and a host adapter. It is geared toward VARs. Features include an installable device driver. \$20,000. **Optitem**, 435 Oakmead Parkway, Sunnyvale, Calif. 94086, (408) 737-7373.

Circle 458

NEW PRODUCTS  
PRINTERS

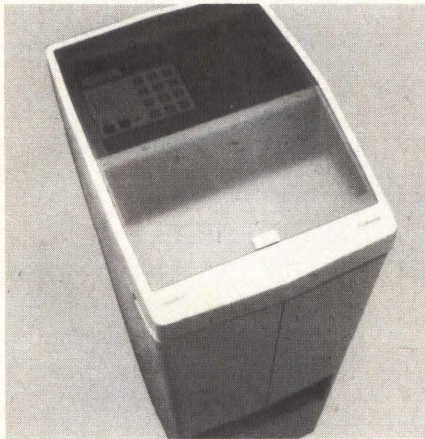

**Printer produces near-offset quality**

- 32 ink jets
- 240 by 240 dpi
- Two ppm

The Pixelmaster printer uses 32 ink jets to produce near-offset quality images. Generating text at two ppm and

running at four minutes per page for full-color graphics, the unit provides a 240-by-240-dpi resolution. The printer's Thermo-Jet system offers over 250,000 shades of color and raised printing. It accommodates standard office paper. \$2,995. **Howtek Inc.**, 21 Park Ave., Hudson, N.H. 03051, (603) 882-5200.

Circle 451

**Laser printer generates 8 ppm**

- 300 by 300 dpi
- 1M-byte bit map
- 56 dB(a)

A desktop laser printer, the LN03 PLUS achieves a resolution of 300 by 300 dpi and a speed of 8 ppm. Graphics are generated via 1M byte of bit-mapped memory. Plug-in RAM is expandable to 256K bytes. The unit offers Tektronix compatibility, 18 resident fonts and a noise level of less than 56

dB(a). An RS232C serial port is standard. \$4,995. **Digital Equipment Corp.**, 146 Main St., Maynard, Mass. 01754, (617) 897-5111.

Circle 452

**Printer weighs under four pounds**

- 150 cps
- Battery powered
- Centronics interface

The Diconix 150 portable ink-jet printer weighs less than four pounds and measures 2 by 6.5 by 10.8 inches. It prints 150 cps, draft, on single sheets of letterhead or continuous-feed computer paper. Emulating the IBM Proprinter or the Epson FX printer, the battery-powered unit connects to computers via a Centronics 8-bit parallel interface. \$479. **Diconix Inc.**, 3100 Research Blvd., P.O. Box 3100, Dayton, Ohio 45420, (513) 259-3100.

Circle 453

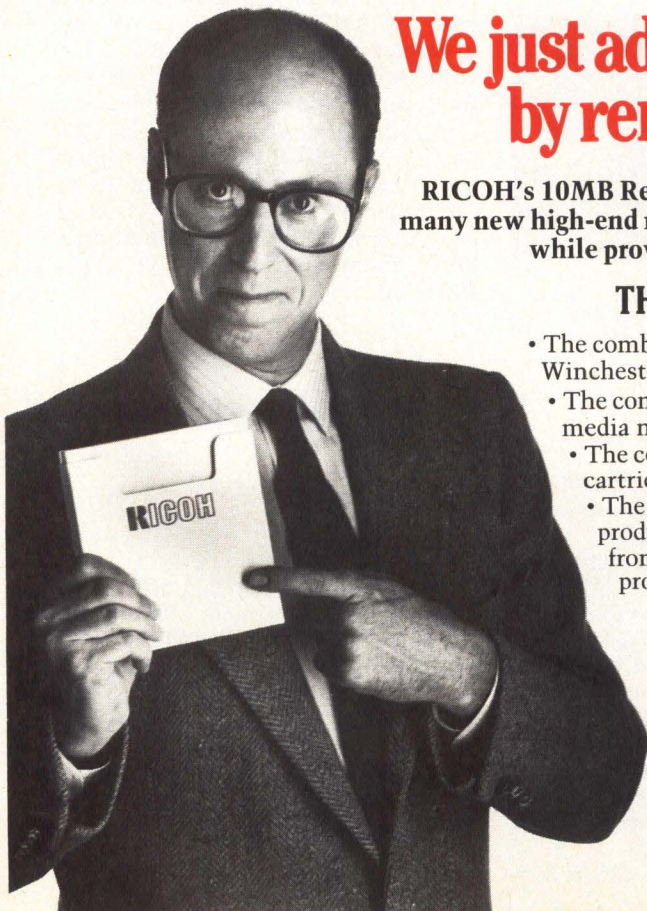

**We just added to your opportunities by removing our cartridge.**

RICOH's 10MB Removable Cartridge Disk Drive offers OEMs and VARs many new high-end marketing opportunities in additional market segments while providing the potential for greater profit margins.

**THE BENEFITS OF RICOH ADD UP**

- The combination of unlimited data storage and transportability with Winchester speed and dependability (5¼" half-height form factor).
- The compatibility of industry standard hardware interface and media makes it work with practically any system.
- The confidence of data security made simple. Lock up your cartridges, not your system.
- The unquestionable reliability, production capabilities and support from an international leader in product quality control.

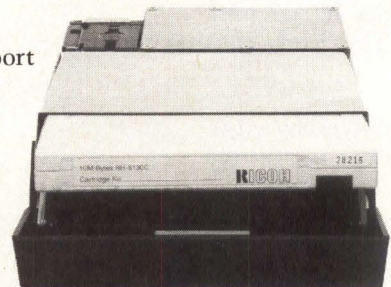

**RICOH**

RICOH SYSTEMS, INC., Marketing Department, 2071 Concourse Drive, San Jose, CA 95131-1887 TEL: 408-946-6200 FAX: 408-262-0662



Jon Garman, Director of Product Engineering  
Workstation Division,  
Sun Microsystems, Inc.



## XYLOGICS SUPPORTS THE POWER OF THE SUN.

When Sun Microsystems began looking at Multibus disk and tape controllers for their high performance engineering workstations, they demanded a lot.

*"We needed a fast Multibus SMD disk controller, one that could read fast drives, like the Fujitsu Eagle, at full speed,"* says Sun Director Jon Garman. *"The boards we were evaluating simply couldn't measure up."*

That's when Sun discovered Xylogics.

*"Getting Xylogics' 440 controllers operational with Sun's workstations was a positive experience,"* Garman remembers. *"What the manual said, the Xylogics boards did, and the software interface was simple to use."*

*"We had our first Xylogics board up and running with UNIX in just four hours. It was quite phenomenal,"* he says.

Next, Sun integrated the Xylogics 450 in its second-generation family of workstations because it was the fastest, most reliable Multibus board they could find.

*"From the start, our number one concern has been performance,"* says Garman. *"But just*

*as important is the support Xylogics gives us. They've always been very responsive.*

*They listen. And take us seriously. We have a close working relationship: engineering to engineering and management to management. They've always delivered on their promises."*

Xylogics' newest product, the 751 VME controller, is now being integrated into Sun's third generation of workstations, The Sun-3 Series.

Little wonder that Xylogics is the secret behind virtually every supermicro and workstation company. Or that nearly half of all high performance Multibus disk and tape controllers in use today are Xylogics.

Find out how Xylogics performance, reliability and support can be part of *your* success story. Call or write for information about our complete line of Multibus and VME bus products.

**THE SECRET'S OUT.**



**Xylogics®**

Your Partner For Performance

144 Middlesex Turnpike  
Burlington, Massachusetts 01803  
(617) 272-8140

Kevin Gonor, Xylogics and Jon Garman,  
Sun Microsystems, with Sun-3/160 C  
Color Workstation

**CIRCLE NO. 76 ON INQUIRY CARD**

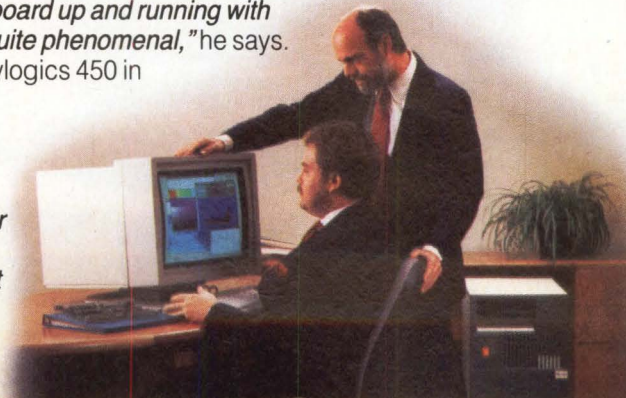

# SPEEDING INFORMATION ACCESS THROUGH OPTICAL DISK TECHNOLOGY

## THE 301 SERIES OPTICAL DISK SUBSYSTEM

■ Hitachi's 301 Series optical disk subsystem enables a computer to access as much as 5.2 gigabytes of on-line information. The 301 Series optical disk subsystem consists of a formatter/controller that handles as many as four disk drives, each having a write-once storage capacity of 2.6 gigabytes. The drives record data by employing a semiconductor laser to score microscopic pits on a 12-inch disk coated with a photosensitive tellurium-selenium medium. This proprietary technique produces sharply defined pits that can be read back with high accuracy and reliability.

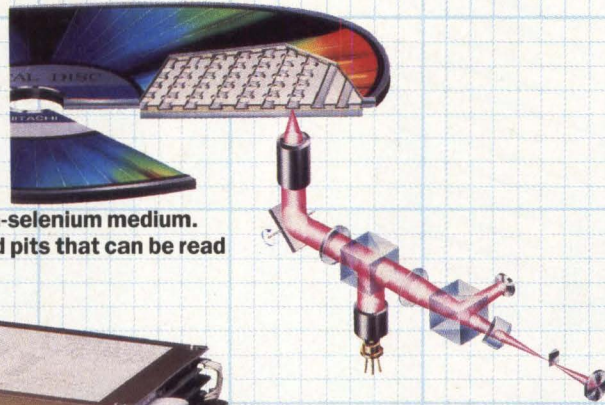

Disk Drive OD301A-1

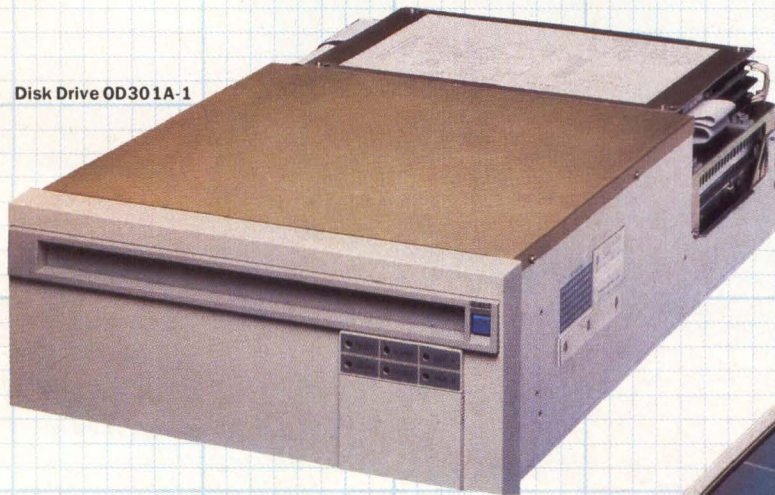

■ The 301 Series drive automatically checks each data bit after it is written and also records error-correcting bits. The combined use of read-after-write checking and error-correction codes reduces expected read errors to  $10^{-12}$ , allowing storage of both image and encoded data.



Disk Cartridge OC301

■ To assure data retention, the 301's disks are sealed in a glass envelope and then encased in an easy-to-handle plastic cartridge. The predicted data life of the doubly sealed disk is more than 10 years.



■ The 301's formatter/controller implements either the industry-standard SCSI interface or a GP-IB (IEEE-488) interface, which enables the disk subsystem to be used with a wide range of computers. The unit includes its own memory buffer to speed data transfer between a host computer and the disk drive, which has a 250 millisecond average access time.



Formatter Controller OF301S-1/2

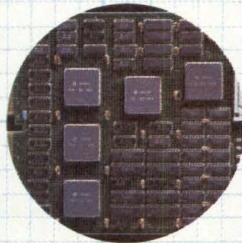

Hitachi Developed  
6000 Gate LS1



Library Unit OL301S-11

■ The 301 Series library unit provides as much as 83 gigabytes of on-line storage capacity. It incorporates a formatter/controller, one or two disk units, and an automatic changer for as many as 32 disk cartridges.

## How Hitachi's 301 Series Facilitate Information Storage and Retrieval

With the introduction of its 301 Series optical disk system, Hitachi has taken a giant step forward in speeding information access. Unlike conventional disk units, which record information magnetically, the model 301 stores data optically—by using a laser to inscribe microscopic pits on a specially coated disk surface and subsequently read them.

The results: a big leap in storage capacity per disk. A 301 Series system can store 2.6 gigabytes of information on a 12-inch disk. The 301 Series library unit, which combines an automatic disk changer with one or two drives, can store and retrieve 83 gigabytes of information—yet occupies no more space in an office than would a large filing cabinet.

The ability to record so much information so compactly opens vast new applications for on-line information storage and retrieval. For example, with the 301 Series, it becomes economically feasible to create extremely compact electronic archives for storing and retrieving copies of medical records, engineering drawings, and other documents, much faster than with conventional microfilm or magnetic tape storage. Other applications include electronic publishing and backup of volatile databases in large-scale information processing systems. For more information, contact:

### Hitachi America, Ltd.

Computer Division  
Peripheral Systems Marketing Department  
950 Elm Avenue, San Bruno, CA 94066  
Tel: 415/872-1902  
or: 313 Speen Street, Natick, MA 01760  
Tel: 617/655-5501

*This 12-inch optical disk can store 2.6 gigabytes of images or encoded data.*



CIRCLE NO. 77 ON INQUIRY CARD

# If your disk doesn't cut it, the MegaRam Disk Emulator does

If your disk cannot access information fast enough to keep your CPU operating efficiently...

The MegaRam eliminates all delays associated with mechanical motion and can allow the system to run more than five times faster than with conventional disk drives.

If downtime caused by disk failures is catastrophic...

The MegaRam, with no moving parts, can provide many years of trouble free operation requiring virtually no maintenance.

If your system is subjected to hostile environments...

The all solid-state MegaRam construction allows error free operation to continue even in the presence of dust, dirt, shock and vibration.

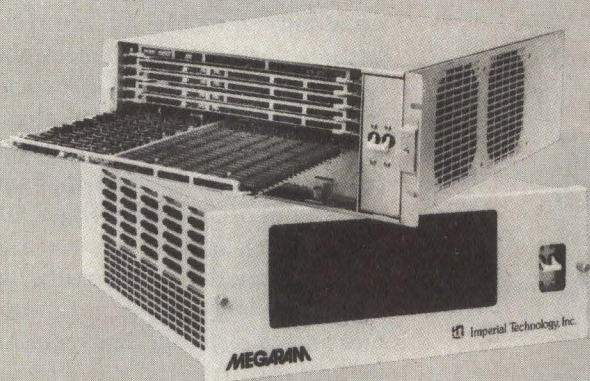

**Designed for the following computers:**  
DEC, Data General, Sperry Univac (V77 Series), Modcomp, Hewlett Packard, SEL, CDC (System 17).

## Features:

- Capacities from 2 megabytes to 40 megabytes in 2 megabyte increments.
- Up to 40 megabytes in a 7" chassis.
- Battery back-up.
- Streaming drive back-up.



**Imperial Technology, Inc.**

831 S. Douglas Street • El Segundo,  
California 90245 • Phone: (213) 536-0018

## REGIONAL SALES OFFICES

Robert K. Singer  
National Sales Manager  
275 Washington St.  
Newton, MA 02158  
(617) 964-3030

### NEW ENGLAND

John J. Fahey  
Regional Manager  
Susan Rapaport  
Regional Manager  
275 Washington St.  
Newton, MA 02158  
(617) 964-3030

### NEW YORK/MID-ATLANTIC

Stephen B. Donohue  
Regional Manager  
1873 Route 70, Suite 302  
Cherry Hill, NJ 08003  
(609) 751-0170  
in N.Y.: (212) 972-0058

### SOUTHEAST

Larry Pullman  
Regional Manager  
6540 Powers Ferry Rd.,  
Suite 170  
Atlanta, GA 30339  
(404) 955-6500

### MIDWEST

Robert D. Wentz  
Regional Manager  
Marianne Majerus  
Sales Coordinator  
Cahners Plaza  
1350 E. Touhy Ave.  
P.O. Box 5080  
Des Plaines, IL 60018  
(312) 635-8800

### SOUTHWEST

Don Ward, Regional Manager  
13740 Midway, Suite 515  
Dallas, TX 75234  
(214) 980-0318

### MOUNTAIN STATES

John Huff  
Regional Manager  
270 St. Paul St.  
Denver, CO 80206  
(303) 388-4511

### SOUTHERN CALIFORNIA/ NEVADA

Len Ganz  
Regional Manager  
18818 Teller Ave.  
Irvine, CA 92715  
(714) 851-9422

### NORTHERN CALIFORNIA/ NORTHWEST

Frank Barbagallo  
Northwestern Regional Sales  
Manager  
Rick Jamison  
Regional Manager  
Sherman Building, Suite 100  
3031 Tisch Way  
San Jose, CA 95128  
(408) 243-8838

### UK/BENELUX/SCANDINAVIA

Jan Dawson, Regional Manager  
39 A Bowling Green Lane  
London, EC/IR/OBJ UK  
1-278-2152  
Telex: 28339

### JAPAN

Kaoru Hara  
General Manager  
Dynaco International Inc.  
7-2-8 Minamiaoyama  
Minato-ku, Tokyo 107  
Tel: 011-81-3-409-4569  
Fax: 011-81-3-499-4554

### TAIWAN

Donald H. Shapiro  
Trade Winds, 2nd Floor  
132 Hsin Yi Road, Sec. 2  
Taipei  
Tel: 3932718  
Telex: 24177 FC Trade

### EUROPE, EXCEPT UK/ BENELUX/SCANDINAVIA

Elan Marketing Group  
Neutor g. 2  
P.O. Box 84  
1013 Vienna, Austria  
Tel. 43-222-663012

### Mini-Micro Marketplace

Carol Flanagan  
275 Washington St.  
Newton, MA 02158  
(617) 964-3030

### Direct-Response Postcards

Carol Flanagan  
275 Washington St.  
Newton, MA 02158  
(617) 964-3030

### Career Opportunities

Carol Flanagan  
Recruitment Advertising Manager  
275 Washington St.  
Newton, MA 02158  
(617) 964-3030

### Cahners Magazine Division

William Platt, President  
T.M. McDermott, Vice President  
Electronics/Computer Group  
Tom Dellamaria, VP/Production  
Ira Siegel, VP/Research

### Promotion Staff

Susan Rapaport  
Marketing Communications  
Director  
Mary Gregory  
Promotion Manager  
Elizabeth Phillips  
Marketing Assistant

### Circulation

Denver, CO:  
(303) 388-4511  
Sherri Gronli  
Group Manager

### ISRAEL

Elan Marketing Group  
13 Haifa St., P.O. Box 33439  
Tel Aviv  
Tel: 972-3-252967  
Telex: 341667

# Digital has it now.



Reseller solutions  
that allow you to sell  
into any computer  
environment  
out there.

As a Digital reseller, you could be selling solutions that work with systems your prospect already owns. You could be selling open-ended solutions, instead of ones that leave your prospect dead-ended. And you could be part of the industry's largest reseller network. Now. Just clip the coupon or attach your business card.

Tell me more about how to be a VAX/PDP-11 reseller and sell to the world.

Name \_\_\_\_\_ Title \_\_\_\_\_

Company \_\_\_\_\_ Phone \_\_\_\_\_

Address \_\_\_\_\_

City \_\_\_\_\_ State \_\_\_\_\_ Zip \_\_\_\_\_

Send to: Digital Equipment Corporation, Inquiry Dept.  
NR02-1/H3, 444 Whitney Street, Northboro, MA 01532.

**digital**™

MM886

© Digital Equipment Corporation 1986. Digital and the Digital logo are trademarks of Digital Equipment Corporation.

CIRCLE NO. 79 ON INQUIRY CARD

# “and we meet at the Invitational Computer Conferences throughout the world”



For 16 years, the “OEM Only” ICCs have brought OEM manufacturers to where the volume buyers live and work. And only the ICCs cover 17 major OEM territories throughout the U.S. and Europe — time and cost efficiently.

In one day, regional design engineers/system integrators can attend a full day of high-tech seminars and meet with major OEM suppliers of mini/micro computers, disk/tape drives, printers, terminals, controllers, etc. And the ICCs unique business hospitality format, unlike big national shows, make it easy for manufacturers to meet their invited guests one-on-one. So don't miss out! If you are a computer and peripheral OEM manufacturer, call us today to reserve space. If you are a volume buyer, call your local OEM supplier, or our offices, for an ICC invitation.

In the U.S., contact B.J. Johnson & Associates, Inc., 3151 Airway Avenue #C-2, Costa Mesa, CA 92626, Phone (714) 957-0171, Telex 5101002189 BJ JOHN.

In Europe, contact C. J. Nicholl & Associates, Ltd., 37 Brompton Road, London SW3 1DE, England, Phone 01-581 2326/9, Telex 888068 CJNAD G.



#### 1986/87 U.S. SERIES:

Newton, MA—9/4/86  
Dallas, TX—9/16/86  
Minneapolis, MN—9/30/86  
Gaithersburg, MD—10/16/86  
Westlake Village, CA—10/28/86

Irvine, CA—1/8/87  
Ft. Lauderdale, FL—1/29/87  
Raleigh, NC—2/19/87  
Austin, TX—3/3/87  
San Jose, CA—3/17/87  
Nashua, NH—4/2/87

#### 1986/87 EUROPE SERIES:

Munich, W. Germany—9/10/86  
Stockholm, Sweden—9/16/86  
London, England—9/22/86

Frankfurt, W. Germany—1/22/87  
Paris, France—1/27/87  
Milano, Italy—2/3/87

CIRCLE NO. 80 ON INQUIRY CARD

# RADICAL

There's never been a desktop printer like this before.



**The Shape.** Sharp. Sleek. And amazingly adaptable. The Genicom 1000 Series Desktop Printers. Ready for anything from business forms to spreadsheets; word processing to heavy-duty data processing. With letter quality printing at 100 cps. And data processing printing at 200 cps. Open the clamshell casing and look inside. Discover just how simple the future can be.

**The Personality.** IBM®, Epson®, Diablo®—the Genicom 1000 can be all of these printers and more. Because we've built their personalities into plug-in cartridges. Changing personalities is as easy as changing your mind. Simply plug in the personality cartridge of your choice, and your Genicom 1000 is off and running. Working with almost any PC or software program you care to mention. Effortlessly.



Express your personality. With font cartridges that plug right into the front of the printer. Pick your type; you've got hundreds of fonts to choose from. Insert up to three cartridges at once, and vary type styles within the same document.

**The Design.** The Genicom 1000 is the first desktop printer designed with common sense, right down to its built-in printer stand.

The unique design also makes paper loading faster and easier than ever before. Feed tractor paper straight through the bottom. Or from the rear. With Genicom's automatic, zero tear-off bar, no matter how you feed it, you'll never waste a piece of paper again.

When you want to print on letterhead, just feed single sheets of paper, typewriter style. You don't even have to remove the tractor paper.

But the 1000 Series was designed for more than ease of use. It was also designed for performance. Its 18-wire printhead delivers high resolution graphics and word processing printing that can only be called letter quality.

**The Controls.** Easy to adapt. Easy to use. And easy to control. With the Genicom 1000's front panel, total command is at your fingertips. Choose fonts, character spacing, line spacing, form length and print quality with the push of a button. No dipswitches. And no fumbling inside the printer.

**The Track Record.** When it comes to reliability, Genicom stands by its record. We've created a full line of printers: from desktop models to machines that print 800 lines per minute. Our printers have proven their rugged dependability performing for some of the world's largest corporations. Now we're ready to prove it to you.

So stop by your authorized Genicom dealer today and ask for a demonstration of the new 1000 Series; the 1025 and the 1020 for wide column printing. We think you'll agree, these printers are a radical departure from the crowd.

For the Genicom dealer nearest you, call 1-800-437-7468. In Virginia, call 1-703-949-1170.



CIRCLE NO. 81 ON INQUIRY CARD

## GENICOM®

The Printers That Mean Business.

One Genicom Drive, Waynesboro, VA 22980

IBM is a registered trademark of International Business Machines Corp.  
Epson is a registered trademark of Epson America, Inc.  
Diablo is a registered trademark of Xerox Corporation.

# And the Lone Ranger didn't settle for ordinary bullets.

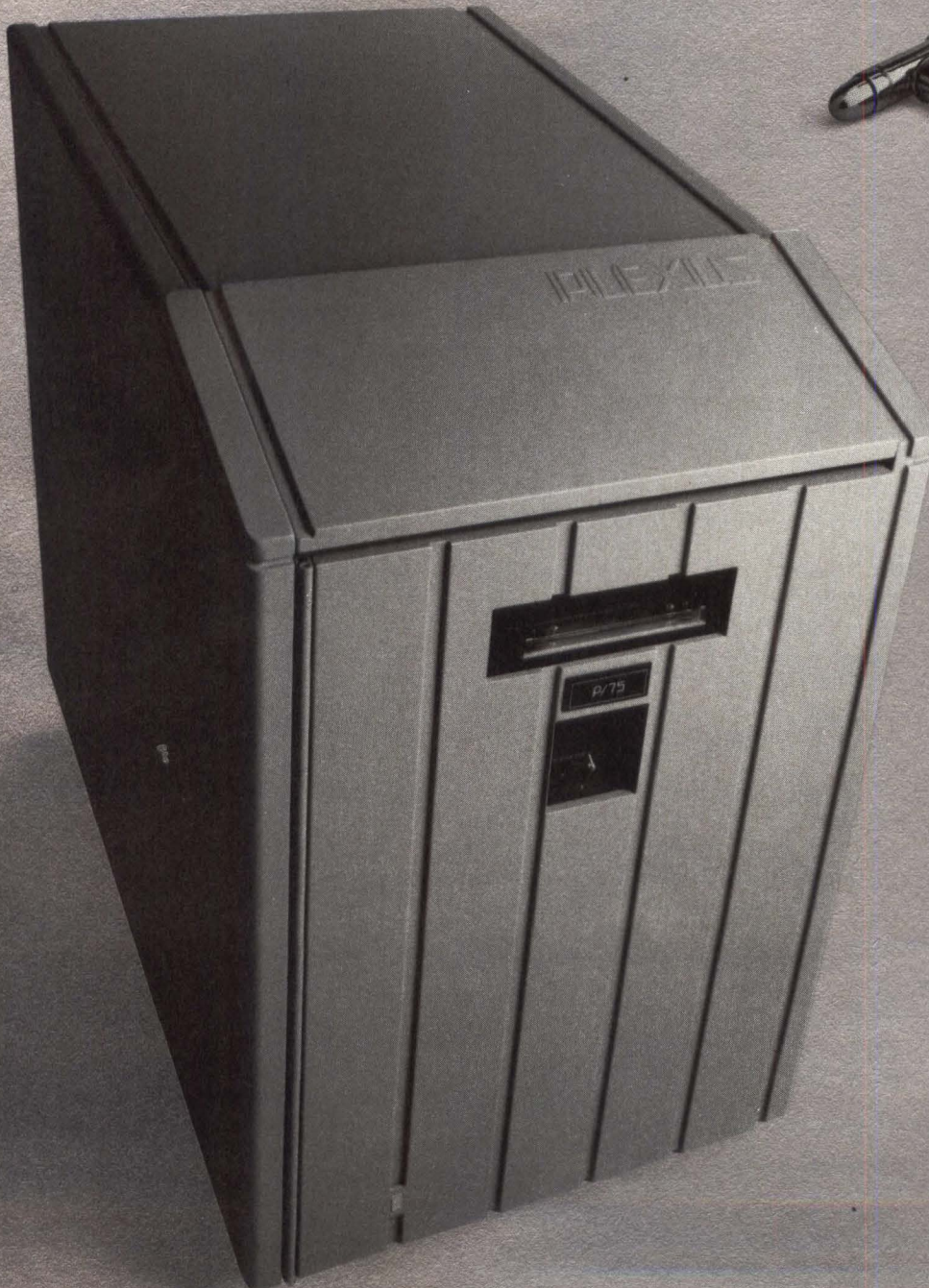

And, in a sense, neither should you. If you're not getting extraordinary performance from your current multifuser system, you're settling for the ordinary.

Which brings us to Plexus.

And what we can bring to you.

At Plexus, we're keenly aware of what you're looking for in a business system. Because we've been delivering the right systems to business for years. Systems that have earned a name for performance and reliability in over 2000 organizations worldwide. Customizable 4 to 80 user systems with innovative multiprocessor architectures—coupled with a finely tuned version of UNIX™ System V Release 2. And on-site service and support even our competition envies.

Take our top-of-the-line P/75. An expandable 32-bit, 68020-based system designed to exceed the demands of today's database-intensive applications. With advanced communications processors—offering a variety of standard or custom protocols and fast terminal response. Plus high-speed enhanced mass storage processors (EMSPs) to speed up disk I/O. (You can even run multiple EMSPs in parallel for lightning-quick access to enormous databases.)

The P/75 also offers storage capacities up to 6.5 Gbytes. A floating-point processor option. Choice of tape back-ups—from cartridge to GCR. And industry-standard interfaces to keep your expansion options open and flexible.

If you'd like more information on the P/75 or any of our other systems, call (800) 523-8874; in California call collect (408) 943-9433. Or write us at 3833 North First Street, San Jose, CA 95134.

Plexus. The lone solution for a wide range of companies.

Just like yours.

UNIX is a trademark of AT&T.

**PLEXUS**  
Plexus Computers, Inc.

CIRCLE NO. 82 ON INQUIRY CARD



# ADVERTISERS INDEX

COMPANY	PAGE NO.	INQUIRY NO.	COMPANY	PAGE NO.	INQUIRY NO.
AIC	6	3	Optotech	24	9
Allen Bradley	110	54	Pelikan	118	68
Applix Inc.	44	23	Peripheral Technology	138	214
B & B Electronics Mfg.	138	207	Pioneer Research	36	17
Caere Corp.	68	36	Plexus Computers	134	82
Cahners Exposition Group	96	48	Pyramid Technology	28-29	10
Charles River Data Systems	23	8	Qualstar	137	204
Communications Research Group	137	203	RDS-Relational Database Systems	54	31
Computerwise Inc.	110	53	Real Time Systems, Inc.	138	212
Convergent Technologies	46-47	25	Ricoh Systems, Inc.	126	75
Craig Data Cable	138	210	Ryan McFarland	122	71
Data Set Cable	138	213	Scientific Micro Systems	90	46
Davidge Corp.	138	211	Seiko Instruments USA	Cov. 2	1
Digital Equipment Corp.	111-114, 131	79	Simpact Assoc. Inc.	76	41
Emulex Corp.	7	4	Softronic	137	202
Equinox Systems	Cov. 3	84	Systech	1	2
Facit Data Products	8	251	Technology Forums	89	45
Falco Data Products	37	18	TeleVideo/Terminals	100	50
Flexstar	50	29	Telxon	79	42
Fortune Systems	79	42	Texas Instruments	2-3, 17-22, 80	—
Fox Research	49, 51	27, 28	Universal Data Systems Inc.	Cov. 4	85
Fujitsu America Inc. Storage Division	99	49	Versatec Inc. (a Xerox Co.)	120-121	70
General Power Systems	56	32	Wave Mate	138	208
Genicom	133	81	Wyse Technology	85	43
GMX	137	205	Xylogics Inc.	127	76
Gould Inc., Computer Systems Div.	136	83	See P. 137-138 for Mini-Micro Marketplace		
Grafpoint	108	52			
Hall-Mark/Capetronic	48	26			
Heurikon Corp.	45	24			
Hewlett-Packard Co./ISG	123	72			
Hitachi America Ltd.	128-129	77			
Houston Instrument Div. of Bausch & Lomb	65, 67	35			
IBM/Information Systems	52-53	30			
IBM/NDD	39	20			
ICC	132	80			
Imagen Corp.	40-41	21			
Imperial Technology Inc.	130	78			
Intercontinental Micro	31, 33, 35	12, 13, 14			
Interface Group	124	73			
Interphase Corp.	70	39			
Ioline Corp.	138	209	Able Computer (multihost terminal network)	D5	57
January Group, Inc.	138	206	Boston Business Computing Ltd. (VAX emulation software for PCs and Rainbows)	D7	59
Keytronic	69	38	Data Access Corp. (multi-user database system)	D2	56
KMW Systems Corp.	61	33	DEXCOMP (DEXCOMP '86)	D10	61
Liberty Electronics USA	30	11	ExpoConsul International (DEXPO West '86)	D16	—
Lundy Electronics	10	5	Graph-On (DEC-compatible graphics terminal)	D11	62
Macrolink	13	6	ID Systems (color graphics terminals)	D15	65
Mannesman Tally	116-117	67	Logicraft (DEC-PC file transfer software)	D1	55
Matrox Electronic Systems Ltd.	14	7	Mercury Computer Systems (coprocessors)	D12	63
Maxtor Corp.	34	16	Quickware Engineering & Design (PDP 11/24/34 board)	D13	64
Method Systems Inc.	68	37	Sequent Computer Systems (parallel computers)	D8-D9	60
Microbar Systems	42	22	Strategic Information (computer time-sharing)	D6	58
Micro Data Base Systems, Inc.	62	34			
Microware, Inc.	137	201			
Microware Systems Corp.	107	51			
Multi-Tech	115	66			
National Electric Cable	38	19			
NCR Tower	86-87	44			
NEC Peripherals	32, 75	15, 40			

## DEC DIRECTIONS ADVERTISERS

Be sure to send for more information about these DEC-compatible products, too:

The following advertisers in DEC DIRECTIONS invite you to send for more information about their DEC-compatible products. (DEC DIRECTIONS is a special MINI-MICRO SYSTEMS supplement appearing only in magazine copies sent to subscribers who have indicated involvement with DEC computers.)

Able Computer (multihost terminal network)	D5	57
Boston Business Computing Ltd. (VAX emulation software for PCs and Rainbows)	D7	59
Data Access Corp. (multi-user database system)	D2	56
DEXCOMP (DEXCOMP '86)	D10	61
ExpoConsul International (DEXPO West '86)	D16	—
Graph-On (DEC-compatible graphics terminal)	D11	62
ID Systems (color graphics terminals)	D15	65
Logicraft (DEC-PC file transfer software)	D1	55
Mercury Computer Systems (coprocessors)	D12	63
Quickware Engineering & Design (PDP 11/24/34 board)	D13	64
Sequent Computer Systems (parallel computers)	D8-D9	60
Strategic Information (computer time-sharing)	D6	58

DEC is a trademark of Digital Equipment Corp.

This index is provided as an additional service. The publisher does not assume any liability for errors or omissions.

# Gould: One-stop UNIX<sup>®</sup> shopping.

Everything you need, from the company that ties it all together. Gould offers the most complete range of UNIX-based systems in the world:

- Secure (C2) UNIX systems
- AT&T System V and BSD 4.x
- Integrated information systems

- Desktop-to-mainframe hardware

For more information on Gould's one-stop shopping, contact Gould Inc., Information Systems Computer Systems Division, 6901 West Sunrise Boulevard, Fort Lauderdale, Florida 33313 1-800-327-9716.

**High Performance Solutions in Factory Automation, Computers, Instrumentation, Defense, and Semiconductors.**



CIRCLE NO. 83 ON INQUIRY CARD

A black and white photograph of a person's hand holding a shopping list in a wire shopping cart. The list is tilted and contains the following text:

Secure (C2) UNIX<sup>®</sup> systems  
Diskless Workstation Support  
Network File System (NFS<sup>®</sup>)  
AT&T System V and BSD 4.x  
Integrated information systems  
Desktop-to-mainframe hardware  
Languages  
C, FORTRAN, Ada, Pascal, ACECOBOL<sup>™</sup>,  
Common Lisp...  
Database Management Systems  
INGRES<sup>™</sup>, UNIFY<sup>®</sup>, EMPRESS/32<sup>™</sup>, INFORMIX<sup>®</sup>...  
Communications  
Ethernet<sup>™</sup> (TCP/IP and XNS<sup>™</sup>)  
IBM 2780/5180, 3270, BSC and SNA  
Public Data Networks (X.25)  
Defense Data Network (DDN)

Trademarks: ACECOBOL — Austec, Inc.;  
INGRES — Relational Technology, Inc.;  
EMPRESS/32 — Rhodnius, Inc.;  
Ethernet and XNS — Xerox Corporation.

Registered Trademarks: UNIX — AT&T  
Bell Labs; NFS — Sun Microsystems, Inc.;  
UNIFY — Unify Corporation; INFORMIX —  
Relational Database Systems, Inc.

# MINI-MICRO MARKETPLACE

A special section for advertisers of hardware, software and services.

**READERS:** Please circle reader service numbers on Reader Inquiry Card for additional information.

## ENCLOSURE PRODUCTS

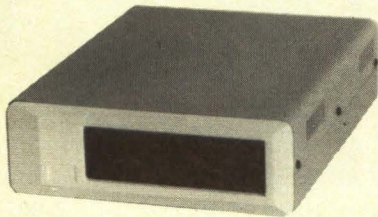

- Tape and Hard Disk Drives Enclosures for all Major Micros.
- Single Board Computer Packages
- Custom Design Available
- Class 'B' Certification Support Can Be Provided
- Call For Pricing and Catalog

**Microware Inc.**

41711 Joy Road • Canton, MI 48187  
(313) 459-3557

CIRCLE NO. 201 ON INQUIRY CARD

## Background Communications

**Softerm PC** lets you transfer files and print in the background while you work. Memory resident, ready to use at any time from your Spreadsheet or Word Processing program. Supports 3 printer and 4 communication ports simultaneously. Includes 32 exact terminal emulations.

For IBM PC/XT/AT, DG, NEC, HP, Wang, TI, Gridcase, Tandy, Zenith

\$195 - Visa, MC, COD  
Call 800-225-8590 orders/info.

**SOFTRONICS**

7899 Lexington Dr., Ste 210  
Colorado Springs, CO 80918  
(303) 593-9540 Telex #450236

CIRCLE NO. 202 ON INQUIRY CARD

**GMX® Micro-20  
68020**  
Single-Board Computer  
Mainframe CPU Performance  
on a 5.75" x 8.8" Board  
(benchmark results available on request)

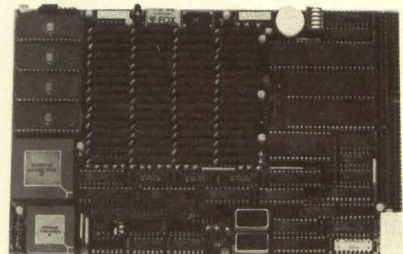

**\$2595**<sup>00</sup> 12.5 MHz Version  
Quantity Discounts Available

### Features

- 32-Bit MC68020 Processor (12.5 or 16.67 MHz)
- MC68881 Floating-point coprocessor (optional)
- 2 Megabytes of 32-bit wide, high-speed RAM
- 4 RS-232 Serial I/O Ports (expandable to 20)
- 8-bit Parallel I/O Port ('Centronics' compatible)
- Time-of-Day Clock w/battery backup
- 16-bit I/O Expansion Bus
- Up to 256 Kbytes of 32-bit wide EPROM
- Floppy Disk Controller for two 5 1/4" drives
- SASI Intelligent Peripheral Interface (SCSI subset)
- Mounts directly on a 5 1/4" Disk Drive

### Software

- Included:**
- GMX version of Motorola's 020Bug Debugger with up/download, breakpoint, trace, single-step, and assembler/disassembler capabilities
  - Comprehensive Hardware Diagnostics

### Optional:

- UNIX™-like Multi-user/Multi-tasking Disk Operating Systems
- OS-9/68000™ (Real-time and PROMable)
- UniFLEX™
- Programming Languages and Applications
- BASIC, C, PASCAL, FORTRAN, COBOL, and ASSEMBLER
- Spreadsheet, Data Base Management, and Word Processing

**GMX INC.**

1337 W. 37th Place, Chicago, IL 60609  
(312) 927-5510 • TWX 910-221-4055  
State-of-the-Art Computers Since 1975

CIRCLE NO. 205 ON INQUIRY CARD

# BLAST®

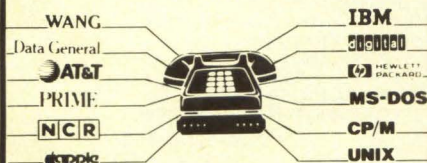

## PC-MINI-MAINFRAME COMMUNICATIONS SOFTWARE

ANY COMPUTER WITH BLAST CAN TALK TO ANY OTHER COMPUTER WITH BLAST, the universal file transfer utility linking many different computers, operating systems, and networks, via RS 232 serial ports

NO ADD-ON BOARDS TO BUY! BLAST software uses any asynchronous modems or direct connect for fast, error-free data transfer through noisy lines and PBXs, across LANs, and over satellites or packet switched networks.

THE PERFECT LOW-COST LINK FOR PC's, MINIS, MAINFRAMES  
Transfer binary or text files, or executable commands. Use BLAST standalone, or build it into your application.

\$250 /Micros \$495-895 /Minis \$2495 /up Mainframes

COMMUNICATIONS RESEARCH GROUP  
(800)-24-BLAST

CIRCLE NO. 203 ON INQUIRY CARD

## 9-Track Tape Drives

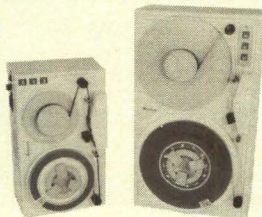

Qualstar's low-cost streaming 1/2" tape drives provide full 1600/3200 BPI capability in a package that is perfect for today's desk-top and desk-side market. Both 7" and 10 1/2" units are available. Interfaces include Cipher/Perfec, SCSI, and IBM-PC. For more information, call us today.

**QUALSTAR®**

9015 Eton Ave., Canoga Park, CA 91304  
Telephone: (818) 882-5822

CIRCLE NO. 204 ON INQUIRY CARD

To advertise in the Marketplace, call Carol Flanagan 617-964-3030.

JANUARY GROUP INC.  
STD BUS 80186 CPU

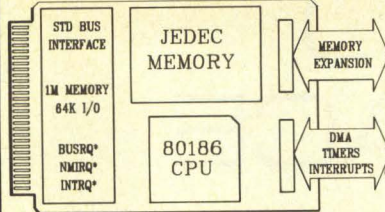

- TRUE 16 BIT 80186 MICROPROCESSOR  
3 TIMERS, 2 CHANNEL DMA, INTERRUPTS
- FOUR 28 PIN JEDEC SOCKETS  
RAM: 6264, 62256 ROM: 2764-27512
- 16 BIT LOCAL MEMORY EXPANSION BUS
- FULL EXTENDED STD BUS INTERFACE
- OPTIONAL MEMORY EXPANSION BOARD  
10 ADDITIONAL JEDEC SOCKETS

JANUARY GROUP INC. (707) 527-9080  
1579 FARMERS LANE #291 SANTA ROSA CA 95405

CIRCLE NO. 206 ON INQUIRY CARD

Share A Serial Printer or Modem without Switching

\$44.95  
Each

Model  
232PDS  
(Printer)

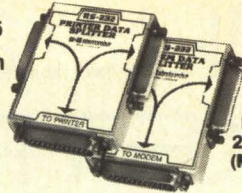

Model  
232MDS  
(Modem)

Both computers or terminals remain connected at same time. Both view same data. No power required. Data lines isolated by passive OR gates. **Order Now! \$44.95 each.** Specify unit desired. All cash orders ppd. (IL Res. add 6% sales tax), MC, VISA accepted. **FREE:** new illustrated catalog of RS-232 interface & testing equipment. Phone: **815-434-0846.** Make checks payable to:

**B & B electronics**  
MANUFACTURING COMPANY  
1500S BOYCE, OTTAWA, IL 61350

CIRCLE NO. 207 ON INQUIRY CARD

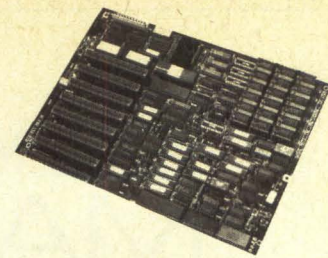

10 Mhz 80286  
IBM PC/XT MOTHERBOARD

- 11.5 Times Faster Than PC; Twice as fast as the AT
- 1MB Ram On-Board Zero Wait States
- Optional 80287 Math Co-Processor
- PC/XT Hardware & Software Compatible
- Supports PC-DOS, Unix, Pick, CP/M-86, SMC OS

**XXX**

WAVE MATE, Inc.

14009 S. Crenshaw Blvd., Hawthorne, CA 90250  
(213) 978-8600 TLX 194369  
In Europe: Brussels 649-1070 TLX 61828

CIRCLE NO. 208 ON INQUIRY CARD

CREATE A BETTER IMAGE

Ioline Corporation introduces the LP3700 large format line plotter: the high performance, professional quality instrument that maximizes value...with a price that draws conclusions:  
**\$4,995.**

The LP3700 offers:

- **Versatility**  
- Lets you plot on any media at any size up through E (37 1/2" x 81")
- **Precision**  
- .0025" Resolution & Repeatability
- **Buffering**  
- 14K to 512K
- **Speed**  
- Up to 10 ips (axial)
- **Reliability**  
- Rugged all metal frame  
- Endurance tested at over 60 million cycles

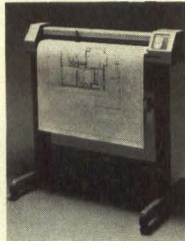

LP3700 Plotter

- **Value**  
- At \$4,995, the LP3700 is in a class all by itself.

19417 36th AVENUE WEST, SUITE D1  
LYNNWOOD, WA 98036  
**IOLINE CORPORATION** (206) 775-7861

CIRCLE NO. 209 ON INQUIRY CARD

600+  
INTERFACE CABLES  
IBM, DEC, HP, PC's  
Overnight Shipping!!  
**EXTENDED DISTANCE**  
PLENUM CABLE  
Lowest Prices  
In The Industry  
TEDC12 Assemblies  
\$15 plus .90 per ft  
**NEW!! NEW!!**  
1200 BPS MODEMS \$159  
2400 BPS MODEMS \$349  
Breakout Boxes, Modem Eliminators, Short Haul Modems, and more!!  
Call for Super Low Introductory Prices!!

Switch Boxes  
ABC BNC S20 95  
ABC RS232C \$39.95  
ABC Centronics \$39.95

USA 800-243-5760 in CT 203-356-9315 Canada 800-233-9542  
FAX 203-323-9044 TWX 510 10 10 669  
Craig Data Products Co., Inc.  
652 Glenbrook Rd Stamford, CT 06906

CIRCLE NO. 210 ON INQUIRY CARD

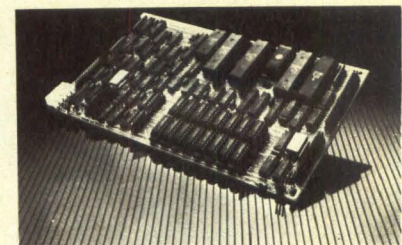

HIGH PERFORMANCE Z-80  
SINGLE BOARD COMPUTERS

Available with either Z-80A or Z-80B CPU, 64-256K RAM, 2-64K ROM or EPROM, 2 or 4 RS-232 serial ports, high speed bi-directional parallel port or an I/O expansion bus. All models have 5 1/4" & 8" disk controller and Centronics parallel printer port. SCSI port and RS-422 ports are also available. Private label systems available.

**DAVIDE CORPORATION**  
P.O. Box 1869E, Buellton, CA 93427  
(805) 688-9598

CIRCLE NO. 211 ON INQUIRY CARD

Real Time Systems, Inc.

Software Systems Developers  
for  
Commercial and MIL-SPEC  
Real Time  
Micro Processor Applications

Robotics	Automated
Avionics	Test Systems
Simulation Software	Communications/ Networking
Process Control	Machine Control Interfaces
Diagnostics	

INTEL 8080, 8085, 8086, 80186, 80286  
MOTOROLA 68000  
DEC 11/XX MINI & MICROS  
IBM PC/XT/AT  
ZILOG Z8000

ADA  
Assembler PASCAL FORTRAN "C" PL/M

For more information contact:  
Al Wehrheim, Vice President  
P.O. Box 22 • Middlebury, CT 06762  
(203) 274-7581

CIRCLE NO. 212 ON INQUIRY CARD

**NOW  
NEW LOW PRICES!**

RS 232C and cables for IBM-PC - high quality imported molded cables with overall shields in choice of frequently used standard lengths. 25 conductor EIA in Male/Male or Male/Female configurations, 10-ft. lengths - \$14.95 each. Call or write our sales engineers for information on Custom Cables or new catalog. **Data Set Cable Company, 722 Danbury Road, Ridgefield, CT 06877-2781 - (203) 438-9684; Las Vegas - (702) 382-6777.**

CIRCLE NO. 213 ON INQUIRY CARD

6809 SINGLE BOARD COMPUTER

The PT-69, a powerful computer system on a single board, performs equal to larger and more expensive systems. It features:

- OS/9 Operating System (Optional)
- 2 8-Bit Parallel Ports
- 2 RS-232 Ports
- Time-of-day Clock
- 56K RAM; 4K EPROM
- Controls up to 4 DS/DD 5 1/4" Drives

**OEM PRICE: \$185**

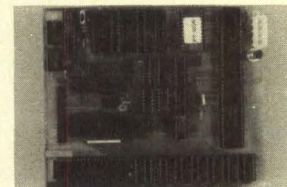

FLOPPY/HARD DISK SYSTEMS AVAILABLE

**PERIPHERAL TECHNOLOGY**  
1480 Terrell Mill Rd., Suite 870  
Marietta, GA 30067  
404/984-0742

• OEM Qty is 100.  
OS/9 is a trademark of Microware and Motorola.

CIRCLE NO. 214 ON INQUIRY CARD

# Thinking of tying low-speed terminals onto a high-speed network?

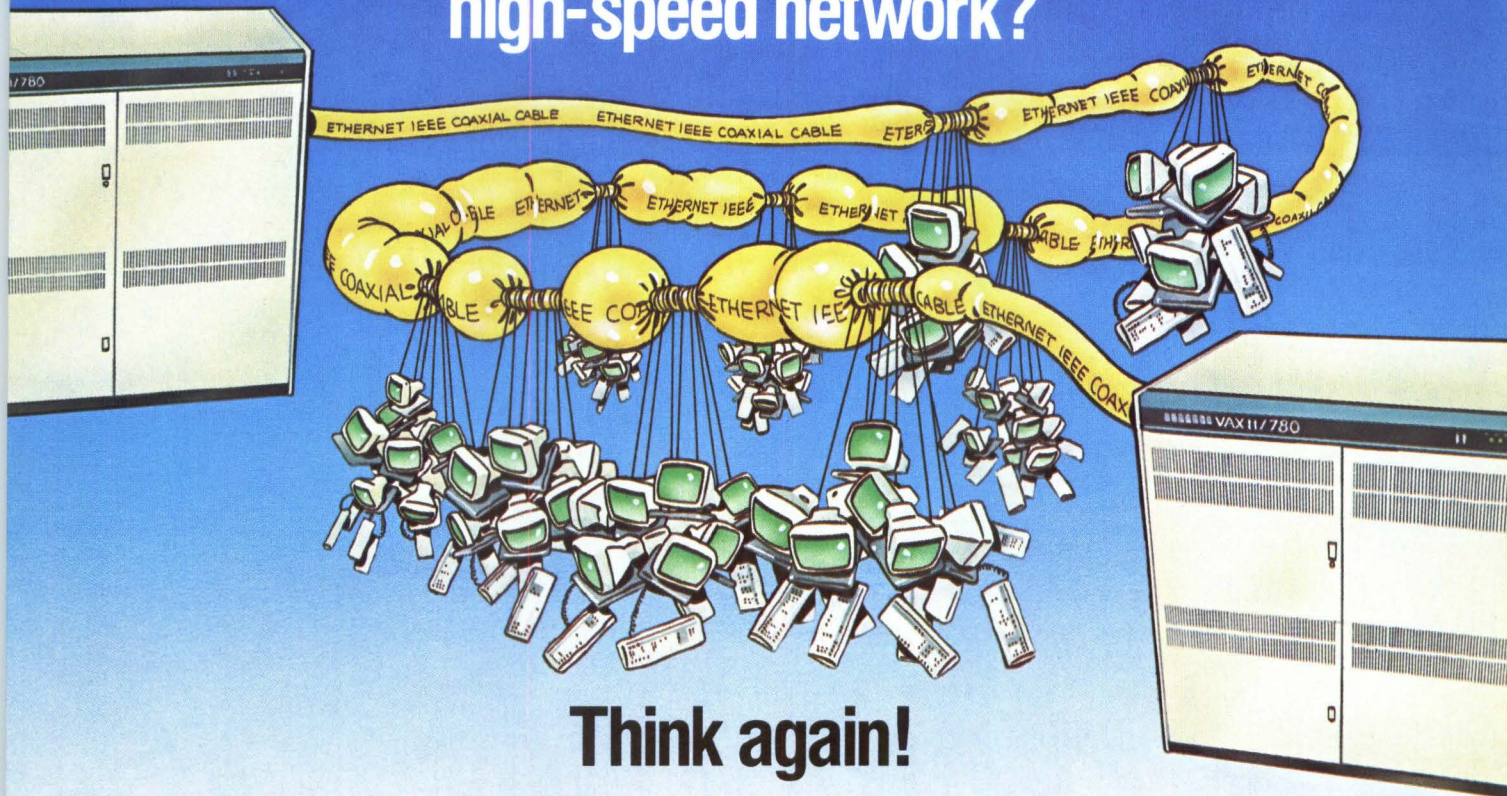

## Think again!

A high-speed LAN is ideal for file transfer, distributed processing and CPU-to-CPU communications. But using it for terminal traffic can cause problems.

### You may be tying up bandwidth.

Low-speed terminal traffic on a high-speed network can rob bandwidth where it's needed most. That means slow file transfers and sluggish response for all network users. The protocol overhead required for a terminal to send small data packets across an Ethernet® link can mean that only 10% of the 10 Mbps bandwidth is available.

By connecting your terminals through an Equinox® Data PBX and connecting your computers together with Ethernet, your LAN runs at top efficiency. An Equinox Data PBX dedicates a full 12 Mbps to terminal data traffic. More than 1300 devices can run continuous 9600 bps data at the same time, providing the best possible response through the network.

### You'll tie up about \$500 per terminal.

When you consider the cost of Ethernet Terminal Servers, Taps, and

Cable, Ethernet can cost between \$300 and \$800 per terminal. An equivalent solution using an Equinox Data PBX with our 8-channel Terminal Servers and twisted pair wiring is about \$100 per terminal.

### You could tie up your computer.

Some Ethernet LANs handle terminal switching by running special software in your computer. So adding terminal traffic means your computer spends more time running the network and less time running applications. An Equinox Data PBX requires no special

software and handles all terminal network processing without disturbing the host. It even allows you to monitor the network load and provides additional security for access control.

### We won't tie you down.

Putting your terminals on an Equinox Data PBX provides more terminal switching features for less money with greater efficiency, so you can get the most out of your LAN. And because it works with all types of computers and terminals you're not tied to a one-vendor solution.

Don't think twice. Call Equinox.  
1-800-DATA-PBX  
In Florida Call (305) 255-3500

Equinox Systems Inc.  
12041 S.W. 144th Street  
Miami, FL 33186-6108

Equinox is a registered trademark of Equinox Systems Inc. Ethernet is a registered trademark of the Xerox Corporation.

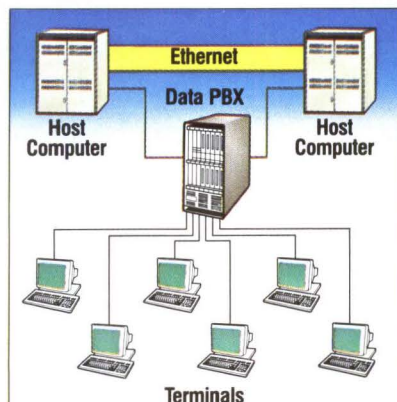

CIRCLE NO. 84 ON INQUIRY CARD

**EQUINOX**  
We Make The Right Connections.

# How to get from dial tone to CTS with UDS' new 224A/D

## Push this, once



Here's a new user programmable, full duplex 2400 bps modem that can handle the entire auto-dial and log-on sequence with a single keystroke! It's the UDS 224A/D — the intelligent version of our 224.

It has all the advantages of our original 224, including V.22bis compliance at 2400 bps and Bell-compatible fallback rates of 1200 and 300 bps. In addition, it offers battery-backed

memory storage for 10 numbers and their log-on sequences, keyboard or automatic dialing (pulse or tone), call progress monitoring and an impressive array of built-in test functions.

For detailed specifications, contact Universal Data Systems, 5000 Bradford Drive, Huntsville, AL 35805.

Phone 205/721-8000  
Telex 752602 UDS HTV.

**NEW!**

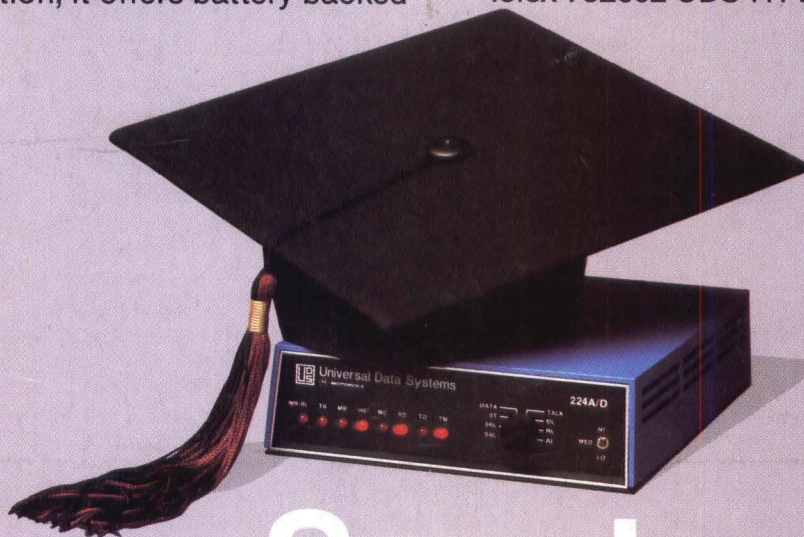

# Smart

 Universal Data Systems



**MOTOROLA INC.**  
Information Systems Group

UDS modems are offered nationally by leading distributors. Call the nearest UDS office for distributor listings in your area.  
DISTRICT OFFICES: Apple Valley, MN, 612/432-2344 • Atlanta, GA, 404/998-2715 • Aurora, CO, 303/368-9000 • Blue Bell, PA, 215/643-2336 • Boston, MA, 617/875-8868 • Columbus, OH, 614/895-3025 • East Brunswick, NJ, 201/238-1515 • Glenview, IL, 312/998-8180 • Houston, TX, 713/988-5506 • Huntsville, AL, 205/721-8000 • Issaquah, WA, 206/392-9600 • Livonia, MI, 313/522-4750 • Mesa, AZ, 602/820-6611 • Milwaukee, WI, 414/273-8743 • Mission Viejo, CA, 714/770-4555 • Mountain View, CA, 415/969-3323 • Richardson, TX, 214/680-0002 • St. Louis, MO, 314/434-4919 • Silver Spring, MD, 301/942-8558 • Tampa, FL, 813/684-0615 • Uniondale, NY, 516/222-0918 • Van Nuys, CA, 818/890-3282 • Willowdale, Ont, Can, 416/495-0008

CIRCLE NO. 85 ON INQUIRY CARD

Created by Dayner/Hall, Inc., Winter Park, Florida