

AUGUST 19, 1976

SEMICONDUCTOR FIRMS FIND PITFALLS IN CONSUMER MARKET/65

Bipolar dynamic memory moves in on MOS/99

How to measure microcomputer input/output performance/ 105

LIBRARY

STATE TECHNICAL INSTITUTE

FOUR DOLLARS

A MCGRAW-HILL PUBLICATION

AT MEMPHIS

Electronics®

38134

1420 TCH598 MCSA9 SEP76
STATE TECHNICAL INST
FREEMAN LIBRARY 017823
5983 MACON COVE
MEMPHIS TN

INPUT / OUTPUT

Applying
optical
isolation
amplifiers



Introducing HP's \$335* DMM.

The right DMM Decision means added performance:

Hewlett-Packard's new 3435A 3½ digit, five function digital multimeter, with full one-year accuracy specifications, is the right decision for your general purpose bench or field needs because it has . . .

Autoranging and manual modes: AC voltage, DC voltage and resistance can be measured either on autorange or manually selected ranges. Select autorange to speed readings and minimize reading error . . . the LED readout always displays appropriate units. For repetitive readings, or AC and DC current measurements, use the manual mode, selecting from at least five ranges for each function . . . again the appropriate units will be automatically displayed.

Wide AC bandwidth, low-range ohmmeter: Eliminate the need for both a high frequency AC voltmeter and a low-range ohmmeter. The 3435A operates over a bandwidth five times greater than most comparably priced DMM's . . . measure AC voltages from 30 Hz up to 100 kHz, with midband accuracy of 0.3% of reading plus three digits. Or, test resistance from a new low range of 20Ω up to 20MΩ. DC voltages up to 1200V are measured with a full-year best accuracy figure of 0.1% of reading plus one digit. AC and DC current ranges extend from 200 μA to 2A. All inputs are protected, polarity is automatically sensed and displayed, and autozero occurs before each reading.

Autoranging and manual modes,

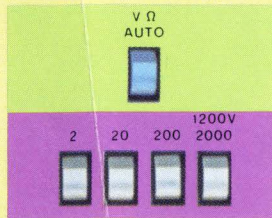

Wide measurement ranges,

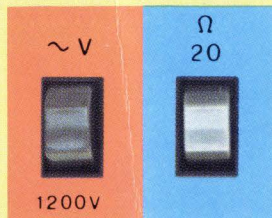

And touch-hold probe accessory.



Special application accessories: For accurate measurements in hard-to-reach spots, use the new 34112A touch-hold probe for only \$40.* You can concentrate on your circuit, conveniently hold the measurement and read the display after removing the probe. You're confident of measuring at the right point without accidentally shorting the circuit. The full line of 3435A accessories also includes probes for measuring AC voltage at frequencies as high as 700MHz and DC voltage up to 40 kV.

Low cost: The standard 3435A priced at \$400* is AC line or battery operated and includes batteries and recharging circuitry. If you don't need battery operation, option 001 gives you line operation only for just \$335.*

Functional design: Low power consumption means fully charged batteries last up to ten hours. And a four-hour charge prepares them for a full eight hours of portable operation. With the modern, rugged case and handle, the 3435A is perfectly suited to demanding field conditions. LSI technology and only three circuit chips mean less down time, greater reliability. A rack mounting model is also available. Of course, the 3435A is backed by HP's service organization. For more information, contact your local HP field sales engineer.

*Domestic U.S.A. price only.

**HP DVM's-
the right decision**

096/45



HEWLETT  PACKARD

Circle 900 on reader service card

Sales and service from 172 offices in 65 countries.

1507 Page Mill Road, Palo Alto, California 94304
For assistance call: Washington (301) 948-6370, Chicago (312) 677-0400,
Atlanta (404) 434-4000, Los Angeles (213) 877-1282, Toronto (416) 678-9430

We've just revolutionized digital troubleshooting. Again.



This time we've done it with a Current Tracing Probe and a Multi-Family Logic Pulser, Probe and Clip.

HP's hand-held logic troubleshooting instruments bring dramatic new capability, speed and convenience to locating logic faults. Use them alone or as a synergistic team to save time, money and frustration. They're the latest wave of the IC troubleshooting revolution we started when we introduced the first logic probe, logic clip and logic pulser.

A Probe that Traces Current! As shown above, the Model 547A Current Tracer's tip lights when on or near a conductor carrying digital current pulses from 1 mA to 1A — in any logic family. Now you know where the current's flowing so you can quickly fix stuck nodes without cutting circuit board traces or removing and often damaging good ICs or micro-processors when searching for bad ones. Now you can quickly find solder bridges and backplane shorts, troubleshoot wired AND/OR busses or three-state busses.

A Logic Pulser That Does More Than Just Give Single Pulses. The new 546A Programmable Logic Pulser (above)

gives one pulse, a 1,10 or 100 Hz pulse stream, or a burst of exactly 10 or 100 pulses. Now you can rapidly set your circuit to any state you wish. It's a voltage and current source that provides the controllable stimulus you need for troubleshooting. It'll drive TTL or CMOS high nodes low or low nodes high.

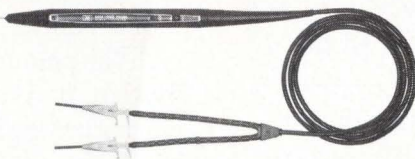

New Multi-Family Logic Probe. The HP 545A tests most positive families including TTL and CMOS. An unambiguous single lamp at probe's tip quickly indicates logic high, low, bad level, pulses, pulse trains. Its built-in pulse memory catches elusive transitions that occur when you're not looking.

New Multi-Family Logic Clip. The Model 548A's 16 LED's show logic states of 16 IC pins at once, revealing the cir-

cuit's truth table. It automatically adapts to TTL, RTL, CMOS and HTL and



automatically seeks Vcc and ground. It draws <math>< 15 \mu A</math> per pin, yet is overload protected to 30 Vdc.

Prices: HP545A \$125, HP546A \$150, HP547A \$350, HP548A \$105, Domestic U.S.A.

Get full details on how this new revolution can help you. Call your nearest HP field engineer today or write.

02604

HEWLETT  PACKARD

Sales and service from 172 offices in 65 countries.
1507 Page Mill Road, Palo Alto, California 94304

We think a board tester should catch \$3 defects while they still cost \$3 to fix.

Any defect your board tester doesn't catch right away is going to cost you money—lots of it. And if the defect goes all the way to your customer, it could even cost you your reputation for reliability.

Catch defects before your customers do.

Consider the Hewlett-Packard DTS-70 Digital Test System for your board testing needs. It's a system designed to let you catch more \$3 defects while they still cost just \$3 to fix—not three hundred dollars or more. The speed and efficiency of the DTS-70 helps reduce human error while actually increasing fault detection and location. Quick, accurate, fault location that tells you what the problem is and where it is.

Our advanced test generation capability can handle large circuit boards, up to 200 MSI IC's or 10,000 gate equivalents, so you need not be concerned that your boards are too large or complex. The DTS-70 simulates faults without needing a known good board. It provides a

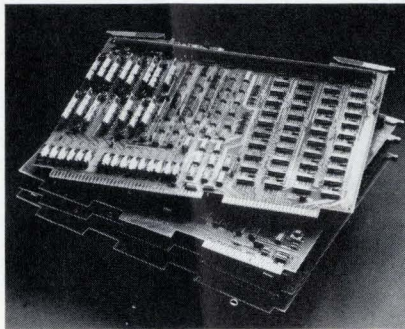

Complex boards mean higher failure rates.

learn the entire testing procedure and start running tests in a few hours. And what's more, our system is the expert. It automatically provides the operator assistance needed. If you make a mistake during test operation the system not only tells you, it gives you instructions on what to do next.

It could pay for itself in less than a year.

The Hewlett-Packard DTS-70 is a system designed to save you money.

In fact, it could literally pay for itself in less than a year of operation.

You can use the system's minicomputer efficiency to generate tests for new boards while normal production testing continues.

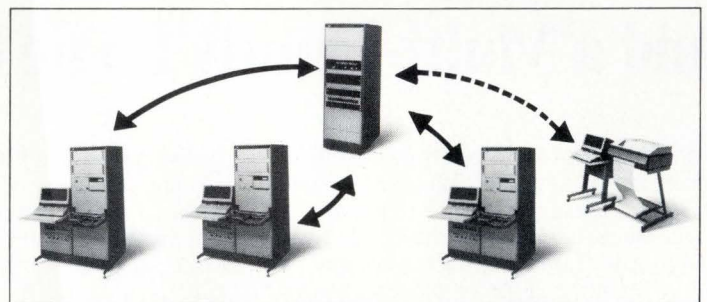

The new Hewlett-Packard DTS-70 Digital Test System.

WARRANTY REPAIR COST	IN PLANT REPAIR COST
\$300.	\$3.00

measure of test effectiveness at each stage of test generation so that you know when you have a truly comprehensive test.

The Board Tester should be an expert. Not you.

Our DTS-70 Digital Test System is so easy to use that your production test operators can

Or, as production test needs grow, up to three test stations can be operated from the same minicomputer.

The new Hewlett-Packard Digital Test System. It gives you all the features that you need at a surprisingly low cost.

We're on the spot to provide service and support worldwide. So for more complete information, call your nearby Hewlett-Packard office or write. We'll be glad to send you our brochures on the DTS-70 Digital Test System and TESTAID III software.

HEWLETT  PACKARD

Sales and Service from 172 offices in 65 countries.
1507 Page Mill Road, Palo Alto, California 94304

06603A

31 Electronics Review

INSTRUMENTS: Analyzers for microprocessors come on strong, 31
LAND-MOBILE RADIO: Try at standards stirs makers, users, 32
RADAR: Balloon-borne radar to look for low fliers, 33
COMPUTERS: Intel 8080 in a box woos systems business, 33
CITIZENS' BAND: 40-channel permit slows 23-channel sales, 34
PACKAGING & PRODUCTION: Hybrid circuit shrinks brushless motor, 36
COMPUTERS: Self-repairing unit being built at Raytheon, 38
NEWS BRIEFS: 38
MATERIALS: Ceramic's properties are enhanced for hybrids, 40
AUTOMOTIVE: GM chooses custom chip for digital ignition timing, 43

51 Electronics International

GREAT BRITAIN: Plessey's push into new memory technologies, 51
AROUND THE WORLD: 51
WEST GERMANY: Standard hybrid RC filter can be customized, 52

65 Probing the News

COMPANIES: The high risk of vertical integration, 65
Sandia's new lab helps IC makers, 69
COMMUNICATIONS: Europeans await new systems, 73
AIR-TRAFFIC CONTROL: Canada getting JETS, 77

81 Technical Articles

COMPONENTS: Optical coupling extends isolation-amplifier uses, 81
MICROPROCESSORS: Z-80 chip set heralds third generation, 89
DESIGNER'S CASEBOOK: Comparators generate 2-phase clock, 94
Amplifier adds sign bit to a-d converter output, 95
SOLID STATE: Dynamic PL RAM competes with MOS designs, 99
COMPUTERS: Evaluating a microcomputer's I/O performance, 105
ENGINEER'S NOTEBOOK: Layouts minimize noise in digital systems, 110
ICs replace memory scope for pulse measurements, 111

117 New Products

IN THE SPOTLIGHT: Multimeter is controlled by 8080 'brain,' 117
Citizens' band radio market spawns novel switch designs, 120
Multimeter/counter rides piggyback on oscilloscopes, 125
INSTRUMENTS: Low-power multimeter has liquid-crystal display, 126
SEMICONDUCTORS: Data-acquisition system components bow, 132
DATA HANDLING: Paper-tape reader loads programs fast, 138
MICROWAVE: Gallium-arsenide FET puts out 25 milliwatts, 146

Departments

Publisher's letter, 4
Readers' comments, 6
News update, 8
People, 14
Meetings, 20
Electronics newsletter, 25
Washington newsletter, 47
Washington commentary, 48
International newsletter, 55
Engineer's newsletter, 114
New literature, 153

Highlights

Cover: Light transforms isolation amplifiers, 81

By enhancing their response and bandwidth, shrinking their size, and getting rid of all electromagnetic interference, optical coupling opens up new applications for isolation amplifiers. Medical electronics, avionics, and nuclear-power generation will be among the beneficiaries.

Cover design is by Art Director Fred Sklenar.

Consumers pose hazards for solid-state firms, 65

The fast-moving market of consumer electronics penalizes any manufacturer whose products fall behind in reliability, technology, delivery, and cost-competitiveness. But the high potential profits are encouraging some semiconductor firms to persevere.

Z-80 heralds third microprocessor generation, 89

With up to five times the throughput of its predecessors and half to a quarter their program memory, the Z-80 chip set achieves a new high in microprocessor performance. It's also software-compatible at the machine-code level with the popular 8080A.

Bipolar RAM butts into main-memory field, 99

A 4,096-bit random-access memory, employing integrated injection logic for its technology and sophisticated processing methods, is the first serious bipolar competitor for 4-k metal-oxide-semiconductor designs. It is twice as fast as them, dissipates about the same amount of power, and costs only a little more.

And in the next issue . . .

Wescon preview: the people, the program, and the products . . . tips for users of 4-k semiconductor memories . . . analog-to-digital conversion at 10 times the speed—a new technique.

EDITOR-IN-CHIEF: Kemp Anderson

EXECUTIVE EDITOR: Samuel Weber

MANAGING EDITOR: Arthur Erikson,
International

SENIOR EDITORS: Laurence Altman,
Ray Connolly, Lawrence Curran,
John Johnsrud, H. Thomas Maguire,
Stephen E. Scrupski

ART DIRECTOR: Fred Sklenar

ASSOCIATE EDITORS: Howard Wolff,
Gerald M. Walker, Alfred Rosenblatt

DEPARTMENT EDITORS

Aerospace/Military: Ray Connolly

Circuit Design: Don Blattner

Communications & Microwave:

Richard Gundlach

Components: Lucinda Mattera

Computers: Stephen E. Scrupski

Consumer: Gerald M. Walker

Instrumentation: Andy Santoni

New Products: H. Thomas Maguire,

Michael J. Riezenman

Packaging & Production: Jerry Lyman

Solid State: Laurence Altman

CHIEF COPY EDITOR: Margaret Eastman

COPY EDITORS: Everett C. Terry, Ben Mason

ART: Charles D. Ciatto, *Associate Director*
Paula Piazza, *Assistant Director*

EDITORIAL SECRETARIES: Janet Noto,
Penny Roberts, Marilyn B. Rosoff

FIELD EDITORS

Boston: Lawrence Curran (Mgr.), Pamela Leven

Los Angeles: Larry Waller (Mgr.)

Midwest: Larry Armstrong (Mgr.)

New York: Bruce LeBoss (Mgr.)

San Francisco: Bernard Cole (Mgr.)

Judith Curtis

Washington: Ray Connolly (Mgr.)

Frankfurt: John Gosch

London: William F. Arnold

Paris: Arthur Erikson

Tokyo: Charles Cohen

McGRAW-HILL WORLD NEWS

Editor: Michael Johnson

Brussels: James Smith

Madrid: Dom Curcio

Milan: Andrew Heath

Moscow: Peter Gall

Paris: Joel Stratte-McClure

Stockholm: Robert Skole

Tokyo: Colin Gibson

PUBLISHER: Dan McMillan

DIRECTOR OF MARKETING: Pierre J. Braudé

MARKETING ADMINISTRATION MANAGER:
Wallis Clarke

CIRCULATION MANAGER: Nancy L. Merritt

MARKETING SERVICES MANAGER:
Tomlinson Howland

RESEARCH MANAGER: Margery D. Sholes

Microprocessors are certainly among the most versatile devices ever created by electronics technology, and it's hard to believe that just a few years ago they did not even exist. Yet new as they are, not even microprocessors are sheltered from progress.

For example, on page 89, you'll find a technical article on a new microprocessor chip set that warrants being called part of the third microprocessor generation. The article, by a team from Zilog Inc., points out that "the Z-80 microprocessor chip set represents as big an advance as was made between the 8008 and the 8080." Incidentally, two of the co-authors of the article—Zilog president Federico Faggin and Masatoshi Shima—also co-authored the first full technical article on the Intel 8080 microprocessor [*Electronics*, April 18, 1974, p. 95].

Amazingly, reports Faggin, "The first time we tested the Z-80 chip, it was almost workable, except for a couple of instructions. But the second time, after we made the changes, we put the wafer under the probe and ran the software directly on it." It worked. "And then we had a celebration, of course."

Incredible as it sounds, this success story has a rationale. "This was probably the first time that a chip was developed at the same time as the software and the development system," explains Zilog's president. Without such an approach, even a small change in one of the three areas can ripple through the other two, requiring many other changes.

Faggin says Zilog, which obtained its final financial commitments from Exxon Enterprises in June 1975, started with a team of 11 people who

remained together throughout the development of the Z-80. Now the company totals 42 employees and is getting ready to move next month from Los Altos to a new plant in Cupertino that will hold the company's own wafer fabrication facilities. Till now, Zilog has had to use outside suppliers.

There's more, too, in this issue about microprocessors. On page 105, we are presenting an article on how to evaluate a microprocessor's input/output performance, which in most applications is as important a parameter as the device's internal data-handling ability.

As Howard Raphael of Intel Corp., who wrote the article, explains: "Through its input/output lines, the microprocessor correlates the activities of all the other system elements, including keyboards, printers, and disk units. Its value to the system depends heavily on how well it performs these input/output functions. For a designer to choose the most cost-effective microcomputer for a given application, therefore, he requires a standard by which to measure and compare different microcomputers."

The article describes a valid method of comparing such performance. The activity index presented should be of help in evaluating what is, after all, a prime characteristic of a microcomputer—its ability to communicate with other system elements.



August 19, 1976 Volume 49, Number 17
96,136 copies of this issue printed

Published every other Thursday by McGraw-Hill, Inc. Founder: James H. McGraw 1860-1948. Publication office 1221 Avenue of the Americas, N.Y., N.Y. 10020; second-class postage paid at New York, N.Y., and additional mailing offices.

Executive, editorial, circulation and advertising addresses: Electronics, McGraw-Hill Building, 1221 Avenue of the Americas, New York, N.Y. 10020. Telephone (212) 997-1221. Teletype 12-7360 TWX 710-581-4879. Cable address: MCGRAW HILL NEW YORK.

Subscriptions limited to professional persons with active responsibility in electronics technology. Publisher reserves the right to reject non-qualified requests. No subscriptions accepted without complete identification of subscriber name, title, or job function, company or organization, and product manufactured or services performed. Subscription rates: in the United States and possessions \$12.00 one year, \$30.00 three years; Canada and Mexico \$14.00 one year, \$32.00 three years; Europe \$35.00 one year, \$87.50 three years; Japan, Israel and Brazil \$60 per year; Australia and New Zealand \$80.00 per year, including air freight; all other countries \$40.00 per year. Limited quota of subscriptions available at higher than basic rate for persons outside of field served, as follows: U.S. and possessions and Canada \$25.00 per year; Europe \$40.00; Japan, Israel and Brazil \$85.00; all other countries \$50.00. Single copies: \$4.00. Please allow four to eight weeks for shipment.

Officers of McGraw-Hill Publications Company: Gordon L. Jones, President; Paul F. McPherson, Executive Vice President; J. Elton Tuohig, Executive Vice President-Administration; Gene W. Simpson, Group Vice President; Senior Vice Presidents: Ralph Blackburn, Circulation; John B. Hoglund, Controller; Ralph R. Schulz, Editorial; David G. Jensen, Manufacturing; Vice Presidents: James E. Boddorf, Planning & Development; Edward E. Schirmer, Marketing Administration.

Officers of the Corporation: Harold W. McGraw, Jr., President, Chief Executive Officer, and Chairman of the Board; Robert N. Landes, Senior Vice President and Secretary; Ralph J. Webb, Treasurer.

Title registered in U.S. Patent Office; Copyright © 1976 by McGraw-Hill, Inc. All rights reserved. The contents of this publication may not be reproduced in whole or in part without the consent of copyright owner.

Subscribers: The publisher, upon written request to our New York office from any subscriber, agrees to refund that part of the subscription price applying to copies not yet mailed. Please send change-of-address notices or complaints to Fulfillment Manager; subscription orders to Circulation Manager, Electronics, at address below. Change-of-address notices should provide old as well as new address, including postal zip code number. If possible, attach address label from recent issue. Allow one month for change to become effective.

Postmaster: Please send form 3579 to Fulfillment Manager, Electronics, P.O. Box 430, Hightstown, N.J. 08520.

From DC to 1 megahertz, the Model 7500 direct coupled amplifier puts up to 75 watts and 125 VRMS at your fingertips. This all solid state unit offers typical frequency response of $\pm .05$ db and harmonic distortion of .05%. Output circuit is both current and voltage protected. Voltage gain is 0 to X100, fixed or variable. Both AC and DC input coupling are provided. Ideal for precision meter calibration and transducer driving. Price \$1500.00. Stick with the WAVEMAKERS.™ Write for complete details, phone (617) 580-1660 or any listed office.

KH KROHN-HITE CORPORATION

Avon Industrial Park, Avon, Mass. 02322 • (617) 580-1660

SALES OFFICES: **ALA.**, Huntsville (205) 534-9771; **ARIZ.**, Scottsdale (602) 957-9110; **CAL.**, San Jose (408) 292-3220; Inglewood (213) 674-6850; **COL.**, Denver (303) 773-1218; **CONN.**, Glastonbury (203) 633-0777; **FLA.**, Orlando (305) 894-4401; **GEO.**, Atlanta (404) 448-2365; **HAWAII**, Honolulu (808) 941-1574; **ILL.**, Des Plaines (312) 298-3600; **IND.**, Indianapolis (317) 244-2456; **MD.**, Baltimore (301) 321-1411; **MASS.**, Lexington (617) 861-8620; **MINN.**, Minneapolis (612) 884-4336; **MO.**, Kansas City (816) 454-5836; St. Louis (314) 423-1234; **N.C.**, Burlington (919) 227-3639; **N.J.**, Cherry Hill (609) 482-0059; **N.M.**, Albuquerque (505) 255-2330; **N.Y.**, E. Syracuse (315) 437-6666; Rochester (716) 328-2230; Vestal (607) 785-9947; Elmont (516) 488-2100; **OHIO**, Chesterland (216) 729-2222; Dayton (513) 434-8993; **OKLA.**, Tulsa (918) 299-2636; **ORE.**, Portland (503) 297-2248; **TEX.**, Addison (214) 661-0400; Houston (910) 881-5532; **VA.**, Falls Church (703) 573-8787; **WASH.**, Bellevue (206) 454-3400; **CANADA**, Montreal, Quebec (514) 341-7630; Ottawa, Ontario (613) 235-5121; Toronto, Ontario (416) 445-9900; Vancouver, British Columbia (604) 253-5555; Halifax, Nova Scotia (902) 454-8321; St. John's, Newfoundland (709) 726-2422.

the 7500 amplifier... WIDEBAND-AID for system designers



Circle 5 on reader service card

2 AMP Ripple Current Capability at 50°C and 40 KHz

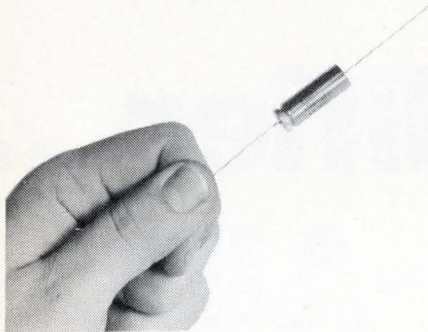

In a capacitor rated
300 microfarads at
30 VDC that measures
only .375 inch diameter
and 1.062 inch long.

You can have that and more with PuriTan™, the tantalum-cased capacitor that precludes silver migration. The secret to PuriTan's superior AC ripple characteristic is its sintered tantalum cathode which provides both a continuous 3 VDC reverse voltage capability and a lower ESR/Impedance characteristic.

Now qualified to MIL-C-39006/22A (CLR79) the PuriTan solves your problems with:

- Superior AC ripple characteristics
- Reverse voltage capability
- Excellent capacitance stability
- True glass-to-tantalum hermetic seal
- Low ESR
- Low DC leakage

For complete information on the PuriTan all-tantalum capacitor and/or other Tansitor capacitors, call your local Tansitor representative, or contact:

Tansitor
ELECTRONICS
DIVISION OF AEROTRON, INC.

West Road, Bennington, Vermont 05201
Phone (802) 442-5473 TWX (710) 360 1782

Specialists in Tantalum Capacitors

TM Trademark of Tansitor Electronics

6 Circle 6 on reader service card

Readers' comments

Collector resistor was too big

To the Editor: In the circuit shown in "Triangular waves from 555 have adjustable symmetry," by Devlin M. Gualtieri [Jan. 8, p. 111], I do not understand how transistor Q_1 switches on and off, depending on collector voltage of Q_3 . The base of Q_1 seems to be pegged at 3.3 v due to the zener connected between supply positive and Q_1 base. Q_3 does not change this voltage.

I. A. Dasan
Salem, India

■ **The author replies:** Dasan is correct in pointing out that the V_{BE} of Q_1 never goes below about 3 volts for the circuit shown because of the current flow through the zener in the base circuit of Q_2 . When Q_3 is off, its collector never goes above about 7.5 v, whereas about 11 v is needed to turn Q_1 off.

In my zeal to simplify the circuit and decrease its current drain, I specified the Q_3 collector resistor too high; 390 ohms or smaller would be correct. Likewise, the current-limiting resistors for the two zeners could be increased. Q_2 , however, has no turn-off problem, since Q_3 clamps its base voltage nearly to ground; thus, a change of one resistor value will correct the circuit.

Encouraging acupuncture

To the Editor: For the last three years, we have been producing electronic acupuncture devices for both "detecting" and "treating" acupuncture points. These devices, while experimental (FDA requirement), have been patterned after both Japanese and Chinese approaches to this field. We have also been offering educational courses to doctors of various disciplines and have earned an excellent reputation for devices and instruction.

Most recently, we have been supporting education and devices for a "newer" discipline, which is done almost exclusively on the ear and is called auriculotherapy, patterned after a French Dr. Nogier's work.

I appreciate the international emphasis ("Laser allows 'needleless' acupuncture," p. 8E, Jan. 8).

Jerry J. Tomacek
Professional Medical Distributors
Wixom, Mich.

the NAKED* ADC



5 DIGIT ACCURACY

The Model 109 yields linearity better than $\pm 0.0025\%$. With gain and offset errors trimmed out, the absolute accuracy of the Model 109 makes it compatible with resolutions of ± 16 bits binary or $\pm 5\frac{1}{2}$ digits BCD.

SUPER STABLE

Gain TC $< \pm 1$ ppm/ $^{\circ}$ C
Offset TC $< \pm 0.2$ ppm/ $^{\circ}$ C

ECONOMIC

\$99.00
(100's)

*Requires external counter and clock.

intech
function modules

282 Brokaw Rd., Santa Clara, CA 95050
Tel. (408) 244-0500, TWX 910 338-0254

Circle 163 on reader service card

sticks sticks sticks!

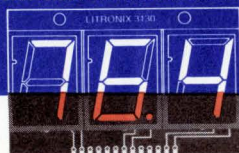

Preassembled LED displays cut price per digit and save labor

Big Sticks are what's new in LED packaging. And naturally Litronix is coming on first and strongest with eight different preassembled displays of 1" and 1/2" digits.

Price per digit is 20% to 25% less than earlier single-digit mounts. Add to that the saving in assembly and inventory costs and you've found the best LED display bargain of the year.

Inch-high displays come in modules of 2, 3, and 4 digits—the last with a colon for clocks and indicator lamps for AM, PM and alarm.

Half-inch displays are available with 2, 3 1/2, 4 and 6 digits per stick. The 3 1/2 digit module has plus and minus signs, and can be combined with the other modules to create instrument displays of almost any length. There are two half-inch 4-digit modules, one for general use with closely spaced digits, and one for clocks with a colon, built-in multiplexing, and indicator lamps for AM, PM and alarm.

If you need big digits, you'll prefer Big Sticks. Can we throw some your way?

Litronix, 19000 Homestead Road, Cupertino, California 95014. Phone (408) 257-7910.

No wonder
we're No.1
in LEDs

litronix

Get the scope you need—Now!

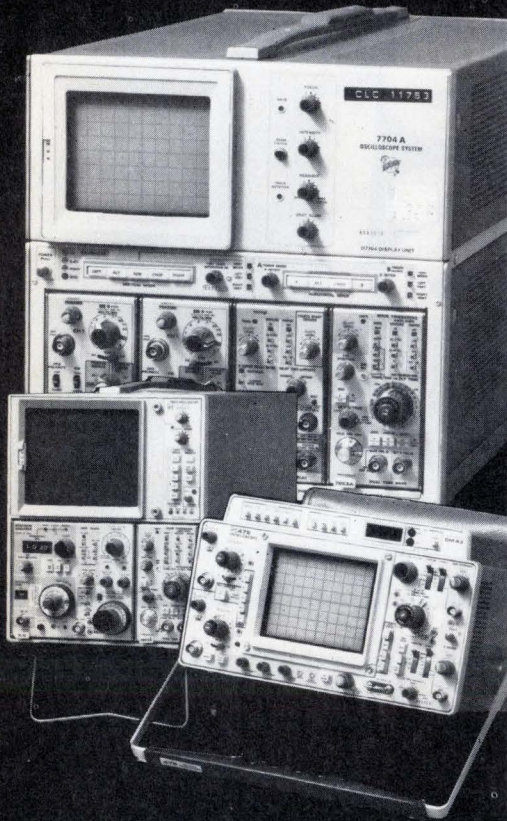

Our "Instrument Professionals" will tell you which scope will do the job best, at the lowest cost, make immediate delivery and guarantee performance.

Write or call for data on our other specialties: Instrument Leasing • Computer Peripherals • Equipment Sales • Instrument Service.

Circle 8 on reader service card

Call  Get our FREE Catalog

Continental Rentals

Div. Continental Leasing Co., Inc.
175 Middlesex Turnpike, Bedford,
MA, 01730 (617) 275-0850

Metuchen, NJ (201) 549-8500;
Gaithersburg, MD (301) 948-4310; TX
(214) 357-1779; Elk Grove, IL (312)
439-4700; Costa Mesa, CA (714)
540-6566; Santa Clara, CA (408)
735-8300; Los Angeles, CA (213) 477-7521

News update

■ When Hewlett-Packard Co decided to compete head-to-head with oscilloscope-industry front-runner Tektronix, it brought out a 100-megahertz-bandwidth scope, the model 1740A. In the year since it challenged the then three-year-old Tektronix model 465 [*Electronics*, Sept. 4, 1975, p 31], HP has done at least well enough to have identified receptive market segments.

Thus, again following Tektronix' lead, it has added a TV-synchronizing option to better fit the scope to market needs. The option, says Herman Hinton, oscilloscope product-line manager at HP's Colorado Springs division, "allows you to conveniently synchronize on the video signal of a TV set." The option will cost between \$150 and \$200, he says, and HP is just beginning to ship it to customers.

As to how well HP, a distant second to Tektronix in overall scope sales with about 15% of the sales dollars, is doing with the model 1740A, Hinton says sales have "exceeded my expectations." He adds that the scope "has been well received at the marketplace," though he concedes that HP's market share has not increased.

■ Fairchild Camera and Instrument Corp.'s variable analog delay line using charge-coupled devices has been available for a year to audio and video processors. Although the company had a large market in mind for the model 311 and even talked of prices in the \$15 area for large-quantity orders [*Electronics*, Sept. 4, 1975, p. 36], it realizes now that the 311 probably was never destined to be produced in high volume because it had only 260 elements—a pair of 130-bit analog shift registers on a single chip.

Now, to expand the market potential a bit, Fairchild has built a second model—a dual 455-element device with a NTSC-standard one-horizontal-line delay. Labeled the CCD-321, it is priced at \$72 in 100-unit orders. The 311, by the way, now carries a \$40 price tag for the same volume, instead of its original \$50.

When you want a small package delivered fast, it's in the bag.



Delta's DASH guarantees delivery on the flight or routing you specify between all Delta cities and most cities served by other airlines through interline agreements. Packages accepted up to 50 lbs. with length plus width plus height not to exceed 90."

Call Delta for an expedited pick-up, or bring your package to Delta's passenger counter at least 30 minutes before scheduled departure time (or to the air cargo terminal at the airport 60 minutes before scheduled departure time). The package can be picked up at the DASH Claim Area next to the airport baggage claim area 30 minutes after flight arrival at destination. Or we deliver it at an additional charge. **DELTA**
The airline run by professionals

Rate examples (Tax included)

Atlanta-Washington	\$21.00
Boston-Miami	26.25
Los Angeles-New Orleans	31.50
Dallas/Ft. Worth- Los Angeles	26.25
San Francisco-Atlanta	31.50
Philadelphia-Houston	26.25
New York-Tampa	26.25
Chicago-Orlando	26.25
Detroit-Memphis	21.00

For full details, call Delta reservations.

For expedited pick-up and delivery at extra charge, call 1-800-424-1092 toll free anywhere in the Delta system. In Washington, D.C. call 466-3131.

Delta is ready when you are.

Circle 164 on reader service card



Introducing the first pocket programmable that remembers your programs and data even when it's turned off. The new HP-25C. \$200.00*

Meet the first Scientific Programmable calculator that lets you take a breather midway through your solution *without* having to start all over again when you get back. The reason: Its memory and storage registers stay ON even when you shut it OFF†—during a phone call, a meeting or a weekend.

It's called the HP-25C. (Incidentally, the "C" stands for "Continuous Memory C-MOS" technology.) *Continuous Memory*

Here's what Continuous Memory does for you:

1. It lets you key in your favorite program—debug it—and retain it in memory for repeated use. So you gain accuracy as well as time.
2. You can add additional functions not on the keyboard (hyperbolics, octal/decimal conversions, etc.), simply by writing programs and storing them permanently in memory.
3. It enables you to gather data one place (such as at a survey jobsite) and retain your results until you get back to work with them later (just think of the time you'll save and the accuracy you'll gain because you *won't* have to re-enter information).

4. You don't lose data when you lose battery power. Here's why:

when all the decimal points display—indicating a low battery—your data and program will not be lost provided the calculator is turned OFF and the recharger is promptly connected. The HP-25C will even retain your data and program for at least 5 seconds—without *any* battery at all—while you are replacing a discharged battery with a charged one.

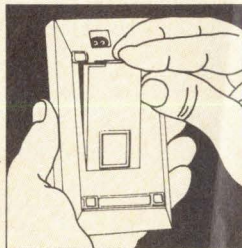

But there's more. Aside from Continuous Memory, the HP-25C is identical to our popular HP-25. Both give you a total of 72 pre-programmed functions and operations; complete keystroke programmability; branching and conditional test capability and fixed decimal, scientific and engineering (exponent in

multiples of ± 3) notations.

You also get our RPN logic system with 4-register stack and 8 storage registers.

And every program written for the HP-25 will work *without modification* for the HP-25C.

The HP-25C. There's never been a Scientific Programmable Calculator like it before.

Best of all, the HP-25C's got HP's name on it. And you know what that means. Design, performance and a back-up support system you just can't get anyplace else.

Why not "test touch" one for yourself? Or, if Continuous Memory is not important to your particular application, try our standard HP-25, \$145.00*. For complete HP-25C specs and the name of your nearest dealer, call toll-free 800-538-7922 (in Calif. 800-662-9862).

THE HP-25C AT A GLANCE

- Program memory and storage registers stay ON at all times.
- 72 functions and operations.
- Keystroke programmability.
- Full editing capability.
- Branching and conditional test capability.
- 8 addressable memories.
- Fixed decimal and scientific notation—plus engineering notation.
- RPN logic system with 4-memory stack.
- \$200.00*

616/10

HEWLETT  PACKARD

Sales and service from 172 offices in 65 countries.
Dept. 214F, 19310 Pruneridge Avenue, Cupertino, CA 95014.

*Suggested retail price, excluding applicable state and local taxes—Continental U.S., Alaska & Hawaii.

†The HP-25C's C-MOS memory chips consume only 1/80,000 of the calculator's normal operating power. Thus, a fully charged battery pack can hold your programs and data for at least 1½ months with the HP-25C turned off.

Circle 9 on reader service card

**Here
come
the
Twenties!**

Here. Advanced Micro Devices.

Registers. Inverters. Buffers. Decoders. Counters. All twenty pins. The nicest thing to happen to TTL logic since low-power Schottky.

The twenty-pin configuration not only makes better packages. It makes better ideas. Eight in. Eight out. Power supply. Ground. And two pins to tell it what to do. Perfect for use with 8-bit wide microprocessors.

No more Too-Much Twenty-Fours. Too much board space. Too much handling difficulty.

No more Not-Enough Sixteens. Not enough functional capability.

The Twenties just happen to be the magic blend of size and logic. Like the Am25LS23. It's an 8-bit serial in/parallel out universal shift register with synchronous clear and three-state outputs. (The Am25LS299, our asynchronous version, is also available.)

Call, write or wire Advanced Micro Devices. The Twenties are here!

Here:

Am25LS SERIES	54/74LS SERIES	FUNCTION	AVAILABILITY
Am25LS15		Quad Serial Adder/Subtractor	Now
Am25LS22		Eight-Bit Register with Sign Extend	Now
Am25LS23		Eight-Bit Shift Register, Synch. Clear	Now
Am25LS240	Am 54/74LS240	Octal Bus Buffer	4th Q.
Am25LS241	Am 54/74LS241	Octal Bus Inverter	4th Q.
Am25LS273	Am 54/74LS273	Octal D-Type Register	4th Q.
Am25LS299	Am 54/74LS299	Eight-Bit Shift Register, Asynch. Clear	Now
	Am54/74LS322	Second Source to Am25LS22	Now
	Am 54/74LS323	Second Source to Am25LS23	Now
Am25LS373	Am 54/74LS373	Octal Transparent Latch	4th Q.
Am25LS374	Am 54/74LS374	Octal D-Type Register	4th Q.
Am25LS377	Am 54/74LS377	Octal D-Type Register	4th Q.
Am25LS381	Am 54/74LS381	Four-Bit Arithmetic Logic Unit	3rd Q.
	Am 54/74LS385	Second Source to Am25LS15	Now
Am25LS2517		Four-Bit Arithmetic Logic Unit	3rd Q.
Am25LS2526		Four-Bit Register (Dual Outputs)	4th Q.
Am25LS2537		One-of-Ten, Three-State Decoder	1st Q.
Am25LS2538		One-of-Eight, Three-State Decoder	1st Q.
Am25LS2539		Dual One-of-Four, Three-State Decoder	1st Q.
Am25LS2568		Four-Bit, Three-State Up-Down Counter	1st Q.
Am25LS2569		Four-Bit, Three-State Up-Down Counter	1st Q.
Am25LS2540		Octal Bus Buffer	4th Q.
Am25LS2541		Octal Bus Inverter	4th Q.
Am2900 SUPPORT			
	Am2907	LSI Bus Transceiver (O.C.)	Now
	Am2911	Microprogram Sequencer	Now
	Am2913	Priority Interrupt Expander	3rd Q.
	Am2917	LSI Bus Transceiver (Three-State)	3rd Q.

Advanced LP/Schottky



Advanced Micro Devices • 901 Thompson Place, Sunnyvale, California 94086 • Telephone (408) 732-2400 •
Distributed nationally by Hamilton/Avnet, Cramer and Schweber Electronics.

Circle 262 on reader service card

"Power FETs bipolars in the next

"Field-effect transistors are one of the oldest branches on the semiconductor family tree, and the simplest active devices to use today. But until Siliconix developed a 25-watt VMOS power FET, you could not take advantage of that simplicity in digital drive, power supplies, servos, motor control and most other high current switching and linear circuits."

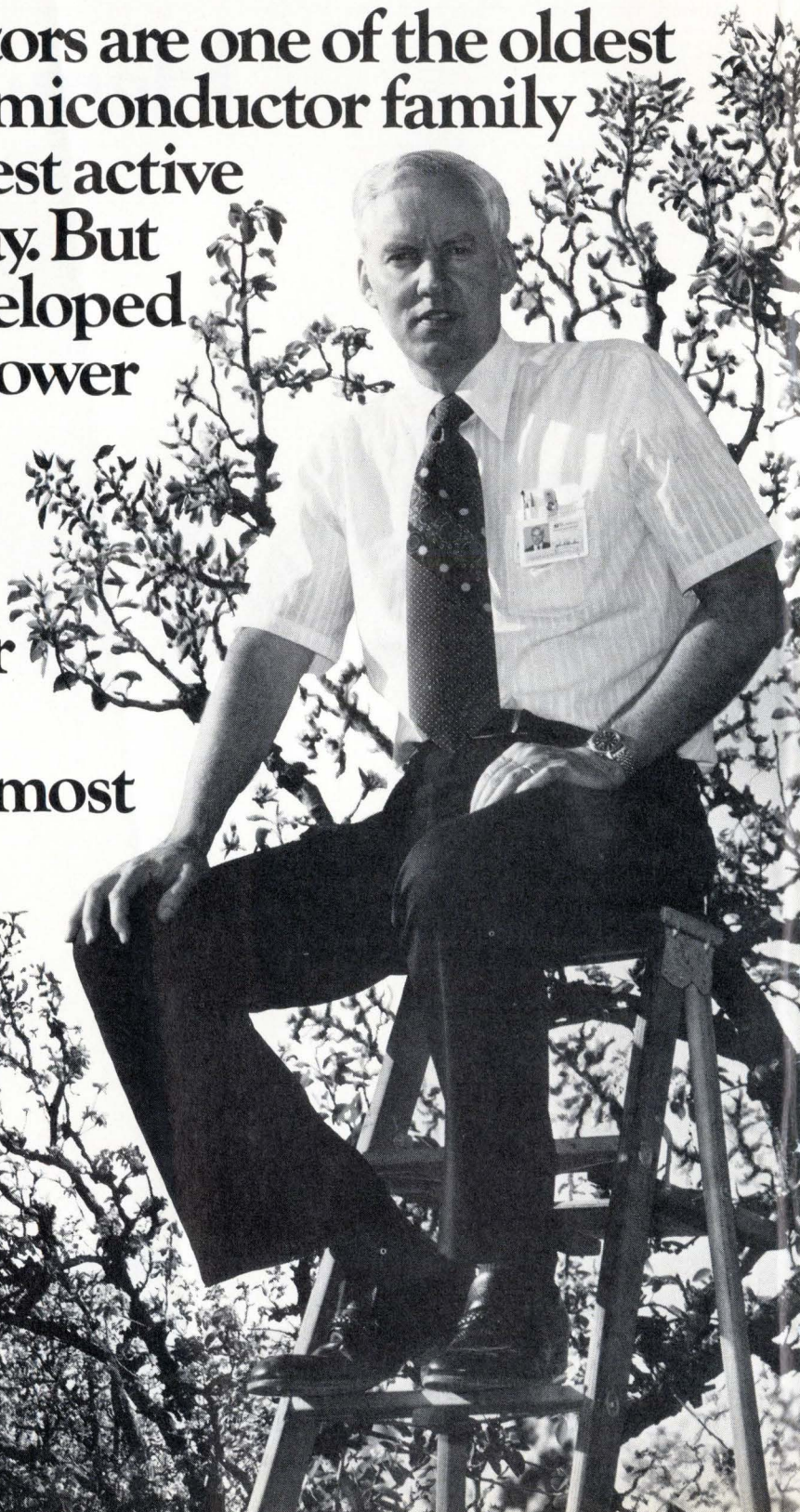

just may eliminate five years."

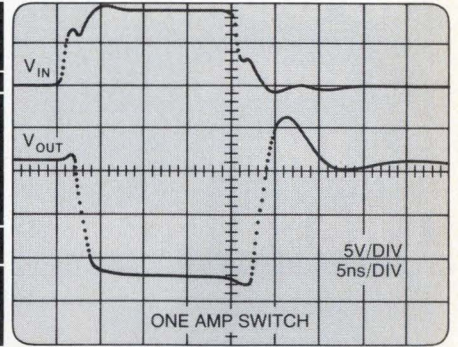
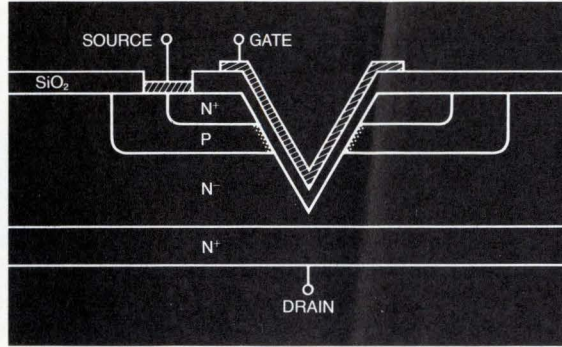

"Historically, designers have had to use Darlington bipolar devices to control high currents. But FETs have the advantage in other respects. They operate with near zero input current, are easier to bias, and are not susceptible to secondary breakdown, thermal runaway, or current hogging, and exhibit no minority carrier storage time.

"With Siliconix' new vertical MOS (VMOS) technology, the current control problem is solved. Our new VMP 1 MOSPOWER™ FET switches 1 ampere in 4 nano-seconds and performs excellently at 2 amps.

"In a VMOS transistor, current flows vertically from a source region at the top of the chip to a substrate drain. This construction multiplies current density through the channel and enhances high speed switching performance.

"Digital designers will find the VMP series as easy to use as a gate. It requires no interface circuit design, can switch faster than TTL and, because FETs are voltage-controlled, it requires negligible input current. For example, CMOS can easily control an ampere of drive current with a single VMP. When multiple devices are used in parallel, they share current instead of hogging it.

"In switching supply regulators, since the VMP series has effectively no minority carrier storage time, switching speeds can be greatly increased offering drastically improved efficiencies.

"Analog control designers can avoid thermal runaway, eliminate preamplifier stages and achieve highly linear control. A high input impedance and low leakage (typically 200 nanoamps or less) gives the current gain equivalent of

nearly infinite bipolar beta. Transfer characteristics are linear from 200 milliamps to over 2 amps.

"In any application that requires drive power, VMOS means economy, simplicity and reliability."

PART NUMBER	BREAKDOWN VOLTAGE	RDS MAX. AT 1 AMP
25 Watts, TO-3 Package		
VMP 11	35 Volts	1.8 Ohms
VMP 1	60	3.0
VMP 12	90	4.0
4 Watts, TO-39 Package		
VMP 21	35 Volts	2.0 Ohms
VMP 2	60	3.0
VMP 22	90	4.5

To order the VMP series, contact our franchised distributors: Components Plus, Cramer, Elmar, Hamilton/Avnet, Pioneer, Quality Components or R.A.E. For more details, call or write Siliconix, 2201 Laurelwood Road, Santa Clara, CA 95054, (408) 246-8000.

Siliconix incorporated

Autoranging Frequency Counting to 60 MHz with 1 Hz Resolution



B&K-PRECISION MODEL 1801 \$240

- For laboratory, production line or maintenance applications
- Automatic ranging, 20 Hz to 40 MHz is guaranteed...readout to 60 MHz is typical
- TTL circuitry updates the six-digit display five times per second
- Resolution to 1 Hz obtained by suppressing digits above 1 MHz when switching to 1 SEC mode

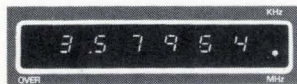

MHz display of
3.579548 MHz input (AUTO mode)



KHz display of overflow of
3.579548 MHz input (1SEC mode)

- Available for immediate delivery, from local B&K-PRECISION distributors
- 10-day free trial offer

B+K PRECISION
PRODUCTS OF DYNASCAN

6460 West Cortland Avenue
Chicago, Illinois 60635 • 312/889-9087
In Canada: Atlas Electronics, Toronto

People

Jasper: launching opposition
to the communications act

Not many jobs are designed so their successful completion leaves the worker out on the street and happy to boot. Yet, that is the prospect facing 47-year-old Herbert N. Jasper in his new post as executive vice president of ACCT—the *ad hoc* committee for competitive telecommunications.

Formed recently by four specialized common carriers, ACCT's sole purpose, says Jasper, is to oppose and defeat "the telephone-monopoly legislation currently before the Congress," better known as the Consumer Communications Reform Act of 1976 [*Electronics*, March 4, p. 33].

But it is unlikely that Jasper's job will end soon. Lobbying against the Bell System and its supporters is an enormous task, particularly in view of ACCT's limited resources. Its only members so far are Data Transmission Co., MCI Telecommunications Corp., Southern Pacific Communications Co., and U.S. Transmission Systems Inc., although it also receives contributions from several other companies as well.

Credentials. His new employers consider that Jasper's seven years of legislative experience in the Federal Government and his contacts on Capitol Hill more than offset his newness to the telecommunications field. He has worked for the Library of Congress, the U.S. Comptroller General's office, and the Senate Labor Committee. He also served from 1969 to 1973 as special and legislative counsel to Sen. Walter Mondale (D., Minn.).

Operating from a small suite in Washington's Commodore Hotel, Jasper, a one-man staff, reflects an appropriate bias: "The telephone companies' position is unsound. They want a guaranteed statutory monopoly." Of the specialized carriers' competitive threat, Jasper contends the Bell System's "claims are egregiously exaggerated." Bell's description of the bill as a consumer



ACCT's man. Herb Jasper is fighting what he sees as a statutory monopoly for Bell.

measure, he calls "fraudulent."

Jasper is more cautious about disclosing specific strategies ACCT will employ, saying only he wants to disseminate the competitors' side of the story "as widely and dispassionately as we can. My role is to coordinate the effort."

Catch up. Beyond ACCT's limited resources, Jasper considers that his main problem is to catch up with the Bell System's eight-month head start in the legislative drive. However, Jasper, who holds a master's degree in public administration, enjoys the role of underdog. "This may sound like a lot of pap, but I wanted a job I could throw myself into," he says. "And I agree with the position of the companies in ACCT" that the bill will eliminate competition in data communications, private-line services, and interconnect hardware.

Wolkins plans GI's
MOS lead in Europe

"We're already the leading manufacturer in Europe of metal-oxide-semiconductor units for the telecommunications and consumer markets, combined," asserts Otis Wolkins, the new vice president and general manager of General Instrument Corp.'s Microelectronics Group Europe, based in Glenrothes, Scotland. "And we intend to become the No. 1 house in total MOS sales dollars to

designed for the User, —logically.

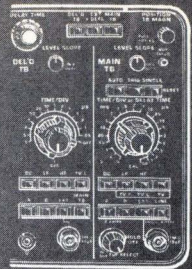

Logical Layout

User-oriented controls provide error-free operation because of logical-use grouping, and selective controls, such as completely separate delayed timebase controls.

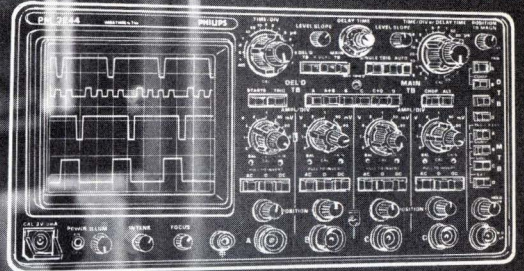

Cold Switching

Permits all the controls necessary for four-trace operation to be positioned in a logical location. Cold switching technology obviates electrical and mechanical problems associated with functional controls.



User-Oriented Features

Solve difficult measuring problems as they arise. Digital Delay enables accurate selection of any particular bit to 99,999 out of the data stream.

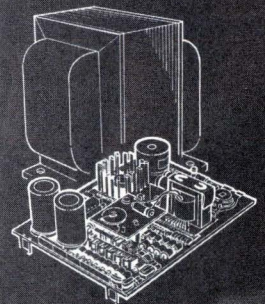

Switching Regulated Power Supply

Gives high efficiency, saves weight (eliminates cooling-fan and filter), and allows instrument use from almost any source without adjustment.

Products that reach ahead because Philips designs ahead. That's why these complex instruments are so easy and efficient to use; they were designed for People . . . who happen to be engineers.

These innovative measurement systems are designed to solve complex measuring problems, dependably, for a long time. They may indeed provide the capability for tomorrow's measuring requirements.

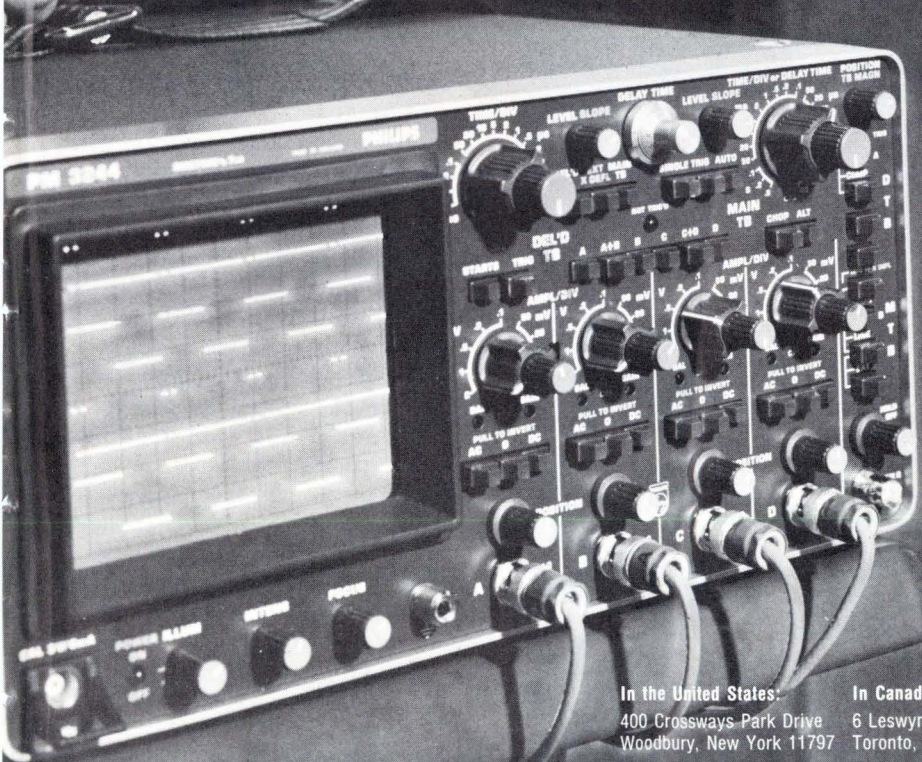

In the United States:
400 Crossways Park Drive
Woodbury, New York 11797

In Canada:
6 Leswyn Road
Toronto, Ontario Canada M6A 1K2

For further information, use our HOT LINE number — 800 645-3043 (N.Y. State residents call (516) 921-8880 collect).

Philips Test & Measuring Instruments, Inc.
A NORTH AMERICAN PHILIPS COMPANY

PHILIPS



For demonstration circle 166 on reader service card

For information circle 15 on reader service card

If you really need
a high performance
low cost

Tracking S/D Data Converter

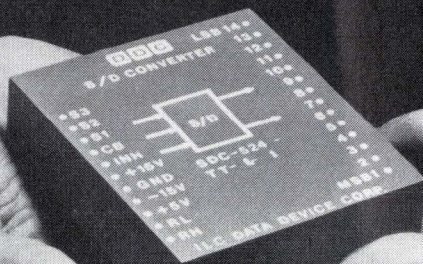

... DDC's new SDC-520 series is the second generation tracking S/D converter and is a pin-pin replacement for the current industry standard, the ESDC. It is available in 10, 12 or 14 bit version. Utilizing the latest in component technology, the SDC-520 represents a significant increase in performance and reliability. The units accept either 3 wire synchro or 4 wire resolver information and provide continually updated digital angle data without velocity lag. Their high input impedance, transformer isolation and transient protection insure trouble free system integration. Standard options include all the normal synchro and resolver format inputs, 0 to +70°C or -55°C to +105°C, and a choice of TTL, CMOS or low power Schottky logic. The SDC-520 series is a true type II servo loop converter having a $K_a = 40,000$ and featuring a 10 rps full accuracy tracking rate at 14 bits (tracking rate increase with lower resolution units). Due to the ratiometric conversion technique used, signal and reference voltage or frequency variations do not affect accuracy.

Encapsulated construction makes these units extremely rugged, meeting the requirements of MIL-STD-202D. They are ideally suited for ground support, avionics, fire control, radar tracking, navigation and collision avoidance systems. The dynamics of this series make them suitable for machine tool and table positioning control systems.

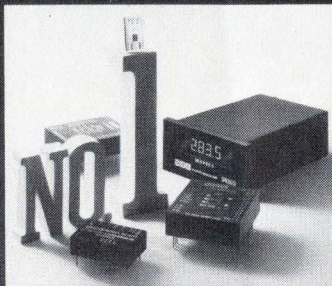

We're Number One in High Performance Data Conversions.



ILC DATA DEVICE CORPORATION

A Wholly Owned Subsidiary of ILC Industries, Inc.

AIRPORT INTERNATIONAL PLAZA BOHEMIA, LONG ISLAND, N.Y. 11716 (516) 567-5600

APPLICATIONS AND SERVICE CENTERS

CALIFORNIA: 2750 Bellflower Blvd.,
Long Beach 90815 (213) 597-5744

EUROPE: England: The Sanctuary,
Oakhill Road, Surbiton. Surrey Tel: 01-399-7262

Interested engineers, write or call Steve Muth or send for our 164-page product line catalog.

both of those markets as well."

The youthful-looking, 36-year-old Wolkins predicts that the Western European MOS market will increase 30% to 35% by 1980 to represent about one fourth of an estimated \$7 billion world market. But unlike his major rivals, such as Philips, Siemens and the American MOS contenders that have set their sights on a broad spectrum, Wolkins is happy to specialize.

"You just can't beat the volume you find when you're producing tuning circuits for television sets and dialer circuits for telephones," says Wolkins in his low-key Midwestern accent. "It far surpasses the numbers in the area that's getting the most attention—microprocessors."

GI, headquartered in Hicksville, N.Y., has been maintaining its pace in Europe with new video-game chips, remote controls, and digital tuning circuits. All are made at GI Microelectronics' sole European production facility at Glenrothes.

Motorola man. Wolkins came to GI in Scotland after 14 years with Motorola's Semiconductor Products division, where he was most recently director of Federal high-reliability operations. And, since he was instrumental in setting up Motorola's complementary-MOS facility in East Kilbride, Scotland, he should know about turning out products.

GI has several new MOS products in the works. "We're expanding our family of telephone circuits that convert push-button tone signals into rotary pulse signals and *vice versa*. And there are plans to produce early next year a family of MOS devices—likely two-chip, p-channel circuits—for commercial facsimile systems."

He envisions a large demand for a new two-chip set that enables record-player turntables to be converted from electromechanical to solid-state control, as well as new chips for the booming video-games market. And the Glenrothes plant will soon begin producing new TV remote-control and tuning circuits, he says. However, he declines to comment on reports that GI has nailed down as customers two of the larger TV set producers in Europe.



YOU'RE LOOKING at the PERFECT SOURCE for CRYSTALS, OSCILLATORS and CRYSTAL FILTERS

ERIE is bursting with a full line of QUARTZ CRYSTALS . . . with deliveries to meet your production schedules. 1 kHz to 200 MHz . . . AT, JT, DT, NT, SL, 5°X, GT.

We have exotic crystals and very simple crystals, low frequency and high frequency crystals. And we manufacture and test to meet or exceed Mil-C-3098 standards. ERIE provides a better crystal because we control our total manufacturing process in-house.

Our broad line of CRYSTAL OSCILLATORS range from low cost TTL dip package types to complex high stability, high reliability oscillators . . . both military and industrial types.

When it comes to CRYSTAL FILTERS, ERIE can design and manufacture the filter best suited to your application. There is virtually no limit to the variety we produce . . . including Monolithic Crystal Filters.

So come to ERIE for a fast, accurate and down-to-earth answer to your frequency control problem. One factor remains constant . . . you'll get a fair, cost-conscious answer. We have the technology and the products to implement effective crystal performance.

WRITE FOR OUR CATALOG
OR CALL 717/249-2232
FOR ENGINEERING AND
PRICING HELP.

ERIE FREQUENCY CONTROL
453 LINCOLN ST., CARLISLE, PENNSYLVANIA 17013
DIVISION OF ERIE TECHNOLOGICAL PRODUCTS, INC.



Omron. 43 years old, and still building a family of relays, switches, and timers for every need.

Mind you, the control component *you* need may not be in the photograph. That's because this picture shows less than 5 percent of the components in our line. But it's more than likely that the "unique" device you're looking for is one which we've

been making for a long time, and which we carry in stock.

Omron hasn't achieved a position of international leadership by sitting still. Since we began making control components in 1933, we've been carving out a reputation for excellence in engineering, manufacturing, and—above all—in serving you, the Omron customer. We're still adding new products all the



**Welcome
to the family,
little fella**

time, and we're providing faster delivery than ever thanks to our expanded distributor network.

To find out what Omron can do for you, contact your nearest Omron distributor or call us at (312) 885-9500. We think you'll want to welcome us as your components supplier... because no matter what little fella you're looking for, we can probably help you give him a home.



*a world leader
in electronics
since 1933*

Omron Corporation of America
Corporate Headquarters
Sears Tower, Chicago, Illinois

Sales and Service
1051 State Parkway
Schaumburg, Illinois 60172
Phone: (312) 885-9500

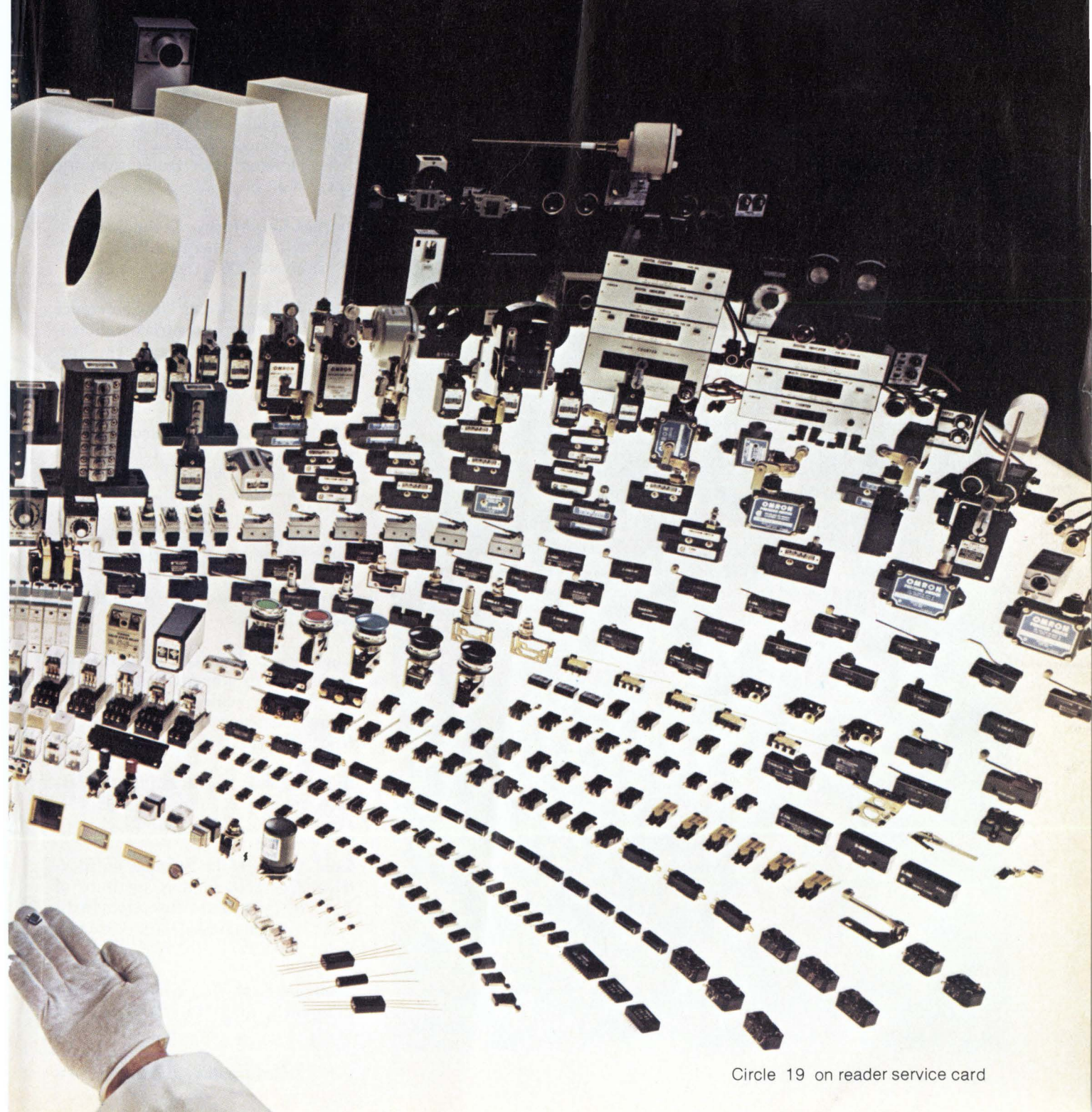

Circle 19 on reader service card

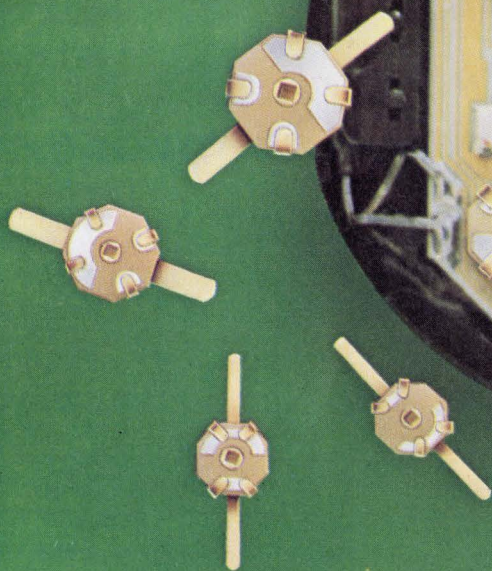

Thin-Trim[®] capacitors

Tucked in the corner of this Pulsar Watch is a miniature capacitor which is used to trim the crystal. This Thin-Trim capacitor is one of our 9410 series, has an adjustable range of 7 to 45 pf, and is .200" x .200" x .050" thick.

The Thin-Trim concept provides a variable device to replace fixed tuning techniques and cut-and-try methods of adjustment. Thin-Trim capacitors are available in a variety of lead configurations making them easy to mount.

A smaller version of the 9410 is the 9402 series with a maximum capacitance value of 25 pf. These are perfect for applications in sub-miniature circuits such as ladies' electronic wrist watches and phased array MIC's.

Johanson Manufacturing Corporation
Rockaway Valley Road
Boonton, New Jersey 07005
(201) 334-2676 TWX 710-987-8367

Meetings

Comcon 76 Fall, IEEE, Mayflower Hotel, Washington, D.C., Sept. 7-10.

1976 International Machine Tool Show, National Machine Builder's Association (McLean, Va.), International Amphitheatre and McCormick Place, Chicago, Sept. 8-17.

Intersociety Energy Conversion Engineering Conference, IEEE *et al.*, Sahara Tahoe Hotel, Stateline, Nev., Sept. 12-17.

25th Annual Conference of Standards Engineers Society, SES, Chalfonte-Haddon Hall Hotel, Atlantic City, N.J., Sept. 13-15.

Oceans '76, Marine Technology Society and IEEE, Sheraton-Park Hotel, Washington, D.C., Sept. 13-15.

Electro Optics/Laser '76 Conference and Exposition, Industrial & Scientific Conference Management Inc. (Chicago, Ill.), New York Hilton Hotel, New York, Sept. 14-16.

WESCON—Western Electronic Show and Convention, IEEE, Los Angeles Convention Center, Los Angeles, Sept. 14-17.

6th European Microwave Conference, Microwave Exhibitions & Publishers Ltd. (Sevenoaks, Kent, England), Palazzo dei Congressi, Rome, Italy, Sept. 14-17.

Convergence 76—International Symposium on Automotive Electronics and Electric Vehicles, IEEE and SAE, Hyatt Regency Hotel, Dearborn, Mich., Sept. 20-22.

International Broadcasting Conference, IEEE *et al.*, Grosvenor House, London, U.K., Sept. 20-24.

22nd Annual Holm Seminar on Electrical Contacts, Illinois Institute of Technology and IIT Research Institute, Pick-Congress Hotel, Chicago, Sept. 21-23.

Semicon/East 76, Semiconductor Equipment and Materials Institute

O.K., you guys, back to the old drawing board.

It's a whole new ball game. And just when you'd made all your panel lamp decisions, right? But Monsanto's patented nitrogen doping process for GaAsP on GaP substrates has improved the light-emitting efficiencies of our LED lamps so dramatically that every good designer will want to take another look.

Monsanto has T-1 and T-1 $\frac{3}{4}$ replacement lamps in standard red color (improved significantly over last year's red LEDs) and new bright red which is *unbelievably* bright. Red. Plus green, yellow, and a dazzling new orange. In two lens choices and two lead lengths. And all improved, as you can see on the chart.

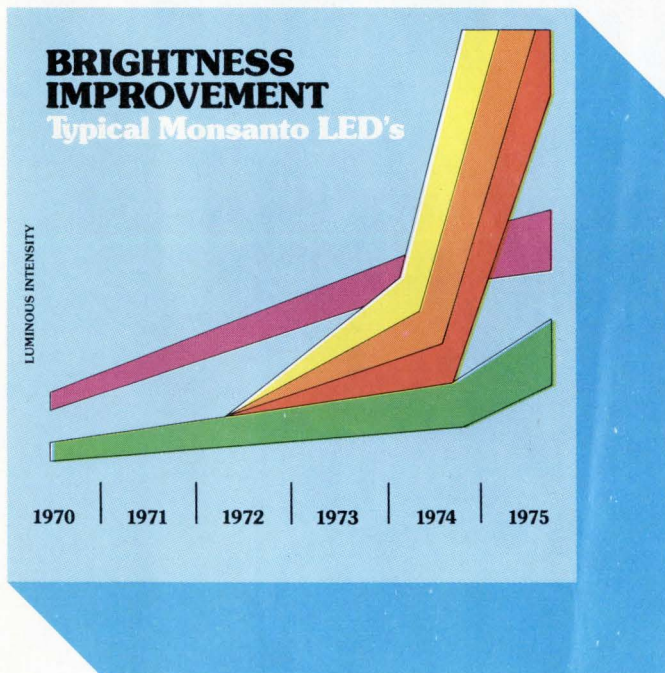

Model Number	Color	Size	Luminous Intensity	Viewing Angle
5174B*	Orange	T-1	5.0 mcd	90°
5274B*	Green	T-1	1.0 mcd	90°
5374B*	Yellow	T-1	4.0 mcd	90°
5774B*	Red	T-1	5.0 mcd	90°
5152**	Orange	T-1 $\frac{3}{4}$	40.0 mcd	28°
5252**	Green	T-1 $\frac{3}{4}$	15.0 mcd	28°
5352**	Yellow	T-1 $\frac{3}{4}$	45.0 mcd	28°
5752**	Red	T-1 $\frac{3}{4}$	40.0 mcd	28°

*Also available with 1" lead lengths, low profile (.138" high) lens, and 180° viewing angle.

**Also available with 24° and 65° viewing angles.

Last year there were some sockets that demanded filament lamps, despite their inherent failure-and-replacement problems. *Bright* was needed, and damn the torpedos.

This year you just might find the bright you need in a shake-rattle-and-roll-proof LED lamp. Come and see.

If you can take the time, you just might be able to add a lot of T to your MTBF.

So it's reset to zero, folks, if you want the best indicator lamps (and widest choice of functional differentiation colors) in your gear.

For product information, circle the service number or call your local Monsanto man. Or write Monsanto Electronics Division, 3400 Hillview Avenue, Palo Alto, CA 94304.

Putting innovation to work.

Monsanto:
the science
company.

Alabama
INTEREP ASSOCIATES
205/881-3677

Arizona
SUMMIT SALES
602/994-4587

Arkansas
SIEMENS CORPORATION
817/261-6543

California-Northern & East Bay
QUADREP, INC.
408/733-7300

California-Southern (L.A.)
VARIGON ASSOCIATES
213/679-0621

California-Southern (San Diego)
S. R. ELECTRONIC
714/565-8411

Colorado
OMEGA, LTD.
303/758-1508

Connecticut
ANCHOR
ENGINEERING CORP
203/658-6261

Connecticut-(Fairfield County)
ERA, INC.
516/822-9890

Kansas
DY-TRONIX, INC.
816/737-1100

Kentucky
DOLFUSS-ROOT & CO.
513/433-6776

Louisiana
SIEMENS CORPORATION
817/261-6543

Maine
ANCHOR ENGINEERING CORP.
617/964-6205
KCA COMPONENTS, INC.
617/861-9024

Maryland
J. A. MAGUIRE & CO., INC.
301/377-0223

Massachusetts
ANCHOR ENGINEERING CORP.
617/694-6205
KCA COMPONENTS, INC.
617/861-9024

Michigan
CMP, INC.
313/477-7700

Minnesota
CAHILL ASSOCIATES, INC.
612/646-7217

Mississippi
INTEREP ASSOCIATES
205/881-3677

New Hampshire
ANCHOR ENGINEERING CORP.
617/964-6205
KCA COMPONENTS, INC.
617/861-9024

New Jersey-Northern
ERA, INC.
516/822-9890

New Jersey-Southern
J. A. MAGUIRE & CO., INC.
609/665-5136

New Jersey-Southern
THOMAS ASSOCIATES, INC.
609/854-3011

New Mexico
A. O. ELECTRONICS
505/255-8701

New York-Metropolitan
ERA, INC.
516/822-9890

New York-Upstate
ELECTRA SALES CORP.
315/455-5783
ELECTRA SALES (Rochester)
716/436-4030/4037

North Carolina
J. A. MAGUIRE & CO., INC.
919/725-7777

Pennsylvania-Eastern
THOMAS ASSOCIATES
609/854-3011
J. A. MAGUIRE & CO., INC.
609/665-5136

Pennsylvania-Western
DOLFUSS-ROOT & CO.
412/561-4125

Rhode Island
KCA COMPONENTS, INC.
617/861-9024
ANCHOR ENGINEERING CORP.
617/964-6205

South Carolina
J. A. MAGUIRE & CO., INC.
919/723-5980

South Dakota
CAHILL ASSOCIATES
612/646-7217

Tennessee
INTEREP ASSOCIATES, INC.
205/881-3677

Tennessee (East)
J. A. MAGUIRE & CO., INC.
919/723-5980

Texas (except El Paso County)
SIEMENS
817/261-6543

Texas (El Paso County only)
A. O. ELECTRONICS
915/545-2363

Connecticut-(except Fairfield County)
KCA COMPONENTS
617/861-9024

Delaware
THOMAS ASSOCIATES, INC.
609/854-3011

Delaware
J. A. MAGUIRE & CO., INC.
301/377-0223

District of Columbia
J. A. MAGUIRE & CO., INC.
301/377-0223

Florida
PERROTT ASSOCIATES INC.
305/275-1132
PERROTT ASSOCIATES INC.
305/792-2211
PERROTT ASSOCIATES INC.
813/585-3327

Georgia
INTEREP ASSOCIATES
404/394-7756

Idaho
OMEGA, LTD.
801/266-9617

Illinois-Southern
DY-TRONIX, INC.
314/731-5799

Illinois-Northern
METCOM ASSOCIATES CORP.
312/696-1490

Indiana
ELECTRA REPS, INC.
317/255-4147

Iowa
GASSNER & CLARK CO.
319/393-5763

Missouri-Eastern
DY-TRONIX, INC.
314/731-5799

Missouri-Western
DY-TRONIX, INC.
816/737-1100

Montana
OMEGA, LTD.
303/758-1508

Nebraska-Eastern
DY-TRONIX, INC.
816/737-1100

Nebraska-Western
OMEGA, LTD.
303/758-1508

Nevada-Northern
QUADREP, INC.
408/733-7300

Nevada-Southern
VARIGON ASSOCIATES
213/679-0621

North Dakota
CAHILL ASSOCIATES, INC.
612/646-7217

Ohio-Northern
DOLFUSS-ROOT & CO.
216/333-7504

Ohio-Southern
DOLFUSS-ROOT & CO.
513/433-6776

Oklahoma
SIEMENS
817/261-6543

Oregon
RAY OVER SALES
206/454-4551

Utah
OMEGA, LTD.
801/266-9617

Vermont
KCA COMPONENTS, INC.
617/861-9024
ANCHOR ENGINEERING CORP.
617/964-6205

Virginia
J. A. MAGUIRE & CO., INC.
301/377-0223

Washington
RAY OVER SALES
206/454-4551

West Virginia
DOLFUSS-ROOT & CO.
412/561-4125

Wisconsin-Eastern
METCOM ASSOCIATES CORP.
312/696-1490

Wisconsin-Western
CAHILL ASSOCIATES, INC.
612/646-7217

Wyoming
OMEGA, LTD.
303/758-1508

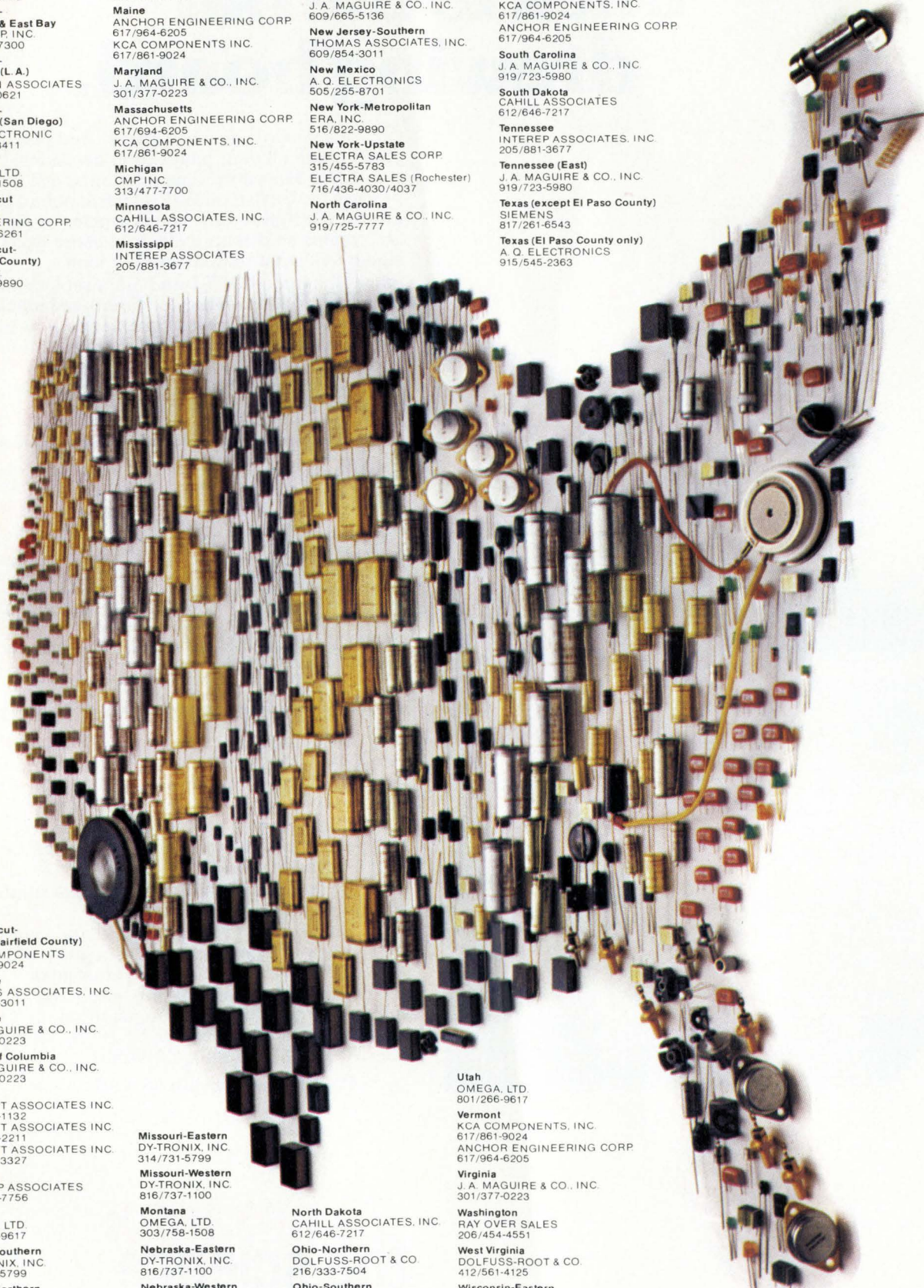

When it comes to components, we're solid in every state.

Our strength comes from an 8 billion dollar company with over 550 million in worldwide component sales. Our sophisticated organization of salesmen and representatives and a distributor network with over 50 U.S. stocking locations is supported from strategically located U.S. manufacturing facilities with world-wide backup.

It's a complete service system designed to make your component buying a whole lot easier—north, south, east, and west.

We can anticipate and provide for your every component need, including: Tantalum, Aluminum Electrolytic, Ceramic, Film, Metalized Film, and Stacked Metalized Film Capacitors, Transistors, Zener Diodes, Tuning Diodes, Rectifiers, Hall Effect Devices, Ferrites, Flash Tubes, Voltage Protection Devices, LED's and LED Drivers.

To support future market requirements, Siemens spends 2 million dollars each working day in R&D. We maintain a dominance in high rel and commercial component production and have earned a reputation for quality and customer service that we go out of our way to protect.

To learn how Siemens and its products can be of service to you, wherever you may be, write or call: Siemens Corporation, Components Group, 186 Wood Avenue South, Iselin, New Jersey 08830, (201) 494-1000.

SIEMENS

Circle 23 on reader service card

Meetings

(Golden Gate Enterprises, Santa Clara, Calif.), Nassau Veterans' Memorial Coliseum, Uniondale, N.Y., Sept. 21–23.

APL76—Putting APL to work, ACM, Skyline Hotel, Ottawa, Canada, Sept. 22–24.

Broadcast Symposium, IEEE, Washington Hilton Hotel, Washington, D.C., Sept. 22–24.

EASCON—Electronic and Aerospace Systems Convention, IEEE, Stouffer's Inn, Washington, D.C., Sept. 26–29.

MICRO-9—Ninth Annual Workshop on Microprogramming, IEEE and ACM, Delta Towers Hotel, New Orleans, Sept. 27–29.

Quality Testing Show, American Society for Nondestructive Testing (Columbus, Ohio), Shamrock Hilton Hotel, Houston, Tex., Sept. 28–30.

Canadian Computer Show and Conference, Canadian Information Processing Society (Industrial and Trade Shows of Canada, Toronto), Place Bonaventure, Montreal, Sept. 28–30.

ITC/USA—International Telemetry Conference, International Foundation for Telemetry (Woodland Hills, Calif.), Hyatt House Hotel, Los Angeles Airport, Sept. 28–30.

Nepcon Central—National Electronic Packaging and Production Conference, Industrial & Scientific Conference Management Inc. (Chicago, Ill.), Hyatt Regency O'Hare Hotel, Chicago, Sept. 28–30.

1976 Microwave Mobile Communications Symposium, IEEE, Department of Commerce Laboratories, Boulder, Colo., Sept. 29–Oct. 1.

IC SQUID—International Conference on Superconducting Quantum Devices, European Physical Society and Physikalische-Technische Bundesanstalt, Berlin, West Germany, Oct. 5–8.

This is what multifunction counters are supposed to be all about.

Model 5740, 7-digit, 100 MHz Multifunction Counter/Timer. \$295*

Quality you can count on. Data Precision's Model 5740 is a 7-digit, 100 MHz Timer/Counter; a superb laboratory quality instrument.

Data Precision built the 5740 to be exceptionally versatile. It measures frequency, period, period average, elapsed time and total events with the kind of accuracy, sensitivity, and upper frequency capability generally found only in higher priced units.

Consider: 10 mV RMS sine-wave to 20 MHz. 50 mV RMS at 100 MHz. That's excellent sensitivity in anyone's book. And this

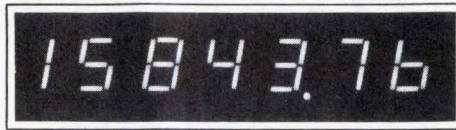

sensitivity is a minimum specification (not a typical) allowing lock-in measurements from even extremely weak signals. The 100 MHz bandwidth means the 5740 handles everything from sub-audio to VHF. Seven, not six digit resolution, means 0.1 Hertz resolution at 1 MHz, 1 part in 10 million in period measurements, with the decimal point always automatically correct.

Want even more? A low-cost optional BCD output provides printer and/or computer/system compatibility while providing

counter status timing and control signals as well as reading and decimal-point data. And an optional remote start/stop control makes this a most flexible elapsed time indicator.

The 5740 Multifunction Counter/Timer. Its quality, versatility and value are unmistakable. And it comes with something no one else gives you: Data Precision dependability.

For complete information or a demonstration contact your local Data Precision representative or Data Precision Corporation, Audubon Road, Wakefield, MA 01880, USA, (617) 246-1600. TELEX (0650) 949341.

*Price U.S.A.

DATA PRECISION[®]
...years ahead

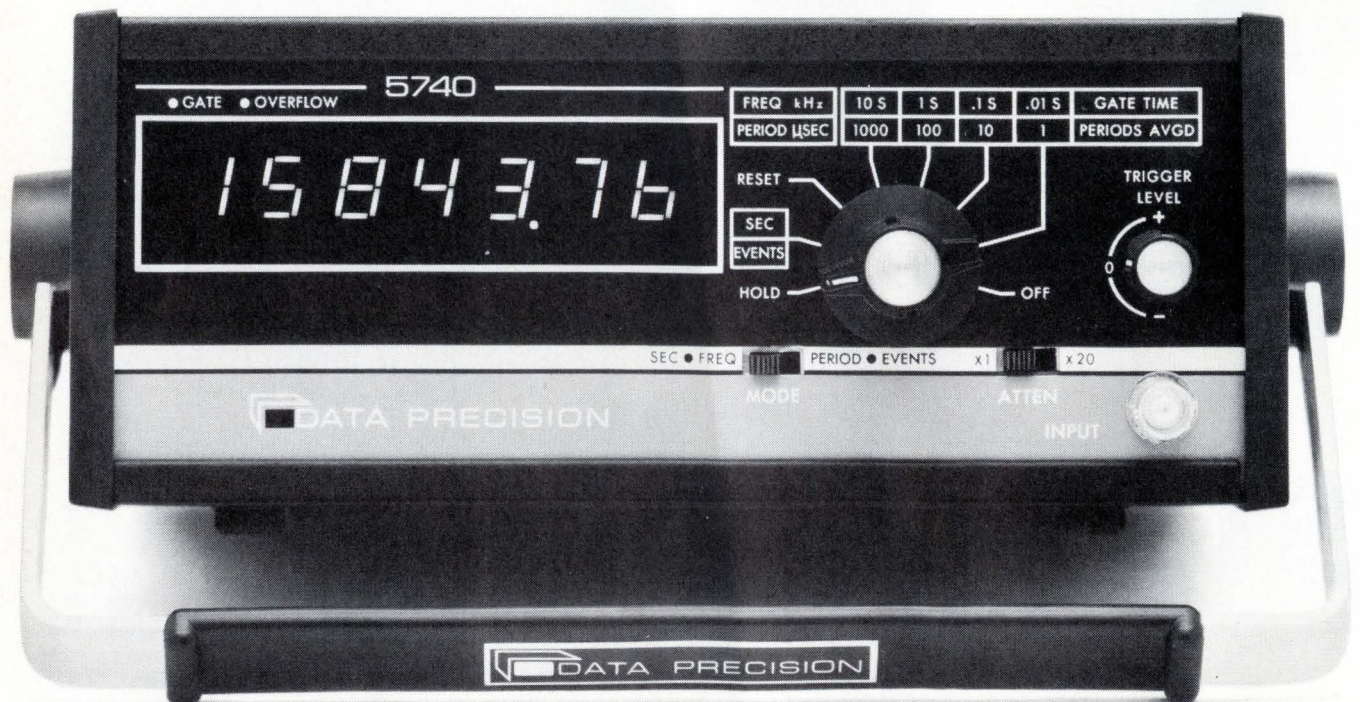

High-accuracy V-f converter to sell for \$8.95

Look for Intech Inc. of Santa Clara, Calif., to begin production soon of a single-supply monolithic voltage-to-frequency converter that has 11-bit accuracy and $\pm 0.05\%$ linearity at 10 kilohertz without external components. **And the device is priced at only \$8.95.** Comparable modular and discrete V-f systems typically cost \$40 to \$70 and require more than one power supply.

Other monolithic converters now available have only 7-bit accuracy with external components and usually require two supplies. Prime applications for such a high-accuracy device are the automotive and data-acquisition markets.

October RFPs due for updated air surveillance system

A request for proposals for the Air Force's Joint Surveillance System will probably come from the Electronic Systems division, Hanscom Air Force Base, Mass., in October. The JSS is an ambitious effort **to update continental U.S. air-surveillance capability** and to improve the Federal Aviation Administration's air-route traffic control by using radar and other sensors at joint FAA-Air Force sites in the U.S. to simultaneously monitor approaching civilian and military air traffic. Some 48 radar installations ringing the periphery of the U.S. will report their data to five regional operations control centers. Although their locations have not been determined, it's known that there will be two centers each on the East and West Coasts, and one in Alaska. The upcoming request for proposals will cover computers, displays, and software to go into those centers.

In all, the JSS program will cost about \$200 million, but it's expected to save the Air Force substantially more than that by replacing SAGE (for semi-automatic ground environment) air-defense system. Its centers were constructed in the 1950s.

GI working on big brother for CP 1600 . . .

General Instrument Corp. is working with manufacturers of process-control and communications equipment to develop a "big brother" to its CP 1600 microprocessor. The new n-channel MOS device, like the 1600 tailored for those industries, **is expected to be available by mid-1977.** While GI declines to specify whether the new processor will offer higher speed, a more powerful and easier-to-use instruction set, or improved input/output interfacing, a spokesman at the Microelectronics Group in Hicksville, N.Y., says it will offer "more than just improved performance."

Honeywell Inc.'s Process Control division in Fort Washington, Pa., is believed to be one of the firms participating in the development effort. That division developed and benchmarked the architecture for the 1600, with circuit design and manufacturing implementation by GI, as part of a two-year multichip development program.

. . . and gains British Post Office stamp of approval

Meanwhile, GI's Microelectronics Group has become the **first MOS LSI manufacturer to receive full British Post Office approval** as a supplier of microcircuits for telephone-exchange equipment. The Post Office, which controls all telecommunications in the country, has approval procedures that are designed to simulate and confirm a 20-year life under adverse anticipated operating conditions with no more than a total of 2% cumulative

failures. The approval relates to the MTNS metal-thick-oxide-nitride process, pioneered by GI, because of its rugged electrical characteristics.

Itek enters typesetting field

A microcomputer-controlled system, the Quadritek 1200, marks the first foray by Itek Corp. into the phototypesetting market. Officials of the Graphic Products division in Lexington, Mass., estimate that phototypesetting was a **\$200 million-a-year business in 1975**. The division, which unveiled the system last week, is aiming it primarily at in-house or small commercial-printing operations. Use of National Semiconductor Corp.'s PACE 16-bit microprocessor allows keyboard selection of four interchangeable font types at will by the operator without stopping production, as some competitive systems require. Some 50 typefaces will be available when the system is marketed this fall for \$9995.

The Quadritek 1200 is small enough (42 by 17½ by 28 in.) to fit on a small table or desk top. Justification, centering, tabulation, and flush right and left are all automatically controlled, and the unit offers 12,288 words of memory, which allows predetermined instructions to be stored. Itek Graphics division officials say the system is a natural extension of their other photocomposition products, which include camera processors, plate makers, and duplicating equipment.

Nonvolatile memory gains at TI lab

Texas Instruments is working on an MOS memory technology that is both nonvolatile and erasable. Called DIFMOS (for dual injection floating-gate MOS), the work is being done at TI's French IC facility where a 256-bit memory has been operating. Unlike the nonvolatile and erasable read-only memories built with Intel's FAMOS technique, which require ultraviolet irradiation to erase, **TI's DIFMOS device is written and erased electrically**. Present performance parameters are: read time, 1 microsecond to 500 nanoseconds; erase and write time, 0.5 millisecond when operating with 30-volt write and erase signals.

The circuit uses a parallel-in/serial-out shift register in the read mode and a serial-in/parallel-out in the write mode. Apparently the technique is still speculative, with size and reliability hurdles still to be overcome. However, progress in reducing cell size has been dramatic: from 120 mil² to 25 mil² per bit.

British offer first high-level compiler for 8080A

The first commercially available compiler that can run a resident high-level language on a microprocessor has been announced by GEC Semiconductors, which has built a Coral 66 compiler for the Intel 8080A microprocessor. Developed to run on the MDS 800 microprocessor-development system, the RCC 80 compiler is aimed for designers in real-time military, telecommunications, and process-control applications. Coral 66 is claimed to be the first high-level language approved for microprocessors. Priced at about \$2,700, the self-compiling program is built to run on the MDS 800 with a 48-kilobit random-access memory, console, and output devices. Options include a line printer, high-speed paper tape, and additional 16-k RAM.

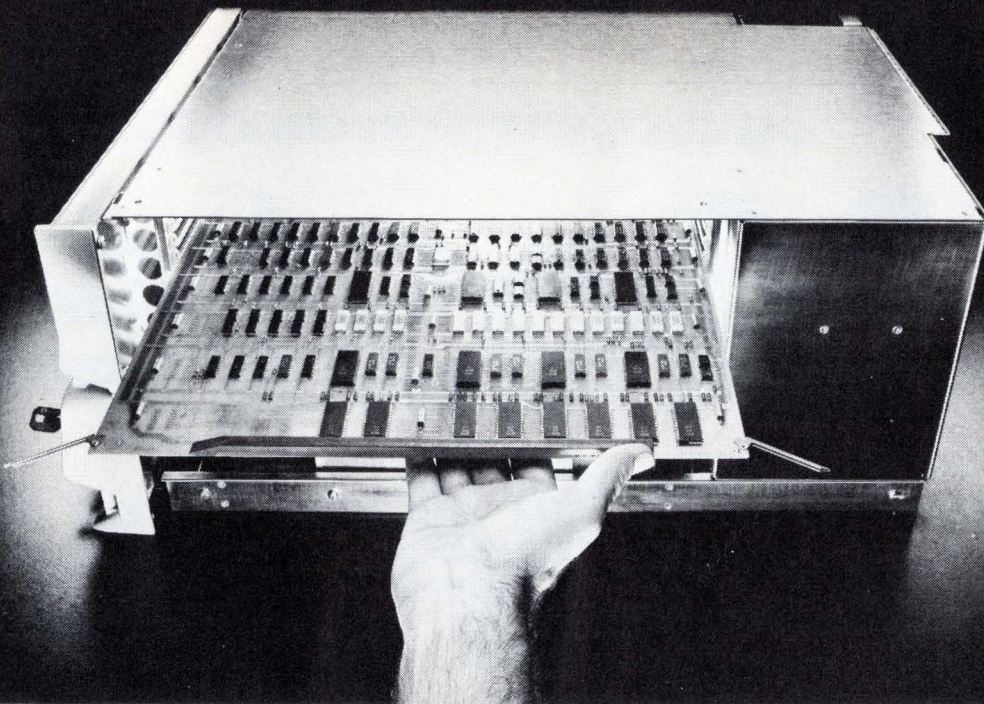

Give your data communications system a little goose and it'll put out ten times as much.

Open up the back of any Data General communications system, pop in our single-board DCU/50 Data Control Unit, run through a little step called COMGEN and stand back. Because that system can start pumping out ten times as much data. And possibly a good deal more.

What makes this all possible is a rather clever piece of engineering.

We've designed the DCU/50 as an intelligent programmable controller. So it takes over jobs the CPU used to do. Things like character handling and code conversion. Which frees up the CPU processing power and speeds up total systems throughput.

On the other hand, you may not need more throughput. Instead, you may need more lines or different types of lines. Both of which are just as easy to get. You just plug in some different boards.

We make modular synchronous and asynchronous multiplexors you can mix

in any proportion. They can handle anything from one to sixteen lines, are fully software supported and work equally well with or without the DCU/50.

Which brings up a rather significant point.

When you buy your communications equipment from Data General, you can get exactly what you need right now. And later, if you need more throughput, more lines or different types of lines, you won't have to throw out anything. All Data General communications hardware and software are completely compatible. So you can add on to what you already have.

Write for our free brochure, "The Sensible Way to Use Computers in Data Communications" and detailed information about the DCU/50 Data Control Unit.

And if that isn't enough information, we'll send a sales engineer who can also put out ten times as much.

DataGeneral

Data General, Route 9, Southboro, Mass. 01772 (617) 485-9100. Data General (Canada) Ltd., Ontario.
Data General Europe, 15 Rue Le Sueur, Paris 75116, France. Data General Australia, Melbourne (03) 82-1361

At last, a true second source for the Mostek We've

Pin for pin, spec for spec, toe to toe.

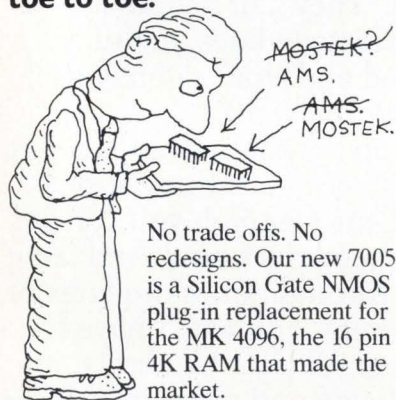

No trade offs. No redesigns. Our new 7005 is a Silicon Gate NMOS plug-in replacement for the MK 4096, the 16 pin 4K RAM that made the market.

Same specifications. Super reliable.

Where others failed.

One made it faster but lost a spate of specs; another hit the speed but oh my the power dissipation; and a third is just plain different. Only Advanced Memory Systems delivers the identical performance, total

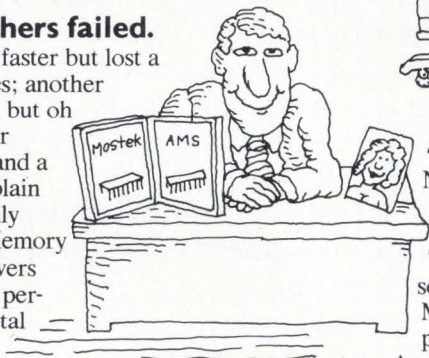

compatibility, and the outstanding quality our vast systems experience has helped us build into all our RAMs. Nice.

Priced for purchasing.

We've priced the 7005 to gain a significant share of the market. We've got the design and process technology, the capacity, the capability and the motivation. You get the parts at a price you'll like. But no applause please, just orders.

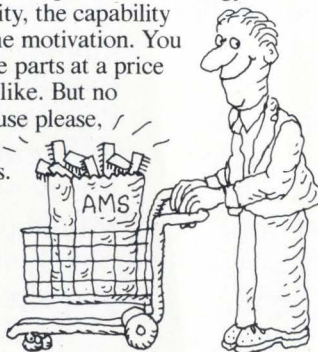

4K OK your way.

Now with our 16 pin 7005 we've got you covered in 4K RAMs. 16, 18 or 22 pin. Our 18 pin 7270 and 22 pin 7280 take the socks off T.I. in Read/Write/Modify and leave Intel burning power and crying out for capacities. And there's no shortage of sources

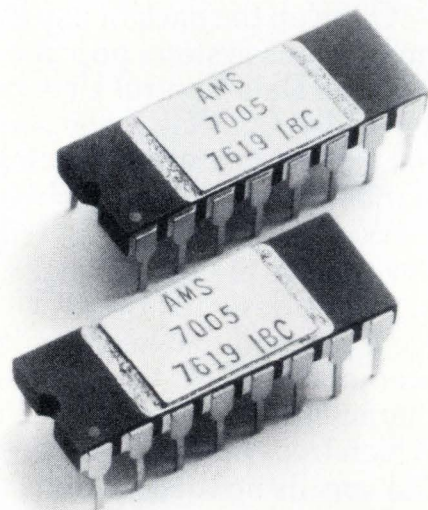

on the 7270/7280 either. The same masks are in production at National.

No bad memories.

We're closer to that goal than any other supplier. With over thirteen million RAMs shipped to date, our cumulative history is 0.03%/1000 hrs; and the current rate is a whopping 0.01%/1000 hrs.

MK4096, 16 pin 4K RAM.

made it. got it.

Our systems helped.

Our expertise in RAMs derives naturally from the fact that we're the largest independent memory systems producer in the world. No other RAM supplier can touch our systems experience. Testing alone is a science in its own right, and we have perfected it. The benefits?

Advanced technology. Advanced components. Device performance. Production. Testing. And above all, systematic thinking.



Information is free.

Write or call collect for immediate requirements. And ask for our complete RAM

Roster, and our article, "RAM Cost Analysis," a complete, systematic review of all cost elements in

building RAM memories. It's the definitive work on the subject. Advanced Memory Systems, 1275 Hammerwood Avenue, Sunnyvale, California 94086. (408) 734-4330. Ask for Semiconductor Marketing.

The RAMS what AM in '76.

Dynamic RAMs	16 pin	18 pin	22 pin
1024X1		6002 (150ns)	6002 (150ns)
2048X1			6003 (350ns)
4096X1	7005 (250ns) Mostek 4096	7270 (200ns) Nat'l 5270	7280 (200ns) Nat'l 5280 Intel 2107B T14060
8192X1		7271 (250ns) TTL Clock	7281 (250ns) TTL Clock
			7008 (150ns) Pin for pin with 7280
Static RAMs			
256X4	7112 (250ns) Intel 2112	7111 (250ns) Intel 2111	7101 (250ns) Intel 2101
1024X1			7001 (60ns)
2048X1			7003 (60ns)

Access time in ()

AMS Advanced Memory Systems.
Memories with a future.

The Raytheon 2900 family gains five new members

Whereas: Raytheon is the established alternate source for the Am2901 and Am2909, (franchised distributors stocked), and,

Whereas: Raytheon brought you RAYASM, the powerful micro-assembler available on the NCSS computer network,

Now Therefore: Raytheon announces five additional 2900 family components, giving us a total of seven, To Wit:

2901 A 4-bit Microprocessor Slice—the fastest, most powerful LSTTL microprocessor in the world. With its cycle-saving two-address architecture, the 2901's speed can't be touched.

2905 A 4-bit Bus Transceiver— general purpose open collector bus interface device. Data to the 100 milliampere bus drivers is provided by a 4-bit register with a two-way multiplexer at its inputs. Data from the bus receiver may be held in the 4-bit receiver latch on its way to the three state receiver outputs.

2906 A 4-bit Bus Transceiver with parity —is equivalent to the 2905 but with the addition of an on-chip parity generator/checker.

2907 A 4-bit Bus Transceiver—similar to the 2906 with the two-way multiplexer at the input to the bus driver register elimi-

nated to allow the device to be packaged in the space saving 20-pin DIP.

2909 A Microprogram Sequencer—that can branch anywhere in memory, perform sub-routines, then return with up to four levels of sub-routine nesting. The device is a cascable 4-bit slice which allows addressing of up to 4K words of microprogram with three devices.

2918 A General Purpose 4-bit Register—with two sets of outputs: TTL and three state. This useful combination can reduce your package count for those status, command, and instruction registers which must drive both your control logic and a data bus.

93415 A 1024 × 1-bit Fully Decoded Random Access Memory—for your high-speed data and control stores.

Raytheon LSI is on the move. More 2900 family components soon to come include PROM's, sequencers, look-ahead carry generators, additional RAM's, and other goodies now in process.

For complete details, contact your local distributor or Raytheon Company, Semiconductor Division, Dept. 2900, 350 Ellis Street, Mountain View, CA 94042, (415) 968-9211.

Am 2900 SOLD & SUPPORTED HERE

The logo consists of a black rectangle containing a white oval. Inside the oval, the word "RAYTHEON" is written in a bold, black, sans-serif font.

RAYTHEON

SEMICONDUCTOR DIVISION

Analyzers for microprocessors coming on strong

Next month, Wescon will show more than a dozen units designed to outdo logic analyzers

"It's going to hit like a wave," predicts David J. Blecki, marketing vice president of Biomation Corp., Cupertino, Calif. He's referring to a blitz of microprocessor analyzers, a dozen or so of which are to be shown at the Wescon show in Los Angeles next month by logic-analyzer makers and newcomers.

Although logic analyzers have proved their usefulness in testing and troubleshooting digital circuits, when it comes to microprocessors, they are found wanting. They display data as it passes through a circuit to the point where a trigger or failure occurs. But they have too many separate test leads that are likely to wind up in a tangled pile, and it is difficult to interpret the 1s and 0s or timing diagrams they display.

For these reasons, microprocessor analyzers are being introduced in ever-increasing numbers. In addition to the companies that have already shown these analyzers—Pro-Log Corp., Monterey, Calif., and Motorola Data Products division, Carol Stream, Ill.—analyzers will be shown at Wescon by Systron-Donner Corp., Concord, Calif.; Hewlett-Packard Co.'s Colorado Springs division, and Scanoptik Instrumentation Co., Rockville, Md. Also, Tektronix Inc., Beaverton, Ore., and Biomation are expected to bring new instruments to Wescon, though nei-



Lots to say. Readout of mnemonic operating codes that match up with the actual program steps makes debugging much easier with HP's \$5,000 microprocessor analyzer (p.32).

ther firm is now discussing its plans. And two firms, E-H Research Laboratories Inc., Oakland, Calif., and Vector Associates Inc., Bellport, N.Y., will have instruments with state displays, which, although not microprocessor analyzers, are aimed at aiding microprocessor-circuit designers.

No two microprocessor analyzers are alike. They range in price and features from Pro-Log's \$500-to-\$650 units, developed for specific microprocessor types, to HP's \$5,000 model 1611A [*Electronics*, July 8, p. 28]. The HP instrument, depending on plug-ins, tests Intel's 8080 or Motorola's 6800, and other plug-ins are in the offing.

All types simplify troubleshooting. Instead of the separate test leads of the usual logic analyzers, the new units interface with the test circuit via a single multipin test clip that fits directly onto the microprocessor package. Readouts of microprocessor analyzers are often hexadecimal displays on either a built-in cathode-

ray-tube screen or an external oscilloscope, in contrast to the 1s and 0s of a logic-state analyzer or the waveforms of a logic-timing analyzer.

Readout. Hexadecimal readout is preferred by software programmers, who use it to compare actual circuit operation to documented programs. Hexadecimal notation also compacts test information, making it easier for production-line personnel to interpret. In smaller, less expensive analyzers, this readout may be presented one program step at a time on a single row of light-emitting diodes.

Another basic difference between a logic and a microprocessor analyzer is the latter's capability to interact with units under test. Logic analyzers, on the other hand, are passive readout devices, with no control over the circuit being tested. Most microprocessor analyzers have halt or wait controls that permit the user to step the microprocessor through its program.

But, unlike the generally more

expensive microprocessor-development systems, microprocessor analyzers cannot be used to prepare programs. "I think of it more as a diagnostic tool," says Robert Bahns-

en, product manager at Motorola Data Products. The analyzer becomes valuable only after the microprocessor is working in a real system, he points out. □

For \$5,000, a fancy analyzer

By far one of the fanciest of the microprocessor analyzers is Hewlett-Packard's model 1611A. Itself built around an 8080-type microprocessor, the 1611A has the important features of its competitors and then some. Like others, the 1611A can be configured to deal with particular microprocessors ("personality modules" to handle the 8080 and 6800 are available, and others are in the works). It can also halt, single-step, and reset the microprocessor under test.

In addition, the 1611A displays system activity on its cathode-ray tube in the alphanumeric mnemonics of the microprocessor's instruction set, as is shown in the photograph of the company's logic-state analyzer on p. 31. This eliminates the need to interpret timing diagrams, 1s and 0s, or hexadecimal notation.

The Hewlett-Packard instrument also has lots of ways to pinpoint a step within a program. It can trigger on a specific address, data word, or combination of 1s and 0s on any or all of eight auxiliary lines. Or the instrument can trigger on any address within a range, or require up to 256 repetitions of the trigger conditions.

The 1611A can also count the number of valid triggers between two points in a program and measure the time taken for a section of a program to run, thus aiding the programmer in minimizing system software.

With a clip-on connector to the microprocessor and keyboard controls, the 1611A is easier to operate than earlier HP logic analyzers, which have a myriad of test leads and rows of operating switches. But despite the 1611A's \$5,000 price, Bruce Farly, HP's digital product planning manager says, "I expect to see more production applications for this instrument than for other analyzers because it can be operated by someone who is far less skilled."

Land-mobile radio

Talk of standards stirs makers, users

Should there be a set of national standards for land-mobile communications hardware? The financial crunch that's hit all levels of government is causing officials to look at standards as a way to save money. But no standards timetable has been set, and attempts to adopt such standards are opposed by major manufacturers and even some users.

This opposition was evident earlier this month at the Association of Public-Safety Communications Officers' conference in New York.

Craig Jorgensen, telecommunications coordinator for Utah's Depart-

ment of Transportation in Salt Lake City, wants standards because it would enable agencies to buy less equipment. "They [the systems] don't interface with one another and, in most instances, they don't interface with older equipment even from the same vendor," says Jorgensen.

Incompatible units. He adds that not only do differences exist in the performance of radio units, but there is incompatibility in the cable assemblies, control heads, battery chargers, and other major system elements. Thus, the agencies must maintain a large inventory of parts, and service and maintenance expenses are high.

"If there were standards for control heads and cables, for example, then if a GE radio goes out, it could easily be replaced with either an RCA or Motorola unit, or even another GE radio of a different

vintage," he continues. "Right now, these aren't compatible."

APCO is an association of officials responsible for the design, operation and maintenance of telecommunication systems serving public-safety agencies. It has formed a committee to produce a set of standards covering the performance, physical characteristics, and test parameters for land-mobile communications hardware. But the committee's efforts have just begun, and a draft won't be ready until the annual meeting next summer in Chicago.

Marshall Treado, communications-systems program supervisor for the National Bureau of Standards in Washington, is, like Jorgensen, in favor of standards. It would lead to "the ability to move equipment in and out [of cars] without having to rip out panels or dismantle a portion of the car," he says.

Competition threat. But user benefits are of less concern to equipment manufacturers than the threat of foreign competition. "One reason we are able to operate in this country without serious offshore competition is that we don't have standards," notes Stuart Meyer, manager of government and industry relations for E. F. Johnson Co. in Waseca, Minn. "If we standardize, offshore producers would have incentive for going after a much broader segment of the market than they have now."

Bob Savajian, a regional manager for RCA's Communications Systems division in Camden, N.J., echoes Meyer's sentiments. "We would be doing all the engineering for them. Without standardization, we are able to keep one step ahead."

Standardization would allow no variation of lines or performance edge, notes Michael Rosen, district sales manager for Motorola's Communications and Electronics Inc. subsidiary in Schaumburg, Ill. "Getting the business would just become a matter of who wants to discount the most," he adds.

User opposition. Users who look askance at standardization do so because they fear their costs would increase. Any standards should have tiers of performance levels, says Al

Talbot, chief engineer for Illinois' division of telecommunications in Springfield, "otherwise we would be forcing the costs of high-performance radios into low-performance operations."

And he cites reasons for opposing standardization that have been cited in other industries when standards have been considered. Too high a degree of standardization "could inhibit engineering prerogatives and systems design" and "impair advances in technology."

But the final say on standards will probably turn on costs. As Jorgensen puts it: "Communities are having to justify expenditures for communications equipment like never before. The days where they could get funds *carte blanche* are over." □

Radar

Balloon-borne radar to look for low fliers

Some time this fall, the Air Force Electronic Systems division will issue an unusual request for proposals for an operational surveillance radar to detect low-flying aircraft approaching the U.S. across the Straits of Florida from the direction of Cuba. The radar will be housed in the underbelly of a tethered balloon, or aerostat, at an altitude slightly higher than 10,000 feet. Data will be telemetered to the ground for digital processing and evaluation. A feasibility-demonstration model of such a radar is aloft now at Cudjoe Key Air Force Station in Key West, Fla.

Solutions sought. In a novel RFP, the Air Force will ask bidders to submit in general terms their most cost-effective answer to the service's needs. For example, the frequency band and kind of antenna probably won't be specified. But Col. Stephen J. Vogel feels industry has the capability "to innovate and come up with ingenious schemes to answer our needs." Vogel is director of the Seek Skyhook program, as it's now called, at ESD headquarters, Hanscom Air Force Base, Bedford, Mass. He says

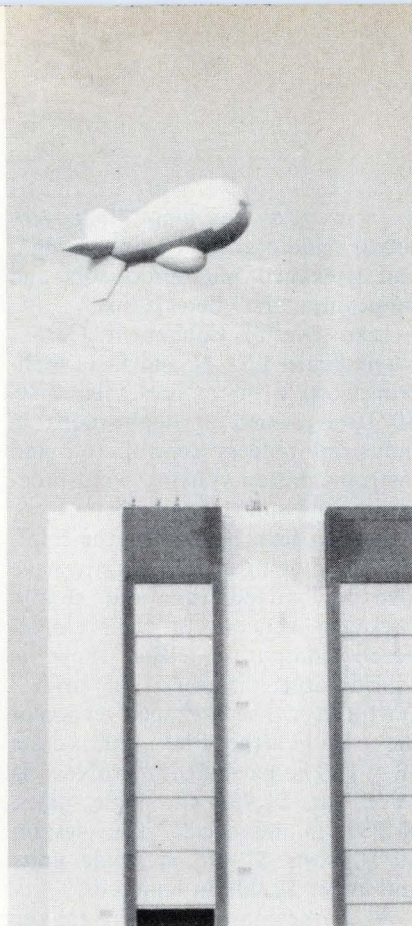

Radar carrier. Aerostat being test-flown at Patrick Air Force Base is the type being considered for Seek Skyhook radar.

Seek Skyhook presents these challenges:

- About triple the range of ground-based surveillance radars, now limited by line of sight to about 35 nautical miles.
- The capability to operate in a severe radar subclutter environment, looking down through clouds and at heavy sea states.
- The capability to detect targets as small as 2.2 square meters—about the size of a Soviet MIG-21 fighter—as well as ships in a search and rescue operation.
- The capability to operate in any weather, although the balloon won't be airborne in winds above about 90 knots.

The need for light weight will be a big consideration, Vogel emphasizes, because the radar's weight will dictate how large the balloon must be. But if the transmitter and receiver are designed so small that they would have to exceed the state of the art, it could lead to a costly development effort.

Weight will also be an important factor in non-electronic portions of

Seek Skyhook. The Westinghouse S-band radar that's been operating since mid-1974 at Cudjoe Key is powered by an on-board generator, but the new system may call for using the tether to carry power or fuel to an on-board system.

Design open. Seek Skyhook will undoubtedly operate in either the L band (390–1,550 megahertz) or S band (1,550–3,900 MHz), Vogel says, but he doesn't want to prejudice any design by backing either one. "L band is purported to be better for the subclutter-visibility problem," Vogel observes. "But it's also purported to be more complex and heavier, and therefore costlier, than S band. There are a lot of tradeoffs, and we will be presenting these tradeoffs and letting industry propose systems to answer them."

Seek Skyhook is funded at about \$12 million for two systems—one aloft and one to go on station while the first is being refueled—plus a backup. Vogel was encouraged by the response to an earlier request for quotations about Seek Skyhook. He won't say how many companies responded, but notes that "we were pleased by the number and strength of those who replied when we asked what parts of the system could be done off-the-shelf and what parts would be needing research and development." □

Computers

Intel 8080 box woos systems business

Intel Corp., the sales leader in microprocessors, has been treading on minicomputer makers' toes by offering not only chips but also one-board computers to original-equipment manufacturers. Now the semiconductor company is about to unnerve mini makers still further with a low-cost fully packaged microcomputer based on its SBC 80/10 one-board computer [*Electronics*, Feb. 5, p. 77].

With this move, the Santa Clara,

Calif., semiconductor manufacturer has placed itself squarely in the minicomputer business. It's going after non-OEM customers like systems houses, which write expensive software for a specific piece of hardware—which they generally buy from a mini maker.

Nearly here. The 80/10 package is already in production. Built around Intel's 8-bit 8080 microprocessor, it comes complete with resident memory, programable input/output, system monitor, power supply, cooling fan, and front panel. The housing measures 3.5 by 19 by 19 inches.

The microcomputer has the 8080's typical instruction-execution time of 1.95 microseconds, a six-source interrupt structure, system bus control and TTL bus drivers for system bus expansion. In addition to 1 kilobyte of static random-access memory, it has up to four kilobytes of read-only memory or programable ROM as resident program storage. Also standard are 48 lines of parallel I/O, organized as six programable I/O ports.

"We weren't reaching all the potential customers we expected to with the single-board computer approach," says Wayne Gartin, system 80/10 marketing manager. Single-board systems like Intel's SBC (\$295 in quantities of 100) were conceived

as a way of reaching "that very broad middle ground between high-end packaged microprocessors and minicomputers," he explains.

Like Digital Equipment Corp.'s single-board LSI-11 and Data General Corp.'s microNova, the SBC 80/10 is aimed at applications in industrial process control, test and instrumentation systems, word processing, and smart terminals.

Bottom line. Several of the mini-computer companies, he says, have also recognized this and supply packaged versions of their single-board computers. "But there is considerable difference in price," Gartin says. The packaged version of the LSI-11 (the PDP11/03) costs \$2,495. The packaged microNova is priced at \$1,995 in single units, \$1,237 in hundreds. The system 80/10 costs \$1,495 in single units and under \$1,000 in hundreds.

A spokesman for mini-maker Data General is not surprised by Intel's 80/10. "We expected it," he says, adding that in any case the microNova is a 16-bit microcomputer. "I suspect there might be some business for a packaged 8-bit computer," he concedes, "but our customers are looking for a more sophisticated software, peripheral, and input/output capability." □

circuits. Should the effort become widespread, the FCC believes smaller CB makers, with limited competence to make the changes, may end up increasing interference and require the FCC to step in and halt the conversion program.

Importers stuck. But importers of Japanese CB transceivers—supplying upward of 70% of the \$500 million U.S. market—are the ones who are really stuck, industry sources agree.

Dealers have a large inventory now but cannot make free modification offers because they cannot ship the sets back to Japan. Big retailers like J.C. Penney Co. and Sears, Roebuck and Co., Chicago, who sell Japanese imports under their own labels, have cancelled all orders, according to industry reports.

Penney headquarters in New York confirmed that its principal CB buyer and two aides were in Japan in mid-August "trying to work out the problem" with suppliers. But a spokesman was unable to provide details.

Other retailers believe they can handle both types of radios. "We haven't cancelled any orders with our Asian sources," says Charles W. Tindall, vice president of Tandy Corp., the Fort Worth, Texas parent of Radio Shack, the electronics retailer that's selling CB radios at a \$45-million-per-quarter clip. "But we're carefully writing new purchase orders with the ability to flip production over to 40-channel units if the 23s don't sell."

After the 40-channel sets are on the market, the question is whether the 23-channel radios can be priced attractively, Tindall believes. "With a \$30 to \$40 spread between them, a 23-channel CB would be an attractive offering," he says, pointing to the fact that Radio Shack now successfully sells a six-channel CB radio for \$69.95.

Some manufacturers are expected to petition the FCC to permit sales of new 40-channel models to begin earlier, with the proviso that the 17 new channels between 27.235 and 27.405 kilohertz not be used by licensees. However, this restriction would be virtually unenforceable.

The Electronic Industries Associa-

Citizens' band

FCC's go-ahead on 40 channels slows sales of 23-channel units

Manufacturers in the booming citizens' band radio market are troubled by the short-term consequences of the Federal Communications Commission's decision to allow CB more air space even while they welcome its long-term potential. Even more upset are big CB radio importers.

Sales are slowing. Since the FCC announced its plan to expand the number of CB channels to 40 from 23 next January [*Electronics*, Aug. 5, p. 49], sales of present 23-channel Class D receivers have been slowing, and fast. That much is acknowledged by the CB radio manufac-

turers' representatives in Washington, D.C., few of whom expect the slowdown to be halted by some makers' offers to modify, at no extra charge, all 23-channel units bought now to 40 channels after next January. Such offers are already being made by Hy-Gain Electronics Corp., Lincoln, Neb., and Pathcom Inc.'s Pace Communications division, and other domestic makers are expected to follow suit.

The FCC's engineering office is also troubled—by the offers, which promise to upgrade transceivers by modifying their phase-locked-loop



Now you can service with a Tektronix Oscilloscope for as little as \$695*

Cost of service instruments is an important factor in any purchase. But so is reliability. Now T900 Oscilloscopes give you both Tektronix quality *and* reliability at prices *designed* for cost sensitive applications.

- T921—Dc to 15 MHz; single trace,
single time base\$695*
- T922—Dc to 15 MHz; dual trace,
single time base\$850*
- T932—Dc to 35 MHz; dual trace,
single time base\$1195*
- T935—Dc to 35 MHz; dual trace,
delayed sweep time base\$1395*
- T912—Dc to 10 MHz; bistable storage;
writing speed to 250 cm/ms; dual trace,
single time base\$1300*

Performance to Spare

All T900 scopes feature large (8 x 10 cm), bright crts; sensitivity

of 2 mV/div to 10 V/div in twelve calibrated steps; regulated power supplies and 3% accuracy. For convenience, T900 Oscilloscopes are equipped with beam finder, single knob triggering, automatic selection of chopped or alternate mode, and automatic selection of tv line or frame display (except T912 Storage model). T900 scopes are compact (7x9x18 in.) and lightweight (only 16 lb.). They are available with a full selection of accessories.

T900 Series— the *quality* low-cost oscilloscopes

For a demonstration of any T900 Oscilloscope or a free copy of the new T900 brochure, write to Tektronix, Inc., P.O. Box 500, Beaverton, OR 97077. For immediate assistance, call (503) 644-0161, extension T900.

*All prices include 10X probes. Prices FOB Beaverton, Oregon.



TEKTRONIX®

committed to
technical excellence

tion has problems with the decision, too, but of a different nature. Long an advocate of expanding CB through a new Class E service in the 220-megahertz region, the association views the latest action as merely an interim solution to the overcrowding of the CB spectrum. "We need a two-band CB service in this country just as we have a-m and fm in broadcast radio," explains EIA's John Sodolski, vice president of the Communications and Industrial division.

Tougher tests. In the new 40-channel CB units, the requirement for harmonic radiation suppression will be raised from 49 to 60 decibels, to minimize interference with TV channels, and much less spurious radiation will be permitted at antenna terminals and from the transceivers' chassis.

In addition, the FCC's laboratory will begin testing for overmodulation effects—excessive transient emissions in adjacent channels.

Modulation transients that show up at the center of either channel adjacent to the one under test must either be attenuated by at least 33 dB or be less than 100 milliseconds long, the FCC says. A manufacturer whose transceivers fail this test will be permitted to redesign his units till they comply. According to the agency, the transients "can readily be measured using a spectrum analyzer (of the type used) for time-domain measurements."

Industry sources expect all the new test criteria to become permanent some time this month, as soon as the FCC issues its revised set of rules. □

Packaging & Production

Thick-film hybrid circuits shrink electronics in brushless motors

Thick-film hybrid technology seems far removed from motor manufacturing. But thick-film techniques applied to the packaging of the internal electronic commutation circuits of a brushless motor have enabled Aeroflex Inc., of Plainview, N.Y., to make a motor that is shorter, lower in cost, and also more

reliable than ever before.

The resulting hybrid structure can accommodate additional power amplifiers so the substrate can be used with a broad range of motors. Previous discrete electronics packages have been limited to lower-power motors.

Brushless dc motors, which are

generally four to five times as expensive as conventional ones, are used in military and aerospace applications. Their "sparkless" commutation adds up to long life, high reliability, efficiency, and low electromagnetic interference.

In an earlier version of Aeroflex's brushless motor [*Electronics*, June 26, 1975, p. 120], the commutation circuitry, composed of discrete components and linear integrated circuits, are placed on a round, two-sided printed-circuit board slightly smaller than the diameter of the motor housing. Two Hall-effect position sensors for commutation are fastened in a ring to the bottom of the board, and the package, although fitting inside the motor, is fairly bulky—about 3/4-inch thick.

In the new electronics package, which is only about 1/8-inch thick, a single-sided alumina substrate, shown in the photo, has screened-on low-cost silver conductors and thick-film resistors. All semiconductors and critical passive parts are sealed under a ceramic lid. Two cylindrical Hall-effect sensors are mounted at right angles on an uncovered part of the substrate.

Cost cut. Mike Schwartz, chief scientist at Aeroflex, says, "The new assembly should cut the cost of production of brushless motors by about \$15. The assembly is only one third the volume of the older pc type, and overall motor length for the same size motor is reduced by 1/4 inch. Actually the new substrate, plus parts, takes up less space than conventional motor-brush assemblies."

Since the packaging density of the hybrid is so much higher than the board it replaces, the unoccupied area on the substrate can hold power-transistor chips that are driven by the basic circuitry. These transistors act as power boosters for large motors. Aeroflex has already fabricated circuits for relatively large size-23 motors (1/6 horsepower) on the hybrid substrate.

More than 100 substrates have already been made for prototype motors, Schwartz says. Most of the motors are size 15s, which have a

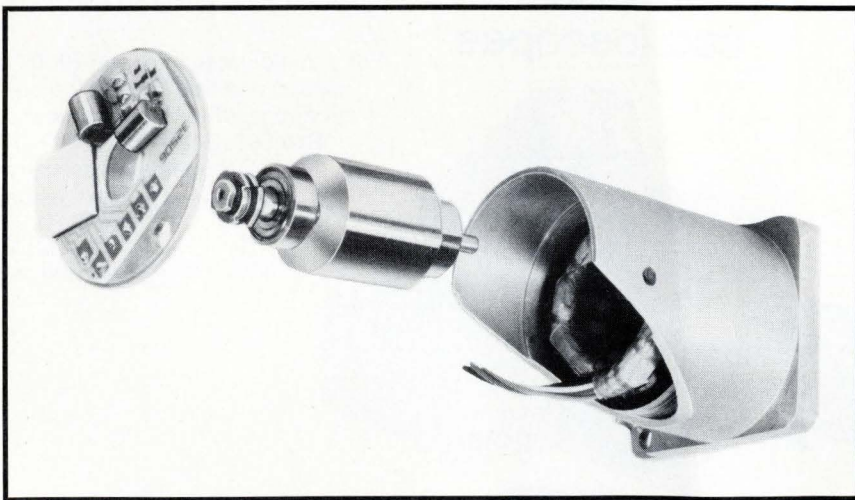

Good fit. Aeroflex's thick-film hybrid (left) that fits inside a brushless dc motor contains critical parts under a ceramic lid with Hall-effect sensors at right angles to each other.

If you can use one of our 3/8" or 5/8" magnetic pickups, you can save a lot of money.

You might expect us to say that Airpax magnetic pickups are precision made and rugged. But here's a fact you can sink your teeth into: our verified return rate last year was zero.

Here's the money saver: The magnetic pickups shown in the chart will enable you to handle most of your motion-sensing problems. Because of this standardization, we can save you money, without sacrificing an ounce of Airpax quality.

Think about it. If you design with Airpax in mind, you'll get excellent magnetic pickups at very reasonable prices. We won't hold you up at the production end either... delivery is virtually off-the-shelf.

Low price, fast delivery, unbeatable quality. What could be better?

For more information, circle our number on the reader service card; if you're in a hurry, give us a call. We're standing by ready to assist you.

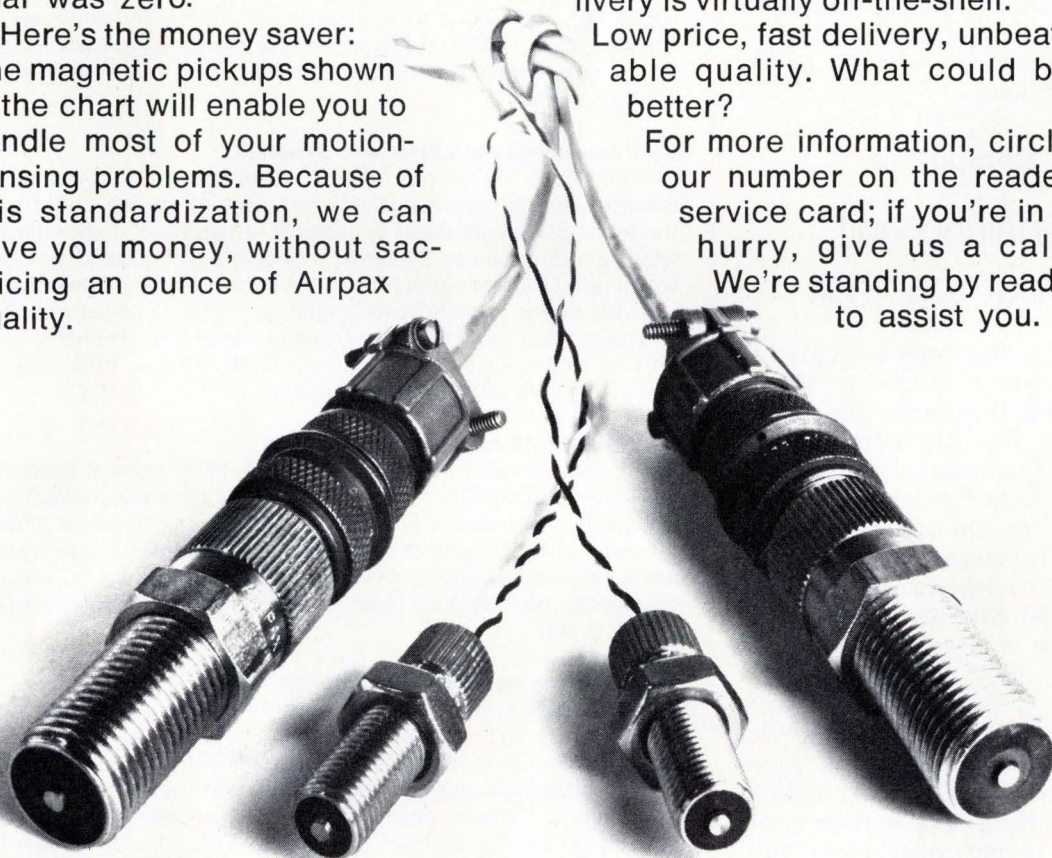

Mounting thread:	5/8-18 UNF-2A	5/8-18 UNF-2A	3/8-24 UNF-2A	3/8-24 UNF-2A
Output voltage:	40-60V (P-P)	150-230V (P-P)	20-32V (P-P)	55-85V (P-P)
DC resistance:	100-130 ohms	1200-1500 ohms	85-115 ohms	550-700 ohms
Inductance:	33mH Ref.	360mH Ref.	22mH Ref.	125mH Ref.
Operating Temp:	-100 to 225° F	-100 to 225° F	-100 to 225° F	-100 to 225° F
Description:	General purpose; stand. sensitivity	General purpose; high sensitivity	Miniature; stand. sensitivity	Miniature; high sensitivity
Model number:	1-0001	1-0002	1-0007	1-0032

AIRPAX
CONTROLS DIVISION

6801 W. Sunrise Boulevard, Fort Lauderdale, Florida 33313 • (305) 587-1100

Other Divisions:

Circuit Breakers and Glass Seals, Cambridge Division, Cambridge, Md.
Broadcast T.V. Equipment, American Data Corp., Huntsville, Ala.

stall torque of 1.5 ounce-inch, stall power of 13 watts, a rotor moment of inertia of 5 grams per square centimeter, and a no-load speed of 3,000 revolutions per minute. The diameter of the new motor is 1.437 in., and the length is 1.90 in.

The design is particularly suited, Schwartz points out, to operating in gas and liquid environments, which have no effect on the magnetic sensor or the sealed-in hybrid circuitry. Other conventional and brushless motors cannot operate under these conditions. □

Computers

Self-repairing unit being put together

Engineers at Raytheon Co.'s Equipment division in Sudbury, Mass., have reached the systems integration phase for the Air Force's self-repairing fault-tolerant spaceborne computer. In fact, program manager Arnold Van Doren expects the computer [*Electronics*, Dec. 25, 1975, p. 36] will be delivered to the Space and Missile Systems Organization on schedule in November.

Samso, in El Segundo, Calif., needs a computer with a 95% probability of operating in space for five years. To achieve that goal, Raytheon is not just building redundancy into the general-purpose computer, but is employing a novel "ripler switch" to perform the self-repairing function while reducing redundancy and simplifying the switching hardware.

C-MOS design. The brassboard for the Air Force uses complementary metal-oxide semiconductors almost everywhere. The exceptions are two of the memory modules, one of which uses n-channel MOS random-access devices while the other employs plated wire. In addition, C-MOS-on-sapphire LSI devices in the arithmetic/logic units and some register files in the central processor assure that the system will achieve the speed of 200,000 instructions per second, says Jack Stiffler, consulting

News briefs

Delco adds big, new MOS plant

Delco Electronics will dramatically increase its MOS capability next April when it turns on a new 25,000-square-foot plant that's going up in Kokomo, Ind. It will have p-channel, n-channel, and complementary-MOS production lines and will eventually build custom microprocessors to be used in vehicle engines to meet Government regulations on emissions, safety, and fuel economy. The firm also sees a need for LSI chips for auto radios, perhaps as early as next year.

Delco has a limited MOS capability now: for 1977 General Motors cars, it's supplying p-MOS chips for thief-deterrent and cruise-control systems and is shipping a few n-MOS prototypes to its Santa Barbara, Calif., R&D center for an airborne computer. The GM subsidiary also has extensive bipolar and hybrid facilities.

Unitrode invests in LSI-maker Synertek

Unitrode Corp., Watertown, Mass., will become the largest stockholder in Synertek, the Santa Clara, Calif., manufacturer of MOS LSI devices, under the terms of an agreement in principle to purchase stock. The purchase is worth \$1.25 million to Synertek. It should be concluded by Sept. 30 and would give Unitrode about 20% of the outstanding Synertek common stock. Unitrode makes discrete semiconductors, including power transistors, triacs, and silicon-controlled rectifiers. Synertek, which uses neither "Co." or "Inc." after its name, began operations in 1974 and was profitable in the year ended June 30, with sales of \$5 million.

Award for F-18 radar goes to Hughes

The multimode radar for the Navy's new F-18 air combat fighter will be built by Hughes Aircraft Co., following its selection by prime contractor McDonnell Douglas Corp. Under a \$64 million fixed-price/incentive contract, Hughes will build 11 radar systems for the flight-test phase of the aircraft's development. Hughes was chosen over Westinghouse Electric Co., which is already developing the multimode radar for the Air Force's F-16 fighter [*Electronics*, July 8, p. 33].

Packet-mode network goes international

Tymshare Inc., Cupertino, Calif., and the Trans-Canada Telephone System have agreed to interconnect Canada's packet-switched network with Tymshare's international data network. This is the first international linking of packet-mode networks for commercial use. The interconnection will give customers in Canada direct packet-mode access to a large universe of computers and data bases in the U.S. The interconnection additionally means that subscribers in the U.S. may now interconnect to Canadian computers tied to Datapac.

Retailer orders \$6 million in POS terminals . . .

A \$6 million, three-year agreement has been signed between National Semiconductor Corp., Santa Clara, Calif., and National Tea Co. for Datachecker electronic point-of-sale terminal systems. The equipment, to be installed at more than 100 National Tea stores, includes T-2500 stand-alone terminals with polling subsystems, scanning equipment, and key entry systems without scanners. National Tea already has installed Datachecker equipment in more than 60 stores in Chicago and St. Louis.

. . . as manufacturer orders hand-held scanners

TRW Inc. has awarded a \$15 million contract to Recognition Products Inc., a subsidiary of Recognition Equipment Inc., Dallas, for the company's hand-held optical-character-recognition wands. All the same model, the wands will be attached to electronic point-of-sale terminals. According to Jay Rodney Reese, REI president, the TRW contract may be the largest OCR order ever received by any manufacturer.

The narrow ^{NEW} thumbwheels with wide application

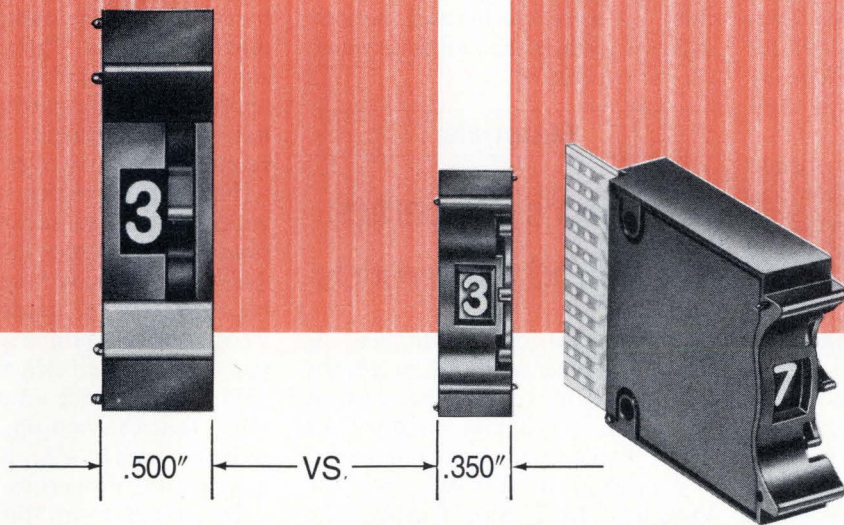

Two new slim thumbwheels...with slim prices, too.

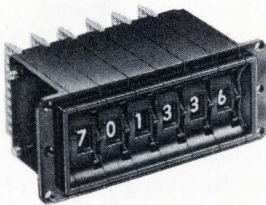

Basic T-35 Series

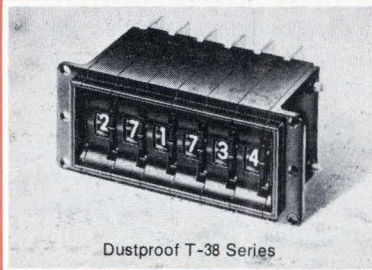

Dustproof T-38 Series

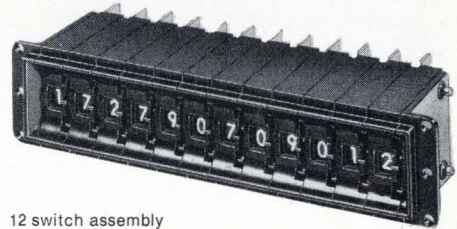

12 switch assembly
uses only 1" x 4½" front panel space.

Two modestly-priced, slim subminiature thumbwheel switches offering substantial savings in panel space. The more switches you need, the more space you save. Available in two new designs:

The easy and accurate to use Series T-35 Basic Thumbwheel with all the high quality engineering and construction features that establish **Cherry** Thumbwheels as the standard by which you judge **other** thumbwheels.

The Series T-38 Dustproof Thumbwheel with a clear

plastic window that covers the dial character opening to keep dust and dirt **outside** where they can't foul or contaminate the mechanism and contacts **inside**.

Best of all, these narrow new thumbwheels are available in 8, 10, 12 and 16 positions in your "most wanted" output codes.

For all the NARROW facts and SLIM prices in a hurry, just TWX 910-235-1572 . . . or PHONE 312-689-7700.

See us at
WESCON
Sept. 14-17
Booth 526



CHERRY ELECTRICAL PRODUCTS CORP.
3608 Sunset Avenue, Waukegan, IL 60085
Cherry switches now available locally from distributors.

scientist for the fault-tolerant computer in the division's Computer and Displays Laboratory [*Electronics*, June 24, p. 25].

Redundancy is provided in the key computer modules through four central processors (two of which work at all times), three main memory modules, two serial interface modules, two direct-memory-access modules, and three configuration-control units. These last have the job of monitoring the entire system for faults and, when they find one, triggering a status word that initiates the reconfiguration of the system by dropping out a failed unit and calling in a spare.

But because redundancy adds weight and volume, Stiffler has come up with the rippler switch to keep both factors in hand. This switch exploits the interchangeability of the modules and module subelements into which the computer is partitioned—it reconfigures functioning subelements into a new operating system after a failure is detected. And it does so without being so complex that it degrades overall reliability—a possible problem in other kinds of switching techniques, Stiffler says.

Backup neighbor. The rippler replaces any subelement in a linear array of identical subelements with its nearest neighbor, then replaces that device with that device's nearest neighbor, and so on, until the last active device is replaced down the line by the first available spare. In each memory module, for example, there are three spare and 38 active bit lines.

If a bit line is faulty, the configuration-control unit is notified and establishes a hardware status word that alerts the central processing unit to the fault. The CPU, using a program stored in its read-only memory, isolates the failed bit line and triggers the rippler switch.

With the C-MOS LSI rippler "we can get as much protection against a failure in a bit line as we could with a complete duplicate memory," Stiffler says. According to him, it's also much simpler than a switch that directly substitutes a spare bit line in

the same location as the failed line.

If the fault is elsewhere than in the memory, error-code decoders, "watchdog" timers or the CPU monitor will detect it. The watchdog timers measure, among other things, the interval between the time a computer element is asked to transfer data and the time it actually does. When a fault is noted, the configuration-control unit is alerted and interrupts the CPU to start the reconfiguration program. In addition, software diagnostics periodically verify that the hardware monitors are operating. □

Materials

Ceramic's properties enhanced for hybrids

A small California company is marketing a ceramic with properties it says could reduce the cost of manufacturing hybrid circuitry for high-reliability avionics equipment.

Designated RW-97, by RW Products Inc., San Carlos, the alumina-based ceramic is priced, depending on how much it is preworked for the customer, from 2% to 10% less than conventional material, says Robert Wire, the company's president. And even further savings are possible for the customer, he continues, because testing can be much simplified.

These benefits are obtained, Wire says, because RW-97 combines the electrical, mechanical, metalization, and temperature characteristics previously found separately in three or four different compounds. Accordingly, fewer separate test procedures and equipment are needed to check out the material.

Others also. RW Products is not alone in developing such a general-purpose material, which is also suitable for the insulators in microwave vacuum tubes. It is, however, the first to reach the market, and its material has been approved by the Defense Electronics Supply Agency.

Considerably larger ceramic-material suppliers than the \$800,000-a-

year RW Products are also rumored to be hard at work on similar materials. These include Coors Porcelain Co., American Lava Inc., a subsidiary of Minnesota Mining and Manufacturing Co., and Western Gold and Platinum Corp. (Wesgo).

To produce hardened alumina ceramics with the right mix of properties, suppliers have their own proprietary mixes of silicas, clays, and rare earths that are combined with aluminum oxide in its raw, powdered form and then compressed and molded into a "green," unfired substance. Depending on the end application, each particular mixture has a characteristic "body" that's related to the mix of raw materials.

The characteristics important for vacuum-tube and substrate applications in the avionics industry have a 94% to 99.5% body range. For example, says Wire, material with a 99.5% body is optimized for physical strength and electrical properties; 97%, for a balance among metalization, electrical, and physical characteristics, and 94%, primarily for metalization properties.

In unfired form, these materials are soft and chalky, but firm enough to be machined to the shape required. They are then heated to about 3,000°F in kilns to produce tough alumina ceramics that are nearly as hard as diamond.

Wire and his engineers have come up with a process that is similar to the old approach, except, of course, for the details of the rare-earth/silica/clay combination and the firing schedule. But Wire says it produces an alumina ceramic that combines the optimum metalizing properties of a 97% body and the electrical characteristics of a 99% body.

According to the company, the only limit to the size of the ceramics it can turn out is set by the equipment. Presently, the limit is six inches in diameter and 10 by 10 inches in area. Surface finish, a measure of the root-mean-square peak-to-valley distance over the entire substrate, is about 28 to 32 microinches in an "as fired" state. Flatness, or camber, a measure of the amount of bowing in the

Our microprocessor is masterminding a major line of microwave ovens. In short order, we can cook up an appliance control circuit for you, too.

There's a revolution simmering in a microwave oven. With the sweet smell of success. We're glad to say, it's the one with our microprocessor in it. Controlling the cooking. The defrosting. Even the time to even out the temperature in between. Controlling the program and the reset. The display of the time or the timing.

Everything. Right down to the beep. Electronically.

Activated by not even a button, but only a touch. It's the first microwave oven with Total Electronic Control. Which probably makes it the most sophisticated kitchen appliance in the world today. And it's only a matter of time before other appliances follow the lead.

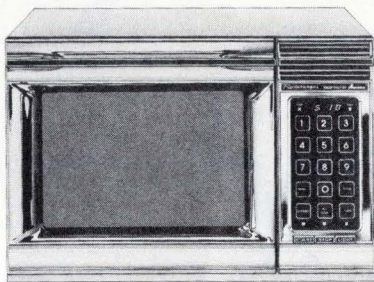

Because the time has come for the Total Electronic Control. As surely as it is running out for the electro-mechanical control. Which, in the long run, cannot compete. Not in feature-oriented consumer appliances. Not when one circuit can carry in it the control features for a whole line, top to bottom, and be the one-item basis for a whole inventory.

This "no-cost/low-cost" features concept of the Total Electronic Control cannot be denied. Not for long. Not in the marketplace.

It's the kind of control, we believe, you will want in your home appliances. For it's the kind of control, we believe, the consumer will have in hers.

General Instrument Microelectronics, at 600 West John Street, Hicksville, N.Y. 11802, 516-733-3107.

We help you compete.

**GENERAL INSTRUMENT CORPORATION
MICROELECTRONICS**



SUPER ROM



Faster than a speeding MPU!

Here is the 16K ROM of the future.

With a maximum access time of 450 ns, the S6831 is ready for this generation of microprocessors—and the next! And it's an unbeatable ally of sophisticated calculators and other demanding applications.

Four versions of this speedy marvel give you pinout compatibility with all the slower 16K ROMs. And a turnaround time of eight weeks means you can improve your product in a hurry.

Whether you're building an AMI 6800 microcomputer or another powerful system that needs fast, low-power memory, our 16K ROM will give you:

Maximum access time of 450 ns

Low power of 150 mw average

S6831 is pinout similar to the S6830 (8K)

S6831A is pinout compatible with the Intel 2316A and 8316A

S6831B is pinout compatible with the Intel 2316B and 8316B

S6831C is pinout compatible with the EA4600

N-Channel silicon gate depletion load technology

2K x 8 bit organization

Static operation

Three-state data output

Three chip enable inputs

Single 5-volt power supply

TTL compatible Input/Output

Want to get SuperROM on your side? Step into a phone booth and call your nearest AMI distributor or sales office. Or write to AMI, 3800 Homestead Road, Santa Clara CA 95051.

It's a sure way to fight obsolescence.

**it's
standard
at AMI.**
AMERICAN MICROSYSTEMS, INC.

Here's AMI:

SALES OFFICES

Long Beach CA • (213) 595-4768
San Jose CA • (408) 249-4550
Altamonte Springs FL • (305) 830-8888
Elk Grove Village IL • (312) 437-6496
Norwood MA • (617) 762-0726
Livonia MI • (313) 478-9339
Minneapolis MN • (612) 559-9004
Monsey NY • (914) 352-5333
Cleveland OH • (216) 292-6850
Ambler PA • (215) 643-0217
Richardson TX • (214) 231-5721

DISTRIBUTORS

ARROW ELECTRONICS:
Minnesota—Bloomington (612) 888-5522
CENTURY ELECTRONICS:
New Mexico—Albuquerque (505) 292-2700
Utah—Salt Lake City (801) 487-8551
CESCO ELECTRONICS, LTD.:
Canada—Montreal (514) 735-5511
COMPONENT SPECIALISTS, INC.:
Texas—Dallas (214) 357-4576
Houston (713) 771-7237
INTERMARK ELECTRONICS:
Washington—Seattle (206) 767-3160
SCHWEBER ELECTRONICS:
California—Costa Mesa (213) 924-5594
and (714) 556-3880
Connecticut—Danbury (203) 792-3500
Florida—Hollywood (305) 927-0511
Georgia—Atlanta (404) 449-9170
Illinois—Elk Grove Village (312) 593-2740
Iowa—Cedar Rapids "Lorenz Sales"
(319) 393-6912

Maryland—Rockville (301) 881-3300
Massachusetts—Waltham (617) 890-8484
Michigan—Troy (313) 583-9242
Minnesota—Edina (612) 941-5280
New Jersey—Somerset (201) 469-6008
New York—Rochester (716) 461-4000
Westbury (516) 334-7474
Ohio—Beachwood (216) 464-2970
Texas—Austin (512) 837-2890
Dallas (214) 661-5010
Houston (713) 784-3600

Canada—Mississauga, Ont. (416) 678-9050

SEMICONP CORP.

California—Newport Beach
(213) 971-5253 and (714) 833-3070

STERLING ELECTRONICS:

Arizona—Phoenix (602) 258-4531
Louisiana—Metairie (504) 887-7610
Massachusetts—Watertown (617) 926-9720
New Jersey—Perth Amboy (201) 442-8000
New Mexico—Albuquerque (505) 345-6601
Texas—Dallas (214) 357-9131
Houston (713) 627-9800

Virginia—Richmond "Meridian Electronics"
(804) 359-0221

R.V. WEATHERFORD CO.:

Arizona—Phoenix (602) 272-7144
California—Anaheim (714) 547-0891
Glendale (213) 849-3451
Palo Alto (415) 493-5373
Pomona (714) 623-1261
San Diego (714) 278-7400

Colorado—Englewood (303) 761-5432

New Mexico—Albuquerque (505) 842-0868

Texas—Dallas (214) 243-1571

Houston (713) 688-7406

Washington—Seattle (206) 243-6340

REPRESENTATIVES

AMMON & RIZOS:

Oklahoma—Oklahoma City (405) 373-2748

Texas—Dallas (214) 233-5591

Houston (713) 781-6240

BARNHILL FIVE:

Colorado—Denver (303) 426-0222

BENEKE & McCAUL:

Missouri—Grandview (816) 765-2998

St. Louis (314) 567-3399

CAN TEC REPRESENTATIVES, INC.:

Ontario—Milton (416) 457-4455

Ontario—Ottawa (613) 225-0363

Quebec—Pierre Sonds (514) 620-3121

COULBOURN DEGREIF, INC.:

Maryland—Baltimore (301) 247-4646

HADDEN ASSOCIATES:

California—San Diego (714) 565-9445

HECHT, HENSCHEN & ASSOCIATES, INC.:

Arizona—Phoenix (602) 275-4411

LOWREY & ASSOCIATES:

Michigan—Brighton (313) 227-7067

MASIN-ESCO, INC.:

New Jersey—North Caldwell (201) 226-2550

New York—Syosset (516) 364-0310

NORTHWEST MARKETING ASSOCIATES:

Washington—Bellevue (206) 455-5846

OASIS SALES, INC.:

Illinois—Elk Grove Village (312) 640-1850

PRECISION SALES COMPANY:

New York—Syracuse (315) 458-2223

REP, INC.:

Alabama—Huntsville (205) 881-9270

Georgia—Tucker (404) 938-4358

North Carolina—Raleigh (919) 851-3007

TECHNICAL REPRESENTATIVES, INC.:

Indiana—Indianapolis (317) 849-6454

Electronics review

substrate is typically 0.002 to 0.003 inch/inch.

Into production. Wire says that Litton Industries, Microwave Associates, and the Relmag division of Varian Associates are gearing up to use his material in their microwave vacuum tubes. In addition, he says, several other companies—including Varian's Solid State division and Aeronutronic Ford—are evaluating RW-97 for use in hybrid-substrate assemblies in satellites.

But these companies aren't saying much yet. However, a materials specialist at Varian says, presaging what could be a problem for small RW Products, "I can't help wondering what companies like Coors and Wesgo have up their sleeves." □

Automotive

GM picks custom chip for digital ignition

Ending speculation on whether auto companies will go to custom or standard microprocessors, General Motors, the biggest of the Big Three, has come down on the custom side. Its first digital computer under the hood will include a 10-bit processor designed by the Delco-Remy and Oldsmobile divisions, produced by Rockwell International, and targeted for the 1977 Toronados.

Economy improvement. The microprocessor will be the brain of an ignition timing and spark regulation system that is expected to increase the Toronado's fuel economy by an average of 8%, or 1.2 miles per gallon.

Called Misar for microprocessed sensing and automatic regulation, the system processes inputs from three sensors—coolant temperature, manifold vacuum, and crankshaft position, related to engine speed. Honeywell is producing the pressure sensor for vacuum and Delco-Remy, the other two.

The microprocessor is programmed to take the speed and vacuum information and interpolate from its memory optimum ignition timing

based on engine conditions. It then establishes the crank position at which to fire the spark, controls dwell time, and adjusts firing based on coolant temperature.

Analog at Chrysler. As for the others in the Big Three, only Chrysler has a similar electronically controlled spark advance as part of its lean-burn system [*Electronics*, April 3, 1975, p. 38]. However, the Chrysler computer-controlled spark is an analog system, less flexible than the new GM Misar. Most likely Chrysler, too, will go to a digital microprocessor for the next generation of lean-burn controls, which it will use on more models.

Ford, meanwhile, has put plans for a microprocessor-controlled fuel-management system on the back burner, preferring to stay with established electromechanical devices.

In GM's case, the microprocessor as designed is far underutilized in its present format. But that was anticipated since the Toronado is obviously a means of getting the auto maker's feet wet in digital technology. After the shakedown expected in making the estimated 35,000 1977 Toronados, the Misar system will be extended to other intermediate-sized cars.

Ease of conversion to other engines for various model cars will be one of the payoffs to GM. The microprocessor can be programmed with engine performance data for individual engines, much as the auto companies now put a preset advance into distributors to match each engine.

More capacity possible. According to Elliott M. Estes, GM president, who unveiled the Misar at the recent West Coast meeting of the Society of Automotive Engineers, the full capacity of the microprocessor may some day be used to cut unwanted engine knock by retarding or advancing the spark to keep it below trace levels. "GM hopes to introduce a knock limiter in the next couple of years," Estes disclosed.

Like the analog Chrysler system, the GM Misar's objective is to meet Federal emission control regulations without limiting performance. □

Ah, alone

at last.

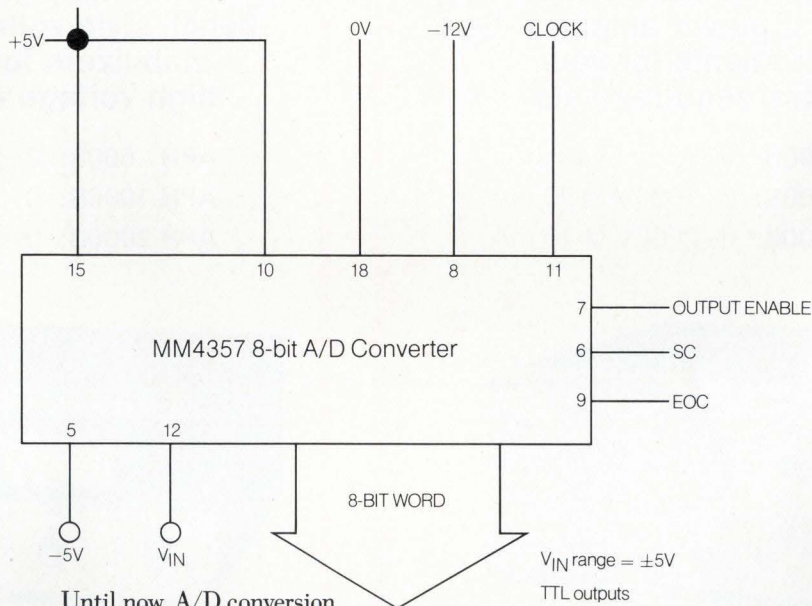

Until now, A/D conversion was a three-ring circus. An 8-bit D/A converter, an 8-bit successive approximation register, a comparator — it took all of them to turn analog into digital.

But now, for as little as \$7.95, you can substitute our 20-microsecond MM4357 8-bit A/D Converter for all that mishmash.

And for a 13¢ stamp and an envelope, you can mail the coupon for data sheets on the MM4357 and another item we're announcing. Our DA1200 12-bit D/A Converter, with internal reference and fast amplifier. As part of the deal, you also get details on our buffered and precision references, our panel meter chips and our 8-bit and 12-bit successive approximation registers.

So, we may be alone in fast single-component A/D conversion.

But back at National, that component has company.

National Semiconductor
2900 Semiconductor Drive, Santa Clara, CA 95051

Gentlemen:
Send me those data sheets. I'd hate to be alone in my field without them.

Name _____ Title _____

Company _____

Address _____

City _____ State _____ Zip _____

National Semiconductor 

for your
**HIGH
VOLTAGE
NEEDS**

KEPCO offers
a choice:

OPS
group IXB

High Speed (no output capacitor) operational power amplifier-type instruments for your control requirements

OPS 500B: 0–500V @ 40 mA
OPS 1000B: 0–1000V @ 20 mA
OPS 2000B: 0–2000V @ 10 mA

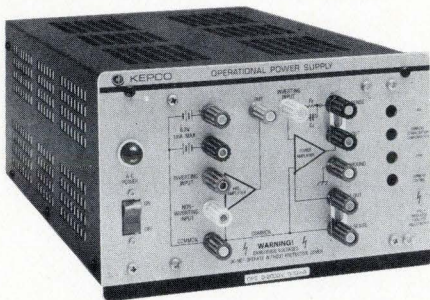

You may exercise control over the high voltage output with a 0–5V control signal, or use the built-in pre-amplifier to scale or sum your inputs operationally. The output follows input signals with a 100 μ sec programming time constant (OPS 500B). Current limit is both adjustable and electrically programmable.

Slew Rate Limit 1 V/ μ sec.
Gain 10^6 V/V
Offset Voltage (for Load) <10 μ V
Noise 0.01% of E_o or 15 mV rms

APH
AUTOMATIC
CROSSOVER

Conventionally filtered (low noise) bench style voltage and current stabilizers for your stable high voltage requirements

APH 500B: 0–500V @ 40 mA
APH 1000B: 0–1000V @ 20 mA
APH 2000B: 0–2000V @ 10 mA



Control voltage with a 10-turn precision panel control (or program like the OPS). Another 10-turn panel control adjusts the output current. LED annunciators signal operation in either voltage mode or current modes. A built-in "uncommitted pre-amplifier" is available for scaling or summing programming inputs. Output is monitored on a pair of 2½" meters.

Stabilization (for Load) <0.005%
8-hour Drift <0.01%
Noise <1 mV rms



Write Dept.
FG-14.

Kepeco high voltage power supplies are designed with your needs in mind. Our Catalog describes models ranging up to 5000 volts; up to 200 watts and includes both unipolar and bipolar instruments.

with KEPCO you're in control!

Electronics firms finding Bombay offshore haven

A U.S. State Department report that has not yet been made public touts Bombay, India, as "tomorrow's Taiwan." That judgment by an international industry analyst at State is based on the growing number of electronics companies—**51 so far, including 17 with American ties**—that have been attracted to the Indian city. They have set up manufacturing operations in an area known as Seepz—the Santa Cruz electronic export zone—which contains 100 acres.

For example, Intersil Inc. has made a deal for production and assembly of digital-watch modules. One of the attractions of Seepz is that it can offer high engineering skills. Unlike Taiwan or Korea, says the report, "there will be very few assembly units operating on a low-technology, labor-intensive basis." So far, the average value added to exports is 60%.

FCC conditionally OKs trades, remakes, resale of CB radios

Citizens' band radio makers that plan to upgrade to 40 channels their 23-channel transceivers (see p. 34) now have FCC approval. The commission says makers **may modify any sets taken in trade and resell them** after expansion of the service on Jan. 1, 1977. [Electronics, Aug. 5, p. 49]. That ruling by the Federal Communications Commission's chief engineer—a compromise on the FCC's earlier prohibition on any alteration of 23-channel radios—contains important provisions, however.

All upgraded transceivers must meet all new 40-channel equipment requirements, including type acceptance and certification. Moreover, the FCC says it plans "extensive sampling of equipment from each manufacturing location" and will hold each manufacturer "solely responsible" for modified units, even though upgrading may be done by others under his direction. "We're going to be very sticky on this," insists one commission official. "Failure of one test unit could lead to cancellation of type acceptance for a complete model line."

FAA awards \$36.7 million more to Univac for ARTS III

Sperry Rand's Univac division has picked up nearly \$36.7 million from the Federal Aviation Administration for **five more ARTS III automated radar-terminal systems**, plus upgrading of 29 of 65 existing stations. Univac says the new contract boosts its ARTS funding to \$131.6 million since its first award in 1969. New systems are set for the New York terminal radar-control room, the San Juan, Honolulu, and Anchorage en-route control centers, and the fifth will go to Nellis Air Force Base, Las Vegas.

The ARTS III enhancement project will expand 29 of the existing 65 installations. Changes include addition of on-scope alphanumeric radar tracking for aircraft not equipped with an identity and altitude transponder, capacity for additional radar displays, and upgraded computer efficiency.

Addenda

The push for electric vehicles got a small but significant boost from a Department of Transportation recommendation to **omit them from Federal energy conservation and mileage-labeling regulation**. Reason: regulation would boost vehicles' costs, slow production and introduction, as well as require redefinition of "fuel" to include electrical energy. . . . Another small boost for U.S. makers of airport X-ray baggage scanners came with a Federal Aviation Administration order requiring all foreign airlines at U.S. airports to use only scanners **meeting performance and safety standards set for hardware used by U.S. airlines**.

Untangling the jumble at the FCC

In a midsummer's mixture of three separate judgments critical to the future of the nation's telecommunications, the Federal Communications Commission has inadvertently provided its critics with some of their best evidence for congressional review of its operation.

First, the FCC inaugurated a second computer inquiry with Docket 20828 "to consider again the use of computers in providing communications or data processing services by common carriers"—an issue it presumably resolved in 1971 with its "final decision" in Docket 16979, its first investigation of the issue. And there is no evidence that the new effort won't occupy several more years of the FCC's time, like that of its predecessor. Under its proposed new inquiry, common carriers would be banned from offering arithmetic or word processing and process-control services unless they established new and separate corporations for that purpose.

Kraushaar as Solomon

Next came the widely publicized and long-awaited verdict of FCC administrative law judge David I. Kraushaar, urging the commissioners to go slowly before advocating any breakup of the Bell System "in the holy names of 'competition' and 'free markets.'" Although Kraushaar's 535-page ruling in Phase II of the FCC's monumental investigation of the lawfulness of AT&T's private-line tariffs is not binding on the commissioners, industry and Government sources agree that Kraushaar's praise of much of AT&T's service quality and corporate and rate structures is well balanced by specific criticisms calling for the opening of the Bell System market to suppliers other than Western Electric Co. and, conversely, permitting WE to compete in other telecommunications markets.

However, to implement these and other recommended changes in AT&T operations, Kraushaar detailed a strong need for upgrading both the company's and the FCC's accounting procedures. He sharply criticized FCC staff challenges to Bell's expenditures and rate-base items, noting these were derived from company records maintained under FCC rules—a system never thoroughly overhauled in 40 years. "The Government has no business taking a citizen out on the proverbial limb and then cutting it off," he declared.

It was those same unenforceable and outmoded accounting principles that caused the FCC in mid-August—a week after Kraushaar's Solomon-like decision—to turn down AT&T's

request to add 40 more cities to the 24 in which it now offers data-under-voice digital Dataphone service. The FCC's reason: AT&T's alleged "failure to keep records of actual costs as previously ordered" and the FCC's resultant "inability to determine the actual cost and revenue relationships" for the service. (In DUV, digital bit streams are transmitted on a full-duplex, simultaneous basis by means of the unused portion of the 4- and 6-GHz baseband of high-capacity microwave radio.)

But in a 3-to-1 split, the commission did grant AT&T authority to expand the service in the 24 existing cities where DUV is employed. Dissenting commissioner Benjamin L. Hooks hit the majority's rule as contrary to the FCC's five-year-old policy on permitting competition, charging that it serves only to tighten "the tentacles of regulatory rigor around one of the most innovative data services yet devised."

Ending indecision

What the three separate FCC decisions have in common is that each of them represents an incompleting action despite many months of investigations, hearings, and study. The Kraushaar judgment alone required 103 days of hearings that took more than a year to complete. More and more, it seems the FCC itself is becoming a classic case of suspended bureaucratic animation where nothing is settled.

In ordering a second computer inquiry, the commission sought to lay the blame on "dramatic advances" in technology, particularly large-scale integrated circuitry, the resultant development of mini- and microcomputers, and "the emergence of a new phenomenon—the distributed-computer network." These advances outdated its first "final decision" five years ago, the FCC now contends. But there is no guarantee that technology will grind to a halt while the FCC muddles through yet another investigation. Who can say that by 1978, say, still a third inquiry may not be warranted—for precisely the same reasons as the second?

But clearly the final resolution of the bedeviled commission's problems must come from the Congress. This is not to say that any satisfying answers rest within the AT&T-sponsored Consumer Communications Reform bill, which would stifle telecommunications competition. Yet that now seems most likely to become the vehicle by which Congress will be obliged to take its first look at FCC since its creation—an underfunded, understaffed anachronism where hand calculators and paper files substitute for computers and data banks. —Ray Connolly

WHO MAKES THESE CUSTOM ICs?

We don't make commodity ICs. Our 15 years of intensive experience in ICs is devoted to the development and manufacture of **innovative** circuits . . . circuits making special contribution to industry technology . . . circuits manufactured under the most exacting QAR program ever implemented . . . **creative** circuits such as the types shown here. **If you can't quite do the job with standard products, we can design integrated circuits tailored to your needs.**

- Printer Controllers
- Ground Fault Interrupters
- Smoke Detectors
- Voltage Regulators
- Photographic Shutter Controls
- Camera Flash Controls
- Stroboscopic Controls
- Auto Ignition Circuits
- Hall-Effect Switches
- Anti-Theft Controls
- Lamp Monitors
- Low Coolant Monitors
- Brake Fluid Monitors
- Seat Belt Interlocks
- Clock Circuits
- Photo Diodes
- Quad FM Decoders
- Electronic Timers
- Electronic Games
- AM/FM/TV Circuits
- Communications Circuits
- CB/Scanner Circuits
- MOS Custom Circuits

For the full story on digital bipolar and MOS circuits, write or call George Tully; for consumer entertainment and other linear circuits, write or call Bob Milewski; for automotive and photographic circuits, write or call Brad Marshall.

*Sprague Electric Company, 115 Northeast Cutoff,
Worcester, Mass. 01606 (Tel. 617/853-5000).*

ICs for IMAGINATIVE DESIGNERS

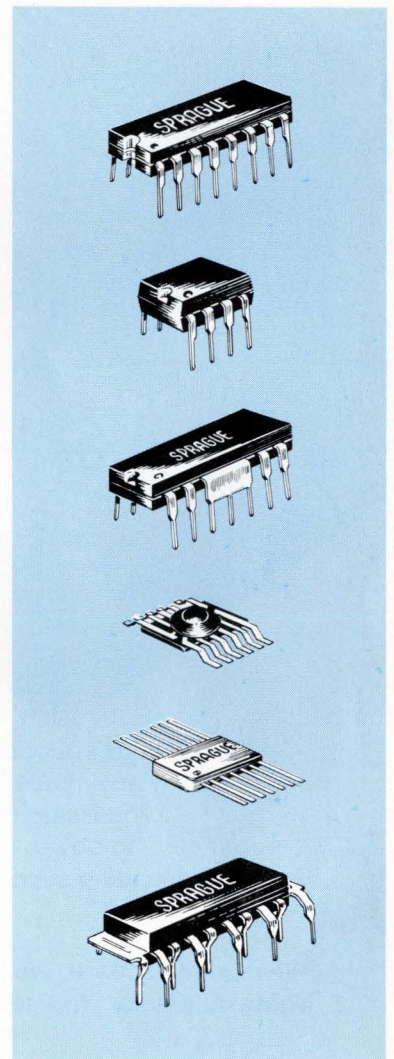

4SS-6113

SPRAGUE®

THE MARK OF RELIABILITY

*. . . and you thought we
only make great capacitors.*

We're kinda square.

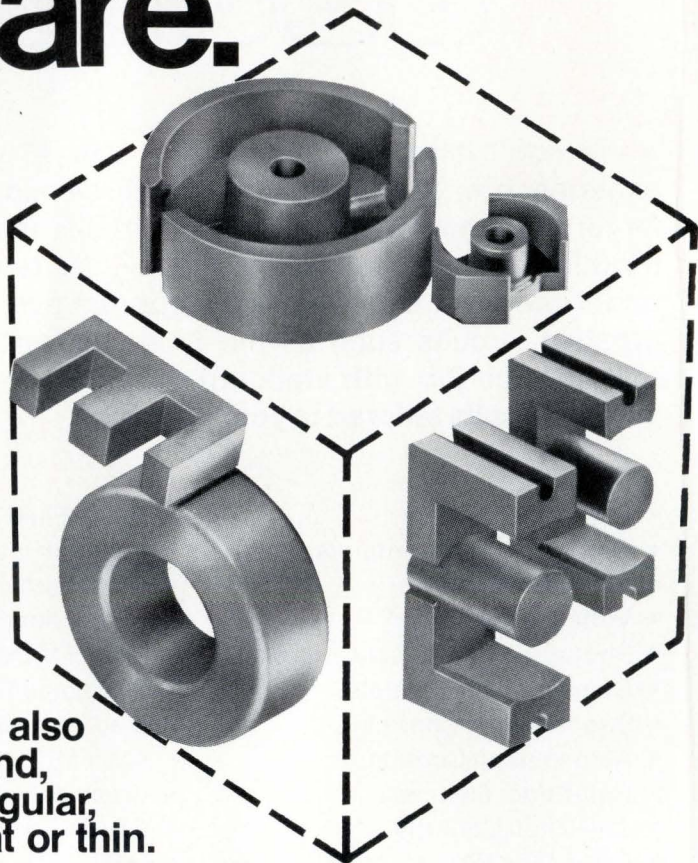
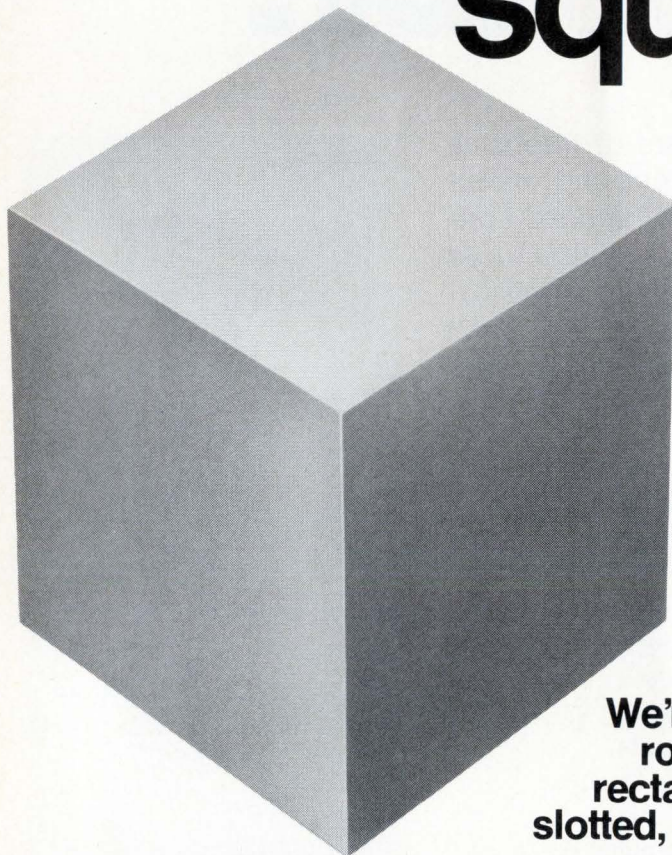

We're also round, rectangular, slotted, fat or thin.

Or, give us your specs and we'll produce nearly any shape imaginable. From data processing to telecommunications, automotive to power supplies, Ferroxcube is the leading supplier of ferrite materials.

Ferroxcube produces toroids, wide band cores, pot cores, slotted toroids, U, E, or I cores, and a variety of special shapes. We also offer a wide variety of bobbins and mounting accessories.

...and we're dependable

We're kinda square. We believe you should get what you pay for. You get the right combination

of price, reliability, variety and operating features. And you get it only from Ferroxcube.

Turn to the Cube.

Get to know us better. Write for a free copy of the new Ferroxcube Linear Ferrite Catalog.

FERROXCUBE

Dept. E-819, Saugerties, New York 12477
Tel: (914) 246-2811



A North American Philips Company

Mechanical mass memories challenged by Plessey's bubbles, CCDs, holograms

Most memory makers are busy these days building up the arsenal of high technology they'll need to capture customers as the bastions of the mass-memory market—disk and drum stores—crumble before the assault of new technologies. The Plessey Co. is no exception. The British firm will have magnetic-bubble memories on the market within a few months. Charge-coupled devices will follow, and Plessey has a holographic mass-memory well along in development.

Plessey already is sampling a 256-kilobit bubble-memory system based on 16-kilobit chips. David C. Stapleton, European marketing manager for Plessey Memories, expects bubble memories will find a place in hierarchical computer-memory systems with a capacity of 500 kilobits to 10 megabits. The cost per bit will be lower than for disk memories, Stapleton expects. And there are other applications in sight for industrial-control systems and point-of-sale systems that currently use tape cassettes.

Bubbling. Plessey is not alone here, of course. Announced competitors in bubble memories include Fujitsu and Hitachi in Japan and Rockwell and Texas Instruments in the U.S. So, the UK company already has plans to move up to 64-kilobit chips.

The 256-kilobit system that Plessey is sampling now is built up of 16 dual in-line packages, each carrying a 16-k chip and two sets of coils. The basic chip is 180 mils square and uses samarium-doped yttrium iron garnet on a single-crystal gadolinium gallium garnet substrate. For good circuit performance and packaging, an "elementary shift-register layout" is used, explains Tony Marsh, a Plessey memory-development engineer.

In the near future, the company plans to announce 64-k chips.

They'll need only slightly more chip real estate because the bubble size—now 6 micrometers in diameter—will be halved. Later, there'll be 256-k and even 1-megabit chips, Plessey hopes. To keep the millisecond access times, though, the layout would be changed from a shift register to a "major-minor loop" for the large chips. In this layout, a row of small loops feeds a long circular

bubble track. There'll also be a new package design that will relocate the coils for easier assembly.

As for CCD memories, Plessey has two kinds of applications in mind, says William Holt, manager of the applications division of Plessey's Allen Clark Research Centre. CCDs will find a place as add-on memories because their lower cost "more than compensates for their longer run-

Around the world

Japanese JFET provides fast logic

So far, the static induction transistor—a junction field-effect transistor with triode characteristics—has made its mark mainly as a power device. Now, however, it looks as if an upside-down version of this particular JFET can score in high-speed logic with an eye-opening delay-power product. At Tohoku University's Research Institute for Electrical Communication, a group has developed models of a variant of integrated injection logic. It substitutes upside-down static induction transistors with multiple drains for the bipolar transistors with multiple collectors used in conventional I²L mainly because the junction capacitances of the static induction transistors are extremely low—about a tenth of those for I²L bipolar transistors. The propagation delay-power product for the new logic layout is also extremely low—somewhat less than 0.01 picojoule. What's more, packing density is high, and the structure can be fabricated with only four masks.

The group fabricates the basic upside-down static-induction transistor in an n⁻ epitaxial layer atop an n⁺ substrate. The gate is a doughnut-shaped diffused p region with a shallow n-diffusion drain at the center. The n⁻ region below it becomes the channel, and the n⁺ substrate the source.

British multiplex data on land-mobile net

A group at the University of Bath in Britain is multiplexing data with voice traffic on a very-high-frequency channel for civil land-mobile radio networks. Within a 12.5-kilohertz channel, the researchers are adding a single-sideband channel to carry voice, and the usual double-sideband amplitude-modulated voice channel transmits data at 2.4 kilobits per second. The Bath group has been testing the idea for two years over an experimental network.

This technique, which allocates 5 kilohertz to the speech channel and the remaining 7.5 kHz to the data and protection channels, unjams traffic from the transmitters to the mobile receivers. What's more, the group chose a "radical" sideband-diversity approach to overcome the problems of multipath fading, which is often encountered in sending data signals from transmitters to mobile units with slightly modified conventional transceivers. A strong signal is transmitted by phase-shifting the modulation applied to several double-sideband transmitters sending on the same frequency. This shifting destroys fade patterns so that a mobile receiver "hopping between sidebands" merely picks up the strongest signal. Error rate is 1:10,000.

The network, if adopted by the group's sponsor, the Home Office, would use available technology and require little additional equipment. Intended for utility and security fleets in public-safety nets, routine messages would be sent to teleprinters and visual displays.

ning/access times," Holt feels. And CCDs will have a niche in the special-purpose memory sector for applications like a 7-k store for Teletext decoders. So far, Plessey has readied only 16-k CCD chips and their introduction has been momentarily delayed by a problem with current leakage. But this 16-k chip, which has a serial-parallel-serial layout, is really just a forerunner to the 64-k chip that Plessey believes is crucial for competitive computer memories.

For archival memories where the need runs to a trillion bits, Plessey claims to be close—technologically—to a commercial system; marketing strategy, though, will govern the timing of the introduction of the company's holographic system. Plessey's system employs conventional laser projection and a special page composer to image holograms on an ultrasensitive Kodak 16-milli-

meter film. A modulator, which flashes 32 tracks of holograms onto the film, transforms the data stream to be stored into holographic "pages." To retrieve the stored data, a replay lens images the page onto an array of photodiodes. The read and write light beams have different polarities, meaning the same optics can be used for both operations.

With 32 tracks across it, 1,000

meters of 16-mm film could store about a trillion bits of data. Access time for a page, mainly a function of film-transit speed, would run between 5 and 10 seconds. In addition to the read-only film system for data retrieval, Plessey is looking at materials like amorphous glasses and photochromic substances that could be used for read/write holographic memories. □

West Germany

Hybrid RC filter is standard product, but it can be customized

In hybrid circuits, as in monolithic integrated circuits, there is a tendency to move away from custom design toward standard approaches. Standard hybrids, so the reasoning goes, cost less because the development

costs are amortized through mass production of a device that can be used in several applications. One hybrid producer taking advantage of this trend is Siemens AG, which has introduced a number of standard

Our 12 Capacitor plants will keep your production line producing

If capacitor problems have been worrying your production people, we can help. For 75 years we have set industry standards with innovations like polystyrene and polypropylene film, metalized film, stacked film and high dielectric ceramic to keep our customers ahead of their competition. Our success can be your success. Twelve capacitor manufacturing facilities strategically placed throughout the world in Austria, Germany, Spain, France, Brazil, Mexico, and in the U.S. will support and cross support your every capacitor need. Our Mesa, Arizona plant, specializing in tantalum capacitors, has earned a reputation for quality products that will satisfy your most demanding industrial and military needs.

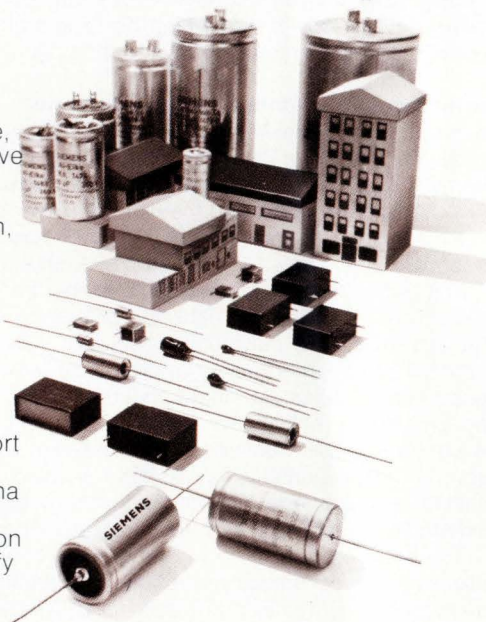

So be it tantalum, standard aluminum electrolytic, computer grade aluminum electrolytic, ceramic, metalized film or stacked metalized film, you can rest assured that our nationwide service organization of representatives and distributors will react with the right capacitor at the right time, and at the right price. You have enough on your mind without worrying about capacitors. So call on us. It will be like owning your own capacitor plant.

**Siemens Corporation,
Components Group,
186 Wood Ave. South,
Iselin, N.J. 08830
(201) 494-1000**

SIEMENS

hybrids this year. One of the latest is an active RC filter that is freely programmable.

Designated B91117, the coil-less filter, made with tantalum thin-film technology, is designed to operate from 20 hertz to 20 kilohertz, primarily in industrial equipment. Significantly, the filter, contained on a single substrate, needs no external components to get the desired parameters. It incorporates an active RC resonator and four operational amplifiers in a 24-pin dual in-line package of only 30.5 by 19.5 by 6 millimeters.

Setting parameters. As Joachim-Ullrich Schwarz, product manager for hybrid circuits, explains it, there are two possibilities in setting the filter parameters. One involves the manufacturer, who, by laser trimming, adjusts the parameters to customer requirements. After that operation, the customer need not

connect any external components to the filter to obtain the desired parameters.

In the second option, the manufacturer supplies the freely programmable filters to the user, who determines the filter parameters himself. When the user has specified the parameters for a particular application, the manufacturer, again by laser trimming, adjusts the filters accordingly.

At the output of the device, three basic filter characteristics are available: low-pass, high-pass, and band-pass—additional characteristics can be obtained by way of suitable combinations of the three basic ones.

Specifications. The high input resistance—about 100 kilohms—and an output resistance of less than 10 ohms make it possible to connect together a number of B91117s without any buffer amplifiers between

them. The temperature coefficient of a trimmed filter is $\pm 40 \times 10^{-6}^{\circ}\text{C}$. This value, in addition to the film circuit's high resistance to aging, makes possible the fabrication of filters that could not heretofore be implemented with conventional inductance-capacitance design techniques or with discrete active filters, Siemens workers say.

The supply voltage for the new filter can be between ± 4 volts and ± 12 v. In applications where a high output voltage and low power-dissipation levels are called for, filter versions are available with separate supplies for the RC resonator and for the amplifiers. For example, the resonator can have a ± 4 -v supply and the amplifiers ± 12 -v supply. With such a configuration, the quiescent power dissipation is reduced by a factor of 30. The operating temperature range for the B91117 extends from 0°C to 70°C . □

Our reputation for quality Hi-Rel zeners just means We're Good, Not Expensive

Look at Our Low Cost DO35 Zener Diode

If you need high-quality low-cost zener diodes for your industrial applications, take a look at our low-cost DO35 double-slug zener. It's available from 3.3 to 47 Volts in the IN5225 to IN5261, IN746 to IN759 and IN957 to IN977 JEDEC series.

Significantly, our low cost zeners come from the same place as our Hi-Rel, Jan, Jantx, Jan TXV, S1N and T.C. zeners and are manufactured with the same attention to detail.

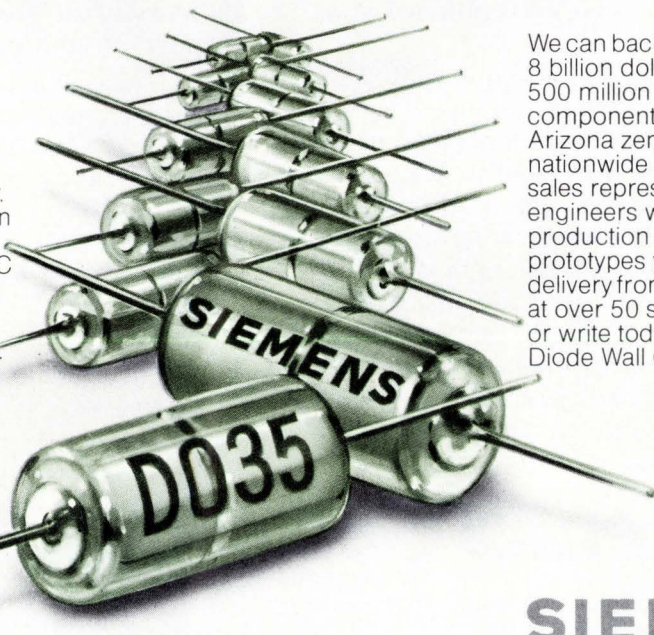

We can back your action. We are an 8 billion dollar company with over 500 million dollars in world wide component sales. Our Scottsdale, Arizona zener diode facility and nationwide service organization of sales representatives and field engineers will keep your production lines supplied. For prototypes you can get instant delivery from one of our distributors at over 50 stocking locations. Call or write today for your free Zener Diode Wall Chart.

Siemens Corporation,
Components Group,
186 Wood Ave. South,
Iselin, N.J. 08830
(201) 494-1000

SIEMENS

**You can buy
this signal generator
for a 3-month job,
and then let it
gather dust.**

**You can rent
this signal generator
for a 3-month job,
and return it
when you're done.**

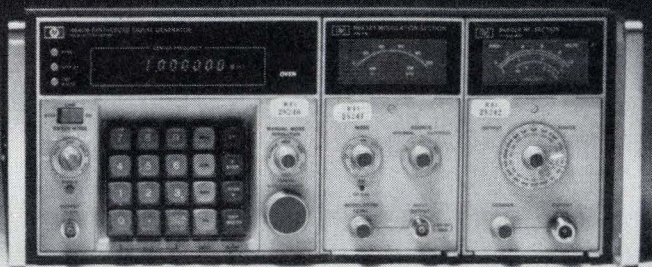
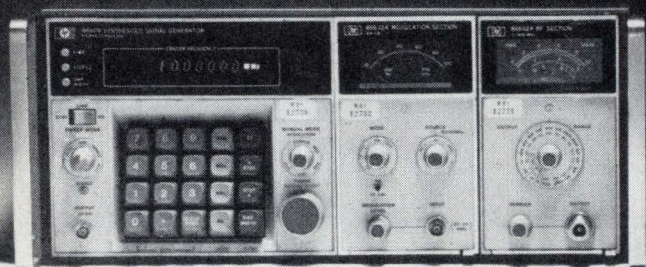

When you buy electronic test equipment for a short-term project, you're stuck with the equipment after the project is completed. Maybe it'll sit around gathering dust and costing you money. Or maybe you could sell it at a loss.

Or maybe, you should have rented it from REI.

When you rent equipment from us, you keep it only as long as you need it. When you're through with it, you send it back. Since you pay only for the time you have your instruments, you never have to spend your money on idle equipment. Short-term needs are just one reason for renting. Immediate delivery is another. Because we maintain over \$10 million in inventory in fully stocked instant inventory centers around the country, you can get delivery within hours.

REI stocks over 8,000 fully checked-out test instruments. And they're ready whenever you are. For the full story on renting as well as our low prices, send in the coupon for prompt delivery of our free illustrated catalog. Or call us now for your immediate requirements.

Rental Electronics, Inc.,
99 Hartwell Avenue, Lexington, Mass. 02173.
Please send me your free instrument rental catalog:

Name _____ Title _____

Company _____

Address _____

City _____ State _____ Zip _____

Tel. Number _____

Rental Electronics, Inc. 

A PEPSICO LEASING COMPANY

Burlington, MA (617) 273-2770 • Gaithersburg, MD (301) 948-0620 • Oakland, NJ (201) 337-3757 • Ft. Lauderdale, FL (305) 771-3500
Des Plaines, IL (312) 827-6670 • Dallas, TX (214) 661-8082 • Mountain View, CA (415) 968-8845 • Anaheim, CA (714) 879-0561
Rexdale, Ontario (PLC Leasing Ltd.) (416) 677-7513

SEE US AT WESCON/76 IN L.A., SEPTEMBER 14-17, BOOTH #493

Circle 54 on reader service card

International newsletter

Darlington vies with thyristors for dc controls

A high-power Darlington transistor is challenging thyristors for direct-current control applications involving moderate voltages but high currents. Applications include chopper control of vehicular motors, inverters, power-supply-control circuits, low-frequency amplifiers, and vibration-test equipment. The manufacturer, Toshiba, points out that **the Darlington turns off when its drive signals are removed.** In contrast, a thyristor used for commutation in dc circuits normally requires a second thyristor of similar size, plus large capacitors and choke coils.

The chip, 40 millimeters in diameter and offered in a flat package similar to that used for large thyristors, has maximum ratings of 400 amperes and 300 volts. The device's Darlington connection typically yields a current-amplification factor of 400 to 500, with a guaranteed minimum of 100. **Such a gain level eliminates the need for high driving power,** formerly a major disadvantage of transistors in high-current applications. A saturation voltage drop of 1.5 volts typical, 2 V maximum, although somewhat higher for the Darlington than it is for a thyristor, is not too high for practical use.

Siemens introduces two microcomputer kits for hobbyists

A couple of do-it-yourself microcomputer kits are being introduced for both the professional engineer and the electronics hobbyist. West Germany's Siemens AG, which is building the kits around the SAB 8080A 8-bit microprocessor, is including assembly and programing instructions, as well as the necessary data books.

The simpler version, the Sikit-N/8080, sells for about \$200. It contains an electrically programable and erasable 256-by-8-bit read-only memory, a static random-access memory, a clock generator, and several other devices. **The more sophisticated \$430 Sikit-DK/8080 comes with two RAMs, two PROMs, and more other components and peripheral devices than the Sikit-N/8080.**

Norway goals set for electronics output in 1980

By 1980, Norway's 40 electronics companies should increase their output by 12.5% in volume by 1980 from the 1973 level, or 21% in value from a 1973 base of \$8.3 million at current prices. That is the conclusion of a survey conducted by an independent consultant for the Norwegian Ministry of Industry. **To achieve these goals, the consultant warns that the government must provide financial support, that both the government and industry must "buy Norwegian,"** and that the work force must be increased by 1980 to 20,400, which is 9,500 above the 1973 level.

French push study on environmental detector for NATO

The French Ministry of the Quality of Life is spearheading a NATO campaign to study the teledetection techniques of member countries. The goal is to evaluate existing systems' efficiency in detecting waste and oil spills at sea, measuring the influence of atmospheric pollution, and gauging the coastal dissemination of pollution.

The studies, which are to begin late next month, will attempt to formulate specifications for a uniform system that may be purchased by participating nations. A French-government spokesman says **the result will probably be a proposal for a teledetection system that combines parts of existing systems in France, the United States, Canada, Belgium, and Britain.**

Japanese JFET puts out 1 kW in ultrasonic band

Output power of 1 kilowatt at ultrasonic frequencies is the March goal set for a vertical junction field-effect transistor by a group at Tohoku Metal Industries Ltd. The first semiconductor product to be developed by the manufacturer of ultrasonic power generators and transducers, the chip will measure 12 to 13 millimeters square.

Potential applications include ultrasonic cleaning equipment, nebulizers, and concrete breakers. The company is also developing smaller units with outputs of several hundred watts for such applications as small broadcast-band transmitters. Manufacture of the transistor will give a total in-house ultrasonic capability to Tohoku, which received a development loan from the Research & Development Corp. of Japan.

UK government cool to industry warning on Japanese imports

The British consumer-electronics industry has lost another round in its battle for import controls on Japanese and Far Eastern television and audio products [*Electronics*, July 22, p. 65]. The British Department of Trade, unconvinced that its policy of voluntary agreements with Japan won't work, says, in effect, that all must wait until the Japanese respond to requests for reduced imports of monochrome sets.

Privately expressing disappointment, the industry—led by giants GEC, Philips, and Thorn—say they will keep up the pressure to prevent what they allege are predatory pricing practices from undermining the "home" electronics industry. **Meanwhile, Mullard Ltd., a Philips subsidiary, is starting a parallel campaign for an annual government investment of \$180 million for the next 10 years** to aid British electronics companies in competition with Japanese and U.S. companies.

High power avoided by video-disk laser pickup from Hitachi

An experimental semiconductor-laser pickup for video disks eliminates the need for a potentially dangerous high-power supply. Developed by Hitachi in Japan for disks of the kind originally produced by Philips of the Netherlands, **the pickup is smaller and simpler than helium-neon-laser types.** The assembly, which uses a buried-heterostructure injection laser, has been simplified by using a single beam for automatic focusing, tracking, and the video-pickup signal.

When operated at a current of about 10 milliamperes, the laser has a spot size of about 2 micrometers. The output power level is about 0.5 milliwatt, and video signals are reproduced with a signal-to-noise ratio of more than 40 decibels, the usual requirement for television.

Addenda

In heavy international competition, AEG-Telefunken has won a contract from Belgian air-safety authorities to deliver a radar system of the German company's SRE-M5 series. **The system, to be installed in the Ardennes region, is to improve the monitoring of traffic in Belgium's airspace and to deliver information to Eurocontrol,** the European air-traffic-control agency. . . . The French government hopes the \$750 million contract it won earlier this month to extend Saudi Arabia's television network will be a marketing boost for the Secam color-television system in other developing Middle East nations. **The contract will be undertaken primarily by Thomson-CSF, which will supply distribution centers and other infrastructure** for the Saudi color-TV system, to become operational in 1982.

New from Centralab...

CERBON™ TRIMMER RESISTORS

Affordable Stability...
300% More
Stable Than Carbon...
at a Carbon
Trimmer Price!

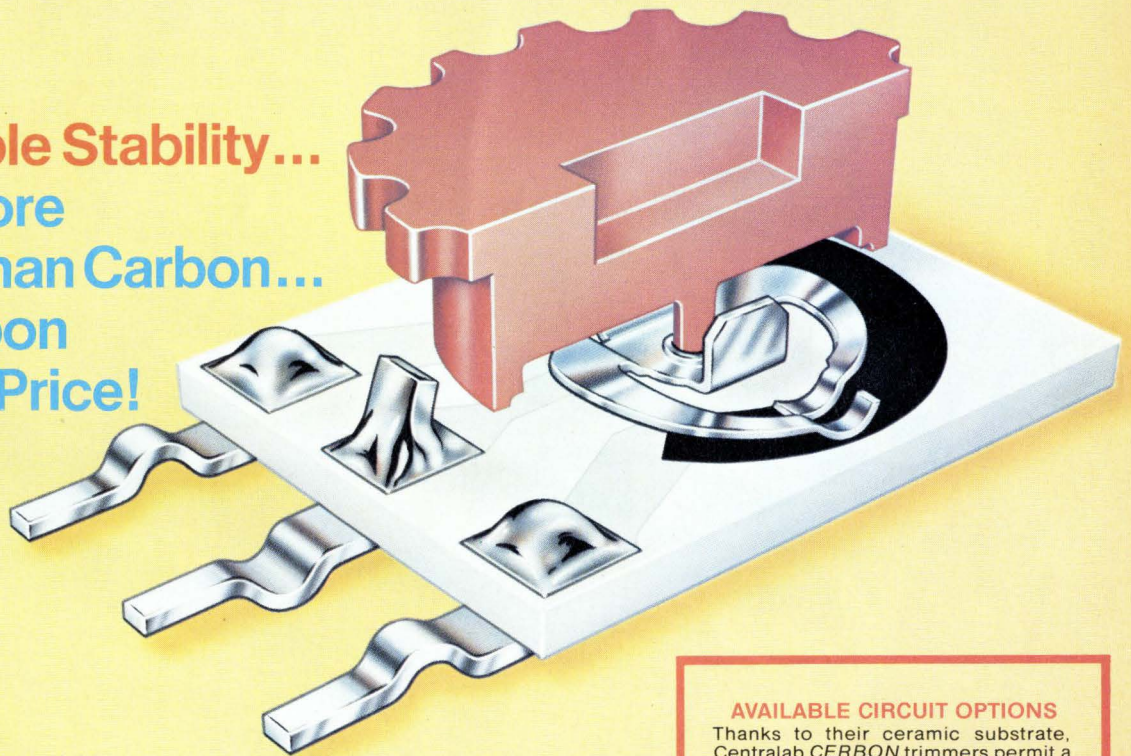

Why pay more? With Centralab's new CERBON trimmers you get stability approaching cermet and at carbon prices... As little as 28¢ in distributor 1,000 quantities; as low as 10¢ in high volume orders.

The secret of CERBON superior performance? A totally new thick film resistor element, which combines both potentiometer and conventional thick film technologies, *plus* a heat stable ceramic substrate, *plus* a dual-tine contact spring, *plus* "Fluxgard" protection from dust and wave soldering contaminants. In short, a totally balanced electromechanical system.

Look at these benefits:

- TCR less than -400 ppm/°C.
- CRV less than 2% of maximum resistance.
- Rotational life exceeds 500 cycles.
- Adjustability (typical) -0.05% of total voltage.
- High overload capability—

1 watt at 25°C ambient for 1,000 hours exhibits less than 2% cumulative resistance change. • Maximum stability in humid environment — Resistors exposed to an atmosphere of 40°C at 95% relative humidity for 300 hours return within four hours to $+2.5\%$ of their initial readings.

CERBON trimmers are offered in a resistance range of 1 K ohm to 1 megohm with a choice of standard PC terminal configurations. They fit universally accepted circuit board mounting patterns. And they're ready now for fast delivery in any quantity.

Write for complete technical data on Centralab's new CERBON trimmer resistors. Or call (915) 779-3961 for a free evaluation sample. Move up to CERBON and save!

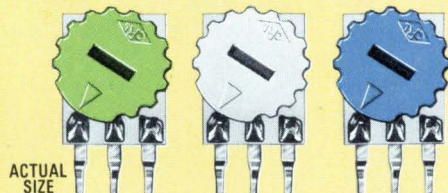

Knob colors available in white, blue, red and green for ease in assembly operations.

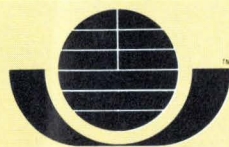

CENTRALAB

Electronics Division
GLOBE-UNION INC.

7158 MERCHANT AVENUE
EL PASO, TEXAS 79915

AVAILABLE CIRCUIT OPTIONS

Thanks to their ceramic substrate, Centralab CERBON trimmers permit a variety of screen printed circuit options. Here are three typical circuits:

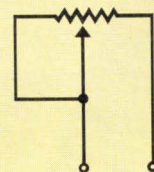

TERMINAL SHORTING

One of five electrical termination options available.

OPERATIONAL AMPLIFIER NETWORK

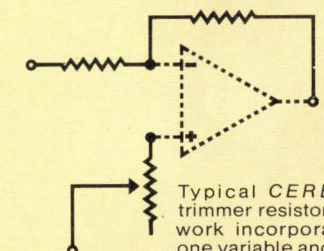

Typical CERBON trimmer resistor network incorporating one variable and two fixed resistors on dual substrate configuration.

VOLTAGE DIVIDER

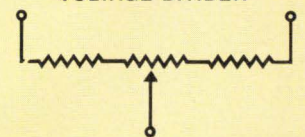

Fixed and variable resistors can be ratio matched for precise values and to insure temperature tracking. Eliminates need for costly discrete resistor selection.

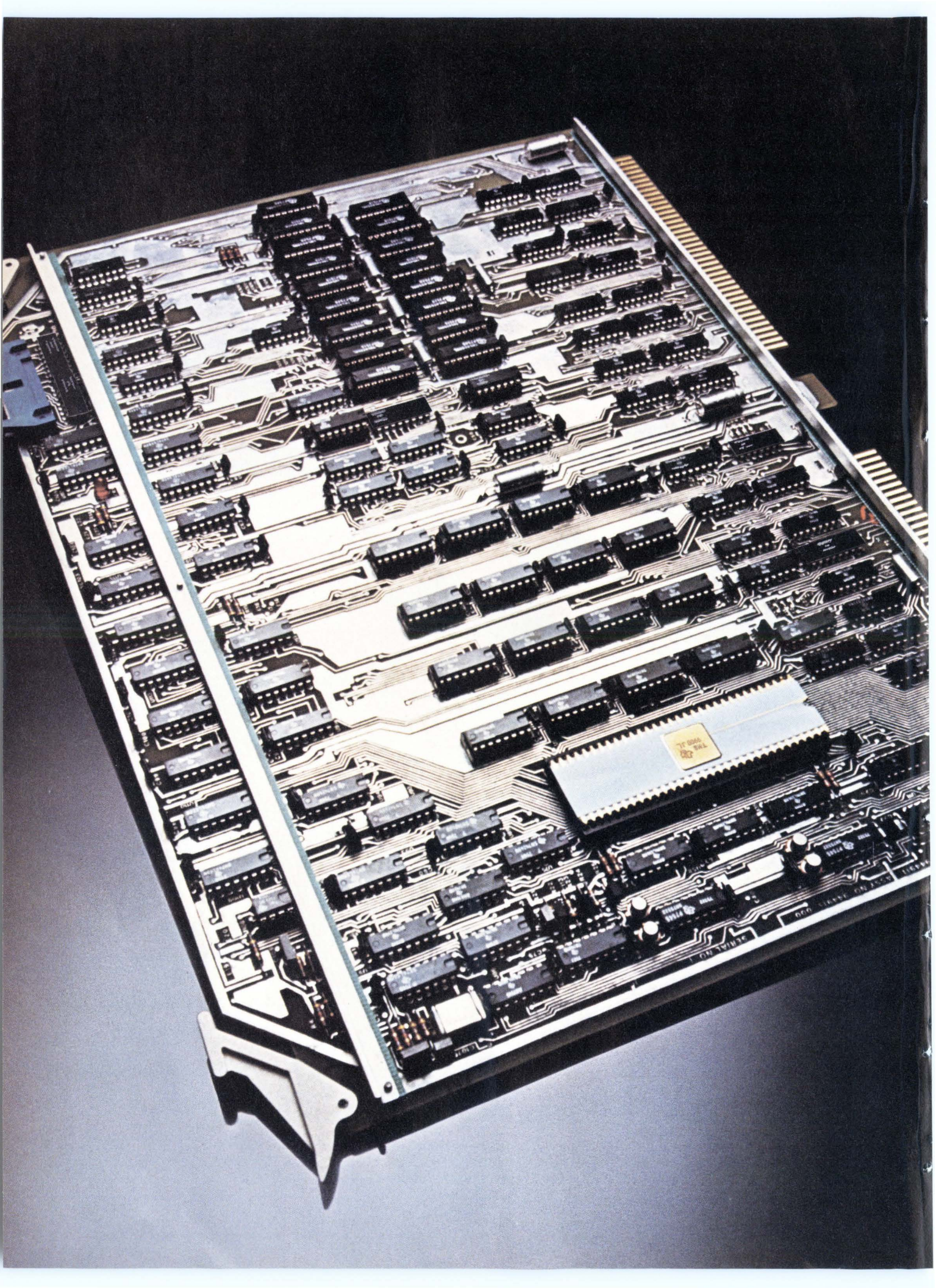

**When you're
designing microprocessors
into your products...
our 990 computer products
can give you a head start.**

TEXAS INSTRUMENTS.

Start with the TMS 9900 microprocessor.

It delivers surprising power, speed and flexibility in a low-cost, single-chip 16-bit package. Its repertoire of versatile instructions and high-speed interrupt capabilities provide computing power usually associated with a 16-bit TTL minicomputer.

Hardware multiply and divide is standard and the software you develop for the TMS 9900 is upward compatible with any other member of the 990 computer family.

When your application calls for a microcomputer—start with the 990/4 microcomputer on a board.

It offers all the advantages of the TMS 9900, plus flexible memory and CPU options ideally suited to manufacturers' applications: up to 8K bytes of dynamic RAM memory, up to 2K bytes of RAM and/or PROM, real-time clock input, eight vectored interrupts, expansion interface and optional ROM utilities. It's our off-the-shelf answer for many production needs.

The 990/4 microcomputer is also available in a low-cost three-slot OEM chassis...or housed in a 6- or 13-slot rack-mount chassis with programmer's panel...or in a 6-slot

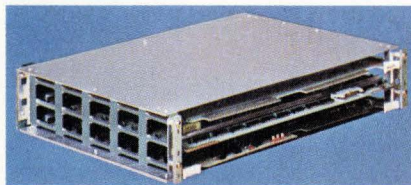

tabletop chassis. And, the 990/4 is available as a complete computer system supported by your choice of performance options and peripherals.

For applications requiring greater speed, we offer the most powerful member of the 990 computer family...the 990/10 minicomputer. It uses a TTL implementation of the 990 architecture and features TILINE*, an asynchronous, high-speed 16-bit parallel I/O data bus which links the CPU, memory, and high-speed peripheral devices.



Rack-Mount 990 Computer

And to help you get on line faster and surer, there's a prototyping system using 990 computer hardware and software packages.

In addition, the 990 family is well supported by a substantial library of software development packages.

Whatever your needs...the TMS 9900 microprocessor, the 990/4 microcomputer, or the 990/10 minicomputer...you'll be working with some of the most attractive



990/9900 Prototyping System

computer component values on the OEM market. Price/performance leadership you expect from Texas Instruments.

You can start today by getting more information on the entire 990 computer family. Contact your nearest TI sales office, or phone (512) 258-5121, Computer Equipment Marketing, for your local distributor. Write Texas Instruments Incorporated, P.O. Box 1444, M/S 784, Houston, Texas 77001.



*Trademark of Texas Instruments Incorporated

TEXAS INSTRUMENTS
INCORPORATED

**Now AMP's most versatile
interconnection system
is even more so.**

**We've added a
whole family
of pin
headers.**



Top performance in a tiny space. AMPMODU posts, receptacles and headers make your packaging designs as tight as necessary.

We've also made it easier to place pins on a board. Forget about positioning pins one at a time. Forget costly front-end insertion equipment. Because AMP engineering ability shows up in our recently introduced AMPMODU pin headers.

Pins are fully protected. Headers are polarized and have self-retention locking latches. Headers fit everywhere on a board, including board center.

Ten basic header styles offer several thousand possible variations. You can approach mass termination with AMPMODU headers. Up to 80 positions.

These headers now complement the AMPMODU interconnection system, which features dual cantilever spring beams in the receptacle, five basic contact types and board to board or board to wire versatility. The forgiving nature of the receptacle design also ensures a uniform, positive electrical contact with the mating posts, everytime.

At AMP our application, service and sales engineers are located throughout the world, and are ready to help you with prototyping as well as providing a complete after-sale service.

For more facts about AMPMODU headers, write or call Customer Service. (717) 564-0100. AMP Incorporated, Harrisburg, PA 17105.

AMP

INCORPORATED

Circle 61 on reader service card

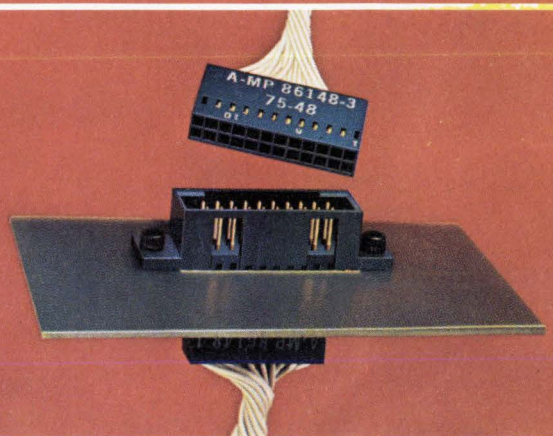
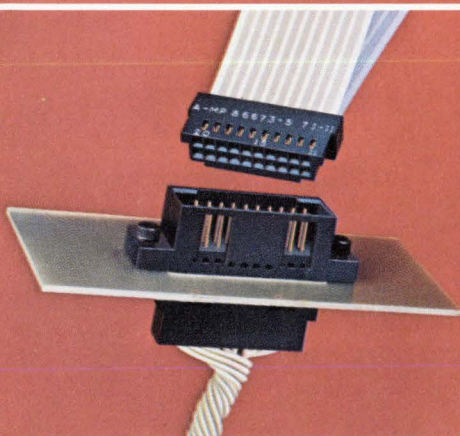
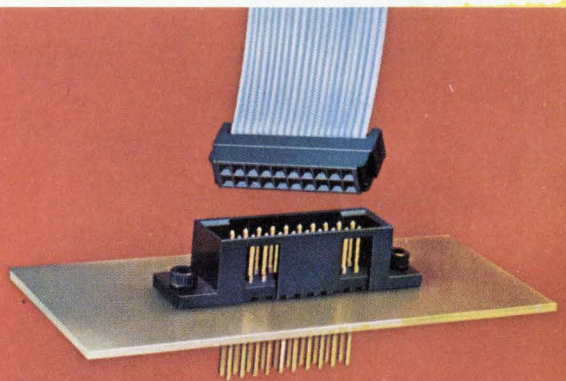
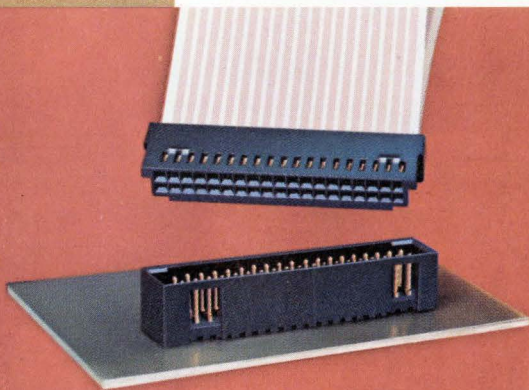

The GOULD/Brush 2000 Series. No other line of direct writing recorders can offer as much.

The newest generation of direct writing recorders from Gould combines every known innovation — plus some new features we've developed — to make them the most advanced recording instruments available today.

Selection: A Gould 2000 Series Recorder to fit your application.

Three new recorders in the 2000 Series lets you choose the instrument that matches your specific needs.

For instance, the Gould 2200 can be ordered as a 100 mm sin-

gle-channel instrument, or with two 50 mm channels. The Gould 2400 can be a two, three or four-channel recorder, utilizing combinations of 50 mm and 100 mm channels totalling 200 mm. And the Gould 2600 utilizes three, five or six channels totalling 300 mm.

The entire series is compatible with existing Gould signal conditioners so you can use your existing preamps for added savings and flexibility.

The 2000 Series Recorders have an unequalled frequency response of 30 Hz at 100 mm, 50 Hz at 50 mm and up to 125 Hz at reduced amplitude.

Superior resolution is assured through a 100 grams/mm high-stiffness servo controlled pen-motor. The Gould patented Metrisite® servo feedback element enforces 99.65% linearity over the entire channel width. The result: accurate, more meaningful traces.

Features: built-in versatility with each Gould 2000 Series Recorder.

All Gould 2000 Series Recorders have 12 chart speeds from 0.05 to 200 mm/sec. Pushbutton controls are activated from the front panel,

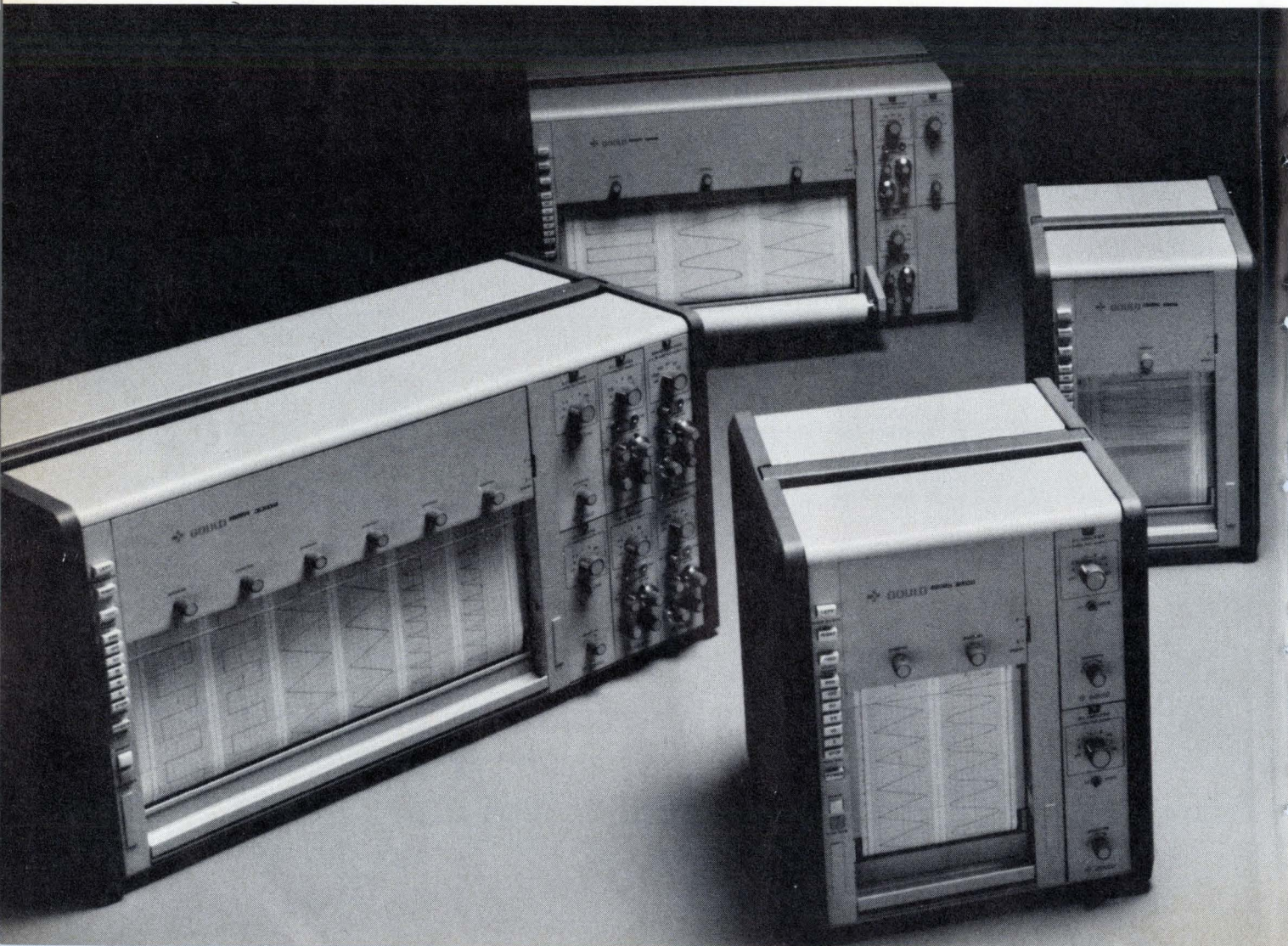

while an external switch closure offers remote stop/start capability at a preselected chart speed.

Plug-in preamplifiers provide a choice of signal conditioners for a large selection of analog measurements. These optional units allow you to expand desired portions of an input signal as well as reject noise or unwanted signal components.

Other standard features include a front panel paper supply indicator with a low paper supply warning light, margin event markers and a programmable timer.

And of course, every Gould Recorder offers the Gould pres-

surized inking system for the highest quality rectilinear traces — with no smudges, skips or puddles. Cartridge ink supply is good for one year's normal use.

**Human engineering:
easy to use,
easy to service.**

Clean, modular design has eliminated dials, controls and gauges you don't need to see. On the inside, maintenance has been simplified due to plug-in serviceability and fast access to all major components.

**Value: A surprisingly
affordable line of recorders.**

To all the features of the Gould 2000 Recorders, add one more: a price you can afford. Call your nearest Gould Sales Engineer to arrange a demonstration. Or write Gould Inc., Instrument Systems Division, 3631 Perkins Avenue, Cleveland, Ohio 44114. Or Gould Allco SA, 57 rue St. Sauveur, 91160 Ballainvilliers, France.



Circle 63 on reader service card

PHONE TOLL FREE FOR BROCHURE (800) 325-6400.

(In Missouri (800) 342-6600)

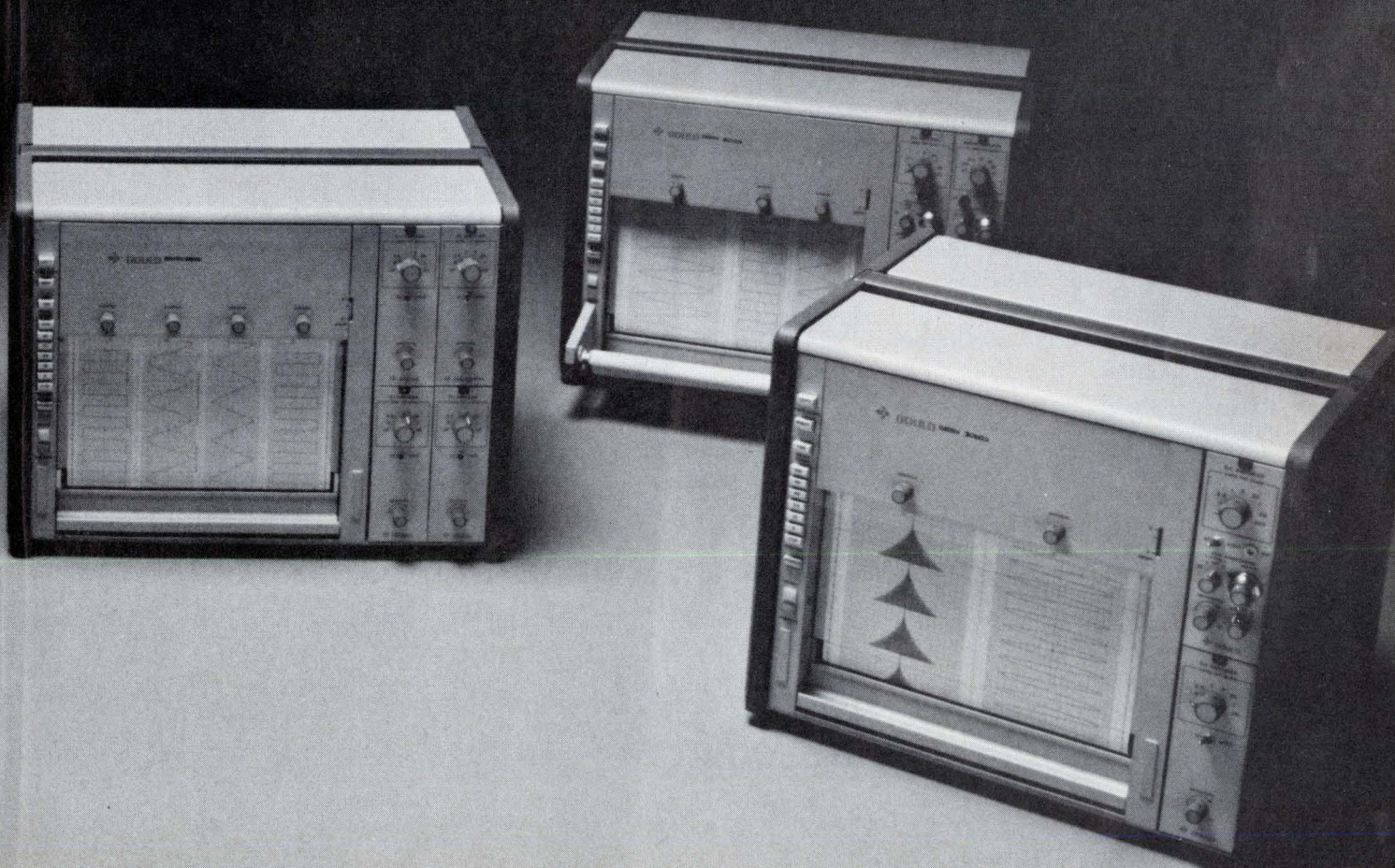

TERADYNE'S J401: THE FULL CAPABILITY IC TEST SYSTEM EVERY ENGINEER CAN USE.

Until now, the complexities of test programming have kept all but a few specialists from using IC test systems. Everyone else had to queue up at the programmer's desk or do without the kind of information that was really needed.

Now there's a J401. A fully programmable test system for T²L ICs with up to 24 pins, complete with built-in CRT, printer, and mag tape unit, that any engineer can learn to use in minutes.

For IC producers this means immediate access to vital process control information. For IC users it means the data necessary to choose components and vendors intelligently. And the ability to extract from field returns the information needed to improve product quality and yield.

The performance and flexibility of a large, computer-operated test system.

The J401 delivers the flexibility ordinarily associated only with larger, more expensive systems. It can datalog any forced or measured function and it can generate an x-y plot of any two parameters. The system also operates as a high throughput go/no-go tester for the production line or incoming inspection.

Product data fast. Higher product yield.

For the semiconductor manufacturer, the easy-to-use J401 allows errors to be spotted before they can begin to multiply. QC engineers can use it to evaluate devices, determine test margins, and check device lots.

The electronic equipment manufacturer will find the J401 useful in monitoring vendor-to-vendor and lot-to-lot variations.

It enables him to spot device characteristics that could be contributing to problems. And QC personnel can use the system to analyze failures and reduce service costs.

A system for meeting the real objectives of incoming inspection.

The J401 gives you fast go/no-go testing with an important difference. It gives control over the way devices are tested. By pushing a few keys you can change test conditions, bin out top-quality ICs, or have datalogging to support returns. All in seconds. This is incoming inspection as it should be.

It's a Teradyne.

Each J401 is built for hard use on the factory floor. Each is supported by Teradyne's ten-year circuit module warranty, a 24-hour telephone troubleshooting service, and a world-wide field service backed up by local parts stocking centers.

For complete information on the J401, write:

Teradyne, 183 Essex Street, Boston, Massachusetts. In Europe: Teradyne, Ltd., Clive House, Weybridge, Surrey, England.

WE SELL PRODUCTIVITY.

TERADYNE



CHICAGO (312) 298-8610/DALLAS (214) 231-5384/NEW ENGLAND (617) 458-1256/NEW YORK (201) 334-9770
SUNNYVALE (408) 732-8770/LONDON (0932) 51431/PARIS 073 16 98/ROME 59 47 62/MUNICH (089) 33 50 61/TOKYO (03) 406-4021

Road to consumer riches is rocky

Semiconductor firms making end products are squeezed between low profits and high delivery pressure

by Bernard Cole, San Francisco bureau manager

Can semiconductor makers find a pot of gold at the end of the consumer electronics end-product rainbow? That question has been raised again after National Semiconductor Corp.'s announcement last month that due to start-up yield problems on its new complementary-MOS watch chip, its profits in consumer electronics would not be as high as estimated. National's stock dropped from the mid 50s to the low 30s and is just now beginning its climb back up.

In addition to highlighting the continued wariness the stock-market community has about the semiconductor industry, the occurrence brings home again a very important fact of life—that making consumer-electronics end products involves both high risks and high profits. "We are all vulnerable to the same problems," says Stewart Carrell, group vice president in charge of Texas Instruments' Consumer Electronics group. "Consumer electronics moves at a phenomenal speed. There's a short cycle time, and if a company is not on top of the shifts, it can be in trouble in a hurry."

The risk is in trying to come out with a small-profit-margin product with a high-technology content under extreme delivery pressure, yet deliver high reliability. That's a tough combination—one that companies like Hughes Aircraft Corp. and Motorola Semiconductor decided not to take on and one that has forced companies like Mostek Corp., American Microsystems Inc., and Intersil Inc. to back off—at least in supplying and merchandising the end product, whether it is watches,

calculators, or home video games.

The Hughes operation, which shipped 1 million watch modules last year and expects to top 3 million in 1976, never has been tempted to jump into selling directly to the consumer. "We're kind of simple minded," quips William M. Weakland, manager of the Newport Beach, Calif., Solid State Products division. "We felt we should stick to what we know."

No go. Motorola looked at the watch business, and even went so far as to put out a digital watch kit several years ago. But the decision was made then by corporate and Semiconductor group executives not to risk the market. Two basic reasons influenced them: a belief that watches would go the calculator route, with price cutting and subsequent losses, and Motorola's lack of experience in jewelry design and selling. John Welty, who runs the group, has since stated most emphatically that his operation is "in the components business, not the jewelry business."

Mostek was one of the first semiconductor companies to go the vertical integrated route in the consumer-electronics business, making and selling hand-held calculators, then taking a bath and getting out in a wave of red ink. Now, several years later, Mostek is returning to profitability by doing what it was doing before it tried merchandising calculators—producing ICs—and staying away from end products. At AMI, the Mostek experience is being repeated with watches. Divesting itself of its entire consumer-end-products business is costing AMI \$9 million in this half alone (55% to

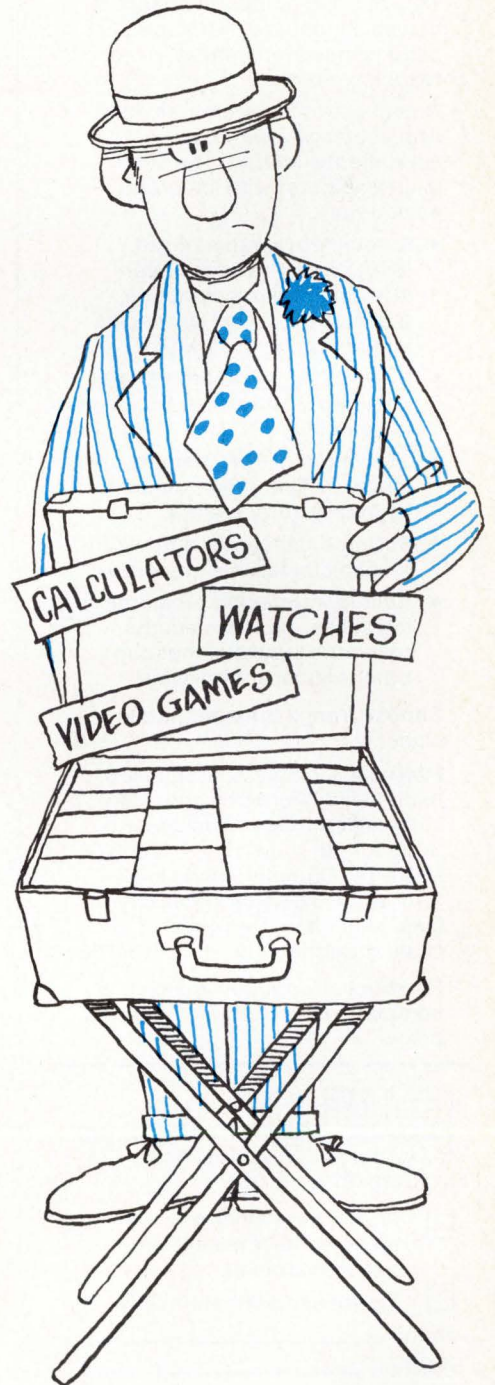



A Warning To My People.

The microcomputer revolution is in danger! Unscrupulous mercenaries have infiltrated our ranks. They promise new freedom, but their equipment is an insult to our cause. High priced toys with blinking lights. Useless frills. TIC TAC TOE games. Incomprehensible manufacturer's specifications masquerading as teaching material.

Do not settle for inferior devices. Arm yourselves with E&L Instruments' MMD-1. The Mini-Microcomputer with important advantages.

- A complete system of self-instruction. Provides understanding of microcomputer technology as well as specific instruction on our MMD-1.
- 8080A CPU, keyboard entry of data and instructions, LED indicators.
- 256 words of R/W memory, and 256 of PROM, programmed for keyboard entry of data.
- Buffered connector outputs for system protection and expansion.
- Built-in interfacing breadboarding socket provides access to input/output buslines and other critical control lines.

Choose from 2 different battle plans:

MMD-1A: Complete, assembled, tested Mini-Micro Designer with software modules... including Bugbook III \$500.00

MMD-1K: Complete parts in kit form and PC Boards necessary to build Mini-Micro Designer... including Bugbook III \$350.00

For more information, please complete and return the coupon below:

E&L E&L INSTRUMENTS, INC.
61 First Street, Derby, Conn. 06418
(203)735-8774

Please have sales representative contact me, I'd like a demonstration.

Please send literature only.

Name _____

Address _____

City _____ State _____

Zip _____ Telephone _____

Probing the news

60% of that in watches) on \$32 million in sales. "It just became too costly," says Kenneth Zerbe, financial vice president.

Hanging in. But, despite the apparent risks, the end-product business is one that semiconductor companies like Intel Corp., National Semiconductor, Fairchild Camera and Instrument Corp., and Texas Instruments, in particular, plan to be in for the long term. "It's an extremely important application area for a large fraction of our new designs and technologies," says Gordon Moore, president of Intel, whose Microma subsidiary makes C-MOS watches with liquid-crystal displays.

Staying in each of these particular segments over the long term, says Floyd Kvamme, vice president and general manager of National's Semiconductor division, means being more than merely a supplier of circuits or modules. "It means getting into the end product," he says. "There is no real choice about it. It's a fact of life that is both market- and technology-driven."

To remain competitive in a very price-sensitive consumer electronics business, says Kvamme, vertical integration—from circuits and displays to modules and finished goods—is necessary. "This means that, as a particular segment matures and several vertically integrated companies begin to dominate, the available non-captive share of the market declines," he says. "The only way to remain in a particular segment and grow is to make the end product."

Problems. But as National's recent experience shows, even the semiconductor companies most successful in the end-product business have had their problems. In calculators, start-up problems caused TI and National to report lower earnings and helped keep Fairchild out of the market altogether. In watches, Intel had trouble with the reliability of the liquid-crystal displays, and Fairchild, spectacularly successful as it has been so far with watches, is rumored to have had at least several minor problems that slowed production temporarily. But, says Kvamme,

referring to National's report, "One glitch does not a disaster make."

But what makes these companies unique is that they seem to have learned from their mistakes and worked out similar approaches to this highly volatile marketplace. Like TI's Carrell, all of the executives at the four companies agree that design-production discipline is important. TI learned that lesson with calculators. He says, "We lost sight of our marketing plan and strategy. Our products were not well positioned in price, there was an overlap, and we had an inventory imbalance. We've corrected this with a clear plan.

"And now, we use design-to-cost strategy. Calculators are designed to a price that is profitable throughout their life cycle and not just at the time of introduction. We've improved production and inventory control." He now believes that both the calculator and watch lines are under reasonably tight control.

Strategy. "It's not the technology that is so important; it is how you manage it," says Greg Reyes, vice president and general manager of Fairchild's Consumer Products group. What this means, says National's Kvamme, is organizing things so that glitches are not likely to occur, but also so that the situation is manageable.

All four companies are similar in the way they have approached particular end products. All maintain some degree of presence in all price and volume segments: in calculators, both TI and National use the larger margins on their middle- and high-priced calculators to counterbalance their low-priced, high-volume units. In watches, Intel, National, and Fairchild are in the market with high-, middle-, and low-priced units. "Any semiconductor company that gets into any end product without the expectation of at least a 10% margin, overall, had better not get in," says Reyes.

Another common characteristic of these four companies that would seem to ensure their success in the consumer-electronics business is size and financial stability. All four have yearly sales in the hundreds of millions of dollars, and all have healthy financial reserves. □

Announcing a BiMOS breakthrough...

The RCA 3140. Most useful op amp since the 741.

For the price of a 741, the CA3140 is a lot more op amp. One that is often far more cost effective, considering circuit and component savings, than BI-FET and other higher priced op amps.

MOS/FET input makes the difference.

In fact, CA3140 is a giant step closer to the ideal. It gives you the big advantages of MOS/FET input... *plus* bipolar speed and high supply voltage operating capability: 4 to 44 V, dual or single supply. MOS/FET input means very high input impedance: 1.5 T Ω typ. Very low input current: 10 pA typ. at ± 15 V. Low input offset voltage: as low as 2 mV max. Wide common-mode input voltage range — can be swung 0.5 V below negative rail. In addition, output swing complements input common-mode range, permitting full utilization of low supply voltages (down to 4 V). When it's driving power transistors, the output swings to within 0.2 V of the negative rail. And PMOS input devices are

CA3140 vs. 741 at a glance		
	CA3140T,S	CA741CT,S
Input Resistance R_i (M Ω)	1,500,000	2
Input Current I_i (pA)	10	80,000
Slew Rate, SR (closed loop) (V/ μ s)	9	0.5
Gain-Bandwidth Product, f_T (MHz)	4.5	1.0

protected by rugged bipolar diodes.

Versatile building block

The CA3140 can perform standard and many other applications. Such as ground-referenced single-supply amplifiers. Sample and hold amplifiers. Long-duration timers/multivibrators. Photocurrent instrumentation. Peak detectors. Active filters. Tone controls. Function generators. Power supplies. Intrusion alarm systems.

Send for 13 useful circuits.

To show you how useful the CA3140 is, we've designed it into 13 typical circuits. To get these circuits plus other information, contact your RCA Solid State distributor. Or RCA. Write: RCA Solid State, Box 3200, Somerville, N.J. 08876; Ste. Anne de Bellevue H9X 3L3, Canada; Sunbury-on-Thames, U.K.; Fuji Bldg., Tokyo, Japan.

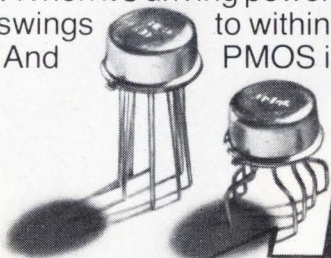

MOS/FET

BiMOS

BIPOLAR

RCA

RCA. Full house in Linear ICs.

A sleeper.

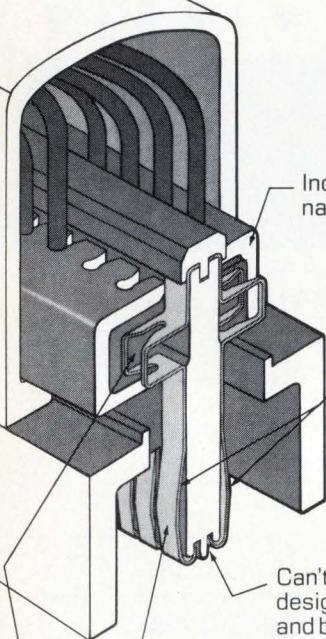

Individual wires reterminated easily by hand.

Full-flexing spring contacts — long life and positive mating with any connector, regardless of brand.

Can't crush spring leaf design — both leading and back ends entrapped — won't pry up or dislodge in mating.

Gold wiping surfaces.

Contact area on each wire is larger than a cross section of the wire itself (.012 sq. in. on 24 awg.). 4 contact areas on each wire (not just 2); strain relief on each wire.

Intermateable with other industry standard 50 pin ribbon contact connectors.

Looks as good as it works. Clean design. High impact plastic, in cable-matching light olive gray.

Can be terminated with one finger on our Push-over field termination tool. The Vitel-F is part of our system. Really the most important part.

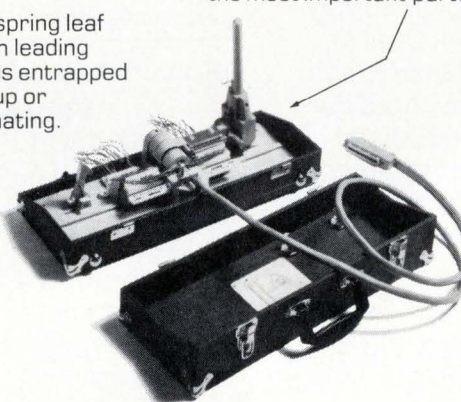

The plain truth is, there just isn't another 50 contact solderless connector you can buy that's this good.

Take a look at the details of the Vitel-F. Compare it with whatever you're now using.

Costs? We'll bet it's no more than you're now paying — probably less; this is a competitive business, you know.

But, frankly, the field termination tool that completes our system, The Pushover, is such a dramatic improvement over the others, that it tends to steal the show.

It shouldn't, of course. The connector is what you and your subscribers have to live with... and we'd like to show you how easy that can be.

Call or write us for details.

**Viking**
CONNECTORS

Viking Industries, Inc./21001 Nordhoff Street/Chatsworth, CA 91311 U.S.A./ (213) 341-4330

Circle 68 on reader service card

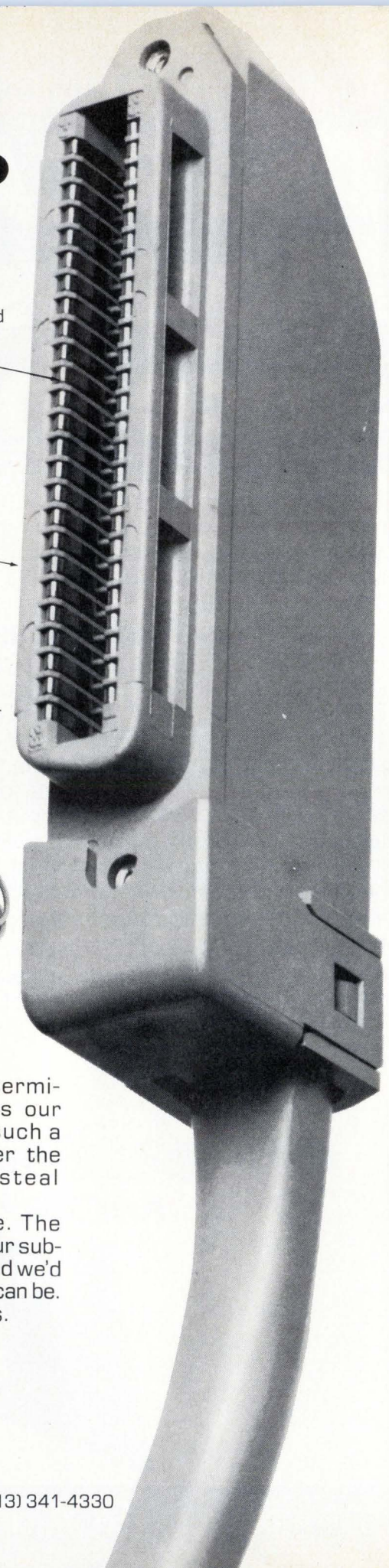

Companies

Work at Sandia helps IC makers

New semiconductor lab develops processes and techniques to radiation-harden devices and offer them to commercial makers

by Larry Waller, Los Angeles bureau manager

It should come as no surprise that Sandia Laboratories' brand-new Semiconductor Development Laboratory is acknowledged to be the free world's leader in radiation-hardening of integrated circuits. After all, nonprofit Sandia, in Albuquerque, N.M., pioneered this critical technology for the Department of Defense in the early 1960s, when ICs first went into nuclear weapons. But what isn't generally known is that the lab sometimes shares its expertise with commercial IC houses.

The Sandia semiconductor lab, built at a cost of \$1.5 million, is crammed with \$2 million worth of equipment. Although it opened only last spring, it already has come up with impressive results in its specialty. Robert L. Gregory, manager of the Integrated Circuit Process department, reports that large-scale-integrated complementary-MOS metal-gate circuits that have been fabricated can operate after exposure to radiation doses as large as 10^6 rads. "This is several orders of magnitude better than commercially available devices, which run from 10^3 up to 10^5 ," Gregory observes. But the four commercial houses that now closely follow the Sandia process—RCA Solid State, National Semiconductor, Harris Semiconductor, and Texas Instruments—also can reach the 10^6 level, he says.

Although simple and workable, this way of bringing Sandia semiconductor expertise to the outside world represents a big change, and it is an important reason for building the new microelectronic lab. As Gregory tells it, Sandia scientists had functioned largely as advisers to commercial vendors for about 10 years,

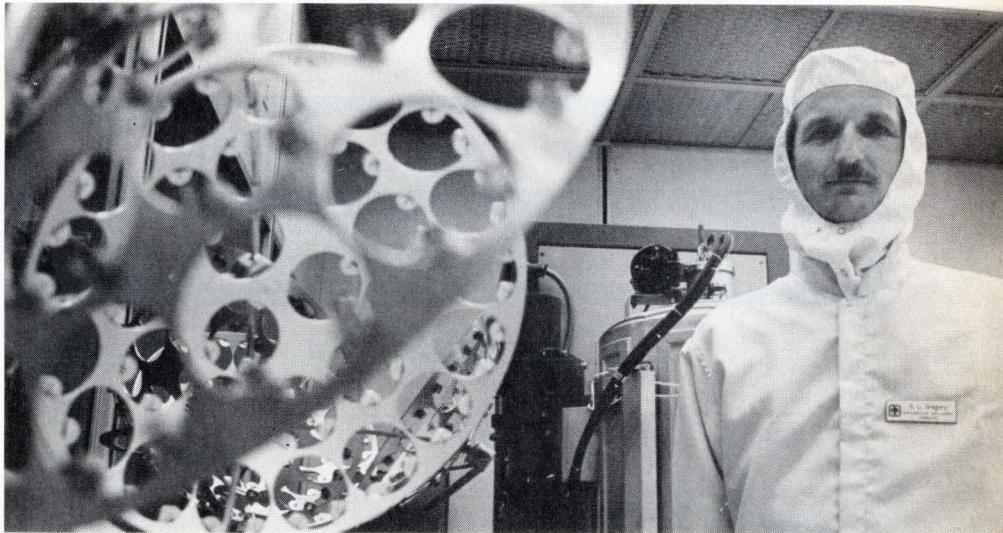

Inner space. Sandia lab's Robert L. Gregory poses beside the planetary wafer fixture. It holds wafers inside a vacuum system for deposition of aluminum.

until 1972–73. "Starting with available devices, we evaluated why one was better in tolerating radiation and suggested to companies they try this or try that. It just didn't work and nothing improved." So Sandia had to "get involved, not only to improve LSI-MOS-device characteristics, but look at the entire technology—to optimize the entire process," he recalls. Yet reaching this objective meant that Sandia had to have a complete in-house design and prototype facility.

Restrictions. But there are ground rules governing who can take advantage of Sandia's semiconductor skills. "We only do work for ourselves and other Government agencies," says Gregory. (Sandia, a nonprofit subsidiary of Western Electric Co., is a prime contractor to the Energy Research and Development Administration, which includes nuclear-weapon responsibilities, as

well as various national-security and energy projects.) "We only work for private companies if they have a Government contract and the agency asks us for help," which it often does, he says.

One indication that things are working right, as the new lab establishes new radiation-hardening processes, is the yields obtained on the first LSI devices fabricated. W.R. Dawes Jr., supervisor of device design and processing, says these yields were an unusually high 49% for 117-by-143-mil devices. Commercial semiconductor houses cannot expect to maintain such yields, but scrupulous attention to the Sandia processes should help them reach an acceptable level, he says.

Probably of most intense interest to the semiconductor industry is a key discovery, by Dawes and others, of a simple way of gold-doping CMOS to prevent latch-up. A major

REAL TIME Analog I/O for Intel SBC 80/10 or MDS-800

A single board Analog I/O system for Intel's new single board computer. For laboratory or industrial measurements our DT1751 system can process 16 analog input channels and has 2 analog output channels with power amplifier for driving industrial loads. Drive CRT's directly as well...using the built-in point plot controller.

Real Time measurements are easily done with standard features such as external A/D trigger plus convenient interrupt operation. Optional switch gain amplifier extends dynamic range to 14-bits. CALL US at (617) 879-3595 for a complete set of applications data.

DATA TRANSLATION

INC

109 CONCORD ST., FRAMINGHAM, MA 01701 (617) 879-3595
TELEX 94-8474

...the analog I/O company

Circle 70 on reader service card

the outclasser



The first 3½-digit DVM with true RMS, circuit-breaker current overload protection plus these other outstanding features:

- 2,000-count capacity
- Five complete functions, 26 ranges
- Large 0.4-inch 7-segment LED display
- Portable—internal battery option
- Simple, clean design utilizing LSI Technology assures high reliability.

For convincing proof that the Model 7003 outclasses all other 3½-digit DVM's, call Scientific Devices or (for real fast action) call Chuck Bishop on the outclasser hotline (415) 825-7003.

SYSTRON  DONNER

1 Systron Drive / Concord, CA 94518

70 Circle 186 on reader service card

Probing the news

disadvantage of bulk C-MOS circuits, gates may be jammed or destroyed when they are exposed to modest doses of ionizing radiation or to an overvoltage. It can be caused, Dawes says, by the injection of less than a microampere into gates. "Even if it doesn't destroy the device, you have to kill the power and also lose data stored in flip-flops or registers."

Adaptation. The solution, called "incredibly cheap," grew out of the group's bipolar experience. "Anybody versed in bipolar [technology] would see it in 10 minutes," he observes, "but most people were reluctant to try it." It involves only one added process, evaporating 50 angstroms of gold "worth one millionth of a penny," on the back of the wafer.

The concentration of gold limits the substrate-carrier lifetime to approximately 25 nanoseconds, preventing latch-up. Tests have confirmed that the process does not degrade performance, yield, reliability, or radiation hardness. It is also commercially feasible, Dawes points out, but can be used only on static devices.

Another major need that prompted the decision to build the new lab is rapid feedback and redesign capability that gives the short turnaround time required in weapons development. This turnaround, or the period from drawing the final logic diagram to a package device, averages about 16 weeks, Gregory says.

A number of serendipitous by-products of Sandia's main business are starting to surface. Closely related developments have been achieved in single photovoltaic solar cells, which have reached 15% efficiency [*Electronics*, July 22, 1976, p. 41] and show promise of further increases. Another is a course put on by lab people, teaching logic designers how to develop new ICs without costly breadboarding. They are shown how to use the much cheaper techniques of employing computer simulation and standard cells, which do not require wasteful experimental hardware. □

Creeping up on daylight

We've just brought the integrated dc-to-daylight frequency synthesizer a couple of steps closer to reality.

The new Plessey IC's offer a quick and easy way to lower synthesizer costs while increasing loop response and channel spacing all the way from dc through the HF, VHF, UHF and TACAN bands.

Start with one of our IC prescalers. They feature input ports for VHF and UHF, self-biasing clock inputs, TTL/MOS-compatibility and variable input hysteresis for wideband operation.

Then add one of our two-modulus dividers. All of them provide low power consumption, low propagation delay and ECL-compatibility, and most of them are available in commercial and MIL-temp versions.

Finally, to make things even simpler, add the Plessey SP8760 control chip and phase lock your synthesizer to any crystal up to 10 MHz. All the stability you need with none of the usual headaches and hassle.

If it all sounds too good to be true, contact us today for details and application notes.

Once you've seen the data, you'll see the light.



PLESSEY SEMICONDUCTORS

1674 McGaw Avenue, Irvine, CA 92714
Tel: (714) 540-9945. TWX: 910-595-1930
Represented world-wide.

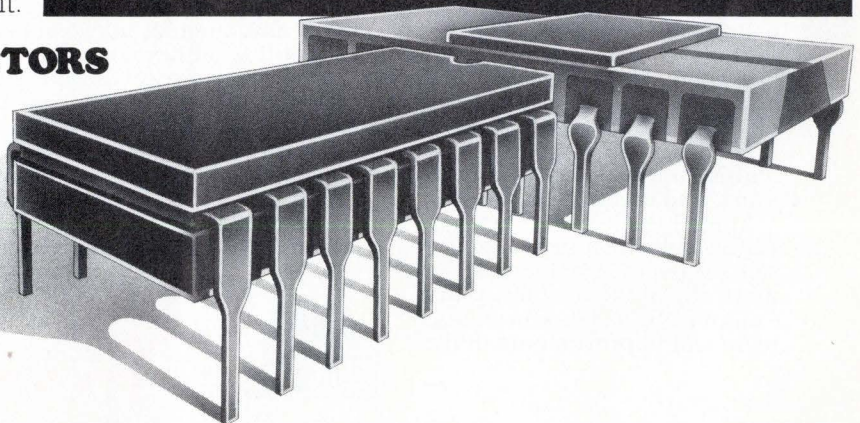
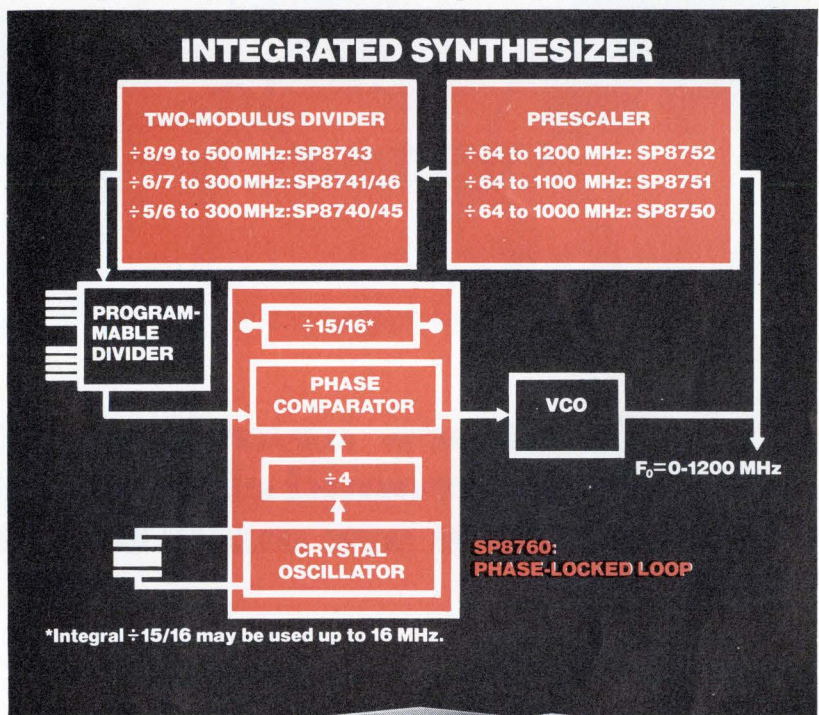

State-of-the-art brought down to earth

Fixed and programmable dividers □ Linear and digital communications circuits

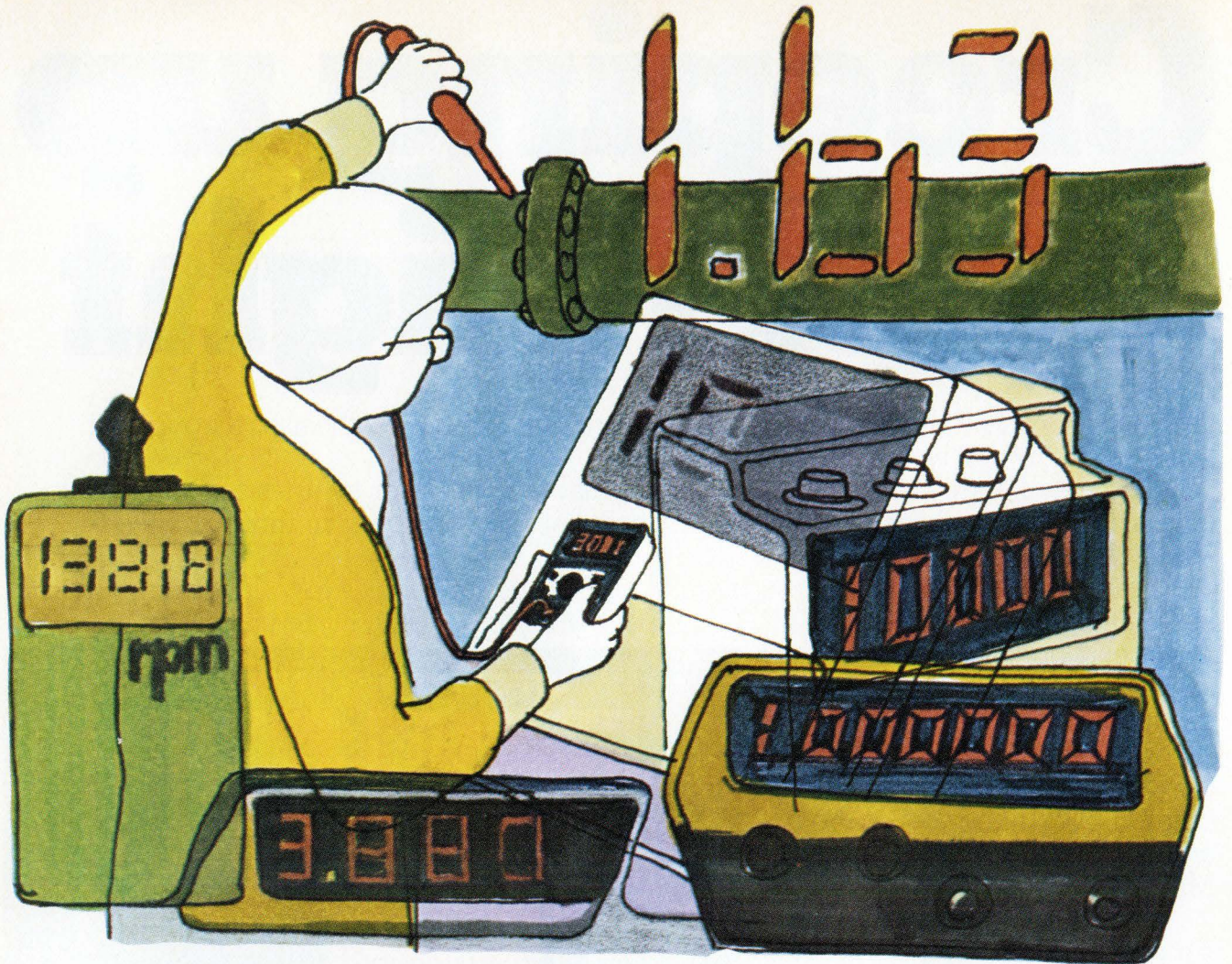

Most new instrumentation products are built around custom integrated circuits. Most of them are made by Micro Power Systems.

Our sole business since 1971 has been helping original equipment manufacturers exploit advanced CMOS and Bipolar LSI technology to improve product performance and reduce production costs. We've helped design and produce numerous proprietary LSI circuits for our customers in the fields of instrumentation, digital timekeeping, communications, and medical electronics.

Applications for this type of LSI in industrial instrumentation products have increased dramatically in the past few years. Custom LSI has produced major technical improvements in the

products themselves and has enabled many companies to achieve dramatic market advantages.

Because of our experience, we now have an unusually extensive capability for development and production of specialized ICs for use in virtually all types of instrumentation equipment, particularly A-to-D and D-to-A converters. If you're considering total integration of any of the following products, we urge you to write or phone us immediately:

- Portable Multimeters • DVMs
- Frequency Counters • LED Decoder/Drivers • Leak Detectors • Ph Meters • Diagnostic Testers • Chemical Monitors
- Gas Analyzers • Portable Tachometers • CB Power Meters

Our knowledge of the custom LSI approach to instrumentation products can help you to evaluate its potential benefits in your own terms. This can lead to your acquisition of a protectable, fully proprietary circuit. If your need is immediate, we invite you to contact Rich Koury, Manager, or ask for Instrumentation Product Marketing at (408) 247-5350.



We sell more than circuits. We sell solutions.

3100 Alfred Street, Santa Clara, California 95050

Communications

Europe refreshes its tactical systems

New technologies ranging from digital switches to PCM incorporated in upcoming battlefield communications



Reading RITA. Soldier works with RITA, the tactical communications system being put together by France and Belgium. It is due to go into the field by 1979.

European battlefield commanders in the 1980s will be able to exchange voice or data traffic in less time than it takes today's citizen to dial a telephone call. They'll acquire this facility, even on mobile units, as soon as sophisticated tactical trunk-communications systems become operational with the Belgian, British, French, and West German armies.

By employing digital switching, stored-program control, and other up-to-date techniques in the field, these "mesh" or area-type systems will give corps, division, and brigade commanders speed and capacity to cope with what is expected to be a highly mobile battlefield. Starting the march will be the West Germans, who next year are to begin development of Autokonetz, a pulse-code-modulation system with channel-transmission speeds of 48 kilobits per second. Expected to follow in the 1990s is Audinetz, a more advanced 16-kb/s system.

The French and Belgians are due to be next into the field in 1979 with

RITA—for le Réseau Intègre de Transmission Automatique—a mostly digital system with 48-kb/s transmission speeds. And the British will follow by 1983 with Ptarmigan, a digital 16-kb/s system, intended in the first place for the First British Corps., which is on duty in West Germany.

Contracts. These systems also signal large contracts for the electronics industries. Although the British army won't decide on how much equipment to buy until next year, Ptarmigan's price tag has varied between \$162 million for 20 central switches and \$288 million for a much larger system.

By comparison, the U.S. Army's Tri-Tac system is a far more elaborate and expensive program. Destined for use in the 1980s at the corps and division levels, Tri-Tac's development costs alone reached \$500 million. The entire program will cost \$5 billion over the next 20 years.

The European plans still will be a

plum for the contractors. For Ptarmigan, Plessey Co. Ltd. is the major contractor. Subcontractors are Standard Telephones and Cables Ltd. for super-high-frequency radio-relay equipment, Marconi Space and Defence Systems Ltd. for ultrahigh-frequency radio-relay and cryptographic gear; British Insulated Callender's Cables Ltd. for cables, and Airtech Ltd., for vehicle fittings. Comparable rewards will be shared by RITA suppliers Thomson-CSF, for transmission equipment, CIT-Alcatel for radio integration, Le Matériel Téléphonique for switching equipment, and CIT for computers. What's more, both countries are lining up prospective export business.

RITA basically consists of mobile central exchanges interconnected by radio links to form a meshed network with high operational flexibility. The meshed structure covers the army corps zone and follows the tactical situation quite independently of unit or subscriber positions. Headquarters are also connected to the network by radio links, while isolated subscribers are connected via single-channel radio-access points located near nodal exchanges. The result, explains Alfred Pirotte, head of the Laboratoire Central de Télécommunications section on the application of electronic switching to military equipment, "is quasi-complete coverage of the army corps zone."

Thus, the RITA system makes possible constant communica-

Design to COST



save
dollars,
save
weight,
power,
and space

with the tough,
proven Analog
MIL ETI's by Curtis

Don't burden your cost with motor-driven digital ETI's. Curtis MIL Elapsed Time Indicators at \$14.80 in quantities of 100 (5v), offer up to 80% direct cost savings, AND, as a bonus, they afford a 5 fold volume reduction, a 15 fold weight reduction, a 30 fold power reduction, generate no RFI noise and are fail-safe.

Design to Cost means buy what you need. 9 times out of 10 Curtis ETI's will do the job. By using them, you're designing to cost. All units meet MIL-I-81219A, are approved by all three services, and have a proven record of reliability from the Lunar Lander to the APX-72.

The Curtis 620-N Series (shown above) is available in 5VDC, 28 VDC & 115VAC. Check out the Curtis 620-PC for monitoring at the modules level too.

Write or call us,
we'll send you
complete infor-
mation.



CURTIS

CURTIS INSTRUMENTS, INC.
215 Kisco Avenue, Mt Kisco, N.Y. 10549
Tel. (914) 666-2971 • TWX 710-571-2163

Probing the news

tions by transmitting pulse-code-modulated data over the multiplex highways that connect the exchanges with line concentrators and each other. The saturation-routing technique allows a quick search for a called subscriber in an unknown location and enables communications to be established in the event of partial destruction by automatic bypassing of faulty equipment. A radio-integration device provides the same services to all subscribers whether concentrated or isolated.

Ptarmigan, though more sophisticated, also bristles with all the best features of a modern telephone exchange. Its comprehensive direct-dialing facilities include pre-emption so that authorized subscribers can make priority calls at any time and conference calls can be prearranged if needed. Other capabilities include broadcast calls, automatic call transfer to an alternate number, a unique permanent directory number for each subscriber, compressed dialing codes, call-holding, and subscriber assistance.

Moreover, Ptarmigan's voice, telegraph, facsimile, and data traffic are all cryptographically protected. There's fully automatic connection with automatic alternative routing to handle such events as movement by a subscriber, regrouping, and traffic overloads. Telegraph messages can be either cleared terminal to terminal, or automatically distributed by a computer-controlled store-and-forward system.

Problems. However, these national systems also present problems because differing levels of technology will be coming into operation at different times. For example, although RITA, a 24-channel, 48-kb/s system, offers better speech quality than Ptarmigan (32 channels, 16 kb/s), its radio-relay links require twice the bandwidth and need twice as much precious spectrum. "If every country on the battlefield bought RITA, you'd be in dead trouble," snaps one military expert. Also, Ptarmigan employs delta modulation, considered by some experts in Europe to be better than RITA's PCM approach.

Perhaps a more serious question is, can the different systems talk with each other? The West German Autokonetz system cannot operate with RITA, Ptarmigan, or the British Bruin system now in West Germany, reports an expert. Until Audinetz comes on line, the West Germans won't have a European standard system. And the French won't be able to hook up their mobile subscribers with single-channel radio access points until 1980, nor with the West German tactical system until much later.

Col. T.M. de Bie, chairman of Eurocomm, a NATO committee in the Hague that designs common interface equipment, concedes that there are problems in hooking up fast PCM, slower delta modulation, and present analog systems. Nevertheless, an arsenal of NATO-standard interface boxes is being developed—in the French and British RITA and Ptarmigan systems, for example—although experts agree that there will be some loss of efficiency in actual operation.

Interfacing. The concept of an interface box may be as near to common as the systems will get. One NATO staff member says, "While you can argue that a single common communications system can represent cost savings for all partners, it would increase costs for some governments who feel they need a system with limited capabilities." And there's always national pride and lucrative contracts for industry at stake.

Overall, "the real problem has nothing to do with electronics," comments one industry source. "It's a problem of language: the Germans speak German, and the English speak English." He foresees that hurdle shrinking with increased digital communications, but in the meantime, the interface may well be human: the German operator may simply be forced to sit in the British communications van to link the two systems. □

By William F. Arnold, London bureau manager; James Smith, McGraw-Hill World News, Brussels; and Joel Stratte-McClure, McGraw-Hill World News, Paris

New MINIATURE SOLID STATE RELAY from CLARE

A hybrid ac relay for low power applications

Clare's new 241 series offers reliable switching for many types of industrial and business machines... wherever a low power synchronous motor needs switching. It's a must consideration for point-of-sales data terminals and similar types of equipment.



241

UL recognized under
Magnetic Motor Controllers
File E47012

Performance you can count on

The reliable solid-state 241 provides load switch with a 1/4 amp rating at 120 Vac. Maximum RMS load current is 250 mA ac. Its one-cycle surge current rating is 1000% rated current, or 2.5 amps for 16 milliseconds. Frequency range is 10-70 Hz. Operating temperature range is -40°C to $+85^{\circ}\text{C}$. All this in a small package with a matching small price.

Designed for printed circuit board

It's unusual to find a hybrid relay that's PCB mountable. But the 241 fills the bill. Reliable reed relay input... triac output. Standard input ratings of 5, 5/6, 12 or 24 Vac are available.

Here's how to find out more

For full technical data, contact your nearest Clare sales office or distributor. For more comprehensive application information, contact Bob Mullins, C. P. Clare & Company, 3101 W. Pratt Avenue, Chicago, Illinois 60645. Or phone (312) 262-7700.

QUALITY, SERVICE, RELIABILITY

C. P. CLARE & COMPANY
GENERAL INSTRUMENT CORPORATION



Announcing...

an important development in pulse generators from Tektronix TM 500

- 20 V, 5 Hz to 50 MHz
- Rise time variable to 5 ns
- Delay and double pulse
- Control error light
- Probe compatible 1-M Ω trigger input
- Three-state trigger light
- Presettable output voltage
- Counted burst capability

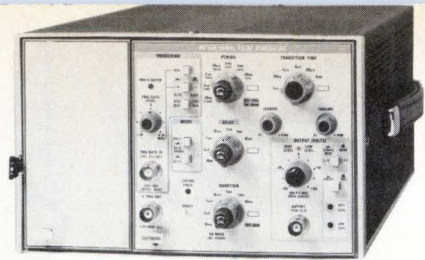

PG 508T (includes mainframe) . . . \$1250

The Tektronix PG 508 50-MHz Pulse Generator is a general-purpose instrument with unique features innovated for versatility and ease of use.

It provides the high-level output required to drive MOS and CMOS (up to 20 V in a ± 20 -V window to hi Z and up to 10 V to 50 Ω).

A control error light helps in setting up the instrument by warning of improper switch or variable control settings of the parameters, which include period, delay, duration, and rise and fall time.

The PG 508 is the first pulse generator on the market to offer independent pulse top and bottom level control by three means: knobs, front-panel screwdriver adjustments, or external tracking. The low reactance 50- Ω output delivers clean waveforms to unterminated cables or reactive loads.

Trigger the PG 508 from your circuitry just as you would your favorite triggered-sweep oscilloscope . . . a selectable 50- Ω or 1-M Ω trigger/gate input lets you use a 1X or 10X oscilloscope probe. A three-state trigger light indicates proper external triggering.

The PG 508 will perform effectively as a pulse regenerator, sine-wave to pulse converter, or logic level translator, as well as a primary source of pulse waveforms. Use it to drive MOS, CMOS, DTL, HTL, I²L, T²L, or ECL.

Order the PG 508T for a self-contained pulse generator complete with mainframe/power supply. Power requirements are: line voltages from 100 to 240 V ac, line frequencies from 48 to 440 Hz.

Tektronix TM 500 is a family of plug-in modular instruments and 1, 3, 4, 5, and 6-compartment mainframe/power supplies. The unique advantage of TM 500 instrumentation is the ability of the instruments to talk to one another and work together through the rear interfacing within their mainframes . . . yet any of the plug-in modular instruments may be chosen on the merit of its performance alone as a monolithic instrument operating from a mainframe/power supply.

The PG 508, for example, can be combined with several other TM 500 Instruments to provide a basic bench setup for CMOS. One suggested lineup includes a TM 506 6-compartment mainframe, DC 505A Universal Counter, DD 501 Digital Delay for counted burst operation, PG 508 Pulse Generator, DM 502 Digital Multimeter, and PS 503A Power Supply. While this is a typical setup, many variations are possible within the TM 500 family to create the optimum instrumentation for your particular needs.

PG 508 50-MHz Pulse Generator \$1100

PG 508T (includes mainframe) \$1250

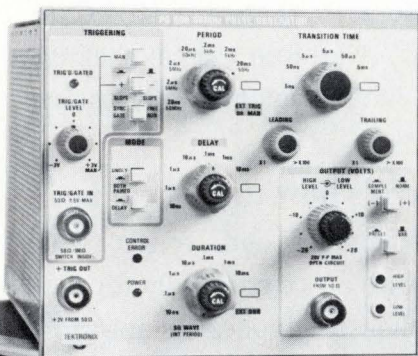

For further information on the PG 508 and TM 500 Instrumentation, ask for a demonstration; a Tektronix Field Engineer will contact you. Ask for literature and you'll get the comprehensive PG 508 Data Sheet and TM 500 Catalog shown below.

To write or phone: Tektronix, Inc., P.O. Box 500, Beaverton, Oregon 97077, (503) 644-0161 ext. 5542. In Europe: Tektronix Limited, P.O. Box 36, St. Peter Port, Guernsey, Channel Islands.

For Technical Data Circle 76 on Reader Service Card.
For Demonstration Circle 77 on Reader Service Card.



TEKTRONIX®

U.S. Sales Prices
FOB Beaverton, Oregon

committed to
technical excellence

Air-traffic control

JETS to speed planes in Canada

Sanders handling displays for Joint En route Terminal System, a \$16.8 million setup including 154 displays and 210 minicomputers

by Lawrence Curran, Boston bureau manager

The Canadian government will begin acceptance tests in December of a new air-traffic-control system that will replace older plan-position indicators and scan-converter monitors. The minicomputer-based distributed-processing network, called JETS, for Joint En route Terminal System, will be installed at eight sites to control both en route and terminal air traffic.

The system is being built for Transport Canada in Ottawa, formerly the Canadian Ministry of Transport, by CAE Industries in Montreal. Sanders Associates Inc., Nashua, N.H., the subcontractor for the display subsystem, also assisted CAE with the overall system definition and designed the computer interface for the display subsystem. The first 14 preproduction displays are now undergoing performance-evaluation tests at CAE.

Sanders and CAE share in the \$16.8 million contract for JETS, which includes 154 display subsystems for various radar data, and 210 minicomputers. Under terms of the contract, which calls for 60% Canadian-dollar content, Sanders has licensed CAE to build all elements of the display subsystem except the cathode-ray-tube module itself, which is a direct-coupled XYZ oscilloscope-type monitor. "It's a precision instrument, not a TV-quality monitor," says Everett Kirtledge, JETS program manager at Sanders.

The Canadian JETS system embodies later technology than the

U.S. Federal Aviation Administration's National Airspace System for en route traffic control and the ARTS-3 terminal-control system. JETS can handle both en route and terminal-control functions—the Montreal and Toronto systems will do both—with the aid of dual-redundant Interdata Inc. Model 70 minicomputers. The Interdata minis are 16-bit machines, whereas the National Airspace System uses a more complex central-processor-based system that has a 64-bit word. In JETS, minicomputers function both as central and display processors.

But it's the sophistication and flexibility of the alphanumeric display subsystem that will aid Canadian air-traffic controllers. They'll

be able to see a wide variety of radar-derived data about the planes under their control, including the airline, flight number, altitude, ground speed, present position, and a dotted trail showing flight direction, as well as vector-velocity information that predicts where the plane will be after an interval. The scope, which can also display blinking emergency or other special conditions provides for weather symbols to be displayed, plus conventional plan-position-indicator symbology.

Sanders engineers have drawn on earlier experience with the National Aeronautics and Space Administration and knowledge of the FAA's systems to come up with what they believe is a simple and versatile

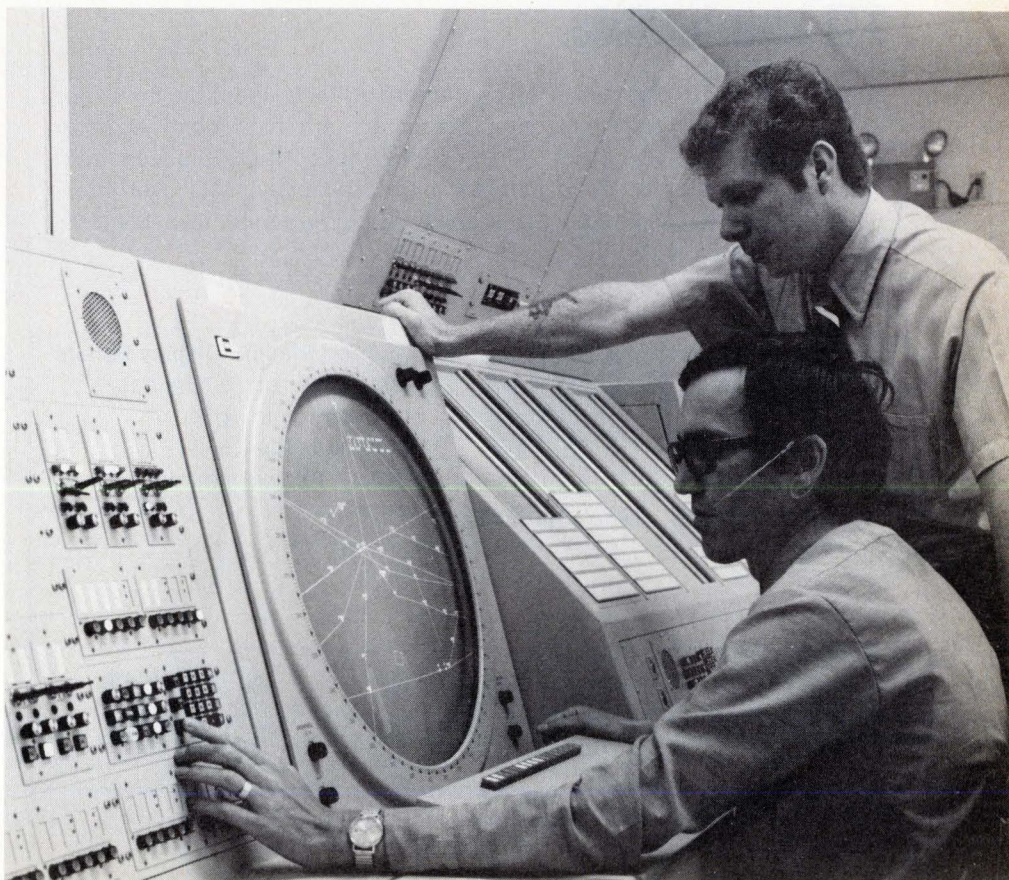

Picture this. Canadian air-traffic controllers check data on Sanders display during their test of minicomputer-controlled Joint En route Terminal System.

Probing the news

display subsystem design. Sanders built a system for NASA's Saturn V Apollo launch vehicle that displayed the data from sensors in the vehicle during prelaunch checkout. For that Saturn V system, the character generator alone required up to 30 printed-circuit boards. However, the JETS characters are generated on a

single board, and a single digitized word determines the character to be displayed, as well as its size.

Configuration. In fact, only seven boards are used in the entire graphics function generator, the all-important module that receives digital data from the display interface controller and generates analog X-, Y-, and Z-axis data to be displayed on the screen.

If a vector is to be generated from

position 1 to position 2 on the screen, the digital coordinates of position 1 are loaded into side A of the d-a converter, where the reference is at +10 volts. Side B of the d-a converter is at 0 v, Kittredge explains, so that side A controls the beam position. Then the coordinates for the second position are loaded into side B of the d-a converter, and the ramp is started so that side A drops from +10 to 0 v as side B goes from 0 to +10 v, making the beam position depend on side B. The vector line is drawn smoothly on the screen, and the process is repeated.

Speedy characters. "Now that we've drawn nice vectors," Kittredge says, "we want to write nice characters, too," and these, like the vectors, are digitally generated. Earlier techniques employed a CRT with mask and raster scan that put out a signal when the character to be displayed was scanned on the mask, but Sanders had graduated to digital character generation for the Saturn V system and has improved it for JETS. Kittredge says that font styles are unlimited, and that up to 62 strokes can be programed in read-only memories in any language.

Because there's no fixed format to follow for character generation—no raster scan or "racetrack" pattern used by earlier systems—character generation is fast.

Another position of the graphics function generator is what Sanders calls the output channel, which transfers data from the generator to the scope screen. The X-, Y-, and Z-axis inputs to the scope are combined on the output-channel board, which also carries the vector and character-position-summing electronics, along with the electronics that controls the eight brightness levels and the blinking function that calls attention to aircraft that require special handling.

The scope itself is built with the latest improvements in yoke and deflection-amplifier developments that have evolved from earlier patented Sanders designs. The resulting display writes "good, crisp, high-speed characters and attains a bandwidth of 3.5 to 4 megahertz," says Kittredge, who claims that about 1 MHz is the best known bandwidth in comparable displays. □



NEC Matrix Plasma Display Panel — compact, complete with driver circuits. TTL compatible.

Type PXD0503A displays 256 characters (32 x 8 lines) in 5 x 7 dot matrix form. The 0.26-inch high characters are high contrast neon orange. No glare, distortion, flicker or fuzziness. NEC's unique transparent electrodes enhance inherent high readability. TTL level interface. Measures 5.5 x 12.6 x 2.1 inches including connectors. Ideal for terminal display applications.

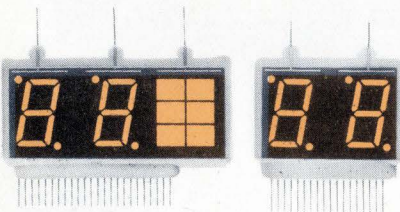

Type PO2504T-02 Type PH2524T-02

AC-coupled Plasma Display Panels

- Inch-high or up to 4 inches.
- Static/dynamic drive.
- Usable up side down.
- Noble display appearance.

NEC America, Inc.

277 Park Avenue, New York, N.Y. 10017 Tel: 212-758-1666

NEC Electronics (Europe) GmbH

4000 Düsseldorf, Immermannstrasse 22 F.R. Germany
Tel: Düsseldorf 357088, 357089, 357080 Telex: NECD 8587419

NEC
Nippon Electric Co. Ltd.
P.O. Box 1, Takanawa, Tokyo, Japan

MOSTEK'S \$20 F8 MICROCOMPUTER

Now, it makes more sense
for less cents.

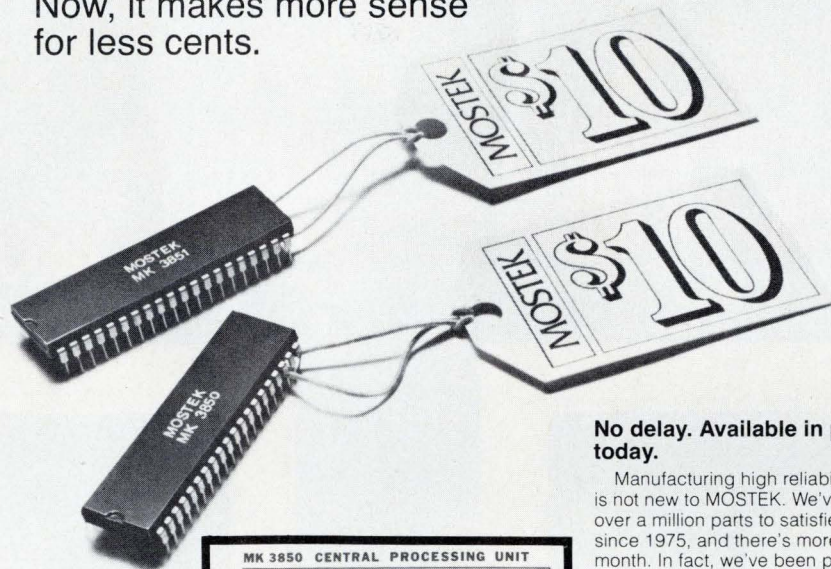

Sensible pricing for more applications.

New low prices for the entire F8 family have broken all barriers to cost effective microcomputer applications. The F8's minimum system configuration represents a complete 8-bit microcomputer, one Central Processing Unit (CPU) and one Program Storage Unit (PSU), for \$20.00. At \$10.00 per device you have the best microcomputer value around. And it's industry's only multi-sourced 2-chip microcomputer.

F8 Family Pricing

MK 3850 Central Processing Unit	\$10.00
MK 3851 Program Storage Unit	\$10.00*
MK 3852 Dynamic Memory Interface	\$ 7.45
MK 3853 Static Memory Interface	\$ 7.45
MK 3854 Direct Memory Interface	\$ 5.95
MK 3861 Peripheral Input/Output	\$ 6.45
EFFECTIVE: August 1, 1976	

F8 Low Cost and High Performance go hand-in-hand.

Mostek's F8 offers the versatile performance you want for a minimum cost. In the minimum 2-chip system configuration you get the same capability found in 5-8 circuits of other μ P families.

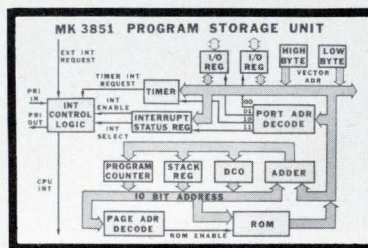
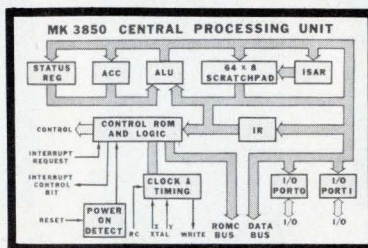

No delay. Available in plastic, today.

Manufacturing high reliability plastic IC's is not new to MOSTEK. We've shipped over a million parts to satisfied customers since 1975, and there's more coming each month. In fact, we've been producing F8 devices in plastic since the first quarter of 1976. That's your assurance of proven reliability.

Find out more about MOSTEK's sensible F8.

F8 μ P family devices are stocked on MOSTEK distributor shelves, now, for immediate delivery. Plus, MOSTEK Field Application Engineers are ready to answer your specific technical questions. Call today, or contact your local MOSTEK representative.

Field Applications Engineers
 Dayton, Ohio (513) 837-0342
 Ft. Washington, Pennsylvania (215) 628-9050
 Tucker, Georgia (404) 934-0330
 Irvine, California (714) 549-0397
 Waltham, Massachusetts (617) 899-9107
 Dallas, Texas (214) 242-0444 ext. 100

*\$1000 mask charge, minimum 500 quantity.

Other systems can be configured using PROM, Dynamic or Static RAM, Direct Memory Access and even multiprocessors. Plus, MOSTEK has the support you'll need for F8 evaluation and product development. All designed to provide maximum cost effectiveness for you.

Visit MOSTEK at
 WESCON/76 Exhibit 1087-1089
 Los Angeles Convention Center
 September 14-17

MOSTEK

1215 W. Crosby Rd., Carrollton, Texas 75006 214/242-0444
 In Europe, contact:
 MOSTEK GmbH, TALSTR. 172, 7024 Filderstadt-1, West Germany
 Telephone: (0711) 701096

Gitchyseff an SFG.

**That's a synthesizer/
function generator, cousin—
the first one ever.**

Our new Model 171 combines the accuracy and stability of a synthesizer with the versatility of a function generator. This means you can generate sine, square, triangle, TTL pulse and dc outputs with synthesizer accuracy. Frequency range is 0.01 Hz to 2 MHz.

Sometimes all you'll need

to use is the generator dial, which is accurate to 3% of full scale. But for more precise operations, you'll want the synthesizer's 4½-digit accuracy which is 0.01% of setting. Synthesizer stability is $\pm 0.002\%$ from 0 to 50°C.

Now we all know that your average synthesizer goes for two grand or better. But the Model 171, which is also a function generator, goes for

just \$795. Which means you could have two of our SFGs for the price of an ordinary synthesizer and have some bucks left over. Gitchyseff a couple. WAVETEK, P.O. Box 651, San Diego, California 92112 Phone (714) 279-2200, TWX 910-335-2007.

WAVETEK®

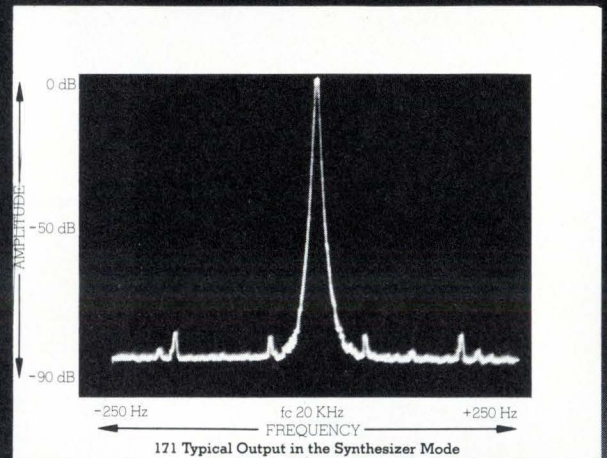
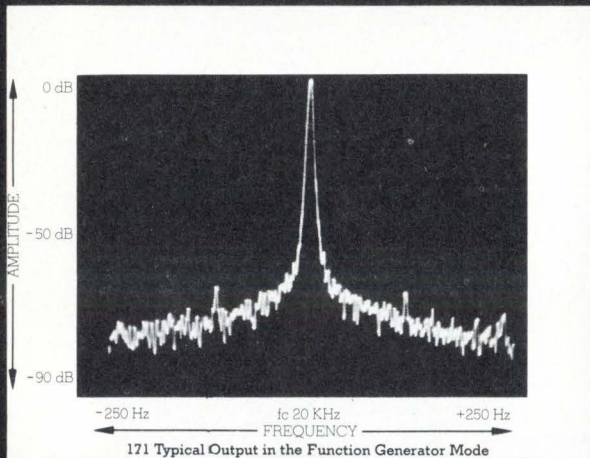

Actual spectrum analyzer photographs showing the improved waveform characteristics in the synthesizer mode.

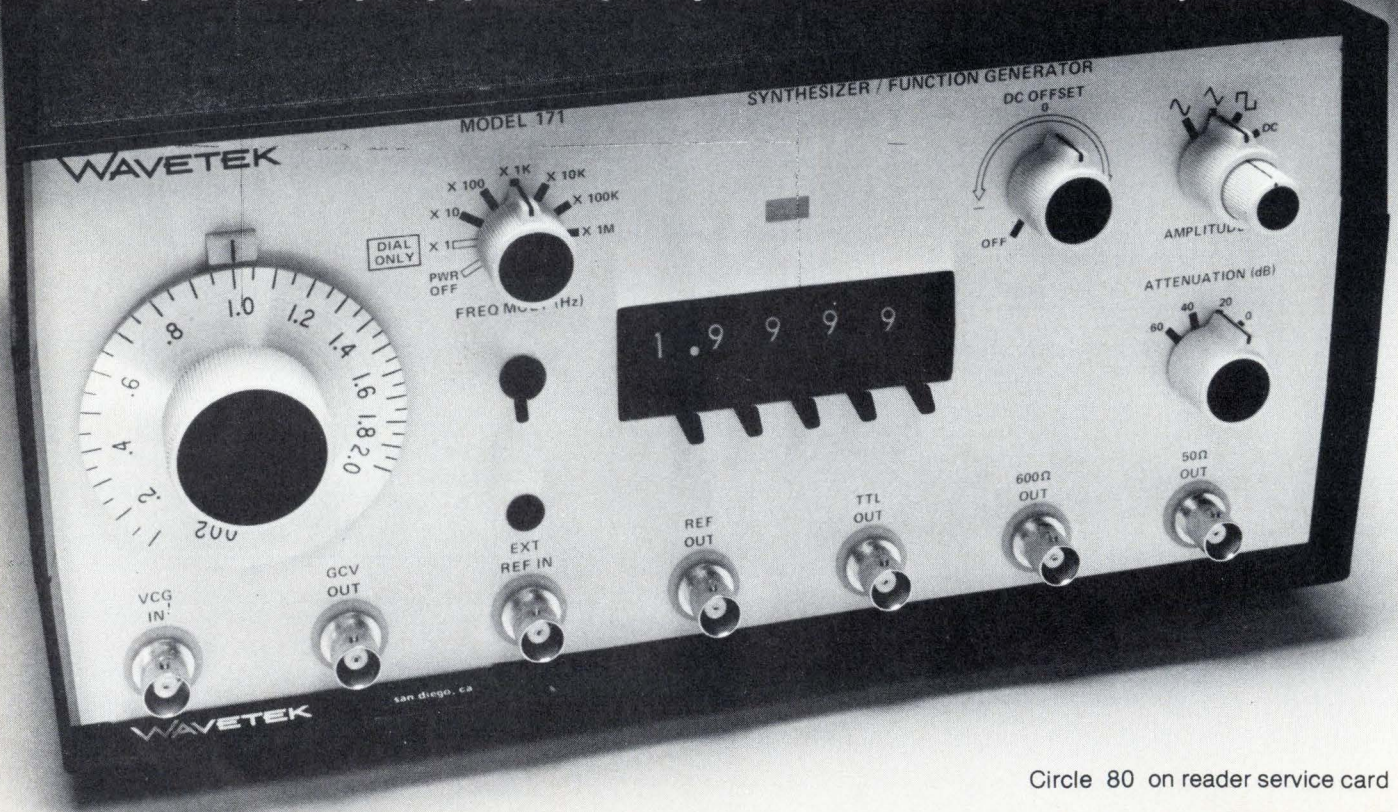

Optical coupling extends isolation-amplifier utility

Faster response and larger bandwidth overcome disadvantages of transformer-coupled amplifiers

by Bill Olschewski, *Burr-Brown Research Corp., Tucson, Ariz.*

□ Sooner or later, almost every analog designer will have to solve an isolation problem. It may arise when a signal to be amplified is superimposed on a high potential, a signal must be transmitted between systems having separate grounds, or a signal path must be completely isolated from a source.

Until recently, the only analog components commercially available to solve such problems were transformer-coupled isolation amplifiers. They work fine for most isolation tasks, but they are usually bulky, costly and have limited bandwidth, as well as slow response. Now, however, optically coupled isolation amplifiers not only eliminate these disadvantages, but also can be used in a number of applications that were previously closed to isolation amplifiers.

Because of the small size and light weight of these hybrid thick-film optically coupled devices, they are the first isolation amplifiers to be suitable for electronic gear in aircraft. And because their optical isolation barrier can be closely controlled, they are also useful for medical electronics, as well as for monitoring and fail-safe equipment in nuclear-power generation, where isolation must be maintained under all possible conditions.

Although not as linear as some transformer-coupled units, these new optically isolated amplifiers provide an operating bandwidth that is 10 times broader and a response time that is five to 10 times faster. High operating frequency is especially important in such biomedical applications as electromyography, which is a method of monitoring the body's nervous system. Additionally, since optical isolation amplifiers do not generate any electromagnetic interference at all, they do not require shielding, as transformer-coupled units do.

Transformer-isolated amplifiers are comparatively large modular units whose volume may even reach 10 cubic inches. In contrast, optical isolation amplifiers are supplied in integrated-circuit-compatible dual in-line packages that measure less than 0.5 in.³ Price differences are significant, too. Optical units cost half as much as transformer units and often less.

One version of the optical amplifier even has a field-effect-transistor input buffer, together with built-in over-voltage-protection resistors. This model is particularly suited to patient-monitoring applications in biomedical instrumentation when high impedances are involved.

As a matter of fact, all the optical amplifiers surpass

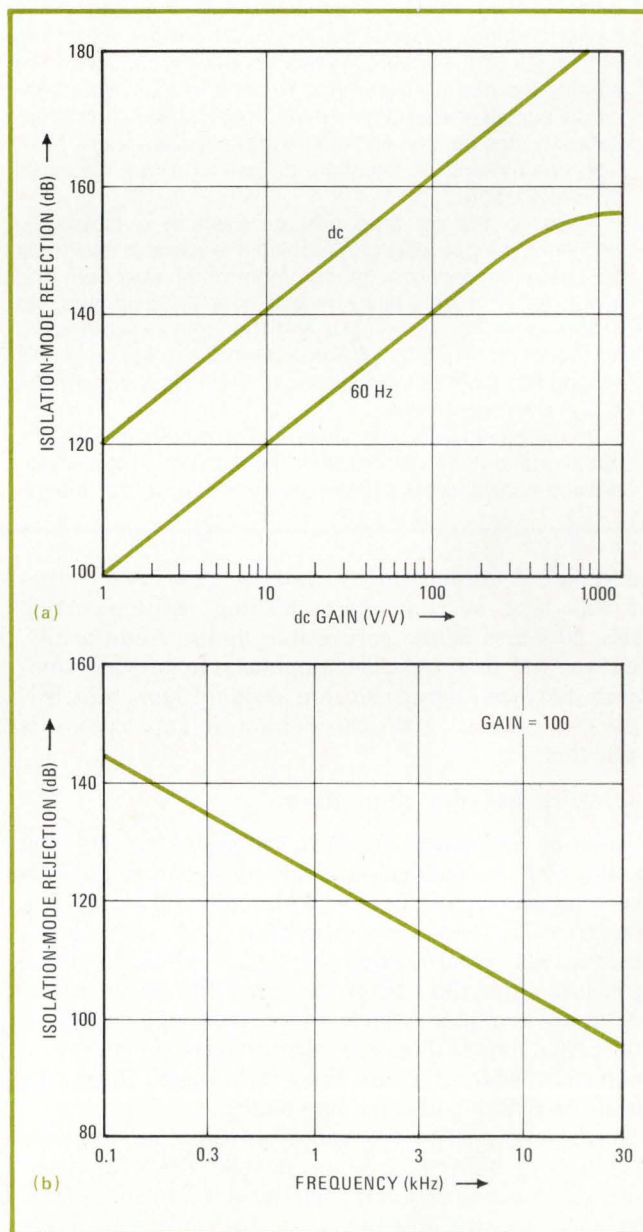

1. Typical characteristics. Isolation-mode rejection, an important property for an isolation amplifier, indicates the change in output voltage as a function of the voltage across the isolation barrier. This specification increases with gain (a), decreases with frequency (b).

Which amplifier is which?

With today's proliferation of specialized dc amplifiers, the differences between the three fundamental types—operational, instrumentation, and isolation—can easily become a bit muddled. In fact, though, the differences are easy to spot, and the type selected depends on what must be done.

As a rule, the op amp is a general-purpose device that can be used in a variety of ways, as an integrator, an oscillator, a level detector, or a straightforward amplifier. For stable operation, the feedback loop between the device's output and its inverting input is usually closed externally.

In transducer-sensing applications, the signal to be amplified—typically a differential voltage of a few millivolts between two wires—is generally superimposed on a higher common-mode voltage of up to several volts from both wires to the ground, guard, or shield connection. To amplify the desired signal and reject unwanted common-mode signals—like hum, interference, spikes, or attenuated bridge-supply voltages—the amplifier must have high common-mode rejection, as well as a true balanced or floating input.

Although the op amp can be used in a differential fashion, the input-resistor matching it requires in this mode of operation reduces its common-mode rejection and lowers its input impedance. In fact, even if the op amp has a field-effect-transistor input and the input resistors used are matched within 0.1%, common-mode rejection is only around 60 decibels, and common-mode input impedance is just a few megohms.

On the other hand, in a differential sensing configuration, the instrumentation amplifier or the isolation amplifier can provide considerably higher—by several orders of magni-

tude—common-mode rejection and common-mode input impedance than the op amp.

The instrumentation amplifier achieves its superior dc-sensing performance by means of an internal voltage-feedback loop, as opposed to the external current-feedback loop of the op amp. Although the instrumentation amplifier is committed to a voltage-in/voltage-out transfer function, its gain can be varied, and it offers ultra-stable closed-loop performance. Common-mode input impedance is typically greater than 100 megohms, and common-mode rejection is about 90 db. However, this device's common-mode voltage capability is usually limited to a voltage somewhat lower than that of the power supply.

Like the instrumentation amplifier, the isolation amplifier has an internal voltage-feedback loop, but its input stage is electrically isolated; that is, the input is completely floating because it is separated from the output by a large dielectric impedance. This input-to-output separation enables the isolation amplifier to withstand, as well as operate with, extremely high common-mode voltages.

For three-wire input connections, the common-mode-input characteristics of the isolation amplifier are the same order of magnitude as those of the instrumentation amplifier. Additionally, though, the isolation amplifier provides an impedance of several gigohms between input and output. And rejection of common-mode signals applied between input and output is generally around 120 db, but can even be as high as 160 db. Typically, isolation-mode test voltages range from 2,000 to 8,000 v, making the isolation amplifier suitable for continuous operation at common-mode voltages, between input and output, of 500 to 3,500 v.

the standard established by Underwriters Laboratories for this type of component, holding leakage-current levels 20 times below permissible limits. Additionally, they are the first isolation amplifiers to provide completely balanced inputs, so that residual hum, which is often encountered in patient-monitoring applications, is negligible.

Analyzing isolation amplifiers

Isolation amplifiers are best suited for sensing and conditioning dc analog signals and ac signals in the low-frequency range. In addition to isolation, these devices can provide linear amplification and high input impedance to avoid loading the signal source. In effect, an isolation amplifier takes the capability of an instrumentation amplifier, which has a very high common-mode input impedance, one step further—to provide a completely floating input that is insulated from the output by a high withstanding voltage.

To achieve this floating input, an isolation amplifier must have a built-in isolation barrier. The component most often used to create the barrier is a transformer. Its excellent linearity and low noise are ideal for signal isolation, and various modulation techniques can be utilized for isolating dc signals.

Instead of a transformer, an optically coupled isolator, consisting of a gallium-arsenide light-emitting diode

paired with a silicon photodetector, can be used as the barrier element. With this device, however, special feedback techniques are needed to compensate for the inherently nonlinear output of a GaAs LED. Other possible isolation techniques include acoustical coupling, Hall-effect devices, and utilization of electric or electromagnetic fields.

An isolation amplifier's characteristics are much like those of an instrumentation amplifier (see "Which amplifier is which?" above) so that most specifications correspond one for one. As might be expected, an isolation amplifier requires additional characterization for its isolation properties between input and output. Depending on the manufacturer, these properties may be referred to as isolation-barrier characteristics, input-to-output common-mode characteristics, or common-mode II characteristics.

Considering key specifications

There are three principal isolation-related characteristics— isolation impedance, isolation-mode rejection, and isolation voltage. Isolation impedance is usually specified as the resistance and capacitance across the isolation barrier. But sometimes the leakage current at a specific voltage and frequency is given instead.

Isolation-mode rejection reflects the change in the output voltage as a function of the voltage applied across

COMPARISON OF ISOLATION AMPLIFIERS

Characteristic	Transformer coupling		Optical coupling
	Amplitude modulation	Pulse-width modulation	Light-intensity modulation
Nonlinearity, max (%)	0.03 - 0.25	0.005* - 0.025*	0.1* - 0.2*
Isolation voltage, test (kV)	up to 7.5	up to 5	up to 5
Isolation-mode rejection, @ 60 Hz & unity gain (dB)	up to 120	up to 120	100
Frequency response (kHz)	2.5	2.5	10 - 30
Emi generated	low, if shielded	low, if shielded	none
High-frequency susceptibility	high	low	very low
Size (in. ³)	5 - 10	6	less than 0.5
Price in lots of 100	from \$49	from \$90	from \$26**

*Measured at full output-voltage swing **Without input power supply

the isolation barrier. Usually expressed in volts per volt or decibels, it may be specified at unity gain or at some higher gain. Typically, isolation-mode rejection increases with rising gain (Fig. 1a), but decreases as frequency becomes higher (Fig. 1b).

As the term implies, isolation voltage is the maximum voltage that may be present between input and output without causing internal breakdown or excessive leakage. In general, a test voltage and a continuous operating voltage, which should be derived by the manufacturer with derating factors, are specified.

Most isolation amplifiers have a three-wire input, like an instrumentation or operational amplifier, giving rise to common-mode characteristics, in addition to their isolation-mode characteristics. Common-mode param-

eters, however, should not be confused with isolation-mode parameters. The former are measured between both inputs and the third input connection, which is usually referred to as a common or guard connection.

Examining modulation schemes

Besides the two different types of isolation—transformer or optical—there are three different possible modulation methods: amplitude modulation or pulse-width modulation for transformer-coupled amplifiers, and light-intensity modulation for optically coupled amplifiers. In each, the isolation amplifier internally generates the carrier that is modulated with the input signal.

Amplitude modulation, the oldest technique, usually

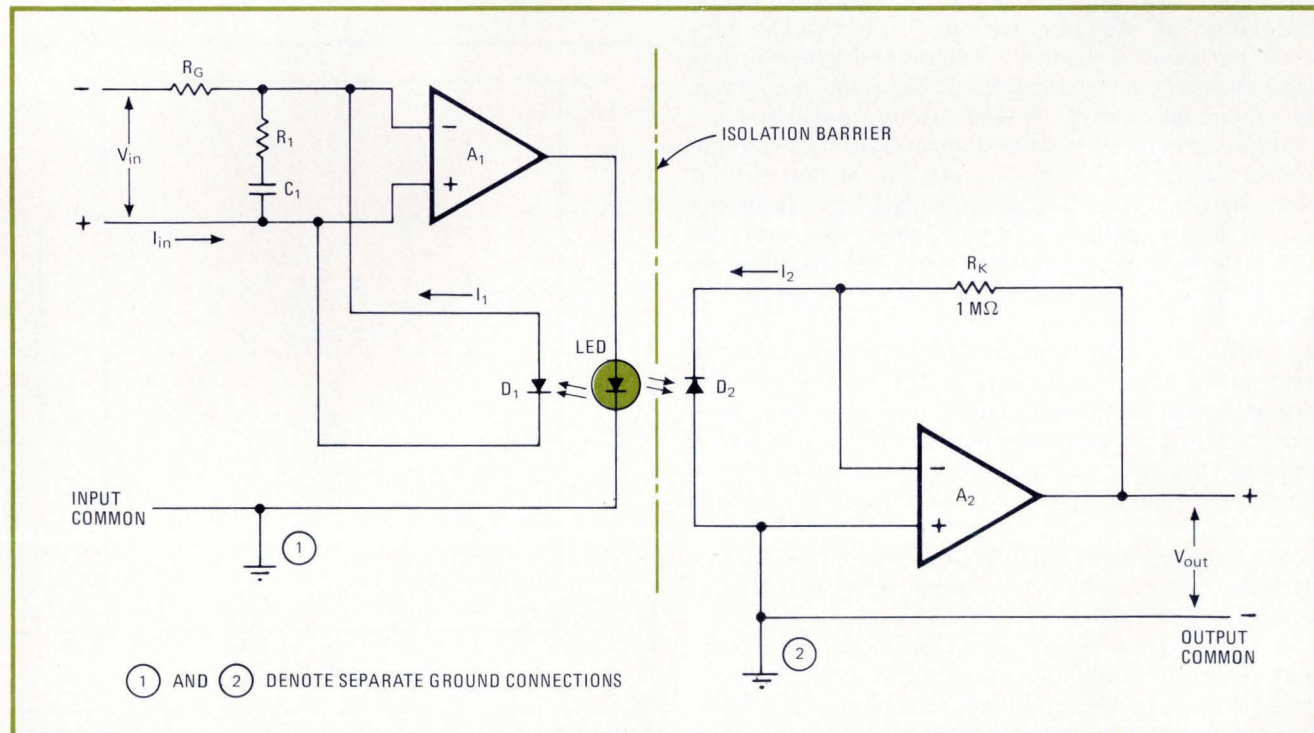

2. **Optical but linear.** In optical isolation amplifier, photodiodes in differential configuration correct for inherent nonlinearities and instabilities of optical semiconductors. Since the matched photodiodes detect the same LED output, they produce equal currents.

involves a double-sideband suppressed carrier having a frequency of around 100 kilohertz. As in the a-m radio, the amplitude of the modulated signal is easily affected by electromagnetic interference, so that this technique has a high degree of emi susceptibility. For demodulation, the carrier and the modulated signal are switched on and off in synchronism, and then the residual carrier is filtered out. This is the same technique commonly employed in chopper-stabilized op amps.

With pulse-width modulation, the carrier is a fixed-frequency square wave having a duty cycle of 50% when no input modulating signal is present. Since only the duty cycle is varied with the modulating signal, all information is contained in the transition time, and the amplitude of the modulated signal can be clipped without affecting accuracy. Pulse-width modulation, therefore, is considerably less susceptible to emi than amplitude modulation. Demodulation is generally accomplished with a dc-restore circuit (like a one-shot) or a balanced diode pair followed by a low-pass filter.

With light-intensity modulation, the input signal modulates the output of a light source whose quiescent light level is fixed. Demodulation is done automatically by the photodetector. Emi susceptibility is low because this technique does not produce cross-modulation products. Also, any emi can be removed by filtering the demodulated signal.

Comparing isolation amplifiers

The table compares the key characteristics among the three classes of amplifiers. Amplitude modulation provides good linearity—sometimes at almost half the cost of pulse-width modulation. On the other hand, pulse-width modulation results in better linearity, with errors down to as little as 0.005%. In many ways, optical modulation is superior to these other techniques, providing higher frequency response and generating no electromagnetic interference at all. Cost, too, is considerably lower, but linearity is moderate in comparison.

At present, there is little compatibility between the products of various manufacturers, except that they all offer isolation. Most include an isolated power supply, but the supply voltage itself can range from the usual ± 15 v dc required for conventional operational amplifiers to a single +28 v dc connection to an ac-line hookup of 115 v ac.

Additionally, input impedance can be either low or high, and a few models have a current, rather than voltage, output. Input connections also vary—from two-wire inverting or noninverting affairs to three-wire hookups that may be two differential inputs plus a common or high- and low-potential inputs plus a guard connection. What's more, since not all manufacturers specify nonlinearity at the full output-voltage swing, this specification can appear to be deceptively better than it actually is.

All of this variation is keeping many potential users at arm's length from isolation amplifiers because finding a second-source supplier, a critical requirement in numerous applications, is extremely difficult, if not impossible. The isolation amplifier that delivers the best cost-performance combination will ultimately gain the widest

market acceptance. The optically isolated amplifier may well represent the first step toward realizing a cost-effective, yet versatile, industry standard.

Optical couplers have a number of inherent stability problems. The luminance of LEDs and the quantum efficiency of photodiodes vary with temperature. LED luminance is also degraded appreciably over a long period of time. What's more, the transfer function of LED input current versus light output is nonlinear, and the LED light output is noisy.

Linearizing the optics

To overcome these instabilities and nonlinearities, a differential photodiode arrangement can correct for errors much like the differential input transistor pair of a dc operational amplifier. Figure 2 shows a simplified schematic of a linear, stable, optical amplifier circuit.

Amplifier A_1 drives the LED; diodes D_1 and D_2 form the differential photodiode pair. Diode D_1 closes the feedback loop around A_1 , so that A_1 drives the LED until:

$$I_1 = I_{in}$$

where I_1 is the current generated by diode D_1 . The output amplifier, A_2 , performs as a current-to-voltage converter; it is driven by diode D_2 . Since the photodiodes are matched and are detecting the light output of the same LED:

$$I_2 = I_1$$

where I_2 is the current generated by diode D_2 . The transfer function of the current-to-voltage converter can be written as:

$$V_{out} = I_2 R_K = I_{in} R_K$$

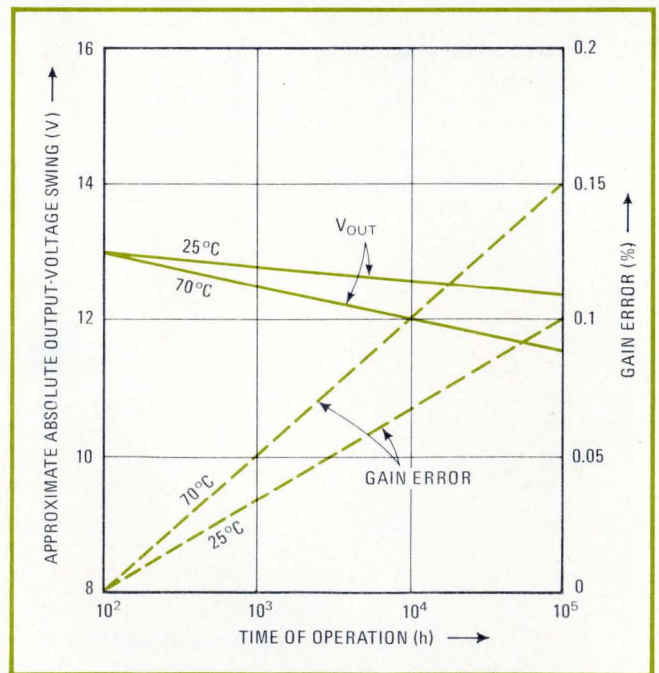

3. Optical but stable. Gain error of optical isolation amplifier is only about 0.1% after 100,000 hours of operation at 25°C. Similarly, under the same conditions, output-voltage swing drops by 0.5 V.

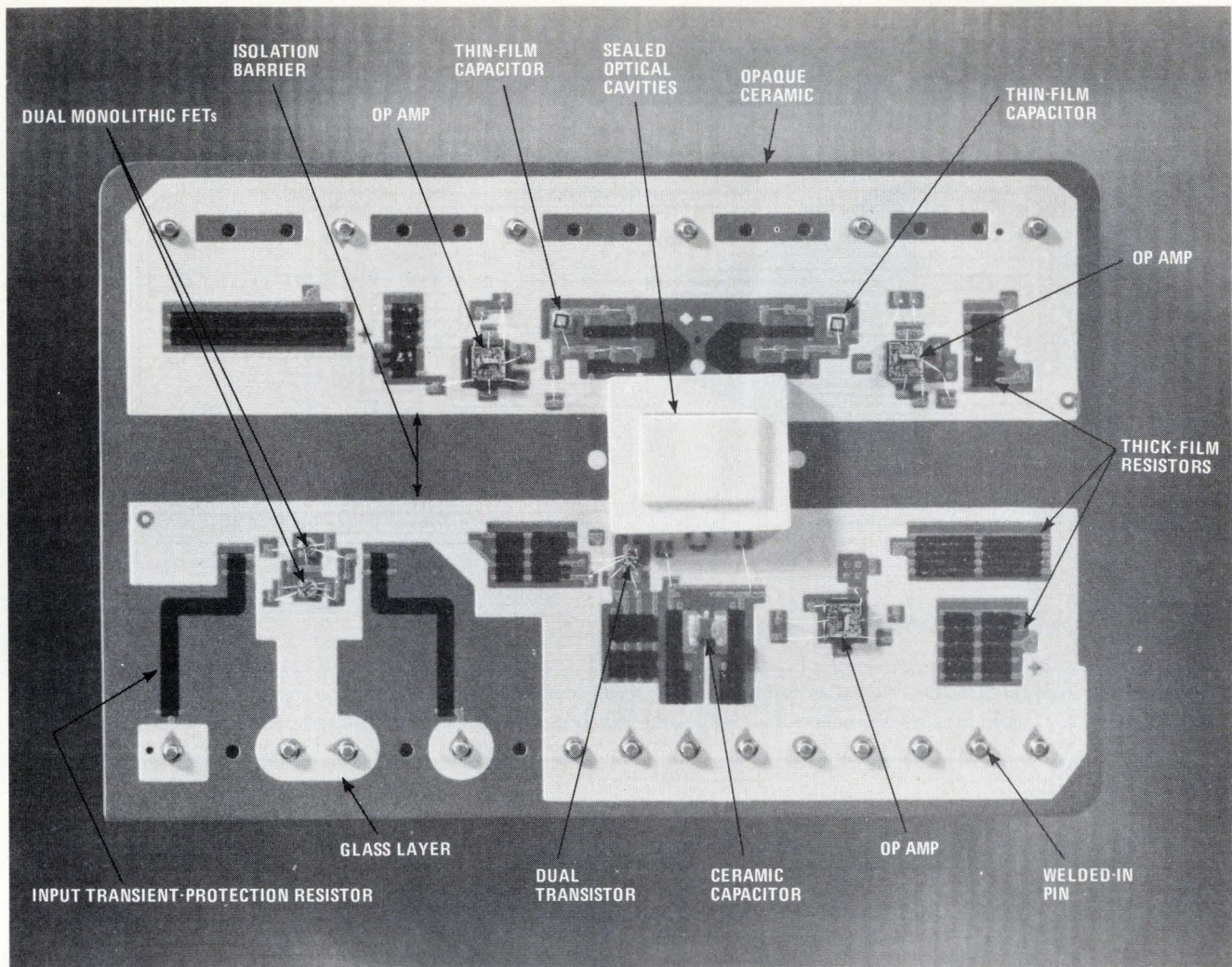

4. Under the lid. Opaque ceramic header serves as substrate for hybrid isolation amplifier. The circuit consists of nine chips, excluding the optical semiconductors, which are encapsulated and sealed in their own housing. The resistors and interconnect pattern are made of thick films. This version of the amplifier includes a differential FET-buffer input and overvoltage-protection resistors.

where R_K is the integral feedback resistance for amplifier A_2 . The overall transfer function for the entire circuit becomes:

$$V_{out} = I_{in}R_K = (V_{in}/R_G)R_K,$$

which is linear and independent of the LED parameters. Resistor R_G is the user-selected gain-setting resistance.

For this circuit, the direction of the unipolar photodiode light current limits amplification to positive signals only. To provide bidirectional signal capability, a second set (not shown here) of LED and differential photodiodes must be employed. Alternate biasing techniques could be used instead, but employing a duplicate set of optical components is more cost-effective in a thick-film hybrid circuit. Resistor R_1 and capacitor C_1 simply phase-compensate the closed-loop input circuit, generating a rolloff of 6 dB per octave.

The long-term stability of such a design is more than adequate. In Fig. 3, output voltage and gain error are plotted against time for the optical isolation amplifier. After 100,000 hours of operation at 25°C, gain error is around 0.1%, and output voltage drops by about 0.5 v from its 100-hour value. At 70°C operation, gain error

increases to 0.15%, while output voltage decreases by approximately 1.5 v.

The voltage gain of the optical isolation amplifier is determined by the input resistors selected. But if high gain is desired, the input impedance drops to a low value, for example, 10 kilohms for a gain of 100.

To overcome this limitation for applications involving high source resistances, one version of the optical isolation amplifier has a differential FET buffer at its input. This model also has integral high-voltage transient-protection resistors for safe operation in the presence of overvoltages as large as 6 kilovolts.

How the hybrid is made

To obtain high isolation breakdown voltage and to space input and output pins as far apart as possible, the amplifier is housed in a DIP that is three times wider than a standard IC DIP. The package is ceramic, with an opaque header that also serves as the circuit substrate and has welded-in pins.

The fully assembled substrate (Fig. 4) contains the optoelectronic circuit, as well as all active and passive chips, plus the interconnect pattern. Not visible here, the

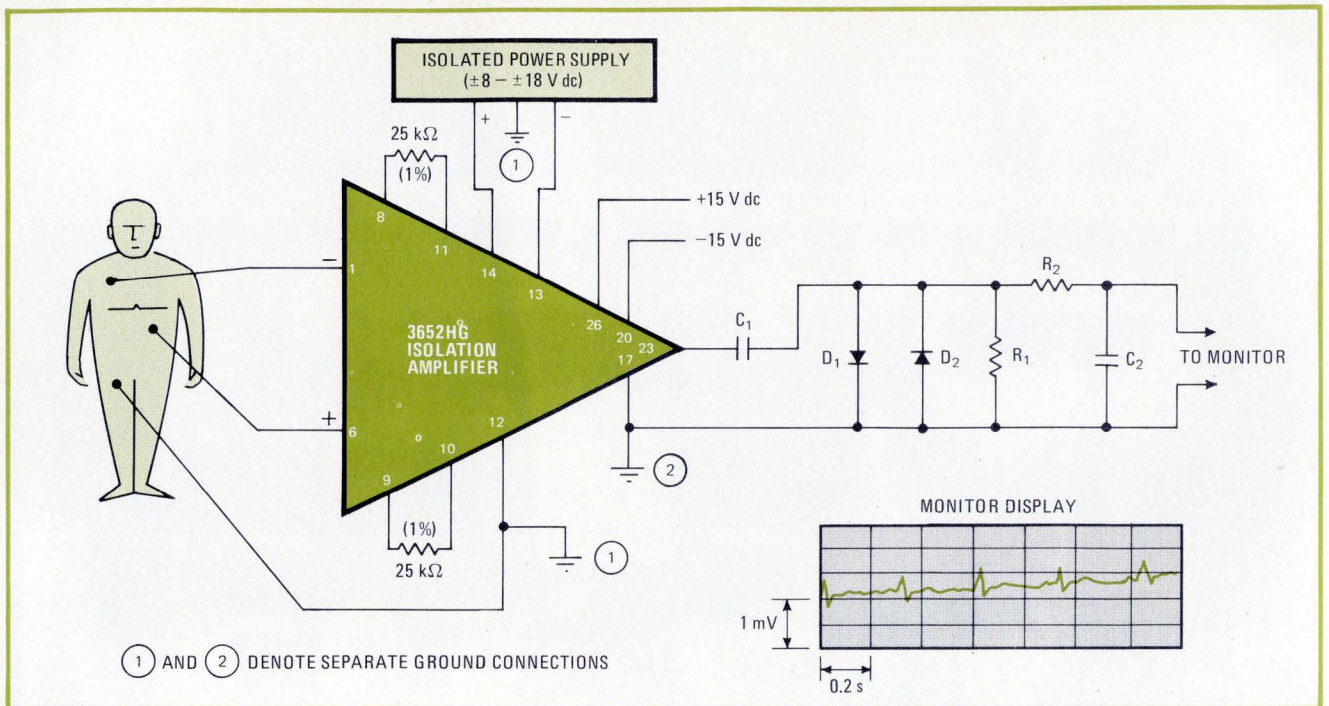

5. Biomedical. Because of its high frequency response, the optically coupled isolation amplifier is suitable for a variety of biomedical applications. Here, it's used to isolate the patient from the possibly lethal potentials of electrocardiographic instrumentation.

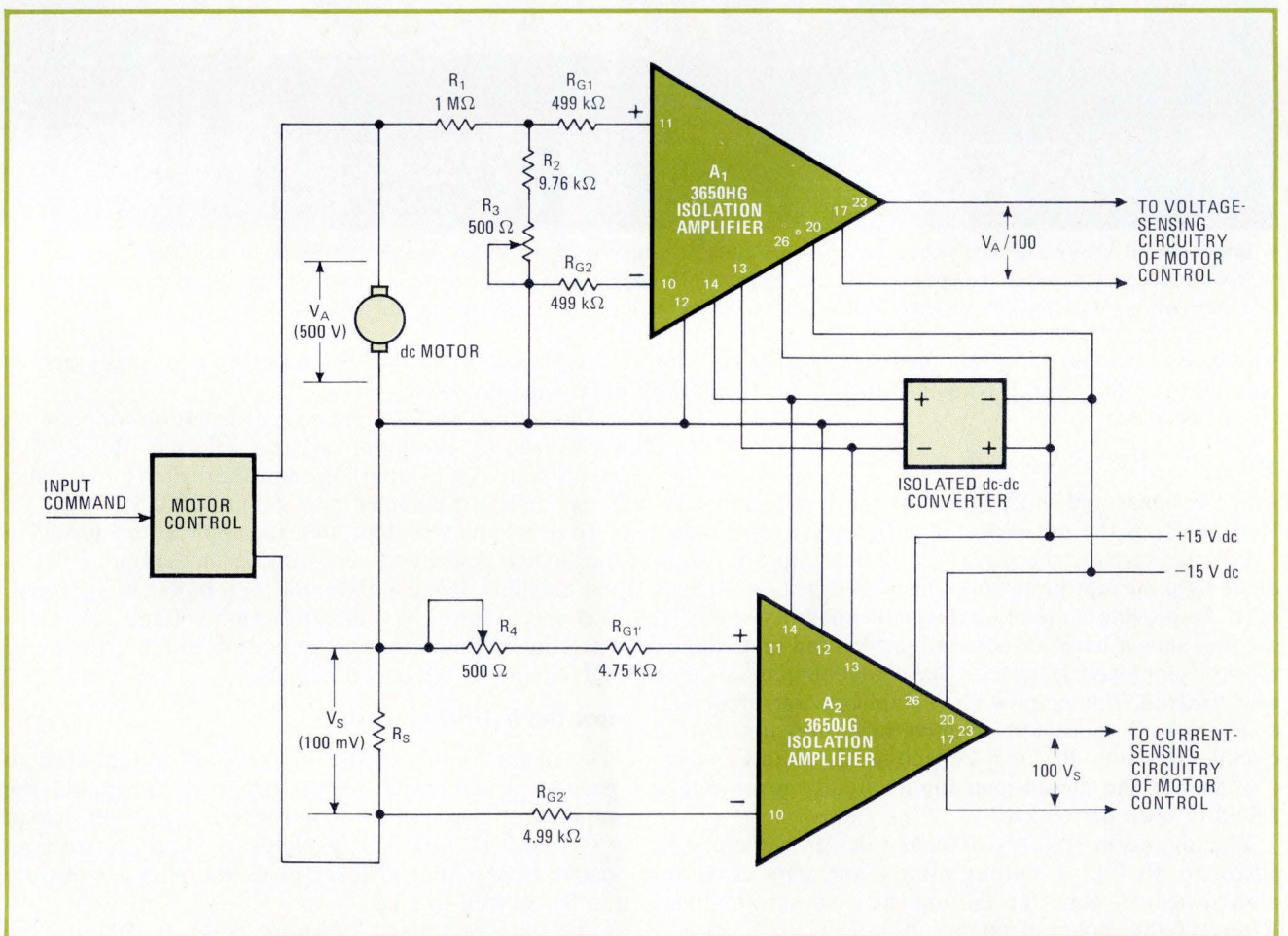

6. Motor control. Pair of optical isolation amplifiers put a voltage barrier between driving circuitry for the motor and the circuits for voltage and current sensing. A single dc-dc converter is used to supply isolated power for both of the amplifiers.

photodiodes are made from silicon, and the LEDs from gallium arsenide. All resistors are screened on with a thick-film cermet material, and the interconnect pattern is printed with a thick-film gold paste. Extra insulation is provided by a layer of printed thick-film glass. Interconnections between the chips and the conductor patterns are made with thermocompression-bonded gold wire.

The isolation barrier is 200 mils wide, narrowing to a 15-mil gap between the LEDs and the photodiodes. This gap is encapsulated in a transparent resin having a high dielectric withstanding voltage, thereby providing a light-transmission medium that has good insulation properties. The resin is contained inside a cavity that is bonded onto the substrate. The cavity also serves as a reflector to distribute the infrared light emitted by the LEDs onto the photodiodes.

After the substrate is complete, the thick-film resistors are laser-trimmed to bring the amplifier's gain and offset voltage within data-sheet limits. Prior to capping with a ceramic lid, the substrate is put through temperature cycling and a stabilization bake.

The device does not have a built-in isolated power supply like most other commercially available isolation amplifiers. This may be less convenient in some applications, but gives the user more flexibility in multiple-channel systems or in systems where isolated power is already available elsewhere.

A companion isolated power-supply module is available for those users who need isolated power. This module can drive from three to 10 amplifiers, depending on the amplifier model and the required output-voltage swing.

Helping medical electronics

Optical isolation amplifiers are particularly suited to biomedical applications because of their clearly defined isolation gap and their extremely low coupling capacitance. Moreover, such monitoring functions as electromyography require a fairly wide frequency response—too wide for most transformer-coupled isolation amplifiers.

In electrocardiography (ECG), for example, the electrical activity of the heart is analyzed by measuring potentials at various surface points of the body. Electrodes are applied to certain body points, and the measured potentials are displayed in real time, usually on a cathode-ray-tube monitor. The signal levels thus generated by the heart range from 300 microvolts to 2 millivolts, superimposed on a galvanic potential of up to 500 mV.

When used as an ECG amplifier (Fig. 5), the optical isolation amplifier is dc coupled, with its gain limited to 20 to prevent it from being saturated by the galvanic potential. The dc-coupled input also provides the fastest possible recovery from input overvoltages of up to several kilovolts, such as those caused by the application of a defibrillator pulse to stimulate the patient's heart.

The galvanic-potential dc component is decoupled at the output of the amplifier by resistor R_1 and capacitor C_1 , which form a high-pass filter having a cutoff frequency of 0.05 hertz. Diodes D_1 and D_2 speed up the discharge of capacitor C_1 after the amplifier has been

saturated by a defibrillator pulse. (This particular circuit has a settling time of less than 0.1 second.) Resistor R_2 and capacitor C_2 serve as a low-pass noise filter. The amplifier's frequency response of better than 15 kilohertz far exceeds the required ECG range of 80 Hz.

Vectorcardiography is a variation of ECG. With this technique, electrodes pick up the heart's signal along three axes, and two of the three axes are displayed as vectors on a CRT monitor. The resulting display is similar to a Lissajous pattern. Such a system requires three isolation-amplifier circuits (identical to the one in Fig. 5) that can utilize a common isolated power source.

Electromyography, a different method of monitoring electrical body impulses, also requires an isolation amplifier for patient safety. In this procedure, the electrodes detect electrically stimulated or normal nerve pulses.

Yet another biomedical application for an optical isolation amplifier is electroencephalography, which involves the measurement of brain waves on the surface of the head. An isolation-amplifier circuit for these waves must have low noise. The circuit of Fig. 5 would have to be modified for higher gain, say, around 1,000.

Controlling industrial motors

Because of their low phase shift, optical isolation amplifiers are also suitable for motor-control applications. In the circuit of Fig. 6, two devices are isolating the drive circuitry from the sensing circuitry for a dc motor requiring an armature voltage of 500 v. This sort of circuit is frequently needed in industrial situations because ground connections are usually dictated by safety considerations, rather than the convenience of the design for the motor-control circuit.

Amplifier A_1 delivers an isolated output that is 1% of the armature voltage ($V_A/100$) to the voltage-sensing portion of the motor-control circuitry. Gain-setting resistors R_{G1} and R_{G2} fix A_1 's gain at unity, while resistors R_1 , R_2 , and R_3 simply serve as a voltage divider, and R_3 permits fine adjustment of the gain. Amplifier A_2 develops an isolated output for the current-sensing portion of the control circuit by amplifying the voltage (V_S) across shunt resistor R_S , which parallels the amplifier's differential input. The gain of A_2 is set at approximately 100 by resistors $R_{G1'}$ and $R_{G2'}$, with resistor R_4 to provide fine gain adjustment. A single dc-dc converter is used to generate the isolated power-supply voltage for both amplifiers.

Controlling single- or three-phase ac loads is still another application for optical isolation amplifiers. Their broad frequency response makes them good candidates even for 400-Hz systems in which transformer-isolated devices would be too slow. In ac applications, isolation becomes necessary when the potentials between input and output are not well controlled because of lengthy wire runs and safety requirements for grounding.

In the bidirectional (triac) control circuit of Fig. 7, three optical isolation amplifiers operate from the same isolated power supply. Each isolation amplifier senses the output voltage of one phase of the line. The phases are sensed against an artificial neutral generated by the output-resistor bridge. Because of the fast frequency

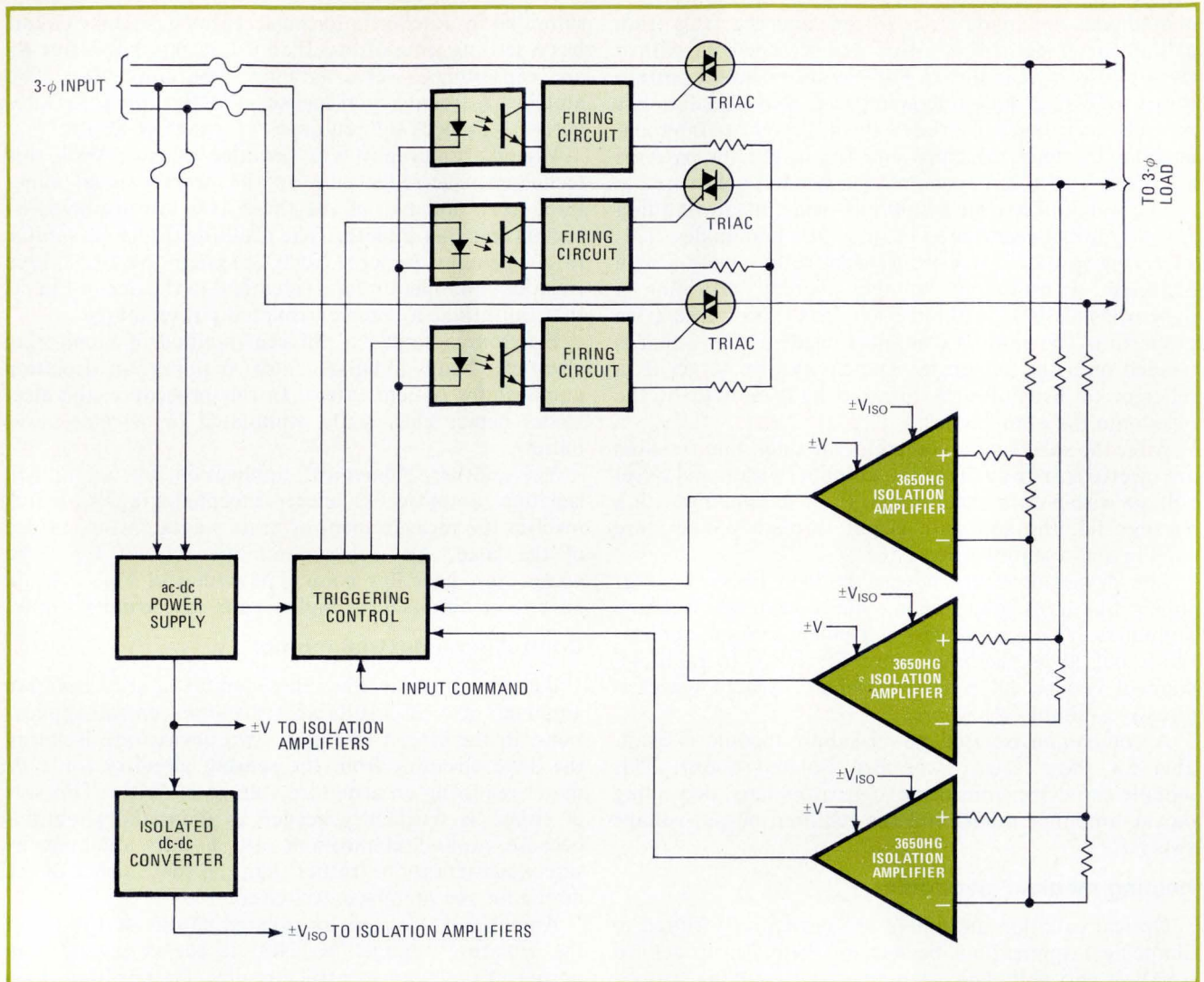

7. Load control. In circuit for switching three-phase ac loads, three optical isolation amplifiers operate from the same isolated dc source. The triacs provide bidirectional control of the load, while the optical couplers guard against false triggering by transients.

response of the amplifiers, the phase-controlled ac waveform is accurately reproduced at the input of the triggering control, permitting further processing, such as averaging or root-mean-square conversion, if desired.

Observing fundamental precautions

To get the most out of any isolation amplifier, some basic guidelines should be followed:

- For low-noise applications, twisted-pair shielded input cable should be used.
- To reduce the effects of output-stage parameters on overall accuracy, the amplifier gain should be set as high as possible without saturating the input. This is a customary practice with instrumentation amplifiers.
- External capacitance across the isolation barrier should be minimized, or it will degrade the amplifier's isolation-mode rejection.
- To reduce the possibility of arc-over, external components and conductors should be located at a distance equal to or greater than the spacing between input and output pins. And in very high-voltage applications, the entire assembled circuit should be conformally coated.

In the future, optical isolation will certainly be a major factor in linear isolation-amplifier designs. Although today's devices have a limited operating-temperature range (0°C to 70°C) and their linearity is comparatively moderate, there are likely to be vast improvements in both parameters shortly. What's more, product cost will probably drop as manufacturing technology improves.

Size reductions are also well within reach. However, user acceptance of smaller units having closer pin spacing is questionable, at least for amplifiers having isolation test voltages in the 5-kv region. Layout standards, as well as just good design practice, will probably continue to keep isolation amplifiers in somewhat larger packages than other amplifier products. □

Bibliography

- Funk-Technik Buecher, "Handbook for High-Frequency and Electrical Engineers," 1964
- Jerry Graeme, "Applications of Operational Amplifiers," McGraw-Hill, 1973
- Peter Strong, "Biophysical Measurements," Tektronix, 1970
- "UL544 Standard for Safety Medical & Dental Equipment," Underwriters Laboratories, May 1974
- "VDE0750 Regulations for Electromedical Equipment," Part 1, July 1973, and Part 2, August 1970, VDE-Verlag, Berlin

Z-80 chip set heralds third microprocessor generation

Fast execution of large instruction set, plus efficient handling of I/O and interrupts, boosts throughput

□ The Z-80 microcomputer chip set represents as big an advance as was made between the 8008 and 8080. Throughput of the Z-80 is two to five times that of its predecessors, yet it needs only half to a quarter of their program memory.

The set's central processing unit has 158 instructions, including all 78 of the 8080A, and executes each of these instructions in an average of 1.5 microseconds. It also streamlines the handling of input/output operations and interrupts.

Because of the large instruction set, programs for the Z-80 will be shorter, so that they will require less preparation time as well as less memory. More convenient yet, the device is software-compatible at the machine-code level with the widely used 8080A, so that 8080A users can not only understand and master the Z-80 quickly, but can design it into new systems with comparative ease.

The chip set is an integrated family of CPU and

by M. Shima, F. Faggin, and R. Ungermann, *Zilog Inc., Los Altos, Calif.*

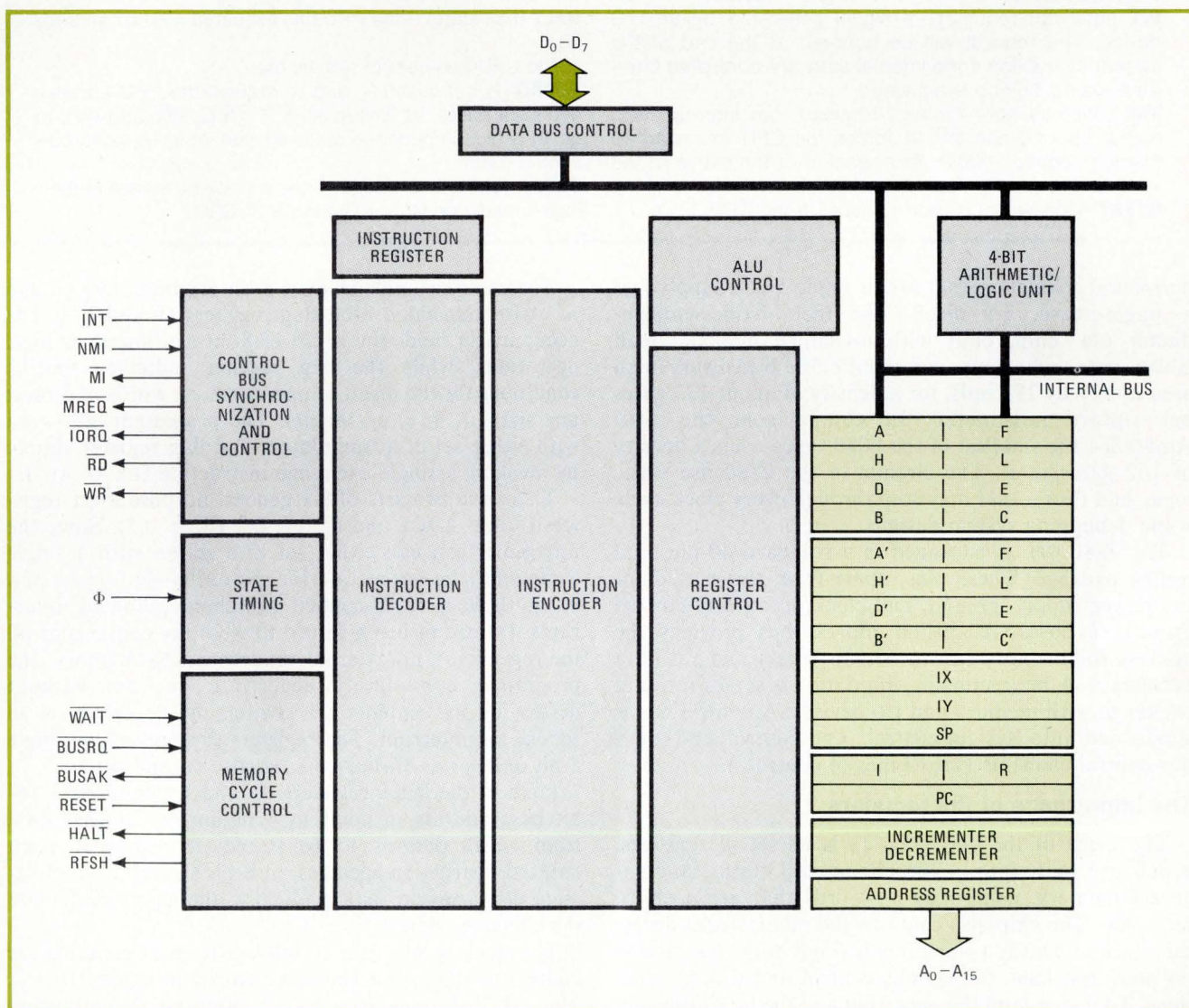

1. Central processor. The Z-80 CPU chip has a bank of 8- and 16-bit registers (right) that allow it great flexibility in such functions as handling interrupts. The device has an 8-bit data bus and a 16-bit address bus, and it employs a single-phase clock signal (ϕ).

Lines of control

The Z-80 has three types of control buses: system-control, CPU-control, and CPU-bus-control.

The system-control signals are:

M₁ (machine cycle 1)—the current machine cycle is the operation-code-fetch cycle of an instruction.

MREQ (memory request)—the address bus holds a valid address for a memory-read or a memory-write operation.

IORQ (input/output request)—the address-bus holds a valid I/O address for an input or output operation. An IORQ is generated during M₁ to indicate an interrupt acknowledge.

RD (memory read)—the CPU wants to read data from memory or an I/O device.

WR (memory write)—the data bus holds valid data to be stored in a memory address or I/O device.

RFSH (refresh)—the lower 7 bits of the address bus hold the refresh address for dynamic memories.

The CPU-control signals are:

WAIT (wait request)—the address memory or I/O device is not ready for a data transfer. The CPU will continue to enter wait states as long as this signal is active.

INT (interrupt request)—a signal generated by an I/O device. The request will be honored at the end of the current instruction if the internal software-controlled interrupt-enable flip-flop is activated.

NMI (nonmaskable interrupt request)—an interrupt with higher priority than INT. It forces the CPU to restart to memory location 0066H independent of the status of the interrupt-enable flip-flop.

RESET—this signal is used to initialize the CPU.

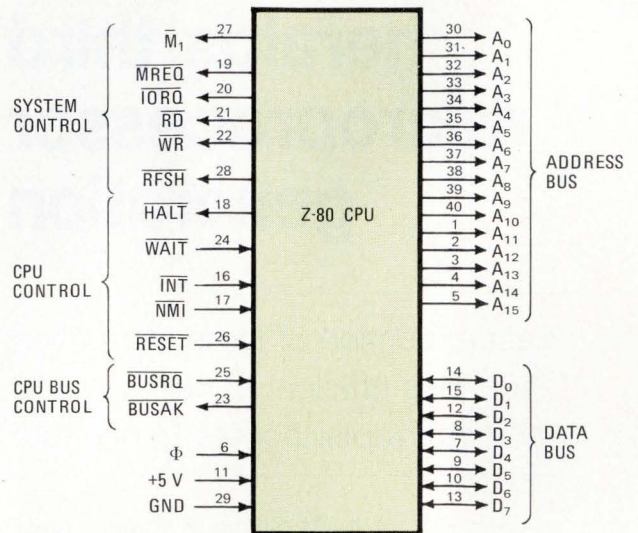

HALT (halt state)—the CPU has executed a HALT instruction.

The CPU-bus-control signals are:

BUSRQ (bus request)—used to request the CPU address and data buses, as well as MREQ, IORQ, RD, and WR, to go to a high-impedance state so that other devices can control them.

BUSAK (bus acknowledge)—the tristate buses are in their high-impedance state following a BUSRQ.

peripheral controllers that uses a single 5-volt supply and a single-phase, 5-v clock. The metal-oxide-semiconductor CPU chip, built with n-channel depletion-load silicon-gate technology, has about 8,500 transistors in an area of 179 by 192 mils, for a density of about 133 gates per square millimeter. In comparison, the AMD Am9080—the smallest of the 8080 types—has a density of 102 gates/mm². The circuits in the Z-80 use static logic, and thus a user may step through every clock cycle while debugging system designs.

The Z-80 CPU is packaged in a standard 40-pin dual in-line package. These pins, apart from those used for the power supply, ground, and clock (ϕ), are organized into three buses. A 16-line address bus provides the address for memory (up to 65,536 bytes) and I/O data exchanges. A bidirectional 8-bit data bus serves for data exchange with memory and I/O devices. A control bus is subdivided into system-control, CPU-control and CPU-bus-control elements (see "Lines of control").

The importance of the registers

The heart of the CPU (Fig. 1) is its set of registers, which are built into a 208-bit on-chip static random-access memory, containing 13 words that are each 16 bits wide. The chip also contains the other blocks necessary to its operation—arithmetic/logic unit, instruction register, and logic for various control and timing functions. To understand the operation and the innovations in the Z-80, however, one must look closely at its array of registers.

There are two independent 8-bit accumulators (A and A') with associated 8-bit flag registers (F and F'). The accumulator holds the result of 8-bit arithmetic or logic operations, while the flag register indicates specific conditions for the result of operations on words of almost any size—1, 4, 8, or 16 bits. The programmer can work with either set of accumulators and flag register simply by invoking a single exchange instruction (EX AF, AF').

There are two sets of six general-purpose 8-bit registers (B, C, D, E, H, L and B', C', D', E', H', L'). Since the programmer can call either set into action with a single command (the instruction for the exchange-register set, EXX), there is rapid-context switching following interrupts. Instead of being forced to store the contents of all the registers in an external random-access memory, the programmer can simply deactivate one set without destroying its contents and switch to the other set to service the interrupt. The registers can operate as single 8-bit units or as 16-bit pairs, BC, DE, HL, and so on.

Each of the index registers, IX and IY, contains a 16-bit base address to point to a region of external RAM from which data is to be stored or retrieved. Each indexed instruction specifies an 8-bit signed-2's-complement displacement that is added to the base to calculate the effective address.

The stack pointer is a 16-bit register that contains the address of the top of the stack stored in external RAM. The external stack is a last-in, first-out file, allowing simple implementation of multiple-level interrupts.

There are two special-purpose registers, I and R, which

aid interrupt and memory-refresh operations, respectively.

The *I* register is used in one of the chip's three different programmable interrupt-response modes. It holds the upper 8 bits of the address of a memory pointer, while the interrupting peripheral controller supplies the lower 8 bits during the interrupt-acknowledge cycle. The CPU then makes an indirect call to the memory location pointed to by the 16-bit address. With this method, the interrupting device will cause the CPU to push the program counter into the stack and go to the beginning of the previously stored required service routine, which can be anywhere in memory.

The *R* register contains the current memory-refresh address. Its content is sent out to the address bus during the second half of each operational code-fetch cycle (M_1 cycle), together with the memory-refresh-control signal (*RFSH*). The content is automatically incremented at every M_1 cycle to refresh a new portion of memory. With this technique, the Z-80 CPU interfaces to dynamic memories with practically no hardware overhead.

Finally, there is a conventional 16-bit program counter, which holds the address of the instruction being fetched from external memory.

The extra instructions

The CPU can execute 158 instruction types with a total of 696 different operational codes. As mentioned, the CPU includes all 78 instructions of the 8080A CPU (a total of 244 op codes) and, since the compatibility is at the machine-code level, it can execute 8080A programs

stored in a read-only memory without needing changes in the ROM pattern.

Among the new instructions are the block-transfer and block-search instructions. With a single instruction, a programmer can transfer a block of information from one region of memory to another region or search for a single character in any block. Other instructions allow block transfers from I/O devices directly to any internal register or to any region of memory. Although this differs from direct-memory-access transfers in that it ties up the CPU during the block transfers, it can serve as a form of DMA in relatively low-speed applications, since it transfers one byte in about 8 microseconds.

There is a full set of rotate-and-shift instructions applicable to any register, rather than just to the accumulator, as in second-generation microprocessors. There are also byte-manipulation instructions, useful in word-processing applications, and bit-manipulation instructions that allow the CPU to set any bit in any memory location or any register. The addressing modes offer programmers more flexibility than any of the second-generation microprocessors (see "How the Z-80 addresses memory," p.93)

The matter of CPU timing

The CPU executes instructions by stepping through a set of basic machine cycles. Thus an instruction cycle is a combination of one or more of the following basic cycles: op-code fetch; memory read or write; I/O-device read or write, and interrupt acknowledge.

Each memory cycle lasts from three to six clock

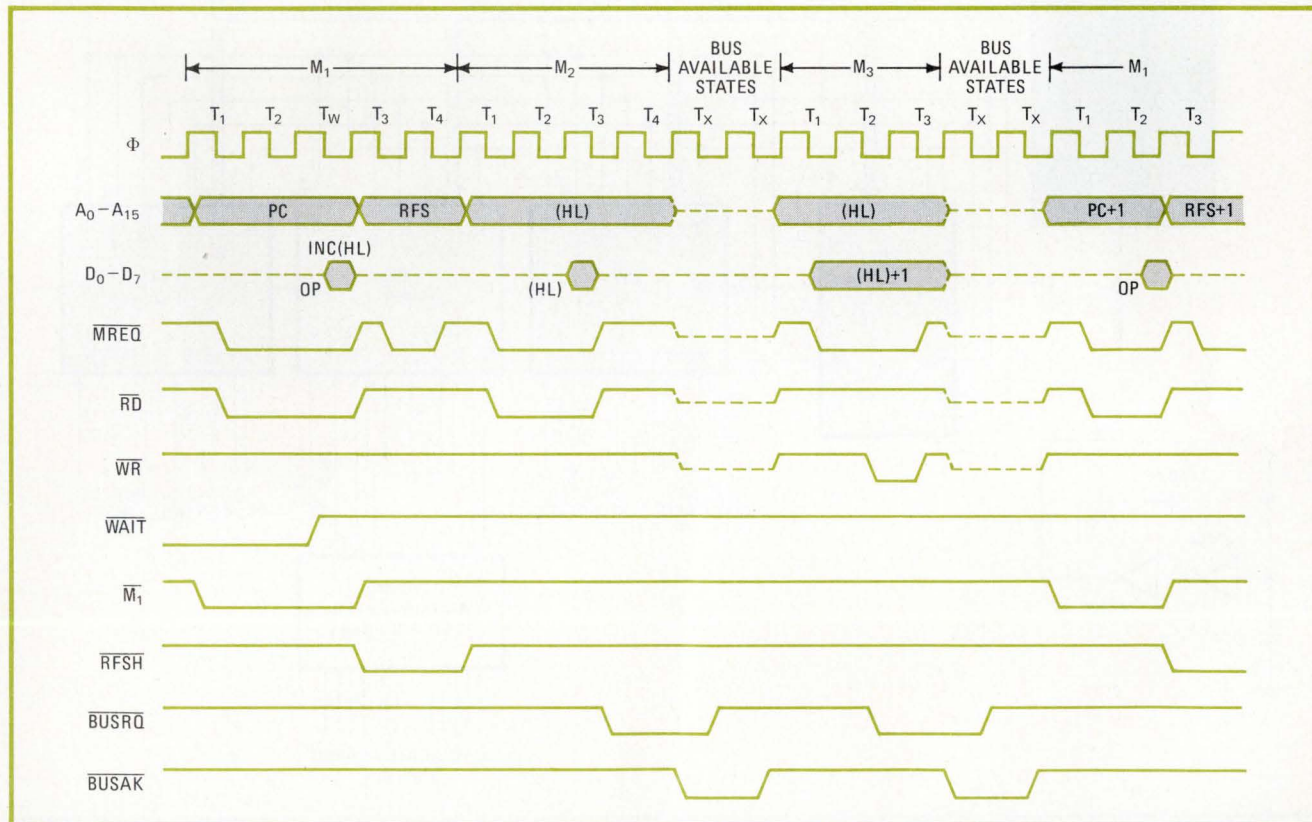

2. Timing counts. During the execution of an instruction—in this case, increment the memory location designated by the content of register HL—note that the refresh address is put out on the address bus while the central processing unit is interpreting the op code.

periods, which are $0.4 \mu\text{s}$ each for the standard-speed version (higher-speed versions with 250-nanosecond cycle times will soon be available). However, a memory cycle can be lengthened by two control signals: wait request (*WAIT*) and bus request (*BUSRQ*). *WAIT* allows the designer to synchronize the speed of external memory or peripheral devices to the CPU's speed by introducing extra idle states (wait states) into a machine cycle. *BUSRQ* allows external devices to have access to the address, data, and control buses. The CPU will complete its current machine cycle and then float its buses for as many cycles as required by the external *BUSRQ* signals.

An example of CPU timing is shown in Fig. 2 for the case of execution of the *INC (HL)* instruction—increment the content of the memory location addressed by the content of *HL*. For illustrative purposes, it is assumed that a wait state is requested during the M_1 cycle and that *BUSRQ* is active during M_2 and M_3 period.

During the M_1 cycle, the op code is fetched from memory and decoded during clock times T_3 and T_4 . At the same time, while the CPU is fully occupied with the op code, the refresh-counter contents are placed on the address bus along with a refresh-control signal. Thus a totally transparent refresh of the memory occurs during

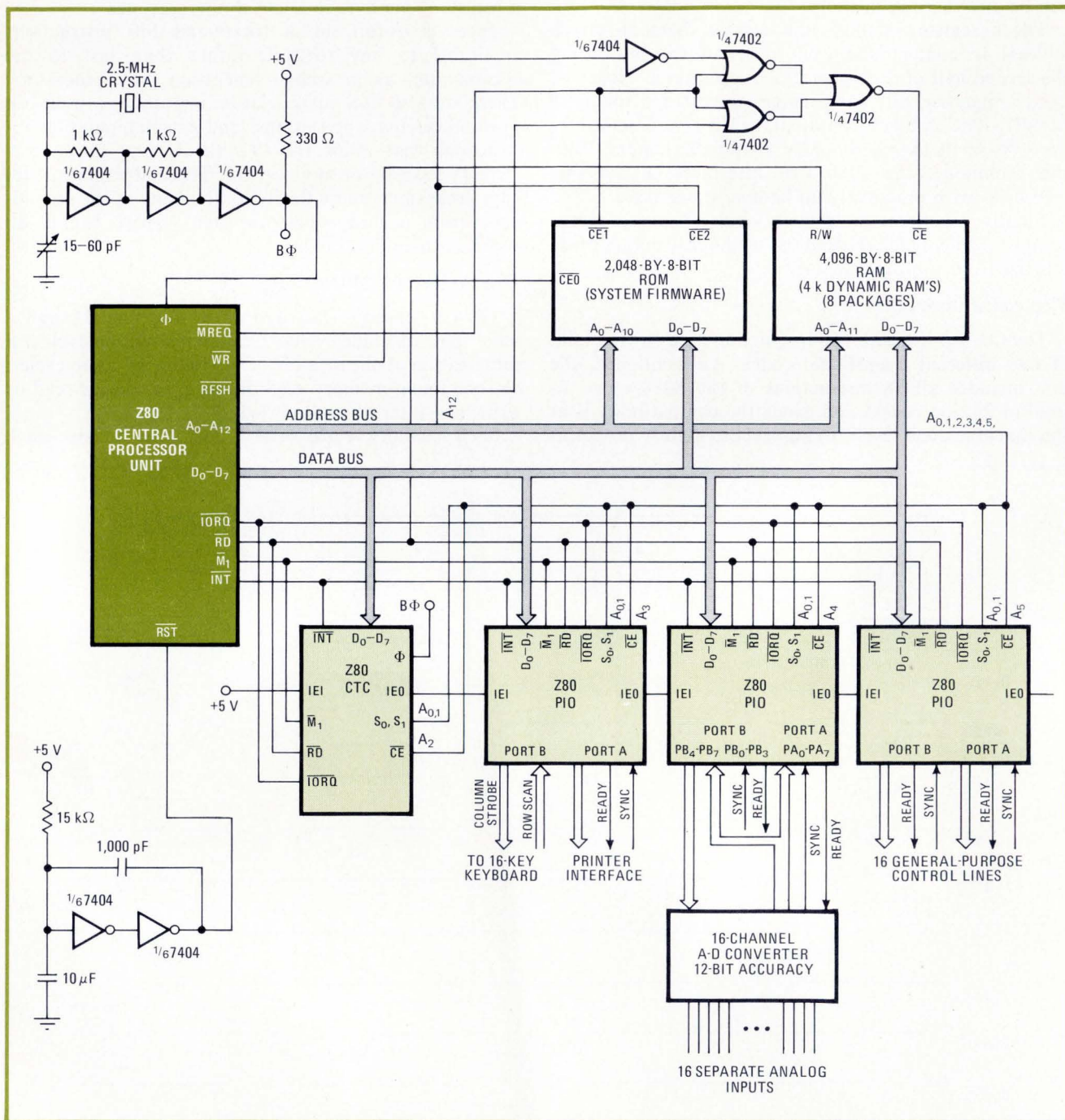

3. Process controller. To handle peripherals, three programmable parallel I/O devices (PIOs) are added to the Z-80 CPU. On the PIOs, the IEI and IE0 pins form a daisy-chain interrupt-control structure, with the device closest to the CPU having the highest priority.

How the Z-80 addresses memory

One of the advantages of the Z-80 is the variety of addressing modes available. Listed below are some of them, including an example of each mode.

Immediate [LD E, n]—load register E with 8-bit value n.
Immediate extended [LD HL, nn]—load register HL with the 16-bit value nn.

Modified page zero [RST 48]—call to location 48.

Extended [LD DE, (nn)]—load DE with the contents of memory locations (nn) and (nn + 1).

Indexed [ADD (IY+d)]—add the content of memory location (IY+d) to the content of the accumulator (d is an 8-bit signed-2's-complement value).

Relative [JR e] or [JR kk, e]—jump from the current program-counter location to a new location offset by an amount indicated by e, the signed 8-bit quantity. This allows jumping up to +127 or -128 locations. A condition code, kk, may also be added to the instruction for conditional jumps.

Register [INC B]—increment the content of register B.

Implied [NEG]—negate the content of the accumulator (2's complement).

Register indirect [LD (DE), A]—load location addressed by the content of DE with the accumulator's content.

Bit addressing [SET 4 (HL)]—set bit 4 of memory location addressed by HL.

Stack addressing [PUSH IX]—push the content of register IX into the stack.

Since many instructions include more than one operand, two types of addressing modes may be employed, one to specify the source and one to specify the destination. The Z-80 CPU is provided with many such addressing combinations:

LD C, (HL)—load register C with the memory content addressed by HL.

LD (IX+d), B—load memory location (IX+d) with register B

LD (IY+d), n—load memory location (IY+d) with the value n.

EX (SP), IX—exchange the contents of the top of stack and register IX.

SBC HL, BC—subtract the content of BC from HL, which then will contain the result of the operation.

OUT (C), D—send the content of register D to the peripheral device addressed by the content of register C.

LDDR—move a string of data from one area of memory to another. At the beginning of the instruction, HL points to the top of the source string, DE points to the top of the destination string, and BC holds the string length.

INIR—move a block of data from the peripheral whose address is the content of register C to a memory area addressed by HL. At the beginning of the instruction, C points to the peripheral, HL points to the bottom of the memory block, and the content of register B represents the block length.

this time without slowing down the processor.

During cycle M_2 , the data from the memory location pointed to by register pair HL is read from memory. This four-cycle operation has been extended two clock periods by an external device that requests the bus for a DMA cycle during the T_4 time periods. During cycle M_3 , the incremented data is written back into the memory.

A versatile system

A set of peripheral controllers allows the implementation of a wide variety of systems, ranging from simple controllers to sophisticated computing systems. There are four of those building blocks.

■ The Z-80 PIO is a programable circuit that allows parallel communication between the CPU and peripheral devices such as printers, plotters, paper-tape readers and punches, keyboards, and many other peripherals.

■ The Z-80 CTC is a programable counter/timer circuit that contains four independent interval counter/timers and allows easy control of practically any electromechanical system, as well as several different communication protocols.

■ The Z-80 DMA is a programable circuit that may be used where there is a requirement for fast direct memory access. However, note that the memory-to-I/O block-transfer instructions in the CPU will allow many applications to do without a DMA channel if the transfer rates are less than 125 kilobytes per second.

■ The Z-80 SIO is a programable circuit that allows easy interface with most serial communications protocols.

A key feature of these peripheral controllers is the interrupt structure. They can be daisy-chained together

to form a priority structure that allows nested interrupts to be handled by the CPU with no hardware or software overhead. Using the interrupt mode, the requesting controller will cause the CPU to go to the beginning of its service routine. At the end of its service routine, a special instruction—return from interrupt—is recognized by the controller, and this allows controllers with lower priority to interrupt the CPU and allows the CPU to automatically resume service routines interrupted by a higher-priority device.

In the example of a small Z-80-based process-control application in Fig. 3, the peripheral devices consist of a 16-key keyboard, a printer, a 12-bit analog-to-digital converter interfacing 16 analog lines into the system, and 16 discrete system-control lines. Three Z-80 PIOs handle the interfaces to the external I/O devices. For each peripheral device, the CPU merely configures a PIO for the required interfacing.

On the peripheral devices, two pins—the IEI (interrupt enable in) and IEO (interrupt enable out)—form a daisy-chain interrupt-control structure where the device closest to the CPU has the highest priority. Here, this device is the CTC, which performs all timing functions to avoid software timing loops. The complete computer requires only 14 circuits, nine of which are memory—2,048 bytes of ROM and 4,096 bytes of RAM.

In such systems, the Z-80's requirement of a single power supply and single-phase clock significantly eases the system design. And, since the CPU carries on-chip memory-refresh circuitry, standard memory chips may be selected. Thus, the Z-80 extends the range of cost-effective applications for MOS microprocessors. □

Micropower comparators generate 2-phase clock

by Norman G. Wheelock
Siliconix Inc., Santa Clara, Calif.

A versatile two-phase clock generator that uses two L161 quad micropower comparators provides signal outputs with variable phase and variable pulse widths. The entire circuit draws only 300 microamperes from a 10-volt supply. The 3-milliwatt power consumption allows the circuit to be used in a broad variety of applications such as time-delay generators, logic sequencers, hand-held signal injectors, and other systems where a multiphase clock is required.

The waveforms in Fig. 2 illustrate circuit operation. As a ramp generated by the first L161 increases in amplitude, the outputs of two window comparators, which are formed by the second L161, rise and fall. A rise occurs when the lower limit of the window comparator is crossed, and the fall comes when the upper limit

is reached. The upper and lower limits of the window comparators are variable throughout the full voltage range of the ramp. Variations in the upper and lower limits of the window comparators allow for change in pulse widths and relative phase of the signal outputs.

The actual circuit diagramed in Fig. 1 is composed of two sections: a ramp generator, formed by three of the four comparators on IC₁, and two window comparators, formed by IC₂. The operating speed and power consumption of the comparators are set by the value of the resistor R_s between the power supply and pin 15 of the integrated circuit; each comparator draws $5 V_{sup}/R_s$, and a bias circuit draws V_{sup}/R_s , so the total current is $21 V_{sup}/R_s$. The 210 μA drawn by IC₁ provides moderately fast operation of the comparators in that IC, and the 21 μA set for IC₂ limits its comparators to slow switching.

The ramp-generation circuit is controlled by the charging of C by a constant-current diode, CR₁. When the charge on C reaches the voltage of pin 2 of IC_{1A}, IC_{1B} is turned on, and C is quickly discharged. IC_{1C} is also turned on at the discharge point, grounding the reference pin. This action provides a form of positive feedback such that IC_{1B} is prevented from being turned off as the charge on C falls below the reference level at pin 2.

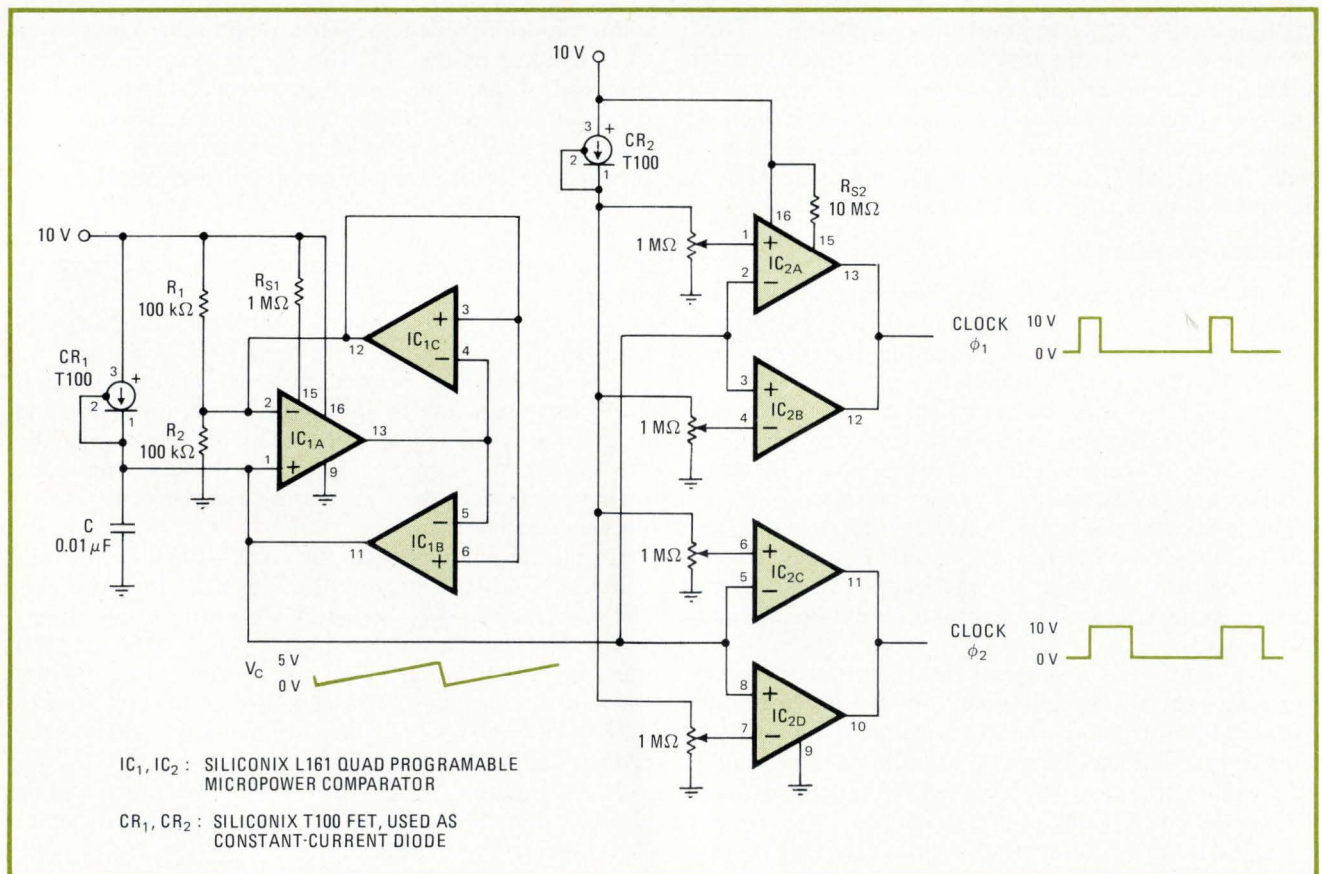

1. Power miser. This clock uses two quad comparators to produce the two pulsed waveforms. Each IC includes provision for programming the current drawn by the comparators, and thus controls their speed. Clock frequency is 100 Hz to 100 kHz.

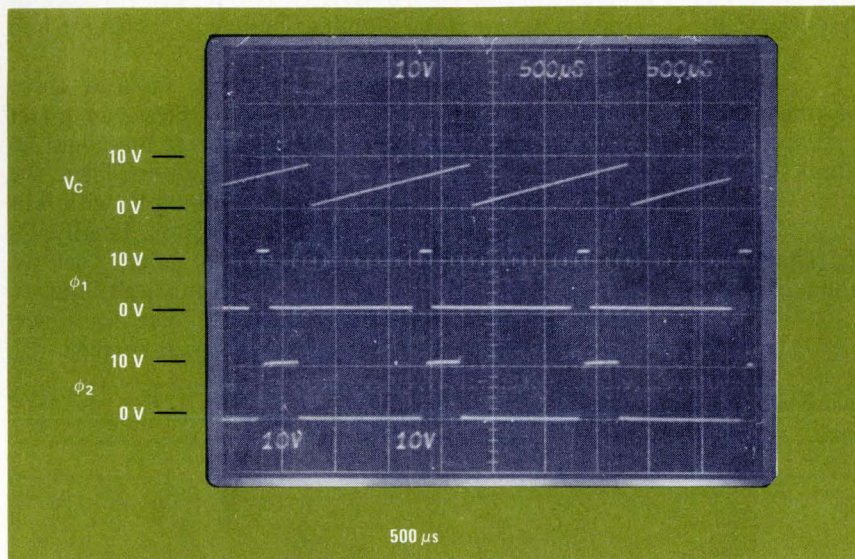
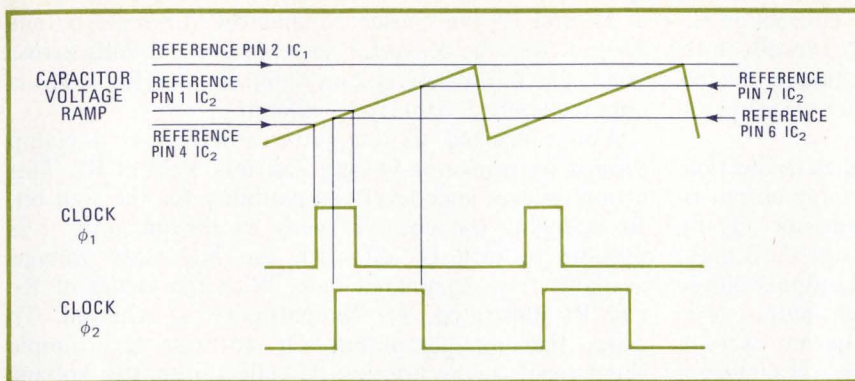

2. Go in and out the windows. Two clock signals, with independently variable widths and variable relative phase, are generated by setting the reference levels of two window comparators driven by a voltage ramp. A biphasic clock finds application in various logic systems.

3. Picture this. Scope photo shows linear voltage ramp across capacitor, plus output pulse trains of the two clock signals, from circuit of Fig. 1. Calculated frequency, for 35- μ A charging current and 5-V ramp height, is 70 kHz; waveforms indicate about 67 kHz. Note complete absence of unwanted glitches in clocks' waveforms during capacitor discharge.

The time T during which the ramp charges is:

$$T = CV_{ref}/I$$

where I is the current provided by CR_1 (30–48 microamperes), V_{ref} is the reference voltage on the inverting input of IC_{1A} (5.0 v), and C is the value of the capacitor charged through CR_1 .

Because the comparator used to generate the ramp has its supply current programed to provide moderate switching speeds necessary for quick discharge of C , the discharge time is negligible. Therefore, the rate, f , at which the ramp cycles is effectively:

$$f = I/CV_{ref}$$

This frequency is set by choosing the value of C , and it can be trimmed by adjusting V_{ref} , if necessary.

The remaining portion of the circuit is composed of

two classic window comparators. Upper and lower limit references are provided by a second current-reference diode (CR_2) and several potentiometers. The comparators in the circuit are programed for slow switching to prevent signal output during the discharge period of C .

Most of the current to the circuit is drawn by IC_1 (210 μ A). IC_2 consumes 21 μ A and the current-reference diodes a total of 60 μ A. The remaining current flows through the resistor network that provides reference voltage for IC_{1A} . The total current delivered to the circuit (341 μ A) is a factor of 100 smaller than that required by nonprogramable comparators.

The T100 field-effect transistors that are used as constant-current diodes also contribute to circuit economy, passing less than an eighth of the current of conventional constant-current diodes. They have a temperature coefficient of only about 82 nA/ $^{\circ}$ C. \square

Amplifier adds sign bit to a-d converter output

by Jerald Graeme
Burr-Brown Research Corp., Tucson, Ariz.

In feedback systems, digital-to-analog converters frequently require bipolar outputs to supply both polarities of feedback-correction signals. One means of developing both polarities is to offset the output, but this method sacrifices the convenience of BCD bit-coding.

A better way to control output polarity is to provide sign-bit control to the digital-to-analog converter by connecting the output operational amplifier of the d-a

converter as a gated amplifier. This connection is possible when the op amp has uncommitted feedback to permit coding options. However, the technique can be applied to any current-output d-a converter by using an external op amp.

Shown in the figure is the gated-amplifier connection that provides the sign-bit control. The op-amp output is switched at the circuit output by transistor Q_2 in response to the sign-bit signal. When the sign bit is high, Q_2 is off, so the amplifier does not control output voltage e_o , and operation is that of a current-output d-a converter driving resistive load R_2 . The output current from the converter, i_o , divides between the internal resistor R_0 and the path through R_1 and R_2 to ground. The output signal, which is negative, is determined by:

$$e_o = -i_o R_0 R_2 / (R_1 + R_2 + R_0)$$

If the sign bit is low, switch Q_2 is turned on so that the op amp can control e_o . Then the amplifier performs as a current-to-voltage converter, giving an output signal of

$$e_o = i_o R_1$$

For a symmetrical response, the above opposite-polarity signals are made to have the same magnitude for a given i_o . This requires that

$$R_2 = R_1(R_0 + R_1) / (R_0 - R_1)$$

The value of R_0 is given on the data sheet for the d-a converter; for the DAC-80, it is 15 kilohms. The values

of R_1 and R_2 are chosen so that the full-scale output current from the converter develops about 2 volts across them. The full scale i_o is 2 milliamperes, so $(R_1 + R_2)$ is approximately $2/0.002$, or 1 kilohm.

Also connected to the gated amplifier is a clamp formed by transistor Q_1 and resistors R_3 and R_4 . This clamp ensures logic-level compatibility for the sign bit. By clamping the positive swing of the op amp, it is possible to turn Q_2 off with the high-state voltage available from command logic. With the values of R_3 and R_4 illustrated, TTL-compatibility is achieved. To clamp the amplifier output, Q_1 performs as a simple shunt regulator by limiting its collector-emitter voltage to a maximum of $(1 + R_4/R_3)V_{BE1}$. At that voltage, Q_1 turns on to clamp the amplifier output by forcing it into current limit.

Preservation of conversion accuracy requires three trimming adjustments to the circuit. First, an offset correction signal should be added to the op amp with Q_2 turned on and only the least significant bit on. Then, the positive output gain is adjusted by trimming R_1 with full-scale output—all bits turned on—and Q_2 on. Finally, Q_2 is turned off, and the negative-output gain is set by adjusting R_2 . In this circuit mode, the op amp's input is overloaded, so it must maintain high input resistance under overload to avoid shunting the signal current. □

Designer's casebook is a regular feature in Electronics. We invite readers to submit original and unpublished circuit ideas and solutions to design problems. Explain briefly but thoroughly the circuit's operating principle and purpose. We'll pay \$50 for each item published.

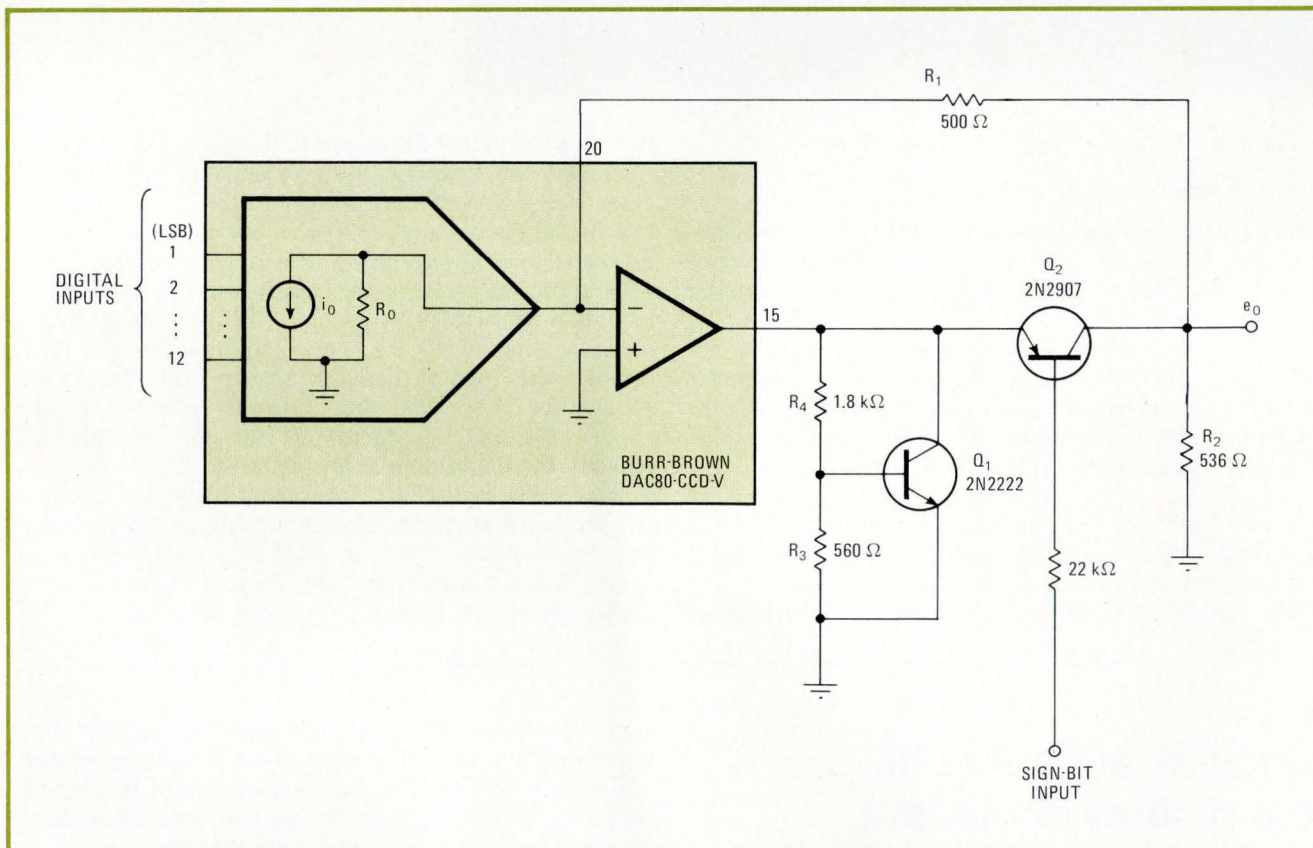

Sign bit sets analog-output polarity. In this circuit, the sign of the output voltage of the digital-to-analog converter is determined by a sign bit applied to Q_2 . If the sign bit is low, the output voltage e_o is positive, and if the sign bit is high, e_o is negative. Here the sign bit is added to the d-a conversion by gating the internal output op amp, but an external op amp can be used on any current-output d-a converter.

This Me Too

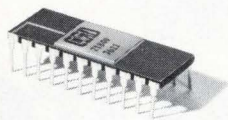

4K RAM

Has Something Extra Going For It

Like the fact that we've never made an MOS RAM before.

MMI 4K MOS RAMs INDUSTRY STANDARD 22-PIN DIP

Part No.	Pins	Temp.	Access Time	100 Qty. Price
2180	22	0-70°C	200 ns	\$15.00
2180-4	22	0-70°C	270 ns	\$10.00

For more information call,
TWX or write:

United States
Monolithic Memories, Inc.
1165 East Arques Avenue
Sunnyvale, CA 94086
Tel: (408) 739-3535
TWX: 910-339-9229

Europe
Monolithic Memories, GmbH
8000 Munich 80
Mauerkircherstr. 4
West Germany
Tel: (089) 982601, 02, 03, 04
Telex: (841) 524385

Far East
Monolithic Memories, Ltd.
Parkside-Flat Bldg
4-2-2, Sendagaya Shibuya-Ku
Tokyo 151, Japan
Tel: (3) 403-9061
Telex: (781) 26364

Think about it. Here we are the world's largest bipolar memory manufacturer coming out with the first device in a new MOS line. We can't afford a mistake.

So, to start things off, we build our RAMs better: to mil standard 883 to be exact. After we test them, we burn them all in dynamically, at 125°C.

Then we test them again. And we don't take any shortcuts. Every part is tested for DC parametrics and for dynamic functional pattern sensitivity at AC speeds. To guarantee that refresh sensitive soft failures are screened out, we perform all this testing at guard banded limits and at temperatures in excess of our published specs.

No price premium for quality.

Best of all, you can buy our 4K RAMs for the same price that you're now paying for someone else's run-of-the-mill parts.

Give us a call. We'll respond with parts for evaluation and all the documentation you need. Delivery, in quantity, is NOW.

Monolithic Memories

Now freedom from compromise is no big thing.

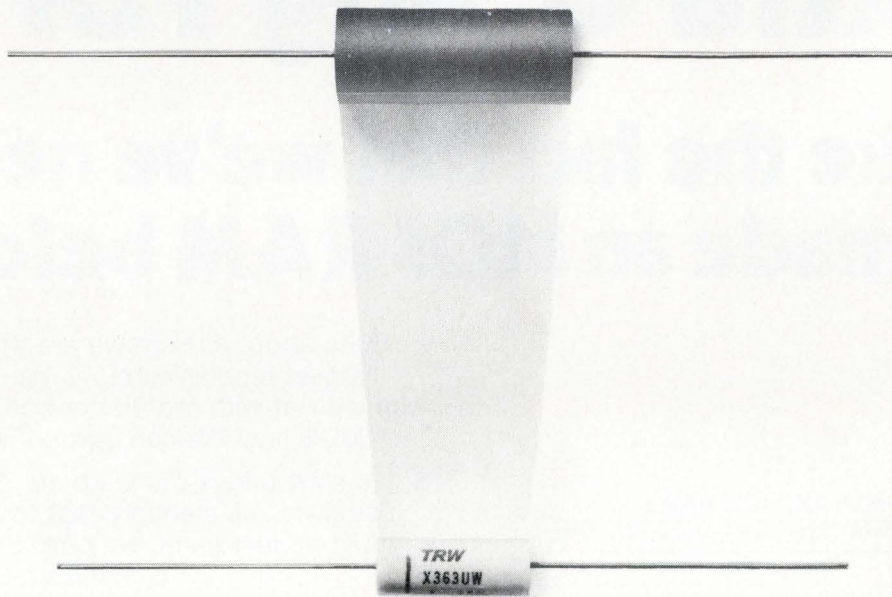

Introducing the metallized polypropylene
X363UW capacitor.

Now, circuit designers have a new freedom in applications where trade-offs were always necessary.

And, our new capacitor is no big thing. It's small where it should be, in physical size. But large in capabilities.

Capabilities such as low dielectric absorption (even better than polystyrene). Outstanding stability. High insulation resistance equal to polystyrene. And a low dissipation factor (High Q).

The result: the X363UW is an excellent all-purpose capacitor ideal for many applications including time base generators, integrators, filters and low level RF circuitry.

Tired of compromising? Tired of trade-offs? Write for complete specs. TRW Capacitors, an Electronic Components Division of TRW Inc., Box 1000, Ogallala, Neb. 69153.

TRW CAPACITORS

ANOTHER PRODUCT OF A COMPANY CALLED TRW

Dynamic I²L random-access memory competes with MOS designs

With an access time of only 100 nanoseconds, this 4,096-bit bipolar RAM satisfies main-memory needs

by Wendell B. Sander, William H. Shepherd, and Richard D. Schinelle, *Fairchild Camera & Instrument Corp., Palo Alto, Calif.*

□ For the first time, bipolar-memory devices are invading the field of dynamic, main-memory systems now dominated by MOS designs. The intruder is a 4,096-bit random-access memory that combines advanced integrated-circuit processing with an elegant integrated-injection-logic or merged-transistor-cell design.

Bipolar devices are prominent in only the fastest static-memory cache and buffer systems. Now they may have the edge over metal-oxide-semiconductor devices in those main-memory applications where the 93481's sub-100-ns speeds offset its modest premium in price.

Those typical access times make the chip twice as fast as most 4-k MOS RAMs, yet with a similar active power dissipation of only 400 milliwatts. The device is powered by a single 5-volt supply (MOS RAMs need three voltage supplies) and can operate easily over the 0–70°C temperature range. It is housed in a standard, 16-pin, dual in-line package and uses the input multiplexing schemes that are standard in 16-pin, 4-k systems. Moreover, chip size is only 112 by 129 mils (less than 14,000 mil²), considerably smaller than most of its metal-oxide competitors.

Being twice as fast makes it a good high-speed companion to MOS 4-k and 16-k RAMs. And, fortunately, the increased speed won't kill the budget: thanks to the compact cell (about 648 square micrometers) and small chip size, the 93481 will sell for a small premium over MOS devices in production quantities.

The heart of the device is the dynamic I²L memory cell

(Fig. 1). In contrast to six-transistor conventional bipolar static cells, this design is astonishingly simple. It consists of a single transistor pair—an npn and pnp—merged on silicon so that it occupies little more space than a single transistor.

The cell design

Moreover, the cell needs no separate space-consuming capacitors to store charge, as do even the most advanced double-level MOS cells. Here 1s and 0s are stored on the easily accessible junction capacitance in the shared collector-base of the merged transistors (the shaded n region in the figure). Since this junction is usually reverse-biased during cell operation, it is nicely isolated from the rest of the circuit. This makes for an extremely efficient charge-storage mechanism.

The new design saves still more space because its operation requires only three access lines (Fig. 2a), or the same number as dynamic MOS cells. There are the two word lines, W_n and W_p , connecting the npn and pnp emitters respectively, plus the bit line connected to the common npn collector and pnp base region.

Using this cell is simple, too, as shown in Fig. 2b, where the action of the npn switching transistor is illustrated. Again, word line W_p is usually reverse-biased. A cycle is initiated with an external timing signal, which controls the level of the bit line—high for 0 and low for 1. When this occurs, the W_n line is pulled from 3.4 v to 0.4 v and remains low until the timing signal is dropped.

The state of the cell is now ready for detection. For the read 1 case, the capacitor is initially uncharged. When the W_n line is pulled down to about 1 v below its resting voltage, the emitter-base diode of the npn, which had been reverse-biased, becomes forward-biased, driving the npn into its active region. The collector-base capacitance then acts as a feedback capacitor, coupling the W_n signal to the bit line through the storage capacitor for multiplication by the beta of the npn transistor.

Typically, the storage capacitance is about 0.1 picofarad, and the npn's β is about 70, making the effective coupling capacitance about 7 pF—enough to assure easily detectable logic swings of 200 millivolts. The result is illustrated by the bit-line 1 signal of Fig. 2b, where this coupling pulls the bit line low.

For the read 0, the capacitor is charged positive-to-

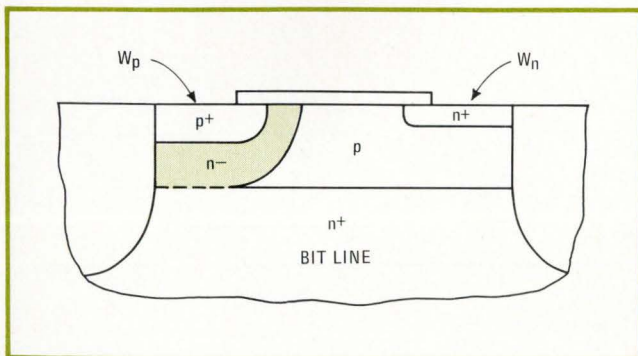

1. Minimal art. The beauty of the dynamic I²L RAM is its extremely simple cell structure, consisting of only a single pair of merged transistors. The entire cell occupies little more space than a single transistor and needs no separate charge-storing capacitor region.

negative (Fig. 2a). When the W_n line is pulled low, the emitter-base diode of the transistor does not become forward-biased, and little or no signal is coupled to the bit line, as illustrated by the bit-line 0 signal in Fig. 2b.

The sense amplifier detects cell signals as soon as the bit line has settled sufficiently for its two states to be distinguishable. A sense-amplifier latch compares the bit-line signal to a reference signal generated from an identical bit line to determine whether a 1 or 0 is present.

A neat feature of the cell's design is its ability to reinforce the nature of its output during each reading. If the bit line is low, the sense amplifier latches, forcing it to a lower active state. If, however, the bit line is high, then the sense-amplifier latch forces it to its rest state, which is high. Therefore, if some charge has been lost, the bit line will force the capacitor to be recharged, refreshing the charged 0 condition.

Writing into the memory is done by changing the state of the sense-amplifier latch while the W_n line is low. To write a 0, the latch is forced to the high-voltage state and the capacitor is charged. To write a 1, the latch is forced to the low-voltage state, and the cell is discharged at the end of cycle.

To refresh a logic 1

Like any dynamic memory, the cell of the 93481 must be refreshed—in this case each of the 32 row addresses every 2 milliseconds with any read/write cycle. As already discussed, the refresh action for 0s takes place during the active part of the cycle. The refresh 1 action,

How cells are built

Although the I^2L cell configuration is conceptually very simple (Fig. 1), it requires a high degree of process sophistication. For one thing, the cell's npn transistors must be fast, which means an epitaxial base with unusually low emitter-base capacitance. That, in turn, requires ion-implanted base layers that must be controlled over a dense LSI chip. The result, however, is outstanding—a β of 70 and an f_T of 1 gigahertz.

Likewise, the pnp is formed in an unconventional manner, by successive diffusion of n- and p-type impurities through a common window. The result is a lateral pnp transistor, with a graded, highly efficient base, with a β of 8 and an f_T of 1 GHz. Because of the high-concentration base, this lateral device has much greater current-carrying capacity for the same geometry than does an epitaxial pnp lateral transistor.

Finally, all stops were pulled out in process technology—washed, walled emitters, isoplanar isolation, and self-aligned photomasking. But (and this is the key) it was not necessary to use component-layout rules that would present difficulties in mask fabrication or in photomasking. Indeed, the requirements in each of these areas are less stringent than those presented by high-density MOS designs. Fabrication is further simplified by using a single layer of metalization, while the full use of ion implantation for doping control at selected steps assures good parameter control where needed. The combination of process techniques results in high yields because of greatly reduced active areas and easy process control.

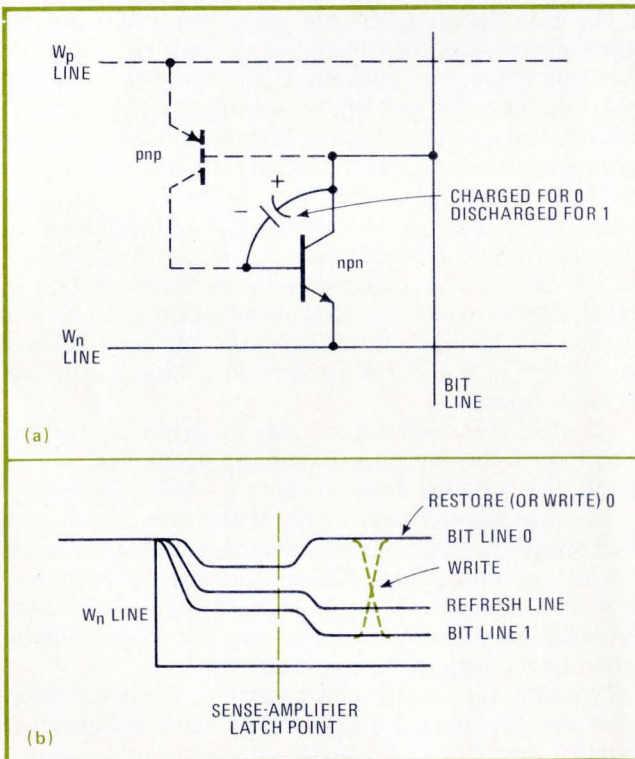

2. Reading and writing. Once the cell's capacitance is charged (a), a sense-amplifier latch (b) compares the bit line signal with a reference and determines whether a 1 or 0 is present. Writing is done by changing the state of the latch while the W_n line is low.

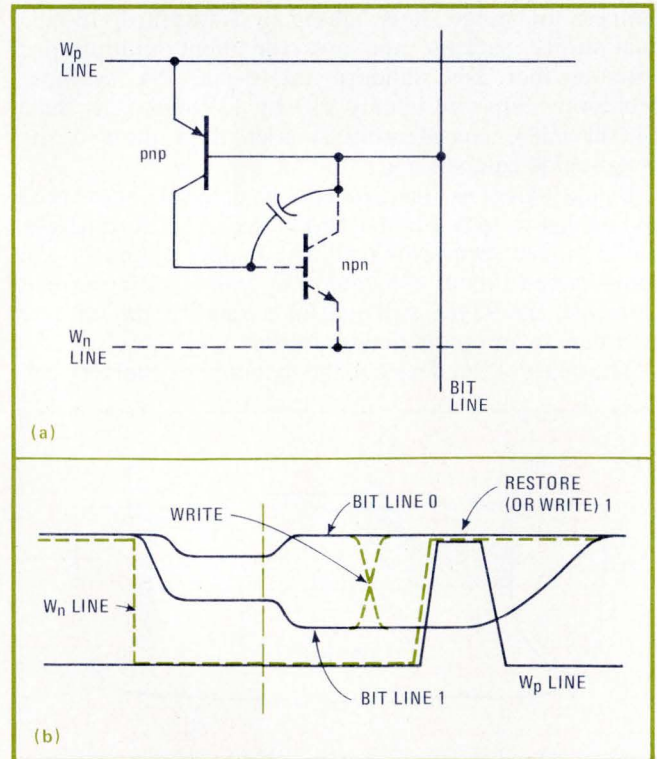

3. How to refresh. First, the storage capacitor is discharged, and the W_p line is returned to a low level. Then the sense amplifier is turned off, the bit lines are returned to their high rest state, and the memory cell is ready for the next cycle.

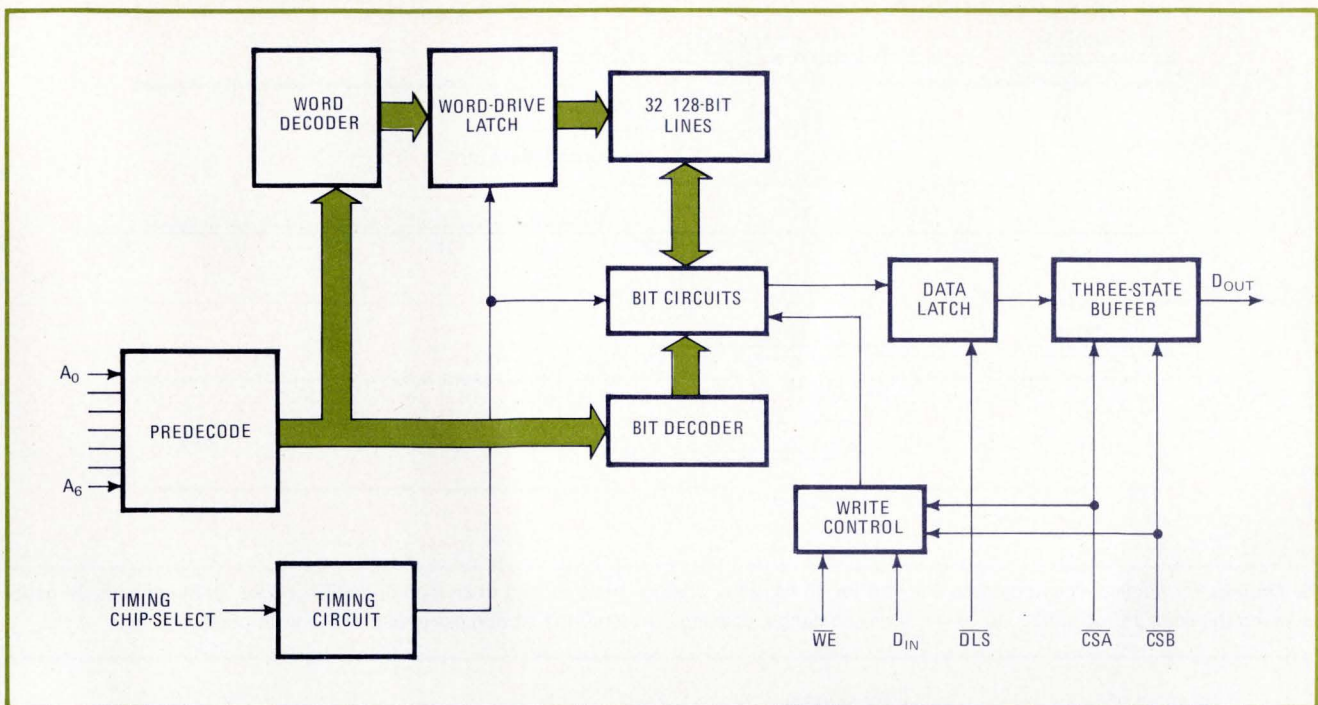

4. Addressing. Seven input address lines are predecoded to drive the word and bit decoders. The first five addresses (A₀ to A₄) are used for the word decoder, while all seven addresses are used for the bit decoder. This latter operation is a simple ripple-through action.

COMPARING THE CHIPS		
	93481	Typical 4-K dynamic MOS RAMs
Access time (ns):	100	200
Read/write cycle time (ns):	200	350
Read/modify-write cycle time (ns):	240	400
Refresh interval (ms):	2 (32 lines to refresh)	2
Chip select access time (ns):	30	60
Temperature range:	0 - 70°C case	0 - 70°C
Power dissipation (mW):	400 (active); 50 (standby)	300 (dynamic); 12 (static)

on the other hand, takes place at the end of the cycle. The end of the cycle is defined by dropping the external chip-selection timing line, which causes the W_n line to recover to its rest condition. Now the pnp region of the cell comes into play (Fig. 3). Because the sense-amplifier latch will remain on for a brief time after W_n goes high, the W_p line, which is tied to the pnp emitter, is pulled high for this brief period. In fact, it is pulled high enough to turn on (forward-bias) the pnp emitter-base diode if the bit line is low.

Thus, all cells on the word line that have low bit lines will have their pnps turned on, discharging the storage capacitors. This provides the refresh 1 action. After this happens, the W_p line recovers to a low level, the sense-amplifier latch is turned off, and the bit lines thereupon return to their high rest state in preparation for the upcoming cycle.

One thing that might not be evident from the discus-

sion so far is the complexity of the peripheral circuitry. This contrasts with a static bipolar RAM, which doesn't need all the special waveform-generating circuits necessary to operate these cells. Moreover, since this cell inherently a single-layer metal design, the remaining peripheral circuitry has employed single-layer metal as well—an approach that imposes constraints on overall chip layout since it requires careful analysis to avoid problems with power distribution. Also, it requires an extensive computer-assisted design in local-circuit areas to minimize the effects of parasitic, buried-layer resistance and capacitance.

Happily, high-speed pnp transistors greatly relieve the difficulty of the peripheral-circuit design. They are in the active circuit elements on the periphery as well as in the cells. An example is the npn and pnp current mirrors, used extensively to provide high-speed decode and sense-amplifier circuitry that is accurate, sensitive, stable, and simple to power down.

Using the memory

The overall chip layout is displayed in the block diagram of Fig. 4. Unlike in 16-pin 4-k MOS RAMs, there are seven input address lines, which are predecoded to drive the word and bit decoders. When the timing signal is activated to begin a cycle, the chip is powered up, and addresses A₀–A₄ are fed to the word decoder and latched in the word driver, where one of 32 word-line pairs is selected. Subsequently, the 128 sense amplifiers are activated to latch the information for each bit stored in that line.

The bit circuits are accessed from the same predecoder by the bit decoders. For bit selection, all seven addresses are used to select one of the bit circuits. The data is then fed through a bypass data latch to an output

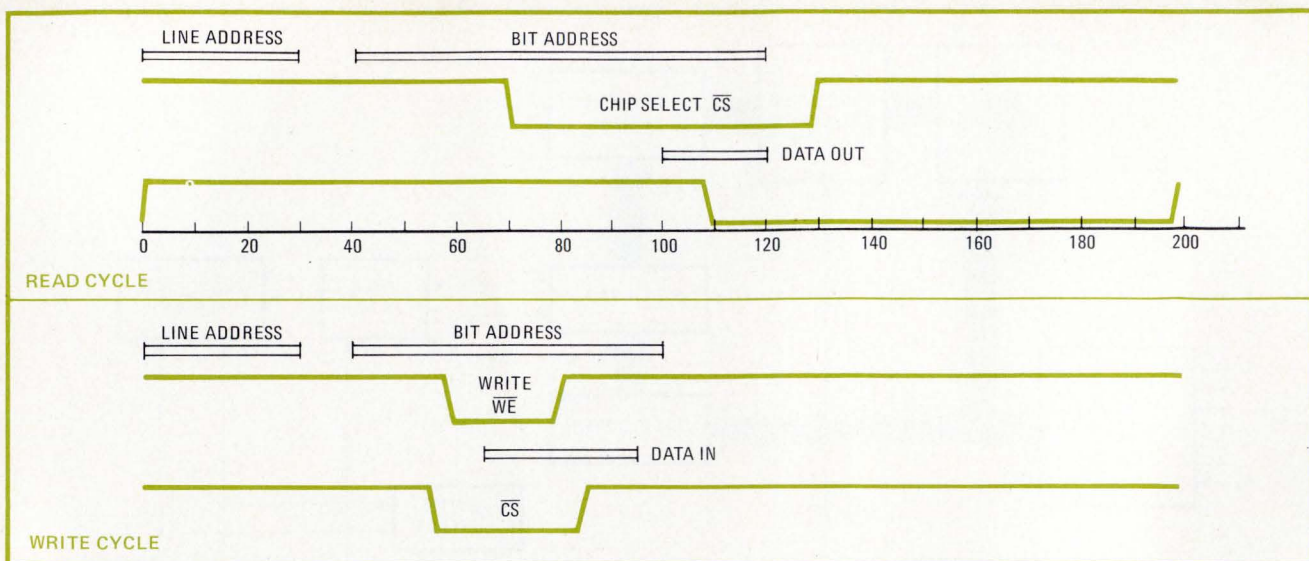

5. Timing. For reading, line addresses are held for 30 ns, while another 10 ns is used to change operating modes. Writing needs 30 ns for keeping the line address stable, 10 ns for address change, plus time to set up the bit address ahead of the write pulse.

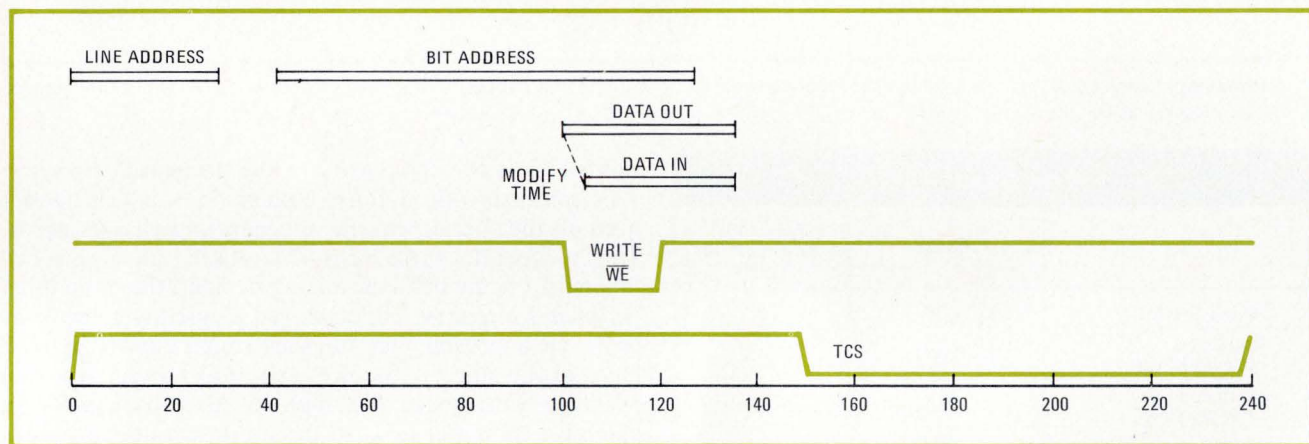

6. Overlap. Read/modify/write is an overlap timing operation between the delay-in line and the write pulse. After the line address has remained stable for 30 nanoseconds and an address period has followed, then the modify-write pulse can be raised.

buffer. Since this addressing is a simple ripple-through action, the bit addressing looks exactly the same as in a 128-bit static RAM. Moreover, other bits on the same word line can be accessed by changing the input address and waiting the appropriate access time, with no further timing strobes required.

Notice that the data latch is placed in the circuitry ahead of the chip-select function. This permits data to be latched in a memory that is not even chip-selected. Thus, data can be held in the latches and subsequently read out via the chip-select lines even while the chip is doing a write or refresh cycle.

The table compares characteristics of the 93481 with a typical 4-k dynamic MOS RAM. Notice that no penalty is paid for the faster access time, except for slightly higher standby power.

The timing

Because most designers of bipolar-memory systems are used to the simpler timing requirements of static devices, it's helpful to walk through the details of a typical cycle timing for the new chip (Fig. 5). For a read

cycle, the line address must be held for 30 ns with another 10 ns for the user to change the operating mode from line address to bit address. The access time, from a stable bit address to data out, is 60 ns. To hold the data out longer, the chip-select timing signal may be tied directly to the data-latch strobe signal. The data will then remain in the output latch until the beginning of the next cycle.

For write cycles, it is again necessary to have the line address stable for 30 ns and to allow time to change the address. It is also necessary to have the bit address set up ahead of the write pulse. Moreover, the data-in line must be stable both before and after the trailing edge of the write pulse, but its state need not be related to the pulse's leading edge.

Figure 6 illustrates a read/modify/write cycle using the 93481. Again the line address must be stable for 30 ns, followed by an address-change period. Once the bit address is stable, the data-out line will become stable 60 ns later. When the required overlaps between the data-in line and the write pulse are observed, the latter can be raised, completing the cycle. □

Technology Breakthrough!

HIGH VOLTAGE CERAMIC CAPACITORS

This breakthrough in high voltage — high temperature ceramic capacitors provides the equipment designer ways to achieve new goals in design and reliability. Semtech high voltage capacitors were initially developed to meet stringent in-house requirements utilized in the manufacture of our industrial and military type solid state high voltage assemblies and multipliers. The resulting products have exceeded our most optimistic expectations. We have now set a new standard of excellence for high voltage ceramic capacitors. As a result of the many inquiries for these devices from our rectifier customers, we have

established a production capability and we are now able to offer these new "state-of-the-art" capacitors for sale to the industry. These devices are now available in quantity from stock at pricing low enough for use in commercial applications.

"MONO-CAP" Chips



Construction: Monolithic with end terminations
Voltage: 1, 2, 3, 4 & 5KV
Capacitance: 18pF to .39 μFd
Dimensions: (Body) from .23"L x .19"W x .15" to .65"L x .60"W x .25"T



"GOLD CAP" Radials



Construction: Monolithic radial leaded and dip coated
Voltage: 1, 2, 3, 4 & 5KV
Capacitance: 18pF to .39 μFd
Dimensions: From (Body) .38"L x .29"H x .25"T to .80"L x .70"H x .68"T

Two Dielectric Types Available!

	X7R	NPO
Temperature Coefficient (T.C.)	0 ± 15% -55 to +125°C	Less than 30 ppm/°C; -55°C to +125°C
Dissipation Factor (D.F.)	2.5% max 1 KHZ 1 VAC, 25°C	Less than .0015 (.15%) at 1 KHZ, 1 VAC, 25°C
Insulation Resistance (I.R.)	100 K megΩ or 1000 megΩ microfarads, whichever is less (25°C, 500 VDC)	100K megΩ or 1000 megΩ microfarads, whichever is less (25°C, 500 VDC)
Aging	1% per decade	0
Dielectric Withstanding Voltage	1.2 Times Rated Voltage*, at 25°C	1.2 Times Rated Voltage*, at 25°C
Voltage Coefficient (V.C.)	Less than 7% at 50V per mil.	0
Dimensional Tolerance	±.010 or 5%, whichever is greater	±.010 or 5%, whichever is greater

*Dielectric Withstanding Voltage Test on Monolithic Chips and Gold-Caps is conducted with charging current limited to 10 mA and the discharge current limited to 5A.

Custom-Cut High Voltage Capacitors at your finger tips!

You can custom design your own capacitor for size and capacitance and maintain corona-free characteristics by cutting with either a diamond saw or laser. Ideal solution for R&D and prototype designs.

Voltage ratings from 2KV - 15KV
Higher ratings available on special request
Corona Inception Voltage rated at 50 Volts/Mil
Single layer construction
Sized from .6" x .6" to 1.80" x 1.80"
Capacitance values from 325pF to 23,000pF
X7R and NPO temperature characteristics

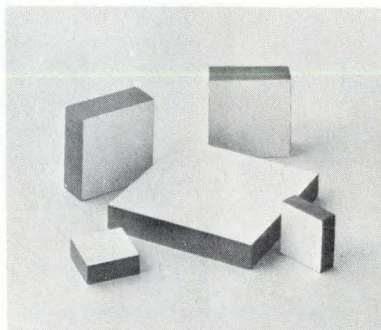

PROTOTYPE KITS
also available for sale!

Contact your nearest Semtech office for our new High Voltage Capacitor Catalog.

1975 NATIONAL SBA SUBCONTRACTOR OF THE YEAR

SEMTECH
CORPORATION

652 Mitchell Road, Newbury Park, California 91320
(805) 498-2111 • (213) 628-5392 • TWX: 910-336-1264

CHICAGO: (312) 352-3227 • DALLAS: (214) 387-3551
FLORIDA: (305) 644-5404 • MARYLAND: (301) 424-6663
NEW JERSEY: (201) 654-4884 • SAN FRANCISCO: (415) 494-0113
EUROPEAN SALES: Bourns AG Zug, Switzerland (042) 232-242

Tough Industrial Micros

At a price you can afford.

The PCS 180 Series. From single board micros for less than \$300* to packaged systems with integrated CRT and full ASCII keyboard for \$995*.

Microcomputers that won't cook in sealed enclosures. With memories that stay up when the power goes off. No one can beat the price. No one can best the performance.

PCS 180s are designed for dirty, corrosive environments. Gathering, analyzing, and sorting data. Monitoring instruments. Starting,

stopping, and regulating events. Even communicating with other computers.

No matter what the application, there's a PCS 180 ready to put on its hard hat and go to work for you. For more information about the PCS 180 microcomputer series call or write us today.



*In quantities of 50

Please send me more information about PCS single board microcomputers the MicroPac 180 the SuperPac 180 all of the PCS hard hats. Please have a salesman call.

Name _____ Title _____

Company _____

Street _____

City _____ State _____

Telephone _____ Zip _____



PCS

Process Computer Systems
5467 Hill 23 Drive, Flint, Michigan 48507
313-767-8920 Twx-810-235-8667

Evaluating a microcomputer's input/output performance

An activity index measures a critical parameter of microcomputer-based systems—the processor's ability to communicate with other system elements

by Howard Raphael, *Intel Corp., Santa Clara, Calif.*

□ Most designers of microcomputer-based equipment rightly pay a lot of attention to a microcomputer's internal data-handling ability. But they really should give as much, if not more, attention to the ease with which a microcomputer communicates with the rest of the system.

Through its input/output lines, the microcomputer correlates the activities of all the other system elements, including keyboards, printers, and disk units. Its value to the system depends heavily on how well it performs these input/output functions. For a designer to choose the most cost-effective microcomputer for a given application, therefore, he requires a standard (figure of merit) by which to measure and compare the input/output performance of different microcomputers. And before he can measure I/O performance, he needs a detailed understanding of the various I/O functions carried out by most microcomputers.

The kinds of information

The microcomputer is called upon to process three types of information—data, status, and control—and it may do so in one of three ways. It may retain complete control of the information transfer, as in polled I/O. It

may allow the I/O device to initiate a transfer, but retain control thereafter, as when interrupts are used. Or it may relinquish control completely to the input/output devices, as in direct memory access (see Fig. 1).

Data generally is bidirectional, flowing to the microcomputer from the I/O devices in the system and flowing from it to them. The nature of the data—whether it's alphanumeric (ASCII) or variable-length binary—strongly influences the microcomputer's optimum word length.

For example, if the data is predominantly ASCII, an I/O word of 8 bits should be selected for a first approximation. In systems where data is decimal or where only moderate performance is required, a 4-bit word may be good enough and indicate selection of a lower-cost microcomputer.

Status information generally flows from the rest of the system to the microcomputer. It describes the states of the peripherals and other input/output devices in such terms as READY FOR DATA, TIGHT TAPE, ON CYLINDER, BUSY, and END OF FORM.

Status information may be transferred in either decoded or encoded form. Decoded status words are assigned 1 bit (or line) each, that is, 1 bit for BUSY, 1 bit

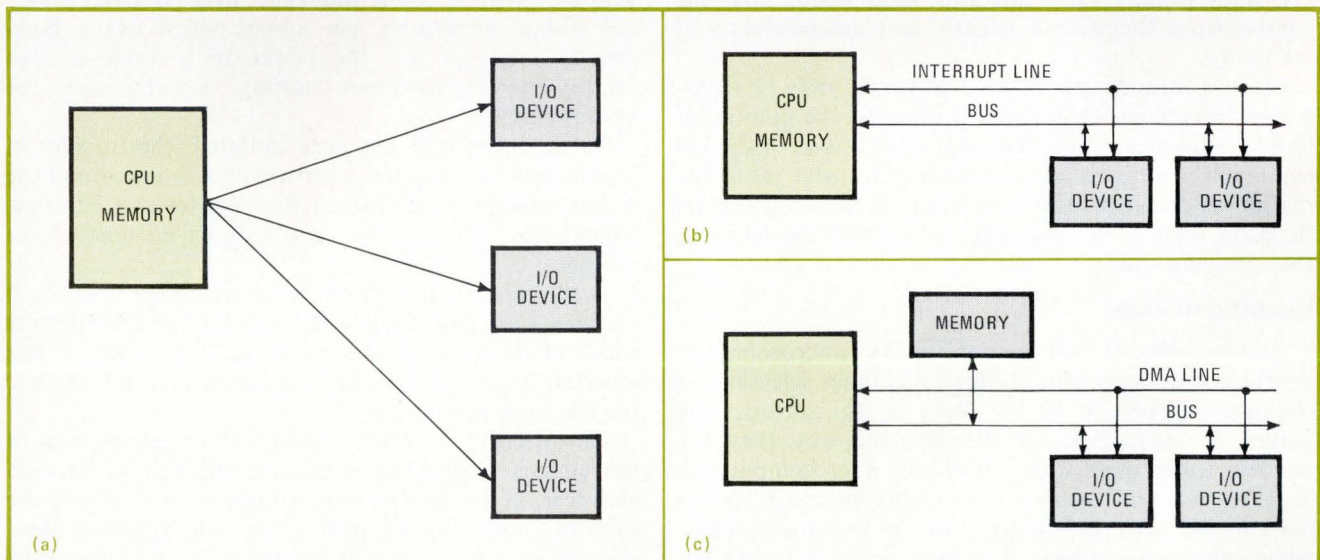

1. Input/output. Three types of microcomputer I/O are polled I/O (a), where the CPU initiates and controls the transfer, interrupts (b), where the I/O device initiates the transfer but the CPU controls it, and DMA (c), where the I/O device is in complete control.

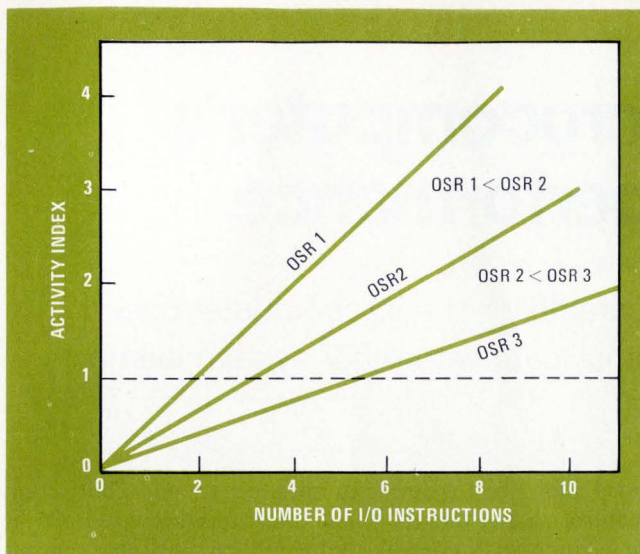

2. Service rates. An over-all figure of merit, the optimum service rate for a multi-port system can be calculated by taking the ratio of I/O instructions to the previously calculated activity index for each port. Different systems can then be compared.

for LIGHT TAPE, and so on. Encoded status words compress more information onto the same number of lines—for example, the four lines needed for four decoded words could handle 16 encoded status words—but do so at the cost of equipping the group of sending I/O devices with additional hardware that would be required to perform the encoding.

Control information flows in the opposite direction from status words, from the microcomputer to the peripherals and other I/O devices. It consists of instructions like TRANSFER CHARACTER, START PRINT, or SEARCH FOR INTER-RECORD GAP. Besides defining the nature of the transfer (data, control, or status), it usually tells whether the instruction is input or output. (In 16-bit machines and larger, control and data usually are contained within one I/O transfer, but with microcomputers, data usually takes the full word width, and the control word therefore is usually sent independently of the data.)

Control information, like status words, may be transferred in encoded or decoded fashion. If the number of control activities is less than the width in bits of the I/O command word, it is advantageous to transfer the information in decoded form, one word bit for each control function. This avoids the need for a decoding device at the receiving end.

Keeping in step

Besides control information, every microcomputer instruction to input/output devices includes selection, or routing, information in the form of an address. The nature of instruction formats and the way they are handled varies quite widely from one microcomputer to another. Some microcomputers provide the control information and selection information in two instructions, while others can provide it in only one instruction but may require several memory cycles. As will become more apparent later, this can have a marked effect on

the device's I/O efficiency.

To synchronize the transfer of data, control and status information between the microcomputer and the I/O devices, typical systems use polled I/O, interrupts, direct memory access, or any combination of these techniques.

In polled I/O, the microcomputer software interrogates each I/O device with an I/O instruction. It does this after setting up the address and control information.

Ideally, the sequence of instructions for a single interrogation should be as short as possible so that polling can be speeded up. A typical poll consists of the microcomputer addressing the I/O device and requesting its status, and the I/O device then responding with its status. The optimum case is for this complete sequence to be accomplished in one I/O read instruction, although three or four such instructions may not pose too much burden on some systems.

There are two basic polling schemes. In ring polling, the I/O devices are weighted equally—polled sequentially and serviced at the same rate. In priority polling, all I/O devices are unequally weighted, so that the certain of them are polled more often than others and are given a higher rate of service.

Priorities established in a polling scheme are relative. That is to say, a higher-priority device, while getting more frequent CPU attention, cannot override an “in-service,” lower-priority element.

Handling interrupts

Interrupts are the second way in which a microcomputer may communicate with the rest of the system. In this approach, the I/O device attracts the microcomputer's attention by activating a control line, to indicate that some external activity is either nearing completion or about to be initiated. An interrupt differs from polled I/O in three important ways. In the polled-I/O sequence, the microcomputer initiates the transfer of I/O and is synchronized with the program. In the interrupt sequence, the I/O element can initiate the transfer and is out of sync with the program. Also, interrupts may be given priorities within the system, but unlike polled I/O, a high-priority interrupt has the power to override a low-priority interrupt whenever “nesting” is permitted by the system design.

Once an interrupt has been initiated, the transfer of information between the interrupting I/O device and the microcomputer must ensue. This transfer can be made either by an I/O instruction or by a direct-memory-access scheme.

In all probability, a system will have several sources of interrupts, so that the microcomputer must determine which of them is requesting service. That done, it can ascertain what I/O transfer is required and will initiate the interrupt subroutine.

The interrupt subroutine consists of a predefined set of instructions unique to each interrupting I/O device. However, in addition to generating this custom I/O, the software must also perform certain housekeeping functions to ensure an orderly transition to the subroutine from the main program and back again.

In particular, before proceeding with an information

transfer, the microcomputer must arrange to preserve its current state. This includes the states of the accumulator and internal registers that are associated with the main program. The subroutine must contain utility codes both to store these elements in memory and to retrieve them later for use in restoring the microcomputer's prior state before the RETURN to the main program.

Ideally, the microcomputer should perform these utility functions with fewest possible instructions and in the shortest possible execution time. Complexity in an interrupt subroutine of course helps to reduce system throughput.

Direct memory access or "cycle stealing" is a technique of transferring data to and from the system memory at high rates of speed (between instruction executions). This feature is seldom found in low-performance microcomputers because DMA requires a lot of interface logic, but it is useful in devices that transfer information in large data blocks as opposed to single bytes.

Data transfers with this technique are typically initiated by the I/O device, which must provide a source and destination address and sometimes also describes the length of message and direction of transfer. The device first raises a DMA request via an appropriate control signal. The microcomputer responds at the completion of a memory or instruction cycle with a DMA acknowledge and relinquishes the bus. The I/O device then takes control of the bus and effects the transfer to or from the memory.

DMA and instruction cycles may be interleaved during the data-block transfer. The information will be transferred until the block-length counter is decremented to

zero or terminated by some other source.

Once the designer has determined how his system will be transferring its data, status, and control information among its various elements, he is then ready to measure the I/O performance of the microcomputer in relation to the rest of the system.

Measuring performance

All I/O lines that must be controlled by the microcomputer should first be identified and then grouped into I/O ports of 4, 8, or 16 bits (depending on the microcomputer selected). Lines may be grouped together and encoded to reduce the number of I/O ports. Whether to reduce the number of I/O ports by adding decoding logic is a decision that the designer must make on the basis of the I/O line service rate, the I/O addressing scheme, and the cost of the hardware.

In measuring the microcomputer's responsiveness to the I/O activity at each of its ports, the first step is to derive a figure of merit called the activity index (AI). The larger the AI, the poorer the I/O performance of the microcomputer.

In most cases, the AI may be obtained simply by dividing the number of specifically I/O instructions (NIO) in an I/O routine into the entire length (total number of instructions) of the I/O routine (LR). To put it more briefly:

$$AI = LR/NIO$$

For example, an I/O routine may require four preparatory instructions before the actual I/O instruction can be allowed to occur and perform its function. Thus the total routine contains five instructions, including one I/O

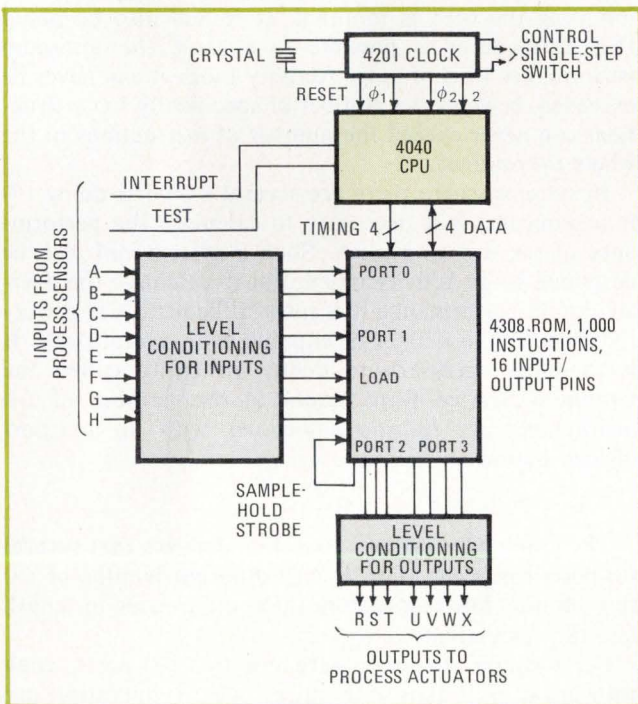

3. Process-control system. A typical control system based on the 4040 microprocessor uses a ROM to interface the inputs from sensors and the outputs to the actuators. Data flows bidirectionally between the ROM and the CPU.

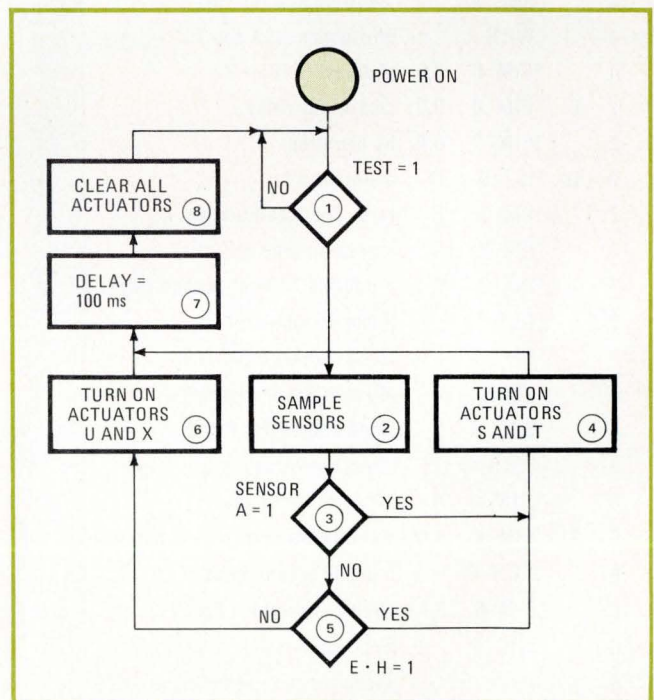

4. Flow chart. The operation of the controller in Fig. 3 can be described by a flow chart which in turn can serve as the basis for programming the controller. The numbers in each block refer to the routines in the program in Fig. 5.

FLOW CHART (Refer to Fig. 4)										
FLOW CHART LABEL	CODE	OPERAND	COMMENT	ROUTINE	OPERATING PORT	LENGTH OF I/O ROUTINE (LR)	NUMBER OF I/O INSTRUCTIONS (NIO)	ACTIVITY INDEX (AI)	OPTIMUM SERVICE RATE (OSR)	
1	A	*JCN 9	A ;Test for TEST = 1	1	Routine 1	Port 2	5	1	0.200	
2		*FIM 4	2,0 ;Set up address for Port 2		2	0	8	1	0.125	
2		SRC 4	;Send address		3	1	11	1	0.091	
2		LDM 1	;Load strobe for accumulator (least significant bit Port 2)		4	2	3	1	0.333	
2		WRR	;Write strobe		5	2 and 3	19	2	9.5	
2		RDR	;Read Port 0		6	2	7	1	7	
					Total	53	7	7.6		
3		*FIM 0	0,0 ;Set up address for Port 0	2						
3		SRC 0	;Send address							
3		RDR	;Read Port 0							
3		CLC	;Clear carry for test	3						
3		RAR	;Shift sensor A into carry							
3		*JCN 2	B ;Test sensor A = 1 if yes go to B							
5		*FIM 2	1,0 ;Set up address for Port 1							
5		SRC 2	;Send address							
5		RDR	;Read Port 1							
5		*FIM 6	9,7 ;Set for E · H test	3						
5		AN 6	;AND 9 with E · H							
5		CLC	;Clear carry							
5		ADD 7	;Add 7 to the accumulator							
5		*JCN 4	B ;If accumulator is ZERO, go to B							
4		LDM C	;Set data to turn on S and T two most significant lines Port 2		4					
4		SRC 4	;Send address for Port 2							
4		WRR	;Write turn on S and T							
4		*FIM 6	3,0 ;Address for Port 3							
7	C	*FIM 0	0,0 ;Set up for delay							
7		*FIM 2	0,E by counting							
7	D	*ISZ 0	D counter up to	5						
7		*ISZ 1	D zero. The accumulative							
7		*ISZ 2	D execution time will							
7		*ISZ 3	D produce a 100-millisecond delay							
8		CLB	;Clear accumulator							
8		SRC 4	;Send address for Port 2							
8		WRR	;Clear actuators S and T	5						
8		SRC 6	;Send address for Port 3							
8		WRR	;Clear actuators							
8		*JUN	A ;Jump to beginning							
6	B	*FIM 6	9,0 ;Set up data to turn on U and X		6					
6		XCH 6	;Load in accumulator							
6		*FIM 6	3,0 ;Set up address for Port 2							
6		SRC 6	;Send address							
6		WRR	;Write—turn on actuators U and X							
6		*JUN	C ;Jump to C							

*Instructions requiring two memory cycles
I/O instructions in color

5. Program. The assembly-language program for the controller in Fig. 3 is broken into six separate I/O routines associated with the various blocks of the flow chart in Fig. 4. The summary table shows the results of calculating an activity index for each routine.

instruction, and the AI works out at 5.

This measure of AI is adequate whenever all the instructions use the same number of memory cycles each. But sometimes some instructions will require two memory cycles, while others require only one. In this case, LR and NIO are more accurately defined in terms of the number of memory cycles each requires. In the above case, for example, if one of the four preparatory instructions is a two-cycle type, then the length of the routine will be six, and AI = 6.

It should be noted that an optimum performance level, AI = 1, occurs when the number of I/O instructions equals the length of the I/O routine. This is most closely approached in DMA routines, where activity prior to initiating the DMA is minimal. It should also be noted that although it is possible to achieve the optimum performance level of unity Activity Index it can never be exceeded, because the number of specifically I/O instructions can never exceed the number of instructions in the whole I/O routine.

In systems where there are several I/O ports doing I/O in a sequence, it is necessary to calculate the performance of the overall system. Such a system can also be described by an activity index. But to calculate the overall system performance it is most difficult to use merely the AI, since this cannot be equated over several ports. It is therefore necessary to define an entity called the Optimum Service Rate, equal to the number of I/O instructions per routine associated with an I/O port divided by the AI. In short:

$$OSR = NIO/AI$$

The graph of AI versus NIO in Fig. 2 shows that several I/O ports can have AI = 1 with different lengths of I/O subroutines. The OSR factors these differences in length into the calculation.

For example, assume there are two I/O ports, each with an AI of 1. Port A requires one I/O operation per routine (i.e., DMA). Port B requires four. The OSR for Port A is thus 1, and the OSR for Port B is 4. Port A hence has the better service even though both ports have an AI of 1.

The OSR for each port may be calculated from the system flow chart. Each port has an associated I/O service routine, which can be measured. Once the OSRs have been calculated for each port, the overall performance of the microcomputer may be calculated by the sum of the OSRs:

$$\sum_{n=1}^M \text{OSR}_n$$

The higher the sum, the more efficient the selected microcomputer is for the given application.

Note, however, that this technique assumes the following when different microcomputers are being compared for a given application:

- The number of I/O ports is the same for each application.
- Both I/O operation and I/O subroutine operation used in the calculation are reduced to a basic memory-cycle count; that is, if an I/O instruction requires two memory cycles, the NIO equals 2. If the LR is 8 instructions and 12 memory cycles, the LR equals 12.
- If the microcomputers being compared have grossly different cycle times, these must be factored in by proportioning the cycle times over the NIO and LR.

From theory to practice

To determine the nature of the I/O required for an application, it's best to begin by drawing a flow chart, showing the type of transfers (data, status, and control) and incorporating the number of I/O ports and the transfer method used (polled I/O, interrupt, and DMA). The next step is to pick a particular microprocessor and use the flow chart to program it for the application. Finally, an activity index for the microcomputer is derived from the program.

As an example, consider a system configured to perform a simple process-controller function (Fig. 3). Here, the 4040 central processing unit executes the program and performs the input and output program operations.

The 4201 system clock provides the CPU with its basic timing via a two-phase clock—a crystal attached to the appropriate lines. The 4201 also has a POWER ON RESET or CLEAR to initialize the system, plus a single-step RUN/STOP mode control to "step" the microcomputer one cycle at a time.

The 4308 read-only memory is linked to the 4040 via a 4-bit data bus and four lines of timing. It is a dual-function device—besides containing 1,024 8-bit words of program, it interfaces to 16 programable input or output lines. (In Fig. 3 the 4308 has 8 bits of input and 8 bits of output, but any combination is possible.)

Since the MCS-40 is a 4-bit computer, the 16 pins of I/O are organized into four 4-bit ports. This does not prevent the computer from sampling some 4-bit multiples 4 bits at a time, as shown in Fig. 3.

The 4308 ROM has a load strobe input, shown being driven by the output labeled a sample-and-hold strobe. The input allows the CPU to sample, at some point in time, eight lines of information. This information can be digested 4 bits at a time after sampling.

The outputs are also organized around the 4-bit port of the 4308. They are fed to a level-conditioning circuit

that produces the final output, driving the system actuators and indicators.

With a flow chart describing the solution to a problem in a specified logical sequence, programming is a simple matter of converting the flow statements into the microcomputer's instructions. The flow diagram in Fig. 4 refers to the system inputs and outputs specified by the system block diagram shown in Fig. 3. Each part of Fig. 4 is numbered, and these numbers will be referenced in the description that follows.

Let us assume that when the test line is active (logical 1), the microcomputer will sample the input sensors and, on the basis of their states, provide a proper output-actuator response. The test line is a direct input to the 4040 CPU. Depending on its state, it can be branched on or used to perform a jump.

When power comes on, the program checks the test line ("diamond" 1). If it is not set, it will wait until it becomes set (test = 1) before proceeding to carry out the remaining instructions. When it has been set by some system variable (such as timer, liquid level, temperature, pressure, etc.), all other system sensors will be sampled and stored ("box" 2).

Sensor A will be the first sensor checked (3). If it is set, actuators S and T will be turned on (4). (For the sake of simplicity, it is implied that the test line is reset when any actuator is set). If sensor A were not set, then sensors E and H would have to be tested (5). If a logical AND existed between E and H, actuators S and T would be activated (4) as described above. If the logical AND of E and H were not true, then actuators U and X would be set (6).

Regardless of which actuators are selected to be turned on, a delay will be implemented (7) before the actuators are all cleared (8), and the sequence will be returned to the beginning.

Calculating performance

Referring to the program (Fig. 5), the code can be broken into Activity Index zones. Each zone is identified by a block in the flow diagram for the purpose of this example. The program can be divided into six discrete routines, or zones, each related to one or two of the major steps in the flow chart. If the number of memory cycles and the number of I/O instructions are counted for each zone, the summary table shown next to the program in Fig. 5 can be generated.

In the table, note that in zone 4, for which AI is 3, there are only two preparatory instructions preceding the I/O instruction, WRR. This represents efficient I/O control. However, note that zone 5 requires several instructions to generate the 100-millisecond delay before the actuators can be cleared, and this results in a rather high AI (9.5).

With the microcomputer chosen, the AIs of this particular program probably could not be reduced. However, greater efficiency might result if another microcomputer were designed into the same application—and now the designer has the tools to calculate the AIs for both devices, compare the two systems, and determine which will better serve the I/O needs of his application. □

Circuit layouts minimize noise in digital systems

by Matthew L. Fichtenbaum
GenRad Inc., Concord, Mass.

Careful design of power and ground structures on printed-circuit boards and in multiboard systems can do much toward reducing the effects of noise from unwanted signal pickup. The layout techniques recommended here, which minimize ground inductance and stray capacitance, have contributed to the successful operation of many systems.

In Fig. 1, gates A and B, both of which are in one integrated-circuit package, drive gates C and D respectively. The ground path to A and B has some stray inductance, shown as L_{ground} , and each signal line has some capacitance to ground, such as C_{stray} on the output of A.

If A's output changes from high to low, the charge on C_{stray} causes a high instantaneous current to flow into A. The return path for this current is the ground lead, and the inductance in this path causes a voltage spike at the ground terminal. Output B, which should be in the low state, also carries this spike because the output cannot be lower than the ground level of the gate. So gate D,

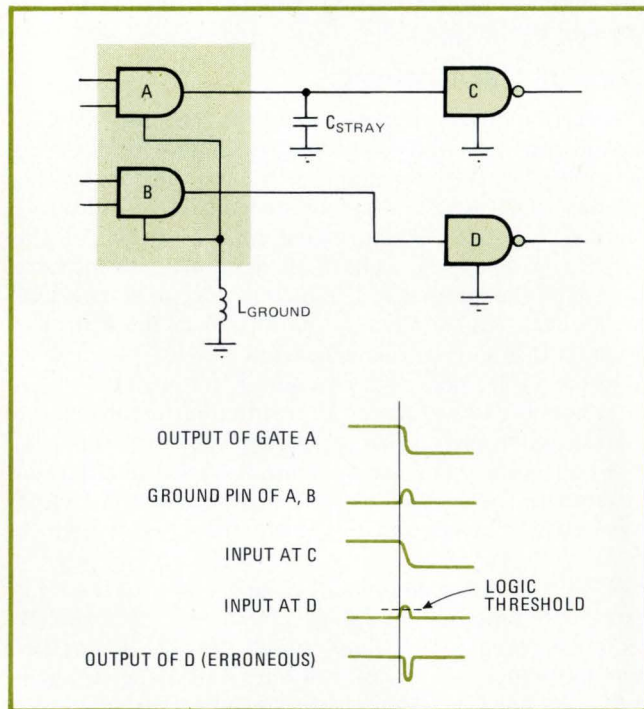

1. Shaky ground. Gates A and B suffer unwanted coupling through inductance L_{ground} in the common ground lead. When gate A discharges C_{stray} , an erroneous signal appears at gate D.

driven by B, sees an erroneous pulse at its input.

This effect may be lessened in several ways. Keeping tracks short, to decrease capacitance C_{stray} , reduces the spike amplitude. Although a resistor or inductor in series with the driver can limit the peak discharge current, they reduce system speed and can place unacceptable limitations on fanout. A better attack is to minimize the inductance in the ground lead through the use of a good ground structure.

An ideal solution is the full ground plane common to multilayer boards, which maintains minimal inductance and maximal amount of interconnection. Unfortunately, multilayer boards are expensive and difficult to justify for most circuitry.

The ground structure on a double-sided board in Fig. 2 gives a good approximation to a full ground plane. A V_{CC} bus runs up the right and left edges of the front surface of the board, and a ground bus runs up both edges on the back. Horizontal buses connected to the risers at the edges carry V_{CC} and ground for each IC. The buses' widely separated paths keep ground inductance low. Bypass capacitors, placed between the power and ground buses that feed a row of ICs, suppress the spikes in the supply current when an output switches. Because of the ample interconnection, few bypass capacitors are

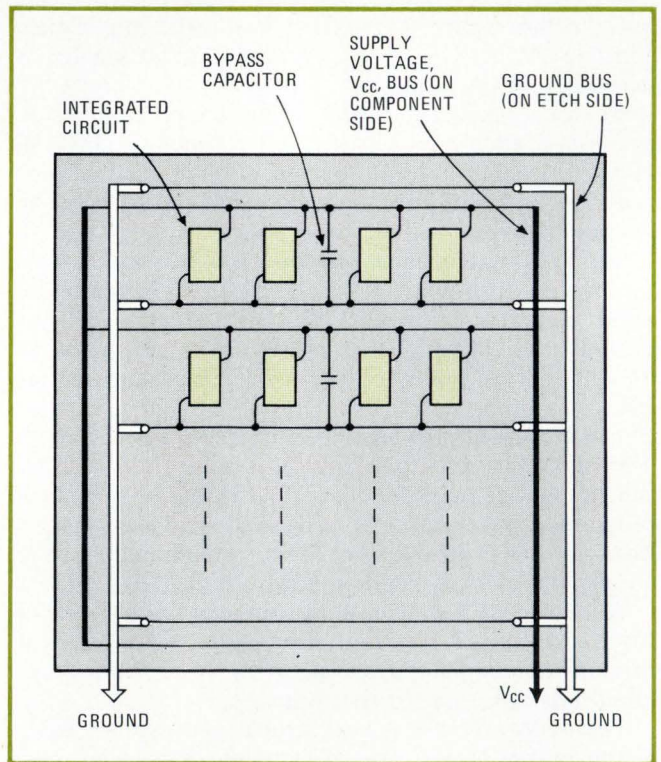

2. Grounds for confidence. The solid bar represents the supply voltage bus on the front of the circuit card, and the open bar is the ground bus on the back. The round holes allow back-to-front crossover. The grid structure of the bus lines approximates power and ground planes to keep inductance and noise low.

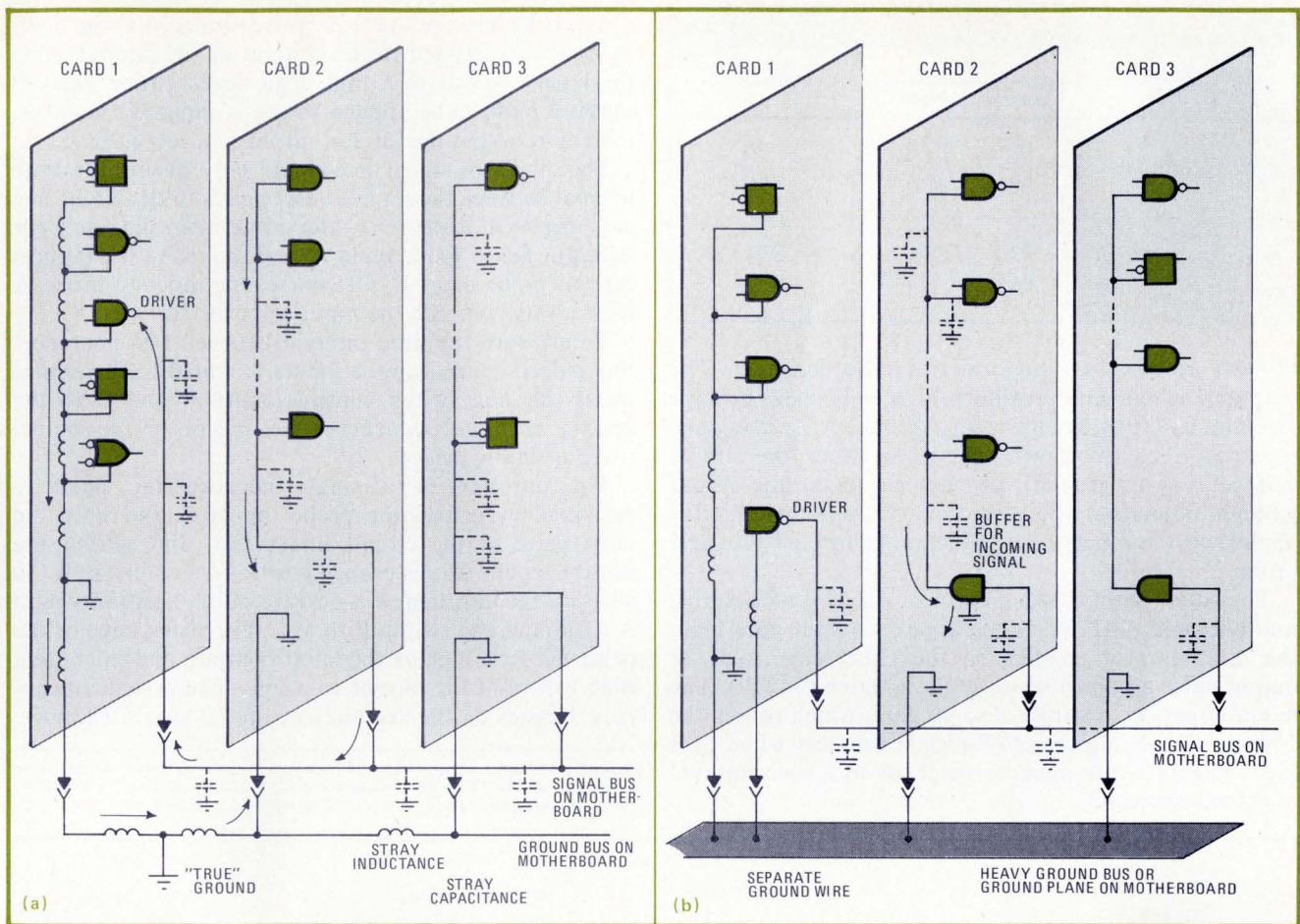

3. Cool bus. Stray inductance and capacitance in a multcard system (a) can cause noise problems between cards. The changed signal paths and ground structure in the arrangement shown on the cards (b) make the system less noisy and more reliable.

required; even so, the distance between any IC and a capacitor is small, so the spike path is short.

The same sort of noise problems exist in multcard systems where the logic signals communicate between cards. In Fig. 3a, the driver gate on card 1 must necessarily drive the stray capacitance on three cards and the motherboard. The resulting ground transients at the driver couple into other devices on card 1, so there could be serious noise.

In Fig. 3b, the system has been restructured to reduce noise. A ground plane or several widely spaced heavy ground tracks on the motherboard help keep all card grounds at the same voltage. Cards 2 and 3 buffer

signals from the signal bus with a device near the bus connector. This buffering reduces the capacitive loading on the bus by shortening the length of track directly connected to it. It also keeps the heavy signal currents in the multiple loads local to the receiving card. Locating the driver near the bus connector keeps its paths short.

Perhaps most important, the driver receives its ground through a separate connection directly from the motherboard. This separate line keeps ground transients from affecting other devices on the card. It can dramatically increase the likelihood that the system will function properly, even with the long bus runs encountered when the card is on an extender. □

ICs replace memory scope for pulse measurements

by Daniel A. Swihart and Robert W. Thompson
DeWild Grant Reckert and Associates Co., Rock Rapids, Iowa

A 10-megahertz crystal oscillator is the secret ingredient in a circuit for reading out the time interval between two

nonrecurring logic pulses or the duration of a single pulse. The circuit is an inexpensive alternative to a memory oscilloscope or a commercial frequency counter for examining the nonrecurring pulses.

By counting oscillator cycles, the circuit provides a digital readout of the nonperiodic time intervals—for example, with proper interfacing circuitry, it can measure the cycle time of a microprocessor function or calibrate test equipment such as a pulse generator. Parts for the complete circuit cost about \$50.

As the figure shows, two-input exclusive-OR gates

FUNCTION TABLE FOR EXCLUSIVE-OR GATE (7486)

Pulse edge to be detected	Inputs		Output
	Control	Probe	
Rising	Low	Low	Low
	Low	High	High
Falling	High	High	Low
	High	Low	High

(7486s) are the first stage in the pulse detection. The output of such a gate provides a high only when the logic levels on its inputs are different (see table). By using one input as a control (switching it to either the supply voltage, V_{CC} , or ground), the user can make the output go high, no matter whether a low or a high logic level is applied to the other input, which is connected to a test probe.

The gates' outputs are connected to a dual monostable multivibrator (74123). When a gate's output goes high, the multivibrator triggers on the rising edge, and an output pulse goes to a set-reset (\bar{S} - \bar{R}) latch (74279). The latch output, Q, controls a NAND gate, which passes the 10-MHz signal to a series of decade counters when Q is high. Each 10-MHz pulse corresponds to a time interval of 0.1 microsecond.

When a nonrecurring logic pulse occurs at probe input A, a pulse is applied to the \bar{S} input of the latch, setting the latch's output to a high logic level. Probe input B causes a pulse to be applied to the \bar{R} input of the latch, thereby resetting the latch's output to a low level.

The oscillator signal is counted only during the time interval between the set and reset pulses to the latch. The data displayed is the time interval between the rising (or falling) edge at probe input A and the rising (or falling) edge at probe input B. Of course, the input to probe A must always precede the input to probe B.

To measure the time interval between two nonrecurring pulses, connect probe inputs A and B to the circuit under test and switch control inputs A and B to the desired positions, whichever are necessary to detect rising or falling edges.

The duration of a single nonrecurring pulse is measured by connecting probe inputs A and B to the same place in the circuit under test, and setting the control inputs to the proper positions. For example, to measure the duration of a positive pulse, position switch A to ground and switch B to V_{CC} . The rising edge of the pulse will set a high on the latch's output, and the falling edge will reset the output to a low. The system's accuracy depends on the accuracy of the 10-MHz oscillator.

Engineer's notebook is a regular feature in Electronics. We invite readers to submit original design shortcuts, calculation aids, measurement and test techniques, and other ideas for saving engineering time or cost. We'll pay \$50 for each item published.

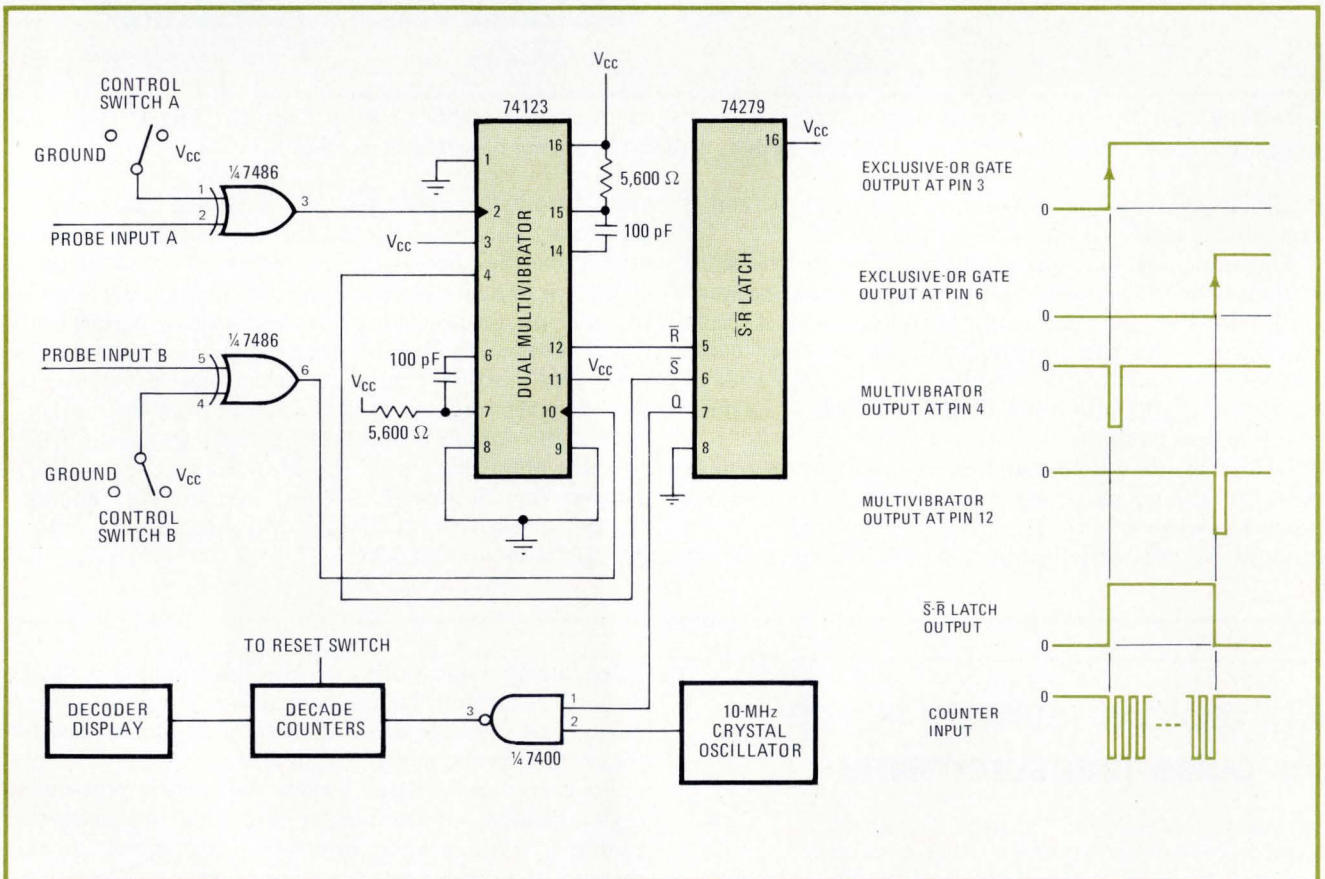

Alternative to memory scope. In this circuit, the spacing or duration of nonrecurring pulses is measured with transistor-transistor-logic detection circuitry that counts cycles of a 10-MHz oscillator. Seven digits can be displayed, giving readings from 0.1 microsecond to 0.9999999 second. This technique can be used in lieu of a memory scope for preserving nonrecurring pulses in digital circuits.

The Right Tape Perforators From **REMEX** Give More Punch For The Money

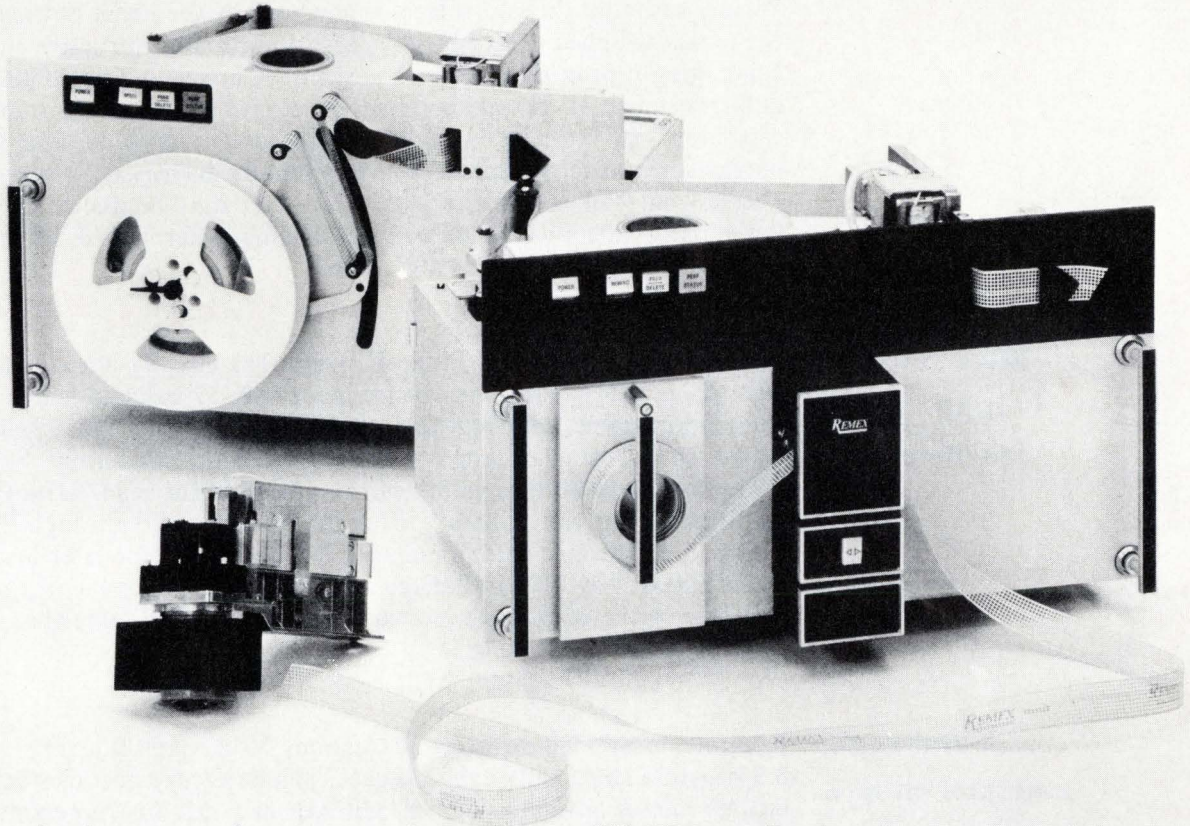

120 cps punched tape perforators and combos are now available for the same price you've been paying for low speed punch units.

The REMEX 6120 series includes the right perforator configuration for minicomputer, NC, test and phototypesetting applications:

- a perforator/spooler system, rack mountable or desk top, for high volume data tape preparation.
- a perforator/reader "combo" — a REMEX exclusive — combining the high speed punch with a 300 cps reader for program preparation, load and edit.
- a high speed punch mechanism for OEM system integration sized 1/3 smaller than other high speed perforators.

All 6120 perforators have motor driven tape feed and sprocket drive design giving longitudinal registration within $\pm .015''$ in 5" of tape. No registration adjustments are required for the life of the product.

Life expectancy of the perforator mechanism is greater than 700 rolls of paper tape and can be further extended by use of an optional carbide punch block.

To satisfy all application requirements, 6120 perforators will punch paper or mylar tape of 5-8 levels for roll or fanfold, bidirectionally. A six level advance feed typesetter version is available.

Call or write for information on the REMEX RPS 6120 Perforator System, the RAB 6120 Combo and the RPM 6120 Punch Mechanism — the **right** perforators for your application.

Ex-Cell-O Corporation

REMEX DIVISION

1733 E. Alton Street, P.O. Box C19533, Irvine, California 92713
(714) 557-6860, TWX (910) 595-1715. In Europe and the U.K.: SpA, Microtecnica
Via Madama Christina 147, Torino, Italy 10126.

Circle 113 on reader service card

The case builds against using LEDs on the ac line

Alan R. Miller's suggestion [*Electronics*, June 10, p. 132] of connecting a light-emitting diode and series capacitor directly to the ac line has come under fire from Nathan K. Weiner, American Science & Engineering, Woburn, Mass., as well as Elliot S. Simons [*Electronics*, July 22, p. 124]. Weiner says that the LED current is governed by the phase of the line when the LED is switched on and by how large a portion of the active chip area is conducting during the turn-on transient. "Current is limited only by the bulk resistance of the junction and the equivalent series resistance of the capacitor," he explains. **Localized high-current densities can burn out portions of the active chip area and eventually destroy the entire LED.** He guesses that Miller's success with this circuit may be due to the use of a low-quality capacitor (not an ac type), having either high series inductance or resistance that limited LED current.

More memory in the SR-52 calculator . . .

In Engineer's Newsletter, Philip R. Geffe has already noted [*Electronics*, July 22, p. 124] that Texas Instruments' SR-52 calculator has some 30 extra addressable data registers, at locations 70 through 99. But, says David M. Mackenzie, program manager at Doric Scientific, San Diego, Calif., **locations 60 through 69 can also be used for read/write functions.** Additionally, he notes, data written into locations 70 through 99 can be recorded on the calculator's magnetic program card for later loading into the registers. "At 0.02 to 0.03 cent a bit, the SR-52 is one of the lowest-cost nonvolatile read/write memories going, although somewhat awkward to use," observes Mackenzie.

. . . and some cautions on how to avoid errors

Each of the SR-52's registers at locations 70 through 99 can store about 8.5 program steps, although the space each keystroke occupies depends on the instruction given, says C. J. Mitchell of C.M. Instrumentation Ltd., Bracknell, Berks., England. If a program does not occupy the machine's full 224-stroke capacity, he notes, the unused program stores may be employed as data stores in the program—but with caution. **For example, if registers 93 and up are empty, it's best not to use 93.** Also, the calculator must be in its floating-decimal-point mode when you're recalling registers, since otherwise a register could seem empty though in fact it contained a very small fraction. Mitchell adds another word of advice—it's not possible, through indirect entry and recall, to use registers 100 upwards. For these locations, all but the last two register digits are ignored.

A lasing material that beats neodymium YAG

Looking for a solid-state laser that's easier to use and offers better performance than neodymium-YAG types? A new material being manufactured for the Air Force Materials Laboratory by Lambia-Airtron division of Litton may be just what you want. It's **anisotropic yttrium aluminate doped with neodymium, which sustains smaller thermal losses than conventional lasing materials,** does not require an external component to polarize the laser light, and gives increased energy storage for electro-optical switched lasers. The new material is suitable for linearly polarized continuously pumped lasers, flash-pumped lasers, and Q-switched lasers for aircraft and satellite applications. AFML will loan tested rods to qualified Government agencies and contractors. Direct inquiries to: Air Force Materials Laboratory, Wright-Patterson AFB, Ohio, 45433.

—Lucinda Mattera

Erased any PROMS lately?

Nitron's MNOS non-volatile memories can be erased and reprogrammed in or out of your circuit. Electrically. No U.V. light source or programming hardware to mess with.

Loss of power doesn't bother data stored in Nitron's NVMs, either. The data is safe even if the power stays off for several years. Without backup batteries.

They're single word alterable and interface with either TTL or CMOS. And because they're fully decoded and bus compatible, using them is just like using more conventional memories.

What more can you ask for?

Nitron's new generation of NVMs: First the 64X4 NCM7040, and now the 256X4 NCM7050. Available off-the-shelf. So don't lose any more valuable time. Or data.

Write or call

NITRON

10420 Bubb Rd., Cupertino, Calif. 95014

(408) 255-7550

NITRON 
A division of **MCDONNELL DOUGLAS**

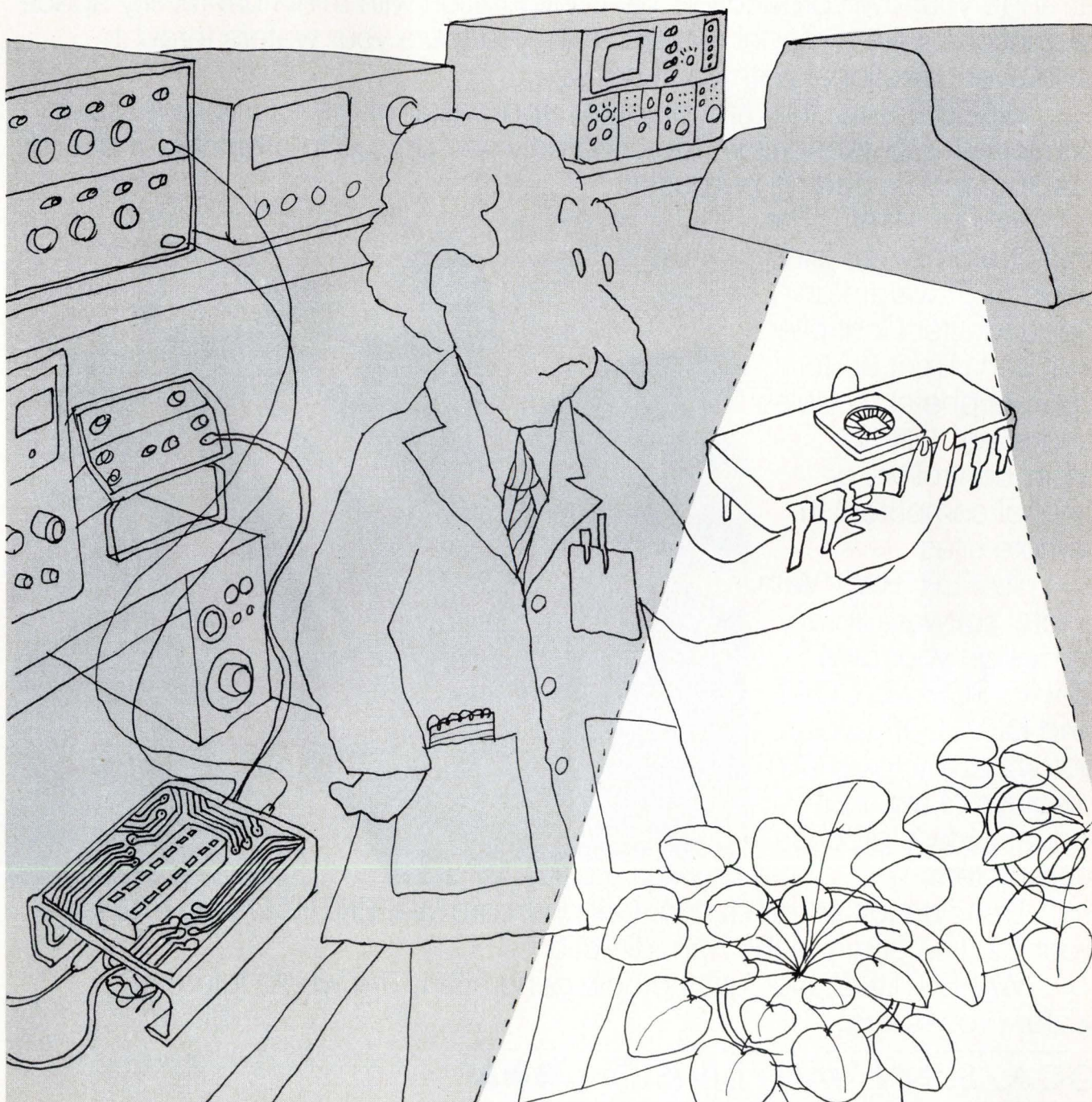

ALL ABOARD! WAFERTRAC IS NOW ON LINE.

**Total microprocessor control of wafer processing for the first time.
Higher yields, yet requiring less facility space.
Up time and reliability higher than ever before.
No more limit to 25-wafer group processing.**

It's already the talk of the industry. Wafertrac—the completely automatic transportation of wafers on patented air bearings through the total process without human intervention.

WAFERTRAC. The microprocessor-controlled system that allows you to arrange your own production line configuration with minimum facility space restrictions. Like a model railroad train, you route your wafers through whatever directional path you choose.

WAFERTRAC. The first practical application of the microprocessor to semiconductor fabrication, requiring only *one* person to attend your line for loading and unloading purposes.

WAFERTRAC. The multi-batch processing of up to 5" wafers under a Master Controller that can direct up to 256 peripheral modules and even "talk" to other controllers or central computers in remote sites.

WAFERTRAC. With a total software library to design your own BAKE, SCRUB, COAT and DEVELOP cycles *automatically*, plus CRT displays of any individual wafer's process parameters.

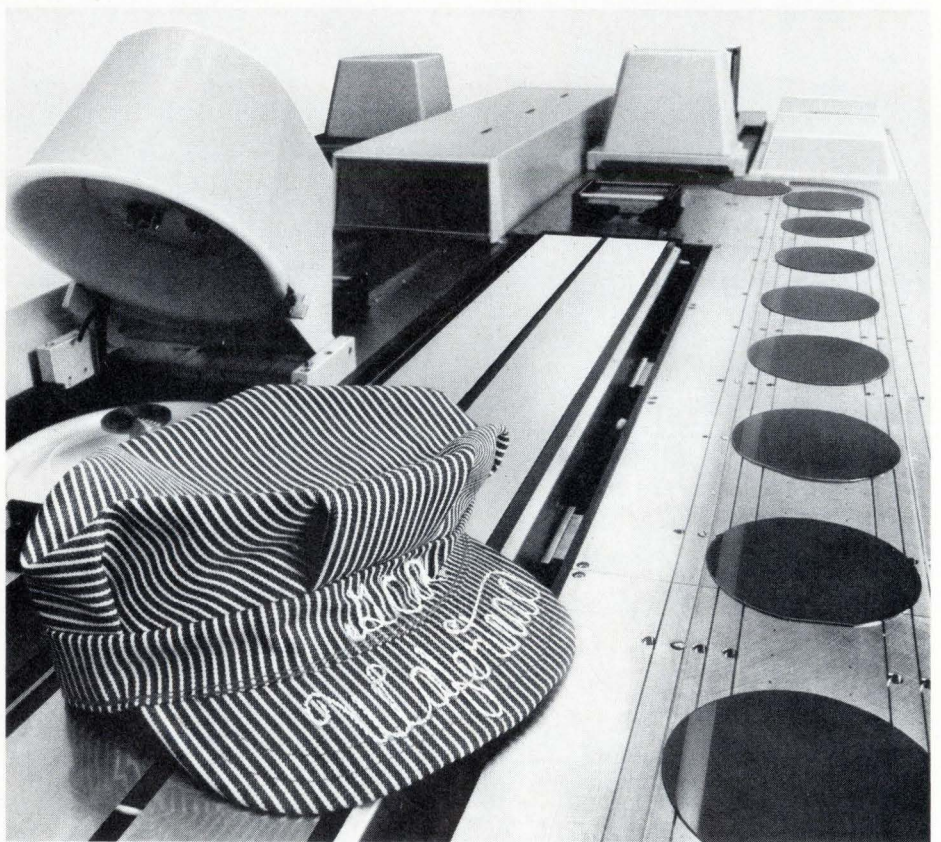

Don't be left at the station. Get on board WAFERTRAC now to keep your fab line going in the right direction.

WAFERTRAC. Not just the new generation. The whole future of wafer processing.

GCA/SUNNYVALE DIVISION ●●▲

1050 Kifer Road, Sunnyvale, CA 94086 (408) 732-5330 TWX: 910-339-9211

Circle 116 on reader service card

Multimeter uses 8080 'brain'

Microprocessor controls separate analog and digital data buses that handle a wide variety of measurement and interface options

by Andy Santoni, Instrumentation Editor

When the Fluke 8500A is first turned on, its seven-segment light-emitting-diode displays light up the legend HI. That's only the first indication that something's different about this meter.

The 8500A's chassis is a simple, passive frame and motherboard into which plug separate printed-circuit cards for input-signal conditioning, a-d conversion, internal control, input/output interface, power supply, and even the front panel. The instrument's "brain" is an 8080-type microprocessor, mounted on the internal control board, which manages communications among the other boards over analog and digital data buses.

The 8500A is an autoranging 5½-digit multimeter that can be configured for instrument-system applications as well as bench-top laboratory use. It has a fairly simple front panel from which the relatively limited range of bench-top measurement capabilities can be controlled. A greater variety of features can be called up by remote control, as in systems applications.

For example, the 8500A's front-panel sample-rate switch has two

positions—two or eight readings per second. But under remote control, the instrument can be programed for any of 17 sample rates, from 500 readings per second to one reading every nine minutes.

Upon initial operation or request, after the salutation has appeared for about two seconds, the 8500A displays its model number and variation for about one second, then reads out the options that have been installed. During this interval, the function switches are active and a function and range may be selected. If a range is not selected, the instrument automatically selects the 1,000-volt dc range.

The 8500A employs Fluke's recirculating-remainder analog-to-digital conversion technique with the addition of bidirectional error-correction. In its basic configuration, the 5½-digit 8500A, priced at \$2,395, measures dc voltage on five ranges with resolution up to 1 microvolt. Automatic ranging is under the microprocessor's control.

Ratio measurements are made by measuring the input signal at the front panel and the external reference applied to a rear-panel connec-

tor, then calculating the ratio. This eliminates some of the inaccuracies of standard ratio circuits, which substitute the external reference for the voltmeter's internal analog-to-digital-converter reference.

Beyond the basic instrument, a large number of options can be added to tailor the 8500A to many applications. Either of two plug-ins may be chosen for ac-voltage measurements. The averaging converter (option 01), priced at \$450, handles up to 1,000 v on four ranges, with a bandwidth from 10 hertz to 300 kilohertz. Accuracies within $\pm(0.1\% + 15 \text{ digits})$ and resolution up to $10 \mu\text{V}$ are obtainable.

The true-rms converter (option 09), priced at \$475, offers similar specifications. A current module (option 03), priced at \$395, adds current-measurement capability for both dc and, when an ac voltage option is installed, ac signals. Readings on five ranges from 100 microamperes to 1 ampere can be made. Accuracies are within $\pm(0.03\% + 10 \text{ digits})$ with a source impedance of 2 kilohms on dc, within $\pm(0.06\% + 8 \text{ digits})$ on ac.

The resistance-measurement op-

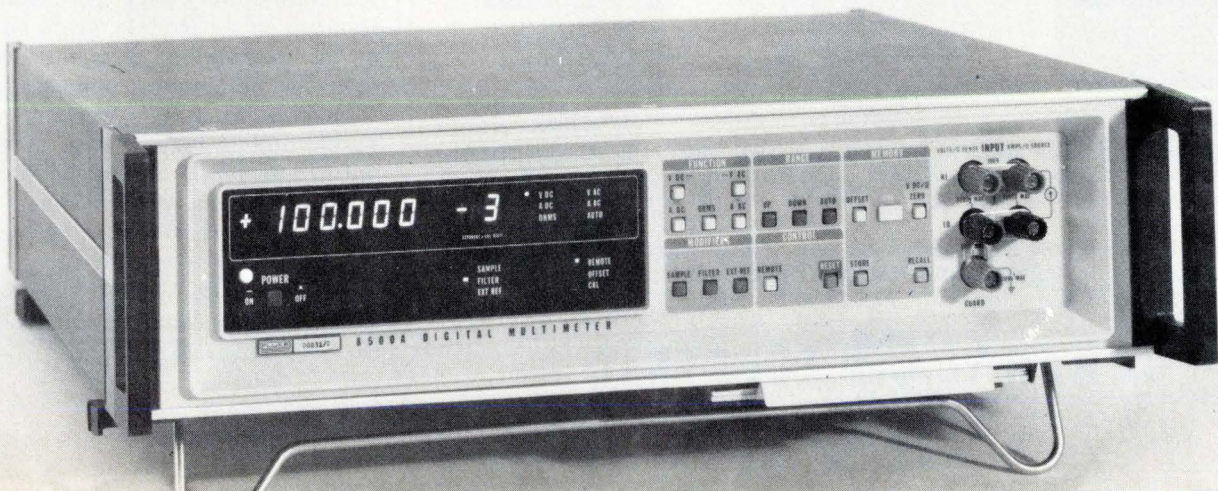

Stay current with small lamp data from General Electric. It's free.

**Check these 6 halogen cycle lamps
GE has added to its low-voltage line.**

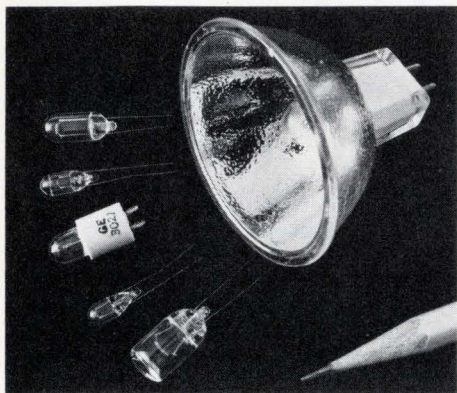

General Electric now offers over 27 halogen cycle lamps that pack high light output in small packages. (In addition, GE offers 8 sealed beam halogen lamps primarily for aircraft applications.) Bulb diameters range from $\frac{3}{8}$ " to $\frac{1}{2}$ ". Lengths from .520" to 2.25". Voltages from 3.5 to 28. O.V. And candlepower from 2.15 cd up to 250 cd.

They're ideal for you if you're designing applications such as optical systems, instrumentation, illuminators, fiber optics, card readers, displays and aircraft navigation. A variety of terminals are offered.

For updated technical information circle the number below or write GE for Bulletin #3-5357.

**These GE wedge base miniature lamps offer
you savings in time, money and space.**

These lamps are ideal for applications such as indicators, markers and general illumination where space is at a premium. Their wedge-based construction makes them easy to insert and remove. They don't require bulky, complicated sockets. And because the filament is always positioned the same in relation to the base, you get consistent illumination from lamp to lamp.

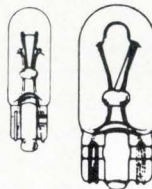

You can choose from over 25 types of GE wedge base lamps. Voltages range from 6.3 V to 28 V. Candlepower from 0.03 to 12 cd. Bulb sizes range from subminiature at 6mm to a heavy-duty bulb at 15mm.

To send for updated wedge base lamp technical information, circle number below or write GE for Bulletin #3-5259.

**These three free GE catalogs include
important data changes that could affect
your present design. Send for yours today.**

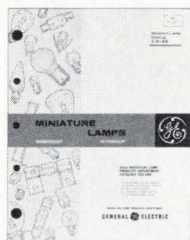

#3-5169

June '75 Miniature lamp catalog features 40 pages and 500 data changes for complete 500-lamp line.



#3-6252R1

Feb. '75 Sub-miniature lamp catalog features 24 pages and 91 changes for more than 210 lamps.

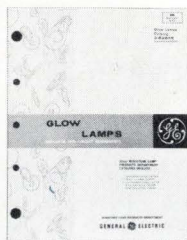

#3-6254R

Dec. '74 Glow Lamp catalog features 8 pages and 50 changes for 83 Glow Lamp Indicator and Circuit Component lamps.

For up-to-date technical information on any of these items write: General Electric Company, Miniature Lamp Products Department #3382-M, Nela Park, Cleveland, Ohio 44112.

GENERAL  ELECTRIC

New products

tion, priced at \$395, offers four-terminal measurements on eight ranges from 10 ohms to 100 megohms.

System options also include measurement isolation, costing \$295, which replaces the jumper printed-circuit board that connects the 8500A's internal analog and digital buses. The module isolates analog signal processing and conversion from digital processing, control, display, and input/output.

The measurement-isolation option is required when any of three available interface options are chosen. The \$395 parallel-interface module, option 07, is a 16-bit duplex register interface that is compatible with many minicomputer systems. The \$295 bit-serial asynchronous interface module, option 06, interfaces the 8500A to systems using either RS232B, RS232C, or current-loop interfaces.

The third interface option, priced at \$450, makes the 8500A compatible with IEEE standard 488 systems. Only one of the three interface options can be installed at one time, but any one can be exchanged when the top cover is removed.

With the \$395 calibration memory installed, correction factors for each range point are derived from a standard input during calibration-mode operations and are stored in a battery-powered nonvolatile memory. This allows the operator to remove power from the instrument, or the system can suffer a power failure, without the loss of automatic-calibration factors.

Power for the memory is supplied by either of two selectable battery packs. The rechargeable nickel-cadmium battery pack, permanently installed on the module, keeps power on the memory to retain the stored data for 30 days at temperatures from 0°C to 30°C. A nonrechargeable lithium-battery pack may be selected to retain the memory contents in excess of five years at temperatures that may range from 0°C to 50°C.

John Fluke Mfg. Co. Inc., P.O. Box 43210, Mountlake Terrace, Wash. 98043. Telephone (206) 774-2211 [338]

What You Need Is What You Get.

Ramtek's new RM9000 modular graphics and imagery system gives you expandability, economy and flexibility.

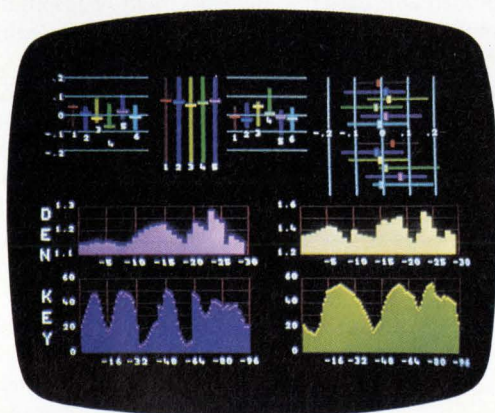

Process Control: Color printing press.



Medical Imaging: Nuclear heart study.

Select The Performance You Need.

The RM9000's total modularity lets you select the exact performance you need to fill your particular application. You pay only for the performance you need. Nothing more. And that's like money in the bank.

Add On As You Have To.

As your needs change and grow, the RM9000's capability will grow right along with them. A comprehensive list of options such as expansion from black and white to grey scale or color—even a complete range of interactive peripherals and additional independent channels.

Microprocessor-Controlled Raster Scan.

The RM9000 is the first raster scan graphics and imagery system to be totally microprocessor

controlled. That means you can implement a higher-order user language to minimize programming costs without a sacrifice in system throughput.

Functional. Reliable. Maintainable.

High reliability is the direct result of intensive testing of components and systems prior to shipment. Solid state components and printed circuit construction are used exclusively. Result? No special preventive maintenance measures are required. In fact, the RM9000 can be pre-programmed with self-diagnostic capability.

You Need To Know More.

To fully appreciate the RM9000's capability, you need more details. Call or write Ramtek Corporation, 585 N. Mary Ave., Sunnyvale, CA 94086. (408) 735-8400.

Our Experience Shows

CB spawns novel switch designs

Squared-off 40-position binary-output rotary units depart from traditional approach of multiple ganged decks

by Larry Armstrong, Midwest bureau manager

Now that the Federal Communications Commission has approved an expansion of the citizens' band radio service to 40 channels, CB-equipment manufacturers are scrambling to find indexing channel-select switches that can handle the expansion without increasing the size of the set. Several switch suppliers have arrived more or less independently at similar solutions: they've scrapped the traditional multiple-wafer rotary switch and opted for a new rotary design that's derived from the thumb-wheel switch.

Instead of using rotating wipers on

stationary printed-circuit boards, most makers connect a disk-shaped printed-circuit card to the switch's shaft. The board is etched and plated with concentric rings of metal—rings that determine the switching pattern as the board rotates past stationary wipers mounted in the switch housing.

With estimates of domestic CB radio production running as high as 3 million units in the U.S. next year, and perhaps another 18 million to be built in Japan, the CB industry will probably sop up as many switches as the components firms can turn out.

The switches are also suitable for other communications applications, as well as for uses in test and measurement equipment, computer peripherals, office equipment, and vending machines.

But it's the lucrative CB market that has lured a handful of new entrants. In addition to Oak Industries' Switch division, the major U.S. supplier of rotary switches for CB radios, and Standard Grigsby Inc., another traditional supplier, newcomers AMP Inc., Cherry Electrical Products Corp., and Digitran Co. are developing new channel-select switches. And Alps Electric Co., the major supplier of rotaries to Japanese CB firms, has designed its own version to become available in the U.S. through Chicago-based Kanematsu-Gosho USA Inc.

After a few months of grappling, the U.S. suppliers have standardized on a package that measures roughly 1½ inches square by ½ to 1½ in. deep. All have pc terminals coming out of the bottom, and all except Standard Grigsby's have the same

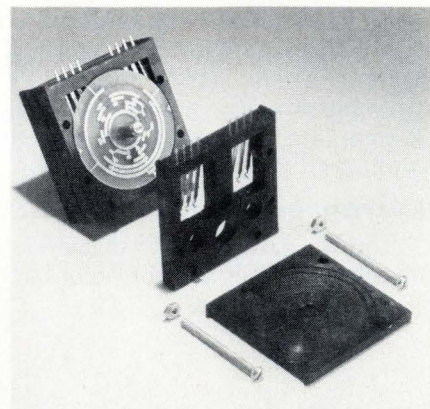
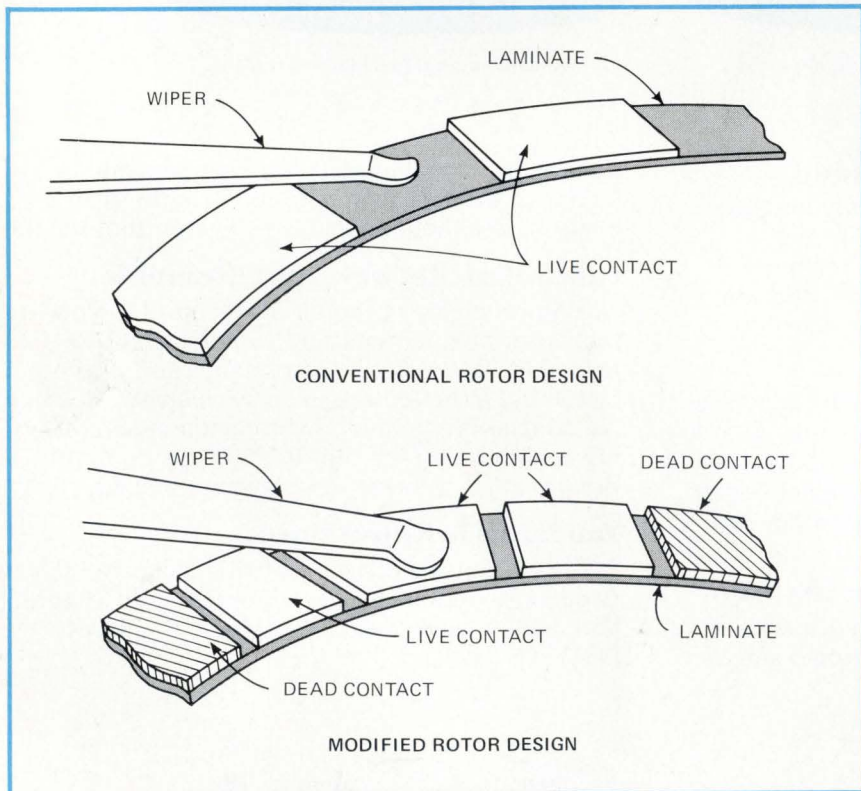

Square rotaries. New breed of rotary switches for CB radio are square, like the one at right from AMP. Internal designs differ, however. For example, most suppliers are using conventional rotor design, while both Oak and Cherry have a modified live/dead-contact version.

TEAMWORK.

P&B pro teamwork keeps your control assembly costs down...simplifies 'make or buy' decisions.

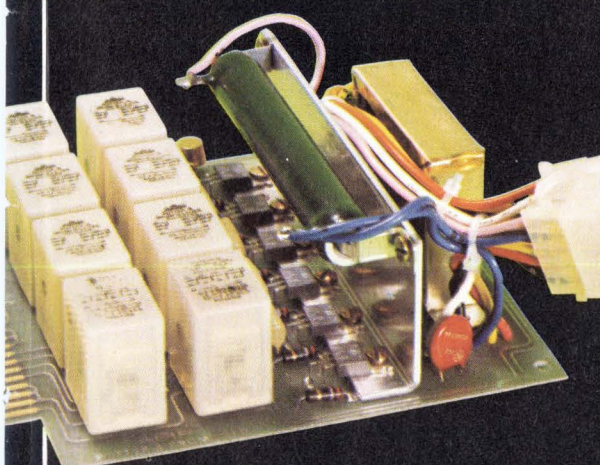
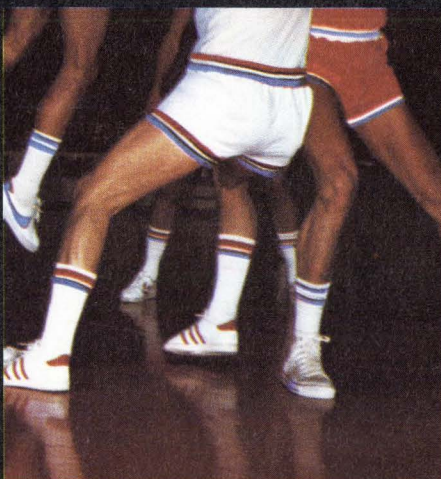
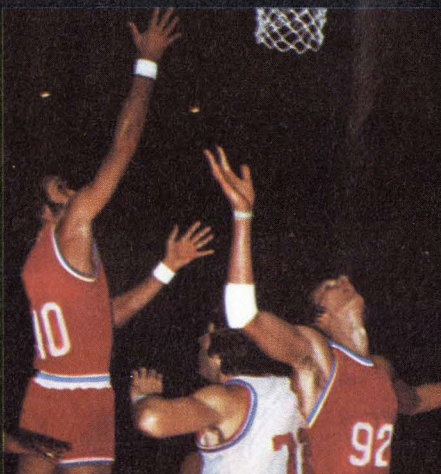

If your equipment requires a control assembly, compare a quote from us with the investment you'll make for in-house production.

Chances are, the bottom line will convince you to go with the P&B Pro Team. We're set up to do the complete job for you. Specialized production equipment and assembly tools. Test equipment. Skilled personnel. Floor space. Engineering help. All the major investments you won't have to make.

And we'll deliver your assemblies to your pre-determined schedule, 100% functionally tested.

For complete information on control assemblies, see your Potter & Brumfield sales representative or contact Potter & Brumfield Division AMF Inc., Princeton, Indiana 47671. Telephone: 812-385-5251

European address: Electrical Products Group, AMF International Limited, AMF House, Whitby Road, Bristol BS4 4AZ, England. Telephone: (0272) 778383. Telex: 449481, AMMAFOCO, BRISTL.

Go with the Pros and you can't go wrong.



They're good...no matter how bad

TW MEETS MIL-S-89731. OFFERS SWITCHING VERSATILITY OF LARGER TOGGLES WITH ADVANTAGE OF SMALL SIZE, PANEL SEALING. IDEAL FOR APPLICATIONS LIKE ON/OFF SWITCH IN THIS MANPACK EQUIPMENT.

SERIES 1 ROUND LIGHTED PUSHBUTTONS OFFER FLUSH MOUNTING, PANEL SEALING AND VERSATILE SWITCH CIRCUITRY; INCLUDING SOLID STATE. MIL SPEC QUALITY (MIL-S-22885) AT COMMERCIAL PRICES FOR CONTROL CONSOLES.

DS SERIES PUSHBUTTONS. COMPACT .75 INCH SQUARE DESIGN OFFERS PLUG-IN DESIGN AND 4 LAMP DISPLAY. RFI ATTENUATION. MIL-S-22885.

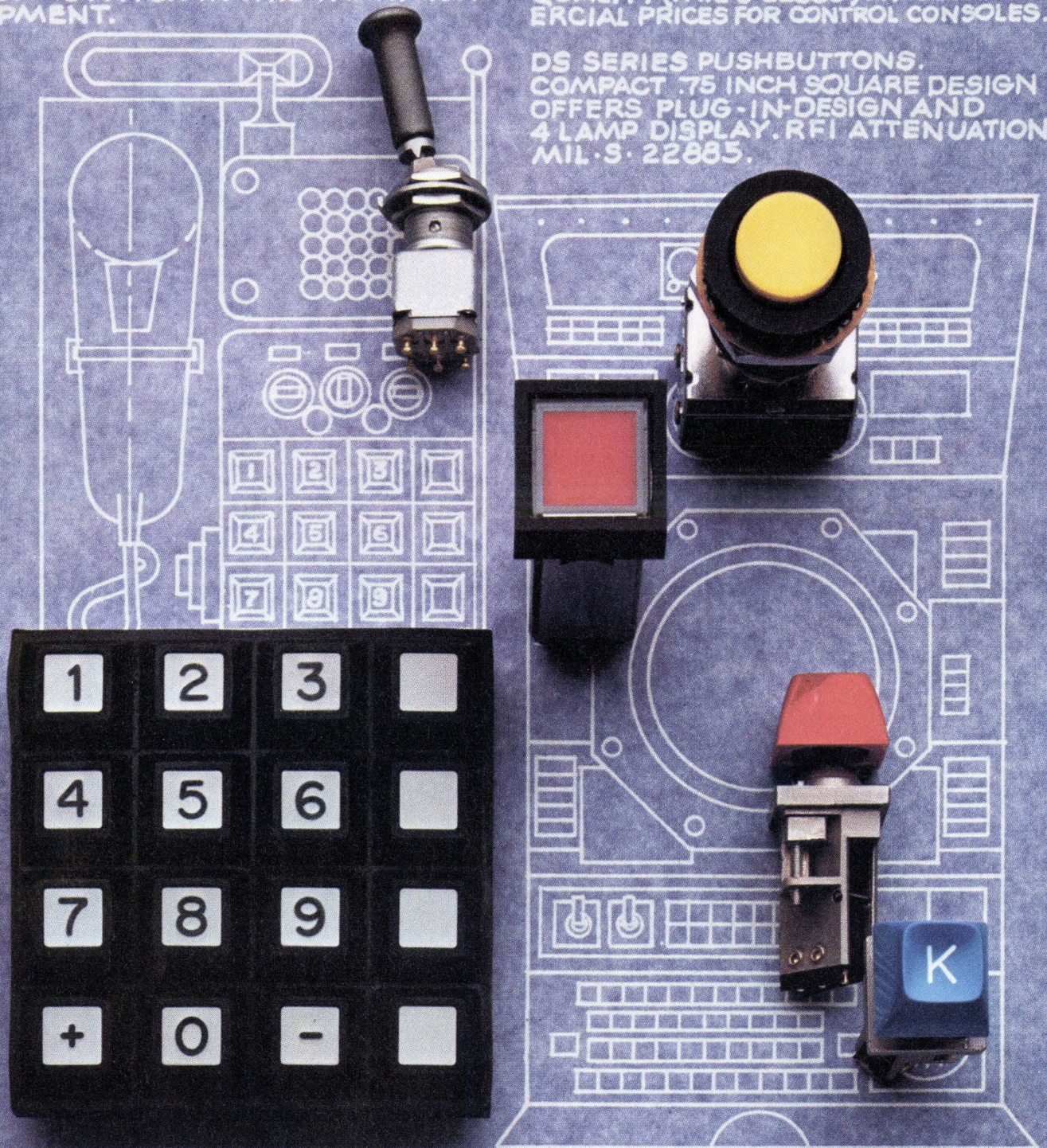

PX KEYBOARDS. TOTALLY SEALED WHEN MOUNTED, WITH ZERO DEPTH BEHIND PANEL, PX IS A NATURAL CHOICE FOR MANPACK EQUIPMENT SWITCH MATRICES.

PANEL SEALED KS KEY SWITCHES. USE OF SPDT SNAP-ACTION SWITCHES (MIL-S-8805) AND FRONT-OF-PANEL REPLACEMENT, MAKE KS IDEAL FOR RUGGEDIZED CONTROL PANEL KEYBOARD APPLICATIONS.

Things get.

The five switches you see here have all been designed to operate reliably under extremely rugged environmental conditions. Exactly the kinds of environments where Command, Communications & Control Systems are required to work.

But if these switches aren't exactly what you need, you're not out of luck.

Because they're only a sampling of literally thousands of MICRO SWITCH listings available to fill your needs. Including toggle switches. Lighted pushbuttons. Unlighted pushbuttons. Key switches. Sealed keyboards. Plus hermetically and environmentally sealed limit, proximity and basic switches.

All of them available almost anywhere in the world, through over 500 MICRO SWITCH Authorized Distributors and Branch Offices.

And if that still isn't enough, our Application Engineers will work with you to modify an existing MICRO SWITCH product to your needs. Or come up with a new one, through our field and factory engineering staff.

If you'd like more information on the devices you see here, or more information on how we can help, write or call your nearest MICRO SWITCH Branch Office or Authorized Distributor.

MICRO SWITCH

FREEPORT, ILLINOIS 61032

A DIVISION OF HONEYWELL

MICRO SWITCH products are available worldwide through Honeywell International.

Circle 213 for Data

122 for Salesman Call

New products

footprint: eight pins per row on 100-mil centers, with rows spaced 200 mils apart. Because the Standard Grigsby P/rel switch is held together with T-struts instead of strut screws, "we can squeeze in two more terminals, and make our disks larger," says Roy Slavin, president. The firm also went to the different footprint to increase reliability: the farther away from the shaft the switching circuitry is, the less critical becomes the alignment between wiper and pc-board metalization, Slavin says.

And the switches have to be reliable. Most CB makers agree that the channel expansion will mean a wholesale change-over from multiple-crystal sets to digitally synthesized transmit and receive channel frequencies from a single reference crystal. The switch generates the binary-coded-decimal number that commands the synthesizer.

The channel expansion will also increase the use of light-emitting-diode channel displays, and since the new rotaries are modular, a second deck can easily be added to drive a pair of seven-segment displays. Cherry, in fact, in addition to its standard Rotocode, is building a custom version (see photo above) that contains a rotating pc board to drive the synthesizer, plus a stationary board with rotating wipers to drive the LEDs and associated components, and an extra pair of pins to bring in the LED-drive voltage. "We can build the whole front end on that board if we're asked," comments Vincent Maida, marketing manager for new products.

Instead of the other suppliers' rotating boards, Digitran uses two fixed, double-sided boards with plated-through-holes—one for the frequency-switching code and one for the LED output. Sandwiched between the two is a notched detent wheel that also carries the wipers.

Contact ratings on all the switches are about 0.125 ampere at 24 or 28 volts dc. Cherry and Digitran use a selective gold plate on contacts and boards; Alps, Oak, and Standard Grigsby use silver; AMP plates bright tin over nickel on the copper contacts and uses electroless nickel

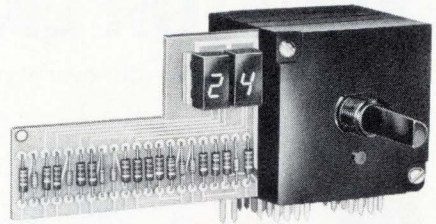

on the rotating boards. Oak and Cherry etch and plate both "on" and "off" areas of the boards—the "off" pads are isolated from the electrical circuit. "The contacts never touch the laminate," says Mike Hassett, Oak marketing vice president. "Precious metal isn't wiped back onto the metal conductors, and the edges of the pads give the switch a self-wiping action."

The other firms etch and plate only the electrical circuits. "We find that filling in the spaces with dead pads is more hazardous," explains Kenneth E. Gookin, product marketing manager at AMP. "The wiper has to step over twice as many edges, leading to contact wear."

Ready to ship. The detents are all different, but all are the star-wheel (notched-wheel) type. Mechanical life is guaranteed for at least 20,000 complete revolutions, and up to 100,000 in some cases. Oak will start shipping its Communicator Series in production volumes this month, followed by Standard Grigsby in September. Alps has started production, and AMP is in pilot production on its 3500 Series. Cherry and Digitran, which have sold samples, expect volume production to begin late this year.

Prices in 100,000 quantities for a two-deck switch range from \$2.25 (Standard Grigsby) to about \$3 (Oak and AMP).

Alps Electric Co. Ltd., 543 W. Algonquin Rd., Arlington Heights, Ill. 60005 [371]

AMP Inc., Industrial Division, Harrisburg, Pa. 17105 [372]

Cherry Electrical Products Corp., 3600 Sunset Ave., Waukegan, Ill. 60085 [373]

Digitran Co., Division of Becton, Dickinson, and Co., 855 So. Arroyo Parkway, Pasadena, Calif. 91105 [374]

Oak Industries Inc., Switch Division, Crystal Lake, Ill. 60014 [375]

Standard Grigsby Inc., 920 Rathbone Ave., Aurora, Ill. 60507 [376]

Dialight INDICATOR LIGHTS

The widest choice for your every application.

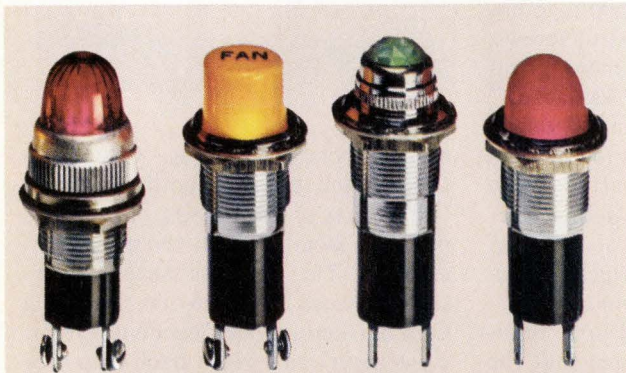

MINIATURE INCANDESCENT OR NEON INDICATORS—1,500,000 varieties to choose from. MIL-L-3661 and UL approved. Red, green, amber, blue, white, yellow or colorless lenses in wide range of shapes, legends, finishes. Stocked by local distributors.

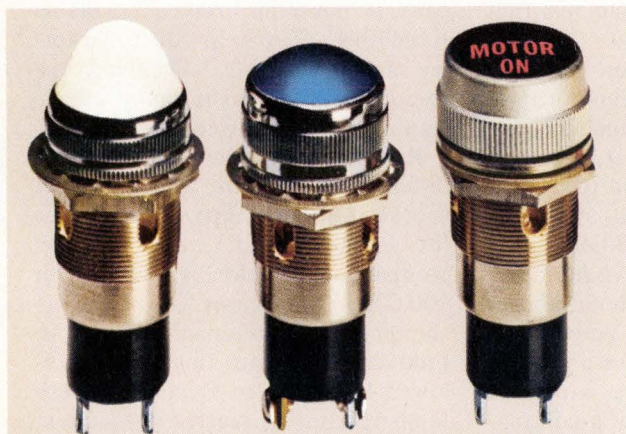

LARGE INCANDESCENT OR NEON INDICATORS—As above, but larger size. Unlimited varieties to choose from. Stocked by local distributors.

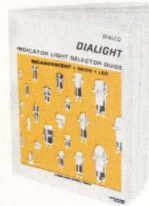

Dialight, the company with the widest choice in switches, LEDs, indicator lights and readouts, looks for needs . . . your needs . . . and then they develop solutions for your every application. No other company offers you one-stop shopping in all these product areas. And no other company has more experience in the visual display field. Dialight helps you do more with these products than any other company in the business, because we are specialists that have done more with them. Talk to the specialists at Dialight first. You won't have to talk to anyone else. Send for your free new copy of Dialight's current catalog.

DIALIGHT

Dialight, A North American Philips Company
203 Harrison Place, Brooklyn, N. Y. 11237
(212) 497-7600

See Dialight.

124 Circle 124 on reader service card

Battery Miniservo® recorder only \$795

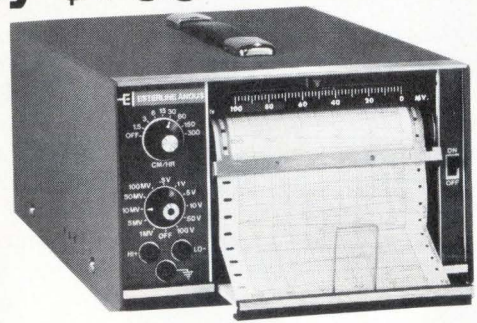

72-hour delivery

For field or remote applications. Input spans are 1, 5, 10, 50, 100, and 500 mVDC and 1, 5, 10, 50, and 100 VDC, with $\pm 100\%$ zero adjust. Eight chart speeds from 6 cm/hr to 20 cm/min. 10 cm wide, Z-fold chart. The rugged Miniservo recorder is powered by internal 12V 8-hour rechargeable battery, or from external battery, or plugged into line power. Replaceable throwaway pen/ink cartridge. For fast delivery, order stock number S22243-1A. Call Larna, 317/244-7611. For more information, write Esterline Angus instrument Corporation, Box 24000, Indianapolis, Indiana 46224.



Circle 187 on reader service card

New! Model 640 Low Cost* Loader Reads 350 Characters per Second

All solid state photo-electronic components.
Reads all standard 5,6,7 or 8 level tapes.
Smooth, quiet, AC drive.

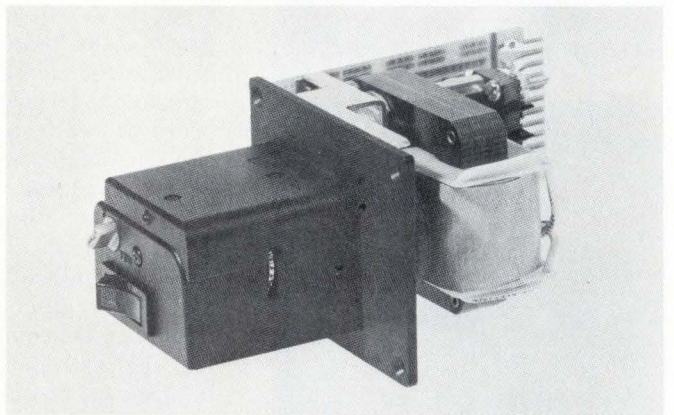

Provides reliable, high speed data entry. Data amplifiers and "character ready" output available for CMOS or TTL interfaces. Fanfold box available.

The Model 640 is the newest addition to the Addmaster line of quality paper tape equipment.

*only \$151! (1-49 units; substantial quantity discounts available.

Addmaster Corporation, 416 Junipero Serra Drive, San Gabriel, California 91776. Telephone: (213) 285-1121.

Circle 188 on reader service card

Multimeter/counter rides on scope

Instrument can be added to Tektronix oscilloscopes including the new 250-megahertz-bandwidth model

by Bernard Cole, San Francisco bureau manager

A current thrust among instrument makers is incorporation of microprocessors to perform calculations and enhance performance. Going counter to this trend, Tektronix is introducing a multimeter/counter "piggyback" option on many of its portable oscilloscopes, including the new model 475A. The add-on, called the DM44, does not include a microprocessor, yet it permits a range of functions—including delta delayed sweep—previously available only on microprocessor-equipped scopes.

Also, earlier techniques used to enhance performance have been limited to more expensive portable and lab-type scopes and added about \$1,000 to their cost. They usually employed a microprocessor, digital-to-analog converter, and two comparators. In addition, a relatively large number of controls was required to operate the processor-based scope.

The DM44 is a simpler, less expensive multimeter/counter (\$410 with temperature probe, \$355 without) that can be added to the medium-price portable scope so indispensable to the maintenance and servicing of digital equipment, according to Soren Vestergaard, portable-instrument marketing manager at Tektronix. The DM44 option does not require a microprocessor nor a d-a converter, and it requires only a single comparator. Only two dials are required to control sweeps, rather than a combination of dials, buttons, and switches. The delay time, he says, can be adjusted continuously rather than in incremental steps, increasing precision. The delta delayed sweep and the time interval are displayed as a

negative quantity, an exclusive feature provided by the DM 44.

The new \$3,300 model 475A scope is a good example of how much power the DM44 option adds, says Vestergaard. Essentially a variation of the earlier model 475 portable oscilloscope, it has a greater bandwidth (250 instead of 200 megahertz), and slightly less sensitivity (5.0 instead of 2.0 millivolts per division) as well as a sweep rate of 1 nanosecond per division. The combination of the 475A scope and the DM44 is priced from \$3,635 to \$3,710.

Speeds time measurements. Compared with conventional single delayed-sweep oscilloscopes, a model equipped with the DM44 multimeter/counter makes timing measurements with greater repeatability, speed, ease, and freedom from error, Vestergaard says. To measure a time interval on-screen, the oscilloscope is set for sweep A, intensified by sweep B. Using the oscilloscope's delayed sweep and delay-time controls, the two intensified spots are positioned at the beginning and end of the interval to be measured. At this

point, the time interval is read out on a 3½-digit display on the DM44.

For greater accuracy, says Vestergaard, the oscilloscope is switched to the sweep-B-delayed-by-sweep-A mode, where detailed views of the beginning and end of the time interval are displayed at the same time. Using the delta time control, the end of the interval is superimposed on the beginning to produce a readout of the interval, correct within 1%. By inverting the measured period for waveforms such as clocks, the DM44 also provides frequency measurements.

For still further convenience, the multimeter/counter add-on includes dc voltage measurement that is accurate within 0.1%, resistance measurement that is accurate within 0.25%, and temperature measurement from -55 to +150°C. All these measurements, says Vestergaard, are made independently of the oscilloscope, allowing dc-voltage monitoring or component-temperature monitoring simultaneously with associated waveforms.

Tektronix Inc., P.O. Box 500, Beaverton, Ore. 97077 [340]

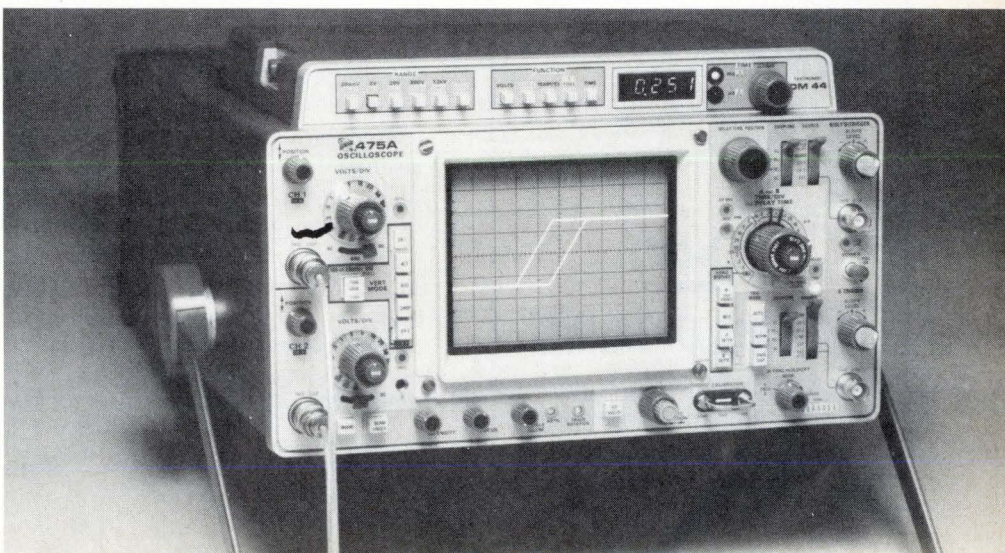

NEW and EXCLUSIVE A/D Converter

features

HIGH SPEED: 4 μ sec.
(220,000 conversions per sec.)

HIGH RESOLUTION: 15 bits

HIGH ACCURACY:
0.0065% of FSR

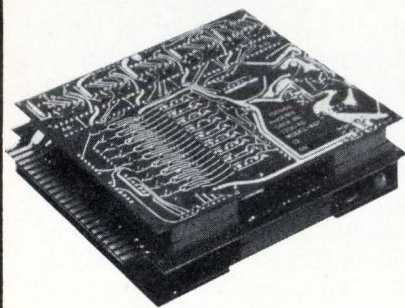

New Model ADC1215F converter from Phoenix Data is available in two basic models: Single-ended and differential.

Phoenix Data's new Model ADC1215F A/D converter has a resolution of 15 binary bits and a total conversion time of 4 microseconds (220,000 conversions per sec). Accuracy of 0.0065% of FSR is **guaranteed** in addition to complete monotonicity. Analog dynamic range is in excess of 86 db.

If it's stability, accuracy, speed, or all-around quality you need in Data Conversion, contact Ron Brunnemer, director of marketing, or the representative in your area.



PHOENIX DATA, INC.

3384 W. Osborn Rd. Phoenix, AZ 85017
Ph. (602) 278-8528, TWX 910-951-1364

New products

Instruments

Multimeter has LCD readout

Display and C-MOS converter hold instrument's power consumption to 300 mW

Because of their low power consumption, liquid-crystal displays are becoming increasingly popular as readouts for portable digital multimeters. Among the latest digital multimeters with an LCD readout is VIZ Manufacturing's model WD-751A.

Priced at \$179, the 751A has a 3½-digit (1,999-count) field-effect liquid-crystal display and uses a complementary-MOS large-scale integrated circuit for analog to digital conversion. Between them, these two components keep power consumption down to 300 milliwatts. A set of four alkaline AA cells provides more than 30 hours of continuous use.

The Seiko liquid-crystal display has black numerals against a gold background to maximize contrast.

In operation, the WD-751A is semi-autoranging. A range-selector switch chooses among three positions, each of which covers two automatically selected ranges.

In ac- or dc-voltage ranges, for example, the first switch position covers 200 or 2,000 millivolts full scale, the second position covers 20 or 200 v full scale, and the third position handles 200 or 1,000 v full scale. Input impedance is 5 megohms in either of the two lower ranges and 10 M Ω in the highest range.

Accuracy is within $\pm(0.3\%$ of reading + 0.1% of full scale + 1 digit) on the lowest ranges, $\pm(0.5\%$ or reading + 0.1% of full scale + 1 digit) on the center ranges, and $\pm(1.5\%$ of reading + 0.1% of full scale + 1 digit) on the 1,000-v dc range. Accuracy is within $\pm(0.8\%$ of reading + 0.7% of full scale + 1 digit) from 40 hertz to 1 khz on the

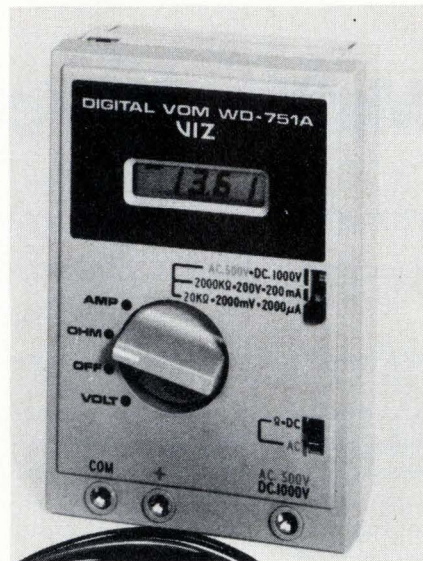

20-v ac range, for example.

Resistance to overload is especially important in voltmeters designed for portable use. On all but the 1,000-v ranges, the WD-751A can withstand up to 500 v dc or ac for up to 1 minute. On resistance ranges, the instrument can withstand up to 200 v dc or 150 v ac for 1 minute, and on current ranges, it can withstand up to 450 milliamperes ac or dc during a maximum of 1 minute on all but the highest range.

VIZ Manufacturing Co., 335 E. Price St., Philadelphia, Pa. 19144 [351]

Dc-coupled DMM measures voltage, current, and power

Capable of making power measurements at dc and at frequencies from 25 hertz to 1.2 kilohertz, the model 2514-16 is a dc-coupled, true-rms digital instrument that can also make individual measurements of dc and ac voltage and current. When measuring only voltage or current, the instrument's frequency range extends to 2 kilohertz.

The instrument's five voltage ranges—30, 60, 100, 150, and 300 v—can be combined with its five current ranges—0.5, 1, 2, 5, and 10 A—to yield power ranges from 15 watts full scale to 3 kilowatts. Maximum error on all ranges is 0.25%. On its most sensitive ranges,

Designing switching regulators?



Here comes help

NEW FERRITE COMPONENTS are designed, specified and tested for storage inductor applications in switching regulators. They're easier to use, smaller, more economical and will improve your regulator performance significantly.

NEW DESIGN DATA makes it easy to use the full range of SWITCHING REGULATOR-RATED™ ferrites. Nomographs relate guaranteed energy storage, temperature rise and inductance for each component to help you select the smallest inductor that meets your design requirements.

DESIGN ASSISTANCE is available to help you apply this new ferrite technology to your products. Please call Application Engineering — (201) 826-5100 or write Indiana General, Keasbey, New Jersey 08832.

EMM indiana general

a division of Electronic Memories & Magnetics Corp.

Keasbey, N.J. 08832 • (201) 826-5100

Circle 127 on reader service card

New products

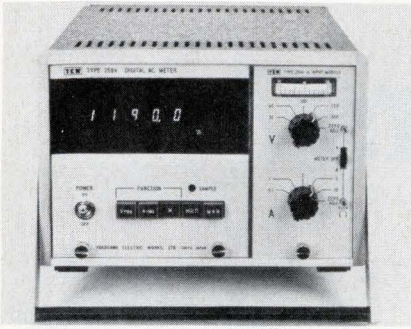

the 2514-16 can resolve 0.01 volt per digit, 0.1 milliamperes per digit, and 0.01 watt per digit.

The meter sells for approximately \$3,300. Its exact price depends upon options such as BCD outputs, programability, etc.

Yokogawa Corp. of America, 5 Westchester Plaza, Elmsford, N.Y. 10523. Phone (914) 592-6767 [353]

Triple-output bench supply has floating outputs

The model MPS 620M power supply is a triple-output bench instrument, but none of its outputs is connected to ground. One output is adjustable from 0 to 6 v dc, and can deliver up to 5 amperes at any voltage setting. The other outputs are a pair of tracking voltages that can be varied from 0 to ± 20 v dc; each output can deliver up to 1 A. The 20-volt outputs can be connected in series to form a 0-to-40-v supply, but they cannot be connected in parallel because they share a common terminal. Line regulation for all outputs is within 0.01%. The 0-to-6-v output also has a load regulation within 0.01% whereas the tracking outputs are regulated to 0.05% or 5 millivolts, whichever is greater. The time



required for the stabilized outputs to recover from a step-load change to within 10 millivolts of the original setting is less than 50 microseconds.

Special features on the 0-to-6-v output include remote error sensing, current limiting, and an adjustable crowbar. The current limiting, which is set to approximately 110% of the maximum rated current, allows the supply to sustain a short circuit indefinitely. The crowbar can be adjusted from 4 to 8v by a screwdriver. The MPS 620M sells for \$475.

Kepeco Inc., 131-38 Sanford Ave., Flushing, N.Y. 11352. Phone Paul Birman at (212) 461-7000 Ext. 742 [354]

1-GHz pulse-generator

system also generates words

An instrument system consisting of a mainframe and six plug-ins may be configured as a 1-gigahertz pulse generator, a 300-megahertz pulse generator, or a 300-MHz generator of 64-bit serial words. The six plug-in modules are a 300-MHz repetition-rate generator, priced at \$795, a

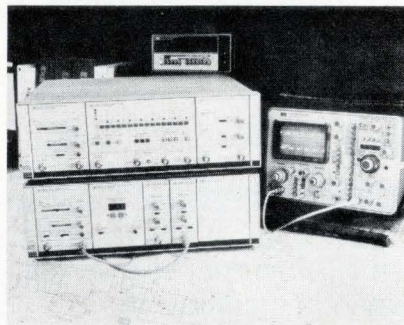

1-GHz rate generator at \$3,145, a 300-MHz output amplifier at \$795, a 1-GHz output amplifier at \$1,585, a word generator at \$2,510, and a combination delay generator/frequency divider at \$2,600. The system mainframe with power supply sells for \$820.

By combining the rep-rate generators with the delay generator/frequency divider and appropriate amplifiers, various single- and dual-channel pulsers can be configured. It should be pointed out that the incredible speed of the 1-GHz unit is

Texas Instruments 4K RAM Distributors

ALABAMA: Huntsville, Hall-Mark Electronics, (205) 837-8700.
ARIZONA: Phoenix, Cramer/Arizona, (602) 263-1112, Kierulff Electronics, (602) 273-7331, R. V. Weatherford Co., (602) 272-7144.
CALIFORNIA: Anaheim, R. V. Weatherford Co., (714) 633-9633, El Segundo, TI Supply Company, (213) 973-2571, Glendale, R. V. Weatherford Co., (213) 849-3451, Goleta, Radio Product Sales, Inc., (805) 964-6823, Inglewood, Time Electronics, (213) 649-6900, Irvine, Cramer/Los Angeles, (714) 979-3000, (213) 771-8300, Los Angeles, Kierulff Electronics, (213) 665-5511, Radio Product Sales, Inc., (213) 748-1271, Mountain View, Time Electronics, (415) 965-8000, Palo Alto, Kierulff Electronics, (415) 968-6292, R. V. Weatherford Co., (415) 493-5373, Pomona, R. V. Weatherford Co., (714) 623-1261, San Diego, Cramer/San Diego, (714) 565-1881, Kierulff Electronics, (714) 278-2112, Radio Product Sales, Inc., (714) 292-5611, R. V. Weatherford Co., (714) 278-7400, Sunnyvale, Cramer/San Francisco, (408) 739-3011, TI Supply Co., (408) 732-5555, Woodland Hills, Semiconductor Concepts, (213) 884-4560, **COLORADO:** Denver, Cramer/Denver, (303) 758-2100, Kierulff Electronics, (303) 371-6500, Englewood, R. V. Weatherford Co., (303) 761-5432, **CONNECTICUT:** Hamden, Arrow Electronics, (203) 248-3801, North Haven, Cramer/Connecticut, (203) 239-5641, Orange, Milgray/Connecticut, (203) 795-0714, **FLORIDA:** Ft. Lauderdale, Arrow Electronics, (305) 776-7790, Hall-Mark Electronics, (305) 971-9280, Hollywood, Cramer/Hollywood, (305) 923-8181, Orlando, Cramer/Orlando, (305) 894-1511, Hall-Mark Electronics, (305) 855-4020, Winter Park, Milgray Electronics, (305) 847-5747, **GEORGIA:** Atlanta, Cramer/Atlanta, (404) 448-9050, **ILLINOIS:** Arlington Heights, TI Supply Company, (312) 593-7660, Chicago, Newark Electronics Corp., (312) 638-4411, Semiconductor Specialists, (312) 279-1000, Mt. Prospect, Cramer/Chicago, (312) 593-8230, **INDIANA:** Indianapolis, Graham Electronics, (317) 634-8202, **IOWA:** Cedar Rapids, Deeco Incorporated, (319) 365-7551, **MASSACHUSETTS:** Billerica, Kierulff Electronics, (617) 667-8331, Newton, Cramer/Newton, (617) 969-7700, Waltham, TI Supply Company, (617) 890-0510, Woburn, Arrow Electronics, (617) 933-8130, **MARYLAND:** Baltimore, Arrow Electronics, (202) 737-1700, Columbia, Technico Incorporated, (301) 461-2200, Gaithersburg, Cramer/Washington, (301) 948-0110, Kierulff Electronics, (301) 948-0250, Hyattsville, Milgray/Washington, (301) 864-1111, **MICHIGAN:** Detroit, Newark Electronics Corp., (313) 967-0600, Wyoming, Newark Electronics Corp., (616) 241-6681, **MINNESOTA:** Bloomington, Arrow Electronics, (612) 888-5522, Edina, Cramer/Minnesota, (612) 835-7811, Minneapolis, Semiconductor Specialists, (612) 854-8841, **MISSOURI:** Kansas City, LCOMP-Kansas City, Inc., (816) 221-2400, Semiconductor Specialists, (816) 452-3900, Hazelwood, Semiconductor Specialists, (314) 731-2400, St. Louis, LCOMP-St. Louis, Inc., (314) 647-5505, **NEW JERSEY:** Camden, General Radio Supply Co., (609) 964-8560, Cherry Hill, Cramer/Pennsylvania, (215) 923-5950, (609) 424-5993, Milgray/Delaware Valley, (609) 424-1300, (215) 228-2000, Clark, TI Supply Company, (201) 382-6400, Moonachie, Cramer/New Jersey, (201) 935-5600, Moorestown, Arrow Electronics, (609) 235-1900, Rutherford, Kierulff Electronics, (201) 935-2120, Saddlebrook, Arrow Electronics, (201) 797-5800, **NEW MEXICO:** Albuquerque, Cramer/New Mexico, (505) 265-5767, R. V. Weatherford Co., (505) 842-0863, **NEW YORK:** East Syracuse, Cramer/Syracuse, (315) 437-6671, Farmingdale, Arrow Electronics, (516) 694-6800, Fishkill, Arrow Electronics, (914) 896-7530, Freeport, Milgray Electronics, (516) 546-6000, (201) 432-4300, Hauppauge, Cramer/Long Island, (516) 231-5600, Semiconductor Concepts, (516) 273-1234, Rochester, Cramer/Rochester, (716) 275-0300, Rochester Radio Supply Co., (716) 454-7800, **NORTH CAROLINA:** Raleigh, Hall-Mark Electronics, (919) 832-4455, Winston-Salem, Cramer/Winston-Salem, (919) 725-8711, **OHIO:** Cleveland, Arrow Electronics, (216) 464-2000, Cramer/Cleveland, (216) 248-8400, Dayton, ESCO Electronics, (513) 226-1133, Kettering, Arrow Electronics, (513) 253-9176, **OKLAHOMA:** Tulsa, TI Supply Company, (918) 437-4555, **OREGON:** Portland, Almac/Stroum Electronics, (503) 292-3534, **TEXAS:** Dallas, TI Supply Company, (214) 238-6830, Houston, Harrison Equipment Co., (713) 652-4700, TI Supply Company, (713) 777-6011, R. V. Weatherford Co., (713) 688-7406, **UTAH:** Salt Lake City, Standard Supply Company, (801) 355-2971, **WASHINGTON:** Seattle, Almac/Stroum Electronics, (206) 763-2300, Kierulff Electronics, (206) 763-1550, **WISCONSIN:** New Berlin, Arrow Electronics, (414) 782-2801, Wauwatosa, Semiconductor Specialists, (414) 257-1330, **CANADA:** Calgary, Canadian Electronics LTD, (403) 287-1800, Downsview, CESCO Electronics LTD, (416) 661-0220, Cramer/Canada, (416) 661-9222, Edmonton, Canadian Electronics LTD, (403) 452-9393, Montreal, CESCO Electronics LTD, (514) 735-5511, Future Electronics, (514) 735-5775, Zentronics LTD, (514) 735-5361, Ottawa, CESCO Electronics LTD, (613) 729-5118, Future Electronics, (613) 232-7757, Zentronics LTD, (613) 238-6411, Quebec City, CESCO Electronics LTD, (418) 524-4641, Rexdale, Future Electronics, (416) 677-7820, Toronto, Zentronics LTD, (416) 789-5111, (416) 787-1271, Vancouver, Canadian Electronics LTD, (604) 324-7911, Future Electronics, (604) 261-1335, Winnipeg, Canadian Electronics LTD, (204) 947-1321.

TEXAS INSTRUMENTS
INCORPORATED

Is Your Memory Design Static?

Make Your Designs Dynamic.

Texas Instruments TTL Compatible 4K RAMs Make It Easy...

HERE'S WHY DYNAMIC DESIGNERS USE TI 4K RAMs.

36% Less Operating Power

Compare 1K low-power static RAMs with TI's TMS 4051 4K dynamic RAM. The table refers to maximum—not typical—values to provide a realistic comparison.

40% Less Standby Power

Low standby power is inherent in the 4K dynamic RAM operation—while static RAMs require extra circuitry to reduce V_{cc} to a low level.

Fully TTL Compatible

The TMS 4051 inputs and output (including clock) interface directly with TTL.

Fast Access Time

TI's 4K dynamic RAMs are fast. The TMS 4051-1 (with TTL clock) has a maximum access time of 250 ns, the

Parameter	Four 1K Static RAMs (2102 AL-2)	One 4K Dynamic RAM (TMS 4051-1)
Power (max.) operating	1368 mW	882 mW
standby	168 mW	101 mW
Access (max.)	250 ns	250 ns
Board area ratio	3.6	1.0
Fully TTL compatible	yes	yes
100 Pc prices	\$20.00	\$12.26

Based on published data

same as the 2102AL-2.

80% Less Board Area

You get almost four times the memory density by switching to TI 18-pin 4K RAMs. The reason? TI's compact 18-pin 300-mil-wide package—available in either plastic or ceramic.

Lower Cost

TI's 4K dynamic RAM offers significant system cost savings even when including the additional simple circuitry for refresh.

Simple Refresh

It's easy! Just 4-8 TTL packages per memory system are typically needed. To see how easy refresh can be, send for our Application Note.

Easy to Use

TI's 18-pin 4K RAMs feature simple 12-line non-multiplexed address and a single non-critical clock. Data input and output are multiplexed—ideal for use with microprocessor-based systems.

Applications Help

For your copy of the 4K dynamic RAM Application Note covering simple refresh, contact: Texas Instruments, M/S 669-4K, P.O. Box 1443, Houston, Texas 77001.



TEXAS INSTRUMENTS
INCORPORATED

New products

even more costly than appears at first because the 300-MHz output amplifier is a dual-channel unit, whereas the 1-GHz amplifier is a single-channel device. The transition time of the 1-GHz amplifier, however, is less than 300 picoseconds.

The word generator, driven by the 300-MHz rep-rate generator, can put

out words 16, 32, and 64 bits long at rates from 10 Hz to 300 MHz. The format may be return-to-zero or nonreturn-to-zero, and the sequence can be automatic, single, or gated.

Delivery estimates for the 8080A family are six to nine weeks
Hewlett-Packard Co., 1501 Page Mill Rd., Palo Alto, Calif. 94304 [355]

Three-axis display includes 32 kilobytes of memory

A three-axis display system, the model 7200B, accepts analog or digital inputs, digitizes the analog ones, and stores them in its 32-kilobyte memory for processing and display. Developed originally for government spectrum-surveillance applications, the display, if connected to a suitable receiver or spectrum analyzer, can show how the spectral composition of a signal varies over time. The photo, for example, is a three-axis view of the 10-megahertz signal transmitted by wvv. Frequency-selective fading of the carrier and sidebands is obvious in the 16.8-second time span shown. The width of the frequency axis in the photo is 2 kilohertz, and the amplitude (vertical) calibration is 30 decibels per centimeter.

But the third axis of the system



need not be time. The instrument may be used, for example, to display some property of a silicon wafer as a function of position on the wafer surface. Other potential applications include voice prints and medical equipment such as that used in computerized axial tomography.

The unit, including 32 kilobytes of memory, a high-resolution cathode-ray tube display, and a 64-line scanner, is priced at \$38,000. Options include up to 64 kilobytes of memory, a bigger CRT, and up to 128 scan lines. The unit, of rack width, is 7 inches high and 21 in. deep. It weighs 56 pounds.

Emtel, Division of Develco, 404 Tasman Dr., Sunnyvale, Calif. 94086. Phone (408) 734-5720 [356]

BAUSCH & LOMB

StereoZoom® 5

microscope

Meet the new MORE and LESS microscope

MORE in optics . . .
MORE in mechanics . . .
LESS in price.

This new StereoZoom 5 completes the royal family of world-leading Bausch & Lomb Stereomicroscopes. Fills a need in electronics for a middle zoom range of 0.8X-4.0X (5:1 ratio) for bonders, welders, assembly, and quality control.

More in optics. Higher resolution . . . 200 lines/mm at 4X. Better color correction. Less distortion. Flatter fields . . . no refocusing to see detail at edge of wide field. Zooming is fast with image continuously in focus through full range, while maintaining full working distance of 4". Workers see more, faster, easier, more accurately.

More in mechanics. Tighter precision tolerances for better alignment, smoother operation. Eye-pieces can be locked in to prevent theft or tampering, but are still rotatable. StereoZoom 5 is directly interchangeable with other Bausch & Lomb pods, and can be used with many of the existing StereoZoom modules and accessories. Attractive new modern styling and professional black and white finish.

Less in price. Priced lower than other stereomicroscopes with equivalent features.

More . . . There's more to the new StereoZoom 5 story. Discover this exciting new instrument by arranging for a free, no-obligation demonstration. Catalog 31-2436 is also just for the asking.

Bausch & Lomb, Scientific Optical Products Division, 30408 N. Goodman St., Rochester, N.Y. 14602
In Canada: Bausch & Lomb, Scientific Optical Products Division, 2001 Leslie St., Don Mills, Ont. M3B 2M3

IF YOU'RE NOT DESIGNING WITH A CSC PROTO-BOARD, LOOK AT ALL YOU'RE MISSING.

Utility—Models are available with or without built-in regulated power supplies (fixed or adjustable).

Economy—Eliminate heat and mechanical damage to expensive parts. Save money by re-using components.

Versatility—Use with virtually all types of parts, including resistors, capacitors, transistors, DIP's, TO-5's, LED's, transformers, relays, pots, etc. Most plug in directly, in seconds.

Durability—All Proto-Board models are carefully constructed of premium materials, designed and tested for long, trouble-free service.

Expandability—Proto-Board units can be instantly interconnected for greater capacity.

Visibility—All parts are instantly and easily visible, for quick circuit analysis and diagramming.

Speed—Assemble, test and modify circuits as fast as you can push in or pull out a lead. Save hours on every project.

Adaptability—Use in design, packaging, inspection, QC, etc. Works with most types of circuits, in many, many applications.

Flexibility—Use independently, or in conjunction with other accessories, such as scopes, counters, CSC Proto-Clip™ test connectors, Design Mate™ test equipment, etc. One Proto-Board unit can serve a thousand applications.

Accessibility—All parts are instantly and easily accessible, for quick signal tracing, circuit modifications, etc.

Variety—A wide variety of models are available with capacities ranging from 630 to 3060 solderless tie-points (6 to 32 14-pin DIP's), to fit every technical and budget requirement.



Whatever type of electronic circuits you work with, you can do more in less time with CSC's solderless Proto-Board systems. As fast and easy as pushing in or pulling out a lead, you can design, test and modify circuits at will. Components plug into rugged 5-point terminals, and jumpers, where needed, are lengths of #22 AWG solid wire. In the same time you took to read this ad, you could be well on your way to assembling a new circuit. For more information, see your CSC dealer, or write for our catalog and distributor list.

CSC PROTO-BOARD SOLDERLESS BREADBOARDS

MODEL NUMBER	NO. OF SOLDERLESS TIE-POINTS	IC CAPACITY (14-PIN DIP'S)	MANUFACTURER'S SUGG LIST	OTHER FEATURES
PB-6	630	6	\$15.95	Kit—10-minute assembly
PB-100	760	10	19.95	Kit—with larger capacity
PB-101	940	10	29.95	8 distribution buses, higher capacity
PB-102	1240	12	39.95	Large capacity, moderate price
PB-103	2250	24	59.95	Even larger capacity; only 2.7¢ per tie-point
PB-104	3060	32	79.95	Largest capacity; lowest price per tie-point
PB-203	2250	24	75.00	Built-in 1%-regulated 5V, 1A low-ripple power supply
PB-203A	2250	24	120.00	As above plus separate ½-amp +15V and -15V internally adjustable regulated power supplies

CONTINENTAL SPECIALTIES CORPORATION

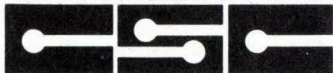

EASY DOES IT

44 Kendall Street, Box 1942
New Haven, CT 06509 • 203-624-3103 TWX: 710-465-1227
West Coast office: Box 7809, San Francisco, CA
94119 • 415-421-8872 TWX: 910-372-7992
Canada: Len Finkler Ltd., Ontario

© 1976 Continental Specialties Corp.
Prices and specifications subject to change without notice.

NOW AVAILABLE!

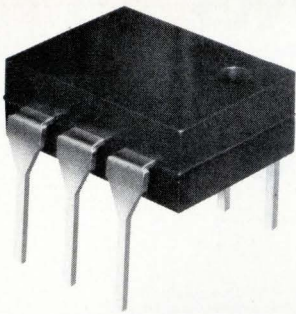

**5KV OPTICAL ISOLATORS
IN 6-PIN DIPS**

Industry's first 5KV isolators to be offered in the popular 6-pin dual in-line package are available now! They are directly interchangeable with standard industrial 6-pin isolators... **UL approved**... **No. E58979**. Circle R.S. NO. 220

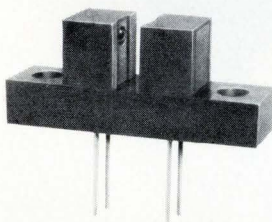

**STANDARD
OPTICAL SWITCHES**

Six, low-cost off-the-shelf optical switches are available as direct replacements for such popular devices as the H13A1, A2; H13B1, B2; MCA 8, 81 and MCT 8, 81. Both phototransistor and photodarlington versions are available from factory stocks. Circle R.S. NO. 221

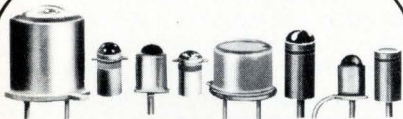

**LOW-COST
PHOTODETECTORS
& LEDs**

Spectronics provides industry's largest selection of standard off-the-shelf detectors and LEDs. Direct replacements for such popular industrial types as: LED55CF, BF, B, C; SSL315, 15, 35; TIL31, 81, 23, 24; and TIL601-616 Series. Call today for prices and deliveries. Circle R.S. NO. 222

Call Spectronics for everything you need in opto.
We make optoelectronics work... for you!



Spectronics
INCORPORATED

830 E. Arapaho, Rd.
Richardson, Texas 75080
(214) 234-4271

WESCON BOOTH No.1055

New products

Semiconductors

**Data-system
components bow**

Monolithic multiplexers,
hybrid sample-and-holds
are first in new family

First in a line of components for data-acquisition systems, a pair of 16-channel monolithic multiplexers and two hybrid sample-and-hold circuits developed by Intersil come in plastic packages and carry price tags that the company says are 20% to 30% below those for discrete counterparts.

Skip Osgood, product manager for data-acquisition products, says the two devices are part of a family of low-cost, low-speed, high-accuracy data-system parts that the Cupertino, Calif., company will introduce

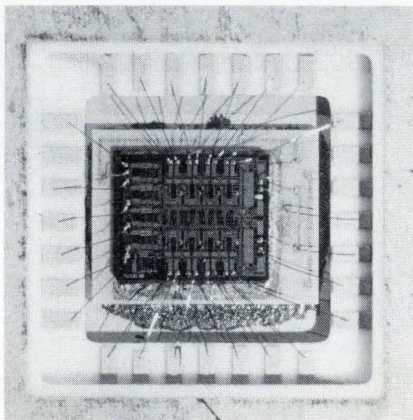

over the next year. In quantities of 1,000, the IH5060/5070 multiplexers (a packaged chip is shown above) are priced at \$9.95 each and the IH5110/5111 sample-and-holds at \$3.65 to \$5.95 each.

The IH5060 is a complementary-MOS 1-out-of-16 analog multiplexer that is a latch-proof replacement for the Siliconix DG506. Four-line binary decoding is used so that the 16 channels can be controlled by four strobe inputs. A fifth input can be used as a system-enable. When the enable line is at 0 volt, none of the channels can be turned on, and when it's at 5 v, the channels can be

sequenced by the four strobe-line inputs.

The IH5070 is a 2-out-of-16 version of the 5060's differential analog circuit that Osgood says is a replacement for the Siliconix DG507. Three-line binary decoding is used so that the 16 channels can be controlled in pairs by binary inputs. A fourth input is used as a system-enable. Both multiplexers have a ± 15 -v analog signal range, an on resistance of less than 500 ohms over the full signal and temperature range, break-before-make switching, two-tier submultiplexing, and a power-supply quiescent current of less than 100 microamperes.

The 5110 and 5111 are complete sample-and-hold circuits, except for external sampling capacitors. The ICs include an input-buffer amplifier, output-buffer amplifier, and C-MOS logic for switching. The 5111 is primarily designed to operate with any input in the ± 10 -v range, regardless of whether it is ac or dc. The 5110 is designed to switch smaller ac signal amplitudes so as to minimize charge-injection effects, the company says.

After its offset voltage has been zeroed, this unit has a typical error amplitude of 1 to 2 millivolts peak-to-peak, corresponding to 10 to 20% of charge. The drift rate for both parts is specified at a maximum of 10 millivolts per second, which corresponds to a 100-picoampere total leakage into a 0.01-microfarad sampling capacitor. While 10 mv/s is the maximum, more typical readings are about 1 mv/s, making the devices ideal for any application requiring very low drift or droop rates. When combined with Intersil's already introduced 3½-digit integrating dual-slope converter pairs, either the 8052/8053 or the 8052/7101, Osgood says the multiplexer and sample-and-hold devices constitute the heart of a data-acquisition system for a price that is less than \$25.

Other devices planned for the family, Intersil officials report, include six C-MOS digital-to-analog converters ranging in accuracy from

SEVEN NEW PRODUCTS SAY WE'RE IN DIGITAL THERMOMETERS. WITH BOTH FEET.

Last month, we couldn't say it.
Now we can.

As of right now, Fluke offers as full and complete a line of digital thermometers as anyone.

Before, we were offering a well received line of 0.1° resolution digital thermometers. And a lot of people asked us to build the same quality digital thermometers in 1° and 0.2° resolution.

Well, here they are.

The 2160A series of panel-mount and portable 1° digital thermometers. And the 2170A series of panel-mount and portable 0.2° digital thermometers.

Both will handle all your thermocouple needs. In fact, we can't think of a single standard thermocouple capability that Fluke digital thermometers can't handle—J, K, E, T, R, S, B and C included. And that's across a temperature range of -200°C to +2327°C or to 3999°F.

And for user convenience, the portable instruments are truly portable and the panel instruments are truly designed for industrial environments. Our bench model is really a bench model, not just an adapted panel meter with legs. And our panel meters conform to DIN Standards.

Ease of use hasn't been forgotten. For example, temperature scale selection (°F or °C) is easily accomplished with a pushbutton on the bench models and front panel access on the panel models. A further convenience is being able to calibrate panel mount instruments in place, without removal from the panel.

Here's a quick look at the new instruments priced from \$299*:

2160A is a panel-mount, 4-digit thermometer capable of resolving 1°C or 1°F over the entire temperature range of any of eight thermocouple types (J, K, E, T, R, S, B, C). 2165A is the portable, bench-top version of the 2160A.

2166A expands the basic capabilities of the 2165A to include monitoring of up to ten thermocouples of the same



We don't go into a new product line halfheartedly.

type with a front panel selection switch.

2168 is another portable, 1° single-point instrument. It can, however, accept any one of eight thermocouple types as input.

2170A is a panel-mount, 4-digit thermometer capable of 0.2° (°F or °C) resolution over a temperature range of

-99.8° to +999.8°, for four thermocouple types (J, K, T, E). 2175A is the portable, bench-top version of the 2170A.

2176A expands the basic capabilities of the 2175A to include monitoring of up to ten thermocouples of the same type with a front panel selection switch.

Options for the new series of instruments include rechargeable battery power, an isolated parallel BCD output, an isolated analog output, a multi-point switch unit, and a Hi-Lo set point comparator.

And if you're wondering what the reaction to these new products has been, well, it's pretty typical.

Users are happy to see Fluke quality and technology in a full line of laboratory and industrial digital thermometers.

And the competition's awfully grumpy.

For data out today, dial our toll-free hotline, 800-426-0361.

John Fluke Mfg. Co., Inc., P.O. Box 43210, Mountlake Terrace, WA 98043
Fluke (Nederland) B. V., P.O. Box 5053, Tilburg, The Netherlands.

Phone: (013) 673-973 Telex: 52237

*U.S. price only.



INTRODUCING 2160A/2170A DIGITAL THERMOMETERS. 

For demonstration on 2160A, circle 168
For literature on 2160A, circle 133

For demonstration on 2170A, circle 212
For literature on 2170A, circle 211



Scanbe-gram



- RE: THE SOCKET THAT ENGINEERS SWEAR BY
- ENGINEERS ALL OVER THE WORLD SWEAR BY - NOT AT -
- SCANBE'S FAMOUS ME-2 SOCKET.
- ME-2'S ARE SPEC'D INTO PRODUCT AFTER PRODUCT...
- BECAUSE ENGINEERS KNOW THIS SOCKET WON'T LET THEM
- DOWN.
- MILLIONS HAVE BEEN SHIPPED....NOT ONE HAS EVER BEEN
- RETURNED DUE TO FAILURE.
- CHECK THESE FEATURES....TAPERED ENTRY CHANNELS....
- EDGE-GRIPPING CONTACTS.....REMOVABLE PINS....CLOSED
- ENTRY DESIGN....REMOVABLE CAP....PLUS MANY MORE.
- SEND FOR COMPLETE SPECS AND PRICES.

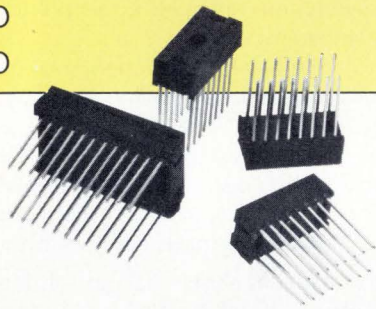

"Imitated... never duplicated."



Scanbe Manufacturing Corp.
 3445 Fletcher Ave., El Monte, CA 91731
 Tel: (213) 579-2300 • TWX: 910-587-3437

Circle 134 on reader service card

Hot Semis? Get relief fast!

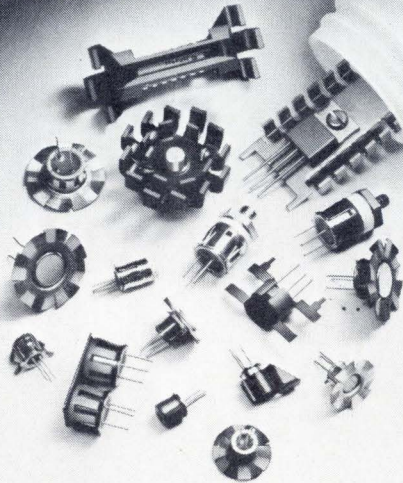

Heat Sinks

INTERNATIONAL ELECTRONIC RESEARCH CORPORATION / A SUBSIDIARY OF DYNAMICS CORPORATION OF AMERICA / 135 WEST MAGNOLIA AVENUE, BURBANK, CA 91502

134 Circle 169 on reader service card

New products

8 to 12 bits, with resolutions of 10 to 12 bits.

Intersil Inc., 10090 N. Tantau Ave., Cupertino, Calif. 95015 [411]

30-kilovolt rectifier

is only 15.2 mm long

Intended for such applications as cathode-ray-tube power supplies, the type TR 30 subminiature silicon rectifier has a 30,000-volt repetitive peak-reverse-voltage rating and a length of only 15.2 millimeters. The device is only 4 mm in diameter, making it possible to encapsulate the rectifier in the flyback transformer in TV sets. Average forward current is 2 milliamperes with a recurrent peak rating of 200 mA.

Electronic Devices Inc., 21 Gray Oaks Ave., Yonkers, N.Y. 10710. Phone (914) 965-4400 [420]

FET performance achieved by double diffusion

Double diffusion gives field-effect transistors developed by Solitron Devices channel widths of less than 1 micrometer and resultant device-performance characteristics that are said to be otherwise impossible on a production basis. Breakdown voltage of the n-channel enhancement-mode FETs can be nearly independently designed for a given application, the company says.

As part of the family of devices, units in the Solitron SDF8000 series are designed for linear and ultra-high-frequency applications. They have gain as high as 1 gigahertz, a

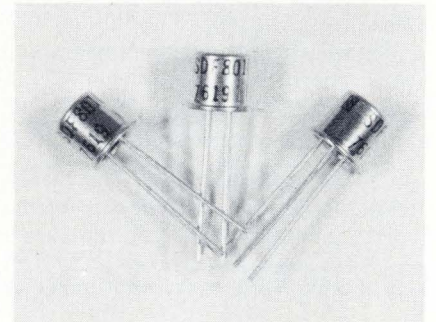

Electronics / August 19, 1976

HOW THE LEADER IN DIGITAL VOLTMETERS PLANS TO STAY THERE.

A while back, we got a head start on everybody else in DVM's. People bought more of our instruments than they did the competition's.

Nothing has changed.

We still have the lead because we discovered a few things about the test and measurement field. We learned some things about developing new DVM's for the changing electronics industry.

Above all, we learned, don't offer a DVM unless it truly has value for the guy on the bench.

That means value across the board.

Five-range AC/DC volts to 1200V	only Fluke
Six-month calibration cycle	only Fluke
10,000-Hour demonstrated MTBF	only Fluke
Environmental capability specified and defined	only Fluke
Full line of accessories offering HI volts to 40 KV, RF to 500 MHz, current to 600A	only Fluke

There's not much competition.

Not just one feature that's unique or one lock-out spec, but an entire package that makes complete sense and offers you total value all the way around. Take specs, for example. We publish very conservative specifications. No one else does, but we think it's important that the instrument gives all the specs we've guaranteed. And then a little more. We feel that you ought to get better performance than you expected when you buy a Fluke instrument.

So what should you expect in a DVM?

First, an initial low cost. But also a low cost of ownership.

The Fluke 8600A sells for \$549.*

But, even more important, the 8600A has a demonstrated 10,000 hours MTBF. We've fully defined and specified environmental capabilities. And the calibration cycle is 6 months.

That's going to save you a bundle in cost of operation.

Without any sacrifice in specs.

Guaranteed six-month accuracy specs at 15°C to 35°C with an extremely low

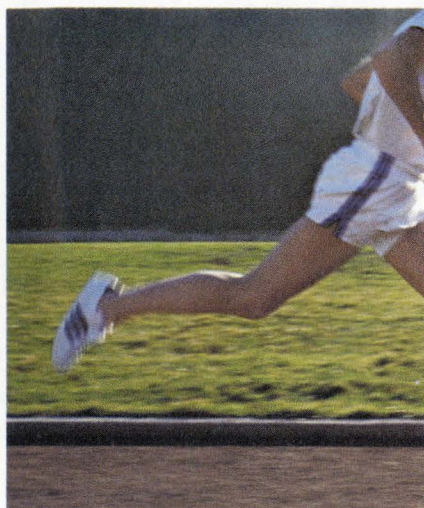

A running start helps.

temperature coefficient. Five ranges each of ac and dc volts to 1200V with 0.02% dc and 0.2% ac accuracy. Five ranges each of ac and dc current to 2A with 0.1% dc and 0.3% ac accuracy. Six ranges of resistance to 20 megohms with 0.1% accuracy. AC bandwidth to 100 kHz.

Autorangeing through all ranges plus individual range selection. Continuous

overload specified for all ranges/functions with overload indication.

Features for flexible operation. Environmental capability specified and defined. Automatic zeroing. Low 7-watt power consumption for reliability. And a full line of accessories including 40 KV high voltage probe, 500 MHz RF probe and 600 A ac current probe. A self-contained rechargeable battery option.

And remember, those are conservative specs for the 8600A. At \$549.

A genuine value from Fluke.

Which suggests we plan on being the leader in DVM's for a long time coming.

No matter how much it upsets our competitors.

For data out today, dial our toll-free hotline, 800-426-0361.

John Fluke Mfg. Co., Inc., P.O. Box 43210, Mountlake Terrace, WA 98043

Fluke (Nederland) B.V., P.O. Box 5053, Zevenhevelenweg 53, Tilburg, Netherlands.

Phone: (013) 673-973 Telex: 52237

**Domestic price only.*



THE INDUSTRY STANDARD. 8600A DVM. 

Your opportunity to up-date your electronics know-how—bring yourself abreast of all the latest advances!

McGraw-Hill COURSE IN CONTINUING EDUCATION FOR ELECTRONICS ENGINEERS

Integrated-circuit technology . . . analog and logic circuit design . . . memory and display devices—all in 8 compact self-study lessons prepared by a panel of top electronics experts

TODAY "OPPORTUNITY KNOCKS" for the electronics engineer who's right on top of the present state of the art—and *you* can be that up-to-the-minute expert sooner and more easily than you think! In fact, you are just 16 reading hours from a new and extended proficiency in today's (and tomorrow's) major electronics advances, concepts, and techniques!

Catch up at home—at your own pace!

If you got your degree five, ten, or more years ago and you've been concentrating on your job ever since, you know it's a real struggle to keep on top of the latest technology *and* on top of new job and promotion opportunities. Now this amazing new Course offers an easy, systematic, and convenient way to catch up on developments in a fast-moving field—and even get a jump on future developments!

Now—without taking time away from your job—without boxing yourself into inconvenient class schedules—you can bring yourself completely up to date on recent development in integrated electronics. You'll discover the latest information on what it is, what it can do, and how you can best use it!

Gives working knowledge of vital advances

Complete in eight lessons, the McGraw-Hill COURSE IN CONTINUING EDUCATION FOR ELECTRONICS ENGINEERS is one of the first available high quality, low cost, self-study courses to enable you to bring yourself *up to date* and *up to top proficiency* in major areas of technology. The Course covers operational-amplifier concepts and applications—active-filter design for a variety of circuits—logic design with TTL—memories for numerous applications—electronic display devices and systems—comparative values of competing technologies—latest advances in the electronics field—latest solutions for troublesome problems—and latest designs!

Each of the eight lessons is compact (from 42 to 96 pages—about two-hours reading time), generously illustrated with appropriate diagrams and charts, and includes a self-checking quiz (with answer keys) so you can gauge your command of the topic. Each lesson is also introduced by a Study Guide that tells you just how to get the most out of it. A Course Completion Certificate is awarded to those who successfully complete and return the final examination.

Pre-test the Course for yourself—free!

Simply return the coupon and we'll send you the *Master Outline and Guide* and *Lesson One: Integrated Circuit Processes*. Look these materials over for 10 days. If you decide the Course is not for you, simply return the materials *with no further obligation whatsoever*. Otherwise, we will begin sending you Lessons Two through Eight at six-week intervals. You pay nothing until you decide whether to keep the *Master Outline and Guide* and *Lesson One*. Then you have the option of paying for each Lesson as you receive it, or **saving over 10%** by paying for the Course in full!

If you're disappointed in the Course at any stage, just notify us and we will stop sending the Lessons and invoices. And if you have paid in advance, we will refund the difference between the value of the Lessons you have received and the payments you have made. So return the "Opportunity Knocks" Coupon below today—*get yourself headed in the direction of bigger and better professional opportunities!*

YOUR "OPPORTUNITY KNOCKS" FREE-EXAMINATION COUPON!

McGRAW-HILL BOOK COMPANY
Professional & Reference Books—25th Floor
1221 Avenue of the Americas, New York, N.Y. 10020



Yes! Send me for 10 days' free examination *Lesson One* plus the *Master Outline and Guide* for the McGraw-Hill COURSE IN CONTINUING EDUCATION FOR ELECTRONICS ENGINEERS.

At the end of ten days, if I want to continue in the Course, I will make my first payment of \$6.50 plus local tax, postage and handling. And I understand that each subsequent Lesson will be accompanied by an invoice for \$6.50 plus local tax, postage, and handling . . . for a total cost of \$52.00 for the eight Lessons. (The Lessons will be shipped at six-week intervals.)

If I pay for the entire course after examining the *Master Outline* and *Lesson One*, McGraw-Hill will pay *regular* postage and handling and send me the rest of the lessons at six-week intervals for only \$46.50 plus local tax . . . a saving of better than 10%! If I decide not to continue in the Course after the ten-day examination period, I will return the *Master Outline* and *Lesson One* *postpaid*, and the matter will be closed.

Name

Address

City

State Zip

Offer good only in U.S., and subject to acceptance by McGraw-Hill

41-18832

New products

low noise figure and high forward transconductance.

The Solitron SDF 9000 series, designed for high-speed switching applications, has low feedback capacitance, low insertion loss, and low output capacitance.

Solitron Devices Inc., 8808 Balboa Ave., San Diego, Calif. 92123. Phone (714) 278-8780 [413]

Optical couplers provide 1-kilovolt isolation

Built to meet requirements in high-reliability applications, three optically coupled isolators from Optron Inc. replace pulse transformers or mechanical relays in solving such problems as common-mode noise rejection, ground loops and voltage-level translation.

The Jedec-registered types 3N243, 3N244, and 3N245 consist

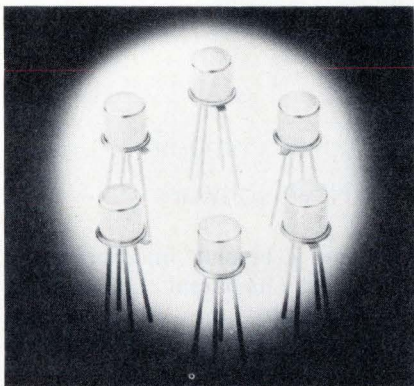

of a gallium-arsenide infrared transmitter coupled with a silicon photo-transistor. They are similar to Optron's OPI 140 standard isolator, and each is available in a hermetically sealed TO-18 package.

All devices in the series offer 1-kilovolt isolation. Guaranteed minimum current-transfer ratios are 15% for the 3N243, which is priced at \$3.35 in quantities of 1,000; 30% for the model 3N244, priced at \$4.31; and 60% for the model 3N245, priced at \$5.83. All are available from stock.

Optron Inc., 1201 Tappan Circle, Carrollton, Texas 75006. Phone (214) 242-6571 [416]

Our newest air variable capacitor's biggest feature:

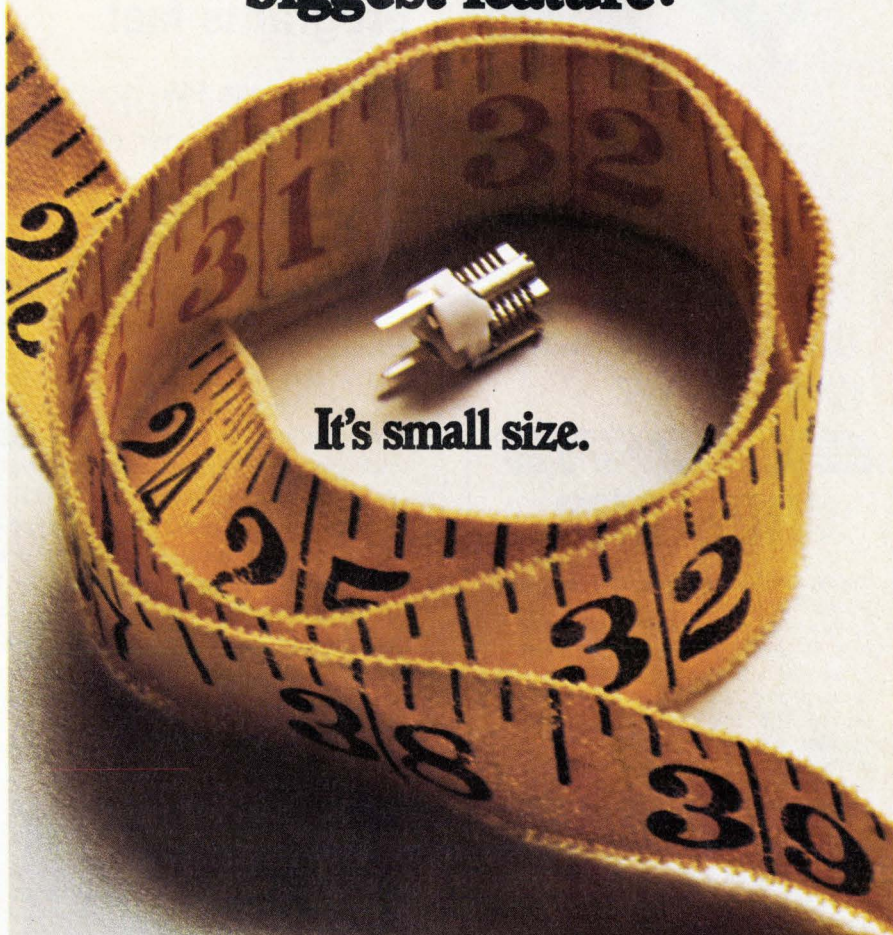

It's small size.

As you can plainly see, our new air variable capacitor is nearly as small as many sub-miniature ceramic trimmers. It also features the same mounting configuration which means you can use it in many of the same applications

But small size isn't the only reason for buying our new Micro T™ capacitor. Because it's air variable, it offers you

great stability. Q is typically 1000 at 100 MHz. TC is $\pm 45 \pm 45$ PPM/°C. And it's available in maximum capacities of 3, 6.5, 12.7, and 19.0 pF in either vertical or horizontal tuning PC and stripline mounting versions. What's more, it gives you all this for a very small price.

E. F. Johnson Company/Dept. EL, Waseca, MN 56093

Please send me technical information on sub-miniature air variable capacitors.

Please send me samples. You can call me at _____

Name _____

Firm _____

Address _____

City _____ State _____

Zip _____

For fast service, contact your local Johnson Distributor.



JOHNSON

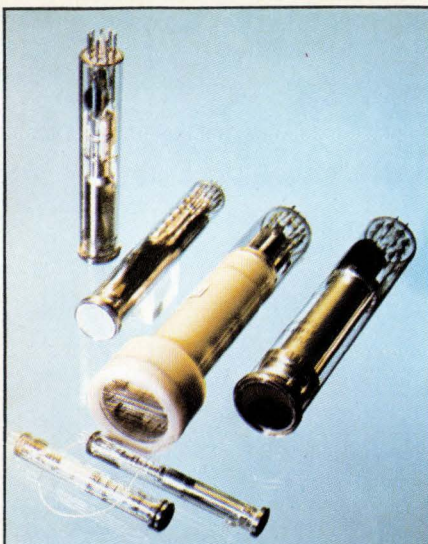

The very dependable eyes —

ELORG VIDICONS

THEIR SPECTRUM IS WIDE. From near-infrared to X-rays.

THEIR FIELD OF USES IS BROAD. B & W and color TV — broadcasting, closed-circuit, applied and small-frame X-ray and infrared TV, phototelegraph, photometry, spectrometry (infrared included), scintillation equipment for monitoring optical quantum generators (lasers).

THEY COME IN MORE THAN FIFTEEN TYPES. Including:

LI-421 — top-quality image is ensured by the new technology of coating the target with the photoconductive layer (based on antimony trisulphide).

Can be used to replace an RSA 8507 Vidicon in any B & W and color TV system.

600 lines resolution **both** at the centre and in the corners — or higher.

LI-430 — length 102 mm, dia. 16 mm. Electrostatic focusing, magnetic deflection. Ideal for compact cameras in applied and closed-circuit TV.

LI-428 — the high-response target enables a TV camera with this vidicon to operate at 1 lux illumination. **Both** deflection & focusing are electrostatic.

Their electronic-optical systems have been processed on spark erosion machines AFTER every part has been assembled and secured; absolute coaxiality of all the apertures is GUARANTEED.



ELORG

32/34 Smolenskaya-Sennaya
Moscow 121200, USSR
Telex 7586

New products

Data handling

Tape reader loads programs fast

Equipped with EIA interface, unit undersells or outpaces competitors

A 300-character-per-second paper-tape reader is said to load mini-computer or microcomputer programs 30 times as fast as a teletypewriter terminal. The Fly Reader 232, as Teleterminal Corp. calls its new product, includes the RS-232 teletypewriter current loop or serial TTL interface and can be directly plugged into the RS-232 or teletypewriter port of most minicomputers and microcomputers.

(RS-232 is the EIA standard covering the interface between a data terminal and other data communications equipment that uses a serial

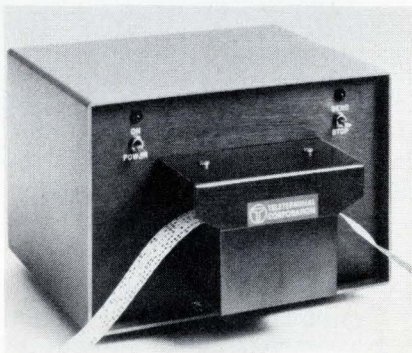

binary interchange. Among other things, it provides for voltage and current compatibility in the equipment and calls out pin functions in the RS-232 connector.)

The desktop unit, which weighs 8 pounds, is priced at \$695. Horace Lyndes, Teleterminal president, says it will compete both with much larger RS-232-equipped readers selling for \$1,000 to \$1,300 and with a slightly lower-priced unit offering only half the Fly Reader's speed. But Lyndes thinks the reader's versatility is one of its strongest points. Rear-panel switches on the machine offer a choice of 16 speeds, ranging from 50 to 19,200 bauds and four char-

acter lengths—5, 6, 7, or 8 bits.

The Teleterminal reader also responds to remote signals DC1 and DC3—the ASCII codes for "reader on" and "reader off." This remote starting and stopping of the reader can be done either in a continuous-reading mode or a character-at-a-time (step) mode, a feature Lyndes claims is new in a relatively low-priced machine. Remote start-stop can also be done through the TTL input or the current-loop input, where the input is made to look like the reader solenoid in some teletypewriters.

The cabinet-mounted version of the reader is 5¼ inches high, 8 in. wide and 7 in. deep. A 19-inch-wide rack-mountable version is also available at the same price. Fan-fold trays that accommodate 200 feet of tape and occupy 7 vertical inches are available with the panel-mounted units as an option.

Delivery is from stock to 30 days. Teleterminal Corp., 12 Cambridge St., Burlington, Mass. 01803. Phone (617) 272-8504 [361]

'Micromini' computer uses Nova software

Applying a bipolar microprocessor chip built by its parent company, the Computer division of Monolithic Memories is selling a "micromini" computer to systems and original-equipment manufacturers. And to simplify using the machine, called the μ Mini 3, its designers have made it software- and input/output-compatible with Data General Corp.'s line of Nova computers. The μ Mini 3 is also microprogrammable so that throughput can be increased by reducing frequently used functions to microcode, which executes them more efficiently than comparable software implementations. Moreover, the application of high-density bipolar LSI (the microprocessor chip is the 4-bit 6701) and n-channel metal-oxide-semiconductor random-access memory in the computer make it possible for a complete 32,768-bit system to fit on a pair of

The Ansley "D" Connector...

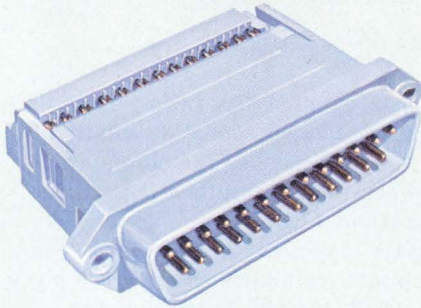

Our new series of male and female "D" connectors offer you a cost effective external mass termination cable and connector system second to none. Its uniqueness begins with a one-piece "D" connector package that meets industry standards for size, pin spacing, and contact reliability. With no loose parts to match up, positive cable-to-contact alignment is assured. Conductors are mass terminated in seconds with our standard BLUE MACS™ hand or bench tools. The results? Faster installation, higher reliability.

Contact pins are spaced on .054" centers — a perfect fit for any standard inter-cabinet "D" type connector application. Our new "D" connectors are designed to mate with standard 50 mil pitch flat cable as well as our new, improved jacketed cable — the only flexible flat cable engineered specifically for out-of-cabinet use.



a new meaning to cost effectiveness.



The Ansley BLUE MACS™ jacketed cable is U.L. listed for external interconnection of electronic equipment. Electrically, it outperforms standard jacketed twisted pairs in typical I/O applications. And there's no special zipper lock tubing required — reducing the need for an extra cable accessory. Installation is faster, easier. And like all Ansley connectors, you can daisy chain our "D" types anywhere in the cable — along with our DIP socket, card edge, or pc board connectors.

Cable alignment and high contact reliability is assured — because both cable and connector are grooved for absolute alignment. Our patented TULIP™ 4-point insulation-displacing contacts are permanently fixed and sealed-in to provide a reliable, gas-tight, corrosion-free mass termination.

For the full reliability/cost effectiveness story and technical data, call or write:

T&B / Ansley

The mass termination company.

**T&B/Ansley Corporation • Subsidiary
of Thomas & Betts Corporation**
3208 Humboldt St. • Los Angeles, CA
90031 • Tel. (213) 223-2331 •
TWX 910-321-3938

**Available through authorized
Ansley distributors**

In Canada: T&B/Ansley, Ltd.
700 Thomas Ave.,
Industrial Park
Iverville, P.Q.

New products

15-by-15-inch printed-circuit cards. Price of the basic system with case, chassis, power supply, front panel and 8 kilobits of memory is \$2,500 in lots of 50 or more. Or the system is available on cards for OEMs.

Computer Division, Monolithic Memories Inc., 1165 East Arques Ave., Sunnyvale, Calif. 94086 [363]

Disk drives offer capacities up to 24 megabytes

Two dual-platter fixed-disk drives, holding 12 and 24 megabytes respectively, have been added to the D1000 family of Pertec Corporation's Peripheral Equipment division. The family of fixed-disk drives provides designers with a range of drive capabilities. Earlier units include the single-platter models D1400 and 1600, with capacities of 6 megabytes and 12 megabytes respectively.

The new 24-megabyte unit, the D1660, has two IBM 3336-type

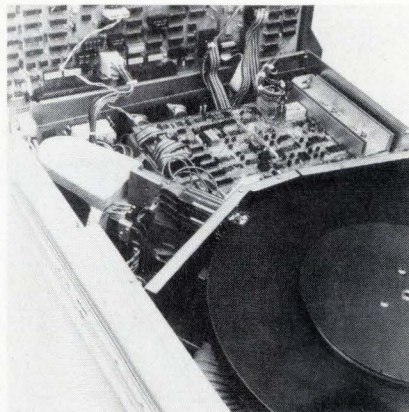

nonremovable platters. Bit density is 4,400 bits per inch; and track density, 200 tracks/in. The D1660 is available with a data-transfer rate of either 3.12 megahertz at 1,500 revolutions per minute or 5.0 MHz at 2,400 rpm. The 12-megabyte unit, the D1460, has two IBM 2316-type nonremovable platters with a bit density of 2,200 bits/in. and track density of 200 tracks/in. Data-transfer rates are either 1.5625 MHz at 1,500 rpm or 2.5 MHz at 2,400

revolutions per minute.

Prices, in OEM quantities, are about \$2,085 for the D1460 and \$2,710 for the D1660.

Pertec Corp., 9600 Irondale Ave., Chatsworth, Calif. 91311. Phone (213) 882-0030 [368]

Printer operates at 300 lines a minute

A new member has been added to Teletype Corp.'s model 40 family of teletypewriters—a 132-column, tractor-feed impact printer designed for the original-equipment market. The printer operates at 300 lines per minute, accommodating up to 6-ply standard fanfold from 4 1/8 to 15 inches wide and 2 1/2 to 22 inches long. It's available with the ASCII monospace set as well as the full 96-character set for upper/lower-case printout. An extended font feature permits character sets of up to 190 characters. Other features include

Problem:

You need more than a card frame.

Solution:

See Bud's new system. It not only provides card carrying capacity, but also affords modular packaging.

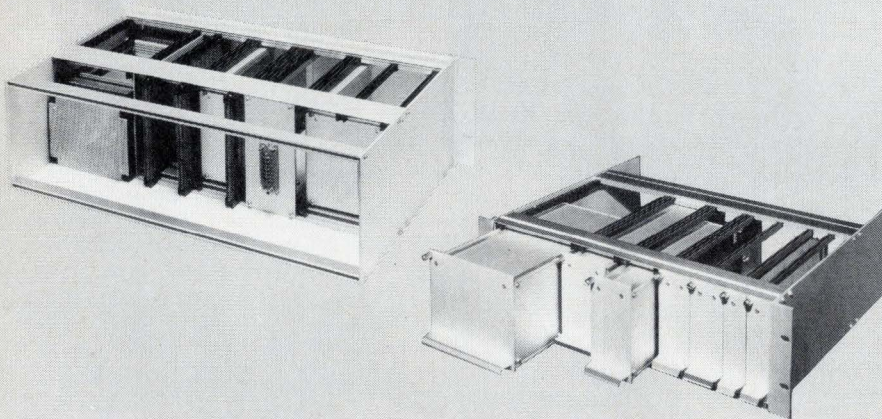

Our new modular packaging system is the most versatile on the market. We know you'll agree when you see it. Eight sizes take 44 different size modules. Yet, the design is simple. Components are easily assembled, easily modified. Your Bud representative will demonstrate it anytime. **YOUR PROBLEM IS SOLVED!**

Call toll free:

(800) 321-1764 for more facts. In Ohio, (800) 362-2265.

Circle 140 on reader service card

BUD

BUD RADIO, INC.
Willoughby, Ohio 44094

If high start-up costs have delayed your expansion, contact Georgia.

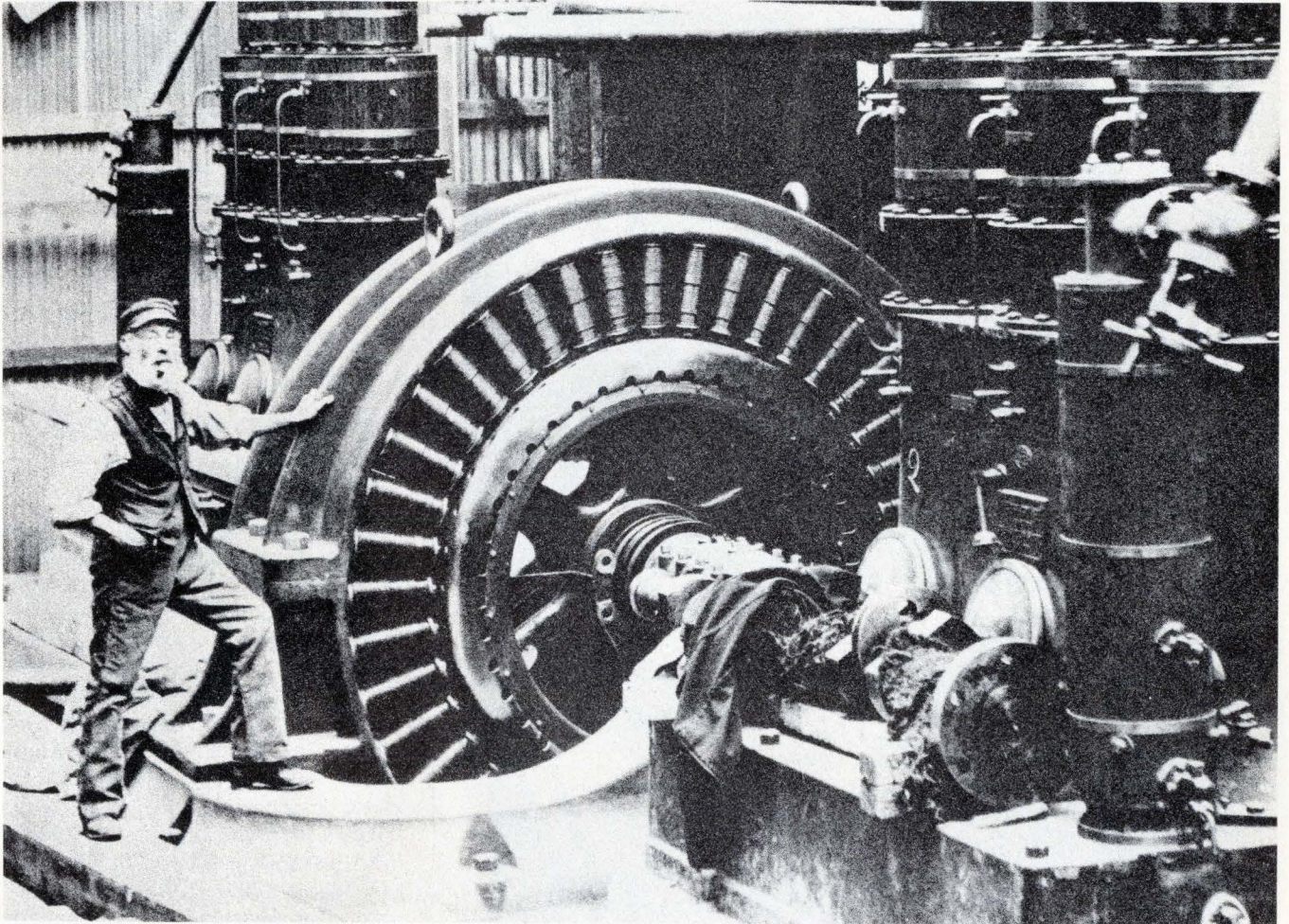

The Bettmann Archive, Inc.

We're wired into the needs of the electronics industry. And we'll come to you with profit incentives you can appreciate.

Like available buildings and low-cost construction. A skilled and stable work force that

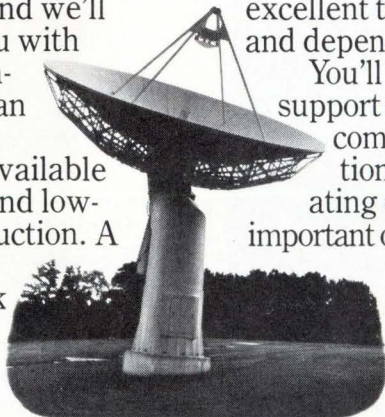

we'll train free. Fiscally-responsible government, excellent transportation and dependable utilities.

You'll also find good support from allied companies. In addition to lower operating costs, we offer important opportunities for higher education. Including the country's

second largest electrical engineering school at Georgia Tech. And the cultural amenities that help provide a pleasing lifestyle.

For more information contact Milt Folds, Commissioner, Georgia Bureau of Industry & Trade, P.O. Box 1776, Atlanta, Georgia 30301, Dept. EL-7321.



Georgia

Profit from sameness.

Precise uniformity. That's what makes Kodak micro resist 747 a bargain.

With less variables to worry about, you'll no doubt find you'll waste less time, get fewer rejects, and improve your yield.

747 resist is negative-working, and it's available at a very positive price.

For details, write Eastman Kodak Company, Dept. 412L (48-E), Rochester, N.Y. 14650.

**RESULTS
COUNT**

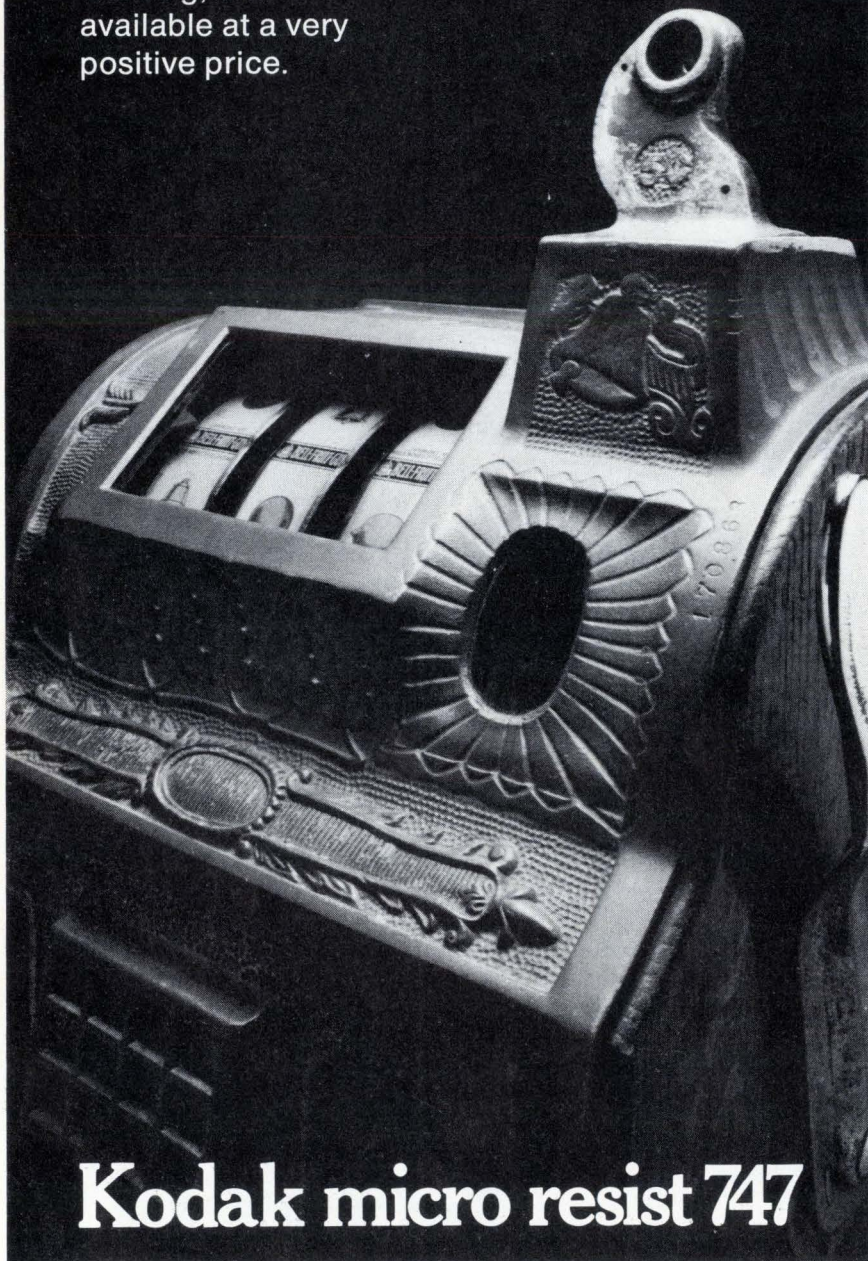

Kodak micro resist 747

New products

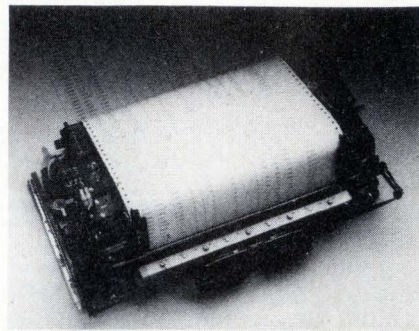

foldover, even or odd parity recognition (optional), automatic new line, and built-in diagnostics. Price is \$2,000.

Sales Headquarters, Teletype Corp., 5555 Touhy Ave., Skokie, Ill. 60076. Phone, 312-982-3134 [364]

Minicomputer tape cartridge said to be error-free

Minicomputer users now can buy what its developers assert is a 100% error-free 1/4-inch data cartridge from Wabash Tape Corp. The four-track cartridge contains Wabash's Quadronix I computer tape, which the company certifies will be free of writing errors. Cartridge-drive elements are protected by a high-impact plastic cover mated to a metal baseplate and by a plastic "door" that automatically closes over the tape-head opening when the cartridge is removed from the transport. The cartridge is interchangeable with others on the market.

Timothy O'Gorman, vice president, marketing, Wabash Tape Corp., 2700 Des Plaines Ave., Des Plaines, Ill. [365]

Matrix printer produces variable-sized characters

Microcomputer-controlled, the IPS-7 Intelligent Printing System is a bidirectional matrix printer designed for OEM and systems applications. Variable-sized alphanumeric characters and bar-code features are optional and permit a user to satisfy present and future needs without a retrofit. Interface options are the

Presenting 10 solid reasons for bringing your firm to Broward County.

- 1** Great weather—less absenteeism.
- 2** International airport, rail lines, super-highways, Florida's deepest port to reach South American/Caribbean markets.
- 3** The nation's most sought-after lifestyle.
- 4** Ever-growing labor force.
- 5** Top educational, health-care and consumer services.
- 6** Florida's enduring popularity for attracting highly qualified personnel.
- 7** Clean, pollution-free environment.
- 8** Low crime rate.
- 9** Low taxes due to a broad tax base.
- 10** Great profit potential in a young, progressive area that welcomes industry.

Presenting 1 solid reason your key personnel will want to come with you.

- 1** It's in Florida. Enough said.

FOR ADDITIONAL INFORMATION, WRITE ON COMPANY LETTERHEAD TO DEPARTMENT C. INCLUDE NAME AND TITLE, PLEASE. CONFIDENTIALITY ASSURED.



The Broward Industrial Board is the central industrial development agency for the Chambers of Commerce of Fort Lauderdale, Hollywood, Pompano Beach, Plantation, Miramar-Pembroke, Coral Springs, Margate, Hallandale, West Broward,

Deerfield Beach, Davie, Lauderdale-By-The-Sea, Dania, Sunrise, unincorporated areas and Port Everglades.

BROWARD COUNTY, FLORIDA Not just another pretty place.

In the heart of the Gold Coast between Miami and Palm Beach.



BROWARD INDUSTRIAL BOARD

2050 East Oakland Boulevard. Fort Lauderdale, Florida 33306. 305/563-4445.

Circle 172 on reader service card

To find a fault fast... "QUIK-FREEZE IT!"

Drops surface temperature to -50°F. in seconds

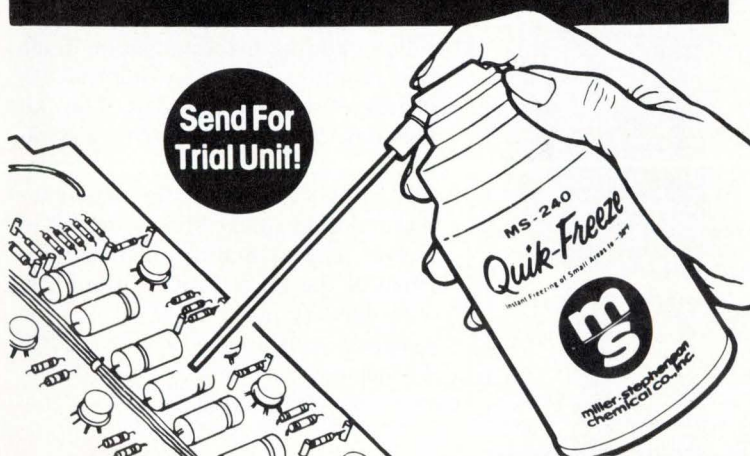

Few things waste more time than locating an intermittent circuit component. Isolate off-again on-again resistors, capacitors, etc., by quick-freezing them during testing. Remember: MS-240 "Quik-Freeze" is not only a circuit cooler, but also a full-fledged freezer. It can drop surface temperature to -50°F. (-45°C.) in seconds. A handy extension nozzle confines the chilling spray to the suspected component. Use MS-240 also to prevent undesirable heat transfer to delicate circuit elements during soldering or welding.



**miller-stephenson
chemical co., inc.**

Danbury, Connecticut 06810 • (203) 743-4447

- Enclosed is \$2.00, please send my "Trial Unit" (MS-240). E-8U
- Please send FREE literature and prices.

Intended Use

Name Dept./Title

Company

Address

CHICAGO • LOS ANGELES • TORONTO / Dist. in • ITALY • GERMANY • FRANCE
• GREAT BRITAIN • SWITZERLAND • LEBANON • SPAIN • NETHERLANDS

The first, accurate digital pyrometer that measures thermocouple and RTD ranges for \$165.00



WITH NEWPORT'S EXCLUSIVE POLYLOG LINEARIZER
Patent applied for

Newport's Model 268 Digital Pyrometer gives you 19 optional bipolar ranges. It can be adapted to almost any application where temperature is measured. Power and signal inputs are attached to a convenient screw terminal barrier strip, while digital signals are handled through a PCB connector.

OTHER OUTSTANDING FEATURES:

- Large 13mm (1/2 inch) LED digits
- Bipolar ranges in either °C or °F
- Less than 0.3% error with five TC ranges
- Platinum RTD ranges with less than 0.15% error
- Reference junction mounted in barrier strip
- 3 μV/count sensitivity
- DIN standard case
- Parallel BCD output standard
- Open TC indication
- 100/115/230VAC power (5VDC optional)
- Lowest parts count for highest reliability
- Linearized analog output (optional)
- One or two digital set point controller (optional)
- NMR 60dB
- CMR 120dB

Newport Laboratories, Inc.
630 E. Young St., Santa Ana, CA 92705
Call Collect: (714) 540-4686
In Netherlands, Call:
Amsterdam (20) 45-20-52

See us at Wescon Booth No. 582

Circle 144 on reader service card

The Answer Book. It makes your job easier. \$25.

Who makes what? Over 4000 products, 6000 manufacturers with their local contacts, directory of trade names and catalogs, inquiry "bingo" card for 5-second ordering of current catalogs.



Electronics Buyers' Guide
1221 Ave. of the Americas
New York, N.Y. 10020

Yes, send me a copy of The Answer Book. I've enclosed \$25 (USA and Canada only, elsewhere send \$35). Full money back guarantee if returned within 10 days.

Name _____
Company _____
Street _____
City _____ State _____ Zip _____

New products

standard parallel, making the IPS-7 plug-to-plug-compatible with other matrix printers, and optional serial—either EIA RS-232 or a 20-milliampere current loop. Positive

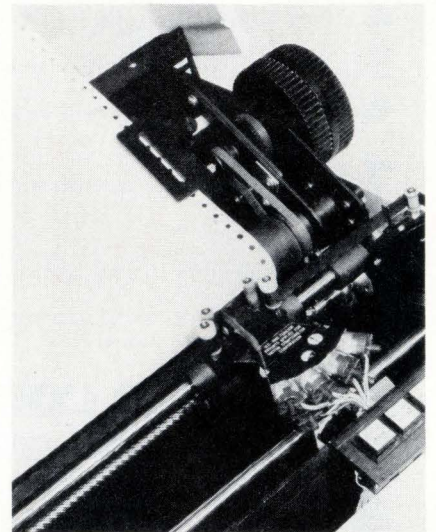

filtered air flow enables the printer to operate continuously without a clean room.

Dataroyal Inc., Main Dunstable Rd., Nashua, N.H. 03060. Phone (603) 883-4157 [366]

Alphanumeric printer in kit form costs \$250

Designed for do-it-yourselfers, the PR-40 alphanumeric printer comes in kit form. The printer is a 5-by-7-dot-matrix impact type that is similar in operation to the printers offered by Centronics Corp. The PR-40 prints the 64-character upper-case ASCII set with 40 characters per line at a rate of 75 lines per minute on standard 3 7/8-inch-wide rolls of adding-machine paper. Each line is printed from an internal 40-character buffer memory. The kit includes the assembled print mechanism, chassis, circuit boards, 120/240-volt ac, 50-60-hertz power supply, one ribbon, one roll of paper, and assembly instructions. Price of the kit is \$250 in the U.S., with delivery in 30 days.

Southwest Technical Products, Corp., 219 W. Rhapsody, San Antonio, Texas 78216. Phone (512) 344-0241 [367]

99% Programmable

and at 10 μ s programming speed

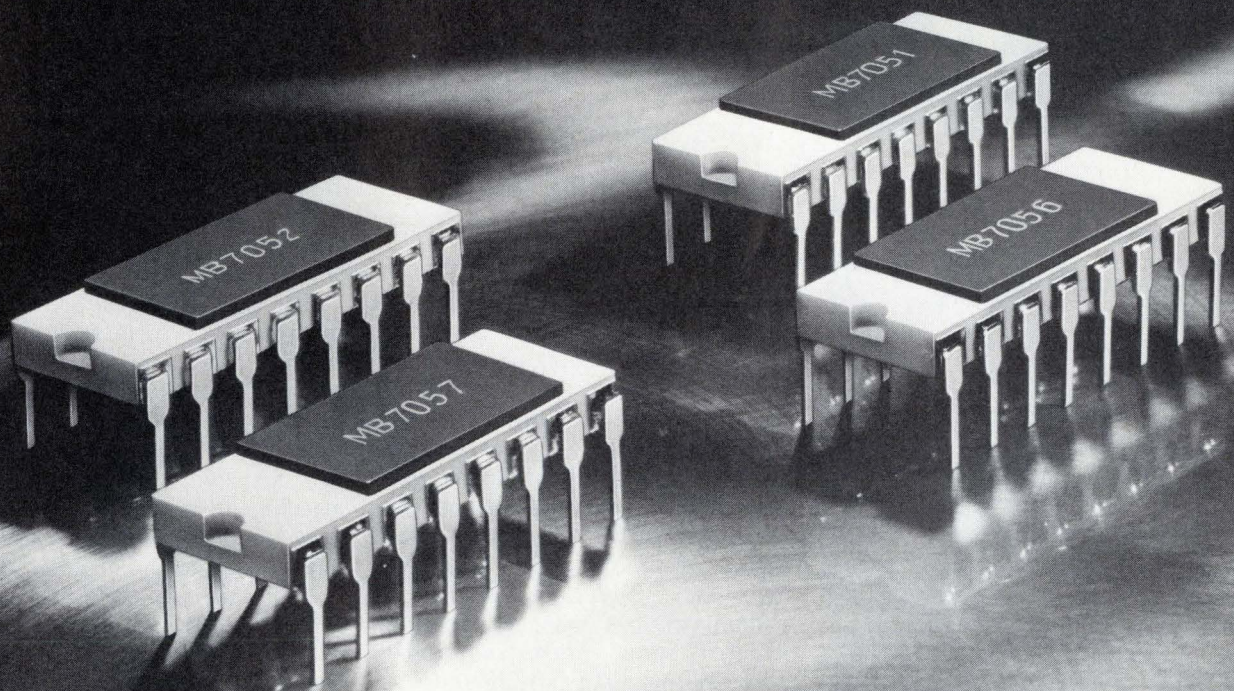

TTL PROGRAMMABLE MEMORIES

MB7051/52/56/57

FUJITSU SEMICONDUCTORS

Fujitsu's innovative approach to semiconductor design and fabrication has done it once more! Yes, we've again smashed through the performance barriers, this time to bring you a new generation of PROMs capable of an amazing 99% typical programmability, and at ultra-fast programming speeds of typically 10 μ s per bit. Of course, our great new PROMs are "Fujitsu superior" in other ways, too. You get gold-doped memory cell construction of proven reliability, reverse-migration immunity via "plus-4" programming, factory-tested parameters (including AC) via our unique method performed *after* packaging for greater validity, and a wealth of features that make for unsurpassed performance.

Choice of memory size/outputs
Fujitsu PROMs are available in both 256-bit (MB 7051/56) and 1024-

bit (MB 7052/57) memory sizes to meet a variety of circuit applications. Also, you get full DTL/TTL-compatible outputs (and inputs, too) in either three-state (MB 7051/52) or open-collector (MB 7056/57) configuration. Yes, whether you specify Fujitsu PROMs as your first choice, or as a replacement for your present device (pin-compatible with the IM5600-family devices), there's a Fujitsu PROMs to meet your needs.

Fast access time/top performance
Fujitsu 256-bit/1024-bit PROMs offer top performance and solid features. All are the popular 16-pin package, with full on-chip decoding. You also get low power consumption (350mW/450mW typ.), fast access times (35ns/40ns typ.), two CE leads per chip for simplified memory expansion, and OR-tie capability. Remember, if your needs run to PROMs, specify the "new

generation" PROMs from Fujitsu, the memory maker.

Proven reliability and available now
The Fujitsu MB 7051/52/56/57 programmable ROMs are built by Fujitsu, a maker with proven reliability. Our stringent production and testing standards, and our capability to meet your requirements, all add up to savings and performance that can't be beat. So contact Fujitsu now for the MB 7051, 52, 56, 57 or any of your other semiconductor requirements. Availability is NOW!

Write or call for more information to Fujitsu California, Inc., Laboratory Division, 1280 East Arques Ave., Sunnyvale, California 94086 phone: 408-735-0735 telex: 346393.

FUJITSU LIMITED
Communications and Electronics
Tokyo, Japan

Circle 145 on reader service card

FF101A FF101B FF101C



Building blocks for the in-circuit/functional test system you need.

The system you use to test printed-circuit assemblies should be tailored to your specific needs and readily expandable to handle your future requirements. When you specify FAULTFINDER® FF101 test systems, you have the building blocks you need to do the job.

Think of Faultfinders first for test hardware, software and experience.

WRITE FOR COMPLETE COLOR BROCHURE
Circle 146 on reader service card

FF FAULTFINDERS Inc.
15 AVIS DRIVE, LATHAM, NY 12110 (518) 783-7786

Irvine, CA
Sunnyvale,
Park Ridge, IL
Faultfinders GmbH, Eschborn, Germany

Cicero, IN
Waltham, MA

New products

Microwave

GaAs FET puts out 25 mW

At 10 GHz, unpackaged chip holds noise to 3.6 dB for gain of 6.9 dB

No longer simply developmental devices, gallium-arsenide field-effect transistors are coming on strong for microwave applications. Initially, Japanese firms dominated this product area, but U.S. manufacturers have been steadily closing the gap. Now, the Microwave Semiconductor division of Hewlett-Packard is offering its first GaAs FET. The device, says Dave Struthers, marketing communications manager, provides wider dynamic range and higher power output than existing units.

Currently available as an unpackaged chip, the HFET-1000 typically delivers 25 milliwatts of linear output power at 10 gigahertz. For this frequency, noise figure is 3.6 decibels typical at an associated gain

of 6.9 dB. The maximum available gain is nominally 11 dB at 10 GHz, while the output power at 1-dB compression is typically 14.5 dBm at 10 GHz.

The HFET-1000 is intended for use in the first and second stages of broadband, as well as narrow-band, low-noise amplifiers operating in the range of 2 to 12 GHz. Applications, notes Struthers, include telecommunications, radar, and electronic-warfare amplifiers.

The chip itself measures 26 by 11 by 5 mils; the gate region alone is merely 1 by 500 micrometers. A scratch- and dust-resistant protective layer covers the entire active area of the chip, making it rugged enough for easy wire bonding and die attachment, says Struthers. A packaged version of the chip will be announced shortly, he adds.

Maximum available gain for the HFET-1000 is 13 dB typical, decreasing to 9.5 dB at 12 GHz. At a frequency of 8 GHz, noise figure is typically 2.9 dB for an associated gain of 8.9 dB. At 12 GHz, the typical noise figure is 4.1 dB for a gain of 4.3 dB. What's more, points out Struthers, the device's s-parameters are very consistent across its entire operating frequency range.

Initial reliability projections place the unit's mean time before failure at an estimated 1,250,000 hours for an operating temperature of 80°C.

In quantities of one to nine, price is \$135 each, dropping to \$105 each in lots of 10 to 24. Availability is from stock.

Hewlett-Packard Co., 1501 Page Mill Rd., Palo Alto, Calif. 94304. Phone (415) 493-1501 [401]

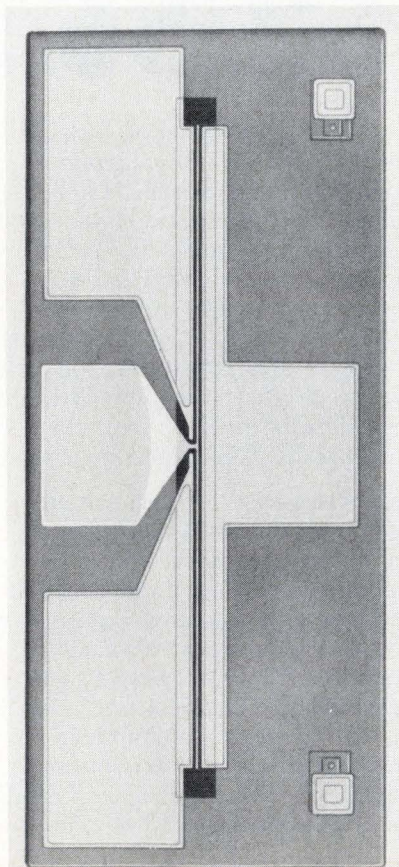

Low-cost attenuator sets designed for breadboarding

Available in calibrated or uncalibrated versions, two sets of 50-ohm coaxial BNC attenuators from Elcom Systems offer accuracy within 0.5 decibel from dc to 1,000 megahertz and within 1 dB from 1,000 to 1,500 MHz. VSWR is less than 1.35 at 1,500 MHz, and it averages 1.2 over the

OAK

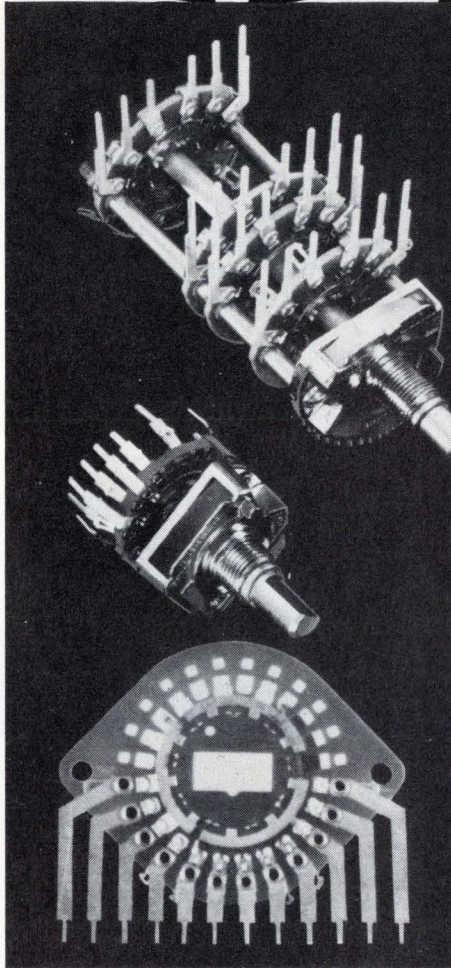

Headquarters
for every kind of
printed circuit
rotary switch

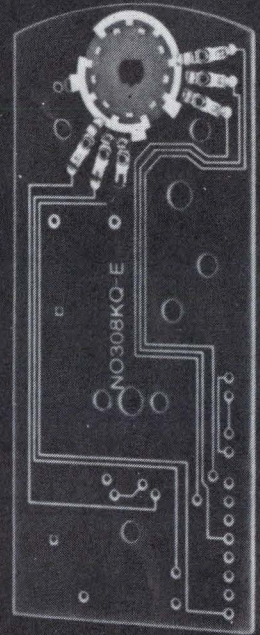
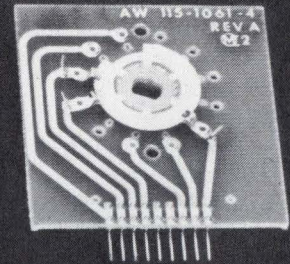
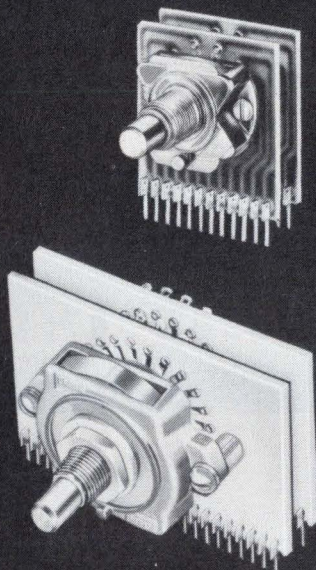

Simplify your equipment design and reduce assembly costs with this broad selection.

1. PCB Terminations can be provided on any conventional Oak rotary switch—the most extensive line in the industry—($\frac{1}{2}$ " to $2\frac{5}{16}$ " diameter sections).

2. Standard PC Board section switches, 12 and 24 position, with PCB terminations are tooled for volume production.

3. Custom designs to meet special applications, including switching built directly into the PC board are readily supplied.

A NEW CATALOG

Detailing Oak PCB switch products and capabilities has just been published. Write for your free copy.

OAK Industries Inc.

SWITCH DIVISION / CRYSTAL LAKE, ILLINOIS 60014

TELEPHONE: 815 • 459 • 5000 ■ TWX: 910 • 634 • 3353 ■ TELEX: 72 • 2447

New products

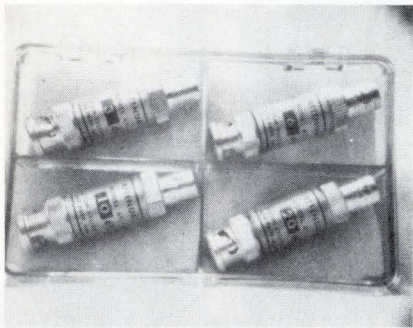

band. The attenuators can dissipate 0.5 watt in continuous operation or 1 kilowatt of peak power.

Each of the two sets contains 3-, 6-, 10-, and 20-dB attenuators in a plastic case. The calibrated set, model AT-50, is priced at \$40, and the uncalibrated set, model AT-51, at \$36. Delivery time is stock to 30 days. The attenuators are also available with type TNC, N, and SMA connectors, and with impedances of 75 Ω or 90 Ω . They are suitable for

breadboarding applications.

Elcom Systems Inc., 127F Brook Ave., Deer Park, N.Y. 11729. Phone Leonard Pollachek at (516) 667-5800 [403]

Connectors use built-in capacitors to suppress rfi

Eliminating the need for external suppression devices, 3-millimeter coaxial connectors from Tek-wave Inc. use built-in capacitors to suppress electromagnetic and radio-frequency interference. This not only lowers system costs, but also makes assembly and disassembly easier in system applications.

Connectors in the series, called the 24-20010210, use four-hole, flange-mounted bodies and are designed for nonhermetic applications that conform to MIL-C-39012. Bodies are built of passivated corrosion-resist-

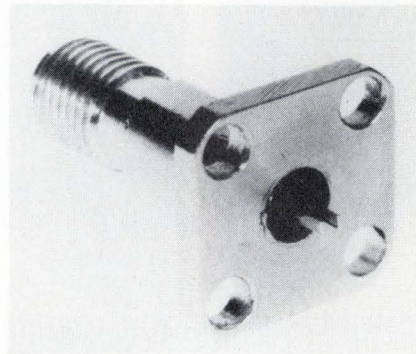

ant steel. Center conductors are heat-treated beryllium copper set in a special low-viscosity, high-strength epoxy.

Frequency range of the connectors is 0.1 to 10 gigahertz. The typical minimum insertion loss is 50 decibels, for example, from 0.2 to 10 GHz.

Tek-wave Inc., Subsidiary of Frequency Electronics Inc., 3 Delaware Dr., New Hyde Park, N.Y. 11040 [405]

EEV marine magnetrons?

+ + + EEV MAGNETRONS FOR MARINE RADAR STOP.

EXPANSION COMPLETE STOP ALL TYPES NOW

AVAILABLE STOP FOR EX STOCK DELIVERIES

ORDER NOW. ENELECTICO

Magnetron puts out peak of
3 megawatts at 2.9 gigahertz

A pulsed coaxial magnetron from Varian offers peak power output of 3.0 megawatts at 2.9 gigahertz. The major application for the tube is in long-range, ground-based radar. The VMS-1143 provides frequency stability, long operating life, and a typical efficiency of 60%. It can serve as a retrofit for the model 6410

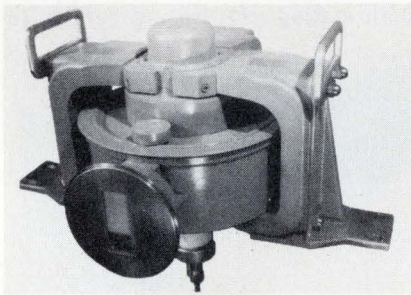

magnetron in FPS-6/89/90 and MPS-14 height-finder radars systems.

Varian, Beverly Division, Salem Rd., Beverly, Mass. 01915. Phone (617) 922-6000 [404]

Dual-channel rotary joint
operates in X band

A dual-channel X-band rotary joint, the model 17-2000, operates over the frequency bands of 7.25 to 7.75 and 7.9 to 8.4 gigahertz. Channel 1, 7.25 to 7.75 GHz, is a receive channel that has a maximum VSWR of 1.15, a maximum insertion loss of 0.15 dB, and a maximum wow (variation in VSWR due to rotation) of 1.05. Channel 2 is designed to carry 12.5 kilowatts continuous wave when pressurized at 30 pounds per square inch. It has a maximum VSWR of 1.10, a maximum insertion loss of

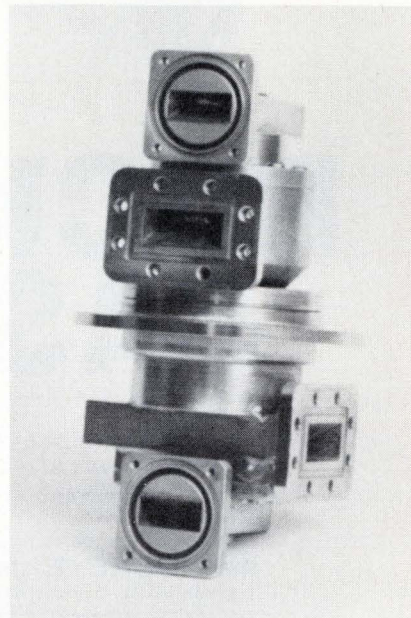

0.1 dB, and a maximum wow of 1.03. The silver-plated aluminum joint weighs 12 pounds. Unit price is

Yes.

To meet increasing world-wide demand, we've stepped up production of EEV marine magnetrons.

Now you can order all EEV types and be sure of getting them from stock.

You'll be sure, too, of getting the world's best tubes. EEV's unique metal/ceramic magnetrons can last 60% longer



than other makers' glass types.

Get the best. Fast. EEV/M-OV magnetrons, modulator tubes, duplexer devices, CRTs - in fact, all the tubes you need for marine radar.

From EEV/M-OV international stockists everywhere. Or if you'd like our equivalents list, contact Chelmsford.

EEV and M-OV know how.

THE M-O VALVE CO LTD, Hammersmith, London, England W6 7PE. Tel: 01-603 3431. Telex: 23435. Grams: Thermionic London. ENGLISH ELECTRIC VALVE CO LTD, Chelmsford, Essex, England CM1 2QU. Tel: 0245 61777. Telex: 99103. Grams: Enelectico Chelmsford. **Genalex**

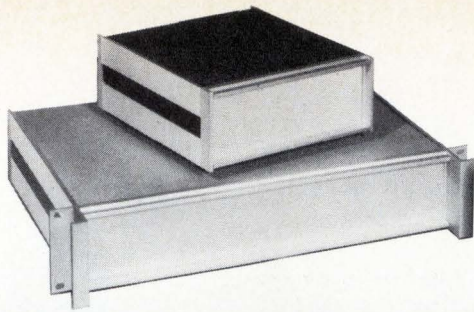

BUCKEYE CASES

Buckeye bord-pak cases are made of aluminum extrusions and available in $\frac{1}{3}$, $\frac{1}{2}$, $\frac{2}{3}$ and full rack widths. Full fabricating capabilities and complete electronic packaging needs from Buckeye include: colorful cabinets, 4 sizes of adjustable P.C.B. Racks, patented card guide modules; retractable tilt-stands with feet, and a complete line of **matching instrument knobs**:

Write today for free colorful literature!
the BUCKEYE stamping co.

555 Marion Rd., Columbus, Ohio 43207

"QUALITY PRODUCTS SINCE 1902"

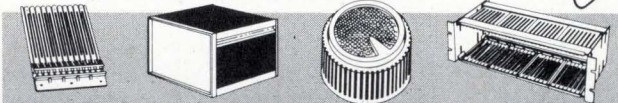

GUIDES • CABINETS • KNOBS • RACKS

See us at Wescon Booth 321

Circle 150 on reader service card

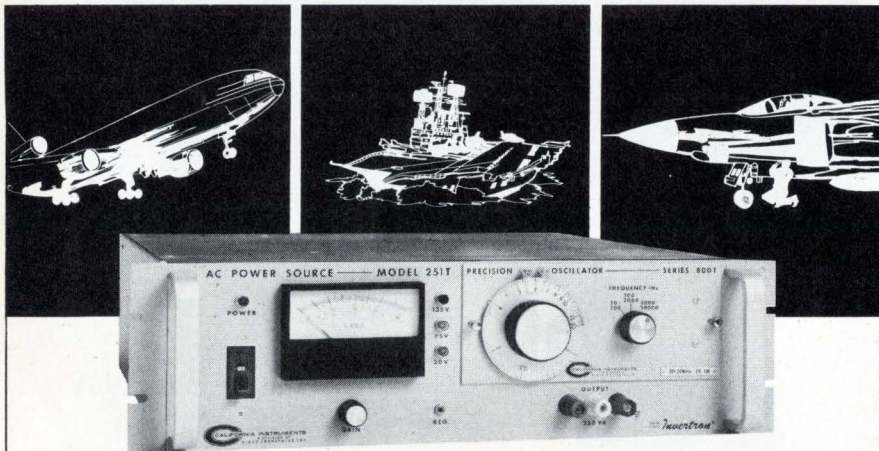

Invertron® AC POWER SOURCES ARE FIRST IN AVIONICS TESTING

For your 400 Hz/800 Hz power requirements you can rely on Invertron® single or three phase fully **isolated** power output with variable voltage and frequency to meet all Avionics Power Specifications. Invertron® features reliability and flexibility which is unsurpassed for today's use or tomorrow. For other frequencies and power to 30 KVA, 21 models of Plug-in oscillators and 16 models of amplifiers are available. Learn more about the oldest and most respected name in AC Power.

FOR FREE AVIONICS BROCHURE WRITE:
 California Instruments,
 5150 Convoy Street, San Diego, California 92111
 Phone: (714) 279-8620 Telex: 695047
 See EEM Pgs. 1.1164, 1.1165

Aiken Industries
 California Instruments
 Division

New products

\$3,500. Delivery time is 60 days after receipt of order.

Eastern Microwave Corp., 4 Gill St., Woburn, Mass. 01801. [406]

Satellite station converters use pretuned frequencies

Designed for three-across, side-by-side mounting, models UC4-1 and DC4-1 up- and down-converters are pretuned, slide-in frequency converters for dedicated carriers at satellite earth stations. Operating bands are

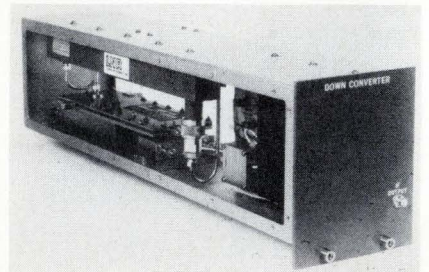

5,925 to 6,425 megahertz for the up-link and 3,700 to 4,200 MHz for the down-link.

For stations that change frequency assignments only occasionally or on a preplanned basis, pretuned frequency converters are said to offer convenience and low cost. When switch-over is necessary, the operating module is quickly replaced with one pretuned to the new frequency. To pretune in the field, the input channelizing filter is replaced, and a crystal in the local oscillator is exchanged.

The UC4-1 and DC4-1, which weigh 10 pounds each, interface at the CCIR standard intermediate frequency, 70 MHz. Bandwidth is 40 MHz, and in-band ripple is less than 0.5 dB. Nominal overall gain is 20 dB. Dimensions of both models are 5.7 inches high by 4.5 in. wide by 18 in. deep. A frame with automatic switchover and alarm is available, providing one-for-one or one-for-two redundancy in critical standby applications. The frame is 7 inches high by 19 in. wide by 22 in. deep.

LNR Communications Inc., 180 Marcus Blvd., Hauppauge, N.Y. 11787. Phone (516) 273-7111 [408]

ALUMINUM KNOBS



Don't just take our beautiful KNURLED KNOBS for granted! They are completely machined, including the knurl and then carefully anodized. This takes a little more time and effort, but we think it's worth it. We're sure you'll agree too, when you see the luster and high quality.

Call or write today for a catalog, sample and price information.

Circle 218 on reader service card

RIGHT-ANGLE PC TOGGLE



The ultimate in submini-toggle switches which are designed expressly for PC applications. Terminals and mounts fit 0.1" hole centers on X and Y axis. Gold or silver contacts are optional. Plain or threaded bushing. Custom PC terminals, too!

Write or call (617) 685-4371 for further information on this and other TT Series models.

ALCO ELECTRONIC PRODUCTS, INC.
1551 OSGOOD STREET, NORTH ANDOVER, MA. 01845 U.S.A.

Tel: (617) 685-4371 TWX: 710 342-0552

A SUBSIDIARY OF **AUGAT** INC.

Circle 219 on reader service card

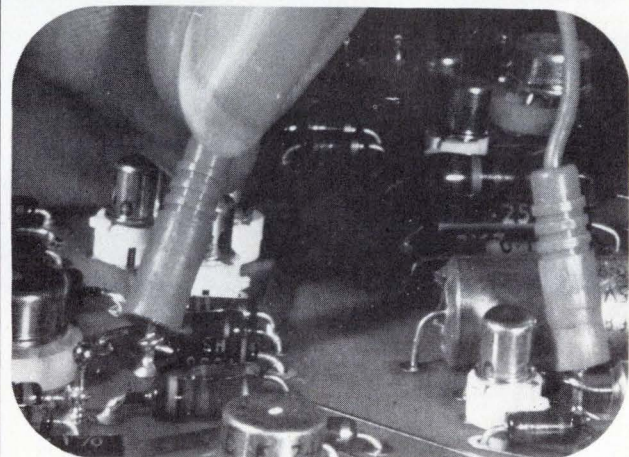

award winning OXLEY Snaplox[®]

Snaplox[®] connector/test point extends Oxley's wide range. Clicks on/off but pulled beyond generous angle, detaches without damage. Bale-ended spills (stand-off or lead-through) available in various executions. PTFE insulated flying socket spherical spring contact, in eleven colours. Request information.

See Snaplox at WESCON STAND 1007

OXLEY  Oxley Developments Co. Ltd.

ULVERSTON · CUMBRIA · LA12 9QG · ENGLAND
CABLES OXLEY ULVERSTON · TELEX 65141 · TELEPHONE: 0229 52621

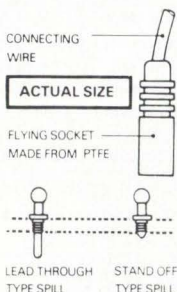

Circle 175 on reader service card



CAMTROL

PROGRAMMABLE CAM CONTROLLER

**Replaces
mechanical cams
and limit switches...
expandable to 20 limits...
not effected by noise**

Theta CAMTROL is a replacement for mechanical cams and limit switches. Through the use of reliable programmable electronics, dwell settings can be remotely adjusted within an accuracy of .01 degrees.

A totally modular concept has been implemented in this heavy duty industrial design to permit range expansion or accuracy changes through the use of plug-in control modules.

LITERATURE:

Write for descriptive literature on the Theta CAMTROL Programmable Cam Controller.

Theta

3003

INSTRUMENT CORPORATION

Fairfield, New Jersey 07006 • Phone: 201-227-1700

Circle 151 on reader service card 151

Hutson Has Thyristor Chips

We Can Also Design One For Your Specific Applications... And Save You Money, Too

TRIAC and SCR chips are available from Hutson in standard geometrics. Or, if you have a special application, Hutson will design the chip you need to meet exact specifications. Hutson standard chips feature all-diffused construction. All chips are glass-passivated and hermetically sealed with reflow-solder construction for ease, reliability and economy of chip mounting. Many Hutson chips are available with center gating for improved di/dt and dv/dt characteristics. Call Hutson... or contact one of the Hutson representatives nearest you.

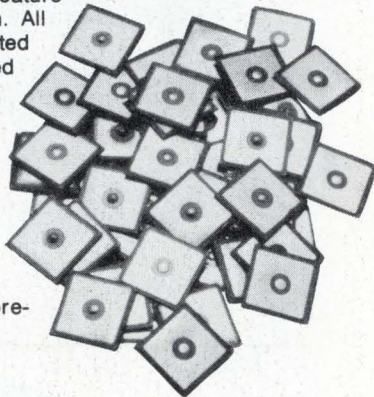

REPRESENTATIVES

ALABAMA Huntsville: K&E Associates (205) 883-9720. **ARIZONA** Tempe: Gassner & Clark (602) 968-9037. **CALIFORNIA** Glendale: Orion Sales (213) 240-3151; Redwood City: Parks & Pruitt (415) 364-1640; Tustin: Orion Sales (714) 832-9687. **COLORADO** Denver: Electrodyne, Inc. (303) 757-7679. **CONNECTICUT** Newton: Gerber Sales (203) 426-3440. **FLORIDA** Lighthouse Point: R.C. Simon (305) 941-2757. **GEORGIA** Hartwell: K&E Associates (404) 376-5438. **ILLINOIS** Chicago: L-Tec, Inc. (312) 286-1500. **INDIANA** Greenwood: Valentine/Schillinger (317) 888-2260; South Bend: Valentine/Schillinger (219) 291-6258. **KANSAS** Wichita: Dytronix, Inc. (316) 943-6221. **MARYLAND** Baltimore: Stemler Associates (301) 944-8262; Pasadena: Stemler Associates (703) 548-7818. **MASSACHUSETTS** E. Longmeadow: Gerber Sales (413) 525-3059; Waltham: Gerber Sales (617) 890-8040. **MICHIGAN** Grosse Point Park: Greiner Assoc. (313) 499-0188. **MINNESOTA** Minneapolis: Bitronics Sales Co. (612) 835-7744. **MISSISSIPPI** Corinth: K&E Associates (601) 287-5369. **MISSOURI** Hazelwood: Dytronix, Inc. (314) 731-5799; Independence: Dytronix, Inc. (816) 737-1100. **NEW JERSEY** Haddonfield: Sunday-O'Brien (609) 429-4013; Irvington: Murray Gallagher, Inc. (201) 399-4350. **NEW YORK** N. Syracuse: Precision Sales (315) 458-2223 (NYC, Gallagher — see New Jersey). **OHIO** Chagrin Falls: Midwest Marketing Association (216) 247-6655; Cleveland: Midwest Marketing Assoc. (216) 249-2816; Dayton: Midwest Marketing Assoc. (513) 433-2511. **OREGON** Beaverton: N. R. Schultz (503) 643-1644. **TEXAS** Plano: Precision Devices (214) 423-7618. **WASHINGTON** Bellevue: N. R. Schultz (206) 454-0300. **WISCONSIN** Greenfield: L-Tec, Inc. (414) 545-8900. **UTAH** Salt Lake City: Electrodyne, Inc. (801) 277-8392.



HUTSON INDUSTRIES

P.O. Box 34235
2019 West Valley View Lane
Dallas, Texas 75234
(214) 241-3511
TWX 910-860-5537

EUROPEAN OFFICE
30 Rue Pierre Semard
Yverres, 91, France
Telephone: Paris 925-8258
TELEX 210-311

Circle 152 on reader service card

Why ACE solderless breadboards are more reliable than others.

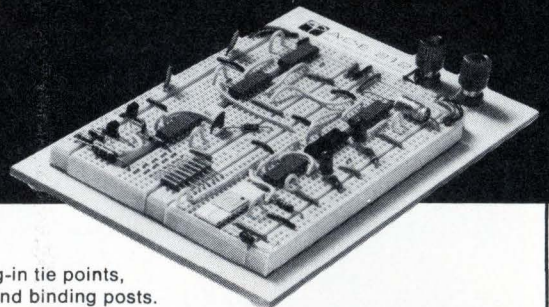
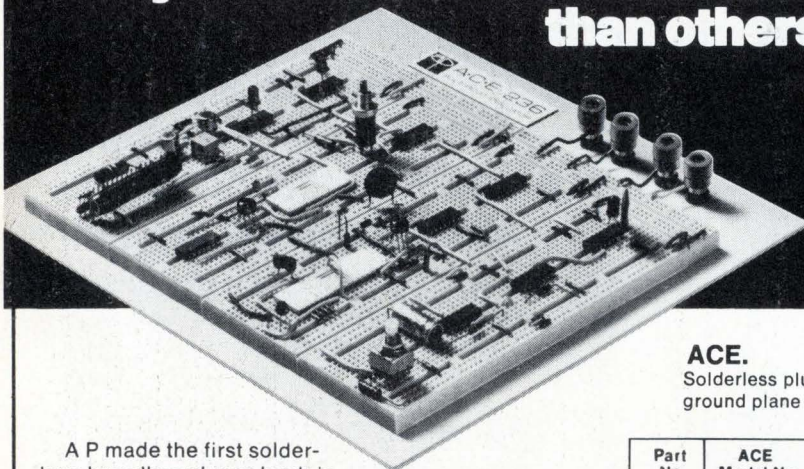

ACE.

Solderless plug-in tie points, ground plane and binding posts.

A P made the first solderless breadboard way back in 1968, and we still make them best. Because our experience taught us to avoid the pitfalls that can mean circuit errors. We do it by paying attention to details. Like using non-corrosive nickel-silver in our frankly superior terminals. And like using a vinyl-insulated back that prevents short circuiting. That's why you can count on the reliability of our solderless boards when you specify A P ACE All Circuit Evaluator Boards, Super Strips™, Terminal and Distribution Strips.



A P PRODUCTS INCORPORATED

Box 110-E Painesville, OH 44077 (216) 354-2101 TWX: 810-425-2250

Part No.	ACE Model No.	Tie Points	DIP Capacity	No. Buses.	No. Posts	Board Size (inches)	Price Each
923333	200-K (kit)	728	8 (16's)	2	2	4-9/16x5-9/16	\$18.95
923332	208 (assem.)	872	8 (16's)	8	2	4-9/16x5-9/16	28.95
923334	201-K (kit)	1032	12 (14's)	2	2	4-9/16x7	24.95
923331	212 (assem.)	1224	12 (14's)	8	2	4-9/16x7	34.95
923326	218 (assem.)	1760	18 (14's)	10	2	6-1/2x7-1/8	46.95
923325	227 (assem.)	2712	27 (14's)	28	4	8x9-1/4	59.95
923324	236 (assem.)	3648	36 (14's)	36	4	10-1/4x9-1/4	79.95

Ohio and California Residents Add Sales Tax. All orders subject to acceptance at factory.

For quick phone service, call the A P distributor nearest you:

(201) 224-8032	(216) 587-3600	(415) 326-5432	(612) 488-0201	(713) 777-1666
(206) 682-5025	(312) 298-8580	(415) 969-9240	(617) 237-6340	(714) 549-8611
(213) 768-3800	(313) 525-1800	(513) 236-9900	(617) 273-1860	(803) 779-5332
(213) 875-2862	(314) 863-7800	(516) 483-9200	(617) 879-0860	(914) 664-0088
(215) 698-4000	(412) 782-2300	(516) 883-0999	(713) 350-6771	

(If no distributors in your area, call factory)

Faster and easier is what we're all about.

New literature

Transient suppressors. Two types of devices for suppression of transient voltages are compared in an eight-page report published by General Semiconductor Industries Inc., 2001 West Tenth Pl., Tempe, Ariz. 85281. The brochure, entitled, "A Comparison Report on TransZorbs versus Metal Oxide Varistors," provides comparative data on published specifications plus data from tests. TransZorbs is General Semiconductor's name for its silicon pn-junction devices used in transient suppression. For a copy of the report, circle 422 on the reader service card.

Shielding foils. A four-page technical bulleting covers the MagnaShield line of electromagnetic and electrostatic shielding foils made by SGL Electronics, 300 Harvard Ave.,



Westville, N.J. 08093. The bulletin describes an empirical method for determining the proper shielding type and placement. Also included are charts covering the technical and performance specifications of the three types of MagnaShield foil—low nickel, high nickel, and silicon steel. [423]

Resistive components. The second issue of "Trimpot Digest," a periodical about the technology and applications of resistive components, has been published by Bourns Trimpot Products division. The content of the current issue centers on unusual applications, material and design

MINILEVER®

**QUICK AND POSITIVE...
... and RELIABLE TOO!**
It's our Series 28000 MINILEVER

- Price competitive with standard thumbwheel switch types
- A 90° sweep of the lever rotates the dial a full revolution
- Positive tactile characteristics
- Smooth action
- Large dial characters (.200")
- Available from local Distributor stock
- Specials available from the factory



Send for a Series 28000 MINILEVER Data Sheet

DIGITRAN®

Pasadena, California • Phone (213) 449-3110

For more information use the Inquiry Form provided on this page.

INQUIRY FORM

1. DO YOU WANT MORE INFORMATION? Yes, send data about:
- KL MINIKEY Keyboard
 - Series 8000 MINISWITCH
 - Series 23000 SNAP-IN SLIMSWITCH
 - Series 29000 ECONOMY MINISWITCH
 - Series 12000 MINIBUTTON
 - Series 24000 DIGILEVER
 - Series 28000 MINILEVER
 - QPL Approved DIGITAL SWITCHES
 - DIGITAL VOLTAGE DIVIDER and RESISTANCE DECADE Catalog
 - Send me your complete "DIGITAL SWITCH" Catalog.
 - Send a

Sales Engineer to see me. My phone is: (_____) _____

2. Is the purchase of this type product anticipated? Yes No. If "Yes", what is your application? _____
3. Is your requirement: Current 1-3 months 3-6 months longer?
4. How many assemblies per year? under 100 100-500 500-1000 or more.
5. Are you responsible for: Design Specification Purchasing?
6. Have you specified or purchased products of the type made by Digitran in the past? Yes No. If yes, whose? Digitran
- Other _____
7. Have you ever been contacted by a Digitran Sales Representative? Yes No. If "Yes", When? Recently 3-6 months ago 6-12 months ago 12 months or more.

Name _____ Title _____

Company _____

Address _____

City _____ State _____ Zip _____

For detailed information about Digitran's products, please complete this INQUIRY FORM, clip and send it to:

THE
DIGITRAN®
COMPANY

A Division of Becton Dickinson Company

E876

855 South Arroyo Parkway • Pasadena, California 91105

THE EQUIPMENT DESIGNERS PANEL METER



PM-4



Unit Quantity— \$170

Standard Features:

- Full four digits with 0.02% accuracy.
 - Large 0.3" LED display.
 - Automatic zeroing & polarity.
 - Low power consumption: 5V @ 0.8W.
 - Small size: 1" H x 2.5" W x 3.25" D.
 - Programmable decimal point.
 - 1, 10, 100 or 1000 vdc ranges.
- Also a unipolar or bipolar, 0.1%, 3-digit PM-3 or PM-3A at \$85 or \$89 and a bipolar, 0.05%, 3-1/2-digit PM-3.5 at \$99.

See your local distributor

Distributor inquiries invited.



Non-Linear Systems, Inc.

Originator of the digital voltmeter.
Box N, Del Mar, California 92014
Telephone (714) 755-1134 TWX 910-322-1132

Circle 154 on reader service card

MICRO68 Microprocessor

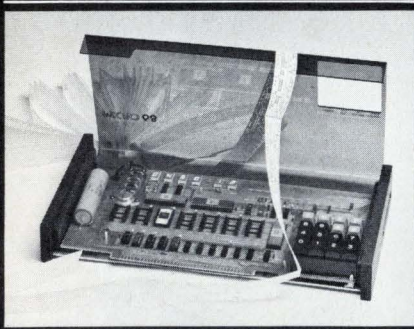

The MICRO-68 is a completely assembled computer, for only \$430. Built around the Motorola/AMI/Hitachi 6800 microprocessor, MICRO-68 has its own integral power supply, 16 button keyboard, six digit LED display, and 128 words of RAM. The 512 word MON-1 PROM contains the service routines necessary to load programs, inspect and edit, insert break points for debugging, and execute. Memory expansion to 64K and full I/O can be obtained with convenient edge connectors.

The MICRO-68 can be expanded with a complete line of EPA peripherals, resulting in the power to accomplish the most demanding applications.

EPA Electronic Product Associates, Inc.
1157 Vega St., San Diego, CA 92110
(714) 276-8911

New literature

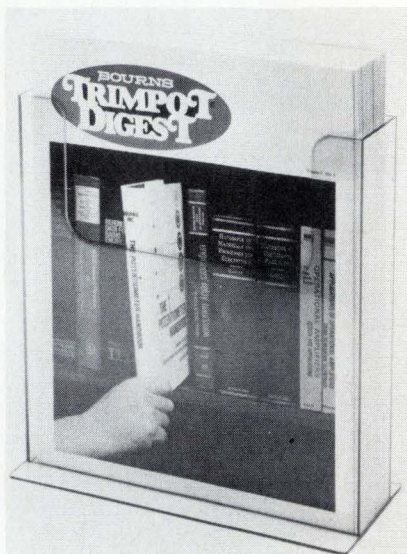

performance characteristics, procurement suggestions, and design aids. In addition, a review of the new McGraw-Hill publication, The Potentiometer Handbook, is included. A copy of the "Trimpot Digest" can be obtained by writing Digest—Bourns Inc., 1200 Columbia Ave., Riverside, Calif. 92507 [424]

Optical components. Low-cost plastic lenses, prisms, mirrors, light pipes, and other specialty optical components are described in a six-page two-color technical bulletin. The publication discusses user advantages of plastic optics, including light-weight, high-visible-light transmittance, resistance to chipping and breakage, and low cost. Applied Products Corp., Horsham Valley Industrial Center, Horsham, Pa. 19044 [427]

Capacitors. As part of its 28-page capacitor catalog, Paktron includes a foldout comparison chart for quick selection of the appropriate device.



Classified section

FOR EMPLOYMENT AND SALES OPPORTUNITIES

FIELD SERVICE

Electronics for Yachting, Ft. Lauderdale, Florida requires a man strong in Single Sideband communications setup and repair. FCC second class radiotelephone license required. Please submit resume to Electronics for Yachting, Inc., 1525 S. E. 16th Street, Ft. Lauderdale, Fla. 33316

POSITION VACANT

Position Available—Need BS Eng. + U.S. exper. in engineering or technical sales. Fee paid by employer. Over 1,000 U.S. client co's. Est. 1959. Send resume & present salary. Atomic Personnel, Inc., Box L, 1518 Walnut, Phila, PA 19102.

EMPLOYMENT SERVICE

Electronics' Industry Newsletter tells you which firms have current employment opportunities, in the field of Electronics, for all types of Engineers, Sales Representatives, Technicians, Executives, Computer Personnel and others. Latest product information is also reported. For information write: Electronics' Industry Newsletter, Dept. 304A, 23573 Prospect Avenue, Farmington, MI 48024.

Think of what just one company can do to stop pollution. We have.



People start pollution. People can stop it.

Please send me a free copy of your guide.

Name _____

Street _____

City _____

State _____ Zip _____



A Public Service of The Magazine & The Advertising Council

Keep America Beautiful
99 Park Avenue New York 10016

New literature

The catalog also contains pictures and complete dimensions of the company's line of capacitors, including several new types. Write to Paktron Division, Illinois Tool Works Inc., 900 Follin La., S.E., Vienna, Va. 22180 [426]

Readout devices. A broad line of light-emitting-diode, incandescent and neon readout devices is described in a Product Selector Guide from Dialight, a North Amer-

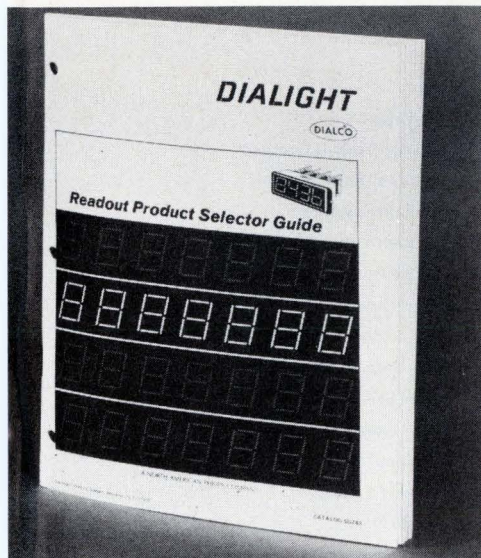

ican Philips company. The 56-page catalog, designated the SG743, describes and illustrates modules that are available as individual components, as integrated systems complete with associated decoder-driver circuitry, and as packages with bezel assembly or panel bracket. Write to Dialight, 203 Harrison Pl., Brooklyn, N.Y. 11237 [425]

Testing technique. Use of gel-permeation chromatography to test epoxy resin, one of the raw materials in the manufacture of printed-circuit boards, is described in a publication from Waters Associates. The case study, entitled Polymer Testing Saves Money in Electronics, tells how two IBM researchers used GPC to reduce the company's reject rates in pc boards. A free copy of publication H66 is available from Waters Associates Inc., Maple St., Milford, Mass. 01757 [429]

Two-Tone SSB RF Test Set

Model 315 combines two Model 925 RF Signal Generators having "Signallock" with a Model 210 Signal Combiner, resulting in a two-tone test set with unsurpassed stability from 50 kHz to 80 MHz. Signal level of each tone or combined tones is adjustable from 0.1 μv to 2 volts with ± 10 Hz stability. Signal spacing is from 100 Hz to almost 80 MHz. Intermodulation distortion is 60 dB down at full output; better at lower outputs. Write or call today for complete specifications and pricing.

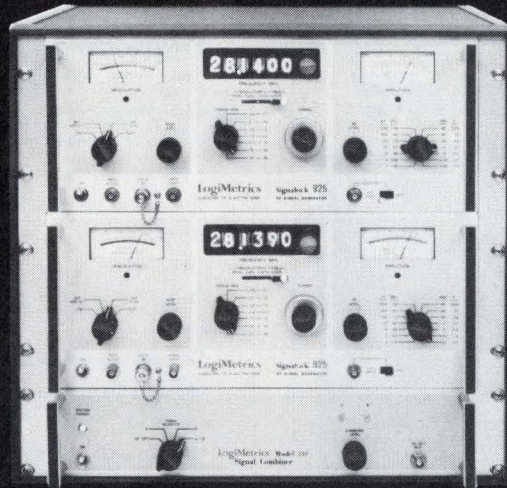

LogiMetrics

121-03 Dupont Street, Plainview, New York, 11803, (516) 681-4700/TWX: 510-221-1833
RF Signal Generators, Frequency Synthesizers, Traveling Wave Tube Amplifiers

Circle 155 on reader service card

33% more power to the people. Power/Mate presents Econo/Mate II. The open frame power supply.

Now Power/Mate brings you 33% more power in the same package size with the second generation of our Econo/Mate series.

The size is the same, the basic components are the same for easy interchangeability. But that's where the similarity ends.

Econo/Mate II adds features like dual AC primary and a plug-in IC regulator for improved regulation.

And Econo/Mate II is tough. Computer design, quality control, and Power/Mate's experience helps insure 100,000 hr. MTBF even at this higher power output.

But for all its features, Econo/Mate II is still, most of all, economical.

We wouldn't call it Econo/Mate if it wasn't.

Econo/Mate II is in stock, ready for delivery. Send for our free brochure.

Prices start at \$19.95.

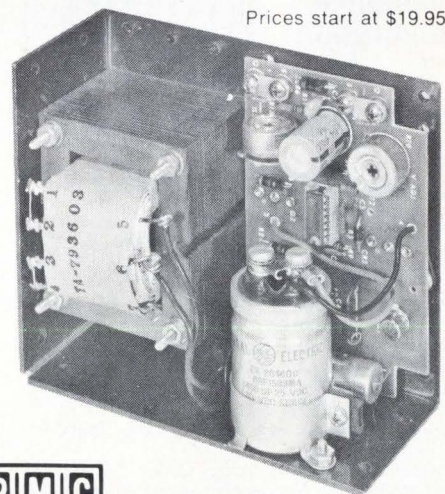

PMC

POWER/MATE CORP.

World's largest manufacturer of quality power supplies:
514 South River Street/Hackensack, N.J. 07601/Phone (201) 343-6294 TWX 710-990-5023

LG

SCREENING Simplified

Now you can save time, money and rework with our major price breakthrough in testing integrated circuits. Our new automated Qualifier performs 100% of the DC and Functional Testing of DTL, TTL, and CMOS devices with either a 6, 8, 14 or 16 pin DIP package within a 1% tolerance.

Meet your production schedules and reliability goals with a call to us.



Associated Testing Laboratories, Inc.
Northwest Industrial Park
Burlington, MA 01803
(617) 272-9050

Circle 156 on reader service card

Low cost tool for design and trouble-shooting

**Pocket Size
Slide-Switch
Resistance
Substitution
Unit**

still only \$58



- Over 11 million ohm values
- 1% accuracy resistors
- Unique in convenient size
- Rugged construction

Small enough to take anywhere in your pocket, this aluminum-housed unit delivers a very broad range of resistance steps. Excellent for both development and repair work.

Half-watt 1% tolerance resistors give an accurate range from 1 to 11,111,110 ohms, in one-ohm steps. Has three binding posts, one to ground case.

Available now from stock. Order Catalog No. 7092-236. 5% discount for cash with order.

Ask your dealer, or contact:



PHIPPS & BIRD, INC.

Manufacturers of Scientific Instruments
P.O. Box 27324 • Richmond, VA. 23261
• 804/264-2858

156 Circle 182 on reader service card

Electronics advertisers

August 19, 1976

Addmasters Corporation	124	Georgia Department of Community Development	141
Advanced Memory Systems	28,29	Gould Advance	62,63
Advanced Micro Devices	10,11	■ Hewlett-Packard	2nd cover 1,2,9
■ Airpax Electronics	37	Hutson Industries	152
■ Alco Electronics Products Inc.	151	■ ILC Data Devices	16
American Microsystems Inc.	42,43	Indiana General	127
AMF/Potter & Brumfield	121	Intech/Function Modules, Inc.	6
■ AMP Incorporated	60,61	International Electronics Research Corporation	134
Ansley Electronics Corp.	139	* ■ ITT Cannon	11E
■ AP Products Incorporated	152	■ Johanson Mfg. Corp.	20
Associated Testing Labs	156	■ Johnson Company, E.F.	137
■ Bausch & Lomb Inc.	130	■ Kepco Inc.	46
° Bayer AG	75	Krohn-Hite Corporation	3
B & K Precision Division Dynascan Corporation	14	Litronix Inc.	7
■ Bourns Inc.	4th cover	* Logabax	5E
Broward Industrial Board	143	■ Logimetrics	155
■ Buckeye Stamping Company, The	150	McDonnell Douglas Company	115
■ Bud Radio	140	McGraw-Hill Book Company	136
° Burr Brown Research Inc.	54	Micro Power Systems	72
■ California Instruments	150	Micro Switch Division of Honeywell	122,123
‡ Centralab Electronics Division of Globe Union Inc.	57	■ Miller Stephenson Chemical Inc.	143
■ Cherry Electrical Products Inc.	39	Molon Motors	97
* ■ C. P. Clare International	23	Monsanto Co.	21
‡ ■ C. P. CLARE Co.	75	Mostek Corp.	79
■ Continental Rentals	8	‡ ■ National Semiconductor Corporation	44,45
■ Continental Specialties Corporation	131	■ Newport Labs.	144
■ Curtis Instr.	74	Nippon Electric Co., Ltd.	78
° Dale Electronics Inc. A Subsidiary of Lionel Corporation	6E,7E	■ Non-Linear Systems	154
Data General Corporation	27	OAK Industries	147
■ Data Precision	24	‡ ■ Omron Corporation of America	18,19
■ Data Translation Inc.	70	* Oscilloquartz	12E
Delta Air Lines	8	Oxley Developments	151
■ Deltec	157	■ Phipps & Bird, Inc.	156
■ Dialight Corporation	124	‡ ■ Philips Test & Measuring Instruments Inc.	15
■ The Digitran Company	153	■ Phoenix Data Inc.	126
■ Eastman Kodak	142	Plessey Semiconductors	71
■ E&L Instruments Inc.	66	■ Power/Mate Corporation	155
■ Electro Scientific Industries	157	Process Computer Systems, Inc.	104
Electrol	22	Ramtek	119
Electronic Navigation Industries	3rd cover	Raytheon Company	30
Electronic Product Associates, Inc.	154	RCA Solid State Division	67
Elorg Electronorg-technical	138	‡ ■ Rental Electronics Inc.	54
English Electric Valve Company Ltd.	148,149	* Rohde & Schwarz	1E
■ Erie Technological Products Co. Inc.	17	Scanbe Mfg. Corp.	134
Esterline Angus Instrument Corporation	124	Semtech Corporation	103
Faultfinders Inc.	146	* Shell International Chemical Co., Ltd.	15
‡ Ferroxcube Corp.	50	* Siemens A.G. Munich	52
Figaro Engineering Inc.	157	‡ Siemens Computes	52,53
■ Fluke Manufacturing Co., John	133,135	‡ Siemens Computest	52,53
‡ Fujitsu Limited	145	‡ Siemens Corporation	22,23
GCA Corporation	116	Siliconix	12,13
General Electric Co. Miniature Lamp Division	118	Sorensen	132
General Instrument Corporation, Microelectronics Division	41	Sprague Electric Corporation	49
		Systron Donner Concord Instrument	70

Transistor Electronics	6
* TEAC Corp.	19
■ Tektronix Inc.	35,76
Teradyne Inc.	64
Texas Instruments Incorporated Components Div.	128,129
Texas Instruments Incorporated Digital Systems Division	58,59
■ Theta Instruments	151
■ TRW/Capacitors	98
Viking Industries	68
Wavetek San Diego	80
* Don White Consultants Inc.	8E
XLO-REMEX	113
* Yokogawa Electric Works	45

Classified & Employment Advertising

F. J. Eberle, Manager 212-997-2557	
Electronics for Yachting Inc.	4
Fairchild Camera and Instrument Corp.	159



ELIMINATE NOISE PROBLEMS WITH DELTEC'S COMPUTER POWER CONDITIONER

5 KVA FOR LESS THAN \$1,500

Only One Computer Power Conditioner Eliminates All Noise Problems. Noise on a computer power line causes data and memory loss as well as mysterious crashes and errors. This noise can pass through voltage regulators and dedicated power lines.

Deltec DLC Series computer power conditioners eliminate noise and regulation problems. Unique shielding provides 120 dB (1,000,000:1) reduction for: Transients—Voltage Spikes—Ground Loops—Line Noise caused by RFI or EMI (radiated noise).

The DLC regulates voltage within 3% over a 30% input voltage range.

For more information, call or write:

DELTEC, 980 Buenos Ave.,
San Diego, CA 92110
Phone (714) 275-1331



Circle 157 on reader service card

Gas Sensing Semiconductor

FIGARO GAS SENSOR

TGS quickly senses
even small
amount
of gas.

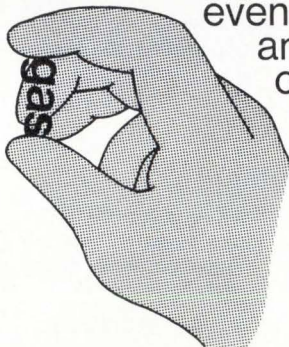

New Models,
some with highly sensitive
CO sensor, now on the market.

Please contact the address below directly for
catalogs and price/delivery information.

FIGARO ENGINEERING INC.

3-7-3, Higashitoyonaka, Toyonaka City, Osaka 560,
Japan/Tel: (06) 849-2156

Cable: FIGARO TOYONAKA/Telex: 05286155 FIGARO J

■ For more information of complete product line see advertisement in the latest Electronics Buyers Guide
* Advertiser in Electronics International
‡ Advertiser in Electronics domestic edition

Electronics/August 19, 1976

Circle 183 on reader service card

Low-cost (under \$1500) IC testers



Model 1234 Linear IC Tester.
Devices tested: Monolithic
or Hybrid Operational
amplifiers.

Tests performed:
 E_{OS} , I_{B-} , I_{B+} , DC
open loop gain, DC
CMRR, oscillation
detection.

Remarks: 3-digit direct
reading digital display
which enables go-no-go testing.

Model 1248 Digital IC Tester.
Devices tested: 14 and 16
pins, TTL, DTL and
CMOS @ 5V. Tests per-
formed: Fixed pattern
functional test.

Remarks: Performs
 2^{20} inspections per test
in from 1 to 5 seconds. No
comparison with a "good"
IC is necessary. 4-digit display
gives absolute test results. Can
also be used to check continuity
of resistor network.



Model 1249
Digital IC Tester.

Devices tested:
TTL, DTL @ 5V, HTL @
15V, CMOS @ 5V,
10V, 15V.

Tests performed: Same as
1248. Remarks: Interfaces with
manual and automatic handlers. Multiple
voltages for CMOS.

Electro Scientific Industries
13900 N.W. Science Park Dr.
Portland, Oregon 97229
503-641-4141



Circle 184 on reader service card

ELECTRONICS ARTICLES AVAILABLE IN REPRINT

No. of
copies
wanted

New reprints

- _____ R-526 How reliable are today's components 16 pp \$3.00
- _____ R-524 Special report on bipolar large-scale integration 12 pp \$3.00
- _____ R-522 Special report on power semiconductors 12 pp \$3.00
- _____ R-514 Eight ways to better radio receiver design 6 pp \$3.00
- _____ R-512 Design of circuits for dangerous environments 4 pp \$3.00
- _____ R-510 Bipolar integration advances with μ L microprocessor 8 pp \$2.00
- _____ R-508 Designing microprocessors with standard-logic devices 12 pp \$3.00
- _____ R-506 The case for component burn-in 7 pp \$2.00

Charts

- _____ R-516 Electronic symbols (chart) \$2.00
- _____ R-211 Electromagnetic spectrum (16-page report and chart) \$4.00
- _____ R-326 Optical spectrum (6-page report and chart) \$3.00

Books

- _____ R-520 Microprocessors—Electronics Book Series \$8.95
- _____ R-031 Circuit Designer's Casebook 182 pp (U.S. only) \$5.50
- _____ Circuit Designer's Casebook (foreign) \$12.00

Other Reprints

- _____ R-434 Designing automated systems with the new standard interface 12 pp \$3.00
- _____ R-432 An update on communications satellites 8 pp \$2.00
- _____ R-430 Choosing the right bipolar transistor model for computer-aided design 20 pp \$3.00
- _____ R-428 Designing with low-cost lasers 6 pp \$2.00
- _____ R-518 Special issue—productivity \$4.00
- _____ R-426 Special issue—technology update 1974 \$4.00
- _____ R-424 Microprocessor applications 28 pp \$3.00
- _____ R-422 A microprogrammable mini-computer 8 pp \$2.00
- _____ R-420 Computerized text-editing and typesetting 8 pp \$2.00
- _____ R-418 Computer analyses of rf circuits 8 pp \$2.00
- _____ R-416 Optical waveguides look brighter 8 pp \$2.00
- _____ R-414 The ion-implanted n-channel process 6 pp \$2.00
- _____ R-412 Liquid cooling of power semiconductors 6 pp \$2.00
- _____ R-410 Special report on passive components 16 pp \$3.00
- _____ R-408 Bringing sight to the blind 8 pp \$2.00
- _____ R-406 Designing with the new logic, C-MOS and bipolar 16 pp \$3.00
- _____ R-328 Special issue—pervasiveness of electronics \$2.00

Payment must accompany your order

Make check or money order payable to Electronics Reprints. All orders are shipped prepaid by parcel post. Allow two to three weeks for delivery.

Back issues now available: 1960 to 1969, \$5.00 each; 1970 to 1973, \$3.00 each; 1974 to 1975, \$4.00 each

USE THIS PAGE AS YOUR ORDER FORM

Cost of orders \$ _____
Plus 10% handling charge \$ _____
TOTAL AMOUNT ENCLOSED \$ _____

Mail your order to:
Janice Austin
ELECTRONICS REPRINTS
P.O. Box 669
Hightstown, N.J. 08520

SEND REPRINTS TO

Name _____

Company _____ Dept. _____

Street _____

City _____ State _____ Zip _____

Advertising Sales Staff

Pierre J. Braudé New York [212] 997-3468
Paris Tel: 720-73-01
Director of Marketing

Atlanta, Ga. 30309
100 Colony Square, 1175 Peachtree St., N.E.
[404] 892-2868

Boston, Mass. 02116: James R. Pierce
607 Boylston St. [617] 262-1160

Chicago, Ill. 60611:
645 North Michigan Avenue
Robert W. Bartlett (312) 751-3739
Robert M. Denmead (312) 751-3738

Cleveland, Ohio 44113: William J. Boyle
[716] 586-5040

Dallas, Texas 75201:
2001 Bryant Tower, Suite 1070
[214] 742-1747

Denver, Colo. 80203: Harry B. Doyle, Jr.
123 Speer Blvd. #400
[303] 837-1010

Detroit, Michigan 48202: Robert W. Bartlett
1400 Fisher Bldg.
[313] 873-7410

Houston, Texas 77002: Paul Reiss
601 Jefferson Street, Dresser Tower [713] CA 4-8381

Los Angeles, Calif. 90010: Robert J. Reilly
Bradley K. Jones, 3200 Wilshire Blvd., South Tower
[213] 487-1160

New York, N.Y. 10020
1221 Avenue of the Americas
Warren H. Gardner [212] 997-3617
Michael J. Stoller [212] 997-3616

Philadelphia, Pa. 19102: Warren H. Gardner
Three Parkway,
[212] 997-3617

Pittsburgh, Pa. 15222: Warren H. Gardner
4 Gateway Center, [212] 997-3617

Rochester, N.Y. 14534: William J. Boyle
9 Greylock Ridge, Pittsford, N.Y.
[716] 586-5040

San Francisco, Calif. 94111: Don Farris
Robert J. Reilly, 425 Battery Street,
[415] 362-4600

Paris: Alain Offergeld
17 Rue-Georges Bizet, 75 Paris 16, France
Tel: 720-73-01

Geneva: Alain Offergeld
1 rue du Temple, Geneva, Switzerland
Tel: 32-35-63

United Kingdom & Scandinavia: Robert Ghey
Tel: 01-493-1451, 34 Dover Street, London W1

Scandinavia: Andrew Karnig and Assoc.
Kungsholmsgatan 10
112 27 Stockholm, Sweden
Tel: 08 51 68 70 Telex: 179 51

Milan: Luigi Rancati
1 via Baracchini, Italy Phone 86-90-656

Brussels: Alain Offergeld
23 Chaussee de Wavre
Brussels 1040, Belgium
Tel: 13-73-95

Frankfurt/Main: Fritz Krusebecker
Liebigstrasse 27c, Germany
Phone 72 01 81

Tokyo: Tatsumi Katagiri, McGraw-Hill
Publications Overseas Corporation,
Kasumigaseki Building 2-5, 3-chome,
Kasumigaseki, Chiyoda-Ku, Tokyo, Japan
[581] 9811

Australasia: Warren E. Ball, IPO Box 5106,
Tokyo, Japan

Business Department

Thomas M. Egan, Production Manager [212] 997-3140

Carol Gallagher Production Manager International
[212] 997-2045

Dorothy Carter, Production Manager Domestic
[212] 997-2908

Frances Vallone, Reader Service Manager
[212] 997-6057

Electronics Buyers' Guide

George F. Werner, Associate Publisher
[212] 997-3139

Regina Hera, Directory Manager
[212] 997-2544

Classified and Employment Advertising

Frank Eberle, Manager
[212] 997-2557

“Fairchild-sponsored career development programs are conducted almost continuously. I know first-hand that anyone with the initiative to take advantage of them can almost chart their own career advancement.”

Manny Fernandez
General Manager
Transistor Division

“Eight years ago, I began at Fairchild as a clerk in customer service. Today, I'm a product marketing engineer. I get most of the credit, but Fairchild made it possible.”

Linda Hageman
Product Marketing Engineer

“A job with challenge is important, but I think a job should also be fun. High technology is about as challenging as you can get, and Fairchild is anything but a dull place to work.”

Doug Peltzer
Technical Director



Fairchild offers more of what you work for.

FAIRCHILD
CAMERA AND INSTRUMENT
CORPORATION

Fairchild has opportunities at many levels for talented design, product and process engineers. For detailed information on specific openings, send your resume to: Director of Professional Staffing, 464 Ellis Street, MS 22-0100, Mountain View, CA 94042. An Equal Opportunity Employer M/F.

The Electronics Book Series offers you:

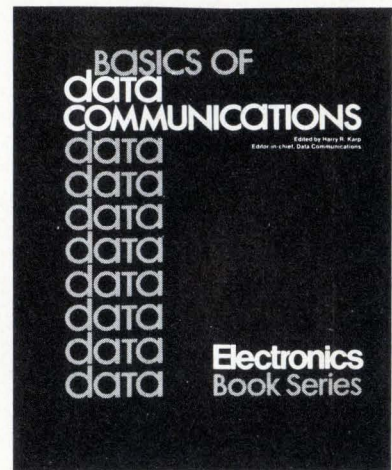
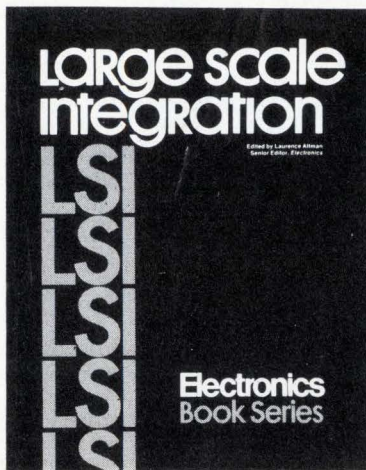
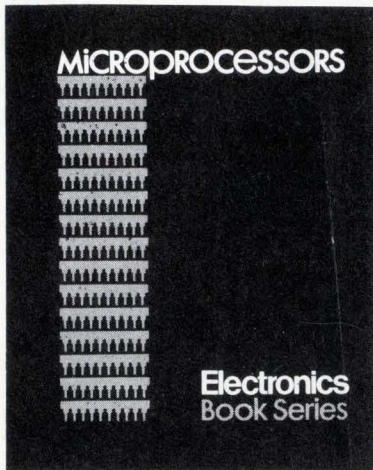

1 MICROPROCESSORS

The microprocessor has permanently changed the methods of designing and building electronic equipment—from process and industrial control to computer-based designs in instruments communication and consumer/commercial equipment.

This book cuts through the confusion, presenting the design and application potential of this exciting technology in a manner that will appeal to the design engineer who needs to know how to use microprocessors as well as the system analyst who must assess the tradeoffs between microprocessors and other techniques to accomplish his system goals.

Using articles from the pages of Electronics, this book contains practical and up-to-date information on available microprocessor devices, technology and applications.

2 LARGE SCALE INTEGRATION

The Electronics Book Series offers you a handbook on the current and revolutionary impact of LSI on digital design. This 220-page book presents a unique opportunity for circuit designers, systems designers, and engineering managers and supervisors to bring their expertise into line with today's LSI design requirements.

"Large Scale Integration" is a compendium of recent articles published in Electronics. Although in some ways it is a companion piece to "Microprocessors" because it explains the new circuits that play in mp systems, it is much more. "Large Scale Integration" deals with the entire range of design applications: main memory systems, peripheral memories, memory controllers, on-line industrial controllers, data acquisition boards, communication systems, calculators, watches, etc.

3 BASICS OF DATA COMMUNICATIONS

Data communications is one of the fastest-growing electronic equipment markets in the U.S.—during the decade of the '70's, better than 15-20% per year, compounded!

Chances are you are going to be a part of the data communications market. There's no better place to start than getting a copy of "Basics of Data Communications"—a 316-page compilation of essential articles which have appeared in Data Communications magazine. From the basic, tutorial, still state-of-the-art information published in the 1972 and 1973 Deskbook issues (now out of print), on through information on the practice of present-day data communications, this book includes forty-seven articles covering more than eleven key areas.

Electronics Book Series • PO Box 669, Hightstown, N.J. 08520



- 1 Send me _____ copies of "Microprocessors" at \$8.95 per copy.
 2 Send me _____ copies of "LSI" at \$9.95 per copy.
 3 Send me _____ copies of "Basics of Data Communications" at \$12.50 per copy.

Discounts of 40% on orders of ten or more copies of each book.

I must be fully satisfied or you will refund full payment if the books are returned after ten day trial examination.

- Payment enclosed Bill firm Bill me

Credit Cards Charge My Book To

- American Express Master Charge
 Diners Club BankAmericard

Name _____
 Title _____
 Company _____
 Street _____
 City _____
 State _____ Zip _____
 Signature _____

Acct. No. _____
 Date Card Expires _____
 Interbank No. _____

(1st No's. above name on Mastercharge only.)