

# Electronic Design 3

VOL. 26 NO.

FOR ENGINEERS AND ENGINEERING MANAGERS — WORLDWIDE

FEB. 1, 1978

**Logic analyzers dig out faults** in digital circuits more easily and quickly than other means. The latest can be used in the field as well as in the lab, and

have lower prices to go along with more features. Comparing against known-good systems or ferreting out nasty gremlins is a snap. For more, see p. 26.

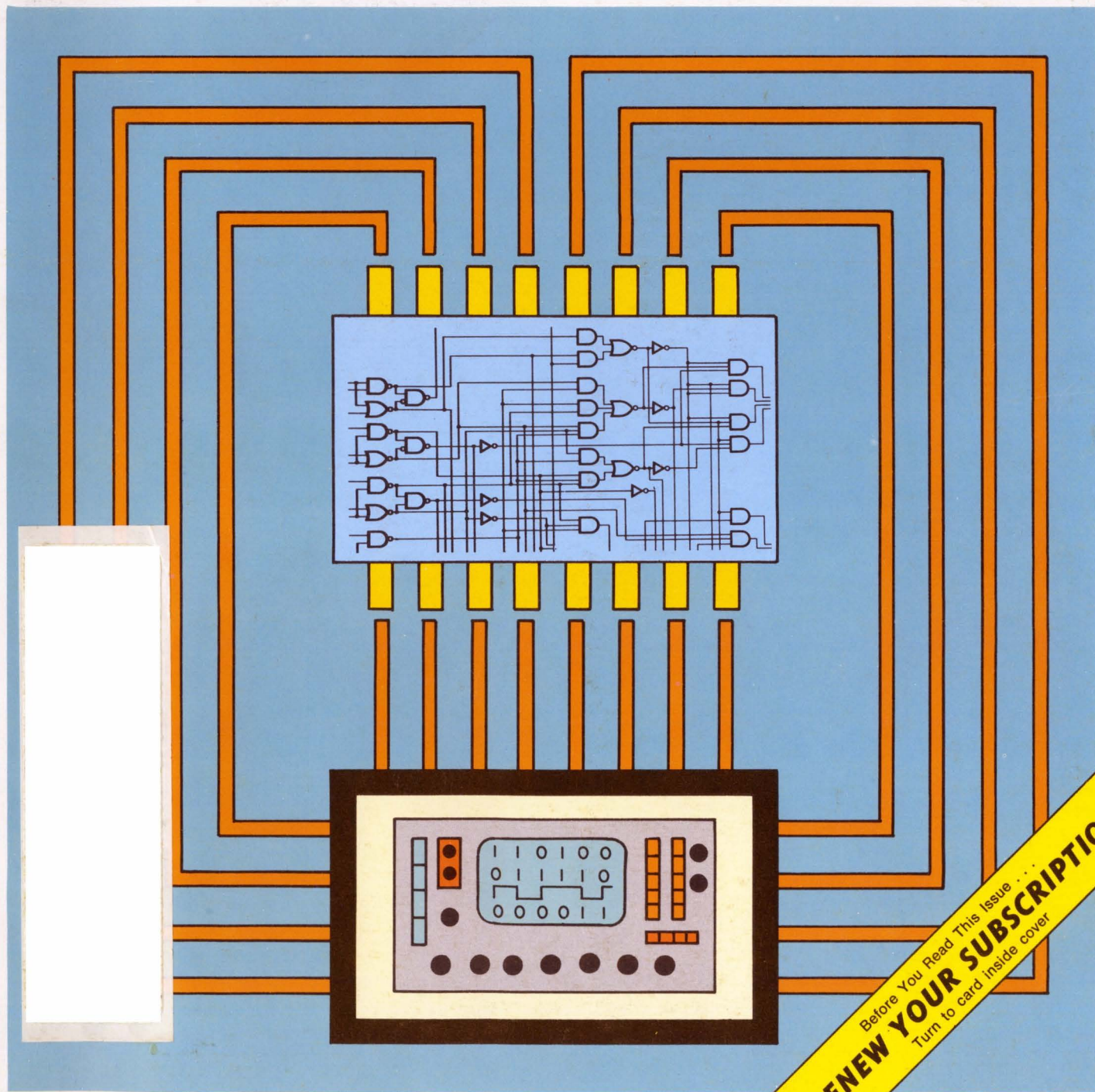

Before You Read This Issue ...  
**RENEW YOUR SUBSCRIPTION**  
Turn to card inside cover

# Look inside our new Precision Pot...

## For reliability, performance and savings.

Since our new potentiometer looks like others on the outside, here's the inside story . . . that's where Bourns makes the difference:

The total construction of this new 1% linearity, conductive plastic, single-turn pot is ingeniously simple. Our one-piece precious metal contact delivers tens-of-thousands more trouble-free revolutions than the typical failure-prone two-piece type. Then, our exclusive silver deposition between the molded-in terminals and the element guarantees a connection that won't migrate or weaken during installation and operation. And, proven techniques like low temperature firing and thermal swaging replace unreliable solder, conductive epoxy and silver cement throughout the potentiometer. No one matches our performance, and our price is just as eye opening — less than \$6.00 in production quantities.

With fewer parts, unique packaging and solid connections, the result is obvious — the most reliable precision potentiometer you can specify for the price.

The 7/8" diameter model is available in either bushing (Model 6637) or servo mount (Model 6537) styles. The larger 1 1/4" diameter bushing mount (Model 6657) also offers a full line of non-linear functions . . . all with the same outstanding design and price advantages.

Take a look inside any other precision pot and you'll see why Bourns makes the difference.

Send for our new catalog today for complete details.

**TRIMPOT PRODUCTS DIVISION, BOURNS, INC.**, 1200 Columbia Avenue, Riverside, California 92507,  
Telephone (714) 781-5200 — TWX 910 332-1252.

ONE-PIECE CONTACT

MOLDED-IN  
TERMINALS

SILVER  
DEPOSITION

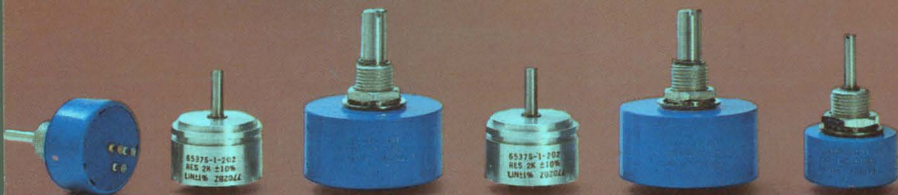

International Marketing Offices: European Headquarters — Switzerland 042/23 22 42 • Belgium 02/218 2005 • France 01/2039633 • Germany 0711/24 29 36 • Italy 02/32 56 88 • Netherlands 70/87 44 00 • United Kingdom 01/572 6531 • Norway 2/71 18 72 • Sweden 764/20 110 • Japan 075/921 9111 • Australia 02/55-0411 03/95-9566 • Israel 77 71 15/6/7

For Immediate Application—Circle 130  
For Future Application—Circle 230

# SURPRISE!

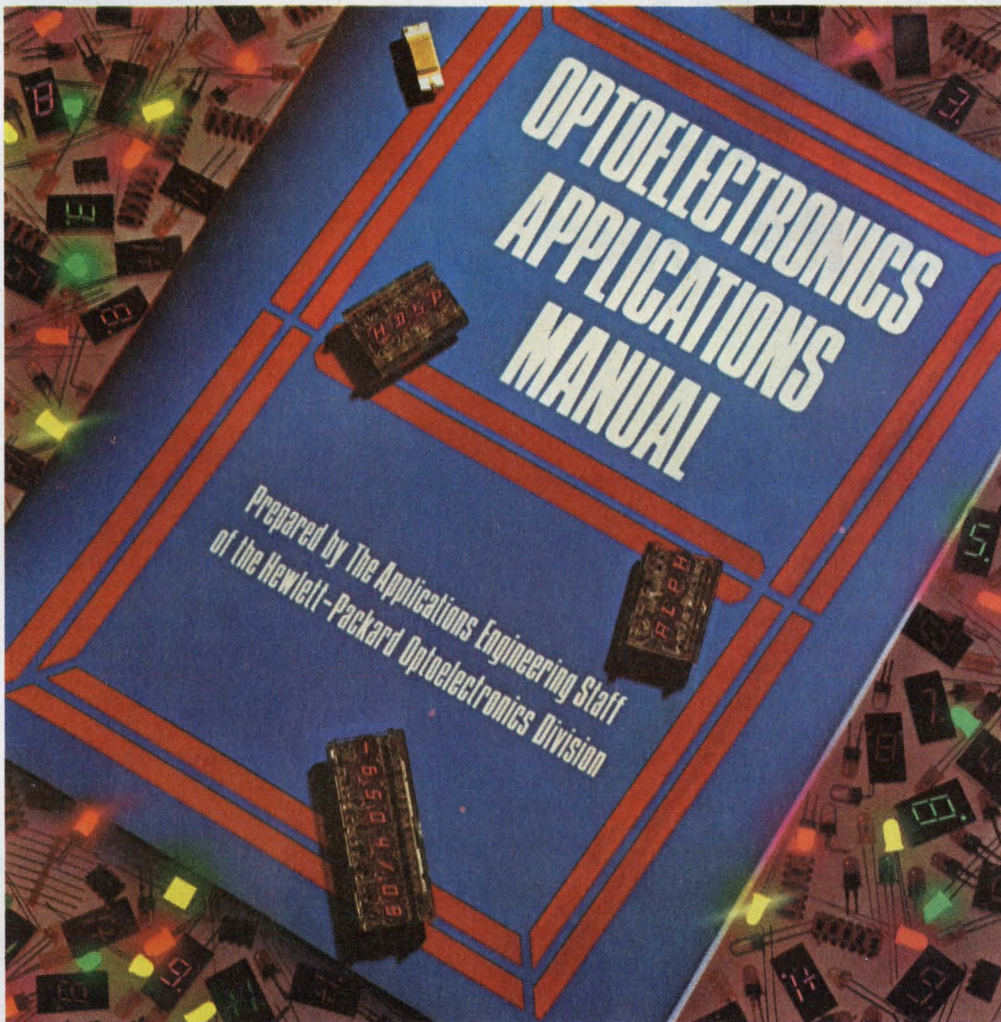

## A Treasury of Opto Applications from HP.

Just published by McGraw-Hill and authored by the Applications Engineering Staff of Hewlett-Packard, this 279 page hardcover book is a practical guide to the use of optoelectronic devices and a foundation for the development of new design ideas. This volume demonstrates the broad potential for optoelectronic components and how to take full advantage of optoelectronics in your design.

In nine chapters you'll explore everything from theory of LED operation, design, packaging, contrast enhancement — even practical insights into photometry and radiometry.

You'll find this book not only invaluable, but will find it can save you time, effort and costs. Contact any HP franchised distributor for your copy — only \$19.25\* ask for HPBK-1000, Optoelectronics Application

Manual. They're in stock right now. In the U.S., contact Hall-Mark, Hamilton/Avnet, Pioneer Standard, Schweber, Wilshire or the Wyle Distribution Group (Liberty-Elmar) for immediate delivery. In Canada, just call Hamilton/Avnet or Zentronics, Ltd. \*U.S. Domestic price only



1507 Page Mill Road, Palo Alto, California 94304

## TO-5 RELAY UPDATE

# Maglatch TO-5: the relay with a mind of its own.

Whenever critical switching circuits call for reprogrammable non-destructible memory, choose Teledyne's magnetic latching TO-5 — the relay that remembers. Once set with a short pulse of coil voltage, it will retain its state until reset or reprogrammed — even if system power fails or is shut off. And you get the added advantage of reduced system power demands, since conventional relay holding power is not required. But reprogrammable memory capability and low power consumption are not the only advantages of our TO-5 maglatch relays. Their subminiature

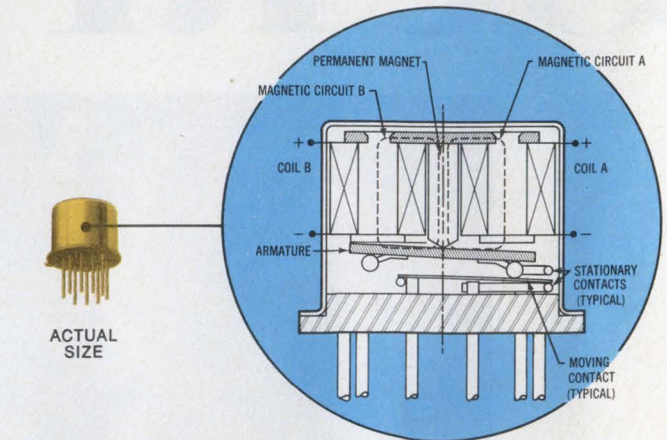

size makes them ideal for high density pc board packaging, and they're available in SPDT, DPDT and 4PST contact forms. And for RF switching, their low intercontact capacitance and contact circuit losses provide high isolation and low insertion loss up through UHF.

Our magnetic latching as well as our complete line of TO-5 relays includes military and commercial/industrial types with MIL versions qualified to "L" and "M" levels of established reliability specs. For complete data, contact Teledyne Relays — the people who originated the TO-5 relay.

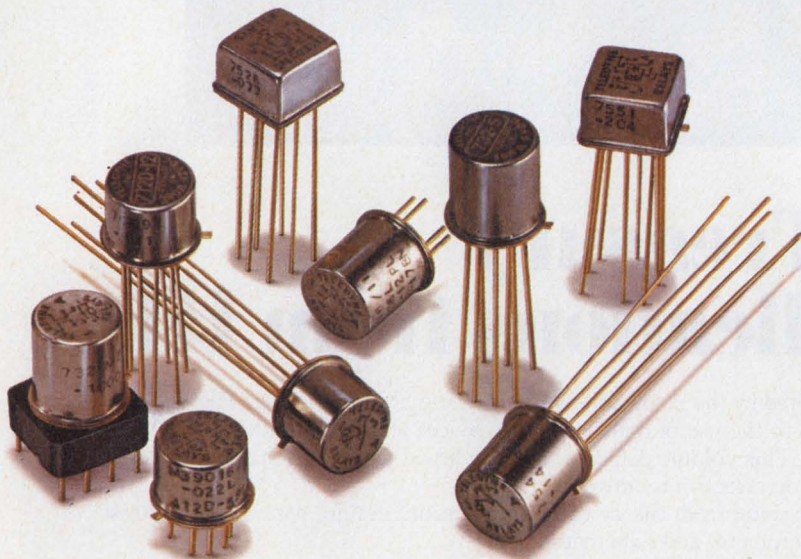

### OTHER TELEDYNE TO-5 RELAYS

- **Hybrid "T" Series**  
SPDT & DPDT types with internal transistor driver and suppression diode. Military and commercial/industrial versions.
- **"D" and "DD" Series**  
With internal suppression and steering diodes. Military and commercial/industrial versions.
- **Centigrad® Series**  
World's smallest relay—only .225" (5.72mm) high x .370" (9.40mm) square. DPDT, with optional internal suppression and steering diodes.
- **Hi-Rel Series**  
Screened versions for space flight applications (NASA qualified).
- **High Environment Series**  
Hi-temperature, Hi-shock, and Hi-vibration types.

 **TELEDYNE RELAYS**

3155 West El Segundo Boulevard, Hawthorne, California 90250  
Telephone (213) 973-4545

CIRCLE NUMBER 3

## NEWS

- 21 **News Scope**
- 26 **The latest logic analyzers** offer more functions in a smaller package and at less cost—A special report.
- 34 **Forget the bugs** in 4-k and 16-k RAMs—the big news is at 64-k.
- 38 **The new GaAs FETs**—less noise, higher power and broader bandwidth.
- 47 **Washington Report**

## TECHNOLOGY

- 56 **Microcomputer Basics: Part 1.** Reduce your  $\mu$ C-based system design time by using single-board microcomputers. Assembled boards in the SBC-80 series offer stock answers to custom demands.
- 70 **Logic analyzers aren't all alike.** Learn the differences between state and timing instruments, and you'll end up with the right troubleshooting tool.
- 80 **Try a Wien-bridge network** instead of a twin-T in your next analog filter design. The advantages begin with a filter you can design in five fast steps.
- 84 **Ideas for Design:**  
Single-shot multi uses few parts, provides high noise immunity.  
Build a constant-current source or sink with an unused comparator of a quad package.  
Gated programmable delay-line oscillator's repetition rate changeable every period.  
Pulser generator determines states of three-state bus drives.  
Convert a temperature-to-frequency signal into four BCD digits and read °F or °C.  
Add foldback protection to your supply and stop pass-transistor failures.

## PRODUCTS

- |     |                         |     |                       |
|-----|-------------------------|-----|-----------------------|
| 99  | ICs & Semiconductors    | 110 | Packaging & Materials |
| 102 | Components              | 114 | Data Processing       |
| 104 | Modules & Subassemblies |     |                       |

## DEPARTMENTS

- |     |                                      |     |                            |
|-----|--------------------------------------|-----|----------------------------|
| 53  | <b>Editorial:</b> Concepting an idea |     |                            |
| 7   | Across the Desk                      | 124 | Employment Opportunities   |
| 118 | New Literature                       | 128 | Advertisers' Index         |
| 119 | Design Aids                          | 128 | Information Retrieval Card |
| 119 | Vendors Report                       |     |                            |

**Cover:** Cover design by Art Director, Bill Kelly.

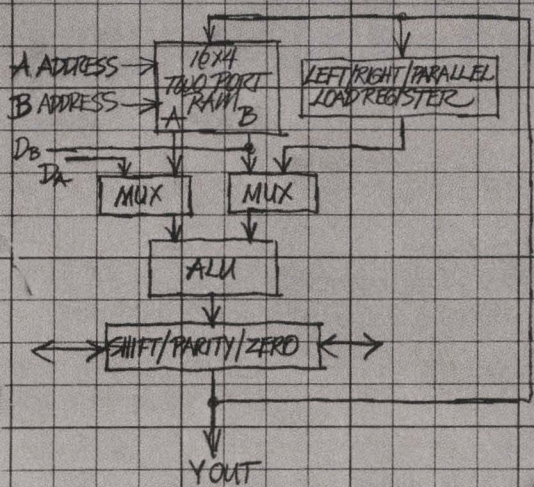

THE AM2903 HAS 2 DATA INPUT PORTS INSTEAD OF 1, AND THE DATA SHIFTER OCCURS IMMEDIATELY AFTER THE ALU INSTEAD OF AT THE RAM INPUT. THESE 2 CHARACTERISTICS MAKE THE REGISTER SUCH AS MULTIPLY, DIVIDE, NORMALISE, AND ARITHMETIC SHIFT ARE BUILT INTO THE PART, SAVING BOTH HARDWARE AND MICROCODE OVER OTHER DEVICES.

THE AM2903 ARCHITECTURE DIFFERS FROM THE AM2901 IN ONLY 2 WAYS.

Advanced Micro Devices' new Am2903. It's a four-bit CPU slice with sixteen internal working registers, two address architecture, multi-function arithmetic logic unit and shifting logic.

# AND NOW, THE SUPERSLICE.™

And if that's not enough, hang on.  
The Am2903's register file is expandable. If sixteen registers aren't enough, add as many working registers as you want and still retain the two-address architecture.

For those of you who think two-address architecture isn't enough, we made three-address operation possible in the Am2903. For those of you who hate using SSI and MSI, we put all the extra hardware to do 2's complement multiply and divide right inside the chip.

And we couldn't resist a few extra touches like built-in, floating-point normalize and parity.

Call, write or wire Advanced Micro Devices.

The magic word is Superslice™

## Advanced Micro Devices



Multiple technologies. One product: excellence.  
901 Thompson Place, Sunnyvale, California 94086  
Telephone (408) 732-2400

CIRCLE NUMBER 103

# I can show you how to find faulty intermittents fast!



Few things waste more time than locating an intermittent circuit component. Isolate off-again, on-again electronic components by quick-freezing them during testing. Remember: MS-240 Quik-Freeze® is not only a circuit cooler, but also a full-fledged freezer. It can drop surface temperature to  $-45^{\circ}\text{C}$  in seconds. A handy extension nozzle confines the chilling spray to the suspected components. Use MS-240 also to prevent undesirable heat transfer to delicate circuit elements during soldering or welding.

For further information, call or write Miller-Stephenson Chemical Co., Danbury, CT 06810 (203) 743-4447

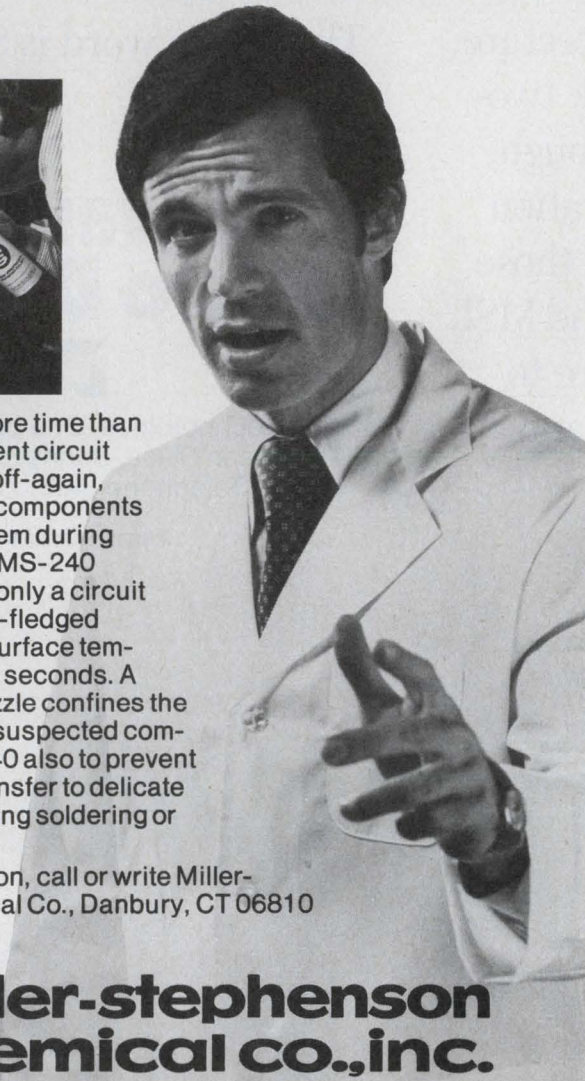

**ms miller-stephenson  
chemical co., inc.**

Danbury, Connecticut 06810 (203) 743-4447

----- ED-2W  
**miller-stephenson chemical company, inc.**  
Danbury, Connecticut 06810 (203) 743-4447



- Ask our Technical Director for application information
- Enclosed is \$2 for trial pack
- Send for literature and prices

I intend to use MS-240 on \_\_\_\_\_

Name \_\_\_\_\_ Title/Dept. \_\_\_\_\_

Company \_\_\_\_\_

Address \_\_\_\_\_

City \_\_\_\_\_ State \_\_\_\_\_ Zip \_\_\_\_\_

®Registered trademark

For industrial use only. Trial Unit must be sent to Company address  
LOS ANGELES • CHICAGO • DANBURY, CONN. • TORONTO

CIRCLE NUMBER 4

## Publisher

William Maass

## Editors

Editorial Offices  
50 Essex St.  
Rochelle Park, NJ 07662  
(201) 843-0550  
TWX: 710-990-5071  
(HAYDENPUB ROPK)  
Cable: Haydenpubs Rochellepark

**Editor-in-Chief** George Rostky

## Managing Editors:

Ralph Dobriner  
Michael Elphick

## Senior Associate Editor

Stanley Runyon

## Associate Editors:

Sid Adlerstein  
Nicholas Bodley  
Dave Bursky  
Morris Grossman  
Gene Heftman  
Andy Santoni  
Max Schindler

## Contributing Editors:

Peter N. Budzilovich, Jules H. Gilder,  
Sidney Moskowitz, Nathan Sussman

## Editorial Field Offices

### East

Jim McDermott, Eastern Editor  
P.O. Box 272  
Easthampton, MA 01027  
(413) 527-3632

### West

Dick Hackmeister, Western Editor  
8939 S. Sepulveda Blvd., Suite 414  
Los Angeles, CA 90045  
(213) 641-6544  
TWX-1-910-328-7240  
Dave Barnes, Western Editor  
465 S. Mathilda, Suite 302  
Sunnyvale, CA 94086  
(408) 736-6667

## Editorial Production

Marjorie A. Duffy, Production Editor  
James Keane, Copy Editor

## Art

**Art Director**, William Kelly  
Richard Luce, Anthony J. Fischetto

## Business Manager

Thomas E. Vachon

## Production

**Manager**, Dollie S. Viebig  
Nancy Hurey

## Circulation

**Director**, Barbara Freundlich  
**Senior Assistant**, Gail Stone

## Information Retrieval

Paula Greenleaf

## Advertising Promotion

Judith Nappo

## Reprints

Maxine Sassano



# Across the desk

## Not that cheap

I wish to correct a few errors in "Software Distribution Is a Problem in Personal Computing—with Solutions" (ED No. 21, Oct. 11, 1977, p. 34). The correct name of our company is Micro-Scan Corporation, and our bar-code scanner is the "Data-Scan" Model BCS-1. Also, a statement inaccurately attributed to me might lead to some confusion—namely, that the price of our bar-code scanner (\$97.50) "is an order of magnitude cheaper than any available optical scanners." In fact, there are a few bar-code scanners that, when coupled with a signal conditioner, may cost as little as two and one-half to five times the price of our bar-code scanner, with its integral signal conditioner.

*Frederick L. Merkwitz*

Micro-Scan Corp.  
P.O. Box 705  
Natick, MA 01760

## You're a rug lifter

Most pieces on stepper motors are usually a rehash of manufacturers' published data, but your Focus (ED No. 22, Oct. 25, 1977, p. 48) pointed out many of the hidden problems that are usually swept under the rug.

Thanks for telling your readers that for some applications dc servos are a better design choice than steppers. We've seen enough cases where a stepper was used in an application better suited for a dc servo to know that many engineers follow the "easy" open-loop path without thoroughly evaluating total-system parameters.

*Allison C. Danzig*  
Marketing Manager

PMI Motors  
5 Aerial Way  
Syosset, NY 11791

## A forceful objection

In the Focus on Stepping Motors (ED No. 22, Oct. 25, 1977, p. 48), we find that

the established way of specifying torque is with force-unit lengths. The examples given are ounce-inches and gram-millimeters. But as I recall, the gram is a unit of mass, not a unit of force. Perhaps we should specify torque in dyne-centimeters, or newton-meters. As we make the transition to metric, let's try to get it right!

*Harold Hallikainen*  
President

Hallikainen & Friends  
340 Higuera  
San Luis Obispo, CA 93401

## Misplaced Caption Dept.



High-yield production requires true clean rooms and suitable attire for personnel.

Sorry. That's Jean Antoine Watteau's "Gilles," which hangs in the Louvre in Paris.

## Don't pass us by

The instruments described in "Precise Signal Sources..." (ED No. 24, Nov. 22, 1977, p. 76), with one exception, by no means represent the latest in technology or flexibility. Indeed, some of  
*(continued on page 120)*

Electronic Design welcomes the opinions of its readers on the issues raised in the magazine's editorial columns. Address letters to Managing Editor, Electronic Design, 50 Essex St., Rochelle Park, NJ 07662. Try to keep letters under 200 words. Letters must be signed. Names will be withheld upon request.

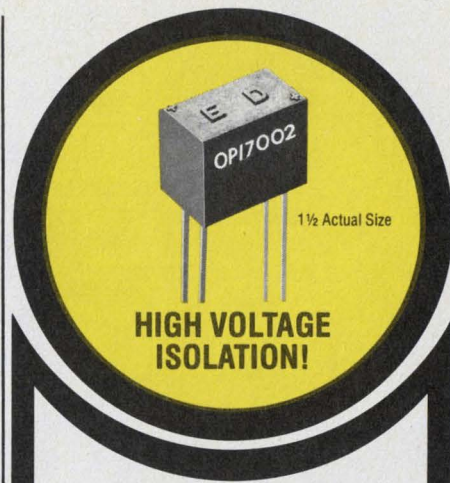

## OPTRON OPTICALLY COUPLED ISOLATORS

NEW OPI 7000 SERIES  
OFFERS LOW COST,  
HIGH VOLTAGE ISOLATION

OPTRON's new OPI 7000 series optically coupled isolators meet the designer's requirements for high voltage isolation, yet at a low cost.

The new series is available from stock and includes OPI 7002, OPI 7010, OPI 7320, and OPI 7340 types.

These devices feature input-to-output steady state isolation voltage of greater than 6000 volts in free air and greater than 10,000 volts when encapsulated. They consist of a gallium arsenide infrared LED coupled with either a silicon phototransistor or photodarlington in a molded plastic package. Standard pin spacing of 0.300 x 0.100 inch is compatible with that of dual in-line sockets.

Current transfer ratios range from 20% to 100% for the phototransistor versions (OPI 7002/OPI 7010), and from 200% to 400% for the photodarlington models (OPI 7320/OPI 7340).

New OPI 7000 series isolators are interchangeable with similar products as follows:

OPTRON	GE
OPI 7002	H15A2
OPI 7010	H15A1
OPI 7320	H15B2
OPI 7340	H15B1

In addition, OPTRON's complete line of isolators includes standard devices in high-rel metal cans and low cost DIP and other plastic configurations for most applications.

Detailed technical information on optically coupled isolators and other OPTRON optoelectronic products ... chips, discrete components, reflective transducers, and interrupter assemblies ... is available from your nearest OPTRON sales representative or the factory direct.



**OPTRON, INC.**

1201 Tappan Circle  
Carrollton, Texas 75006, U.S.A.  
TWX-910-860-5958  
214/242-6571

**Total cpu control**  
High level command keys and binary/hexadecimal displays provide complete system control, easy operation.

**Worldwide portability**  
 $\mu$ Scope 820 is fully self-contained, with accessory storage space. Operates on all standard U.S. and worldwide power sources.

**Preprogrammed diagnostics**  
Overlay memory socket enables designers to plug in and execute customized diagnostics for each end product.



**Breakpoint control and trace memory**  
Built-in high level diagnostics speed and simplify isolation of even the most difficult system problems.

**Human engineered**  
Extensive prompting simplifies operation for test and service personnel, minimizes training time.

**Interchangeable front panels, personality cards and personality probes**  
 $\mu$ Scope 820 adapts to a variety of microprocessors. Probe plugs directly into system microprocessor socket.

# Intel delivers $\mu$ Scope<sup>TM</sup> 820. Finally, a diagnostic instrument just right for the Age of the Microprocessor.

Troubleshooting microprocessor systems is easier than ever with Intel's new  $\mu$ Scope<sup>TM</sup> 820 Microprocessor System Console. It's a powerful, programmable, fully portable real-time diagnostic instrument. And it's designed specifically to speed and simplify system checkout of your microprocessor-based products.

$\mu$ Scope 820 is really the first test instrument of its kind. It's built around its own microprocessor, to provide a "smart" solution that's highly sophisticated, yet easy to use. Because it's user programmable with interchangeable plug-in ROMs or PROMs, it's like taking a design engineer along on every service call. And because it's fully portable, the  $\mu$ Scope 820 console goes wherever the action is—to the design lab, the production line or into the field.

Unlike logic analyzers, the  $\mu$ Scope 820 console provides a genuine solution for test and service personnel. It provides the same inside look at system operation that you get with a logic analyzer. But the  $\mu$ Scope 820

goes far beyond the mere collection of data. Its internal microprocessor system can actually analyze the data it collects. It does that with diagnostic programs you design specifically for your end product.

Rather than passively watching system operation, the  $\mu$ Scope 820 console lets you execute application programs or diagnostics you develop, in real time or single steps. And it provides full breakpoint capability and a large trace memory.



High level command keys, operator prompting, and binary/hexadecimal display of all system registers, I/O ports and memory give you greater control and make it easier to use than any other test instrument.

Until now the only way to get this kind of diagnostic capability was to use your Intellec<sup>®</sup> Microcomputer Development System. Now we've taken the Intellec features that have proven most useful for field service and production-level system checkout and have packaged them in this self-contained 20-lb attache case. That's portability.

And we've enhanced that portability with a  $\mu$ Scope 820 price of just \$2000\*, complete with personality probe and all accessories. So you can afford to put a  $\mu$ Scope 820 console wherever you need one, and free your development lab instruments to concentrate on development. No longer must you invest in in-house-designed custom test instruments for each of your end products. And the  $\mu$ Scope 820 console will be available with a selection of front panel overlays, "personality" cards and system probes to support a variety of microprocessors.

To get your copy of our  $\mu$ Scope 820 brochure and to arrange for a demonstration right in your lab, contact your local Intel distributor or sales representative. Or write: Intel Corporation, 3065 Bowers Avenue, Santa Clara, California 95051. Telephone (408) 987-8080. In Europe contact: Intel International, Rue de Moulin a Papier, 51-Boite 1, B-1160, Brussels, Belgium. Telex 24814. In Japan contact: Intel Japan, K.K., Flower Hill-Shinmachi East Bldg. 1-23-9, Shinmachi, Setagaya-Ku, Tokyo 154. Telex 781-2846.

**intel<sup>®</sup> delivers.**

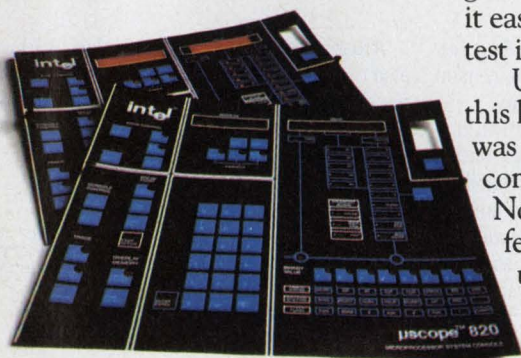

\*Domestic U.S. price only, quantities 1-10.

# Here's your golden opportunity to meet our better half.

Texas Instruments Incorporated  
Mail Station 2-16, Attleboro, MA 02703

I'd like to meet TI's better half. Please send information on your new H4 Series .156" x .200" Edgeboard Connector.

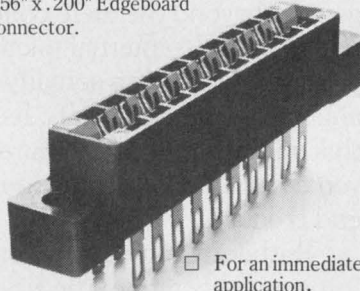

- For an immediate application.  
 Please contact me directly.  
 For reference.

Name \_\_\_\_\_

Title \_\_\_\_\_

Company \_\_\_\_\_

Area code \_\_\_\_\_ Phone \_\_\_\_\_ Ext \_\_\_\_\_

Address \_\_\_\_\_ Mail Station \_\_\_\_\_

City \_\_\_\_\_ State \_\_\_\_\_ Zip \_\_\_\_\_

ED

## Our better half.

TI's new H4 Series edgeboard connector half of a PC board/edgeboard connector system. It's today's best connector value because we made it better in so many ways.

Better functional and dimensional interchangeability, better design and construction, better porosity and wear characteristics, and better price and delivery advantages.

But we've done ourselves even one better. Specifically, our better half uses more gold to

get more performance and reliability. And yet there is a substantial cost savings. The reason is our proprietary clad metal technology.

Cladding permits gold to be concentrated only where it is needed—at the contact mating surface—the area critical to contact reliability.

Therefore, significant cost savings can be realized in terms of labor and precious metal consumption. This savings is being passed on to you in the form of a lower price. Or if you prefer, a bigger value.

After all, TI pioneered gold inlay. And we also make extremely high performance connectors. So it was only natural to put them together in our better half.

If you haven't met our better half yet, don't miss out on this truly golden opportunity. Return the coupon above or call Texas Instruments Connector Systems Marketing today. (617) 222-2800, Extension 268 or 269.



**TEXAS INSTRUMENTS**  
INCORPORATED

# Touch switches are

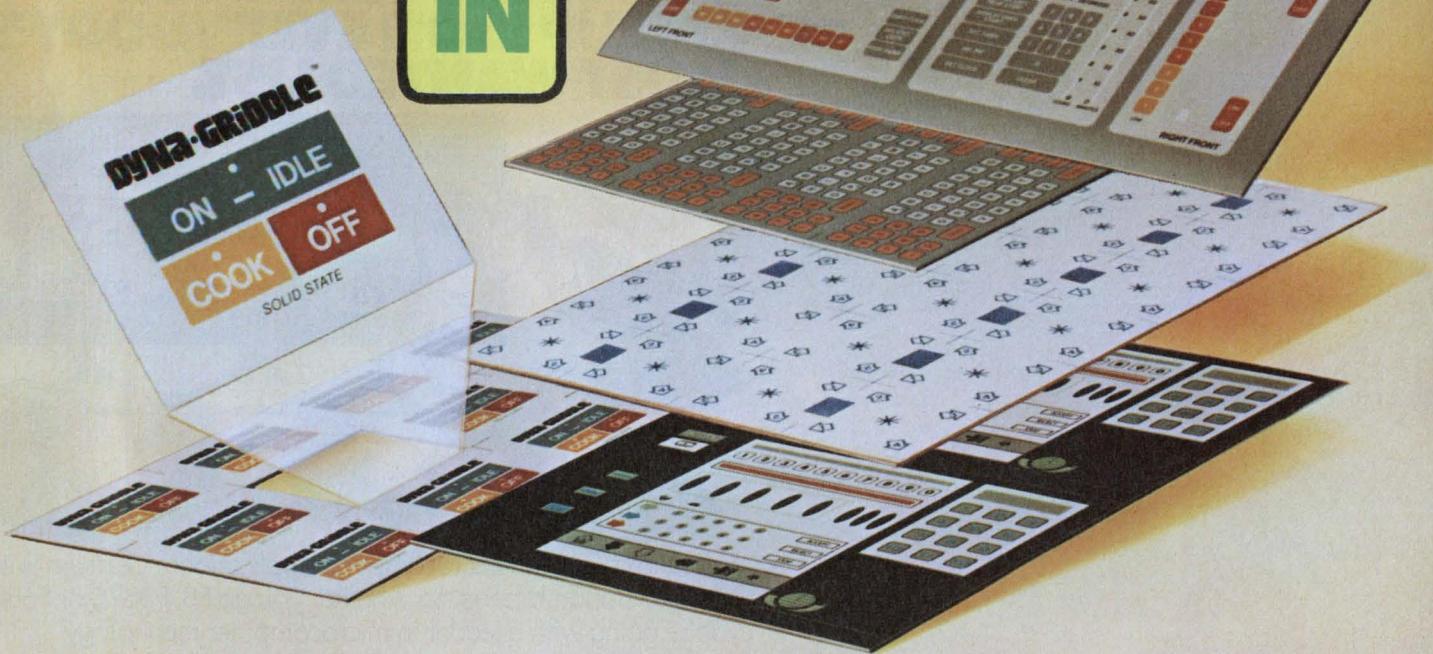

## ... and CENTRALAB has them NOW

When Centralab introduces touch switches you can be sure they're "In". Backed by 40 years of switch know-how, and after years of intensive research and testing, Centralab is now delivering, in batch-process volume, a complete touch switch system. We call it MONOPANEL.

MONOPANEL is a thin, light, flat, front panel subassembly containing micro-motion touch switches already mounted and interconnected . . . with LED's, nomenclature, graphics and colors to meet your functional and aesthetic requirements.

### Batch-Processed For Economy With Quality

MONOPANELS are batch-processed as 11" X 17" master panels only .075" thick, each containing up to 700 switches. Every Monopanel is a complete, 100% pre-tested subassembly containing switches, front panel and graphics.

### 60,000,000 Cycles Without Failure!

The basic MONOPANEL switch has been operated for sixty million switching cycles without mechanical or electrical failure. And MONOPANEL has been tested and proven against 22 separate mechanical, electrical and environmental standards.

### Custom Designed For Your Application

On each 11" X 17" panel you can custom-design individual boards to meet your front panel needs. The illustration

above shows just a few of the almost endless variations possible from each master panel.

### Unlimited Graphics Available

The flat, smooth, front panel surface permits unlimited choice of graphics. Functions may be grouped by color, with 480 colors available. Thirty choices of type style and size. And whatever visual symbols meet your specific needs.

### THIS IS MONOPANEL:

- A complete touch switch sub-assembly, ready to mount.
- All switches and graphics on a .075" thin panel.
- Flat, spill-proof surface wipes clean.
- Noiseless.
- 100% tested.
- Choice of terminations.
- Operating voltage: 50 V max.
- Operating current: 100 mA max.
- Contact resistance: 0.2 ohms typical.



**CENTRALAB**

Electronics Division  
GLOBE-UNION INC.

5757 NORTH GREEN BAY AVENUE  
MILWAUKEE, WISCONSIN 53201

Standard 12 and 16 position keyboards are available through Centralab Industrial Distributors. For more information on custom MONOPANELS, call Bill Klug, (414) 228-2604, or send for this FREE brochure today.



**Quality Products For Your Design:** Ceramic Capacitors • EMI/RFI Filters • Thick Film Circuits • Rotary, Slide and Pushbutton Switches  
• Touch Switches • Potentiometers and Trimmers.

CIRCLE NUMBER 8

## OUR MICROCOMPUTER LINEUP IS ON EVERYBODY'S MOST WANTED LIST.

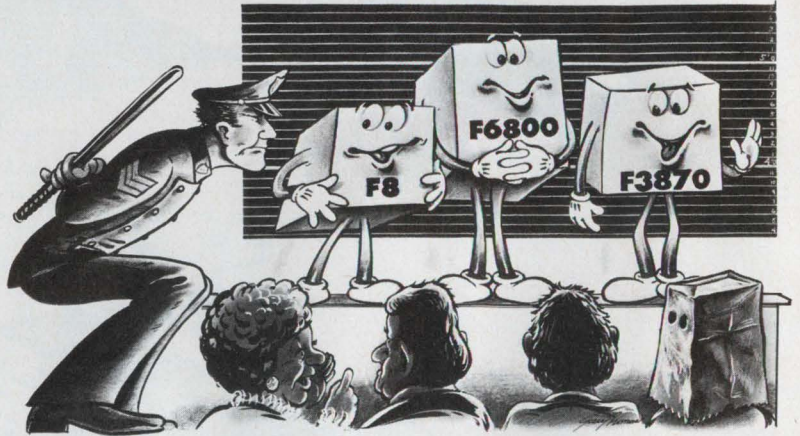

Fairchild covers the microcomputer applications spectrum with industry standard parts. So whether you go F8, F3870 or F6800, you're going with a leader in microcomputer technology.

### A MULTIPLE CHIP SET THAT'S SINGULARLY OUTSTANDING.

If you're designing controllers for printers, TV tuners, gas pumps or any other controllers where requirements are input/output peripheral intensive, cost sensitive, 1 to 4K Bytes dedicated store and high volume, our F8 family is your solution.

It's an established standard in the controller segment for high volume dedicated controllers. The F8 family set of peripherals are partitioned with an optimized mix of I/O, ROM and timers to accomplish your specific design needs at minimum cost.

An example of our F8 family is the F3856. A program storage unit with 2K Bytes of ROM, 16 bi-directional I/O ports and strobe, programmable timer/counter and internal-external interrupt modes.

### A SINGLE CHIP MICROCOMPUTER WITH MULTIPLE BENEFITS.

If controllers for extremely cost sensitive markets like toys or automobiles are giving you design headaches, take two aspirin and call for information about our F3870 MicroMachine™

It's the first in a series of Fairchild one-chip microcomputers. Features include F8 instruction set and I/O compatibility with 2K Bytes of ROM, 64 Bytes of RAM, 32 bi-directional I/O ports with strobe, programmable timer/counter and internal and external interrupt modes.

Clocking is on-chip, driven by inexpensive TV crystals up to 4 MHz. The F3870 operates from  $5V \pm 10\%$  supply and only dissipates 275 mW typical. And all these features are compactly packed in a 40-pin plastic package.



## A FORMIDABLE FORMULATOR.

And here's more good news.

Fairchild also makes designing easy. Just one investment in our formulator design aids allows you a common support system for F8 or F3870 designs.

Then, to check out your prototype/production board, Fairchild offers the Formulator F3870 Emulator Cable or F3870 Emulator Board with 2K EPROM (2708) storage.

## USER SELECTIONS.

F8 Family Series		F3870 MicroMachine Series	
F3850	CPU/RAM/16 I/O	F3870	SINGLE CHIP MICROCOMPUTER
F3851	1K ROM/TIMER/16 I/O	F3871	TIMER (3870)/16 I/O
F3856	2K ROM/TIMER/16 I/O		
F3857	2K ROM/TIMER/SMI		
F3852	MEMORY INTERFACE-DYNAMIC/TIMER		
F3853	MEMORY INTERFACE-STATIC/TIMER		
F3861	TIMER/16 I/O		
F3854	DIRECT MEMORY ACCESS		
F3899	1K ROM ONLY		

## A FAMILY WITH POWER AND INTELLIGENCE.

If controllers for communications, intelligent terminals, data processing or instrumentation systems are your problem, our F6800 microcomputer family is your solution.

Made specifically for controllers where requirements are RAM intensive and call for a full selection of intelligent LSI programmable peripherals.

The F6800 family is an established industry standard with a full range of intelligent programmable peripherals to meet a wide range of peripheral communication challenges and back-up with a complete selection of memory options.

## MORE SELECTIONS.

F6800 FAMILY SERIES			
<b>Processors</b>			
F6800	CPU	F6802	CPU/RAM
<b>Peripherals</b>			
F6820/21	Peripheral Interfaces	F68488	INSTRUMENTATION BUS (IEEE)
F6850	ACIA, COMMUNICATIONS		CONTROLLER
F6852	SSDA, COMMUNICATIONS	F6846	2K ROM/TIMER/16 I/O
F6840	PROGRAMMABLE TIMER	F6854	AUTOMATIC DATA LINK CONTROLLER
<b>Memory</b>			
F6830/308	1K x 8 ROM	F2708	1K x 8 EPROM
F68316/317	2K x 8 ROM	F4027	4K, DYNAMIC RAM
F6810	128 x 8 RAM STATIC	F16K	16K, DYNAMIC RAM
F2102	1K x 1 RAM STATIC		
<b>Interfaces</b>			
$\mu$ A9708	6-CHANNEL, 8-BIT A/D CONVERTER		
<b>Coming Soon</b>			
F6843	CRT CONTROLLER	F3846	BISYNC/SDLC COMMUNICATIONS CONTROLLER
F6844	DIRECT MEMORY ACCESS		
F6845	FLOPPY DISK CONTROLLER	$\mu$ A9706	8-CHANNEL, D/A CONVERTER

## A PLACE TO START.

To learn more about our Microprocessors, Formulators and Emulators, contact your Fairchild sales office or representative today. For a quicker response, call us direct. Fairchild MOS Microcomputer, 464 Ellis Street, Mountain View, Calif. 94042. Telephone: (408) 998-0123. TWX: 910-338-0558.

**FAIRCHILD**

**CALL US ON IT.  
(408)998-0123**

# AMP connectors with unique Bonded Lubrication cut insertion force up to 40%.

## Without compromising performance.

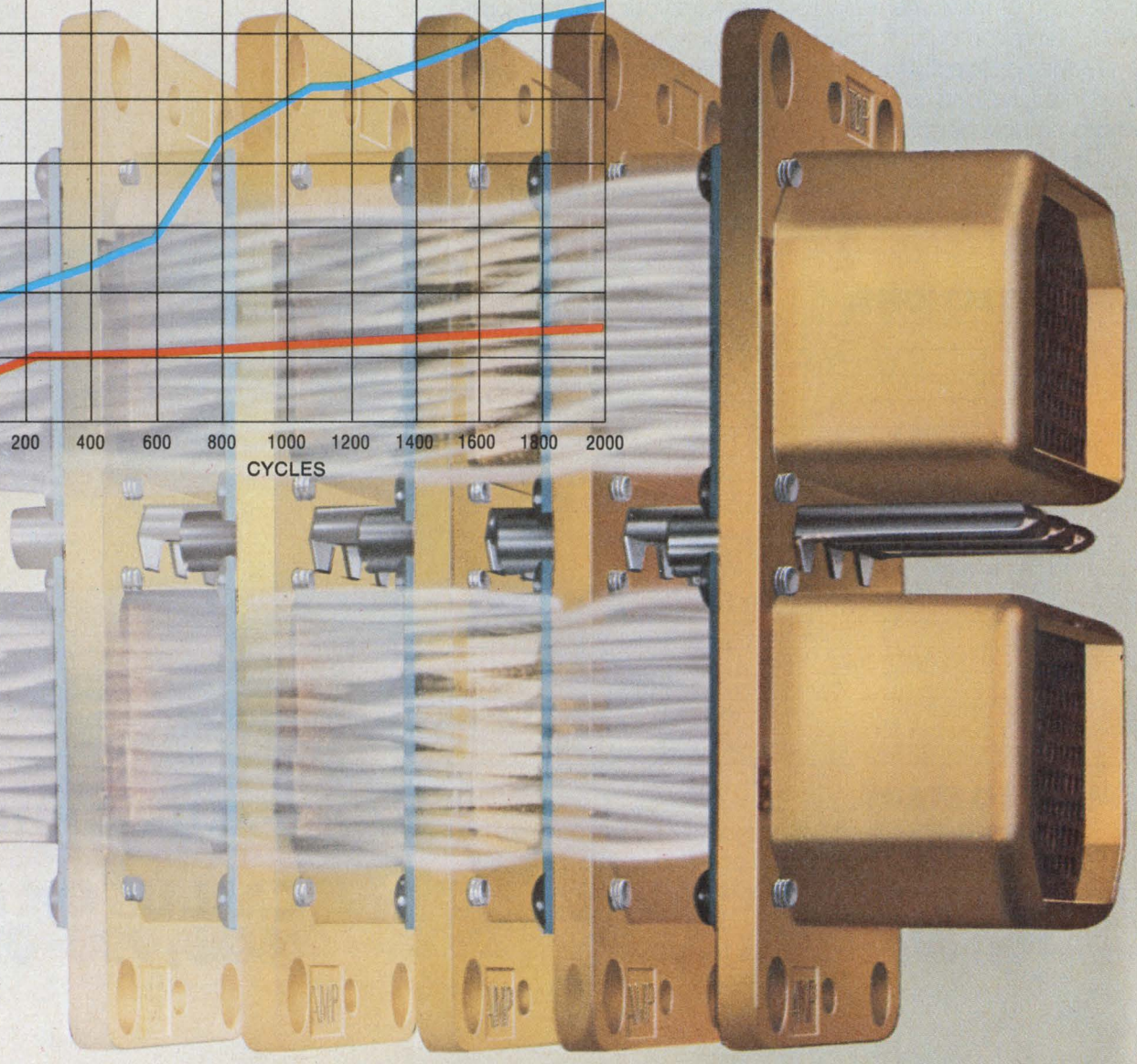
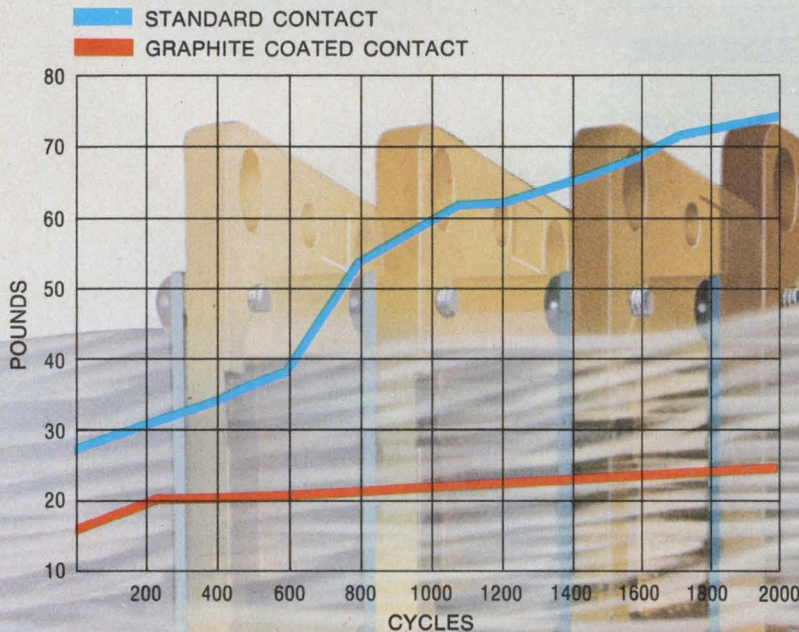



They give you all the advantages of lower insertion force without sacrificing proven contact geometries, or electrical stability. Insertion and extraction forces can be reduced as much as 40% which also results in extended contact life by more than 100% (as the table indicates).

The secret of this outstanding, exclusive improvement lies in the integration of lubricant and plating material, which now can be used on both round or flat contact surfaces. Where used, plating thickness can be cut appreciably with no change in electrical stability. That's why Bonded Lubrication has become one of the industry's most significant and cost effective performance breakthroughs.

And there are many more ways AMP Bonded Lubrication can improve your designs. It facilitates the use of larger pin counts with resulting savings in space, size, weight, materials and assembly time. It reduces servicing and maintenance because there is less damage, wear and replacement of mating contacts. And with it come the advantages

of AMP technical assistance . . . first rate engineering help in design, production or prototype planning. Because we want to help you get the most out of your product and ours.

AMP Bonded Lubrication is already available in a variety of our connectors. In our DUALATCH line, for example, it extends cycle life to a minimum of 20,000 insertions and withdrawals . . . a 100% increase. In our ARINC front release connectors and MI Series metric types, it further increases their premium reliability, ruggedness and overall ability to meet performance requirements. And in our ECONOMATE printed circuit connectors, it ensures even greater protection against board damage and contact wear.

Why not put all the advantages of the better way, AMP Bonded Lubrication, to work in your products. For technical information just call Customer Service at (717) 564-0100. Or write on your Company Letterhead to AMP Incorporated, Harrisburg, PA 17105. For product information, please circle the reader service number.

AMP has a better way.



The dramatic difference in wear between Bonded Lubrication and ordinary contacts is shown by these electron images.

# AMP

INCORPORATED

AMP, DUALATCH, & ECONOMATE are trademarks of AMP Incorporated.

CIRCLE NUMBER 10

# IT TOOK UNITRODE TO DELIVER A WHOLE POWER CIRCUIT FOR LESS THAN THE PRICE OF ITS PARTS.

## Unitrode's Power Output Switching Regulator Circuits.

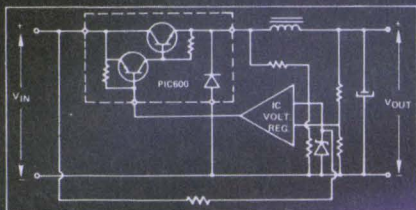

Typical Schematic for Positive Voltage Switching Regulator:

**\$2 and up.**

If you've ever designed a switching power supply, you already know how tricky it is. Especially when you're trying to mate the driver and output transistor with the catch diode.

But you could always argue that you were saving the company money.

Well, Unitrode has just priced that argument out of existence.

Because now, in high volume, you can get that power output circuit already designed and built for less than the price of the individual components. And you not only save design time, you also save breadboarding and debugging time.

You can also look forward to a switching circuit that will probably have greater efficiency and superior noise performance than the one you were thinking about building. Because our circuits switch faster, you can reduce the size and the cost of other components and operate at frequencies up to 100kHz.

Our power switching circuits (PIC600 through PIC656) are available, off-the-shelf, with both positive and negative outputs, from 5 to 20A and up to 80V.

Discover what more and more design engineers are discovering in applications ranging from microprocessor memories to instrumentation - that you might be able to build as good a power switching circuit as Unitrode, but you won't be able to do it for less.

To get more detailed information about our specs, along with our application notes on buck, boost and flyback regulator design, circle the reader service number or call or write: Unitrode Corporation, 580 Pleasant Street, Watertown, MA 02172. Tel. 617-926-0404.



**UNITRODE**

**IN SEMICONDUCTORS, UNITRODE MEANS POWER.**

© Copyright Unitrode Corporation 1977

# The Z80<sup>®</sup> Program Development System.

## A low-cost high performance programmer's work station.

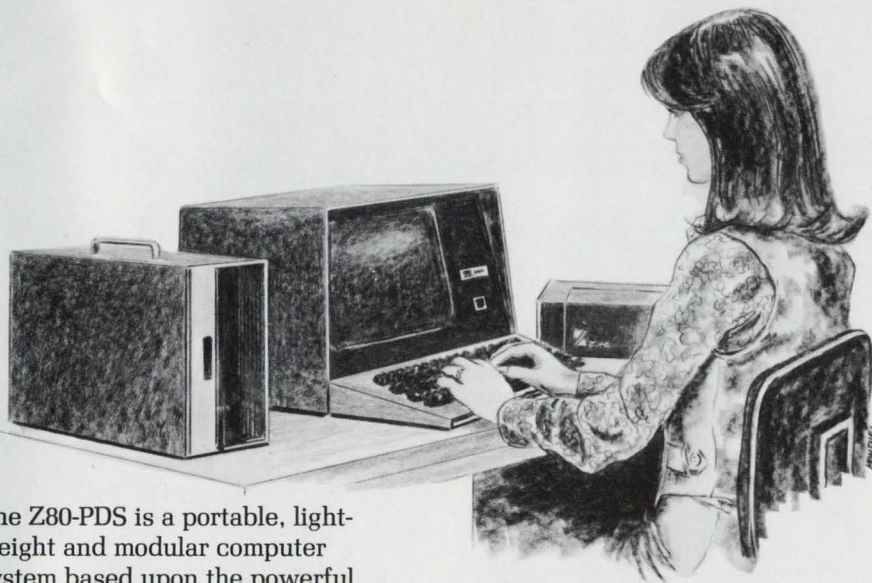

The Z80-PDS is a portable, light-weight and modular computer system based upon the powerful Z80-CPU. It offers an ideal solution for developing and debugging Z80 programs. The PDS is available with options that allow easy expansion for additional I/O or memory. And the price for the basic Z80-PDS is only \$2850\* That includes:

- 16K bytes of RAM memory plus 3K bytes of Monitor PROM.
- Floppy disc drive with 300K bytes of on-line data storage.
- Serial I/O with R-232 or current

loop interface at rates from 110 BAUD to 19.2K BAUD—allows interconnection to any type terminal.

- PROM Resident I/O drivers, debug package and bootstrap loader.
- Powerful disk resident software including operating system, assembler, editor, file utilities and complete documentation and support.

- Optional items available:
  - Printer I/O Port
  - Zilog Video Monitor and Keyboard
  - PROM Programmer
  - Up to 64K bytes of Memory
  - Additional Serial or Parallel I/O Ports.

Full disc compatibility with Zilog's larger Development Systems makes the Z80-PDS an excellent low-cost work station for adding program development power to microcomputer design teams.

For more information on Zilog's new Z80-PDS and complete product specifications, call or write us today.

\*Excluding CRT.

10460 Bubb Road, Cupertino, California 95014  
(408) 446-4666/TWX 910-338-7621

EASTERN REGION: (617) 667-2179  
MIDWESTERN REGION: (312) 885-8080  
SO. WESTERN REGION: (714) 549-2891  
NO. WESTERN REGION: (408) 446-4666  
EUROPE (ENGLAND): (0628) 36131/2/3

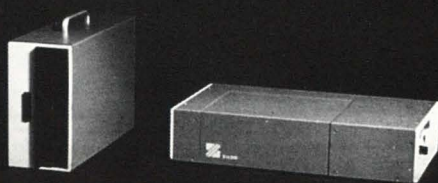
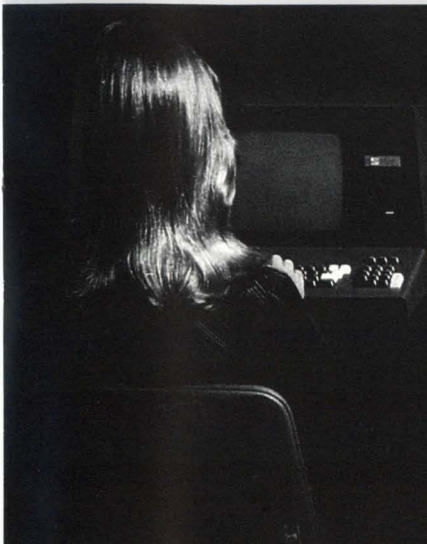

**WE WANT YOU TO KNOW MORE  
ABOUT MICROCOMPUTERS**





**We can't afford to run out of ideas.**

# **Make America smarter. Give to the college of your choice.**

A shortage becomes a crisis only when there is a shortage of trained minds to solve it. And for today's manifold shortages, that means college-trained minds.

Colleges are facing an altogether different kind of shortage. They're having to drop courses, fire professors, close laboratories, limit libraries. Without your help, we'll have the ultimate crisis on our hands: a shortage of ideas.

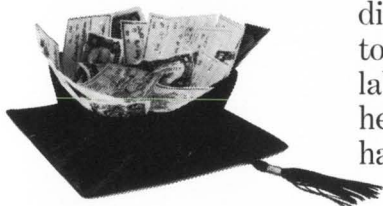

What plastic film  
is transparent,  
electro-conductive,  
cost-effective as a  
component or as a  
consumable, as thin  
as this page and a  
yard wide and  
longer than six  
football fields?

Intrex<sup>®</sup> films from Sierracin  
are all of the above and more.

These transparent electro-conductive films have already found applications as part of, or used with electro-photography, x-ray imaging, micrographics, electronic circuits, touch panels for CRTs, health care equipment, RF/EMI shielding and heated anti-fogging eye wear.

We'd like to send you samples of Intrex film so you can see for yourself how clear it is that we have the right material for your application. Call or write:



**Sierracin/Sylmar**

12780 San Fernando Road, Sylmar, CA 91342

213/367-6184 Telex 167122

Attention: Intrex Film Marketing



# Ceramic capacitors. Another part of our whole.

## Always in step with today's demand.

To cater to today's wide-ranging needs for capacitors, we've brought together a broad selection. At the bottom end of the size scale, for example, our high-voltage capacitors for microwave ovens and our trimmer capacitors featuring excellent temperature characteristics have a diameter of only 3 mm. Our semi-conductor capacitors are in the spotlight because they provide higher capacitance for minimized size. Our disc-shaped capacitors also deserve a mention. They were one of the first parts we turned out for automatic parts insertion systems.

All these capacitors and many more are a true reflection of the length and breadth of our technology. Because our total manufacturing approach is different; our capacitors have that something different. Perhaps that's why they've justly earned a reputation for being safer and more reliable.

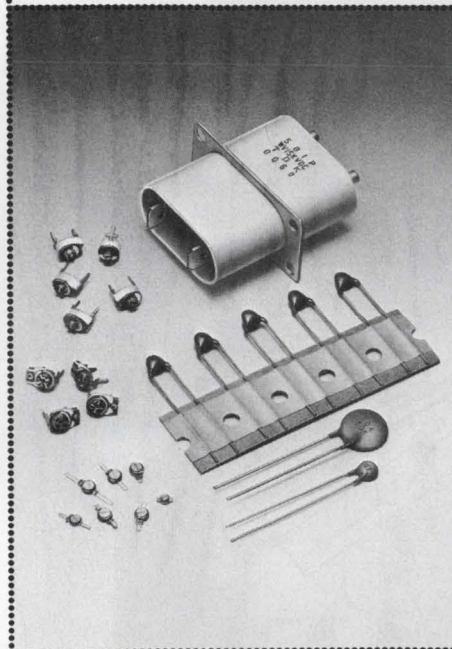

You can see an important part in the photo. But the parts you can't see are equally as important. They go out all over the world to assemblers and end-product manufacturers who want that something special.

Like our ferrite cores made of our exclusive magnetic materials without which many of today's electronics product could not exist. Or our ferrite

magnets for speakers and motors, our singular heat-sensitive PTC thermistors, our electromagnet wave absorbers, coils, transformers or filters. Every part has a full line-up.

Popular among the world's manufacturers of communications equipment are our low-loss, high-permeability materials and other ferrite materials.

Then again, we've also made an inter-

national name for ourselves in cassette tapes. You'll find them wherever people like good music.

TDK is a company of many parts. Our whole is the sum total of over 40 years' experience in magnetic materials and products. It binds our parts together into an attractive whole which we deliver all over the world.



**TDK ELECTRONICS CO., LTD.** 14-6, Uchikanda 2-chome, Chiyoda-ku, Tokyo 101, Japan Phone: Tokyo 031-257-2525  
**TDK CORPORATION OF AMERICA** 2041 Rosecrans Avenue, Suite 365, El Segundo, California 90245 U.S.A. Phone: (213) 644-8625 **CHICAGO BRANCH** 2906 West Peterson Avenue, Chicago, Illinois 60659 U.S.A. Phone: (312) 973-1222  
**NEW YORK BRANCH** 755 Eastgate Blvd., Garden City, N.Y. 11530 U.S.A. Phone: (516) 248-5230 **EL PASO BRANCH** 3501 Frutas Street, El Paso, Texas 79905 U.S.A. Phone: (915) 533-5799  
**TDK ELECTRONICS CORP.** (Handles recording tapes only) 755 Eastgate Blvd., Garden City, N.Y. 11530 U.S.A. Phone: (516) 746-0880  
**TDK DE MEXICO S.A. de C.V.** (Handles ferrite magnets only) Carr. Juárez-Porter, Parque Ind. A.J. Bermúdez, Cd. Juárez, Chih., Mexico Phone: 3-88-27  
**MH&W INTERNATIONAL CORP.** (Handles professional ferrites only) 14 Leighton Place, Mahwah, New Jersey 07430 U.S.A. Phone: (201) 891-8800 Telex: 134 484  
**MH&W INTERNATIONAL (CANADA) LTD.** (Handles professional ferrites only) 6358 Viscount Road, Mississauga, Ontario, L4V 1H4 Phone: (416) 245-3606  
**MONTREAL** 7575 Trans-Canada Highway, Suite 305, St. Laurent, Quebec, H4T 1V6 Phone: (514) 331-2827



# Choice!

## New Dale MSP Networks let you match profile, power and package to meet your resistance needs.

Dale's new MSP single-in-line networks are the shape of things to come in resistance. Rugged. Machine insertable. And available in your choice of profiles: .350" with up to .3 watts per resistor or .195" (.19 watts) to meet critical board spacing requirements. Both are molded for extra protection. Both give you the kind of quality assurance we developed for Dale's SDM—the first network to meet MIL-R-83401. Sample the MSP now. It's available fast in quantity from stock... and it's only part of Dale's complete line of SIP and DIP networks.

Contact your Dale Representative or phone 402-371-0080

DALE ELECTRONICS, INC.  
Box 74, Norfolk, Nebraska 68701  
In Canada: Dale Electronics Canada Ltd.  
In Europe: Dale Electronics GmbH,  
8 Munchen 60, Falkweg 51, West Germany  
A subsidiary of The Lionel Corporation.

CIRCLE NUMBER 351

AVAILABLE FAST: .350" model (MSPXXXX) available in 1 week from factory or from distributor stock. 6, 8 or 10 pin models (-01 circuit) in 49 standard values. Consult factory for fast delivery times on other configurations and schematics.

APPLICATIONS: Standard circuit (-01) has 5, 7 or 9 resistors with 1 pin common. Typical applications include "wired OR" pull-up, power gate pull-up, MOS/ROM pull-up/pull-down, open collector pull-up, TTL input pull-down, TTL unused gate pull-up.

SPECIFICATIONS: *Power:* .350" model=.3 watts max. per resistor; .195" model=.19 watts max. per resistor. *Resistance:* 33 $\Omega$  to 1 Meg. standard. *Tolerance:*  $\pm 2\%$  standard. *T.C.*  $\pm 100$  PPM/ $^{\circ}$ C. *T.C. Tracking:* 50 PPM/ $^{\circ}$ C. *Operating Temperature:*  $-55^{\circ}$ C to  $+125^{\circ}$ C.

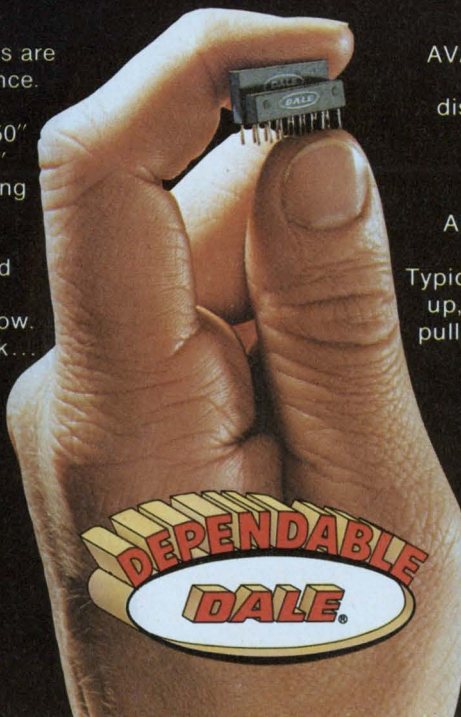



## Our family gives you a flat answer.

Our new flat cable connector family has both standard and stackable sockets, PCB connectors and headers, all designed for lowest total applied cost.

In socket connectors our BA Series gives you a low profile package with the option of either open or closed cover design for both end-cable and through-cable applications.

Our BD Series stackable socket line concept permits stacking two connectors on a wire-wrappable post.

For direct solder applications our BC Series handles PCB connector needs.

Featured with the product family is a simple universal termination system designed for minimum tooling cost.

For your header applications our low profile BB Series line is available for both vertical and right-angle mounting in solder or wire-wrappable designs.

Contact GTE Sylvania, Connector Products Operation, Box 29, Titusville, PA 16354. Phone: 814-589-7071.

Remember, good connections run in our family.

**GTE SYLVANIA**

CIRCLE NUMBER 14



## Now $\mu$ Ps help cut heat bills and sync filmstrip sound

How'd you like to cut your fuel bill in half by designing a microprocessor-based heating system that uses solar heat—and your swimming pool for a heat sink? Or perhaps you would like to add a microprocessor control system to an educational film-strip projector so that the narrative sound, on cassette tape, automatically follows any selected sequence of film frames—for less than \$10.

If you're interested, go to the Consumer Systems Session at the Industrial Applications of Microprocessors Conference in Philadelphia, March 20 through 22, where the designers of both systems will give you a nuts and bolts description of how you can.

The solar residential heating system, which is controlled by an Intel 8035 CPU with a 2-k  $\times$  8-type 2716 PROM, comes from S.C. Peek, senior engineering specialist for GTE Sylvania, Salem, MA. He is operating the system in his home and pool.

The microprocessor is used not only for control, but was also used to simulate system operation, Peek explains in "A Solar Heating System Simulated, Controlled and Instrumented by a Microcomputer."

According to simulation based on the weather of 1958, a standard year used by solar-system designers, the fuel bill using the solar system will be only \$314 against \$666 using oil heat.

To provide low-cost control, the  $\mu$ P system, using Sylvania's Modular Electronic Control Assemblies, takes inputs from glass-bottle thermistors strategically placed in the system and applies their analog signals to simple, ramp-generating a/d converters. Algorithms controlling the system can be readily modified because the program is designed in Basic language. A Z-80 programmer is being used at the Peek home.

The microprocessor controls the exchange of energy from solar panels to the swimming pool, and from the swimming pool to a heat pump that

extracts heat from the water and circulates hot air. The bank of five solar panels (Peek will have 10 next year) captures the heat in 300 ft of common black neoprene garden hose. As the water heats above a preset temperature, the system starts circulating it, while transferring heat to the pool. The collection panels have proven to be 68% efficient, with 25 F outside temperature. This contrasts with the more usual high temperature solar panels which have 40 to 50% efficiency.

Another way to get solar heat is via the pool itself, which is covered with a few hundred blank, transparent fluorescent-lamp tubes acting like thermos bottles floating on top of the water. The sun's radiation goes through them and is trapped in the pool. A pump circulates the pool water through a radiator that extracts heat to warm up air to 130 F. The air is then circulated through the house.

This solar system is more efficient than solar systems that circulate 140-F hot water, according to Peek.

Jack V. Landau, staff engineer at the Singer Corporate R&D Laboratory in Fairfield, NJ, was given an objective of producing a control system for \$10 that would keep the narrative sound on a tape cassette in step with a random choice of the frames of a film-strip projector. He started with a PPS-4/1 microcomputer from Rockwell.

But because the chip doesn't have an accurate timing system, software was used to solve several timing problems, according to Landau in "A Microcomputer Controlled Filmstrip Projector." One major challenge, providing the timing to keep the cassette tape in sync with either regular or random frame changes, was met with a 50-Hz cueing signal 450 ms long to advance the frames.

Software also provides delayed signals from the various switches in the projector to eliminate extraneous transients and a debounce function to prevent erroneous operation. Software

also keeps track of whether or not the tape has broken or run out, by checking the status of signals produced by a switch that is actuated by the tape-player spindle.

The processor provides the operator with a "book-mark" key to identify and recall automatically any frames the operator selects.

It also monitors the pulse widths of the cueing signals to reject noise or other transients that might accidentally advance the film strip.

According to Landau, he brought in the design for less than the \$10 goal.

## Programs don't disappear in thumbwheel calculator

Programmable calculators have an annoying tendency to lose their programs when turned off. One way to solve this problem is found in a unique hybrid programmable, the EL 5001, which permanently stores six engineering programs as well as 26 other preprogrammed scientific functions. This 39-key machine from Sharp in Paramus, NJ, was introduced at the recent Winter Consumer Electronics Show in Las Vegas.

The programs are selected not by keystroke but by a six-position thumb-



wheel switch. Answers in the \$49.95 calculator appear in a 10-digit fluorescent display with a two-digit exponent in a scientific-notation mode.

Programs cannot be keyed into the EL 5001, but those designed-in were judged to be solutions to the most common engineering problems. Electronic designers will be particularly interested in four programs that have simple keystroke routines for solving complex number, impedance, vector, and stability problems.

For complex numbers, impedance and vector problems, add, subtract, multiply and divide operations are programmed-in. Answers to complex-number arithmetic appear for both real and imaginary components. And transformation to polar coordinates is provided.

For impedance and vector calculations, answers can be obtained in polar form with a magnitude and an angle, or in rectangular coordinates. For stability analysis of simple systems, one program solves for the real and imaginary roots of quadratic functions. Another program used integrates polynomial functions simply. And a statistical program permits the standard deviation of experimental samples and their populations to be calculated.

One unusual program makes it easy to plot monomial and polynomial functions of  $X^2$ ,  $X^{1/2}$ ,  $Y^x$ , and  $Y^{1/x}$ .

If a wrong number is entered at any program step, it can be corrected simply by keying in the proper number and repeating that step. The error is simply overwritten.

CIRCLE NO. 317

## $\mu$ P-controlled tester cuts mini-based cost by half

A printed-circuit board tester designed at RCA Laboratories in Princeton, NJ, uses a microprocessor development system as a controller to cut hardware costs to about \$5000—a far cry from the \$10,000 or more for commercial minicomputer-based testers.

“Microprocessors offer the opportunity to apply computer control to testing problems that do not justify a more powerful and costly processor,” says Angelo Marcantonio, a member of RCA Labs’ technical staff. In this case, an RCA 1802 CMOS microprocessor, housed in a COSMAC development system, was chosen for its I/O architecture and because the project members knew it well.

The board tester, used for high-volume production line testing at RCA, can perform 100 measurements per second on a board populated by diodes, capacitors, inductors and resistors. One board can be tested in about one second; inserting and removing the PC card raises the handling time to about nine seconds.

The tester makes both dc and ac two-terminal impedance measurements on the boards. Resistance measurements are made with a stable dc source by

calculating the voltage drop across a precision resistor in series with the unknown. The magnitude and polarity of the potential across diodes is checked by applying a low amplitude direct current and measuring the response with an a/d converter. Reactive components are tested either by a fast-pulse technique or by calculating the phase shift on a 5-kHz sine wave.

All measurements are referenced to readings obtained from a known-good PC board. Test programs and limits are stored in EPROM that is separate from the EPROM that stores the tester’s control program. The test program can therefore be modified simply by updating the directive EPROM without changing the test system’s control program.

The tester consists of the microcomputer, interfaces, a control panel, a printer, and an air-actuated contact assembly mounted in a standard rack. Interfaces include a 12-bit a/d, software-controlled relay matrix, signal multiplexer, 20-column printer interface, and a signal package with a dc source, pulse generator, ac generator, and phase-measurement circuitry.

The control program occupies less than 1.5 kbytes of memory, and test directives occupy 2 kbytes. That means there are 128 tests at 16 bytes per test in the program.

Since boards to be tested consist of passive components, signal and detection circuits are relatively simple and inexpensive.

## Listen carefully: Your car’s calling you

Ever return home from a business trip only to wander aimlessly around the airport parking lot, trying to find your car? Well, take heart: An electronic auto-security system that responds to a pocket transmitter will locate it for you in a flash—of the lights, that is—and with a blast of the horn.

Press the button on your lighter-sized uhf transmitter, and if your car is parked within 100 ft the Pulsafe Auto Security System from TMX, Inc. (Los Angeles, CA) will recognize your custom-coded transmission, turn the car’s parking lights on, deactivate the alarm system, remove the ground from the ignition wires, and honk the horn.

Five pulses are transmitted in sequence during a 400-ms time window.

Each pulse duration is resistor-programmed to one of 25 particular val-

ues, and the same resistor programming takes place in the receiver. Five pulses combined with 25 steps and 10 different channel frequencies yield over 140-million code combinations.

“No station license is required,” notes TMX General Manager Nate Sassover. “Because the unit’s radiated power is so low, it complies with FCC rule number 15.”

After parking your car, lock it, then push the transmitter button—the intrusion system is armed, the ignition ground is activated and the horn beeps twice to verify.

To guard against intruders, Pulsafe isn’t wired to the auto’s door switches, but uses an audio detection system with an adjustable threshold. Should an unauthorized person enter the car or tamper with the engine compartment, he will have to contend with the horn sounding and the headlights flashing alternately for one minute.

## Paramedics’ load lightened by new voice/ECG radio

Paramedics looking for a lightweight coronary observation transceiver to help them take care of heart attack victims will welcome a unit weighing less than 19 lb including battery and handset. This transceiver from Motorola’s Communications Division in Ft. Lauderdale is much lighter and more compact than available “portable” units, which weigh as much as 50 lb.

The weight of the APCOR Duplex/Multiplex Coronary Observation Radio is kept down by putting much of the circuitry into hybrid modules, and by replacing steel and fiberglass with lighter alloys and high-impact-resistance plastic.

The Motorola unit consists of a uhf-FM voice transmitter and receiver, and signal-processing circuits for the electrocardiogram (ECG). With this transceiver, a paramedic can talk to a doctor at a hospital while sending him an ECG over the same channel. The ECG signal is multiplexed into the voice-transmit channel by modulating a 1.4 kHz subcarrier. Voice is passed through a notch filter at the subcarrier frequency, and then mixed with the subcarrier for transmission.

With 12 W, the range can extend to as much as 20 miles, under ideal conditions. For a bit more range, transmit power can be increased to 15 W. Operation is full duplex in the 450 to 470-MHz band, with a transmit frequency 5 MHz above receive.

# KW-PAC

**"COOL POWER"**

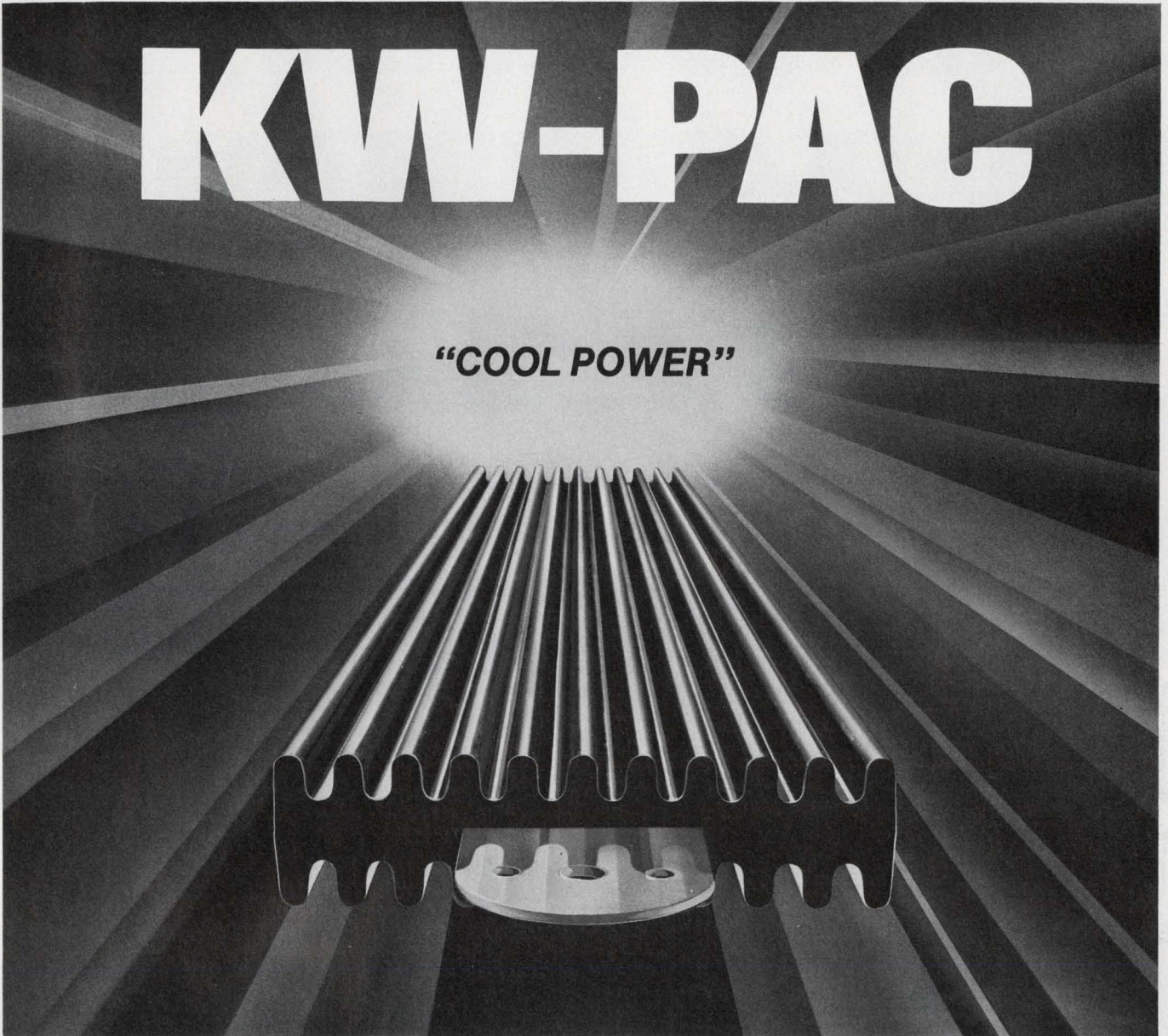

## **HIGH VOLTAGE — HIGH CURRENT SILICON RECTIFIERS**

KW-PAC is an economically priced, rugged and versatile family of silicon rectifiers. "Off-the-shelf" units can be assembled into any standard circuit and handles kilowatts to megawatts.

- Easy mounting and terminations
- More surface area for better cooling
- Can be used in air or oil
- 750V to 72,000 Volts
- 3.8 to 20 Amperes (55°C oil)

*A 72KW driver power supply, built by Continental Electronics Manufacturing Co., Dallas, Texas, featuring three KW-PAC rectifiers.*

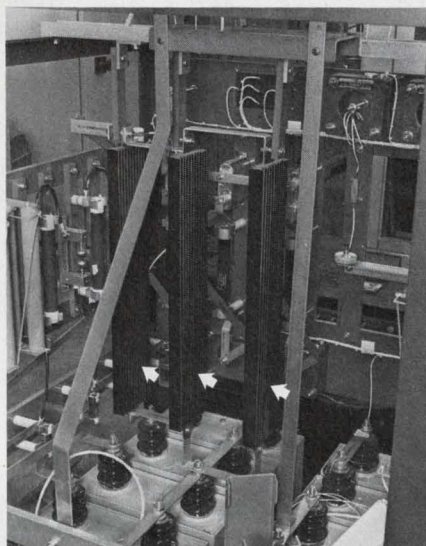

Available as half wave rectifiers, center taps and doublers. For special orders, "KW-PAC" can be provided with fast recovery characteristics or other factory specials.

**1975 NATIONAL SBA SUBCONTRACTOR OF THE YEAR**

**SEMTECH CORPORATION**

652 Mitchell Road, Newbury Park, California 91320  
(805) 498-2111 • (213) 628-5392 • TWX: 910-336-1264  
CHICAGO: (312) 352-3227 • DALLAS: (214) 234-6523  
DAYTON: (513) 274-8356 • FLORIDA: (305) 644-5404  
MARYLAND: (301) 937-0070 • NEW JERSEY: (201) 654-4884  
SAN FRANCISCO: (415) 494-0113 • SEATTLE: (206) 455-4807  
EUROPEAN SALES: Bourns AG Zug, Switzerland (042) 232-242

# Who makes the most microcomputer-based

# Mostek.

Powerful software gives Mostek's AID-80F™  
exciting advantages and capabilities.

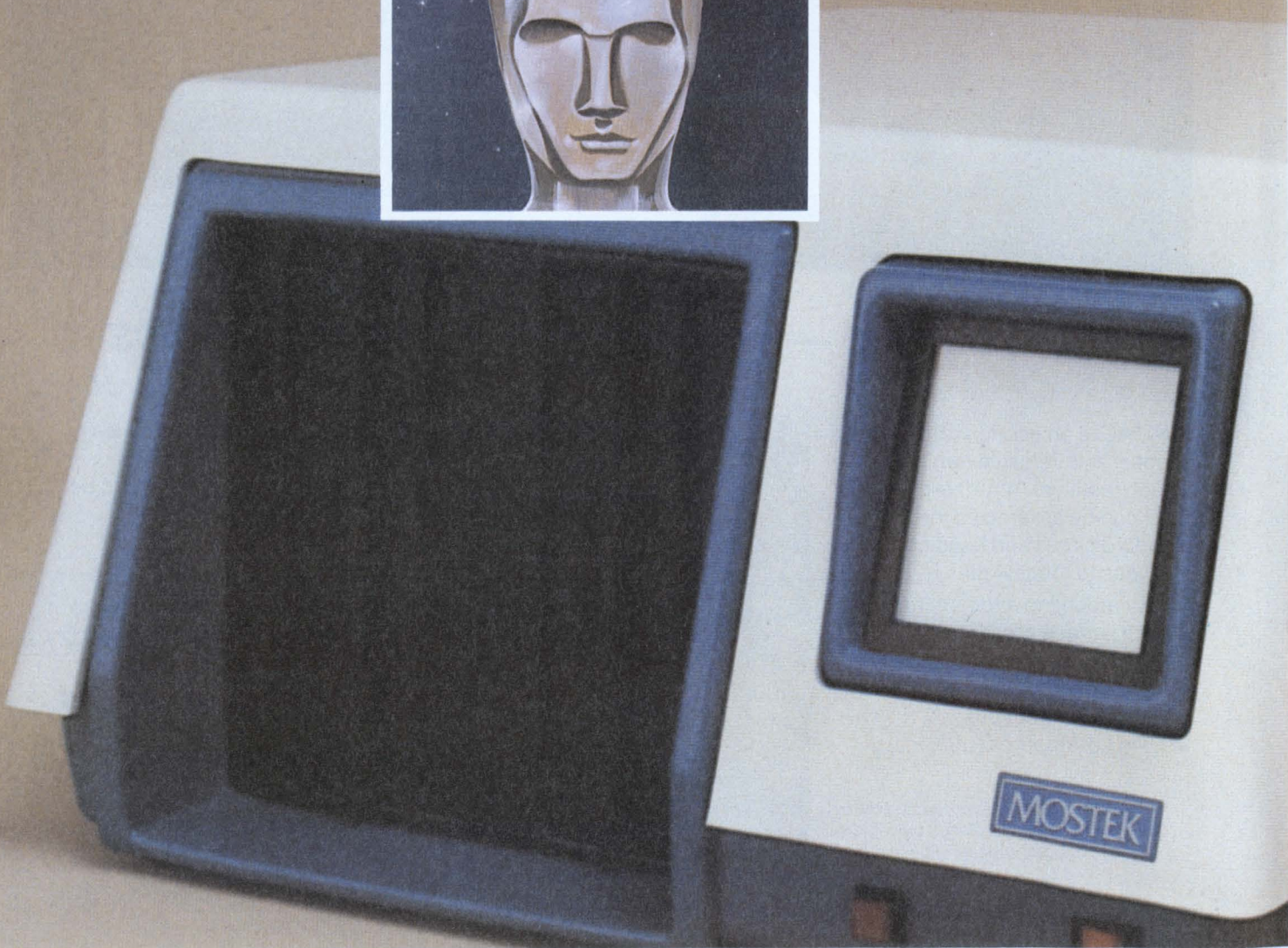
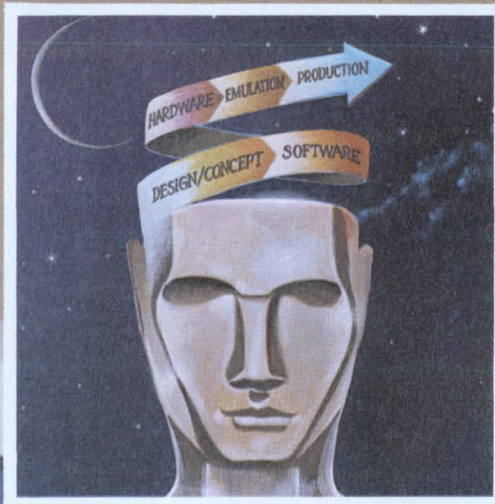

# powerful floppy-disk system?

AID-80F offers powerful software and versatile hardware for microcomputer applications or Z80 program development. As a complete disk-based computer it provides all the tools required for hardware/software development and debug.

The efficient, straightforward hardware organization of AID-80F includes the powerful Z80 Software Development Board, OEM-80; a memory and I/O expansion board, RAM-80; and the floppy-disk controller board, FLP-80. Optional in-circuit emulation capability is provided by Mostek's Application Interface Module, AIM-80™.

## AID-80F Software.

Mostek software is state-of-the-art: efficient, comprehensive, and easy-to-use. It's designed to

accelerate your own programming rate, allowing you to concentrate on the application problem, which greatly reduces the overall development cycle.

The power of Mostek software is found in programs like Monitor, Text Editor, Assembler, Relocating Linking Loader, and Debugger. In addition, the Peripheral Interchange Program (PIP) offers the most complete peripheral management system in the industry.

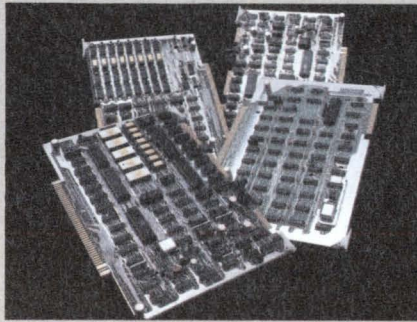

AID-80F Hardware.

**OEM-80.** It's the heart of Mostek's new AID-80F, providing the power of the Z80 microcomputer plus 16K bytes of on-board RAM.

**RAM-80.** This memory and I/O expansion board includes 16K bytes of RAM (expandable to 64K bytes) and four eight-bit I/O ports.

**FLP-80.** Mostek's flexible disk-drive controller board interfaces OEM-80 with up to four drives with soft sector format.

**AIM-80.** This optional board allows real-time, in-circuit emulation with extensive debug, trace and diagnostic capabilities.

AID-80F is priced at just \$5995 and each board is also available separately. To get a complete descriptive package on the AID-80F Microcomputer, contact your sales representative or write Mostek Corporation; 1215 W. Crosby Road; Carrollton, Texas 75006; (214) 242-0444. Mostek GmbH; West Germany; Telephone: (0711) 701096

# MOSTEK

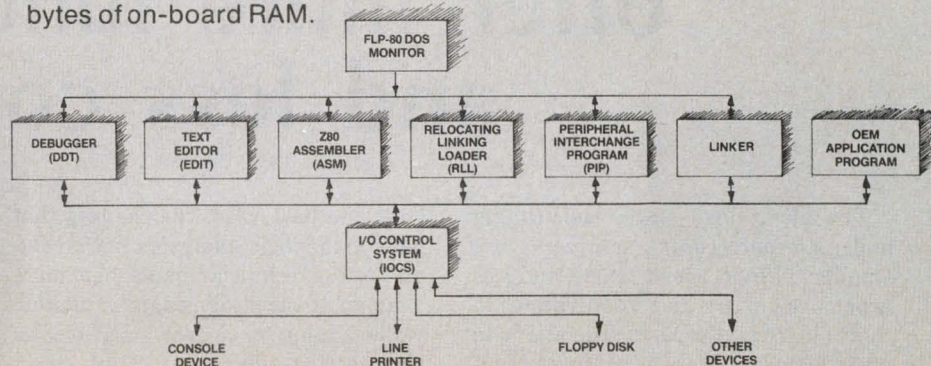

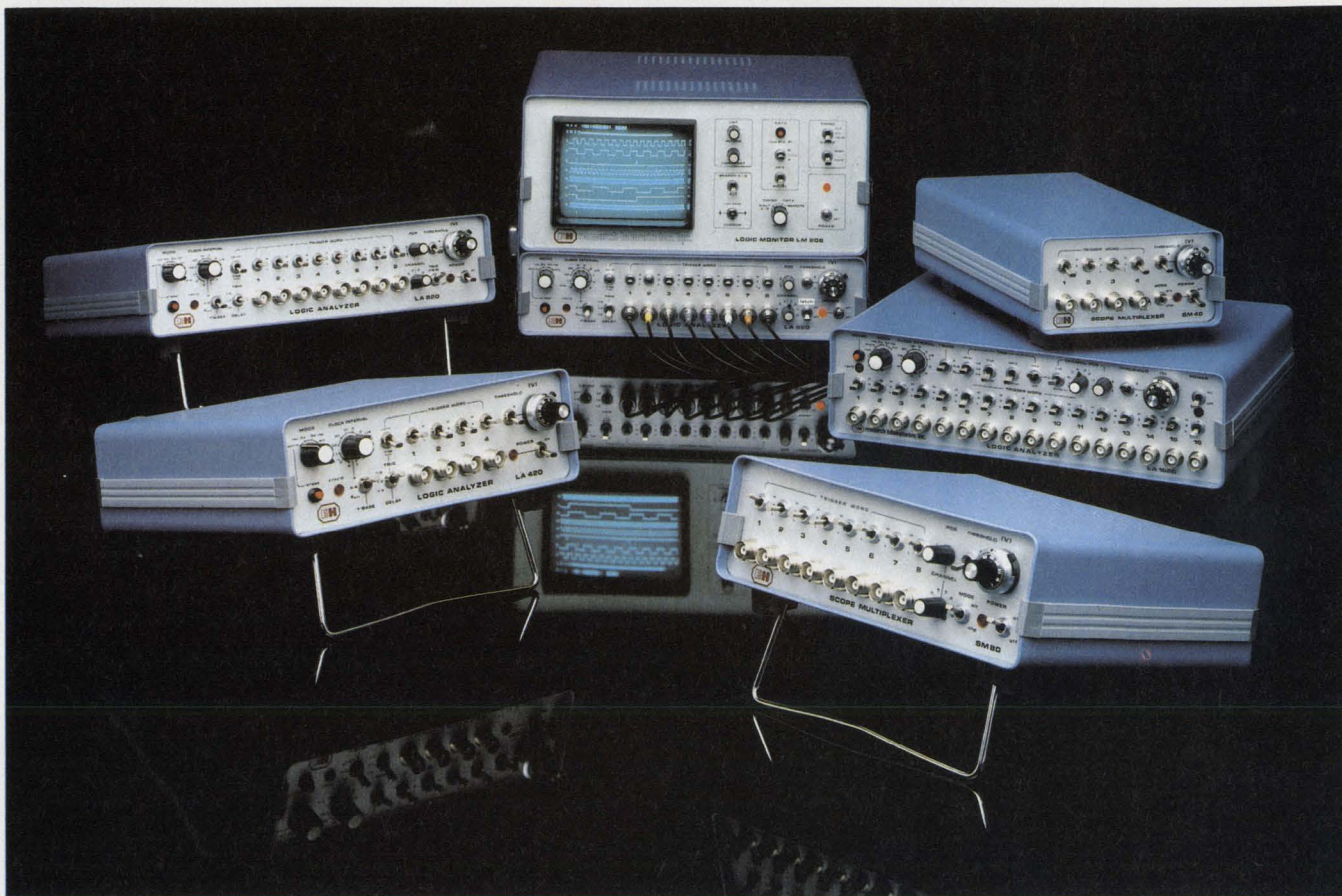

# The latest logic analyzers offer more functions and less cost

The latest logic-state, logic-timing and microprocessor analyzers are smaller, lighter, easier to use, and less expensive to buy and to operate than their older counterparts. The aim is to make logic analyzers as useful in field-service testing as in the design lab.

While most older logic analyzers are designed specifically for engineers to test and debug new digital circuits and systems, many new ones are being optimized for the field-service technician trying to get a once-working system back on the air. But this doesn't mean that design engineers have to make do with their older instruments while all the new gear goes elsewhere.

Over the past year, the changes that have made logic analyzers more valuable to the technician make them more valuable to the design engineer as well, while adding to a growing choice of logic-testing aids.

## Testing logic

Not too long ago, logic-analyzer suppliers could be counted on the fingers of one hand—now more than two dozen are in the game. And each one makes an instrument—or a line of instruments—that's a little bit different.

While the most popular logic-timing analyzers sample digital signals at 10 or 20 MHz, some units can't even exceed 2 MHz. But at least one (Biomation's Model 8200) can sample up to 200 MHz.

Then there's the logic-state analyzer, a slightly different breed that samples at the clock frequency of the unit under test. Recently, Hewlett-Packard introduced its Model 1615A, which combines logic-state and logic-timing analysis.

Yet another variation, the microprocessor analyzer, is aimed at microprocessor-based systems. Some, like American Microsystems Inc.'s MDC-140, are so dedicated to microprocessor testing that they are nearly useless for testing random logic. And some only test specific device types.

Suppliers are placing more emphasis on field-service applications for all analyzers because field-service departments buy hundreds of one model at a time, to give all technicians the same kit of aids.

**Andy Santoni**  
Associate Editor

**There's plenty to choose from now** in logic analyzers, as can be seen from just one manufacturer's offerings. E-H International offers analyzers, scope multiplexers, and monitors from about \$450 to \$2700.

Moreover, field-service departments are ready for logic analyzers, says Bruce Farly, product manager at Hewlett-Packard Co.'s Colorado Springs Division. Since this relatively new breed of instruments is already accepted and understood by most design engineers, he explains, suppliers are now ready to take in a new group of potential users.

### Cutting costs

A good example is the Model 920-D from Biomation Corp., Cupertino, CA. At less than \$1300, the 920-D is Biomation's least expensive analyzer, yet it retains most of the features of the firm's older models, and even adds a few. It has nine input channels, and its operation is triggered on any user-selected combination of these nine channels. The ninth channel can operate just like any of the other eight, or it can be used as a trigger marker and qualifier. It can also be used to gate the clock of the system under test when this signal doubles as the recording clock of the analyzer.

Like all Biomation logic analyzers, the 920-D has a latch input mode for capturing narrow pulses or glitches—in this case, as narrow as 10 ns. Input impedance is 1 M $\Omega$ , and either  $\times 1$  or  $\times 10$  scope probes can be used. Threshold levels can be fixed to TTL or ECL levels, or adjusted by a front-panel slotted control.

Unlike Biomation's older eight-channel Model 810-D, which operates to only 10 MHz, the 920-D boasts 20 MHz. And neither combinatorial triggering nor digital trigger delay is covered by the older unit's \$1500 price.

Why is the new model less expensive, yet more powerful? The tried-and-true methods for cutting the cost of electronic equipment apply as well to logic analyzers as to any other product. With field-service needs in mind, Biomation can expect higher volume for its new instrument. This expected volume justifies using a molded plastic box that is lighter and more durable, yet less expensive, than the 810-D's metal cabinet. And large-scale integrated circuits replace many of the small and medium-scale and discrete devices in the 810-D.

"Because of its compact size and light weight, the instrument is a willing companion for the field service technician," says Roy Tottingham, applications engineer at Biomation. Designers gain, too—"Because of the operating features and modest cost, the instrument is also quite suitable as a design aid for the engineer."

### Keyboard control helps

Similar accolades can be given to Hewlett-Packard's Model 1602A logic-state analyzer. Its keyboard control panel and quick connect and disconnect edge-connector probe simplify service and production-line applications, as does its programmability. With Option 001, the Model 1602A becomes compatible with the HPIB—HP's version of the IEEE-488 standard instrument interface bus—so it's easy to tie into an automatic functional test system.

For example, working with a computing controller, the 1602A can test a computer system that has failed. Enough tests can be performed in a short enough time for the failure to be tracked down to the errant board.

Swapping boards at random to find the one bad board is avoided—and money saved—if the bad board is discovered quickly. Otherwise, bad boards going back to the factory for rework and good boards going out to field-repair depots create what is called a "float" of assemblies that represents a costly inventory.

Even though a calculator-controller and logic-state analyzer combination may seem rather large and cumbersome for the field, faster and more accurate field repairs may make such a combination seem lighter. In fact, HP believes that solving service and production problems will occupy most of the 1602A's time. However, the company also believes that the analyzer will make a superb companion to laboratory equipment.

The primary reason that the 1602A is useful for both laboratory and field applications is that it's very easy to use, says HP's Farly. At turn-on, the unit performs a self-test that, if all is well, ends with the display lighted up in all-eights so that even the display is tested. If a failure occurs, the instrument can be commanded to single-step through



**Timing or state analysis, or both at the same time,** is a feature of Hewlett-Packard's Model 1615A. It can also catch glitches as short as 5 ns, and display them on a built-in CRT. Price is \$6800.



**Keeping costs down** is the aim of HP's Model 1602A. IEEE-bus compatibility and testing are special features of the instrument, which sells for only \$1800.

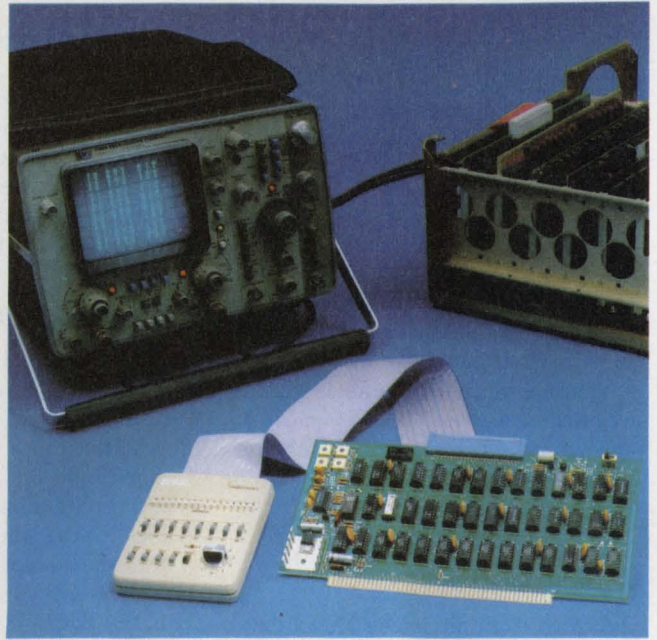

**Testing the S-100 bus** standard for small-computers is simplified with the Paratronics Model 150. And it costs only \$449 (\$369 in kit form).

the test program and tell an operator where the failure is.

A signal-source card that plugs into the 1602A's probe pod makes it possible to test even the probe, so that both the design engineer and service technician can be sure there are no instrument problems to contend with while making measurements.

### Checking out the bus

The probe pod can also be connected, via two optional modules, to an IEEE-488 bus system. The logic analyzer then becomes a bus-system analyzer and can check that the instruments are communicating with each other in the proper sequence and with the proper handshake signals.

As a matter of fact, adding the ability to check the 488 bus to a logic analyzer's bag of tricks is becoming more common, as illustrated by the DF2 bus-analyzer plug-in for Tektronix Inc.'s Model 7D01 logic analyzer. The DF2, like the basic 7D01 logic analyzer from the Beaverton, OR, firm, plugs into the company's 7000 Series of oscilloscopes. Another Tektronix logic analyzer, the LA 501, plugs into the firm's TM-500 Series of modular-instrument mainframes.

### Catching glitches

Often, new modules for one set of logic-analyzer plug-ins become avail-

able in a different format for the other module series. Last fall, for example, Tektronix added the DL2 digital latch, which mates with 7000-Series scope mainframes, and the DL 502, which mates with TM-500-Series mainframes. Either unit can latch glitches as narrow as 5 ns and with amplitudes as small as 500 mV centered on a threshold set by the user.

The DL 502 is part of a convenient, though expensive, package for field-service logic testing. Also included are a WR 501 word-recognizer and digital



**More features, less cost** is the hallmark of Biomation's 20-MHz, 9-channel Model 920-D, shown here with optional CRT display.

delay, an LA 501 logic analyzer, and an SC 502 dual-trace, 15-MHz oscilloscope—all in a six-hole TM-500 mainframe. More likely, this \$7400 combo (\$5990 without the scope and in a four-hole frame) will be found in the lab where the mainframe and scope plug-in can work with a different set of plug-ins for other applications, and the flexibility of the modular system can be put to good use.

A less-expensive logic analyzer plug-in package is the LC-320 from Scanoptik Inc., Rockville, MD. Tektronix' SC 502 is combined with Scanoptik's LC-32 logic analyzer in a three-hole mainframe for \$4390.

The \$1595 LC-32 has 32 channels and a 4-MHz maximum clock rate. It can store in its memory then feed up to 64 words of data, typically from a microprocessor's address and data buses, to an external CRT display unit.

### Checking out microprocessors

Another logic analyzer aimed at testing microprocessor systems—and only \$1020—is the MPA-1 from E-H International Inc. located in Oakland, CA. Designed by Yucca International Inc. (Scottsdale, AZ), the MPA-1 comes with a probe for one microprocessor type, and can be configured for other microprocessors by changing probes. So far, 6800 and 8080 probes are available, and probes for the Z-80, F-8, and SC/MP are in the works.



# HERE'S YOUR CHANCE TO TRY FIBEROPTICS.



Here for the first time is a reasonably priced, off-the-shelf fiberoptic engineering kit with all the electronic and mechanical components necessary for use in TTL systems up to 5 mbps.

Augat developed it to give engineers a quick and easy way of evaluating the exciting new technique of fiberoptic interconnection in their existing or prototype systems. The price

give you all you need to know to use it... even assuming no prior experience in fiberoptics.

The kit contains a 5-meter length of Hytrel-f-jacketed cable terminated with ferrules that have precision ground and polished ends. All connector

5 mbps over a temperature range of 0 to 55°C without drifts or inadvertent comparator switching usually associated with non-temperature referenced pre-amps.



Cable Assembly

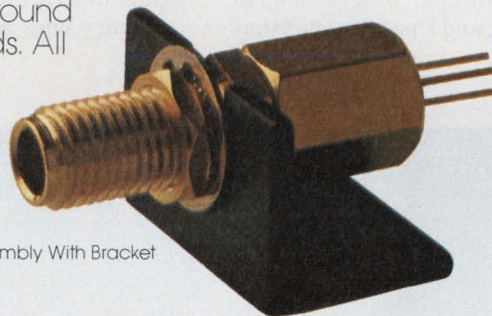

Detector Assembly With Bracket



TO-18 Socket

is right.\* And the kits are in stock at Augat's nearly 200 worldwide distributor locations.

The combination of the kit's driver, emitter, cable assembly, pre-amp, and detector provide the necessary elements for a complete TTL-compatible digital fiberoptic system. We've even included mounting brackets and sockets for convenience. And its comprehensive instruction manual will

elements feature gold-plated brass construction to ensure the integrity of shielded enclosures.

The temperature referenced pre-amp operates from dc to

All components of the kit are available separately. Standard accessories include butt splices, o-ring seals, and cables of other lengths. For more details and a list of Augat distributors, write Augat, Inc., 33 Perry Avenue, P.O. Box 779, Attleboro, Mass. 02703. Tel. (617) 222-2202



Driver and Pre-amp Modules

\*Complete Kit (No. 698-OK-002): \$190. Kit less driver and pre-amp (No. 698-OK-001): \$99.50.

†Dupont trademark

## AUGAT<sup>®</sup>

Augat interconnection products, Isotronics microcircuit packaging, and Alco subminiature switches.

Most of the other logic analyzers in E-H's product line were also designed by another firm—Dolch Logic Instruments in Germany. Like the MPA-1, they are marketed in the U.S. by E-H, which expects soon to be manufacturing the instruments, too.

All the new logic analyzers from E-H have clock rates up to 20 MHz. Memory depths are 256, 512, or 1024 words of 4 to 16 bits, and prices range from under \$1000 to about \$2300.

Besides its logic analyzers, E-H has a pair of logic monitors that, when connected to any logic analyzer, add comparison-mode testing to that analyzer's roster of features. Data are stored in one register, then more data are stored in a second register and compared with the first set. Since differences are flagged, spotting faults is simplified. The eight-channel LM 208 is priced at \$2295 and the 16-channel LM 216 is \$2695.

Meanwhile, some of the lowest-cost logic analyzers are coming from Paratronics Inc. of San Jose, CA. For example, the Model 100A, an eight-channel unit that stores 16 words, is \$295—or \$229 in kit form. For the same prices, the Model 10 expander adds 16 bits of triggering and display.

The Paratronics analyzer is a logic-state instrument that displays one-zero truth tables on an external CRT. The Model 100A/10 package also provides a user-programmable digital delay for paging through programs up to 1000 steps long, and a pass counter that

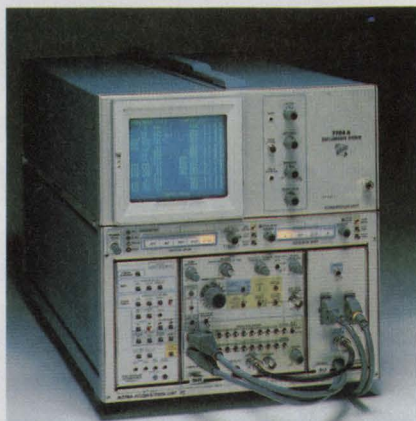

**Grab the bus and check it out** with a logic analyzer that has an IEEE-488 adapter, like this Tektronix combination of analyzer, adapter, and latch in a 7000-Series scope mainframe.

permits a microprocessor's state to be monitored after a set number of passes through a loop.

Another Paratronics analyzer, the Model 150 Bus Grabber, is designed to test computers that conform to the S-100 bus standard. For \$449 (\$369 in kit form), the 150 plugs into a computer slot and monitors 56 bus signals. Eight more signals can be picked up by an optional plug-in flat-ribbon probe assembly.

The latest Paratronics analyzer, the Model 532, goes for \$1500. This 32-channel  $\mu$ P-based instrument captures and displays up to 250 words either in alphanumeric hexadecimal notation or in binary ones and zeros. It also fea-



**Different strokes—timing diagram, state diagram, or map**—are available in a few logic analyzers like this BP Instruments 50D with optional 50D011 display formatter.

tures a wide range of triggering modes, including the ability to trigger on the nonoccurrence of an event.

### Variations on triggering

Extensive triggering facilities are also featured in HP's Model 1615A. This unit combines logic-timing and logic-state analysis so that time-domain problems like glitches or state-domain problems like program errors can be traced. In fact, the state-domain display can be triggered by a time-domain occurrence, and vice versa.

The \$6800 Model 1615A can trace events on as many as 24 channels at up to 20 MHz, with a 256-word memory. And with a 6-bit clock qualifier, the user can select specific data such as read or write instructions or I/O instructions.

The analyzer can be configured by keyboard entry into 24 bits for state analysis, 8 bits for timing analysis, or a combination of 16 bits of state and 8 bits of timing information. Glitches greater than 5 ns wide can be captured and made part of the unit's trigger specification.

Unlike most analyzers, which use a pulse-stretching circuit to catch and display transients, the 1615 uses a second memory to store transient data. With pulse stretching, a transient is stored, then displayed on the analyzer's next clock edge. If the signal line goes through a normal transition between the glitch and the clock edge, the transient may be lost. In the 1615A, the glitch would be shown as a brightened edge on the transition.

The ability to display both time and data-domain problems helps a design engineer debug both hardware and



**Testing microprocessor systems is easier** with an analyzer that's dedicated to the task. The AQ8080 can handle 8080 and 8085 types by changing probes.

# Now you can save money and get the counter you want— immediately

A frequency counter should deliver all the performance you expected when you placed the order. If the counter is a B&K-PRECISION you'll be getting that plus some equally important benefits—a price that you can easily afford and off-the-shelf delivery.

B&K-PRECISION has engineered a line of full-feature frequency counters to suit most

applications. All have been conceived as cost-effective answers to frequency measurement needs in communications, lab, field and plant applications. Every B&K-PRECISION counter features: autoranging, liberal input overload protection, a minimum of 1Hz resolution, conservative specifications, and easy-to-read LED displays.

#### MODEL 1850

- 520MHz guaranteed; 600MHz typical
- Period measurement capability

#### MODEL 1801

- 40MHz guaranteed; 60MHz typical
- Reliable discrete TTL logic

#### MODEL 1827

- 30MHz guaranteed; 50MHz typical
- Compact size; portable
- 8 digit accuracy with 6 digit readout

#### MODEL 1820

- 80MHz guaranteed; 100MHz typical
- Period, event and time measurements

At the top end of our line is the new Model 1850, very conservatively rated at 520MHz. Features include: TCXO time base...Period measurements from 5Hz to 1MHz...Leading zero suppression...Bright .43" LED display... Gate times from 10 ms to 10 seconds...\$450.

The 1820 Universal Counter is one of the most versatile counters available at any price. Frequency measurement typically extends beyond 100MHz...Period measurements from 5Hz to 1MHz... Period average, auto and manual positions... Elapsed time measurements to 9999.99 seconds (plus overflow)... Totalizes event counts to 999999 (plus overflow)... \$260.

At only \$120, the 1827 portable frequency counter is slightly larger than a pocket calculator. 30MHz guaranteed; 50MHz typical... Battery saver for all-day field use... Full range of optional accessories available.

The 1801 is a rugged frequency counter designed for production line and maintenance applications. Readings to 40MHz guaranteed; 60MHz typical... Easy to use and read...Wide range input eliminates the need for level adjustments...\$200.

Isn't it time you stopped sacrificing features and performance for price? See your local distributor for immediate delivery.

**B&K PRECISION** **DYNASCAN CORPORATION**

6460 W. Corland Avenue, Chicago, IL 60635 312/889-9087

In Canada: Atlas Electronics, Ontario

International Sales: Empire Exporters, Inc., 270 Newtown Road, Plainview, L.I., NY 11803

CIRCLE NUMBER 18

software problems, notes Ken Pine, marketing vice-president of BP Instruments Inc. The Cupertino, CA, firm's Model 50D or Model 50D16 can be attached to the Model 50D011 display formatter to allow an operator to examine stored digital information in timing-diagram, binary, hex or octal, or map modes. The map-mode format generates an XY plot of the 510 words stored in memory, arranging them in 4 x 4 (Model 50D) or 8 x 8 (Model 50D16) patterns—which is also done in some HP and Tektronix analyzers.

Even more information is available in the display generated by the logic-analyzer option to the MDC microprocessor development system from American Microsystems Inc., Santa Clara, CA. A very flexible and high-powered logic analyzer for 6800-Series microprocessor systems, the MDC-140 is also an expensive choice—about \$4000, in addition to \$9600 for the  $\mu$ P development system.

For the additional \$4000, a buyer gets 40 data channels with 1024 traced steps, delay from 0 to 64-k clocks, four clock types with speeds to 10 MHz, and four qualifiers—two to start the delay, one to define clock cycles, and one to trigger external equipment such as an oscilloscope. The display can be in almost any format—binary, octal, hexadecimal, or symbolic.

Since the logic analyzer is tied to the microprocessor-development system and its floppy-disc drive, it can even display disassembled instructions—the mnemonics used to program the system—instead of numeric equivalents. That simplifies program tracing.

### Using different microprocessors

Another analyzer, the  $\mu$ scope 820 from Intel Corp., Santa Clara, CA, can not only monitor the activity in a microprocessor-based system but can also modify system parameters and program flow. Housed in an attache case, the 820 is low enough in cost—about \$2000—to be useful in the field.

Preprogrammed maintenance and troubleshooting programs can be executed directly from the instrument's front panel. High-level command keys and operator prompting simplify operation, minimize operator errors, and ease operator training.

The 820 interfaces to the system under test via the microprocessor socket, and the microprocessor itself is plugged into the 820's probe pod. Probe pods and control-panel overlays for 8080 and 8085-type microprocessors

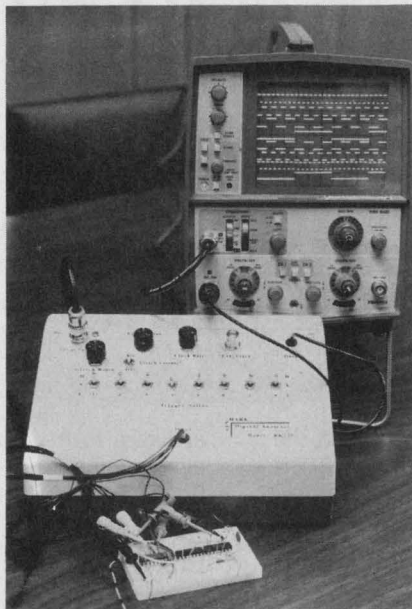

**Eight lines in timing-diagram format** can be displayed on a scope screen with the Kenmark Model RK778—which goes for just \$225.

are available.

One problem with this type of interface is that the  $\mu$ P of the unit under test has to be socketed. Unsoldering the  $\mu$ P will most likely destroy it. Even pulling the microprocessor out of a socket will at least bend pins and at worst destroy the chip through static discharge. A better way to interface with a unit under test is to clip onto

the microprocessor itself without disturbing it mechanically.

That's the usual way with the microprocessor analyzers from AQ Systems Inc., Yorktown Heights, NY. The firm's 6800-type analyzer can be configured to test 6502-type devices by changing the probe. In the same way, the company's 8080-type analyzer can be configured to test 8085s.

The newer of the two analyzers is the AQ8080, priced at \$2550 with an 8080 probe and \$2390 with an 8085 probe. An extra 8080 probe is \$355 and an extra 8085 probe \$495.

The AQ8080 has bidirectional access to a microprocessor's internal registers as well to its memory and I/O ports. It also has a conditional hardware breakpoint and monitor, and can trace up to 128 program steps, with cycle and instruction step modes. Absolutely no memory from the unit under test has to be allocated to the AQ8080's functions. As a result, system design does not have to take the tester into account.

The latest supplier to enter the logic analyzer field is Kenmark Development Group Inc., East Northport, NY. Its Model RK778, an eight-channel real-time analyzer, displays timing diagrams on an external CRT. A glitch catcher can detect positive or negative-going glitches less than 13 ns long, and the analyzer can operate at up to 20 MHz. Price is \$225. ■

## Need more information?

Not every manufacturer of logic analyzers has been cited in this report, nor has every analyzer made by each of these suppliers been described in detail. For additional details, circle the appropriate number on the Reader Service Card and consult the GOLD BOOK.

- American Microsystems Inc., 3800 Homestead Rd., Santa Clara, CA 95051. (408)246-0330. (Ed Barnett) **Circle No. 501**
- Applied Microsystems, P.O. Box 245, Bothell, WA 98011. (206)827-9111. (R. Knoke) **Circle No. 502**
- AQ Systems Inc., 1736 Front St., Yorktown Heights, NY 10598. (914)962-4264. (Steve Halpern) **Circle No. 503**
- BP Instruments Inc., 10601 S. De Anza Blvd., Cupertino, CA 95014. (408)446-4322. (D. Creech) **Circle No. 504**
- Biomation Corp., 10411 Bubb Rd., Cupertino, CA 95014. (408)255-9500. (Ed Jacklitch) **Circle No. 505**
- Brensil Electronics Ltd., 24 Park Row, Bristol, England. (David Hunt) **Circle No. 506**
- Databyte Inc., 7433 Hubbard Ave., Middleton, WI 53562. (608) 831-7666. (Jeff Livingston) **Circle No. 522**
- Davco Manufacturing Co., 169 Ridgedale Ave., Morristown, NJ 07960. (201)267-4990. (James C. Lawless) **Circle No. 507**

- Digital Broadcast Systems Inc., Brentwood Lane, P.O. Box 381, Madison, AL 35758. (205)837-2183. (Winton Churchill) **Circle No. 508**
- Digital Laboratories, 600 Pleasant St., Watertown, MA 02172. (617)924-1680. (William M. Kahn) **Circle No. 509**
- E-H International Inc., formerly E-H Research Laboratories Inc., 515 Eleventh St., Oakland, CA 94607. (415)834-3030. (Pete Mara) **Circle No. 510**
- Hewlett-Packard Co., 1501 Page Mill Rd., Palo Alto, CA 94304. (415)493-1501. (Inquiries Manager) **Circle No. 511**
- Intel Corp., 3065 Bowers Ave., Santa Clara, CA 95051. (408)987-8080. (Tom Jones) **Circle No. 512**
- Kenmark Development Group Inc., 6 Meadowlark Drive, East Northport, NY 11731. (516)368-3314. (Marc Chomet) **Circle No. 513**
- Motorola Data Products, 455 E. North Ave., Carol Stream, IL 60187. (312)690-1400. (Donna Dorn) **Circle No. 514**
- Moxon Inc., 2222 Michelson Dr., Irvine, CA 92715. (714)833-2000. (Walter B. Larson) **Circle No. 515**
- Paratronics Inc., 150 Tait Ave., Los Gatos, CA 95030. (408)263-2252. (Ira H. Spector) **Circle No. 516**
- Pro-Log Corp., 2411A Garden Rd., Monterey, CA 93940. (408)372-4593. (Joe Maggioro) **Circle No. 517**
- Scanoptik Inc., P.O. Box 1745, Rockville, MD 20850. (301)977-9660. (Jerry L. Shumway) **Circle No. 518**
- Systron-Donner Corp., Ten Systron Dr., Concord, CA 94518. (415)676-5000. (Darryl Watanabe) **Circle No. 519**
- Tektronix Inc., P.O. Box 500, Beaverton, OR 97077. (503)644-0161. (Dave Parmley) **Circle No. 520**
- Vector Associates Inc., 685 Station Rd., Bellport, NY 11713. (516)286-9000. (Sheldon Bienstock) **Circle No. 521**

# FOR RENT...NOW...

Beehive's versatile and easy-to-use B100 and Mini Bee 2 terminals, both available for immediate short-term, low cost rentals today.

If you need a self-contained, feature-filled video display terminal fast, the B100 will fill the bill . . . and it's available today. Beehive International's B100 features both RS232C or current loop interface, has switch selectable transmission rates from 75 to 19,200 bps, and includes cursor control. You'll also like the addressable cursor. The terminal has an easy-to-read 12-inch non-glare screen which is formatted to display 24 lines with 80 characters per line. You can choose upper and lower case characters, too. The B100 has a total page memory of 1920 characters, and the 82-key, ANSI compatible keyboard features auto repeat, 2-key rollover and alpha lock. The addressable cursor lets you directly position by line and column, and an erase mode allows you to erase from cursor to end of line, from cursor to end of memory, and clear. You'll also find operation more efficient because of B100's 11-key numeric pad with decimal and additional function keys. Communications mode is Full Duplex (Echoplex), Half Duplex, and Block (asynchronous 10 or 11-bit word). It's ready for you now.

The low-rental rates on Mini Bee 2 will make you happy if you need a TTY-compatible terminal with cursor control and a detachable keyboard. Beehive's Mini Bee 2 is a stand-alone, operator/computer accessible remote display terminal with a detachable keyboard. You use Mini Bee 2 to transmit and receive data serially through an RS232C interface at any of several preselected transmission rates to a maximum of 9600 baud. Mini Bee 2 has a 12" rectangular monitor which displays 25 lines with 80 characters per line. It has a total page memory of 2000 characters, and each character is generated from a 5x7 dot matrix with two dot spacing between adjoining characters. Communications mode can be full duplex, half duplex, 10 or 11-bit asynchronous word. Mini Bee 2 also features character-by-character transmission, an escape sequence mode for unique CRT functions, and an erase mode. It's also available off-the-shelf from REI immediately.

**Rental Electronics, Inc.**  
Another of the **AMERICAL** companies

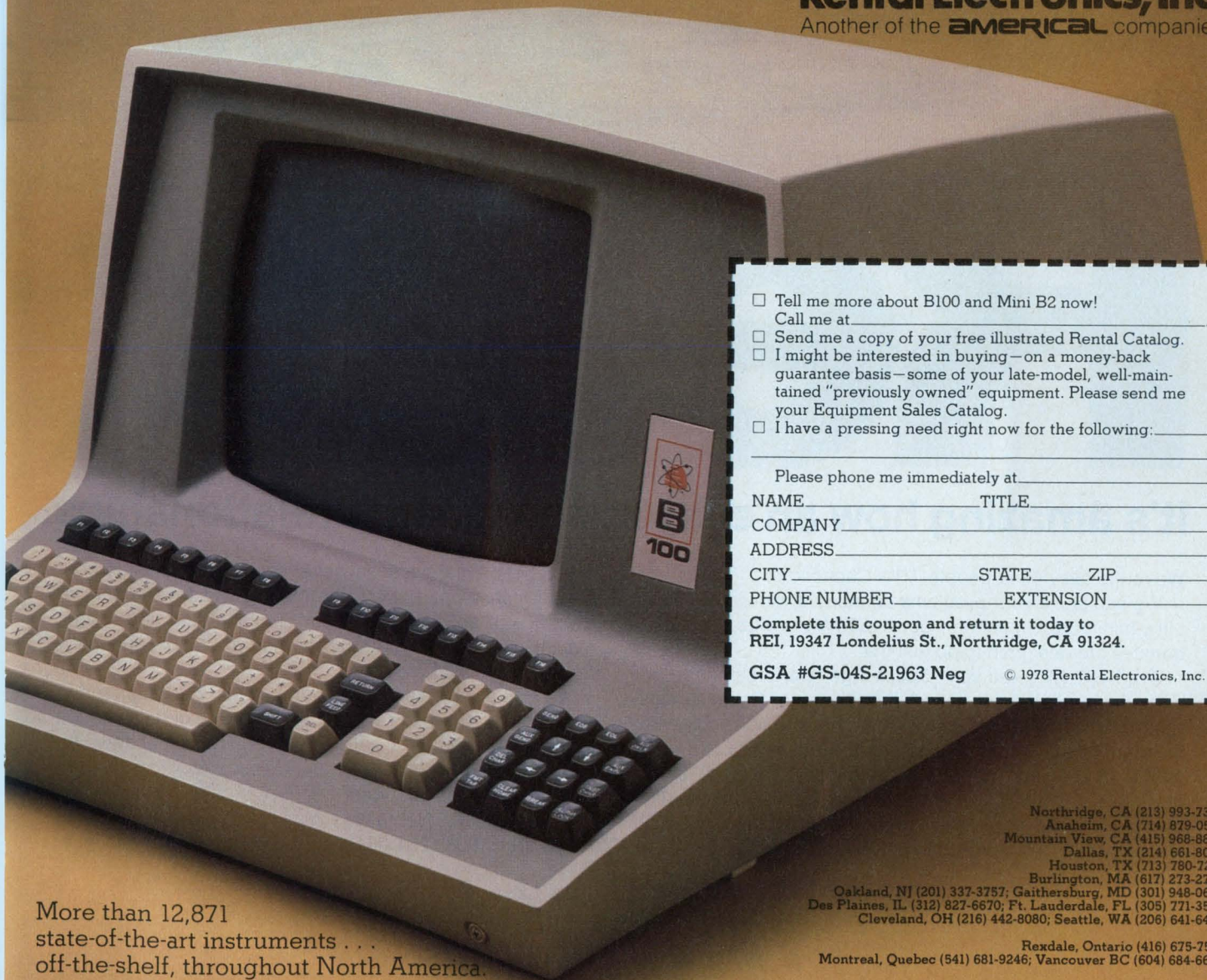

More than 12,871  
state-of-the-art instruments . . .  
off-the-shelf, throughout North America.

- Tell me more about B100 and Mini B2 now!  
Call me at \_\_\_\_\_
- Send me a copy of your free illustrated Rental Catalog.
- I might be interested in buying—on a money-back guarantee basis—some of your late-model, well-maintained "previously owned" equipment. Please send me your Equipment Sales Catalog.
- I have a pressing need right now for the following: \_\_\_\_\_

Please phone me immediately at \_\_\_\_\_  
NAME \_\_\_\_\_ TITLE \_\_\_\_\_  
COMPANY \_\_\_\_\_  
ADDRESS \_\_\_\_\_  
CITY \_\_\_\_\_ STATE \_\_\_\_\_ ZIP \_\_\_\_\_  
PHONE NUMBER \_\_\_\_\_ EXTENSION \_\_\_\_\_

Complete this coupon and return it today to  
REI, 19347 Londelius St., Northridge, CA 91324.

GSA #GS-04S-21963 Neg © 1978 Rental Electronics, Inc.

Northridge, CA (213) 993-7368  
Anaheim, CA (714) 879-0561  
Mountain View, CA (415) 968-8845  
Dallas, TX (214) 661-8082  
Houston, TX (713) 780-7218  
Burlington, MA (617) 273-2770  
Oakland, NJ (201) 337-3757; Gaithersburg, MD (301) 948-0620  
Des Plaines, IL (312) 827-6670; Ft. Lauderdale, FL (305) 771-3500  
Cleveland, OH (216) 442-8080; Seattle, WA (206) 641-6444

Rexdale, Ontario (416) 675-7513  
Montreal, Quebec (514) 681-9246; Vancouver BC (604) 684-6623



# Relax

**It's amazing how an easy mind cements relationships.**

We're the easy mind people. TRW Capacitors.

We can solve your problems connected with reliability in ultra-miniature capacitors. Our X463UW metallized polycarbonates are designed to do just that.

The X463UW gives you "Space Age" performance in circuits demanding the smallest possible size. Capacitances range from .001 to 10 mfd, at 50, 100, 200 and 400 vdc—with less than 1.5% capacitance change from  $-55^{\circ}\text{C}$  through  $125^{\circ}\text{C}$ . IR is 60,000 megohm x mfd minimum at  $25^{\circ}\text{C}$ . DF is less than 0.3% at  $25^{\circ}\text{C}$  and 1 KHz. And stability? In humidity and shelf life tests the stability of the X463UW is actually two to three times better than polysulfone.

You get all that because we've applied the latest in component technology to combine the improved electrical performance of polycarbonate with dramatic size and weight reductions made possible by the use of our exceptionally reliable metallized dielectric.

We also put the same kind of effort into our engineering services and our field support. Try us. We can help reduce the tension. Give us a call, or write: TRW capacitors, An Electronic Components Division of TRW, Inc., 301 West "O" St., Ogallala, Nebraska 69153. Tel: (308) 284-3611.

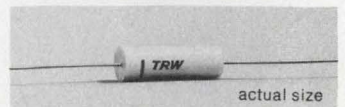

**TRW** CAPACITORS  
ANOTHER PRODUCT OF A COMPANY CALLED TRW



**Your team  
needs our  
transformer  
coach.**

Let's hear it for Dormeyer when you need standard or special commercial type transformers at very competitive prices.

We can ship standard open coil channel frame, bracket mount or commercial mount (U/L listed, CSA certified) types from stock.

Our engineers have many years experience to share on applications requiring control, high voltage, isolation, auto and high reactance power transformers. You name it . . . Dormeyer engineers can do it.

Send or call today for the Dormeyer "Coach's Kit" complete with catalog to help you with your requirements.

**DORMEYER INDUSTRIES, A Division of A.F. DORMEYER MFG. CO., INC.**  
3418 N. Milwaukee Avenue Chicago, IL 60641  
(312) 283-4000 TWX: 910-221-3831



# You Don't Have To Beg, Borrow Or Buy...

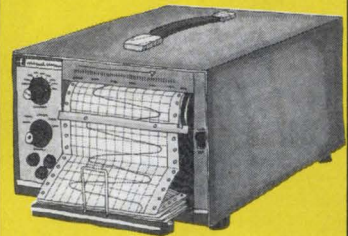
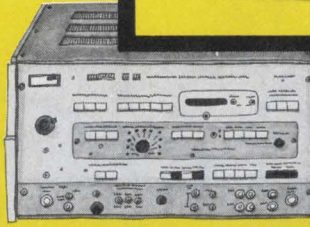
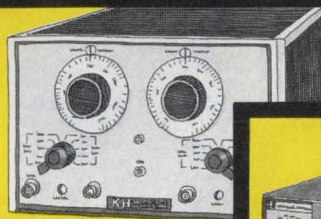
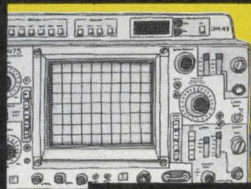
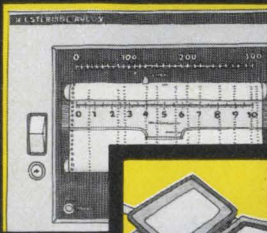
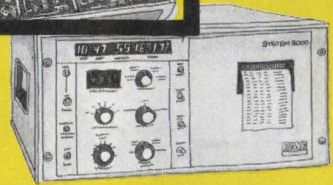
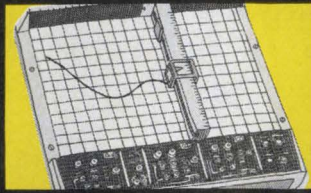

## Rent'em From GE

Short or long-term instrument rentals give you flexibility and economy.

GE has over 9,000 instruments available for immediate shipment: □ Tek Scopes □ Biddle Megger Insulation Testers □ H-P Signal Generators □ Honeywell Oscillographs □ Complete Data Systems □ Esterline Angus Recorders □ GE Chart Recorders □ Modems □ Communication Terminals . . . all calibrated to the manufacturer's specs.

We have over 100 Sales/Service Centers,

and one of them is near you. In addition to maintaining our Rental Inventory, they can also repair and calibrate your own equipment.

Don't borrow someone else's GE Rental Catalog. **Call collect (518) 372-9900** or your nearest Sales/Service Center.

**Quick-rental<sup>®</sup>**  
**instruments**

ALA. BIRMINGHAM (205) 925-3101 • ARIZ. PHOENIX (602) 278-8515 or 8516, TUCSON (602) 294-3139 • CAL. LOS ANGELES (213) 642-5350, SAN FRANCISCO (415) 436-9260 • COL. DENVER (303) 371-1260 • CONN. SOUTHINGTON (203) 621-4059 • FLA. JACKSONVILLE (904) 751-0610 • GA. ATLANTA (404) 457-5563 • ILL. CHICAGO (219) 933-4500 • IND. INDIANAPOLIS (317) 639-1565 • KY. LOUISVILLE (502) 452-3311 • LA. NEW ORLEANS (504) 367-6528 • MD. BALTIMORE (301) 332-4700 • MASS. BOSTON (617) 396-9600 Ext. 160, SPRINGFIELD (413) 781-1111 • MICH. DETROIT (313) 285-6700 Ext. 208 • MINN. MINNEAPOLIS (612) 522-4396 • MO. KANSAS CITY (816) 231-4377, ST. LOUIS (314) 965-7115 • N.J. CLIFTON (201) 471-6556 • N.Y. BUFFALO (716) 876-1200, SCHENECTADY (518) 385-2195 • N.Y.C. CLIFTON, N.J. (201) 471-6556 • N.C. CHARLOTTE (704) 525-0311 • OH. CINCINNATI (513) 874-8512, CLEVELAND (216) 523-6382, TOLEDO (419) 691-3501 • OR. PORTLAND (503) 221-5101 • PA. PHILADELPHIA (609) 424-4450, PITTSBURGH (412) 462-7400 • TEX. DALLAS (214) 357-7341, HOUSTON (713) 672-3570 • VA. RICHMOND (804) 232-6733 • WASH. SEATTLE (206) 854-0211 • W.V. CHARLESTON (304) 345-0920 • WISC. MILWAUKEE (414) 744-0110 • PUERTO RICO PONCE (809) 843-4225.

GENERAL  ELECTRIC



# DESIGN BECKMAN CONVERTERS IN. DESIGN PROBLEMS OUT.

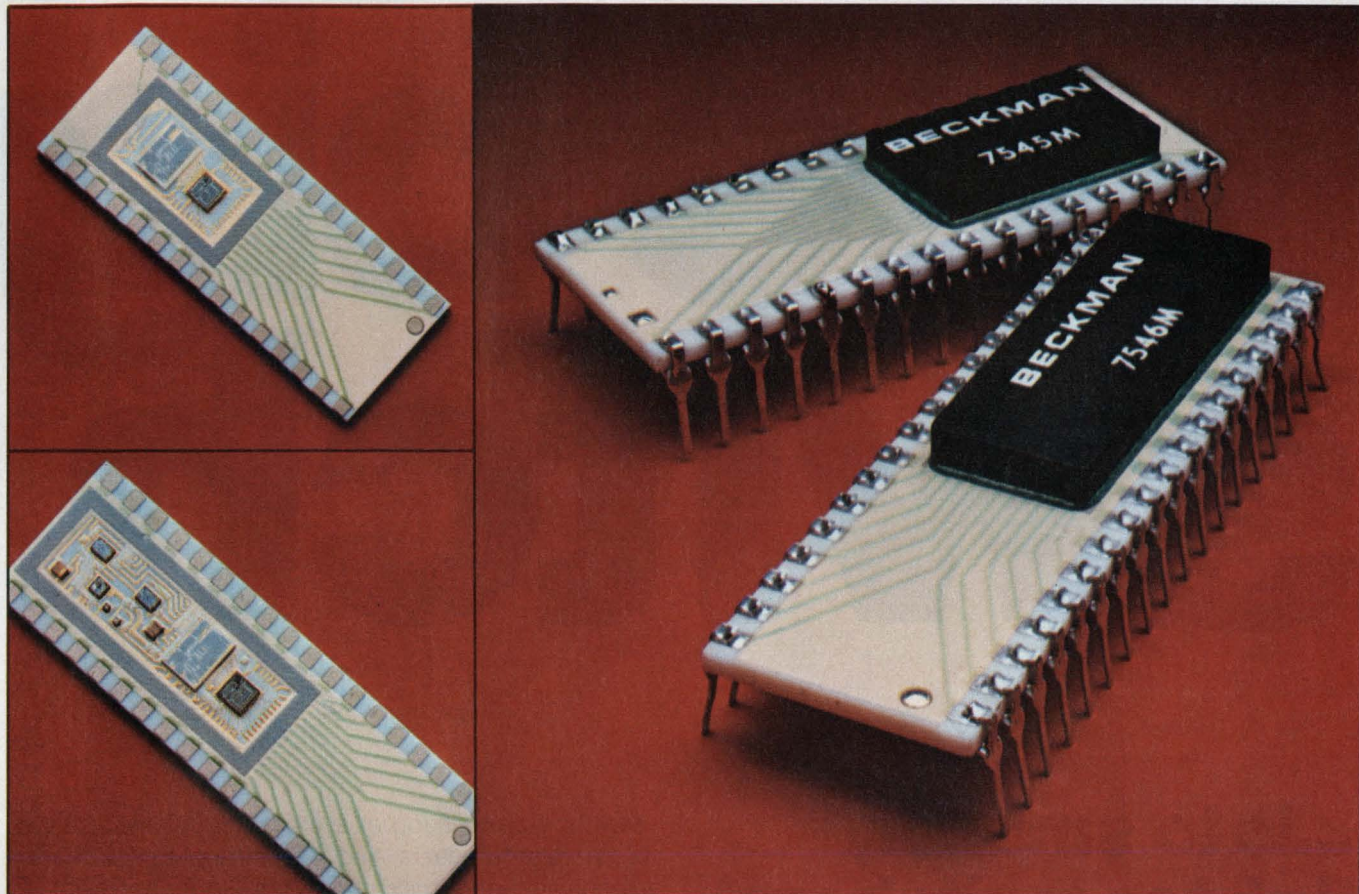

## Our new line is 8-bit microprocessor compatible with true 12-bit performance. And that's not just another line.

Presenting our new CMOS 12-bit DACs and ADCs. They're the first to offer complete 8-bit microprocessor compatibility. Real 12-bit accuracy. And CMOS or TTL logic compatibility, all in a single competitively-priced package.

They're exceptionally accurate, so put them to your toughest test. We did. And that's why we can guarantee  $\pm 0.012\%$  linearity over the full operating temperature range for each model in the 7545 or 7555 series. Gain and offset are also guaranteed over the full operating temperature range for the 7546 series. When you select 7546 DACs or 7556 ADCs with built-in reference and output buffers or comparators, gain and offset specifications are also guaranteed.

All series can operate in a serial or parallel mode. And they can be alternately switched from one mode to the other.

Both the DAC input registers and the ADC three-state output registers can accept either TTL logic levels using a +5 volt supply or CMOS logic levels using supply levels from +5 to +15 volts.

Simplify your 8-bit microprocessor interface. Put exceptional accuracy to work, and minimize your overall system error. Come to Beckman, the converter source. Call your local Beckman representative. To get his number, or immediate technical literature, call (714) 871-4848, ext. 1776. The price of designing accuracy in doesn't have to be out of hand.

# BECKMAN®

# The big switch

**...is to smaller, lighter switchers.**

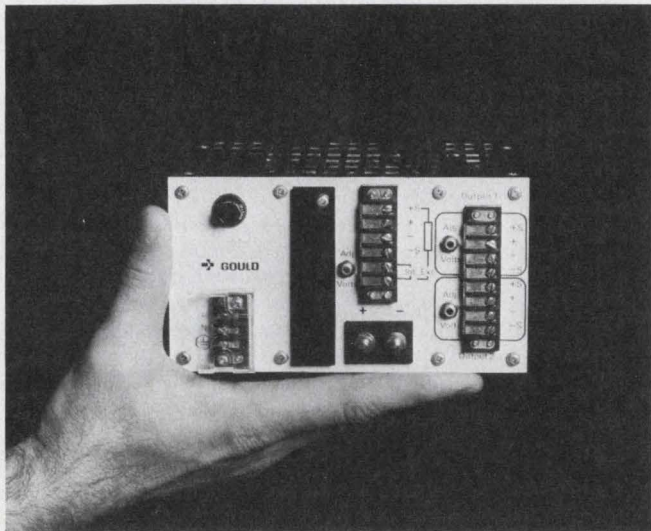

The 100 watt MGT 5-20A: 7" x 6.4" x 3.5" 7.5 lbs.

Switching power supplies average about  $\frac{1}{3}$  the size and  $\frac{1}{4}$  the weight of linears. And in many applications that's reason enough to make the switch. But it's not the only reason. Compared to linears, switchers can cut energy consumption in half, generate far less heat, and offer better holdup protection. That's why more than 40,000 Gould switchers are already in use around the world.

Gould offers single and multiple output units with power levels from 8 to 2,250 watts. And custom designs can be provided to meet your exact specifications. You'll be backed by a high volume production capability and worldwide service network that only a \$1.5 billion company like Gould could offer.

For more information or to arrange for an evaluation unit contact Gould, Inc., Electronic Components Division, 4601 N. Arden Drive, El Monte, CA 91731. Telephone (213) 442-7755.

**Gould.**  
**The power in switching power supplies.**

 **GOULD**

CIRCLE NUMBER 96

CIRCLE NUMBER 97 ►

# FOR RENT...NOW...

the high-performance, high-resolution 8565A Microwave Spectrum Analyzer from Hewlett-Packard that combines .01 to 22 GHz frequency coverage and -120 to +30 dBm amplitude range in an easy-to-use instrument.

The HP 8565A gives you the full frequency coverage necessary for evaluating all portions of your microwave system. Plus, the automatic display of the Power Reference Level in dBm for all input attenuator and IF gain settings lets you get a direct reading of signal power right on the 8565A's CRT.

You can cover frequency from 10 MHz to 22 GHz in two spans, and you have octave-wide bands for rapid signal location prior to close-in analysis. The digital frequency display of tunable marker also works in Full Spans for individual octave-plus frequency bands. A Zoom-In feature (starting with spans as wide as 500 MHz/Div) lets you narrow down to 1 KHz/Div without having to re-adjust resolution. The inherently accurate 8565A also gives you the accuracy to minimize the uncertainty of power measurements. You can use IF substitution to place signals as low as -102 dBm on the Reference Level. The instrument also provides excellent frequency response on all input circuitry (RF attenuator, preselector and mixer) as well as frequency band gain variations. You can make a choice of scale factors, make amplitude measurement over a 140 dB range +30 dBm to -110 dBm, while benefitting from internal preselection (measuring distortion products as small as 100 dB down and identifying all applied signals) with low distortion. You can also recover modulation waveforms in the time domain, with calibrated sweep times ranging from 10 sec/Div to 2 microsec/Div.

The HP 8565A lets you make most measurements using just three controls, offers internal preselection from 1.7 to 22 GHz, features eight resolution bandwidths from 1 KHz to 3 MHz, provides absolute amplitude calibration during all measurements, and—most important—is available for rent immediately from inventory.

Hewlett-Packard leads the way in Microwave Spectrum Analyzers, and the state-of-the-art 8565A is the leader in accuracy plus user convenience. The instrument is truly designed with the user in mind, allowing most measurements to be made in three simple steps—1) Tune to Signal, 2) Zoom-In, and 3) Set Amplitude Level. With the three controls, you can measure Center Frequency, Frequency Span and Reference Level, and Resolution Bandwidth, Sweep Time, and Video Filtering are automatically set. Plus, you have automatic frequency stabilization on narrow spans, and the CRT Bezel readout displays your pertinent control settings. You'll also like the measurement range (up to 140 dB) on this versatile new instrument. You can rent all this HP 8565A performance from REI. Now.

More than 12,871  
state-of-the-art instruments . . .  
off-the-shelf, throughout  
North America.

## Rental Electronics, Inc.

Another of the **AMERICAL** companies

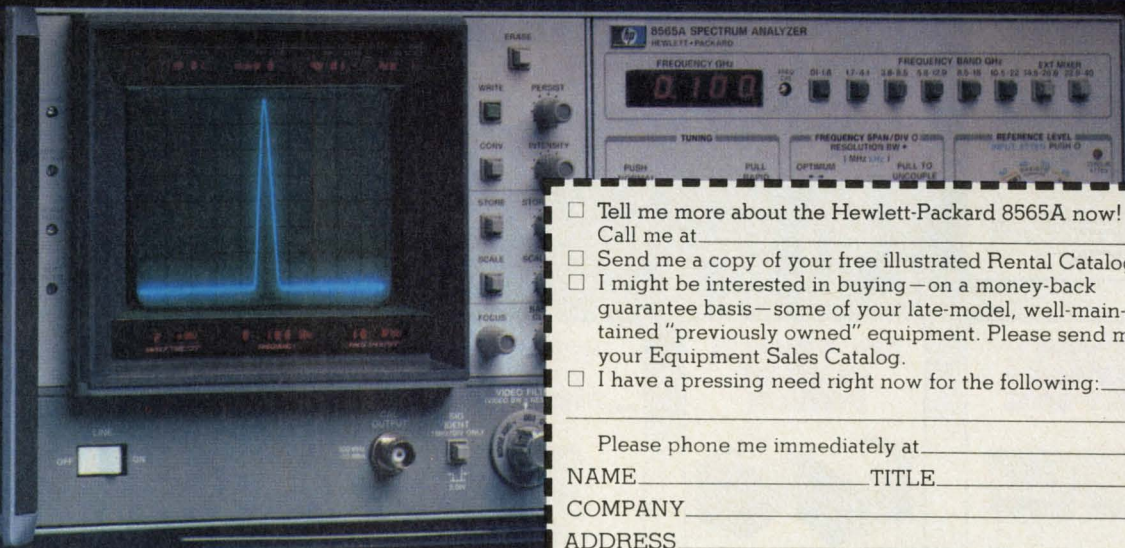

- Tell me more about the Hewlett-Packard 8565A now! Call me at \_\_\_\_\_
- Send me a copy of your free illustrated Rental Catalog.
- I might be interested in buying—on a money-back guarantee basis—some of your late-model, well-maintained "previously owned" equipment. Please send me your Equipment Sales Catalog.
- I have a pressing need right now for the following: \_\_\_\_\_

Please phone me immediately at \_\_\_\_\_

NAME \_\_\_\_\_ TITLE \_\_\_\_\_

COMPANY \_\_\_\_\_

ADDRESS \_\_\_\_\_

CITY \_\_\_\_\_ STATE \_\_\_\_\_ ZIP \_\_\_\_\_

PHONE NUMBER \_\_\_\_\_ EXTENSION \_\_\_\_\_

Complete this coupon and return it today to  
REI, 19347 Londelius St., Northridge, CA 91324.

© 1978 Rental Electronics, Inc.

GSA #GS-04S-21963 Neg

Northridge, CA (213) 993-7368  
Anaheim, CA (714) 879-0561  
Mountain View, CA (415) 968-8845  
Dallas, TX (214) 661-8082  
Houston, TX (713) 780-7218  
Burlington, MA (617) 273-2770

Oakland, NJ (201) 337-3757; Gaithersburg, MD (301) 948-0620  
Des Plaines, IL (312) 827-6670; Ft. Lauderdale, FL (305) 771-3500

Seattle, WA (206) 641-6444  
Cleveland, OH (216) 442-8080;

Rexdale, Ontario (416) 675-7513

Montreal, Quebec (514) 681-9246; Vancouver BC (604) 684-6623

### POWER MINI'S FOR LOGIC OR OP AMPS



Terminal strip input/output connections on these miniature power modules eliminate the need for sockets or soldering. They mount in an area only 2.5" x 2.5". Ratings: 5 volt models to 2.5 amps, 15 volts to 5 amps. Other models from 1 to 75 volts, all with 3-day shipment guaranteed.

### NEED A POWER SYSTEM?

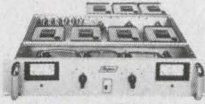

Order multiple output power systems without searching through a catalog, preparing mechanical layouts, item-by-item pricing and detailed purchase requisitions. Instead, call Acopian. We'll listen to your needs, quote a firm price, and then ship your built-to-order system, fully wired and tested, in just 9 days.

### POWER FOR YOUR $\mu$ PROCESSOR



Single, dual, and triple output power supplies in a broad selection of output voltage combinations. Output current ratings from 30ma to 60 amps. Various package styles suitable for virtually every application. Any module you select will be shipped within 3 days; rack mounting models, within 9 days.

### MATCHED OR DISSIMILAR DUAL OUTPUT



Select the combination of matched or dissimilar outputs that you require. Hundreds of ratings available, from 1.5 to 150 volts. Outputs are isolated, and may be used in the same or opposite polarities. Acopian's 3-day shipment promise applies for any combination.

### HIGHLY ISOLATED POWER



For applications requiring a power supply with unusually high isolation, such as for powering strain gage or other transducer circuits. Acopian offers models with ratings from 5 to 36 volts. Input-output isolation: 10,000 meg-ohms minimum, 1 pF maximum. Guaranteed 3-day shipment.

### POWER FOR RELAYS AND DISPLAYS



Drive relays, lamps, small motors and similar loads with low-cost Acopian unregulated power modules. Built-in fusing protects against overloads or shorts. Series U models use terminal strip connections. Plug-in modules mount in standard octal sockets; many have adjustable outputs. Guaranteed 3-day shipment.

### RACK MOUNT POWER ...TO 60 AMPS

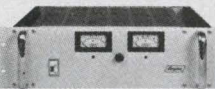

Designed for mounting in standard 19" RETMA cabinet racks, these power supplies are available in 78 different output ratings from 1 to 50 volts, and from 5 to 60 amps. Regulation,  $\pm 0.05\%$  or better; ripple, 1 mV rms or better. Options include metering and overvoltage protection. Shipment, 9 days after receipt of your order.

### SOLDER TERMINAL MODULES

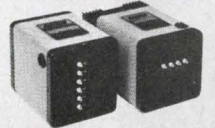

For applications where hard wiring is desired, Acopian offers modules with solder terminals. Included are single output models (regulated and unregulated), duals with two like or dissimilar voltages and high isolation supplies. Guaranteed 3-day shipment.

### MULTIPLE VOLTAGES FOR PCB'S



Simplify pc board layout with multiple output power mini's. Duals supply two isolated like or dissimilar outputs, 1 to 28 volts each. Op amp supplies provide 12 or 15 volts. Triplets have two balanced, tracking outputs, a third for powering other circuits. Guaranteed 3-day shipment.

### MIL-TESTED PLUG-IN POWER



MIL-tested power supplies withstand unusually severe environmental conditions. These extended-temperature plug-in modules exceed MIL specs for humidity, altitude, vibration and shock. Hundreds of single output models, thousands of dual output combinations, all guaranteed for 3-day shipment.

### BENCHTOP POWER ...FROM \$99



Reliable yet low-cost power supplies for circuit development and component evaluation. Single, dual and triple output models. Ratings from 0-7 to 0-50 volts. All have adjustable current limiting, coarse and fine voltage adjustments and two meters. They may be stacked to conserve bench space. Regulation, 0.01% or 2 mV. Ripple, 0.25 mV rms.

### SUPPLIES THAT FIT IN THIN SPACES



Measuring only 1.68" high, Acopian narrow-profile power supplies fit where many others cannot. Available in a wide range of ratings from 1 to 150 volts, to 4 amps. Regulation to 0.005%. Tracking dual output models for op amps also available. Guaranteed 3-day shipment.

### SINGLE, DUAL PLUG-IN POWER

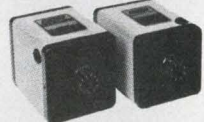

A plug-in power module can be installed in seconds. Simply plug it into a standard octal-type socket. Single output models from 1 to 200 volts. Duals combining two matched or dissimilar outputs, in one case available in over 10,000 combinations. Warranty: 5 years. Shipment: 3 days.

### REDUNDANT POWER SYSTEMS

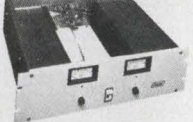

Output reliability is maximized by including two power modules for each voltage. If either fails, the other will continue to provide an uninterrupted output. Ratings from 3.6 to 28 volts, to 32 amps. Shipment, 9 days after receipt of your order.

### 5V OR $\pm 15V$ POWER FOR PCB'S



Mount these mini power modules, as small as 2.3" x 1.8" x 1.0", directly on printed circuit boards to save space and simplify wiring. Ratings at 5 volts from .250 to 2.5 amps; at  $\pm 15$  volts from .025 to 5 amps. Short circuit protected. Prices start at \$24. Guaranteed 3-day shipment.

### GENERAL PURPOSE POWER

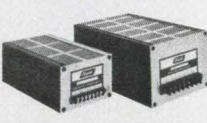

Series A offers premium performance, with regulation to 0.005%, ripple of 0.25 mV maximum and electronic current limiting. Series B supplies provide a lower-cost approach, with regulation typically  $\pm 0.1\%$ . Ratings to 200 volts, to 32 amps. Guaranteed 3-day shipment.

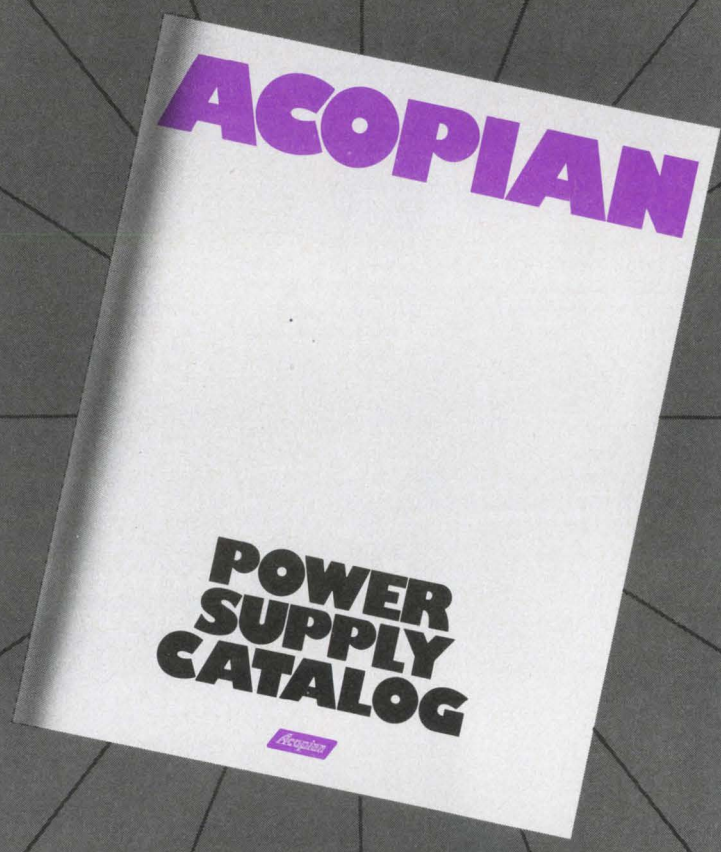

Write for your copy of the Acopian 48-page catalog



Corp., Easton, Pennsylvania 18042 • Telephone (215) 258-5441

**RELIABILITY:** When the highest capacitor reliability is required for critical filtering, bypass and coupling circuits in medical equipment, space vehicles and undersea communications equipment, KEMET GR500 Series Graded Reliability Capacitors are specified.

Each GR500 Series Capacitor is thoroughly tested and precisely performance-graded. Your order is shipped with the actual test data documenting the failure rate—as low as 0.001% per 1,000 hours. They are available now for prompt delivery in six hermetically sealed case sizes in a CV range of 0.0047 to 1,000  $\mu$ F, 6 to 100 VDC for operation at  $-65^{\circ}\text{C}$  to  $+125^{\circ}\text{C}$ .

The performance characteristics and specifications for these capacitors are described in a new series of product catalogs. Write today for this latest information.

Components Department, Union Carbide Corporation, P.O. Box 5928, Greenville, SC 29606; phone (803) 963-6300, TWX: 810-287-2536, or Telex: 57-0496.



**KEMET® OFFERS YOU MORE.**



**UNION CARBIDE COMPONENTS DEPARTMENT**

KEMET is a registered trademark of Union Carbide Corporation

**CIRCLE NUMBER 19**

In Europe: Union Carbide Europe, S. A. 5, Rue Pedro-Meylan, Geneva 17, Switzerland Phone: 022/47 4411 Telex: 845-22253

## A Preview of the Solid-State Circuits Conference

# Forget the bugs in 4-k and 16-k RAMs—the big news is at 64-k

The problems with 4-k RAMs haven't been sorted out, and 16-k RAMs haven't been around long enough for all the problems to surface. Yet the top question at the memory sessions of this year's International Solid-State Circuits Conference (San Francisco, Feb. 15 to 17) will be: Which technology will bring home a 64-k RAM first?

"That level of density is now in active development," says Vir Dhaka, director of Xerox Corp.'s Microelectronics Center in El Segundo, CA. Dhaka is chairman of an ISSCC session designed to "provide a forum for all the approaches to fabricating a 64-k RAM," he says.

Three technologies that could yield

64-k RAM devices (which actually store  $2^{17}$ , or 65,536, bits) will be described:

- NMOS, the most mature technology, is being used in a device under development at Nippon Telephone and Telegraph Public Corp. in Tokyo.

- I<sup>2</sup>L, a bipolar process, is already yielding 16-k devices at Fairchild Camera and Instrument Corp.'s research and development laboratories in Palo Alto, CA, and may be extended to 64 k.

- VMOS, which researchers have pushed from 1-k to 64-k just in the last year, is actively being developed by both Siemens AG of Munich and American Microsystems Inc., Santa Clara, CA.

Another technology, charge-coupled devices, has also reached the 64-k level, but only in serial memories. Like shift registers, CCDs continuously circulate data and have first-in/first-out access

to stored information, not totally random input and output. Fairchild will describe a buried-channel CCD memory that operates at clock rates from 1 to 5 MHz and uses an eight-phase ripple clock within an interlaced series-parallel-series structure.

### A straightforward problem

The most straightforward way to achieve 64-k densities in RAMs is NMOS technology, says Dhaka. Many manufacturers with NMOS processing expertise could simply extend this expertise to making 64-k devices, he explains.

But pushing NMOS technology to 64 k, while straightforward, is far from easy. Simply scaling devices down would increase density enough to quadruple bits on a chip from 16 k, but would also have to shrink signal lines to a couple of microns, less than half that of present lines. Otherwise, chips would be so large that defects on any given chip would be inevitable.

Most researchers are looking to electron-beam or X-ray lithography to gain so great an improvement in line widths.

The Nippon Tel & Tel approach to increasing NMOS RAM density is to make a single-transistor cell and a single-level polysilicon gate with improved photolithography. Prototypes access in 200 ns and dissipate 150 mW.

### Going bipolar

But lower power dissipation at shorter access times may come with I<sup>2</sup>L (integrated-injection logic). Using this technology, Fairchild researchers have already developed a 16-k RAM, organized in a 16,384 × 1-bit array. The device's outputs are compatible with TTL circuits.

Fairchild's dynamic memory can challenge MOS devices with its 130-ns

**Andy Santoni**  
Associate Editor

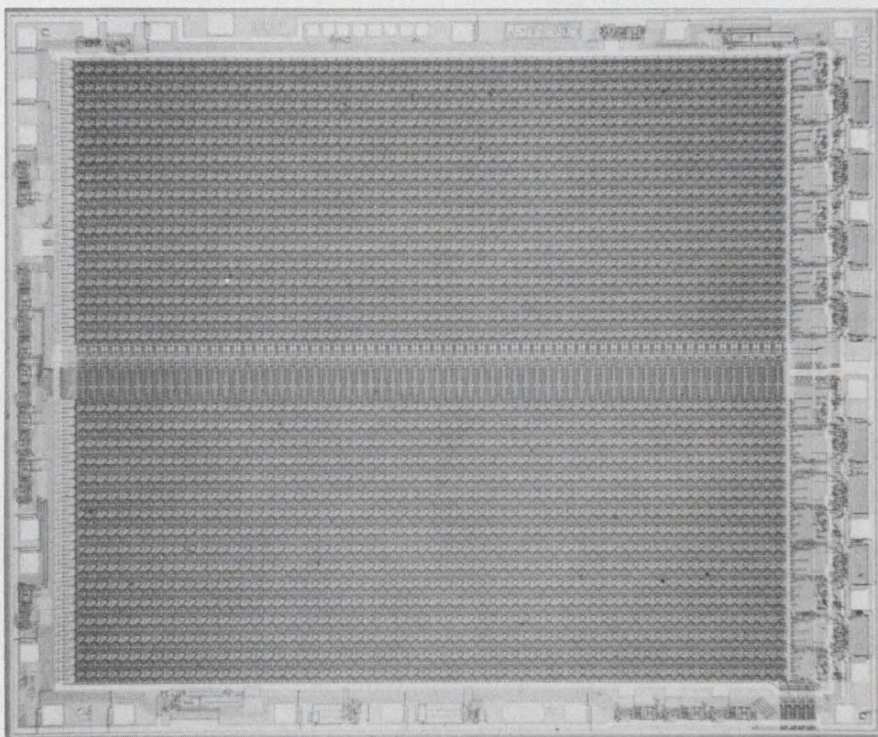

**The densest static RAM yet** is an 8192-bit device from EMM-SEMI. Operating from a single 5-V supply, the device is aimed at microprocessor applications.

# Smart pros count faster— and spend less.

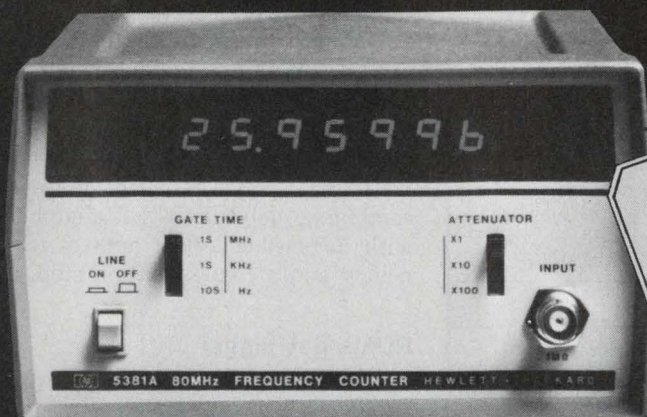

80 MHz  
\$295\*

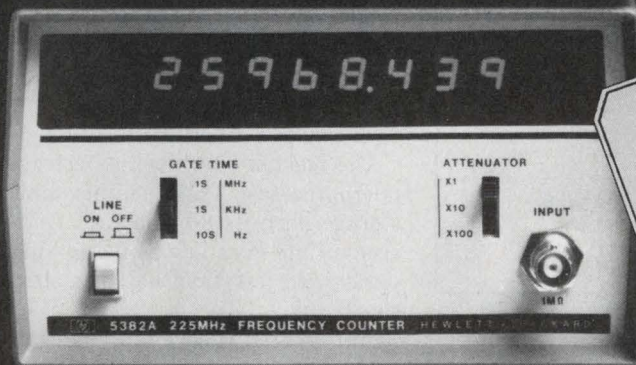

225 MHz  
\$395\*

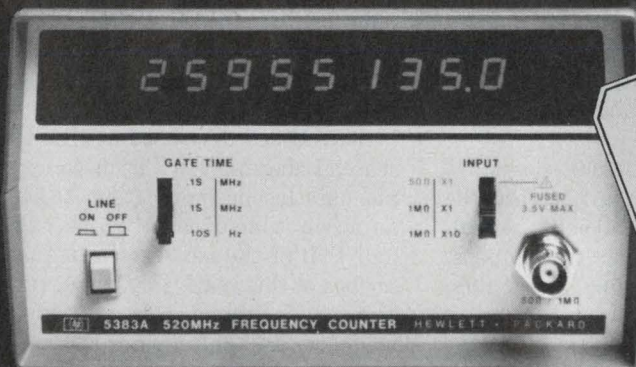

520 MHz  
\$650\*

It can be downright aggravating to wait longer for a reading than it takes you to make the adjustment.

The direct counting professional grade HP 5380 "Frequency-Only" Series solves this problem by giving you 1 Hz resolution in just one second. Every time, all the way up to 520 MHz. No more waiting for pre-scalers to prescale.

You'll like the new 20% lower prices for the HP 5382 and HP 5383, too.

Using state-of-the-art components common to HP's most sophisticated counters, this "frequency-only" series also offers high accuracy, high input sensitivity, input attenuators, a rugged metal case and a temperature-compensated crystal oscillator for improved measurement accuracy.

Each instrument is tested and calibrated to the industry's most precise frequency standards before shipment. The same high quality that's built into every HP instrument.

To find out more about the HP 5380 "Frequency-Only" Series and the entire family of sophisticated and versatile HP electronic counters call your nearest HP field office or write for our new electronic counter brochure.



HEWLETT **hp** PACKARD

1507 Page Mill Road, Palo Alto, California 94304

For assistance call: Washington (301) 948-6370, Chicago (312) 255-9800, Atlanta (404) 955-1500, Los Angeles (213) 877-1282



HP: MAKING EXPERIENCE COUNT.

# Memories at ISSCC

Memory Devices				
Developer	Storage (bits)	Access time (ns)	Power dissipation (mW)	Technology
<b>Dynamic RAMs</b>				
Nippon T-T	64k	200	150	NMOS
Siemens	64k	—	—	VMOS
Fairchild	16k	130	350	I <sup>2</sup> L
<b>Static RAMs</b>				
EMM-SEMI	8k	300	80	NMOS
Hitachi	4k	25	350	TTL
Nippon Elec.	4k	40	50	TTL
Hughes	256	—	—	Nonvolatile
<b>ROMs</b>				
Mostek	64k	80	150	NMOS
<b>PROMs</b>				
Intersil	4k	—	—	CMOS
Memory Cells				
Developer	Application	Area	Technology	
IBM	16k RAMs	—	Josephson junction	
Signetics	Static RAMs	645 $\mu\text{m}^2$	I <sup>2</sup> L	
Philips	ROMs	100 $\mu\text{m}^2$	Bipolar punch-through	
Catholic Univ. Leuven	Digital filter	—	NMOS	
SGS-ATES/Telefunken	TV tuner	—	Nonvolatile	
SGS-ATES/Telefunken	PROMS	—		
CCDs				
Developer	Storage (bits)	Clock rate (MHz)	Package	
Fairchild	64k	1-5	16-pin	

access time and operation from a single 5  $\pm$ 0.25-V supply. And the device is said to operate over a temperature range of 25 to 75 C.

## In the groove

However, a 64-k RAM is being brought along with V-groove technology by Siemens AG and American Microsystems. Using existing photolithography, Siemens has fabricated one-transistor memory cells small enough to build a chip that can fit into a standard 16-pin package.

So the technology race for a 64-k RAM is on. Xerox's Dhaka notes that the ISSCC papers indicate that commercial availability is no longer considered pie-in-the-sky or even several years away. But which technology will be first?

"The 64-k RAM, in a shrunk version of NMOS, will most definitely be available," Dhaka believes—"even though users will still come back and say they really can't get good 4-k devices, and that 16-k memories are hard to get at

all." Dhaka predicts sample quantities of 64-k devices trickling out of vendors the second half of this year, with production quantities starting to flow in 1979.

So far the 64-k RAMs closest to production are all dynamic, with all the problems and additional refresh circuitry dynamic operation implies. But density is increasing, albeit more slowly, in static RAMs, too.

## Larger statics are here, too

The highest-density static RAM now available is an 8-k device from EMM-SEMI Inc., Phoenix. Its aim at microprocessor-based systems is obvious from its organization—1024 eight-bit words.

Chip timing matches the 2-MHz microprocessor requirement, and the chip matches the common I/O and three-state requirements of data-bus systems.

EMM-SEMI applied three concepts to increase performance and density:

- Clocked peripheral chip circuitry,

which reduces power consumption, increases speed, and prevents race problems.

- High-value polysilicon resistors, which decrease memory cell size and power.

- A high-performance silicon-gate process, which increases density and performance.

In bipolar static RAMs, the two densest devices are 4-k static circuits from Hitachi Ltd. in Tokyo and Nippon Electric Co. Ltd. in Kawasaki. The Hitachi part has an access time of only 25 ns, yet dissipates a meager 350 mW. Nippon's answer is a 40-ns, 50-mW RAM that improves performance by combining polysilicon self-alignment with diffused-collector, non-epi technology and a local-oxidation step.

## ROMs get bigger

Read-only memories haven't been left behind. A 64-k ROM is being developed at Mostek Corp., Carrollton, TX. Organized as 8192 eight-bit words, it operates from a single 5-V power supply, with a typical access time of 80 ns and power dissipation of 150 mW.

The Mostek part, too, is perfect for microprocessor and minicomputer storage with its 8-bit layout. And its access time is as low as many bipolar parts with less than half the storage capacity.

But no matter how dense a memory gets, it remains basically an array of cells, one per bit. That's why the development of a smaller or faster cell, which by itself has no practical use, is important.

A RAM cell developed at IBM's Research Laboratory in Zurich, for example, uses Josephson junctions to attain an access time of about 15 ns—about half that of the next-fastest RAM described at this year's ISSCC (see table). The cell is intended as a feasibility model for a 16-kbit memory that, with its very high speed and fairly high density, should find a home in interim-storage computer memories.

For high-density static memories, a bipolar cell has been developed at Signetics Corp., Sunnyvale, CA. It measures only about 1 mil (25.4 microns) on a side, and uses I<sup>2</sup>L technology, with four transistors in a single isolated region.

An even smaller cell, for dense bipolar ROMs, has been developed at the research laboratories of Signetics' parent, Philips (Eindhoven, The Netherlands). These cells have areas as small as 100 square microns. ■■



# There's a better way to measure or monitor mechanical motion—

## magnetically-activated 'Hall effect' integrated circuits

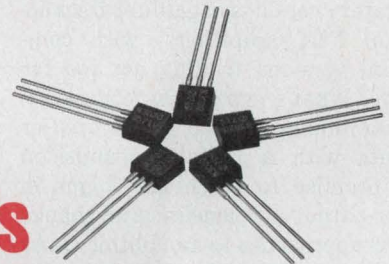

- Convert mechanical motion to electronic signals by sensing changing magnetic fields.
- Excellent for position sensing, thickness determination, weight measurement, speed control, pressure monitoring.
- Provide contactless switching—no contacts to wear, no contact welding.
- Highly reliable under adverse environmental conditions.
- None of the contamination problems suffered by mechanical or photo-electric switches.
- No moving parts to cause spurious signals often associated with conventional switches.
- Economical transistor-style package.
- Ideal interface between mechanical motion and electronic controls, counters, etc.

### TYPE UGN-3020T DIGITAL SENSORS

#### TYPICAL APPLICATIONS

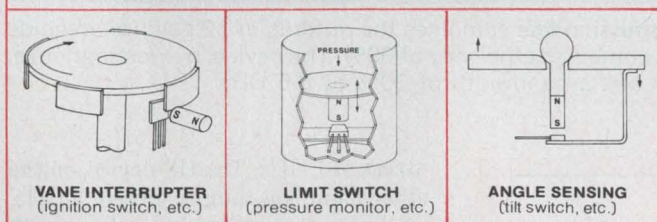

**VANE INTERRUPTER**  
(ignition switch, etc.)

**LIMIT SWITCH**  
(pressure monitor, etc.)

**ANGLE SENSING**  
(tilt switch, etc.)

- Designed for use with readily-available samarium cobalt or sintered alnico VIII permanent magnets.
- Operate at any voltage from 4.5 to 24 VDC.
- Constant amplitude output, independent of frequency up to at least 100 kHz.
- Higher sensitivity, wider operating temperature range, smaller physical size, more economical than any other device of its type.

### TYPE UGN-3501T LINEAR SENSORS

#### TYPICAL APPLICATIONS

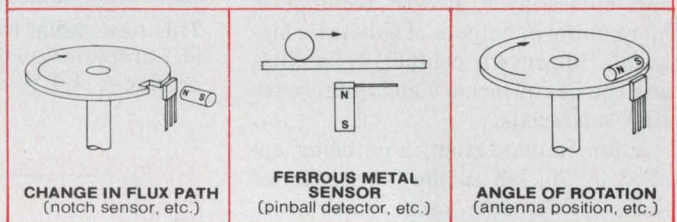

**CHANGE IN FLUX PATH**  
(notch sensor, etc.)

**FERROUS METAL SENSOR**  
(pinball detector, etc.)

**ANGLE OF ROTATION**  
(antenna position, etc.)

- Voltage output of these devices is proportional to magnetic field intensity.
- Will operate if slightest change in flux path is made.
- Operate at any voltage from 8 to 12 VDC.
- Hall cell and linear differential amplifier integrated in one monolithic device to simplify problems relating to handling of millivolt analog signals.
- Exceptional temperature stability.

Call your nearest Sprague stocking distributor for price and delivery information. For easy-to-understand application engineering assistance, write or call John Haussler, Hall Cell IC Product Manager, Sprague Electric Co., 70 Pembroke Rd., Concord, N.H. 03301; telephone 603/224-1961. For complete technical data, write for Engineering Bulletins 27404.11 and 27500 to: Technical Literature Service, Sprague Electric Company, 347 Marshall Street, North Adams, Mass. 01247.

4SS-7131R2V2

**SPRAGUE**  
THE MARK OF RELIABILITY

a  
**General Cable**  
subsidiary

**THE BROAD-LINE PRODUCER OF ELECTRONIC PARTS**

CIRCLE NUMBER 21

# The new GaAs FETs—less noise, higher power and broader bandwidth

Broader bandwidth, lower noise and higher power are being attained in laboratory versions of gallium arsenide (GaAs) FET amplifiers, with commercial versions trailing not too far behind. What's more, new techniques, like combining a dozen FET amplifier outputs with a radial transmission line, promise to reach new highs in power-output efficiencies. And thanks to new approaches to monolithic GaAs FET IC technology, broadband amplifiers are emerging with direct coupling that requires no matching network. All these FET developments and more will be reported at the ISSCC:

- GaAs FET noise figures range from less than 1 dB at 4 GHz and to 3 dB at 18 GHz in the lab. And theoretically, they may go as low as 0.7 dB for 9.5-W output at 4 GHz. These figures will be achieved with such technological improvements as new active and buffer-layer growth techniques, more uniform batches of substrate material, improved contact reliability, and the use of ternary and quaternary III-V materials.

- Ion implantation, now being applied in the lab to the fabrication of GaAs FETs, may prove superior to current processing methods. At 4 GHz, packaged GaAs FETs prepared by ion implantation have demonstrated 1.1 dB with gains of 12 dB. At 15 GHz, the noise figure rises to only 2.5 dB with a power gain of 7 dB.

- A new kind of de-coupled device, a monolithic microwave IC for use in instrumentation, has an unusually broad bandwidth from 0 to 4 GHz. Unlike other GaAs microwave FET amplifiers, this device operates without coupling or matching networks. It will be described by R.L. Van Tuyl, project manager for GaAs IC Development at Hewlett-Packard's Santa Rosa, CA, division.

**Jim McDermott**  
Eastern Editor

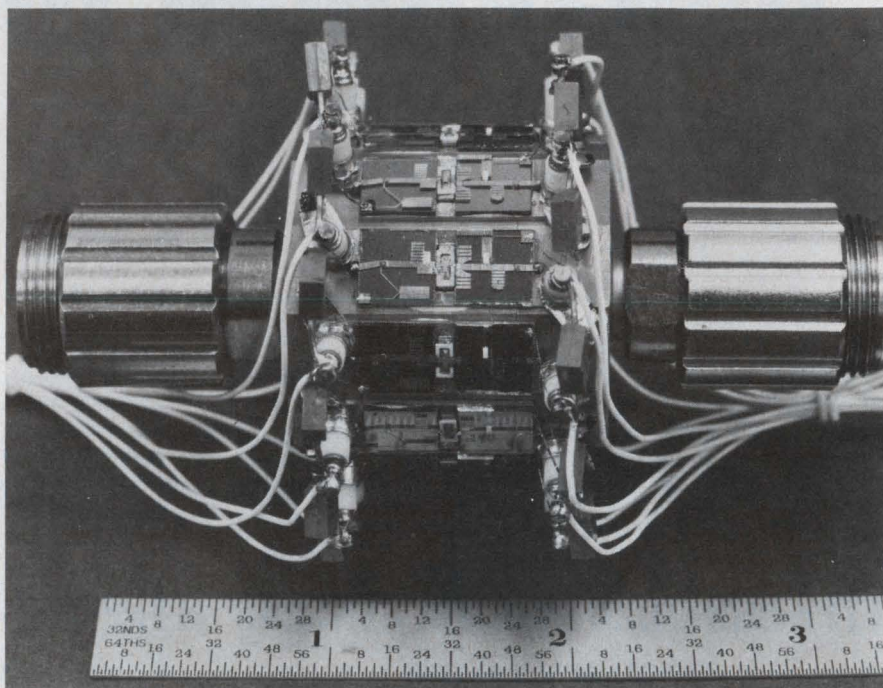

This new radial transmission line combines the outputs of 12 gallium-arsenide FET amplifiers with a combined efficiency of 90%. The device, by Westinghouse, produces 4.4 W and has a bandwidth of 30% at 8.5 GHz.

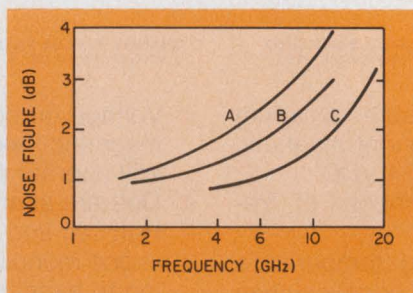

**Performance of commercial 0.5- $\mu$ m-gate devices (B) exceeds that of 1- $\mu$ m units (A). (C) shows laboratory-device figures.**

The IC is too tiny to permit inductors and capacitors on the chip. While attempts have been made using bipolar monolithic technology to achieve the same kind of broadband performance, the best previously reported obtained a unity-gain frequency somewhat in

excess of 1 GHz. The HP device, on the other hand, has a unity gain of 6 GHz.

- A GaAs multistage amplifier with the broadest bandwidth to date of its kind—7 to 18 GHz—will be reported by S.R. Hennies, engineer at Avantek, Inc., Santa Clara, CA. The device, which has the lowest noise figure of any 18-GHz amplifier at present, uses Avantek's M107 gold metalized GaAs FET chips for a six-stage gain module with an amplification of 28 dB. Power output is over 10 dBm. The FET structures have a 0.5- $\mu$ m gate length and a 300- $\mu$ m gate width. A limiter is included in the first stage of the amplifier.

- High-power GaAs MESFETs from Nippon Electric in Japan have an output of 7 W at 5.6 GHz. This unusually high output stems from a simplified recess structure to reduce the drain breakdown, details of which will be

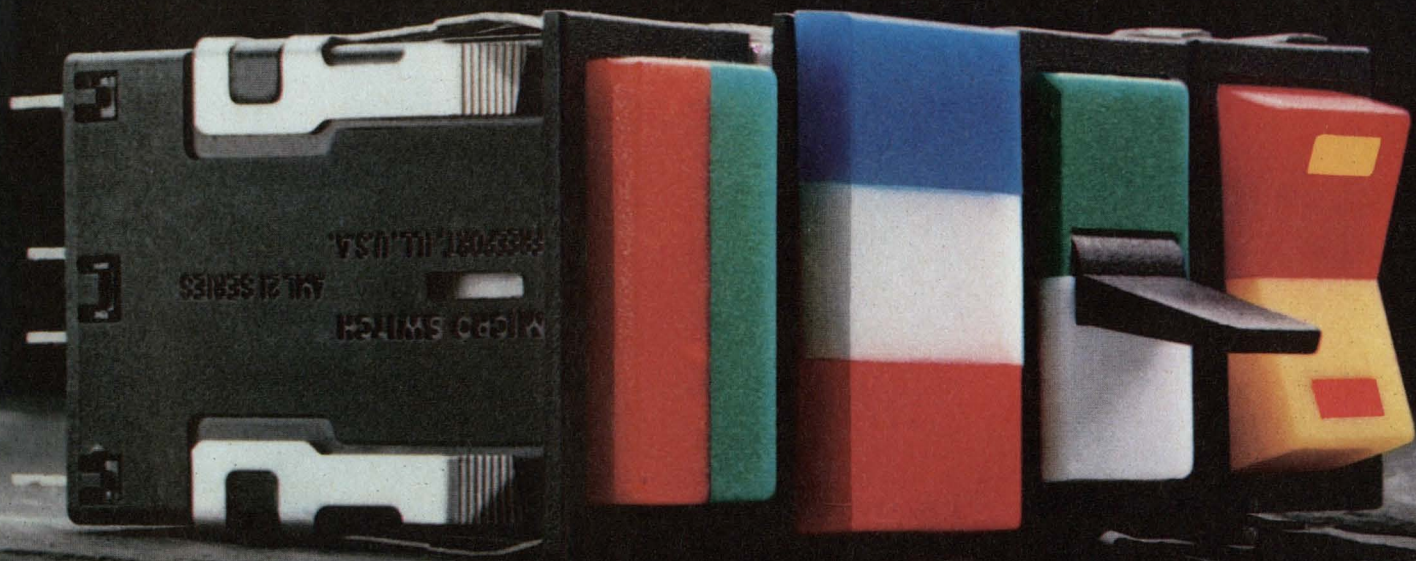

## To make a complete line of pushbutton controls, you need more than pushbuttons.

Pushbuttons from MICRO SWITCH's AML (Advanced Manual Line) have always been attractive to designers. Because they look so good.

And because they're so easy to mount and wire.

But now, the AML series is even more appealing. Because now there's a variety of rocker and paddle switches to choose from, including dual lamp and dual color. Which means now you can perform just about any function with a harmonious display. You don't have to compromise.

AML controls also look appealing to the people who have to do the wiring. All are designed with the same depth for single level termination, regardless of switch or terminal type.

There's easy snap-in mounting from the front, PC board mounting or sub-panel mounting using individual, strip or matrix hardware.

Which means mounting is simpler. Wiring is simpler. Engineering time is reduced. And total installed cost is lower.

Plus, they offer solid state, electronic control or power switching in the same size housing. All AML devices are designed to meet international, UL and CSA standards.

Displays include split screen, hidden color, and a unique three-segment lens cap indicator. The choice of lamps includes T-1 $\frac{3}{4}$  wedge base, neon and LED.

AML has it all — pushbuttons, indicators, and now, paddles and

rockers. But to see how good-looking AML really is, contact us for a personal demonstration.

MICRO SWITCH will provide you with field engineers for application assistance and a network of authorized distributors for local availability. Write us for details or call 815/235-6600.

MICRO SWITCH products are available worldwide through Honeywell International.

### MICRO SWITCH

FREEPORT, ILLINOIS 61032

A DIVISION OF HONEYWELL

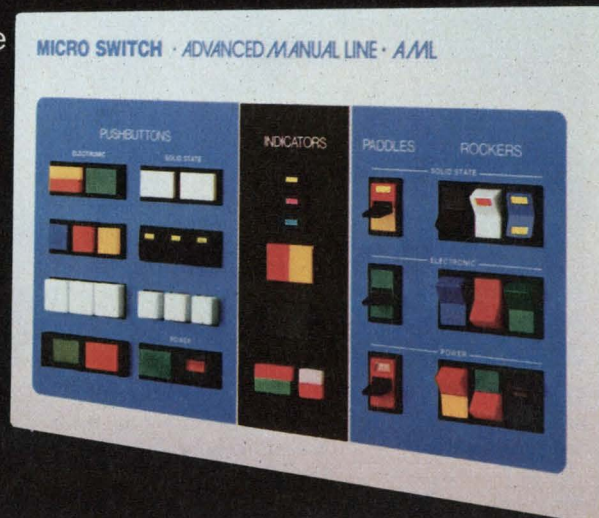

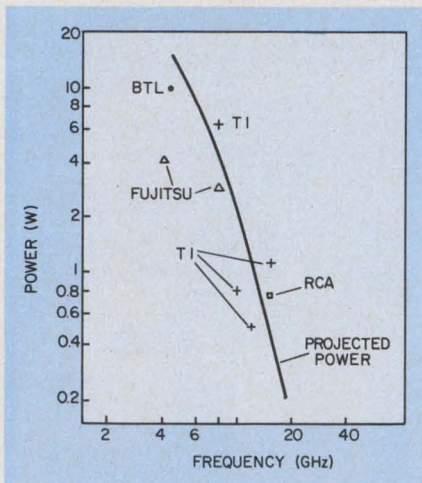

**GaAs-FET power**, projected from devices measured by researchers, will reach 10 to 15 W at 4 GHz and between 6 to 7 W from 8 to 10 GHz.

reported by the Japanese researchers who developed it. An internal matching network is incorporated to improve device efficiency.

■ A 1-W, 2 to 6-GHz amplifier using a discretely packaged MSC8004 GaAs power FET demonstrates that broad bandwidths can be obtained from state-of-the-art packaged commercial devices. The amplifier, which will be described by P.C. Wade, project leader for GaAs FET applications at Microwave Semiconductor Corp. (Somerset, NJ), has 100% (4 GHz) bandwidth and compares with those using chips or chip carriers. The discrete GaAs FET is incorporated in a hermetic stripline package called the MSC Flipac. It is the first commercially available power amplifier to cover such a broad bandwidth in this kind of package.

The MSC Flipac is also one of the

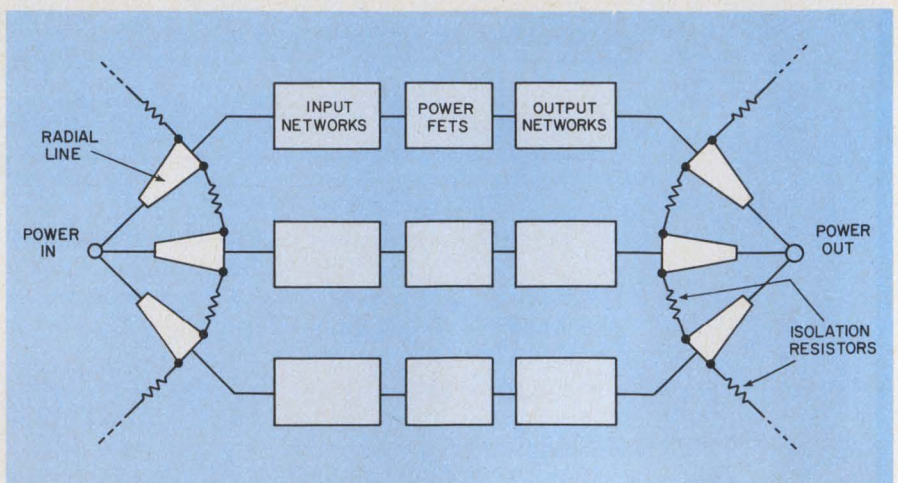

**The key advantage of this radial power combiner** is that failure of one FET power stage drops power output only 0.8 dB. This feature is achieved through the isolation provided by resistors between sectors. The technique could result in a 100-W amplifier one day.

first power amplifiers to be characterized in terms of large-signal impedance rather than small-signal parameters. And its 15% efficiency is good for broadband amplifiers.

■ The design and fabrication of a GaAs amplifier that simultaneously provides relatively high power, bandwidth and efficiency will be described by Texas Instruments researchers. The device, an X-band amplifier operating in the 9 to 10-GHz region is a three-stage microwave IC power FET with 1.6-W output, 20-dB gain and 28% efficiency.

■ An idea dating back to the MIT Radiation Laboratory days of the 1940s has been resurrected by the race for GaAs FET amplifier designs with ever higher outputs. The idea is the radial transmission line, the resurrectors are researchers at Westinghouse's Ad-

vanced Technology Laboratory in Baltimore. The result is a distributed type of amplifier that combines the power output of twelve 340-mW GaAs FET amplifiers with an output efficiency of close to 90% over a bandwidth of more than 30% at 8.5 GHz.

The radial combining circuitry will be described by James Schellenberg, senior engineer at the Advanced Technology Laboratory and Marvin Cohn, manager of microwave physics at the ATL's Systems Development Division. The circuitry provides both a broader bandwidth and lower loss than other kinds of coupler-type schemes. The radial coupler, designed by Schellenberg, has obtained a loss slightly over 11 dB, which is about 0.25 dB above the theoretical 10.8-dB loss associated with the 12-way power division, and only about 0.05 dB higher than that of a typical single-stage, two-way combiner circuit.

A radial line is used to form the two microstrip power driver/combiners that cap each end of the cylindrical amplifier. The amplifier circuits are arranged around the circumference of these radial circuits and connected to the radial lines by coaxial feed-throughs.

The combiner circuits are built in thin-film form on fused-silica substrates. For a given frequency, the electrical size of the elements is about 50% greater than alumina or sapphire because of the low dielectric constant of the silica material. This increase in effective electrical size provides the proper aspect ratio for the radial combining circuit.

Ideally, the combiner should be a plain disc, fed from 50-Ω lines. But to

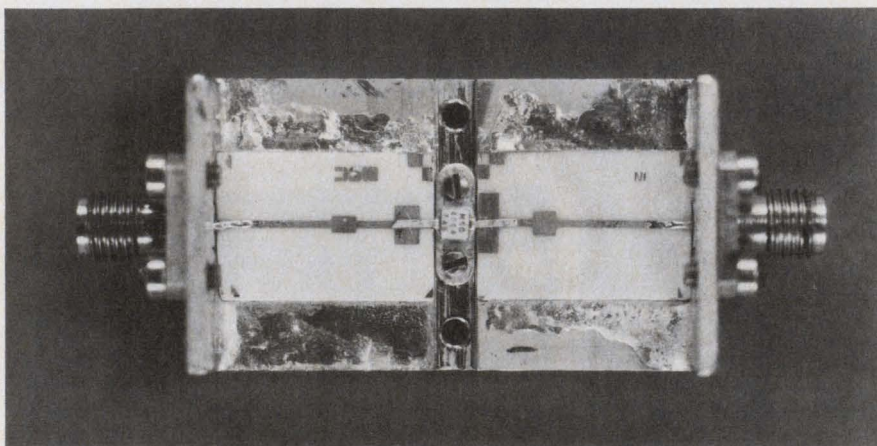

**This hermetically sealed stripline package** with a GaAs FET amplifier has 100% bandwidth and uses commercial devices by Microwave Semiconductor. The amplifier covers a 2 to 6-GHz band and operates with 15% efficiency.



# 24 GHz

## -30 dBm sensitivity, FM tolerance standard

Just those three features alone put Systron-Donner's Model 6054B Microwave Counter in a class by itself! But there's lots more:

**Complete Coverage:** From 0.02 to 24 GHz in one band with one connector input. *Eleven* digits give you fully displayed readings.

**Sensitivity:** -30 dBm to 10 GHz; -25 dBm to 18 GHz; -20 dBm to 24 GHz.

**Dynamic range:** No dead zone! Operative over the complete range up to +30 dBm (1 watt).

**Protection:** Unlike other counters offered to date, the Model 6054B provides early warning of pending overload conditions via flashing LED's.

**FM tolerance:** Full channel loading and heavily modulated signals with rates up to 10 MHz are measured easily with S-D's FLACTO™ technique.

**IEEE-488:** For systems applications, the 6054B is fully compatible with IEEE-STD-488-1975.

**Speed:** Fast acquisition and 1 Hz resolution in one second are provided over the entire frequency range.

**Discriminator output:** Gives the operator a visual picture of any modulation characteristics on the carrier.

**Other models:** If you don't need 24 GHz coverage, S-D offers four counters starting at \$4,600. (U.S. price only).

To find out more about the performance leaders in microwave counters, call Scientific Devices or contact S-D at 10 Systron Drive, Concord, CA 94518. Phone (415) 676-5000. Overseas, contact Systron-Donner in Munich; Leamington Spa, U.K.; Paris (Le Port Marly); Melbourne.

SYSTRON  DONNER

CIRCLE NUMBER 23

compensate for differences in amplifier characteristics, the disc has been slotted and 100-Ω resistors have been connected across the open ends of the slots. Isolation achieved with the radial combiner ranges from 14 to 22 dB, port to port, depending on whether

the two ports are adjacent or opposite.

Although the operating characteristics of the FET devices in the combiner differed substantially, the Westinghouse design was able to match amplifier modules to within 1.2 dB in amplitude and 13° in phase. One de-

sirable feature of this combiner system is that it is "fail safe." Failure of a single FET reduces the net output power by only 0.8 dB. Three device failures reduce it by only 2.5 dB.

This technique is expected to bring a 100-W amplifier one day. ■■

## μP controls pay-phone calls—and collections

A microprocessor enables a new pay telephone to meet the special requirements of different countries—coin denominations, coin materials, rates, signal levels required by switching centers and methods for requesting additional payments. The NT2000 telephone comes from Standard Elektrik Lorenz AG, an International Telephone & Telegraph subsidiary in Stuttgart, Germany.

A microprocessor in the pay telephone controls such elements as the hook switch, additional call button, and keyboard, as well as the coin-handling process, which is signaled by electronic coin filters and detectors in the coin channels.

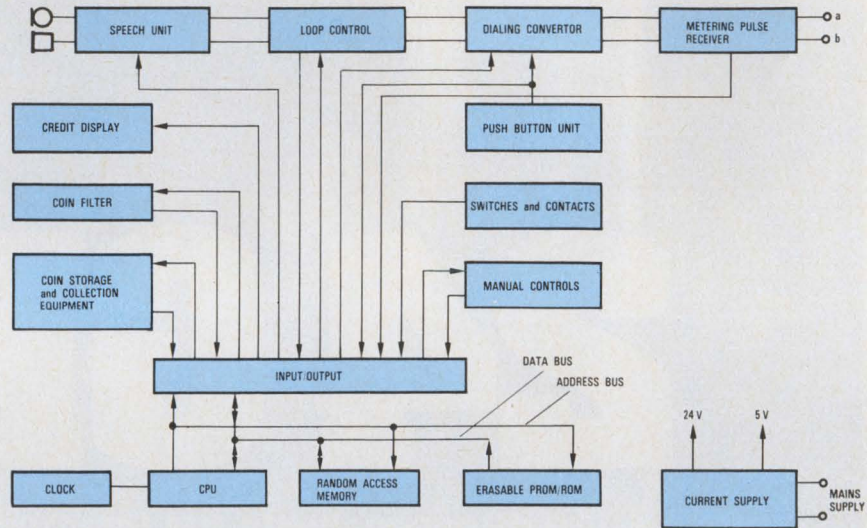

Coin slots and keypads in a new telephone from ITT's Standard Elektrik Lorenz AG are under the control of a microprocessor CPU.

### Money tallied, too

The microprocessor also counts tolls paid, determines refunds when necessary, and compares numbers dialed with numbers stored in ROM to determine if the number should be accepted by the coin telephone. In response to the results obtained from its supervisory and computing functions, the μP carries out such control func-

tions as controlling deflector and collection magnets in the coin channels.

The microprocessor system includes a CPU, RAM, EPROM, input/output interfaces, and a clock generator. EPROM was selected to shorten program generation time as well as the time it takes to try out prototypes supplied to telephone administrations,

according to D. Adolphs, who is in charge of coin-telephone projects at Standard Elektrik Lorenz.

A version of the NT2000 was built with standard CMOS integrated circuits, and a second with custom MOS LSI circuits, Adolphs adds. But the microprocessor simplifies adaptation to customer requirements. ■■

## Dual-laser system improves welding accuracy

A dual-laser system that uses one laser to direct another precisely to its target is being used to weld terminals very accurately and very quickly in telephone switching equipment.

This so-called "edge-detection" system is an optical package that enables the beam from a low-power (1 mW) HeNe laser to scan targets continuously while remaining concentric with the beam of a pulsed high-power Nd:YAG laser. This creates reflections off the targets and these are detected by a photodiode in the optical package.

The system is being used at Western

Electric's Omaha, NE, plant to weld common-bus terminals on a multi-contact crossbar switch. Differences in reflectivity between the terminals to be welded and their backgrounds trigger the Nd:YAG laser at exactly the right instant for welding—accuracy is within 0.002 in.

More than 200 welds per second can be achieved with the system, a far cry from the maximum 20 welds per second with current computer-controlled welding systems.

Before edge detection was developed, variations in the size of switches and

in the number of terminals created severe problems for the resistance welding system that was being used. Each variety of switch required a separate indexing installation and elaborate fixturing. Also, resistance welding electrodes had to be replaced and complex part handling mechanisms made for excessive downtime.

Western's edge-detection system, on the other hand, can handle multipart devices that have large cumulative tolerance buildups. It can also handle large variations in component dimensions. ■■

# Tired of selecting 741's and 747's to get premium performance?

## Specify our OP-02, OP-04, OP-14!

If your design requires premium 741 performance that right now can be met only by a costly and time consuming "selection game," the PMI OP-02 is for you.

A high performance general purpose Op Amp that really fills the gap between standard 741's and precision 725's, the OP-02 fits **all** 741 sockets. It's even better than the PMI SSS741! Input offset voltages are guaranteed better than the 725, but the speed of the 741 is retained. MIL STD 883 processing is available—level B right from stock.

Prices run higher than standard 741's, of course, but well below standard 725's. For a little bit extra you get **guaranteed** better performance across the board, low noise, low drift, low  $TCV_{OS}$ , low  $TCl_{OS}$ , and insensitivity to output load conditions. Check the specs.

Three steps to end your selection worries:

1. Get a complete OP-02 data sheet to compare to your selected 741 and 725 requirements.
2. Call your PMI distributor for a few OP-02's to convince yourself that PMI's specs are for real.
3. Specify the OP-02 as the **preferred** source. (You can still use the selected stuff as the second source.)

	Input Offset Voltage mV MAX		Input Offset Current nA MAX		Input Bias Current nA MAX	
	MIL	Comm.	MIL	Comm.	MIL	Comm.
<b>Industry</b>						
Standard 741	6.0	7.5	500	300	1500	800
PMI SSS741	3.0	7.5	10	50	100	200
PMI OP-02	1.0	3.0	5	10	50	100
<b>Industry</b>						
Standard 725	1.5	3.5	40	50	200	250
PMI SSS725	0.18	1.6	4	25	120	180

### ***DUALS also available!***

Standard	Superior Second Source	Premium Performance
<b>747</b>	<b>SSS747</b>	<b>OP-04</b>
<b>1458/ 1558</b>	<b>SSS1458/ 1558</b>	<b>OP-14</b>



**Precision Monolithics Incorporated**  
1500 Space Park Drive, Santa Clara, CA 95050  
(408) 246-9222. TWX 910-338-0528.  
Cable MONO.

CIRCLE NUMBER 24

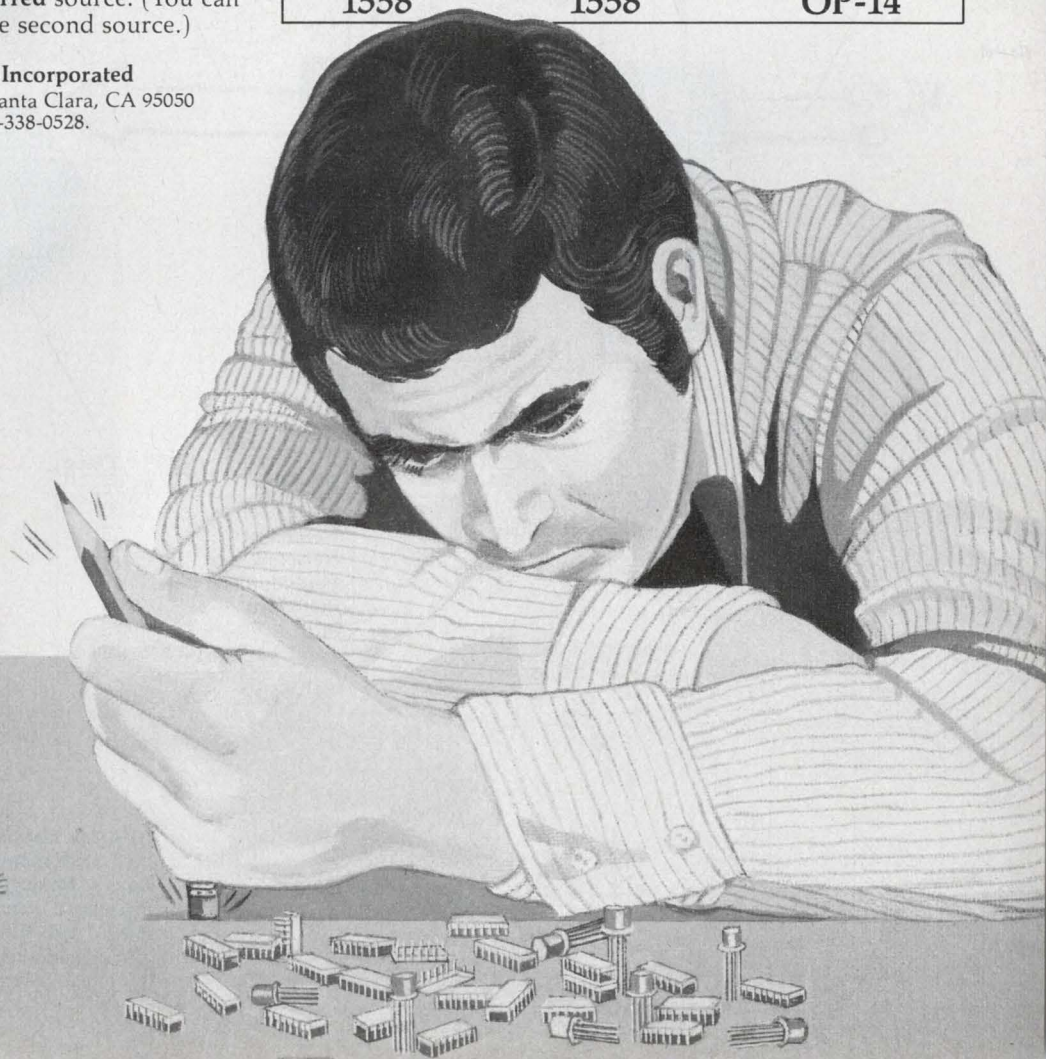

# Need a 3½ digit DPM?

Build your own LED or LCD panel meter and tailor it to fit your system.

No external active components.  
Only 7 passive components needed  
for an operating DPM.

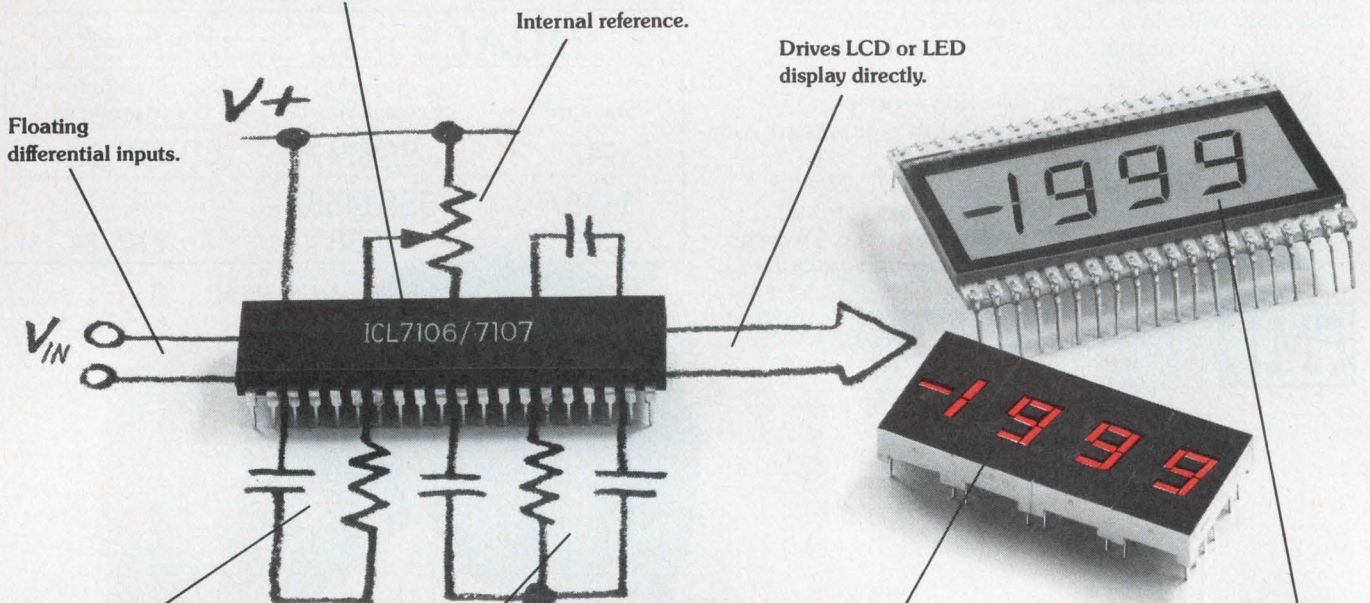

Built-in clock.

Precision auto-zero/  
auto-polarity circuitry.

\*

Part	5000+ Price
ICL7107	\$5.95
LED displays	3.00
Capacitors	.58
Resistors	.12
Potentiometer	.60
PC board	1.00
Misc.	.75
<b>Total parts cost</b>	<b>\$12.00</b>

Prices FOB Calif.

Part	5000+ Price
ICL7106	\$6.50
LCD display	6.50
Capacitors	.58
Resistors	.12
Potentiometer	.60
PC board	1.00
Misc.	.75
<b>Total parts cost</b>	<b>\$16.05</b>

Prices FOB Calif.

**Intersil stocking distributors:** Advent Electronics, Inc., (Indianapolis); Arrow Electronics; Century Electronics; Elmar/Liberty Electronics; Harvey (Upper N.Y.); Intermark (San Fran.); Kierulff Electronics (Mass.); R.A.E. Ind. Elect. Ltd. (Van. B.C.); RESCO (Raleigh, N.C.); Schweber Electronics; Sheridan Assoc.; Diplomat (Fla., N.J.); Weatherford; Zentronics (Canada).



# Put it all together for as little as \$12.\*

## Intersil's new single chip 3½-digit 7106 and 7107 A/D converters for LCD or LED displays.

Meet the latest in A/D converters: Intersil's 7106, the first single-chip CMOS A/D for driving LCD displays—including backplane—directly.

And the 7107, first single-chip CMOS A/D for driving instrument-size LED displays directly without buffering.

Each provides parallel seven segment outputs, ideal for DVMs, DPMs and anywhere modern digital displays are needed.

Both new devices provide cost advantages over multi-chip designs, because they require no additional active components. Both have internal reference and clock, and both are CMOS so you get low noise (12 to 15  $\mu$ V) comparable with the finest bipolar devices, and low power (10mW max. @ 10V). A few more features:

- $\pm 1$ -count accuracy over the entire  $\pm 2000$ -count range.
- Guaranteed to read Zero for 0 Volts input.
- Provides true polarity at Zero count for precise null detection.
- Differential input from 200mV to 2.000V full scale.

Get additional technical information, including detailed data sheet and application notes, from Intersil, 10710 North Tantau Ave., Cupertino, CA 95014.

## Build a working DPM in ½ hour with these complete evaluation kits.

Test these new parts for yourself with Intersil's low-cost prototyping kits, complete with A/D converter and LCD display (for the 7106) or LED display (for the 7107). Kits provide all materials, including PC board, for a functioning panel meter. Available from Intersil stocking distributors.

Kit No. ICL7106EV/KIT (LCD) \$29.95 complete.

Kit No. ICL7107EV/KIT (LED) \$24.95 complete.



**Intersil sales offices:** Boston (617)861-6220; Chicago (312)986-5303; Dallas (214)387-0539; Dayton (513)278-4837; Denver (303)750-7004; Los Angeles (213)532-3544; Ft. Lauderdale (305) 772-4122; Minneapolis (612)925-1844; New York (201)567-5585; San Francisco Bay Area (408) 996-5000.

# INTERSIL

if you're designing ATE systems  
you really ought to talk to  
our power supplies



...hundreds of models  
interface the IEEE 488 BUS  
through the  
KEPCO SN-488 programming system

Write Dept. BYF-05 for all the details

**KEPCO**®

131-38 SANFORD AVENUE • FLUSHING, N.Y. 11352 U.S.A. • (212) 461-7000 • TWX # 710-582-2631 • Cable: KEPCOPOWER NEWYORK

CIRCLE NUMBER 26

## U.S. to keep patent rights to government-funded R&D

The Carter Administration has informed Congress that it will continue the policy of retaining title to patents stemming from federally financed research and development, and will not assign title to the inventors, who would then license the government to use the results.

A controversy has raged for 30 years over these two approaches to patent rights for government-sponsored inventions, according to John H. Shenefield, assistant attorney general in charge of the Justice Department's Antitrust Division, in testimony before the Senate monopoly subcommittee. Under the "title" policy, favored by the Justice Department, the government takes title to the patents involved, and private interests may use the inventions by obtaining a government license. Under the "license" policy, which is backed by some government contractors, the contractor gets title to the invention, with the government retaining a royalty-free license. But the contractor doesn't have to license its use by any third parties.

Shenefield argued that the "title" policy best ensures that when the government underwrites R&D, the public receives the benefits. Under the "license" policy, he claimed, "the public would pay the contractor twice—first through the governmental research support and then again through the patent-monopoly surcharge in the marketplace, which is reflected in the price the public pays for goods subject to that surcharge."

## Ten firms vie to integrate MX missile guidance

Ten companies are competing for a development contract to integrate the guidance and control system in the new MX mobile intercontinental ballistic missile, and the Air Force expects to select at least two companies for parallel efforts by May.

The highly accurate guidance system, known as the Advanced Inertial Reference Sphere (AIRS), has been developed by the Charles Stark Draper Laboratory, and prototypes have been built by Northrop Corp. The two winning contractors will study linking the AIRS system with an inertial measurement unit developed by Honeywell's Aerospace Division and mission-oriented software.

In the running for the guidance-integration contract are Litton Industries, General Motors' Delco Electronics Division, Northrop, Rockwell International's Autonetics Group, Raytheon, General Electric, Boeing, Texas Instruments, Bendix, and Hughes Aircraft.

After an initial system definition phase, which is expected to run through December, the Air Force can exercise a contract option for one firm to continue with engineering development of the system through September, 1983. However, this will depend on the availability of funds in this year's defense budget. Although Defense Secretary Harold Brown has not yet approved the MX concept for engineering development, the Air Force is trying to define all the missile subsystems during this calendar year in anticipation of development funds in next year's budget. Brown has been reluctant to push ahead with MX until the SALT negotiations with the Soviet Union over strategic weapons are concluded.

Another key MX contract to be awarded in May will cover missile assembly, test and system support. It will also run through December, with an option to extend it through September, 1983. Competitors are Boeing, Rockwell, GTE Sylvania and Martin Marietta's Denver Division.

## **Five aircraft land automatically in Atlanta**

The first fully automatic multiple landings under zero-visibility weather conditions have been conducted at Atlanta's Hartsfield Airport. According to the Federal Aviation Administration, five Lockheed L-1011s, four from Delta Airlines and one from Eastern Airlines, performed full Category III instrument landing operations, which means that the landings were automatic right down to the application of brakes after touchdown.

The weather conditions during the landings satisfied the minimum requirements for full CAT III operations: clouds on the ground, recorded as zero ceiling, and a visual range on the runway between 700 and 1200 feet.

## **Weather satellite needed for global project**

Western European and American space scientists are trying to come up with a synchronous-orbit weather satellite to replace the Soviet satellite that was supposed to be part of the 1979 Global Atmospheric Research Program.

GARP is scheduled to begin next Jan. 1 to collect weather data for a year from a variety of sources, including five satellites in synchronous orbit 22,300 miles above the earth. Four of the weather satellites are already orbiting, but last month the Soviets informed World Meteorological Organization (GARP sponsor) that they wouldn't be able to launch their satellite until late 1979, almost a year behind schedule.

All four orbiting satellites were launched by the National Aeronautics and Space Administration—two for the National Oceanic and Atmospheric Administration (NOAA), one for Japan and one for the European Space Agency (ESA). One possible fifth is another NOAA weather satellite, due to be launched in May this year.

**Capital capsules:** The National Science Foundation will replace its Directorate for Research Applications on Feb. 6 with a Directorate for Applied Science and Research Applications in an attempt to strengthen the links between the Foundation's basic research activities and applied research needs. Dr. Jack T. Sanderson, assistant NSF director for research applications, will head the new organization....The National Bureau of Standards will sponsor a conference on microcomputer-based instrumentation at its Gaithersburg, MD, headquarters June 12 and 13. Co-sponsors are the IEEE Computer Society and the Group on Instrumentation and Measurement....NASA is turning its launching of satellites into a profitable business. Of the agency's 25 launches scheduled for 1978, 15 will be "paying customers," including the European Space Agency, Comsat Corp., Japan, the United Kingdom, Canada and other U.S. government agencies.

# Now...LOOK at GPIB Activity:

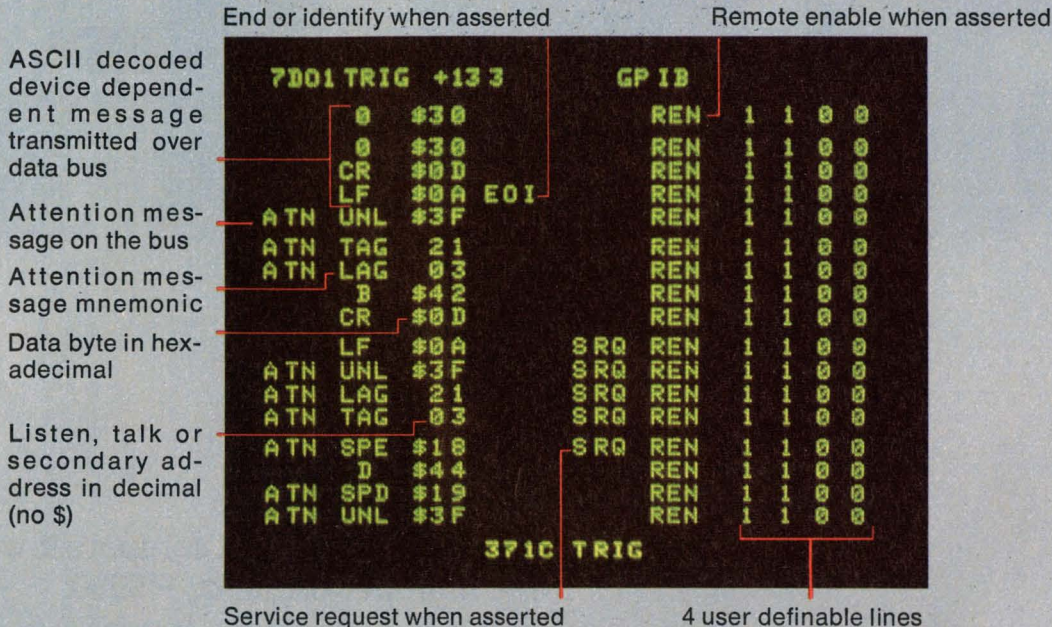

Announcing *visible* GPIB communications at the touch of a button: the new TEKTRONIX DF2 Display Formatter. The DF2 monitors *and displays* activity on the GPIB bus as disassembled instructions in familiar IEEE 488 mnemonics.

Touch another button, and information is displayed in ASCII format, with further character decode in hex, binary, or octal—all on the same display.

**The DF2 Display Formatter works with our 7D01 Logic Analyzer: for the first time, you have a complete logic analysis tool that can deal specifically with GPIB activity. And that means GPIB design and integration is now faster. Simpler. And more convenient.**

## Designing A Controller? Use The DF2!

It's plug-to-plug compatible with GPIB controllers so you monitor commands at a glance.

## Designing Talkers/Listeners? Use The DF2!

Now it's simple to make sure talkers are responding properly to the controller and listeners are receiving correct data.

## Integrating GPIB Systems? Use The DF2!

You know monitoring and displaying bus events and their sequence are essential for effective integration of multi-vendor GPIB products. Now you have the essential tool: use the DF2 to analyze any specific data transaction you wish.

You'll also find the DF2 a powerful service tool. Observe GPIB bus activity to simplify troubleshooting and keep your system up and running properly.

The DF2 Display Formatter also provides displays in timing and mapping modes as well as state tables in binary, hexadecimal, or octal notation. Combined with the DF2, our 7D01 Logic Analyzer System is the most comprehensive and versatile logic analysis tool available today. And because the 7D01 Logic Analyzer System is compatible with *any* TEKTRONIX 7000 Series oscilloscope, you may already own part of a Logic Analyzer package.

TEKTRONIX Logic Analyzers: we call them The Versatile Ones.

Now, with the unique and exclusive DF2 Display Formatter, they're more versatile than ever.

And GPIB is a lot more visible.

Call your local Tektronix Field Engineer for more information about the DF2. Or write Tektronix, Inc., P.O. Box 500, Delivery Station 76-260, Beaverton, Oregon 97077. In Europe, write Tektronix Limited, P.O. Box 36, St. Peter Port, Guernsey, Channel Islands.

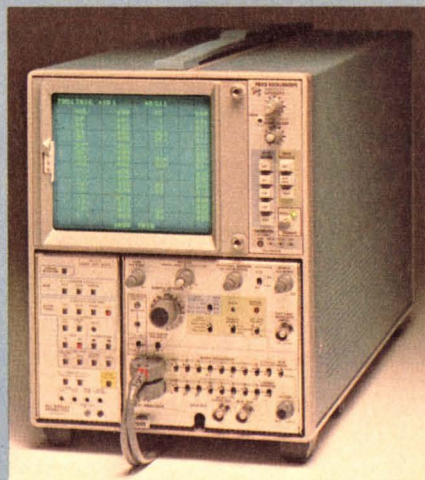

**Tektronix**  
COMMITTED TO EXCELLENCE

**TEKTRONIX Logic Analyzers: The Versatile Ones**

# BENCHM

**Before you design-in  
a Z-80, 6800 or 8085, compare it with  
the high performance R6500.**

Rockwell's R6500 delivers boosted performance and economics through its third-generation pipelined architecture with 13 powerful addressing modes, true indexing capability, complete decimal/binary arithmetic mode selection, on-chip clock and proven 2MHz performance. Prove it to yourself—Benchmark it!

R6500



# MARK IT!

## **R6500 offers innovative architecture and technology.**

The 8-bit R6500 is produced with N-channel, silicon gate, depletion load technology and innovative architecture. The result is smaller, faster chips to keep your system costs down and performance up.

A family of ten software compatible CPUs in 28- and 40-pin DIP packages give you the most cost-effective fit for your application. Prove it to yourself—Price it!

## **R6500 is designed for greater memory and I/O efficiency.**

Of the leading NMOS microprocessors, only the R6500 has 13 addressing modes and true indexing capability. More addressing modes coupled with an advanced instruction set makes programming the R6500 easy and efficient. Fewer program steps means lower memory cost and faster program execution.

R6500 memory-managed I/O eliminates performance bottlenecks associated with the separate I/O buses, I/O commands and register overhead required by other microprocessors.

A broad selection of memory, I/O and combination memory-I/O-timer circuits are available. And Rockwell is presently delivering the industry's first fully static 32K ROM—the R2332—and the industry's fastest 32K ROM—the R2332-3.

## **SYSTEM 65 gets you started for less.**

SYSTEM 65 Microcomputer Development System is efficient and easy-to-use and is equipped with dual mini-floppies. It's priced at only \$4800.

ROM-resident SYSTEM 65 firmware features a two-pass assembler, text editor and symbolic debug/monitor package. Current loop, RS-232C, printer and scope sync ports are also provided. The optional USER 65 (User System Evaluator) module extends the power of SYSTEM 65 for in-circuit emulation.

Other design support includes KIM-1, TIM, timesharing cross-assembler, complete documentation and extensive applications engineering.



Industry researchers say the multiple-sourced 6500 outshipped the Z-80, 6800 and 8085 during the last quarter of 1977. Benchmark it!

For more information, contact your local Hamilton/Avnet distributor or write: D/727-C Microelectronic Devices, Rockwell International; P.O. Box 3669; Anaheim, CA 92803 or phone (714) 632-3729.



**Rockwell International**

...where science gets down to business

# At 100 nanoamps...

## Our knee makes their knee look sick

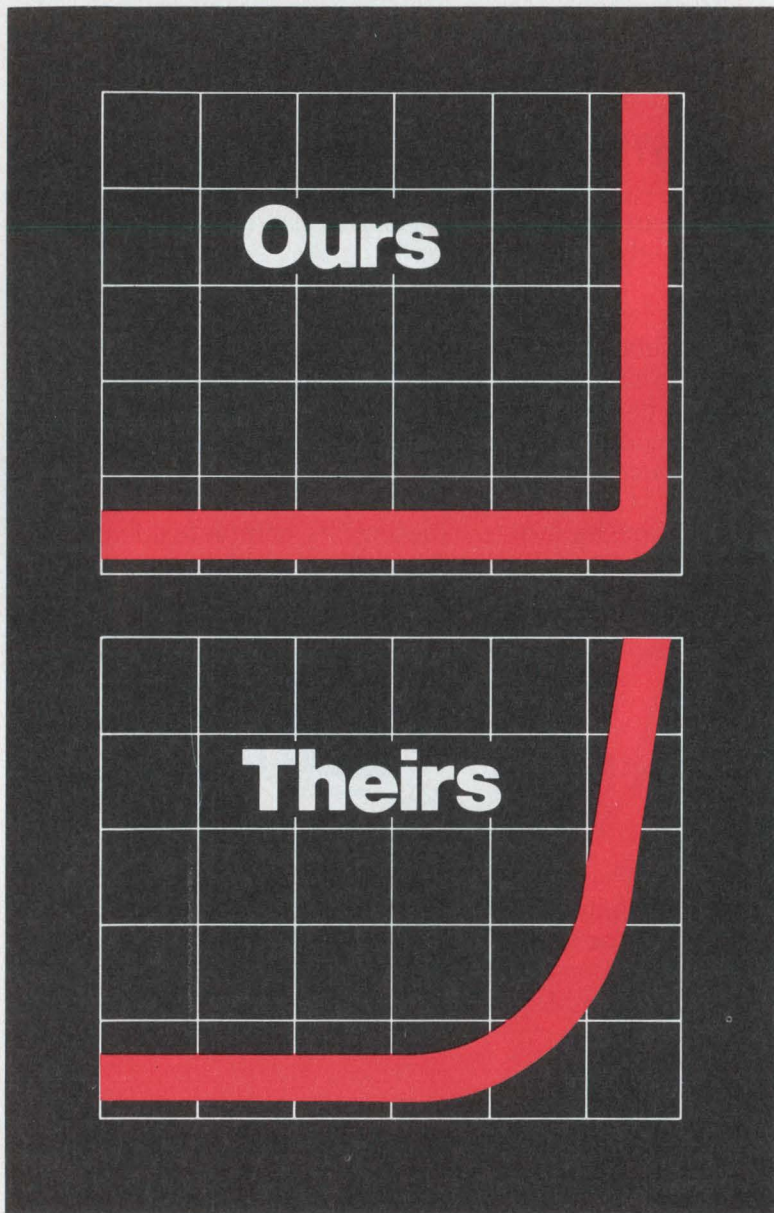

If your logic circuit needs an extremely constant reference voltage, but you want to draw as little current as possible, *our new LVA zener is your only choice.*

That's right. Your only choice. Other zeners can give you a stable voltage at 50 microamps. Only we can do it at 100 nanoamps.

Teledyne low voltage avalanche zeners are available in a range of voltages from 4.7V to 10V at your tolerance requirement. Let us know what you need, and we'll give you exact specs. And the most pleasant surprise of all may be the price.

For complete information and/or evaluation samples, contact Jerry Kramer at (415) 968-9241.

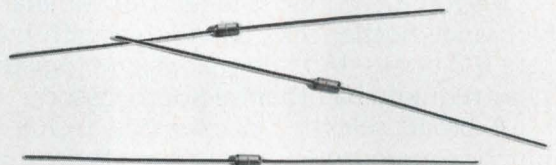

### TELEDYNE SEMICONDUCTOR

1300 Terra Bella Avenue, Mountain View, California 94043 • (415) 968-9241

SALES OFFICES: DOMESTIC: Salem, N.H. (603) 893-9551; Stony Brook, N.Y. (516) 751-5640; Des Plaines, IL (312) 299-6196; Los Angeles, CA (213) 826-6639; Mountain View, CA (415) 968-9241  
INTERNATIONAL: Hounslow, Middlesex, England (44) 01-897-2503; Tiengen, West Germany 7741-5066; Kowloon, Hong Kong 3-240122; Tokyo, Japan 03-403-8141

CIRCLE NUMBER 30



## Concepting an idea

A fellow telephoned for help the other day. He was trying to find new applications for his company's product and—I swear he said this—he was “concepting an idea.”

Well, I wanted to help, but I stumbled on his “concepting an idea,” so I asked him to explain. I shouldn't have. His explanation befuddled me even further. As far as I could determine, he was doing market research. But on his company's Table of Organization he no doubt shows up as the man who concepts ideas, which is more “scientific.” And the club of idea conceptors is certainly more exclusive than the club of market researchers.

Though any specialty certainly requires specialized language, the practice of using obfuscating language where simple English would do has been with us a long time. Doctors code their prescriptions in Latin to keep understanding away from you and me, and lawyers write in gobble-de-gook for the same reason.

Nowhere is the practice spoofed more effectively than in the chapter-heading quotations in Max Shulman's delightful *Barefoot Boy with Cheek*. In French—for French is more “literary” than English—Shulman quotes some of the world's great Frenchmen. We find Rabelais saying “Le livre est brun” (“The book is brown”), Voltaire saying “Le crayon est sur le table” (“The pencil is on the table”), and Anatole France asking “Ou est mon chapeau?” (“Where is my hat?”) Had Shulman thought of it, I'm sure he could have done something with “concepting an idea” or some of the language we engineers use to befuddle and intimidate our neighbors.

Let's eschew obfuscation.



GEORGE ROSTKY  
Editor-in-Chief

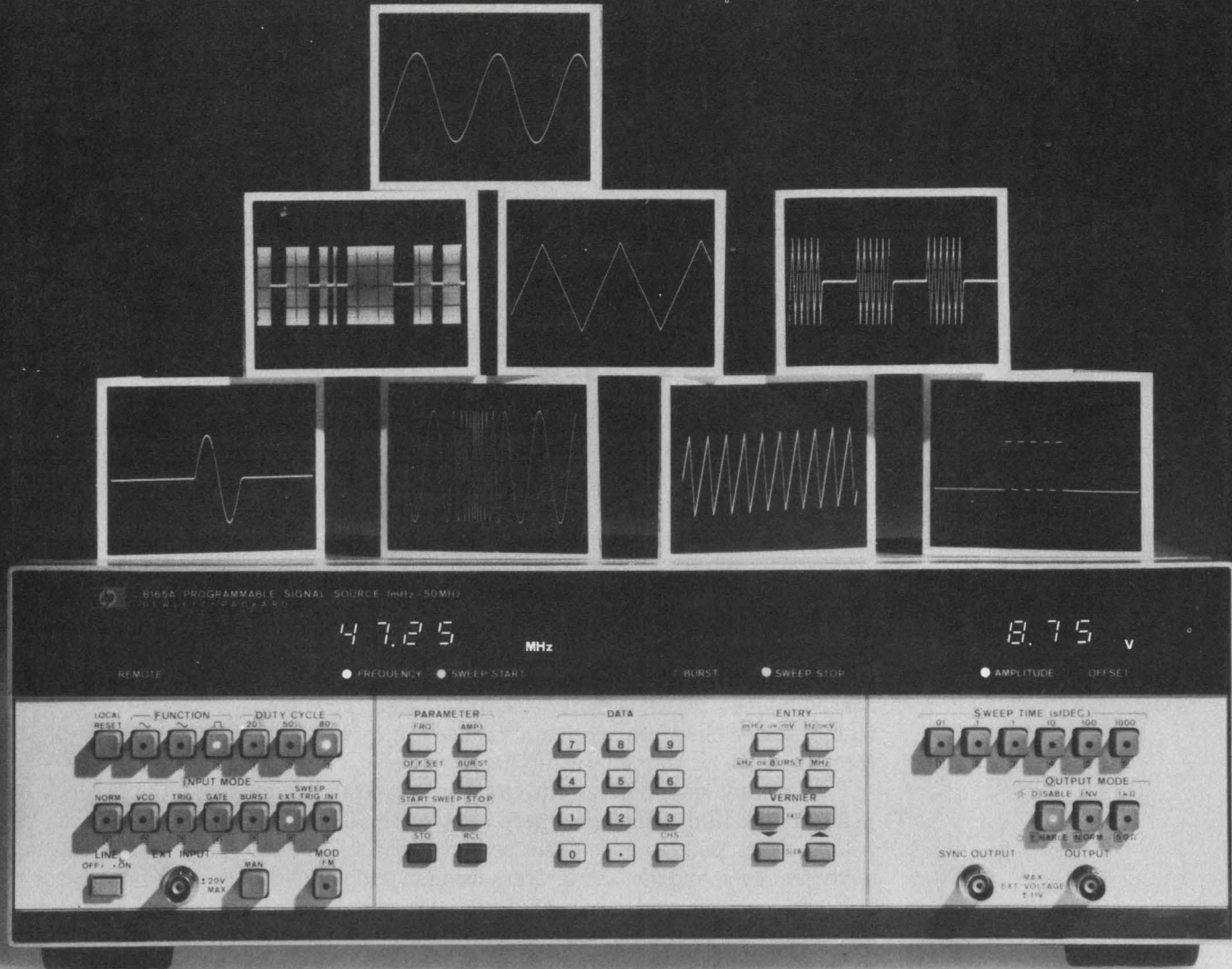

Instrument shown with optional sweep mode

## Now, quickly program these waveforms...

**Using HP's new 8165A, the first programmable signal source with a 0.001 Hz to 50 MHz range.**

**Easy manual and remote programming.** Here's a multi-function programmable signal source that's microprocessor controlled, easy to set-up and quick to program for greater testing throughput. Manually, you set up the 8165A using easy-to-interpret push-buttons and you can store 10 complete front-panel settings for quick recall. Remotely, you program the 8165A on the HP-IB\* via controller keyboard or in HP's "learn mode" where a computing controller scans and stores the front-panel settings.

**Analog and digital waveforms.** Sine waves, triangle and square waves up to 50 MHz and pulses or ramps up to 19.99 MHz can be quickly programmed for your testing needs. And there's a DC mode that gives you a 200mA current source. One instrument performing the functions of several gives you a cost-effective way to perform automatic and semiautomatic testing.

**External trigger and burst modes.** You can either trigger one cycle of a selected waveform using an external signal or in the counted burst mode, generate a specified number of wave-

forms. The latter eliminates the uncertainties associated with conventional gating.

**Sweep control.** The standard configuration (VCO) lets you control the master oscillator with an external voltage level. An optional sweep mode (\$330\*\*) logarithmically controls the oscillator internally for a programmed time period. And you trigger the sweep either internally or externally.

The 8165A, priced at \$6000\*\*, also gives you high accuracy, eliminating the need for time-consuming setup verification with expensive counters and volt meters. Contact your local HP field engineer for complete details.

\*HP's implementation of IEEE Standard 488-1975.  
\*\*Domestic U.S.A. prices only.

08715



1507 Page Mill Road, Palo Alto, California 94304

For assistance call: Washington (301) 948-6370, Chicago (312) 255-9800, Atlanta (404) 955-1500, Los Angeles (213) 877-1282

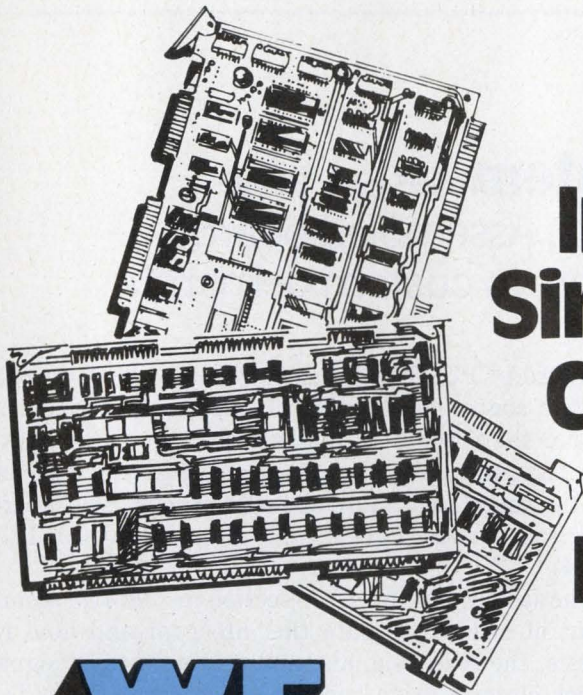

# Intel Single Board Computers from Hamilton/Avnet.

**WE  
HAVE  
LOCAL  
SYSTEMS  
STOCK.**

Hamilton/Avnet has the complete line of Intel Single Board Computers in local stock and ready for immediate delivery. Numbers? We have them all including Intel's popular CPU Boards - The SBC 80/04, 80/05, 80/10, 80/20 and the SBC 80/20-4. We stock all of Intel's Expansion Boards too. Memory, Peripheral Controller, Digital I/O, Analog I/O, Communication, all backed by the first real time multi-tasking executive; the RMX 80. All you need to easily build a complete microcomputer system.

We'll even help get you started in selecting the right Intel SBC. Simply call your local Hamilton/Avnet facility and we'll send along a free Intel Configuration Guide.

Consider Hamilton/Avnet your number one local source for all of your Intel SBC and microcomputer systems requirements.

**Hamilton**  **Avnet**  
ELECTRONICS  A DIV. OF AVNET, INC.

World's largest local distributor with 35 locations stocking the world's finest lines of system components

#### SOUTHERN CALIFORNIA

Hamilton, L.A. (213) 558-2121  
Avnet, L.A. (213) 558-2345

#### NORTH WEST

Mountain View (415) 961-7000  
Seattle (206) 746-8750

#### SOUTH WEST

San Diego (714) 279-2421  
Phoenix (602) 275-7851

#### ROCKY MOUNTAIN

Salt Lake City (801) 262-8451  
Denver (303) 534-1212  
Albuquerque (505) 765-1500

#### NORTH CENTRAL

Chicago (312) 678-6310  
Minneapolis (612) 941-3801  
Detroit (313) 522-4700  
Milwaukee (414) 784-4510

#### SOUTH CENTRAL

Dallas (214) 661-8661  
Houston (713) 780-1771  
Kansas City (913) 888-8900

#### INTERNATIONAL

Telex 66-4329  
Telephone (213) 558-2441

#### MID CENTRAL

St. Louis (314) 731-1144  
Dayton (513) 433-0610  
Cleveland (216) 461-1400

#### CANADA

Toronto (416) 677-7432  
Montreal (514) 331-6443  
Ottawa (613) 226-1700

#### NORTH EAST

Boston (617) 933-8000  
Syracuse (315) 437-2641  
Rochester (716) 442-7820

#### METROPOLITAN

Georgetown (203) 762-0361  
Westbury (516) 333-5800  
Cedar Grove (201) 239-0800

#### MID-ATLANTIC

Baltimore (301) 796-5000  
Mt. Laurel (609) 234-2133  
Raleigh (919) 829-8030

#### SOUTH EAST

Miami (305) 971-2900  
Atlanta (404) 448-0800  
Huntsville (205) 533-1170



# Intel from Hamilton/Avnet.

## Reduce your $\mu$ C-based system design time by using single-board microcomputers. Assembled boards in the SBC-80 series offer stock answers to custom demands.

System designers eager to take advantage of the dramatically increased capabilities of microcomputers have been hindered two ways: Their production volumes have been too low to amortize software and hardware development costs effectively, or hardware subtleties and test requirements have confined them to fully assembled and tested computer subsystems. But now those obstacles are overcome with families of fully assembled and tested microcomputers and system-expansion boards like the Intel SBC-80 series. They are ready-to-use, flexible and inexpensive—prices range from just \$195 to \$825 in unit quantities.

The main members of the SBC-80 family are the 80/04, 80/05, 80/10A, 80/20 and 80/20-4 central-processor boards, with either an 8080A or 8085 microprocessor acting as the master CPU (Table 1). Most of the boards measure  $6.75 \times 12$  in. and contain the CPU, clock, read/write memory, control ROM, I/O ports, serial communications interface and bus-control logic.

I/O interfacing is an area where design flexibility is essential to meet changing requirements efficiently. The programmable parallel and serial I/O structures of the boards make them versatile enough to do just that. What's more, upgrading system performance is easy thanks to the SBC-80 system bus, the Multibus, which permits modular performance expansion.

The Multibus provides a defined, standard interface between the SBC-80 single-board computers and expansion boards. As many as 16 SBC-80 family boards can simultaneously share the bus.

### All in the SBC-80 family

As exemplified by the block diagram of the SBC-80/10A (Fig. 1), the SBC-80 microcomputer system has all that's needed for many applications. The SBC-80/10A is the oldest board in the family and has been widely imitated since it was one of the first "standardized" microcomputers commercially available.

The CPU section of the 80/10A board consists of

the 8080A CPU, the 8224 clock generator and the 8238 system controller. Capable of fetching and executing any of the 8080A's 78 instructions, the CPU section can respond to interrupt requests originating on and off the board. (For more about the 8080A, see "Microprocessor Basics, Part 2," ED No. 10, May 10, 1976, p. 84).

The system-bus interface section includes an assortment of circuits to gate the interrupt and hold requests, the ready signals, and a system-reset signal. Other circuits drive the various control lines. Two 8216s help drive the bidirectional data bus, and six 8226s drive the external system-data and address buses as part of the SBC-80/10A's Multibus interface.

The RAM section of the 80/10A consists of 1024 bytes of static MOS memory. For program storage, up to 8192 bytes of ROM can be mounted on the board in 1024-byte increments by means of a 2708 or 8708 EPROM, an 8308 mask-programmed ROM, or in 2048 byte increments via the 2716 EPROM or 2316 ROM.

A serial interface on the board uses an 8251 programmable universal synchronous/asynchronous receiver/transmitter to provide a serial-data channel. The serial port operates at programmable rates up to 38,400 baud (synchronously) or 19,200 baud (asynchronously) with a choice of character length, number of stop bits, and even, odd or no parity. On-board interfaces provide direct EIA RS-232 or teletypewriter current-loop compatibility.

Two 8255 programmable peripheral interface circuits provide 48 I/O lines for transferring data to or from peripheral devices. Eight already-committed lines have bidirectional drivers and termination networks permanently installed, so that they can be inputs, outputs or bidirectional (jumper-selectable). The other 40 lines are uncommitted. On-board sockets permit drivers and termination networks to be installed, as needed. Since software configures the I/O lines, I/O can be customized for every application.

The 80/10A also responds to a single-level interrupt that can originate from one of many sources, the USART, programmable I/O and two user-designated interrupt-request lines. When an interrupt is recognized, a Restart-7 instruction is generated, and the processor accesses location  $38_H$  to get the starting address of the service routine.

System expansion and support are possible with a

George Adams, Product Line Manager, Single-Chip Microcomputers, Intel Corp., 3065 Bowers Ave., Santa Clara, CA 95051.

wide variety of alternate-source CPU, memory, and I/O boards (Tables 2 and 3). Up to 65,536 bytes of ROM, PROM or RAM can be accessed by one 80/10A. Expandable backplanes and card cages are also available to support multiboard systems.

### Interfacing starts with the bus

Although the SBC-80/10A is a complete micro-computer system, it can be expanded readily or it can serve as a primary master controller for other micro-computer cards. The 80/10A has five edge connectors, three on the top of the board and two on the backplane, or bottom, side. Two of the "top" connectors, J<sub>1</sub> and J<sub>2</sub>, serve as parallel I/O ports, while J<sub>3</sub> is a serial I/O

port. All parallel I/O lines on the 50-contact J<sub>1</sub> and J<sub>2</sub> connector areas are paired with an independent signal/ground pin to permit alternate signal/ground wiring when using flat-cable interconnects. Serial port J<sub>3</sub> uses a 26-contact PC-edge connector to provide interfaces for both RS-232 and current-loop devices.

To communicate with other system-compatible boards, the 80/10A uses the 86-pin Multibus (P<sub>1</sub>). To provide accessible test points, the 80/10A has a 60-pin edge connector (P<sub>2</sub>). The control signals on the Multibus provide the real power and capability in control applications.

Of the 86 pins that make up the Multibus, 24 are assigned to power and ground, 16 to addressing, eight to bidirectional data, and 12 to signal and control

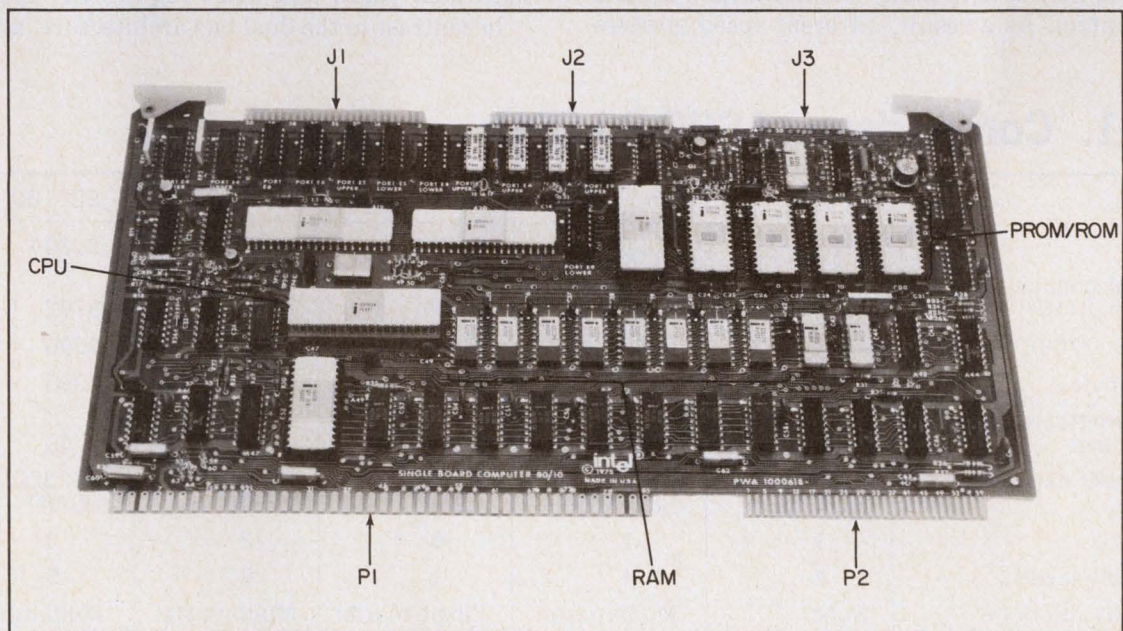
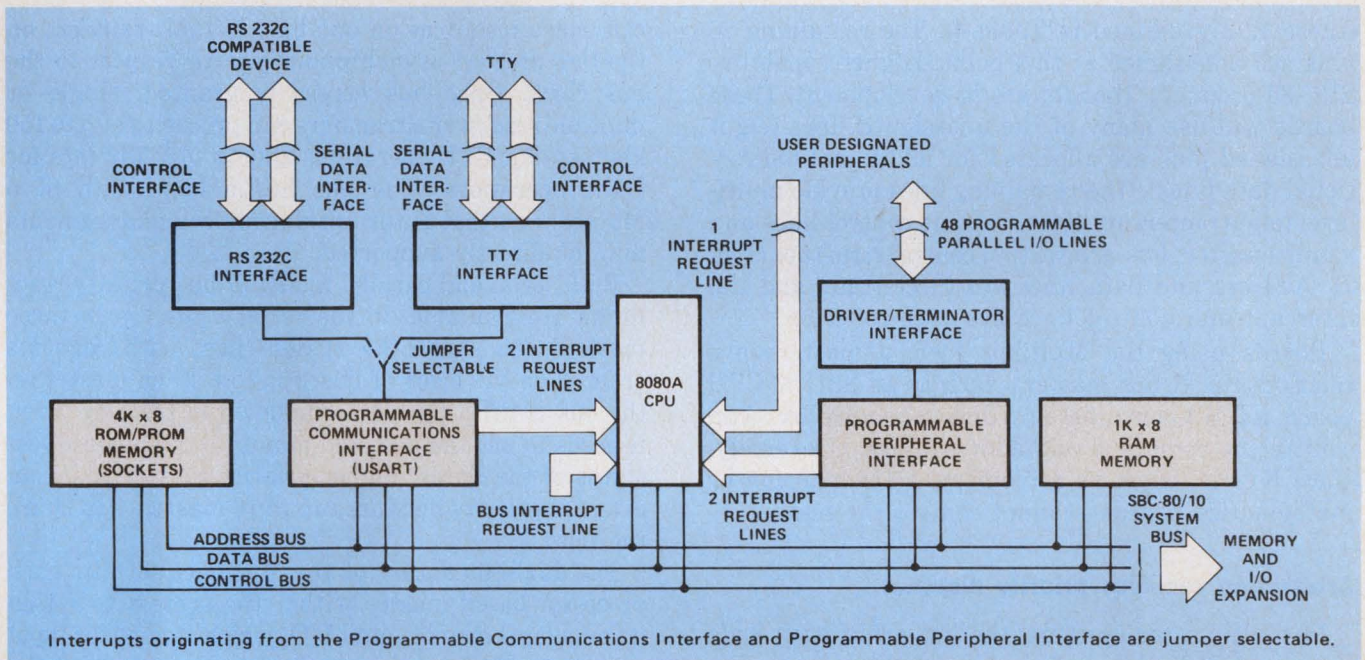

1. Based on an 8080A  $\mu$ P, the 80/10A microcomputer has a straightforward design suitable for general-purpose

computing and control. The board has 48 programmable I/O lines and serial interfaces.

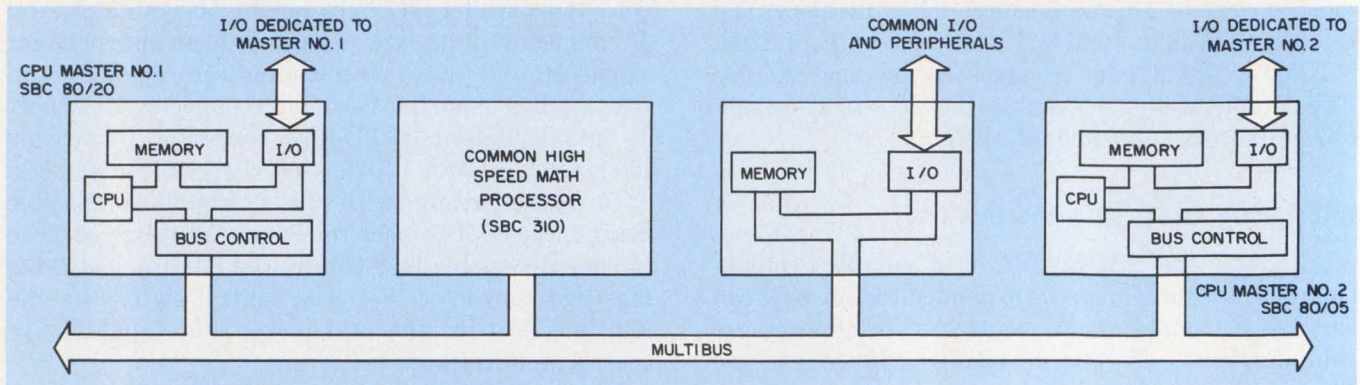

2. The Multibus interface for the SBC-80 CPU boards not only permits simultaneous multiprocessing, but also enables several processors to share the same bus and

peripheral devices. Arbitration logic on the CPU boards decides which board gets on the bus first if several units simultaneously access the bus.

(these 12 are defined in Table 4). The remaining 26 pins are unassigned at this point. Higher capability SBC-80 products, though, are in development. These boards will use many of the unassigned lines (eight unassigned pins are allocated for additional bidirectional data lines). The remaining lines provide multi-level (eight) interrupt lines, various control lines and a multimaster, bus-arbitration control structure (Fig. 2). Address and data lines are three-state, and the interrupt and control lines are open-collector.

Boards using the Multibus have a master-slave relationship: A bus master—such as an SBC 80 CPU board, a DMA controller or a diskette controller—can control the command and address lines. Conversely, slave boards—such as a memory, I/O-expansion or mathematics boards—cannot control the bus.

### Arbitration resolves priority disputes

In multimaster systems, the bus-arbitration logic uses the  $\overline{CLK}$  signal of the bus to provide a timing reference to help satisfy many simultaneous requests for bus control. As a result, different speed masters

can share resources on one bus. Actual transfers on the bus proceed asynchronously with respect to the bus clock. Once bus access is granted, single or multiple read/write transfers can proceed at up to 150 kbytes/s for CPU operations and up to 1 Mbyte/s for DMA operations. The bus has a bandwidth of 5 Mbytes/s so that future performance enhancements may be directly supported.

Both serial and parallel modes of bus-priority resolution are available. In the serial mode, up to three masters can share the system bus, with requests ordered on the basis of bus location. Each master on the bus notifies the next one down in priority when it needs to use the bus, and monitors the bus-request status of the closest higher-priority master. With an external priority network, up to 16 masters can share the bus.

The dual-bus nature of the Multibus permits each processor-based master within the system to retain its own local memory and I/O, which it uses for most operations. Such local operations occur entirely on the individual board and don't require the system bus.

In contrast to the dual bus architecture, all masters

**Table 1. Comparison of SBC-80 CPUs**

	SBC 80/04	SBC 80/05	SBC 80/10A	SBC 80/20	SBC 80/20-4
CPU	8085	8085	8080A	8080A	8080A
EPROM capacity (bytes) (with 2716)	4096	4096	8192	8192	8192
(with 2708)	2048	2048	4096	4096	4096
RAM (bytes)	256	512	1024	2048	4096
Programmable parallel I/O lines	22	22	48	48	48
Serial I/O capability	RS232C SID/SOD <sup>1, 2</sup>	RS232C SID/SOD <sup>1, 2</sup>	RS232C/TTY USART	RS232C <sup>2</sup> USART	RS232C <sup>2</sup> USART
Timers	1	1	0	2	2
Interrupt levels	4	4	1	8	8
Multibus interface	None	Multi-master	Single-master	Multi-master	Multi-master
Price (unit quantity)	\$195	\$350	\$495	\$735	\$825

Notes: <sup>1</sup>Provided by 8085 CPU SID and SOD serial I/O lines. <sup>2</sup>Optional SBC 530 TTY interface is available.

**Table 2. Additional SBC support boards**

Function	Model	Description	Price (unit qty)
RAM	SBC 016	16 kbyte dynamic RAM	\$ 825
	SBC 032	32 kbyte dynamic RAM	\$1360
	SBC 048	48 kbyte dynamic RAM	\$1860
	SBC 064	64 kbyte dynamic RAM	\$2200
	SBC 094*	4 kbyte CMOS static RAM with 96 hour battery backup.	\$ 795
EPROM	SBC 416	16 kbytes using 2708 type (1024 x 8) EPROM	\$ 295
Digital I/O	SBC 508*	32 input lines/32 output lines, all buffered/terminated	\$ 350
	SBC 517	48 programmable parallel lines with full buffering/termination options, full RS232C port, 1 ms real-time clock, and 8-line interrupt control	\$ 400
	SBC 519*	72 programmable parallel lines with full buffering/termination options, real-time clock (interval is jumper selectable to 0.5, 1, 2, or 4 ms), and 8-level programmable interrupt control.	\$ 395
Communications	SBC 534	Four programmable synchronous/asynchronous serial ports, each with: programmable baud rates, programmable data formats, programmable interrupt control, 16 RS232C buffered programmable parallel I/O lines configured as a Bell Model 801 automatic calling unit interface. Two programmable 16-bit interval timers (usable as real-time clocks), and software selectable loopback of serial ports for diagnostic use.	\$ 650
	SBC 556*	48 optically isolated lines; 24 input 16 output, and 8 programmable (in/out), 8-level programmable interrupt control, and 1 ms real-time clock.	\$ 395
Analog I/O	SBC 711*	16/8 (single-ended/differential) 12-bit a/d channels; user expandable on-board to 32/16 channels	\$ 895
	SBC 724*	Four 12-bit d/a channels	\$ 750
	SBC 732*	Combination analog I/O; same a/d capability as SBC 711 plus 2 d/a channels	\$1125
Combination memory and I/O	SBC 104	8 kbytes capacity (sockets) using 2716 (2 k x 8) EPROM or 4 k using 2708, 4 kbytes dynamic RAM, 48 programmable parallel I/O lines, with full buffering/termination, as options. RS-232C port, a 1 ms real-time clock, and an eight-line interrupt control	\$ 715

in multimaster/single-bus systems use the common bus for all instruction or data fetches or whenever data must be written to output devices or memory. Rapidly, then, the system bus becomes the bottleneck for over-all system throughput. Masters in SBC-80 systems only use the Multibus when data or instructions are resident in common, or global, memory or I/O. Since masters can request the Multibus simultaneously, on-board arbitration logic resolves any multiple contention.

**Examine board performance**

A look at the entire family of SBC-80 microcomputers reveals varied levels of performance. All five boards are inexpensive, but the most inexpensive is the 80/04, which costs \$99 in 100-unit quantities, and is intended for stand-alone applications. To get the cost down, the board was designed to use the 8085 CPU and the 8155 RAM, timer and I/O circuit.

The 80/04 contains an 8085 CPU, 256 bytes of RAM, space for up to 4 kbytes of EPROM (two 2716 EPROMs, or four 2708 EPROMs), 22 programmable parallel I/O lines with sockets for buffer and termination options, a 14-bit programmable timer/event counter, and provision for an RS-232-C serial port using the 8085 SID/SOD serial interface. The board can also house an on-board +5-V regulator, so an unregulated voltage can be connected.

The next step up, the 80/05, has the same architecture and connector types and pinouts as the 80/04. Direct software compatibility is achieved with the same CPU along with the same RAM, ROM, I/O, and timer addressing. However, the 80/05 contains twice as much RAM as the 80/04. And since the 80/05 has the full Multibus multimaster interface, 80/05-based systems can be expanded with any of the Multibus-compatible boards from Intel or other suppliers.

The SBC-80/10A comes next. It provides more on-board memory and I/O for systems requiring expanded on-board resources. Based on the 8080A CPU, the board contains 1 kbyte of RAM, up to 8 kbytes of EPROM/ROM, 48 programmable parallel I/O lines, a full USART serial port with RS-232-C and tele-

	SBC 108	Same as SBC 104, except has 8 kbytes of dynamic RAM	\$ 815
	SBC 116	Same as SBC 104, except has 16 kbytes of dynamic RAM	\$ 985
High-speed math	SBC 310*	High speed mathematics processor including floating-point capability (32 bit).	\$ 595
Peripheral control	SBC 201	Dual single-density diskette controller	\$ 995
	SBC 202	Quad double-density diskette controller	\$1290
DMA control	SBC 501	DMA controller, up to 1 MHz transfer rates	\$ 450

\*Requires +5 V only.

typewriter interfaces, and a full Multibus interface (but only single-master capability; the board has no multimaster capability). Intended for single-CPU systems with only one other Multibus peripheral controller, the 80/10A can interface with such as the SBC-201 or SBC-202 single and double-density diskette controllers, or the SBC-501 DMA controller.

System designers requiring the same on-board I/O capability as the SBC-80/10A but with more RAM, more efficient real-time capability, and full multimaster Multibus control can go further up the ladder to the SBC-80/20 or SBC-80/20-4. These boards differ only in that the 80/20 contains 2 kbytes of RAM and the 80/20-4 contains 4 kbytes. Both boards can hold up to 8192 bytes of ROM (21) or EPROM, handle up

to eight levels of prioritized interrupt, and share the Multibus in the multimaster mode. Either board has two programmable interval timers/event counters. Auxiliary power buses and memory-protect control logic on the board permit battery backup of the RAM.

### Take advantage of interrupts and timers

Real-time applications frequently require that high-priority programs operate on the basis of external events, time-of-day, or elapsed time without impacting current background processing. These multi-programming requirements are supported in the 80/20 and 80/20-4 by an eight-level programmable interrupt controller (PIC) and two programmable interval timer/event counters. The priority level of any event generating an interrupt request is assigned through jumper selection and the priority algorithm chosen by system software.

Any combination of interrupt levels may be masked by storing a single byte in the interrupt-mask register contained by the PIC, whose four software-selectable priority algorithms are described in Table 5. The PIC generates a unique memory address for each interrupt level. These addresses are equally spaced at intervals of 4 or 8 bytes (software-selectable). The resulting 32 or 64-byte block may begin at any 32 or 64-byte boundary in the 65,536-byte memory space. A single 8080A jump instruction at each of these addresses then provides linkage to locate each interrupt service routine independently anywhere in memory.

The two programmable timers may be used to generate real-time clocks by requesting periodic interrupts through the PIC, so that the CPU is free to handle numerous other system-timing and control functions. The outputs and gate/trigger inputs of the timer/counters can be routed via jumpers to the PIC, the I/O driver/terminators, or the programmable parallel I/O.

Seven software-selectable timing/counting functions are available. Either timer may be set to act as a rate generator (divide-by-N counter), a square-wave

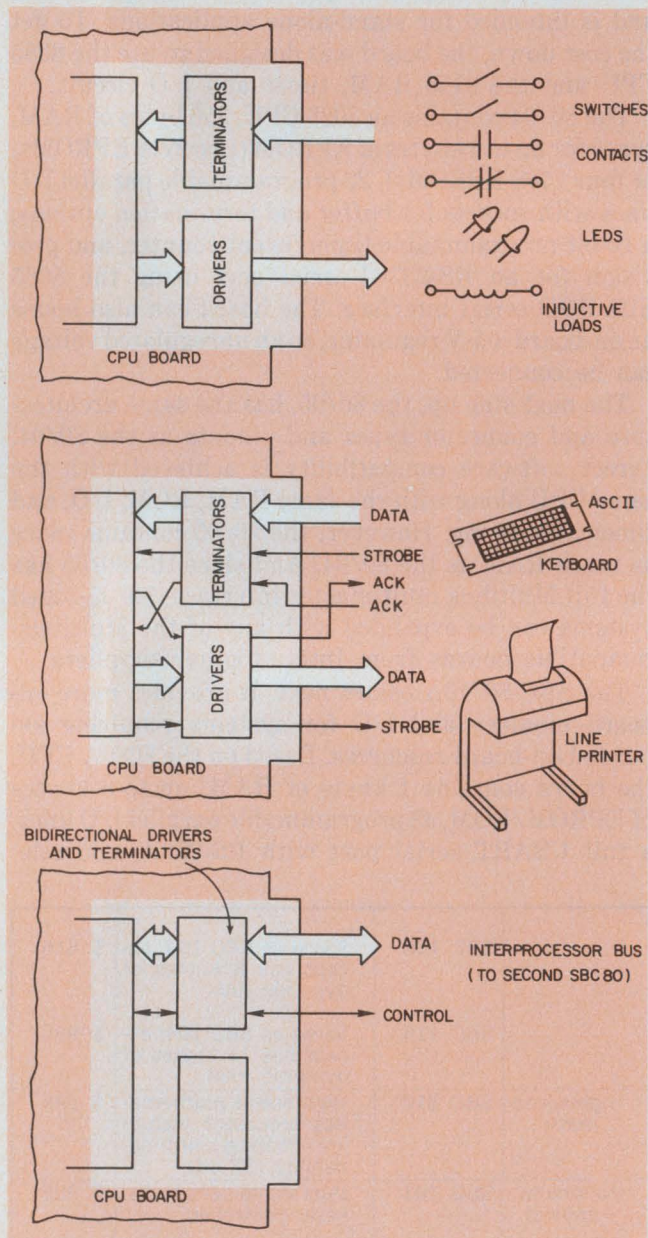

3. Programmable I/O lines from the SBC-80 parallel interfaces can be set so that they are individually programmable as inputs or outputs (a), byte-programmable as inputs or outputs with handshaking (b), or bidirectional on a byte-programmable basis (c).

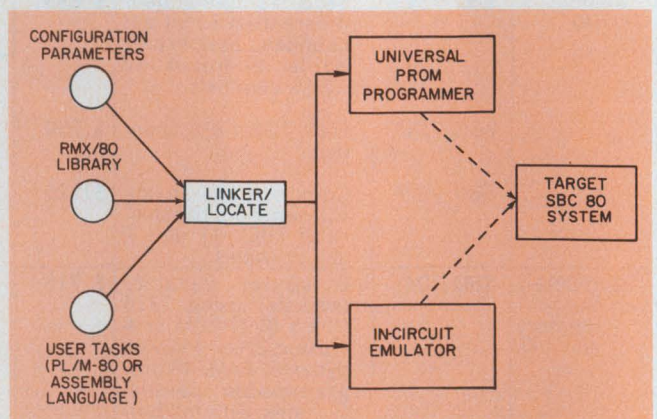

4. By using the RMX-80 executive and the library of often-used subroutines, program development can be simplified since the subroutines are modular and can be linked together, then checked out in a system prototype.



### Table 3. Non-Intel SBC-compatible boards

Manufacturer	Multibus CPU boards	RAM boards	Core memory boards	PROM/ROM boards	Analog boards	AC power control boards	IEEE-488 bus	Tape interface	Floppy-disc controller	Communications interface	Video boards	Math processors	Breadboards	Circle no.
ADAC Corp., 118 Cummings Park, Woburn, MA 01801. (617) 935-6668					•									451
Ampex, Memory Products Div., 200 N. Nash St., El Segundo, CA 90245. (213) 640-0150			•											452
Analog Devices, Route 1 Industrial Park, P.O. Box 280, Norwood, MA 02062. (617) 329-4700					•									453
Augat Inc., 33 Perry Ave., P.O. Box 779, Attleboro, MA 02703. (617) 222-2202													•	454
Burr-Brown, International Airport Industrial Park, P.O. Box 11400, Tucson, AZ 85734. (602) 294-1431					•									455
Cybernetic Microsystems, 2460 Embarcadero Way, Palo Alto, CA 94303. (415) 321-0410					•							•		456
Data Translation Inc., 23 Strathmore Road, Natick, MA 01760. (617) 655-5300					•									457
Datacube Corp., 25 Industrial Park, Chelmsford, MA 01824. (617) 256-2555											•			458
Datel Systems Inc., 1020 Turnpike St., Building S., Canton, MA 02021. (617) 828-8000					•									459
Digidata Corp., 8580 Dorsey Run Road, Jessup, MD 20794. (301) 498-0200							•							460
EDAC Corp., 1417 San Antonio Ave., Alameda, CA 94501. (415) 521-6600											•			461
Electronic Engineering & Prod. Services, TE. #2, Louisville, TN 37777. (615) 984-9640						•								462
Electronic Solutions, 7969 Engineer Rd., San Diego, CA 92111. (714) 292-0242	•	•		•										463
Garry Mfg. Co., 1010 Jersey Ave., New Brunswick, NJ 08902. (201) 545-2424													•	464
Hal Communications Corp., Box 365B, 807 E. Green St., Urbana, IL 61801. (217) 367-7373											•			465
Iasis, 815 W. Maude Ave., Sunnyvale, CA 94086. (408) 732-5700	•													466
ICOM, 6741 Variel Ave., Canoga Park, CA 91303. (213) 348-1391									•					467
Megalogic Corp., 9650 National Road, Brookville, OH 45309. (513) 833-5222								•						468
Micro Memories Inc., 9438 Irondale Ave., Chatsworth, CA 91311. (213) 998-0700			•											469
Microtec, P.O. Box 60337, Sunnyvale, CA 94088. (408) 733-2919				•										470
Monolithic Systems Inc., 14 Inverness Drive, East, Englewood, CA 80110. (303) 770-7400	•	•												471
National Semiconductor, 2900 Semiconductor Drive, Santa Clara, CA 95051. (408) 737-5000	•													472
North Star Computers Inc., 2465 Fourth St., Berkeley, CA 94710. (415) 549-0858												•		473
The Thomas Engineering Co., 1201 Park Ave., Emeryville, CA 94608. (415) 547-5860										•				474
Vector Electronic Products, 12460 Gladstone Ave., Sylmar, CA 91342. (213) 365-9661													•	475
Zia Tech., 10762 La Roda Drive, Cupertino, CA 95015. (408) 996-7082							•							476

generator, a programmable retriggerable one-shot, or software or hardware-triggered strobe. One of the timers can be jumper-selected as an event counter, and either can generate an interrupt after a specified interval or after a specified number of events.

The programmability of each on-board timer allows timing intervals from approximately 2  $\mu$ s to over 60 ms. But the two timers may be cascaded to provide intervals greater than 1.1 hour, in 1.86  $\mu$ s increments. In the event counter mode, external event rates up to 1.1 MHz may be counted.

### Flexible I/O, a must for any system

All SBC-80 microcomputers provide 22 or 48 programmable parallel I/O lines that, grouped as 8-bit ports, are fully programmable to allow enough flexibility to handle any changes in system interfacing. Programmability is permitted through data direction, control mode, interrupt handling, and buffer/termination. The I/O configuration for a specific application is selected through software initialization of the parallel I/O control logic, jumper selection of control/interrupt line routing, and the particular buffer and termination devices chosen.

Fig. 3 illustrates the basic modes of operation that may be selected by software to meet application requirements. Mode 0 is used for slow-to-medium-speed interfacing where immediate handshake response or interrupt generation is not needed. This mode is extremely useful for interfacing to inputs such as switches or outputs such as LED indicators or numeric displays.

Mode 1 provides handshaking lines required for many medium to high-speed peripherals. A typical output function could be a line printer; an input device could be an encoded keyboard or paper tape reader.

In addition, the 80/10A and 80/20 have Mode 2, a bidirectional data/control structure. This interface may provide, for example, a communication link between parallel processors.

The SBC-80 I/O structure also permits multiple options for output buffering and input termination. TTL drivers with 16 to 48 mA of drive can be used, and input lines may be terminated to minimize the impact of noise and cable disconnects. Any of the TTL drivers (four outputs) or input terminators (for inputs) listed in Table 6 may be inserted into sockets to provide proper buffering or termination.

Like the design flexibility of the SBC-80 parallel I/O structure, the serial I/O structure allows interface characteristics to be revised rapidly through software, jumper, and buffer changes. Besides the SBC-80/10A, the 80/20 and 80/20-4 contain the USART serial channel. These boards provide RS-232 interfaces, but the SBC-80/10A also has a teletypewriter current-loop interface. Synchronous/asynchronous mode, data format, control-character format, and parity are all under program control. So is baud rate on the 80/20 and 80/20-4. Baud rate is jumper-selectable on the

**Table 4. Multibus control signals**

$\overline{\text{ACK}}$	Advance-acknowledge signal, used in 8080A-based systems. It is sent to the SBC-80 board by a memory bank in response to a memory-read command, allowing the memory to complete the access without requiring the CPU to wait.
$\overline{\text{BCLK}}$	Bus clock, used to synchronize bus-control circuits on all master boards. It has a period of 101.725 ns (9.8304 MHz) and a 30 to 70% duty cycle. The signal may be slowed, stopped or single-stepped.
BPRN	Bus-priority-input signal, used to indicate to the master that a higher-priority master board wants to use the system bus. When brought high, the signal suspends processing activity and places line drivers of the master in a standby mode.
$\overline{\text{BUSY}}$	Bus-busy signal, a bidirectional control line that allows control and monitoring of the Multibus in multimaster systems. As an output from a bus master, $\overline{\text{BUSY}}$ indicates the bus is being used by the board. It prevents all other master boards from gaining control of the bus. Each master monitors $\overline{\text{BUSY}}$ as an input to determine current Multibus usage status.
$\overline{\text{CCLK}}$	Constant clock, used to provide a 9.8304-MHz clock signal for optional memory and I/O expansion boards. $\overline{\text{CCLK}}$ coincides with $\overline{\text{BCLK}}$ and has a period of 101.725 ns and a 30 to 70% duty cycle.
$\overline{\text{INIT}}$	Initialize signal, used to reset the entire system to a known internal state.
$\overline{\text{INTR1}}$	Interrupt input, used to interrupt the processor via an externally generated interrupt request.
$\overline{\text{IORC}}$	I/O-read command, a signal generated by the master to indicate that the address of an input port has been placed on the system-address bus and that the data at that input port are to be read and placed on the system-data bus.
$\overline{\text{IOWC}}$	I/O-write command, a signal generated by the master to indicate that the address of an output port has been placed on the system-address bus and that the contents of the system-data bus are to be output to the addressed port.
$\overline{\text{MRDC}}$	Memory-read command, a signal generated by the master that indicates that the address of a memory location has been placed on the system-address bus. It specifies that the contents of the addressed location are to be read and placed on the system-data bus.
$\overline{\text{MWTC}}$	Memory-write command, a signal generated by the master to indicate that the address of a memory location has been placed on the system-address bus. It causes information on the data bus to be written into the addressed memory location.
$\overline{\text{XACK}}$	Transfer-acknowledge signal, an input signal to the master board from an external memory location or I/O port to indicate that a specified read or write operation has been completed.

80/10A CPU board.

The synchronous and asynchronous nature of the serial interface makes it compatible with virtually every standard serial data-transmission technique used today (including IBM's Bi-Sync). This allows multiple SBC-80 boards to be interconnected as a distributed-processing network. The resulting task segregation or redundancy (or both) significantly improves both system performance and reliability.

Two jumper-selectable interrupt requests may be generated automatically by the serial interface. One occurs when a newly received character is ready to be loaded into the CPU (receive-channel buffer is full). The other occurs when new data are ready to be transmitted to the remote device (transmit-data buffer is empty).

Both the SBC-80/04 and 80/05 provide serial I/O capability through the serial input data (SID) and serial output data (SOD) functions of the 8085 CPU. These functions are controlled by software executing the 8085 read-interrupt mask (RIM) and set-interrupt mask (SIM) instructions.

For systems requiring many serial channels, the SBC-534 communications-expansion board provides four USART channels with RS-232-C and optically isolated current-loop interfaces, programmable interrupt, timing, baud-rate control, and a Bell 801 Auto-Call unit interface.

### Expand the system via the Multibus

The SBC-80 family is gaining not only in popularity but in support for its Multibus as more and more companies offer SBC-compatible boards. Intel now provides high-speed mathematics, RAM, EPROM, mass storage, digital I/O, combination memory and I/O, serial communications, and analog-I/O expansion boards.

For applications requiring fast, high-precision number crunching, the SBC-310 math unit acts as an intelligent slave to perform floating-point and fixed-point mathematics. A processor uses the 310 by passing parameters to it along with a command byte to select the desired operation from the SBC-310's 14 instructions. The repertoire includes 32-bit floating-point (single-precision) addition, subtraction, multiplication, division, squaring, square root, comparisons, and tests; 16-bit fixed-point multiply, subtract, extended divide, and extended compare; and conversion from fixed to floating point or vice versa.

A completed operation may be signaled either by the math unit via an interrupt or by the host processor's polling the "operation complete" flag in the unit's status register. The result may be retrieved at this point or left in the 310's accumulator for further use.

In addition, the 310 provides control circuitry so that it may be treated as a "shared resource" among several CPU boards.

Two diskette options are available for mass storage.

**Table 5. Programmable interrupt modes, SBC-80/20-4**

Mode	Operation
Fully nested	Interrupt request line priorities fixed at 0 as highest, 7 as lowest.
Autorotating	Equal priority. Each level, after receiving service, becomes the lowest priority level until next interrupt occurs.
Specific priority	System software assigns lowest priority level. Priority of all other levels based in sequence on this assignment.
Polled	System software examines priority-encoded system interrupt status via interrupt status register.

**Table 6. Line drivers and terminators**

Line drivers		
Driver	Characteristic	Sink current (mA)
7438	I,OC	48
7437	I	48
7432	NI	16
7426	I,OC	16
7409	NI,OC	16
7408	NI	16
7403	I,OC	16
7400	I	16

Note: I = inverting; NI = noninverting; OC = open collector

The SBC-201 diskette controller provides full control for one or two single-density diskette drives and acts as a programmable slave to masters on the Multibus. All diskette information is stored in the IBM soft-sectored format. For systems requiring greater storage capacity, the SBC-202 provides full control for up to four double-density diskette drives. Thus, 2 Mbytes of mass storage may be added to SBC-80-based systems for each SBC-202 plugged into the bus.

Digital I/O may be expanded using any of three Intel boards. The SBC-519 provides 72 programmable parallel I/O lines as well as interrupt handling and a real-time clock.

The 519's clock can interrupt the appropriate CPU periodically so that the CPU can monitor system-I/O status. High-speed I/O events can gain the CPU's attention via interrupts. The SBC-517 combination I/O board and the SBC-104, 108 and 116 combination memory and I/O boards offer 48 programmable parallel lines, a full RS-232 USART serial channel, interrupt handling and a 16-ms real-time clock. The

## Table 7. RMX-80 routine library

RMX/80 module	Function
Nucleus (executive)	Provides basic capabilities (concurrency, priority, and synchronization/communication) found in all real-time systems.
Terminal handler	Provides real-time asynchronous I/O between an operator's terminal and tasks running under the RMX/80 executive, includes a line-edit feature similar to that of ISIS-II (supervisory system on the Intellec development system) and type-ahead facility.
Diskette file systems	Diskette driver and file management capabilities, allows user to load tasks into the system and to create, access, and delete files in a real-time environment without disrupting normal processing. File formats compatible with ISIS-II for both single and double-density systems.
Free space manager	Maintains a pool of free RAM and allocates memory out of the pool upon request from a task; reclaims memory areas when no longer needed.
Debugger	Specifically designed for debugging software running under the RMX/80 executive; used by linking it to an application program or task. Thus, it can be run directly from the single-board computer's memory.
Math handler	Provides full control and communication for SBC 310 math board for high-speed fixed and floating-point math functions.
Analog interface handler	Provides real-time control for SBC 711, 724, and 732 analog I/O expansion boards.

104, 108 and 116 also hold up to 8 kbytes of EPROM, along with 4, 8 or 16 kbytes of RAM, respectively.

For systems geared to especially noisy environments, the SBC-556 provides 48 optically isolated I/O lines, which are configured as 24 input lines, 16 output lines, and eight programmable-I/O lines. The user fixes the optical-isolation characteristics according to his exact system requirements by installing the optoisolators and current-limiting resistors of his choice into the board sockets. Input voltages up to 48 V, output lines up to 30 V and currents up to 60 mA may be interfaced.

Of course, many more RAM, ROM, communications and interface options are available. But for systems to come together quickly during development, there must be some standardized operating software to provide some of the most fundamental system routines.

### System software: the glue that binds

Where the Multibus provides a standard hardware structure, RMX-80, a real-time multitasking executive supplies a modular software framework. With RMX-80, routines don't have to be developed for task synchronization, priority resolution and peripheral control (printers, terminals, diskettes, etc.). Versions

are available for the SBC-80/20, 80/20-4 and 80/10A CPU boards.

Critical projects can be completed rapidly because RMX-80 provides major portions of the software requirements for many real-time systems. For example, the diskette file-extension software of the RMX-80 program may be linked into the system software. Thus, users can immediately have a diskette file structure with facilities to open and close files, create and delete files, read or write files sequentially or randomly (read function may be used for initial program load, if desired), or allocate file storage dynamically on single or double-density diskettes.

The compactness of RMX-80—the entire executive resides in 2 kbytes of ROM—reduces memory requirements and eliminates the need for bootstrap-program loading. All RMX-80 operations are based on individual tasks. A task is a program with unique data and stack that operates asynchronously with other such programs in the system.

Basically, the RMX-80 is a library of "standard" routines (Table 7), such as an analog-interface handler and a terminal handler. Fig. 4 illustrates how to develop software by selecting appropriate RMX-80 modules, then locating and linking them with particular software tasks on an Intellec microcomputer development system. In addition, a debugger module

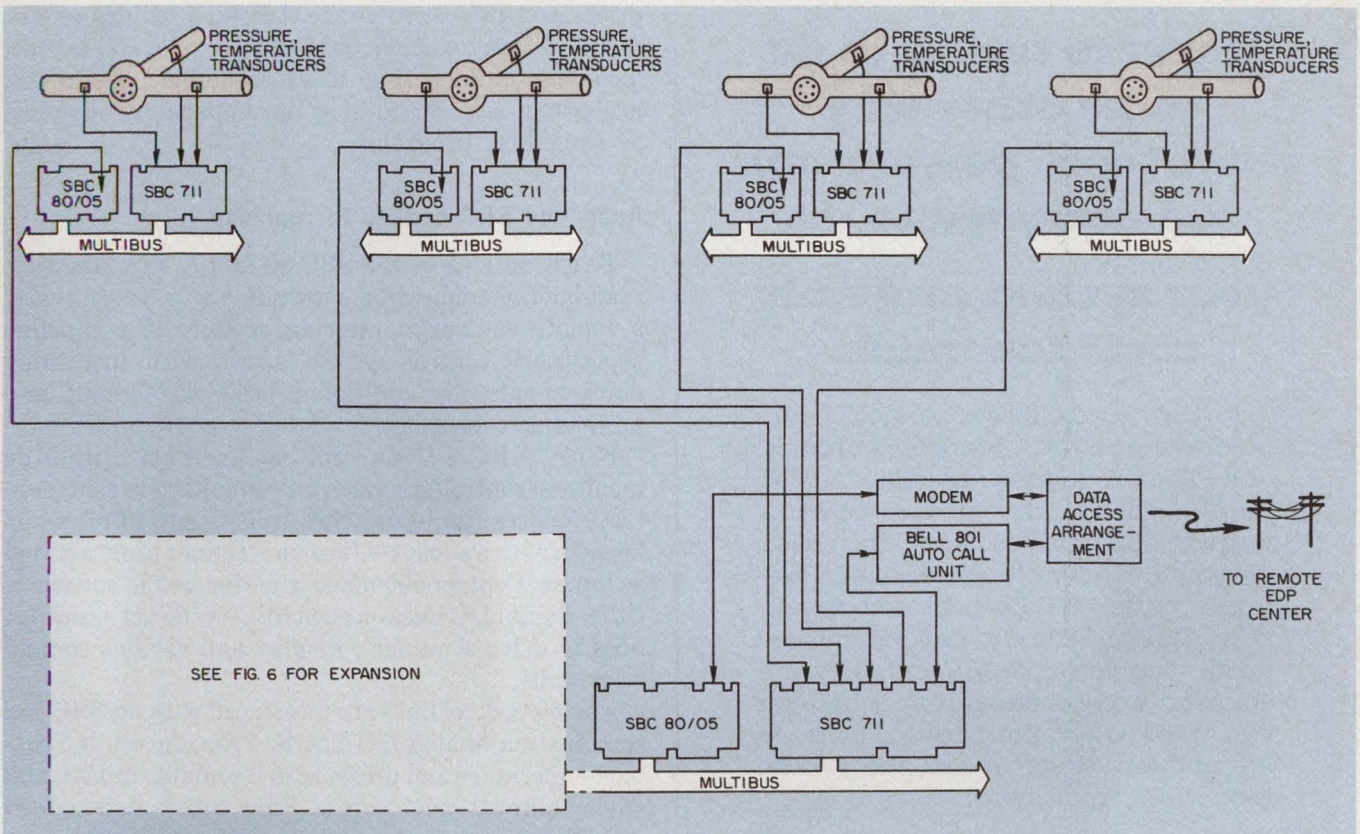

5. This possible SBC-80 system configuration uses four SBC-80/05s to monitor and control pipeline parameters

and feed data back to a master controller, an SBC-80/20-4. The master controller sends data back to a host system.

in the RMX-80 speeds real-time system development.

The executive accesses system resources according to task priority, intertask communication, interrupt-driven control for standard devices, real-time clock control, interrupt handling, and other optional functions. In all, there are 255 separate task-priority levels, and since multiple tasks may share the same level, the actual number of tasks is limited only by memory size.

### Develop programs with the Intellec

The Intellec and its ICE-80 and ICE-85 in-circuit emulators help minimize the time required to develop software and hardware. Standard Intellec stand-alone software includes resident macroassemblers for the 8080A and 8085 CPUs, a text editor, and a system monitor/debugger. As a result, programs can be assembled, loaded, edited, executed, and debugged. ICE diagnostics can significantly reduce program development and debug time. Break points may be set on user-specified memory-read or write operations, I/O read or write operations, or user-defined extension parameters. Programs can be single-stepped to check operating conditions and performance.

PL/M-80 is the high-level systems-programming language. The optional Intellec-resident PL/M compiler provides the ability to program in this natural, algorithmic language, so there is no need to manage register usage or to allocate memory. PL/M programs

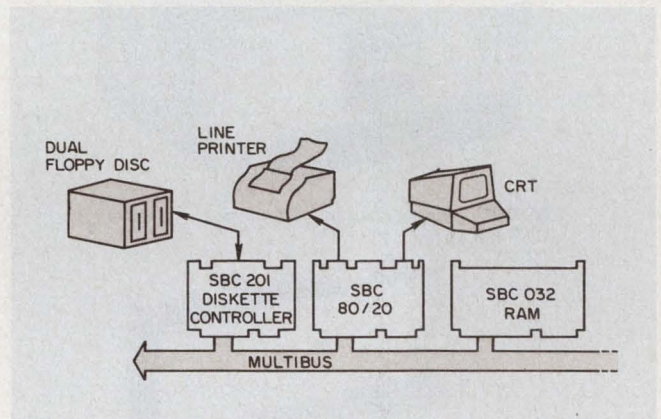

6. Expanding the pipeline monitor/controller system is as simple as plugging more cards into the Multibus and altering the software. By adding another SBC-80/20 to the master controller, some local processing can be done and a local CRT and high-speed printer can be added as well as RAM and diskette-memory space.

may be linked to assembly-language programs to hasten product development further.

A relocatable macroassembler residing on the Intellec translates symbolic assembly language into 8080 or 8085 machine code and permits the use of relocatable and linkable object code. With full macro capability, similar sections of code needn't be written over and over.

Intellec options include a diskette operating system, ISIS-II, with diskette controller, single or dual diskette

**If you're trying to do  
— some other way —  
what these power amps  
are designed to do,  
your system probably  
costs too much.**

In the DC to 30KHz range, Crown power amps are practically unbeatable. They're rugged, reliable, and can handle almost any load — right or wrong. Their performance has been proven in many different kinds of systems, under wildly different conditions. Designed for 19" rack mount and quick, simple hook-up. And they are almost always cheaper than whatever you think is an alternative. For more information, write or call the Crown Industrial department.

**The Better Way Amps**



**M-600** Single-channel, 750 watts into 8 ohms, 1000 watts into 4 ohms.

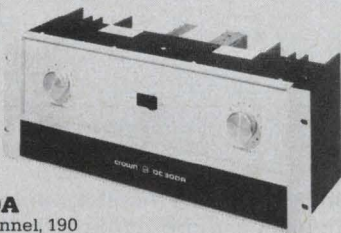

**DC-300A**  
Two-channel, 190 watts/ch into 8 ohms, 340 watts/ch into 4 ohms, (switch convertible to single-channel, 650 watts into 8 ohms).



**D-150A**  
Two-channel, 75 watts/ch into 8 ohms, (switch convertible to single channel, 250 watts into 8 ohms).



1718 Mishawaka Rd., Elkhart, Indiana 46514 • 219/294-5571

CIRCLE NUMBER 35

drives and ISIS-II software. ISIS-II provides all the facilities for producing and handling relocatable code, including a relocating macroassembler, relocating loader and a linker to help link separately compiled or assembled programs.

**Apply the SBC boards to real use**

To get an idea of the SBC 80 family's capabilities, examine the application shown in Fig. 5. In this case, a remote control/monitoring section of a pipeline supervisory control system grows with increasing requirements for additional local throughput and processing capability.

Four SBC-80/05s act as remote pipeline monitors/controllers. Each unit monitors various contact closures (limit switches, relays, etc.) and a hex keypad, with a subset of its own I/O lines programmed as inputs. Contact debounce is performed in software. Other digital I/O lines on each SBC-80/05 act as output lines to drive a numeric display and various control relay coils.

Analog-control lines are interfaced with an SBC-732 combination analog-I/O board. Transducers indicating temperature and pressure drive analog inputs, and analog outputs drive valves. Flow rate is determined in software by manipulating differential pressure data available from pressure transducers.

The four 80/05s are linked serially to a remote SBC-80/20-4-based data concentrator. An SBC-534 communications expansion board provides four RS-232-C serial channels, each interfacing directly with one of the four 80/05-based pipeline monitor/controllers. The 80/20-4 periodically queries each monitor to determine its current status. The concentrator also relays control commands from a host computer controlling the entire pipeline. The 80/20-4's own RS-232-C serial channel provides the interface for this high-speed synchronous link to the host CPU.

The 80/20-4 can contact the host CPU with the Bell 801 automatic calling-unit interface on the SBC-534. The synchronization and control of communication between the four 80/05s and the host are handled by RMX-80 on the 80/20-4.

The 80/20-4 system can be expanded to provide local processing capability, as shown in Fig. 6. Here, another 80/20-4 is added as a second master on the Multibus to provide control for a local CRT and high-speed printer, and to provide local processing capability.

An additional 32 kbytes of RAM are furnished by an SBC-032 RAM-expansion board. A third master, an SBC-202 dual-density diskette controller, can also be added to the Multibus, along with two double-density diskette drives. Communication between the two 80/20s is handled via user-written intermaster message tasks.■

*Note: Multibus, RMX-80 and Inteltec are registered trademarks of Intel Corp.*

CIRCLE NUMBER 36 ►

# Introducing

## HP's first general-purpose Logic State Analyzer designed for both controllable production testing and field service...and it's low cost.

Until now, production line testing of digital equipment has meant complex test gear, large sums for computerized equipment or time-consuming manual checks . . . perhaps all three. In the field, it's been traditional test gear without the measurement capabilities of logic state analyzers.

Now, with the low-cost 1602A, HP offers a general-purpose, Logic State Analyzer that's easy to use in a number of plant or field applications. Manufacturing can use it in automatic functional test systems or in board-level and incoming inspection testing. And its ease of use, light weight and portability makes it a natural for field service applications, too.

For manual production line testing and for field service troubleshooting, the 1602A keyboard lets you define testing and display parameters with just a few keystrokes. The LED display then lets you compare line or bus activity with test specifications.

For automatic systems, an HP-IB\*\* option lets you do setups and evaluation using a computing controller. When used with HP's 9830A or 9825A controllers, programming is simple. An operator just presses a few special-function keys, and the HP-IB's "Learn Mode" does the rest.

Edge-connector probes speed setup. When test points are built into your system's boards or board extenders, the probes are simply plugged in. Time-consuming and error-prone probe connections can be eliminated.

This instrument minimizes chances of error two ways: Extensive messages tell the operator that the 1602A is being used properly. And internal diagnostics verify proper operation.



\* Domestic U.S.A. price only.  
\*\* HP's implementation of IEEE Standard 488-1975.

HEWLETT  PACKARD

1507 Page Mill Road, Palo Alto, California 94304

For assistance call: Washington (301) 948-6370, Chicago (312) 255-9800, Atlanta (404) 955-1500, Los Angeles (213) 877-1282

067/12

Dense, it is.

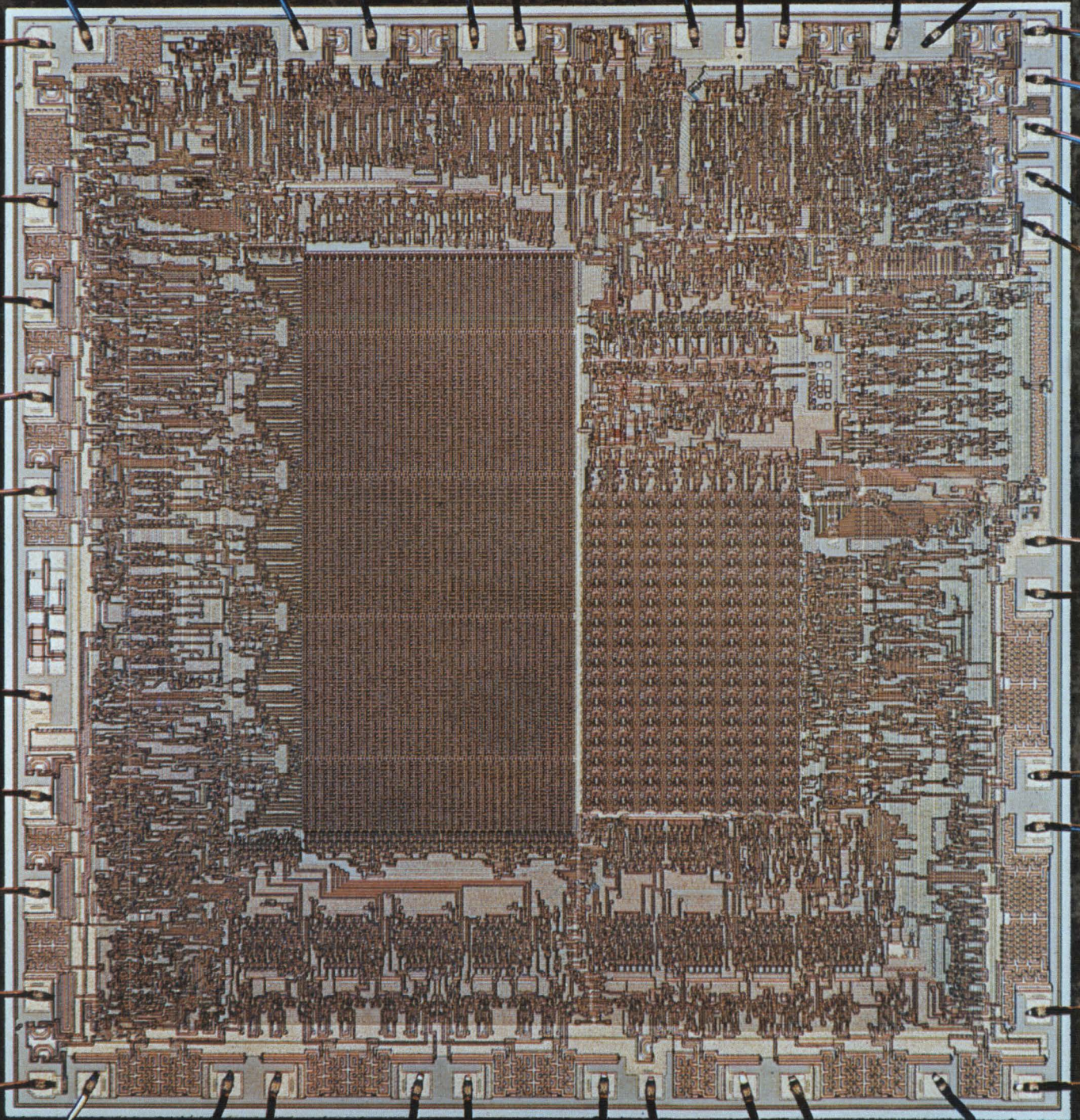



# Dumb, it ain't.

Our new S2000 microcomputer contains more than 13,000 transistors on a chip less than .2" square. It was designed specifically to run appliances. Yet it's flexible enough for all kinds of products now dependent on electromechanical controls.

The S2000 is an entire microcomputer on a single chip, with expandable program ROM and versatile I/O. So you can implement or enhance your control schemes quickly and easily.

It's an amazingly efficient circuit, too. All 51 instructions in its powerful software set occupy just one ROM byte apiece. All but two execute in four microseconds, a single machine cycle. And this fast NMOS device can operate from one power supply.

For less than \$5 each in quantity, each S2000 contains:

1. The CPU, including Control Unit, Arithmetic Logic Unit, Registers and Program Counter.
2. 1Kx8 ROM (externally readable and expandable to 8Kx8).
3. 256-bit RAM.
4. 29 I/O lines.
5. 7-segment display (normal or inverted) decoder and LED drivers.
6. Triac drive capability.
7. Line frequency (50/60 Hz) timer.
8. TouchControl capacitive switch interface.
9. Three-level subroutine stack and two flags.
10. Power-on reset and clock oscillator.

Soon, other S2000 family microcomputers will have vacuum fluorescent display drivers and on-chip 2K ROMs. In addition, AMI welcomes modifications to the S2000 to meet your particular I/O requirements, making your system even more cost effective.

Our Microcomputer Development Center (MDC) contains a powerful array of hardware and software tools to get your product to the market fast. Its intelligent 6800 microprocessor system controls a CRT with a flexible text editor, a smart macro-assembler, and a built-in PROM burner.

The DEV-2000 Development Board lets you do hardware emulation and software debug at the same time. The SES-2000 Static Emulator Module plugs right into your prototype. Our Logic Analyzer gives you computer power to create your own diagnostic display layouts and formats. And we even have software that simulates the S2000 within the MDC.

What more could you ask, except for some Application Engineers to help you do a fast turnaround. We have those, too. Specialists in the S2000 are ready and waiting for your call at (408) 246-0330. Or simply write to AMI Marketing, 3800 Homestead Road, Santa Clara CA 95051. You'll be amazed how smart one dense little chip can be.

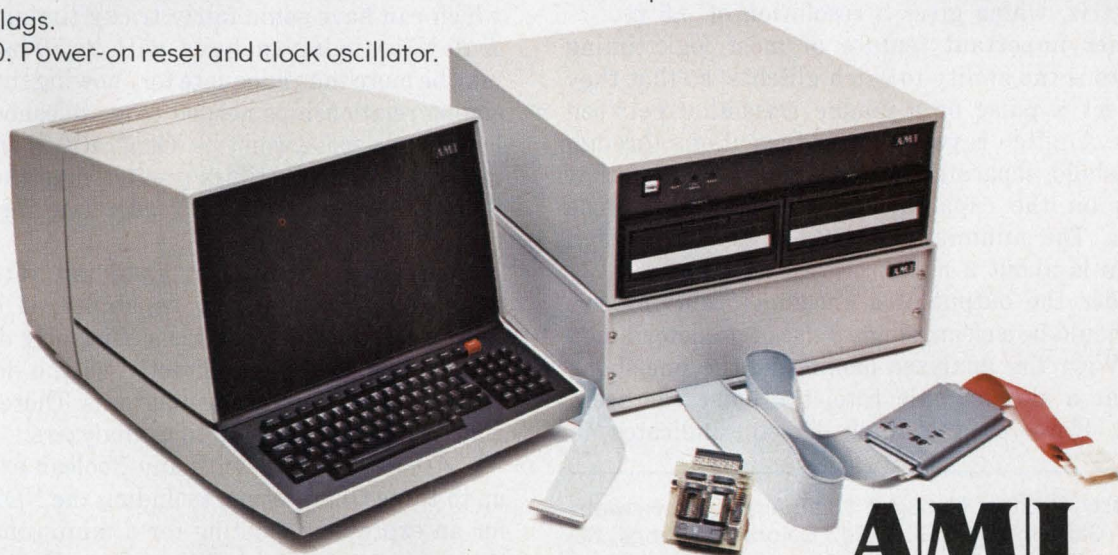

# Logic analyzers aren't all alike.

Learn the differences between state and timing instruments, and you'll end up with the right troubleshooting tool.

Don't choose a logic analyzer until you can determine if your application calls for a logic-timing or logic-state instrument. A timing analyzer primarily depicts multichannel, low-repetition-rate or single-shot timing events. A state analyzer is meant to record state sequences, which are often complex and require fairly sophisticated recognition techniques.

Don't assume right off that the state analyzer is by default a software instrument just because the timing type—in its quest to uncover glitches and race conditions—is generally considered a hardware tool. It's true that the state analyzer can depict software in execution. But calling it a software analyzer ignores the countless hardware phenomena that lead to the creation of false states. And a hardware designer may be misled into thinking that a state analyzer can't handle his problem, when quite often it can.

### Take a microcosmic view

With that in mind, look at how a timing analyzer works. Immediately, you see a variable-rate, internal reference clock generating a sampling sequence to read all channels simultaneously. The recorded data are the outputs of comparators that indicate whether the input lines are high or low relative to a threshold voltage at the clock edge.

The data are subsequently displayed on a CRT so that changes from low to high states appear as ideal waveform transitions (Fig. 1). Obviously, the more rapid the sampling rate, the better the resolution in time. Right now, the fastest available sampling rate is 200 MHz, which gives a resolution of  $\pm 5$  ns.

Another important feature of most logic-timing analyzers is the ability to catch glitches, so that they can detect a pulse or a double transition between samples. A glitch is two or more transitions through the threshold, separated by a minimum duration that depends on the capability of the particular logic analyzer. The minimum detectable width on glitch detectors is about 2 ns.

Consider the output of a one-shot multivibrator, which should be a clean, single pulse of predetermined width. With the analyzer looking at the one-shot's output at a slow sample rate, the pulses do seem uniform. However, the glitch detector indicates an

occasional second pulse, or glitch, on the pulse-trailing edge (Fig. 2a).

By specifying the glitch as the trigger condition, you can get a stable display. Expand the trailing edge of the pulse with higher sweep speeds, and you see the real problem—a double pulse (Fig. 2b). Connect probes to all of the monostable's inputs, and you'll see which of the inputs makes the monostable double-pulse.

### Rethinking resolution

Still, a timing analyzer has its critics, who point out that unless you are willing to spend a lot, the obtainable resolution doesn't begin to approach that of an average-priced scope. That's true for measuring two or four-channel repetitive events, but not for multichannel, single-shot events above chop frequencies; negative-time events (those prior to the trigger); and very narrow pulses relative to long periods—all of which a scope can't check nearly as easily, and some not at all.

Actually, a timing analyzer's strength is not fine-tuned timing resolution, but functional timing measurements. Suppose you'd like to display handshake sequences for memory or I/O data transfer. Or you'd like to examine a handshake sequence on the IEEE standard interface (Fig. 3). You'll be interested in the sequence in which lines toggle—not resolution to the nearest nanosecond on precise edges. The distinction may be subtle, but it can change your outlook toward the features needed in a timing analyzer.

Take a microprocessor-based, real-time controller, which can have some fairly tricky timing sequences. A 20-MHz timing analyzer, with its 50-ns resolution, may be more than adequate for showing the functional timing relationships needed to troubleshoot the problems. But a scope won't be. Generally, if the sampling rate is at least five times greater than the data rate, then resolution is probably adequate for functional timing measurements.

But more crucial than sampling rate in many applications is triggering capability. If data recognition (or nonrecognition) is sufficiently definitive, it often provides answers directly, so you don't have to study the recorded timing diagrams. There are several ways to trigger logic-timing analyzers:

- *Asynchronously*, with any Boolean expression of up to three ORed terms, including the NOT condition for an expression existing for a minimum selectable time (e.g.,  $A \cdot B \cdot C \cdot D$ ;  $A \cdot \bar{B} \cdot C + D + E$ ;  $A \cdot \bar{B} + \bar{A} \cdot B$ ).

---

**Bruce Farly**, Product Manager, Logic Analyzers, Hewlett-Packard, Garden of the Gods Rd., Colorado Springs, CO 80907.

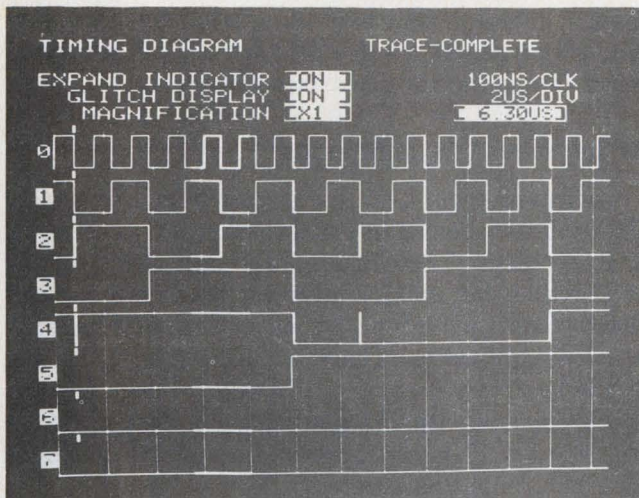

1. This timing-diagram display shows functional timing relationships. Double transitions of sufficient energy between samples, called glitches, are highlighted by brightened video. The recorded trigger point is indicated by a brightened vertical dashed line.

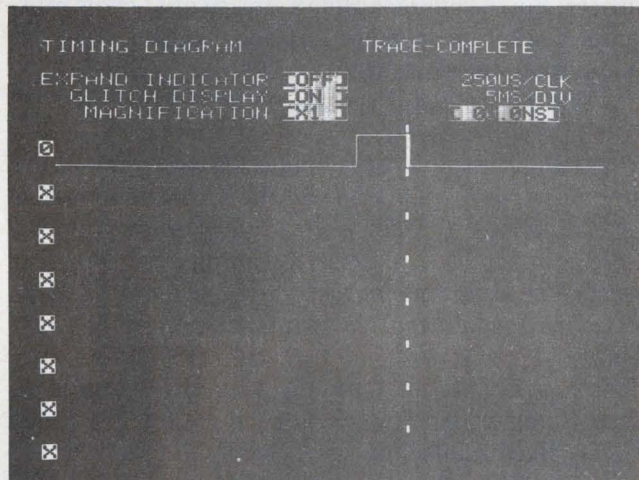

(a)

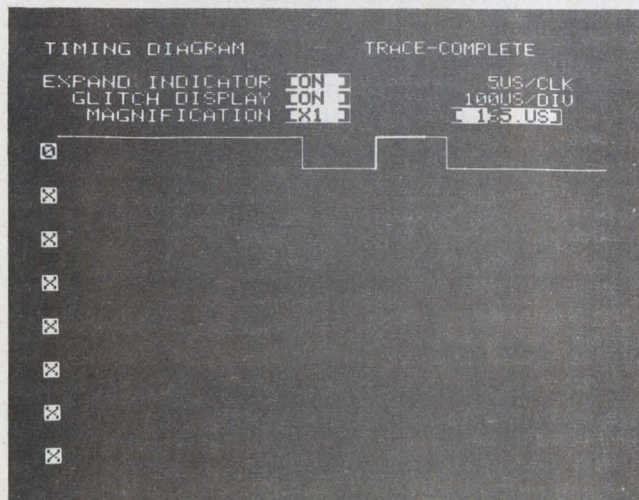

(b)

2. A 6-ms-wide output pulse of a one-shot multivibrator appears to have an occasional glitch on the trailing edge (a). Expanding the appropriate edge with faster sampling rates shows that the glitch is actually a double pulse (b).

- *Synchronously*, with an ANDed condition on the inputs of highs, lows and "don't cares," but only when the data are sampled. (This can be troublesome when the sample period is increased because the probability of sampling the desired trigger condition is reduced.)

- *On a glitch*, with a glitch on a given channel, between successive samples, and simultaneously with any allowed Boolean expression.

(Some analyzers can trigger on a latched, or pulse-stretched glitch, which obviously cannot be combined with a specified high or low condition on the same channel. Latched glitches, if adjacent to a normal data transition, may go undetected.)

- *Externally*, with an additional nondisplayed input that permits triggering from either an edge or level, depending on the instrument.

- *Delayed*, with a triggering hold-off until a digital delay is counted down or a specified time interval passes.

- *Armed*, with a two-condition sequential trigger in which any of the outlined triggering methods are possible once the arming signal is received.

Not all triggering methods are available on one logic analyzer. Let your application dictate triggering flexibility. The more precisely the instrument can home in on a problem, the less dependent it will be on large memories or high sample rates.

The most crucial features of a timing analyzer, therefore, are the maximum sample rate, hence, best resolution; the largest memory depth needed to record the longest time interval for a given sample rate; a glitch detector; and triggering capability. How does the logic-state analyzer differ? A look at a typical design cycle may clear things up (Fig. 4).

### How state analysis works

The graphic algorithmic process in the figure could represent the design cycle for a microprocessor or a minicomputer-based system, or even a ROM-based controller with no CPU, but with a simple automatic sequencer. "Algorithm," in fact, means a sequence of steps designed to perform a given task, for which hardware is to be designed and software written.

Quite often software and hardware are developed by separate design teams. They are distinctly different tasks. At any rate, the output of the hardware team, circuit boards of some kind, and the software output, object code, must come together sooner or later.

The final objective is to create a unique sequence of states resulting from the marriage, or the interaction, or the melding of software and hardware. However combined, they must act together.

When the sequence of states is wrong, be it from timing, glitches, noise, or software or algorithmic mistakes, there is a state-flow error, which shows up as an erroneous-state sequence. But how do you detect it? With an instrument that records logic states in the same way hardware responds to those states.

Often, the bulk of algorithmic-based hardware operates synchronously with a strobe signal—a master

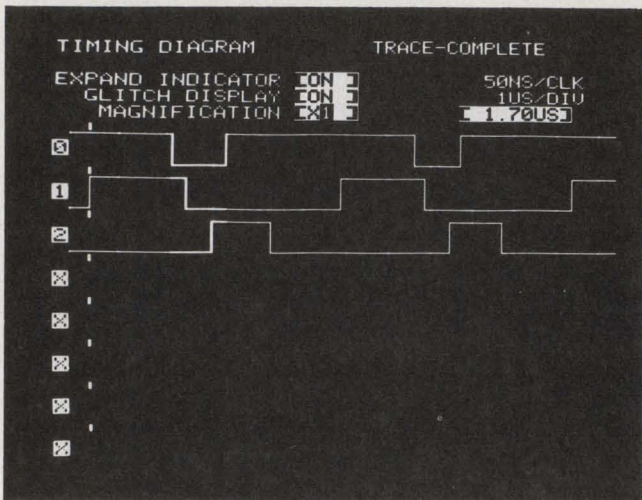

3. The IEEE 488 interface handshake sequence is grist for a timing analyzer. Channel 0 = DAV, channel 1 = NRFD, and channel 2 = NDAC.

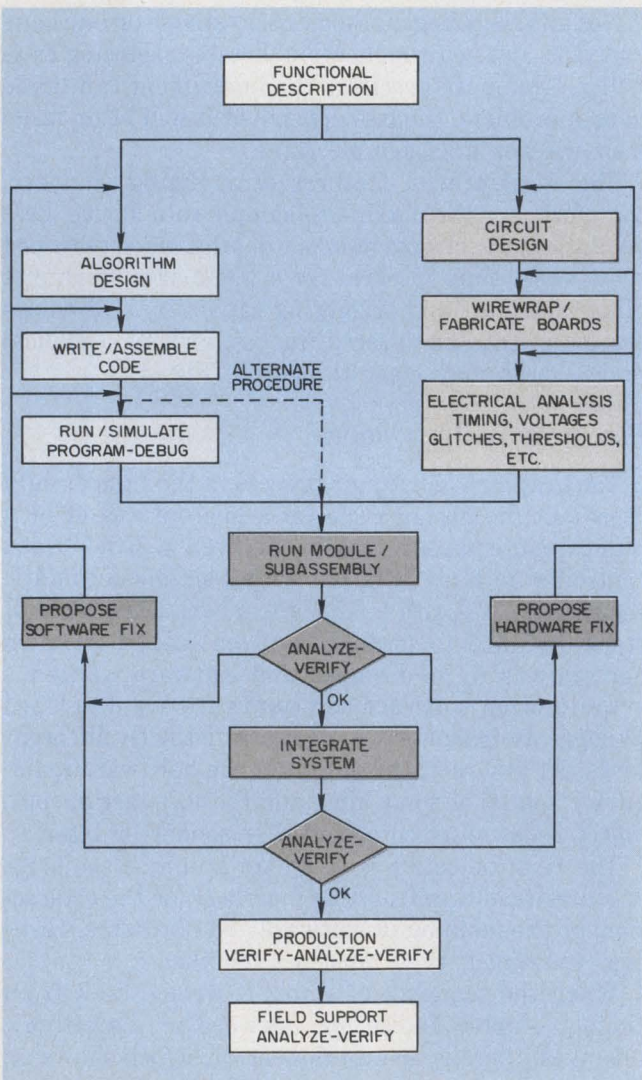

4. This generalized flow diagram depicts a typical design cycle. Note the separate tasks of writing software and building hardware, and the crucial junctions where the two jobs are systemized. Logic-state analysis is aimed at the resulting real-time hardware/software interaction.

clock, a subset of that master, or a handshake occurring only when data are valid. Whatever the strobe, when it toggles, the hardware responds.

### Synchronous? Asynchronous?

Obviously, then, a state analyzer must operate on the strobe—not on an internal clock signal as a timing analyzer does. This difference might lead you to believe that the timing analyzer is asynchronous and that the state analyzer is synchronous. That belief is an oversimplification. However, to read the same data as the hardware does, a state analyzer must operate synchronously with the system under test. In other words, it must read word parameters or state parameters, not timing parameters.

What's more, because a state analyzer reads data the way the hardware does, it should not require any hold time—that is, a period in which the data must remain stable after a strobe edge. That's because nearly all synchronous systems operate with D flip-flops, or their equivalent, which are edge-triggered devices. Furthermore, unlike a timing analyzer's maximum clock rate, a state analyzer's needn't be any faster than the data rate.

A typical problem for a state analyzer involves an 8-bit microprocessor with a 16-bit address field. The state sequences of address values are essential, as are the values on the data bus and the activity on the I/O ports. Obviously, then, a state analyzer requires a large number of channels. A timing unit wouldn't because to examine more than eight simultaneous waveforms would confuse rather than help the problem.

With state parameters, the multiple-channel information is boiled down into an appropriately coded display like hexadecimal, or even a reconstruction of the mnemonic code representing the data values (Fig. 5). Even though more than 32 channels of recorded data are displayed in the figure, there's no difficulty reading them.

To understand real-time tracing of state flow, consider the problem of monitoring microprocessor stack operations (Fig. 6). Here a state analyzer in its "trace-triggers" mode records successive stack pushes (writes) and pops (reads) as they occur in an 8080 system. Such measurements are easy to make with a state analyzer, and can help track down lost programs caused by stack overflows.

### What is selective trace?

A state analyzer can selectively trace data two ways. In a clock-qualification scheme, data are strobed in only if certain external qualifiers are true at the clock edge (valid memory address flag is true, a write pulse is present, etc.). Such capability is essential to deciphering data on a multiplexed bus. The other way is to qualify recorded data within the analyzer itself. A state analyzer should be able to do both.

Note that the "trace-triggers" mode records data

```

----- TRACE LIST ----- TRACE-COMPLETE -----
LABEL      A      D      E      F      STATE COUNT
BASE      HEX    HEX    BIN    OCT    DEC
SEQUENCE  29E4  96    1    177
START     0002  23    1    177    33
+01      0001  06    1    177    522
+02      0002  23    1    177    944
+03      0001  06    1    177    2302
+04      0002  23    1    177    31
+05      0001  06    1    177    522
+06      0002  23    1    177    944
+07      0001  06    1    177    2302
+08      0002  23    1    177    31
+09      0001  06    1    177    522
+10      0002  23    1    177    944
+11      0001  06    1    177    2302
+12      0002  23    1    177    31
+13      0001  06    1    177    522
+14      0002  23    1    177    944
+15      0001  06    1    177    2302
+16      0002  23    1    177    31
+17      0001  06    1    177    522
+18      0002  23    1    177    944

```

(a)

5. A state-analyzer listing of trace data boils down information on 6800-series microprocessor RAM addresses (a). The A-label is the 16-bit RAM address, the D label is

```

ADDRESS DATA EXTERNAL
TRIGGER <= 0100 C3

TRIGR OCCUR=5 PRE-TRIGR=6
LINE 0
-----
ADRS OPCODE/DATA EXTERNAL
013A POP PSW 0000 0000
08F5 56 READ 0000 0000
08F6 3E READ 0000 0000
013B RET 0000 0000
08F7 EE READ 0000 0000
08F8 00 READ 0000 0000
00EE JMP 00F1 0000 0000
00F1 CALL 011B 0000 0000
08F8 00 WRITE 0000 0000
08F7 F4 WRITE 0000 0000
011B PUSH PSW 0000 0000
08F6 3E WRITE 0000 0000
08F5 56 WRITE 0000 0000
011C MVI A,03 0000 0000
011E STA 0200 0000 0000
0200 03 WRITE 0000 0000

```

(b)

the 8-bit data bus, both coded in hex. Another listing, of 8080A data captured in real time, is displayed in the microprocessor's assembly language (b).

```

ADDRESS DATA EXTERNAL
ENABLE 08FE
TRIGGER <= 08FE
        >= 0800

TRACE TRIGGERS-----LINE 19-----
ADRS OPCODE/DATA EXTERNAL
08F1 56 READ 0000 0000
08F2 16 READ 0000 0000
08F3 09 READ 0000 0000
08F4 01 READ 0000 0000
08F4 01 WRITE 0000 0000
08F3 11 WRITE 0000 0000
08F2 02 WRITE 0000 0000
08F1 56 WRITE 0000 0000
08F1 56 READ 0000 0000
08F2 02 READ 0000 0000
08F3 11 READ 0000 0000
08F4 01 READ 0000 0000
08F5 56 READ 0000 0000
08F6 55 READ 0000 0000
08F7 E5 READ 0000 0000
08F8 00 READ 0000 0000

```

6. When recording real-time stack transactions on an operating 8080A-based system, selective tracing allows pushes (writes) and pops (reads) to be examined easily to help track down stack overflows.

```

ADDRESS DATA EXTERNAL
ENABLE 8000
TRIGGER XXXX
DISABLE 8000

ADRS OPCODE/DATA EXTERNAL

TIME = 791 MICROSECONDS
MAX = 792 MICROSECONDS
MIN = 759 MICROSECONDS

```

7. Direct measurement of time intervals between two states is very desirable in a logic-state analyzer. One unit, the HP 1611A, actually keeps track of the measured minimum and maximum values.

only within a given address range—the second kind of selective-trace recording. Selectiveness is important because quite often the state sequence of interest is more significant than that which occurs on every strobe signal. In fact, by prior analysis of the problem, most data transactions can be discarded. Without selective tracing, no practical memory would be deep enough to solve all possible state-analysis problems. A timing analyzer, on the other hand, would not be able to use selective tracing because the display created would be unintelligible.

So selective tracing reduces data and enables reasonable measurements of events that are widely separated in state time. Which points to another quite useful feature—the ability to measure either the time between events or the number of states occurring between events (Fig. 7).

Quite often, such information alone can ferret out a functional problem. The number of lower-order states occurring between successive high-order states is quite often a clue to an anomaly. By actually depicting the path length, a state count can be a tremendous help in spotting problems or optimizing operations.

When state sequences get extremely complex, finding a unique sequence may call for sophisticated tracing. The spotlight here falls on trigger power.

### Triggering and formatting

Actually, "trigger" is a misnomer for a logic-state analyzer. Selecting unique states from a sequence to begin or end recording certainly can involve more than recognizing a single event. Quite often a state analyzer is required to recognize and record a sequence of events, so that a particular path can be traversed through the sequence to arrive at a state of interest (Fig. 8).

Suppose the state sequence beginning at address



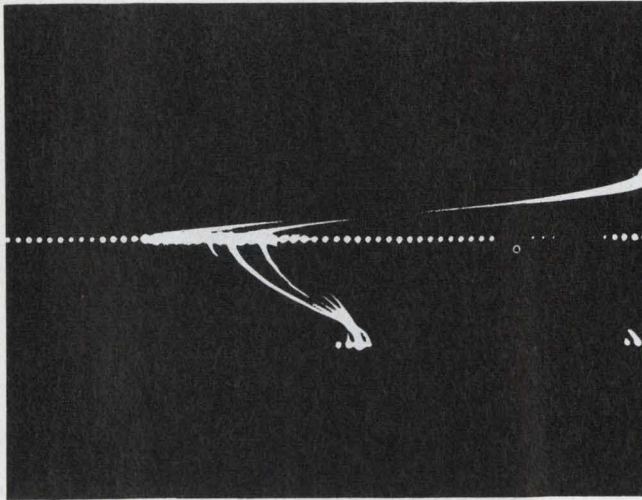

12. One "map" display mode provides a dynamic overview of state activity to identify errant behavior, recognizable repeated patterns or response to a stimulus.

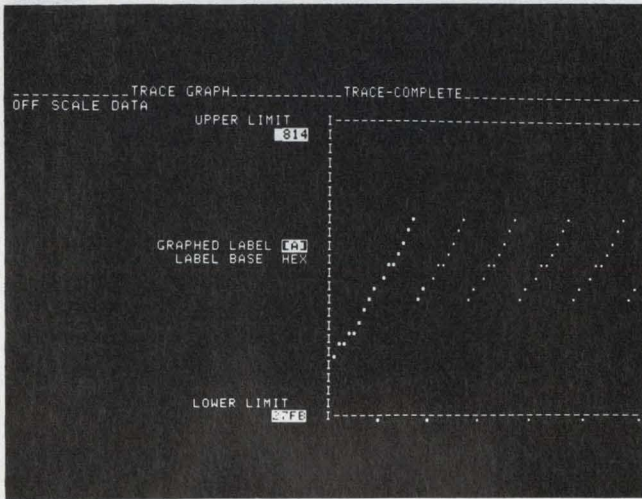

13. A data-domain graph also presents state activity. The axes are state magnitude (vertical) vs state sequence (horizontal). Label A—address, in this case—is graphed showing a looping operation (sawtooth waveform) in the  $28XX_{16}$  range of addresses.

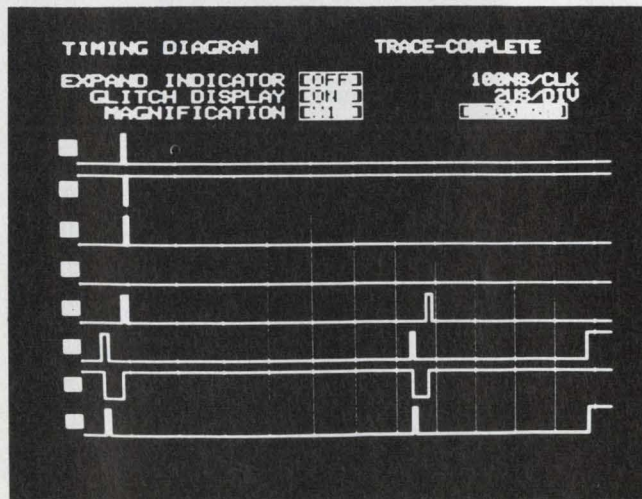

14. Sometimes, both logic states and timing information must be recorded simultaneously. This combo is the forte of one unit, the HP 1615A.

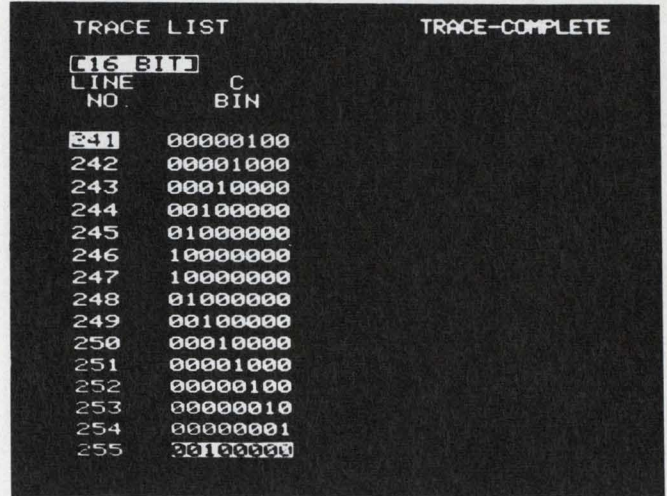

15. State measurement of data transacted during an IEEE-488 bus transaction shows the absence of the last data byte (00000001) before the control character (inverse video). Here, the time recording of Fig. 16 triggered the state recording.

or a 16-bit minicomputer. A state analyzer should accommodate every need (Fig. 11).

### Mapping the big picture

One way to format data is to reduce the information to a graphic overview. Two types are available: the map in Fig. 12 and the data-domain graph in Fig. 13. But not all maps are alike. While all manufacturers have adopted axes similar to those introduced by the HP 1600A, some offer only a static plot of the data recorded in memory, with or without lines connecting the dots to show state sequence. Lines connecting the state values help you recognize patterns. Others offer a rapid display/record cycle that presents a dynamic view of state activity.

To see how mapping can help your measurements, ask yourself: In pattern recognition, does the sequence always occur the same way? Does my system respond to a stimulus? Does state XXXX ever occur? Does my system ever make excursions outside or inside certain bounds? The last question especially can be addressed effectively only with a dynamic map.

A data-domain graph, on the other hand, plots state magnitude as a function of state sequence. Note in Fig. 13 that when the p counter is graphed, program looping always takes the shape of a sawtooth waveform. The graph is another way to make complex operations more comprehensible, which quickens analysis.

The most crucial features of a state analyzer, therefore are sufficient word width to read all data of interest, simultaneously, with as flexible a data format as possible; a speed only as fast as the data rate, but with zero positive hold time; selective data strobing, both on a clock and data-selection basis, if possible; and as flexible triggering as possible. A state analyzer can also be a big help if it can map, graph,

# Design it for safety!

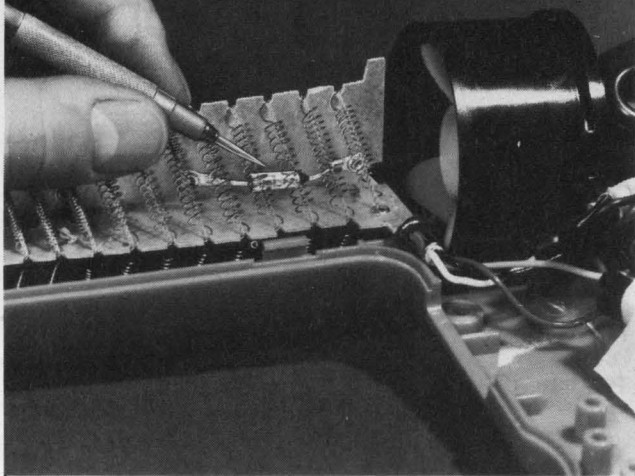

4000 Series MICROTEMP<sup>®</sup> Thermal cutoff in electric hair dryer

## Guard your products and profits with MICROTEMP<sup>®</sup> thermal cutoffs

This hair dryer is protected by our 4000 Series MICROTEMP<sup>®</sup> thermal cutoff. Those who use this product, and those who make and sell it, are likewise protected by the precise, yet low-cost MICROTEMP<sup>®</sup>.

If the hair dryer overheats, for any reason, the MICROTEMP<sup>®</sup> promptly cuts off the power. The fault must be corrected and the MICROTEMP<sup>®</sup> cutoff replaced before the appliance can be used again.

Accuracy of operation is within  $\pm 3^{\circ}\text{F}$ . You can choose from a wide range of cutoff temperatures (136 to 468 $^{\circ}\text{F}$ ), terminals and mounting packages to best meet your design/production requirements.

Millions of MICROTEMP<sup>®</sup> thermal cutoffs are now being used on hundreds of successful OEM applications. Write or call us for data and test samples.

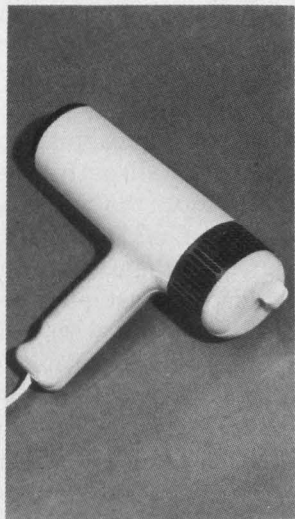

**MICRO DEVICES**



DIVISION OF EMERSON ELECTRIC CO.  
1881 SOUTHTOWN BLVD.  
DAYTON OH 45439 513-294-0581

CIRCLE NUMBER 38

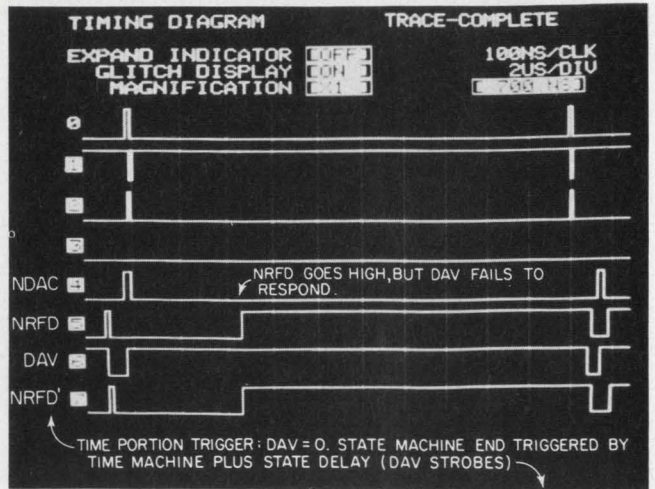

(a)

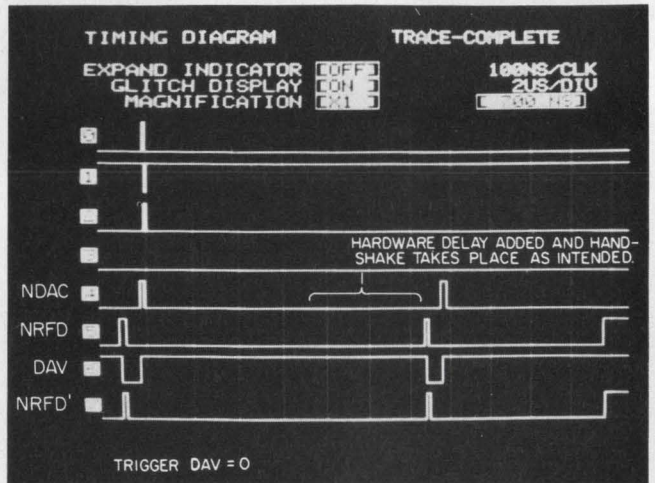

(b)

16. Referencing timing-diagram displays by combining the capabilities of trigger and digital (state) delay: An incorrect handshake sequence causes the data byte to be dropped (a). The sender shuts down early—NRFD goes high but no DAV is received. The handshake is corrected by adding some delay (b).

or count states, and measure elapsed time between states.

So the differences between a timing analyzer and a state analyzer are considerable. Given the functions of each analyzer, they have to be.

But when all is said and done, you may still have to record state sequences while triggering a timing analyzer so that you can view timing related to the same functional events. The combination instrument in Fig. 14 does both simultaneously, not alternately.

Suppose a DMA error on an HP-IB interface shows up as a missing data transaction (Fig. 15). You must examine the HP-IB handshake sequence just before the control character—while recording the state data.

The tricky part is to place the timing display on the appropriate data transaction. Success depends on a combined asynchronous-pattern trigger and digital delay (by the external state clock). Fig. 16a shows a sender shut down prematurely, and 16b shows the problem corrected by adding some delay. ■■



# Intel delivers the only 16-pin 4K RAM that's sure to keep you smiling.

You may or may not think of your memory system as a masterpiece. But one thing is certain, once you've reached volume production you're going to be reluctant to make major changes. That's why it is so frustrating to find that a supplier has painted you into a corner by deciding to stop delivering the part you want. Or by trying to switch you to a newer, non-compatible part.

Smile. Our 2104A 16-pin 4K RAM is the answer. It's a direct replacement for both the older 4096 metal gate and newer 4027 silicon gate parts. The 2104A keeps your production line moving without expensive re-design. Plug it in and you're ready to go.

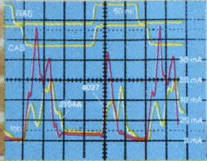

The 2104A is best for your new designs, too. We've been delivering this part in volume since July, 1976. So you can count on Intel to deliver the quantity you need, when you need it.

Delivery is not the only reason to specify the 2104A. There's not a 16-pin 4K RAM anywhere with lower power consumption. And because the 2104A has significantly lower current spikes

than other 16-pin 4K RAMs, there's less system noise. What it all means is that when you design your next system, it makes sense to design it using our 2104A.

	Maximum Access Time	Maximum Read/Write Cycle	Maximum I <sub>DD</sub> Average
<b>2104A-1</b>	150 ns	320 ns	35 mA
<b>2104A-2</b>	200 ns	320 ns	32 mA
<b>2104A-3</b>	250 ns	375 ns	30 mA
<b>2104A-4</b>	300 ns	425 ns	30 mA
<b>2104A</b>	350 ns	500 ns	30 mA

You can order the 2104A from distributor stock. Contact: Almac/Strom, Component Specialties, Cramer, Hamilton/Avnet, Harvey Electronics, Industrial Components, Pioneer, Sheridan, Wyle/Elmar, Wyle/Liberty, L.A. Varah, Zentronics. Or write Intel Corp., 3065 Bowers Ave., Santa Clara, CA 95051.

In Europe, Telex 24814, Brussels.  
In Japan, Telex 28426, Tokyo.



intel delivers.

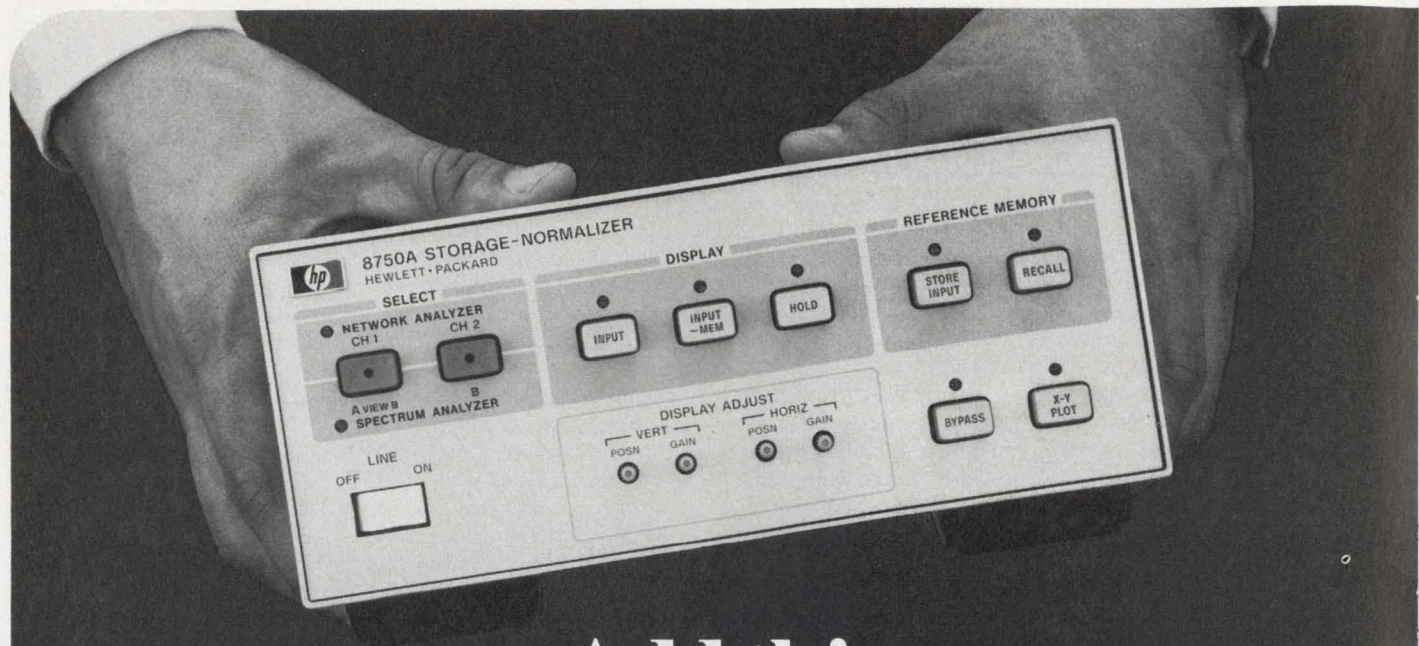

**Add this  
to your HP Network or  
Spectrum Analyzers  
and  
immediately enhance  
their capability.**

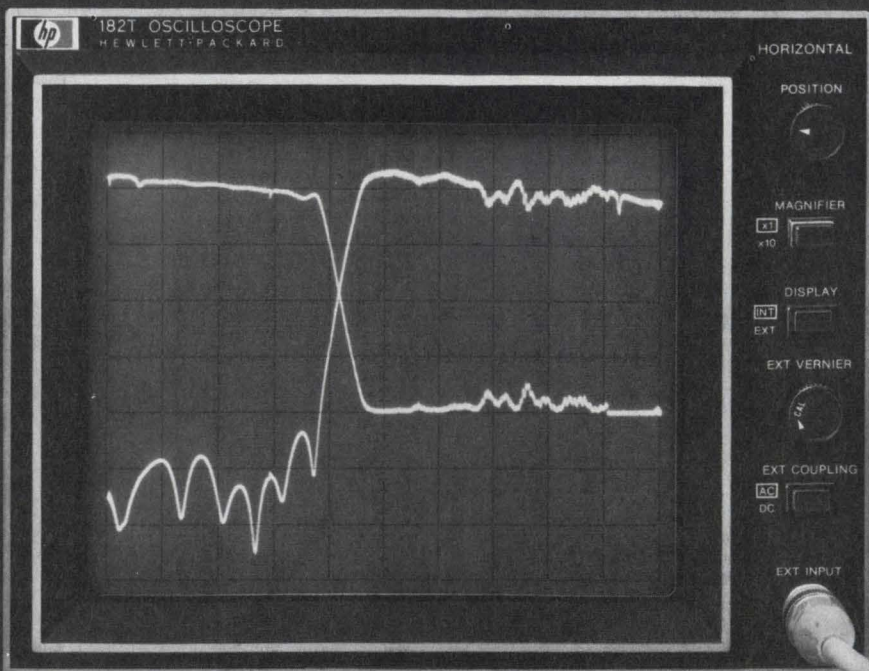

# The HP8750A Storage-Normalizer: It brings additional accuracy and simplicity to swept frequency measurements.

Here's an extremely useful and versatile accessory for most HP Network and Spectrum Analyzers. The 8750A Storage-Normalizer employs memory techniques to "normalize"—that is, remove system response from measured data. And its digital storage, constantly updated, provides a continuous flicker-free display regardless of sweep speed.

Here are some examples of the improvements it can bring to your swept frequency measurements:

## High Accuracy Measurements.

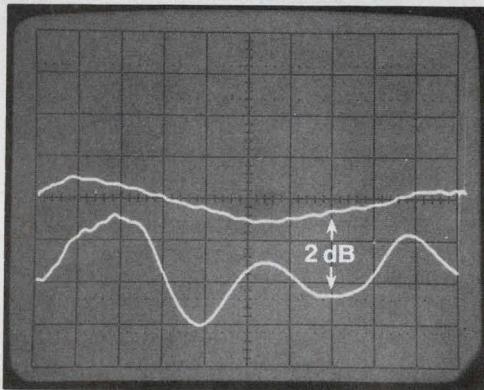

Before Normalization

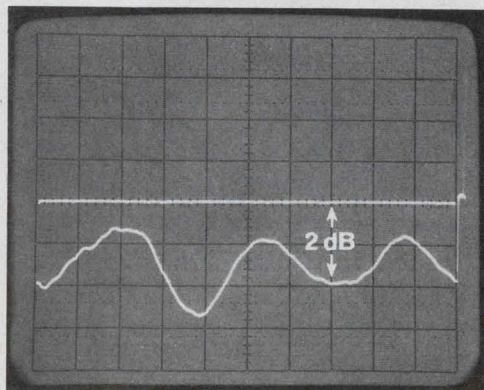

Normalized

Frequency response or tracking errors in transmission or reflection measurements are eliminated with normalization. You can calibrate the test system's response and store it, then subtract it from the measured data. The resultant difference represents the corrected measurement that's displayed directly in dB.

## Comparison Measurements.

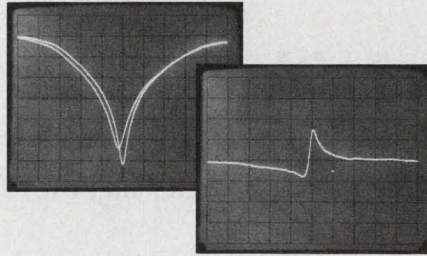

No longer is it necessary to visually scale deviations between two traces. With the HP 8750A, you can now display the *difference* between the two. Deviation between test devices is displayed directly in dB with a single trace.

## Slow Sweep Measurements.

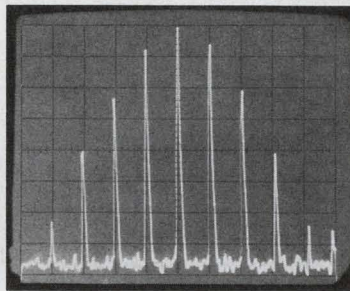

Use it for high resolution measurements when slow scan times are needed and get a bright, flicker-free display. Measurement data are displayed from memory with continuous refresh, independent of scan time and scope adjustments.

## Spectral Comparisons.

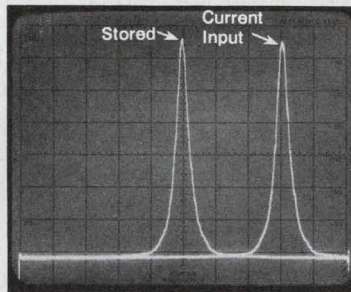

Using the 8750A in spectrum analysis applications, a signal spectrum can be frozen on the CRT and then compared directly with the current input signal.

Because the HP 8750A can "freeze" the display, photography is simplified and hard copies such as X-Y recordings can automatically be plotted, even while new measurements are being made.

Domestic U.S. price of the Storage-Normalizer is \$1450.

Call your HP field engineer for more information on how the 8750A enhances measurements made with HP 8755, 8410, 8407 and 8505 Network Analyzers, HP 8557, 8558 and 8565 Spectrum Analyzers, plus other instruments. Or write.

HEWLETT  PACKARD

1507 Page Mill Road, Palo Alto, California 94304

## Try a Wien-bridge network instead of a twin-T in your next analog filter design. The advantages begin with a filter you can design in five fast steps.

Put a Wien-bridge network, instead of a more popular twin-T network, into your analog filter and you'll get deeper notches and higher Qs. An added bonus is the simple design equations. With a five-step procedure that contains only three linear equations, you can build a Wien-bridge notch filter that has fewer frequency-determining components than a twin-T.

With fewer components to adjust, it's easier to trim a Wien-bridge filter to a desired notch frequency. You'll get higher Qs because the need for critical balance required between the two parallel branch networks of a twin-T is eliminated. Tuning for the best null is simple, because there's no interaction between null-determining and frequency-determining components. And a Wien-bridge can be designed for any practical bandwidth, with notch depths limited only by stray leakage capacitance.

You can apply a Wien-bridge filter to the same signal-filtering jobs usually assigned a twin-T. Depending on your design, it will reject unwanted frequency components, let you measure harmonic distortion, or serve as a building block to synthesize bandpass filters.

To find the component values of a Wien bridge, start by examining its transfer function to see how the design equations are developed.

### Equations are in the transfer function

You can find the transfer function of a Wien-capacitance-bridge notch filter from the schematic diagram of Fig. 1. In Laplace notation, the general form of the transfer function is:

$$H(s) = \frac{E_{out}}{E_{in}} = \frac{k_2}{1-k_f} \left[ \frac{s^2 + \left( \frac{3k_2-1}{k_2} \right) \omega_0 s + \omega_0^2}{s^2 + \left( \frac{2-3k_f}{1-k_f} \right) \omega_0 s + \omega_0^2} \right], \quad (1)$$

where  $k_2$ ,  $k_f$  and  $\omega_0$  can be defined in terms of the

circuit components as

$$k_2 = \frac{\frac{1}{R_2}}{\frac{1}{R_1} + \frac{1}{R_2} + \frac{1}{R_f}}, \quad (2)$$

$$k_f = \frac{\frac{1}{R_f}}{\frac{1}{R_1} + \frac{1}{R_2} + \frac{1}{R_f}}, \quad (3)$$

and  $\omega_0 = 1/RC$ . (4)

But if the circuit of Fig. 1 is to act as a notch filter, the transfer function must take the following form:

$$H(s) = \frac{s^2 + \omega_0^2}{s^2 + b\omega_0 s + \omega_0^2}, \quad (5)$$

where  $b$  is defined as the notch bandwidth,  $1/Q$ . Comparing like terms in Eqs. 1 and 5, you can see that the "s" term in the numerator of Eq. 1 does not appear in Eq. 5. Therefore, the coefficient of  $s$  must equal zero:

$$3k_2 - 1 = 0 \quad (6)$$

Solving for  $k_2$ :

$$k_2 = 1/3. \quad (7)$$

Examine Eqs. 1 and 5 again. The notch bandwidth,  $b$ , in the denominator of Eq. 5 must equal the coefficient of the  $\omega_0 s$  term in the denominator of Eq. 1. Bandwidth is then expressed as:

$$b = \frac{2 - 3k_f}{1 - k_f}. \quad (8)$$

When Eq. 7 and Eq. 8 are substituted into the expressions for  $k_2$  and  $k_f$  (Eqs. 2 and 3), you get design equations for two of the network's five resistive components:

$$R_2 = \frac{b(R_1)}{3 - b} \quad (9)$$

$$R_f = \frac{b(R_1)}{3 - (2-b)} \quad (10)$$

Glenn Darilek, and Oren Tranbarger, Senior Research Engineers, Southwest Research Institute, 6220 Culebra Rd., San Antonio, TX 78284.

The frequency determining resistors are calculated from Eq. 4:

$$R = \frac{1}{2\pi f_0 C} \quad (11)$$

Comparing Eqs. 1 and 5, the gain coefficient can be written as,

$$H_0 = \frac{k_2}{1 - k_f} \quad (12)$$

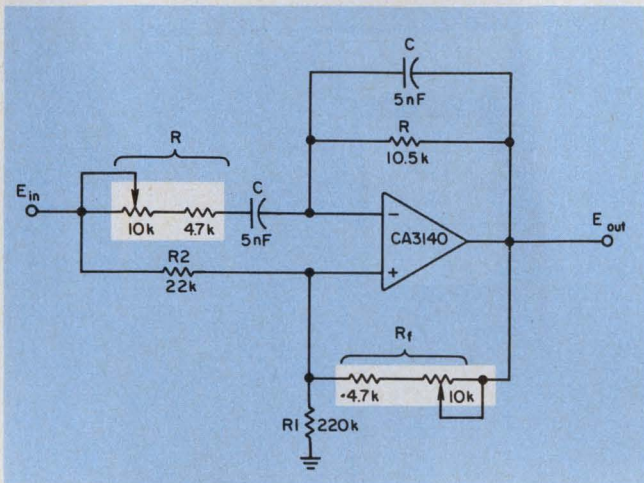

1. **This Wien-bridge notch filter** can replace a twin-T filter in analog signal-processing applications. The 10-k $\Omega$  potentiometers are provided for easy nulling of the signal at the notch frequency.

By substituting Eqs. 2 and 3 into Eq. 12, the gain coefficient reduces to:

$$H_0 = \frac{1}{1 + \frac{R_2}{R_1}} \quad (13)$$

But from Eq. 9,

$$R_2/R_1 = b/(3-b), \quad (14)$$

and after substituting Eq. 14 into Eq. 13,

$$H_0 = 3 - b/3. \quad (15)$$

Eq. 15 shows that the out-of-notch gain of the filter is related to its bandwidth. And in some cases, particularly a high-Q filter where  $b$  is relatively small ( $b = 1/Q$ ), the circuit has essentially unity gain.

Now you're ready to apply the equations in a procedure that determines a filter's component values.

### Five steps to a Wien-bridge filter

When using the Wien-bridge design procedure, you must calculate some component values and select others:

1. Select a value for  $R_1$ . For most applications, a value between 100 k $\Omega$  and 1 M $\Omega$  can be used. You can

calculate the fractional bandwidth, that is, the ratio of the filter bandwidth in Hz, to the rejection frequency, also in Hz. If the ratio is 0.1 or less, choose an  $R_1$  value that is closer to the high end of the resistance range.

2. Calculate  $R_2$  from Eq. 9.

3. Calculate  $R_f$  from Eq. 10.

4. Select a value for  $C$ . It can be any stock value capacitor whose impedance at the notch frequency is within an order of magnitude larger or smaller than 10 k $\Omega$ .

5. Calculate the frequency-determining resistor,  $R$  from Eq. 11.

Notice, from Eqs. 4, 9 and 10 that frequency-determining components are independent of bandwidth-determining components. Therefore, frequency can be changed without affecting bandwidth and vice versa.

In putting the 5-step procedure to work, assume that a notch filter is required to reject a signal at 3 kHz and have a bandwidth of 800 Hz. Now, find the component values of the filter.

The fractional bandwidth,  $b$ , is  $\frac{800}{3000}$  or 0.267.

Select a value of 220 k $\Omega$  for  $R_1$ . Calculate  $R_2$  from Step 2 (Eq. 9):

$$R_2 = \frac{(0.267)(220 \times 10^3)}{(3.0 - 0.267)} = 21.5 \text{ k}\Omega.$$

Calculate  $R_f$  from Step 3 (Eq. 10):

$$R_f = \frac{(0.267)(220 \times 10^3)}{3(2 - 0.267)} = 11.3 \text{ k}\Omega.$$

For  $C$ , select 5 nF. From Step 4,  $X_c$  will be 10.6 k $\Omega$  which is close enough to 10 k $\Omega$ .

Calculate  $R$  from Step 5 (Eq. 11):

$$R = \frac{1}{2\pi(3 \times 10^3)(5 \times 10^{-9})} = 10.6 \text{ k}\Omega.$$

The component values for this example are part of the schematic in Fig. 1, but to make adjustments easier, 10-k $\Omega$  potentiometers have been inserted in series with both  $R$  and  $R_f$ . Tuning the circuit is easy. Alternately adjust the pots until the signal at the required notch frequency is nulled out. For proper adjustment, use a very pure test signal or you'll find it difficult to determine when you're at null. That's because some signal generators generate test-signal harmonics that can interfere with tuning. If you need more than 50 dB of rejection, you'll have to be careful about circuit layout and shielding. And your op amp must have high gain and high input impedance at the notch frequency, in addition to being able to pass all signals of interest. ■

# NEW AlphaNumeric Printers with a microprocessor brain!

from the makers of high-reliability printers

This series of designer-styled Digitec printers delivers high contrast, easy-to-read, fade-free matrix printout and quiet operation. The "smart" microprocessor provides versatility by simplifying systems interface and using the universally accepted ASCII code set.

- Choice of serial (RS-232-C and 20mA current) with baud rates to 1200, or 8-bit parallel bus input with data rates up to 1000 characters/second.
- Up to 24 characters per line
- Double font printing for special emphasis and variable formatting for easy data analysis.
- 24-hour clock and day/month calendar.

Contact us now for more information on our complete line of numeric and alphanumeric printers.

#### ATTENTION OEM's:

As a leading supplier of OEM printers, we're flexible to your requirements and offer generous OEM discounts.



Model 6310 single quantity  
ready-to-print price

## \$595.

DIGITEC: Precision measurements to count on.

**Digitec**

**UNITED  
SYSTEMS  
CORPORATION**

918 Woodley Road, Dayton, Ohio 45403  
(513) 254-6251, TWX (810) 459-1728

CIRCLE 41 FOR INFORMATION ONLY

CIRCLE 43 FOR DEMONSTRATION ONLY

## Floppy Disk triple output power Under \$1 per watt UL-RECOGNIZED

The field-proven AED 101. A high-efficiency power supply designed to provide the special DC power range required to operate floppy disk subsystems with one to four drives. Extremely compact and lightweight in design, the AED 101 provides the correct power for floppy disks. Triple output (5V @ 12 Amps, -12V @ .7 Amps, +24V @ 3.5 Amps) for four drives, drive electronics, formatter and interface circuitry. Other features include OVP foldback current limiting, 5V switching regulator, and superior cost/efficiency ratio. Contact us today for detailed specifications and our low prices. Delivery from stock in production quantities \$137.50.

**ADVANCED  
ELECTRONICS  
DESIGN, INC.**

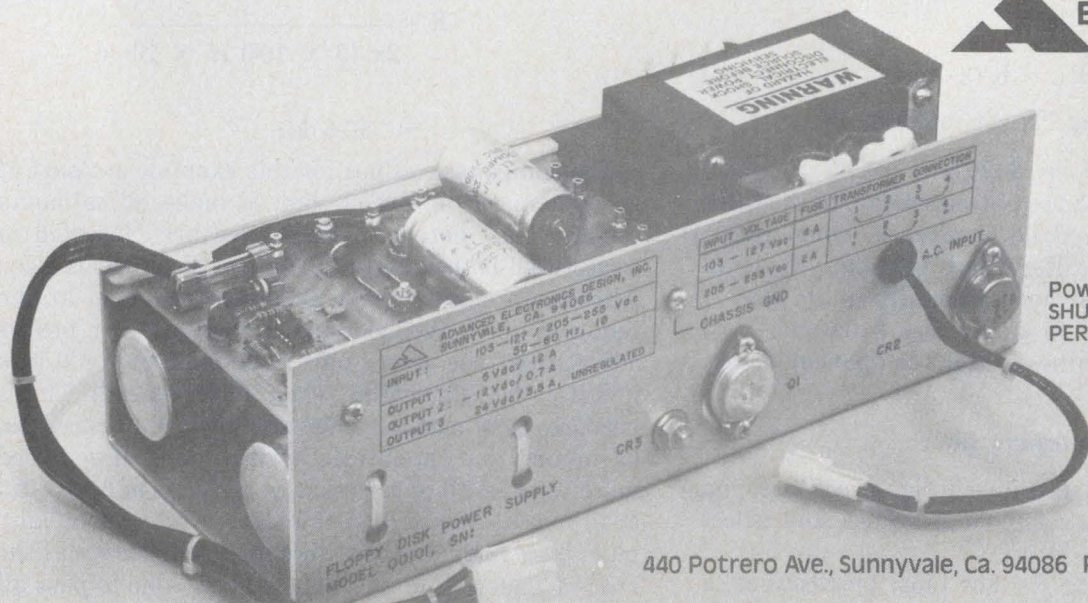

Power for  
SHUGART, MEMOREX,  
PERTEC AND OTHERS

440 Potrero Ave., Sunnyvale, Ca. 94086 Phone 408-733-3555

CIRCLE NUMBER 42

# How does GE intend to keep its lead in transient protection?

## Staying power.



Most people recognize GE-MOV<sup>®</sup> varistors as the ultimate in system transient protection. With good reason. These metal oxide varistors, or movistors, are the result of research and experience that stems from the early years of General Electric, celebrating in 1978 its 100th birthday.

You may have shared our excitement along the GE path to leadership. Steinmetz' lightning generator demonstration in 1922. Anderson's lightning measurements on the Empire State Building in the 1930's. The definitive study of surge voltages in residential and industrial circuits formulated by Martzloff and Hahn of GE's Corporate R&D Center in 1970. And, of course, GE's \$10 million investment relating to the introduction of GE-MOV<sup>®</sup> varistors six years ago.

But in our view, the best is yet to come. GE's R&D work on transient protection continues to find more

sophisticated materials, better measurements and standardization. Soon, you'll be able to put the resulting new products and new ideas to work for you.

Experience. Innovation. Staying power. It's what you've come to expect, and can expect from GE when you need transient protection.

For the full story on GE-MOV<sup>®</sup> varistors, call your local authorized GE semiconductor distributor, or write General Electric Co., Electronics Park 7-49, Syracuse, N.Y. 13221.

\* Registered Trademark of General Electric Co.

222-06

**There's more  
to GE semiconductors  
than meets the eye**

**GENERAL  ELECTRIC**

## Single-shot multi uses few parts, provides high noise immunity

A single-shot multivibrator built with an LM 3900 current-differencing amplifier uses only one capacitor and three resistors and needs no diodes for clamping or pulse steering (see figure). Its nonregenerative circuit has greater noise immunity than conventional single-shots. The circuit generates an output pulse for each input positive-going transition.

In the quiescent state,  $4.5 \mu\text{A}$  supplied to the 3900's inverting input through  $R_1$  holds the output at ground. The drop across the noninverting input terminal is  $0.5 \text{ V}$ , because of the amplifier's input diode. A positive-going edge at the circuit's input, differentiated by  $CR_3$ , causes a larger current to flow through  $R_2$  than  $R_1$ , so the amplifier output switches high ( $+5 \text{ V}$ ). The switching time is limited only by the 3900's slew rate. As the differentiator voltage,  $V_{R3}$ , decays, current flow in  $R_2$  falls until it equals the flow through  $R_1$ , and produces a  $1.35\text{-V}$  drop across  $R_2$ . This voltage

together with the  $0.5\text{-V}$  diode drop at the noninverting input results in  $1.85 \text{ V}$  at  $V_{R3}$ , where the amplifier output returns to the ground state.

The positive-going output pulse width  $t$ , is, obtained by solving

$$1.85 = 5 e^{-t/CR_3},$$

where

$$t = (10^{-9})(3 \times 10^4) \ln (5/1.85) \\ \approx 30 \mu\text{s}$$

A negative-going output pulse can be generated simply by interchanging the inputs to the noninverting and inverting terminals of the amplifier. Note that the pulse width can be controlled by a variable-voltage to  $R_1$ ; a higher voltage than  $5 \text{ V}$  would widen the pulse.

*Tom Frederiksen, Applications Engineer, National Semiconductor, 2900 Semiconductor Dr., Santa Clara, CA 95051*

CIRCLE NO. 311

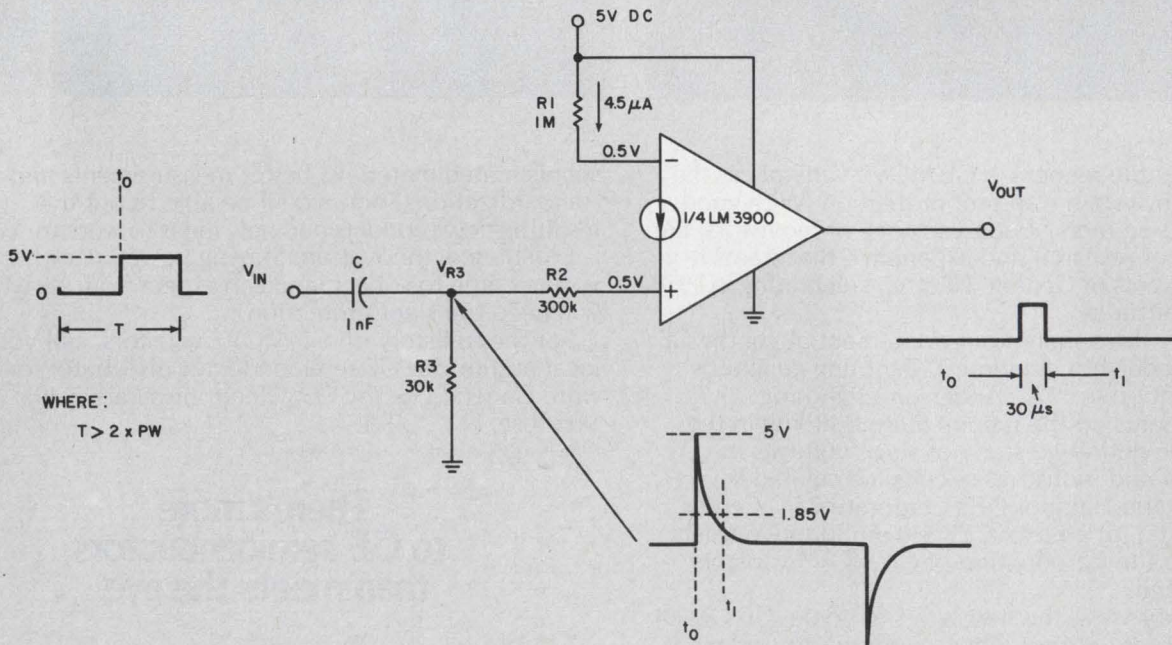

A simple single-shot multivibrator uses only four passive components and a current differencing

amplifier. The amplifier changes state when current into one input exceeds that in the other.



If you need  
**top-quality**  
**panel**  
**instruments**  
 with a clean,  
 modern look...

Buy  
**Triplett's**  
**Series GL**  
**or GL/B**

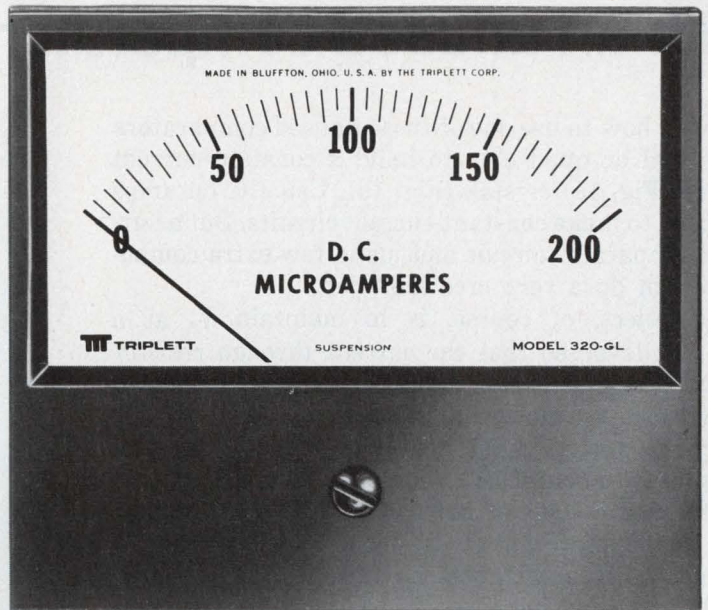

GL

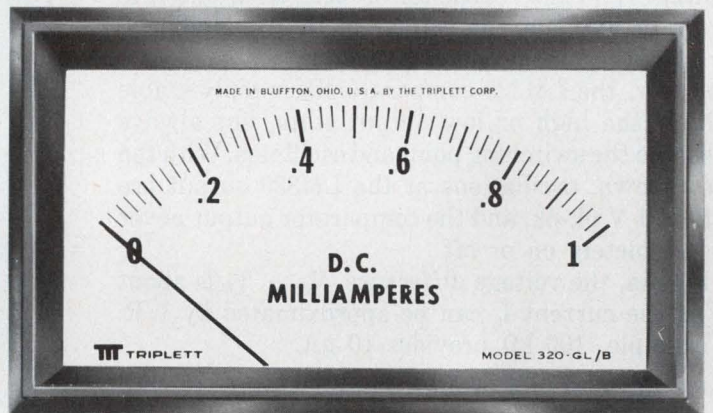

GL/B (mounted appearance)

Triplet's newest panel instruments, the Series GL and GL/B, feature glass windows, matte-finish phenolic cases and a dial design that can readily accommodate multiple scales. They are available in 3½", 4½" and 5½" sizes.

The GL Series features a standard 2-stud mount with 3- and 4-stud mounts available. The feature of the GL/B Series is behind-the-panel mounting with a bezel which is an integral part of the case.

CIRCLE # 45 FOR INFORMATION

There's a choice of more than 275 stock sizes and ranges — in DC microammeters, milliammeters, ammeters, millivoltmeters and voltmeters; AC milliammeters, ammeters, and voltmeters; RF thermoammeters; dB meters and VU meters. For those who need special instruments . . . custom dials, pointers, scales, accuracy, tracking, resistance, response time or practically any combination of unusual specs can be put into these new cases. For quick, dependable delivery

of small quantities of these adaptable new instruments, contact your Triplet Sales/Service/Modification Center or distributor. For prototypes or production quantities, contact your Triplet representative. Triplet Corporation, Bluffton, Ohio 45817.

**TRIPLETT**  
 BLUFFTON, OHIO 45817  
 Manufacturers of the World's  
 most complete line of V-O-M's

CIRCLE # 46 FOR FREE DEMONSTRATION

## Ideas for design

# Build a constant-current source or sink with an unused comparator of a quad package

Here's how to use one of those unused comparators of a dual or quad chip to build a constant-current source (Fig. 1a) or sink (Fig. 1b). Usually, op amps are used to make constant-current circuits. But a left-over comparator circuit and just a few extra components can do a very creditable job.

The object, of course, is to maintain  $V_e$  at a constant level, so that the current through resistor  $R$  and hence transistor  $Q$ , is constant regardless of changes in  $V_c$ . However, the voltage difference between  $V_c$  and  $V_e$  must exceed the emitter-collector drops of  $Q$ —about 0.5 V. Voltage  $V_e$  is compared with a reference voltage of about 4.2 V. If  $V_e$  is too low, the comparator output is open, and capacitor  $C$  charges via  $R_a$  and  $D_1$ , which reduces the base current in  $Q$ —and thus increases  $V_e$ ; if too high, the comparator output is low, and  $C$  discharges through  $R_b$  to lower  $V_e$ . Thus, capacitor  $C$  acts as a filter to smooth, or average, the voltage of this "bang-bang" type of output from the comparator.

However, the LM339 comparator isn't truly stable in either the high or low output state, but always overshoots the switching point and oscillates. With the values shown, oscillations at the LM339 output are less than 1 V pk-pk, and the comparator output never goes completely on or off.

In Fig. 1a, the voltage difference,  $V_{cc} - V_e$  is about 1 V, so the current  $I_s$  can be approximated by  $1/R$ . For example, 100 k $\Omega$  provides 10  $\mu$ A.

Mark R. Gardner, Plato V Consultant, Carroll Manufacturing Co., 1212 Hagan St. Champaign, IL 61820.

CIRCLE NO. 312

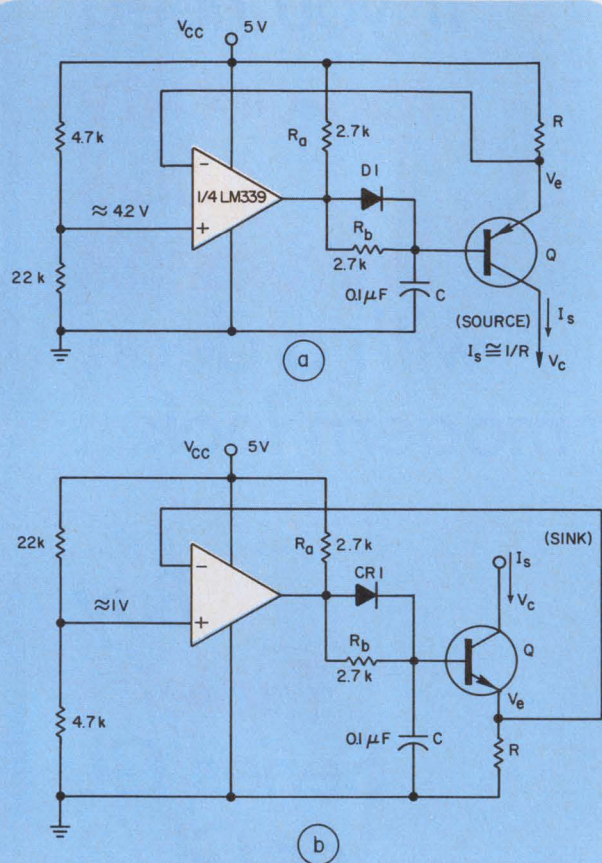

1. A constant-current source (a) or sink (b) can be built with a comparator operated in an oscillating state. Capacitor C smooths the output.

## Gated programmable delay-line oscillator's repetition rate changeable every period

Need a clock-pulse generator, whose repetition rate can be changed on a period-to-period basis without settling time before changing the period length? The programmable delay-line oscillator in Fig. 1 does it, and provides 10-ns incremental changes of the time between pulses from 100 to 990 ns.

Even the first period is accurate. Moreover, the circuit can be restarted after a return to its quiescent state with a delay of only 1/2 its least period. And oscillations can be stopped any time without gener-

ation of extraneous pulses.

The generator's output consists of pulses about 25 ns wide. For a 50% duty-cycle, you can use the output from a flip-flop driven by the generator running at twice the output frequency. The circuit shown has worked at frequencies as high as 20 MHz. Low frequencies can be obtained by dividing the output with decade counters. Or, different base periods can be achieved with delay lines having time constants different from those in Fig. 1.

# Another Industry Breakthrough!



## Introducing... The Harris HI-562 D/A Converter.

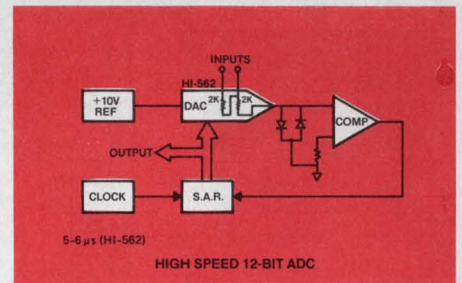
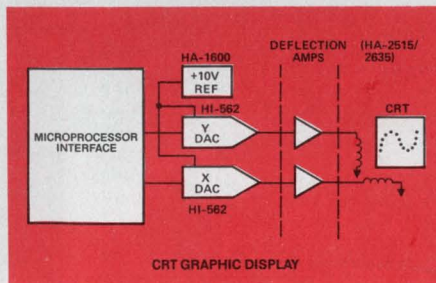
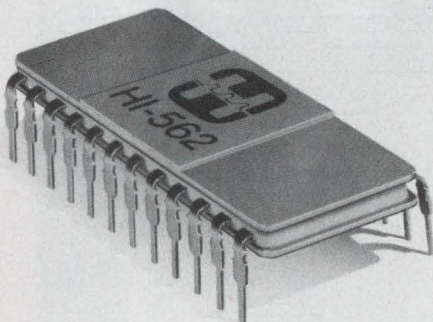

If you've been looking for the right D/A converter to match your brightest design ideas, you can stop looking... it's here... the new Harris HI-562.

The HI-562 is the first monolithic D/A to combine high speed performance and true 12-bit accuracy on the same chip—attained through the utilization of the most advanced laser resistor trimming techniques in the industry. Consider these features:

- Fast Settling: 200 ns to  $\pm 1/2$  LSB
- Excellent Linearity:  $\pm 1/4$  LSB
- Low Gain Drift:  $\pm 2$  ppm/ $^{\circ}$ C
- Fully monotonic over temperature

At only \$29 (100-up), the Harris HI-562 is the cost-effective answer to your most demanding data conversion

design problems. So if you are into A/D converters, CRT graphic displays, process control systems, precision instruments, data acquisition systems, communication terminals... to mention a few... the Harris HI-562 can provide you with the performance, economy, accuracy and design versatility you won't find in any other D/A converter.

Available in a 24-pin DIP, the 562 operates on +5V and -15V supply voltages and a +10V reference.

*Harris Technology  
... Your Competitive Edge*

Check out this new dimension in data conversion. Contact your nearby Harris Semiconductor distributor for evaluation devices. For full details, call the Harris Hot Line, or write: **Harris Semiconductor Products Division, P.O. Box 883, Melbourne, Florida 32901.**

**HARRIS HOT LINE!  
1-800-528-6050, Ext. 455**

Call toll-free for phone number of your nearby Harris sales office, authorized distributor or expedited literature service.



**HARRIS**  
SEMICONDUCTOR  
PRODUCTS DIVISION  
A DIVISION OF HARRIS CORPORATION

The least-significant-digit (LSD) input in BCD is presented to latch IC<sub>1</sub>, and the most-significant-digit (MSD), to down counter IC<sub>5</sub>. Multiplexers IC<sub>2</sub> and IC<sub>3</sub> select the desired tap on delay lines DL<sub>1</sub> and DL<sub>2</sub>, which determine the oscillating frequency. Gate IC<sub>4</sub> synchronously controls starting and stopping of the oscillator. Note: You need two eight-input multiplexers for the 10 steps of the LSD; the unused inputs are grounded. Multiplexer IC<sub>3</sub> selects the 80 and 90-ns steps, when IC<sub>1</sub>'s  $\overline{Q}_3$  output is low. And the circuit's logic requires the use of the noninverting outputs of the multiplexers.

When the enable signal is high for at least half a period, the circuit is in its quiescent state. Also, the output of IC<sub>4</sub> is low; therefore, all inputs to the multiplexers are low. A high pulse to the Reset line with the Enable line high initializes the circuit. Down counter IC<sub>5</sub> resets and its Borrow output, B<sub>0</sub>, goes low, since its clock line is low. NOR gate IC<sub>6</sub> and D flip-flop IC<sub>7</sub> differentiate IC<sub>7</sub>'s clock input to provide a negative-going pulse at IC<sub>6</sub>'s output when IC<sub>7</sub>'s D input is high. Similarly, IC<sub>8</sub> and IC<sub>9</sub> provide a negative and a positive-going pulse, respectively, but only when IC<sub>8</sub>'s D input is low. The IC<sub>9</sub> output pulse acts as a loading signal for IC<sub>5</sub>, and the IC<sub>8</sub> output pulse as a load/clocking signal for IC<sub>1</sub>.

A period starts when the Enable line goes low. The output of IC<sub>4</sub> then goes high, and the initial positive clock edge from IC<sub>4</sub> passes through the delay lines to the multiplexer inputs. After the delayed signal ar-

rives at the input selected by the stored LSD, it is sent back to IC<sub>4</sub>, inverted, and sent through the delay line again. After this second pass, a positive transition appears at the IC<sub>4</sub>'s output, which completes the first cycle and resets the LSD latch to zero. The first clocking cycle may be the base period determined by DL<sub>1</sub> (in this case 100 ns) or an extended period of 100 ns plus the incremental delay provided by DL<sub>2</sub>. Subsequent cycles occur at the base period until the down counter reaches zero, when an output signal can load digits available at the circuit's inputs.

Note that DL<sub>1</sub> is tapped. Select a tap that produces a 50-ns half-cycle delay when added to the multiplexer and IC<sub>4</sub> gate delay. No further tuning should be necessary. A continuously variable untapped DL<sub>1</sub> line could, of course, provide more precise initial calibration.

The data input to the down counter must be the MSD value minus one (MSD-1), since the base—or minimum—delay period is in the circuit when the loaded MSD digit is a zero. Therefore, the BCD adder, IC<sub>10</sub> must be inserted in the circuit. The adder's A inputs receive the desired MS digit, its B inputs are hardwired to the value 9 and its carry-input is held low to produce a subtraction of one.

*A. M. Patlach, E-beams Device Fabrication, San Jose Research Lab, IBM, Monterey & Cottle Rds., San Jose, CA 95193.*

CIRCLE NO. 313

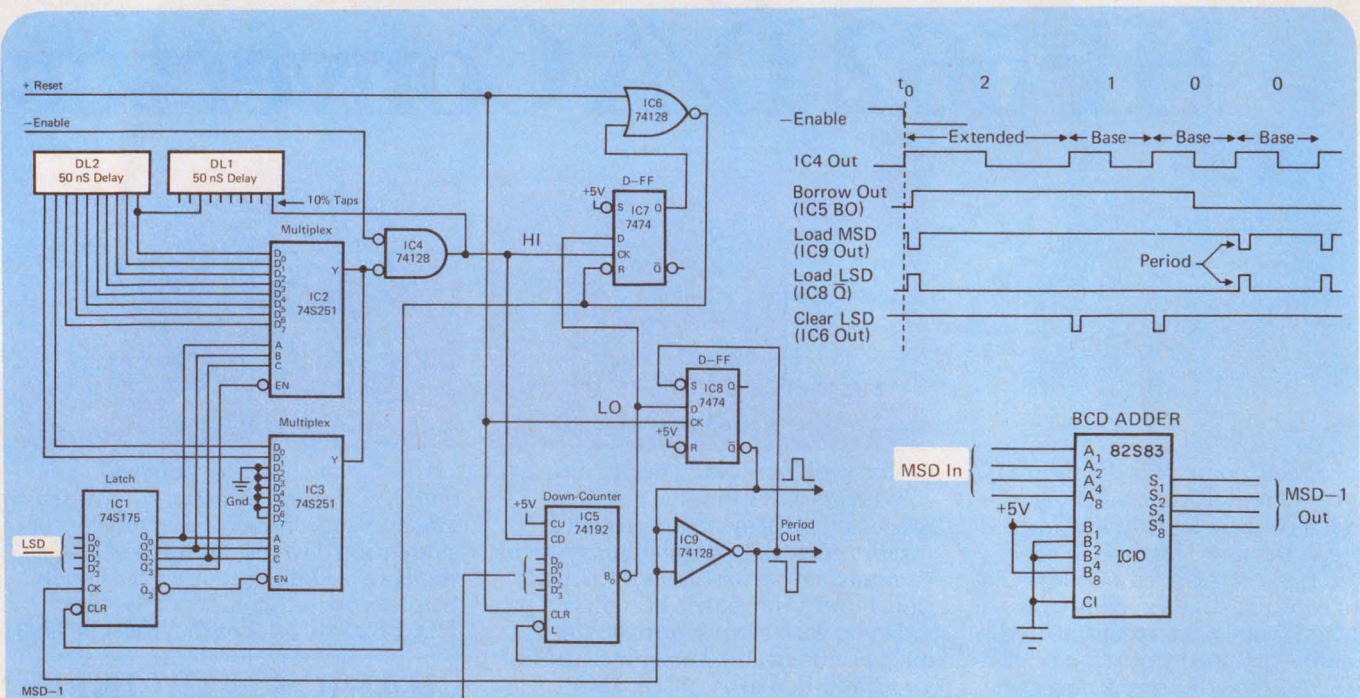

**A programmable delay-line oscillator** with the components shown provides output pulses approximate-

ly 25 ns wide and spaced on a variable period-to-period basis from 100 to 990 ns apart.

# Imitation is the sincerest form of flattery.



## But it's surprising they waited 5 years to copy this DIP Monolythic<sup>®</sup> Ceramic Capacitor.

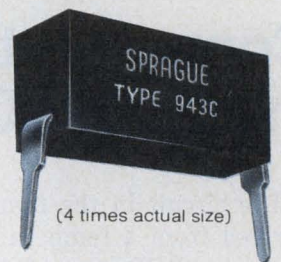

In 1972, when we started producing our Monolythic<sup>®</sup> Ceramic Capacitors in a 2-pin dual in-line package, you might have expected several of our competitors to follow suit immediately.

But our competitors said that such capacitors were neither needed nor wanted. Now, 5 years later, another manufacturer is trying to take full credit by advertising its 2-pin DIP as "the one of a kind ceramic capacitor." Apparently the old adage is true . . . *imitation is the sincerest form of flattery.*

SPRAGUE CONTINUES TO LEAD THE WAY in making a wide variety of layer-built ceramics. We

originated this construction. And because Sprague started early to package Monolythic<sup>®</sup> Ceramic Capacitors for compatibility with standard DIP integrated circuits, you can get *what* you need *when* you need it.

SPRAGUE LETS YOU BE MORE SELECTIVE by providing Type 943C Capacitors with formulations to meet temperature characteristics COG (NPO), X7R (semi-stable), or Z5U (general-purpose). Their low height saves space on printed wiring boards. You can choose from capacitance values to .47 $\mu$ F @ 50 volts! (25V and 100V ratings are also available.)

For more information on these and other Monolythic<sup>®</sup> Ceramic Capacitors, write for Engineering Bulletin 6242B to: Technical Literature Service, Sprague Electric Company, 347 Marshall Street, North Adams, Mass. 01247.

**THE BROAD-LINE PRODUCER OF ELECTRONIC PARTS**

CIRCLE NUMBER 48



a  
General  
Cable  
subsidiary

# Pulsar generator determines states of three-state bus drives

When testing party-line bus systems employing three-state logic, you often experience difficulty determining whether the bus is in its high-impedance state or not. The simple high-impedance-source pulse circuit in the figure produces a distinctive waveform that makes each of the system's three bus states immediately obvious on a scope display.

The circuit employs a 555 timer to generate a square wave of approximately 1500 Hz. The network formed by  $R_2$  and  $C_1$  shapes the waveform to a distinctive sawtooth that is unlikely to be mistaken for a valid signal on a three-state digital bus. Variable resistor,  $R_1$ , determines the signal strength and should be set to limit the drive to about half the LOW current of the logic family under test. A center setting of 10 k $\Omega$  is suitable for common TTL.

With the scope input in parallel with the test probe, the ramp waveform from the pulse generator will be observed on the scope when the bus signal is in its high-impedance state. However, if the bus has a normal signal on it, the signal will dominate the display, because the bus drive is in a low-impedance state. For this same reason the scope also will indicate when the bus is set to either a ONE or ZERO state, without interference from the ramp waveform.

With resistor  $R_1$  properly adjusted, drive current

from the pulsar is limited so that logic circuits connected to the bus aren't falsely triggered, while the bus is at high impedance. Of course, the frequency of the pulse-generator output and the time constant of the  $C_1R_2$  low-pass filter should provide a signal that best corresponds to the sweep speed used to observe the bus. Thus,  $C_1R_2$  and the 555's frequency may be changed from the values shown to meet your needs.

*John Walker, Consultant, Marinchip Systems, 16 St. Jude Rd., Mill Valley, CA 94941.*

CIRCLE NO. 314

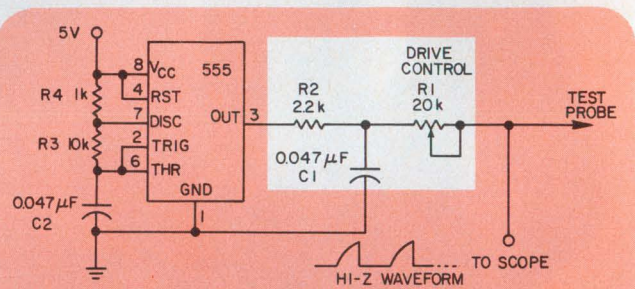

**A simple high-impedance pulse generator** helps check the states of three-state bus systems.

## Convert a temperature-to-frequency signal into four BCD digits and read °F or °C

The circuit in the figure can change a frequency derived from a temperature-to-frequency (T/f) converter to a BCD output for the display of either degrees C or F, without switching anything in the analog input. Also, the circuit can handle temperature both above and below zero without switching ranges.

Temperature-to-voltage and voltage-to-frequency converter circuits, which have been published in the Ideas for Design columns, can be combined to form a T/f converter. None, however, provide a digital output.

The heart of the frequency-to-BCD circuit consists of five-decades of 74192 up/down counters. The least-significant decade is undisplayed to avoid a bobbling last digit. A temperature-conversion cycle begins when the up/down counters are preset by the Load signal to a number larger than the largest negative temperature to be displayed. Simultaneously, the Minus flip-flop (7474) is cleared, which sets the decade counters to count down.

The T/f-converter pulse train is then counted for a fixed period of time determined by a 555 timer, 74161 counter and gating 7474 flip-flop. If the temperature is positive, the decade counters pass through zero. This event is detected by the 74260 zero-detector gate, which sets the Minus flip-flop and causes the decade counters to count up. At the end of the counting period the contents of the four most-significant counters are loaded into 74174 latches.

If the transfer function of the T/f converter is  $f_{out} = cT + \theta$ , then the circuit's master-clock period,  $t_s$ , must be  $10^2/c$ , and the decade counters must be preset to a number equal to that of  $\theta \times t_s$  to read the temperature,  $T$ , in degrees C. The offset constant,  $\theta$ , and input frequency,  $f_{out}$ , are in hertz and the constant,  $c$ , is in (degrees  $\times$  seconds) $^{-1}$ . The  $10^2$  factor allows the circuit to resolve tenths of a degree. To read the temperature in degrees F, you merely preset the counter to

# Featherweight Miniature Panel Mount Thermal Printer



#### DPP-7 QUICK SPECS

##### Printing Rate:

3 lines per second

##### Inputs

Full parallel BCD

TTL logic inputs, selectable positive or negative true

##### Printouts:

Six digits and sign, 99±9999,

±999999 or 9±99999

(Hexadecimal optional)

##### Input Storage

BCD data must be valid only 1.5 microseconds during print command

##### Data Capacity

9000 lines on 150 foot x 1.75 inch (44.5mm x 45m) thermal paper rolls

##### Power Supply:

Choice of: +5VDC, or 100, 115 or 230VAC, 47 to 440 Hz

##### Size Case:

4.50" wide x 2.72" high (115mm x 69mm)

##### Depth:

5V Models

6.2" (158mm)

28V, 12V or

AC Models: 8.7"

(221mm)

#### New! Datel's Model DPP-Q7

Whisper Quiet  
5 Lines/sec.

\$495

COVERED BY  
GSA CONTRACT  
NO. GS-00S-27959

Datel's new model DPP-7 Digital Panel Printer uses only 2 moving parts for OEM reliability. At only 2.3 Lbs, (1,1Kg) it is one of the lightest panel-mounting recording instruments available.

#### Includes all electronics.

The \$475\* single quantity price includes everything required for full parallel BCD/TTL data inputs *plus* an input storage register for multiplexed bus applications *plus* an AC power supply! There are no extra boards to design or bulky cables and power supplies needed. The DPP-7 is ready to use.

**Thermal printing** means no messy inks, banging hammers or twirling print-wheels. Nothing to jam or run out of ink.

**Use** the miniature DPP-7 for simple data logging systems, automatic test fixtures or with a digital panel meter for accurate unattended data measurement.

The **small size** of the DPP-7 makes it ideal for panel-mounting in analytical instruments and compact data systems. Up to six digits and sign may be printed to identify channel number and data.

The DPP-7 uses +5VDC power in a very short 6.2" (158mm) deep version or 100, 115 or 230 VAC power in an 8.7" (221mm) deep version.

\*U.S.A. domestic price only



**DATEL**  
SYSTEMS, INC.

1020 Turnpike St., Canton, MA 02021  
TEL. (617) 828-8000 / TWX: 710-348-0135

• Santa Ana, CA (714) 835-2751

• LA Exchange (213) 933-7256

• Sunnyvale, CA (408) 733-2424

• Gaithersburg, MD (301) 840-9490

• Houston, TX (713) 932-1130, 1132

• Irving, TX (214) 256-4444

• Tokyo, Japan 793-1031; Osaka, Japan

(06) 354-2025 • Andover, UK (0264)

51055 • Paris, Fr. 620-06-74

• Muenchen, W. Ger. (089) 776095

Send for your FREE Brochure

CIRCLE NUMBER 49

$$[(9 \times \theta \times t_s)/5 - (32 \times 10^2)]$$

and set the master-clock period to  $(9/5) \times t_s$ .

Changing the preset value of the counter is easily and directly done in the circuit with the SPST C/F switch. However, to generate the period of  $(9/5) t_s$ , the circuit starts with a primary clock period of  $t_s/5$ , and then multiplies  $t_s$  by five for reading in degrees C and by nine for degrees F. To multiply the period, the circuit simply divides the clock as required.

As an example, suppose the T/f transducer has an offset,  $\theta$ , of 20 kHz at 0 C and a temperature coefficient,  $c$ , of 400 Hz/°C. Then

$$f_{out} = 400T + 20,000,$$

and  $t_s = 10^2/400$ . Therefore the primary clock period is  $t_s/5 = 0.25/5$ , or 0.05 s, and the counters are preset to  $t_s \times 20,000 = 5000$  for degrees C, and 9000 - 3200

= 5800 for degrees F. To assure a square wave for the Count-Gating signal, the master-clock frequency is divided by two. Thus, the period of the Count-Gating signal becomes  $0.25 \times 2 = 0.5$ s.

Best results are attained when the T/f converter's offset count is set at a value well below the temperature range you desire to measure accurately. High offset values present little difficulty to the digital processor. A high offset has the advantage of eliminating the extreme low end of a T/f converter's output, where a large portion of its nonlinearity lies.

*Glen Miranker, Research Assistant, Laboratory for Computer Science, Massachusetts Institute of Technology, 545 Technology Square, Cambridge, MA 02139.*

CIRCLE NO. 315

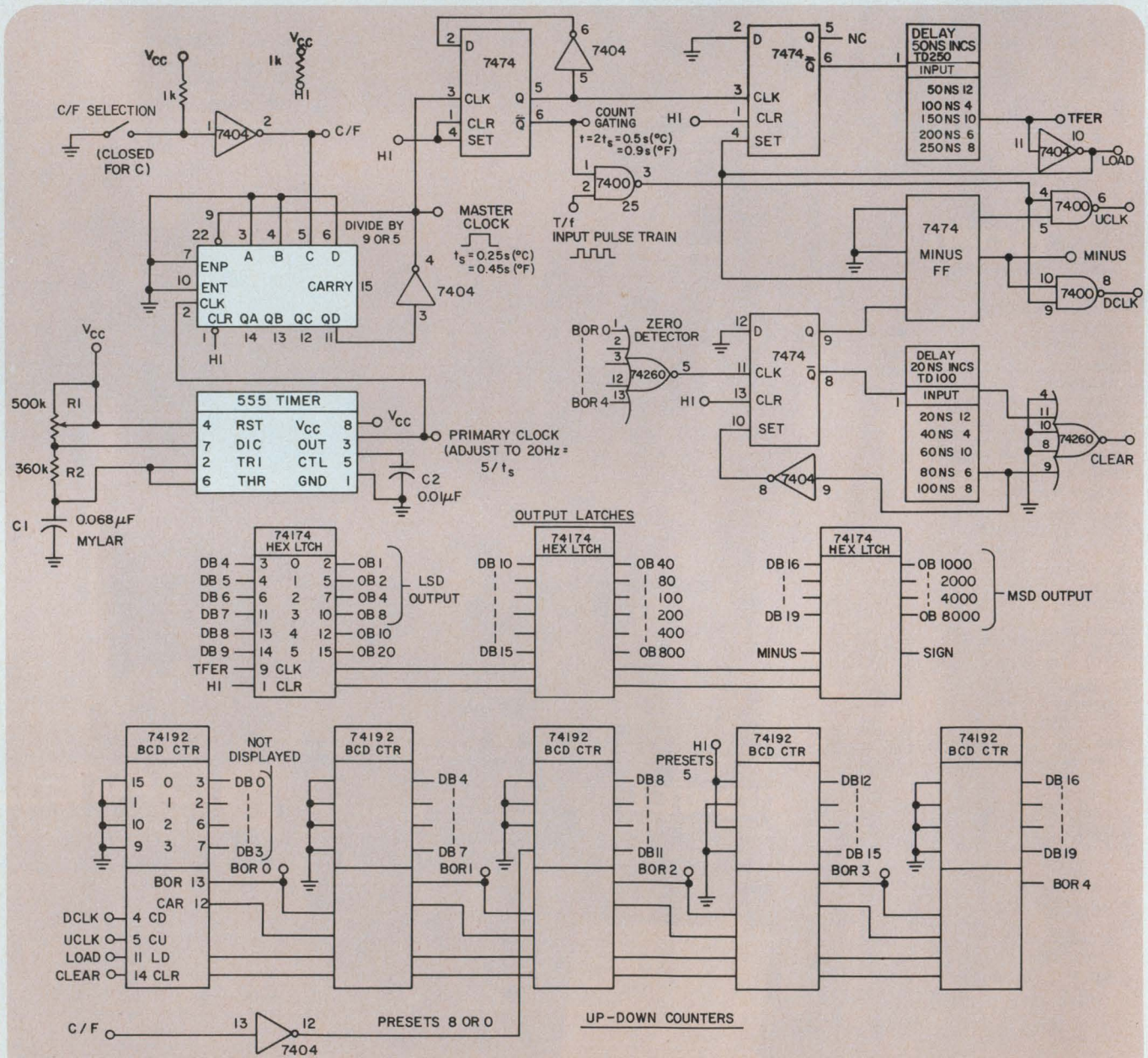

**A counter circuit provides a four-digit BCD output to resolve 0.1 of a degree of fahrenheit or centigrade**

temperature, and does it over the whole range, both below and above zero, without range switching.



# The 8080 A/D & D/A Advantage

super-software supplied • fast, on-card DMA logic • 80 (to 256) channel expansion from just 2 cards

Datel's SineTrac 800 has it. SineTrac 800 slide-in A/D and D/A cards provide a complete analog "front-end" inside your Intel MDS-800 or SBC-80/10/20 microcomputers.

SineTrac 800 is ideal for industrial data logging, process loops, and high speed data acquisition systems.

The A/D card contains 32 single-ended or 16 differential channels with 12-bit resolution. An A/D Expander card offers 48 additional channels. Thus, two cards give 80 single-ended or 64 differential channels! Card addressing allows expansion to 256 channels. Throughput is 20 microseconds with rates up to 36,000 samples/second in DMA mode.

SineTrac D/A cards contain either 8 channels or 4 channels.

More SineTrac system advantages include on-card start and final address register/counters to save time and CPU housekeeping, and an adjustable IC scan clock with interrupt-flagged scan markers for event-triggered or internal scan starts.

The paper tape diagnostic test programs, supplied, allow channel calibration and a multi-scan accuracy test with decimal printout. The programs diagnose error conditions, give a descriptive TTY printout between selected channels, and continuously loop for scope or logic analyzer troubleshooting.

A/D or D/A cards are \$650\* (singles). Write today for complete details.

\*U.S.A. domestic prices only.

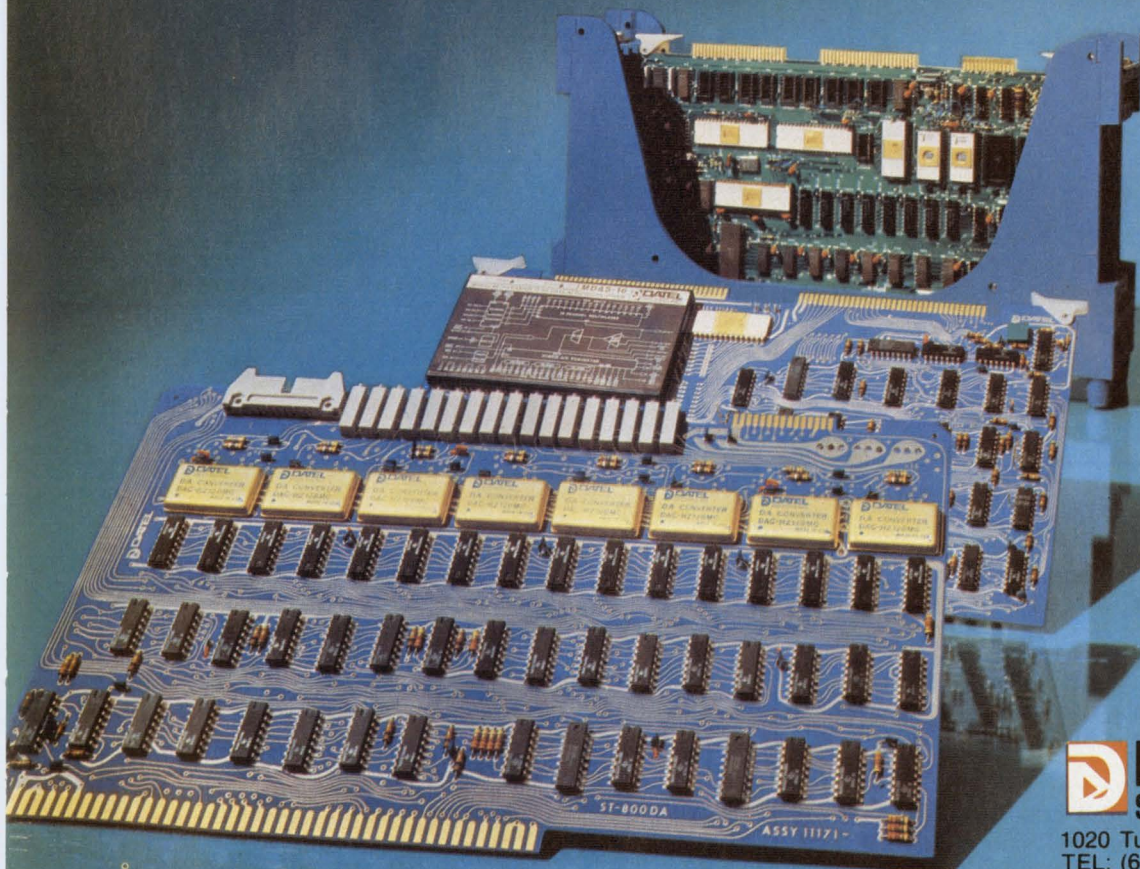

 **DATEL**  
SYSTEMS, INC.

1020 Turnpike Street, Canton, MA 02021  
TEL: (617) 828-8000 TWX: 710-348-0135

# Add foldback protection to your supply and stop pass-transistor failures

You can save your power supply's series pass transistor under shorted-output conditions by adding two resistors that provide voltage feedback. Otherwise, a sustained short circuit in a current-limiting power supply, like the one in Fig. 1, can cause a damaging temperature rise in power Darlington pass transistor,  $Q_2$ .

The circuit of Fig. 1 is modified by adding two voltage-feedback resistors,  $R_3$  and  $R_4$  (see Fig. 2a). Control transistor  $Q_1$ 's emitter voltage depends on the power-supply output voltage as sampled by the  $R_3$ ,

$R_4$  voltage divider. If  $R_1$  senses a current overload, the drop across it decreases the output voltage and lowers the emitter voltage of  $Q_1$ . Then  $Q_1$  turns on at reduced current through  $R_1$ , which limits current flow through  $Q_2$  as shown in the current-foldback characteristic of Fig. 2b. You can adjust the foldback ratio by changing  $R_3$  and  $R_4$ , or  $R_1$ , or all three.

*Floyd S. Griffin, Vice President, Ordnance Research Inc., P.O. Box 1426, Fort Walton Beach, FL 32548.*

CIRCLE NO. 316

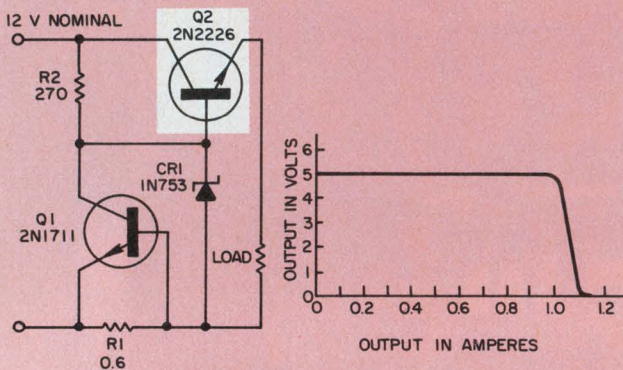

1. A conventional current-limiting power supply is protected from instantaneous short-circuits, but long-duration shorts can overheat pass transistor  $Q_2$ , leading to its eventual failure.

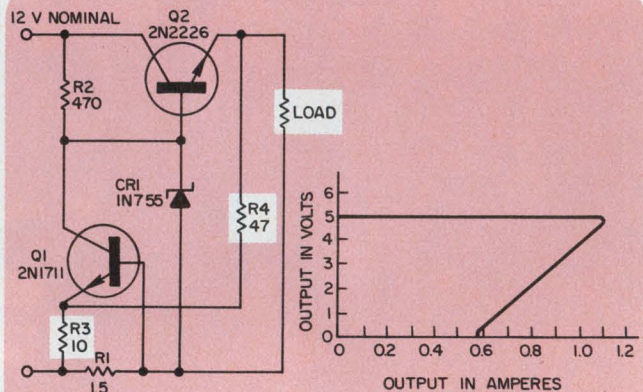

2. Two resistors added to Fig. 1 provide voltage feedback (a) and generate a current-foldback output characteristic (b).

### IFD winner of September 27, 1977

**Joe Orender**, General Manufacturing Co., P.O. Box 5123, Wichita Falls, TX 76307. His idea "Transformer Completely Isolates Contact without a Floating Power Source" has been voted the Most Valuable of Issue Award.

Vote for the Best Idea in this issue by circling the number for your selection on the Reader Service Card at the back of this issue.

**SEND US YOUR IDEAS FOR DESIGN.** You may win a grand total of \$1050 (cash)! Here's how. Submit your IFD describing a new and important circuit or design technique, the clever use of a new component or test equipment, packaging tips, cost-saving ideas to our Ideas for Design editor. Ideas can only be considered for publication if they are submitted exclusively to ELECTRONIC DESIGN. You will receive \$20 for each published idea, \$30 more if it is voted best of issue by our readers. The best-of-issue winners become eligible for the Idea of the Year award of \$1000.

# New, 16 Bit Microcircuit D/A Converter

Datel has it...



Two versions to choose from:

#### DAC-HP16BMC

- ▶ 16 Bit Binary Resolution
- ▶ 15 ppm/°C Max. Tempco
- ▶ ±0.003% Linearity
- ▶ 0 to +10V, ±5V Output
- ▶ 35 μsec. Settling Time

#### DAC-HP16DMC

- ▶ 4 Digit BCD Resolution
- ▶ 15 ppm/°C Max. Tempco
- ▶ ±0.005% Linearity
- ▶ 0 to +10V Output
- ▶ 15 μsec. Settling Time

**\$7750\***  
(100's)

Price, both versions: \$119.00\* (1-24)

\*U.S.A. domestic prices only

When high resolution and stability are demanded, Datel's DAC-HP series provides the performance—applications such as precision signal reconstruction, automatic test systems, and ultra-linear ramp generation. DAC-HP's excellent performance results from special low tempco nichrome thin-film resistors, laser trimmed for optimum linearity, and a low tempco zener reference circuit. Operating temperature range is 0 to 70C, with models available for -25 to +85 and -55 to +125C operation.

**DATEL**  
SYSTEMS, INC.

1020 Turnpike Street, Canton, MA 02021  
TEL: (617) 828-8000 TWX: 710-348-0135

Santa Ana, (714) 835-2751, (L.A.) (213) 933-7256 • Sunnyvale, CA (408) 733-2424 • Gaithersburg, MD (301) 840-9490 • Houston, (713) 932-1130 • Irving, TX (214) 256-4444  
OVERSEAS: DATEL (UK) LTD—TEL: ANDOVER (0264) 51055 • DATEL SYSTEMS SARL 620-06-74 • DATELEK SYSTEMS GmbH (089) 77 60 95

CIRCLE NUMBER 51

# THANK YOU

FOR GOING TO BAT FOR US  
BY VOTING **Electronic Design**

- **MOST HELPFUL**
  - **MOST PREFERRED**
- OF ANY ELECTRONICS PUBLICATION  
IN THE WORLD!**

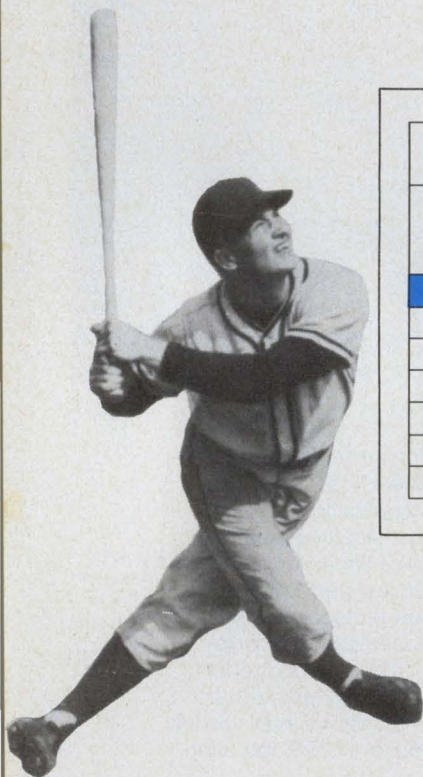

**INDEPENDENT READERSHIP STUDY BOX SCORE** (Oct. 1977)  
(175 STUDIES TO DATE)

PUBLICATION	Number of 1st Rankings	Number of 2nd Rankings	Number of 3rd Rankings	Number of 4th Rankings
<b>ELECTRONIC DESIGN</b>	<b>152</b>	<b>18</b>	<b>4</b>	<b>1</b>
Electronics	2	42	34	35
EDN	16	72	7	15
Electronic Products Magazine	1	6	41	26
Electronic News	—	3	6	8
EET	—	3	8	23
ECN	—	—	—	2

The results are now in, and for the 18th straight year *Electronic Design* has been voted first in "Read Regularly" as well as the "Most Helpful" and "Most Preferred" electronics publication in the world.

Look at the score board. 152 "wins" for *Electronic Design*. The runner-up, *EDN*, has won 16. Some well-known electronics publications have won none at all!

Thank you for going to bat for us. It's often a bother to fill in the many readership questionnaires you must receive. We appreciate the time and trouble you take to stand up and be counted . . . to state your preference and loyalty to this magazine. We're doing everything we can to continue to deserve your support.

# Whatever you can conceive, Norplex can help you achieve.

While the sages of yore could only ponder the infinite, modern man literally is reaching for it.

With the advent of space-age circuitry comes the need for base materials of unexcelled reliability and consistency.

The manufacture of highest-integrity industrial laminates has been our only business for more than a quarter-century. No other company has the combined experience, technical resources, and exhaustive quality-assurance program that Norplex offers you.

At Norplex, the creative engineering and development of new products—and the

improvement of existing ones—is an ongoing process. We are continually designing and manufacturing laminates and other base materials for unique applications, helping customers find new ways to produce systems better and faster. And so we can for you.

At Norplex, imagination knows no earthly limits.

Norplex Division, UOP Inc. U.S. operations: LaCrosse, Wisconsin (World Headquarters); Black River Falls, Wisconsin; Franklin, Indiana; Postville, Iowa. European Headquarters: Wipperfurth, West Germany. Pacific Headquarters: Kowloon, Hong Kong.



# When you need LED readout displays or more than LED readout displays...

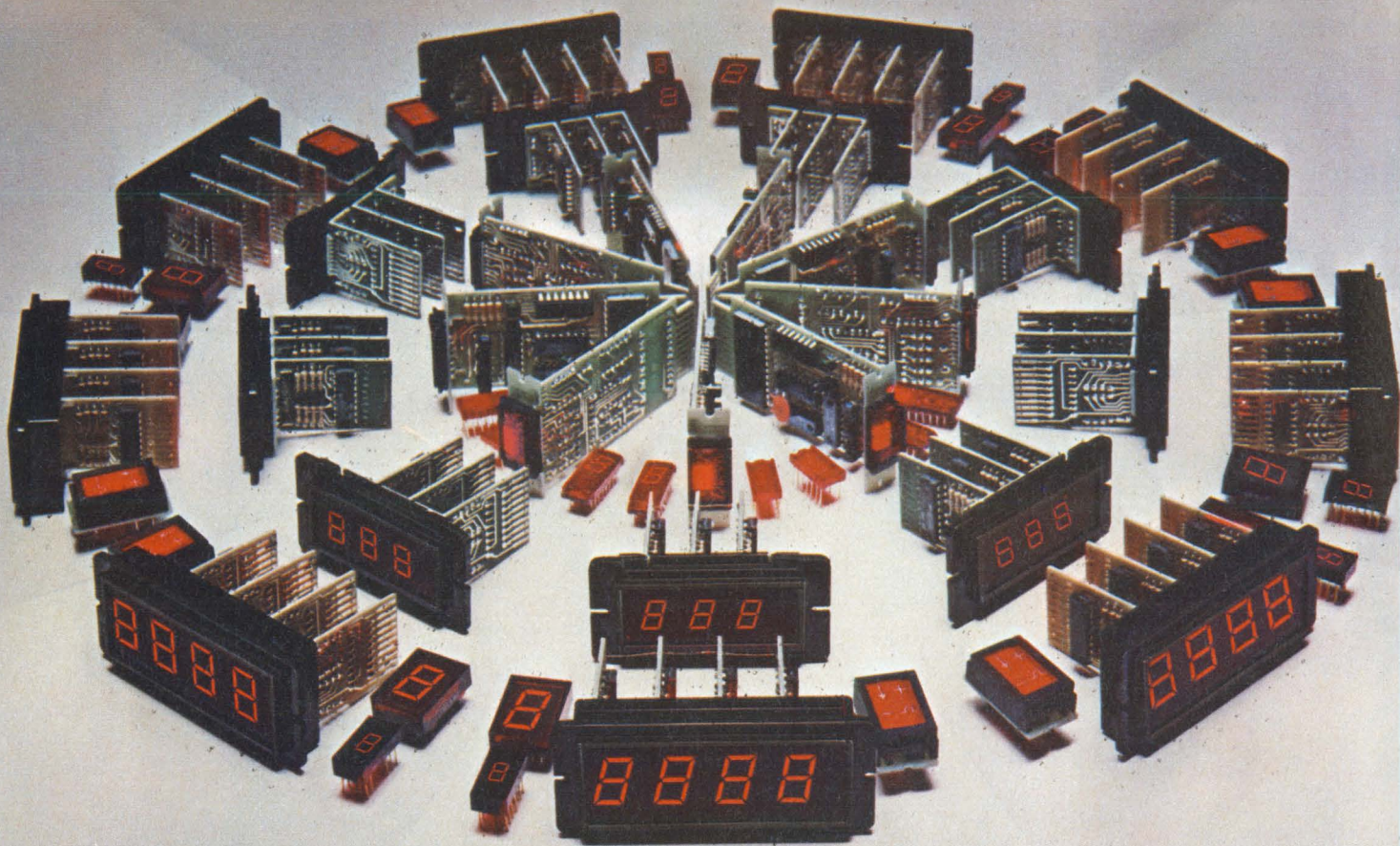

Come to Dialight. For built-in circuitry for example. If that's the type of convenience you're considering, then Dialight's the first place to look . . . because Dialight's the first in value-added LED readout displays.

For many years now we've been offering not only the latest technology, but also the latest in time and labor-saving pre-engineered displays. These can be ordered any way you wish: with or without on-board decoder/driver, with or without code generator, in any

number of digits in an assembly, complete with bezel for instant panel mounting.

We also offer high brightness, low cost design flexibility with a choice of discrete and assembly displays with character heights of .270", .300" and .600".

For your free copy of our new Readout Product Selector Guide, call or write to us at Dialight today.

**DIALIGHT**  
A North American Philips Company

## Dialight meets your needs.

Dialight, 203 Harrison Place, Brooklyn, N.Y. 11237 (212) 497-7600

CIRCLE NUMBER 53

# New products

## Peripheral circuit chips handle human interfacing



Intel, 3065 Bowers Ave., Santa Clara, CA 95051. Rob Walker (408) 248-8027. 100 qty. prices: \$62.50 (8275), \$14.10 (8279); stock.

The Models 8275 programmable CRT controller and 8279 programmable keyboard/display interface are peripheral circuit chips that cover the human interface needs of popular CPUs such as the 8080A, 8085 and 8048. The 8275 operates almost any kind of raster-scan display. In addition to scan control and operation of the character-generator ROM, the chip handles refreshing, transfer of data from main memory, limited graphics generation, cursor control, light pen detection and other auxiliary functions. The 8279 handles most other kinds of "man-machine" functions such as keyboard scanning and display multiplexing and also interfaces a wide range of control devices.

CIRCLE NO. 301

## Make your own ICs with design kit

Interdesign, 1255 Reamwood Dr., Sunnyvale, CA 94086. (415) 734-8666. \$59; stock.

The MO-K monochip design kit contains all the ingredients you need to convert your discrete linear or digital circuits to custom ICs. Divided into linear and digital subsections, the design manual explains bipolar and n-channel MOS technologies in detail. Breadboard components are included to enable you to verify your linear circuits.

CIRCLE NO. 302

## CMOS quartz clocks drive sync motors

RCA, Box 3200, Somerville, NJ 08876. (201) 685-6423. \$1.30 to \$1.75 (100 qty); stock.

Five timing ICs, types CD22011E through CD22015E, use CMOS technology to drive synchronous or stepping motors. Each circuit consists of an input inverter for use as a crystal oscillator, a frequency divider, one or more zener diodes for transient protection and one or two output drivers. They differ primarily in quartz-crystal frequency, output-pulse width and duty cycle. With oscillator frequencies from 1.9666 to 4.194 MHz, output-pulse frequencies from 1 to 64 Hz can be obtained. The devices are in 8-lead mini-DIP packages.

CIRCLE NO. 303

## Temperature sensor spans -55 to 150 C

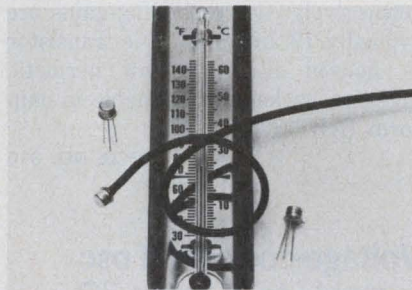

Analog Devices, 829 Woburn St., Wilmington, MA 01887. Jeff Riskin (617) 935-5565. \$1.95 to \$7.95 (100 qty).

An IC temperature sensor, AD590, is capable of 1-C absolute accuracy over -55 to +150-C range. The device is a two-terminal unit that produces an output current proportional to absolute temperature when driven by a dc supply voltage between 4 and 30 V. The sensor is laser trimmed to produce an output of 298.2  $\mu$ A at 25 C. The output changes 1  $\mu$ A/ $^{\circ}$ C from that point. Three models are available. The "L" version has a calibration accuracy of  $\pm 1$ -C and  $\pm 1$ -C linearity from -55 to 150 C; the "K" version has 2-C accuracy with -1-C linearity; and the "J" version has 5-C accuracy and  $\pm 2$ -C linearity. Packaging is in a TO-52 metal can.

CIRCLE NO. 304

## Micropower IC drives alarm circuits

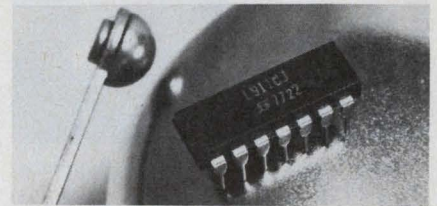

Siliconix, 2201 Laurelwood Rd., Santa Clara, CA 95054. Jim Graham (408) 246-8000. \$2.18 (100 qty); stock.

The L911 detector IC is for micropower systems requiring a high-input-impedance comparator and alarm driving capability. The use of the circuit only requires a few resistors that control the set current of the IC and the threshold setting of the input comparator. The output can be used for logic triggering or in conjunction with higher current driver SCRs or transistors. The L911 interfaces with a variety of detector on/off control systems and monitor alarms. Input impedance is greater than  $10^9 \Omega$  and current consumption is less than 10  $\mu$ A at 9 V. The output current sourcing is adjustable from 0.5 to 30 mA. Housed in a 14-pin plastic DIP the L911 operates from 6 to 16-V supplies.

CIRCLE NO. 305

## Detector converts light to pulse signals

Integrated Photomatrix, 1101 Bristol Rd., Mountainside, NJ 07092. Marie Rozar (201) 233-6010.

The IPL-13 device combines a planar light sensor with amplification and triggering to provide an output frequency that is a function of incident-light level. The trigger converts light intensity to a variable pulse rate with 2% linearity. Response peaks in the infrared at 0.8 microns, but is between 50 and 70% of the peak across most of the visible spectrum. Output rate of the 1- $\mu$ s pulses varies from 10 pulses/s in the dark to 100,000 pulses/s when exposed to 30 mW/cm<sup>2</sup>. The 0.0075-in. square diode, on a 0.040-in. square silicon chip is packaged under glass in a four-lead TO-18 case.

CIRCLE NO. 306

### HV rectifier goes into magnetron supplies

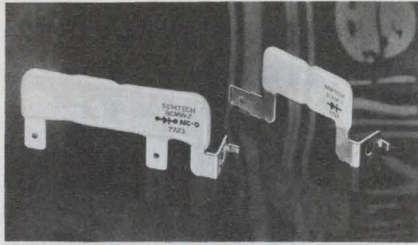

Semtech, 652 Mitchell Rd., Newbury Park, CA 91320. Bill Krause (805) 498-2111. \$1.50; stock.

The type SCMW-1 and SCMW-2 (isolated) high-voltage rectifiers are designed for magnetron power supplies. These multichip silicon rectifiers are mounted on metal flanges and encapsulated for better heat dissipation. The voltage breakdown at 100  $\mu$ A is 12 kV min and reverse operating voltage is 5 kV. The average rectified current at 55 C is 350 mA.

CIRCLE NO. 307

### HV isolator is optically coupled

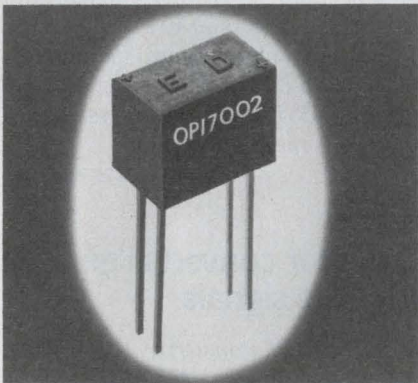

Optron, 1201 Tappan Circle, Carrollton, TX 75006. (910) 860-5958. \$1.00 to \$1.15 (1000 qty); stock.

The OPI 7000 series of optically coupled isolators has an input-to-output isolation voltage of 6000 V in free air and 10,000 V when encapsulated. An isolator consists of an infrared LED coupled with either a silicon phototransistor or photo-Darlington in a molded plastic package. Standard pin spacing of 0.3  $\times$  0.1 in. fits DIP sockets. Current transfer ratios range from 20 to 100% for the phototransistor versions (OPI 7002 and 7010), and from 200 to 400% for the photo-Darlington models (OPI 7320 and 7340).

CIRCLE NO. 308

### 3-digit chip forms low-cost DPM

Analog Devices, P.O. Box 280, Norwood, MA 02062. Joe Codispoti (617) 329-4700. \$5.50 (1000 qty); stock.

A three-digit I<sup>2</sup>L LSI requires only 10 additional components to become a complete digital panel meter. The AD2020 chip includes an input amplifier, a comparator band-gap reference, counters, clock, control logic, multiplexer and all drivers needed to implement a dual-slope conversion DPM. Only a capacitor, three transistors, one decoder/driver, two potentiometers and three displays are needed to complete the DPM. The device is housed in a 16-pin plastic DIP.

CIRCLE NO. 309

### Bipolar transistor has low noise up to 4 GHz

Aertech, 825 Stewart Dr., Sunnyvale, CA 94086. (408) 732-0880. \$20/\$50; stock.

The ABT7701 is an npn, silicon, bipolar transistor designed for low-noise, small-signal amplifier use to 4 GHz. The transistor has typical noise figures of 1.7 and 2.7 dB at 2 and 4 GHz, respectively. Corresponding gains are typically 12 and 8 dB. The transistor is housed in a 100-mil hermetic stripline package or available in chip form (ABT7700).

CIRCLE NO. 310

### Voltage-controlled osc is stable to 20 ppm/ $^{\circ}$ C

Exar Integrated Systems, P.O. Box 62229, Sunnyvale, CA 94088. (408) 732-7970. \$0.97 (100 qty); stock.

The ultra-stable voltage-controlled oscillator IC, SR-2209, has 20 ppm/ $^{\circ}$ C temperature stability and 1000:1 sweep range. It comes in an 8-pin DIP and produces independent symmetrical triangle and square-wave outputs. The oscillator operates over eight decades of frequency, from 0.01 Hz to 1 MHz. The frequency is set by an external R-C combination, and it can be linearly swept over a 1000 to 1 control range. The output waveforms are unaffected by frequency sweep. An internal regulator makes the device insensitive to supply voltage changes; it can operate with a supply voltage of 8 to 26 V or  $\pm 4$  to  $\pm 13$  V.

CIRCLE NO. 320

### Voltage reference diodes have low noise

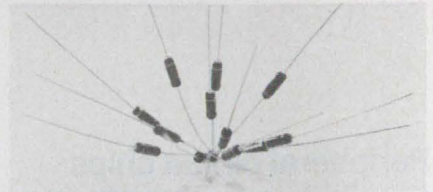

CODI, Pollitt Dr. S., Fair Lawn, NJ 07410. John Halgren (201) 797-3900. \$35 (100 qty); stock to 6 wks.

A family of low noise, ultrastable, precision reference diodes (PRD) includes an equivalent to the Motorola MZ605, the PRD 7530. This diode has a nominal operating current of 7.5 mA and time stability of 30  $\mu$ V or 5 ppm/1000 h. Noise is 1 ppm of output, and the TC is 1 ppm (at the zero TC operating current) from 25 to 45 C.

CIRCLE NO. 321

### GaAlAs diodes are sources for fiber optics

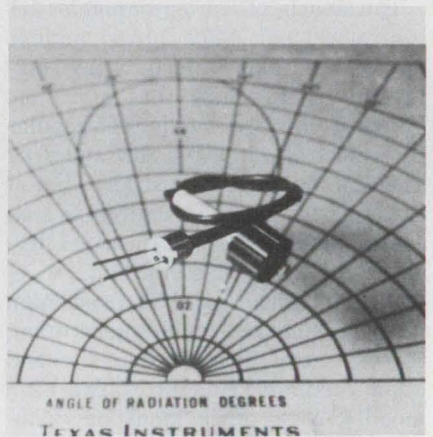

Texas Instruments, P.O. Box 5012, MS 308 (Attn: TXES475/476), Dallas, TX 75222. Jim Walyus (214) 238-4422. \$50/\$75 (100 qty).

Two gallium-aluminum-arsenide infrared emitting diodes, the TXES475 and the TXES476, have a peak emission wavelength of 790 nm to match an optical window in DuPont's new PFX-PIR infrared transmitting plastic fiber-optic cable. Two times higher output powers are achieved at this wavelength than are available with shorter wavelength emitters. The emitters are mounted in a modified TO-18 package and have an integral PFX-PIR140 fiber-optic cable for coupling the optical power from the emitter chip. Optical rise time is typically 25 ns. Output power at 50-mA diode current for a 25-cm cable length is 50  $\mu$ W for the TXES475 and 75  $\mu$ W for the TXES476.

CIRCLE NO. 322



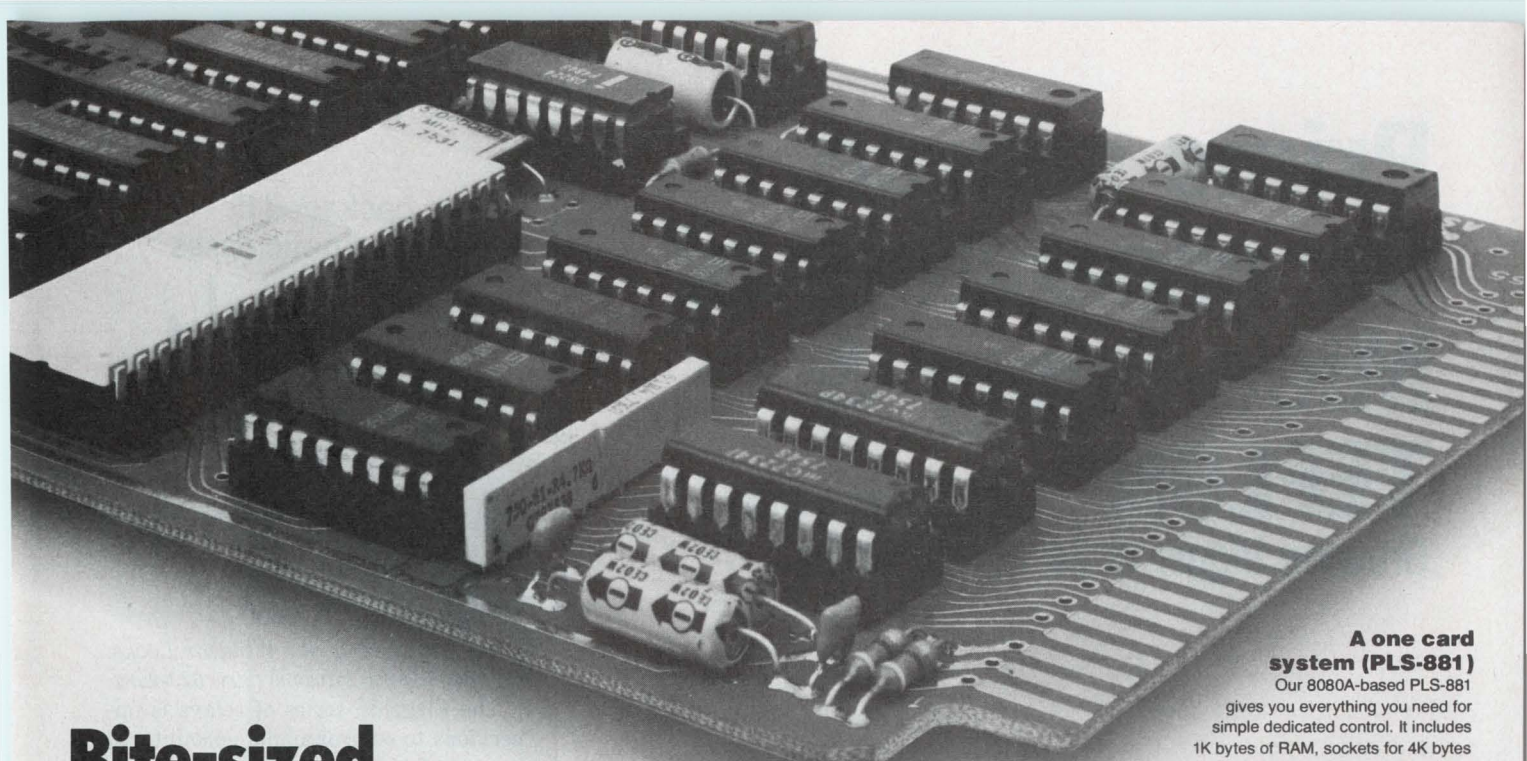

# Bite-sized 8080A systems make big boards hard to swallow.

## A one card system (PLS-881)

Our 8080A-based PLS-881 gives you everything you need for simple dedicated control. It includes 1K bytes of RAM, sockets for 4K bytes of PROM program memory, interrupt input, crystal clock, power-on and external reset, three 8-bit output ports, and two 8-bit input ports. It costs only \$165 in 100 piece quantities.

*X*  
#165

### Simple, flexible, standardized Pro-Log 8-bit microprocessor systems a best buy for OEM's.

We sell 8080A and 6800 microprocessor cards two ways; as single and multicard systems, or as individual CPU and support cards so you can build a system of your own.

Our cards are all standard 4.5" by 6.5" with 56 pin edge connectors. They fit into standard card racks. To keep you from being tied to a specific semiconductor manufacturer for parts, delivery and pricing, our 8080A and 6800-based systems use only second-sourced parts.

Buy 250 of any particular card and we throw in free its manufacturing and assembly plans and non-exclusive rights to manufacture it, allowing you to build your own hardware, relying on us as an established and dependable second source.

### We've got 4-bit systems, instruments, education and literature, too.

4-bit 4040 and 4004 systems; 4- and 8-bit microprocessor system analyzers; PROM programmers; a half-day economics seminar for decision makers; a three-day hands on design course for engineers; manuals and support documentation.

Call or write for data sheets or a free copy of The Microprocessor User's Guide.

*Check our new low prices!*



**PRO-LOG CORPORATION**  
2411 Garden Road  
Monterey, CA 93940  
Telephone (408) 372-4593  
TWX 910-360-7082

CIRCLE NUMBER 54

*#160*

### An expandable plug-in CPU card (8821)

Our "buffered bus" 8821 processor card implements the 8080A as a fully TTL buffered microprocessor. Add one I/O card and it becomes a complete two-card system. Or expand it to use full 8080A memory and I/O capability—it's compatible with all the Pro-Log ROM, RAM and I/O modules shown here plus many more. The 8821 costs only \$160 in 100-piece quantities. We also have equivalent cards implementing the 6800 microprocessor.

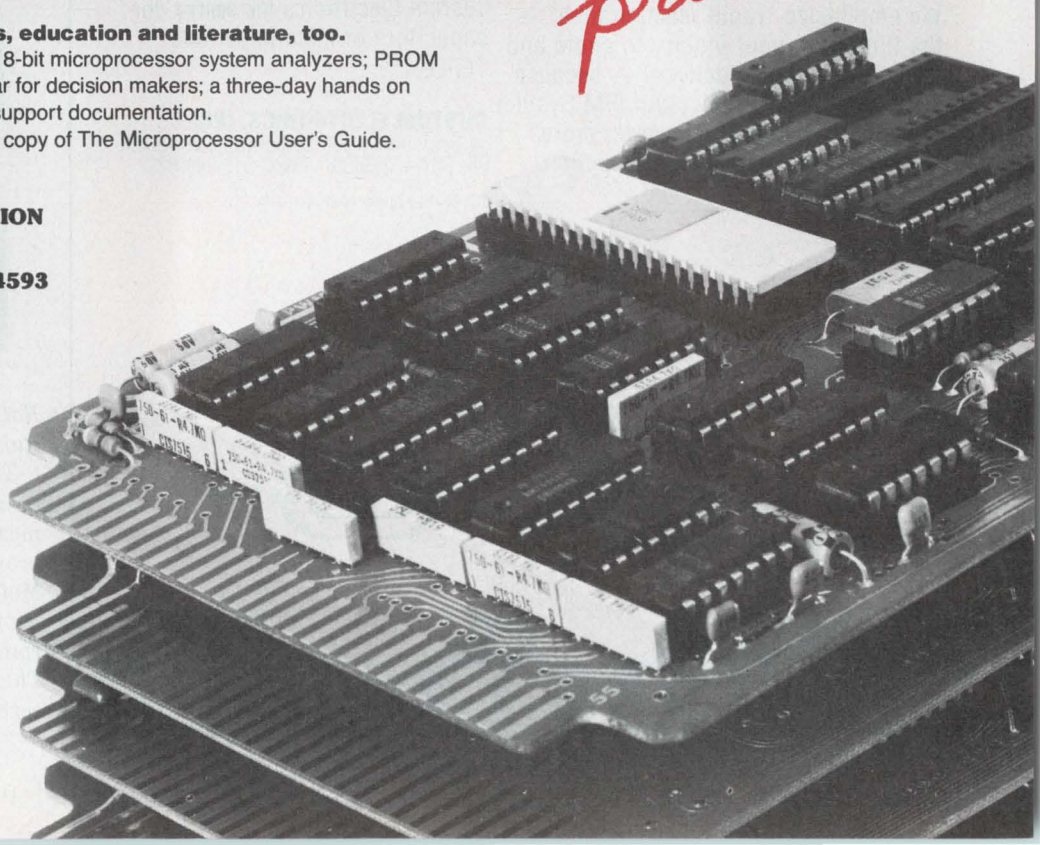

# Prime source for capacitors of Mica-Paper & TEFLON\* Custom Electronics . . . Growing Bigger to Serve You Better

Custom Electronics has expanded its capabilities and facilities to meet your growing demand for mica capacitors. Plant size alone has increased 30% in the past year; and is seven times its original size.

Our recent acquisition of Balco capacitors expands our product line to include high precision capacitors of TEFLON\* and eliminates shopping a dozen sources for capacitors.

We emphasize "rapid reaction time" — the time from your inquiry to quote and from your order to delivery — because your time means money! An IBM System 3 computer handles your order more efficiently, and expedites production.

Fast delivery is half the story. Every Custom Electronics capacitor must meet the toughest quality control standards in our 11 Test Centers,

because you cannot afford failure in the field.

Find out how Custom Electronics can help your production plans.

Send for FREE Brochure which describes the facilities, the products, and the philosophy that have made Custom Electronics the source for capacitors of mica-paper and TEFLON\*.

**CUSTOM ELECTRONICS, INC.**  
4 Browne Street, Oneonta, N.Y. 13820  
Ph: 607-432-3880 TWX: 510-341-8292

\*DuPont's registered trademark.

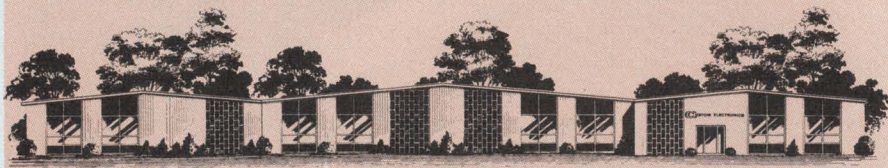
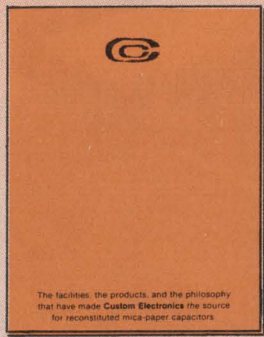

CIRCLE NUMBER 55

## COMPONENTS

### Relays packaged in welded hermetic cases

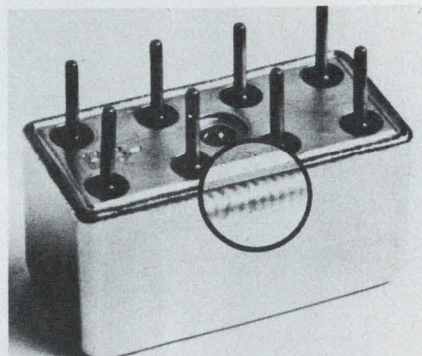

Hi G, 580 Spring St., Windsor Locks, CT 06096. John Parsons (203) 623-2481.

The Flagship series of relays is impervious to environments encountered in manufacturing and on the job, because of an all-welded metal case. The use of laser-welding techniques makes possible a degree of environmental protection hitherto available only in more costly relays. The relays are completely impervious to the strong solvents used in the cleaning of PC boards. Each relay is filled with inert gas.

CIRCLE NO. 323

### Thin wafer fan yields low noise



Rotron, Woodstock, NY 12498. Pete Rakov (914) 679-2401.

The wafer, a thin tube-axial fan with an acoustical rating as low as NC-41, measures only 1 x 3.63 in. The fan can provide up to 37-cfm free-air delivery. Motor voltage of 115 or 220 V can be supplied for nominal speeds of 2730 rpm at 50 Hz or 3300 rpm at 60 Hz. The fan is UL-recognized and CSA certified.

CIRCLE NO. 324

## Green LEDs provide guaranteed brightness

Litronix, 19000 Homestead Rd., Cupertino, CA 95014. Terry Snowden (408) 257-7910. See text; stock.

Green GaP LED lamps, with guaranteed brightness, come in T-1-3/4 and T-1 sizes. The GL-4950, a T-1-3/4 size, has a large, full-flood radiating surface. At 20 mA, its guaranteed minimum brightness is 1 mcd, typical brightness is 1.8 mcd. The GL-211, a T-1 size, at 20 mA has a guaranteed minimum brightness of 0.8 mcd; typical brightness of 1.5 mcd. Both lamp types can be powered directly by standard TTL and MOS IC circuitry. Snap-in mounting clips for panel mounting are available. Prices in quantities of 1000 are 30¢ for GL-4950 and 19¢ for GL-211.

CIRCLE NO. 325

## Stepper motor converts pulses to angular steps

Haydon Switch & Instrument, 1500 Meriden Rd., Westbury, CT 06705. (203) 756-7441.

A two-wire stepper motor, Type 31300, directly converts electrical impulses into discrete angular steps of an output shaft. Operating from simple "on/off" pulses, no control logic is required. The rotor turns 180° when power is applied and an additional 180° when power is removed; no power is consumed between pulses. Motors for 12 or 24-V-dc operation are available. Rotation is unidirectional, cw or ccw, and standard available step angles are 36, 30, 6 and 0.36°. Output torque at 0.36° step angle is 2.5 oz-in. at pulse rates up to 40 pulses/s. Size is 1-1/6 in. dia. by 1-1/16 in. long.

CIRCLE NO. 326

## 10-A time-delay relay spans 5-to-300-s range

Zenith Controls, 830 W. 40th St., Chicago, IL 60609. (312) 247-6400.

Solid-state time-delay relays, Series SS, are for electronic timing use in the range of 5 to 300 s. They feature a heavy-duty output relay with gold-flashed contacts, UL recognition, a 10-A-DPDT, 120-V-ac resistive rating and minimum life of 10 million cycles. Repeatability is ±1% of full range, and its 95-to-130-V-ac input-voltage range has no effect on timing. Operating ambient temperature is -40 to 80 C.

CIRCLE NO. 327

## Rotary switches have coded outputs

Oak Industries, Crystal Lake, IL 60014. J.C. Vodnansky (814) 549-5000. See text.

Seven standard communicator-series rotary switches are available. They include one and two-section models offering 16, 24 and 40 positions with various coded outputs. The 24 and

40-position models include a cam that acts as a precision, internal detent that eliminates both backlash from loose rotors and stack-up tolerance problems. Coded outputs available include binary 01 through 40, two-digit, seven-bar displays and 1 through 24 and hexadecimal. Price for a single-section switch is \$9.10 (1-24), \$5.46 (100); two section, \$13.78 (1-24), \$8.27 (100).

CIRCLE NO. 328

# Our beauty is skin deep. And then some.

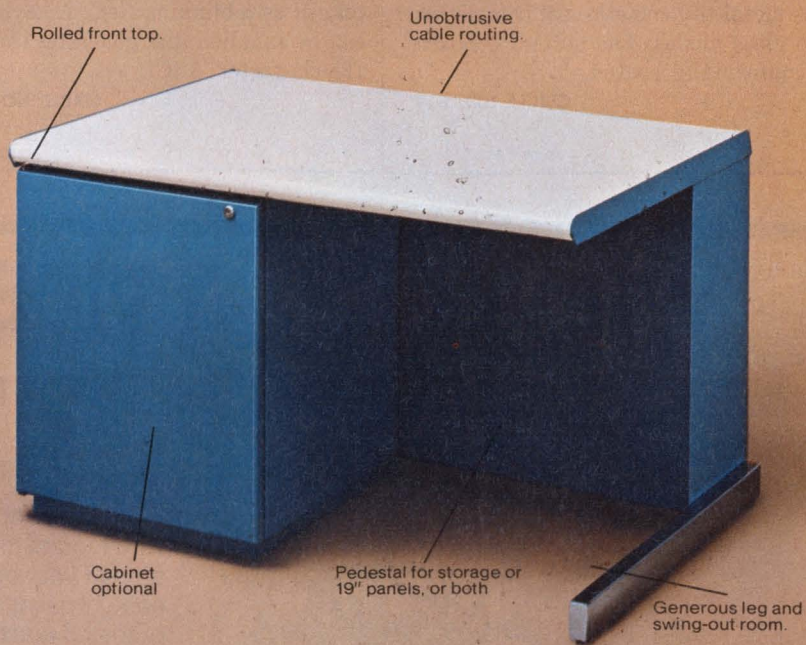

For beautifully efficient use of office space, you can get this Optima desk with bays for instruments, general storage or a combination of both. Cabling from instruments on top are unobtrusively routed into the pedestal. With cantilever construction, brushed stainless steel legs and rounded top edge, it's the most beautiful desk yet designed for your equipment.

Send for our catalog.

We make you look better

## OPTIMA<sup>®</sup> Scientific-Atlanta

2166 Mountain Industrial Blvd., Tucker, Ga. 30084 • Tel: (404) 939-6340  
Europe: McKetrick-Agnew, Macmerry, East Lothian,  
Scotland, EH33 1EX • Telex: 72623.

CIRCLE NUMBER 56

## MODULES & SUBASSEMBLIES

### Digital-tape transport works in hostile areas

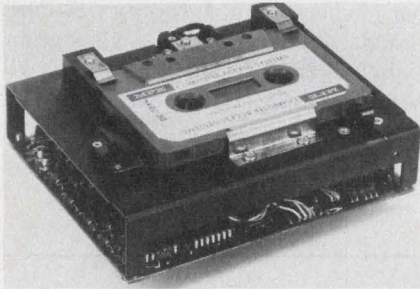

MFE, Keewaydin Dr., Salem, NH 03079. Jim Saret (603) 893-1921. \$1150; 4 wks.

Model 250BH-1 digital tape-cassette transport operates from  $-30$  to  $+55$  C. The transport is qualified mechanically to MIL-E-5400R and MIL-STD-810C "Helicopter Environment" for vibration, shock and 30-g crash safety. The electronics consist of MIL-type 5400 ICs, metal-to-hermetic seal transistors and glass diodes. The unit's PC board is conformally coated.

CIRCLE NO. 329

### Smart monitor shows upper/lower case

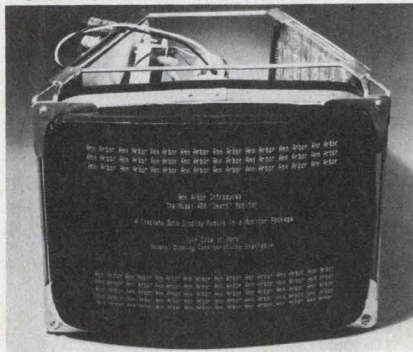

Ann Arbor Terminals, 6107 Jackson Rd., Ann Arbor, MI 48103. Sarah Freeman (313) 769-0926. \$900; 8 wks.

Model 400W Smart Monitor modules display upper and lower case characters. Characters are written in a  $7 \times 10$  dot matrix in a  $10 \times 12$  dot field. The unit displays 20 lines of 80-character alphanumeric, with five additional lines that can be accessed in either roll or scroll modes. Blinking characters are available and the cursor is displayed as a blinking field. A keyboard can be supplied that generates the full 128-character ASCII set.

CIRCLE NO. 330

### DPM draws trickles from the battery



Datel Systems, 1020 Turnpike St., Canton, MA 02021. Eugene Murphy (617) 828-8000. \$49 (100 qty); stock to 4 wks.

Digital panel meter, DM-310001, draws only 3 mA from a 9-V battery. The device's liquid-crystal display includes a volt, ohm or amp descriptor label that operates under logic control. Display resolution is  $3\frac{1}{2}$  digits and the input configuration is balanced differential. Automatic-zero correction eliminates the temperature drift of zero. The device measures a slowly varying or dc voltage between  $-2$  V and  $+2$  V and displays this voltage 3 times per second as black decimal digits against a light background. The instrument comes in a  $2.53 \times 3.25 \times 0.94$ -in. plastic case.

CIRCLE NO. 331

# WHO NEEDS A VIDEO OP AMP

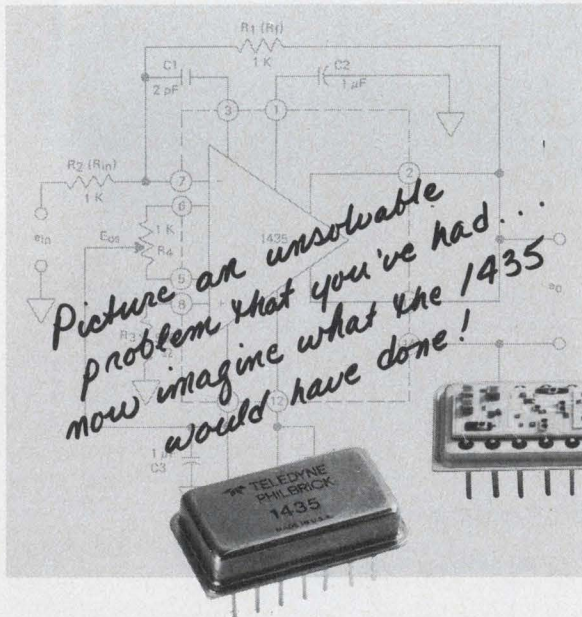

## With 1 GHz Gain Bandwidth Product and 70 Nanosecond Settling to 0.01%?

Far more people than you would have imagined! People who require the performance of a true differential input op amp at frequencies from DC to beyond 100 MHz, with the ease of using a 741 at 100 kHz. Those who want a  $\pm 5$  volt output to reach an accuracy of 0.01% in 70 nanoseconds. Others who require this state-of-the-art performance from  $-55$  C to  $+125$  C, and many more who require the high reliability provided by MIL STD 883 processing.

Your application may not need the full temperature range or the hermetically sealed DIP, but for many industrial applications these and other features of the new Video Op Amp offer you vital reliability.

All of this and more is available to you off-the-shelf with the 1435 - The op amp that solves problems you didn't even try to solve before!

**TELEDYNE PHILBRICK**

Allied Drive at Route 128  
Dedham, Massachusetts 02026  
Tel: (617) 329-1600

TWX: (710) 348-6726  
Telex: 92-4439  
Cable: TELEPHIL

CIRCLE NO. 78

---

# If you think logic analyzers, recorders or scopes are the only way to debug digital circuitry, you're wrong.

**We'll** You'd like to take the  
**show you.** guesswork out of debugging  
the complex circuitry you've  
designed. Make it less of an art  
and more of a science.

You'd like to have a known, stable signal to input to your circuit, so you can tell whether its output is on target. But the multiple pulse or wave generators, flip flops, logic gates or other gear you've been using to generate your word and timing patterns just aren't enough. You can't program them easily or with any guarantee they're accurate.

You'd rather have a single instrument that has multiple channels and is easily programmed. So you can input *exact* duplicates of the real programs your circuit will be handling. So you can tell at a glance whether your output is right.

But nobody makes a single unit like that, right? Wrong!

Interface Technology is going to show you.

We'll show you a self-contained, low-cost, small digital debugging tool for \$2,500 and up. A multi-channel, microprocessor-controlled data and timing generator that's programmable with only 16 instructions. A general purpose tester that can generate large amounts of digital data, that's interactive, can respond to external stimuli and make decisions. A benchtop instrument that can be used rack-mounted as part of a computer-driven system, or as the core of a low-cost, stand-alone digital test system.

We'll show you how our multi-channel programmable digital systems can lower your design time. We'll show you how you can be *sure* about your final product. And we'll show you how we're already working for people like General Dynamics, Rockwell and Hughes and how we can work for designers like you.

We'll put the whole show on the road and demonstrate our digital test systems for you in person. And all you have to do is call collect: (213) 966-1718. Or write to the address below.

**interface**  
TECHNOLOGY

---

852 North Cummings Road • Covina, California 91724 • (213) 966-1718

CIRCLE NUMBER 57

# Buy yourself a little present.



Reward yourself for the great job you're doing.

Buy the new Fluke 8020A DMM so you can keep up the good work. Although it's small in size and price, it's big on performance. Only \$169.\*

Lightweight (13 ozs.) and rugged, it goes on the job with you. And you carry typical benchtop capabilities such as super-stable band-gap reference and 2000-count resolution with 100  $\mu$ V sensitivity.

Like you, the 8020A is an innovator, and it has many features most meters can only envy. Like conductance, the missing function on many meters, for leakage measurements all the way up to 10,000 M $\Omega$ !

The 8020A saves you time as well as money, with its autopolarity and

autozero. And the crystal-clear 3½-digit LCD display can be read in any light, and keeps on displaying your accurate measurements for up to 200 hours on one simple 9V battery.

Inexpensive to own and to operate. And safe as well, with 3-way overload protection against overvoltage, overcurrent and transients to 6000V. Fully guaranteed (including NBS-traceable calibration) for a full year.

A nice gift for someone who has to keep up the good work: you. Call (800) 426-0361, toll free. Give us your charge-card number for fast delivery. If you have a large gift list, buy the "Ten-Pack" of 8020As for only \$1521\* and let us buy you a present; your tenth 8020A comes free!

\*U.S. price only.

## Command Performance: Demand the Fluke 8020A.

1809-7003



CIRCLE NUMBER 58 FOR LITERATURE

## MODULES & SUBASSEMBLIES

### $\mu$ printer selects baud rates

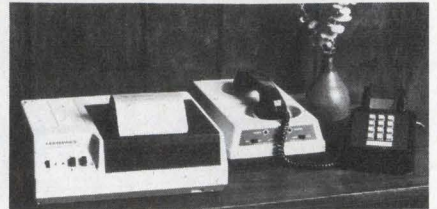

Centronics, Hudson, NH 03051. Tom Eifler (710) 228-6505. \$695.

The user can select baud rates, parity and the number of stop bits on the Microprinter-S1. The printer provides a 7-bit serial RS-232 interface, standard ASCII 96-character set and operates from 50 to 9600 baud. Copy is produced on aluminum-coated paper by an electric-arc discharge. 80 columns can be printed on 4¾-in. roll paper.

CIRCLE NO. 334

### Flat-panel display is $\mu$ P controlled

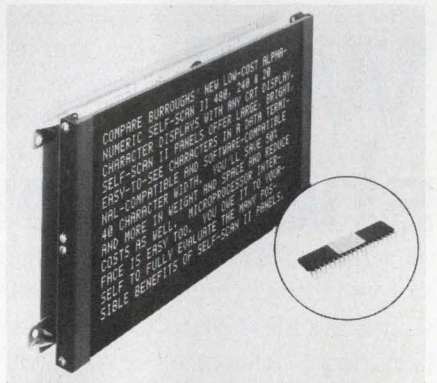

Burroughs, P.O. Box 1226, Plainfield, NJ 07061. (201) 757-5000. See text; stock.

To operate the microprocessor-controlled flat-display panel, Self-Scan II, feed it 8-bit signals. The displays include editing and control routines for insertion, deletion or blinking of letters, words or lines, increasing or decreasing brightness and right-to-left data entry. The display subsystem operates off an 8-bit bidirectional bus or a TTL bus. In DMA mode, data can be entered at a rate up to 1 MHz. With the addition of a keyboard and communication interface, the combination serves as a compact data terminal. Prices in 100 quantity are: \$225, 40-char; \$500, 240-char; \$750, 480-char.

CIRCLE NO. 335

## Output subsystem gives simple 8080 conversion

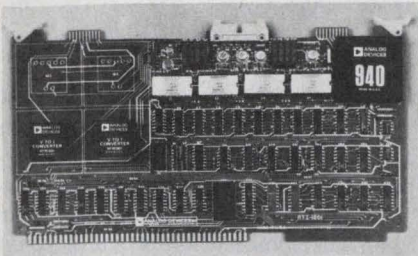

Analog Devices, P.O. Box 280, Norwood, MA 02062. Russ Ver Nooy (617) 329-4700. \$298/\$379.

A d/a converter board, RTI-1201, provides simplified 8080 data conversion, with hardware and software to interface the Intel SBC-80 computers to the outside world. The board is a complete 2 or 4-channel analog-output subsystem that includes four digital outputs and is compatible with the RTI-1200 I/O interface board, the Intel System-80 microcomputers, the Intel MDS development system and the National Semiconductor BLC-80/10 board-level computer.

CIRCLE NO. 336

## Cartridge transport works on low power



Kennedy Co., 540 W. Woodbury Rd., Altadena, CA 91001. Russ Bartholomew (213) 798-0953. \$500 to \$795; 8 wks.

A 3M-type cartridge transport, Model 631, requires only a dual-voltage power supply from which it takes only 22.6 W max during start, dropping to 8.2 W when running. The transport is bidirectional and can be equipped with one, two or four read/write and erase heads, giving a maximum unformatted storage capacity of 720 kbytes/track or 2.88 Mbytes/cartridge. Normal operating speed is 30 in/s. Using a phase-encoded format at a recording density of 1600 bits/in., the transport has a data transfer rate of 48 kbits/s.

CIRCLE NO. 337

## Scanner eliminates false triggering

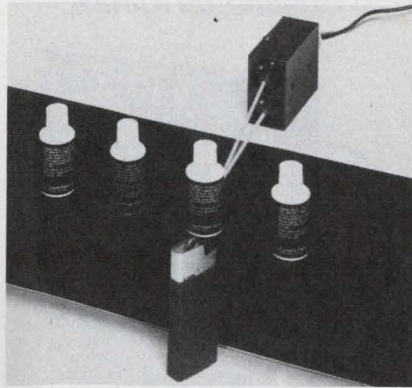

Banner Engineering, 9714 10th Ave. N., Minneapolis, MN 55441. Floyd Schneider (612) 544-3164. \$80; stock.

The SP-1000V scanner uses a narrow, modulated, converging beam to sense at approximately 4 in. and not beyond. This eliminates false triggering from background objects. The beam converges to a 0.12-in. diameter spot and is useful for sensing through narrow gaps. The beam can easily differentiate white objects an inch thick on a white background or very dark objects not easily sensed with conventional diffuse scanners.

CIRCLE NO. 338

## Electronic stepper goes forward and reverse

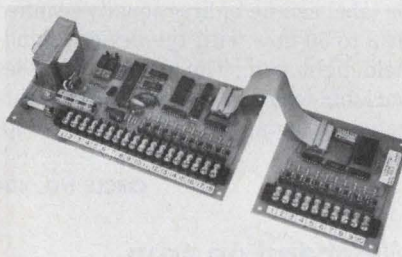

Vorne Industries, 5023 W. Belmont Ave., Chicago, IL 60641. Tom Canene (312) 725-3077. See text; stock to 4 wks.

A bidirectional sequencing stepping switch, Model 301, is expandable to 60 steps. The stepper consists of a master board that controls the first 10 steps and up to five slave boards of 10 steps each may be added to expand the switch. A preset switch on the master board sets the maximum number of steps in a sequence and a 0.4-in. LED display indicates each step in the sequence. The unit will switch up to 1 A at 24 V dc. Power requirement is 35 VA at 120 V, 60 Hz. Price of the master board is \$120 in 25 to 990 quantity and each slave board is \$40.

CIRCLE NO. 339

# We'll show you:

## PACIFIC COAST

Ward/Davis Associates  
Lawndale, CA 213-542-7740  
La Jolla, CA 714-459-3351  
Sunnyvale, CA 408-245-3700

## MID-ATLANTIC

Eastern Instrumentation of New York  
Englewood, NJ 201-567-9505  
Eastern Instrumentation of Philadelphia  
Philadelphia, PA 215-927-7777  
Naco Electronics  
Syracuse, NY 315-699-2651  
Utica, NY 315-732-1801  
Fairport, NY 716-223-4490  
Creative Marketing Associates  
McLean, VA 703-893-6612

## ROCKIES/SOUTHWEST

BFA Corporation of Arizona  
Scottsdale, AZ 602-994-5400  
Denver, CO 303-837-1247  
Albuquerque, NM 505-292-1212  
Las Cruces, NM 505-523-0601  
Salt Lake City, UT 801-466-6522

## NEW ENGLAND

Instrument Dynamics  
Wakefield, MA 617-245-5100

## SOUTH CENTRAL

Data Marketing Associates  
Houston, TX 713-780-2511  
Dallas, TX 214-661-0300  
San Antonio, TX 512-828-0937  
Austin, TX 512-451-5174  
Norman, OK 405-364-8320

## MIDWEST

Carter Electronics, Inc.  
Minneapolis, MN 612-559-1976  
Chicago, IL 312-585-5485  
Indianapolis, IN 317-293-0696  
Milwaukee, WI 414-464-5555  
St. Louis, MO 314-569-1406  
Overland Park, KS 913-649-6996

# interface

TECHNOLOGY

Just  
Published!

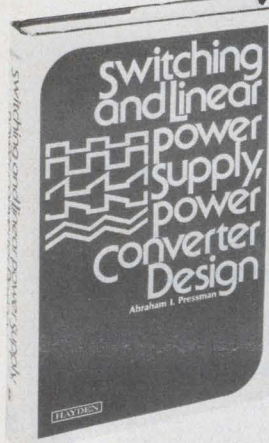

# Switching and Linear power supply, power converter Design

Abraham I. Pressman

A "how-to-design" book written from a power supply designer's point of view!

Covers all the circuits, systems, magnetics, and thermal design skills essential to modern power supply design.

#5847-0, cloth, 384 pages, \$19.95

**ORDER YOUR 15-DAY EXAMINATION COPY NOW!** When billed, remit or return book.

**HAYDEN BOOK COMPANY INC.**  
50 Essex Street,  
Rochelle Park, N.J.  
07662



## MODULES & SUBASSEMBLIES

### Bar-code reader goes into existing terminals

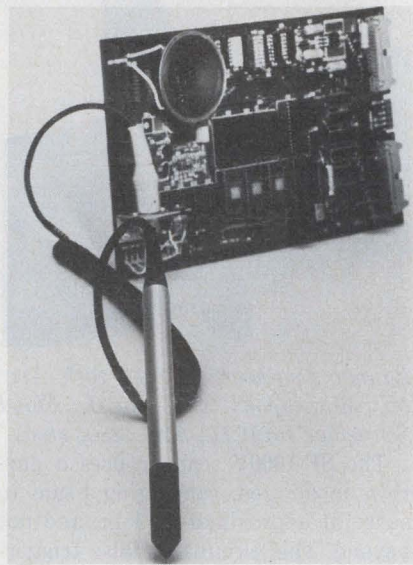

Interface Mechanisms, 5503-232nd St. S.W., Mountlake Terrace, WA 98043. Alison Grey (206) 774-3511. \$420 (100 qty); 4 to 8 wks.

Single-card mounting eases inclusion of the Model 9200 bar-code reader into existing terminals. The unit is a complete reader except for an enclosure and power supply. All the needed programming for normal operation is on the card and the device reads all popular bar codes including UPC, Codabar and Code 39. A bar-code tag or label can be bidirectionally scanned at 3 to 50 in/s with the device's hand-held light pen. The reader processes variable-length messages up to 32 characters (standard) or 64 characters (optional).

CIRCLE NO. 404

### Wideband op amp comes in 16-pin DIP

Optical Electronics, P.O. Box 11140, Tucson, AZ 85734. Mrs. Mac (602) 624-8358. \$55; stock.

The 9932 wideband FET-input op amp is electrically similar to the National Model LH0032 and is available in a standard 16-pin DIP. The device has a differential input, which exhibits common-mode rejection at higher frequencies. Slewing rate is  $\pm 600\text{-V}/\mu\text{s}$  min at unity gain. Unity-gain frequency is 150 MHz. Output is  $\pm 10\text{ V}$  at 50 mA and input-bias current is 100 pA. Max settling time to 0.1% error is 100 ns. The device operates from  $-65$  to  $+85\text{ C}$ .

CIRCLE NO. 405

### Two-module system cuts data-acquisition cost

Micro Networks, 324 Clark St., Worcester, MA 01606. John Munn (617) 852-5400. \$137.50 (100 qty).

A two-package system, the MN 7130 multiplexed sample/hold amplifier and ADC80 12-bit a/d converter, combine to form a 12-bit 16-channel data-acquisition system costing less than \$140. The combination provides 12-bit resolution, 16 single ended or eight full-differential input channels, and better than a 30,000 sample/s throughput rate. The sample/hold provides input channels addressable with a single digital word and a fast, 8- $\mu\text{s}$ , acquisition time. An internal instrumentation amplifier is included that provides 250-M $\Omega$  input impedance and over 80 dB of common-mode rejection in the differential-input configuration.

CIRCLE NO. 406

### Synchro converters yield 10, 12 or 14 bits

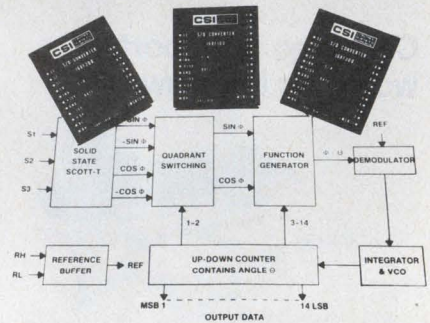

Control Sciences, 8399 Topanga Canyon Blvd., Canoga Park, CA 91304. Hal Ericsson (213) 887-7344. See text; stock.

A family of miniature synchro (or resolver) to digital converters (s/d), Type 168F, has 10, 12 and 14-bit outputs. Price for the 14-bit Model 168F100 is \$395, 10-bit Model 168F200 is \$195 and the 12-bit Model 168F300 is \$245. The devices measure  $2.62 \times 3.12 \times 0.42$  in. and operate from 50 to 1200 Hz. The 10-bit models operate at up to 65 rps with  $K_a = 30,000$ , while the 12-bit and 14-bit models track at up to 30 rps and 10 rps, respectively. Higher acceleration constants and tracking rates can be supplied when units are operated at 400 Hz or higher excitation frequencies. The 14-bit model provides  $\pm 4$  min  $\pm 0.9$  LSB, while the 12 and 10-bit units are  $\pm 8.5$  and  $\pm 30$  min, respectively.

CIRCLE NO. 407



# SIEMENS

## No matter which IC test system you have, we've got your DIP handler.

No other DIP handlers can match the performance of the Siemens 1108 Series. It's a complete line, adaptable to virtually any DIP handling requirement and any IC test system. There are three standard configurations: ambient, hot, and

hot/cold. Field retrofit kits are available, so you can upgrade from ambient to temperature capability as the need arises.

Siemens offers a maximum rate of 10,000 devices per hour *including* 250 ms of test time. And you get that speed not only in ambient testing, but in environmental testing as well. No other handlers made today have both these important features.

The 1108 Series is designed for the high-volume end user as well as the IC manufacturer, and is equally at home in either environment. Moreover, all Siemens handlers are backed by experienced applications engineers who can help you get the most for your test dollar.

For the full story, write or call Cliff Small, **Siemens Corporation**, Measurement Systems Division, 3 Computer Drive, Cherry Hill, New Jersey 08034. (609) 424-2400.

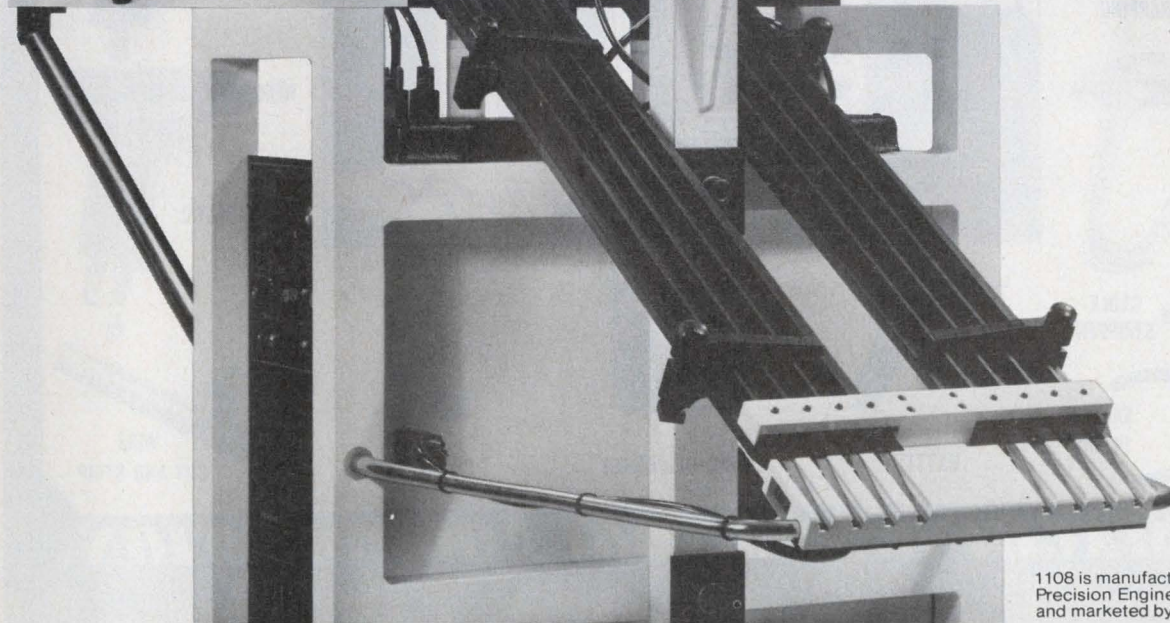

1108 is manufactured by Precision Engineered Products, Inc. and marketed by Siemens.

## PACKAGING & MATERIALS

### Rework head solders and desolders ICs

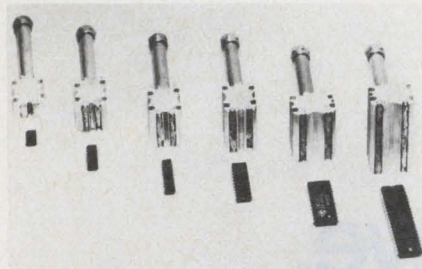

Micro Electronic Systems, 8 Kevin Dr., Danbury, CT 06810. (203) 746-2525. \$35 to \$40.

Two miniature solder pots in dual-in-line configurations fit all IC sizes. Called the Heat-a-DIP, the pots are available for Weller TCP stations. There are six tips for every DIP size, for 6 to 40 pins and for 0.3, 0.5 and 0.6-in. widths. The pot is made of a high-temperature aluminum extrusion with tiny iron-pot inserts pressed and soldered into slots. Solder contamination is eliminated and MIL specs are met.

CIRCLE NO. 340

### Crimping tool measures compression force

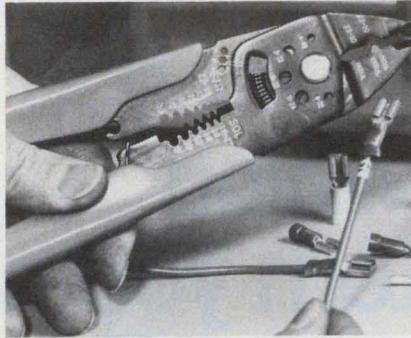

Thomas & Betts, 36 Butler St., Elizabeth, NJ 07207. (201) 354-4321.

Hand-crimping tool, WT2000, has a crimp indicator that permits the user to visually determine the proper compression for a particular wire size to meet UL and CSA standards. In addition, the tool incorporates a shear-type wire stripper. The tool crimps both insulated and noninsulated terminals for sizes from 22 to 10 AWG. It also cuts and strips wire, cuts bolt sizes 4 through 10 and reshapes damaged bolt threads.

CIRCLE NO. 341

### Solderless wrap used on edgeboard connectors

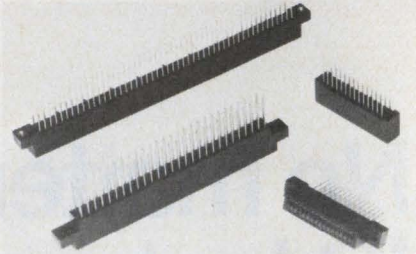

Elfab, P.O. Box 34555, Dallas, TX 75234. John Garcia (214) 233-3033. See text.

A line of solderless-wrap edgeboard connectors has 0.1, 0.125, 0.15 and 0.156-in. centers with row spacings from 0.2 to 0.3 in. on staggered grids. The connectors accept 0.062 and 0.125-in. PC boards and have 0.025-in.-square wiring terminations. The body is molded of black phenolic per MIL-M-14 and contacts are made of phosphor-bronze alloy 510, finished in gold over nickel. The connectors are rated from 3 to 5 A at 600 to 1800 V rms. Typical pricing for the BW 1020 25/50 position is \$2.29 in 1000 quantity.

CIRCLE NO. 342

## IN WIRE-WRAPPING HAS THE LINE.....

COILTITE® SLEEVES

COILTITE BITS

HAND WRAPPING

HAND UNWRAPPING

MANUAL

CABLE STRIPPER

SAFETY PLIERS



WWM-600  
N/C WIRE-WRAPPING MACHINE

ELECTRIC

PNEUMATIC

WIRE CUT AND STRIP



BATTERY



WIRE DISPENSER



IC INSERTER

## OK MACHINE AND TOOL CORPORATION

3455 CONNER STREET, BRONX, NEW YORK, N.Y. 10475 U.S.A.  
PHONE (212) 994-6600 TELEX NO. 125091

CIRCLE NUMBER 79

## Additive PC boards have solder mask

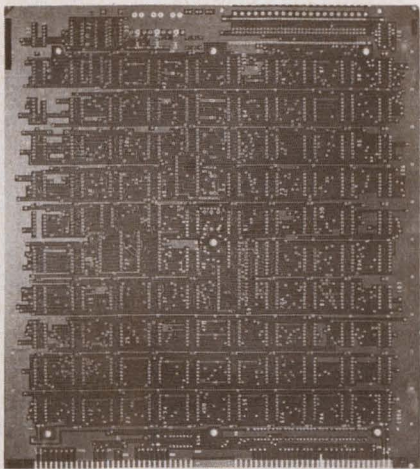

Photocircuits, 31 Sea Cliff Ave., Glen Cove, NY 11542. (516) 448-1301.

Solder-coated CC-4 additive PC boards are made by first applying a permanent solder mask to one, or more commonly to two sides of a standard bare-copper board. The entire board is then coated with hot solder and hot-air leveled. This results in a uniform solder coating, 0.0003-in. thick, on the nonmasked pad areas and also through the plated holes.

CIRCLE NO. 343

## Guillotine screw allows quicker terminal wiring

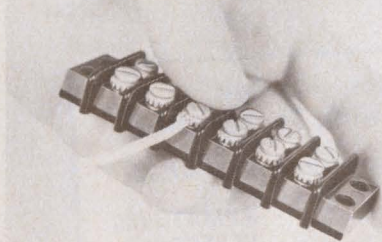

Kulka Electric, 520 S. Fulton Ave., Mount Vernon, NY 10551. (914) 664-4024.

The Guillotine Screw, which gets its name from its insulating-piercing mechanism, is available on a wide variety of terminal boards and blocks. Hook-up wire can be inserted under the screw head without stripping the insulation. When the screw terminal is tightened, effective electrical contact is made right through the insulation. The terminal is made with a sharp-toothed captive washer mounted under the screw head. The terminal can be used with either stranded or solid wire of #22 through #16 AWG at 12 to 125 V up to 20 A.

CIRCLE NO. 344

## Automatic device aids PC board assembly

Universal Instruments, P.O. Box 825, Binghamton, NY 13902. (607) 772-7522. \$13,200; 12 to 14 wks.

The Model 6232 Man-U-Sert performs all the functions of PC-board assembly except the actual component insertion. Guided by a stored program, an 80-compartment rotary bin pres-

ents the proper component, while the workholder moves the board, so that the component is always inserted in the same work area. A programmable image of 24 different characters is projected on the board to show the set of holes and the proper way a component is to be inserted. Programming can be manual with a keyboard terminal or with an off-line coordinate-measuring system.

CIRCLE NO. 345

**Faster is Better..**

**WIDE BANDWIDTH**  
1.0 GHz GBW min

**SLEW RATE**  
1000 V $\mu$ sec min

**FAST SETTLING**  
150nsec to 0.05% max

**HIGH OUTPUT CURRENT**  
100mA min

**3554**

## ...When There Are No Performance Surprises!

Designing wideband or high speed equipment? Here's an op amp that puts it all together:

Fast slewing, fast settling, large gain-bandwidth product, excellent DC performance (drift of 15 $\mu$ V/ $^{\circ}$ C) and one that produces a full 100mA output!

The 3554 offers the best compromise when you must have top performance in these critical areas. It maintains gain accuracy with high frequency signals. Fast settling time

means better system accuracy with transient signal conditions. High output current lets you drive heavy loads with good total frequency response.

This FET differential input op amp, priced from \$39.60 in hundreds, is fully specified in an 8-page data sheet that includes 26 performance curves, typical application information and circuits.

Contact Burr-Brown, P.O. Box 11400, International Airport Industrial Park, Tucson, AZ 85734, U.S.A. Phone: (602) 746-1111

**BURR-BROWN**



Putting Technology  
To Work For You

CIRCLE NUMBER 61

## PACKAGING & MATERIALS

### Tool cuts and strips wire for wrapping

CUT-and-STRIP TOOL  
FOR WIRE-WRAPPING

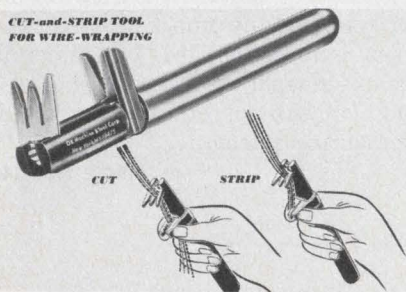

OK Machine & Tool, 3455 Conner St., Bronx, NY 10475. Judy Camen (212) 994-6600.

The ST-100 hand tool strips wire without nicking and automatically generates the proper strip length for wire-wrapping. A slim design makes it easy to store in a pocket, belt holster or tool kit. To operate, you first place wires (up to 4) in stripping slot with ends extended beyond the cutter blades. Then, you press the tool and pull. The tool handles #20 to #30 AWG.

CIRCLE NO. 346

### PC lampholder is submini size

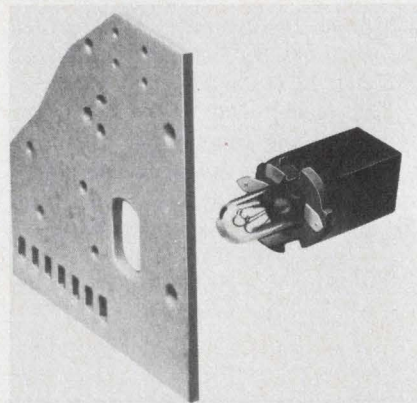

Leecraft Mfg., 21-16 44th Rd., Long Island City, NY 11101. J. Rattinger (212) 392-8800. \$0.20; 3 to 4 wks.

The Series 69-07 PC-board lampholder takes a T-1-3/4 size wedge-base subminiature lamp. The lampholder connects board circuitry via leaf-spring contacts and prelocated board pads. The lamp projects through the board to present a low profile, allowing the board to be positioned as close as 1/4 in. from a translucent covering panel.

CIRCLE NO. 347

### Backpanels are PDP compatible

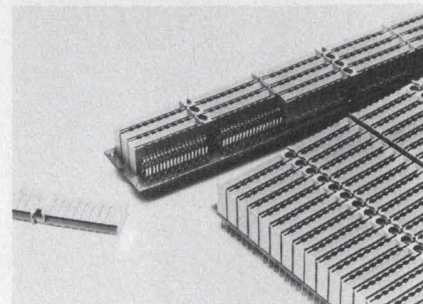

Elfab, P.O. Box 34555, Dallas, TX 75234. (214) 333-3033.

PDP-compatible backpanels use solid-pin contacts that are press-fitted into the PC board to form a gas-tight interface with its plated-through holes. The contacts are located on a 0.125 x 0.125-in. staggered grid and housed in a thermoplastic-polyester molded insulator. The PC board is made from FR-4 per MIL-P-13949 and the contacts from phosphor bronze with 50-μin. gold over 30-to-150-μin. of nickel in the engagement area. The backpanels come in all popular slot configurations.

CIRCLE NO. 348

## MICROPAC

AVAILABLE FROM STOCK

## HYBRID VOLTAGE REGULATORS



4 TO 10 amp  
output current

- 5 to 37 fixed voltage range
- Positive & Negative voltages
- 120 Watts power dissipation
- Internal short circuit protection
- Available to MIL-S-883 B
- External components not required
- Standard TO-3 Package
- Available from stock
- Economically priced

Write for Micropac Capabilities Brochure on Custom Thick & Thin Hybrid Microcircuits



**MICROPAC INDUSTRIES, INC.**

905 E. WALNUT ST. GARLAND, TEXAS 75040 Tel. 214-272-3571  
TWX 910-860-5186

CIRCLE NUMBER 80

## Test With Confidence

**Automatic Coil  
and Winding Test Station**  
Micro-Processor Controlled — Coils

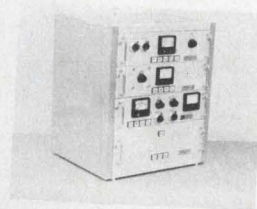

**ARMATURES  
STATORS  
FIELDS**

Series  
**720**

**TEST RATES TO  
1000 PARTS  
PER HOUR**

READY-TO-GO PACKAGE HANDLES 90% OF COIL WINDING TEST APPLICATIONS — QUICK CHANGE TEST FIXTURES — FULLY AUTOMATIC GO/NO-GO CYCLE.

MANUFACTURERS OF INSULATION TESTERS  
CABLE & HARNESS TESTERS ... MEGOHMMETERS  
STROBOSCOPES ... COIL & WINDING TESTERS  
& BATTERY TESTERS

**SLAUGHTER COMPANY**

MOORE & HAILEY STS  
Tele: 405-223-4773

ARDMORE, OKLAHOMA 73401  
TWX: 910-830-6972

CIRCLE NUMBER 81

ELECTRONIC DESIGN 3, February 1, 1978

## NEW LOW PROFILE LSI SOCKETS FROM SMK

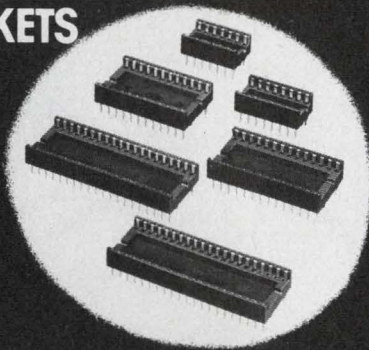

The SI-2440 Series complete line of new LSI Sockets, including 14, 16, 24, 28, 40 and 42 pin versions on 0.1" centers are designed so that they can be flush mounted end-to-end maintaining the 0.1" center-to-center pin spacing. For example, two 24 pin LSI Sockets can be mounted end-to-end to accommodate the latest 48 pin ROM.

The glass-filled Nylon bodies (66% Nylon) are designed to withstand soldering temperatures to +350°C for 3 seconds and are available with either tin plating, selective gold contact plating or gold flash.

Typical 100 piece price for the fourteen pin unit, tinned plated, is \$3.11 each.



SMK Electronics Corporation  
of America

118 East Savarona Way Carson, California 90746  
Tel: (213) 770-8915

CIRCLE NUMBER 62

## Buzzzzz. (Write for new catalog.)



Solid state electronic MICRO-BUZZER from CITIZEN: High reliability, competitively priced with immediate delivery.

A complete range: SMB 1.5, 6, 12, 24, VDC  
RMB 3, 6, 12, 24, VDC  
IMB (Intermittent) 6, 12, VDC

### CITIZEN

CITIZEN AMERICA CORPORATION  
1710 - 22nd St.  
Santa Monica,  
CA 90404

Toll Free (800) 421-6516  
In Calif. (213) 829-3541  
TWX: (910) 343-6450

Name \_\_\_\_\_  
Company \_\_\_\_\_  
Address \_\_\_\_\_  
City \_\_\_\_\_ State \_\_\_\_\_  
Zip \_\_\_\_\_ Phone \_\_\_\_\_

CIRCLE NUMBER 64

## Join the IMC Book Club\*

IMC MAGNETICS Corp.  
NEW HAMPSHIRE DIVISION  
Precision Cooling Devices  
Tubaxial Fans • Propeller Fans • Centrifugal Blowers

*Airmovers*

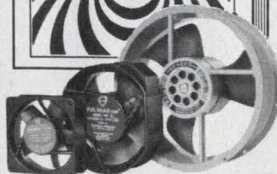
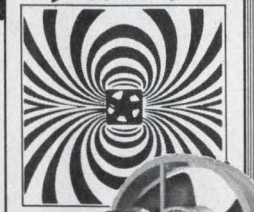

\*Product Literature Broadside and request card will be sent to you along with this catalog.

Free 24 page catalog contains facts on IMC's Off-The-Shelf precision cooling devices.

This airmover catalog is devoted to technical information and illustrations on the full line of Tubaxial Fans, Propeller Fans and Centrifugal Blowers. IMC Boxer®, Fulmar®, Condor®, and IMCair® airmovers are featured.

For immediate service please call  
603/332-5300

SERVING INDUSTRY OVER 25 YEARS

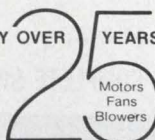

IMC MAGNETICS CORP.

NEW HAMPSHIRE DIVISION  
ROUTE 16B, ROCHESTER, NEW HAMPSHIRE 03867

CIRCLE NUMBER 63

ELECTRONIC DESIGN 3, February 1, 1978

## LCD CONNECTORS

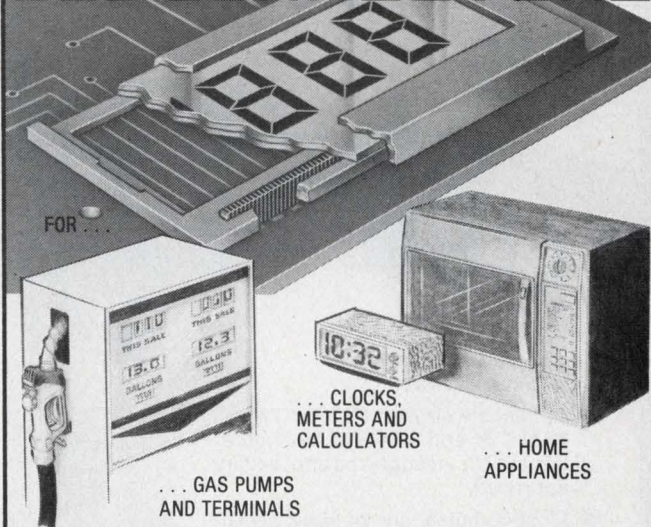

### WITH ZEBRA® CONDUCTIVE ELASTOMER

- No soldering required to make contact
- Easy assembly by simply clamping mating surfaces together
- Eliminates lead straightening and positioning
- Minimum space required
- Good contact without marring contact pads.

**TECKNIT®** *The Conductive People*

Eastern Division • 129 Dermody St., Cranford, NJ 07016 (201) 272-5500  
Western Division • 427 Olive St., Santa Barbara, CA 93101 (805) 963-1867

CIRCLE NUMBER 82

## DATA PROCESSING

### Medium-distance modem operates at 4800 bits/s

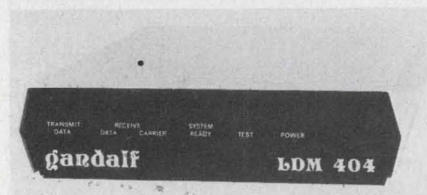

Gandalf Data, 1019 S. Noel St., Wheeling, IL 60090. (312) 541-6060.

The LDM 404B medium-distance modem is for use in a metropolitan area where unloaded cable pairs are unavailable. The modem operates at 4800 bits/s synchronously with an option for a dual-channel 2400 bits/s configuration. Operation can be over standard-tariff 3002 voice-grade leased lines with most carrier systems including T carrier. No special tools or test equipment are required for installation. A built-in tuning meter simplifies alignment.

CIRCLE NO. 356

### Data recorder contains baud-rate converter



Columbia Data Products, 6655 Amberton Dr., Baltimore, MD 21227. Don Knight (301) 796-2300. Stock to 4 wks.

A data cartridge recorder with a built-in baud rate converter, the Model 300 C connects between a modem or CPU and a terminal with an on-line/off-line storage capacity of  $1.5 \times 10^6$  char. The unit is equipped with dual RS-232 ports, dual UARTs and a 512-char buffer to get the baud-rate conversion. Speeds are selectable from 110 through 19,200 baud with current-loop capability in the terminal port. In the on-line mode, characters received on one port will be immediately retransmitted on the other port at the pre-selected baud rate.

CIRCLE NO. 357

### Terminal displays dual languages

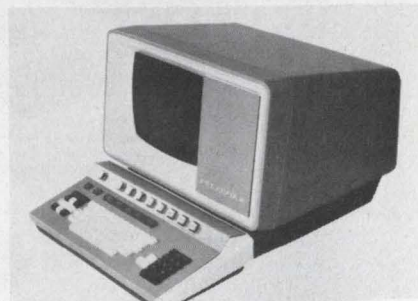

Megadata, 30 Orville Dr., Bohemia, NY 11716. (516) 589-6800. \$5800 to \$6850; 8 to 12 wks.

The dual-language terminal, Model 700/DL, operates in English plus any other language. When required, the operator can enter data from right to left. Characters are represented by a  $10 \times 15$  matrix. The terminal includes insert, delete and text editing features. The device has a memory of up to 73 kbytes, a 126-station keyboard, a 15-in. diagonal display and rates from 50 baud to 38.4 kbaud serial, or 10,000 char parallel. The terminal is available with interfaces and protocols for most popular mainframes.

CIRCLE NO. 358

## QUALITY CABLE TIES



### Engineered to Reduce Your Total Installed Cost

- Applicable sizes of PANDUIT® PAN-TY® and STA-STRAP® cable ties are U.L. recognized and military approved.
- Most complete line of sizes, styles and colors for all applications.
- Quickly installed by hand or with reliable PANDUIT® tools.
- Fast shipment from local Distributor stock.

FREE SAMPLES



Tinley Park, Ill. 60477 • Phone: (312) 532-1800 In Canada: Panduit (Canada) Limited

Visit PANDUIT at NEPCON WEST Booth 149  
CIRCLE NUMBER 65

## NEW! From CAPITOL

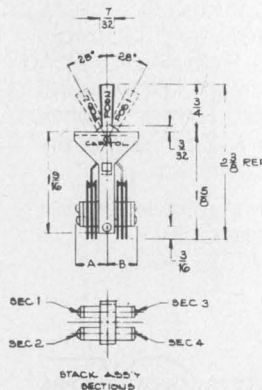
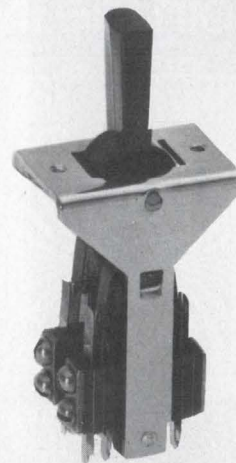

### MODEL MLA LEVER SWITCH

A panel-mount switch with one-piece molded cam and handle. It extends only  $1\frac{5}{8}$ " behind panel. Extremely smooth operation with positive detent action.

COMPLETE SPECIFICATIONS IN NEW BROCHURE

## CAPITOL

The Capitol Machine & Switch Co.  
87 Newtown Road,  
Danbury, CT 06810  
203-744-3300

CIRCLE NUMBER 66  
ELECTRONIC DESIGN 3, February 1, 1978

# ABSORB FLEX, PULL, PUSH, TWIST...

With Heyco Strain Relief Bushings.

Heyman Nylon Strain Relief Bushings are the easy, low-cost way to insulate and protect cable connections. They absorb any push, pull, twist or excessive flex on wire or cable, for full protection. Available in half a hundred sizes for chassis holes from 3/8" thru 1 3/16". U.L. Recognized, C.S.A. approved. Write for **FREE** sample pack and catalog.

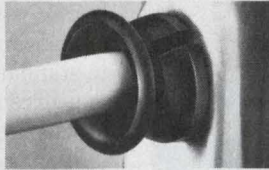

## HEYMAN MANUFACTURING COMPANY

KENILWORTH, NEW JERSEY 07033 WAUKESHA, WISCONSIN 53187  
(201) 245-2345 • TWX: 710-996-5986 (414) 542-7155 • TWX: 910-265-3668

Call Toll-Free (800) 558-0917 except from Wisconsin.  
If calling from Wisconsin use (800) 242-0985



296 A

CIRCLE NUMBER 67

## IM1000 UNIVERSAL PROM PROGRAMMER



- HIGHEST PERFORMANCE/PRICE RATIO
- CAPABILITY TO PROGRAM ANY PROM FROM ALL MANUFACTURERS
- COMPACT FOR PORTABILITY
- TWO RS232 I/O PORTS FOR INTERFACING TO MICROCOMPUTER DEVELOPMENT SYSTEM OR TIMESHARE COMPUTERS
- 32000 BIT RAM FOR FULL EDITING OF PROM DATA

The IM1000 sells for \$1695. Personality Modules \$330. Contact us for a demonstration by our nationwide representatives.

TEL: 301/340-7505

**IM** International Microsystems, Inc.  
638 Loftstrand Lane  
Rockville, Md. 20850

CIRCLE NUMBER 68

ELECTRONIC DESIGN 3, February 1, 1978

## LOW COST LOGIC STATE ANALYZER

78	111	818
87	888	989
84	999	110
88	888	888
18	888	888
78	888	818
97	888	899
88	888	887



KIT-\$229.00

ASSEMBLED-\$295.00

The Model 100A has the major features of more costly logic state analyzers. Operates with virtually any scope and logic family; captures and displays sixteen 8-bit words before or after a pre-defined trigger word; formats data in HEX or OCTAL groupings; offers single or repeating truth tables; provides trigger output for waveform analysis.

For more advanced applications, add the mating Model 10 Trigger Expander to the Model 100A. This integrated package offers 24 bits, qualifiers, program paging and loop analysis capabilities. Model 10 prices: KIT-\$229.00; ASSEMBLED-\$295.00; Model 100A/10 mounting baseplate-\$9.95.

Each unit includes a 100-page User's Manual.



**PARATRONICS, INC.**

(408) 263-2252

800 CHARCOT AVENUE • SAN JOSE, CALIFORNIA • 95131

For Information Only Circle 85 For Demonstration Circle 86

## MOUNT A ZEBRA CONNECTOR ON ANY PC BOARD

- ZEBRA is constructed of alternating layers of conductive and nonconductive elastomers
- Electrical contact is achieved by deflecting the ZEBRA between two contacts
- No soldering required
- Eliminates contact pad abrasion.



- ZEBRA connector elements are used in assemblies for stacking connectors as well as edge and flat mount LCD's to PC boards.

Send for Connector Catalog.

EASTERN DIVISION — 129 DERMODY STREET, CRANFORD, N. J. 07016 (201) 272-5500  
WESTERN DIVISION — 427 OLIVE STREET, SANTA BARBARA, CA. 93101 (805) 963-1867

CIRCLE NUMBER 70

## DATA PROCESSING

### IBM-compatible display has 12 lines of 40 char

Trivex, 3180 Red Hill Ave., Costa Mesa, CA 92626. R.J. Martin (714) 546-7781. \$2950.

A 480-char display, Model 0771, is compatible with IBM 3271-2 and 3272-2 controllers, and arranges text into 12 lines of 40 char each. The display is plug-compatible with IBM units; enhancements include local display-to-print, 10-key numeric pad, light pen, OCR wand, operator prompting line, cursor position display, cluster diagnostics and response time indicator. The latter displays average and maximum response time, number of transactions, and number of responses above a pre-set (0 to 30 s) response-time threshold.

CIRCLE NO. 359

### Acoustic coupler is compatible with Ma Bell

Anderson Jacobson, 521 Charcot Ave., San Jose, CA 95131. Bob Miller (408) 263-8520. \$795.

The AJ 1245 is a Bell-compatible 103 and 202-mode acoustic coupler including a modem. It interfaces with any EIA terminal and communicates acoustically at 0 to 450 baud in 103 mode and 0 to 1200 baud in 202 mode. The user switch-selects the mode and the coupler automatically adjusts baud rate and interface protocol. The unit also functions automatically, as a slave to a remote 202 modem, and simultaneously provides a 103 full-duplex interface to the terminal at speeds up to 1200 baud.

CIRCLE NO. 360

### Data digitizing stylus has one moving part

RAD, 346 Summer St., Duxbury, MA 02332. Dick Diozzi (617) 585-9440. \$105.

The RAD II digital input stylus has a removable tip and only one moving part—the Fisher #14 ink refill which activates a switch when pressure is applied. The stylus' pick-up coil is compatible with most graphic display systems, sensing the 300 mA tablet current and providing a resolution of 100 lines/in.

CIRCLE NO. 361

### Terminal combines video with daisy printer



DTC, 1190 Dell Ave., Campbell, CA 95008. Ron Lampe (408) 378-1112. From \$5000; 4 wks.

The DTC-382 Data Communications Terminal combines a video display unit with a daisy-wheel printer and provides the advantages of high-speed CRT operation with hard-copy print-out. The video portion has four pages of data, each 80 columns by 24 lines, which can be scrolled over the screen. Eight different field attributes can be used. Insertion and deletion of characters and lines is standard as well as sending from screen memory to either printer and/or an RS232 line. Shadow printing, automatic underline, and plotting are included. The unit prints forwards and backwards without the need for host-computer programming.

CIRCLE NO. 362

### Modem handles data at two distinct rates

General DataComm, 131 Danbury Rd., Wilton, CT 06897. Ed Tworowski (203) 762-0711.

The Model 212A modem handles serial data at two distinct rates over switched networks: The low-speed mode is asynchronous with a rate of 300 bits/s, while the high-speed mode is either synchronous or asynchronous at 1200 bits/s. The protocol is the same for high and low speeds. Speed selection is determined by the calling modem (by a switch or an EIA interface lead) and the answering modem automatically operates at the proper speed. Standard features include local and remote signal-loopback diagnostics, manual or automatic call origination and answering, and DTR control.

CIRCLE NO. 363

### Software package Mac is a macro assembler

Digital Research, P.O. Box 579, Pacific Grove, CA 93950. (408) 373-3403. \$70.

A macro assembler called Mac operates with a Diskette Operating System and implements the revised Intel standard macro facility. Repetition of source statements is provided with indefinite repeat on characters, text and numerics. Parameterized macros can be called out from previously defined macro libraries.

CIRCLE NO. 364

### Portable data logger operates at 32 samples/s

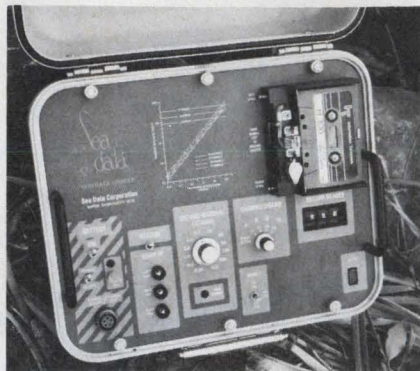

Sea Data, 153 California St., Newton, MA 02158. Lon Hocker (617) 244-3216. \$4195; stock.

The Model 1250 data logger is a compact unit that provides operating speeds up to 32 samples/s and storage capabilities in excess of 10 Mbits on a standard 300-ft Philips-type cassette. A high-resolution stepping motor provides an 8-channel scan interval of 250 ms with 12-bit accuracy on a single 5-Ah battery charge. The scan interval is 0.25 to 512 s and the channel scan conversion rate is 15 ms/channel. The recorder circuitry is CMOS and uses power only during scans.

CIRCLE NO. 365

### Acoustic coupler mates with Bell 212A

Omnitec Data, 2405 S. 20th St., Phoenix, AZ 85034. Paul Shatusky (602) 258-8244. \$341; stock.

The Model 701R acoustic coupler is fully compatible with the Bell System Model 212A at 300 baud. The device can be supplied to operate at data rates up to 600 baud. TTY and RS232 interfacing, acoustic or hardware coupling and half or full duplex operation are available.

CIRCLE NO. 366



## POWER SOURCES

### Line-voltage regulators are solid state

Superior Electric, 383 Middle St., Bristol, CT 06010. Joe McMahon (203) 582-9561. \$275 to \$695; stock.

Four solid-state Stabiline automatic voltage regulators in the SVR series are rated from 0.75 to 4 kVA. The regulators have an efficiency of 95% at 60 Hz and a correction rate of 1/2 cycle per 7-V step without overshoot or undershoot. Accuracy is  $\pm 3.5\%$  for line, load and power factor variations. All four types can be operated over an ambient temperature range of 0 to 50 C. The regulators have virtually zero waveform distortion and are insensitive to load power factor.

CIRCLE NO. 367

### Lab supply has three outputs

Amber Electronics, 17752 Sky Park Blvd., Irvine, CA 92714. Dejan Cvetkovich (714) 754-0272. \$195.

Tri-Power-Mate is a laboratory power supply with four separate outputs. The output voltages are 5,  $\pm 15$  and variable 0 to 30 V dc with current limiting at 10, 50, 100, 500 mA and 1, 2 A. Max ripple at 1 A is 0.1% (5 V), 0.3% ( $\pm 15$  V), 4 mV pk-pk (0 to 30 V). Load regulation is 0.3% ( $\pm 15$  V), 0.03% (0 to 30 V) and line regulation is 0.01% (0 to 30 V). The variable output is monitored by an ammeter and a voltmeter.

CIRCLE NO. 368

### Switchers spread 200 W over five outputs

Power/Mate, 514 S. River St., Hackensack, NJ 07601. Joe Geronimo (201) 343-6294. \$290 up.

Type ES open-frame, multiple-output, switching-regulated power supplies deliver a total of 200 W to five outputs. The dc supplies are available in a wide variety of voltage and current combinations. The supplies have efficiencies of 78% and operate to 50 C without derating. Hold-up time is 30 ms after loss of input power. Weight is 4.5 lb, size is 11.5 x 5.5 x 4 in.

CIRCLE NO. 369

## Low Cost TO-3 Coolers

### Thermalloy quality At NEW Lower Prices.

The 6051 Series offers the quality and performance that you expect from Thermalloy... at prices that will surprise you. With high volume, automated tooling we have lowered heat sink costs. Look at our numbers. Compare performance, compare value. Then specify Thermalloy. \*Black Anodize

Model	Fin Height	R <sub>θ</sub> @75°C Rise	5,000 Piece Price
6051B*	0.50"	7.4	18c
6052B*	0.75"	5.9	22c
6053B*	1.00"	4.4	24c
6054B*	1.25"	3.3	29c

Number one in Semiconductor Accessories

**Thermalloy, Inc.**  
 Post Office Box 34829  
 2021 West Valley View Lane  
 Dallas, TX 75234 • (214) 243-4321

Free sample and new 1978 catalog with your response

CIRCLE NUMBER 71

## What Every Design Engineer Should Own... FREE!

### New Klinger Catalog 06/07

More than 400

## ELECTRO-OPTICAL-MECHANICAL MODULAR CONSTRUCTION ELEMENTS

Ideal for

Design... Development...  
 Testing... Prototyping  
 ... Education

Send for your FREE copy today.

**KLINGER** SCIENTIFIC CORP. 83-45 Parsons Blvd. Jamaica, N.Y. 11432 (212) 657-0335

CIRCLE NUMBER 72

# New literature



## Semi test sockets

Test sockets and carriers for integrated and hybrid circuits, MSI and LSI, rectifiers, and other semiconductor devices are highlighted in a 12-page catalog. Textool Products, Irving, TX

CIRCLE NO. 370

## Transistors

Specifications for 2000 transistors are contained in a 16-page catalog. Products included are high-power switching, high voltage, small signal, and rf devices. Semicoa, Costa Mesa, CA

CIRCLE NO. 371

## Processors

Two publications describe the HP 2240A Measurement and Control Processor. A six-page brochure describes the processor's features and its advantages in manufacturing and engineering. The second, a 22-pager, is an application note containing measuring and control examples using the 2240A. Hewlett-Packard, Palo Alto, CA

CIRCLE NO. 372

## 1978 calendar

A 1978 calendar shows the San Francisco skyline, Alcatraz Island and the Golden Gate Bridge, as seen from the bay. This four-color calendar measures 46-1/2 in. long, 10-1/2 in. wide and is suitable for framing. California Microwave, Sunnyvale, CA

CIRCLE NO. 373

## Drafting aids

A 132-page PC-drafting-aids technical manual and catalog is divided into two separate sections, a product catalog and a technical manual. The product-catalog portion features illustrations and data (expressed in both standard inch and metric measure) on over 15,000 printed-circuit drafting aids. Bishop Graphics, Westlake Village, CA

CIRCLE NO. 374

## Flexible keyboards

The flexible PRO keyboard for personal computer, hobbyist and OEM users is described in an eight-page catalog. Cherry Electrical Products, Waukegan, IL

CIRCLE NO. 375

## Portable oscilloscopes

Selection considerations, applications, and basic specifications of portable oscilloscopes are included in a 24-page brochure. Tektronix, Beaverton, OR

CIRCLE NO. 376

## Bug hound

The 2220 Bug Hound is described in a four-page brochure. GenRad, Concord, MA

CIRCLE NO. 377

## MOS circuits

More than 80 standard MOS large-scale-integrated circuits are detailed in a 36-page catalog. The catalog includes descriptions and functional diagrams of the AMI S2000 4-bit computer-on-a-chip  $\mu$ P and the S6800 and S9900 microprocessors and products. American Microsystems, Santa Clara, CA

CIRCLE NO. 378

## One-chip microcomputer

A 64-page reliability report covers 21-million hours of device testing of the TMS 1000 Series one-chip microcomputers. Included are a review of how MOS devices function, various failure mechanisms and a discussion of the terminology and methodology used by TI in the TMS 1000 quality-assurance and reliability program. Texas Instruments, Houston, TX

CIRCLE NO. 379

## Single-board computer

The MSC 8001, Z80 multibus single-board computer, is described in a 16-page brochure. Colored block diagrams superimposed over the board illustrate functions and interactions among the computer's various elements and buses. Monolithic Systems Corp., Englewood, CO

CIRCLE NO. 380

## Rectifiers and zeners

Electrical characteristics for semiconductor rectifiers and zener diodes are given in tabular form in a 50-page catalog. Line diagrams of the various component configurations with full dimensional data are shown. Semicon, Burlington, MA

CIRCLE NO. 381

## Analog ICs

A 343-page analog integrated-circuit data book provides specifications, performance curves, and circuit diagrams. Also included are a 118-page application section covering 21 topics, sections on chip geometries, quality and reliability programs, and packaging. The book costs \$2.95. Harris Semiconductor, P.O. Box 883, Melbourne, FL 32901

CIRCLE NO. 382

## Programmable keyboards

Standard features, specifications, and diagrams of programmable keyboards are shown in a bulletin. Cortron Div., Illinois Tool Works, Chicago, IL

CIRCLE NO. 383

## Selector guide

An OEM pricing product information selector guide combines product summary specifications, industry-wide cross-reference, and OEM pricing on all Siliconix products into one catalog. Siliconix, Santa Clara, CA

CIRCLE NO. 384

## Knobs and accessories

Over three dozen basic styles of machined-aluminum and molded-plastic control knobs are described in a 36-page catalog. Dimensional drawings detail each style; color choices are described; and prices for knobs and accessories are shown. Alco Electronic Products, North Andover, MA

CIRCLE NO. 385

# Design aids

## Wall chart/calendar

A data-converter wall chart/1978 calendar contains data-acquisition design aids such as charts, graphs and nomograms. Teledyne Philbrick.

CIRCLE NO. 386

## Electroplating processes

"Comprehensive Guide to Precious Metal Plating Processes For Engineering Applications" lists and describes over 60 precious-metal processes specifically designed for electronics and general industrial use. Sel-Rex.

CIRCLE NO. 387

## Bipolar circuits

Key specifications of high-speed LSI bipolar signal-processing circuits are presented in a chart. TRW LSI Products Div.

CIRCLE NO. 388

## Industrial plastics

Complete property data, application information and standard mill-shape availabilities of industrial plastics are included in a 26-page guide. The Polymer Corp., Reading, PA

CIRCLE NO. 389

## Data-comm, code charts

Two wall mountable charts are available—the RS-232C and current-loop data communication chart and an ASCII code chart. Termiflex.

CIRCLE NO. 390

## Time scheduler

With the turn of a dial on a calculator, you can find the number of business days between any two calendar days for a five or six-day work-week, the number of calendar days between any two dates and the number of seven-day weeks between two dates. The calculator costs \$3.95. Ergo Enterprises, 1241 Welsh Rd., Huntingdon Valley, PA 19006

CIRCLE NO. 391

# Vendors report

Annual and interim reports can provide much more than financial position information. They often include the first public disclosure of new products, new techniques and new directions of our vendors and customers. Further, they often contain superb analyses of segments of industry that a company serves.

Selected companies with recent reports are listed here with their main electronic products or services. For a copy, circle the indicated number.

**Management Assistance.** Data processing.

CIRCLE NO. 392

**Paprican.** R&D laboratory.

CIRCLE NO. 393

**Datapoint Corp.** General-purpose processors and compatible software, programs and peripherals.

CIRCLE NO. 394

**General Instrument.** Data products, cable-TV products, components and semiconductors.

CIRCLE NO. 395

**The Plessey Co.** Telecommunications and telegraphic equipment, electronic equipment including radio and radar, aerospace equipment and industrial hydraulic products, electronic and mechanical components.

CIRCLE NO. 396

**Tocom.** Bidirectional cable systems.

CIRCLE NO. 397

**Computer Automation.** Minicomputers, data-processing systems and automatic test equipment.

CIRCLE NO. 398

**Network Systems.** Adapters to interconnect computers and peripherals.

CIRCLE NO. 399

**Inco Ltd.** Metals, batteries and related products.

CIRCLE NO. 403

# Power Amplifiers THE WIDE ONES

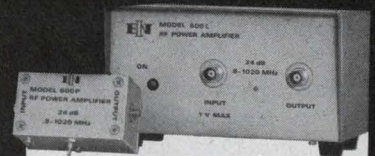

Add a signal generator or TV channel converter to ENI's Model 600L/600P ultrawide band solid state amplifier, and get the ultimate in linear power for applications like TV/CATV UHF signal distribution, high speed data transmission, broadband signal pre-amplification and more.

Incorporating all of the outstanding features of an ENI design (unconditional stability, instantaneous failsafe provisions and absolute protection from overloads and transients), the Model 600L/600P will "boost" the output of any signal source by 24 dB. And it provides more than 150 mW of linear Class A or 300 mW of saturated power over the 0.8-1020 MHz frequency range.

For additional specifications, a demonstration, or a copy of our new, full-line catalog, contact ENI, 3000 Winton Road South, Rochester, New York 14623. Call 716-473-6900 or Telex 97-8283 ENI ROC.

# ENI

The World's Leader  
in Power Amplifiers

CIRCLE NUMBER 74

## Across the desk

(continued from page 7)

the instruments mentioned have been on the market for nearly eight years. It struck me as odd, however, that Rockland System Corp.'s name was not mentioned in your "Need More Information?" box. We have been manufacturing frequency synthesizers—and indeed have dominated a portion of the frequency synthesizer market, according to Frost & Sullivan—since 1971.

David Kohn

Vice President, Marketing  
Rockland Systems Corp.

*Ed. Note: Sorry about the oversight. For more information contact: Rockland Systems Corp., 230 W. Nyack Rd., West Nyack, NY 10994. (914) 623-6666.*

CIRCLE NO. 318

## Try these for size

Douglas Varney's "Determine Wire Size with Equations" (ED No. 20, Sept. 27, 1977, p. 20) brings to mind the following well-seasoned equations for estimating AWG sizes; cross-sectional areas, in circular mils ( $A_{cm}$ ); and diameters, in mils ( $D_m$ ):

$$AWG = 10 \log (325^2/A_{cm}).$$

$$AWG = 20 \log (325/D_m).$$

$$A_{cm} = 325^2/10^{AWG/10}.$$

$$D_m = 325/10^{AWG/20}.$$

David Michael Myers  
Chief Engineer

Autocybernism Unlimited  
Hughesville, MD 20637

## Ten years after

I was rather disappointed with your "new" instruction set (see "Late WOM Tester," ED No. 21, Oct. 11, 1977, p. 7). With the exception of one instruction (IDC: Initiate Destruct Command, in place of EM: Emulate 407), this set is at least 10 years old. I first obtained a copy of this set, then entitled "Proposed 360 Instructions," from my college roommate, who in turn had ob-

tained it from his older brother, who at the time was a student at Reed College in Oregon.

Steven P. Northrup

Monroe

The American Road  
Morris Plains, NJ 07950

## Get the picture?

Our apologies to everyone—especially PolyMorphic Systems, Santa Barbara, CA—for a pix mix on p. 219 of ED No. 21, October 11, 1977. The photo is of asynchronous line drivers by Micon Systems, Chatsworth, CA. Here's what the PolyMorphic System 8813 compact, complete disc-based microcomputer really looks like:



## OOFF!

Say, processor manufacturers. How about having future processor instruction sets include both  $00_{16}$  and  $FF_{16}$  as NOP codes? Users could then include both unprogrammed "little gaps" in their PROM programs into which jumps could be inserted for program changes or field updates. Fusible-link PROMs and EPROMs could then be modified quickly without redoing the entire program. One could also eradicate incorrect code statements by overwriting up to the next "little gap." Many systems won't find the NOP time objectionable but rather a fair trade-off for easier development and field updating.

John Robertson  
President

Telesis Laboratory  
P.O. Box 387  
Chillicothe, OH 45601

## Give me a standard text editor anytime

Add me to the list of those who want a standardized interactive text editor. Now that I'm using brand XXX editor in the morning, brand XX in the afternoon and cheapo brand X at night at

home, I've begun to kick my dog. And all because  $1A$  in  $XXX = 1L$  in  $XX = A1$  in  $X$ . And  $1L = 1T = V1$  and  $Gstring\ 1\$-1C2\$ = Cstring1\$string\ 2\$ = C/string1/string2/$  and  $1K = 1K = D1$ . "Insert," in  $XXX$  and  $XX$ , inserts before the current line, but after the current line in  $X$ . And so on, ad nauseum.

Why not a standard text editor just as there is a standard FORTRAN? As with FORTRAN, it would be difficult to define I/O commands, i.e., those that read into or write from the text buffer. But it's easy enough to define a standard set of buffer-manipulation commands. How does one go about getting the ANSI, IEEE, or EIA interested in writing a draft proposal? And how does one find out if there is enough popular support for such a standard?

Mike Duncan  
Engineer

Atmospheric Technology Div.  
National Center for Atmospheric  
Research  
P.O. Box 3000  
Boulder, CO 80303.

## Clearly invisible display

The caption under Fig. 2 of a recent article on EMI control (ED No. 25, Dec. 6, 1977, p. 76) insists that the display "clearly shows the grid coordinates where the picture was taken." Because the printer failed to separate the red color of the original photo, the display clearly shows nothing. The real reading should have been:

115 MG  
6930 6589

## Right product, wrong company

Somehow, Barber-Colman got listed as a vendor of stepping motors in our article on the subject in ED No. 22, Oct. 25, 1977, p. 48. The company makes fractional horsepower motors, but not the stepping kind. If you're interested.

CIRCLE NO. 319

## Me an editor?

If you'd like to be among the first to know (and write about) what's going on in the electronics industry, you might enjoy being an editor. Call Ralph Dobriner at (201) 843-0550.

# Electronic Design

## Advertising Sales Staff

Susan G. Apolant  
Sales Coordinator

## Rochelle Park, NJ 07662

Robert W. Gascoigne  
Thomas P. Barth  
Stan Tessler  
Constance McKinley  
50 Essex St.  
(201) 843-0550  
TWX: 710-990-5071  
(HAYDENPUB ROPK)

## Philadelphia

Thomas P. Barth  
(201) 843-0550

## Boston 02178

Gene Pritchard  
P.O. Box 379  
Belmont, MA 02178  
(617) 489-2340

## Chicago 60611

Thomas P. Kavooras  
Berry Conner, Jr.  
200 East Ontario  
(312) 337-0588

## Cleveland

Thomas P. Kavooras  
(312) 337-0588

## Los Angeles 90045

Stanley I. Ehrenclou  
Burt Underwood  
8939 Sepulveda Blvd.  
(213) 641-6544

## Texas

Burt Underwood  
(213) 641-6544

## San Francisco

Robert A. Lukas  
465 S. Mathilda, Suite 302  
Sunnyvale, CA 94086  
(408) 736-6667

## England

Constance McKinley  
50 Essex St.  
Rochelle Park, N.J. 07662  
Phone: (201) 843-0550

## Europe

Sanders, W. J. M.  
Raadhuisstraat 24  
Graft-De Ryp, Holland  
Phone: 02997-1303  
Telegrams: Euradteam-Amsterdam  
Telex: 13039-SIPAS

## G. Nebut

Promotion Presse Internationale  
7 ter Cour des Petites Ecuries  
75010 Paris, France  
Telephone: 5231917, 1918, 1919

## Dieter Wollenberg

Erikastrasse 8  
D-8011 Baldham/Muenchen  
Germany  
Telephone: 0 8106/4541

## Tokyo

Haruki Hirayama  
EMS, Inc.  
5th Floor, Lila Bldg.,  
4-9-8 Roppongi  
Minato-ku, Tokyo, Japan  
Phone: 402-4556  
Cable: EMSINCPERIOD, Tokyo



# Electronic Design

ELECTRONIC DESIGN's function is:

- To aid progress in the electronics manufacturing industry by promoting good design.
- To give the electronic design engineer concepts and ideas that make his job easier and more productive.
- To provide a central source of timely electronics information.
- To promote communication among members of the electronics engineering community.

**Want a subscription?** ELECTRONIC DESIGN is circulated free of charge to those individuals in the United States and Western Europe who function in design and development engineering in companies that incorporate electronics in their end product and government or military agencies involved in electronics activities. For a free subscription, use the application form bound in the magazine or write for an application form.

If you do not qualify, paid subscription rates are as follows: \$30.00 per year (26 issues) U.S./Canada/Mexico, \$40.00 per year (26 issues) all other countries. Single copies are \$2.50 U.S. and all other countries. The Gold Book (27th issue) may be purchased for \$30.00 U.S./Canada/Mexico, and \$40.00 all other countries.

**If you change your address,** send us an old mailing label and your new address; there is generally a postcard for this in the magazine. You will have to requalify to continue receiving ELECTRONIC DESIGN free.

**The accuracy policy** of ELECTRONIC DESIGN is:

- To make diligent efforts to ensure the accuracy of editorial matter.
- To publish prompt corrections whenever inaccuracies are brought to our attention. Corrections appear in "Across the Desk."
- To encourage our readers as responsible members of our business community to report to us misleading or fraudulent advertising.
- To refuse any advertisement deemed to be misleading or fraudulent.

Individual article reprints and microfilm copies of complete annual volumes are available. Reprints cost \$6.00 each, prepaid (\$5.00 for each additional copy of the same article), no matter how long the article. Microfilmed volumes cost \$23 for 1976 (Vol. 24); \$30 for 1973-75 (Vols. 21-23), varied prices for 1952-72 (Vols. 1-20). Prices may change. For further details and to place orders, contact Customer Services Dept. University Microfilms, 300 N. Zeeb Rd., Ann Arbor, MI 48106. (313) 761-4700.

**Want to contact us?** If you have any comments or wish to submit a manuscript or article outline, address your correspondence to:

Editor  
ELECTRONIC DESIGN  
50 Essex St.  
Rochelle Park, NJ 07662

## Move Air... Not Components!



## There's an **Etri Fan** (just say ee-tree) for virtually every application

Etri fans move more air... no matter how crowded it is behind the panel. You don't have to burn up hours juggling components and making trade-offs just to get the airflow you need. We're not a bit hard to fit into your panel. Sizes on our flat axials range from a skinny 1" profile on up... all on standard mounting centers. Air deliveries from 20 to over 2000 CFM will help you keep your cool.

Etri fans are plenty rugged, too. Vibration-resistant housing; precision-molded, reinforced impellers; lifetime bearings... that's just part of the story.

Want to see more?

Send for our free catalog!

**Etri, Inc.**  
8002 S. Madison Street  
Burr Ridge, IL 60521  
(312) 325-9380

CIRCLE NUMBER 75

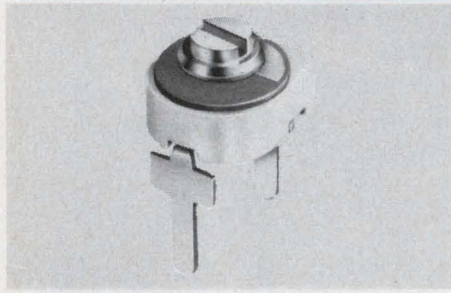

**MINIATURE CERAMIC TRIMMER CAPACITORS** 9371 series of ceramic trimmer capacitors are compact, economical and rugged. They are 50% smaller than other trimmers of this type yet provide high capacitance values. Available in 4 capacitance ranges, 1.5 to 4, 3.0 to 10, 3.5 to 18 and 5.0 to 25 pf with Q's > 300 at 10 MHz. They have an overall diameter of .225" with .215" above board height. **JOHANSON MANUFACTURING CORPORATION**, Rockaway Valley Road, Boonton, N.J. 07005 201-334-2676

TRIMMER CAPACITORS

181

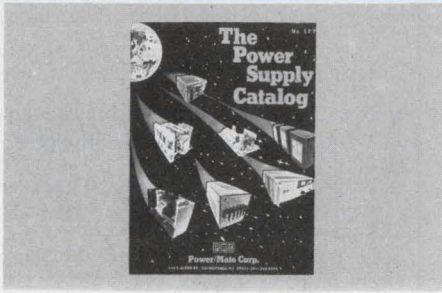

**Free New catalog** contains over 34,500 quality power supplies from the world's largest manufacturer, Power/Mate Corp. Power Supplies for every application including submodulars, open frame, variorated, encapsulated, laboratory & system. All units UL approved and meet most military and commercial specs for industrial and computer uses. Power/Mate Corp., 514 S. River St., Hackensack, NJ 07601 (201) 343-6294

POWER SUPPLIES

184

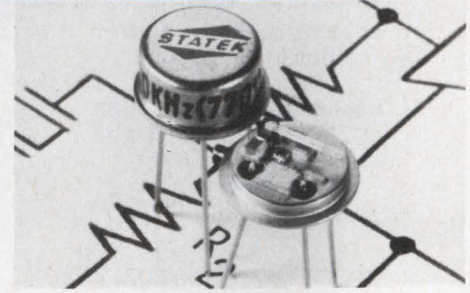

**CMOS Crystal Oscillators in Low profile TO-5.** Frequency range is 10 kHz to 300 kHz (divided outputs to 1 kHz, low as one cycle per month available). Low milli-amp current consumption. Accuracy  $\pm 0.01\%$ . Shock 1000 g. Hybrid thick and thin film chip and wire design is rugged and ideally suited for portable equipment. Details in Gold Book & EEM \* **STATEK CORP** \* 512 N. Main, Orange, Ca. 92668 \* (714) 639-7810 \* Telex 67-8394.

CRYSTAL OSCILLATOR

187

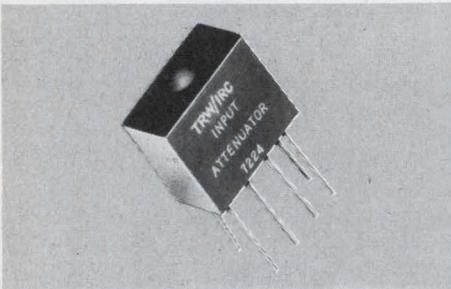

**AR Ultra-Precision Resistor Networks** from TRW provide maximum environmental protection. They feature lower effective cost, high density packaging, and all-welded construction. And, the AR Matched Resistor Sets provide ultra-precision performance at the lowest possible cost. TRW/IRC Resistors, an operation of TRW Electronic Components, 401 N. Broad St., Phila., Pa. 19108. (215) 922-8900.

AR MODULES

182



**COMPUCHESS I** is a microprocessor based chess component with six selectable intelligence levels, randomized strategy, programmable capability, automatic or selectable pawn promotion, castling and en-passant. Level 1-4 for practical game playing. Level 5-6 for programmed problems. Strongly user-oriented for finding, deleting or adding pieces for handicap chess or alternate chess-like games. Stock to 4 weeks at \$169.95 or ask for brochure; CompuChess, Dept. ED, Bx 65, Largo, FL 33540, (813) 585-3850.

COMPUCHESS I

185

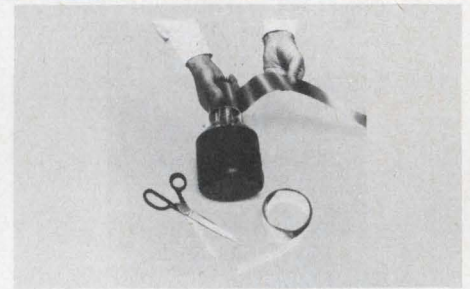

**FORM YOUR OWN MAGNETIC SHIELDS** When you need only one or two magnetic shields, save time and money by shaping your own. All it takes is a scissors and our improved Eagle alloys for magnetic shielding. We'll gladly help. Check the card in this publication and we'll send full details on Eagle foil and sheet stock. Eagle Magnetic Co., Inc., Box 24283, Indianapolis, IN 46224 317/243-1030.

MAGNETIC SHIELDING

188

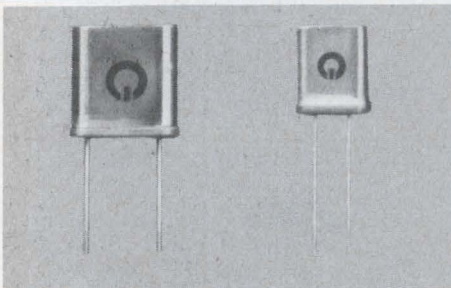

**HIGH STABILITY LOW COST QUARTZ CRYSTAL** for  $\mu$ -processor and clock oscillator. Accuracy is  $\pm 0.002\%$  at 25°C, Frequency change over -10 to +55°C is within  $\pm 20$ ppm. 1.000, 1.8432, 2.000, 2.097152, 2.4576, 3.2768, 4.0000, 5.0000, 5.0688, 5.1850, 5.7143, 6.5536, 10.0000, 18.0000, 18.4320, 20.0000, 22.1184 Immed. Dlv. \$1.85 ea. 10 MHz up in HC-18/u; (Min. 100 pcs.) Q-MATIC CORP., 3194-D Airport Loop Dr., Costa Mesa, CA 92626, (714) 545-8233, Telex 678389

CRYSTAL

183

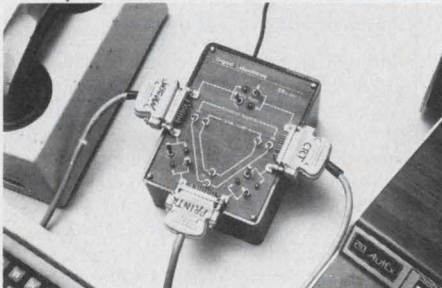

**UNIVERSAL JUNCTION UNIT** . . . for three devices, RS232C or current loop.

. . . Six switches provide all 63 interconnects that are possible between three I-O devices. LED's indicate data flow. . . . Designed to provide circuit compatibility and easy data routing between different manufacturer's devices. . . . \$350 (1-4) from DIGITAL LABORATORIES, 600 Pleasant St., Watertown, MA 02172 (617) 924-1680

3 PORT RS232 & 20 MA LOOP

186

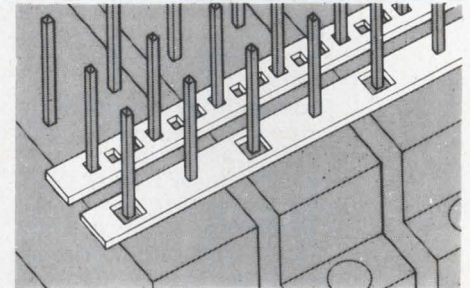

**STRIP/BUS BY ROGERS.** Low Cost Bussing Systems; easy installation, reliable solder joints; greater pin exposure. Write or call for details. Rogers Corporation, Chandler, AZ 85224. Phone (602) 963-4584. (EUROPE: Mektron NV, Ghent, Belgium; JAPAN: Nippon Mektron, Tokyo)

STRIP/BUS

189

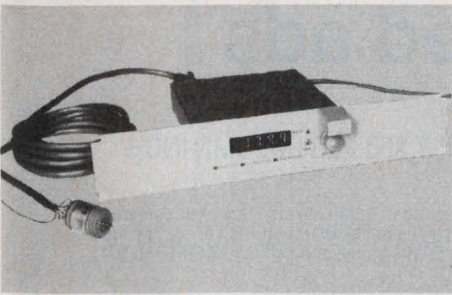

**ABSOLUTE ENCODER**— $\pm 1$  Part in 3600 System Accuracy, Electro-Magnetic Transducer + LED Display + BCD, Binary, and DC Output—Infinitely Adjustable Scale Factor (0 to 9999)—Hi Noise Immunity—Zero Offset—Single and Multi-Channel Units From \$375/Axis (1 pc.) Other CCC products are Synchro to Digital, Synchro to Linear DC, Digital or DC to Synchro Converters, and Solid State C.T.'s or CDX's. Send for Free Catalog & Application Notes. Computer Conversions Corp., East Northport, N.Y. 11731 (516) 261-3300.

ENCODER

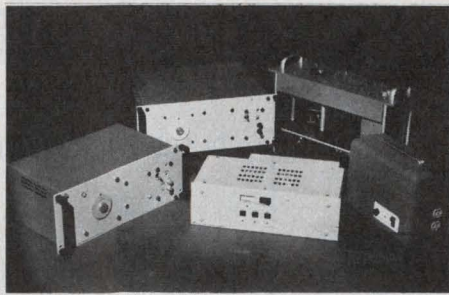

**LINE VOLTAGE PROBLEMS? BROWNOUT PROTECTION?** Select from the broad field-proven line of Variac® Automatic Voltage Regulators. Up to  $\pm 20\%$  correction. Regulation accuracy 0.2%. Output current from 8.7A to 85A. Input 50, 60, or 400 Hz (120 or 240V). Single and three phase. Portable, bench, wall and rack models. Militarized versions. GenRad, 300 Baker Ave., Concord, MA 01742 (617) 369-4400.

VARIAC® REGULATORS

193

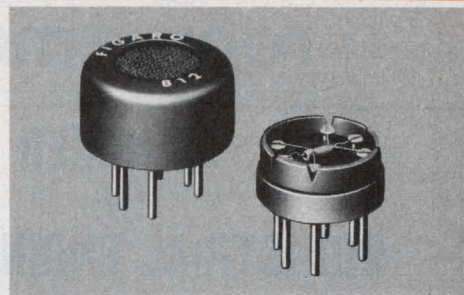

**FIGARO GAS SENSOR TGS** is a gas sensitive semiconductor. When combustible gas is absorbed on the sensor surface, a marked decrease of electrical resistance occurs. Major features of the sensor include high sensitivity, long term reliability and low cost. The applications are: GAS-LEAK ALARM, AUTOMATIC FAN CONTROL, FIRE ALARM, ALCOHOL DETECTOR, etc. Figaro Engineering Inc., North America Office-3303 Harbor Boulevard, Suite D-8, Costa Mesa, Calif. 92626 Tel: (714) 751-4103 Telex: 678396

GAS SENSOR

196



**Free 1978 Catalog of Recorder Products.** Complete description of all Memodyne incremental and continuous digital cassette recorders, data loggers, transports, universal readers and high speed recording system with illustrations, block diagrams, mechanical dimensions and timing sequences are contained in this new catalog. Accessories, supplies, cassettes and a price list are also included. Write for your free copy! Memodyne Corporation, 385 Elliot Street, Newton Upper Falls, MA 02164 (617) 527-6600

FREE RECORDER CATALOG

191

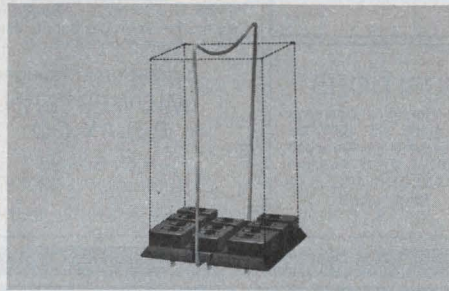

**NEW FLANGELESS PRINTED CIRCUIT BOARD SOCKETS** for use with square base relays are now available from Custom Connector Corporation. Mounting flanges have been removed to reduce required surface area. Optional hold down bail (HDB-5) insures contact integrity if a relay installation is subjected to mechanical vibration; use with 2-pole (CM08-PCB-1S) and 3-pole (CM11-PCB-1S) sockets. Immediate delivery. Contact James R. Crosby, Custom Connector Corporation, 1738 E. 30 St., Cleveland, Ohio 44114.

CUSTOM CONNECTOR SOCKET

194

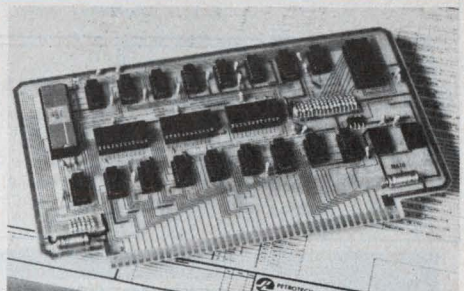

**HARDWARE MAT BOARD—RAM SAVER!!** performs logarithmic & trigonometric functions,  $e^x$ ,  $y^x$ , multiply, add, divide, subtract, etc., etc., 8 digit mantissa, 2 digit exponent, very fast (comparable with in-system software) Compatible with M-6800 Microprocessor KITS AVAILABLE AT \$72.80, \$252, \$555. A - Board, software, full instructions B - 'A' and all components, unassembled C - Assembled, inst. manual, sftwr. pkg. WOODTRON LTD., PO. BOX 4067, STATION "C", CALGARY, ALBERTA, CANADA.

HARDWARE MAT BOARD

197

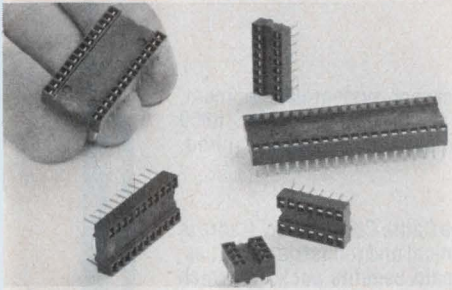

**METHODE IC SOCKETS** are end and side stackable for ultra-high density packaging. Sizes for all standard DIP packages are available on .300", .400" and .600" centers. Anti-wicking contact design with stand-off makes soldering and clean-up easy. Large ramped lead-in for simple assembly and field repairs. Insulators are glass filled nylon and contacts are tinned brass. Methode Manufacturing Corp. 1700 Hicks Road, Rolling Meadows, IL 50008, (312) 392-3500.

IC SOCKETS

192

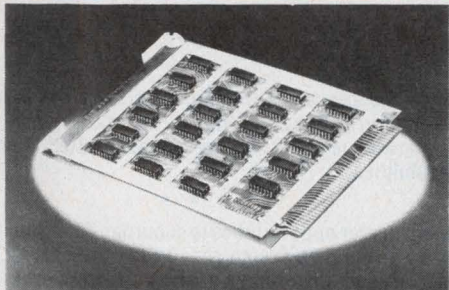

**T2L Power Distribution**—Noise attenuation and highest packaging density for P.C. boards with T2L logic are yours with Mini/Bus®, the Rogers way to eliminate the cost of multilayer boards by off-board power distribution. Rogers Corporation, Chandler, AZ 85224. Phone (602) 963-4584. (EUROPE: Mektron NV, Ghent, Belgium; JAPAN: Nippon Mektron, Tokyo)

PC POWER DISTRIBUTION

195



**Free Catalog** contains complete line of Power Supplies from Computer Products, Inc. Miniature encapsulated models from 3.6 to 28V, 25mA to 2A. DC/DC Converters, 5 to 12 Watt models, single and dual outputs. High-efficiency supplies, single and dual output, models to 100 Watts. Attractive OEM discounts. Computer Products, Inc. 1400 N. W. 70th Street, Fort Lauderdale, FL. 33309 305/974-5500

POWER SUPPLY CATALOG

198

# Electronic Design

## recruitment and classified ads

### MANAGER OF INDUSTRIAL ENGINEERING

One of our clients, in a central part of the state, needs a manager of Industrial Engineering with a BSIE degree or equivalent and at least 5 years experience in a supervisory capacity. Duties will include: developing standard time data, preparing plant layout, training work measurement analysis, implementing new job standards, and most important of all, revising the companies wage incentive plan.

If you are interested in directing the activities of an Industrial Engineering Department, for an electronics company engaged in commercial products, in a non-union atmosphere, that is offering a starting salary of \$25,000, please send your resume to:

Jean Handman  
Rath & Strong, Inc. — Management Consultants  
21 Worthen Road, Lexington, MA 02173

An Equal Opportunity Employer

PLACE YOUR AD AT ONLY \$55 PER COLUMN INCH

Camera-ready film (right reading negatives, emulsion side down) or camera-ready mechanicals must be received by deadline. Or, if you wish us to set your ad (typesetting is free) simply pick up the phone and call our RECRUITMENT HOT LINE — (201) 843-0550. Ask for:

Constance McKinley  
RECRUITMENT ADVERTISING MANAGER  
ELECTRONIC DESIGN  
50 Essex Street, Rochelle Park, New Jersey 07662

### MICROWAVE SYSTEMS ENGINEER

Midwestern Relay Co., a video and message data common carrier operating in Wis., Minn., Ill., has a challenging position for an engineer with BSEE or equivalent or experience in microwave system design and path analysis. FCC filing and frequency coordination experience desirable, but not essential. Send resume in confidence to:

Operations Manager  
MIDWESTERN  
RELAY CO.

P.O. Box 68  
Rubicon, WI 53078

An Equal Opportunity Employer

**2** RECRUITMENT ADS  
FOR THE PRICE OF **1**

### ELECTRONIC PROJECT ENGINEERS

Design of Industrial Control Systems and 1 to 20 kVA Inverters. A BSEE and 5 years experience desirable. Excellent starting salary and comprehensive benefits. Located in suburb of Chicago.

ELECTRO-PAC® DIVISION



Gerald Servos  
129 Laura Drive  
Addison, IL 60101  
(312) 543-6200

### ELECTRONIC ENGINEERS

Openings, in Aerospace, Communications, Sonar, RMA, Digital/Analog, RF, Software, Test Engineering fields. BSEE & U.S. citizenship req'd. (firm). Replies kept confidential. EOE Fee Pd. Agcy. To save time, pls. send res. 1st. D. Jones, Tech-Prof. Empl., Est. 1967, 3111 St. Paul St., Balto., Md. 21218. (301) 243-1545.

### TEXAS POSITIONS

Engineering, EDP & technical openings throughout Texas & the U.S. 100% fee paid. Send your resume in confidence to ENGINEERING/EDP SEARCH (Agency)  
84 N.E. Loop 410, Suite 124E  
San Antonio, Texas 78216

## ENGINEERING OPPORTUNITIES IN ATLANTA

### • MINICOMPUTERS- PROGRAMMER/ANALYST

BSEE required with minor in Computer Sciences and 3-5 years experience in data acquisition and processing equipment analysis and programming. Specific programming experience on DEC PDP-11 utilizing RT-11 and RSX-11M operating systems is essential.

### • MICROPROCESSORS SYSTEMS ENGINEER

BSEE required with minor in Computer Sciences and 3-5 years experience in microprocessor system development, including software and system architecture. Specific "hands on" experience with INTEL 8080 and MAC 6800 microprocessors is essential. A good knowledge of microprocessor associated input/output devices is also required, together with control logic design capabilities.

\* \* \* \* \*

The above positions represent permanent career opportunities in suburban Atlanta with The Cadre Corporation. Cadre is a multidisciplinary engineering company performing design and turnkey projects for technical and industrial facilities. We offer excellent salaries, pay relocation costs, and have a comprehensive company-paid benefits package which includes an early vesting retirement plan. Qualified candidates may submit a complete resume and salary history in confidence to:

Manager of Engineering  
**THE CADRE CORPORATION**  
P.O. Box 47837  
Atlanta, Georgia 30362  
An Equal Opportunity Employer



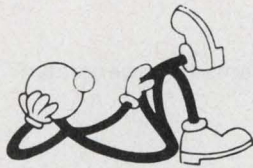

## EFFORTLESS . . .

If you're ready to move on with your career, it can be a lot easier than you expect.

We are the members of



who work extensively with electronics industry leaders. The companies we service have many openings and pay for us to search you out.

Send your resume to the office nearest you. Then sit back and relax while we do the work.

### BRENTWOOD PERSONNEL ASSOCIATES

Electronics Division  
1280 Route 46  
Parsippany, New Jersey 07054  
(201) 335-8700

### CAREER SPECIALISTS, INC.

4600 El Camino Real, Suite 206  
Los Altos, California 94022  
(415) 941-3200

### STAFF DYNAMICS, U.E.

26 Sixth Street  
Stamford, Connecticut 06905  
(203) 324-6191

### PETER A. KECHIK & ASSOCIATES, INC.

1420 Renaissance Drive  
Park Ridge, Illinois 60068  
(312) 298-1148

### HAMPSHIRE ASSOCIATES, INC.

51 East 42nd Street, Suite 414  
New York, New York 10017  
(212) 697-6327

### AVAILABILITY, INC.

Suite 285  
5401 W. Kennedy Blvd.  
Tampa, Florida 33609  
(813) 872-2631

*190 associates internationally*

Engineering

# NORTHROP DESIGN ENGINEERING

*great purposes...  
greater achievements*

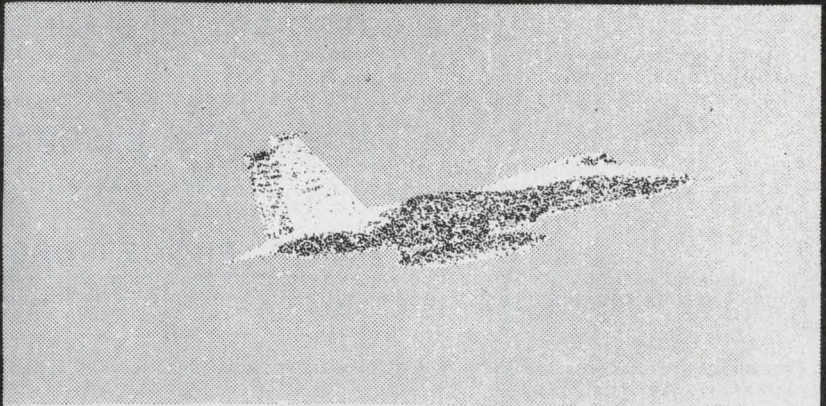

Establishing goals that challenge your ability. . . creates a sound beginning. Advancing beyond those objectives. . . instills pride.

At Northrop Defense Systems Division, a leader in advanced Electronic Countermeasure technology, we provide the guidance and professional freedom necessary for creative problem-solving and maintaining our leadership in the state-of-the-art.

If you are a Design Engineer with the following qualifications and possess a strong drive toward self-fulfillment, we invite you to consider an exciting career at Northrop.

- \* 5-10 years experience in electronics and electromechanical high density packaging of military support equipment. Knowledge of investment casting and metal fabrication method processes.
- \* RF design and analysis. Octave bandwidth MIC and stripline components. ECM TWT and equipment experience, plus familiarity with MIL-STD-38510 and 5400E requirements.
- \* PROJECT ENGINEER with background in power supplies, modulators and high power TWT's required. Will be responsible for design and development of ECM transmitter.

In addition to the opportunity to join one of the finest engineering teams in the nation, we offer an excellent salary/benefits program. Qualified individuals are invited to send brief letter or resume in confidence, to:

Director—Design Engineering  
Department E21

**NORTHROP CORPORATION**

Defense Systems Division

600 Hicks Road, Rolling Meadows, Illinois 60008

An equal opportunity employer m/f

# NORTHROP



**HOW TO PLACE YOUR AD**

**CALL THE RECRUITMENT  
HOT LINE 201-843-0550**

# VOUGHT CORPORATION

Dallas, Texas

Our wide variety of activities in aircraft, missiles, space and support equipment programs have generated interesting and challenging work assignments for:

## ELECTRONIC HARDWARE DESIGNERS

Requires engineering degree and three or more years experience in hardware design of:

- Digital Video Processors
- Computer Graphics
- Computer Interfaces and Controllers

Experience in flight simulator development is preferred.

## ELECTRO-OPTICS ENGINEERS

Requires engineering or physics degree and experience in military electro-optical systems. Must have background in EO modeling and computer simulation and analysis of EO systems and related components. Must be familiar with available materials components and devices for implementing imaging and non-imaging EO systems.

## SIGNAL PROCESSORS

Requires electrical engineering degree and recent analytical and design experience in processing of signals derived by scanning non-imaging electro-optical sensors using complex focal plane arrays to perform both search and tracking functions.

## DIGITAL PROCESSORS

Requires electrical engineering degree and experience with application and integration of digital computers in military avionics including development of overall system architecture. Experience must include development of operational software.

These jobs are located in the Dallas metroplex which has excellent schools, lower than average cost of living and outstanding recreational facilities.

Vought offers relocation assistance, excellent employee benefits and competitive salaries. If your qualifications match any of these jobs, send resumes to:

Professional Placement  
**VOUGHT CORPORATION**  
P.O. BOX 5907  
Dallas, Texas 75222  
Equal Opportunity Employer

## STATE OF THE ART

Dunhill is an industrial recruiting organization for electronic engineers offering superior positions.

To offer such an exceptional service to people we must represent excellent to superior positions — positions which offer high promotability and exceptional challenge.

To do this we have over two hundred offices to serve you well — to offer you good opportunities in your backyard and across the country.

We are currently staffing for some outstanding organizations across the country involved in medical electronics, automotive electronics, power electronics and controls and instrumentation.

Your interest in reaching your objectives, in advancing yourself to your goals, is our interest as well. This we respect in strict confidence. You have our trust.

For placement assistance, please call or write Gene Trusky CEC.

**DUNHILL  
PENN CENTER**  
Pgh., Pa. 15235 (412) 241-8383

## RELIABILITY MAINTAINABILITY

Participate in Shipboard electronic systems acquisition management. Perform engineering evaluations, develop reliability, maintainability and test specifications. BSEE or equivalent with 5 years experience.

Please forward resumes to:

Mr. L. Orlando

### General Research Corporation (SWL DIVISION)

Suite 700 Park Place  
7926 Jones Branch Drive  
McLean, Virginia 22101

Equal Opportunity Employer

## KEEP Electronic Design's GOLD BOOK HANDY

### — GET A REPEAT AD FREE!

With our 2 for 1 plan, your net cost in *Electronic Design* is only \$27.50 per column inch, lowest among all the national newspapers and electronics media. You get a total of 165,418 exposures to EDEM engineers and engineering managers (not counting 11,668 more among general or corporate managers) at only 33¢ per thousand! You can't beat the price. You can't beat the coverage and you can't beat the quality.

## ELECTRICAL ENGINEERS

An NYSE company, located in the southern Midwest and involved in the design, manufacture and sale of air pollution control equipment for industrial and utility applications, is currently seeking to add qualified Electrical Engineers to its staff in the following positions:

### ELECTRICAL DESIGN

This individual must be experienced in design of large industrial electrical systems and in the supervision of electrical designers. Duties will include vendor contact in specifying and selecting equipment, and preparing "scope of work" for electrical contractors.

### PRECIPITATOR START-UP SPECIALIST

This individual must be experienced in the start-up and troubleshooting of large electrostatic precipitators or large industrial electrical systems. Duties will include on-site start-up of large precipitator systems and coordinating with engineering and marketing to follow through and solve any problems as necessary to insure timely and successful startup. This position will require 75% travel.

These positions offer the opportunity to gain knowledge of widely varied systems in many different industries. Both offer competitive salaries and excellent benefits.

For confidential consideration please send your resume with salary requirements to:

**Steve Sons**  
**P.O. Box 21181**  
**Louisville, Kentucky 40221**

An Equal Opportunity Employer M/F

## Field Engineer

Sencore, a leading manufacturer of test equipment for the consumer service, communications, and industrial maintenance markets, has an exciting position for a well rounded FIELD ENGINEER.

Duties will include writing application manuals for our line of O-Scopes, Freq. Counters, DVM's, Video/CB/Stereo Analyzers and more. You also write and produce video tape programs for training and sales. You'll travel 5-10 days per month, working with major TV, VTR, Audio, Stereo, communications and computer manufacturers from a design and approval standpoint. Also involved is technical training of Sales Engineers both in-house and in the field.

We need a minimum Associate Degree, with EE or BSEE preferred. We desire an individual experienced in Field Engineering with a high degree of communication skills.

\$12k-\$18k starting salary, with profit sharing, insurance package, and expense account while traveling.

If you would like to work with a dynamic firm, in a key position, where your decisions will help break new markets . . .

### WRITE OR CALL:

**E. A. Bowden**  
(605) 339-0100

**SENCORE, INC.**  
3200 Sencore Drive  
Sioux Falls, South Dakota 57107

## ELECTRONIC ENGINEERS OR TECHNICIANS

To sell instrument product line part time. Instruments test, calibrate or control electronic circuits. Price range \$20-100. Contact:

Don Horn  
CINCINNATI  
ELECTROSYSTEMS, INC.

469 Wards Corner Rd.  
Loveland, Ohio 45140  
(513) 831-4347

## TIRED OF SNOW AND ICE?

There's a place in the sunbelt for you!

Company retained professional recruiters

## DUNHILL OF DAYTONA BEACH

1320 Oak Forest Drive  
Ormond Beach, Florida 32074  
(904) 673-2333

# HP and YOU in Oregon!

## SEE US DURING THE ISSC CONFERENCE IN San Francisco February 14-17

Technical staff members will be available in our HOSPITALITY SUITE to answer your questions.

For suite location and advance information, call Diane Pugh in Corvallis, (503) 757-2000, Ext. 2023, or call us during the conference at (415) 397-7039.

Hewlett-Packard's Corvallis Division, responsible for the development and manufacture of the most advanced personal calculator products, has challenging career opportunities in the Integrated Circuits Department.

### I.C. PRODUCT DEVELOPMENT ENGINEERS/MTS

Responsible for the coordination of new I.C. development, device modeling, yield analysis and cost reduction engineering on production circuits. Requires experience in I.C. design, applications, or product engineering.

### I.C. TEST ENGINEERS/MTS

Involves I.C. test system management including hardware design, software development, and diagnosis of the functional test systems (Megatest and Fairchild Sentry). Related experience required.

### MOS AND LCD PROCESS ENGINEERS/MTS

Hands-on diffusion and masking in the LSI operation/process & test development in the LCD operation; our commitment to engineering excellence provides ample opportunity for state-of-the-art process development. Related experience required.

### EQUIPMENT DEVELOPMENT ENGINEERS/MTS

Responsible for equipment design, feasibility tests, evaluation studies and installation for wafer fab, liquid crystal and thin film operations. Engineering experience in chemical processes and material required.

Corvallis is situated in the beautiful mid-Willamette Valley, 1½ hours drive from the Oregon Coast, the Cascade Mountains, and Portland, the beautiful "City of Roses." Corvallis provides a university atmosphere with skiing, fishing, sailing and hiking in the picturesque nearby surroundings. The Pacific Northwest provides the opportunity to learn, explore and be challenged.

HP offers outstanding benefits, including flexible working hours, cash profit sharing and stock purchase program. If you cannot meet with us at the show, please send your resume in confidence to Diane Pugh, 1000 N.E. Circle Blvd., Corvallis, Oregon 97330. An equal opportunity employer.

Corvallis Division

**HEWLETT**  **PACKARD**

# 6800 PROCESSOR EMULATOR

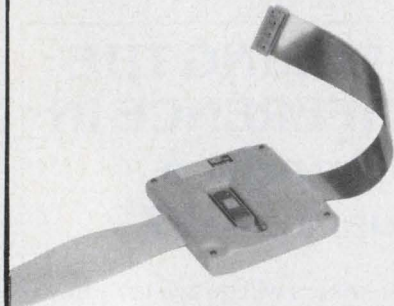

- \* IN-CIRCUIT EMULATOR
- \* SINGLE STEP
- \* BREAKPOINT
- \* TRACE MEMORY
- \* REGISTER ACCESS
- \* SELF POWERED
- \* STAND ALONE
- \* PORTABLE



GET THE BUG!

**\$1860.**



**APPLIED  
MICROSYSTEMS**

11064 118th Place Northeast  
Kirkland, Washington 98033  
Phone (206) 827-9111

CIRCLE NUMBER 76

## Advertiser's index

Advertiser	Page	Advertiser	Page
AMP, Incorporated.....	14, 15	Micro Devices Corp.....	76
Acopian Corp.....	32H	Micro Switch, A Division of Honeywell.....	39
Advanced Electronic Design.....	82	Micropac Industries, Inc.....	112
Advanced Micro Devices.....	4, 5	Miller-Stephenson Chemical Co., The... 6	
American Microsystems, Inc.....	68, 69	Mostek Corporation.....	24, 25
Applied Microsystems.....	128		
Augat, Inc.....	29		
		Norplex Division, UOP, Inc.....	97
B & K Products of Dynascan Corporation.....	31	OK Machine & Tool Corporation....	110
Beckman/Helipot Division.....	32E	Optron, Inc.....	7
Bourns, Inc., Trimpot Products Division....	Cover II		
Burr-Brown Research Corporation....	111	Panduit Corporation.....	114
		Paratronics, Inc.....	115
Capitol Machine & Switch Co., Inc., The.....	114	*Philips Electronic Components and Materials.....	105
Centralab, The Electronics Division of Globe-Union, Inc.....	11	Power/Mate Corp.....	122
Citizen America Corporation.....	113	Precision Monolithics, Incorporated... 43	
CompuChess.....	122	Pro-Log.....	101
Computer Conversions Corp.....	123		
Computer Products, Inc.....	123	Q-Matic Corp.....	122
Continental Specialties Corporation.....	Cover III		
Crown International, Industrial Products Division.....	66	RCA Solid State Division.....	Cover IV
Custom Connector Corporation.....	123	Rental Electronics, Inc.....	32A, 32G
Custom Electronics, Inc.....	102	Rockwell International.....	50, 51
		Rogers Corporation.....	122
Dale Electronics, Inc.....	19		
Datel Systems, Inc.....	91, 93, 95	SMK Electronics Corporation of America.....	113
Dialight, A North American Philips Company.....	98	Scientific Atlanta Inc./Optima Div....	103
Digital Laboratories.....	122	Semtech Corporation.....	23
Dormeyer Industries, Inc.....	32C	Siemens Corporation.....	109
		Sierracin/Sylmar.....	17
Eagle Magnetics, Inc.....	122	Slaughter Company.....	112
Electronic Navigation Industries.....	119	Sprague Electric Company.....	37, 89
Etri, Inc.....	121	Statek Corp.....	122
		Systron-Donner.....	41
Fairchild Semiconductor.....	12, 13		
Figaro Engineering, Inc.....	123	TDK Electronics.....	18
Fluke Mfg. Co., Inc., John.....	106	TRW Capacitors, an Electronic Components Division of TRW, Inc.....	32B
		TRW/IRC Resistors, an operation of TRW Electronic Components.....	122
GTE Sylvania.....	20	Tecknit.....	113, 115
GenRad.....	123	Tektronix, Inc.....	49
General Electric Company, Instrument Rentals.....	32D	Teledyne Philbrick.....	104
General Electric Company, Semiconductor Products Department.....	83	Teledyne Relays, A Teledyne Company.....	2
Gould, Inc., Electronic Components..	32F	Teledyne Semiconductor.....	52
		Texas Instruments, Incorporated.....	10
Hamilton/Avnet Electronics.....	55	Thermalloy Company.....	117
Harris Semiconductor, A Division of Harris Corporation.....	87	Triplett Corporation.....	85
Hayden Book Company, Inc.....	*105, 108, *109		
Hewlett-Packard.....	1, 35, 54, 67, 78-79	Union Carbide, Components Department.....	33
Heyman Manufacturing Company....	115	United Systems Corporation.....	82
		Unitrode Corporation.....	16
IMC Magnetics Corporation.....	113		
Intel Corporation.....	8, 9	Woodtron Ltd.....	123
Intel Memory Systems.....	77		
Interface.....	105, 107	Zilog.....	16A
International Microsystems.....	115		
Intersil.....	44, 45		
Johanson Manufacturing Corp.....	122		
Kepeco, Inc.....	46		
Klinger Scientific Corp.....	117		
Memodyne Corporation.....	123		
Methode Manufacturing Co.....	123		

\*Advertisers in non-U.S. edition

# \$74.95 SOURCE.

It's CSC's DP-1: the automatic signal source that cuts hours from trouble-shooting TTL/DTL, CMOS and other popular logic circuits.

This compact, circuit-powered unit lets you inject signals at key points to test digital circuits with fast stimulus-response troubleshooting techniques. Just set a switch to the proper logic family; connect two clip-leads to the circuit's supply, and touch the DP-1 probe to a node. It automatically senses the circuit's condition (high or low state) and produces an opposite-polarity pulse of the proper level. That's all there is to it!

**Versatility-flexibility.** Select single-pulse or 100 pulse-per-second operation with the handy pushbutton control. A LED indicator signals single-shot or continuous mode. DP-1 can also be connected indefinitely, presenting a 300K impedence to the circuit under test. Short circuits can't harm it, even over prolonged periods. It's also protected against overvoltage up to 25V and reverse-polarity up to 50V.

For all its versatility, portability, operating ease and compact size, DP-1 is priced at only \$74.95—a fraction of what you'd expect to pay for a precision digital pulse source.

**Order today.** Call 203-624-3103 (East Coast) or 415-421-8872 (West Coast): 9 a.m.-5 p.m. local time. Major credit cards accepted. Or see your CSC dealer. Prices slightly higher outside USA.

**Logic family switch**—Sets proper pulse level for TTL/DTL or CMOS families.

**Rugged, high-impact plastic case**—Built to take it... in the lab or in the field.

**Protected**—Features built-in short-circuit, overvoltage and reverse-polarity protection.

**Operating mode pushbutton**—Selects single-shot or 100 pps operation.

**LED Pulse indicator**—Monitors operating mode.

**Interchangeable ground leads connection**—provide ground-side input connection, where desired, via optional cables.

**Interchangeable probe tips**—For greater versatility. Straight tip supplied; optional alligator clip and insulated quick-connecting clip available.

**Plug-in leads**—24" supplied, with non-corrosive nickel-silver alligator clips.

**Tri-state-output**—DP-1 is isolated from circuit under test:  $Z \geq 300K$

**Auto-polarity pulse sensing**—DP-1 automatically produces proper polarity pulse for circuit under test: logic "0" level produces a "1" pulse; logic "1" level produces a "0" pulse

**LED indicator**—flashes once for single pulse, stays lit to indicate pulse train

**Short-circuit protection**—can pulse into short circuit continuously

**Power**—overvoltage protected to 25V, reverse-voltage protected to 50V, voltage range 4-18V, 30mA max.

**Pulse modes**—Single pulse: press pushbutton for one sec. or less. Pulse train (100pps): hold pushbutton down

Pulse specs	TTL	CMOS
Pulse width	1.5usec + 30%	10usec + 30%
Fan out	60 loads	
Sink and Source	100mA source to 3.5V; sink to 6V	50mA source to logic 1; sink to logic 0
$T_r$	100nsec	100nsec
$T_f^*$	one TTL load, 500nsec	100K load, 8nsec

\* $T_r$  is directly proportional to load resistance

**Dimensions** (l x w x d) 5.8 x 1.0 x 0.7" (147 x 25.4 x 17.8mm)

**Weight** 3 oz. (.085kg)

**Power Leads** plug-in 24" (610mm), color coded insulated clips; others available

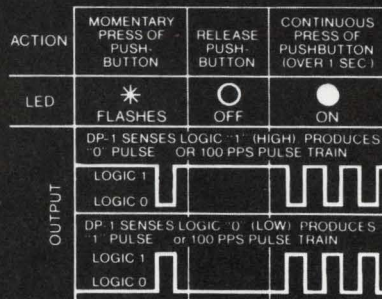

CONTINENTAL SPECIALTIES CORPORATION



70 Fulton Terrace, Box 1942, New Haven, CT 06509  
 203-624-3103 TWX 710-465-1227  
 West Coast: 351 California St., San Francisco, CA 94104  
 415-421-8872 TWX 910-372-7992  
 Great Britain: CSC UK LTD  
 Spur Road, North Feltham Trading Estate,  
 Feltham, Middlesex, England  
 01-890-8782 Int'l Telex 851-881-3669

CIRCLE NUMBER 231



\*Manufacturer's Recommended Resale

© 1978 Continental Specialties Corporation

New RCA kit makes it easy ...

# Evaluate CMOS microprocessing for yourself.

Here's a microprocessor kit that lets you prove how cost-effective the all-CMOS RCA 1800 system can be.

You'll quickly see how the RCA COSMAC architecture and a repertoire of 91 powerful instructions give you maximum performance with minimal memory. And how you can take advantage of CMOS low power dissipation, single wide-range power supply, full operating temperature range, high noise immunity, and single-phase clock.

## Multi-purpose Tool

Build this inexpensive kit to evaluate not only the benefits of its CMOS CPU, but also CMOS memory and CMOS I/O. Use it for easy prototyping and debugging. Exercise it with start, stop, and single-step controls. And, via the utility ROM,

generate, evaluate, and verify software.

The CDP18S020 Evaluation Kit comes complete with the RCA CDP1802 COSMAC CPU plus clock and control, display, memory and I/O sections, and all passive components needed for a low-cost microcomputer system. For just \$249. Add a power supply and I/O terminal and you're into CMOS microprocessing. The CDP18S024 EK/Assembler-Editor Design Kit allows assembly language software development.

To get your kit or more information, contact your local RCA Solid State distributor. Or contact RCA Solid State headquarters in Somerville, NJ; Sunbury-on-Thames, Middlesex, England; Quickborn 2085, W. Germany; Ste.-Anne-de-Bellevue, Quebec, Canada; Sao Paulo, Brazil; Tokyo, Japan.



RCA 1800. Cost-effective microprocessing.