

Electronic Design. 6

VOL. 24 NO.

FOR ENGINEERS AND ENGINEERING MANAGERS

MARCH 15, 1976

The first four-trace portable scope brings new capabilities to field measurements. With a weight of only 21 lb and a power drain of just 29W, this 50-MHz unit lets

you compare simultaneously two sets of differential signals. With an optional battery, you can get 5 hours of continuous operation. Learn the details on page 111.

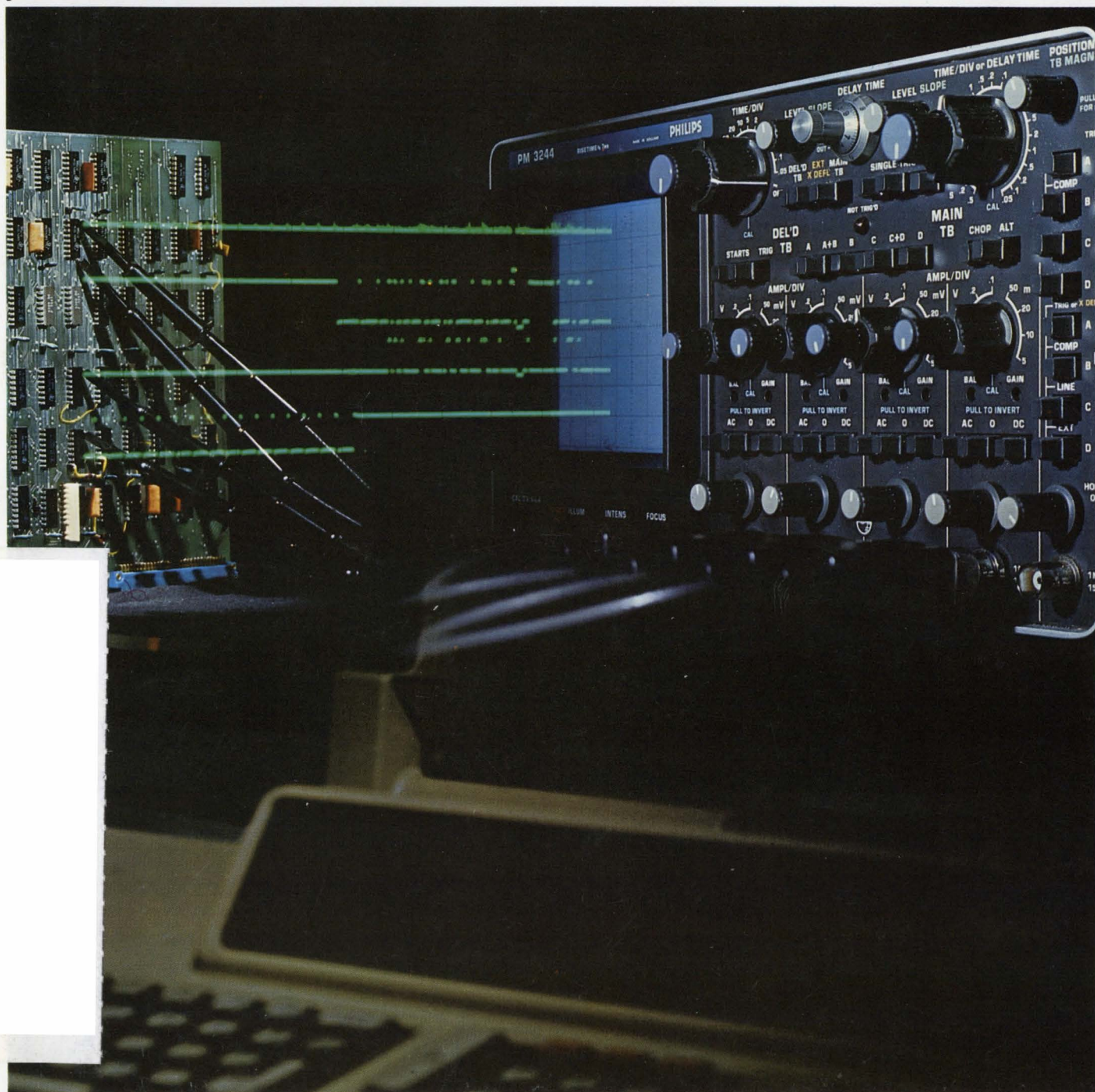

What Every Designer or Specifier Should Know About RESISTOR NETWORKS!

A wise man once said, "A chain is only as strong as its weakest link". That phrase says as much for electronic circuitry today . . . as it originally did for the value of the individual quality of man. For example, the failure of a single tiny printed conductor path in a resistor network can cause the failure of an entire circuit . . . or system.

Bourns doesn't want that to happen to one of your circuits. For that reason, we want to share some "inside" information about the design and manufacture of thick-film networks . . . so that you can be a more knowledgeable and more selective specifier.

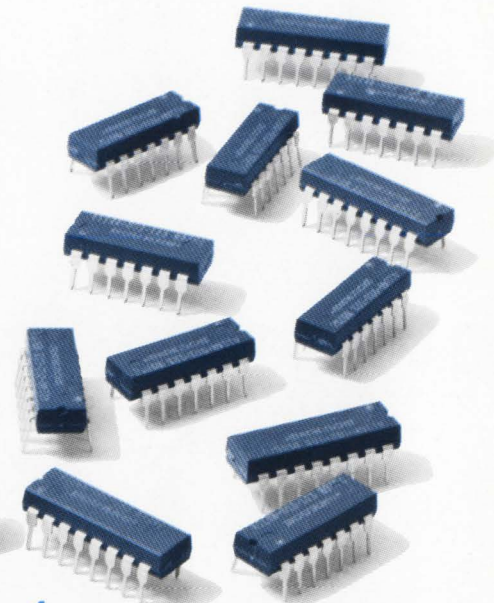

1. Lead Termination Failure

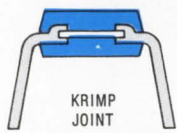

During Bourns initial design program, customer interviews indicated that commonly used "lap joint" and "butt joint" lead termination designs were subject to failure due to weakening of the solder termination during PC board wave soldering operations, and in-circuit heat cycling and vibration. These design-types depend heavily on solder alone for both mechanical and electrical bonding of leads to the substrate.

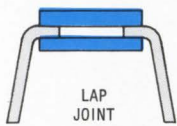

With this in mind, Bourns engineers developed the "Krimp-Joint™" lead frame termination design to protect customers from this hazard.

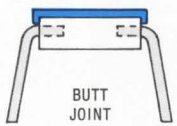

Bourns Krimp-Joint leads are firmly crimped onto the network element, much like a vise grasps a piece of lumber. To "cinch" the electrical connection, a special high temperature, reflow resistant solder is also used.

3. The Packaging

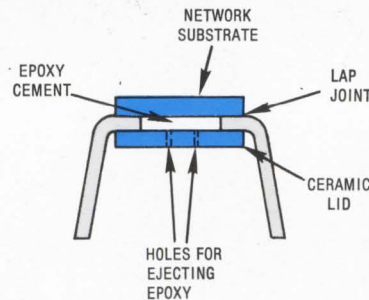

Various types of DIP packaging are utilized of which the molded and "sandwich" types seem most common. One problem that frequently occurs with the sandwich types is delaminating. This happens when air in tiny voids remaining in the epoxy filler (bonds the substrate to the sandwich "lid") expands in hot operating environments to the extent that the package comes apart and fails.

Bourns Krimp-Joint networks are encased in a homogenous **molded** thermoset plastic package, which is highly heat resistant. Both 14- and 16-pin DIP models are machine insertable, and are available in handy cartridge packages.

4. Power

Bourns uses a high-copper alloy lead material to **enhance** power dissipation capacity. Other materials — ferrous and brass alloys — do not have comparable performance. Furthermore, there is potential for rust with the ferrous alloy material. The high-copper alloy costs us more . . . but we think your satisfaction is worth it.

5. A Good Coat Is Important

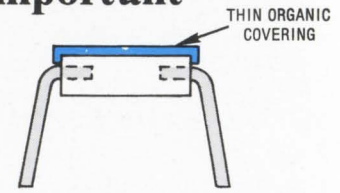

Our little network package must "weather" the homo sapien as well as the electrical environment. Example? Some users report that marking the top of thinly coated networks actually changed internal resistor values. With the tight board spacing found in most equipment cabinets, components occasionally get scraped when boards are inserted and/or removed. Customers report that some thinly protected networks have shorted-out or opened under these conditions. Bourns networks wear a heavy coat of molded plastic to weather the homo sapien climate.

2. Krimp-Joint Eliminates "Edge-Arounds"

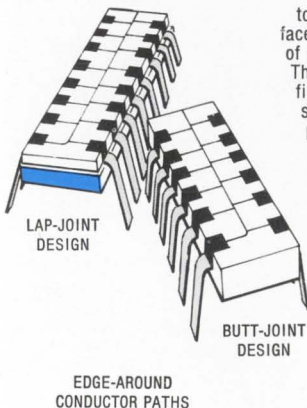

"Edge-around" thick-film printing techniques are required by some designs to electrically connect the network circuit — printed on the horizontal surface of the substrate — to pin leads which are always "buted" to the **edge** of the substrate, or are "lap-jointed" to the opposite side of the substrate. The latter condition exists with lap-joint designs when more complex thick film circuits are executed which require printing on both sides of the substrate (such as resistor/capacitor networks, dual terminators, special application circuits, etc.). Edge-around printing leaves a natural conductor path weakness on the fine edges of the substrate, resulting in the possibility of a very "tenuous" connection. Such connections are subject to failure after exposure to heat cycling, shock, vibration, etc., and can result in an open circuit condition. Sometimes an intermittent condition results, which makes fault diagnosis more difficult.

Since most packages are not tested at full rated power during manufacturing QC, weak edge-arounds sometimes pass final tests . . . and then burn-out (like a fuse), when subjected to full power in an operating circuit.

Bourns Krimp-Joint **mechanically** contacts **both** top and bottom surfaces of the resistor network substrate, resulting in a strong, positive connection between pin lead and both sides of a network circuit. No edge-around paths are required.

FREE SAMPLES

Try the Bourns "Krimp-Joint" Resistor Network Design. Write to us on your company letterhead telling us

1. current manufacturer's part number you are now using,
2. what resistance values you need . . .

and we will send samples for your evaluation. We'll also include a complete data packet, with a handy **cross-reference guide**.

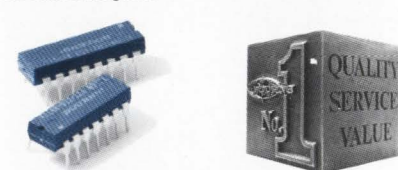

Gitchyseff an SFG.

**That's a synthesizer/
function generator, cousin—
the first one ever.**

Our new Model 171 combines the accuracy and stability of a synthesizer with the versatility of a function generator. This means you can generate sine, square, triangle, TTL pulse and dc outputs with synthesizer accuracy. Frequency range is 0.01 Hz to 2 MHz.

Sometimes all you'll need

to use is the generator dial, which is accurate to 3% of full scale. But for more precise operations, you'll want the synthesizer's 4½-digit accuracy which is 0.01% of setting. Synthesizer stability is ±0.002% from 0 to 50°C.

Now we all know that your average synthesizer goes for two grand or better. But the Model 171, which is also a function generator, goes for

just \$795. Which means you could have two of our SFGs for the price of an ordinary synthesizer and have some bucks left over. Gitchyseff a couple. WAVETEK, P.O. Box 651, San Diego, California 92112. Phone (714) 279-2200, TWX 910-335-2007.

WAVETEK®

CIRCLE NUMBER 2

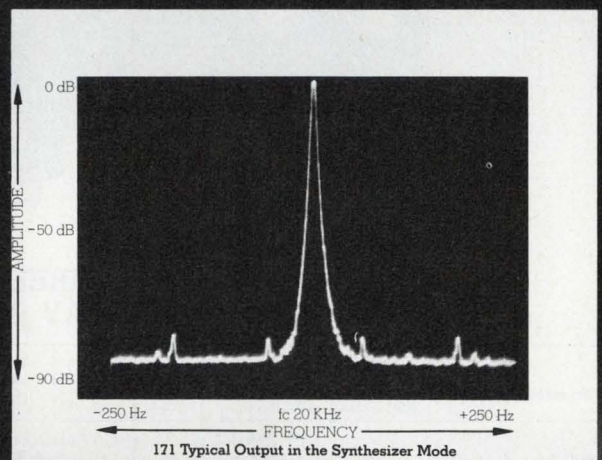
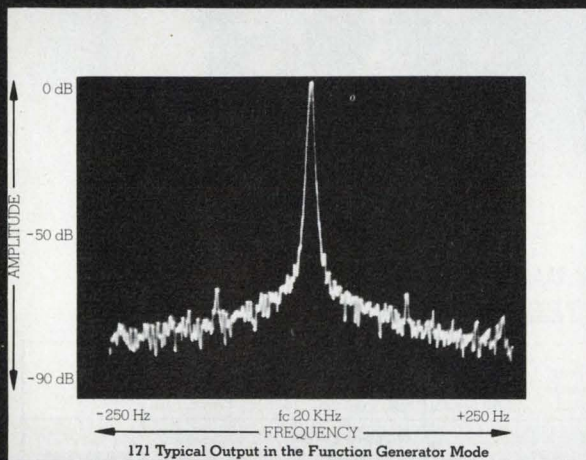

Actual spectrum analyzer photographs showing the improved waveform characteristics in the synthesizer mode.

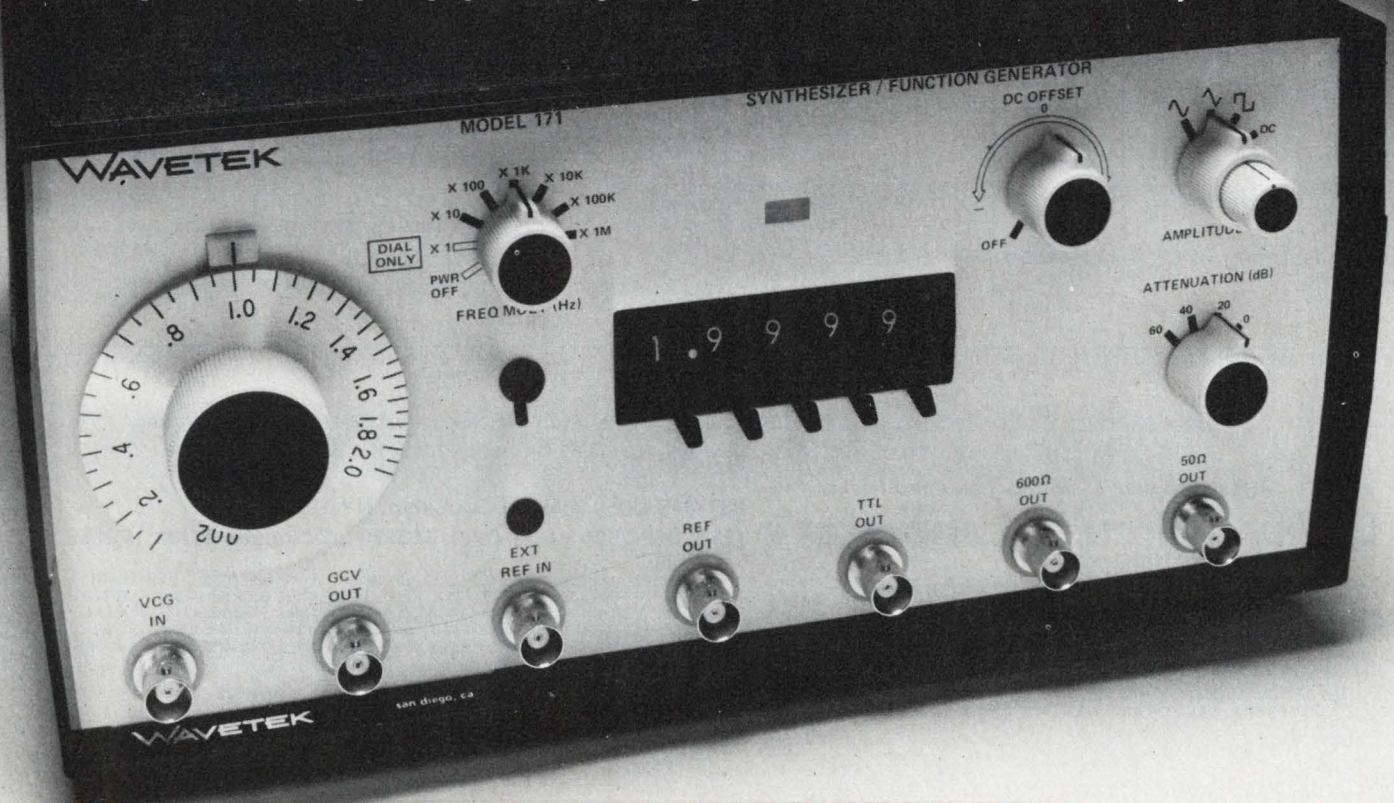

The largest selection of "OFF-THE-SHELF" POWER SPLITTERS/COMBINERS Available!

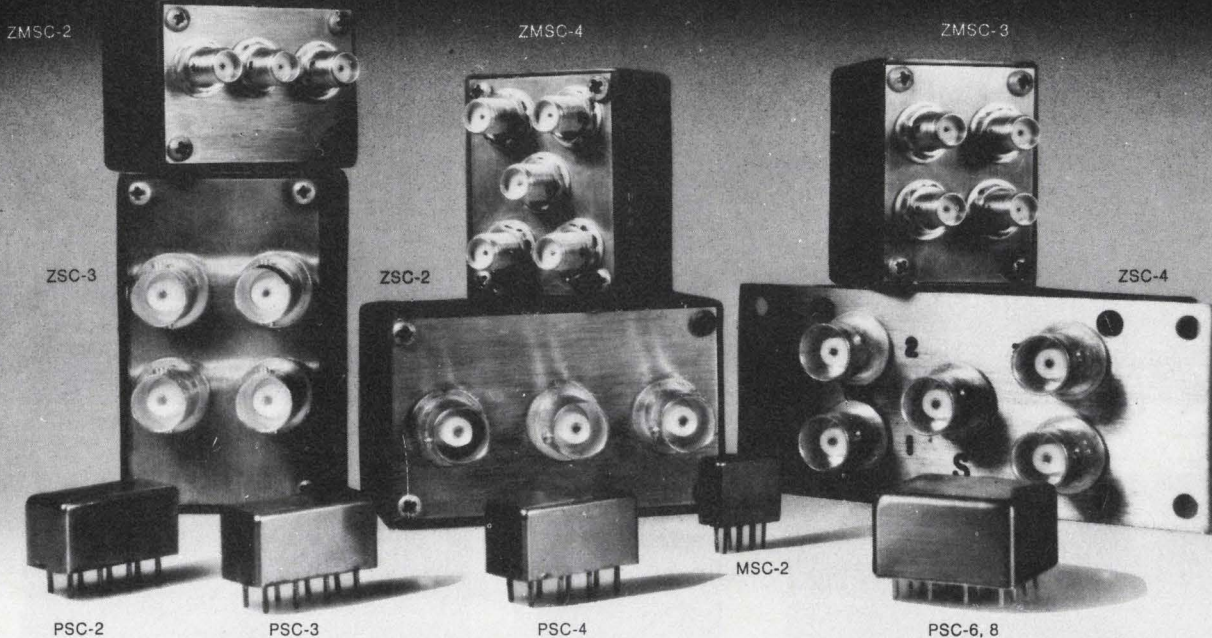

TWO-WAY, THREE-WAY, FOUR-WAY, SIX-WAY AND EIGHT-WAY POWER SPLITTER/COMBINERS

Model No.	Freq. range (MHz)	Isolation between outputs (dB) typical	Insertion loss (dB) (typical)	Unbalance		Price (Quantity)	Model No.	Freq. range (MHz)	Isolation between outputs (dB) typical	Insertion loss (dB) (typical)	Unbalance		Price (Quantity)
				ϕ (deg)	Amp. (dB)						ϕ (deg)	Amp. (dB)	
Two-way 0°							Three-way 0°						
PSC 2-1	0.1-400	25	0.4 above 3dB split	1	0.1	\$ 9.95 (6-49)	PSC 3-1	1-200	30	0.4 above 4.8 split	2	0.1	\$19.95 (6-49)
ZSC 2-1						\$24.95 (4-24)	ZSC 3-1						\$34.95 (4-24)
ZMSC 2-1						\$34.95 (4-24)	ZMSC 3-1						\$44.95 (4-24)
PSC 2-2	0.002-60	40	0.3 above 3dB split	1	0.1	\$19.95 (6-49)	PSC 3-2	0.01-30	40	0.25 above 4.8 split	2	0.1	\$29.95 (6-49)
ZSC 2-2						\$34.95 (4-24)	ZSC 3-2						\$44.95 (4-24)
ZMSC 2-2						\$44.95 (4-24)	ZMSC 3-2						\$54.95 (4-24)
PSC 2-1W	1-650	25	0.5 above 3dB split	3	0.20	\$14.95 (6-49)	Four-way 0°						
ZSC 2-1W						\$29.95 (6-49)	PSC 4-1	0.1-200	30	0.5 above 6dB split	2	0.1	\$26.95 (6-49)
ZMSC 2-1W						\$39.95 (6-49)	ZSC 4-1						\$41.95 (4-24)
PSC 2-1-75*	0.25-300	25	0.4 above 3dB split	1	0.05	\$11.95 (6-49)	ZMSC 4-1						\$51.95 (4-24)
MSC 2-1	0.1-450	30	0.4 above 3dB split	1	0.1	\$16.95 (6-24)	ZSC 4-2	0.002-20	33	0.45 above 6dB split	2	0.1	\$64.95 (4-24)
							ZMSC 4-2						\$74.95 (4-24)
Two-way 180°							PSC 4-3	0.25-250	30	0.5 above 6dB split	2	0.1	\$23.95 (6-49)
PSCJ 2-1**	1-200	33	0.6 above 3dB split	2.5	.15	\$19.95 (5-49)	ZSC 4-3						\$38.95 (4-24)
ZSCJ 2-1						\$34.95 (4-24)	ZMSC 4-3						\$48.95 (4-24)
Two-way 90°							Six-way 0°						
PSCQ 2-90	55-90	30	average of coupled outputs less 3dE 0.3	3	1.0	\$19.95 (5-49)	PSC 6-1	1-175	30	0.75 above 7.8dB split	4	0.2	\$59.95 (1-5)
							Eight-way 0°						
							PSC 8-1	0.5-175	30	0.8 above 9dB split	3	0.2	\$59.95 (1-5)

COMMON SPECIFICATIONS FOR ALL MODELS: Impedance all ports, 50 ohms. *Except 75 suffix denotes 75 ohms VSWR:1.1-1.2 typical Nominal phase difference between output ports, 0° **Except J suffix denotes 180° Q denotes 90° Delivery from stock; One week max.

For complete product specifications and U.S. Rep. listing see MicroWaves' "Product Data Directory," Electronic Designs' "Gold Book" or Electronic Engineers Master "EEM"

World's largest supplier of double balanced mixers

Mini-Circuits Laboratory
A Division Scientific Components Corp

837-843 Utica Avenue, Brooklyn, NY 11203

(212) 342-2500 Int'l Telex 620156 Domestic Telex 125460

International Representatives: AUSTRALIA General Electronic Services, 99 Alexander Street, New South Wales, Australia 2065; ENGLAND Dale Electronics, Dale House, Wharf Road, Frimley Green, Camberley Surrey; FRANCE S. C. I. E. - D. I. M. E. S., 31 Rue George - Sand, 91120 Palaiseau, France; GERMANY, AUSTRIA, SWITZERLAND Industrial Electronics GMBH, Klüberstrasse 14, 6000 Frankfurt/Main, Germany; ISRAEL Vectronics, Ltd., 69 Gordon Street, Tel-Aviv, Israel; JAPAN Densho Kaisha, Ltd., Eguchi Building, 8-1 1 Chome Hamamatsucho Minato-ku, Tokyo; EASTERN CANADA B. D. Hummel, 2224 Maynard Avenue, Utica, NY 13502 (315) 736-7821; NETHERLANDS, BELGIUM, LUXEMBOURG: Coimex, Veldweg II, Hattem, Holland. NORWAY Datamatik AS, Ostensjoveien 62, Oslo 6, Norway

US Distributors: NORTHERN CALIFORNIA Cain-White & Co., Foothill Office Center, 105 Fremont Avenue, Los Altos, CA 94022 (415) 948-6533; SOUTHERN CALIFORNIA, ARIZONA Crown Electronics, 11440 Collins Street, No. Hollywood, CA 91601 (213) 877-3550

NEWS

- 19 **News Scope**
- 24 **Major solar-cell programs** strive to lower cost, improve efficiency—An Electronic Design special report.
- 34 **Portable color TV camera's** size and power drain are cut in half.
- 39 **Washington Report**

TECHNOLOGY

- 47 **MICROPROCESSOR DESIGN**
- 60 **FOCUS on Photodetectors:** This detailed report gives the specifying engineer the knowledge he needs to clear the confusion in selecting and using photodetectors. Discussed are the various kinds of detectors, the characteristics of each, what tradeoffs to make and how to step around poorly specified products.
- 70 **Consider CCDs for a wide range of uses.** Existing charge-coupled-device products encompass image sensors, high-density memories and analog-signal processors.
- 82 **Plug a programmable calculator** into your system and enjoy computer-like performance. But take care to avoid some computer-like problems.
- 90 **Need rf-tight enclosures?** Observe these six rules to optimize enclosure seam design. They ensure meeting tough specifications on radiation leaks.
- 96 **Tadashi Nakamura Of Ise Electronics** Speaks On Developing Your Engineers.
- 102 **Ideas for Design:**
 - Build a glitchless microprocessor clock with only a two-chip divider.
 - Automotive charging regulator gives overvoltage and undervoltage warnings.
 - Power-supply regulator simplified with Norton op amps.
- 108 **International Technology**

PRODUCTS

- 111 **Instrumentation:** 50-MHz portable oscilloscope lets you compare four signals.
- 134 **Modules & Subassemblies:** Data-acquisition modules keep costs low and performance high.
- 116 Packaging & Materials
- 123 Power Sources
- 126 Components
- 132 Integrated Circuits
- 140 Data Processing
- 144 Discrete Semiconductors
- 146 Microwaves & Lasers

DEPARTMENTS

- 57 **Editorial:** The Reward
- 7 Across the Desk
- 148 Application Notes
- 149 Evaluation Samples
- 150 New Literature
- 153 Bulletin Board
- 158 Advertisers' Index
- 160 Product Index
- 160 Information Retrieval Card

Cover: Photo courtesy of N. V. Philips' Gloeilampenfabrieken, Eindhoven, the Netherlands.

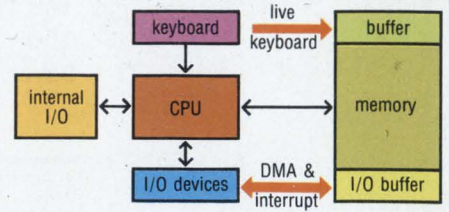
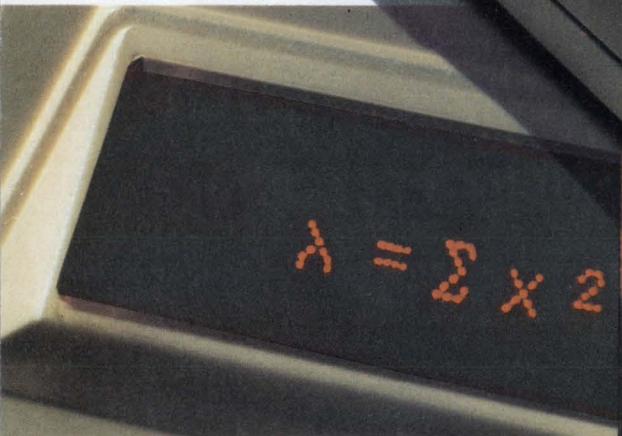
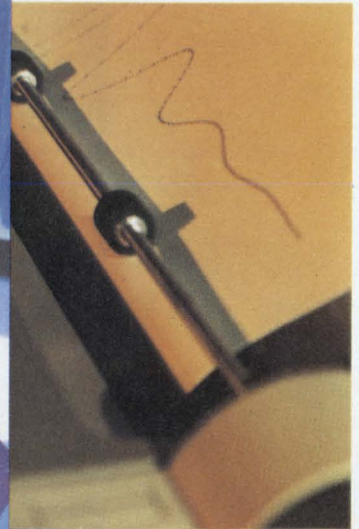
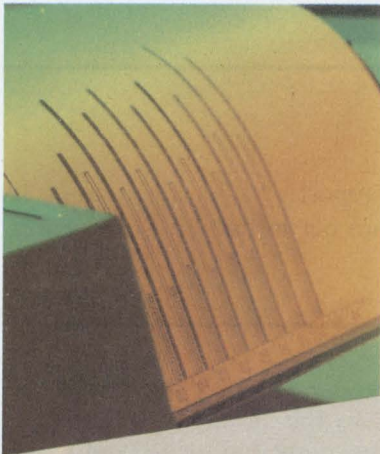

Introducing the HP 9825 with vectored priority interrupt, direct memory access, live keyboard, multidimensional arrays, buffered I/O...

That's big-system computing performance.

The all-new 9825 Computing Calculator: a very versatile, very powerful device for high-speed problem-solving and for interfacing applications. Consider these performance-oriented features:

Vectored priority interrupt allows virtually simultaneous processing of multiple jobs. It's easily programmed to suspend processing, gather or send data and messages to instruments and peripherals, then automatically return to the original job.

Live keyboard lets you interact with the system while a program is running to examine or change program variables—or even perform keyboard calculations.

Up to 400k transfers per second direct memory access provides mini-computer speeds which allow real-time data acquisition and data transfer with high-speed devices.

High-speed, 250k byte tape cartridge with 6-second average access time permits rapid processing of data and loading of programs.

Multidimensional arrays allow you to organize data logically, thus saving program space and execution time. A 20 x 20 matrix can be inverted in 10 seconds.

Buffered I/O increases throughput by providing a programmable software buffer between the program and an external device.

Memory load and record allows you to suspend processing whenever you want and store the complete contents of memory on tape—including data and pointers—for continuation later on.

High level language (HPL) offers you power and efficiency for handling equations, data manipulation,

and input/output operations. Yet it is easy to learn and use.

Other features and capabilities enhance 9825 performance and versatility: for example, upper and lower case alphanumerics on both the display and printer; interfacing to any of eight HP calculator peripherals through three I/O slots, and up to 45 different instruments via HP Interface Buses.

Simultaneous processing of several diverse jobs.

Say you're using a 9825 to control an instrument test stand, and acquiring data from it at speeds in excess of 1000 bytes a second; then printing the results on the new HP 9866B Thermal Line Printer. At the same time, the same 9825 can also be processing and plotting a statistical problem. And through the 9825's live keyboard, you can check the

progress of either program and even change parameters if you desire. It seems the 9825 is doing all these operations simultaneously, thanks to its speed, buffered I/O, and interrupt capability.

Unexpected performance from a computing calculator

All this performance comes in a 26-pound, 5" x 15" x 19" package. Yet, with all its power and computer-like features, the 9825 still retains the friendliness and simplicity of a calculator. You don't have to be a programmer to get performance out of a 9825; nor do you need to be a systems expert to do interfacing applications. When you know all the facts, we think you'll agree the 9825 is a great buy. Write for your free copy of the 16-page 9825 brochure, or call your local HP sales office for more information.

HP computing calculators put the power where the problems are.



Sales and service from 172 offices in 65 countries.
P.O. Box 301 Loveland, Colorado 80537

CIRCLE NUMBER 4

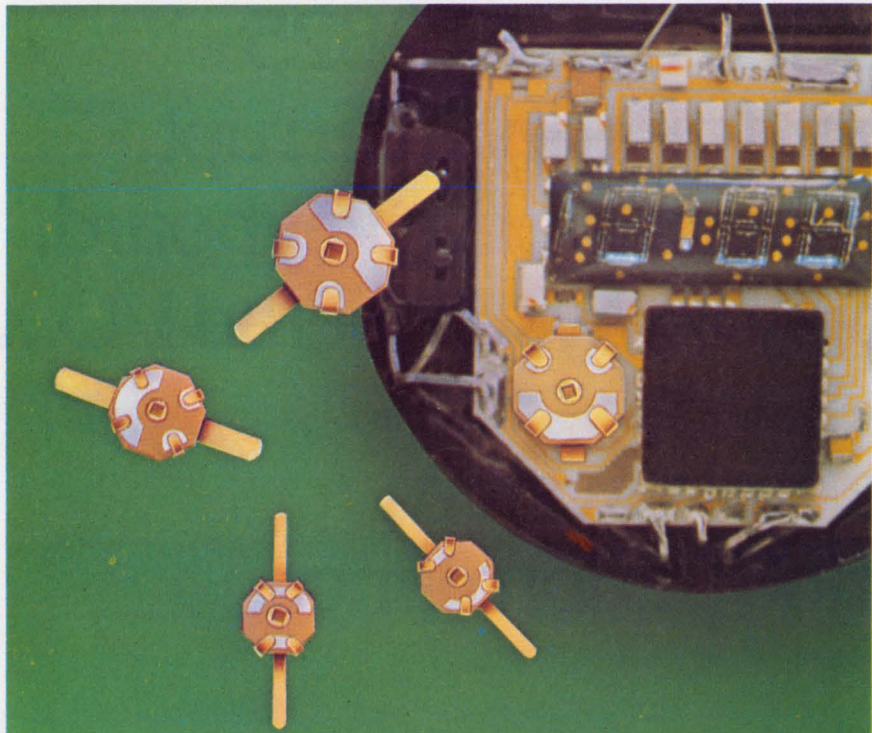

Thin-Trim[®] capacitors

Tucked in the corner of this Pulsar Watch is a miniature capacitor which is used to trim the crystal. This Thin-Trim capacitor is one of our 9410 series, has an adjustable range of 7 to 45 pf, and is .200" x .200" x .050" thick.

The Thin-Trim concept provides a variable device to replace fixed tuning techniques and cut-and-try methods of adjustment. Thin-Trim capacitors are available in a variety of lead configurations making them easy to mount.

A smaller version of the 9410 is the 9402 series with a maximum capacitance value of 25 pf. These are perfect for applications in sub-miniature circuits such as ladies' electronic wrist watches and phased array MIC's.

Johanson Manufacturing Corporation
Rockaway Valley Road
Boonton, New Jersey 07005
(201) 334-2676 TWX 710-987-8367

Sr. Vice President, Publisher
Peter Coley

Editors

Editorial Offices
50 Essex St.
Rochelle Park, NJ 07662
(201) 843-0550
TWX: 710-990-5071
Cable: Haydenpubs Rochellepark

Editor-in-Chief George Rostky

Managing Editors:

Ralph Dobriner
Michael Elphick

Associate Editors:

Dave Bursky
Samuel Derman
Morris Grossman
John F. Mason
Stanley Runyon
Michael Shunfenthal
Edward A. Torrero

Contributing Editors:

Peter N. Budzilovich
John Kessler
Alberto Socolovsky
Nathan Sussman

Editorial Field Offices

East

Jim McDermott, Eastern Editor
P.O. Box 272
Easthampton, MA 01027
(413) 527-3632

West

David N. Kaye, Senior Western Editor
8939 S. Sepulveda Blvd.
Suite 510
Los Angeles, CA 90045
(213) 641-6544
TWX: 1-910-328-7240

Jim Gold, Western Editor
1454 Burrell Court
San Jose, CA 95126
(408) 246-6094

Editorial Production

Marjorie A. Duffy, Production Editor
Tom Collins, Copy Editor

Art

Art Director, William Kelly
Richard Luce
Anthony J. Fischetto

Production

Manager, Dollie S. Viebig
Helen De Polo
Anne Molfetas

Circulation

Manager, Barbara Freundlich

Information Retrieval

Peggy Long

Promotion, Creative Layouts

Manager, Albert B. Stempel
Maxine Correal
Nancy Gordon (Reprints)

Across the Desk

Calculator problems with parentheses

I would like to comment on a letter by George Fergus (ED No. 26, Dec. 20, 1975, p. 13) which in turn commented on my letter (ED No. 20, Sept. 27, 1975, p. 7) regarding two types of problems with some calculators that employ algebraic notation with parentheses.

The moral of my original letter was that regardless of which scientific calculator you buy—whether RPN or algebraic—you must take the time to learn its features and its quirks.

Calculators with parentheses loudly proclaim that you can enter a problem *exactly as written* without regard to the normal calculator convention that calculations are done in the order in which they are entered. Taking that advertising claim to the letter, one enters the problem

$$((s/4)^3)^3 \cdot ((4/2)^3)^3 =$$

and promptly obtains the wrong answer. Adding yet another set of parentheses, as Mr. Fergus suggests, doesn't help because most such calculators only permit two sets of nested parentheses, and also because one then must go against the advertised procedure of entering the problem exactly as written.

The problem stems from the ambiguity of the y^x (or x^y) key. Is it a function like a sin or log (which merely operates on the number displayed)? Since the x^y procedure is done by using a log and then the antilog, one would intuitively expect the former; unfortunately, most calculators treat it as the latter.

In my mind, this is an unsatisfactory solution that can only lead to errors, as in the above example. By way of comparison, it is interesting to note how computer languages such as FORTRAN solve

this dilemma. In a given assignment statement, the four operations of addition, subtraction, multiplication, and division are done *from left to right*, whereas exponentiation is done *from right to left!* Hence, exponentiation is always done only on the quantity just before the exponentiation symbol. It is treated as a function of the preceding quantity, not as an operation. Calculators should operate the same way.

Peter A. Stark

196 Forest Dr.
Mount Kisco, NY 10549

Misplaced Caption Dept.



"Try a little reverse Polish."

Sorry. That's Winslow Homer's "Croquet Scene," which hangs in The Art Institute of Chicago.

Correct terms, incorrect terminology

You included one of our news releases on Eccoband 60 C in "New Products" (ED No. 25, Dec. 6, 1975, p. 125). We appreciate this, but an error was made in the transition from our copy to your copy: Volume resistivity is measured in ohm-cm as we expressed it in our copy. It is incorrect to say ohm/cm.

Eino J. Luoma
Publicity Manager

Emerson & Cuming, Inc.
Canton, MA 02021

Electronic Design welcomes the opinions of its readers on the issues raised in the magazine's editorial columns. Address letters to Managing Editor, Electronic Design, 50 Essex St. Rochelle Park, N.J. 07662. Try to keep letters under 200 words. Letters must be signed. Names will be withheld on request.

The finest

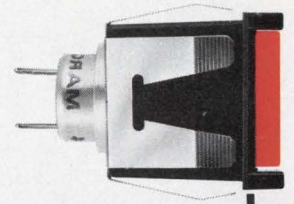

lighted pushbutton

switches and indicators are

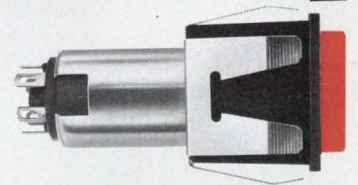

also the easiest to install



Snap!

- Snap-in instant panel mounting
- Choice of sizes, colors, and lens styles
- Flush or barrier configurations
- Re-lampable from front of panel.

Lighten your decisions
contact . . .

ILLUMINATED PRODUCTS INC.

A subsidiary of OAK Industries Inc.
2620 South Susan St., P.O. Box 11930
Santa Ana, California 92711
Tel: (714) 540-9471 • TWX 910-595-1504



COMPONENTS GROUP

CIRCLE NUMBER 6



Unique Action Pins solve panel-production problems.

No more rupturing of plated-thru holes. Fewer rejects.
Wide commercial tolerances on plated-thru hole diameters.
Increased contact area. Higher production yields. Stable
electrical properties. Highest reliability. Low cost.
Now you can get them all with AMP ECONOMATE Panels
loaded with new Action Pins. Or in your panels with our
Action Pin Components.

HOW ACTION PINS WORK. AMP Action Pins incorporate a spring section to give a higher degree of compliance than ever before possible. The diagonal measurement of the spring section—before insertion—is larger than the hole diameter (Fig. 1). When the Action Pin is inserted, the two opposing spring members readily compress, and after insertion, exert a force sufficient to effect a gas-tight interface with the plated-thru hole walls (Fig. 2). Yet their rounded corners prevent rupture of the plated-thru hole. They come with a variety of configurations: card-edge contacts, .025² feed-to and feed-thru posts, and SEM (NAFI-style) two-piece receptacle-and-blade contacts. All are compatible with wrap-type terminations or I/O connections.

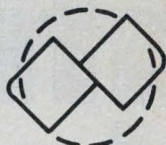

Fig. 1

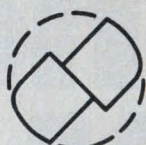
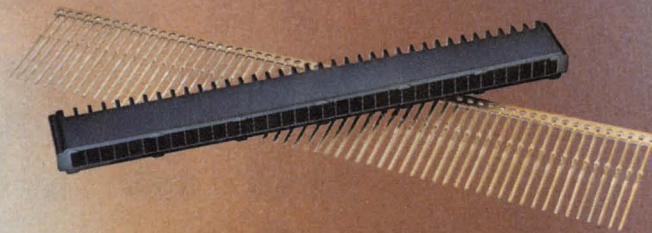

Fig. 2

AMP ECONOMATE panels are made to your specifications and consist of two elements: the pc board—either two-sided or multi-layer with plated-thru holes—and the AMP ECONOMATE Action Pin contacts.

ECONOMATE I card-edge contacts, and ECONOMATE II two-piece receptacle-and-blade, SEM (NAFI-style), contacts both feature snap-on housings for maximum maintainability of panels. Posted panels feature .025² feed-to and feed-thru posts for automatic, semi-automatic, or manual point-to-point wiring. All types hold costs to a minimum through AMP's high-speed automated assembly process.



MAKE OR BUY. AMP can supply all your panel requirements. Or, you can make them yourself using our reliable Action Pin components. Contacts come in strip for high-speed, low-cost gang insertion at rates up to 10,000 an hour with our high-productivity assembly tools.

Action Pins solve the problems that bother you most. They won't broach, rupture, tear, distort or damage the plated-thru hole—giving you the ultimate in reliability.

When it comes to panels, AMP is where the action is. Get the whole story. Call (717) 564-0100 or write AMP Incorporated, Harrisburg, PA 17105.

AMP and ECONOMATE are trademarks of AMP Incorporated.

**SEE US AT PARIS
INTERNATIONAL ELECTRONICS
COMPONENTS SHOW, FRANCE**

**AMP
INCORPORATED**

CIRCLE NUMBER 7

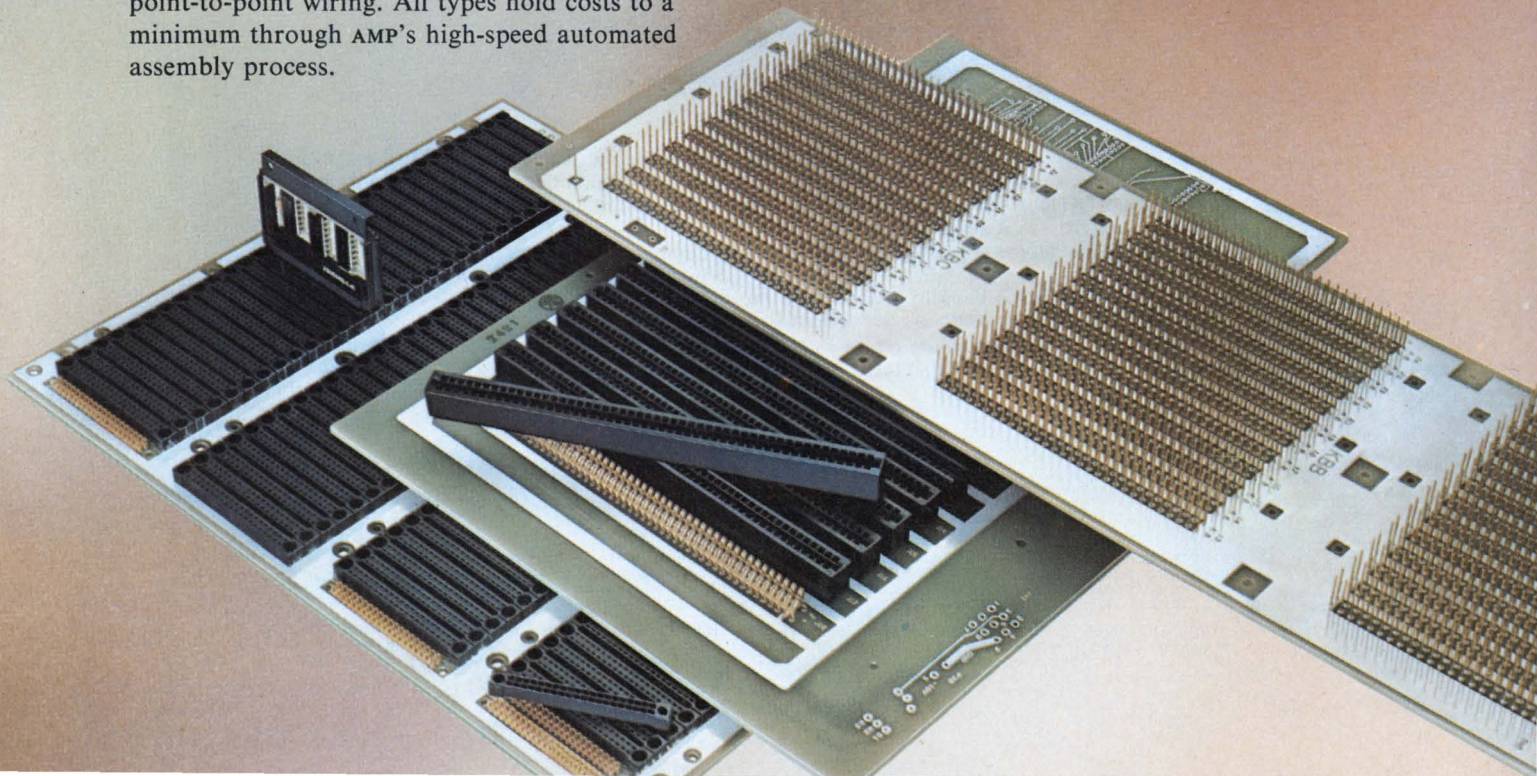

It's 4K! It's fast! It's static! It's a whole RAM system!

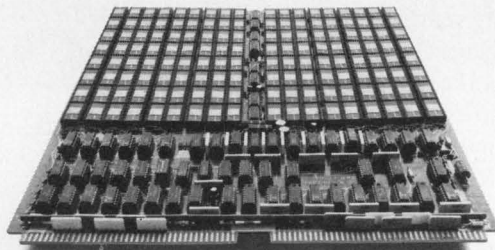

It's all of those and more, much more. It's our new Microram 3400N — a 32K x 16 or 18 bit memory system using our own SEMI 4402, 4K STATIC RAM components . . . the only production 4K STATIC RAM's available today. The 4402 is fast, with a worst case access time of 200 nsec. And . . . it's second-sourced, of course!

The Microram 3400N is form, fit, and functionally compatible with all core and NMOS members of the Micromemory family, and is completely contained on a single printed circuit card. Optional features include chassis and power supply. The Microram 3400N is immediately available with a worst case access time of 275 nsec.

Call your nearest EMM sales office and discover how "The Memory Company" can give you system building block flexibility, 4K to 32K, core or NMOS.

EMM SEMI

A subsidiary of Electronic Memories & Magnetics Corp. • 3883 North 28th Avenue, Phoenix, Arizona 85017
(602) 263-0202

EMM OFFICES: WESTERN REGION, Regional Office, San Francisco (408) 247-9711, Los Angeles Area (213) 644-9881, Orange County Area (714) 639-5811; EASTERN REGION, Regional Office, Boston (617) 861-9650, Chicago Area (312) 297-7090, New York Area (516) 423-5800, Cleveland Area (216) 842-8920; INTERNATIONAL OFFICES, European Headquarters, United Kingdom (01) 751-1213, West Germany (089) 714.30.40.

REPRESENTATIVES: Gentry Associates, Orlando (305) 894-4401, Huntsville (205) 534-9771, Burlington, N.C. (919) 227-3639. In Canada: Cantec, Toronto (416) 457-4455, Montreal (514) 620-3121, Ottawa (613) 225-0363. In Sweden: Svensk Teleindustri, OB-890435. In Great Britain/Ireland, MEMAC Whitchurch (029 664) 366/7/8. In Netherlands/Belgium, Famatra, Benelux 076-133457. In Norway, Henaco A/S (02) 15 75 50. In Japan, Nissho Electronics (03) 544-8396.

CIRCLE NUMBER 8

HUGHES

HUGHES AIRCRAFT COMPANY
CONNECTING DEVICES DIV.

Today we
supply the spark
for America's
defense.

Connections were much simpler 200 years ago. Torch the fuse and the cannon fired.

Supplying the vital spark that makes a modern weapon system do its job is a lot more complicated.

That's where we come in. For many years, primes and OEMs for military and aerospace products have depended on us to provide the vital links in their electronic systems—flat cable, etched circuitry, connectors, and total interconnection systems.

Our high-rel connections have to be the best. They're used in systems like Phoenix, Maverick, Lance, Minuteman, AWACS, F-14, F-15, Space Shuttle, Viking, Sonobuoy, F-4, A-7, Condor, Standard Missile, F-18, AAH, Cruise Missile, F-8, Trident, Hobo, Sprint and many more.

To learn how we can serve your interconnection needs, contact Jack Maranto or Dave Cianciulli: Hughes Connecting Devices, 17150 Von Karman Ave., Irvine, CA 92714.

Or call (714) 549-5701.

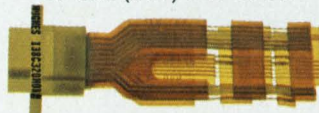

**Hughes
Connecting Devices**

Surprise!



...in 25 years Dale has grown to be lots more than a great resistor supplier.

Dale is the efficient way to get a lot of things done at once. In addition to being the industry's most complete source of discrete resistors, we're strong, and getting stronger, in trimmer potentiometers, inductors, transformers, connectors and thick film networks. As a result, your man from Dale is better equipped than ever to help you save time and cut project costs. How old we are really doesn't matter, it's what we can do for you right now that counts. You'll be pleasantly surprised.

T-Pots

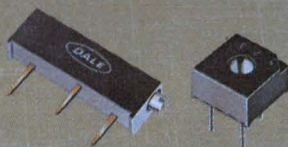

Check the price and performance on our low profile 700 Series and $\frac{3}{8}$ " single turn 100 Series. We'll match them against anyone in the industry...and we're ready to deliver all popular values from stock. See EEM, Gold Book or our full line catalog for complete details on Dale trimmers including Mil. Spec. models or call 402-564-3131.

Networks



Compare our DIP and SIP thick film networks with Beckman, CTS, et al. You'll find we have the facilities and the know-how to help you use networks to their best advantage. Our lineup of standard, military and custom thick-film circuitry is described in a brand new brochure. To get it, circle the Reply No. or call 402-371-0080.

Connectors



Working with displays? Dale ES Connectors expand to fit your special designs without burdensome tooling costs. And Dale also has a solid line of budget-stretching edgeboards that provide .100" and .156" spacing at low cost per contact. Rack and panel and umbilical styles, too. Ask your man from Dale or call 605-665-9301.

Inductors



Take a look at our growing line of epoxy molded and roll-coated chokes and toroids (MIL-C-15305D and MIL-T-27). Check the price and the extra reliability of our IR Series against the varnish-coated choke you're now using. Need low-cost industrial transformers? Our laminated PL Series offers models to 25 watts. Details begin on Page 179 of the catalog our rep is ready to deliver.

**The best in resistors
...and a lot more**



DALE ELECTRONICS, INC., 1300 28th Avenue, Columbus, Nebraska 68601

A subsidiary of the Lionel Corporation

In Canada: Dale Electronics Canada Ltd. • In Europe: Dale Electronics GmbH, 8 Munchen 60, Falkweg 51, West Germany

OUR COMPLETE PRODUCT LINE CAN BE FOUND IN ELECTRONIC DESIGN'S **GOLD BOOK.**

CIRCLE NUMBER 20

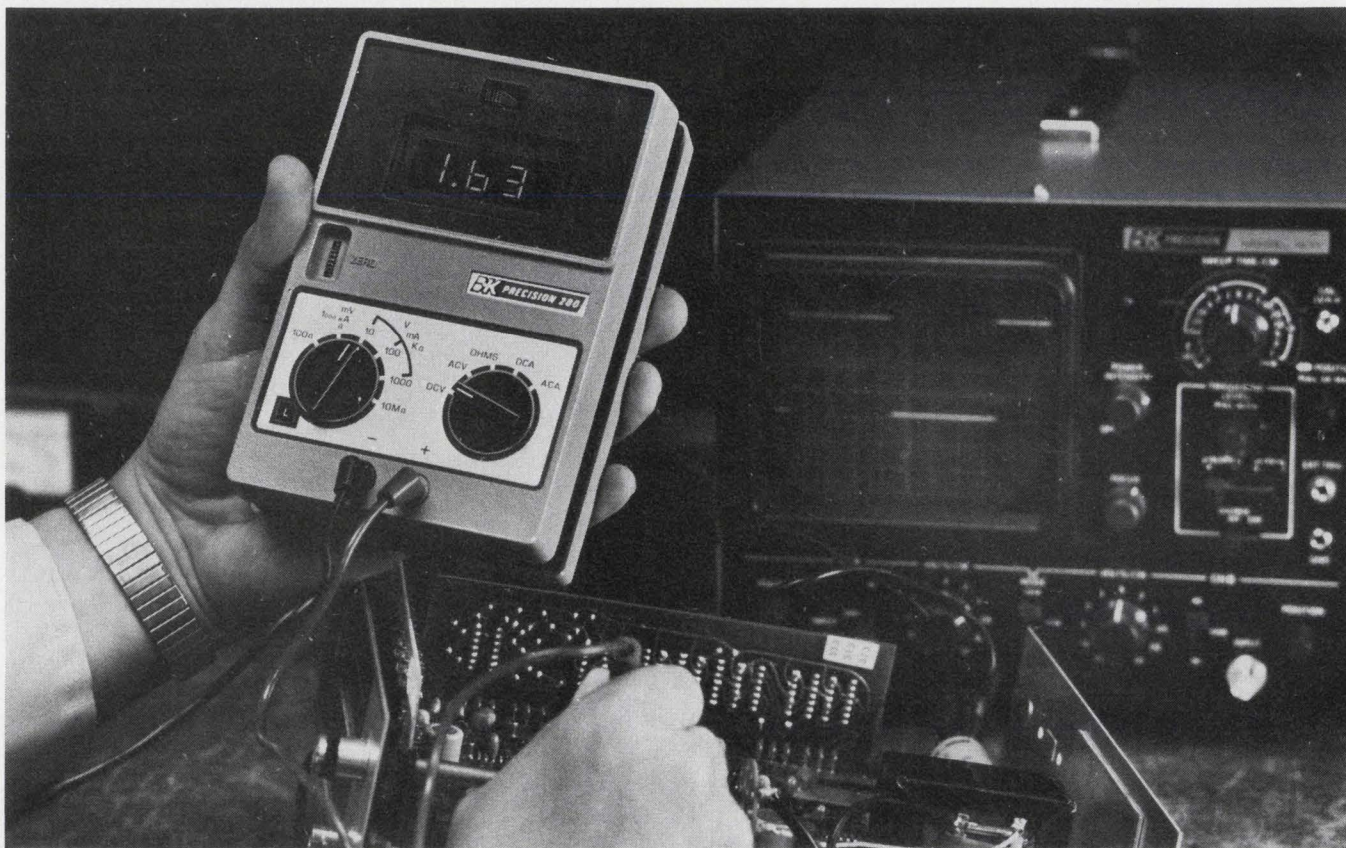

Why is the 280 at \$99⁹⁵ our fastest selling multimeter ever?

Ever since we introduced the 280 last year, sales have been breaking records.

The reasons are easy to understand. The 280 is a battery-operated portable, full-feature digital multimeter at less than the price of a pre-

cision analog meter. The 280 features a large three-digit LED readout, automatic polarity indication, automatic decimal point placement and out-of-range indication. The 280 is fully overload protected for reliability and has an industry-standard input impedance of 10 megohms for all voltage ranges.

It has High/Low power ohms ranges for accurate in-circuit measurements, not available on most analog meters. And digital accuracy (1% typical for DCV; 2% for ACV and ohms, except 2.5% on highest ranges) and digital resolution (1mV, 1 μ A, 0.1 ohm)—not available on *any* analog meter.

No compromises on range either—DC and AC voltage ranges to 1000V, DC and AC current ranges to 1000mA and ohms ranges to 10 megs.

Our fastest seller ever? We're not surprised. *In stock at your distributor.*



BK PRECISION
PRODUCTS OF DYNASCAN

1801 W. Belle Plaine • Chicago, Illinois 60613 • (312) 327-7270

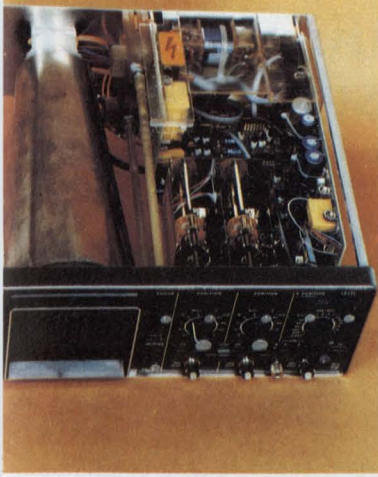

BEAUTIES ALRIGHT... IN MORE WAYS THAN ONE!

- Real portability: Single trace model PM3225 is only 8 pounds 2 ounces Dual trace model PM3226 is only 9 pounds 10 ounces
- Convenient compactness: PM3225: 5.4" H x 10.2" W x 12.4" D and PM3226: 5.4" H x 11.9" W x 12.4" D
- Sensitivity: 2mV/div at 15 MHz bandwidth • 8 x 10 division screen
- Complete triggering facilities: Auto, line, External, TV line or frame • Automatic DC balancing and drift control
- Logical layout of operating controls for quick error free setup • A most logical and convenient internal layout for optimum servicing
- Prices that put genuine professional scopes easily within your budgets

Human engineering . . . ease of operation . . . logical panel layout. Philips attaches great importance to this subject by maintaining the largest industrial design center in the western world. Here many of our test and measuring instruments, including oscilloscopes, are not only designed, but exhaustively tested by typical users. By filming the method by which the instruments are used, a truly objective user-oriented evaluation is achieved. The layout is designed with group controls that fall naturally to hand. Cable connections are placed away from oscilloscope displays and functional controls. Special contoured knobs and pushbuttons are designed to give the user unambiguous touch control. These special design considerations, plus versatile performance specifications, are the reasons more and more engineers and technicians look to Philips for the test equipment required in today's complex electronics.

To obtain further information about these new Philips oscilloscopes, use our toll free Hot Line number 800 645-3043. New York State residents call (516) 921-8880 collect.

• In the United States:
Philips Test & Measuring Instruments, Inc.
400 Crossways Park Drive
Woodbury, New York 11797 (516) 921-8880

• In Canada:
Philips Test & Measuring Instruments, Inc.
6 Leswyn Road
Toronto, Ontario M6A 1K2 (416) 789-7188



FOR INFORMATION CIRCLE #241

FOR DEMONSTRATION CIRCLE #242

PHILIPS

Let's talk about solving communications problems between your microprocessor and your system.

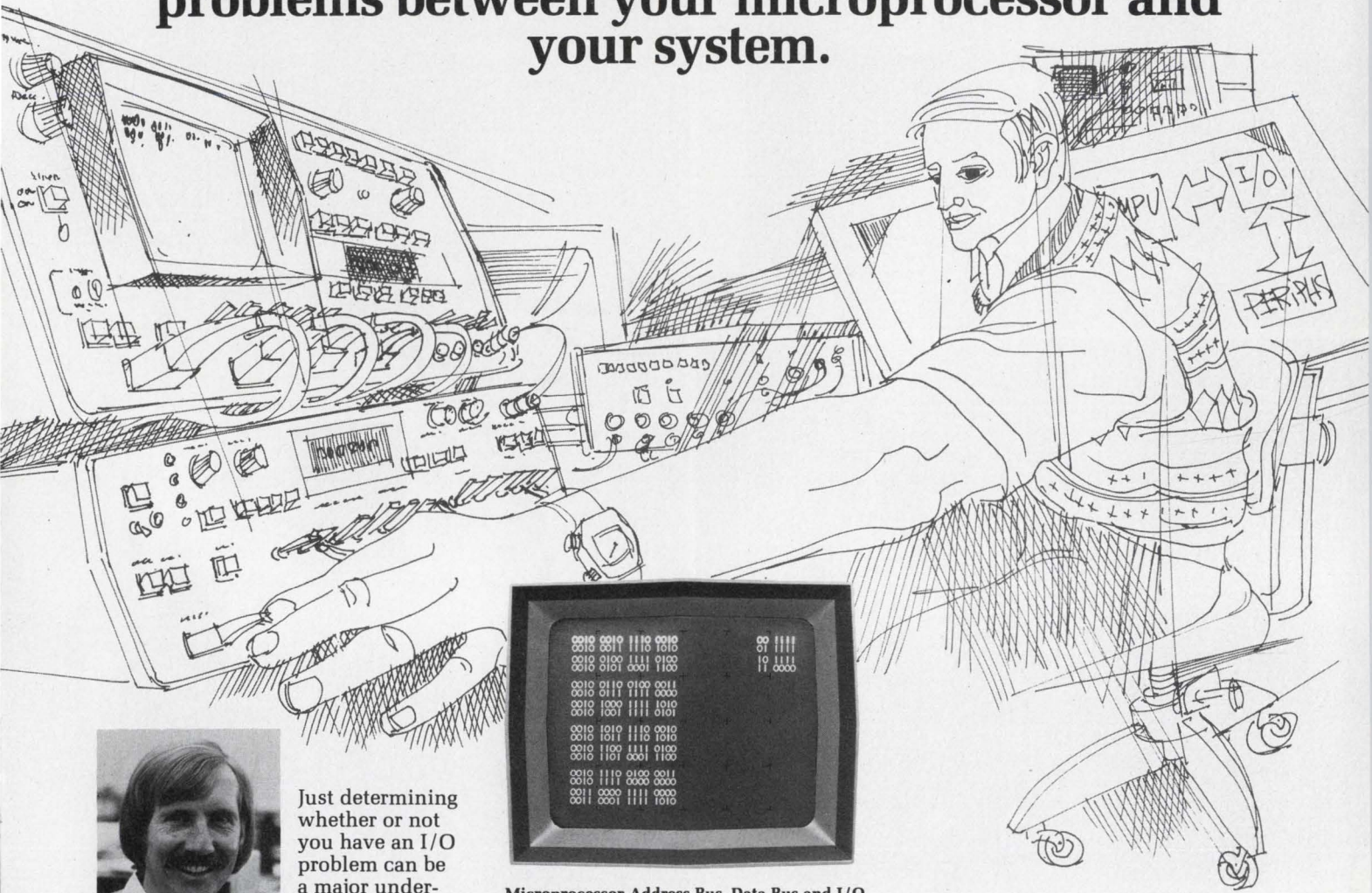

Just determining whether or not you have an I/O problem can be a major undertaking... I know, I've been there too. We call communication

with the microprocessor "hand-shaking," but sometimes information transfer, especially across an I/O port, reminds me more of "armwrestling."

Analysis of data transfer across an I/O port can be very tricky. The microprocessor and the peripheral may have independent system clocks, or the peripheral may be asynchronous. There may be a parallel-to-serial data transformation, or vice-versa. The systems may require a common trigger to interact properly. How do you verify all that? And how do you determine that the instructions are being received and executed properly?

About the only way I know that you can really be sure everything is working right (without spending an excessive amount of time) is to look at it on an HP 1600S Logic State Analyzer. Then it doesn't matter whether you have independent system clocks going. Or whether part of the system is asynchronous.

The HP 1600S lets you display two separate tables of data on one

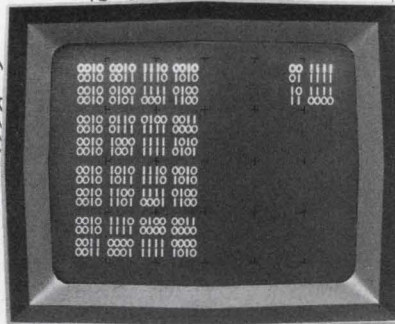

Microprocessor Address Bus, Data Bus and I/O input and output data are displayed simultaneously on the HP 1600S screen.

screen, so you can look at program flow right alongside the input and output states of the I/O port. That way there's no question about correct sequencing—or about data flow in either direction.

Confidence in your system design and operation will be high. I mean, when you can actually look at all those data buses, read their information flow, and see that it's all perfect—that's confidence!

What's more, if you do find a problem, the HP 1600S will help you pinpoint it more quickly than any other way I know. It can help you put an end to armwrestling within your microprocessor systems.

The HP 1600S, at \$6800*, is one of the biggest timesavers you'll ever find. You should learn more about it. HP has arranged a number of seminars around the country to make that possible. Find out how you can attend the one in your area by calling your local HP field engineer. He can also supply you with complete spec sheets and application notes detailing the use of

mapping for troubleshooting minicomputer and microprocessor systems. You'll discover an exciting new concept in digital troubleshooting.

*Domestic U.S.A. price only.



086/6

HEWLETT  PACKARD

Sales and service from 172 offices in 65 countries.
1501 Page Mill Road, Palo Alto, California 94304

CIRCLE NUMBER 12

O.K., you guys, back to the old drawing board.

It's a whole new ball game. And just when you'd made all your panel lamp decisions, right? But Monsanto's patented nitrogen doping process for GaAsP on GaP substrates has improved the light-emitting efficiencies of our LED lamps so dramatically that every good designer will want to take another look.

Monsanto has T-1 and T-1^{3/4} replacement lamps in standard red color (improved significantly over last year's red LEDs) and new bright red which is *unbelievably* bright. Red. Plus green, yellow, and a dazzling new orange. In two lens choices and two lead lengths. And all improved, as you can see on the chart.

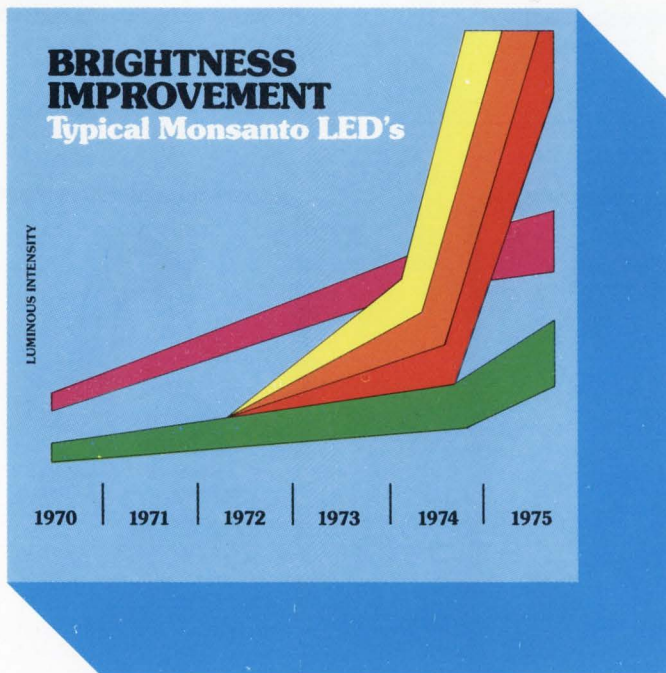

Model Number	Color	Size	Luminous Intensity	Viewing Angle
5174B*	Orange	T-1	5.0 mcd	90°
5274B*	Green	T-1	1.0 mcd	90°
5374B*	Yellow	T-1	4.0 mcd	90°
5774B*	Red	T-1	5.0 mcd	90°
5152**	Orange	T-1 ^{3/4}	40.0 mcd	28°
5252**	Green	T-1 ^{3/4}	15.0 mcd	28°
5352**	Yellow	T-1 ^{3/4}	45.0 mcd	28°
5752**	Red	T-1 ^{3/4}	40.0 mcd	28°

*Also available with 1" lead lengths, low profile (.138" high) lens, and 180° viewing angle.

**Also available with 24° and 65° viewing angles.

Last year there were some sockets that demanded filament lamps, despite their inherent failure-and-replacement problems. *Bright* was needed, and damn the torpedos.

This year you just might find the bright you need in a shake-rattle-and-roll-proof LED lamp. Come and see.

If you can take the time, you just might be able to add a lot of T to your MTBF.

So it's reset to zero, folks, if you want the best indicator lamps (and widest choice of functional differentiation colors) in your gear.

For product information, circle the service number or call your local Monsanto man. Or write Monsanto Electronics Division, 3400 Hillview Avenue, Palo Alto, CA 94304.

Putting innovation to work.

Monsanto:
the science
company.

GENERAL OPTOELECTRONIC COUPLERS,

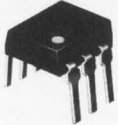

H11A Coupler

- Transistor output
- Patented GE Glass Isolation used on all H11 Series Couplers. Yields industry's highest CTR and isolation voltages
- All popular "4N" types
- UL File E51868

65¢*

NEW



H74A, C Couplers

- Compatible with 7400 Series T²L
- H74A Transistor output
- H74 SCR output up to 400V
- Guaranteed over 0-70°C

87¢*

NEW



H11C Coupler

- SCR output up to 400V, 6 models
- Marriage of G.E.'s SCR and Optoelectronic technologies
- For use in solid state relays
- UL File E51868

95¢*



H11B Couplers

- Darlington output
- 500% CTR with 2500V isolation
- 200% CTR @ 0.5mA input
- Popular "4N" types
- UL File E51868

83¢*

NEW



H11D Coupler

- 300V Transistor output
- 20% min. CTR with 2500V isolation
- Performs many reed relay functions

\$1.36*



H11AA Coupler

- INDUSTRY'S FIRST AC Coupler
- 2 LEDs in inverse parallel for AC to logic interfacing
- For telecommunications

\$1.43*

*Recommended Resale 10,000 lot quantity

"The Best Costs No More"

ELECTRIC

INTERRUPTERS, EMITTERS, DETECTORS

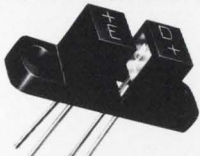

H13 Interrupters

- 4 models offer "no contact" switching
- Transistor and Darlington versions
- For use on:
 - shaft encoders — counters
 - limit switches — keyboards
 - position sensors

\$1.21*

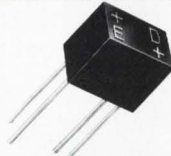

H15 Couplers

- 4000V RMS isolation
- H15A transistor output
- H15B Darlington output
- For:
 - pulse transformer replacement
 - thyristor triggering
 - logic interfacing
- UL File E51868

\$1.10*



H17 Matched Pair

- Industry's lowest cost matched emitter/detector pair.
- Transistor or Darlington outputs
- For general purpose "no contact switching" applications

\$1.05*

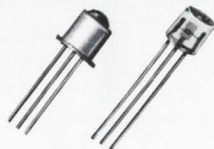

L14 Detectors

- 13 models
- Choice of TO-18 metal or TO-92 plastic package
- Transistor or Darlington configuration

L14 Plastic 28¢*

L14 Metal \$1.00*

NEW



LED Infrared Emitters

- 6 models in TO-18 metal packages
- Flat and curved lens configurations
- LED55C — the industry's highest power output LED
- 150°C operating capability

\$1.30*

*Recommended Resale 10,000 lot quantity

Competitively priced and available from any authorized GE distributor.

Semiconductor Products Department, Electronics Park 7-49, Syracuse, New York 13201

GENERAL  ELECTRIC

Hurry. 1¢ opto-couplers while they last.

No kidding.

Right now, for a limited time only, you can buy any of these very fine *medium-isolation* opto-couplers from Fairchild for 1¢ each.

Is there a catch?
Yes indeed.

The catch.

For every quantity of 1¢ opto-couplers, you must purchase an equal quantity of our terrific new *Glassolated™* high-isolation 5kV and 6kV opto-couplers.

Fairchild 5kV and 6kV Glassolated™ Opto-couplers

Device	CTR	Isolation	1K Price (\$)
FCD810C	10%	5kV	.60
FCD810D	10%	6kV	.85
FCD820C	20%	5kV	.75
FCD820D	20%	6kV	1.00
FCD825C	50%	5kV	.85
FCD825D	50%	6kV	1.05
FCD830C	20%	5kV	1.00
FCD830D	20%	6kV	1.20
FCD831C	10%	5kV	.90
FCD831D	10%	6kV	1.10
FCD836C	6%	5kV	.85
FCD836D	6%	6kV	1.00

Substitutions of other coupler products may be allowed. Your Fairchild Representative has details.

1¢ Opto-coupler Sale

Fairchild Phototransistor Coupler

MCT-2
MCT-2E
MCT-26
H11A2
H11A3
H11A4
IL-1
IL-12
IL-15
IL-74

TIL111
TIL112
TIL114
TIL115
TIL116
TIL118

MOC1000
MOC1001
MOC1002
MOC1003

4N25
4N26
4N27
4N28

Second Source to

Monsanto
Monsanto
Monsanto
General Electric
General Electric
General Electric
Litronix
Litronix
Litronix
Litronix

Texas Instruments
Texas Instruments
Texas Instruments
Texas Instruments
Texas Instruments
Texas Instruments

Motorola
Motorola
Motorola
Motorola
Industry
Industry
Industry
Industry

This offer cannot be repeated.

So hurry. Get your 1¢ opto-couplers while they last. Because once they're gone, they're *gone*. This special 1¢ Sale ends May 31, 1976. And the minimum factory order of our 5kV and 6kV opto-couplers is \$1,000.

For smaller quantities, contact your nearest Fairchild Sales Office or Representative for the name of the participating franchised Fairchild Distributor nearest you.

Semiconductor Components Group, Fairchild Camera & Instrument Corp., 464 Ellis St., Mountain View, CA 94040. (415)493-3100. TWX: 910-379-6435.

Expensive? Not at all. In fact, at these prices, you can see why we're selling all our old couplers for just 1¢ apiece.

Who wants a medium-performance opto-coupler any more when they can get a high-performance coupler with *twice* the isolation — at the same kind of low, low price?

FAIRCHILD

ANOTHER MYTH EXPLODED:

All solenoids are NOT created equal.

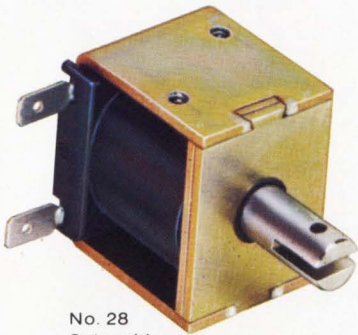

No. 28
Solenoid

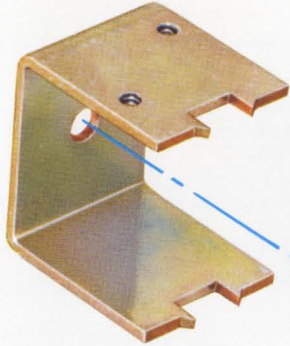

New Uni-Guard II molded bobbin and coil covers are Valox® 420 SE-O... to meet or surpass all U/L and CSA component recognition requirements; also meet tough U/L flammability spec 94V-0.

New Uni-Guard II construction minimizes wear by holding concentricity between plug and plunger... and minimizes double seating.

New Uni-Guard II coil cover gives snug, protecting fit, yet leaves space for addition of thermal cutouts or diodes.

Dual endplates on model shown improve mechanical strength and magnetic efficiency.

Bright Nickel plated plunger for low friction, corrosion resistance.

Lugs are press fitted and ultrasonically welded to bobbin to withstand eight pound pull test.

Endplates are swage formed and staked to field piece to provide continuous magnetic flux field for most efficient operation.

Only Guardian solenoids have new Uni-Guard® II molded bobbin and coil covers that give you savings of up to 25%... with at least 25% longer life. How long? Up to 5 million operations. This new construction is now available on nearly all Guardian box frame and U-frame solenoids. Including pull type, push type and solenoid switches. All have .187" or .110" QC lug or solder lug termination for easier, faster, less expensive installation. And Guardian has more types available from stock than anyone else.

Variations and options? Get them from Guardian. Return springs, plunger configurations, anti-bottoming or silencers, voltages, termination, mounting, coil finishes... you spec it and Guardian's ready to produce it.

Let the Guardian Angel show you why Guardian is No. 1 in solenoids. Send for your free copy of this 72 page catalog.



This mark indicates recognition under the component program of Underwriters Laboratories, Inc.

GUARDIAN®

GUARDIAN ELECTRIC MANUFACTURING CO.

1572 West Carroll Ave., Chicago, Illinois 60607 • 312/243-1100

Interested in network variety? Select from a spectrum of 347 standards.

Allen-Bradley has the popular configurations you need. Pull-ups, Pull-downs. Line Terminators. Networks to complement Core Memory Sense Amplifiers. TTL to ECL Translators. O-Pad Attenuators. All styles available from your Allen-Bradley *Electronic Distributor*. Call for specs or check your EEM Catalog. If you need specials, contact your local Allen-Bradley district office for fast turn-around. Ask for Publication 5840. A-B is an experienced twin-film manufacturer, i.e. precision thin film and thick film.

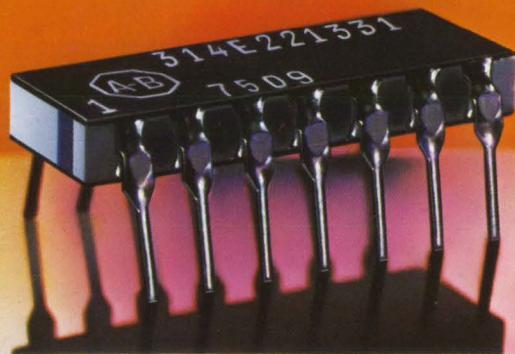
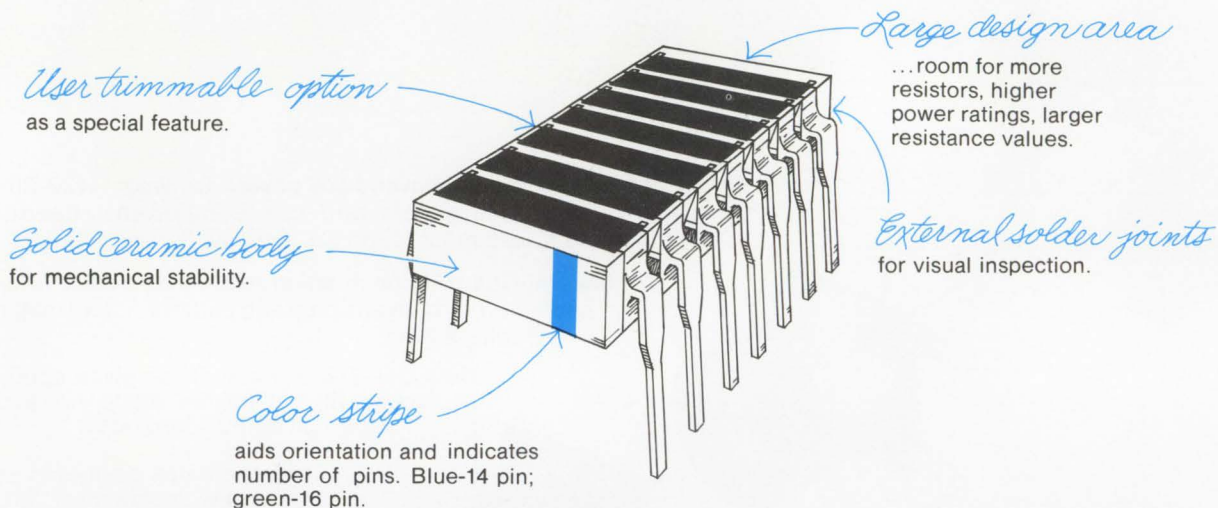

Quality in the best tradition.



ALLEN-BRADLEY
Electronics Division
Milwaukee, Wisconsin 53204

CIRCLE NUMBER 142

EC111



THE EYE in your future



United Detector Technology has an eye for your light detection problems. With our extensive line of standard photodetectors and years of experience in custom detector design, even the most puzzling and unusual requirements are quickly satisfied.



Technical Depth in Schottky, Planar Diffused and Mesa technologies has enabled UDT to develop solutions to hundreds of applications with standard and custom electro-optic devices.

Unique devices such as the special Schottky barrier, 360° detector shown here. Six active areas, located symmetrically around the sphere, provide position information by sensing the intensity on various segments.



Spot-continuous position sensors, single and dual axis, for numerical control, alignment and surface



integrity verification.

Standard and special purpose arrays for inspection and quality control. This "POP-EYE" array scans bottles for flaws prior to resealing.



Photops™ light to voltage converters. Hybrid PIN silicon photodiodes with FET op amps to drive analog meters, recorders or digital displays.



General purpose photodiodes with areas to 6 cm², lengths to 12", capacities as low as 2 pf/cm², and rep rates over 100 MHz.

We set the standard in the fabrication of new custom detector devices and yet we offer over 50 catalog products. We want to hear about your requirement, be it special or standard. Write or call today. Ask for our catalog. **The eye of your future is at UDT.**



CIRCLE NUMBER 14



UNITED DETECTOR TECHNOLOGY, INC.

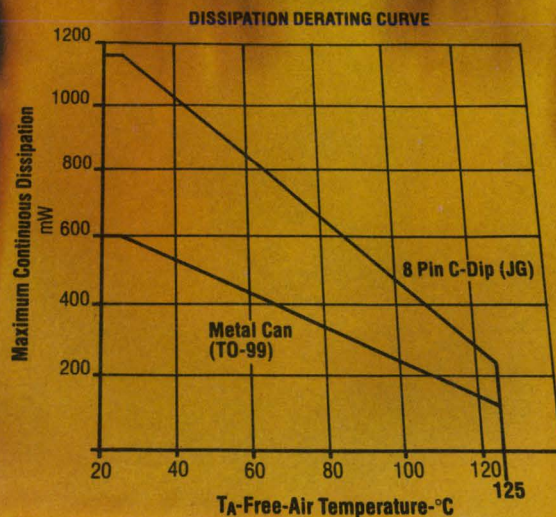
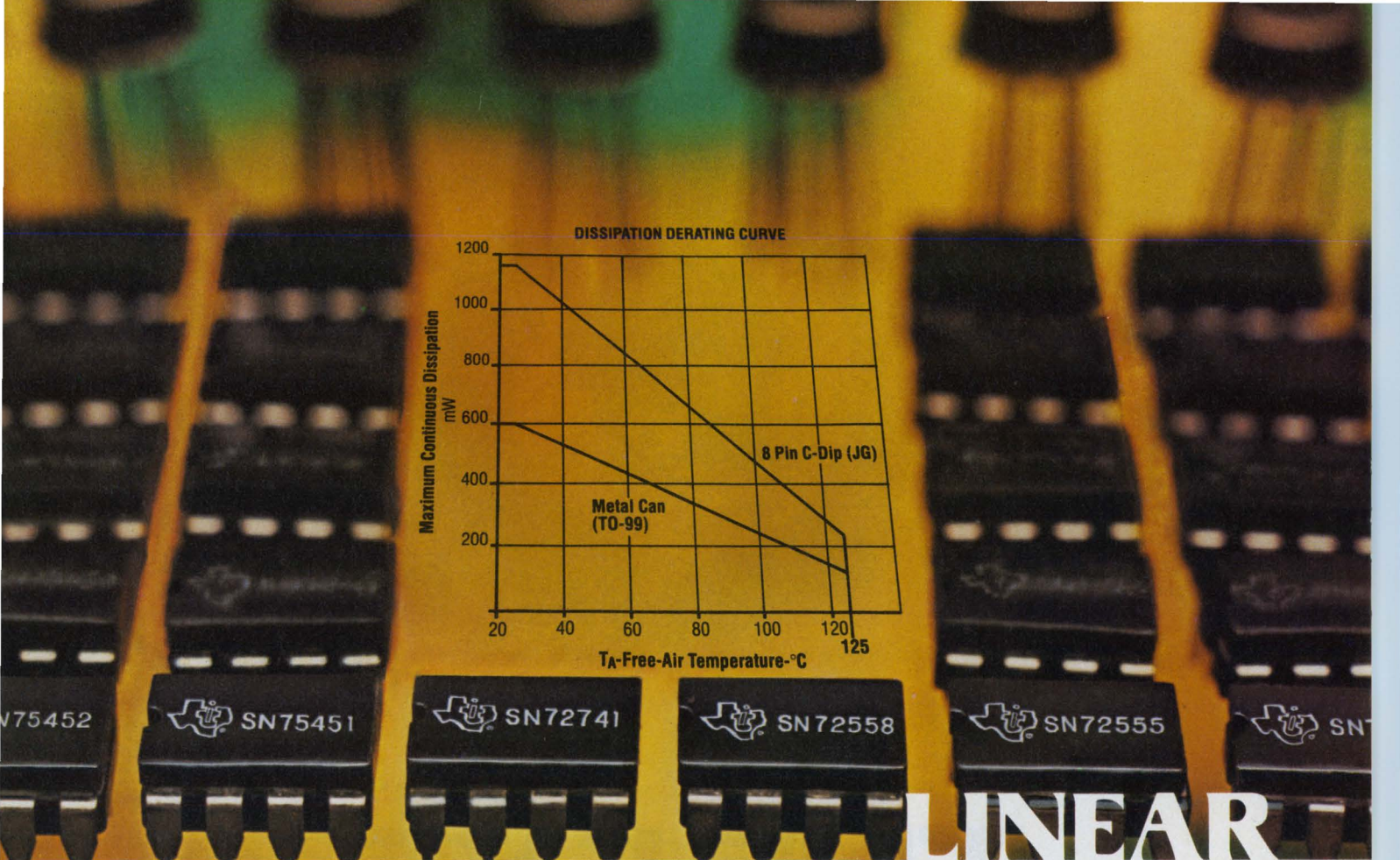

LINEAR

New hermetic dual-in-line package offers superior thermal characteristics... automatic insertion...improves reliability.

Say good-bye to linear circuits in TO-99 cans. Welcome a new packaging milestone. TI's new hermetic 8-pin ceramic dual-in-line linear package.

The innovative JG-package with superior thermal characteristics provides substantially improved device reliability over the old TO-99 can, as the derating curve illustrates. Under identical operating conditions, chip junction temperature in the new 8-pin C-Dip may be as much as 50°C cooler than in a metal can (see box for more details).

As with all dual-in-line packages, the JG-package can be automatically inserted in p.c. boards which will cut

Thermal characteristics (typical operational amplifier)			
PARAMETER	TO-99 PACKAGE	JG-PACKAGE	UNIT
Thermal Impedance (θ)J-A	210	106.5	°C/W
Max. Dissipation @ 70°C	384	744	mW
Max. Dissipation @ 125°C	120	232	mW
Operating Junction Temp. . .			
T _J @ 500 mW & T _A = 25°C	130	79	°C
T _J @ 300 mW & T _A = 70°C	133	102	°C
Typical functions available in JG package			
High Performance Op Amp	SNC52101AJG/SN72301AJG		
Differential Comparator	SNC52111JG/SN72311JG		
Universal Timer	SNC52555JG/SN72555JG		
Dual Op Amp	SNC52558JG/SN72558JG		
General Purpose Op Amp	SNC52741JG/SN72741JG		
Dual Peripheral Driver	SNC55451JG/SN75451JG		
Dual Peripheral Driver	SNC55452JG/SN75452JG		

All TI linear products offered in 8-pin Plastic are also available in 8-pin C-Dip-JG.

your installation costs. Another saving: The non-conducting ceramic base eliminates the need for insulators.

But you pay no more for all these advantages. TI's linear devices in the JG-package are priced the same as equivalent metal-can functions. Hermeticity and space requirements are the same. The JG-package has also passed all military requirements of Mil-Std-883 and data is available on request.

For more information on the linear circuits available in the new dual-in-line package, contact your nearest authorized TI distributor. Or write Texas

Instruments Incorporated, P. O. Box 5012, M/S 964, Dallas, Texas 75222.



TEXAS INSTRUMENTS
INCORPORATED

MARCH 15, 1976

Components conference will focus on new hybrid uses

New applications of hybrid technology to solid-state devices will be featured at next month's Electronic Components Conference in San Francisco. The conference will be held April 26-28 at the Jack Tar Hotel.

Key papers in the hybrid area will include discussions of the following:

- A new kind of low-cost, crystal-controlled clock oscillator with superior frequency stability.

- A hybrid MOS-LSI package design that protects the circuits against 6000-V discharges.

- A realistic look at the cost and technical factors to be considered in selecting the optimum hybrid design.

In a Session V paper entitled, "A New Type of Crystal-Controlled Clock Oscillator," H. D. Hinnah, vice president of CTS Knights, Inc., Sandwich, IL, will report on a new approach to clock oscillator design.

"Instead of using the standard AT-cut crystal we're using a dual monolithic-coupled resonator as the frequency-control element," Hinnah told ELECTRONIC DESIGN in an interview.

"It's actually a dual resonator on the same crystal blank with acoustic coupling between them. That's a technique currently used in multiple monolithic-crystal filters. The oscillator can operate over a wide temperature range, has excellent symmetry and fast rise and fall times.

"The frequency stability of the new design is superior to standard AT units because it is used as a resonant transformer that allows one to work into the low input and output impedances of commercially available digital circuitry.

"With standard AT crystals," Hinnah explains, "such loading degrades the crystal stability and

tends to introduce marginal start-up problems.

"With our monolithic-coupled resonator, a 74S00 Schottky gate, and a couple of resistors we have a reliable, low-cost unit, that works in the 3-to-30-MHz range," he adds.

A Session II paper entitled: "Hybrid Protection Devices for MOS-LSI Chips" will present solutions to a major failure problem with MOS-LSI circuitry—electrostatic discharges. The paper is by F. H. De La Moneda, D. E. Debar, K. P. Stuby, and C. L. Bertin, all of IBM's Systems Communication Division, Manassas, VA.

The main concern of protective-device design has been to produce monolithic structures with excellent voltage-clamping characteristics. But according to the authors these requirements can be relaxed to increase the maximum overvoltage that a chip can handle.

One new monolithic clamping structure to be described gives 1000 V more protection than conventional clamping designs.

In the IBM design this protection is extended to over 6000 V by use of a spark-gap configuration that is fabricated on the chip-carrying module. The protection does not incur added cost, nor does it decrease circuit reliability.

A Session V paper entitled "Application-Oriented Hybrid Technology" will present specific guidelines for selecting hybrid technology.

"Often the selection is determined by personal bias rather than by cost or technical requirements," says R. E. Gardner, the paper's author and supervisor of hybrid microcircuit applications for the Autonetics Group of Rockwell International, Anaheim, CA.

Gardner's advice is based on extensive experience with thin-film,

thick-film and cofired devices. (In the latter, the ceramic and conductor pattern are fired at the same time.)

In an interview, Gardner outlined some key points for ELECTRONIC DESIGN.

"Precision analog circuitry generally requires the thin film process," he said. "Thin-film techniques produce high-precision resistors. But where a wide range of resistor values are needed on the same substrate, the use of thick film may be advisable.

"With thin film you can achieve finer line width so this technique is useful at higher frequencies, such as for microwave ICs.

"For small quantities, thin film is least costly. Thick-film processes are readily automated, and for quantities on the order of 500 or so it has the lowest cost. Cofired devices have the highest tooling costs, and 200 to 1000 units are required for you to break even."

Video system has high program-store capacity

A video teaching system that can record and transmit still color pictures and sound at a high rate of speed for storage and playback has been developed for use in learning centers and homes. It uses a combination of digital coding and multiplexing to store up to 60 different half-hour programs on a standard hour-long videotape cassette.

Called Rapid Transmission and Storage, the system was invented by Dr. Peter C. Goldmark, president of Goldmark Communications Corp., Stamford, CT.

Through the use of digital coding, up to 30 programs can be selected from a single tape. They can be shown simultaneously on as many as 30 sets, using a Mark I version of the system developed for multiple-classroom instruction.

Use of the Goldmark system will enable public broadcasting stations to transmit as many as 2800 different half-hour lessons during an eight-hour nonbroadcast period, such as early morning hours, when the station is normally off of the air.

For the home viewer, a recording attachment that is expected to cost about \$300—a Mark II version—

will enable an individual to select study programs and record them during sleeping hours. Lessons can be erased and tape re-used.

The Mark I version will be introduced in the fall of this year in six community-college districts across the United States.

A principal reason for the high information-packing density is the use of slides and still pictures. Motion can be introduced into the scenes when required, but it reduces the recorded-lesson time. The use of stills also cuts production costs by about 90 percent.

Goldmark Communications has formed a wholly-owned subsidiary, Electronic Publishing, Inc., to produce course text and picture material in collaboration with individual college design teams.

Airborne computer may cut consumption of fuel

An airborne computer-based management system under development could cut airline fuel expenditures by 2 to 5 percent, according to its developer Simmonds Precision Instrument Systems Div., Vergennes, VT.

The "Performance Management System" is an airborne computer programmed with the performance characteristics of the aircraft. Real-time data presented on a control-and-display unit enable the flight crew to get maximum aircraft performance with minimum fuel consumption from take-off to landing.

The system is designed to help the pilot manage the aircraft by indicating optimum take-off thrust, angle of attack, cruise speed, altitude and other factors. In addition, the system would enable the pilot to predict the effect of alternate speeds, altitudes, temperatures and other variables on fuel consumption.

A company spokesman said if used by all major airlines, the system could save at least \$100-million a year.

Edge-board connector protection is discussed

Two layers of gold, at least 100-microinches thick, can provide a

good way to protect edge-board connectors against variation in the contact resistance, according to Robert Wasson, staff engineer at the IBM Systems Product Div., Endicott, NY.

"Contact resistance variation is the most common failure mechanism in edge-board connectors," he told last month's National Electronic Packaging and Production Conference in Anaheim, CA.

If the contacts have at least 100 microinches of gold applied in two layers—a layer of soft gold over a layer of hard gold—the connection will last a long time without variation. Not only does the gold provide protection against oxidation, but the hard layer also provides resistance against rapid wear.

Many connectors have a lifetime of only 5 to 10 insertions, Wasson noted, but the user rarely knows when the connector's contact resistance changes, or what has gone wrong to make it change.

He cited IBM's "workhorse" SLT computer-edgeboard connector as an example of a very reliable make. Selectively plated, it has about 5 to 10 m Ω when new. Over a lifetime of 50 insertions, the contact resistance does not vary more than 10 m Ω , Wasson said.

For consistent connections, he feels 150 to 200 gm of insertion force are ideal.

16-bit μ P's increase in speed and density

A 16-bit NMOS microprocessor that competes in speed with bipolar systems was unveiled at last month's Solid-State Circuits Conference. Also on view was a 16-bit CMOS μ P built on a single chip.

Both designs were developed by Tokyo Shibaura Electric Co. of Kawasaki, Japan.

The NMOS micro was described by Kenji Yoshida in the paper, "A 16-bit LSI Minicomputer." The mini employs a kind of bit-slice microprogrammable configuration. A single-chip Arithmetic Control Unit (ACU) teams up with four Bus Control Units (BCUs) and an external control ROM. The result is a system that operates at speeds more typical of CPUs employing standard bipolar circuits than of a MOS/LSI version.

"The system's architecture overcomes processing constraints," said Yoshida, who cited several speed-enhancing features. First, the control ROM is external to the ACU—as in DEC's LSI-11 mini—so the memory can be made large enough to contain virtually any instruction set. In the system described a 117-instruction set, based on the company's TOSBAC-40 minicomputer, was used.

Second, fetch and execute operations of microinstructions are pipelined, as in Intel's 3000 bipolar micro slice. During execution of one microinstruction, the fetching of the next microinstruction is carried out simultaneously. This technique allows a 300-ns cycle time even when relatively slow microprogram ROMs are employed. Further speeding CPU operations is special fast-carry logic contained in the ACU.

Both ACU and BCUs are housed in 42-pin packages. The relatively small package was made possible by the use of a single-bus configuration and a microinstruction word length of only 11 bits.

The CMOS μ P was described by Kenshi Manabe, who delivered the paper, "A C²MOS 16-bit Parallel Microprocessor." The unit employs clocked-MOS circuitry (hence the term C²MOS) to minimize the number of active elements without reducing system functions. Specifically, the use of a dynamic ROM for the μ P's instruction decoder and control circuit avoids the need to reduce the number of basic instructions.

The CMOS μ P responds to 72 basic instructions, and it has an instruction execution time ranging from 10 to 26 μ s (with an 8-MHz input signal). The chip employs standard aluminum-gate technology, and dissipates about 5 mW, not including drivers. Packaging in a 28-pin DIP is possible because the memory-address register is external to the μ P chip.

Other features include three levels of interrupt-request inputs and the capability for multiple-interrupt handling. Addressing modes consist of direct, indirect, indexed, immediate and pointer.

Though not available now, Manabe said that the CMOS μ P might be offered for a unit cost in the range of \$30 to \$40.

We saw your microprocessor

coming. So we designed an entire family of socket homes for it. *Socket cards* for card file mounting, and we've even got the card files. *Socket boards* for LSI mounting in frames, drawers, and racks,

and we've even got the frames, drawers, and racks. Our socket cards, the 3D Series, come with built-in test points, a ceramic monolithic bypass capacitor

at each socket, and solder tab connection to pins on LSI chips. Our socket boards, the 2D Series,

offer a good selection of socket complements, and are compatible with other boards for hybrid installations. We also offer automated wiring service. We're ready for you.

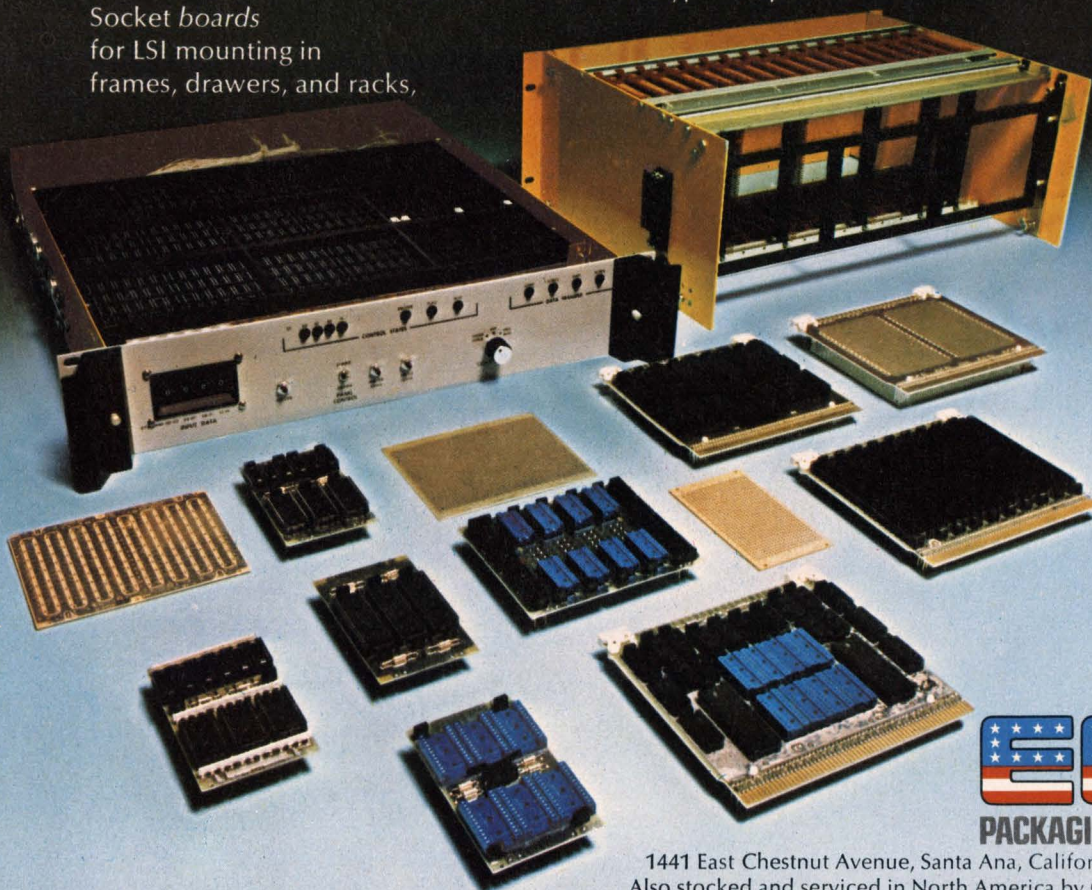

EECO
PACKAGING/SWITCHES/READERS

1441 East Chestnut Avenue, Santa Ana, California 92701 Phone 714/835-6000
Also stocked and serviced in North America by G. S. Marshall, R-A-E, Zentronics.

Counting minutes? Gallons? Bottles?

Any other way is obsolete.*

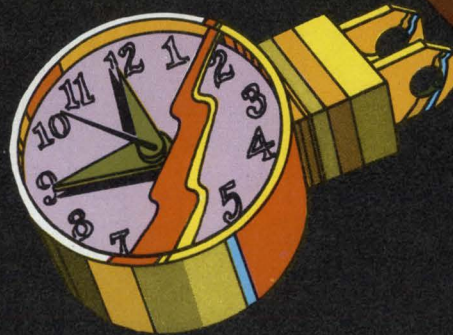

**Save space,
time and system cost.
Intersil has the broadest
line of counting and
timing microcircuits.**

Nowhere else will you find such a variety of microcircuits for use as timers, counters and clock generators. Problems such as event timing, frequency generation and unit counting are now simpler to solve, at less cost.

By going solid state, you tremendously enhance system reliability and reduce size. By coming to Intersil you save time and get the right product for your application.

1. Externally settable counter/timer circuits.

Intersil's 8240, 8250 and 8260 are a family of counter/timers which can generate accurate, externally settable time delays from microseconds to five days.

The 8260 counts in seconds, minutes and hours, will work with a 60 Hz line for reference. Three in cascade, using thumbwheel switches with the digits 0 to 5 and 0 to 9 for setting start-stop time, make a counter/timer settable in units of one second up to a maximum of 60 hours.

8250 counts in decimal terms. Each unit, using two decimal thumbwheel switches (0 to 9) provide two decades of counting from 1 to 99.

And the 8240 counts in binary. An eight-term binary input from computer, A/D converter, etc., allows one device to count from 1 to 255.

2. Battery operated counter/timer.

The 7045/7205 is a complete CMOS industrial counter/timer in a single IC package. Works beautifully from a stack of three NiCad batteries. For a complete system, add a quartz crystal, trimming capacitor, four switches and an 8-digit LED display.

3. Low cost precision timer.

Our 555 is a stable controller which can generate time delays from microseconds to hours, with the addition of only one resistor and capacitor.

If you need more than one timer, the 556 contains two identical 555s in a single package.

4. Versatile low power counter.

The 7208 is a 7-digit fully integrated frequency or unit counter. For a unit counter, add an LED display, two resistors, a capacitor and control switches. For use as a timer or frequency counter, in addition to the above, simply add an oscillator/controller circuit such as our 7207.

*For state of the art counter-timer application and product data, send for Intersil's new Timing and Counting Circuits brochure.

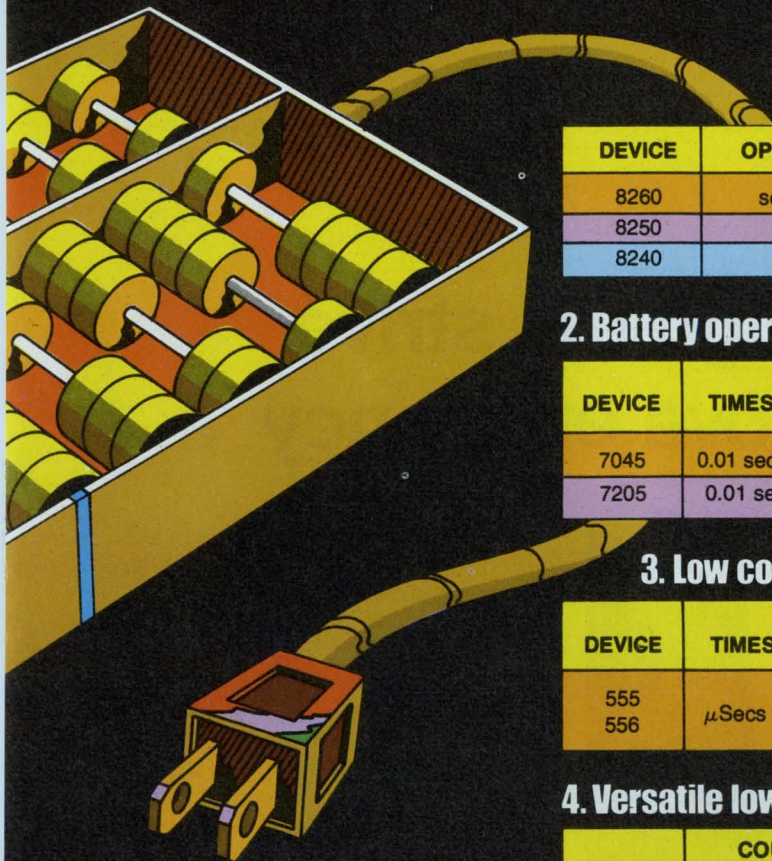

1. Externally settable counters/timers.

DEVICE	OPERATES IN	OUTPUT FROM	PACKAGE	PRICE 1000+
8260	sec/min/hrs	1-59	16 pin DIP	\$2.90
8250	decimal	1-99	16 pin DIP	3.60
8240	binary	1-255	16 pin DIP	3.10

2. Battery operated counter/timer.

DEVICE	TIMES FROM	TYP. POWER	OUTPUT INTERFACE	PACKAGE	PRICE 1000+
7045	0.01 sec-24 hrs	0.9 mW	LED display	28 pin DIP	\$17.00
7205	0.01 sec-1 hr.	2.5mW	LED display	24 pin DIP	11.10

3. Low cost precision timer.

DEVICE	TIMES FROM	NO. IN PACKAGE	STABILITY	PACKAGE	PRICE 1000+
555	μ Secs to hours	single	0.005%/°C	8 pin DIP	.39
556		dual		14 pin DIP	.79

4. Versatile low power counter.

DEVICE	COUNT CAPACITY	TYP. POWER	OUTPUT INTERFACE	PACKAGE	PRICE 1000+
7208	7 decades	5-10 mW	LED display	28 pin DIP	\$ 9.95

5. Low power crystal frequency generators.

These CMOS frequency sources all provide low power operation plus the outstanding accuracy and stability of high frequency crystal circuits.

The 7207 is a complete frequency counter timebase. By using a 6.55 MHz crystal, it expands the 7208 into a frequency or period counter, and dissipates less than 5 mW at 5 volts.

7209 is a versatile high frequency clock generator for 5 volt systems.

7038A is a low voltage, micropower oscillator, frequency divider and output driver for synchronous motors, etc.

The 7213 is a complete oscillator, divider and waveshaping circuit providing various outputs including one-second and one-minute pulses.

All from Intersil, number one in solid state counters. 10900 North Tantau Ave., Cupertino CA 95014.

5. Low power crystal frequency generators.

DEVICE	CRYSTAL FREQ.	DIVIDER STAGES	PACKAGE	PRICE 1000+
7207	1-10 MHz	$\div 1, 2^{12}, 2^{17}, 10(2^{17})$	14 pin DIP	\$2.50
7209	10 kHz-10 MHz	$\div 1, 2^3$	8 pin DIP	1.50
7038A	200 kHz-15 MHz	$\div 1, 2^{13}, 2^{15}$	8 pin DIP	2.50
7213	1-6 MHz	$\div 1, 2^{22}$	14 pin DIP	2.50

Send for counter/timer brochure.

For more information regarding pinouts, applications, external circuitry requirements and parametric specifications, ask for Intersil's new Timing and Counting Circuits brochure.



Intersil stocking distributors

Arrow Electronics (Conn., Dayton, Minn.,
Md./D.C., N.J., N.Y., Wisc.)
Century Electronics (N.M.)
Elmar/Liberty Electronics
Kierulff Electronics (Mass.)

R. A. E. Ind. Elect. Ltd. (Van. B.C.)
Schweber Electronics
Semiconductor Specialists
Southland (Fla.)
Weatherford

Intersil area sales offices

Boston (617)273-2055
Chicago (312)371-1440
Dallas (214)387-0539
Los Angeles (213)532-3544
Miami (305)971-6160

Minneapolis (612)925-1844
New York (201)567-5585
San Francisco Bay Area (408)984-2170
Upstate New York/Canada (315)463-3368
Representatives in all major cities.

Major solar-cell programs strive to lower cost, improve efficiency

A major national effort is currently underway by many companies, universities, and private organizations to develop solar-cell technology as a potential large-scale energy source.

The U. S. Government's Energy Research and Development Administration (ERDA) plans to spend more than \$20 million in 1976 on solar cell development alone—a fourfold increase over 1975's outlay. Other branches of the government, as well as a number of private industries, have committed additional funds.

The major technological objectives of this far-reaching program are:

- To lower the capital cost of solar-cell-generated electricity from today's figure of about \$25,000/kW to less than \$500/kW in 1985—by developing new mass-production manufacturing processes for solar cells and for complete solar-cell arrays.

- To produce single-crystal silicon in large quantities at low cost.

- To maximize the performance of today's solar cells by means of new photovoltaic materials and by cell-design innovations.

- To foster the growth of the solar-cell industry in this country, and to develop photovoltaic technology to such a level that eventually a significant fraction of the nation's total electrical power will be produced by this method.

Solar cells come down to earth

Consuming no fuel, generating no waste products, and operating



1. Long continuous ribbons of silicon crystal grown at Mobil Tyco Labs may lead to mass-produced low-cost solar cell arrays.

virtually without attention for long periods of time, photovoltaic solar cells have become the object of renewed interest by leaders in government and industry.

Their greatest single application to date have been in the space program, where the cell's high initial cost is outweighed by its desirable features and demonstrated ability to supply steady power to orbiting spacecraft. NASA's Skylab, launched in 1973, carried an array of 147,840 individual 2×4 -cm solar cells—the largest concentration of photovoltaic power ever borne aloft.

Weighing 5060 lb, the array was

capable of generating approximately 11.5 kW. A slightly smaller solar-cell array (11.3 kW) was carried aloft by the 1973 Apollo telescope.

On a more mundane level, solar cells are currently finding use in a large number of terrestrial applications, especially where relatively small amounts of reliable electric power are needed at remote or inaccessible sites.

Typical uses are found in navigational buoys, telephone repeater stations, and roadside call boxes. Along the Atlantic City Expressway in New Jersey, 96 roadside radio-telephone call boxes run on rechargeable batteries; the recharging is done during daylight hours by solar cells. Cells can also be mounted aboard small boats to charge their batteries.

SES Inc., Newark, DE; and Solar Power Corp., Wakefield, MA, are both currently marketing solar cells for boat applications.

Other current uses for solar cells include supplying power for children's toys, and more recently, for charging the batteries in LED-display wristwatches. Edmund Scientific Co., Barrington, NJ, offers individual cells for use by experimenters.

The total electric power generated nationally by all solar-cell applications is small. It is estimated to run currently at a level of hundreds of kilowatts, less than the power used by a medium-sized office or apartment building. The goal of ERDA however is to increase this figure by many orders of magnitude—to such a point that by the year 1985 solar cells will be providing more than 500 MW (peak power) nationally.

Even more significant, by 1985

solar-cell arrays would be fabricated at such a rate that the 500-MW figure would also represent the yearly national increase in solar-cell generating capacity.

Large-scale uses proposed

Of the variety of possible methods for large-scale solar-cell application, the following three schemes have been frequently proposed:

1. The first possibility would see solar-cell arrays placed on individual buildings, either by mounting them on the outside, or by making them an integral part of the building's exterior. Such an installation could supply an average daily output of up to 5000 kWh. In comparison, the average single-family home today is estimated to require 500 kWh of electricity per day; the figure for an apartment in a multiple-family dwelling is half that amount.

2. Another arrangement would be to construct large, central generating stations similar to those existing today. Instead of consuming fossil or nuclear fuels, however, the new stations would derive their power from vast arrays of solar cells. The central station would operate mainly as a collection point.

This system would require equipment, first for converting the solar-cell current to ac, then for stepping up the voltage, for transmitting the power, and for distributing it. Such installations might vary in size from 0.5 to 25,000 MWh average daily output. To generate 500-MW peak power using solar cells of 10 percent efficiency would require an array of many hundreds of thousands of cells covering approximately 2 sq. mi.

3. The third and most unusual possibility is to position large arrays of solar cells in geosynchronous orbit, 35,800 kilometers above the earth. The collected power would be transmitted to ground-based receiving stations by microwave beams.

First proposed by P. E. Glaser in 1968, this scheme has recently been brought closer to reality. Late last year a joint engineering group from the Jet Propulsion Laboratory, Pasadena, CA, and Raytheon Co., Waltham, MA, announced the successful microwave transmission

of 30 kW over a distance of 1.5 km ("Wireless Power-Transmission Test Aims at Harnessing Sun One Day," ED No. 25, Dec. 6, 1975, p. 32).

Despite technical advances, this scheme must yet come to grips with a myriad of problems—among them, the cost of orbiting the enormous amount of material required. Questions have also been raised about the possible environmental impact (notably the effect on the earth's ozone layer) by the great

by the incident radiation. Optimum efficiency requires the silicon to be very pure, and as structurally uniform as possible.

Efficiency is but one aspect that must be considered. Cell life is another. According to Drs. David Redfield and George Cody of the RCA Sarnoff Research Laboratory, Princeton, NJ, silicon has an almost indefinite life in terrestrial solar cells.

But single-crystal cells are expensive to produce because of the

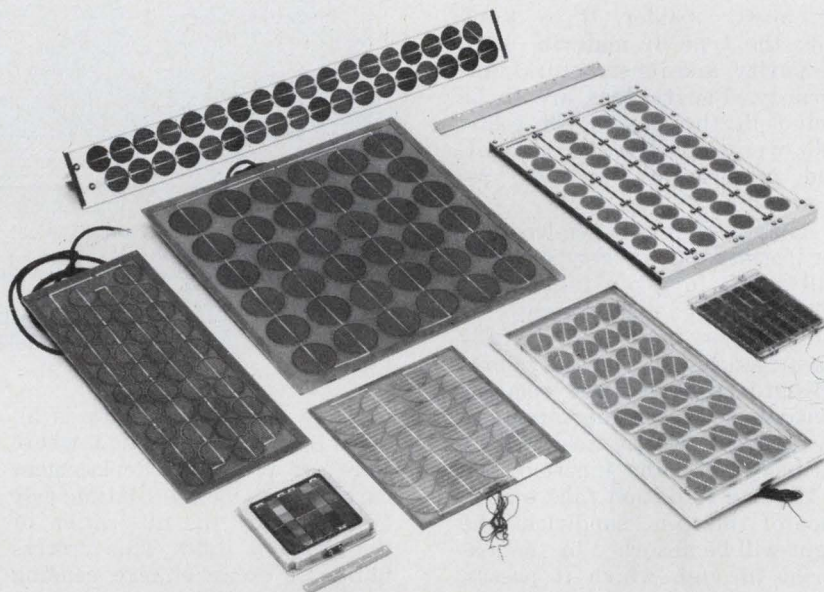

2. **Solar-cell arrays** are available in a variety of shapes and sizes, depending on the output voltage and current desired. Each cell generates about 0.5 V.

number of space flights that may be necessary.

An abundance of solar cells

To provide some means of classifying the many types of solar cells now available in the rapidly growing photovoltaic field, experts in the industry generally divide present-day devices into two broad categories: those made with a single silicon crystal and "all other types." Single-crystal cells are given special status because of the advanced state of development of single-crystal silicon technology and because of their greater efficiency and demonstrated reliability.

Solar-cell efficiency is defined as the ratio of the cell's electrical power output to the power carried

cost of preparing the pure silicon crystal from the raw material. Current costs average about \$2000 per square meter of array, when purchased in quantities above 400 m².

"All other types," the second major solar-cell category, may be divided into two branches, one group consisting of thin-film cells, and the other group made up of the rest.

Of the thin-film cells, the one most technologically developed is the cadmium sulfide/copper sulfide cell. This device, discovered in 1954 by D. C. Reynolds, typically is made by joining a very thin (1 μm) layer of copper sulfide to a thicker layer (50 μm) of cadmium sulfide. The copper sulfide is the active layer, the material in which the charge

carriers are generated.

A serious disadvantage of the cadmium sulfide/copper sulfide cell is its short life. Serious deterioration is often observed after two or three years, primarily due to the effects of water vapor and oxygen.

However, since these cells offer the advantage of low cost, a num-

ber of organizations are working intensively to improve their operation.

An array of cadmium sulfide solar cells 0.25 m² in area and generating a peak of 300 mA at 12 V currently sells commercially for about \$100.

Another thin-film solar cell, still

in an early stage of development, is made of polycrystalline silicon. Polycrystalline silicon is less expensive to produce than single crystals because the need for perfect uniformity is no longer present. Moreover, thin-film silicon cells have the potential of being mass produced.

Here's how solar cells work

Among the many design factors that solar-cell manufacturers must consider, three stand out: the type of material used, its purity, and its structural uniformity. The reasons are to be found in the physics of solar-cell operation. Here is a brief, and necessarily simplified, review.

A layer of p-type semiconductor formed on an n-type wafer will result in a p-n junction at the interface (see figure). If the junction has been carefully manufactured so that the atomic crystal-lattice structure remains continuous across the interface, an internal electric field will be formed across the junction.

If solar radiation falls on one face of this p-n "sandwich" the light will be absorbed by the material through which it passes. The absorption process generates electron-hole pairs (free charge carriers) in the material. This free-charge generation occurs only if the energy of the light is higher than the energy gap of the semiconductor material—that is, higher than the energy binding the electrons.

The particular charge carriers that ultimately become the solar cell's output current are the *minority carriers*, electrons generated within the p-type material, and holes generated in the n-type material.

The internal electric field at the p-n junction is of such polarity that any minority carriers that happen to be in its vicinity are swept across the junction by the electric field. This continuous process of removing the minority carriers at the junction results in more minority-carriers existing within the semiconductor than at the junction.

As a result, these carriers'

average direction of flow is always toward the junction, where they are collected. Replacement carriers are being continuously generated by the absorption of the incident light. This process builds up excess charge, causing a potential difference to exist between the p-type semiconductor and the n-type. For present-day silicon semiconductors this voltage is about 0.55 to 0.60 V.

When the outer surfaces of the p and n-type materials are electrically connected to a load, a current will flow.

Electrical contact is made to the materials as follows: On the surface closest to the light, a grid of fine wire or other type of conductor is deposited; this forms one terminal of the cell. Connection to the material on the opposite side of the junction can be made via a metal film covering the outside face.

Not all the photo-generated charge carriers are collected. During the time it takes the charges to physically traverse the material and reach the junction a fraction of them (about 10 percent) recombine. Recombination reduces the available output current.

The rate of recombination (inverse of the carrier lifetime) is determined by the relative amount of impurities in the semiconductor and by any imperfections in the crystal. The lower the percentage of impurities and the more uniform the crystal, the longer the lifetime of the free charges and the greater their probability of being collected.

Because the incident solar light is not monochromatic but covers a range of colors or frequencies (frequency is directly proportional to energy) it turns out that some portion of the solar spectrum provides more energy than is necessary to form electron-hole pairs. This excess energy is wasted as far as the photovoltaic process is concerned, ultimately going into heating the semiconductor.

When silicon is illuminated by solar light about 50 percent of the energy entering the silicon is lost by this process.

The combined effects of heating loss and recombination loss are a major cause of the relatively low average efficiencies—on the order of 20 percent—of solar cells.

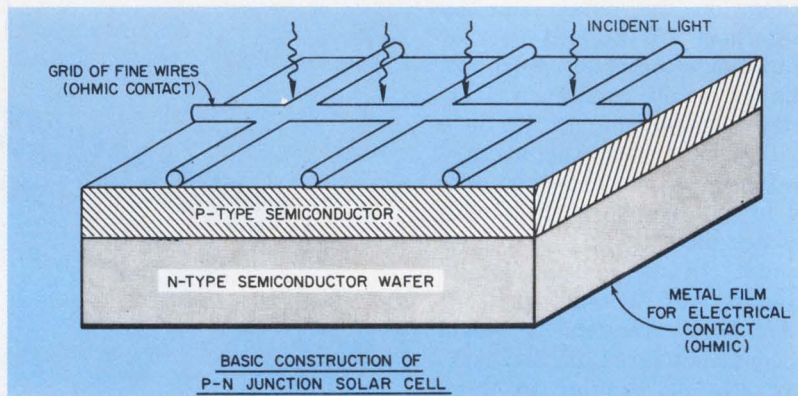

Transient Voltage Suppressors! Zeners - Voltage Regulators!



**Maximum Power
in a Mini Package!**

Semtech technology once again sets the standard for semiconductors! Now, a new generation of Voltage Regulators and Transient Suppressors for protection of delicate logic circuits and sophisticated power supplies, providing protection against voltage transients in airborne equipment as well as suppression of relay coil and contact noise.

The smallest package in the industry and with power ratings up to 1500 watts is available now thanks to a breakthrough in junction technology, combined with the proven metoxilite (metal-oxide) coating and superior non-cavity monolithic high temperature bonded construction!

LOW DYNAMIC IMPEDANCE VOLTAGE REGULATORS "ZENERS"

These new devices offer significantly lower dynamic impedance. Lower impedance means improvement in regulation ripple reduction and transient protection.

1 watt

1N5559A,B thru 1N5589A,B.
Nominal Voltage: 6.8 to 120 V ($\pm 5\%$)
Low Reverse Leakage
Dimensions (max.): Body .070"D x .165"L
Leads .031"D x 1.25"L

5 watt

1N4954 thru 1N4984
Nominal Voltage: 6.8 to 120 V ($\pm 5\%$)
Low Reverse Leakage
Dimensions (max.): Body .140"D x .165"L
Lead .038"D x 1.10"L

3 & 5 watt

SX6.8 thru 120
Nominal Voltage: 6.8 to 120 V ($\pm 5\%$)
Low Reverse Leakage
Dimensions (max.): Body .140"D x .165"L
Lead .040"D x 1.10"L

10 watt

SY6.8 thru 120
Nominal Voltage: 6.8 to 120 V ($\pm 5\%$)
Low Reverse Leakage
Dimensions (max.): Body .165"D x .165"L
Lead .040"D x 1.10"L

BI-POLARITY TRANSIENT SUPPRESSORS

At last, a single chip device providing symmetrical transient voltage protection. Voltage matching to 5% in either direction. Protection for A.C. and D.C. circuits.

500 watt Peak Pulse Power

L 10A, 20A, 30A, 39A, 51A, 60A, 82A, 100A and 110A.
Nominal Voltage: 10 to 110 V
Dynamic Impedance (max.): 1.5 to 70 Ohms
Dimensions (max.): Body .140"D x .165"L
Lead .031"D x 1.25"L

1500 watt Peak Pulse Power

TS 10A, 20A, 30A, 39A, 57A, 60A, 82A, 100A and 110A.
Nominal Voltage: 10 to 110 V
Dynamic Impedance (max.): 0.7 to 35 Ohms
Dimensions (max.): Body .165"D x .165"L
Lead .040"D x 1.10"L

1975 NATIONAL SBA SUBCONTRACTOR OF THE YEAR



652 Mitchell Road, Newbury Park, California 91320
(805) 498-2111, (213) 628-5392 / TWX: 910-336-1264
CHICAGO: (312) 352-3227
DALLAS: (214) 387-3551
FLORIDA: (305) 644-5404
MARYLAND: (301) 424-6663
NEW JERSEY: (201) 654-4884
SAN FRANCISCO: (415) 494-0113
EUROPEAN SALES HDQ: Bourns AG Zug,
Switzerland, (042) 232-242

Contact factory for complete specifications.

CIRCLE NUMBER 18

As shown in the table, the efficiency of polycrystalline thin-film silicon cells is lower than for single-crystal cells. The efficiency of polycrystalline cells is a function of their grain size which in turn depends on the process used in making the cells. Thin-film silicon solar cells have not yet been manufactured commercially.

Of the types that are not thin-film cells—the final solar-cell category—the gallium arsenide cell currently offers the greatest potential. It has demonstrated one of the highest efficiencies of all present-day solar cells, and can be operated at higher temperatures than silicon cells.

A variety of other cell types are also under serious study. In particular, Schottky-barrier (metal-semiconductor) junctions are being investigated because of the relative ease of constructing them and their potential low materials cost. These devices have not yet gone beyond the laboratory stage.

Efforts to shrink costs

In order for solar-photovoltaic

energy to successfully compete with conventional energy sources, experts estimate that the present cost of generating photovoltaic energy must drop from today's \$25,000 per peak kilowatt to \$500 or less. To achieve a cost reduction of this magnitude, the government is encouraging a large number of investigators to pursue a wide variety of approaches.

One way to cut costs is to reduce the price of the raw material and to use as little of it as possible. Another way is to devise mass-production techniques for manufacturing and encapsulating entire cell arrays.

Current procedures involve the costly hand assembly of arrays from solar cells approximately 1 × 1 in. This method would be prohibitively expensive for the vast solar-cell installations envisioned for the future.

For silicon cells one way to minimize the cost is to cut the amount of silicon needed, by using thin films, rather than single crystals. Evaporation and chemical-vapor deposition (CVD) are among the methods currently used to produce

thin films.

Thin-film polycrystalline silicon, however, is less practical for solar energy conversion than single-crystal (thicker) silicon. There are two reasons:

First, silicon requires a thickness of at least 20 μm to absorb most of the incident sunlight, and films this thick are not easily produced by evaporation or CVD.

Second, thin films of silicon are polycrystalline in structure. The grain boundaries of the polycrystalline material shorten the lifetime of the minority-charge carriers that are photo-generated within the crystal, thus lessening the available photocurrent.

Despite these disadvantages, the lower cost of thin-film silicon cells still makes them the subject of great interest.

Texas Instruments Inc., Dallas, TX; RCA Corp., Princeton, NJ; and Motorola, Phoenix, AZ, are three firms currently investigating methods to develop automated processes for mass production of complete silicon-solar-cell arrays.

One of the crucial phases of this program is still in the development stage. It is a detailed study of cost tradeoffs with respect to all the other tasks in the silicon-cell program. There may be, for example, silicon-crystal shapes that are easy to grow but that may not fit readily into an automated-array manufacturing scheme.

Among the many early engineering decisions that must be made is the size of the basic solar cell to be used in the array, since millions of such cells will have to be produced. Circular or hexagonal cells about 6 in. in diameter, or ribbon silicon cells 3 in. wide (length undecided) are being considered, a Texas Instruments spokesman reports.

A step-up in array production

Under contract from ERDA, the Jet Propulsion Laboratory, Pasadena, CA, is overseeing the Low-cost Silicon-Solar-Array Project. JPL is coordinating a large number of contractors in an attempt to produce arrays in great quantity.

According to project manager Robert Forney of JPL, a major part of the effort is aimed at developing processes and facilities for producing solar-grade raw silicon by 1985 for less than \$35/kg—

Terrestrial efficiencies of present-day solar cells

Cell type	Efficiency (%)	Comments
Single-crystal silicon	13 - 14	Commercially available; lab models reported to have higher efficiencies; maximum practical eff. is 21%; high reliability.
Polycrystalline silicon		Laboratory devices only.
a) Large grain size	7 - 8	Grain size, 3 to 4 mm dia.
b) Small grain size	4	Grain size, 3 × 10 ⁻⁴ to 5 × 10 ⁻⁴ mm dia.
Copper sulfide/cadmium sulfide	6 - 7	Commercially available; polycrystalline; maximum practical eff. is 10%; efficiency of commercial units is 3-4%; reports indicate relatively low reliability.
Gallium arsenide		Laboratory devices only;
a) Single crystal	14 - 15	Maximum practical eff. about 21%.
b) Polycrystalline	-	No current data available.
Cadmium telluride	5 - 6	Laboratory devices only; current work is mainly in Europe.
Cadmium sulfide/indium phosphide	12	Laboratory devices only; single crystal.
Schottky-barrier Types		Laboratory devices only.
a) Metal oxide/gallium arsenide	13	
b) Other Schottky devices	Up to 10%	

Note:

Data for maximum practical efficiency include cell-improvement features such as surface texturing, anti-reflection coatings, carrier lifetime improvement processes, etc.

THE LATEST TECHNICAL INFORMATION ON OUR 18 PIN 4K RAM.

\$20.00

A thick, curved pink line starts at the \$20.00 price point on the left and curves downwards and to the right, ending at the \$12.00 price point on the right. The background is a light blue grid.

\$12.00

One of them, our MM5270D, has dropped to \$12.00 in quantities of 100 or more. And that's just the MM5270D. So why don't you write for the new prices on all our 4K RAMS? And find out how significant this breakthrough really is?

National Semiconductor 

2900 Semiconductor Drive, Santa Clara, CA 95051, (408) 732-5000

slightly more than half the current price. At the same time, processes and facilities are being developed for manufacturing large-area silicon sheets at an aimed-for-cost of less than \$1.60/ft². (Current costs are about \$28/ft².)

Development of economical encapsulation techniques and materials is also proceeding, with a goal of ensuring a lifetime of more than 20 years for solar-cell arrays. Present costs of processing silicon wafers and sheets into solar-cell arrays—including encapsulation—

While many crystals can be cut from such an ingot, the process of sawing and polishing involves loss (kerf loss) of the expensive, already-refined silicon. It also adds labor costs.

The Czochralski process has been extensively used for the past two decades in the semiconductor industry; its technology is now highly developed.

The second method, more amenable to mass-production techniques (see Fig. 1), is the edge-defined film-fed-growth (EFG) technique.

distribution and density.

One of the difficulties encountered by the EFG-ribbon process is that concentrations of impurities—mostly silicon carbide—are introduced by the carbon die. These macroscopic islands of impurities, known as inclusions, produce an effect similar to that of crystal-structure imperfections. That is, they reduce the lifetime of the minority-charge carriers and lower the cell's output current.

Dr. Glenn Cullen, head of the Materials Synthesis Group at RCA, reports that progress is being made on developing an alternate approach—the Stepanov Method—to growing silicon ribbon from a die to reduce the number of inclusions.

Design innovations abound

The methods available to improve solar-cell operation seem at times to be limited only by the imagination of the experimenter. Each innovation, however, brings with it not only progress but problems, and the tradeoffs between the advantages and the disadvantages are not always easily discernable. For example:

One technique currently being investigated is the use of optical concentrators—such as lenses—to focus sunlight and thereby reduce the required amount of cell area. As the optical material's unit-area cost is less than the cost of equivalent cell material it would seem at first that this approach would offer economic advantages for large-scale arrays.

However, this method requires that the system continuously track the sun, a procedure that involves a moving mechanism, and all its attendant problems—including wear, energy for motors, and need for lubrication.

Further, such a system unavoidably operates at a higher temperature, a factor that can seriously affect the life of the cell. Repeated thermal expansion and contraction of the cell's wire-grid overlay can cause it to peel away from the underlying semiconductor. This introduces series resistance and lowers the cell's operating voltage.

On the other hand, a higher temperature isn't necessarily all bad. It allows for the design of a photovoltaic cell in combination with a solar thermal collector that has a

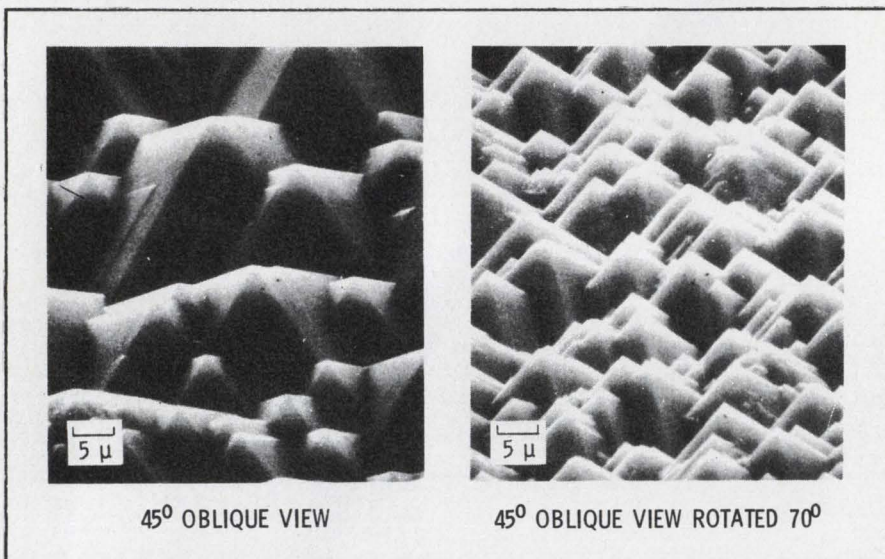

3. Etching the silicon surface results in lower reflection and improved absorption of the incident sunlight.

are about \$140/ft². The goal of the project is to bring the cost of the finished silicon solar-cell array to under \$1.60/ft² by 1985.

Techniques and necessary equipment are being developed also for low cost, mass production of complete solar-cell arrays.

Under another part of the program large quantities of solar cells would be purchased each year to encourage competitive manufacture, Forney explains. Purchases for 1976 are expected to total 176 kW of electrical generating capacity.

There are currently two methods for growing large crystals of silicon. The conventional, or Czochralski, method uses a "seed" of pure silicon crystal dipped into a bath of the molten material. A large ingot of relatively pure silicon crystal can be grown by this method.

This method, still in the early stages of development, produces a single, continuous crystal of silicon ribbon as much as 65 ft in length, by allowing molten silicon to solidify as it passes through a carbon die.

Mobil Tyco Solar Energy Corporation, Waltham, MA, reports typical speeds of growing ribbon silicon as 0.75 to 0.80 in./min, with growth speeds of up to 2 in./min in experimental units. Their silicon ribbons are 1 in. wide and 0.008 to 0.010 in. thick.

Recent reports describe the efficiency of EFG silicon-ribbon cells as ranging from 8 to 10 percent under conditions of solar illumination above the earth's atmosphere.

Current work in EFG-silicon ribbon includes efforts to improve the purity of the silicon, and attempts to reduce and control the defect

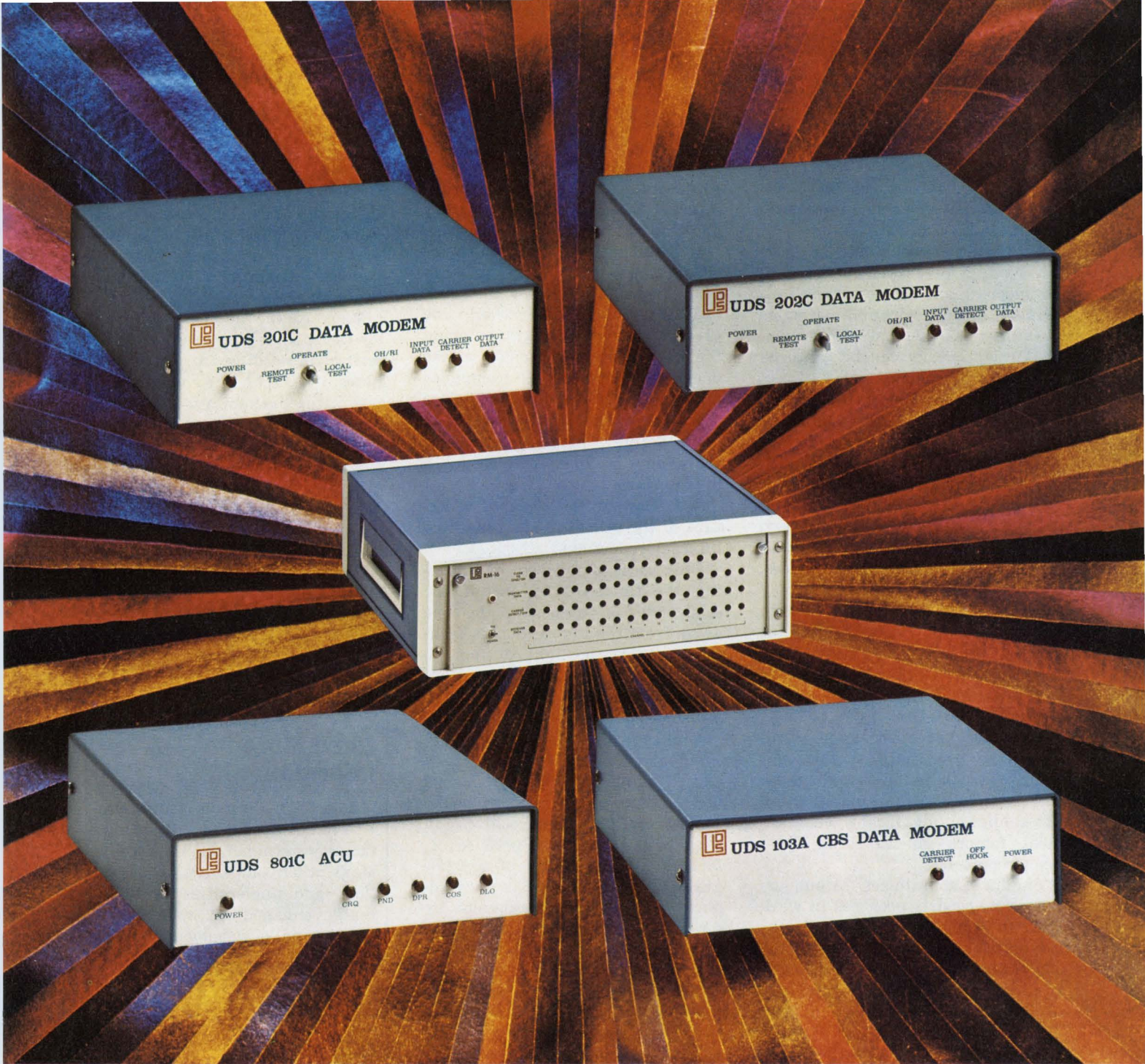

UNIVERSAL MODEMS

Making data move is the name of the game in today's switched or dedicated line networks. If you're moving it at any speed up to 2400 BPS, Universal Data Systems has the proper modem for reliability, economy and efficiency in your system.

UDS has more than 20,000 modems in active field service, and that total is growing by more than 1000 units per month. Our product line includes CMOS 201s, plus 103s, 202s and the multiple-modem RM-16 which contains up to 16 units in any configuration mix you desire.

In addition to our products, we're extremely proud of our customer service. Check us out: Call us on the telephone. You'll like what you hear.



universal data systems

member of
IDCMA

4900 Bradford Drive • Huntsville, Alabama 35805 • Telephone (205) 837-8100 • TWX 810-726-2100

Created by Hall & McKenzie Advertising, Winter Park, Florida

CIRCLE NUMBER 20

liquid or gas flowing through pipes mounted behind the cell to carry away the heat. The combination can provide not only electricity, but also thermal energy for home heating.

Solar-energy consultant Dr. Martin Wolf, a professor of electrical engineering and science at the University of Pennsylvania, estimates that up to 60 percent of the incident solar energy can be captured with such a scheme.

When large concentrators are used for installations where the combination of solar cell and thermal converter is impractical, cooling the solar cell becomes mandatory. RCA reports successful results with passive radiant coolers, which simply radiate the cell's heat into the air. Using such devices, solar-cell temperature rises of only 10 F have been recorded even with sunlight concentration factors of up to 1000.

Solar concentrators in a variety of forms are being investigated at Arizona State University, Tempe, AZ, where experimental concentrators have been built that do not require tracking. Although these merely enhance the concentration of sunlight, significant enhancement factors—up to seven—have been reported.

Sandia Laboratories, Albuquerque, NM, reports progress in work with the photovoltaic-thermal converter combination. These use solar concentrators to concentrate the sunlight and raise the temperature of the circulating fluid (usually water) to up to 200 F.

Even higher temperatures are possible, Sandia researchers explain, by using solar tracking with concentration factors up to 1000, and with different fluids for removing the heat. The solar cell must be optimized for operation at these higher temperatures because its efficiency generally decreases as the temperature rises.

Other facets of cell improvement currently being investigated include:

- Antireflection coatings to enable more of the incident light to enter the cell.

- Texturizing the front surface. This procedure uses chemicals to etch the surface on which the light falls, and produces a myriad of

microscopic pyramids on the surface (Fig. 3). Two benefits result. First, surface reflection is reduced by more than half. Second, multiple internal reflections occur, thereby allowing more light to be absorbed.

- Reducing the total area covered by the wire grid on the semiconductor surface facing the light.

The less surface covered, the greater amount of light entering the cell. Improved metal masks made by photo-resist techniques have made it possible to reduce the wire grid's average coverage from a figure of 10 percent five years ago, to today's range of 5 to 7 percent.

- Designing the physical structure of the cell to produce multiple internal reflections.

This is accomplished by tapering the thickness of one of the semiconductor elements (the one away from the light). Such a technique causes the light to undergo multiple passes through the semiconductor material thus increasing its absorption.

- Manipulating the density gradient of the semiconductor's added impurities (dopants) in order to create a "back surface field."

Surfaces and ohmic contacts in a solar cell generally produce effects similar to those of crystal-grain boundaries; that is, they reduce the cell's output current by acting as sites for the premature recombination of the photo-generated charge carriers.

In a back-surface-field cell an internal electric field (in addition to the one at the junction) is created at the back surface of the semiconductor. Such a field acts to prevent the charge carriers from recombining at the surfaces.

Accelerating the technology

Before photovoltaic power can be accepted on a wide scale, the problem of energy storage must also be solved.

Solar cells generate little or no power during nighttime or cloudy days. Such conventional energy storage techniques as storage batteries are available, but are also relatively expensive. More exotic energy schemes are under consideration by the Conservation Research and Technology Division of ERDA.

These include using massive flywheels, storing compressed air in caverns, and pumping water to a higher elevation. In the latter case, during periods of darkness the stored water can fall to a lower level—into an abandoned mine, for example—driving an electric generator in the process.

Many of the numbers projected for the solar cell program are staggering. According to some estimates, to achieve a photovoltaic generating capability of 40,000 MW—about 10 percent of today's national electrical output—would require covering 800 square miles with solar cells (assuming an efficiency of 12 percent).

This would use about 1 million tons of solar-grade silicon. In discussing these numbers, Drs. David Redfield and George Cody of RCA suggest that the Arab countries might be well advised to sell their oil and hoard their sand. ■■

Need More Information?

The following is a representative list of firms presently manufacturing commercial solar cells. Many other companies, organizations and universities are currently engaged in related research and development work.

M7 Inc., 210 Campus Dr., Arlington Heights, IL 60004. (312) 255-7796.

Circle No. 591

Optical Coating Lab., Inc., Photoelectronics Group, 15251 E. Don Julian Rd., City of Industry, CA 91746. (213) 968-6581.

Circle No. 592

Sensor Technology Inc., 21012 Lassen St., Chatsworth, CA 91311. (213) 882-4100.

Circle No. 593

Solar Energy Systems, 1 Tralee Industrial Park, Newark, DE 19711. (302) 731-0990.

Circle No. 594

Solar Power Corp., 23 North Ave., Wakefield, MA 01880. (617) 246-2355.

Circle No. 595

Solar Systems Inc., 8124 N. Central Park, Skokie, IL 60076. (312) 676-2040.

Circle No. 596

Solarex Corp., 1335 Piccard Dr., Rockville, MD 20850. (301) 948-0202.

Circle No. 597

Spectrolab Inc., 12500 Gladstone Ave., Sylmar, CA 91342. (213) 365-4611.

Circle No. 598

An October, 1975 report by the Energy Research and Development Administration (ERDA), Washington, DC 20545 listed 52 organizations that recently submitted bids for ERDA-sponsored R & D work in solar-cell technology.

Sprague puts more passive component families into dual in-line packages than any other manufacturer.

Call Sprague First!

HIGHER
PACKAGING
DENSITY

LOWER
PRODUCTION
COSTS

plus improved performance and compatibility with DIP microcircuits

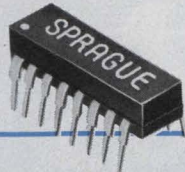

**DIP
MULTIPLE
TANTALUM CAPACITORS**

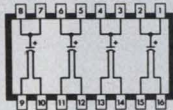

Solid-electrolyte tantalum capacitors with 2 or 4 sections per package. 8- or 16-pin configurations. Standard ratings are $6.8 \mu\text{F} @ 35\text{V}$, $15 \mu\text{F} @ 20\text{V}$, $22 \mu\text{F} @ 15\text{V}$, $33 \mu\text{F} @ 10\text{V}$. Capacitance tolerance, $\pm 20\%$. Operating temperature range, -55°C to $+85^\circ\text{C}$. Write for Bulletin 3542 or circle 151 on reader service card.

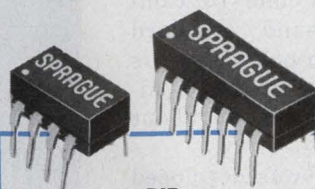

**DIP
MULTIPLE
CERAMIC CAPACITORS**

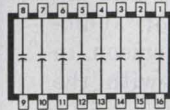

Monolithic[®] construction . . . alternate layers of ceramic dielectric material and metallic electrodes are fired into a solid homogenous block. 2, 4, 7, or 8 capacitor sections per package. Standard ratings, 18 pF to $0.1 \mu\text{F} @ 100\text{V}$. Capacitance tolerance, $\pm 20\%$. Write for Bulletin 6242 or circle 152 on reader service card.

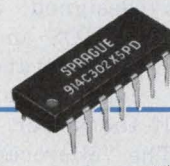

**DIP
TANTALUM/CERAMIC
CAPACITOR ASSEMBLIES**

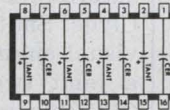

Solid tantalum and Monolithic[®] ceramic alternating isolated sections. Choice of 4 or 8 sections per package. Standard tantalum ratings, $6.8 \mu\text{F} @ 35\text{V}$, $15 \mu\text{F} @ 20\text{V}$, $22 \mu\text{F} @ 15\text{V}$, $33 \mu\text{F} @ 10\text{V}$. Ceramic ratings .01, .047, $.1 \mu\text{F} @ 100\text{V}$. Cap. tol., $\pm 20\%$. Write for Engineering Bulletin 6642 or circle 153 on reader service card.

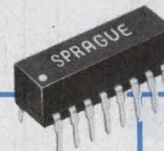

**DIP
RESISTOR/CAPACITOR
NETWORKS**

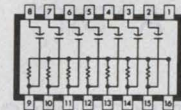

(1 of 3 designs)

Metanet[®] metal-film resistors and Monolithic[®] ceramic capacitors in bypassed pull-up, R-C coupling, speed-up, and active terminator networks. Resistor ratings, 100 to 6800Ω with 125 mW power dissipation. Capacitor ratings, 100 pF to $.01 \mu\text{F} @ 100\text{V}$. Write for Engineering Bulletin 6612 or circle 154 on reader service card.

**DIP
MULTIPLE
METAL-FILM RESISTORS**

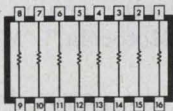

Noble metal film resistors encased in protective glass. Choice of 7 or 8 resistors per 14- or 16-pin package. Resistance values, 50Ω to $100,000 \Omega$. Power dissipation, 125 mW . Standard resistance tolerance, $\pm 5\%$. Operating temperature range, -55°C to $+70^\circ\text{C}$. Write for Bulletin 7042 or circle 155 on reader service card.

**DIP
PRECISION RESISTOR
NETWORKS**

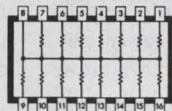

(1 of 5 designs)

Noble metal film resistors in pull-up, pull-down, interfacing, and terminating configurations, for applications requiring repetitive resistance patterns. 14- or 16-pins. Up to 28 resistors per package. Individual resistors from 50 to $100,000 \Omega$. Dissipation, 125 mW . Write for Bulletin 7042 or circle 156 on reader service card.

**DIP
MULTIPLE
PULSE TRANSFORMERS**

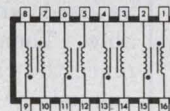

(1 of 2 designs)

Four transformers in 16-pin package. All cores have exclusive protective coating. Inductance values from 10 to $1000 \mu\text{H}$. ET product values of $5 \text{ volt-}\mu\text{sec}$. Choice of four turns ratios . . . 1:1, 2:1, 3:1, 4:1. Operating temperature range, 0°C to $+70^\circ\text{C}$. Write for Engineering Bulletin 40400 or circle 157 on reader service card.

**DIP
TAPPED
DELAY LINES**

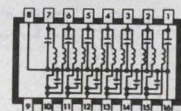

Lumped constant delay lines . . . ideal for timing and pulse synchronization circuits. 14- or 16-pin packages with delays of 50, 100, or 150 nanoseconds at a characteristic impedance of 100Ω . Working voltage, 50 VDC . Operating temperature range, 0°C to $+70^\circ\text{C}$. Write for Bulletin 45004 or circle 158 on reader service card.

Popular Types Now Available OFF-THE-SHELF From Your Sprague Industrial Distributor.

For complete technical data, write for any of the above-mentioned Engineering Bulletins to: Technical Literature Service, Sprague Electric Company, 347 Marshall Street, North Adams, Mass. 01247.

THE BROAD-LINE PRODUCER OF ELECTRONIC PARTS





RCL
HAS THEM ALL!

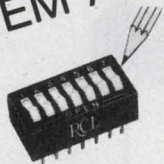

FROM A "PIP"
OF A "DIP"
TO
INDUSTRY'S
LARGEST
SELECTION
OF
**MINIATURE
ROTARY
SWITCHES**

2-24 POSITIONS
1-24 DECKS

*Others Promise
RCL Delivers!*

Call Our Hotline For Name Of
Your Local Representative Or
Stocking Distributor.

(201) 374-3311

AMF

RCL Electronics

General Sales Office:
700 So. 21st Street
Irvington, N. J. 07111

NEWS

Portable color TV camera's size, power drain halved

A new hand-held color-TV camera designed around standard CMOS, MOS and bipolar chips is half the size and weight of similar cameras—and draws about half the power.

The "Microcam" was developed by Renville H. McMann, Jr., now president of Thomson-CSF Laboratories, Stamford, CT, and by Clyde Smith, director of audio-visual engineering at Thomson, in a joint two-year effort with the CBS television network.

The Microcam consists of an 8-lb. optical head and a 3-lb. hip pack (see photo) that contains most of the electronic circuitry. The head, which has the lens system and three 2/3-in. Plumbicon color-camera tubes with a prism beam splitter, has only the deflection circuitry and video preamplifiers for the Plumbicon.

"The reason we partitioned the electronics between the head and the hip pack, was so charge-coupled photo devices with better performance and reliability could be used when they become available. Then you could simply replace the camera head with a new one using the CCDs. The hip-pack electronics will remain intact," says McMann.

"We're using RCA's digital CMOS to memorize control functions in the camera as well as to reduce power drain," he adds. "These control functions are stored in CMOS latches and are fed to CMOS d/a converters to generate control voltages.

"The CMOS remembers control functions such as video gain and color balance between the red, blue and green channels. Once these controls are adjusted they are controlled automatically."

A small nickel-cadmium battery is incorporated into the electronics pack so that if the camera is disconnected from its main bat-



Use of standard ICs helped reduce the Microcam color TV camera to half the size and weight of competing units.

tery supply the CMOS memory retains the control settings.

"For the camera sync generator, National Semiconductor MOS devices are used, and for the 3.58-MHz color-signal-encoder circuitry we use bipolar analog multipliers from Motorola," McMann says.

Minimizing the power drain of the camera was a prime objective because the weight of two cameras is the same, when one camera draws twice as much power as the other, the operator also has to carry twice the weight in batteries. The Microcam uses 2.5 lb. of nickel-cadmium batteries for an hour's operation.

The camera uses a switching-type power supply with a constant frequency and a variable-width duty cycle. It has an exceptionally high efficiency of 92% over an input range of 10.4 to 20 V.

The camera output is fed through a 75-ohm cable to a color monitor, a portable tape recorder or a microwave backpack transmitter. ■■

You do enough hard work already, don't you? Besides, you're covered. Plessey Semiconductors manufactures the best IC's for the radar OEM: the new SL550, low noise wideband amplifier with external gain control; the new SL541C, high-speed video amplifier; the new SL1521, second-generation replacement for the widely accepted SL521—both are limiting amplifiers incorporating low level video detection; and the SL530, monolithic true log IF/RF amplifiers. Most are available to Mil Spec temperature ranges.

There's a reason Plessey is the world leader in radar IC's: nobody else comes close in performance and quality. Take a look:

SL1521—Limiting Wideband Amplifier for 160 MHz Strips	
Voltage gain	11.5 min/12.5 max
Frequency range	10-300 MHz
Maximum rectified output at 120 MHz	0.95 min/1.05 max
Noise	3 dB

SL550—Low Noise Wideband Amplifier	
Wide Bandwidth	200 MHz
Low Noise	2.2 dB at 100 MHz
Gain Control Range	25 dB
Gain	40 dB
Output Voltage	0.5 V r.m.s.

SL541C—High-Speed Video Amplifier	
High Slew Rate	175 V/ μ s
Fast Settling Time	1% in 50 ns
Open Loop Gain	70 dB
Wide Bandwidth	DC to 100 MHz at 20 dB Gain
Very Low Thermal Drift	0.02 dB/ $^{\circ}$ C Temperature Coefficient of Gain

Now, maybe you have slightly more than a normal amount of healthy scientific curiosity.

O.K. We're ready for you. Write or give us a call, and we'll quickly send you all the supporting evidence. Read and believe.



PLESSEY SEMICONDUCTORS

1674 McCaw Avenue, Santa Ana, California 92705, Tel: (714) 540-9979, TWX: 910-595-1930; Cheney Manor, Swindon Wiltshire, England, Tel: (0793) 6251, Telex: 449637; West Germany, Tel: 811 3516021, Telex: 5215322; France, Tel: 727-4349, Telex: 62789; Italy, Tel: 3491741, Telex: 33245; Sweden, Tel: (08) 23 55 40, Telex: 10558.

CIRCLE NUMBER 23

If you're in radar, let Plessey take the work out of your IF design.

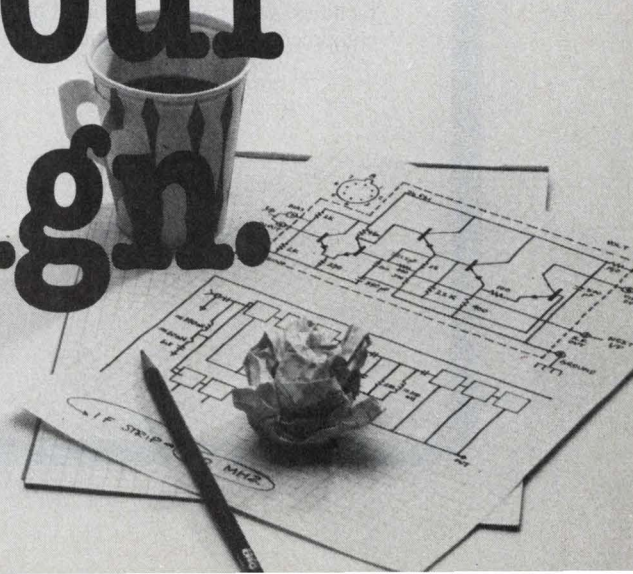

*Four basic
ways to handle 100%
of your resistor
network needs.*

If resistor networks aren't already in your life, they should be.

Why? Because in many cases they offer very significant cost savings over using discretes. Networks are less expensive, in overall use, because they cut assembly time, save a lot of precious board "real estate," and significantly reduce procurement, inventory, and quality control costs.

Why should you look to Beckman? Well, not just because we pioneered DIP resistor network packaging and have become one of the world leaders in making resistor networks, but also because our huge, modern facilities, with highly automated network manufacturing equipment, assure you of uniform, reliable high quality

thick- or new thin-film Dual In-line Packages (DIPs), thick-film Single In-line Packages (SIPs) — including new 6- and 10-pin types — flatpacks, and customs.

And also because we offer hundreds of standard networks available fast through local Beckman distributors — off-the-shelf and in volume.

Our four ways-to-go — DIPs, SIPs, flatpacks, and customs — mean a dependable, one-source answer for all your resistor network needs.

On the next page is a small sampling of our standard RESNET™ line, representing hundreds of available models. Look into it, and we think you'll find that the great age of the discrete resistor — with only rare exceptions — is about past.

Beckman®

HELIPOT DIVISION

Here are some typical examples of our extensive RESNET line. Many additional network types are also available. (All resistance values are in ohms; DIP/SIP prices are based on 1,000-piece quantity, flatpacks on 500-piece quantity.)

(1) DIP RESISTOR NETWORKS

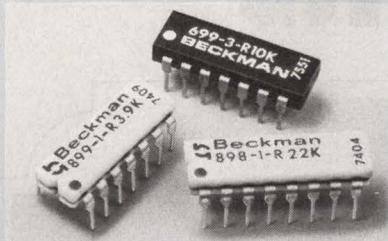

Thick-Film Series 899/898

- 14-pin (899) and 16-pin (898) configurations
- Automatic-insertion compatible
- Thick-film reliability and performance
- $\pm 2\%$ (or ± 2 ohms) resistance tolerance
- 0.15W (898/899-1, -5) or 0.250W (898/899-3) resistor power rating (+25°C)

899-1
13 resistors
Price: \$.61

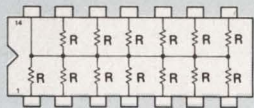

899-3
7 resistors
Price: \$.59

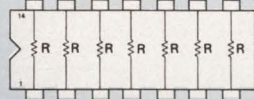

Series 899 Stock Resistance Values

22	110	510	2.7K	12K
24	120	560	3K	13K
27	130	620	3.3K	15K
30	150	680	3.6K	16K
33	160	750	3.9K	18K
36	180	820	4.3K	20K
39	200	910	4.7K	22K
43	220	1K	5.1K	33K
47	240	1.1K	5.6K	47K
51	270	1.2K	6K	68K
56	300	1.3K	6.2K	100K
62	330	1.5K	6.8K	150K
68	360	1.6K	7.5K	220K
75	390	1.8K	8.2K	330K*
82	430	2K	9.1K	470K*
91	470	2.2K	10K	
100	500†	2.4K	11K	

†899-1 only * 899-3 only
Similar values available for Series 898-1 and 898-3

899-5 Line Terminators
Price \$1.12

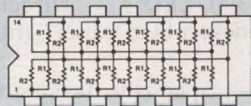

Series 899/898-5

Stock Resistance Values (R_1/R_2):
180/390 220/330 330/470
220/270 330/390

New Thin-Film Series 699 If your design factors call for even closer tolerances than those offered by our thick-film networks, consider our thin-film DIPs.

- 50 ppm/°C tempco
- 0.5% stability/1,000 hrs.
- Negligible voltage coefficient
- < -50 dB noise

Schematically, our thin-films are identical with Model 899-3. Stock resistance values are: 100, 200, 500, 1K, 2K, 5K, 10K, 20K, 50K and 100K.

(2) SIP RESISTOR NETWORKS

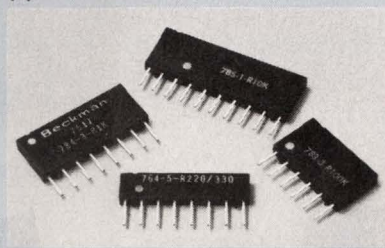

High-Power Series 783/784/785

- 8-pin and new 6- and 10-pin configurations
- Automatic insertion compatible
- $\pm 2\%$ (or ± 2 ohms) resistance tolerance
- 0.17W to 0.5W resistor power rating (+25°C)

785-1
9 resistors
Price: \$.42

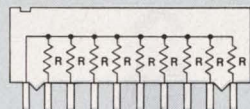

784-3
4 resistors
Price: \$.37

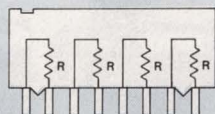

Series 783/784/785-1

Stock Resistance Values

100	470	1.5K	4.7K	18K	82K
33	120	500	1.8K	5.6K	22K
39	150	510	2K	6K	27K
47	180	560	2.2K	6.8K	33K
50	220	680	2.7K	8.2K	39K
56	270	820	3K	10K	47K
68	330	1K	3.3K	12K	56K
82	390	1.2K	3.9K	15K	68K

Series 783/784/785-3

Stock Resistance Values

22	120	680	15K
33	150	1K	22K
39	180	1.5K	33K
47	220	2.2K	47K
50	270	3.3K	68K
56	330	4.7K	100K
68	390	6.8K	
100	470	10K	

783-5
Line Terminators
6 pins, 8 resistors
Price: \$.51

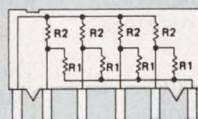

Series 783/784/785-5

Stock Resistance Values (R_1/R_2)
81/130 162/260 220/330
121/195 180/390 330/390
330/470

Low-Profile Series 764

- 8-pin low-profile package — 0.200" max. height
- Automatic insertion compatible
- $\pm 2\%$ (or ± 2 ohms) resistance tolerance
- 0.180W (764-1), 0.200W (764-3), 0.125W (764-5) resistor power rating (+25°C)

Resistor network configurations and stock resistance values identical to Series 784-1, -3 and -5.

(3) FLATPACKS

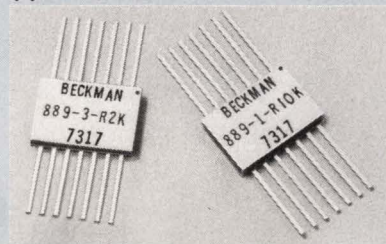

Series 889

- Lowest profile (0.065" max.) for critical board height and multilayer applications
- $\pm 2\%$ (or ± 2 ohms) resistance tolerance
- 0.6W package power rating
- 0.150W (889-1), 0.250W (889-3) resistor power rating (+25°C)

889-1 13 resistors
Price \$5.40

889-3 7 resistors
Price: \$5.40

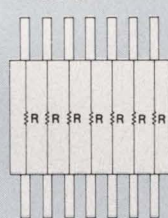
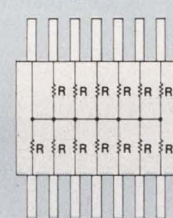

Series 889 Stock Resistance Values
1K 2K 3.3K 4.7K 10K

(4) CUSTOM NETWORKS

Need something special? We can build practically any kind of network you require . . . fast.

Our large staff of applications/design specialists — all heavy in experience — can mix resistance values on the same substrate. Or give you capacitor networks, or diode networks, or resistor/capacitor or resistor/diode combinations. Even shorting bars.

You see, we're not just a leader in standards, we're also a front-runner in custom specials. So, ask us. You'll like the answer.

To order, or for more information and free evaluation samples, call your nearest Beckman Helipot distributor. Or phone (714) 871-4848, Ext. 1776.

LED Super-Brights

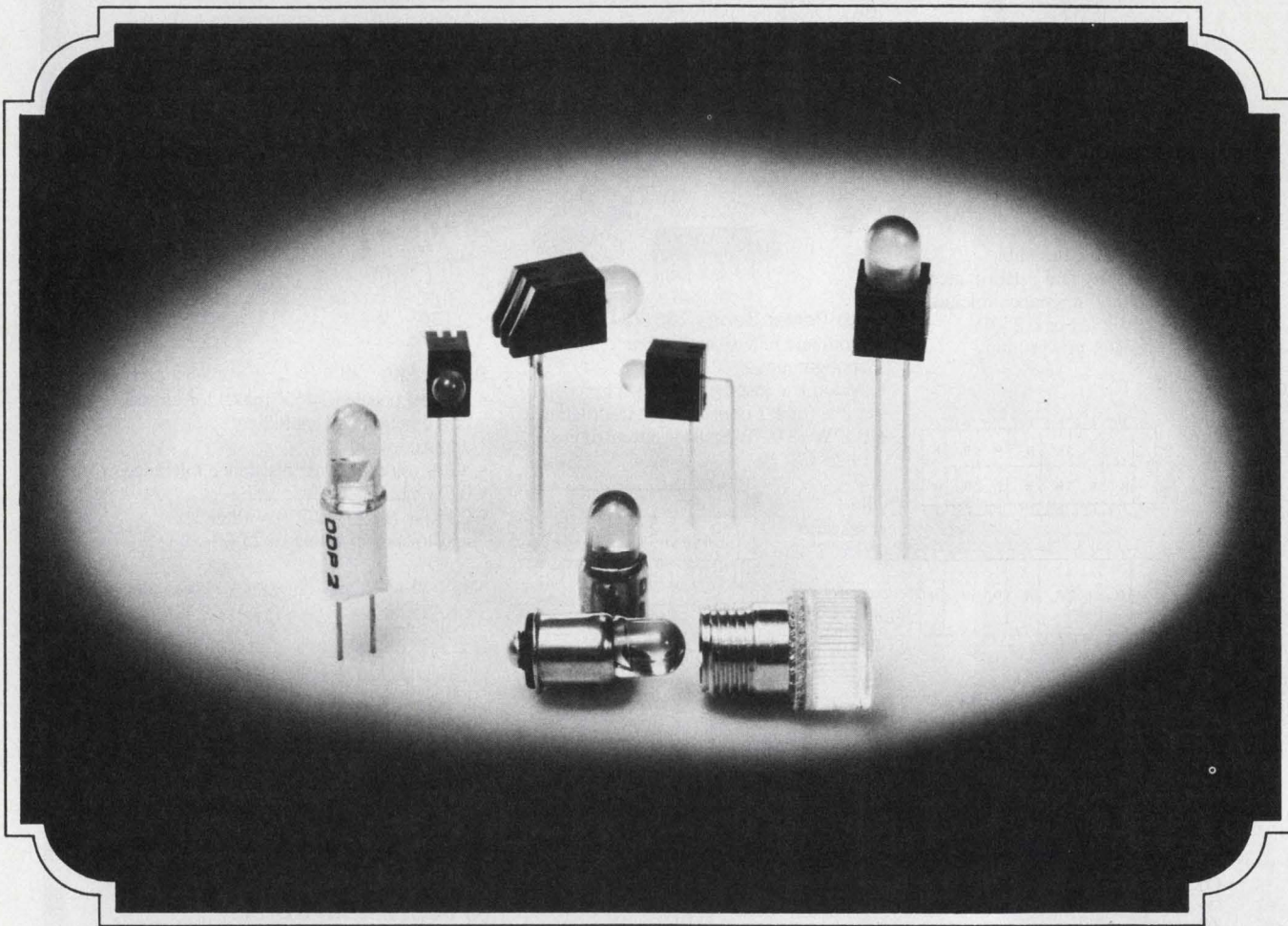

Ideal replacements for incandescents!

Here come the LED Super-Brights . . . red, amber and green. Their high brightness (50 MCD @ 20mA — typical clear red) make them **the** perfect cost and power saving replacements for incandescents. Available with built-in resistors for all popular voltage ranges.

PCB LED's — Horizontal or vertical viewing . . . optional built-in resistor for 5V applications.

Bi-Pin (T1-3/4) LED's — Ideal for dead front panel applications, e.g. DEC's PDP Series computers.

Midget-Flanged (T1-3/4) LED's — Direct replacements for incandescents in panel light and switch applications.

Replacement Lenses — Specially designed for use with Midget-Flanged LED's.

There's lots more too, Send for our Catalog today: Data Display Products, 5428 W. 104th Street, Los Angeles, Ca. 90045, (213) 641-1232.

We're the original "little light" people.

DATA DISPLAY PRODUCTS

Washington Report

Defense R&D chief warns of Soviet technology gains

In his plea for full approval of the Defense Dept.'s \$10.9-billion research, development, test and evaluation budget for fiscal year 1977, Dr. Malcom R. Currie, director of Defense Research and Engineering, is buttressing his arguments with some sobering assessments of Soviet progress in military weaponry.

Unless the US takes action, he says, the Soviets could achieve dominance in deployed military technology in the 1980s.

Although the US is generally ahead at the moment, Dr. Currie says the U.S.S.R. has developed two new classes of satellites for ocean surveillance, possibly for target information to be used by missile carrying ships or attack submarines.

"One of these (satellite) systems uses active radar," Dr. Currie reports. "We have no similar system."

He is also advising Congress that the Soviets have an integrated command-and-control system and an electronic warfare system not matched in the US and certainly not in NATO.

The reason the Soviets are behind the US at all, Currie says, is because they were late in understanding the significance of IC technology and computers, a failure they are trying to remedy by importing technology from the west. The Soviets, he notes, have surpassed the US in the area of hf radio-wave propagation.

Rumsfeld gets good reviews from Pentagon

The Pentagon's apprehension about Donald H. Rumsfeld's being named Secretary of Defense is rapidly fading, particularly after his performances before the armed services committees on the Hill.

Anticipating a Congressional fight to cut the administration's proposed defense budget—possibly by as much as \$5 billion—the services were worried about their new chief's ability to slug it out with such groups as the Senate's powerful Budget Committee.

But, thus far, Rumsfeld has fielded questions crisply and confidently. His replies are also detailed, showing he's done his homework and has a sound grasp of the facts.

Are uhf, vhf and FM radios a hazard to your health?

During the next two years the Environmental Protection Agency will be checking the intensity of broadcast radiation from uhf and vhf television transmitters, and FM radio transmitters, in major American cities.

The EPA uses a special van, manned by a three-man crew, to find out how much electromagnetic radiation is present in populated areas and whether it constitutes a health hazard. From 14 to 18 locations will be surveyed in each city. The data will go into a small computer in the van, where it will be correlated with medical data. The result will be used to determine whether environmental criteria are required to control those nonionizing, radiation sources.

More competition, fewer specs for contractors

If Congress goes along with the comprehensive government procurement policy proposed by the Office of Management and Budget, you can look for some significant changes in the way major weapon systems are developed, and the way Congress, the Secretary of Defense, military departments and government contractors operate.

According to Sen. Lawton Chiles (D-FL), chairman of the Senate subcommittee on Federal spending practices, efficiency and open government, the new policies "will go to the heart of cost overruns, contractor bailouts and poor performance results in defense weapon programs."

Among the changes called for in the OMB proposal are:

- More extended competition between contractors up through system demonstration;
- Elimination of specifications so detailed as to stifle innovative technology;
- A clear, early Defense Secretary-level decision on the roles and missions of the military departments with regard to specific weapons.

Chiles predicts that Congress will adopt the new policy without major changes. The executive agencies, he says, are lukewarm to the proposal.

Labor decries loss of jobs because of imports

Although Government statistics point to improvement in the unemployment rate, organized labor is continuing to press for revision of the Trade Act of 1974. Paul Jennings, president of the International Union of Electrical, Radio and Machine Workers (AFL-CIO), says that the act has failed to halt the loss of jobs in the electrical and electronics industries caused by imports.

Jennings told the Senate Finance Committee that the act enables more than 100 underdeveloped countries and territories to export products duty free to the US. Specifically mentioned were television sets and electronic components.

Capital Capsules: The Air Force's Avionics Lab is seeking interested parties to perform field experiments to quantify the radar parameters associated with snow on the ground. The electromagnetic characteristics of interest are backscatter, attenuation per foot, phase distortion (as a function of frequency), polarization incident. . . . The Navy's Training Equipment Center in Orlando, FL, is sounding out firms with a capability to design and develop an advanced multiband SAM radar system. . . . The National Bureau of Standards has issued a user's guide to its new Synchrotron Ultraviolet Radiation Facility (SURF II). NBS scientists say extreme ultraviolet radiation, such as produced by SURF, has possible applications in the fabrication of miniaturized electronic circuits and lasers.

Get Tektronix TM 500 versatility in a counter/DMM combo

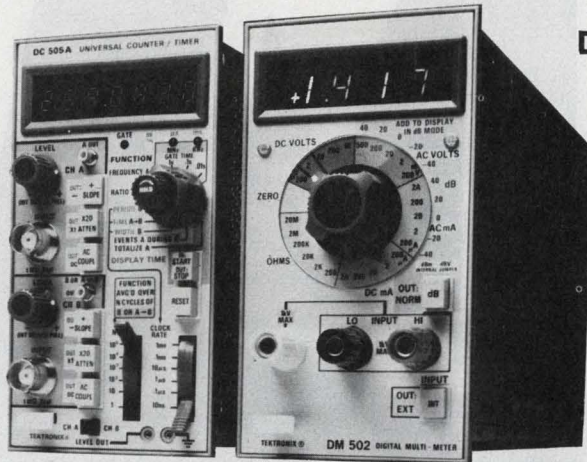

**DC 505A / DM 502
for only \$1900**

When you plug in a TEKTRONIX DC 505A Universal Counter alongside a DM 502 Digital Multimeter, you get more than a 225 MHz counter and a full-function DMM. The TM 500 Mainframes that receive these plug-in modular instruments feature a common interface

circuit board, allowing the instruments to work together and with other instrumentation. For example, with the interface connections set up, you can read counter trigger level on the DMM at the touch of the INT (internal) pushbutton. Touch INT again, and you have separate and simultaneous universal counter and DMM capability. Among other examples: A TM 500 counter/DMM combo can work with the TEKTRONIX 31/53 Programmable Calculators for applications such as obtaining data from mechanical measurements.

The 10 nanosecond clock rate of the DC 505A Universal Counter (\$1395) means you get single shot resolution to 10 nanoseconds in period or time interval measurements . . . and resolution to 100 picoseconds on repetitive events when you set the averaging to 10^5 cycles. A single function switch selects FREQUENCY (channel) A, PERIOD (channel) B, RATIO A/B, TIME A>B, WIDTH B, EVENTS A DURING B, and TOTALIZE A. Flip the slide switch on the front panel to CH A or CH B to read channel A or B trigger level on an adjacent TM 500 digital multimeter connected through the rear plug-in interfacing, or on other instruments, such as an oscilloscope, through the tip jacks on the front panel. The DM 502 Option 2 Digital Multimeter (\$325) measures ac and dc voltage and current, dBm, dBV, and resistance. Temperature (\$125 more) can be read in °F and °C. A single front panel switch selects all ranges. A pushbutton called dB provides dB readout of ac functions in lieu of ac voltage or current, and the INT pushbutton selects the input available at the rear plug-in interface (trigger level from an adjacent DC 505A counter or any other voltage routed to that point). But the DM 502 is even more versatile: Internal jumpers provide readout in dBm or dBV and FET input $> 1000 \text{ M}\Omega$ or $10 \text{ M}\Omega$ input on the two lowest dc voltage ranges. And the temperature probe lets you check for abnormally operating components in tightly packed circuitry.

The TM 500 Product Line includes mainframes with 1, 3, 4, 5, and 6 compartments. Plug the DC 505A and DM 502 into a TM 504, 4-compartment mainframe (\$180) for the equivalent of a monolithic instrument offering exceptional capabilities . . . the DC 505A/DM 502 Combo \$1900. Utilize the additional compartments for later expansion, selecting from the total TM 500 line of more than 30 plug-in instruments including signal sources, power supplies, oscilloscopes, and more.

Contact your local Tektronix Field Engineer for a DC 505A / DM 502 demonstration, or write Tektronix for the TM 500 Catalog containing full specifications and applications discussions.

Write to Tektronix, Inc., P.O. Box 500, Beaverton, Oregon 97077. In Europe write Tektronix Limited, P.O. Box 36, St. Peter Port, Guernsey, Channel Islands.



TEKTRONIX®

committed to
technical excellence

FOR TECHNICAL DATA CIRCLE #281
FOR DEMONSTRATION CIRCLE #282

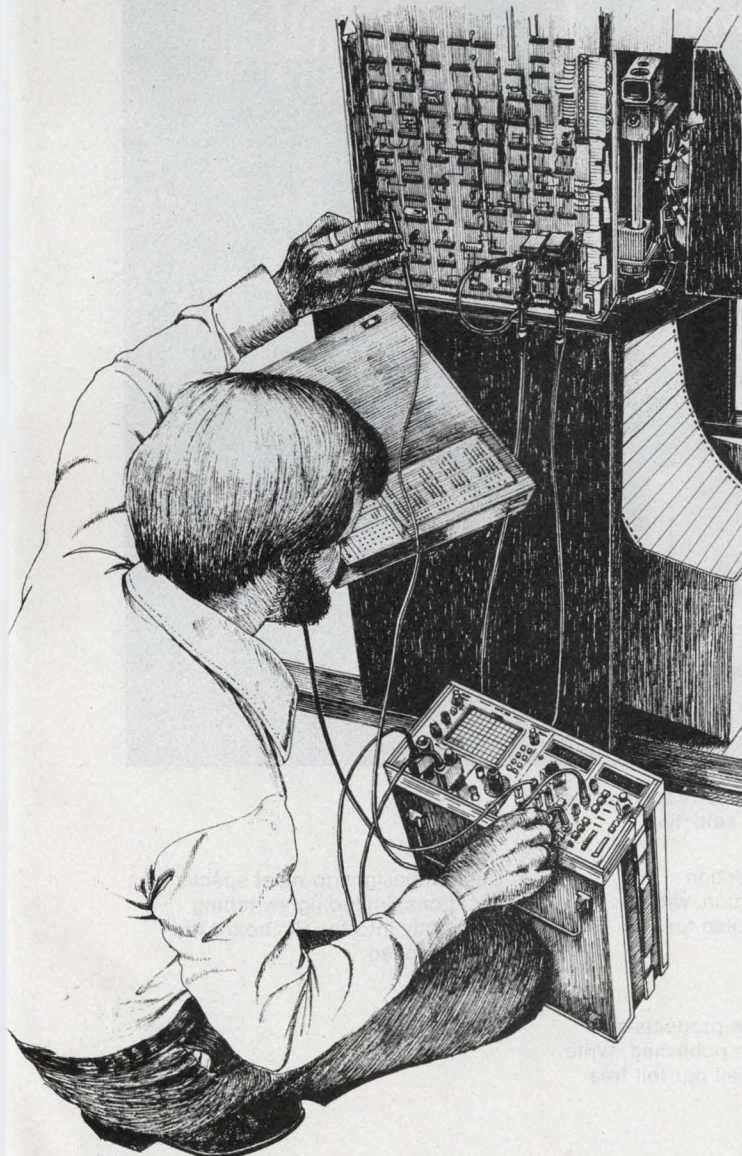

OAK

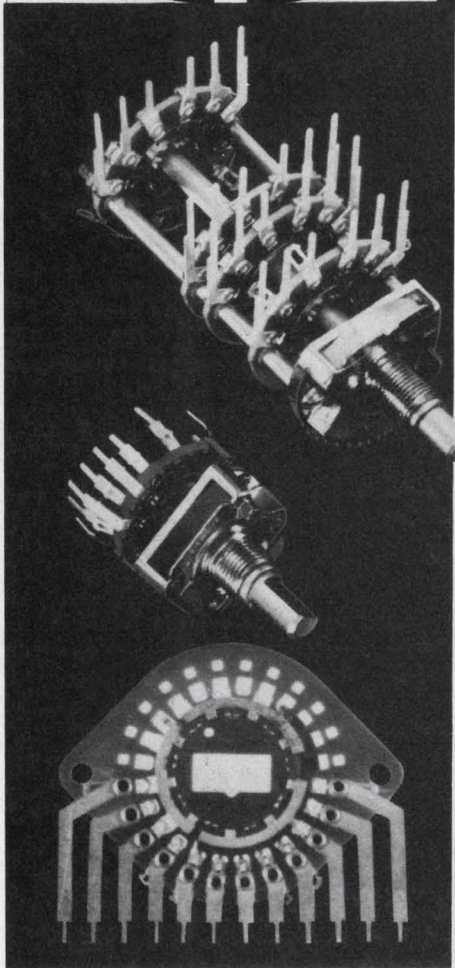

Headquarters
for every kind of
printed circuit
rotary switch

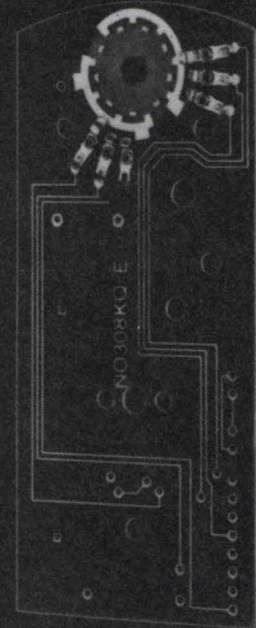
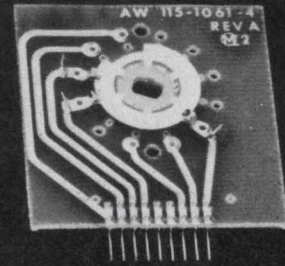
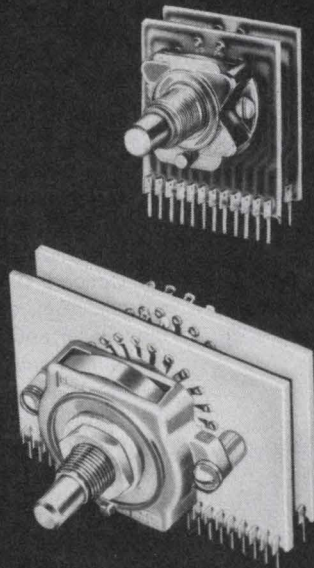

Simplify your equipment design and reduce assembly costs with this broad selection.

1. PCB Terminations can be provided on any conventional Oak rotary switch—the most extensive line in the industry—($\frac{1}{2}$ " to $2\frac{5}{8}$ " diameter sections).

2. Standard PC Board section switches, 12 and 24 position, with PCB terminations are tooled for volume production.

3. Custom designs to meet special applications, including switching built directly into the PC board are readily supplied.

A NEW CATALOG

Detailing Oak PCB switch products and capabilities has just been published. Write for your free copy... or call our toll free number: 800-435-6106.

OAK Industries Inc.

SWITCH DIVISION / CRYSTAL LAKE, ILLINOIS 60014

TELEPHONE: 815-459-5000 ■ TWX: 910-634-3353 ■ TELEX: 72-2447

CIRCLE NUMBER 27

Look what you get when Tektronix builds a 50 MHz portable

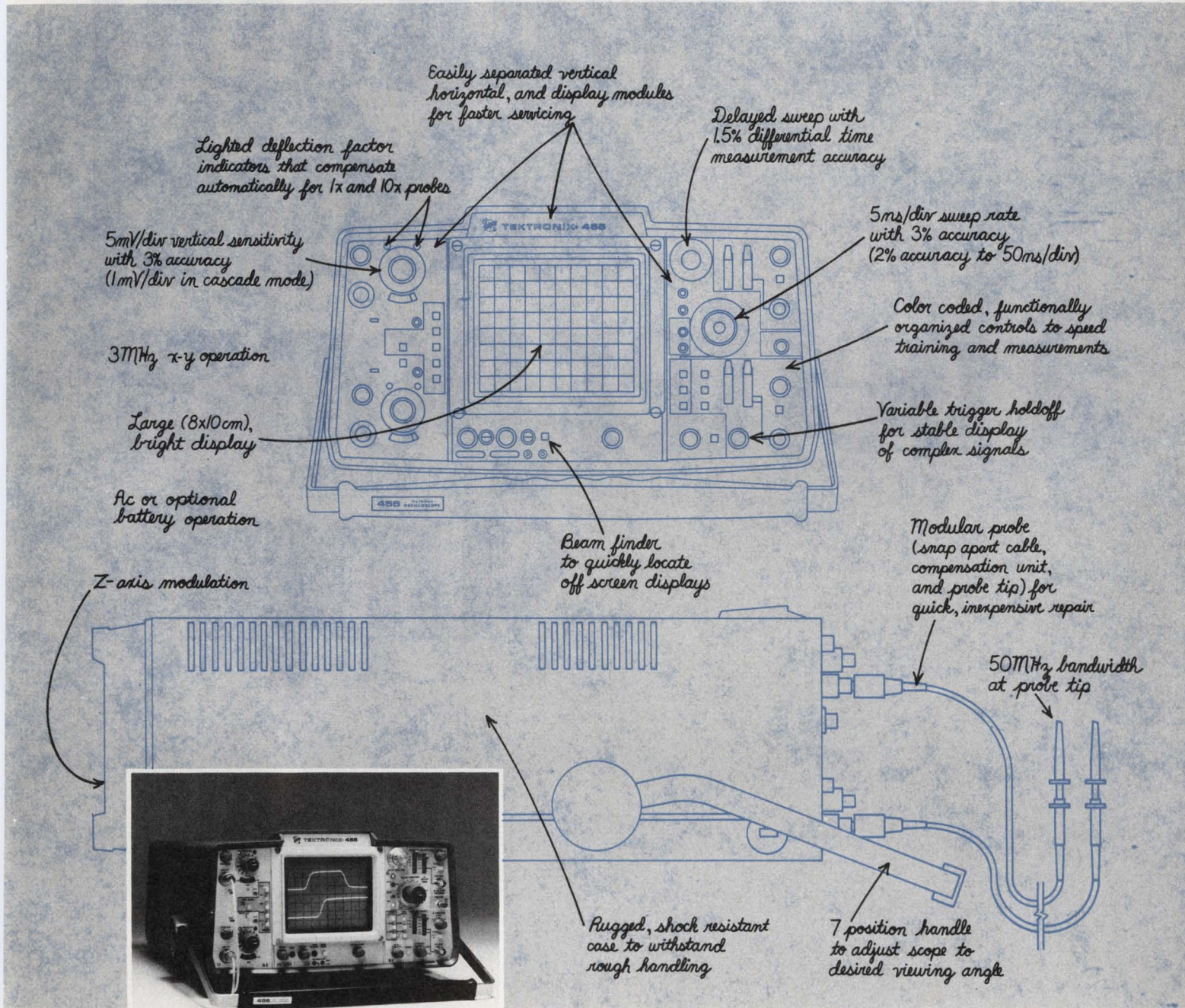

TEKTRONIX 455 — \$1695

And the 455 offers the quality, reliability, and service you expect from Tektronix.

If your application requires higher bandwidth and/or storage, the high performance TEKTRONIX 400 Series offers 6 other outstanding portable oscilloscopes. Bandwidths include 100 MHz, 200 MHz, and 350 MHz. Also offered are a fast transfer storage model capable of displaying single-shot, 100 MHz signals and a split screen, bistable storage model.

For a no obligation demonstration of how the 455 and other TEKTRONIX Portable Oscilloscopes deliver performance, convenience, and cost effectiveness for your

application, contact your Tektronix, Field Engineer. Or for complete information write: Tektronix, Inc., P.O. Box 500, Beaverton, Oregon 97077. In Europe write: Tektronix Limited, P.O. Box 36, St. Peter Port, Guernsey, Channel Islands.



TEKTRONIX®

committed to
technical excellence

U.S. Sales Prices FOB Beaverton, Oregon

FOR TECHNICAL DATA CIRCLE #245

FOR DEMONSTRATION CIRCLE #246

**We want you
to build
a better power
supply.**



Introducing Unitrode's new high-efficiency power rectifiers.

If you're building switching power supplies, chances are you've had problems with efficiency, voltage or temperature. That's why we came up with our new line of low-cost industrial power rectifiers.

Now you can enjoy advantages like —

Higher efficiencies. Made possible by a very low forward voltage drop (typically .7 volts under maximum operating conditions) and extremely fast recovery times (forward: typically 15ns, reverse: typically 30ns).

Ratings that are second to none. 25 amps in a DO-4, 30 amps in a TO-3, and 70 amps in a DO-5. All three products are available to 150 volts.

Low thermal resistance. Less than 1.5°C per watt for our DO-4, .8°C per watt for our TO-3, and only .6°C per watt for our DO-5.

High junction temperature. Maximum temperature of 175°C for greater system reliability.

Rugged mechanical construction. Designed to dramatically increase the useful life of your particular power supply.

What all these advantages add up to is a lower overall cost for your entire system.

Best of all, our industrial power rectifiers are competitively priced and are available in any volume you need. For complete specs, circle our number on the reader service card, or drop us a line. Unitrode Corporation, 580 Pleasant Street, Watertown, Massachusetts 02172.



UNITRODE

CIRCLE NUMBER 29

The EC series is ACDC's new line of power supplies designed for OEM applications. No bells and whistles, no fancy frills or extras. Just solid, reliable power supplies designed and built by ACDC Electronics... a name synonymous with quality.

The EC series is mechanically and electrically interchangeable in form, fit and function with other open frame power supplies that meet accepted industry standard. There are over 50 models to choose from in a wide range of voltages and currents so you can order the exact power supply for your application. Power supplies with a maximum of reliability at minimum cost.

**STOCK DELIVERY
2 YEAR GUARANTEE
18 WORLD-WIDE SERVICE CENTERS**



INTRODUCING THE EC SERIES - A NEW LINE OF LOW COST POWER SUPPLIES



SINGLE OUTPUT POWER SUPPLIES

Nominal Output Voltage	Max. Current (amps)	Model Number	Price		
			1	100	250
2 V.	3.0	EC2N3	\$ 31.00	\$ 24.95	\$ 22.95
	6.0	EC2N6	51.00	41.50	39.00
	9.5	EC2N9.5	63.00	51.00	48.50
	12.0	EC2N12	80.00	65.50	62.00
	17.0	EC2N17	101.00	82.00	78.00
25.0	EC2N25	137.00	112.00	106.00	
5 V.	3.0	EC5N3	31.00	24.95	22.95
	6.0	EC5N6	51.00	41.50	39.00
	9.5	EC5N9.5	63.00	51.00	48.50
	12.0	EC5N12	80.00	65.50	62.00
	17.0	EC5N17	101.00	82.00	78.00
25.0	EC5N25	137.00	112.00	106.00	
6 V.	2.6	EC6N2.6	31.00	24.95	22.95
	5.4	EC6N5.4	51.00	41.50	39.00
	8.5	EC6N8.5	63.00	51.00	48.50
	11.0	EC6N11	80.00	65.50	62.00
	15.0	EC6N15	101.00	82.00	78.00
23.0	EC6N23	137.00	112.00	106.00	
12 V.	2.2	EC12N2.2	31.00	24.95	22.95
	3.5	EC12N3.5	51.00	41.50	39.00
	6.0	EC12N6	63.00	51.00	48.50
	7.5	EC12N7.5	80.00	65.50	62.00
	10.0	EC12N10	101.00	82.00	78.00
16.0	EC12N16	137.00	112.00	106.00	
15 V.	1.8	EC15N1.8	31.00	24.95	22.95
	3.0	EC15N3	51.00	41.50	39.00
	5.0	EC15N5	63.00	51.00	48.50
	6.5	EC15N6.5	80.00	65.50	62.00
	9.5	EC15N9.5	101.00	82.00	78.00
14.0	EC15N14	137.00	112.00	106.00	
20 V.	1.5	EC20N1.5	31.00	24.95	22.95
	2.5	EC20N2.5	51.00	41.50	39.00
	4.2	EC20N4.2	63.00	51.00	48.50
	5.3	EC20N5.3	80.00	65.50	62.00
	8.0	EC20N8	101.00	82.00	78.00
11.0	EC20N11	137.00	112.00	106.00	

Nominal Output Voltage	Max. Current (amps)	Model Number	Price		
			1	100	250
24 V.	1.3	EC24N1.3	31.00	24.95	22.95
	2.4	EC24N2.4	51.00	41.50	39.00
	4.0	EC24N4	63.00	51.00	48.50
	5.0	EC24N5	80.00	65.50	62.00
	7.5	EC24N7.5	101.00	82.00	78.00
	10.0	EC24N10	137.00	112.00	106.00

DUAL OUTPUT POWER SUPPLIES

Nominal Output Voltage	Max. Current (amps)	Model Number	Price		
			1	100	250
±12/15	0.5	EC12D0.5	\$ 45.00	\$ 38.00	\$ 35.00
	1.5	EC12D1.5	69.00	57.00	53.00
±12/15	3.0	EC12D3	89.00	72.00	67.00
	3.0	EC15D3	89.00	72.00	67.00
±12	3.0	EC12D5	122.00	99.00	92.00
	5.0	EC12D5	122.00	99.00	92.00
±15	5.0	EC15D5	122.00	99.00	92.00

TRIPLE OUTPUT POWER SUPPLIES

Nominal Output Voltage	Max. Current (amps)	Model Number	Price		
			1	100	250
5V	6.0	ET401	\$113.00	\$ 92.00	\$ 85.00
	1.0	ET601	165.00	135.00	125.00
	12	ET602	165.00	135.00	125.00
±12	3				
	12				
5V	12				
	3				
±15	12				
	3				

OVERVOLTAGE PROTECTION OPTION

Rated output current of power supply	Price		
	1	100	250
0 to 12 Amps	\$ 8.00	\$ 7.50	\$ 6.50
12 to 25 Amps	12.00	10.50	10.00

acdc electronics
ACDC Electronics, 401 Jones Road, Oceanside, CA 92054 • West Coast (714) 757-1880; East Coast (201) 687-6633

Microprocessor Design

Second generation CMOS microprocessors rival performance of n or p-channel units

If you are thinking of using a CMOS μ P because of its low power dissipation, you may be hesitant because they're not as fast as the NMOS units and don't have a second source. Hesitate no more. RCA (Route 202, Somerville, NJ 08876. 201-722-3200) has developed its second-generation μ P, an 8-bit, single-chip design that's faster than RCA's original two-chip version (CDP1801), which was introduced over a year ago. The new CDP1802 will be alternate sourced by Intersil (10900 Tantau Ave., Cupertino, CA 95014. 408-257-5450), and a wide range of memory and I/O circuits to simplify microcomputer-system design will be introduced along with the 1802.

The new μ P comes in either a +5 or +15-V version, with execution times of 3.75 and 2.5 μ s, respectively. These high speeds are directly competitive with the n or p-channel microprocessors currently available. Fetch time

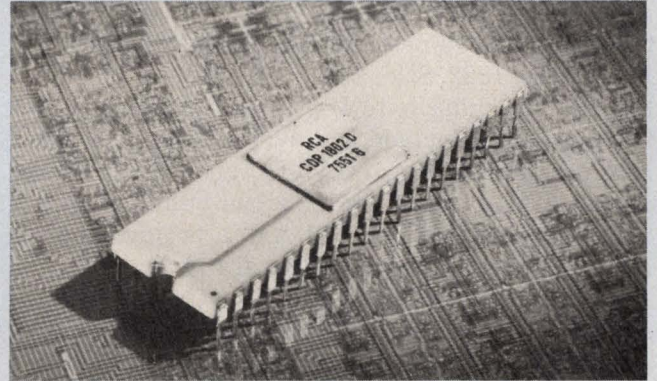

is 1.25 μ s and execute times are either one or two cycles of 1.25 μ s each.

You can update your present system if you're presently using the COSMAC 1801 μ P, because the 40-pin 1802 is completely software compatible with the 1801. Many new

(continued on page 48)

\$230 bipolar μ P kit sells for \$100

Signetics (811 E. Arques Ave., Sunnyvale, CA 94086. 408-739-7700) offers a bipolar microprocessor kit—valued at \$230—for \$100. The kit contains all the components needed to design a high-speed, 8-bit microcomputer or controller. The 12-chip kit is built around the company's N3001 microprogram-control unit (MCU) and the N3002 central-processing element (CPE). The N3002 features a pace-setting cycle time of 45 ns.

Each kit contains one N3001 MCU, four N3002 CPEs, one high-speed look-ahead carry generator, three 2-k PROMs (256 \times 24 bits), one 8-bit bi-directional I/O port, two quad bidirectional bus transceivers, and an introductory manual.

CIRCLE NO. 501

μ P interface gives printer users added flexibility

With a new programmable microprocessor interface, users of Centronics' family of printers gain the flexibility of remote and/or direct-connect operation. Because the unit is under firmware control, a wide variety of functions can be performed by a single hardware design. Only program changes are needed to change operating modes. Centronics (Hudson, NH 03051. 603-883-0111) offers the unit for \$1325. Delivery is 60 days.

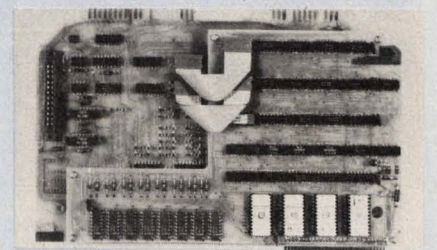

CIRCLE NO. 502

MICROPROCESSOR DESIGN

(continued from page 47)

instructions are also available with the 1802, though. Its increased speed is due to the use of self-aligned silicon-gate technology that permits faster, more compact circuits.

For orders of 100 or more, the full-voltage version, the CPD1802D, costs \$36.50, and the low voltage unit, the 1802CD, costs \$23.50.

Several memory and input/output circuits are also being introduced with the 1802. They are the mask-programmable CDP1831 and 1832, 512 × 8 ROMs; the 1824, 32 × 8 RAM; the 1821, silicon-on-sapphire 1024 × 1 static RAM; the 1822, SOS 256 × 4 RAM; and the 1852 latching byte I/O circuit. Devices soon to be released include a universal asynchronous receiver/transmitter (UART), a multiply/divide unit, a 3-bit latch/decoder, a bus buffer, a 128 × 8 RAM, a 256 × 4 RAM, a programmable bit I/O and an analog-to-digital converter.

The 1831 ROM interfaces directly with the μ P and in each memory cycle the ROM compares its address with the multiplexed address lines to determine whether or not to respond. If it does respond, it generates a signal that can disable the RAMs. This permits you to eliminate bank-switching circuits.

The other available ROM, the 1832, is

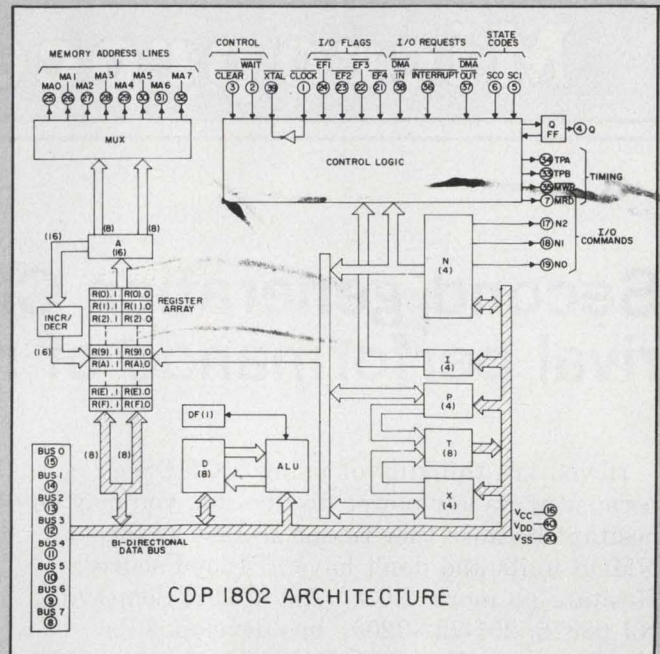

pin-compatible with the Intel 2704 PROM. All the other memory circuits are designed to operate directly with the μ P.

Prices for the RAMs and I/O circuits in 100-up quantities are \$21.25/\$24.45, \$28/\$32.25, \$9.50/\$10.50 and \$8.35/\$9.25, for the 1821, 1822, 1824 and 1852, for the CD and D versions, respectively. Prices for the ROMs depend upon the masking and the quantities ordered, but are said to be industry-competitive.

μ C development systems also prepares program PROMs

A self-contained, general-purpose microcomputer system is designed for 8080A program development. The system, called PDA-80 and developed by NEC Microcomputers (Five Militia

Dr., Lexington, MA 02173. 617-862-6410), requires only an interactive terminal to make it a powerful aid for developers and designers of microcomputer

(continued on page 50)

Now...Mike 3!

\$149
CPU Board

The **MIKE 3** is a good example of the flexibility of the **modular micro** approach. An optimal small system — yet fully expandable. A three-board version, the AT813, includes the Model 471 CPU board (with 8080A); memory board with 8080 Monitor PROM, 512 bytes RAM (expandable to 2K PROM, 1K RAM); console board with keyboard, six LED digits; connectors; and Manual . . . only \$395. (Manual alone, \$35.) Priced at \$149. in quantities of one, with 8080A, the 471 CPU features:

- 3 interrupt levels (8-level priority interrupt board optional)
- Automatic hardware exit from masked interrupt after set interval
- Controls for one DMA channel (8-level prioritized DMA control optional)
- Power bus drivers for system expansion
- 8080, 6800, 8008 I/O address modes

martin research
3336 Commercial Ave.
Northbrook, IL 60062 (312) 498-5060

Yes, your installation costs can go down... while data integrity goes up. That's because the MICROMUX remote transmitter converts analog signals to frequency-coded, time multiplexed digital data... near the source. This greatly reduces problems of line loss and noise interference. Built in safeguards eliminate common-mode noise and detect open sensor or transmitter/receiver lines. You get accurate, reliable information at the MICROMUX receiver for computer input.

How do you save? MICROMUX cuts wiring needs by 94%. Each remote transmitter is housed in a NEMA 4 case and transmits up to 16 channels of data over a single wire pair—at distances to 5,000 feet. You can connect from one to four remote units on a single receiver for 16 to 64 channels.

And with additional receivers MICROMUX can be further expanded to 512 channels on one computer communication interface.

Calculate the wire savings MICROMUX would provide in your plant. It could easily be more than the \$2,790 MICROMUX price.*

We have other data acquisition systems too. Our SDM850 module family lets you custom build your own 8- to 256-channel multiplexed system. And our analog I/O systems interface popular microcomputers to the analog world. A host of other amplifier and converter products provide building blocks for whatever data-acquisition system you have in mind. Get all the details on MICROMUX and on our other systems and modules, contact Burr-Brown, International Airport Industrial Park, Tucson, Arizona 85734. Telephone (602) 294-1431.

**Price of one 16-channel transmitter and receiver.*



BURR-BROWN
BB

**Complete data
 acquisition
 solutions**

CIRCLE NUMBER 32

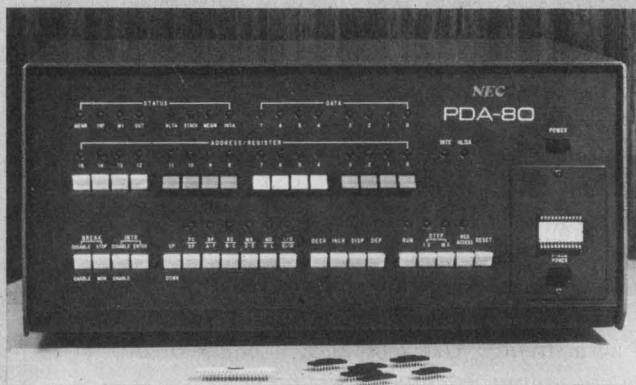

systems. The PDA-80 also supports a high-speed paper-tape reader/punch.

The system can erase and program NEC's electrically alterable PROM (μ PD454D), and its front-panel lights and switches give finger-tip control over emulation and debugging routines. The panel lets you single-step through any program, either by instruction or machine cycle, and to display and examine the contents of the seven internal registers in the processor, as well as the program counter, the stack pointer, or memory.

The internal registers displayed can be changed either by system software or the front panel. In addition, break points in the program loops can be inserted either through the terminal, or through the PDA-80 front panel.

The capability of the PDA-80 to electrically erase and program a PROM eliminates the need for a large inventory of blank PROMs and speeds up changes in programs already imbedded in PROM.

The Program Development Aid is not limited to teletypewriter terminals, but can accept an interactive device that operates at speeds from 110 to 1200 baud (10 to 120 characters per second). The console interface is speed selectable without software modification, and accepts either an EIA RS-232, or 20-mA current loop device.

The PDA-80 system includes a μ COM-8 central processing unit (μ PD8080A processor, 2-MHz clock, address drivers, input bus receiver, output bus driver and peripheral logic); up to 56-k bytes of RAM and up to 16-k bytes of PROM; baud rate selectable interface for terminals; and system software on punched paper tapes. The system comes in a cabinet that measures 18 x 11 x 9 in. and operates from 117 V, 50/60 Hz, although 100 and 230-V line inputs are available as options. The PDA-80 costs \$4095 and is available in 30 days. The μ P454D 256 x 8-bit electrically erasable PROM costs \$26 (100-up).

CIRCLE NO. 503

Wire-wrappable packaging assembly accepts 8080 and 8080A

A wire-wrappable packaging assembly for interfacing with Intel 8080 and 8080A microprocessors is offered by Garry Manufacturing (1010 Jersey Ave., New Brunswick, NJ 08902. 201-545-2424). The board fits the standard Intel processor rack, and it includes two I/O connectors to mate with external wiring. A UL-approved assembly, the Garry entry is available on 4-to-6 week delivery at prices ranging from \$1.50 to \$1.00 per chip-position.

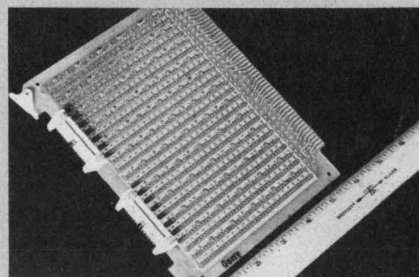

CIRCLE NO. 504

CPU-emulator simplifies development of 6800-based systems

The DICE/68 μ C-development aid provides users of Motorola's 6800 μ P and Exorciser system with the capability of in-circuit emulation. The new design/debug tool from Digital Electronics (2126 Sixth St., Berkeley, CA 94710. 415-548-2944) also includes such system-control features as status indicators for data and address busses.

The 40-pin DICE/68 adapter plugs directly into the 6800 μ P socket on your own hardware. By using the full range of diagnostic aids available through Motorola's Exbug operating

(continued on page 52)

Nobody ever made a 4K static RAM family. Until today.

Advanced Micro Devices
announces the Am9130 and
Am9140. They do things that
have never been done before.
Look at it this way:

There have always been a
lot of static RAM's. And 4K
RAM's. But there's never been
a 4K static RAM family.
Until today.

Look:

Fully static—no refresh required.
Single 5V power supply.
High speed: Access times to 200 nanoseconds
Two organizations for flexibility: Am9140-4K x 1
Am9130-1K x 4
All input and output logic levels identical to
TTL—full 400mV noise immunity.
Low power dissipation:
700mW maximum (½ power per bit)
350mW typ compared to 2102)

High output drive: 3.2mA @ 0.4V
Full military range available:
– 55°C to + 125°C ambient
DC standby mode reduces power dissipation
by 80%.
Memory status signal indicates when data are
valid, allows improved overall performance
and, simplifies timing (optional at no
extra cost).
MIL-STD-883, of course.

Like the picture? Send for the family album.

Advanced MOS/LSI

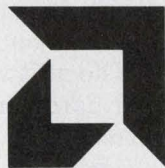

Advanced Micro Devices • 901 Thompson Place, Sunnyvale, California 94086 • Telephone (408) 732-2400 •
Distributed nationally by Hamilton/Avnet, Cramer and Schweber Electronics.

CIRCLE NUMBER 33

(continued from page 50)

system, you can debug a 6800-based prototype, complete with RAM, ROM, I/O circuitry and two-phase clock. Hardware debugging can begin immediately after a block memory has been allocated to the prototype system.

The DICE/68 CPU-emulation technique effectively extends the Exorciser system bus onto the prototype bus. Thus all user-memory and I/O interfaces on the prototype can be accessed readily through Exorciser software. No special interfaces or test devices are needed.

The DICE/68 system consists of two electronic assemblies, plus interconnecting flat cable and the 40-pin adaptor. One assembly is a PC card designed to plug directly into the Exorciser; this card connects through flat cable to a system-status console. Lights on the panel give visual indication of the status of address and data lines on the system bus. Controls on the console permit single stepping through the control program, and the initiation of an interrupt, system halt or a reset. Also, a microstep feature can be used to review the status of the system bus during all sub-cycles of a previously executed instruction.

The new development aid costs \$795. Delivery is stock to 4 wks.

CIRCLE NO. 505

Modularized microcomputer system permits high flexibility

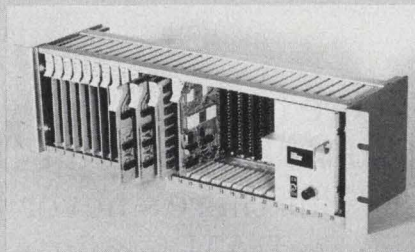

The μ P Series microcomputer system designed by Wyle Computer Products (3200 Magruder Blvd., Hampton, VA 23666. 804-838-0122) has major subsystems on individual logic cards. This gives the designer flexibility in configuring memory and I/O structure.

The μ P Series can interface to the Digital Equipment Corp. PDP-11, which allows the PDP-11 to exercise full control over the microprocessor address, control and I/O

busses. This feature along with a proprietary microprocessor on-line development system (MODS) and cross-assembler allows the user to completely develop and debug microcomputer software using the larger system. A RAM/ROM memory module is available for program development directly on the microcomputer system.

In addition to configuration as a stand-alone device, the μ P Series communications features permit the microcomputer system to function as a remote data acquisition or control device under the supervisory control of a host computer. Modules in the μ P Series include: an 8080A CPU; up to 64 k of RAM in 1 and 4-k increments; an analog I/O that includes an 8-channel, programmable-gain, 8- or 12-bit a/d converter, an 8-channel programmable-gain differential amplifier and an 8- or 12-bit differential d/a converter; and a digital I/O which offers a choice of an RS-232-C interface for remote serial communications, a general-purpose instrument bus per IEEE Standard 488-1975 or an 8-bit buffered I/O.

Also available are such features as priority interrupt, DMA, PDP-11 control interface, and PROM programmer. The μ P series CPU module costs \$170 and memory modules start at \$100 for a 1-k RAM. Other modules start at \$30.

CIRCLE NO. 506

μ P emulator directly replaces 8080 for debugging

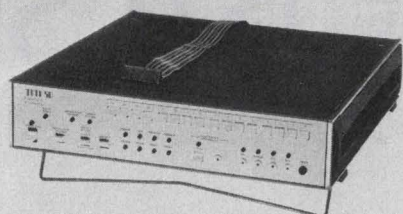

The MM80, an 8080 μ P emulator, can directly replace the μ P in a system. It allows you to examine, alter and control any 8080-based system. The Icebox, as the MM80 is called, plugs directly into the 8080 socket and requires no special design considerations.

The unit weighs 16 lb and can be expanded with software and hardware options, such as PROM programmers, memory expanders and custom software. The MM80

contains a ROM-resident one-pass assembler, is available from Ramtek Corp. (292 Commercial St., Sunnyvale, CA 94086. 408-735-8400) and costs \$3950.

CIRCLE NO. 507

VACTEC optoelectronics

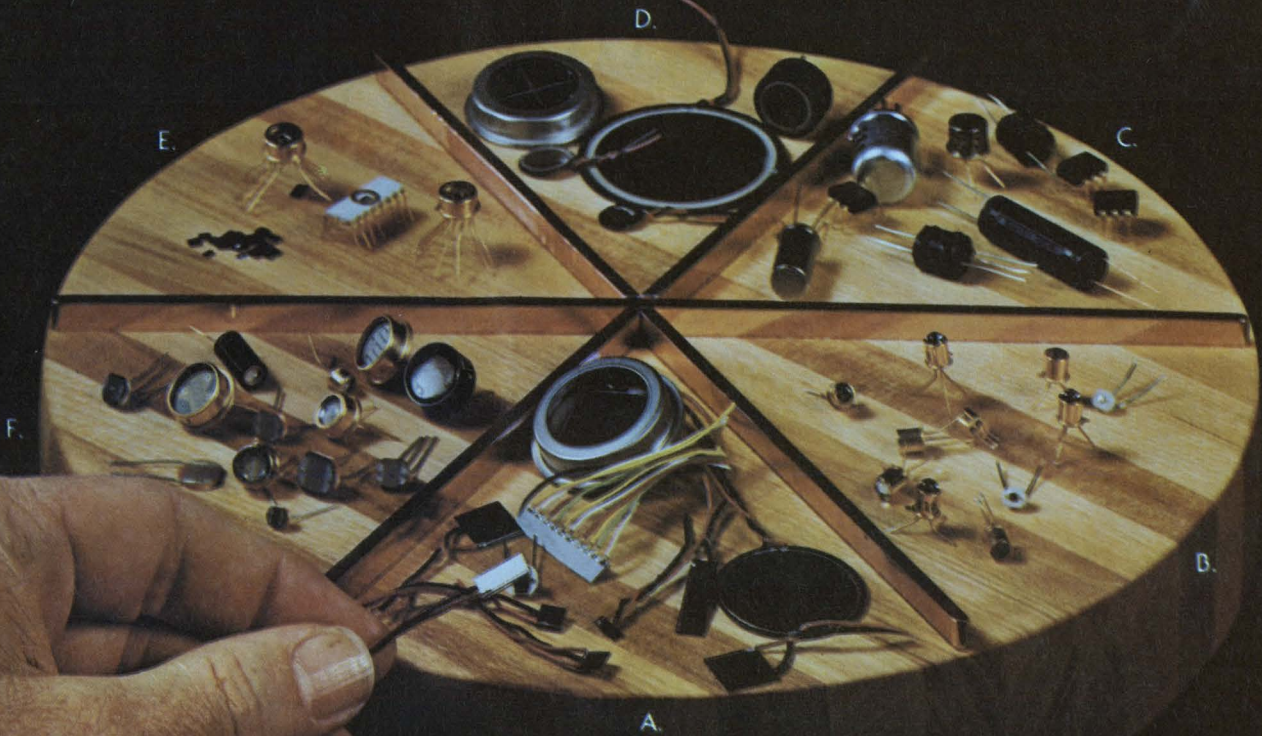

New High Speed Silicon Photovoltaic Cells

Ten times faster with excellent linearity, high temperature stability, and high low-light sensitivity.

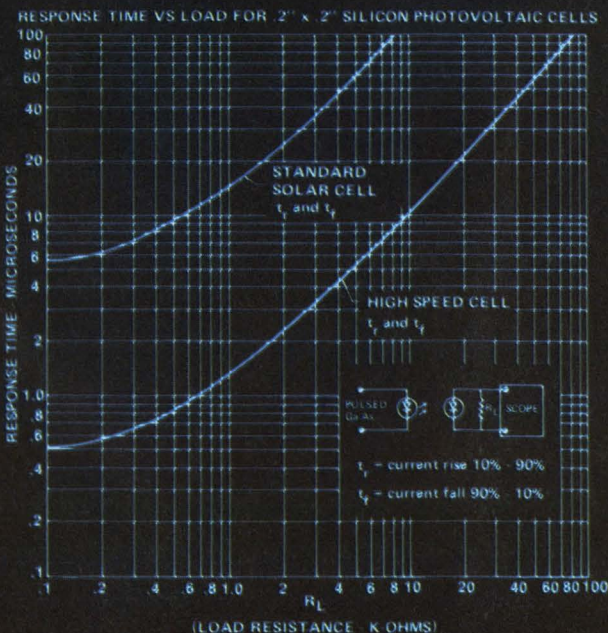

THE INDUSTRY'S BROADEST LINE:

- A. Standard Silicon and Blue-Enhanced Photovoltaic Cells, Blue-Enhanced Photodiodes, and PIN Photodiodes
- B. Phototransistors and Photodarlingtons
- C. Vactrols (Opto-Isolators)
- D. Selenium Photovoltaic Cells
- E. Custom IC's Design and Fabrication
- F. Photoconductive Cells

Write today for more details.



Vactec, Inc.
2423 Northline Industrial Blvd.
Maryland Heights, Mo. 63043
Phone (314) 872-8300

**KEITHLEY OFFERS:
A 3½-DIGIT MULTIMETER.
4 EXCLUSIVE FEATURES.
\$315.**

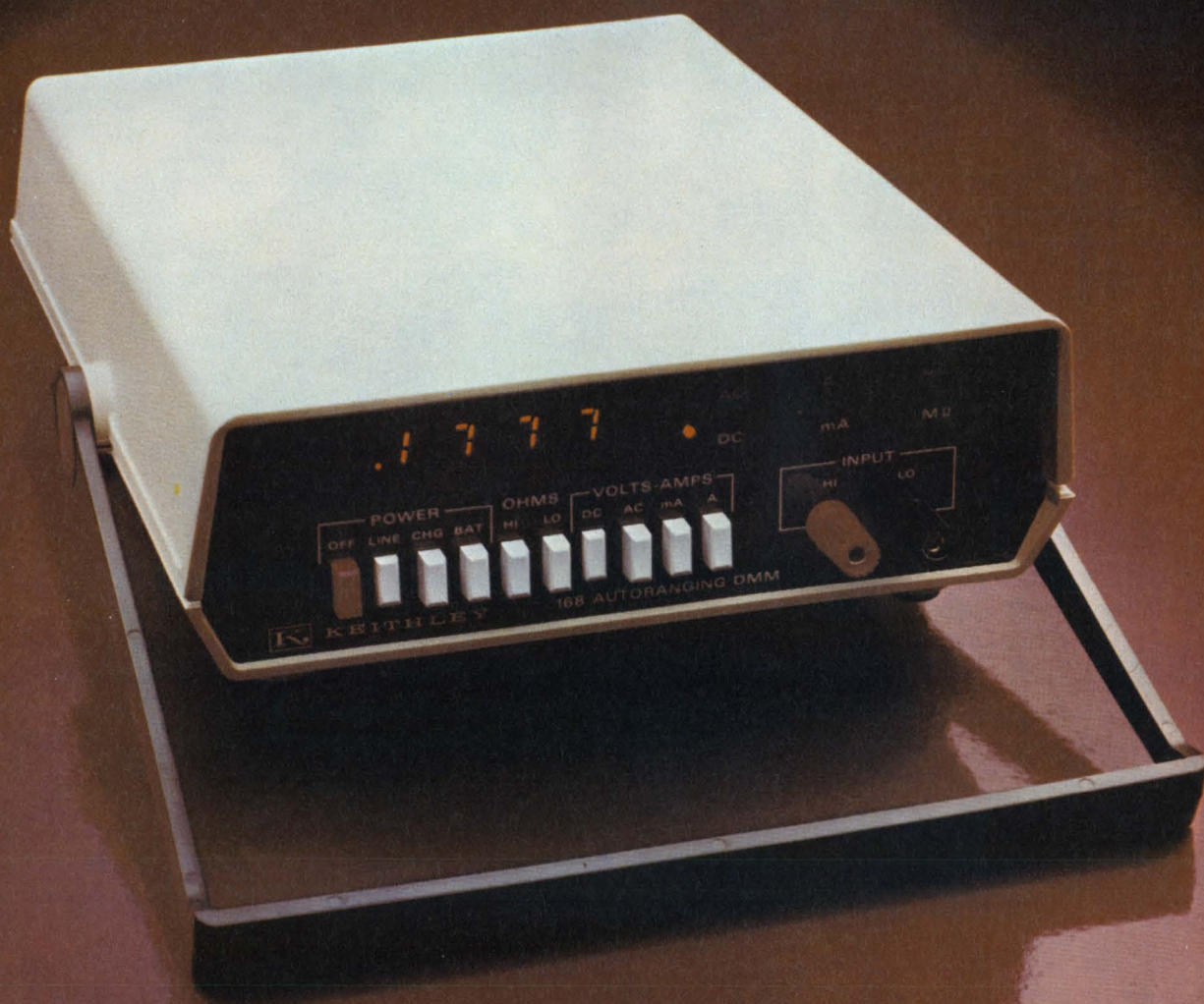

The Keithley 168 Digital Multimeter gives you every key performance feature offered by other first-line 3½-digit DMMs.

But only the Keithley 168 gives you 4 extra features—all useful and all at a competitive price. Compare our 3½ with the others and you'll come to an inescapable conclusion: the 168 is the best buy in 3½-digit DMMs.

For \$315: a superior DMM

For openers, you get a rugged, reliable, easy-to-read, general-purpose, 5-function DMM with more ranges than you'll normally need. Measure from 100 microvolts to 1000 volts dc, 100 microvolts to 500 volts ac, 100 milliohms to 20 megohms, 100 nanoamps to 1 amp, ac or dc. Basic accuracy is 0.1%. All modes fully overload protected. The 168 brings Keithley quality to general-purpose measurement.



4 extra features, no extra cost.

- *Automatic ranging* gives you the most accurate reading, with decimal in the right place, faster than you could do it with switches. Saves you time every time you make a measurement.
- *HI-LO Ohms* lets you turn on a semiconductor junction to see if it's good or measure an in-circuit resistance without turning on a semiconductor.
- *2-terminal input* for all measurements on all functions. You can't get it wrong. Terminals accept banana plugs, alligator clips, spade lugs or bare wire.
- *Lighted function indicator* so you know precisely what you're measuring, instantly.



Surprise: more valuable features.

That's not all. We've packed even more value into the 168. Optional battery pack that you buy now or add later. Patented A-D converter to simplify circuitry. No-nonsense, full-year guarantee on parts, workmanship, and specs—including accuracy. Convenient calibration instructions right inside the cover. Light weight for easy portability.

Full complement of accessories.

Use these optional accessories to make your Keithley 168 DMM even more versatile: Wide-range RF probe. Test lead sets. Clamp-on ammeter. 50-amp shunt. High-voltage probe. Carrying case. Rack mount kit.



Now the logical choice.

The 168 is out-front in value. And it's backed up by our reputation for quality. Don't you wish all decisions were this easy?

Ordering a 168 is easy, too. Just contact: Keithley Instruments, 28775 Aurora Road, Cleveland, Ohio 44139. (216) 248-0400. Europe: D8000 München 70, Heighhofstrasse 5, West Germany. (089) 7144065.

DMMs for all your needs.

We know you have a variety of measurement requirements. So we offer a growing family of DMMs to meet your application and price objectives. Send for our Selector Guide.

180: 4½-digits, 30 nV sensitivity.

190: 5½-digits, high-stability, outstandingly low price.

171: 4½-digits, wide ranging 5-functions.

616: dc, 3½-digits, down to 0.1 picoamp full scale!

160B: dc, 3½-digits, high-sensitivity, low price.

KEITHLEY

The measurement engineers.

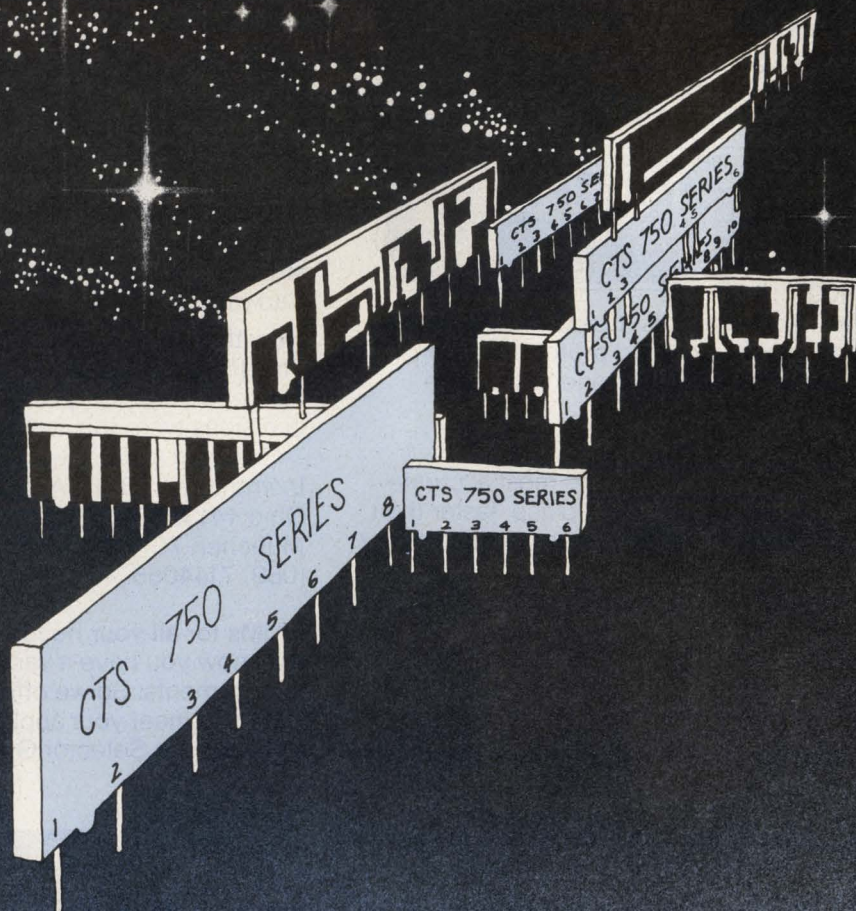

CTS conquers space.

And has for *well over a decade* with space saving Series 750 SIP cermet resistor networks. And with space a very important commodity in modern systems, you'll want to make CTS a very special source for your network needs.

You conserve valuable PCB space, enjoy greater system reliability, use fewer components, install easier—automatically, cut handling costs and derive faster inspection. CTS experience, technology and production capacity insure the highest quality, fastest delivery available.

Where one of our more than 130 *standard* off-the-shelf SIP's won't meet your circuit require-

ments, we'll custom design the resistor network you need in either conventional or low profile package configurations.

Be assured of ultra-high stability and reliability. Over 900 million hours of test data prove CTS reliability with an established failure rate of only 0.00051% per 1000 hours @ 95% confidence level—considerably superior to military failure level S of established reliability specs.

For your copy of our reliability report or complete resistor network data, write: **CTS OF BERNE, INC.**, 406 Parr Road, Berne, Indiana 46711. Phone (219) 589-3111.

CTS CORPORATION

Elkhart, Indiana

A world leader in cermet variable resistor technology.



The Reward

In his "Entrance Fee," Alexander Woolcott tells of the cadets at Saint-Cyr who decided it would bring great honor to their school if one of them could spend the night with Cosette, the most desirable woman in France. But Cosette would require 5000 francs—an astronomical sum.

With a stroke of genius worthy (their Commandant said later) of a Marshal of France, one of the young men brought forth the idea of a lottery. Somehow, with the aid of great self-denial, urgent letters to maiden aunts, and other desperate appeals, each of a thousand boys was able to raise five francs. The lottery winner sallied forth to Cosette, for the honor of the school.

The following morning, Cosette learned from the lad how a poor student could afford 5000 francs—a figure that must have looked to him like the National Debt. The story of the lottery moved her deeply. "Let it never be said that Cosette is not a woman of sentiment," she told him. "For this honor that the boys of Saint-Cyr have paid me," she added, "you shall pay nothing. Not a sou."

And she returned his five francs.

Woolcott's story has entertained countless readers. It's unfortunate that he did not tell the story of Ken, a talented, hard-working engineer. Ken loved engineering and was deeply grateful to his employer for providing the opportunity to show his engineering prowess. In time, Ken proved his worth by developing a dramatic product that was the envy of all around him. It was obvious, even from the start, that the product would bring power and glory to his company—and money, too.

On reviewing Ken's contribution, his boss recognized its value and wanted it known that Ken's contribution would never be forgotten. "As a token of our appreciation for the patent rights you are about to sign over to us, Ken, we want you to have this." And he gave him a dollar. "But that's not all. You've worked loyally and untiringly and we think you deserve a holiday. The company is going to give you the rest of the year off. With full pay."

It was December 30th.

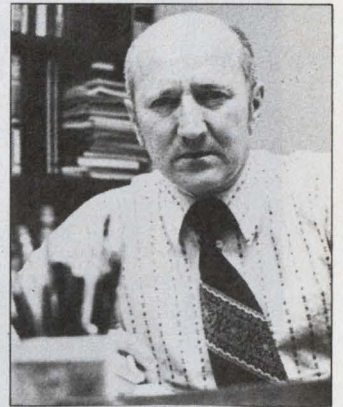

GEORGE ROSTKY
Editor-in-Chief

NOW CHOOSE FROM HIGH-VALUE DELCO

MAJOR PARAMETER LIMITS

TYPE	V _{CEO}	V _{CBO}	min h _{FE} @ I _C	Package*
DTS-4061	600V	—	8 @ 15A	TO-3
DTS-4059	600V	—	5 @ 15A	TO-3
DTS-4041	400V	—	8 @ 15A	TO-3
DTS-4039	400V	—	5 @ 15A	TO-3
DTS-4026	600V	—	150 @ 5A	TO-3
DTS-4025	400V	—	150 @ 5A	TO-3
DTS-4010	250V	—	150 @ 5A	TO-3
DTS-1010	120V	—	200 @ 10A	TO-3
DTS-1020	120V	—	500 @ 10A	TO-3
DTS-2000	—	40V	2000 @ 600 mA	TO-92*

*TO-92 package modified. TO-3 devices packaged in solid copper cases.

INDUCTIVE SWITCHING CAPABILITY OF THE DTS-4039, 41, 59, 61 DARLINGTONS

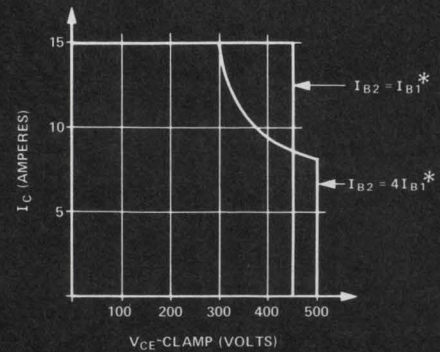

* WITH I_C = 8A I_{B1} = 1A
WITH I_C = 8A I_{B1} = 2A

MOTOR SPEED CONTROL INVERTER OUTPUT WITH DELCO DARLINGTONS

APPLICATIONS DATA AVAILABLE UPON REQUEST

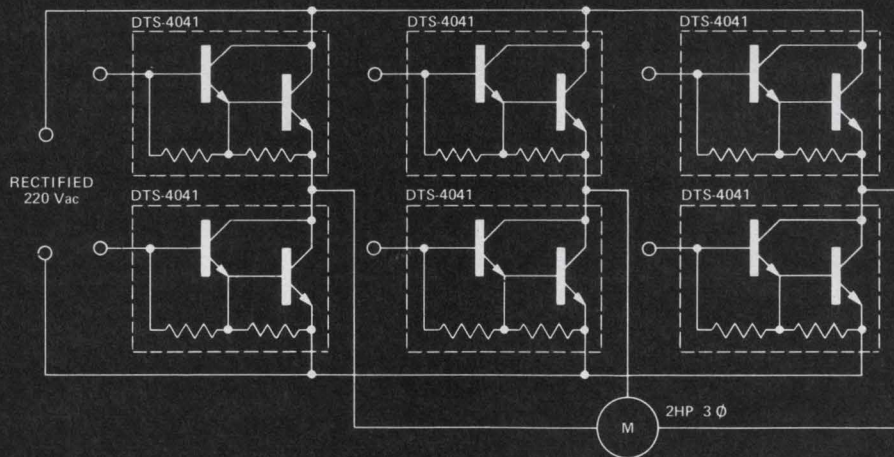

We've added three new ways to save you money on NPN triple diffused silicon power Darlington. Delco Electronics' new DTS-4010, 4025 and 4026 are high powered yet practically priced and give you exceptional energy handling value.

Delco power Darlington's triple diffused mesa construction gives them outstanding peak power handling capability (as shown in the graph of clamped inductive switching). The reverse biased switching data shown illustrates the high energy handling capabilities of these units.

And Delco Darlington's can be purchased with t_{off} grouping for improved current sharing in parallel operation.

The planar DTS-2000 is a TO-92 Darlington

and is applied in driver circuits designed for the referenced 2 and 10 hp induction motor speed controls. Five low voltage power supplies in the control circuit for this application use our DTS-1010, 120 V_{CEO} Darlington's.

All Delco Darlington's bring you the space saving design flexibility you expect from Darlington's, PLUS Delco's proven high energy handling capability.

Select any Delco Darlington up to 600 V_{CEO} and contact your Delco distributor for complete application and device data, prices and prompt delivery.

Specify Delco Darlington's for power at practical prices.

TEN HIGH-ENERGY, DARLINGTONS.



**NOW AVAILABLE FROM THESE DISTRIBUTORS
IN PRODUCTION QUANTITIES.**

ALABAMA, Birmingham
Forbes Distributing Co., Inc.
(205) 251-4104

ALABAMA, Huntsville
Powell Electronics
(205) 539-2731

ARIZONA, Phoenix
Sterling Electronics, Inc.
(602) 258-4531

CALIFORNIA, Gardena
Bell Industries
Electronics Distributors Div.
(213) 321-5802

CALIFORNIA, Goleta
R.P.S. Electronics, Inc.
(805) 964-6823

CALIFORNIA, Los Angeles
Kierulff Electronics, Inc.
(213) 685-5511

CALIFORNIA, Los Angeles
R.P.S. Electronics, Inc.
(213) 748-1271

CALIFORNIA, Palo Alto
Kierulff Electronics, Inc.
(415) 968-6292

CALIFORNIA, San Diego
Kierulff Electronics, Inc.
(714) 278-2112

CALIFORNIA, San Diego
R.P.S. Electronics, Inc.
(714) 292-5611

CALIFORNIA, Sunnyvale
Bell Industries
(408) 734-8570

COLORADO, Denver
Kierulff Electronics, Inc.
(303) 371-6500

CONNECTICUT, Norwalk
Harvey Electronics
(203) 853-1515

FLORIDA, Clearwater
Diplomat/Southland
(813) 443-4514

FLORIDA, Miami Springs
Powell Electronics/Florida
(305) 592-3260

ILLINOIS, Elk Grove Village
Kierulff Electronics, Inc.
(312) 640-0200

ILLINOIS, Skokie
Bell Industries
Electronics Distributors Div.
(312) 282-5400

INDIANA, Indianapolis
Graham Electronics Supply, Inc.
(317) 634-8202

MARYLAND, Baltimore
RESCO/Baltimore
(301) 823-0070

MARYLAND, Beltsville
RESCO/Washington
(301) 937-5890

MASSACHUSETTS, Billerica
Kierulff Electronics, Inc.
(617) 935-5134
(617) 667-8331

MASSACHUSETTS, Newton
The Greene-Shaw Co., Inc.
(617) 969-8900

MICHIGAN, Livonia
Pioneer/Michigan
(313) 525-1800

MINNESOTA, Minneapolis
Stark Electronics Supply Co.
(612) 332-1325

MISSOURI, Kansas City
Walters Radio Supply, Inc.
(816) 531-7015

MISSOURI, St. Louis
LCOMP-St. Louis
(314) 647-5505

NEW JERSEY, Cinnaminson
Wilshire Electronics/Philadelphia
(609) 786-8990 (215) 627-1920

NEW JERSEY, Clifton
Wilshire Electronics/New Jersey
(201) 340-1900 (212) 244-8930

NEW MEXICO, Albuquerque
Sterling Electronics
(505) 345-6601

NEW YORK, Binghamton
Harvey Electronics
(607) 748-8211

NEW YORK, Buffalo
Summit Distributors, Inc.
(716) 884-3450

NEW YORK, Farmingdale
Wilshire Electronics/Long Island
(516) 293-5775

NEW YORK, Freeport
Milgray/New York
(516) 546-6000

NEW YORK, Woodbury
Harvey Electronics
(516) 921-8700 (212) 895-9260

OHIO, Cincinnati
United Radio, Inc.
(513) 761-4030

OHIO, Cleveland
Pattison Supply Co.
Industrial Electronics Division
(216) 441-3000

OHIO, Dayton
Pioneer/Dayton
(513) 236-9900

PENNSYLVANIA, Philadelphia
Almo Electronics
(215) 698-4000

PENNSYLVANIA, Pittsburgh
CAM/PC Electronics
(412) 288-2600 (412) 782-3770

SOUTH CAROLINA, Columbia
Dixie Radio Supply Co., Inc.
(803) 253-5333

TEXAS, Dallas
Sterling Electronics
(214) 357-9131

TEXAS, Houston
Harrison Equipment Co., Inc.
(713) 652-4700

TEXAS, Houston
Sterling Electronics
(713) 627-9800

WASHINGTON, Seattle
Kierulff Electronics, Inc.
(206) 763-1550

IN CANADA: ONTARIO—Toronto
Zentronics Ltd.
(416) 787-1271

OVERSEAS: EUROPEAN INQUIRIES:
European Parts & Accessories
Marketing Group

General Motors Continental
Plant 2, Noorderlaan, Postbus 9
B-2030 Antwerp, Belgium

ALL OTHER OVERSEAS INQUIRIES:
General Motors Overseas
Operations

Parts & Accessories Dept.
767 Fifth Avenue
New York, N.Y. 10022
(212) 486-4412

Delco Electronics Regional Sales Offices
Union, New Jersey 07083
Box 1018 Chestnut Station
(201) 687-3770

Van Nuys, California 91404
Box 2968
(213) 988-7550

General Sales Office
700 E. Firmin, Kokomo, Ind. 46901
(317) 459-2175

Delco Electronics



Division of General Motors

CIRCLE NUMBER 38

FOCUS

on Photodetectors

Photodetectors are among both the simplest and most complicated of discrete semiconductor devices. They are simple because of what they do—they merely convert light to current or voltage—but are complicated because their operating characteristics depend on optical, electrical, physical and often on mechanical parameters.

Once the design engineer knows what has to be done and how much he can spend, he usually will know what major category of device he needs. But even then, depending on particular parameters, several different devices might work for the same application.

Phototransistors are widely used

Phototransistors—along with their close cousins, photo-Darlington—are by far the most popular of all photodetectors. Since they are essentially transistors, the photon-generated current is multiplied by the current gain of the device. Photosensitivity for a given light level is thus 100 to 500 times higher than for a photodiode. Over-all performance characteristics are pretty standard: voltage should be 50 V or less; current capability is 1 to 50 mA; and typical speed (rise and fall time) is 2 to 100 μ s.

Some basic tradeoffs involve active-area size, use of a lens, speed and gain. Generally, large area devices are used for high sensitivity at low light levels, or for high-output-current applications; small-area devices are used when high speed is a requirement. But sometimes the mechanical structure can become a variable parameter that's difficult to deal with in calculating device sensitivity.

For example, suppose a device with an active

area of 25 mils² provides the speed required for your application. You decide to add a lens to increase light sensitivity. But a slight misalignment of the lens can prevent any light from falling on the active area of a small device, and use of an aperture presents a mechanical variable that is difficult to calculate precisely. One solution is to test the system at the breadboard stage.

A recurring problem is that an engineer fails to specify the exact spectral irradiance (mW/cm^2) under which the device will be used. As a result, when buying a device he may be misled by the manufacturer's stated value for the light current. He may believe the phototransistor to be extremely sensitive when the irradiance-biasing condition is actually the controlling factor in sensitivity.

Fairchild makes all its phototransistor and photo-Darlington measurements at a standard radiant flux density of 5 mW/cm^2 ; National Semiconductors Ltd. uses 10 mW/cm^2 and other companies use 20 mW/cm^2 . The source color/temperature ratings usually can vary from 2800 K to 2870 K without greatly affecting the value of the collector current.

However, color temperature can vary from 1825 K to 3533 K, depending on the filament of the lamp. If you are using a GaAs LED emitting at 900 nm there will be no correlation at all between the manufacturer's figure for sensitivity (based on the color temperature of a tungsten wire) and your own.

To get a rough estimate of the difference between a tungsten source emitting at 2870 K and a LED emitting at 900 nm and 5 mW/cm^2 , figure on obtaining about three times as much current with the LED—because the light is emitted in a narrow spectral range where silicon is most

John Kessler
Contributing Editor

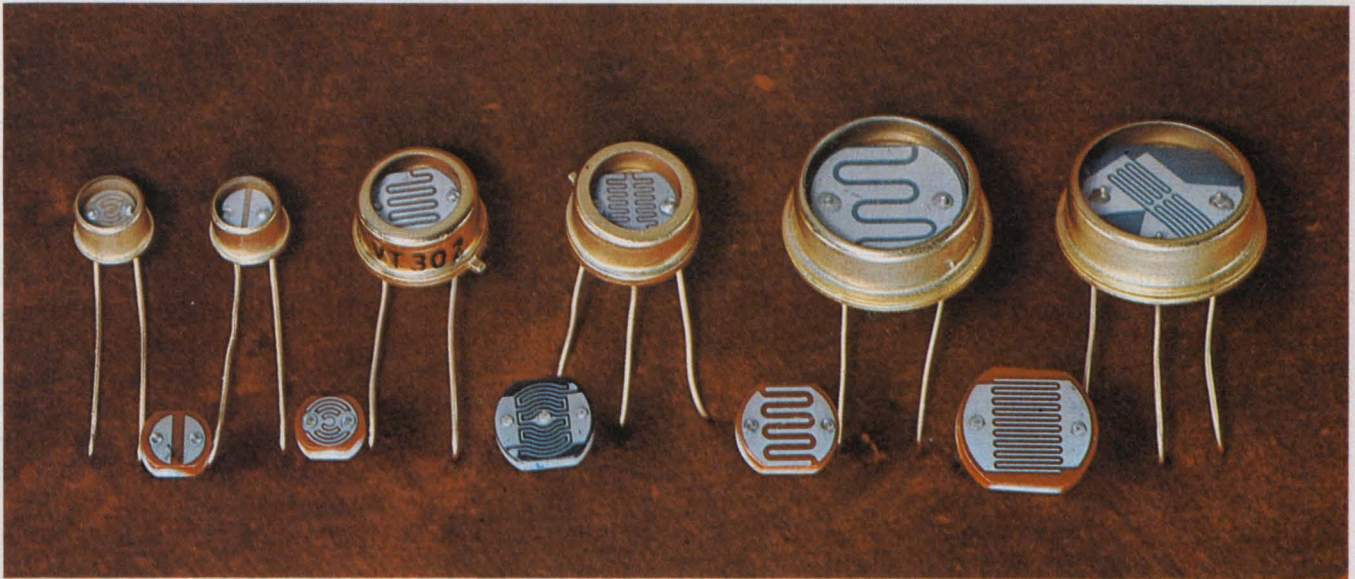

See the light around 520 nm with CdS photoconductive cells, or toward 670 nm with CdSe cells. Vactec makes

a complete line of both types—shown above arranged by ascending surface area.

sensitive—as from the incandescent.

But even here you have to be careful: there are two types of GaAs LED sources available: vapor-diffused (which emits at 900 nanometers) and the liquid epitaxial LED (which shifts the wavelength to about 940 nm). Although the 940-nm device is not centered on the peak sensitivity of the phototransistor, its over-all efficiency will provide a better match, current for current. And so the 3:1 figure applies only to the vapor-diffused source.

Because of the confusion over the sensitivity specification, Motorola lists the current output for specific light intensities. The company specifies light current instead of having the customer do the calculation. For example, a customer usually calculates $S = I/H$ (where $S = \text{mA}/$

mW/cm^2 , $I = \text{mA}$, $H = \text{mW}/\text{cm}^2$). Motorola's method: $I = S \times H = \text{mA}$.

There are three other ways to avoid getting confused over sensitivity specifications: (1) be sure of the color temperature of your device, or if it's a LED, determine its spectral irradiance; (2) while you're still in the breadboard stage, buy limit samples of the phototransistor you think will do the job, and test them out; (3) buy emitter-sensor matched pairs from the manufacturer; that way you are assured a given LED current will result in a given current in the phototransistor.

Should the manufacturer make the match?

Until recently manufacturers have been wary of developing matched emitter-sensor packages as standard products. They felt the market for such devices was quite selective and that a standard combination wouldn't satisfy a large enough number of customers. That feeling is changing now.

General Electric has two emitter-sensor packages: its H17A1 phototransistor and LED, and its H17B1 photo-Darlington and LED. Texas Instruments sees the sensor-emitter combination in a single package as a major application trend. TI has 17 sensor-emitter combinations both as single elements and as arrays.

Most companies offer LED emitters that are spectrally matched to a sensor, but most of these operate at distances measured in inches. Skan-A-Matic, however, has a matched LED-phototransistor pair (the L33007 and P33001) that can operate without pulsed electronics over distances as great as 3 ft. In a pulsed mode, the units can operate over distances as great as 25 ft.

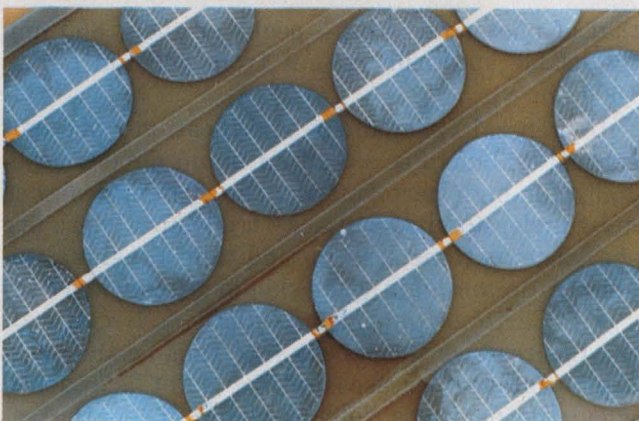

Let the sun shine in on these photovoltaic cells and you can power buoys, VHF/UHF repeaters, railroad signal controls—any remote application where power is not readily available. These solar cells are made by Solar Energy Co. For increased current, connect in parallel; for increased voltage, connect in series.

For high-reliability applications, Spectronics offers hermetically sealed phototransistors in a TO-46 case, with a round or flat lens (SD-5443 and SD-3443), matched to Spectronics infrared LEDs (SE-5455). Optron, another high-reliability vendor, will design and build emitter-sensor pairs for specific applications.

Clairex engineers see this development being taken one step further. They expect detector/emitter functions to become an integral part of ICs.

For the new Mallory electronic ignition system General Electric supplies a small optical package that replaces the points in the distributor. William H. Sahm, consulting applications engineer at GE, says the LED and phototransistor are not only optically and electrically matched, but also form a temperature-compensated combination. They are both in hermetic packages that permit them to operate over a temperature range of -40 F to $+140$ F.

In the ignition system, the emitter and sensor face each other; a cup-shaped rotor fits in the gap between them and over the cam in the distributor. As the cam revolves, the rotor continuously breaks the beam of light, replacing conventional points.

Consider the application

In some applications it is important to maintain a phototransistor's collector-to-emitter current within a very tight range. In a smoke detector, for example, one might be inclined to go to a tight, double-ended spec to be sure that particles between the light source and the sensor are readily detected. But Doug Schmieskors, product marketing manager at Fairchild Semiconductor, says an inexpensive phototransistor such as the FPT-110, which has no upper limit on its light current, can do the job if the designer uses a potentiometer to set a fixed threshold level.

Position sensing is another major application in which phototransistors perform well. Usually there is ample light available to detect the position of such an object as the armature of a distributor in a car, or the position of a gear tooth on a wheel. In these applications the specs that cause the most difficulty are those for the optical portion of the system. As we saw earlier, a lack of focus or alignment can easily cancel out the advantage of using a sensitive detector.

Photodiodes offer performance diversity

If the main characteristic of phototransistors and photo-Darlington is their uniformity of performance, the distinguishing characteristic of silicon photodiodes is their diversity and the

wide range of parameters under which they operate. For example, maximum voltage (reverse bias) can range from 1 V to 2000 V for some avalanche photodiodes (APDs); current capability is typically 50 to 200 μ A at 200 mW/cm², but speeds of less than 1 ns can typically be obtained with p-i-n photodiodes.

The photodiode is simply a pn junction operated with a reverse bias. Its sensitivity problems are the same as that of the phototransistor, except that the current levels are lower because there is no built-in amplification. Instead of the hundreds of microamps or milliamps available from phototransistors, diode photocurrents under the same conditions run to several microamps. While the spectral response of photodiodes—like

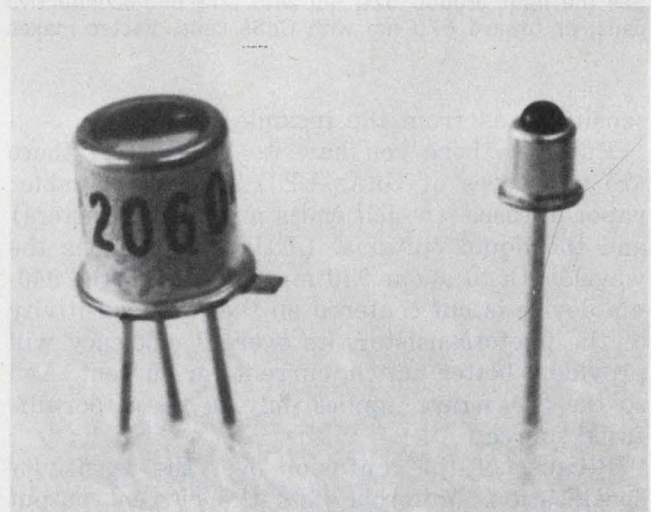

Silicon phototransistors, such as these from Clairex, are the most popular of all photodetectors. Phototransistors offer low power requirements, high reliability, small size, TTL/DTL compatibility, and are easily interfaced with integrated circuits.

that of phototransistors—peaks at about 850 nm, the usable spectrum ranges from 300 nm out to 1600 nm.

In general, photodiode specifications are not confusing, but to select an optimum device, especially for high performance, the system designer must understand some tricky tradeoffs. There are six basic parameters, in addition to signal-to-noise ratio and gain, that should be considered:

- *Capacitance of the pn junction.* Because of the reverse-bias the capacitance falls as the operating voltage increases until a point is reached when the device is fully depleted. Then the capacitance is independent of voltage, and you have a truly p-i-n device. Thus, for lowest capacitance you need a high enough operating voltage. The trade-off is that as the operating voltage increases, so does noise and dark current.

▪ *Dark current.* This is a function of the area of a device; the larger the area, the more dark current. It is measured in amperes, and increases with applied voltage. The noise resulting from dark current is shot noise.

▪ *Quantum efficiency.* Of all the solid-state photodetector devices, photodiodes have the highest quantum efficiency (the ratio of electrical current to incident light)—approaching 95 percent.

▪ *NEP.* Noise Equivalent Power simultaneously accounts for quantum efficiency, or responsivity, and noise. NEP is the amount of light you have to shine on a detector to produce a signal equal to the noise level. The lower the NEP, the more sensitive the device. If NEP is used as a criterion for selecting a photodiode, the designer should also specify the wavelength, the test frequency and the bandpass around the test frequency. Vendors often omit this important information.

▪ *Responsivity.* It is more practical to convert electrons to amperes and photons to watts, rather than deal with quantum efficiency. But the value of responsivity (A/W) is a function of wavelength, applied-bias voltage, frequency and temperature. All these parameters should be called out when a value of responsivity is given.

▪ *Detectivity.* Since you get more noise as the area of a detector increases, NEP naturally tends to be worse with a large-area device. Detectivity provides a figure of merit that's independent of the area. It is defined as NEP/active area (in cm^2). Thus the higher the detectivity, the more sensitive the detector.

Problems in specifying photodetectors still remain even if one understands the terminology and the important tradeoffs. According to Dr. Paul Wenland, president of United Detector Technology, "In low-light-level detection, the combination of both detector and amplifier parameters to obtain maximum performance is often misunderstood, which leads to mistakes in the specification of detector parameters."

The problem often involves attempts to compare photometric and radiometric terms. Specifications in foot-candles, foot-lamberts and millilamberts are sometimes confusing to a designer trying to equate such measurements with a microwatt reading. There are really no direct equivalents because photometric specifications are based on what the human eye can see rather than on a measured electrical signal.

Use photodiodes for linearity

In addition to the gain offered by phototransistors, they differ from photodiodes in another important way. Because the phototransistor depends on its current gain for over-all sensitivity,

there is a built-in nonlinearity: gain increases with increased light current. But with photodiodes, no nonlinear mechanism is involved; so photodiodes are usually followed by a good linear amplifier to preserve the over-all linearity.

A number of photodiode makers are integrating silicon photodiodes into a TO-99 or TO-5 transistor can along with internal feedback resistors and a low noise, low bias-current operational amplifier. The obvious advantage of this kind of packaging is to reduce the noise and capacitance that would otherwise be induced on a connection between the amplifier and the photodiode.

With the Bell & Howell 539 series, for example, the internal resistors are small, shielded and

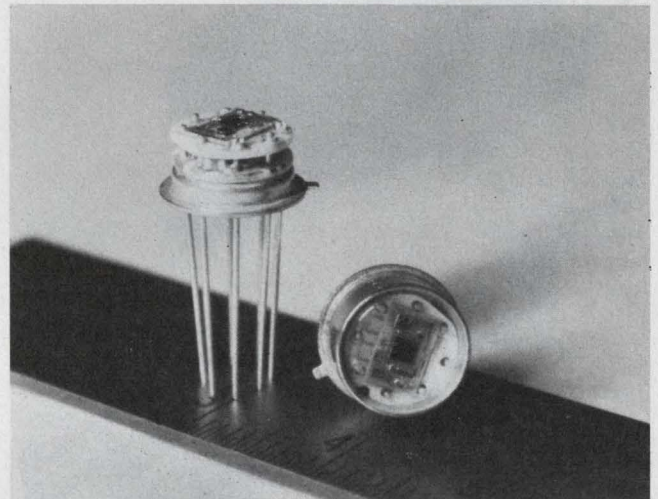

Meriting attention are these photodiodes, which are readily adaptable for data acquisition systems. The R1100 made by Meret gives TTL logic level signals out. It packs a transimpedance amplifier and voltage comparator, along with its photodiode.

physically close to the amplifier—thus providing low noise. System gain can be programmed through the use of external resistors. Output polarity, gain, offset adjust, response compensation, etc., can be programmed. Applications vary from light measurement to phototypesetting.

Other manufacturers that supply similar photodiode/detector packages include EG&G Inc., United Detector Technology Inc., Integrated Photomatrix Ltd., RCA and Electro-Nuclear Laboratories, Inc.

For fiber-optic communications systems, Meret has detector/amplifier combinations in TO-5 cans that operate over a spectral range of 360 to 1150 nm at up to 50 MHz. Meret's R1100 incorporates detector, amplifier, coupling network and voltage comparator in a TO-5 can. It is also probably the only such device on the market that provides TTL digital output for a light-signal input. With the

R1100 and a digital LED connected to it by a fiber-optic pipe, you can build a complete digital system. Commercial and private plane manufacturers are using these photodiode assemblies for actuation systems and equipment readouts.

In some systems designers need large-area detectors or quadrant detectors (four detector elements on one substrate). For large-area detection they turn to Schottky-barrier photodiodes. One reason for going to Schottky devices is that sensitivity can't be obtained over a large area

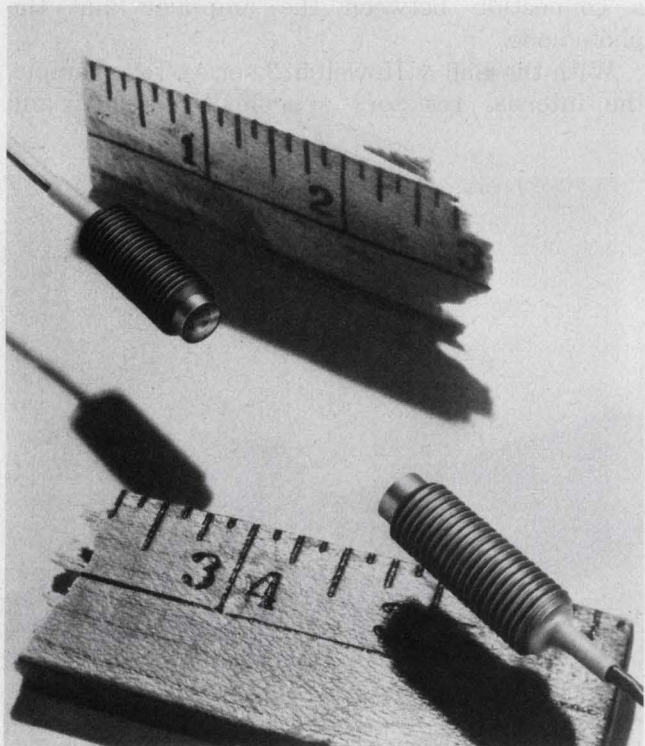

Emitter-detector pair from Skan-A-Matic detects a beam at a distance of up to 3 ft. between the LED and the phototransistor.

with a pn junction because the diffusion depth cannot be uniformly maintained. The Schottky-barrier structure avoids this problem by using a step junction in the form of a thin layer of evaporated gold on the surface of the silicon.

With this technique companies such as United Detector Technology are making standard devices with active areas in strips as long as 4 in., and special devices with strips as long as 12 in. For extraordinary accuracy in position-sensing equipment UDT has three standard Schottky-barrier photodiodes: the FC/10 (with an active area of 1 cm²), the FC/25 (with an active area about 2 cm²), and the FC/50 (active area 4 cm²).

Higher accuracies are obtained with smaller-area devices, but linearities are much the same with all sizes. The FC/10 can resolve 0.1 mil movement with linearities of a few tenths of a percent. With special devices, UDT can detect

0.1 microinch of movement across a small area.

Just a brief warning about Schottky photodiodes: Most suppliers indicate that they should not be used at temperatures above 130 F, or at light levels higher than 10 mW/cm².

Avalanche photodiodes (APDs) provide the highest speed solid-state photodetection with the maximum signal-to-noise ratio. But these devices are still (after more than eight years) in the development stage. Texas Instruments, RCA's Electronics Components Division, and General Electric all have APDs available for engineering evaluation.

Internal avalanche multiplication in the APD is almost noiseless, making the device 10 to 15 dB more sensitive than a p-i-n photodiode. But this sensitivity comes at the cost of temperature-compensating circuits to stabilize the gain, and a high reverse bias (200 V to 400 V or more) to obtain a current multiplication of about 100.

The table below compares some of the parameters of p-i-n photodiodes vs APDs:

Parameter	P-i-n photodiodes	APDs
Spectrum (nm)	400-1200	600-1200
Responsivity (A/W)	0.66	60
Rise time (ns)	4	1
Price (\$)	5-100	30-200

Because APDs are still developmental, potential users should always discuss a proposed system with a supplier before starting the design. Such a discussion should clarify trade-offs between active area and dark current; and between package design and cost and performance.

Photoconductive cells for low cost sensitivity

When it comes to sensing visible light levels that are very low, and where speed is not a factor, the photoconductive cell turns out to be the cheapest and most sensitive photodetector. Photoconductors will produce a usable signal with light levels as low as 0.0001 fc and in volume they cost as little as \$0.37. Typically used for smoke detectors, for light meters in cameras, and for operating street lights, the photoconductive cell is a device with conductance that varies with the amount of light energy striking the cell.

The most widely used photoconductive cells consist of aluminum-oxide ceramic substrates coated with a layer of cadmium sulphide or cadmium selenide. Among the more undesirable characteristics of photoconductive cells is their "memory" or dark-current history. This causes a hysteresis-like effect in the illumination-vs-resistance curve.

The magnitude of the effect depends on the illumination level at which the cell is stored. It is very minor when the cell is used at illumination levels above 5 fc, but does become a severe prob-

lem below 0.1 fc. The effect can be corrected by the use of a bridge circuit, or by maintaining a constant low level of illumination.

Photoconductors are usually sensitive throughout the visible region of the spectrum. The response peaks at 500 nm for CdS and at 700 nm for CdSe. However, Vactec president, Monroe D. Levy, says his firm has developed CdS devices that, "when used with a well-blocked interference filter, are capable of excellent sensitivity down to 250 nm, with good response time and stability." Clairex, Hamamatsu and National Semiconductors Ltd., make broad ranges of photoconductors whose parameters can be shifted to meet specific requirements.

Photovoltaic devices generate power

Photovoltaic cells are pn devices operated at zero bias. They are self-generating. With one lead connected to the p and one to the n region, light shone on the device produces an output voltage. Most commonly made of silicon and selenium, photovoltaics can also be made of germanium, gallium arsenide, and experimental compounds such as polycrystalline cadmium sulphide deposited on a substrate of single-crystal indium phosphide.

Since the photovoltaic cell operates at zero bias voltage, noise is very low and sensitivity is good. Photovoltaics are ideal for low-frequency applications (such as photometry, spectroscopy, and some medical electronic instruments) where speeds of 1 to 100 μ s are satisfactory.

Photovoltaic devices are also inexpensive, because yields tend to be high and the structure does not have to withstand high operating voltages. Price usually depends upon the area of the device because of the raw material cost. The memory problem discussed earlier for photoconductive cells, applies to selenium photovoltaics, too, but is very slight with silicon photovoltaics.

Photovoltaics can produce a logarithmic response (when the external impedance is high compared with that of the diode) or a linear response (when the external impedance is very low).

The cells can be manufactured in practically any size or shape. For increased circuit current, the cells are connected in parallel; for greater voltage, they are connected in series.

Photovoltaics can be tailored to meet a variety of special requirements. Their spectrum can be shifted from the near-infrared to the blue region. At 400 nm blue-enhanced silicon detectors, such as those made by Vactec, produce four to five times the current of a conventional silicon photovoltaic cell. These detectors are useful for colorimetric instrumentation.

David M. Jones, marketing manager at OCLI, says that when designers use LEDs as a light source for photovoltaics they often don't consider the lack of uniformity of the spectral emissions over a given area for some LEDs. This lack becomes critical when apertures are placed between



Watching brightness levels is the job of NSL's 200 series CdS/Se photocells. The combination of materials offers the speed and sensitivity of CdSe and the stability of CdS. These photoconductive cells operate over a spectral range of 630 to 690 nm—also well suited for detecting light from GaP and GaAsP emitters.

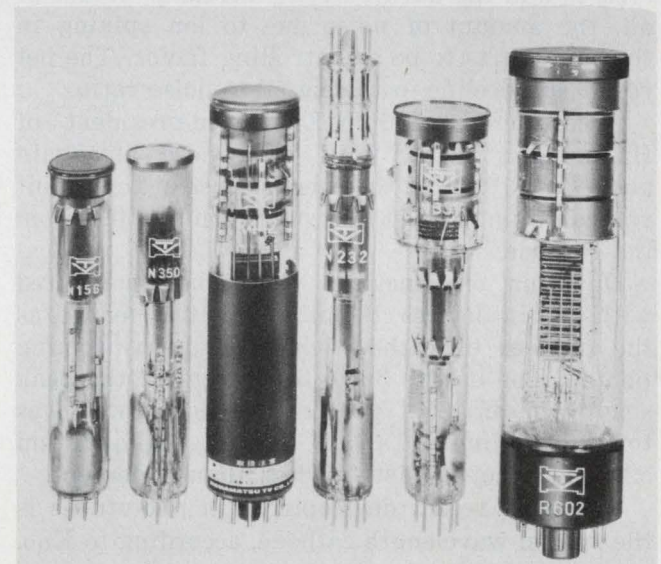

Phototubes from Hamamatsu such as these can produce gains of 100 to 100 million. Used for very low light level detection where good signal-to-noise ratios are important, their best sensitivity is at about 400 nm.

the LED and the detector; if the aperture lines up with the portion of the LED light beam that emits less energy, detector output will be less than expected.

Today there is a growing interest in photovoltaic cells as solar batteries. In designing solar-energy systems, not only are photometric and radiometric specs important, but the effects of weather, the angle of declination of the sun, and the amount of solar radiation available in different regions are all factors to be considered.

A general guideline for determining the size of a solar cell panel, according to a Solar Energy Co. spokesman, is to determine the average current used by the load over a time span of one year. The recommended panel should be capable of producing 10 times the average load current, and no less than seven times the average load.

Phototubes detect low light levels

For very low light-level detection over broad areas, where good signal-to-noise ratios are important, the phototube still finds its leadership unchallenged. Its major advantage over solid-state counterparts is the ability to amplify current without adding much more than 20 percent to the noise of the signal. The major disadvantage is the requirement for 300 to 2500 V in order to produce gain. That gain can range from 100 to 100 million. The costs also run high—from about \$200 to \$10,000 per tube.

One of the most confusing specs is anode sensitivity, a measure of gain in which a high value does not mean a better signal. As the gain goes up, the inherent stability of the tube decreases and the dark current increases. Worst of all, the amount of noise due to ion spiking in the tube starts to be a controlling factor. The net result is a decline in the signal-to-noise ratio.

According to Ralph Eno, vice-president of Hamamatsu Corp., "you don't need any gain above 5×10^5 from the tube because at that point you can count almost every electron emitted from the cathode."

Quantum efficiency of phototubes, compared with silicon devices, is quite low. It is defined as the number of cathode electrons per incoming photon. The best is 30 to 35 percent at the peak sensitivity of about 400 nm. As the light moves toward the limit of about 1100 nm, the quantum efficiency drops—fast—to less than 5 percent.

The most recent development in phototubes is the special-wavelength cathode, according to Eno. "It results from the requirements of laser technology in applications such as point-of-sale terminals where maximum efficiency at the wavelength of the He-Ne laser is required." ■■

Need more information?

The manufacturers and products mentioned in this report represent a small sample of the scope and diversity of photodetectors available. For further information, circle the appropriate information retrieval numbers. More vendors and some data sheets may be found in ELECTRONIC DESIGN's GOLD BOOK. The code letters after each company define, very roughly, the various product lines: photomultiplier tubes (A), phototransistors, photo-Darlington (B), photodiodes (C), photoconductive cells (D), and photovoltaic cells (E).

- Amperex Elec. Corp., 230 Duffy Ave., Hicksville, NY 11802. (516) 931-6200. (D. Steen) (A) **Circle No. 521**
- Bell & Howell Control Prods. Div., 706 Bostwick Ave., Bridgeport, CT 06605. (203) 368-6751. (I. Isdale) (C) **Circle No. 522**
- CBS Labs Div., Columbia Broadcasting, 227 High Ridge, Stamford, CT 06905. (203) 327-2000. (W. E. Glenn Jr.) (C) **Circle No. 523**
- Cetron Elec. Corp., 715 Hamilton St., Geneva, IL 60134. (312) 232-4140. (T. R. Sweet) (C) **Circle No. 524**
- Clairex Elecs., 560 S. 3 Ave., Mount Vernon, NY 10550. (914) 664-6602. (G. F. Smith) (B, D) **Circle No. 525**
- EG&G Inc., Electro-Optics Div., 35 Congress St., Salem, MA 01970. (617) 745-3200. (J. Murachver) (B, C, D) **Circle No. 526**
- Elec. Micro Sys. Inc., 1672 Kaiser Ave., Santa Ana, CA 92705. (714) 549-2295. **Circle No. 527**
- Electro Nuclear Labs Inc., 62 Fourth Ave., Waltham, MA 02154. (617) 890-5400. (F. Perry) **Circle No. 631**
- EMI Gencom Inc., 80 Express St., Plainview, NY 11803. (516) 433-5900. (F. Belasco) (A, C) **Circle No. 528**
- EMR-Photoelectric, P.O. Box 44, Princeton, NJ 08540. (609) 799-1000. (H. K. Yingling) (A) **Circle No. 587**
- Energy Elec. Prods Corp., 6060 Manchester Ave., Los Angeles, CA 90045. (213) 670-7880. (E. Bacher) (C) **Circle No. 529**
- Fairchild Semiconductor, 464 Ellis St., Mountain View, CA 94042. (415) 962-5011. (J. Duffy) (B, C) **Circle No. 530**
- Ferranti Electric Inc., E. Bethpage Rd., Plainview, NY 11803. (516) 293-8383. (B, C) **Circle No. 531**
- General Electric Co., Space Technology Prods., P.O. Box 8439, Philadelphia, PA 19101. (215) 962-4000. (E) **Circle No. 532**
- General Electric Semiconductor Prods., Elecs. Park Bldg. 7-49, Box-1122, Syracuse, NY 13201. (315) 456-2798. (B, C) **Circle No. 533**
- General Electric Tube Prods., 316 E. 9 St., Owensboro, KY 42301. (502) 683-2401. (J. N. Holeman) (A) **Circle No. 534**
- General Sensors Inc., P.O. Box 231, Athens, TX 75751. (214) 675-5229. (B) **Circle No. 535**
- Hamamatsu Corp., 120 Wood Ave., Middlesex, NJ 08846. (201) 469-6640. (R. Eno) (A, C, D) **Circle No. 536**
- Harrison Elecs. Corp., 20 Smith St., Farmingdale, NY 11735. (516) 283-7990. (B. Schreiner) **Circle No. 537**
- HEI Inc., Jonathan Industrial Center, Chaska, MN 55318. (612) 448-3510. (R. Hasselman) (B, C) **Circle No. 538**
- Hewlett-Packard, 1501 Page Mill Rd., Palo Alto, CA 94304. (415) 493-1501. (B, C) **Circle No. 539**
- Hoffman Engineering Corp., 183R Sound Beach, Old Greenwich, CT 06870. (203) 637-1719. (B, C) **Circle No. 540**
- Infrared Inds., 62 4 Ave., Waltham, MA 02154. (617) 890-5400. (G. Davidson) (C) **Circle No. 541**
- Innotech Corp., 181 Main St., Norwalk, CT 06851. (203) 846-2041. (R. W. Ahrons) **Circle No. 542**
- Instrument Technology, Box 381, Westfield, MA 01085. (413) 562-5132. (D. Carignan) (A) **Circle No. 632**
- Integrated Photomatrix Inc., 1101 Bristol Rd., Mountainside, NJ 07092. (201) 233-6010. (P. J. W. Noble) (C) **Circle No. 543**
- International Light Inc., Dexter Indl. Green, Newburyport, MA 01950. (617) 465-5923. (R. Ryer) **Circle No. 544**
- ITT Electro Optical Prods Div., 7635 Plantation Rd., Roanoke, VA 24019. (703) 563-0371. (J. C. Kylander) (C) **Circle No. 545**
- Lindly & Co. Inc., 248 Herricks Rd., Mineola, NY 11501. (516) 746-6505. (V. A. Mateyka) **Circle No. 546**
- Litek Inc., 2143-1 Wyandotte St., Mountain View, CA 94043. (415) 965-4338. (C. W. Kanaule) **Circle No. 547**
- Litronix Inc., 19000 Homestead Rd., Cupertino, CA 95014. (408) 257-7910. (B. Santos) (B) **Circle No. 548**

Dialight sees a need:

(Need: The widest choice for your every application.)

Meret Inc., 1815 24 St., Santa Monica, CA 90404. (213) 828-7496. (P. Pitino) (C) **Circle No. 549**

Micro Components Corp., 99 Bald Hill Rd., Cranston, RI 02920. (401) 737-3200. (C. Grandmaison) (C) **Circle No. 550**

Monsanto Elecs Div., 3400 Hillview Ave., Palo Alto, CA 94304. (415) 493-3300. (R. Schweikher) (B, C) **Circle No. 551**

Motorola Semiconductor Prod. Inc., P.O. Box 20912, Phoenix, AZ 85036. (602) 244-6900. (H. Koski) (B, C) **Circle No. 552**

M 7 Inc. Optoelects Group, 210 Campus Dr., Arlington Heights, IL 60004. (312) 255-7796. (K. D. Cox) (C) **Circle No. 553**

National Semiconductors Ltd., 331 Cornelia, Plattsburgh, NY 12901. (518) 561-3160. (D. F. Clifton) (B, C) **Circle No. 554**

North Coast Optical Sys., P.O. Box 6812, Santa Rosa, CA 95406. (707) 727-7283. (J. E. Drake) (C) **Circle No. 555**

Optical Coating Lab. Inc., Photoelects Group, 15251 E. Don Julian Rd., City of Industry, CA 91746. (213) 968-6581. (D. M. Jones) (E) **Circle No. 556**

Optics Technology Inc., 934 Charter, Redwood City, CA 94063. (415) 364-3830. (K. P. Yeisley) **Circle No. 557**

Optron Inc., 1201 Tappan Circle, Carrollton, TX 75006. (214) 242-6571. (C. E. Bates) (B, C) **Circle No. 558**

Penn Keystone Corp., 14 Division St., Ansonia, CT 06401. (203) 734-3301. (E. M. Parker) **Circle No. 559**

Photobell Co., 12T East 22 St., New York, NY 10010. (212) 674-2121. **Circle No. 560**

Plessey Semiconductors, 1674 McGaw Ave., Santa Ana, CA 92705. (714) 540-9979. (D. Chant) (B, C) **Circle No. 561**

Quanrad Corp., 139 Illinois St., El Segundo, CA 90245. (213) 322-1452. (R. L. Fox) **Circle No. 562**

Quantrol Elecs., 1822 Mills Ave., El Paso, TX 79901. (915) 532-4651. (E.K. Chamberlin) **Circle No. 563**

Radiation Devices Co., P.O. Box 8450, Baltimore, MD 21234. (301) 665-2764. (C) **Circle No. 564**

Raytheon Co., Indl. Components Op., 465 Centre St., Quincy, MA 02169. (617) 479-5300. **Circle No. 565**

RCA Industrial Tube Div., New Holland Ave., Lancaster, PA 17604. (717) 397-7661. (E. McDonough) (A, C) **Circle No. 566**

Recognition Systems, 15531 Cabrito Rd., Van Nuys, CA 91406. (213) 789-4264. (Abe Armonii) (C) **Circle No. 567**

Reticon Corp., 910 Benicia Ave., Sunnyvale, CA 94086. (408) 738-4266. (C) **Circle No. 568**

Santa Barbara Research Center, 75 Coromar, Goleta, CA 93017. (805) 968-3511. (P.J. Granke) (C) **Circle No. 569**

Scientific Technology Inc., 1201 San Antonio Rd., Mountain View, CA 94043. (415) 965-0910. (D. Persen) **Circle No. 570**

Semiconductor Technology Inc., 124-14 22 Ave., College Point, NY 11355. (212) 445-4466. (F.G. Seigel) **Circle No. 571**

Sensor Technology Inc., 21012 Lassen St., Chatsworth, CA 91311. (213) 882-4100. (W.E. Wilson) (C) **Circle No. 572**

Shigoto Ind. Ltd., 350 Fifth Ave., New York, NY 10001. (212) 695-0200. (M. Rubin) (B, C) **Circle No. 573**

Siemens Corp., 186 Wood Ave. S., Iselin, NJ 08830. (201) 494-1000. (B. Mayer) (B, C, E) **Circle No. 574**

Sigma Instrument Inc., 170 Pearl St., Braintree, MA 02184. (617) 843-5000. (R. McMahon) **Circle No. 575**

Siliconix Inc., 2201 Laurelwood Rd., Santa Clara, CA 95054. (408) 245-8000. (L. Lynberg) **Circle No. 576**

Skani-Matic Corp., P.O. Box S, Elbridge, NY 13060. (315) 689-3961. (P. Mims) **Circle No. 577**

Solar Energy Co., 818 18th St. NW, Washington, DC 20006. (202) 347-4568. (G.O. Hamilton) (E) **Circle No. 578**

Solar Systems Inc., 8124 N. Central Park, Skokie, IL 60076. (312) 676-2040. (W.E. Hegberg) (E) **Circle No. 579**

Spectrolab Inc., 12500 Gladstone Ave., Sylmar, CA 91342. (213) 365-4611. (R.L. Westlund) (C) **Circle No. 580**

Spectronics Inc., 830 E. Arapaho Rd., Richardson, TX 75080. (214) 234-4271. (J.D. Crownover) (B, C) **Circle No. 581**

Texas Instruments Inc., P.O. Box 5012, Mail Station 84, Dallas, TX 75222. (214) 238-2011. (C. Clough) (B, C) **Circle No. 582**

United Detector Technology, 2644 30 St., Santa Monica, CA 90405. (213) 396-3175. (P. Nelson) (C) **Circle No. 583**

Vactec, Inc., 2423 Northline Industrial Blvd., Maryland Heights, MO 63043. (314) 872-8300. (D. Hartley) (C) **Circle No. 584**

Valtec Corp., 99 Hartwell St., W. Boylston, MA 01583. (617) 835-6082. **Circle No. 585**

Varian Associates, 611 Hansen Way, Palo Alto, CA 94393. (415) 493-4000. (J. Heldack) (A) **Circle No. 586**

Versitron, 6310 Chillum Pl. NW, Washington, DC 20011. (202) 882-8464. (D.C. Sherrick) **Circle No. 587**

Xercon Inc., P.O. Box 554, Portland, OR 97207. (503) 292-4436. **Circle No. 588**

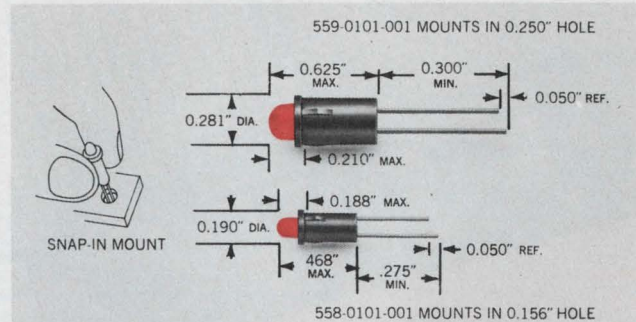

558 and 559 SERIES Available in red, green or yellow LEDs, with and without integral current limiting resistors. Snap-in mounting requires no additional hardware. Straight terminals suited for wire-wrapping and/or soldering. Low power requirements—15 to 20mA. In 1000-lot quantities each
558-0101-001 . . \$33. 559-0101-001 . . \$33.

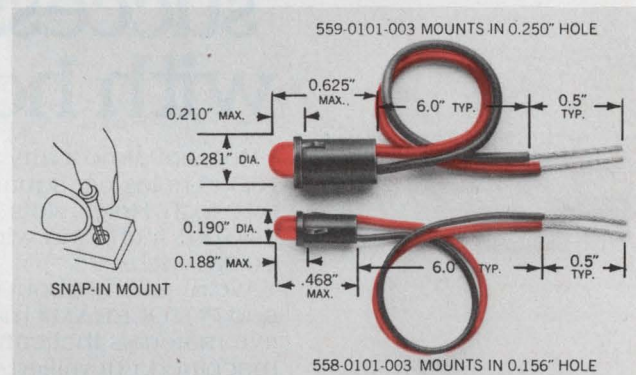

558 and 559 SERIES Available with 6" wire leads, these red, green or yellow LEDs are designed for quick positive insertion in 0.031" to 0.062" panels. Compact design allows high density packaging. In 1000-lot quantities each
558-0101-003 . . \$75. 559-0101-003 . . \$71.



Dialight, the company with the widest choice in switches, LEDs, indicator lights and readouts, looks for needs . . . your needs . . . and then they develop solutions for your every application. No other company offers you one-stop shopping in all these product areas. And no other company has more experience in the visual display field. Dialight helps you do more with these products than any other company in the business, because we are specialists that have done more with them. Talk to the specialists at Dialight first. You won't have to talk to anyone else. Send for your free new copy of Dialight's current catalog.

DIALIGHT

Dialight, A North American Philips Company
 203 Harrison Place, Brooklyn, N. Y. 11237
 (212) 497-7600

See Dialight.

CIRCLE NUMBER 39

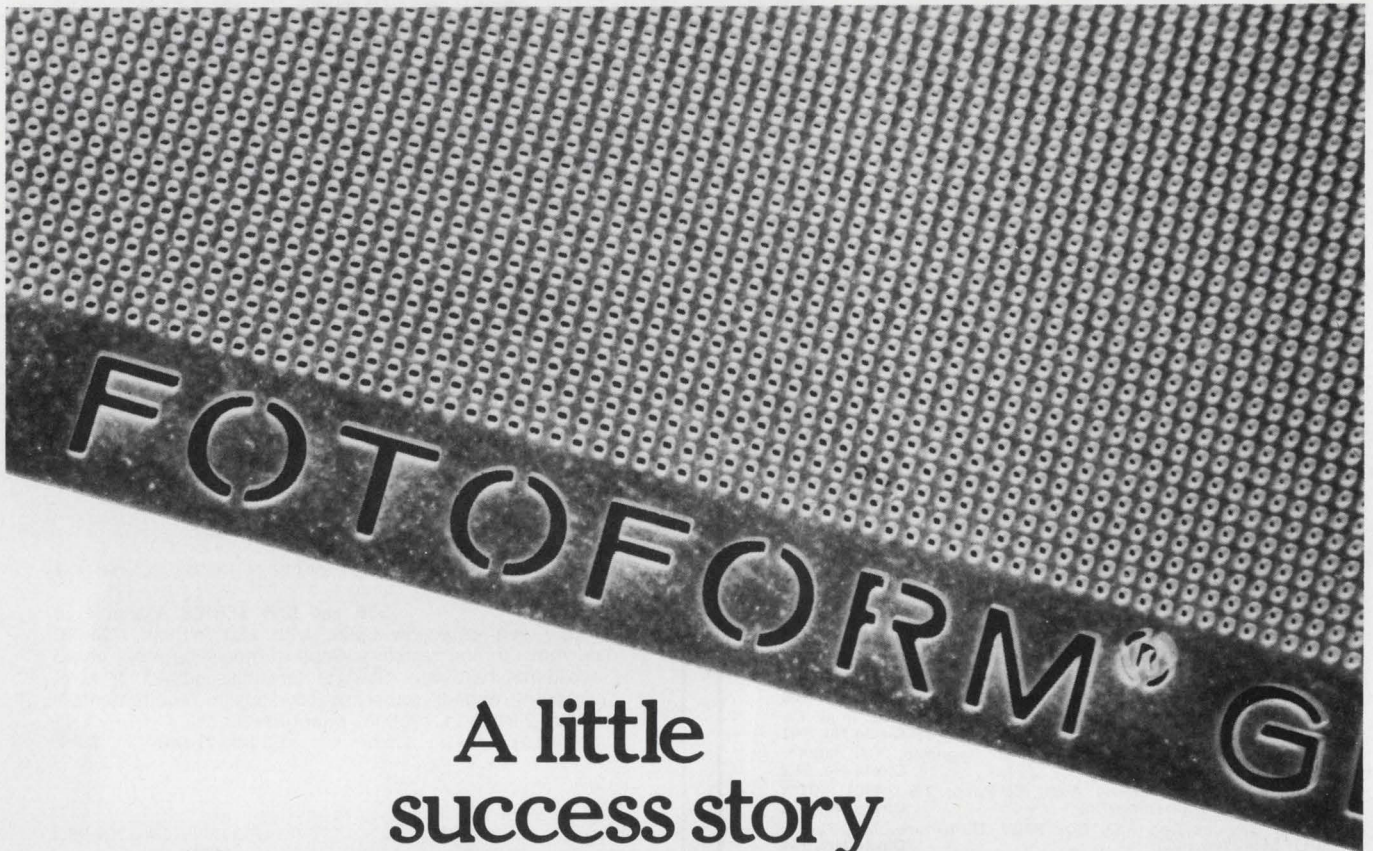

A little success story with holes in it...

Holes of almost any shape and size. Up to 10,000 holes per square inch, in pieces as thin as 0.10 inch. Holes, slots, and channels, as small as 0.005 inch. And with tolerances as close as ± 0.001 inch.

We're talking about Corning FOTOFORM® and FOTOCERAM® materials. Unique, photosensitive materials that can be precision-etched, machined, cut, milled, chamfered, ground, lapped, polished, sealed to glasses or ferrites. And even metalized.

The real beauty of FOTOFORM and FOTOCERAM materials is they offer you engineering flexibility—the flexibility to do it your way.

And at Corning, your way is the only way. That's why we developed FOTOFORM and FOTOCERAM materials. They may help you write your own success story. We'll help. We're the Fotoform Products Group, Corning Glass Works, Corning, New York.

You ought to get to know us better. Find out more about FOTOFORM and FOTOCERAM materials. Write, under your letterhead, for a free sample depicting the 1776 Bennington Flag and complete specifications to:

FOTOFORM Products Group Dept. ED-36
Corning Glass Works, Corning, New York 14830
(607) 974-8583

CORNING
CORNING GLASS WORKS

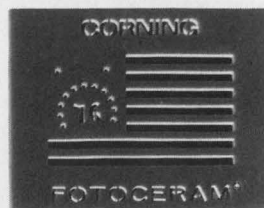

Write for free sample today!

Optical switches tailored to fit.



Clairex offers a choice of standard and custom switches with hermetically sealed components.

Don't make your design to fit an optical switch. Let Clairex® make the optical switch to fit your design.

You can get two standard sizes with gap widths of .100 in. or .250 in. Or we'll make them to any width or size you specify.

We seal both the LED and phototransistor in hermetic cases for long life in the harshest environments. Then pretest each switch to make sure it works. The lenses or windows are glass, not plastic, to reduce dust pickup. (Lenses position the light beam more accurately, preventing false signals from stray light.) Outputs are compatible with T²L inputs.

Sensors are either phototransistors or photodarlingtons.

You can forget about friction wear, switching "noise", and contact bounce. The two switch heads are completely isolated. Switching time can be as short as 5 microseconds — impossible with mechanical switches.

Tell us what you need. We'll develop the solution. With Clairex, you get the best in opto-electronic components — photodarlingtons, phototransistors, photoconductors, opto-isolators. Write Clairex Electronics at 560 South Third Avenue, Mount Vernon, New York 10550. Or phone (914) 664-6602.



CLAIREX ELECTRONICS

Consider CCDs for a wide range of uses.

Existing charge-coupled-device products encompass image sensors, high-density memories and analog-signal processors.

Announced only six years ago, CCDs today span virtually the entire range of the electronics industry. The charge-coupled devices are being used as image sensors, analog-signal processors and high-density memories.

Basically, CCDs are shift registers for analog-charge signals. The registers are formed by a string of closely spaced MOS capacitors.¹ The amazing versatility of CCDs stems from the fact that they can store and transfer charge signals that have been introduced either electrically or optically.

As self-scanned photosensor arrays, CCDs provide rugged solid-state image sensors. Because they have potentially higher storage capacity than n-channel MOS RAMs, CCDs are also leading contenders for high-density block-oriented semiconductor memories. And in the area of analog-signal processing, CCDs can be used for electronically variable delay lines, recursive and transversal filters, signal correlation, multiplexing and signal reformatting.

Image sensors limit pick-up noise

The ability to detect optical signals allows CCDs to be constructed into very effective self-scanned image sensors. These sensors can store and transfer the detected charge image under the control of clock pulses, yet remain free of unwanted switching-transient pick-up—a unique characteristic. The clock pick-up is thus limited to a single output stage, and can be filtered out readily from the video signal. The operation principle of charge-coupled image sensors appears in Fig. 1.

The optical image can be applied either from the top side through the semitransparent polysilicon gates, or from the bottom side, if the silicon substrate is made thin enough. During the optical integration period, the clocks are adjusted to form stationary potential wells—one for each optical resolution element. At the end of the inte-

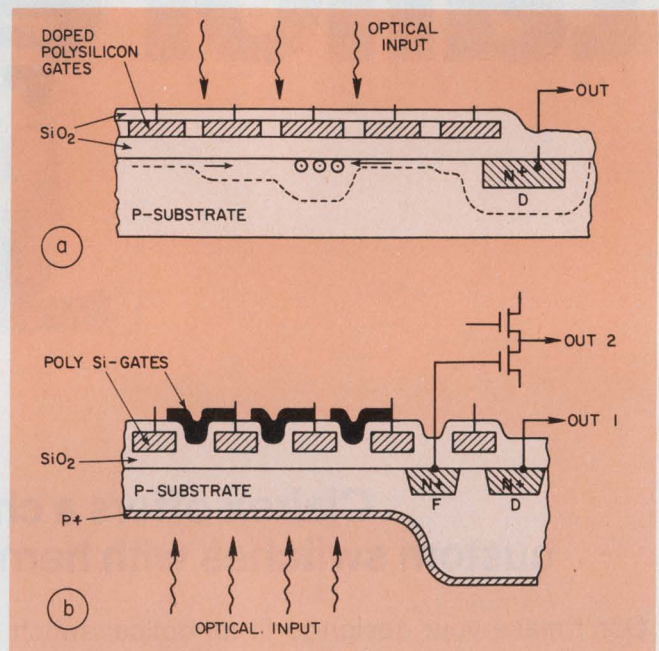

1. Charge-coupled sensors detect optical images either from their top side, through semitransparent polysilicon gates (a), or from their bottom side—back illumination—through a thin substrate (b). In either case a floating-diffusion or floating-gate on-chip amplifier detects the sensor's output.

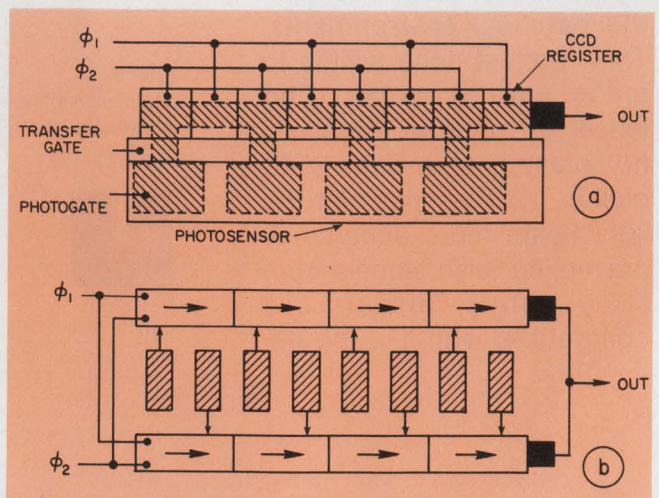

2. Line-image sensors continuously integrate the optical input through an array of photosensors (a). Resolution can be increased by a factor of two with a dual CCD-channel construction (b).

Walter F. Kosonocky and Donald J. Sauer, Members of the Technical Staff, RCA Laboratories, Princeton, NJ 08540.

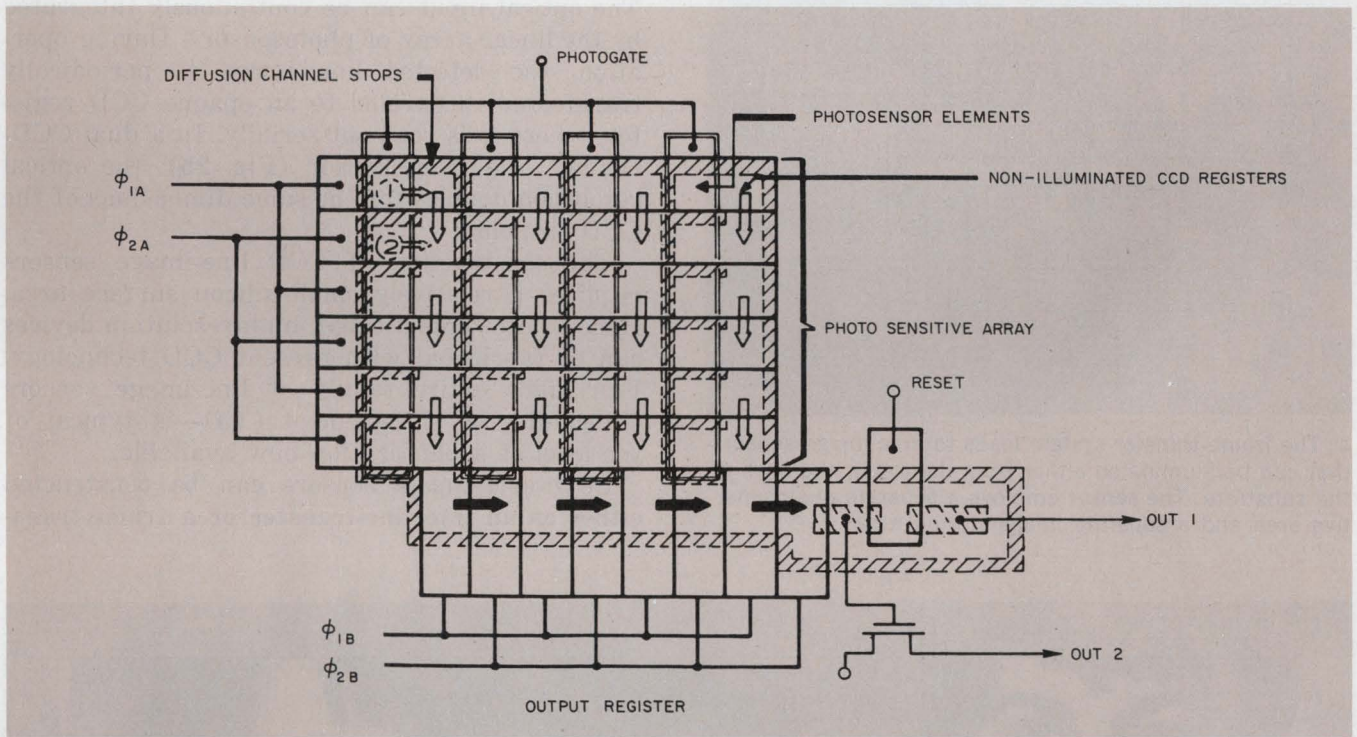

3. **The interline-transfer system**—one way to make area-image sensors—employs parallel arrays of line sensors and nonilluminated registers. The combination leads into

a single output register. The image is detected as two vertically interlaced modes. The sensor can be operated in either a high-resolution or standard-TV interlace mode.

gration time, the accumulated charge packets representing the integrated optical input shift down the CCD register to be detected by a single output amplifier. To prevent image smearing, the optical integration time should be much longer than the total time required to transfer the detected image from the sensor.

All charge elements use the same amplifier, so nonuniformities (a problem in optical arrays in which each sensor element uses a separate amplifier) are avoided. Also since only the clock frequency outside of the video bandpass is used for this transfer, clock pick-up doesn't present the problem that it does in x-y scanned arrays. There, one of the clocks occurs at a horizontal line frequency and cannot be removed by simple filtering.

The output of an image sensor is usually detected by a floating-diffusion or a floating-gate

Table 1. CCD area-image sensors

	No. of Elements Vertical × Horizontal	Type (See note)	Commercially Available
Fairchild	100 × 100 190 × 244 (380) × (488)	IT, BCCD	Yes Yes (Under Development)
RCA	320 × 512	FT, SCCD	Yes
TI	400 × 400	FT (Back-Illuminated)	No
Bell Labs	475 × 496	FT, SCCD	No
GE	100 × 100 200 × 250	CID	Yes (As Cameras Only)

Note: IT—Interline Transfer System
FT—Frame Transfer System
CID—Charge Injection Device

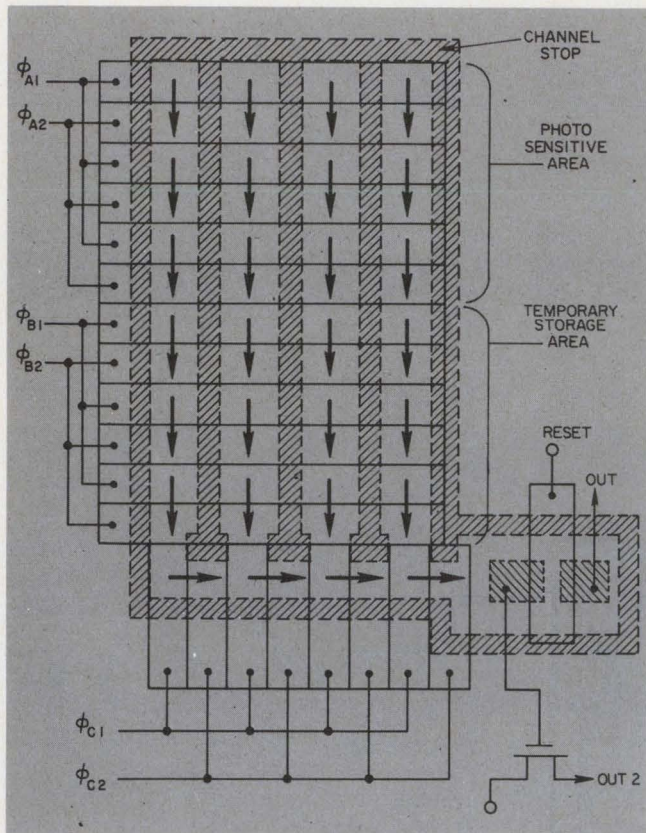

4. The frame-transfer system leads to area-image sensors that can be illuminated either from the top or the back of the substrate. The sensor employs a separate photosensitive area and a separate image-storing area.

on-chip amplifier (Fig. 1b). The amplifier generally has a very low input capacitance—on the order of 0.1 pF—which results in a high sensitivity and large dynamic range, especially for buried-channel devices operating below room temperature (0 to -40°C). At room temperature, however, sensitivity is limited mainly by local variations in dark current.

Constructing line-image sensors

Line-image sensors with nonilluminated CCD registers have the construction shown in Fig. 2. The optical input can be continuously integrated by the linear array of photosensors. During operation, the detected line image is periodically transferred in parallel to an opaque CCD register, where it is read-out serially. In a dual CCD-channel line-image sensor (Fig. 2b), the optical resolution doubles for the same dimensions of the CCD elements.

The construction of CCD line-image sensors requires a relatively small silicon surface area. Hence quite sophisticated, high-resolution devices can be fabricated with present CCD technology. Fairchild's entire family of line-image sensors—including a 1728-element CCD—is typical of the level of sophistication now available.

CCD area-image sensors can be constructed either as an interline-transfer or a frame-trans-

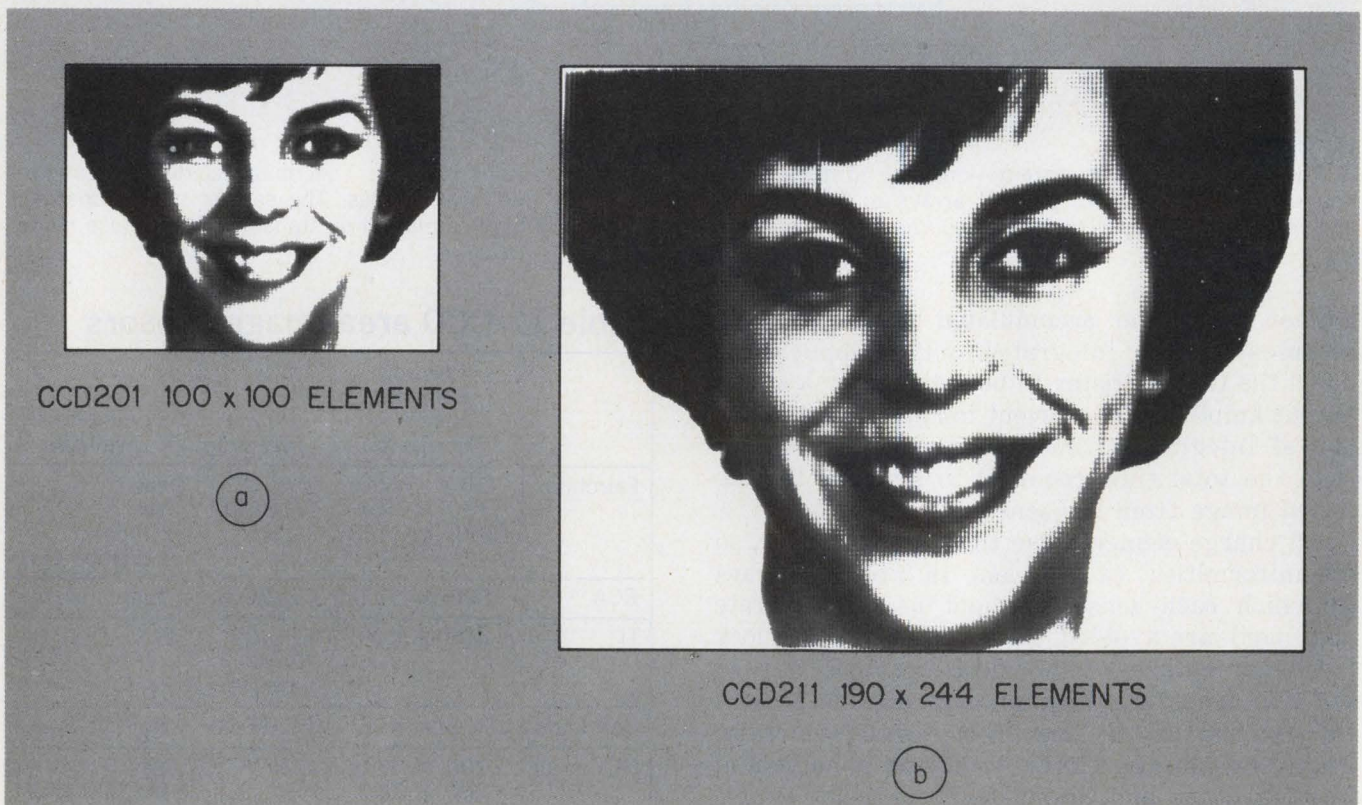

5. The resolution required of area-image sensors depends on the application. Shown are images detected by Fairchild's CCD201, a 100×100 -element array (a),

and the company's CCD211, a 190×244 -element array. Fairchild also manufactures a family of line-image sensors that include a 1728-element unit.

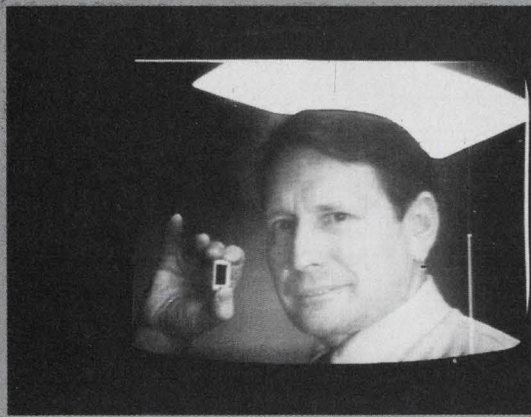

(a)

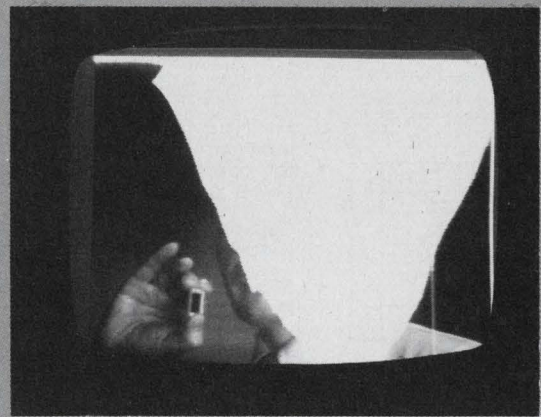

(b)

6. The improvement rendered by blooming control can be seen in RCA's 320 × 512 frame-transfer sensor (a).

Uncontrolled blooming produces the impaired image shown as a reference (b).

fer system. The interline-transfer system (Fig. 3) can be thought of as a parallel array of line sensors and nonilluminated registers all leading in parallel into a single output register. The optical image is detected by vertical lines of photosensitive MOS capacitors formed with transparent polysilicon gates. Vertical line sensors are separated from each other by opaque vertical CCD registers. Two photosensor elements can be read by one stage of the vertical register. Thus the image is detected as two vertically interlaced fields.

Two interlace modes are possible—a high-resolution and a standard-TV interlace mode. The high-resolution mode has a 1/30-second optical integration time for each field. Once every 1/60-second, one field transfers into the nonilluminated registers. Then, the entire detected image shifts down uniformly (at the rate set by clock A) and transfers into the output register a horizontal line at a time. The horizontal lines then transfer out of the output register (at the rate set by high-frequency clock B) before the next horizontal line shifts in.

The standard TV-interlace mode has a 1/60-second optical integration time for each field. Charge signals detected by two adjacent photosensors combine into a single charge at the vertical CCD registers. Thus the standard-TV mode effectively overlaps photosensor elements in the vertical direction. In contrast, the high-resolution mode has contiguous photosensor elements in the vertical direction.

Because of opaque, vertical CCD registers, the interline-transfer system has noncontiguous photosensor elements in the horizontal direction, and it cannot be illuminated from the back side of the array. The frame-transfer system, though, can be illuminated either from the top or back

of the substrate (Fig. 4). The optical image is detected by a separate photosensitive area of CCD registers. If we assume a TV format with 1/60-second field time, the image is transferred into the opaque temporary storage array by clocks A and B during the vertical blanking time—900 μ s.

From the storage array, the image shifts down one horizontal line at a time into the output register and transfers out at the rate set by high-speed clock C. The time available for parallel loading of the output register corresponds to the horizontal-line retrace time of 10 μ s. This leaves 50 μ s for the read-out of the horizontal line from the output register.

The frame-transfer sensor has contiguous photosensor elements in the horizontal direction and overlapping photosensor elements in the vertical direction, when operated in a standard-TV interlace mode. The effective position of the photosensor elements shifts up and down by one-half stage of the vertical CCD registers (between the two interlaced fields), thereby effectively doubling the vertical resolution of the image sensor.

When the frame-transfer image sensor is made as a surface-channel CCD, it can be operated with a so-called accumulation mode of blooming control: During the optical integration time, each charge-detecting potential well is surrounded on all four sides by accumulation (charge recombination) regions. These tend to confine blooming—a serious impairment of a CCD image—due to high-intensity localized overloads.

For operation with an optical shutter, the imaging area of the frame-transfer system can be extended to the full area of the device. The frame-transfer system can also be operated in a time-delay-integration (push-broom) mode: Charge transfers in the parallel section are syn-

Synchronously clocked serpentine loop memory

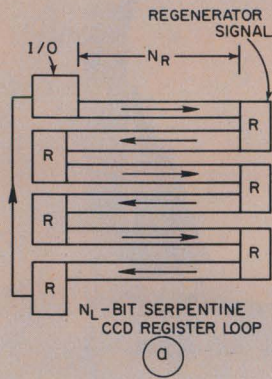

1. Average access time = $\frac{N_L}{2 f_c}$
2. For $N_R \ll N_L$, structure can be built with very long registers for operation at low standby power at low clock frequency
3. Capable of operation with widest range of data rates
4. Requires large clock power at maximum data rate and large capacitance external clocks
5. Not suitable for very high packing density construction

SPS random addressable memory

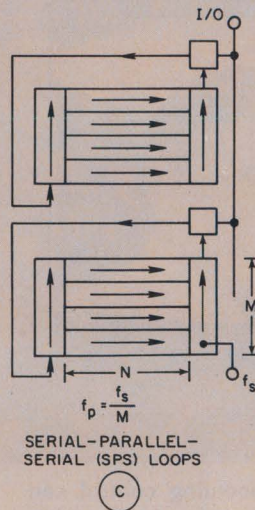

1. Avg. access time = $\frac{N \times M}{2 f_s}$
2. Min. practical average access time about 100 μ s
3. Number of transfer stages between signal regeneration = $N + M$
 - (a) Allows large loop size ($N \times M$)
 - (b) Restricts the min. data rate due to dark current
4. Suitable for on-chip clocks because the large capacitance clocks operate at low clock frequency $f_c = \frac{f_s}{M}$
5. Memory organization with highest packing density when parallel registers of the SPS cells are:
 - (a) Interlaced 2:1, 3:1 or 4:1, increasing packing density by a factor of 2, 3 or 4, respectively.
 - (b) Operated in electrode-per-bit clock mode, improving density by up to a factor of 2.

Synchronously clocked random addressable loop memory

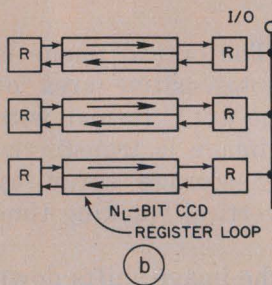

1. Average latency time = $\frac{N_L}{2 f_c}$
2. Min. avg. latency time = 64 μ s at $N_L = 256$, $f_c = 2$ MHz
3. Short random access time to any loop (< 500 ns)
4. Requires high power for operation with minimum latency
5. Min. dark current sensitivity allows wide range of bit rates
6. Requires 2 to 4 large capacitance external clocks
7. On-chip clocks are not practical
8. Packing density limited by size of signal regeneration stages

Line addressable random access memory (Laram)

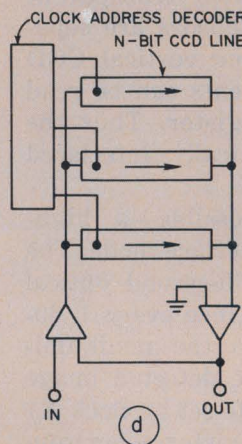

1. Random access to any CCD line
 - (a) Avg. access time = $\frac{N}{2 f_c}$
 - (b) Min. practical access time = 12.8 μ s at $N = 128$, $f_c = 5$ MHz
2. Number of stages between regeneration = N
3. Only one CCD line register can be clocked at a time by an addressable on-chip clock driver
4. Laram is capable of short access time and high bit rate at low power
5. Most sensitive CCD memory system to dark current—local spikes are not averaged
6. Requires the most complicated CCD technology and tends to give the lowest packing density

7. CCD memories employ one of four different structures. The synchronously-clocked serpentine loop (a) operates with the widest range of data rates, and the synchronously-clocked random-addressable loop (b) permits short access to any loop. A serial-parallel-serial version (c) of the latter permits the highest packing density. The Laram, or line-addressable random-access memory (d), combines short access and high bit rate with low power.

chronized with the motion of the image, and the device operates as a sensitivity-enhanced line-image sensor.

Makers of area-image sensors

Development of CCD area-image sensors began at several companies only four years ago. Since then commercially available units have arrived with resolutions comparable to those of television, and full TV resolution has been reported by Bell Laboratories and Fairchild.

Recently announced or reported CCD area-image sensors are summarized in Table 1. Also included is the charge-injection device (CID), since it can be considered a type of CCD x-y addressable-image sensor. The performance of the Fairchild 100×100 and 190×244 interline-transfer CCD image sensors appears in Fig. 5, and Fig. 6 illustrates the blooming-control characteristics of the RCA 320×512 frame-transfer CCD image sensor.

Charge-coupled image sensors constitute the largest LSI devices available. For example, the

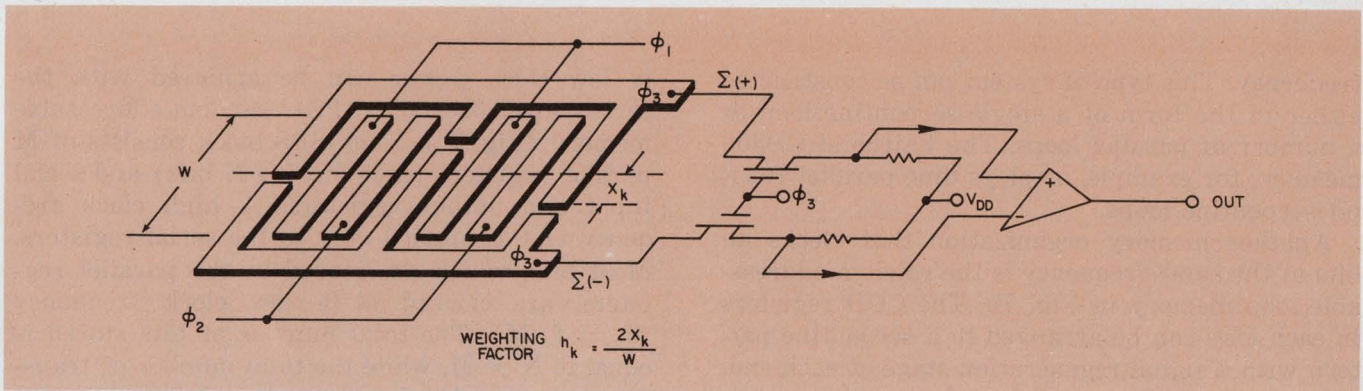

8. The split-electrode tap-weight technique simplifies construction of fixed-weight transversal filters.

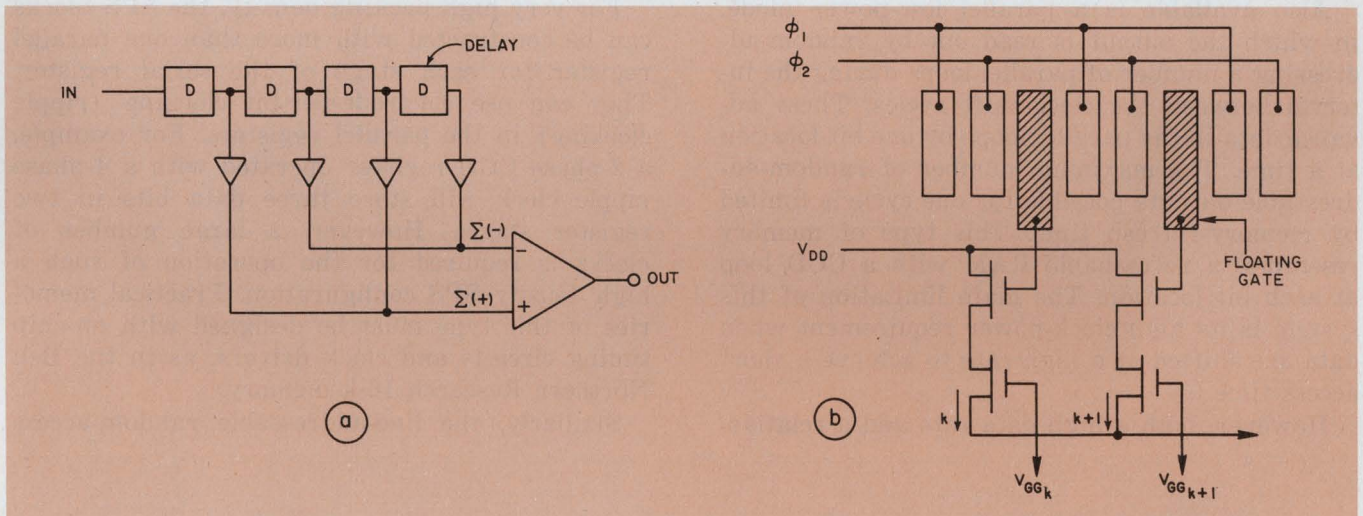

9. Signals can also be tapped with floating gates, and weighted and summed with source followers. The block

diagram of a variable-weight transversal filter (a) can be realized by the scheme shown (b).

Fairchild 1728-element CCD line-image sensor measures almost one inch in length, and the RCA 320×512 CCD area-image sensors extends over $1/2 \times 3/4$ in. of silicon.

Available CCD line-image sensors can provide 200 line/inch resolution on an 8.5 in. page, and available area-image sensors can be used for a variety of medium-quality closed-circuit TV systems. The next generation area-image sensors should extend performance to full TV resolution and to broadcast-quality TV cameras.

CCD memories: 65-k bits now and getting larger

The first CCD memory products appeared last year. Both Fairchild and Intel introduced units with storage capacities up to 16,384 bits/chip. Bell Northern Research (BNR) also has developed a 16-k CCD memory chip. Though not commercially available, the BNR memory employs a design approach that can be used to achieve even higher packing density. The largest CCD memory—a 65-k chip—has recently been reported by Mnemonics.

To store digital signals in these devices, charge signals must be periodically refreshed, or regenerated. The construction of signal-refreshing stages follows procedures similar to those used in dynamic MOS memories. The over-all design of different memory chips reflects the emphasis placed on one or more of the following: clock power, access time, chip overhead for peripheral circuits, frequency range, temperature range, and the number of CCD clock phases.

Four different arrangements can be used to form the basic memory (Fig. 7). In the synchronously clocked serpentine configuration, all the bits in the memory array are clocked at the same frequency (f_c). The number of bits between regenerating amplifiers (N_R) depends on either transfer efficiency or the lowest operating frequency desired in the standby, or idle, mode of operation. The number of bits between the data input and output (N_L) determines the average access time.

At the maximum data rate, the serpentine arrangement requires high clock power, since all bits in the memory array are clocked at the same

frequency. This type of system can be constructed either in the form of a single serpentine loop or a number of parallel loops. The Fairchild CD450 memory, for example, employs nine parallel 1024-bit serpentine loops.

Another memory organization that clocks all bits at the same frequency is the random-addressable loop memory in Fig. 7b. The CCD registers in each loop can be arranged in a serpentine pattern with a signal-regeneration stage at each end. The content of one register can be read-out serially, though for high data rates this serial mode requires high clock power.

Also available is a parallel low-power mode, in which the output is read out by random-addressing a number of parallel loops during the interval between the clock-shift cycles. These advance data in the parallel loops by one bit location at a time. The maximum number of random-addressable outputs possible for one cycle is limited by memory-refresh time. This type of memory resembles a refreshable RAM with a CCD loop at each bit location. The main limitation of this system is its high clock-power requirement when data are shifted at a high rate to achieve a short access time.

However, both a high data rate and a relative-

ly low clock power can be achieved with the serial-parallel-serial (SPS) random-addressable memory (Fig. 7c). Each SPS block consists of M parallel registers (each storing N bits) and serial input and output registers. A high clock frequency (f_s) is applied only to the serial registers. Most bits, which are stored in the parallel registers, are clocked at a low clock frequency ($f_p = f_s/M$). The total number of bits stored is equal to $N \times M$, while the total number of transfers between signal-regeneration stages is equal to the sum of the transfers through one serial register and one parallel register.

For very high packing density, the SPS blocks can be constructed with more than one parallel register for each stage of the serial register. They can use electrode-per-bit clocking (ripple clocking) in the parallel registers. For example, a 2-phase CCD register operated with a 4-phase ripple clock will store three data bits in two register stages. However, a large number of clocks is required for the operation of such a high density SPS configuration. Practical memories of this type must be designed with on-chip timing circuits and clock drivers, as in the Bell Northern Research 16-k memory.

Similarly, the line-addressable random-access

Table 2. High-density CCD memories

Company Model (Bit Size)	Fairchild CD460 (16k)	Intel 2416 (16k)	Bell Northern-Research CC16M1 (16k)	Fairchild CD450 (9k)
Organization	4 Blocks Of 32 128-Bit Registers 4 Data I/O	64 256-Bit Registers, 1 Data I/O	4 4096-Bit Registers, 4 Data I/O	9 1024-Bit Registers, 9 Data I/O
Operating Modes	Read, Write Read/Modify/Write, Recirculate	Read, Write, Read/Modify/Write, Shift	Read, Write, Recirculate	Read, Write, Read/Modify/Write, Recirculate
Power Supplies (V)	-5, +5, +12	-5, +12	-5, +5, +12	-2.5, +5, +12
External Clocks	1 @ 120 pF 1 @ 15 pF	2 @ 500 pF 2 @ 700 pF	2 @ 60 pF	2 @ 400 pF
Data Rate, Per I/O (MHz)	0.5 to 5.0	0.1 to 2	1 to 10	0.05 to 3
Average Access Time (μ s)	12.8	96	200	170
Refresh Time (ms)	2 (halt) 10 (recirculate)	1.2 (9- μ s max shift interval)	4	2.5
Temperature Range ($^{\circ}$ C)	0 to 55	0 to 70	0 to 70	0 to 55
Chip Power (max) Ext. Clock Power (max) Standby Power (mW)	200 97 50	300 230 24	340 86 200	265 345 31
Interface	All TTL except clocks	All 12 V except enhanced TTL Data In	All TTL except clocks and WE	All TTL except clocks
Chip Size (mils)	201 x 219	143 x 237	136 x 169	135 x 200
DIP Package (No. Of Pins)	22	18	16	18
Process	NMOS, BCCD	NMOS, SCCD	NMOS, SCCD	NMOS, BCCD

memory (Laram) developed by Fairchild is only practical because clock drivers have been incorporated on the chip (Fig. 7d). The memory achieves a very short access time.

The Laram consists of an array of M CCD lines (registers) each storing N bits of data. The CCD lines operate with one common dc-bias clock phase and a separate clock phase applied to each line under the control of an address decoder. When the Laram array is unselected it stores data in the stationary wells of the CCD lines. To periodically regenerate—or recirculate—the data and to perform a read or write operation, a clock pulse train must be applied to the selected lines.

The Laram's very short access times at low clock power result from its transferring data at high rates from only one CCD register at a time. The price paid for the short access is a higher sensitivity to dark-current spikes and a higher storage area/bit than the previously described SPS system.

Comparing different memories

The performance characteristics of representative CCD memories appear in Table 2. The Fairchild CCD 450, a synchronously clocked kilobyte device, is organized as 1024 words by 9 bits. It contains nine 1024-bit registers that are shifted in parallel by two clock phases. Data I/O is handled with nine bidirectional TTL-compatible data lines that have three-state output buffers. The device has a typical data-rate range of 50 kHz to 3 MHz.

A signal-refreshing stage appears every 128 bits, at each corner of a serpentine arrangement that reverses the direction of charge transfer in adjacent channels. The minimum data rate of 50 kHz corresponds to the maximum time of 2.56 ms between refresh stages. The CCD 450 uses a buried-channel ion-implanted barrier structure for the CCD registers and an n-channel, silicon-gate Isoplanar structure for the MOS circuitry.

The Intel 2416, a synchronously clocked, 16,384-bit serial memory, consists of 64 recirculating shift registers of 256 bits each. Any one of the 64 shift registers can be accessed by means of a 6-bit address input. The 256-bit register consists of two 128-bit registers in series, and a refresh amplifier at each end.

The 128-bit registers are formed by multiplexing two adjacent 64-stage CCD channels, so that the data rate around the shift-register loop is twice the frequency of the four-phase CCD clocks employed. After a shift operation (half-clock period) the contents of the 64 registers at the current bit location are available for nondestructive

reading, and/or modification. I/O functions are accomplished in a manner similar to that of a 64-bit dynamic RAM, between shift operations.

One shift operation must be performed every $9 \mu\text{s}$ in order to satisfy the refresh requirements of the 2416. This interval corresponds to a maximum time between refresh amplifiers of 1.2 ms. The 2416 has a maximum serial data-transfer rate of 2 Mbit/sec, and an average latency time to any bit of less than $100 \mu\text{s}$. The chip employs Intel's high-voltage n-channel silicon-gate MOS process and a double polysilicon-gate CCD structure.

The Fairchild CCD460, also a 16,384-bit memory, contains four parallel Laram blocks of 4096 bits each. Each Laram block consists of 32 128-bit CCD shift registers, or lines, that can be randomly addressed by an on-chip clock decoder. Each 4096-bit block also has a separate TTL-compatible input and three-state output.

The access time to any 128-bit line is 200 ns, and the data rate is variable from 0.5 to 5 MHz except in the read-modify-write mode, which has a maximum data rate of 3 MHz. For the maximum data rate of 5 MHz the average access time to any bit within the line is $12.8 \mu\text{s}$. The device requires one external clock with 120-pF capacitive loading, and one clock at 15 pF. As in a RAM, each line must be addressed at least once within the refresh time.

The 16-k chip with the highest packing density has been developed at Bell Northern Research. The BNR CC16M1 measures $136 \times 169 \text{ mil}^2$. It has a storage-area cell density of $0.57 \text{ mil}^2/\text{bit}$ and an over-all chip density of $1.4 \text{ mil}^2/\text{bit}$. The memory has a so-called condensed SPS organization—an SPS construction with 2:1 interlacing (two parallel channels for each stage of the serial registers) and 4-phase-electrode/bit clocking of the parallel registers.

The BNR CC16M1 is divided into four 4096-bit blocks. Each block has a separate TTL-compatible input and three-state output. Each 4-k-bit block consists of two multiplexed 2048-bit condensed SPS loops that provide a maximum data rate of 10 MHz when the high-speed serial registers of the SPS structure are clocked at 5 MHz. The chip includes differential sense amplifiers and on-chip clock and timing circuits. It requires two external clocks with 60-pF capacitive loading each.

The Bell chip has three modes of operation: read, write, or recirculate. In the read or write modes, the 4-k block can be interconnected into larger serial-data blocks with no sacrifice of the maximum data rate. At the maximum rate of 10 MHz, the average access time to a random bit

(continued on page 78)

within the block is 200 μ s.

CCD memories are usually intended for applications involving data storage in large blocks where access times of 100 μ s or so can be accepted. The price per bit for CCD memories is expected to drop to 1/2 to 1/4 that of n-channel MOS RAMs, their major competitors.

An example of a CCD memory that is already price competitive with NMOS RAMs is Intel's CCD Memory System, designed to replace magnetic drum memories and small-to-medium-capacity disc memories. The MV-65-8 memory support card contains 131,072 bytes of storage and costs 0.25¢/bit.

Present projections for CCD memories in two to four years are 0.01 to 0.02¢/bit. However to remain price-competitive with 16-k MOS RAMs—several are expected this year—CCD memories can be expected to move up to 65-k and larger capacities.

Analog-signal processing

In the area of analog-signal processing, CCDs promise lower costs, lower power requirements, and in some cases, better performance than conventional digital techniques. CCDs are generally expected to become much cheaper than digital filters because (1) CCDs eliminate the need for a/d and d/a conversion, and (2) a single CCD filter can replace a large amount of digital hardware.

Fixed or electronically variable delay lines for video or audio signals represent one of the most direct and obvious applications of CCDs. Since the CCD delay line samples the input signal once every clock cycle, signal bandwidths approaching $f_c/2$ can be achieved. The electronically variable delay is obtained by varying the clock frequency.

Other signal-processing functions that can be performed conveniently with CCDs include these: multiplexing and demultiplexing, time synchronization and time conversion (compression and expansion), frame storage and various types of frame-format conversions. Transversal filters, with fixed and variable weights, represent perhaps the most effective charge-coupled devices for processing of analog signals.

Signals at each CCD delay-line stage can be tapped, weighted, and summed by the technique shown in Fig. 8. The split-electrode weighting and summing approach is a very effective way for construction of transversal filters with fixed weights. Another approach employs floating-gate signal tapping and source-follower weighting and summing (Fig. 9). Signal weighting can be varied by external or on-chip control of the gate

voltage to the MOS load device.

Fixed-weight transversal filters in development include the following: filters for various spread-spectrum communication applications, radar-pulse compression and bandpass filters, and chirp-z transform filters for spectral analysis. The most advanced devices are an 800-stage CCD bandpass filter and a 500-stage chirp-z transform filter, both reported by Texas Instruments.

Recursive filters (Fig. 10), which include both feedback and feedforward, have been reported by General Electric. The filters employ bucket-brigade devices as the delay sections. In another development, a general-purpose two-pole recursive filter using CCD delay lines has been reported by

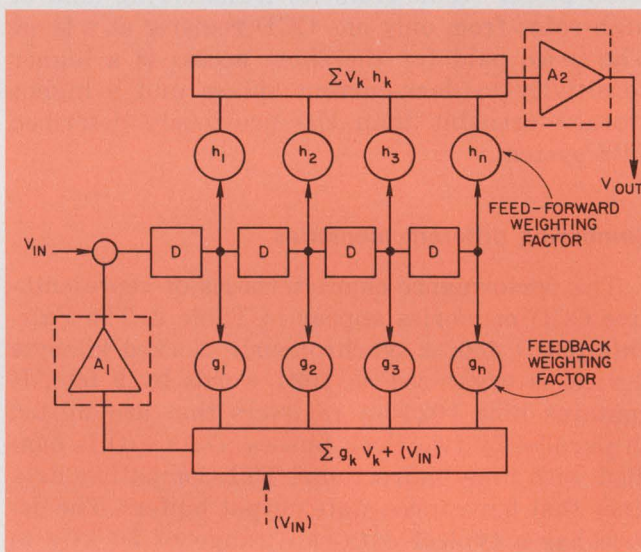

10. Recursive filters can be built to include both feedback and feed-forward.

Westinghouse. In this filter, a group of three ROMs in combination with a/d converters store the feedback and feedforward coefficients. Unlike transversal filters, which can have only a finite impulse response, the use of feedback by recursive filters results in an essentially infinite impulse response. Therefore, a high-quality bandpass recursive filter can be designed with only a small number of delay sections.

The trend in CCD signal-processing devices is toward custom units with ever more support circuits on the chip. An example of this is an 800-element bandpass transversal filter recently reported by Texas Instruments. The filter contains clocks and input and output signal-charge amplifiers. ■■

Reference

1. Kosonocky, Walter F. and Sauer, Donald J., "The ABCs of CCDs," *Electronic Design*, April 12, 1975, pp. 58-63.

Microcomputers. How to make the make-or-buy decision.

<u>MAKE</u>	\$
CPU CHIP	_____
CLOCK CIRCUITRY	_____
CRYSTAL	_____
LATCHES	_____
MEMORY	_____
MISC. TTL CIRCUITRY	_____
MEMORY + I/O CONTROL	_____
ETCHED BOARD	_____
ENGINEERING DESIGN	_____
SYSTEM SOFTWARE DEV.	_____
DIAGNOSTIC SOFTWARE DEV.	_____
PROTOTYPE ASSEM. + TEST	_____
PURCHASING	_____
INCOMING INSPECTION	_____
INVENTORY	_____
DOCUMENTATION	_____
PLANT SPACE	_____
PRODUCTION PERSONNEL	_____
PRODUCTION EQUIPMENT	_____
TESTING EQUIPMENT	_____
PER UNIT TOTAL	\$ _____

<u>BUY</u>	\$
LSI-11	\$ <u>634*</u>
16-BIT, 4K OF RAM,	
8 1/2" x 10" BOARD	
PER UNIT TOTAL	\$ <u>634</u>

When you're through comparing costs — which should wind up about the same — consider these additional facts:

Make your own micro and you waste up to a year just developing your product for market. Buy an LSI-11 and you don't.

Make your own micro and you have to maintain your own field service for it. Buy an LSI-11 and you don't.

Make your own micro and you get a dedicated machine you have to chuck next time you improve your product. Buy an LSI-11 and you don't.

Make your own micro?
Buy an LSI-11.

For the complete story, call 800-225-9480 (Mass. 617-481-7400 ext.6410). Or write: Components Group, Digital Equipment Corp., One Iron Way, Marlborough, MA

01752. Canada: Digital Equipment of Canada, Ltd. Europe: 81 Route de l'Aire, 1211 Geneva 26, Tel. 42 79 50.

*In 100's. Prices apply to U.S.A. only.

digital
COMPONENTS
GROUP

CAN THE ANALOG SWITCHES SYSTEM PASS THE HARRIS

The Harris Personality Test asks important questions about the behavior pattern of your system.

In doing so, it'll help you determine whether your analog switches and multiplexers are as trouble-free as they should be. Of course, our own popular pin-for-pin compatible CMOS switches and multiplexers will be used as the standard of comparison. Why not see how your system measures up (Test results on opposite page).

1. Does your system have a latch-up problem that it can't cope with?

With the Harris devices, you have

nothing to worry about. They're problem-free. That's because each MOS transistor on the chip is surrounded by an insulating layer, so no four-layer parasitic SCR's could ever be created.

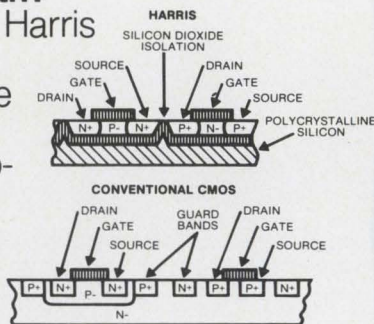

2. Does your system ever feel restricted on the sequence of power?

If it does, your system may have a slight disorder. The Harris analog switches and multiplexers never feel any restriction on sequence of power. And that goes for signal application or removal as well.

3. Does your system compromise its performance to achieve latch-free operation?

Harris has no such maladjustment. Leakage currents, capacitances, AC crosstalk

are equal or better than the best of the other brands. And switch parameters are essentially independent of analog level.

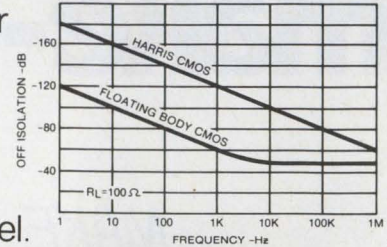

4. Does your system need extra support in order to give you on-board resistor-diode protection in all digital address inputs?

(In order to prevent failures during the handling of loose PC cards.) Harris doesn't need any. We have all the support we need on the same device.

5. Do your systems' digital address inputs have severe negative resistance characteristics in their personality?

Many times this can cause double triggering or oscillations with TTL drive. Harris is free of this personality defect.

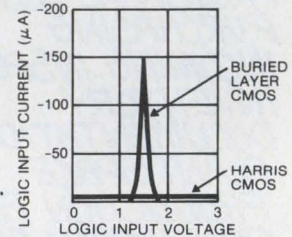

6. Do your systems' supply currents sometimes get very high when they shouldn't? You can count on Harris supply currents to remain low, even when switching at 100 KHz rates!

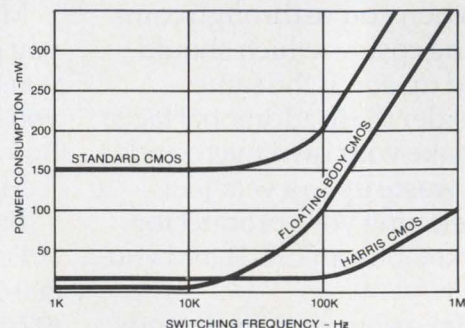

WHERE TO BUY THEM: OEM SALES OFFICES: CALIFORNIA: Long Beach, (213) 426-7687; Palo Alto, (415) 964-6443 **FLORIDA:** Melbourne, (305) 724-7430 **ILLINOIS:** Hinsdale, (312) 325-4242 **MASSACHUSETTS:** Wellesley Hills, (617) 237-5430 **MINNESOTA:** Minneapolis, (612) 835-2505 **NEW YORK:** Endwell, (607) 754-5464; Melville, L.I., (516) 249-4500 **OHIO:** Dayton, (513) 226-0636 **PENNSYLVANIA:** Wayne, (215) 687-6680 **TEXAS:** Richardson, (214) 9031.

SALES REPRESENTATIVES: ARIZONA: Scottsdale, (602) 948-5590 **CALIFORNIA:** Los Angeles, (213) 870-9191; Mountain View, (415) 961-8121; San Diego, (714) 565-9444 **COLORADO:** Denver, (303) 773-0666 **FLORIDA:** Boca Raton, (305) 395-6108; Oviedo, (305) 365-3283; Tampa, (813) 933-3183 **ILLINOIS:** Elk Grove Village, (312) 640-1850 **KANSAS:** Wichita, (316) 943-6221 **MARYLAND:** Randallstown, (301) 922-1248 **MASSACHUSETTS:** Lawrence, (617) 685-7973 **MICHIGAN:** Farmington (313) 476-2446 **MISSOURI:** Hazelwood, (314) 731-5799;

AND MULTIPLEXERS IN YOUR PERSONALITY TEST?

7. Do you find that your system has more burnouts from voltage transients than it should for its age? Harris devices are much more immune to those kind of things.

In fact, we invite you to test our devices side-by-side with yours in the usual bread-board environment, and you'll see what we mean.

8. Does your system feel insecure because it can't offer you extra protection in critical situations?

For example, in a system where multiplexer input signals come from outside the equipment and the signal lines could pick up induced voltage spikes, static electricity, or have signals present when the MUX power is off. Well Harris feels very secure with its HI-506A/507A/508A/509A Overvoltage Protected Multiplexers which can withstand up to ± 35 volts continuously or over 1000 volts momentarily on an analog input. The internal protection networks not only prevent system damage, but prevent the

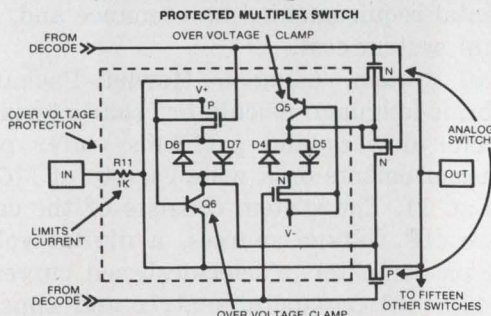

overvoltage spikes from appearing at the MUX output. As a result, the only tradeoff is added ON resistance, which you'd have to create externally to protect any other MUX. So, if you need overvoltage protection, Harris can give it to you. On the chip, featuring the same low leakage currents

with inherent low error, but without additional cost. If protection is not your problem, then you can choose from the industry's largest selection of switches and multiplexers, which retain all the other personality traits.

ANALOG CMOS DEVICES AND MULTIPLEXERS					FOR MORE INFORMATION CIRCLE NO. ON REPLY CARD
Data based on information available 1/1/76					
PRODUCT DESCRIPTION	HARRIS	SILICONIX	INTERSIL	ANALOG DEVICES	
MULTIPLEXERS:					
Over voltage protected					
16 Channel	HI-506A				601
8x2	HI-507A				602
8	HI-508A	DG-508			603
4x2	HI-509A	DG-509			604
Non-protected, low ron					
16 Channel	HI-506	DG-506	IH-5060	AD 7506	605
8x2	HI-507	DG-507	IH-5070	AD 7507	606
8	HI-1818A			AD 7501*	607
				/7503	
4x2	HI-1828A			AD 7502*	608
SWITCHES					
Dual DPST	HI-1800A				609
Quad—SPST—(600 Ω)				AD 7516 AD 7519	
75 Ω :					
Dual SPST	HI-200	DG-200	DG-200	AD 7513	610
Quad SPST	HI-201	DG-201 (150 Ω)		AD 7501* /7511*	611
SPST	HI-5040		IH 5040		612
Dual SPST	HI-5041		IH 5041		613
SPDT	HI-5042		IH 5042		614
Dual SPDT	HI-5043		IH 5043	AD 7512*	615
Dual DPST	HI-5044		IH 5044		616
Dual DPST	HI-5045		IH 5045		617
Dual DPDT	HI-5046		IH 5046		618
4PST	HI-5047		IH 5047		619
30 Ω :					
Dual SPST	HI-5048		IH 5048		620
Dual DPST	HI-5049		IH 5049		621
SPDT	HI-5050		IH 5050		622
Dual SPDT	HI-5051		IH 5051		623
DPDT	HI-5046A				624
4PST	HI-5047A				625

Test score results.

If you've answered "yes" to any of the Harris Personality Test questions about your system, then maybe it's time you talked to a Harris distributor or representative. We offer a complete line of analog multiplexers and CMOS switches. Available now. All with healthy, trouble-free constitutions.



P.O. Box 883, Melbourne, Florida 32901 (305) 724-7412

Kansas City, (816) 761-6543 **NEW JERSEY:** Keasbey, (516) 567-5900 **NEW YORK:** Albany, (518) 489-7408 or 4777; Huntington Station, (516) 567-5900 **NORTH CAROLINA:** Raleigh, (919) 828-0575 **OHIO:** Cleveland, (216) 831-8292; Dayton, (513) 890-2150 **OREGON:** Beaverton, (503) 643-1644 **PENNSYLVANIA:** Allison Park, (412) 487-4300; King of Prussia, (215) 265-0634 **TENNESSEE:** Shelbyville, (615) 684-4544 **TEXAS:** Dallas, (214) 691-4592; Houston, (713) 661-3007 **VIRGINIA:** Falls Church, (703) 534-1673; Lynchburg, (804) 237-4740 **WASHINGTON:** Bellevue, (206) 454-0300 **CANADA:** Montreal, (514) 626-6723; Ottawa, (613) 749-0740; Toronto, (416) 676-1042.

NATIONAL DISTRIBUTORS: Hamilton/Avnet; The Harvey Group, Inc.; Schweber Electronics; R.V. Weatherford Company.

Plug a programmable calculator into your system and enjoy computer-like performance. But take care to avoid some computer-like problems.

The programmable calculator now offers an attractive alternative to the use of the minicomputer or microcomputer as a system controller. Modern programmable machines approach the power of a dedicated mini. And several manufacturers—Hewlett-Packard, Tektronix, Wang, Keithley and others—provide peripheral controls and extensive I/O capability that need a minimum of software.

For the engineer who needs flexibility, the computer approach seems the most desirable. Yet the problems of interfacing and software are often difficult, time consuming and unpredictable. The high-level languages available in minicomputers generally call for a large memory and, in addition, may not be applicable to many machine control uses. Assembly or machine-language programs of microcomputers are at least as unwieldy and are generally unsuitable for many industrial uses.

Tasks such as gathering and processing data, controlling numerical-input equipment, operating test equipment and providing terminal services are ideal for the calculator.

Computer-like performance—at a price

Such capability tends to be expensive, however, and supplier specifications can be confusing. Each vendor's product uses its own high-level language so that the age-old computer problems of "how much memory" and "which benchmark programs" can also plague you with calculator systems.

As an aid in specification consider the following factors:

- Peripheral capabilities.
- System speed.
- Programming language.
- Storage requirements.
- Data input and output.

Other important factors include documentation, vendor support, program security, facilities and

Robert Green, Consultant, 2971 Magliocco #10, San Jose, CA 95128.

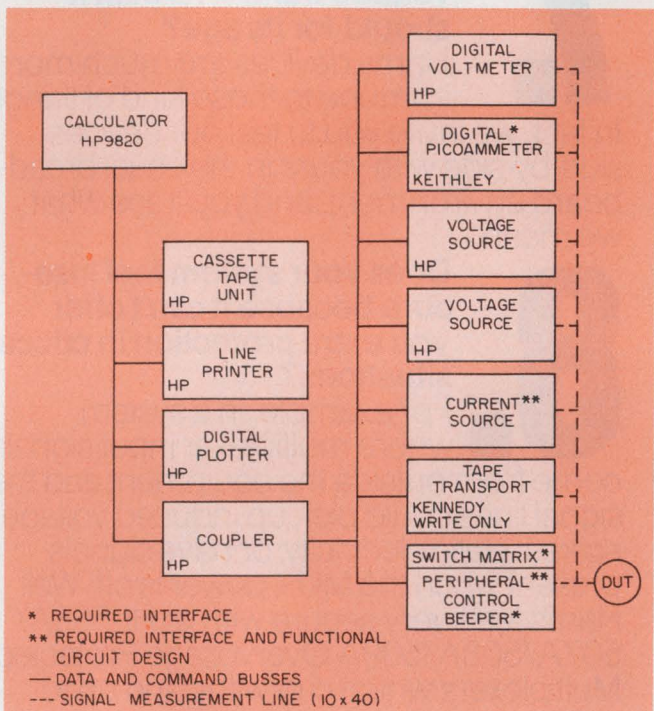

1. Typical calculator-controlled system measures circuit parameters, performs calculations, plots curves.

environmental requirements, maintenance and, of course, total system cost.

A typical system, using a Hewlett-Packard 9820 algebraic-language calculator, characterizes semiconductor devices and performs wafer parameter measurements on a wide variety of MOS circuits (Fig. 1). The system consists of the calculator, two HP voltage sources, a digital voltmeter and picoammeter, a user-designed current source, a 40×10 crosspoint matrix and appropriate controllers.

Peripherals include an external cassette tape unit, a digital plotter, a nine-track, write-only tape transport and a thermal line printer. The calculator controls part of the system directly and handles the rest through an HP 2575A coupler (Fig. 2).

The thermal line printer functions mainly in wafer-measurement routines; combinations of other peripherals handle device measurements. For instance, the plotter can record point-by-

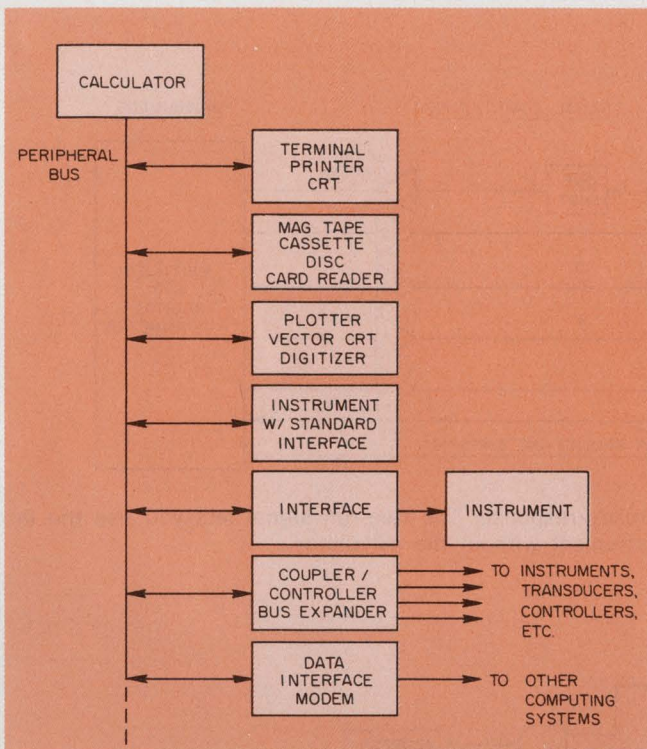

2. It's the ability to communicate with a wide range of peripherals that makes the programmable calculator so universally useful.

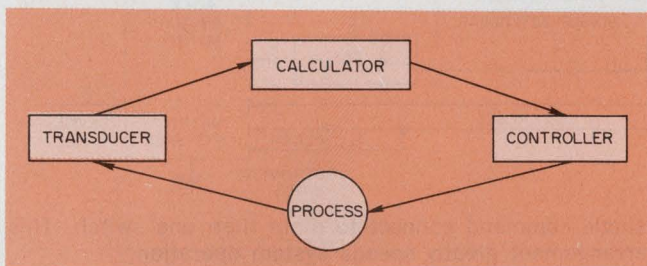

3. Simplest calculator system, for machine control, is comprised of just one input port and one output port.

point data and, at the same time, show best-fit curves or theoretically expected results.

The DVM can monitor any instrument that delivers an analog output. Thus, in conjunction with a standard capacitance meter, the system can measure a MOS C-V characteristic. And, of course, the calculator can prescale or convert data to normalized, logarithmic or other functional units.

An operating system forms the first part of the program. Each user keeps his programs on cassette tapes, in addition to the library of common test programs. When the system isn't testing, the calculator can perform general data analysis.

Extensive peripheral control is possible

If any one feature makes the programmable calculator a candidate for system control it is the machine's ability to communicate with external

devices (Fig. 3). These include instruments, graphic equipment, transducers, computers and computer components, relays and other programmable equipment. If you consider the calculator as a mini, it is easy to realize the potential of such an approach.

For machine-control applications, a simple system may suffice (Fig. 4). Here, a minimum of one input port and one output port are needed so that the calculator can provide the required feedback. In existing calculators, this input/output path may be through a peripheral interface device that communicates with the calculator's peripheral-control bus.

For instance, Tektronix uses such a peripheral concentrator for its Model 31, and Hewlett-Packard offers a coupler adapted from its computer line for the company's 9800 series calculators.

Recently, however, the IEEE issued an interface standard—IEEE 488—which is a step toward direct calculator communication. But, even with the standard, bus expanders and other interfaces probably will be necessary.

Most systems aren't as simple as that shown in Fig. 4. Several inputs and outputs may be required, even for applications that call for hard copy or terminal readout of current situations or actions. Especially in data acquisition, output devices such as tape units, cassettes, line printers, computer interfaces and CRT displays become essential.

Most calculator I/O activities are serial in nature: the system samples inputs, does calculations, then performs output functions. The speed of the system is greatly affected by the I/O operations at the interfaces, but because of their general nature these interfaces are usually slower than one might desire. Also critical to the operating speed is whether the calculator stops while it waits for the completion of both interface protocol and peripheral activity. You must consult the vendor to learn the various cycle times for his equipment as it communicates with its peripherals.

Be cautious at the interface

Most applications end up with at least one peripheral device or instrument that doesn't have a vendor-supplied interface. In that case you must obtain the complete interface specifications from the supplier (before purchase if possible) to pin down the complexity of the required outboard electronics. Depending on the equipment, there may be protocol options that can boost system speed—for example, in cases where a complete handshake cycle isn't required. Waiting for a peripheral to reply can use a lot of time and may not contribute to a more reliable system.

The general-purpose output devices provided

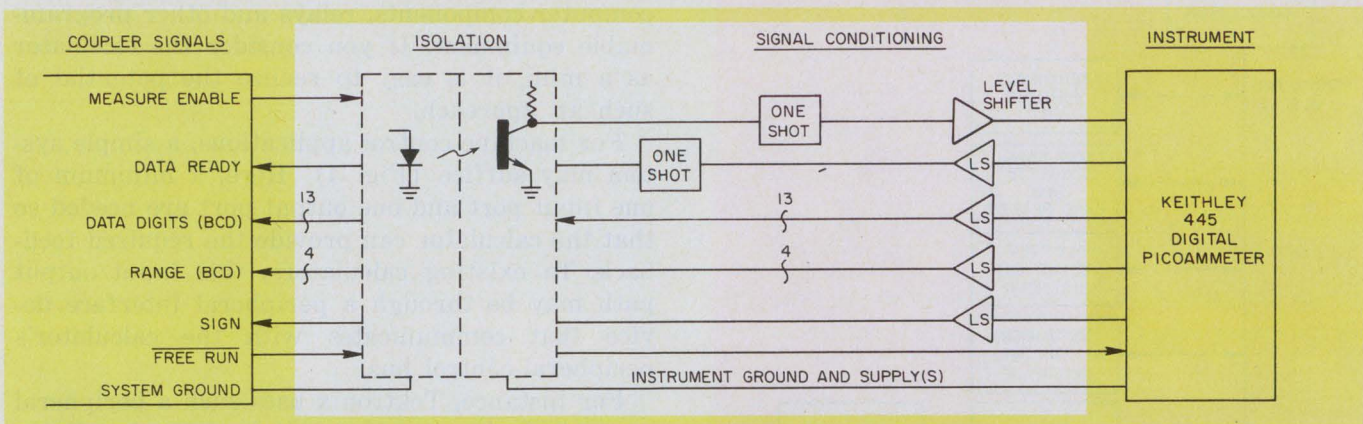

4. In a typical instrumentation interface, a coupler issues a measurement command, then waits for a data-

ready response. The free-run signal lets you use the instrument without the calculator.

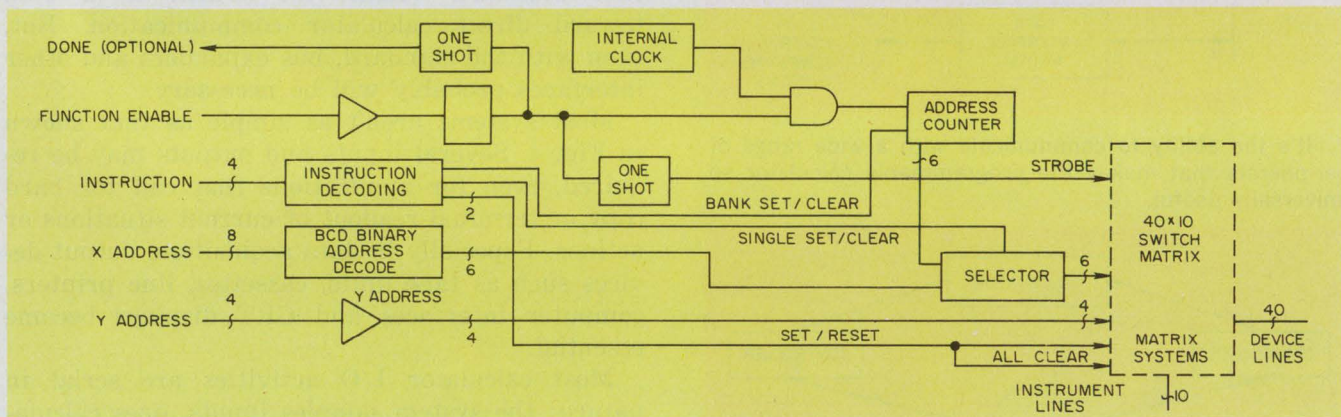

5. System speed can be boosted in various ways. Here, in a switching-matrix subsystem, extra circuitry lets a

single command connect to more than one switch. This arrangement greatly speeds system operation.

by most vendors can be thought of as a collection of programmable switches, the outputs of which are loaded with BCD characters arranged in groups of four. With such an arrangement, problems can arise if the most significant bit must be programmed to ON. While most calculators provide the hexadecimal values A through F, the machine may not be able to store these values in numeric registers or directly calculate the values.

Programs that determine the states of the BCD groups must then contain complex algorithms to generate the appropriate calculator output. Grouping the outputs by threes in octal may help, although it is certainly easier if the proper character can be calculated directly. Consult the vendor to see how to best handle this type of output.

In addition, you might find that various input/output interfaces handle only a limited character set. Particularly if designed for instrument control, the characters may include only numerics, plus and minus, E (exponent) and others, such as decimal, comma and blank. Again, it is im-

portant to have a complete interface description before you purchase equipment.

One important difference between calculators and minicomputers is the speed of execution. The calculator is generally slower, for several reasons. First, the calculator is (or was) originally designed for relatively slow human operation. Second, the machine operates with what can be considered a high-level language, with consequent time-consuming overhead.

Finally, many programming functions—program packing, line labeling, memory allocation and editing, among others—generally take time to execute. Consequently, the execution time may be longer than you'd like.

How fast does it go?

To see what execution time you'll get, ask the manufacturer for functional operating times or enlist his aid in constructing a suitable benchmark program, one that gives typical execution times. Remember that I/O time should be simu-

lated, since it can be significant.

Note also that a calculator's execution times depend on its configuration. For instance, the HP 9820 can use either of two plug-in ROMs to control the system coupler. One ROM makes it easy to program and connect a plotter. However, this ROM is somewhat slower than the other, which doesn't give as much emphasis to the plotter.

Another, more obscure, aspect of system speed is the time required to program and to load previously written programs. Much time is usually spent in constructing and checking out programs. Either you can load directly with the keyboard or you can use off-line methods, like cards or paper tape. Restrictions on program input vary with the calculator and don't necessarily apply to data input. Features such as trace mode allow faster program debugging and more efficient editing.

Most calculators offer some sort of permanent program storage to avoid the problems of power loss. Cassette tapes and PROMs are among the most convenient of these; magnetic cards are among the least convenient because of the greater possibility of misloading and the longer loading time.

Checked-out software can be changed to firmware for permanent storage—an attractive feature for a production-line, calculator-controlled, system (Tektronix, for one, offers such a PROM programming service.)

One not-so-attractive feature is that each calculator manufacturer offers his own programming language. In fact, language can vary with different models from the same manufacturer or even with variations of the same model. The choice of a language depends on the projected task of the system plus the capability of the user. Also, one machine may win over another in the amount of programming (and thus machine storage) required for peripheral control.

For semiconductor devices much of the work involves algebraic manipulation of data. Logic functions, subroutine capability, labeled branches—all are invaluable in the construction of programs. Time permitting, you should work out a benchmark function to determine firsthand the difficulty of programming and the amount of machine storage you'll need. In addition, should you require several similar systems, don't forget to investigate possible common-language capabilities that will permit program sharing.

Subroutines simplify programming

Some thought should be given to generating an operating system base program. Although this

sounds difficult and time consuming at first, it is likely you'll be able to construct without difficulty a simple set of basic instructions.

Use of the calculator's subroutine capability greatly simplifies user programming. For example, in the setting of proper relays in a switch-point matrix, you can write a three-line subroutine in which you have only to specify the proper connections. The subroutine then generates all of the proper input/output functions.

In another case, a complete test sequence is called simply by specifying the device configuration and then calling the subroutine. Subroutine capability is common in minicomputer-controlled systems, and demonstrates the power of the calculator with only a small amount of programming effort.

Of course, an operating system does consume available storage. A built-in language on the other hand, is mostly invisible to the user (except for some ROM requirements on some machines). The control software for the semiconductor test system takes 86 out of about 1400 available storage registers, leaving over 1300 registers for program and data storage.

Overhead is relatively small in this maximum-memory machine. However, in a minimum-memory machine, nearly one-third of the calculator's memory is consumed, so you must trade off between programming convenience and available program area.

As with other computer systems, the calculator user is at odds with available program storage. Because of the various existing languages, the estimation of actual requirements is not straightforward. The safest approach (although not the least expensive) seems to call for the maximum available memory size. But additional memory can represent a large fraction of the total expenditure.

How much memory?

The HP 9810 and Tektronix 31 machines separate program and data-storage areas so that an estimation of program length and the number of required variables is an immediate guide to the needed hardware. The 9820's language doesn't correspond on a key-to-key basis to the amount of memory required. However, this machine packs the program portion into the storage area without wasted space. All registers not used for program storage can hold variables on a value-per-register basis.

Another programmable unit, the HP 9830, uses BASIC language, and its memory size is given in bytes. So bytes, registers, program steps or data registers—take your pick.

In addition to the operating memory, most calculators can access tape memories for program and bulk-data storage. Some can even access disc memories or computers. The penalty for using these media is slow response time; tape units take time to find and load data.

Program linking with tape is also possible for low-speed requirements, which means the calculator can fill itself with a program segment, execute that segment, return data to the tape, and then load-in another segment. Magnetic tape can also be used to store frequently used routines and, by use of the editing capabilities, to assemble a program.

One disadvantage of tape loading is that the calculator can perform only a rudimentary check on data accuracy. Thus a bit error can result in the execution of an unwanted function or in the loss of critical information. On the HP built-in cassettes, however, a Checksum routine gives some assurance of program accuracy.

Most calculators come with a keyboard for input and with a multidigit display for the data-output port. Obviously the display leaves no permanent record and so is not sufficient for most applications. If for no other reason than program listing, you'll need a hard-copy capability. Commonly found are the paper-tape printer, with about 16 characters, per line and thermal printers with about 80.

The tape output is generally simple to use. However, with large amounts of data, tape can become unwieldy. The thermal line printer is often more practical, though there may be some restrictions on its use. For example, the HP 9820 can't provide a program listing for the line printer. A difficulty with thermal printers is that the copy tends to fade and darken with age. The paper also is sensitive to environmental conditions and is difficult to reproduce on standard copying machines.

Many output units are available

Other output devices include teletypewriters and CRT displays with vector capability. One CRT unit, from Tektronix, provides a hard copy of the tube display.

Data outputs can be formatted and listed with headings and other labels, much as with computer outputs. The form of the data—fixed or floating point—number of digits, and decimal placement are all programmable. Features such as these allow direct composition of reports and summaries, and the display of messages. Notifying the operator for some action can be accomplished with the display, with a printer or with audible devices.

Probably one of the most useful output devices is the graphics display (plotter or CRT), which shows large amounts of data in an easily comprehended format. Much of the busywork of scaling and labeling is implemented within the calculator firmware so that programming is relatively simple.

One example: the plotting of measured MOS weak-inversion characteristics on a log-linear graph, with the calculator computing device parameters and plotting theoretical curves on the same graph. Other applications include histogram and scatter plots of large numbers of samples.

Among additional output methods are mag-

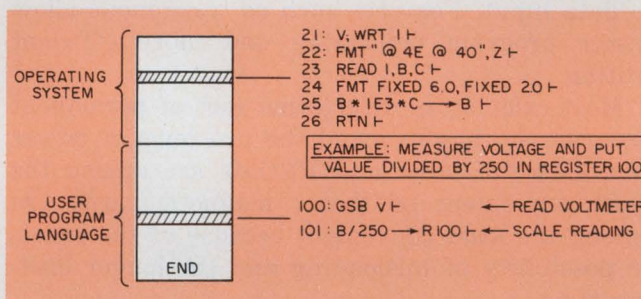

6. With an operating-software approach to program design, little training is needed to write test programs.

netic tape for entry into other computing systems; cassette storage for further processing on the calculator; paper tape; disc storage; and modems.

Data to the calculator are entered when the program requests it, or when you interrupt processing to change a variable. Or data enter automatically under program control. At this date, no calculator offers an external interrupt capability save through the keyboard or by program interrogation. Halting a program with the keyboard can disrupt the sequence of operation.

Depending on the input device, either numerics or alphanumeric are entered. There may be restrictions on the destination of the input, however, especially with alpha. Most transducer or instrument outputs are simply numbers, sometimes formatted with scientific notation or range code. Since the input to the calculator is character-by-character, you must give the machine the proper format; BCD and ASCII are the most common. Scaling, units conversion and decimal placement are executed on most systems by simple input statements.

Other important data input devices include magnetic tape and cassette, external terminals, digitizers, paper tape and card readers. ■■

Opening new frontiers with electro optics

Solid state laser breakthrough: CW output at room temperature!

You get at least 5 mW of continuous lasing in a solid state package. RCA's new AlGaAs CW injection lasers have a rise time of less than 1 ns—allowing modulation rates beyond 100 MHz. This plus small source size (13x2 μ m typical) and 820 nm wavelength make the C30130 and C30127 well suited to optical communications, facsimile, fiber-optic transmission, document reading, flying spot scanning. RCA also offers complete solid state systems (C30125 and C30131), which include a regulated DC power supply and a thermal stabilization network.

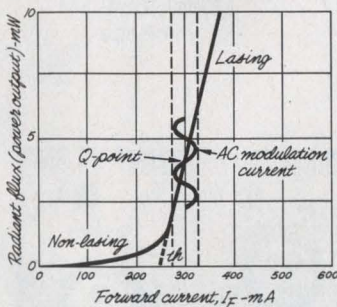
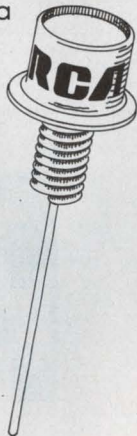

Circle 291

New PMT looks for oil at temperatures as high as 150°C.

To help geophysicists in their search for oil and minerals, RCA has produced new, long-life photomultipliers designed for repeated cycling at temperatures up to 150°C (302°F). They're being operated at depths as far down as 20,000 feet. These tubes can take the heat because of a special bialkali (NaKSb) photocathode. The 1" dia. C31016G for gross counting systems meets MIL-STD-810B. Larger sizes 1 1/8, 1 1/2 and 2" for differential counting systems.

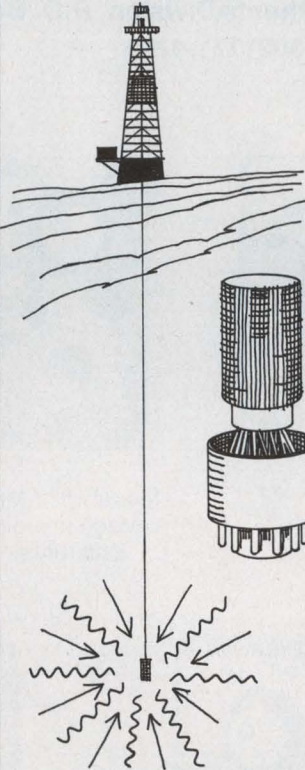

Circle 292

RCA lowers the bloom in S-T camera tubes. New Si target the key.

RCA has developed a new target that limits charge leakage between diodes. The result: bloom is dramatically reduced to provide more picture information in the presence of bright highlights. You can get low-bloom plug-in replacement versions of the popular 1" 4532 S-T vidicon series and 4804 silicon intensifier target (SIT) camera tubes.

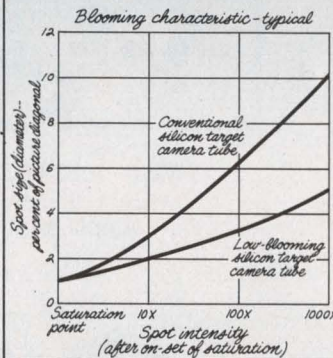
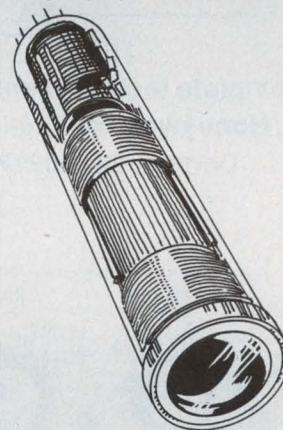

Circle 293

Low-cost IR emitting diodes from RCA: 940 & 1060 nm types.

When you think IR for fire and smoke detection, auto ignition, sorting, counting or reading—think RCA. Our mass-produced, off-the-shelf diodes have high power outputs (see table) and can replace many types you may be using. Other GaAs emitters have outputs from 1.1 to 3 mW at 940 nm, 20 to 50 mA drive. Packages to suit your needs. And our 1060 nm InGaAs emitter has typical rise time of less than 10 ns with a minimum continuous output of 100 μ W, making it an excellent simulator for Nd: YAG systems.

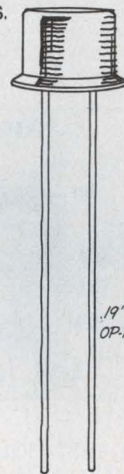

1/8" dia.
OP-17 package

Power output		
Types (940 nm)	CW with 100 mA drive	Pulse with 1 A drive
SG1009 SG1009/F	3.5 mW Typ.	26 mW Typ.
SG1009A SG1009A/F	7 mW Typ.	50 mW Typ.

Circle 294

If electro optics can solve your problem, remember: EO and RCA are practically synonymous. No one offers a broader product spectrum. Or more success in meeting special needs. Call on us for design help or product information. RCA Electro Optics, Lancaster, PA 17604. Phone 717-397-7661.

RCA

Why does our graphic data 7 different plug-in modules? variety of applications.

The Honeywell Model 1858 gives you a choice of seven different plug-in signal conditioning modules for maximum flexibility. One of these, our Honeywell 1887, provides simultaneous input signal conditioning for magnetic tape and graphic recording or serial record and playback from tape to the Model 1858.

Compact? Our Honeywell Model 1858 is an unbelievably short 8¾ inches high, including plug-in signal conditioning and internal paper take-up. The 65-pound-light 1858 is easy to take anywhere; you

can use it in a rack, on a table, on the seat of a car or plane.

You'll also appreciate the total convenience offered by the Model 1858, with its 18 channels (expandable to 32), each with dc to 5,000 Hz response (15 kHz squarewaves) and without amplitude restrictions for superior recording capability. What's more, the 1858 also allows you to get up to 7-inch trace amplitude for all channels, allowing for common baseline recording . . . the most useful and accurate record available.



For complete technical specifications, call or write:
Lloyd Moyer, Honeywell Test Instruments Division, P.O. Box 5227,
Denver, CO 80217, (303) 771-4700.

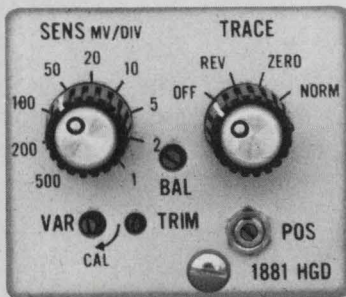

Model 1881-HGD
High-Gain Differential
Amplifier

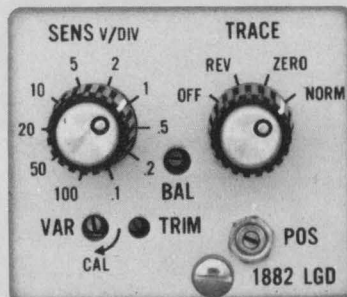

Model 1882-LGD
Low-Gain Differential
Amplifier



Model 1883-MPD
Medium-Gain
Differential

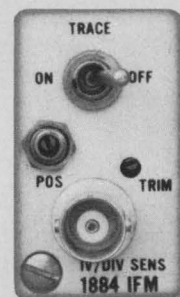

Model 1884-IFM
Interface



Model 1885-SGC
Strain Gage Control
and Amplifier



Model 1886-TCU
Thermocouple/Control and
Microvolt Amplifier

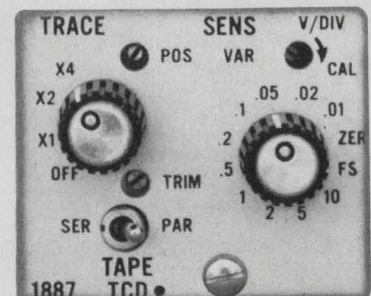

Model 1887-TCD
Tape-Compatible
Differential Amplifier

acquisition system have So you can use it for a wide

1881-HGD — A high-gain, floating and guarded dc amplifier. Accepts low-level input signals of from $\pm 1\text{mV}$ to $\pm 1\text{V/div}$ at common mode voltages up to $\pm 300\text{V}$.

1882-LGD — A low-gain, floating and guarded dc amplifier. Accepts input signals of from $+100\text{mV}$ to $\pm 100\text{V/div}$ to a maximum of 300V , and at common mode voltages to $\pm 300\text{V}$.

1883-MPD — A medium-gain, differential dc amplifier. Sensitivity is from $\pm 50\text{mV}$ to $\pm 1\text{V/div}$.

1884-IFM — Adapts to inputs from existing or unique signal conditioning units to the 1858 system. Module is single-ended to ground and consists only of a voltage-to-time converter to convert the analog signal to the PDM format required by the Model 1858.

1885-SGC — For strain gage signal conditioning. In addition to signal amplification, provides for gage excitation and balance as well as "dial-in" voltage

substitution calibration and suppression of the input signals. Sensitivity is from $+ 1\text{mV}$ to $\pm 100\text{mV/div}$. Calibration and suppression range is $+$ and $- 1$ to 100mV .

1886-TCU — For thermocouples or other low-level signals. High sensitivity range of from $100\ \mu\text{V}$ to 50mV/div , dial-in voltage substitution calibration and suppression are provided. Thermocouple compensation units for standard thermocouple types are available as accessories.

1887-TCB — A high-sensitivity, wide-gain range differential amplifier designed to simultaneously provide input signal conditioning for the 1858 and instrumentation-type magnetic tape recorders. Convenient front-panel switch selection allows parallel recording on the 1858 and the tape recorder, or serial playback recording from the tape recorder to the 1858. Recordings to $100\ \text{kHz}$, beyond the $5\ \text{kHz}$ frequency capability of the 1858, can be recorded at high tape speed and played back at a lower speed.

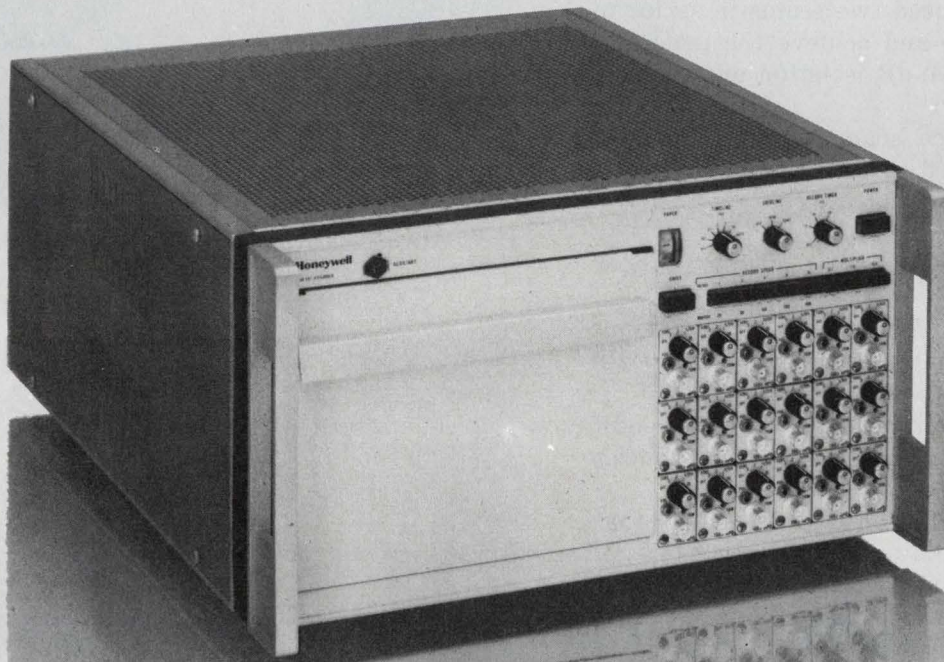

Honeywell

Need rf-tight enclosures? Observe these six rules to optimize enclosure seam design. They ensure meeting tough specifications on radiation leaks.

If you design, specify, select or approve housings for electronic equipment that must meet specifications on radiation leakage, such as the MIL-STD-461A RE02 test for the frequency range 14 kHz to 10 GHz, make sure the enclosures' seams conform to the six important rules of good design.

Strangely, commercial shielded rooms are prime examples of what should *not* be done. They violate two important rules (Rules 1 and 2).

Shielded rooms often use the poorest type of seams and typically do nothing to minimize the number and length of seams. They usually provide only about 40 to 50 dB per seam of shielding effectiveness with simple overlap-type seams, only 3/8-in. wide.

Much wider seams are needed, so most shielded rooms must use double walls. Their metal thickness is not inadequate—it's usually more than adequate. The rooms need two seams in series to prevent gross leakage and achieve the generally required more than 100-dB isolation over a wide range of frequencies.

Illustrative of a good seam is the example of a paint-can lid installed in a test-panel (Fig. 1). The performance of such an installation is shown in Fig. 2.

This example illustrates most of the rules of good seam design:

- Circular seams enclose a maximum amount of area with a minimum perimeter—minimizes potential sources of leakage (Rule 2).

- Seams have a desirable zero vertical height—reduces radiation, especially at low frequencies (Rule 3).

- Seams have a labyrinthine interface that forces radiation to follow a broken path to get through the seam—minimizes transmission, since radiation tends to follow straight lines, especially at high frequencies (Rule 4).

- Curved seams are much better than straight seams—avoids any substantial length of seam in parallel with the polarization of radiating wave.

This reduces the possibility of leakage (Rule 2).

- Seams are closed over the lid's full perimeter—fits tightly with pressure uniformly distributed about the circle (Rule 5).



1. A paint-can lid installed in a test panel is an example of a good rf seam design.

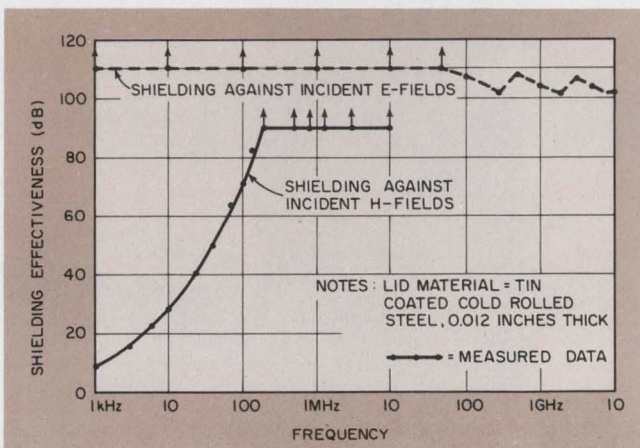

2. High shielding effectiveness against both magnetic and electric-field leakage results from the good seam characteristics of the paint-can lid (Fig. 1).

Robert B. Cowdell, Collins Radio Group, Rockwell International, Newport Beach, CA 92663.

Rule 1. Use the widest possible seams.

Wide seams improve the contact between mating surfaces. Even an extra 1/8 in. can make the difference between a good design and a poor one.

Screw holes in the middle of a seam can cut the effective width by more than half. Instead, use externally mounted pull-down clamps or screws, if at all possible. If you must use screws, don't put them along the center of the seam wall. Grounding them helps, though the leakage path still exists.

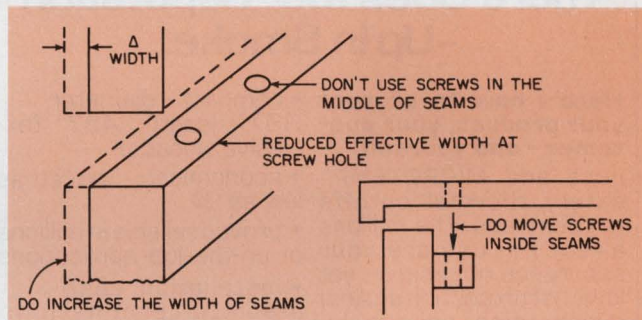

Rule 2. Minimize the number and length of seams.

The more seams you have and the longer they are, the greater will be the number of potential sources of leaks. And long seams can leak at low frequencies, especially when wave polarities are parallel to the seams. So reduce the number and length of seams where rf sealing is required.

A curved seam path reduces the probability that incident radiation is polarized parallel to the seam over any substantial portion of its length. Such paths reduce the chance of direct radiation passage through the seam.

The best designs are those with no seams, such

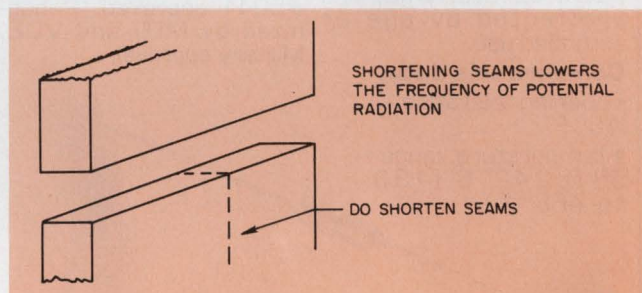

as a deep-drawn enclosure with a front panel attached by a brazed, solid seam.

Rule 3. Minimize the height of seams.

Seam gaps, even when filled with rf gaskets, can leak. Wide seam gaps allow leakage at low frequencies; seam heights appear electrically even larger at low frequencies and act as slot radiators.

The DO example uses a retainer along the side of the seam to hold the gasket material so the height between mating surfaces is a minimum when the seam is closed.

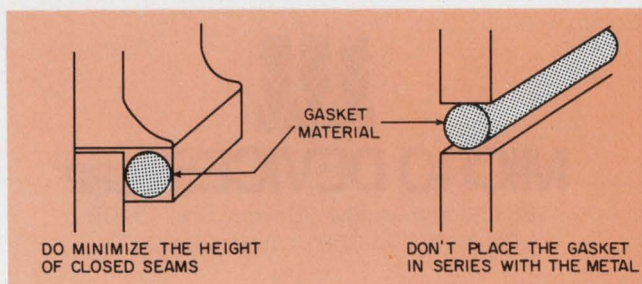

(continued on page 92)



There Goes Your Reputation --Up In Smoke.

Here's how to protect your product, your customer—and yourself!

Just add MICROTEMP[®] safety thermal cutoffs to your plans. The millions already in use are your assurance of positive, yet low cost protection against overheating caused by malfunctions in electrical circuits and components.

MICROTEMP is a reliable, accurate, easy to install, "one shot" thermal limiter. Because of its patented design and construction, it won't derate. And, it's unaffected by age or extended use.

Compare this data:

- opening tolerance — $\pm 3^\circ$ F.
- temperature range — 58 to 242 $^\circ$ C. (136 to 468 $^\circ$ F.)

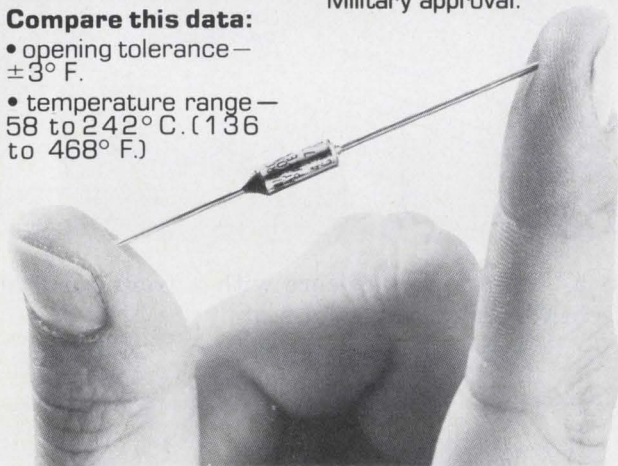

For additional information, check the reader service card, or call or write:



MICRO DEVICES CORP.

1881 Southtown Blvd., Dayton, Ohio 45439
Ph: (513) 294-0581 Telex: 28-8087

CIRCLE NUMBER 47

(continued from page 91)

Rule 4. Design seams with a labyrinth interface.

Radiation tends to travel in straight lines, so a broken path in the seam interface will cause energy to be deflected and absorbed, and result in attenuated leakage.

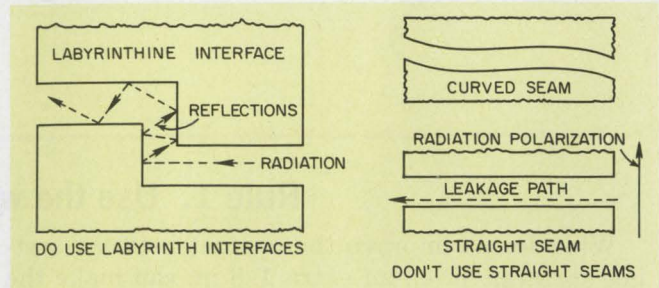

Rule 5. Design the seams to mate tightly.

Tightly torqued bolts can produce waves in the surface of overlapped enclosure walls. This can allow a significant amount of leakage. It's better to use fewer bolts with a stiffener plate, and arrange the fasteners to gain maximum flatness when the seam is closed.

If sufficient flatness can't be obtained, then use rf gaskets to fill the openings. This is one of the instances where gasketing is justified.

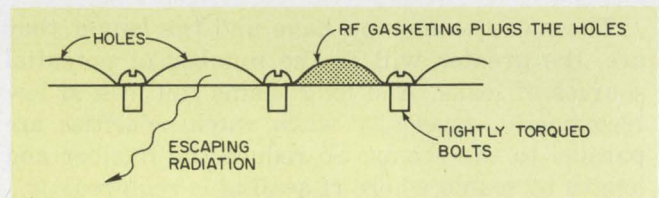

Rule 6. Avoid multiple-plane seams.

Corners of enclosures, where three planes meet, are extremely difficult to shield. Inevitably an opening appears along the seams. Most equipment enclosures avoid this problem by brazing, or the use of solid metal-to-metal corners.

Commercial shielded rooms partially solve the problem by use of end caps. But even with caps, it is difficult, if not impossible, to pull a tight corner seam for all three planes. ■■

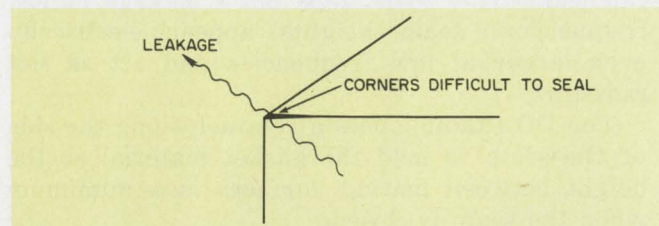

If you spend more than 20 minutes picking a P.C. connector

It's your guide to the broadest line of printed circuit connectors made by any single manufacturer. We have just about everything and in more combinations and more depth than anyone — more types of contact terminations, insulator materials, mounting styles, contact designs, types of plating.

Send for our catalog. Browse through it and you'll discover that picking out the right printed circuit connector for your job is as simple as it should be.

Quick delivery.

And you can get your hands on our connectors, too — in a hurry if need be. We keep a large inventory; so do our distributors.

Our "Whatever-you-need-we've-got" department.

As you can guess, we have a lot of tooling filed away. Our production engineers have a unique talent at taking an existing bit of tooling, fiddling with it, and turning out a "custom" connector that's exactly what you need. Your extra cost is only a modest set-up charge... a long way from a full retooling cost. Use the coupon.

...you don't have this catalog.



Ok. Send me:

- Your latest printed circuit connector catalog.
- ...and your nearest rep. I want to talk to him about a particular problem I have.

NAME: _____

TITLE: _____ TELEPHONE: _____

COMPANY: _____

ADDRESS: _____

CITY: _____ STATE: _____ ZIP: _____



Viking

CONNECTORS

Viking Industries, Inc./21001 Nordhoff Street
Chatsworth, CA 91311 U.S.A./ (213) 341-4330/ **DATACON DIVISION**

CIRCLE NUMBER 48

"We're switching from EEM to

"The GOLD BOOK provides more data and our sales offices recommend it."

North Atlantic Industries, which invented the Phase-Angle Voltmeter almost two decades ago, joins the growing list of companies moving to the GOLD BOOK.

Sales Manager Peter G. Wittenberg, who is a working group member of DOD's DEFENSE SCIENCE BOARD TASK FORCE on "Electronic Test Equipment," reports he has selected the 1976-77 GOLD BOOK for his catalog pages. Among the items he will feature are three new products: Digital Phase-Angle Voltmeter/Ratiometer, Angle-Position Indicator with LSI that provides improved performance and reliability at lower cost, and S/D and D/S conversion modules.

"This past year," Mr. Wittenberg says, "We've received many inquiries here and abroad just from our listing in the GOLD BOOK. And they're all top-grade inquiries." Mr. Wittenberg says this prompted him to make a thorough analysis of electronics directories. "As a result," he says, "We'll be in the GOLD BOOK as our main directory promotion this year. It's being used by engineers and engineer managers throughout the United States and overseas."

The GOLD BOOK is first in every important editorial comparison!

First in number of product headings in the Product Category.
GOLD BOOK has 5182. EEM has 3335.

First in number of pages in the Product Directory. GOLD BOOK has 542. EEM has 255.

First in number of pages in the Trade Name Directory.
GOLD BOOK has 33. EEM has 24.

First in number of pages in the Manufacturers Directory. GOLD BOOK has 397. EEM has 338.

First in number of manufacturers listed. GOLD BOOK has 6771. EEM has 3300.

And on top of all this, GOLD BOOK rates are lower than EEM rates by far.

Source: 1975-76 Editions



Electronic Design / GOLD BOOK

the GOLD BOOK this year”

**– says Peter G. Wittenberg
Sales Manager
North Atlantic Industries**

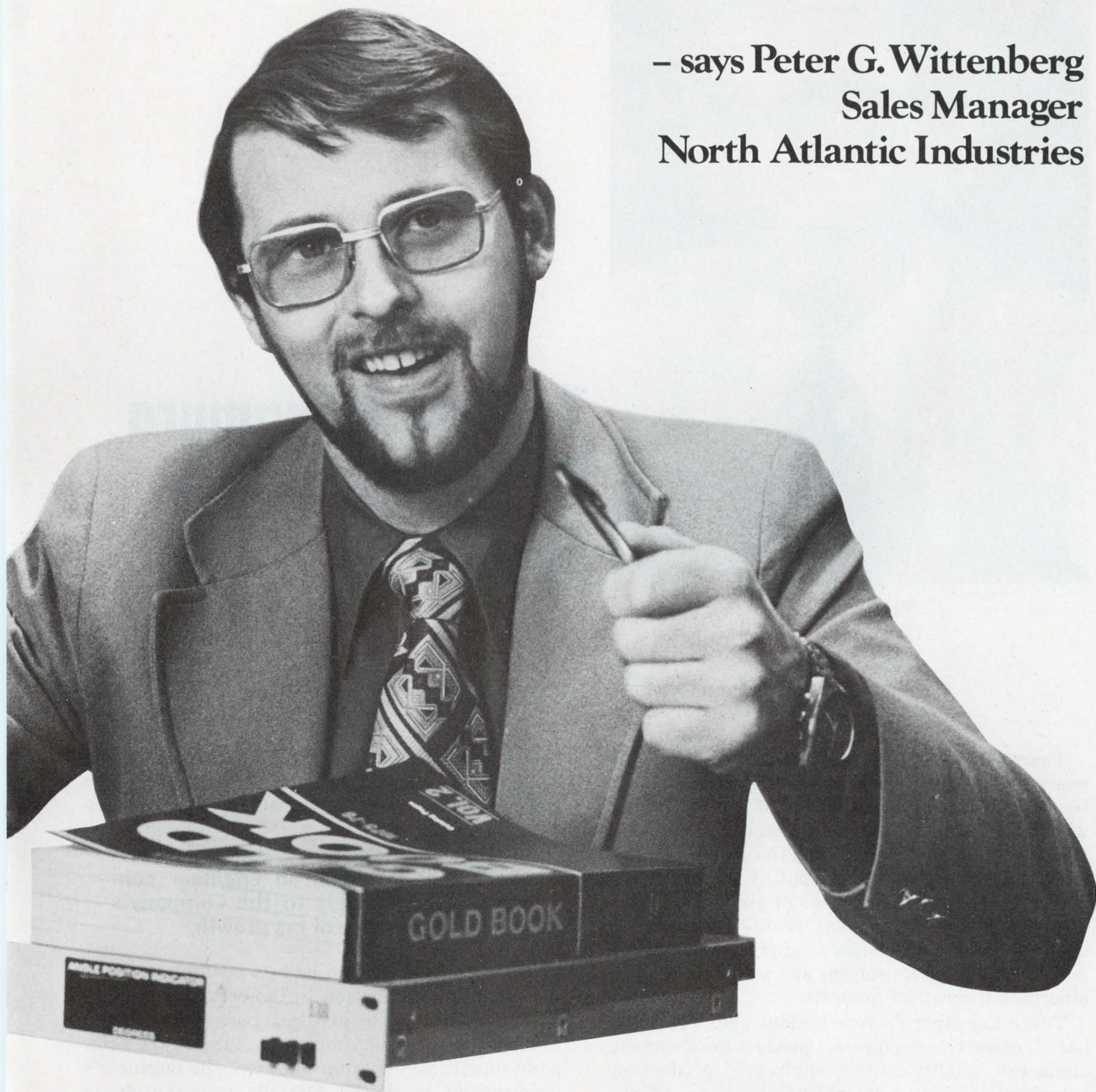

**Join the parade to the GOLD BOOK
It can work for you!**

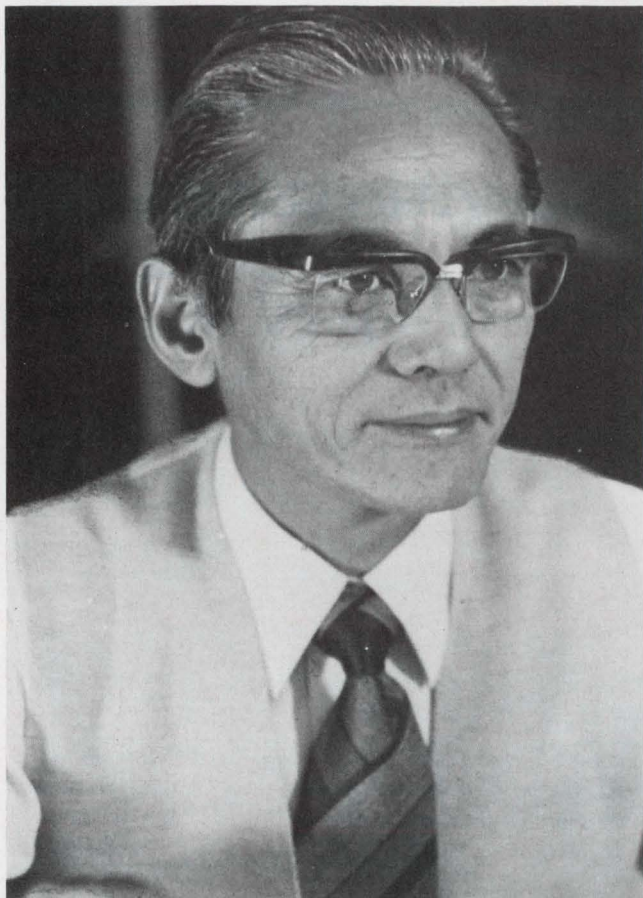

Tadashi Nakamura Of Ise Electronics Speaks On

Developing Your Engineers

There's no single mechanism for helping engineers grow and become more productive. That's because there are many kinds of engineers, all with different interests, motivations and outlooks. It's obvious, for example, that the outlook of the engineer who has just come out of school will be markedly different from that of the person who has been designing for many years—the man, for example, who knows when to apply a quick pragmatic solution to a problem and when to apply a laborious theoretical analysis.

There are other factors besides age. You have basic research engineers, product-development engineers, quality-control engineers, production engineers. Unless you orchestrate their efforts properly, they may all incline to sing their own songs. The basic research engineer, for example, tends to think only in terms of some dramatic new discovery. He wants to create something new, something that never existed. He forgets about cost. The production engineer doesn't care what the product is; he just wants to manufacture it as quickly and smoothly as possible, and at lowest cost. The quality-control man wants to be certain that the product meets its specifica-

tions with an adequate margin. But all groups should have a common objective—making the company profitable. They must all help the company make money.

The extent to which an engineer contributes increasingly to the company's profit is a measure of his growth.

Every engineer should be in a position to make his greatest contribution to the company and, in so doing, derive the greatest personal satisfaction. But the company must help him. If the company unwittingly sets up barriers, the engineer's development is slowed and his contribution is reduced.

As one might expect, an important part of any program to help develop engineers should involve improved communications. That absolutely does not mean increased memo writing. That's not necessarily real communications.

We use several techniques. First, we have two committees, the Technical Committee and the Product Development Committee, that meet monthly. A major part of the work of the Tech-

nical Committee lies in developing future products while the Product Development Committee is mainly concerned with getting recently developed products manufactured and delivered to customers as effectively as possible.

Now committees in themselves can be meaningless, and meetings can be worse, unless all people who have a stake in the decisions are involved and all know that they can discuss things freely, then act decisively once decisions are reached. The Product Development Committee, for example, includes managers from engineering and from marketing.

If an engineer thinks he has a bright idea for a new product, a marketing man might be able to discourage him if he feels the product won't sell. Or the marketer might try to modify the engineer's thinking along lines that might give the product a greater chance of success. Similarly, engineering might easily quash an idea from marketing for a product that can't make it economically.

But that's just part of the communications picture. There's another part that's more important, but more subtle. That involves human relations. If human relations are poor in a company, you can be certain that lots of things will go wrong.

For example, when a product is developed in the laboratory and moved into the factory, the factory people will often find many ways to make sure that the product won't work and can't be manufactured. They're not interested in having their routines changed with a new product on the line, especially a dramatic new product.

So they tend to work against the product rather than with it. The people who designed the product are strangers to them, so it can take a long time before that product really gets rolling on the production line. The factory people, almost unconsciously, will find ways to slow things down. But if human relations are good the factory people can really help a great deal in making the product work.

Of course, everybody is in favor of good human relations. But how do you get it?

We have found one important ingredient—fluidity. We maintain a great deal of fluidity in our organization; we try to make it easy for people to move around. We don't want to see a person locked forever in one position. This has many benefits.

Take the case of Dr. Kiyosumi, who was in charge of developing our flat multi-digit fluorescent display. When the R&D phases of that development were completed, Dr. Kiyosumi moved to the factory to take charge of its production. He stayed with the factory engineers for more than

a year until all the production kinks were ironed out and these displays were rolling smoothly off the production line. Then he returned to the laboratory to work on newer developments.

Dr. Kiyosumi understands that display more thoroughly than anybody does because he spent so much time developing it. So he was able to guide the production people in getting it manufactured most effectively. He knew exactly which compromises were permissible without affecting performance. That's an obvious advantage.

But also, it develops closer communications between the factory people and the R&D group. The factory people get to know the R&D people as human beings, and they get to like them. So they want to help the R&D people, not hinder them. This is part of human relations.

If you assume, as I do, that people will like each other when they get to know each other, then you can readily see how shifting people around improves communications and thus improves the cooperation towards a common goal. Now let me show you a third element in our efforts to help people develop.

We want to develop our younger engineers so that they can become senior engineers—not just older engineers.

In most companies the responsibility of the supervisor is to have his department run smoothly and effectively. In our company, we place an additional burden on the shoulders of the supervisor. We give him responsibility for the education of our younger engineers. Every once in a while I ask our senior engineers to write reports on the progress of the junior engineers on their staff.

This serves two goals. It keeps me informed on the progress of our younger engineers. Second, it puts pressure on the senior men to spend at least part of their time educating the junior engineers. I take a very active interest in our younger engineers because I feel that's where the future of our company lies. We have about 50 engineers at Ise and I feel development of the younger ones is extremely important. I stay very close to them and read the reports about them.

In addition, I read all engineering reports because I can get insight into an individual and his thinking from the reports he writes. These reports can often be a first sign that I should work more closely with an individual, particularly if he is misplaced in his job or is going in the wrong direction.

Now there's still another factor that concerns us greatly. The heart of any electronics company, of course, is engineering. And the heart of what you always want from engineering is a new

Who is Tadashi Nakamura?



Younger men plead for rest when they try to keep pace with 53-year-old Tadashi Nakamura, chairman of Ise Electronics Corp.—a man with boundless energy, whose mind is as restless as his body. His professional life started at the age of 20 when he graduated from the Nagoya Institute of Technology and joined Kobe Kogyo, which was subsequently acquired by Fujitsu. At these companies he spent most of his time designing cathode-ray tubes so he learned a lot about phosphors.

That knowledge proved useful when he invented the fluorescent display, which became the foundation stone for his founding of Ise Electronics Corp. 10 years ago, just three years after a dissertation on electronic displays won a doctorate for him from Osaka University. The fluorescent display is by no means Nakamura's only innovation; he holds some 50 patents.

It's no surprise that Nakamura named his company after his home town, a lovely resort city with a population of 100,000. He and his ancestors have been living in Ise for 14 generations. One of the problems of having a company in a resort city is that it's difficult to find technical people. And yet, Ise Electronics has succeeded in attracting good engineers from Nagoya, a city of 2,000,000, 120 km away, and from Osaka, a city of 4,000,000, 150 km away.

These engineers have helped Ise Electronics grow to the point where, in its 1974 fiscal year, it enjoyed a sales volume of \$15,000,000, a number that Dr. Nakamura hopes to double in 1975. The company was sufficiently attractive to draw the interest of Noritake, a company with a volume of \$120,000,000. Noritake, one of the world's leading manufacturers of fine chinaware, acquired Ise a year ago.

idea. I feel you get more new ideas and better new ideas if you look for them actively. I spend lots and lots of time with our president, Mr. Takafumi Kurata, trying to encourage our people to develop patents and other new ideas that can be useful to the company.

This encouragement takes the form of cash awards, among other things. When a patent is filed, the engineer responsible for it gets cash. When a patent is granted, he gets more cash. When the patent is used by the company, and starts developing profits for the company, the engineer gets still more cash.

And everybody knows it. So there's a well-known incentive for thinking about new ideas. We don't pay just for patents. We make cash

awards for "know-how" ideas that may not be patentable. We have been quite successful. We have about 120 Japanese and international patents already granted and another 400 or so that we've applied for.

So you see, we've developed several techniques for helping our engineers develop. We have regular meetings in which they communicate with each other and with others in the company. We have a fluid organization that allows people to move from one group to another. We charge senior engineers with the responsibility of helping to educate junior engineers. And we have cash incentives for good ideas. All these factors help our engineers grow, so they help our company grow. ■■

Point by point,
line by line:

See why our lowest-cost Graphics package has no competition.

Our 1024 X by 780 Y viewable points separate Graphics from mere graphing. The price has never been lower. But Tektronix' new 4006-1 provides the same superior information capacity that has made us the company for all your graphics needs.

We'll throw you a curve. Tektronix will graph circles around the competition. Now, thanks to our new low priced 4006-1, we're in the same ballgame with mere alphanumeric terminals.

Graphics to gain. Nothing to lose. Add the graphics extra at an everyday price: \$2995 or \$150 a month on a two year lease. Alphanumerics? Up to 2590 on screen characters. Plus a spectacular package that includes confirmed compatibility with most mainframes through proven interfaces and time-tested software packages. And expert maintenance that follows you all over the world.

Plug-in peripherals standing by. Like our 4631 Hard Copy Unit for up to four 4006-1's with 8½"x11" copies, or

4923 Digital Cartridge Tape Recorder for low-cost, off-line storage.

Why wait for graphics? Let graphics wait on you. See what our fine-line, full-line graphics can mean for your applications. Check out the whole story and all the prices right now with your local Tektronix Sales Engineer. Or write:

Tektronix, Inc.
Information Display Group
P.O. Box 500
Beaverton, Oregon 97077



CIRCLE NUMBER 50

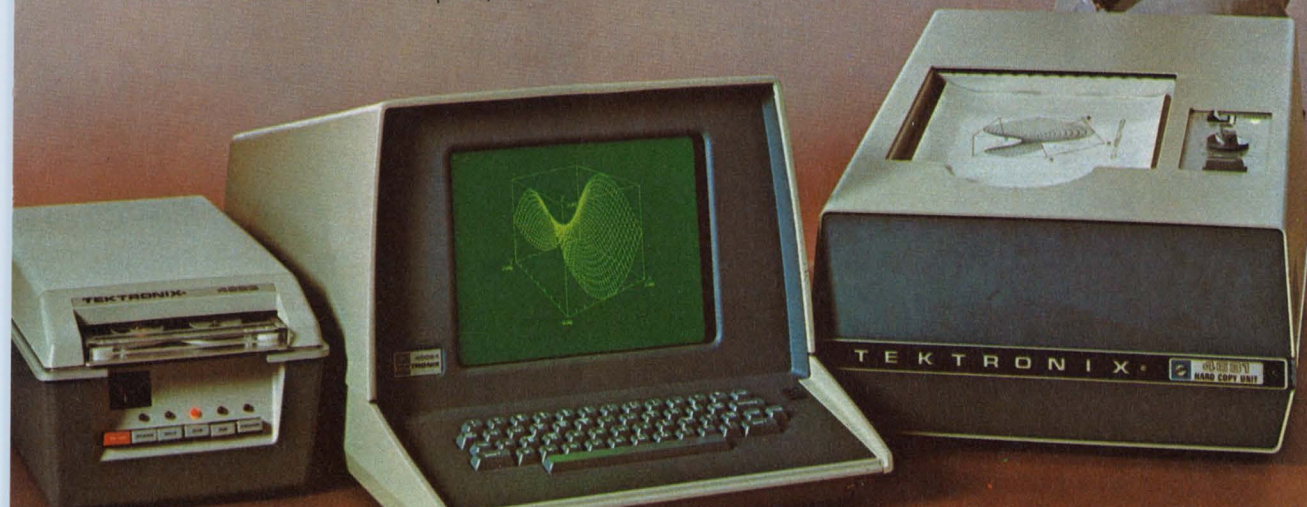
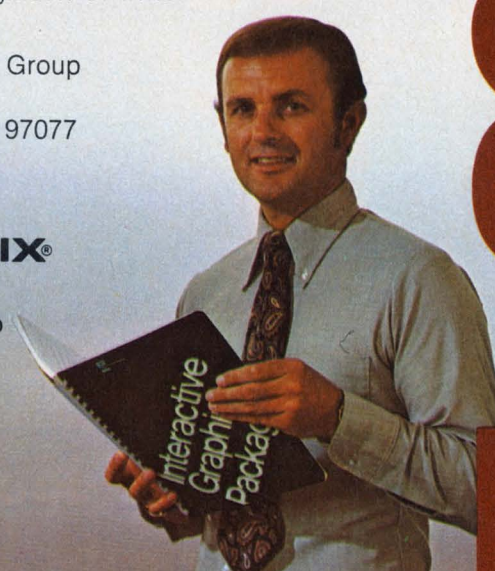

Graphics
\$2995

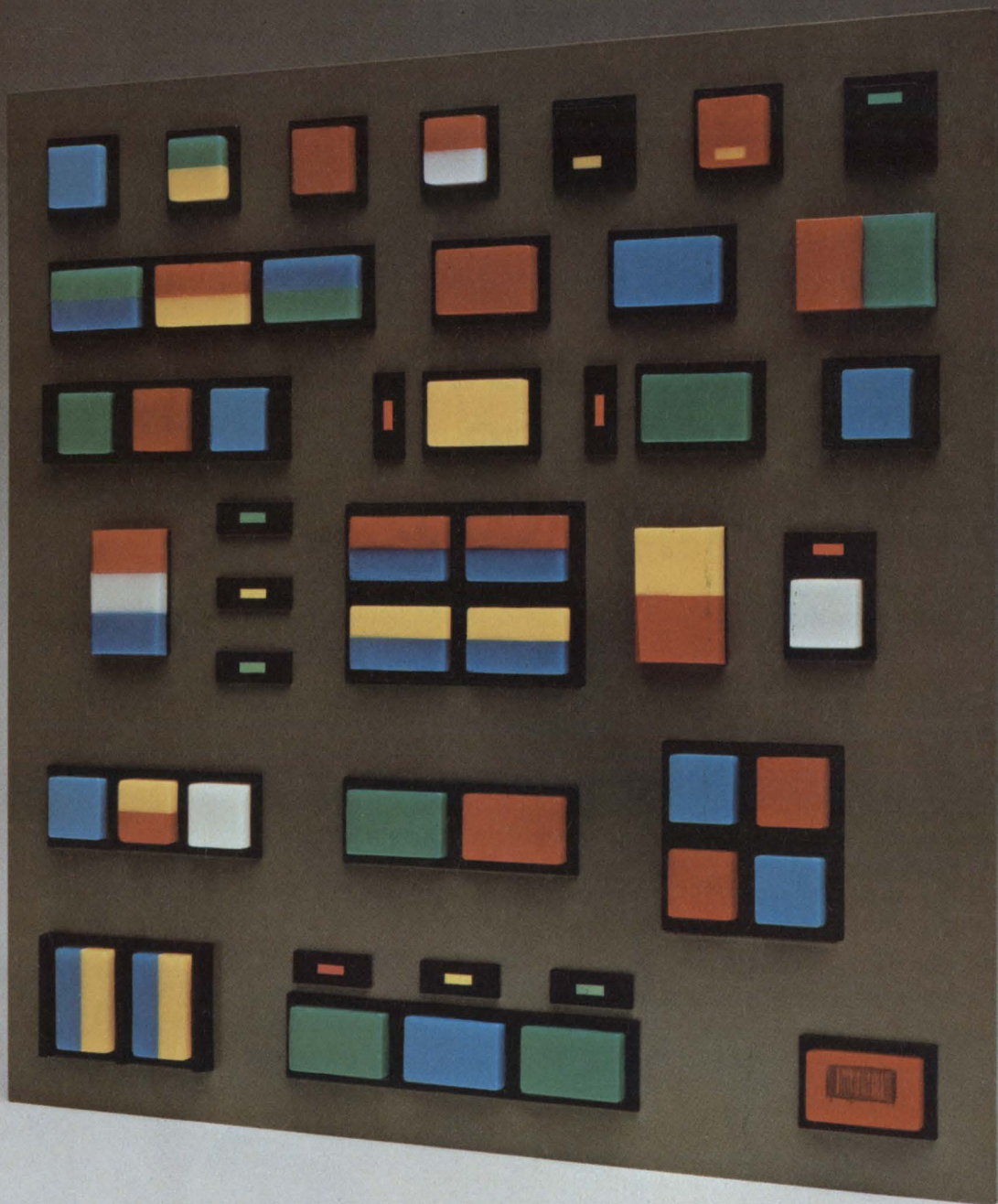

The first good-looking pushbutton that looks

Until recently, if a pushbutton looked good, its electrical flexibility usually didn't. And if it offered electrical flexibility, it usually didn't offer much in the way of looks.

Then MICRO SWITCH introduced the AML (Advanced Manual Line) pushbuttons and indicators. The most comprehensive line ever designed.

AML devices have been designed for appearance by industrial designers. Button height, bezel size, and the compatibility of the square and rectangular shapes combine to "harmonize" your panel. Because the AML line is so broad, you won't have to end up with different looking units to perform different functions.

Displays range from split-screen and hidden-color to a unique, three-segment lens cap indica-

tor, all with transmitted or projected illumination, and a choice of lamps including a T-1 $\frac{3}{4}$ wedge base lamp, neon and LED.

The AML units have been designed to look good to electrical engineers, too.

Particularly in flexibility. Three different electrically rated switches in the same size housing. You can choose solid state pushbuttons that operate at 5V or 6-16V with a built-in regulator, sink (TTL) and source (CMOS). Electronic control from logic switching to 3 amps, 120 VAC. And power control up to 10 amps at 120 VAC.

All AML units have been designed to offer the same shallow depth, to provide a unique

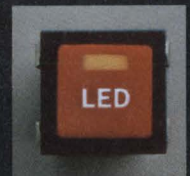

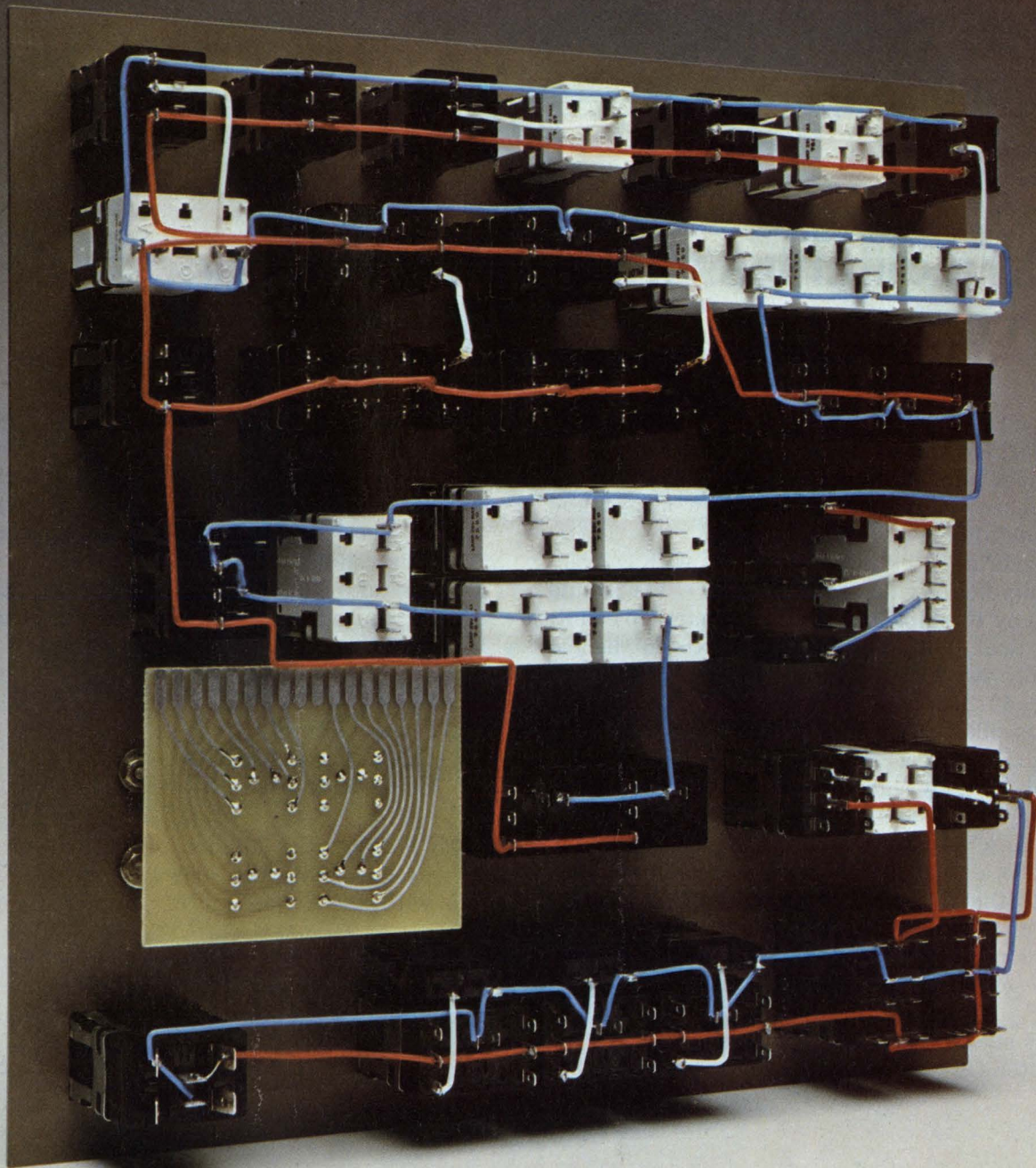

just as good when it's time to wire it.

single level termination. Which means easier wiring and a neat, "clean" appearance. You can either snap them in place from the front, or sub-panel mount them, using individual, strip or matrix mounting hardware.

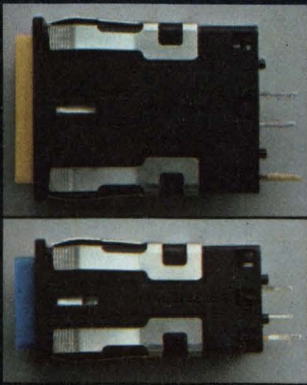

There's no problem with international acceptance, either. Every AML device is designed to meet the requirements of IEC, CEE24, UL and CSA standards.

But we believe there's more to building better panels than just offering better pushbuttons

and indicators. That's why we have MICRO SWITCH personnel available to help you solve your specific panel design problems on a personal basis. For more information, write for our "Control Panel Layout Design Guide." Or call your nearest MICRO SWITCH Branch Office or Authorized Distributor.

Either way, you'll end up with one thing. A pushbutton that works as well as it looks.



MICRO SWITCH

FREEPORT, ILLINOIS 61032

A DIVISION OF HONEYWELL

CIRCLE 231 FOR DATA; 232 FOR SALESMAN CALL.

Ideas for Design

Build a glitchless microprocessor clock with only a two-chip divider

If you're using Intel's 8008 or 8008-1 microprocessor, the circuit in Fig. 1 can save you from the headache of trying to avoid glitches in your clock phases caused by propagation delays and rise and fall times.

To generate clock pulses properly with conventional flip-flop dividers and decoders, you would need many IC chips, but the dual binary-up counter and dual D flip-flop in Fig. 1 can do the job with only two CMOS chips—an SCL 4520A and an SCL 4013A.

The oscillator in the circuit uses a colorburst crystal that has a 279-ns clock period. For the 8008, dividing by eight results in a 2.23- μ s period. Flip-flop FF₁, serves as a state decoder.

During a transition from binary counts five to six, the Q₁ output of counter C_A clocks its Q₂ output into the Q output of flip-flop FF₁ (Fig. 2). This signal, in turn, is clocked into the Q output of flip-flop FF₂ by the next clock pulse to generate a reset pulse for both the counter C_A and flip-flop FF₂. At the end of this reset pulse, a count of ONE is clocked into C_B.

Counter C_B resets when Q₁ of counter C_A goes

HIGH again, two clock periods later. Note that the Q₂ output of C_A remains HIGH for three counts and LOW for five counts to generate the ϕ 1 phase. The Q₀ output of counter C_B generates the ϕ 2 phase by staying HIGH two counts and LOW six counts.

After taking into account the propagation delays of the counters and flip-flops—a typical delay time is 70 ns at 25 C—you will have the following:

Pulse width of ϕ 1	900 ns
Pulse width of ϕ 2	600 ns
Clock delay from ϕ 1 to ϕ 2	210 ns
Clock delay from ϕ 2 to ϕ 1	520 ns
Total \cong	2230 ns

To convert the divider circuit to divide by seven for use with the 8008-1, clock the FF₁ flip-flop with the Q₀ output of counter C_A instead of Q₁.

Sam Deus, Design Engineer, Multisonics, 3300 Crow Canyon Rd., San Ramon, CA 94583.

CIRCLE NO. 311

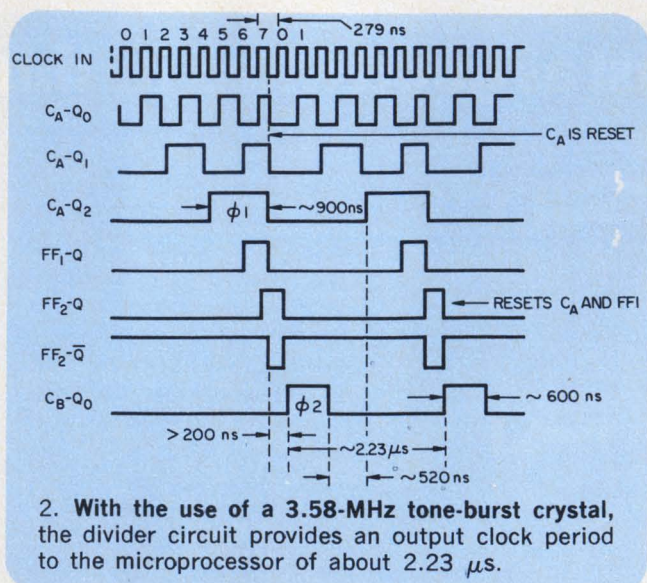
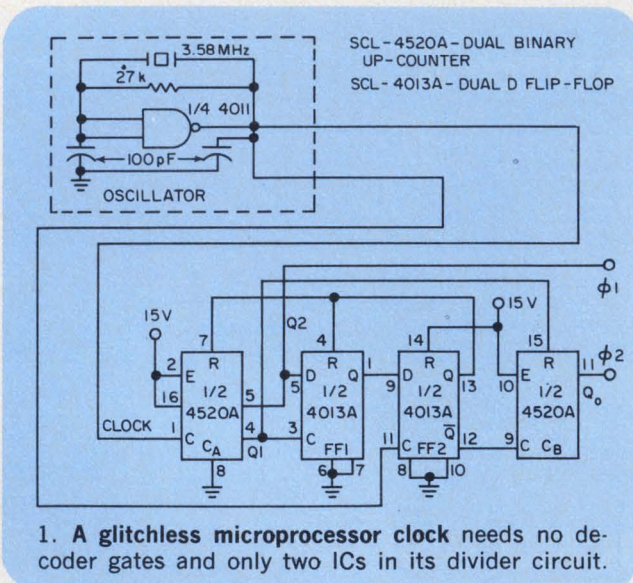

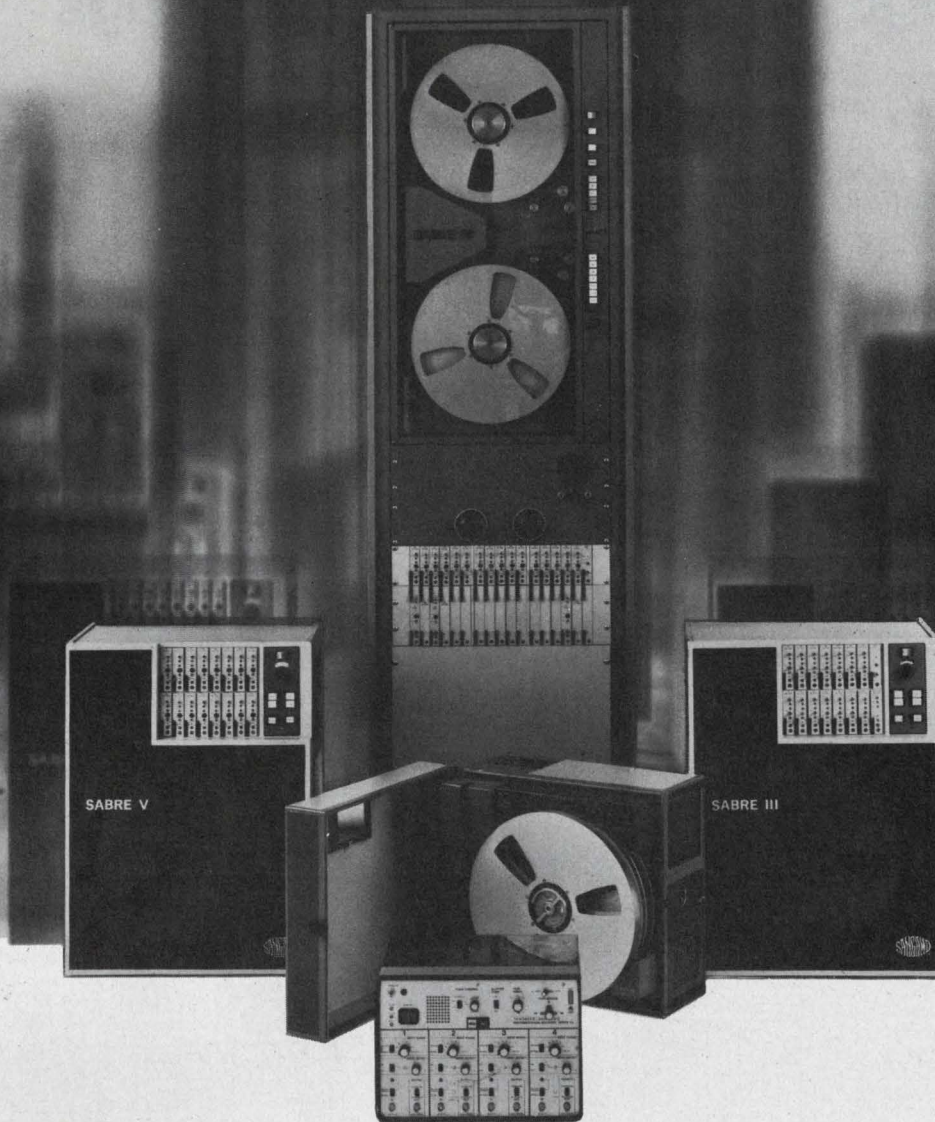

Now our expandable line offers DC to 4 million bits per second!

We offer PCM capability, in addition to Direct and FM electronics, in three of our recorder/reproducers. There's the 7 to 14 channel Sabre III and the 28/32 channel Sabre V, both IRIG all-band portable recorders; and the Sabre IV, a 7 to 48 channel laboratory recorder/reproducer.

In addition our line includes the new Sabre VI which offers superior performance plus ultra-portability, and the Tandberg TIR-115, a 4-channel, FM, 25-pound system.

Those basic five recorders are actually an almost unlimited line because each is designed and built to adapt to an amazing variety of functions. Just tell us what you want one to do!

For information write: Sangamo Electric Company, Data Systems Division, P.O. Box 3347, Springfield, Illinois 62714. Area Code 217, 544-6411. Telex 406-461. Sales and service representatives worldwide.

SANGAMO RECORDERS
THE INNOVATORS IN TAPE INSTRUMENTATION

Automotive charging regulator gives overvoltage and undervoltage warnings

An automotive voltage regulator that uses an LM124 quad op-amp warns the driver of improper battery-charging conditions. The circuit has the following features:

- An overvoltage warning circuit that blinks a red warning light on the dashboard. Amplifier A_2 of the quad package operates as a threshold detector and A_4 as a low-frequency oscillator.
- An undervoltage warning circuit that brightly lights the same red warning light. Amplifier A_1 senses the undervoltage.
- Linear temperature compensation, which adjusts the charging voltage as the ambient temperature changes. Voltage V_{be} of Q_4 serves as the sensing signal.¹
- Internal regulation by use of an LM340-8, 8-V regulator.

The internal regulator buffers the quad op-amps from overvoltage and transients. Though the LM124 can operate over a supply range of 3 to 30 V, the temperature compensation circuit

needs a stable regulated supply for accuracy.

Today's American cars use alternators that are self-current-limiting and thus don't need overcurrent protection. However, for use with a generator battery-charging system, such as in a VW, an overcurrent detector control circuit is required in series with the generator armature. Also, the VW generator field must be grounded to be energized. Thus the field circuit is modified—the circuit with Q_{1A} replaces Q_{1B} —and the leads to input terminals 9 and 10 of A_3 must be interchanged.

Reference

1. Loe, J. M., "Linear Temperature Sensor Uses Only a Single Transistor," *Electronic Design*, Feb. 15, 1970, pp. 86-87.

John Okolowicz, Senior Electrical Engineer, Honeywell Inc., 1100 Virginia Dr., Fort Washington, PA 19034.

CIRCLE NO. 312

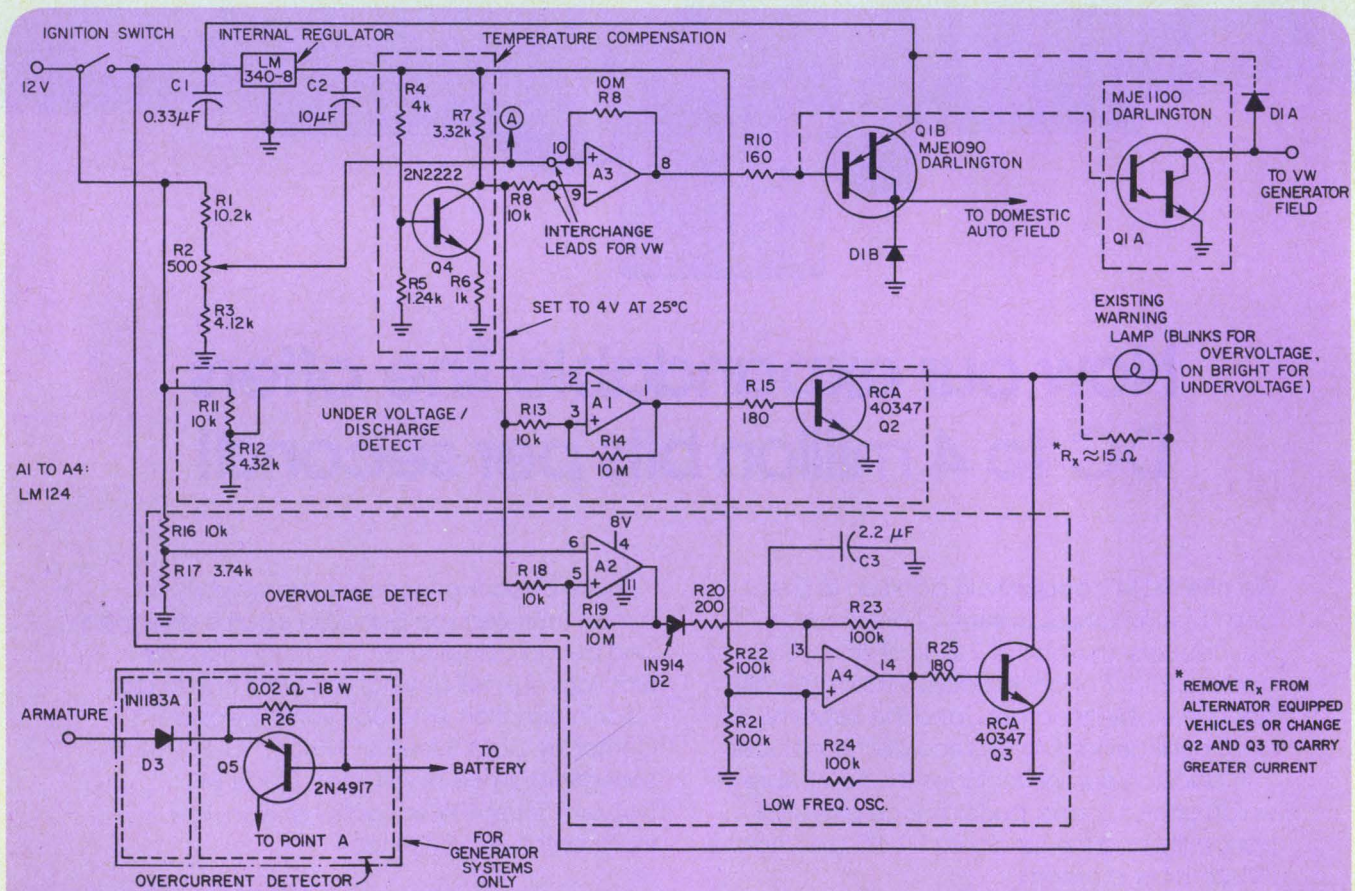

Alternators on American autos are self-current-limiting, but a generator charging system needs

the current-limiting circuit, shown in the lower-left corner, to protect the battery.

**You can buy
this Spectrum Analyzer
and take a big chunk
out of your budget.**

**You can rent
this Spectrum Analyzer
and get more
equipment out of
your budget.**



Even the best equipment budget can only go so far. And at the price you pay for electronic test equipment nowadays, that's not very far at all.

Unless you rent your equipment from REI.

When you rent from us, there's no large cash outlay. You pay only for the time you have your instruments, and you return them when you're through. So you never have to spend your money on idle equipment.

Getting more for your money is just one reason for renting from REI. Immediate delivery is another. We have over \$10 million in inventory in fully stocked centers around the country. And, when you have short-term needs, you can rent equipment for just as long as you need it, and make it pay for itself.

REI stocks over 8,000 fully checked-out test instruments, and they're ready whenever you are. For the full story on renting, as well as our low prices, send in the coupon for prompt delivery of our free illustrated catalog... or call us now for your immediate requirements.

Rental Electronics, Inc.
99 Hartwell Avenue, Lexington, Mass. 02173
Please send me your free instrument rental catalog:

Name _____ Title _____

Company _____

Address _____

City _____ State _____ Zip _____

Tel. Number _____

Rental Electronics, Inc. 

A PEPSICO LEASING COMPANY

Burlington, MA (617) 273-2770 • Gaithersburg, MD (301) 948-0620 • Oakland, NJ (201) 337-3757 • Ft. Lauderdale, FL (305) 771-3500
• Des Plaines, IL (312) 827-6670 • Dallas, TX (214) 661-8082 • Mountain View, CA (415) 968-8845 • Anaheim, CA (714) 879-0561
• Rexdale, Ontario (PLC Leasing Ltd.) (416) 677-7513

CIRCLE NUMBER 54

Power-supply regulator simplified with Norton op amps

Operational amplifiers can aid in simplifying power-supply-regulator design by eliminating many components required in the usual circuits. However, for best performance conventional op amps need a plus/minus power source; a single-ended supply causes problems, because of common-mode voltage limitations. By use of a Norton op amp, the common-mode problem disappears.

In the design in the figure, four Norton amplifiers in the same IC package are paralleled for added current capability. Adjustment of variable-

resistor R_1 allows the designer to choose the current at which the regulator output will current limit. A value of about 68Ω provides a 4-A limit, which represents about the maximum capability of this circuit with the components shown. The $0.01\text{-}\mu\text{F}$ feedback capacitor limits the circuit's high-frequency response and prevents oscillations.

Mike Hadley, CMOS Applications, Motorola Semiconductor Products Inc., 3501 Ed Bluestein Blvd., Austin, TX 78721. CIRCLE NO. 313

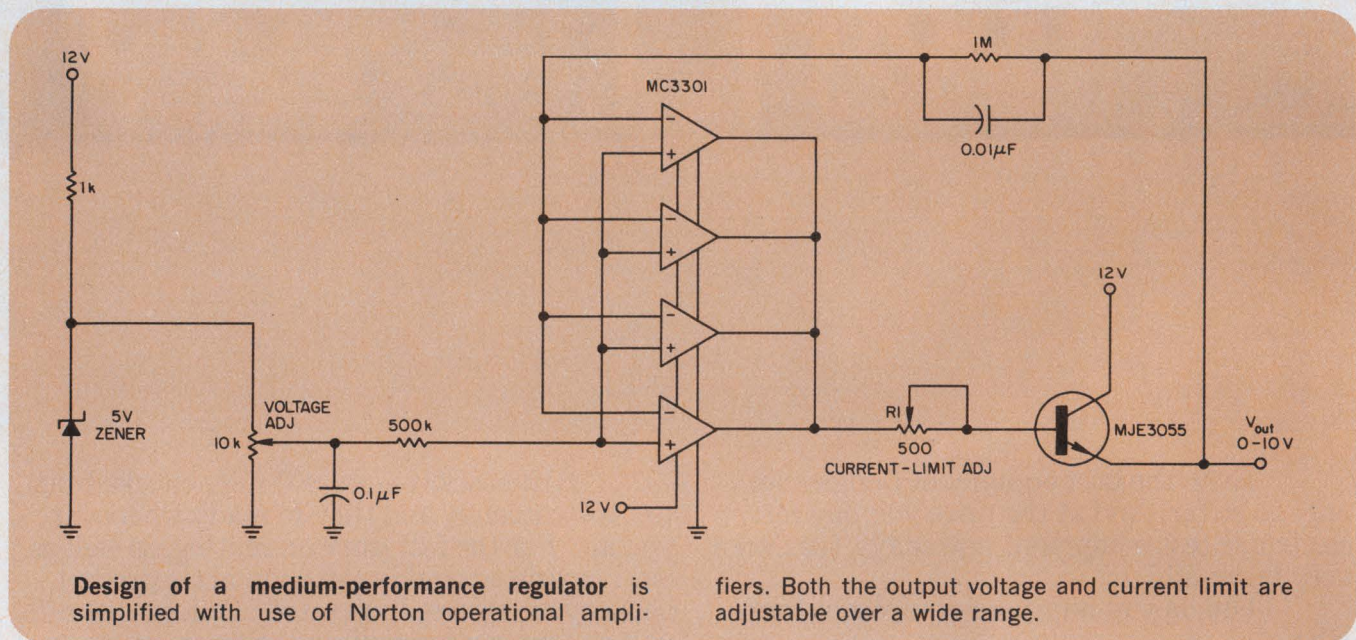

Design of a medium-performance regulator is simplified with use of Norton operational ampli-

fiers. Both the output voltage and current limit are adjustable over a wide range.

IFD Winner of November 8, 1975

Peter Lefferts, Design Engineer, MS 220, National Semiconductor Corp., 2900 Semiconductor Dr., Santa Clara, CA 95051. His idea "Power-Failure Alarm Operates a Long Time on a Single 1.5-V Cell" has been voted the Most Valuable of Issue Award.

Vote for the Best Idea in this issue by circling the number for your selection on the Information Retrieval Card at the back of this issue.

SEND US YOUR IDEAS FOR DESIGN. You may win a grand total of \$1050 (cash)! Here's how. Submit your IFD describing a new or important circuit or design technique, the clever use of a new component or test equipment, packaging tips, cost-saving ideas to our Ideas for Design editor. Ideas can only be considered for publication if they are submitted exclusively to ELECTRONIC DESIGN. You will receive \$20 for each published idea, \$30 more if it is voted best of issue by our readers. The best-of-issue winners become eligible for the Idea of the Year award of \$1000.

Who provides the industry's broadest line of electronic packaging hardware ... including Logic Panels?

SAE does! And we offer several types of panels to choose from. Our standard 8186 Series accommodates up to 180 device patterns and accepts a variety of I/O connectors. The plug-in version is compatible with other industry-supplied modules, and contains 122 contacts in the I/O connector section.

Features include machined socket terminals with closed entry contacts; a double-sided board with power and ground planes, and pin spacing for almost any IC configuration.

Our EX700 Series supports dual-in-line ICs, discrete components, etc. in a modular, high-density configuration (a third greater than conventional panels). It comes in almost any IC pattern for extra design flexibility, and a plug-in version with an 80-pin I/O connector is also available.

A total ground plane concept provides a much lower ground impedance characteristic, resulting in excellent noise immunity. Power distribution is through bus-bar interconnection, and/or through direct power and ground input terminals.

And if we haven't described one you like, we'll be pleased to quote a custom panel to your specifications including ECL and Schottky logic. Our new 128 page packaging handbook gives complete details. It also describes our other family of logic panels and our entire line of electronic packaging and interconnection hardware.

CIRCLE NUMBER 55

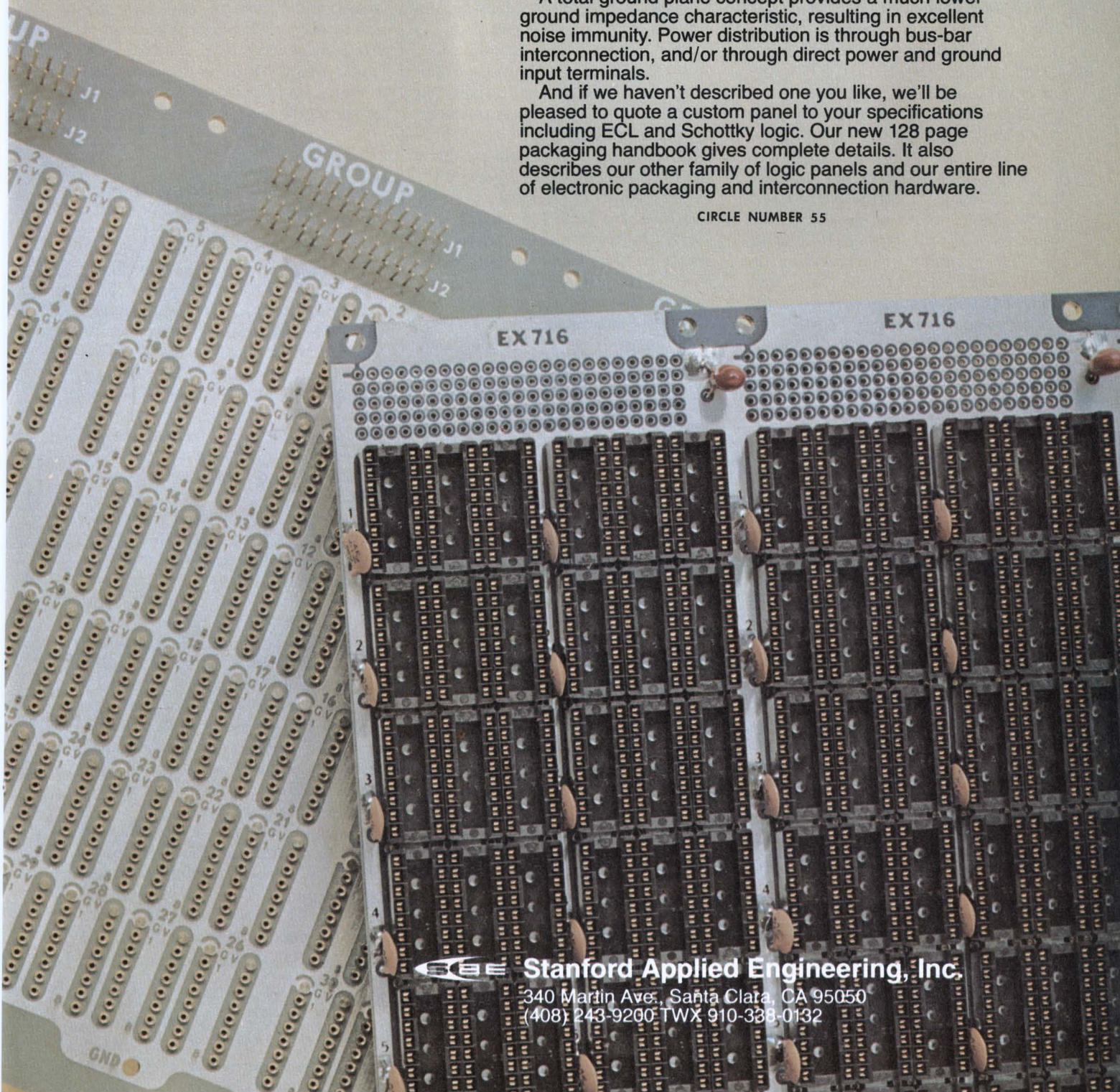

 **Stanford Applied Engineering, Inc.**
340 Martin Ave., Santa Clara, CA 95050
(408) 243-9200 TWX 910-338-0132

First European μ P system features low-cost simplicity

The first general-purpose microprocessor developed in Europe has been produced at General Instrument's Glenrothes, Scotland division. Called the Series 8000, the family consists of five devices developed from a two-chip system originally produced for a European end-user.

The major features are simplicity and low cost. Attractive to first-time microprocessor users is the low cost of prototyping equipment.

The minimum configuration is two chips: the LP8000 CPU and the LP6000 program-storage unit, both second-sourced by AEG-Telefunken in Germany and SGS-Ates in Italy. To these, General Instrument has added the LP1030 clock generator, the LP1000 memory interface and the LP1010 input/output circuit. The latter two devices

replace the mask-programmed LP6000 in low-volume applications and program development.

The LP8000 CPU contains 48 accessible 8-bit registers, and for most Series-8000 applications no additional random access memory will be required. There is no provision for interrupts but rather a strong emphasis on I/O capability.

The two-chip system has 48 I/O lines available for driving displays, interfacing to keyboards, and so on. The LP6000 contains 1-k bytes of program storage in addition to the program counter, two 8-bit I/O ports and a four-word-deep hardware stack for subroutine nesting. Initial cost of the two-chip system in quantities of 100 or more, is under \$60.

Users of the LP8000 include the British Post Office.

planted lifetime of more than ten years. The nuclear batteries are essentially thermocouples heated by a nuclear source consisting of under one-fifth of a gram of plutonium oxide enclosed in a shock-proof metal case.

Electrolytic capacitor has high stability

A long-life aluminum electrolytic capacitor has been developed by N. V. Philips' Elcoma Div., Eindhoven, the Netherlands, for use in switched-mode power supplies for decoupling of steep pulses in digital circuits and for energy storage in pulse systems. The capacitors have high capacity-voltage products and low high-frequency impedances that enable them to withstand substantial ripple currents.

Low-inductance-wound foils are employed to give negligible parasitic inductance, and the multiple cathode and anode terminations are brought out at the top of the winding, thereby reducing electromagnetic radiation. The etched anode foil is made of 99.99% pure aluminum and the anode and cathode foils are separated by a tissue spacer with a low specific resistance. The oxide layer is not attacked by the electrolyte, ensuring high stability and operation over a wide temperature range.

Capacitance values up to 150,000 μ F are possible at rated voltages up to 63 V. Operating temperatures range from -40 C to $+85$ C. A 150,000 μ F, 6.3-V capacitor can handle a maximum rms, ripple current of 21.3 A at 85 C with an impedance of only 3.5 m Ω at 20 kHz.

CIRCLE NO. 315

TV camera can operate over wide light range

A solid-state TV camera that can operate over 24 hours, from bright sunshine (10^5 lux) to dark night conditions (10^{-4} lux), has been developed by the Danish company Jorgen Andersen Ingeniørfirma S/A. The camera—the JAI 730 SIT—has a silicon-intensifier target tube combined with a fully automatic brightness control

circuit. In the optics tube a thermostatically controlled heater eliminates condensation on the front glass.

A standby mode is provided in which the beam current is switched off and time from standby to operation is less than 2 seconds. Resolution is 650 lines and the output is composite video.

Atomic pacemaker has a 10-year lifetime

A cardiac pacemaker powered by a nuclear battery has been developed at the Atomic Energy Research Establishment at Harwell, Oxfordshire, England. While con-

ventional pacemakers with chemical batteries must be surgically replaced about every three years, prolonged trials indicate that the Harwell units could have an im-

New "Cricket" sub-miniatures: Interchangeability plus full 6 amp rating.

Cutler-Hammer introduces a broad new line of quality sub-miniature switches whose specifications meet industry standards for size, terminal spacing and bushing height. They're rated 6 amps. They're fully interchangeable. They feature high torque bushings. They're competitively priced. And they're available right now. For more information on new, interchangeable sub-miniature switches, call your Cutler-Hammer sales office or Stocking Distributor. Just ask for "Cricket."

Flat Lever. Designed for comfortable, finger-tip control. Keyed bushing prevents switch rotation.

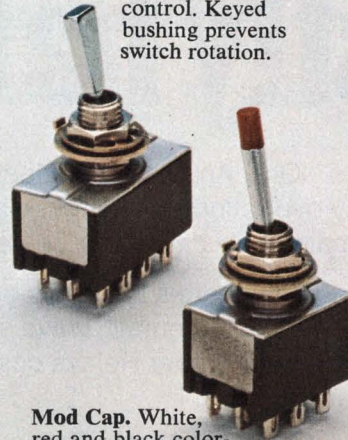

Lever Lock. Locks in position to assure precise control of vital or sensitive functions and equipment. No accidental operation.



Mod Cap. White, red and black color-tipped caps let you choose and vary your operational coding.



Watertight. Toggle or pushbutton. "O" ring seal shuts out dirt and moisture. Keeps switch mechanism dry in adverse environments.

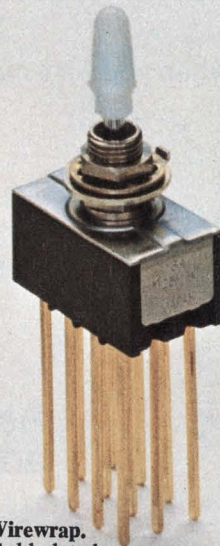

Wirewrap. Gold plated terminals in .750 and .964" lengths to satisfy power or dry circuit requirements.

Printed Circuit. Toggle or pushbutton. Fits standard printed circuit board mounting dimensions. Right angle and vertical mounting.

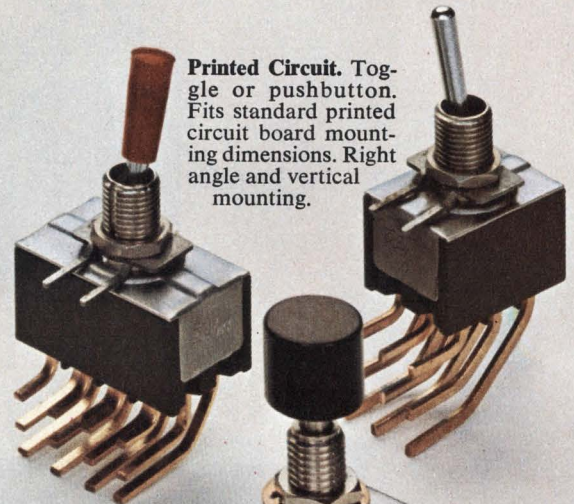

Rockers. Sub-panel or snap-in. Variety of paddle or low-profile styles. With decorative bezels. Also with L.E.D. for illuminated functions.

Standard. Toggle or pushbutton. One to four poles. Eight circuits. Two decorator cap styles in a variety of colors. Dry circuit capability, too.



 **Switch to No.1**

CUTLER-HAMMER
SPECIALTY PRODUCTS DIVISION, Milwaukee, Wis. 53201



Arrow-M Amber Relays eliminate costly hand soldering.

Only Arrow-M manufactures gas-filled plastic sealed relays, proven to have top reliability over a long life. They're applicable from very low level to high capacity contact loads and maintain highly stable contact resistance, even after long use.

Now here's the really big news: by using Arrow-M Amber Relays on your PC board and using automatic wave soldering, you can substantially reduce your labor costs. And since Arrow-M Amber Relays cost less than sealed metal can relays, the savings are even greater.

Arrow-M Amber Relays. When you want maximum reliability *and* maximum savings. And only Arrow-M makes them.

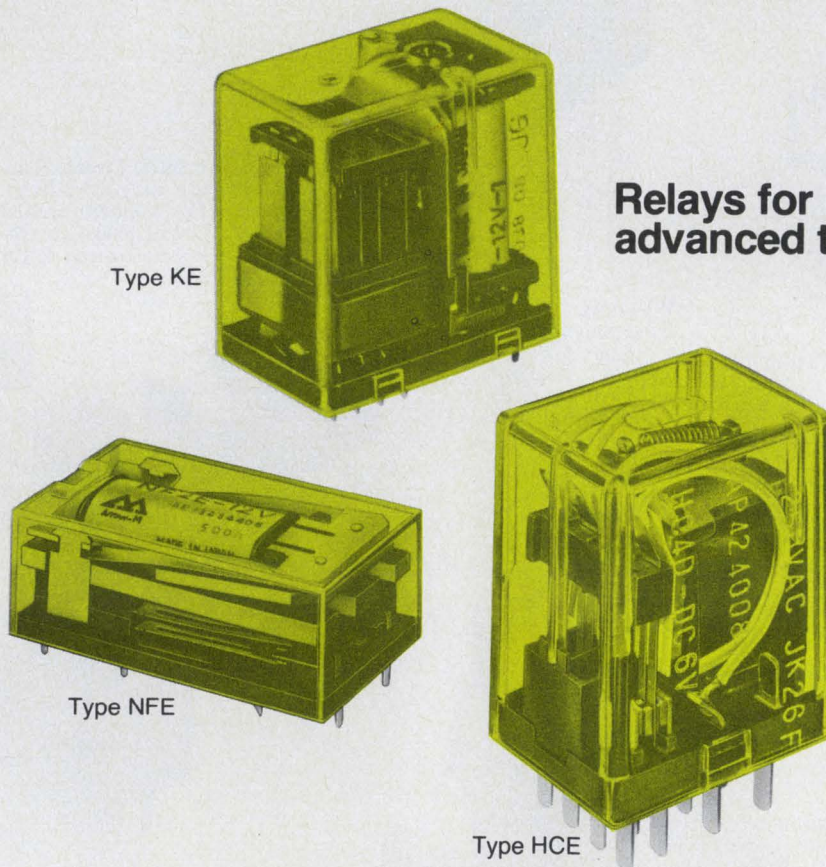

**Relays for
advanced technology.**

For more information on exact specifications of our Amber Relays, write or call your nearest Arrow-M office.

Arrow-M Corporation
250 Sheffield St.
Mountainside, N.J. 07092
(201) 232-4260

Western Office:
22010 South Wilmington Ave.
Suites 300 & 301
Carson, California 90745
(213) 775-3512



New Products

50-MHz portable oscilloscope lets you compare four signals

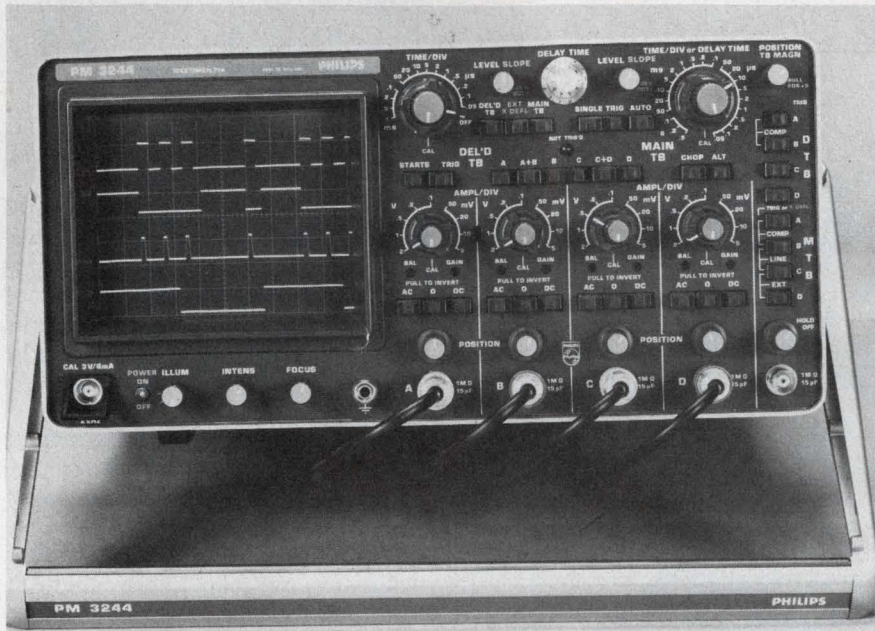

Philips Test & Measuring Instruments, 400 Crossways Park Dr., Woodbury, NY 11797. (516) 921-8880. See text.

The first four-trace portable oscilloscope—the 50-MHz PM3244 from Philips Test & Measuring Instruments—does more than let you look at four signals simultaneously. With it, you can combine the inputs in various modes without changing probes. You can also trigger either the main or delayed time base from various sources, internal or external, without moving probes.

Thus you can look at each channel—A, B, C or D—by itself, add channel A to channel B, add C to D, invert B or D, combine modes, and so on. You also have the option of displaying the traces in either a chopped or alternate mode. All this with just the push of a button.

Triggering the main sweep—which ranges from 50 ns/div to 0.5 s/div—can be done from any Y-axis signal, from a composite signal, from the line frequency or from an external source.

The delayed time base (50 ns to

1 ms per div) triggers immediately after the set delay period. Or after delay it can be triggered by any selected source, independently of the main trigger. Again, all you do is push buttons.

Perhaps more significant than the PM3244's versatility is that you can do all signal manipulation and triggering in the field: the 9.5-kg scope offers up to five hours of battery operation with the optional pack.

The Y axes of the Philips scope have four identical amplifiers, arranged on one board in a symmetrical four-quadrant layout. Sensitivity of the vertical inputs can be varied from 5 mV/div to 2 V/div in nine steps (1-2-5 sequence). An uncalibrated control provides a vernier between the steps.

Rise time of the input amplifiers is 7 ns, and the input impedance of all four channels is 1 M Ω across 15 pF. Coupling can be ac or dc.

Other key specs of the Y-axis amplifiers include a drift of less than 0.3 div/h at 20 C (after a 15-min. warmup) and a tempo of

60 μ V/ $^{\circ}$ C. Cross talk is listed at less than 35 dB in chopped mode for all attenuator settings.

You can also use the unit in an X-Y mode. Here, the horizontal amplifier provides a 3-dB bandwidth of 1 MHz and a deflection of 450 mV/div when the external connector is used. However, the vertical attenuator coefficients apply when any of the four Y channels are used for X deflection.

For those interested in making photographic records, the writing speed of the PM3244 is specified at a fairly fast 750 cm/ μ s. To get that number, Philips used a Steinheil M5 scope camera with an aperture of f/1.2 and an object-to-image ratio of 2. The film used was 10000-ASA Polaroid 410, with no prefogging.

The useful screen area of the 3244 covers 8 \times 10 cm. The rectangular-mesh CRT (10-kV accelerating potential) comes with P31 phosphor as standard.

How Philips managed to pack so much into a 31.6 \times 15.4 \times 41-cm case makes an interesting design story. Keys to the impressive packaging lie in the compact, switching power supply, the central vertical amplifier board, the Philips' "cold-switching" technique and, of course, extensive use of ICs and multitransistor arrays. Only 15% of the instrument's 21 lbs is borne by the mechanical structure.

Cold switching, a technique found in other Philips' scopes, separates all electronics and controls. The controls handle dc levels only, but not analog or low-level signals. Thus, only simple rotary switches—with one or two decks—are needed, and both electronics and controls can be grouped for optimum physical packaging.

First deliveries of the Philips PM-3244 are expected in late spring. The price? Just \$2500. **CIRCLE NO. 301**

INSTRUMENTATION

Solid-state totalizer offers 12,000 cpm

Waugh Controls Corp., 9001 Fullbright Ave., Chatsworth, CA 91311. (213) 998-8281. \$45 (100).

Minicounter 11 solid-state counter with eight-digit LED display and compact housing of only 24 x 48 mm is priced as low as \$45 in

100-piece quantities. Model 428 features silent operation and counting speeds of 12,000 counts per minute. Battery connection retains counting during power outage and unit is available with or without reset. Counts are received from either switch closures, voltage pulses of 4 to 50 V pk-pk amplitude or pulses from standard TTL, DTL, or CMOS logic.

CIRCLE NO. 306

Time base lets scope compute, display Δ



Tektronix, P.O. Box 500, Beaverton, OR 97077. (503) 644-0161. 7B80, \$725; 7B85, \$875.

An oscilloscope that computes and digitally displays time intervals along with the waveform being measured is the result of adding the 7B80 time base and 7B85 delaying time base to the company's 7700, 7800 or 7900 Series mainframes. Delta time-delay mode differs from previous scope operation by creating two controllable intensified zones, computing the time difference between them, and digitally presenting this value on the CRT. The operator can view either the main sweep with its two intensified zones or the two delayed and expanded sweeps, or all three waveforms along with the digital measurement.

CIRCLE NO. 307

The Proven Price Setter

Analogic's "Single Chip" Digital Panel Instrument

Less Than
\$6900

(in OEM quantities)



Who else, but Analogic, the world's largest manufacturer of DPIs could have set the pace 18 months ago with the first and most advanced "single chip" DPI. The AN2538 is a line-powered 3½ digit DPI . . . with an 18 month proven (thousands in operation) market performance and dependability.

It has the lowest failure rate ever achieved in a 3½ digit DPI — enhanced by a 96-hour, 50°C burn-in cycle. Its monolithic circuitry allows exceptionally cool (5°C rise) operation over -10° to +60°C. Autozeroing. High CMRR/NMRR for noise and ground loop immunity. Extremely low bias current. These and other features all add up to usable ±0.05% accuracy. Universal power transformer (100V, 117V, 220V, 240V, all ±10%, 47-63Hz).

For complete data on the AN2538 or on any of our 16 types of DPIS contact Bob Shipione at (617) 246-0300, for your local Analogic sales office or stocking distributor, or write today: Analogic Corp., Audubon Road, Wakefield, Mass. 01880.

ANALOGIC ■

...The Digitizers

CIRCLE NUMBER 58

Counter-timer gets the 'smarts'

Ballantine Labs, P.O. Box 97, Boonton, NJ 07005. (201) 335-0900. \$695; 4-6 wks.

Model 5500B universal counter/timer features automatic micro-processor-controlled circuitry. The instrument provides 10 modes of operation including frequency measurement capability up to 118 MHz. The automatic resolution and autoranging features make the unit suitable for ATE systems use. The ROM used in the Model 5500B's self-programming circuitry is said to greatly simplify and reduce the number of control lines and commands needed from the ATE system controller.

CIRCLE NO. 308

Function generator works nine ways

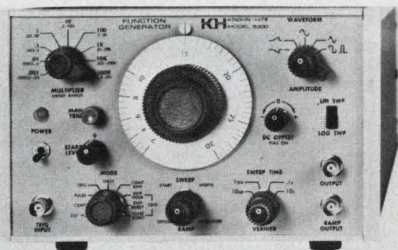

Krohn-Hite, Avon Industrial Park, Avon, MA 02322. (617) 580-1660. \$695; 60 days.

Model 5300 function generator offers nine modes of operation. Included are an exponential ramp function for logarithmic sweeping, plus separate waveform and ramp outputs, pulse, sweep and burst modes and external voltage control of main output frequency. The exponential sweep, in conjunction with the linear sawtooth, enables semilog plotting. In external and sweep modes, the frequency range extends from 0.00003 Hz to 3 MHz.

CIRCLE NO. 309

Multipen recorder overlaps up to 6 traces

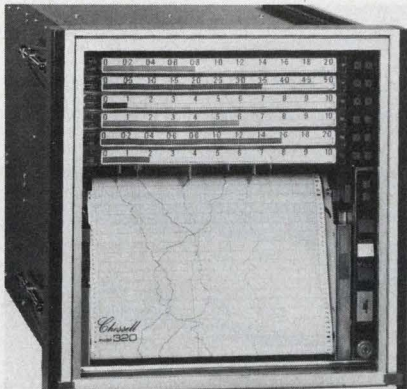

Chessell Ltd., Broadwater Trading Estate, Southdownview Rd., Worthing Sussex, BN14, SNL, England.

Series 320 continuous-trace, multipen chart recorder offers fully independent pen crossover covering the entire chart width of 250 mm (10 in.), each trace in a contrasting color. Featured are modular construction and a choice of from one to six channels, single or ten-speed electronic chart drive and high/low individual channel alarms. There is a range of more than 300 plug-in signal-conditioning units, each with isolation and electronic linearization.

CIRCLE NO. 310

Strip-chart recorders offer 3 or 4 pens

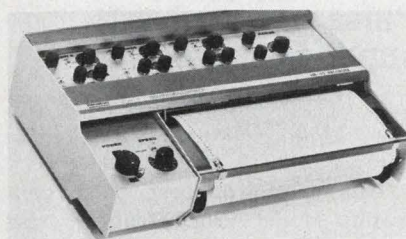

Houston Instrument, One Houston Square (at Cameron Rd.), Austin, TX 78753. (515) 837-2820. Start at \$3200; 30 days.

The OMNIGRAPHIC HR-40 series are 3 and 4-pen strip-chart recorders with a full 10-in. (250 mm) recording span. Each pen covers the total chart width. Writing distance between channels is only 2 mm. The recorder uses disposable fiber-tip cartridge pens, available in four colors. Full-scale response is 1/4 s. The sprocketed paper drive has 16 switch selectable chart speeds. Two interchangeable plug-in pen axis modules are available: a 12-range, 1-mV to 10-V module or an 18-range 0.5-mV to 200-V unit.

CIRCLE NO. 320

Selective level meter resolves 10 Hz



Siemens, 186 Wood Ave. S., Iselin, NJ 08830. (201) 494-1000. \$5395.

Selective measurements of transmission parameters in the 1-kHz-to-18.6-MHz frequency range are made by the D2008US. The meter is dedicated to in-plant applications for multiplex, L-Carrier, WLEL, radio, etc. Features include: 10-Hz frequency resolution, 0.02-dB expanded scale resolution, SSB (phase jitter) output, and a built-in monitoring speaker. Also included are a C-message equivalent, 1.74-kHz effective noise bandwidth filter, an 80-Hz pilot pick-off filter and an optical search indicator (hit or spurious tone detector).

CIRCLE NO. 321

CIRCLE NUMBER 59 ▶

Break your analyzer bottleneck

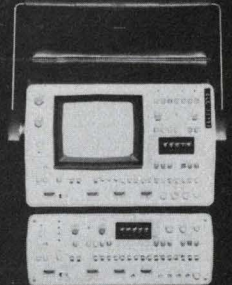

Today's best may be second-best tomorrow! If you're pushing the state-of-the-art and need the latest in speed, range and accuracy call the "Instrument Professionals". We can deliver the best available and replace it immediately when a better one comes along.

Write or call for data on our other specialties: Instrument Leasing • Computer Peripherals • Equipment Sales • Instrument Service.

Call Get our FREE Catalog

Continental Rentals

Div. Continental Leasing Co., Inc.
175 Middlesex Turnpike, Bedford, MA, 01730 (617) 275-0850; Metuchen NJ, (201) 549-8500; Rockville, MD, (301) 881-7997; Dallas, TX, (214) 357-1779; Elk Grove IL, (312) 439-4700; Costa Mesa, CA (714) 540-6566; Santa Clara, CA, (408) 735-8300; Los Angeles, CA, (213) 477-7521

3-D

DISPLAY SYSTEM

FROM

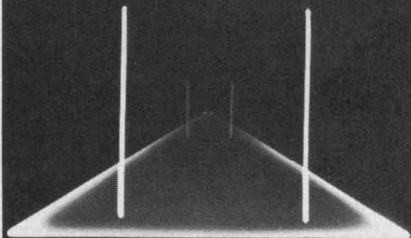

Add 3-D to any X-Y display or oscilloscope for only \$147.00 (basic DC-500 KHz system). The 6100 Series of 3-D Modules come with bandwidths from DC-500 KHz up to 5 MHz. The modules generate aerial and geometric perspective, 360° rotation, interposition, depth of focus, and binocular (stereo) depth cues.

The entire image is described by $\pm 10V$ full-scale analog voltages.

Since the 6100 Series of 3-D Modules are analog by nature, it provides full compatibility with analog systems. When used with digital systems, the 6100 Series is placed at the CRT, X, Y inputs.

COMPLETE SPECIFICATIONS ON REQUEST

Optical Electronics, Inc., manufactures a complete line of OP AMPS, analog function modules, 3-D displays, and ultrasonic imaging systems.



OPTICAL ELECTRONICS INC.

P. O. BOX 11140 • Tucson, Arizona 85734
PH. (602) 624-8358 • TWX (910) 952-1283

CIRCLE NUMBER 60

INSTRUMENTATION

Pulse gen delivers super fast rise times

E-H Research Labs, 513 11th St., Box 1289, Oakland, CA 94604. (415) 834-3030. \$5995; 30 days.

This special-purpose pulse generator, Model 125B, features rise and fall times (10 to 90%) of 200 ps, or less, and less than 500 ps, respectively. Output amplitude is $-10 V$ (fixed) into 50Ω and rep rate is 10 Hz to 1 MHz in 10 ranges. Distortion is less than 5% pk-pk.

CIRCLE NO. 322

It's a DMM, supply and calibrator—all in one

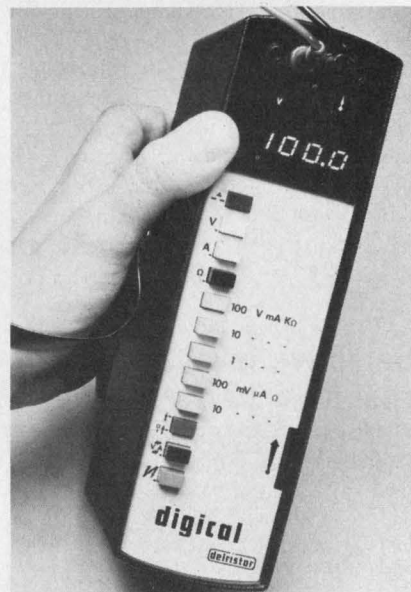

Deltrisor Ltd., 21 Windsor St., Uxbridge, Middlesex, England.

The Digical is claimed to be the first hand-held portable instrument to combine the functions of dc calibration, simulation, measurement, check and test. The unit performs all functions with just two terminals and is a precision voltage and current generator, voltage, current and resistance multimeter and constant voltage/current power supply. Featured are 25 ranges and a 0.31-in., 3-1/2-digit bipolar LED display. The Digical generates $10 \mu V$ to $100 V$ (at up to 100 mA) and $10 nA$ to $100 mA$ (at up to $100 V$). Weight, including the self-contained battery pack, is 5.51 lb and size is approximately $8.8 \times 2.5 \times 4.7$ in.

CIRCLE NO. 323

50-MHz pulse generator drives CMOS circuits

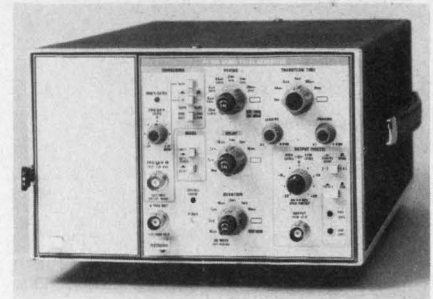

Tektronix, P.O. Box 500, Beaverton, OR 97077. (503) 644-0161. \$1250; 6 wks.

Model PG 508T 5-MHz pulse generator provides the high-level output required to drive CMOS ($20 V$ in a $\pm 20-V$ window to hi-Z and $10 V$ to 50Ω). It features a control error light that warns of improperly set switches or variable controls. Both the high and low levels of the output waveform are independently controllable. It has a true $50-\Omega$ output. A three-state trigger light indicates proper external triggering. And selectable $50-\Omega$ or $1-M\Omega$ trigger/gate input lets you use a 1X or 10X scope probe with the PG508T.

CIRCLE NO. 324

Counter-timer comes in pieces—you build it



Beco Inc., P.O. Box 67, Wirtz, VA 24184. (703) 483-9258. \$279 (kit).

UNIC 2001 counter-timer measures frequency from 1 Hz to 120 MHz, period from 5 s to 10 ns, and has automatic ranging and decimal positioning, automatic trigger level, variable display rate and blink-store and hold-time display modes. The UNIC can be used as a totalizer to 99,999,999, to measure elapsed time (start-stop) to 115 days and, with various special function cards, can be interfaced with a computer. It can perform computational functions, like rpm, and can be used as a high-low limit alarm in go-no-go testing.

CIRCLE NO. 325

The Right DMM Decision Means Five-Function Autoranging for only \$225*

Introducing HP's 3476A DMM

The price is a big story in itself. But performance and reliability play a large part too. Take a look at the 3476A:

Autoranging—a big plus in a low cost DMM. It lets you concentrate on the point of measurement... minimizes reading errors... and speeds readings too. All readings are made directly in volts, kilohms, or amps—on an LED display. And there's a rangehold button to speed and simplify repetitive measurements.

Five functions—all the functions you want and need in a low cost DMM. Simply push the appropriate button to read AC volts, DC volts, AC or DC current, and ohms. There's no worry about polarity or zero... they're both automatic.

Advanced design—both circuit and packaging. And both contribute to high reliability. One circuit board contains all the electronics.

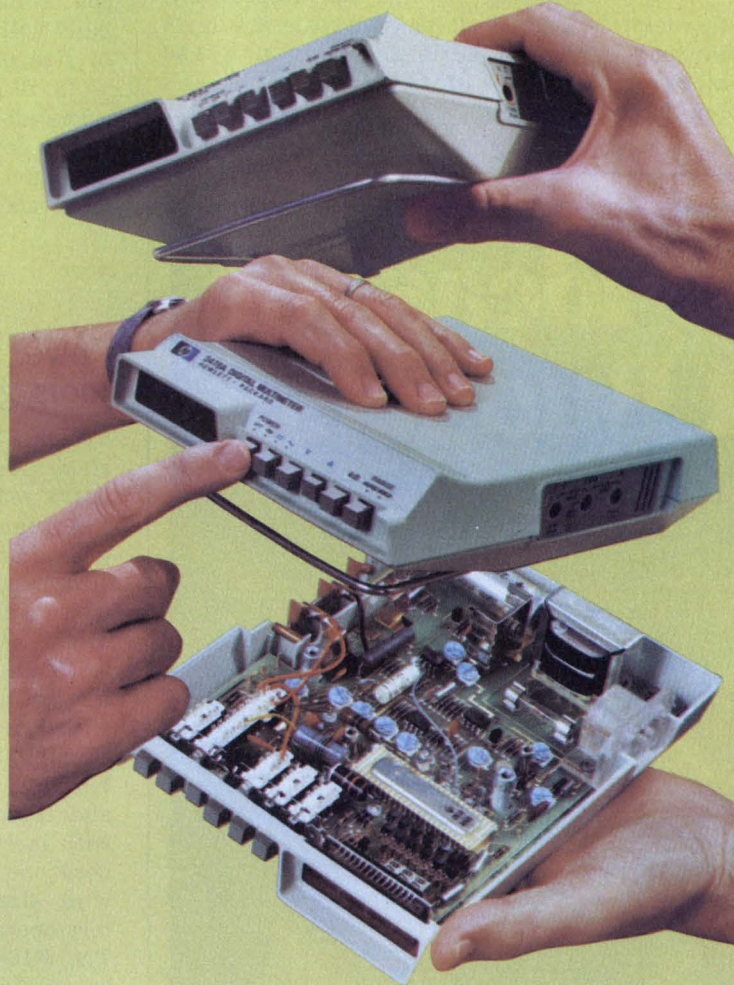

Tantalum nitride on sapphire processing allows replacement of all front end precision resistors by a single chip. That means greater reliability and better temperature stability. Of course it's input protected.

Convenient size—just right to hold in your hand... take with you in a brief case... or use on your bench. An optional carrying case and probe kit let you hang the instrument from a strap for "no-hands" operation. The "A" version (\$225*) operates from the AC line for lab use. And for portable applications, the "B" version (\$275*) has built-in batteries and recharging circuitry.

The 3476A is backed by HP's service organization... another big plus for a low-cost DMM. With these prices and features, why not put your hands on the 3476A for your 3-1/2 digit measurements? Your local HP field engineer can tell you how.

*Domestic U.S.A. prices only.

**HP DVM's—
the right decision**

Actual Size

095/52

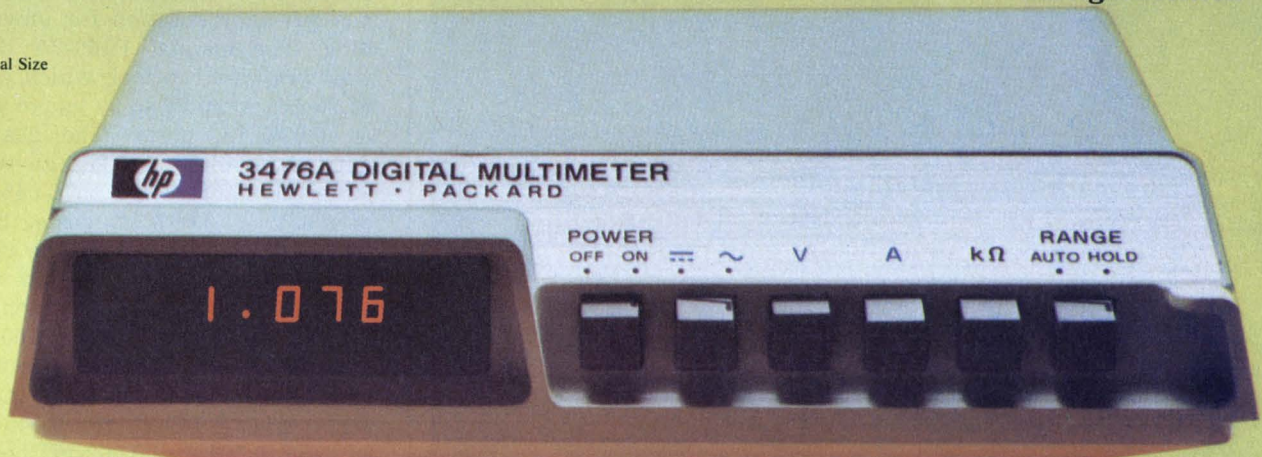

HEWLETT  PACKARD

Sales and service from 172 offices in 65 countries.
1501 Page Mill Road, Palo Alto, California 94304

CIRCLE NUMBER 61

Rare-earth magnets available as powders

Hitachi Magnetics Corp., Edmore, MI 48829. (517) 427-5151. See text; stock.

Rare-earth magnetic powders, when formed into permanent magnets, have residual inductions of up to 8600 gauss (Hicorex 90).

The powder, a sintered rare earth (cobalt), can be compressed and have a tensile strength of 5000 psi. The Hicorex 90 has an energy product of 18 and the Hicorex 95 a product of 14. The material has a required magnetization field of 30,000 Oersteds and a recoil permeability of 1.05 or 1.1 for the Hicorex 90 and 95, respectively. The cobalt powder costs \$50/lb in lots of 50 lb and drops to \$14.50 for lots of 10,000 lb.

CIRCLE NO. 326

Display bezel installs easily, without tools

RMF Products, P.O. Box 413, Batavia, IL 60510. (312) 898-4571. \$0.65 (1000-up); stock.

A bezel and filter for digital readouts can cut costs since it uses slide-in, snap-in construction and can be installed without tools. The bezel will display two 0.6 in. or up to five 0.3-in. digits through a 2 x 13/16-in. viewing area. Standard colors include a black bezel and red, yellow, green or clear filters. Other bezel and filter colors are available on special order.

CIRCLE NO. 327

Bright Ideas for Tight Budgets.



Tight manufacturing budgets and tighter delivery schedules are where we shine. SOLICO offers quick delivery of pilot and indicator lights: complete range of voltages, lamps, lenses, colors, bezels, and terminals. Many snap-in to slash installation costs. All are recognized under the component program of Underwriters' Laboratories, Inc. and CSA approved. Write for complete catalog: SORENSON LIGHTED CONTROLS, INC., 530 Oakwood Avenue, West Hartford, Conn. 06110 or phone (203) 236-3267.

SOLICO

LIGHTS THE WAY TO BRIGHT IDEAS

A matching line of switches is available from Carlingswitch, Inc. West Hartford, Conn. 06110.

CIRCLE NUMBER 62

Power and manual wiring tools good for 5 gauges

Vector Electronic Co., 12460 Gladstone Ave., Sylmar, CA 91342. (213) 365-9661. See text; stock.

A family of wrapped-wiring tools includes "dual-way wrap-n-strap" tools, dual-way unwrap tools, and a rechargeable power driver. Post sizes of 0.025, 0.028, 0.045 in. square or 0.031 x 0.045 in. can be handled and wrapped with wire in sizes from No. 22 through 30. Only two shanks are required for the five wire gauges and three post sizes as compared with most competitive tools, which need one shank for each post and wire size. The rechargeable battery-operated drivers weigh 9 oz. The P160-4R driver costs \$45.68, has right-hand rotation for wrapping; the P160-4L costs \$55 and has left-hand rotation for unwrapping. The manual P160-2A dual-way wrap-n-strap tool, which costs \$7.95 can wrap 26 to 30 gauge wire on 0.025 in. posts. The heavier duty P-160-6 for \$15.25 can wrap 22 to 26 gauge wire on 0.045 in. of 0.031 x 0.062 in. posts. Both tools will strap in either the right or left-hand direction. With a wire spool assembly for pin strapping, Models P160-2A-1 and P160-6-1 cost \$12.45 and \$19.95, respectively. The P160-1A (for 0.025-in.-sq. posts) and P-160-7 (for 0.045-in.-sq. and 0.031 x 0.062-in. posts) manual dual-way unwrapping tools will unwrap wires originally wrapped in either direction. Either tool costs \$9.50.

CIRCLE NO. 328

What's your design problem...
Unit-size? Complexity? Reliability?
Packaging? Field service?
Multi-component handling?

Garrett hybrid
microcircuits are
the solution.

Garrett custom engineering can meet your requirements with hybrid microelectronic technology, performance-proved in consumer, industrial, and military products.

Our high-volume production capability, which encompasses thick film, thin film, component attach of discretes or chips, and automated testing, allows you to order just one micro device instead of many separate components. Reduces your material-handling and labor costs. And increases efficiency.

Whatever your hybrid microcircuit requirements, contact the one reliable source that offers maximum performance at minimum cost. Garrett. Send us your design specs for fast response on price quote and delivery. Contact: Manager, Microelectronic Sales, Garrett Manufacturing Ltd., 40 Voyager Court North, Rexdale, Ontario, Canada. M9W 4Y3. Tel. (416) 677-9790.



The Garrett Corporation One of The Signal Companies

GARRETT
MICROCIRCUITS
They solve the problem

IC test clip now has improved body size

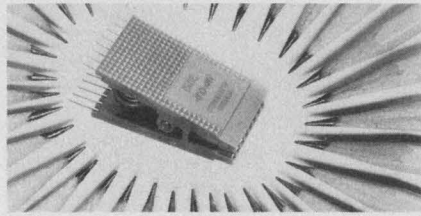

ITT Pomona Electronics, 1500 E.

9th St., Pomona, CA 91766. (714) 623-3463. \$5.75 (unit qty.); 1 wk.

A revised version of the company's Model 3916 "dip clip" is wider and longer than its predecessor and uses polycarbonate thermoplastic for insulation. The 3916 can clip onto 14 or 16-lead DIPs and permits hands-free testing. Contacts are spring-tempered nickel silver, while the hinge pin and compression spring are stainless steel.

CIRCLE NO. 329

Silver-filled epoxy has R of only 0.0001 Ω

Formulated Resins Inc., P.O. Box 508, Greenville, RI 02828. (401) 949-2060. For 10 to 49 packages: From \$1.25/2 gr; stock.

A silver filled conductive epoxy, CCR-4100, has a resistivity of less than 0.0001 Ω-cm. The epoxy has a shrinkage of 0.003 in./in., a tensile strength of 9500 psi and an operating temperature range of -50 to 170 C.

CIRCLE NO. 330

Diode mounting clamp has 10,000 lb pressure

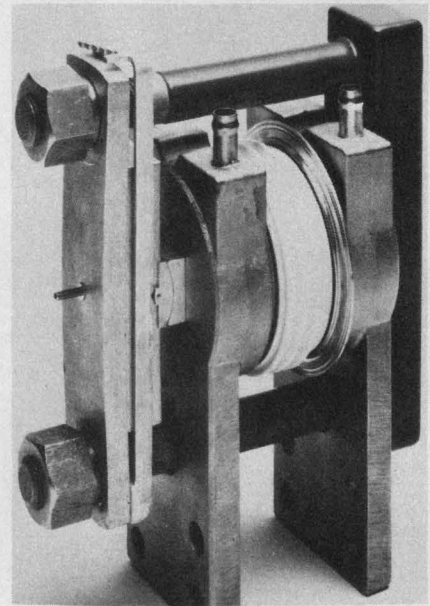

Wakefield Engineering, 77 Audubon Rd., Wakefield, MA 01880. (617) 245-5900. \$10.30 (100-up); stock.

The series 145 mounting clamp is designed to hold compression type SCRs and diodes. It is claimed by the company to be the first clamp to provide 10,000 pounds of clamping pressure. Included among the clamp's features is a cantilevered force indicator which gives high-accuracy readings of the clamping force. Each 0.07 in. increment denotes 2000 lb of pressure, with a maximum of 10,000 lb available. The crossbar/stud portion of the clamp is coated up to the threads with a minimum thickness of 0.02 in. of epoxy compound. This insulation is rated Class B, for 40,000 h of operation at 130 C, or for shorter times up to 180 C, with a minimum breakdown voltage of 500 V ac per mil.

CIRCLE NO. 331

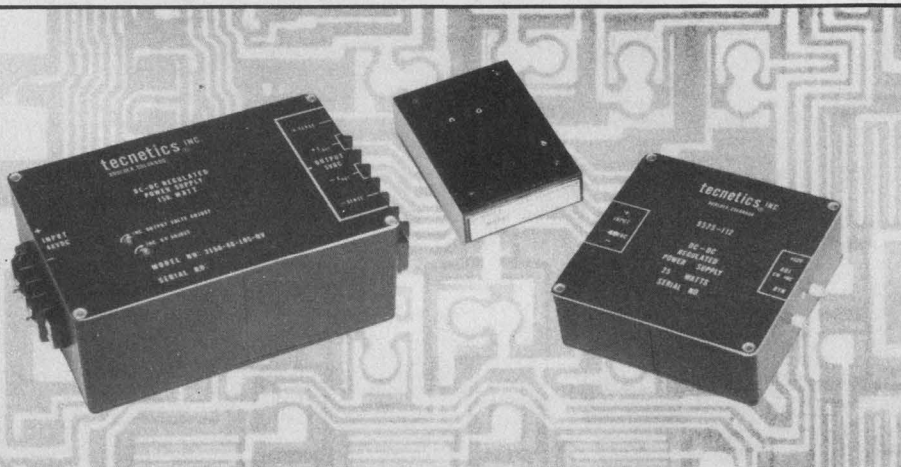

Designing solid state telecommunication equipment? Let Tecnetics convert your 48VDC power source.

Tecnetics high efficiency power converters are the reliable and cost effective way to convert 48VDC power sources into usable power for solid state devices.

Tecnetics offers a wide range of 48VDC input power converters with outputs ranging between 5 and 48VDC and power up to 150 watts. All are super reliable, too, because Tecnetics is a high technology company that has been supplying the telecommunications industry with converters since 1958.

We pioneered numerous technological advances including pulse width modulation techniques which enable us to achieve extremely high efficiency in our power supplies.

Features of our 48VDC power supplies include full input/output isolation, overload protection, remote error sensing and input filters to reduce conducted EMI.

For full specifications on these and over 300 other power supplies, write for our new 1976 catalog.

48VDC POWER SUPPLIES FROM TECNETICS

SERIES	POWER Watts	OUTPUT		EFFICIENCY	DIMENSIONS			PRICE RANGE U.S. \$ 1 to 9
		SINGLE (S) DOUBLE (D) TRIPLE (T)	VOLTAGE VDC		L IN.	W IN.	H IN.	
3150-48	150	S	5-48	High	6	4	2.25	500
3100-48	100	S	5-48	High	6	4	2.25	450
3050-48	50	S	5-48	High	4	4	2.25	425
3025-48	25	S	5-48	High	4	4	2	395
9525-48	25	S,D,T	5-24	Std.	4	4	1.5	250,295,365
1000	10	S,D,T	5-24	Std.	3.5	2.5	0.96	115,125,140
1600	6	S,D,T	5-24	Std.	3.5	2.5	0.96	89,99,109
1300	3	S,D,T	5-24	Std.	2.35	2.125	0.84	79,89,99
1100	1	S,D	5-24	Std.	1.75	1.50	0.65	49.55

tecnetics® The Power Conversion Specialists P.O. Box 910, 1625 Range Street, Boulder, Colorado 80302 (303) 442-3837 TWX 910-940-3246

CIRCLE NUMBER 64

JOIN OUR BME-KAPTM SAVINGS PLAN

SAVE 30% TO 50% ON THE COST OF MONOLITHIC CERAMIC CAPACITORS

This major cost saving is the result of our new BMETM capacitor technology. We've eliminated precious metals entirely from the electrodes and terminations of our BMETM capacitors. No precious metals means lower cost. So now we offer you our complete line of monolithic ceramic capacitors — BME ChipsTM, BME RadialsTM and BME AxialsTM — at a genuine savings of 30% to 50%.

This significant reduction is not based on a momentary drop in precious metal prices. This is a long-term solution due to the replacement of precious metals by non-noble metals which are not subject to the same dramatic cost spirals.

SAVE WITH RELIABILITY

Our BMETM capacitors have not sacrificed the inherent electrical and mechanical Ceramolitic[®] quality. Their reliability can be demonstrated by the extensive test procedures to which they have been subjected. Write to our Applications Engineering Department for complete test reports.

SAVE WITH DESIGN FLEXIBILITY

Now you can seriously consider monolithics to replace micas and tantalums. Our BMETM capacitors feature non-polarity, a wide range of capacitance value, low leakage, high volumetric efficiency, availability in chip, radial and axial packages at prices competitive with mica below 1000pF and tantalum up to 2.2 μ F.



TYPICAL SELLING PRICES PER UNIT QUANTITIES OF 5000 OR MORE

BME TM "J" DIELECTRIC (COG)	BME-Chip TM	BME-Axial TM	BME-Radial TM
1 thru 100 pF, 5%, 50WVDC	5.1¢	6.8¢	7.5¢
1000 pF, 5%, 50WVDC	12¢	16¢	16¢
BME TM "S" DIELECTRIC (X7R)	BME-Chip TM	BME-Axial TM	BME-Radial TM
.01 μ F, 20%, 50WVDC	3.5¢	5.8¢	5.8¢
.1 μ F, 20%, 25WVDC	9¢	16¢	14¢
1.0 μ F, 20%, 25WVDC	52¢	—	73¢
BME TM "R" DIELECTRIC (Z5U)	BME-Chip TM	BME-Axial TM	BME-Radial TM
.1 μ F, +80 -20%, 25WVDC	5.7¢	8.8¢	8.8¢
.47 μ F, +80 -20%, 25WVDC	13¢	16.5¢	16.5¢
1.0 μ F, +80 -20%, 25WVDC	19¢	27¢	25¢
2.2 μ F, +80 -20%, 25WVDC	35¢	—	49¢

JOIN THE USCC/CENTRALAB BMETM CAPACITOR SAVINGS PLAN

Get all the details today. Write on your company letterhead for your concise Savings Plan Price list — your pass book to the lowest monolithic ceramic capacitor prices available. Compare it with anyone else's price list and see.

Remember, USCC/Centralab—Quality, Volume, Savings.

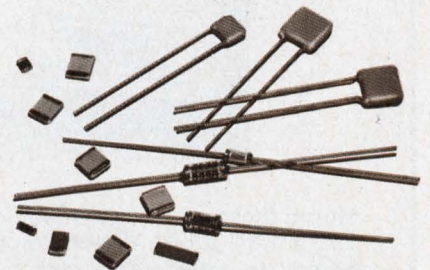

USCC **USCC/Centralab** 
 Electronics Division ■ Globe-Union Inc.
 4561 Colorado Boulevard ■ Los Angeles, Ca. 90039
 (213) 240-4880

Sub-micron size powders offer improved operation

Aremco Products, P.O. Box 429, Ossining, NY 10562. (914) 762-0685. P&A: See text.

Extremely fine high-purity powders are available in the sub-micron size range. Sub-micron powders have chemically greater reaction rates due to large surface-area-to-mass ratios, reduced settling rate in fluid suspensions which yields substances requiring much less agitation and greater density and hardness in flame or plasma spray coating and casting formulations. The available powders include 99.8% aluminum, 99.8% aluminum carbide, 99.9% barium titanate, 99.7% boron carbide, 99.9% cobalt oxide and many more. Small quantities are available from stock and pricing ranges from \$75 to \$125 per pound, depending upon material, purity and quality.

CIRCLE NO. 332

Aluminum heat sinks hold plastic transistors

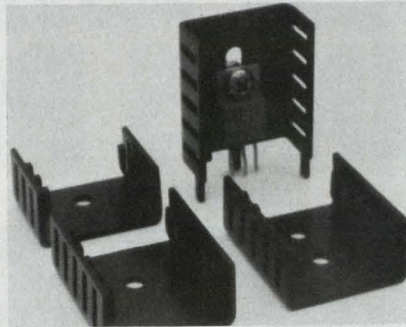

Aham, 968 W. Foothill Blvd., P.O. Box 909, Azusa, CA 91702. (213) 334-5135. \$0.11 (5000-up); stock.

The series 371 aluminum heat sinks are designed to hold plastic-case transistors. Model 371 is available with tabs and mounts vertically on a PC board. The Model 371 without tabs, measures 1.19 x 1 x 0.5 in., will hold one or two devices and is used where a low profile heat sink is specified. The Model 373 measures 0.776 x 1 x 0.5 in. and can hold one device. The heat sinks can dissipate 16.6 C/W and come with a black finish unless otherwise specified.

CIRCLE NO. 333

Adapter plug widens DIP leads from 0.3 to 0.6 in.

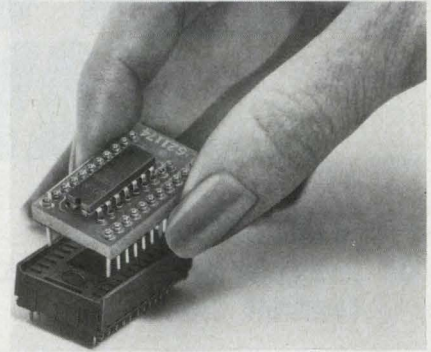

Garry Manufacturing Inc., 1010 Jersey Ave., New Brunswick, NJ 08902. (201) 545-2424. \$1.50 to \$4.50; 2 to 4 wks.

An adapter plug permits the use of 0.3-in. wide ICs in sockets with 0.6-in. row spacing. The plugs are available for 18 and 24-pin ICs, and will accommodate both flat leads and round leads with diameters of from 0.016 to 0.019 in. The adapter plugs include a printed-circuit pattern that interconnects the 0.3-in. and 0.6-in. patterns and permits reduction on a fixed, printed-grid pattern.

CIRCLE NO. 334

5V OR ±15V POWER FOR PCB'S



Mount these mini power modules, as small as 2.3" x 1.8" x 1.0", directly on printed circuit boards to save space and simplify wiring. Ratings at 5 volts from .250 to 2.5 amps; at ±15 volts from .025 to .5 amps. Short circuit protected. Prices start at \$24. Guaranteed 3-day shipment.

Acopian

Corp., Easton, Pa. 18042 Tel: (215) 258-5441

CIRCLE NUMBER 161

MATCHED OR DISSIMILAR DUAL OUTPUT



Select the combination of matched or dissimilar outputs that you require. Hundreds of ratings available, from 1.5 to 150 volts. Outputs are isolated, and may be used in the same or opposite polarities. Acopian's 3-day shipment promise applies for any combination.

Acopian

Corp., Easton, Pa. 18042 Tel: (215) 258-5441

CIRCLE NUMBER 162

ELECTRONIC DESIGN 6, March 15, 1976

Part spacers come in 148 different sizes

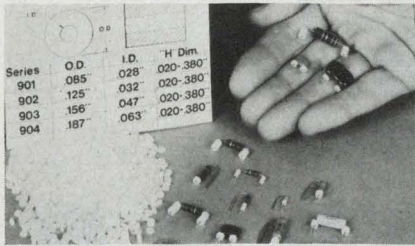

Bivar Inc., 1617 E. Edinger Ave., Santa Ana, CA 92705. (714) 547-5832. See text.

Made from natural nylon per MIL-M-20693A, a line of permanent spacers provides a wide selection of tubular spacings for PC board mounting of discrete devices. Four basic I.D./O.D. combinations with thicknesses ranging from 0.02 through 0.38 in., with 0.01 in. increments are available. There are 148 standard units to choose from, and special thicknesses are also readily available. A typical part, the 902-070 (0.032 in. I.D., 0.125 in. O.D. and 0.07 in. thick) costs \$10/1000, in 10,000 pc lots. Delivery is from stock to 2 weeks.

CIRCLE NO. 335

Contact cement bonds permanently in seconds



Tescom Corp., Instrument Div., 2600 Niagara Lane North, Minneapolis, MN 55441. (612) 546-4351. See text; stock.

Zipbond I, an alpha cyanoacrylate adhesive, bonds materials in just seconds. Almost all materials, whether similar or dissimilar, can be joined together in permanent unbreakable bonds. The adhesive requires no mixing and is easily dispensed from a safe, soft-plastic bottle. Bonding or fusion takes place when pressure is applied between the two surfaces which are to be bonded. A sample 1 oz. bottle is available for \$10.

CIRCLE NO. 336

Rf connectors designed for 50-Ω impedances

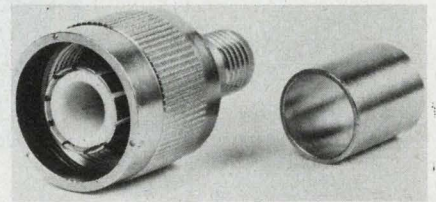

Amphenol, RF Div., 33 E. Franklin St., Danbury, CT 06810. (203) 743-9272. \$2 (1000-up); 8 wks.

A series of medium-sized coaxial connectors has constant, 50-Ω impedances. This Series of SC connectors is qualified to MIL-C-39012/35 through 42. The devices are true crimp/crimp connectors, in that cable affixment of both the center contact and the outer ferrule is accomplished using the MIL-M-22520 die sets and the company's twin hex crimp tool. Straight plugs, angle plugs and straight jacks are available for 214, 225, 393, 142B and 400 RG/U cables. Also offered are bulkhead jacks and panel receptacles for panel mounting. All have captivated contacts and Teflon insulation.

CIRCLE NO. 337

RACK MOUNT POWER ...TO 60 AMPS

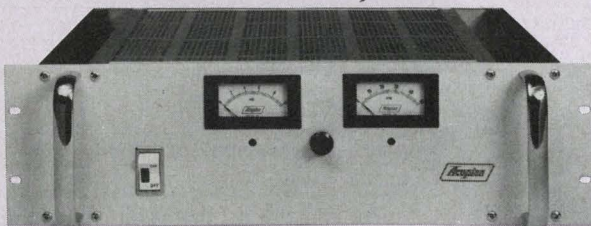

Designed for mounting in standard 19" RETMA cabinet racks, these power supplies are available in 76 different output ratings from 1 to 50 volts, and from 5 to 60 amps. Regulation, $\pm 0.05\%$ or better; ripple, 1 mv rms or better. Options include metering and overvoltage protection. Shipment, 9 days after receipt of your order.

Acopian

Corp., Easton, Pa. 18042 Tel: (215) 258-5441

GUARANTEED 3 DAY SHIPMENT

ACOPIAN

POWER SUPPLY CATALOG 1976-1977

Every power module listed in the Acopian 48-page catalog is shipped within 3 days of order. Guaranteed! Miniaturized supplies, narrow profile and plug-in modules, premium performance models, and a wide choice of other types are described in detail. Ask for your copy.

Acopian

Corp., Easton, Pa. 18042 Tel: (215) 258-5441

CIRCLE NUMBER 163

ELECTRONIC DESIGN 6, March 15, 1976

CIRCLE NUMBER 164

121

At last! An EPROM that's going nowhere.

Once our EPROM is on board, it's there for keeps. You don't have to take it off to erase, program or reprogram. All it takes is a single high-voltage programming line, while all the other lines remain at TTL levels.

Instead of stocking a mass of different boards, now you can inventory a few common ones and personalize them later.

This on-board programmability is a huge advantage for our S6834, the latest member of the AMI microprocessor family.

Another version, the S5204A, gives you the same bonus as a second source to National's MM5204. But it's a lot faster.

Both AMI parts have other features that mean a big difference in your system's performance. You get the benefit of a dense 512x8-bit organization. The 575 ns access time makes it speed compatible with the AMI 6800. And the P-Channel SiGate process delivers an EPROM you can trust.

In fact, every spec makes our EPROM worth pinning down:

512x8-bit organization

Single high-voltage pin for programming

All I/O lines TTL compatible for read and program operations

Less than one minute programming time for all 4096 bits

575 ns access time

UV light erasable

Static operation: no clocks

Three-state data outputs

Standard power supplies: +5V, -12V

P-Channel Silicon Gate process

Hermetic package

For an EPROM that's going nowhere, it's certainly got a lot going for it.

And it's available now from your local AMI sales office, distributor or representative. Give him a call. Then welcome our EPROM on board.

it's
standard
at **AMI**
AMERICAN MICROSYSTEMS, INC.

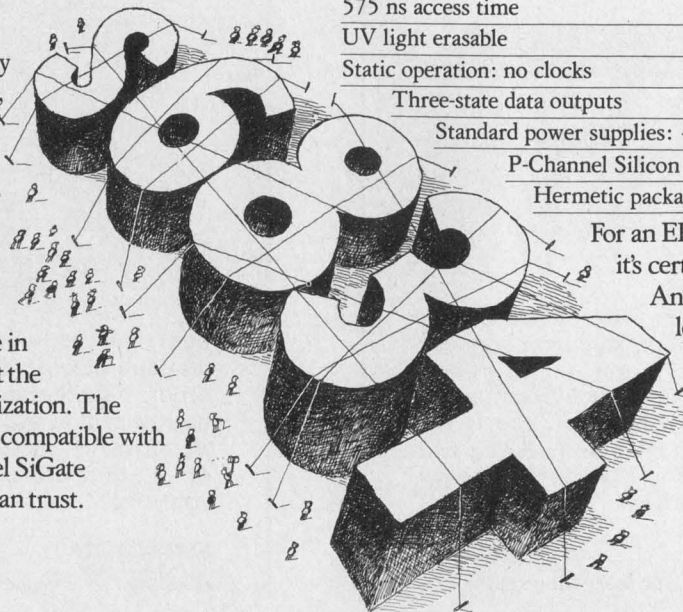

Our EPROM is here to stay:

SALES OFFICES

Manhattan Beach CA • (213) 379-2452
 San Jose CA • (408) 249-4550
 Altamonte Springs FL • (305) 830-8889
 Elk Grove Village IL • (312) 437-6496
 Norwood MA • (617) 762-0726
 Livonia MI • (313) 478-9339
 Minneapolis MN • (612) 559-9004
 Monsey NY • (914) 352-5333
 Cleveland OH • (216) 292-6850
 Ambler PA • (215) 643-0217
 Richardson TX • (214) 231-5721

DISTRIBUTORS

ALTA ELECTRONICS:
 Utah—Salt Lake City (801) 486-7227

ARROW ELECTRONICS:
 Minnesota—Bloomington
 (612) 888-5522

CENTURY ELECTRONICS:
 New Mexico—Albuquerque (505) 292-2700
 Utah—Salt Lake City (801) 487-8551

INTERMARK ELECTRONICS:
 Washington—Seattle (206) 767-3160

SCHWEBER ELECTRONICS:
 California—Costa Mesa (213) 924-5594
 and (714) 556-3880

Connecticut—Danbury (203) 792-3500
 Florida—Hollywood (305) 927-0511
 Georgia—Atlanta (404) 449-9170
 Illinois—Elk Grove Village (312) 593-2740
 Iowa—Cedar Rapids "Lorenz Sales"
 (319) 393-0100

Maryland—Rockville (301) 881-3300
 Massachusetts—Walham (617) 890-8484
 Michigan—Troy (313) 583-9242
 Minnesota—Edina (612) 941-5280
 New Jersey—Somerset (201) 469-6008
 New York—Rochester (716) 461-4000
 Westbury (516) 334-7474

Ohio—Beachwood (216) 464-2970
 Texas—Austin (512) 837-2890
 Dallas (214) 861-5010
 Houston (713) 784-3600

Canada—Mississauga, Ont. (416) 678-9050

SEMICOMP CORP.:
 California—Newport Beach
 (213) 971-5253 and
 (714) 833-3070

STERLING ELECTRONICS:
 Arizona—Phoenix (602) 258-4531
 Louisiana—Metairie
 (504) 887-7610

Massachusetts—Watertown (617) 926-9720
 New Jersey—Perth Amboy (201) 442-8000
 New Mexico—Albuquerque (505) 345-6601
 Texas—Dallas (214) 357-9131
 Houston (713) 627-9800

Virginia—Richmond "Meridian" (804) 335-6521

R.V. WEATHERFORD CO.:
 Arizona—Phoenix (602) 272-7144
 California—Anaheim (714) 547-0891
 Glendale (213) 849-3451
 Palo Alto (415) 493-5373
 Pomona (714) 623-1261
 San Diego (714) 278-7400

Colorado—Englewood (303) 761-5432
 New Mexico—Albuquerque (505) 842-0868
 Texas—Dallas (214) 243-1571
 Houston (713) 688-7406
 Washington—Seattle (206) 243-6340

REPRESENTATIVES

ARNESON ASSOCIATES:
 Oregon—Beaverton (503) 643-5754
 Washington—Seattle (206) 762-7664

BARNHILL FIVE:
 Colorado—Denver (303) 426-0222

BENEKE & MCCAUL:
 Missouri—Grandview (816) 765-2998

CANTEC REPRESENTATIVES, INC.:
 Ontario—Ottawa (613) 225-0363

HADDON ASSOCIATES:
 California—San Diego (714) 565-9445

HECHT, HENSCHEN & ASSOCIATES, INC.:
 Arizona—Phoenix (602) 275-4411

LOWREY & ASSOCIATES:
 Michigan—Brighton (313) 227-7067

PRECISION SALES COMPANY:
 New York—Syracuse (315) 458-2223

REP. INC.:
 Alabama—Huntsville (205) 881-9270
 Georgia—Tucker (404) 938-4358

AMI
 AMERICAN MICROSYSTEMS, INC.

POWER SOURCES

High-voltage supply delivers 150 W

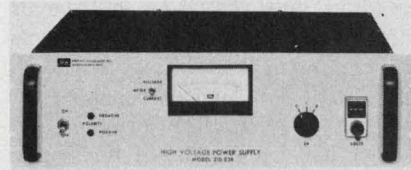

Bertan Associates, 180 Miller Pl.,
 Hicksville, NY 11801. (516) 433-
 3110. \$875; stock-4 wks.

Model 210-03R, the first unit in a new series, provides an output of 0 to ± 3000 V dc at 50 mA. Standard features include digital voltage controls, front-panel voltage and current metering, remote voltage and current monitoring, remote voltage and resistance programming and reversible polarity. Regulation and ripple are 0.001% and tempco is 50 ppm/ $^{\circ}$ C. An optional capability is available for remote digital computer programming of the high-voltage output via either 4-decade BCD or 16-bit binary TTL-compatible input.

CIRCLE NO. 338

Dual-output switchers work at 78% efficiency

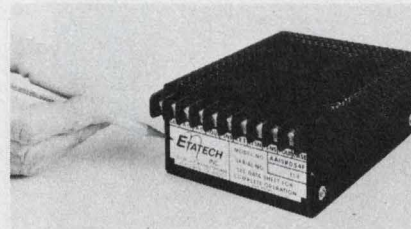

Eatech, Inc., 187-M W. Orange-
 thorpe, Placentia, CA 92670. (714)
 996-0981. \$325 (100) fully regu-
 lated; 4-6 wks.

The AA Series of dual-output switching power modules provide 120 W at voltages of ± 12 V dc (Model AA12ROS5) and ± 15 V dc (Model AA15ROS4), with power densities of 2.2 W/in³ and 45 W/lb at minimum efficiencies of 78%. The standard model provides a fully regulated (0.2% line-load combined) positive output and a semiregulated (0.1% line + 2.5%/A load) negative output. Units also feature short-circuit/overload and input overvoltage protection (both with automatic recovery) and remote error sensing. Size is 4 \times 6 \times 2-1/4 in.

CIRCLE NO. 339

Aerospace Optics make this the only miniature pushbutton switch that is Sunlight Readable

Patents in Process

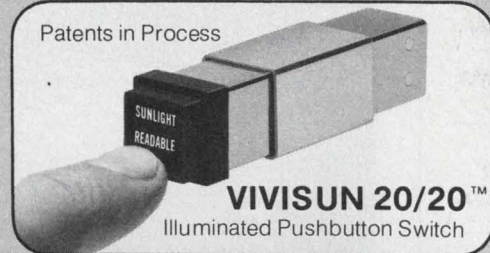

VIVISUN 20/20™
 Illuminated Pushbutton Switch

Tested and Proven

Only Vivisun 20/20 legends are readable in a light ambient of 10,000 foot-candles (sunlight). When the lamps are not energized the hidden legend characters are not discernable in a 10,000 foot-candle ambient (sunlight).

- Switches are designed in accordance with MIL-S-22885
- Single or multi-color legend option
- Individual unit or matrix mounting options
- Momentary or alternate pushbutton action available with SPDT, DPDT, or 3PDT switches
- Companion sunlight readable annunciator available (without switching)
- 1, 2, 3, or 4 separate messages
- Messages available in green, yellow, red, or white
- Designed for low power consumption (5, 12, 14, 18 or 28 volts available)
- Lamps replace from front without tools

AEROSPACE OPTICS INC.
 7112 Burns Street, Dept. 33,
 Fort Worth, Texas 76118
 (817) 284-2293 (Ext 33) Telex 75-8461

Researchers, Designers and Manufacturers
 of Sunlight Readable Lighted Displays

POWER SOURCES

Switcher module meets MIL specs

Abbott Transistor Laboratories, 5200 W. Jefferson Blvd., Los Angeles, CA 90016. (213) 936-8185. Start at \$395; 10 wks.

UUN-15A series of dual-output power modules converts 115 V ac, 400-Hz input power to 25, 50, or

100 W of regulated dc power at ± 15 V. The series operates over the full military temperature range of -55 to $+100$ C. Regulation of dc input voltages is to 0.3% over the full input range of 115 V rms $\pm 10\%$. Load regulation is 0.5%, no load to full load at constant input voltage. PARD (ripple and noise) has been reduced to 25 mV rms, 100 mV pk-pk over the temperature range of 25 to 100 C.

CIRCLE NO. 340

Switcher power density reaches 1.4 W/in.³

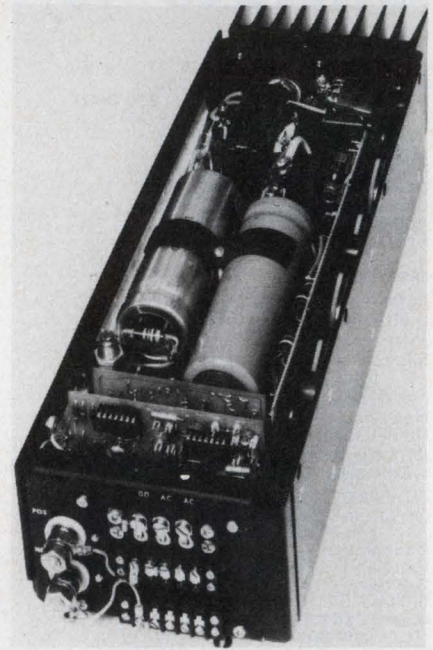

Technipower, Benrus Center, Ridgefield, CT 06877. (203) 431-1300. \$510.

EF/EFE 300-W power supply series offers models with outputs between 4.5 and 30 V dc with currents up to 50 A. Featured in this new product line are power densities up to 1.4 W/cu-in. and 80% efficiency. Overvoltage protection, remote sense, remote turn-on/off control, power-fail detection and parallel operation are all standard for this series.

CIRCLE NO. 341

This is a rack-full of counter capability.

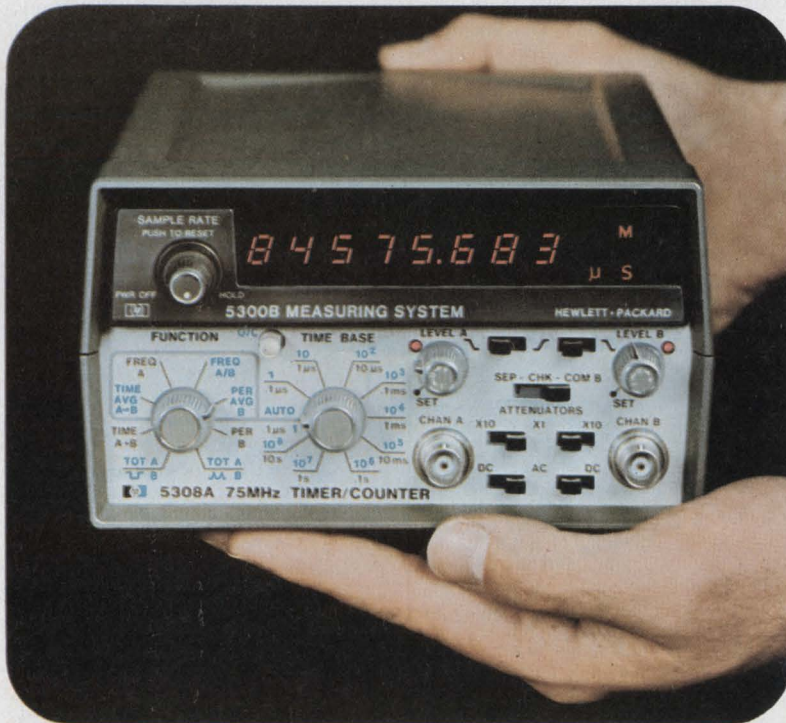

HP's new 75 MHz Timer/Counter is easily held in your hands. Take a look at the front panel: Never before has there been so much counting capability in such a small package at such a small price. Seven other modules snap on to convert to other instruments — including a DMM — or to connect to the HP Interface Bus.

Features include: 1 nsec time interval averaging • autoranging of frequency, frequency ratio, period average, time interval average • full complement of triggering controls, monitor LEDs • preset ECL and TTL thresholds • an astonishingly low price of only \$910* total for 5308A module with 5300B mainframe. *Domestic USA price only.

HEWLETT  PACKARD

Sales and service from 172 offices in 65 countries.
1501 Page Mill Road, Palo Alto, California 94304

02503

CIRCLE NUMBER 68

Open-frame supplies targeted for OEMS

ACDC Electronics, 401 Jones Rd., Oceanside, CA 92054. (714) 757-1880. \$22.95 to \$106 (250); stock.

Called the EC series, this new line of open-frame, low-cost power supplies includes over 50 models ranging from 2 V at 3 A to 24 V at 10 A. Dual and triple-output models are also available. The EC series is mechanically and electrically interchangeable in form, fit and function with other open-frame power supplies that meet accepted industry standards. They meet UL requirements and feature quick disconnect or solder combination terminals, adjustable overvoltage protection (optional), 115/230-V-ac input connections and hermetically sealed, metal-case transistors.

CIRCLE NO. 342

There's a reason we make so many types of precision resistors.

You need them.

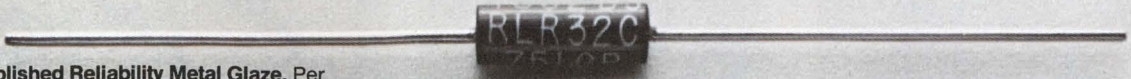

Established Reliability Metal Glaze. Per MIL-R-39017, 55182 and program specifications.



Precision Metal Glaze™. Rugged performance at low cost. An industry standard for semiprecision and precision film resistor applications.



Precision Metal Film. Excellent high stability performance in a wide variety of sizes and specs. S level MIL-R-55182.

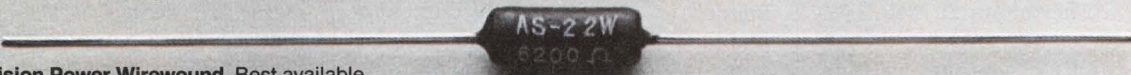

Precision Power Wirewound. Best available power-to-size ratio from ½-10W. Tolerances to 0.1%, TC < 20ppm.



Precision High Voltage, High Resistance Metal Film. Excellent high voltage load stability; 1.5-20KV, to 500 Megohms ± 1%.



Ultra-Precision MAR™. Bulk property metal film. Rugged molded construction. Broad resistance range, high frequency response with TC's and tolerances to 2ppm and .01%.



Precision Power Metal Glaze. 3W rating in a molded RW69 size. Runs cooler than wirewound. Has excellent frequency characteristics.



Precision Power Metal Film. Excellent power-to-size ratio, 1-5W ratings. High frequency response. Tolerances and TC's to 0.1%, 25ppm.

Precision Film Resistor Networks. 7,8,10 and 12 bit R2R ladders replace up to 27 discretes. Other precision TaN-Film™ networks available.



Most types available from your local distributor. Or, for the broadest choice in resistors for all types of applications, write or call TRW/IRC Resistors, an Electronic Components Division of TRW, Inc., 401 N. Broad St., Phila., Pa. 19108. Tel. 215-922-8900.

TRW IRC RESISTORS
We give you a choice.

COMPONENTS

DIP solid-state relays withstand 2000 V ac

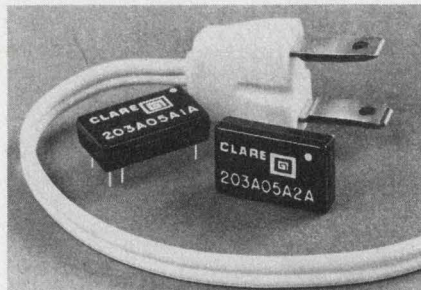

C. P. Clare & Co., 3101 W. Pratt Ave., Chicago, IL 60645. (312) 262-7700. \$7.20 (1000 up); stock.

Series 203 solid-state DIP relays, said by C. P. Clare to be the smallest of their kind available, are now offered with upgraded load and dielectric-withstanding voltage ratings at no increase in price. The series now includes two models that feature a 240-V-ac load rating as well as the original 140-V-ac rating. Both models provide dielectric-withstanding voltage ratings of 2000 V ac, increased from the Series' original 1500-V-ac rating.

CIRCLE NO. 343

New sockets fit wedge-based lamps

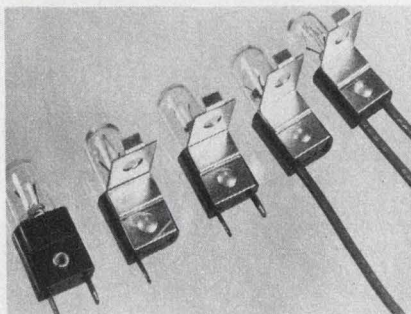

Christiana Industries Corp., 6500 N. Clark St., Chicago, IL 60626. (312) 465-6330. Typically \$0.10 (OEM qty).

A new line of sockets for the ever-expanding number of all-glass, wedge-base lamps is now available with either wire leads or solder lugs and a variety of standard mounting brackets. The CIC-9000 series sockets are for either T-3-1/4 or T-5 low-voltage lamps and are molded from a flame-retardant material. Terminals are electroplated and metal parts are cadmium-plated. Brackets can be custom produced to specifications.

CIRCLE NO. 344

Trimmer capacitors offer insulated shafts

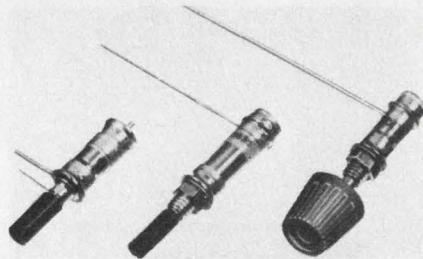

Voltronics Corp., East Hanover, NJ 07936. (201) 887-1517. Typical \$3.40 to \$3.55 (500 up); 10 days for samples, production 3 to 5 wks.

A full line of multiturn trimmer capacitors with insulated extended shafts features tuning screws that only rotate and don't move in and out. Thus the metal shafts can be extended for front-panel tuning like a potentiometer. Typical types include a 60-pF glass capacitor with 34 turns and a 14-pF air capacitor with 10 turns. The trimmers are sealed with "O" rings that can withstand 40 psi of water pressure and provide stability under difficult environmental stresses.

CIRCLE NO. 345

REED RELAYS TO FIT YOUR SPECS... AND BUDGET

Our **Open-Line** reed relays will give you high performance at remarkably low cost if you have no critical environmental factors to worry about.

Our **Encased-Line** is epoxy sealed to meet extreme environmental and handling conditions.

Both offer top performance; choice of Form A, B, or C dry reed contacts; Form A mercury wetted reed contacts; up to 6 poles; coil voltages 5 to 48 Vdc; either .1" or .15" terminal spacing; optional electrostatic or magnetic shielding.

Available from distributors. Or contact us today.

26477 North Golden Valley Road • Saugus, Calif. 91350
(805) 252-8330 • (213) 788-7292 • TWX 910-336-1556

ELEC-TROL, INC.

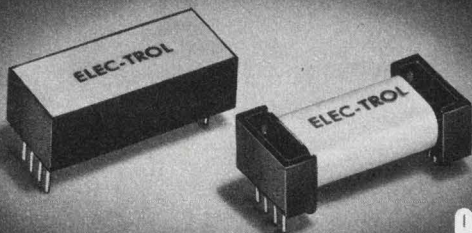

eem

CIRCLE NUMBER 70

NEW LOW COST REED RELAY ROCK HARD EPOXY COATED

\$1.85 to 49¢

Depending on coil voltage, contact level and volume.

Blue Boy Reed Relays offer:

- Protection from handling, solvents, tough environments
- 1 pole normally open contacts up to 10 watts
- General purpose or logic level contacts
- Coil voltages 5 through 48 VDC; .35" H x 1" L

Available from distributors.

26477 Golden Valley Road • Saugus, California 91350
(805) 252-8330 • (213) 788-7292 • TWX 910-336-1556

ELEC-TROL, INC.

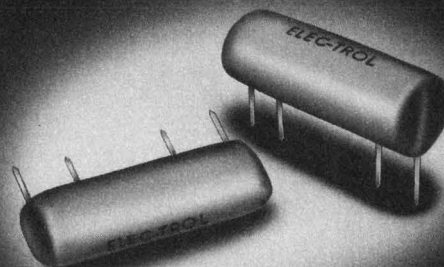

CIRCLE NUMBER 71

ELECTRONIC DESIGN 6, March 15, 1976

Bandpass filters reject noise, harmonics



TT Electronics, Inc., 2214 S. Barry Ave., Los Angeles, CA 90064. (213)-478-8224. \$59 (unit qty); 2 to 3 wks.

Bandpass filters are available for any frequency from 100 to 500 MHz. These filters are intended for 50-Ω source and load terminations. Any bandwidth from $\pm 1\%$ to $\pm 10\%$ may be specified. The typical stopbands for the narrow-bandwidth types are -30 dB at 0.8 and 1.35 times the center frequency. Filters of this type are used for the rejection of harmonics and noise adjacent to the passband.

CIRCLE NO. 346

RFI/EMC filters recognized by UL

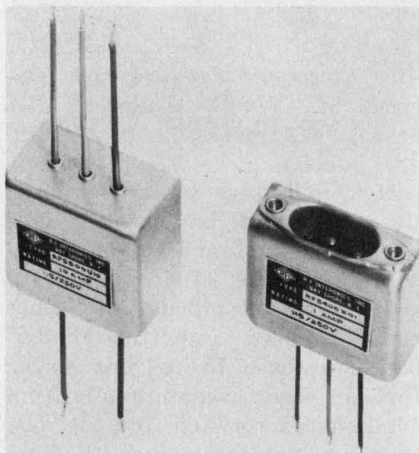

RF Interonics, 100 Pine Aire Ave., Bay Shore, NY 11706. (516) 231-6400. Under \$3.00 (OEM qty).

Designated the RF5400 Series, a line of RFI/EMC filters has current ratings from 1 to 30 A, voltage ratings of 115 V ac and 250 V ac and is listed under the component-recognition program of UL. The filters are available with a variety of terminations including wire leads, solder lugs and three-wire power receptacles.

CIRCLE NO. 347

Don't puzzle over how to achieve a higher level of analog output accuracy in your D-to-A designs. Turn to Crystalonics' new ultra-low on resistance switching transistors.

Used independently or as complements, the 2N6566 and 2N6567 NPN/PNP silicon epitaxial junction switching transistors will transform almost any low level digital signal to precise digital input voltages, with extremely low signal loss.

The only registered switching transistors of their kind, these devices also feature low offset voltages, low Ceb, super-low leakage and 50 volt

collector-to-base, emitter-to-base breakdowns.

When you're faced with the need for higher accuracy in your D-to-A converters, design-in Crystalonics' 2 ohm switching transistors; they're too good to resist!

Samples available.

Or for greater design freedom, we can provide military grade microcircuits combining switches and a ladder network in one compact package.

Send for our Transistor and Hybrid catalogs, or for immediate design assistance call Alan Alaimo, Jack Senoski or Richard Antalik.

We've reached a new low! 2 ohm switching transistors.

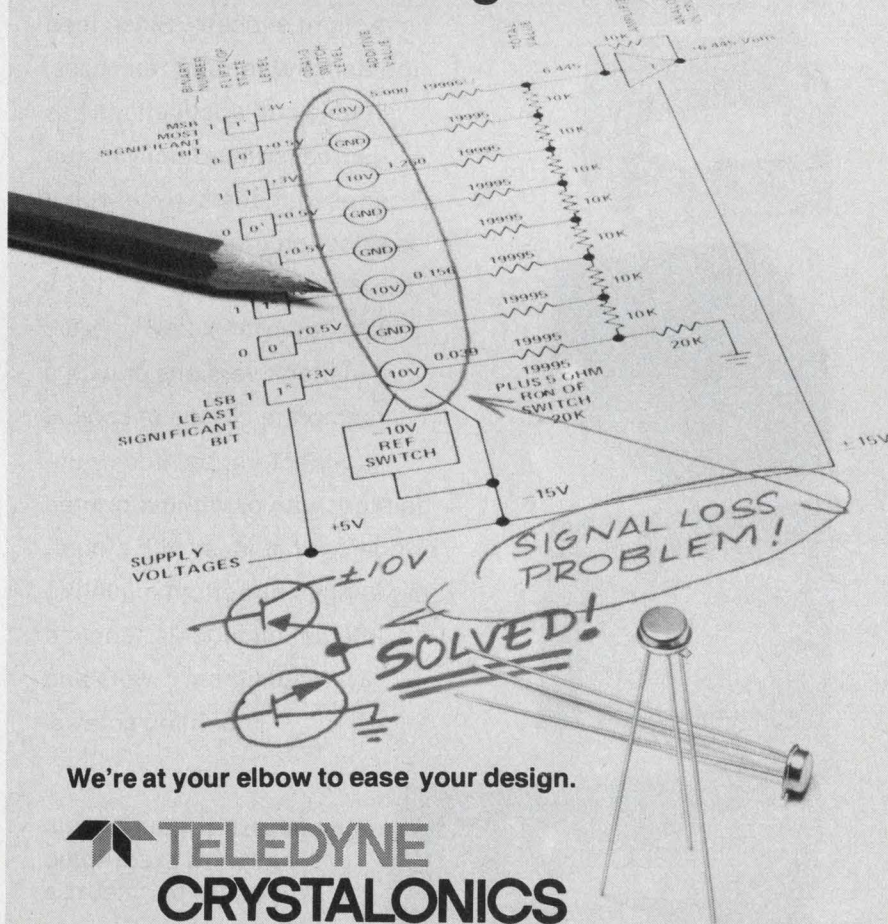

We're at your elbow to ease your design.

**TELEDYNE
CRYSTALONICS**

147 Sherman Street, Cambridge, Mass. 02140
Tel. 617-491-1670 • TWX 710-320-1196

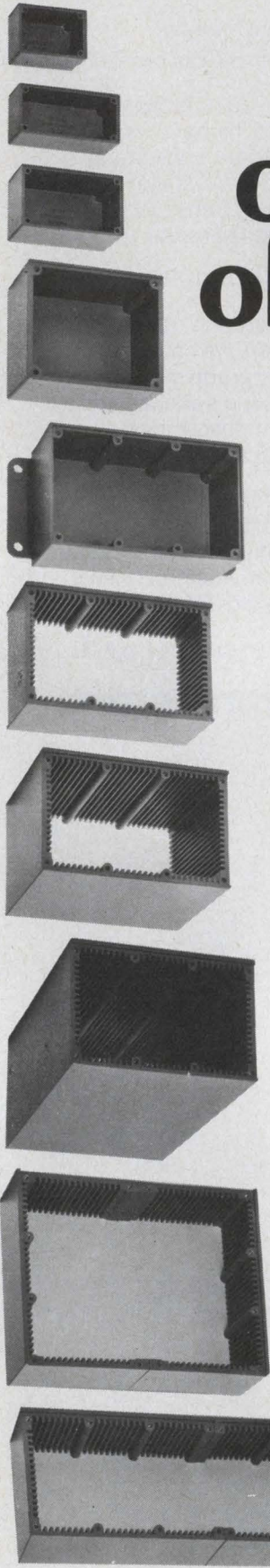

MEET OUR family of shielded "BLACK BOXES"

Almost 10 years ago (1966 to be exact) we introduced our first two series of shielded electronic enclosures. They became an overnight success. Since then the demand for different sizes, shapes and applications has increased our family to ten series of models, each with a noise rejection greater than 70db.

Sizes range from 1.50" x 1.13" x 0.88" to 4.13" x 2.68" x 6.0"; in blank versions or with a complete choice of coaxial connectors; painted or unpainted; with or without printed circuit card guides; with mounting flanges or bottom mounting plates. All models supplied with aluminum covers and mounting screws.

AVAILABLE THROUGH YOUR
FAVORITE ELECTRONIC
PARTS DISTRIBUTOR

ITT POMONA ELECTRONICS

1500 East Ninth St., Pomona, Calif. 91766
Telephone (714) 623-3463, TWX: 910-581-3822



CIRCLE NUMBER 73

COMPONENTS

Chip tantalum capacitor comes in eight sizes

Sprague Electric Co., North Adams, MA 01247. (416) 664-4411.

The new Sprague Type 194D Midget chip tantalum capacitor is available in eight sizes. Capacitance sizes for the lowest working voltage, 4 WV dc, range up to 100 μ F; at the highest working voltage, 50 WV dc, the maximum capacitance is 4.7 μ F. The capacitors can be reflow-solder attached to substrates at temperature up to 300 C for 3 min without significant deleterious effects. Operating temperature is -55 to 125 C. The standard end terminations are nickel caps with a gold electroplate.

CIRCLE NO. 348

Small rotary switches feature adjustable stops

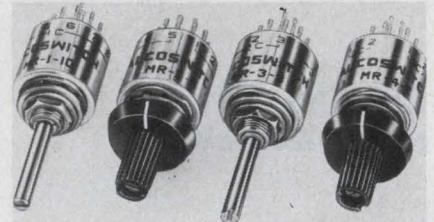

Alco Electronic Product, 1551 Os-good St., North Andover, MA 01845. (617) 685-4371. \$3.33 (500 up); stock.

New miniature rotary switches, the MRC series, are provided with adjustable stops and turret terminals suitable for hand-wired or PC applications. Terminals are permanently molded into the diallyl-phthalate base to prevent solder flux or other contaminants from damaging the switch interior. The switches are available with 1-to-4 poles. All models have a 36-degree detent action with stops adjustable from 2 to 10 positions, and they are supplied in two shaft styles: 1/8-in. dia \times 0.75 long with screwdriver slot or 5/32 in. with a black-phenolic knob that has a white hairline. Contacts and terminals are silver; common terminals are silver-plated brass; switches are rated 500 mA at 125 V ac with a minimum life cycle of 10,000 operations.

CIRCLE NO. 349

General-purpose relays handle 10-A loads

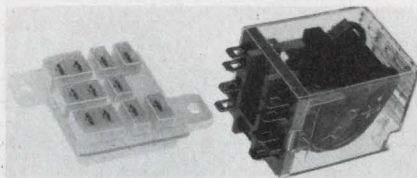

American Zettler, Inc., 16881 Hale Ave., Irvine, CA 92714. (714) 540-4190. \$2.65 (1000-up); stock.

The TEC-1270 series of general-purpose relays has 10-A contacts, in 1, 2 or 3PDT configurations. Either ac or dc coils are available with ratings of up to 220 V. The relays are UL approved and have terminal spacings of 3/16 in. in air, and 3/8 in. over a surface, as required for motor controllers by UL 508. Protection against dust and mechanical damage is afforded by a clear polycarbonate dust cover. Mechanical life is greater than 100 million operations. In a circuit board arrangement, seated height of the unit above the board is 1.971 in.

CIRCLE NO. 350

Clutch/drag brake has adjustable drag torque

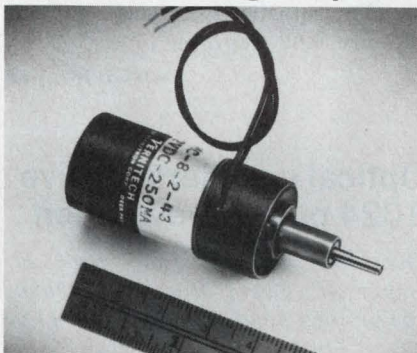

Vernitron Corp., 300 Marcus Blvd., Deer Park, NY 11729. (516) 586-5100. About \$20 (10,000 up); 10 wk.

The P-63 Series of clutch/drag-brake units for computers, peripherals and tape drives has adjustable drag torque that allows the clutch to be used as a drag brake. Torque is 3 oz-in. minimum and operation voltage can range from 24 to 28 V dc. The input drag torque is 0.2 oz-in. maximum and 0.05 oz-in. minimum. The brake unit can operate over 0 to 120 F and has a fast response at speed up to 2000 rpm.

CIRCLE NO. 351

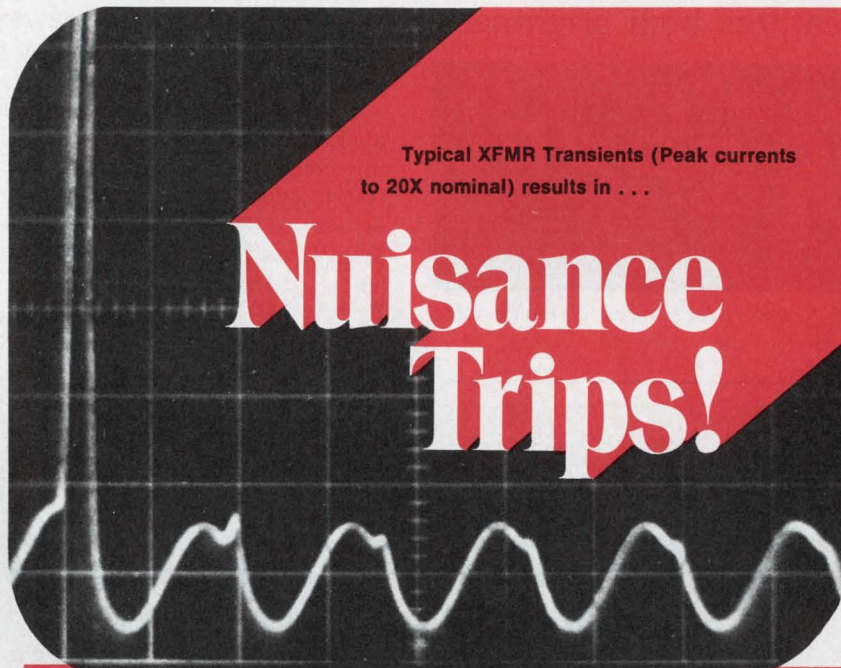

Typical XFMR Transients (Peak currents to 20X nominal) results in . . .

Nuisance Trips!

Eliminate them with Airpax Electromagnetic Circuit Protectors

with *patented* Inertial Delay

Many circuit protector applications involve a transformer turn-on, an incandescent lamp load, or a capacitor charge from a dc source. Each of these applications have one common factor: a steep wave front transient of very high current amplitude and short duration. This takes the form of a spike, or a single pulse, and is the cause of most nuisance tripping associated with circuit protectors.

Airpax circuit protectors, with patented inertial delay, assure positive protection without nuisance tripping by providing tolerance of short duration inrush currents without decreasing steady state protection. This does not affect standard delay curves and trip points.

Just another example of Airpax "application-oriented" engineering.

Get the full story on Airpax electromagnetic circuit protectors. Write for Short Form Catalog 2013.



Type AP/UP

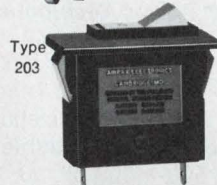

Type 203

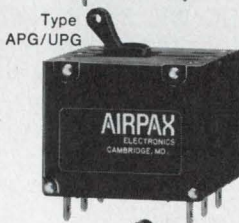

Type APG/UPG

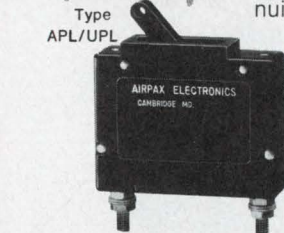

Type APL/UPL



Type 209 (E-Frame)

AIRPAX

Airpax Electronics
CAMBRIDGE DIVISION
Cambridge, Maryland 21613
Phone (301) 228-4600

Other Airpax Divisions:

CONTROLS DIVISION, Ft. Lauderdale, Florida 33313, Instruments for Industry
AMERICAN DATA, Huntsville, Alabama 35805, TV Products

CIRCLE NUMBER 74

COMPONENTS

4-digit display panel features high brightness

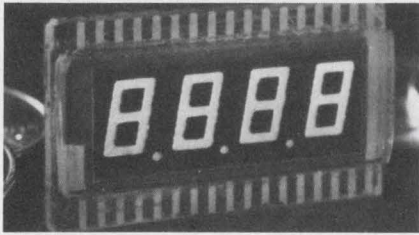

National Electronics, Geneva, IL

60134. (312) 232-4300. \$29 (100 up); stock.

The NL-1284 Plasmac display panel is a four-digit, 0.25-in.-character-height gas-plasma panel designed specifically for applications requiring high brightness and readability under high-ambient lighting conditions. Brightness is 0.28 ft-L to 400 ft-L; temperature range is -40 to 85 C; and power is only 80-mW nominal for four digits at 50-ft-L brightness.

CIRCLE NO. 352

Angular transducers provide dc output



Astrosystems, Inc., 6 Nevada Dr., Lake Success, NY 11040. (516) 328-1600. \$375 (1 to 4).

Durapot dc-to-dc angular transducers are intended as replacements for precision potentiometers where life, accuracy and friction are problems. This rotary device uses electromagnetic coupling to measure angular position. Internal electronics perform all the necessary conversions from an external dc input to a dc output that is proportional to shaft rotation. An internal precision dc-reference voltage is also available. The unit has an infinite resolution, an accuracy of 0.05% and 360 degrees of continuous rotation with a dead band of only 0.02 degrees.

CIRCLE NO. 353

You can't beat our high voltage ceramic capacitors' quality... at any price!

Experience can't be bought at any price and with over 30 years in the design and manufacture of high voltage ceramic capacitors, Murata has experience that's unsurpassed in the field. This experience has made Murata the world's largest producer of high voltage ceramic capacitors and generated a reputation for quality and performance second to none. What's more, our line covers virtually every high voltage application requirement. Check some of the brief features listed below and we're sure you'll want to

know more. Our complete information package is yours for the asking. Write or call today.

DH, DHL, DHG Types. For Power Supplies and Power Distribution Systems: 10-30 KVDC WV. 40, 50 & 60 KVDC WV also in DH. 500-5,000 pF. Z5V, Y5P & N4700 Temp. Char. Epoxy Resin Encapsulation. **DHR Type. For Color TV Doublers and Triplers:** 500-1,000 pF. 10, 12 and 15 KVDC WV. Z5P & N4700 Temp. Char. Extremely Low Noise Level. (Higher Capacities are also available.)

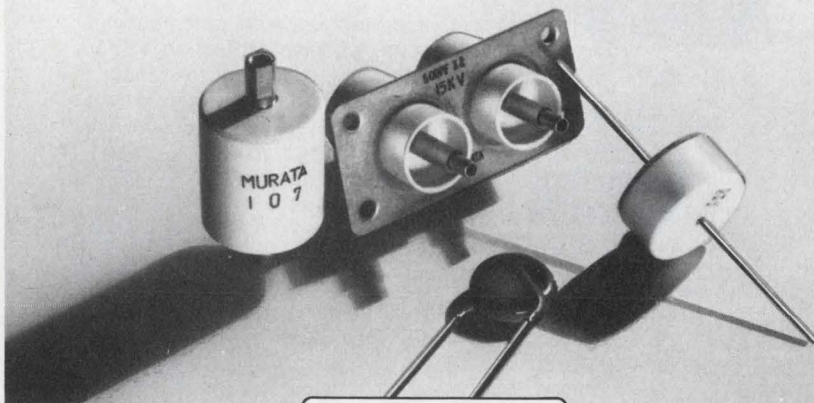

muRata
CORPORATION
OF AMERICA

Rockmart, Georgia 30153

Phone: 404-684-7821 • Telex: 54-2999 • TWX: 810-766-1340

CIRCLE NUMBER 75

Optical encoders resolve 1024 pulses/revolution

Disc Instruments, Inc., 1024 E. Baker St., Costa Mesa, CA 92626. (714) 979-5300. \$99 (81), \$125 (82); stock.

The Rotaswitch Model EC 81 (single-channel output) and Rotaswitch EC 82 (dual-channel output) optical encoders can resolve up to 1024 pulses per revolution at speeds to 5000 rpm. The encoders are accurate to ± 2.5 minutes of arc. Both models use LED sources for maximum service life, precision instrument bearings, and solar cells as light sensors. Outputs (logic 1) range from 5 to 15 V. The encoders weigh only 6 oz., have diameters of 2.75 in. and lengths of 1.88 in. They have drilled faceplates for easy mounting and 0.25-in. diameter shafts for interfacing.

CIRCLE NO. 354

COMMUNICATION FIBEROPTICS

CABLES AND DATA LINKS

LOW LOSS < 10dB/Km

Single Mode
Multimode (N.A.-.20)
Graded Index
Step Index

MEDIUM LOSS 20 to 40 dB/Km

Multimode Step Index
(N.A.-.30)
Single Fiber Channels or
Bundles

HIGH LOSS < 400 dB/Km

Multimode Step Index
(N.A.-.56)
Various Cable Diameters
and Fibers per Cable

ALL CABLES ARE:

DuPont HYTREL® Sheathed
DuPont KEVLAR® Reinforced
Easily Strippable
Color Coded



Optical Signal Communication by Dual Lightguide with Two LED-Photodetector Units. Lightweight Link Provides High Transmission Capacity, Electrical Isolation, Maximum Security, and Eliminates Electronic Interference

SINGLE CHANNEL AND MULTI-CHANNEL CABLES AVAILABLE



VALTEC CORPORATION

WEST BOYLSTON, MA 01583 617-835-6083

CIRCLE NUMBER 76

"ETC."

More O.E.M. customers are making ALCO their one source of supply for sub-miniature switches and other front panel components. Why not investigate how you could benefit with prompt deliveries from our vast inventory of stock items, or our ability to satisfy your special needs.

Call (617) 685-4371 for technical assistance, samples and pricing information.

ALCO ELECTRONIC PRODUCTS, INC.
1951 OSGOOD STREET, NORTH ANDOVER, MA, 01849 U.S.A.
TEL: (617) 685-4371 TWX: 710 342-0552 A SUBSIDIARY OF **AUGAT** INC.

CIRCLE NUMBER 77

ELECTRONIC DESIGN 6, March 15, 1976

10 amps of switching in a 1" cube

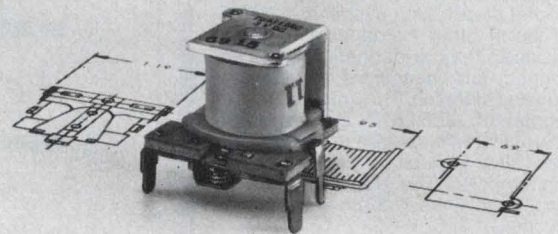

Series 19 Relay. One of the most compact and reliable relays you'll ever use.

In just one cubic inch, the remarkable Series 19 relay combines the advantages of miniaturization with a capacity to handle heavy switching loads. Result: more performance in a smaller overall package. Yet the cost is low — less than \$2.00 each in 100-piece quantities.

Contact arrangement is SPDT. Rating is 10 amps, 28 vdc or 115 v, 60 hz. Available coil voltages range from 3 to 24 vdc.

Consider the Series 19 relay for low level to 10 amp switching applications such as remote control, alarm systems and similar industrial and commercial uses.

Send for information now!

NORTH AMERICAN PHILIPS CONTROLS CORP.

Frederick, Md. 21701 • (301) 663-5141

FOR IMMEDIATE NEED CIRCLE #271

FOR INFORMATION ONLY CIRCLE #272

131

SOLID STATE GYROS just won't quit



- Instant 20 millisecond startup
- Uses only 2 watts DC Power
- Guaranteed 10,000 hours
- .002 Hz to 7 Hz bandwidth
- Zero to 50° per second range

These solid state, single axis angular rate sensors can be used as direct replacements for small diameter rate gyros in many of today's advanced guidance and control systems... including autopilots, radar and helicopter stabilization systems, and hundreds of other instrumentation applications. They're hermetically sealed, rugged, and insensitive to acceleration and vibration. They provide output signals of ± 2.5 VDC. 3-axis Models and units with ranges up to 3000°/sec. also available. Write Humphrey, Inc., Dept. ED 376, 9212 Balboa Ave., San Diego, CA 92123. Phone (714) 565-6631

WRITE FOR ENGINEERING APPLICATIONS BULLETIN

Describes various circuits that can be added to sensor to allow use as angular position, rate, or acceleration transducer.



Manufactured under license from Hercules, Inc., U. S. Patent 3,500,691



CIRCLE NUMBER 79

INTEGRATED CIRCUITS

Mini DIPs hold Schmitt triggers

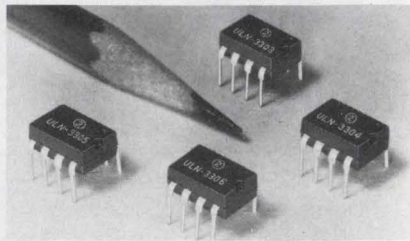

Sprague Electric Co., North Adams MA 01247. (416) 664-4411. \$1.25 to \$1.35 (100).

A series of Schmitt-trigger ICs comes in 8-pin miniature DIPs. All devices in the new ULN-3300M series operate over the -40 to +100 C temperature range. Supply voltage is 2.2 to 6 V, and the units can withstand a continuous voltage reversal without damage. Devices feature either complementary or zener-diode clamped outputs.

CIRCLE NO. 355

256-bit MNOS memory comes fully decoded

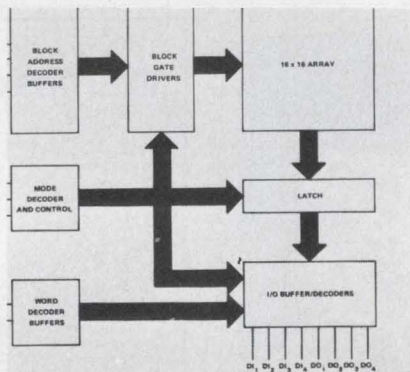

Nitron, 10420 Bubb Rd., Cupertino, CA 95014. (408) 255-7550. \$10 (100); samples from stock.

The first commercially available fully decoded MNOS nonvolatile memory—the NCM 7040—is organized as 64-words of 4 bits each. Six address and two mode inputs electrically control data reading, storing, and erasing. A P-MNOS circuit, the 256-bit NCM 7040, retains data indefinitely, even with the power supplies disconnected. Other features include nondestructive readout, single word alterability, standard ± 15 -V power supplies, three-level outputs, and compatibility with CMOS and TTL product families.

CIRCLE NO. 356

“off the shelf”

a rugged, well constructed, high quality switch from Capitol it has the same solid reputation as our custom ordered switches

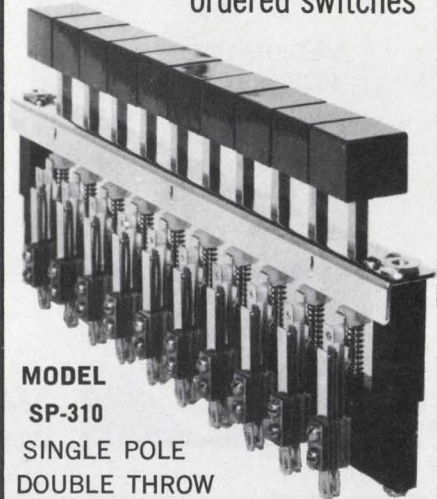

MODEL SP-310
SINGLE POLE
DOUBLE THROW
CONTACT
SQUARE BUTTON,
NON-ILLUMINATED

Contacts: Palladium
rated at 3 amp, 110VAC, non-inductive

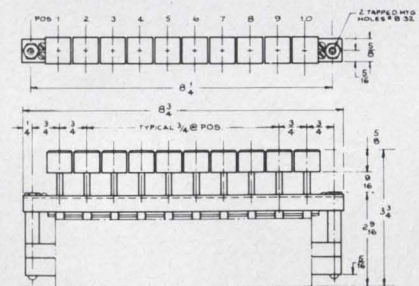

NOTES: 1. CONTACTS 1 FORM C EACH POS. SEC. 1
2. MECHANICAL ACTION: INTERLOCKING WITH POSITIVE LOCKOUT BETWEEN POS.
3. BUTTONS: 23-32 SQ.

We manufacture top quality push button and lever circuit selector switches or banked assemblies. Write for our catalog.

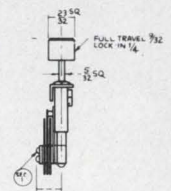

Representatives in principal cities.

CAPITOL SWITCHES

THE CAPITOL MACHINE & SWITCH CO.
87 NEWTOWN RD. DANBURY, CONN. 06810
(203) 744-3300

CIRCLE NUMBER 80

ELECTRONIC DESIGN 6, March 15, 1976

I²L counter operates at 5.5 MHz

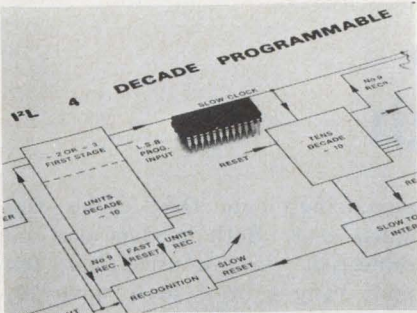

Plessey Semiconductors, 1674 McGaw Ave., Santa Ana, CA 92705. (714) 540-9979. \$10.56 (100).

A four-decade, fully programmable I²L counter, the SP8210, operates at speeds up to 5.5 MHz and has a typical power consumption of 10 mW, compared with 3.5 MHz and 30 mW for a competing CMOS device. The SP8210 may be programmed to divide by any number from 11 to 15,999. Outputs and inputs are TTL-compatible, and the device will operate with supply voltages down to 1 V.

CIRCLE NO. 357

A/d chip set counts to ± 40 k

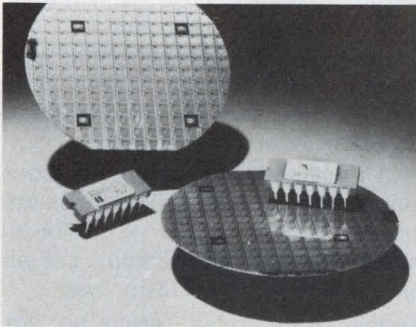

Intersil, 10900 N. Tantau Ave., Cupertino, CA 95014. (408) 996-5000. \$9 (1000).

A two-package microcircuit pair, the 8052A and 8053A, provides the circuitry for an analog-to-digital converter capable of up to $\pm 40,000$ counts. Each chip comes in a 14-pin DIP. The 8052A provides signal-conditioning circuits, including buffer amplifier, integrator, comparator and voltage references on chip. The 8053A provides the a/d switch network, plus switch drivers, on chip. With a few standard components, the analog pair can form a complete family of DVMs having full-scale ranges of ± 200 mV to ± 4.00 V.

CIRCLE NO. 358

FREE!

COMPLETE CIRCUIT CARD WITH ANY

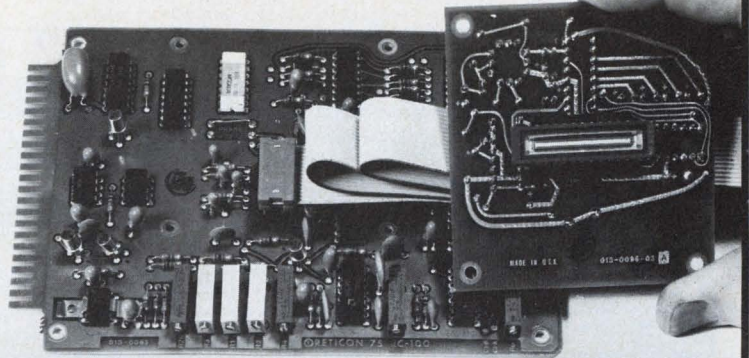

SOLID STATE IMAGE SENSOR

Of course, as with most "freebies", there is a catch to it.

Our "C" series solid state image sensors offer 128, 256, 512, 768 and 1024 elements in a single ceramic DIP with an optical quality quartz window. They require a two or four-phase clock drive and will provide analog video at up to 400:1 dynamic range. That is, if you are an expert in both analog and digital design.

However, when you purchase one of these arrays (in the U.S., at single-unit prices.) and get our RC100 series card set with it free, you'll be on the air with a complete operating system the day you get it. All you need is a power supply and an oscilloscope to admire the results. Up to 400:1 dynamic range, 2 KHz to 2MHz scan rate and a sampled and held "box car" video output.

You can mount the array with its detachable card directly behind a lens remoted from the motherboard without any reduction in the dynamic range and end up with a complete page reader, facsimile or non-contact measurement and inspection system.

And here is the catch! You'll like our approach so much, you'll be buying our arrays in large quantities before you know it. And you won't get any more "freebies". You'll have to build or buy the card yourself.

We know what we're doing when we invest over \$300 in you.

RETICON®

910 Benicia Avenue
Sunnyvale, California 94086
(408) 738-4266 • TWX: 910-339-9343

CIRCLE NUMBER 81

Data-acquisition modules keep costs low and performance high

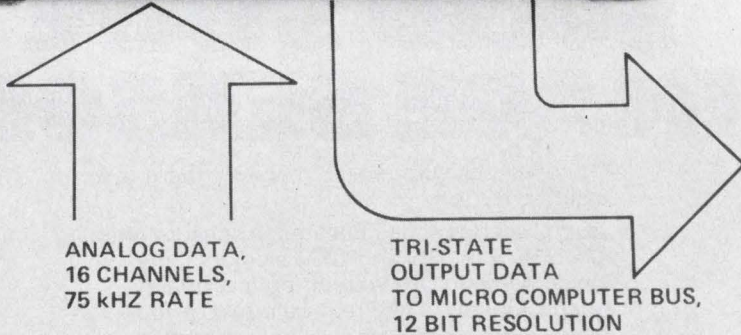
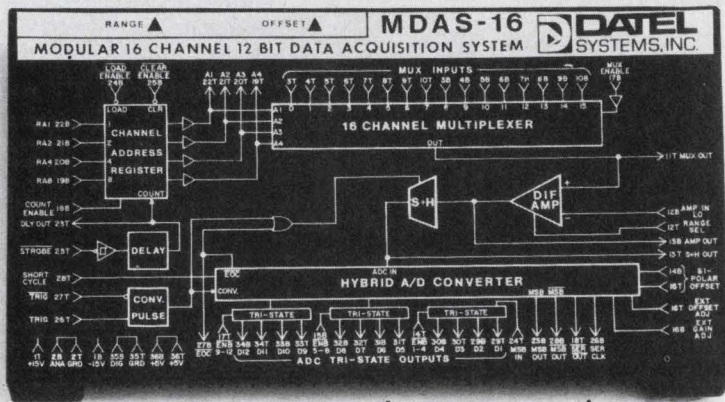

sequencing logic that cycles the multiplexer. Both models can be connected, via pin strapping, for input ranges of 0 to 5, 0 to 10, ± 2.5 , ± 5 or ± 10 V.

All MDAS units are pin-compatible with such competitive models as the 6912 and 6812 from Analogic (Wakefield, MA), the SDM 850 and 851 from Burr-Brown (Tucson, AZ), and the DT1600 series from Data Translation (Concord, MA).

The throughput rate of the MDAS units is not the highest of all—Analogic and Data Translation offer systems that have a 100-kHz throughput—but they cost almost twice as much. Analogic's 6912 costs \$595 and the Data Translation DT1610 costs \$695, compared with the \$295 for the MDAS systems.

If you don't need the high speed offered by these units, lower throughput-rate units are available at costs approaching those of the MDAS. You can also get units with resolution lower than 12 bits. Data Translation, for instance, offers 8 10-bit conversion systems.

All modules offer a 100-M Ω input impedance. The MDAS systems are housed in 4.6 x 2.5 x 0.375-in. cases while the other units are all in a 4.6 x 3 x 0.375-in. case.

- Datel CIRCLE NO. 302
- Analogic CIRCLE NO. 303
- Burr-Brown CIRCLE NO. 304
- Data Translation CIRCLE NO. 305

Datel Systems, 1020 Turnpike St., Canton, MA 02021. (617) 828-8000. P&A: See text.

By taking advantage of hybrid circuit construction, Datel Systems has developed a series of data-acquisition modules with throughput rates of 75 kHz. They cost about half as much as equivalent speed modules and are slightly smaller.

The MDAS-16 is a 16-channel subsystem and the MDAS-8D is an eight-channel unit. The MDAS-16

handles single-ended inputs and the MDAS-8D handles differential inputs. Both units provide 12-bit resolution and relative accuracies of 0.025%. Three-state logic outputs are used to ease module interface with micro and minicomputer busses.

Included in the modules are the multiplexer, sample-and-hold amplifier, a/d converter and all programming logic. You need only provide the dc supplies and the digital-



ANALOGY

THE A-733 IS A MULTIPLE FUNCTION MODULE PROGRAMMED TO MULTIPLY DIVIDE SQUARE ROOT, SQUARE, SQUARE OF A RATIO AND RAISE YOUR RATIOS TO AN ARBITRARY POWER. INPUTS FROM 100 mV TO 10V CAN BE PROCESSED WITH MAXIMUM OUTPUT ERROR OF LESS THAN 0.5% OF FULL SCALE. TAKE IT HOME TO MOTHER.

intech INCORPORATED
(408) 244-0500
1220 COLEMAN, SANTA CLARA CA 95050

CIRCLE NUMBER 82



Select One...

One of these tachometer generators is suited to your application. We offer them in two-bearing and single-bearing versions, no-bearing overhung versions and in sealed housings for use in environments containing oil and hydraulic fluids. Outputs range from 2.6V/1000rpm to 45V/1000rpm; brush life up to 100,000 hours—that's over ten years!

FREE CATALOG of rotating components available.

Be Selective, Turn To...

SERVO-TEK®
PRODUCTS COMPANY

1086 Goffle Road, Hawthorne, NJ 07506 • 201-427-3100

Servo-Tek of California, Inc.

8155 Van Nuys Blvd., Van Nuys, CA 91402 • 213-786-0690

CIRCLE NUMBER 84

MODULES & SUBASSEMBLIES

Sequence controllers have 12 or 16 outputs

Purrco Mfg. Co., 1495 Sierra Creek Dr., San Jose, CA 95132. (408) 258-2200. \$115 (3012); \$135 (3016); stock.

The SC3012 and SC3016 sequential controllers provide timed sequential control of up to 12 or 16 outputs, respectively. Both models may be set to control fewer loads without cycling through unused outputs. The sequence rate can be set between 5 and 120 s, while duration can be set between 0.1 and 4 s. Other ranges are also available for both controls on special order. Each output can handle up to a 1-A load at 110 V ac. The controllers are all solid state with rugged steel frames and are designed for mounting in any NEMA enclosure that measures at least 8 × 10 in. Neon lamps on the controller panel show which output is energized at any time.

CIRCLE NO. 359

Fast a/d converter series has low drift

Intech, 1220 Coleman Ave., Santa Clara, CA 95051. (408) 244-0500. From \$350 (unit qty); stock.

The A-851 family of a/d converter modules is claimed to use an improved successive-approximation technique that provides very fast conversion with 1/2-LSB linearity. The family's two basic models are the A-851-10, which has 10-bit resolution and a conversion speed at 1.5 μs, and the A-851-12, with 12-bit resolution and a speed of 2.5 μs. Both A-851 models are self-contained and can operate without adjustments, however, external potentiometers may be added to trim offset and gain. Maximum quantizing and nonlinearity errors are ±1/2 LSB each and the maximum differential noninverting error is less than ±1/2 LSB. Temperature drift is also low, ±10 ppm/°C maximum for offset and gain, and ±20 ppm/°C maximum for nonlinearity. Power supply sensitivity is ±0.01%/1%. Both models are supplied in 2 × 4 × 0.4-in. cases and weigh 4 oz.

CIRCLE NO. 360

SAM[®] IS THE LOWEST PRICED READER YOU CAN BUY. BUT YOU DON'T GET SHORT CHANGED.

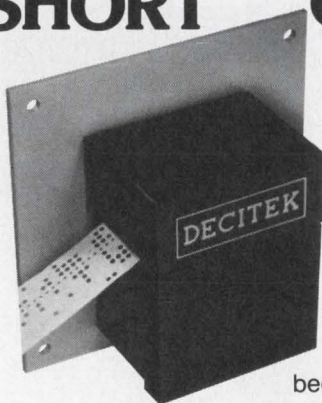

You could spend a lot more for a tape reader and still not get all of SAM'S quality features. SAM clips along at 300 cps, has our sure-footed dual sprocket drive and our state-of-the-art fiber optic light source and photo transistor read head. We can make SAM do all this *and* save you money because we do things differently.



This is the plain, brown wrapper SAM comes in.

The more you know about punched tape equipment, the better you read us.

DECITEK

250 CHANDLER STREET, WORCESTER, MASSACHUSETTS 01602, U.S.A. (617) 798-8731

CIRCLE NUMBER 85

Precision references housed in 14-pin DIPs

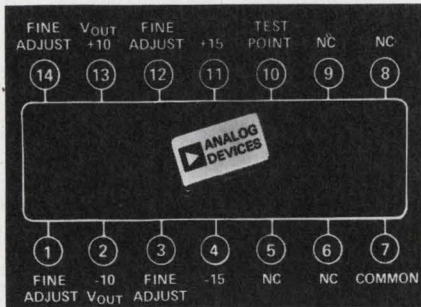

Analog Devices, Rte. 1 Industrial Park, Norwood, MA 02062. (617) 329-4700. From \$10 (100-up); stock.

The AD2700 series of ± 10 and -10 -V precision references are housed in 14-pin DIPs. They include the AD2700/L which operates over -55 to 125 C and has a $\pm 0.03\%$ total maximum error guaranteed from -25 to 85 C. Its load regulation over the 0-to-20-mA range is $\pm 0.004\%$. The military versions of the precision reference, the AD2700/U and the AD2700/U/883 with screening to MIL-STD-883A, 5004.2, Class B, have been improved to $\pm 0.03\%$, -0.05% total maximum error over -55 to 125 C. The AD2701 offers identical specifications, versions and prices to those of the AD2700, but with a -10.000 -V output. The third precision reference, the AD-2702, provides a ± 10.000 -V output (10 mA max.) with identical specifications and versions as the other references.

CIRCLE NO. 361

Multiplying DACs have response range of 1 MHz

Dynamic Measurements, 6 Lowell Ave., Winchester, MA 01890. (617) 729-7810. \$225; 2 wks.

The 2000 Series of multiplying d/a converters has a 1-MHz full power response range. Their feed-through is less than 1 LSB, typical, at 1 MHz. These converters provide two-quadrant multiplication out to $+10$ V and four-quadrant multiplication (to 400 mV typ.) near the origin. The units supply 40 mA at ± 10 V and have an output impedance of less than 0.1Ω . By strapping pins, output ranges of 0 to $+10$, ± 5 , and ± 10 V are available.

CIRCLE NO. 362

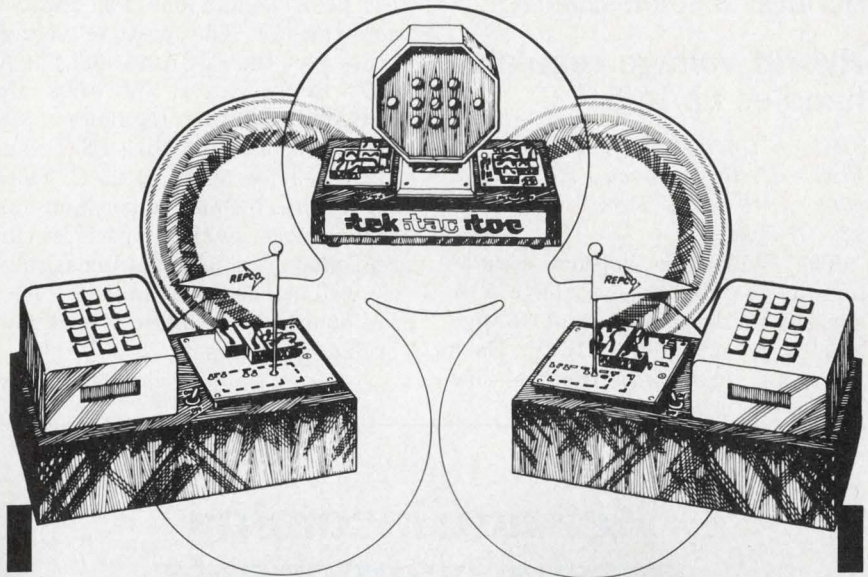

Undiscovered genius contest.

The slightly zany, yet fully workable idea illustrated is an RF link-controlled tic-tac-toe game using Repeco's modular RF links. It was developed by our engineers to demonstrate the potential and versatility of our RF links. We figured, since creativity is widespread, other design engineers could come up with even more clever ideas.

And the Undiscovered Genius Contest was born.

Sure, there are limitless practical applications for Repeco's RF links. But one of the characteristics of creative engineers is to develop commercial applications while jiving around with off-the-wall ideas.

We'd like you to enter our Undiscovered Genius Contest. The payoff is 12 fantastic prizes for our 6 winners and 6 runners-up.

If you're one of the six winners, you'll receive a Texas Instruments SR51 calculator — retail value \$149.95. Six runners-up win Texas Instruments SR50 calculators — retail value \$99.95.

But just for entering, we'll send you a bright button which identifies you as an Undiscovered Genius. It also makes a neat, semi-deadly frisbee on days there's nothing much doing around the lab.

Just draw a quick sketch or diagram illustrating your clever (but workable) idea incorporating Repeco's RF links on an $8\frac{1}{2}$ " x 11" sheet of paper and sign it. We **absolutely** will not appropriate or use your idea in any way except for advertising purposes. Your entry constitutes permission for us to use your drawing in our advertising.

Please send your entry directly to Repeco, and for further information and contest details pull reply card in this magazine. Contest expires April 30, 1976.

• decision of judges is final • limit one entry per person • void where prohibited by law, or where taxed • all entrants will be notified of winners • employees of Repeco, Scope, Inc., or their advertising agency are not eligible (darn!) • and all prizes will be awarded.

Don't delay... enter now, and become an undiscovered genius!

REPCO Incorporated

A subsidiary of SCOPE Incorporated

P.O. Box 7065, Orlando, Florida 32804 • (305) 843-8484

CIRCLE NUMBER 86

MODULES & SUBASSEMBLIES

Hybrid voltage regulator handles up to 5 A

Solitron Devices, 1177 Blue Heron Blvd., Riviera Beach, FL 33404. (305) 848-4311. From less than \$20; 2 wks.

The hybrid dc voltage regulators in the CJCA series have 5 A current ratings and output voltage ranges from ± 8 to ± 56 V. Each regulator has two versions—one

for positive and one for negative applications. The positive voltage units over the CJCA001 and CJCA007; the negative, CJCA002 and CJCA008. These regulators will operate from -55 to $+125$ C, and are rated for 50 W at 25 C. These regulators include a constant-current source, which provides current-mode regulation automatically, as well as current limiting. They are housed in hermetic, 8-lead, low-profile TO-3 cases.

CIRCLE NO. 363

Low-power d/a converter accepts 12 bits

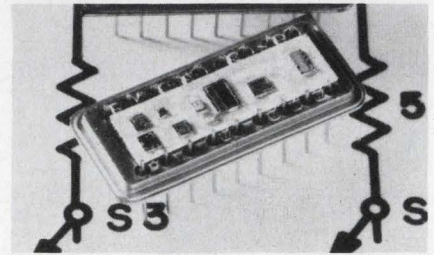

Hybrid Systems, Crosby Dr., Bedford, MA 01730. (617) 275-1570. From \$115 (1 to 9); stock to 4 wk.

The DAC347-LP-MIL is a 12-bit general-purpose d/a converter designed for low-power operation. The unit has a power dissipation of less than 150 mW, is housed in an 18-pin hermetic DIP and is available with either MIL-STD-883 level B or C processing. Model DAC347-LP-MIL has an input range of 0 to $+10$ V; a G version is available for ± 10 -V inputs. Some key specifications include: linearity error from -25 to $+85$ C is $\pm 0.05\%$ FSR max. and from -55 to $+125$ C is $\pm 0.1\%$ FSR max. The settling time is 10 μ s and power supplies are ± 15 V at ± 4 mA.

CIRCLE NO. 364

Measure incoming passive components and make it pay.

Right away.

Not only does our 1 kHz LRC meter at \$1400 (U.S.A.) cost less than half as much as similar instruments, its accuracy is 0.25% (plus 1 digit) and it is automatic (no manual balance). Wide ranges make it versatile. Add all this to ESI's reputation for reliability, and you get payout and profit. Right away.

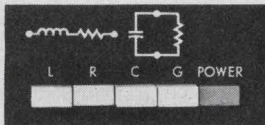

The rest is bonus:

- Four terminal measurements: Lead resistance, leakage, environmental effects are no problem.

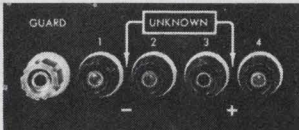

- 3½-digit display has overload blanking to prevent false readings.
- Set only range and function, the rest is automatic.
- Four terminal fixture available for sorting.



Sorting Fixture

There's more to this fast payout story. Ask for Jim Currier, Electro Scientific Industries, 13900 N.W. Science Park Drive, Portland, OR 97229, phone 503/641-4141.

esi
ELECTRO
SCIENTIFIC



Automatic Balance At 0.25% Precision

- Ranges: 200 μ H to 200 H for L, 200 pF to 200 μ F for C, 2000 m Ω to 2000 k Ω for R, 2000 nS to 2000 mS for G.

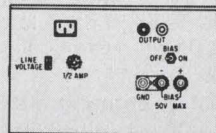

Rear Panel Bias Analog Output



CIRCLE NUMBER 87

Synchro transmitters provide difference angle

Computer Conversions Corp., 6 Dunton Ct., East Northport, NY 11731. (516) 261-3300. \$400 (prod. qty.); 4 wks.

The SCDX series of synchro control differential-transmitter modules can directly replace conventional electro-mechanical transmitters. The modules measure $2.6 \times 3.1 \times 0.82$ in. and have standard accuracies of ± 4 , ± 15 or ± 30 minutes of arc. They simultaneously accept synchro or resolver inputs of 11.8 or 90 V, 400 Hz or 90 V, 60 Hz, and 14, 12 or 10-bit binary digital data. The output delivers the sine and cosine of the difference between these two input angles. Standard output voltage is 7 V rms and the output impedance is 10 Ω max $\angle -90^\circ$. The converters typically require $+15$ V at 90 mA, -15 V at 25 mA and $+5$ V at 75 mA. Available operating temperature ranges are 0 to 70 or -55 to $+85$ C.

CIRCLE NO. 365

DRIREED SWITCHES

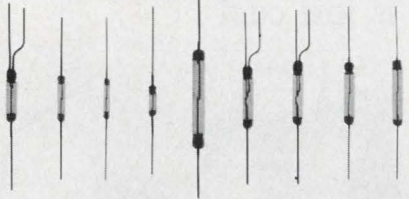

- Quality controlled precision construction
- Microminiature Sub-miniature, Miniature, Intermediate sizes — Any Quantity

AND DRIREED SWITCH PRODUCTS



LOW-PROFILE PUSHBUTTON SWITCHES

- Single or ganged
- Momentary, alternate-action, and illuminated units
- Long life, dependable
- Patented design eliminates magnetic interference

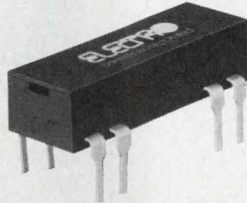

D.I.P. DRIREED RELAYS

- Positive action—6 to 26 VDC coils
- Contact ratings to 200VDC
- Gold alloy or rhodium contacts
- 5×10^6 operations at rated load
- Low cost—high reliability

Available from Stock or Custom Designed for Your Application

ELECTRO
controls, incorporated

Write for Catalogs

Matthews Ave.,
Canton, Miss 39046
(601) 859-5511/TWX (810) 990-0938

CIRCLE NUMBER 88

Reduce ECL system noise with off-board voltage and ground distribution.

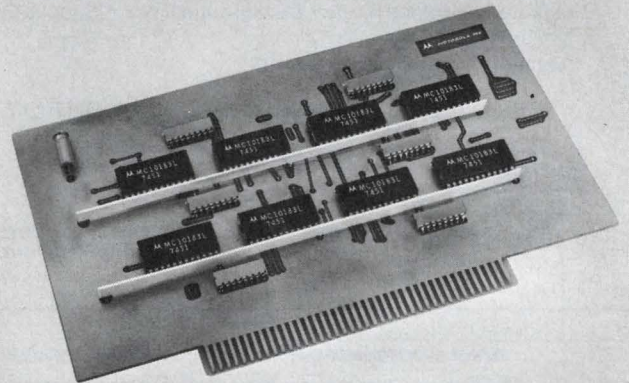

SP-G10, H-10 SPEEDEX RECORDER

3 different power supplies available!!

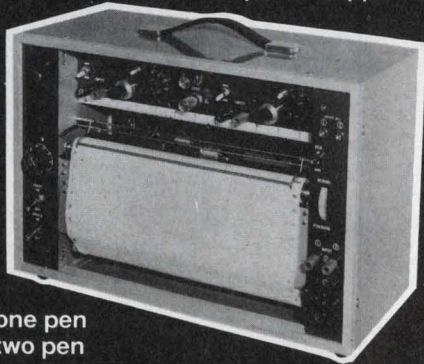

G10...one pen
H10...two pen

FEATURES

1. High sensitivity. Switchable from 0.5mV/250mm full scale to 500V in 12 steps.
2. 3 different power supplies.
 - a) Internal battery
 - b) AC power line (110, 220V 50/60Hz)
 - c) External 12V power supply
3. Easy to operate.
4. Durable plastic potentiometer.
5. All solid-state circuitry.
6. Pulse motor chart feed also permits chart feed by external pulse. Chart can be freely wound and un-wound.

• Please write us on your letterhead for detailed information.

Riken Denshi Co., Ltd.

5-5-2, Yutenji, Meguro-ku, Tokyo, Japan. TEL: 711-6656 TELEX: 0246-8107

CIRCLE NUMBER 89

ELECTRONIC DESIGN 6, March 15, 1976

MINI/BUS® does it...

Benefits of Rogers Mini/Bus start with design time (lots less for PC boards with ECL circuits) and keep going:

- Eliminate cost of multi-layer boards
- Give higher packaging density
- Reduce system noise

For design data, details of the many versions of Mini/Bus (full card matrix, vertical strips, horizontal strips), and data on why Mini/Bus reduces noise and lowers costs, contact Ray Jodoin at:

R Rogers Corporation
Chandler, AZ 85224
(602) 963-4584

CIRCLE NUMBER 90

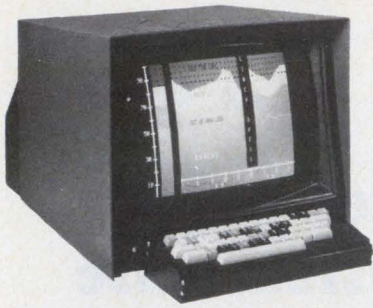

UNBELIEVABLE!!!!

The Intecolor® 8001
A Complete 8 COLOR
Intelligent CRT
Terminal
\$1,995*

"Complete" Means

- 8080 CPU • 25 Line x 80 Character/Line • 4Kx8 RAM • PROM Software
- Sockets for UV Erasable PROM • 19" Shadow Mask Color CR Tube
- RS232 I/O • Sockets for 64 Special Graphics • Selectable Baud Rates to 9600 Baud • Single Package • 8 Color Monitor • ASCII Set
- Keyboard • Bell • Manual

And you also get the Intecolor® 8001 9 sector Convergence System for ease of set up (3-5 minutes) and stability.

Additional Options Available:

- Roll • Additional RAM to 32K • 48 Line x 80 Characters/Line • Light Pens
- Limited Graphics Mode • Background Color • Special Graphic Characters
- Games

*Quantity 100 (Unit Price \$2,495.)

ISC WILL MAKE A BELIEVER OUT OF YOU!



Intelligent Systems Corp. 4376 Ridge Gate Drive, Duluth, Georgia 30136
Telephone (404) 449-5961

CIRCLE NUMBER 91

Hanover makes markets Afresh every year



28th April - 6th May '76

Hanover Fair

- | | |
|---|--|
| <ul style="list-style-type: none"> • Refuse collection, disposal and utilization • Propulsion engineering including installation engines • Construction equipment • Building materials and components, prefabricated and system building • Machinery for building materials and concrete blocks • Catering, coin-operated machines • Office and information systems (CeBIT) • Chemicals, rubber and plastics technology • Steam and heat • Iron and steel, non-ferrous metals, foundry products • Electric lighting • Production and conversion of electricity • Distribution of electricity | <ul style="list-style-type: none"> • Domestic electric installations and equipment • Specialized electrical processes and processing • Electronic components and assemblies • Research and technologies • Measuring, testing, controlling and automation • Telecommunications • Surface treatment • Cleaning and maintenance of property • Transport • Advertising • Tools • Decorative consumer goods |
|---|--|

EXPOCLIMA

European Specialised Exhibition for Refrigeration, Air-conditioning Air-handling and Drying

Schenkers International Forwarders, Inc., One World Trade Center, Suite 1867, New York, N.Y. 10048, Tel. 212432-3000

CIRCLE NUMBER 92

DATA PROCESSING

Printer for μ Ps is low cost

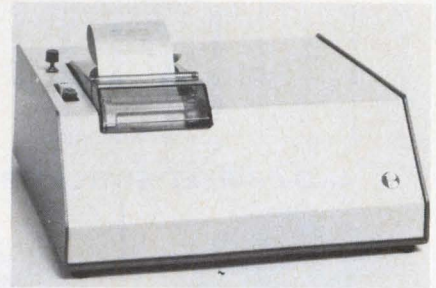

The Binary Corp., 2680 Bayshore Frontage Rd., Mountain View, CA 94040. (415) 965-9590. \$395 (100 up).

A low-cost, high-speed printer for microcomputers, the Binary MP-01, can operate asynchronously at any speed up to 160 char/s. The unit is self-contained and is based on a Sharp electric-discharge printer, which prints on 20-column, 2-1/4-in. paper. The 64-character set includes the full alphabet, all digits and some special symbols.

CIRCLE NO. 366

Panel displays octal data and addresses



Control Logic, Inc., Nine Tech Circle, Natick, MA 01760. (617) 655-1170. Begins at \$250.

A low-cost address and data-display panel (ADDP) provides octal readouts of both busses for M Series microcomputer systems. The ADDP can display the latch bus in L-Series systems as well. The upper "DATA" display shows the contents of the data bus (D_7-D_0) as a 3-digit octal number. The middle "PAGE" display shows the contents of $A_{13}-A_8$, the page number section of the address bus. The lower "WORD" display shows the contents of A_7-A_0 , the word number within a 256-byte page of memory.

CIRCLE NO. 367

Data-processing mini aims at first-time users

NCR Corp., Dayton, OH 45479. (513) 449-2150. Start at \$17,900.

A general-purpose data-processing system designed mainly for first-time computer users, the new NCR 499 is a successor system to the NCR 399 minicomputer. A basic 499 system includes a 12 k-byte miniprocessor, an integrated, bidirectional, 75-character-per-second impact matrix printer, a magnetic-tape-cassette transport and forms handler. A standard 10-key numeric keyboard is used for numeric data.

CIRCLE NO. 368

30-Mbyte disc system sells for under \$10,000



Datum, Inc., 1363 S. State College Blvd., Anaheim, CA 92806. (714) 533-6333. See text.

A 10-platter, moving-head disc system adds low-cost storage capacity to Data General Nova and Eclipse, Digital Computer Controllers D-116, and Keronix IDS-16 minicomputers. Designated the 4091-N, the disc drive and controller sells for \$9995 in unit quantities—significantly below the \$15,000 to \$16,000 price of comparable units. The unit has a storage capacity of 30×10^6 bytes with a recording density of 2200 bpi. Average random access time is 55 ms; data are recorded on 20 surfaces at 100 tracks per inch with 203 tracks per surface. Transfer data rate is 312 kbytes per second; write frequency is 5 MHz $\pm 0.3\%$. Storage media are IBM 2316-type disc packs, which rotate at 2400 rpm.

CIRCLE NO. 369

WHENEVER YOUR NEED IS

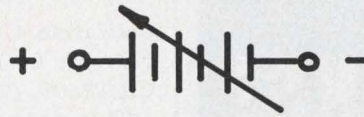

YOU NEED

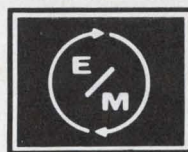
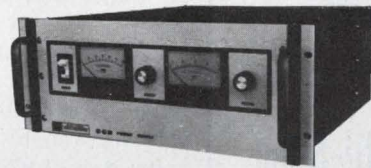

DC OUTPUT SCR REGULATED POWER SUPPLIES

HIGHEST—EFFICIENCY, RELIABILITY
LOWEST—COST, SIZE, RIPPLE

POWER OUTPUT	V	A	SIZE	PRICE
500W	0	0	3.50H	425 — 500
800W	TO	TO	3.50H	500 — 650
1600W	7.5V	.75A	5.25H	750 — 850
2400W	UP	UP	7.00H	900 — 1100
2500W	TO	TO	7.00H	1200 — 1600
5000W	600V	3000A	8.75H	1500 — 2300
10000W	DC	DC	12.25H	2300 — 2900
TO 60KW			TO 4' H	TO 9500

**ELECTRONIC
MEASUREMENTS INC.**

405 ESSEX ROAD
NEPTUNE NJ 07753

TELEPHONE
201-922-9300

TOLL FREE
800-631-4298

FOR DETAILED INFORMATION SEND

NAME _____

COMPANY _____

TITLE _____

STREET _____

CITY _____ STATE _____

ZIP _____

PHONE _____

CIRCLE NUMBER 93

from drawing board
to production sample
in just
3 WEEKS!

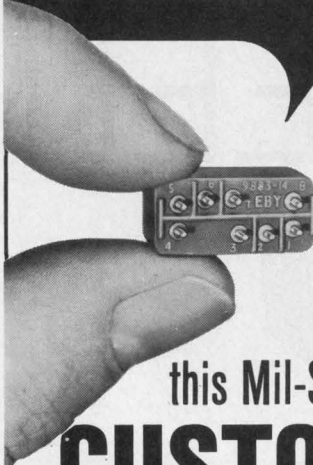

this Mil-Spec
**CUSTOM
RELAY
SOCKET**

for application to VRC-77 ground control rugged communications system. Meets required Military specifications.

Eby can meet your custom design and manufacturing requirements for all types of electrical connectors and related components... including high reliability Military applications.

Request more information and FREE SAMPLES of this or similar items... representative of Eby capabilities.



HUGH H. EBY CO.

4701 GERMANTOWN AVENUE
PHILADELPHIA, PA. 19144
(215) 842-3000
a division of REDM Corp.

E 105

CIRCLE NUMBER 101

DATA PROCESSING

**Table-top plotter
turns out 34-in. artwork**

California Computer Products, 2411 W. La Palma Ave., Anaheim, CA 92801. (714) 821-2541. \$8700.

This drum plotter, the CalComp 836, is intended to replace the CalComp 563 drum plotter, a unit claimed to have set the industry standard in low-cost, 30-in. plotting for over 15 years. The new plotter's advantages include quietness of operation and plug compatibility for on-line operation with any minicomputer or computer having an asynchronous EIA RS-232-C connection or a CalComp standard 500 series interface. Table-top size is 51 in. by 18.75 in., drawing speed is 1.97 in./s and increment size is 0.004 in.

CIRCLE NO. 370

**OEM line printer
controlled by μ P**

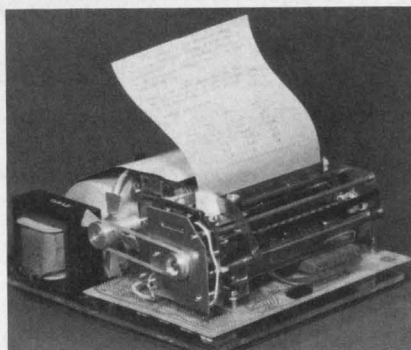

Axiom Corp., 425 E. Green St., Pasadena, CA 91101. (213) 684-2246. \$965 (1-9); stock.

The EX-800 series of electrostatic line printers is designed specifically for OEM use. There are three models—20, 40 or 80-columns—and each comes equipped with a microprocessor-controlled 64-character ASCII interface and power supply. Users may specify parallel or serial—up to 12,000 baud—data entry, with or without RS232C. A combination FIFO/RAM input buffer can store up to 160 characters of multiline information to allow continuous printing of most serial data. Maximum print speed is 2 lines/s to produce a high contrast printout of 5 x 7 dot-matrix characters.

CIRCLE NO. 371

**32-k bit add-in memory
offered on one board**

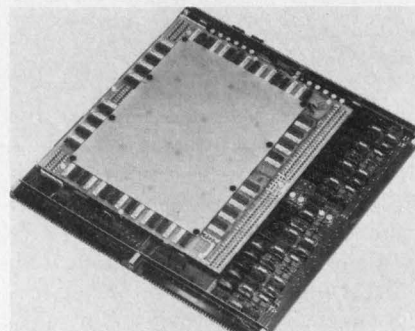

Dataram Corp., Princeton-Hightstown Rd., Cranbury, NJ 08512. (609) 799-0071. \$1980 (32 kb); 30 days.

DR-716 is an add-in, single-board, 32-k bit core memory system for use with Interdata's Model 50, Model 70, 7/16, 7/32, and 8/32 minicomputers. A 16-k bit version is also available. By means of an internal jumper, the 716 can be set to operate at either 750-ns or 1- μ s cycle time. Parity is available at no additional cost. The board is completely pin-compatible with Interdata memory.

CIRCLE NO. 372

**Matrix printer spews
out 125 lines/min**

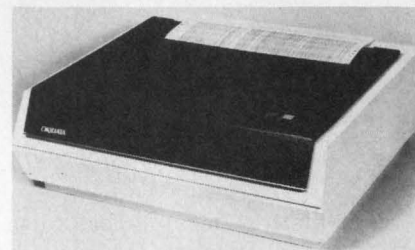

Okidata Corp., 111 Gaither Dr., Moorestown, NJ 08057. (215) 546-6537.

A new 132-column matrix printer is said to offer significantly greater speed at substantially lower prices than competitive models. The proprietary print head uses constant-current drivers plus 22 pin drivers instead of the standard seven or nine found in other models. The unit comes as a desktop or pedestal-mounted model that produces 132 columns of 5 x 7 matrix characters at 125 lines per minute or 256 characters per second continuously with no limitation on the duty cycle. It is available with OEM parallel and RS232 serial interfaces.

CIRCLE NO. 373

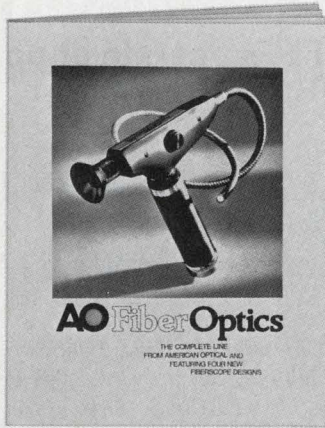

FREE Fiber Optics Catalog

Features the complete AO line of fiber optics products—from Inspection Fiberscopes and Light Guides to Illuminators, Image Conduits, Faceplates and Custom Components. Includes the four newest remote inspection fiberscopes now available.

Describes the principle, technology and techniques used to make flexible light and image transmissions a proven, practical fact. Write today for your FREE copy of the AO Fiber Optics catalog to American Optical Corporation, Fiber Optics Division, Southbridge, Mass. 01550.

AO
American
Optical

CIRCLE NUMBER 102

FOR SALE

New and Used Computer Equipment In Part or Whole Lot

- | | |
|--------|--|
| 3 each | DDC Fixed Head Disk Drives
Model 7312-B4
Capacity: 15.7K bits
Access Time: 8.5 miloseconds
Cost: \$19,800 each |
| 2 each | Diablo Moveable Head Disk Drives
Model #43
Capacity: 50,000K bits
Access Time: 38 miloseconds
Cost: \$5,065 each |
| 5 each | CFI IBM 5440 Type Disk Packs
Cost: \$125 each |

Prices On All Items Are Negotiable

For Further Information Contact:

J. P. Childress
P. O. Box 36827
Houston, Texas 77036
A/C 713-777-1381 Ext. 562

CIRCLE NUMBER 103

ELECTRONIC DESIGN 6, March 15, 1976



**We
Get to
the Heart of
the Matter.**

Precision on the Inside Makes it Work.

As a design or product engineer, it has to be frustrating to design a product and then encounter problems with a seemingly "insignificant" part.

At ITT Thermotech we care about the inside of your product and manufacture precision plastic parts with a long life that help keep your product running, whether "insignificant" or critical.

Another real plus to you is that ITT Thermotech is an U.L. recognized source.

So, if you're looking for precision on the inside, contact ITT Thermotech. Since we are a full service molder we can also assist you from design through manufacture and delivery of the finished part(s).

Beauty is not only skin deep.

ITT THERMOTECH

1202 South Fifth St. • Hopkins, MN 55343 • 612/938-7671
 3200 Tyrone Blvd • St. Petersburg, Florida 33710 • 813/347-2191

CIRCLE NUMBER 104

Bring your photodiode problems to Cetron.

Nobody has more experience in specialized photodiode applications than Cetron. Our designers have helped countless customers to solve their application problems. Some needed only the proper usage of our standard photodiodes . . . others required our years of know-how to come up with a high performance, specialized design that would do the job.

Talk over your application with one of our experienced sales engineers. Whatever your problem, we can help you to select a reliable photodiode that will meet your exact specifications.

Check the reader service number or call Cetron to receive our Rapid Reference Data Catalog.



SPECIALISTS IN PHOTODIODE DESIGN & MANUFACTURING FOR OVER 40 YEARS.

715 Hamilton St. Geneva, Ill. 60134 (312) 232-4140

CIRCLE NUMBER 105

DISCRETE SEMICONDUCTORS

GaAs FETs operate at up to 8 GHz as amplifiers

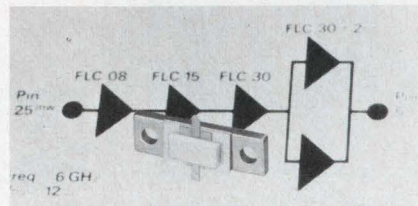

Fujitsu Components Div., 1-1 Shinbashi 6 chome Minato-ku, Tokyo Japan. \$740 (FLC08), \$980 (15) \$1200 (30); stock.

Three specially-designed, n-channel GaAs Schottky-barrier FETs, the FLC series, are intended for common-source applications. They can be used in Class A microwave linear power amplifier and oscillator applications at frequencies up to 8 GHz. Power outputs at 4, 6 and 8 GHz for these units are: 3, 2.4 and 1.9 W for the FLC30; 1.5, 1.2 and 1 W for the FLC15; and 0.8, 0.7 and 0.6 W for the FLC08. The FETs are housed in hermetically sealed metal/ceramic packages.

CIRCLE NO. 374

Laser diodes operate continuously at 35 C

RCA, Solid State Div., Route 202, Somerville, NJ 08876. (201) 722-3200. \$350 (C301027); \$375 (130); \$1950 (125); 5 to 30 days.

Two continuous-wave injection laser diodes, types C30127 and C30130, are capable of continuous or high-duty-cycle operation at case temperature of up to +35 C. The C30127 is supplied in a hermetically sealed OP-4A package and the C30130 in a geometrically-centered OP-12 package. Also available is a laser system, type C30125. It consists of a laser diode, a regulated dc power supply and a closed-loop temperature stabilization system. Both the C30127 diode and the C30125 system provide a minimum power output of 5 mW at 820 nm while the C30130 diode has a slightly higher minimum power output of 6 mW at 820 nm. All three devices have a source size of typically $12 \times 2 \mu\text{m}$, and can be modulated at frequencies up to and beyond 100 MHz.

CIRCLE NO. 375

Everything in Fail-Proof Digital Printers.

Whatever your hard-copy need — alpha-numeric/digital print-out; multi-copy; multi-color; ordinary calculator paper/pressure-sensitive tape; card, label, fan-folded forms, sales slip, — one of our 12 basic field-proven impact printers will suit you perfectly.

Products of Shimshu-Seiki, world-famous for a decade of reliability. Choose up to 21 columns, up to 42 characters/column, 3.4 lines/sec printing speed. Lowest sample prices. Phone Floyd Makstein, V.P. Marketing, or write. . .

C. Itoh Electronics, inc.

SYSTEMS & COMPONENTS DIVISION
280 Park Avenue, New York, NY 10017
(212) 573-9466. Telex: WUD 12-5059

CIRCLE NUMBER 106

Fast switching SCRs block up to 1200 V

International Rectifier, Semiconductor Div., 233 Kansas St., El Segundo, CA 90245. (213) 678-6287. P&A: See text.

The 250 RL series of 450 A rms, fast-switching inverter SCRs has blocking voltages of up to 1200 V. Maximum turn-off time, and typical turn-off time with feedback diode, is 60 μ s. The cases of units in the 250RL Series conform to JEDEC outline TO-118. Typical cost for the 250RL50 is \$67.80 in 10 to 99 quantities; delivery is 4 weeks.

CIRCLE NO. 376

Electro-optic design kit has 6 photodetectors



United Detector Technology, 2644 30th St., Santa Monica, CA 90405. (213) 396-3175. \$245; stock.

The Light Kit, an electro-optics designers assortment, contains six silicon photodetectors, a silicon photodetector slide rule and design manual. The photodetectors include: the PIN 10CAL/PR, a 1 cm² Schottky barrier photodiode with continuous radiometric calibration curve and mountable photopic filter for CIE correction; the PIN SC/10, a continuous, dual-axis, Schottky barrier position sensing photodiode; the PIN 125, a lensed, planar-diffused photodiode for photovoltaic operation; the PIN 8LC, low-capacitance, large area, Schottky-barrier device for fast response requirements; the PIN 10D, 1 cm², general-purpose, planar-diffused photodiode for photoconductive and photovoltaic use and the PIN 020, a low-noise, isolated, planar-diffused photodiode for low-light-level applications.

CIRCLE NO. 377

Optical detectors with amp come in TO-99 case

Bell & Howell Control Products Div., 706 Bostwick Ave., Bridgeport, CT 06605. (203) 368-6751. \$48 (1 to 9), stock to 4 wks.

The 539 Series of optical detectors combines a planar-diffused silicon photodiode, a 100-MHz gain-bandwidth product op amp and a

gain determining resistor—all in a TO-99 package. The detectors operate from ± 15 -V supplies. Diode areas of 0.8 or 5 mm² are available with gain resistor of 30, 50 or 100 k Ω . Responsivity for a tungsten (2870 K) illuminant ranges from 7 to 22 mV/ μ W and rise times from 28 to 90 ns. Dark offsets of 8 to 11 mV are typically present over the 0-to-70-C operating range.

CIRCLE NO. 378

DANA INTRODUCES THE SMART COUNTER.

Series 9000: World's First Microprocessing Timer/Counter.

The Dana Series 9000 is smart enough to make your work a lot easier. Microprocessing controls provide all the features of a premium timer/counter, a reciprocating counter and a calculator. Plus interfacing options and operating capabilities never before available in one instrument.

The Dana Series 9000 Microprocessing Timer/Counter goes so far beyond all other counters it takes a whole brochure just to explain its capabilities. Ask for it. It's the smart thing to do.

Dana Laboratories, Inc., 2401 Campus Drive, Irvine, California 92664, 714/833-1234.



FOR PRODUCT DEMONSTRATION CIRCLE #289

FOR LITERATURE ONLY CIRCLE #290

**PROFESSIONAL
DISCOUNT
PRICES
AVAILABLE ON**

**Texas
Instruments
Engineering
Calculators**

**PHONE TOLL-FREE
800-638-8906**

**FOR THE CURRENT LOW DISCOUNT PRICE
OF THE LATEST MODEL TEXAS
INSTRUMENTS CALCULATOR OF
YOUR CHOICE**

Texas Instruments SR-52



Programming power from Texas Instruments. Easy hand held programming for scientists, engineers, students — anyone who works with advanced mathematics. Check these features: 224 program locations, 20 addressable memory registers, 23 pre-programmed key functions, indirect addressing, permanent program storage on magnetic cards.

Texas Instruments SR-56



More power from Texas Instruments. Hand held key programmable calculator. 100 program steps, 5 program levels (up to 4 levels of subroutine may be defined). Easy single step editing. Main features include 26 preprogrammed key functions, 10 addressable memory registers, algebraic logic and 9 levels of parentheses.

PC-100 Lock down printer; for a hard copy of your results; step by step listing of programs, or "debugging" programs. The PC-100 printer may be used with the SR-56 or SR-52.

OTHER MODELS AVAILABLE

SR-50A, SR-51A, TI 25501I, TI 25001I, TI 5100

**ALL THE FAMOUS
TEXAS INSTRUMENTS
ELECTRONIC CALCULATORS
ARE AVAILABLE AT DISCOUNT PRICES**

Mail and phone orders accepted. Master Charge and BankAmericard accepted. Add \$2.50 per unit for shipping and handling. Maryland residents add 4% sales tax.

Use our toll free phone: **800-638-8906** (Maryland residents phone: **(301) 340-7200**) to order or for current discount quotations on the leading brands of electronic calculators: Texas Instruments, Hewlett-Packard, Rockwell, Ricoh, Kingspoint, Corvus, Novus, and many more.

THE GUARANTEE

10 day money back trial. If you are not completely satisfied you may return the Texas Instruments calculator you order within 10 days for a cash refund or charge cancellation. In addition Texas Instruments Inc. and Capital Calculator Co. Inc. warrant each calculator for a period of one year against defective parts and workmanship.

Capital Calculator Company

**701 East Gude Drive
Rockville, Maryland 20850**

CIRCLE NUMBER 108

MICROWAVES & LASERS

**25-50-MHz circulator
fights intermodulation**

Microwave Associates Inc., 850A Stewart Dr., Sunnyvale, CA 94086. (408) 736-9330. \$365; 30 days.

A low-band circulator—for the 25-to-50-MHz frequency range—presents a practical alternative to existing methods for combating low-band transmitter intermodulation problems. The intermodulation-eliminating device is available for use with both high and low-power transmitters. It provides an isolation of 22 dB and an insertion loss of only 0.75 dB.

CIRCLE NO. 379

**Laser system measures
to ±1/2-microinch**



Recognition Systems, 15531 Cabrillo Rd., Van Nuys, CA 91406. (213) 785-2179. \$40,000; 120 days.

An automated optical-computer inspection system measures photomasks to microinch accuracy at four times the speed possible with manually operated equipment. Called MAME (Microinch Accuracy Measured Electro-optically), the system uses Fourier-transform optics and a minicomputer that analyzes the diffraction patterns produced by each line or gap inspected on the mask. Typical accuracies of ±0.75% can be obtained on a 100-microinch line. The system can detect variations as small as ±1/2 of a microinch in a line only 60 microinches wide. MAME displays dimensions in microinches or microns on a TV viewing system, and it can accept positive or negative masks up to 5 in. square, a size range that covers wafers measuring from 3/4 to 4 in.

CIRCLE NO. 380

**Amp outputs linear
power at 400 MHz**



Amplifier Research, 160 School House Rd., Souderton, PA 18964. (215) 723-8181. \$900; stock to 30 days.

The Model 4L class-A amplifier has an instantaneous bandwidth of 400 MHz, and can provide over 4 W of linear and greater than 7.5 W of useful power. The solid-state unit doesn't require tuning or special drive sources. Gain of the amplifier is typically flat within 1 dB, and it can be varied from 20 to over 36 dB by means of a front-panel attenuator. Harmonics are down at least 23 dB below the fundamental frequency at 4 W of output power. Noise figure is typically 9 dB. Input VSWR is 1.5:1 maximum; when a 50-Ω load is used.

CIRCLE NO. 381

**Compact 4-way dividers
work to 500 MHz**

Merrimac Industries, Inc., 41 Fairfield Pl., West Caldwell, NJ 07006. (201) 228-3890. PDF-4E-50: \$75; stock to 30 days.

Small lightweight four-way power dividers—the PDF-4E series—cover the frequency range of 50 kHz to 500 MHz, and feature high isolation and uniform output characteristics. Housed in flatpacks, the devices are designed for mounting to stripline and PC boards, and they meet or exceed MIL-STD-202 environmental and physical conditions. Representative of the series is the Model PDF-4E-50, covering the 2-to-100 MHz frequency range and featuring —6-dB coupling and 30-dB isolation. Other characteristics include: amplitude balance of 0.2 dB, phase balance of 1°, insertion loss of 1 dB, impedance of 50 Ω, VSWR of 1.3:1, and power rating of 1 W with matched loads. Units in the series measure 0.4 × 0.83 × 0.83 in. and weigh 8 grams.

CIRCLE NO. 382

HP9830A USERS: HAS THIS EVER HAPPENED TO YOU?

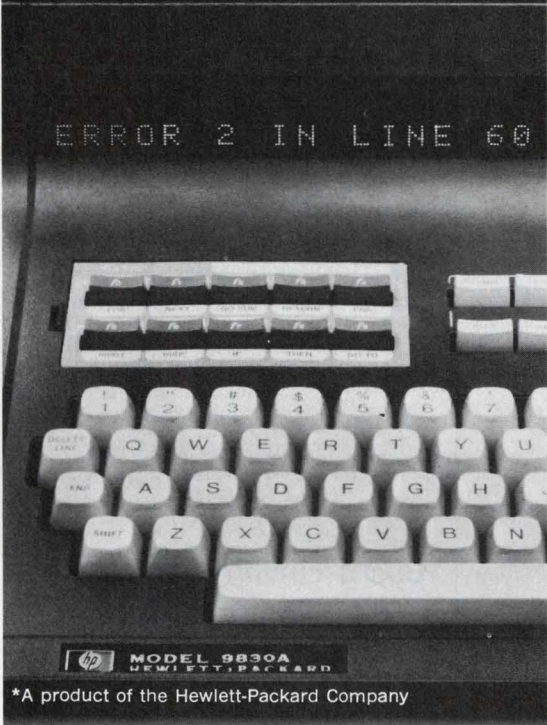

*A product of the Hewlett-Packard Company

Memory overflow problems can now be a thing of the past. The EM-30 Extended Memory System eliminates the necessity of re-designing your programs as a result of ERROR 2.



You can now economically expand the read/write memory capacity of your 9830 to a full 32K bytes.



You can easily work with large arrays of data without resorting to peripheral storage.



With the EM-30 you are assured of full compatibility with all software, peripherals, and HP ROM options.



The EM-30 is a direct plug-in replacement for HP memory and you can install it in minutes with just a screwdriver.

The HP9830A* already approaches the power of a minicomputer. The EM-30 Extended Memory System significantly furthers the dimensions of this versatile machine by giving you minicomputer memory capacity with desk-top convenience. For as little as \$4,230 you can expand a fully loaded 15K byte 9830 to 32K bytes. You can integrate the extended memory capability of the EM-30 into the 9830 without changing any of your existing programs.

The design of the EM-30 Extended Memory System is based on proven 4K RAM chips for low power requirements and high reliability. All units have passed extensive tests to ensure that they are consistent with the high quality and reliability that you expect from HP products.

INTRODUCTORY OFFER: Send us a list of your ROM's, options and peripherals and we will send you a cassette containing a collection of appropriate commercial programs. Your name will be added to a growing list of 9830 users who are interested in a mutual exchange of programs and techniques. For additional information circle the reader number or call us collect.



Infotek Systems

733 E. Edna Place • Covina, Calif. 91723
(213) 966-7431 • TWX 910-584-1812



CIRCLE NUMBER 109

CUSTOM-CRAFTED Constant Voltage Transformers

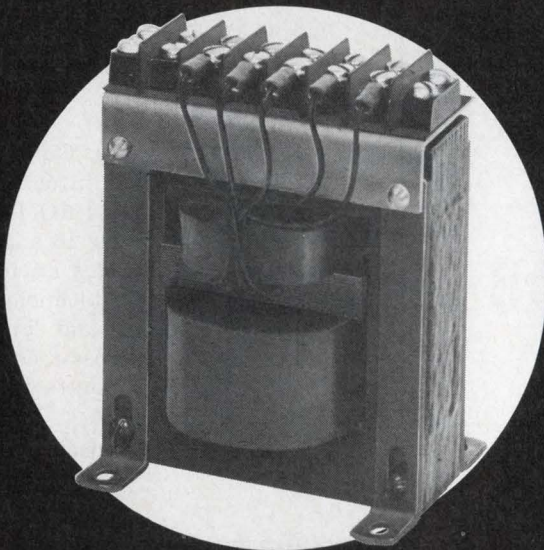

Datatex manufactures a wide range of transformers, inductors, toroids, chokes, matched audio and sub-audio units in many sizes and voltages. For automatic controls, aerospace, computers, biomedicine, and other industrial uses.

DATATEX CORPORATION

TRANSFORMER DIVISION

10935 South Wilcrest Drive □ Houston, Texas 77072 □ (713) 495-1171

CIRCLE NUMBER 110

ELECTRONIC DESIGN 6, March 15, 1976

Rose enclosures. New. Beautiful. Quality. Standards.

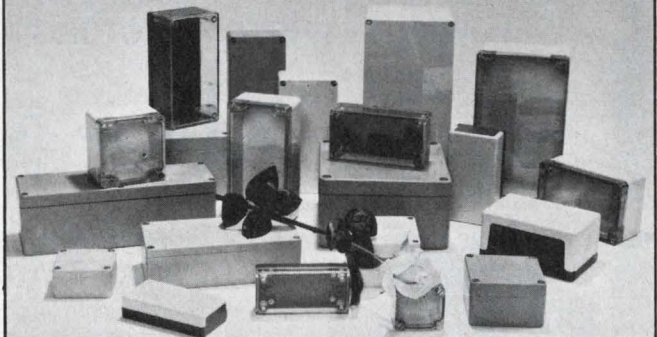

Rose Enclosures, made specifically for electronic use, culminate years of design, engineering and production experience. Extra high quality, precision-finished units provide functional protection, easy access, excellent esthetics. Available materials: Lexan, Aluminum, Polyester and ABS. Clear plastic covers with Lexan and ABS. A competitively-priced stock of Rose Enclosures is maintained in Belding, Mich. for immediate shipment. Contact us at (616) 794-0700.

STAHLIN
BROTHERS, INC.
Belding, Michigan 48809

CIRCLE NUMBER 111

147

What's your Mu IQ?

A QUICK QUIZ ON MAGNETIC SHIELDS

1	2	3	4	5	6
Who has the most complete magnetic shield facility in the U.S.?	How many ways can a magnetic shield be fabricated?	Who gives you design help, prototypes, drawings, testing and quality assurance?	How many layers of .004" Hipernom foil will attenuate a 4 oersted field by a factor of 10?	Why are Amuneal magnetic shields cooked 22 hours in 99.9% dry hydrogen?	What is "Mu" anyway?



Answers: 1. Amuneal; 2. six; spot welded, heliarc welded, drawn, spun, wrapped or hydroformed; 3. Amuneal; 4. two layers; 5. to restore the optimum magnetic shielding properties of the metal destroyed during fabrication; 6. the Greek letter denoting permeability, the ability of the shield to carry the field.

For all the answers, send for your free Magnetic Shield Source Book today.

amuneal
MANUFACTURING CORP. 4737 Darrah St., Philadelphia, Pa. 19124 Telephone: 215-535-3000

CIRCLE NUMBER 112

Application Notes

Thermal rms converters

Designers are given an operational description of the Model 4131 thermal rms-to-dc converter element as well as specific circuit details for several applications in a six-page application note. The note, complete with circuit diagrams and performance curves, starts with an analysis of the static and dynamic behavior of the wideband monolithic converter and uses models to develop the transfer function. Burr-Brown, Tucson, AZ

CIRCLE NO. 383

Guard circuitry

The application and use of guard circuitry with attention to increasing the accuracy of measurements of DVMs, digital thermometers and calibrators are discussed in a bulletin. Detailed diagrams show how to connect guard circuitry for different measurement conditions. John Fluke Manufacturing, Mountlake Terrace, WA

CIRCLE NO. 384

PROM guide

"The PROM User's Guide," a 26-page booklet, gives information on selecting and using PROMs and the equipment available to support PROM users. It includes an introduction to PROM technologies, covering both MOS and bipolar PROMs, and a cross-reference guide to PROM manufacturers. Pro-Log, Monterey, CA

CIRCLE NO. 385

Vacuum system analysis

A detailed theoretical study of vacuum control systems analyzed by computer solutions to the nonlinear equations governing system performance is given in a four-page bulletin. MKS Instruments, Burlington, MA

CIRCLE NO. 386

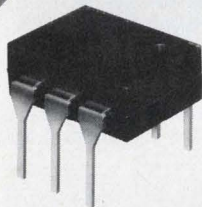

SPECTRONICS 5KV OPTICAL ISOLATORS IN 6-PIN DIPS

Spectronics offers the first 5KV isolator in the popular 6-pin dual in-line package. These components are directly interchangeable with standard industrial 6-pin isolators.

Circle #131

LOW-COST PHOTODETECTORS & LEDs

Spectronics provides industry's largest selection of standard off-the-shelf detectors and LEDs. Direct replacements for such popular industrial types as GE, TI, Monsanto and Motorola.

Circle #132

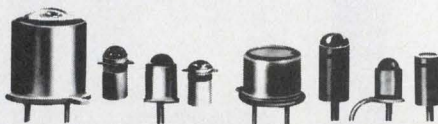

STANDARD OPTICAL SWITCHES

Six, low-cost off-the-shelf optical switches are available as direct replacements for such popular devices as the H13A1, A2; H13B1, B2; MCA 8, 81 and MCT 8, 81. Both phototransistor and photodarlington versions are furnished.

Circle #133

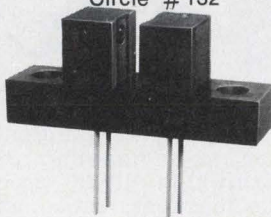

Call Spectronics for everything you need in opto. We make optoelectronics work... for you!



830 E. Arapaho Rd.,
Richardson, Texas 75080
(214) 234-4271

CIRCLE NUMBER 134

Evaluation Samples

Contact springs

Gold-plated contact springs come in diameters from 0.037 to 0.125 in. and lengths range from 0.043 to 0.142 in. Due to very light spring rates, force requirements of 0.04 oz per 0.001 in. of travel are available. Servometer Corp.

CIRCLE NO. 387

Contacts

Rivet-type contacts for electrical connectors and circuit boards are produced by cold forming. Wire diameter is from 0.03 to 0.093 in., length to 0.56 in. Parts with nail-type heads, depressed or cup-type heads, extended shanks and chamfered ends are available. Art Wire & Stamping.

CIRCLE NO. 388

Silicon rectifier bridge

The PK rectifier bridge is rated at 10-A continuous, 150-A surge and is available in voltage ratings from 50 to 800 V. The bridge is housed in a cylindrical case that has a diameter of 0.89 in. and is 0.3 in. high. Leads are wire. Electronic Devices.

CIRCLE NO. 389

MOS/LSI sockets

24 and 28-position versions of the company's zero insertion force sockets feature self-ejection of the LSI module, positive lock in the loaded LSI position and zero axial force during the loading cycle. Molex.

CIRCLE NO. 390

PVC foam tape

A double-coated, pressure-sensitive PVC foam tape for mounting, holding, cushioning and sealing applications is coated both sides with a durable press-on adhesive. Adhesion is unaffected in any weather or temperature. The Mutual Paper Co., P.S.I. Div.

CIRCLE NO. 391

Bushings

The B-468-343 nylon bushing used for mechanical protection of shafts and protection of electrical wires and cables has a 1/4-in. profile and protrudes less than 1/8-in. into a chassis. It has a 17/32-in. head dia., an 11/32-in. inside dia. and is designed for a 15/32-in.-dia. mounting hole. Heyman Manufacturing.

CIRCLE NO. 392

Fuse clip

The MC-27 fuse clip is made of beryllium copper, heat treated after forming for maximum spring properties. The clip is designed to accommodate a 1/4-in.-dia. fuse and is available in electro-tin or gold plating. The clip has a current rating of 10 A and a contact resistance of less than 5 m Ω . Components Corp.

CIRCLE NO. 393

digital edgewise meters

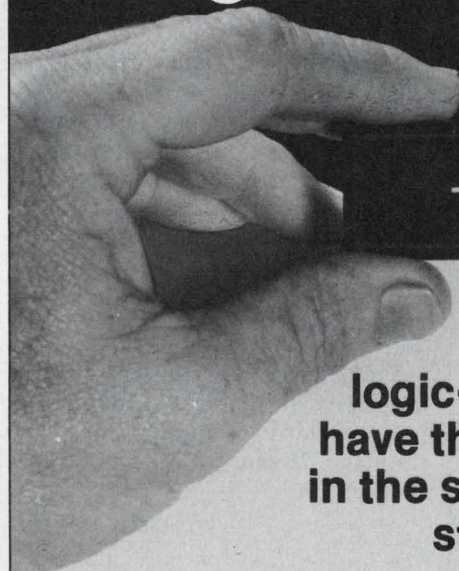

Newport's new logic-powered DPVMs have the largest display in the smallest space... starting at \$65.00*

The models 213 and 216 offer 2000 and 6000 count capacity respectively. Four ranges of voltage are available for each unit. The DIN standard case and cut-out permits mounting without occupying precious front panel space. The depth, including the connector, is 71 mm.

Newport's DPVMs will replace your edgewise analog meter with bright 13mm (1/2 inch) LED digits easily read from a distance.

Low power consumption and low parts count, plus Newport's ten years experience, add up to real reliability you can count on.

*OEM quantities

OTHER OUTSTANDING FEATURES:

- Differential input
- Common mode voltage isolation
- Bias current <1nA
- One watt power consumption
- Dual slope average value
- DIN standard case
- Bipolar ranges
- Automatic zero
- High 50/60Hz NMR
- 3-wire ratio standard
- 4-wire ratio (optional)
- Character serial BCD output (optional)

NEWPORT LABS—
630 East Young Street
Santa Ana, California 92705
Phone: (714) 540-4686

NEWPORT

CIRCLE NUMBER 114

The original open-chassis power supply

125,000+ units in the field:
your assurance of
quality and reliability



List price
only \$28 (1-9)
—generous OEM
discounts

DPS Series

- * Three models produce 0.8-3.5 amp at 5-24 Vdc
- * Operate on 105-125 or 210-250 V, 47-63 Hz
- * Regulation: $\pm 0.25\%$ line and load
- * Easy mounting
- * UL listed

See EEM for complete
specs and 110 stocking
distributor locations

FREE!

Catalog and Designer's Handbook
—includes specs and tips
for designing with
Tele-Dynamics
power supplies
and line
regulators



TELE-DYNAMICS DIVISION OF AMBAC

525 Virginia Drive, Fort Washington, PA 19034
(215) 643-3900

An equal opportunity employer M/F

© Tele-Dynamics

6535

CIRCLE NUMBER 115

New Literature



Thumbwheel switches

Miniature 8 and 10-position thumbwheel switches are described in a 24-page brochure. Both sealed and enclosed types are described. Full electrical and mechanical specifications are provided. AMP, Harrisburg, PA

CIRCLE NO. 394

Disc drive

The Series 700 head-per-track disc drive is illustrated in a four-page brochure. General Instrument, Rotating Memory Products, Hawthorne, CA

CIRCLE NO. 395

Opto-electronics

Standard silicon and blue-enhanced photovoltaic cells, blue-enhanced photodiodes, and p-i-n photodiodes are covered in a 12-page guide. Also shown are CdS and CdSe photoconductive cells, selenium photovoltaic cells, npn phototransistors and photo-Darlington and opto-isolators. Vactec, Maryland Heights, MO

CIRCLE NO. 396

Components

Over 2500 items, including computers, music synthesizers, motors, special ICs, chips, relays, keyboards, alarms, LEDs, etc., are listed in a catalog. Prices are included. World Wholesale Electronic Supply, Hathorne, MA

CIRCLE NO. 397

Optical industry directory

"The Optical Industry & Systems Directory 1976" is a two-volume set that includes a 420-page buyer's guide and a more than 300-page encyclopedia dictionary. The set costs \$35. The Optical Publishing Co., Inc., 59 Bartlett Ave., Pittsfield, MA 01201

INQUIRE DIRECT

Freq conversion modules

Application information and design suggestions for v/f and f/v converters are given in an eight-page folder. Dynamic Measurements, Winchester, MA

CIRCLE NO. 398

Relays

Reed, general-purpose, sensitive, power, hybrid and solid-state relays are covered in a 24-page catalog. Also included are opto-isolators and photoelectric control components. Sigma Instruments, Braintree, MA

CIRCLE NO. 399

High power amplifiers

Solid-state Class-A linear high-power amplifiers for general rf and microwave laboratory test applications are featured in a two-page data sheet. Microwave Power Devices, Plainview, NY

CIRCLE NO. 508

LEDs

Nine data sheets describe discrete LED lamps and panel-mounting hardware. Each sheet details a separate CM Series, showing features, optical specs, dimensional drawings and electrical characteristics. Key tradeoff characteristics are displayed in graph form. Chicago Miniature Lamp, Chicago, IL

CIRCLE NO. 509

IC technology textbook

The 7th edition of the "Basic Technology" textbook on ICs is written to provide an in-depth look at the industry and the latest IC production techniques. The 600-page volume contains over 500 photographs, figures and charts. The book costs \$150 plus shipping. Integrated Circuit Engineering, 6710 E. Camelback Rd., Suite 211, Scottsdale, AZ 85251

INQUIRE DIRECT

Bicentennial Issue

Electronic Design 4

\$4
JUST
SUPPLY LIMITED

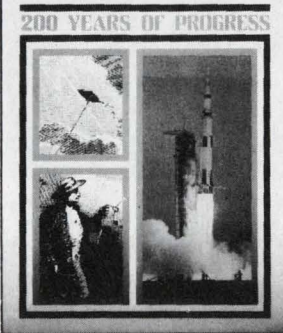

We've saved a limited number of copies of the unique 254-page February 16th Bicentennial issue of *Electronic Design*. It traces the historic and technological developments of the electronics industry from the Colonial period to today.

In a message from the White House published in the Bicentennial issue, President Ford commends the issue as "a special part" of our nation's 200th anniversary.

If you'd like an extra copy as a memento of this historic event, we'll be happy to provide it at \$4.

Hurry! When the supply runs out you'll have to wait another hundred years for anything like it!

Bicentennial Issue Electronic Design

Hayden Publishing Company, Inc.
50 Essex St., Rochelle Park, N.J. 07662

Please send me _____ copy (copies) of *Electronic Design's* February 16 Bicentennial issue at \$4 each. I enclose my check for _____.

Name _____

Title _____

Company _____

Address _____

THE COMPLETE PORTABLE DVM

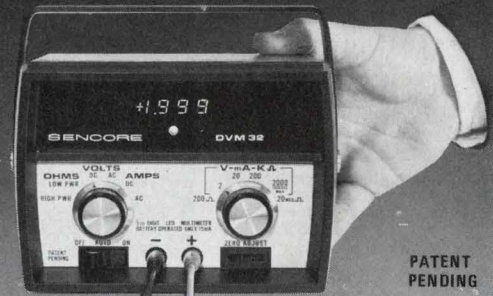

\$198
Lab ordering and optional AC adaptor

PATENT PENDING

■ **IT'S PORTABLE**
FOR BENCH OR FIELD...

COMPACT & LIGHTWEIGHT, (Only 2 1/4 lbs with batteries.) Fits in any tool box or tube caddy.

DROP-PROOF with tough Cyclocase® case that will stand up to any field use.

BURN-OUT-PROOF up to 2000V DC. Saves you from costly downtime.

VERSATILE 3-WAY POWER: Standard "C" cells, rechargeable "C" cell Nicads or line operation. (No special built-in, recharger pack. Standard "C" cells for the DVM32 for true portability.) And you'll get up to 10 times the battery life with the DVM32, using the patent pending *auto-off* that turns off the bright L.E.D. displays between measurements. The DVM32 is truly portable.

■ **IT'S COMPLETE**
FOR ANY JOB...

Most portable DVM's sacrifice functions, features, or accuracy. Not the DVM32. *HIGH ACCURACY* Accurate with full 3 1/2 digit readout, .5% of reading accuracy and 15MegΩ input impedance. *COMPLETE FUNCTIONS AND RANGES*: From 1mV to 1999V DC, 1mV to 1000V AC rms, .1 ohm to 19.99 MegΩ and 1uA to 1.999A, AC, and DC, plus Hi and Lo power ohms. The DVM32 . . . complete and versatile measuring capabilities in a truly portable meter.

IN STOCK NOW AT YOUR LOCAL SENCORE FULL LINE DISTRIBUTOR

DVM32 backed by SENCORE'S 100%
MADE RIGHT LIFETIME GUARANTEE

SENCORE 3200 Sencore Drive, Sioux Falls, S.D. 57107
Phone: 1 605 339-0100 TWX: 910-660-0300

CIRCLE NUMBER 116

KNOB KNOW-HOW

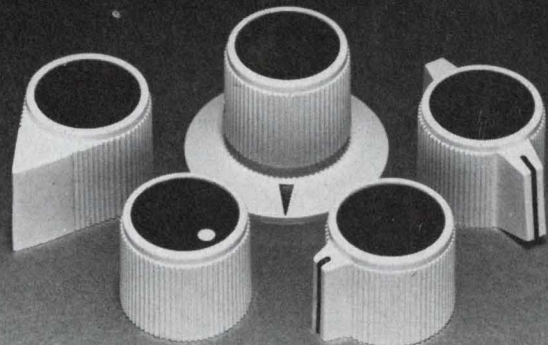

We know how to build quality and attractive styling into our knobs & dials. We've been doing it for more than 30 years.

ROGAN CORPORATION

Telephone (312) 498-2300
3455 Woodhead Drive, Northbrook, Illinois 60062

CIRCLE NUMBER 117

MAGNALOX™ INJECTION MOLDED MAGNETS

More Than Magnets!

Think in terms of complex shapes: gears, cams, bobbins, rotors, thin sections... whatever turns you on.

One of these Magnalox applications may trigger an idea for you. If you're already thinking injection molded magnetics, call Xolox. We have good news for you!

(A) Biasing a reed switch by making the bobbin a permanent magnet eliminates the usual separate magnet. This improved the design and lowered cost.

(B) Combining a solid state switch and a magnetized rotor gives you a position/speed sensor with digital output from DC to 100 Kilohertz. (Up to 30 pulse/inch of rotor dia.). Curves and data using Honeywell or Sprague switches available.

(C) A single Magnalox molding with integral poles makes a simple reed switch commutator. The one illustrated was formerly produced using two separate horseshoe magnets and a die-cast holder.

Now For Your Application

WE CAN HELP WITH TECHNICAL ASSISTANCE AND PROTOTYPES

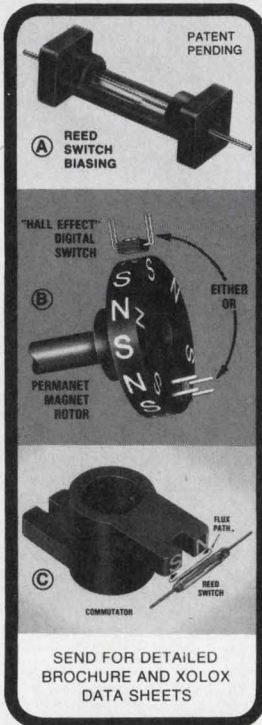

XOLOX CORPORATION

Phone (219) 432-0661
6930 Gettysburg Pike
Fort Wayne, Indiana 46804

CIRCLE NUMBER 119

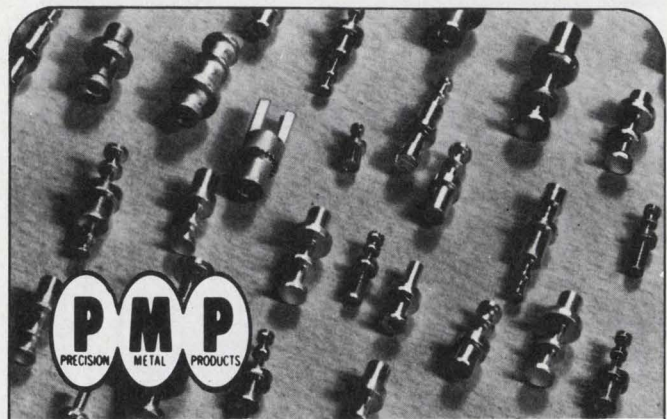

SOLDER TERMINALS

low prices, fastest delivery, highest quality...and more standards in stock than anyone!

More than 25 years of know-how, the broadest line of standards in the industry, a complete selection of plating options... it all adds up to savings in costs and on-time deliveries everytime. Got a special? Send us your print and we'll respond instantly with price and delivery information that will please and surprise you. Call us today.



PRECISION METAL PRODUCTS CO.

41 ELM ST., STONEHAM, MASS. 02180
Telephone: (Area Code 617) 438-3650

CIRCLE NUMBER 121

Free!

Power advantage... economic advantage. Get full details on the energy future... new Gates rechargeable, sealed lead-acid batteries. Send today for our free, informative brochure containing exclusive battery features, application information, ratings and specifications. Find out what this new third-generation energy cell could mean to your design work.



Yes! I would like to know more about these new energy cells. Please send free information.

Name _____

Title _____

Company _____

Address _____

City, State, Zip _____

Mail to: George Sahl,
Gates Energy Products, Inc.
1050 S. Broadway, Denver CO 80217



ED 36

Where the energy future is now

CIRCLE NUMBER 120

WHEN IT'S TIME FOR A SWITCH...

It's time for Shigoto. Because every Shigoto switch is backed by solid engineering know-how. A reliable piece of equipment you can count on. To perform every time. We've got toggle and rocker, lever and leaf, push button, panel, rotary, radio, knife, slide and snap action switches. All sizes, all ratings. Leaf through our Catalog and pick the switch that's compatible with your requirements. If we haven't already made it, we can, specially for you. And while you're at it, check out our other outstanding O.E.M. components, too.

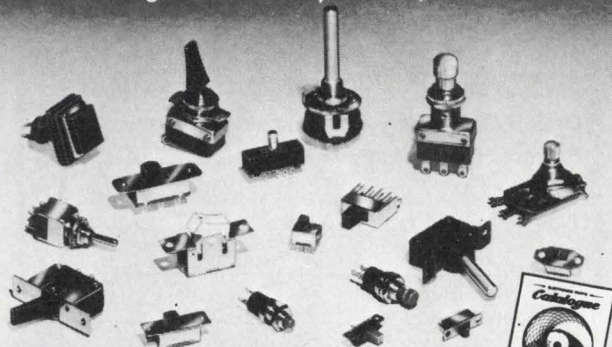

SHIGOTO. A STANDARD FOR INDUSTRY

Write or phone for our catalog and more information

Shigoto Industries Ltd.

350 Fifth Ave., N.Y., N.Y. 10001/(212) 695-0200/Telex 224219
One of the World's Largest Manufacturing Importers

CIRCLE NUMBER 122

ELECTRONIC DESIGN 6, March 15, 1976

NEW LITERATURE

Discrete semi chips

Discrete silicon transistors, diodes and zener diode chips for use in thick and thin-film hybrid circuit applications are shown in an eight-page catalog. Sprague Electric, North Adams, MA

CIRCLE NO. 510

Gaussmeters

Analog and digital gaussmeters plus optional accessories are described in an eight-page brochure. RFL Industries, Boonton, NJ

CIRCLE NO. 511

Components

650 pages of components from over 90 manufacturers are assembled in the Cramer Buyer's Guide. Items ranging from semiconductors to meters, batteries and tools are included. Cramer Electronics, Newton, MA

CIRCLE NO. 512

IC components

Descriptions, dimensions and part numbers for all major categories of IC and DIP components are included in a 56-page catalog. Circuit Assembly, Costa Mesa, CA

CIRCLE NO. 513

Linear interface circuits

A 36-page revised and updated linear integrated circuits brochure describes over 130 circuits that bridge the gap between otherwise incompatible devices and device families to ease the development of high-performance electronics systems. Motorola, Semiconductor Products Div., Phoenix, AZ

CIRCLE NO. 514

Potentiometer handbook

"The Potentiometer Handbook" contains nine fact-filled sections—from an introduction to pots to packaging guidelines. The 320-page illustrated handbook costs \$14.50. For more information on this handbook circle the number below. Bourns, Riverside, CA

CIRCLE NO. 515

Bulletin Board

During a special promotion, purchasers of Hewlett-Packard's HP-65 fully programmable pocket calculators will receive \$195 worth of applications software free. The offer is good until April 30, 1976 in the domestic U.S. only.

CIRCLE NO. 516

Diablo Systems has announced two optional features for its HyType II serial printers—"Paper-Out" and "Ribbon-Out" signals—designed to help users get higher efficiency and printer use.

CIRCLE NO. 517

Precision Monolithics has taken major steps to increase availability of its Superior Second Source 1408A/1508A d/a converter. The device was specially designed to provide all the benefits of the 1408/1508 with the addition of faster settling time (250 ns) and lower power consumption (157 mW).

CIRCLE NO. 518

Motorola and AMI have announced that their second-source agreement on the M6800 family of components is extended for a period of two years.

CIRCLE NO. 519

NCR has announced software designed to simplify and speed the development of on-line systems using the NCR 796-031 visual display terminal. The software is designed to overcome two difficult problems: design of CRT screen formats and interfacing to an on-line communications driver.

CIRCLE NO. 520

ECSSL is Electronic Associates' integrated hybrid programming system that provides for equation-oriented specification of continuous system simulation models and the automated setup, checkout and operation of modern hybrid computing equipment.

CIRCLE NO. 588

... so I said ... OK, show me a switching power supply with the brains to perform reliably in my environment, where others have failed

TODD'S SW SERIES FEATURES:

- High efficiency. Greater than 75%.
- Most reliable.
- Complete range of outputs thru 48V and currents to 120 Amps.
- Lowest price.
- Full 5 year warranty.

Start getting your moneys worth. Write or call for complete information today.

TODD PRODUCTS CORP.

123 Milbar Blvd., Farmingdale, N.Y. 11735. (516) 293-3440.

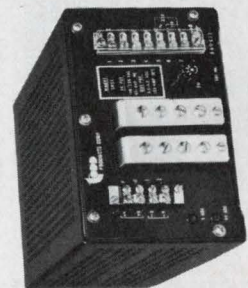

CIRCLE NUMBER 123

Design Data from Manufacturers

Advertisements of booklets, brochures, catalogs and data sheets. To order use Reader-Service Card
(Advertisement)

Electronic Design

ELECTRONIC DESIGN's function is:

- To aid progress in the electronics manufacturing industry by promoting good design.
- To give the electronic design engineer concepts and ideas that make his job easier and more productive.
- To provide a central source of timely electronics information.
- To promote communication among members of the electronics engineering community.

Want a subscription? ELECTRONIC DESIGN is sent free to qualified engineers and engineering managers doing design work, supervising design or setting standards in the United States and Western Europe. For a free subscription, use the application form bound in the magazine. If none is included, write to us direct for an application form.

If you do not qualify, you may take out a paid subscription for \$30 a year in the U.S.A., \$40 a year elsewhere. Single copies are \$1.50 each.

If you change your address, send us an old mailing label and your new address; there is generally a postcard for this bound in the magazine. You will have to requalify to continue receiving ELECTRONIC DESIGN free.

The accuracy policy of ELECTRONIC DESIGN is:

- To make diligent efforts to ensure the accuracy of editorial matter.
- To publish prompt corrections whenever inaccuracies are brought to our attention. Corrections appear in "Across the Desk."
- To encourage our readers as responsible members of our business community to report to us misleading or fraudulent advertising.
- To refuse any advertisement deemed to be misleading or fraudulent.

Microfilm copies are available of complete volumes of ELECTRONIC DESIGN at \$19 per volume, beginning with Volume 1, 1952 through Volume 20. Reprints of individual articles may be obtained for \$3.00 each, prepaid (\$5.00 for each additional copy of the same article) no matter how long the article. For further details and to place orders, contact the Customer Services Department, University Microfilms, 300 North Zeeb Road, Ann Arbor, Michigan 48106 telephone (313) 761-4700.

Want to contact us? If you have any comments or wish to submit a manuscript or article outline, address your correspondence to:

Editor
ELECTRONIC DESIGN
50 Essex Street
Rochelle Park, N.J. 07662

GIANT FREE CATALOG

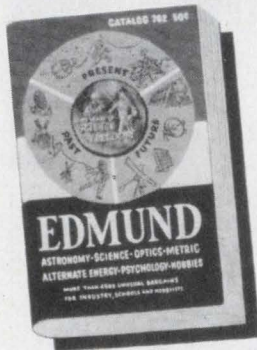

New 172-page catalog! Packed with 1,000's of hard-to-find buys in Optics, Science, Electronics. Loaded with optical, scientific, electronic equipment available from stock. Rare surplus buys. Many "one-of-a-kinds". Ingenious scientific tools. Components galore: lenses, prisms, wedges, mirrors, mounts, accessories. 100's of instruments: pollution test equipment, lasers, comparators, magnifiers, microscopes, projectors, telescopes, binoculars, photo attachments, alternate energy sources. Shop, save by mail! Request free Catalog "DA".

Edmund Scientific Co.

America's Largest Science-Optics-Electronics Mart
300 Edscorp Bldg., Barrington, New Jersey 08007 (609) 547-3488

CIRCLE NO. 274

Real Time Spectrum Analyzer Provides Simultaneous On-Line and Averaged Displays

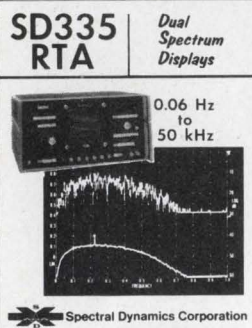

The new SD335's built-in scope and dual memory display instantaneous (on-line) frequency spectra with averaged spectra (up to 1024 ensembles) from 0.06 Hz to 50 kHz, while overall RMS level of input data appears at right of screen. Its 500-line resolution, 10 analysis ranges, greater than 60 dB dynamic range, and 5-digit readout of frequency and amplitude (linear or log) provide instant identification for even the smallest signals hidden in noise. Unique harmonic cursor automatically places an intensified dot on each integer harmonic of a selected fundamental component. SIMULPLOT feature allows simultaneous viewing and X-Y plotting under complete analyzer control. Instrument is specially designed for noise, vibration and communication systems analysis.

Spectral Dynamics Corporation

P. O. Box 671, San Diego, CA. 92112
(714) 565-8211

CIRCLE NO. 275

Are you using the #1 training courses in electricity & electronics?

BASIC ELECTRICITY and BASIC ELECTRONICS

By Van Valkenburgh, Nooger & Neville, Inc.

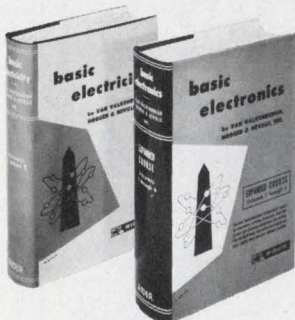

Derived from the COMMON-CORE Training Program initially developed for the U.S. Navy, these unique texts are now about to enter their third decade of use in schools, industries, and communication utilities. They continue to be exemplary training texts in their subjects. Carefully integrated illustrations comprise almost half the course material. These perform a remarkable job of visualizing complex theory and applications. Readers are able to grasp essential concepts right away without having to wade through pages of wordy explanation. Thorough, comprehensive coverage. Available in separate paperbacks or one cloth volume. Write for FREE brochure.

Hayden Book Company

50 Essex St. Rochelle Pk, N.J. 07662

CIRCLE NO. 276

Electronic Design

Advertising Sales Staff
Tom W. Carr, Sales Director

Rochelle Park, NJ 07662
Robert W. Gascoigne
Daniel J. Rowland
50 Essex Street
(201) 843-0550
TWX: 710-990-5071

Philadelphia
Thomas P. Barth
50 Essex Street
Rochelle Park, NJ 07662
(201) 843-0550

Boston 02178
Gene Pritchard
P.O. Box 379
Belmont, MA 02178
(617) 489-2340

Chicago 60611
Thomas P. Kavooras
Berry Conner, Jr.
200 East Ontario
(312) 337-0588

Cleveland
Thomas P. Kavooras
(Chicago)
(312) 337-0588

Los Angeles 90045
Stanley I. Ehrenclou
Burt Underwood
8939 Sepulveda Boulevard
Los Angeles, CA
(213) 641-6544

Texas/Oklahoma
Burt Underwood
(Los Angeles)
(213) 641-6544

San Francisco 94040
Robert A. Lukas
3579 Cambridge Lane
Mountain View, CA 94040
(415) 965-2636

London, Amsterdam, Tokyo, Seoul
Malcolm M. Thiele
Wood Cottage, Shurlock Row
Reading RG 10-QE, England
Phone: Shurlock Row 302 &
619
S.T.D. 073 581

Sanders B.V.
Raadhuisstraat 24
Graft-De Ryp, Holland
Phone: 02997-1303
Telegrams: Euradteam-Am-
sterdam

Haruki Hirayama
Electronic Media Service
5th Floor, Lila Bldg.,
4-9-8 Roppongi
Minato-ku, Tokyo, Japan
Phone: 402-4556
Cable: Electronicmedia, Tokyo

Mr. O-kyu Park, President
Dongbo Intl Corp.—
World Marketing
C.P.O. Box 4010
Seoul, Korea
Tel. 76-3910/3911
Cable: DONGBO SEOUL
Telex: EBKOREA K27286

ABP

BPA

Send us 2 Bucks*
—Get a sample

Miniature SOLID STATE BUZZER



L'I'L **EARSPLITTER**

with big, rich sound

High reliability in a compact elec-
tronic buzzer. 3, 6, 9, 12, 24 volts.
Very low current consumption; no
arcing contacts, no RF noise.

Write for bulletin ED-376 today!

KOLIN INDUSTRIES, INC.

Manufacturers of Electronic
Warning Signals and Alarm Devices

59-B3 West Pondfield Rd.
Bronxville, N.Y. 10708
(914) 961-5065 Telex: 137453

*\$1.99 list; lower in quantity

CIRCLE NUMBER 124

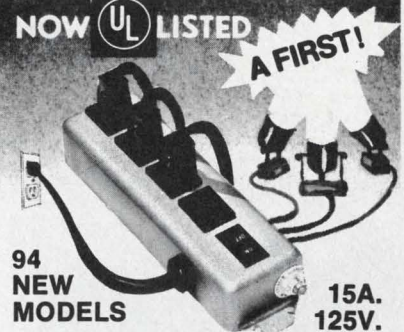

94
NEW
MODELS

15A.
125V.

SGL WABER®

**FIRST
UL LISTED**
Line of temporary
POWER TAPS

- CIRCUIT BREAKER PROTECTION
- EXCEEDS NEC REQUIREMENTS
- HELPS MEET OSHA STANDARDS

Send For
FREE CATALOG

SGL WABER Electric

A division of SGL INDUSTRIES, INC.

303 HARVARD AVENUE
Westville, N.J. 08093

CIRCLE NUMBER 125

classified ads

manufacturers representatives

Air Moving Devices & Equipment

Manufacturers Representatives to sell Air Moving Devices to Electronics, Business Machine and Aerospace Markets in:

Pennsylvania, New Jersey, Southeastern & Middle Atlantic States

Representatives with prior experience in air moving or those presently handling electromechanical devices for sale to above markets.

Must be able to sell to both engineering and purchasing personnel.

Principal is an established leader in air moving product lines seeking to expand its marketing force. *An equal opportunity employer m/f*

Write stating background and interest to:

BOX #CK

HAYDEN PUBLISHING COMPANY
50 ESSEX STREET
ROCHELLE PARK, NJ 07662

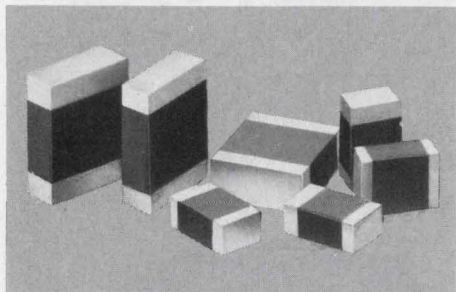

HIGH Q MULTILAYER CAPACITORS feature very high quality factors at microwave frequencies. Offered in three standard sizes: .050 x .040, .080 x .050, .125 x .095. Capacitance values from 0.1 pf to 1000 pf with close tolerance and voltages to 1000 VDCW. Johanson/Monolithic Dielectrics Div., Box 6456, Burbank, Ca. 91510, (213) 848-4465.

MULTILAYER CHIP CAPACITORS 251

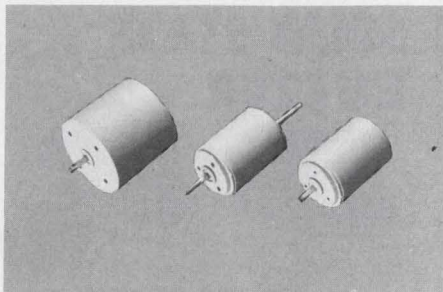

MINIATURE IRONLESS ROTOR DC MOTORS offer efficiencies to 80%, low inertia, rapid response and high starting torque. 24 and 12 VDC models available. Motor time constants are 17 and 23 MS respectively. Rotor torque is 100 and 50 gcm and starting torque 600 and 230 gcm, respectively. 12 VDC units can be ordered with either a single or extended double shaft. Tach versions also available. For reel and capstan drives, chart and pen drives, etc. North American Philips Controls Corp., Cheshire, Conn. 06410. (203) 272-0301.

IRONLESS ROTOR 254

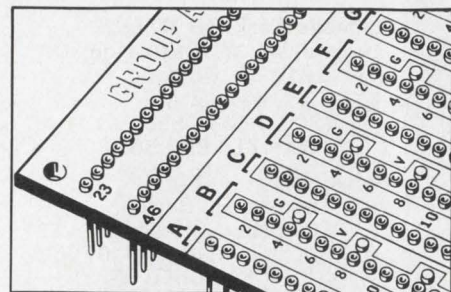

STANDARD IC PANELS, Available right now from AMP. And they're backed by AMP technical assistance that's second to none. Universal 1 thru 8 bay assemblies and 30 x 60 position with I/O sockets or edge card fingers. Call (717) 564-0100, or write: AMP Incorporated, Harrisburg, Pa. 17105.

STANDARD IC PANELS 257

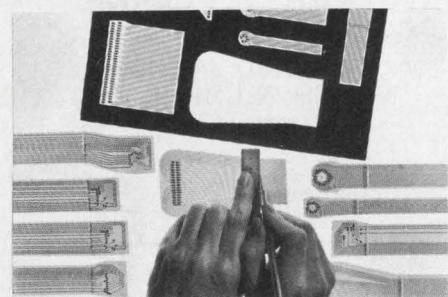

PROTOTYPE YOUR OWN FLEXIBLE CIRCUITS Exacto knife, soldering iron, plus our kit make all circuits shown—and more! Kit includes sheet of 1 oz. copper conductors on 1 mil polyimide film, plus matching sheets with about 15 connector patterns. 100's of combinations possible. . . . Easy instructions, parts list, dimensional drawings included. Flexible Circuit Kit, \$25 from stock. Rogers Corporation, Chandler, AZ 85224 (602) 963-4584.

FLEXIBLE CIRCUITS KIT 252

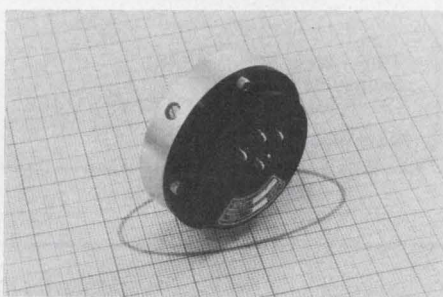

LOW COST PENDULUM CP17-0601-1 provides vertical references for monitoring and control of pitch and roll angular displacements. Replaces expensive vertical gyros for many instrument and control system applications. Potentiometric output; hermetically sealed; fluid damped; range of $\pm 45^\circ$; resolution less than 0.20%; linearity within 0.5; total error band of $\pm 1\%$ full scale. Wide range of models available. Humphrey, Inc., 9212 Balboa Ave., San Diego, CA 92123. Tel. (714) 565-6631

PENDULUM 255



SPEED LEAD BENDING OPERATIONS. Cut costs by 50%! Fast, exact, thumbwheel control adjusts to precise measurements. Match pointers with eyelet holes in circuit boards by adjusting knurled wheel with thumb, automatically spacing bends for insertion of component into boards. All axial lead components accommodated. From $\frac{1}{2}$ " x $1\frac{1}{2}$ " long with max. distance between inside of bends of 1.725". Harwil Co., 903 Colorado Ave., Santa Monica, Ca. 90401. (213) 394-4710.

COMPONENT LEAD BENDER 258

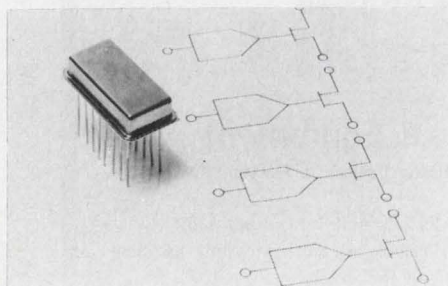

ULTRA-HIGH SPEED QUAD ANALOG GATE The CAG-49 functions as four analog switches for the price of two. Features include: four switches in one compact package; ton, typ. 12 nS; low on resistance, typ. 35 ohms. Ideal for high speed store and hold and sign analog gating applications. Samples on request. Price: \$85., 1-99; \$62., 100-999. Teledyne Crystalonics, 147 Sherman Street, Cambridge, MA. 02140. (617) 491-1670.

CAG-49 QUAD ANALOG GATE 253

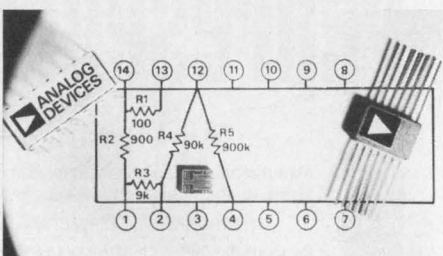

Low Cost Decade Divider: The AD1802 low cost divider offers decades of 10,000:1, 1,000:1, 100:1 and 10:1 in 14 DIP ("D"), FLATPAK ("F") and in a 4.064mm x 5.334mm chip ("C"). Operating range -55°C to $+125^\circ\text{C}$ with "S" (0.1%) and "U" (0.01%) ratio accuracies. Optional processing to MIL-STD-883A, Class B. Price "S" in 100's (DIP) \$2.80. Analog Devices, Norwood, Mass. 02062 617-329-4700.

LOW COST DECADE DIVIDER 256

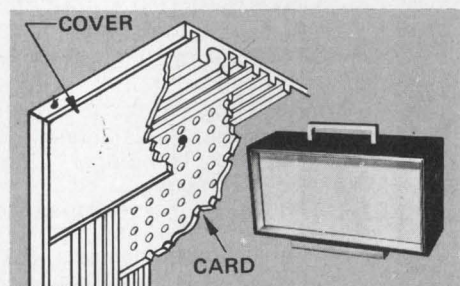

Vector's Multi-Mod Cases For Packaging Excellence—Beautiful satinized aluminum with continuous internal slots for screwless mounting of circuit boards. Low priced painted or anodized models from stock, beginning at \$3.09. Widths from 1.6 in. to 4.5 in. for panels from 2.20 in. x 3.70 in. to 9.88 in. x 6.50 in. Write Vector Electronic Co., Inc., Dept. MM, 12460 Gladstone Avenue, Sylmar CA 91342.

MULTI-MOD CASES 259

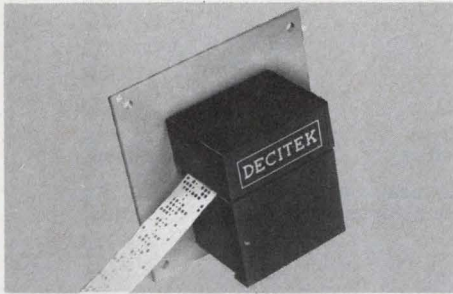

Low-cost tape reader is fast—up to 300 cps—and quality-built. Dual sprocket drive, a state-of-the-art fiber optic light source and photo transistor read head. Simplicity of design makes it easy to adapt to specific OEM requirements. Decitek, 250 Chandler Street, Worcester, MA 01602 (617) 798-8731

SAM® TAPE READER

260



over 500 systems, detectors, controls, sounders, tools, locks, supplies

FREE ALARM catalog. Huge selection of hard-to-find security equipment from stock. Highest quality burglar-fire systems, supplies, to protect home, business, industry: motion detectors, infrared beams, ultrasonics, radar, magnetic contacts, smoke & heat detectors, controls, door switches, bells, sirens in 96 fact-filled pages with technical details, diagrams, notes. (Outside U.S. send \$1). Mountain West Alarm, 4215 N. 16th St., Phoenix, AZ 85016 (602) 263-8831.

SECURITY ALARM CATALOG

263

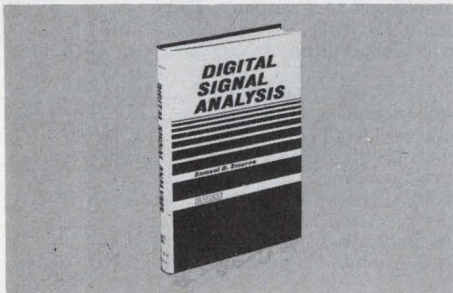

DIGITAL SIGNAL ANALYSIS, S. Stearns. Contains the most recent advances, brand-new design material, and a comparison between continuous and digital systems, making it an ideal master reference to today's signal processing techniques and systems. #5828-4, 288 pages, \$18.95. Circle the Info Retrieval Number to order 15-day exam copy. When billed, remit or return book with no obligation. Hayden Book Co., 50 Essex Street, Rochelle Park, N.J. 07662.

DIGITAL SIGNAL ANALYSIS

261

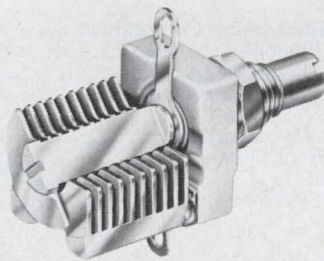

Small, high capacity Type V air variable capacitors. Printed circuit and panel mount types mount in less than 0.3 sq. in. Rotors and stators machined from solid brass extrusions provide reliability and stability. Metal parts are silver-plated and Iridited. Ceramic is steatite. High torque (2-1/2 to 10 oz./in.) Low temperature coefficient (+50 ±20 ppm/°C). Uniform delta C and voltage characteristics. E.F. Johnson Co., Waseca, Mn., 56093. (507) 835-5222

TYPE V CAPACITORS

264



ALTERNATE SOURCE DC-DC CONVERTERS. Three watt DC-DC converters are now available in the most popular configuration from Reliability. Inputs of 5, 12, 24, 28 volts DC and outputs of 5v @ 600 ma, ±12v @ ±125 ma, and ±15v @ ±100 ma. Reliability, Inc., 5325 Glenmont, Houston, TX 77036. Phone 713-666-3261.

DC-DC POWER SOURCE

262

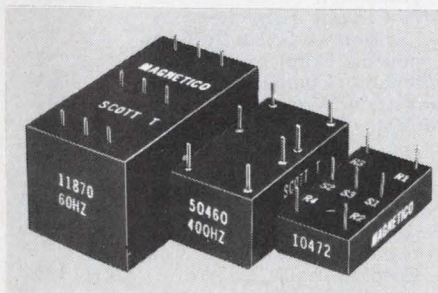

Scott T Transformer. 11870: 60HZ, 90v, L-L in. 1.1x2.1x1.1. 50460: 400 HZ, 90v, L-L in. 7/8x1-5/8x11/16. 50642: 400HZ, 11.8v, L-L in. 7/8x5/8-11/16. 10472: 400-HZ, 11.8v, L-L in. 3/4x1-1/2x3/8. All with 6v RMS sine & cosine output. MAGNETICO, INC., 182 Morris Ave., Holtsville, N.Y. 11742 516-654-1166.

TRANSFORMER

265

Advertisers wishing to reserve Quick Ad units should note the following mechanical requirements: Specs—Supply glossy photo of product and approximately 40 words which will set no more than 10 lines of 34 characters each. AFTER SUBMISSION NO COPY CHANGES CAN BE ACCEPTED. Quick Ads cost only \$325 per insertion, less for frequency advertisers.

RATES:

1x
\$325

7x
\$300

13x
\$275

19x
\$270

26x
\$265

39x
\$260

52x
\$255

104x
\$250

We want to break up your marriage.



You and your
SMA supplier —
maybe you've
been a twosome
long enough.

Now there's an alternative—Amphenol[®] SMA's. You can't get better SMA connectors than Amphenol SMA's. They operate at all microwave frequencies up to 25 GHz. RF performance and mechanical integrity comply with MIL-C-39012. They're easy to assemble with either crimp or solder connections. And our quality will give you a change of heart: all shell and body parts are gold-plated stainless steel. The center contact is gold-plated beryllium-copper. The dielectric is solid TFE, making Amphenol SMA's completely interchangeable with your present source.

Our price will make you want to change partners. When you hear our price, you'll know Amphenol SMA's are the best value around. So ask for a quote.

There's a big selection of popular types. Including styles for cable mounting, flange and bulkhead mounting, and stripline mounting. We also offer between-series adapters.

And Amphenol SMA's are available. Wherever you are. Your Amphenol Industrial Distributor can fix you up with the SMA connectors you need, by giving you fast off-the-shelf service. He's close to you (there are over sixty Amphenol Industrial Distributors—nationwide). Give him a ring (on the phone, not the finger). Or for more information, write or call us: Bunker Ramo RF Division, 33 East Franklin Street, Danbury, Connecticut 06810. (203) 743-9272.



*When you can connect it
and forget it...that's quality.*

AMPHENOL CONNECTORS FROM

CIRCLE NUMBER 285

**BUNKER
RAMO**

What's new in solid state...

The RCA 1800 μ P has what you want: CMOS, simplicity, low cost.

Unlike the typical 8-bit microprocessor, the RCA 1800 COSMAC has simple architecture. Which makes it easy to understand. And low in cost. Yet it offers tremendous flexibility—thanks to powerful built-in I/O and an ability to accept virtually any I/O device.

Memory economy

Simple architecture allows compact 1-byte instructions: less to store, less to fetch—which means fewer bytes to buy. Individual instructions don't need addresses because registers act as pointers. One even acts as a built-in DMA—an RCA first.

System cost effectiveness

How many other microprocessors give you the economy of one power supply? And a single-phase clock? With RCA 1800 you can use 3-15 V unregulated and save weight as well as money.

CMOS adaptability

Low power comes, of course, as a CMOS dividend. So does wide supply tolerance, allowing battery operation. You also get -55°C to $+125^{\circ}\text{C}$ operation, minimizing cooling costs. And tolerance of noise up to 45% of supply voltage, typical.

These, plus comprehensive design support, are good reasons why the RCA 1800 series is coming on strong. Reasons why you should consider it now—for applications of today and tomorrow.

For more information, contact your local RCA Solid State distributor. Or RCA.

Write: RCA Solid State, Box 3200, Somerville, New Jersey 08876; Ste. Anne de Bellevue 810, Canada; Sunbury-on-Thames, U.K.; Fuji Bldg., Tokyo, Japan.

RCA

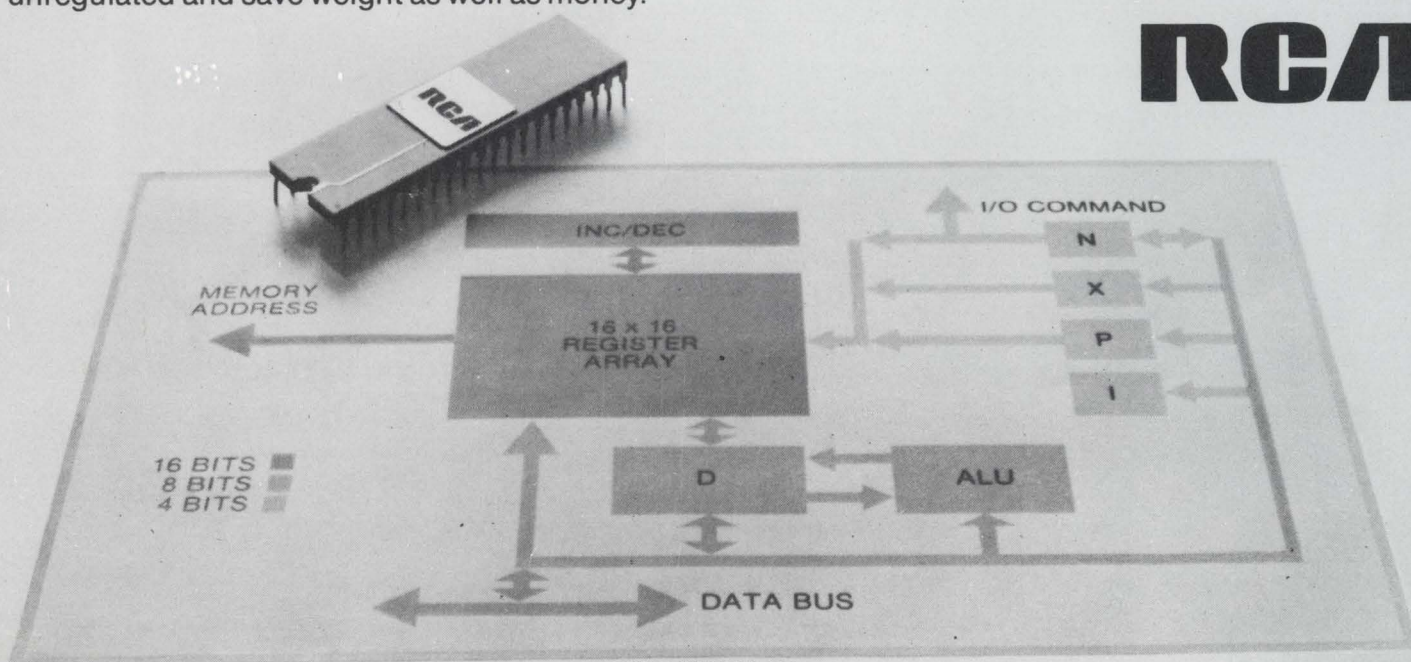

CIRCLE NUMBER 286

RCA 1800. Low-cost approach to microprocessing.