

# Electronic Design <sup>®</sup> 6

VOL. 23 NO.

FOR ENGINEERS AND ENGINEERING MANAGERS

MARCH 15, 1975

**Solid-state technology** is having an increasing world-wide impact. Minicomputers, pocket calculators and communications satellites are just a few of the products made

possible by advances in signal processing techniques, high-speed logic, memories, optoelectronics and microwave devices. A report on solid state begins on page 22.

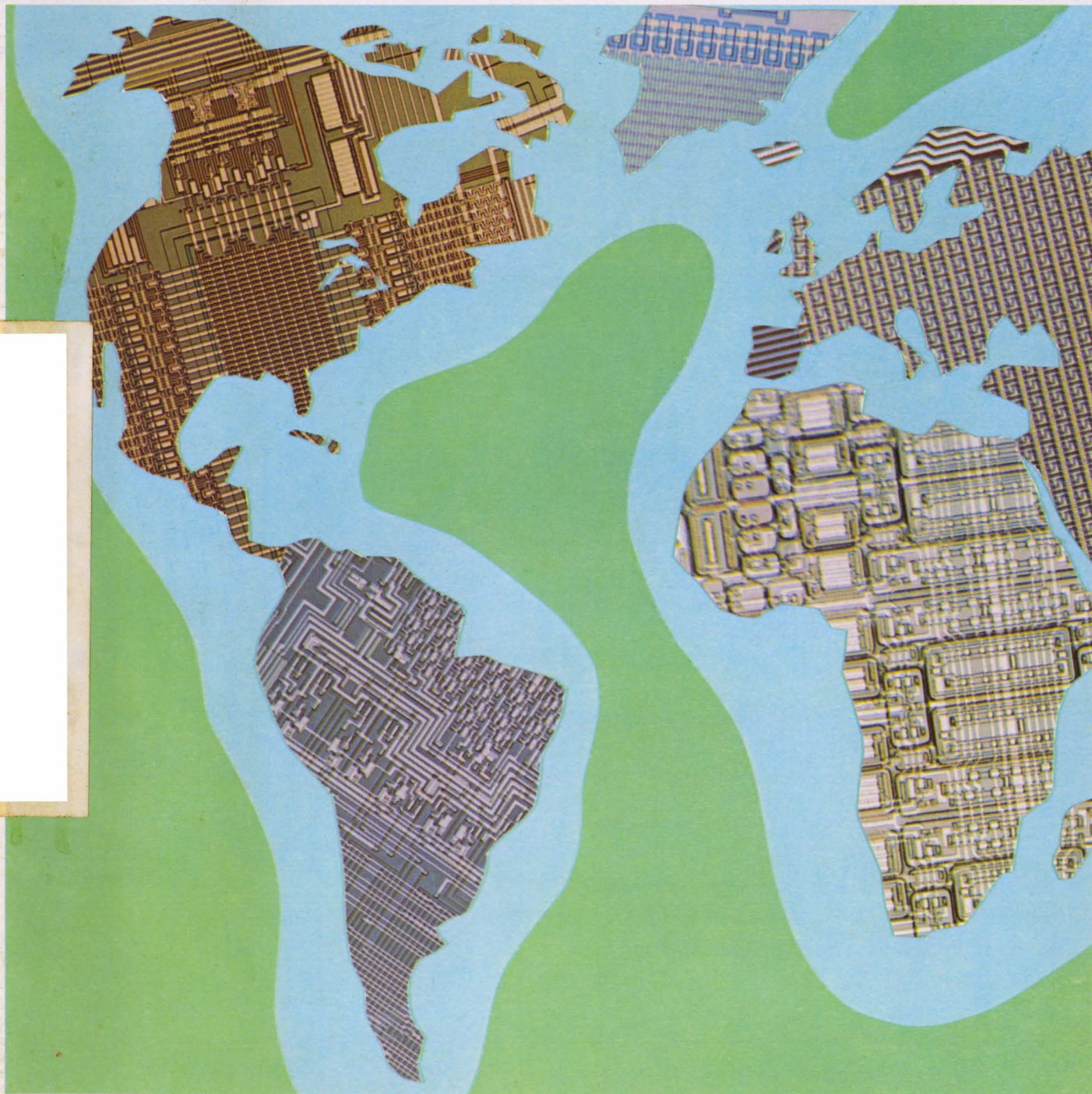



# ultra-miniature transformers

## 1/4" X 1/4"

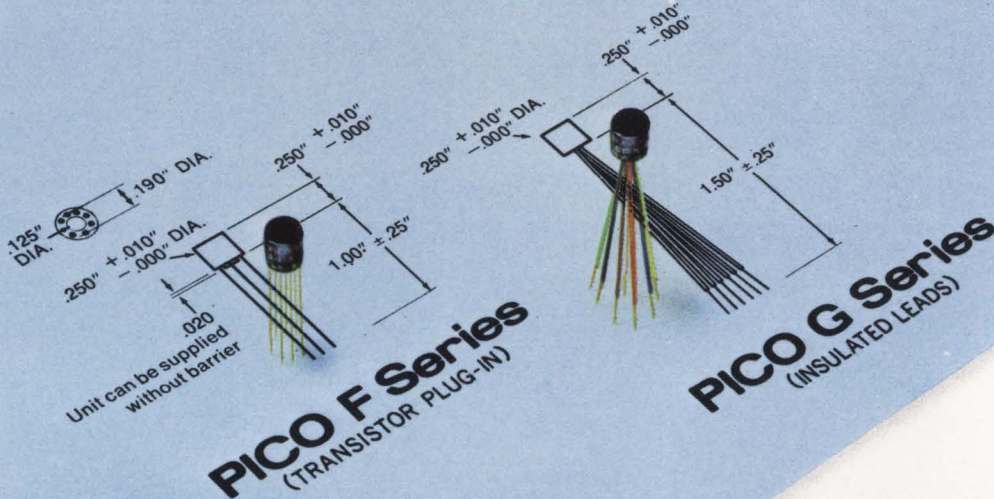

### SPECIFICATIONS

- **MIL-T-27D:** All Units Are Designed to MIL-T-27D and Are Hermetically Sealed in a Metal Case. PICO is a QPL source.
- **Frequency Response:**  $\pm 3$  db, 400 Hz-250 KHz at 1.0 milliwatt.
- **Maximum Distortion:** 5% With Rated Power Level at 1 KHz.
- **Dielectric Strength:** All Units Tested at 200 V RMS.
- **Insulation Resistance:** Greater than 10,000 Megohms at 300 V DC.
- **Weight:** 1.1 GRAMS.
- **Operating Temperature:**  $-55^{\circ}\text{C}$  to  $105^{\circ}\text{C}$  (All Units Can Be Supplied to Class S Requirements  $130^{\circ}\text{C}$  maximum).
- **Terminals:** .012 Diameter Gold Plated Dumet Wire In Accordance With MIL-STD-1276 Type D. Leads May Be Welded or Soldered.
- **Thermal Shock:** 25 Cycles, Method 107C, MIL-STD-202D, Test Condition A-1

PICO PART NUMBER F Series	PICO PART NUMBER G Series	PRIMARY IMPEDANCE OHMS	SECONDARY IMPEDANCE OHMS	PJWER MILLIWATTS at 1 KHz	PRIMARY UNBALANCED DC CURRENT ma	PRIMARY DC RESISTANCE OHMS	SECONDARY DC RESISTANCE OHMS	MILITARY DESIGNATION
F5705	G6005	50	50	100	5.0	7.5	9.0	TF5RX17ZZ
F5710	G6010	100	100	100	5.0	15	18	TF5RX17ZZ
F5715	G6015	120 ct	3.2	100	4.5	15	0.75	TF5RX17ZZ
F5720	G6020	150 ct	12 split	100	4.0	20	2.4	TF5RX17ZZ
F5725	G6025	300 ct	600 split	100	3.0	40	90	TF5RX17ZZ
F5730	G6030	400 ct	400 split	100	2.5	54	58	TF5RX17ZZ
F5735	G6035	500 ct	50 split	100	2.0	62	10	TF5RX17ZZ
F5740	G6040	500	600	100	2.0	62	90	TF5RX17ZZ
F5745	G6045	600 ct	600 split	100	2.0	70	90	TF5RX17ZZ
F5750	G6050	900 ct	600	100	1.5	130	90	TF5RX17ZZ
F5755	G6055	1K ct	1K split	100	1.5	110	140	TF5RX17ZZ
F5760	G6060	1.5K ct	600 split	100	1.2	175	69	TF5RX12ZZ
F5765	G6065	2K ct	8K split	80	1.0	200	1000	TF5RX12ZZ
F5770	G6070	10K ct	500 split	80	0.5	1000	60	TF5RX12ZZ
F5775	G6075	10K	500	80	0.5	1000	60	TF5RX12ZZ
F5780	G6080	10K ct	1 2K split	80	0.5	1100	160	TF5RX12ZZ
F5785	G6085	10K	1.2K	80	0.5	1100	130	TF5RX12ZZ
F5790	G6090	10K ct	2K split	80	0.5	1100	250	TF5RX12ZZ
F5795	G6095	10K ct	10K ct	80	0.5	1100	1100	TF5RX12ZZ
F5800	G6100	10K	10K	80	0.5	1100	1100	TF5RX12ZZ
F5805	G6105	10K ct	10K split	80	0.5	1100	1100	TF5RX12ZZ
F5810	G6110	25K ct	1K split	50	0.3	2100	130	TF5RX12ZZ
F5815	G6115	25K	1K	50	0.3	2100	130	TF5RX12ZZ
F5820	G6120	30K ct	1.2K	50	0.3	2300	180	TF5RX12ZZ

### Send today for PICO's Designers Kit!

PICO now offers a Designer's Kit containing ten (10) representational 1/4" x 1/4" transformers. The kit contains PICO's F5710 and G6025; F5730 and G6045; F5755 and G6065; F5770 and G6090; F5795 and G6110.

PICO's Designers Kit No. FG-100 . . . \$50.00 each

In addition to the 1/4" Series PICO offers  
over 600 other standard transformers to choose from.

Delivery—stock to one week... specials take a little longer—9 days.

Send for free 36 page catalog.

### INDUCTORS

PICO PART NUMBER F Series	PICO PART NUMBER G Series	INDUCTANCE HENRIES	DC CURRENT ma	DC RESISTANCE OHMS	MILITARY DESIGNATION
F5825	G6125	SERIES { 10.0 2.75 2.5	0 2 0	2250	TF5RX20ZZ
		PARALLEL { .65	4	560	
F5830	G6130	SERIES { 5.5 1.5	0 2	1000	TF5RX20ZZ
		PARALLEL { 1.3 .40	0 4	250	
F5835	G6135	SERIES { .85 .25	1 6	240	TF5RX20ZZ
		PARALLEL { .21 .06	2 12	60	
F5840	G6140	SERIES { .6 .15	0 5	144	TF5RX20ZZ
		PARALLEL { .15 .04	0 10	36	

## PICO Electronics, Inc.

50 South MacQuesten Pkwy., Mt. Vernon, New York 10551 • Telephone 914-699-5514

For immediate pricing and engineering information—call collect

INFORMATION RETRIEVAL NUMBER 252



If you've been looking for a function generator that plugs into an automatic system about as easily as it plugs into the wall, Wavetek is your stop. Our Models 152 and 159 are both ASCII coded and are fully compatible, which means they can be used with the new general-purpose instrumentation bus . . . and just about any computer. They also have pushbutton manual

controls if you'd rather keep them on the bench. Either way, you'll be able to see what's happening with the LED digital display panels.

Model 159 is a general-purpose low-cost function generator with programmable frequency, amplitude, offset and waveform. Its frequency range is 1 Hz to 3 MHz.

Model 152 provides two to

eight separate outputs, each with individually programmable phase, amplitude, waveform and offset. Frequency is programmable from 1 Hz to 100 kHz. For more information, contact Wavetek, P.O. Box 651, San Diego, CA. 92112. Telephone (714) 279-2200, TWX 910-335-2007.

**WAVETEK®**

INFORMATION RETRIEVAL NUMBER 2

# Buy our ASCII programmable function generators and you'll be ready for the bus.





# HP's New 5 Volt 100 Amp Switching Supply is Ready For the Most Important Test in the World...

# YOURS

We designed the Model 62605M Switching Supply to give the top performance and reliability demanded by today's OEMs. But, more importantly, you want to know exactly how it will perform for you, in your system. So check designs, examine the modular construction, put it through your own tests. We think you'll find the kind of conservative, sophisticated design and careful attention to detail that adds up to lasting product value.

Of course, the 62605M offers all the benefits of a technologically advanced 20KHz switching supply — high efficiency — small size — low heat dissipation. We've added important "standard" features like a soft-start circuit to hold down in-rush current, plus overvoltage and overcurrent protection. And, it's UL recognized.

The 62605M operates from 120/220/240 Vac, 48-63Hz, with 70% conversion efficiency. Regulation is 0.1%, with ripple and noise of 15mV rms, 50mV p-p. The supply measures 5"H x 8"W x 12"D, and weighs only 14 pounds.

There's a lot more, so get the complete story including the generous OEM and quantity discounts from your local HP Field Engineer.

HEWLETT  PACKARD

Sales and service from 172 offices in 65 countries.  
1501 Page Mill Road, Palo Alto, California 94304

21502

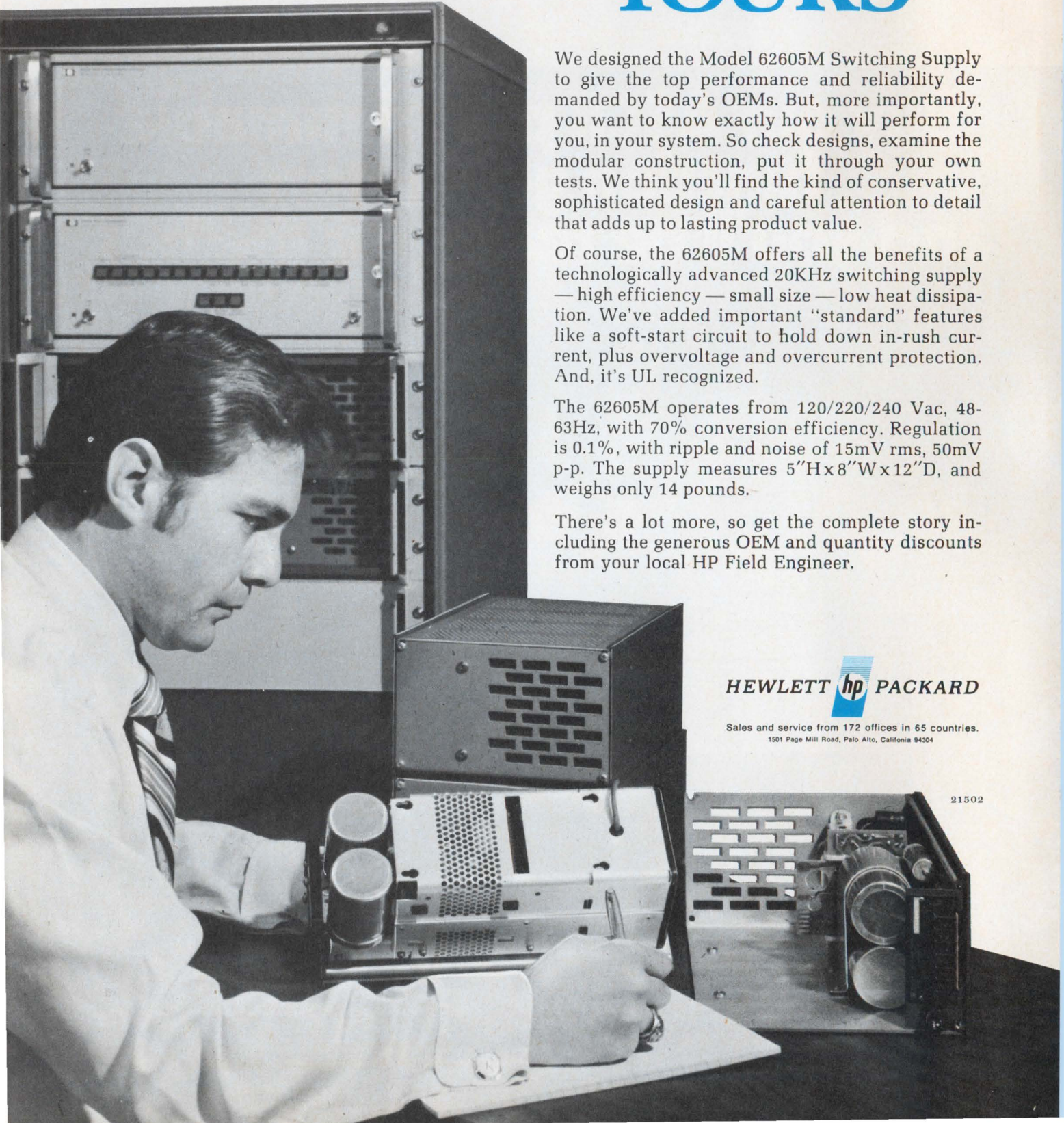



---

## NEWS

- 19 **News Scope**
- 22 **Advances in bipolar LSI** yielding faster, denser low-power devices.
- 26 **4-k RAM race still wide open** as designers try different paths.
- 30 **Analog circuit specialists battling** to survive digital onslaught.
- 38 **Monolithic phased-locked-loop ICs** are taking on dedicated jobs as temperature and voltage ills recede.
- 45 **Washington Report**

---

## TECHNOLOGY

- 54 **Choose switching regulators** for your computer power-supply design. Two major benefits are high efficiency and protection against line dropouts.
- 62 **Damper diodes: Do you need them?** They serve a useful purpose, but you might be able to do without them. Here's a test circuit that can help you decide.
- 68 **Beware of CMOS-switch failure modes.** Without extra special care, some analog-switch ICs can latch up even under normal operating conditions.
- 74 **Test that SCR turn-off time** if you would forestall circuit burnout. Doing the job yourself will guarantee that the device is fast enough.
- 78 **Level with your staff**, especially when it's necessary to kill a project. An IBM executive discusses the basics of motivating (and placating) engineers.
- 82 **Annual Index**
- 96 **Ideas for Design:** Build a multiphase clock that never loses its sequence . . . Flat, flexible TV antenna offers high gain . . . Convert your pocket calculator into a programmable counter.
- 102 **International Technology**

---

## PRODUCTS

- 105 **Instrumentation:** Dual-trace battery-powered scope weighs 10 lb and operates to 10 MHz.
- 106 **Instrumentation:** Extra-safe VOM provides self-test.
- 110 **Instrumentation:** Low-cost counter/timer has 100-MHz range.
- 112 **Modules & Subassemblies:** Hybrid-IC converter series gives high speed at low cost.
- 132 **Components:** High-voltage chip capacitors? Cut your own from a slab.
- 142 **Packaging & Materials:** Power connector stresses safety, combines fuse and voltage selection.
- 118 Data Processing
- 124 Power Sources
- 126 Discrete Semiconductors
- 129 Microwaves & Lasers
- 138 Integrated Circuits

---

## DEPARTMENTS

- 51 **Editorial:** One plus six makes one.
- 7 Across the Desk
- 144 Bulletin Board
- 146 New Literature
- 156 Advertisers' Index
- 158 Product Index
- 160 Information Retrieval Card

**Cover:** Designed by Art Director, Bill Kelly



# The first available 256x4 CMOS RAM

Intel's new 5101 1K silicon gate CMOS static RAM is the first easy to use nano-power RAM. It combines high density and ultralow power with a fast, fully static, 256 x 4 modular organization that eliminates clocks, interface circuits and special power supplies while minimizing package count. Now available from stock at Intel distributors, the 5101 is the ideal RAM for upgrading non-volatile, battery back-up and portable equipment memory system designs.

Even at elevated temperatures, the 5101 keeps battery drain extremely low.

At 70°C, maximum standby current is 15 nA per bit, limiting standby power to 75 nW per bit.

Worst case access time (and minimum cycle time) is only 650 ns over the 0°C to 70°C temperature range.

This March, Intel distributors will also stock the M5101 for military temperature range applications. At 125°C, maximum standby current is 200 nA/bit, maximum standby power 1000 nW/bit. Worst case access time for the M5101 is 800 ns over the -55°C to 125°C temperature range.

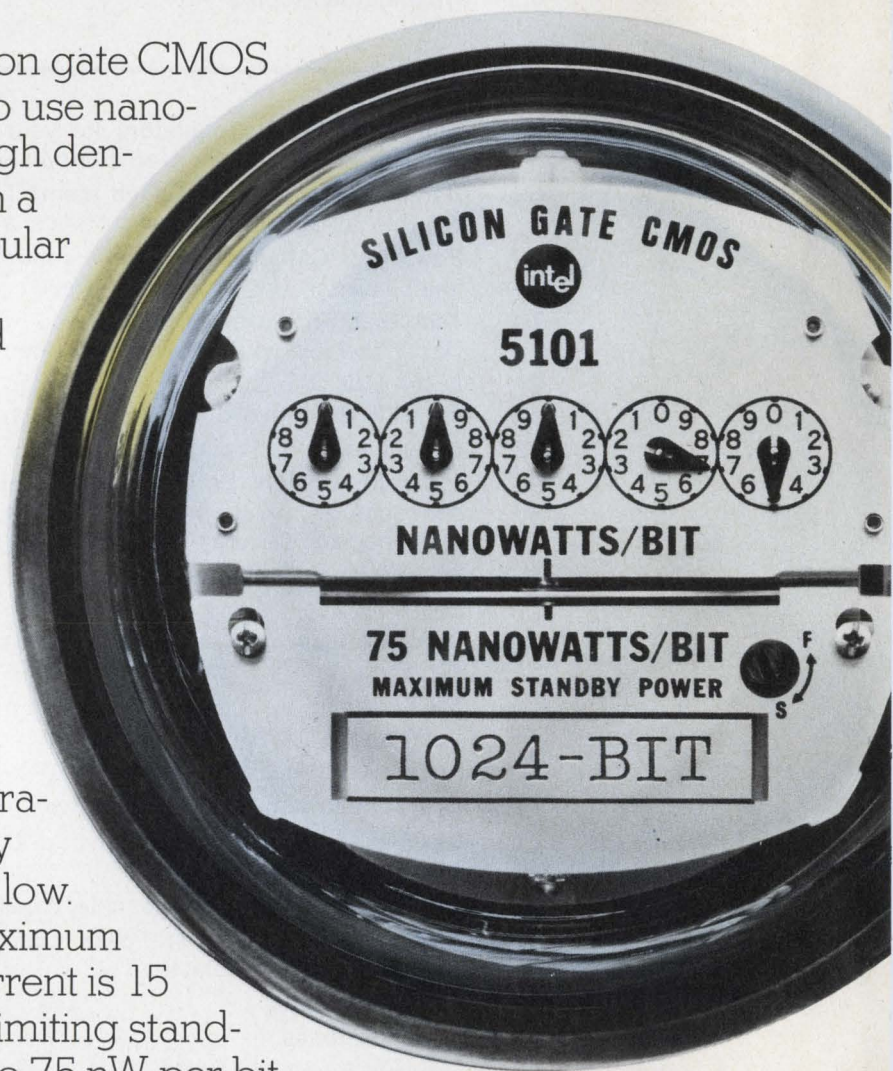



# Available nanopower M. Intel's 5101.

**AVAILABLE AT  
YOUR INTEL  
DISTRIBUTOR**

**INTEL'S 1K CMOS STATIC RAM FAMILY**

PART NO.	WORST-CASE SPEED*	SIZE	PINS	STANDBY POWER/BIT	AVAIL.
5101	650 ns	256x4	22	75 nW	Now
5101L**	650 ns	256x4	22	75 nW	Now
5101-3	650 ns	256x4	22	1 $\mu$ W	Now
5101L-3**	650 ns	256x4	22	1 $\mu$ W	Now
M5101-4	800 ns	256x4	22	1 $\mu$ W	March
M5101L-4**	800 ns	256x4	22	1 $\mu$ W	March
M5101-5	800 ns	256x4	22	5 $\mu$ W	March
M5101L-5**	800 ns	256x4	22	5 $\mu$ W	March

\*Worst case access times and minimum cycle times are guaranteed over full operating temperature range (-55°C to +125°C for M5101-4, M5101L-4, M5101-5, M5101L-5; 0°C to +70°C for all other types).  
\*\*Guaranteed data retention at power supply voltage as low as 2V.

The easy to use 5101 is fully static, chip enable clocking is not required during address transitions. It also interfaces directly with TTL or CMOS and operates with a single +5V supply.

The 256 x 4 configuration is optimum for any memory system organization and is an ideal building block for memory expansion. You get two chip enable inputs, four data inputs, four three-state outputs with output disable control, and read/write control. The output disable pin controls bus states, making bidirectional logic unnecessary in common I/O buses.

The 5101, with its high density and ease of use, is the ideal nanopower RAM for portable instruments and microprocessors, advanced calculators, data collection devices, process controllers, POS, OCR, medical, avionics, ground support—for any equipment demanding long battery life, or non-volatility with battery

back-up. The 5101 silicon gate CMOS RAM is in full production and in distributor stock, along with our other easy to use n-channel static RAMs.

For immediate delivery contact Almac/Strom, Component Specialties, Inc., Cramer, Hamilton/Avnet, Industrial Components, Inc., Sheridan, and L.A. Varah Ltd.

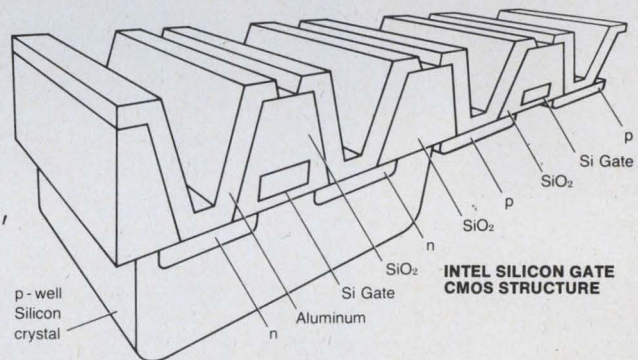

**intel® delivers.**



# HARNESSES

Simple jumpers to massive power signal assemblies. Flat ribbon form or programmed, multi-purpose, multi-layer. Machine made or hand-tied. Delivered in absolute conformance to your system requirements and ready for drop-in. Flat woven cabling gives you broadest design capability, superior control and performance characteristics of individually insulated leads and precise positioning.

For maximum benefits, let us assist in planning. End those harness hang-ups. Think Woven—your complete source for flat interconnects.

## WOVEN ELECTRONICS

P.O. Box 189/Mauldin, S.C. 29662  
(803) 963-5131

### Vice President, Publisher

Peter Coley

### Editors

Editorial Offices  
50 Essex St.  
Rochelle Park, NJ 07662  
(201) 843-0550  
TWX: 710-990 5071  
Cable: Haydenpubs Rochellepark

### Editor-in-Chief George Rostky

### Managing Editors:

Ralph Dobriner  
Michael Elphick

### Associate Editors:

Dave Bursky  
Jules H. Gilder  
Morris Grossman  
Seymour T. Levine  
John F. Mason  
Stanley Runyon  
Edward A. Torrero

### Contributing Editors:

Peter N. Budzilovich  
Alberto Socolovsky  
Nathan Sussman

### Editorial Field Offices

#### East

Jim McDermott, Eastern Editor  
P.O. Box 272  
Easthampton, MA 01027  
(413) 527-3632

#### West

David N. Kaye, Senior Western Editor  
8939 S. Sepulveda Blvd.,  
Suite 510  
Los Angeles, CA 90045  
(213) 641-6544

### Editorial Production

Marjorie A. Duffy

### Art

Art Director, William Kelly  
Richard Luce  
Anthony J. Fischetto

### Production

Manager, Dollie S. Vieblg  
Helen De Polo  
Anne Molfetas  
Christopher G. Hill

### Circulation

Manager, Evan Phoutrides

### Information Retrieval

Peggy Long

### Promotion

Manager, Walter G. Salm  
Karen Kerrigan (Reprints)



## across the desk

### A 'break' discovered in converter code

My joy from reading the Oct. 25, 1974 issue and Eugene Zuch's article "Know Your Converter Codes" (ED No. 22, pp. 130-135) was unbounded. Mr. Zuch's article gathered the multitudes of a/d and d/a codes into a single compendium.

Just the other day, when I confidently retrieved the article from my 8-1/2 x 11-in. electronic-memory system to demonstrate the BCD table on p. 131 to a lesser-equipped associate, I discovered that the code was "broken." Imagine my decline in his esteem as I stumbled through trying to convert those BCD columns into the +10-V FS figures. My mentor in this area, Steve Connors of Dynamic Measurements, pointed out that except for full scale, all the numbers in the BCD table are repeated straight

binary from the preceding table.

*Joel M. Cohen*

BBF Group, Inc.  
42 Fourth Ave.  
Waltham, MA 02154

### The author replies

Here are the corrections to the BCD portion of Table 2 (p. 131) of my article. Mr. Connors and Mr. Cohen are absolutely correct: Binary values were mistakenly put in by me instead of the BCD values.

The BCD coding given in the corrected table columns corresponds to the decimal digits of the +10-V FS column. The +5-V FS column assumes only that a scale-factor change has been made at the input of the converter.

I also found another error in Table 4 (p. 134). Please reverse

*(continued on page 14)*

Binary coded decimal	Complementary BCD
1001 1001 1001	0110 0110 0110
1000 0111 0101	0111 1000 1010
0111 0101 0000	1000 1010 1111
0110 0010 0101	1001 1101 1010
0101 0000 0000	1010 1111 1111
0011 0111 0101	1100 1000 1010
0010 0101 0000	1101 1010 1111
0001 0010 0101	1110 1101 1010
0000 0000 0001	1111 1111 1110
0000 0000 0000	1111 1111 1111

# Thin-Trim<sup>®</sup> capacitors



Tucked in the corner of this Pulsar Watch is a miniature capacitor which is used to trim the crystal. This Thin-Trim capacitor is one of our 9410 series, has an adjustment range of 7 to 45 pf., and is .200" x .200" x .050" thick. The Thin-Trim concept provides a variable device to replace fixed tuning techniques and cut-and-try methods of adjustment. Thin-Trim capacitors are available in a variety of lead configurations making them very easy to mount.

A smaller version of the 9410 is the 9402 series with a maximum capacitance value of 25 pf. These are perfect for applications in sub-miniature circuits such as ladies electronic wrist watches and phased array MIC's.

Johanson Manufacturing Corporation,  
Rockaway Valley Road., Boonton, N.J.  
07005. Phone (201) 334-2676, TWX 710-987-8367.

*Johanson*

MANUFACTURING CORPORATION

Electronic Design welcomes the opinions of its readers on the issues raised in the magazine's editorial columns. Address letters to Managing Editor, Electronic Design, 50 Essex St. Rochelle Park, N.J. 07662. Try to keep letters under 200 words. Letters must be signed. Names will be withheld on request.

INFORMATION RETRIEVAL NUMBER 6 ▶



# This automatic transistor tester works in-circuit when others can't.



**B&K PRECISION**  
**520 Dynapeak™**  
**\$150.00**

Now you can avoid wasting time unsoldering good transistors that test bad in-circuit and good out-of-circuit because of erroneous testing. With B&K-Precision Dynapeak™ Transistor Tester you can quickly determine whether a transistor is good or bad in circuits where automatic transistor testers have never worked before. Low impedance circuits are becoming more and more common in TV, audio and industrial controls—and the Dynapeak™ pulse testing system will let you test transistors in these circuits which have shunt impedances as low as 10 ohms or 50 mfd!

## COMPLETE TEST IN 9 SECONDS:

You connect the leads any way, turn the switch and the rest is automatic: Pulsating audio tone and a light automatically indicate a good device. PNP or NPN determination and Germanium or Silicon identification are automatically indicated by LED's. Leakage tests require no charts, because leakage current limits are shown on the meter face for the different kinds of devices.

Actual transistor action is determined in-circuit—not just junction or diode characteristics; you know you're making a valid test.

Write for our full color brochure explaining why the Dynapeak™ transistor testing system will stop time-wasting diagnostic errors and speed solid state servicing.

## EVEN WORKS IN CIRCUITS LIKE THIS!

If you don't have a 520 Dynapeak™, you'll have to unsolder the transistor to test it in this circuit.

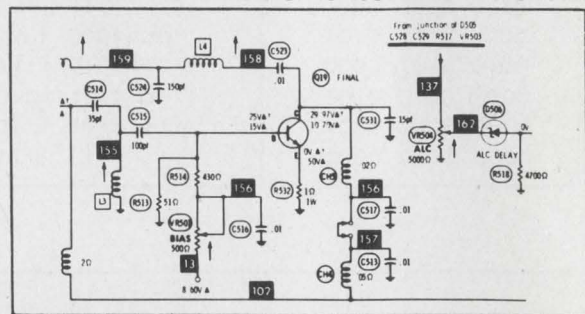

**B&K PRECISION**  
**PRODUCTS OF DYNASCAN**

1801 W. Belle Plaine Avenue • Chicago, IL 60613

INFORMATION RETRIEVAL NUMBER 7



# The fastest data acquisition system. Anywhere.

Our 4855 ultra-high speed sample-hold ahead of our 4133 ultra-high speed 12-bit ADC. System aperture time is an ultra-low 1 nsec. Guaranteed throughput rate is 350 kHz. And you get this system speed at 0.03% total accuracy.

The 4855/4133 combination gives you a functional capability you can't achieve elsewhere. For example, the exceptionally low feedthrough of the 4855 allows you to multiplex during conversion without affecting system speed and accuracy.

FFT, high speed data acquisition, video digitizing, radar pulse digitizing and multi-channel simultaneous sample and hold—applications where greater than nanosecond uncertainty slow you down.

The 4855's 250 nsec acquisition time to 0.01% accuracy assures exceptionally high throughput rates for precision systems. The 4133 gives you high linearity, excellent stability and 2.5  $\mu$ sec max. conversion time.

Together they're unbeatable for highly accurate, high speed data acquisition. And they're only available from Teledyne Philbrick at unbeatable prices (\$160 and \$485 in 100's).

For complete information, write for our Application Bulletin today. Or "DIAL" (our Direct Information Access Line) 617-329-1600. Teledyne Philbrick, Dedham, MA 02026. In Europe, Tel. 673.99.88, Telex: 25881. Or write, 181 Chaussee De La Hulpe, 1170 Brussels.

See us at Salon des Composants Allée F-93

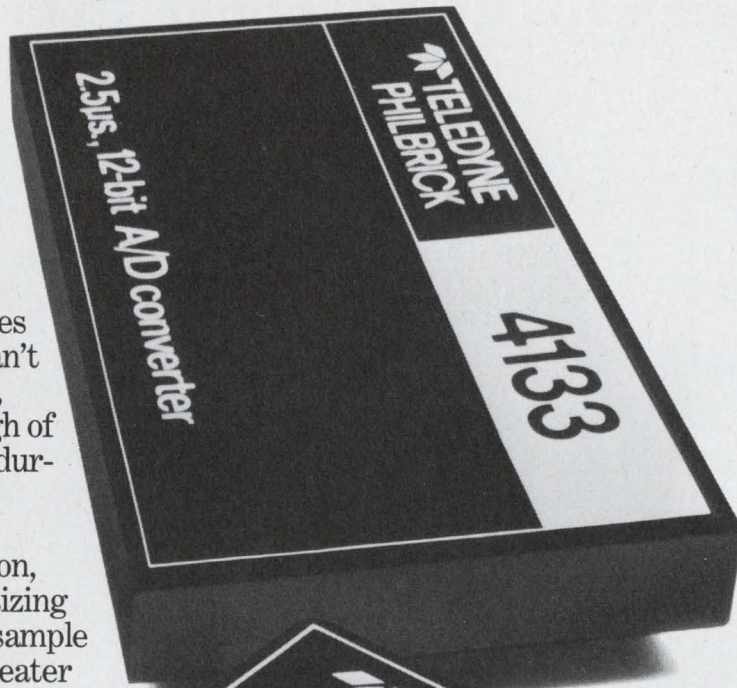

INFORMATION RETRIEVAL NUMBER 8



# decoding the codes

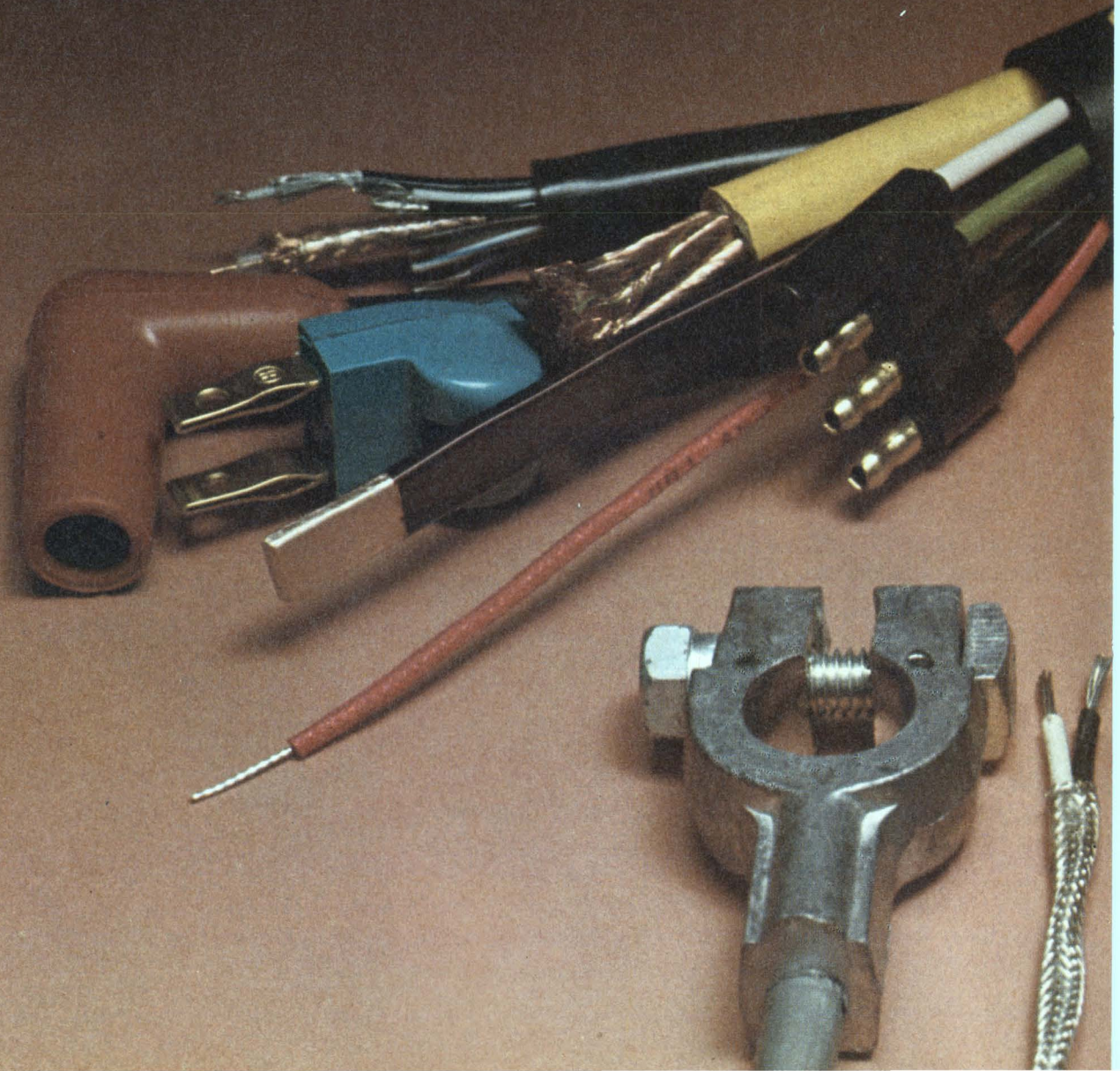



With ever-changing technology and increasing demands for innovative products, more precise safety guidelines are a must.

Belden knows the codes, standards, requirements and limits of acceptability in the wide world of industrial wire, cable and cord. As supplier of thousands of standard items for electrical, electronic and automotive needs we can readily help you select the right product for the job. Belden products meet or exceed industry code needs. And we can custom design and manufacture complex cable configurations to meet the most demanding specifications. If a code is puzzling you, or you have an application where you're not sure what the standards are, check with Belden. We cope with codes every day.

If you want answers right now, phone:  
(312) 887-1800, Transportation Division  
(312) 681-8920, Electrical Division  
(317) 966-6681, Electronic Division  
Or write Belden Corporation, 2000 South Batavia Avenue,  
Geneva, Illinois 60134.

H-3-3

**BELDEN** 

INFORMATION RETRIEVAL NUMBER 234

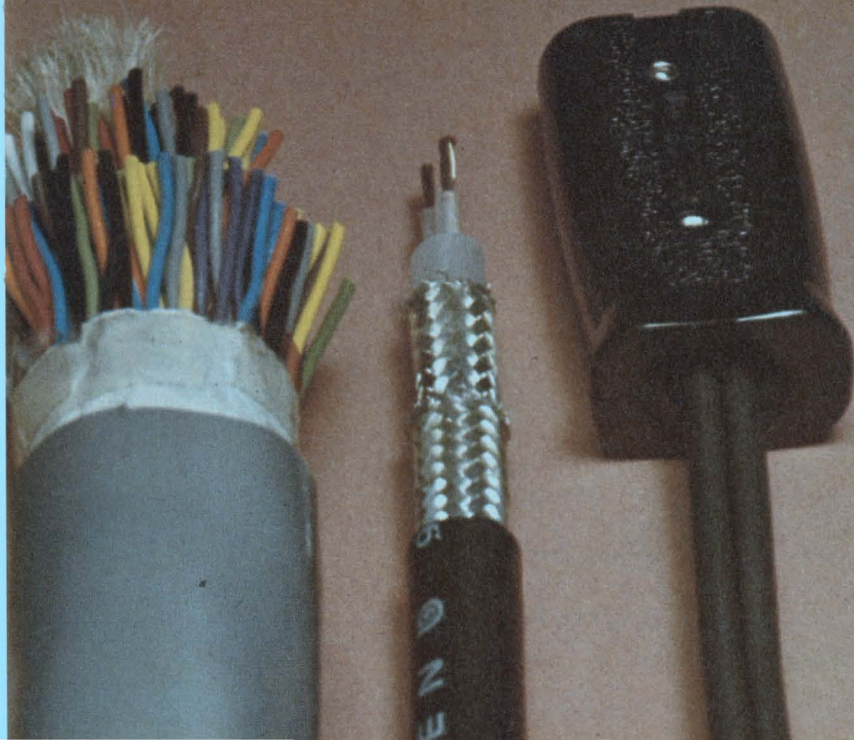



# Anatomy of a brute.

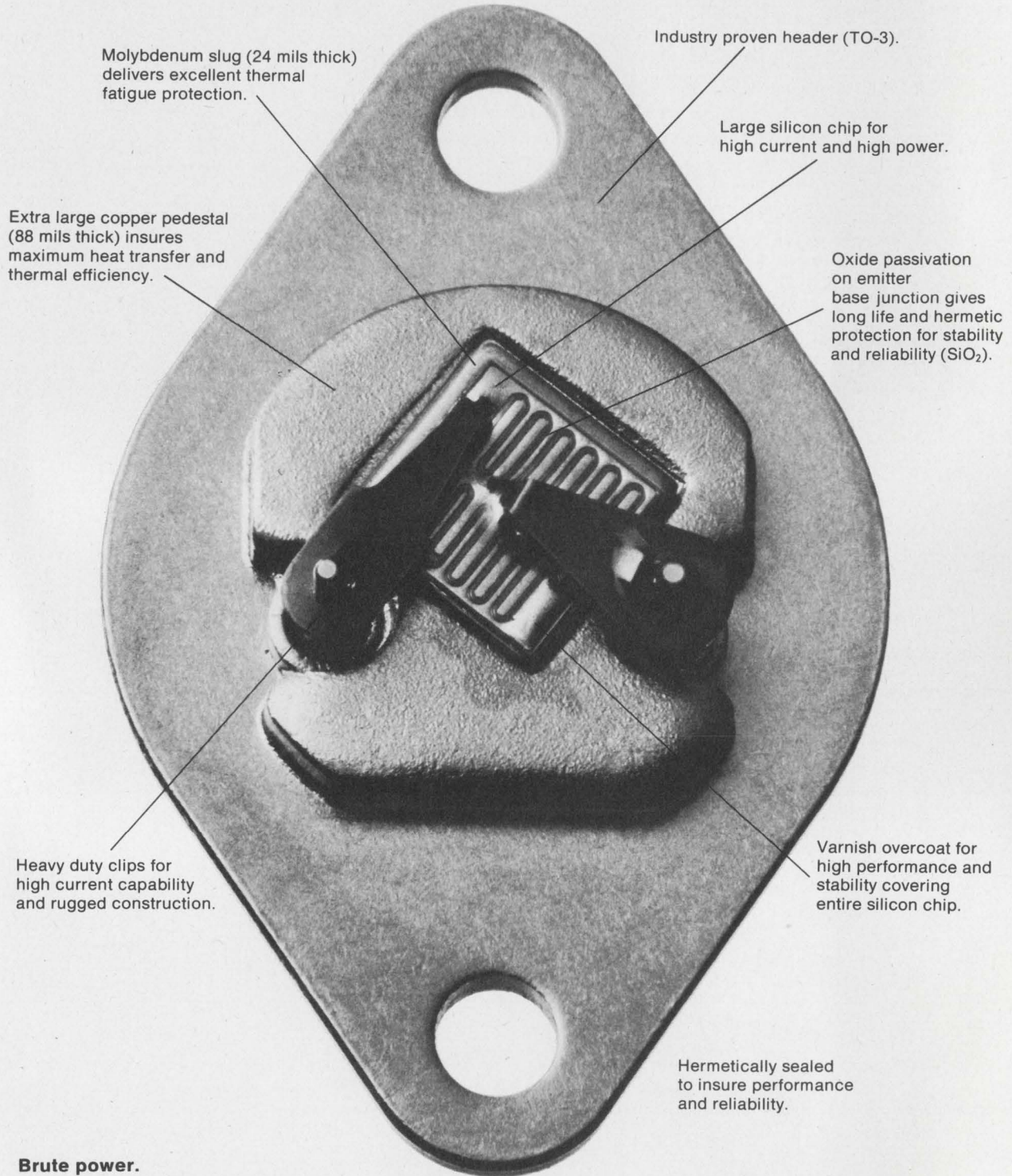

## Brute power.

That's what our TRW Types 2N3773 and 2N6259 deliver. So do our other reliable, single-diffused power transistors like the 2N3771, 2N3772 and 2N6258. All 100% power tested.

Send for a set of spec sheets. Or, for faster action or information on volume production of custom units, call Frank Joutras, TRW Capacitors, Solid State

Operation, an Electronic Components Division of TRW, Inc., Box 1000, Ogallala, Nebraska 69153. (308) 284-3611.

TRW high-power transistors. So powerful we had to call them, "The Brutes."

**TRW**® CAPACITORS  
SOLID STATE OPERATION



The AN2538 is the lowest-cost line-powered 3½ digit DPM you can buy . . . with the performance and dependability you need. Big ½" LED display for long life and wide-angle viewing. Autozero for long term stability. High CMRR/NMRR for noise and ground-loop immunity. Very low bias current (100pA max), for error-free high-impedance. Super-regulated power supplies. All this adds up to *usable* ±0.05% accuracy.

But price and performance are only part of the breakthrough. The

AN2538 takes *full* advantage of its monolithic circuitry. It runs exceptionally cool (5°C rise) and operates over -10°C to +70°C. It has the longest MTBF ever achieved in a 3½-digit DPM—enhanced by a 96-hour, 50°C burn-in cycle. Its tough LEXAN® case meets both NEMA and DIN standards. It has a universal power transformer, for worldwide use.

Last year, we broke through the interface problem with our AN2533/53 pluggable interface, premium-performance DPM . . . still

the best for many applications. The AN2538 reflects Analogic's 200,000-DPM experience . . . experience unmatched by any other source.

Want complete data? Ready to evaluate a sample? Call Analogic's Marketing Dept. at (617) 246-0300, or your local Analogic sales office, or write today: Analogic Corp., Audubon Road, Wakefield, Mass. 01880. Also available, new 70 page Circuit Application Handbook, write on letterhead.

**ANALOGIC** ■  
... The Digitizers

INFORMATION RETRIEVAL NUMBER 10

# This new A/D converter CHIP\*...

# ...makes this new DPM today's best value, <\$69. (in OEM quantities)

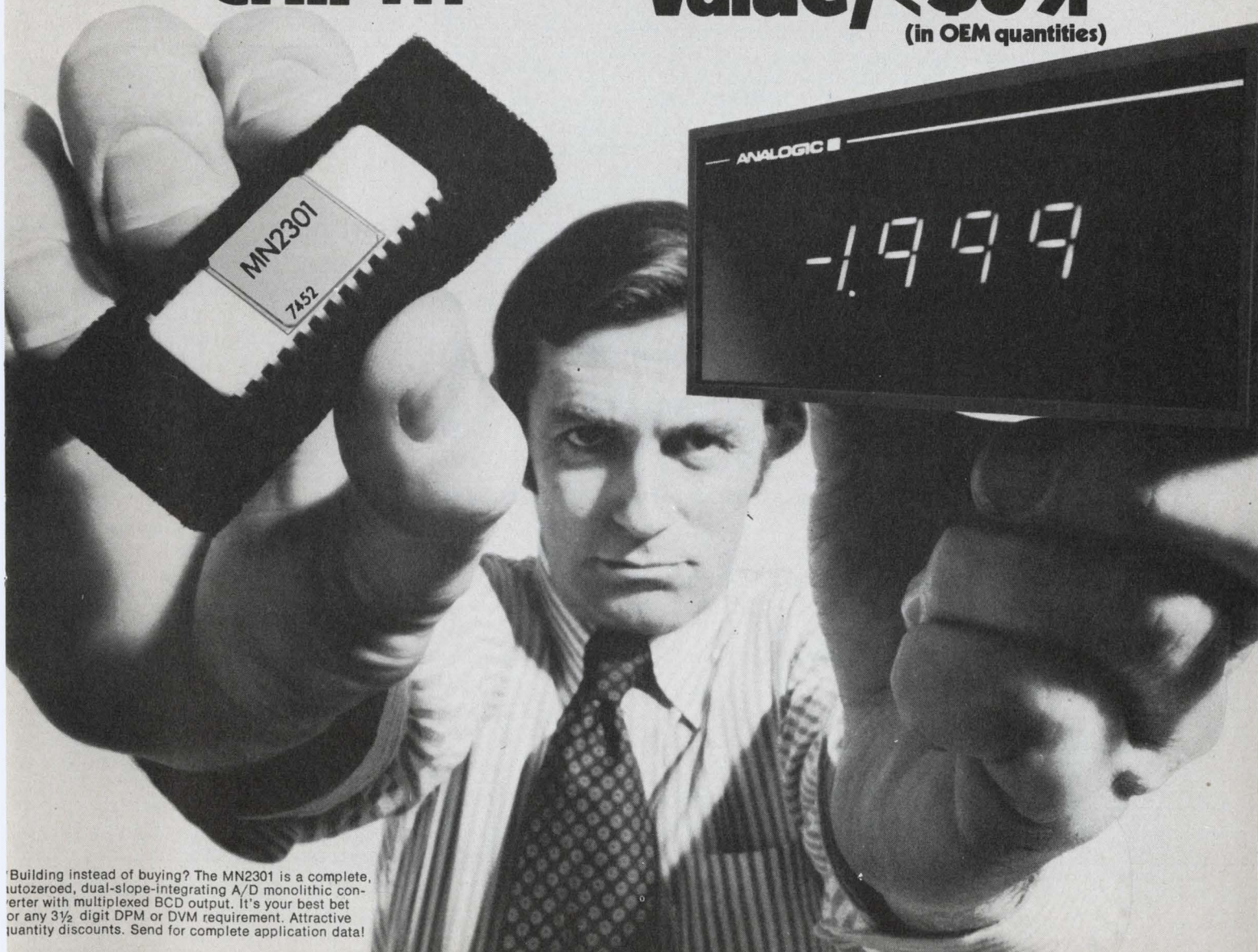

Building instead of buying? The MN2301 is a complete, autozeroed, dual-slope-integrating A/D monolithic converter with multiplexed BCD output. It's your best bet for any 3½ digit DPM or DVM requirement. Attractive quantity discounts. Send for complete application data!



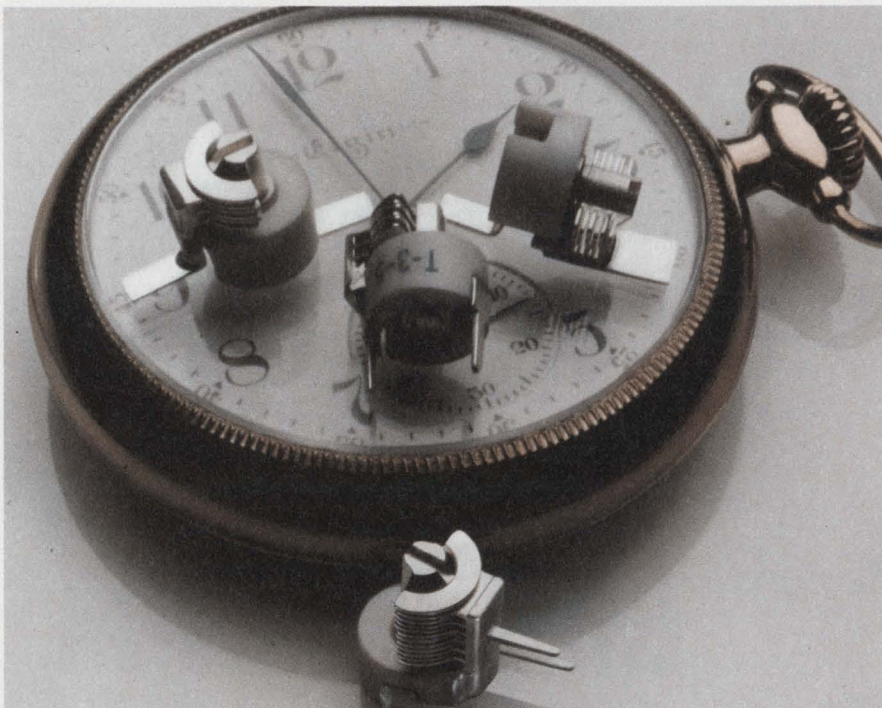

## We can deliver the world's smallest 180° air variable capacitors. On time.

And since we're nice people, we don't even charge much for them. So if you have an application that calls for a sub-miniature capacitor that you can "tweak" to a specific frequency, these Johnson trimmers are ideal.

You can choose from either PC or stripline mount, either vertical or horizontal tuning. These Type "T" capacitors are about one-third the size of the familiar type "U" capacitors, so you can save space, cut costs and insure improved performance in the most compact electronic equipment.

Rotors and stators are precision-machined from solid brass extrusions, resulting in exceptional stability and uniformity. High Q—typically 2000 at 150 MHz. Temperature coefficient is a low plus  $30 \pm 15$  ppm/°C. High torque (1½ to 8 oz./inches) holds rotor securely under vibration. They're designed to meet or exceed EIA-RS 204 and MIL Standard 202C Methods 204A and 201A.

In short, these capacitors may be just what you've been looking for. It'll only cost you a stamp to get more information. And if you give us your phone number, we'll call you and send free samples after we have clarified your application.

E. F. JOHNSON COMPANY  
3005 Tenth Ave. S.W. / Waseca, MN. 56093

Please send me technical information on the type T.

Also, include information on your entire line of variable capacitors.

I want test samples. Please call me at \_\_\_\_\_

NAME \_\_\_\_\_

TITLE \_\_\_\_\_

FIRM \_\_\_\_\_

ADDRESS \_\_\_\_\_  
CITY \_\_\_\_\_ STATE \_\_\_\_\_ ZIP \_\_\_\_\_



**E. F. JOHNSON COMPANY**

## ACROSS THE DESK

(continued from page 7)

the terms marked +1/2 FS and +FS -1 LSB in the first column.

Eugene L. Zuch

Product Marketing Manager

Datel Systems, Inc.

1020 Turnpike St.

Canton, MA 02021

## Samples are tough all over

My memory of most of your editorials is that they're full of \_\_\_\_\_. [Ed. Note: Uncharitable comment.]

However, the one you ran in the Dec. 20, 1974 issue is really very good ("Making it Tough for European Engineers," ED No. 26, p. 49). You might have included that, even in this country, it's near impossible to get sample quantities of an item (at any reasonable price).

Norman Schwarz, P.E.

7901 Oakwood Rd.

Glen Burnie, MD 21061

## Fowl play

Recalling how ELECTRONIC DESIGN confused hams and Citizen Band operators in an issue last year, Brick McElwain, advertising manager of Clare-Pendar Co., Post Falls, ID, points to a comparable blooper in his company's in-house publication, *The Clare-Pendar Pen-lite*.

An item in the Dec. 13, 1974 issue, "Turkey Day for All Clare-Pendar," announced the company's intention to distribute Christmas turkeys to its employees.

"Here's how it works," *The Pen-lite* advised. "The Personnel Department will set up a small table in the Cafeteria, check you off as you enter so we can verify that you work here, give you a ticket which you redeem for a truck parked in back of the turkey from the refrigerated plant. . . ."

McElwain observes: "I had a hell of a time locating 14-lb trucks at \$.53 per lb."



# LOOK WHO'S CLIMBING UP IN THE WORLD.

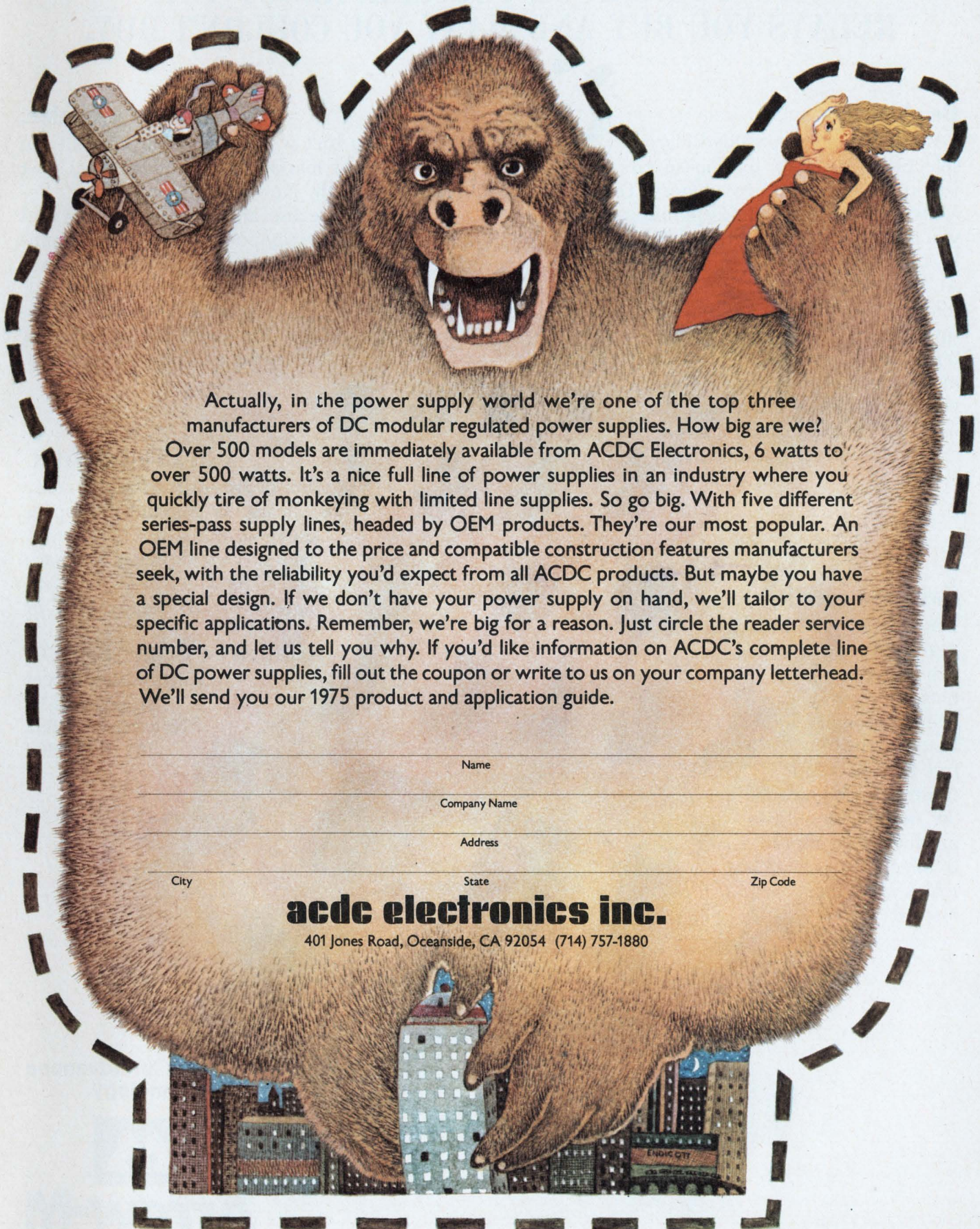

Actually, in the power supply world we're one of the top three manufacturers of DC modular regulated power supplies. How big are we? Over 500 models are immediately available from ACDC Electronics, 6 watts to over 500 watts. It's a nice full line of power supplies in an industry where you quickly tire of monkeying with limited line supplies. So go big. With five different series-pass supply lines, headed by OEM products. They're our most popular. An OEM line designed to the price and compatible construction features manufacturers seek, with the reliability you'd expect from all ACDC products. But maybe you have a special design. If we don't have your power supply on hand, we'll tailor to your specific applications. Remember, we're big for a reason. Just circle the reader service number, and let us tell you why. If you'd like information on ACDC's complete line of DC power supplies, fill out the coupon or write to us on your company letterhead. We'll send you our 1975 product and application guide.

Name

Company Name

Address

City

State

Zip Code

**acdc electronics inc.**

401 Jones Road, Oceanside, CA 92054 (714) 757-1880



# MATSUSHITA LAUNCHES ARROW-M.

NOW YOU CAN BE CHOOSIER ABOUT THE RELAYS YOU BUY AND MANY YOU COULDN'T BUY.

## Be choosier.

Yesterday when you needed a large selection of relays to choose from, you could only go to two places. Today Matsushita's Arrow-M Corporation gives you a third source for a broad base of relays. But quantity isn't the whole story. At Arrow-M you find more than currently available relay types. You find quality relays built to electrical and physical specs unmatched by other firms. Relays you just can't buy elsewhere. Relays that shrink a product while expanding its performance and reliability.

## Switch to excellence.

Engineered by Matsushita, Arrow-M relays are in use in diverse products the world over. The number of trouble-free field hours for these relays is unestimable. So design them into your product with absolute confidence. You can't buy relays with more integrity.

## Always available.

Who isn't worried about availability in today's market? Availability now. Next month. Next year. Don't worry. Because all critical materials and components used in the manufacture of Arrow-M relays are internally controlled, you can count on relays being available from stock whenever you need them.

## Read all about it.

Send for our general relay catalog. It contains full specs on reed, miniature and power relays. We'll also send along advanced data on newly-designed, state-of-the-art relays. Call or write now.

ARROW-M CORPORATION  
250 Sheffield Street  
Mountainside,  
New Jersey 07092  
201 - 232-4260

Relays for advanced technology.



# Arrow-M



# There's more behind a carbon film resistor than carbon

Particularly if the resistor comes from Piher. There's 25 years experience for a start. Which is why we are one of the world's leaders in the carbon film resistor field.

With an output of 10 million resistors *per day*, they are obviously in demand. Everywhere.

Which is why we have opened a manufacturing plant in the USA to help satisfy North American



needs, quickly, and help give a bigger share of European production to European markets.

Find out about the Piher resistor range

— and all the other products that have made us a leader in component technology.

Fill in the magazines reader reply card, or write direct to the office in your area for our technical literature. We're worth knowing.



USA - PIHER Corporation, 399 Washington Street, Woburn, Massachusetts 01801. Tel: 617 935 8750

Germany - PIHER International GmbH, 85 Nurnberg, Tuchergartenstrasse 4, Tel: 0911 533 051

France - PIHER International SARL, 83 Rue Etienne Dolet, 94230, Cachan, Tel: 656 8484

Italy - PIHER International SPA, Via Cenisio 34, 20154 Milan, Tel: 314 532/316 213

UK - PIHER International LTD, Romar House, The Causeway, Staines, Middlesex, Tel: Staines 56157

Spain - PIHER SA, Riera Canado, s/n. Apartado de Correos, 53 Badalona (Barcelona), Tel: 389 03 00





## MOS memories

# TI's new 3rd generation 4K RAMs. 200ns speeds in 18-pin packages. And availability is now!

Texas Instruments brings you third generation 4K MOS RAMs: TMS4050-2 (200ns), TMS4050-1 (250ns) and TMS4050 (300ns). These compact 18-pin 4K RAMs offer even better board packing density than their 22-pin counterparts, as much as 70 to 100%.

Volume availability is now. The TMS4050s are in full production. They utilize the same single-transistor cell design and reliable N-channel silicon gate process as TI's popular TMS4030 4K RAM. This helps insure on-time delivery.

The TMS4050s have been made easy to use. All inputs, except clock, are compatible with Series 74 TTL,

	ACCESS TIME MAX	100-999 PRICE
TMS4050NL	300ns	\$19.64
TMS4050-1NL	250ns	\$21.64
TMS4050-2NL	200ns	\$24.62
TMS4050JL	300ns	\$22.78
TMS4050-1JL	250ns	\$25.07
TMS4050-2JL	200ns	\$28.56

while power dissipation is kept low (420mW operating, 0.1mW standby, typically). A full 12-line address and single hi-level clock minimize system timing headaches. Plus, data input and output are multiplexed to provide a simple memory bus interface.

Compare prices (see insert). You can see that TI's TMS4050s offer the best performance at the lowest price. And why shouldn't they? TI has more experience in building 4K RAMs. Plus, volume production experience means lower cost-to-you — and higher PC board density.

The TMS4050-2, TMS4050-1, and TMS4050 are available through TI's authorized distributors in 18-pin plastic (NL) or ceramic (JL) packages. For data sheet, write Texas Instruments at P.O. Box 5012, M/S 308, Dallas, Texas 75222.



TEXAS INSTRUMENTS  
INCORPORATED



## RCA video-disc entry gives hour of inexpensive viewing

RCA's long-awaited entry into the video-disc race is an inexpensive 12-in. record that can provide up to an hour of viewing.

Called SelectaVision VideoDisc, the new system has these key features:

- A grooved metallic and dielectrically coated vinyl disc to provide positive tracking of the stylus by mechanical means.

- A capacitance pickup made from sapphire, with a deposited metallic electrode that can be used to resolve signal elements smaller than the wavelength of light. This makes it possible to use electron-beam recording techniques.

- A low rotational speed of 450 rpm that reduces vibration problems and makes it easier to correct errors in signal timing.

The details will be discussed publically for the first time next month in Washington, DC, at the 1975 international exhibition of The Society for Information Display.

With the exception of the stylus, the RCA VideoDisc player is fabricated almost completely from components that have been used in conventional phonographs. The use of the grooved disc eliminates the need for expensive servo mechanisms to provide accurate tracking.

The spiral groove that is pressed into the disc is roughly circular and contains information recorded as transverse slots of varying width and separation. The information is read out by a stylus that rides in the groove and changes capacitance as the relief pattern of the record passes under the tip of the stylus.

The stylus-record capacitance is made part of a tuned circuit—about 915 MHz—with the tuning varied by the stylus-record capacitance variations. When driven by an oscillator of suitable frequency,

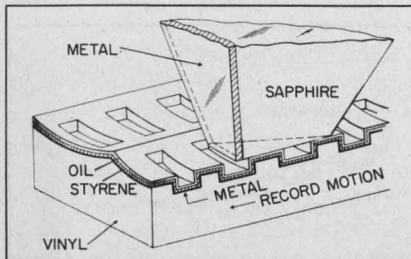

**Capacitance pickup** detects variations in the width and separation of slots in record groove that contains recorded information.

the variable-frequency resonant circuit will provide a variable impedance, and thus a variable amplitude, of the oscillator signal as it passes through the resonant circuit. The amplitude modulation is stripped by a diode detector to provide a signal that rises and falls with the passage of the slots. This FM signal is then demodulated to provide a composite video signal.

The average speed of the playback turntable is 450 rpm, achieved with a synchronous motor that is locked to the power-line frequency. This speed, which is lower than that of many other video discs, has advantages, RCA says. Errors in signal timing that might result from warp or eccentricities of the disc occur at a frequency that is easier for the television receiver to compensate for. In addition, a simple, inexpensive electromechanical device, the "arm stretcher," can be used to reduce time-base errors.

The arm stretcher is similar to a loudspeaker moving-coil element, driving the stylus arm back and forth parallel to the record groove. If the record runs slow, the stylus is pulled towards the transducer to increase the relative speed between the stylus and the record. If the record is going too fast, the stylus is pushed away from the transducer, thereby reducing the relative speed.

The system is not yet commercially available. Minor problems must still be overcome, RCA says. One is perfecting the real-time capability of the master disc. Less than real-time recording is now possible, but RCA says that the capability is being refined so that all recording will be done in real time when the product is introduced.

## 'How to' emphasized at computer parley

Six technical sessions at the Computer Society International Conference in San Francisco dealt with microprocessors. But the emphasis was on how to use them rather than on new devices.

A new way of looking at the meaning of the instruction set of a microprocessor has been developed by John Nichols, vice president of Logical Services, Mountain View, CA. He calls it the source-destination matrix of the instruction set.

Nichols explained that most instructions were data transfers. Since the data are transferred from a source to a destination, a matrix can be drawn to give the various sources on one axis and the various destinations on the other. Typical sources and destinations are registers, accumulators, memory and program counter. Entered on the matrix table are the instructions to go from the source of interest to the destination of interest.

Nichols noted that once the engineer defined his problem and the required types of data manipulation, he could use the source-destination matrix to select the microprocessor with the most workable instruction set.

Michael Maples, an electrical engineer at the Lawrence Livermore Laboratory in Livermore, CA, pointed out that utility was often more important than speed and efficiency when selecting a microprocessor for a problem involving basic calculations. He described the development of a microprocessor-based measurement system that uses the Intel 8008 microcomputer for such things as base-line correction calculations. Maples used triple precision arithmetic for



these calculations.

A pair of new integrated circuits aimed at use with microprocessors came to light during the conference. Ready for delivery is a programmable bit-rate generator from Fairchild Semiconductor, Mountain View, CA. According to Krishna Rallapalli, staff engineer at Fairchild: "The CMOS IC provides 16 different bit rates programmably. Each bit rate is available on any of eight different lines."

When used with a universal asynchronous receiver-transmitter, a great deal of data communications flexibility is provided, he said.

## TV course scheduled on microprocessors

For four days in April, a cram course in microprocessors will be televised for early risers in 20 major cities. Tuition is free. All you have to do, if you can receive the telecasts (see list), is to turn your set on at either 6 AM or 6:30 AM, depending on where you live, on the mornings of April 15 through 18.

Put on by Texas Instruments in Dallas, the first telecasts will cover the evolution of system architecture as a basis for understanding

## TV lectures Apr. 15-18

City	Channel	Time
Boston	7	6:20-6:50 AM
Chicago	9	6:00-6:30 AM
Cleveland	8	6:00-6:30 AM
Dallas	5	6:00-6:30 AM
Dayton	7	6:00-6:30 AM
Denver	4	6:30-7:00 AM
Detroit	2	6:00-6:30 AM
Houston	11	6:30-7:00 AM
Los Angeles	11	6:30-7:00 AM
Miami	4	6:30-7:00 AM
Minneapolis	11	6:30-7:00 AM
New York City	5	6:30-7:00 AM
Orlando	6	6:00-6:30 AM
Philadelphia		
Phoenix	5	6:00-6:30 AM
Rochester	10	6:00-6:30 AM
San Diego	6	6:30-7:00 AM
San Jose	11	6:00-6:30 AM
Seattle	11	6:30-7:00 AM
Washington, DC	5	6:30-7:00 AM

the wide range of applications for microprocessors and the varieties of chip architecture.

Next there will be a detailed discussion of the technological choices involved, including the new integrated-injection-logic (I<sup>2</sup>L) technology.

The third session will define the types of systems suitable for microprocessors, discussing the principal parameters of several types of microprocessor equipment and giving examples of applications.

The final lesson will discuss the application of microprocessors to digital communications systems.

If you want to bone up on the subject before the telecasts start, TI will send you for \$24.95 a "Microprocessor Handbook," which contains a summary of the microprocessors currently available, a discussion on how to use them and background on digital design along with reference material.

The book also includes lesson summaries for the telecast sessions.

To obtain the handbook, write to Texas Instruments, P.O. Box 3640, MS-54, Dallas, TX 75285.

## Productivity increased in new minicomputer

What may be the most productive minicomputer built so far has been introduced.

Called the 8/32 it is the second 32-bit machine to be introduced by Interdata since its Model 7/32 in September, 1973. The CPU and up to 1-Mbyte of core memory in the 8/32—directly addressable—reside in a single RETMA cabinet. The processor uses Schottky TTL and memory interleaving to give a basic cycle time of 300 ns.

Compared with the 7/32, the new machine uses a 32-bit wide bus with one fetch to memory rather than a pair of 16-bit fetches. Eight stacks, each with 16, 32-bit registers, simplify I/O operations and provide the means for rapid context switching.

To enhance reliability, yet keep fabrication costs down, Interdata has used multiwire board fabrication. A single PC board contains layers of connections sealed with epoxy.

Dual-bus architecture—one slow

and one fast bus—also contributes to system throughput. The machine runs typical problem mixes under OS/32 MT (multiple task) or OS/32 ST (single task) at double or triple the 7/32 speed.

Prospective customers are comparing the 8/32's architecture and instruction execution times with those of the IBM 370/158.

## 16-bit microprocessor operates at 5 MHz

The fastest 16-bit microprocessor announced to date—it operates at 5 MHz—has eight general registers and a selection of software.

Introduced by General Instrument's Microelectronics Div., Hicksville, NY, the microprocessor—the CP-1600—"is the only single-chip, n-channel, 16-bit microprocessor available," says Jess Stein, manager of microprocessor development. "It's about five times faster than the single-chip, p-channel competition."

The eight general registers in the CP-1600 are in contrast with a number of present microprocessors, which are accumulator-based machines having only one active working register and one or two other temporary registers.

The CP-1600 registers can be used for accumulators, address registers, data pointer-to-memory storage and index stores, Stein notes. The CP-1600 also has a memory pointer to maintain a main memory stack.

The designers shortened the development and debugging of the CP-1600 considerably, Stern reports, by laying out the chip in two separate sections: control and data processing.

"Two designers could thus work on their own sections at the same time," Stein explains, "and it allowed us to have two parallel debugging efforts going on."

The CP-1600 is the first of a family of microprocessors that General Instrument intends to introduce over the next year, Stein says.

"All of these microprocessor machines will be single-chip, higher performance devices, and they all will be software-compatible upward," he notes.

CIRCLE NO. 319





## When you've been making CMOS for six years, you can do a few things the new guys can't.

- 1969 First CMOS 8-bit counter, shift register, decoder for NASA satellite program.
- 1970 First alternate source for 4000 series. First double buffered CMOS gates.
- 1971 First production quantity CMOS IC for automobile clocks.
- 1972 First production quantity CMOS decoder-driver for LCD watches.
- 1973 First CMOS Content Addressable Memory. First CMOS 256 bit (64 x 4) RAM.
- 1974 First high-yield, high-quality 3-inch CMOS wafer processing facility.
- 1975 First complete high-rel screening program for commercial CMOS. Solid-Plus.

That's a short time in years. But it's a lifetime of experience in the 4000 series. Consider our new Solid-Plus grade. 100% screened and burned-in cerdip. Our highest-in-the-industry level of delivered quality, and the most attractive pricing in the industry. If you're a little skeptical about all that, ask us to quote and see what happens. You'll find a supplier you'll never want to be without again.



**SOLID STATE SCIENTIFIC INC.**

Montgomeryville, Pa. 18936/(215) 855-8400/TWX 510-661-7267

**The alternate source that's better than equal.**









## Better looking Beckman Displays are a natural for clocks and clock-radios



There are several big reasons why Beckman Displays are being used in more and more electronic clocks and clock radios. First, there are special 12 and 24-hour clock modules which help make application and production assembly easier. Secondly, the better looking Beckman Displays help attract buyers, help build sales. Next, in addition to multiplex mode, the displays can be DC driven to reduce RFI to a minimum.

For electronic clocks and clock radios you can choose from a variety of 1/2" clock display combinations from Beckman: hour and minute readouts; hour, minute, second displays;

even with AM and PM indicators. Beckman Displays produce crisp, clear, unbroken numerals that add "buy appeal" to any product. They have a pleasing neon orange color (filterable to red) and are bright enough (210 foot lamberts) to be read in all ambient light conditions including direct sunlight.

Add to this the low cost (as low as \$.70 per digit in large OEM quantities), the proven reliability, and you have the ideal display for today's new designs. See for yourself. Compare Beckman Displays side-by-side with LEDs or any other readout. You'll choose Beckman because they look better, are better.

For the telephone number of your Beckman/Helipot sales office, or the name of your Beckman stocking distributor, call toll free (800) 645-9200 (in N.Y. State call collect 516-294-0990). Or write, Beckman Instruments Inc., Information Displays Operations, P. O. Box 3579, Scottsdale, Arizona 85257.

Beckman®  
INFORMATION DISPLAYS OPERATIONS

*There's more eye appeal in Beckman Displays!*



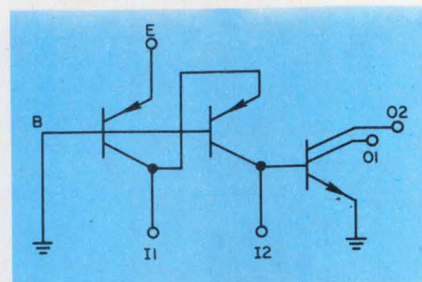
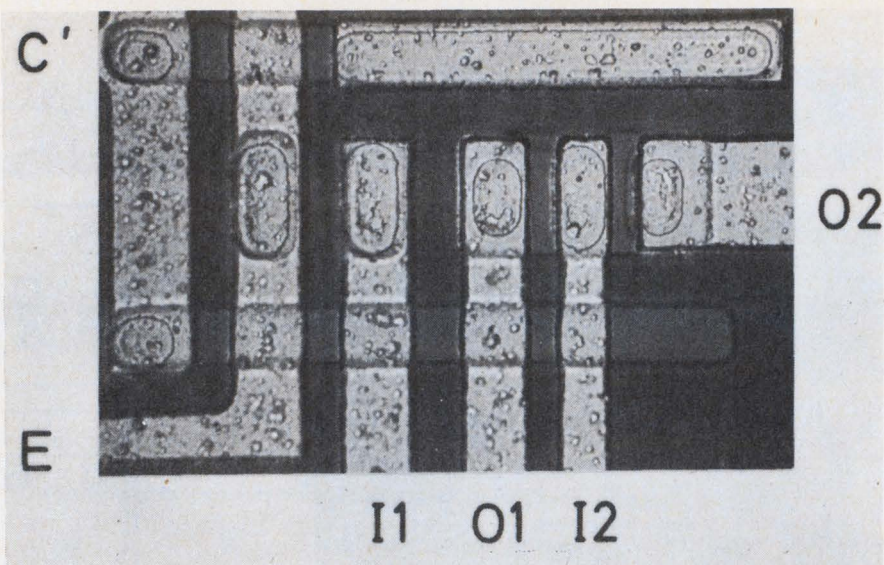

**Current-hogging injection-logic NAND gate (left) is 20% smaller than equivalent I<sup>2</sup>L cells. Schematic of cell (right) shows CHL gate with a functionally integrated output transistor.**

top of another. This results in three levels of logic, with level shifting and interfacing between them. Multilevel logic is very useful in some digital operations, and the approach is already being used in some isolated versions of injection logic.

A key advantage of C<sup>3</sup>L, its high density, stems from the simple structure used in the basic NAND cell. This cell requires only one transistor, regardless of the number of cell inputs or outputs.

Gate-array cells having five connectable outputs occupy 10 to 13 square mils, and nearly 1000 gating operations can be performed on a 130-mil-square chip. Switching speeds, Peltier reported, can be as fast as 3 ns with power consumption of 1 mW per gate, or as slow as 100 ns with power consumption of 0.01 mW.

### Injection logic refined

Integrated injection logic (I<sup>2</sup>L), a technology that has only recently become available in commercial products, is still undergoing intensive research and development. Two advances that have resulted from this work are Schottky transistor logic and current-hogging injection logic.

Schottky transistor logic was described by Horst H. Berger, a researcher from IBM's Semiconductor Device Development Laboratories in Boeblingen, West Germany. He reported several ways to improve the performance of I<sup>2</sup>L de-

vices. For example, the power-delay product is proportional to the logic swing, which is about 750 mV for I<sup>2</sup>L. But because bipolar transistors have a high transconductance, internal circuits can operate just as well with a swing as low as 150 mV. This results in a fivefold improvement of the device's power delay.

Another area where improvements can be made, Berger said, is the intrinsic time delay of the device. Part of the long intrinsic delay of conventional I<sup>2</sup>L is due to excessive charge storage that results from the high inverse current gain of the upside-down-operated npn transistor. By elimination of the need for the high inverse gain, which prevents current hogging, the intrinsic delay can be reduced by a factor of 2.

Both of these improvements can be obtained by use of Schottky technology. The basic logic cell uses Schottky diodes for output decoupling, and thus eliminates the need for the high inverse current

gain that limits the intrinsic delay. The Schottky diodes also provide the reduction in logic swing required to decrease the power-delay product.

Development has not advanced enough to permit the fabrication of monolithic Schottky transistor gates, but Berger noted that experimental devices had been fabricated from discrete components. The voltage swing of such a gate was reduced by a factor of 1.4 and the power delay improved by the same amount. The delay of the gate improved by a factor of 2, as was expected.

Another approach for implementing STL in monolithic form is being investigated, Berger noted. This involves the use of a pnm (m for metal) transistor. This would have a genuine Schottky collector that would replace one of the active semiconductor regions with metal. This would result in a simple structure that had only three active semiconductor regions, compared with four in regular I<sup>2</sup>L.

Experimental vertical pnm transistors have been fabricated, Berger reported, and the results look promising.

### The best of two worlds

CHIL, the technique that combines the input flexibility of current-hogging logic with the packing density and performance of injection logic, was described by Rudiger Muller, an engineer from Siemens AG in Munich. The new technology results in area reduction of 20% when compared with I<sup>2</sup>L and 300% when compared to CHL, according to Muller. He said the total area of a complete

Comparison of I<sup>2</sup>L, CHL and CHIL technologies

	I <sup>2</sup> L	CHL	CHIL
AREA	1.2	3	1
POWER / DELAY	0.8	100	1
DELAY	0.8	100	1
MULTI-INPUT GATES	-	+	+
COMPLEX GATE FUNCTIONS	-	+	+
NO ISOLATION	+	-	+
NOISE IMMUNITY	0	+	0



# SERVICE:

When you want Solid Tantalum or Monolithic Ceramic Capacitors—you want prompt, reliable ordering information and service.

And that's what you get when you specify quality-built KEMET Capacitors. The exclusive KEMET computerized Electronic Product Inventory Control—EPIC, for short—reports the up-to-the-minute status on all capacitors in inventory.

Call your KEMET factory sales office. It and many of our distributor locations are tied by video terminal to our headquarters computer system. You can learn instantly the availability status of the capacitors you need. And you can immediately enter your order through the same computer network. Result: Your order will be processed in hours, and shipped air-freight, if required.

When you need quality-built capacitors, specify KEMET. We can assure you superior ordering service—and EPIC delivery.

Components Department, Union Carbide Corporation, P.O. Box 5928, Greenville, SC 29606; phone: (803) 963-6300, TWX: 810-287-2536, or Telex: 57-0496.



COMPONENTS DEPARTMENT



## KEMET® OFFERS YOU MORE.





circuit could be reduced even further, because like CHL, CHIL offers the possibility of realizing complex multifunction gates.

In use, the inversely operated transistor of a two-input CHIL gate can be turned off when a LOW-level voltage of less than 300 mV is applied to either of the  $I_1$  or  $I_2$  inputs. If both inputs are

turned off, the output transistor is in the ON state, since current-hogging takes place between the injecting emitter, E, and the floating control collectors  $I_1$  and  $I_2$  of the lateral pnp transistor.

Thus, Muller noted, the operation of a CHIL gate can be explained as an  $I^2L$  inverter with controlled injection or as a CHL gate

with a functionally integrated output transistor.

A disadvantage of the CHIL approach is slightly increased pulse delay per stage compared with that for  $I^2L$ . But this is more than compensated for, Muller noted, by a significant reduction in the number of stages resulting from higher fan-in per gate. ■■

## 4-k RAM race still wide open as designers try different paths

The winner of the 4-k RAM race could be a dark horse. One year after 4096-bit dynamic memories "finally arrived," manufacturers are still jockeying for position with upgraded versions and new models. And the latest entries underscore the field's surprising lack of standardization.

**Edward A. Torrero**  
Associate Editor

Virtually all chip designers, for example, agree on the need for an n-channel process to achieve high speeds and high chip densities. But there are supporters of special metal-gate, standard silicon-gate and coplanar silicon-gate variants.

And different designers argue for different circuit configurations. Primarily these are based on a three-transistor inverting cell or one-transistor cell. Versions of the latter can have a single-ended sense

amp or balanced sense amp (often with a dummy cell).

At the system level, memory chips come in 22, 18 and 16-lead DIPs. Both the 18 and 16-lead package permit higher PC-board densities than is possible with a 22-lead DIP. However, some vendors with more than one package option are designing the 22-lead version to have the highest speeds. Moreover different manufacturers employ different pin configurations for both 22 and 18-lead packages. And although at present there's only one 16-lead version (Mott's), it requires external multiplexing of addresses.

The merits of the various approaches were debated in a panel session of the 1975 Solid-State Circuits Conference entitled "Which Way the 4-k RAM?" The panel contained representatives of most manufacturers that have announced products, and each naturally tended to promote the approach used in his company's IC. Nevertheless the often spirited discussion was at times remarkably candid.

### Reliability still a goal

All manufacturers agreed, for example, that they have yet to reach their reliability goal of 0.01% per thousand hours, or  $10^7$  hours mean-time between failure.

"For many systems this value is almost essential to cut costs," said Reese Brown, a senior staff engineer at Burroughs and the only user of memories on the panel. However, Brown conceded that with error-correction circuit-

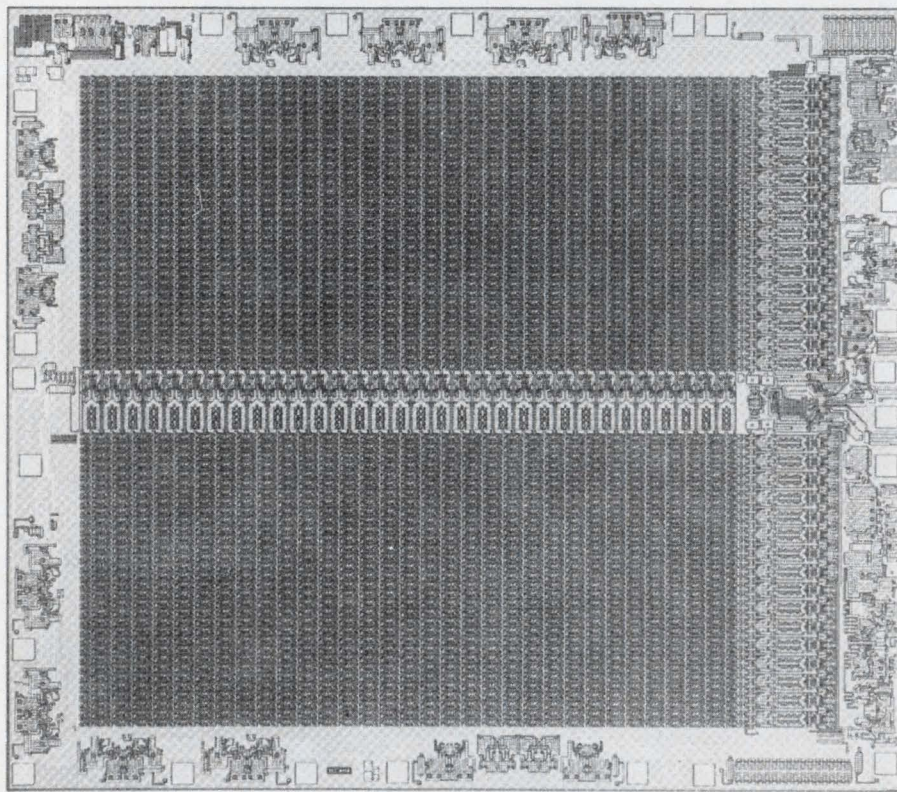

**Aiming for ECL-oriented systems, Intel's latest 4096-bit MOS RAM has access time of less than 80 ns. The ECL-compatible chip employs charge-pump techniques to obtain operational features of static units.**



# Gates introduces the future in energy cells.



There's now a new energy source that's a superb alternative: Rechargeable, sealed lead-acid batteries from Gates.

We call these batteries the future in energy cells. And for good reason.

They have all the product advantages you need plus economic advantages that may well give a new dimension to your product pricing.

Advantages: Gates Energy Cells are as compact as nickel cadmium or gelled type cells. And they are completely sealed, so that no acid vapor can leak out (they also include a self-sealing vent for extra safety). Gates Energy Cells provide low internal impedance for high discharge rates (more than 100 amps from the D cell and 200 amps from our X cell for short periods of time). And can be operated or stored in any position.

Gates Energy Cells offer great packag-

ing flexibility. In fact, our individual cell availability allows you to choose your own specific voltage (in 2-volt increments) and current, as well as configuration.

Just as important as what Gates Energy Cells have to offer is what they don't have to offer. Like outgassing problems. Or cell reversal. Or "memory" problems.

Because Gates Energy Cells are made from low-cost materials that are readily available, they're very high in watt-hr. per dollar value. Which means that if you specify them, you'll probably save your company more than a few dollars. And make yourself into something of a hero in the bargain.

To find out more about the future in energy cells, circle our reader service number or write us. We'll send you *free* literature containing features, application information, ratings and specifications. George Sahl, Gates Energy Products, Inc., 1050 S. Broadway, Denver, CO 80217.



**Energy Products**

**Where the  
energy future is now**



ry, a lower MTBF could be tolerated.

Clinton Kuo of Texas Instruments—the company generally conceded to be the leading 4-k-RAM supplier—reported that his products had an average reliability of 0.09% per thousand hours at present. Other manufacturers reported smaller percentages.

Similarly panelists felt that a package size smaller than the 22-lead DIP was gaining in popularity. But there was no agreement on whether the winner would be an 18 or 16-lead version. Some manufacturers liked an 18-lead approach because they could readily modify existing chip designs intended for the larger package. But most appeared to be moving toward a multiplexed 16-pin version.

“The usual arguments involving multiplexed addressing is irrelevant,” said Richard Foss, manager

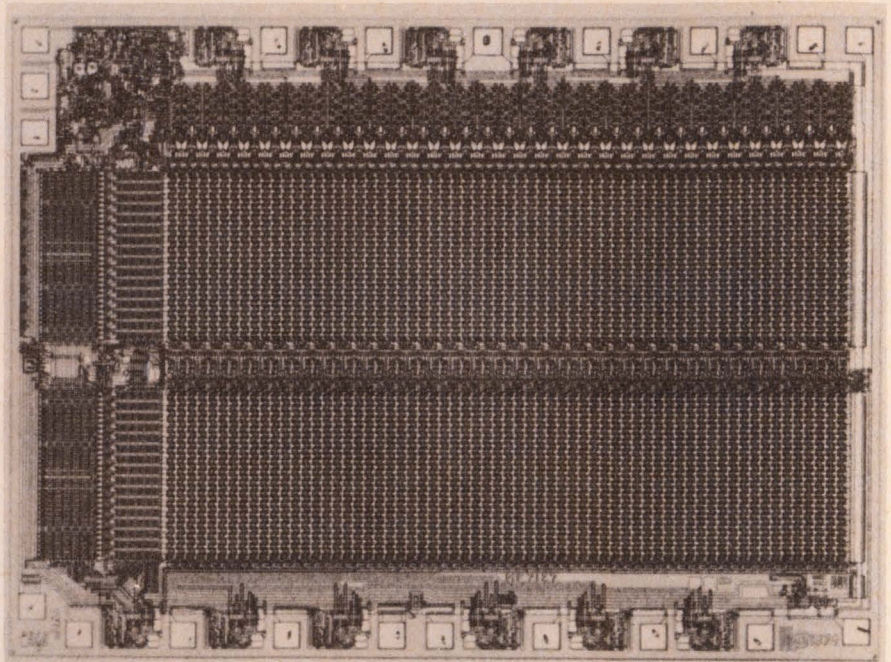

Avoidance of dummy cells simplifies circuit tolerances and reduces on-chip circuitry in Microsystems' 2107C, the company's latest 4-k RAM.

## Representative 4096-bit dynamic RAM chips

Supplier Model No.	Process	Chip area (mil <sup>2</sup> )	Transistors per cell	Number of masks (including scratch protection)	Access time (ns)	Supplies (V)	Leads per package	Number of high level clocks	Refresh cycles	Refresh time at 70 C (ms)
*Intel 2107A	Si gate	22,700	3 (non-standard)	6	350	+12, ±5	22	1	64	1
2107B	Si gate	18,400	1	7	200	+12, ±5	22	1	64	2
*Microsystems 7112	Si gate low res	24,700	3	6	400	+12, -2	22 <sup>†</sup>	3	16	2
2107C	Si gate coplanar	20,100	1	5	300	+12, ±5	22	1	64	2
Mostek 4096	Met gate special	28,700	1	7-9	** 350	+12, +5, -9	16	0	64	2
Motorola, American Microsystems 6605	Si gate coplanar	32,600	3	6	230	+12, ±5	22 <sup>†</sup>	1	32	2
Signetics 2604	Si gate coplanar		1			+12, ±5	22	1	64	2
Texas Instruments 4030	Si gate coplanar	28,600	1	6	** 300	+12, +5, -3	22	1	64	2
4050	Si gate coplanar	28,600	1	5	200	+12, ±5	18	1	64	2
Western Digital 1701			3		200	+12, ±5	22	1	16	2

\* Being phased out of manufacturer's line

\*\* Upgraded version has 200-ns access

† Pinout differs from TI/Intel 22-lead package



# Why you can afford the very finest in function generators.

Because Interstate's new F77 truly is a universal signal source. With F77's 0.00002 Hz to 20 MHz range, you can test with frequencies from infrasonics through video, and beyond. There are 6 output waveforms, 7 operating modes, and precision interface controls (waveform inversion and a 5/95% waveform variable symmetry vernier, for example) that can be actuated with remarkable variations. And output amplitude is specified at 15 volts p-p into 50 ohms — that's 50% more voltage swing than most 20 MHz function generators provide.

Because the F77 also incorporates a very capable, independent sweep generator offering linear and logarithmic performance, with a selection of auxiliary outputs. Sweep up or down, sweep reset control, and continuous, triggered, burst, sweep-and-hold modes, too. Interstate's special frequency dial has a direct-reading sweep limit cursor, plus two calibration scales (X1 and X2) to improve resolution and permit continuous tuning across the 20 Hz-to-20 KHz audio band.

Because this function generator is the first of its kind to deliver real pulse generator capability. The F77 produces a 15 ns rise time pulse to 20 MHz with



constant width setability from 30 ns to 10 milliseconds, and full offset and mode flexibility. The generator's fully-calibrated attenuator gives you 15-volt unipolar pulses into high impedance loads, particularly useful for testing MOS, or millivolt pulses down to 1.5 mv.

Because there's also a constant duty cycle pulse (in addition to F77's standard pulse) for a variety of digital signal response applications. Circuit sensitivity to duty cycle on/off times can be tested using varying pulse rates without adjusting the width control.

Because the F77 can be used as an analog power amplifier to amplify externally applied signals as much as 600%. Even TTL pulses can be amplified to drive 50-ohm loads, and the resulting output has controlled dc offset and attenuation.

Because the F77 gives you many other high performance and human engineering features, like VCF capability for sweeping frequency-sensitive devices, and "oscilloscope-style" triggering with a variable start-stop phase control to generate haversines and havertriangles. There's even a "brown-out" switch to allow the instrument to operate at low line voltages.

Because the F77 only costs \$1,095.\*

\*U.S. price; other 20 MHz Series 70 models available from \$695.



**INTERSTATE ELECTRONICS CORPORATION**

707 E. Vermont Ave., P.O. Box 3117, Anaheim, California 92803 (714) 772-2811



of new products at Microsystems International. He pointed out that virtually any one-transistor-cell memory lent itself to address multiplexing. This is because the bits defining the column cannot be used until some time after charge has been dumped from each of the 64 cells on a row, and after the sense amps have been strobed. Also, the circuit's speed can be enhanced when operated in a "page" mode rather than the usual random-access.

"However, it's still not easy for TI, Intel or anyone else with a balanced flip-flop sense amp to replicate the Mostek part," Foss said in an interview. The Mostek circuit's unbalanced, or single-ended, sensing scheme requires heightened stored charge. Hence process complexity must increase to obtain the needed dielectric (nitride) or area, or both. But the result is decreased power dissipation in an almost totally dynamic part.

"To convert to a 16-lead DIP, the tradeoff is low power vs low manufacturing cost—not both at the same time," Foss said.

### One-transistor cell vs three

The speed benefits of a three-transistor cell vs one-transistor were conceded by Bob Proebsting, a senior circuit designer of Mostek, which employs the one-transistor. "A three-transistor cell has a 10 to 15% speed advantage," he said. "You get a decent signal out of the matrix, so that you don't have to slowly process a very small signal, like that from a one-transistor cell." However, the latter generally provides the fabrication-cost advantage.

But for Motorola's Bud Broeker, a three-transistor-cell design was somewhat more reliable because of reduced thin-oxide, or active, area on the chip. At the 4-k level, he noted, both circuit techniques result in about the same over-all chip size. But the three-transistor chip design has about one-half the active area of a corresponding one-transistor design.

Countering Broecker's contention, Rampower's Joel Karp pointed out that the thin-oxide areas on chips have been increasing steadily as RAMs have evolved from 64-bit

levels up to the present 4 k. But reliability hasn't gone down correspondingly. Instead poor reliability has been linked to circuit designs and manufacturing techniques.

### Dissipation woes

On more solid ground, Broeker compared the lower power needs of his company's 4-k RAM with the higher requirements of Intel's latest RAM (both are 22-lead DIP versions). Assuming a 1/4-mega-bit system in operation 16 hours a day 250 days a year, Broeker estimated that the Motorola memories would have an average con-

cluded: "It was an engineering error."

However, improved circuits are on the way. "There's nothing magic about that sense amp," said Karp, who pointed out that the problems cited were fundamental to the amps used. Alluding to developmental work, Karp predicted that newer sense amps would maintain the differential character of flip-flops while operating in a dynamic mode. And read-modify-write times will not be degraded, he said.

Karp's company, a Palo Alto consulting team, is reported to have worked on National Semiconductor's forthcoming 4-k RAM in an 18-lead package.

The National version won't have the same pinout as the 18-lead model from Texas Instruments. The TI RAM multiplexes input and output data on a single terminal, and it eliminates the chip-select terminal by having the chip-enable clock and read/write-mode control perform the enable function. The National unit replaces three leads with one that serves the functions of read/write, logic chip select and  $V_{CC}$ . Neither circuit requires address multiplexing.

### Larger memories ahead

The current scramble of 4-k RAMs hasn't stopped manufacturers from looking ahead to larger memories. Arguing for the 16-lead rather than 18-lead package, Broeker said that the smaller package could also serve as a forerunner of the 16-k bit RAM, "which we're all working on and don't want to talk about." Among the panelists who did talk was a Siemens senior research specialist, Karl Stein, who exhibited a photo of an experimental 16-k RAM chip.

However, papers presented at the conference dealt with RAMs having capacities no larger than 4-k bit. At this density level, new chips were unveiled by both Microsystems International and Intel. The Microsystems' entry, the Model 2107C, was described by Richard Foss in a paper, "Simplified Peripheral Circuits for a Marginally Testable 4-k RAM." The Intel development, geared for high-speed ECL-oriented systems, was described by John Gionis in "A

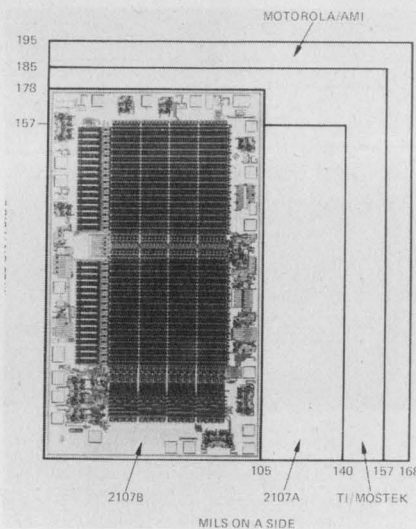

One of the smallest 4-k RAM chips is Intel's 2107B. The memory has 200-ns access.

sumption of 76 W against 25 W for Intel's 2107B.

"And for each million devices, it would take another 719 barrels of oil to run the 2107B," he said.

In defense, Mike Geilhufe, Intel's MOS memory manager, linked the IC's high dissipation of a watt to the internal sense amp. The basic design seeks to achieve a fast read-modify-write cycle—an important feature for large systems employing error correction. But the result is a classic speed-power tradeoff. The sense amps draw dc power.

"Also, we didn't fine-tune the peripheral circuitry," Geilhufe said. "They probably draw more power than they should." In a rarely heard admission, he con-



# Again. The heir apparent of the digital temperature indicator world is a chip off the old Doric block.

Using a single custom-designed "super chip", the Doric Series 400 Trendicators have 75% fewer parts. With less to fail, MTBF is 10 years. And since they need only 1.5 watts of power, they run nice and cool. They're reliable. Very.

Flexibility, versatility, or whatever you want to call it, is another strong feature. For example, you can measure six TC types with one unit (J,K,T,R,S & B). Switching from degrees F to degrees C or vice versa is a snap (built-in). Field range/type change is just as easy.

The looks are pretty snappy too. Big readable

LED's. Cast aluminum case, no tacky plastic. And a clean compact size (a little larger than a 1 lb. box of sugar).

Same stellar Doric performance, with prices starting at \$299 for onesey, twoseys. A paltry \$799 for the 12 range 1° model. A few coins more for the 0.1° version.

Call Frank Schulte COLLECT at (714) 565-4415 or write Doric Scientific, 3883 Ruffin Rd., San Diego, CA 92123.

Be sure to ask him about our infinite life warranty.

## Doric Scientific

An armadillo among the sheep.

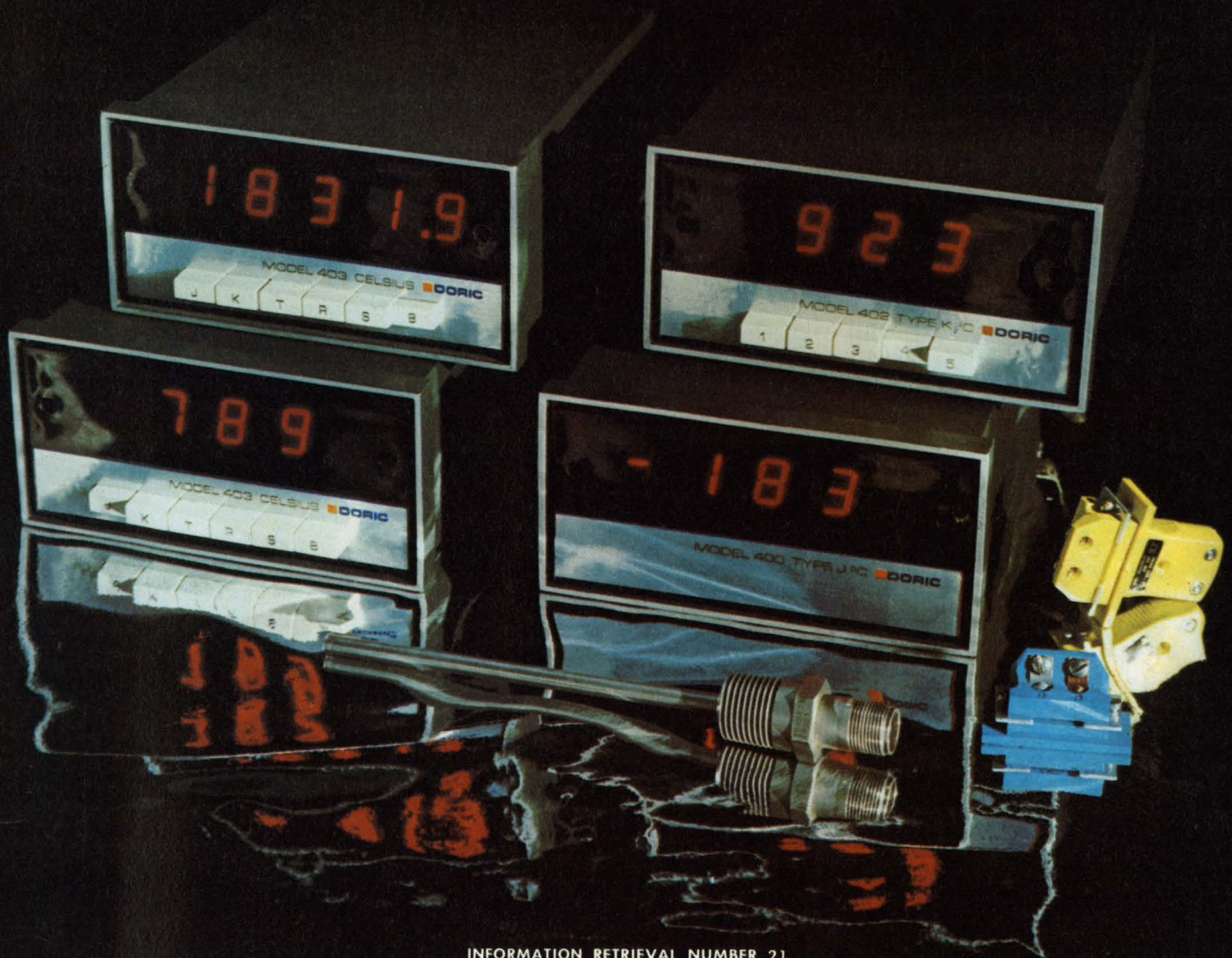



4096-Bit, High-Speed, ECL-Compatible RAM."

The Microsystems' chip employs TI's one-transistor cell with a balanced sense amp, but without the usual dummy cell. Hence associated on-chip level-setting and timing circuits can be eliminated for a reduction in fabrication complexity

and area. The chip measures about 20,000 mil<sup>2</sup>—only about 30% larger than a standard 1-k bit RAM.

The chip permits the testing of internal operating margins through the use of  $V_{CC}$  as the reference potential. Variations of  $V_{CC}$  to failure provide the internal ONE and ZERO margins.

The new Intel chip, also an MOS memory, features high speeds and static operation through the use of charge-pump techniques. Access and cycle times are less than 80 and 150 ns, respectively. And dissipation is typically 500 mW in the operating mode and 300 mW in standby. ■■

## Analog circuit specialists battling to survive the digital onslaught

While analog circuit designers announced no dramatic breakthroughs at the Solid State Circuits Conference, they did give some clear indications of how they planned to survive in an increasingly digital world.

We can expect to see increased use of sampled-data techniques for analog processing—many such systems will harness the ubiquitous charge-coupled device (CCD). We can also expect a proliferation of converter circuits that cleverly exploit the latest process technologies to perform analog functions in addition to the original digital function. Here CMOS will probably be used for low-cost circuits, while integrated injection logic (I<sup>2</sup>L) may be used for the digital portions of high-performance bipolar circuits.

An impressive example of how I<sup>2</sup>L logic can be combined with analog circuitry on a single chip surfaced during a panel discussion of "Compatible Analog/Digital Techniques for a Monolithic Process." A pioneer of I<sup>2</sup>L, Case Hart of Philips Research, Eindhoven, the Netherlands, described and demonstrated a monolithic tone generator for pushbutton telephones. The system, whose performance met European telephone standards, used I<sup>2</sup>L for such digital functions as frequency division, while the same bipolar chip included such sophisticated analog circuits as a gyrator and line drivers. To ensure that the circuit

would be relatively inexpensive to manufacture, Hart limited himself to just four masks for device fabrication.

### Better passive components

As evidenced by papers at the conference, analog designers are showing considerable ingenuity in improving the precision of passive components for analog ICs. Resistors have long been a limiting factor in IC performance—especially in the bit-weighting networks of a/d and d/a converters and in the offset-nulling and gain-defining networks of operational and instrumentation amplifiers.

An extreme solution—throw out the resistors and use capacitors

instead—was advocated in a paper by James McCreary and Paul R. Gray of the University of California, Berkeley, CA. The authors described a successive-approximation a/d converter that exploited the excellent matching characteristics exhibited by area-ratioed MOS capacitors. The experimental n-channel metal-gate circuit performed a 10-bit conversion in 20  $\mu$ s. Measurements on experimental chips made by conventional photolithography showed that if capacitor ratio error were the only factor affecting yield, the yield to  $\pm 1/2$  LSB would be 98% for 8-bit resolution and 45% for 10 bits.

The experimental chip contained the capacitor array, an offset-compensated comparator and the output latch. However, it did not include the reference source, clock generator or control and sequencing logic. Though the capacitive-weighting technique had been proposed before, the authors' circuit avoided a parasitic-capacitance problem that had hitherto restricted the attainable resolution.

Another way to eliminate the resistors from converter circuits was proposed by Thomas Hornak and John Corcoran of Hewlett-Packard Laboratories, Palo Alto, CA. Hornak, who delivered the paper, described an a/d converter that consisted of an analog signal-processor chip, containing both MOS and bipolar devices, and an external transformer with a precise ratio that essentially defined the converter's accuracy. The accuracy was said to be consistent with a resolution of better than 12 bits. The conversion technique was re-

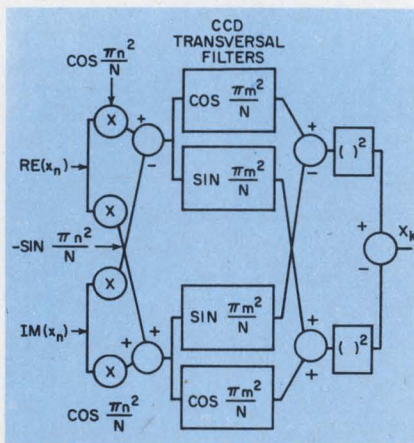

An analog Fourier transformer can be built by use of charge-coupled devices as transversal filters. The technique shown employs a sliding chirp Z transform for periodic waveforms and stationary signals. A practical system has been built to generate a 500-point transform.

Michael Elphick  
Managing Editor





# They're running 1-2 in the 16K static ROM speed race

Someday, someone may produce a faster static 16K ROM than Motorola's new MCM6832. Chances are, it will be Motorola. Until we developed the MCM6832 with its 550 ns access time, our own MCM-6590 was fastest at 800 ns, and it's still much faster than any other.

The MCM6832 was developed to provide a large ROM which allows the MC6800 microprocessor to operate at its full speed capability. As such, it's naturally the first one fast enough to permit full speed operation of any MOS MPU system. The MCM6590 is still the most cost effective 16K ROM, though, when ultimate speed isn't the primary requirement.

These mask programmable memories are identical in most vital characteristics, with but one other significant difference. The MCM-6590 uses +12, +5 and -3V supplies, for compatibility with the popular MCM6560, 6570, 6580 series of 8K ROMs. The MCM6832 uses -5V in place of the -3V supply for direct compatibility with NMOS

RAMs. Both are ideal for fixed program storage, look-up tables, terminal character generators, and of course, microprogramming for microprocessors.

Three-state outputs permit common busing, and programmable chip selects and wire-OR capabilities help minimize unwanted external components in memory expansion. Programming is easy. Prototype parts are typically delivered six weeks after receipt of a mask pattern.

For system characterization of parts prior to ordering custom programmed ROMs, the MCM6591 and the MCM6832L91 are pre-programmed versions, containing a

potpourri of conversion codes and USASCII characters.

One to 24 prices are \$35.90 for the MCM6591, \$43.08 for the MCM-6832L91. Minimum MCM6590 and MCM6832 orders are 500 units per custom mask. From there to 999 they are priced at less than 15/100 and 2/10 cent per bit respectively, excluding the mask charge. For information, write Motorola Semiconductor Products Inc., P.O. Box 20912, Phoenix, AZ 85036, or circle the reader service number.

One other thing. Motorola's complete line of NMOS 8K ROMs is as great and competitive as ever and there is an alternate source. Any authorized distributor or Motorola sales office can provide 8K ROM information and/or take your order.

Device	Access Time ns	Power Supplies V	2048 x 8 Organization	Power Dissipation (max) mW	TTL Compatible	CMOS Compatible	Price per bit (100-999)¢	Ceramic Dual In-line Package
MCM 6590	800	+12, +5 -3	✓	<500	✓	✓	<15/100	24-pin
MCM 6832	550	+12, +5 -5	✓	<500	✓	✓	<2/10	24-pin



## MOTOROLA MOS

— leader in NMOS memories

INFORMATION RETRIEVAL NUMBER 22



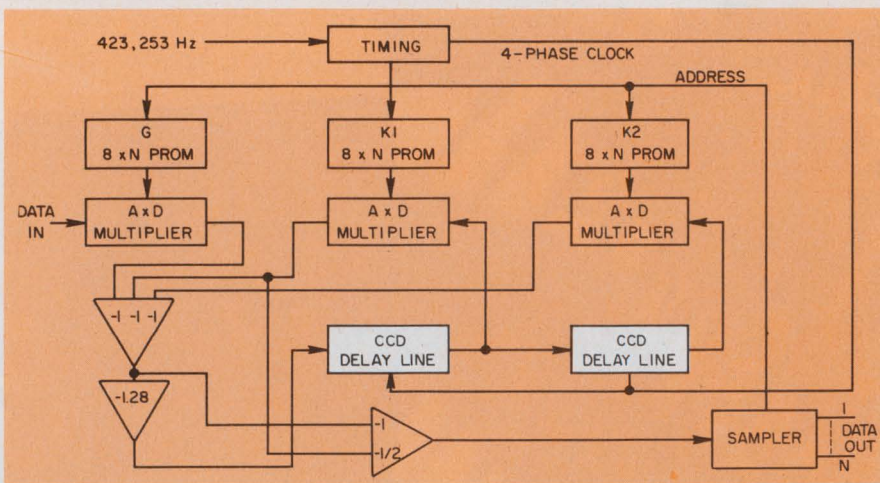

A 32-channel multiplexed filter uses a single tapped CCD delay line. The center frequency, bandwidth and gain of each channel can be programmed independently by data stored in just three PROMs. The basic filter is the canonic form of the two-pole, one-zero recursive filter network.

cursive (bit at a time) and based on the Gray Code (absolute value) algorithm. A conversion rate of 20 kHz was used to evaluate circuit performance. Hornak pointed out that the circuit's Gray Code output could easily be converted to binary code by external logic.

### Improved trimming techniques

Of course, proponents of resistors argue that these components pose a performance and yield problem only if one is trying to use diffused resistors in a truly monolithic circuit. If one is allowed to use external components, why not stay with precision resistors?

This was the approach chosen by Robert B. Craven of Analog Devices Semiconductor, Wilmington, MA. In his paper, Craven described a 12-bit d/a converter that consisted of two chips in a single package. One chip contained a laser-trimmed, thin-film resistor network, while the companion chip contained bipolar circuitry for current switching. For the resistor chip, laser trimming was performed automatically at the wafer level. The switching-network chip included a new type of biasing circuit that reduced sensitivity to device parameter variations. Settling time for the converter was  $1.5 \mu\text{s}$  to within 0.01% of full scale. The circuit was designed to accept both CMOS and TTL inputs and to operate from  $\pm 15\text{-V}$  supplies.

A technique that may give new life to diffused resistors for analog ICs was described in a paper by George Erdi of Precision Monolithics, Santa Clara, CA. He showed how the offset voltage of a precision operational amplifier could be nulled at the wafer-probe phase, where circuits are handled in mass. This economical approach involved short-circuiting zener diodes that had been designed into the chip to shunt strategically placed diffused resistors. According to Erdi, the current required to perform the short-circuiting operation was around 100 mA, though the exact value depends on the duration of the pulse. When the current pulse is passed through the emitter-base junction, the localized power dissipation is of such magnitude that metal from the emitter and base contacts fuses into the silicon thus shorting the two contacts. The fusion is permanent and typically results in a  $1\text{-}\Omega$  resistor.

Though the basic technique of shorting diodes to program circuits was first proposed by J. E. Price of Fairchild Semiconductor in 1962, Erdi said that designers were only now starting to use it for linear ICs. Other engineers at the conference, however, indicated that they had been using the technique for several years.

### Data sampling gains favor

While progress in digital processing of analog signals is tem-

porarily stymied by a lack of suitable compact, low-cost converters, analog circuit designers are paying increasing attention to sampled-data processing. With this "semi-digital" approach, of course, the data samples are still handled as analog signals, but the timing and control functions can be handled by digital logic.

Recently the development of CCDs gave sampled analog processing a powerful shot in the arm. Compared with digital filters, CCDs offer potential advantages in cost, weight, size, power consumption and reliability. But CCDs have several disadvantages that presently curb the range of applications. The number of delay stages is limited by charge-transfer loss, the total time delay is limited by thermal leakage, and filter bandwidth is limited by speed restrictions. Several papers at the conference described practical applications for CCDs, while others showed how CCD performance could be improved.

The enormous potential of CCD processing was demonstrated in a paper by Robert W. Broderon, Horng-Sen Fu, Robert C. Frye and Dennis D. Buss of Texas Instruments, Dallas. The paper was delivered by Broderon, who described how CCDs could be used as transversal filters in a system to perform a 500-point discrete Fourier transform.

Instead of using a true DFT, the Texas Instruments engineers used an approximate algorithm called a sliding chirp Z transform (CZT). This approach required three signal-processing steps: pre-multiplication of the samples by a complex chirp waveform, convolution in a filter having a complex chirp impulse response and post-multiplication by a complex chirp waveform. Custom CCD filters were fabricated with electrode weighting on  $160 \times 100\text{-mil}$  chips. The devices were found to have 99.98% charge-transfer efficiency from 1 kHz to 8 MHz.

According to Broderon, it's possible to build real-time Fourier transformers that operate to 10 MHz, but the technique is presently limited to 1000-point resolution. Chirp generation, pre-multiplication and output squaring were performed off chip, but a future de-



# From the *Quality* DMM Specialists



**At last! True RMS in a  
low cost DMM.**  
(Buy it now... or add it later)

What's so great about true RMS? Well, did you ever have to measure distorted sinewaves? Triangles? Squarewaves? Pulses? Don't bet that you won't have to tomorrow. True RMS is the only *accurate* way to do it. And only Systron-Donner's Model 7224 lets you buy true RMS now or add it later.

The new 20,000-count, autoranging Model 7224 is a quality-built "customer's" DMM. Plug-in boards make it easy to service or to install options at any time. Outstanding features include:

- choice of TRUE RMS or AC averaging • 0.001 ohm resolution • autoranging • large in-line/in-

- plane segmented display with automatic polarity, decimal point and annunciator • DC/DC ratio option • 5 ranges DC volts, 7 ranges ohms standard • optically isolated BCD output • FAST and SLOW sample rate

Here's how to get details on the first of a new breed of quality DMM's:

In the United States, give your local Scientific-Devices office a call or contact us in Concord. Abroad, contact Systron-Donner GmbH, Munich; Systron-Donner Ltd., Leamington Spa, U.K.; Systron-Donner S.A., Paris (Le Port Marly); Systron-Donner Pty. Ltd., Melbourne.

1 Systron Drive, Concord, CA 94518 • Phone (415) 676-5000

**SYSTRON  DONNER**

INFORMATION RETRIEVAL NUMBER 23



# FREE Engineering Handbook from RCL Electromagnetic Delay Lines

Including Dual-In-Line  
(DIP)

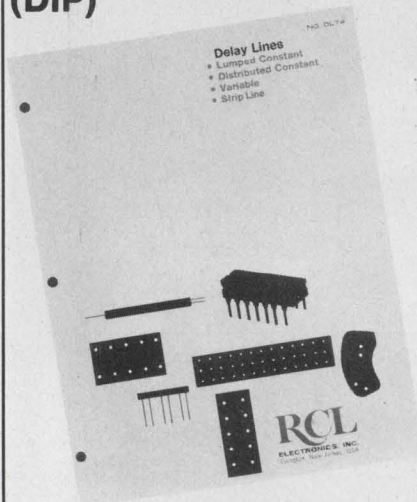

## NEW '75 EDITION

Terms... engineering definitions... test methods  
... how to specify delay lines  
... characteristics of various types... specifications  
... they're all included in this concise, easy-to-read handbook... yours for the asking.

DIP DELAY LINES  
LUMPED CONSTANT...  
DISTRIBUTED CONSTANT  
... VARIABLE

**NEW** LOW PRICED SERIES  
OF COMMERCIAL  
DIP DELAY LINES

**AMF**

**RCL Electronics**

General Sales Office:  
700 So. 21st Street  
Irvington, N. J. 07111

velopment program will integrate these functions to produce a self-contained spectral-analysis IC.

The sliding version of the CZT is significantly less affected by charge-transfer efficiency than the true CZT. But it has the disadvantage of not yielding a true DFT for some waveforms, though it does give the power-density spectrum of a DFT for periodic waveforms and stationary random signals. Broderson predicted important applications in doppler processing for radar and sonar, image processing for bandwidth compression, and spectral analysis for target identification and speech recognition.

Use of CCDs in a reprogrammable filter bank for doppler processing was described in a paper by John Mattern and Donald Lampe of the Westinghouse Defense and Electronic Systems Center, Baltimore. The system used a 32-stage CCD analog shift register to provide the delay for a recursive two-pole, one-zero network. The serial data output was demultiplexed onto parallel output lines. Though a 32-stage CCD can theoretically provide up to 32 filter channels, the version described was limited by the output sampler to just 16 channels.

The center frequency, bandwidth and gain of each filter channel were independently programmable. Three PROMs contained the necessary three programming constants for all channels, while three multiplying d/a converters accomplished the required instantaneous weighting of the analog signals. According to Mattern, who delivered the paper, each of the nonuniformly spaced center frequencies, in the range of 150 to 250 Hz, were within 1 Hz of the design frequency—a tolerance of about 0.5%.

Some members of the audience questioned the usefulness of the Westinghouse filter bank, saying that it would be more economical to use 16 separate active RC filters built with inexpensive op amps. But Mattern explained that his approach became more economical as the number of channels increased, because the system still needs only a single CCD and three PROMs and converters. Also, the PROMs can be replaced with computer generated codes to allow con-

tinuous readjustment of filter characteristics.

## Overcoming CCD limitations

A couple of papers at the conference showed how some of the problems of CCDs could be circumvented. For example, Miles A. Copeland and Dipak Roy of Carleton University, Ottawa, Canada, in a paper coauthored by Chong C. Chan of Bell Northern Research, showed how a 10-channel multiplexed CCD and delay line could be constructed for video delay applications. This approach allowed the analog sampling rate to be 10 times the CCD clock rate, thus avoiding the inherent sampling-rate limitation of CCDs. The system was designed to delay a color TV signal by one line duration, thus allowing synchronization and bandwidth compression. Though bandwidth, linearity and phase behavior were adequate, the authors encountered problems with fixed pattern noise. This noise had components concentrated at harmonics of the CCD clock rates, and it was caused by imbalances of bias and gain at the inputs and outputs of the CCD channels.

Another paper, by John Shott and Roger Melen of Stanford Electronics Laboratory, Stanford, CA, showed how a "razorback" structure could be used to place multiple input taps on a CCD while achieving high transfer efficiency and large bandwidth. With this type of CCD delay line, the input taps can be used singly to provide a selectable bit delay, or in parallel to perform delay-sum and multiplexing operations. ■■

## Papers, anyone?

A complete digest of the papers presented at the International Solid-State Circuits Conference is available at \$20 for IEEE members and \$30 for nonmembers. Write to: International Solid-State Circuits Conference, Philadelphia Section IEEE Office, Moore School of Electrical Engineering, University of Pennsylvania, Philadelphia, PA 19174.



# The perfect RF/DC millivoltmeter



Now for Only \$950 Measure Any RF/DC Voltage

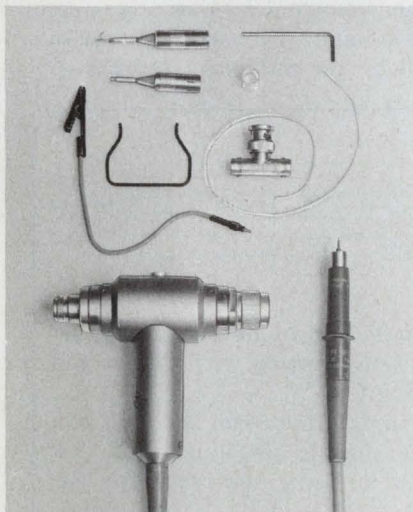

A complete line of accessories for both AC & DC voltages and current measurements are available.



## FEATURES:

- The Rohde & Schwarz Model URV measures DC and RF from 1 kHz to 1.6 GHz
- Wide Measuring Range — 50 $\mu$ V to 1050V (30 kV-DC)
- True RMS and Peak value measurements
- Floating input eliminates ground loops, hum, pick-up ... and it provides added safety
- Measure superimposed AC/DC voltages
- Linear DC recorder output
- Low VSWR — 1.02
- Measure 4 terminal networks rapidly and easily with switched dual probe inputs

Call or write for more information or a demonstration.



World Leader in Test Inst. & Communications for Over 40 Years

**ROHDE & SCHWARZ**

14 Gloria Lane, Fairfield, N.J. 07006 ■ (201) 575-0750 ■ Telex 133310



# PLL ICs taking on dedicated jobs as temp and voltage ills recede

Monolithic phased-locked-loop devices—one of the most promising electronic developments to emerge in recent years—are maturing with semiconductor-chip design experience.

Temperature sensitivity has been improved substantially, especially at higher frequencies. As a result, the operating ranges have been extended into the rf and vhf regions.

Voltage sensitivity is being controlled by inclusion of regulators on the chips.

Most important, the attempt to develop general-purpose PLL devices has given way to the design of a variety of special circuits that do one dedicated job. They do it better and at lower cost than other approaches do. These special PLL circuits are being used in the following applications:

- FSK data modulation and demodulation.
- Tone detection and decoding.
- Data-stream synchronization.
- Digital tuning (frequency synthesis).
- Stereo multiplex decoding.
- Discrete four-channel sound decoding.
- TV chroma subcarrier regeneration.
- TV horizontal oscillator sync.
- FM i-f demodulation.
- TV-sound i-f demodulation.
- TV-picture demodulation.

Phase-locked-loop integrated circuits, first fabricated by Signetics in 1969 as frequency-selective circuits, are designed for a wide range of filter, demodulator and signal-conditioning applications. But the performance of first-generation IC devices was disappointing, because of temperature instability of the key element of the loop—the volt-

**Jim McDermott**  
Eastern Editor

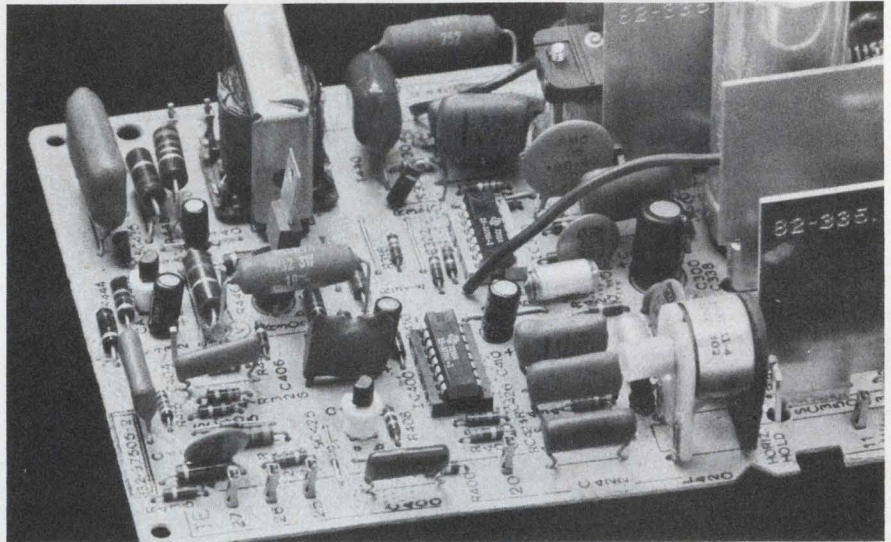

The horizontal oscillator and phase detector of this Sylvania TV-set PLL used for horizontal hold are in the IC (center, front). The oscillator tuning coil shown at the right stabilizes the oscillator frequency.

age-controlled oscillator (see box).

Temperature instability limited application to noncritical circuits with wide tolerances. And this instability, which increases with the VCO operating frequency, limited the upper frequency at which the devices could be used.

In addition undesirable drift of the VCO frequency was present with variations in supply voltage.

A number of the new PLL circuits, particularly those for consumer electronics—like FM stereo radios and TV sets—are being used by the millions. (*continued*)

## Basic phase-locked loop theory

The basic phase-locked loop (PLL) is a feedback system in which the frequency and phase of a voltage-controlled oscillator ( $c_v$ ) is compared with that of an input signal ( $c_i$ ). When there is a difference an output appears at the comparator.

This output is passed through a filter and applied to the voltage controlled oscillator (VCO) to bring it back in step with the input signal. In this manner, the frequency and phase of the VCO tracks that of the

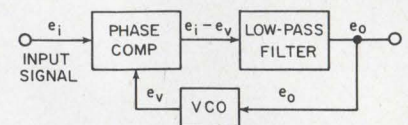

input to provide frequency selection filtering without a tuned circuit.

In discrete form the PLL has been highly developed in NASA and military receivers for extracting signals from noise. And this application continues to be a major reason for its use in IC form.



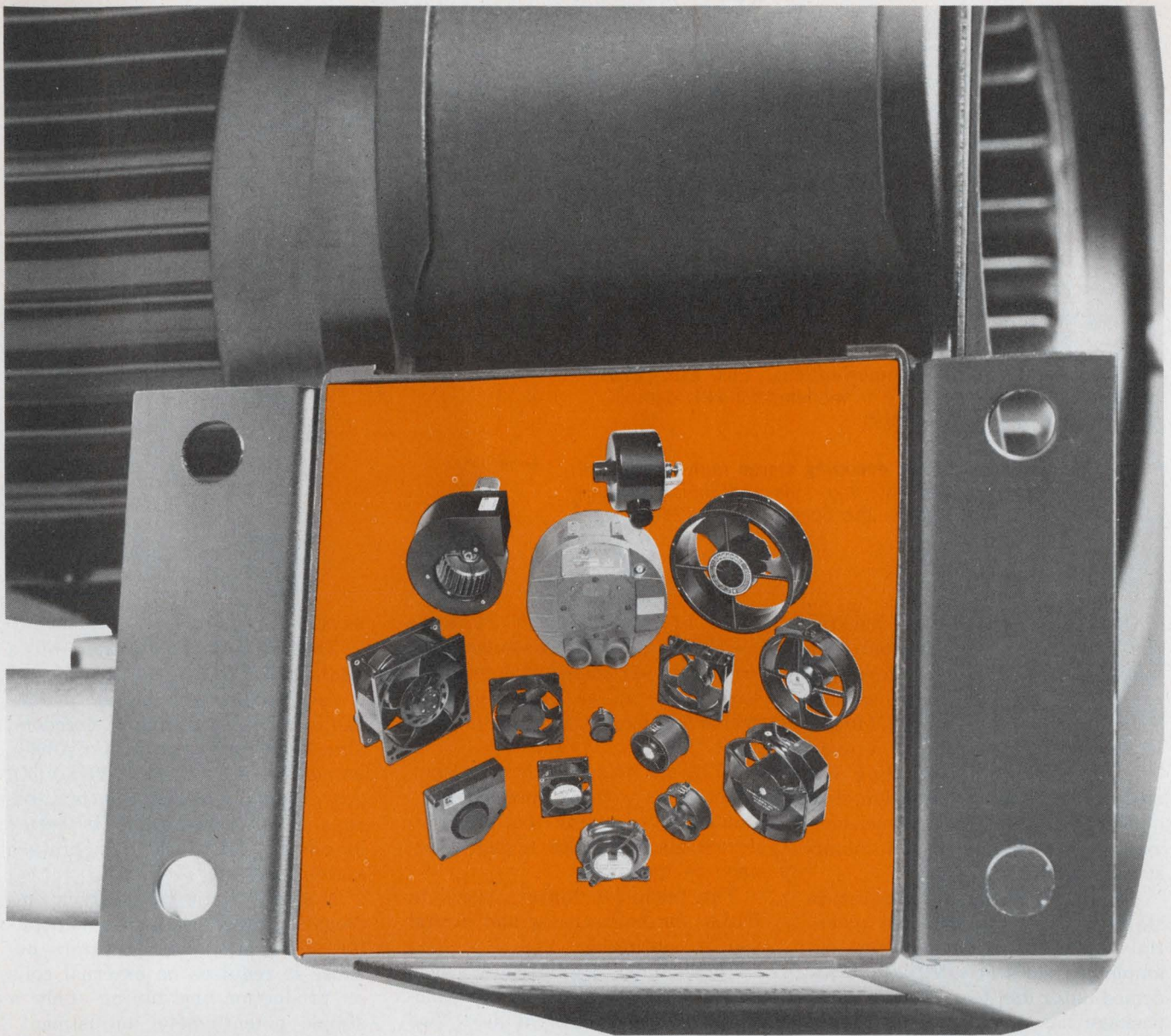

## ***Behind every Rotron fan and blower... Product Variety***

There's a good reason why there are more than 150 standard model air movers in the Rotron fan and blower line.

It's you.

Your air moving requirements may not be the same as those of someone else. And you yourself may have a number of different air moving needs, calling for different electrical inputs, different housing configurations, various pressures and volumes.

Over the years, Rotron, as the world's leading manu-

facturer of precision air moving devices for electronic and industrial applications, has learned to provide the most meaningful selection of such performance characteristics. You can get just the product you need, when you need it, at a price that's realistic.

Next time you have an air mover requirement, go to the one place you're most likely to find the right answer. In a standard model. Or one specially tailored for you. Rotron will even help you make the choice.

*Why settle for less when the best costs no more?*



**ROTRON INC.**

Woodstock, N. Y. 12498 □ 914 • 679-2401 □ TWX 510-247-9033

Pacific Div., Burbank, Cal. 91506, 213-849-7871 • Rotron B.V., Breda, Netherlands, Tel: 79311, Telex: 844-54074

INFORMATION RETRIEVAL NUMBER 26

18512



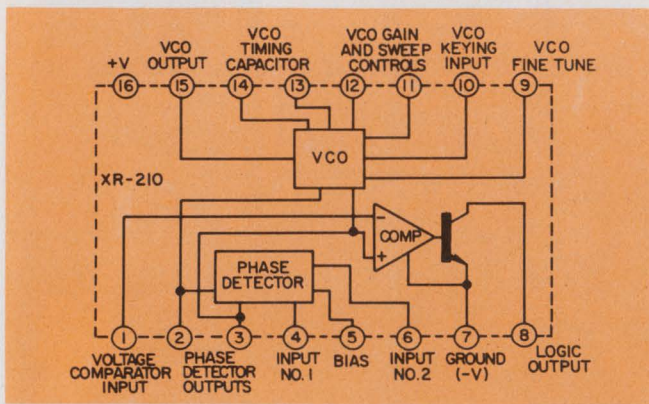

1. Designed for data communications, this Exar 210 phase-locked-loop IC is used in modems for FSK demodulation and for tone decoding.

2. Monolithic PLLs for decoding stereo multiplex signals in FM receivers eliminate the coils and tuning formerly required. Shown here is the Sprague ULN-2244A.

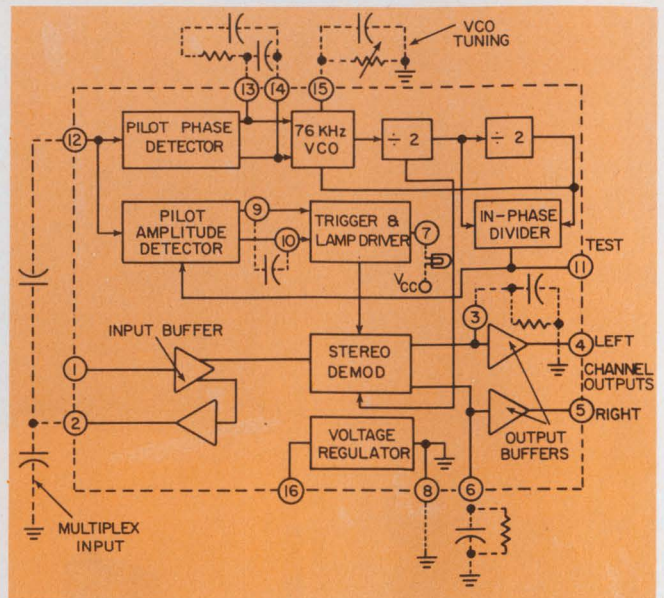

One phase-lock device bucking the trend to specialization is a micropower CMOS unit developed by RCA (CD4046) and second-sourced by Motorola (MC14046). It has been designed for a number of applications, including FM modulation and demodulation, frequency synthesis, data synchronization, tone decoding and motor-speed controls.

The improvement in temperature stability has expanded the potential uses of PLL devices. One example is Exar's new XR-2211 FSK demodulator and tone decoder. This package has a high VCO stability of 20 ppm/°C, compared with 600 ppm or more for first-generation units.

"The 2211 has improved the state of the art—so far as temperature sensitivity is concerned—by a factor of five," says Alan Grebene, Exar's president and developer of the first practical monolithic PLL at Signetics. He adds: "It opens up a wide range of telephone and FSK modem applications where channel widths require a higher stability than that currently available."

Stanley Canter, engineering manager of Omnitec Corp., Phoenix, AZ, one of the largest suppliers of acoustic modems and telephone couplers for computer time-sharing and data communication, uses PLLs for FSK modulation and demodulation.

"We have to pay careful attention to the temperature character-

istics of the monolithic PLLs we use," he says. "Excessive VCO frequency variations with temperature show up as bias distortion, which changes the mark-to-space ratio."

"The use of a PLL is more cost-effective as well as more reliable," Canter says, adding that the PLL device also provides higher tolerance to line noise.

The push for higher speeds in PLLs, for both analog and digital use, is continuing.

"For analog signal work," says L. J. Reed, Motorola Semiconductor Products design engineer, "we have a linear PLL that will be available this summer. The part, the MC12030, will operate above 50 MHz. At present there are typical parts that can operate at 30 MHz but that have guarantees of only 15 MHz.

"Another feature of the MC12030 will be the fact that it is a 5-V device, as opposed to the 8-to-12-V devices now on the market. This part will directly interface with ECL, for example, in the divide-feedback chain of a synthesizer. For existing products, translators must be added to both input and output for interfacing with any kind of digital circuit."

Another high-speed product that Motorola plans to release in July is a high-frequency balanced modulator that can interface with linear circuits or be driven directly by ECL. Called the MC12002, it will operate above 500 MHz, Reed

says.

The largest application of a dedicated PLL IC—on the order of a few million a year—is in FM-radio stereo multiplex decoders. One basic type, the RCA CA3090, employs an LC-tuned, 76-kHz VCO. An externally tuned coil is used, says RCA, because of its better long-term drift and temperature stability.

A second basic type, which employs RC-tuned oscillators, is popular with radio manufacturers because it requires no external coils or production-line tuning—only a simple potentiometer adjustment.

"The use of the RC-tuned type stereo decoder is the most cost-effective way to go," says Les Wilkinson, supervisor of radio IC development for Delco Electronics, Kokomo, IN. "You eliminate a tuned circuit, the labor of aligning it, plus a few extra capacitors."

While present stereo decoders are reasonably well-refined circuits, temperature and other effects cannot be ignored.

"The dynamics of stereo decoders is no problem," says Wilkinson. "You don't have to worry about overloading the loop. But you do have to be concerned about your capture and lock range.

"You have to make sure that your VCO capture and lock range are wide enough so that the VCO won't wander out of the range due to temperature changes. However, the capture range must be small enough to provide good selectivity



# if it's a meter or meter relay,

# Simpson

Stock or Special . . .  
Digital, Analog, AnaLed . . .

# makes it.



## Stock:

Simpson distributors nationwide stock over 2,000 types, ranges, styles and sizes of panel meters, relays and controllers. They're all listed in our new Catalog 4400. Write for your free copy.

## Special:

Need a special or unusual meter? Let Simpson help you custom design it. Send us your specs and we'll send you a quote. But check our catalog first—that "special" may be a standard Simpson stock item.

Get off-the-shelf delivery from your local electronics and electrical equipment distributors.



**SIMPSON ELECTRIC COMPANY**  
853 Dundee Avenue, Elgin, Illinois 60120  
(312) 697-2260 • Cable: SIMELCO • Telex: 72-2416

IN CANADA: Bach-Simpson, Ltd., London, Ontario  
IN ENGLAND: Bach-Simpson (U.K.) Limited, Wadebridge, Cornwall  
IN INDIA: Ruttonsha-Simpson Private, Ltd., Vikhroli, Bombay

KATY INDUSTRIES



INDUSTRIAL  
EQUIPMENT  
GROUP

INFORMATION RETRIEVAL NUMBER 27



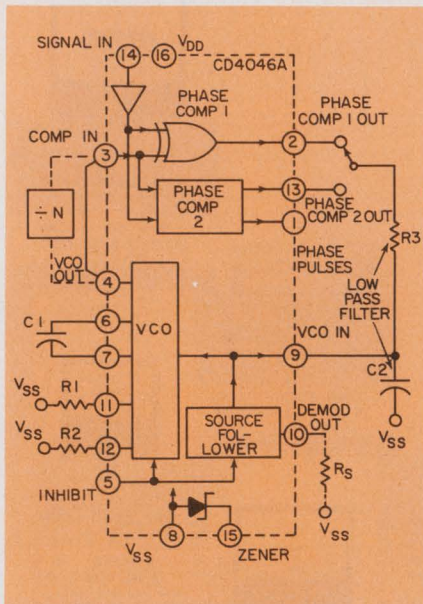

3. Micropower CMOS PLLs, like this RCA CD4046, draw but 75  $\mu$ W. They are general purpose circuits.

Phase Locked-Loop Applications	PLL Manufacturers								
	Exar	Fairchild	Harris	Motorola	National	Plessey	RCA	Signetics	Sprague
FSK de-modulation	•		•		•	•		•	
FM de-modulation Less than 5 MHz	•		•						
Above 5 MHz	•		•		•	•			•
Frequency synthesis Less than 5 MHz	•		•						•
Above 5 MHz	•		•	•	•	•			•
Signal conditioning	•		•		•	•			•
Tone detection	•				•				•
AM detection					•				•
Motor speed control	•		•			•			
Stereo decoder		•		•					•
TV networks				•	•		•	•	
CMOS PLL				•			•		

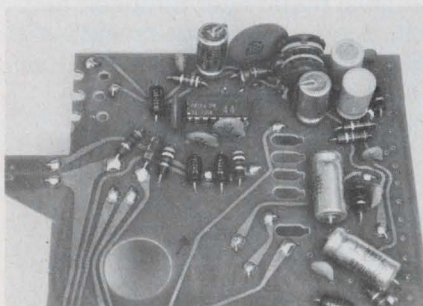

One mass-produced PLL IC is the FM stereo demultiplexer, shown here on a Delco FM auto radio PC board. This IC has a 76-kHz VCO, which is divided into 38-kHz segments for demodulating stereo information.

for the 19-kHz pilot.

"If it's too wide, it is possible for a 15 or 18-kHz audio signal to fool the decoder into thinking that it has a stereo station. In this case the stereo light mistakenly signals a stereo station."

Two types of high-volume dedicated PLL circuits are those in color TV horizontal oscillator hold-control systems and in chroma sub-carrier regenerator circuits. Refinements remain to be made in these ICs.

"We've had discrete PLLs for many years in the horizontal oscillator system," says Joseph Thomas, engineering manager for large-screen color TV receivers at Sylvania Entertainment Products, Batavia, NY. "The biggest problem we have putting it into an IC is getting a controlled, balanced phase detector that will remain balanced over a wide spectrum of noise frequencies, yet also be balanced from device to device."

"For example, the kind of horizontal oscillator you're using—RC, blocking or sine wave—has an effect on what kind of phase detector and loop gain are needed, particularly from the noise and pull-in requirements and stability standpoints. The choice of the oscillator somewhat dictates the kind of systems you can use in front of it—the tuner, the i-f and the agc system."

"A problem with ICs is that some are designed totally by IC manufacturers and their application engineers, who haven't been exposed to the peculiar problems involved in TV sets."

For best temperature sensitivity, Sylvania uses an LC oscillator. Only the tuning coil and capacitor are external to the IC. Thomas notes: "We frankly don't have enough experience with RC oscillators—which are highly sensitive to temperature, even in a discrete component circuit—to have much confidence in them."

The increasing use of CMOS in circuits requiring low-power dissipation has created a demand for these PLLs and RCA has developed one—the CD4046. (Motorola's MC-14046 is a pin-for-pin replacement.)

Suitable for data-communication circuits and motor-speed controls, the 4046 consists of a linear VCO and two separate phase comparators (Fig. 3). Comparator 1 is an exclusive-OR network that operates analogously to an over-driven balanced mixer. It enables the system to remain in lock despite high amounts of noise in the input signals.

Comparator 2 is a pulse-edge-controlled digital memory network that operates only on the positive edges of the input signal and comparator networks.

The operating frequency of the CMOS PLL is up to 1.2 MHz, according to RCA.

A unique PLL package, the Signetics 563, is essentially a complete i-f strip for either narrow or wide-band FM. It incorporates a double-conversion technique in which the second oscillator is a VCO that demodulates the FM signal.

Specifications indicate that the high-frequency response of the 563 is better, the sensitivity greater and the distortion lower than they would be with use of a separate monolithic PLL. The circuit requires no alignment in most applications, Signetics says. For circuits that do, only a single potentiometer adjustment is required.

Peripheral functions such as agc, afc, signal-strength meter drive and variable muting are incorporated in the 563. ■■

### Need more information?

For more information on the products discussed in this article and referenced in the table contact the following manufacturers:

Exar Integrated Systems, 750 Palomar Avenue, Sunnyvale, CA 94086 (408) 732-7970

CIRCLE NO. 400

Fairchild Semiconductor, 464 Ellis St., Mountain View, CA 94042 (415) 962-5011

CIRCLE NO. 401

Harris Semiconductor, PO Box 883, Melbourne, FL 32901 (305) 727-5407

CIRCLE NO. 402

Motorola Semiconductor Products, Attn: PLL Applications, PO Box 20912, Phoenix, AZ 85036 (602) 244-6000

CIRCLE NO. 403

National Semiconductor Corp., 2900 Semiconductor Drive, Santa Clara, CA 95051. (408) 732-5000

INQUIRE DIRECT

Plessey Semiconductors, 1674 McGraw Ave., Santa Ana, CA 92705. (714) 540-9979

CIRCLE NO. 404

RCA Solid State Division, Box 3200, Somerville, NJ 08776. (201) 722-3200

CIRCLE NO. 405

Signetics, 811 East Arques Ave., Sunnyvale, CA 94086. (408) 739-7700

INQUIRE DIRECT

Sprague Electric Co., North Adams, MA 02147. (413) 664-4411

CIRCLE NO. 406



## New Super-Fast Silicon Rectifiers!

### 30 Nanosecond Recovery Time

A major breakthrough in junction technology makes Super-Fast silicon rectifiers possible. These new high speed silicon rectifiers feature low forward voltage drop at higher operating currents and reverse recovery time better than 30 nanoseconds.\* In addition, these devices have extremely low reverse leakage and high surge ratings.

Super-Fast rectifiers use Semtech's proven Metoxilite non-cavity monolithic high temperature construction. Super-Fast rectifiers are designed for high frequency

\*Typical readings are as low as 15 ns.

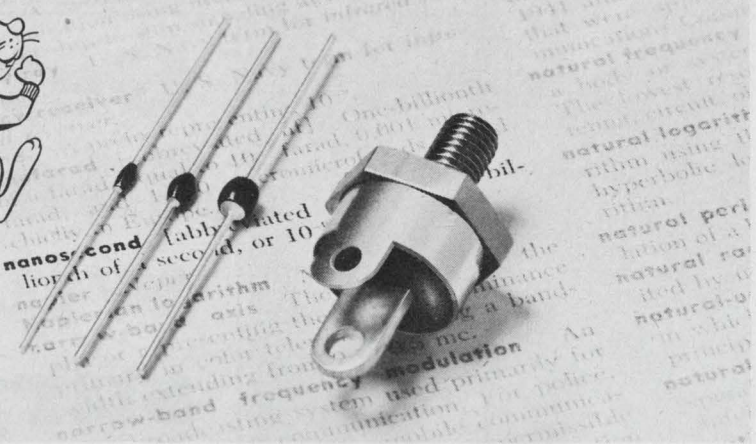

applications, such as high speed switching regulators and converter circuits. These rectifiers are radiation hardened for use in military applications, even though they

are priced for volume usage in industrial and commercial equipment.

Semtech's Super-Fast Silicon rectifiers are stocked for immediate delivery.



## SUPER-FAST METOXILITE RECTIFIERS

### TYPES: FF05, 10 & 15

Peak Inverse Voltage @ .25°C: 50, 100 and 150 V  
Reverse Current (Max): @ 25°C 1.0  $\mu$ A  
Instantaneous Forward Voltage @ 1.5 A (Typical): 0.97 V @ 100°C  
Capacitance @ 12 V DC (Max): 24 pF  
1 Cycle Surge Current (tp = 8.3 ms): 25 A  
Reverse Recovery Time, Trr (Max): 30 ns  
Dimensions (Max): Body; .070" D x .165" L  
Leads; .031" D x 1.25" L

### TYPES: 3FF05, 10 & 15

Peak Inverse Voltage @ .25°C: 50, 100 and 150 V  
Reverse Current (Max): @ 25°C 5  $\mu$ A  
Instantaneous Forward Voltage @ 3 A (Typical): 1.0 V @ 100°C  
Capacitance @ 12 V DC: 58 pF  
1 Cycle Surge Current (tp = 8.3 ms): 50 A  
Reverse Recovery Time, Trr (Max): 30 ns  
Dimensions (Max): Body; .110" D x .165" L  
Leads; .040" D x 1.10" L

### TYPES: 5FF05, 10 & 15

Peak Inverse Voltage @ 25°C: 50, 100 and 150 V  
Reverse Current (Max): @ 25°C 10  $\mu$ A  
Instantaneous Forward Voltage @ 5 A (Typical): 0.8 V @ 100°C  
Capacitance @ 12 V DC: 230 pF  
1 Cycle Surge Current (tp = 8.3 ms): 125 A  
Reverse Recovery Time, Trr (Max): 30 ns  
Dimensions (Max): Body; .165" D x .165" L  
Leads; .040" D x 1.10" L

## SUPER-FAST DO-5L STUD

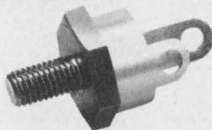

### TYPES: STFF05, 10 & 15

Add "R" to type number for reverse polarity. Designed with the new Super-Fast Metoxilite silicon rectifiers in a DO-5L base. Especially suited for high frequency converter applications.

Peak Inverse Voltage @ 25°C: 50, 100 & 150 V  
IR (Max) @ PIV: @ 25°C .1 mA and @ 100°C 3 mA  
VF (Max): 10 Amps; @ 25°C .84 V, @ 100°C .70 V and 150°C .60 V.  
30 Amps; @ 25°C .96 V, @ 100°C .85 V and @ 150°C .78 V.  
50 Amps; @ 25°C 1.05 V, @ 100°C .93 V and @ 150°C .90 V.  
Recovery Time, Trr (Max): 30 ns.  
Dimensions (Max): Body .69" D x .45" H  
Stud ¼ 28 UNF x .43" L

"We're number 1 because we try harder"



**SEMTECH CORPORATION**

652 Mitchell Road, Newbury Park, California 91320  
(805) 498-2111, (213) 628-5392 / TWX: 910-336-1264

CHICAGO: (312) 352-3227  
DALLAS: (214) 253-7644  
FLORIDA: (305) 644-5404  
NEW JERSEY: (201) 654-4884  
SAN FRANCISCO: (415) 328-8025  
EUROPEAN SALES HDQ: Bourns AG Zug, Switzerland (042) 232-242

NOTE: V<sub>F</sub> is measured @ pulse if duration = 8.0 millisecc. Maximum.

INFORMATION RETRIEVAL NUMBER 28



# Attenuator/Switch

**\$27.95**

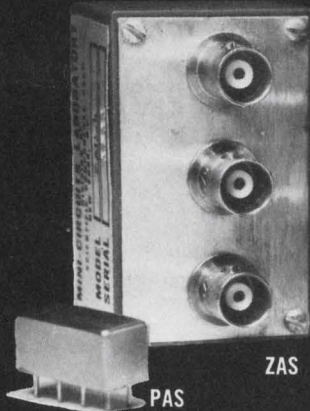

The PAS/ZAS series of electronic attenuators enable attenuation control of rf signals with a maximum of only 20 mA of control current. Due to the specific properties of these attenuators, for a single frequency input all harmonics even and odd order are virtually eliminated at the output. As a consequence, the PAS/ZAS intercept point is greater than +50 dBm. The series covers a very broad frequency range from 1-450 MHz.

## Electronic Attenuator/Switch

		Model PAS-1 ZAS-1		Model PAS-3 ZAS-3	
		Typ.	Max.	Typ.	Max.
Frequency Range, MHz	OUTPUT	5-450		1-200	
	INPUT	5-450		1-200	
	CONTROL	dc-0.05		dc-0.05	
Insertion loss, dB		Typ.	Max.	Typ.	Max.
	One Octave From Band Edge	3.5	4.0	1.4	2.0
	Total Range	3.5	4.7	1.6	2.5
Signal, 1 dB Compression Level		Greater than 1 Watt			
Isolation, dB		Typ.	Min.	Typ.	Min.
	Lower Band Edge to One Decade Higher	IN-OUT	65	50	65
Mid Range	IN-CON	35	25	35	25
	IN-OUT	55	45	50	40
Upper Band Edge to One Octave Lower	IN-CON	25	15	20	15
	IN-OUT	35	25	50	40
IN-CON	20	10	15	10	
Impedance, All Ports		50 ohms		50 ohms	
Price (Quantity)		PAS-1: \$27.95 (5-24)		PAS-3: \$28.95 (5-24)	
		ZAS-1: \$42.95 (4-24)		ZAS-3: \$43.95 (4-24)	

## Get just the fundamental with no surprises!

# THIS

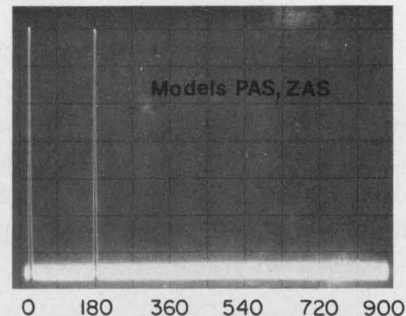

# NOT THIS

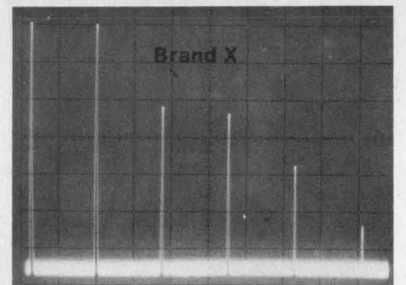

Control current set for 10dB attenuation,  
Signal frequency: 180 MHz,  
Signal power: 0 dBm Vertical scale: 10 dB per cm  
Horizontal scale: 100 MHz per cm

## Mini-Circuits Laboratory

OUR NEW ADDRESS IS: 837-843 Utica Avenue,  
Brooklyn, NY 11203 (212) 342-2500 Int'l Telex 620156

Foreign Sales Representatives:  AUSTRALIA General Electronic Services, 99 Alexander Street, New South Wales, Australia 2065;  ENGLAND Dale Electronics, Dale House, Wharf Road, Frimley Green, Camberley Surrey;  FRANCE S. C. I. E. - D. I. M. E. S., 31 Rue George - Sand, 91120 Palaiseau, France;  GERMANY, AUSTRIA, SWITZERLAND Industrial Electronics GMBH, Klüberstrasse 14, 6000 Frankfurt/Main, Germany;  ISRAEL Vectronics, Ltd., 69 Gordon Street, Tel-Aviv, Israel;  JAPAN Denso Kaisha, Ltd., Eguchi Building, 8-1 1 Chome Hamamatsucho Minato-ku, Tokyo;  EASTERN CANADA B. D. Hummel, 2224 Maynard Avenue, Utica, NY 13502 (315) 736-7821;  ITALY Microel Italia s. r. l. via M. Loria 50, 20144 Milano & via Senafe 27, 00199 Roma;  NETHERLANDS Coimex, Veldweg 11, Hattem, Holland

US Distributors:  NORTHERN CALIFORNIA Cain-White & Co., Foothill Office Center, 105 Fremont Avenue, Los Altos, CA 94022 (415) 948-6533;  SOUTHERN CALIFORNIA, ARIZONA Crown Electronics, 11440 Collins Street, No. Hollywood CA 91601 (213) 877-3550



# washington report

## **Air Force to check production of contractors**

The Air Force plans to get more involved in the production end of contracts, to make sure that the processes and technology are the most efficient possible.

Air Force officers and civilian engineers have begun training with industry and will be assigned to program offices and other key spots to check on performance.

"Ideally," says Lt. Gen. John B. Hudson, vice commander of the Air Force Systems Command, "there ought to be (Air Force) manufacturing engineers involved in the planning and design of major new products, and they should stay with the program to completion. Unless they are there when the plans are made, the chances are poor that we'll get an end product that will be producible in the desired quantity and quality at the right time and the right cost. Getting the manufacturing analysts involved early helps us make more accurate cost estimates and to lay out more realistic schedules. It also improves the likelihood that once production starts, it will proceed without glitches and without waste."

## **1975 defense spending cuts sought**

While the spotlight is focused on fiscal 1976 budgets, the Ford Administration is still flailing away at Government spending in fiscal 1975. If Congress approves of recently proposed cuts and deferrals, there will be some shrinkage in defense and R&D spending.

The Army would not buy \$5.7-million worth of UH-1H helicopters, and the Air Force would not buy 24 A-7D and 12 F-111 fighter aircraft at \$152.5-million. The Bureau of Standards' Telecommunications Office would have \$4.63-million deferred. Most of this—\$3.54-million—would slow technology "incentive" projects and would delay, to beyond 1976, the development of an electromagnetic measurement program. Slightly over \$7.76-million would be deferred from the Maritime Administration authorization, including \$3.47-million for R&D on a nuclear-powered tanker and advanced communications.

## **CATV warned on interfering radio signals**

Growing concern about flight safety may force cable-television operators to shut down abruptly during equipment malfunctions. The Federal Communications Commission has warned the industry of possible interference with air traffic control services in the 108-to-136-MHz bands.



Cable television systems carry high level signals falling within a typical bandwidth of from 50 to 300 MHz.

Recent studies indicate that improper termination of the shielded coaxial cables that CATV employs could result in the radiation of sufficiently strong signals to disrupt other transmissions in the atmosphere including those in the critical 108-136 MHz range. The FCC is strongly suggesting that operators consider the use of alternate frequencies until it has reviewed the problem.

Major concern is with the delay expected in locating and repairing malfunctions. Should malfunctions arise, the FCC will require service to be terminated immediately.

## Inputs sought on world radio allocations

The Federal Communications Commission is facing a rugged job in developing the American position for negotiations at the World Administrative Radio Conference to be held in Geneva in 1979. High on the agenda at the conference will be international frequency allocations to cover the communications spectrum for the remainder of the century. The FCC's major problems will be to reach compromises between users of the services.

The commission is asking for inputs from Government, industry and the public for use in reaching agreements with some 140 nations on regulation of the various radio services—broadcasting, space, aeronautical and amateur.

**Capital Capsules:** A contractor is being sought by the Air Force Systems Command at Eglin AFB in Florida to design and fabricate an optical communicator system that will transmit and receive data from one point on an aircraft to another point on the same aircraft. Data consisting of 70 analog parameters, having a frequency of 100 Hz or less, are to be transmitted by a light source over a maximum range of 50 ft. The receiver will have to detect and present the data with accuracy to within 1%. . . . If Congress agrees, the General Services Administration's automatic data-processing fund will be \$73.2-million in fiscal 1976, up from \$56.9-million in the current budget. . . . NASA's Goddard Space Flight Center has issued a request for proposals for providing telecommunications services for a Tracking and Data Relay Satellite System. A ground terminal in the continental U.S. would relay data, commands and voice to and from mission spacecraft through two specialized relay satellites in synchronous earth orbit. The envisioned network would support all orbital spacecraft below 5000 kilometers. The system would be developed and operated by industry to NASA requirements. . . . A very flexible electron pre-ionized research laser system is on the shopping list of the Los Alamos Scientific Laboratory. It's to be used to study a wide variety of molecular gases. . . . Concern over data-communications security has prompted the Federal Reserve System to seek information on ways to raise the security of its communications system, a national network of 14 computer switching centers with many remote terminals. . . . The Labor Dept.'s Office of Foreign Economic Research plans to award a contract for a research study on the marketing and employment changes to be expected in the electronics industry brought on by the new foreign trade bill. Products to be covered are electronic components and accessories, radio and TV receivers and transmitting equipment, electronic calculators and industrial controls.



# YOU'VE JUST BEEN TOLD THE MICRO COMPUTER YOU SPECIFIED HAS BEEN DISCONTINUED.

## Don't worry. Help is here.

While other OEM suppliers are discontinuing their micro computer models because of the unavailability of LSI CPU chips, Microdata is delivering the MICRO-ONE.

Smart system designers will use the Microdata computer-on-a-board to open up new market areas while lowering component and assembly costs and increasing profit margins and reliability.

The MICRO-ONE is a high-speed microprogrammed micro

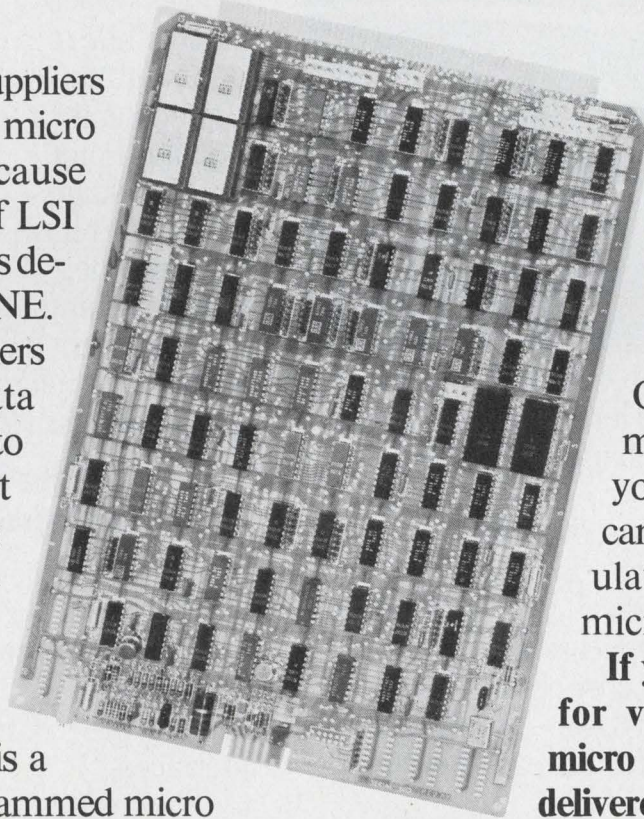

computer whose flexibility and functional modularity make it ideally suited for dedicated volume applications.

Because the MICRO-ONE is microprogrammable, that software you've already written can be saved. We'll emulate the discontinued micro computer.

**If your requirements are for volume quantities of micro computers that *can be* delivered, write or call:**

## Microdata

17481 RED HILL AVENUE · IRVINE, CALIFORNIA 92705  
TELEPHONE 714/540-6730 - TWX 910-595-1764

MICRODATA SALES OFFICES: New York 201/871-3411; Washington, D.C. 301/881-6282; Detroit 313/649-1650; Chicago 312/948-9440; Dallas 214/239-8186; San Francisco 415/786-1155

INFORMATION RETRIEVAL NUMBER 30



# There's more to than

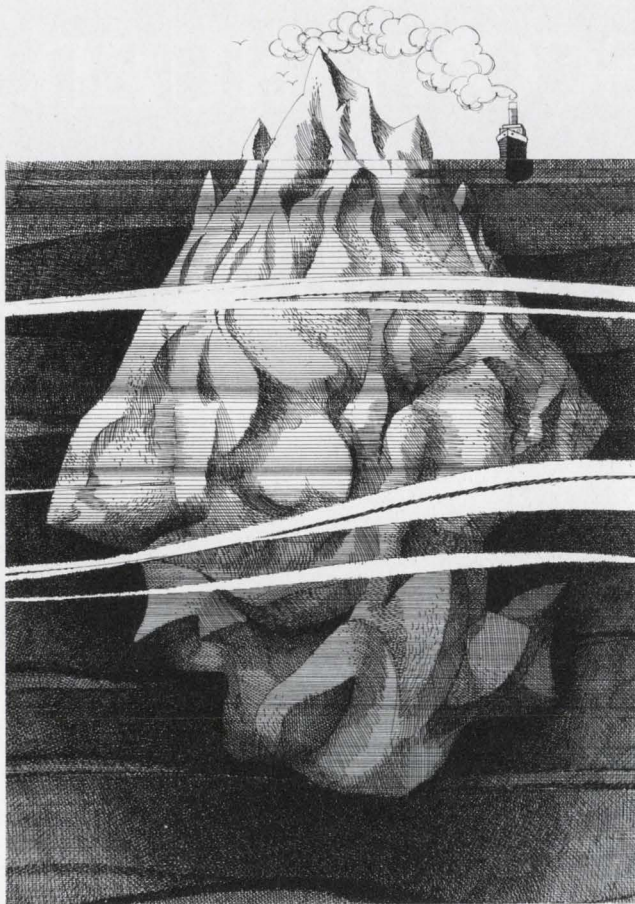

Putting a microprocessor to work for you involves a whole lot more than buying a few LSI chips and slapping them together.

You need LSI chips, of course. And National Semiconductor is the only company that makes them all: the IMP family for 4, 8, and 16 bit applications.

But to meet your cost objective, you need more. You need tools — the kind of tools that can make things easy for you. National has them.

National offers the best Prototyping Systems around; plus the only Micropro-

gram Development System in the industry, to help you develop new machine instruction sets. On top of that we supply the kind of software, documentation, and technical support that helps bring designs in on time and under budget.

No other microprocessor supplier offers you all that.

For the production end, there's our new POWR I/O,<sup>™</sup> an instruction set option that doubles your I/O speed while it cuts your memory requirements; a Floating-Point Math Package, so you don't have to invent one; and everything else you'll need in your system...right out to the sensors.

No other microprocessor supplier offers you all that, either.



IMP Prototyping System.

## **The Blue Chips<sup>™</sup> and the Green Chips<sup>™</sup>**

Something new.

The Blue Chips let you put together a complete 16-bit processor with only 9 chips for less than \$140.00 in volume. And the optional Green Chips simplify your I/O interfaces.

The result: more bang per buck... more throughput with fewer components than any other microprocessor.



# microprocessing microprocessors.

Here's a diagram of how it all goes together:

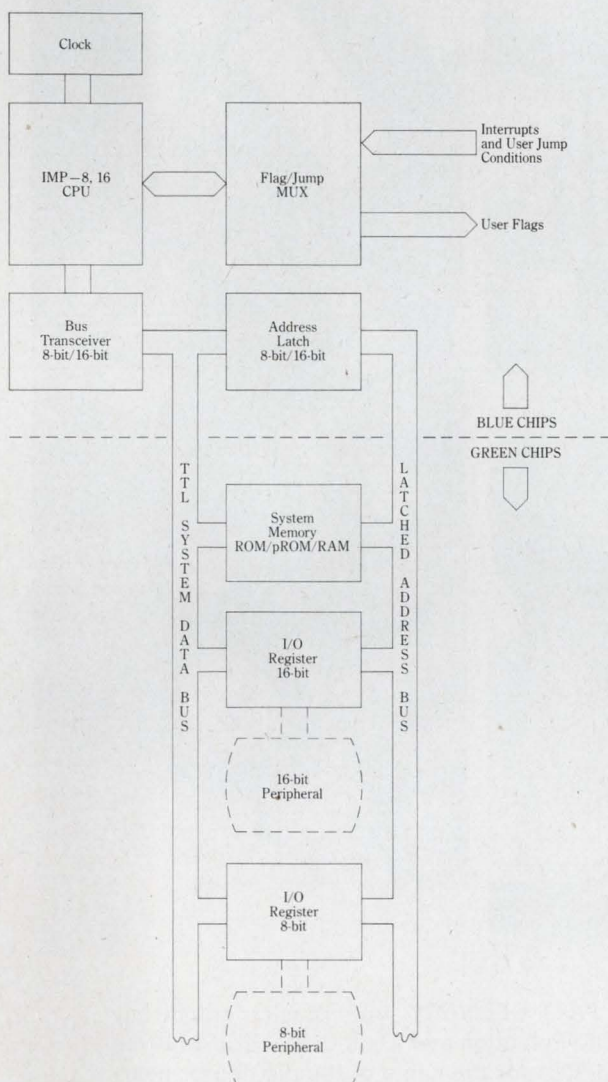

## We've got it all.

A flock of companies are now trying to make hay out of the fact that they've just entered the microprocessor chip business.

We've been in it more than two years.

Two years during which we've developed microprocessors with unmatched performance. Microprocessors that do more useful work per dollar than any other you can buy.

Two years during which we've developed *everything* you need to get into microprocessing, right down to the interfaces. And we're the only company that has.

We offer the strongest support package in the industry — hardware, software, firmware, field technical support, and training.

Before you commit yourself to a company that offers you anything less than everything, you really ought to write for our microprocessor brochures.

Please send me a copy of your Microprocessor Brochures.

Name \_\_\_\_\_

Company \_\_\_\_\_

Address \_\_\_\_\_

City \_\_\_\_\_ State \_\_\_\_\_ Zip \_\_\_\_\_

Mail to: National Semiconductor, 2900 Semiconductor Dr., Santa Clara, Ca. 95051.

# National



# We're everything you need in pots and trimmers. We're TRW/IRC Potentiometers.

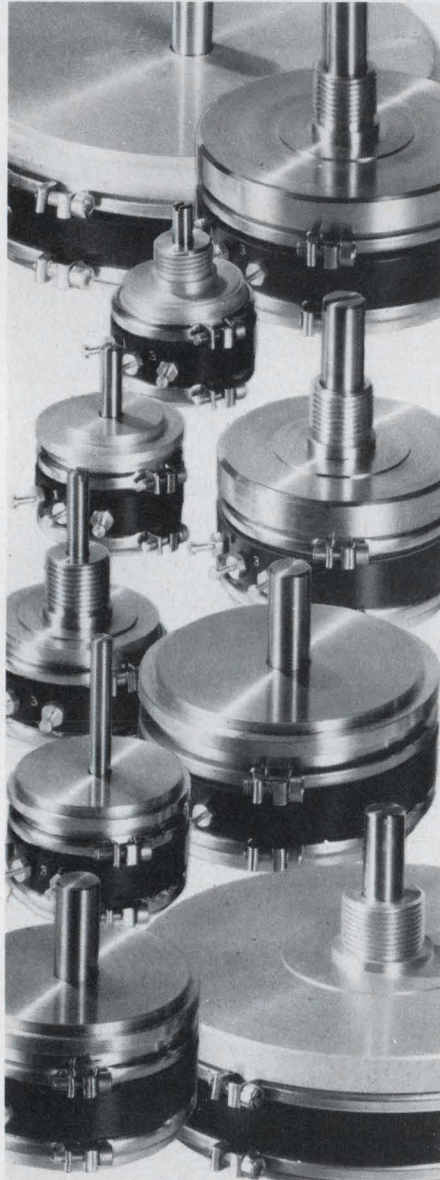

From precision potentiometers to low cost 1/4" trimmers, TRW/IRC has the resistance control device you need—no matter what your environmental specifications or mounting requirements may be.

Most types are available in choice of cermet or wirewound elements, as military approved or economical industrial units.

FOR FAST DELIVERY, from stock, contact any TRW/IRC Potentiometer Distributor. Dial toll-free 800-645-9201 for the name of the distributor nearest to you.

TRW/IRC Potentiometers, an Electronic Components Division of TRW, Inc., 2801-72nd Street North, St. Petersburg, Florida 33733. Phone (813) 347-2181.

CPI-7502

## **TRW**® IRC POTENTIOMETERS

INFORMATION RETRIEVAL NUMBER 32



## One plus six makes one

If anybody were to call Steve a tyrant, he'd be shocked. He sees himself as a most reasonable person, a guy who's very democratic and always ready to hear what his subordinates have to say. But the engineers who work for him feel he stifles them.

Steve happens to be an excellent engineer but, without realizing it, he thinks he's the only one. He insists that everybody do things his way, that everybody think about problems the way he thinks about them. He acts as if there's only one possible approach to the thinking process. That, in itself, wouldn't be bad. Nobody objects to the way Steve thinks and, in fact, he's often brilliant. The problem lies in the fact that if anybody on his staff takes a different approach, Steve raises hell.

As a result, his engineers have pretty much stopped thinking. They simply try to figure out how Steve would want the problem solved—even if it's not a good way. They often waste their company's money catering to Steve's whims because Steve, like many of us, occasionally has some nutty hang-ups. They go through exercises that have no practical value because Steve thinks they're useful.

He's made it impossible for anybody to challenge him. Some years ago one of his engineers worked up the courage to say, "Hey Steve, this procedure is a complete waste of time. It's never done us a bit of good. It's expensive and it slows us down. Why can't we drop it?" In a fury, Steve turned on him and told him he was being negative. That effectively terminated the conversation because Steve was the boss and, when he said something was negative, that meant it was bad and therefore forbidden.

Well, Steve finally succeeded in surrounding himself with Yes-men. But he doesn't realize it. He sincerely thinks he has molded a great team because his engineers are astute enough to analyze problems the right way—his way. By weight of his authority, he crushes criticism. He has created an atmosphere that stifles creative thoughts, though he's a strong advocate of creativity. Steve doesn't see that he's using authority to crush arguments. He sees only the mastery of his impeccable logic.

Steve has six engineers working for him, but only one mind—his own.

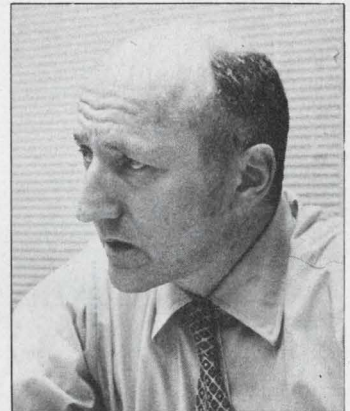

*George Rostky*

GEORGE ROSTKY  
Editor-in-Chief



# Announcing the first 0.5" multi-digit LEDs

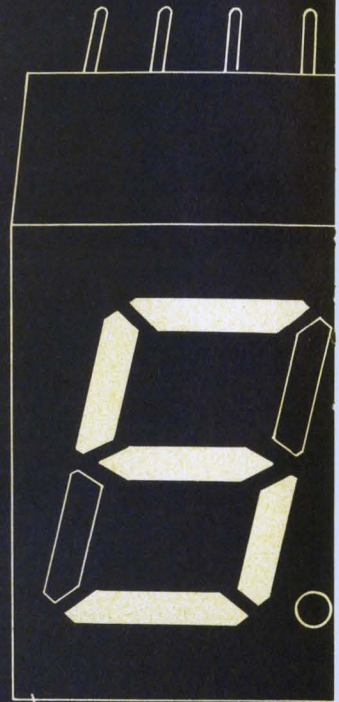
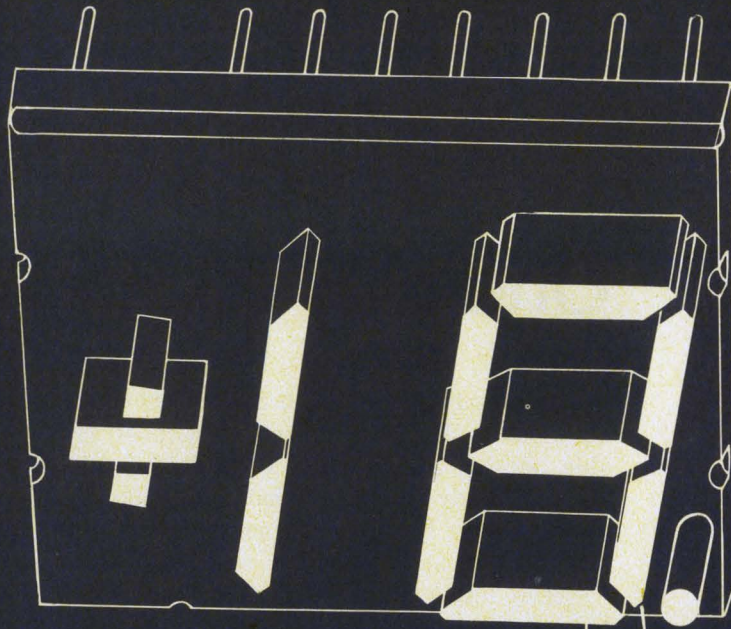

One DIP  
handles  
two digits

Mitered corners  
increase  
eye appeal

Light pipes spread  
illumination evenly  
over broad segments



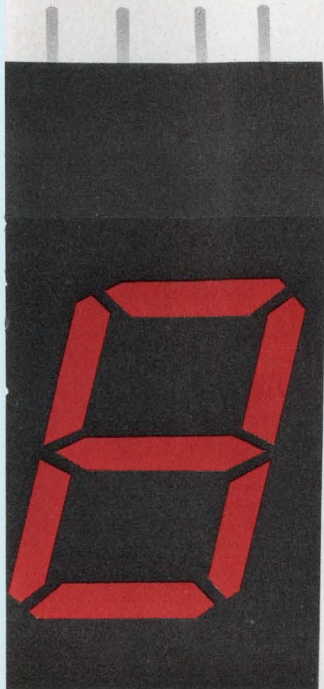

Here we go again. It's another first from Litronix: multi-digit 0.5"-high LEDs.

These two-in-one packages are tailor made for anyone who wants to save money in lower production costs. They require only half the inventory. Half the handling. Half as many components to assemble and test.

Makers of digital time pieces will find them ideal, as will those who manufacture point-of-sale terminals. FM digital readout tuning systems. TV channel tuners, and instrumentation.

The modules are end-stackable to produce any combination of 0.5" digits on 0.5" centers. The DL-727 is a two-digit module that's ideal for clocks. And our DL-721 module offers a  $\pm$  sign and a "1" for polarity and over-range indications on instruments.

Each module has the same drive requirements. Power required is only 30 to 40 mW per segment from standard logic voltage supplies. Modules are packaged in standard DIPs.

Naturally, you enjoy all the solid state advantages of LEDs. They're compatible with today's IC circuits. Rugged. Easy to multiplex. And offer fast response.

In any business lower costs make a difference. Our dual 0.5"-high digits help your products keep a competitive edge.

Our data sheets tell all. Contact Litronix, 19000 Homestead Road, Cupertino, Calif. 95014. Phone (408) 257-7910.

**No wonder  
we're No.1  
in LEDs**

**litronix**



# Choose switching regulators for your computer power-supply design. Two major benefits are high efficiency and protection against line dropouts.

For the best efficiency in power supplies, the supply designer's choice is clear: The switching regulator is several times more efficient than the conventional linear regulator.

This is especially important in computer and computer-related applications, which usually need relatively high power levels, and where battery-operated standby systems are a must to prevent loss of memory or catastrophic errors. For these applications, not only does the switching regulator allow the use of smaller batteries. It provides another benefit: high energy-storage capability.

With such storage—provided by filter capacitors working at high voltages—it's possible to sustain from two to 10 cycles of line dropouts before an error occurs. For example, a switching regulator working from a 12-V NiCd battery can maintain a 32-k bit MOS memory for two hours.

But for all its benefits, the switching-regulator supply isn't as easy to design as the linear type. Here's what you should know to do the job.

## Two types of regulators

Switching regulators can be either free-running or of fixed frequency, depending on whether the transistor switch operates at variable frequency with a fixed pulse width or at fixed frequency with a variable ON time (Fig. 1).

In the fixed-frequency regulator, one switch transition is always performed by the external source; the other transition occurs when the output voltage reaches a predetermined threshold level. The sampling period is fixed by the external frequency, and the duty cycle is free to vary.

The fixed-frequency type, when thought of as an op amp, has a response time limited to one-half cycle of the switching frequency. Since all switching regulators require an output LC filter, the over-all system has two predominant low-frequency time constants—one determined by the LC filter and the other by the switching frequency of the oscillator.

For high efficiency, the fixed frequency is made

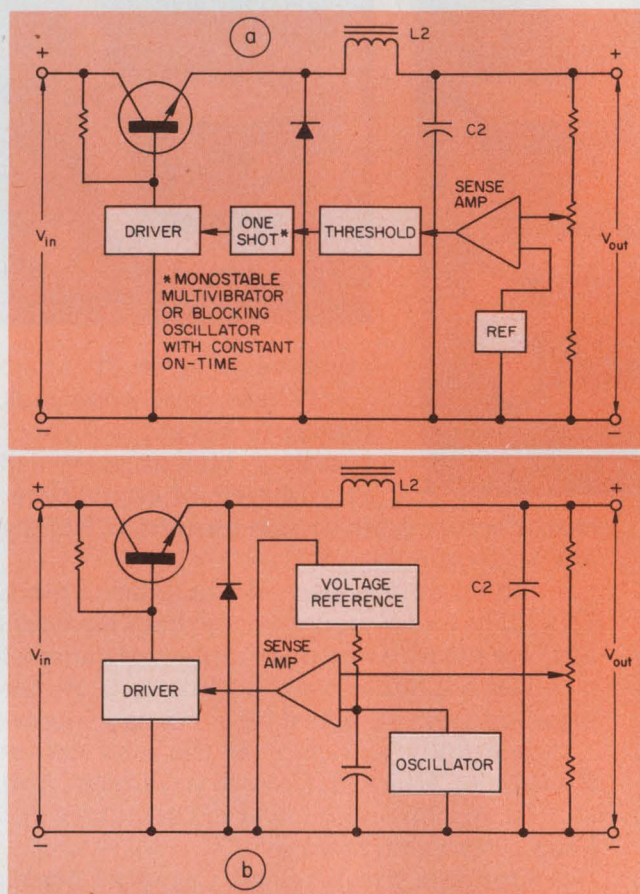

1. Switching regulators can be of the free-running type—in which the transistor operates at constant pulse width and variable frequency (a)—or of the fixed-frequency type, in which the transistor ON time varies (b). Efficiencies exceed those of conventional linear regulators.

low—about 10 to 20 kHz. Consequently it becomes extremely difficult to stabilize the fixed-frequency regulator and still achieve good attenuation of input ripple coupled with low output impedance.

In the free-running unit, both switching transitions are controlled by the sensed voltage, and the regulator cycles between an upper and a lower threshold of the output voltage; both the duty cycle and frequency are free to vary. Frequency is primarily a function of  $L_2$ ,  $C_2$  and threshold range, but it also varies with  $V_{in}$  and,

Eugene R. Hnatek, Director of Marketing, DCA Reliability Laboratories, 645 Clyde Ave., Mountain View, CA 94040.



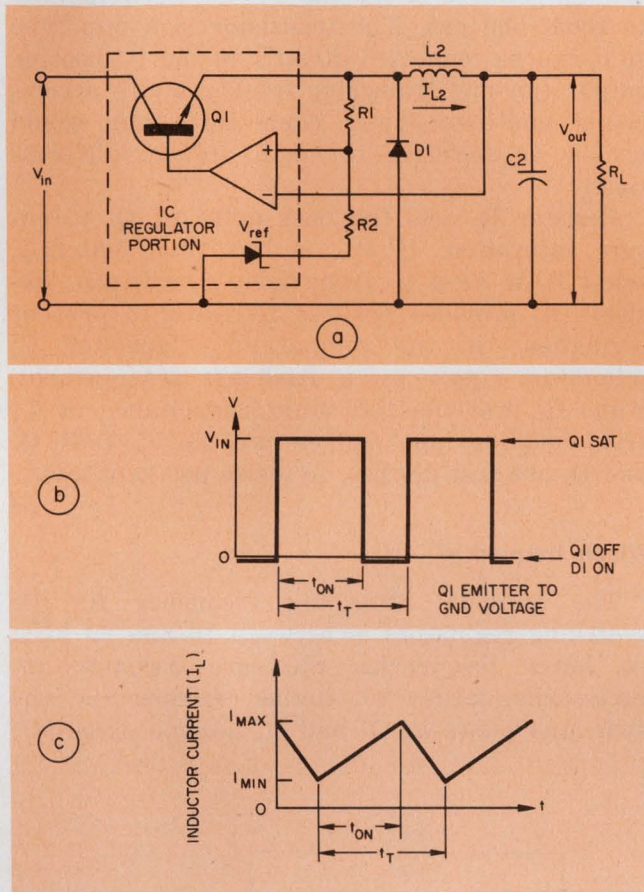

2. Basic elements of a switching regulator consist of a transistor switch, a voltage reference, a comparator and an output filter (a). Regulation is achieved by variation of the relative on/off times of the switch (b). The load current varies as shown in "c."

to some extent, with the load current.

Since the free-running regulator's bandwidth is limited only by the rise and fall times of the various transistors in the circuit, response times run from 2 to 4  $\mu$ s. Now, in any switching regulator, the output ripple depends on the frequency (higher frequency gives lower ripple but also lower efficiency) and its input voltage. Since the free-running regulator operates from its own ripple—which remains fairly constant—the frequency adjusts to the minimum necessary for the specified output ripple. The free-running circuit

also operates well over a wide range of output load currents.

### Duty cycle controls regulation

The basic free-running regulator contains a switch, a comparator, a voltage reference and a filter (Fig. 2). Regulation is achieved by control of the duty cycle of  $Q_1$  with an op amp that compares the output voltage with a reference: ON time is increased in proportion to OFF time to raise the output level, or the ON time is decreased to lower the output level.

Transistor  $Q_1$  is either on (saturated) or off, so that its power dissipation is minimized. Free-wheeling, or commutating, diode  $D_1$  conducts during the interval  $Q_1$  is cut off, and thereby maintains current flow through inductor  $L_2$ . The diode also limits the induced voltage,  $L_2 di/dt$ , whenever the transistor switch is turned off. When  $Q_1$  turns on, the load current through  $L_2$  increases according to:

$$V_{in} - V_{out} = L_2 \left( \frac{\Delta i_L}{t_{on}} \right). \quad (1)$$

This current flows through the load and charges capacitor  $C_1$ .

When  $V_{out}$  reaches  $V_{ref}$ , the voltage comparator turns  $Q_1$  off. The current through  $L_2$  then decreases until  $D_1$  is forward-biased. At this point the inductor current flows through  $D_1$  and decreases at a rate given by:

$$V_{out} = L_2 \left( \frac{\Delta i_L}{t_{off}} \right). \quad (2)$$

When the inductor current falls below the load current,  $C_1$  begins to discharge and  $V_{out}$  decreases. When  $V_{out}$  decreases to slightly less than  $V_{ref}$ , the comparator turns  $Q_1$  back on and the cycle repeats. The output voltage is given by

$$V_{out} = \frac{V_{in} \times t_{on}}{t_{on} + t_{off}}. \quad (3)$$

In the circuit of Fig. 2, both  $Q_1$  and  $D_1$  must switch fast to minimize the losses that occur primarily during the transitions between saturation and cutoff—when semiconductor devices are resistive. The source voltage is selected to be two to five times greater than the output—within the voltage limitations of the input-circuit compo-



nents, of course.

Choosing a commutating diode is a relatively simple task—mostly one of looking through data sheets. In addition to safely handling all peak currents, the diode must have a short recovery time, a small forward-voltage drop and a peak inverse-voltage rating that is at least twice as large as the input voltage.

The diode's recovery time is important because of its influence on output noise. After the switching transistor shuts off, the diode conducts, charging capacitor  $C_2$ . When  $Q_1$  turns on again,  $D_1$  is still in its conducting state and shorts  $Q_1$  to ground for a little while. This double conduction dissipates power in both  $Q_1$  and  $D_1$  and is a prime source of noise.

### Switching time: A prime spec

Selection of the switching transistor also involves looking through data sheets for sufficient peak and average current-handling capabilities, as well as a safe collector-emitter breakdown voltage rating. This voltage is generally 1.2 times larger than  $V_{in}$ . In addition, the transistor's saturation voltage should be as small as possible when the collector current is at a maximum.

Switching time is the most important transistor spec. Maximum efficiency is achieved when the transistor is either saturated or in cutoff. However, since transistors cannot switch instantaneously, a considerable amount of power (say 10%) can be dissipated during the switching time. To minimize the losses, keep switching times small compared with the period of the frequency.

The switching frequency should be high enough to keep the values of inductor  $L_2$  and capacitor  $C_2$  small, but not so high that  $Q_1$  and  $D_1$  become prohibitively expensive. Typical operating frequencies range from 10 to 50 kHz. Since the faster the switching, the greater the noise, this must be traded off against EMI requirements.

Note that the catch diode (and any bypass capacitance at the unregulated input) should be grounded separately from other parts of the circuit. This is because the diode carries large current transients, which can develop high voltage drops across even a short length of wire.

To select a core for  $L_2$ , look for materials with "soft" saturation characteristics. A core that saturates abruptly can cause excessive peak currents in the switching transistor if the output current goes high enough to bring the core close to saturation. A material such as powdered molybdenum-permalloy exhibits a gradual reduction in permeability with increasing current, yet the material retains excellent high-frequency

characteristics.

Since the filter capacitor's ripple current will be quite high, the capacitor should be rated accordingly. Low dissipation factors and voltage ratings that exceed the dc circuit voltages are called for.

IC switching regulators include the comparison amplifier and pass transistor. Most also have an internal voltage reference, which may be supplemented in some applications by an external zener diode.

In the IC design of Fig. 3, an on-chip voltage reference is used, but an external pass transistor,  $Q_1$ , is added to get the current capability up to about 500 mA. The transistor is a pnp type so it can be connected directly to the IC booster output (an npn transistor would require a compound emitter-follower connection that would not be as sensitive to small voltage differentials).

Resistor  $R_3$  sets the base drive of  $Q_1$  to ensure saturation. If  $I_{max}$  is less than 500 mA, select  $R_3$  to keep  $Q_1$  from being overdriven. Resistor  $R_4$  provides positive feedback to prevent oscillations in the comparator. Capacitor  $C_2$  minimizes ripple by a feedback arrangement, while  $C_3$  prevents the shunt capacitance of  $R_4$  from coupling input spikes into the IC. Both  $Q_1$  and  $D_1$  are fast devices, so losses are kept low.

### Which frequency?

The optimum switching frequency for IC switching regulators is between 10 and 50 kHz. At lower frequencies the core becomes unnecessarily large; at higher frequencies the switching losses in  $Q_1$  and  $D_1$  become excessive.

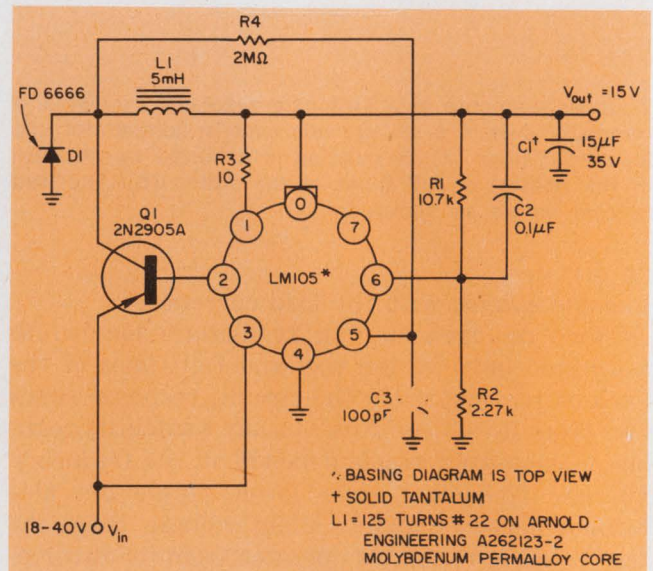

3. An IC regulator can be used as the basis for a switching design. Transistor  $Q_1$  is added to increase the current-handling capability.



The output ripple of the regulator at the switching frequency is determined mainly by  $R_4$ . The peak-to-peak output ripple is nearly equal to the peak-to-peak voltage fed back to pin 5 of the LM105. Since the resistance measured at pin 5 is approximately  $1000 \Omega$ , this voltage will be

$$\Delta V_{ref} \cong 1000 \frac{V_{in}}{R_4} \quad (4)$$

In practice, the ripple will be somewhat larger than that given by the equation. When the switching transistor shuts off, the current in the inductor will exceed that of the load so the output voltage will continue to rise above the value required to shut off the regulator.

It's important that the value of the inductor be large enough to keep the current through it from changing drastically during the switching cycle. Thus the switching transistor and the catch diode don't have to handle peak currents that are significantly larger than the average load current. The change in inductor current can be written as

$$\Delta i_L = \frac{V_{out} t_{off}}{L} \quad (5)$$

For the peak current to be about 1.2 times the maximum load current, it is necessary that

$$L_1 = \frac{2.5 V_{out} t_{off}}{(I_{out})_{max}} \quad (6)$$

A value for  $t_{off}$  can be estimated from

$$t_{off} = (1/f) [1 - (V_{out}/V_{in})], \quad (7)$$

where  $f$  is the desired switching frequency and  $V_{in}$  is the nominal input voltage. The size of the output capacitor can now be determined from

$$C_1 = \left( \frac{V_{in} - V_{out}}{2L_1 \Delta V_{out}} \right) \left( \frac{V_{out}}{fV_{in}} \right)^2, \quad (8)$$

where  $V_{out}$  is the peak-to-peak output ripple and  $V_{in}$  is the nominal input voltage.

Now determine if these component values just obtained give a satisfactory load-transient response. The overshoot of the regulator for increasing loads is

$$\Delta V_{out} = L_1 (\Delta i_L)^2 / (C_1 V_{in} - V_{out}). \quad (9)$$

For decreasing the loads, the overshoot is

$$V_{out} = L_1 (\Delta i_L)^2 / (C_1 V_{out}), \quad (10)$$

where  $i_L$  is the load-current transient. The recovery time,  $t_r$ , for increasing and decreasing loads is, respectively:

$$2L_1 \Delta i_L / (V_{in} - V_{out}) \quad (11)$$

and

$$2L_1 \Delta i_L / V_{out}. \quad (12)$$

In the circuits described previously the regulator is not protected from overloads or output shorts. Providing short-circuit protection is no simple problem, since it is necessary to keep the regulator switching when the output is shorted. Otherwise the dissipation will become excessive, even though the current is limited.

Fig. 4 illustrates the various methods of overload protection. Notice that with current limit or

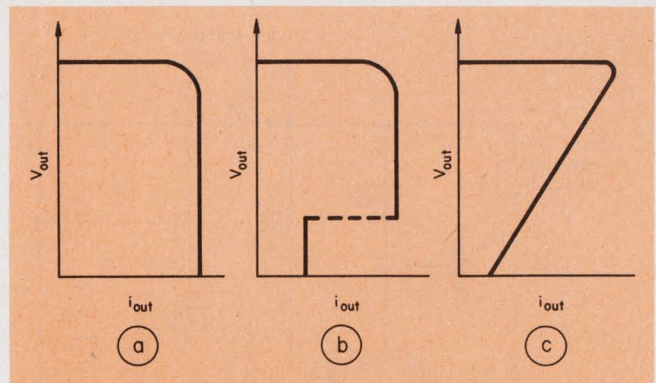

4. Various methods of overload protection can be used. They include current limiting (a), short-circuit shutdown (b) and current foldback (c).

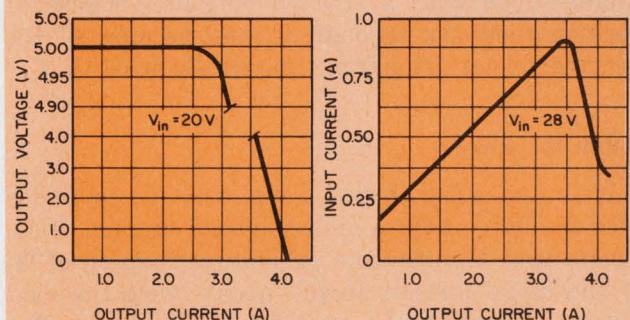
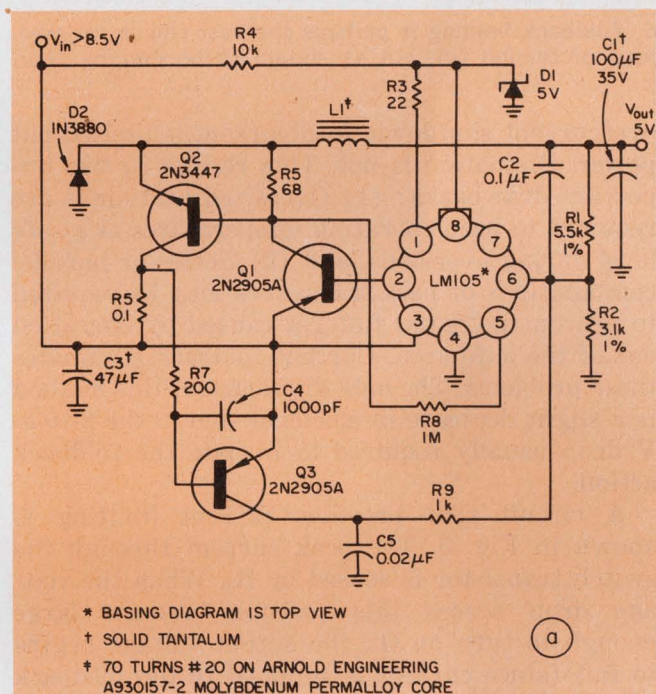

5. Additional components can be added externally to an IC regulator to provide current limiting (a). The achieved characteristics are shown in "b." When the circuit goes into limiting, the input current drops (c).



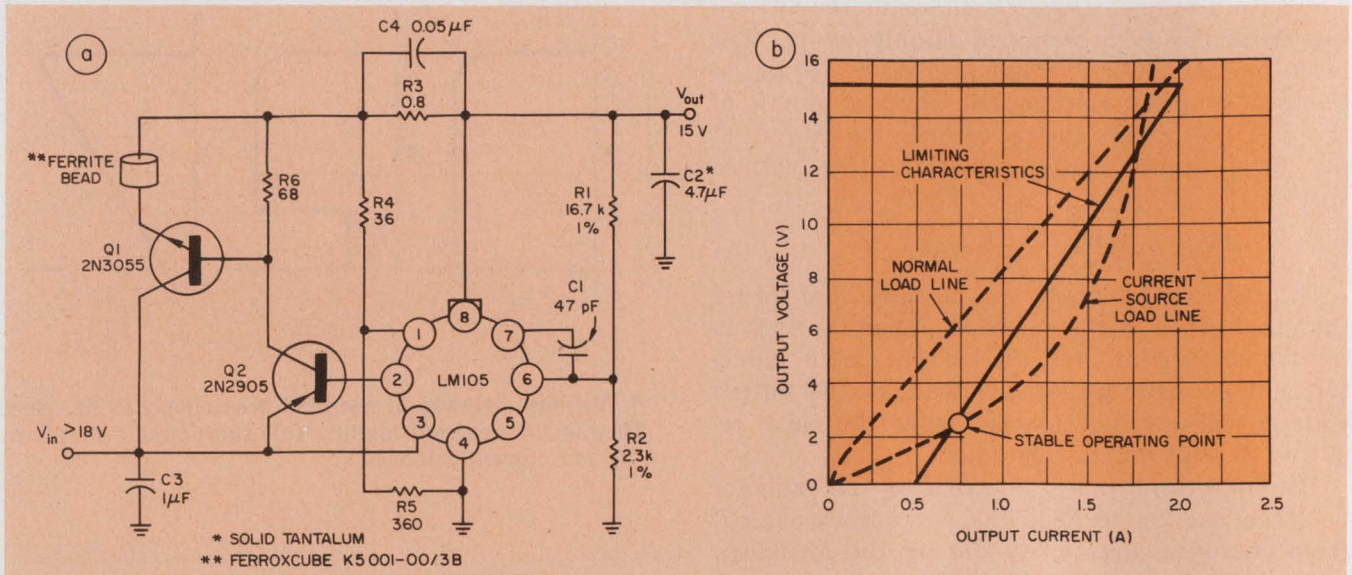

6. Foldback limiting is perhaps the best choice for over-load protection (a), but as shown in the limiting char-

acteristics, some loads should be avoided (b). Under special conditions, oscillations can occur.

overcurrent shutdown, load current is limited but power dissipation is not. This results in two important drawbacks: (1) Oversized heat sinks are required to keep operating temperatures at a safe level during overloads, and (2) Series or parallel combinations of pass transistors may be required to prevent potential failures caused by operation out of the safe area. Current foldback eliminates these problems. The only drawback of this method is a slight decrease in efficiency due to the 2-to-5-V drop usually required to initiate the foldback action.

A circuit that provides current limiting is shown in Fig. 5. The peak current through the switch transistor is sensed by  $R_6$ . When the voltage drop across this resistor becomes large enough to turn on  $Q_3$ , the output voltage begins to fall (since current is supplied to the feedback terminal of the regulator from the collector of  $Q_3$ , less must be supplied from the output through  $R_1$ ). Furthermore the circuit will continue to oscillate—even with a shorted output—because of positive feedback through  $R_6$  and because of the relatively long discharge time constant of  $C_2$ .

#### Watch for spikes

It is necessary to put a resistor,  $R_7$ , in series with the base of  $Q_3$  to limit the base current. Also, a capacitor,  $C_4$ , prevents premature turn on of  $Q_3$  by the large current spike—about twice the load current—through the switching transistor. The spike is caused by removal of the stored charge by the catch diode. A zener-diode bias supply must also be used on the output of the LM105, since current limiting won't work if the voltage at this point drops below about 1 V.

The current-limiting characteristics of this

circuit are shown in Fig. 5b, and Fig. 5c shows how the average input current drops as the circuit goes into current limiting. With high-current regulators, the heat sink for the pass transistor must be made quite large—often inconveniently so—to handle the power dissipated under worst-case conditions. This problem can be overcome with foldback limiting, which—under overload conditions—forces the output current to decrease below the full-load value as the output voltage is pulled down. With this technique, the short-circuit current can be made a fraction of the full-load current.

#### Foldback is the best choice

A high-current regulator using foldback limiting is shown in Fig. 6. A second booster transistor,  $Q_1$ , has been added to provide a 2-A output without excessive dissipation in the LM105. The resistor across the emitter-base junction bleeds off any collector base leakage and establishes a minimum collector current for  $Q_2$  to make the circuit easier to stabilize with light loads.

The foldback characteristic is produced with  $R_4$  and  $R_5$ . The voltage across  $R_4$  bucks out the voltage dropped across the current sense resistor,  $R_3$ . Therefore more voltage must be developed across  $R_3$  before current limiting starts. After the output voltage begins to fall, the bucking voltage—proportional to the output voltage—is reduced. With the output shorted, the current drops to a value determined by the current-limit resistor and the current-limit sense voltage of the LM105.

Load currents up to 2 A are handled by the foldback circuit. Heavier loads will cause the output voltage to drop and reduce the available cur-



rent. With a short at the output, the current is only 0.5 A. The value of  $R_3$  is given by

$$R_3 = \frac{V_{lim}}{I_{sc}}, \quad (13)$$

where  $V_{lim}$  is the current-limit sense voltage of the LM105 and  $I_{sc}$  is the design value of short-circuit current. Resistor  $R_5$  is then obtained from

$$R_5 = \frac{V_{out} + V_{sense}}{I_{bleed} + I_{bias}}, \quad (14)$$

where  $V_{out}$  is the regulated output voltage,  $V_{sense}$  is the maximum voltage across the current-limit resistor for 0.1% regulation,  $I_{bleed}$  is the preload current at the regulator output provided by  $R_5$ , and  $I_{bias}$  is the maximum current coming out of pin 1 of the LM105 under full-load conditions.  $I_{bias}$  equals 2 mA plus the worst-case base drive for the pnp booster transistor,  $Q_2$ .  $I_{bleed}$  should be made about 10 times greater than  $I_{bias}$ .

Finally,  $R_4$  is given by

$$R_4 = \frac{I_{fl} R_3 - V_{sense}}{I_{bleed}}, \quad (15)$$

where  $I_{fl}$  is the output current of the regulator at full load. It is recommended that a ferrite bead be strung on the emitter of the pass transistor to suppress oscillations under certain conditions (Fig. 6). It is advisable also to include  $C_4$  across the current-limit resistor to prevent damage to the regulator from fast spikes.

In some applications the power dissipated in  $Q_2$  becomes too great for a 2N2905 under worst-

case conditions—even when a heat sink is used (as it should be). When dissipation is a problem, the 2N2905 can be replaced with a 2N3740. The ferrite bead and  $C_4$  are not needed then because the 3740 has a lower cutoff frequency.

A further advantage of foldback limiting is that it sharpens the limiting characteristics of the IC. And the maximum output current is less sensitive to variations in the current-limit sense voltage: A 20% change in sense voltage will affect the trip current by only 5%. Also, the temperature sensitivity of the full-load current is reduced by a factor of four (but the short-circuit is not).

Though the voltage dropped across the sense resistor is larger with foldback limiting, the minimum input-output voltage differential is not increased above the 3 V specified for the LM105—as long as the resistor drop is less than 2 V. The low differential can be traced to the low sense voltage of the IC.

Fig. 6 shows that foldback limiting can be used only with certain loads. When the load is predominantly a current source, the load line can intersect the foldback characteristic at a point at which the regulator can't come up to rated voltage, even without an overload. Fortunately most solid-state loads present no problem. However, the regulator must be designed with the load in mind. ■■

## You don't have to buy a new car to get an electronic ignition.

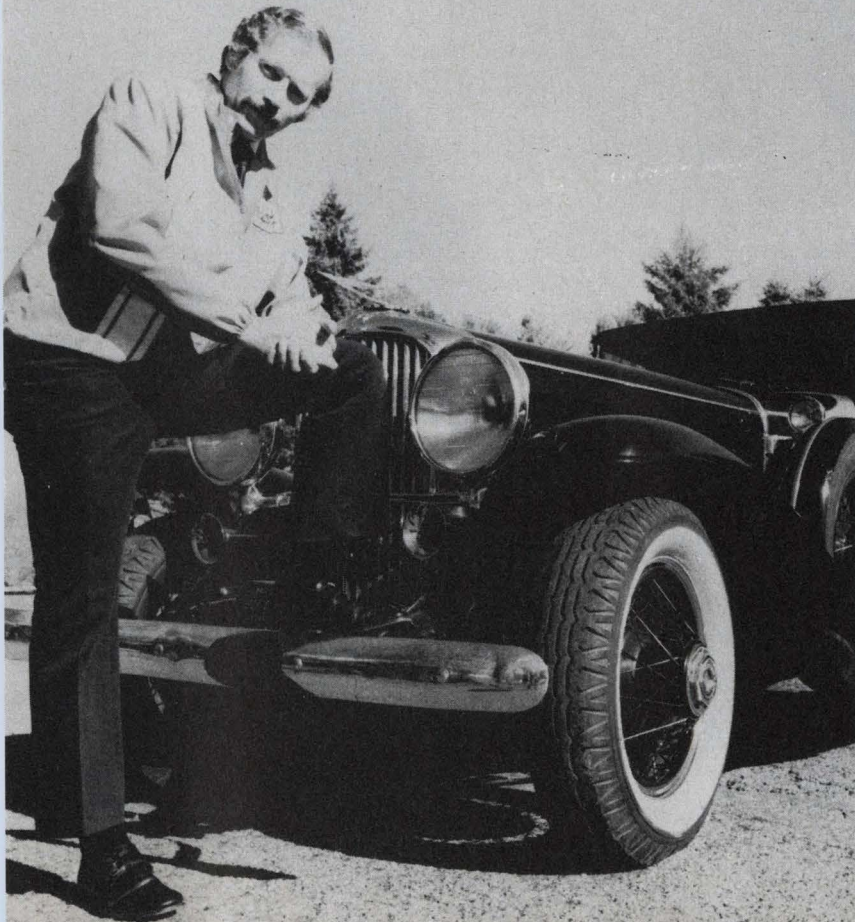

Most of you know the evaluation of automotive electrical systems . . . an evaluation characterized only occasionally by efficiency and performance. I know that, and that's why I use the Delta Mark Ten B CDI on all my cars, new and old. And believe me, you don't have to have a new car to appreciate the best electronic ignition available today. Study these features and you'll know what I mean.

1. Mark Ten and Mark Ten B Capacitive Discharge Ignition Systems are manufactured by Delta Products, Inc., a company with a conscience, and with a proven record of reliability both in product and in customer relations.
2. The Mark Ten CDI's really do save money by eliminating the need for 2 out of 3 tune-ups. Figure it out for yourself. The first tune-up or two saved pays for the unit, the rest is money in your pocket. No bunk!
3. Because the Mark Ten CDI's keep your car in better tune, you actually can save on expensive gasoline.
4. With a Mark Ten, spark plugs stay clean and last longer . . . fouling is virtually eliminated.



No matter what kind of car you drive, it too can use a Delta quality lift.

I want to know more about Mark Ten B CDI's. Send me complete no-nonsense information on how they can improve the performance of my car.

Name

Address

City  State  Zip



**DELTA PRODUCTS, INC.**

P.O. Box 1147, Dept. ED, Grand Junction, Colo. 81501  
303-242-9000

Mark Ten B,  
assembled . . . . \$64.95 ppd  
Mark Ten B, kit . . . \$49.95 ppd

Standard Mark Ten,  
assembled . . . . \$49.95 ppd  
Deltakit® . . . . \$34.95 ppd



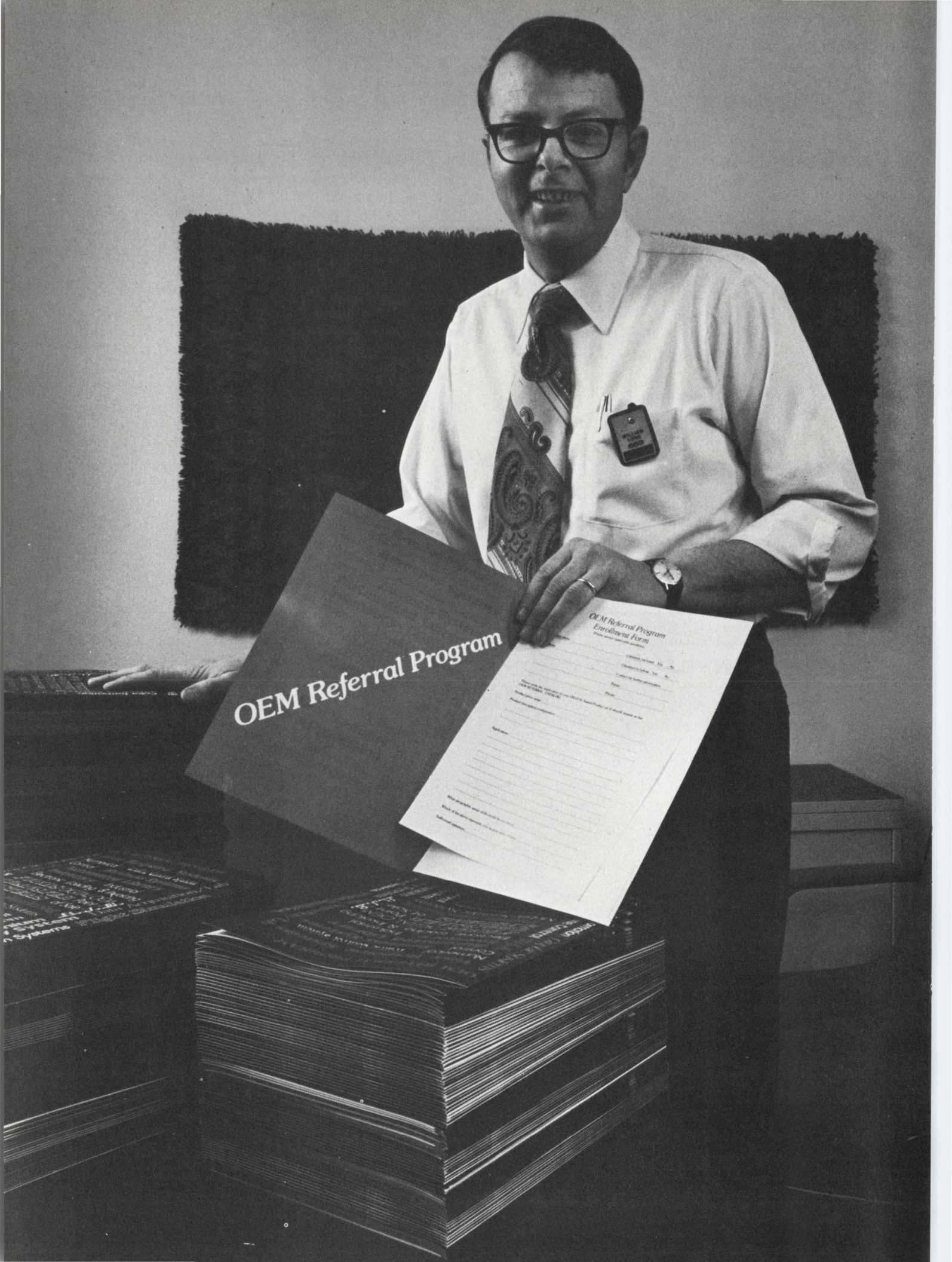

# OEM Referral Program

## OEM Referral Program Enrollment Form

*Please print name and address in block letters.*

Company Name: \_\_\_\_\_  
Company Address: \_\_\_\_\_  
City/State/Zip: \_\_\_\_\_  
Phone: \_\_\_\_\_  
Fax: \_\_\_\_\_

Name: \_\_\_\_\_  
Title: \_\_\_\_\_

Signature: \_\_\_\_\_

Date: \_\_\_\_\_

Comments: \_\_\_\_\_



# "If you're an OEM, I'd like you to join in an exciting new sales building program."

William Long  
VP OEM Group  
Digital Equipment Corporation

It's our brand-new catalog of OEM systems.

A book Digital salesmen will be using regularly to point out Digital OEMs to potential users of OEM systems.

A book which should mean bigger sales for everyone who's in it — and one of them can be you.

The OEM catalog is the key to a massive new program. Its whole intent is to help our OEMs sell computerized systems to end users. It's the OEM Referral Program. Here's how it works.

We're compiling a catalog of information supplied by our OEM customers on their systems.

With the total support of our worldwide sales force, backed by an advertising campaign in industrial magazines, we're offering help to anyone contemplating the purchase of major equipment.

That help takes the form of detailed suggestions on how to buy

computerized equipment. Suggestions on where to buy the type of equipment they need, and who they can buy it from.

The systems we suggest, of course, are systems sold by Digital OEMs.

What the catalog does is to categorize these systems (which span virtually the entire spectrum of OEM systems on the market today) so our salesmen can match prospects' needs with appropriate OEM systems.

The catalog, like the whole program, is serious business. It has only one purpose: to help your sales effort. After all, every system you sell to your customers is one more computer we sell to you.

But while the OEM Referral Program will be an increasingly important part of our own marketing strategy, it's not the whole story by any means.

We will continue to come out

with new breakthroughs in the areas of price and performance.

And we will continue to work with our OEMs in every way we can to help keep us both profitable in these profit-squeezed times.

In short, we will continue the policies that have kept us the leader in the OEM computer field ever since it started. Because in all that experience, we've learned something about the OEM marketplace:

**We're a success only if you are.**

For more information, write Digital Equipment Corporation, Maynard, Massachusetts 01754. (617) 897-5111. European headquarters: 81 route de l'Aire, 1211 Geneva 26. Tel: 42 79 50. Digital Equipment of Canada Ltd., P.O. Box 11500, Ottawa, Ontario K2H 8K8. (613) 592-5111.

**digital**



## Damper diodes: Do you need them? They serve a useful purpose, but you might be able to do without them. Here's a test circuit that can help you decide.

Damper diodes. They're considered by some to be useless; by others, a necessary component in CRT horizontal-output circuits. To evaluate the need for this diode, consider these factors in your analysis: drive requirements, dissipation, device rating, efficiency and cost.

You can build a test circuit that can simulate most common horizontal-output sections. This circuit can help you determine when to use the damper diode.

The horizontal output stage of a CRT display provides an almost linear ramp of current through the CRT scan coils during the trace period. This trace is followed by a rapid reversal of current during retrace and a high (retrace) voltage pulse across the collector-emitter terminals of the output transistor.

The use of high-voltage transistors with damper diodes in the horizontal output stage is common today. The inherent problems of switching such transistors, and the circuit techniques to control them, have been described in many papers.<sup>1, 2, 3</sup>

If a damper diode is not used, the transistor operates in an inverted mode to pass the current. During the efficiency period the transistor passes current through a forward-biased collector-base junction; the charge stored contributes to the total collector charge at the end of scan. Thus for optimum circuit operation, the drive conditions to the output device will be different from those needed when the damper diode is used.

In comparison with the total circulating volt-amperes in scanning coils, the dissipated energy of the horizontal output circuit is small. The current in the coils has a large ac component. And during the first part of the scan, the current in the coils is negative. When a damper diode is used in the circuit, it passes the negative current until the transistor conducts.

The component values in the test circuit (Fig. 1) are similar to those found in television horizontal-output sections.

The components  $L_1$ ,  $L_2$ ,  $C_3$  and  $C_4$  represent the scanning coils, high-voltage transformer and tuning capacitance. Resistor  $R_1$  represents the total circuit losses during scan. The damper diode,  $D_1$ , can be put into the circuit or removed to run the different tests. A pulse generator can be used to evaluate different pulse widths.

### How the test circuit works

Transistor  $Q_1$  is switched on by the pulse generator, and the transformer supplies a pulse of current to the base of  $Q_2$ . Resistor  $R_1$  limits the average primary current of the transformer, and components  $R_2$  and  $C_1$  damp the collector voltage overswing as  $Q_1$  switches off. This damping shapes the leading edge of the base current in  $Q_2$ . The base current produces a negative voltage in series with the secondary voltage of the driver transformer.

The switching action of the high-voltage transistors must be controlled accurately.<sup>2</sup> Inductance  $L_B$ , which represents the total secondary circuit inductance and may be all or part of the secondary leakage inductance of the transformer, is included to achieve the control. It does this by slowing the rate of fall of the base current,  $dI_B/dt$ , of  $Q_2$ .

This control results from the following: At the instant of turn-off of the secondary voltage, inductor  $L_B$  presents a high reactance in the base circuit and thus opposes any abrupt change in  $I_B$ . The energy stored in  $L_B$  during the on period of  $Q_2$  maintains  $I_B$ . Inductor  $L_B$  has a voltage of  $V_{off} + V_{BE(on)}$  across it, which defines the rate of change,  $dI_B/dt$ , of  $I_B$ .

The base current falls at a constant rate through zero to a value of  $I_{B(off)}$ , which depends on the type of transistor and its operating conditions. When  $I_B = I_{B(off)}$  zero current point, the collector current is turned off. The energy stored in  $I_B$  (which is equal to  $1/2 L_B I_{B(off)}^2$ ) causes the base-emitter voltage to swing negative until it is limited by the breakdown voltage,  $BV_{EBO}$ , of the device. Inductor  $L_B$  now has a voltage ( $V_{off} - BV_{EBO}$ ) across it. This voltage defines a rate of rise of  $I_B$  towards zero. When  $I_B$  reaches zero,  $V_{BE}$  equals

Richard G. Woodhead, Development Engineer, Texas Instruments, Ltd., Bedford, England.



$V_{off}$  and  $I_B$  remains at zero.

Let's take a look at how the test circuit operates with the damper diode connected. Typical waveforms (Fig. 2) produced by the circuit simulate those of a TV horizontal output section. Fig. 2a shows the collector-emitter voltage,  $V_{CE}$ , of the output transistor,  $Q_2$ . You can see that the retrace pulse is 12  $\mu s$  wide and almost 1000 V in amplitude. The central dip clearly shows the effect of third harmonic tuning.

### Using the test circuit

The voltage across the output transistor at the end of the retrace period is clamped at the negative drop across the damper diode during conduction—approximately 1 V. When base current is re-established, the transistor conducts first through the forward-biased collector-base junction. After the collector current passes through zero, the transistor conducts normally in a forward direction as the voltage rises to  $V_{CEsat}$ .

Waveform 2 (Fig. 2b) shows the collector current of output transistor  $Q_2$ . This current is negative at the beginning of base drive. The collector current rises to a peak value of 3.5 A—a value defined by  $L_1$ , the power supply, dc loading and the scan time. At the start of base-current turn-off, the collector current continues to rise until the decreasing amount of charge stored in the collector can no longer maintain conduction. At that point the current starts to fall, and the collector voltage rises.

The base current of the output transistor (Fig. 2c) reaches a maximum value of 2 A before it falls linearly to  $-2$  A under the control of  $L_B$ . The small glitch in both the base and collector currents at the end of retrace is caused by the charging of the stray reactances of the damper diode and output transistor before the

diode conducts the scan current.

The base-emitter voltage of the output transistor (Fig. 2d) is approximately 1 V during conduction. When the base current reaches its maximum negative value,  $I_{Boff}$ , the voltage  $V_{BE}$  reverses and the base-emitter junction goes into breakdown. After the base current has reached zero, the voltage rises to  $V_{off}$ . The transient ringing is due to oscillations in the base circuit as the transistor comes out of breakdown.

Now let's remove the damping diode and compare the different waveforms. The switching action of the circuit is basically the same, and there is almost no change in the retrace voltage. After retrace, the collector-emitter voltage is not clamped by the damper diode but limited by breakdown voltage of the base-emitter diode,  $BV_{EBO}$ .

Typical transistors used for this application include the BU105, BU108, BU308, BUY71 and the TIP550 to TIP553. These have specially designed base-emitter junctions that can operate reliably in breakdown during the efficiency period.

Fig. 3b shows the collector current that flows through the forward-biased collector-base junction immediately after retrace. Just after retrace, the base current (Fig. 3c) is positive, since the voltage at the base terminal is more negative than that of the driver transformer secondary.

The transistor thus operates in an inverted mode with a gain of  $I_E/I_B$ . This inverse operation reduces the clamping voltage on the collector-emitter terminals and reduces the power dissipation. For transistors with high inverse gains, the reducing voltage may rise toward  $V_{off} + V_t$ , where  $V_t$  is the base-collector forward voltage.

The waveform in Fig. 3d shows the base-emitter voltage that returns to  $BV_{EBO}$  after retrace. The voltage then drops in magnitude during the efficiency period. The last two waveforms (Fig.

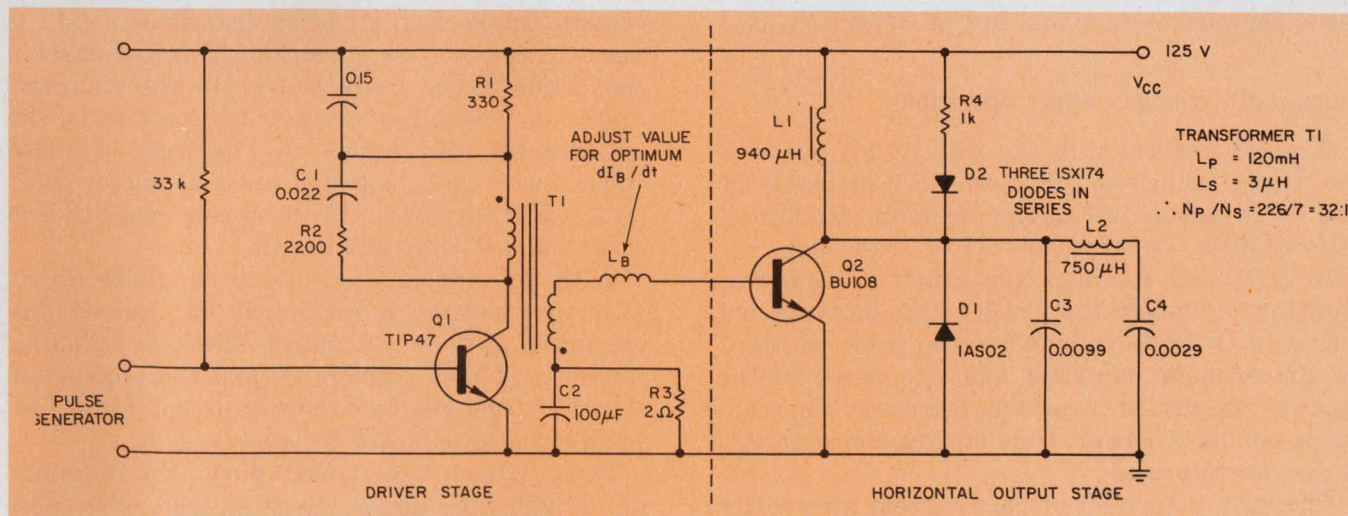

1. A test circuit can simulate the horizontal output stage of most CRT display systems. This can help evaluate the

need for a damper diode connected across the horizontal output transistor.



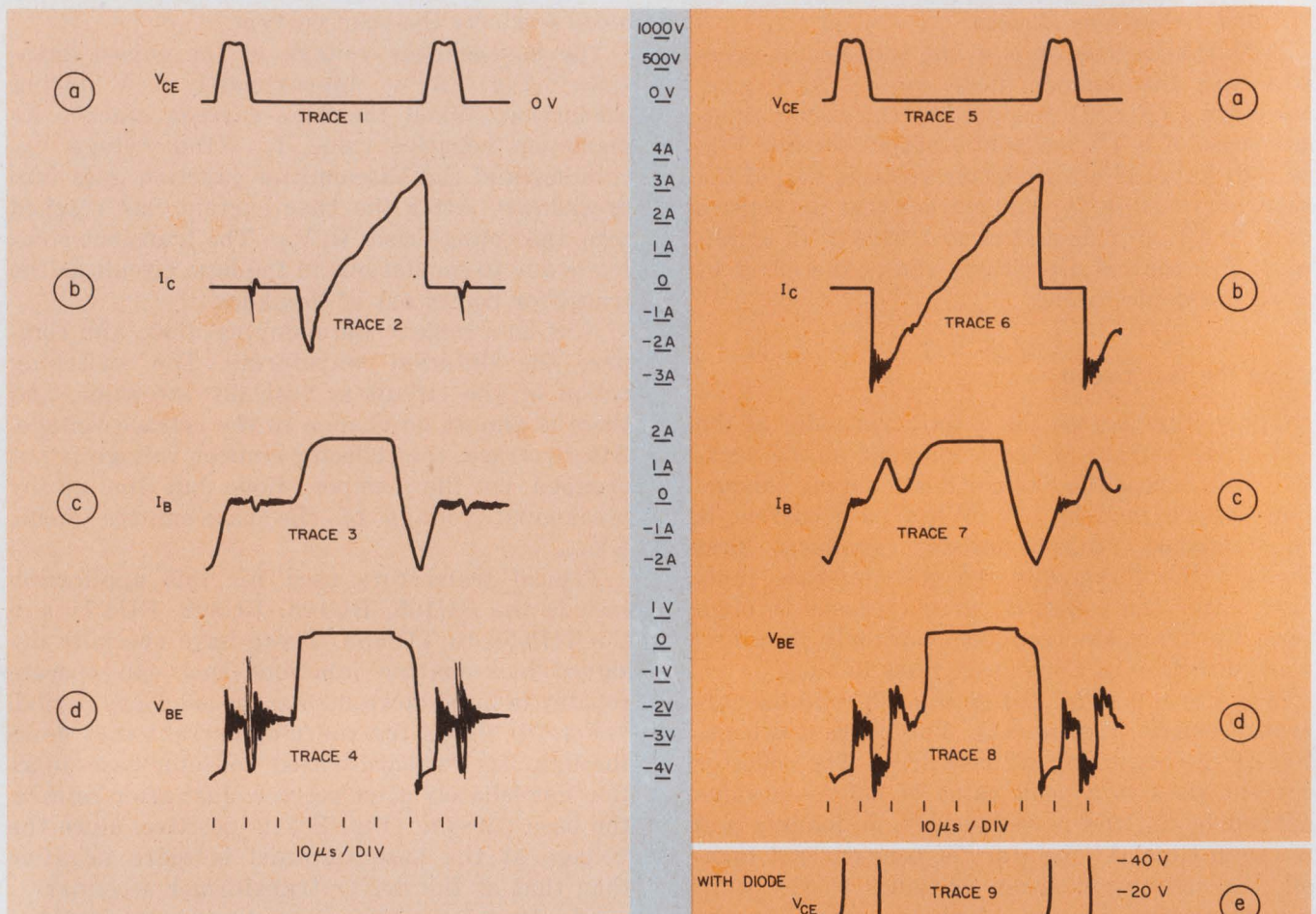

2. Typical horizontal output traces, taken at various points in the test circuit, are used as a reference for circuit modifications to optimize performance.

3. Without the damper diode, these scope traces (a to d), can be compared with those in Fig. 2. The last two traces (e and f) show the collector-emitter voltages of the circuit with and without the damper diode.

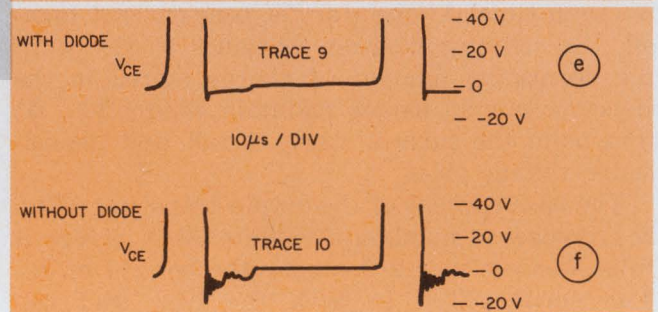

3e, 3f) show the collector-emitter voltage at the end of the retrace with and without the damper diode. In Fig. 3e the voltage is clamped to the diode forward voltage and in Fig. 3f to  $BV_{EBO}$ .

### Pulse-width changes affect operation

A pulse generator in the test circuit switches the driver transistor. In most CRT displays the line oscillator, locked to the incoming synchronization pulses, switches the driver transistor.

In both cases the inverting action of the driver transformer causes the width of the base-current pulses in  $Q_2$  to decrease when the pulse width of the driver stage increases, and vice versa. As the pulse to the driver transistor increases, the transistor conducts longer, thus storing more energy in the transformer.

The rate of turn-off of base current also varies with changes in drive pulse width to transistor  $Q_1$  and component values.

When a damper diode is used in the circuit, the effect of the driver pulse width on the operation is considerable. As the pulse width of  $I_B$  increases, the horizontal output transistor conducts more in the reverse direction. This increase in conduction stores more charge in the collector. Since the amount of stored charge affects the optimum  $dI_B/dt$  needed, the increase in pulse width means that the transistor is no longer operating optimally. Also it will be more sensitive to small changes in  $I_B$  and  $dI_B/dt$ .

With the damper diode removed, there aren't as many problems. Since the output transistor is operating as its own damper, the total scanning current will flow through it, and the amount of stored charge will be constant, except for a few small variations caused by base current.

Thus, without the damper diode, the optimum  $dI_B/dt$  will hold almost constant and variations in pulse width will have little effect on the output transistor characteristics.



Once the diode is removed, some of the other circuit parameters will change. Consider device dissipation. The total transistor power dissipation should be a minimum at high temperatures, so that at lower temperatures the power dissipation can increase.<sup>2</sup> Typical power-dissipation curves are shown in Fig. 4a.

A poor choice, for example, would be to optimize the transistor family at the low temperature extreme and operate the devices at the value of  $dI_B/dt$  noted in Fig. 4a as point 1. In this example the case temperature would rise because of thermal radiation from other components and the device's dissipation would also rise to point 2. However, if the optimization had taken place at high temperatures, the transistor would operate at the level indicated by point 3.

At low temperatures the device would not dissipate optimum power, but as the case temperature increased, the power dissipation would approach optimum (point 4). This power level is less than the value at point 2; thus the internal runaway problem is practically eliminated.

Optimum-power measurements must allow for a  $\pm 20\%$  tolerance to account for variations in voltages and currents. This may also mean that the circuit will work with higher power losses at low temperatures but that the circuit parameters will converge to optimum as the temperature rises.

The variation of dissipation vs. pulse width of the drive current for a typical transistor can be plotted with and without the damper diode (Fig. 4b). In each case  $dI_B/dt$  is set to optimum at a particular pulse width. Although dissipation at optimum increases when the damper diode is removed, the variation in  $P_D$  with pulse width is much smaller.

### The test results compared

Six parameters of the horizontal output transistor can be measured in the test circuit: collector current, base current, rate of change of base current, storage time, fall time and power dissipation. All these are measured first with the damper diode in the circuit and then without. The optimum  $dI_B/dt$  is set at a pulse width of 29  $\mu s$ . Three sets of measurements are taken: First with the circuit optimized and the damper diode in the circuit; second, with the same circuit but with the damper diode removed; and, third, with the  $dI_B/dt$  adjusted to optimize power dissipation again in the output transistor with the damper diode removed.

The results of these tests are shown in the table. When the diode is removed and the rest of the circuit unaltered, changes in three parameters can immediately be noticed.

The changes in  $I_{B(end)}$  and  $dI_B/dt$  occur because

of the following: Since the efficiency action of the transistor draws forward base current, the average secondary current increases, thus increasing the voltage across  $C_2$  and  $R_3$ . This adds to the off voltage and subtracts from the on voltage of  $V_{BE}$ , thus increasing  $dI_B/dt$  and reducing  $I_{B(end)}$ .

The increase in dissipation comes from the increased efficiency action of the transistor. Some increase is also due to large switching losses caused by deviation from optimum operation.

The third column in the table shows the values of parameters after they have been optimized again for minimum power. To achieve optimum operation,  $dI_B/dt$  must be reduced, since larger amounts of charge are stored in the transistor. The dissipation, although less than that in the second column, is 40% higher than when a damper diode is used. However, this increase in dissipation is still acceptable. Let's see why.

If the optimization process for the whole spread of transistors is done at a case temperature of, say, 70 C and the worst-case dissipation is found to be 4 W, reliable operation of the transistor, if it is mounted on a heat sink with a thermal resistance of 4 C/W, will be guaranteed up to an internal board ambient of  $70 - (4 \times 4) = 54$  C.

### Consequences of circuit changes

With the same conditions, removal of the damper diode might cause the power dissipation to rise to about 7 W. Now the safe board temperature decreases to  $70 - (4 \times 7) = 42$  C. If, because of high external ambients, the limit of the board must be higher, two options are available.

1. Reduce the heat-sink thermal resistance by increasing the heat-sink size. For instance, if thermal resistance drops to 3 C/W, a maximum board temperature of  $70 - (3 \times 7) = 49$  C would be permitted.

An approximate formula for the thermal resistance of sheet aluminum is given by  $R_a = 22/L$ , where L (in inches) equals the  $\sqrt{\text{surface area}}$ . Thus, if the thermal resistance of the heat sink must be reduced by 1 C/W, the surface area of the heat sink must be more than doubled.

2. You can also optimize the transistor again at a higher case temperature. For example, if the new case temperature is 85 C, the device family might have a higher worst-case dissipation of, say, 8.5 W. The maximum safe board temperature (with a 4 C/W thermal resistance) would be  $85 - (8.5 \times 4) = 51$  C. A compromise between the two options is also possible—a slight increase in heat-sink size and a lower temperature for optimization again.

The increase in case temperature of the hori-



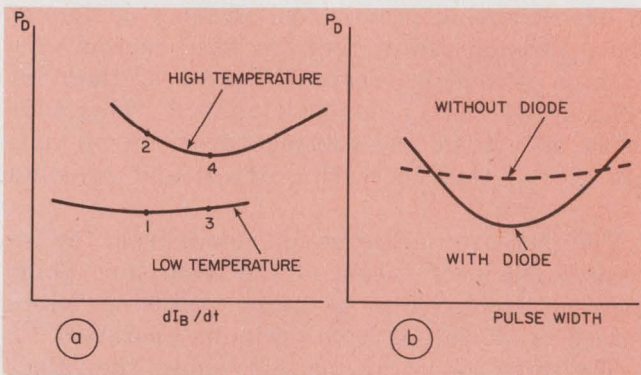

4. Power-dissipation curves of the output transistors are useful in determining safe operating levels for the circuit. Worst-case calculations provide the best guidelines for reliability and stress.

### Parameter comparison with and without the damper diode

Parameter	Optimum with diode	Diode removed	Optimum without diode
$I_C$ (A)	3.4	3.4	3.4
$I_{B(end)}$ (A)	2	1.9	2
$dI_B/dt$ (A/ $\mu$ s)	0.46	0.48	0.35
$t_s$ ( $\mu$ s)	8.7	8.8	11.2
$t_r$ (ns)	700	950	800
$P_D$ (W)	3	4.5	4.2

With a pulse width of 33  $\mu$ s with the diode connected, the device dissipation rose to 3.3 W.

zontal output transistor will have no effect on reliability, provided that the drive conditions to the transistor are optimized for the worst-case dissipation and the board ambient is not allowed to rise above that guaranteed for maximum case temperature.

The linearity of the scanning beam will change when the damper diode is removed. This is because of the difference in voltage across the coils during the efficiency period, when the damper diode is used and when the transistor operates as the diode. The change in voltage is small, and the increase in nonlinearity will be less than 2%. This amount of nonlinearity can be compensated by an adjustment of the CRT linearity coil.

There are also possible cost-reduction benefits when you remove the damper diode. An obvious starting point is the diode itself. To reduce some of the heat problems, you can increase the heat-sink size or use a larger or better designed cabinet for increased air venting. However, with a well-designed output stage an increase in case temperature can be tolerated. ■■

#### References

1. Maytum, M. J., "Monochrome TV Circuit Design Using the BUY71 2.2-kV Transistor," *Texas Instruments Applications Report B126*, Texas Instruments, Dallas, TX.

2. Maytum, M., J., Lear, A., "Driver Circuit Design Considerations for High-Voltage Line Scan Transistors," *IEEE BTR*, Vol. 19, No. 2, 1973.

3. Salmon, K. A., E., "High-Voltage Switching Transistors," *Texas Instruments Applications Report B131*, Texas Instruments, Dallas, TX.

## Consider all the ins and outs of your new circuit design. Then consider Curtis® Terminal Blocks.

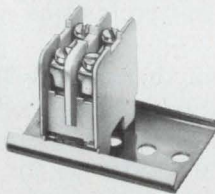

Tangled, twisted, and loose wires can snarl up even the best circuit design. So don't tangle with trouble. Curtis offers 19 electronic and electrical terminal blocks with hundreds of model variations available to straighten out almost any wiring layout problem.

Here are just a few of the features offered----

- capacities ranging from 5 amps/300 volts to 250 amps/600 volts
- modular, channel-formed, closed-back, feed-thru and fully insulated feed-thru designs offered
- choice of tab, screw, clamp, PC pin or taper pin termination
- heavy duty lug and tubular, high pressure solderless types available for high current applications
- full mechanical thread system incorporated in many units

Specify Curtis electronic and electrical terminal blocks and you'll have the best line in the industry to work with. Specify anything less and you may be tangling with trouble.



**CURTIS** INDUSTRIES, INC.

8000 West Tower Avenue, Milwaukee, Wisconsin 53223

Call (414) 354-1500 for the name of a representative or distributor near you.

In Canada: A.C. Simmonds & Sons, LTD, Willowdale, Ontario.

For Current Source Data,  
Call Dial-A-Source Toll Free  
800-645-9200  
(New York State, Call Collect)  
516-294-0990



INFORMATION RETRIEVAL NUMBER 36



Inherently rugged, these triple-diffused devices permit circuit operation directly from rectified 117V or 220V line — eliminating transformers. Ideally suited for inverters, convertors, switching regulators, motor controls and wherever there's hi-rel applications. The exploded view demonstrates our single chip design and packaging

concept which makes high-voltage, high-current transistors off-the-shelf availability possible. Pre-rating and pre-testing techniques of chip allows choice of solid copper packages. For further information

and application assistance, call Sales Engineering, PowerTech, Inc., 9 Baker Court, Clifton, N.J. 07011. (201) 478-6205.

TYPE #	(pk.) I <sub>c</sub>	V <sub>CE</sub>	h <sub>FE</sub> @ I <sub>c</sub>	Switching Speed (Typ.)
PT-3512	70A	325	10 @ 30A	t <sub>r</sub> = .5 μs
PT-3513	70A	400	10 @ 30A	t <sub>s</sub> = 1.2 μs
PT-3522	90A	325	10 @ 50A	t <sub>r</sub> = .5 μs
PT-3523	90A	400	10 @ 50A	

350 Watt Power Rating      Guaranteed SOAR

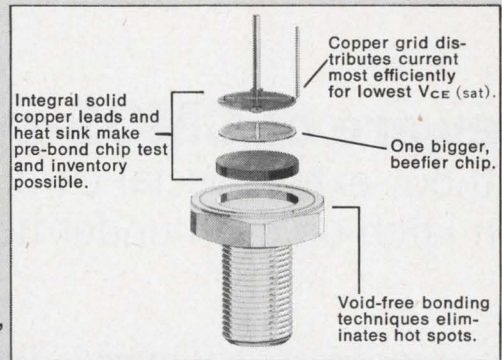

**PowerTech, Inc.**

"BIG IDEAS IN  
BIG POWER"

# 400v90AMP



NPN Silicon  
Power Transistor  
Switch — Highest KVA  
at lower cost,  
weight & space.



# Beware of CMOS-switch failure modes.

Without extra special care, some analog-switch ICs can latch up even under normal operating conditions.

You've just bought some CMOS analog switches and connected them into your system. Now you turn on the power and observe that the system malfunctions or the new chips burn up. What happened?

Chances are that it wasn't anything you did wrong. Rather, there was little that you could have done right.

Conventional CMOS-switch structures inherently contain parasitic SCRs that can give rise to latch-up conditions in a wide number of cases. To minimize the problem, some manufacturers recommend such remedies as the turning on of power supplies in special sequences, the use of external components, or the avoidance of transients. But for a host of applications—especially industrial and military—these recommendations can't be applied easily.

The ultimate solution lies in improved fabrication techniques that avoid the detrimental parasitics altogether. Fortunately manufacturers are providing the answer with such processes as dielectric isolation (Harris Semiconductor, Melbourne, FL, among others) and floating body (Intersil, Cupertino, CA).

## The cause of the problem

A simplified schematic of one channel of a typical CMOS analog switch appears in Fig. 1a. The basic transmission gate consists of an n and p-channel MOSFET. The two are connected in parallel and their gates are driven out of phase by 180°. This technique tends to linearize ON resistance over a wide signal-voltage range. And it makes the resistance virtually constant and only slightly dependent on input-signal amplitude.

In the physical equivalent of the basic gate (Fig. 1b), note that parasitic transistors are inherent in CMOS processing. The n-channel device, for example, has these transistors: a vertical npn, a horizontal npn and the collector part of a lateral pnp.

**Richard Wilenken**, Engineering Manager for Hybrid and Discrete Products, Intersil, Inc., 10900 N. Tantau Ave., Cupertino, CA 95014.

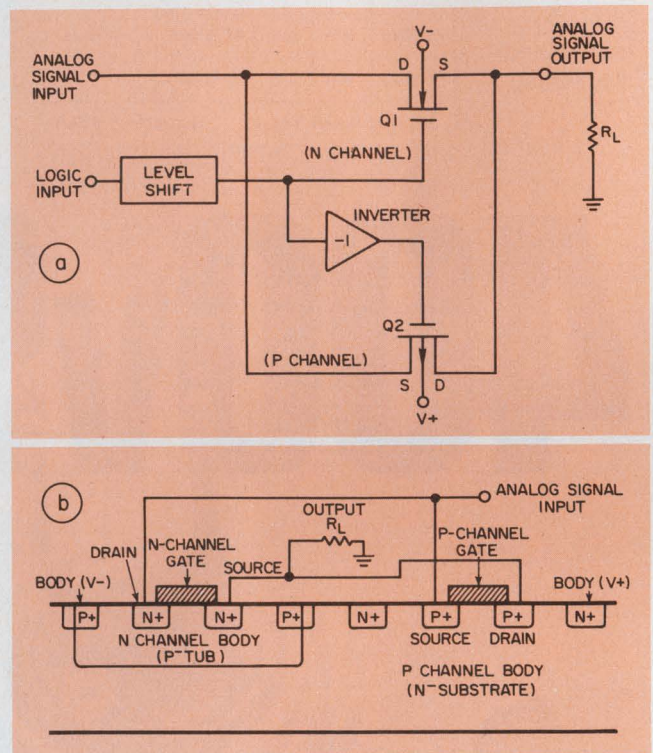

1. A typical CMOS analog switch employs an n and p-channel MOSFET in parallel (a). The gate's cross-section (b) contains three parasitic transistors that are inherent in conventional CMOS processing.

The vertical npn results from either a source or drain acting as an emitter. The body acts as a base; and the n-type substrate, as a collector. The horizontal npn comes from either a source or drain acting as an emitter, the p-tub forming a base, and the source or drain providing a collector. Finally the p-type tub acts as a collector of the lateral pnp formed by the proximity of the complementary pair.

Similarly for the p-channel device, a lateral pnp transistor exists in two different directions. In one direction the source or drain acts as an emitter, the n-substrate as a base, and the p-tub as the collector. In another direction there is a horizontal pnp for which a source or drain acts as an emitter, the n-substrate forms a base, and the source or drain provides a collector.

The main culprits causing the latch-up problem



are the vertical npn and the lateral pnp (Fig. 2). Note that the base of the lateral pnp is simultaneously the substrate and the collector of the vertical npn; these points are tied electrically. Also the base of the npn, the p-tub, is the collector of the pnp.

This little transistor pair forms an SCR with the characteristics shown in Fig. 2b. It looks like a dual-gate SCR, because either the base of the npn or the pnp can trigger it.

### How bad can the problem get?

As long as the plus and minus 15-V supplies are on, no SCR action is possible (Fig. 3). Both emitter-to-base junctions of the npn and the pnp transistors are reverse biased by about 5 V or more.

But let's say you are switching  $\pm 10$  V—any value above a couple of volts will do—and the 15-V supply is turned off by a glitch, or spike. Since the internal impedance of most references is low, the base of the pnp then looks like a ground. And the pnp becomes forward biased and starts to conduct current.

The circuit will latch if the beta product of the npn and pnp devices equals or exceeds 1.0. Then  $V_{out}$  will be locked at approximately the signal-input value less 1.5 V—a  $V_{BE}$  drop plus a  $V_{CE}$  drop. The only limit on the current drawn will be the value of  $R_L$  and the current-carrying capacity of the reference analog input.

The only way to unlatch the circuit is to remove the input-signal voltage; you have to reduce the current drawn to a level below the holding current of the SCR. In this case the current is limited by the load resistor and the worst result probably will be a system malfunction. This case doesn't lead to a destructive latch-up.

Another nondestructive latch-up can occur even though the 15-V supply is rock steady, never has any glitches and cannot be turned off while an analog signal is present. An overvoltage spike in the signal input can boost the signal level over 15.7 V. Then the pnp becomes forward biased again, and the latch-up returns.

Fortunately the current is limited, so only a malfunction occurs. Suppose, however, that you have a low value of  $R_L$ , or you are just driving a capacitive load. Then peak currents, which follow the formula  $i = C \times dV/dt$ , can become high enough to blow the metal interconnects on the chip for a destructive latch-up.

While the pnp stage has been selected as the trigger for the SCR, you can just as easily reverse the roles and the analog-signal voltage polarity. Now the npn stage becomes the trigger for the action, and the  $-15$  V supply is the key. Here again, an overvoltage spike of  $-15.7$  V can start the SCR action.

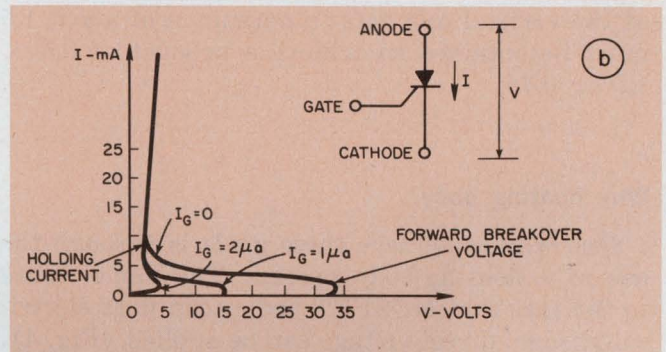
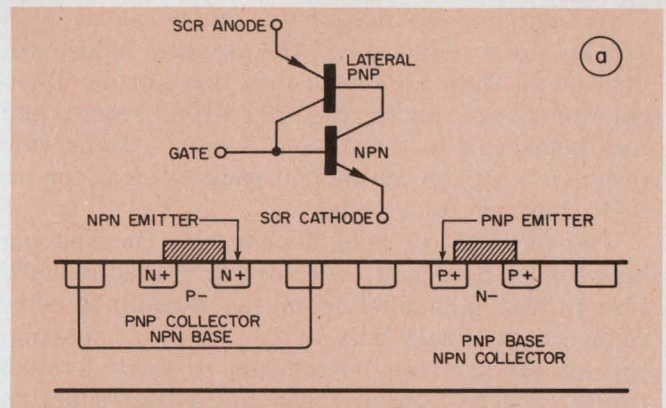

2. A parasitic SCR results from the combination of vertical and horizontal npn transistors with a lateral pnp (a). Either the base of the npn or pnp can trigger the dual-gate SCR and the parasitic device has the characteristic curve shown in "b."

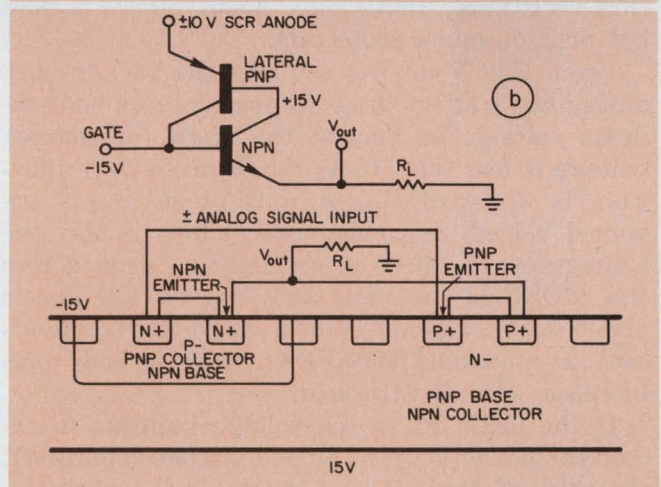
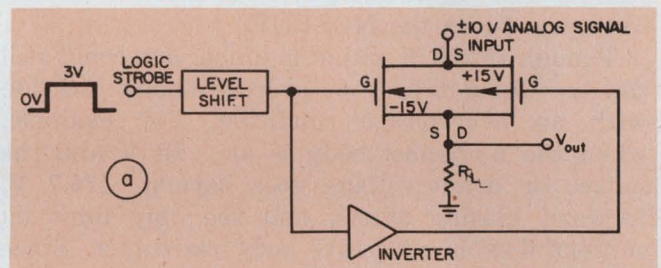

3. No SCR action can occur as long as the  $\pm 15$ -V supplies are turned on. However, under normal operating conditions, such as the switching of analog signals (a), the circuit can latch up (b). A sufficiently high load resistance,  $R_L$ , can avoid destructively high currents.



A complete elimination of the parasitic SCR action—by a reduction of the npn-pnp beta product to less than 1.0—runs into this hurdle. Typical npn betas run in the 100-to-1000 range, and pnp betas run in the 0.1-to-2.0 range. Hence the product is in the 10-to-2000 range—ideal for an SCR, but not for a gate.

The pnp lateral beta depends on the spacing between emitter and collector; increased separation of the p-channel from the n-channel helps reduce beta. Practically, with 2-to-5-mil spacing, the lateral pnp can be reduced to the 0.1-to-0.5 range. The real stopper has to be the reduction of the vertical npn beta; a maximum of about 1.5 must be obtained to achieve a product of  $0.5 \times 1.5 = 0.75$ .

### Why floating body?

One way to achieve these goals is through the use of a floating-body process. The name refers to the fact that MOSFET bodies can float electrically, so no direct voltage can be applied (Fig. 4). Instead, the body voltage comes through a back-to-back diode voltage divider.

Diode  $D_1$  comes from the junction formed by the p-tub and n-substrate. It results automatically, if no connection is made to the body of the n-channel device. A back-to-back-diode structure forms because of source-to-body or drain-to-body junctions of the MOSFET. Thus there is no way to forward-bias the MOSFET.

Though the SCR action is killed, one could still zap the drain-to-body or source-to-body junction with an overvoltage condition. For example, when the n-channel body is at  $-15$  V and the source or drain voltage goes beyond  $-15.7$  V, forward biasing starts, and the only limit on current flow is substrate body resistance. Since this resistance equals only about  $50 \Omega$ , it does not provide much protection.

From Fig. 5 you can see why the back-to-back diodes don't affect the body-to-source or body-to-drain voltage. As long as the drain (or source) voltage is less than 15 V, the drain-to-body junction is forward biased and diode  $D_1$  is reversed biased. Since the current flow is only the leakage of  $D_1$ , there is virtually no drop across the MOSFET junction and  $V_{BD}$  or  $V_{BS}$  equals about 0 V. This condition is particularly important to n-channel MOSFETs, because body bias increases circuit threshold.

If the drain or source voltage happens to exceed the power supply (an overvoltage condition), the roles of diode  $D_1$  and the drain-to-body junction reverse. Diode  $D_1$  becomes forward biased and the MOSFET junction is reversed biased. No harmful condition results as long as the breakdown of the MOSFET junction is not exceeded.

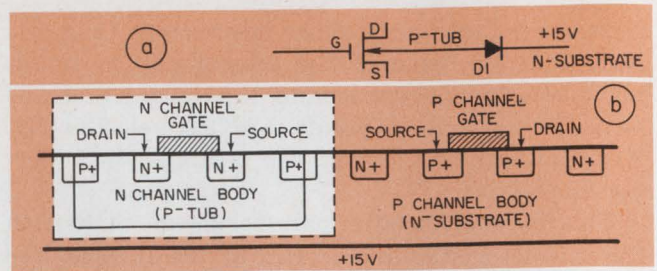

4. The floating-body technique eliminates the parasitic SCR. The technique uses back-to-back diodes that electrically float the body. The diode in series with the n-channel MOSFET body results automatically by use of the p-tub-to-substrate junction (b).

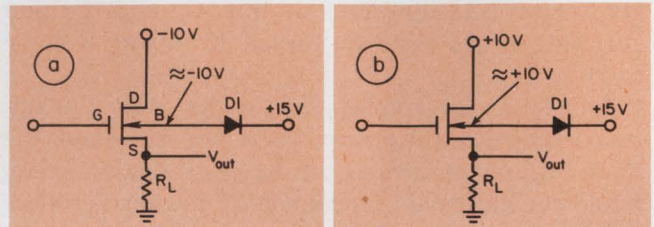

5. The back-to-back diodes don't significantly affect body-to-source or body-to-drain voltage, even though the analog input may be  $-10$  V (a) or  $+10$  V (b). For both cases the voltages referenced to body are both about 0 V.

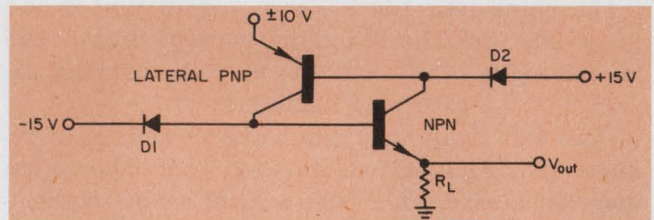

6. The diodes introduced by the floating-body technique allow either the positive or negative 15-V supply to be turned off without latch up.

The back-to-back diode structure provides complete circuit protection up to plus and minus 25-V overvoltage.

In addition, if either the plus or minus 15-V supply turns off for any reason, no forward-bias condition can exist (Fig. 6). Diodes  $D_1$  and  $D_2$  form back-to-back combinations with respective emitter-to-base diodes.

The first products to use the floating-body process are Intersil's IH5040 family of analog gates. The family consists of spst, spdt, dpst, dpdt, 4pst, and dual versions of each. Maximum ON resistance is  $75 \Omega$  for any input signal between  $-11$  and  $+11$  V. Also the entire line is TTL as well as CMOS compatible.

A typical schematic—for an spdt switch—in the IH5040 series appears in Fig. 7. The driver part of the schematic is always the same for all members of the family; only the output connection differs from unit to unit.



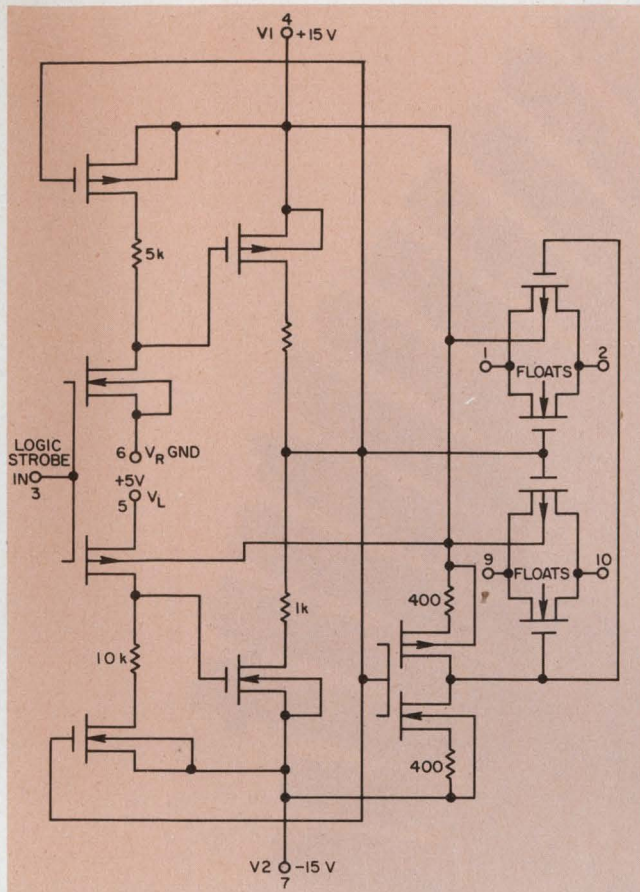

7. A typical driver gate using floating body, Intersil's IH5042, employs standard 0-to-3-V TTL levels to change the switch state.

All circuits have a beta product (for the vertical npn and the lateral pnp) that doesn't exceed 0.1; typically, it's 0.01. Therefore no latch up is possible. The signal can be present while any power supply is turned off in any sequence. Also you can exceed the signal-input level up to  $\pm 25$ -V overvoltage with 15-V supplies.

#### The tradeoffs

Of course, increased reliability has required some sacrifice in other areas. One disadvantage of the process is that OFF leakage currents are higher than in a conventional CMOS process. They are spec'd at 5 nA max, compared with typical values of 1 to 2 nA in conventional circuits.

Another disadvantage is that the overvoltage protection scheme limits the pk-pk voltage that the switch can handle. CMOS can usually switch an input signal that reaches the power-supply value. In applications of the IH5040 family where each side of the switch goes to the opposite polarities, pk-pk handling capability is spec'd at 22-V pk-pk minimum, and at about 26-V pk-pk typical. Thus you cannot switch 30-V pk-pk with  $\pm 15$ -V supplies, as you can with other CMOS versions. ■■

# Get CUSTOM MOS in any quantity

(and we mean **ANY** quantity  
—starting from 1 piece)

LSI Computer Systems, an experienced MOS company, will supply your custom MOS circuits in any process using the latest design techniques for highest reliability at the lowest cost. MOS circuits can be supplied to commercial or military specifications.

#### PARTIAL LIST OF CUSTOM CIRCUITS SUPPLIED

- Industrial Controls
- Juke Box Logic
- Digital Instrument Controls and Display
- Electronic Organs
- Data Communications
- Counter/Display
- Crystal Oscillator/Dividers
- Editing Typewriter
- Computers

MULTI PROCESS CAPABILITY  
for  
HIGH SPEED • LOW POWER • LOW VOLTAGE  
HIGH DENSITY • NOISE IMMUNITY  
SINGLE POWER SUPPLY

**LSI computer systems, inc.**  
22 Cain Drive, Plainview, N.Y. 11803  
(516) 293-3850



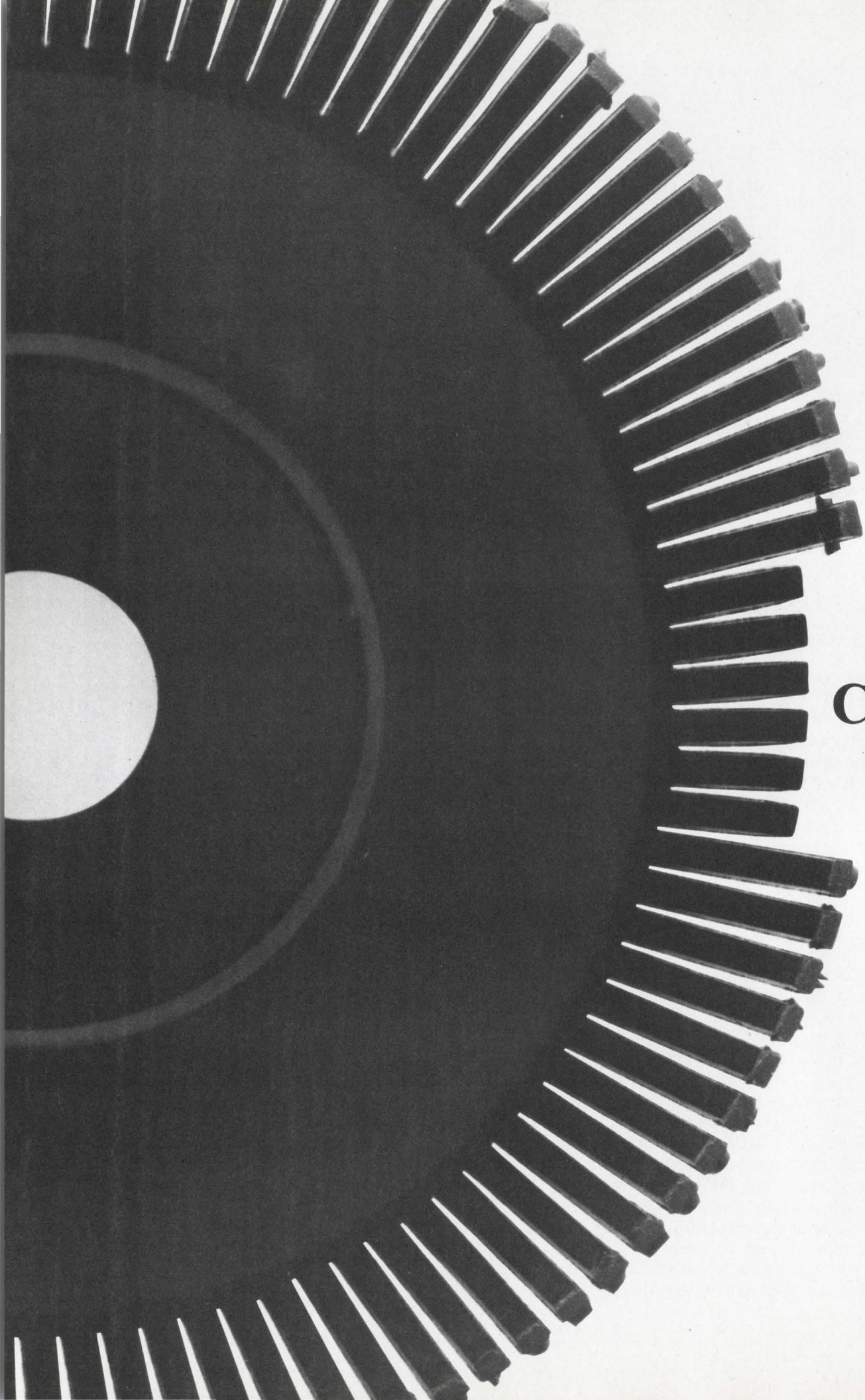

**Carousel:**



# the first impact printer with print quality that rivals Selectric.\*

We're introducing a high-performance 30 CPS, serial impact printer with a big difference. Print quality. It's so good you can't tell a Carousel printout from a Selectric printout.

The print quality is the result of the Carousel's rugged interchangeable print cup. And it's available in a variety of type fonts. A print cup with up to 100 character capacity.

But Carousel quality doesn't stop there. It also has a microprocessor built into its print mechanism.

What this means to you as a systems builder is high-quality print capability together with maximum system versatility.

Both of which you get at low cost.

It also means that whether you're developing a word processor, special purpose terminal, data station, or even a teletype replacement, the Carousel printer makes your job easier.

Carousel has a lot of other quality features, too. Just send in the coupon. And we'll send you all the facts about what makes our new Carousel go 'round.

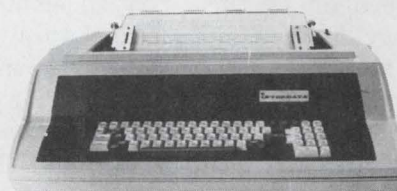

Interdata, Inc., Terminal Products Group  
Oceanport, N.J. 07757

Gentlemen:

- Please send me more information about the Carousel Printer.
- Have a sales representative call on me.

Name \_\_\_\_\_

Title \_\_\_\_\_

Company \_\_\_\_\_

Address \_\_\_\_\_

City \_\_\_\_\_ State \_\_\_\_\_

Zip \_\_\_\_\_ Telephone \_\_\_\_\_

**INTERDATA®**

A subsidiary of The Perkin-Elmer Corporation

Terminal Products Group  
Oceanport, N.J. 07757 (201) 229-4040

INFORMATION RETRIEVAL NUMBER 39

\*Registered trademark of the International Business Machines Corporation.



# Test that SCR turn-off time if you would forestall circuit burnout. Doing the job yourself will guarantee that the device is fast enough.

If you are designing silicon controlled rectifiers into power-control circuits that operate above 400 Hz, make sure the SCRs turn off fast enough. If the turn-off time is too long, circuits may fail.

What you need is a good, easy way to test the SCRs for turn-off time. This testing can be done by the device manufacturer—but you'll pay for it. Turn-off time is one of the most difficult parameters to measure routinely. A fairly complex test circuit and a thorough understanding of electrical and thermal measurement techniques are required.

Most SCR manufacturers provide detailed turn-off test circuits in their handbooks or application notes. You can build your own from one of these.

SCRs are easy to use in equipment like series inverters, parallel inverters and choppers. They can be turned on by their control element—the gate—at any time. Unlike transistors, though, they can't be turned off just by removal of the voltage from the gate, as you turn off a transistor by removing the voltage at the base. SCRs need special turn-off circuitry. Without this, they lose their ability to act as control elements.

## What is SCR turn-off?

The turn-off time of an SCR,  $t_q$ , is defined as the minimum time (in microseconds) following the end of forward current and until the SCR can again block a reapplied forward voltage. Initially an SCR blocks a forward voltage,  $V_{DRM}$ , at an operating junction temperature  $T_j$  (Fig. 1). A gate signal to the device starts the forward current flow. This current increases at a rate  $di_f/dt$  (amps/microsecond) until it reaches a peak of  $I_{TM}$ .

The peak current is maintained until it is forced to decrease at a rate of  $di_f/dt$ . Turn-off time is measured from the point at which the forward current flow drops through zero. After

the current passes through zero, it continues its negative flow until it reaches a value  $I_{RM(REC)}$ . Then it goes back to zero during the period known as reverse recovery ( $t_{rr}$ ).

This reverse-voltage period lets the SCR regain its internal charge equilibrium. The equilibrium is necessary, of course, for successful turn-off. At the end of the reverse-voltage period, the forward voltage,  $V_{DRM}$ , can be reapplied.

The SCR turn-off waveforms under test conditions are seldom the same as when the devices are operating in practical circuits. Here are common reasons why this is so:

- Increased  $di_f/dt$  and/or  $I_{TM}$  causes higher operating junction temperatures and thus longer turn-off times.
- Increased  $di_f/dt$  causes larger  $I_{RM(REC)}$  losses and thus longer turn-off times.
- Increased reapplied  $dv/dt$  causes longer turn-off times.
- Reduced reverse voltages (such as when SCRs are clamped with inverse diodes) also cause longer turn-off times.
- Reduced operating temperatures can help shorten the SCR turn-off time.

## Measuring the turn-off time

Let's simplify a manufacturer's test circuit to ease understanding of what turn-off time is and how it affects intended circuit performance (Fig. 2a). Section 1 supplies the forward current to the SCR under test. This current provides an independently controlled  $di_f/dt$  and  $I_{TM}$ . When the SCR triggers at time  $t_1$ , the forward current flow,  $I_{TM}$ , starts.

In Section 2 the triggering of SCR<sub>2</sub> at time  $t_2$  starts the  $di_f/dt$  portion of the forward current. The reverse voltage to the test SCR is supplied by supply  $V_2$ . Diode  $D_1$  in Section 3 is the most critical component in the test circuit. Its function is to isolate the forward current and reverse voltage supplies from the reapplied  $dv/dt$  supply (Section 4). Poor selection of this diode will produce improper voltage waveforms. This includes reducing the rate of the reapplied  $dv/dt$  as time  $t_3$  decreases or the reverse voltage mag-

---

**Julian Rydeski**, Sr. Quality Control Engineer, Semiconductor Div., Westinghouse Electric Corp., Youngwood, PA 15697.



nitude decreases.

Section 4 is the reapplied  $dv/dt$  supply. When SCR<sub>3</sub> is triggered at time  $t_3$ , linear charging of capacitor C takes place. Thus the forward voltage is applied to the SCR under test at the reapplied  $dv/dt$  rate.

The actual value of turn-off time can be observed on an oscilloscope (Fig. 2b). If you decrease the time interval between  $t_3$  and  $t_2$ , you can see that the turn-off time also decreases until the SCR under test cannot support the reapplied  $dv/dt$ .

This  $dv/dt$  turn-on is nondestructive if the rate of current rise,  $di_t/dt$  is limited to rated values for two-terminal SCR turn-on. The turn-off time, as defined earlier, is the minimum value of observed time for which the device will support reapplied forward voltage.

### Testing can create problems

But even when you use a test jig, you can run into the following problems:

- Temperature stability. Maintaining the junction temperature of the SCR under test is important. Variations can alter the measured value of  $t_q$ .
- Poor selection of D<sub>1</sub>. This diode isolates the forward-current and reverse-voltage supplies from the reapplied  $dv/dt$ . Poor isolation can lead to changes in  $t_q$ .
- Soft commutation turn-off time testing. If the test SCR has an inverse diode in parallel, as specified in some inverter diode designs, tests cannot be performed with this circuit to give useful results.

SCRs with fast turn-off capabilities are found in power-inverter circuits and can be used in phase-control circuits, but they do not always offer any performance improvements over slower SCR types.

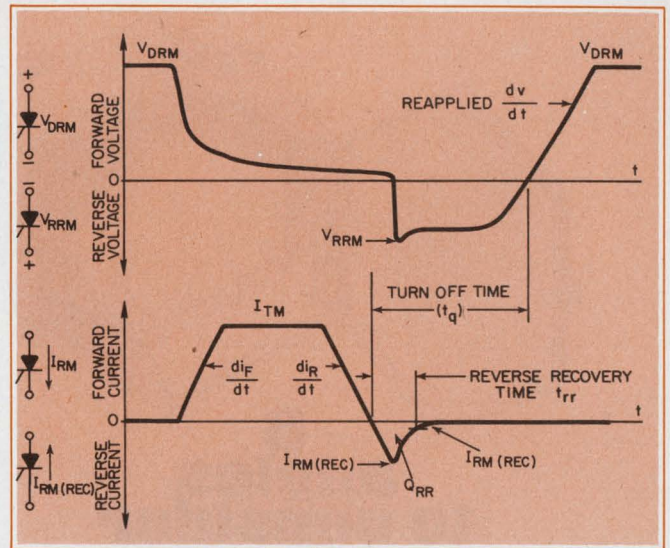

1. Voltage and current waveforms for an SCR start changing as soon as a gate signal is applied to the device. When the current waveform passes through zero, it starts the turn-off time period of the SCR.

Turning off the SCRs in power-control circuits requires special care. In the case of the series-inverter circuit (Fig. 3a) a capacitor may be used in series with the load. A gate pulse to SCR<sub>1</sub> charges the capacitor to the dc supply voltage. When this happens, SCR<sub>1</sub> turns off because the charged capacitor limits further current flow. When SCR<sub>2</sub> is gated on, it discharges the capacitor and turn-off is thus attained.

If SCR<sub>1</sub> and SCR<sub>2</sub> are alternately fired, load-dependent, half-sine waves of current can be generated. Short-circuit currents and damaging overloads result if one SCR fails to turn off before the other is turned on.

The parallel inverter circuit (Fig. 3b) has a capacitor in parallel with the load. As with the series inverter, circuit operation is load dependent. Current through the SCR does not auto-

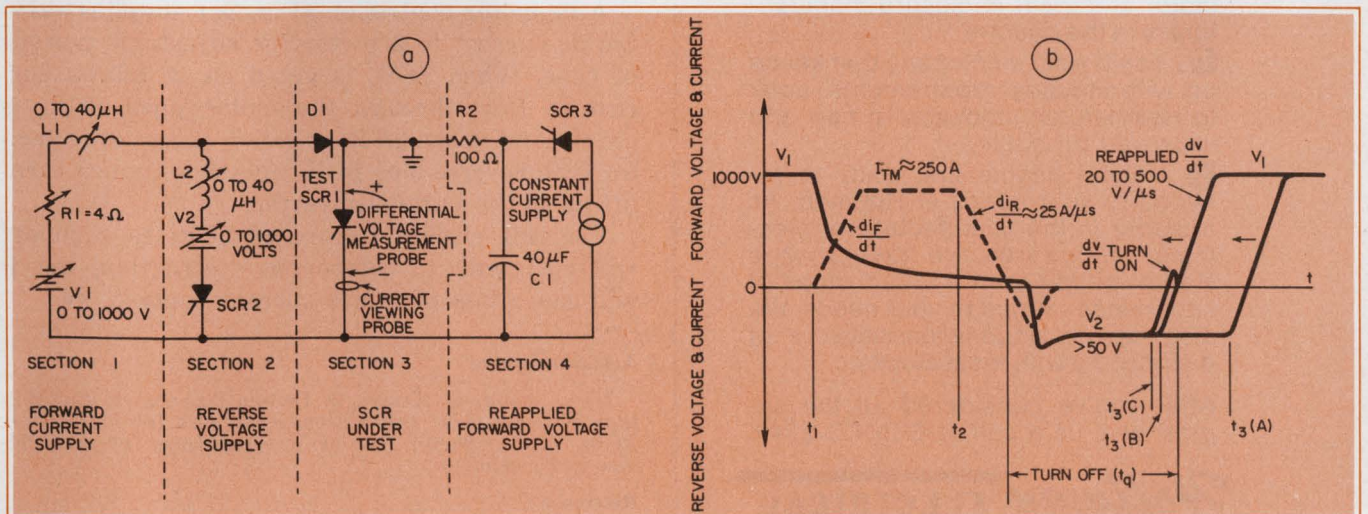

2. Simplified version of a typical SCR test circuit (a) can test for turn-off time as well as many other parameters.

Superimposed waveforms (b) show the interdependence of forward voltage and reverse current.



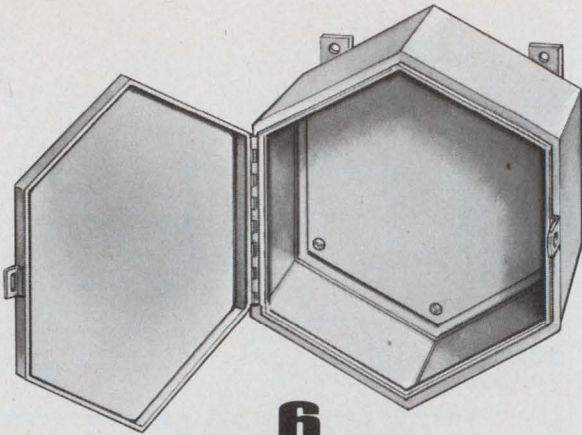

## 6 angles to consider in filling your enclosure needs:

**1.** You'll be looking for a company with real depth in know-how to carry out the details of your special requests. Hoffman has a large staff of knowledgeable engineers and years of manufacturing experience.

**2.** You want a supplier with a broad production capability. You'll find that at Hoffman. Our factory is equipped to produce over 1,700 standard products and hundreds of custom jobs on a continuing basis.

**3.** You'll want to deal with a company with a dedication to quality. Hoffman pays meticulous attention to quality and has gained a reputation for exceeding industry standards.

**4.** You'll want to deal with a reliable, financially stable company. Hoffman has a long record of serving industry needs and has become one of the major electrical enclosure manufacturers in the country.

**5.** You'll want a company that keeps up with industry requirements. Look to Hoffman, an innovator in new and improved products.

**6.** Helpful people are ready to respond to your needs at Hoffman. As a leader in the manufacture of electrical enclosures, we have a large staff of people with a broad range of experience related to your needs. We also have a nationwide network of distributors with local stocks.

After you've considered all the angles, give us a call at 612/421-2240.

**Hoffman**® **ELECTRICAL ENCLOSURES**  
HOFFMAN ENGINEERING COMPANY  
 Division of Federal Cartridge Corporation  
 ANOKA, MN 55303 DEPT. ED-551

INFORMATION RETRIEVAL NUMBER 40

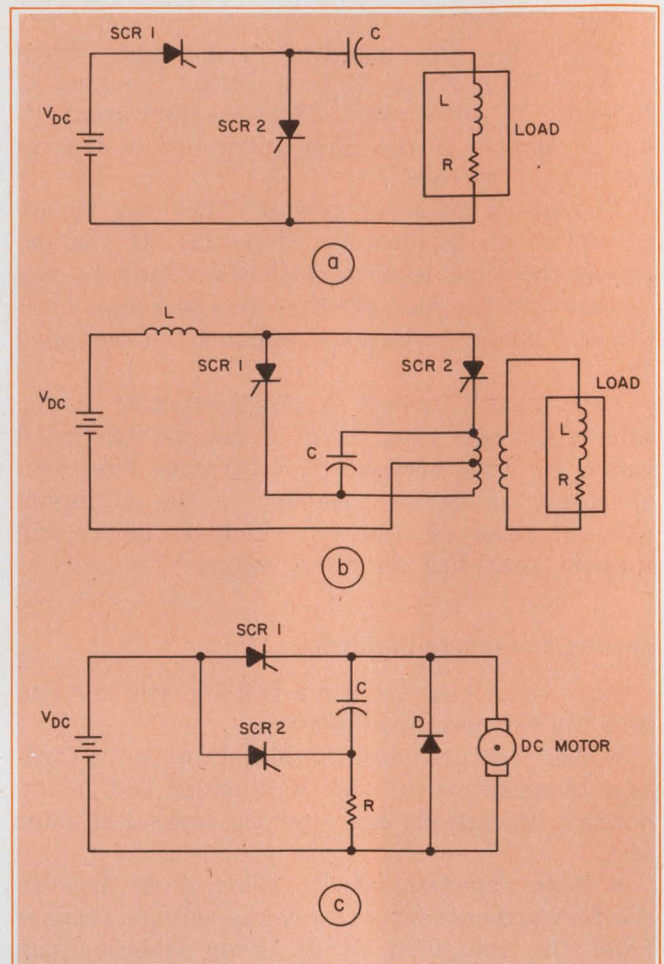

3. Some typical turn-off circuits for a series inverter (a), a parallel inverter (b) and a dc motor controller (c) don't require much additional circuitry.

matically decrease to zero to achieve turn-off. Alternate SCR gating causes the commutating capacitor to reverse-bias the conducting SCR, resulting in turn-off. Again, should one of the SCRs fail to turn off properly, short-circuit current can cause device failure.

A dc motor controller (Fig. 3c) supplies varying dc current to a motor for adjustable periods of time. When SCR<sub>1</sub> is gated on, it allows current to flow through the motor until SCR<sub>2</sub> is gated. And, when SCR<sub>2</sub> is gated, it causes capacitor C to reverse-bias SCR<sub>1</sub>, and thus induce turn-off as in the parallel inverter.

For this circuit, failure of SCR<sub>1</sub> to turn off will not result in component destruction, but it will cause loss of motor-current control. ■■

#### Acknowledgment

Many thanks to Messrs. J. Dennis Balenovich and William H. Karstaedt, applications engineers for high-power SCRs, Semiconductor Div. of Westinghouse, for their advice and comments.

#### Reference

1. "Thyristor Design Tradeoffs in Turn-off Specifications," *Application Note AD 54-580*, Westinghouse Electric Corp., Youngwood, PA 15697.



# Can you spot this counter problem?

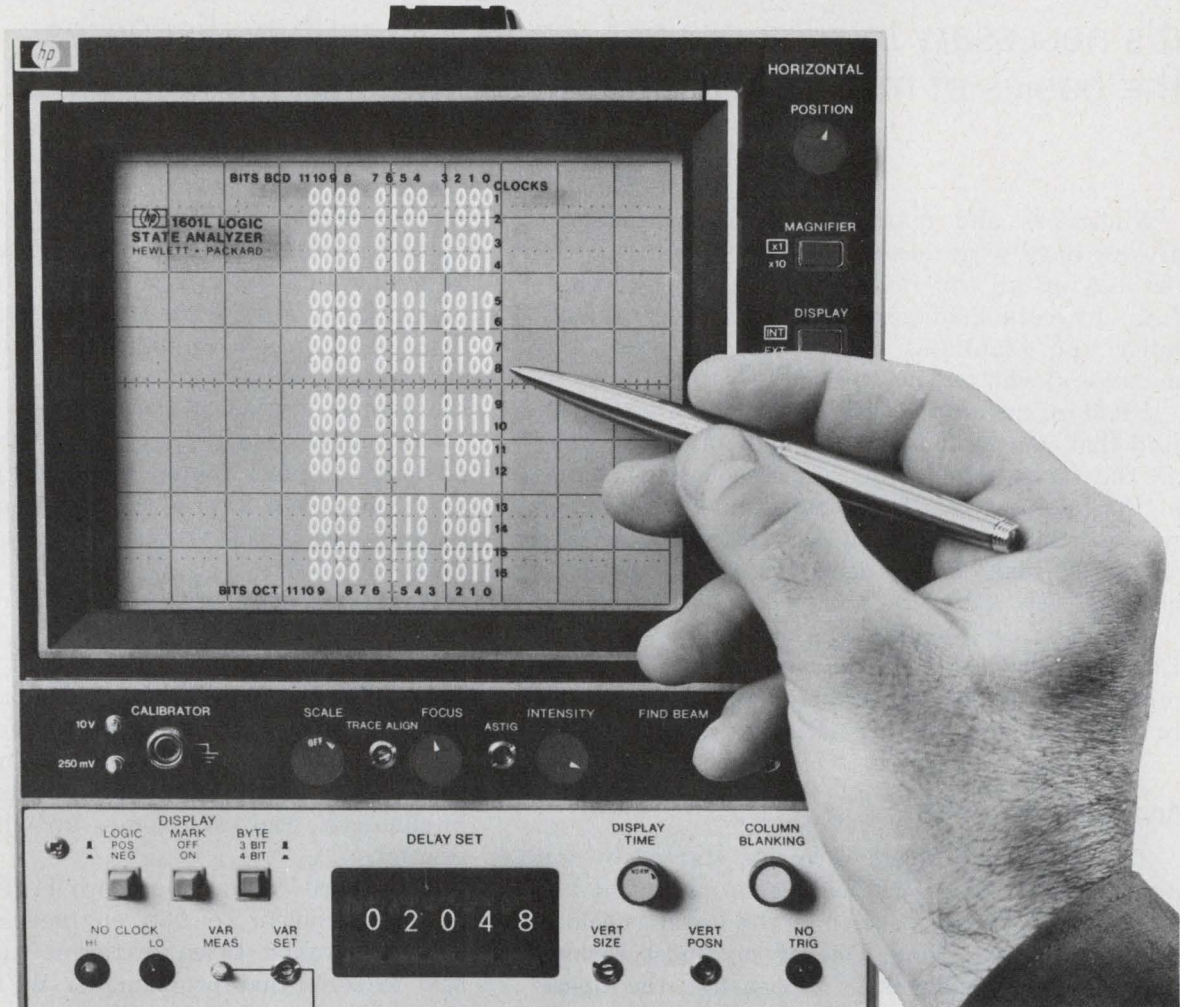

## With the new HP-1601L Logic Analyzer, it's just this easy.

HP gives you this added dimension in digital testing so you can watch counter sequences, microprocessor program flow, or any other digital-logic circuit dynamically step through its operation. You can see the display of "1's" and "0's" appear exactly as your logic calls for—in hexadecimal, BCD, or octal format, 16 words at a time, each 12 bits wide. You see them as they actually occur in your design.

**See negative time.** Think of the time you can save with this breakthrough in performance capability. You can trigger the display on the first word or the sixteenth

word to look ahead, or look back in time (negative time).

**See dynamic data flow.** The 1601L operates from your strobe signal (up to 10MHz), so you can conveniently dial in a delay of up to  $10^5$  bits. You can select positive or negative logic display, depending on the type of circuitry you're working with... and adjust threshold over the  $\pm 10V$  range provided. With pattern triggering or digital delay, it's easy to select a window in time to help you diagnose logic-circuit problems. And once you isolate the problem, the 1601L provides a trigger for your scope to help you locate the component or circuit at fault.

The 1601L gives you a view of your digital circuits that you never had before. And you get all of this

capability for only \$3050\*.

Give your local HP field engineer a call for more information. He'll also be glad to give you details about other members of HP's growing family of digital analyzers, including: The 5000A with LED display, two channels, thirty-two bits; the 4-bit AND-gate Trigger Probes for TTL, MOS, and ECL; and the new 1620A 16-bit Pattern Analyzer that gives your scope a word trigger.

\*Domestic USA price only.

**HEWLETT  PACKARD**

Sales and service from 172 offices in 65 countries.  
1501 Page Mill Road, Palo Alto, California 94304



## **Level with your staff,** especially when it's necessary to kill a project. An IBM executive discusses the basics of motivating (and placating) engineers.

Engineers and managers everywhere almost always have to decide the fate of a project without having all the facts. I try to do it successfully by establishing a reputation for creditability and frankness among the engineers and managers who report to me.

I had an argument with an executive once who said that you can't make decisions until you have all the facts. I told him that I thought that one of the talents I was being paid for as a manager was to make decisions on less than all the facts and then make those decisions turn out to be right.

When do we terminate or redirect a project? Usually when the requirements change or we've misinterpreted the requirements. A project is rarely killed because the engineering solution is bad.

### **Appeasing the losers**

This poses a problem. Projects started by top management have a difficult time making it unless there's a spear carrier in the lower echelons to help push it along. One of my most serious management problems is appeasing the spear carrier whose project has been killed. Often he'll have difficulty accepting it. He has sold a lot of people on the project and suddenly he realizes that he's been doing the wrong thing.

Another problem in a company our size is competing projects—two engineers running around on white chargers with spears. The problems these two engineers started with were similar, but not exactly the same. As time evolves there'll be a partial overlap of the two products they're working on, and this may spread until eventually these two products are competing to fill the same product requirements.

The manager of these two engineers has to review the requirements of each project and decide which will give the company a better solution. The tough part of that decision is that the

staff of the doomed project can't accept the fact that the reason their program was killed had nothing to do with how good a job they were doing. It's a very hard thing to accept. If that happened to me, I couldn't help but think that if I'd worked harder and smarter, I'd have been the winner instead of the loser.

Occasionally we'll have a case where one group is doing a much better technical job than the other, and we'll level with them. But usually we redirect one of the projects strictly for business reasons.

As a rule engineering groups are technically equal; the IQ level of most people in one group will equal the IQ level of most of those in the other. If we had one-man programs, there might be a great variance in performance, but when you have 20 to 30 people in each group, I've found that each group approaches a problem intelligently, and each comes up with acceptable solutions.

There are cases where we'll give the same product problem to two engineers, so we can look at two or three different approaches on how to solve that problem. Or we'll "blue sky" it; we'll pit two project groups against each other. But they'll know that's the game from the beginning. The decision of which project to stop will be based on cost and performance.

### **Making yourself credible**

The only way I know to convince the engineer of a losing project that it wasn't his fault is to establish credibility with him at the outset. No matter how much he believes you, though, if an engineer has done three projects in a row that have been killed, he's going to be very low emotionally. That leads to another management challenge: Recognize a sure project winner for that man and get him on it quickly.

I try to be very open as a manager—open with my problems and open with my successes. It's rare that there's a reason to withhold anything from my subordinates. I don't post news of a confidential nature on the bulletin board, but I

---

**Dr. Kenneth Haughton**, Manager of Systems Storage, General Products Div., IBM, San Jose, CA 95114.



## Dr. Kenneth E. Haughton and IBM

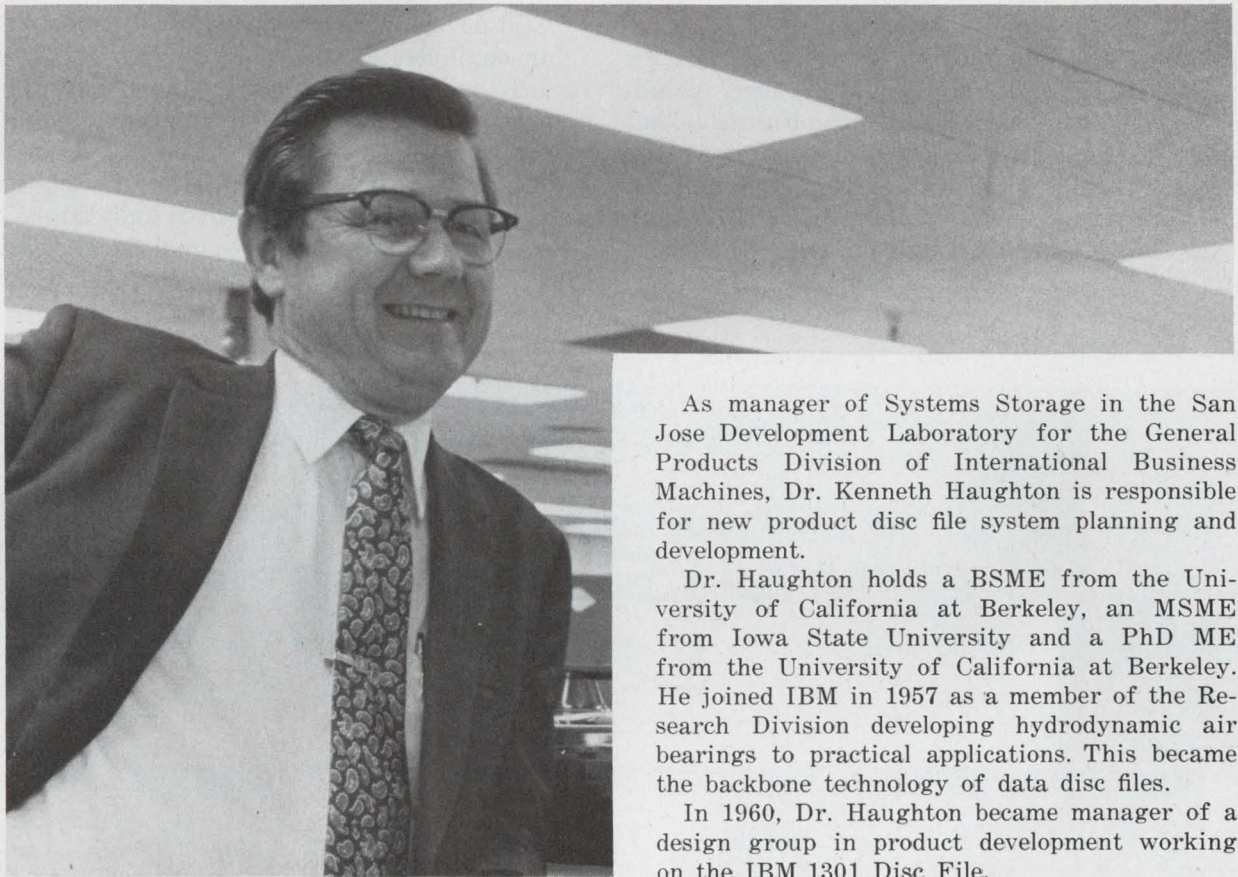

As manager of Systems Storage in the San Jose Development Laboratory for the General Products Division of International Business Machines, Dr. Kenneth Haughton is responsible for new product disc file system planning and development.

Dr. Haughton holds a BSME from the University of California at Berkeley, an MSME from Iowa State University and a PhD ME from the University of California at Berkeley. He joined IBM in 1957 as a member of the Research Division developing hydrodynamic air bearings to practical applications. This became the backbone technology of data disc files.

In 1960, Dr. Haughton became manager of a design group in product development working on the IBM 1301 Disc File.

After using an IBM Fellowship to complete his PhD in 1964, he subsequently assumed prime responsibility in the development of the IBM 1360 Photodigital Data File. In this capacity, he managed a group that developed an electron beam recorder for this file. After delivery of this system, he managed a magnetic recording technology group until he was promoted to his present position.

In addition to his IBM career, Dr. Haughton has taught various subjects at Iowa State University, Cornell University, and the University of California at San Jose, including Engineering Graphics, Engineering Mechanics, and Thermodynamics.

don't hesitate to discuss things of a confidential nature with the individual affected. When I'm in trouble, I tell them. I also tell them what's bothering me, and I try to find out what's bothering them.

There's a tendency in our business to destroy credibility by playing games with one another. When I want a man to do something, I don't aim in that general direction and hope that he'll do it accidentally; I tell him exactly what I want.

To have a successful project, you must have engineers who are enthusiastic about what



they're doing and who understand what you're doing. Every product organization is interested in developing vitality in its people.

We condition people to look for the usual goals, like raises and promotions, but these are not the total definition of success. A man is a success if he finds his work constructive, creative and enjoyable. It's not a job; it's part of his life.

I've learned that the most successful projects are those that start in the ranks. An engineer will come up with an idea to solve a problem in the company, and he or his manager or someone else will try to convince everyone of the validity of the solution. Those projects are successful because the men believe in them and know what they're doing.

Here in San Jose we make storage products. When we start a new project, we define the requirements first. For example, we may specify the characteristics for a disc file product, including speed, size, performance and cost. That project will start with a small nucleus of people, including an individual who is heavily committed to an approach he wants to sell. More often than not, he sells his idea to the group while the entire team enlarges the concept until a satisfactory solution to the project requirements is at hand.

We continually review our product objectives, to make sure we don't drift off the target. Engineers like to solve tough technical problems, and if they can really see the target, they'll steer around rocks in the road.

One of the talents I look for in people is the ability to recognize when they've met the requirements for the project. They have to know if the next refinement they're planning is worth the man-hours and development effort they'd be putting into it. A big problem for engineers is knowing when to stop developing a product. Development leads to better and better ideas, which makes the average engineer want to keep trying new approaches. That's why you'll see nearly identical products on the marketplace, with the newest one just a little bit better than the older one.

In developing a product over a period of years, an engineer will see another way to do it. And he'll be convinced that the new way should be pursued especially since he doesn't have as much data about this new way as he has about the old. The management problem is to keep the engineer acquainted with his objectives and ensure that he always has his eye on the goal. If he doesn't, he can keep spinning around the development loop forever. ■■

# 1953A Programmable Counter/Timer

## One of Fluke's 'New Breed' of powerful LSI/MOS counters

# \$849

U.S. price F.O.B. Buffalo, N.Y.  
Remote programming and other options extra.

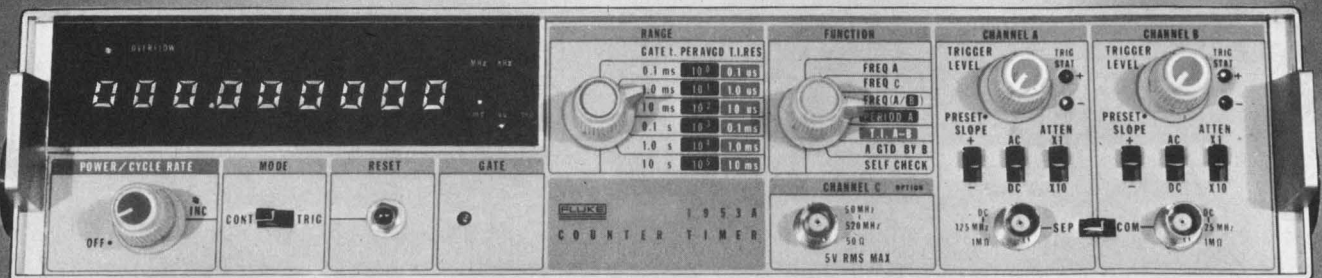

**FLUKE**  
COUNTER DIVISION

John Fluke Mfg. Co. Ltd.  
Counter Division  
P.O. Box 1094 Station D  
Buffalo, N.Y. 14210  
Phone (716) 842-0311 TWX 610-492-3214

FOR DEMONSTRATION, CIRCLE 295

FOR INFORMATION, CIRCLE 296

ELECTRONIC DESIGN 6, March 15, 1975



**NEW!  
FROM**



# NINE DIGIT Scientific Calculator Array

SIN <sup>-1</sup>	COS <sup>-1</sup>	TAN <sup>-1</sup>	RAD	F↑
SIN	COS	TAN	DEG	
1/x	x <sup>2</sup>	10 <sup>x</sup>	e <sup>x</sup>	CA
CM	√x	LOG	Ln	CE
STO	CONV	↔XY	CHS	EEX
RCL	M+			
Y <sup>x</sup>	π	[	]	
÷	7	8	9	
X	4	5	6	
-	1	2	3	
+	0	.	=	



## A Flexible Display

-123.45678 FLOATING POINT  
AND  
-1.2345-12 SCIENTIFIC

- Automatic Format Control
- LED or Fluorescent Displays

## A Powerful Scientist

- Algebraic Entry
- 2 Parenthesis Levels
- Full 8 Digit Accuracy
- 18 Scientific Functions
- Full Range Trig. (DEG. or RAD.)
- Full Feature Memory

\*Custom Keyboard Configurations  
Available on Request

HEADQUARTERS—  
Product Mgr., Mr. Julius Hertsch:  
MOS Technology, Inc., 950 Rittenhouse Rd.,  
Norristown, Pa. 19401 (215) 666-7950  
EASTERN REGION—  
Mr. William Whitehead, Suite 307-88 Sunnyside Blvd.,  
Plainview, N.Y. 11803 (516) 822-4240  
WESTERN REGION—  
MOS Technology, Inc., 2172 DuPont Dr., Suite 221  
Patio Bldg., Newport Beach, Calif. 92660 (714) 833-1600

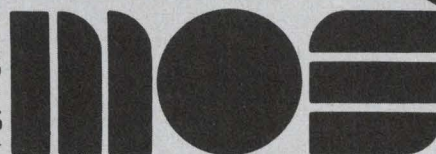

**MOS TECHNOLOGY, INC.**  
VALLEY FORGE CORPORATE CENTER, NORRISTOWN, PA. 19401 (215) 666-7950



# Electronic Design 1974 Annual Index of Articles

## Circuits & Circuit Theory

A/d converter remembers signal peaks whose duration is less than 50 ns... IFD, ED 12, p. 152

Algebra finds logic-circuit glitches... ART, ED 4, p. 90

Approximate logs easily... ART, ED 9, p. 176.

Avoid wiring-inductance problems... ART, ED 25, p. 62

Biphase waveforms generated by shift-register circuits... IFD, ED 16, p. 112

Boost audio-amplifier efficiencies... ART, ED 8, p. 96

Boost transistor-level supply voltages to make a low-power, high-voltage supply... IFD, ED 21, p. 126

Bootstrapped RC differentiator performs accurately without phase inversion... IFD, ED 5, p. 60

Build a general-purpose power supply with built-in temperature protection... IFD, ED 23, p. 144

Build high-gain, wide-range log amps... ART, ED 6, p. 116

Burst of preset number of pulses obtained with easily expanded circuit... IFD, ED 21, p. 126

Bypass multivariable Karnaugh maps... ART, ED 21, p. 86

Calculate with a v/f converter... ART, ED 12, p. 130

Circuit adds BCD numbers with binary 4-bit full adders... IFD, ED 25, p. 92

Circuit provides slow auto-wiper cycling, with one to 20 seconds between sweeps... IFD, ED 26, p. 108

Circuit warns automobile driver when he exceeds preset speed... IFD, ED 26, p. 106

Clean up your logic schematics... ART, ED 13, p. 80

Clocked circuit debounces multiple single-throw contacts synchronously... IFD, ED 6, p. 158

## Department key

ART	Technical Article
IFD	Idea for Design
NEWS	News
PF	Product Feature
SR	Special Report

Combinatorial logic circuit calculates the absolute difference of numbers... IFD, ED 14, p. 114

Comparator detects volts in narrow window and accurately nulls to reference level... IFD, ED 20, p. 124

Consider more than power... ART, ED 26, p. 74

Consider the indefinite matrix... ART, ED 2, p. 76

Convert two-port circuit parameters... ART, ED 20, p. 76

Counter has symmetrical output though the input signal is asymmetrical... IFD, ED 20, p. 118

Counter resets itself reliably with one additional flip-flop... IFD, ED 20, p. 126

Coupling circuit ensures drive current from op amp to emitter-follower booster... IFD, ED 15, p. 108

Curb analog data errors with PCM... ART, ED 12, p. 124

Current clamp blocks destructive discharges of large filter capacitors... IFD, ED 12, p. 150

Customize your audio filter... ART, ED 11, p. 94

Design CMOS commutative filters... ART, ED 23, p. 116

Design a floating-point a/d converter... ART, ED 11, p. 80

Design a nonaveraging tachometer... ART, ED 6, p. 122

Design rf oscillators... ART, ED 20, p. 70

Differential amplifier will allow low-distortion output from mixer... IFD, ED 17, p. 124

Digital delay circuit for one-shot controls timing interval in programmable integer steps... IFD, ED 2, p. 94

Digital three-phase signals cover wide frequency range... IFD, ED 19, p. 178

Double multiplexer logic capability... ART, ED 17, p. 86

ECL 10,000 interconnects economically... ART, ED 20, p. 90

Edge-triggered R-S flip-flop built without capacitors... IFD, ED 3, p. 80

Electronic ignition system uses standard components... IFD, ED 24, p. 198

EXCLUSIVE-OR circuit handles wide range of input levels without power supply... IFD, ED 2, p. 78

Few extra components adapt 741 op amps for high-voltage-swing applications... IFD, ED 9, p. 206

Fine control of high-power voltage with a low-current variable transformer... IFD, ED 13, p. 116

FOCUS on DC/DC converters... SR, ED 23, p. 70

FOCUS on Packaged oscillators... SR, ED 19, p. 118

Four-digit BCD programmability featured in variable modulus 60-MHz counter... IFD, ED 6, p. 156

Four-input EXCLUSIVE-NOR gate made from a BCD-to-decimal converter... IFD, ED 17, p. 118

Frequency doubler covers wide frequency range for unsymmetric square waves... IFD, ED 16, p. 114

Full and half-step motor operation obtained with 3-1/2-chip stepper circuit... IFD, ED 18, p. 102



Full first pulse is assured in variable-frequency, gated oscillator...IFD, ED 23, p. 146

Gain set accurately with a single resistor in a high-performance differential amplifier...IFD, ED 19, p. 172

Generate a linear sweep of uniform duty cycle and amplitude...IFD, ED 22, p. 154

Generate a PSK modulated wave with an all-digital circuit...IFD, ED 23, p. 142

Get high voltage with low-cost multipliers...ART, ED 13, p. 64

Get notch Qs in the hundreds...ART, ED 16, p. 96

Get standby LSI memory power...ART, ED 12, p. 116

High-speed s/h circuit gives gain up to 1000...PF, ED 12, p. 168

Hows and whys of log amps...ART, ED 3, p. 52

IC timer, stabilized by crystal, can provide subharmonic frequencies...IFD, ED 23, p. 148

Improve memory systems with 4-k RAMs...ART, ED 22, p. 100

Improved dot-matrix generator ignores empty display positions...IFD, ED 14, p. 112

Inexpensive AM modulator replaces clipping types and gives less distortion...IFD, ED 20, p. 122

Inexpensive low-Q bandpass filters made with tweaked standard chokes...IFD, ED 11, p. 110

Interface CMOS logic with switches...ART, ED 17, p. 80

Is a crowbar alone enough...ART, ED 20, p. 106

Know your converter codes...ART, ED 22, p. 130

Laser trimmed, 12-bit DACs offer tempcos of 1 ppm/°C...PF, ED 13, p. 142

Less than 1.5% distortion over 1000:1 range provided by swept-frequency oscillator...IFD, ED 1, p. 154

Linear systems analysis simplified...ART, ED 11, p. 70

Look to asynchronous sequential logic...ART, ED 20, p. 98

Low-cost data converters provide 0.01% linearity...PF, ED 1, p. 167

Low-cost way to send digital data...ART, ED 2, p. 68

Match impedances accurately and easily...ART, ED 5, p. 46

Modified data-transmission module can handle ASCII and BCD...IFD, ED 8, p. 110

Modified differential amplifier controls p-i-n diode attenuator...IFD, ED 2, p. 90

Multiple-feedback bandpass circuit allows use of standard capacitors in elliptic filter...IFD, ED 7, p. 76

Multiplex signals the analog way...ART, ED 15, p. 74

## Subject Listing

Circuits & Circuit Theory

Communications, Microwaves & Lasers

Components

Computers & Data Processing

Consumer Electronics

Displays

Electro-Optics

General Industry

Industrial Electronics

Management

Materials & Packaging

Medical Electronics

Military & Aerospace

Semiconductors

Test & Measuring

Multiplexed operation of MOS registers more than doubles the data rate...IFD, ED 3, p. 76

Need a special power supply...ART, ED 23, p. 110

One-shot adds the clock pulses to help recover phase-encoded data...IFD, ED 7, p. 78

Op amp in current-differencing mode becomes a noninverting audio mixer...IFD, ED 10, p. 130

Op amps multiplex analog signals without need for FET switches...IFD, ED 13, p. 118

Opto-isolator logic units...ART, ED 12, p. 92

Passive system tames high static electricity...NEWS, ED 7, p. 25

Pick the right DAC...ART, ED 10, p. 110

Plot your voltage-divider designs...ART, ED 17, p. 102

Precision timer can be used to make a stable, adjustable crowbar driver...IFD, ED 21, p. 130

Prevent damaging overloads...ART, ED 5, p. 58

Prevent op-amp output instability...ART, ED 17, p. 98

Program gives filter time response...ART, ED 9, p. 192

Protect against nuclear transients...ART, ED 4, p. 64F

Reference voltage can be varied and the optimum zener current maintained...IFD, ED 22, p. 156

Represent transistor beta variations...ART, ED 19, p. 146

Resolve gain/efficiency conflicts...ART, ED 13, p. 72

Rise of active filters: They're running strong in two major fields...NEWS, ED 13, p. 34

Sharpen active null networks...ART, ED 13, p. 102

Simple feedback circuit improves linearity of light-dependent resistors...IFD, ED 22, p. 148

Simple reconnection reduces rise time of CMOS delay circuit...IFD, ED 1, p. 158

Simple serial/parallel transformations aid network analysis and synthesis...IFD, ED 22, p. 144

Simplify LC rf-oscillator design...ART, ED 19, p. 140

Single EXCLUSIVE-OR quad produces complementary spikes from clock pulses...IFD, ED 13, p. 116

Single part minimizes differences in monostable and astable periods of 555...IFD, ED 15, p. 110

Slash high-voltage power-supply drain...ART, ED 19, p. 158

Slash power converter design time...ART, ED 1, p. 130

Slave clock can run free at center frequency and lock in within one cycle...IFD, ED 24, p. 196

Split a temperature degree to 10  $\mu^{\circ}\text{C}$ ...ART, ED 10, p. 102

Squeeze more from power supplies...ART, ED 14, p. 100

Switch high inductive loads fast...ART, ED 3, p. 72

Taming noise in IC op amps...ART, ED 15, p. 64

There's more to thermal drift...ART, ED 8, p. 90

Those bigger n-flops...ART, ED 21, p. 94

Threshold logic can cut gate count...ART, ED 22, p. 106

Transform the biquad into a biquartic...ART, ED 1, p. 120

Transistor bleeder gives opto-isolator a wide temperature range of operation...IFD, ED 7, p. 74

Transistor reduces output variation in three-terminal regulator circuit...IFD, ED 9, p. 204

Triple-output dc/dc converter claims highest output power...PF, ED 19, p. 220

True rms voltage conversion...ART, ED 4, p. 66

Try condition/action diagrams...ART, ED 5, p. 50

Unify two-port calculations...ART, ED 1, p. 112

Up/down counter controls pulse width of a one-shot...IFD, ED 24, p. 94

Use CAD to optimize broadband amp design...ART, ED 10, p. 92

Use pulse width modulation...ART, ED 3, p. 68



## ANNUAL INDEX

- V/f converters maintain specs while prices drop... PF, ED 21, p. 138
- V/f converters offer low power drain, total isolation or programmability... PF, ED 19, p. 228
- Versatile programmable-counter chains are built from simple MSI modules... IFD, ED 11, p. 108
- Voltage control is featured in zero-phase-shift filter... PF, ED 5, p. 76
- Voltage-tunable active filter features low, high and bandpass... IFD, ED 25, p. 96
- Watch out for problems... ART, ED 1, p. 144
- Which dc/ac inverter... ART, ED 25, p. 54
- Why complicate frequency synthesis... ART, ED 15, p. 80
- Wide-range pulse-shaping circuit gives square waves with 50% duty cycle... IFD, ED 8, p. 116
- Wiper noise removed and measured with a single nonlinear filter... IFD, ED 5, p. 64
- 8-bit a/d converter module cuts size and price in half... PF, ED 26, p. 113
- 10-MHz differential video line receiver built with monolithic IC transistor array... IFD, ED 9, p. 202
- 12-bit hybrid a/d converters designed for high performance by two companies... PF, ED 24, p. 209
- 14-bit a/d converter keeps price/performance ratio low... PF, ED 6, p. 165

### Communications, Microwaves and Lasers

- Analyze TV noise performance... ART, ED 20, p. 82
- A-power project to try new laser optic setup... NEWS, ED 8, p. 28
- CATV, fiber optics and telepathy: The promise and the problems... SR, ED 6, p. 56
- Comes the satellite revolution in American communications... NEWS, ED 12, p. 38
- Drive fiber-optic lines at 100 MHz... ART, ED 15, p. 96
- Fiber-optic link transmits data at 80 Mbit/s for 100 ft... PF, ED 9, p. 226
- First X-ray waveguide opens three new application areas... NEWS, ED 10, p. 21
- Ground clutter is rejected by phased-array look-down radar... NEWS, ED 18, p. 38
- IMPATT power sources produce 10 mW at 150 GHz... NEWS, ED 5, p. 21
- Laser communications spurred by modulation... NEWS, ED 6, p. 26

- Laser excited by atomic reaction points to new power possibility... NEWS, ED 23, p. 52
- Laser technique promises repair of ICs from 'spares' on the chip... NEWS, ED 26, p. 34
- Laser unit to monitor driving visibility... NEWS, ED 26, p. 20
- Lasers get powerfully efficient and efficiently small in R&D lab... NEWS, ED 19, p. 32
- Low-cost, standard MIC units are within designer's reach... NEWS, ED 12, p. 49
- Mm waveguide heralds bigger phone capacity... NEWS, ED 16, p. 33
- MW sensor detects oil slicks in sea... NEWS, ED 7, p. 26
- Match impedances in microwave amplifiers... ART, ED 6, p. 108
- Mini-laser techniques speed 3-dimensional X-ray imaging... NEWS, ED 5, p. 36
- Mobile communications get more megahertz... NEWS, ED 11, p. 26
- Multiple-beam antenna could boost communications satellite capacity... NEWS, ED 14, p. 34
- Nerem to focus on radars: limited-scan and CCD aids... NEWS, ED 17, p. 39
- Poof! And big reflector forms in ionosphere... NEWS, ED 26, p. 19
- Satellites to give WU 30 times more capacity... NEWS, ED 8, p. 28
- Semi laser and detectors to use common substrate... NEWS, ED 4, p. 26
- Study of internal laser damage may lead to smaller devices... NEWS, ED 16, p. 42
- Tunable lasers aid study of atoms and molecules... NEWS, ED 6, p. 26
- Vhf, uhf and microwave systems reap cost and efficiency benefits... NEWS, ED 17, p. 44
- Wall Street Journal printed via satellite... NEWS, ED 23, p. 31
- With solid-state advances, airborne radar climbs higher... SR, ED 19, p. 67
- 2-GHz low-noise amplifier features new package style... PF, ED 17, p. 136
- 35-MHz linear rf amp outputs new high of 300 W... PF, ED 20, p. 150
- 28,244 calls handled by one phone link... NEWS, ED 23, p. 31

### Components

- Aluminum electrolytics are hard to beat... ART, ED 21, p. 78
- Amplifier tube claims 'first' in performance... NEWS, ED 20, p. 25
- Cadmium-telluride detector has highest sensitivity yet... NEWS, ED 12, p. 53
- FOCUS on Rotary and thumbwheel switches... SR, ED 20, p. 56

- Fuses or circuit breakers... ART, ED 26, p. 66
- Inductance calculation simplified for small air-wound coils... IFD, ED 21, p. 124
- In power, longevity and voltage, batteries are reaching new peaks... NEWS, ED 11, p. 28
- Iron-core transformers get tiny; Now only the price must shrink... NEWS, ED 25, p. 36
- Little-known source of power, the thermal cell, bids for attention... NEWS, ED 20, p. 30
- Look out! All electrolytic capacitors... ART, ED 1, p. 138
- Low profile mini-relays can handle up to 26.5 W... PF, ED 26, p. 120
- New laminar-flow electron gun promises brighter, better CRTs... NEWS, ED 18, p. 38
- Piezoelectric ceramic transducers... ART, ED 18, p. 78
- Small crystal gauge overpowers noise... NEWS, ED 5, p. 22
- Uncased ceramic disc filters boost available capacitance... PF, ED 15, p. 130

### Computers & Data Processing

- Automatic interrogator doesn't need a computer... NEWS, ED 26, p. 19
- Basic microcomputer software... ART, ED 9, p. 142
- Big, small and tiny computers advance... SR, ED 9, p. 64
- Brain-wave system monitors meditation... NEWS, ED 18, p. 20
- CCD memories impinge on drum and disc terrain... SR, ED 19, p. 64
- Calculator-based acquisition system handles remote sites by phone line... PF, ED 22, p. 163
- Calculator-instrument system offers flexible programming... PF, ED 6, p. 66
- Ceramic disc memory undergoing tests... NEWS, ED 1, p. 36
- Circuit converts unipolar digital data to alternate-mark inverse format... IFD, ED 4, p. 106
- Clues to next IBM computer point to major advances... NEWS, ED 24, p. 27
- DEC goes West to build LSI mini... NEWS, ED 5, p. 21
- Data display competes with AT&T terminal... NEWS, ED 16, p. 33
- Data-logging system mixes mini, printer and tape... PF, ED 2, p. 112
- Decentralized networks allowing the computer to be moved to the job... SR, ED 9, p. 66
- Design with lockout logic... ART, ED 15, p. 80
- Digital data handled over single pair of wires, with sync lock derived from the data... IFD, ED 19, p. 174



# 2 GREAT MONOLITHIC D/A'S- COMPLETE WITH REFERENCE & AMP!

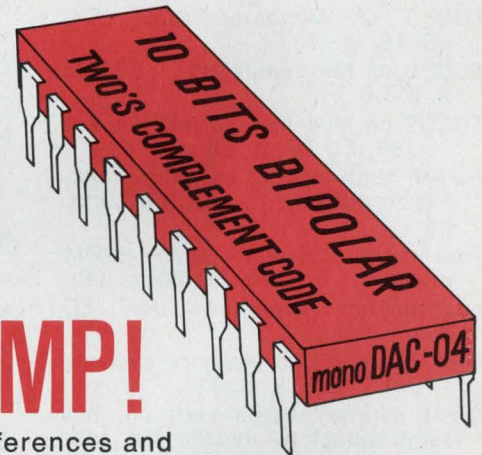
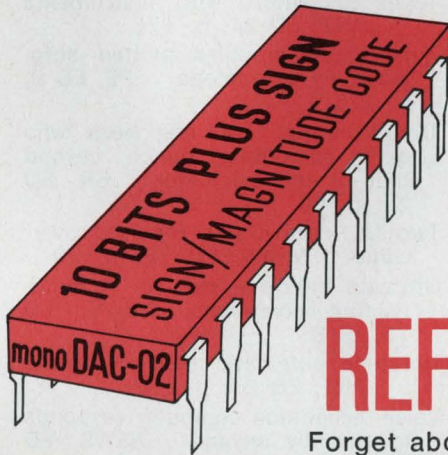

Forget about complex external voltage references and expensive high speed op amps — they're right on the chip! Precision Monolithics monoDAC-02's unique sign/magnitude code or monoDAC-04's handy two's complement code allow a perfect match to any application. These DAC's are 100% tested for monotonicity over the entire 0/70°C temperature range. The other specs are just as impressive — tight 60ppm/°C max tempco, fast 1.5  $\mu$ sec settling time, low 225 mw power consumption @  $\pm 15V$ , .015%/V power supply rejection — these DAC's are true performers! Don't let the low cost fool you — these easy-to-use converters are 100% burned-in at +125°C for assured reliability. And they're available. Get 'em from your Precision Monolithics distributor today.

MONOTONICITY	INPUT		PRICE
	SIGN/MAGNITUDE (10 BITS PLUS SIGN)	TWO'S COMPLEMENT (BIPOLAR — 10 BITS)	
GUARANTEED, 0/+70°C			@ 100 PCS.
7 BITS	monoDAC-02DDU1(U2)*	monoDAC-04DDU2*	\$15.00
8 BITS	monoDAC-02CCU1(U2)	monoDAC-04CCU2	\$20.00
9 BITS	monoDAC-02BCU1(U2)	monoDAC-04BCU2	\$30.00
10 BITS	monoDAC-02ACU1(U2)	monoDAC-04ACU2	\$60.00

\*  $\pm 10$  VOLT OUTPUT — U1 SUFFIX ...  $\pm 5$  VOLT OUTPUT — U2 SUFFIX



1500 SPACE PARK DRIVE, SANTA CLARA, CALIF. 95050  
TEL. (408) 246-9222 • TWX 910-338-0528 • CABLE MONO

#### AUTHORIZED DISTRIBUTORS:

NEW YORK METROPOLITAN AREA Harvey Radio, Westbury, N.Y.: (516) 921-8700 • NEW ENGLAND AREA Gerber Electronics, Dedham, Mass.: (617) 329-2400 • UPSTATE NEW YORK Harvey Federal Electronics, Binghamton, N.Y.: (607) 748-8211 • NORTHEAST Newark Electronics, Woburn, Mass.: (617) 935-8350 • BALTIMORE-WASHINGTON Whitney Distributors, Baltimore, Md.: (301) 944-8080 • PENNSYLVANIA Hallmark Electronics, Huntingdon Valley, Pa.: (215) 355-7300 • Pioneer/Pittsburgh: (412) 391-4846 • MICHIGAN RS Electronics, Detroit, Mich.: (313) 491-1000 • SOUTHEAST Kirkman Electronics, Winston-Salem, N.C.: (919) 724-0541 • EAST CENTRAL Pioneer/Cleveland, Cleveland, Ohio: (216) 587-3600 • Pioneer/Indianapolis, Indianapolis, Indiana: (317) 849-7300 • Pioneer/Dayton, Dayton, Ohio: (513) 236-9900 • CENTRAL Hallmark Electronics, Elk Grove Village, Ill.: (312) 437-8800 • Minneapolis, Minn.: (612) 884-9056 • St. Louis, Mo.: (314) 291-5350 • TEXAS-OKLAHOMA Sterling Electronics, Houston, Texas: (713) 627-9800 • Dallas, Texas: (214) 357-9131 • SOUTHWEST Sterling Electronics, Albuquerque, N.M.: (505) 345-6601 • Phoenix, Ariz.: (602) 258-4531 • WEST Westates Electronics Corp., Chatsworth, Calif.: (213) 341-4411 • Sunnyvale, Calif.: (408) 733-8383 • Intermark Electronics, Sunnyvale, Calif.: (408) 738-1111 • Denver, Colo.: (303) 936-8284 • San Diego, Calif.: (714) 279-5200 • Santa Ana, Calif.: (714) 540-1322 • Almac-Stroum, Seattle, Wash.: (206) 763-2300 • Portland, Ore.: (503) 292-3534 • CANADA Intek Electronics, Vancouver, B.C.: (604) 324-6831.

INFORMATION RETRIEVAL NUMBER 44



## ANNUAL INDEX

- Digital printers juggle data for quick printout analysis... PF, ED 2, p. 104
- Extend LSI-processor capabilities... ART, ED 22, p. 90
- Ferroelectric semi used for nonvolatile memory... NEWS, ED 19, p. 27
- First OEM electron-beam laser scans flat fields in microseconds... NEWS, ED 23, p. 36
- First floppy disc peripheral made for microcomputers... PF, ED 20, p. 138
- Floppy-disc drive scores low in size and price, high in capability... PF, ED 8, p. 158
- FOCUS on Data-acquisition equipment... SR, ED 12, p. 70
- FOCUS on Microprocessors... SR, ED 18, p. 52
- FOCUS on Minicomputers... SR, ED 2, p. 56
- FOCUS on Modems and multiplexers... SR, ED 22, p. 68
- Forget hardware design; start thinking programming... SR, ED 19, p. 64
- Four-in-one calculator has PROM modules... NEWS, ED 24, p. 28
- Four-function 'scientific'... ART, ED 8, p. 102
- Give flexibility to memory systems... ART, ED 18, p. 72
- Great memory battle goes on, but semiconductors appear the ultimate victors... SR, ED 22, p. 40
- HP introduces versatile time-sharing system... NEWS, ED 22, p. 27
- HP-65 calculator arrives: First pocket programmable... PF, ED 4, p. 120
- Hand-held computer terminal gives a full ASCII display... NEWS, ED 9, p. 29
- Hitch your telemetry system to a mini... ART, ED 9, p. 158
- Honeywell Series 60 eases update process... NEWS, ED 11, p. 25
- How HP engineers built world's first pocket programmable calculator... NEWS, ED 4, p. 34
- $I^2L$  microprocessor reported being built... NEWS, ED 17, p. 40
- IBM saving energy—with computer, naturally... NEWS, ED 6, p. 26
- IC specs available in 'seconds' with automatic microfilm systems... NEWS, ED 8, p. 42
- Implement complex Boolean expressions... ART, ED 22, p. 114
- Improve interrupt-handling capability of microprocessor with a few ICs... IFD, ED 24, p. 202
- Improved solid-state memories and microprocessors altering the structure of computers... SR, ED 22, p. 34
- Intelligent controller aids remote data-acquisition... PF, ED 26, p. 123
- Let a computer design memory circuits... ART, ED 23, p. 122
- MOS/LSI microcomputer coding... ART, ED 8, p. 66
- MOS memory capability built into IBM typewriter... NEWS, ED 7, p. 25
- Matrix or daisy wheel? Thermal or ink jet? Serial printers offer these options and more... SR, ED 22, p. 50
- Memory power source outputs a variety of bias voltages... PF, ED 22, p. 222
- Microprocessor ICs improve instruments... ART, ED 9, p. 150
- Microprocessor runs a facsimile machine... NEWS, ED 17, p. 40
- Mini addresses up to 1 Mword without increase in cycle time... PF, ED 21, p. 133
- Mini systems grab attention at Interkama... NEWS, ED 25, p. 24
- Mini with core or semi offers 200-ns speed and error control... PF, ED 22, p. 166
- Minis and mini peripherals will lean more on LSI, and software will be easier to use... NEWS, ED 1, p. 48
- Minis monitor weather at nuclear power sites... NEWS, ED 13, p. 32
- Minimize computer 'crashes'... ART, ED 9, p. 168
- Off-shelf speech recognizers let users talk the data into computer... NEWS, ED 23, p. 46
- Optical coupler helps transmit data and clock signals on single wire pair... IFD, ED 26, p. 104
- Optical data systems find a niche in the world of fast, fast computing... SR, ED 9, p. 126
- Optical tape reader speeds at 450 characters a second... PF, ED 9, p. 230
- Pocket-calculator race sizzles behind scenes... NEWS, ED 2, p. 27
- Point-of-sale systems still need standardized data-code readers... SR, ED 6, p. 54
- Portable printing calculators expected this year at \$100... NEWS, ED 4, p. 25
- Printer control... ART, ED 25, p. 74
- Program cuts logic-design costs... ART, ED 9, p. 186
- Program selects standard resistor values for calculated values when tolerance is given... IFD, ED 1, p. 160
- Programmable calculators fill middle spot for users... PF, ED 6, p. 65
- Programmable frequency multiplier uses octave scaler to simplify programming... IFD, ED 18, p. 100
- Reduce state tables by computer... ART, ED 22, p. 122
- Sealed disc made for OEMs is rugged and inexpensive... PF, ED 26, p. 126
- Secure messages sent via phone by terminal... NEWS, ED 20, p. 26
- Short subroutine computes standard component values from nonstandard... IFD, ED 10, p. 134
- Shrunken mini thinks like its predecessor... PF, ED 2, p. 108
- Smarter terminals join with floppy-disc drives to stretch data capability... SR, ED 9, p. 108
- Software for MOS/LSI microprocessors... ART, ED 7, p. 50
- Start a logic circuit in the proper mode when power is turned on or interrupted... IFD, ED 16, p. 110
- Successive approximation a/d converter uses three ICs and costs under \$25... IFD, ED 17, p. 120
- TI challenge to HP-35... NEWS, ED 3, p. 24
- Take-your-pick software is making the mini mighty, but watch out: it costs... SR, ED 9, p. 78
- Team calculators with instruments... ART, ED 24, p. 176
- Time share graphics plotted automatically on a scope... PF, ED 9, p. 225
- Time sharing: For engineers who need computing punch beyond that of the calculator... SR, ED 22, p. 56
- Two OCR drawbacks reported overcome... NEWS, ED 18, p. 20
- Ultimate interface studied: A mind-reading computer... NEWS, ED 16, p. 33
- Untangle automatic test equipment... ART, ED 24, p. 182
- Voice-recognition computer responds to virtually anyone... NEWS, ED 18, p. 19
- Written data converted to ASCII code by pen... NEWS, ED 17, p. 39
- 5-MHz bandwidth attained with CRT deflection system... PF, ED 16, p. 132
- 16-channel acquisition system includes controls... PF, ED 9, p. 244
- 32-k words squeezed into one core memory... NEWS, ED 24, p. 27

### Consumer Electronics

- CMOS parking meter eliminates dead time... NEWS, ED 25, p. 23
- Computer spots causes of vehicle accidents... NEWS, ED 19, p. 28
- Consumer electronics heading for a year of improvements paced by monolithic ICs... NEWS, ED 1, p. 50
- Digital recording used by home video player... NEWS, ED 13, p. 31
- Electronics for cars? It's only the beginning... NEWS, ED 1, p. 35
- FM stations reducing noise the Dolby way... NEWS, ED 20, p. 26
- $I^2L$  turns up in wristwatch and a microprocessor chip... NEWS, ED 26, p. 19
- IR ignition system... NEWS, ED 6, p. 26



# FAST Switching Speed

... is just one of the exceptional performance features of the NEW GR synthesizers

## Here are some others:

- To 160 MHz or 500 MHz • Optional resolution to 0.1 Hz
- Non-harmonic spurs >80 dB down
- Low Residual Phase Noise >60 dB down
- AM, FM and PM Modulation Capabilities
- Built in Search Sweep Capability
- BCD Programmable Frequency Control

A magnified look at the transition point of a programmed frequency change provides the necessary information to verify switching speed performance. We've summarized the details of this technique in a new Application Note entitled "Reviewing Switching Speed Performance" — Send for it today.

GR Applications Engineers are ready to provide further technical information and assistance in specific applications for our GR 1061 (160 MHz) and GR 1062 (500 MHz) Synthesizers.

INFORMATION RETRIEVAL NUMBER 45

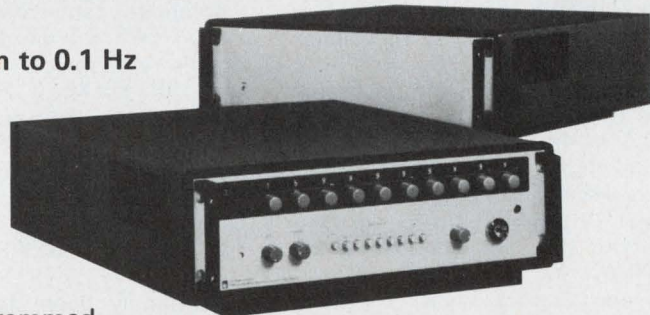
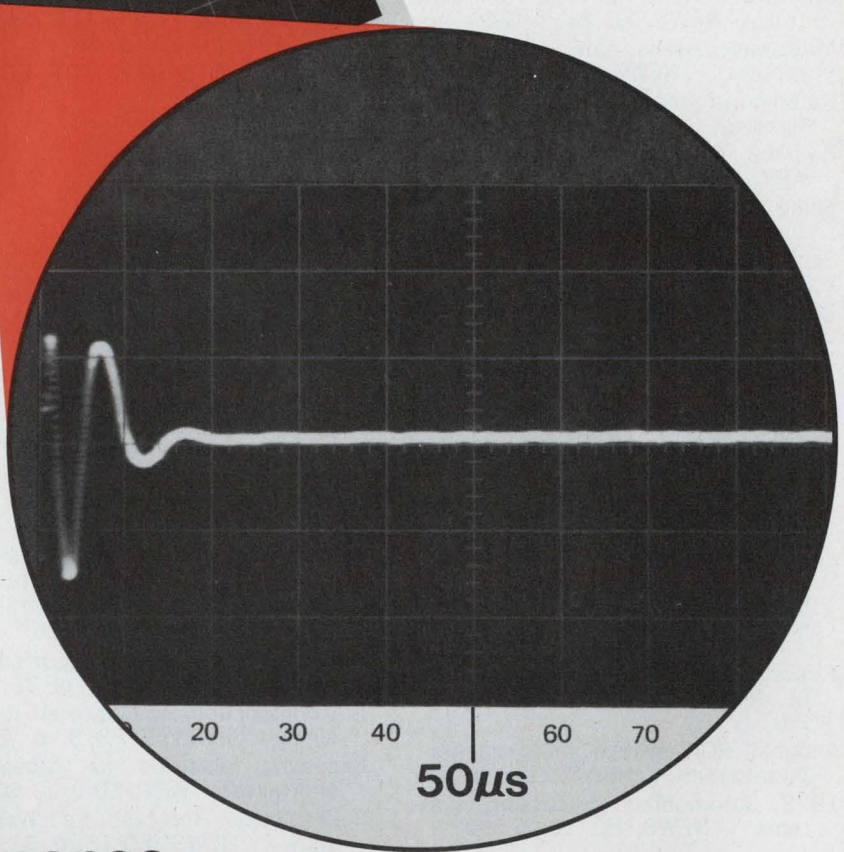

**General Radio**

300 BAKER AVENUE, CONCORD, MASSACHUSETTS 01742  
NEW YORK (N.Y.) 212 964-2722, (N.J.) 201 791-8990  
BOSTON 617 646-0550 • DAYTON 513 294-1500  
CHICAGO 312 992-0800 • WASHINGTON, D. C. 301 948-7071  
ATLANTA 404 394-5380 • DALLAS 214 234-3357  
LOS ANGELES 714 540-9830 • SAN FRANCISCO 415 948-8233  
TORONTO 416 252-3395 • ZURICH (01) 55 24 20  
GR COMPANIES • Grason-Stadler • Time Data



Japanese radar setup deploys car air bags... NEWS, ED 6, p. 25  
 Kodak video player televises 8-mm film... NEWS, ED 15, p. 27  
 Laser-reader sorts baggage for airline... NEWS, ED 1, p. 36  
 Life-cycle appliance costs still rising... NEWS, ED 14, p. 30  
 Microwave car license plate designed with a spate of uses... NEWS, ED 19, p. 36  
 Microwave ovens get solid-state control... NEWS, ED 21, p. 24  
 Microwave ovens safe, IEEE panel reports... NEWS, ED 7, p. 25  
 Radio-controlled nozzle expedites fire fighting... NEWS, ED 2, p. 27  
 Replace mechanical TV tuners... ART, ED 19, p. 152  
 Seiko down-plays the digital watch... NEWS, ED 17, p. 40  
 Sensor-computer setup troubleshoots cars fast... NEWS, ED 4, p. 26  
 Sophisticated large-scale IC chips are turning up in consumer items... NEWS, ED 6, p. 36  
 TV picture quality adjusted automatically... NEWS, ED 13, p. 31  
 Video players for the home turning to card and disc units to cut cost... NEWS, ED 13, p. 46  
 Video recording system employs low-cost discs... NEWS, ED 4, p. 26  
 With new car, TV and power applications, semiconductor makers see no end to boom... NEWS, ED 1, p. 44  
 1-rpm video disc system shown to be feasible... NEWS, ED 14, p. 29  
 4-signal RCA system joins quadraphonic race... NEWS, ED 8, p. 27  
 1978 automobile: Processing systems... NEWS, ED 12, p. 30

## Displays

Bicolor LED coming with a simpler drive... NEWS, ED 23, p. 31  
 Body displayed sonically in real time... NEWS, ED 7, p. 38  
 Electrochromic display offers challenge to liquid crystals... NEWS, ED 12, p. 44  
 Flat-panel displays due in 1980 cockpits... NEWS, ED 24, p. 28  
 Flat-panel TV promises are back, but this time they could be for real... NEWS, ED 1, p. 76  
 FOCUS on Displays... SR, ED 26, p. 52  
 Heads-up display gives a wider field of view... NEWS, ED 21, p. 52  
 Improve CRT-display systems with NMOS... ART, ED 1, p. 100  
 Large-scale display to use 3-color LEDs... NEWS, ED 9, p. 29  
 Liquid crystal displays are great—but... ART, ED 14, p. 76  
 Liquid crystals help spot IC defects... NEWS, ED 23, p. 31

New switch cuts cost of liquid-crystal panel... NEWS, ED 12, p. 30  
 Now, magnetic bubbles for displays... NEWS, ED 16, p. 40  
 Plasma and liquid crystals take on the champ, CRT... SR, ED 19, p. 73  
 Seminar to evaluate displays of the future... NEWS, ED 7, p. 25  
 Seven-segment display modified to reduce readout confusion... IFD, ED 6, p. 158  
 Should you use LCD or LED displays... ART, ED 23, p. 88  
 Which LCD is best?... ART, ED 16, p. 76

## Electro-Optics

Digital-image system reconstructs in color... NEWS, ED 26, p. 20  
 Fiber-optic signal losses reduced by star coupler... NEWS, ED 22, p. 27  
 Night-vision modules yield alterable device... NEWS, ED 5, p. 22

## General Industry

Beckman adds a line in process-control field... NEWS, ED 18, p. 20  
 Central maintenance: Wave of the future... NEWS, ED 6, p. 25  
 Demand for engineers reported on rise... NEWS, ED 10, p. 22  
 EIA components show geared to designers... NEWS, ED 3, p. 24  
 Engineers disagree on cause of shortages... ART, ED 8, p. 60  
 'Full house' forecast for Wescon show... NEWS, ED 13, p. 31  
 Growth of additive PC technology expected to double by 1975... NEWS, ED 19, p. 42  
 IEEE sees ample jobs for flexible engineers... NEWS, ED 5, p. 22  
 Inflation, energy, semiconductors to dominate tomorrow's electronics... NEWS, ED 15, p. 40  
 Japan's electronics: Fighting back... SR, ED 26, p. 25  
 London parley to weigh tomorrow's electronics... NEWS, ED 7, p. 26  
 New rules for faster design... ART, ED 9, p. 198  
 Parts labeling speed raised to 20,000/hr... NEWS, ED 10, p. 22  
 Power-supply boom linked to computers... NEWS, ED 1, p. 36  
 Recycling gives U.S. copper self-sufficiency... NEWS, ED 18, p. 19  
 Reflection of the industry's banner year... SR, ED 19, p. 62  
 Roving course offered on microprocessors... NEWS, ED 10, p. 22  
 Shortages of components forcing engineers to alter their thinking and designs... SR, ED 9, p. 136

Soviet to exhibit for export at New York IEEE show... NEWS, ED 5, p. 21  
 Struggle to raise efficiency and power while dropping cost... NEWS, ED 7, p. 30  
 White House office of science backed... NEWS, ED 24, p. 28  
 With an energy crisis at the door, designers begin to think stingy... NEWS, ED 2, p. 34  
 Yet another national shortage: Basic research, across the board... NEWS, ED 4, p. 28  
 3-day work week spurs semiconductor output... NEWS, ED 5, p. 21  
 1960s dream begins to come true under the seas... NEWS, ED 18, p. 24

## Industrial Electronics

ICs and transistor provide brain and muscles for motor control... NEWS, ED 21, p. 38  
 Hand-held gas detector promised, with 1-part-per-billion sensitivity... NEWS, ED 20, p. 36  
 Huge fuel cell planned for use by utilities... NEWS, ED 2, p. 28  
 Industrial systems makers gear for a prosperous '74... NEWS, ED 1, p. 35  
 LED on miner's cap warns of radiation... NEWS, ED 16, p. 34  
 Minis, minis everywhere, when it comes to control of industrial processes... SR, ED 9, p. 118  
 Monolithic switch array developed for phones... NEWS, ED 17, p. 40  
 Newer electronics helping police short-circuit crime at source... NEWS, ED 17, p. 56  
 Ulf direction finder for miners passes tests at 1500-ft depth... NEWS, ED 20, p. 32  
 When the power blows, how safe will your system be... SR, ED 19, p. 71

## Management

Aggressive R&D and a dash of serendipity = market success... ART, ED 19, p. 78  
 'Anticipation' is management's best bet... ART, ED 2, p. 84  
 Designs that sell require compromise... ART, ED 17, p. 110  
 Diversity keeps engineers on their toes... ART, ED 21, p. 118  
 Don't be a slave to a project schedule... ART, ED 14, p. 106  
 Every new engineer needs a design guide... ART, ED 13, p. 108  
 Forecasting is an engineering job, too... ART, ED 1, p. 148  
 Getting management behind your project... ART, ED 19, p. 166  
 Good design is a business challenge... ART, ED 11, p. 100



How sweet it is...



To find over 1000 ratings on the shelf at Old Fashioned prices!

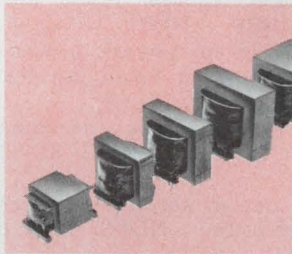

First we'd like to put a "Plug-In" for our Printed Circuit Power Transformers since they are the *most complete and diversified selection available*. There are 5 basic sizes, each available with

115V or 115/230V 50/60 Hz primaries and secondary voltages from 5V to 120V. Our smallest is rated 1 VA and is 0.83 inches high. This allows 1 inch board spacing. The largest is rated 24 VA (e.g., 24V @ 1A) which is virtually impossible to find as a standard item (except at Signal) and, it is only 1 3/8 high.

A special "plug" is warranted for our "LP" series of Flat Plug-Ins which is designed for 6VA with a height of *only 0.85 inches*. Special features are humbucking construction, non-concentric winding, dual 115/230V primaries and outputs from 5 to 230V. This is a Signal exclusive!

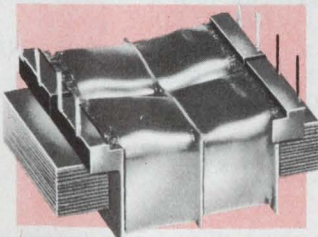

You will also find on Signal's shelves the most extensive line of Rectifier Power Transformers and Chokes (5 to 300V, 0.1 to 200 A). They are ideal for use in single or dual output DC power supplies.

The real heavy stuff is on the floor nearby with ratings such as 12V at 1000 Amps and 3 phase transformers with DC output ratings like 24V at 200 Amps.

Something really new is our "2-for-1" series of small power transformers with ratings from 2.4 to 60 VA. A fresh design approach has cut weight, size and cost almost in half, with improved performance. Special features include non-concentric winding, solder or quick-connect terminals, and 2500V hipot.

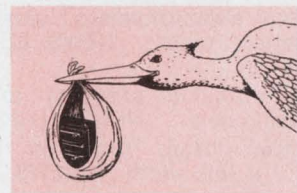
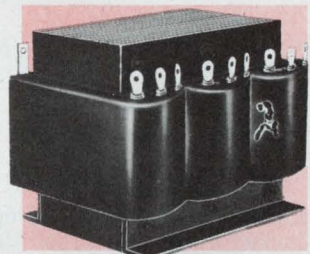

**signal transformer co., inc.**

1 Junius Street, Brooklyn, N.Y. 11212  
Tel: (212) 498-5111 • Telex 12-5709

and Signal has it in Stock!



Help finish big, creative projects fast  
... ART, ED 23, p. 134

How to be a top designer and remain  
a designer, despite corporate lures  
... SR, ED 9, p. 100

Learning to wear two hats on the job  
... ART, ED 16, p. 104

Let the engineers run the company  
... ART, ED 10, p. 124

'Meet' the applicant before talking  
to him... ART, ED 25, p. 86

Project success: The main concern in  
'74... ART, ED 26, p. 98

Remember testing in 1844? If you  
can't, Siemens Corp. can... SR,  
ED 24, p. 124

Servicing a high-technology product  
... ART, ED 20, p. 114

Spell out specs and contract lan-  
guage... ART, ED 22, p. 138

Start your own electronics business  
—but look before you leap...  
ART, ED 12, p. 142

Stop second-guessing on projects  
... ART, ED 4, p. 100

The case for unstructured manage-  
ment... ART, ED 15, p. 102

Today's mature designs, as seen by  
a young 'old-timer'... SR, ED 24,  
p. 84

Using consultants takes consultation  
... ART, ED 7, p. 70

Want to cut costs to the bone...  
ART, ED 6, p. 132

When you have no choice but  
changeover... ART, ED 18, p. 92

### Materials and Packaging

Alternative to multilayers proposed:  
Stacked PC boards at half the cost  
... NEWS, ED 7, p. 40

Better components and materials  
widening magnetic applications  
... SR, ED 1, p. 64

Built-in heat pipe proposed to cool  
GHz power transistors... NEWS,  
ED 14, p. 32

Case for using ceramics... ART, ED  
8, p. 74

Choose cleaning solvents carefully  
... ART, ED 5, p. 54

Cooled alloy promises better mag-  
netic circuits... NEWS, ED 25, p.  
24

Disc diffusion expected to lower  
semi costs... NEWS, ED 22, p. 28

Electron beam produces ICs of  
0.2- $\mu$  line width... NEWS, ED 12,  
p. 30

Explosive bonding is used to connect  
microcircuits... NEWS, ED 14, p.  
29

Film-carrier system used for IC pack-  
ages... NEWS, ED 19, p. 28

Flexible material changes resistance  
in one direction... PF, ED 13, p.  
160

'Flints' that don't wear out... ART,  
ED 13, p. 88

FOCUS on Cooling electronic pack-  
ages... SR, ED 14, p. 62

FOCUS on Round multipin connec-  
tors... SR, ED 4, p. 54

From \$2.50 to \$1500, good systems  
can save you time in circuit de-  
sign... NEWS, ED 8, p. 30

Guide to good air cooling... ART,  
ED 4, p. 76

Hunt is on for ways to counter tight  
supply of oil-based materials...  
NEWS, ED 2, p. 38

Impulse-bonded wiring allows fast  
PC changes... NEWS, ED 8, p. 44

Mini system promises cheaper IC  
masks... NEWS, ED 21, p. 24

New computer tape resists edge  
damage... NEWS, ED 7, p. 40

New devices a possibility with IBM  
'organic metal'... NEWS, ED 21,  
p. 23

One-step process bonds copper to ce-  
ramic without adhesives... NEWS,  
ED 14, p. 40

Organic materials investigated for  
superior semis and memories...  
NEWS, ED 10, p. 32

PC-board holes made with simpler  
technique... NEWS, ED 8, p. 27

Plastic protects components at 800  
F... NEWS, ED 18, p. 40

Shape foil into a magnetic shield...  
ART, ED 18, p. 86

Silicon carbide studied for micro-  
wave devices... NEWS, ED 11, p.  
26

Super-thin copper foil for PCs uses  
up to 75% less of the metal...  
NEWS, ED 14, p. 38

Thermal imaging furnaces grow crys-  
tals from 'difficult' materials...  
NEWS, ED 10, p. 34

Thick or thin-film resistors... ART,  
ED 17, p. 92

Today's resins provide a cure for al-  
most every embedding ill...  
NEWS, ED 25, p. 28

Why not use hybrids... ART, ED 14,  
p. 84

X-ray imaging method improves crys-  
tal growth... NEWS, ED 15, p. 28

3M substitutes tin for gold in con-  
nectors... NEWS, ED 21, p. 23

600 IC contacts possible with el-  
astomeric system... NEWS, ED 6,  
p. 25

### Medical Electronics

Device simulates effects of heat on  
human tissue... NEWS, ED 22, p.  
28

Heart monitor replaces skin-piercing  
methods... NEWS, ED 9, p. 29

Prosthetics, orthotics, etc.—there's  
new hardware for body... SR, ED  
19, p. 69

Simplified biofeedback circuit de-  
tects alpha-wave activity... IFD,  
ED 12, p. 154

Sound sensor detects hard-to-find  
heart ills... NEWS, ED 15, p. 27

Spurious radio noise viewed as  
health peril... NEWS, ED 16, p.  
34

### Military and Aerospace

Air-traffic radar trainer contains sev-  
eral 'firsts'... NEWS, ED 22, p.  
28

Army vehicles to get intelligent ter-  
minal... NEWS, ED 25, p. 23

Automatic sonobuoy locator spots  
up to 31 beacons simultaneously  
... NEWS, ED 4, p. 36

Bubble data recorder to be tested  
by NASA... NEWS, ED 11, p. 25

C-band landing system adopted by  
the FAA... NEWS, ED 20, p. 26

Computerized van will help Navy  
train for war without leaving port  
... NEWS, ED 23, p. 36

DOD standard designs... NEWS, ED  
9, p. 30

Digital storage offered in light-plane  
radar... NEWS, ED 13, p. 32

Dual radar distinguishes between 2  
air targets... NEWS, ED 5, p. 22

Lower atmosphere to be studied by  
sensors on manned balloon...  
NEWS, ED 21, p. 48

Military to spend \$80-billion in fiscal  
'74 and more in '75... NEWS, ED  
2, p. 27

Navy display speeds weather fore-  
casts... NEWS, ED 16, p. 46

New approach radar proves highly  
accurate... NEWS, ED 3, p. 24

New flight recorder would warn of  
accidents... NEWS, ED 2, p. 28

Nuclear ILS for aircraft proves safe  
and sound in feasibility test...  
NEWS, ED 16, p. 44

One man radar relies on minicom-  
puter control... NEWS, ED 21, p.  
23

Optical design slashes encoded alti-  
meter price... NEWS, ED 3, p. 24

Picosecond timing sharpens laser-  
ranger resolution... NEWS,  
ED 15, p. 48

Second weather buoy being placed in  
Pacific... NEWS, ED 13, p. 32

Sensors in space are uncovering  
clues to new energy sources...  
NEWS, ED 2, p. 40

Skylab's balking gyros to be used on  
shuttle... NEWS, ED 4, p. 25

Touch communication investigated  
by Army... NEWS, ED 10, p. 21

Tough Army survey simplified by  
software... NEWS, ED 18, p. 19

U.S. gets its first domestic satcom  
net... NEWS, ED 3, p. 23

With a \$3.1-billion budget, NASA  
sees year of growth... NEWS, ED  
3, p. 23

### Semiconductors

Advances on three fronts herald next  
generation of linear circuits...  
NEWS, ED 6, p. 32

After 13 years, standardization of  
opto-isolators is beginning...  
NEWS, ED 3, p. 26

Amorphous memories ordered by  
Burroughs... NEWS, ED 1, p. 36



# DISC PRICES HIGHER?

## NOT AT ERIE!

### No. 1 Worldwide in Ceramic Capacitors

ERIE . . . the same quality house that brings you the full range of Ceramic Capacitors, holds prices on their broad line of Ceramic Disc Capacitors. While others raise prices, ERIE helps fight inflation by keeping the lid on Disc prices.

-  **All Disc Sizes**
-  **All Disc Temp. Char.**
-  **All Disc Voltages**

ERIE offers unmatched versatility in ceramic disc capacitors. And ERIE has lowered or maintained pricing for over 10 years, despite recent inflationary pressures. Competition has not. *Let us quote you.*

Write today on your letterhead for our Fixed Ceramic Capacitor catalog . . . or better, call our nearby office listed at right.

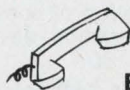

**CALL YOUR  
NEARBY  
ERIE SALES OFFICE**

**CALIFORNIA**  
Palo Alto 94306, 460 California Ave.;  
Phone: 415-327-1520  
Santa Ana 92707, 1420 E. Edinger St.,  
Suite 211; Phone: 714-835-4822

**FLORIDA**  
Maitland 32751, 235 Maitland Ave.;  
Phone: 305-644-0954

**ILLINOIS**  
Des Plaines 60018, 3150 Des Plaines Ave.;  
Phone: 312-297-5560

**INDIANA**  
Fort Wayne 46805, 2118 Inwood Drive,  
Executive Park; Phone: 219-484-1528

**MASSACHUSETTS**  
Wakefield 01880, Lakeside Office Park,  
591 North Ave.; Phone: 617-245-7880

**NEW JERSEY**  
Pennsauken 08109, 5425 Marlton Pike;  
Phone: 609-665-4787 (New Jersey)  
Phone: 215-925-9228 (Philadelphia)

**NORTH CAROLINA**  
Greensboro 27403, 612 Pasteur Drive;  
Phone: 919-299-1905

**CANADA**  
Trenton, Ontario, 5 Fraser Ave.;  
Phone: 613-392-2581

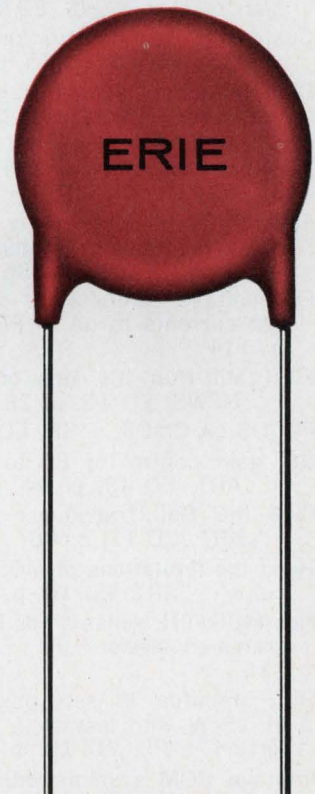

**ERIE TECHNOLOGICAL PRODUCTS, INC.**

State College, Pennsylvania Phone 814/237-1431





## ANNUAL INDEX

- Analog-function array aids instrument designs...PF, ED 20, p. 131
- Better and cheaper ICs on the way with two advances in processing...NEWS, ED 12, p. 34
- Bipolar IC microcomputer claims a number of 'firsts'...NEWS, ED 25, p. 23
- Bipolar/LSI processor races to the forefront...PF, ED 18, p. 109
- Bipolar microcomputer chips set the pace for flexibility...PF, ED 22, p. 185
- Bipolar microprocessor—the first to hit the market...NEWS, ED 19, p. 27
- Bipolar op amp matches specs of chopper-stabilized units...PF, ED 15, p. 120
- Bubble memories advance from chip to module stage...NEWS, ED 12, p. 29
- CCD memory emerging an alternate for DEC...NEWS, ED 15, p. 27
- CCD memory ICs heading for market...NEWS, ED 10, p. 22
- CCDs proving worth in digital memories...NEWS, ED 12, p. 29
- CID image sensor a replacement for tubes...NEWS, ED 10, p. 36
- CMOS microprocessor stirring design race...NEWS, ED 4, p. 26
- Custom IC technology 'for sale' to users...NEWS, ED 15, p. 28
- Digital memory sought from organic materials...NEWS, ED 10, p. 22
- Divide by 10/11 at high of 512 MHz without power rise...PF, ED 19, p. 183
- Electron-beam-projection system gives 3-way improvement in ICs...NEWS, ED 12, p. 36
- FET voltage comparators shrink input currents to pA...PF, ED 18, p. 114
- First 'Mill Run' ICs come off the line...NEWS, ED 15, p. 28
- FOCUS on CMOS...SR, ED 6, p. 86
- Get gain control of 80 to 100 dB...ART, ED 13, p. 94
- Give the Hall transducer flexibility...ART, ED 11, p. 88
- Heed the limitations of MOS I/O circuitry...ART, ED 10, p. 82
- Hex MOS/TTL sense amps have programmed levels...PF, ED 26, p. 116
- Hi-fi amplifier IC sets power mark of 15 W with less than 1% distortion...PF, ED 10, p. 141
- Improve ROM systems with PROMs...ART, ED 14, p. 92
- Integrated injection logic shaping up as strong bipolar challenge to MOS...NEWS, ED 6, p. 28
- Ion implantation: From a specialty to a standard method for new ICs...NEWS, ED 11, p. 36
- LED panel lamps match incandescents at less current...PF, ED 16, p. 150
- LSI finding a place in homes in multi-purpose alarms...NEWS, ED 8, p. 27
- Low-cost, 10-MHz FET op amp provides higher stability...PF, ED 1, p. 178
- MOS/bipolar monolithic op amp gives high performance at low cost...PF, ED 22, p. 182
- MOS/LSI microprocessor selection...ART, ED 12, p. 100
- Magnetic bubbles produced in thin films by evaporation...NEWS, ED 22, p. 27
- Microprocessors enter boom era—from 4-bit machines and up...SR, ED 6, p. 52
- Microprocessors showing promise in test equipment, but haven't made it big yet...SR, ED 9, p. 90
- Microprocessors turn to NMOS for speed, CMOS for low power...NEWS, ED 6, p. 38
- More bipolars eligible for flip-chip conversion...NEWS, ED 10, p. 21
- NMOS microprocessor boosts speed, instruction-set power...PF, ED 8, p. 144
- New CCD image structure makes processing easier and lifts yields...NEWS, ED 6, p. 30
- New amplifier increases s/n ratio of CCD imager...NEWS, ED 23, p. 31
- New generation of computer foreseen with Josephson devices...NEWS, ED 2, p. 30
- New imaging technology grabs hold: Charge-transfer devices...SR, ED 6, p. 59
- New memory, the crosstie, stores data in magnetic-domain walls...NEWS, ED 5, p. 34
- Op amp combines CMOS and bipolars...NEWS, ED 21, p. 24
- Optics and acoustics generate new microelectronic devices...NEWS, ED 10, p. 24
- Parley will offer solutions to defects in hybrid circuits...NEWS, ED 20, p. 25
- Performance soars as digital LSI moves to center stage...SR, ED 24, p. 42
- Power hybrid ICs improve switching-regulator response...IFD, ED 11, p. 119
- Quad IC timers squeezed into a 16-pin plastic DIP...PF, ED 16, p. 128
- Review the basics of MOS logic...ART, ED 6, p. 98
- SOS devices: Not yet making it in LSI...but wait till next year...NEWS, ED 16, p. 36
- Simplify UJT relaxation-oscillator design...ART, ED 4, p. 84
- Single monolithic chip holds 16-bit microprocessor...PF, ED 25, p. 105
- Static 1-k RAM accesses in 80 ns and has chip select...PF, ED 15, p. 122
- Superconducting diode promises tenfold decrease in mixer noise...NEWS, ED 10, p. 30
- TI MOSFET paces TV tuner race...NEW, ED 14, p. 30
- Touchtone converted to pulsed dialing...NEWS, ED 26, p. 20
- Triple-varactor IC promises to better the AM car radio...NEWS, ED 10, p. 38
- Watch that op-amp noise...ART, ED 6, p. 128
- Which IC timer to buy...ART, ED 3, p. 62
- 2 new RCA RAMs to use SOS/CMOS...NEWS, ED 24, p. 28
- 3-1/2-digit a/d chip set shrinks converter design...PF, ED 4, p. 115
- 4-k NMOS RAM combines high speed and low power...PF, ED 8, p. 148
- 16-bit microprocessor/mini, a 'first,' uses SOS chips...NEWS, ED 11, p. 25
- 256 × 4-bit static RAM simplifies system designs...PF, ED 13, p. 134
- 500-A one chip transistors have super-low  $V_{cc}(\text{sat})$ ...PF, ED 5, p. 80
- 1000-W solid-state power amplifier...ART, ED 7, p. 58
- 2000-A diode offers high reverse voltage at low cost...PF, ED 6, p. 172
- 4096-bit RAMs making the scene as an alternative to core—finally...NEWS, ED 3, p. 40

## Test and Measuring

- A/d and d/a converter testing...ART, ED 7, p. 64
- Accurate 10-MHz reference obtained from counter's 1-MHz internal standard...IFD, ED 18, p. 98
- Acoustic microscope nearing production...NEWS, ED 9, p. 30
- Analyze gaseous mixtures...ED 26, p. 82
- Analyze signals as never before with digital methods...SR, ED 24, p. 100
- Analyzer picks out patterns in long digital data streams...PF, ED 17, p. 131
- Are your humidity readings valid...ART, ED 16, p. 90
- Audible gas alarm uses CMOS gates to provide time delays and transient protection...IFD, ED 10, p. 132
- Autoranging 80-MHz counter is industry's least expensive...PF, ED 16, p. 123
- Build a low-cost ECL logic probe that also has and overrange indicator...IFD, ED 17, p. 116
- Build counters with calculator chips...ART, ED 26, p. 90
- Built-in microprocessor available in scope...NEWS, ED 20, p. 25



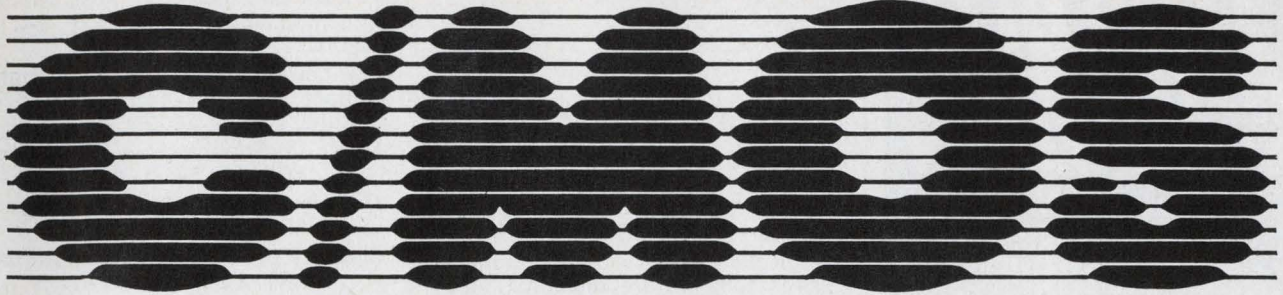

# HIGH NOISE IMMUNITY

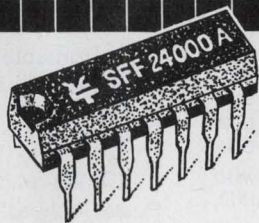
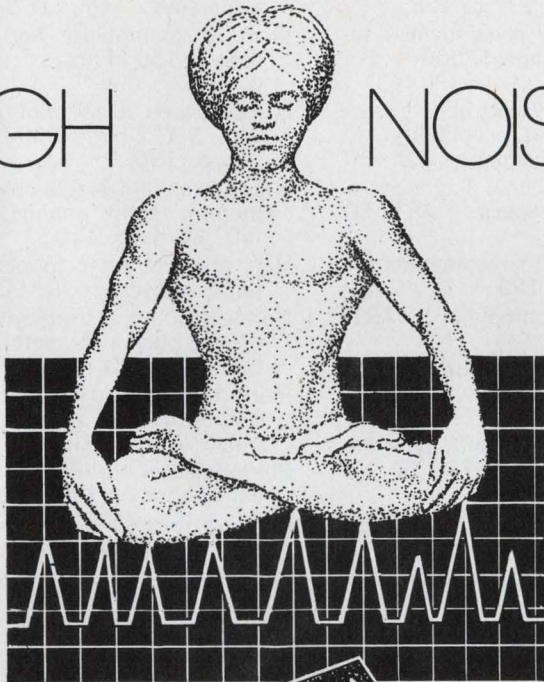

## SFF 2400 A SERIES

- An ion implantation for better control of performance.
- The best possible selection in the field of industrial electronics (numerical control, process control, industrial automation) for noise immunity.
- The best possible choice for portable equipment owing to its wide supply voltage range and low power consumption.

Full specifications of this series are given in our 1974/1975 MOS and C/MOS catalog.

Perez Publicité. 102A



**THOMSON-CSF**

SEMICONDUCTOR DIVISION  
50, rue Jean-Pierre-Timbaud / B.P. 120 / 92403 Courbevoie  
Téléphone 788 50 01 Têlex Sescom 61560 F

**SALES REPRESENTATIVES IN EUROPE**

BELGIQUE - Bruxelles - Thomson S.A. Tel. 648.64.85 Twx : 23.113 - BRD - München - Thomson - CSF GmbH Tel. (089) 76.75.1 Twx : 5.22.916 - DANMARK - København - Scansupply Tel. Aegir 5090 Twx : 19037 - ESPAÑA - San Juan Despi (Barcelona) - Componentes Electronicos S.A. Tel. 319.46.50 Twx : 53.077 - FINLAND - Helsinki - OY Sufrä AB Tel. 49.01.37 Tlg : Pierrejoly Helsinki - GREAT BRITAIN - London - Thomson CSF UK Ltd Tel. (01) 579.55.11 Twx : 25.659 - ITALIA - Milano - Sescosem Italiana Tel. 68.84.141 Twx : 31.042 & ROMA Tel. 31.27.22/35.30.05 Twx : 61.173 Telonde - NEDERLAND - La Haye - Compagnie Generale d'Electricité Tel. 60.88.10 Twx : 31.045 - NORGE - Oslo - J.M. Feiring A/S Tel. 02.68.63.60 Twx : 16.435 - OSTERREICH - Wien - Transalpina Tel. (0222) 56.15.71 Twx : Ausland 12.717 - PORTUGAL - Lisboa 2 - Sd. Com. Rualdo Tlg : Rualdo Lisboa Tel. PP.C 33 725 - SUISSE - Berne - Modulator S.A. Tel. 232.142/43 Twx : 32.431 - SVERIGE - Solna - Elektroholm AB Tel. 08/82.02.80 Twx : 19.389

INFORMATION RETRIEVAL NUMBER 48



# AMPERITE

## TOP QUALITY

Still at LOW PRICE!

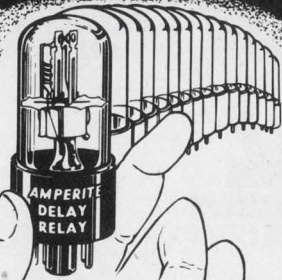

### Thermostatic DELAY RELAYS

Hermetically Sealed for Maximum Stability

Delays: 2 to 180 Sec.\*

Hermetically sealed — not affected by altitude, moisture, or climate changes... SPST only — normally open or normally closed... Compensated for ambient temperature changes from  $-55^{\circ}$  to  $+80^{\circ}\text{C}$ ... Rugged, explosion-proof, long-lived... Standard radio octal and 9-pin miniatures.

Price, standard or min., under \$4.00 ea.

\*Miniatures delays: 2 to 120 seconds.

PROBLEM? Send for Bulletin No. TR-81.

## New! LONG DELAYS

240 & 300 Sec.

Same rugged construction, hermetic sealing and stability as the shorter Delay Relays described above... For delays beyond 300 seconds, these Relays may be used in series.

Price, under \$6.00 ea.

Write for Bulletin No. LD-73.



## DIFFERENTIAL RELAYS

For automatic overload, over-voltage or under-voltage protection... Made only to specifications for 70V, 80V, 90V and 100V.

Price, under \$6.00 ea.

## AMPERITE BALLAST REGULATORS

Automatically keeps current and voltage at a definite value. For AC or DC... Hermetically sealed, rugged, vibration-resistant, compact, most inexpensive.

Price, under \$3.00 ea.

Write for 4-p. Bulletin No. AB-51.

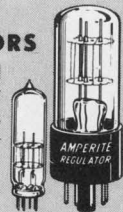

# AMPERITE

600 PALISADE AVE., UNION CITY, N.J. 07087

Telephone: 201 UNION 4-9503

In Canada: Atlas Electronics, Ltd.,  
50 Wingold Ave., Toronto 19

## ANNUAL INDEX

Character-generation circuit uses single Y-axis scope input to display alphanumeric... IFD, ED 4, p. 108

Choose the right storage oscilloscope... ART, ED 24, p. 150

Circuit built with quad op amp measures temperature digitally... IFD, ED 6, p. 160

Design a low-cost pH meter... ART, ED 24, p. 190

Differentiator circuit monitors stability of slowly changing dc signals... IFD, ED 21, p. 128

Digital phase meter gives highest accuracy, at less than \$2000... PF, ED 13, p. 127

Diode-resistor network adds user-selected readout capability to scope display system... IFD, ED 1, p. 156

Don't lean on a/d specs... ART, ED 8, p. 80

Don't sweat polar to rectangular... ART, ED 23, p. 129

Explore the lock-in amplifier... ART, ED 21, p. 104

Fastest logic scope captures 8 data streams at 200 MHz... PF, ED 5, p. 69

Find the new and different, turn the package inside-out... SR, ED 24, p. 140

Find the quietest JFETs... ART, ED 23, p. 98

FOCUS on Electronic counters... SR, ED 10, p. 58

FOCUS on Panel meters... SR, ED 16, p. 60

For fast digital troubleshooting, low-cost detectors can't be beat... NEWS, ED 5, p. 26

Function generator offers ASCII programmability... PF, ED 6, p. 68

Generate sine waves digitally with two ICs and eight resistors... IFD, ED 22, p. 152

Generate waveforms with a single IC... ART, ED 19, p. 132

IC applications demand new highs in instrument accuracy... SR, ED 24, p. 90

In 3 major ways look for changes in compatible equipment... SR, ED 24, p. 74

Instrument speeds noise-figure measuring... NEWS, ED 19, p. 28

Interpolate sampled data rapidly... ART, ED 15, p. 92

It's a new world of measurement at 1 GHz and higher... SR, ED 24, p. 114

It's a wide, wide field, with some 'standards' challenged... SR, ED 24, p. 130

LED test set uses only four components, and it's short-circuit proof, to boot... IFD, ED 22, p. 152

Low power at ohmmeter's probes al-

lows safe usage on most sensitive components... IFD, ED 14, p. 110

Low-power CMOS digital voltmeter built with only six integrated circuits... IFD, ED 22, p. 146

Match impedances with tapered lines... ART, ED 12, p. 136

Measure open-loop servo response... ART, ED 24, p. 170

Measure power with a calculator chip... ART, ED 21, p. 112

Measure sheet resistance easily... ART, ED 4, p. 96

Measure time interval precisely... ART, ED 24, p. 162

Memory tester handles 16 million addresses... PF, ED 8, p. 140

Modules manipulate and send test data at 150 Mbits/s... PF, ED 26, p. 136

Multifeatures at a mini price come with 3-1/2-digit DMM... PF, ED 10, p. 156

Multiplexer lets single-channel scope monitor eight analog signals... IFD, ED 4, p. 110

New problem rises to plague users: panel clutter... SR, ED 24, p. 56

Nondestructive testing advances with unique pulse-echo setup... NEWS, ED 13, p. 50

Peak detector provides both the amplitude and a peak-event timing pulse... IFD, ED 23, p. 140

Photodetector calibrated by electrical method... NEWS, ED 2, p. 28

Plug-ins turn DPM into many instruments... NEWS, ED 7, p. 25

Pocket-sized Geiger counter built with three micropower ICs... IFD, ED 8, p. 114

Predict wideband amplifier response... ART, ED 25, p. 68

Programmable equality comparator built with single hex inverter... IFD, ED 2, p. 92

Programmable sine-wave oscillator uses only one CMOS IC... IFD, ED 24, p. 200

Pulse echoes to measure size of metal cracks... NEWS, ED 14, p. 30

Semi testing service for medium-sized firms... NEWS, ED 19, p. 28

Sensors in 5 areas are getting tinier, cheaper and more precise... NEWS, ED 15, p. 30

Shock and vibration transducers... ART, ED 21, p. 68

Simple circuit tests coaxial cables for opens, shorts and intermittents... IFD, ED 13, p. 120

Simple tally system ranks events in the order of occurrence... IFD, ED 20, p. 120

Simplified waveform digitizer uses TV camera to capture the trace... NEWS, ED 14, p. 42

Sine/square-wave generator speeds amplifier testing... IFD, ED 22, ED 22, p. 150

Single transistor circuit provides



- CRT-level sweep and blanking signals... IFD, ED 6, p. 62
- Six ways to control transients... ART, ED 11, p. 52
- Smarter, handier and smaller instruments will appear as unexplored markets open up... NEWS, ED 1, p. 44
- Solid-state panel meter fills the gap between analogs and digitals... PF, ED 15, p. 126
- Space antennas use quasar signals to predict earthquakes... NEWS, ED 20, p. 38
- Spectrum analyzer outperforms rivals in 7 areas—at a price... PF, ED 6, p. 137
- Spectrum analyzer takes dynamic input range title... PF, ED 9, p. 236
- Switched op amps and a sign detector make 2-quadrant divider a 4-quadrant... IFD, ED 10, p. 134
- Test-equipment users suggest software-hardware improvements... SR, ED 6, p. 59
- Tester built for less than \$10 gives GO/NO GO check of timer ICs... IFD, ED 11, p. 106
- Timer/counter chip synthesizes frequencies, and it needs only a few extra parts... IFD, ED 13, p. 114
- Tough measurements, try IAs... ART, ED 16, p. 84
- Troubleshooters for logic emerge as digital trend gains... SR, ED 24, p. 64
- Use pulse instead of cw signals... ART, ED 11, p. 60
- View two video sources on one CRT... ART, ED 10, p. 116
- Voltage monitor uses LED indicators to show out-of-tolerance voltage... IFD, ED 19, p. 176
- Voltage probe uses five LEDs to indicate highest level reached... IFD, ED 15, p. 112
- Your voice tells when you're lying with small, solid-state analyzer... NEWS, ED 25, p. 40
- 2 new ways reported to detect trespassers... NEWS, ED 9, p. 30
- 2-ton package testing stratosphere pollution... NEWS, ED 11, p. 26
- 2.2-pound rubidium standard for systems uses only 12 W... PF, ED 5, p. 72
- 3-output variable supply regulates to within 0.01%... PF, ED 24, p. 220
- 13-MHz function generator offers both sweep and AM/FM... PF, ED 19, p. 82
- 20-MHz logic analyzer fits in the palm of a hand... PF, ED 19, p. 194
- 20-MHz synthesizer unit offered for less than \$2000... PF, ED 4, p. 142
- 50-MHz digital logic scope stores and displays 8 signals... PF, ED 2, p. 103
- \$99 3-digit panel voltmeter doubles as a counter... PF, ED 19, p. 88

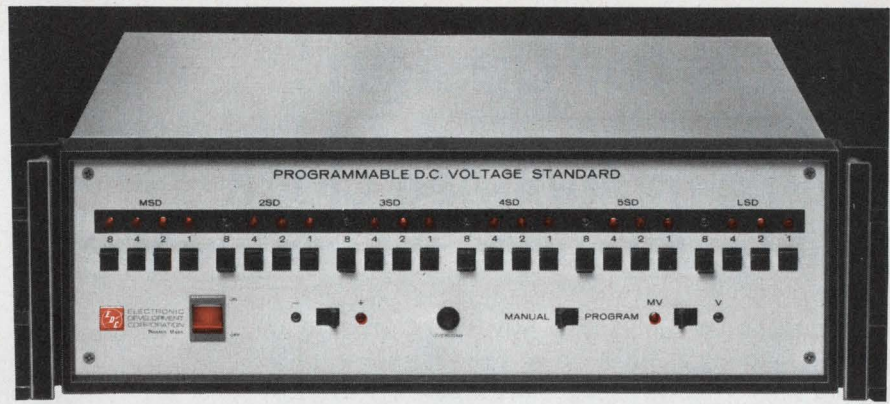

## programmable microvolts for \$1,485

### The EDC third generation 501 H has:

- Speed:** 50  $\mu$ s switching and settling time
- Ranges:** 100 mV, 10 V, 100 V, 200 V DC
- Resolution:** 1 ppm to steps of 0.1  $\mu$ V
- Accuracy:**  $\pm$  0.005% of programmed value
- Programming:** TTL, BCD 8-4-2-1; other codes available including binary and ASCII
- Options:** Added resolution, ranging, CMOS compatibility
- Accessories (field installable, plug-in):** Serial-to-parallel converter, memory register, opto-isolators, ranging amplifier

For complete specs and prices on the 501 H and other EDC calibrators and standards, circle reader service number. To evaluate the 501 H in your application call Bob Ross at 617-268-9696.

"standards of excellence since 1958"



**ELECTRONIC DEVELOPMENT CORPORATION**  
11 Hamlin St., Boston, MA 02127

INFORMATION RETRIEVAL NUMBER 50

## think small . . . with sub-miniature ceramic capacitors



Thick film hybrid design engineers can choose sub-miniature single and multi-layer ceramic chip capacitors with the widest range in capacitances, sizes, temperature characteristics and terminations in the industry from Centre Engineering.

In frequency critical areas requiring accuracy and stability, consider Centre Engineering's NPO type chip capacitors. Applications

requiring less stringent specifications Centre Engineering W5R and Z5U chip capacitors are economy savers.

Single layer and multi-layer ceramic chip capacitors, as small as .080 x .050 x .55T up to .460 x .420 x .65T with extremely high capacitance to volume ratios are ultra-reliable.

If you are thinking small . . . write for our catalogue.



**CENTRE ENGINEERING**

2820 E. COLLEGE AVE., STATE COLLEGE, PA 16801  
814-237-0321 ■ TWX 510-691-2634

INFORMATION RETRIEVAL NUMBER 51



# ideas for design

## Build a multiphase clock that never loses its sequence

A multiphase clock that always returns to its normal sequence, even if a random-noise pulse temporarily throws it off, can make a logic system more reliable (Figs. 1 and 2). In addition a built-in single-burst mode enhances its use for trouble-shooting.

Many designers use a simple Johnson counter to generate a multiphase nonoverlapped clock. But this works well only in a noise-free environment. Noise spikes can put such a circuit out of sequence; the output phases never return to normal unless a clear pulse is issued.

Fig. 1 shows the timing sequence, phase states and Karnaugh map for the design of a four-phase clock. The technique is based upon an article previously published in *ELECTRONIC DESIGN*.<sup>1</sup> Any even number of phases can be generated by this method, but four phases are sufficient to illustrate the design procedure. If the number of phases equals  $2^n - 2$ , the simplest circuits are obtained, because there are no unused states in the circuit's Karnaugh map.

Each phase is nonoverlapped and equal to one full period of the master oscillator. For TTL

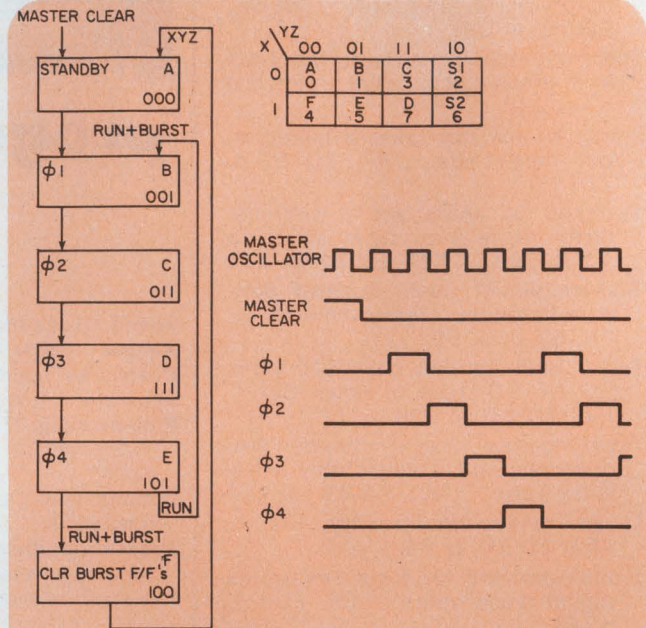

1. A timing diagram, state chart and Karnaugh map for a four-phase clock system illustrate a technique for designing a self-clearing mutiphase clock with an even number of phases.

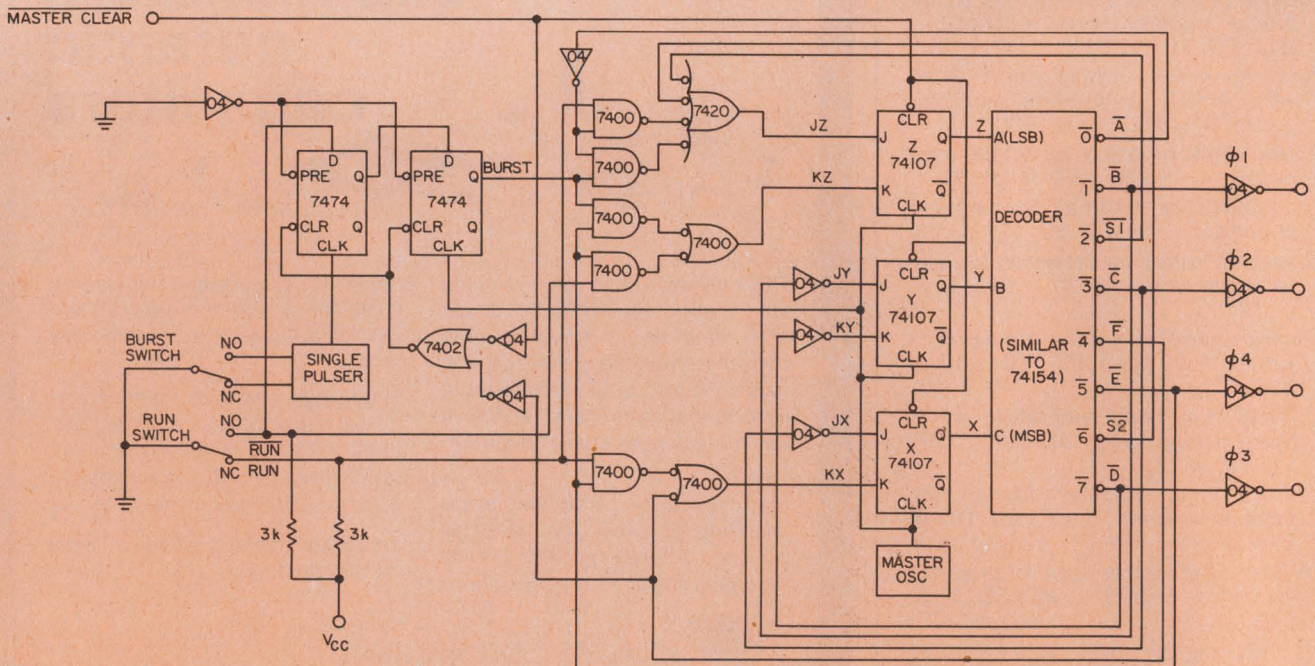

2. A multiphase clock should automatically resume its normal sequence even if temporarily thrown off

by noise pulses. Other clock circuits with a lower parts count may not have this self-reset feature.



Pulse handling:  
there's more to  
resistors than  
resistance.

If you're really  
serious about cost,  
be serious about quality.

Experience shows that Allen-Bradley fixed composition resistors can withstand far greater pulse energy levels than resistors manufactured by some other technologies.

For example, a pulse equivalent to the energy from the rapid discharge of a  $10\mu\text{f}$  capacitor charged to 600 volts (1.8 watt-seconds) will have an insignificant effect on Allen-Bradley  $\frac{1}{4}$  watt resistors.

This performance is characteristic of the hidden values built into all Allen-Bradley composition resistors by our exclusive hot molding process. Quality that can make important differences in your design and procurement decisions.

Ask your Allen-Bradley distributor for "7 ways to tell the dif-

ference in fixed resistors." Or write: Allen-Bradley Electronics Division, 1201 South Second Street, Milwaukee, WI 53204. Export: Bloomfield, NJ 07003. Canada: Allen-Bradley Canada Limited, Cambridge, Ontario. United Kingdom: Jarrow, County Durham NE32 3EN.

A-B Type	Rated Watts	Pulse Energy Capability Watt-Seconds	Equivalent Energy Source
BB	$\frac{1}{8}$	0.45	$2\mu\text{f}$ @ 670 volts
CB	$\frac{1}{4}$	1.8	$10\mu\text{f}$ @ 600 volts
EB	$\frac{1}{2}$	6.4	$32\mu\text{f}$ @ 630 volts
GB	1	16	$32\mu\text{f}$ @ 1000 volts
HB	2	44	$32\mu\text{f}$ @ 1650 volts

EC70



**ALLEN-BRADLEY**

Milwaukee, Wisconsin 53204

INFORMATION RETRIEVAL NUMBER 52



logic, the upper frequency limit of the master oscillator is approximately 20 MHz.

The circuit uses a run switch, a burst switch and a master-clear signal (Fig. 2). The master-clear signal forces the system to the standby state. When the run switch is turned on, the sequencer leaves the standby state and cycles through the phases until the run switch is turned off. Each phase follows the preceding one in sequence. If a noise spike causes the sequencer to jump some states, the circuit continues to cycle properly from that point on. If an unused state is entered, the next clock pulse forces the sequencer to the adjacent used state and back into the mainstream again.

If a single four-phase burst is desired, the momentary burst switch is activated. The run switch must be in the OFF position.<sup>2</sup> This action sets the first 7474 of the burst flip-flop pair. The second stage of the pair thereafter sets on the rising edge of the next master-clock pulse and synchronizes the burst request with the sequencer. The burst flip-flops are automatically

cleared after the four phases are generated, and the sequencer returns to a standby condition.

The input equations for the sequence control flip-flops to implement the control loop and Karnaugh map are:

$$\begin{aligned} JX &= C \\ KX &= E \cdot \text{RUN} + F \\ JY &= B \\ KY &= D \\ JZ &= \overline{A} \cdot (\text{RUN} + \text{BURST}) + S1 + S2 \\ KZ &= E \cdot (\overline{\text{RUN}} + \text{BURST}) \end{aligned}$$

Though this technique may require more parts than some other multiphase clock designs, this disadvantage is offset by high operational reliability.

**References**

1. Bentley, James H., "The Foolproof Way to Sequencer Design," *Electronic Design*, No. 10, May 10, 1973, pp. 76-80.
2. Laurino, A. J., "Single IC Pulser Eliminates Contact Bounce," *Electronics*, Nov. 9, 1970, p. 79.

*James H. Bentley, Principal Development Engineer, Government & Aeronautical Products Div., Honeywell Inc., 1625 Zarthan Ave., St. Louis Park, MN 55416.*

CIRCLE No. 311

## Flat, flexible TV antenna offers high gain

Better than the simple indoor TV "rabbit ears," but not as good as a complex, multi-element outdoor antenna, a flexible PC antenna is limited to the reception of single-direction vhf and uhf broadcasting.

The design uses the configuration of a multi-element outdoor antenna, but in a flexible printed-circuit form. It can bring the advantages of high gain and directivity into a den or living room, and avoid the problems of the outdoor environment.

All the user needs to do is orientate the flat antenna under the rug, in close proximity to the TV, and connect it to the set's 300-Ω input with flat, twin-lead wire. However, expect some loss in range compared with a roof installation, because of the lower elevation.

The design in the figure has 13 elements. In theory, there is very little restriction on the maximum number of elements that you can use. A flexible plastic sheet can be pieced together from Mylar velum. Other necessary materials include 1/8-in.-wide adhesive copper tape, 1/4-in.-wide adhesive copper doughnuts and Mylar insulating tape for crossovers. The copper ma-

terials are solderable, but avoid overheating them.

*Marshall K. Kessie, Bechtel Corp., P.O. Box 60860, Term. Annex, Los Angeles, CA 90060.*

CIRCLE No. 312

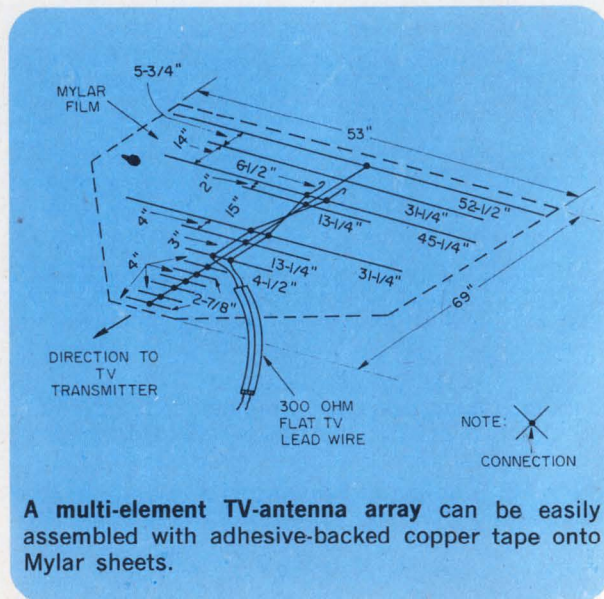

**A multi-element TV-antenna array can be easily assembled with adhesive-backed copper tape onto Mylar sheets.**



# New... OEM II

**Powertec's second generation  
open-frame D.C. Power Supplies  
featuring**

**3 great new packages**



For years, our original OEM's have been recognized as the finest on the market. Now, we're introducing the OEM II Series . . . and it is even better!

First, to help you avoid costly "over-buying," we've expanded the line by adding 3 new packages and 9 new models. Take our new Model 2A5-1.2A, for example. 5V at 1.2A — the smallest open-frame standard power supply available today. Anywhere.

Second, there are completely new electronics. Fewer components, simplified circuitry. Higher efficiency and increased reliability. Improved specs for every model.

- And features:
- Remote sensing and programming
  - IC regulated design
  - Output screw terminals, fanning strip compatible
  - All hermetic transistors and diodes
  - Reverse polarity protection
  - Open remote sense lead protection
  - Improved temperature rating
  - 100% interchangeable with previous models
  - Conservative component selection. And more. Much more.

It all adds up to *extra performance at no extra cost.*

**FOR COMPLETE DETAILS, SEND FOR THE NEW OEM II BROCHURE**  
Powertec, Inc., 9168 DeSoto Ave., Chatsworth, CA 91311 • (213) 882-0004

MODEL 2A — FROM 5V, 1.2A  
**\$24<sup>95</sup>**

MODEL 2CC — FROM 5V, 9A  
**\$67<sup>00</sup>**

MODEL 2DD — FROM 5V, 18A  
**\$109<sup>00</sup>**

Model Number	Voltage-Current	Price	Model Number	Voltage-Current	Price	Model Number	Voltage-Current	Price
2A5-1.2A	5V - 1.2A 6V - 1.0A	\$24.95	2C5-6A	5V - 6.0A 6V - 5.0A	\$54.00	2D5-12A	5V - 12.0A 6V - 10.0A	\$ 87.00
2A15-.5A	12V - 0.5A 15V - 0.5A	\$24.95	2C15-2.8A	12V - 3.0A 15V - 2.8A	\$54.00	2D15-6A	12V - 6.5A 15V - 6.0A	\$ 87.00
2A24-.4A	18V - 0.4A 20V - 0.4A 24V - 0.4A	\$24.95	2C24-2.3A	18V - 2.0A 20V - 2.3A 24V - 2.3A	\$54.00	2D24-5A	18V - 4.5A 20V - 5.0A 24V - 5.0A	\$ 87.00
2B5-3A	5V - 3.0A 6V - 2.5A	\$32.00	2CC5-9A	5V - 9.0A 6V - 7.5A	\$67.00	2DD5-18A	5V - 18.0A 6V - 16.0A	\$109.00
2B15-1.3A	12V - 1.5A 15V - 1.3A	\$32.00	2CC15-4.4A	12V - 4.8A 15V - 4.4A	\$67.00	2DD15-9A	12V - 10.0A 15V - 9.0A	\$109.00
2B24-1A	18V - 1.0A 20V - 1.0A 24V - 1.0A	\$32.00	2CC24-3.7A	18V - 3.3A 20V - 3.7A 24V - 3.7A	\$67.00	2DD24-7.5A	18V - 6.8A 20V - 7.5A 24V - 7.5A	\$109.00

Regulation: 5V Models 0.1%  
 15V & 24V Models 0.05%

Line Load  
 0.1% 0.15%  
 0.05% 0.05%

Ripple: 3 mV PK-PK

# POWERTEC

INFORMATION RETRIEVAL NUMBER 53



# Convert your pocket calculator into a programmable counter

A pocket calculator can do the job of a counter, if you bring out the contacts of the  $\equiv$  key switch (or the  $+$  switch on some models) and use a reed switch or photodiode to make a circuit closure. The built-in-constant feature of most of today's low-cost calculators is also used.

If you enter 0  $+$  1  $\equiv$  into the calculator, every time you press the  $\equiv$  button thereafter, you will add one to the sum. Consequently if you use the external contacts, the calculator counts the number of times the contacts close, and the display shows one count more than the number of closures.

If you use a magnetic-reed switch as the external contact, a small magnet attached to a rotating, or moving part of a device can operate the reed switch. A photodiode requires a light source and a moving light shield or reflective surface.

You can program the calculator to count up or down by entering either  $+$  or  $-$ . And you can start with a number other than one, and the calculator will count in multiples of this number. For example, the revolutions of a capstan can be converted to inches if a number equal to the capstan's circumference is entered.

But calculators are not very fast, so don't attempt to use one for high-speed counting. However, for most chores around the lab, you can't beat it.

*George Alexandrovich Sr., Vice President Engineering, Robins/Fairchild, 75 Austin Blvd., Commack, NY 11725.* CIRCLE No. 313

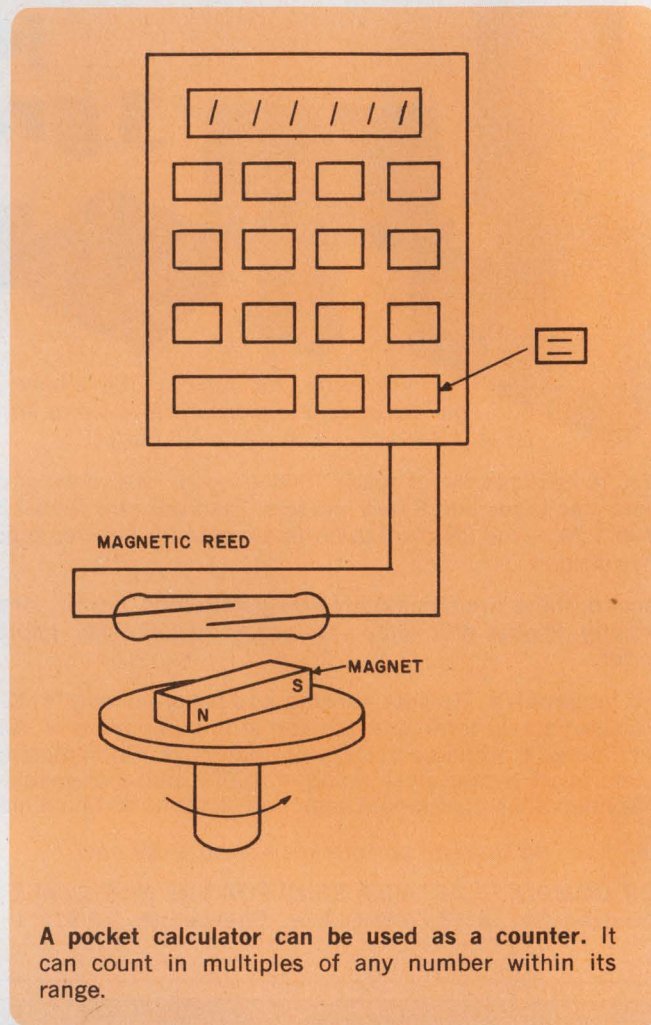

### IFD Winner of November 8, 1974

**Jack Althouse**, Palomar Engineers, P.O. Box 455, Escondido, CA 92025. His idea "IC Timer, Stabilized by Crystal, Can Provide Subharmonic Frequencies" has been voted the Most Valuable of Issue Award.

**Vote for the Best Idea in this issue** by circling the number of your selection on the Information Retrieval Card at the back of this issue.

**SEND US YOUR IDEAS FOR DESIGN.** You may win a grand total of \$1050 (cash)! Here's how. Submit your IFD describing a new or important circuit or design technique, the clever use of a new component or test equipment, packaging tips, cost-saving ideas to our Ideas for Design editor. Ideas can only be considered for publication if they are submitted exclusively to ELECTRONIC DESIGN. You will receive \$20 for each published idea, \$30 more if it is voted best of issue by our readers. The best-of-issue winners become eligible for the Idea of the Year award of \$1000.

ELECTRONIC DESIGN cannot assume responsibility for circuits shown nor represent freedom from patent infringement.



# When RFI problems get sticky, try **stickn fingers**®

**Attaches faster, shields better than anything else!**

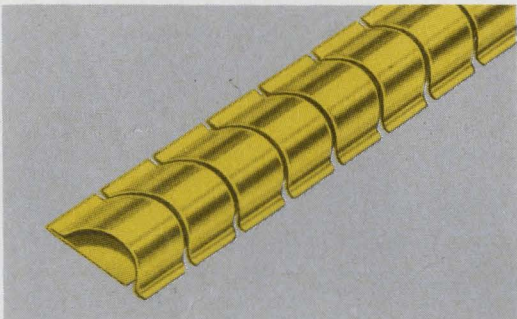

**SERIES 97-500** The original Sticky Fingers with superior shielding effectiveness.

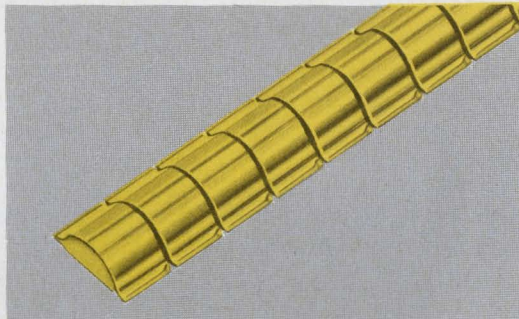

**SERIES 97-520** A smaller size Sticky Fingers for high shielding effectiveness in less space.

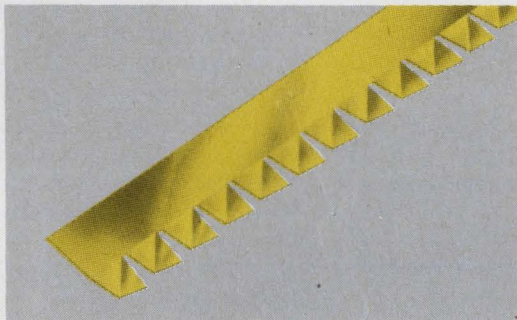

**SERIES 97-555** New Single-Twist Series for use when space is at a premium. Measures a scant  $\frac{3}{8}$ " wide.

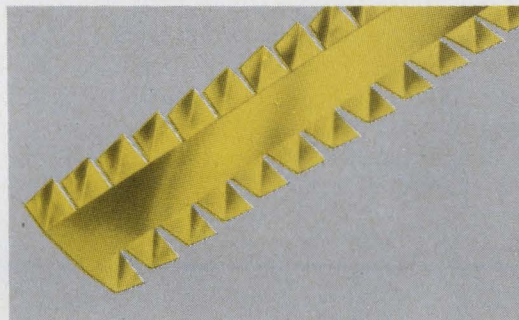

**SERIES 97-560** New  $\frac{1}{2}$ " wide Double-Twist Series, ideal for panel divider bar cabinets.

Now you can specify the exact type beryllium copper gasket that solves just about every RFI/EMI problem. Perfect for quick, simple installation; ideal for retro-fitting. Self-adhesive eliminates need for special tools or fasteners. Write for free samples and catalog.

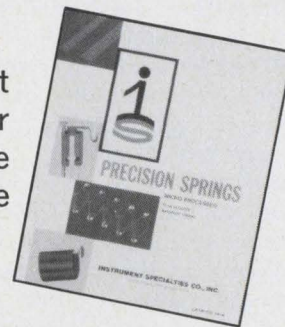

**INSTRUMENT SPECIALTIES COMPANY,** Dept. ED-65

Little Falls, N.J. 07424

Phone—201-256-3500 • TWX—710-988-5732



## New image tube moves into 8-to-14- $\mu\text{m}$ region

An image tube based on the electron-mirror principle and using a pyroelectric target has been developed for operation in the 8-to-14- $\mu\text{m}$  wavelength region.

Designed at the Services Electronics Research Laboratory in Baldock, England, the tube has sufficient sensitivity to detect temperature differences of 1 K.

A time-varying thermal scene, focused onto a triglycine sulphate pyroelectric element by wide-aperture germanium optics, produces voltages on the order of millivolts for image temperature differences of a few degrees K. Because the spatial frequencies in a 10-to-20-mm diameter image can easily be a few line-pairs per millimeter, the thermal image produces pyroelectric fields of over 10 V/m.

In the tube, electrons are reflected from the target, which is held close to the potential of the electron-gun cathode. The reflected electrons, after acceleration to 3 to 6 keV, strike a fluorescent screen. The thermal image is reproduced there with sufficient detail to give recognizable images of human faces or hands.

Many tubes have a sensitivity comparable to that of a pyroelectric Vidicon. But the electron-mirror tube's power consumption is considerably less. The electron reflection process in the mirror tube allows the use of thicker targets without loss of sensitivity. Thus spatial definition in the new tube will probably exceed that of the Vidicon. The mirror tube can also be expected to be less microphonic.

## Bandwidth improved in optical fibers

The transmission bandwidth of optical fibers has been improved at the Siemens Laboratories in Munich, West Germany, by control of the mode coupling. The control was achieved by application of tension to an optical fiber.

In experiments, a 1-km-long fiber was wound onto a 38-cm-diam drum of expanded polystyrene. When the drum and fiber were heated from 0 to 50 C, expansion of the drum—which was greater than that of the fiber—stressed the fiber. The researchers report that temperature rise alone does not affect the fiber properties.

Pulses of infrared energy from a gallium-arsenide laser were sent into one end of the fiber. At the

other end of the fiber, a p-i-n diode and a sampling oscilloscope detected and displayed the output. The mode coupling increased with mechanical tension, and the output pulses became smaller, but more symmetrical, in shape. The pulse shape is independent of the input conditions when the fiber is under moderate tension. With excess tension, losses increase in the fiber and the output pulses become very small.

The Siemens researchers determined that light originally transmitted in a mode of certain velocity does not remain in this mode throughout the length of the fiber. Instead the energy is randomly coupled to modes of different velocities, and the fiber output is a mixture of lower and faster light components.

## Video recorder offers long playing times

BASF, one of the largest European chemical concerns and a pioneer in the manufacture of magnetic tape, is planning to enter the consumer electronics market with a Longitudinal Video Recording (LVR) cassette system.

The LVR system uses a  $4.4 \times 4.4 \times 0.06$ -in. cassette and a chromium dioxide ( $\text{CrO}_2$ ) tape, for extremely high signal-packing density. The 1/4-in.-wide tape can be used for color and black-and-white recording. It is said to offer 90 or 120 min of playing time, depending on the thickness of the tape used.

The machine uses a fixed head, and recording is done longitudinally, in contrast with the usual helical recording techniques. The LVR system contains a contact-pressure tape transport that is driven by a motor. The tape is pressed against the rotating transport drum from the moment it leaves the spool. It passes the head assembly, still in contact with the transport drum, and leaves it at the point where the take-up spool is pressed against the drum.

This feature allows the use of very thin tapes—9  $\mu\text{m}$  for 90 min of playing time and 6  $\mu\text{m}$  for 120 min. The tape speed is 3 meters/s, which equals about 118 in./s. Another unusual feature is that there are 28 parallel, tightly spaced tracks on the quarter-inch tape. This makes switching between tracks necessary. BASF does the trick in track-to-track switching time of 80 ms.

## Tiny transmitter sends body data from animals

Unlike traditional designs, a new miniaturized radiotelemetry transmitter can telemeter dc outputs from temperature, heat-flow, pressure and other transducers. Developed at the Cambridge Institute of Animal Physiology in England, the transmitter has been used for telemetering biological data from animals without hindering their movement.



# CELANEX. DOUBLE INSULATION.

Celanex is tough. It has excellent dielectric strength, dimensional stability and creep resistance. Very low moisture absorption. All necessary for this motor housing.

More important.

Celanex thermoplastic polyester provides double insulation. Protection from electrical hazard for users of the top-of-the-line Kirby vacuum cleaner.

Reasons enough for The Kirby Company, division of The Scott & Fetzer Co., Cleveland, Ohio, to choose Celanex. But there's more.

Cost saving, for example.

Automatic injection molding in Celanex speeds production. Eliminates expensive machining and finishing. And saves you from the skyrocketing costs of metal.

For more about what Celanex can do for you, write Celanese Plastics Co., Dept. X-611, 550 Broad St., Newark, N.J. 07102. Celcon® Celanex® Celanese® Nylon

Celanese Plastics Company is a division of Celanese Corporation.



**CELANESE  
ENGINEERING  
RESINS**

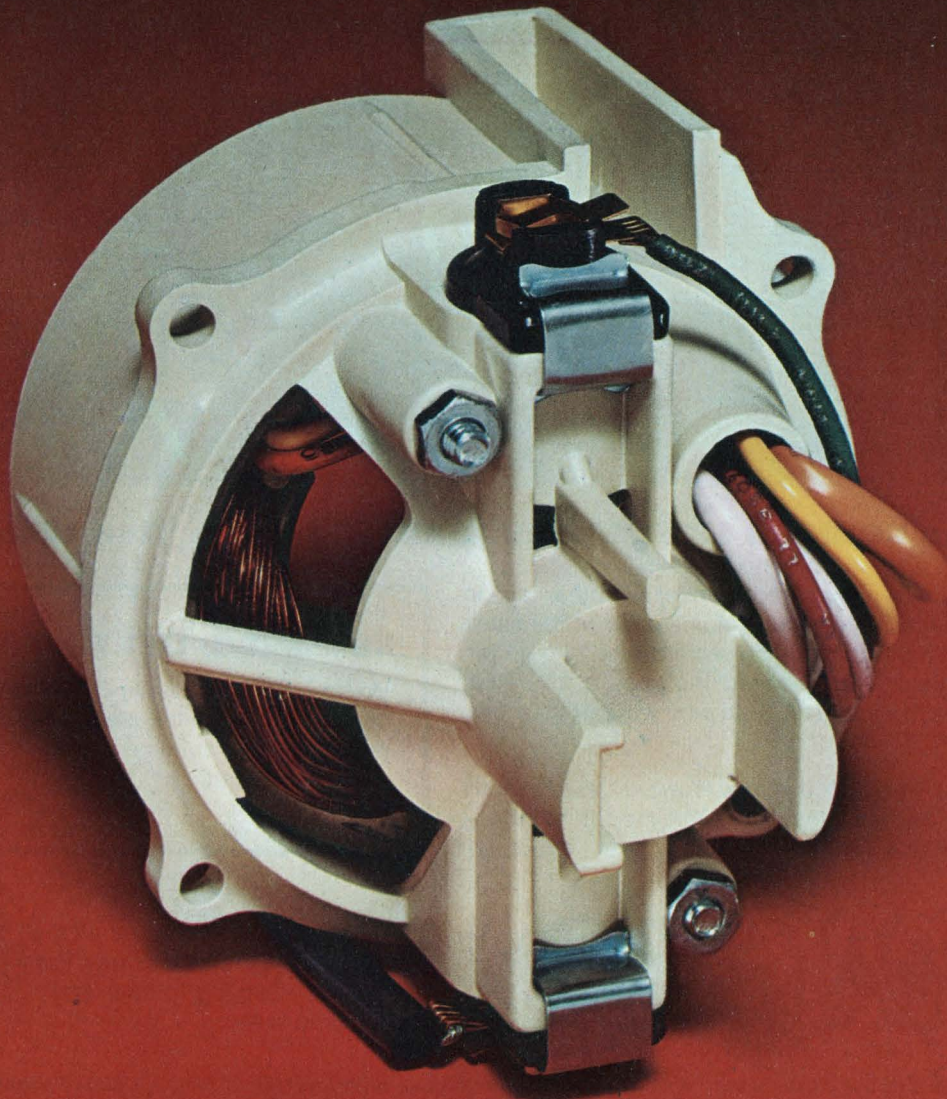



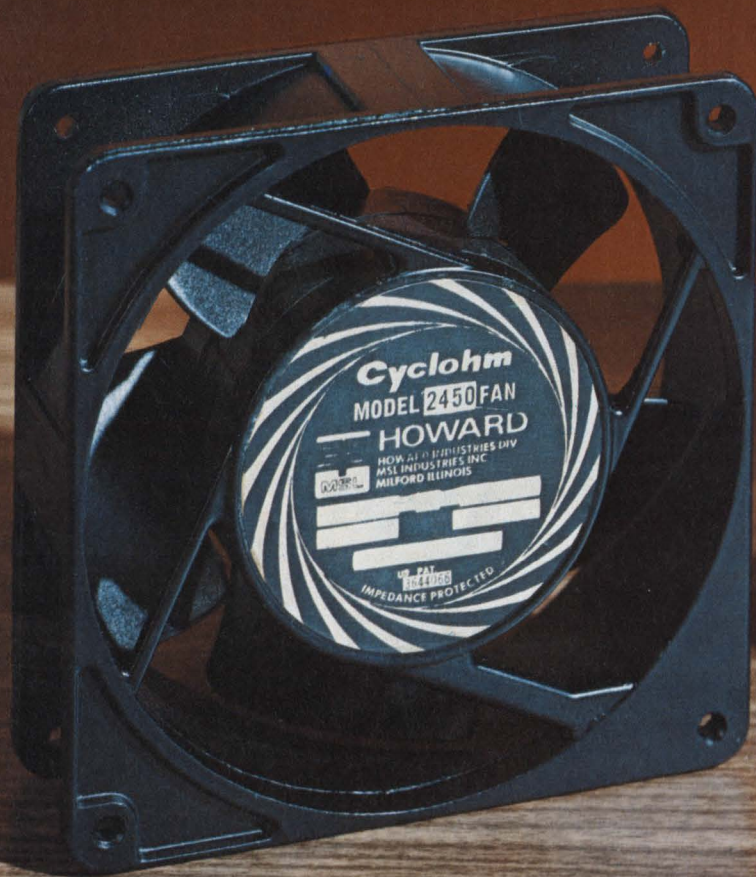

# an unfair comparison...

## The HOWARD LIFETIME GUARANTEE fan vs. "the other fan"

The new Howard Cyclohm fan matches the "other fan" in every way. It delivers the same volume of air in the same quiet way—even costs about the same as the "other" fan you are now using. But Howard includes a LIFETIME GUARANTEE with every fan. (See why we call the comparison "unfair"?)

In all fairness we admit this new Howard fan is exactly the same size as "the other fan". They're interchangeable. And available "air away" and "air over" motor.

**HOWARD'S LIFETIME GUARANTEE**

Howard will replace any Cyclohm fan that fails in normal service **for the life of your product.** Accidents or intentional damage are not included.



**Be fair to yourself**—Send for all the "unfair facts". Howard's new Fan and Blower Catalog is now available—write today.



## new products

# Dual-trace battery-powered scope weighs 10 lb and operates to 10 MHz

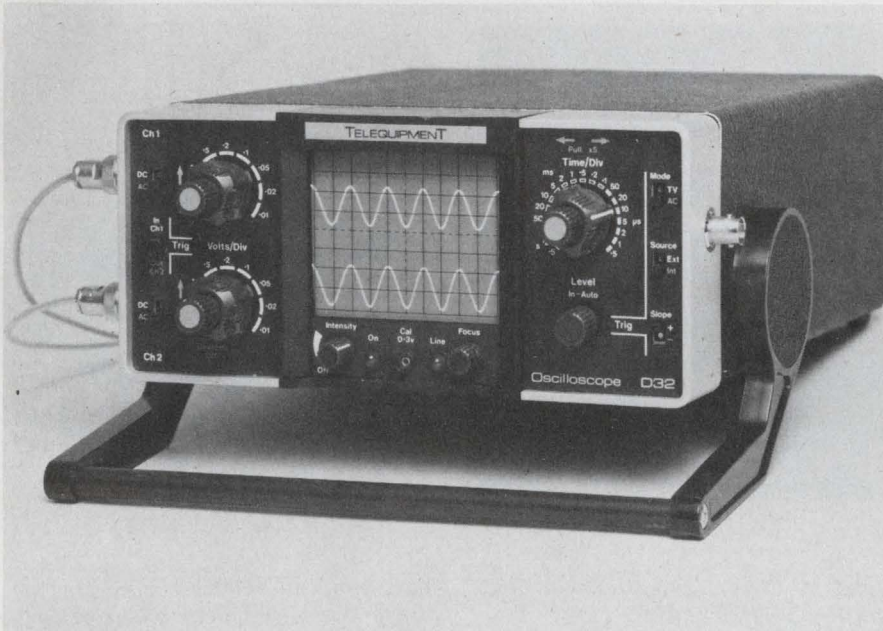

Telequipment Div. of Tektronix, P.O. Box 500, Beaverton, OR 97077. (503) 644-0161. P&A: See text.

A dual-trace portable scope, the D32, developed by the Telequipment Div. of Tektronix, weighs 10 lb. and has a 3-dB bandwidth of 10 MHz. The scope uses rechargeable D-cell batteries that provide up to four hours of continuous use.

The screen of the CRT has an  $8 \times 10$  division graticule, with each division 0.7 cm on a side. The CRT uses a standard p31 phosphor and has a 3-kV accelerating voltage. The package dimensions, only 4 in. high  $\times$  9 in. wide  $\times$  11 in. deep, include all projections except for three female BNC input connectors on the scope sides.

Among the D32 features are vertical sensitivity from 10 mV/div to 5 V/div in nine steps; 19 sweep speeds from 500 ns/div to 500 ms/div (extended to 100 ns/div with a  $\times 5$  magnifier); auto selection of TV line frame displays; auto selection of chopped or alternate mode display; and triggering level control.

A built-in charger circuit permits either trickle charging while the scope is operating or overnight charging when the unit is off. The power source is six D cells at 1.25 V each, or 100 to 250 V ac, 50 to 400 Hz. When operated from ac, the unit consumes 14 VA; under battery power, dissipation drops to 7 VA.

A front-panel ac output of 0.3 V pk-pk, permits simple field calibration of input voltage. Front-panel indicator lamps show when the instrument is on and when the ac line is in use.

The time-measuring accuracy of the scope on the  $\times 1$  scale is  $\pm 5\%$ . On the  $\times 5$  scale, from 200 ns/div to 100 ms/div, accuracy is  $\pm 7\%$ , and on the 100-ns range,  $\pm 10\%$ . The trigger level can be adjusted over the full eight-division display (for positive and negative slopes). In the absence of a trigger signal, a bright line automatically appears on the screen.

Included as standard equipment in the \$1000 price are the rechargeable battery pack, two  $\times 10$  passive probes with 3.5-ft cables, BNC

connector and spring-loaded probe sheath; and a molded front-panel cover to protect the scope during transportation and storage. An optional feature is a shoulder-strap carrying case.

The D32 is available in 16 wk.

CIRCLE NO. 305

## Meter locks on signals with 3 MHz equivalent bw

Evans Associates, P. O. Box 5055, Berkeley, CA 94705. (415) 848-6839. \$1350; 4 wks.

Model 4103A digital lock-on-voltmeter measures incoming periodic signal amplitudes over the frequency range of 1 Hz to 100 kHz, with an equivalent filter bandwidth selectable down to less than 2 mHz. Tracking is automatic—less than four periods are required to lock onto any desired frequency. A variable phase control permits measurement of vector component values.

CIRCLE NO. 320

## New DPM family includes 3-3/4-digit models

Gralex Industries, 155 Marine St., Farmingdale, NY 11735. (516) 694-3607. Start at \$80 (100); 4-6 wks.

A new family of DPMs is highlighted by its 3-3/4-digit models. Features include Beckman planar gas-discharge displays, ac line or 5-V-dc powered versions, full-scale voltage ranges of 399.9 mV, 3.999 V and 39.99 V, and an accuracy of  $\pm 0.1\%$  of reading  $\pm 1$  digit. Space and supply voltages are provided to permit the user to incorporate his own circuitry within the meter.

CIRCLE NO. 321



# a little A-300 goes a long way.



**In high frequency transmission. RF power generation for industrial and research processes. RFI/EMI and general laboratory applications, too.**

The Model A-300 is a totally solid state power amplifier, covering the frequency range of 0.3 to 35MHz with a gain of 55dB. Capable of delivering 300 watts of linear Class A power and up to 500 watts in the CW and pulse mode, the A-300 is the ultimate in reliability.

Although the unit is perfectly matched to a 50 ohm load, it will deliver its full output power to any load (from an open to a short circuit) without oscillation or damage.

Complete with power supply, RF output meter and rack mount, the A-300 weighs a mere 89 pounds and operates from ordinary single phase power.

High power portability goes a long way for \$5350.

For further information or a demonstration, contact ENI, 3000 Winton Road South, Rochester, New York 14623. Call 716-473-6900 or TELEX 97-8283 E N I R O C

## ENI

The World's Leader  
in Solid State  
Power Amplifiers

SEE  
Electronic Design's  
**GOLD BOOK**  
FOR COMPLETE  
PURCHASING  
INFORMATION

## INSTRUMENTATION

# Extra-safe VOM provides self-test

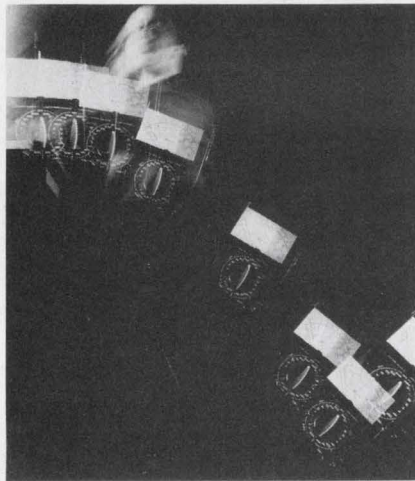

Triplett Corp., 286 Harmon Rd., Bluffton, OH 45817. (419) 358-5015. \$90; stock.

Drop a new VOM from a 5-foot height and what happens? Nothing. Check a fuse on the  $\times 1$ -ohm range, then try to measure line voltage without changing range and function. And what happens? You may blow one or two of the meter's three fuses. But you don't blow the meter and you don't even wrap the pointer around the peg.

But you're nervous. In that first millisecond after you realize that you forgot to switch to a voltage range, you figure "there goes a \$90 meter," or "there goes 30 days and a \$25 repair bill," or "if this survives, it's because I've been living right, but I'll have to send it to the cal lab to find out." Not so. After you replace any blown fuses (there are two spares in the meter), you can check out the Triplett "Extra Chance" Model 60 in about 30 seconds.

You set the mechanical zero adjust, switch to the  $\times 10k$  ohms position, short the leads and adjust the ohms control for a zero reading. Then, with the leads still shorted, you switch to "Test." If the needle lands in a mid-scale red

bar, you can relax.

In short, Triplett has made it difficult to damage this meter electrically or mechanically, and easy to find out if some fiendish accident has spoiled the specified accuracy—2% of full-scale on dc ranges, 3% on ac ranges.

If the accuracy isn't good enough for you, Triplett has the \$100 60A, a mirror-backed version with 1.5% dc accuracy.

Both versions have input impedance of 20,000 ohms per volt dc and 5000 ohms per volt ac. Each has 23 ranges for dc voltage and current, ac voltage and resistance, and a decibel scale.

A wide range of accessories includes a \$28.50 clip-on ammeter that provides six ac ranges from 6 to 300 A.

The Extra Chance is designed to be extra safe for humans as well as for itself. It has, for example, no exposed metal parts. Connections from the four-foot test leads to the meter are through insulated banana jacks on the leads to recessed banana plugs in the meter. At the other end, the pin-tip probes can accept slip-on, boot-protected alligator clips.

CIRCLE NO. 304



**Facit 4553 Alphanumeric Serial Page Printer**

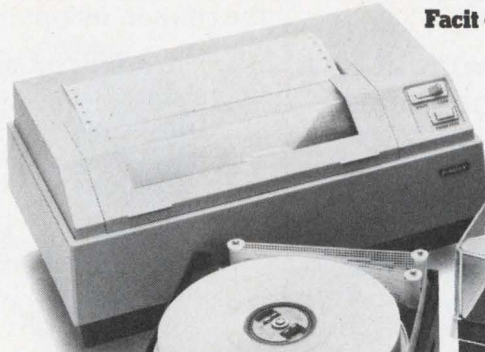

**Facit 4070 Tape Punch**



**Facit 4020 Paper Tape Reader**

# We'll read, type, record, print, punch, spool and reproduce for just about anybody.

In our eyes, just about everyone is created equal.

Because our peripheral data components—alphanumeric page and strip printers, punches, readers and recorders, to name just a few—are designed and engineered to fit into just about any configuration.

And, while being easy to get along with, our equipment is also dedicated to working tirelessly to give you top performance and long service, with a minimum of maintenance.

In fact, we honestly feel that no other OEM manufacturer offers a better performance to price ratio.

To show you just how open-minded we are about helping just about anybody, we're asking everybody to fill out the coupon and send it to us.

We'll be very happy to send

you all the information you need on the equipment that was brought up to be compatible just about anywhere it goes.

Facit. A leading manufacturer of peripherals for all types of computer and data recording systems.



# FACIT

**DEDICATED TO EFFICIENCY.**

**FACIT-O.E.M. DIVISION**

LD375

501 Winsor Drive  
Secaucus, New Jersey 07094

Gentlemen:

Please send information on peripheral data equipment that will perform well in just about any situation.

NAME \_\_\_\_\_

FIRM \_\_\_\_\_

ADDRESS \_\_\_\_\_

CITY \_\_\_\_\_ STATE \_\_\_\_\_ ZIP \_\_\_\_\_



**DIRECT FROM STOCK**

**SINGLES  
72<sup>00</sup>**

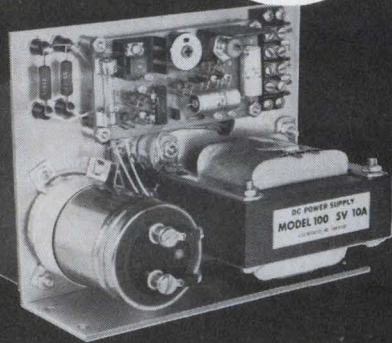

**5V10A**

**SINGLES AND DUALS  
FULL RATING AT 71°C**

**SPECIFICATIONS**

Size: 7 x 5.5 x 5.5 overall  
 Input: 105-125V, 47-420 Hz  
 Output: Any DC voltage 3 to 30  
 Regulation: Line — 0.005%  
 Load — 0.05%  
 Ripple: Less than 500 Microvolts  
 Temp. Operative —20 to +71°C  
 Storage —65 to +85°C  
 Coefficient —0.01%/°C Max.  
 Current Limiting: Fixed Foldback Type  
 Overvoltage: Optional

SINGLE OUTPUTS			DUAL OUTPUTS		
Model	Voltage	Amps	Model	Voltage	Amps
100-5	5.0	10.0	100-0505	5.0	5.0
				5.0	5.0
100-10	10.0	8.0	100-1212	12.0	3.5
				12.0	3.5
100-12	12.0	7.0	100-1515	15.0	3.0
				15.0	3.0
100-15	15.0	6.0	100-2424	24.0	2.0
				24.0	2.0
100-24	24.0	4.0	100-2828	28.0	2.0
				28.0	2.0

**ORDERING INFORMATION**

Quantity	Singles	With O.V.*	Duals	With O.V.*
1-9	\$72 ea	\$78 ea	\$85 ea	\$97 ea
10-14	68	73	81	91
25-49	62	67	73	83
50-99	57	61	67	76
100-	53	57	63	72

\*O.V. = Overvoltage protection

**CALL (714) 279-1414**

**Electrostatics, inc.**  
 7718 CLAIREMONT MESA BLVD. • SAN DIEGO, CA 92111

**INSTRUMENTATION**

**Synthesizers work at low end of frequency scale**



Philips Test & Measuring Instruments Inc., 400 Crossways Park Dr., Woodbury, NY 11797. (516) 921-8880.

These 100-kHz and 1-MHz synthesizers, designated the PM 5141 and PM 5142, respectively, offer optional programmable operation. Outputs are sines and square waves. The frequency is set by four thumbwheel switches and five pushbuttons, which determine the range. Out-of-range is indicated by a warning light. The amplitude is 10-V open circuit, 5 V into 600 Ω. Pushbutton attenuation provides two 10-dB and one 20-dB steps, with an additional continuous attenuation of 20 dB for a total of -60 dB. No price is available at press time.

CIRCLE NO. 322

**Counter retains data for more than 1000 h**



OKI Electronics of America, P.O. Box 24260, Fort Lauderdale, FL 33307. \$150

Model DC-401, a four-digit electronic digital counter, has all-solid-state electronic circuitry controlled by a CMOS IC and includes a built-in battery that allows data retention for more than 1000 h in case of power failure. Including the 12-pin connector, the unit is only 4-in. long and 2-in. wide. Weight is about 4 oz. The counter uses 5 V dc, is shock resistant and has a 4-digit, 7-segment LED display with character height of 1/8 in. Counting speed is 300 pps.

CIRCLE NO. 323

Before you forget, mail the coupon on opposite page

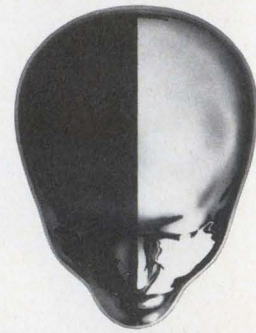

or contact your nearest **NITRON** representative for the facts about **EAROM**.

**EASTERN REGION**

**R. H. STURDY CO., INC.**  
 167 Worcester St., Wellesley Hills, MA 02181  
 Phone: (617) 235-2330  
 32 Horseshoe Road, Guilford, CT 06437  
 Phone: (203) 453-5424

**GANS-FRYLING, INC.**  
 2062 14th St. North, Arlington, VA 22201  
 Phone: (703) 527-3262  
 12027 Scaggsville Rd., Fulton, MD 20759  
 Phone: (301) 837-6311

**TECHNOLOGY MARKETING ASSOCIATES**  
 1010 E. Atlantic Blvd., Pompano Beach, FL 33061  
 Phone: (305) 942-0774  
 450 Andalusia Ave., Ormond Beach, FL 32704  
 Phone: (904) 672-2314  
 10118 Shades Rd., Huntsville, AL 35802  
 Phone: (205) 883-7893

**AD-EL-TEK CO.**  
 14 S. Walnut St., Englewood, OH 45322  
 Phone: (513) 836-2741 or 836-8471  
 13201 Abbey Rd., North Royalton, OH 44133  
 Phone: (216) 327-4472

**ELECTRO REP INC.**  
 366 North Broadway, Jerico, NY 11753  
 Phone: (516) 938-0540

**CENTRAL REGION**

**CARLSON ELECTRONIC SALES CO.**  
 7448 N. Harlem Ave., Chicago, IL 60648  
 Phone: (312) 774-9022 or 774-4812  
 Northbrook Executive Ctr. Suite 209  
 10701 W. North Ave., Milwaukee, WI 53226  
 Phone: (414) 476-2790  
 453 N. Lindbergh, St. Louis, MO 63141  
 Phone: (314) 991-0262  
 2310 W. 75th St., Shawnee Mission, KA 66208  
 Phone: (913) 432-2144

**WESTERN REGION**

**R. W. THOMPSON ASSOCIATES, INC.**  
 4140 Transport St., Palo Alto, CA 94303  
 Phone: (415) 321-7388

**ORION SALES, INC.**  
 1310 Air Way, Glendale, CA 91201  
 Phone: (213) 240-3151  
 430 East Main St., Tustin, CA 92680  
 Phone: (714) 832-9687  
 5832 Kantor Court, San Diego, CA 92122  
 Phone: (714) 299-8322

**INTERNATIONAL**

**KYOKUTO BOEKI KAISHA LTD.**  
 7th Floor, New Otemachi Bldg.  
 2-1, 2-Chome, Otemachi, Chiyoda-ku  
 Tokyo, 100-91 Japan  
 Telex: 781-02222044

**SILVERSTAR, LTD.**  
 20, Via Del Gracchi  
 20146 Milano, Italy  
 Telex: 843-32634

**TEKELEC AIRTRONIC**  
 Cite des Bruyeres  
 Rue Carle Vernet  
 92310 Sevres, France  
 Telex: 842-25997

**KLAASING ELECTRONICS B.V.**  
 Tramsingel 74  
 Breda, Holland  
 Telex: 844-54598

**JOHAN LAGERCRANTZ KB**  
 Gardsvagen 10B, Box 3014  
 17103 Solna 3, Sweden  
 Telex: 854-10363



# Introducing the incredible Nitron EAROM memories...

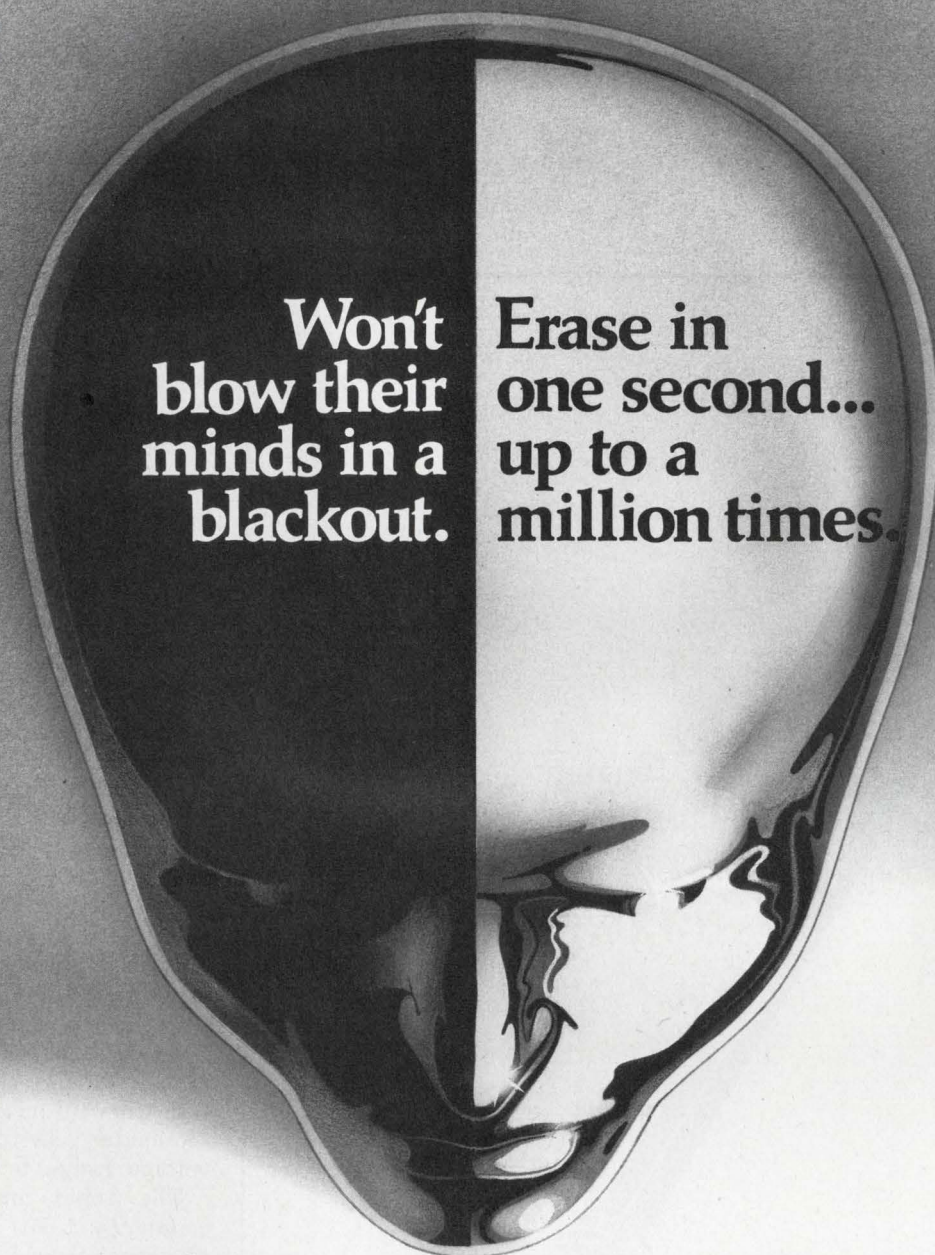

Won't  
blow their  
minds in a  
blackout.

Erase in  
one second...  
up to a  
million times.

Our non-volatile, electrically alterable, read-only memories (EAROMs) are the tiny memory devices that do it all:

1. They can store data for years without power.
2. They're non-destructive and immune to external power interruptions.
3. They let you erase stored information in just one second, without ultraviolet irradiation.
4. They let you alter the memory as often as needed — up to a million times.
5. They're particularly useful for communications, computer peripherals, and very low power applications.
6. Standard products and custom capability.

Part Number	Description	Power Supplies (Volts)	Package	Notes
NC7001	64 x 1	±15	18 DIP	ROM Organization
NC7002	1024 x 1 512 x 2	±15	40 DIP	ROM Organization
NC7010	1024 x 1 512 x 2	±15	28 DIP	ROM Organization
NC7030	8 x 16	±15	18 DIP	Shift Register Stack
NIT-80C	1K x 8	±15	PC Board	8K Memory Module
NIT-80T	1K x 8	±15, +5	PC Board	8K Memory Module

Before you forget, call us at (408) 255-7550.  
Or send the coupon for the full NITRON story.

**NITRON**

A division of  
**MCDONNELL DOUGLAS**



NITRON, 10420 Bubb Road, Cupertino, CA 95014

Before I forget, please tell me more about NITRON memories.

name

company

title

address



Victor now offers you a ready source of high quality, competitively priced miniature connectors... ruggedly built for reliable performance. Currently being used on portable, rechargeable calculators and similar small, solid state equipment. Standard configurations incorporate strain relief, but your cord set can be custom designed to your specifications...with or without strain relief.

Write or phone for details, and find out why Victor has become the standard of quality in cord sets and other wire specialty items.

**Victor Electric Wire & Cable Corp.**  
 618 Main St., West Warwick, Rhode Island  
 02893  
 Telephone: 401 821-1700



**New  
 miniature  
 connector.**

**Standard and  
 custom designs  
 in male & female  
 configurations.**

## INSTRUMENTATION

### Low-cost counter/timer has 100-MHz range



*Data Precision, Audubon Rd., Wakefield, MA 01880. (617) 246-1600. \$295; stock.*

A seven-digit, 100-MHz frequency counter, Model 5740, also measures period, period average, elapsed time and total events. The counter costs only \$295 in unit quantity and uses a 0.5-in. high LED display.

The measurement capabilities of the counter/timer include: frequency from 5 Hz to 100 MHz; single-period time (sine wave) from 1  $\mu$ s to 0.2 s; period average with 1-ns resolution to 99,999.99  $\mu$ s; event counting (totalizing) from 0 to 9,999,999; and time interval (stop watch) from 0 to 99,999.99 s (27.8 hr). Over a frequency range of 5 Hz to 20 MHz, the sensitivity is 10 mV rms, but as frequency increases to 100 MHz, the sensitivity drops to 50 mV rms.

Decimal-point placement is automatic, and an adjustable trigger-level control on the front panel allows odd-shaped waveforms to be measured. The trigger-level control, in conjunction with a 20:1 attenuator switch, extends the voltage range to  $\pm 250$  V.

The input impedance of the counter is 1 M $\Omega$  shunted by a 25-pF capacitance, although a 50- $\Omega$  input impedance termination is optional. A special feature of the counter is its ability to count and resolve random pulses. It can, for instance, count pulses as close together as 15 ns.

Four separate gate times can be switched by a front-panel control to take full advantage of the seven-digit resolution. The control covers gate times of 10, 1, 0.1 and 0.01 s for frequency resolutions of 0.1, 1, 10 and 100 Hz, respectively. The same switch, when used with a mode slide switch, allows single period time or average measurement over 10, 100 or 1000 periods.

CIRCLE NO. 302



# These sentries never relax



## L 120-L 121: monolithic drivers for SCRs and Triacs in high precision control systems

The L 120 and L 121 are monolithic integrated circuits each acting as a complete control system for SCRs and Triacs.

They will find application in speed and temperature control systems in a wide variety of industrial situations and in home appliances.

Both devices feature output short-circuit protection and are available in a 16 pin dual in-line plastic package for 0°C to + 70°C operation.

### L 120 - phase control

Continuous control of the firing angle of the SCR or Triac is provided by pulses having the same polarity as the mains in each half-cycle.

### L 121 - burst control

The L 121 is a device developed for burst type control systems with SCR or Triac power output stages. Its action determines the number of half-cycles of output power to be transferred to the

load in a set "base-period" (half-cycle resolution). In each base-period the duty cycle can be varied from 0 to 100% linearly.

The firing pulses produced when the system is ON have the same polarity as the mains.

### L 120 - block diagram

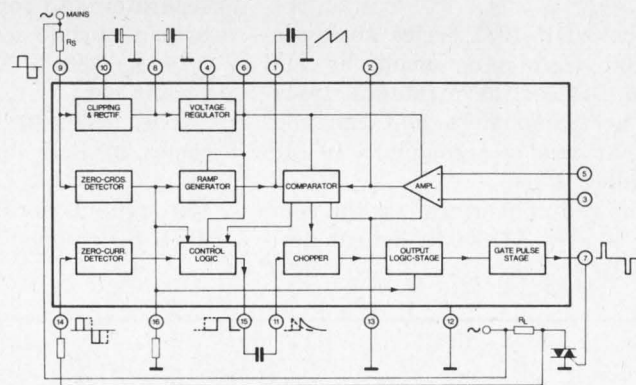

SGS-ATES Semiconductor Corporation - Newtonville, Mass. 02160 - 435 Newtonville Avenue - Tel: 617-9691610 - Telex: 922482

#### Stocking Distributors:

Energy Electronic Products  
6060 Manchester Avenue  
Los Angeles, CA 90045  
Tel.: (213) 641-9020

KA Electronic Sales  
1220 Majesty Drive  
Dallas, TX 75247  
Tel.: (214) 634-7870

Radar Electric Co.  
168 Western Avenue W.  
Seattle, WA 98119  
Tel.: (206) 282-2511

Wilshire Electronics  
1 Wilshire Road  
Burlington, MASS 01803  
Tel.: (617) 272-8200

Rosyl Electronics  
73 Cleveland Ave.  
Bayshore, NY 11706  
Tel.: (516) 586-1800

Prelco Electronics Ltd.  
480 Port Royal Street W.  
Montreal 357, Quebec  
Tel.: (514) 389-8051



# Hybrid IC converter series gives high speed at low cost

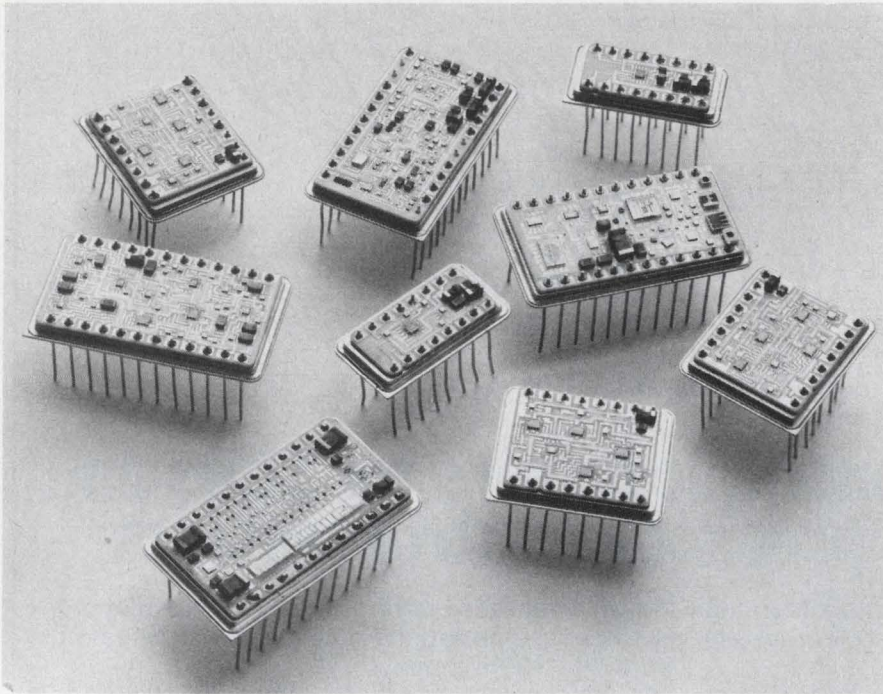

I/LC Data Devices Corp., Airport International Plaza, Bohemia, NY 11716. (516) 567-5600. P&A: See text.

The ADH-10/1 series analog-to-digital converters, made by I/LC Data Devices, have integral track-and-hold amplifiers and can convert an analog signal into 10 bits in under 1  $\mu$ s.

The a/d converters use the company's new ADH-030 hybrid digi-

tal-to-analog converter and the new ADH-050 hybrid track-and-hold amplifier (which are also available separately) to form an 8 or 10-bit hybrid module a/d that fits on a 5.25  $\times$  5.38  $\times$  0.375 in. printed-circuit card.

The ADH-10/1 a/d converter comes in four different versions: the 8/1-3, 8/1-1, 10/1-3 and 10/1-1. Throughput word rate for the two ADH-8 versions is 1.6 MHz since

they are accurate to only 8 bits. The ADH-10 units, though, are accurate to 10 bits and have a 1-MHz throughput.

Both the d/a converter and t/h amplifier are housed in hermetic DIPs that measure 1.4  $\times$  0.8  $\times$  0.2 in., not including pin height. There are two versions of the ADH-30 d/a available: the 030-8, with a current output linearity of 0.2%; and the 030-10, with a linearity of 0.05%.

Either d/a has a resolution of 12 bits and settles to within 0.01% of final value in 50 ns. The converters have current output capabilities of 0 to -16 mA or  $\pm$ 8 mA and a tempo of  $\pm$ 25 ppm/ $^{\circ}$ C. Glitch height for the converters is  $\pm$ 40 mV with a duration of approx 6 ns per peak.

The ADH-050 t/h amplifier, which has a 500-ps aperture time and 120-ns acquisition time, also comes in two versions: the 050 and 051.

The 051 has a longer acquisition time (600 ns) because it uses a larger internal holding capacitor. The larger capacitor also reduces the slew rate from 200 V/ $\mu$ s for the 050 to 40 V/ $\mu$ s typical, and it drops the signal bandwidth from 5 MHz to 1 MHz. It improves the drift,

(continued on page 114)



**ANALOG**  
GET THE BARE FACTS ON THE A-843 VOLTAGE TO FREQUENCY CONVERTER. STREAKS YOUR SYSTEM AT 0.1MHZ IN A STRAIGHT LINE  $\pm$ 0.01%. NEAT LITTLE 1 $\frac{1}{2}$ "  $\times$  1 $\frac{1}{2}$ "  $\times$  3 PACKAGE. RUN OUT AND GET ONE.

**intech** INCORPORATED  
(408) 244-0500  
1220 COLEMAN, SANTA CLARA CA 95050





## The Digisec® Encoder keeps little bits from becoming big mistakes.

As some people have found out the hard way, all bits are not of equal length. And what may appear to be just a small error—say a fraction of an arc-second, can lead to a large accumulated error.

As the long recognized leader in encoders, Itek realizes the importance of maintaining accuracy commensurate with resolution. And Digisec Encoders have resolutions and accuracy up to 22 bits/revolution. But that's just part of the story.

Write for our free catalog. Read all about Digisec Encoders. They're more than a bit ahead of their time.

**Itek**

**Measurement Systems**

A Division of Itek Corporation  
27 Christina Street, Newton, Mass. 02161

INFORMATION RETRIEVAL NUMBER 64

## FIELD ENGINEER TOOL KITS



### MORE THAN 40 STANDARD KITS UNLIMITED CUSTOM DESIGNS

Jensen leads the way in precision tool kits for field engineers, electronic technicians, scientists, instrument mechanics. Each kit engineer-designed to do a specific job. The JTK-17D illustrated above, for example, contains more than 100 tools. Most mounted on two removable pallets. Available with optional VOM meter. Deluxe attache case features hardwood construction, scuff-proof llama-grain cover, brass hardware. Roomy compartments hold spare parts, additional tools. Document pouch inside cover holds schematics, service manuals, etc.

Free Catalog. Write for new 112-page catalog detailing other kits, hard-to-find precision tools, and prices.



**JENSEN TOOLS and ALLOYS**  
4117 N. 44th Street, Phoenix, Arizona 85018

A BLISS & LAUGHLIN industry

INFORMATION RETRIEVAL NUMBER 65

ELECTRONIC DESIGN 6, March 15, 1975

# Dialight sees a need:

(Need: The widest choice for your every application.)



**739 SERIES** Save design time and installation costs . . . this LED display assembly is attractively designed in a convenient package with bezel and is ready for instant panel mounting. Available in groups of one or more characters, with or without decoder/driver . . . characters are 0.625" and come with either green or red LEDs in seven-segment format. Read-out offers lowest cost per character for comparable size.



**755 SERIES** High brightness planar gas discharge displays in a 0.550" character. Orange color gives high contrast ratio and allows readability to 40 feet even in high ambient lighting. Designed for interfacing with MOS/LSI, displays have an expected life of 100,000 hours or more.



Dialight, the company with the widest choice in switches, LEDs, indicator lights and readouts, looks for needs . . . your needs . . . and then they develop solutions for your every application. No other company offers you one-stop shopping in all these product areas. And no other company has more experience in the visual display field. Dialight helps you do more with these products than any other company in the business, because we are specialists that have done more with them. Talk to the specialists at Dialight first. You won't have to talk to anyone else. Send for your free new copy of Dialight's current catalog.

**DIALIGHT**

Dialight, A North American Philips Company  
203 Harrison Place, Brooklyn, N. Y. 11237  
(212) 497-7600

# See Dialight.

INFORMATION RETRIEVAL NUMBER 66

113



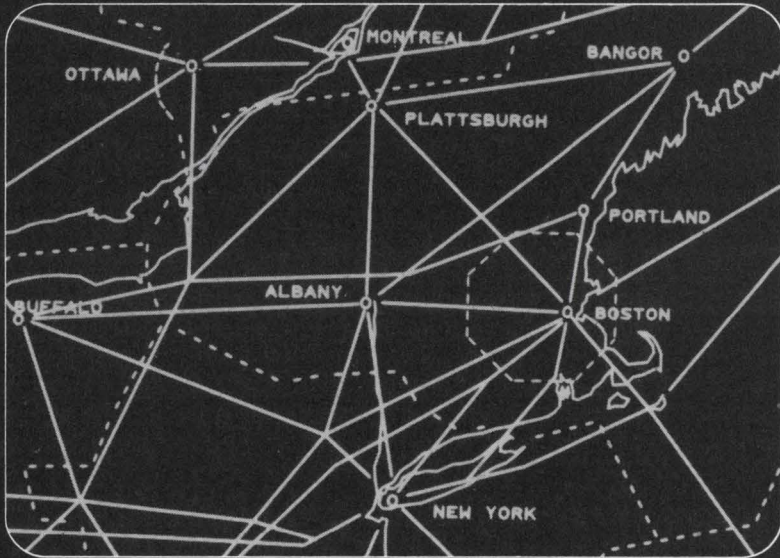

## Raytheon CRTs The ideal way to display your "Wheres"

Whether your display is for air traffic control, navigational, tactical, or some other sophisticated application, Raytheon CRTs and subassemblies deliver maximum brightness and resolution. They do it in a wide range of sizes, shapes, deflection types and phosphors... with special innovations too, like the RAYVUE Spectral Filter for viewability enhancement.

If you have a display requirement, you won't have the whole picture until you're aware of Raytheon's capabilities. Contact Raytheon Company, Industrial Components Operation, 465 Centre Street, Quincy, Mass. 02169. (617) 479-5300.

**RAYTHEON**

## MODULES & SUBASSEMBLIES

(continued from page 112)

however, from 1 mV/ $\mu$ s to 0.2 mV/ $\mu$ s. Both t/h amplifiers handle  $\pm 5$ -V signals and have linearity of 0.0125%.

You pay for the high speed—and not only in dollars—since these units use ECL circuits. Power consumption is a high 9 W maximum for the a/d, 2.275 W for the t/h and 1.5 W for the d/a.

Prices for the modules in unit quantities follows: ADH-8/1-3, \$675; 8/1-1, \$845; 10/1-3, \$725; 10/1-1, \$895; ADH-050 or 051, \$275; ADH-030-8, \$250; and 030-10, \$295.

All units are available with delivery times of 2 to 6 weeks and operate over a temperature range of  $-55$  to  $+85$  C. Processing to MIL-STD-883, level C, is standard, and level B processing is available at slightly extra cost.

CIRCLE NO. 301

## Adjustable timers have dpdt output contacts

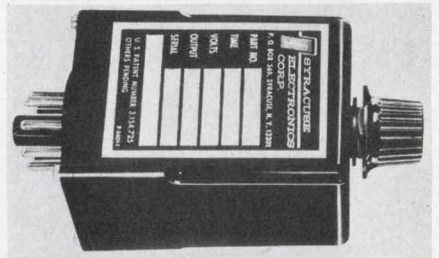

Syracuse Electronics, P.O. Box 566, Syracuse, NY 13201. (315) 488-4915. From \$16; 8 wk.

The TNR series timer has a repeat accuracy of  $\pm 2\%$  (typical) and 10-million-operation reliability. The TNR is a dpdt timer. It is plug-in, adjustable and comes in a wide range of delay intervals and input voltages. Plug-in timers are available over standard operating ranges of 0.1 to 480 s. Within each range, the timer is locally or remotely adjustable, and will accept variable input voltages from 12 to 115 V ac and from 24 to 230 V dc. Maximum output is 2 W. Reset time is 100 ms during and after timing. The timer will operate according to specs at temperatures ranging from  $-10$  to  $+60$  C.

CIRCLE NO. 324



# FULL CIRCLE SURGE PROTECTION

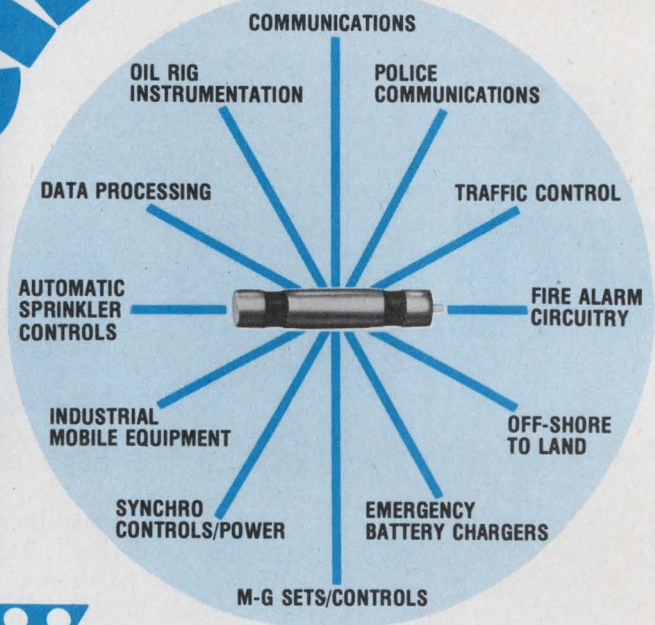

Protect your solid state equipment from junction damage caused by high-current surges due to power switching and lightning transient induction. Ordinary protective devices ground only one wire, allowing currents to reach your equipment through the "other" wire. TII 3-Electrode Gas Tube Surge Arresters simultaneously ground both wires of a signal or power pair. TII protection can end unnecessary service calls and customer complaints. To learn more about surge and how to protect against it, write for your free copy of "Surge Protection for Solid State Circuitry" or circle the appropriate reader reply number.

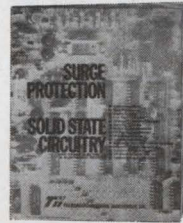

Worldwide Patents:  
 1,137,000; 1,170,361; 1,488,343;  
 2,281,428; 742,940; 2,332,153;  
 2,546,831; 748,990; 750,286;  
 3,035,779; 3,022,870; 3,791,711

UL-Listed and  
 REA-Accepted  
 Models Available

Licensed by M-O Valve Co., Ltd.,  
 and by Western Electric Co.  
 Made in U.S.A.

**TII TELECOMMUNICATIONS INDUSTRIES, INC.**  
 ® More than 2,000,000 TII Gas Tube Surge Arresters in Service.

1375 Akron Street  
 Copiague, New York 11726  
 (516) 842-5000 • Telex: 144631

INFORMATION RETRIEVAL NUMBER 68

## Environmental Control?

We've been doing it for 40 years with...

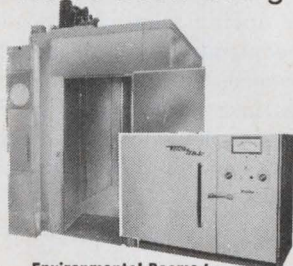

**Environmental Rooms/  
 Temperature Humidity Chambers**  
 Bench-top to walk-in.

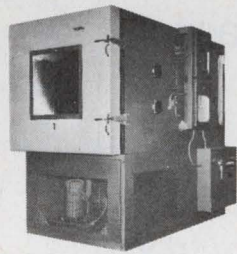

**TenneyZphere**  
 For simulation of  
 temperature, humidity, vacuum.

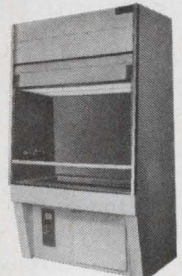

**Laminar-Flow  
 Clean Stations**

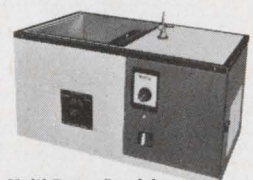

**Multi-Range Precision  
 Temperature Baths**

Write or call for further information on any of these, or autoclaves, packaged refrigeration systems, thermal shrouds, low temperature storage chests, etc.



1090 Springfield Rd., Union, N. J. 07083  
 (201) 686-7870 • (212) 962-0332

674C

"VISIT US AT BOOTH #2717 AT IEEE"  
 INFORMATION RETRIEVAL NUMBER 69

## You get something extra with Kurz-Kasch logic probes!!



Kurz-Kasch logic probes **do** replace scopes for field service applications. Here's how you get that something extra.

They provide optimum performance with duty cycle information and open circuit detection at no extra cost. You may not find these benefits with other probes, even as optional extras.

There is no better way to check out digital electronic equipment than with a Kurz-Kasch logic probe. Besides duty cycle and open circuit information, they display logic **Lo's**, **Hi's** and Pulses through the unique Kurz-Kasch White, Red and Blue color system.

You really won't know until you try one **FREE** for 30 DAYS. Call us: Kurz-Kasch, Inc., Electronics Division, 2876 Culver Avenue, Dayton, Ohio 45401. Tel: (513) 296-0330.



**FREE TEST DATA**



**Kurz-Kasch, Inc.**  
 ELECTRONICS DIVISION  
 2876 Culver Avenue  
 Dayton, Ohio 45401  
 Telephone 513/296-0330

INFORMATION RETRIEVAL NUMBER 70



# Sprague Delivers!

# YOU DON'T HAVE TO TAKE A SUBSTITUTE.



## THE CAPACITOR:

Sprague's Type 192P Pacer® ...  
The Dependable Low-Cost  
Miniature Polyester Film Capacitor.

## THE DELIVERY CYCLE:

Large Production Quantities  
4 - 8 Weeks ARO on All Popular  
Ratings. Off-the-Shelf Delivery from  
your Sprague Industrial Distributor.

## THE CATCH:

None.  
Sprague Delivers Film Capacitors.

Call your nearest Sprague district office or  
sales representative for complete information.

Sprague Electric Company,  
North Adams, Mass. 01247  
Tel. 413/664-4411

**SPRAGUE**®

THE MARK OF RELIABILITY

THE BROAD-LINE PRODUCER OF ELECTRONIC PARTS

## MODULES & SUBASSEMBLIES

### Scanning sequencer made for thermocouples



Omega Engineering, Box 4047,  
Stamford, CT 06907. (203) 359-  
1660. \$329; stock.

The Model 1695 thermocouple scanning sequencer automatically samples up to 24 thermocouples. It has a continuously variable channel dwell capability and can be set from 5 s to 1 min to reach each thermocouple. To change the amount of dwell-time for a particular thermocouple reading, rotate the dwell-time indicator a few degrees. The sequencer can be used with any thermocouple calibration. The unit is designed to operate from 110 V ac and consumes only 10 to 40 W during scanning. In addition to continually scanning up to 24 thermocouples, the 1695 can be operated manually as a 24-position thermocouple selector switch or anywhere sampling of various signals is desired.

CIRCLE NO. 325

### 14-bit d/a converter has 15 $\mu$ s settling time

Analogic, Audubon Rd., Wakefield,  
MA 01880. (617) 246-0300. \$129;  
stock to 2 wk.

The MP1814 digital-to-analog converter provides 14-bit resolution. The unit also includes a high speed voltage amplifier that slews at 10 V/ $\mu$ s. It has a throughput settling time of less than 15  $\mu$ s for conversion to within  $\pm 0.005\%$  of a full 20-V step. The MP1814 has pin-selectable analog output ranges of  $\pm 10$ ,  $\pm 5$ , 0 to 10 and 0 to +5 V.

CIRCLE NO. 326



## Monopulse comparator has 0.1 to 50 MHz range

Olektron, 6 Chase Ave., Dudley, MA 01570. (617) 943-7440. \$185.

The Model P-MC-50 monopulse comparator has four antenna inputs and provides reference, elevation, and azimuth. When used with a four-sector antenna array the comparator network provides bore-sight axis information for directing the array. Basic specifications of the comparator are as follows: frequency range, 100 kHz to 50 MHz; impedance, 50  $\Omega$  (all ports); VSWR 1.2 to 1 (all ports); isolation, 30 dB min between antenna ports; insertion loss, 0.5 dB (max); amplitude and phase balance, 0.25 dB and 3°, respectively; and bore-sight null depth, 35 dB on azimuth and elevation. The comparator measures 1.23  $\times$  1.109  $\times$  0.5 in.

CIRCLE NO. 327

## Vhf crystal oscillators intended for 400 MHz

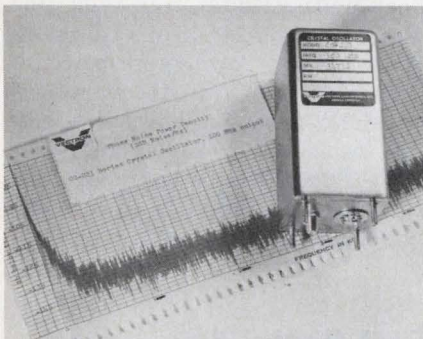

Vectron Laboratories, 121 Water St., Norwalk, CT 06854. (203) 853-4433. From \$325 (unit qty.); 1 to 4 mo.

Model CO-224 vhf crystal oscillator is available at any fixed frequency in the 25 to 400 MHz range. It provides an output level of 20 mW (+13 dBm) up to 200 MHz and 7 mW (+5 dBm) up to 400 MHz. The signal-to-noise ratio is 130 dB/Hz, 1 kHz from carrier. Aging is lower than  $1 \times 10^{-8}$  per day and temperature stability of  $\pm 5 \times 10^{-8}$  over 0 to 50 C is achieved by housing the oscillator in a proportionally controlled oven. Options include operation over the -55 to +85 C temperature range and voltage frequency control to permit phase locking on to an external reference or for remote frequency control.

CIRCLE NO. 328

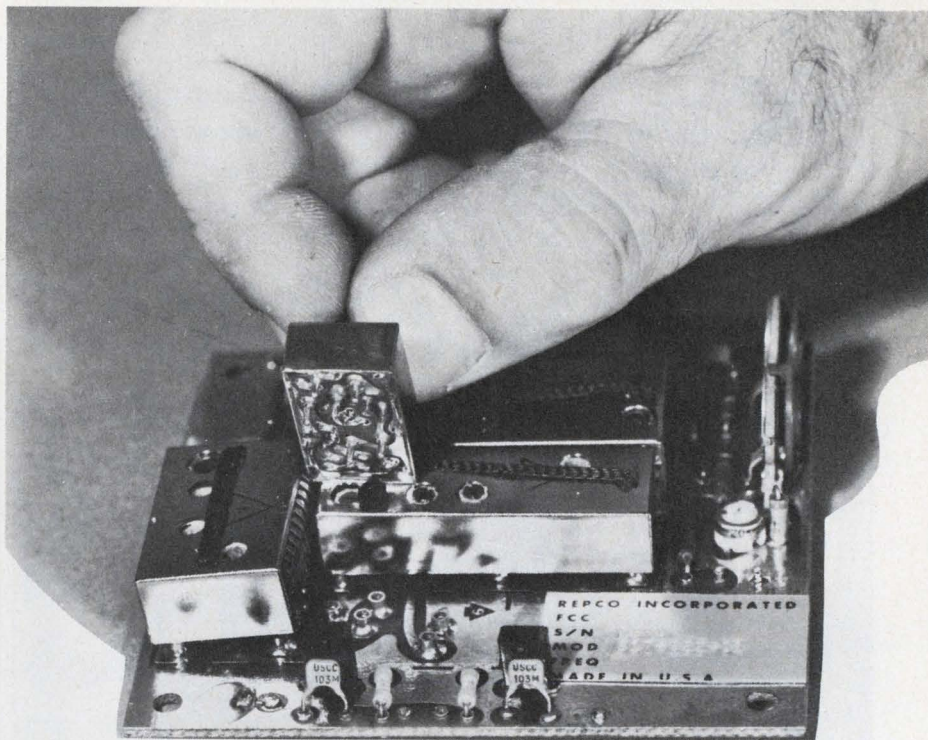

ACTUAL SIZE

# Link up

with Repco RF transmitters and receivers

Repco's FCC type accepted RF links give you design flexibility with proven reliability (actual cases report systems in use for years with no RF failure), excellent MTBF, rapid MTTR (with low cost, off-the-shelf PBC modules). Suitable for voice, low-speed digital, or tone. 25-50 Mhz, 66-88 Mhz, 132-174 Mhz; and our new UHF 450-470 Mhz ranges. Repco's delivery, production capacity, and volume pricing will warm your heart! Write today for our free specs brochure and special evaluation unit price.

## ----- Special evaluation offer! -----

### Repco, Incorporated

Special Products Department  
P. O. Box 7065, Orlando, Florida 32804  
(305) 843-8498 TWX 810-850-0120

Please send me free specs brochure and special low unit price available for evaluation of your RF links.



Name \_\_\_\_\_ Title \_\_\_\_\_

Company \_\_\_\_\_ Address \_\_\_\_\_

City \_\_\_\_\_ State \_\_\_\_\_ Zip \_\_\_\_\_

ED3

**Repco** World's leading manufacturer of modular handheld portable radios.

INFORMATION RETRIEVAL NUMBER 72



# Premier Electronic Cabinets and Cases

- ESTHETICS KEYED TO MODERN SYSTEMS
- RUGGED-FUNCTIONAL CONSTRUCTION
- ECONOMICAL PRICING
- PROMPT SERVICE & AVAILABILITY

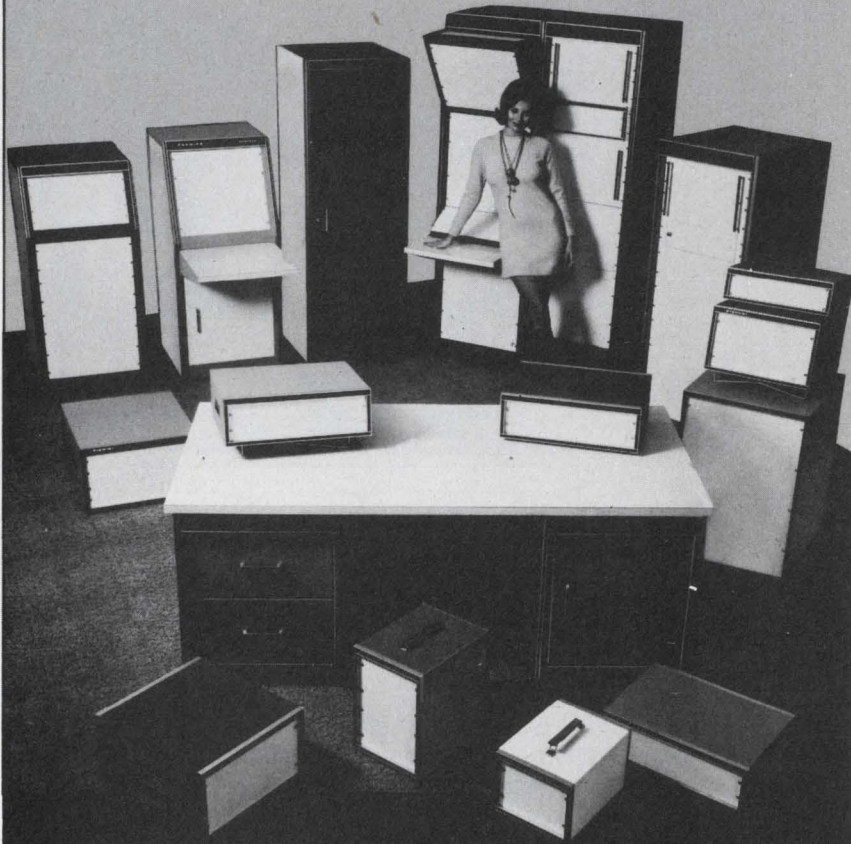

INSTRUMENT CASES-- TIC SERIES

**TVA Series Vertical Assembly—**  
Construction Details  
(1 Frame, 2 End Panels, Rear Door)

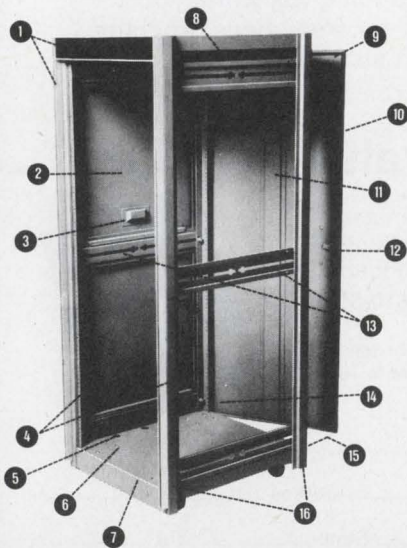

1. Trim: extruded anodized aluminum with textured vinyl inlays
  2. Outside removable flush end panels (16 ga.)
  3. Recessed hand grip for panel removal
  4. 2 pr. panel mounting angles, fully adjustable front to rear with tapped 10-32 holes on EIA & WE Standards spacing (12 ga.)
  5. 1" dia. holes for cable entry beneath base
  6. Recessed caster mounting holes
  7. 1 piece formed steel base provides for heavy equipment mounting area and concealed caster mounting (14 ga.)
  8. 1 piece solid top for extra rigidity and squareness (14 ga.)
  9. Foam gasketing (3 sides)
  10. Magnetic closure gasket
  11. Door stiffener channel
  12. Keyed latch and brushed aluminum pull handle
  13. Horizontal cross-brace and panel mounting angle supports
  14. Quick release, spring loaded door hinges (top and bottom)
  15. 1 1/8" dia. knock-outs for rear cable entry underneath rear door
  16. Formed steel uprights (14 ga.) provide 1/2" recess to panel mounting angles
- All features shown are standard in the Trimline TVA Series  
Welded, formed steel construction

Complete catalog and prices on request



**PREMIER METAL PRODUCTS CO.**  
335 Manida St., Bronx, N.Y. 10474/(212) 991-6600

"Visit our booth #1207--1209 at the IEEE INTERCON-75 SHOW APRIL 8th-10th"

INFORMATION RETRIEVAL NUMBER 73

## DATA PROCESSING

### CRT terminal enhanced by microprocessor

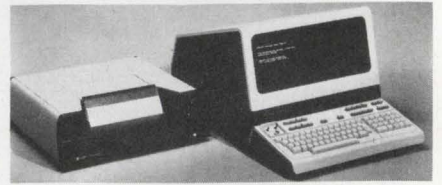

Hewlett-Packard, 1501 Page Mill Rd., Palo Alto, CA 94304. (415) 493-1501. From \$2640 (qty 6); Stock.

First in a series of new micro-programmed computer terminals, the Model 2640A CRT Terminal operates in either a page mode or a character mode. Among the benefits of microprocessing are a smart memory that can store over 400 lines of data (that can be viewed 24 lines at a time) up to four plug-in character sets, off-line data preparation and editing capability, and easy expandability. The user can verify and correct data before transmission to the CPU. The Model 2640A transmits one character or a block of characters at a time. Asynchronous data transmission of ASCII characters is RS-232-C compatible and selectable rates up to 2400 baud. The Model 2640A can be equipped with up to 14 powered slots of memory or peripheral interface.

CIRCLE NO. 329

### Fast floppy-disc system boasts long life

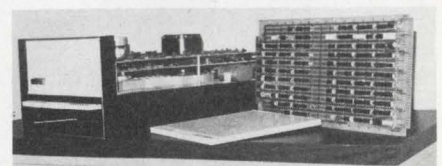

Fort Communications, 710 North Central, Richardson, TX 75080. (214) 690-0050. \$3500; 60 days.

A flexible disc system with hard disc longevity is available for CAI computers and PDP-11s. The controller fits on a half board, and handles up to eight drives. Each disc has a 2.16 M user bit capacity with a 17.26 M bit capacity for an eight drive system. Track-to-track seeks take 100 ms with 300 ms for 63 tracks. Data are transferred at 2.5 Mbit/s in DMA or regular I/O modes.

CIRCLE NO. 330



# When "off the shelf" won't do, call us!

If you're talking precision pots, then talk to Duncan. For the past 15 years, Duncan's crack engineering team has designed literally thousands of 'specials.' We're proud to have some of the nation's finest technical minds to help solve your engineering problems. And a short step away is Duncan's modern production and testing facilities. Since 'specials' are a major part of our regular business, you'll be equally impressed by our competitive prices and unusually quick delivery schedules.

Duncan is keeping up and ahead of our times to meet

your growing requirements for better more reliable products; including non-wirewound Resolon<sup>®</sup> Conductive Plastic elements and single-turn or multi-turn precision wirewound pots, both available with linear or non-linear functions. Call us for design assistance or write today for technical literature.



**DUNCAN ELECTRONICS**  
SUBSIDIARY  
**SYSTRON S+ DONNER**

2865 Fairview Road • Costa Mesa, California 92626  
PHONE: (714) 545-8261 □ TWX 910-595-1128



**Duncan: Your prime source for  
custom designed pots.**



# QUALITY IN VOLUME

When you achieve it, you can offer true competitive value. That's just what we're doing at USCC/Centralab for 1975. MONO-KAP™ radial, and MONO-GLASS axial monolithic ceramic capacitors are now available to volume users *from stock* to eight weeks. Our investment and "learning curves" last year guarantee competitive responsiveness — USCC will welcome your specials and non-stock orders. Here's an offer you haven't heard lately — your money is going to buy more at USCC. Cash in on the best values in monolithic ceramic capacitors.

## DISCRETE ASSEMBLY

MONO-KAP™ radial-leaded epoxy coated capacitors are reliable performers; they're rugged enough to work in MIL environments. 4.7 pF to 10 Mfd., 50 to 200 WVDC in 4 dielectrics, including Z5U, in a variety of case sizes featuring meniscus control to 0.032 inches. Large quantity orders from stock.

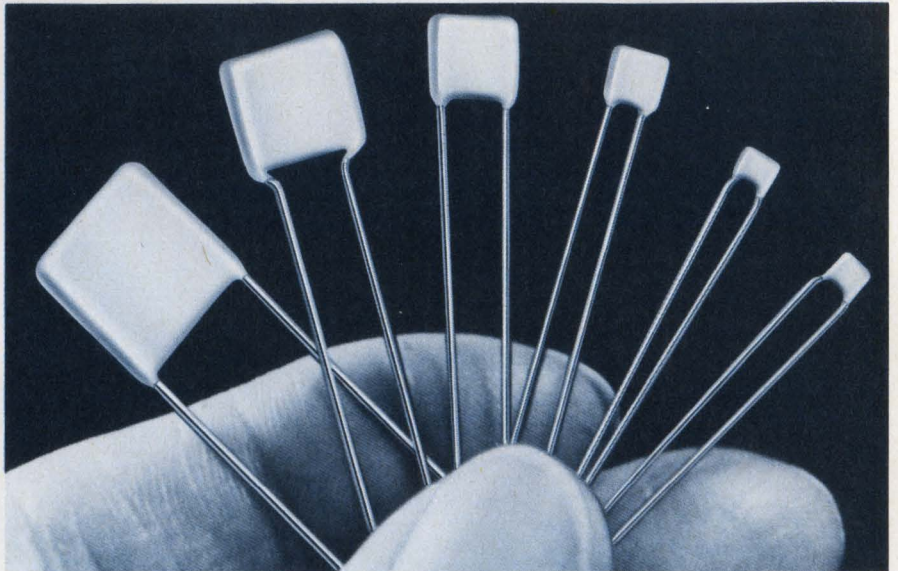

## AUTOMATIC INSERTION

MONO-GLASS axials are glass encapsulated, designed for automatic PCB insertion; furnished reel-packed for high volume applications. They're available in 50 and 100 WVDC from 1pF to 1.0 Mfd.; four dielectrics: COG, X7R, Z5U and Y5V.

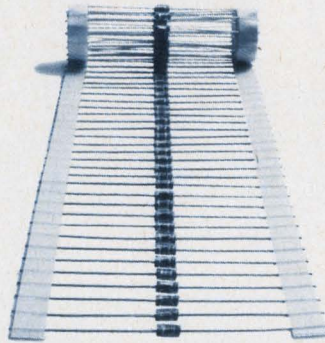

## CUSTOM DESIGN

We're responsive to your design requirements; get USCC's new expanded 1975 catalog.



If you need a special, call (213) 843-4222 for assistance or evaluation samples.

Remember. USCC/Centralab. Value.

FOR QUICK REFERENCE, SEE OUR PRODUCTS IN YOUR EEM, GOLD BOOK OR EBG PAGES.



**USCC/Centralab**

Electronics Division • Globe-Union Inc.

2151 North Lincoln Street ■ Burbank, California 91504

(213) 843-4222 ■ TWX: 910-498-2222

INFORMATION RETRIEVAL NUMBER 75





## Printer/plotter offers 200 dot/in. resolution

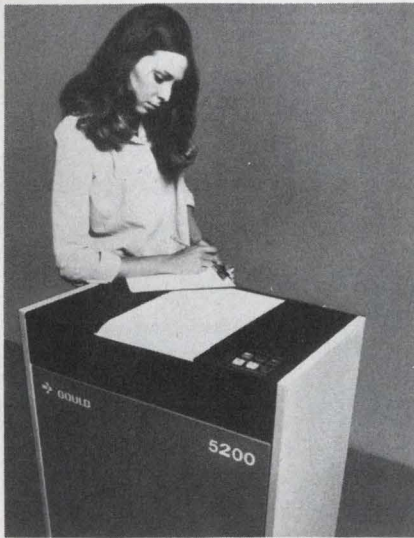

Gould, Inc., Instrument Div., 20 Ossipee Rd., Newton, MA 02164. (617) 969-6510. \$9700; stock.

An electrostatic printer/plotter with a resolution of 200 dots/in., the Model 5200, provides 0.2% accuracy for graphic plots. When printing, the unit generates 132 characters per line at 650 line/min. with fixed character spacing on 11-in. wide paper. The 5200 also has the ability to generate variable spacing between characters. Printing and plotting software packages and on-line/off-line hardware packages are available for most computer systems.

CIRCLE NO. 331

## Modem does 9600 bit/s on unconditioned lines

Intertel, 6 Vine Brook Park, Burlington, MA 01803. (617) 273-0950. \$9700; 30 days.

The MCS9600 is said to be the first 9600-bit/s modem to operate over unconditioned private telephone lines. Normally C2 or D1 line conditioning is required in order to improve leased telephone lines for use with conventional modems. The MCS9600 can also be multiplexed to mix 2400, 4800, and 7200 bps data rates. A switched carrier control capability allows multiplexing in multipoint networks without any hardware or software modification to the central computer or front-end equipment.

CIRCLE NO. 332

## Minis linked to maxi over 1-mile coax cable

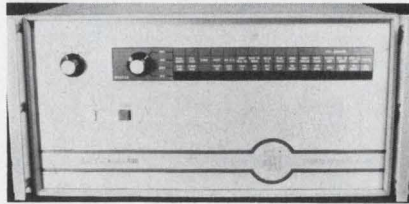

Systems Associates, 55 Park St., Troy, MI 48084. (313) 585-7995. See text; 90 days.

Any mini can communicate to an IBM System/360 or 370 at 277 kbyte/s. The LLA 400 (long-line adapter) uses a single coax wire up to a mile in length. In addition the LLA 400 can communicate with up to 64 computers even in industrial environments. The protocol used is that of IBM's mini-oriented Sensor Based Control Unit. A complete unit with mini interface and single coax driver sells for \$4500.

CIRCLE NO. 333

## Line controller handles up to eight channels

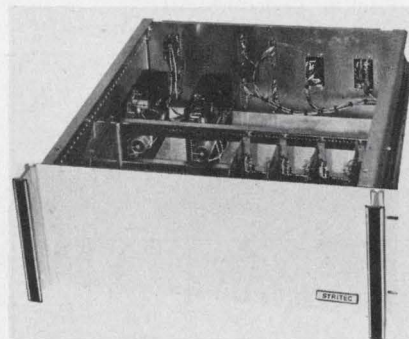

Stritec, 5352 Sterling Center Dr., Westlake Village, CA 91361. (213) 889-3540. From \$3508; 8 wks.

A flexible data line controller interfaces most RS-232-C compatible devices with Honeywell minicomputers. Model S100 Asynchronous Interface unit is designed for use with H316, DDP416 and DDP-516 minicomputers and allows interface with line printers, CRTs, Modems and TTYs. They are provided with one to eight channels. Baud rate, data word length, parity mode and number of stop bits are independently programmable. Selectable baud rates (at time of order) range from 75 to 9600 baud with simultaneous reception and transmission capability.

CIRCLE NO. 334

# Schottky Barrier Rectifiers

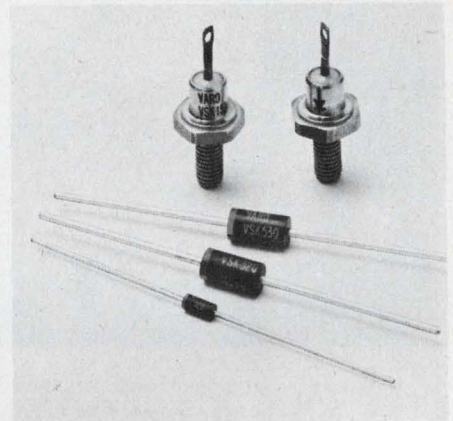

- Four series: 1A, 3A, 5A and 15A (I<sub>o</sub>) with 20V and 30V (V<sub>RRM</sub>).

- Extremely fast recovery (t<sub>rr</sub>), very low forward voltages (V<sub>F</sub>), high reliability and low cost.
- VSK 120 & 130-1A series in DO-41 packages. 450 & 550 mV (V<sub>F</sub>), 40A peak 1/2 cycle surge (I<sub>FSM</sub>), 10 mA (i<sub>R</sub>) at 100°C.
- VSK 320 & 330-3A series. Epoxy package, axial leads. 475 & 500 mV (V<sub>F</sub>), 150A surge, 30 mA (i<sub>R</sub>) at 100°C.
- VSK 520 & 530-5A series. Epoxy package, axial leads. 380 mV (V<sub>F</sub>), 250A surge, 75 mA (i<sub>R</sub>) at 100°C.
- VSK 1520 & 1530-15A series in DO-4 metal stud cases. 550mV (V<sub>F</sub>), 300A surge, 75 mA (i<sub>R</sub>) at 100°C.
- All series have junction operating temperature range of -65°C to +125°C.
- Typical pricing, 1000 qntys, from \$1.38 ea. (VSK 120) to \$3.67 ea. (VSK 1530).

Call Charlie Merz 214/272-4551 for complete information

WRITE ON YOUR LETTERHEAD FOR FREE SAMPLES.



VARO

VARO SEMICONDUCTOR, INC.

P.O. BOX 676, 1000 NORTH SHILOH, GARLAND, TEXAS 75040  
(214) 272-4551 TWX 910-860-5178

INFORMATION RETRIEVAL NUMBER 76



# THE POWER SUPPLY AN ENGINEER COULD LOVE



If you're an engineer, or in engineering management, you might find our new SCR Series Single Phase Input Power Supplies very attractive. They provide 800, 1600 or 2400 watts of power and precise 0.1% regulation in both voltage and current modes (for higher power ask about our three phase input SCR units). All offer the highest power output per mechanical volume in the industry.

## Check these superior benefits:

- \* High Efficiency
- \* Remote Sensing
- \* Remote Programming
- \* Series or Parallel Operation
- \* 5 Year Warranty
- \* Rack or Bench Mount
- \* Overvoltage Protected (optional)
- \* Constant voltage or current with automatic crossover
- \* Optional Input Voltages

For applications assistance and technical information, phone TOLL FREE (800) 631-4298

VOLTAGE	CURRENT	CV-rms RIPPLE	CC-rms RIPPLE	% EFF.	AC input I NOM.E.	PRICE \$
0-7.5	100	75 mv	1000 ma	63	13	650
	180	80 mv	1920 ma	65	26	850
	250	80 mv	2990 ma	66	20	1100
0-10	80	75 mv	600 ma	65	13	600
	150	80 mv	1200 ma	68	26	850
	210	80 mv	1680 ma	69	19	1100
0-20	40	60 mv	120 ma	67	13	600
	80	80 mv	320 ma	70	25	800
	120	80 mv	480 ma	73	18	1000
0-40	20	60 mv	30 ma	68	13	500
	40	100 mv	100 ma	75	24	750
	60*	100 mv	150 ma	80	18	900
0-60	13	70 mv	15 ma	70	13	500
	26	90 mv	39 ma	81	23	850
	40	90 mv	60 ma	81	18	1000
0-80	10	80 mv	10 ma	77	12	500
	20	120 mv	30 ma	83	21	850
	30**	100 mv	35 ma	82	18	1000
0-150	5	150 mv	5 ma	80	10	500
	10	200 mv	13 ma	87	20	850
	15	200 mv	20 ma	84	18	1000
0-300	3	250 mv	3 ma	85	6	550
	5	300 mv	5 ma	87	20	850
	8	300 mv	8 ma	85	17	1000
0-600	2	700 mv	2 ma	87	6	650
	3	700 mv	4 ma	88	20	850
	4	750 mv	5 ma	85	17	1100

\*Specify Model No. SCR40-58  
\*\*Specify Model No. SCR80-28



## ELECTRONIC MEASUREMENTS INC.

405 Essex Road, Neptune, N. J. 07753  
Phone: (New Jersey) 201 - 922-9300 • (Toll-Free) 800 - 631-4298  
Specialists in Power Conversion Equipment

## DATA PROCESSING

### Recorder has time printout and dual alarms

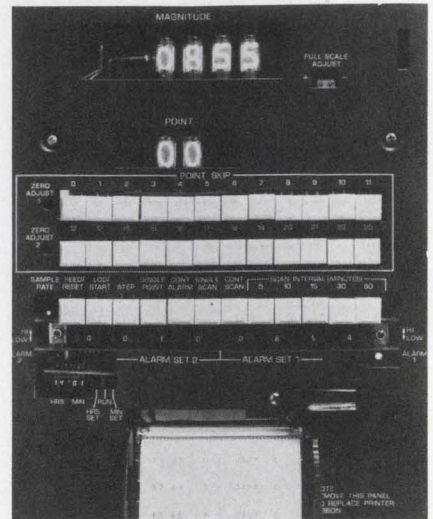

Doric Scientific Corp., 3883 Ruffin Rd., San Diego, CA 92123. (714) 565-4415. From \$2195; stock to 5 wks.

Designed for industrial environments, the ruggedized Digitrend 200 will scan, display, log and produce alarm outputs from thermocouples, transducers, transmitters, strain gauges or other millivolt sources. An optional digital clock automatically adds the time-of-day to the recording and provides a continuous display in hours and minutes. If the power is interrupted for longer than 500 ms, the time display will flash on and off upon resumption of power and the time printout will be disabled until reset. A new feature is the dual alarm option—two separate alarm circuits that are common to all set-points to provide High/Higher, High/Low, and Low/Lower alarm setting capability.

CIRCLE NO. 335

### Versatile matrix printer available as a plug-in

Practical Automation, Trap Falls Rd., Shelton, CT 06484. (203) 929-1495. \$195; 4 wks.

An 18 column printer now exists as a plug-in module that measures only 3 x 3.5-in. on the panel. At 100 char/sec. the DMTP-3 prints 7 x 5 dot-matrix characters at a rate of 2.3 line/s. Interfaces to the printer can be serial, parallel or RS-232C.

CIRCLE NO. 336



# Can't Tell A .015" PC Tape Width From A .020"?

Now You Can ...  
AT A GLANCE ...

With Bishop's  
Exclusive New

Color Core  
Coding!



No more "miking", guessing or measuring PC artwork tape widths . . . with Bishop tapes you know. New color coded cores tell you instantly . . . and only Bishop has it! You even get a full-color chart that identifies the color core with tape size. Affix it to your light table, drafting machine . . . anywhere it's handy. Think of the valuable time you'll save!

### New Bishop FLAT Packaging

All Bishop PC Precision Slit Artwork tape now comes in a brand-new, flat package called the FLATPAK™. This reusable

package keeps tapes clean, fresh and safe . . . prolongs shelf life.

### Another Bishop Exclusive!

Each FLATPAK™ has dated labeling which not only gives tolerances, size, order no. and quantity . . . but shows "use before" dates for your protection . . . and only Bishop has it!

### FREE Bulletin Tells All

New full-color Bishop Technical Bulletin No. 1019 tells the whole story. Call your local Bishop dealer for a copy and to order, or contact us direct.



The Innovators

**Bishop Graphics, Inc.**

20450 Plummer St. • Chatsworth, CA 91311  
Phone: (213) 993-1000 • Telex: 66-2400

INFORMATION RETRIEVAL NUMBER 78

## The New Brush 2400: the best performing, most versatile wide channel recorder you can buy.

It is available in 2, 3 and 4 channel configurations utilizing combinations of 50 mm and 100 mm channels totalling 200 mm. It has a 99.65% linearity over the full 100 mm channel. Its frequency response is an outstanding 30 Hz at 100 mm, 50 Hz at 50 mm and up to 125 Hz at reduced amplitude. It has a full range of plug-in signal conditioners for just about any industrial-scientific-medical application.

For full details on why the new Gould 2400 is the best performing direct writing recorder you can buy, write Gould Inc., Instrument Systems Division, 3631 Perkins Avenue, Cleveland, Ohio 44114. Or Kouterveldstraat 13, B 1920 Diegem, Belgium.



 **GOULD**

INFORMATION RETRIEVAL NUMBER 79

ELECTRONIC DESIGN 6, March 15, 1975

# Now... AC MEASUREMENTS GO DIGITAL!

- True RMS Volts
- True RMS Current
- AC Watts

. . . all in YEW's new 2504 AC DMM!

The new 2504 digital AC instrument offers unexcelled accuracy and versatility for the measurement of sinusoidal and non-sinusoidal waveforms and for measurements at low power factors. Flexible design allows optional purchase of just the measuring functions required while push-button controls provide ease of operation.

The YEW 2504 is the AC DMM. Its 0.25% accuracy and 0.01% resolution, standard analog output, and low cost (Prices start at \$1,590.) make it the ideal instrument for quality control, lab, field maintenance, and instrument calibration applications. Write for details.



Standard ranges (Multirange Model):  
30V/60V/100V/150V/300V,  
0.5A/1A/2A/5A/10A (15W to 3,000W)  
Frequency range: 25 Hz to 1 kHz



Yokogawa Electric

**YEWTEC CORPORATION**

1995 Palmer Avenue  
Larchmont, N.Y. 10538  
Telephone: 914-834-3550

60 Years of Measuring and Recording Instrumentation

INFORMATION RETRIEVAL NUMBER 80



## POWER SOURCES

### 500-W switching supply weighs in at just 14 lb

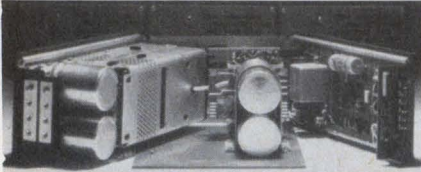

Hewlett-Packard, 1501 Page Mill Rd., Palo Alto, CA 94304. (415) 493-1501. \$650; 6 wks.

This 500-W, 5-V switching-regulated (20 kHz) modular power supply, Model 62605M, reduces heat-sink requirements and permits greater freedom in mounting. Integral forced-air cooling in many cases eliminates other in-cabinet cooling. Inherent efficiency is approx. 70%. Size is 5 × 8 × 11-1/2 in. and weight is 14 lbs. Regulation is to 0.1% with ripple and noise of 20 mV rms, 40 mV pk-pk (20 Hz to 20 MHz).

CIRCLE NO. 337

### Silicon solar cell delivers 1 A

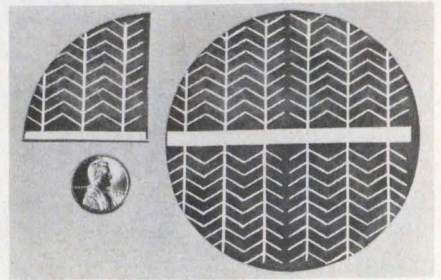

Edmund Scientific, 380 Edscorp Bldg., Barrington, NJ 08007. (609) 547-3488. \$19.95; stock.

A new 3-in.-diameter silicon solar cell will deliver over 1 A at 0.5 V dc, or 1/2 W. It is said to be five times more efficient per unit cost than any cell previously offered. For higher current requirements, multiple cells can be hooked up in parallel. Or the cells can be used in series for higher voltage applications. Since the new cell uses no plastic lenses to increase its efficiency, it is extremely flat—only one mil thick; and the cell is complete with tab leads for any circuit.

CIRCLE NO. 338

## Now you can turn to MCL for reliable high power r-f and microwave testing.

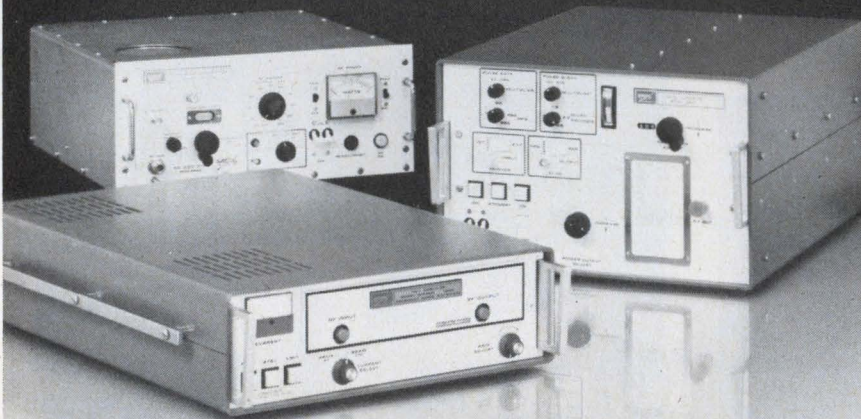

Many customers remember us for the "extras" engineered and built into our microwave cavities, e.g., our potted anode bypass assembly.

But some may not be aware that today MCL also offers one of the industry's largest and most diverse power oscillator, amplifier and systems lines.

The same extra margin of reliability and performance customers have learned to expect from our cavities is also a feature of our instrumentation products.

For a recommended solution to your high power testing problem—without obligation—write us today.

MCL, Inc., 10 North Beach Avenue, La Grange, Illinois 60525.  
Or call (312) 354-4350.

Now on GSA contract GSOOS-27086 See us in EEM-Vol. 1 pp. 284-291



### Switcher line covers 150 to 750 W

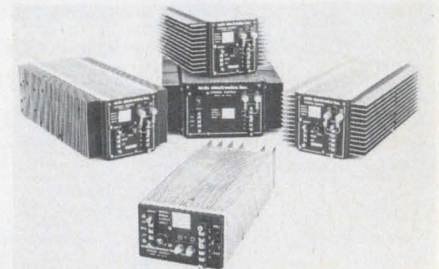

ACDC Electronics, Oceanside Industrial Center, Oceanside, CA 92054. (714) 757-1880. About \$275 (150-W unit); 2 to 4 wks.

Six new high-efficiency, switching-type power supplies have been added to the company's JP series. The additions include a 750-W and five 150-W units. This brings the JP Series to a total of 16 models, ranging from 150 to 750 W. These 20-kHz inaudible switchers operate from a selectable input of 115/230 V ac (100 V ac also available), 47 to 63 Hz, with 70 to 80% efficiency and 0.1% regulation. Overvoltage and overload protection are standard and radiated and conducted EMI is minimized by shielding and filtering.

CIRCLE NO. 339



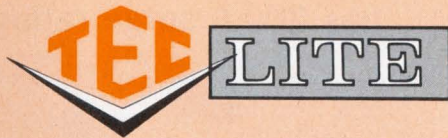

# LOW-COST LED DIGITAL READOUTS IN RED, ORANGE, YELLOW OR GREEN

Solid State Modules Come Ready to Install and Operate — Include Decoder/Driver and all Circuitry Needed to Hook up to Your System

- Standard 0-9 plus overflow, with character heights of 0.30" and 0.40" — and both sizes at the same low price!
- Accept BCD input code
- Compatible with TTL
- Optional bezel with choice of 5 filters

And Immediate Delivery!

**DISTRIBUTORS**

Audio Electronics, Inc., Canada (416) 495-0720  
 Bodelle Co., Inc., Chicago (312) 323-9670  
 Bordewick Co., New England (617) 659-4915  
 Century Aero Corp., So. California (213) 772-1166  
 Peerless Radio Corp., Florida (305) 566-5966  
 Ratel Electronics, No. California (415) 965-2010



Only  
**\$7.95** Per Digit  
 in 100 quantities

0.30" High: MDA-6151 (green), MDA-6171 (red),  
 MDA-6181 (yellow), MDA-6191 (orange)  
 0.40" High: MDA-7151 (green), MDA-7171 (red)  
 MDA-7181 (yellow), MDA-7191 (orange)



TEC, Incorporated • 9800 NORTH ORACLE ROAD • TUCSON, AZ USA 85704 • (602) 297-1111 • TWX 910-952-1377

INFORMATION RETRIEVAL NUMBER 82

## PREMIUM QUALITY COMPONENTS

"Industry comes to Ancrona for big help with small quantities."



### C-MOS

1-9	10 up	4021AE	2.70	2.50	4050AE	1.10	.90	
4000AE	.48	.45	4022AE	2.70	2.50	4051AE	3.35	2.90
4001AE	.48	.40	4023AE	.48	.45	4052AE	2.15	2.05
4002AE	.48	.40	4024AE	1.80	1.60	4053AE	2.90	2.80
4004AE	5.85	5.85	4025AE	.48	.45	4054AE	2.70	2.60
4006AE	3.50	3.30	4026AE	8.40	7.90	4055AE	2.70	2.60
4007AE	.48	.42	4027AE	1.20	1.00	4056AE	3.45	3.41
4008AE	2.90	2.70	4028AE	2.20	2.00	4060AE	3.30	3.00
4009AE	.87	.86	4029AE	4.00	2.90	4066AE	1.80	1.60
4010AE	.55	.54	4030AE	1.00	.90	4069AE	.80	.70
4011AE	.48	.45	4033AE	3.40	2.90	4071AE	.50	.45
4012AE	.48	.45	4035AE	2.80	2.75	4076AE	2.70	2.50
4013AE	.95	.85	4040AE	2.80	2.60	4081AE	.48	.42
4014AE	2.80	2.50	4041AE	1.20	.90	4088AE	3.90	3.50
4015AE	2.80	2.50	4042AE	2.80	2.60	4510AE	2.70	2.50
4016AE	1.00	.90	4043AE	2.80	2.60	4516AE	2.90	2.80
4017AE	2.60	2.50	4044AE	2.80	2.60	4518AE	3.30	3.00
4018AE	2.80	2.60	4047AE	3.10	3.00	4520AE	3.30	3.00
4019AE	.95	.85	4048AE	1.45	1.35	4911AE	.48	.42
4020AE	2.80	2.60	4049AE	1.10	.90	4911AE	.45	.42

### 74LS

74LS00	.58	74LS76	.92
74LS01	.58	74LS78	.92
74LS02	.58	74LS107	.92
74LS03	.58	74LS109	.92
74LS04	.63	74LS112	.92
74LS05	.63	74LS113	.92
74LS08	.58	74LS114	.92
74LS09	.58	74LS138	2.38
74LS10	.58	74LS139	2.38
74LS11	.58	74LS151	2.10
74LS15	.58	74LS153	2.38
74LS20	.58	74LS157	2.10
74LS21	.58	74LS158	2.40
74LS22	.58	74LS160	2.70
74LS27	.64	74LS161	2.70
74LS30	.64	74LS170	5.92
74LS32	.64	74LS174	3.02
74LS51	.58	74LS175	2.90
74LS54	.58	74LS181	3.72
74LS55	.58	74LS251	2.55
74LS73	.92	74LS253	3.05
74LS74	.92	74LS260	.58

**TWO-PHASE MOS CLOCK DRIVER**  
 MH0026CN  
 \$5.50

## Microprocessors \$79.95

8 Bit Parallel CPU on a single chip • complete instruction decoding and control • TTL compatible (Inputs, Outputs and Clocks) • Address or retrieve 16K x 8 bits of memory (RAM, ROM or SR) • DIP package. Build your own micro-computer with one CPU, one added ROM and 20 added TTL interface devices. Type 8008: \$79.95 - Type P2102 Static RAM: \$8.00

## MOS-LSI

P1101A	6.90	C2102-2	8.00
P1101A-1	8.50	P2102-2	6.00
1402AN	5.40	2505K	3.30
1403AH	8.00	2512K	5.50
1403AN	5.40	2521V	4.00
1404AH	8.00	2524V	3.90
1404AN	5.40	2525V	5.30
1405A	4.10	2533V	8.50
1505	4.00	3341PC	8.20
1507	4.00	MM5025N	20.00
1602	33.00	MM5026N	20.00
1702	33.00	MM5027N	20.00
C2102	8.00	MM5055N	5.50
P2102	6.00	MM5056N	5.50
C2102-1	8.00	MM5057N	5.50
P2102-1	6.00	MM5058N	5.50

TERMS: Check or M.O. (no C.O.D.) minimum order \$10.00 (add \$1 to cover postage & handling) California residents add 6% sales tax.

SPECIFICATION SHEETS: \$.25 ea.



**ANCRONA CORP.**  
 P.O. Box 2208L, Culver City, CA 90230

## economy model

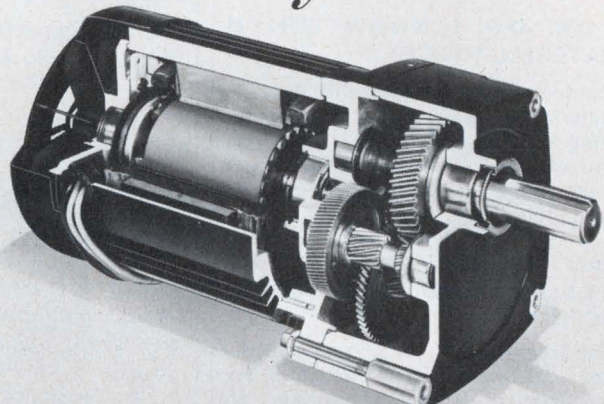

Bodine makes quality fhp motors and drive systems. Some may cost a little more. Initially. But, in the long run they cost less to use.

After Delivery Economies (ADE) are the reason. You get fewer rejects. Consistent quality, motor to motor, lot to lot. Less profit robbing service and downtime problems. Bodine motors perform. Reliably. Run stronger and last longer. Help protect your reputation and profit.

If you're concerned about today's bottom line costs and tomorrow's repeat sales, take a close look at Bodine. (1/2000 thru 1/4 Hp.)

ADE (After Delivery Economies) make Bodine a better fhp buy



Bodine Electric Company, 2528 W. Bradley Place, Chicago, IL 60618

INFORMATION RETRIEVAL NUMBER 83

INFORMATION RETRIEVAL NUMBER 84



# the facts about E.M.I. SHIELDING

Design information from Mag-Shield's  
30 years experience in E.M.I. shielding.

## WHAT IS THE ADVANTAGE OF USING NETIC OR CO-NETIC SHIELDING ALLOYS?

These alloys are especially prepared and treated to attain optimum E.M.I. shielding efficiency. They are available in thicknesses up to .010" for continuous foil, and up to .062" for sheet stock. Shielding foil is easily hand-formed into shields for prototype testing or small production runs. Stress annealed sheet stock has maximum workability properties. Fully hydrogen annealed sheet stock provides maximum permeability.

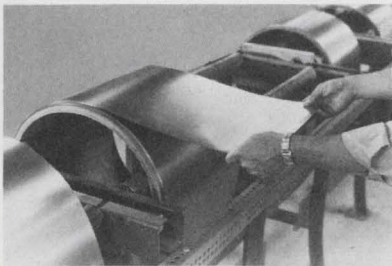

Netic and Co-Netic foil is easily shaped into simple shield configurations.

## HOW DO I KNOW WHICH MATERIAL TO USE?

The high saturation capability of Netic material is ideally suited for attenuating high intensity E.M.I. fields. High permeability Co-Netic material provides maximum attenuation at low field intensities.

## CAN YOU SERVICE MY SHIELD DESIGN AND PRODUCTION NEEDS?

Mag-Shield offers complete shield design and fabrication service. And, we can provide immediate delivery on standard shields that will accommodate a wide variety of components. Just circle the reader service number, or write Mag-Shield direct to receive complete information on sample materials and specifications.

## MAGNETIC SHIELD DIVISION



Perfection Mica Company  
740 Thomas Drive  
Bensenville, Illinois 60106  
(312) 766-7800 TWX (910) 256-4815

INFORMATION RETRIEVAL NUMBER 85

## DISCRETE SEMICONDUCTORS

### Varactor tuning diodes have low inductance

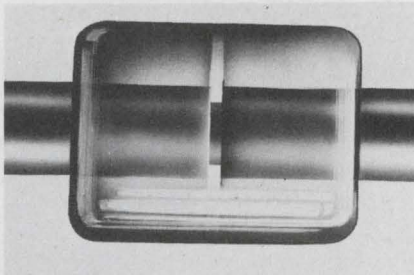

MSI Electronics, 34-32 57 St.,  
Woodside, NY 11377. (212) 672-  
6500. \$5.50 (100-up); 2 wk.

The G801A to G522A varactor tuning diodes have the silicon chip in butt contact with the DO-35 case leads. This eliminates whiskers or ribbons that contribute to series inductance. The resulting packages have a 1.5-nH inductance, which, with a 0.1-pF capacitance make the tuning diodes suitable for operation in the uhf and low microwave ranges. The 4-V capacitance values range from 1.8 to 22 pF and Qs from 800 for the low capacitance diodes to 500 for the higher capacitance diodes at 50 MHz. These capacitor diodes have less than 0.5  $\mu$ A of leakage current at 20-V reverse voltage and exhibit capacitance ratios of 2:1 from 2 to 20 V.

CIRCLE NO. 340

### High voltage rectifiers handle up to 15 kV

Electronic Devices, 21 Gray Oaks  
Ave., Yonkers, NY 10710. (914)  
965-4400. \$0.50 (100,000 pcs);  
stock.

The SR-15 high stress silicon diode can handle 15,000 V PRV repetitive and 18,000 V nonrepetitive. The diode is designed specifically for use in 35-kV dc multiplier applications. Special construction and diffused junctions that have avalanche characteristics provide high surge capability, low leakage, and recovery time of 150 ns typical and 300 ns maximum. Diode diameter is 0.16 in. and body length is 0.6 in. Leads are a minimum of 0.5 in. long and have diameters of 0.02 in.

CIRCLE NO. 341

### Silicon rectifier series has 200-A surge ratings

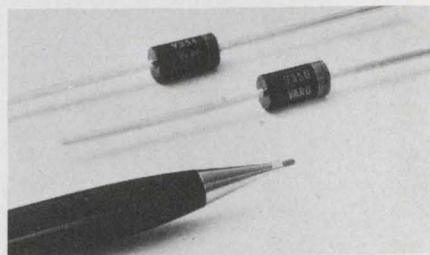

Varo Semiconductor, P.O. Box 676,  
1000 N. Shiloh, Garland, TX  
75040. (214) 272-4551. From \$0.22.

A line of 32 rectifiers includes a controlled avalanche series with 250, 450, 650 and 850 V min. avalanche ratings, a noncontrolled avalanche series with 50 to 1000 V ratings ( $V_{RRM}$ ), and a fast recovery time series with 200-ns reverse recovery time ( $t_{rr}$ ). The devices are rated at 3 A ( $I_o$ ) at  $T_A = 40$  C, for both 100 and 200-A peak surge. The fast recovery series has a 75 and 150-A surge rating. Operating temperature range is  $-50$  to  $+150$  C. Part number designations for the 100 A surge line are V322, 4, 6, 8 (controlled avalanche), V330, 1, 2, 4, 6, 8, 10 (noncontrolled avalanche) and V330X, 1X, 2X, 4X and 6X (fast recovery).

CIRCLE NO. 342

### LED lighted switches come in three colors

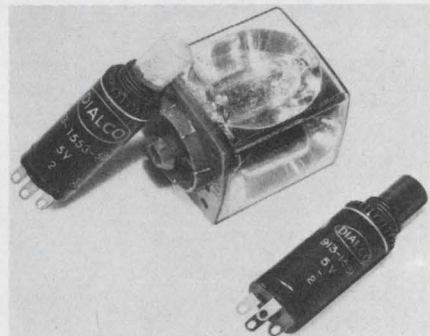

Dialight, 203 Harrison Pl., Brook-  
lyn, NY 11237. (212) 371-8800.  
From \$2.59 (1000-up); 3 to 4 wk.

The series 913 miniature, momentary action switches are available with red, green or yellow LEDs. The LED in the switch operates from a 5-V-dc supply. The switch is available in either a normally-open, normally-closed, or two-circuit version. A long cylindrical lens cap has an internal fresnel ring for uniform light distribution.

CIRCLE NO. 343



# POWER FOR YOUR IC'S OR OP AMPS

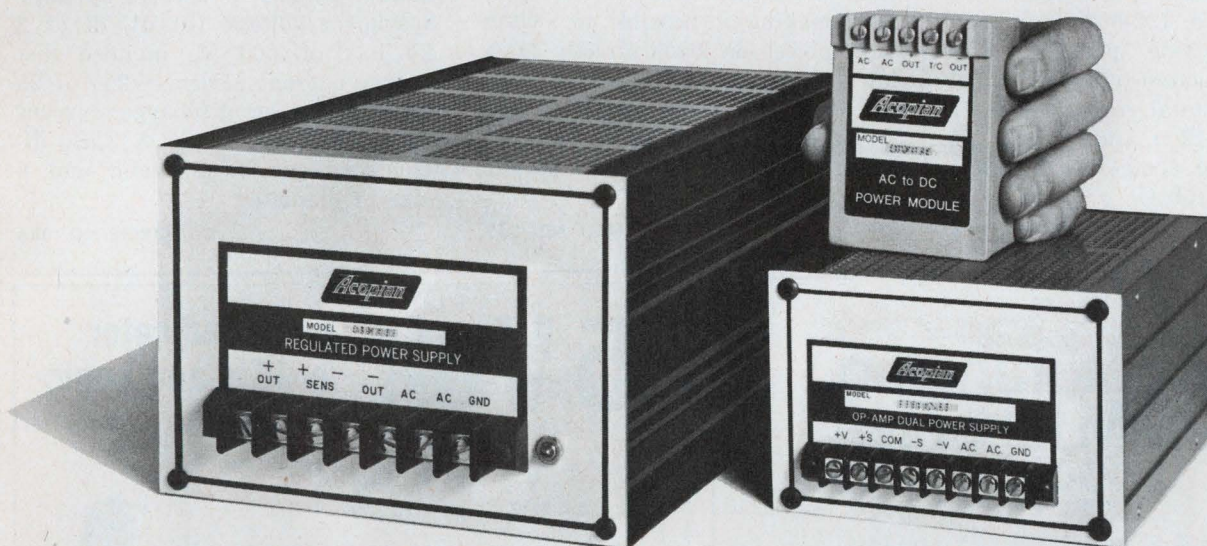

ALL MODELS U.L. RECOGNIZED

## 5 VOLTS

OUTPUT CURRENT AMPS	SIZE INCHES	PRICE	MODEL
.5	3.5 x 2.5 x 1.4	\$55	5EB50
1.0	3.5 x 2.5 x 1.6	75	5EB100
2.0	3.5 x 2.5 x 2.4	115	5EB200
2.5	3.5 x 2.5 x 2.4	130	5EB250
5.1	3.4 x 5.1 x 6.6	150	A5MT510
9.0	3.4 x 5.1 x 9.3	180	A5MT900
12.0	3.4 x 5.1 x 13.3	200	A5MT1200
22.0	5.1 x 7.4 x 11.3	270	A5HT2200
32.0	5.1 x 7.4 x 16.0	320	A5HT3200

## ±15 VOLTS

OUTPUT CURRENT AMPS	SIZE INCHES	PRICE	MODEL
.1	3.5 x 2.5 x 1.4	\$55	DB15-10
.15	3.5 x 2.5 x 1.4	65	DB15-15
.2	3.5 x 2.5 x 1.4	75	DB15-20
.4	3.4 x 5.1 x 5.1	85	TD15-40
1.0	3.4 x 5.1 x 5.1	125	TD15-100
1.6	3.4 x 5.1 x 6.6	150	TD15-160
2.5	3.4 x 5.1 x 9.3	160	TD15-250
4.5	3.4 x 5.1 x 13.3	225	TD15-450
8.5	5.1 x 7.4 x 11.3	299	TD15-850

Line/Load Regulation:  $\pm 1\%$  or better; Ripple: 1.5 mv or less; Input: 105-125 VAC

Three day shipment guaranteed. Complete details on these plus a comprehensive line of other power supplies and systems are included in the Acopian 73-74 catalog. Request a copy.



Corp., Easton, Pa. 18042. Telephone: (215) 258-5441.

INFORMATION RETRIEVAL NUMBER 86



## Schottky mixer diodes have high dynamic range

Alpha Industries, 20 Sylvan Rd., Woburn, MA 01801. (617) 935-5150. \$8.25 (1000-up); 10 to 30 day.

The D4007 Schottky barrier silicon diodes provide low intermodulation distortion performance in local oscillator/mixer high-drive level applications. These diodes have beam-lead construction and are mounted in a quad configuration to achieve minimum size and optimum uniformity. The diodes are available for use through the X-band frequency range. Typical turn-on voltages are 600 mV at a 1 mA current level. The mixer quads are mounted on the company's 132-002 four lead ceramic substrate package. Max junction capacitance at  $V_R = 0$  V is 0.6 pF, total resistance at  $I_F = 10$  mA is 12  $\Omega$ , and the storage and operating temperature range is -65 to +150 C.

CIRCLE NO. 344

## High-voltage Darlington handle up to 300 V

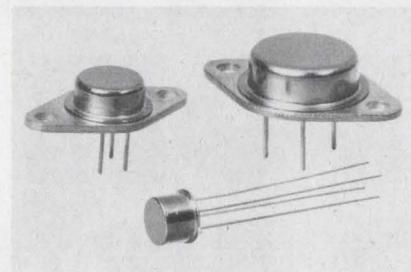

Unitrode, 580 Pleasant St., Watertown, MA 02172. (617) 926-0404. From \$3.40 (100-up); 2 to 3 wk.

The U2T700 and U2T800 series high voltage Darlington transistors are available in hermetic TO-5, TO-66 and TO-3 packages. They are rated up to 300 V  $BV_{CEO}$  and can handle dc currents to 5 A or pulse currents to 10 A. Gains are typically 2000 at rated dc currents, thus making it possible to switch high power dc loads directly from low level logic. All types in both the 2 A, 700 series and 5 A, 800 series have provision for external biasing of both input and output transistors.

CIRCLE NO. 345

## Surge arresters handle voltage spikes of 230 V

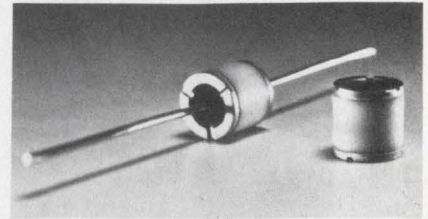

Cerberus AG, CH-8708 Mannedorf, Switzerland.

The Cerberus surge arresters are compact metal/ceramic devices that have a fast and accurate response, a very high shunt capacity and consistent performance, even after loading. All arresters maintain their tolerances and meet the CCITT and VDE 0845 requirements. Some of the surge arrester specs include: static sparkover voltage of 230 V  $\pm 10\%$ , dynamic sparkover voltage (at  $dU/dt$  of 2 kV/ $\mu$ s) of 600 V, impulse discharge current (Form 8/20) of 25 kA and an ac discharge current (1 s, 50 cycles) of 20 A. Case dimensions are 8 mm long and 8 mm in diameter.

CIRCLE NO. 346

## An autoranging DMM for only \$299?

Yes. And it's a KEITHLEY—no less. The new Model 168 is a full-function DMM. It measures ac/dc volts, ac/dc amps and ohms too. Autoranging, optional battery operation, two-terminal input, push-button operation and lighted function indicators are only a few of its added features. Send for full details now.

1-year accuracy guarantee, too!

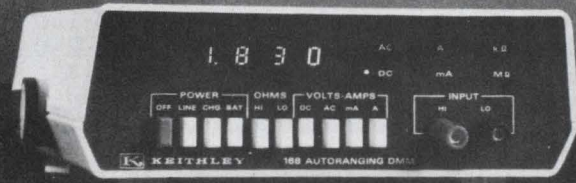

**KEITHLEY INSTRUMENTS**  
U.S.A.: 28775 AURORA ROAD, CLEVELAND, OHIO 44139  
EUROPE: 14, AVENUE VILLARDIN, 1009 PULLY, SUISSE

INFORMATION RETRIEVAL NUMBER 87

## 5 Volt Audio Indicator for IC's and Logic Circuits

AI-105 . . .  
5 vdc . . .  
draws 30 ma

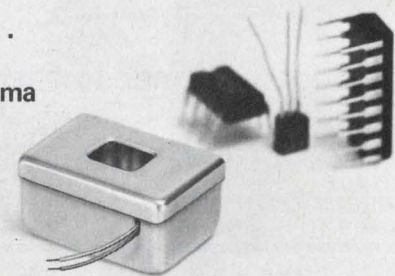

Shown actual size

This small, 7-gram, steel encased AI-105 solid state unit is ideal where you need a compact, highly reliable warning or alarm system. Installs with panel mounts or tape. Other models in 1.5 - 3 and 12 volts.

Special offer for U.S.A. and Canada only: engineering samples \$4.95 each. Check must accompany order. Limit: five. Offer expires June 30, 1975.



3680 Wyse Road  
Dayton, Ohio 45414  
Tel. 513-890-1918  
TWX 810-450-2523

IN EUROPE  
projects unlimited/  
Europe B.P. 15;  
B-6100 Mont Sur  
Marchienne  
Belgium, Telex 51-390  
Tel (071) 36.84.86

D.I.A.L. 800-645-9200 for the name of your nearest representative.  
In New York call 516-294-0990 collect.

INFORMATION RETRIEVAL NUMBER 88

ELECTRONIC DESIGN 6, March 15, 1975



## System monitors noise and gain

*International Microwave Corp., 33 River Rd., Cos Cob, CT 06807. (203) 661-6277.*

The NTM-0260R system for noise and gain monitoring consists of compact solid-state modules, which readily integrate into earth stations or radar equipment. Rf range extends from 300 MHz to 18 GHz, depending on the noise source used, and i-f range is 30 to 100 MHz. The system has a noise-temperature spec of 200 to 9000 K, and a gain range of  $\pm 3$  dB. Accuracies are  $\pm 6\%$  for noise temperature and  $\pm 0.25$  dB for gain.

CIRCLE NO. 347

## Tunable laser emits visible-to-IR spectrum

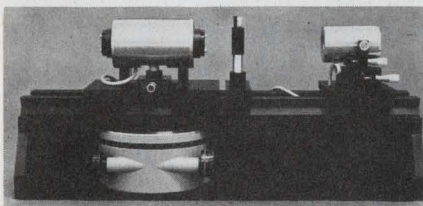

*Interactive Radiation Inc., 406 Paulding Ave., Northvale, NJ 07647. (201) 767-1910.*

With a new tunable laser, output wavelengths can be continuously tuned over the spectral range from 415 to 2100 nm. A 20-J ruby-pump input yields an optical-parametric-oscillator output of 3 to 20 kW per pulse unfocused. The pulse width is 5 ns and the line width is 0.01 nm in blue, increasing to 0.3 nm at 630 nm. The beam divergence is 2 mr at 470 nm in the TEM<sub>00</sub> mode.

CIRCLE NO. 348

## New vendor takes over plug-in line

*Optimax Inc., P.O. Box 105, Advance Lane, Colmar, PA 18915. (215) 822-1311.*

Filling the market void created by Fairchild's recent withdrawal from the hybrid amplifier and attenuator business, the company is now offering the equivalents to the Fairchild FMA Series of modular plug-in components in TO-3, TO-8 and DIP packages.

CIRCLE NO. 349

# How to buy an RF Signal Generator

# Choose from the industry's most complete line

LogiMetrics

Instrument Catalog



Signal Generators



TWT Amplifiers



Frequency Synthesizers

RF SIGNAL GENERATORS



LogiMetrics provides the industry's most complete line of solid state signal generators, all of which are equipped with digital frequency readout. The signal generators cover the range of 50 kHz to 520 MHz with integral counters and leveled outputs. A precision attenuator allows the power to be varied from  $+23$  dBm (3 V RMS) to  $-127$  dBm (0.1  $\mu$ V RMS) into 50 ohms.

The generators inherent stability and ease of calibration allow users to perform RF measurements with superior convenience and accuracy and at the best cost effectiveness.

Model 315 combines two models 925 for single side-band test.

Among the many features offered in the line is Signallock<sup>®</sup>, the capability to count external signals and full modulation. Solid state design, self calibration and plug-in circuit cards insure ease of maintenance and long equipment life.

LogiMetrics signal generators are available with Federal Stock Nomenclature and under G.S.A. contract.

\*LogiMetrics holds the original patents on the digital readout signal generator and Signallock<sup>®</sup>. The circuit that is the key to stabilized signal generators. These patents are licensed to other major companies.

Model	Frequency Range MHz	Accuracy	Digits Display	Features
925	.05 to 80	$\pm 10$ Hz	6	AM, Signallock*
920B	.05 to 80	$\pm 500$ Hz	5	AM, High Accuracy
921A	.05 to 80	0.01%	3 (+ x 100)	AM, Low Cost
750A	4.5 to 520	$\pm 0.0001\%$	5	FM/AM Pulse
950A	1.5 to 80	$\pm 500$ Hz	5	FM/AM Com. Test
315	.25 to 80	$\pm 10$ Hz	6	Two Tone S.S.B. Test

LogiMetrics provides the industry's most complete line of solid state signal generators, all of which are equipped with digital frequency readout. LogiMetrics holds the original patents on the digital readout, signal generators and the circuit that is the key to stabilized signal generators, Signallock<sup>®</sup>. The signal generators cover the range of 50 kHz to 520 MHz with integral counters, precision attenuators and leveled outputs.

The generators' inherent stability and ease of calibration allow users to perform RF measurements with superior convenience and accuracy and at the best cost effectiveness.

Of special interest: the 750A and 950A FM-AM generators, both of which allow continuous one-knob tuning over their entire frequency bands without band switching.

For details on LogiMetrics signal generators, or TWT amplifiers or the new frequency synthesizers, use the Reader's Service Card or contact us directly.

**LogiMetrics** 121-03 Dupont Street, Plainview, New York 11803  
(516) 681-4700 TWX: 510-221-1833



### Transmitter tests noise loading

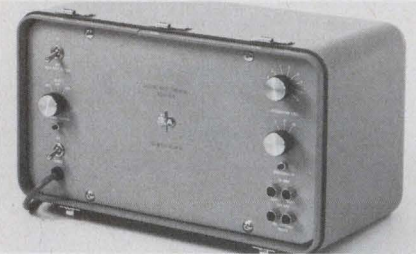

Scientific-Atlanta, Inc., 3845 Pleasantdale Rd., Atlanta, GA 30340. (404) 449-2000. Under \$1900; 8-10 wks.

The Model 4641 baseband noise transmitter provides band-limited white noise for noise-loading microwave-radio relay systems. The transmitter features selectable band limiting and band-stop filters for two separate radio loads, simulating up to 2100 channels of voice traffic. Output power is 0 to -29 dBm adjustable in 1-dB steps. Band-stop filters provide noise discrimination greater than 70 dB over 3-kHz bandwidth.

CIRCLE NO. 350

### Synthesizer spans 0.5-to-18-GHz range



Watkins-Johnson Co., 3333 Hillview Ave., Palo Alto, CA 94304. (415) 493-4141.

With new components for the company's WJ-1250 Modular Synthesizer System, automatic coverage is obtained over the full 0.5-to-18-GHz frequency range. The new WJ-1253A Multisource Chassis houses up to three WJ-1251 Series rf sources. These are automatically interfaced with the WJ-1250 microwave frequency synthesizer mainframe via the WJ-1253B Interface Module. By stacking two Multisource Chassis, up to six rf sources can be accommodated. Two new double-band rf sources, employing fundamental YIG-tuned oscillators, have also been introduced. The WJ-1251-7 provides 5 mW (min) output power from 8 to 18 GHz, while the WJ-1251-8 supplies 20 mW (min) over the 1-to-4-GHz band. With the present WJ-1250 system, 5 mW, 10 mW or higher minimum output power can be provided, and 100-kHz resolution and 3 parts per 10<sup>9</sup>/day long-term stability are standard.

CIRCLE NO. 351

### 8-GHz TWTs output 500 W

Varian, 611 Hansen Way, Palo Alto, CA 94303. (415) 493-4000.

Traveling wave tubes are offered for use in ground-based cw satellite transmitters. The VTX-6281H3 operates from 7.9 to 8.4 GHz, and it delivers a saturation output of at least 500 W. A control anode permits pulse modulation. The VTX-6281H3 has a minimum gain of 37 dB at 500-W output, maximum noise figure of 35 dB and load VSWR of 1.15:1. It weighs only 12 lb. A 250-W version—the VTX-6281H2—is also available.

CIRCLE NO. 352

## The DC to DC jewel

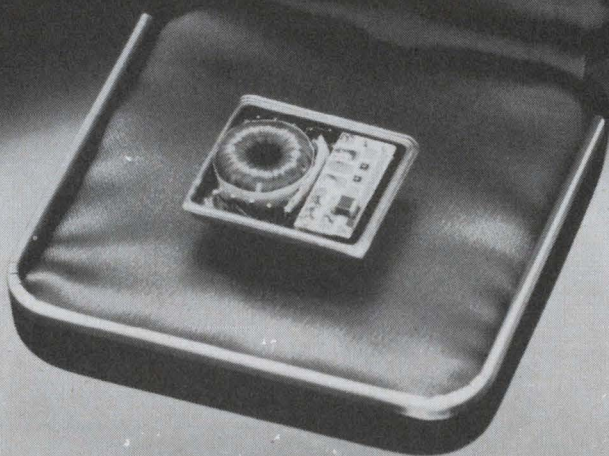

### Now with a narrower input range.

The Tecnetics HC Series unregulated DC to DC power supplies are more of a jewel than ever. We've optimized performance by adding a more efficient core and narrowing the input range. And it still weighs only 0.3 ounces.

Choose from a wide variety of input voltages and single or dual outputs. HC Series power supplies are available in a non-hermetic package for industrial and commercial applications, a her-

metic package for military, space and industrial applications that require protection from severe environmental conditions, and a fully-encapsulated package for use where extreme shock and vibration are expected.

Write for our 26-page catalog that gives full specs and prices on the HC Series and over three hundred other power supplies.

#### HC SERIES UNREGULATED ISOLATED DC-DC CONVERTER

INPUT VOLTAGES	5VDC±1V to 28VDC±4V
OUTPUT VOLTAGES	5VDC @ 2 watts to 300VDC @ 3 watts
OPERATING TEMP.	-55° C ambient to 125° C case, without derating
DIMENSIONS	1.05 x 0.94 x 0.32 Inches
EFFICIENCY	65% to 75% typically at full load 55% to 60% typically at half load
PACKAGE OPTIONS	HCH (Hermetic) 59.00
AND PRICES	HCH (Hermetic) 59.00 HCE (Encapsulated) 69.00

**tecnetics**®

The Power Conversion Specialists

P.O. Box 910, 1625 Range Street, Boulder, Colorado 80302 (303) 442-3837 TWX 910-940-3246

INFORMATION RETRIEVAL NUMBER 90



# It's 4K! It's fast! It's static! It's a whole RAM system!

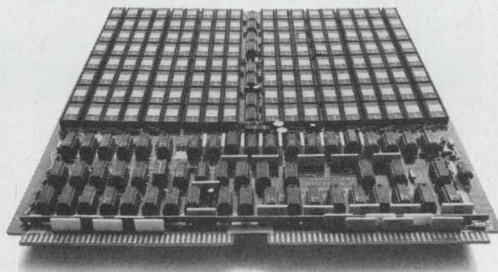

It's all of those and more, much more. It's our new Microram 3400N — a 32K x 16 or 18 bit memory system using our own SEMI 4402, 4K STATIC RAM components . . . the only production 4K STATIC RAM's available today. The 4402 is fast, with a worst case access time of 200 nsec. And . . . it's second-sourced, of course!

The Microram 3400N is form, fit, and functionally compatible with all core and NMOS members of the Micromemory family, and is completely contained on a single printed circuit card. Optional features include chassis and power supply. The Microram 3400N is immediately available with a worst case access time of 275 nsec.

Call your nearest EMM sales office and discover how "The Memory Company" can give you system building block flexibility, 4K to 32K, core or NMOS.

**EMM SEMI**

A division of Electronic Memories & Magnetics Corporation • 3883 North 28th Avenue, Phoenix, Arizona 85017  
(602) 263-0202

EMM OFFICES: WESTERN REGION, Regional Office, San Francisco, (408) 247-9711, Los Angeles Area, (213) 644-9881, Orange County Area (714) 639-5811, Minneapolis Area, (612) 941-2404, Phoenix Area (602) 968-2492, Dallas Area (214) 231-7207, EASTERN REGION, Regional Office, Boston, (617) 861-9650, Chicago Area, (312) 297-7090, Washington, D.C. Area (703) 941-2100, New York Area 516) 423-5800, Cleveland Area (216) 842-8920 INTERNATIONAL OFFICES, European Headquarters, Belgium (031) 76.69.75, United Kingdom (01) 751-1213, West Germany (089) 714.30.40.

REPRESENTATIVES: Gentry Associates: Orlando (305) 894-4401, Huntsville (205) 534-9771, Burlington, N.C. (919) 227-3639.  
In Canada: Megatronix, Ltd., Toronto (416) 742-8015, Montreal (514) 488-0404, Ottawa (613) 729-4004, Vancouver (604) 526-3312.  
In Japan, Nissho Electronics (03) 542-2351.

INFORMATION RETRIEVAL NUMBER 91



# convert 3V logic to 15V logic

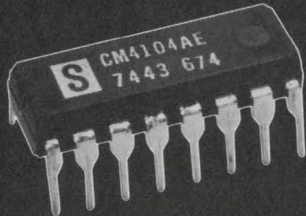

## with this new Solitron CMOS chip

TTL TO CMOS LOGIC  
LEVEL CONVERSION  
CMOS TO CMOS INTERFACE  
CMOS TO PMOS INTERFACE

Our new CM 4104A consists of 4 low-to-high voltage level translators, with an output enable control pin. All inputs are level translated, and any input may be driven more positive than  $V_{IO}$ , up to a level equal to  $V_{IH}$ . True and complement outputs are simultaneously available. When the Enable input is "low", all outputs become a high impedance. Price, \$3.62 (100 pieces).

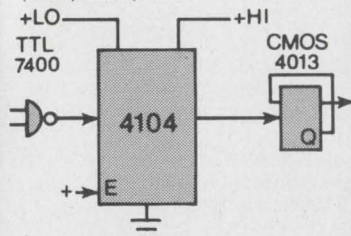

WATCH FOR NEW  
DEVELOPMENTS IN OUR OVER  
70 "4000 SERIES" DEVICES

# Solitron

8808 BALBOA AVENUE  
SAN DIEGO, CALIFORNIA 92123  
TELEPHONE (714) 278-8780

INFORMATION RETRIEVAL NUMBER 92

## COMPONENTS

# High-voltage chip capacitor? Cut your own from a slab

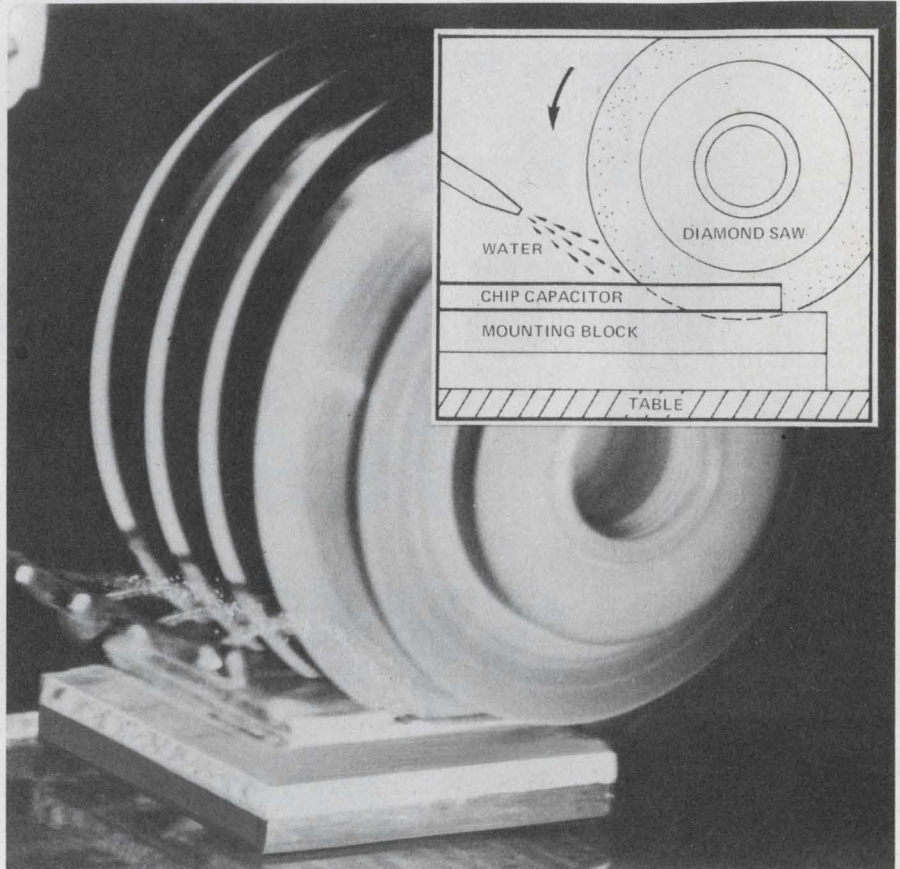

Semtech Corp., 652 Mitchell Rd.,  
Newbury Park, CA 91320. (805)  
498-2111. See text; stock to 4 wk.

A major bottleneck in the design and prototyping of high-voltage circuits is the lack of a large variety of capacitance values for high-voltage chip capacitors. Along comes the Semtech Corp., and it says, in effect: "If you need a high-voltage chip capacitor of a particular value, cut it yourself."

Available from the company are high-voltage slab capacitors, Series SC6000, that can be cut either by diamond saw or laser to custom capacitances and shapes. Once the prototype has been determined. Semtech can provide the required size and shape in large quantities.

Each slab is a single layer of barium titanate ceramic, with either silver or palladium silver terminations for contact to the

circuit. Slabs come in various sizes—from 0.6 × 0.6 in. to 1.8 × 1.8 in., and in capacitance values up to 23,000 pF.

Voltage ratings of 2, 3, 4, 7.5, 10, 15, and 20 kV are standard. Up to 70-kV slabs can be provided, with low-capacitance values on special order.

Semtech guarantees that all slabs are corona free within the voltage rating and are of uniform dielectric strength and value throughout. Capacitance tolerance can be specified as +10%, +20% or +100%, -0%.

Insulation resistance is 100 kMΩ or 1000 MΩ-μF, whichever is less at 25 C and 500 V dc. A maximum dissipation factor of 2.5% and a ±15% max temperature characteristic for the X7R ceramic ( $\Delta C$  between -55 and +125 C) are standard.

(continued on page 134)





# We make deliveries

FMC 40C Thyristors are available for off-shelf delivery and immediate installation. Designed in a T065 case, this power semiconductor replaces bulky T094 and T083 packages and upgrades 35 amp devices to 40 amp.

**The FMC 40C Thyristor is equivalent to IR-40RCS and GE-C147 and operates at a higher case temperature of 95°C.**

For detailed information, contact:  
FMC Corporation  
Semiconductor Products Operation  
Homer City, Pa. 15748  
(412) 479-8011

**FMC** Special  
Products



# Beat the Brownout\* Blues

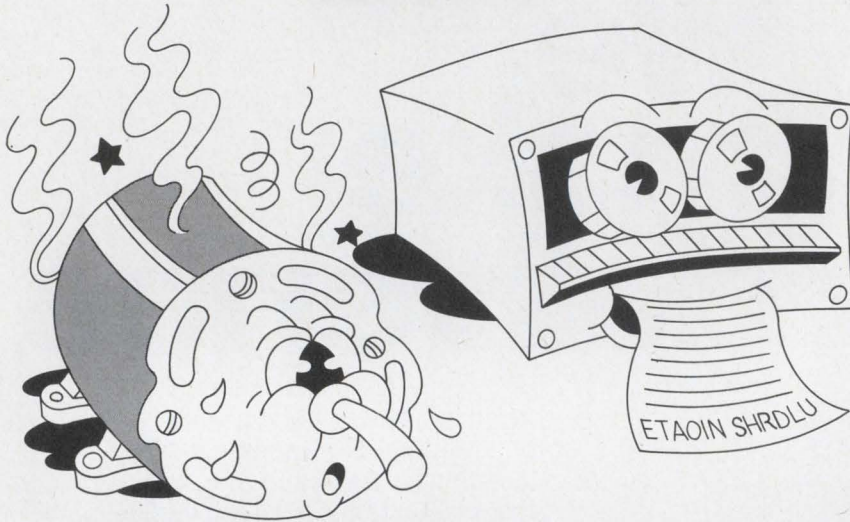

## No more computer garble, instrument error, or overheated motors.

\*Uncontrolled line-power reductions or in-plant voltage fluctuations can ruin performance, shorten equipment life. Patented Varax® line regulator maintains nominal voltage for extreme line swings—output stays at 115 Vac even when line drops to 90 volts.

Varax protects better than ferroresonant devices. Available in low-cost OEM or new enclosed versions for in-plant use. Models for U.S., European, or Japanese voltages, 500 or 1500 VA ratings.

Off-the-shelf delivery from 110 stocking distributor locations.



**TELE-DYNAMICS** DIVISION OF **AMBAC**  
WANLASS POWER SUPPLIES AND  
LINE CONDITIONERS

525 Virginia Drive, Fort Washington, PA 19034 • (215) 643-3900

An equal opportunity employer M/F

©Tele-Dynamics

See us at IEEE Booth 2203

6165

INFORMATION RETRIEVAL NUMBER 99

## COMPONENTS

(continued from page 132)

Since the edges of these chip capacitors are unfinished after cutting, they must be used in circuits that are to be potted before use.

In 1-to-10 quantities the slabs cost from 66 cents to \$10 apiece, depending upon size and value. At the 100-quantity level, the price dips to 45 cents to \$7. Large quantities of a single capacitor cut to order cost about 50% less than the 1 to 10 quantity price of an uncut slab of similar value.

CIRCLE NO. 306

## Solid tantalum caps are plastic encapsulated



Arco Electronics, Community Dr., Great Neck, NY 11022. (516) 487-0500. \$0.16 to \$0.90 (1000 up); stock.

Miniature, plastic-encapsulated, dipped, tantalum capacitors, type ART, are designed with a solid electrolyte plus a highly stable oxide layer and finished with an epoxy coating. The tantalums have a capacitance range from 0.1 to 680  $\mu\text{F}$  and tolerances of  $\pm 20\%$  or  $\pm 10\%$ . The working voltage range is 3 to 50 V dc. Straight leads are standard, crimped, formed, leads are optional.

CIRCLE NO. 353

## Set time digitally in delay relay

International Microtronics Corp., 4016 E. Tennessee St., Tucson, AZ 85714. (602) 795-9440. \$16 to \$34.95 (unit qty).

A digitally controlled time-delay relay, the 276 series, uses a frequency-division technique to generate time delays. The desired time delay is selected by setting binary-coded miniature switches. The delays have 0.5% accuracy and repeatability, and a zero-crossing switching circuit is used. The standard time range is 1 s to 4-1/4 min. Other models from 16 ms to over 29 h and accuracy to  $\pm 0.05\%$  are also available.

CIRCLE NO. 354



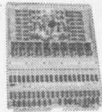

# This is not a semiconductor memory.

But then, semiconductor memory isn't always the answer. What you're looking at is our new 16K X 20 core memory board. It's the newest addition to our fine family of compatible memory products. (We reduced it just to get your attention).

We call this board the Harris 3800. You'll call it reliable. Reliable because they meet the exacting demands of our own computer systems. And, they'll meet the unpredictable demands of your unpredictable needs.

Harris memories. Another source when you need economy in quantity purchases. When you need field proven memories. When you need custom design. Or when you expect reliability.

- 250 ns access time
- Size: 11½ X 13¾
- Power required: +15 vdc, +5 vdc
- cycle time 650 ns
- random access
- no field adjustments

Write for the newest in 16K memory boards... the newest non-semiconductor that is. But if your need is semiconductor... we'll be pleased to discuss pin compatible HARRIS semiconductor memory systems.

**HARRIS**



**COMMUNICATIONS AND  
INFORMATION HANDLING**

1200 Gateway Drive, Fort Lauderdale, Florida 33309 (305) 974-1700



## COMPONENTS

### Single in-line package houses resistor network

Beckman Instruments Inc., 2500 Harbor Blvd., Fullerton, CA 92634. (714) 871-4848. 784-1: \$0.65; 784-3: \$0.60; (1-99).

Single in-line packaged resistor network, Series 784-1, contains seven equal resistors with a common termination at pin 1. Series 784-3 contains four equal, but iso-

lated resistors. Resistor tolerance is  $\pm 2\%$ . Each of these eight-pin networks comes in 15 different resistance versions from 100  $\Omega$  to 22 k $\Omega$ . Other resistance values or configurations can be special ordered on an OEM basis. The total package dissipation rating is 2 W at 25 C. Individual resistors are rated at 0.3 W for the 784-1 and 0.5 W for the 784-3. Maximum recommended operating temperature is 125 C.

CIRCLE NO. 355

IT'S WHAT COUNTS FOR YOU THAT MATTERS TO US.

## Because it's from HP it's more than just an 1100 MHz counter.

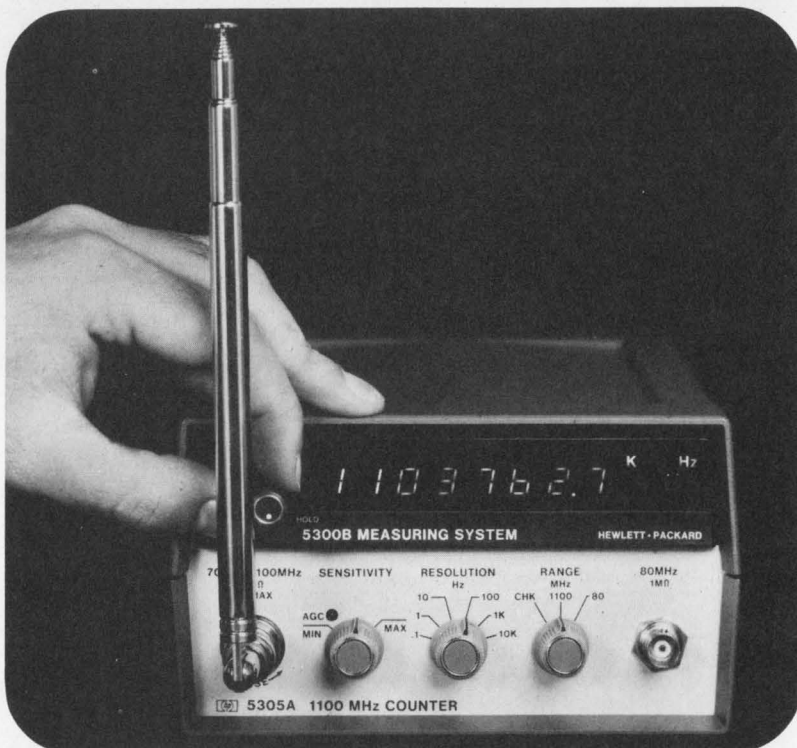

Check its features. The HP 5300B/5305A has the quality, convenience and portability your applications demand. But it doesn't stop there. Snap the 5305A counter module off the 5300B mainframe and in seconds you're ready to snap on any one of seven other modules including a full-range multimeter. All backed by the full HP guarantee and HP world-wide service.

\*Domestic USA prices only.

- High speed fuse-protected input; front panel accessible.
- Burst or CW signals.
- AGC or manual attenuation; measures modulated or noisy signals.
- 10 mV sensitivity at 500 MHz; 25 mV at 1100 MHz.
- Options: Battery pack. HP interface bus for data acquisition systems.
- Prices: 5300B mainframe, \$460.\* 5305A 1100 MHz module, \$1100.\*

**HEWLETT  PACKARD**

Sales and service from 172 offices in 65 countries.  
1501 Page Mill Road, Palo Alto, California 94304

02502

INFORMATION RETRIEVAL NUMBER 101

### Tiny rotary switch provides coded output



Janco Corp., 3111 Winona Ave., Burbank, CA 91504. (213) 845-7473.

A new miniature rotary switch for circuit board applications, the Janco Mini Code switch, is similar to a thumbwheel, but it occupies much less space. The unit measures 3/8-in. high and is less than 9/10 in. in diameter so that it can be used with card racks on 1/2-in. centers. The unit can be produced to provide decimal, octal, hexadecimal and most other common digital codes. Markings can be parallel to any axis and in any of six colors. Also the switch can be lighted internally. Seals, rotational stops and accessories to gang units for panel mounting are available. The basic switch is designed to meet the environmental requirements of MIL-S-22710.

CIRCLE NO. 356

### Fiber-optic display gives high brightness

Industrial Electronic Engineers, Inc., 7720-40 Lemona Ave., Van Nuys, CA 91405. (213) 787-0311. \$28.35: Numeric (250 up); 4-6 wks.

Special for avionics and cockpit applications, IEEE-Hellios high-intensity fiber-optic displays provide both high-density packaging and extreme brightness. The units are available in either seven-segment numerical or 16-segment alpha-numerical models with 1/4-in. high characters. They conform to MIL-E-5400 requirements, have a low power demand of 20 mA per segment at 5 V dc and standard modules are offered in from one to six digits. The units operate from -40 through 80 C and feature both easy readability in direct sunlight and controlled brightness for night vision. Average life expectancy for the subminiature incandescent lamps is 10,000 h at 5 V.

CIRCLE NO. 357



# OEM Buyers take note: CONTROL DATA® Storage Module Drives Models 9760 and 9762.



40 and 80  
megabyte  
capacities.  
Removable  
media.

9760—now being  
delivered in  
production  
quantities.

#### Features:

- Offers substantial lower cost per megabyte than current competitive products of equivalent capacity.
- Basic unit consists of a spindle and associated drive motor; voice-coil head positioner and servo systems; read/write, fault, transmitter/receiver electronics; and air filtration system.
- Options available include:
  - 5 power supply options for versatility.
  - phase-lock oscillator data separator and NRZ to MFM data encoder simplify interface design.
  - daisy-chaining for system expandability.
  - rack-mount package.
  - base cabinet for stand-alone configuration.
  - hysteresis brake to reduce pack stop time to 18 sec.
  - variable sector length for flexibility.
- Specifications
  - Capacity - 40 MB - Model 9760/80 MB - Model 9762
  - Average Access Time — 30 MS
  - Bit Transfer Rate — 9.67 MHz @ 3600 RPM
  - (Optional) — 6.45 MHz @ 2400 RPM
  - Tracks per Inch — 192-9760/384-9762
  - Bits per Inch — 6038
  - Number of Disks — 5 (3 recording, 2 protective)
  - Usable Surfaces — 6 (5 read/write, 1 servo)
- Deck and logic chassis hinged for easy access to all components.
- Compact size — 10.5" H x 17.25" W x 30" D.
- Field test exerciser with head alignment feature is available.

40 and 80 MEGABYTE STORAGE MODULE DRIVES . . . add a whole new dimension to meeting medium to large capacity storage needs in a package less than half the size of other drives; use CDC® 9876 or 9877 removable disk packs; pack has 5 disks (3 for data and head positioning, 2 for data protection); rack-mount package or optional base cabinet; daisy-chain interface; average access time 30 ms.; data rate 9.67 MHz (6.45 MHz optional); MODELS 9760 AND 9762 RESPECTIVELY.

Control Data Corporation  
Ray Crowder, OEM Marketing Manager  
Normandale Operations,  
7801 Computer Ave. So.  
Dept. ED-35 Minneapolis, MN 55435

**CONTROL DATA**  
CORPORATION

Name \_\_\_\_\_

Title \_\_\_\_\_

Company \_\_\_\_\_

Address \_\_\_\_\_

Phone \_\_\_\_\_

City \_\_\_\_\_

State \_\_\_\_\_

Zip \_\_\_\_\_

I want to see a demonstration of the Control Data Models 9760 and 9762 Storage Module Drive. Have my Representative call.



**NEW!  
MINI-BREADBOARD  
BUDGET KIT  
FOR THE ECONOMY-MINDED  
EXPERIMENTER...**

# Proto 100 Board



Patent Pending  
Made in USA

Here's a low cost, big 10 IC capacity breadboard kit with all the quality of QT Sockets and the best of the Proto Board series. Complete down to the last nut, bolt 'n screw. Includes 2 QT-35S Sockets; 1 QT-35B Bus Strip; 2 5-way binding posts; 4 rubber feet; screws, nuts, bolts and easy assembly instructions. Order off-the-shelf today from CSC or local distributor. Charge: BAC, MC, AX. Write for free catalog. Free English/Metric Slide Rule with each order. Dealer inquiries invited.

Complete Kit:  
**19<sup>95</sup>**

Add \$1.50 shipping/handling.  
Foreign orders add 15%.  
Prices subject to change



**Continental  
Specialties Corp.**

Box 1942, New Haven, CT 06509 • 203/624-3103  
W. Coast Off.: Box 7809, S. Fran., CA 94119 415/383-4207  
Canada: Available thru Len Finkler Ltd., Ontario

INFORMATION RETRIEVAL NUMBER 103

## CUSTOM ELECTRONICS' MICA CAPACITORS: short on DELIVERY long on RELIABILITY

That describes our CMR type capacitor, ideal for "potted-in" applications where minimum size and low per-unit cost are important. All our dielectric is screened before production to avoid failure in the field.

Installation No.	TYPICAL UNITS:			1 to 10 Qty. Price
	Cap.	WVDC	L x W x T Max.	
CMRIA102104K	0.1 $\mu$ f	1,000	2.062" x 1.425" x 0.200"	\$8.05
CMRIA302104K	0.1 $\mu$ f	3,000	2.562" x 1.620" x 0.270"	9.25
CMRIA103103K	0.01 $\mu$ f	10,000	2.562" x 1.800" x 0.350"	8.80

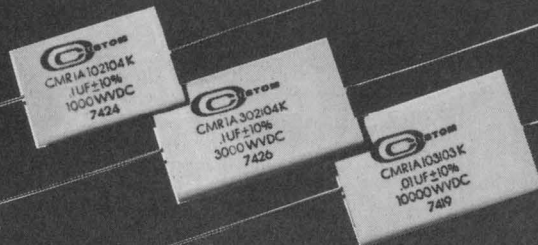

FREE: Descriptive TechniTip,  
includes Mica Sample. Write:



**CUSTOM ELECTRONICS, Inc.**

4 Browne St., Oneonta, N.Y. 13820  
PH: (607) 432-3880 TWX: 510-241-8292

INFORMATION RETRIEVAL NUMBER 104

## INTEGRATED CIRCUITS

### CMOS MSI line expands with 2 ICs

Motorola Semiconductor, P.O. Box 20924, Phoenix, AZ 85036. (602) 244-3466.

The company's line of 14500 Series CMOS MSI circuits now includes an adder (MC14560) and 9's complementer (MC14561). The MC14560 can add two 4-bit natural binary-coded decimal (NBCD or 8-4-2-1 code) words. Consisting of a 4-bit binary full adder, the MC14560 operates with a typical quiescent power dissipation of 0.1  $\mu$ W. The MC14561 is a 9's complementer consisting of a 4-bit binary adder and inverting logic on a single chip. When a BCD number (8-4-2-1 code) is applied to the data inputs, that number, or its 9's complement, appears at the outputs. Propagation delay is, typically, 130 ns, and all inputs are buffered.

CIRCLE NO. 358

### MOS chips form terminal xmtr/rcvr

Nitron Corp., 10420 Bubb Rd., Cupertino, CA 95014. (408) 255-7550. \$9 (100); stock.

The NC2257, 59 and 60 terminal transmitter/receiver MOS circuits provide the required interface for data systems using a serial communications link. All circuits are direct replacements for like-numbered Motorola ICs. The NC2257/NC2260 transmitters transform parallel binary data, in the form of characters, to serial data, with internally generated parity—even, odd, or none. Other features include externally selectable character length of 5, 6, 7 or 8 bits; 1 or 2 stop bits externally selectable for asynchronous mode; input clock frequency of 64, 16 or 1 times bit rate, and up to 200 bits per second. The NC2260 also provides internal clock and word-complete outputs. The NC2259 receiver accepts serial digital data from a modem or other source, organizes the data into fixed word lengths corresponding to characters and transfers these characters to a buffer register from which the character may be accessed in parallel form.

CIRCLE NO. 359





## THIS SYMBOL "■" HAS A MESSAGE FOR YOU

Look at the listings magnified above. They're from the PRODUCT DIRECTORY of *Electronic Design's* GOLD BOOK. Note that each product classification begins with boldface listings. These manufacturers have provided catalog pages for that product in vols. 2 or 3 of the GOLD BOOK.

But what about the other companies shown? Do they really make the product or would they merely *like* to make the product if your order is big enough? A printer's bullet (■) in front of its name means that the company has submitted printed literature on that product to the editors of the GOLD BOOK. It's reasonable to assume that these suppliers actually make the product, for its not likely that a supplier would prepare literature for a product he can't ship. The bullet ■ gives you a measure of verification.

Manufacturers listed in boldface in the second sub-group have provided catalog pages, but not for the specific product heading the list.

In a constantly moving industry, these measures of verification are of course subject to change. Yet they can be helpful guides as you seek out potential suppliers.

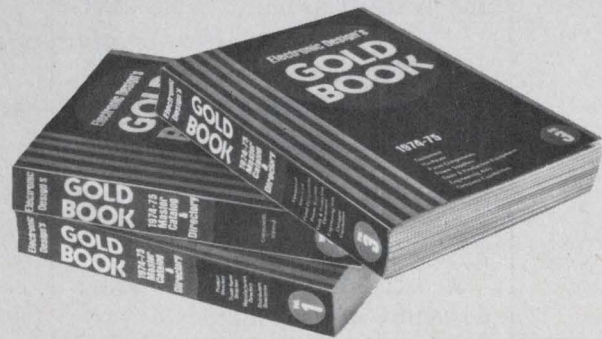

# Electronic Design's GOLD BOOK

BIGGEST AND BEST ELECTRONICS MASTER CATALOG  
& DIRECTORY IN THE WORLD



## What makes GENERAL SCANNING OEM RECORDER MODULES



A better selection of standard 'specs' to easily fit particular applications. We developed our complete line of strip chart recorder modules — with OEM needs in mind. Needs like reliability, accuracy, compactness, flexibility and, of course, low cost.

Chances are General Scanning has a standard off-the-shelf recorder module just right for your application. If we don't, our modular construction method makes it simple to fill the most unique requirements. A sample of 'specs' to choose from:

- **Number of Channels**  
single through eight
- **Channel Widths**  
20, 40, 50, 80 & 100 mm
- **Paper Feed**  
roll  
fan fold
- **Chart Speeds**  
multi-speed, electrically selectable
- **Pen Motor Operation**  
open loop  
velocity feedback  
closed loop
- **Inkless Thermal Writing**

We offer packaged recorders for your lab, portable DC recorders and precision pen motors, too. Make "the designer's choice", call or write for full details. The general awaits your orders.

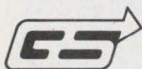

**GENERAL SCANNING INC.**  
150 Coolidge Avenue  
Watertown, MA 02172  
TEL: (617) 924-1010

INFORMATION RETRIEVAL NUMBER 106

## INTEGRATED CIRCUITS

### Low power Schottky-TTL aims for MIL uses

*Signetics, 811 E. Arques Ave., Sunnyvale, CA 94086. (408) 739-7700.*

Military-temperature range low-power Schottky-TTL circuits—the 54LS series—are offered by the company. Circuits operate at a toggle rate of 35 MHz. Power dissipation is 2 mW per gate and propagation delay is 8 ns. The 54LS series has a speed-power product of 15 pJ, or five times better than standard 5400-TTL circuits.

INQUIRE DIRECT

### 1-k shift register uses 5-V supply

*Intersil Inc., 10900 N. Tantau Ave., Cupertino, CA 95014. (408) 257-5450. \$9.90 to \$16.80 (100-999); stock.*

A static 1024-bit shift register—the IM7733—uses silicon-gate, n-channel MOS enhancement-mode technology. It has a 1024 × 1-bit organization, features TTL/DTL compatibility, uses a single 5-V supply and requires no external pull-up components. Clock to output data delay is typically 100 ns. An on-chip generator yields the three clock phases used in the static register cells. The push-pull output buffer provides a fanout of two TTL loads. The IM7733 is pin-for-pin compatible with the Signetics and AMD 2533, National's MM5058 and Texas Instruments' TMS 3133.

CIRCLE NO. 360

### 1-k static RAM has 500-ns access

*SGS-ATES Componenti Elettronici SpA, Via C. Olivetti 1, 20041 Agrate (Milano), Italy*

A 1024-bit static RAM, using n-channel silicon-gate MOS technology, operates from a single 5-V supply and doesn't require clocks or refresh. The output of the M 330 is read nondestructively, with the same polarity as the input data. Three versions are offered for these maximum access times: 500 ns (suffix C); 650 ns (suffix B), and 1000 ns (suffix A).

CIRCLE NO. 361

### CMOS switch handles ±15-V signals

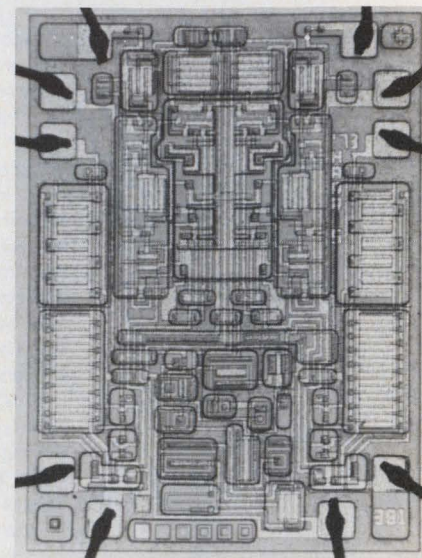

*Harris Semiconductor, Melbourne, FL 32901. (305) 727-5407.*

A dual SPST CMOS analog switch—the HI-200—is pin-for-pin and function-for-function replaceable with the DG-200 from Siliconix. (Within the next two months, Harris expects to alternate source the entire Siliconix CMOS analog-switch family.) The new switch has an analog signal range of ±15 V. Other features include DTL/TTL and CMOS compatibility, switch current of 80 mA at 25 C, power dissipation of 15 nW and typical ON-resistance of less than 60 Ω.

CIRCLE NO. 362

### ECL family offers 1-GHz rates

*Fairchild, Integrated Circuits Group, 464 Ellis St., Mountain View, CA 94042. (415) 962-3816. \$2.05 to \$54.95 (1000).*

An ECL family—the F11C00 series—for instrumentation and communication applications kicks off with five circuits, featuring the 11C05, a 1-GHz divide-by-four counter which operates from standard ECL or TTL power supplies; and the 11C06, a 750-MHz D flip-flop. Both prescalers employ the company's Isoplanar II technology. The 11C44 phase/frequency detector can be used in synchronization applications. The 11C24 and 11C58 voltage-controlled multivibrators are intended for clock generators and as variable frequency elements.

CIRCLE NO. 363



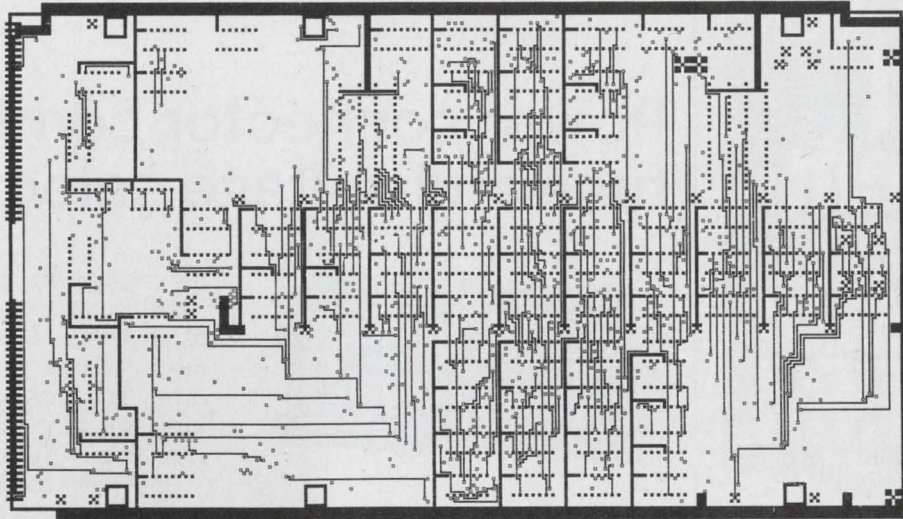

# By the time your drum plotter turns this out, a Gould printer/plotter can turn it out 400 times.

If what you're looking for is higher plotting speed and lower plotting cost, we've got something that can give you both. And something else besides.

A Gould electrostatic printer/plotter. The one that makes your old drum plotter remarkably underproductive. The one that gives you a useful printing capability in the bargain. A Gould plotter is so fast, it can turn out this plot in only 2 seconds — versus an average 13½ minutes for your old drum plotter.

And what gives that Gould plotter its blinding speed is its direct on-line operation to your computer. Whether it's the PDP-8/E, PDP-9, PDP-11, PDP-15, HP2100, Nova/Supernova, H316/516, Raytheon 704, UNIVAC 1108, IBM 360/370, CDC 3000/6000, Interdata 70 and more.

In addition to output speeds up to 400 times faster, a Gould printer/plotter gives you a lower unit cost, as well as lower paper cost. Better-looking output, since there's no ink to smudge, clog or run out of. Few moving parts for quiet operation, high reliability. Software that's up-

ward compatible with the leading drum plotter. Without any sacrifice in mainframe CPU time.

And, in addition to everything else, it gives you an alphanumeric printing capability that also lets you compile management reports at speeds up to 3000 lines per minute.

Users will tell you that a Gould electrostatic printer/plotter makes their computer-aided design system truly interactive since output of modified data for verification can be quickly obtained. And by producing hardcopy output in a matter of seconds — instead of the many minutes it can take with older methods — time savings are maximized.

This all adds up to the best printing/plotting hardware and software available anywhere. And it's backed by Gould's own factory trained service technicians.

To learn more about Gould electrostatic printer/plotters — get in touch with Gould Inc., Instrument Systems Division, 3631 Perkins Ave., Cleveland, Ohio 44114 U.S.A., or Kouterveldstraat 13, B 1920, Diegem, Belgium.



 **GOULD**

INFORMATION RETRIEVAL NUMBER 107



# A bench and system use innovator from T.R.I.

**New**

Model: 6141  
Programmable DC V/I Generator

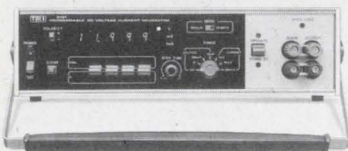

Model: 6120 Programmable DC Standard

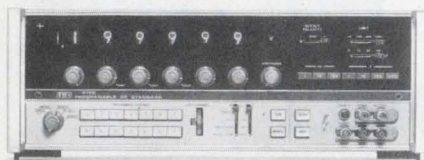

## Two DC V/I Generators for all new applications

1. A stimulus to auto testing equipment...Programmable functions for OEM use.

Two DC V/I generators can control externally the functions you need for OEM applications. These units have a pulse-width modulation system, so switching output noise is far less than that of conventional products.

2. Includes a 14-step memory and flip switch for newer, wider bench uses.

Model 6120 includes a 14-step memory so it can be used as a simple testing device for storage of the desired output. Model 6141 has a new flip switch enabling quick setting of the output.

3. High accuracy and very small step advantages permitting use as a standard device.

Both models have very small step advantages, continuously variable, and highly stabilized output for adequate use as standard device.

4. Continuous function highly suited for instrumentation checks and maintenance.

Both models can vary the output level both stepwise and continuously, making them highly suited for checking and maintenance.

	Model 6141	Model 6120
DCV	0~±12V (1μV step)	0~±1200V (1μV step)
DCI	0~±120mA (0.1μA step)	0~±120mA (0.1μA step)
Price	\$890	\$2995



**T.R.I. Corporation**

505 West Olive Avenue Sunnyvale, CA 94086  
(408) 733-9080

INFORMATION RETRIEVAL NUMBER 108

## Power connector combines fuse and voltage selection

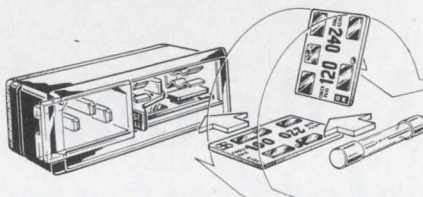
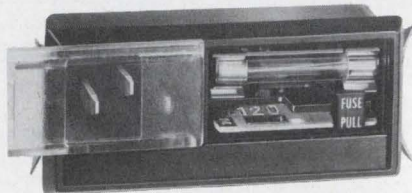

Corcom, Inc., 2635 N. Kildare Ave., Chicago, IL 60639. (312) 384-7400. \$4.95: 6J1; \$9.75: 6J4 (100-2499).

Corcom's Type 6J1 voltage-selecting and fused (VS & F) connector combines a power voltage-selection system with a fused connector. This type of connector was formerly made only by instrument manufacturers for their own use. Now Corcom has been licensed to market it as a separate component.

The unit allows the user to change the line-power voltage to

his equipment safely and to select 100, 120, 220 or 240 V at 50 to 400 Hz. Voltage selection is made with a replaceable selector card. The maximum current rating is 6 A, and the replaceable fuse is a 3-AG type.

Only one rectangular cutout is needed for snap-in mounting. And spring-actuated mounting tabs eliminate the need for mounting hardware, regardless of panel thickness. The housing is made of UL-approved, SE-01 fire-retardant polyester. The connector also complies with International Electrotechnical Commission (IEC) requirements.

The fuse and the voltage-selector card are behind a see-through cover, which cannot be removed until the power cord is detached from the equipment. This ensures safety when a fuse is changed or a new operating voltage is selected.

The VS & F connector is available with an RFI powerline filter, Type 6J4, which also meets both UL and IEC safety and reliability requirements for industrial equipment.

CIRCLE NO. 303

## Ceramic-fiber gaskets are asbestos free

Cotronics Corp., 37 W. 39th St., New York, NY 10018. (212) 531-9376.

Cotronics asbestos-free ceramic-fiber gaskets are fabricated from high-purity refractory fibers with a melting point of 3200 F and a continuous-use temperature in excess of 2300 F. This ceramic fiber product offers high-temperature stability, resistance to most chemicals and solvents and it meets OSHA requirements. The gaskets are produced by a low-cost die-cutting process from ceramic paper, blanket or board.

CIRCLE NO. 364

## GGG crystals available as wafers or boules

Deltronic Crystal Industries, Inc., P.O. Box 323, Denville, NJ 07834. (201) 361-2222.

Gadolinium-gallium-garnet crystals of uniformly high quality are available as wafer blanks and boule sections for use primarily in thin-film growth of magnetic rare-earth garnets. Crystals are strain and core free, with dislocation counts less than 3/cm<sup>2</sup>—and often zero—over the entire surface area. Lattice constant is 12.383 Å; standard orientation is (111). Sizes available range from 3/4 to 1-1/2 in. dia.

CIRCLE NO. 365



# "No-Fault" Insurance...

A precision Voltage/Current Source that guards against accidental damage with a six point program.

- Its unique "Compliance Voltage" limiting provides control of the maximum open circuit voltage appearing across the current or voltage terminals.
- Separate output terminals, provided for the "mA", "mV", and "V" ranges, protect against erroneous application of signal.
- All output terminals can be short-circuited without damage.
- Range changes utilize make-before-break switching which eliminates output transients.
- Conventional dial settings have been replaced with a 4½ digit, solid state display.
- A "Hi-Volt" warning light indicates that the selected range has the capability of producing hazardous high voltage.



The Model 3110 features five voltage ranges spanning  $\pm 1 \mu\text{V}$  to  $\pm 100\text{V}$  and two current ranges spanning  $\pm 1 \mu\text{A}$  to  $\pm 100\text{mA}$ , with an accuracy of 0.01% of setting. It delivers the stability, resolution and setability you expect from a DigiTec "HT Series" instrument!

Model 3110 Precision Voltage/Current Source.

ONLY **\$995.**

With immediate delivery.

Your local United System representative can supply full specifications.

**DigiTec**

UNITED SYSTEMS CORPORATION

a subsidiary of **Monsanto**

918 Woodley Road • Dayton, Ohio 45403 • Ph: (513) 254-6251 • TWX: (810) 459-1728

FOR INFORMATION, CIRCLE 151

FOR DEMONSTRATION, CIRCLE 152

## NEW PANDUIT® FLAT CABLE MOUNT

Economical, versatile method of mounting or bundling flat cable

- Secures stacked cables, folds and breakouts
- Maintains flat cable's inherently uniform transmission characteristics
- Mount to any surface using screws or commercial adhesive
- Low profile
- Removable and reusable
- Stacking up to 5¼" high; cable widths to 3".



**FREE  
SAMPLES**

Sold through Authorized Panduit Distributors

**PANDUIT** CORP.

Tinley Park, Ill. 60477  
Phone: (312) 532-1800  
In Canada: Panduit (Canada) Limited

## MORE SIDE-ON PHOTOMULTIPLIER TUBES

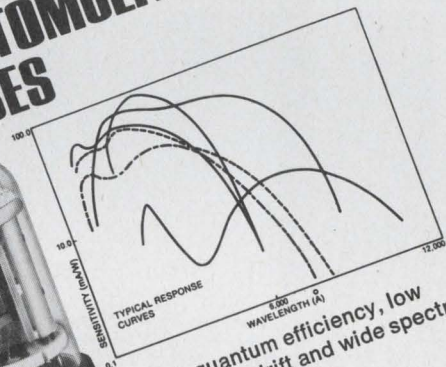

Call or write for catalog

- High quantum efficiency, low noise, low drift and wide spectral range
- Window materials—UV-glass, fused-quartz or borosilicate
- Cathode materials include alkali, multialkali and GaAs as well as solar blind and S-1
- Choose from the most complete line of exceptional quality Side-On photomultiplier Tubes.

**HAMAMATSU  
CORP.**

120 Wood Avenue  
Middlesex, New Jersey 08846  
(201) 469-6640

INFORMATION RETRIEVAL NUMBER 115

ELECTRONIC DESIGN 6, March 15, 1975

INFORMATION RETRIEVAL NUMBER 116

143



# Now there's an alternative to the shielded room

The IFI Crawford Cell. It not only costs far less than a screened room — it's more versatile; instrumentation requirements are simpler; it eliminates both antennas and resonance problems. The IFI Crawford Cell provides broadband measurement of radiation from, or susceptibility to radiation of equipment placed in the cell. Compact (53" x 24" x 16" with larger or smaller units available), the Model CC-103 Crawford Cell can be located anywhere in the lab. VSWR is <math>< 1.1:1</math> up to 300 MHz. Calibration traceable to NBS.

For complete details, write IFI — the leader in field generating and measuring equipment.

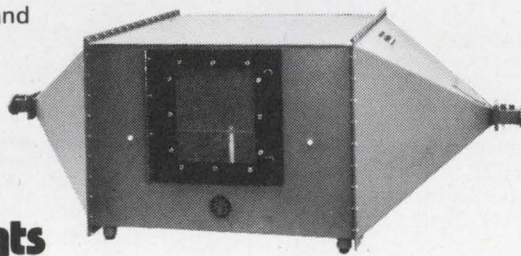

**instruments  
for industry,  
inc.**

(516) 694-1414

151 Toledo Street,  
Farmingdale, N.Y. 11735

INFORMATION RETRIEVAL NUMBER 110

## Shielded Adjustable Coils Mil & Commercial Grades from .1uh - 10 mh

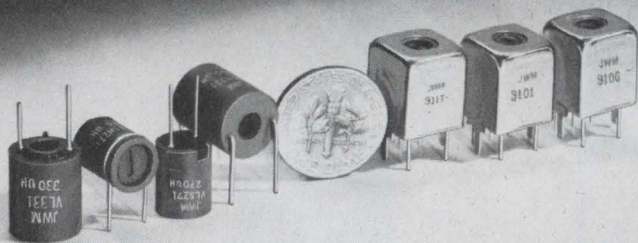

Write on your letterhead for full line catalog.

**BELL INDUSTRIES / J. W. Miller Division**

19070 REYES AVENUE ■ P. O. BOX 5825 ■ COMPTON, CALIFORNIA 90224

See our listing in *Electronic Design's GOLD BOOK*.

INFORMATION RETRIEVAL NUMBER 111

## bulletin board

Digital Equipment has introduced a series of PDP-15 hardware configurations priced 6 to 11% below previously available configurations. Called the PDP-15/78 and PDP-15/76-C systems, they are priced from \$35,000, with deliveries scheduled for March, 1975.

CIRCLE NO. 366

Silicon Transistor has announced the immediate availability of JAN silicon power transistor types 2N1485, 86, 89 and 90 and 2N3715 and 16. The JAN 2N1485, 86, 89 and 90 are single diffused types supplied in TO-8 and TO-3 packages. The JAN 2N3715 and 16 are epitaxial base, high power types capable of dissipating 150 W in the TO-3 package.

CIRCLE NO. 367

NCR Corp. has raised rental and maintenance charges on most Century Series computer systems. The rental increases range from 1 to 8%. Century 50 rental charges have increased 6% and Century 101 charges 8%, while the larger 200 and 201 models will increase only 2% and 1%, respectively.

CIRCLE NO. 368

Monsanto has announced a series of opto-isolators with JEDEC registration. The new units, 4N25 to 4N28, are optically coupled photo-transistors.

CIRCLE NO. 369

### Price reductions

RCA has reduced gate prices more than 30% and MSI prices more than 20% for standard CD4000 series devices in 100 to 999 quantities.

CIRCLE NO. 370

Kinetic Technology has announced an average 15% across-the-board price reduction on all standard thick-film hybrid active filter modules.

CIRCLE NO. 371



# FOR PEOPLE WHO WANT TO READ ALL ABOUT IT!



We have nothing less than a fully illustrated, systematic, easy-to-use survey of the entire field of data management as it exists today. It covers it all, from A to Z, so it's for everybody. The programmer tightening up his files. The analyst working out a workable timesharing program. Top management needing industry-wide perspective on competitive system designs.

It's a rare publication that takes a unique "blueprint approach" to current know-how. Beginning with the single data item as the first building block in total system design. And progressing through specific techniques for data structures, streams, files . . . total hardware and operating system control . . . the latest advances in timesharing and multiprogramming . . . system modeling and simulation . . . complete

designs for various types of commercial accounting and document-oriented storage and retrieval systems. It all adds up to a vast and impressive "top to bottom" view.

And it does it all in fresh, jargon-free language, with scores of illustrations and diagrams for a rapid, visual grasp.

Whether you use it as an on-the-job manual, as a desk-top reference, or as a conference room companion with all the answers, it's an indispensable tool guaranteed to broaden your perspective and practical skill in a field that knows no limits to growth and progress. And generally give you the professional confidence that comes from knowing just about everything that's going on.

#5100-X, 6 x 9, 300 pages, cloth \$14.95

## To Order:

Circle the **Information Retrieval Number** to order your 15-day free examination copy of **Data Management for On-Line Systems** by **David Lefkowitz**. At the end of that time please remit payment or return the book with no further obligation.



**Hayden Book Company, Inc., 50 Essex Street, Rochelle Park, N. J. 07662**

TO ORDER, CIRCLE 94





**Wire-  
Wrap  
Panels**

**EMC**

**Nurl-Loc<sup>®</sup>  
Delivers!**

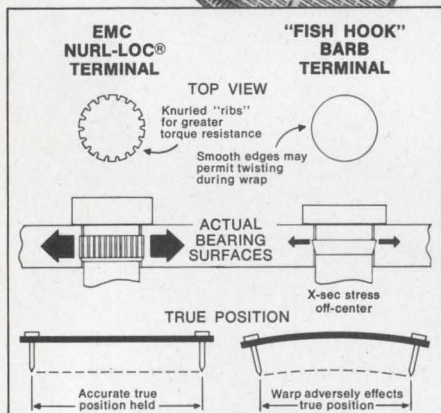

## Nurl-Loc Terminals flatten EMC Panels for pinpoint wrapping

Patented Nurl-Loc permits wider use of lower-cost  $\frac{1}{16}$ " panels, that mate with existing connectors and p.c. board set-ups. Nurl-Loc terminals hold better, won't twist during wrapping, and simplify terminal replacement. And funnel-entry design simplifies I.C. lead insertion. Standard  $\frac{1}{8}$ ", or  $\frac{1}{16}$ " panels in 2 or 3 levels of wrap, 12 to 180 or more positions . . . or custom designs that match existing systems and cut wrapping costs.

### Delivery Faster, too!

Contact EMC today for instant info on off-shelf delivery and fast engineering service. Electronic Molding Corp., 96 Mill St., Woonsocket, R. I. 02895. Phone (401) 769-3800.

Wire-Wrap<sup>®</sup> Gardner-Denver Co.



INFORMATION RETRIEVAL NUMBER 113

## new literature

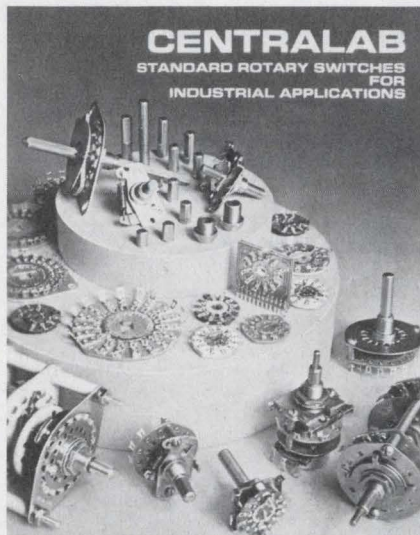

**CENTRALAB**  
STANDARD ROTARY SWITCHES FOR INDUSTRIAL APPLICATIONS

### Rotary switches

A 40-page rotary switch catalog is complete with a quick-reference chart, dimensional drawings, general, electrical and mechanical specifications and distributor cross-reference. Included is a specification sheet and ordering information. Centralab, Milwaukee, WI

CIRCLE NO. 372

### Tube commemorative

"Fifty Years of Innovation," a 20-page illustrated publication, traces the company's history, starting with the first production of Sylvania radio tubes in 1924. GTE Sylvania, Waltham, MA

CIRCLE NO. 373

### Hand-held DMM

Model 21 hand-held digital multimeter is described in a four-page brochure. Features, illustrations and a comparison of the Model 21 with similar HP and Dana DMMs are included. Data Technology, Santa Ana, CA

CIRCLE NO. 374

### Test equipment

A 230-page catalog is complete with product descriptions and applications on frequency synthesizers, pulse echo test sets, level meters, noise loading test sets and return loss measuring sets. The units are manufactured by Anritsu, Tokyo. Tau-Tron, North Billerica, MA

CIRCLE NO. 375

### Integrated circuits

A 96-page book tells the designer the ground rules for using the SL600 series integrated circuits. Typical circuit connections are presented, with clear and comprehensive discussions of alternative connections and their relative advantages and disadvantages. Plessey Semiconductor, Santa Ana, CA

CIRCLE NO. 376

### Photomultipliers

A 12-page selection guide of photomultiplier tubes, electron multipliers and gas-filled and vacuum photodiodes allows a quick comparison of the characteristics of the different RCA devices to facilitate initial selection. RCA, Harrison, NJ

CIRCLE NO. 377

### Inductive devices

A 20-page brochure details inductive devices and custom networks for military, computer and industrial applications. Specifications, dimensional data, MIL-Spec numbers and application information are included. Vanguard Electronics, Inglewood, CA

CIRCLE NO. 378

### Crystals

Low and medium-frequency crystals, crystal ovens, plug-in transistor oscillators and accessories and frequency meters are described in a 28-page catalog. How-to-order information is included. International Crystal Manufacturing, Oklahoma City, OK

CIRCLE NO. 379

### Modular motor system

A 32-page catalog describes a major innovation in motor design. Unlike conventional motors, new synchronous H4 motors are assembled from modular components. Detailed graphs and application information tell the key facts about performance. General Time, Industrial Controls Div., Thomaston, CT

CIRCLE NO. 380



# DO COLLEGES HELP BUSINESS AS MUCH AS BUSINESS HELPS COLLEGES?

Yes, they do. But not in the same proportion.

Business contributes about 15% of the total voluntary support received by colleges.

But today, business gets half the college-trained men and women who are employed. Tomorrow, it will need even more.

As a result, businessmen should think seriously about increasing the level of corporate giving to education. Can you think of a better investment?

For the latest national figures on corporate giving to higher education, write on your letterhead for "CFAE Survey of Corporation Support of Higher Education," and enclose \$2.00 to help cover costs. Mail to: Council for Financial Aid to Education, 6 East 45th Street, New York, N.Y. 10017.

Give to the college of your choice. Now.

Advertising contributed for the public good.

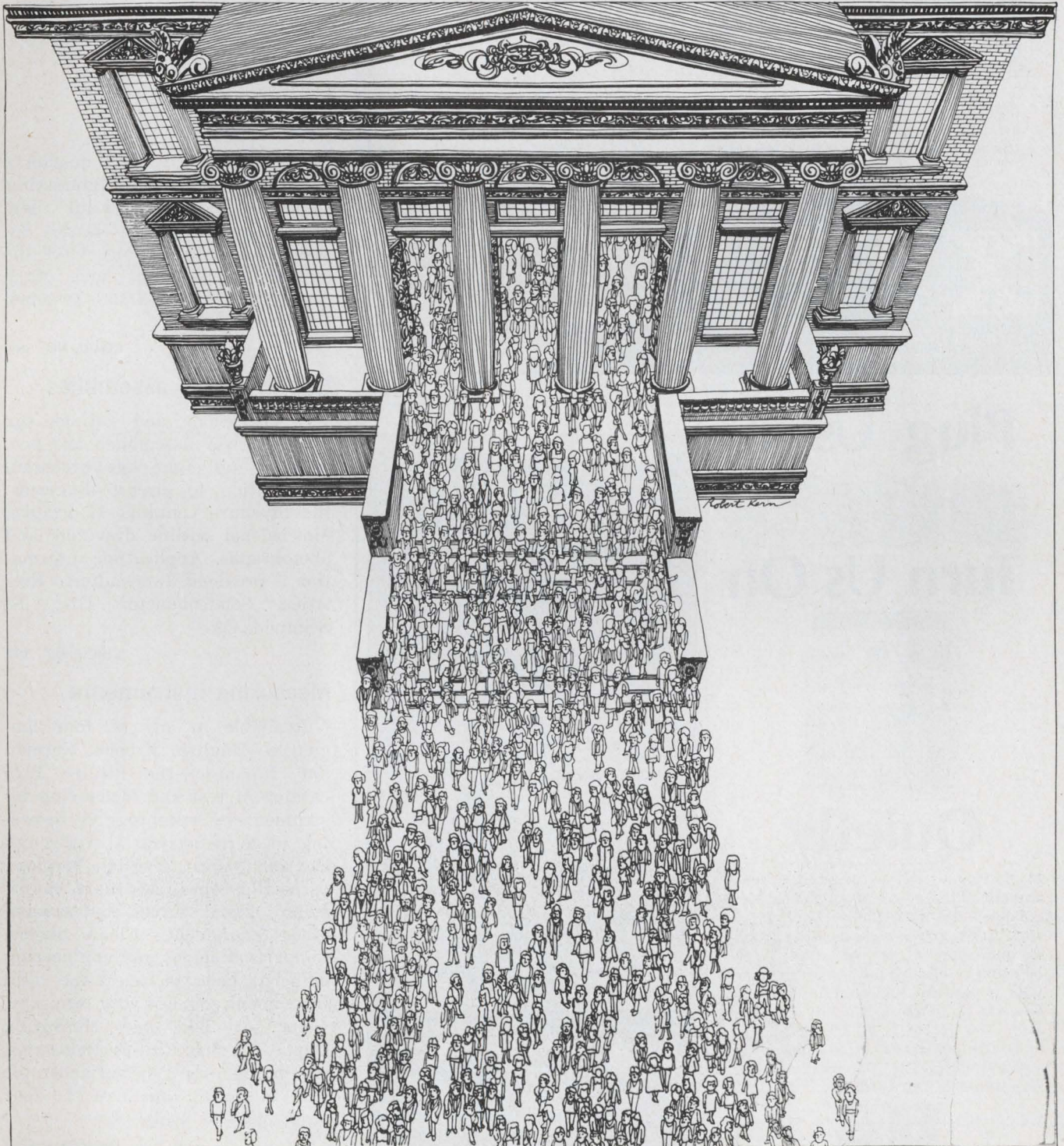



# NEW DIP TRIM POT

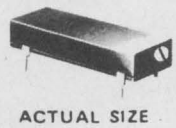
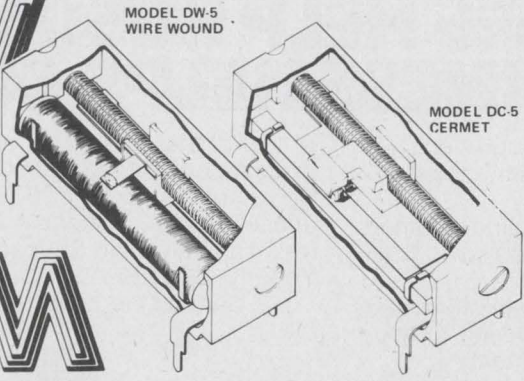

ACTUAL SIZE

- HIGH-IMPACT PLASTIC HOUSING RESISTS CLEANING AGENTS.
- LOW INDUSTRIAL PRICING.
- DESIGNED FOR DIP AUTOMATIC INSERTION EQUIPMENT.
- AVAILABLE IN SINGLE OR MULTIPLE LOADING MAGAZINES.

Minelco's new Dual In-Line Potentiometer is a low cost trimmer specifically designed for PCB automatic insertion equipment.

The DW-5 wire-wound model offers low TC to  $\pm 50$  PPM and resistance values up to 25K.

The DC-5 model with CERMET element and multiple point wiper contact for stability and reliability will retain accurate settings within 0.5% of desired voltage; TC of  $\pm 100$  PPM; resistance range up to 2 megs, infinite resolution.



**MINELCO**<sup>®</sup>

Division General Time Corp  
A TALLEY INDUSTRIES COMPANY

135 SOUTH MAIN STREET • THOMASTON, CONN. 06787  
PHONE: 203/283-8261 • TWX: 710/475-1091

Send for  
free brochure.

INFORMATION RETRIEVAL NUMBER 117

## Plug Us In



## Turn Us On

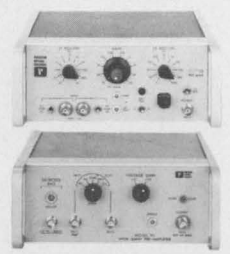

## Quietly

Measuring low level signals is tough enough without adding noise—so our preamplifiers are quiet. To find out more about our wide range of quiet preamps, write or call for our handy full color wall chart; it will help you in selecting the best preamp for your application. Princeton Applied Research Corporation, P.O. Box 2565 Princeton, New Jersey 08540, 609/452-2111. In Europe, contact Princeton Applied Research GmbH, D8034 Unterpfaffenhofen, Waldstrasse 2, West Germany.



286

INFORMATION RETRIEVAL NUMBER 118

## SOLID STATE, ALL DC RATE SENSORS, ONLY 2 WATTS, GUARANTEED 10,000 HOURS

.002 Hz to 7 Hz bandwidth  
Zero to 50° per second range

Rugged, fast starting hermetically sealed solid state angular rate sensors. Insensitive to acceleration and vibration. Provide output signals of  $\pm 2.5$  VDC. Direct replacement for small rate gyros for autopilots, radar and helicopter stabilization, yaw damping, instrumentation. 3-axis models and ranges up to 3000° also available. Write for data sheet.

Model RT03-0108-1  
2.56 inches diameter  
Model RT01-0102-1  
1.0 inch diameter



**Humphrey** Inc.

Dept. ED375  
9212 Balboa Ave.  
San Diego, CA 92123  
Telephone (714) 565-6631

INFORMATION RETRIEVAL NUMBER 119

## NEW LITERATURE

### DATTEL DIGEST

PRODUCT NEWS FROM DATTEL SYSTEMS INC.



## Dattel Digest

The Dattel Digest is a quarterly publication featuring interesting summaries of significant new products. The stories features descriptions, specifications, block diagrams, photographs and other useful information. Dattel Systems, Canton, MA

CIRCLE NO. 381

## Hybrid power assemblies

Specifications and ratings for hybrid power assemblies are provided in an eight-page brochure. In addition to circuit diagrams, the brochure contains 11 graphs, dimensional outline drawings and photographs. Application information is provided. International Rectifier, Semiconductor Div., El Segundo, CA

CIRCLE NO. 382

## Measuring instruments

Available in any of four languages—English, French, German and Japanese—the Philips 1975 catalog of test and measuring instruments is sure to give browsing pleasure as you flip through the 288 pages (English version) of oscilloscopes, recorders, multi-meters, signal sources, counters and other equipment. Clear photos, comparison charts and engineering data will help you select the right instrument, too. For your own copy, write to: Test and Measuring Dept., TQ. 3-4, Philips Industries, Eindhoven, the Netherlands. Be sure to specify which of the four languages you'd like.

INQUIRE DIRECT



# Save on Calculators

Before you buy a calculator, check our prices.

## Hewlett-Packard

The utmost and ultimate in high quality, precision, sophisticated calculators. Made in U.S.A. (Beware of imitations.)

- HP-35 Scientific, hand-held with 4 memories.
- HP-45 Scientific, hand-held with 10 memories.
- HP-65 Scientific, hand-held with 100 step programming.
- HP-70 Hand-held for business, finance. 6 memories.
- HP-80 Hand-held for business, banking, finance. 10 memories.
- HP-46 Printing Scientific with 48 functions. 10 memories.
- HP-46 Option 001. Printing and display.
- HP-81 Printing for business. 20 memories.

## New from HP

- HP-55 Most sophisticated hand-held programmable calculator on the market. 20 addressable data storage registers. Keystroke programming, 86 keyboard commands, plus 4-register operational stack and "computer logic" system.
- HP-21 New Scientific hand-held with 8-digit display, scientific notation. Similar to HP-35 plus rectangular to polar, degree to radian. Fixed or floating display. Register arithmetic. \$125.00.

All HP hand-held calculators include charger, instruction manual, etc. One full year guarantee by HP.

## Texas Instruments

- TI-2502 Hand-held with percent and automatic constant.
- TI-1500 Smaller hand-held with percent and automatic constant.
- TI-2550 Hand-held with full memory, percent and constant.
- TI-3500 Desk-top. 10 large digits with constant.
- TI-4000 Desk-top with 12 large digits, full memory and punctuation.
- SR-10 Slide rule. Hand-held with scientific notation. \$49.95.
- SR-11 Slide rule similar to SR10 plus pi and constant.
- SR-50 Scientific hand-held, including batteries and charger.
- SR-51 Scientific. Very sophisticated. 10 memories, hand-held.
- SR-16 Scientific, hand-held. Between the SR11 and the SR50.
- SR-20 Scientific, desk-type with scientific notations.
- SR-22 The Hexadecimal calculator / converter, compatible with computer.
- TI-500 Electronic printer with constant.
- TI-620 Electronic printer, add-mode, stop/start motor, buffered keyboard, memory.

## Bowmar

- MX 100 Hand-held Scientific with charger, \$89.95.
- MX 140 Hand-held, scientific notations, 10 digits. \$109.95.
- MX 90 10 digits, dual memory, square root, hand-held.

## Kingspoint

- SC-40 Sophisticated hand-held Scientific. Multi-memories, parentheses. \$99.95.
- SINCLAIR 105 Scientific. Only \$39.95.

Thousands of calculators, adding machines, typewriters of all makes: REMINGTON, SMITH CORONA, VICTOR, COMPUCORP, SINCLAIR, OLIVETTI, 3 M, ROCKWELL INTERNATIONAL, SONY TVs and Stereos.

Olympic Sales Co. is one of the largest, if not the largest, distributors of electronic calculators representing the best products on the market. Because we deal in volume we can pass the savings on to you. Call us before buying any kind of calculator. Call us or write us and ask for our calculator catalogue so we can give you the best possible deal.

## OLYMPIC SALES COMPANY, INC.

216 South Oxford Avenue  
P.O. Box 74545  
Los Angeles, CA 90004  
Phone (213) 381-3911 • (213) 381-6031  
Telex 67-3477

INFORMATION RETRIEVAL NUMBER 120

## Digital instruments

A four-page brochure provides a quick look at features of digital instruments for any type of physical measurement. Doric Scientific, San Diego, CA

CIRCLE NO. 383

## Vacuum capacitors

A vacuum capacitor catalog includes information on the variable and fixed types, which are available in glass or ceramic versions. The catalog includes individual data sheets, applications, OEM prices and cross-reference information. As new data sheets become available, they will be added to the catalog via a monthly mailing to qualified recipients. Amperex Electronic, Hicksville, NY

CIRCLE NO. 384

## 'See-through' control

Features and applications of a "see-through" photoelectric control are given in a bulletin. Micro Switch, Freeport, IL

CIRCLE NO. 385

**SUBSCRIBER SERVICE** For prompt service include the addressed label when writing about your subscription.

### CHANGE OF ADDRESS

city	company address	division/department	company	name	NEW ADDRESS
state					
zip					

If you're moving, please let us know six weeks before changing your address. If you have a question, place your magazine address label here and clip this form to your letter.

MAIL TO: ELECTRONIC DESIGN Circulation Dept. Hayden Publishing Co., Inc., 50 Essex Street, Rochelle Park, NJ 07662

INFORMATION RETRIEVAL NUMBER 121 ►

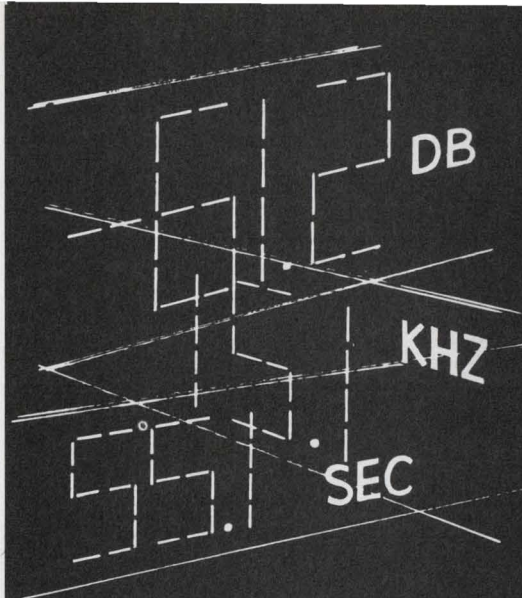

# Only with an EMR Real-Time Spectrum Analyzer...

## All digital Fourier analysis at a price you can afford

The New EMR 1510 represents a significant breakthrough in the field of Real-Time Spectrum Analysis... Using Fourier techniques the analysis is all digital. Digital analysis requires no calibration. Gain and offset errors are contributed by only the very stable input amplifier and aliasing filter. Result: you get greater than 60 dB dynamic range, ± 0.1% frequency accuracy, a well defined window function and resultant analysis bandwidth... not possible with analog techniques.

Take the first step and write... we'll also tell you about our unique LED display of Frequency/Amplitude/Averaging Time, complete programmability, and much more!



Only From EMR!

**EMR** EMR Schlumberger

EMR Telemetry  
Weston Instruments, Inc.  
Box 3041, Sarasota, Florida 33578  
813-371-0811



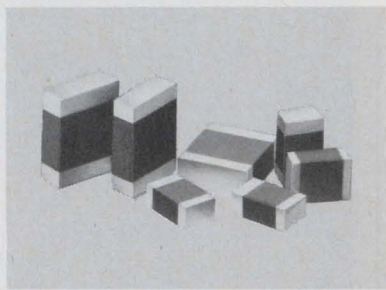

**HIGH Q MULTILAYER CAPACITORS** feature very high quality factors at microwave frequencies. Offered in three standard sizes: .050 x .040, .080 x .050, .125 x .095. Capacitance values from 0.1 pf to 1000 pf with close tolerance and voltages to 1000 VDCW. Johanson/Monolithic Dielectrics Div., Box 6456, Burbank, Ca. 91510, (213) 848-4465.

INFORMATION RETRIEVAL NUMBER 601



**Free catalog of 34,500 power supplies** from the worlds largest manufacturer of quality Power Supplies. New '74 catalog covers over 34,500 D.C. Power Supplies for every application. All units are UL approved, and meet most military and commercial specs for industrial and computer uses. Power Mate Corp. (201) 343-6294.

INFORMATION RETRIEVAL NUMBER 604

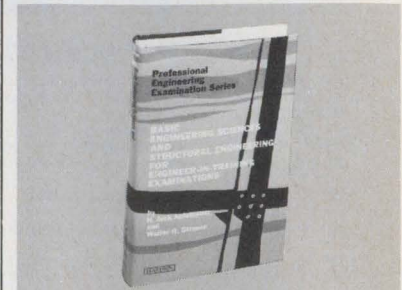

**Basic Engineering Sciences & Structural Engineering for E-I-T Exams.** Sampling for test problems makes the best preparation yet for exams. #5712-1, 424 pp., \$17.20. Circle the Info Retrieval No. to order 15-day exam copy. When billed, remit or return book with no obligation. Hayden Book Co., 50 Essex St., Rochelle Pk., N.J. 07662

INFORMATION RETRIEVAL NUMBER 607

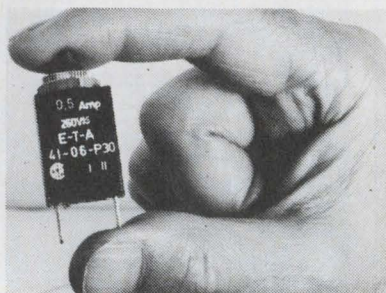

**Overcurrent Protector**, manual reset eliminates fuse replacement. Convenient panel mounting. 15 fractional ratings from 0.1 to 3 amp. Other models up to 400 amp. Trip-free and fool-proof, UL and CSA approved. High quality, low cost \$1.29 ea. in 1000 lots. E-T-A Products Co. of America, 7400 N. Croname Rd., Chicago, Ill. 60648. Tel: (312) 647-8303. Telex: 253780.

INFORMATION RETRIEVAL NUMBER 602

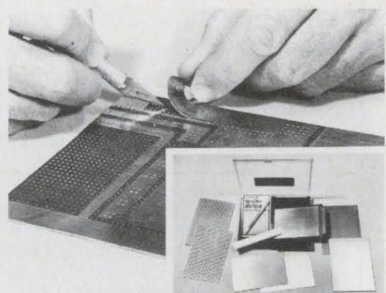

**Cut & Peel Circuit Board Kit.** Cut prototype boards or ground planes. Assortment of 7 includes one and two sided Cut & Peel Boards on .100" grid drilled and plain epoxy-glass, "X" and "X-Y" Board, a plug-in Cut & Peel GP Board with etched gold/nickel edge connector, and a special knife. Kit #8964 is \$37.00. Circuit-Stik, Inc. Box 3396, Torr., CA 90510.

INFORMATION RETRIEVAL NUMBER 605

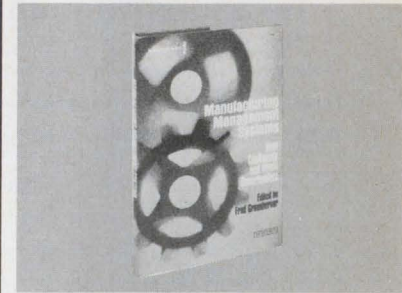

**Manufacturing Management Systems.** Technical and managerial expertise to handle today's progressive manufacturing systems. #5940-X, 160 pp., \$10.50. Circle the Info Retrieval No. to order 15-day exam copy. When billed, remit or return book. No obligation. Hayden Book Company, 50 Essex St., Rochelle Pk., N.J. 07662.

INFORMATION RETRIEVAL NUMBER 608

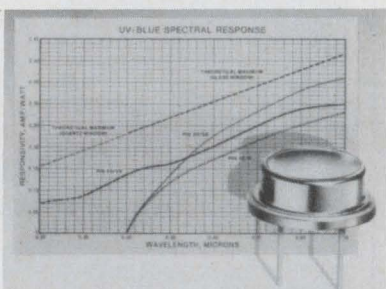

**UV Blue Response Photodiode:** United Detector Technology now offers blue, super blue, and UV enhanced silicon photodiodes with near theoretical responsivity in the range from 200 to 550 nanometers. Available in both the Pin-5 .5 cm<sup>2</sup> and the Pin-10 1 cm<sup>2</sup> configuration. United Detector Technology, 2644 30th St., Santa Monica, Ca. 213 396-3175.

INFORMATION RETRIEVAL NUMBER 603

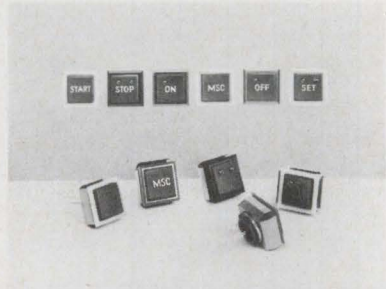

**Touch Activators** for solid-state switch circuits eliminate pushing, pulling, or flipping of switches. No moving parts; high reliability. A mere touch of finger activates switch circuit. Interface with CMOS, TTL, DTL, and HTL. Snap-in panel mounting. Lighted or unlighted. Master Specialties, 1640 Monrovia, Costa Mesa, Calif. 92627.

INFORMATION RETRIEVAL NUMBER 606



**Atomic Frequency Standards.** Models FRK-H/L for airborne/mobile systems, navi/comm TV-Broadcast Features: stability typi 1x10<sup>-11</sup>/month, rapid warm-up < 10 Min., power 12W only, weight 2.2 lbs. Warranty 5 years lamp/cell. Price: \$5100/\$3480. OEM avail. EFRATOM CA., INC. 3303 Harbor Blvd., E1, Costa Mesa, CA. 92626 (714) 556-1620

INFORMATION RETRIEVAL NUMBER 609



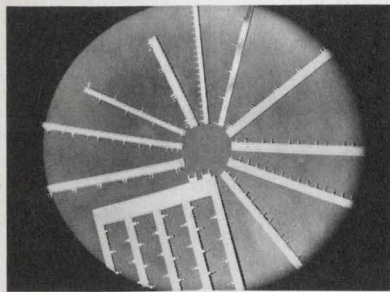

**Mini/Bus® Evaluation Kit, \$25**, in stock. Lets you try Rogers' low-cost, noise attenuating, high packaging density power distribution system for PC boards. Millions in use. Standard parts on 2 weeks delivery, or less! Customer parts 4 to 6 weeks delivery. Rogers Corporation, Chandler, Ariz. 85224. Phone (602) 963-4584

**INFORMATION RETRIEVAL NUMBER 610**

## TORQUE SEAL® INSPECTION LACQUER

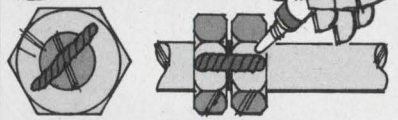

Inspectors can visually detect any movement or tampering as TORQUE SEAL becomes brittle and will crack. Widely used as an Anti-Sabotage Lacquer. Fast Drying. Excellent Adhesion. In 1/2 oz. poly squeeze tubes. Available in fluorescent colors. Send for free sample and catalog. ORGANIC PRODUCTS CO., Box 428, Irving, TX 75060

**INFORMATION RETRIEVAL NUMBER 613**

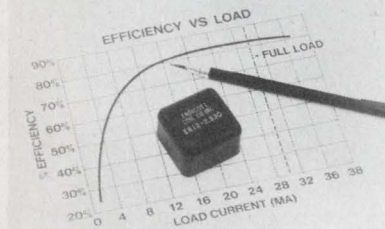

**Activate gas discharge readouts!** DC-to-DC power supplies convert low DC line voltages of 5, 9, 12 or 15 volts to nominal 200 and 250 volt DC levels required to run gas discharge information displays. Ideal for battery powered applications! Free literature. Endicott Coil Co., Inc., 31 Charlotte Street, Binghamton, N.Y. 13905

**INFORMATION RETRIEVAL NUMBER 611**

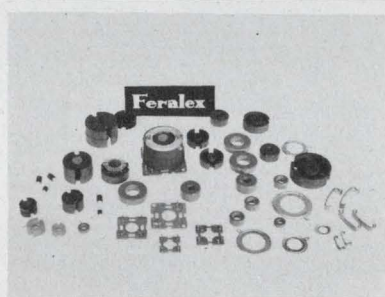

**Ferrite Ring and Pot Cores**, permeability ranges of 60 to 3000 mu, in a wide range of Ring Sizes; Pot Cores to IEC sizes 14 to 36, adjustable and no gap, mounting hardware, technical data available. Connolly & Company, Inc., 914 No. Rengstorff, Mountain View, Ca. 94043 (415) 967-6988

**INFORMATION RETRIEVAL NUMBER 614**

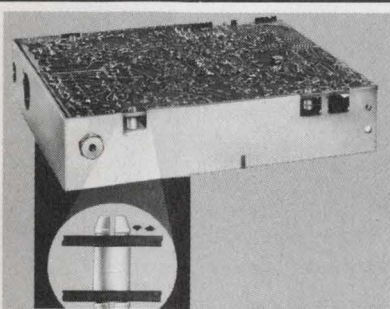

**New combination spacer/bushing.** Cut assembly time and costs substantially with these new, low Polyamide Spacer/Bushings from Johnson. Allows quick mount of PC boards to chassis. "Mechanically secure, yet P.C. boards easily removed." Made of non-conductive polyamide in various sizes. E. F. Johnson, Waseca, MN. 56093 (507) 835-2050.

**INFORMATION RETRIEVAL NUMBER 612**

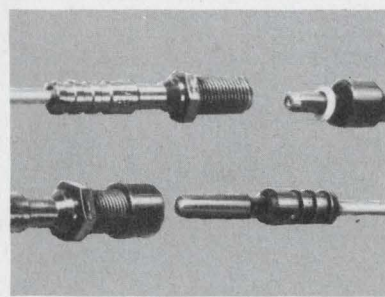

**Safe HV Connector Assemblies.** Up to 20KVDC . . . with LGH single-position commercial high-voltage connectors. Deeply recessed pins prevent exposure to high voltage. Meet applicable min. clearance and creepage specs. Quick connect/disconnect. Leads any length. Contact AMP Capatron Division, Elizabethtown, PA 17022 (717-367-1105).

**INFORMATION RETRIEVAL NUMBER 615**

Advertisers wishing to reserve Quick Ad units should note the following mechanical requirements: Specs—Supply glossy photo of product and approximately 40 words which will set no more than 10 lines of 34 characters each. AFTER SUBMISSION NO COPY CHANGES CAN BE ACCEPTED. Quick Ads cost only \$300 per insertion, less for frequency advertisers.

### RATES:

1x  
\$325

7x  
\$300

13x  
\$275

19x  
\$270

26x  
\$265

39x  
\$260

52x  
\$255

104x  
\$250



# IT'S CLEARLY THE CHOICE OF ELECTRONICS ENGINEERS – WORLDWIDE

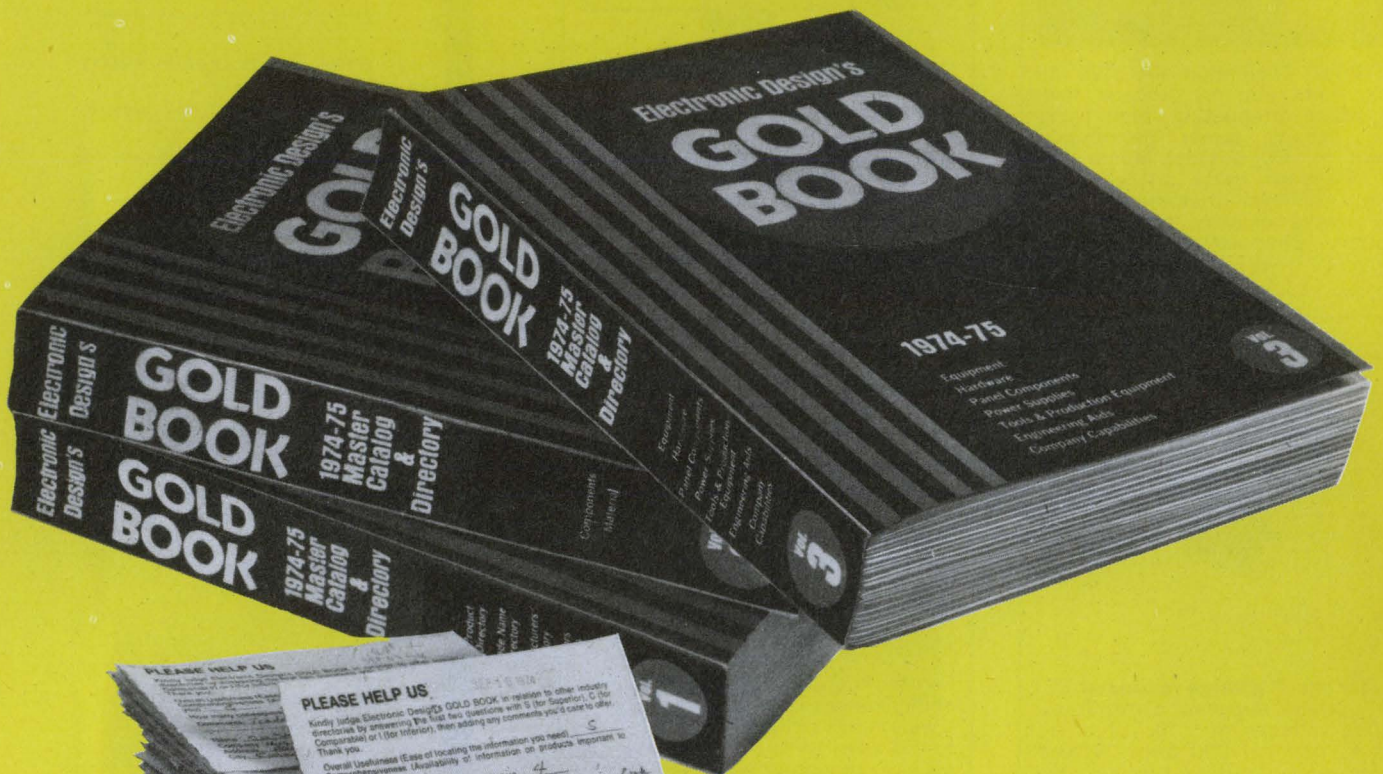

PLEASE HELP US

Kindly judge Electronic Design's GOLD BOOK in relation to other industry directories by answering the first two questions with S (for Superior), C (for Comparable) or I (for Inferior), then adding any comments you'd care to offer. Thank you.

Overall Usefulness (Ease of locating the information you need) 5  
Comprehensiveness (Availability of information on products important to you) 5

How many colleagues use your GOLD BOOK? 4

Comments: I like the set with the Master Catalog & Directory. I like the set with the Master Catalog & Directory.

Name: JAYE CARLISLE  
Company: TECH. RES. LAB.  
Address: 1000 S. 10th St.  
City: LAUREL, MD.

PLEASE HELP US

Kindly judge Electronic Design's GOLD BOOK in relation to other industry directories by answering the first two questions with S (for Superior), C (for Comparable) or I (for Inferior), then adding any comments you'd care to offer. Thank you.

Overall Usefulness (Ease of locating the information you need) 5  
Comprehensiveness (Availability of information on products important to you) 5

How many colleagues use your GOLD BOOK? 25 to 50

Comments: I THINK THE SET OF BOOKS ARE WELL TO USE AND SUPERIOR TO OTHERS.

Name: THE KES EMP.  
Company: THE KES EMP.  
Address: 1000 S. 10th St.  
City: LAUREL, MD.

PLEASE HELP US

Kindly judge Electronic Design's GOLD BOOK in relation to other industry directories by answering the first two questions with S (for Superior), C (for Comparable) or I (for Inferior), then adding any comments you'd care to offer. Thank you.

Overall Usefulness (Ease of locating the information you need) 5  
Comprehensiveness (Availability of information on products important to you) 5

How many colleagues use your GOLD BOOK? 6

Comments: IT IS A VERY GOOD SET OF BOOKS.

Name: THE KES EMP.  
Company: THE KES EMP.  
Address: 1000 S. 10th St.  
City: LAUREL, MD.

PLEASE HELP US

Kindly judge Electronic Design's GOLD BOOK in relation to other industry directories by answering the first two questions with S (for Superior), C (for Comparable) or I (for Inferior), then adding any comments you'd care to offer. Thank you.

Overall Usefulness (Ease of locating the information you need) 5  
Comprehensiveness (Availability of information on products important to you) 5

How many colleagues use your GOLD BOOK? 1

Comments: I USE THE 1974-75 MASTER CATALOG & DIRECTORY.

Name: R.H. BARNETT  
Company: 171 ABBOTT APT. 101  
Address: 171 ABBOTT APT. 101  
City: FORT WORTH

PLEASE HELP US

Kindly judge Electronic Design's GOLD BOOK in relation to other industry directories by answering the first two questions with S (for Superior), C (for Comparable) or I (for Inferior), then adding any comments you'd care to offer. Thank you.

Overall Usefulness (Ease of locating the information you need) 5  
Comprehensiveness (Availability of information on products important to you) 5

How many colleagues use your GOLD BOOK? 7

Comments: THEY ARE VERY GOOD. I HAVE BEEN VERY USEFUL TO ME.

Name: DONALD C. COMBLEY  
Company: COMBLEY CONSULTING ENGINEERS  
Address: 1000 S. 10th St.  
City: LAUREL, MD.



# WHEN YOU HAVE Electronic Design's GOLD BOOK YOU DON'T NEED ANY OTHER INDUSTRY DIRECTORY

In just a few months, the first issue of *Electronic Design's* GOLD BOOK has become the leader among all directories used in this industry. Engineers have responded enthusiastically throughout the U.S. and from all over the world — especially in Europe where they've never seen anything like it before. The GOLD BOOK has become number one almost overnight.

## HERE'S HOW YOUR FELLOW ENGINEERS RATE THE INDUSTRY ANNUALS

	Annals Consulted Within Past Month	Annals Preferred
Electronic Design's GOLD BOOK	85%	60%
Electronic Engineer Master (EEM)	63%	42%
Electronic Buyer's Guide (EBG)	32%	8%
Thomas Register	16%	7%
Conover-Mast Purchasing Directory	2%	1%

SOURCE: Study by Dr. Eugene D. Jaffe, Associate Professor of Marketing, St. John's University, Nov. 1974. Base: respondents using directories. Totals exceed 100% due to multiple mentions.

The GOLD BOOK has revolutionized directory use patterns in this industry. Here's why: The GOLD BOOK is by far the largest, most complete one-step electronics purchasing and reference tool ever produced. And it's far easier to use. Look at these comparisons:

## COMPARISON OF ELECTRONICS INDUSTRY DIRECTORIES (1974-75 editions)

	EBG ELECTRONICS BUYERS' GUIDE	EEM ELECTRONIC ENGINEERS MASTER	ELECTRONIC DESIGN'S GOLD BOOK
Number of manufacturers listed	5,800	3,165	7,528
Total number of products listed	4,267	3,235	4,799
Number of direct products listed	2,479	2,250	2,925
Number of cross-reference products listed	1,788	985	1,874
Number of distributors listed in Distributors Directory — Alphabetic	0	1,720	5,780
Number of distributors listed in Distributors Directory — Geographic	0	1,720	5,780
Is complete mailing address given each time a company is listed in product directory?	No	No	Yes
Is telephone number given for each company listed in product directory?	No	No	Yes
Are distributors listed for each manufacturer?	No	Partial <sup>1</sup>	Yes
Does manufacturers listing include FSCM numbers?	No	No	Yes
Does manufacturers listing include facsimile equipment by make and call number?	No	No	Yes
Total Circulation	30,017 <sup>2</sup>	89,169 <sup>3</sup>	Over 90,000
Overseas Circulation <sup>2</sup>	1,339 <sup>2</sup>	0 <sup>3</sup>	13,200
Number of ad pages	590 <sup>4</sup>	2,752	2,820

<sup>1</sup> Paid listings only  
<sup>2</sup> Includes Canada

<sup>3</sup> Standard Rate & Data; Oct. 24, 1974  
<sup>4</sup> Includes fractionals

## MOST THOROUGH, MOST COMPLETE, EASIEST-TO-USE ELECTRONICS INDUSTRY DIRECTORY IN THE WORLD



# Design Data from Manufacturers

Advertisements of booklets, brochures, catalogs and data sheets. To order use Reader-Service Card  
(Advertisement)

## Why Test Semi-Conductors For Noise?



The **QUAN-TECH NOISE FILE** contains technical reports on the nature and origin of electrical noise in semi-conductors.

The effects of noise in terms of impaired performance have been widely recognized, and the **RELATIONSHIP BETWEEN NOISE AND COMPONENT RELIABILITY** generally accepted in the electronic industry. Thus the analysis of electrical noise generated by components is not only vital to the development and production of low-noise circuits, but also is becoming of major importance in achieving maximum reliability of instrumentation.

Instruments are available for testing noise of transistors, and thin film circuits. Applications include Incoming Inspection, Laboratory Studies, and High-Speed Production Testing.

### Quan-Tech

Div. of Scientific Atlanta, Inc.  
Randolph Park West, Route #10  
Randolph Township, N.J. 07801, Phone #201-361-3100

CIRCLE NO. 171

Share in the nation's top managerial policies, strategies, techniques . . .

## MANUFACTURING MANAGEMENT SYSTEMS

New Challenges and Opportunities Edited by Fred Gruenberger

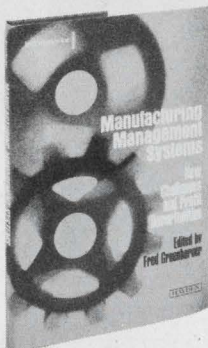

By crystallizing the results of the 1973 Informatics/UCLA Symposium, this book offers a powerful blend of technical and managerial expertise for enhancing the overall success and profitability of today's manufacturing management systems. Some of the nation's top industrial and technical leaders speak freely and in depth of their organization's objectives and specific operations, as well as their personal strategies and methods. You'll find the newest computerized tools available to manufacturers . . . crucial managerial skills for directing progressive systems . . . the tact and care needed for the sensitive human problems of system implementation, and more. #5940-x, 160 pages, \$10.50. Circle the Info Retrieval No. to order a 15-day exam copy. When billed, remit or return book. No obligation.

CIRCLE NO. 172

Hayden Book Company, 50 Essex St., Rochelle Pk, N.J. 07662

## MATERIALS FOR MAGNETIC FUNCTIONS

by Fennimore N. Bradley

This valuable reference provides a thorough background as well as practical design techniques for the materials needed for magnetic functions. Included in its exhaustive coverage is detailed treatment of key parameters of about 30 classes of ferrite materials relating processing to costs and design trade-offs . . . and equally thorough coverage of about 40 classes of both conventional and exotic magnetic metals and processes. The book focuses on design problems encountered in a wide range of permanent-magnet applications . . . pinpoints design problems in nearly 30 categories of electromagnetic devices . . . and concludes with coverage of environmental influences such as corrosion, magnetic field, temperature, stress, etc. 360 pp., 6 x 9, illus., cloth, \$17.20. Circle the reader-service number to order a 15-day examination copy.

CIRCLE NO. 173



HAYDEN BOOK COMPANY, INC., 50 Essex St., Rochelle Park, N.J. 07662

# Electronic Design

ELECTRONIC DESIGN's function is:

- To aid progress in the electronics manufacturing industry by promoting good design.
- To give the electronic design engineer concepts and ideas that make his job easier and more productive.
- To provide a central source of timely electronics information.
- To promote communication among members of the electronics engineering community.

**Want a subscription?** ELECTRONIC DESIGN is sent free to qualified engineers and engineering managers doing design work, supervising design or setting standards in the United States and Western Europe. For a free subscription, use the application form bound in the magazine. If none is included, write to us direct for an application form.

If you do not qualify, you may take out a paid subscription for \$30 a year in the U.S.A., \$40 a year elsewhere. Single copies are \$1.50 each.

**If you change your address,** send us an old mailing label and your new address; there is generally a postcard for this bound in the magazine. You will have to requalify to continue receiving ELECTRONIC DESIGN free.

**The accuracy policy** of ELECTRONIC DESIGN is:

- To make diligent efforts to ensure the accuracy of editorial matter.
- To publish prompt corrections whenever inaccuracies are brought to our attention. Corrections appear in "Across the Desk."
- To encourage our readers as responsible members of our business community to report to us misleading or fraudulent advertising.
- To refuse any advertisement deemed to be misleading or fraudulent.

Microfilm copies are available of complete volumes of ELECTRONIC DESIGN at \$19 per volume, beginning with Volume 1, 1952 through Volume 20. Reprints of individual articles may be obtained for \$3.00 each, prepaid (\$5.00 for each additional copy of the same article) no matter how long the article. For further details and to place orders, contact the Customer Services Department, University Microfilms, 300 North Zeeb Road, Ann Arbor, MI 48106 telephone (313) 761-4700.

**Want to contact us?** If you have any comments or wish to submit a manuscript or article outline, address your correspondence to:

Editor  
ELECTRONIC DESIGN  
50 Essex Street  
Rochelle Park, NJ 07662



classified ads

# RENT a MINI

1 DAY DELIVERY  
DEC PDP 8I (4K)  
DEC PDP 8L (8K)  
ASR 33

## FOR SALE

MINIS DEC • DG • CAI • GTE  
HP • HIS • IBM • INT  
LOCK • MICRO • SEL  
VARIAN • XLO

PRINTERS MDS 4330 .....\$3950  
CDC 9322 .....\$2500  
DP 2440 .....\$7500

CARD DOC M200 .....\$950  
READERS GDI 100, 110 .....\$750

PAPER DIGITRONICS 2500 .....\$350  
TAPE CHALCO • BRPEII .....\$250

MAG PERTEC • WANGCO  
TAPE POTTER • AMPEX

617-261-1100

AMERICAN USED COMPUTER CORP.

P.O. Box 68, Kenmore Sta., Boston, MA 02215  
member COMPUTER DEALERS ASSOCIATION

CIRCLE NO. 291

## HERMETIC SEALING

Connectors • Headers • Relay Bases  
Terminals • Custom Seals • Testing  
Glass/Ceramic To Metal • Since 1959

## DETORONICS CORPORATION

10660 E. Rush • S. El Monte, CA 91733  
(213) 579-7130 • TWX 910-587-3436

CIRCLE NO. 292

Protect Your Heart  
HAVE REGULAR MEDICAL  
CHECK UPS



Give Heart Fund

# Electronic Design

## Advertising Sales Staff

Tom W. Carr, Sales Director

### Rochelle Park, NJ 07662

Robert W. Gascoigne  
Daniel J. Rowland

(Recruitment, Quick Ads, Classified)

50 Essex Street  
(201) 843-0550  
TWX: 710-990-5071

### Philadelphia

Thomas P. Barth  
50 Essex Street  
Rochelle Park, NJ 07662  
(201) 843-0550

### Boston 02178

Gene Pritchard  
P.O. Box 379  
Belmont, MA 02178  
(617) 489-2340

### Chicago 60611

Thomas P. Kavooras  
Berry Conner, Jr.  
200 East Ontario  
(312) 337-0588

### Cleveland

Thomas P. Kavooras  
(Chicago)  
(312) 337-0588

### Los Angeles 90045

Stanley I. Ehrenclou  
Burt Underwood  
8939 S. Sepulveda Boulevard  
Suite 510

Los Angeles, CA  
(213) 641-6544

### San Francisco 94022

Jerry D. Latta  
P.O. Box 1248  
Los Altos, CA  
(415) 965-2636

### London, Amsterdam, Tokyo, Seoul

John Ashcraft  
12, Bear St.  
Leicester Square  
London WC2H 7AS England  
Phone: 01-930-0525

W. J. M. Sanders  
John Ashcraft & Co.  
Herengracht 365  
Amsterdam C., Holland  
Phone: 020-24-09-08

Haruki Hirayama  
Electronic Media Service  
5th Floor, Lila Bldg.,  
4-9-8 Roppongi  
Minato-ku, Tokyo, Japan  
Phone: 402-4556

Cable: Electronicmedia, Tokyo  
Mr. O-kyu Park, President  
Dongbo Int'l Corp.—  
World Marketing  
C.P.O. Box 4010  
Seoul, Korea  
Tel: 76-3910/3911  
Cable: DONGBO SEOUL  
Telex: EBKOREA K27286

ABP

BPA

# LAB AMPS

C-COR has the  
right LABORATORY  
AMPLIFIER for you.

Wideband or Pulse  
Instrument Case or  
Rack Mountable  
AC Powered

FOR EXAMPLE

MODEL	4375-A	4313	4392
BW	.003-300 MHz	.005-500 MHz	DC - 20 MHz
Gain	20, 40, or 60dB	20 or 40dB	6 to 20dB
Z In/Out	50 or 75 ohms	50 ohms	50/5 ohms
Output	+30dBm @ 50 MHz into 50 ohms	+30dBm	+32dBm into 50 ohms
	+27dBm @ 250 MHz into 50 ohms		

For a complete amplifier catalog  
call, write, or wire:

**C-COR**  
*Electronics, Inc.*

60 Decibel Road  
State College, PA 16801  
814-238-2461  
TWX 510-691-1933

CALL TOLL FREE 800-458-3751

INFORMATION RETRIEVAL NUMBER 122

# USC GR/RGR HIGH DENSITY WRAP/CRIMP CONNECTORS

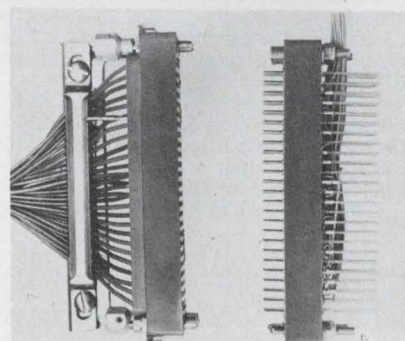

1 of over 20,000 types  
of Connectors. Send today  
for GR/RGR Series Catalog.

## U. S. COMPONENTS, INC.

Leader in advanced engineering & design

1320 Zerega Avenue, Bronx, N. Y. 10462  
(212) 824-1600 TWX: 710-593-2141  
Telex: 1-2411 Cable: COMPONENTS, N. Y. K.

INFORMATION RETRIEVAL NUMBER 123

155



# advertiser's index

Advertiser	Page	Advertiser	Page	Advertiser	Page
ACDC Electronics, Inc.	15	Heinemann Electric Company	159	Projects Unlimited	128
AMP, Incorporated, Capatron Division	151	Hewlett-Packard	2, 77, 136	QuanTech, Division of Scientific Atlanta, Inc.	154
Acopian Corp.	127	Hoffman Engineering Company	76	RCA Solid State	Cover III
Advertising Council	147	Howard Industries, A Division of MSL Industries, Inc.	104	RCL Electronics, Inc.	36
Alco Electronic Products, Inc.	157	Humphrey, Inc.	148	*Rafi-Raimund Finsterholz	128
Allen Bradley Co.	97	Instruments for Industry, Inc.	144	Raytheon Company, Industrial Components Operation	114
Amperite Co., Inc.	94	Instrument Specialties Company Inc.	101	Repcor, Incorporated	117
Analogic Corporation	13	Intech, Incorporated	112	Rogers Corporation	151
Ancrona Corp.	125	Intel Corporation	4, 5	Rohde & Schwarz	37
Arrow-M Corp.	16	Interdata Inc., Terminal Products Group	72, 73	Rotron, Inc.	39
Beckman Instruments, Inc., Information Displays Operations	23	Intersil	48, 49	SGS Ates Semiconductor Corporation	111
Belden Corporation	10, 11	Interstate Electronics Corporation	29	Seastrom Manufacturing Co., Inc.	159
Bell, Inc., F. W.	157	Itek Measurement Systems Division	113	Semtech Corporation	43
Bell Industries, J. W. Miller Company	144	Jensen Tools & Alloys	113	Signal Transformer Co., Inc.	89
Bishop Graphics, Inc.	123	Johnson Manufacturing Corp.	7	Simpson Electric Company	41
Bodine Electric Company	125	Johnson/Monolithic Dielectrics Division	150	Skam-A-Matic Corp.	157
C-Cor Electronics, Inc.	150	Johnson Company, E. F.	14, 151	Solid State Scientific, Inc.	21
Celanese Plastics, Company	103	Keithley Instruments, Inc.	128	Soliton Devices, Inc.	132
Centre Engineering	95	Kurz-Kasch, Inc.	115	Sprague Electric Company	116
Circuit Stik, Inc.	150	LSI Computer Systems, Inc.	71	Systrom-Donner	35
Connelly & Company	151	Litronix, Inc.	52, 53	TEC, Incorporated	125
Continental Specialties Corporation	138	LogicMetrics	129	T.R.I. Corporation	142
Control Data Corporation	137	3M Company	Cover III	TRW Capacitors, an Electronic Components Division of TRW, Inc.	12
Curtis Industries, Inc.	66	MCL, Inc.	124	TRW/IRC Resistors, an Electronic Component Division of TRW, Inc.	160
Custom Electronics, Inc.	138	*Marconi Instruments Limited	97	TRW/IRC Potentiometers, An Electronic Component Division of TRW, Inc.	50
Delta Products, Inc.	59	Master Specialties	150	Tecnetics, Inc.	130
Dialight Corporation	113	Microdata Corporation	47	Telecommunications Industries, Inc.	115
Digital Equipment Corporation	60, 61	Minelco Division General Time Corp.	148	Teledyne Philbrick	9
Doric Scientific Inc.	31	Mini-Circuits Laboratory, A Division of Scientific Components Corp.	44	Tele-Dynamics, Division of Ambac	134
Duncan Electronics, Subsidiary of Systrom-Donner	119	Monsanto, United Systems Corporation Subsidiary	143	Tenney Engineering, Inc.	115
Dynascan Corporation	8	Mos Technology, Inc.	81	Texas Instruments, Incorporated	18
EMR Telemetry, Weston Instruments, Inc.	149	Motorola Semiconductor Products, Inc.	33	Thomson CSF	93
E-T-A Products Co. of America	150	National Semiconductor Corporation	48, 49	USCC/Centralab Electronics Division, Globe-Union, Inc.	120,*121
Efratom California, Inc.	150	Nitron, McDonnell/Douglas	108, 109	U. S. Components, Inc.	155
*Electronic Design	111	Olympia Sales Company, Inc.	149	Union Carbide Corporation, Components Department	25
Electronic Development Corp.	95	Organic Products Co.	151	United Detector Technology	150
Electronic Measurements, Inc.	122	*Oscilloquartz S A	104	United Systems Corporation, a Subsidiary of Monsanto	143
Electronic Memories & Magnetics Corp.	131	Panduit Corporation	143	Varo Semiconductor, Inc.	121
Electronic Molding Corporation	146	Penntube Plastics Co., Inc.	159	Victor Electric Wire & Cable Corp.	110
Electronic Navigation Industries	106	Perfection Mica Company	126	Wavetek	1
Electrostatics, Inc.	108	*Philips Electronic Components and Materials	103	Woven Electronics	6
Endicott Coil Co. Inc.	151	Pico Electronics, Inc.	Cover III	Yewtec Corporation	123
Erie Technological Products, Inc.	91	Piher Corporation	17		
FMC Corporation	133	Power/Mate Corp.	150		
Facit-Addo, Inc.	145	Power Tech, Inc.	67		
Fluke Mfg. Co., Inc., John	80, 159	Powertec, Inc.	99		
Gates Energy Products, Inc.	27	Precision Dynamics Corporation	148		
General Radio Company	87	Precision Monolithics, Incorporated	85		
General Scanning, Inc.	140	Premier Metal Products Company	118		
Gold Book, The	139, 152, 153, 157				
Gould Inc., Instrument System Division	123, 141				
Hamamatsu Corp.	143				
Harris Communications and Information Handling	135				
Hayden Book Company, Inc.	*127, 145, 150, 154				

\*Advertisers in non-U.S. edition.



## Sexy Skanners to detect small stuff.

.001 inch and smaller.  
Coaxial fiber optic design puts  
the phototransistor  
in the tip away  
from lamp or LED heat  
for negligible drift.  
Response time from scanner to  
amplifier output in  
5 microseconds.

And there's more.  
Widest selection of subminiature  
photoelectric sensors ever offered.  
Controls and automation systems  
to match. 3 day shipments.

SEND FOR COMPLETE CATALOG.

**SKAN-A-MATIC**<sup>®</sup>  
CORP.  
P.O. BOX S, ELBRIDGE, N.Y. 13060  
PHONE (315) 689-3961

INFORMATION RETRIEVAL NUMBER 124

## WHO MAKES WHAT & WHERE TO FIND IT

Volume 1 of **Electronic Design's GOLD BOOK** tells all. And, when you look up an item in its **PRODUCT DIRECTORY** you'll find each manufacturer listed **COMPLETE WITH STREET ADDRESS, CITY, STATE, ZIP AND PHONE.** Save time. There's no need to refer elsewhere to find missing information.

**IT'S ALL THERE**  
in  
**Electronic Design  
GOLD BOOK**

# GAUSSMETERS



model 811

high accuracy  
excellent repeatability  
rugged

Bell gaussmeters measure magnetic field strength from .0001 gauss to 100,000 gauss. There are six gaussmeter models and 110 probe models for each gaussmeter. The resulting combinations meet the challenging requirements of all magnetic field measurement applications.

F. W. Bell has the experience and know-how to offer you the best instruments that are available. Your local representative is equipped to give you a demonstration. Use the inquiry card to find out how these instruments can benefit you.

4949 Freeway Drive East  
Columbus, Ohio 43229  
Phone: 614/888-7501  
TWX: 810-337-2851



a subsidiary of Arnold Engineering

INFORMATION RETRIEVAL NUMBER 125



## We're #1 in MINIATURES

Alco was **FIRST** to realize Industry's need for miniature switches. **FIRST** with realistic pricing, **FIRST** with highest quality and **FIRST** with originality.

MTA  
SERIES

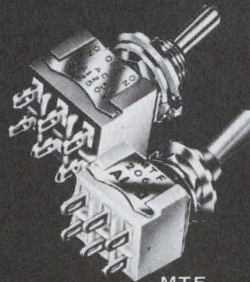

MTF  
SERIES

Believe or not! Alco's current prices are within 12% of our 1958 schedule and for this slight difference we include years of improvements in design. Furthermore, we practice "truth in selling" where options, if any, are clearly spelled out! Our listed prices include solid silver on all contact surfaces, molded-in terminals, anti-push-in levers, high temperature plastics and much more, all as standard features on **ALL OUR SWITCHES**, not just a representative few.

If you're looking for highest quality at a realistic cost, it will pay you to get the complete story from us first!

Call (617) 686-0126 or write for our catalog describing the widest variety of miniature switches and accessories the industry has to offer.

# ALCOSWITCH

ALCO ELECTRONIC PRODUCTS, INC.  
1551 Osgood Street, North Andover, MA. 01845 U.S.A.

INQUIRE DIRECT



# product index

**Information Retrieval Service.** New Products, Evaluation Samples (ES), Design Aids (DA), Application Notes (AN), and New Literature (NL) in this issue are listed here with page and Information Retrieval numbers. Reader requests will be promptly processed by computer and mailed to the manufacturer within three days.

Category	Page	IRN	Category	Page	IRN	Category	Page	IRN
<b>Components</b>			indicator lights	113	66	<b>Microwaves &amp; Lasers</b>		
adjustable coils	144	111	multidigit LEDs	53	33	comparator, monopulse	117	327
arrestors, surge	128	346	power transistor switch	13	10	laser	129	348
audio indicator	128	88	rectifiers	43	28	plug-in components	129	349
CRTs	114	67	rectifiers, silicon	126	342	rf and microwave		
capacitors	14	11	SCRs	121	76	testing	124	81
capacitors	25	18	surge protectors	115	68	synthesizer	130	351
capacitors	95	51	switches, LED-lighted	126	343	TWTs	130	352
capacitors	120	75	thyristors	133	93	transmitter	130	350
capacitors	138	104	transistors, Darlington	128	345			
capacitors, chip	132	306				<b>Modules &amp; Subassemblies</b>		
capacitors, tantalum	134	353	<b>Instrumentation</b>			comparator, monopulse	117	327
crystals, GGG	142	365	amplifiers	155	122	converter, a/d	112	301
DIP trimpot	148	117	audio indicator	128	88	converter, d/a	116	326
delay relays	94	49	counter	110	323	electronic ignition	59	34
display, fiberoptic	136	357	counter/timer	80	42	encoder	113	64
electromagnetic delay			counter, 1100-MHz	136	101	delay relays	94	49
line handbook	36	24	DMM	35	23	motors and drive		
electronic ignition	59	34	DMM	123	80	systems	125	84
encoder	113	64	DMM	128	87	oscillators, crystal	117	328
fans	104	56	DMM, 5-1/2-digit	159	131	overcurrent protectors	159	130
fans and blowers	39	26	DPM	105	321	photoelectric scanners	157	124
motors and drive			function generators	1	2	power amplifier	106	57
systems	125	84	gaussmeters	157	126	sequencer, scanning	116	325
oscillators, crystal	117	328	lock-on voltmeter	105	320	v/f converter	108	59
overcurrent protectors	159	130	logic analyzer	77	161			
photomultiplier tubes	147	116	logic probes	115	70	<b>Packaging &amp; Materials</b>		
potentiometers	50	32	monitor system	129	347	adjustable coils	144	111
relays	16	13	panel meters	41	27	breadboard kit	138	103
resistor networks	136	355	power amplifier	106	57	cabinets and cases	118	73
resistors	97	52	rf and microwave			cable	6	5
resistors	160	132	testing	124	81	connector, power	142	303
rotary switch	136	356	rf equipment	117	72	connector system	III	253
surge protectors	115	68	rf signal generator	129	89	connectors	155	123
switches, miniature	157	127	recorder modules	140	106	connectors, miniature	112	63
terminal blocks	66	36	recorders	123	79	crystals, GGG	142	365
time-delay relay	134	354	scope, dual trace	105	305	EMI shielding	126	85
timers, adjustable	114	324	sequencer, scanning	116	325	enclosures	76	40
			synthesizer	130	351	environmental rooms	115	69
<b>Data Processing</b>			synthesizers	87	45	fans	104	56
calculators	149	120	synthesizers	110	322	fans and blowers	39	26
computer-on-a-board	139	105	temperature indicator	31	21	flat cable	147	115
controller, line	121	334	timer/counter	108	302	gaskets	101	54
core memory board	135	100	transistor tester	143	109	gaskets, ceramic-fiber	142	364
data logger	122	335	VOM	106	304	PC artwork tape	123	78
interface, computer	121	333				terminal blocks	66	36
logic analyzer	77	161	<b>Integrated Circuits</b>			thermoplastic polyester	103	55
logic probes	115	70	CMOS	21	16	tool kits	113	65
memory, floppy disc	118	330	CMOS	93	48	tubing	159	128
modem, synchronous	121	332	CMOS and micro-			wire, cable and cord	11	234
module driver	137	102	processors	125	83	wire-wrap panels	149	121
peripheral data			CMOS chip	132	92			
components	145	112	custom MOS	71	38	<b>Power Sources</b>		
plotter, electrostatic	121	331	DACs	85	44	batteries	27	19
printer, matrix	122	336	ECL family	140	363	cell	144	110
printer/plotter	141	107	ICs, CMOS	138	358	generators, dc V/I	142	108
terminal, CRT	118	329	monolithic ICs	109	60	power supplies	15	12
			RAM, 1-k	140	361	power supplies	127	86
<b>Discrete Semiconductors</b>			RAM, 4-k	131	91	power supplies, dc	110	61
arrestors, surge	128	346	register	140	360	power supplies, dc-dc	130	90
digital readouts	125	82	scientific calculator			solar cell	124	338
diodes, high voltage	126	341	array	81	43	switching supplies	107	58
diodes, mixer	128	344	switch, CMOS	140	362	switching supply	124	337
diodes, varactor	126	340	terminal xmtr/rcvr	138	359	voltage standard	95	50



SEASTROM OFFERS ITS ALL NEW COMPREHENSIVE CATALOG #40B. This 250 page catalog features the company's full range of products in a colorful book specially indexed for ready reference.

Including such items as . . .

- Flat Round Washers—Metallic
- Flat Round Washers—Non-Metallic
- Spring Washers
- Shoulder Washers
- Tab & Notch Washers
- Washers—Miscellaneous Configurations
- Expansion Plugs
- Military Standards
- Clamps & Brackets
- Spring Clips
- Solder Lugs
- Solid State Insulators
- Bus Bars, Terminal Blocks & Insulating Strips
- Miscellaneous Electrical/Electronic Hardware/Tags
- Sheet Metal Nuts & Strips
- Engineering Tables, Materials & Finish Specifications
- Numerical & Alphabetical Index of Parts

No need to design it . . . you will undoubtedly find it in Seastrom's Catalog all stocked for immediate delivery . . . write to



**SEASTROM**

MANUFACTURING CO., INC.

701 SONORA AVE., DEPT. E-3  
 GLENDALE, CALIF. 91201  
 (213) 245-9121 • TWX 910-497-2271

**FREE**



INFORMATION RETRIEVAL NUMBER 128

## Reliable DC transient protection you don't have to design and build.

Protect your power supplies and other semiconductor equipment from sudden death with an economical Heinemann JA/Q® combination voltage-transient/overcurrent protector.

The JA/Q gives you nanosecond response to voltage transients that could destroy a transistor or an entire IC chip. Lower-level sustained overvoltages are simply absorbed by our suppressor network, while the bigger spikes are diverted before they ever reach the protected circuits.

Write for Bulletin 3372, which tells you not only about the JA/Q but about our wide range of DC and AC overvoltage and brownout protectors.

**HEINEMANN**  
 We keep you out of trouble.

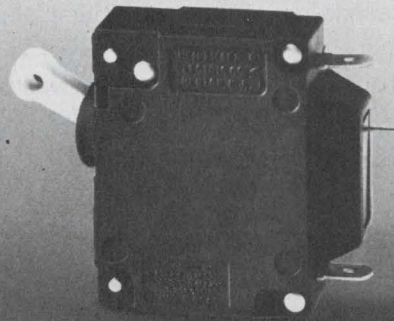

INFORMATION RETRIEVAL NUMBER 130

**UP TIGHT** **50%**  
 SHRINKDOWN AT ONLY 160°F  
 with PENNTUBE† VII-B  
**Neoprene\***  
**SHRINKABLE**  
**TUBING**

Tough! Flexible! Protective! Inexpensive! Shrinks down in hot water above 140°F. Good electrical and mechanical strength. Resists corrosion and chemicals and will not support a flame. Used for electrical insulation on wires, mechanical protection for pipes and fittings. Effective as scuff resistant jacketing for electrical cables and harness . . . and much more. Sizes 1/4" to 4". Black only.



**PENNTUBE Plastics Co., Inc.**

**SUBSIDIARY OF DIXON INDUSTRIES**

Madison Ave. & Holley St.  
 Clifton Heights, Pa. 19018  
 (215) 622-2300

Export Div. • 5710 Empire State Bldg., N.Y. 10001  
 \*Du Pont Reg. TM. †Penntube Plastics Co. Reg. TM

SEND FOR  
 FREE SAMPLE  
 and Bulletin #71SN-B

INFORMATION RETRIEVAL NUMBER 129

ELECTRONIC DESIGN 6, March 15, 1975

## It's everything you asked for in a 5½ digit DMM.



If our Model 8800A is not the perfect 0.005% bench DMM, it's close. You won't find any weak points. It's strong in every area: ■ 1 μV resolution with 0.01% accuracy for 90 days over a temperature span of 18° to 28°C. ■ 15 ranges. ■ DC input impedance of 1000 megohms through the 20 V range. ■ True 4-wire ohm measurements on all ranges. ■ 3.3V maximum open circuit ohms voltage. ■ The industry's best overload protection. ■ MTBF of 10,000 hours, demonstrated. ■ 8 watt power consumption. ■ Small 3½ x 9 x 12½" package. ■ Low \$1099 price. ■ Some of the 8800A's best specs can't even fit here. The list is just too long. So write now for our data sheet.

For data out today dial our toll-free hotline, 800-426-0361



John Fluke Mfg. Co., Inc., P.O. Box 7428, Seattle, WA 98133

INFORMATION RETRIEVAL NUMBER 131

FOR DEMONSTRATION, CIRCLE 132



# TRW's MAR<sup>TM</sup> ultra stable resistors. Performance plus.

Our ultra-precision MAR resistors match the performance of precision wirewound, *plus* they give the inherent advantages of TRW metal film.

Like smaller size, better frequency response, higher resistance values and lower cost.

And MAR's are not "selected" from a lower grade process. The entire facility was *designed* to yield *only* high accuracy devices.

And it *DOES*:



## MAR axial lead family

Tolerances to  $\pm 0.01\%$ . TC's  $\pm 5$  to 25 ppm/ $^{\circ}\text{C}$ . Where speed and precision count, the MAR does it all. In a dimensionally clean, axial lead molded package.

With the non-measurable noise, low voltage coefficient, load stability, resistance/size ratio and *reliability* of our metal film process.

*Plus* MAR matched sets and packaged networks have tolerance and TC matching to  $\pm 0.005\%$  and 1 ppm/ $^{\circ}\text{C}$ .

## Specifications

IRC Type	Resistance Range* (Ohms)	Temperature Coefficients -20 $^{\circ}\text{C}$ to +85 $^{\circ}\text{C}$ ( $\pm$ ppm/ $^{\circ}\text{C}$ )	Tolerances ( $\pm\%$ )	Power Rating** @ 85 $^{\circ}\text{C}$ (Watts)	Voltage Ratings (Volts)
MAR3	20 - 100K	T10 = 15	1.00, 0.50, 0.25,	$\frac{1}{2}$ <sub>0</sub>	200
MAR5	20 - 250K	T13 = 10	0.10, 0.05, 0.02,	$\frac{1}{4}$ <sub>0</sub>	250
MAR6	20 - 500K	T16 = 5	0.01	$\frac{1}{8}$	300
MAR7	20 - 1 Meg			$\frac{1}{4}$	500

\*Wider ranges available, contact factory.

\*\*Higher power ratings available. Contact factory.

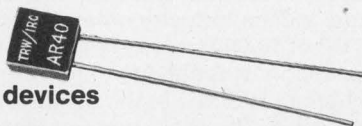

## AR40 radial lead devices

This plug in configuration offers absolute accuracy and documented reliability. TC's to  $\pm 2$ ppm/ $^{\circ}\text{C}$ , tolerances to  $\pm 0.01\%$  are standard.

*Plus*, AR40 uses only .03 in.<sup>2</sup> PCB area including lead attachment, and has the same mechanically rugged terminations used on all MAR resistors.

## Specifications

TCR Class.	Standard Temp. Coeff. ( $^{\circ}\text{C}$ )	Resistance Range* (Ohms)	Standard Tolerance ( $\pm\%$ )	Wattage 85 $^{\circ}\text{C}$
T-18	2 ppm 0 to 60 $^{\circ}\text{C}$ 5 ppm -55 to 125 $^{\circ}\text{C}$	20 to 100K	.01, .02, .05, .10,	.3 watts
T-16	5ppm 0 to 60 $^{\circ}\text{C}$ 10 ppm -55 to 125 $^{\circ}\text{C}$		.25, .50, 1.00	

\*Wider ranges available, contact factory.

## AR90 high range resistors

Designed for applications where you need values up to 10 Meg Ohms—such as precision voltage dividers, input attenuators.

*Plus*, despite its high resistance range, the AR90 has standard TC's to  $\pm 5$ ppm/ $^{\circ}\text{C}$  and tolerances to  $\pm 0.05\%$ . And it is a *real* space saver.

## Specifications

IRC Type	Resistance Range* (ohms)	Temperature Coefficients -20 $^{\circ}\text{C}$ to +85 $^{\circ}\text{C}$ ( $\pm$ PPM/ $^{\circ}\text{C}$ )	Tolerances	Power Rating	Voltage Rating
AR90	1M - 10M	T10 = 5 T13 = 10 T16 = 15	1.0, 0.5, 0.25, 0.1, 0.05	.5W	1000

\*Wider ranges available. Contact factory.

## Need prototypes fast?

TRW has on stream another *big plus*—a short order production line (in addition to our regular facility) designed to give you quick delivery on bread board quantities. Delivery to satisfy your needs, typically 2-3 weeks.

For more information on ultra-precision resistors, contact TRW/IRC Burlington. TRW/IRC Resistors, an Electronic Components Division of TRW, Inc., 2850 Mt. Pleasant St., Burlington, Iowa 52601. (319) 754-8491.

# TRW<sup>®</sup> IRC RESISTORS

INFORMATION RETRIEVAL NUMBER 133



# Design with the complete flat cable/connector system.

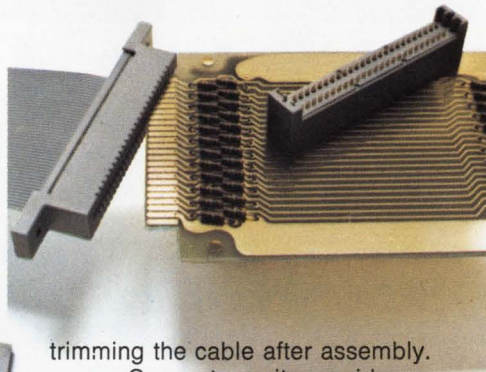

trimming the cable after assembly.

Connector units provide positive alignment with precisely spaced conductors in 3M's flat, flexible PVC cable. The connector contacts strip through the insulation, capture the conductor, and provide a gas-tight pressure connection.

Assembly-cost savings are built in when you design a package with "Scotchflex" flat cable and connectors. But more important, 3M Company offers you the full reliability of a one-source system: cable *plus* connectors *plus* the inexpensive assembly aids that crimp the connections quickly and securely (with no special operator training required).

The fast, simple "Scotchflex" assembly sequence makes as many as 50 simultaneous multiple connections in seconds, without stripping, soldering or

With cable, connectors and assembly tools from one design and manufacturing source, you have added assurance the connection will be made surely, with no shorts or "opens."

And "Scotchflex" now offers you more design freedom than ever. From stock you can choose shielded and non-shielded 24-30 AWG cable with 10 to 50 conductors, and an ever-increasing variety of more than

The 3M DELTA pin and socket connector.

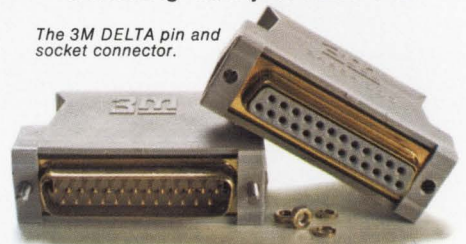

100 connectors to interface with standard DIP sockets, wrap posts on standard grid patterns, printed circuit boards, or headers for de-pluggable applications. 3M's DELTA "D" type pin and socket connectors are now also available. For full information, write Dept. EAH-1, 3M Center, St. Paul, MN 55101.



**3M**  
COMPANY

# 3M's "Scotchflex" line.

"Scotchflex" is a registered trademark of 3M Co.



What's new in solid state...

# Leak-proof, torque-proof thyristors from RCA.

Now readily available: RCA thyristors with our no-strain solution to lead torque problems.

It's flexible-lead packaging, and it works this way. We attach long flexible leads to the cathode and gate terminals — and then completely embed those couplings plus the glass hermetic seal in epoxy. Device leads are solidly locked in position, so there can be no strain on the glass-to-metal seal. You have an extra barrier against dust, dirt, oil and moisture. Wiring into your equipment is much easier. And so is meeting UL and IEC creepage specs.

On short notice, you can have flexible-lead packaging on any RCA standard

commercial press fit thyristor, mounted either on a stud or TO-3 base, and in both isolated and non-isolated versions.

Many are available off the shelf: Triacs (10, 15, 30 and 40 amps; 200-600 volts), and SCRs (20-35 amps; 200-600 volts). For

availability information and prices, contact your local RCA Solid State distributor. Or RCA.

Write: RCA Solid State, Box 3200, Somerville, New Jersey 08876; Ste. Anne de Bellevue 810, Canada; Sunbury-on-Thames, U.K.; Fuji Bldg., Tokyo, Japan.

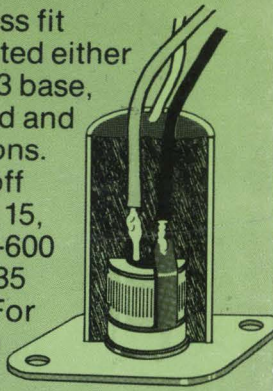

# RCA

INFORMATION RETRIEVAL NUMBER 254

RCA. A powerhouse in thyristors.