

Electronic Design 5

VOL. 22 NO.

FOR ENGINEERS AND ENGINEERING MANAGERS

MARCH 1, 1974

Check fast logic, bit by bit, or up to 2048 bits at a time, in each of eight pulse trains. Set thresholds you want, then record data at rates to 200 MHz and

view at your leisure. Locate two cursors to isolate the pulses you want to study and display timing down to 5 ns. You can even catch 1-ns spikes. See page 69.

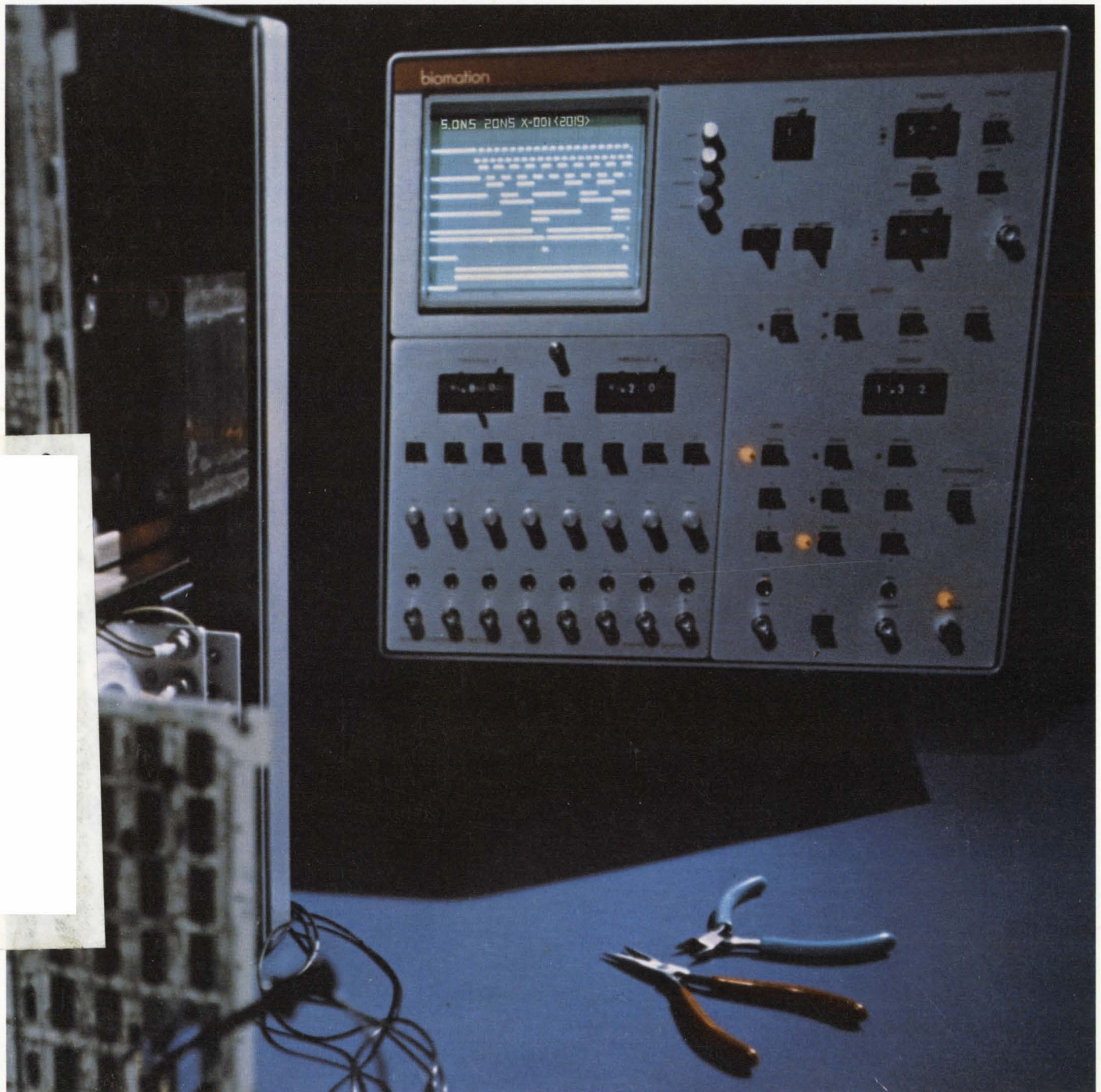

How to cut the cost of special resistors

(even if you don't know what you want)

Project costs don't have to escalate when you find you can't use a standard resistor. There are positive ways you can save money and time—and even come out ahead in the bargain.

You can start cutting project costs by reducing what we call "visualization loss". This is the expensive extra time required to figure out an exact set of electrical, physical, environmental and dimensional parameters for the special part you need. *Don't go too far.* Especially don't wait until you're completely bogged down before you ask Dale for help. In electrical terms, we've long since figured out practical ways to deliver resistance as low as .001 ohm... tolerance as low as .01%... TC as low as ± 5 ppm and power just as high and as stable as you want it to be. And we can put your non-standard electrical parameters in unique packages that are one part sophistication and one part mid-western ingenuity. Every day we're showing companies how they can bend, squeeze,

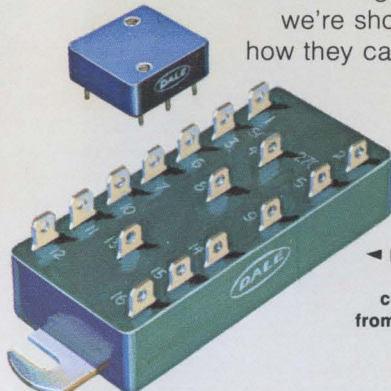

Space-saving P.C. board module containing 3 non-inductive resistors. (Far left)

Network with 16 quick couple connections containing 12 resistors from .025 ohm 50 watts to .1 ohm 10 watts.

High Pulse Wattage railway safety resistor. Special housing for underground use.

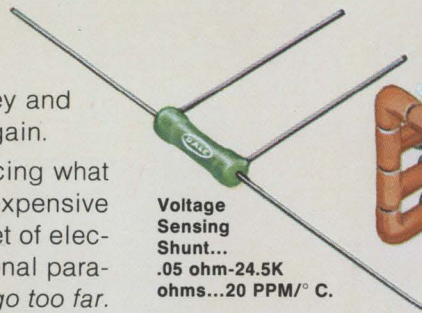

Voltage Sensing Shunt...
.05 ohm-24.5K ohms...20 PPM/° C.

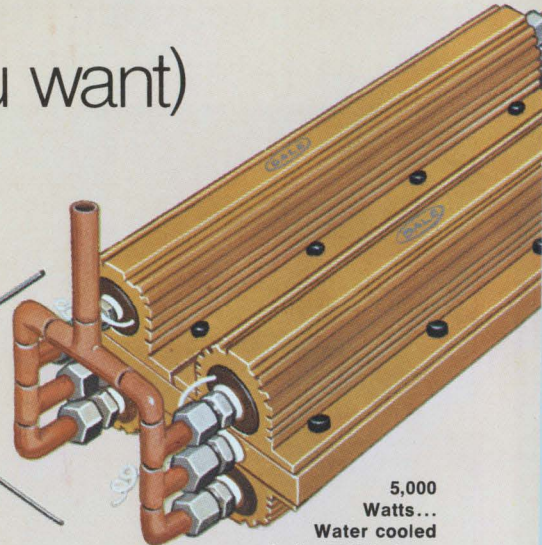

5,000 Watts...
Water cooled
.1 ohm-500K ohms,
0.5%-5% tol.

mill, tap, bury and inter-connect resistors for special purposes. We even put in plumbing, when required. Your non-standard resistor may only need a different kind of lead or it may look like a Rube Goldberg nightmare. Either way, you'll find Dale is unique among resistor suppliers in the ability to help you quickly visualize what you need... and to deliver a prototype with a minimum of design lag. We've already designed and built nearly 5,000 special resistors—so it's quite possible we've already blueprinted the design you need.

Call us. You'll be glad to find someone is working to make the basics better.

Send for our free Functional Guide to Non-Standard Resistors.

DALE ELECTRONICS, INC.
1300 28th Avenue, Columbus, Nebraska 68601
A subsidiary of The Lionel Corporation
In Canada: Dale Electronics Canada Ltd.
In Europe: Dale Electronics GMBH,
8 Munchen 60, Falkweg 51, West Germany

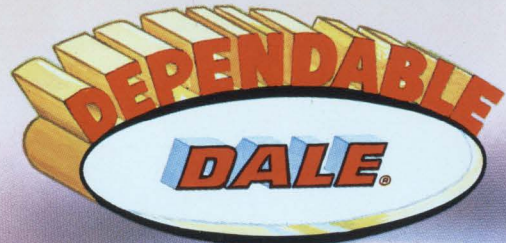

SURPRISE!

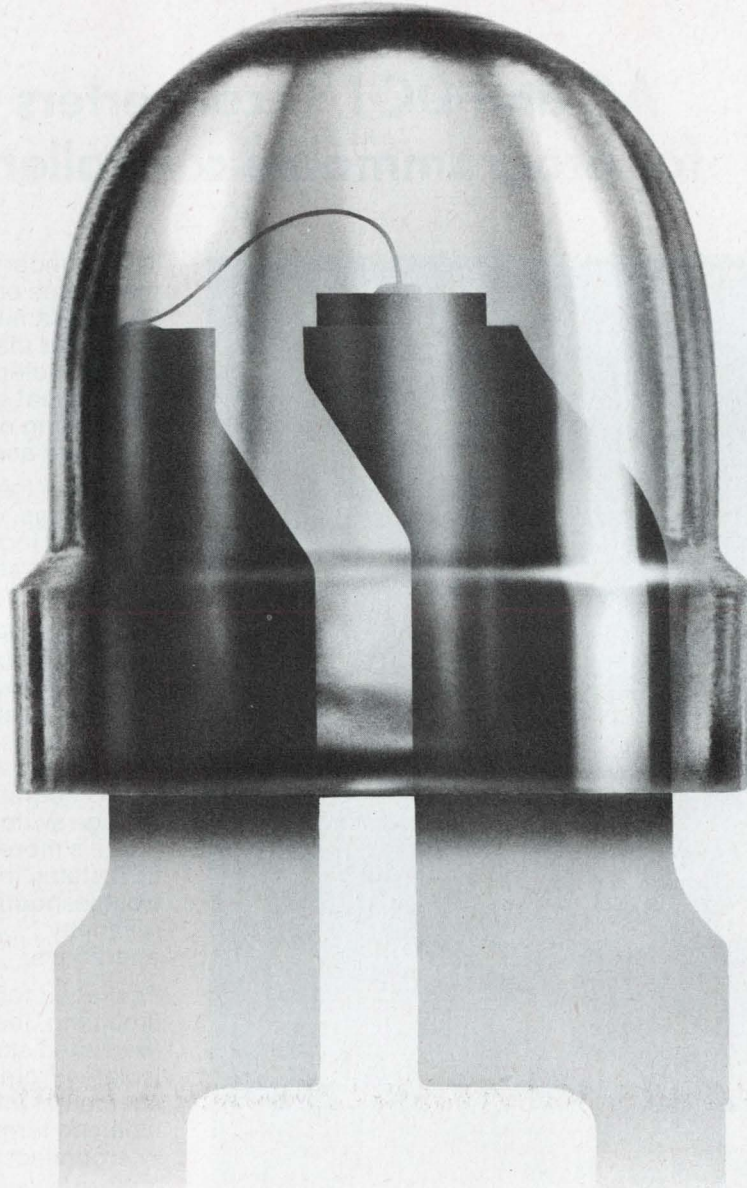

A quality LED for just 9¢*.

Now you can get HP quality in an LED lamp for only 9¢*. That's your price when you order one million. If you only need one thousand, the price is a low 17¢*. And HP is ready to deliver that kind of volume to meet your schedule.

This T-1 size lamp features a new low profile lens for high density application in calculators, cameras, computers, appliances and automobiles. The 5082-4487 and 5082-4488 both have a clear lens and a 0.8 mcd at 20 mA typical light output. Get the full story from your nearby HP distributor or, write Hewlett-Packard directly.

01333

*US Domestic only.

INFORMATION RETRIEVAL NUMBER 2

HEWLETT  PACKARD

Sales, service and support in 172 centers in 65 countries.
Palo Alto, California 94304. Offices in principal cities throughout the U.S.

Teledyne in solid control

AC and DC I/O converters for programmable controllers

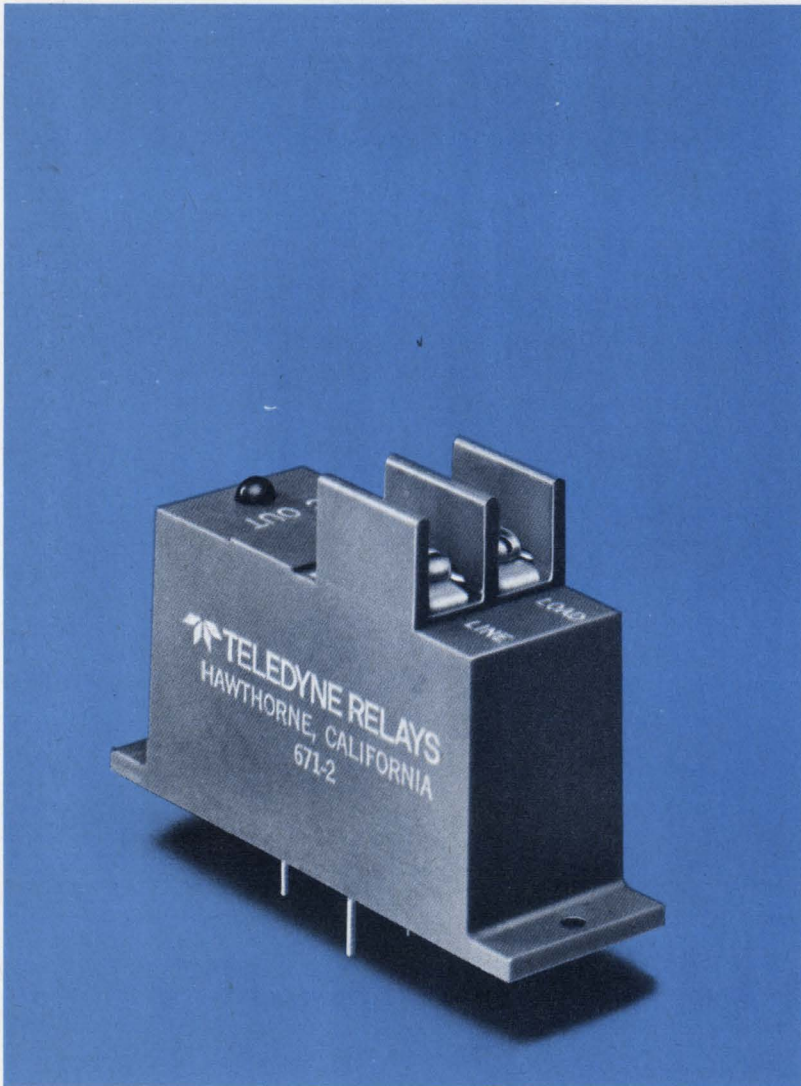

The boundary of the minicomputer mainframe or CPU world — of sensitive IC logic families — and the process control or machine tool world of motors, solenoids, lamps, and electro-mechanical switches is a tough place, demanding devices for fast quiet switching and load sensing — reliably.

Teledyne, the world's leader in solid state relays, offers the 671 series AC or DC input and output converter modules — state of the art in circuitry and packaging.

ALL SOLID STATE, the 671's are optically isolated between logic and AC or DC power; high noise immunity prevents misfiring in industrial atmospheres. Output converters have high surge ratings for inductive loads; an AC output unit is available with zero voltage switching to minimize RFI. There's more: easy multiplex operation, LED status indicators for simple troubleshooting, and solid state reliability . . . *minimum* life of 10^8 operations.

Packaged for side-by-side panel mounting, the power terminals (barriered screws) are physically isolated from the logic pins to prevent accidental intrusions; side-by-side units mean no terminal strips and interconnect wiring.

If you're in the mainframe business and want to offer process control, or if you're in the processing world and want computer control, write or call about the 671 series; our application engineers will put you in solid control.

 **TELEDYNE RELAYS**

3155 West El Segundo Boulevard Hawthorne, California 90250
Telephone (213) 973-4545

INFORMATION RETRIEVAL NUMBER 3

NEWS

- 21 **News Scope**
- 26 **Report on Portable Circuit Testers:** For fast digital troubleshooting, low-cost detectors can't be beat.
- 34 **New memory, the crosstie,** stores data in magnetic-domain walls.
- 36 **Mini-laser techniques** speed 3-dimensional X-ray imaging.
- 39 **Washington Report**

TECHNOLOGY

- 46 **Match impedances accurately and easily.** The Mac chart gives quick approximate values, and an equivalent computer program adds numerical accuracy.
- 50 **Try condition/action diagrams** to lighten your design load. They can help you untangle complex interactions between system parameters.
- 54 **Choose cleaning solvents carefully.** Engineers often use or specify chemical solvents for cleaning electronic equipment. But not all are mindful of the hazards.
- 58 **Prevent damaging overloads** to dc-to-dc converters. Reflected noise, thermal changes and transients can strain capacitors. Don't exceed component ratings.
- 60 **Ideas for Design:** Bootstrapped RC differentiator performs accurately without phase inversion . . . Single transistor circuit provides CRT-level sweep and blanking signals . . . Wiper noise removed and measured with a single nonlinear filter.
- 66 **International Technology**

PRODUCTS

- 69 **Instrumentation:** Fastest logic scope captures 8 data streams at 200 MHz.
- 72 **Modules & Subassemblies:** 2.2-lb rubidium standard for systems uses only 12 W.
- 76 **Modules & Subassemblies:** Voltage control is featured in zero-phase-shift filter.
- 80 **ICs & Semiconductors:** 500-A one chip transistors have super-low $V_{CE(sat)}$.
- 78 Data Processing
- 83 Components
- 84 Power Sources
- 86 Microwaves & Lasers
- 87 Packaging & Materials

Departments

- 45 **Editorial:** The mother-in-law
- 7 Across the Desk
- 90 Design Aids
- 91 New Literature
- 94 Advertisers' Index
- 96 Product Index
- 96 Information Retrieval Card

Cover: Photo by George Young, courtesy of Biomation.

The Danameter.

\$195.



1 Year Battery Life.

In a digital instrument, you'd expect to fool with a battery regularly, recharging it or replacing it.

Not with The Danameter.

The battery will last you at least one year. And even if you find a way to wear it out, you're only talking about 69¢.

Liquid Crystal Readout.

The specifications on The Danameter show at a glance that this is a more accurate instrument than the one it's designed to replace.

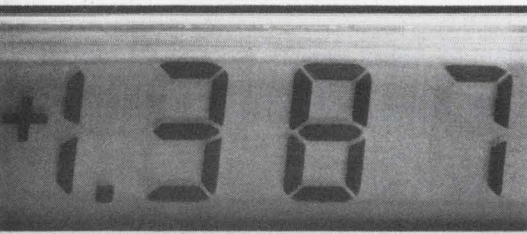

Yet there is another type of inaccuracy The Danameter solves—in an even more dramatic way.

These are the errors that occur every day in reading an analog voltmeter. Scales are hard to separate. Increments of measurement are greatly restricted. Precise readings are difficult to make.

When you measure with The Danameter, you interpret nothing. All you are shown is a number that is precisely the information you require.

It's accurate to a degree that you never imagined possible in an instrument at this price.

Once you have selected the proper function position, The Danameter instantly interprets, selects, and converts your information. It shows in a large liquid crystal display that adjusts to all light conditions. Even direct sunlight.

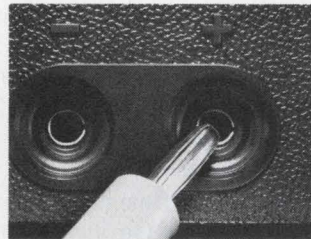

Automatic Polarity.

In measuring voltage, you're accustomed to swapping leads to get a reading.

The Danameter instantly determines polarity, and then displays it as either positive or negative. All in a fraction of a second, with no help from you.

Almost indestructible.

The Danameter has only one function selector. It's recessed behind the molded edges of its cyclac case. You can drop it on concrete. You can kick it down the hall.

When you pick it up, it'll be working perfectly. This is the first true portable instrument of its kind. For \$195.



Call Cliff Hamilton collect at (714) 833-1234. Ask for your nearest Dana representative.

DANA[®]
Others measure by us.

INFORMATION RETRIEVAL NUMBER 4

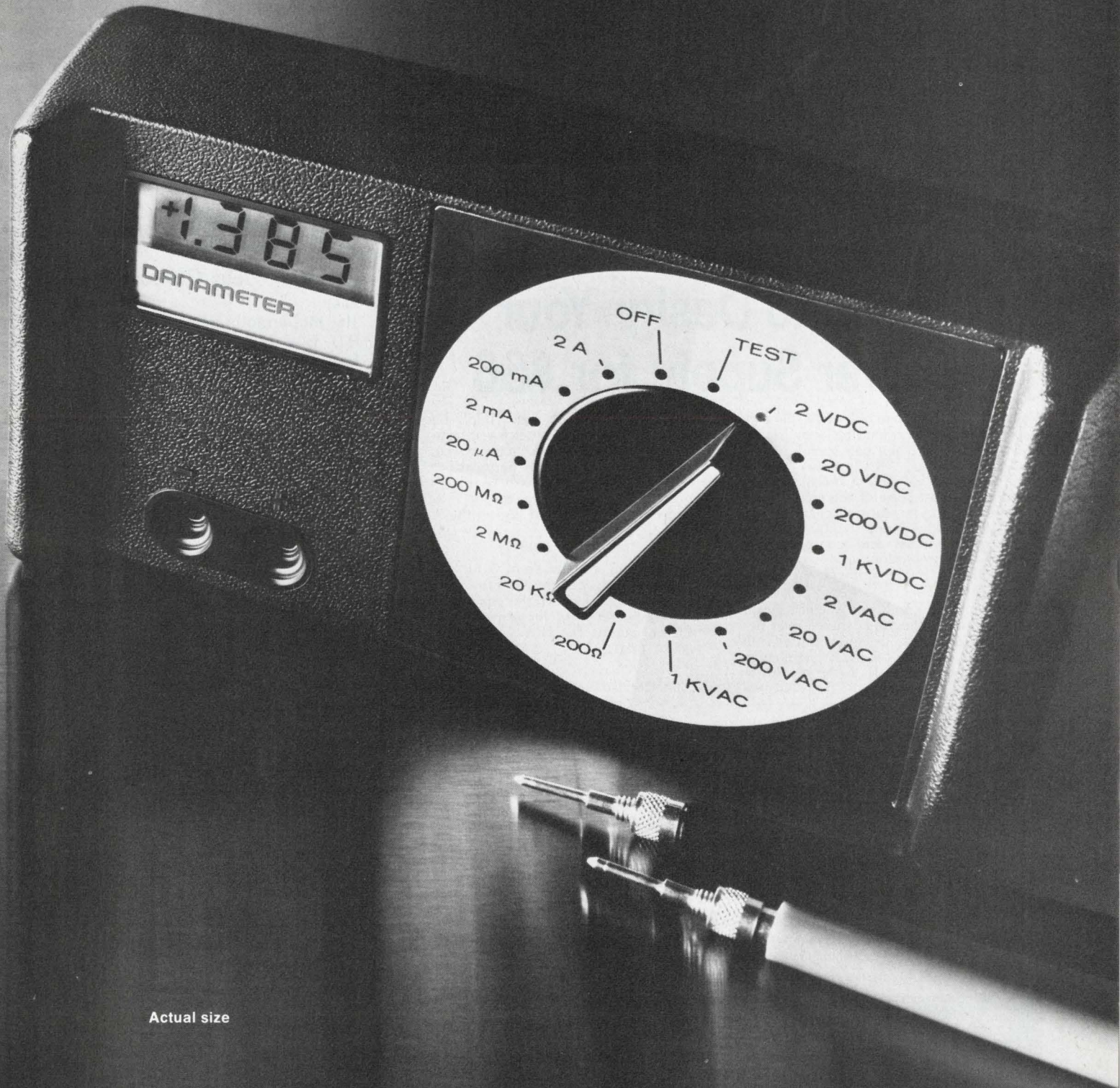

Actual size

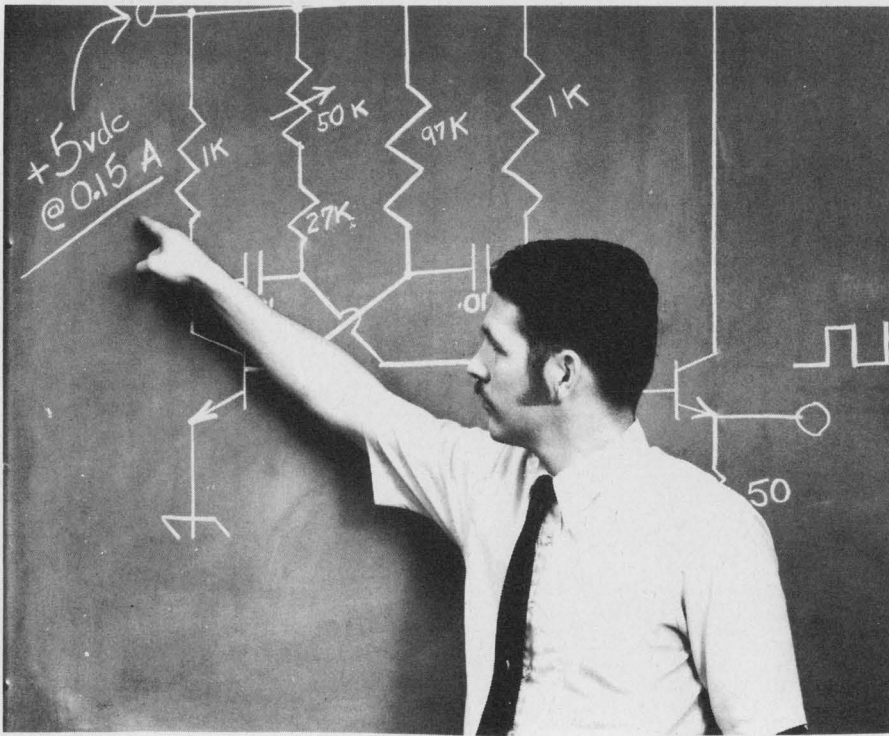

How to Design Your Power Supply for \$66

You get the **complete schematic diagram, and parts list** with operating and installation instructions when you spend \$66 for an Abbott Model "RN" power supply. Two years in development, this model represents the latest state of the art in power module design. It features close regulation (0.1%), low ripple (0.02%), automatic short circuit and complimentary overvoltage protection and continuous operation in a 160°F ambient.

Abbott Engineers followed specific design criteria in engineering these modules. First, the electrical design was carefully engineered to insure that all components operate well within their limits, under "worst case" operating conditions. Second, the thermal design, including case construction, was carefully made to insure that the maximum temperature limits of all components are never exceeded. Then the size and weight of these modules were controlled to a minimum, without sacrificing reliability. Finally these units were thoroughly tested to make certain that all design and performance specifications were met.

So, you can build your own power supply using our schematic diagram if you want to—but we think we can build it more

reliably and for less cost, simply because we have been doing it for ten years. Put our power supply in your system first and try it. Examine its performance. We think you will be pleasantly surprised at the quality, adherence to specifications, and the reliability you find in the Abbott Model "RN".

Any output voltage from 5 to 100 volts DC with current from 0.15 to 20 amperes is available. **Many of the popular voltages are carried in stock for immediate delivery.** Please call us for attractive O.E.M. discount prices.

Abbott also manufactures 3,000 other models of power supplies with output voltages from 5.0 to 3,650 volts DC and with output currents from 2 milliamperes to 20 amperes. They are all listed **with prices** in the new Abbott catalog with various inputs:

- 60 A to DC, Hermetically Sealed
- 400 A to DC, Regulated
- 28 VDC to DC, Regulated
- 28 VDC to 400 A, 1 ϕ or 3 ϕ
- 24 VDC to 60 A, 1 ϕ

Please see pages 581-593 of your 1973-74 EEM (ELECTRONIC ENGINEERS MASTER Catalog) for complete information on Abbott Modules.

Send for our new 56 page FREE catalog.

abbott transistor

LABORATORIES, INCORPORATED
general offices eastern office

5200 W. Jefferson Blvd./Los Angeles 90016
(213) 936-8185 Telex: 69-1398

1224 Anderson Ave./Fort Lee, N.J. 07024
(201) 224-6900 Telex: 13-5332

INFORMATION RETRIEVAL NUMBER 5

Vice President, Publisher
Peter Coley

Editors

Editorial Offices
50 Essex St.
Rochelle Park, N.J. 07662
(201) 843-0550
TWX: 710-990 5071
Cable: Haydenpubs Rochellepark
Editor-in-Chief George Rostky

Managing Editors:

Ralph Dobriner
Michael Elphick

Associate Editors:

Dave Bursky
Jules H. Gilder
Morris Grossman
Seymour T. Levine
John F. Mason
Stanley Runyon
Edward A. Torrero
Richard L. Turmail

Contributing Editors:

Peter N. Budzilovich

Editorial Field Offices

East

Jim McDermott, Eastern Editor
P.O. Box 272
Easthampton, Mass. 01027
(413) 527-3632

West

David N. Kaye, Senior Western Editor
2930 West Imperial Highway
Inglewood, Calif. 90303
(213) 757-0183
Northe K. Osbrink, Western Editor
112 Coloma St.
Santa Cruz, Calif. 95060
(408) 426-3211

Washington

Heather M. David, Bureau Chief
2506 Eye St., N.W.
Washington, D.C. 20037
(202) 338-3470

Editorial Production

Marjorie A. Duffy

Art

Art Director, William Kelly
Richard Luce
Anthony J. Fischetto

Production

Manager, Dollie S. Viebig
Helen De Polo
Anne Molfetas
Christopher G. Hill

Circulation

Manager, Nancy L. Merritt

Information Retrieval

Peggy Long

Promotion

Manager, Jeffrey A. Weiner
Karen Kerrigan

Product safety seen giving way to profits

I'm writing in response to Stanley Runyon's editorial "Let's Not Become Another Auto Industry" in the Oct. 25, 1973 issue. In this editorial, Mr. Runyon stated that workers in the TV industry (engineers included) are to blame for safety hazards in TV sets. They should design, build, inspect and test these hazards out of existence.

Being somewhat familiar with the electronics industry, I can tell you that TV engineers do not control product safety any more than auto engineers do. A TV engineer can gripe about unsafe designs, but that will not have one iota of impact on the safety of TV sets as long as the marketing VP decides to sell a 16-inch, instant-on color TV for \$249.95 and still make a reasonable profit. The TV engineer can design cool-running circuits with adequate safety margins, thermal and overload protection. His reward for these noble efforts will be (if he's lucky) a reprimand not to waste the company's money designing noncompetitive products. If he's unlucky, the reward will be severance pay. And the same strictures apply to wiremen, assemblers and testers. The workers are powerless to alter the safety of the product, because they're professionally powerless. Ralph Nader pointed that out years ago.

Mr. Runyon's lofty sentiments about the designer's conscience and responsibility are so much eye-wash, because someone else is calling the shots, and his name is inscribed in gilt letters on the door of the corporate president's office. Until such time as safety hazards are legislated out of existence, or

some engineering genius develops safer circuits at negligible additional cost—or the public gets educated and demands better—unsafe TV sets are here to stay. Just try buying a TV set with a three-wire plug and line cord.

These comments do not apply to my employer.

Robert Bruce, MSEE

15 Johnstone Rd.
Great Neck, N.Y. 11021

An old circuit is born again

In reference to "Line-Voltage Control Technique Improves Resolution, Lowers Parts Cost" (ED No. 23, Nov. 8, 1973, p. 138), the voltage-control circuit described is an old one, well-known to transformer people. I was first introduced to this technique over 10 years ago, and there was nothing new about it even then. The arrangement is known as a "buck/boost" circuit, and transformer manufacturers have for many years been making transformers specifically intended for use in such circuits.

*William A. Robinson
Design Engineer*

Oak Industries
Selectronics Div.
200 S. Main St.
Crystal Lake, Ill. 60014

The author replies

Mr. Robinson is quite right that the "buck/boost" transformer idea has been around for a long time. However, I have never seen this technique used in conjunction with an autotransformer as a continu-

(continued on page 10)

Electronic Design welcomes the opinions of its readers on the issues raised in the magazine's editorial columns. Address letters to Managing Editor, Electronic Design, 50 Essex St. Rochelle Park, N.J. 07662. Try to keep letters under 200 words. Letters must be signed. Names will be withheld on request.

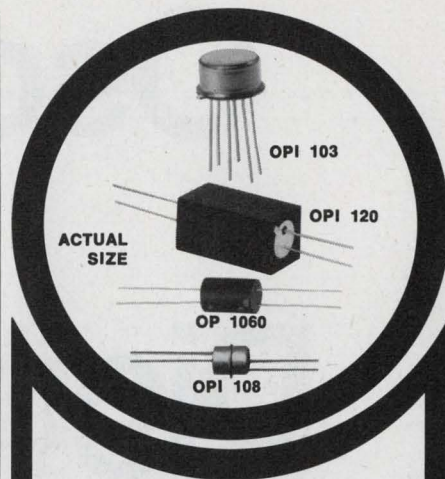

OPTRON OPTICALLY COUPLED ISOLATORS

HIGH RELIABILITY
STABLE CHARACTERISTICS
IMMEDIATE DELIVERY

OPTRON optically coupled isolators feature true hermetically sealed packages for the utmost in reliability for coupling, switching, relaying, or isolating an electrical signal.

They consist of high efficiency gallium arsenide light emitting diodes coupled with silicon sensors. Each OPTRON isolator is available in phototransistor or photodarlington versions to offer the design engineer a greater choice in matching device performance with circuit requirements.

OPTRON's broad selection of isolator packages (see photos) provides electrical isolation from 1 to 25 Kv for maximum electrical and mechanical design flexibility.

OPI 103 1 Kv isolation and 100% current transfer ratio. Phototransistor base lead available. Hermetic TO-5 package.

OPI 120 25 Kv isolation and 10% current transfer ratio. Hermetic sensor and LED in 0.30 x 0.60" plastic package.

OP 1060 5 Kv isolation and 10% current transfer ratio. Hermetic sensor and LED in .200" dia. plastic package.

OPI 108 1 Kv isolation and 20% current transfer ratio. 5 μ sec switching time in a welded axial lead hermetic package.

Detailed technical information on these and other OPTRON optoelectronic products . . . chips, discrete components, assemblies, and PC board arrays . . . is available from your nearest OPTRON sales representative or the factory direct.



OPTRON, INC.

1201 Tappan Circle
Carrollton, Texas 75006
214/242-6571

Oscilloscope plus Digital Plug-ins

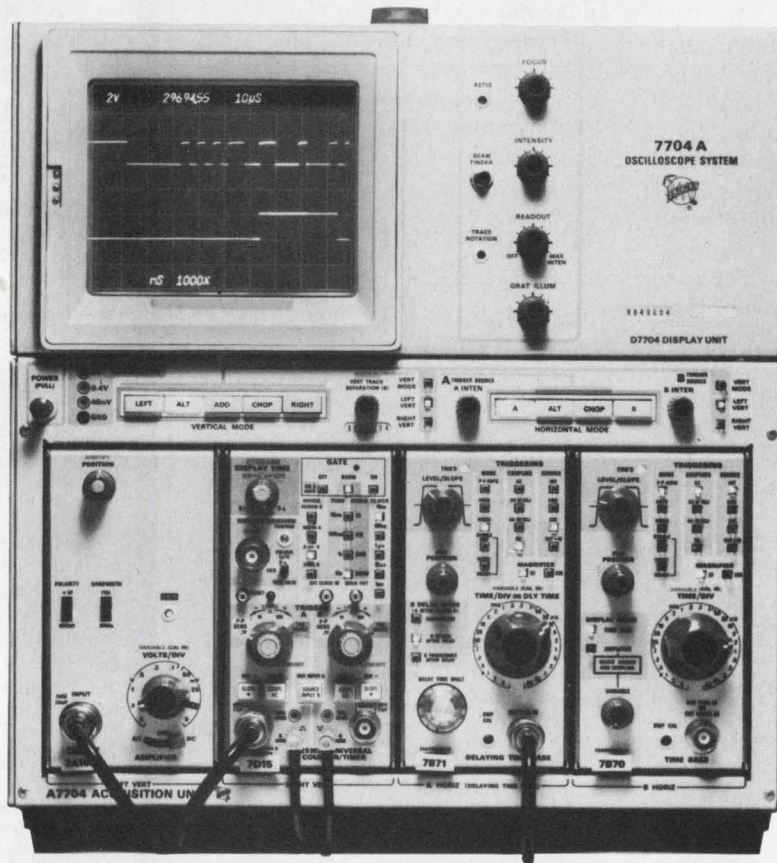

Unique Solutions to Difficult Problems

Using the 7D15 Universal Counter/Timer

Problem:

Accurately measure the time between two nonadjacent pulses in a word train (displayed in upper trace).

Solution:

Use the scope's delayed sweep gate to selectively control the counter's measurement interval (displayed in lower trace). A time interval of 29694.55 ns is measured and displayed on the scope's CRT READOUT.

A Time Interval Counter, a Frequency Counter, a DMM, and a Delay Unit make up the 7000-Series Digital Family. These plug-ins bring the accuracy and convenience of digital technology to waveform measurements. Both analog and digital information can be displayed simultaneously.

Applications unique with the new 7D15 Universal Counter/Timer include measuring: time intervals

7000 Series Digital Family



of selected portions of complex waveforms (such as telemetry and computers); time between nonadjacent pulses; time between desired events (such as radar)—while ignoring effects of noise; frequency of burst—the arming feature permits measurement inside a burst so that burst turn on can't introduce possible error; and frequency of events—while ignoring signal ringing.

Teaming the 7D15 with a scope gives you more solving power for today's complex measurements. This unique combination allows you to: (1) *Display* on the CRT the measured signal together with the measurement interval, or the counter Schmitt trigger signal; (2) *Precondition* the signal via the scope's vertical



amplifier to provide input possibilities such as, 10 μ V sensitivity, Differential input, and Current probe input; and (3) *Accurately Control* the start and stop points of measurement by selective arming.

The new 7D11 Digital Delay Unit with its 100 ns-to-1 s delay range in Time-Delay mode and its 10,000,000 count range in the Events-Delay mode, fulfills many measurement requirements for accurate delays.

Applications in the Time-Delay mode include measuring: accurate low jitter sweep delays; propagation delays of delay lines or delay devices; delay path equalization in networks, logic systems, cable systems, or distribution amplifiers; oscillator

stability; pulse width jitter, pulse-to-pulse jitter; and more.

Applications in the Events-Delay mode include: disc memory skewing adjustments; computer main storage or local storage timing adjustments; lost bit identification and location on disc memory or magnetic tapes; modulation analysis on time division multiplexing (TDM) or pulse modulation (PWM) in communication and data systems; and more.

The 7D13 Digital Multimeter with its unique temperature probe and 7D14 525-MHz Digital Frequency Counter are two more problem solvers in TEK's digital family.

TEK's concept of integrating these digital measurement capabilities with the scope brings you many advantages over separate test units:

- measuring convenience and confidence
- easier and faster solutions to complex problems
- fewer dollars invested
- more bench working space
- signal conditioning

Add to these, the new dimension of scope-controlled measurements and you realize why we say "7000 Series . . . more than just an oscilloscope."

For more information contact your local TEKTRONIX Field Engineer or write: Tektronix, Inc., P.O. Box 500, Beaverton, Oregon 97005. In Europe write: Tektronix Ltd., P.O. Box 36, St. Peter Port, Guernsey, Channel Islands.



TEKTRONIX®
committed to
technical excellence

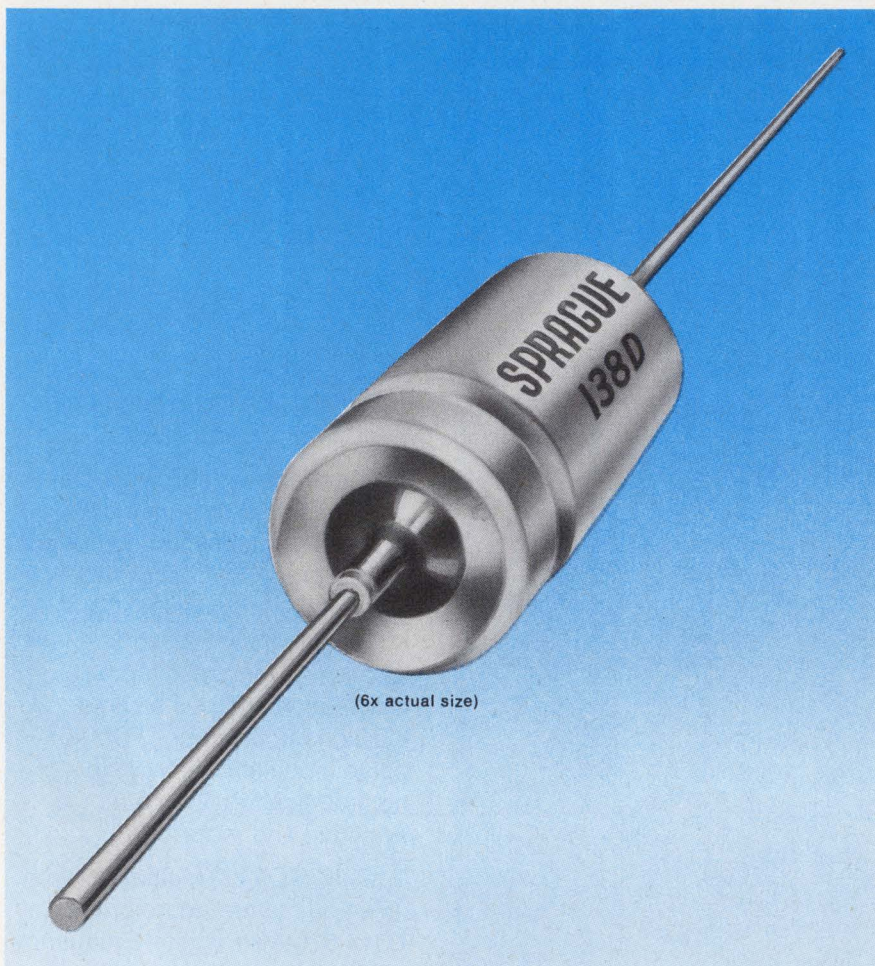

seal of improval

Improved reliability through the use of a glass-to-tantalum **true** hermetic anode seal is the prime feature of new Type 138D gelled-electrolyte sintered-anode Tantalex® Capacitors. This new construction eliminates all internal lead welds while retaining the strength of conventional internal lead-welded parts. In addition, the new construction offers outstanding resistance to extensive temperature cycling.

Type 138D Tantalum Capacitors are designed to meet or exceed

the environmental and life test requirements of MIL-C-39006. The gelled-electrolyte employed in these new capacitors gives premium performance for all capacitor parameters with respect to frequency and temperature variations.

Originally developed for use in aerospace applications, this capacitor design is now available for general industrial and aviation use where the utmost in component performance and reliability are primary necessities.

For complete technical data, write for Engineering Bulletin 3704A to: Technical Literature Service, Sprague Electric Co., 347 Marshall St., North Adams, Mass. 01247.



THE BROAD-LINE PRODUCER OF ELECTRONIC PARTS

INFORMATION RETRIEVAL NUMBER 8

ACROSS THE DESK

(continued from page 7)

ously variable buck/boost device.

I designed this device for an application that I could not fill with commercially available devices. The only cheap variable-voltage devices I found in the catalogs (Staco, Ohmite, etc.) were standard full-range autotransformers.

Although this simple idea may be "well-known to transformer people," this knowledge is apparently neither reflected in their products nor disseminated among "nontransformer" engineers and production people.

M. J. Salvati

Sony Corp. of America
47-47 Van Dam St.
Long Island City, N.Y. 11101

Don't overlook CAD to ease workload

The recent article by A. H. Hilbers and M. H. Burden titled "Calculate Large-Signal Behavior" (ED No. 23, Nov. 8, 1973, pp. 90-94) was well done. Unfortunately the basic premise—that S parameters cannot be used under large-signal conditions—is faulty (see Leighton, Chaffin, and Webb: "RF Amplifier Design with Large Signal S-Parameters," Sandia Laboratories, Albuquerque, N.M. 87115).

One of the biggest drawbacks to industry acceptance of CAD programs as a design tool has been the inconvenience in construction of valid device models and the near impossibility of relating model parameters directly to simple experimental measurements. This started because the old ECAP program forced the user to work with artificial models in the frequency domain; it took almost 10 years for frequency-domain CAD to recover.

In 1971 our program, MAGIC, marketed by University Computing Co., pioneered the complete avoidance of the "device-mode" concept by working directly with measured data. Virtually all modern frequency-domain programs now use device parameters.

(continued on page 16)

If you need a 3-Station Digital Logic Test System, we can save you

\$92,000

Compare the Hughes 1024's price and performance with the General Radio 1792, Teradyne 115, and other higher-priced systems. Three Teradyne 115s, for example, can easily set you back \$210,000. Get the new Hughes 1024 system with three independent work stations instead, and you invest only \$118,000.

We can charge less because we've built in more flexibility and economy. The 1024's disk-based system uses a common mini-computer and disk mass storage to drive up to three work stations. You can start with the basic control unit and one work station (256 two-way lines) for as little as \$68,000, and readily add two more stations for \$25,000 each.

The stations can be remotely located. They operate simultaneously, with each one performing a programming task or testing different card types. Not only that. Each station can handle up to 1024 two-way lines, with special interface configurations to test ECL and other logic families.

You get high speed, automatic dynamic-response testing (100 nsec) vs. the static testing most competitors offer. And a software-controlled probe quickly isolates manufacturing failures.

Now, all this might not mean much if the Hughes 1024 didn't have a superior test language and supporting software to cut test-program generation down to size. But it does. Plus a comprehensive file management, interactive CRT edit, and a real-time, disk-based operating system.

We'll supply test programs for your 1024, or other test systems. We'll also convert existing test programs to the 1024 language.

Hughes has pioneered in developing automatic test equipment for many projects. And now Hughes offers a complete logic-testing capability from hardware through test-generation service.

Mail the coupon today. How could you find a better way to save \$92,000?

HUGHES

HUGHES AIRCRAFT COMPANY
INDUSTRIAL PRODUCTS DIVISION

TELL ME MORE ABOUT HOW TO SAVE \$92,000.

Mail to: Hughes Aircraft Co., Industrial Products Division, P.O. Box 92904, Los Angeles, CA 90009. Or call (213) 670-9040, Ext. 6582.

NAME _____ TITLE _____

COMPANY _____

ADDRESS _____ CITY _____ STATE _____

ZIP _____ PHONE _____



Omnigraphic™ Capable Recording

X-Y CAPABILITY

Some 27 interchangeable modules plug into the basic chassis to give you the most capable X-Y recorder in the world or any place else.

- 30 in/sec speed (40 in/sec available)
- $\pm 0.2\%$ accuracy
- local/remote pen control
- electric pen lift
- high input resistance
- interchangeable amplifiers

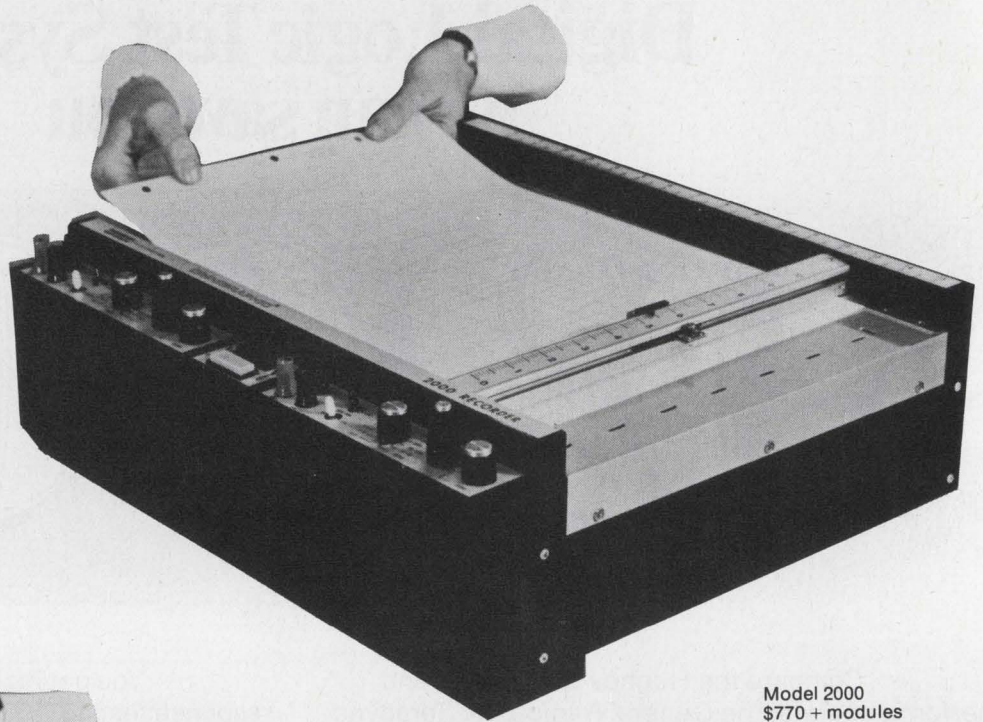

Model 2000
\$770 + modules

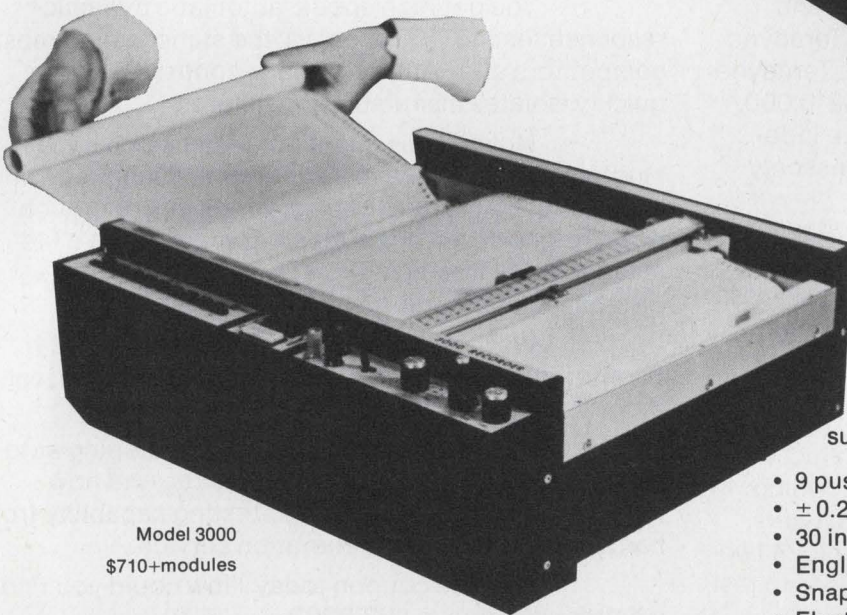

Model 3000
\$710+modules

STRIP CHART CAPABILITY

A truly capable strip chart recorder for such diverse functions as GC or spectrometry.

- 9 pushbutton speeds from 20 to 0.05 in/min
- $\pm 0.2\%$ accuracy
- 30 in/sec slewing speed (with 40 in/sec available)
- English/Metric scaling at the flick of a switch
- Snap-in disposable pen
- Electric pen lift

Plug-in modules include:

Type 0 Customizing
Type 1 DC Coupler
Type 2 Ranging
Type 3 Switching
Type 4 Switching
/Time Base

Type 5 Precision Attenuator
Type 6 Precision Attenuator
/Time Base
Type 7 Pre-Amp Attenuator
Type 8 Pre-Amp Attenuator
/Time Base

Type 9 Precision Ranging
Type 10 High Sensitivity
AC Converter
Type 11 1 mv Full Scale
Type 12 Precision Attenuator/Offset
Type 13 Integrator
Type 14 Log Converter
Type 15 Two Channel

Type 16/17 Point Plotter
Type 18 Thermo Couple
Type 19 Strain Gauge
Type 20 AC, DC Switching
Type 50 Chart Drive
Type 51 Chart Drive
Type 52 Chart Drive
Type 53 Chart Drive
Type 100 Control
Type 200 Control

**THE
RECORDER
COMPANY**

**houston
instrument**

4950 Terminal Avenue, Bellaire, Texas 77401
(713) 667-7403 TWX 910-881-5782 Cable HOINCO

European Office Rochesterlaan 6, 8240 Gistel, Belgium
Telephone 059-27445 Telex BAUSCH 19399

OEM DISCOUNT

Be sure to ask about our unique module trade-in plan.

TYPE - 256 x 1 Static SOS/CMOS Ram

NUMBER - INS4200

READ CYCLE TIME - 180 nS

WRITE CYCLE TIME - 140 nS

QUIESCENT POWER DISSIPATION - 40 μ W @ 10 V

INPUT CAPACITANCE - 6.5 pF

SUPPLY VOLTAGES - 5 to 15 volts

OUTPUT - Three-state TTL compatible, full address decoding and bipolar compatible pin-outs.

PACKAGE - 16 pin dual-in-line

PRICE - Mil Range (100-999) \$38.00

Comm. Range (100-999) \$21.00

**256X1
CMOS
RAMS**

Only Inselek makes the lowest power, highest speed 256x1 Static SOS/CMOS RAM currently available. And the price is only \$38.00 in the military range and \$21.00 for the commercial version (100-999).

Excellent prices when you consider the added benefits you're getting with our proven SOS technology . . . exceptional reliability, high speed and low power. With an Inselek INS4200 Ram, a minimum number of additional components are required due to the 3 chip select inputs, especially when employed with large memory arrays. For the applications minded engineer or manager, you'll be glad to know that they're perfect for use in point-of-sale systems, mini & micro computers, computer peripherals, calculators & portable electronic systems. One more point. The Inselek INS4200 Ram is fully compatible with other CMOS and TTL devices. Check the specs above and then contact Bob Burlingame, your applications engineering specialist at Inselek. Bob will be glad to discuss your specific requirements. Call Bob collect at (609) 452-2222, or write him at INSELEK, Inc., 743 Alexander Road, Princeton, New Jersey 08540.

 **INSELEK™**

SALES OFFICES IN:
CONCORD, MASS. (617) 369-5298
LOS ANGELES, CALIF. (213) 889-2788

DISTRIBUTORS

West Coast - WESTATES (213) 341-4411 • New England - GREEN SHAW (617) 969-8900 • Mid-Atlantic - WILSHIRE ELECTRONICS (609) 786-8990

engage and disengage entire sub-systems with Transitron PE-1000 connectors



Take advantage of industry's largest selection of contact terminations: crimp removable, wire-wrap, solder dip, etc. Check these features:

- proven two-piece pin and socket construction, with pins recessed in a precision cavity to provide mechanical protection, polarization and positive contact alignment
- true closed entry socket protection
- crimp-removable contacts with a proven rear-release retention system similar to NAS-1599, also wire-wrap and solder dip
- high density (0.100" x 0.050" offset PCB grid) available in 41, 66, and 114 contact configurations
- high reliability (meets or exceeds MIL-E-5400, contact factory for approval information)
- gasket sealing for weatherproofing and complete environmental protection
- low average insertion/extraction forces

Transitron also makes a wide variety of rack and panel connectors, wire-wrap panels and backplanes. Contact the factory for complete descriptive literature or a price quotation on designs of any complexity.

Precision Connector Division
Transitron Electronic Corporation
168 Albion Street
Wakefield, Massachusetts 01880
617-245-4500

wherever there's electronics — there's Transitron



**This is
not an
Augat
board.**



**It's
better.**

The more creative your mind, the better you'll like our dual-in-line socket boards and cards. Because they give you more design freedom than Augat's.

For example, we put both 14- and 16-pin sockets on the same board. We build in a unique "wire wrappable" section for discrete

components. Also a "universal" section to take unusual components. And power decoupling. And "wire wrappable" test points. And so on, and so on.

Everything to serve you better.

We're EECO. We'll see you through.

EECO

1441 East Chestnut Avenue
Santa Ana, California 92701
Phone 714/835-6000
Also from G. S. Marshall Company nationwide.

FREE SOCKET BOARD AND PACKAGING
HARDWARE CATALOG!
We'll send it to you if you'll send us the
information below.

Name _____
Position _____
Company _____
Address _____

(continued from page 10)

Frequency-domain, large-signal CAD is still state of the art, and it is conceivable that we may be forced back to device models. I sincerely hope not.

John D. Trudel
President

Scientific System Technology, Inc.
603 Business Parkway
Richardson, Tex. 75080



NEW AC/DC Digital Multimeter has all the sensitivity, ranges and functions you need ... built in.



The new Keithley Model 171 Microvolt Digital Multimeter provides you with more measuring ranges than any other multimeter in its class. At only \$895 the 4½-digit Model 171 is the only multimeter you need whether it be for bench, systems, or servicing use — or all three.

This DMM eliminates the need for add-on preamps, plug-in circuit boards, hang-on shunts or other run-arounds. The only option we need offer is an easy-to-interface BCD output — and that's available built in.

The Model 171 measures

- dc voltage - from 1 microvolt to 1000 volts
- ac voltage - from 10 microvolts to 1000 volts
- ac & dc current - from 100 picoamperes to 2 amps
- resistance - from 100 milliohms to 2000 megohms

With all its capability this new Multimeter is really "sweet to have" . . . and our newest "how sweet" button proclaims just that. Get yours — and complete data or a demonstration of the Model 171 — today.



**KEITHLEY
INSTRUMENTS**
U. S. A.: 28775 AURORA ROAD, CLEVELAND, OHIO 44139
EUROPE: 14, AVENUE VILLARDIN, 1009 PULLY, SUISSE

Women in ads leave future engineer cold

I have done a research project on "Treatment of Women in Technical Advertising," which focuses on material from *ELECTRONIC DESIGN*, *Electronics*, and *Electronic Products*, and I want to comment on your editorial "Women" (ED No. 17, Aug. 16, 1973, p. 41). Among the ads of prime interest in my study was the series on "Guardian Angel," which included the center-page foldout. My audience was both amazed and disgusted at the means to which the advertisers had gone to attract attention.

Let me pose a few questions to both the advertisers and editors of ED:

Why don't advertisers appeal to engineers in a professional way instead of screaming at them for attention?

Why are women pictured only as models and secretaries in the ads? This only serves to label women in servile roles, to which I object.

Why does a magazine editor think he can divorce the content of the magazine from the ads? I believe the ads reflect on the quality and appearance of the total magazine.

As a future woman engineer, I suggest that both the advertisers and the editors consider carefully what they choose to represent them.

Joyce Wetenkamp

803 Harding
Urbana, Ill. 61801

relays renewed

2 HANDED DEADMAN'S THROTTLE

OSHA should be happy with this foolproof interlocked switching circuit that occupies both hands of a machine operator. The Run switch of Fig. 1 can't be simply taped closed, it must be cycled after each "Stop" of the "Forward-Stop-Reverse" Traverse switch.

Almost any combination of electromechanical or reed relays can be used since most contacts switch other control relays. However, with reed relay coils rated at 48 VDC maximum, the motor starter usually would require a separate power supply. Depending upon the size of motor starter MSF, control relays CRA and CRD could be S-D Frames 283, MRRN, or 314. For TCRB a modification of our Frame 236 would make an excellent choice.

Thanks to B.C.M., Nazareth, Pa. for this idea which he suggests for overhead cranes to insure that the operator keeps both hands inside the cab and on the controls.

Here are just two of more than 800 relay applications submitted during Struthers-Dunn's 50th Anniversary Relay Contest last year.

These thought starters are a small sample of the endless possibilities for relay-operated systems.

RELAY GUARDS SPRING-OPERATED MECHANISM

Here's a device that actually operates a conventional relay both electrically and mechanically. Its use of spring-stored energy may have other applications where a mechanical operation is needed without power or with only a local standby power source. Now used on stored energy operators of oil circuit breakers, this suggestion comes from F.L. of Foxboro, Ma.

The gear reduction motor of Fig. 2 charges a spring in one revolution of its output shaft. With the spring fully charged, a cam mechanically actuates the control relay into the energized position. As Fig. 3 shows, CR1 then stops the motor while CR2 readies a solenoid circuit that can delatch the spring whenever required. When the spring discharges, the cam "unlatches" the relay and the motor starts recharging the spring. A failure elsewhere in the mechanism operates a contact that electrically energizes the control relay and stops the motor to prevent damage from repetitive spring discharges.

Relays such as S-D Frames 314, B1, 425, 219, are only a few of many types suited for such an arrangement. The choice depends largely on mounting requirements and number of poles required.

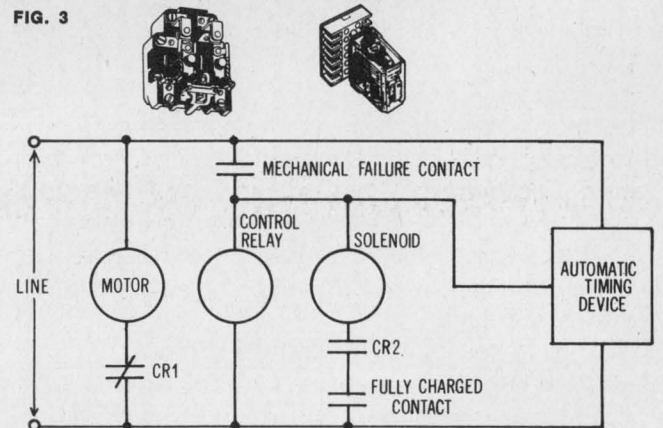
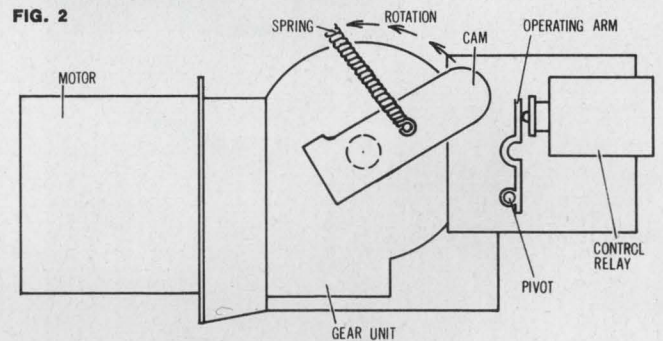
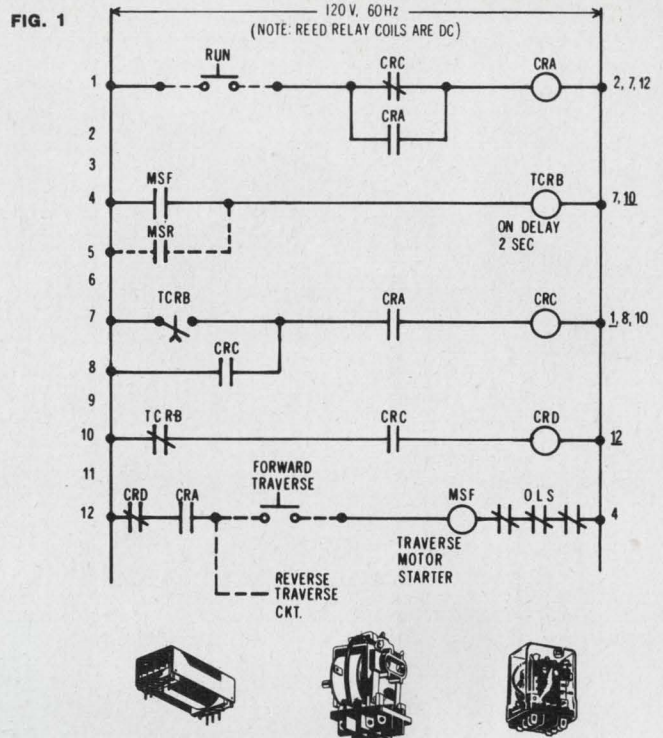

STRUTHERS-DUNN, INC.

PITMAN, NEW JERSEY 08071

Canada: Struthers-Dunn Relay Div., Renfrew Electric Co., Ltd.

1974 Catalog includes over 100 basic relay types — EM, Reed, Hybrid, Solid State plus solid state programmable controllers. Circle reader service card number for your copy.



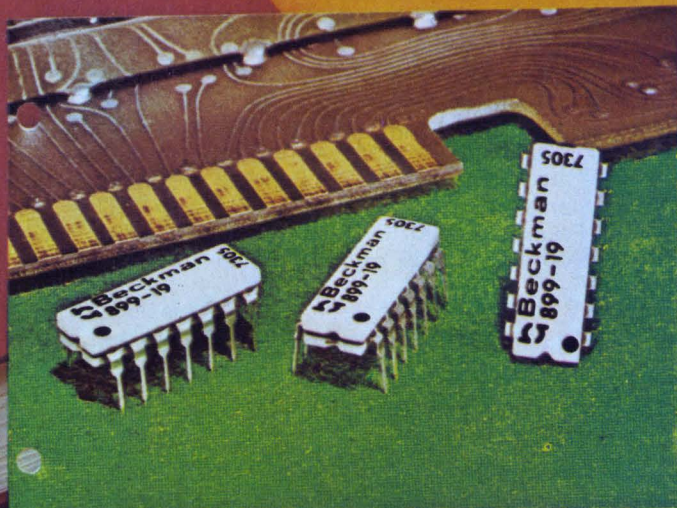
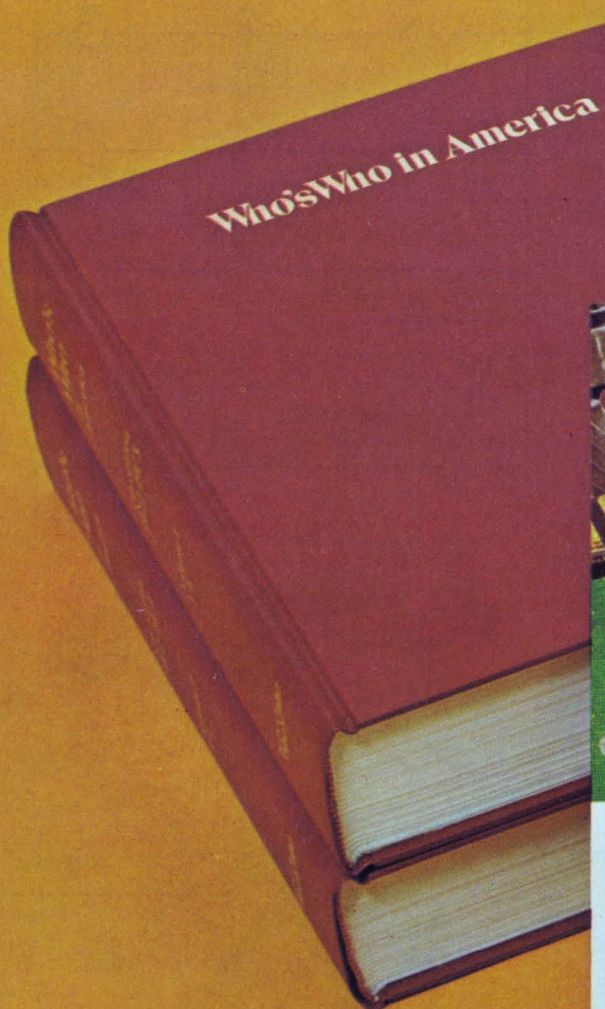

Beckman Resistor Networks
Technical Bulletin • December 1973

Beckman

The two-volume set is famous as a living, changing record of persons whose accomplishments are notable and important in American life. The catalog is growing famous, too. Because it details the Beckman RESNET™ DIP resistor network line—No. 1 in worldwide brand preference.

For good reasons, you should think of Beckman resistor networks, too, for any applications involving pull-up/pull-down, digital pulse squaring, line termination, current limiting, ECL terminators, and interface networks.

Why? Consider this. Production is totally automated. Laser tailoring is computer-controlled. Every part is 100% inspected, in process and during final assembly. Packages are dimensionally uniform, which means Beckman RESNET DIPs are ideal for automatic insertion techniques.

Then, we offer the broadest available line of standard resistor networks—both 14- and 16-pin versions. And these are kept in full stock by our distributors all around the country.

Another reason we're No. 1 in preference is our materials technology. We have 20 years in developing, improving and manufacturing our cermet materials. This shows up on your end as performance... accuracy... reliability.

Of course, if you need custom resistor networks, think of Beckman again. We offer them to suit virtually any market application. And custom applications assistance, as well. (If you need immediate literature, or the phone number of your local Beckman/Helipot representative, call toll-free 800-437-4677.)

Look into Beckman RESNET DIPs. Our achievement can help you with your achievement.

There's a standard source for What's What in resistor networks, too.

Beckman Electronic Component Distributors

EASTERN REGION

Arrow/Angus

P.O. Box 126
Moorestown, N.J.
(609) 235-1900
(215) 928-1800

Arrow Electronics, Inc.

5207 East Dr.
Baltimore, Md.
(202) 737-1700
(301) 247-5200

Arrow Electronics, Inc.

900 Route 110
Farmingdale, N.Y.
(516) 694-6800

Arrow Electronics, Inc.

295 Treadwell St.
Hamden, Conn.
(203) 248-3801

Arrow Electronics, Inc.

No. 15 A Street
Burlington, Mass.
(617) 273-0100

Arrow Electronics, Inc.

285 Midland Ave.
Saddle Brook, N.J.
(201) 797-5800

Harvey R & D Electronics

44 Hartwell Ave.
Lexington, Mass.
(617) 861-9200

Kierulff Electronics, Inc.

49 Bestpage Rd.
Hicksville, N.Y.
(516) 433-5530

Kierulff Electronics, Inc.

5 Industrial Dr.
Rutherford, N.J.
(201) 935-2120

Lynch-Gentry Associates, Inc.

1932 Drew Street
Clearwater, Fla.
(813) 443-2697

Lynch-Gentry Associates, Inc.

3470 Bowman Dr.
Winter Park, Fla.
(305) 671-7649

Marshall Industries G. S. Marshall Products Group

88 Needham St.
Newton Highlands, Mass.
(617) 965-5115

Marshall Industries

G. S. Marshall Products Group

230 Sherwood Ave.
Farmingdale, L.I., New York
11735
(516) 293-4141

M & C Sales

1106 Burke St.
Winston-Salem, N.C.
(919) 723-1001

M & C Sales

904 Bob Wallace Ave.
Huntsville, Ala.
(205) 539-8476

Ossmann Component Sales Corp.

395 Cleveland Dr.
Buffalo, N.Y.
(716) 832-4271

Ossmann Component Sales Corp.

411 Washington Ave.
Kingston, N.Y.
(914) 338-5505

Ossmann Component Sales Corp.

280 Metro Park
Rochester, N.Y.
(716) 442-3290

Ossmann Component Sales Corp.

132 Pickard Building
Syracuse, N.Y.
(315) 454-4477

Ossmann Component Sales Corp.

1911 Vestal Parkway East
Vestal, N.Y.
(607) 785-9949

CENTRAL REGION

Magnuson Electronics

2420 Oakton St.
P.O. Box 130
Mount Prospect, Ill.
(312) 956-0700

Magnuson Electronics

1246 West 7th St.
St. Paul, Minn.
(612) 227-8495

Norvell Electronics

10210 Monroe Dr.
Dallas, Tex.
(214) 350-6771

Norvell Electronics

6440 Hillcroft Ave.
Houston, Tex.
(713) 774-2568

Norvell Electronics

3340 S. Memorial Dr.
Tulsa, Okla.
(918) 663-1247

Sheridan Sales Co.

Box 37826
Cincinnati, Ohio
(513) 761-5432

Sheridan Sales Co.

Box 4457
Cleveland, Ohio
(216) 524-8120

Sheridan Sales Co.

Box 423
Dayton, Ohio
(513) 277-8911

Sheridan Sales Co.

33708 Grand River Ave.
Farmington, Mich.
(313) 477-3800

Sheridan Sales Co.

P.O. Box 677
Florissant, Mo.
(314) 837-5200

Sheridan Sales Co.

Suite 5009
1717 Penn Ave.
Wilkinsburg, Penn.
(412) 244-1640

WESTERN REGION

Almac/Stroum Electronics

8888 S.W. Canyon Rd.
Portland, Ore.
(503) 292-3534

Almac/Stroum Electronics

5811 Sixth Ave. South
Seattle, Wash.
(206) 763-2300

Marshall Industries

G. S. Marshall Products Group

5633 Kendall Court
Arvada, Colo. 80002
(303) 423-9670

Marshall Industries

G. S. Marshall Products Group

835 W. 22nd Street
Tempe, Ariz. 85282
(602) 968-6181

Marshall Industries

G. S. Marshall Products Group

9674 Telstar Ave.
El Monte, Ca.
(213) 686-0141

Marshall Industries

G. S. Marshall Products Group

8057 Raytheon Rd.
San Diego, Ca.
(714) 278-6350

Marshall Industries

G. S. Marshall Products Group

788 Palomar Ave.
Sunnyvale, Ca.
(408) 732-1100

Wyle Distribution Group:

Elmar Electronics
6777 East 50th Avenue
Commerce City, Colo.
(303) 287-9611

Elmar Electronics

2288 Charleston Road
Mt. View, Ca.
(415) 961-3611

Liberty Electronics

124 Maryland Street
El Segundo, Ca.
(213) 322-8100

Liberty Electronics

3130 North 27th Avenue
Phoenix, Ariz.
(602) 257-1272

Liberty Electronics

8248 Mercury Court
San Diego, Ca.
(714) 565-9171

Liberty Electronics

5305 Second Avenue South
Seattle, Wash.
(206) 763-8200

Beckman[®]

HELIPOT DIVISION

INFORMATION RETRIEVAL NUMBER 16

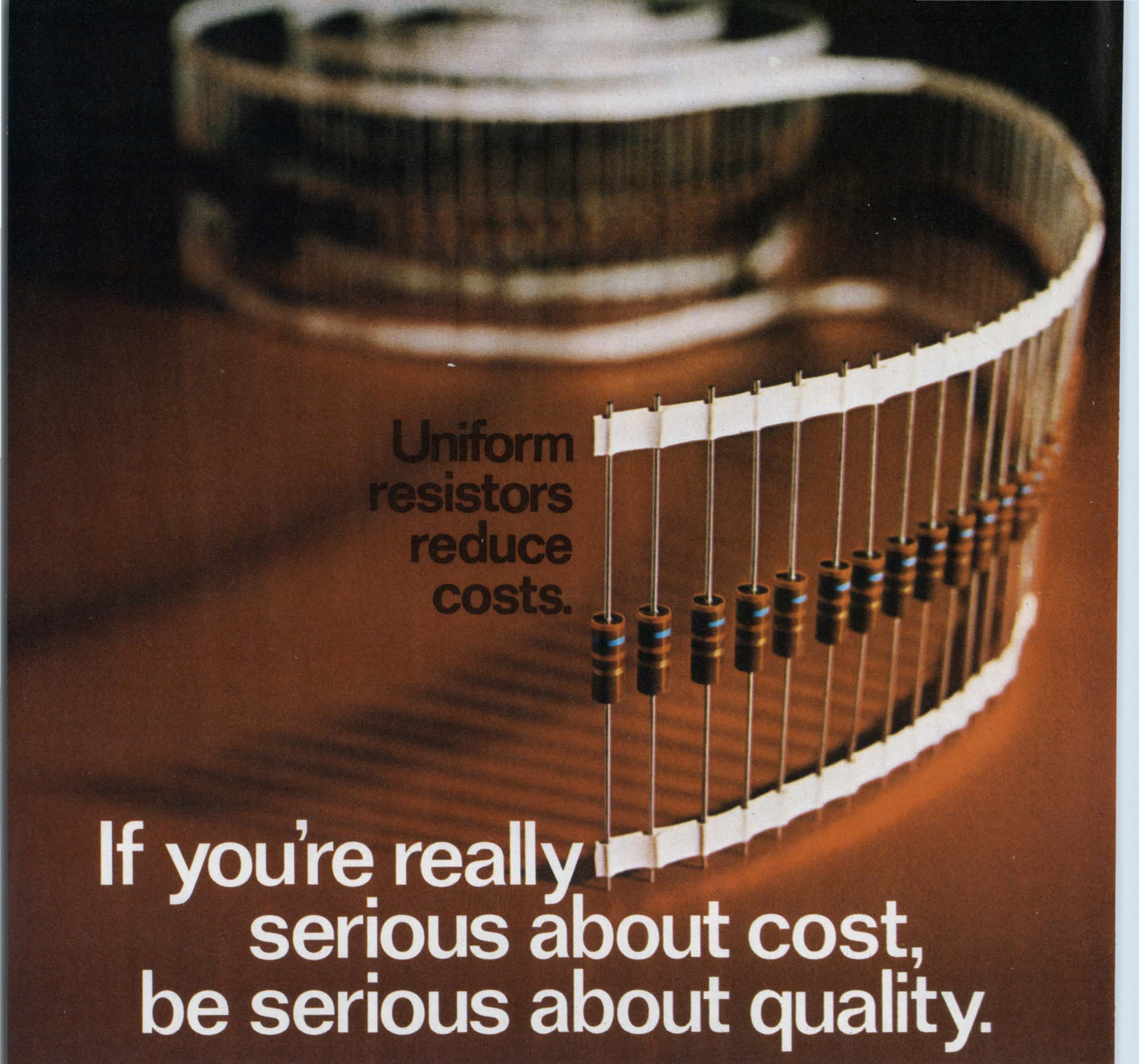

**Uniform
resistors
reduce
costs.**

**If you're really
serious about cost,
be serious about quality.**

That could be money in your pocket. Allen-Bradley's exclusive hot molding process offers physical consistency that can reduce your installation costs. Bodies are a uniform size with clean squared ends, free from coatings which adversely affect automatic handling equipment. Lead

lengths and diameters are precise. Resistors with uniform physical characteristics, accurately placed on tape reels, eliminate insertion machine jam-ups. And trouble free assembly means less production down-time; lower cost. That's A-B quality. Consistent shipment after shipment. If you

think all resistors are the same, send for our free booklet, "7 ways to tell the difference in fixed resistors." Allen-Bradley Electronics Div., 1201 S. 2nd St., Milwaukee, WI 53204. Export: Bloomfield, NJ 07003. Canada: Allen-Bradley Canada Ltd., Cambridge, Ont. U. K.: Jarrow, Co. Durham NE32 3EN.

EC80



ALLEN-BRADLEY
Milwaukee, Wisconsin 53204

INFORMATION RETRIEVAL NUMBER 17

Soviet to exhibit for export at New York IEEE show

For years the Russians have been familiar attendants at the IEEE show in New York City's Coliseum. Treading softly in comfortable sandals, they are usually equipped with cameras and flash bulbs, tape recorders, ballpoint pens and notebooks, and they ask good questions. This year they're moving in, and in a big way—six booths, or 600 square feet, on the main floor—with products for export.

For newcomers—and the first exhibitors from the Communist bloc—six booths are not a bad start. The Japanese, who dropped permanent anchor some years ago at the IEEE show, will have exhibits by 13 companies using 28 booths, Britain will have eight companies in 15 booths, the West Germans, five companies in seven booths, and the French, two booths.

The Russians may even bring technical papers, "but we won't know this until they get here," says Ted Shields, assistant manager of the show, called Intercon, which will be held March 26-29.

The Soviet exhibit, organized by Amtorg Trading Co. of New York, will feature components, computers and microwave equipment, according to the entry forms, Shields reports. The products they said they would show are general-purpose analog and digital computers, computer peripherals, control equipment, data-acquisition and processing equipment, valves (tubes), semiconductor devices, integrated circuits, SHF instruments, gas discharge devices, camera and oscillographic tubes, electronic multipliers, photocells, ferrite elements, as well as a line of resistors and capacitors.

3-day work week spurs semiconductor output

How can a semiconductor manufacturer with a backlog of orders save energy, increase production without making new capital outlays and have happier employees who miss fewer work days?

Advanced Memory Systems in Sunnyvale, Calif., says it has achieved all by changing its production schedules and putting its employees on a three-day week.

Like many semiconductor makers, it formerly operated 24 hours a day, using three shifts, five days a week. This meant that the furnaces, which are never turned off in a semiconductor plant, burned two days, or 48 hours a week, without producing anything.

Now the plant runs round the clock, six days a week—which leaves the furnaces going unproductively for only 24 hours a week.

On the new schedule, two crews work 12 hours a day for three days and then have four days off. Two more crews come in from their long weekend and work the remaining three days.

Production is up by 40 percent due to the extra work day and more employees. Though labor costs have increased—more employees have been hired and the pay is higher—there are savings in energy, and the company won't have to build a new plant—an alternative that had been considered.

"Before the change, we already had the highest density output per area of any semiconductor manufacturer, and now with the new schedule we've increased this by 20%," a company spokesman says.

"The employees like the new arrangement, because they have so

much time off. They also make more money—overtime every day after the first eight hours."

Absenteeism has also dropped. "Maybe you think twice about staying home a day when that day means a third of your week's pay," the company spokesman notes.

DEC goes West to build LSI mini

In an effort to meet competition from West Coast LSI minicomputer manufacturers, Digital Equipment Corp., Maynard, Mass., has given Western Digital a \$6-million contract to develop an LSI version of its PDP-11/05 mini.

The LSI-11 processor that is being developed will consist of a two-chip set that uses fast n-channel MOS technology. It's reported that the new machine will be faster than the initial LSI mini offered by Computer Automation and will have wider memory access than the 8-bit SOS unit from General Automation.

The LSI-11 is expected to sell for about \$2000, which would be \$1000 less than present units are going for.

Although neither DEC nor Western Digital has made any official announcements of this project, the latest annual report from Western Digital shows a picture of the PDP-11/05 with two LSI chips next to it.

IMPATT power sources produce 10 mW at 150 G

By combining ion-implanted, double-drift IMPATT oscillators with careful packaging, scientists at Hughes Aircraft Co. Research Laboratories, in Malibu, Calif. have produced the first active solid-state power sources that operate above 100 GHz. The cw output power levels are in excess of 80 mW in the 135-to-140-GHz region, and over 10 mW at 150 GHz.

Dr. John Forster, associate director of the facility, says the major application of the sources will be to pump parametric amplifiers that operate in the 50-to-70 GHz range and to serve as local oscillators for mixers up to 150

GHz. Efficiency is about 2%, and MTBF is estimated at 10,000 hours.

"The crucial part of the program was the development of the semiconductor diode itself," Forster says. "Although circuit work is difficult because of the small dimensions, it is generally a scaled version of lower-frequency technology.

The diode technology combines ion implantation, carefully controlled thin-layer epitaxial growth, and ultra-shallow, low-temperature diffusion. Packaging of the diodes requires a combination of large-area bonding techniques, an integral heat sink and a quartz stand-off with a tapered ribbon contact lead. The output is via rectangular waveguides.

Development of the sources is the result of a year-long research project that was supported by the Air Force Avionics Laboratory, Wright-Patterson AFB, Ohio.

Small crystal gauge overpowers noise

Quartz and sapphire crystal gauges are extremely handy for measuring very-high-pressure shock waves of short duration from impacts, explosions or pulses of radiation from solid-state materials. But the gauges also have a disadvantage. When they're small—for use on small devices—they put out a signal so weak that it's often drowned out by electrical noise.

A lithium-niobate crystal gauge has been developed that overcomes this problem: Even when small, the gauge produces a clear, strong electrical signal that can be easily distinguished through noise. According to its developers at Sandia Laboratories in Albuquerque, N.M., the new gauge comes through loud and clear under conditions that would render the quartz and sapphire gauges useless.

The only tradeoff—and this is important only in very special cases—is a loss in range in pressure. The lithium-niobate gauge can measure pressures up to 250,000 psi (about 17 kilobars) when created by shock waves that last only a few millionths of a second. The quartz gauge can measure pressures up to 600,000 psi and the

synthetic sapphire gauge up to about a million psi.

Making accurate measurements of high-pressure, short-duration phenomena is of vital importance to laboratory engineers who are working with pulsed-laser effects in solids and pulsed lasers for diffusion, as well as for engineers working with solid-state materials.

The lithium-niobate gauge is relatively simple, says the principal investigator, Robert A. Graham of Sandia's Physics of Solids Research Dept. It consists basically of a disk of lithium niobate, a piezo-electric material—ranging from 0.5 to 2 inches (1.27 to 5.08 cm) in diameter and 0.1 to 0.5 inches (0.25 to 1.2 cm) thick—with electrodes on both faces. The front of the disk is placed flush against the back of the test object, and the electrodes are then connected to electronic circuitry.

When a shock wave strikes the test object, the wave passes through it and into the gauge, compressing the lithium niobate and causing a charge to flow between the two electrodes. The charge varies directly with the amount of compression.

Night-vision modules yield alterable device

The days of one-of-a-kind, custom night-vision devices may be over. The Army has tested successfully a prototype comprised of building-block components that can be arranged and rearranged to fit the night-vision application that is needed.

Known as the Standard Far-Infrared Component program, it is intended to reduce design, procurement and maintenance costs. The work has been carried out at the Army's Night Vision Laboratory in Fort Belvoir, Va.

According to Richard Riordon, project engineer for the program, the new system design organizes thermal imaging night sights operating in the 8-to-14- μm band into seven standard modules. These can be used in a variety of night sights.

The building blocks are the detector; detector cooler; scanning system and infrared optics; video electronics, and a light-emitting diode array for image display. The

Night Vision Laboratory's new modules are compatible with both low and medium-performance night-vision sights, because the detector is designed to accept different types of detector coolers. The detector-cooler combination is at present the most expensive part of a custom system.

The laboratory's component program is in the advanced development stage, Riordon reports. The standard modules are being incorporated into night sights for the Chaparral missile, the Tow missile system, the A-7 aircraft, the advanced remotely piloted vehicle, the airborne laser locator designator, and the Navy's Mark-68 gun director.

IEEE sees ample jobs for flexible engineers

"Career opportunities in electronics will continue to grow in most all areas of the industry." That's the conclusion of the first engineering and manpower report published by the Institute of Electrical and Electronics Engineers.

Titled "IEEE Manpower Report 1973," the 225-page compilation looks for significant growth in the power field—including utilities, machinery and switching-gear components. Employment in this area is expected to more than double by the 1980s.

The report is divided into four sections: industry, manpower, careers in engineering, and the engineering challenge. Engineers are advised to remain flexible, ready to transfer into another area as activity changes focus. Changes will be a fact of life, the report adds.

Dual radar distinguishes between 2 air targets

The Naval Research Laboratory in Washington, D.C., has developed a radar tracking system that can distinguish between two airborne targets that are very close to each other. It does this with two radars, one at millimeter wavelengths and the other at X band. The mm radar narrows the beamwidth that holds onto the targets, even when they move to within one or two beamwidths of the horizon.

The first interactive graphic calculator.

It's the 31/10 system.

A powerful calculator, graphic terminal and software combination. The first ever to place math-power, graphics and alphanumeric display at your fingertips!

The 31/10 is personal. Fast. And highly interactive. It lets you explore ideas and concepts on the spot. Plot single variable functions, specify X-Y coordinates and a lot more. Corrections and plot changes are immediate. From data entry to display, your ideas are quickly brought to light. That's responsive!

Plug in our software packages. They put the 31/10 to work. No heavy programming experience

needed. So you can deal in your concepts and not the mechanics of programming. And get graphic and alphanumeric output from natural math input.

There's more to our 31/10. Such as add-on memories for long programs. The optional silent thermal printer for listing and keeping track.

Peripherals like our hard copy unit to put in hand what's on the screen.

The costs are low, the results are priceless.

Get the facts about the 31/10 and the Tektronix reliability and worldwide service behind it. See your Tektronix sales engineer for a demonstration or write: Dwain Quandt, IDD Calculators, Tektronix, Inc., P. O. Box 500, Beaverton, Oregon 97005.

Our programmable calculators. Natural. Powerful. Significantly less expensive.



TEKTRONIX®

INFORMATION RETRIEVAL NUMBER 18





The U. S. Government does not pay for this advertisement. It is presented as a public service in cooperation with The Department of the Treasury and The Advertising Council.

Invest in the United States of America.

**Almost 200 years
at the same location.**

The U.S.A.'s been in business a long time. So it's pretty solid.

And that's what makes U.S. Savings Bonds such a reliable and sure way to build a nest egg.

Bonds are completely safe, too. Lost, stolen, burned. It makes no difference. Your Bonds will be replaced if anything happens to them.

Why not turn a few green dollars into some blue chip U.S. Savings Bonds? Join the Payroll Savings Plan where you work or

buy Bonds at your bank.

U.S. Savings Bonds. They're a solid way to save.



Now E Bonds pay 5½% interest when held to maturity of 5 years, 10 months (4% the first year). Bonds are replaced if lost, stolen, or destroyed. When needed they can be cashed at your bank. Interest is not subject to state or local income taxes, and federal tax may be deferred until redemption.



Take stock in America.
Bonds are a safe way to save.

the 'best buy' counters are here!

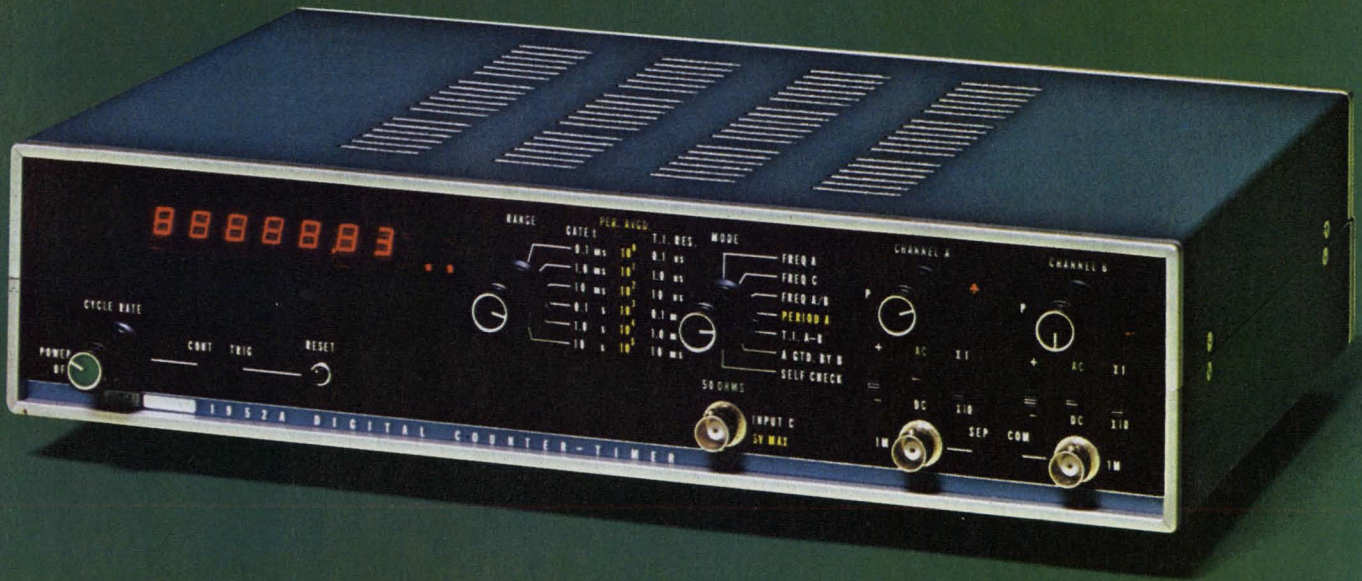

Now is the time for all of us to carefully consider every purchase.

For instance, if you are planning to purchase a new counter/timer, we invite you to take a flinty eyed look at the new Flukes. Nowhere in the entire market place are there better buys. Nowhere will you find a counter line where owner benefits are constantly raised and at the same time owner costs are being lowered.

Take our Model 1952 for instance. Here's an instrument which counts from DC to 80 MHz or 515 MHz optionally. It offers 50 mV sensitivity. It provides six functions: 1. frequency, 2. frequency ratio, 3. single period, 4. multiple period average, 5. time interval measurement, and 6. gateable totalize. Read-out is 7-digit LED or optionally 8 and 9 digits. Matched input channels feature full control of coupling, slope and trigger level. Features include units annunciation, overflow, gate and trigger level status lamps. Optionally you can add BCD output and a TCXO with improved temperature stability. Yet the base price is only \$695. Add every option we've got and you're still under \$1400.

Or look at our Model 1980A VHF/UHF Telecommunications Frequency Counter. Here's the precision instrument to service



mobile land, sea, and air communications systems quickly, accurately. Measure frequencies in the field or in the lab from 5 Hz to 515 MHz with a sensitivity of 50 mV over the entire range. Read frequency from a 6-digit LED display. For total portability, add a snap-on battery pack for completely portable operation with up to 5 hours continuous use. And the cost of this little gem is only \$795. Add all of the options and you're still under \$1200.

Then there's our blue plate special, the full five function Model 1950A. Measure frequency, frequency ratios, single periods, multiple period averages, or totals. Features include 6-digit LED display with automatic annunciation, variable trigger level control with status lamps and a switch selectable input attenuator. For field use, remember the instrument weighs only 5 pounds and will operate from 12 vdc.

Optional features include BCD output and TCXO for super stability as well as full accuracy. Price of the basic unit is just \$445. All the options are less than \$300 more.

So you see, the Fluke counter attack has been launched with a vengeance. Perhaps you should join our army.

In the continental U.S., dial our toll free number 800-426-0361 for the name and address of your nearest local source. Abroad and in Canada, call or write the office nearest you listed below, John Fluke Mfg. Co., Inc., P.O. Box 7428, Seattle, Washington 98133. Phone (206) 774-2211. TWX: 910-449-2850. In Europe, address Fluke Nederland (B.V.), P.O. Box 5053, Tilburg, The Netherlands. Phone 013-67-3973. Telex: 844-52237. In the U.K., address Fluke International Corp., Garnett Close, Watford, WD2 4TT. Phone, Watford, 33066. Telex: 934583. In Canada, address ACA, Ltd., 6427 Northam Drive, Mississauga, Ontario. Phone 416-678-1500. TWX: 610-492-2119.



IEEE BOOTH 2203-2207, 2302, 2306

INFORMATION RETRIEVAL NUMBER 19

REPORT ON PORTABLE CIRCUIT TESTERS

For fast digital troubleshooting, low-cost detectors can't be beat

Logic probes, clips, comparators and pulsers are all part of a growing family of low-cost, portable digital circuit testers. They are saving time in the troubleshooting of digital equipment in the field and proving to be useful to the circuit designer in the laboratory as well.

A logic probe allows the user to view the static logic states of a circuit node, and, in more complex probes to see single-shot pulses and pulse trains as well. The logic clip is another digital-state indicator, allowing the logic state on each of the 14 or 16 pins of an IC to be observed simultaneously. A logic comparator clips on a suspect IC and compares the activity with a known good reference IC. Any difference in state is indicated on a LED array. The logic pulser injects a signal into a digital circuit, which permits the circuit to be exercised slowly enough to view changes of state and digital activity.

The units show only the digital activity in a circuit. They provide no information about pulse shapes, quantitative data on pulse timing relationships or other data that must be analyzed when digital circuits are designed. They cannot replace the oscilloscope for viewing the shape of pulses, but they can analyze most of the common circuit failures.

According to Jesse Pipkin, product manager-digital test for Hewlett-Packard, Santa Clara, Calif.: "Both field engineers and circuit designers find that 70 to 80% of all digital circuit failures are of the 'stuck node' variety. Usually one or more circuit nodes are not

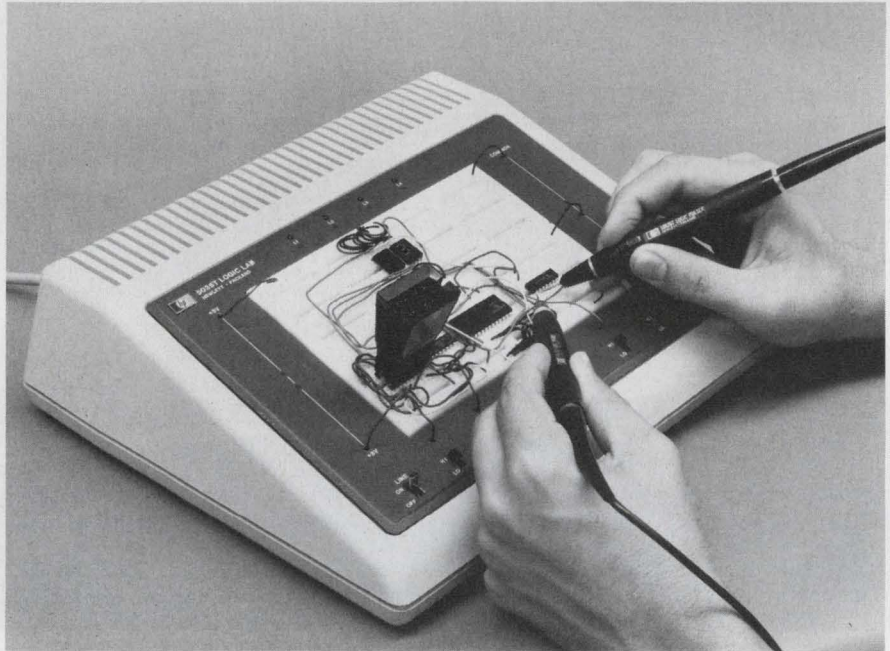

Evaluation of a typical digital-circuit breadboard is expedited by the HP 10525-26T and 28A logic probe, pulser and clip.

changing state, either due to a catastrophic IC failure or to a PC-board failure. The small logic testers are an ideal way to find such faults. They give just enough information and not too much for normal troubleshooting."

The opinion is echoed by others in the field, including Allen Ross, president of Signal Laboratories, Orange, Calif. He says: "The logic probe and other small testers are potent tools. They enable the field serviceman to tackle a large piece of digital equipment with a minimum of test equipment. It represents a real improvement in technique over trying to do stimulus-response tests with scopes and signal generators."

The new logic testers that are emerging offer a choice of readouts, more sensitivity to logic

levels and provision for more data. The next step is the "universal" logic probe, which will work with any logic family.

Probes: Simple and versatile

The simplest logic tester is the probe. It is touched to a circuit node and can indicate the logic state and show if it is static or pulsing. Manufacturers have shown great ingenuity in providing probes that give good dependable data, although the amount of data varies with the cost and complexity of the probe.

"In many instances a logic probe provides enough information to locate a fault or at least localize it to a small part of the circuit," says Russell V. Filingier, manager of accessories engineer-

ing for Tektronix, Beaverton, Ore.

The least expensive type of logic probe is typified by the \$19.95 Model 300 from Alco Electronic Products of North Andover, Mass. The unit is compatible with TTL/DTL logic levels, is powered by clipping to the 5-V logic supply and has a single LED that lights for the logic ONE state. The indicator is dark for logic ZERO, open-circuit or indeterminate states. The input impedance is 250 k Ω at dc, dropping to 40 k Ω at 100 Hz. The indicator dims at increasing pulse-repetition rates, extinguishing at 12 MHz. The logic probe is primarily an instrument for indicating static logic states, since it provides no pulse stretching; it will not show brief pulses.

Building on the basic concept is the \$35 Model L-2000 probe from Aqua Survey and Instrument Co., Cincinnati, Ohio. This probe has two LED indicators—one for static state, the other for stretching pulses of 10 μ s or longer to make them visible. At rates to 120 Hz, the LED shows the frequency divided by four, and it stays on at rates up to 1 MHz. The unit has a 40-k Ω impedance, and it takes 50 mA from the 5-V supply. Aqua Survey also makes several other probes, including a model that detects 40-ns pulses and a battery-operated model.

Digi-Tronix of San Jose, Calif., offers a \$59 single-LED unit, the Model HS50A. It detects pulses as narrow as 20 ns, which are stretched to 90 ms. The indicator follows pulse rates to 15 Hz and flashes or remains lighted up to 25 MHz, depending on the symmetry of the pulse.

Two new products are expected soon from Digi-Tronix, according to Al Espinoza, president: "An eight channel monitor—equivalent to eight logic probes in one case—and a universal logic probe suitable for any of the current logic families."

A TTL probe from Tektronix—the Model P6401—is not yet available but is expected soon. It uses two incandescent lamps, one red and one green. A steady high state

is indicated by a steady red light and a steady low by a steady green. Pulse trains are shown by full-intensity blinking of both lamps. An important feature is that combinations of the lamp indications show excessive input voltage. The probe has a built-in pulse



The first CMOS probe, the Kurz-Kasch LP-575, features digital readout of logic states.

memory and will recognize pulses of 10 ns, and it also has an input impedance of 7.5 k Ω for all states. It sells for \$75.

Hewlett-Packard put the first logic probe on the market by introducing the Model 10525A in late 1968. Its current line now includes probes for TTL/DTL, high-level logic (HTL) and ECL. The units each require a power input that is compatible with the logic family, and each has input protection in case of contact with the ac line or with a supply that powers the Nixie tubes. The readout is a single incandescent lamp, mounted in a plastic band on the probe tip to permit viewing at all angles.

HP's readout shows full brilliance for logic ONE, half brilliance for open circuits or indeterminate logic levels, and it is extinguished by a logic ZERO or ground. Single pulses of 10 ns are stretched to 50 ms, and pulse rates of up to 50 MHz cause the lamp

(continued on pg. 28)

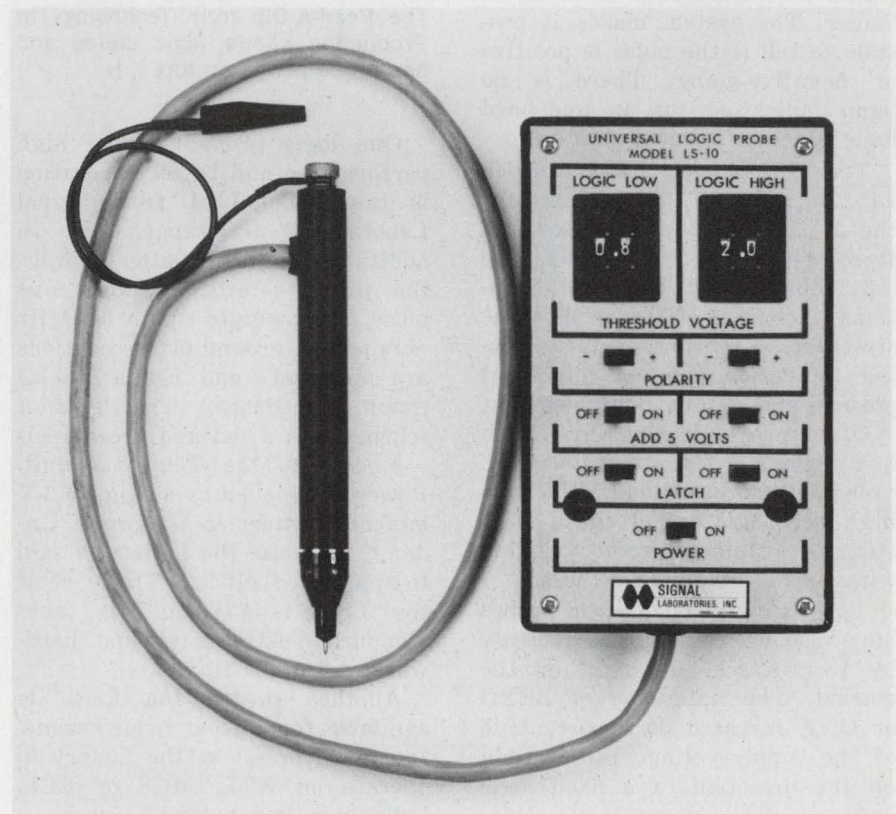

The first universal logic probe will be available from Signal Laboratories before mid-year. It's battery powered.

(continued from page 27)

to flash at a 10-Hz rate.

The HP TTL unit, designated Model 10525T, has a 25-k Ω input impedance for both logic states (many probes do not specify low-logic-state impedance). It sells for \$95, and a \$25 accessory memory is available for storing any pulse detected by the probe. The memory is connected between the probe power cable and the power source. An indicator on the memory shows any pulse detectable by the probe, and it remains lighted until reset. As one HP engineer explains: "The pulse memory does not interfere with normal probe operation in any way. Most built-in memories prevent normal operation of a probe when used."

The Hewlett-Packard HTL and ECL probes—Models 10525H and E, respectively—sell for \$95 each, and accessories are available.

Kurz-Kasch Electronics, Dayton, Ohio, takes a different approach to probe readout with its 500 series. The Kurz-Kasch probes have three incandescent lamps in the transparent tip. A red lamp lights on steady logic ONE, a white lamp on steady logic ZERO and a blue lamp to indicate high-speed pulse trains or single pulses of 50 ns or longer. The system makes it possible to tell if the pulse is positive or negative-going. There is no lamp indication for an undefined logic state or open circuit.

The Kurz-Kasch TTL model, LP-520, has a 35-k Ω impedance for the HIGH state, and is powered from the TTL power supply. The unit sells for \$69.95, and \$10 options include a latch mode/pulse stretcher, a gating feature—giving indication only on coincident pulses—and a 5-ns pulse detector.

Other probes in the Kurz-Kasch line include a less expensive TTL probe without the blue light, two high-level logic probes and a more rugged "student-proof" version with extra protective devices.

A pair of CMOS logic probes have also been announced recently by Kurz-Kasch, the first on the market. The indication of ZERO or ONE is based on a percentage of the supply voltage rather than on the detection of a fixed logic level.

Thomas E. Barth, general manager of the Kurz-Kasch Electron-

ics Div., says: "Due to the variation in logic levels in the CMOS family, it was necessary to take a new approach in designing our CMOS probes. The range provided by our new probes gives good indication of CMOS levels regardless of the supply voltage."

The Model LP-575, which features a seven-segment LED readout of levels, operates on a supply voltage of 5 to 15 V at 25 mA. It has a 25-M Ω input impedance. The probe will indicate a logic ZERO at 30% of the supply voltage and a logic ONE at 80%, with a dead band from 30 to 70%. Pulses light a separate LED indicator. The unit sells for \$89, and options include a memory-pulse stretcher and a coaxial power lead. The Model 579, using the conventional three-lamp display costs \$79.

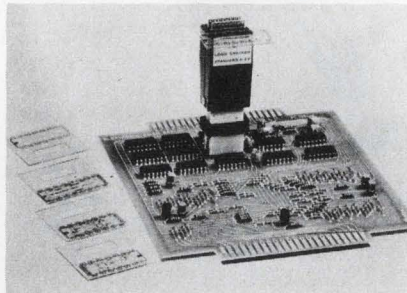

The Read-A-Dip from Technology In Production shows logic states and has probe points on top.

One logic probe offering high performance and battery operation is the Model LS-1 from Signal Laboratories of Orange, Calif. In addition to built-in battery power, the probe detects a single 5-ns pulse, will operate up to 50 MHz (higher if grounding precautions are observed) and has a 100-k Ω input impedance. The readout scheme uses a red and green LED—similar to the Tektronix unit. Power is supplied by a single 4.2-V mercury battery in the probe. Under normal use the battery is said to approach shelf life. The price of the LS-1 is \$77, and it takes standard Tektronix ground hardware and probe tips.

Another model, the LS-2, is available for custom requirements. It can be preset at the factory to operate on HTL, MOS or ECL, but it requires external power.

Signal Laboratories may be the farthest advanced in the develop-

ment of a universal logic probe. The unit will be called the LS-10, be packaged in a probe with separate control box and sell for about \$250. The tentative specifications include the ability to test any logic family with thresholds in the range of -14.9 to +14.0 V, including TTL, RTL, DTL, HTL, CMOS and ECL. Power will come from internal batteries. The high and low thresholds will be selectable and accurate to ± 50 mV, and the unit will have a standard pulse latch feature.

According to Ross, Signal Laboratories' president: "The LS-10 is breadboarded and performing to specifications. The remaining engineering work is primarily in packaging the unit. We expect to have it on the market sometime before the middle of the year."

A logic probe with an integral binary counter in addition to normal logic level indication is available from Zi-Tech of Palo Alto, Calif. The probe is said to be useful for checking multiple clock or trigger pulses in the count mode, which also serves as a pulse memory. The \$66.50 TTL probe operates from a 5-V logic supply, detects 50-ns pulses, has a 50-k Ω input impedance and is fuse-protected.

In the normal logic mode, the Zi-Tech probe indicates high and low logic levels with LED indicators. In the count mode, it counts up to six pulses and holds the count until reset. If more than six pulses are received, it indicates this with an overflow light, which serves as a pulse memory.

Clips 'watch' whole IC

For monitoring all the input and output states of a digital IC at once, the easiest solution is the logic clip. It clips directly over the pins of a DIP IC and continuously shows the logic state on each pin. These units all indicate the logic levels with a LED for each pin on the IC, and they are equipped to work with 14 or 16-pin DIPs.

These units do not include the pulse-stretching or pulse-detection circuitry of logic probes. To see the logic states changing, the clock rate must be slowed down to about 15 Hz or less, or the circuit must be stepped through its cycle. All units have followed the Hewlett-

MONO-KAP™

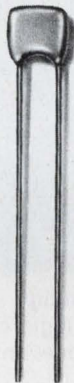

**RADIAL LEADED
MONOLITHIC CAPACITOR**

Underneath its epoxy coating, it's got a chip for a heart — a USCC/Centralab ceramic chip capacitor, 100% monolithic construction. Solid reliability for business machines, computer and communications use; rugged enough to meet mil-spec requirements yet priced for commercial applications.

Capacitance from 4.7 pF to 10 Mfd, working voltages 50 to 200 VDC and a variety of dielectric characteristics.

Best of all — AVAILABLE. USCC has recently improved chip capacitor deliveries . . . now radial leaded

Mono-Kaps are available in as little as 12 weeks for non-stock items.

Remember. USCC/Centralab or your local Centralab industrial distributor.

We deliver.



USCC/Centralab

Electronics Division ■ Globe-Union, Inc.



2151 North Lincoln Street ■ Burbank, California 91504
(213) 843-4222 ■ TWX: 910-498-2222

INFORMATION RETRIEVAL NUMBER 21

Packard example and provide automatic means to find the supply voltage and ground to power the clip from the circuit under test.

Some engineers feel that the logic clip is limited for troubleshooting applications. One engineer says: "Logic clips are actually tools for the designer rather than the field engineer. The designer has control of his circuit and can step it through to watch responses. The field serviceman is more interested in watching the dynamic response of a circuit without having to disable anything."

HP introduced the first logic clip in late 1969—the Model 10528A. The current HP clip is still called the 10528A, although present units have improved springs on the clip to make better IC contact. All circuitry and 16 LEDs are incorporated in the body of the clip. The input threshold is 1.4 ± 0.6 V, making it TTL or DTL compatible. The input impedance is equivalent to one TTL load—sufficiently high to prevent excessive loading on all but circuits with inadequate fan-out. The power required is 120 mA, and it is taken from the IC power pin.

The HP clip is still the smallest available, making it the easiest to use in cramped boards, and it is relatively foolproof—it can be clipped on the IC without regard to pin numbers. The unit sells for \$125.

Both Jermyn of San Francisco and Alco have imported logic clips that perform similarly to the HP unit and that contain a feature not available from HP—a supply of 24 plastic overlays with standard IC logic diagrams. The overlays are placed over the LED array and help the engineer follow the operation of the circuit. The Jermyn unit, Model A23-2086, sells for \$85, and the Alco, Model 201, for \$99.95.

Another logic clip, the Read-A-Dip, from Technology In Production, Danbury, Conn., has the V_{cc} -seeking ability and LED array in common with other clips, and logic symbol masks are available. Two versions of the Read-A-Dip are made—one for TTL/DTL and the other for high-level logic. In addition to being the only logic clip for high level, the unit has probe points on its top that connect directly to the IC pins. This aids in probing voltages or waveforms in

crowded boards. The unit sells for \$125—either TTL or HTL version.

The Logiscope from Rohde & Schwarz, Passaic, N.J. is used for the same tests as a logic clip, but the unit is in two parts. The IC clip is connected by cable to the instrument proper. The main advantage claimed for this technique is that the LED display is about 10 times larger than those on the clips. The instrument is supplied with 100 circuit overlay cards, which are used like those on the clips. In addition to the normal functions, an overvoltage LED indicator is included, which lights when the protective circuit is being activated by overvoltage. The unit is also capable of detecting a

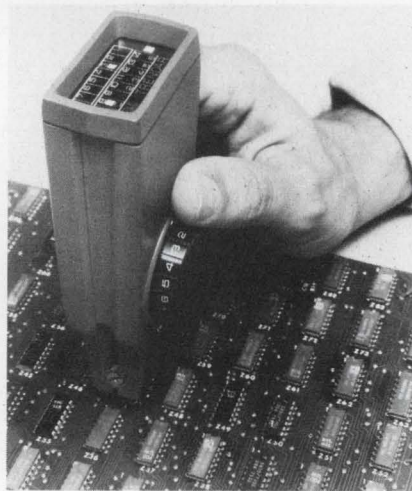

Trendar's Testclip combines the functions of a logic comparator, clip and probe in one unit.

1-ms pulse, and clock pulses as fast as 10 Hz can be followed. The Logiscope costs \$225 and is a TTL/DTL unit.

Pulses from a 'pen'

Still, in many cases the clock rate of a circuit is too fast or the activity too complex for the user to follow. The need then arises for an instrument either to slow the action or even force it to proceed one step at a time. A logic pulser is such an instrument. It is a pen-sized signal injector that can be used to stimulate digital circuits in either single steps or slowly enough so the circuit operation can be followed. To be really useful,

you should be able to apply it to any point in the circuit, regardless of the original logic state of the circuit. If a circuit node is at ZERO, it will pulse any connected circuits with a ONE, and vice versa.

Two units are available that perform in this way. The Hewlett-Packard Model 10526T was the first pulser on the market. It produces two pulses—one over 2 V and a low pulse of less than 0.8 V—at currents of about 0.65 A, depending on load, each time the button is pressed. The active impedance is less than 2Ω and the static impedance over $1 M\Omega$. The pulse width is nominally $0.3 \mu s$ —which limits the delivered energy to prevent any damage to components. The unit is powered from the 5-V logic supply and requires less than 25 mA to operate. According to one HP engineer:

"There are some circuit nodes on which the pulser will not work, just as there are some which make any logic probing difficult. Hopefully when most designers are aware of logic-testing techniques, they will eliminate the difficult nodes from the circuits, making testing and servicing much simpler."

The HP Model 10526T sells for \$95. Special tips are available including a kit for multipin stimulation.

The comparable logic pulser, from Kurz-Kasch, has two operating modes. In the one-shot mode, it provides two $1\text{-}\mu s$ pulses—one 3 V minimum, the other 0.6 V maximum. In the continuous mode it produces similar pulses with a 5-Hz repetition rate. Like the HP unit, the HL-582 operates from the logic supply. It sells for \$89.

A similar instrument, the P-2002 signal injector from Aqua Survey and Instrument Co., provides a much more flexible choice of test signals. The only disadvantage is that the outputs are standard TTL clock pulses rather than the "brute force" variety. The unit can be used to substitute for the system clock or drive unloaded circuits, but it will not overcome existing ONE or ZERO states on nodes.

A 10-position switch provides either 50% duty-cycle frequencies from 100 Hz to 1 MHz or single pulses from $1 \mu s$ to 10 ms. The

3-in-1 logic tester

logic probe
logic clip
IC tester

Logic misbehaving? Forget old-fashioned scope-and-probe, hunt-and-peck methods. The Fluke Trendar TESTCLIP™ finds and displays logic defects. It pinpoints faults ten times faster: component faults... solder faults... board defects.

3-in-1: A logic probe, logic clip and IC tester are combined in one pocket-size unit. TESTCLIP finds the culprit where loops or multiple faults defy the most sophisticated test systems. The reference IC plugs in the side and TESTCLIP does the rest. Your test technicians can now turn out more product... Service can fix boards on site... R & D can cut prototype checkout time.

The result: inventory is saved, productivity zooms, and customers admire your fast, reliable field service. All for only \$395. Your Fluke representative has TESTCLIP in stock for immediate delivery and will show you the secret of FAULTRACK®, the universal troubleshooting method. Ask him.

\$395

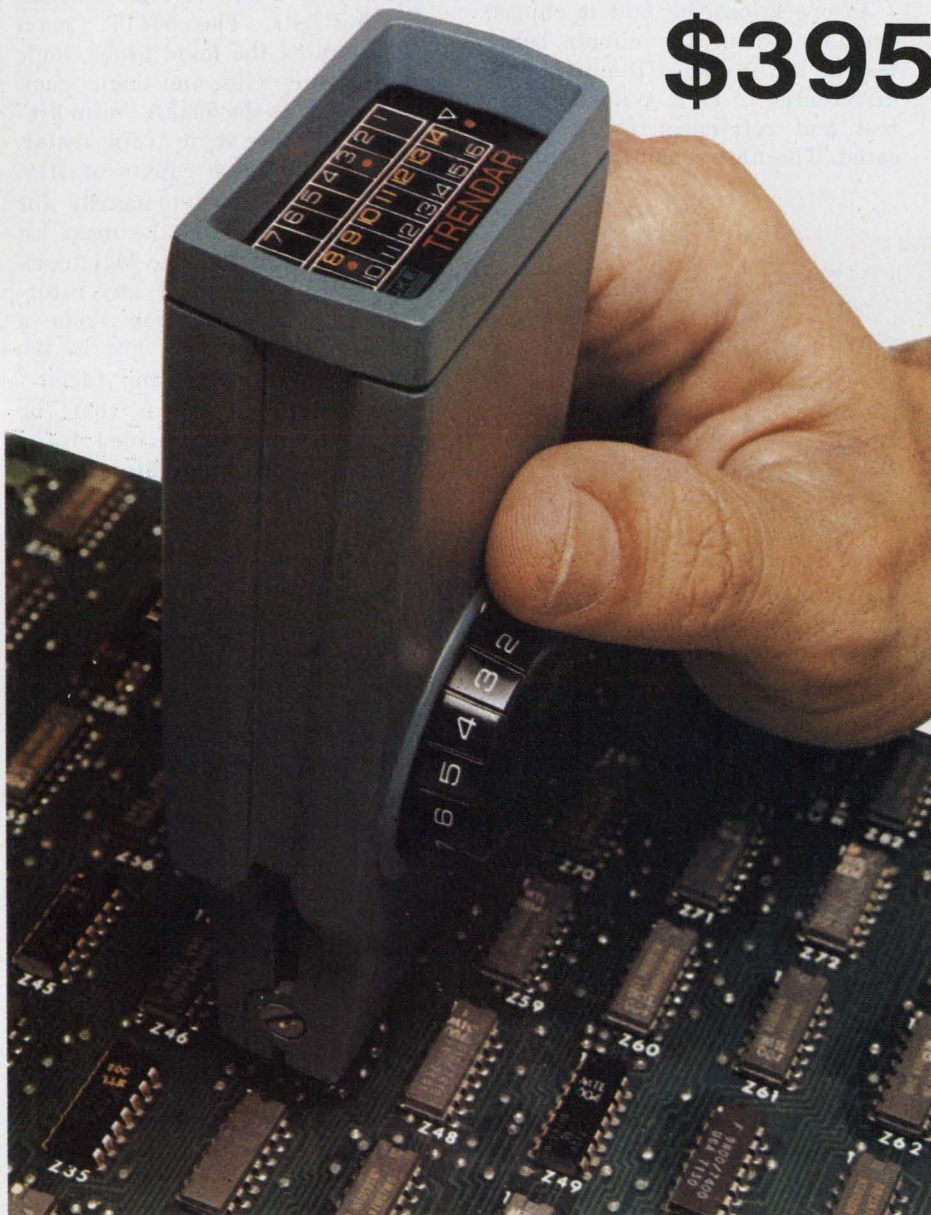

Sales and Service

U.S. AND CANADA

Albuquerque, NM (505) 299-7658
Cleveland, OH (216) 267-0445
Dayton, OH (513) 434-7500
Denver, CO (303) 934-5505
Des Plaines, IL (312) 298-3600
Detroit, MI (313) 892-2500
Glastonbury, CT (203) 633-0777
Glendale, CA (213) 245-9404
Greensboro, NC (919) 273-1918
Houston, TX (713) 621-0040
Huntsville, AL (205) 881-6220
Indianapolis, IN (317) 244-2456
Kensington, MD (301) 881-5300
King of Prussia, PA (215) 265-1600
Lexington, MA (617) 861-8620
Minneapolis, MN (612) 884-4336
Orlando, FL (305) 896-4881
Pittsburgh, PA (412) 892-2953
Pleasantville, NY (914) 769-1811
Richardson, TX (214) 231-2573
Rochester, NY (716) 266-1400
San Diego, CA (714) 565-2555
Santa Clara, CA (408) 244-1505
San Juan, PR (305) 896-4881
Scottsdale, AZ (602) 947-7841
St. Louis, MO (314) 423-1234
Seattle, WA (206) 624-9020
Vancouver, WA (503) 283-3287
Union, NJ (201) 687-8737
Calgary, Alta (403) 261-0780
Montreal, Que (514) 670-1212
Ottawa, Ont (613) 829-9651
Toronto, Ont (416) 678-1500
Vancouver, BC (604) 253-7136

INTERNATIONAL

Athens, Marios Dalleggio Rep. 710-669
Auckland, David J. Reid, (N.Z.) Ltd.
Bangkok, G. Simon Radio, Ltd. 30991-3
Bogota, Marones Ltda 36 47 31
Bombay, Hinditron Services Pvt. Ltd. 365344
Brookvale, (Australia)
Elmeasco Instruments Pty. Ltd. 939-7944
Brussels, C. N. Rood S.A. 352135
Buenos Aires, Coasin S.A. 523185
Caracas, Coasin C.A. 72 23 11
Copenhagen, Tage Olsen A/S 294800
Helsinki, OY Findip AB 717799
Hong Kong, Gilman & Co., Ltd. 227011
Johannesburg, Elairco, (Pty.) Ltd. 20272
Karachi, Pak International Operations
Kota Kinabalu, O'Connor's (Pte) Ltd.
Lagos, Deemtee Electrotechnics, Ltd.
Lima, Importaciones Y Rep Elect 272078
Lisbon, Equip. De Laboratorio Ltda 976551
Madrid, Atajo Ingenieros S.A. 2153543
Mexico, Mexitek, S.A. 5-36-09-10
Milano, Sistrel SpA 248-52-33
Montevideo, Coasin Uruguay S.A.
Munich, Fey Elektronische Messgeraete 184041
Oslo, Morgenstjerne & Co. A/S 372940
Paris,
(Suresnes) M. B. Electronique, S.A. 7723108
Quito, Proteco Coasin CIA, Ltda 526-759
Rijswijk, C. N. Rood B. V. 996360
Rio de Janeiro, Ambriex, S.A. 264-7406
Rome, Sistrel SpA 500-1860
Santiago, Coasin Chile Ltd. 396713
Sao Paulo, Ambriex, S.A. 52-7806
Selangor, O'Connor's (Pte) Ltd.
Seoul, Asia Science & Co. 24-1431
Singapore, O'Connor's (Pte) Ltd. 637944
Taipei, Heighten Trading Co. Ltd. 518324
Tehran, Berkeh Company Ltd. 628294
Tel Aviv, R. D. T. Electronics Engrg. Ltd. 456181
Tilburg, Fluke (Nederland) B.V. 013-673973
Tokyo, Toyo Trading Co. Ltd. (03) 279-0771
Vallingby, Telinstrument AB 380370
Vienna, Kontron GmbH & Co. KG 420202
Watford, U.K., Fluke International Corp. 33066
Zurich, Kontron Electronic AG 628282
Caribbean, West Indies Sales Co.
(San Juan) (809) 723-3743
Peoples Rep. of China,
May Lee Industries (N.Y.) (212) 532-9200
U.S.S.R., Codevintec Pacific, Inc.
(L.A.) (213) 348-1719

FLUKE

TRENDAR

® subsidiary of John Fluke Mfg. Co., Inc.

500 Clyde Avenue, Mountain View, California 94043 • 415 / 965-0350 TWX 910-379-6573
Europe, Fluke (Nederland) B.V., P.O. Box 5053, Tilburg, Netherlands, Tel. 013-673973. Telex 52273.
U.K., Fluke International Corp., Garnett Close, Watford, WD2 4TT, Tel. Watford (0923) 33066, Telex 934583

INFORMATION RETRIEVAL NUMBER 22

output rise time is 20 ns, the output impedance 68 Ω , and the instrument draws 80 mA at 5 V. Useful for many applications, the P-2002 sells for \$85.

Easiest in-circuit IC tests

A new concept for in-circuit TTL IC testing appeared in mid-1971 with the first logic comparator—the Model 10529A from Hewlett-Packard. The instrument clips onto the IC under test—powered and operating under dynamic conditions in the circuit. The logic states at the pins of the suspect IC are compared with those of a known good reference IC, and only the differences are displayed on a 16-LED array.

The logic comparator connects the inputs of the two ICs in parallel, so the reference IC is driven by the same signals as the IC under test. If any differences in output are detected that last longer than 200 ns, a failure is indicated on the array, and the malfunctioning pin is identified.

The reference IC is soldered to a board that fits inside the 10529A, and the V_{cc} , ground, signal input and output pins are programmed by soldering and use of a supplied tool to break PC conductors. The output from the tester loads the input of the tested IC with about two TTL loads, and the output of the IC is loaded by one equivalent TTL load. The 10529A will operate up to 2.5 MHz. It costs \$375.

Mark Baker, product marketing engineer for HP, reports that his company, starting possibly next month, will deliver the 10529A with an additional switch-program reference board. The plug-in board will substitute for a regular programming board and will have a zero-insertion-force IC socket and small switches to permit testing of infrequently encountered ICs. A switch on the board will allow the comparator to be used as a logic clip. As such, it will accept 200-ns-to-200-ms positive or negative pulses. The new board will be included with the comparators and be available to users of older units. It will have automatic V_{cc} and ground-seeking and will protect the power supply from accidental shorting of the V_{cc} supply if the board is improperly programmed.

One unit, the Model 200 IC Testclip, manufactured by Trendar, a subsidiary of John Fluke, Mountain View, Calif., combines a logic comparator, test clip and logic probe in one compact instrument.

The Testclip looks like a rather large logic clip, with a LED-array readout on one end and a pin-selector switch on the bottom. For use as a logic comparator, a reference IC is inserted in a "programmed" replaceable pin socket. The programming is done by use of long and short pins in the socket—which is then inserted in another socket on the Testclip.

In operation, the unit is clipped over an IC in the circuit being tested. As in the HP units, only differences in logic states between test and reference ICs are indicated. The unit considers faults as



"Mini" and "maxi" logic test kits from HP combine the most essential testers in custom cases.

differences in state lasting over 400 ns.

With the reference IC removed, the Testclip functions as a logic clip, indicating the logic states on each of the IC pins. Because of the comparator circuitry the states are shown inverted—a logic ZERO is lighted and a logic ONE is dark. While the IC is being observed, the switch on Testclip allows any of the pins to be selected and examined with a logic-monitor (probe) circuit. The logic monitor indication is on a separate LED and will detect 100-ns pulses, stretch pulses to 100 ms and flash at a 5-Hz rate for pulse-repetition rates through 1 MHz.

The Trendar Model 200 Testclip comes with the probe cable, 10 IC sockets and 40 programming pins. The complete package sells for

\$395. According to Noel P. Lyons, manager of marketing services for Trendar:

"The configuration of the Testclip is due to a number of engineering considerations. First, it eliminates the lead lengths between contact and circuit when used as a logic clip or comparator. Second, it can be programmed without having to solder anything, enabling new IC types to be tested in the field. Most importantly, it combines the most necessary digital testers into one instrument."

Hewlett-Packard has combined its line into a pair of logic troubleshooting kits. The 5011T "maxi kit" contains the logic probe, logic pulser, logic clip and logic comparator, while the 5015A "mini kit" eliminates the logic comparator. According to Jesse Pipkin of HP:

"The mini kit is primarily for circuit designers and the maxi kit for field engineers. The logic comparator doesn't provide any information that can't come from a probe, pulser and clip, but in the field it works faster and easier."

The feeling at HP is that the greater flexibility provided by a combination of separate instruments outweighs any advantages of combining functions. The mini kit costs \$285 and the maxi kit \$625.

The market future appears bright for small logic testers. Both field and design engineers who have used them have found that they can spot trouble easier and faster than with other methods. They are using troubleshooting techniques especially suited to digital rather than adapting techniques that are fundamentally analog.

According to Frank C. Partin, an industry spokesman for John Fluke in Seattle: "The number of digital IC packages in service is continuing to rise sharply, particularly in equipment such as industrial controllers and even game machines, where down time is very costly. The field serviceman traditionally went on a call with a truckload of spare boards; he had to get the equipment back in service fast, so he made repairs by board swapping. Now, with a few tiny instruments, he can go anywhere, even in out-of-the-way places and replace bad ICs. In these cost-conscious times such an ability is very valuable." ■■

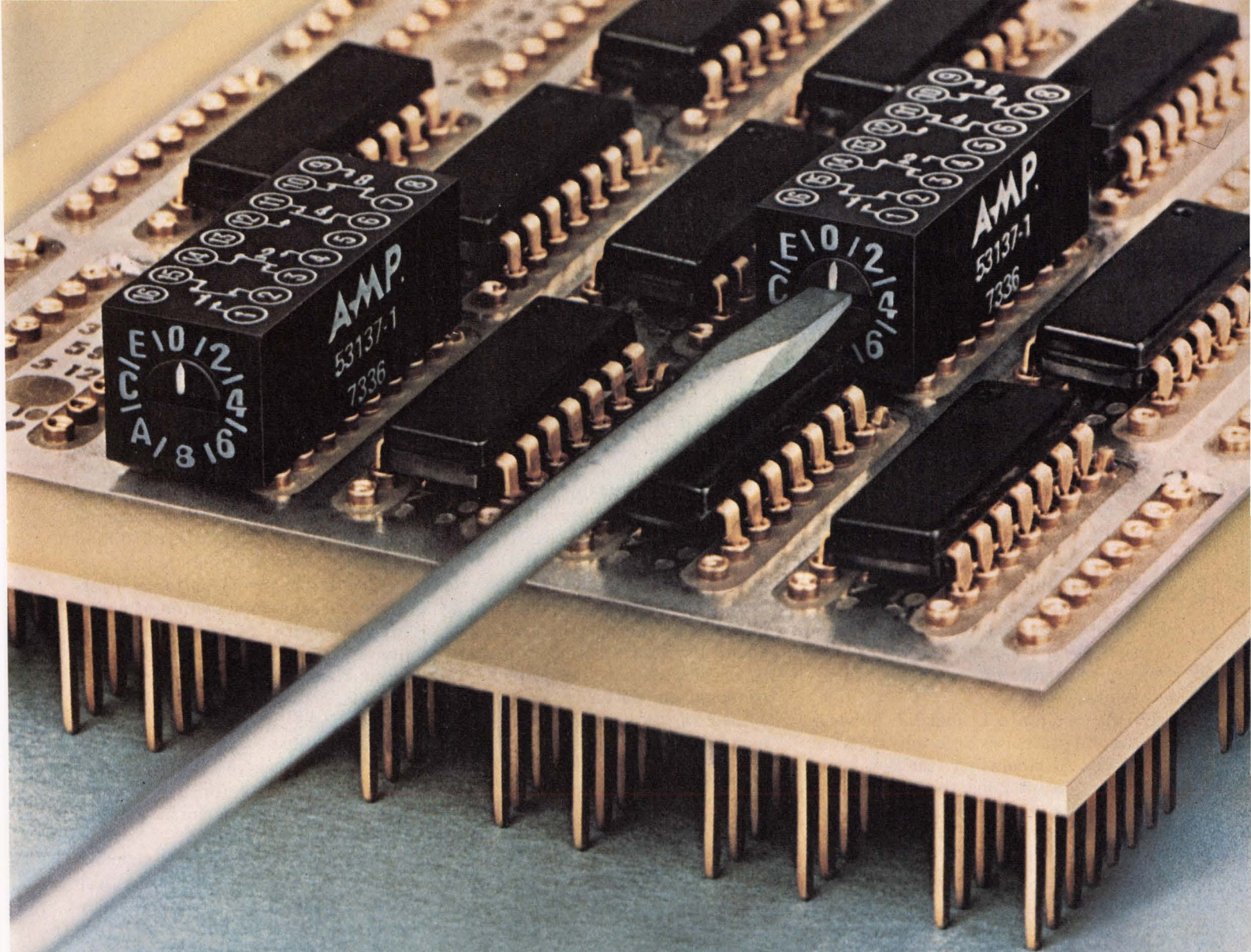

Introducing our new member of the board.

Meet the pluggable AMP Hexadecimal Rotary Switch, a fast, economical 16-pin DIP type performer. It's made to be programmed manually—on the pc board itself.

Put a screwdriver in the slot. Turn the bi-directional binary encoded cam to the desired, easy-to-read setting. You're now in business.

This AMP innovation, housing four Form "C" switches, is completely compatible with current packaging techniques.

Input/output pins are spaced on .100" x .300" centers. So you can mount it by any method normally used for 16-lead ICs.

What about environmental damage to the surfaces of the gold plated phosphor bronze contacts? The fully enclosed design provides all the protection you need.

And what about seeing our board member in action? Just call this number: (717) 564-0101. Or write AMP Incorporated, Harrisburg, Pa. 17105.

AMP
INCORPORATED

AMP is a trademark of AMP Incorporated.

New memory, the crosstie, stores data in magnetic-domain walls

A new memory technology that combines the high speed of semiconductors with the nonvolatility of magnetic memories is being developed by the Naval Ordnance Laboratory in Silver Spring, Md., as well as several computer manufacturers.

Known as a crosstie memory, the technique is a radical departure from previous magnetic methods, in that the storage of information is in magnetic-domain walls rather than the domains themselves.

According to Leonard J. Schwee, a solid-state research physicist at the naval laboratory, the new technology is intended for applications requiring block-oriented, random-access memory or fast auxiliary memory. The advantages, Schwee notes, are high speed, high bit density, nonvolatility, low cost, low power requirements and a wide range of operating temperature.

What is it?

Like the magnetic-bubble memory, the crosstie is a serial type, and thus the basic building block is a shift register. The magnetic wall in a thin Permalloy film about 300 Å thick serves as a track for the shift register. ONEs in a crosstie shift register are represented by sections of wall that are opposite in polarity from the remainder of the wall. This is called a crosstie Bloch-line pair. ZEROs are represented by the absence of ONEs at periodic sites along the wall. The ONEs and ZEROs are introduced at one end of the wall, by application of a local magnetic field, and propagated along the

wall without change in the distances between each pair. At the other end of the wall, the pairs are detected and read out in serial form.

One main reason why crosstie memories show promise, Schwee says, is that they appear to offer very high performance. With present techniques, it's possible to achieve data rates as high as 20 Mbits/sec. This can be speeded to about 125 Mbits/sec, Schwee says, by a decrease in the size of the propagation patterns and an increase in the anisotropy of the magnetic film.

The crosstie memory also offers

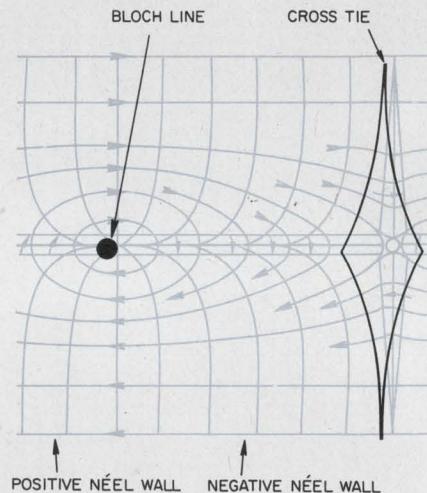

Crosstie Bloch-line pairs are inversions of the magnetic wall in thin films that store data.

high storage densities, Schwee reports. Present technology can yield densities of about 1 million bits/in², he says, and this can be boosted to at least 70 million bits/in² by an increase in the anisotropy of the film. Further improvements should raise that to about 1 billion bits/in², Schwee predicts.

One major problem to be overcome, he says, is detection of crosstie Bloch-line pairs. Since these pairs are local changes in the magnetic field, it's necessary to differentiate between at least two magnetic field conditions to sense information.

"Currently we're trying to adapt sensors developed for bubble sensing to crosstie-memory applications," Schwee notes.

Although much of the basic research on crosstie memories was done at the Naval Ordnance Laboratory, the technique is not limited to military applications. Both Honeywell and Sperry Univac are pressing crosstie-memory development programs.

A spokesman for Honeywell says the crosstie memory is a "long-shot technology," because it is relatively new and there is very little in the way of feasibility studies. He notes, however, that it is based on the very well known Permalloy thin-film technology, and that is part of the reason Honeywell is looking into it. ■■

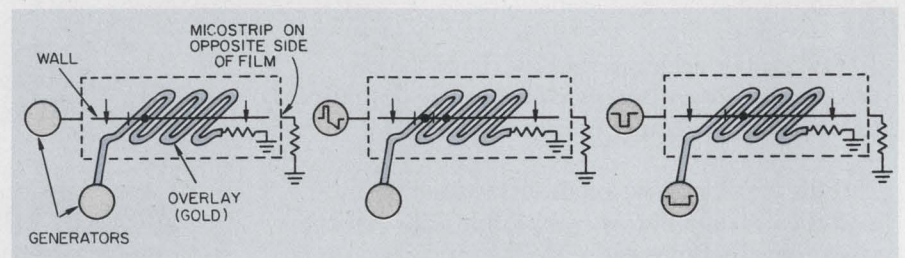

Data are propagated by first entering it into the memory (left), duplicating it (middle) and then annihilating the original entry (right).

Jules H. Gilder
Associate Editor

Now you can intermix low level, high level and simultaneous sample & hold inputs

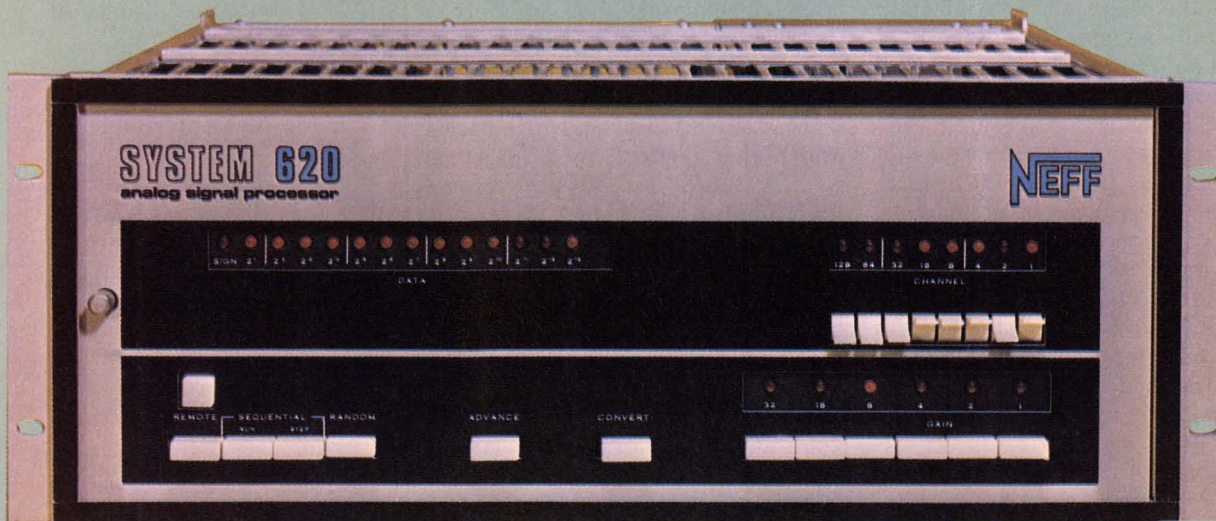

With amplifier-per-channel System 620

SYSTEM 620. A BETTER MOUSETRAP

In less than 2 years, our amplifier-per-channel System 620 has become industry's most popular high speed data acquisition system. Today, thousands of channels are performing reliably in the field. In scores of applications from Turbine Engine Test to Earthquake Engineering. Now System 620 is even more flexible than before. With 3 input amplifier options, four analog-to-digital converters to choose from. So here's the latest chapter on System 620, the new approach in data acquisition.

LOW LEVEL AMPLIFIERS

Our field proven low-level differential amplifiers are perfect for strain gages & thermocouples since transducer signals are isolated right at the source. Our specs are impressive, too. With gain accuracy of 0.01%, 2 microvolt stability and 120 dB common mode rejection. More protection, too. If one channel gets wiped out by an overload, the rest don't feel a thing.

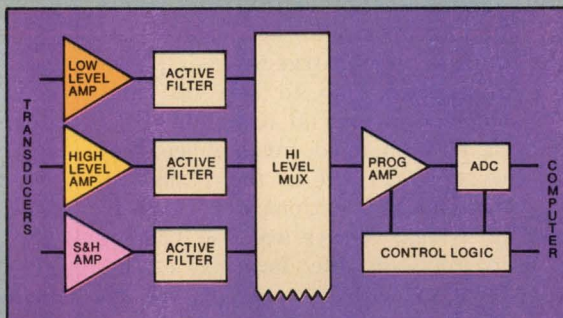

NEW HIGH LEVEL AMPLIFIERS

Since high gain isn't always required, we've added an amplifier option which, for just \$80 a channel, provides system gain of 1 to 400. That's more than adequate for many applications. Yet, retains all the features of our low-level amplifiers.

NEW SIMULTANEOUS SAMPLE & HOLD AMPLIFIERS

Low level sample & hold amplifiers are absolutely necessary in applications such as transient and vibration analysis, where data must be grabbed in a few nanoseconds or time correlation of data is important.

Low level, high level and sample & hold amplifiers can be freely intermixed in System 620.

And each amplifier in the system includes an active low pass filter with selectable cutoff frequency. Another important point. Continuous analog output is available on all channels.

FOUR ADC OPTIONS

System 620 now has four analog-to-digital converters to choose from. If you need high accuracy, we can give you 14 bits at 20kHz. In most systems our economical 12 bit, 10 kHz analog-to-digital converter will suffice. Or if higher speed is your need, specify 12 or 15 bits at 50 kHz.

COMPUTER INTERFACE

System 620 has been interfaced with a number of computers, both large & small. Interface hardware and software is available for most popular computers.

For the up-to-date story on System 620 — the new approach to data acquisition — phone or send for our brochure today.



1088 E. Hamilton Rd., Duarte, Calif. 91010
Tel. (213) 357-2281 TWX 910-585-1833

Mini-laser techniques speed 3-dimensional X-ray imaging

With the help of a minicomputer and a laser, Philips Research Laboratory, Eindhoven, the Netherlands, has come up with two new methods for speeding the fabrication of three-dimensional X-ray images. In addition it has significantly reduced the amount of radiation to which a medical patient must be exposed.

The two techniques include an electronic approach that yields images in minutes and an opto-holographic method that takes longer but produces images of higher quality.

To fabricate a three-dimensional X-ray picture, the Philips researchers first make a series of about 24 X-ray images. This takes only a few seconds. In the electronic technique, the images are stored in a video disc memory. For a sharp picture of a particular human organ or subject, the images are superimposed on one another in a storage tube. The correct position of each image is determined by a minicomputer.

The picture thus synthesized can be recorded on the video disc and displayed on a television screen. This technique can give images of 50 different layers with

a single exposure cycle of only a few seconds. Obtaining the same results manually would require 50 X-ray exposures.

In a second method, which yields the higher quality, the first steps are the same as with electronic technique: A series of X-rays is taken. But instead of storing them on a video disc, the images are recorded on film. A hologram is prepared for each image in the series. The holograms are then arranged so their positions correspond to the position of the X-ray tube during the original exposure. By illuminating the entire series of holograms with a laser reference beam, the researchers get a three-dimensional image.

Three-dimensional X-rays are becoming more useful in medical diagnoses—for spotting early tumors or examining defective organs without surgery—but physicians have had to rely on time-consuming manual techniques that haven't changed much since they were first used in the 1930s. Industrial applications for three-dimensional X-rays are also stirring interest—in the locating of defects in critical materials, for example. ■■

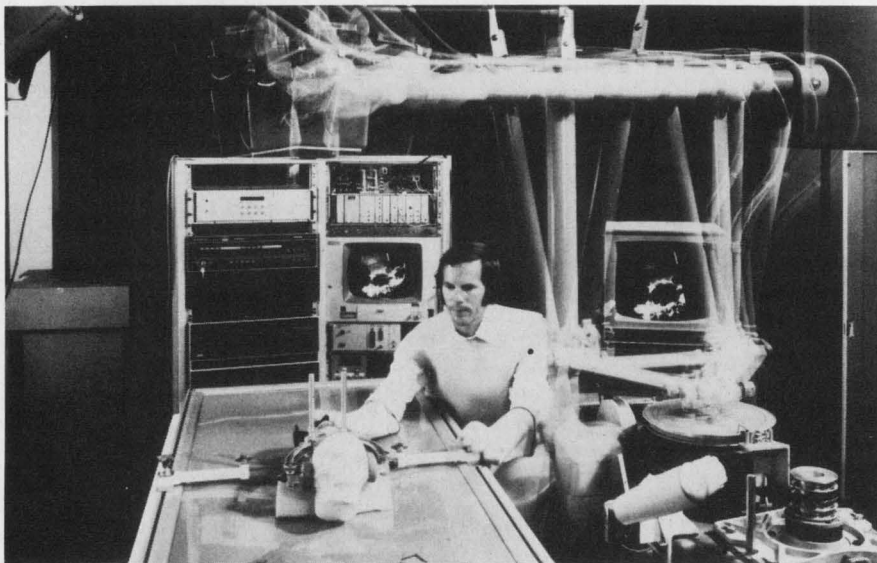

Automated X-ray camera takes a series of photographs that are fed into a video disc recorder. A minicomputer superimposes the pictures on a TV storage tube to construct three-dimensional images.

Your closest SIGNETICS distributor is...

ARIZONA
Phoenix: Hamilton/Avnet Electronics (602) 275-7851
Phoenix: Kierulff Electronics (602) 273-7331

CALIFORNIA
Culver City: Hamilton Electro Sales (213) 870-7171
El Monte: G. S. Marshall (213) 686-1500
Los Angeles: KT/Wesco Electronics (213) 685-9525
Mountain View: Hamilton/Avnet Electronics (415) 961-7000
Palo Alto: Wesco Electronics (415) 968-3475
San Diego: Hamilton/Avnet Electronics (714) 279-2421
San Diego: Kierulff Electronics (714) 278-2112
Sunnyvale: Cramer Electronics (408) 739-3011

CANADA
Downsview: Cesco Electronics, Ltd. (416) 661-0220
Downsview: Cramer Electronics (416) 661-9222
Montreal: Cesco Electronics, Ltd. (514) 735-5511
Montreal: Hamilton/Avnet (514) 735-6393
Ottawa: Hamilton/Avnet Electronics (714) 725-3071
Ottawa: Cesco Electronics, Ltd. (613) 729-5118
Quebec: Cesco Electronics, Ltd. (418) 524-3518

COLORADO
Denver: Hamilton/Avnet Electronics (303) 534-1212
Denver: Cramer Electronics (303) 758-2100

CONNECTICUT
Hamden: Arrow Electronics (203) 248-3801
Georgetown: Hamilton/Avnet Electronics (203) 762-0361
North Haven: Cramer Electronics (203) 239-5641

FLORIDA
Hollywood: Hamilton/Avnet Electronics (305) 925-5401
Hollywood: Schweber Electronics (305) 927-0511
Orlando: Hammond Electronics (305) 241-6601

GEORGIA
Atlanta: Schweber Electronics (404) 449-9170
Norcross: Hamilton/Avnet Electronics (404) 448-0800

ILLINOIS
Elk Grove: Schweber Electronics (312) 593-2740
Elmhurst: Semiconductor Specialists, Inc. (312) 279-1000
Schiller Park: Hamilton/Avnet Electronics (312) 678-6310

INDIANA
Indianapolis: Semiconductor Specialists (317) 243-8271

KANSAS
Lenexa: Hamilton/Avnet Electronics (913) 888-8900

MARYLAND
Hanover: Hamilton/Avnet Electronics (301) 796-5000
Rockville: Pioneer Washington Electronics, Inc. (301) 424-3300
Rockville: Schweber Electronics (301) 881-2970

MASSACHUSETTS
Burlington: Hamilton/Avnet Electronics (617) 273-2120
Needham Heights: Kierulff/Schley (617) 449-3600
Newton: Cramer Electronics (617) 969-7700
Waltham: Schweber Electronics (617) 890-8484

MICHIGAN
Livonia: Hamilton/Avnet Electronics (313) 522-4700
Detroit: Semiconductor Specialists, Inc. (313) 255-0300

MINNESOTA
Minneapolis: Semiconductor Specialists, Inc. (612) 854-8844
Edina: Hamilton/Avnet Electronics (612) 941-3801

MISSOURI
Hazelwood: Hamilton/Avnet Electronics (314) 731-1144

NEW YORK
Buffalo: Summit Distributors, Inc. (716) 884-3450
Farmingdale, L. I.: Arrow Electronics (516) 694-6800
Rochester: Schweber Electronics (716) 328-4180
Syracuse: Hamilton/Avnet Electronics (315) 437-2642
Westbury: Schweber Electronics (516) 334-7474
Westbury: Hamilton/Avnet Electronics (516) 333-5800

NEW MEXICO
Albuquerque: Cramer Electronics (505) 265-5767

NORTH CAROLINA
Greensboro: Hammond Electronics (919) 275-6391

NORTHERN NEW JERSEY
Cedar Grove: Hamilton/Avnet Electronics (201) 239-0800
Saddlebrook: Arrow Electronics (201) 797-5800
Moorestown: Arrow/Angus Electronics (609) 235-1900

SOUTHERN NEW JERSEY AND PENNSYLVANIA
Mt. Laurel, N. J.: Hamilton/Avnet Electronics (609) 234-2133
Cherry Hill, N. J.: Milgray-Delaware Valley
New Jersey (609) 424-1300 Philadelphia: (215) 228-2000
Somerset, N. J.: Schweber Electronics (201) 469-6008

OHIO
Beechwood: Schweber Electronics (216) 464-2970
Cleveland: Arrow Electronics (216) 464-2000
Cleveland: Pioneer Standard Electronics (216) 587-3600
Kettering: Arrow Electronics (513) 253-9176

TEXAS
Dallas: Hamilton/Avnet Electronics (214) 661-8661
Dallas: Cramer Electronics (214) 350-1355
Houston: Component Specialties (713) 771-7237
Houston: Hamilton/Avnet Electronics (713) 526-4661

UTAH
Salt Lake City: Alta Electronics (801) 486-7227
Salt Lake City: Hamilton/Avnet Electronics (801) 262-8451

WASHINGTON
Bellevue: Hamilton/Avnet Electronics (206) 746-8750

BCD arithmetic, all in a single IC.

Figure on whopping savings in parts, design time, systems costs.

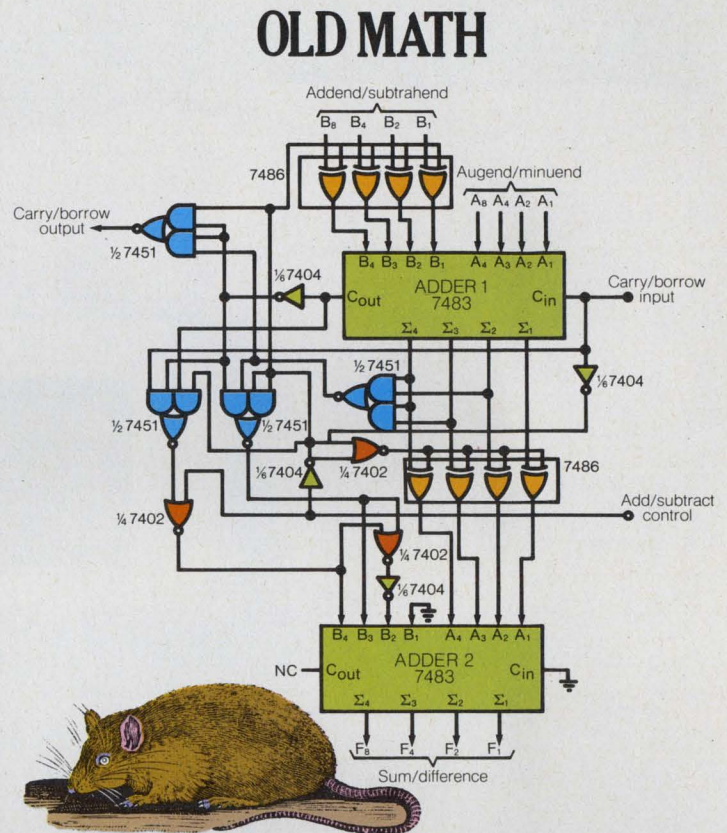
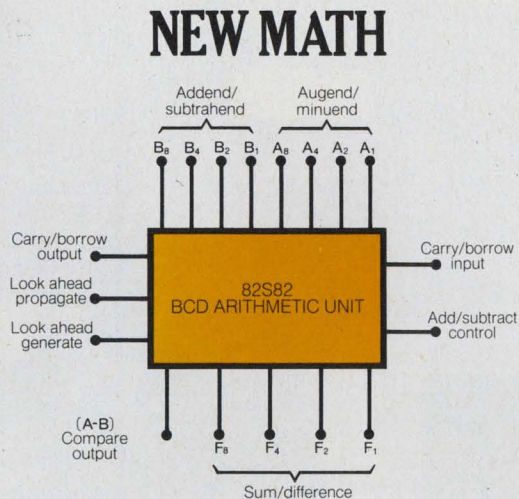

We've cut BCD arithmetic down to size. By applying Schottky MSI to those functions where it counts, we're delivering revolutionary tools in superfast processing — that are real power misers at a fraction (about half) of conventional circuitry costs. A lot more of exactly what you need. For less cost going in and coming out.

Available from Signetics, the under ten buck (100 up) 82S82 Adder-Subtractor slashes inventory requirements. Replaces four MSIs, and a rat's nest of gates and connections, now wasting valuable board space. With a staggering improvement in performance. Quadruples speed (22ns typical propagation delay). Cuts power 50%-67%. Wipes out a huge chunk of design, checkout and assembly time.

Versatile? Stand back. This unique Arithmetic Unit adds and subtracts in BCD directly, compares two BCD words, and can even be used for binary-to-BCD conversion. Cascades to operate on multiple decades. If you need ultra-high speed, get complete look-ahead carry with our 74182 fast-carry extender. What does the 82S82 do? Everything.

For a straight BCD add without all the bells and whistles, our companion 82S83 Adder gives you the same bonuses as the 82S82 Arithmetic Unit. Eliminates two MSI packages and a fistful of logic elements. Saves time, saves dollars — works better, faster, cheaper. Has to, for the same reasons as with the 82S82. It's less than seven bucks per 16-pin device, in 100-up quantity.

The way to get big, rich and famous: deliver faster, smaller, more powerful processors. Now you can. Get the facts quick. (And for immediate evaluation quantities, see your local Signetics Franchised Distributor. His name and telephone number are in the adjoining column.)

FOR SPEED ATTACH COUPON TO LETTERHEAD AND MAIL FAST

Signetics—BCD AU/Adder
811 East Arques Avenue
Sunnyvale, California 94086

You have what counts, can't miss it. Send me your new, comprehensive MSI 82S Data Booklet with full specs of the BCD AU/Adder, (containing also your complete family of 100MHz counters, 60MHz universal shift registers, parity checkers, decoders, multiplexers, and exclusive OR/NOR functions.)

Name _____

Title _____

Signetics Corporation—A subsidiary of Corning Glass Works.

signetics

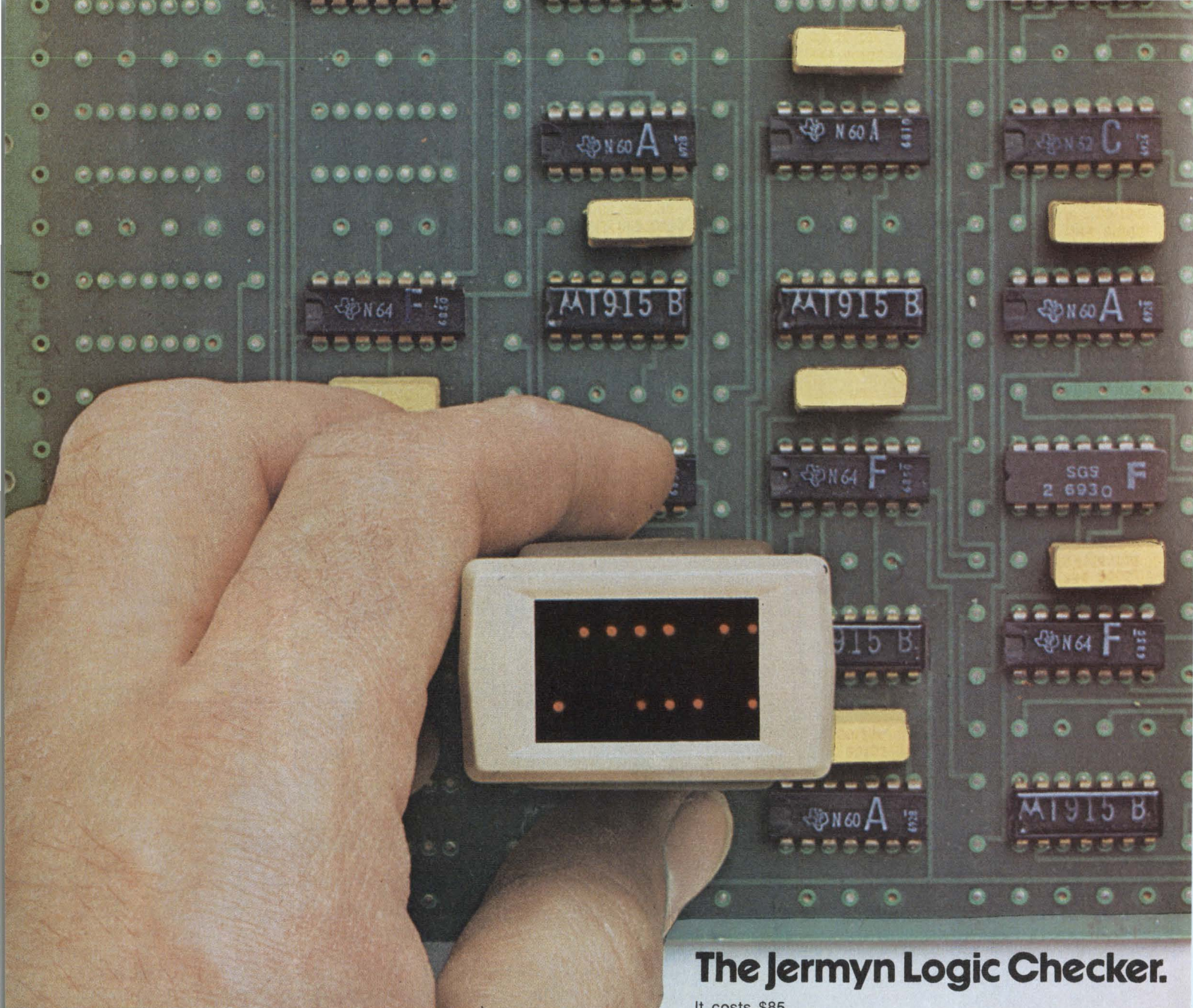

The Jermyn Logic Checker.

It costs \$85.

If you work with logic IC's, it'll save that amount of time and trouble in the first couple of weeks.

After that, you'll wonder how you ever managed without it.

It clips over a 5v IC (up to 16 pins) and shows you immediately the logic state of each pin.

It does this without a separate power source, because it takes its power from whichever two pins on the IC carry the 5v supply. Then it monitors all the other IC terminals and shows their logic state on an array of 16 light emitting diodes.

Lamp on means logic state 1 (or open circuit).

Lamp off means logic state 0 (or ground).

Unused terminal and the 5v supply pin also show logic state 1.

And of course it gives exactly the same result whichever way round you clip it.

The checker is suitable for most TTL and DTL devices and is supplied with 24 masks to help check the most common logic configurations. We also give you a free Jermyn IC insertion tool as an added bonus.

With very little practice you'll be able to check 10 or more IC's in a minute. Compare that with other methods, using a single probe and a CRO for example.

The Jermyn logic checker weighs 1-1/2 oz., and is only 2.6 ins long and takes only 250mA with all lamps on. It's completely British made and designed, which is why we can sell it at the remarkably reasonable price of \$85 (plus 75¢ for postage). Send a check for \$85.75 (please add California sales tax where appropriate) and you'll get yours by return mail, or ask for a leaflet.

Jermyn

712 Montgomery Street San Francisco California 94111

Telephone 415-362-7431

London (0732) 58271 Munich (089) 39 88 01 Paris 744 29 - 71

INFORMATION RETRIEVAL NUMBER 26

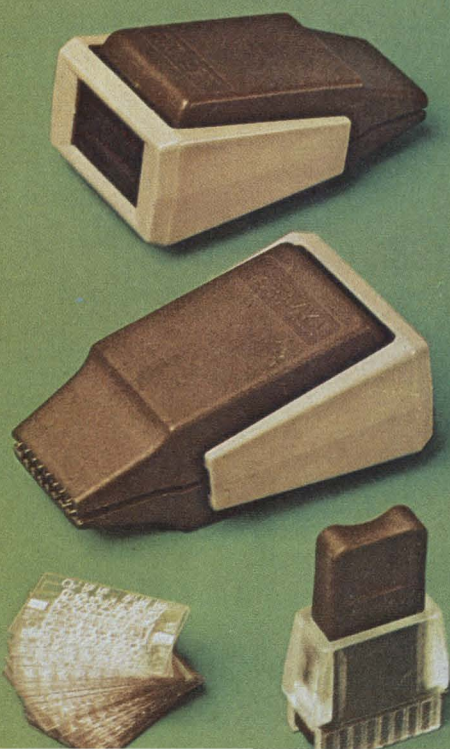

washington report



Heather M. David
Washington Bureau

Defense budget for 1975 climbs sharply

Stalwart Congressional defenders of the military are raising their eyebrows at the \$85.8-billion Pentagon budget for FY 1975. The size of the increase over this year's \$79.5-billion led Sen. John Stennis (D-Miss.), chairman of the Senate Armed Services Committee, to say he was "disappointed" the Pentagon could not keep its budget down. Defense Secretary James Schlesinger told Congress the boost is necessary to meet inflation and to hedge against technological achievements by the Soviets. Within that total is a \$1.4-billion increase for research and development, but Schlesinger said the \$8.4-billion R&D request actually contains a real increase of only \$900-million, the rest going to inflation. Intelligence and communications projects at \$6.5-billion represent a \$600-million increase over FY 1974, but Schlesinger said only \$200-million will go to actual program increases.

Drones, fighters, satellites and missiles

Remotely piloted vehicles and drone programs, which have been proposed for a variety of missions from high altitude reconnaissance to missile launching by all three services, will receive \$127.4-million, an increase of about 30%. The Air Force is planning design studies for modular RPVs with interchangeable body parts, subsystems and payloads, so that they could be adapted for a variety of missions. Some \$25-million in a separate account is also requested for work on a prototype Precision Emitter Location Strike System (Pelss), a system of receivers, beacons, ground control facilities and aircraft or RPVs designed to knock out enemy radars, with IBM as prototype contractor. The Pentagon will try again this year to get Congressional approval for a phased array radar system to provide early warning of a sea-launched ballistic missile attack against the continental U.S. The Air Force is asking \$49.7-million. The service is also seeking \$25.4-million for the NavStar navigation global positioning system and associated ground equipment and control stations.

Both the Air Force and Navy want to start work on new fighter aircraft prototypes. The Air Force, which is already conducting a competitive prototype program for a lightweight fighter (\$22.7-million requested in FY 1975), wants \$36-million for a new highly maneuverable air combat and air-to-ground fighter. The Navy is requesting \$34-million for a supersonic, carrier-based air superiority fighter. The Air Force is also asking \$20-million for a new tanker aircraft that could carry cruise missiles, and \$80-million for a long-range subsonic cruise missile apparently based on the Boeing SCAD. The Navy has earmarked \$45-million for a new strategic cruise missile, and \$33-million for a guidance system for that missile.

The Defense Dept. will devote some \$248-million to programs for in-

creasing the accuracy of strategic ballistic missiles through improved guidance systems. This includes \$20-million for the new Maneuverable Reentry Vehicle (MaRV) system for the Trident missile; \$32-million for research on improved guidance for the Minuteman III missile system; \$25-million for a new higher yield Mark IIIA reentry vehicle for Minuteman III; \$32.5-million for a system to measure the accuracy of Minuteman's multiple reentry vehicles; \$5-million for an advanced ballistic missile reentry vehicle for a mobile missile, and \$19-million for a program to increase the number of reentry vehicles on Minuteman III. Some \$37.3-million is in the new budget for advanced development of a new generation of Air Force ICBMs, called the M-X.

NASA: \$3.3-billion, a few new starts

The National Aeronautics and Space Administration will start three new spaceflight projects with the FY 1975 budget. One, the Pioneer Venus mission, given top priority by scientists, will consist of two spacecraft to be launched in 1978. The first would send probes into the atmosphere of Venus at four locations, the second would orbit the planet to study the characteristics and temporal changes in the atmosphere. Hughes Aircraft has been selected contractor for the Pioneer Venus design. The second new project will be an experimental applications satellite called Seacat, to observe and measure physical characteristics of the oceans. Seacat-A would be launched in 1978 and carry instrumentation to remotely measure sea state, wave height, wind speed, ocean temperatures and other phenomena. The third would be another experimental applications project utilizing a small "Explorer" type satellite to make heat measurements of the earth's surface, for purposes of identifying areas with mineral resources, for construction projects, and for locating geothermal sources for energy. Launch is scheduled for 1977.

Space agency head Dr. James Fletcher said the space shuttle program will slip because of budget problems, which will mean a shift in the first manned orbital flight to the second quarter of 1979. NASA also plans a new earth-bound project with the FY 1975 budget, the construction and installation of the world's largest infrared telescope on Mauna Kea, Hawaii. The new three-meter (120-inch) telescope will be available in 1976. NASA's total funding request is \$3.3-billion, up an inflationary \$100-million from FY 1974. Subtotals in the budget include \$1.124-billion for manned space flight; \$547-million for space sciences; \$177.5-million for space applications; \$241.2-million for aeronautics and space technology and \$250-million for tracking and data acquisition.

DOT: More R&D

Research and development programs of the Dept. of Transportation will increase by 7% in FY 1975, if the Administration plan prevails. The Federal Aviation Administration will have \$70-million for intensified development of advanced aircraft radar beacons and automated flight service stations, as well as the continued development of a microwave landing system. The Federal Railroad Administration will have \$64.2-million for high speed ground transportation research. The Urban Mass Transportation Administration is requesting \$75-million for R&D, an increase of \$8.8-million over FY 1974. The Mitre Corp., under a prime contract from UNTA, will request proposals soon for development of a magnetic card transport to be used in an automatic fare collection system. DOT is also expected to award three contracts soon to define the concept and preliminary design of a new high-performance personnel rapid transit system, and will hold a bidders' conference Mar. 1 in Washington, D.C.

The frequency synthesizer that takes you from .01 Hz to 20 MHz without stopping at the bank

Exact makes it low cost

The new Model 801 Frequency Synthesizer takes its place between the highly sophisticated (and highly expensive) synthesizers and the less versatile RC and LC oscillators. Now at a reasonable cost, you can have a signal source with crystal controlled stability, high frequency accuracy and resolution, and the capability of remote control programming.

Exact makes it simple

Simple to operate, simple to calibrate, simple to maintain. Just six plug-in circuit boards plus a plug-in power supply perform all frequency synthesis functions. Convenient test points make location of faulty cards quick and easy. And, in case of trouble, you can substitute a new card without extensive recalibration.



Exact makes it stable and accurate

The Model 801 offers frequency stability of 10 ppm/year and accuracy of .001% of setting. Bandswitching by decade ranges maintains a constant 6-digit resolution throughout the frequency range. Outstanding signal purity with low phase noise and low harmonic and non-harmonic spurious outputs permit accurate measurement of narrow band communications circuits. Non-harmonic spurious is -60 db and harmonic levels are below -40 db from 1-to-20 MHz, -50 db below 1 MHz.

Exact makes it versatile

In one instrument, the Model 801 offers frequency coverage from 1 Hz to 20 MHz, or 0.01 Hz to 20 MHz as an option, for an extremely stable source of signals typically requiring more than one instrument. Frequency accuracy is $\pm .001\%$, or by using the Model 801's phase lock input, it can be slaved to an external frequency standard for even higher accuracy. Options include digital programming, low frequency extender (to 0.01 Hz), and rack mounting adapters.

Price: Model 801 \$1,995.
f.o.b. Hillsboro, Oregon



(A Subsidiary of Danalab, Inc.)
BOX 160, HILLSBORO, OREGON 97123
(503) 648-6661 TWX 910-460-8811

INFORMATION RETRIEVAL NUMBER 27

Here's how we help jumbo jets get off the ground.

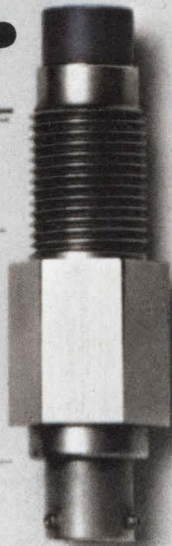
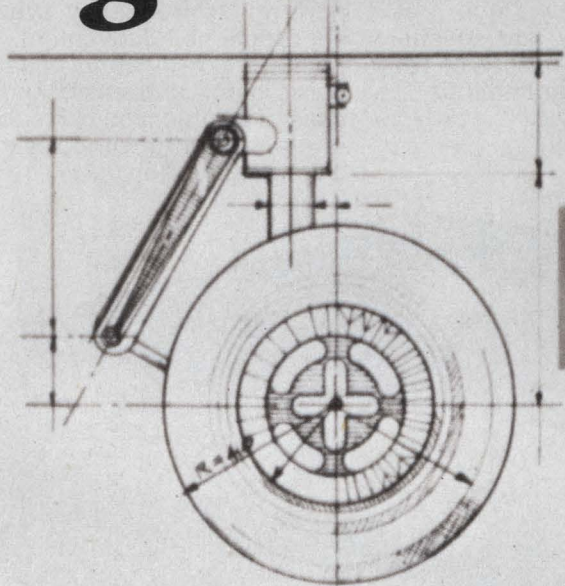

SOLID-STATE FW PROXIMITY HAS SWITCHING & SENSING ELEMENTS SEALED IN SINGLE UNIT. PROVIDES RELIABLE, NO-TOUCH SWITCHING FOR LANDING GEAR AND CONTROL SURFACE POSITION DETECTION. VARIATIONS OFFER SURFACE OR THRU-PANEL MOUNTING, HIGH-SPEED SENSING AND CIRCUITRY OUTPUT OPTIONS.

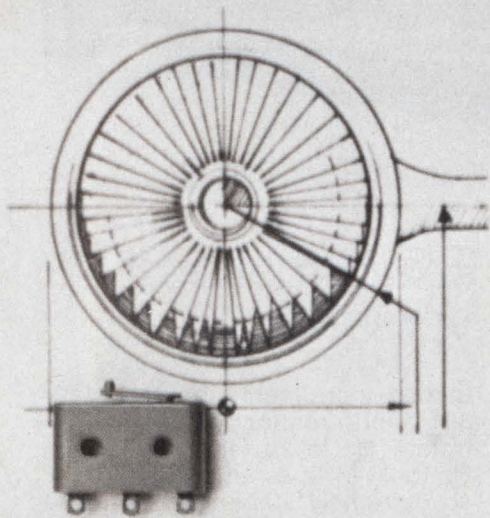

HERMETICALLY-SEALED HM FUNCTIONS IN PRESSURE SWITCH CONTROLS AND CONTROL VALVES. LARGER, HERMETICALLY-SEALED HS OPERATES IN TEMPERATURE RANGE FROM -100° TO $+500^{\circ}$ F AND TO 25 AMP DC

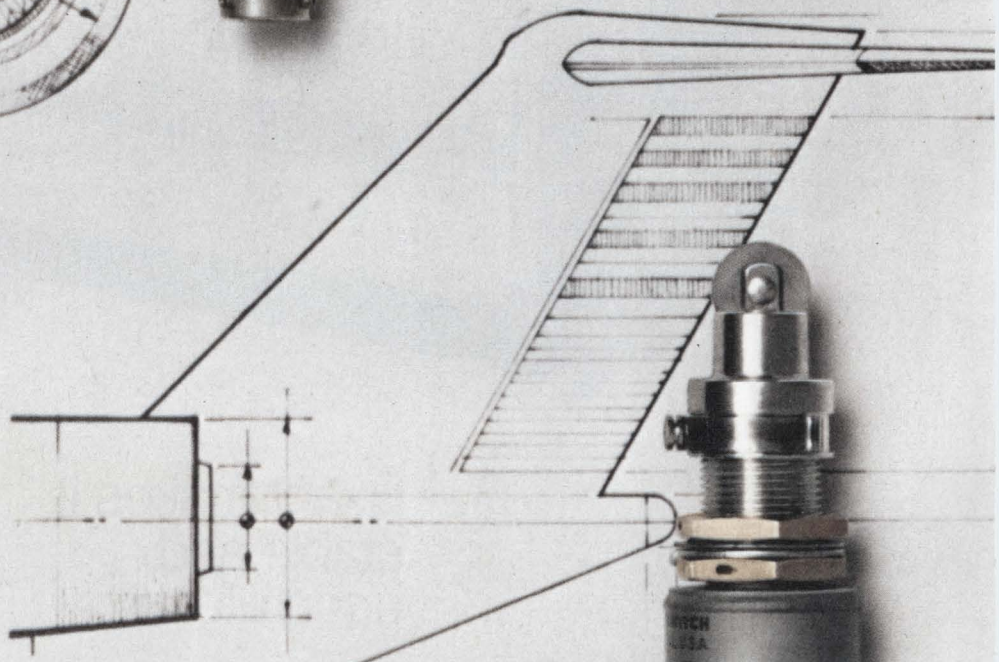

ENVIRONMENTALLY-SEALED EN'S CAN SENSE POSITION OF DOORS & CONTROL SURFACES, INDICATE STATUS OR INITIATE ACTUATOR CONTROL. OFFER WIDE ELECTRICAL RANGE, CHOICE OF TERMINATIONS & OPERATING CHARACTERISTICS. COMPLEMENTARY PRODUCTS OFFER HERMETIC SEALING AND TEMPERATURE RANGES TO $+600^{\circ}$ F.

TL TOGGLES WORK AS COCKPIT CONTROLS AND IN MANUAL INPUT PANELS. MEET MIL-S-3950. AVAILABLE WITH UP TO FOUR SPDT CIRCUITS & WITH SCREW, SOLDER, OR INTEGRATED WIRING TERMINATIONS. COMPLEMENTARY TOGGLES OFFER VARIETY OF ACTUATORS, HERMETIC SEALING, UP TO 10 POLES, SPECIAL CIRCUITRY AND ROCKER ACTION.

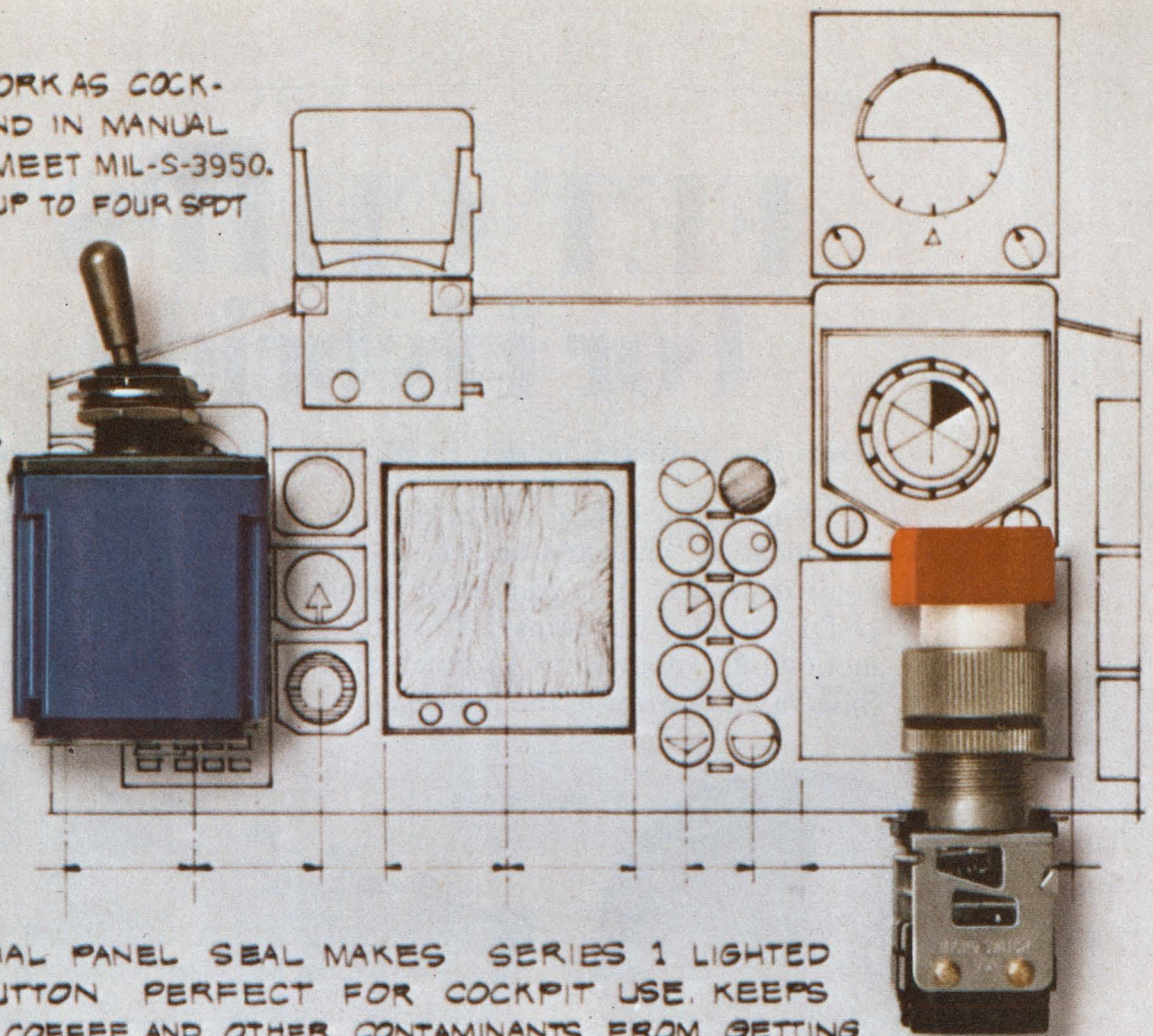

A SPECIAL PANEL SEAL MAKES SERIES 1 LIGHTED PUSHBUTTON PERFECT FOR COCKPIT USE. KEEPS WATER, COFFEE AND OTHER CONTAMINANTS FROM GETTING THROUGH PANEL. MIL APPROVED UNDER M-22885-81. OTHER MIL APPROVED PUSHBUTTONS OFFER MULTI-POLE, MULTI-LAMP OPTIONS.

EXIT

ENVIRONMENTALLY-SEALED SE AND XE SWITCHES HANDLE SENSING AND MONITORING FUNCTIONS AT LOW COST. APPLICATIONS INCLUDE VALVE MONITORING AND EMERGENCY EXIT CONTROL. UNSEALED SM AND SX OFFER GREATER COST SAVINGS. UNSEALED HT OPERATES TO +1000°F. IDEAL FOR THRUST REVERSERS AND VALVE CONTROL MONITORING.

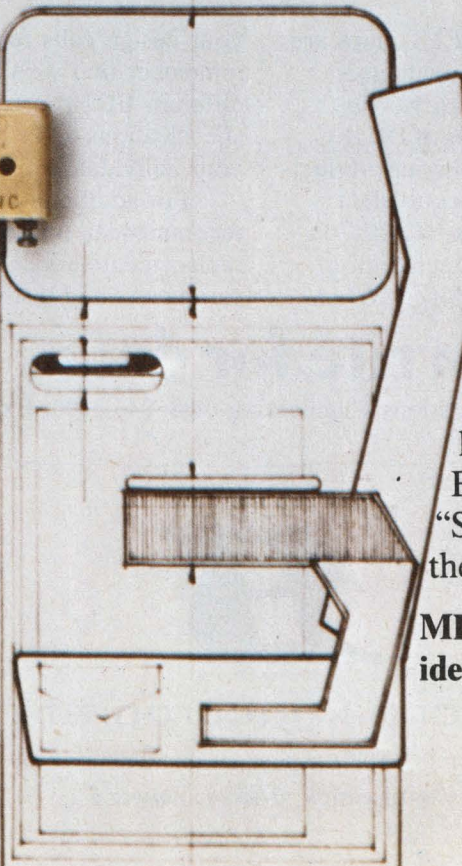
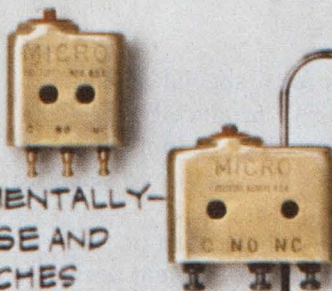

Aerospace applications present special problems.

So MICRO SWITCH has designed entire families of special switches to handle them.

The result is one of industry's most complete lines of rugged high-performance switches for both military and civilian use.

A few examples are shown here. But your MICRO SWITCH Branch Office (Yellow Pages, "Switches, Electric") can provide the full story. Contact them today.

MICRO SWITCH makes your ideas work.

MICRO SWITCH

FREEPORT, ILLINOIS 61032
A DIVISION OF HONEYWELL
INFORMATION RETRIEVAL NUMBER 28

FET CHIPS For Hybrids

from the industry leader in high-quality FET products

When your hybrid design calls for FET chips to a JEDEC specification, your first choice should be Siliconix JEDEC-equivalent dice. You can select from more than 500 different JEDEC-type FET chips, all manufactured with the same meticulous attention to product quality which has made Siliconix a byword in the industry.

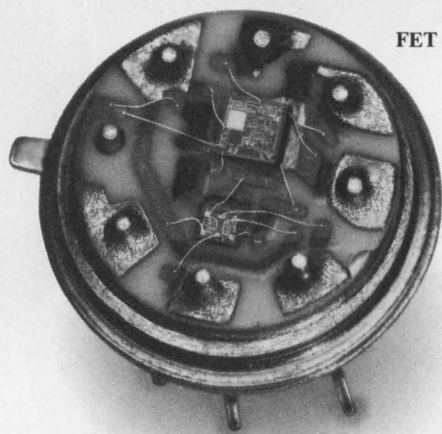

FET Input Op Amp

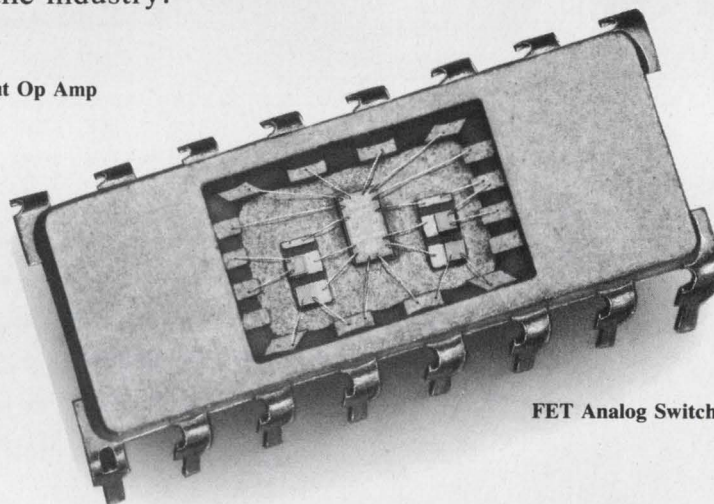

FET Analog Switch

All standard Siliconix FET chips are equivalent to their JEDEC or house-numbered parents on *all testable parameters*. We have hundreds of JEDEC and house-numbered parts in our product line. To specify a JEDEC-equivalent chip simply add the suffix "CHP," as in 2N4416 (JEDEC registration) = 2N4416CHP (chip form). When

your design calls for a special device, remember that we've produced over 4000 different FETs sorted to custom electrical specifications—We'll be happy to select to your individual requirements.

For additional information on chips recommended for new equipment design or replacement service, plus a list of tested parameters and test conditions.

write for data

FET Applications Engineering (408) 246-8000, Ext. 120



Siliconix incorporated

2201 Laurelwood Road, Santa Clara, California 95054

INFORMATION RETRIEVAL NUMBER 29

The mother-in-law

There's an old story about an executive who justified many of his decisions on the basis of surveys he had conducted. He was always secretive about the nature of the surveys and, particularly, about the group he had surveyed. But after a long succession of decisions proved to be bad he was forced to reveal that he had been surveying the opinions of his mother-in-law.

The story of that sorry executive was no doubt father to the many tales of the ad man who advertised the products of all his clients in *Advertising Age* because everybody he knew read that paper. It never occurred to him that a paper that's widely read and respected by advertising people might not be the best vehicle for selling detergent to housewives, fertilizer to farmers and razors to barbers.

With the wisdom that distance gives, we can all laugh at the myopic ad man who thought his colleagues in advertising were the universe. But in our own profession, how many of us are really free of equivalent decisions? How many of us have never based decisions on mother-in-law surveys?

I know an engineer in the consumer-electronics field who always tries his prototypes on his wife. "If she likes it," he said, "the public will love it." Another fellow I know—a test-equipment designer—would bring home a prototype of a new instrument, explain its function to his teen age daughter, then see if she could figure out how to use it. And dozens of engineers check their more subjective design decisions with their secretaries, girl friends, bridge partners and quaffing buddies.

There are some questions, of course, that don't have absolute answers. But all opinions aren't equal. If you want some worth while opinions on the relative merits of Enrico Caruso and Jussi Bjorling, you should survey opera lovers. If you want views on John Gielgud and Ralph Richardson, ask theater goers. And if you want ideas on a magnificent Bordeaux and a fabled Burgundy, check some wine buffs.

Decisions on which readout looks best, which panel color is most pleasing or which knob has the best appearance and feel will always involve some difference of opinion. But let's at least recognize the limitations of our research.

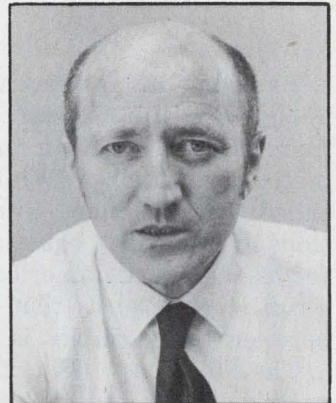

A handwritten signature in cursive script that reads "George Rostky".

GEORGE ROSTKY
Editor-in-Chief

Match impedances accurately and easily.

The Mac chart gives quick approximate values, and an equivalent computer program adds numerical accuracy.

By using an interactive computer program—along with a McAlister chart—you can achieve numerical accuracy in the design of impedance-matching networks. While the chart—familiarly called the Mac chart¹—provides easy approximations of network equations, the computer performs the exact numerical calculations. The program logic ensures that the proper relationship between the variables is maintained.

The Mac chart (Fig. 1a) provides a graphical representation of two-element series or parallel networks that have equal driving-point impedances (see box). The curves display the relationships between five quantities— R_p , R_s , X_p , X_s and Q . The location of any two variables on the chart yields values for the three others. Similarly the program (Fig. 1b) accepts any two quantities if they satisfy the same mathematical constraints, and it also calculates the three other quantities. No series-parallel calculations are necessary for

an approximate solution with the Mac chart. However, if greater accuracy is required, the program, which uses the defining equations of the chart, can perform the required transformations.

Consider, for example, the design of a π network that matches 500 Ω to 50 Ω with an overall Q of at least 10 (Fig. 2). Assume a Q of 10 and an R_p of 500 Ω . Enter the chart at A and find that $R_s = 5 \Omega$ and $X_s = 50 \Omega$. And from point A, find that $X_p = 50 \Omega$.

Now let's do the same step on the computer. Type NO to the two questions in Fig. 1b, then enter the same values for Q and R_p . Almost immediately you get the answer: $R_s = 4.950 \Omega$, $X_s = 49.505 \Omega$, and $X_p = 50 \Omega$. To match the 5- Ω series resistor, use a parallel-to-series transformation on the left half of the network. Enter the chart at point B ($R_s = 5 \Omega$, $R_p = 50 \Omega$) and find that $X_s = 15 \Omega$ and $X_p = 17 \Omega$. An answer of YES to the "parallel and series" mixture question shows that $X_s = 14.933 \Omega$ and furnishes values for X_p and Q of 16.574 Ω and 3.02, respectively.

John F. Storm, Senior Principal Development Engineer, Honeywell Inc., Government and Aeronautical Products Div., 1625 Zarthan Ave., St. Louis Park, Minn. 55416.

Transformation equations

A series combination of resistance and reactance can always be found that exhibits the same equivalent impedance as any given parallel combination of resistance and reactance.

The transformations give the relationship between the elements of the series and parallel networks (shown below) when the driving-point impedances are equal. The equations for the respective impedances are

$$Z_p = \frac{R_p \cdot (jX_p)}{R_p + jX_p},$$

$$Z_s = R_s + jX_s.$$

Equating the real and imaginary parts of both expressions for network equivalency yields

$$R_s = \frac{R_p X_p^2}{R_p^2 + X_p^2},$$

$$X_s = \frac{R_p^2 X_p}{R_p^2 + X_p^2}.$$

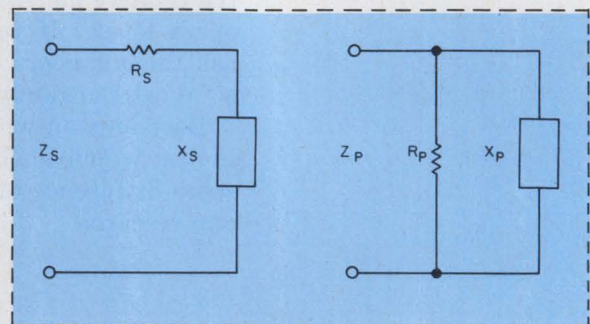

This simplifies to

$$R_p = R_s [1 + (R_p/X_p)^2],$$

$$X_p = X_s [1 + (X_p/R_p)^2].$$

It can also be shown that

$$\frac{R_p}{X_p} = \frac{X_s}{R_s} = Q.$$

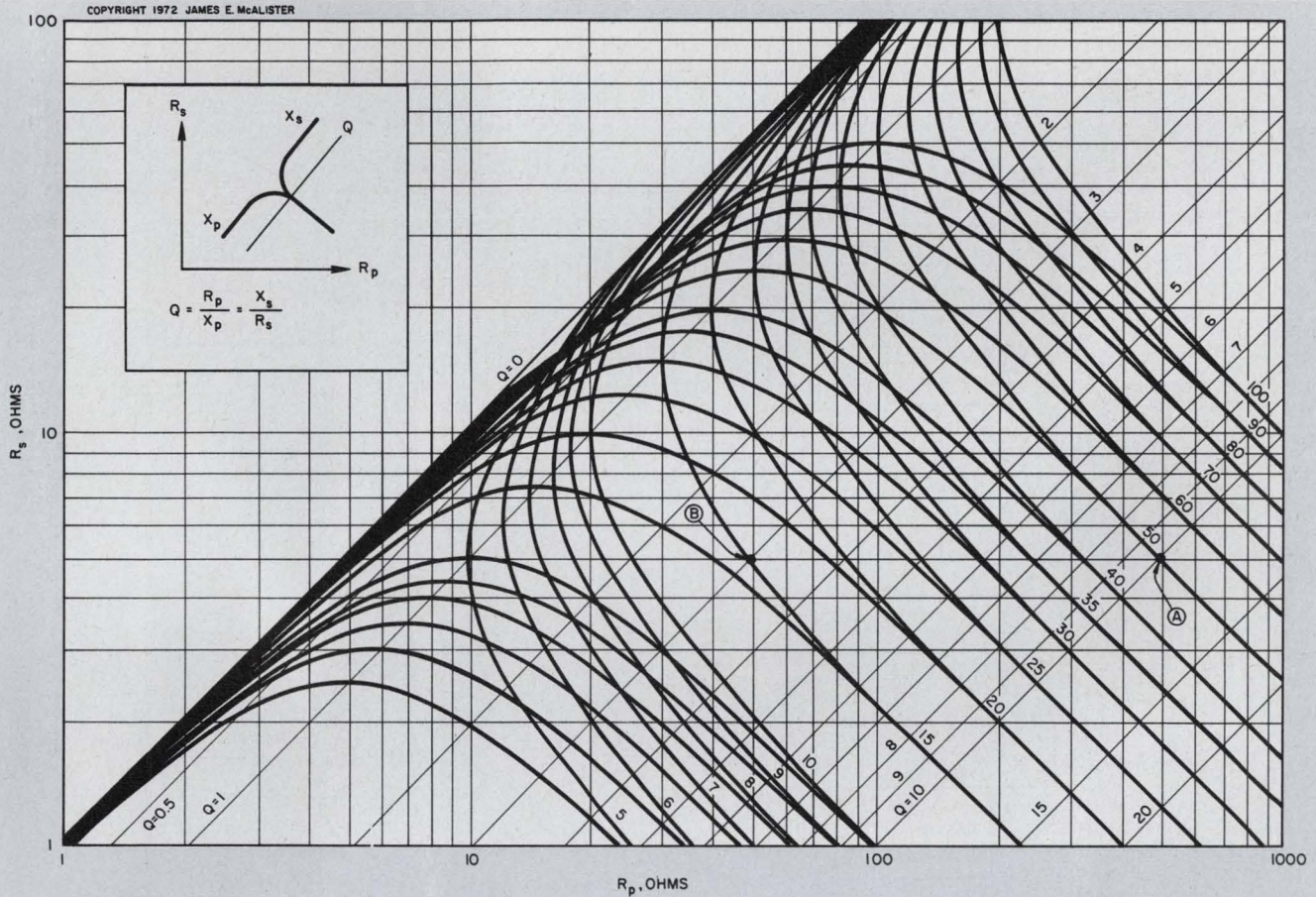

(a)

CHART POINT (A)

?LOAD (EASY 42) EASY 41

DØ YOU WISH SERIES - PARALLEL TRANSFORMATION ?! NØ

DØ YOU WISH TØ MIX PARALLEL & SERIES RESISTANCES ØR REACTANCES ?! NØ

ENTER Q,RP,XP ENTER 0.0 IF NØT KNØWN! 10.0,500.0,0.0

RS= 4.950 ØHMS XS= 49.505 ØHMS XP= 50.000 ØHMS
STOP, NORMAL

CHART POINT (B)

?RIN EASY 42

DØ YOU WISH SERIES - PARALLEL TRANSFORMATION ?! NØ

DØ YOU WISH TØ MIX PARALLEL & SERIES RESISTANCES ØR REACTANCES ?! YES

ENTER RP,PS,XP,XS ENTER 0.0 IF NOT KNOWN! 50.0,4.95,0.0,0.0,

XS= 14.933 OHMS XP= 16.574 OHMS Q= 3.02
STOP, NORMAL

(b)

1. Family of curves (a) represents the transformation equations that give equal driving-point impedance for two-element series or parallel networks. The chart can be entered with any two circuit quantities and the three

others can be determined. The computer program (b) provides exact values, instead of approximations, for the same input data. The program uses the defining equations of the chart.

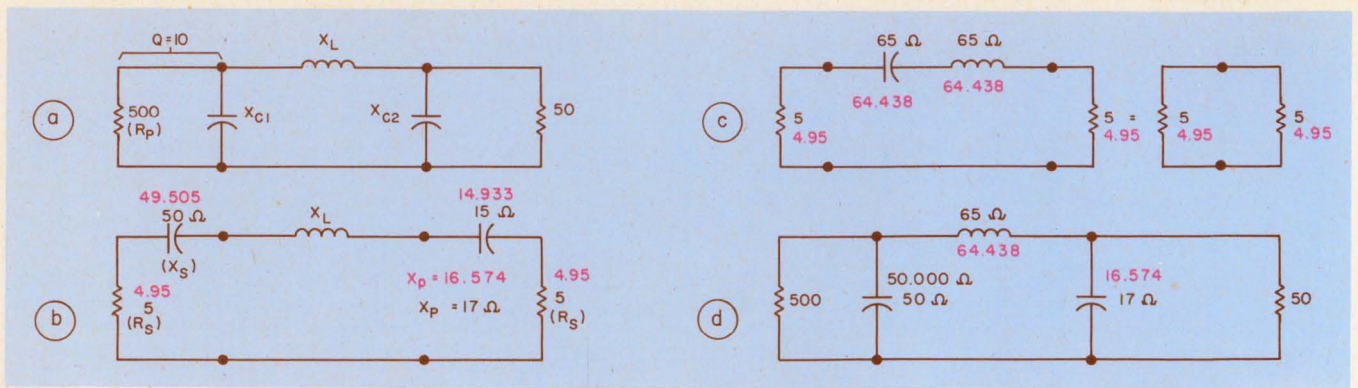

2. A π network problem (a) is solved with two parallel-to-series transformations (b,c). The value of inductance is chosen to cancel the capacitive reactance (c). Values

found from the chart are shown in black; computed values from the program are in color. Just two executions of the program solve this problem.

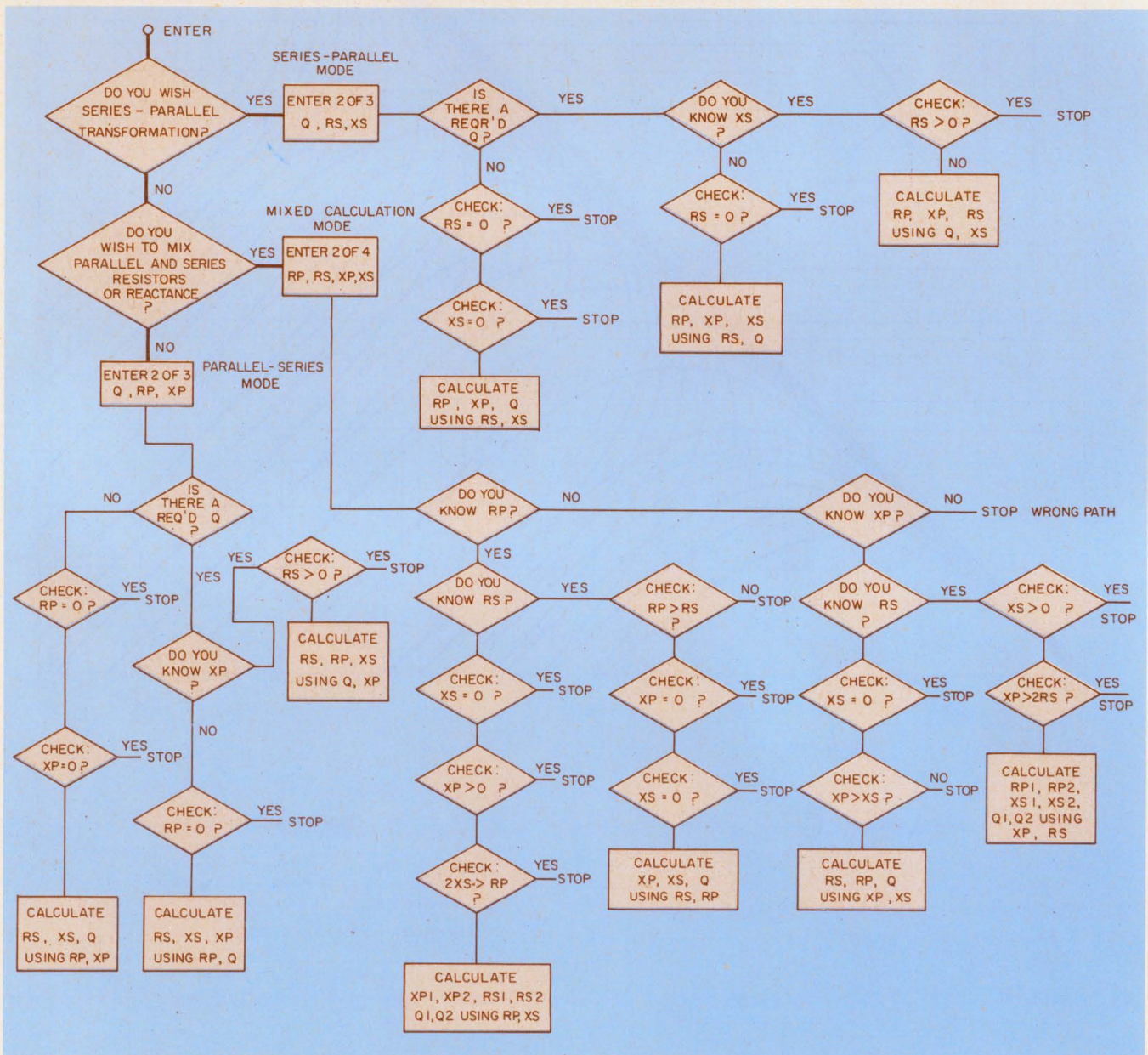

3. The program subdivides the calculations into three categories: series-parallel, mixed and parallel-series. The proper category is selected by typing YE or YES at the appropriate decision point. Extensive validity checks of

the input data are made before the actual calculations are performed. All calculations use two input variables, and an input of zero designates an unknown variable to the program.

Last of all, the choice of 64.438Ω for X_L cancels the equivalent reactance of the two capacitors and so completes the solution of the design problem.

The Fortran program offers the user three types of network calculation, series-parallel transformation, mixed calculation and parallel-series transformation. Either of the first two modes is selected by typing YE or YES when the corresponding two questions are printed out. The third mode occurs by default when anything but a YE or YES response is given twice. Once a particular mode is entered, the program performs a series of validity checks before the calculation is performed. An input of 0.0 informs

the program that the value of the corresponding variable is unknown. Also, the program prompts the user with statements that define which variables are to be inputted.

A number of built-in safeguards cause the program to halt. Too much information is unacceptable, and certain interrelations between variables must be maintained. For instance, R_s must be less than R_p . The Mac chart displays these requirements, which are also designed into the program as "STOP ABNORMAL" statements. ■■

Reference:

1. McAlister, James E., "The Easy Way to Match Impedances," *Electronic Design*, Mar. 1, 1973, pp. 76-78.

Time-shared Fortran program for series/parallel impedance transformations

FORTRAN FILE: EASY10/631 12/04/73 10:39 CT PAGE 1

```

101* JOHN F STORM EXT 5867 A1681
201* THIS PROGRAM PROVIDES SERIES - PARALLEL
301* OR PARALLEL - SERIES TRANSFORMATION
401 JA = 'YE'
501 WRITE (9,1)
601 1 FORMAT ('DO YOU WISH SERIES - PARALLEL TRANSFORMATION?')
701 READ (9,2) IAMS
801 2 FORMAT (A2)
901 IF (IAMS.EQ.JA) GO TO 100
1001*
1101* WRITE (9,19)
1201* 19 FORMAT ('DO YOU WISH TO MIX PARALLEL & SERIES/'
1301* '+RESISTANCES OR REACTANCES?')
1401* READ (9,20) IAMS
1501* 20 FORMAT (A2)
1601* IF (IAMS.EQ.JA) GO TO 200
1701*
1801* WRITE (9,3)
1901* 3 FORMAT ('ENTER Q,RP,XP ENTER 0.0 IF NOT KNOWN')
2001* READ (9,4) Q,RP,XP
2101* 4 FORMAT (3F10.3)
2201* IF (Q.GT.0.0) GO TO 18
2301* IF (RP.EQ.0.0) STOP RP MISSING
2401* IF (XP.EQ.0.0) STOP XP MISSING
2501* RS=(RP*(XP**2))/(RP**2+(XP**2))
2601* XS=(RP**2+XP)/(RP**2+(XP**2))
2701* Q=RP/XP
2801* WRITE (9,5) RS,XS,Q
2901* 5 FORMAT ('RS='F10.3,' DHMS',3X,'XS='F10.3,' DHMS',
3001* '+3X,'Q='F6.2)
3101* STOP NORMAL

3201* 18 IF (XP.GT.0.0) GO TO 7
3301* IF (RP.EQ.0.0) STOP RP MISSING
3401* XP=RP/Q
3501* RS=(RP*(XP**2))/(RP**2+(XP**2))
3601* XS=(RP**2+XP)/(RP**2+(XP**2))
3701* WRITE (9,6) RS,XS,XP
3801* 6 FORMAT ('RS='F10.3,' DHMS',3X,'XS='F10.3,' DHMS',
3901* '+4X,'XP='F10.3,' DHMS')
4001* STOP NORMAL

4101* 7 IF (RP.GT.0.0) STOP ABNORMAL
4201* RP=Q*XP
4301* RS=(RP*(XP**2))/(RP**2+(XP**2))
4401* XS=(RP**2+XP)/(RP**2+(XP**2))
4501* WRITE (9,8) RS,XS,RP
4601* 8 FORMAT ('RS='F10.3,' DHMS',3X,'XS='F10.3,' DHMS',
4701* '+4X,'RP='F10.3,' DHMS')
4801* STOP NORMAL

4901* 100 WRITE (9,9)
5001* 9 FORMAT ('ENTER Q,RS,XS ENTER 0.0 IF NOT KNOWN')
5101* READ (9,10) Q,RS,XS
5201* 10 FORMAT (3F10.3)
5301* IF (Q.GT.0.0) GO TO 12
5401* IF (RS.EQ.0.0) STOP RS MISSING
5501* IF (XS.EQ.0.0) STOP XS MISSING
5601* RP=(XS**2)+(RS**2)/RS
5701* XP=RP*RS/XS

```

FORTRAN FILE: EASY10/631 12/04/73 10:39 CT PAGE 2

```

5801* Q=XS/RS
5901* WRITE (9,11) RP,XP,Q
6001* 11 FORMAT ('RP='F10.3,' DHMS',3X,'XP='F10.3,' DHMS',
6101* '+3X,'Q='F6.2)
6201* STOP NORMAL

6301* 12 IF (XS.GT.0.0) GO TO 14
6401* IF (RS.EQ.0.0) STOP RS MISSING
6501* XS=Q*RS
6601* RP=(XS**2)+(RS**2)/RS
6701* XP=RP*RS/XS
6801* WRITE (9,13) RP,XP,XS
6901* 13 FORMAT ('RP='F10.3,' DHMS',3X,'XP='F10.3,' DHMS',
7001* '+4X,'XS='F10.3,' DHMS')
7101* STOP NORMAL

```

```

7201* 14 IF (RS.GT.0.0) STOP ABNORMAL
7301* RS=XS/Q
7401* RP=((XS**2)+(RS**2))/RS
7501* XP=RP*RS/XS
7601* WRITE (9,15) RP,XP,RS
7701* 15 FORMAT ('RP='F10.3,' DHMS',3X,'XP='F10.3,' DHMS',
7801* '+3X,'RS='F10.3,' DHMS')
7901* STOP NORMAL

8001* 200 WRITE (9,21)
8101* 21 FORMAT ('ENTER RP,RS,XP,XS ENTER 0.0 IF NOT KNOWN')
8201* READ (9,22) RP,RS,XP,XS
8301* 22 FORMAT (4F10.3)
8401* IF (RP.GT.0.0) GO TO 23
8501* GO TO 29

8601* 23 IF (RS.GT.0.0) GO TO 24
8701* IF (XS.EQ.0.0) STOP XS MISSING
8801* IF (XP.GT.0.0) STOP ABNORMAL
8901* IF (RP=-2.0*XS) 17:27:27

9001* 24 IF (RS-RP) 25:17:17

9101* 25 IF (XP.GT.0.0) STOP ABNORMAL
9201* IF (XS.GT.0.0) STOP ABNORMAL
9301* XS = SQRT (RP*RS-RS**2)
9401* XP = SQRT (RS*(RP**2)-(RP-RS)
9501* Q = RP/XP
9601* WRITE (9,26) XS,XP,Q
9701* 26 FORMAT ('XS='F10.3,' DHMS',3X,'XP='F10.3,' DHMS',
9801* '+3X,'Q='F6.2)
9901* STOP NORMAL

10001* 27 RS1=RP/2.0+SQRT(RP**2-4.0*(XS**2))/2.0
10101* RS2=RP/2.0-SQRT(RP**2-4.0*(XS**2))/2.0
10201* XP1=((XS**2)+(RS1**2))/XS
10301* XP2=((XS**2)+(RS2**2))/XS
10401* Q1=XS/RS1
10501* Q2=XS/RS2
10601* WRITE (9,28) RS1,XP1,Q1,RS2,XP2,Q2
10701* 28 FORMAT ('RS1='F10.3,' DHMS',3X,'XP1='F10.3,' DHMS',
10801* '+3X,'Q1='F6.3,' RS2='F10.3,' DHMS',3X,'XP2='F10.3,' DHMS',
10901* '+3X,'Q2='F6.2)
11001* STOP NORMAL

```

FORTRAN FILE: EASY10/631 12/04/73 10:39 CT PAGE 3

```

11101* 29 IF (XP.EQ.0.0) STOP WRONG PATH
11201* IF (RS.GT.0.0) GO TO 30
11301* IF (XS.EQ.0.0) STOP XS MISSING
11401* IF (XP-XS) 17:17:33

11501* 33 RS=SQRT(XP*XS-XS**2)
11601* RP=SQRT((XS*(XP**2))/(XP-XS))
11701* Q=RP/XP
11801* WRITE (9,34) RS,RP,Q
11901* 34 FORMAT ('RS='F10.3,' DHMS',3X,'RP='F10.3,' DHMS',
12001* '+3X,'Q='F6.2)
12101* STOP NORMAL

12201* 30 IF (XS.GT.0.0) STOP ABNORMAL
12301* IF (XP-2*RS) 17:31:31

12401* 31 RP1=((XP**2)/2.0)+(1.0+SQRT(1.0-4.0*(RS**2)/(XP**2)))
12501* RP2=((XP**2)/2.0)+(1.0-SQRT(1.0-4.0*(RS**2)/(XP**2)))
12601* XS1=((RP1**2)*XP)/(RP1**2+(XP**2))
12701* XS2=((RP2**2)*XP)/(RP2**2+(XP**2))
12801* Q1=XS1/RS
12901* Q2=XS2/RS
13001* WRITE (9,32) RP1,XS1,Q1,RP2,XS2,Q2
13101* 32 FORMAT ('RP1='F10.3,' DHMS',3X,'XS1='F10.3,' DHMS',
13201* '+3X,'Q1='F6.2,' RP2='F10.3,' DHMS',3X,'XS2='F10.3,' DHMS',
13301* '+3X,'Q2='F6.2)
13401* 16 STOP NORMAL

13501* 17 STOP ABNORMAL

13601* END

```

Try condition/action diagrams to lighten your design load. They can help you untangle complex interactions between system parameters.

You're designing a complicated system, and you want to see how the various parts of the system interact. Don't start by trying to draw a detailed and confusing schematic. Instead, draw a condition/action diagram—also called a C/A diagram—and you've got the picture clearly, simply and rapidly. These diagrams are similar to—but more general than—the familiar flow chart used in computer programming.

Though the C/A's forte is its ability to portray the interactions of a large number of variables, it offers other advantages as well.

For one, C/A diagrams use standard English, so that you don't have to wade through detailed schematics or diagrams that overflow with unfamiliar jargon. For another, a C/A can often pinpoint troubles in a system. Perhaps more significantly, a C/A is useful when you try out new ideas, since it can accurately predict the consequences of making a change.

Furthermore, C/A diagrams find application not just in design but in the generation and portrayal of organizational procedures as well.

The diagrams have been used successfully to design digital voltmeters and MOS/LSI testers. And the diagrams have also helped in working out procedures in such areas as order handling, shipping, quality control, people-machine interfacing, and scheduling of R&D programs. Let's see how C/As are constructed.

Conditions lead to actions

The operation of many systems—for example, digital computers—can be described in terms of two classes of parameters: conditions and actions. In these systems, conditions cause certain actions, which, in turn, bring about new conditions.

In C/A diagrams, condition statements are enclosed in rectangles, action statements are enclosed in circles, and lines are used to intercon-

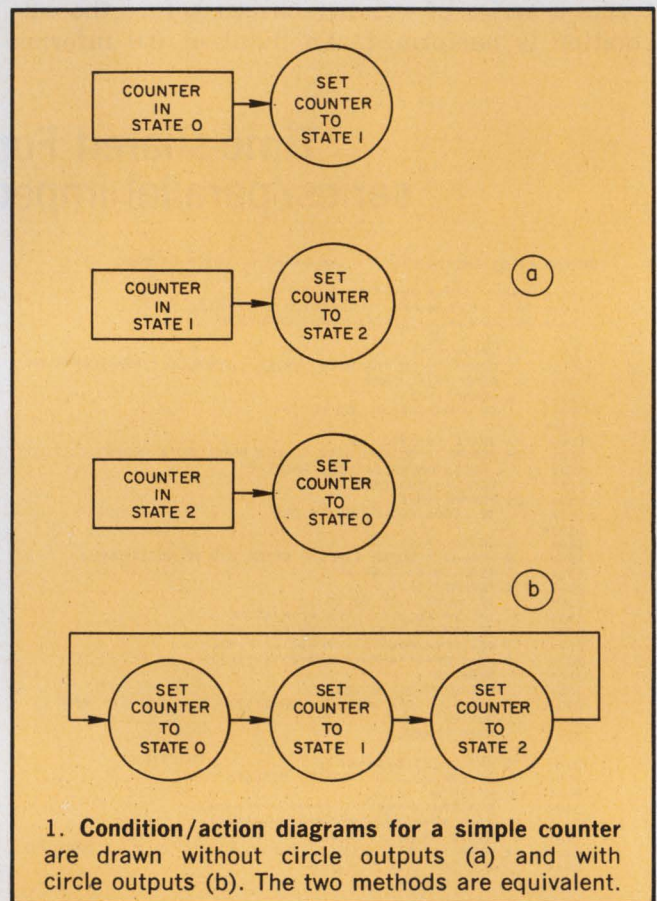

nect the two. Each line has one arrowhead; an arrowhead that bears against a rectangle or a circle denotes an input, while the end of a line opposite from the arrowhead denotes an output.

A rectangle may have no input at all, but is limited to no more than one input and one output. A circle, on the other hand, can have as many inputs as desired.

Rectangles connected in cascade denote the AND function, whereas rectangles connected in parallel denote the OR function. Multiple inputs to a circle also denote the OR, and any one of the inputs can cause the indicated action. Some elementary C/A diagrams, together with their meanings, are shown in the table.

Outputs from circles are not essential in C/As. Any set of conditions and actions can be dia-

Richard W. Hofheimer, Project Manager, Non-Linear Systems, Inc., P.O. Box N, Del Mar, Calif. 92014.

Table. Elementary condition/action diagrams and their meanings

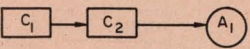
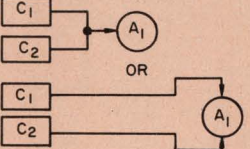
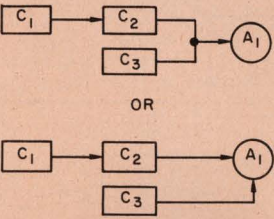
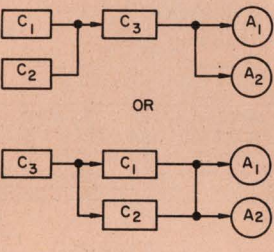
	<p>IF CONDITIONS C_1 AND C_2 EXIST SIMULTANEOUSLY, PERFORM ACTION A_1.</p>
	<p>IF CONDITION C_1 OR C_2 EXISTS, PERFORM ACTION A_1.</p>
	<p>IF CONDITIONS C_1 AND C_2 EXIST SIMULTANEOUSLY, OR IF CONDITION C_3 EXISTS, PERFORM ACTION A_1.</p>
	<p>IF CONDITION C_1 OR C_2 EXISTS SIMULTANEOUSLY WITH CONDITION C_3, PERFORM ACTIONS A_1 AND A_2.</p>

grammed without them. However, defined in a special way, outputs from circles can save space, while clarifying the path to be followed in a sequence of events.

A circle can have no more than one output. And when an output is present, the output is treated as though it were attached to a condition rectangle. In this case, however, the condition is that which results from the action indicated in the circle. A simple example should clarify this concept:

Fig. 1a shows a C/A for a simple counter, in which outputs from circles are not used. Another C/A—for the same counter—does use outputs from circles (Fig. 1b), but is equivalent to the C/A of Fig. 1a.

These are all the rules needed to construct and

interpret condition/action diagrams. To show how the rules are used in a practical application, let's look at a C/A for a digital voltmeter (Fig. 2).

C/A for DVM demonstrates technique

In this DVM, measurement is started in one of three ways, as determined by the setting of a front panel control:

If the control is set to INTERNAL, measurement starts internally. As soon as the measurement is complete, a new one starts. If the control is set to EXTERNAL, the user starts a measurement by supplying an external command signal. If the control is set to STANDBY, no measurement takes place. Finally, if the control is moved from STANDBY to SINGLE and back to STANDBY, a single measurement is made.

Other controls either let the user determine range and polarity or set the voltmeter to automatically make these determinations. In the latter case, the meter takes one reading upon receipt of a start signal. This reading is automatically compared with built-in criteria, and any needed change in range or polarity is made. Additional readings are taken and the process repeated until the range and polarity are correct.

Refer now to the C/A diagram (Fig. 2). The numbers in the small circles correspond to the states of a five-state program counter, which controls the sequence of events in the voltmeter.

All counters, flip-flops and delays are triggered by clock pulses, which are not shown on the diagram. However, clock pulses may be thought of as additional condition rectangles in series with each action-circle input.

Program states 1 through 4 are used when the voltmeter is started internally. On EXTERNAL or SINGLE, all five states of the program counter are used, where state 5 is the "home," or start, position of the counter. Let's begin at state 5 and use the C/A to run through all the meter sequences.

The conditions involved in the state-5-to-state-1 transition concern the ways in which a measurement is started. When the mode switch is set

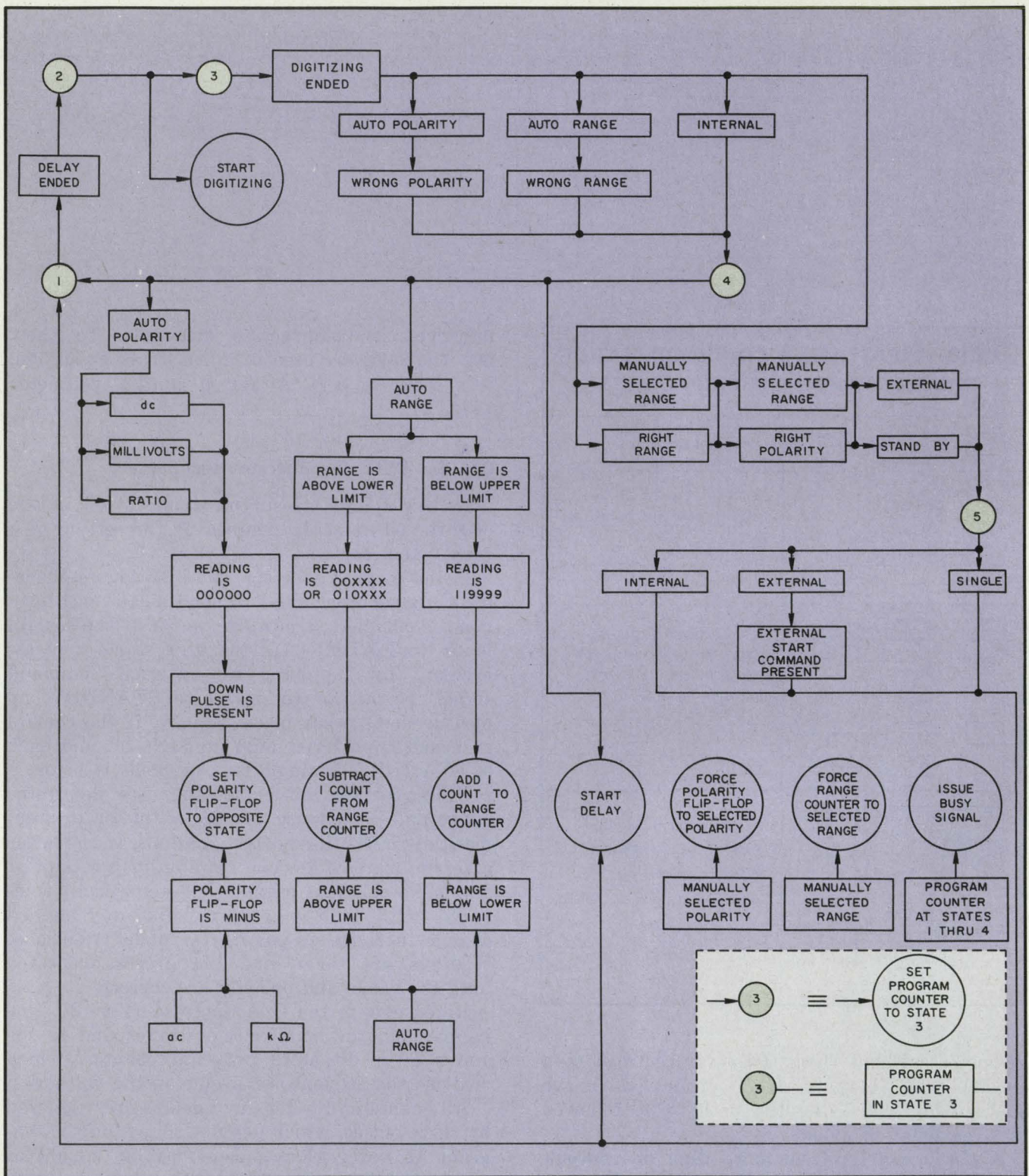

2. Digital voltmeter C/A diagram portrays the instrument's operation and the various internal interactions

in an effective and simple way. The figure in the corner illustrates equivalent diagram blocks.

to INTERNAL or SINGLE, the program counter immediately progresses to state 1. However, when the mode switch is set to EXTERNAL, an additional condition is required before the program counter can progress to state 1. This condition is the presence of the external start command.

Notice that in addition to the path from state

5 to state 1, there is also a path through the same conditions to an action circle entitled "start delay." This means that a delay will begin every time the transition from state 5 to 1 occurs. The purpose of the delay is to allow time for the signal-conditioning input buffer to settle. The transition from state 1 to state 2 occurs when

the delay has ended.

The action circle in the lower right-hand corner of the diagram shows that a busy signal is issued whenever the program counter is in states 1 through 4. The busy signal indicates that a measurement is in progress but is not yet complete. As long as the busy signal is present, the DVM output should not be used to operate a recorder.

Since there are no conditions interposed between states 2 and 3, the program counter will progress immediately from 2 to 3. The same clock pulse that sets the counter to state 3 also starts the digitizing process.

When the program counter reaches state 3, a fork-in-the-road situation exists. Under some conditions, the counter is set to state 4. Under other conditions, it is set to state 5.

There are three paths through which the transition from state 3 to 4 can occur. All three include the condition "digitizing ended." If the polarity-selection switch is set to AUTO POLARITY, and if the polarity displayed in the readout is incorrect, the program counter will then be set to state 4.

If the range-selection switch is set to AUTO RANGE, and if the range displayed in the readout is incorrect, the program counter will again be set to state 4. Finally, if the mode switch is set to INTERNAL, the program counter will be set to state 4.

Any change required in range or polarity is normally accomplished during the state-4-to-state-1 transition. To allow the input buffer to settle, the delay also begins.

Notice that below the action circles associated with range and polarity changes are conditions that are not tied to the program counter. These make it possible to change range whenever the range limits for the function being measured are exceeded. When the function is either kΩ or ac, the polarity flip-flop is set to plus.

If the mode switch is set to INTERNAL, the program counter continues to traverse the loop consisting of states 1 through 4. If the mode switch is not set to INTERNAL, the counter traverses 1 through 4 until a condition path exists between states 3 and 5. This path must consist of all of the following conditions:

- Digitizing ended.
- Range counter set to the correct range, or range-selection control set to MANUAL.
- Polarity flip-flop set to the correct polarity or the polarity-selection control set to MANUAL.
- Mode switch set to EXTERNAL or STANDBY.

With the return of the program counter to state 5, the busy signal disappears, thus indicating that the measurement is complete and that the results are suitable for printout. ■■

Congratulations!

You are paying 1/3 more for your wirewrap boards...

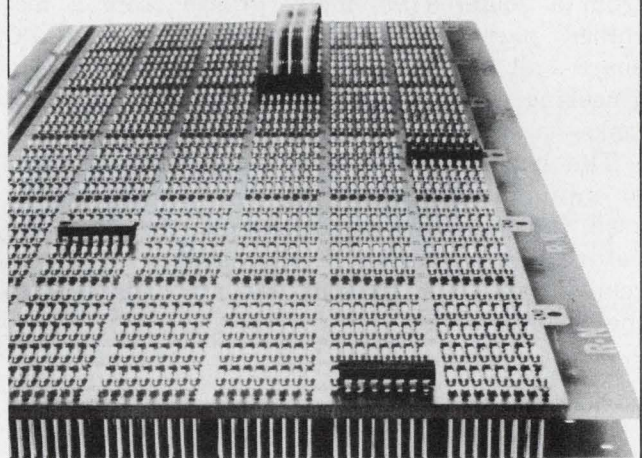

than you should

If high cost is your measure of quality, you're paying more and getting less. Inexpensive isn't always cheap. Take RN's A-OK boards. Advanced design and engineering let us make boards more simply. And, about 1/3 less expensive than the competition. And, still offer more advantages: super-low .025" above-board profile - one-piece contact/terminal reliability - high retention of IC leads, even those just .035" long - easier (even "O") device insertion between angled lead-in arms - replaceable contact/terminals - extra heat dissipation - unobstructed visual inspection - a complete array of packaging hardware. A-OK is the most sophisticated wirewrap system available. But, all the sophistication is in the design, not the cost. RN's reputation for quality is unsurpassed. Now, we've added economy, too. It makes good sense. Think it over, then connect with...



ROBINSON NUGENT INC.
800 EAST EIGHTH STREET
NEW ALBANY, INDIANA 47150
(812) 945-0211/TWX 810-540-4082

INFORMATION RETRIEVAL NUMBER 30

Choose cleaning solvents carefully.

Engineers often use or specify chemical solvents for cleaning electronic equipment. But not all are mindful of the hazards.

Removing dirt from a switch contact, flux from a soldered assembly, grease from a machined part or etching residues from a PC board—all are common enough in electronic engineering. All are also potentially hazardous tasks—a fact that engineers often forget.

The hazard varies from comparatively great to minimal, depending on the cleaning agent used. It's important to understand, therefore, the nature and properties of the common agents to remove personnel hazards and avoid damage to the cleaned parts.

First check the contamination

There are two general types of contamination: ionic (or chemically polar) and nonionic (or nonpolar). Each requires different cleaning solvents. Examples of ionic contaminants include residues of plating salts, perspiration and skin salts from handling of parts and from acid-flux residues. Common nonionic contaminants include dirty grease and oil, and rosin soldering flux (Table 1). Some often overlooked sources of nonionic contamination are hair sprays and makeup, and hand lotions used by electronic assemblers and wiremen.

Ionic contaminants, such as fingerprints that contain perspiration salts, can cause corrosion when combined with moisture. Such ionic solutions destroy metals, especially the more reactive ones like aluminum, and they may produce electrical shorts and elusive leakage paths.

Though nonionic contaminants like oil, grease and wax can cause problems by themselves, far worse is their flypaper-like attraction for lint, dirt and ionic contaminants. Combined with moisture, such trapped particles produce a nasty corrosive mixture and tricky electrical leakage paths.

The two types of contamination usually require a two-step cleaning process for thorough removal. Solvents for one type of contamination



are generally not effective on the other. Further, the sequence of cleaning is important.

Clean the nonionic before ionic

The nonionic cleaning step should be done first. Sticky nonionic contamination that traps ionic dirt can act as a barrier to an ionic cleaning agent. For instance, water, an ionic cleaning agent, can't penetrate a layer of grease. Application of an organic solvent to remove greasy contaminants should be followed by a water-detergent, or other ionic, cleaning step.

Thus in cleaning a PC board after soldering

Jeremy Agnew, Senior Engineer, Vicon Instrument Co., Colorado Springs, Colo. 80901.

with an activated rosin flux, first clean off the rosin residues with an organic solvent, such as isopropanol. Then remove the remaining flux and any ionic residues with deionized water.

Single-step cleaning is possible with azeotropes, or blends and emulsions of ionic and non-ionic solvents. Blends of trichlorotrifluoroethane and isopropanol or emulsions of trichlorotrifluoroethane and a water-detergent are sometimes used.

What solvents are best? It depends on both the contaminants present and the materials that the assembly is made of (Tables 2 and 3). But take care. Test all cleaning agents for compatibility with the object being cleaned. Many plastics warp, swell, crack or dissolve in some solvents.

Of the organic solvents, the ketones and chlorinated hydrocarbons are popular. They are very effective and fast, but don't use them on the materials they can damage (see Table 2).

The simplest ionic solvent is water. But even water can damage some components and materials. One of the alcohols, such as ethanol or isopropanol, is often an effective substitute. But alcohols have a limited ability to remove ionic contaminants.

Other ionic cleaning solvents include acid and alkaline solutions and detergents in water. An acid or an alkaline bath is often used to remove stubborn residues of plating or etching salts.

Solvents must be pure

Ionic or nonionic, the solvent should be pure. Technical or industrial grades of some organic solvents can deposit more impurities than they clean off. And ordinary tap water can contain many impurities. They can range from dead bacteria to the chlorine disinfectants that killed them. Also, dissolved salts in hard water can contaminate instead of clean. Thus distilled or deionized water is generally recommended. Of course, the needed solvent grade, or quality, depends on the degree of cleaning required.

Particulate contamination is sometimes a prob-

Table 1. Typical contaminants

Ionic	Nonionic
plating salts	oil
etching salts	grease
perspiration salts	wax
fingerprints	gum
acid flux	rosin flux
	hair oil
	makeup
	hand lotion

Table 2. Effects of organic solvents on plastics

Solvents	Recommended for**	Not recommended for*
Alcohols	most plastics	—
Chlorinated Hydrocarbons	nylon polyethylene polypropylene fluoroplastics	polystyrene polycarbonate PVC ABS vinyl acrylic neoprene silicone } elastomers
Ketones	nylon polyethylene polypropylene fluoroplastics	polystyrene polycarbonate PVC ABS vinyl acrylic urethane
Fluorocarbons	most plastics	elastomers

*Can crack, craze, swell or dissolve these materials

**Recommend compatibility tests on actual materials to be cleaned

Table 3. Properties of common cleaning solvents

Solvent	Dissolves	Applications	Combustibility	Toxicity
Acetone Ketone group TLV = 1000 ppm	oils greases	ultrasonics general wash	highly flammable, explosive	low; irritating to eyes and respiratory tract.
Benzene (Benzol, coal-tar naphtha) Aromatic hydrocarbon group TLV = 1000 ppm	oils greases	ultrasonics general wash	flammable, very explosive	high; small quantities dangerous; cumulative.
Carbon Tetrachloride Chlorinated hydrocarbon group TLV = 10 ppm	oils greases	general wash	nonflammable	extreme; not recommended for cleaning; absorbed through unbroken skin.
Ethyl Alcohol (Ethanol) Alcohol group TLV = 1000 ppm	oils greases limited ionic	ultrasonics general wash	flammable	will irritate respiratory tract and cause headaches.
Isopropyl Alcohol (Isopropanol, 2-propanol) Alcohol group TLV = 400 ppm	oils greases limited ionic	drying agent ultrasonics general wash	highly flammable	low; irritating to eyes and respiratory tract.
Methylene Chloride (Dichloromethane) Chlorinated hydrocarbon group TLV = 500 ppm	oils grease solder-flux	general wash	nonflammable	high; damages internal organs.
Perchloroethelene Chlorinated hydrocarbon group TLV = 100 ppm	oils greases	general wash vapor degreasing (needs acid inhibitors)	nonflammable	low; avoid fumes.
Toluene (Toluol) Aromatic hydrocarbon group TLV = 200 ppm	oils greases	general wash	highly flammable	moderate; absorbed through unbroken skin; cumulative.
1, 1, 1-Trichloroethane (Methyl chloroform) Chlorinated hydrocarbon group TLV = 350 ppm	oils greases	ultrasonics general wash (needs acid inhibitors)	nonflammable	low; avoid skin contact and fumes.
Trichloroethylene Chlorinated hydrocarbon group TLV = 100 ppm	Excellent for oils greases works fast	ultrasonics general wash vapor degreasing (needs acid inhibitors)	nonflammable	moderate; absorbed through unbroken skin; causes dermatitis and kidney damage with cumulative exposure.
Trichlorotrifluoroethane (Freon) Fluorinated hydrocarbon group TLV = 1000 ppm	Moderate solvent for oil grease	general wash vapor degreasing particulate removal ultrasonics drying agent	nonflammable	low; can cause dermatitis; use good ventilation to prevent suffocation.
Xylene Aromatic hydrocarbon group TLV = 200 ppm	oils greases	general wash	highly flammable, explosive	high; absorbed through unbroken skin.

Note: TLV = threshold limit value, or the maximum safe concentration for human exposure. The values are periodically revised. The largest is 1000 ppm. Check manufacturer for latest data.

lem. Examples include metal filings, paper fibers, sand, lint, ash and dust. These particles are often held by grease or solder-flux residues in motor bearings, rotary switches, chassis slides and many other hard-to-reach places. An organic solvent, such as trichloroethylene or isopropanol, can dissolve the organic trapping agent and flush away the particles.

And to assist in the mechanical removal of the particles, ultrasonic cleaning or jet-spray washing can be helpful. The cavitation action of ultrasonic agitation is particularly effective in removing particles. However, not all components can withstand ultrasonic action without damage. Transistor and diode internal connections are often broken, and hermetic seals can be damaged.

The question is: How harmful?

In addition to damaging parts and materials, organic solvents can seriously hurt you. All are harmful to some degree, and some are very toxic. Most are highly flammable, and the vapors can form dangerously explosive mixtures with air. Care in working with all is advised.

All solvent work should be done under a fume hood or at least in a highly ventilated area. Avoid all skin contact and the breathing of fumes. Wear solvent-resistant gloves. Solvents in contact with the skin remove natural oils and fats, which at best can lead to skin irritation. At worst, some solvents are absorbed directly into the body, even through unbroken skin. However, the most common way of absorbing a toxic solvent is by breathing in the vapors. Many vapors attack the internal organs such as the kidneys, liver, lungs and the nervous system.

Wear safety goggles or a face shield to protect the face, especially the eyes. Many solvents are absorbed very rapidly, if splashed into the eyes.

Even if not toxic, solvent fumes can still be dangerous. Trichlorotrifluoroethane vapor, though not considered toxic, can displace enough room air to cause suffocation.

When heated, some solvents are especially dangerous. Chlorinated and fluorinated hydrocarbon fumes decompose into hydrochloric acid and phosgene. Both are highly toxic and corrosive to the eyes, throat and lungs.

One final note: With all chemicals, consult the manufacturer for full information, read the labels and instructions, and follow them. ■■

Bibliography

1. E. I. du Pont de Nemours & Co.: *Solvent Properties Comparison Chart*, Bulletin FS-6, 1966.
2. MC/B Manufacturing Chemists: *Safety in Handling Hazardous Chemicals*, 1971.
3. N. Irving Sax: *Handbook of Dangerous Materials*, Reinhold Publishing Corp., New York, 1951.
4. Sandia Laboratories: *Contamination Control Handbook*, NASA SP-5076, 1969.



Licon takes the "butterflies" out of holding patterns.

By putting its double-break, double reliable Butterfly® switches to work in today's modern aircraft.

Waiting to touch down. Critical moments for a jet flying a tight holding pattern in heavy air traffic. No room for ordinary switching performance. Which is why Licon® patented double-break Butterfly switches are on board so many jetliners today. Performing with beautiful precision.

Even if you're not designing jumbo jets, you can be sure of the same quality and dependability throughout the entire Licon switch line. Basic Switches, Lighted Pushbutton Switches, Keyboards. Shorten your design time—put Licon's engineering know-how to work for you. Your Licon representative or distributor has a switch solution for you.

 **LICON**

Division Illinois Tool Works Inc.
6615 W. Irving Park Road
Chicago, Illinois 60634
Phone (312) 282-4040
TWX 910-221-0275

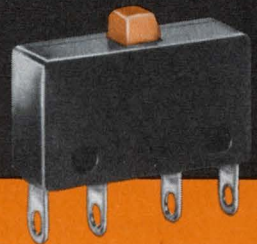

LICON

puts ideas to work
in electronics

The Innovative Electronic Group of ITW...
LICON ■ ELECTRO MATERIALS ■ PAKTRON

© ILLINOIS TOOL WORKS INC. 1974

Prevent damaging overloads to dc-to-dc converters. Reflected noise, thermal changes and transients can strain capacitors. Don't exceed component ratings.

To extend the operating life of dc-to-dc converters, avoid overstressing the capacitor at the input of the pi filter that is usually found in these converters.

Converters, used to provide dc power isolation, have an ac ripple that is reflected back into the input. A pi input filter, using solid-tantalum electrolytic capacitors, is included within most converters and helps to reduce the input ripple. But stress on the input filter can cause premature failure of the converter. By understanding how the ratings are determined, you can extend the converter's operating life.

Tantalum capacitors are used because of their small size, wide temperature range and superior high-frequency characteristics. The reactance of a solid tantalum capacitor can generally be characterized by three ideal components in series: a capacitor, representing the capacitive reactance of the device; a resistor, representing the resistive loss term (called the equivalent-series resistance); and an inductor, representing the inductive reactance of the lead wires (Fig. 1).

If we assume that inductive component is negligible at the operating frequency, the current that will flow through the capacitor, if an ac voltage (E_s) is impressed across it, will be determined by the following:

- The frequency of the voltage (ω_s).
- The capacitance (C').
- The equivalent series resistance (ESR).

Calculate the filter dissipation

The magnitude of the current can then be calculated by

$$|I_s| = \frac{|E_s|}{\sqrt{R^2 + X_c^2}}, \text{ where } X_c = \frac{1}{\omega_s C'} \quad (1)$$

Since the capacitor has an internal resistance, R , the current, I_s , will produce a power dissipation of $P = I_s^2 R$.

In the terms of Eq. 1, this would be

$$P = \frac{|E_s|^2}{R^2 + X_c^2} \cdot R = \frac{|E_s|^2}{R + X_c^2/R} \quad (2)$$

If we know the ac voltage across the capacitor

terminals, the frequency of that voltage and the equivalent series resistance (R) of the capacitor, we can easily determine the resulting power dissipated in the capacitor. This power will heat the capacitor internally.

The added heat may cause excessive internal temperatures and result in premature failure of the capacitor. Most capacitor manufacturers specify a maximum power dissipation for a particular capacitor, with appropriate derating factors if the unit is to be operated at elevated ambient temperatures. A typical unit of the size and style that would commonly be employed for the input filter of dc-to-dc converters might have a power rating of 0.1 W at 25 C—which derates to 0.09 W at 85 C.¹

When the dc-to-dc converter is used in an environment where excessive ac voltage is impressed upon the input, failures of the input-filter capacitor can result—especially if the dissipation levels are exceeded. A typical capacitor value might be 15 μ F at 25 V dc. At 25 C, a dc-to-dc converter could have those voltage-frequency combinations listed in the table as a maximum to avoid premature failure. You derive the numbers from Eq. 2, when $P = 0.1$ W, and solve for E_s .

You can see from the table that even a comparatively poor capacitor has a high value of ESR. Thus it would tend to be less reliable than a unit of lower ESR, because the power dissipation ($I_s^2 R$) would be higher. This assumes, of course, that the magnitude of the current, I_s , is determined by either the capacitive reactance or some other circuit component.

Start to analyze the application

Thus any system design for dc-to-dc converters should include an investigation of the dc input voltage to be applied. All equipment that would normally be powered from the same voltage source should be energized, and a wideband rms voltmeter (such as the HP 3400A) should be used to measure the magnitude of the ac voltage at the point where the converter is connected.

If an accurate measurement cannot be made

Jim Green, Product Engineer, Stevens-Arnold, 7 Elkins St., South Boston, Mass. 02127.

because of reflected noise voltage generated by the converter, then dc isolate the converter input with a large value, low-impedance, capacitor. Now the converter itself is not operating, but it still shows the same ac impedance to the dc power line. Some error is introduced by doing this, but this is best accommodated by being overly conservative when interpreting the results (Fig. 2).

A measurement of 50-mV rms or less would be

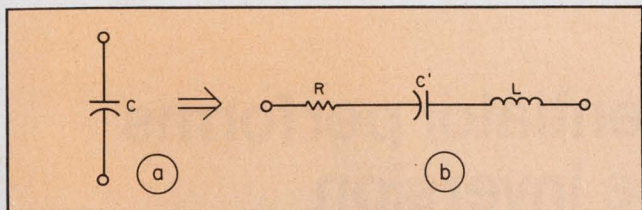

1. The practical capacitor (a) can be represented by a series R, L, C' circuit (b), where R is the equivalent series resistance, L is the inductance of the leads and C' is the actual capacitance.

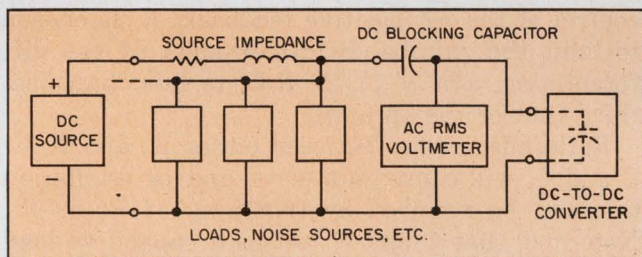

2. The ac rms voltage at the converter's input can be measured if a dc blocking capacitor is added.

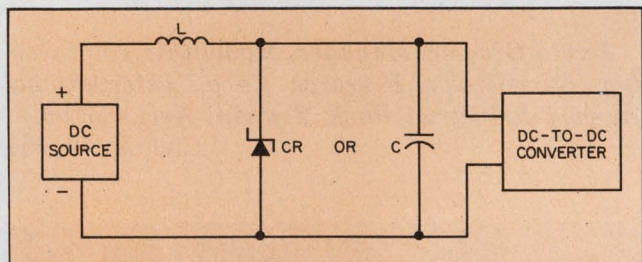

3. To prevent overloads from reaching the converter when the load is removed, a zener diode or large electrolytic capacitor can be placed in shunt across the input of the converter.

Table: Component parameters vs increasing frequency²

Frequency	Xc (Ω)	ESR (Ω)	E _s (max) V rms
120 Hz	90	1.5	27
1 kHz	11	1	3.5
10 kHz	1.1	0.6	0.52
100 kHz	0.11	0.4	0.21
1 MHz	negligible	0.25	0.16

completely safe; if it is greater than 50 mV rms, investigate to determine if the voltage is predominantly at a single frequency or spread across the frequency spectrum. If the signal is less than 1 kHz, a voltage level of 0.5-V rms would seem very safe. Remember, of course, not to let the peak value fall outside the limits for the input voltage specified by the dc-to-dc converter manufacturer.

If the signal amplitude and frequency are considered unsafe for the converter, insert a current limiting impedance in series with the input. Simply use a series choke to provide sufficient reactance to limit the possible current to less than 50 mA at the frequency of the observed voltage. The value of inductance can be calculated from

$$L = \frac{E_s \times 10^3}{\omega_s \times 50} \quad (3)$$

Other critical factors for this choke include these:

- Dc current rating.
- Voltage drop due to the dc current through the choke resistance.
- Resonant frequency.

Also a clamping zener diode should be connected in shunt after the choke—at the input to the dc-to-dc converter—to absorb the released energy from the choke should the converter load be removed suddenly. Alternatively, a shunt aluminum electrolytic capacitor can be used. Its energy-storage capability should be at least 10 times greater than the choke, and its capacitance can be calculated from the following equation: $(1/2) (C) (V_{DC})^2 \geq 10 \times (1/2) (L) (I_{DC})^2$, where V_{DC} = input voltage and I_{DC} = maximum input current to the converter (Fig. 3).

Remember that most dc voltage sources—including batteries—have output impedances that increase rapidly with increasing frequency. With any load that draws ac power, pulsed or transient currents can create a noise source—sometimes of surprisingly low impedance—close to the input of the converter.

MIL Handbook 217A on "Reliability Stress and Failure/Rate Data for Electronic Equipment" recognizes this characteristic of solid tantalum capacitors. The handbook suggests that you multiply the failure rate by a factor of 0.07, when a circuit impedance of 3 Ω/V or greater is inserted (vs a reference multiplier of 1 for a circuit impedance of 0.1 Ω/V). This means that the mean time between failure of a dc-to-dc converter can be seriously degraded by just a few tenths of a volt of low-impedance ripple on the input. ■■

References

1. "Applications Information," KEMET (Union-Carbide), type KGF solid tantalum capacitors, pp. 6-10.
2. Interpolated from the ESR-vs-frequency charts in Reference 1.

Bootstrapped RC differentiator performs accurately without phase inversion

An op amp differentiator can be built without the phase inversion of the usual circuit. As shown, the noninverting differentiator uses a simple RC high-pass circuit that is bootstrapped and buffered by an op amp.

By itself the RC network (R_2 and C) produces only a rough approximation of a differentiator response. However, positive feedback supplied through capacitor C_1 corrects the response. The op amp amplifies the corrected differentiator signal to produce the following output:

$$e_o \approx (n+1) R_2 C \frac{de_1}{dt},$$

provided that

$$R_3 \ll R_2/n \text{ and } f \ll n/2\pi R_3 C.$$

The frequency response resembles that of a conventional differentiator. The response must deviate from the ideal prior to the intercept point with the open-loop response of the op amp. Otherwise the combined phase shifts of the op amp

and the differentiator feedback would cause oscillation.

Stability is ensured by choice of R_3 and control of the net positive feedback. R_3 is chosen to limit the gain-bandwidth product of the differentiator, $n(n+1)/2\pi R_3 C$, to less than one-third that of the op amp.

Ratio mismatches between either R_1 and R_4 or C and C_1 will cause gain error and/or oscillation that can be removed by trimming of R_1 or R_4 . Note, too, that C and C_1 act as a capacitive load to the op amp. This can also lead to oscillation (Tobey, G., Graeme, J. and Huelsman, L., "Operational Amplifiers; Design and Applications," McGraw-Hill Book Co., 1971).

Jerald Graeme, Manager, Monolithic Engineering, Burr-Brown Research Corp., International Airport Industrial Park, Tucson, Ariz. 85706.

CIRCLE NO. 311

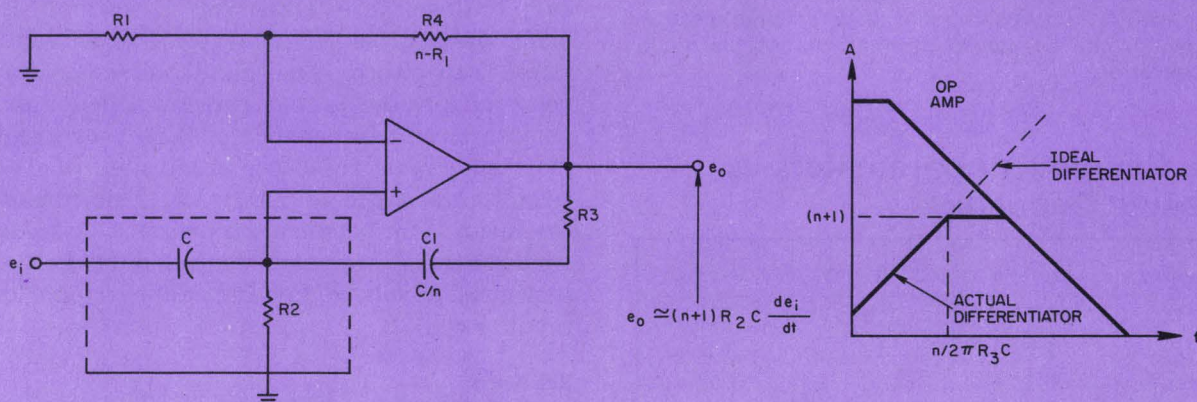

Precise differentiation without phase inversion is obtained from a bootstrapped RC high-pass circuit.

POWER FOR YOUR IC'S OR OP AMPS

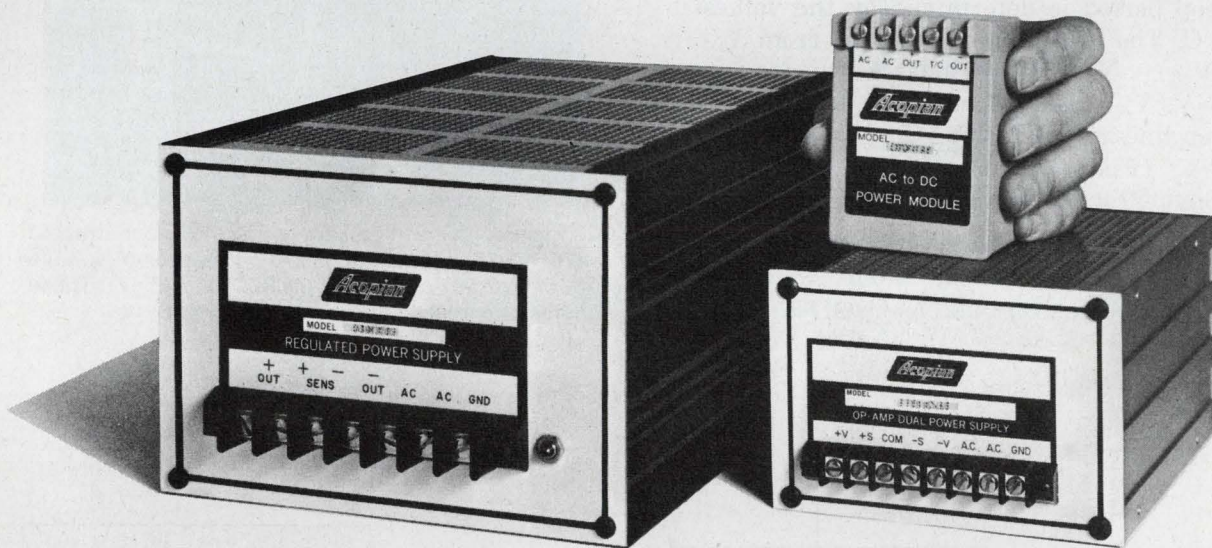

5 VOLTS				±15 VOLTS			
OUTPUT CURRENT AMPS	SIZE INCHES	PRICE	MODEL	OUTPUT CURRENT AMPS	SIZE INCHES	PRICE	MODEL
.5	3.5 x 2.5 x 1.4	\$55	5EB50	.1	3.5 x 2.5 x 1.4	\$55	DB15-10
1.0	3.5 x 2.5 x 1.6	75	5EB100	.15	3.5 x 2.5 x 1.4	65	DB15-15
2.0	3.5 x 2.5 x 2.4	115	5EB200	.2	3.5 x 2.5 x 1.4	75	DB15-20
2.5	3.5 x 2.5 x 2.4	130	5EB250	.4	3.4 x 5.1 x 5.1	85	TD15-40
5.1	3.4 x 5.1 x 6.6	150	A5MT510	1.0	3.4 x 5.1 x 5.1	125	TD15-100
9.0	3.4 x 5.1 x 9.3	180	A5MT900	1.6	3.4 x 5.1 x 6.6	150	TD15-160
12.0	3.4 x 5.1 x 13.3	200	A5MT1200	2.5	3.4 x 5.1 x 9.3	160	TD15-250
22.0	5.1 x 7.4 x 11.3	270	A5HT2200	4.5	3.4 x 5.1 x 13.3	225	TD15-450
32.0	5.1 x 7.4 x 16.0	320	A5HT3200	8.5	5.1 x 7.4 x 11.3	299	TD15-850

Line/Load Regulation: $\pm 0.1\%$ or better; Ripple: 1.5 mv or less; Input: 105-125 VAC

Three day shipment guaranteed. Complete details on these plus a comprehensive line of other power supplies and systems are included in the Acopian 73-74 catalog. Request a copy.



Corp., Easton, Pa. 18042. Telephone: (215) 258-5441.

INFORMATION RETRIEVAL NUMBER 32

Single transistor circuit provides CRT-level sweep and blanking signals

A circuit that uses a neon glow lamp and a transistor generates both a 47-V sweep signal and an 80-V blanking pulse. The entire circuit operates off a 200-V line—a voltage consistent with CRT circuit operation.

The transistor acts as a current source that allows capacitor C to charge toward the supply voltage linearity (Fig. 1). Once the lamp breakdown voltage, V_B , is reached, the lamp switches to the maintaining voltage V_M , and discharges the capacitor. The transformer couples the rapid discharge current to the base of the transistor. This "trigger" signal shuts off the transistor current and the lamp extinguishes. Then the cycle repeats, with the voltage across C increasing toward V_B from V_M .

The sweep period is determined by the values of R_E and C. The sweep voltage varies from $V_{CC} - V_M$ to $V_{CC} - V_B$. The periods shown are for $V_B = 100$ V, $V_M = 52$ V and $C = 0.01 \mu\text{F}$ or $1 \mu\text{F}$. Sweep linearity is about 5% with a retrace time of $10 \mu\text{s}$ (Fig. 2). The width of the trigger pulse is about $50 \mu\text{s}$ with a rise time of $18 \mu\text{s}$.

Sheldon G. Rabin, Manager, Applications Engineering, General Instrument Corp., Signalite Div., 1933 Heck Ave., Neptune, N.J. 07753.

CIRCLE NO. 312

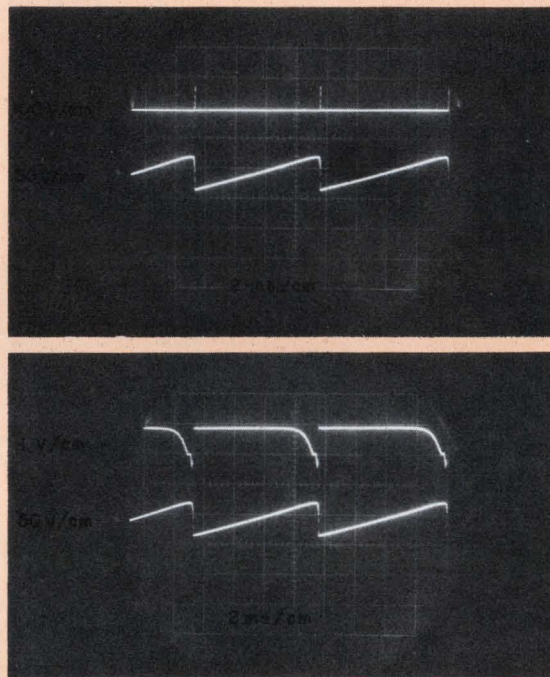

2. Positive-going blanking pulses (upper traces) have heights of about 80 V. The sweep voltage (lower traces) varies from 88 to 135 V. These photos are reversed from left to right.

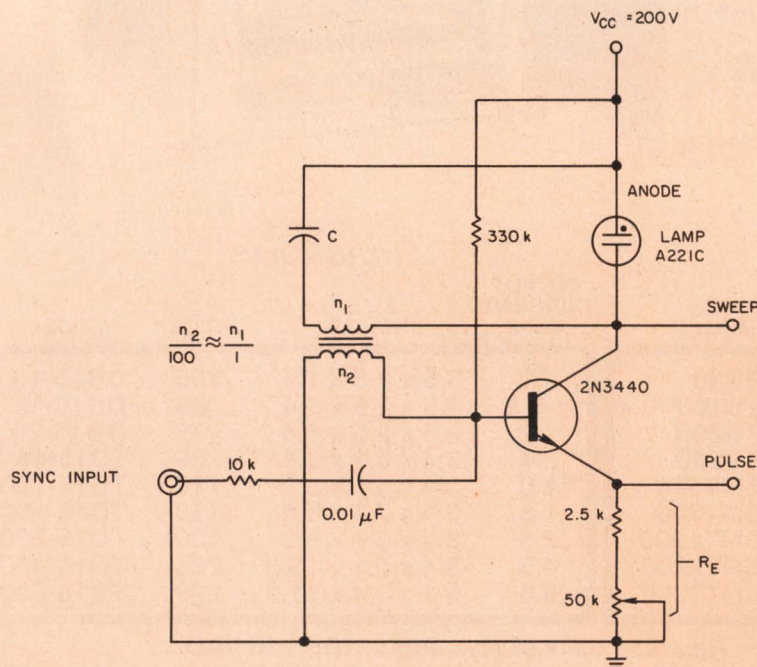

C	R_E (k Ω)	SWEEP PERIOD
0.01 μF	3	17 ms
	6	35
	12	70
	24	130
	48	220
	60	250
1 μF	6	1.25 sec

1. Periodic sweeps and blanking pulses are generated each time the glow lamp fires and discharges capacitor C. An inexpensive audio output

transformer couples the discharge pulse to the base of the transistor to extinguish the lamp. The transistor also supplies constant charging current.

Semiconductor technology is invading the memory market.

Here's the book to expand your applications knowledge in this explosive field.

Semiconductor memories are rapidly changing the traditional structure of the memory market. Faster access and cycle times. Simpler architecture. Reduced power dissipation. The increasing use of semiconductor devices as the main storage components of memory systems stands as one of the major innovations in contemporary computer technology.

The field of semiconductor memories is becoming enormously complex—and to the creative designer, increasingly confusing. "Semiconductor Memories Design and Application" helps to clarify the present state of the art by providing systems designers with the first fully integrated, comprehensive guide to the application of semiconductor storage elements in the construction of larger memory systems. Produced by the Texas Instruments Learning Center, this single volume systematically details the ideas and techniques which today's successful designer must master to build electronically competitive, cost-effective memory units.

Among subjects discussed are: Memory Functions and Economics • Reliability • Sequentially Accessed Storage Design and Application • Random Access Memory Design and Application—both Bipolar and MOS • Fixed Program Storage Design and Application.

"Semiconductor Memories Design and Appli-

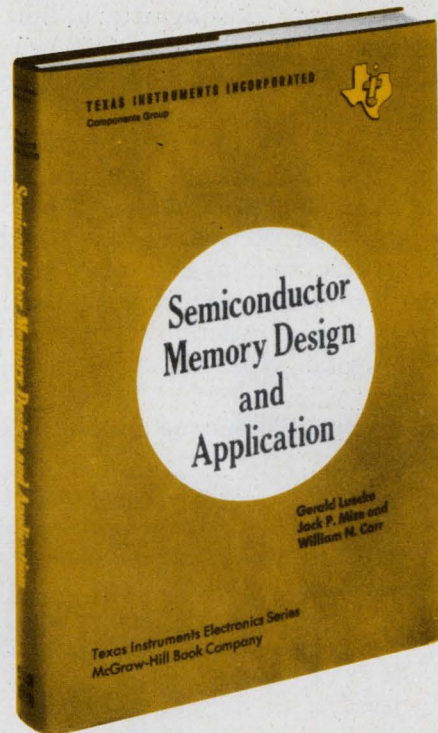

cation" has been organized to meet the needs of the practicing designer who is going to apply semiconductor storage elements and build larger memory systems. Both practical and up-to-date, it outlines the motivations shaping semiconductor memory technology and supplies the design and applications information necessary to make optimal circuit decisions.

Hard-bound. 321 pages. McGraw-Hill Book Company. Use accompanying coupon to order now.



MOS, TTL design aids also available.

If you want to update your knowledge of MOS/LSI, Texas Instruments' "MOS/LSI Design and Application" provides concise yet thorough information. From basic principles to practical system applications, this volume discusses device physics, economics and reliability for the entire spectrum of this vital technology.

And from the bipolar side, "Designing with TTL Integrated Circuits" covers design philosophy, economics, basic principles, device performance and practical applications in digital systems. Use coupon to order either volume.

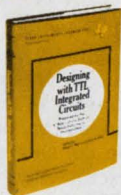

To: Texas Instruments Learning Center, P. O. Box 3640, Dallas, Texas 75221

Please send:

- "Semiconductor Memories Design and Application." \$18.50
- "Designing with TTL Integrated Circuits." \$18.50
- "MOS/LSI Design and Application." \$18.50

Enclosed is check or money order for \$ _____

Please add state and local taxes where applicable.

Name _____ Company _____
Address _____
City _____
State _____ Zip _____

TEXAS INSTRUMENTS
INCORPORATED

95100

Wiper noise removed and measured with a single nonlinear filter

A nonlinear filter attenuates potentiometer noise spikes without causing attenuation or time lags in the waveform. Spike heights are reduced an average of 100 times more compared with linear filters.

The circuit shown allows measurement of wiper noise to test the potentiometer as well as to provide a clean signal output.

Buffer amplifier A_1 passes the wiper signal to both the filter and inverter A_2 . Amplifier A_3 sums the filter output signal with the inverted wiper signal. The subtraction of the filtered signal from the total wiper signal leaves the wiper noise.

The RC network filters the spikes to give their

average dc value for the recorder. The nonlinear filter provides the clean signal for further processing.

Potentiometer R_1 is adjusted for maximum signal cancellation. The test potentiometer wiper is set to the supply side and a 20-V pk-pk, low-frequency sine wave is injected. R_1 is set for minimum output from A_3 .

The values used for C_1 and C_2 depend on the maximum slope of the signal. The values in μF are calculated from

$$C_1 = C_2 = 1.65/\text{max slope.}$$

The slope is measured in terms of V/s.

Ray Mittenthal, Professional Engineer, 6 Crossland Pl., Norwalk, Conn. 06851.

CIRCLE NO. 313

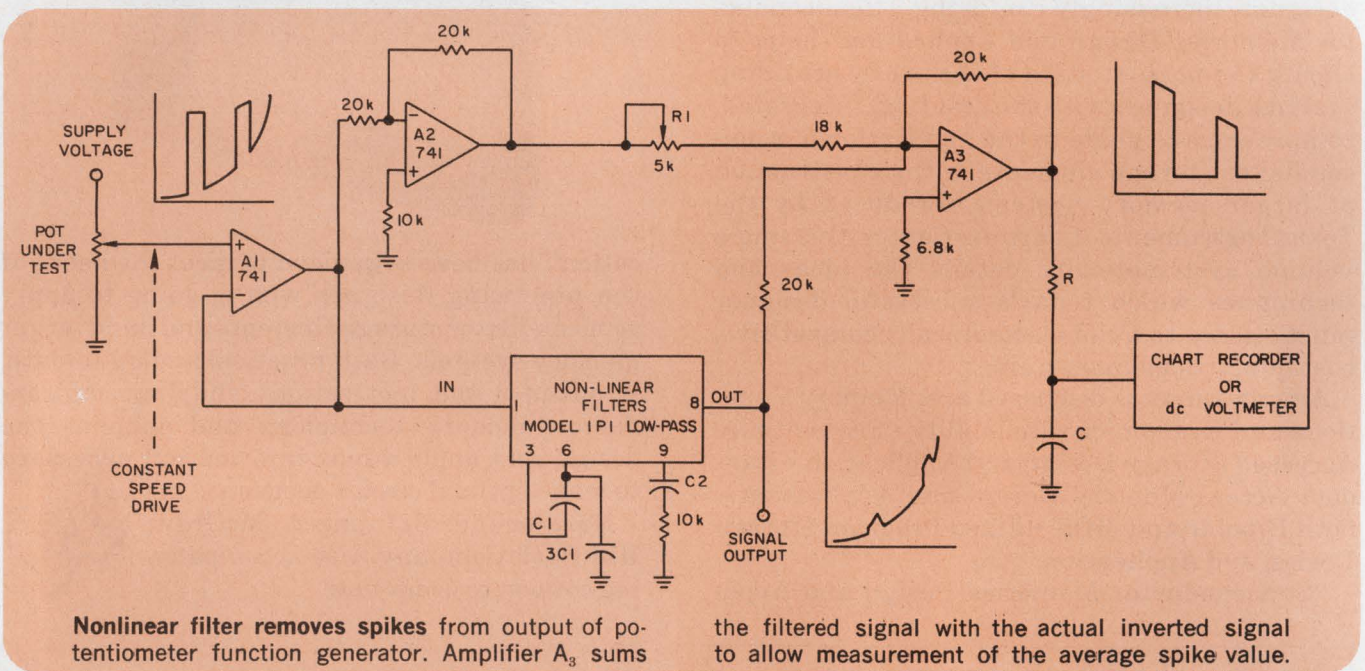

IFD Winner of October 25, 1973

Bruce C. Roe, Bell Laboratories, Naperville, Ill. 60540. His idea "Unijunction oscillator helps increase range of monolithic timer without use of big capacitors" has been voted the Most Valuable of Issue Award.

Vote for the Best Idea in this issue by circling the number for your selection on the information Retrieval Card at the back of this issue.

SEND US YOUR IDEAS FOR DESIGN. You may win a grand total of \$1050 (cash)! Here's how. Submit your IFD describing a new or important circuit or design technique, the clever use of a new component or test equipment, packaging tips, cost-saving ideas to our Ideas for Design editor. Ideas can only be considered for publication if they are submitted exclusively to ELECTRONIC DESIGN. You will receive \$20 for each published idea, \$30 more if it is voted best of issue by our readers. The best-of-issue winners become eligible for the Idea of the Year award of \$1000.

Dialight sees a need:

(Need: The right switch for the right price.)

See Dialight.

For the switch buyer, choice of function and esthetics, reliability, ease of mounting, and low cost are his prime concerns. He may need a pushbutton switch for panel, sub-panel or snap-in mounting. He may need a choice of bezels with or without barriers in black, gray, dark gray or white. He may need a legend that's positive, negative, or hidden until ener-



gized...one that's white when "off" and red, green, amber, blue or light yellow when "on"...or colored both "on" and "off." He may need a highly reliable switch proven in thousands of installations. Matching indicators with same front-of-panel appearance are also available. Obtainable from our world-wide distributor network.

The cap has a metal insert designed for proper heat dissipation. Cap is illuminated by a T-1 3/4 incandescent lamp in voltage range to 28V. Lamp can be easily replaced without special tools from front of panel.

More than 12 colors available in round, square, or rectangular shapes in six basic sizes—1/2" to 1 1/2". Choice of engraved, hot stamped or replaceable film legends with positive or negative presentations.

Available with or without bezels. Bezel allows for simple snap-in mounting. Without bezel, switch can be used for panel or sub-panel mounting.

Terminals are gold plated for oxidized free solderability, and come in choice of solder blade or pc terminations.

NOW LISTED IN UNDERWRITER'S
RECOGNIZED COMPONENTS INDEX.

Bezels available in black, gray, dark gray or white and in round, square or rectangular shapes.

Fingertip grip simplifies insertion or replacement of pushbutton cap.

Stainless-steel clips lock switch into panel on four sides. No tools or additional hardware required for installing. Panel mounting switches come with required hardware for panel or sub-panel mounting.

Alternate, momentary, and snap-action contacts with ratings to 5 amps. All switch contacts are gold plated for high reliability. Normally open, normally closed, and two-circuit (one N.O., and one N.C.). Totally enclosed within anodized aluminum housing. Low level and D.P.D.T. snap action, and contactless solid state switches also available.

DIALIGHT

Dialight Corporation, A North American Philips Company • 60 Stewart Avenue, Brooklyn, N.Y. 11237 (212) 497-7600



Piher components are going places

With our exports hitting an all time high in the first quarter of 1973 – particularly carbon film resistors and trimming potentiometers – we can rightly claim that our products are going places. They are going to every country in the world where the name Piher is synonymous with product excellence in the highly competitive component business.

It takes much more than a slick sales machine to build up one of Europe's biggest component companies. It takes total dedication to one end – ensuring that every customer knows that the Piher label stands for technical excellence.

And it does.

That's the major reason why we have grown to nearly 4,000 employees in six major plants achieving a \$50m annual turnover.

We design all our own production machines to ensure quality and reliability. We have no licence agreements, no subcontract working. From start to finish we are in control of every product that goes out to a customer. And we have a lot of customers.

We produce 8 million carbon film resistors *a day* to meet world demand – and we have the largest variety of quality preformed resistors available anywhere.

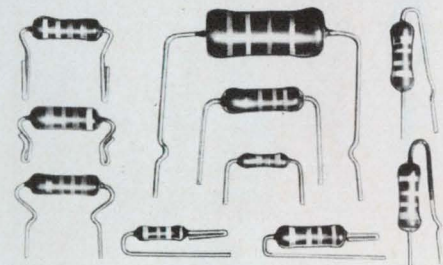

Piher output of carbon film resistors is a staggering 8 million a day.

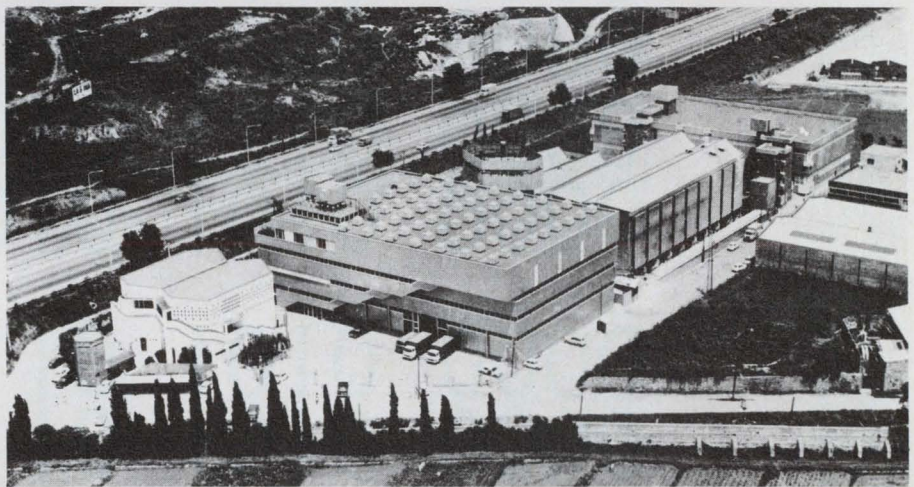

Headquarters of Piher International in Barcelona. The company employs nearly 4,000 people in six major manufacturing centres throughout Spain.

We also provide the best range of quality, low-cost encapsulated trimmer pots – also slider and rotary versions – for every type of application, custom built to specific requirements where the need arises.

And that's only the beginning.

Our small signal and medium power transistor range is growing fast.

Our ferrites are in the forefront of magnetic ceramic technology.

And we have just laid down the most modern ceramic capacitor line in Europe. Apart from our six manufacturing centres we have a world-wide distribution network backed by five Piher companies in the USA, Germany, Great Britain, France and Italy. They are only a 'phone call away if you need details on the best components in the business.

Or write to us for data sheets on the product area you are interested in.

Find out more about us. It pays.

U.K. – Piher International Ltd., Romar House, The Causeway, Staines, Middlesex, England.
Tel: Staines 56157. Telex 934167

U.S.A. – Piher International Corp. 1239 Rand Road, Des Plaines, Illinois 60016, U.S.A.
Tel: 312-297 1560. Telex 282154

Germany – Piher International GmbH, 85 Nuremberg, Westtorgraben, 5. Germany.
Tel: 0911 260 469. Telex 623354

France – Piher International SARL, 83 Rue Etienne Dolet, 94230, Cachan, France.
Tel: 656 26 07. Telex 27107

Italy – Piher International S.P.A. Via Cenisio 34, 20154 Milan, Italy.
Tel: 314532/316213

Head Office – Riera Cañado, s/n Apartado de Correos 53 Badalona (Barcelona) Spain.
Tel: 389 03 00. Telex 59521



0000	0100	1000
0000	0100	1001
0000	0101	0000
0000	0101	0001
0000	0101	0010
0000	0101	0011
0000	0101	0100
0000	0101	0100
0000	0101	0110
0000	0101	0111
0000	0101	1000
0000	0101	1001
0000	0110	0000
0000	0110	0001
0000	0110	0010
0000	0110	0011



Can You Spot This Counter Problem?

With the new HP-1601L Logic Analyzer it's just as easy.

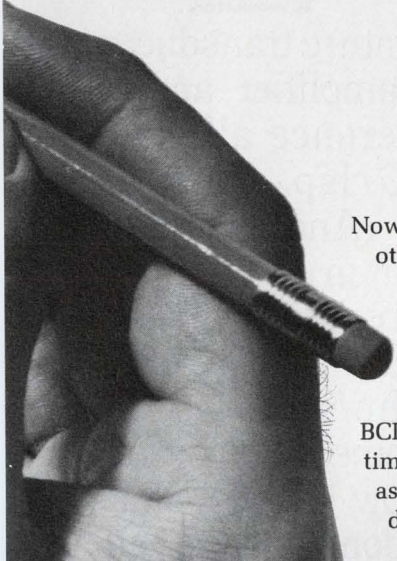

Now, watch your counters, or any other digital logic, dynamically step through their operations. Watch the display of "1's," and "0's" appear exactly as your logic calls for. Watch all this in hexadecimal, BCD or octal format, 16 words at a time, each 12 bits wide displayed as they actually occur in your design.

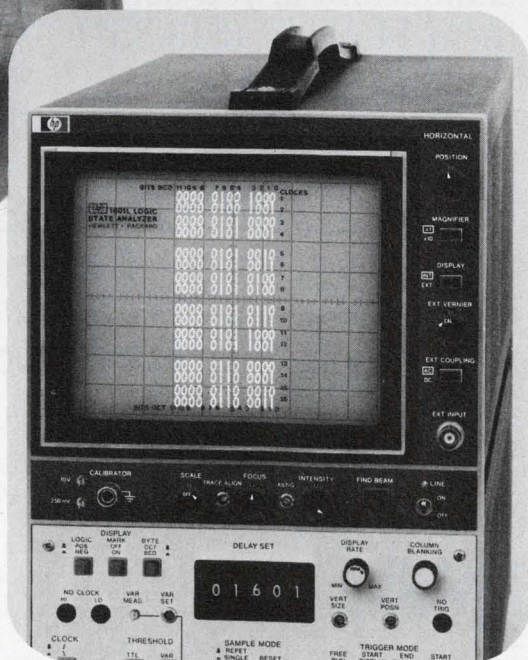

See negative time. Think of the time you can save with this breakthrough in performance capability. You can trigger the display on the first word or the sixteenth word to look ahead, or look back in time (negative time). **See dynamic data flow, much more.** Because the 1601L operates from your strobe signal (up to 10 MHz), delay can be conveniently dialed in up to 10^5 bits. Select positive or negative logic display depending on the type of circuitry you're working with, and adjust threshold over the $\pm 10V$ range provided. If a problem should occur, it's easy to select a window in time to help you diagnose the cause of your problem... quickly. And once the problem is isolated with the 1601L Logic Analyzer, your oscilloscope will help you to locate the component or circuit at fault. The 1601L provides a trigger for your scope making fault isolation even faster. **See things you've never seen before.** See those digital events you've always wanted to see. For all this capability the 1601L is priced at only \$2650*. Or consider the 5000A with LED display, two channels, thirty-two bits that sells for only \$1900*. Your local HP field engineer will be happy to arrange a "hands-on" demonstration in your office or lab.

*Domestic U.S. prices only.

HEWLETT  PACKARD

Sales, service and support in 172 centers in 65 countries. Palo Alto, California 94303. Offices in principal cities throughout the U.S.

083/9

BREAKTHROUGHS. \$1.50 AND UP.

(1) The universe's very first and only transistor that's an IC.

Old style power transistors join the buggy whip because LM 195/295/395 are blow out proof. (just \$4.95 for the LM 395 — all prices in batches of 100 plus.)

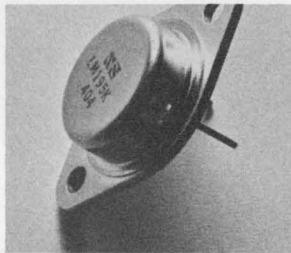

The first transistors that are blow out proof and short circuit proof.

And if that doesn't blow your mind, how 'bout...

(2) A proprietary timer in which the output is short circuit proof.

The output state of LM 322 can be inverted, eliminating the need for external circuits. Another thing that should have an effect on you is that inputs on the trigger terminal after it's triggered have no effect on the timer output. (\$1.50*)

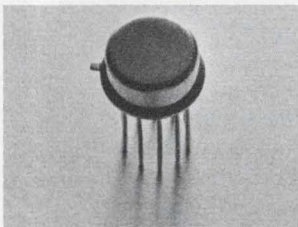

The first timers with a short circuit proof output.

(3) A 3-amp IC regulator.

Another first.

The number is LM 323, and it's a

logical extension of the self-protected 3 terminal regulator field which guess-who has pioneered. (\$6.75*)

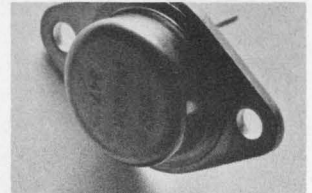

The first 3-amp positive IC regulator.

(4) An IC temperature transducer.

Linear sensor, amplifier and a stable voltage reference all on a single monolithic IC chip.

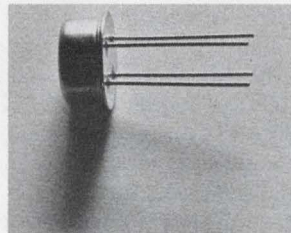

The first temperature transducer on a chip.

And they read out in real temperature (degrees Kelvin) instead of ohms. So when someone asks you how hot the what-chamacallit is you don't have to tell them 14 ohms. (\$13.35*)

Pens ready?

LX5600AH/LX5600H and LX5700AH/LH5700H.

Buy 'em quick 'cause we can use the money. Or, for the stubborn among you, details are available from National Semiconductor Corp., 2900 Semiconductor Drive, Santa Clara, California 95051.

*In batches of 100 plus.

NATIONAL

National Semiconductor Corp., 2900 Semiconductor Drive, Santa Clara, Calif. 95051; Scottsdale, Ariz. (602) 945-8473; Mountain View, Calif. (415) 961-4740; Sherman Oaks, Calif. (213) 783-8272; Tustin, Calif. (714) 832-8113; Miami, Fla. (305) 446-8309; Chicago, Ill. (312) 693-2660; Indianapolis, Ind. (317) 255-5822; Lenexa, Kan. (816) 358-8102; Glen Burnie, Md. (301) 760-5220; Burlington, Mass. (617) 273-1350; Farmington, Mich. (313) 477-0400; Minneapolis, Minn. (612) 888-4666; Englewood Cliffs, N.J. (201) 871-4410; Syracuse, N.Y. (315) 455-5858; Dayton, Ohio (513) 434-0097; Dallas, Tex. (214) 233-6801.

Digitec introduces
 another product in the
HT SERIES (a breakthrough in
 High Technology)
 a new, portable Digital Multimeter.

Digitec's new Model 2110, 3½ Digit Multimeter is the latest product in the new HT Series (High Technology). This new family is the realization of a long term R & D program producing digital instrumentation with the ultimate in reliability and performance. These demanding standards have been achieved by using field proven technology combined with proprietary design, state-

of-the-art components and advanced production techniques. The application of human engineering principles, enables simple and self evident use of the instrument. Our proudest achievement, the HT series instruments are housed in attractive, designer-styled, enclosures that protect and enhance the advanced technology they contain.



ieee intercon 74
 Booth 2531-33

Model 2110 Digital Multimeter

\$219.

Features: DC ranges to 1000 volts with autopolarity, sensitivity 0.1mV / AC ranges to 500 volts, sensitivity 1mV / Ohms ranges to 20MΩ, sensitivity 0.1Ω / Monsanto, easy-to-read, long life LED's / 115/230VAC, 50 to 400Hz line operation or self-contained batteries yielding 8 hrs. continuous operation / Built-in automatic battery charger / Batteries optional \$35.00 / Compact, lightweight and rugged / Ideal for bench or field operation / "Off-the-shelf" availability from your local Digitec Representative.

UNITED SYSTEMS CORPORATION
 918 Woodley Road, Dayton, Ohio 45403
 Ph. (513) 254-6251 Twx. (810) 459-1728
 a subsidiary of

Monsanto

INFORMATION RETRIEVAL NUMBER 84

Digitec

FOR DEMONSTRATION CIRCLE 348

ELECTRONIC TELECOMMUNICATION EMPLOYMENT OPPORTUNITIES

We are a leading innovator of electronic communications systems supply to the telephone industry. Telephone communications are growing at an accelerated pace to meet the ever increasing demands for service by industry, commerce, government and the general public.

As a result, we require increasing numbers of creative, skilled and responsible people who desire even greater opportunities for achievement. We are particularly interested in individuals with experience in telephone development, manufacturing or service companies, similar electronics manufacturers, or computer corporations.

SYSTEMS HARDWARE AND/OR TRUNK DESIGN

We have openings available in the hardware design and development of medium and large scale electronic switching systems. You must have the ability to comprehend the system as a whole and make the appropriate trade-off decisions. You will be involved in originating, planning and designing circuits for new systems or modifying existing systems. This entails the design of electronic logic and the interface with previous electro-mechanical designs. Requirements: A BSEE or MSEE degree with several years of relevant design experience.

SOFTWARE DESIGN

We have opportunities available in the software programming area. You will be involved in the development of system software beginning with the project configuration stage; designing and developing executive control programs, man-machine interface routines and billing type programs for toll and central office electronic switching systems. Requirements: A minimum of three years design experience in the development of Call Processing and Executive Control Programs. An MSCS degree is also desired.

DIAGNOSTIC DEVELOPMENT

You will be responsible for the design of fault recovery and diagnostic programs for the computer controlled hardware of electronic switching systems. This involves the implementation and development of maintenance facilities to detect and correct present or latent hardware and software faults within the system. The system must be developed to handle calls during fault conditions and during system growth. Abundant man-machine communication must also be designed into the system. Requirements: These positions require a BS or MS in Electrical Engineering, Computer Science or Physics and at least 2 years experience in Software and Hardware design of large realtime systems with automatic malfunction detection, recovery and diagnostics.

KEY TELEPHONE SYSTEM DESIGNER

You would be responsible for the design and development of new equipment and techniques, in the areas of telephone signalling and transmission, as applied to Key Telephone Systems. You must be familiar with integrated circuit technology, relay technology and semiconductor devices. We are seeking an individual with a B.S.E.E. and two years relevant experience.

SUPPLY PRODUCTS EVALUATION

We have specific assignments available for engineers who will be responsible for providing technical support and guidance in the procurement of a wide range of supply items utilized by telephone operating companies. You will be required to prepare specifications defining performance, quality and endurance requirements in order to determine the applicable test methods that confirm the products acceptability. Additional responsibilities will be performing laboratory and field tests when necessary and dealing with vendors regarding specifications and the qualification of their products. Requirements: A broad technical education coupled with a minimum of 2 years related experience.

PCM SYSTEMS ENGINEER

We have openings available for those that have experience with Stored Program Systems Control. You will be responsible for the evaluation of Control System Techniques for future generation switching systems. You will be working in the early conceptual stages of systems development with a small systems group. An MSEE degree, or equivalent degree in Computer Science, is required plus real-time control experience in the Telephone or Computer Industry.

DESIGN AUTOMATION PROGRAMMER

Our Design Automation staff is looking for a Programmer who will be responsible for the definition and development of programs to aid in the design, engineering and production of electronic switching systems. Program development areas include computer-generated logic diagrams, printed wiring card artwork design, automated wiring, circuit logic, load analysis and logic simulation. Requirements: Experience in 360/370 OS-MUT, Cobol and Assembly language programming plus a BSEE or Computer Science is desirable.

MINI-COMPUTER PROGRAMMERS

We have specific assignments available on project development teams responsible for the design and implementation of various telecommunication processing utilizing Min-Computers as the processing element. Responsibilities will include the development of software programs for real-time operating systems as well as unique hardware elements incorporated into the system. Requirements: A minimum of 2 to 5 years experience in the development of assembly language programs for mini-computer processing systems is desirable, plus a Bachelors degree in Electrical Engineering or Computer Science.

You'll find the salary range open plus a liberal compensation along with full fringe benefit package. Confidential resumes outlining experience, education, salary history and goals should be submitted to: Christine Rosenbach, GTE Automatic Electric Laboratories, Professional Employment, 400 North Wolf Road, Northlake, Illinois 60164.

GTE AUTOMATIC ELECTRIC LABORATORIES

"An Equal Opportunity Employer M/F"

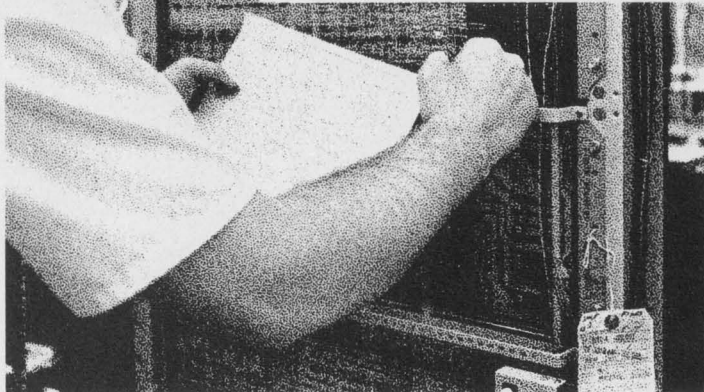
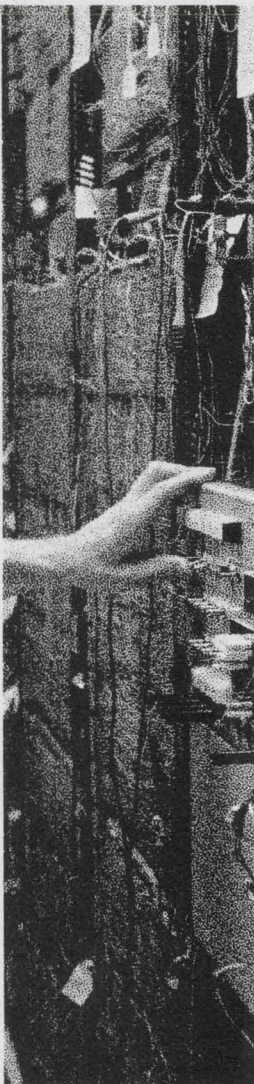

INFORMATION RETRIEVAL NUMBER 901

New HEATH/SCHLUMBERGER INSTRUMENTS CATALOG FREE

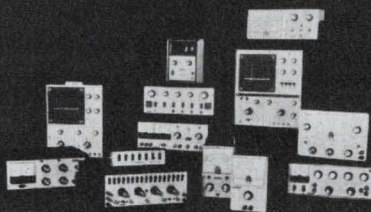

**12 New
Test Instruments
New \$335,
10mV-10V, 10 Speed
Chart Recorder
New \$325, auto-ranging
110MHz Counter**

from Heath/
Schlumberger

HEATH
Schlumberger
Copyright Heath Company 1973
Catalog 811/09

The latest issue . . . includes complete details and specifications on dozens of high performance, low cost instruments for design, R&D and teaching applications. Here are just a few examples:

New 10 mV to 10 V Strip Chart Recorder . . . only \$335*. Four calibrated, hi-Z input ranges . . . full 10" chart . . . ten digitally-derived chart speeds from 10 to 0.01 inches or cm/minute . . . switchable input filtering . . . complete remote programming capability . . . easy conversion to metric work . . . pushbutton chart advance . . . rack mount design.

600 MHz Frequency Counter . . . just \$795*. 1 Hz to 600 MHz guaranteed range . . . input sensitivity: 10 mV @ 35 MHz, 15 mV @ 200 MHz, 50 mV @ 600 MHz . . . 50 and 1 megohm inputs . . . high stability TCXO time base . . . complete remote programming capability for all inputs, outputs & functions, plus BCD output . . . FCC type-approved for AM & FM broadcast.

Dual Trace 15 MHz scope . . . only \$595*. 15 MHz vertical bandwidth with 24 ns risetime . . . 50 mV/cm sensitivity . . . 1 megohm/35 pf input impedance . . . 9 position attenuator . . . 18 calibrated sweep rates from 0.2 us/cm to 100 ms/cm . . . Chop, Alternate, Ch. 1, Ch. 2 and X-Y modes . . . Internal/External, AC/DC, +/- triggering . . . external trigger input, sweep gate output. Standard camera mount bezel.

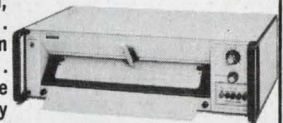

For your FREE copy, use coupon NOW!

HEATH
Schlumberger

Heath/Schlumberger Instruments
Dept. 531-265
Benton Harbor, Michigan 49022
Please send electronic instruments catalog.

Name _____
Title _____
Company/Institution _____
Address _____
City _____ State _____ Zip _____

*Mail order prices; FOB factory. EK-415R

Digital transmitting tests to use phone system

The British Post Office plans to install six high-speed multiplexers for experiments in digital transmission via the trunk-telephone system. Built by the General Electric Co. Ltd. in England, each multiplexer can combine four separate streams of electrical pulses into a single stream—equivalent to 120 simultaneous telephone conversations.

Each unit combines four independent inputs at 2048 kilobits/sec into a single output at 8448 kilobits/sec. The multiplexers also separate a received input of 8448 kilobits/sec into four individual pulse streams at 2048 kilobits/sec.

During the next stage of development the multiplexers will be tested for performance and reliability. The units will then be linked to experimental digital-transmission systems that are to be available early in 1975 between Guildford, Portsmouth and Southampton, in southern England. The Post Office announced last March that contracts had been placed with Standard Telephones and Cables Ltd., GE and Plessey for two separate designs of line-transmission equipment.

The experimental transmission systems will provide digital trans-

mission at 120 Mbits/sec over 1.2/4.4-mm coaxial-cable pairs. Signals at 2048 kilobits/sec will be assembled into a 120-Mbits/sec stream in two stages. The first will use the GE multiplex units. The second will use equipment that combines 14 inputs at 8448 kilobits/sec to produce an output of 120 Mbits/sec. The latter units are being developed for the Post Office by another English company, Pye TMC Ltd.

Equipment for the Guildford-Portsmouth-Southampton experiment will also include a group encoder. An interface will be provided between the analog and digital systems by conversion of frequency-division multiplexed signals from 60 telephone circuits into a digital signal. The signal can be transmitted over a path of 8448-kilobits/sec.

Tests of second-order digital multiplexing will also be carried out by use of a variant of the GE 2048/8448-kilobits/sec multiplexer which combines three 2048 kilobits/sec inputs into a 6336 kilobits/sec output. Tests will take place over a lower 6-GHz digital radio system (also developed by GE), which is being evaluated on an existing microwave radio path.

Thick-film hybrid unit is TV focus control

A thick-film hybrid focus control module for use in solid-state color TV receivers has been developed by the EMI Microelectronics Div. in Middlesex, England.

The compact and highly stable unit can be operated at up to 10

kV. The module has been designed so that under limiting conditions, with 8.3 kV applied, the focus voltage range is 3.7 to 5.7 kV.

The ink pattern of the resistive element is printed onto a 2 × 1-in. alumina substrate, and the unit

is enclosed in a case that measures about 2-1/2 × 2 × 1/2 in., molded in flame-retardant, thermoplastic polypropylene.

The control element consists of three resistors in series, with the center resistor the variable component that provides the focus adjustment. The contact arrangement uses a steel spring that is rolled round the thick-film potentiometer track. The spring provides contact between the track and the center conductor.

CIRCLE NO. 318

CAD system gives optimum PC designs

A computer-assisted design system for the manufacture of printed-circuit boards has been developed by Quest Automation Ltd. of England. With the computer's help, the designer creates the optimum layout while the equipment automatically checks the work, carries out calculations, draws and executes modification instructions.

The designer works freehand at a digitizer that is designed to look and feel like a conventional drawing board. The integral Nova 1200 minicomputer checks clearances and other limitations and stores design information. Incorrect patterns are indicated immediately on a solid-state display. Standard layout features need be drawn only once and can be called up after that when required.

The designer can stop work at any time and obtain a tape of the design details so far. Modifications and deletions can be carried out at any stage, and special software can make minor adjustments that may be needed in the final stages of design.

Multilayer boards can be laid out either on a single sheet that uses different colors or on individual drawings, and numerical-control drilling and component-insertion data can be included.

The system's output is a punched tape, suitable for direct input to an off-line precision photoplotter called EMMA. The photoplotter equipment—also made by Quest—can generate plots up to 23 × 29 in. with an accuracy of ±0.001 in.

CIRCLE NO. 319

broad band- rated™

Ferramic® components
guarantee circuit
performance

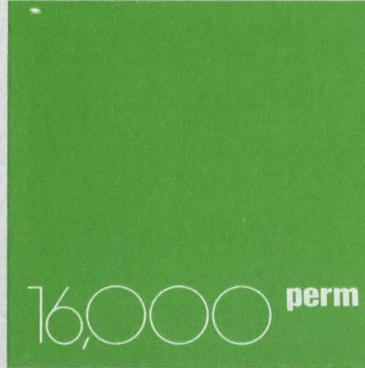
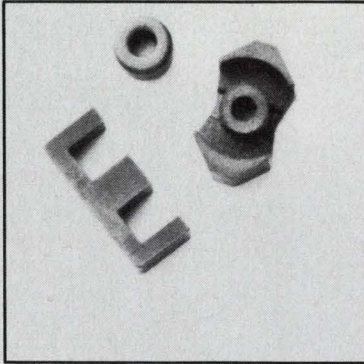

New expanded line

Now you can get *Broad Band-Rated* components designed specifically for your critical bandwidth applications from 100 Hz to above 250 MHz. New shapes include mated parts in pot core, RM6 and E core configurations.

Best specs available

Ferramic components give you the highest effective permeability available today with values above 5,000. Toroidal perm in small toroids over 16,000. All our specs are based on your circuit requirements—not just routine magnetic parameters.

We give you the data you need to make broad band circuit design easier and more precise. Our complete specs on each component include shunt resistance and reactance per turn squared, temperature coefficient, disaccommodation and hysteresis core constant.

Application tested

We test these components under applied conditions to assure performance in your circuit. The complete line features closer magnetic tolerances and is guaranteed to meet specified electrical characteristics.

We end the guesswork by giving you components you can design with and depend on.

Free design manual

Our new design manual 132 gives you all the facts, a few suggestions and complete design examples for both high and low frequency applications.

For your copy and details on how you can apply the latest ferrite technology to your broad band circuits, check the reader service card and get 32 pages of help. Or call (201) 826-5100 for right-now answers to your broad band ferrite requirements.

Either way, if you're talking ferrites, talk to the ferrite experts.

That's us.

Indiana General
Electronic Products
Keasbey, N.J. 08832

National distribution
through Permagon in Atlanta,
Boston, Chicago, Dallas,
Detroit-Toledo, Los Angeles,
New York and
San Francisco.

indiana general 

a division of Electronic Memories & Magnetics Corp.

INFORMATION RETRIEVAL NUMBER 35

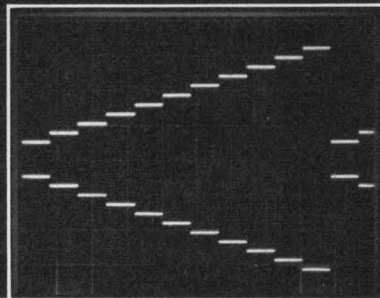
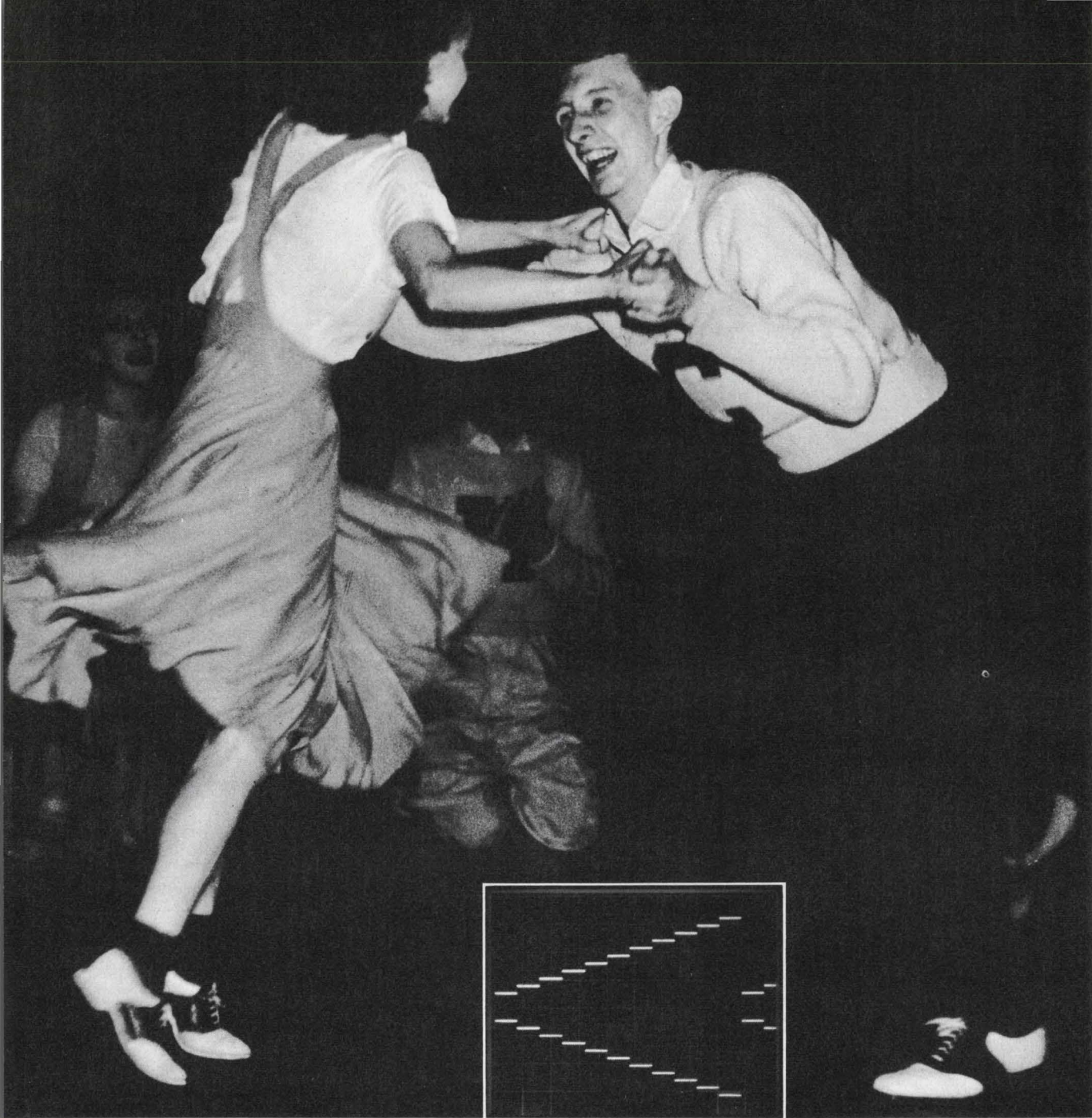

The new step that will sweep the country.

All the way to 30 MHz, people will be doing the new step from Wavetek. Ramping up, ramping down. Stepping up, stepping down.

They'll be making graceful 1,000:1 frequency sweeps smoothly and in discrete 10% steps.

And they'll be doing it with one of the most sophisticated function generators ever built... the Wavetek 164.

Not only does the 164 do fancy steps, it can show off a trapezoidal waveform with adjustable rise and fall time, dip as low as $3\mu\text{Hz}$ with continuous, triggered or gated modes, and give you a choice of 9 output waveforms. All that talent for just \$995 should be music to your ears.



WAVETEK®

P.O. Box 651, San Diego, California 92112
Telephone (714) 279-2200, TWX 910-335-2007

new products

Fastest logic scope captures 8 data streams at 200 MHz

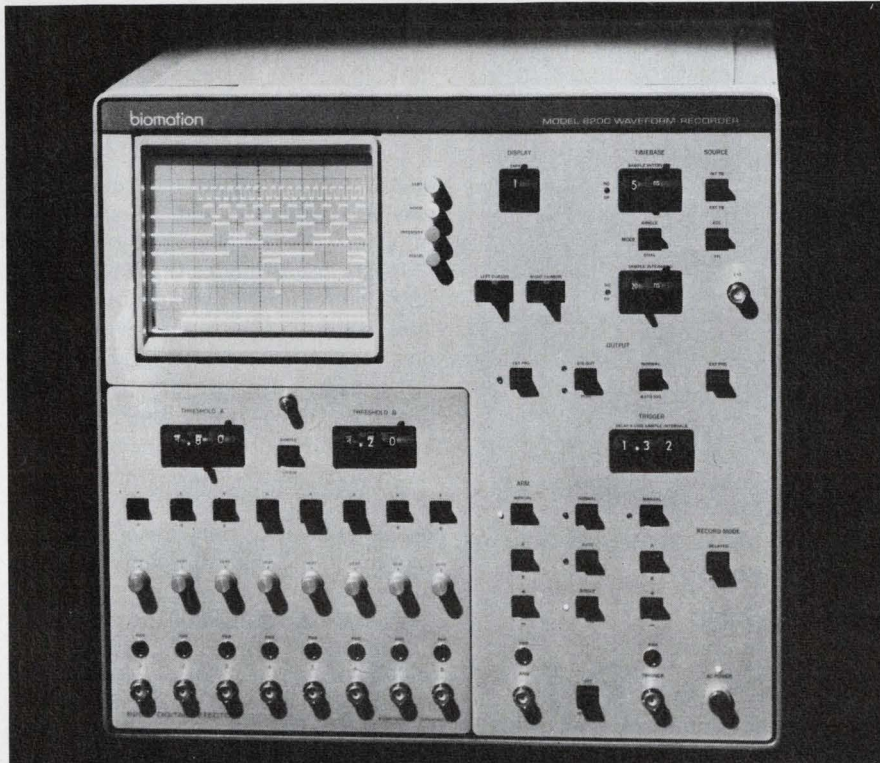

Biomatation, 10411 Bubb Rd., Cupertino, Calif. 95014. (408) 255-9500. See text; 90 days beginning May, 1974.

Although Biomatation's Model 8200 digital logic analyzer is the third such instrument to be unwrapped recently by as many vendors, the 8200's 200-MHz input data rate catapults it to the lead position as the fastest unit of its class.

The other neophytes—Hewlett-Packard's 1601L Logic State Analyzer and E-H Research Laboratories' AMC 1320 Digiscope—handle data rates of 10 Mb/s and 50 MHz, respectively.

Thus the Biomatation 8200 is the first logic scope to enter the super-fast world of ECL logic. If you need this speed, however, be prepared to pay for it. The 8200 costs \$14,200—without probes.

This contrasts sharply with \$2650 for the HP unit and about \$9800 for E-H's Digiscope, both of which include the probes in the cost.

Other features and specs give each of these store-and-display analyzers its own "personality," as well as tradeoffs to the specifier.

For example, both the Biomatation and the E-H are eight-channel, stand-alone instruments that can accept various plug-ins. The HP unit has 12 inputs and is itself a plug-in for the company's 180-series scopes (the price, however, includes a 182 mainframe).

And while the displays of the 8200 and the AMC 1320 are similar—both show timing diagrams—the 1601L displays a numeral one or zero to represent the logic ONEs and ZEROs of 16 consecutive 12-bit words.

Other significant differences exist. With respect to bit capacity, Biomatation leads the pack with a memory of 8 bits by 2048 words; E-H follows with 8 by 100 and HP brings up the rear with 12 bits by 16 words.

The 8200, as well as E-H's Digiscope, provides an alphanumeric readout along with the timing relationships. In the 8200, two vertical cursors—superimposed on the display—can be moved along the screen. Numeric characters then show the number of bits between cursors, as well as such items as the time between samples (inverse of clock selected) and the horizontal expansion factor, which goes to $\times 50$ on the 8200.

The information display on the Digiscope goes one better: The unit provides an alphanumeric display of many of the important settings of the instrument, such as time scale, trigger modes, logic thresholds and delay. Joystick-type controls replace the familiar multiposition rotary switches found on most scopes, and settings are read on the screen.

Logic thresholds are settable on all three units, so various types of logic can be handled. Both the Biomatation and the HP 1601L are single-threshold devices—that is, a single level (externally variable) is used within a comparator to decide whether an input is a ONE or ZERO. (With the Biomatation, you can select either of two levels for each channel.)

On the other hand, the E-H AMC 1320 provides a double threshold—two levels, one each for ZERO and ONE—and it uses fairly complicated logic criteria to decide whether a ONE or ZERO should be displayed.

The advantage of the double
(continued on page 70)

Improved magnetic characteristics!

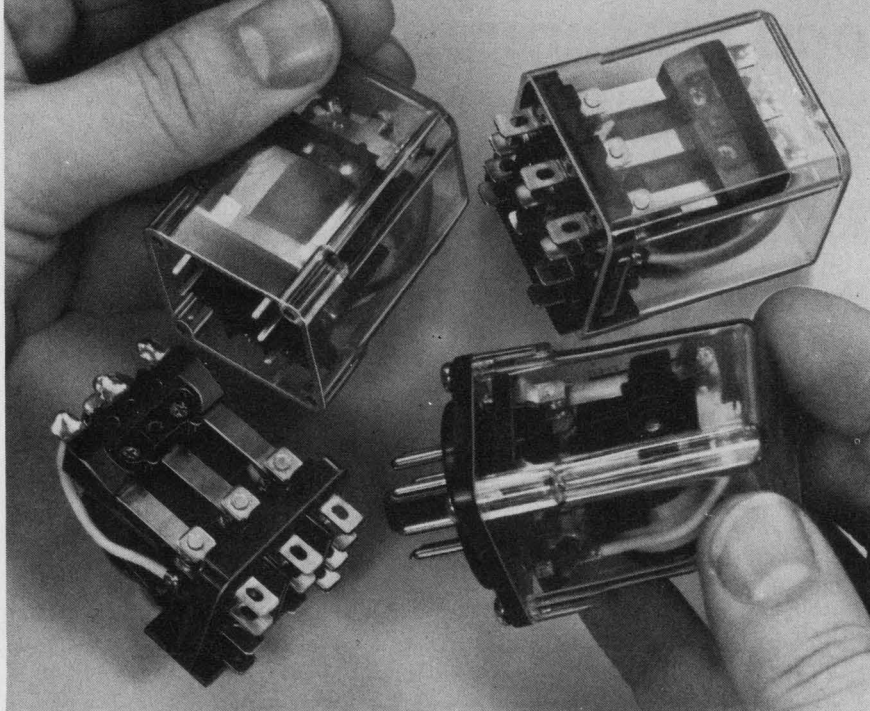

Unique coil core design of new GP relay family minimizes eddy current losses.

Two features have been incorporated into the new NAPCC Series 12 and 13 GP relay family to improve operating characteristics. First is a unique new spiral wrap core. This helps minimize eddy current losses and results in cooler operation. Second, the core has been welded to the frame to further improve magnetic characteristics. The results: an improved relay which is available to you at competitive prices.

Contact arrangement is SPDT, DPDT, or 3 PDT. Coil voltages range from 6—230 V, 60 hz, or 6—110 vdc. Series 12 has contact rating of 10 amp

resistive and is available with .087" quick connect terminals. Series 13 is available in 5 and 10 amp contact ratings and in octal, PC or wired terminals. Each Series comes in open or enclosed styles.

If you are currently working with such applications as machine controls, data processing equipment and office copiers, garage door openers, appliances and other devices where space is at a premium and premium performance essential, it will pay you to investigate the Series 12 and 13 relay family. Their improved characteristics offer many advantages.

Send for information today!

PRICE ELECTRIC RELAYS

NORTH AMERICAN PHILIPS CONTROLS CORP.

A NORTH AMERICAN PHILIPS COMPANY
E. Church & 2nd St. · Frederick, Md. 21701 · (301) 663-5141

INFORMATION RETRIEVAL NUMBER 37

INSTRUMENTATION

(continued from page 69)

threshold is this: With it, you won't miss low ONEs, high ZEROs, ringing and glitches—as you may with just a single level.

All three units offer a number of triggering options and delays to let you "look" anywhere within a data stream to see both pretrigger and post-trigger events.

In the Biomation 8200, which updates the stored data synchronously with the internal or external clock, the trigger can be derived from one of the input signals or from an external signal. The HP 1601L does the same, except that the clock is external only. By contrast, the E-H AMC 1320 operates asynchronously only and can be triggered from a logic combination of the input signals.

In its latch mode, the Biomation 8200 can capture glitches or single-shot events. Thus narrow spikes down to 1 ns are detectable. The E-H unit also grabs glitches—down to 10 ns—and displays them as a one-bit-wide transition.

Though the HP unit can't directly show glitches, a trigger-out signal is provided that can be used to trigger an analog scope. Hence glitches are "indirectly" spotted.

The Biomation 8200 is programmable, as is the E-H AMC 1320. The HP 1601L is manual only.

For Biomation **CIRCLE NO. 254**
For E-H Research **CIRCLE NO. 255**
For Hewlett-Packard **CIRCLE NO. 256**

Portable recorder consumes just 8 W

Astro-Med, Atlan-Tol Industrial Park, West Warwick, R. I. 02893. (401) 828-7010. \$395; 30 days.

Model 101-DC OEM recorder operates on a 12-V battery and weighs only 4 lb. Power consumption is just 8 W. A single-channel unit, the recorder features a channel width of 50 mm, with automatic chart threading. Recordings are made without ink by a heated stylus on a new type of heat-sensitive paper that is 50% less costly than conventional heat-sensitive papers.

CIRCLE NO. 257

RF Admittance Bridges 1MHz to 100MHz

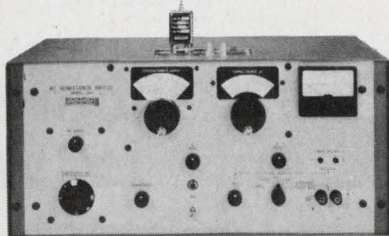

MODEL 33

Boonton Model 33 bridges measure two-terminal capacitance and conductance of high-Q diodes, varactors, and capacitors at 7 crystal-controlled frequencies from 1 to 100MHz, and provide accurate, high resolution balance at the low signal levels necessary for testing solid-state devices. Both internal and external DC bias facilities are standard. Contact: Boonton Electronics, Parsippany, N.J. 07054.

INFORMATION RETRIEVAL NUMBER 91

Full Programmability is standard on RF Millivoltmeters 10kHz to 1.2GHz



ANALOG 92B DIGITAL 92BD

Boonton rf millivoltmeters offer state-of-the-art sensitivity, accuracy, and bandwidth with an unrivaled choice of features and options. Analog or digital versions, both with linear dc outputs. Digital version has ancillary analog dBm meter and BCD outputs, optional autoranging and dB display (0.01 dB resolution). Contact: Boonton Electronics, Parsippany, New Jersey 07054.

INFORMATION RETRIEVAL NUMBER 92

Inductance Bridges measure nanohenries to henries

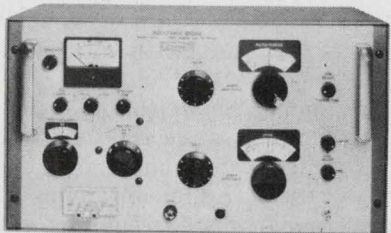

MODEL 63

Boonton Model 63 direct-reading inductance bridges have extremely wide useful ranges for both series L and R. Internal wide-range oscillator provides constant current, independent of balance condition. Three versions span 0.2nH to 11H, 0.4kHz to 500kHz. Contact: Boonton Electronics, Parsippany, N.J. 07054.

INFORMATION RETRIEVAL NUMBER 93

INFORMATION RETRIEVAL NUMBER 94 ▶



Who said a digital-readout signal generator has to be hard to handle, hot and heavy, and cost \$4,450?

Not us!

Our Model 102A, at \$2,975, has everything you need for just about any AM/FM application — plus seven performance and convenience features you won't get in the \$4,450 design.

What did we leave out?

Phase-lock synchronization, for one (but our dc-coupled FM channel can be externally locked if you need better stability than our typical 4 ppm); and narrow-pulse modulation (belongs in a different class of generators).

What did we add?

Four different signal-generation techniques — for optimum performance in each band, from 4.3 to 520 MHz, without the usual compromises in noise, stability, or residual-distortion characteristics.

The most logical panel layout and convenient control setup you've ever seen. And a unique adjustable "feel" main drive mechanism for narrow-band receiver setting with ease — even without our electrical vernier.

Separate meters for modulation and output — no annoying autoranging or out-of-range annunciators ... we don't need them.

15 minute warmup to typically

meet 10 ppm/10 minute stability — made possible by low internal dissipation (only 30 watts; no fan!)

Wider FM deviation at low carrier frequencies than any other design in this class (how does 2 MHz peak-to-peak grab you?)

A detected-AM-output option, to verify our negligible phase-shift for VHF-omni testing.

Versatile modulation features — like five internal frequencies, 30% and 100% AM scales, and true-peak-responding AM and FM metering.

All these performance pluses are coupled with low spurious and close-in noise, excellent low-frequency phase integrity, really effective leveling, a low and flat VSWR curve, accurate wide-range attenuation, high output power ... all of it buttoned up tight for low leakage in a lightweight 30 pound package.

... and it's all yours for \$2,975. Get the full specs today — before you spend 50% more .

For complete data or a demonstration write or call Boonton Electronics Corp., Rt. 287 at Smith Road, Parsippany, N. J. 07054, (201) 887-5110.

BOONTON

Sky Caps



... in quantity from the world's largest manufacturer of ceramic capacitors

Sky Cap® is a dip-coated version of the best in multi-layers. That's because nobody makes more or better multilayers than AVX.

Sky Caps come in six basic sizes and a new rectangular configuration with 1/4-inch lead spacing. Capacities range between 2.2 pf and 4.7 MF. Standard tolerances. Temperature coefficients include NPO, X7R and Z5U.

Working voltages of 50, 100 and 200 volts — with 25 to 500 volt ratings available on special order. For complete information, request a copy of the AVX Short Form Catalog. Write, AVX Ceramics, P.O. Box 867, Myrtle Beach, S. C. 29577. Telephone: (803) 448-3191. TWX: (810) 661-2252.



MODULES & SUBASSEMBLIES

2.2-pound rubidium standard for systems uses only 12 W

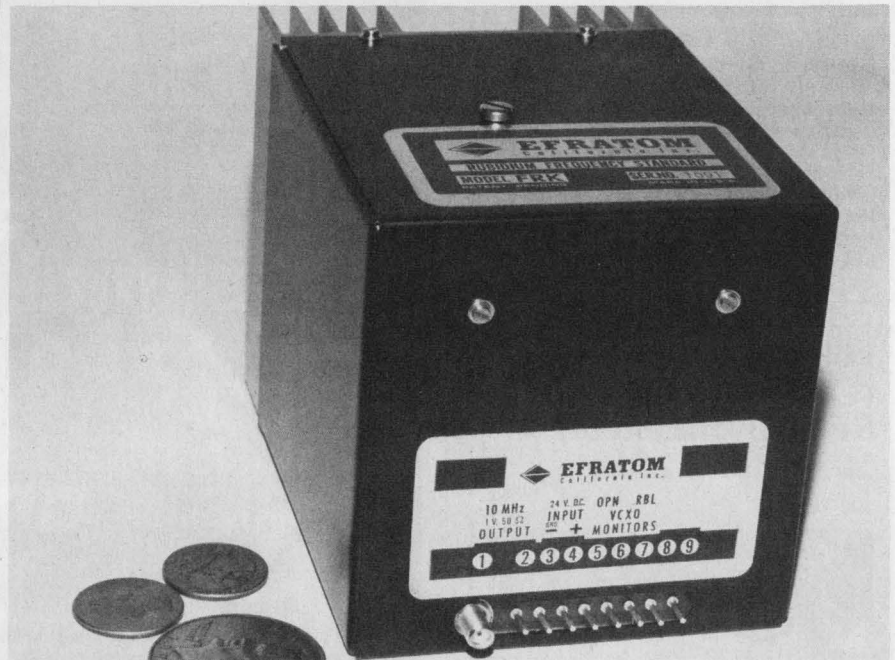

Efratom California, Inc., 3303 Harbor Blvd., Costa Mesa, Calif. 92626. (714) 556-1620. \$5100. 4 wk.

A rubidium frequency standard that weighs only 2.2 lb. consumes just 12 W. It is the smallest, lightest and lowest in power consumption of any on the market. Known as the model FRK, from Efratom, the standard has a long-term stability of less than 1 part in 10^{-10} for a month and short-term stability of less than 5×10^{-11} for 1 s.

The standard measures $3.9 \times 3.9 \times 4.4$ in. The company has achieved the small size by building the resonant rubidium cell into a microwave cavity. In most other standards, the cavity is a separate component that follows the cell as an output filter.

The output frequency of the standard is a 10-MHz signal. The trim range of the output is 2×10^{-9} , controlled by a 25-turn potentiometer. The level of the output is 1-V rms from a 50- Ω source impedance.

At frequencies more than 200 Hz away from the nominal frequency of the standard, the signal-

to-noise ratio is greater than 120 dB in a 1-Hz band.

Rapid warm-up is a feature of the FRK. In 10 min. a stability of 2×10^{-10} is achieved. Supply voltages of 23 to 32 V can be tolerated with a nominal 24 V dc. An internal diode protects the standard against reversed polarity connection. The output connector is an OSM 211 jack.

The operating temperature range of the standard is -25 to $+65$ C, with a maximum frequency drift of less than 1×10^{-9} over the whole range. For airborne applications the drift with altitude is less than 5×10^{-13} /mbar.

In comparison with other low-cost rubidium standards, such as the Tracor Instruments Model 308-A, the Efratom unit wins all spec comparisons except for stability. The Tracor standard has long-term stability of better than 3×10^{-11} /month and short-term stability of better than 2×10^{-11} s. However, the Tracor unit requires a 19-in. rack, weighs 31 lb. and has a 50 W power dissipation.

For Efratom **CIRCLE NO. 250**
For Tracor **CIRCLE NO. 251**

WESTON for frequency counters you can really count on.

Weston—the nation's oldest name in test equipment—presents its newest line of high-reliability frequency counters.

For the engineer, service technician or serious hobbyist, there's the new Model 1252, an auto-ranging crystal-clock counter, 5 Hz to 30 MHz range, 6-digits, and all solid-state circuitry. With four autoranging gates plus two pre-set gates, automatic blanking of leading zeroes, at an unbelievably low price.

Those wanting more capacity in a counter can find it in Model 1253, a 1 Hz to 200 MHz instrument with separate 1-megohm and 50 ohm inputs, 7-digit LED with overrange indicator, 1 MHz time base, and external clock input. Great for precision work. Comparably low priced.

Scientists, lab technicians and experimenters requiring the utmost from a counter, can find it in either Model 1254 or Model 1255. Both have high-stability TCXO time bases, 1 Hz to 200 MHz range, BCD output, push-button re-set (first display is always correct), and remote programming capability. Model 1255 also has a pre-scaled 600 MHz capability.



To complement these fine counters, Weston also offers the Model 1251, a programmable 20 MHz time with 100 nsec. resolution. It provides time interval, period, time average, event and ratio measurements in a 5-digit LED display. And, there's also Model 1259, a 600 MHz scaler which will extend the range of any counter to 6 MHz-600 MHz, automatically.

All of these ultra-reliable Weston Frequency counters are lightweight, compact, and easy to use. Each has a lockable, multi-position handle which serves as a tilt-stand. See them at your Weston distributor today. Or, write Weston Instruments, Inc., 614 Frelinghuysen Ave., Newark, N.J. 07114.

We're either first or best. Or both.

WESTON[®] WESTON
Schlumberger



MODULES & SUBASSEMBLIES

Xtal oscillator output has high spectral purity

Damon Corp., 80 Wilson Way, Westwood, Mass. 02090. (617) 449-0800.

Overtone voltage-controlled crystal oscillators provide high spectral purity at output frequencies ranging from 36 to 150 MHz. They have a linear deviation capability up to $\pm 0.025\%$ of center frequency. Temperature stability is typi-

cally ± 10 ppm from 0 to +50 C. The Model 6897WXA has the following characteristics: Center frequency of 114.008 MHz, with a ± 1 kHz adjust; frequency deviation of ± 20 kHz at 4 kHz/V; linearity of $\pm 1\%$ of best straight line; output power of 0 dBm into 50 Ω and harmonically related components are a minimum of 30 dB down, none within 72 MHz of cf. The power supply requirements are ± 12 V dc at approximately 50 mA. The case size is 4 x 2 x 1 in.

CIRCLE NO. 258

CMOS DAC uses only 15 mW and is small

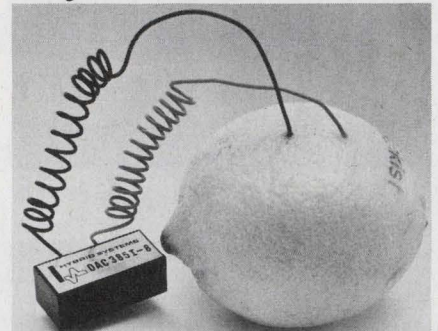

Hybrid Systems, 87 Second Ave., Burlington, Mass. 01803. (617) 272-1522. \$19 (1 to 9); stock to 6 wk.

The DAC385I-8, 8-bit CMOS d/a converter needs something stronger than a lemon to power it. It draws only 15 mW of power from a single +15 V power supply—less than half the power of a TTL gate. The DAC385I-8 plugs into a single 16-pin IC socket and is only 1.3 x 0.6 x 0.48 in. The unit is complete with its own internal reference, precision resistor ladder network and network switches. Its output may be converted to voltage by means of a simple resistor to ground. Other key specifications: Accuracy vs temperature is 200 ppm/ $^{\circ}$ C, linearity is 1/2 LSB. The unit settles to 0.1% in 1 μ s, it has binary coding and its full scale output current is 0.67 mA.

CIRCLE NO. 259

Automatic 0.25% impedance measurement:



Our new Model 251 Digital Impedance Meter provides the most accurate measurements of inductance (L), resistance (R), capacitance (C), and conductance (G) available in any instrument up to five times the cost—plus it's fast and reliable.

Big, fat claims, right? But consider this: Accuracy of 0.25% + 1 digit, measurement speeds of a fraction of a second, high-intensity 3½-digit read-out has overload blanking to prevent false readings, solid-state construction packed into a rugged 10-pound frame. And simple to operate.

You might consider this. Our reputation. We've led the building of precision impedance measur-

ing instruments for laboratory and quality control applications for 25 years. Check us out, then call or write for the complete story. Ask about our discrete IC testers, too.

Electro Scientific Industries
13900 N. W. Science Park Drive
Portland, Oregon 97229
Phone: (503) 646-4141

Openings: Product Manager, Application Engineers.

\$990.
(U.S.A.)



INFORMATION RETRIEVAL NUMBER 41

Vibration detector responds to 5000 Hz

Columbia Research Labs, MacDade Blvd. & Bullens Lane, Woodlyn, Pa. 19094. (215) 532-9464. 1 to 2 wk.

The CV-104 series of vibration detectors provides automatic warning or shutdown due to excessive vibration. The basic vibration detectors are available in all types of enclosures, including miniature cases, JIC enclosures and explosion proof types. They can have built-in time delays that eliminate false shutdowns caused by accidental high level short duration vibration or impacts, an on-off trigger output and an adjustable alarm-set-level. Frequency response is from 2 to 5000 Hz with an operating temperature range from -40 to +170 F. Repeatability is within 1% of set value. Operation is from 115 V, 60 Hz, or 28 V dc.

CIRCLE NO. 260

Frame them any old way

Or any new way.

Then sit back and watch your Ise display electronics get your ideas across. Beautifully.

In an eye-easy fluorescent green glow.

At the same time, they're low on voltage and current drain.

High on stability.

Pick the readouts that offer more of everything, including variety, for a whole host of digital display ideas.

They're a difference you can see

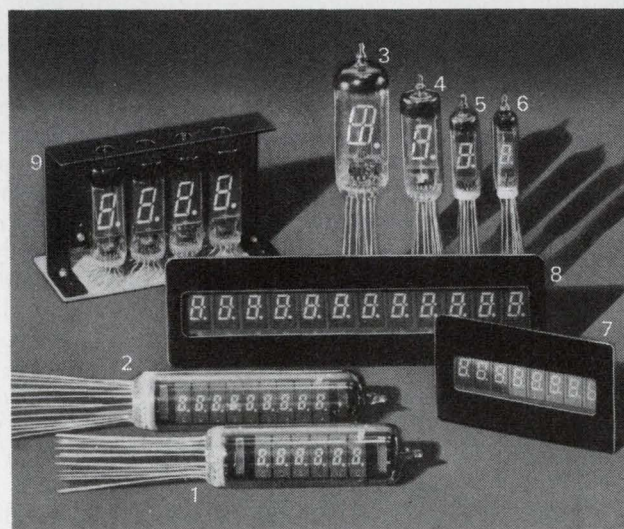
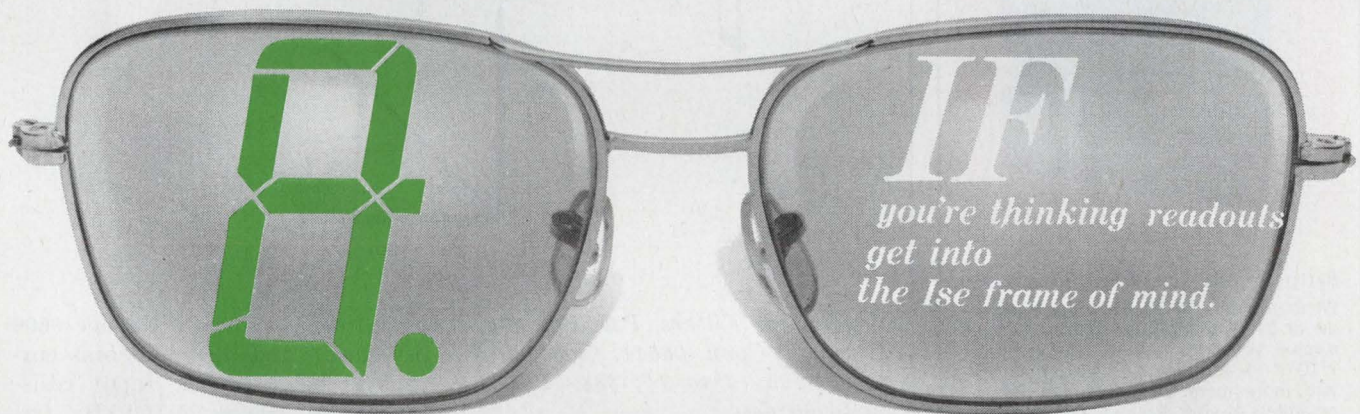

1. DP60A
2. DP90A
3. DG19E
4. DG12H
5. DG10F1
6. DG 8F
7. DP 89A
8. DP127F
9. DMCL12H (NEW)

Display module w/counter & latch

- Fluorescent green glow.
- 12-pin connector.
- Three performance perfect models.
- Custom ROM programming with other than BCD and seven-segment output.

International Div.

ISE INTERNATIONAL CORP.

No.2-7-7, Higashi-Shinbashi, Minato-ku, Tokyo, Japan
Tel: 433-6616~9 Telex: J26546
Cables: "ISEWORLDREP" TOKYO



The Brighter Side of Electronics

ISE ELECTRONICS CORP.

P.O. Box 46 Ise-city, Mie Pref., Japan

Representative: Los Angeles, Paris, Munich, Amsterdam, Stockholm, Vienna, Milan, Bombay, Hong Kong, Taipei.

INFORMATION RETRIEVAL NUMBER 42

What
you see
is what
you get.



Better yet, what you set is what you get!
When you set a DIGIVIDER voltage divider or DIGIDECAD resistance decade at a value, you get only that--value (within 1/10 of 1% accuracy). We make them with more liberal tolerances, too. But, regardless of your accuracy requirements, (1.0%, 0.5%, 0.25% or 0.1%) you get...

- In-line readout • Positive detent action
- Absolute repeatability (no hysteresis)

...in less space and for less money per digit than a 10 turn precision potentiometer.

We make DIGIVIDERS or DIGIDECAD assemblies in any of our modular switch lines.

Send for our DIGIVIDER, DIGIDECAD Catalog today and see what you get.

There is a Digitran authorized distributor and a sales engineering group in your area.

See pages 1148 and 1149, Vol. 2 in the 1973-74 EEM Directory for more Digitran products.

DIGIVIDER
DIGIDECAD
MORE SWITCHES FROM THE
DIGITRAN
COMPANY

Division of Becton, Dickinson and Company [B-D]
855 South Arroyo Parkway / Pasadena, Ca. 91105
Telephone: (213) 449-3110 / TWX 910-588-3794

INFORMATION RETRIEVAL NUMBER 43

Voltage control is featured in zero-phase-shift filter

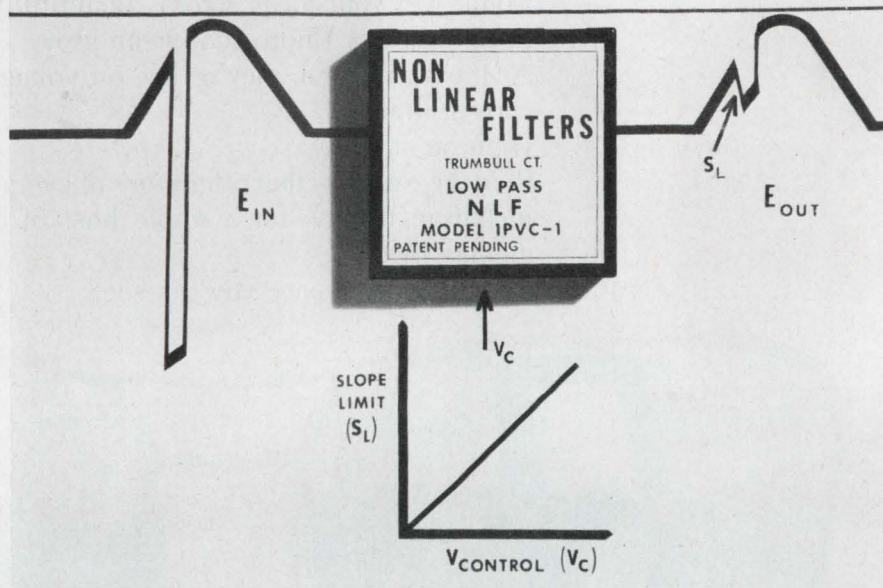

Non Linear Filters, P.O. Box 338, Trumbull, Conn. 06611. (203) 268-6309. \$125 (1 to 9); \$88 (100s); 30 to 60 day.

The Model 1PVC-1 voltage-controlled low-pass nonlinear filter attenuates noise spikes without introducing any phase lag into the signal above or below the corner frequency.

The ability to control the corner frequency, by changing a few component values, makes this unit from Non Linear Filters useful in a variety of applications. The control-voltage input "instantaneously" (within 0.1 μ s) controls the value of the limiting slope over a 500-to-1 range (54 dB).

With the control voltage set at a particular value, a constant-frequency, low-amplitude sine wave passes through the filter undistorted. As the amplitude is increased, the output becomes a triangular wave. But if the control voltage is also increased, the sine wave again passes through undistorted (without slope limiting).

The 1PVC-1 operates from dual 15-V supplies with a current drain of 20 mA max. The input-to-out-

put offset is typically 200 mV (600 mV max), and the input bias current is below 2 nA. Input resistance over the dc-to-100-kHz frequency range is 3.6 k Ω max.

Output voltage swing with a load resistance of greater than 2.5 k Ω is ± 10 V or more, while the input voltages are limited to ± 11 V max. The slope-limiting is determined by the external components and can be calculated from a simple equation.

The corner frequency can be set externally by use of two approximately equal capacitors. You calculate their values by dividing a circuit constant by the corner frequency required. The answer is in microfarads.

The filter operates over a 0-to-70-C temperature span. It is housed in a 2.56-in.-square-by-0.88-in.-high encapsulated module that weighs 7 oz.

Typical uses for the filter include phonograph record surface and scratch noise rejection, phase-locked-loop FM detection, nonlinear autocorrelation, shot-noise filtering and digital communications.

CIRCLE NO. 253

Signal transducers handle V, I, W or VARs

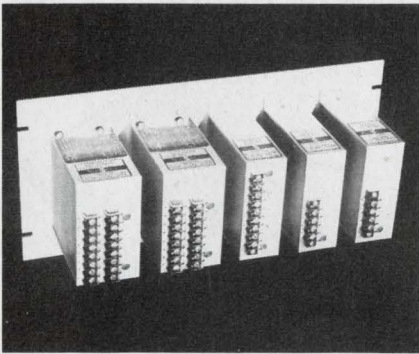

The Arnold Engineering Co., P.O. Box G, Marengo, Ill. 60152. (815) 568-2000.

The R-2000 series of transducers measures power, voltage or current. It offers accuracies of 0.5% of rated output across a broad range of operating conditions. Dielectric insulation and surge limit capabilities exceed proposed IEEE standards. Outputs are isolated low-ripple dc signals proportional to the ac quantities being measured. The units use modular circuit board construction, have IEEE standardized dimensions and terminal placement all in one plane.

CIRCLE NO. 294

Dual audio op amp delivers 2 W per channel

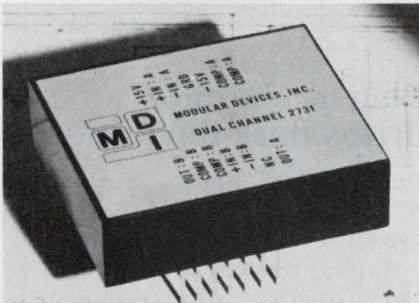

Modular Devices, 1385 Lakeland Ave., Airport International Plaza, Bohemia, N.Y. 11716. (516) 567-9620. \$39; stock to 30 day.

The Model 2731 is a dual, low noise, audio operational amplifier. With the addition of an output transformer the module can drive a speaker with 4-W continuous peak power. Model 2731 has an output power of 2 W per channel. Other features include: Output short-circuit protection, small size of 1-1/2 x 1-3/4 x 1/2 in., dual in-line 14-pin configuration for PC board mounting and simplified system wiring.

CIRCLE NO. 295

Efficiency Experts

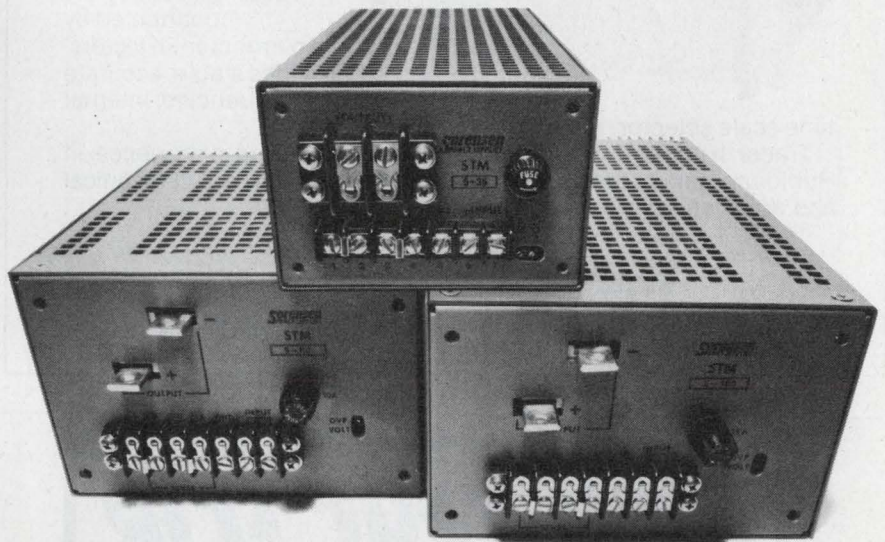

Built to save energy — modular STM switching-transistor power supplies from Sorensen. Exceptional power density and efficiency. Up to 1.5 watts per cu. in., and up to 75% efficiency in half the space of comparable competitive units. 40 models offer outputs from 72 to 780 watts (3 to 56 volts) — all with these features: cool running... excellent performance characteristics... built-in overvoltage protection... quiet operation... adjustable current limiting. For complete data, contact the Marketing Manager at Sorensen Company, a unit of Raytheon Company, Manchester, N.H. (603) 668-4500.

Representative Specifications — STM

Regulation (comb. line & load)	0.05%		
Ripple (PARD)	rms: 3 to 10 mv. p-p: 30 mv. typ.; 50 mv. worst case		
Module Sizes & Prices	Module	Size	Price
	III	5.12" x 3.31" x 9.50"	\$240-270
	IIIA	5.12" x 3.31" x 14"	\$300-330
	IVA	7.5" x 4.94" x 10.5"	\$475-495
	VI	7.5" x 4.94" x 14"	\$600-650

Sorensen
POWER SUPPLIES

WHAT PRICE STABILITY?

Tracor Model 308-A Rubidium Frequency Standard. \$5,900.

Atomic accuracy at near crystal prices. Utilizes stable quartz crystal oscillator whose frequency is controlled by atomic resonance of rubidium 87. Low cost, high reliability, modular construction.

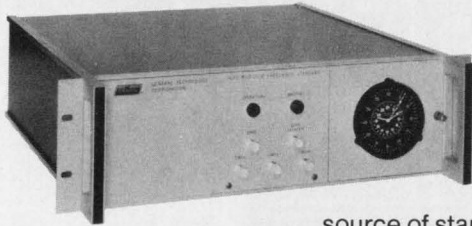

Tracor Model 304-D Rubidium Frequency Standard. \$7,300.

For general lab and field use. Almost entirely unaffected by environmental factors. Provides stable, accurate source of standard frequencies. Integral

time scale selector. Modular construction.

Tracor has more manufacturing and engineering experience in Rubidium standards than anyone else. Write or call for full technical and application information.

Tracor, Inc. Industrial Instruments

6500 Tracor Lane • Austin, Texas 78721 • AC 512/926-2800

INFORMATION RETRIEVAL NUMBER 45

Plan your trip in time*

come to Hanover.
On the „days of the year”
for planners and decision makers.



**Hanover
Fair '74**
Thursday, April 25
to Friday, May 3

*
**Attention
front office:
Hanover is o.k.**

watch the date!

German American Chamber of Commerce, Inc.
666 Fifth Avenue
New York, N.Y. 10019

German American Chamber of Commerce of Chicago
77 East Monroe Street
Chicago, Ill. 60603

German American Chamber of
Commerce of the Pacific Coast, Inc.
465 California Street, Suite 1228
San Francisco, Calif. 94104

270

INFORMATION RETRIEVAL NUMBER 46

DATA PROCESSING

Cassette recorder offers 9-hour play time



Answer Line Associates, Inc., One Northern Blvd., Great Neck, N.Y. 11021. (516) 466-9333. \$99.50.

A cassette recorder designated the Long-Play gives nine hours of recording time on a single cassette. According to the manufacturer, specially selected heads and sophisticated circuitry provide excellent frequency response at a 5/8-in/s tape speed. Suitable for voice recording and many data logging applications where a minimum of operator handling is desirable, the instrument comes with an ac adaptor or can be operated in the field with five inserted "C" batteries. The suggested list price of \$99.50 includes remote control microphone, carrying case, ac adaptor and a C180 cassette.

CIRCLE NO. 261

Plug-in interface drives desk-top printer

Data Interface Inc., 4 W. Kenosia Ave., Danbury, Conn. 06810. (203) 792-0290. \$650; 30 days.

A plug compatible interface for Data General's Nova computers is available for Data Interface's non-impact printers. Occupying one I/O slot position in the Nova computer, the interface can be connected either directly to the printer or to one of the output connectors on the computer frame. The interface occupies only two of the eight card positions in the plug in assembly. The combination of printer and interface is compatible with Nova line-printer software. The small desk-top printer may be located up to 20 feet from the computer, and prints the full 96 character ASCII font at rates up to 180 lines/min.

CIRCLE NO. 262

Intelligent terminal contains own mini

Megadata Computer & Communications Corp., 10 Evergreen Pl., Deer Park, N.Y. 11729. (516) 667-2900.

The SiR-1000 terminal can be thought of as a general-purpose minicomputer attached to a CRT and selectric-type keyboard. Seven circuit modules that use MOS/LSI comprise the entire system. The CPU portion uses eight-bit words and is expandable from 4 k to 10 k of memory. The keyboard is completely programmable and includes 51 function keys. The terminals handle a wide variety of interfaces including serial data ports (75 to 13,500 baud) and parallel eight or 12-bit ports. Standard terminal capabilities include code conversion, text editing and format control.

CIRCLE NO. 263

Floppy-disc drive is IBM 3740 compatible

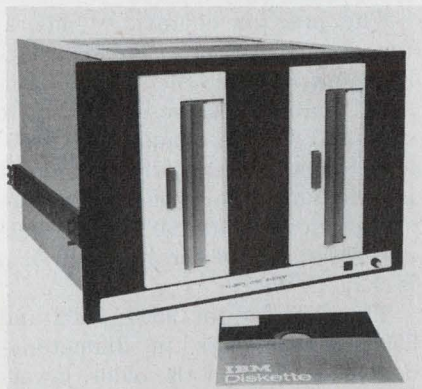

Applied Data Communications, 1509 E. McFadden Ave., Santa Ana, Calif. 92705. (714) 547-6954. \$3750; 45 days.

The Series 61 Floppy Disc System is IBM 3740 compatible. The controller installs in a small peripheral controller slot or wired system unit. A rack mounted enclosure contains one or two drives, power supply, and formatting electronics. Up to eight drives may be operated for one controller-formatter. Diskette capacity is 242-k bytes in IBM compatible format; transfer rate is 242-k bits/s. The system is supplied with all necessary hardware, basic software and support documentation needed for installation and operation with DEC PDP-11, PDP-8/e and Data General processors.

CIRCLE NO. 264

Modem speed increased with digital techniques



Timeplex, Inc., 65 Oak St., Nor-

wood, N.J. 07648. (201) 767-1650. From \$205; 30 days.

Designated the "202 Compatible Modem System," the unit provides 1800 baud communications over unconditioned lines and 2000 baud over C-2 conditioned leased lines. A digital filter system is said to provide the increased data rate over regular 202s. Options include a 5 or 150 baud reverse channel and a four-wire polling section. The modem is available in stand-alone form or as a card.

CIRCLE NO. 265

Hi!—I'm
PLASMAC

the New
DISPLAY PANEL
from
NATIONAL ELECTRONICS

- Numeric, alpha numeric and fixed messages are available in a single panel.
- Custom design displays to suit your needs.

Call or write for full details

NATIONAL ELECTRONICS
a varian division
geneva, illinois 60134 (312) 232-4300

designed
by Grayhill
as the
world's
smallest
rotary switch



**10 positions, 1 or 2 poles,
diameter less than .300"**

- Non-shorting...wiping contacts
...rated to make or break 15,000
cycles minimum at logic loads.
- Now available with integral knob
...as well as screwdriver or
shaft operated.
- For communications circuits,
electronic stopwatches, and
other low voltage applications
where size is critical

As the pioneer in switch microminiaturization, we present our Series 75, designed as the smallest the state of the art permits. If you think that small switch means big price...guess again. Here's a lot of switch in a tiny package at a cost that's surprisingly low. Write for Bulletin #237 describing these miniature switches...and consult EEM for more information on Grayhill products.



561 Hillgrove Avenue • LaGrange, Illinois 60525
(312) 354-1040

INFORMATION RETRIEVAL NUMBER 48

ICs & SEMICONDUCTORS

500-A one chip transistors have super-low $V_{CE(sat)}$

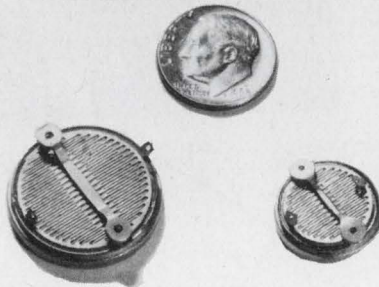
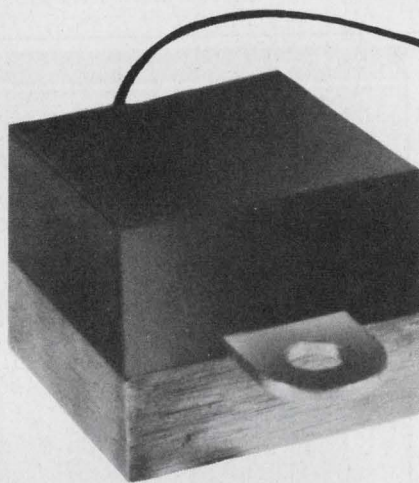

*PowerTech Inc., 9 Baker Court,
Clifton, N.J. 07011. (201) 478-
6205. P&A: See text.*

Single-chip transistors that can handle 500 A? It's true. PowerTech's Models PT-9501, 9502 and 9503 are the largest available silicon npn transistors, and they can control currents up to 500 A or voltages up to 120 V at 400 A.

The 9501 and 9502 can handle 500 A at 60 V and 80 V, respectively. The 9503, though, can pass only 400 A—but at 120 V. All three transistors have a $V_{CE(sat)}$ max of 0.5 V at 300 A, and except for the 9503, they have a $V_{CE(sat)}$ max of 1 V at 500 A.

Power dissipation for the units is 625 W at a case temperature of 25 C, with derating down to 400 W at 100 C. Transistor beta at an I_C of 300 A is 10. When the current

is increased to 500 A, the beta drops to 5. Switching speed at a current level of 75 A is a combination of 3- μ s rise time, a 3- μ s storage time and a 3- μ s fall time, for an absolute max switching frequency of 10 kHz.

All transistors are housed in a PB-500 Power-Block case 1.5-in. square by 1.1-in. high. Other case styles are available upon request. Each unit is subjected to a power test at 40 V, 10 A and a 100-C case temperature for preliminary reliability burn-in.

The junction operating-temperature range is from -65 to 200 C, although the case epoxy can withstand ambient temperatures up to only 150 C. This causes no problems, though, since when the unit is heat-sunk, the case temperature stays below about 100 C. The thermal resistance of the junction Θ_{j-c} , is 0.25 C/W.

The chip for the 9501, 9502 and 9503 is 820 mils in diameter—double the area of the older, lower-power modules. The chips can also be packaged in a power-system array that can switch currents of up to 3500 A. Collector capacitance is 5000 pF when tested at a $V_{CB} = 10$ V and when $f = 100$ kHz.

Competing units from other companies use a multichip approach for the high current—paralleling as many as 10 lower current transistors.

The 100-up price for the 9501 and 9502 is \$123.50 each, while the price for the 9503 is \$138 for the same quantity. All devices are available from stock.

Applications for these transistors include high-current switching for motor controls, battery-test equipment, dc-to-ac inverters for auxiliary power sources and solid-state relays.

CIRCLE NO. 252

i'm free



**I'M A
MAIL-LITE®
SHIPPER**

**1 CASE of Mail-Lite FREE when you buy my
\$50 table model heat sealer.**

**2 CASES of Mail-Lite FREE when you buy my
\$100 floor model heat sealer.**



*Labor Savings: Can be heat sealed closed in 2 seconds
Postal Savings • Waterproof • Pufferproof • Lightweight • Clean*



WRITE TODAY FOR INFORMATION ON OUR
MAIL-LITE SHIPPERS AND THE SPECIAL
HEAT SEALER OFFER.

Sealed Air Corporation

19-01 State Highway 208, Fair Lawn, New Jersey 07410

INFORMATION RETRIEVAL NUMBER 49

**CUT
PRODUCTION
TIME WITH
THESE
LOW COST
COMPONENT
LEAD BENDERS**

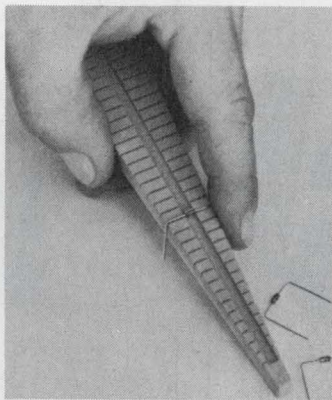

Up to 1200 component leads per hour may be formed with these simple, precise units. They cut production time and eliminate damage to components and leads. Designed primarily for resistors and diodes, MARK Series Component Lead Benders produce perfect bends. Tantalum capacitors, axial lead components, jumper wires, and other similar parts may also be formed easily and efficiently. Ideal for both prototype and production situations.

Bends are made rapidly with gentle finger pressure and meet N.A.S.A. Specification MSFC-PROC-256. No other tools are required. The aggravation and component damage associated with the long-nose plier "free bending" technique is completely eliminated. Industry proven since 1959, the MARK Series offers 5 models for forming 1/8 watt, 1/4 watt, 1/2 watt, 1 watt, and 2 watt size component leads. Priced under \$5.00, these quality tools are available for off-the-shelf delivery. For complete information write or call:

RG ENTERPRISES, INC.

P.O. BOX 667

SCOTTSDALE, ARIZONA 85252

TELEPHONE (602) 948-9888

INFORMATION RETRIEVAL NUMBER 50

ELECTRONIC DESIGN 5, March 1, 1974

STILL LOOKING FOR A SPECIAL COMBINATION OF SWITCHING ACTIONS? ... YOU WOULDN'T BE IF YOU'D CHECKED OUR INVENTORY OF SWITCH DESIGNS FIRST!

*... we've been making special
pushbutton, toggle, and limit
switches for over 35 years!*

Typical CSI Switches with Unusual Features:



INDUSTRIAL

Limit switch designed to operate underwater for long periods without maintenance. For use in harsh environments such as machine shops, oceanography, etc.



COMMERCIAL AVIATION

Low cost, airline, lighted hostess call switches chime only once when depressed, but can be actuated many times without resetting. For use in commercial aviation.



TEXTILE MACHINERY

Yarn detector switches sensitive enough to detect fine yarn breakage or over tension and facilitate smooth operation of knitting machines in the textile industry.



MEDICAL ELECTRONICS

Lightweight miniature switch for use in electronic heart pacer applications features high reliability operation in medical equipment.

**Write For Technical Bulletins, or send us the specs
of the switch they said couldn't be made . . . we'll
send you a quote!**





CONTROL SWITCH INC.

A SUBSIDIARY OF CUTLER-HAMMER INC.

1420 Delmar Drive • Folcroft, Pa. 19032 • (215) LU-6-7500

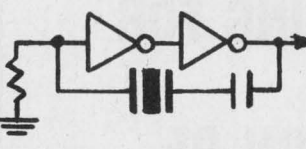
Representatives and Stocking Distributors Throughout the
United States, Canada, and Europe

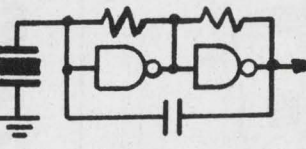
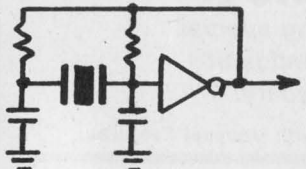
INFORMATION RETRIEVAL NUMBER 51

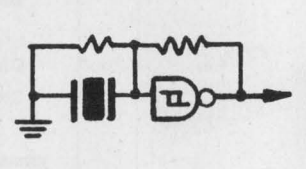
 <p>Fa TTL CLOCK</p>	<p>RMC</p> 	 <p>Fa C/MOS CLOCK</p>
<p align="center">CERAMIC RESONATORS For Clock Generators</p> <p>Frequency control is better than 0.2% deviation from the 25°C value over the temperature range of -20°C to +65°C. 195 KHz to 500 KHz available. Standard tolerance (± 1 KHz) units are priced at \$0.50 in 100 quantities.</p>		
 <p>Fa C/MOS CLOCK</p>		 <p>Fr TTL CLOCK</p>
<p align="center">Radio Materials Company Div. of P. R. Mallory & Co. Inc. 4242 West Bryn Mawr Avenue Chicago, Illinois 60646 (312) 478-3600</p>		

INFORMATION RETRIEVAL NUMBER 52

Fer- rights!

The right Ferramic™ for the right application... everytime!

With Permagan supplying application-rated Indiana General Corp. Ferramics, you'll always get exactly what you need. Complete fabricating facilities. Prototype quantities available. Engineering assistance. Annealing and field testing. Prompt 24-hour delivery. Extensive stock of ferrite parts at all locations. Catalog available.

FERRAMICS™
FROM PERMAG

Consult your Yellow Pages
for address and telephone number of Permagan near you.

Cable Address: MAGNETS NEWYORK

YOUR NO. 1 SOURCE
FOR ALL MAGNETIC MATERIALS



ALL ACROSS THE COUNTRY

ICs & SEMICONDUCTORS

Counter/timer IC has μ s-to-5-day delays

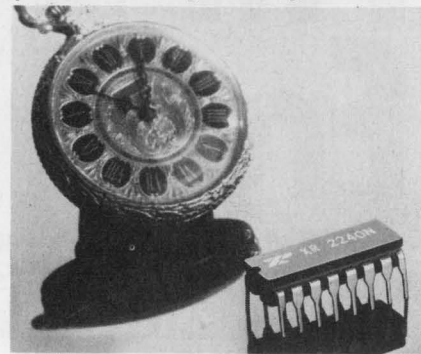

Exar Integrated Systems, 750 Palomar, Sunnyvale, Calif. 94086. (408) 732-7970. \$5.75 (100); stock.

A monolithic counter/timer generates precise, very long time delays with an external RC setting. It can be used to obtain programmable time delays from microseconds up to 5 days with an accuracy of 0.5% and a temperature stability of 40 ppm/°C. Because of the binary counting method, it is also possible to cascade two XR-2240 timers to generate programmable time delays up to three years. The circuit combines an analog time-base oscillator with a programmable 8-bit counter on the same chip.

CIRCLE NO. 266

Bridge rectifiers come in compact package

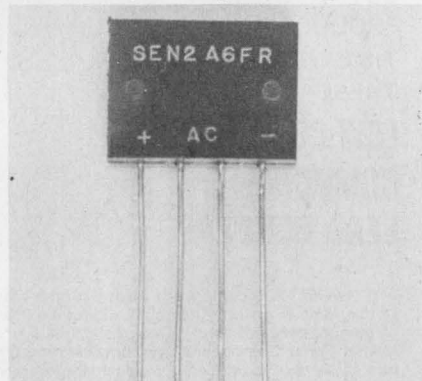

Sensitron Semiconductor, 221 W. Industry Ct., Deer Park, N.Y. 11729. (516) 586-7600.

A single-phase subminiature 2-A fast-recovery bridge rectifier series comes in a compact epoxy case. Continuous current rating is 2 A at 55°C ambient temperature. Surge rating is 50 A for 8.3 ms. The series lists voltage ratings of 50 through 800 V.

CIRCLE NO. 267

INFORMATION RETRIEVAL NUMBER 53

Linear-motion pot has 0.1% linearity

Computer Instruments Corp., 92 Madison Ave., Hempstead, N.Y. 11550. (516) 483-8200. 8-10 wks.

A miniature but rugged linear-motion potentiometer, the Model 120, has a 1-in. stroke and is furnished in an aluminum housing $1/2 \times 5/16 \times 2$ -in. long. Clearance holes are provided for mounting. Plain, threaded or slotted shaft endings are available. The unit uses a conductive-film resistive element that is suitable for ac or dc operation without amplification. Maximum linearity is 0.1% and maximum resistances from 500 Ω to 100 k Ω are standard. Wattage rating is 1 W and the operating temperature range is -55 to 125 C.

CIRCLE NO. 268

Switches solder directly to PC board

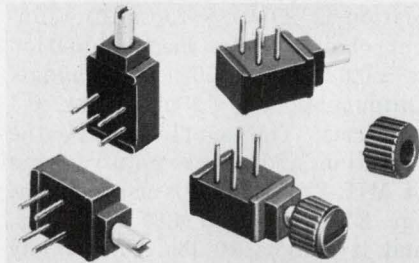

Control Switch, Inc., 1420 Delmar Dr., Folcroft, Pa. 19032. (215) 586-7500. \$1.25: pushbutton; \$0.95: toggle (unit qty).

Pushbutton and toggle switches are designed for solder-pin insertion into 1/16, 3/32, and 1/8-in. thick PC boards. They are also available for thru-panel mounting. Only 0.6 in. in length, the switch body requires no mounting hardware. Terminals are 0.13 in. long. Two and three-position toggles and momentary action or latch-down pushbuttons are available. All switches are two circuit with a mechanical life in excess of 500,000 operations. Resistive load is rated from 0.01 A, 6 V dc, to 0.5 A, 28 V dc and ac. Cases and actuators are molded of impact and heat-resistant plastic. Terminals and contacts are gold-plated silver for long shelf life and minimum resistance.

CIRCLE NO. 269

Multipole reed relay features low profile

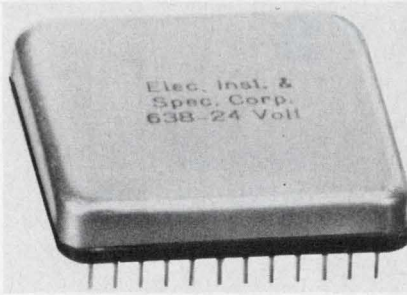

Electronic Instrument & Specialty Corp., 42 Pleasant St., Stoneham, Mass. 02180. (617) 438-5300. Typical \$12.30 (500 up); 4-6 wk.

This multipole (4 to 8 contacts, Form A) flat-pack reed relay needs only a 0.5-in. height and mounts on a PC board into standard contact strips. Specifications of the relay include 0.5-A, 200-V and 10-W maximums. Multiple coils and a variety of contact forms are also available.

CIRCLE NO. 270

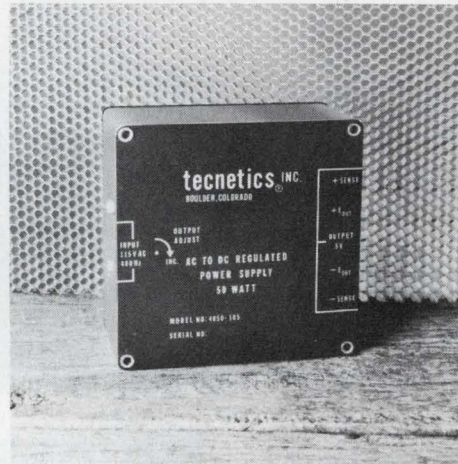

400 Hz Input High Efficiency High Density

400 Hz-DC regulated power supplies

tecnetics 4000 series 400 Hz-DC regulated power supplies feature high efficiency up to 85% and high density packaging up to 2.5 watts/in³.

Regulation: Line (115V rms \pm 10%) 0.2%
Load (NL to FL) 0.4%
Temperature 0.01%/°C max.

Output powers 25, 50, 100 watt

Output voltages in 5V to 48V models

Short circuit and overload protected

Dimensions: 4x4x2 inches (25 and 50w models)
5x4x2 inches (100w models)

Availability: Four weeks

Prices: \$375 (25w) \$395 (50w) \$425 (100w)

Write or call for more details on specifications, applications and the new 1974 catalog from tecnetics.

tecnetics The Power Conversion Specialists

P. O. Box 910 1625 Range Street, Boulder, Colorado 80302
(303) 442-3837 TWX 910-940-3246

OPEN-LINE REED RELAYS

Quality Engineered at Low Cost
Broad Line . . . From Distributor Stock

An exceptionally high quality line of Form A and Form C open frame reed relays — with up to 6 contacts (Form A) and 4 contacts (Form C) per relay! Available in standard coil voltages 5 to 48 VDC . . . Capable of switching up to 1/2 amp, 250 VDC (Form A) or 1/4 amp, 28 VDC (Form C). Only .350" high by 1.125" long, with terminals on .1" or .15" grid spacing. Electrostatic and electromagnetic shielding optional. Top performance at low cost . . . Tailored to fit your cost/environmental requirements.

Phone, wire or write.

ELEC-TROL, INC.

26477 N. Golden Valley Road
Saugus, California 91350
(213) 788-7292
TWX 910-336-1556

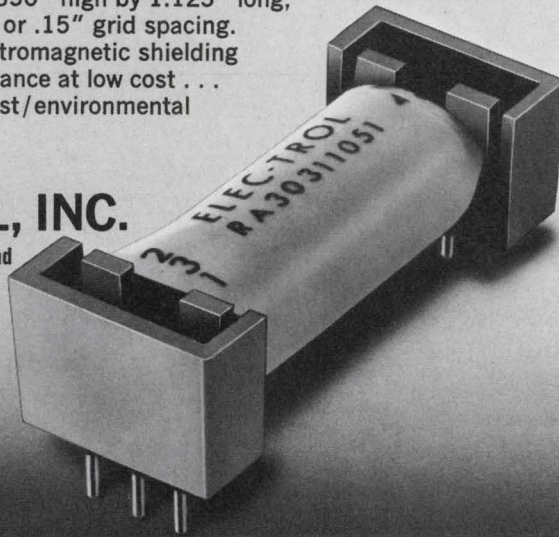

1973-74
eem
VOL. TWO

INFORMATION RETRIEVAL NUMBER 71

Defeat 1/f noise and power line pickup in your PHOTOMETRIC experiment!

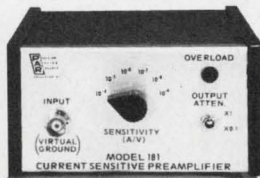

With our new Model 181 Current Sensitive Pre-amplifier and a lock-in amplifier, you can modulate your light beam at any frequency up to one hundred kilohertz—more than enough to beat low frequency interference and flicker noise. You won't have to give up sensitivity either—in fact, with an internal noise current of only 4 fA/Hz^{1/2}, the Model 181/lock-in combination can resolve currents typically less than 1 fA (10⁻¹⁵A). And, you don't have to worry about the photodetector's quiescent current or stray light, because the Model 181 can handle dc inputs up to 10 times its current-to-voltage conversion setting without overload.

Find out how our Model 181 Pre-amplifier can simplify your photometric measurements. Write or call Princeton Applied Research Corporation, Post Office Box 2565, Princeton, New Jersey 08540. Telephone [609] 452-2111. In Europe contact Princeton Applied Research GmbH, D8034 Unterpfaffenhofen, Waldstrasse 2, West Germany.



243

INFORMATION RETRIEVAL NUMBER 72

84

DO-IT-YOURSELF WAVEFORMS



Exact waveform synthesizer lets you build your own custom waveforms bit-by-bit

The Models 201 and 202 Waveform Synthesizers generate complex waveforms — either analog or digital — for many applications, including distortion compensation, cardiac simulation, acoustics, general research, waveform analysis, staircase and code transmission, PCM-PWM telemetry, PAM and shock table drive.

Forty selectable bits, each independently controlled in amplitude, width and slope, are available. Instrument can be free-run, triggered or gated for one shot or burst operation, or stepped through the waveform one bit at a time.

Model 201 \$1995.00
Model 202 (incorporates cycle length counter with 0-to-40 selectable steps) \$2495.00



Box 160, Hillsboro, Ore.
97123 • (503) 648-6661

a subsidiary of Danalab, Inc.

EXACT electronics, inc.

INFORMATION RETRIEVAL NUMBER 73

POWER SOURCES

Series pass supply is more than 50% efficient

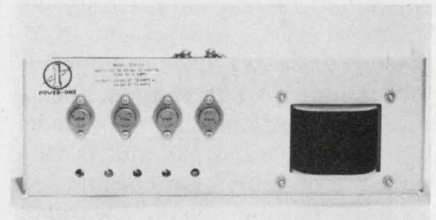

Power One, 6324 Variel Ave., Building E., Woodland Hills, Calif. 91364. (213) 887-5730. \$98.95 (1 to 9).

The Model E5-18, a 5 V (±5%) 18 A series pass, dc power supply, provides greater than 50% efficiency. The supply incorporates an adjustable current foldback, 0.02% regulation and reverse voltage protection as standard features with overvoltage protection available as an option. Input power is 105 to 125 V ac, 47 to 440 Hz while the operating temperature range is 0 to 50 C at full output but can be derated at 70 C to 40%. Line regulation is ±0.01% for a 10 V input change while load regulation is ±0.02% for a 50% load change. Output ripple is 1.5 mV pk-pk, 0.4 mV rms. The supplies meet the vibration and shock requirements of MIL-STD-810B. Over-all size of the E5-18 is 3 × 4.87 × 14 in. and it weighs 10 lbs. The supply is also available in 15 and 24 V output models.

CIRCLE NO. 271

Modular supplies come in many standard sizes

Air Design Inc., 3824 Terrace St., Philadelphia, Pa. 19128. (215) 483-1383. From \$26.75; stock.

Series AD modular power supplies can be powered by an input voltage of 115±10 V ac at 50, 60 or 400 Hz. Regulated dc outputs are available up to 200 V at 2 A maximum, although models at 3.6, 5, 6, 10, 12, 15, 18, 20, 24 and 28 V are standard. Output currents range from 250 to 2000 mA. Line and load regulation (NL to FL) is 0.02% within specified range. Ripple is less than 0.5 mV maximum within specified range. Options include programmable or field-adjustable output models.

CIRCLE NO. 272

SCIENCE · OPTICS · ELECTRONICS
ONOSOAC & HARD TO FIND BARGAINS
 NEW PRODUCTS · NEW MATERIALS · NEW METHODS



SUPER 6" SPACE CONQUEROR
 Superb Astronomical Reflector. Includes electric drive w/manual slow-motion control, setting circles, heavy-duty equatorial mount, pedestal base. Features aluminumized, overcoated 6" 1/8 ground + polished Pyrex(0) parabolic mirror accurate to 1/4 wave. 48" F.L. 6X achromatic finder. 4 eyepieces—48X Kellner, 1/2" 96X, 1/4" 192X Ramsdens, & a Barlow to double or triple power—rack & pinion focusing mount. 47-3/4" aluminum tube.
 No. 85.085DA (Shp. Wt. 66 lbs.)\$259.59 FOB
 6" Without Clock Drive\$222.50 FOB
 4-1/4" Reflector (48X to 275X)\$115.00 FOB
 No. 85.105DA\$149.95 FOB
 4-1/4" Reflector W/Clock Drive\$149.95 FOB
 No. 85.107DA\$36.95 Ppd.
 3" Reflector (60X to 180X)\$36.95 Ppd.
 No. 85.050DA

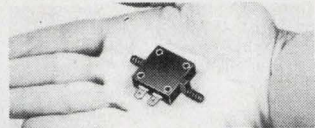

ULTRA LOW PRESSURE SENSOR
 Big surplus bargain—tiny electrical pressure switch activated by only 0.02 psi air or 1/2" or less water pressure. Single pole, normally open. 10ma DC contact rating. 30v AC/DC (usual loads require sensitive relay or solid state control). Use as sensor, switch, control, counter, edge guide, instrument alarm. Long life (1,000,000 operations). Impervious to extreme shock, vibration. 1" sq. polycarbonate case. 3/16" diameter barbed pressure ports. Wt—10 grams. ORIGINAL COST \$11.50. Stock No. 41.623DA\$4.50 Ppd 100 or more\$3.95 each
 No. 41.509DA 1-OZ. BOTTLE\$8.75 Ppd



He-Ne LASERS FROM \$99.50!
 Edmund quality, TEM00 mode, cold cathode for long life. Completely self-contained units; solid state power supply; 110v AC. 0.3mW min—GREAT GENERAL PURPOSE LASER: 1.2mm beam dia., 2.0m-Rad beam Diverg.
 Stock No. 79.061DA\$99.50 Ppd.
 1.0mW min—HI-PERFORMANCE LAB LASER: 1.2mm beam dia., 1.0mRad beam Diverg.
 Stock No. 79.050DA\$150.00 Ppd.
 3.0mW min—DEPENDABLE HI-POWERED LASER: 1.0mm beam dia., 0.8m-Rad beam Diverg.
 Stock No. 79.052DA\$325.00 Ppd.

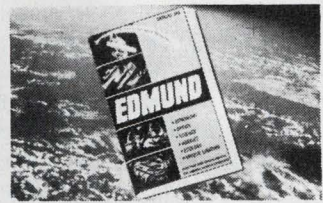

GIANT FREE CATALOG
 Brand new 1974 edition — 180 pages. Hundreds of unique new items! Hard-to-get surplus bargains. Ingenious scientific tools. 1000's of components: lenses, prisms, wedges, mirrors, mounts, all types of accessories. 100's of instruments, lasers, comparators, magnifiers, telescopes, projectors, microscopes, binoculars, photoattachments, black-light equipment and the world's largest selection of unique lighting equipment. Fully illustrated. Great buys! Write for Catalog "DA".

EDMUND SCIENTIFIC CO. TELEPHONE: 609-547-3488
 300 EDSORP BLDG. BARRINGTON, NEW JERSEY 08007
 ORDER BY STOCK NUMBER. MINIMUM ORDER \$10.00 ON OPEN ACCOUNT TO RATED FIRMS. MONEY-BACK GUARANTEE.

INFORMATION RETRIEVAL NUMBER 56

Engineering samples on request.



May we offer you a light?

The super-dependable light of C&K's newest ILLUMINATED ROCKER SWITCHES. Available in SPDT and DPDT models, these contemporary, sub-miniature snap-in switches are completely "made-in-America" from quality materials, yet the prices are surprisingly competitive! Front relappable, they accommodate midget screw base bulbs in popular T-1 1/2 and T-1 3/4 sizes, and you can choose snap-off actuator/lens in either Red, Green, Amber or White. And, quite honestly, they're matchless!

C&K COMPONENTS, INC., 103 Morse Street, Watertown, MA 02172. Tel: (617) 926-0800 TWX: 710-327-0460.

"See us at IEEE"

INFORMATION RETRIEVAL NUMBER 58

TOOL KITS

FIELD ENGINEER TOOL KIT JTK-17



Write for brochure!

More than 100 fine tools used for maintenance and adjustment of electronic equipment, computers and office machines. Small tools are held securely on two removable pallets. Three roomy compartments in the bottom of the deluxe attache' case hold larger tools, optional test meter and parts boxes. A space for service manuals and schematics is provided in the cover.

FIELD ENGINEER ATTACHE TOOL CASES



Five styles available

Jensen attache' cases provide a convenient way to carry a large number of tools. Three models are offered: thin-line, standard and extra deep. All cases feature solid wood frames with mahogany paneling and dovetail corners, solid brass hardware and anodized aluminum partitions. Covering is scuff-proof Marvlon. Removable small-tool pallets and partitioned compartments in bottom of the case hold tools securely in a well organized manner. Write for brochure giving dimensions and full details.

Free Catalog ELECTRONIC ASSEMBLY TOOLS

Lists over 1700 hard-to-find tools used by electronic technicians, instrument mechanics, engineers and scientists. Includes a solder section and four pages of useful "Tool Tips" with valuable data on insulations, color coding, fasteners, and tool selection. Write for your free copy!



JENSEN TOOLS and ALLOYS
 4117 N. 44th Street, Phoenix, Arizona 85018

INFORMATION RETRIEVAL NUMBER 57

ELECTRONIC DESIGN 5, March 1, 1974

Look to Ballantine for TRUE RMS Voltmeters



- True RMS • Battery Option
- 100 μ V to 300 V
- 2 Hz to 20 MHz (Usable to 50 MHz)
- 1% Mid-Range Accuracy
- Fast Response
- Fully Overload Protected

From \$595



Ballantine Laboratories, inc.
 P.O. Box 97, Boonton, New Jersey 07005
 201-335-0900, TWX 710-987-8380

INFORMATION RETRIEVAL NUMBER 59

10-ns SW driver comes in flatpack

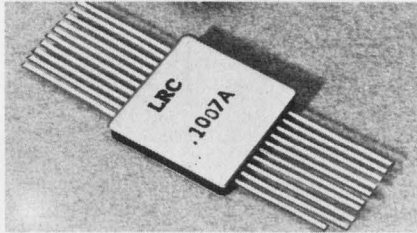

LRC, Inc., 11 Hazelwood Rd., Hudson, N.H. 03051. (603) 883-8001.

An rf switch driver can provide current from either positive or negative 12-V supplies, depending on the input from a TTL gate. Called the Model SD-1007A, the switch drivers have a total switching time of 10 ns maximum, with typical delay and rise time of less than 5 ns. The drivers are compatible with both TTL and DTL circuits and contain a pull-up circuit built into the input to provide for dc testing.

CIRCLE NO. 275

BNC termination priced at \$4.50

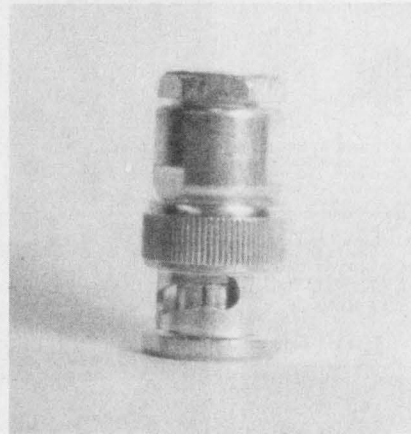

Elcom Systems, Inc., 127F Brook Ave., Deer Park, N.Y. 11729. (516) 667-5800. \$4.50 (100); stock to 30 day.

A 50-Ω coaxial BNC termination sells for \$4.50 in 100-piece quantities. The termination has an average VSWR of 1.1:1 over the frequency range of dc to 4 GHz; maximum VSWR is 1.3:1. Dissipation is spec'd at 1/2-W cw and 1 kW peak over the -25-to-85-C temperature range.

CIRCLE NO. 276

Simulators speed laser tests

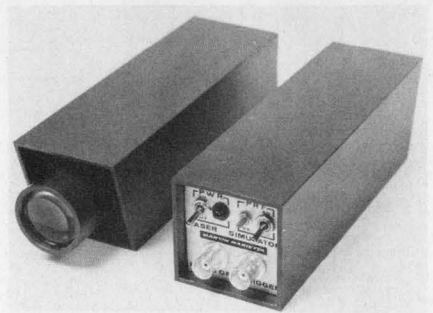

Martin Marietta Aerospace, P.O. Box 5837, Orlando, Fla. 32805. (305) 855-6100. LS-1: \$650; LS-2: \$450; LS-3: \$425.

A compact laser simulator, for rapid checkout of laser seekers and receivers, weighs only 1 lb, and uses a 9-V battery that provides over 10-hours continuous operation. Three models are available: The LS-1 provides 3-mW peak output and 20-ns pulse width at 1.06 μ. The LS-2 offers a 3-W output at 0.905 μ. The LS-3 lists a 3-mW peak output and 60-μs pulse width at 0.660 μ. All models have a selectable PRF.

CIRCLE NO. 296

now, A-C torque motors from stock

Bodine fhp reversible torque motors are ideally suited for a variety of holding, positioning, tensioning and winding applications.

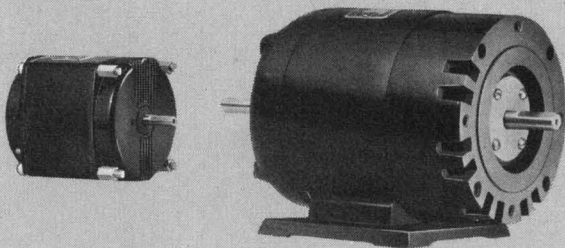

■ Four models from our popular Type "K-2" and "N" lines ■ For intermittent locked rotor operation at rated voltage and continuous locked rotor duty at reduced voltage ■ Four wire connection arrangement for servo operation ■ Variable voltage power supplies can be used to achieve an infinite number of speed settings ■ Four frame sizes: from 2.405" diam. in the KCI-26 motor to 5.68" in the NCI-55.

**BODINE
ELECTRIC
COMPANY**

Write for bulletin MTQ-CI.

Bodine Electric Co., 2554 West Bradley Place, Chicago, Illinois 60618

INFORMATION RETRIEVAL NUMBER 60

POWER & ACCELERATION for Disc, Reel, Capstan and Carriage Drives

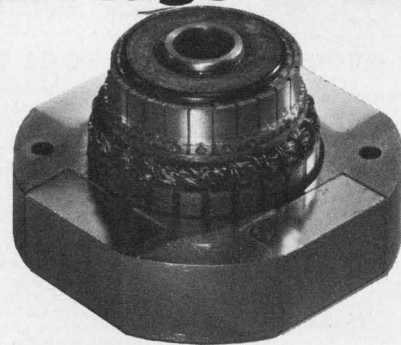

Here's a rugged DC servo motor that'll take hard, stop-go, forward-reverse, accel-decel, continuous duty without overheating. 100 oz.-in. peak torque to max speed packaged in housed or frameless unit with replaceable cartridge brushes . . . and tachometer, if desired.

INLAND MOTOR DIVISION OF KOLLMORGEN CORP.
Radford, Va. 24141 • (703) 639-3973 • TWX 710-875-3740

INFORMATION RETRIEVAL NUMBER 61

ELECTRONIC DESIGN 5, March 1, 1974

Wire dispenser uses no reels

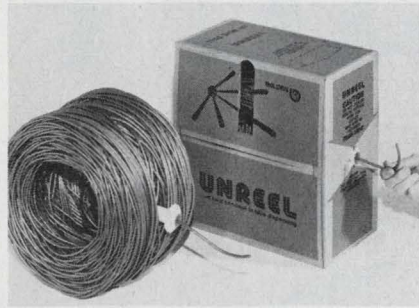

Belden Corp., 415 S. Kilpatrick Ave., Chicago, Ill. 60601. (312) 378-1000.

Unreel is Belden's new packaging innovation that greatly simplifies the dispensing of wire and cable and substantially cuts user handling costs. The packaging method provides virtually inertia-free payout of wire and cable from a stationary, self-supporting, reel-less coil contained within a rough paperboard carton. The wire, or cable, may be drawn from the package at high speeds with essentially no drag and with instantaneous start and stop. This eliminates tangles, which result from reel inertia that must be overcome on starting or stopping. For wire installers, the Unreel package means that neither a pipe-rack stand nor an assistant to tend reels during pulling is necessary. The new package thus saves space at the job site, reduces the load the installer must carry and eliminates set-up time when reels are changed. For the manufacturer, Unreel eliminates the need for tensioning equipment, when used with discontinuous, start-stop wire and cable processing equipment.

CIRCLE NO. 277

Blower motor controlled by solid-state circuit

McLean Engineering Laboratories Inc., 70 Washington Rd., Princeton Junction, N.J. 08550. (609) 799-0100.

A solid-state motor control permits this line of blowers to operate at low audible-noise levels. A thermostatic probe senses outlet air temperature to operate the blower at full volume only when the temperature rises above 90 F.

CIRCLE NO. 278

Magnetic fluids that don't settle out



Ferrofluidics Corp., 144 Middlesex Turnpike, Burlington, Mass. 01803. (617) 272-5206.

Ferrofluidics' magnetic fluids are a new class of materials that can solve ink settling and clogging problems in traditional as well as new printing techniques. The non-settling and stable behavior of these magnetic fluids produce magnetic inks that have long storage life both in the printing machine and on the shelf. Ferrofluids contain particles in the 0.01- μ range and they do not require mixing or stirring. The fluids are available in a wide range of carrier liquids to allow printing on many different surfaces. They are particularly applicable to ink-jet printing systems, which spray ink from tiny orifices, and they also enable the magnetic control of the printing jet.

CIRCLE NO. 279

DIP socket wire-wraps on component side

Robinson Nugent, Inc., 800 E. Eighth St., P.O. 470, New Albany, Ind. 47150. (812) 945-0211.

The A-OK/U-Type socket allows wire-wrapping on the same side of the board on which packages are mounted. Body height of the U-Type is just 0.175-in. over-all. All contacts and terminals are of spring-tempered beryllium copper in a one-piece configuration with contact lead-in arms angled at 30 degrees to provide for easy automatic or manual IC insertion. Terminals are 0.025-in. square to allow for either wire-wrap or soldered connection. Socket body ends are notched for individual or series mounting with #2 screws.

CIRCLE NO. 280

New Digital Photometer/Radiometer \$865.00

80X Digital Opto-Meter™

The 80X Digital Opto-Meter™ is a portable photometer/radiometer with eight ranges of sensitivity to 10⁻¹⁰ watts. This instrument with 3½ digit display offers AC or battery operation. The new 80X Digital Opto-Meter™ is supplied complete for radiometric and photometric measurements... \$865.00.

Write or call today, United Detector Technology, 1732 21st Street, Santa Monica California 90404, telephone number: (213) 829-3357.

 UNITED DETECTOR TECHNOLOGY, INC.



GET READY



In a few months *Electronic Design's Master Directory* — the GOLD BOOK — will be rolling off the presses and moving on to desks, lab benches, reference shelves, and information centers throughout the U.S. and Europe. It's the directory that will change your thinking about directories . . . the most massive compendium of product information ever compiled . . . a one-step reference source for the data you need to specify, select and buy.

Recognizing potential paper shortages, rising printing, postage and mailing costs, many manufacturers have taken action to be sure their catalog material will reach you no matter what happens. They're choosing the GOLD BOOK to be their personal industry representative.

CONTENTS INCLUDE:

- PRODUCT DIRECTORY (Lists the manufacturers of each product.)
- DIRECTORY OF MANUFACTURERS AND SALES OFFICES (Includes company profiles.)
- DIRECTORY OF DISTRIBUTORS
- DIRECTORY OF TRADE NAMES
- CATALOG DATA AND TECHNICAL INFORMATION SECTION (A massive compendium organized by product category.)

TO REACH FOR THE GOLD BOOK

Electronic Design's 1974 Master Directory

PRODUCT CATEGORIES

0100 Amplifiers	1700 Engineering Aids (Copying Equipment, Drafting Equipment & Supplies)	3100 Meters, Panel (Analog & Digital)
0200 Audio Equipment	1800 Environmental Testers & Chambers	3200 Microwave, Radar Components/Accessories
0300 Books	1900 Fans, Blowers, Cooling Devices & Cooling Equipment	3250 Microwave, Radar Systems & Subsystems
0400 Cabinets, Chassis, Containers, Racks, etc.	2000 Filters, Electrical	3300 Motors, Rotating Components
0500 Calculators	2100 Function Modules	3400 Multiple Products
0600 Capacitors (Fixed & Variable)	2200 Hardware and Panel Components (Non-Current Carrying)	3500 Optoelectronic and Laser Components, Equipment & Systems (except Discrete LEDs and Displays)
0700 Circuit Breakers, Fuses and Other Protective Devices	2300 Inductors & Transformers (Fixed and Variable)	3600 Panel Lamps, Discrete LEDs & Lampholders
0800 Communications Equipment	2400 Instruments, Measuring and Testing (except Panel Meters)	3700 Power Supplies, Batteries
0900 Computer Peripherals (including I/O Equipment, except Storage Equipment)	2450 Instruments, Recording	3800 Production Machinery & Automation Equipment
0950 Computer Peripherals, Storage (including Disc, Drum and Tape Equipment)	2470 Instruments, Signal Source	3900 Relays & Solenoids
1000 Computers and Data Handlers (except Peripherals)	2500 Integrated Circuits (Monolithic), MSI, LSI	4000 Resistors, Fixed
1100 Connectors, Sockets, Terminals & Terminal Boards	2560 Integrated Circuits, Hybrid	4050 Resistors, Variable
1200 Controls, Control Components & Control Systems	2600 Keyboards & Keyswitches	4100 Semiconductors, Discrete (except LEDs)
3450 Corporate Profiles	2700 Manufacturing, Subcontracting, Fabrication Services	4200 Services (Engineering, Software, Timesharing, etc.)
1300 Crystals, Oscillators, Timing Devices	2800 Magnetic Components & Materials (except Memory)	4300 Switches
1400 Delay Lines	2900 Materials, Chemicals and Printed Circuits, Fabricated & Non-Fabricated (except Magnetic)	4400 Thermal Devices
1500 Displays & Readouts (Alpha, Numeric & Graphic)	3000 Memory Components, Equipment & Systems (except ICs and Peripherals like Discs, Drums, Tape Drives)	4500 Tools, Soldering Supplies
1600 Distributors		4600 Transducers
		4700 Tubes
		4800 Wire & Cable

A HAYDEN PUBLICATION

50 Essex Street, Rochelle Park, New Jersey 07662 • Tel: 201-843-0550

THE LOGICAL PCB LIGHTS

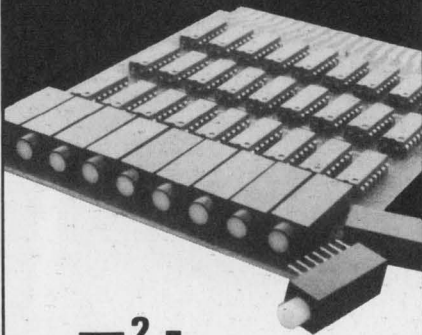

T² Lite

LED & Incandescent Lights with Built-in TTL or ECL Integrated Circuits

- Standard Dual-In-Line package contains complete logic I.C. plus visual indication
- Choice of standard 74 or 74H Series I.C.
- LED's feature built-in series resistor
- Long life incandescent lamps include built-in keep alive bias

Convenient combination package reduces cost, saves space and speeds up assembly. Units are available for immediate delivery with a wide choice of lens colors.

Call or write for more information today!

the little light people

DATA DISPLAY PRODUCTS

5428 W. 104th St., Los Angeles, Ca. 90045
(213) 641-1232

design aids

English-metric converter

The hand-held circular Anglo-Met is a convenient tool for accurate English-metric conversions. It gives conversions of length, weight, area, volume and dry or liquid measurements. The 6 in. diameter converter is constructed of heavy-duty plastic and is laminated to prevent wear on lettering. Telex.

CIRCLE NO. 281

Wire and cable kit

A design kit enables users to specify the information required for development of "special" wire and cable products. The kit includes a specification/quotation form that organizes and identifies design parameters, a design guide that outlines basic factors affecting performance and a reference catalog. Belden.

CIRCLE NO. 282

Breadboard kits

A miniature cable chain and belt breadboard development kit consists of grilled breadboard plates, assorted shafts, rotating component hangers, dials and over 650 associated parts for building a complete test system. Winfred M. Berg.

CIRCLE NO. 283

Filter reference table

An easy-to-use reference table lists several liquid and gas filter variables including materials of construction, dimensions, port size, pressure rating and flow capacity and cross-references them with the company's filters. Balston.

CIRCLE NO. 284

Clock display readout

An actual-size printed version of a clock display readout is ideal for use on equipment mock-ups and other preproduction applications. The orange-and-black strip has a pressure-adhesive backing. Sperry Information Displays Div.

CIRCLE NO. 285

The CONTROFLUXERTM
"off-the-shelf"
AC LINE VOLTAGE
REGULATORS...

8 ways
better...
at less
cost!



A totally new concept for truly flat, instantaneous regulation despite extreme input power line fluctuations or "brownouts."

Discover why a basic CONTROFLUXERTM can outperform conventional regulators. These inherent characteristics eliminate the need for "add-on" circuits, cut cost and weight:

1. Instantaneous line voltage regulation.
2. Instantaneous step elimination.
3. Wider input voltage range: 50 to 260V.
4. Wider input frequency range: 45 to 66 Hz.
5. Better short-circuit protection.
6. Better transient protection.
7. 200% overvoltage protection.
8. Higher reliability. No vulnerable semiconductors in the power path.

GET THE NEW CATALOG

Ask your distributor or contact the factory for the 16-page catalog that describes the new concept and lists 23 standard regulators now available off-the-shelf from 38 nationwide distributor locations: Apollo, Arneson, Arrow, Arrow/Angus, ESCO, Ft. Wayne Electr., LComp, Lykes, Rose, RS Electr., Taylor, and Weatherford.

**ADVANCED
AP POWER, INC.**

1621 So. Sinclair St., Anaheim, CA 92806
(714) 997-0034 • TWX 910-593-1332

BROADBAND POWER AMPLIFIERS

Milliwatts
to
KILOWATTS



"State-Of-The-Art"

NO TUNING

MODEL	POWER OUT	BANDWIDTH
M500	0.3 Watts	2-500MHz
M502	2 Watts	0.5-450MHz
M305	5 Watts	0.3-300MHz
M310	10 Watts	0.3-300MHz
30-12	12 Watts	2-32MHz
30-25	25 Watts	2-32MHz
30-50	50 Watts	2-32MHz
250-10C	10 Watts	0.2-250MHz
250-10	10 Watts	0.005-250MHz
30-12L	12 Watts	0.01-25MHz
30-25L	25 Watts	0.01-25MHz
300-145	75 Watts	0.2-300MHz
250-145	100 Watts	0.005-250MHz
220-250B	200 Watts	0.01-250MHz
220-560A	500 Watts	0.01-220MHz
220-1K60L	1000 Watts	0.01-220MHz

..... And Many Many More!



R. F. POWER LABS, INC.
11013-118th Pl. N.E.
Kirkland, Wa. 98033
(206) 822-1251

Foreign Representatives: Australia-Scientific Devices; England-Wessex; Finland-Into Oy; France-REA; Holland-Air-Parts Itn'l; India-Electric Enterprises; Israel-RDT; Italy-Motordiesel; Japan-Seki; New Zealand-S. D. Mandeno; Norway-Morgenstierne; Portugal-Rualdo; So. Africa-K. Baker; Sweden-Wentzel; Switzerland-Silectra.

INFORMATION RETRIEVAL NUMBER 66
ELECTRONIC DESIGN 5, March 1, 1974

new literature

OEM modems and dialers

A four-page short-form catalog covers OEM and end-user modems and automatic dialers. The Vadic Corp., Mountain View, Calif.

CIRCLE NO. 286

Ferrofluids

A 16-page handbook contains data on today's state of the art for ferrofluids as well as typical areas of application. Ferrofluidics, Burlington, Mass.

CIRCLE NO. 287

Interconnections

Adapta-Con electrical connector series for dual-contact PC and I/O interconnecting packaging designs is described in a 12-page brochure. ITT Cannon, Santa Ana, Calif.

CIRCLE NO. 288

Magnetic iron oxides

Updated data on general-purpose magnetic iron oxides are contained in two bulletins. Hercules, Wilmington, Del.

CIRCLE NO. 289

Selector switches

The 223 series 1-inch selector switches are detailed in a catalog. CTS Keene, Paso Robles, Calif.

CIRCLE NO. 290

Power supplies

Power supplies for OEM systems and general-purpose slot applications in both single and dual output configurations are described in a 16-page catalog. NJE, Dayton, N.J.

CIRCLE NO. 291

Laser illuminators

YAG laser illuminators are described in a brochure. International Laser Systems, Orlando, Fla.

CIRCLE NO. 292

Components

Terminals, jacks, plugs, handles, battery holders, IC sockets, IC breadboards, coils and chokes are described in a catalog. Cambion, Cambridge, Mass.

CIRCLE NO. 293

WIDE BAND RF TRANSFORMERS

Great Value at

\$2.95
10 piece quantities

Some Models \$3.45

0.1 - 500 MHz
50 Ohm impedance
1:1 to 16:1
impedance ratio
micro-miniature case

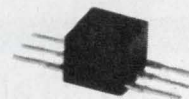

A breakthrough in technology and high production volume enables Mini-Circuits Laboratory to offer these new products at an unprecedented low price.

Ruggedness and durability are built in the T-series transformers. These new units are packaged within a 1/3 D.I.P. package. They use uniquely designed transmission line transformers for extra wide bandwidth.

Impedance ratios of standard models are 1:1, 2:1, 4:1, 9:1 and 16:1. MCL kit TK-1 includes 2 units of each type and sells for \$32.

We invite you to convince yourself. Place your order now and check our delivery, product performance and reliability.

**Mini-Circuits
Laboratory**

2913 Quentin Rd., Brooklyn, N.Y. 11229
(212) 252-2522, Int'l Telex 620156
A Division Scientific Components Corp.

*FRANCE: S.C.I.E., *31, rue, George-Sand, Palaiseau 91, France. *GERMANY, AUSTRIA, SWITZERLAND: Industrial Electronics GMBH, *Klüberstrasse 14, 6000 Frankfurt/Main, Germany. ENGLAND: Dale Electronics, Dale House, Wharf Road, Frimley Green, Camberley, Surrey. JAPAN: Densho Kaisha Ltd. Eguchi Building, 8-1 1-Chrome, Hamamatsucho, Minato-Ku, Tokyo. *ISRAEL: Hamashbir Electronics, 76 Giborei Israel St., Tel-Aviv, Israel

*UNIT IN STOCK

INFORMATION RETRIEVAL NUMBER 67

DIGITAL FOURIER ANALYSIS SYSTEM 306

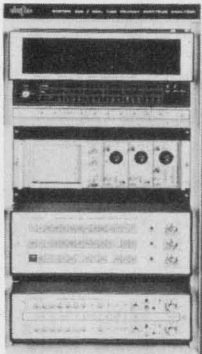

Provides complete spectral, cross spectral, correlation, cross correlation and related analysis.

- One Push Button per function eliminates programming.
- Simultaneous display of two spectra or phase and magnitude.
- Digital storage provides uninterrupted display (flicker-free).
- Drives two XY Plotters simultaneously (doubles throughput).
- Zoom FFT analysis for super high resolution.
- Unique Fourier-Fortran™ for your own non-standard or automated analysis.
- 1/3 and 1/15 octave analysis.

OPTIONAL: Magnetic tapes and discs, high speed plotters, multi processor configurations, multi channel analog multiplexer, teletypes and CRT Terminals.

ALSO AVAILABLE: Medium and high speed hardwired FFT and general purpose array processors for Data General Nova Computers.

ELSYTEC INC.

212 Michael Drive, Syosset, N.Y. 11791
Phone (516) 364-0560

CIRCLE NO. 171

Operator Can "Talk" Directly to Automatic Spectrum Processing System



Engineers without prior knowledge of computer operation "talk" directly to the SD1007D Automatic Spectrum Processing System after only brief indoctrination. Unusually flexible software allows complete operator/system interaction: changes in test procedures and data-processing input/output formats can be made as the test program requires. A single typed-in "DO" command in easily learned FOCAL language initiates an entire computer operation, complete to typed-out results. System includes a 500-line resolution Real Time Analyzer, large-screen oscilloscope, PDP 11-105 computer with 8K of core, and a Teletype for program loading, operator interaction and typing out results.

Spectral Dynamics Corporation

P.O. Box 671, San Diego, Calif. 92112
(714) 278-2501

CIRCLE NO. 172

FREE
new 20 page
catalog

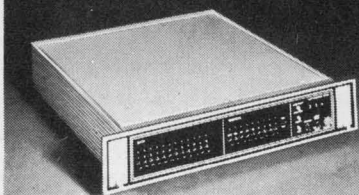

Computer Compatible Data Acquisition System

256 CHANNELS

C/MOS logic reduces power consumption and physical size by 3 times over conventional systems and reduces cost by up to 50%...

priced from \$1900

DATEL SYSTEMS, INC.

1020 Turnpike Street, Canton, MA. 02021

CIRCLE NO. 173

ELECTRONIC DESIGN's function is:

- To aid progress in the electronics manufacturing industry by promoting good design.
- To give the electronic design engineer concepts and ideas that make his job easier and more productive.
- To provide a central source of timely electronics information.
- To promote communication among members of the electronics engineering community.

Want a subscription? ELECTRONIC DESIGN is sent free to qualified engineers and engineering managers doing design work, supervising design or setting standards in the United States and Western Europe. For a free subscription, use the application form bound in the magazine. If none is included, write to us direct for an application form.

If you do not qualify, you may take out a paid subscription for \$30 a year in the U.S.A., \$40 a year elsewhere. Single copies are \$1.50 each.

If you change your address, send us an old mailing label and your new address; there is generally a postcard for this bound in the magazine. You will have to requalify to continue receiving ELECTRONIC DESIGN free.

The accuracy policy of ELECTRONIC DESIGN is:

- To make diligent efforts to ensure the accuracy of editorial matter.
- To publish prompt corrections whenever inaccuracies are brought to our attention. Corrections appear in "Across the Desk."
- To encourage our readers as responsible members of our business community to report to us misleading or fraudulent advertising.
- To refuse any advertisement deemed to be misleading or fraudulent.

Microfilm copies are available of complete volumes of ELECTRONIC DESIGN at \$19.00 per volume, beginning with Volume 9, 1961. Work is now in process to complete the microfilm edition of Volumes 1-8. Reprints of individual articles may be obtained for \$2.00 each, prepaid (\$.50 for each additional copy of the same article) no matter how long the article. For further details and to place orders, contact the Customer Services Department, University Microfilms, 300 North Zeeb Road, Ann Arbor, Michigan 48106 telephone (313) 761-4700.

Want to contact us? If you have any comments or wish to submit a manuscript or article outline, address your correspondence to:

Editor
ELECTRONIC DESIGN
50 Essex Street
Rochelle Park, N.J. 07662

DO COLLEGES HELP BUSINESS AS MUCH AS BUSINESS HELPS COLLEGES?

Yes, they do. But not in the same proportion.

Business contributes about 15% of the total voluntary support received by colleges.

But today, business gets half the college-trained people who are employed. Tomorrow, it will need even more.

As a result, businessmen should think seriously about increasing the level of corporate giving to education. Can you, as a businessman, think of a better investment?

For the latest national figures on corporate giving to higher education, write on your letterhead for "CFAE Survey of Corporation Support of Higher Education," and enclose \$2.00 to help cover costs. Mail to: Council for Financial Aid to Education, 6 East 45th Street, New York, N.Y. 10017.

Give to the college of your choice. Now.



Advertising contributed for the public good.

Electronic Design

Advertising Sales Staff
Tom W. Carr
Vice President &
Sales Manager

Rochelle Park, N.J. 07662
Robert W. Gascoigne
Daniel J. Rowland
(Recruitment, Quick Ads, Classified)
50 Essex Street
(201) 843-0550
TWX: 710-990-5071

Philadelphia
Thomas P. Barth
50 Essex Street
Rochelle Park, N.J. 07662
(201) 843-0550

Boston 02178
Gene Pritchard
P.O. Box 379
Belmont, Mass. 02178
(617) 489-2340

Chicago 60611
Thomas P. Kavooras
Berry Conner, Jr.
200 East Ontario
(312) 337-0588

Cleveland
Thomas P. Kavooras
(Chicago)
(312) 337-0588
(call collect)

Los Angeles 90303
Stanley I. Ehrenclou
Burt Underwood
2930 Imperial Highway
Inglewood, Calif.
(213) 757-0183

San Francisco 94022
Jerry D. Latta
P.O. Box 1248
Los Altos, Calif.
(415) 965-2636

London
For United Kingdom and Europe
John Ashcraft
John Ashcraft & Co.
12, Bear St.
Leicester Square
London WC2H 7AS England
Phone: 01-930-0525
W. J. M. Sanders
John Ashcraft & Co.
Herengracht 365
Amsterdam C., Holland
Phone: 020-24-09-08

Tokyo
Haruki Hirayama
Electronic Media Service
5th Floor, Lila Bldg.,
4-9-8 Roppong
Minato-ku
Phone: 402-4556
Cable: Electronicmedia, Tokyo



recruitment
and
classified Ads

**IMMEDIATE
DELIVERY**
Minis & Peripherals
**DEC - HIS - NOVA
SEL - HP - MOHAWK**
CPU, Card, Printer, Tape, Disk
NEW • MOHAWK 4320
PRINTERS
**PDP11 PERIPHERALS
CPU, MEMORY**
PDP 8 CPU \$1500
\$750 Minis
**TELETYPE 35 & 37
DEC & HONEYWELL Modules**
617/261-1100
Send for Free Report "Maintenance
of Computers"
AMERICAN USED COMPUTER CORP.
P.O. Box 68, Kenmore Sta.
Boston, MA 02215
"Members Computer Dealers Association"

CIRCLE NO. 210

**SCOPES UNLIMITED
IS NOT
LIMITED TO SCOPES**
Complete line of new and used
electronic test equipment.
SCOPES UNLIMITED, INC.
1938 S. Anaheim Blvd.
Anaheim, Ca. 92805
(714) 772-0330
East Coast Office (617) 894-5670



**Take
stock
in America.**

Buy U. S. Savings Bonds

Now E Bonds pay 5½% interest when held to maturity of 5 years, 10 months (4% the first year). Bonds are replaced if lost, stolen, or destroyed. When needed they can be cashed at your bank. Interest is not subject to state or local income taxes, and federal tax may be deferred until redemption.



The U. S. Government does not pay for this advertisement. It is presented as a public service in cooperation with The Department of the Treasury and The Advertising Council.

advertiser's index

Advertiser	Page	Advertiser	Page	Advertiser	Page
AVX Ceramics Corporation	72	Elec-Trol, Inc.	84	Jensen Tools and Alloys	81
AMP, Incorporated	33	Electro Scientific Industries	74	Jermyn Industries	38
Abbott Transistor Laboratories, Inc.	6	Elsytec, Inc.	92	Johanson Manufacturing Corp.	95
Acopian Corp.	61	Exact Electronics, Inc.	41, 84		
Advance Power, Inc.	90			Keithley Instruments, Inc.	16
Allen Bradley Co.	20	Federal Scientific Corporation	94	Licon, Division of Illinois Tool Works, Inc.	57
Andex Corporation	95	Fluke Mfg. Co., Inc.	25		
Arnold Magnetics Corp.	95	Fluke Trender	31		
				Micro Switch, A Division of Honeywell	42, 43
Ballantine Laboratories, Inc.	85	GTE Automatic Electric	64H	Mini-Circuits Laboratory	91
Beckman Instruments, Inc. Helipot Division	18, 19	General Electric Company	95, Cover III	Motorola Semiconductor Products, Inc.	16A thru 16F
Bodine Electric Company	86	Gold Book, The	88, 89		
Boonton Electronics Corporation	71	Grayhill, Inc.	80	National Electronics, A Varian Division	79
				National Semiconductor Corporation	64F
C & K Components, Inc.	85	Hanover Fair	78	Neff Instrument Corporation	35
Control Switch, Inc.	81	Heath/Schlumberger Instruments	65	North American Philips Controls Corporation	70
		Hewlett-Packard	1, 64D, 64E		
Dale Electronics, Inc.	Cover II	Houston Instruments, A Division of Bausch & Lomb	12	Optron, Inc.	7
Dana Laboratories Inc.	4, 5	Hughes Aircraft Company, Industrial Products Division	11		
Data Display Products	90			Permag	82
Data Precision	95	ISE International Corp.	75	Piher International Corp.	64B, 64C
Datel Systems, Inc.	92	Indiana General, Electronic Products	67	Princeton Applied Research Corp.	84
Dialight Corporation	64A	Inland Motor Division	86		
Digitran Company, The	76	Kollmorgen Corporation	86	R & G Enterprises	81
		Inselek, Inc.	13	RCA Solid State	Cover IV
ECCO	15			R. F. Power Labs, Inc.	91
E-T-A Products Co. of America	95			Radio Materials Company	82
Edmund Scientific Company	85			Robinson Nugent, Incorporated	53

Design Data from Manufacturers

Advertisements of booklets, brochures, catalogs and data sheets. To order use Reader-Service Card.
(Advertisement)

MEMORY & NON-STORAGE LARGE SCREEN DISPLAYS FOR REAL-TIME SPECTRUM ANALYZERS

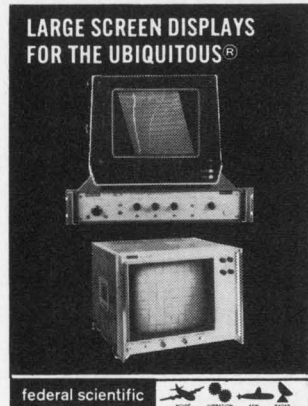

To facilitate viewing & increase measurement accuracy of frequency spectra, Federal Scientific, manufacturer of the Ubiquitous® family of Real-Time Spectrum Analyzers, offers: (1) Memory Oscilloscope DO613, which operates with Federal's 66-2A 3-D Display Generator to provide a time history of changing spectra—such as radar doppler shifts, machine vibration signature during speed changes, speech patterns—by means of successive traces placed one under the other on the 6x8-inch storage CRT. (2) Non-storage Oscilloscope DO1300 provides on-line display of real-time frequency data produced by UA-500-1 Ubiquitous Spectrum Analyzer/Averager on a 8x10-inch screen. Two traces from the analyzer's dual memory are displayed one above the other for direct visual comparison of two separate sets of averaged spectrum data.

CIRCLE NO. 174

Federal Scientific Corporation An Affiliate of Nicolet Instrument
615 West 131st St., New York, N.Y. 10027 (212) 286-4400 TWX: 710 681 4059

SSAC Precision Products, Inc.	95
Sealed Air Corporation	81
Signetics Corporation	36, 37
Siliconix, Incorporated	44
Sorensen Company, A Unit of Raytheon Company	77
Spectral Dynamics Corporation	92
Sprague Electric Company	10
Stacoswitch	96
Struthers-Dunn, Inc.	17
Tecnetics	83
Tektronix, Inc.	8, 9, 23
Teledyne Relays, A Teledyne Company	2
Texas Instruments, Incorporated	63
Tracor, Inc.	78
Transitron Electronic Corporation	14
USCC/Centralab Electronics Division, Globe-Union, Inc.	29
United Detector Technology, Inc.	87
United Systems Corporation	64G
Wavetek	68
Weston Instruments, Inc.	73

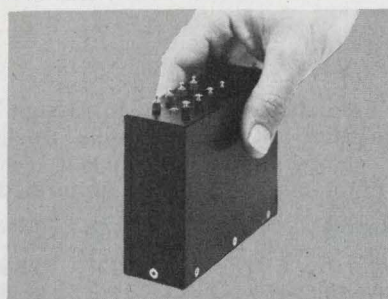

Big power supply for little spaces. 115 VAC, 50-500 Hz input. 1 to 6 isolated & regulated DC outputs. 120 W per output. 3.9 W delivered per cu. in. Modular construction lets you "Design-As-You-Order". Over 1200 configurations using off-the-shelf modules. Immediate deliveries! Arnold Magnetics Corp., Culver City, Ca. (213) 870-7014.

INFORMATION RETRIEVAL NUMBER 181

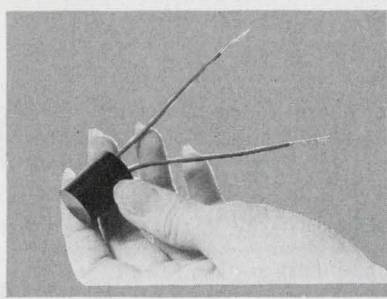

Solid state ac flashers—Low cost from \$1.95—and brand new. Why settle for thermal type flashers due to cost? Designed to operate incandescent, inductive, or resistive loads up to 1 amp (120 watts). Virtually infinite life. Request data on Type FS127. SSAC PRECISION PRODUCTS, INC., P.O. Box 395, Liverpool, N.Y. 13088. (315) 699-2551.

INFORMATION RETRIEVAL NUMBER 182

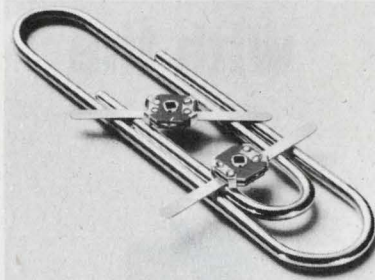

Thin-Trim variable capacitors provide a reliable means of adjusting capacitance without abrasive trimming or interchange of fixed capacitors. Series 9401 has high Q's and a range of capacitance values from 0.2-0.6 pf to 3.0-12.0 pf and 250 WVDC working voltage. Johanson Manufacturing Corporation, Boonton, New Jersey (201) 334-2676.

INFORMATION RETRIEVAL NUMBER 183

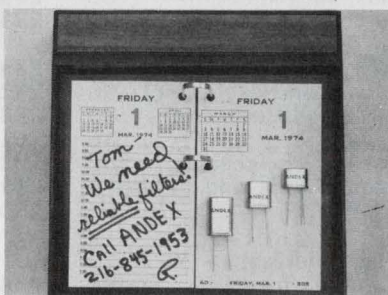

Stable ceramic resonators available in new extended frequency range from 2.8 kHz to 200 kHz. Applications include frequency control in oscillators and clock generators (CMOS) and narrow bandpass filters for remote control, navigational receivers, and underwater signalling. Analex Corp., 7076 Big Creek Pky, Middleburg Hts., OH. (216) 845-1953

INFORMATION RETRIEVAL NUMBER 184



Pocket Size Tri-Phasic™ Multimeter Model 245 \$295. Miniature, Rugged laboratory-quality 4½ digit DMM. 0.005% resolution, 100% over-range. ±0.05% basic accuracy. Measures DCV, ACV, DC and AC current and resistance. Battery and line operation 1¾"H x 3½"D x 5½"W. Data Precision, Audubon Road, Wakefield, Ma. 01880. (617) 246-1600.

INFORMATION RETRIEVAL NUMBER 185

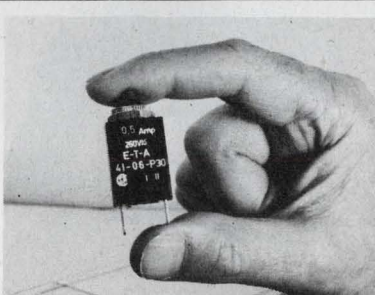

Overcurrent Protector, manual reset eliminates fuse replacement. Convenient panel mounting. 15 fractional ratings from 0.1 to 3 amp. Other models up to 400 amp. Trip-free and fool-proof, UL and CSA approved. High quality, low cost—\$1.12 ea. in 1000 lots. E-T-A Products Co. of America, 6284 N. Cicero Ave., Chicago, Ill. 60646. Tel. (312) 545-1553.

INFORMATION RETRIEVAL NUMBER 186



Best buy, 5½ DMM \$1295. 5½ Digit Tri-Phasic™ Multimeter 2540A1. Auto ranging; 1 μV to 1000 VDC; 1 milliohm to 12 megohms; AC/DC ratio; 1 μV to 500 VAC; DC/DC ratio; Isolated BCD output; Remote Control; Autozero. Data Precision, Audubon Road, Wakefield, MA. 01880. (617) 246-1600.

INFORMATION RETRIEVAL NUMBER 187

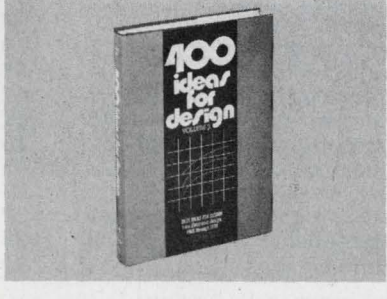

400 Ideas for Design, Vol. 2, Edited by Frank Egan. Ready to borrow, modify, or adapt, the top recent contributions to Electronic Design's popular "Ideas for Design" column range from amplifiers to switching circuits. 288 pp., illus., cloth, \$11.95. Circle below for 15-day examination copies. Hayden Book Co., New York, N.Y. 10011.

INFORMATION RETRIEVAL NUMBER 188

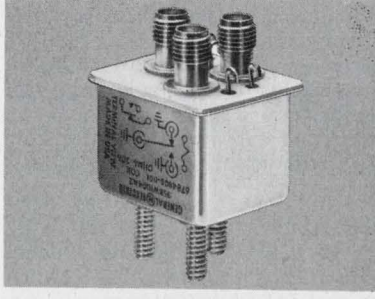

For critical RF switching GE offers space-proven relays with co-axial connections. Welded construction, hermetically sealed, removes dangers of exposed arcing of open relays. Reliability failure rates to .01%/10,000. RF switching up to 150 watts and auxiliary contacts for microvolt signals to 2 amps. Less than 1 cu. in. GE, Waynesboro, Va.

INFORMATION RETRIEVAL NUMBER 189

Stacoswitch stacks up with the finest

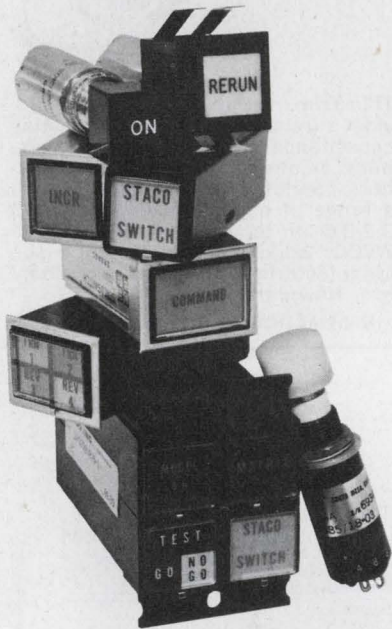

Here's a stack of answers to your illuminated pushbutton switch problems. Staco's full line of pushbutton switches and indicators provides a wide selection of circuitry, size, switch action, legend display style, and mounting method. Whatever your control panel design requirements... whether its an individually mounted switch or sixty in a matrix mount, low cost commercial/computer grade or rugged Mil Spec reliability... there's a Stacoswitch to correctly fit the need.

In addition to the finest in design and performance features, Stacoswitch gives you realistic delivery schedules. Many switches are available from factory stock in one week. Optional switch features are assembled to order from factory parts in four to six weeks.

Check out Staco's stack of fine illuminated switches and indicators. Write today for GC-5 Catalog and Product Selector Guide. When you think switch... think STACOSWITCH.



1130 BAKER STREET, COSTA MESA, CALIF. 92626
(714) 549-3041 TWX: 910-595-1507

Other STACO Company products: Fixed Ratio Transformers, STACO, INCORPORATED, Richmond, Indiana; Variable Transformers, STACO, INCORPORATED, Dayton, Ohio.

INFORMATION RETRIEVAL NUMBER 69

product index

Information Retrieval Service. New Products, Evaluation Samples (ES), Design Aids (DA), Application Notes (AN), and New Literature (NL) in this issue are listed here with page and Information Retrieval numbers. Reader requests will be promptly processed by computer and mailed to the manufacturer within three days.

Category	Page	IRN	Category	Page	IRN
Components			converter, CMOS d/a	74	259
capacitor	10	8	converter, I/O	2	3
capacitor, ceramic	29	21	oscillator, overtone	74	258
capacitors	96	69	preamplifier	90	64
components (NL)	91	293	sensor, vibration	74	260
ferrofluids (NL)	91	287	standard, rubidium	72	250
isolator	7	6	transducers	77	294
LEDs	14	12			
lights, LED	76	43	Packaging & Materials		
potentiometer, linear	83	268	blower, controlled	87	278
readout, clock display (NL)	90	285	boards, PC	53	30
relay	17	15	converter, anglo-metric (NL)	90	281
relay, reed	83	270	dispenser, wire	87	277
relays	70	37	fluids, magnetic	87	279
relays, reed	86	60	interconnections (NL)	91	288
resistors	11	243	iron oxides, magnetic (NL)	91	289
resistors	111	244	kit, wire and cable (NL)	90	282
resistors, fixed	20	17	kits, breadboard (NL)	90	283
switches	43	28	kits, tool	86	61
switches	81	51	materials, magnetic	82	53
switches, rocker	85	58	socket boards and cards	15	13
switches, rotary	80	48	socket, DIP	87	280
switches, selector (NL)	91	290			
switches, toggle and PB	83	269	Power Sources		
			generator, marx	84	274
Data Processing			inverters	67	35
interface, printer	78	262	regulator, voltage	90	63
modem, data	79	265	supplies, power	83	54
modems and dialers, OEM (NL)	91	286	supplies, power (NL)	91	291
recorder, cassette	78	261	supply, high-V	84	273
storage, disc	79	264	supply, modular	84	272
terminal, intelligent	79	263	supply, power	6	5
			supply, power	77	44
ICs & Semiconductors			supply, power	84	271
counter-timer IC	82	266			
rectifiers, bridge	82	267	new literature		
transistors, one-chip	80	252	catalog	85	56
			components	91	293
Instrumentation			ferrofluids	91	287
analyzer, logic	69	254	illuminators, laser	91	292
digital logic test system	11	9	interconnections	91	288
divider, voltage	84	55	iron oxides, magnetic	91	289
photometer/radiometer	87	62	modems and dialers, OEM	91	286
recorder	70	257	supplies, power	91	291
recorders, strip-chart	12	10	switches, selector	91	290
standard, frequency	78	45			
synthesizer, frequency	41	27	design aids		
tester, logic	31	22	converter, anglo-metric	90	281
tester, logic	38	26	filter reference table	90	284
voltmeter, rms	85	59	kit, wire and cable	90	282
			kits, breadboard	90	283
Microwaves & Lasers			readout, clock display	90	285
diodes, p-i-n	86	275			
driver, rf switch	86	276			
illuminators, laser (NL)	91	292			
resonators, ceramic	82	52			
			Modules & Subassemblies		
Modules & Subassemblies			amplifier, audio	77	295
amplifier, audio	77	295	amplifiers	35	24
amplifiers	35	24	control, voltage	76	253
control, voltage	76	253			

Your files are not up-to-date until you get this Solid State Lamp (LED) data from General Electric.

FREE

Each item includes data new or revised since October, 1973.

- Solid State Lamp catalog with complete GE family of infrared and visible SSL's. #3-3358. (Oct. 73)
- Industry cross reference of solid state lamps. #3-3493. (Oct. 73)
- GaP vs. GaAsP informative bulletin. #3-489. (Feb. 74)
- Photoelectric Systems Guide. #3-3471.
- Set of Infrared SSL Product Bulletins.
- Set of Visible SSL Product Bulletins.

ONLY \$1.00/SET

Complete Two-Part SSL Manual. Covers theory, characteristics and applications with 108 pages of diagrams, graphs and circuit applications. #3-488.

EXCLUSIVE OFFER – ONLY \$1.75. Tell-Tale Infrared Detector. #3-3361.

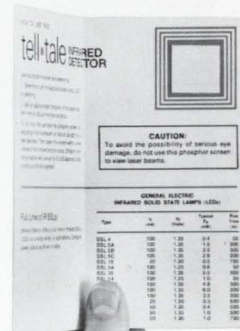

GE's unique Tell-Tale Infrared Detector is great for checking, installing or aligning opto coupled devices or systems. It is a one square-inch phosphor screen mounted on a 4" x 6" card that converts the invisible infrared energy into a visible image. Get yours now for only \$1.75.

All this worthwhile information is available from your GE electronic distributor listed below. Or from GE's Miniature Lamp Products Department listed in your Yellow Pages. Or write General Electric, Nela Park, #4454-L, Cleveland, Ohio 44112. Or call GE collect

at (216) 266-6651 and ask for Bill Lenkner. And remember, GE makes a full line of competitively priced visible and infrared SSL's. Most popular lamps are available for immediate delivery. Let us quote you on your requirements.

GE electronic distributors (listed alphabetically by company name)

Almac/Stroum Electronics
Seattle, WA 97108

Almo Electronics
Philadelphia, PA 19114

Barnhill Five, Inc.
Denver, CO 80226

Brill Electronics
Oakland, CA 94600

Carlton-Bates Company
Little Rock, AR 72209

Cramer Electronics
East Syracuse, NY 13057
Irvine, CA 92705
Mt. Prospect, IL 60056
Newton Center, MA 02159
Sunnyvale, CA 94086

Cramer New Mexico, Inc.
Albuquerque, NM 87108

Electra Distributing Company
Nashville, TN 37203

Electronics Marketing Corp.
Columbus, OH 43212

Electronics Parts Company
Denver, CO 80226

Electronic Supply
Riverside, CA 92507

Elmar Electronics
Mt. View, CA 94043

General Electric Supply Company
Rochester, NY 14623

General Radio Supply Co.
Camden, NJ 08102

Gerber Electronics
Dedham, MA 02026

Graham Electronics Supply Co.
Indianapolis, IN 46204

G. S. Marshall Company
El Monte, CA 91731

Hamilton/Avnet Electronics
Burlington, MA 01803
Culver City, CA 90230
Dallas, TX 75207
Denver, CO 80211
Hazelwood, MO 63042
Houston, TX 77019
Lenexa, KS 66215
Mt. View, CA 94040
Salt Lake City, UT 84119
Schiller Park, IL 60176
Syracuse, NY 13211

Hamilton Electro Sales
Hanover, MD 21076

Hammond Electronics
Orlando, FL 32802

Harpe Electronics, Inc.
Chattanooga, TN 37408

Hughes/Peters, Inc.
Cincinnati, OH 45227
Columbus, OH 43211

Kierulff Electronics, Inc.
Los Angeles, CA 90040

L Comp
North Kansas City, MO 64116

Lykes Electronics Corp.
Atlanta, GA 30325

Milgray Electronics
Freeport, NY 11520

Newark Electronics
Chicago, IL 60624

Newark Electronics, Inc.
Salt Lake City, UT 84115

Oil Capitol Electronics Corp.
Tulsa, OK 74115

Olive Industrial Electronics, Inc.
St. Louis, MO 63130

Pioneer/Dayton
Dayton, OH 44481

Pioneer/Cleveland
Cleveland, OH 44105

R.S. Electronics
Detroit, MI 48227

Rem Electronics
Warren, OH 44481

Rochester Radio Supply Co., Inc.
Rochester, NY 14614

Rome Electronics, Inc.
Rome, NY 13440

Schweber Electronics
Atlanta, GA 30340
Beachwood, OH 44122
Elk Grove Village, IL 60007
Hollywood, FL 33020
Rochester, NY 14624
Rockville, NJ 20852
Somerset, NJ 08873
Waltham, MA 02154
Westbury, NY 11591

Semiconductor Specialists, Inc.
Elmhurst, IL 60126
Indianapolis, IN 46241
Pittsburgh, PA 15238

Southeastern Radio Supply Co.
Raleigh, NC 27603

Standard Electronics, Inc.
Cheektowaga, NY 14225

Sterling Electronics
Houston, TX 77027

Sterling Electronics Corp.
Dallas, TX 75229

Western Electromotive
Culver City, CA 90230

Zack Electronics
San Francisco, CA 94102

GENERAL  ELECTRIC

COS/MOS is Power Conscious

Plagued by expensive power supplies and cooling systems? Having a rough time trying to cram too many system functions into a mini-package? Heat causing a reliability problem?

"Yes" to any of these problems means you have a need for RCA COS/MOS IC's.

COS/MOS power dissipation is negligible at dc and increases linearly with frequency. Since many logic elements in a digital system are idle much of the time, or switch at lower rates than the maximum clock frequency, a substantial net power saving can be achieved with COS/MOS in comparison with other logic families whose dissipation remains constant with frequency.

For example, a Digital Clock with 21 COS/MOS IC's takes only 6.3 milliwatts for the countdown from a 262 KHz crystal and the logic to drive an hours, minutes and seconds display. A comparable TTL

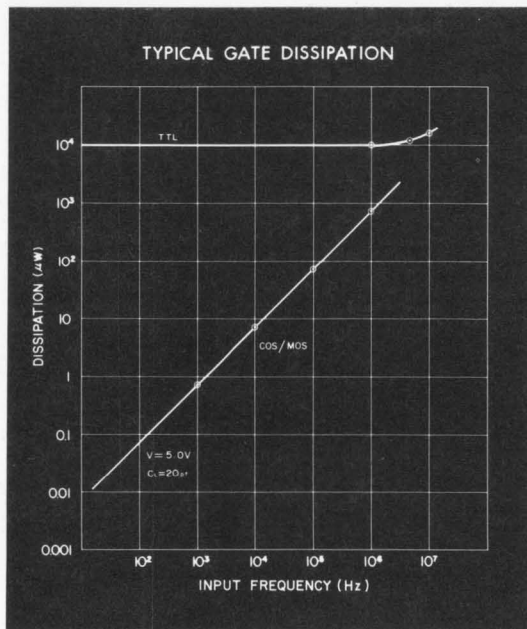

system will consume 600 milliwatts—a difference of almost 100 to 1 in power cost savings with COS/MOS.

Power conscious? You bet it is. But ultra-low power consumption is not the only great feature you get.

□ COS/MOS circuits

work from 3 to 15 volts, eliminating expensive regulators.

□ COS/MOS noise immunity is among the highest of any technology (typically 45% of supply voltage).

□ COS/MOS features stable transfer characteristics—less than 3.0% change over the full temperature range of $-55^{\circ}C.$ to $+125^{\circ}C.$

It all adds up to ease of use and cost-effective designs. Try it. You'll

be convinced that the digital world is a COS/MOS world.

Send for your guide to the ever-growing COS/MOS Product Family. Write: RCA Solid State, Section 57C-1,

Box 3200, Somerville, N.J. 08876. Or phone: (201) 722-3200, Ext. 2565.

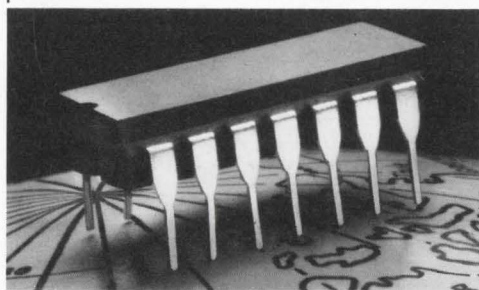

RCA Solid State
products that make products pay off