

# Electronic Design 10

VOL. 19 NO.

FOR ENGINEERS AND ENGINEERING MANAGERS

CALMA CO.

MAY 13, 1971

**Nonvolatile bipolar memory** is here! A new random-access chip tolerates total power interruption for 5 ms, holds data indefinitely for supply voltages as low as 2.0

volts and costs only 10¢ / bit. Using cross-coupled SCR cells, the 256-bit memory dissipates only 100  $\mu$ W/bit and has a 70-ns access time. Turn to page 99.

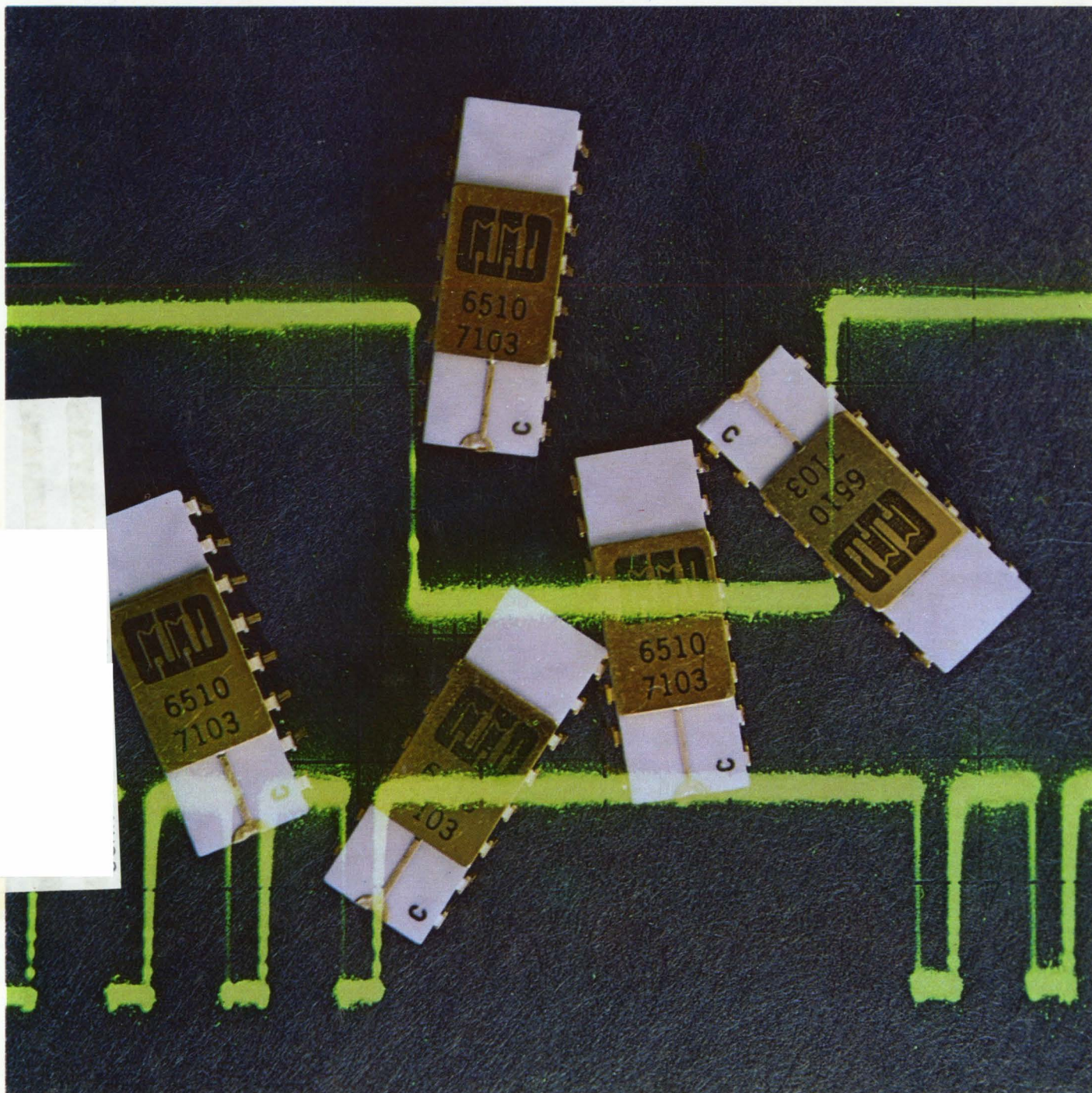



# Introducing: "The Portables" from HP



## The 1707A – Fastest in Its Class

If you're looking for speed in a \$2000 portable scope, then the new dual-channel HP 1707A is your baby. It gives you 75 MHz bandwidth (<4.7 ns risetime)—more than any other scope in its class. And you get 10 ns/div sweep speed, delayed sweep, and 10 mV/div over the full bandwidth. With this capability, you can measure T<sup>2</sup>L or ECL pulse timing and propagation delay. Yet the 1707A costs only \$1925.

And, you get this performance in a truly portable scope. The 1707A weighs only 24 lbs. And it can be powered from an internal, rechargeable battery pack (\$200)—or from any dc source from 11.5 V to 36 V, as well as any standard ac outlet.

Its low power requirement not only allows battery operation—but also eliminates the need for fans, or even dust-admitting vent holes. And although the 1707A is small and light, you still get a large 6 x 10 cm CRT

viewing area—larger than competitive scopes. Compare the display brightness, too!

If you need even more measurement capability, a \$125 option gives you our "lab package" which includes mixed sweep, calibrated delay, and external trigger input for delayed sweep. It also includes external horizontal input, and cascading capability at reduced bandwidth. (How's that for a bargain?)

Our new 1700 Series of portable scopes begins as low as \$1680—for the dual-channel, 35 MHz 1700A (<10 ns risetime). Add delayed sweep, and you've got our 1701A, for only \$1800.

The philosophy behind the 1700 Series is simple—providing the maximum in useful capability per dollar. The 1700A, 1701A, and 1707A offer wide flexibility, giving you everything you need for digital field service work. And they won't cost you a for-

tune. Compare them with anyone's competitive models—prove to yourself that the HP 1700's are the best values in portable scopes today.

For further information on "The Portables"—HP's new 1700 Series scopes—contact your local HP field engineer. Or write Hewlett-Packard, Palo Alto, California 94304. In Europe: 1217 Meyrin-Geneva, Switzerland. \*Option 020 Shown, HP's lab version of the 1707A, \$2050.

Scopes are changing.  
Are you?

081/12 A  
**HEWLETT**  **PACKARD**



# GOODBYE SOLID STATE.



## Hello better switching alternatives.

Until now, you considered solid state the only approach to multiplexing low-level, sensor-based analog information or to matrixing both analog and digital stimuli/response signals. High common mode or handling signal and power levels with the same switching device still causes you problems. But no more! Clare developed two mercury-wetted relays that do a better job. We call them the HGJ and the HGQ. And only Clare has anything like them. The "J" and the "Q" give you a direct, reliable and economical solution to switching problems in process control, data logging/acquisition, and automatic component/system testing.

### A PROVEN APPROACH

Clare is already supplying these new relays in quantity to manufacturers of computer control systems and automated test equipment. Names like IBM, Teradyne, Westinghouse,

SEL, G.E., and Honeywell. If our new mercury-wetted relays are used in their advanced systems, they can work for you, too.

### ECONOMICAL

Why? "J" two-pole versions are designed specifically for capacitor-transfer switching applications and the "Q" is designed for direct three-wire multiplexing. You don't need *any* other components for timing-sequencing or to protect solid-state devices from CMV.

### RELIABLE

Like all Clare mercury-wetted relays, the heart of the "J" and the "Q" is a hermetically sealed glass capsule. Contact switching is mercury-to-mercury. So there's *no* contact wear, *no* contact bounce, constant ON and OFF impedances—*every* operation. Clare "J" and "Q" mercury-wetted relays are rated for *billions* of operations.

### GREATER VERSATILITY

Clare "J" and "Q" mercury-wetted relays can switch wide ranges of signals simultaneously . . . from microvolt to 500 volt levels, from nanoamperes to 2 amps, from dc to megahertz frequencies, and handle common mode to 1500 vac. The "J" can be driven to 250 Hz, the "Q" to 400 Hz. And they both mount on 0.5" PCB centers.

For enough information on C. P. Clare & Company, and all mercury-wetted relays (including the new "J" and "Q") to fill a coffee break, circle our reader service number or write to us. C. P. Clare & Co., 3101 Pratt Avenue, Chicago, Ill. 60645.



a GENERAL INSTRUMENT company



# Is Job Security a worry for Power Supply Designers?

If so, TRW Semiconductors has the answer!  
It's our new SVT 450-5 high voltage  
(450 v at 10 amps), fast (100nsec)  
Power Switching Transistor.

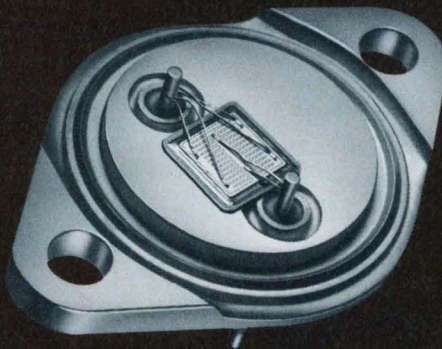

TOLL FREE

**Call: 800-421-2061**

In California Call Collect (213) 679-4561 Ext 455

## The SVT 450-5 could make you a company hero!

Those transformers and slow switching devices you've been using can't meet the demands for lower manufacturing costs and miniaturization in today's markets. And the demands will continue to increase unless you create a smaller, more efficient power supply. The SVT 450-5 provides you with the means to do it. Whether you are designing power supply systems

for computers, communications or avionics, the size and weight reductions you can create, using this 450 volt transistor and our applications, are limitless. Delivery? No empty promises... the SVT 450-5 and applications data are ready to go! See your local TRW sales office or distributor. Most important, with TRW Semiconductors there is no compromising of quality when your

job performance relies on the performance of *our* transistors TRW Semiconductor Division, 14520 Aviation Boulevard, Lawndale, California 90260.

# TRW®

INFORMATION RETRIEVAL NUMBER 3



# Electronic Design 10

VOL. 19 NO.  
MAY 13, 1971

FOR ENGINEERS AND ENGINEERING MANAGERS

---

## NEWS

- 19 **News Scope**
  - 22 **The electronic car gets a green light** in Detroit and for component manufacturers the timing couldn't be better.
  - 28 **Low-cost NASA camera system** shoots unattended under water
  - 30 **Linear motor with pulsed dc** is being studied for a nonstop, point-to-point transportation system.
  - 32 **Technology Abroad**
  - 37 **Washington Report**
- 

## TECHNOLOGY

- 49 **Designing for the Pollution-Free Industrial Era.** A civionics report on new hardware to monitor pollution.
  - 58 **Watch those losses** in low-power amplifiers. Otherwise you may find that your transistors aren't lasting as long as they should.
  - 64 **Here are more protective circuits** for power supplies and their loads. They can keep a local failure from destroying an entire system.
  - 70 **Improve your project control** with this 'hand-operated' reporting system. It's faster and less expensive than any computerized counterpart.
  - 76 **The minicomputer and the engineer—Part 3:** Programming: the key to your mini's success
  - 90 **Ideas for Design**
- 

## PRODUCTS

- 99 **ICs & Semiconductors:** A semiconductor RAM is nonvolatile for up to 5 ms.
  - 104 **Instrumentation:** DVOM pair offers 50-m $\Omega$  resolution and 0.1% accuracy.
  - 106 **Instrumentation:** New oscilloscope offers 500-MHz real-time bandwidth.
  - 112 **Data Processing:** Only \$800 will pay for a custom designed minicomputer.
  - 110 Data Processing
  - 116 Packaging & Materials
  - 120 Components
  - 124 Modules & Subassemblies
  - 130 Microwaves & Lasers
  - 144 Product Index
- 

## Departments

- 47 **Editorial:** You may be a sharp EE, but are you an MD, too?
- 7 Letters
- 13 Designer's Calendar
- 132 Evaluation Samples
- 132 Design Aids
- 134 Application Notes
- 136 New Literature
- 139 Bulletin Board
- 142 Advertiser's Index
- 144 Information Retrieval Card

**Cover:** Photo courtesy of Monolithic Memories, Inc.

---

ELECTRONIC DESIGN is published biweekly by Hayden Publishing Company, Inc., 850 Third Avenue, New York, N.Y. 10022. James S. Mulholland, Jr., President. Printed at Brown Printing Co., Inc., Waseca, Minn. Controlled circulation postage paid at Waseca, Minn., and New York, N.Y. Copyright © 1971, Hayden Publishing Company, Inc. 82,501 copies this issue.



# Bridge the Computing Gap

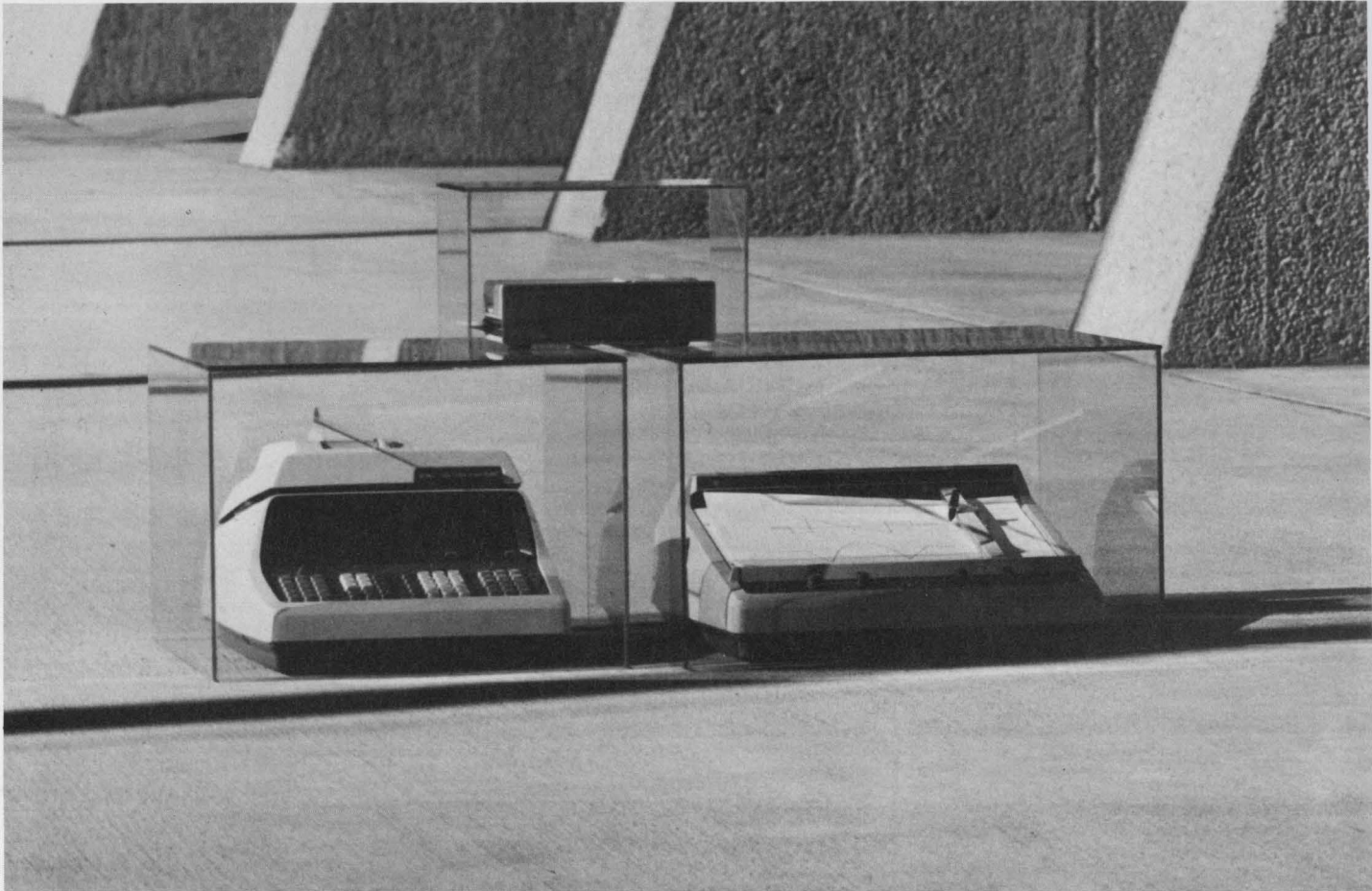

## The HP Calculator System 9100. For People Who Demand More Than Just A Calculator

Chances are, you, like most other engineers, scientists, and businessmen, have found that a calculator alone isn't enough. Many times the tasks of entering data and putting solutions into useable form can eat up more time than the computation itself. That's why the HP Calculator System 9100 gives you more ways to

enter your data, more memory to perform the calculations, and more ways to receive your solution than any other calculator on the market. This true system approach allows you to fit the right machine to your needs yet retain the low cost and ease of operation of a calculator.

For instance, if graphs and charts

are important in your work, the System 9100 has the only X-Y Plotter on the market that can produce linear, log-log, and semi-log plots. Need a card reader? A large screen display? A strip printer? Formatted output? They're also available if you need them. Exclusive interface capability allows you to expand your system as your needs change—or add new peripherals as they become available. So, even if you bought the first 9100, you can take advantage of these new work-saving peripherals with no modification to your present equipment.

Now you can emancipate your time from big problems with long programs or large amounts of data. The **new 9101A Extended Memory** has the power you need to perform a 14 X 14



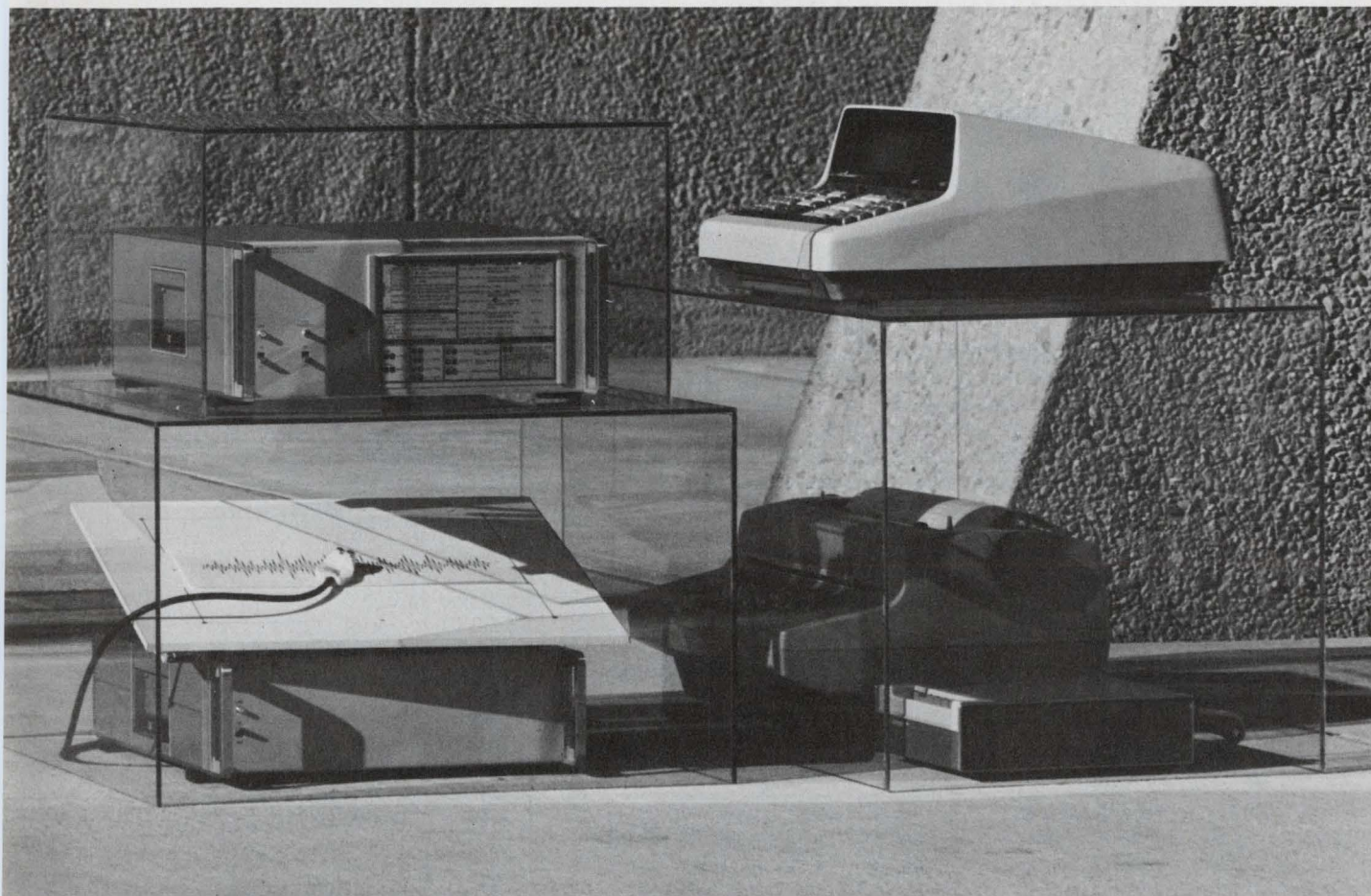

matrix inversion, or find real and complex roots of thirtieth degree polynomials. The Extended Memory is the biggest in the business. Its 248 storage registers will store up to 100 programs (3472 program steps), yet programming is quick and easy since you use indirect addressing.

And you can emancipate your time from tabulating data and solutions. The **new 9106A Typewriter Interface** will couple your 9100 Calculator with an IBM Model 73 Typewriter for fast, formatted numeric printout.

Or, you can couple the **new 9107A Digitizer** to your 9100 Calculator and have a fast, automatic means for checking mechanical drawings, profiles, maps—or analyzing strip chart data. The Digitizer automatically converts lines or points on charts or

drawings to digital data for instant analysis by your 9100 Calculator. Just enter the appropriate program in the Calculator, move the Digitizer's cursor over the data line, and the Calculator computes and prints out the solution you desire. Your imagination is the only limit to the application of this versatile data input device.

You can also couple your 9100 to a host of HP measurement instruments and automatic test systems. The new 9108A and 9108B Coupler/Controllers (not shown) will make your 9100 a true real-time, on-line data processing and control system.

All 9100 Calculators and Peripherals are backed by fully documented program packages—including a host of application Program PACs in many

disciplines of science, engineering, and business—so your System 9100 goes to work the moment you take it out of the box.

You can put the System 9100 to work for you for as little as \$1.11 per computing hour. Purchase, lease, and rental options are available for all System 9100 equipment. For further information, or to arrange a “hands-on” demonstration at your desk, write: Hewlett-Packard, P.O. Box 301, Loveland, Colorado 80537. In Europe: 1217 Meyrin-Geneva, Switzerland.

090/22

**HEWLETT**  **PACKARD**

**HP CALCULATOR SYSTEM 9100**

INFORMATION RETRIEVAL NUMBER 4



**The Best Potential for  
... Phototubes  
... Photomultipliers  
... Ion Sources  
are KEITHLEY  
DC High Voltage Supplies**



**NEW LOW COST MODEL 244** furnishes negative-only potentials from  $-200$  to  $-2200$  volts at up to 10 milliamperes. It operates quietly, with less than 500 microvolts noise and is solidly stable to 50 ppm. Fully overload-protected, with automatic recovery, the 244 also offers a unique photomultiplier protection circuit option—the Model 2441 (price on request). The Model 244 is budget priced at only \$298. Less in quantity.



**PERFORMANCE-PROVEN MODEL 240A** reliably supplies bipolar voltages from 0 to 1200 volts in 1 volt steps. Rated at 10 milliamperes, the 240A smoothly recovers from no load to full load in 35 milliseconds. Capable of both resistance and voltage programming, the 240A also features full overload protection with automatic recovery within 250 milliseconds.

Stable to 0.02% and steady to 0.005% for both load and line changes. Get all this for just \$375. Less in quantity.

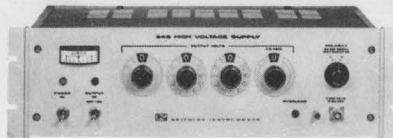

**MODEL 246 HIGH VOLTAGE SUPPLY** gives a selection of any output of both polarities from 0 to 3100 volts. The 246 is rated at 10 milliamperes and features automatic recovery from overloads within 1 second. Maximum output current is electronically limited to 13 milliamperes. It adapts easily to either voltage or resistance programming. Stable to better than 0.01% with 0.002% load regulation. A perfect buy at \$475. Less in quantity.

**OTHER KEITHLEY HIGH VOLTAGE SUPPLIES — PRICES LOWER IN QUANTITY**

Model 241  $\pm 0$  to 1000 volts, floating/accurate . . . \$950  
Model 245  $\pm 0$  to 2100 volts, stable/bipolar . . . . . \$435  
(U.S.A. Prices)



**KEITHLEY INSTRUMENTS**

U.S.A.: 2875 AURORA ROAD, CLEVELAND, OHIO 44139 / EUROPE: 14, AVENUE VILLARDIN, 1009 PULLY, SUISSE

INFORMATION RETRIEVAL NUMBER 5

**Publisher**

Peter Coley

**Editors**

New York Office  
850 Third Ave.  
New York, N.Y. 10022  
(212) 751-5530  
TWX: 710-581-2874  
Cable: Haydenpub

Editor: Frank Egan  
Managing Editor: Ralph Dobriner  
Managing Editor: Raymond D. Speer  
Microelectronics, Steven A. Erenburg  
Computers, Raymond D. Speer  
Microwaves, Michael J. Riezenman  
Circuits, Edward A. Torrero  
Special Projects, George Rostky  
Management, Richard L. Turmail  
Military-Aerospace, John F. Mason  
New Products, Roger Allan

**Field Offices**

**Massachusetts**  
Jim McDermott  
P.O. Box 272  
Easthampton, Mass. 01027  
(413) 527-3632

**West Coast**  
David Kaye  
2930 Imperial Highway  
Inglewood, Calif. 90303  
(213) 757-0183

**Washington**  
Don Byrne  
1425 N St. NW  
Washington, D.C. 20005  
(202) 667-6568

**Editorial Production**

Dollie S. Viebig

**Art**

Art Director, William Kelly  
Rita Jendrzewski  
Richard Luce

**Production**

Manager, Thomas V. Sedita  
Helen De Polo  
Kathleen McConkey  
Leslie Stein

**Circulation**

Manager, Nancy L. Merritt

**Information Retrieval**

Peggy Long



# letters

## About that editorial criticizing unions . . .

Sir:

I'm writing in response to Raymond Speer's editorial, "Our Industry Reels—while Unions Get 17%," in the Feb. 18, 1971 issue of *ELECTRONIC DESIGN*. In case anyone forgot, that's the one which moaned at how awful it is that union workers win big raises, while engineers suffer layoffs. Mr. Speer comes to the brilliant conclusion that engineers should write to their Congressmen, asking for a curb on the power of unions. There's a fable about a dog in the manger, which seems to have some pertinence to this editorial. If at first you don't succeed, don't let anyone else.

I find if union laborers earn more than I do, there's probably something I could learn from them (besides plumbing). I could also learn a lot from doctors and university professors. In fact there's hardly anyone in this society I couldn't learn from, except perhaps Mr. Speer.

I think it's about time the engineering community took a rational attitude toward human acquisitiveness. Everyone is out to do fewer hours of work and get more remuneration. The difference between engineers and union workers is that the latter have instrumented their wishes. I suggest the next time Mr. Speer wants a raise, he go to his boss and groan about the greedy unions. Does that sound like a formula for success? It is by engineering standards of performance.

*Robert Bruce,*

Just another engineer

15 Johnstone Road  
Great Neck, N. Y.

Sir:

Referring to the editorial in the Feb. 18, 1971 issue of *ELECTRONIC DESIGN*, I'd like to express my admiration for your spelling out of the real cause of the current inflation and the engineers' loss of jobs, and your courage in pointing out the ill effects of trade unions.

On the other hand, I was disenchanted by the discussion on pp. 82-85 of the same issue on the subject of unionization ["What Price Unionization?"]. I think that article missed the whole point. In my opinion, this is not the time for engineers to talk about profit-sharing, pension plans, and "luxuries" like that; it's time to talk about preservation of the national technical competence.

True enough, the law of supply and demand always prevails, but the collective-bargaining power of a union hardly fits this principle. I am not really suggesting an overturn of the historical union system. I am only saying this:

Either Big Brother imposes wage controls for the sake of upholding our national technical competence and improving our productivity, or let's all join a nationwide union for professional engineers and scientists—the only way in which the silent minority can protect itself.

*T. M. Yeh*

862 E. Evelyn Ave.  
Sunnyvale, Calif.

---

## Accuracy is our policy

In the February 18, 1971 issue, P. 108, a new op amp from Silicon General was reported as model SG118/208/308. This should have read SG118/218/318. Also prices should have been stated as \$30/\$20/\$10 for the SG118/218/318 and \$3.95/\$2.45/\$1.50 for the SG-1217/2217/3217, all in 100-unit quantities.

---

Electronic Design welcomes the opinions of its readers on the issues raised in the magazine's editorial columns. Address letters to Managing Editor, *Electronic Design*, 850 Third Ave., New York, N.Y. 10022. Try to keep letters under 200 words. Letters must be signed. Names will be withheld on request.

## Computer Automation introduces NAKED MINI™ computer at \$1700

**FULL COMPUTER POWER FOR A FRACTION OF THE COST.**

A unique concept — the minicomputer as a component — has been launched by Computer Automation. Called the NAKED MINI™, this new computer delivers all the power of a packaged machine . . . at a price that breaks through the \$2000 barrier.

The NAKED MINI is a fully operational 8-bit or 16-bit computer, stripped of its power supply, console, and metal chassis. You get everything that really counts — memory and processor — without the ancillary components.

Functionally, the NAKED MINI is identical to Computer Automation's existing machines. None of the previous line's superb features have been sacrificed. The 16-bit NAKED MINI, for example, still gives you hardware multiply/divide as a standard item. Moreover, all machines offer direct memory channels, vectored interrupts, and 32K of addressability. Because the software and I/O interface are compatible, all of the options and programs for Computer Automation's present machines are useable with the NAKED MINI.

For the systems designer, the NAKED MINI means an opportunity to get full computer power and greater design freedom at drastically reduced prices. In all industries, this innovative concept opens up new application areas, with general purpose minicomputers replacing hard-wired circuitry.

The NAKED MINI with 4K of expandable memory is priced from \$1700 (\$2400 for the 16-bit unit) in 200-unit quantities. First deliveries are scheduled for this November.



COMPUTER AUTOMATION, INC.  
895 West 16th Street • Newport Beach, California  
92660 • Phone (714) 642-9630 • TWX 910-596-1377

INFORMATION RETRIEVAL NUMBER 6



# Our TTL family gives you freedom where it counts.



The Fairchild TTL family offers the freedom-loving designer the broadest range of speed/power trade-offs and an extraordinary variety of logic and memory and interface support functions.

**FAIRCHILD  
TTL FAMILY**



# Now you can design with Low Power TTL/MSI at even less cost than with Standard!

93L21 Dual 1 of 4 Decoder		93L22 Quad 2 Input Multiplexer				
93L11 1 of 16 Decoder		93L12 8 Input Multiplexer	93L28 Dual 8 Bit Shift Register	93L14 4 Bit Latch	93L40 4 Bit Arithmetic Logic Unit	93L16 Binary Counter
93L01 1 of 10 Decoder	93L18 8 Input Priority Encoder	93L09 Dual 4 Input Multiplexer	93L00 4 Bit Shift Register	93L08 Dual 4 Bit Latch	93L24 5 Bit Comparator	93L10 Decade Counter
DECODERS/ DEMULTIPLEXERS	ENCODERS	MULTI- PLEXERS	REGISTERS	LATCHES	OPERATORS	COUNTERS

## Our Low Power TTL now sells for the same price as Standard TTL and costs even less to use.

If you don't need the speed of Standard, why pay the freight? In our TTL Family you'll find 15 low cost Low Power MSI devices to choose from. All compatible. All off the shelf.

It's the largest, most complete, most versatile selection in the business. Designed to give the cost-conscious designer freedom now. And freedom where it really counts:

- No board redesign (pin-for-pin equivalent to and compatible with Standard TTL/MSI devices).
- Smaller power supply.
- Less noise (fewer decoupling elements required).
- Less heat.
- High fanout (fewer buffers needed).
- Largest Low Power MSI/TTL family around.

Typical performance:

Gate Tpd = 20ns Gate Pd = 2mW

Binary Toggle Rate = 10MHz

MSI Clock Rate = 10MHz

You might re-examine your current design. If speed is not a critical factor, then look at our 93L Low Power series. If you care about costs, they have a lot to give. Our new catalog tells the whole story. Send for it.

**FAIRCHILD**  
SEMICONDUCTOR



**If we told you that  
Automatic Metal Products Corp.  
is now  
Plessey Incorporated,  
Connector Division,  
would you remember it?**

**We hope so.**

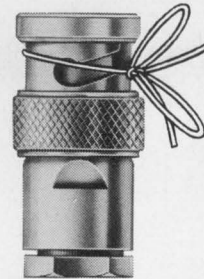

Along with our new name, we have a new location, and vastly superior manufacturing and test facilities.

These changes now enable us to offer you much more in the way of service and dependability than ever before. Why not call us now, while it is still "fresh" in your mind? Whether it be to place an order, request a quotation, or just to make an appointment to visit our new home, we'll be happy to hear from you.



**PLESSEY INCORPORATED/CONNECTOR DIVISION**  
400 MORELAND ROAD/COMMACK, NEW YORK 11725  
TELEPHONE: (516) 543-5000

A COMPLETE LINE OF COAXIAL CONNECTORS  
COAXIAL SWITCHES / HIGH POWER DIRECTIONAL COUPLERS / CYLINDRICAL POWER CONNECTORS  
HIGH DENSITY CYLINDRICAL CONNECTORS / RACK AND PANEL CONNECTORS  
PRINTED CIRCUIT CONNECTORS / COMBINATION MULTIPIN AND COAXIAL CONNECTORS  
SPECIAL PURPOSE CONNECTORS

INFORMATION RETRIEVAL NUMBER 8



**Unbeatable  
portability  
and range  
coverage!**



the new **Simpson** **460** DIGITAL VOM



- Completely portable . . . no separate battery pack or power supply needed. Self-contained battery or line operation.
- Non-blinking 3½-digit display of 26 most used ranges . . . 5 each AC/DC voltages and AC/DC currents . . . 6 resistances . . . with "plus" and "minus" and overrange . . . analog meter readout . . . analog to digital converter uses the dual slope technique.
- A compact, lightweight, multi-use Digital VOM for lab, in-field or general testing . . . . . only \$395.00 (less batteries)

NOW IN STOCK AT YOUR LOCAL ELECTRONICS DISTRIBUTOR • WRITE FOR BULLETIN T-811



**SIMPSON ELECTRIC COMPANY**

GENERAL OFFICES AND EXPORT:

5200 West Kinzie Street, Chicago, Illinois 60644 • (312) 379-1121 • CABLE: SIMELCO

IN CANADA: Bach-Simpson, Ltd., London, Ontario

IN INDIA: Ruttonsha-Simpson Private, Ltd., International House, Bombay-Agra Road, Vikhroli, Bombay



DIVISION

INFORMATION RETRIEVAL NUMBER 9



# For basic industrial connectors

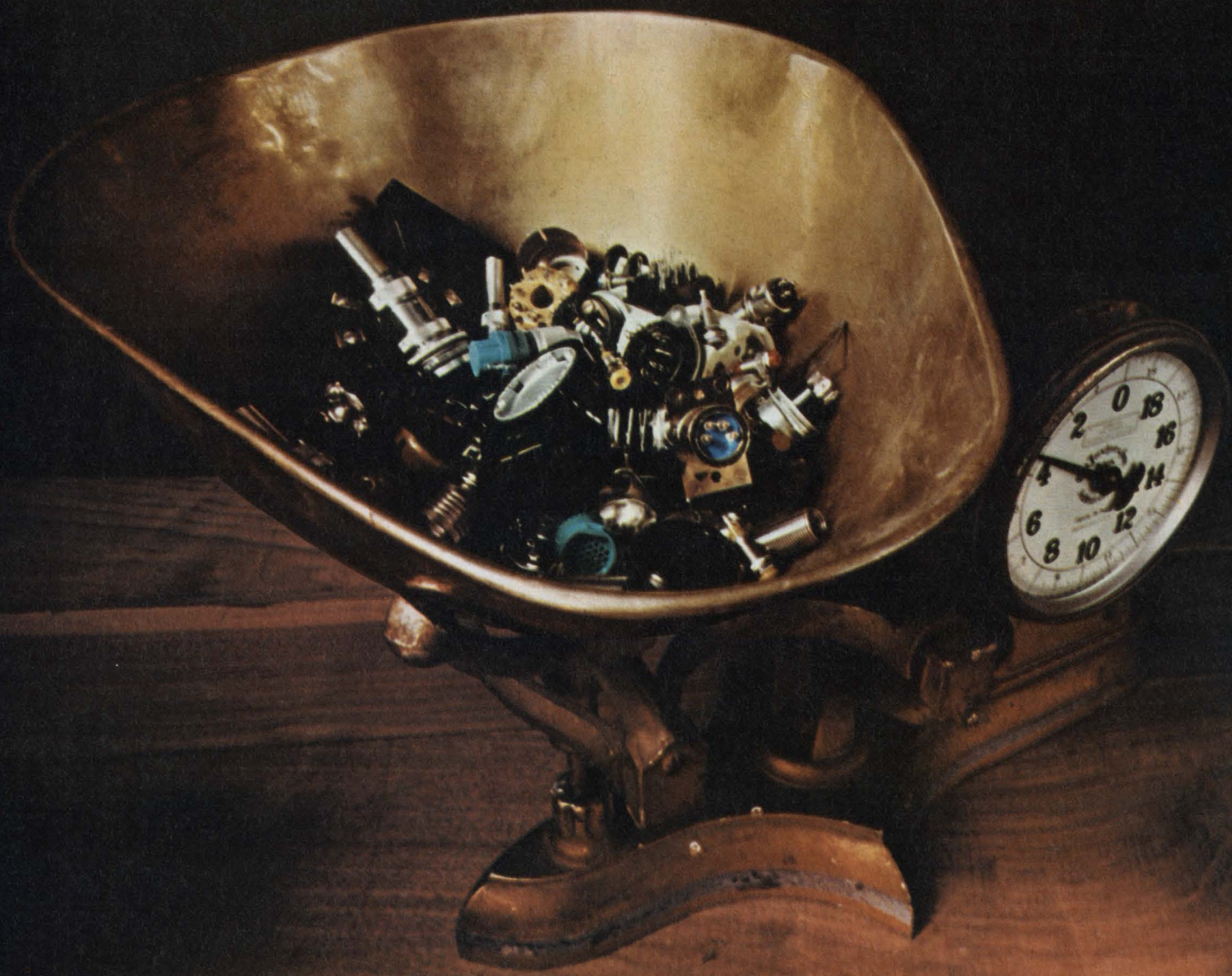

## think of us as your hardware store.

Plugs, sockets, connectors, hardware and accessories—for relays, tubes, cable connections, sound systems or whatever—a whole raft of things you'd never expect from us. They've been in our industrial product line for many years. In fact, it's the broadest line available anywhere. So next time you need something

in basic black, think of us as your connector hardware store. Drop us a line and we'll send you our latest 32-page II-1 Catalog along with the name of your closest Amphenol distributor. Write to Amphenol Industrial Division, The Bunker-Ramo Corporation, 1830 South 54th Avenue, Chicago, Illinois 60650.

**BUNKER  
RAMO** AMPHENOL



# designer's calendar

JUNE 1971						
S	M	T	W	T	F	S
		1	2	3	4	5
6	7	8	9	10	11	12
13	14	15	16	17	18	19
20	21	22	23	24	25	26
27	28	29	30			

June 2-4

Conference on Laser Engineering & Applications (Washington, D. C.) Sponsors: IEEE et al. D. E. Caddes, Sylvania Elec. Systems, Electro-Optics Div., Mountain View, Calif. 94040.

CIRCLE NO. 413

June 14-16

International Conference on Communications (Montreal, Quebec, Canada). Sponsor: IEEE. W. C. Benger, Northern Elec. Co., Ltd., POB 3511, Station C, Ottawa 3, Ontario, Canada.

CIRCLE NO. 414

June 27-30

Consumer Electronics Show (Chicago). Sponsor: EIA. Alfred L. Perkins, Harshe-Rotman & Druck, Inc., 108 N. State St., Chicago, Ill. 60602.

CIRCLE NO. 415

JULY 1971						
S	M	T	W	T	F	S
				1	2	3
4	5	6	7	8	9	10
11	12	13	14	15	16	17
18	19	20	21	22	23	24
25	26	27	28	29	30	31

July 13-15

International Symposium on Electromagnetic Compatibility (Philadelphia). Sponsor: IEEE. Ralph Showers, Moore School of EE, Univ. of Pennsylvania, Philadelphia, Pa. 19104.

## MORE POWER PER PENNY FROM POWER/MATE

### A NEW SERIES OF POWER SUPPLIES FOR INTEGRATED CIRCUITS

ICX SERIES FROM  
POWER/MATE CORP.  
POWER SUPPLIES  
FOR INTEGRATED CIRCUITS

**\$75.**

WITH LIBERAL OEM DISCOUNTS

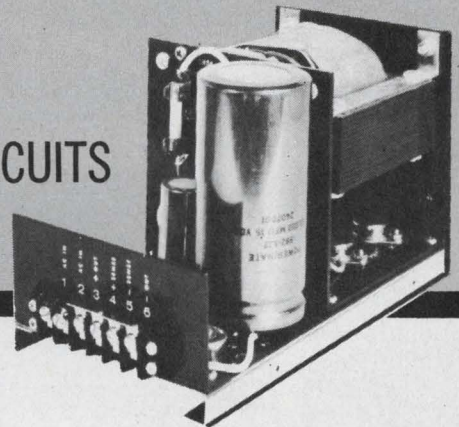

#### THE ICX SERIES GIVES YOU MAXIMUM ECONOMY WITH MAXIMUM RELIABILITY

Using an open chassis construction for economy and IC regulators, the ICX SERIES has been designed especially for integrated circuit applications.

Highly flexible... with optional features allow the user to purchase only those requirements needed for his particular application. Ideal for OEM needs.

Each power supply has built in overvoltage protection — and is completely short circuit and overload proof.

#### ICX SERIES FEATURE:

- \* INTEGRATED CIRCUIT REGULATOR
- \* BUILT-IN OVERVOLTAGE CROWBAR PROTECTION
- \* BUILT-IN OVERLOAD AND SHORT-CIRCUIT PROTECTION
- \* ADJUSTABLE VOLTAGE RANGES
- \* REMOTE OR LOCAL SENSING REMOTELY PROGRAMMABLE
- \*  $\pm 0.1\%$  LINE AND LOAD REGULATION
- \* 115 VOLT 47-420 CPS AC INPUT
- \* TWO MOUNTING SURFACES
- \* TOP QUALITY COMPONENTS
- \* ALL SILICON SEMI-CONDUCTORS
- \* FIVE-YEAR WARRANTY
- \* SAME-DAY-SHIPMENT

SEND FOR  
FREE CATALOG  
giving specs  
and prices



# POWER/MATE CORP.

514 S. RIVER STREET, HACKENSACK, N. J. 07601  
Phone (201) 343-6294 / TWX 710-990-5023



# Sooner or later you're going to specify SEMTECH RECTIFIERS!

**Metoxilite** (200 to 1,000 V)  
"Non cavity" silicon rectifier.

**Ministac**<sup>®</sup> (1 to 7 kV)  
Miniature axial lead stack.

**Ministic**<sup>®</sup> (10 to 40 kV)  
Miniature high voltage assembly.

**Sempac**<sup>®</sup> (3 to 10 kV)  
High voltage axial lead rectifier.

**Compac** (50 to 3,000 V)  
Flat and functional bridge.

**Alpac**<sup>®</sup> (50 to 600 V per leg)  
Aluminum package-bridges, doublers & center taps.

**Cupac** (50 to 600 V)  
A "fast recovery" stud rectifier replacement.

**Slimpac**<sup>®</sup> (5 to 25 kV)  
Slim package — high voltage assembly.

**Stacpac** (5 to 1,000 kV)  
High power, high voltage stack.

**Impac** (50 to 600 V)  
Low cost epoxy rectifier.

**KVpac** (5 to 15 kV per leg)  
Commercial high voltage rectifier assembly.

**Sticpac** (50 to 200 kV)  
High voltage X-ray rectifier.

**Tubepac** (575A, 7018, 5973, etc.)  
Solid state rectifier tube  
replacements.

Ask for our 1971 catalog.

CHICAGO — 140 N. La Grange Road, La Grange, Illinois 60525 — (312) 352-3227 / TWX: 910-683-1896 DALLAS — 402 Irving Bank Tower, Irving, Texas 75060 — (214) 253-7644 FLORIDA — 2304 Aloma Ave., Room 2, Winter Park, Florida 32789 — (305) 644-5404 NEW YORK — 116-55 Queens Blvd., Forest Hills, N.Y. 11375 — (212) 263-3115 / TWX: 710-582-2959 PHILADELPHIA — 209 Chester Ave., Rm. 5, Moorestown, N.J. 08057 — (609) 234-1244 SAN FRANCISCO — 941 E. Charleston, Suite 10, Palo Alto, Calif. 94303 — (415) 328-8025 EUROPEAN SALES — Bourns A. G. Alpenstrasse 1, Zug, Switzerland — (042) 4 82 72 73.

"Cool Power" rectifiers and assemblies —

 **SEMTECH**  
CORPORATION

652 Mitchell Road, Newbury Park, California 91320  
(805) 498-2111, (213) 628-5392 / TWX: 910-336-1264



# BOURNS MAKES WIREWOUND, CERMET AND CARBON POTENTIOMETERS!

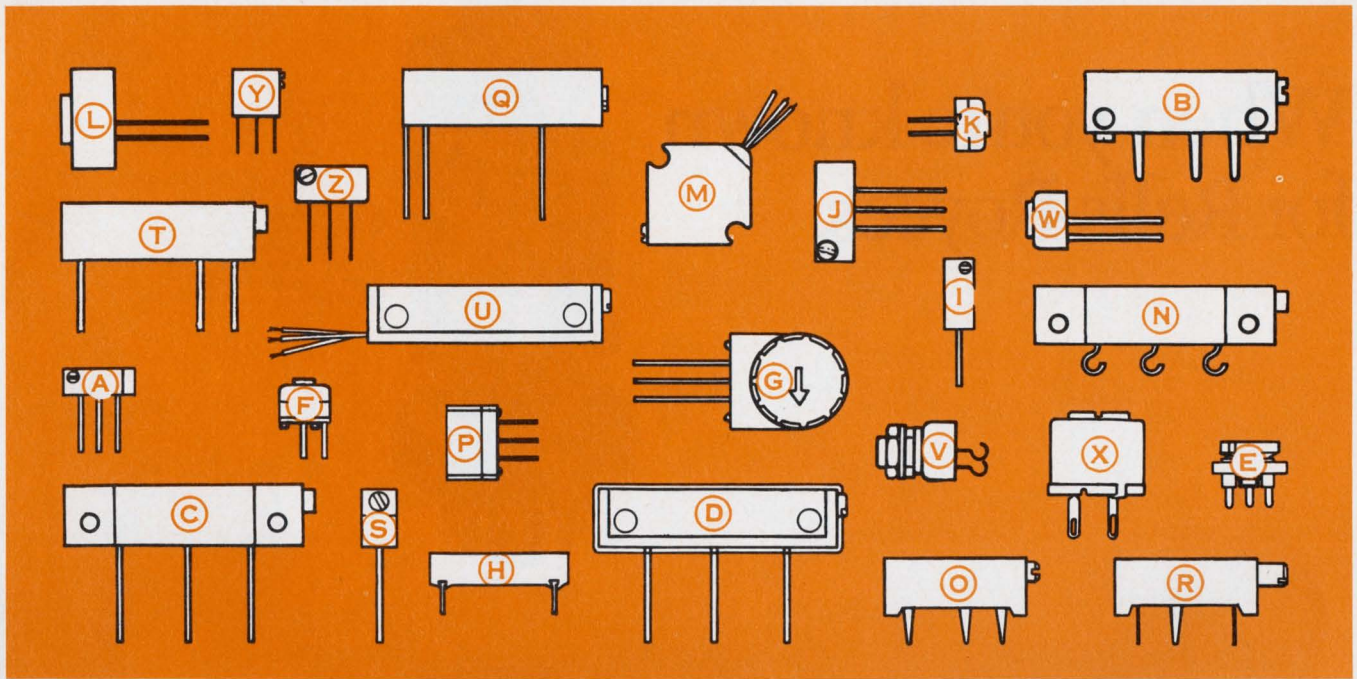

## BE A WINNER... FIND THE WIREWOUNDS

Give up? We'll give you a few hints. In selecting potentiometers it's the performance that counts. When you need *high power, stability, low tempco* and *price*, wirewounds may be your best bet. Six best bets are described below and illustrated above — among a wide assortment of Bourns po-

tentiometers. We challenge you to match the six correct potentiometers to the six descriptions. To the first 250 who submit winning entries we will send a deck of Bourns first quality playing cards. All entries will receive a packet of information on wirewounds and the correct answer. Try your skill.

The key to winning is matching identification letters with descriptions below. If you're handy with words, the six correct letters should make you win.

- MODEL 3260**  
Very tiny 1/4" square; 0.2 watt at 70°C; high temp. to 175°C; qualified as RT26.
- MODEL 3005**  
E-Z-TRIM® 3/4" rectangle for small places; 1 watt at 40°C; temp. to 125°C; sealed; very inexpensive.
- MODEL 260**  
We'll give you a lead; 1 1/4" rectangle; metal cover, 1 watt at 70°C; high temp. to 175°C; self-locking adjustment for stable setting.
- MODEL 3300**  
A 5/16" dia. single turn; 1/2 watt at 70°C; high temp. to 175°C; excellent shock and vibration stability.
- MODEL 3290**  
Thin 3/8" square; 1 watt at 70°C; high temp. to 175°C; qualified as RT24. Edge mounting version is very popular.
- MODEL 3057**  
1 1/4" rectangle; 1 watt at 70°C; high temp. to 150°C; temp. stability to 1/2%; sealed. Some users specify solder lugs.

CLIP THIS COUPON AND SEND IT TO:

### WIREWOUND CONTEST



1200 COLUMBIA AVE., RIVERSIDE, CA. 92507

My winning words are

with wirewounds.

NAME \_\_\_\_\_

TITLE \_\_\_\_\_ COMPANY \_\_\_\_\_

ADDRESS \_\_\_\_\_

CITY \_\_\_\_\_ STATE \_\_\_\_\_ ZIP \_\_\_\_\_

Bourns factory, representative and distributor personnel and their families are ineligible.

Contest closes June 30 (ED 571)



# When you're known for Rolls-Royces,

# it's hard to get Volkswagen buyers to think of you.

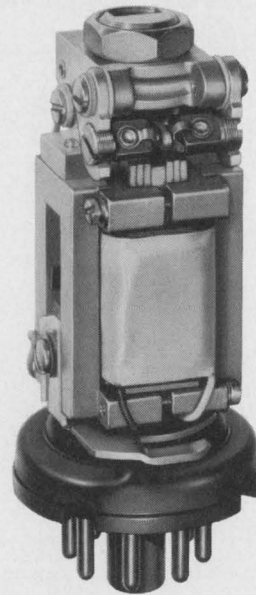

Series 72 Pulse and  
Telegraph Polar Relay  
... pulse repetition to  
400/sec., life in hun-  
dreds of millions of  
operations

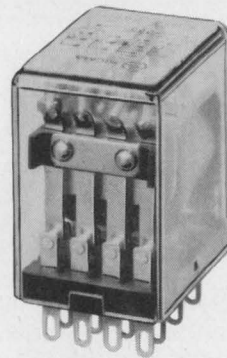

Series 67  
General purpose  
AC & DC, 4PDT, 5A

**SIGMA has 2000 good, different general-purpose relays— many for 50¢/pole.**

If you think of Sigma as a sensitive, close-differential relay house, you're partly correct. We're also a low-priced, general purpose relay house — as a substantial number of vending machine, alarm system, industrial control, copier and communications equipment manufacturers will attest.

For demanding applications such as computer peripherals, you can have one-cubic-inch 4PDT switching, on AC or DC coil signals, of low-level to 5-amp. loads at least 100,000 times with the Series 67. Fast wiring, mounting and interchangeability results from PC or solder terminals, or in sockets with PC or solder terminals.



Single-, two- or three-pole switching of loads up to 10 amps, for one million operations at 28 VDC or one-half million at 115VAC, is provided by the versatile and quickly-installed Series 68.

For up to 6PDT switching of low-level to 5 amp. loads by voltage adjustment, or 1-amp. loads on sensitive current adjustment, the Series 62 combines long life (up to 50 million operations with bifurcated contacts) with moderate cost.



For positive response to coil signals as low as 50 mw, at a cost of under 75¢/relay in quantity, the Series 65 is well-suited to TV channel selectors, slide projectors, vending machines and similar uses involving SPDT switching of 1-amp. loads.

Up to 3PDT switching of 5- or 10-amp. loads, on AC or DC voltages, is available in the compact and low-cost Series 50; wide application in automated equipment, switching small motors, solenoids and other relays.



We'll be glad to supply detailed technical data on any of the general-purpose relays mentioned, with complete price and delivery information on standards. Better yet, tell us your requirements (load, life, cost, driving signal, operating speed and environment) and let us recommend the relay best suited to the job. We can save you time, disappointment and perhaps some money as well. Sigma Instruments, Inc., 170 Pearl St., Braintree, Massachusetts 02185.

## SIGMA

INSTRUMENTS INC



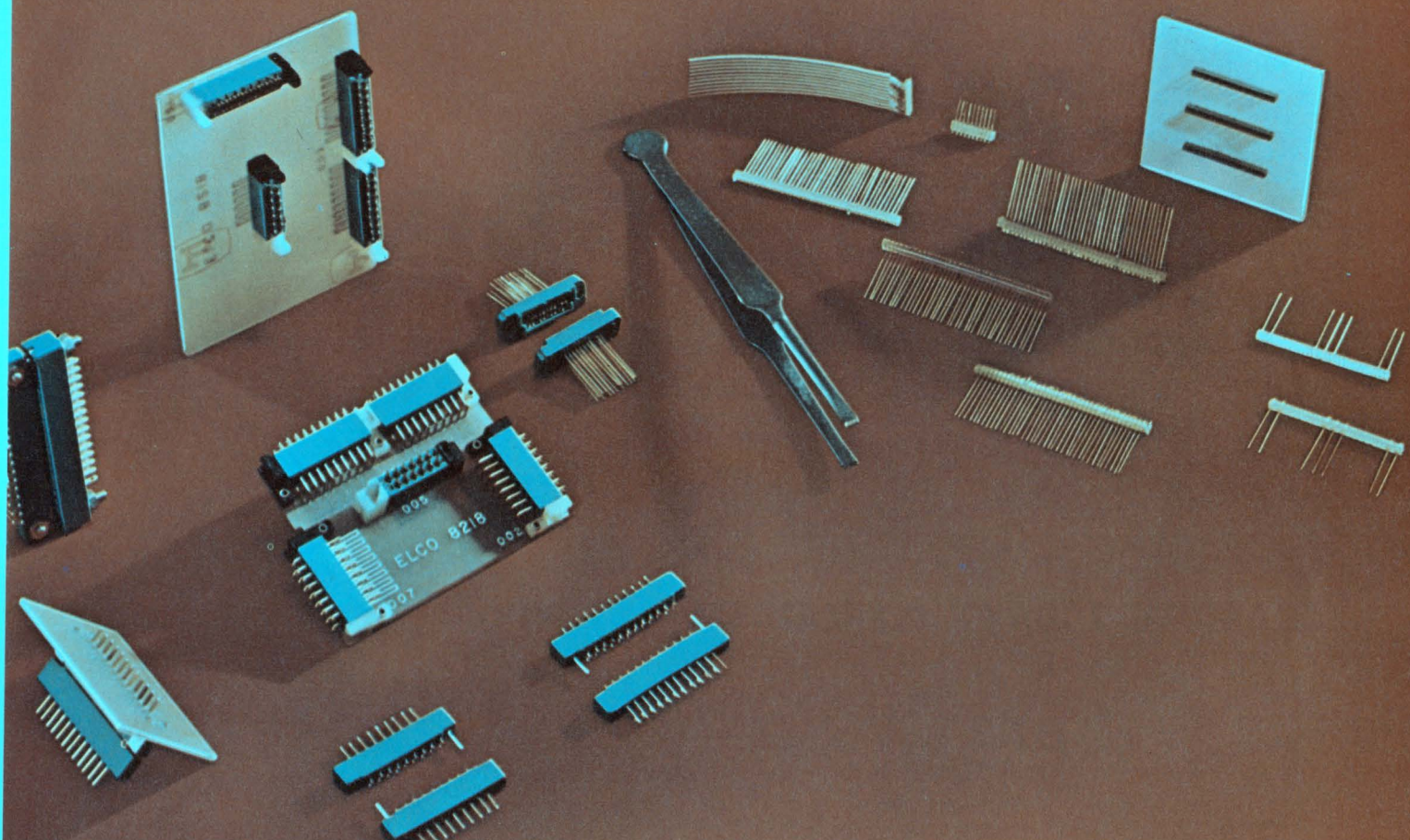

# Miniature, subminiature connectors, yes.

## Miniature, subminiature contacts, no.

Microelectronics can give you a pain in the tweezers. You have to be perfect. And you have to be perfect in places so small that a flea would have trouble scratching his back.

Actually, the electronics part isn't too hard, what with piezoelectric this's and thin-film that's to work with.

But, inevitably, there comes the day when all the this's and that's have to be put together. It's a problem. Mechanically. Electrically.

You don't want to put a big fat plug on a skinny little mini-circuit.

So you need miniature or subminiature connectors. Those we have. By the catalogfull.

But you sure don't need undernourished contacts. You need all the strength you can get, all the contact area you can get, all the hang-togetherness you can get.

Those we give you. Every miniature in our catalog is made with our patented Varicon™ contacts (you probably already know about them). Our newer sub-miniatures are made with Bi/Con™ contacts (which

is sketched at the left).

See the four mating surfaces?

Four mating surfaces, coined so that they're exceptionally hard and smooth.

Four mating surfaces, held together snugly by the spring-like action of the design. And by the innate characteristics of the phosphor-bronze.

Four mating surfaces, strengthened by a reinforcing web.

Four mating surfaces, on a contact that floats in its insulator to make sure that the four mating surfaces mate.

No comparably sized contact can match the Bi/Con's dimensional, electrical, and mechanical characteristics.

And no subminiature contact can match the Bi/Con's incredibly low price, either.

For your copy of our Microelectronics catalog, write us at Elco, Willow Grove Division, Willow Grove, Pa. 19090 Elco, Huntingdon Division, Huntingdon, Pa. 16652. Elco, Pacific Division, 2200 Park Place, El Segundo, California 90245.

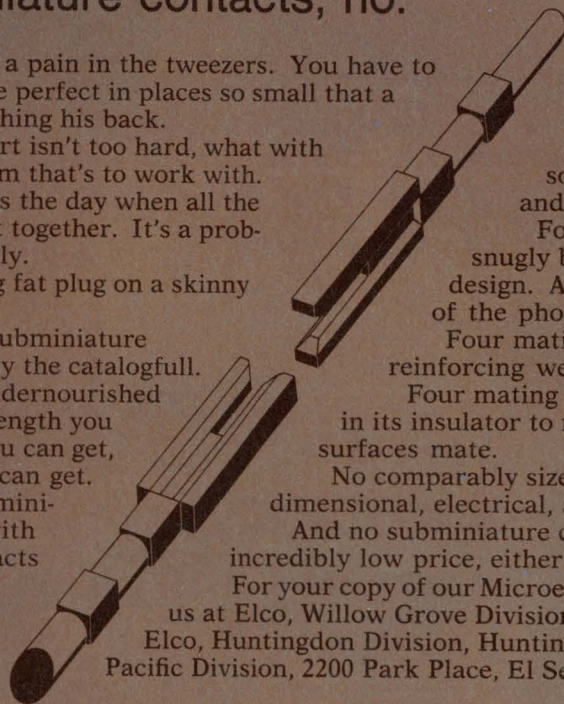

Send for your 1971 Design Handbook

**ELCO** Varicon® miniatures  
Bi/Con® subminiatures



Manufacturing in USA, Australia, Belgium, Canada, Denmark, England, France, Germany, Israel, and Japan. Sales offices throughout the world.



# 256 TO 1 YOUR BEST BET IS BURROUGHS

**LEADING TODAY'S DISPLAY REVOLUTION**

#### **NIXIE® INDICATOR TUBES**

Burroughs NIXIE Tubes are available in a complete line of sizes, shapes and costs to satisfy all of your requirements for numeric displays requiring 1 to 8 digits of displayed readouts.

#### **BURROUGHS NIXIE TUBE MODULES**

Off-the-shelf, low-cost readout system flexibility for 3- to 15- digit numeric applications. Decoder drivers and counters are available in any number of configurations and for all applications.

#### **PANAPLEX™ NUMERIC PANEL DISPLAYS**

Lowest cost-per-digit, in-plane numeric readout for 8- to 16- digit applications provides a 150° viewing angle. Nine-segment format allows centered numeral "1". Less than 2 connections per digit. One-piece common-segment construction with no internal welds assures digit alignment and guarantees high shock/vibration resistance. Unitized packaging cuts display length by 25%. Available in 8-, 10-, 12- or 16-digit displays.

#### **32-, 18-, 16-CHARACTER SELF-SCAN™ PANEL DISPLAYS**

This family of SELF-SCAN panel displays is available in a variety of sizes and complexities for any application requiring 16 to 32 characters of alphanumeric information displayed on one line. Only power and ASCII code required for a 64-character format. Units can be supplied less the electronic board for graphic or special applications.

#### **256-, 128-, 64-CHARACTER SELF-SCAN PANEL DISPLAYS**

Alphanumeric displays equivalent to over 12,000 light-emitting diodes arranged in a matrix format. These lightweight, in-plane displays with dots on 0.040" centers are available in a variety of capacities including 256 characters (8 rows of 32 characters); 128 characters (4 rows of 32 characters); and 64 characters (2 rows of 32 characters).

For further information, write or call Burroughs Corporation,  
Electronic Components Division, Box 1226  
Plainfield, N. J. 07061 (201) 757-3400

**Burroughs** 

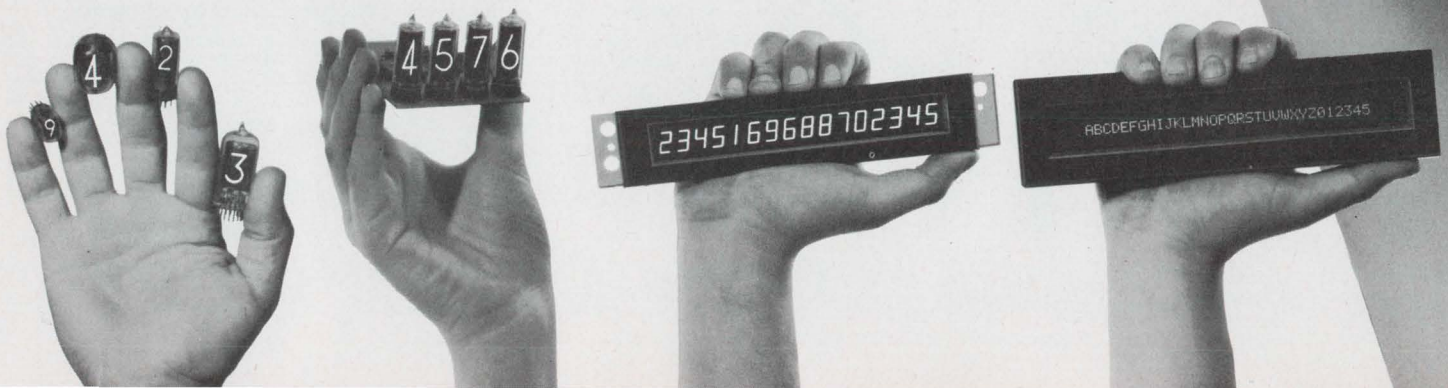



## Motorola aims to penetrate a growing CMOS market

Motorola plans to become a major competitor in complementary MOS logic (CMOS), because it believes this logic will emerge as "the dominant form within the next few years."

For a couple of years, Motorola's CMOS line at its Semiconductor Div. in Phoenix has been limited to three standard types of gates and flip-flops. But now it plans to second-source the popular functions introduced by RCA (see "With the Price Right, CMOS ICs Headed for New Applications," ED 8, April 15, 1971, p. 32) while developing Motorola's own set of proprietary functions. Eight stand-

ard products in the works range in complexity from a Quad 2 NOR gate to a fully decoded 64-bit read/write memory with 275-ns cycle time and quiescent power dissipation of less than 1  $\mu$ W. Seventeen additional circuits are scheduled for introduction before the end of the year.

Motorola predicts a world market of more than \$200-million for CMOS by 1975. Some of this growth will come at the expense of TTL logic, the company believes, and it sees as one major reason the lower cost of CMOS. Costs will go down; it says, because of the following:

- The CMOS process is inherently simpler and less critical.

- It offers greater packing density than any bipolar logic form, permitting more circuitry in a given area and reducing the cost per function.

- Power dissipation is only a small fraction of the lowest power required to drive bipolar logic. This permits larger chips—with greater packing densities—to be used without exceeding the thermal limitations of the package.

From a performance standpoint also, CMOS is viewed as competitive with TTL. "It generates very little noise, operates over a wide supply voltage range, with logic-swing amplitudes from ground to the full power-supply voltage," according to a Motorola spokesman.

The company sees a very strong penetration of the consumer market by logic circuits, primarily because of CMOS in watches, clocks and various automotive safety and control devices. It predicts that the consumer market will be the biggest user of CMOS by 1974.

Even more surprising, Motorola forecasts that the vast computer market will be the smallest customer of CMOS. The majority of the circuits, it says, will go into medium-speed, low-power buffer memories. It sees these memories displacing bipolar memories in future systems, primarily because of micropower operation.

### Europe component sales cloudy with a silver lining

PARIS—What are the prospects for European components sales this year? Largely pessimistic, but not without a touch of promise, according to a spot check by ELECTRONIC DESIGN.

A very tight active components market is reported by Dr. Gordon C. Martin, manager of electronic materials for Monsanto Europe S. A., Brussels. With European sales down abruptly some 20% in the last quarter of 1970, he expects no further decline this year, but he does not see a reviving market before 1972. The best prospects at present, Martin says, are in the industrial control sector—process control and regulation, and automation. Monsanto is pressing

### World CMOS market predicted by Motorola

	1972	1974	1975
<b>Consumer</b> (All figures represent millions of dollars)			
Watches & clocks	4.0	25.0	48.0
Automotive	0.54	9.0	19.0
Appliance controls	...	2.0	6.0
Cameras	0.4	2.1	2.9
Toys	...	0.4	1.0
<b>Computer</b>			
Memories	2.5	14.0	25.0
Peripherals	0.5	2.0	3.7
Calculators	>0.1	2.3	5.0
Terminals	>0.1	2.0	4.0
<b>Federal</b>			
Avionics	3.0	7.6	11.0
Area denial	2.8	8.6	10.0
Inertial navigation	2.0	5.6	6.9
Fuses	1.2	5.8	9.4
Special-purpose computers	1.0	3.7	6.0
Secure communications	1.0	3.7	5.0
<b>Industrial</b>			
Communications	0.68	14.0	29.0
Instrumentation	0.82	8.4	17.0
Controls	1.1	6.5	11.5
Medical electronics	0.46	2.2	4.0



construction of a new materials plant near Brussels.

On the optimistic side, Peter Schurholz, export sales manager for passive components in Siemens's Components Div., Munich, expects 12% growth this year in the European market for passive components. He singles out the telecommunications market as the most healthy. His division manufactures, among other products, pot-core coils—a form of ferrite-core inductor used widely in telecommunications equipment. Schurholz expects Siemens to supply 30% of the pot-core coils used in the world this year.

Martin and Schurholz gave their views at the annual Paris Salon des Composants Electroniques, which this year drew visitors from 57 countries.

Among the others who expressed opinions on European electronic prospects:

Dr. Johannes Berghammer, head of the Siemens IC group in Munich, reports the integrated-circuits market is one of the poorest. He lists three main problems: a general downturn in business in the U. S. and Europe; swiftly dropping prices, especially for TTL, because of world overproduction; and an increasing and aggressive presence of U. S. IC manufacturers in Europe.

Berghammer looks for an upswing in the European IC market in the second half of 1972. He and other business specialists believe the Olympic Games, to be held in Munich in 1972, will stimulate sales in the consumer sector.

## MOS/LSI digital filter kit, first on market

Telecommunications long search for a cheap, flexible, precision MOS/LSI digital filter is nearing an end (see "Digital filters with LSI promise a new world of applications," ED 2, Jan. 21, 1971).

North American Rockwell Microelectronics Co., in Anaheim, Calif., is offering a family of three building-block MOS/LSI circuits that, when used together, make very flexible digital filters.

According to Stanley A. White, member of the product development staff at NRMEC, "There is

no limitation on the complexity or type of transfer function that the filter can assume." These filters can be used in analog systems at frequencies of from dc to about 50 kHz. The speed is limited in these products because of the p-channel, enhancement mode process used in making the chips. Other faster processes, such as channel or silicon-on-sapphire, will enable future circuits to operate at higher frequencies.

Functionally, the three chips are: a serial/parallel multiplier, a shift register/adder, and an analog-to-digital/digital-to-analog converter.

## 'Electronic sight' studied to help the blind see

Will optical sensors, now attached to missile warheads to "see" targets, one day be worn by blind humans to help them see? Researchers at the Huntington Institute of Applied Medical Research, Pasadena, Calif., are conducting feasibility studies aimed at developing such a synthetic sight system.

In normal vision, electrical impulses from the retinas of the eyes are carried, via the optic nerves, to the visual centers of the brain, where they are interpreted and returned to eyes as sight. In blind people, the retinas or optic nerves don't function. The system being studied by the Huntington Institute would substitute the optical sensors of missiles for the human eye and a micro-computer for the optic nerves.

The system has three subsystems, according to the leader of the study, Dr. Robert H. Pudenz, an authority on brain implants and electro-neurological stimulation: (1) The optical sensing device, which, like glasses, would be worn by a blind person; (2) The micro-computer, implanted in the skull, to process signals from the sensor and organize them for transmission to the brain, and (3) A network of electrodes, implanted on the surface of the brain, to deliver the electrical impulses to the visual centers of the brain.

Sponsored by the National Institute of Health, the feasibility study will take another year to

verify the concept, according to Dr. Pudenz. While the electronic vision is not expected to approach anywhere near that of good eyesight, the researchers feel that it should be good enough to enable blind people to identify objects and forms.

## Civilian satellite use stressed in Europe

PARIS—Advanced navigation and TV satellites are being planned in Europe, along with European launching vehicles. Development work is being carried out under the European Space Research Organization, which includes France, Britain, Germany, Italy and other countries of Western Europe.

The navigation satellites, described here by speakers at the recent International Conference on Space and Communications, are of particular interest to the French and English because of growing air traffic over the North Atlantic and the development of the Concorde SST. The satellites will use the tone-ranging technique, with a carrier frequency of about 1.5 GHz and a ranging tone of 8 kHz.

The satellite system uses a recursive localization technique and is designed to give position fixes accurate to 0.8 nautical mile for aircraft equipped with inertial-guidance systems.

TV satellites, the subject of many papers at the conference, are now of great interest to the Europeans, particularly the French. Marcel Thué, Ingénieur General des Telecommunication with Centre National d'Etudes des Telecommunication in Paris and president of the scientific committee for the conference, points to the lack of an extensive, up-to-date ground-based network. The French are now using only a two-channel TV system, which can feasibly be upgraded to four channels.

The French believe, according to Thué, that by 1976 they can build an 800-MHz telecast satellite, with a bandwidth of about 100 MHz, that will be economically competitive with a ground-based system. A competitive 12-GHz system, with a bandwidth of 500 to 750 MHz, is envisioned by 1980.



# URGENTLY NEEDED: RELIABILITY

## Accidental Electrocutions Claim 1200 Patients a Year

**Fairchild News Service**  
At least three patients in United States hospitals are accidentally electrocuted each day.

The total number of electrocutions annually is about 1200.

According to Dr. Paul W. Wright, a surgeon at the City of Hope Hospital, Kansas, who supplied the figures, most of the patients

condition but were undergoing "routine diagnostic tests," or "routine treatment."

Dr. Wright's figure on accidental electrocutions was quoted last week at a Symposium held in London at a session of the Medical Instrument Engineers Association.

search Council, Canada, said:

"Internal electric shock is a subtle hazard that has often escaped recognition. As a result, many patients were attributed to a computer study

patients a year are electrocuted during hospital treatment in the U.S.A."

In a telephone interview last week, Dr. Wright said he received the figures from an actuary for a national United States insurance company's computer study

NEWS

## The tiny flaws in medical design can kill

Errant currents from faulty electronic equipment are reported imperiling patients in certain cases

Ronald Gechman  
West Coast Editor

aware that small electrical currents applied to the human body can be fatal

Reproduced from: *Electronic News*

Reproduced from: *Electronic Design*

# FROM SPRAGUE: RELIABLE CAPACITORS

Sprague Electric has long been aware of the crucial importance of reliability . . . particularly in medical electronics, where failure can be fatal. The capacitors shown on this page are designed for utmost reliability . . . not merely to meet existing standards, but to be as failure-free as the present state of the art will permit.

### HYREL® Capacitors



Manufactured under climate- and dust-controlled conditions in factory space used solely for high reliability production. 100% tested for optimum quality control. Exceed military and industrial standards for shock, vibration, moisture resistance, life. Reliability documented by extensive test data. Applications now include cardiac pacers and coronary care units. One 4-year user reports no failures. Available in following types:

- Type 350D HYREL® ST Solid Tantalum  
6 to 75 WVDC, .0047 to 330  $\mu$ F
- Type 351D Non-Polar HYREL® ST Solid Tantalum  
6 to 50 WVDC, .0023 to 160  $\mu$ F
- Type 309D HYREL® GT Sintered-Anode Tantalum  
6 to 150 WVDC, 1.7 to 1200  $\mu$ F
- Type 330D HYREL® GT Sintered-Anode Tantalum  
4 to 100 WVDC, 1.7 to 1200  $\mu$ F
- Type 195P HYREL® Q Subminiature Paper  
200 to 600 WVDC, .001 to 1.0  $\mu$ F
- Type 168P HYREL® PQ Subminiature Paper  
50 WVDC, .001 to 1.0  $\mu$ F

### Type 118P Subminiature DIFILM® Metallized Capacitors

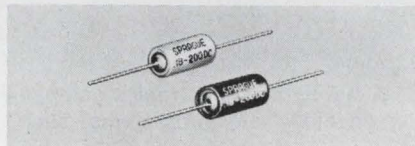

Unmatched for reliability at 125C by any other metallized paper capacitor. Higher insulation resistance than that of any other metallized paper design. Unique dielectric combines metallized paper and polyester film impregnated with special high temperature mineral wax. Hermetically sealed.

200 to 1000 WVDC, .001 to 12.0  $\mu$ F

### Heart Defibrillator Capacitors

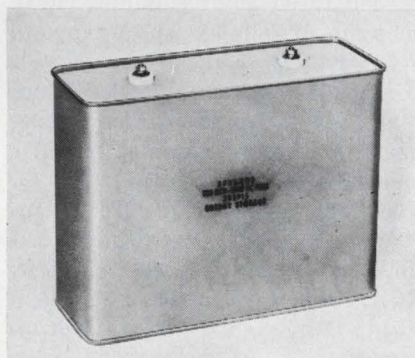

True energy-storage capacitors expressly developed for heart defibrillators. Charged in milliseconds and discharged in a fraction of a millisecond.

Three case sizes available.

Each rated 16  $\mu$ F, 7500 WVDC.

### Type 260P METFILM® 'K' Film Capacitors



Exceptional versatility and superior electrical characteristics in small physical size. Metallized polycarbonate-film dielectric provides high insulation resistance, high capacitance stability, low dielectric absorption, low dissipation factor. Hermetically sealed.

200 to 600 WVDC, .01 to 10.0  $\mu$ F

### COMPULYTIC® Aluminum Electrolytic Capacitors

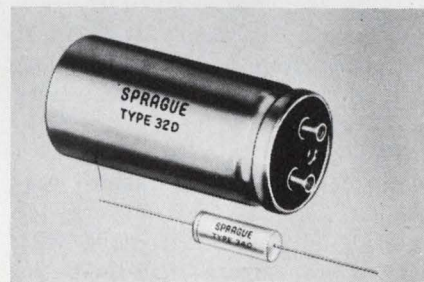

Power supply filter capacitors with low leakage currents, low ESR, long shelf life. Feature the most reliable seal yet developed for aluminum electrolytics.

Type 32D—Cylindrical with tapped terminal inserts or solder lug terminals

2.5 to 450 WVDC, 35 to 200,000  $\mu$ F

Type 34D—Tubular with axial leads

2.5 to 450 WVDC, 1 to 13,000  $\mu$ F

For technical literature on any of these capacitors, or engineering assistance without obligation, write or call Mr. John Moynihan, Sprague Electric Company, 347 Marshall Street, North Adams, Mass. 01247. Telephone (413) 664-4411

**THE BROAD-LINE PRODUCER OF ELECTRONIC PARTS**



Sprague and 'S' are registered trademarks of the Sprague Electric Co.



For years the electronics industry has looked longingly at the giant citadel of wealth that is Detroit. Just a \$1 item on every car would mean \$10-million to the electronics industry every year. A \$50 item would bring in \$500-million. But there were no invitations.

Now the drawbridge has been lowered and the portals are opening. The timing couldn't have been more opportune. Aerospace and military spending is down in the electronics industry, and consumer products are fighting an invasion from abroad.

"When automobiles become really electronic, IC and power transistor companies will have to build new facilities," says RCA's Ralph Hartz, manager of the company's Solid State Div. in Somerville, N. J. "As it is, we estimate that power transistor sales will go from 15 million in 1971 to 40 million in 1974."

Texas Instruments in Dallas sees semiconductor sales to automobile makers moving from \$70-million in 1970 to \$500-million by 1980.

Bendix is also optimistic: "Detroit is the semiconductor industry's salvation," says Jerry Rivard, director of programs for the Electronic Fuel Injection Div. in Southfield, Mich. "Where else are you going to see such high volume?"

Happily, the car makers are equally enthusiastic about the new relationship. It wasn't by accident that they dropped the drawbridge. Detroit needs help, and electronics is the solution.

The Government has slapped a number of stiff performance regulations on the car makers for safety and pollution control, with threats to impose more. At the same time, the customer has succumbed to the Ralph Nader influence—a malfunctioning product is the manufacturer's fault, especially if an accident is involved. On top of all this, the customer wants more performance in his car, even in a cheap one. He also wants reliability; repairs are expensive and a nuisance. One repair too many causes a customer to shop for a different make the following year,

**John F. Mason**  
News Editor

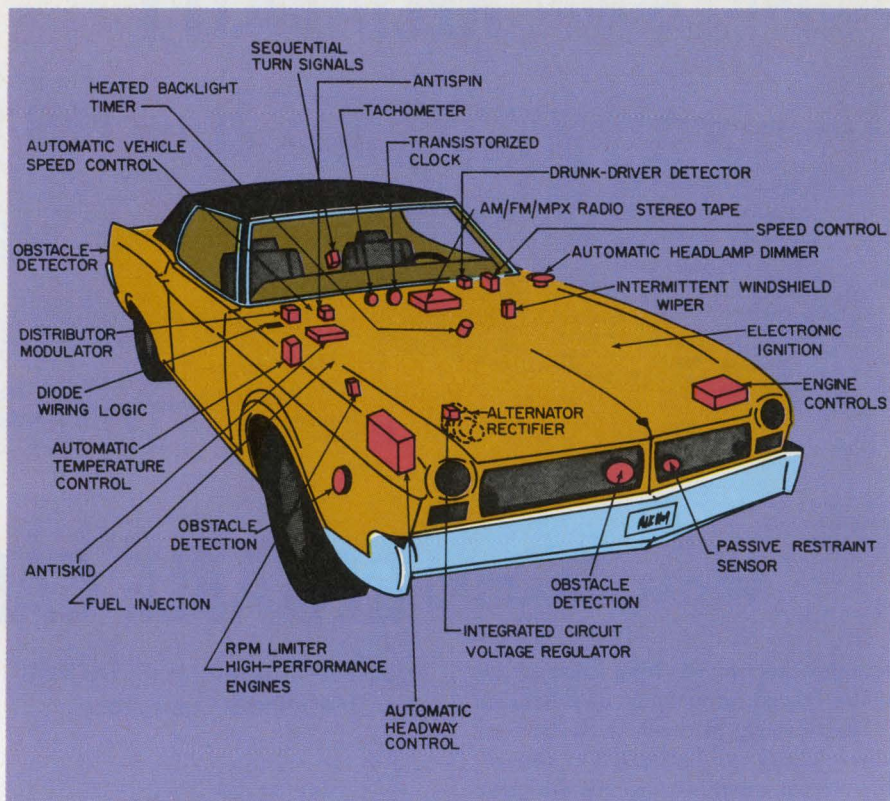

1. A number of electronics companies, along with the car makers, are working on electronic subsystems, such as these, for automobiles.

## The electronic car gets

and Detroit knows it.

Fortuitously, almost like the ending of a B movie, the electronics needed to do all this is now cheap enough—or almost cheap enough—to save the day.

Already a number of electronics companies are supplying components and are designing modules and subsystems for cars (Fig. 1). The companies include Texas Instruments, Fairchild Semiconductor, Motorola, General Electric, RCA, Delco Electronics, Philco-Ford, Bendix, and Essex International.

Speaking for General Motors, Trevor O. Jones, director of the company's Electronics Control Systems Group in Detroit, says: "The drop in prices for ICs, MSIs, LSIs and MOSs has been so drastic that the automobile industry can—or must—look toward electronics for building subsystems and controlling them with a central logic system of some kind."

RCA's Hartz agrees. "The time

is ripe for electronics to go into cars. The cost of ICs is down. Power transistors, now packaged in plastic, cost 30¢ to 40¢—half what they did. And the two industries have evolved so that they're really ready to work together."

### The most likely to succeed

Manufacturers of semiconductors and transducers are the naturals for moving into the automotive industry, Jones says. There's a crying need for good, low-cost transducers: for pressure, temperature, hydraulic and fuel injection measurements, to name a few. Most of the transducers available now, Jones says, are analog, and since we use a digital language, an analog-to-digital converter is required. "We'd like to skip this step with some digital transducers."

Most of the semiconductor manufacturers already in the car business plan to play it cool, concentrating on producing semiconduc-



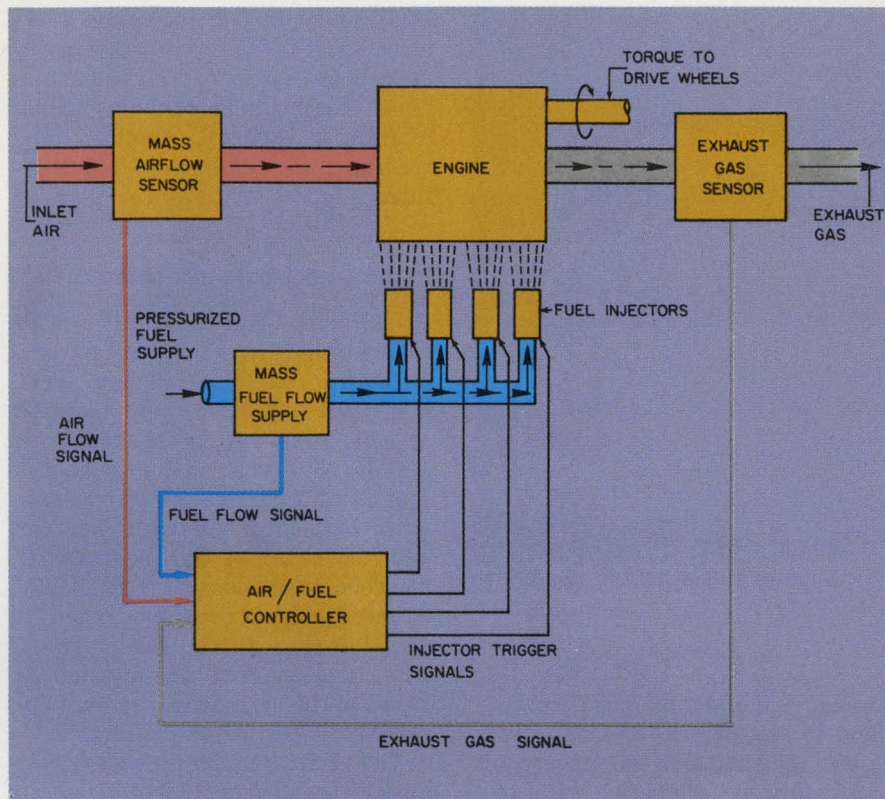

2. Ford plans to reduce exhaust gas with a mass-flow electronic fuel system that controls the fuel-to-air ratio going into the engine.

## a green light in Detroit

tors as cheap and as reliable as possible, while learning as much as they can about cars. They will work gradually toward building and selling complete modules, and even complete subsystems. These include antiskid and antispin controls (Fig. 4.), radar detectors, electronic systems for fuel injection (Fig. 5.), fuel metering, ignition and voltage regulators. They will also design variable windshield wipers, sequential flashers, automatic headlight dimmers, and of course, entertainment products.

Most of these companies will sell to the electronics subsidiaries of the car makers: Ford's Philco-Ford in Lansdale, Pa.; General Motors' AC Electronics in Milwaukee and Delco Electronics in Kokomo, Ind.; and Chrysler's group in Huntsville, Ala.

They will also sell to Bendix in Detroit, one of the few electronics companies designing electronic subsystems for engines that is not owned by a car maker.

The first thing to learn about this market, says RCA's Hartz, is "what a wild place an automobile engine is for electronic components." Temperature extremes are greater than those specified by the military. Components must be built to withstand ambient temperatures in the engine of from  $-40^{\circ}\text{C}$  to  $+120^{\circ}\text{C}$ . The junction temperature of a device might reach  $150^{\circ}\text{C}$ , with worst-case conditions pushing it to  $200^{\circ}$ . Components must also contend with vibration, shock, dust, sand, salt and humidity.

### Controlling the engine

Detroit's toughest hurdle is to comply with the Government's regulation on cleaning up pollutants in the exhaust by 1975. The ultimate goal, toward which all car makers are working, is a computerized adaptive control system for the entire engine—one that senses, identifies and eliminates excessive

effluents in the exhaust by changing the inputs. The Ford Motor Co. has done this on an experimental basis, in what it describes as a "very simple minded system using an air valve with laboratory sensors." The equipment needed fills a cubic yard.

"We were able to vary the air-fuel ratio [Fig. 2] and to control the carbon monoxide coming out of the exhaust," says William L. Ronci, manager of the Ford Controls Research Dept. "Whether Detroit can do this for 10 million cars a year, however, I don't know."

Adaptive engine control involves the ignition; fuel injections; exhaust gas (Fig. 3), recirculation of exhaust; control of the exhaust gas, to protect some of the catalytic beds of chemicals that are installed in the muffler to absorb the gases; sensors; actuators and reliable switches in between. While this is being developed, individual parts will be built and incorporated piecemeal.

One of the biggest problems is finding the right sensors that are rugged enough and cheap. Perhaps, Ronci says, a semiconductor sensitive to each pollutant could be used. It might measure the pollutant or simply any change in the amount of the pollutant.

Ford does not foresee an adaptive system that would continually readjust the inputs in the engine based on the output. There are too many starts and stops, accelerations and decelerations. The system would make adjustments periodically. The point is to keep the pollutants within legal limits as the engine deteriorates during its first 50,000 miles of operation. The Government's clean-air regulation calls for curbs on pollution during the first 50,000 miles.

The key to controlling the three constituents in exhaust gas—carbon monoxide, nitric oxide and unburned hydrocarbons—is to control with extreme accuracy the ratio of air to fuel fed into the engine, says Ford's assistant chief research engineer, Harold Johnson. This calls for more accurate means of measuring airflow and metering the fuel coming into the engine and distributed to the cylinders.

"We might get this accuracy by mechanical means," Ronci says,



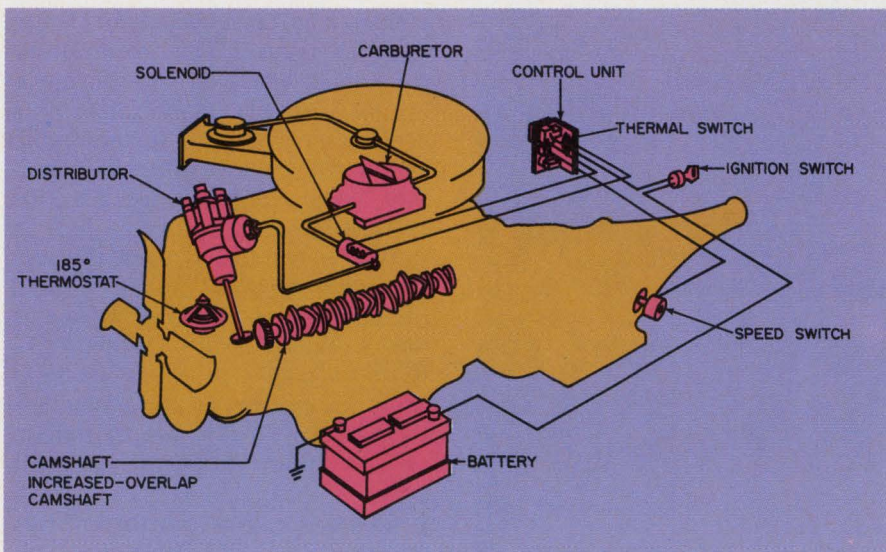

3. A nitric oxide control system is already in Chrysler's cars sold in California and is available for models sold elsewhere.

"but we think it will have to be with electronics—electronic sensors and logic."

Ford is looking at several techniques for making accurate measurements. A hot-wire anemometer is one way to measure airflow, but it is too expensive. "Maybe it's because they're built in lots of ten instead of in millions," Ronci says.

Another technique for measuring fuel or airflow is an analog equivalent of a Wheatstone bridge. The four elements of the bridge, rather than being resistors or electrical components, are matched orifices. The flow to be measured is directed across one junction of the bridge, and the corresponding pressure drop is measured at the other. The drop then is a linear function of the mass flow. This works in the laboratory. "The issue now," Ronci says, "is to make it work in mass-produced cars."

Bendix is working on a computerized engine control system that includes an electronic fuel injection system that sends exhaust gas back to the engine for recycling in precisely the correct amount. It also includes an electronic ignition system.

Whereas the conventional mechanical spark advance does not control the amplitude nor the duration of the spark, the electronic system does. This is important for reducing pollutants and for prolonging the engine's life.

Bendix says the system can successfully sense exactly what the

engine is doing and make corrections to the prime functions, such as the ignition and the amount of fuel going in compared with the amount of air. This, the company says, will keep the car within the Government's 50,000-mile requirement without necessitating an adjustment every six months.

The catalytic reactors built into an engine's exhaust to reduce pollution must also be controlled, Bendix has found. Temperature control is important to prevent overheating and destroying the reactors. To do this, temperature sensors have been installed that send signals back to the computer, which in turn changes the engine's operating conditions—such as its fuel-air mixture and fuel-injection rate.

A new system for reducing nitrous oxides went into all of Chrysler's cars sold in California this year and in some cars elsewhere, notes Earl Meyer, assistant chief engineer of Chrysler's Engine Electrical Group. Control of the pollutant is achieved by lowering peak burning temperatures during combustion. This is done by a combination of factors involving valve timing, retarding of the spark advance at low vehicle speeds and the use of lower temperature thermostats.

The use of a modified camshaft causes an increase in valve overlap, which means that both the intake and exhaust valves are open longer at the same time. During

this interval, the incoming fuel-air charge to be burned is diluted by exhaust gases being discharged from the cylinder. This slight dilution is very important in controlling peak combustion temperatures.

### Radar and lasers considered

If radars can be built cheap enough, there are innumerable applications for them on cars. Bendix has developed an adaptive speed-control system that uses a c-w doppler radar and a computer that displays range and range rate (rate of change) between one car and the car directly in front. If attached to the car controls, it will automatically slow a car when it gets too close to the car in front. And if a marked deceleration is noted in the car ahead, it would apply the brakes in the trailing car.

The first Bendix doppler radar model operated at 16,642 MHz. To reduce the size of the transmitting antenna from a foot to a half foot, Bendix is building a new version to operate at 36,647 MHz. It, too, will be c-w doppler, with a narrow beam—about 4 degrees, which is lane width at a distance of 200 to 250 feet.

Cheap radars might be used in the rear of the car to give the driver information in a car's blind spots. This could be helpful on a highway when a driver wanted to change lanes and couldn't see a car gaining on him in the next lane. The display could consist of a buzzer or a light. Not only would a visual display be too expensive, it would not even be desirable. If the driver got too involved with what was happening behind him, he would neglect what was happening ahead.

A radar could also be helpful to warn of obstacles when the car was backing up in a driveway. A wide beam would be used here—perhaps 180 degrees. In tests, Bendix has detected a one-pound coffee can at 15 feet.

Radars also make good speedometers, Bendix says, and are being considered for an antiskid braking system to give data on the actual speed over the ground when the car's wheels are locked and no speed is being registered on the speedometer.



General Motors has looked at small radars and lasers for obstacle detection and for crash detection. Radar has an edge over lasers, says Jones, the company's electronics control chief, because the laser gives no indication of an object's third dimension. A piece of newspaper dropped from a truck will reflect a laser beam as if it were a dangerous, solid object. The radar would tend to ignore it.

One problem with any sensor on a car, Jones concedes, is keeping it clean. Mud and dirt will put a laser or a radar out of commission.

### Getting rid of the tangle

All the car makers are working on ways to reduce the amount of wire that goes into a car—approximately 1300 feet—or, measured by harnesses, about 250. "You can imagine trying to find the right harness when something goes wrong," says Chrysler's Meyer.

Probably the most ambitious plan is one by Essex International, Inc., in Detroit that would boil the whole thing down to two wires: one for power and one for signals. Capable of controlling every automotive function in a car, the Essex system consists of electro-fluidic controls, incorporating a central computer, with a single energy distribution and control harness that is routed throughout the vehicle. The central logic unit sends and receives coded information to and from actuators and sensors. The single harness carries electronic signal information and electric and pneumatic power to all automotive subsystems.

Integrated-circuit receiving elements are placed at control points throughout the car. When the correct code is received by a receiving element, the primary device associated with the receiver is actuated. Each receiver contains an IC, along with a power transistor or a fluidic IC, or both. The IC provides a control signal that turns on the electrical or pneumatic power.

The central logic is used by every function on the car, from antiskid control to lamp outage detection in the lighting system.

Essex is testing its third generation "total vehicle electronic system." According to Robert E. Valk, vice president of Essex's Wire As-

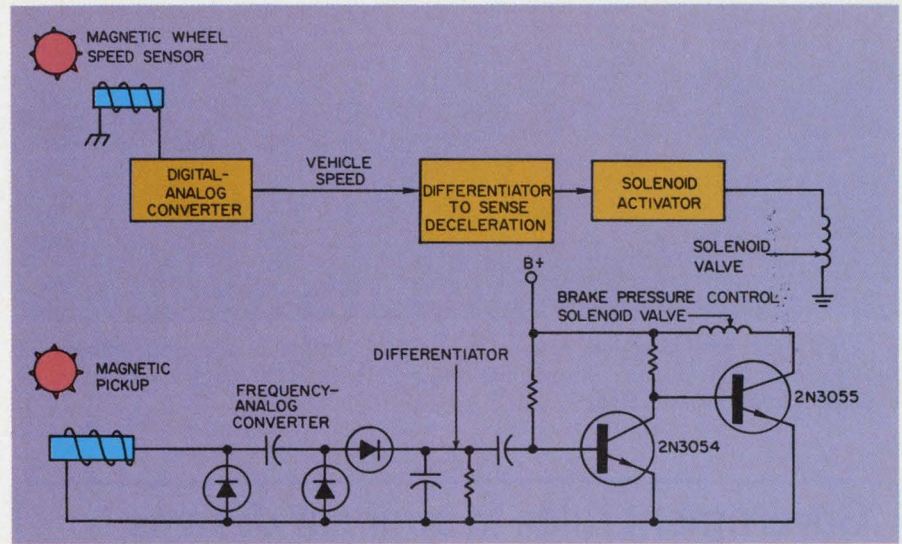

4. RCA's antiskid braking system senses wheel deceleration and activates a solenoid valve to reduce the hydraulic brake pressure to a safe value.

sembly Div. in Detroit, "We don't believe we're going to sell a total vehicle electronic system and never have. But we know we have to develop the whole system so we can develop the components of the system which we might sell. And, as time evolves, it will end up a total system."

The new system uses a single computer to direct all the operations in a car. Valk predicts, however, that when a total system is finally built into a production-line car, it will probably use a number of computers, gradually evolving to a single computer.

Ford's Ronci says his group has looked at the two-wire scheme for 10 years, "but we always fall out of bed on cost, unless we are talking about a special system where we have special problems."

Ford says a total system, such as the one that Essex is developing, is still too expensive because of the cost of power transistors. "If we could get them for about 10¢ each, we might consider it," Ronci says. "Wire is cheap and so are relays."

Chrysler's Meyer says his company's Huntsville group is working on a wire system similar to the one Essex is developing, but "ours is more practical and cheaper."

Bendix has had a team studying multiplexing schemes for six months, with the conclusion that the cost justification can not be made at this time. Maybe 10 or 15 years from now, the company says,

but not now. Wire is too cheap.

On-off operations are easy, say Ralph Rothfusz and Robert Henrich on Bendix's team. But you run into problems when you start getting into sensing and control functions and sampling rate problems.

The next step for Bendix, Rothfusz says, is to take some of the systems already built and to try to integrate them. "We have antiskid and electronic fuel injection," he notes. "There are some inputs common to both. The greatest potential for Bendix now is to integrate them."

### Detroit is the systems boss

The market is there and it's big, but will everyone find instant happiness in Detroit? Electronics companies will find that close liaison with the customer is a must when designing auto equipment—much closer liaison than they may have been used to heretofore. Many electronics companies, for example, are accustomed to working with the Pentagon and NASA in a systems engineering capacity. If they design systems for cars, they may find they're doing it on their own, with no buyers in sight.

General Motors, Ford and Chrysler, all plan to design their own systems. Electronics companies are welcome—even urged—to do parallel systems work but only to make sure that the portion of the system they hope to sell will fit in.

In defense of this approach, Valk



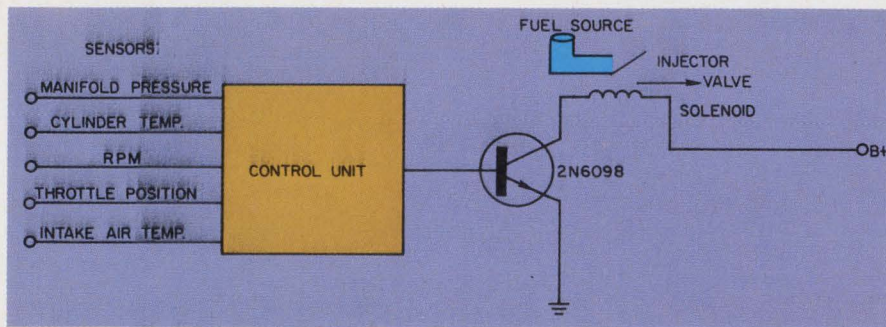

5. **Electronic fuel injection**, designed by RCA, offers a metered amount of fuel to meet the engine's immediate requirements. The metering is done by a solenoid-controlled valve.

## Government rules to alter car designs

To save lives and reduce pollution, the Federal Government and some states have hit the automobile industry with a number of regulations, some easy and some tough:

- 1973 cars must have front bumpers that can withstand a crash at 5 mph.

- 1974 models must contain a passive restraint system—a sensor that automatically foresees an accident and actuates some kind of safety measure that will protect front-seat occupants as the car rams into a brick wall at 30 mph. All 1975 models must protect all occupants of the car in any kind of wreck—head-on, from the rear, turning over, etc. Some prob-

lems: What kind of sensor? How to make it fail-safe and fool-proof? What kind of cushion? An airbag? Padded interiors?

- 1974 models in California and 1975 models in the rest of the United States must reduce by 90% the emission of carbon monoxide, hydrocarbon and nitric oxide. "To comply with this," a spokesman says, "would make air coming out of a car cleaner than when it went in."

Several more regulations are pending, including these:

- A drunken-driver test device that would have to be passed successfully before the ignition could be turned on.

- Antiskid control.
- A top speed limiter.

of Essex International, a supplier to the automobile industry for 41 years, says:

"It's difficult to design a product and take it to the car maker and sell it. The product needs integration, much testing and a knowledge of the environment. We build a system parallel to one a car maker is building. They may decide theirs is better, but they'll let us bid on producing it. Chances are that they'll settle on a hybrid."

There's no question among the car makers that this is the way to go. "The electronics industry should be glad we're here to do the systems work," General Motors' Jones says. "And the sooner we do it, the sooner electronics companies can begin supplying us with what we need."

Ford's Ronci agrees: "Only Detroit can do the systems design

work on something as complicated as an engine control or emission control system. No one else has the expertise in internal combustion engines that we do. Engine control is liable to be the biggest electronics application on an automobile that Detroit has ever seen."

Chrysler does most of its own systems work, but less than General Motors or Ford. Its Huntsville, Ala., group, which used to build subsystems for missiles, will build Chrysler's electronic ignition system.

As for innovations from outside, General Motors' Jones says: "We are always happy to talk with anyone who brings us an idea. If we like it, we may buy it. We might put it on a few cars and see how it goes. The next year we might put it on the whole line."

Jones sees two or three unsolicited visitors a week from the electronics industry. He recently bought an image intensifier developed for the military that he is considering for use in a rear-vision system, now that the maker has promised a staggering reduction in cost.

Ford has bought a number of subsystems, including an antiskid system. Kelsey-Hayes designed and built it, with Texas Instruments supplying the printed-circuit boards.

Detroit's main reservation about doing business with the electronics industry is that it doesn't know automobiles. One electronics company says that breaking through this "Detroit syndrome" is not easy. "It's taken us about three years to get them to open up," a spokesman for the company says. "Lately, however, the products we've been taking them seem to suit them better."

Another supplier points out another Detroit characteristic: "The car makers are a hyper-security group—worse than the Pentagon." Essex's Valk, however, says that strict integrity and time will overcome this.

GM's Jones cites several adjustments that are necessary if electronics companies want to make it big in Detroit. "If we put a radar on every car and want to buy them outside," he says, "what electronics company is geared, or can gear up, to produce five million of them a year?"

Electronics companies have no experience in producing anything in such quantity, Jones says. If the car makers decide to go with light emitting diodes for displays, can the industry grow that much gallium arsenide every year? And can they learn how to price large-quantity, low-cost items?

"We're concerned whether something costs 8 cents or 9 cents," Jones says. "Aerospace companies talk in thousands of dollars. They don't even bother with the last three digits."

As for the ex-aerospace engineers themselves, however, who are now designing for automobiles, both General Motors and Chrysler say they are doing extremely well. "I'd be happy to hear from more of them," Jones says. ■





**It's new. Our Molex 1820 Switch. You can use one, or a gang of them, for an infinite variety of applications. Its lighted push button can be wired to light independently of the switch. And there are colors galore. But what's really nice is price. About seventy cents in quantity.**

**It's a good example of the Molex creative approach to design problems. And the ability to design reliability and ease of assembly into a product without letting costs run wild due to over-engineering.**

**The 1820 is really one you have to see to believe.**

**And we would like to show it to you. For a free sample of our new switch, write or phone (312) 969-4550.**

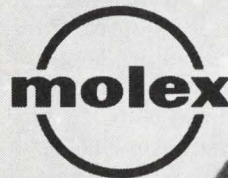



# Low-cost NASA camera system shoots unattended under water

Investigation of a pollution problem—the eutrophication, or overabundant growth of algae, that robs Lake Erie of oxygen—has led to development of a low-cost, camera and flashgun system that takes pictures unattended under water. In operation 83 feet below the surface, it has taken one picture an hour for more than 10 days.

Developed by NASA for the U. S. Environmental Protection Agency's Water Quality Office in Cleveland, the system uses common, low-cost components. The timing mechanism that operates the camera shutter and flashgun, for example, comes from a 1.5-V, battery-powered wall clock. Engineers at NASA's Lewis Research Center in Cleveland estimate that the entire system costs about \$500, compared with approximately \$2500 for commercially available systems.

Clever circuit design by Russell J. Jirberg, research engineer at the Lewis center, eliminates the need for an expensive waterproof cable and connectors between the

watertight housings of the camera and flashgun. Instead, bare brass terminals, exposed to the water, are used on both the camera and flash units, and the units themselves are encased in clear, acrylic plastic and unpressurized. The terminals are connected with ordinary two-conductor cord.

The system was designed for a joint study of Lake Erie by the U. S. Water Quality Office and the Canadian Center for Inland Waters. A total of over 400 color photographs of the bottom were taken last year.

The camera, according to Jirberg, is a 35-mm Nikon-F, with an integral motorized shutter release and film advance. With a maximum load of 33 feet of film, it can take 250 pictures.

The flashgun unit is a modified Braun Lite 515.

The timing system for taking one picture an hour, as described by Jirberg to the 14th Conference on Great Lakes Research at the University of Toronto last month, is controlled by the battery-power-

ed clock mechanism. This method was chosen because it is reliable, has sufficient timing accuracy and low power consumption. One D cell powers the mechanism for over a year.

A cam, fastened to the minute-hand shaft of the clock mechanism, actuates a microswitch at one-hour intervals. At this time the SCR conducts, discharging the 3000- $\mu$ F capacitor and energizing the relay coil momentarily.

This action briefly reverses the voltage that is applied to the control leads of the camera's motor-drive system, initiating the camera sequence.

Between exposures the 3000- $\mu$ F capacitor is recharged rapidly, thereby conserving battery energy.

Because the camera and flashgun units are connected under water by divers, an added input circuit—a rectifier bridge—was added between the flash unit input terminals and the SCR. With this circuit, it makes no difference which wire the diver connects to which input terminal. ■■

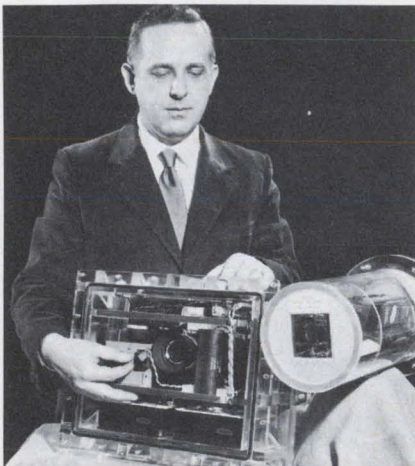

Underwater camera system developed by NASA. Russell J. Jirberg adjusts the timing mechanism that he designed for the system.

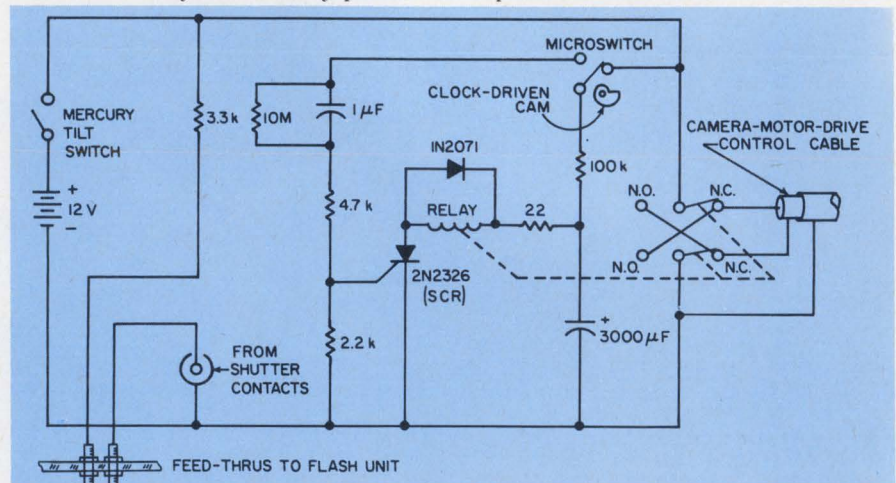

Control circuit of the NASA camera uses a battery-operated clock mechanism to drive a timing cam. The single-lobe cam takes pictures at one-hour intervals, but a multi-lobe cam could be installed to reduce the intervals to minutes. The output of the control circuit is fed to the flash unit.



# C-LINE PLASTIC SCRs



## A simple case of putting 12 years of thyristor know-how in a simple case.

### It's Elementary.

We offer plastic SCRs at competitive prices for those who don't require the optimum environmental protection of our hermetically sealed metal packages. In either case, there's the same Unitrode high quality inside. The kind you expect from a company that makes thyristors a major part of its effort . . . not just a sideline. Our expanding line of SCRs offers a wide range of choices for easy interchangeability in literally hundreds of applications, including lamp and relay driving, or as sensors in pulse generators, tuning circuits, motor controls and process controllers. We can build an even more convincing case for these IP100-IP104 series industrial SCRs when you request complete specs, pricing and samples. For fast action, call Sales Engineering collect at (617) 926-0404. Unitrode Corporation, 580 Pleasant St., Watertown, Mass. 02172

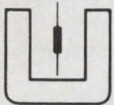

**UNITRODE** quality takes the worry out of paying less.

Unitrode Corporation, Inquiry Processing Dept. 5B,  
37 Newbury St., Boston, Mass. 02116

Please send me two free samples of IP100 Series plastic SCRs in  
 30V,  60V,  100V,  150V,  200V models.

NAME \_\_\_\_\_ TITLE \_\_\_\_\_

COMPANY \_\_\_\_\_

ADDRESS \_\_\_\_\_

CITY \_\_\_\_\_ STATE \_\_\_\_\_ ZIP \_\_\_\_\_



# Linear motor for mass transport improved by pulsed-dc technique

With auto pollution and mass transportation at crisis stages in many sections of the country, engineers are investigating a variety of highly reliable electrical propulsion systems that could carry passengers on or above a guideway. Linear-synchronous and linear-induction motors are leading contenders for the new propulsion systems (see "Designing Tomorrow's 8:05 Express," ED 1, Jan. 7, 1971, p. 71). But these motors have limitations.

The Aerospace Corp. in El Segundo, Calif., is studying a unique alternative that overcomes the major problems: a digitally synchronized dc linear motor. Control functions are under the command of a large central computer and several small, special-purpose computers.

According to Harry Bernstein, group director of transportation systems at Aerospace, "Passenger comfort, instead of traction requirements, operation of the ve-

hicles at close headways and the minimization of pollution led us to consider linear electric motors to fit the drive requirements of the system."

The linear motor limitations that had to be overcome were these:

Linear-synchronous motors work off ac with fixed magnets in the guideway. The pole spacing and the frequency of the ac determine the speed of the vehicle. To vary the speed, the frequency must be varied. But the frequency-conversion equipment is very expensive for a system with many cars.

Linear-induction motors have problems with maintaining a constant gap between the stator and the rotor. They also have fairly low efficiencies and could have braking problems.

The digitally synchronized linear motor developed by Aerospace runs off pulsed dc. The guideway is lined with a series of alternating-polarity permanent magnets. On each vehicle is a 42-inch set of eight coils that can be individually activated. The coils are activated in sets of four, with each set consist-

ing of alternate windings. Current is passed through each winding in the polarity that will import forward or reverse thrust to the vehicle. Current is only passed through a winding when that winding is directly across from a magnet. The current pulsing is synchronized by the use of a device, such as a Hall generator, at the leading edge of the first coil. The device senses the presence of a magnetic field and therefore notes the position of the magnets on the guideway.

The velocity of the vehicle is proportional to the frequency of the pulsed dc. Thrust is varied by changing the average magnitude of the current. Therefore, acceleration or deceleration is accomplished by the use of both pulse-rate and pulse-width adjustment. Pulse-width adjustment is a convenient way to change the average value of the current.

Commands to the motor are given by special-purpose computers that control traffic at intersections on the system. Each of these computers must note open slots in the flow of traffic and adjust the speed of merging vehicles so that they will flow into the open slots without interfering with one another.

Whether a vehicle goes straight or turns at an intersection is determined by the local computer on instructions from a large, central computer. If the central computer fails, the system can still operate safely but merely cannot get updated routing information.

The Aerospace system envisions satisfying these requirements: Each vehicle must maintain a constant speed and constant position, and it must be capable of operating at headways of as little as five feet at 60 mph. ■■

**David Kaye**  
West Coast Editor

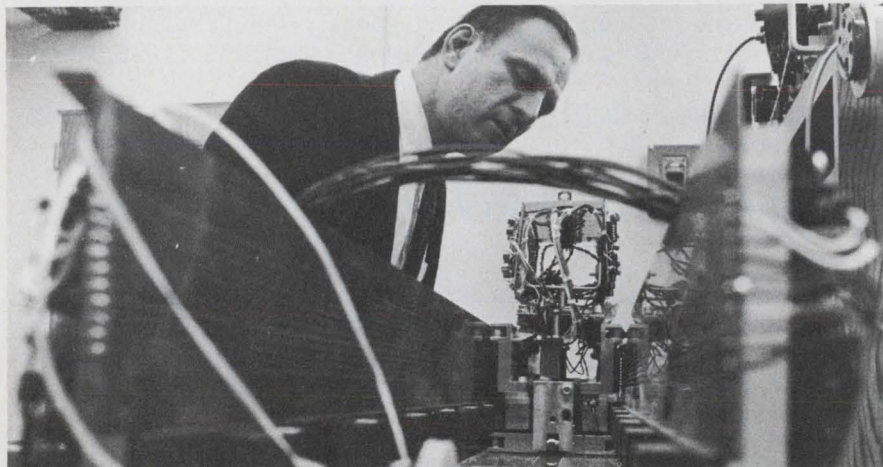

A model of the digitally synchronized dc linear motor, built at one-sixth scale, is demonstrated by Robert A. Mack, manager of the control and guidance laboratory at Aerospace Corp.



# Five watt power in a cermet pot!



Allen-Bradley Type CJ. That's right, 5 watts at 70°C. Now you can have the stepless control of cermet without sacrificing power-handling capability. Replace wirewounds with performance that's hard to match. Low noise. No inductance. Smooth mechanical operation.

Operating temperature range -65°C to +150°C. Rotational life 50,000 cycles with less than 10% resistance change. Resistances from 100 ohms to 5 megs. Single, dual or triple section units with plain or locking bushings. Dust-tight and "splash-proof." Large variety of shaft

and bushing options available. Allen-Bradley CJ. Available through your A-B electronics distributor, or write today for further information to Allen-Bradley, Electronics Division, Milwaukee, Wisconsin 53204. Export: Bloomfield, N. J. 07003. In Canada: Galt, Ontario.

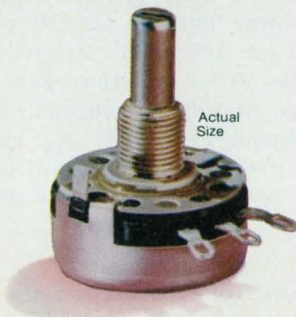

NEW DIMENSION ELECTRONICS  
**ALLEN-BRADLEY**





# NEW MICRO-MINIATURE CERAMIC TRIMMER CAPACITOR



now  
available for  
45¢ in quantities  
of 1,000



We are pleased to introduce the 9300 series. You will find the unit is truly micro-miniature (.315 high with a .276 diameter and .200 pin spacing). Its rotary assembly is designed with special ceramic materials which provide longer life and complete environmental stability. Capacitance values are available up to 70 pf. For immediate delivery, please phone (201) 334-2676.

#### STOCK MODELS

MODEL	CAPACITY RANGE pF	TEMP. COEF. / °C	MIN. Q @ ±10MHz
9312	2.8 — 10	—350 PPM/°C	300
9313	3.2 — 18	—550 PPM/°C	300

MANUFACTURING CORPORATION

400 ROCKAWAY VALLEY ROAD  
BOONTON, NEW JERSEY 07005

ELECTRONIC ACCURACY THROUGH  
MECHANICAL PRECISION

# technology abroad

A digital data transmission system for use on existing telephone systems has been developed by Philips Research Laboratories of Eindhoven, the Netherlands. The company claims virtually distortion-free performance at 48, 72 or 96 kbits/s. Philips reports success in minimizing the number of electronic circuits at both the transmitting and receiving ends of the system. The problem of maintaining a required pilot signal of 84 kHz, within the 60-to-180-kHz frequency band, was overcome by a new modulation/demodulation system. This system isolates the transmitted data signals from both the outside edges of the available frequency band and the pilot frequency. A multi-level converter was designed to increase the bit rate 96,000 bps. At present in Europe, telephonic computer channels are restricted to the 4-kHz bandwidth. However, a tentative international agreement will make the 60-to-180-kHz region available.

The fastest MOS memory available of the read-write random access type is being claimed by Britain's Mullard. It has a typical maximum access time of 250 ns with a total cycle time of less than 750 ns. A single silicon chip contains 16 four-bit words and an address decoder. Buffers on each unit of the bit-storage register isolate them from the bit line while they are being read. Reading is done by sensing the output current of the buffer stage.

A new magnetic resistor device—a unit built into a magnetic circuit measuring 4 x 4 x 4 mm—has been announced by Siemens of Germany. The device has a 0.7% temperature coefficient and is used in contactless switches, displacement pickups and pressure elements.

Precise and fast laser-beam deflection systems are the key to large laser optical memories and

large-screen displays. In Europe, Philips has already demonstrated one such display, and now Thomson CSF has demonstrated two distinct deflection systems. In one, Thomson passes the laser beam through a series of light polarizing cells. In its present form this system is capable of deflecting the beam to one of 64 positions and of scanning at 200 kHz. The company is now planning a 1024 x 1024 array cycled at 50 kHz. It has also developed an acousto-optic laser deflection technique. This can produce points of 250 x 120 positions, re-cycled 25 times a second.

A liquid-crystal numeric display is being readied for production in early 1972 by Thomson CSF of France. The 10 individual digits of the display will be of the seven-segment type, with figures 10 mm high. It will be available in four, six, and eight-digit combinations. Prices for the display units will be in the region of 200 to 300 francs (\$36 to \$54) each in small quantities.

Techniques for manufacturing green light-emitting gallium phosphide alphanumeric arrays are also being refined at Ferranti's Withenshaw laboratory in England. At present most displays are constructed by diffusing junctions into a slice of GaAsP, causing them to emit in the red. But Ferranti has developed a liquid-phase epitaxial process for producing green-emitting GaAs chips. This basically involves dunking the crystal in the liquid dopant.

A large and extremely low-powered random-access memory is currently being developed at Ferranti's Withenshaw laboratory. The 512-bit unit will be fabricated with a collector-diffused isolation technique. This memory reduces the power per bit to 250 pW, a factor of 200 to 1. Access time will be 50 ns and the cycle time 100 ns. Standby power will be in the region of 5 μW. An experimental chip has been built, and work is under way on a 512-bit RAM.



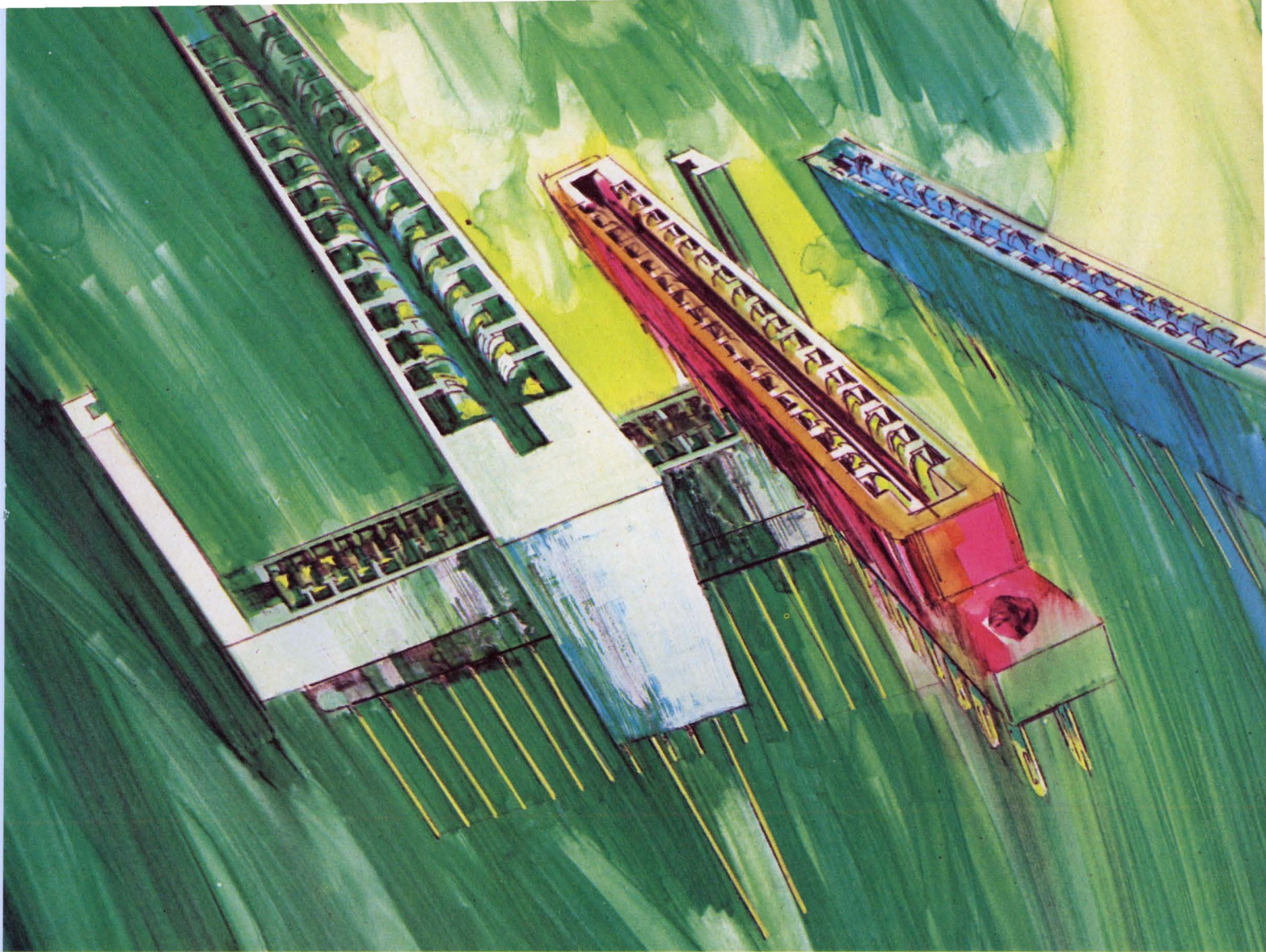

## NEW CINCH .100" CENTER PC LINE... THE CONNECTORS WITH SOMETHING EXTRA

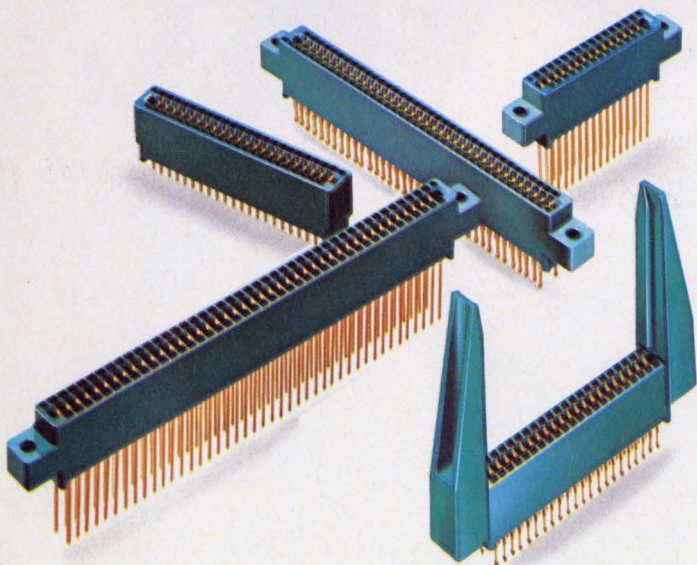

**EXTRA**—Selectively plated contacts with 30 microinches (or more on special order) gold on contact areas, with 10 microinches gold in non-contacting areas, means extra economy with no change in performance.

**EXTRA**—Cantilevered, bifurcated contact construction means uniform contact pressure, minimum insertion force and maximum withdrawal force for extra dependability.

**EXTRA**—Wire wrap, dip solder or solder tab terminals, 16 sizes from 10 to 50 double readout contact positions and detachable card guides for extra versatility.

**EXTRA**—Off-the-shelf delivery from Cinch distributors on five popular sizes (15, 22, 36, 40 and 43 position) in all three terminal types with or without card guides for extra convenience.

For information contact your Cinch Sales Office or Cinch Industrial Distributor, or write Cinch Manufacturing Company, a division of TRW Inc., 1501 Morse Avenue, Elk Grove Village, Illinois 60007; telephone (312) 439-8800.

C -7130





**Reliability is a spring, a wheel  
and two thingamajigs.**

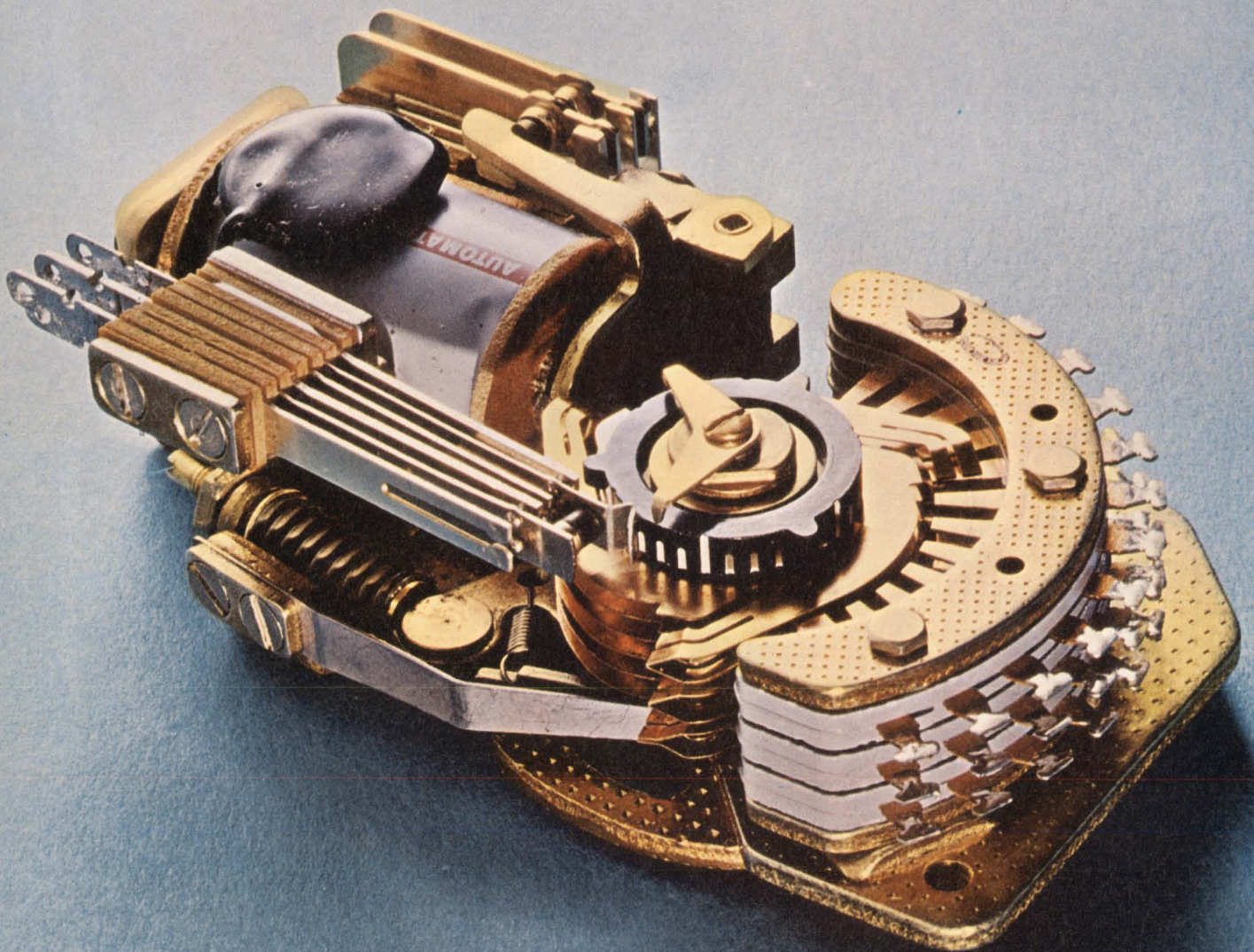





Every AE Type 44 stepping switch comes with them.

### One-spring power.

The drive spring is a coil. What it does is store up power. When it comes time to switch, the spring lets loose and moves the wiper assembly forward. Each time using precisely the same pressure.

Notice our spring is tapered at one end. It's designed to perfectly match the power input. That's why you always get the best possible transfer of energy.

At one end of the drive spring is an adjusting screw. We turn it a little this way or a little that way and the tension is always perfect.

Try that with a flat spring.

### We re-invented the wheel.

The ratchet wheel is a little different. The way it's made, for one thing. First, we blank it. Next, shave it. And finally, case-harden it. Then it's super strong.

Notice the big, square teeth that always provide a sure bite.

### A thingamajig with teeth.

That thingamajig next to the wheel is the armature assembly. When the teeth on the end of it mesh with the teeth on the ratchet wheel, they stop the wiper assembly and position it precisely on the contact bank. Smooth as silk, every time. No jarring, no jamming, no banging.

No adjustments, either. As the teeth wear, they just drop further into the wheel. So nothing ever gets out of whack.

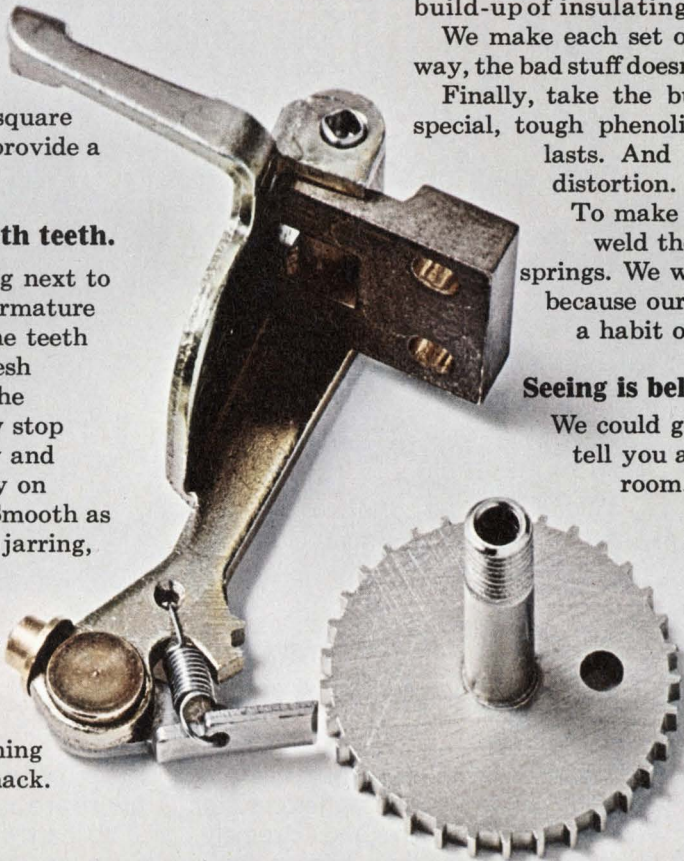

### A pawl that floats.

On the end of the armature is the pawl. We made it "free floating" to eliminate the jamming and binding that go with the old style pawl stop block. And while we were at it, we stopped pawl breakage and put an end to double-stepping or overthrow.

Don't bother looking for this special set-up anywhere else. It's patented.

### The other thingamajig.

It's called a contact spring. We've got some strong feelings as to what makes a contact spring strong.

In the first place, we believe there's strength in numbers. So we put two sets of contacts on each spring. This means you get a completed circuit every time. Without fail.

But some of the credit for this has to go to our solving the most common cause of contact failure—the build-up of insulating films on the contact points.

We make each set of points self-cleaning. That way, the bad stuff doesn't have a chance to build up.

Finally, take the buffers. We make ours of a special, tough phenolic material that lasts. And lasts. And lasts. All without wear or distortion.

To make sure they stay in place, we weld the buffer cups to the contact springs. We weld, rather than use rivets, because our lab found that rivets have a habit of falling off or wearing out.

### Seeing is believing.

We could go on talking reliability and tell you about our testing and run-in room. There's a lot more to tell.

But we'd rather have our Sales Representative show you. And let you see first hand the reliability that's built into every AE stepping switch.

Just call or write. GTE Automatic Electric, Industrial Sales Division, Northlake, Ill. 60164.

# GTE AUTOMATIC ELECTRIC



# Siemens

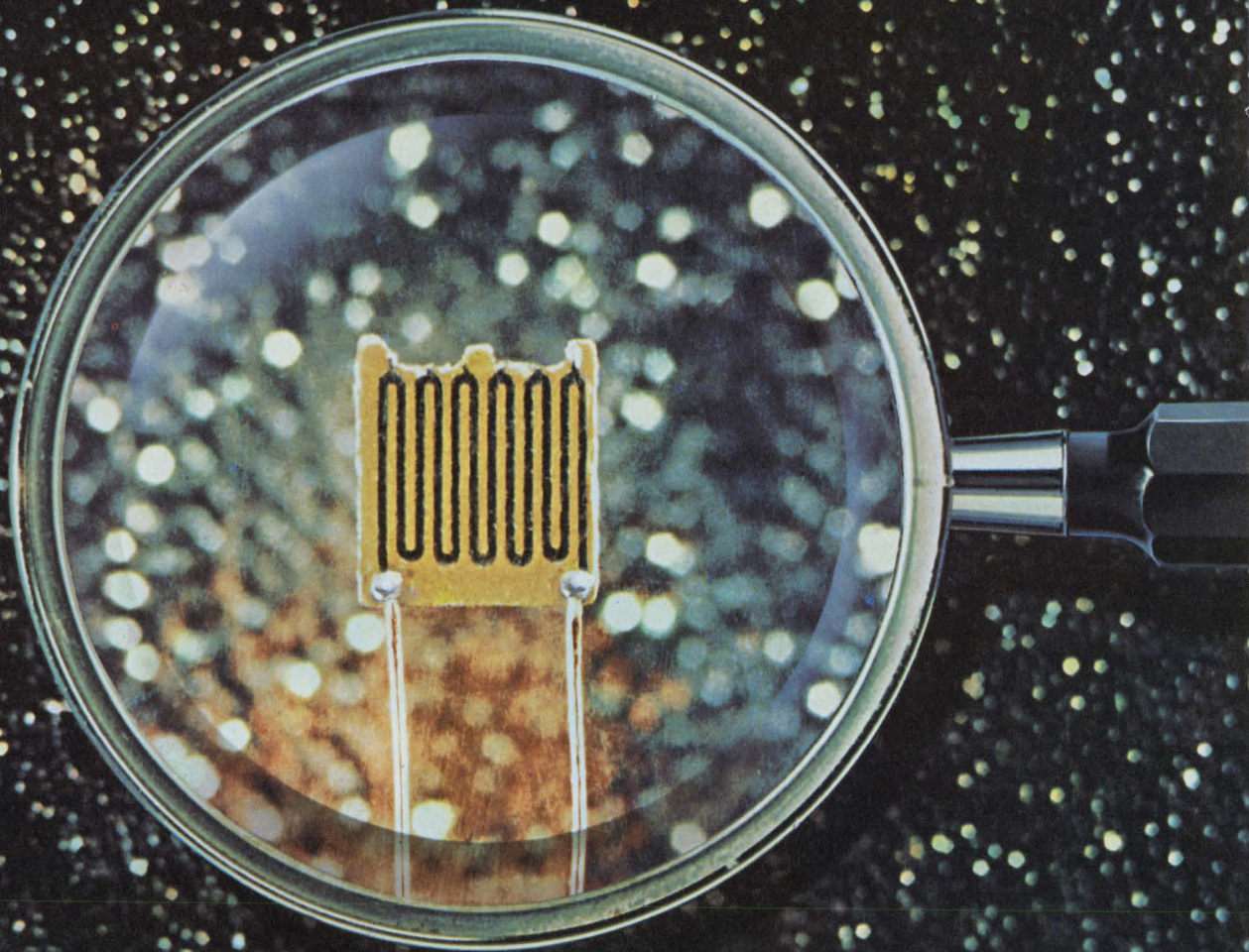

Magnetoresistor shown 13x actual size

**Our low-cost magnetoresistors change resistance from 12 to 18 times in a magnetic field.**

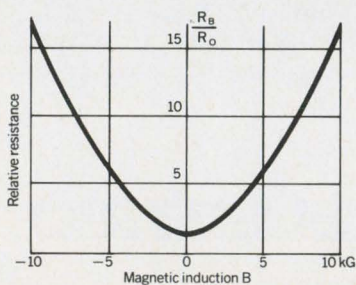

One of the most interesting new Siemens devices is the magnetoresistor. This is a highly sensitive and extremely reliable little device that changes its resistance as the magnetic field around it is either increased or decreased.

Applications range from keyboards to contactless current and position sensors. Ten types with basic resistances from 50

to 500 ohms are available. Quantity prices are as low as 60 cents.

To learn more, contact Klaus Bahr, Siemens Corporation, 186 Wood Ave. South, Iselin, New Jersey 08830. (201) 494-1000.

Siemens. A four billion dollar name in quality products.

  
**SIEMENS**



# washington report

DON BYRNE, WASHINGTON BUREAU

## **New skirmish over defense spending looms**

A potpourri of environmentalists, doves and financial conservatives in Congress is cooking up trouble for military programs. With the death of the SST, the environmentalists now see themselves as a power to be reckoned with, and the antiwar movement grows more vocal in Congress every day. House sources say that the F-14, F-15, Sram missile, the Ax, support aircraft, Cheyenne helicopter and Navy shipbuilding programs will bear the brunt of the assault on defense spending. In the Senate, William Proxmire (D-Wis.) has launched his annual anti-C-5A program, charging now that the aircraft is not only expensive but also mechanically defective.

The General Accounting Office is poring over the F-14 books, looking for cost overruns, and members of various House and Senate committees are wondering about the proliferation of aircraft and the need for a manned bomber. There is a possibility that the Administration may ask Congress to approve loan guarantees for Lockheed on its Tri-Star jetliner program, but Congressional sources almost unanimously say there is little hope of getting such a measure approved.

One of the few bright notes is NASA appropriations. A space agency spokesman says the fight for funds "shouldn't be any worse than last year." Last year NASA's appropriation squeaked through, but Russian advances this year toward developing a space platform and unemployment at home are seen as helping NASA.

## **FAA calls for new transponder standards**

The Federal Aviation Administration will hear comments until the end of next month on proposed rules which eventually would make obsolete about 35,000 radar beacon transponders on military and civilian aircraft. The FAA rules, if adopted, would expand the types of data offered by the transponder and set minimum performance standards for the instruments. No such standards currently exist. Transponders would have to meet the new standards by January 1, 1972.

## **Decision on airline microwave system still pending**

Aeronautical Radio, Inc., the airlines' subsidiary on communications matters, may decide before the year is out whether to build its own private microwave communication system. Arinc officials say they are watching tariff proceedings here and a Telpac case in New York before making a decision. The microwave system would cost \$257-million, and Arinc says it may have to build it because of climbing AT&T line costs. At present rates, an Arinc spokesman told ELECTRONIC DESIGN, the AT&T system would cost the airlines \$137-million a year to lease by 1975. The



proposed microwave system would be operated for about \$79-million.

Arinc has been pondering a microwave system for more than six years, and three formal studies have been made in that period. The latest, by Collins Radio, envisions a system three times the size of the existing one, with 784 microwave stations. Included over 21,815 route miles are 307 terminals with 102,941 voice-channel ends. Previous studies have been criticized by AT&T as unworkable and as a ploy in rate cases, but Arinc insists it is not engaged in a ploy. While it doesn't want to build the system, it says, it may have to because of AT&T charges.

An Arinc spokesman said "there is no problem there" when asked how Arinc would pay for the \$257-million system. He said construction would probably take about five years, and the project could be financed over that period by using guaranteed user charges as loan collateral.

## **Honeywell wins AF contract over competitor's protest**

The Air Force has selected the Honeywell Aerospace and Defense Div., West Covina, Calif., to build the multimillion-dollar Undergraduate Navigator Training System. Announcement of the winner has been held up pending completion of a General Accounting Office report requested by General Precision's Link Div. in Binghamton, N. Y. Other contractors in the simulator contest were Conductron, Inc., St. Charles, Mo.; LTV Electronic Systems, Inc., Greenville, Tex., and General Electric's Apollo and Ground Systems Div., in Daytona Beach, Fla. The airframe competition is between Boeing and McDonnell Douglas. The Air Force has already received \$22.4-million for 14 simulators and is seeking \$32.6-million for 28 more. Honeywell will use 12 of its own minicomputers.

**Capital Capsules:** A gloomy commentary on the engineering unemployment picture has emerged from a recent tour through the aerospace West by a House investigative committee. One manufacturer told the committee with pride how his company now "saves" money on Government aircraft contracts. **When a recall of engineers is needed, the company goes to the top of the seniority list of engineers who have been laid off and offers the prevailing lowest engineering salary.** The company reported "savings" of about \$5000 a year on each engineer it recalled. . . . Almost as fast as it was launched, **a plan by the Dept. of Transportation for an electrically powered, tracked air-cushion vehicle to link Dulles International Airport and Washington, D. C., was killed by the House Appropriations Committee.** The department had viewed the plan as a test bed for future mass-transit systems and had sought to reprogram \$25-million in transit funds to it. The committee said no, and a department spokesman says the program is dead. . . . **Several of the erstwhile SST subcontractors are expected to make a pitch for a \$185-million contract to build 550 electric subway cars for Washington's 98-mile system, now under construction.** Bids are expected next month from Rohr, LTV, General Electric and Grumman. Final awards are expected in December. . . . **The Hughes Sports Network has urged the Federal Communications Commission to make sure that the domestic satellite program it approves will have capacity for other networks besides the Big Three.** FCC Chairman Dean Burch has told the House Appropriations Committee that the agency expects to have decisions on that satellite system and on a microwave common carrier case by the end of this year. . . . **NASA and Canada have reached agreement on a 1974 launching of an experimental communications technology satellite.**



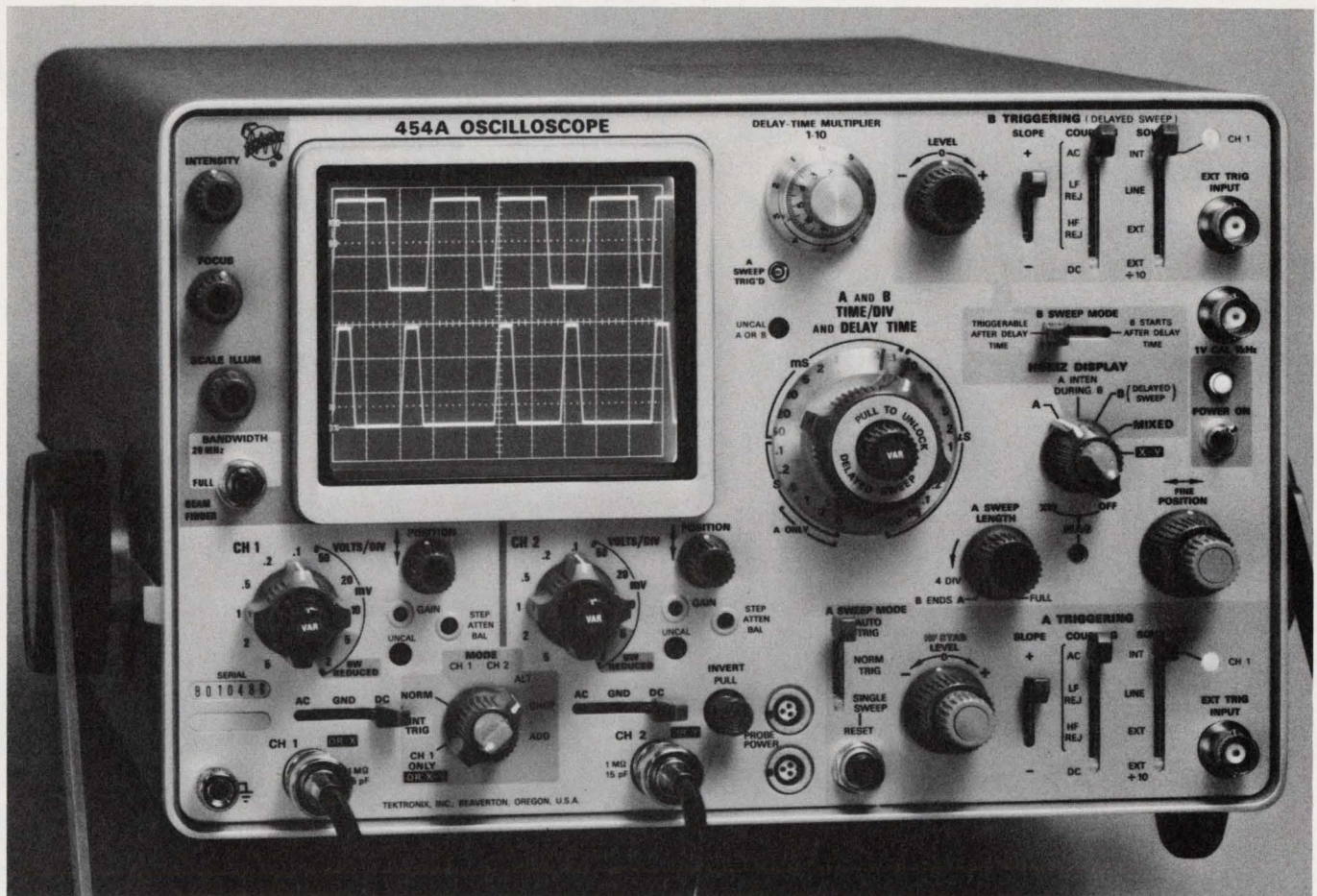

## THE NEW 454A 150-MHz OSCILLOSCOPE MAKES PORTABLE PERFORMANCE BETTER THAN EVER BEFORE

The New 454A has even more built-in performance and measurement ease than its field-proven predecessor. Here are just a few of many examples.

	BEFORE	NOW	TO YOU THIS MEANS
CRT Size	6 x 10 Div (0.8 cm/div)	8 x 10 Div (0.8 cm/div)	33% more display area—More vertical resolution
Max Sweep Rate	5 ns/div	2 ns/div	2 1/2 times more horizontal resolution
FET Inputs	No	Yes	More stability—More reliability
Max Def Fact @ 150 MHz	20 mV/div	10 mV/div	Measure lower amplitude signals at higher BW
Max Def Fact	5 mV/div	2 mV/div	2 1/2 times more gain
Calibrated Mixed Sweep	No	Yes	More display capability
Maintenance	Easy	Easier	More on-site measurement time
Color-Coded Panels	No	Yes	More operating ease
150-MHz Probe	Yes	Yes	It's easier to handle Still—maximum BW at the probe tip



Tektronix rental and lease programs are available in the U.S.

AND—just like the 454, high impedance inputs are standard on every 454A. It all adds up to a NEW model of a field-proven oscilloscope. An oscilloscope designed to measure with laboratory precision and to be carried with small-package ease.

Your field engineer will gladly arrange a demonstration. See for yourself *all* that's NEW about the 454A. U.S. Sales Price is \$3050 FOB Beaverton, Oregon.

INFORMATION RETRIEVAL NUMBER 25



# The Magn

HP's got a great new idea in counters: buy one that just fits your specific application—without paying for extras you'll never use. Yet make your choice from a family of six counters with a wide range of unique features, at prices so low you'll wonder how we did it.

You'll get all the things you expect from our 5326 and 5327 family of counters: totalizing, frequency, ratio, period and time interval measurements, in a range of 50 MHz or 550 MHz.

In addition, they let you perform tasks no counters could handle before.

For instance, you can now do IC logic timing testing simply and economically with 15 picosecond resolution. HP's unique time interval averaging mode makes it possible! (Request HP Application Note 129 for the story.) Price is just \$1195 for a 50 MHz unit and \$1795 for the 550 MHz model with this powerful time interval capability.





# ificent Six.

For just \$355 more you can get a counter with a DVM built in. So you can do things like measure rise times more rapidly, simply and accurately than with a scope. And you can check external dc voltages with it, too. Add a \$60 HP 11096A Probe if you need rf voltage measurements.

Want programming capability? Our options will permit remote control of all front panel functions, including trigger levels and attenuators.

Computer interface is easy and costs less than ever.

Suppose you just want the basics? Our frill-free models will supply them with trouble-free, simple operation. They'll cost you \$950 for 50 MHz, \$1495 for 550 MHz.

Your HP field engineer has the 5326/27 data sheet that tells the complete story about these precise new counters. Or write to Hewlett-Packard, Palo Alto, California 94304; Europe: 1217 Meyrin-Geneva, Switzerland.

INFORMATION RETRIEVAL NUMBER 26

02102



HEWLETT  PACKARD

Counters that promise a lot and deliver it all.



## Electronic Memories gently draws your attention to an off-the-shelf planar stack so small that it will fit most commonly used printed circuit boards.

We built this one to solve our problems with the mini-computer people—and their problems as well. Yes, it's low cost: competitive with any other low cost planar stack on the market. Yes, it's off-the-shelf: we can deliver in volume in sixty days or less.

But the main point is this: the size is so small that you can fit this baby on just about any type of PC board. It's 1/2" high x 6" wide x 6 1/2" deep. And in that little package you get 4K x 18 bits of core storage. At a price no semiconductor can match. To the mini-computer designer, this means an immediate core memory source regardless of the system's physical room for storage area.

The stack will operate at either 700 or 800 nanoseconds, depending on whether you order 18 or 20-mil diameter core. Extended temp cores are standard for operation from 0 to 70° C.

The rather unusual "folded" design gives you almost fifteen percent decrease in drive line inductance. Winding impedance and uniformity compares favorably to the compact frame designs. Much better than other planars.

Incidentally, we held a contest to find a good name for this stack. It is now called the EM 2220. Just goes to prove that we know more about core than about fancy names.

**Here and Now:** EM 2220 is in limited production for off-the-shelf delivery. Come in and we'll show them to you. Figure about sixty days for volume orders.

**EM** Electronic Memories is a division of Electronic Memories & Magnetics Corporation, 12621 Chadron Avenue, Hawthorne, California 90250, (213) 644-9881.

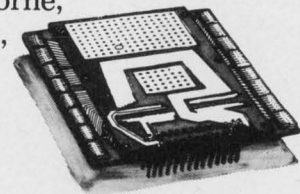

("I still think a couple of 'incredibles' would help.")



# Ring up a savings on keyboard switches.

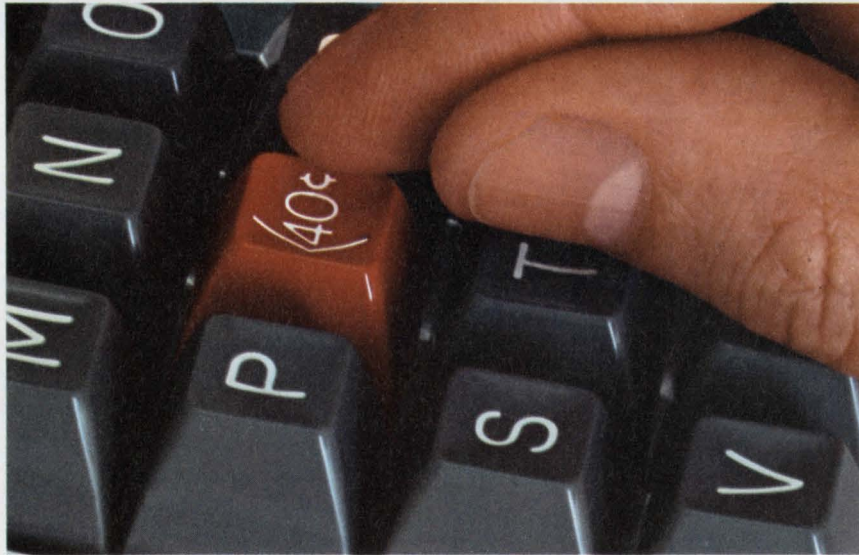

As much as **40%**  
[savings per key]

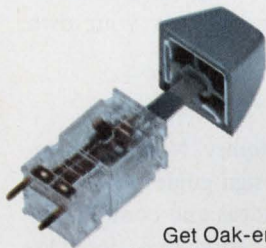

## The new Oak Series 400.

Get Oak-engineered quality in keyboard switches with the inherent reliability of electro-mechanical operation. Ideal for peripheral data-processing equipment. Contact bounce is less than 3 milliseconds. Long life, up to 20 million operations per key. Designed with self-cleaning crossbar-wiping contacts.



Under **40¢**  
each.

For SPST/NO in production quantities. Other versions comparably priced. Keypot button and snap-in mounting extra.



## A feather touch.

We kept the operator in mind. Standard operating force is approximately 85 grams (3 oz.).

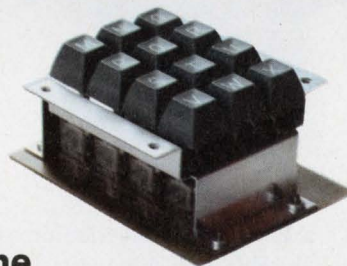

## The configurations you want.

The Series 400 is available in limitless arrangements, including standard 10, 12, and 16-button keyboards. And you can specify any of six different contact circuitries. Choose snap-in or plug-in P.C. mounting. Compact—only 1/2" x 1/2" x 1".

Write today for our Series 400 brochure.

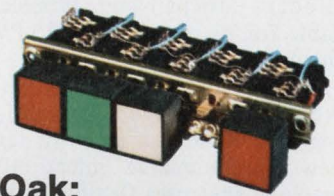

## Also from Oak: Series 300 Lighted Pushbutton Switches.

Featuring Oak's exclusive twin-lamp lighting. If one lamp goes out, the other stays on. Double-wiping contact clips. Short stroke. Smooth, quiet operation. Unlimited combinations. Request our Series 300 brochure.

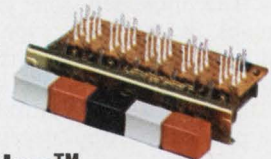

## And our Series 800 Econo-Line™ Pushbutton Switches.

Compact—more buttons and more contacts in less space: 1 PST to 8 PDT per button. Your choice of mechanical actuation. Colored buttons, legend engraving to your specifications. Request our Series 800 brochure.

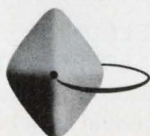

**OAK MANUFACTURING CO.**

CRYSTAL LAKE, ILLINOIS 60014 • A DIVISION OF OAK ELECTRO/NETICS CORP

Telephone: 815-459-5000

TWX: 910-634-3353

TELEX: 722-447

INFORMATION RETRIEVAL NUMBER 28



# THE CROWN STREET NEWS

## Modern Methods Flexible Etched Cable Offers Substantial Cost Savings Over Conventional Harnesses

## Manufacturers Continue to Turn to Flexible Etched Cable

### How to Beat the \$ Squeeze

Although flexible etched cabling has long found wide acceptance in the aerospace and specialized electronics industries, companies producing products for commercial markets have not availed themselves of its many advantages. But just recently a New Hampshire producer of injection molding machinery for the plastics industry has turned to Teledyne Electro-Mechanisms flexible etched cable for its new Model 176 Production Injection Molding Machine.

Improved Machinery Inc. of Nashua, New Hampshire, a subsidiary of Ingersoll-Rand, has recently developed a new programmable injection molding machine that uses flexible etched cables manufactured by Teledyne Electro-Mechanisms. "As a leading builder of injection molding machinery for the plastics industry we're experts in hydraulics and mechanics," says H. Martin Allard, Vice President, Engineering of the Plastics Machinery Division, "but the demand for fully automatic equipment and increased reliability has gotten us deeply involved in electronics.

"The increased role given to electronics in our new sophisticated machines presented us with unfamiliar packaging problems. We were unaware of the need for specialized tooling and the production steps necessary to assure repeatability in production runs.

"When we turned to Teledyne Electro-Mechanisms for assistance they designed a flexible etched cable harness that completely bridged our wire bundling problems. Our designers indicate that the decision to go directly to flexible etched cable in our new machines has saved us countless dollars in manufacturing and test costs. Decidedly, flexible etched cables in our new machines has helped us maintain a technological edge in the marketplace."

## What's Happening—

\* \* \*

\* \* \*

### The Economy

**T**IGHT MONEY may become more relaxed later this year. Some large banks have begun to reduce their interest rates. But what can be done right now to keep your profits from getting lost in the dollar squeeze? One way is for your company to look inside for ways to maintain profit levels. But often cutting back on spending just isn't enough to keep up with a plunging sales curve — real economy has to begin on the drawing board. That's where Teledyne Electro-Mechanisms flexible etched cable can give you a competitive edge.

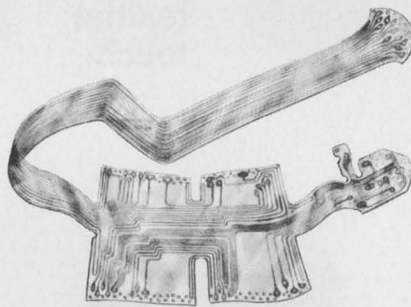

\* \* \*

**It's a Fact** that production of conventional cable harnesses costs you a major portion of your assembly and test budgets not to mention costs for rework and final assembly failures. Teledyne Electro-Mechanisms flexible etched cable can cut assembly and test costs by as much as 50 per cent, weight by as much as 60 per cent, and volume by as much as 80 per cent. When you couple these savings with the attendant overall reduction in production rework and final test costs you can beat the dollar squeeze.

**Early Assembly Failures** due to faulty harness and hand wiring can make your product prohibitively expensive by increasing test and rework costs. A field failure can injure your company's reputation and undermine your best sales efforts. If your customer's demands for reliability are not satisfied, you are developing sales for your competition with each unit you deliver.

\* \* \*

**You Can Reduce Costs** by improving reliability. Teledyne Electro-Mechanisms can help you improve product reliability, and by so doing, hone your competitive edge with flexible etched cables designed to your own specifications.

\* \* \*

**Circle Our Inquiry Number** to receive our free design guide. It's full of good packaging ideas and contains design and special fabrication tips. Discuss your own packaging problems with us and find out for yourself how easily a troublesome interconnect problem can be solved. We can design and manufacture almost any interconnect without using a single wire. Think of the production and test economies.



\* \* \*

 **TELEDYNE  
ELECTRO-MECHANISMS  
29 Crown Street  
Nashua, N.H. 03060**

INFORMATION RETRIEVAL NUMBER 29



# Introducing: "The Portables" from HP

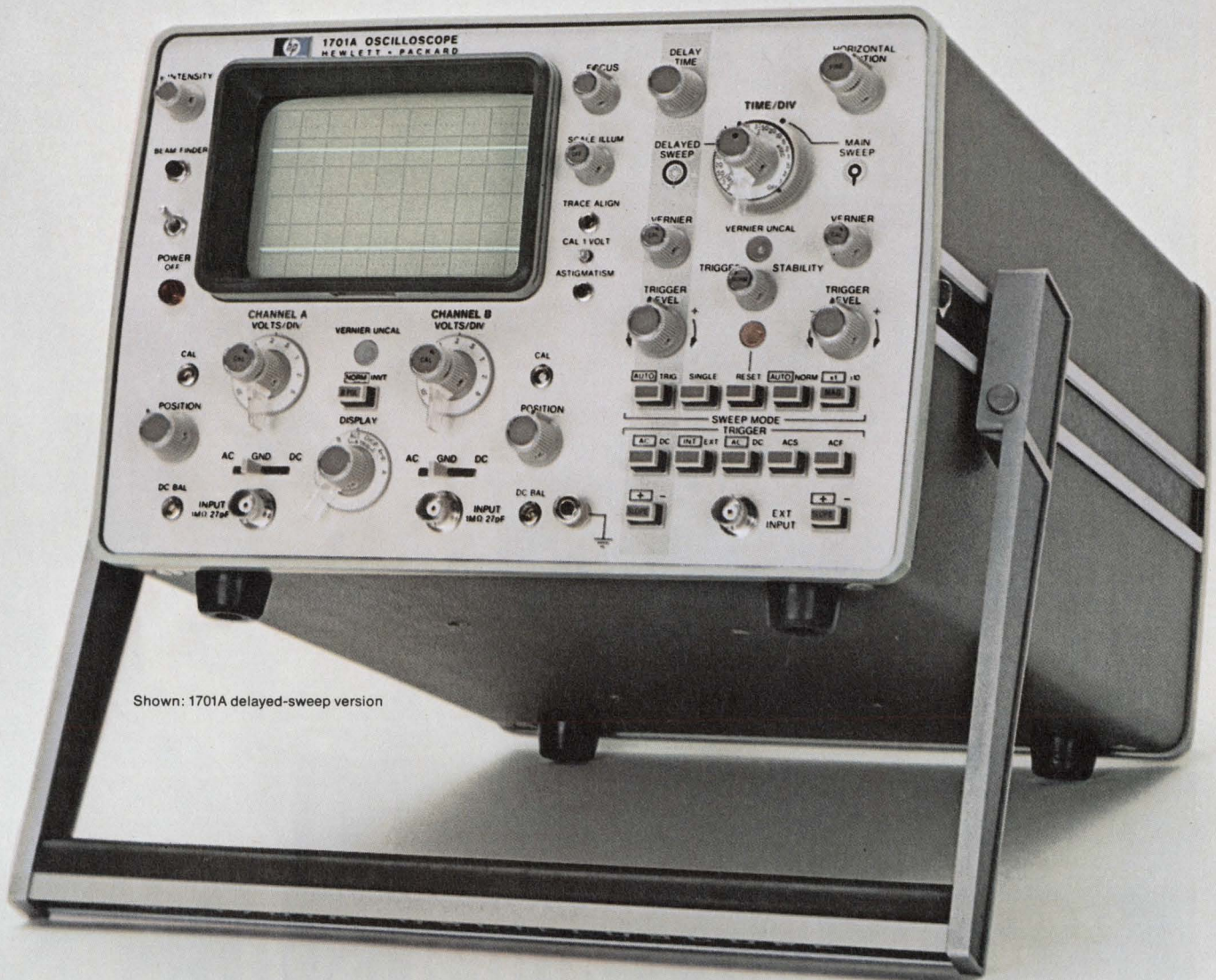

Shown: 1701A delayed-sweep version

## They make your budget seem bigger.

HP's new dual-channel, portable scopes make slim budgets look fatter. At only \$1850, our delayed-sweep model, the 1701A, weighs in at \$200 less than the competition, which adds up to a 10% savings for you. (Our non-delayed-sweep model, the 1700A, is even lower—\$1680.)

The 1701A weighs less in pounds, too—24 as compared to 28—which makes it easy to carry around in the field. But the 1701A is no "light-weight" in its performance. It gives you all the necessary capabilities for digital field service work.

Its 10 ns/div sweep time and <10 ns rise time (35 MHz) let you measure T<sup>2</sup>L pulse timing and propagation delay.

And its simple-to-use delayed sweep allows expansion of complex waveforms, for easy observation on the large 6 x 10 cm screen.

Another advantage is the 1701A's low power requirement. This HP breakthrough eliminates the need for fans (or even vent-holes), which means that dust and moisture are kept out of the circuits. It also assures extreme reliability, as all components are operating at less than 20% of rated capability. And, this low power requirement allows battery operation in the field—a capability you get with no other scope in this class. (Internal battery pack, \$200 extra.)

For further information on "The INFORMATION RETRIEVAL NUMBER 30

Portables"—HP's new 1700 Series scopes—contact your local HP field engineer. Or write Hewlett-Packard, Palo Alto, California 94304. In Europe: 1217 Meyrin-Geneva, Switzerland.

Scopes are changing.  
Are you?

081/7

HEWLETT  PACKARD





## an unfair comparison...

### The new Cyclohm Fan from Howard vs. "the other fan"

The new Howard tubeaxial fan delivers a larger volume of air over a wider range, runs up to 10 years without service or lubrication, has a rugged cast aluminum frame, yet costs about the same as "the other fan" you're now using. (See why we call the comparison "unfair"?)

In all fairness, we admit the new Howard Cyclohm fan is exactly the same size as "the other fan." They're interchange-

able. But then we come to comparisons like Howard Cyclohm's six-blade impeller (vs. three) which is computer-mated to the famous Howard Unit Bearing Motor with an engineered life-span of 10 years (vs. a traditional bearing motor). Then, too, there's 115 CFM air delivery (vs. 100). And cost: The new Howard Cyclohm never costs more than "the other fan" . . . and Howard delivery is overnight!

**Be fair to yourself: Send for all the unfair facts.  
Ask for Information Packet ED57**



# HOWARD

HOWARD INDUSTRIES  
A DIVISION OF MSL INDUSTRIES, INC.  
2420 18th STREET, RACINE, WISCONSIN 53403  
414-632-2731 TWX 910-271-2387



# editorial

## You may be a sharp EE, but are you an MD, too?

INTERROGATOR: How's your health?

ENGINEER: You mean economically or physically?

INTERROGATOR: Physically. What kind of shape are you in?

ENGINEER: Look, there isn't a thing wrong with me that I don't know about. Nothing. Over-all, I'm in pretty good shape. A little overweight perhaps, a bit tense at times—we just had another job cutback, you know; makes you kind of jumpy sometimes—but over-all nothing I can't handle without running off to the doctor. As a matter of fact, just the other day I got a notice to see the company doc for a checkup, and maybe I'll go and maybe I won't.

If that sounds almost like you talking, it's because it probably is you. *ELECTRONIC DESIGN* isn't a medical book, but it recently asked a number of doctors in electronics companies across the country: "Are there any particular health hazards that engineers as a group are susceptible to because of the type of work they do? What are engineers like as patients?"

One of the findings that the informal survey turned up is that the engineer is often an opinionated patient. He's positive he knows what's wrong with him, which sometimes makes him difficult to treat. Because of his training, he's seldom open to a simple solution. Another point was that he's inclined to put off medical examinations. He's apt to consider the body a machine that needs to be "oiled" only occasionally, and then only when convenient.

Other qualities that engineers seem to have as a group, the doctors said, include these:

- They're health conscious. They try to maintain themselves physically. If an engineer shows up at work with back strain or a Charley horse, he probably got it working out.
- They're safety conscious. They know the rules and follow them; they're not accident-prone.
- They're aggressive. They've got to produce, and they're constantly reminded of it. They're more susceptible to hypertension than the average worker may be.

Moral: Engineers are in a demanding, tense business, frequently under pressure of deadlines. They're also human and subject to the frailties of all humans. When was the last time you had a physical checkup? Get one if it's time for one. In many companies, it's on the house.

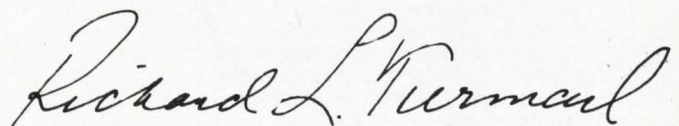

RICHARD L. TURMAIL



# We Interrupt Your Single-Diffused Silicon Power Designs To Bring You These 8 Advantages From EpiBase

## 1. COMPLEMENTARY CAPABILITY

Only EpiBase\* technology possesses the inherent capability to afford you the advantages of complementary power circuitry. And only Motorola has PNP/NPN EpiBase pairs from 1 to 50 amperes in most popular voltages and packages.

## 2. DARLINGTON CAPABILITY

Only EpiBase can give you this revolutionary new way to go for lower-cost circuit simplicity and top performance in relay and solenoid drivers, audio amps and power supply, servo amp. and series pass regulators, etc. EpiBase now offers 13 complementary, metal and plastic Darlington pairs. And more coming.

## 3. HIGHER GAIN

Only EpiBase with its inherently better emitter efficiency gives you higher output current for a given area. Generally, at least twice the current gain is available at equal current levels.

## 4. HIGHER FREQUENCY WITH EXCELLENT SOA

You're out ahead in both amplifier and switching applications with EpiBase. This results in improved circuit performance with minimum distortion and device dissipation. Along with its top speed and efficiency, EpiBase gives you outstanding, 100%-tested, safe operating area.

## 5. LOWER SATURATION VOLTAGE

10 to 20% lower internal series resistance in the EpiBase chip results in lower  $V_{CE(sat)}$  characteristics, consequent higher efficiency and more usable device power at higher operating temperatures.

## HIGHER SWITCHING EFFICIENCY 6.

The inherently faster speed of an EpiBase device offers much lower switching losses. Test one.

## LOWER COST 7.

Slicing silicon ingots lengthwise to make large rectangular slabs producing 30% more dice than round wafers and eliminating wasteful, "edge effects" results in lower costs to you and us. Recently, prices on 104 Motorola-registered devices were dropped as much as 50%. The majority are EpiBase.

## TRUE VALUE FOR THE FUNCTION 8.

That means you get exactly what you need and pay only for what you get. Choose from 8 different EpiBase chip sizes from 45 to 275 mils, design-spec'd to afford the widest choice of preferred standards and unsurpassed custom capability.

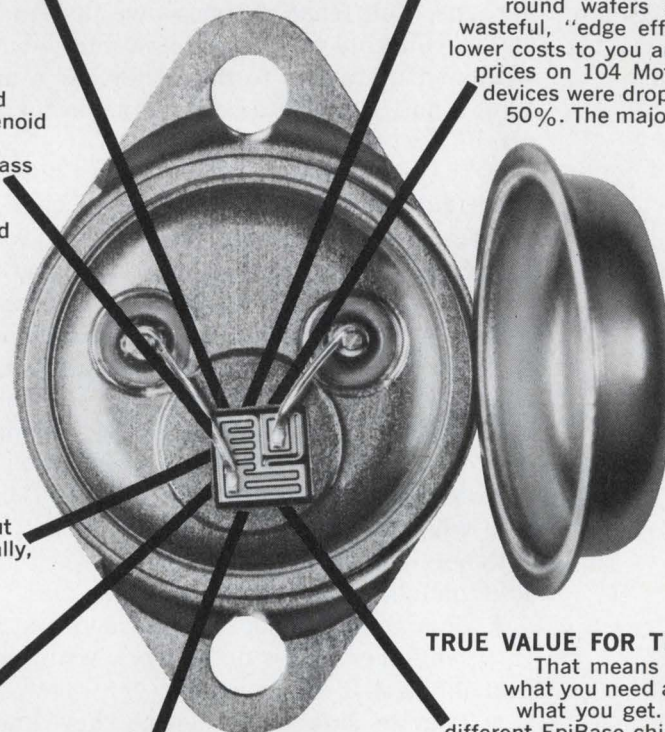

There's a group of EpiBase Silicon Power data sheets available now showing complete-line advantages of EpiBase silicon power transistors, applications-oriented to solve 95% of today's design needs . . . high-current, high frequency, Darlington, complementary and general-purpose types.

Bring a set to your desk today by writing Box 20912, Phoenix, AZ 85036. Or circle the reader number.



**Motorola EpiBase**  
—Silicon Power At Its Best.

\*Trademark Motorola Inc.



## New hardware on tap to monitor pollution

An Electronic Design Special Report

"... the 1970s absolutely must be the years America pays its debt to the past by reclaiming the purity of its air, its water, and our living environment. It is literally now or never."

With these words, President Nixon signed into law last year the National Environmental Policy Act—a massive effort at every level of government to push the new

# civionics

offensive against pollution and waste. The Federal Government is already allocating hundreds of millions of dollars annually for research into many types of pollution control and monitoring.

Private industries so far have not responded as rapidly or extensively, but their days of unconcern are numbered. Under the prodding of more rigid laws, industries will be forced in the years ahead to invest considerable sums in pollution monitoring and control equipment. By far the largest market in the pollution business in the next decade will be hardware that can monitor air and water at the source of their emission from plants. Today this is done largely by wet chemical methods. Tomorrow it will be accomplished by electronic instruments.

The arsenal in the antipollution war includes such equipment as gas chromatographs, mass spectrometers, microwave spectrometers and laser scattering systems. Some of these are being used in laboratories; others are still

on the drawing boards or in very early stages of development.

The challenge to the designer is not only to come up with new pollution sensors and monitoring equipment, but also to convert these rather delicate types of instruments into rugged, reliable service-free "field" sensors. In addition to basic pollution sensors, private industry will need a variety of auxiliary electronic equipment, including telemetry, data acquisition and control electronics.

The pollution and waste-disposal market is a relatively virgin one today, and electronics companies are understandably cautious about committing large capital investments until they see the demand more clearly. But the innovators in our society inevitably run far in front of the pack, and the dividends for the more daring corporations and designers should be substantial.



# DESIGNING FOR THE POLLUTION-FREE INDUSTRIAL ERA

David N. Kaye West Coast Editor

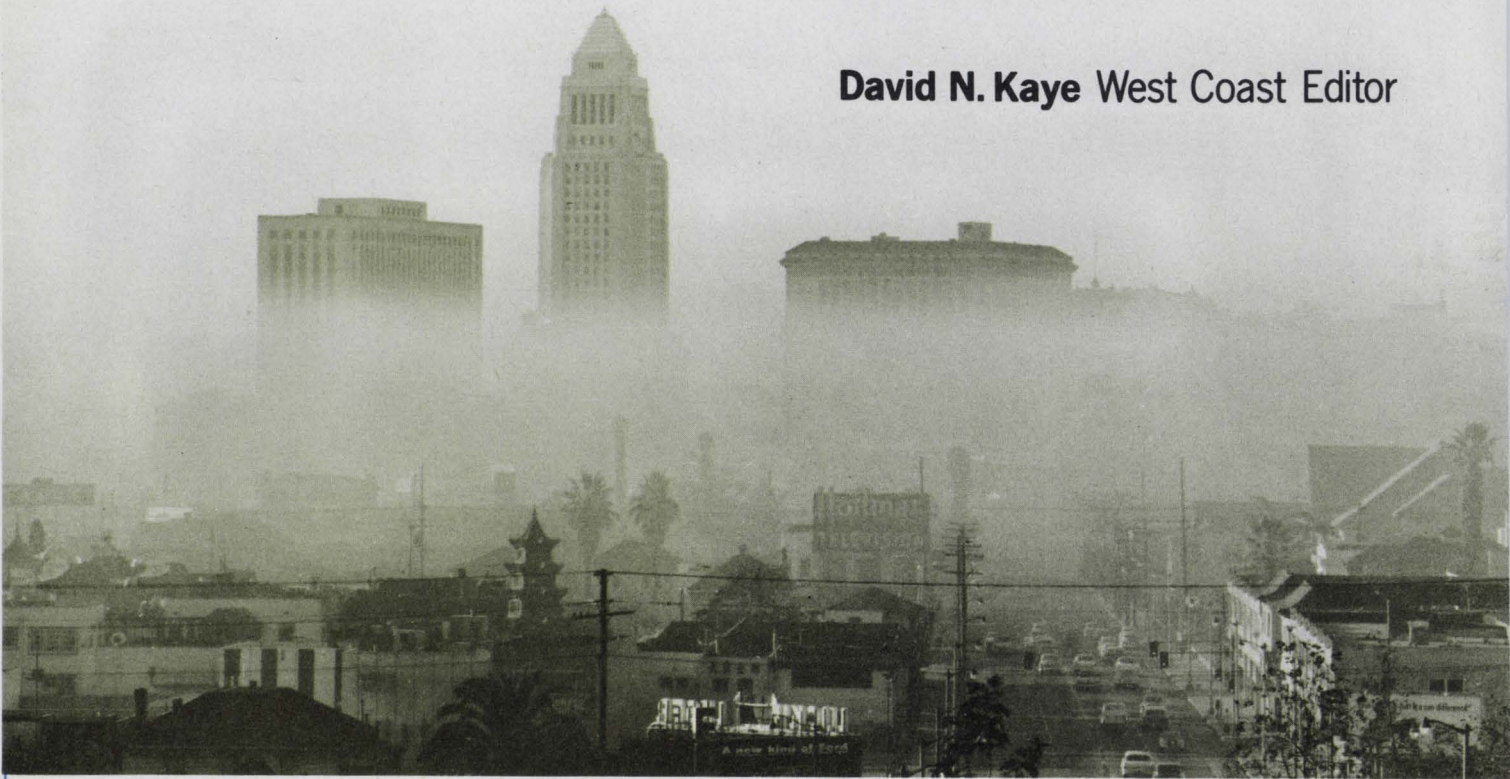

The talk about pollution among civilians in the United States goes something like this:

"It's disgusting" . . . "My eyes are starting to water" . . . "Phew, close the windows till we drive past this place!" . . . "There ought to be a law" . . .

But the talk among people trying to do something about pollution goes like this:

"Monitoring instrumentation in sewage treatment is really in the Dark Ages. We have one of the most modern plants in the country, and most of our instruments are about 30 years old."—William F. Garber, assistant chief engineer of the Los Angeles Dept. of Public Works.

"What is needed is a new generation of reliable instruments that are based on electronics and use basic physics rather than wet chemistry as a means of detecting pollutant levels."—Dr. Kay Jones, deputy assistant commissioner for science and technology in the Air Pollution Office of the Environmental Protection Agency, Rockville, Md.

The man to bridge the widening gap between complaints and remedies is the electronics engineer. He is highly qualified to build efficient sensor and monitoring equipment to track pollution to its sources. He can design automatic

systems to control industrial processes so they don't pollute.

The potential customers for such aids are offending industries, in particular, and also city, state, county and federal agencies. Very little pollution source monitoring is being done by industries today. But antipollution laws aimed at industrial plants and products are getting tougher by the month. The auto industry is one of the first to feel the pinch, and many others are certain to be affected before long.

The Esso Research and Engineering Co. of Linden, N.J., has estimated, on a contract from the Environmental Protection Agency, that the market between 1970 and 1980 for probes and measuring instruments to detect industrial air pollution will be \$226-million. That total does not include recording hardware, telemetering equipment or any other associated control or display electronics. When these are added in, a sampling of sources indicates that the market expands to about \$400-million over the same 10-year period.

If all air and water pollution requirements for instrumentation and associated electronics are lumped together, the market over the 1970-1980 period figures out to be in the neighborhood of



\$1.4 billion, industry sources say.

Seven pollutants are regularly monitored today: carbon monoxide, total hydrocarbons, ozone, nitric oxide, nitrogen dioxide, sulfur dioxide and particulates. At least 31 other pollutants are under investigation by the Environmental Protection Agency. They include heavy metals such as mercury, nickel, iron, manganese and zinc; hydrocarbons such as ethylene, formaldehyde and a variety of organic carcinogens; pesticides; radioactive substances; and pollens.

Most monitoring today is done by wet chemistry. In other words, fluids are pumped around, mixed and the color changes observed.

And monitoring is being done in two basic ways: source and ambient.

Stationary source monitoring measures the pollution output at its source. It includes measurements of smoke coming out of stacks and of discharges from industrial plants into waterways. The output is called the effluent.

Ambient-level monitoring measures the pollutants in air and water at any given point.

In general, equipment developed for source monitoring must withstand extremely foul environments and be fairly precise, but not necessarily highly sensitive. Ambient-monitoring equipment must be precise and very sensitive.

### Electronics available to do the job

What electronic "field instruments" are available today or are in an advanced state of development? The sensors and monitoring equipment includes:

- Nondispersive infrared analyzers.
- Hydrogen flame photometers.
- Chemiluminescent ozone monitors.
- Specific electrode instruments.

What electronics will be needed for pollution monitoring in the near future? The equipment includes:

- Gas chromatographs.
- Mass spectrometers.
- Microwave spectrometers.
- Laser scattering systems.

Each of these "future" instruments depends upon the characteristic spectral signature of a particular contaminant for identity and on pulse height for density. These instruments are being used in laboratories today, or in some cases they are in the early R&D stages.

Other needs include control electronics for tying antipollution sensors directly into the industrial processes (closed-loop systems), and telemetry data-acquisition and display equipment for automating the monitoring process.

Nondispersive infrared analyzers are in wide use today. In these devices a sample of the gas

is injected into a cavity. Infrared is transmitted through the gas and focused on a chamber containing a high coefficient of thermal expansion material. If carbon monoxide is present, the infrared will be attenuated proportional to its concentration. Detection is by measurement of the expansion of the material in the chamber, due to heating.

### Photometers are versatile detectors

Hydrogen flame photometers (Fig. 1) are able to measure several different pollutants. The basic principle is that a sample of the unknown gas is injected into a hydrogen flame. If a particular pollutant is present, a characteristic color is given off, and a filter and photomultiplier detect the color.

If the hydrogen flame is used for total hydrocarbon measurement, the filter and photomultiplier are replaced by a loop of metal. About 100 V are put on the loop, and when the unknown gas is injected into the flame, it is ionized, and the electrical conductivity in the chamber is measured. The conductivity is a measure of the level of total hydrocarbons.

Much interest is being focused today on the chemiluminescent ozone monitor (Fig. 2). A sample of atmospheric air is injected into a vessel. The air is mixed with ethylene. If ozone is present in the sample, a characteristic chemiluminescent glow will be detected by a photomultiplier tube through a filter. The level of the glow is proportional to the density of the ozone in the sample.

Both hydrogen flame and chemiluminescent instruments have sensitivities on the order of less than 1 part per million full-scale, and they should be kept in environmentally controlled housings at between 50°F and 90°F.

### Using current to spot contaminants

Specific electrode instruments are electrochemical in nature. They contain a pair of electrodes in an electrolyte and a membrane at the input of the device. The unknown gas passes through the membrane. The electrolyte and probe materials are selected to react with a particular contaminant. If that contaminant is present, a current is set up between electrodes. The magnitude of the current is proportional to the density of the contaminant.

According to Ramesh Chand, engineering manager for air pollution at Dynasciences Corp. in Chatsworth, Calif., this type of instrument can be made to any of a variety of different pollutants. Its sensitivity is on the order of a few parts per million full-scale, and its precision is 2% full-scale.



Whereas the chemiluminescent and hydrogen flame photometers seem best suited for ambient measurements, the specific electrode monitor has been used mostly in source monitoring. Each of these three basic types of sensors requires calibration only once a week or less, as compared with once a day for wet chemical methods.

Of today's laboratory instruments, the one that has stirred the widest interest for development into a field instrument is the gas chromatograph (Fig. 3). A gas is injected into a separation tube. The tube is filled with some chemical, such as charcoal. Different gases go down the tube at different speeds. A monitor of some sort at the end of the tube notes a pulse as each constituent of the gas reaches the end of the tube. The time from injection of the sample until the pulse is detected determines the compound. The level of the pulse determines the concentration.

Any type of detector can be used on the output. The most common is a thermal conductivity monitor. For very delicate measurements, a mass spectrometer could be used. A gas chromatograph is quite sensitive, with measurements in parts per billion, is simple to operate, separates mixtures of compounds, is relatively specific and modestly quantitative. But it requires a good deal of time to calibrate. Once calibrated, however, it has no zero drift and can operate a long time.

Mass spectrometers have been proposed for monitoring of pollutants. A sample is injected into a chamber. It is ionized, and the length of time it takes for specific ions to transverse a particular path through an electric field is measured. These times are related to the spectral signature of the materials of the sample.

A mass spectrometer is readily interfaced with computers, but easily confused by mixtures and not at all quantitative.

A mass spectrometer, when used as a detector for a gas chromatograph, combines the best features of both instruments. Both instruments are big, clumsy and very expensive at present. Development of inexpensive, easily maintained, reliable versions are still some way off.

### Microwave spectroscopy looks promising

Of the antipollution techniques, the one with the greatest potential is microwave spectroscopy (Fig. 4). The device consists of a length of waveguide, a microwave sweep oscillator and a detector. A sample of the unknown gas is injected into the waveguide. A microwave signal is transmitted through the gas, and the frequency is swept through some range (typically 26.5 GHz to 40 GHz). The gas will absorb energy at certain characteristic frequencies, and these frequencies will show up as dips in the detected signal re-

ceived at the other end of the waveguide. The magnitude of the dips will be proportional to the concentrations of the various pollutants. Each pollutant has its own spectral signature. The signature can either be recorded on a recorder or digitized and compared in a small computer with known spectral signatures.

John Hearn, engineering manager of the Scientific Instruments Div. of Hewlett-Packard in Palo Alto, Calif., notes that microwave spectroscopy is moderately sensitive (one to 10 parts per million), very highly specific for mixtures and single compounds, shows high specificity for highly reactive compounds, is very quantitative (better than 1% typically), and is not as subject to contamination as are some of the other techniques. Additional processing of the sample can improve the sensitivity.

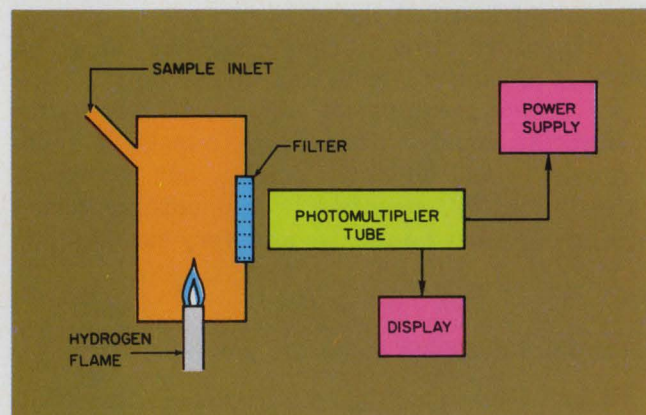

Fig. 1. Reaction of a hydrogen flame with an unknown gas yields an emission at a wavelength that is characteristic of the constituents of the gas.

The signal conditioning that must go with the microwave spectrometer is not too complex, and the instrument is readily interfaced with digital signal processing equipment. At present it is still a laboratory instrument, but it can be made simple, inexpensive, easy to maintain and easy to operate remotely.

Just as microwave spectroscopy allows viewing of the microwave signature of a compound or molecule, lasers can be used to look at the optical, infrared or ultraviolet spectral signature of a molecule. Two techniques are being worked on in a variety of laboratories, including the California Institute of Technology, Stanford University, the Polytechnic Institute of Brooklyn, Westinghouse, the Aerospace Corp. and others. The techniques are called Raman scattering and absorption scattering.

According to Dr. Malcolm L. Stich, assistant general manager of the Korad Div. of Union Carbide, Santa Monica, Calif.: "In Raman scattering, you hit the gas with a pulse of energy



in the ultraviolet. Electrons in the gas change state and emit energy at a wavelength that is shifted by some fixed amount from the incident wavelength. You detect the return, and by noting the wavelength shift, you can determine constituents of the gas.

"Actually each constituent emits several wavelengths in the form of a characteristic spectral signature. If the gas has more than one constituent, you may get many returns. The biggest problem with this technique is that the returns are very low and you need an extremely sensitive detection setup."

Absorption scattering makes use of the fact that every pollutant has a resonant or absorption wavelength. If the gas is hit with a pulse of energy at the absorption wavelength of one of its constituents, electrons will change state

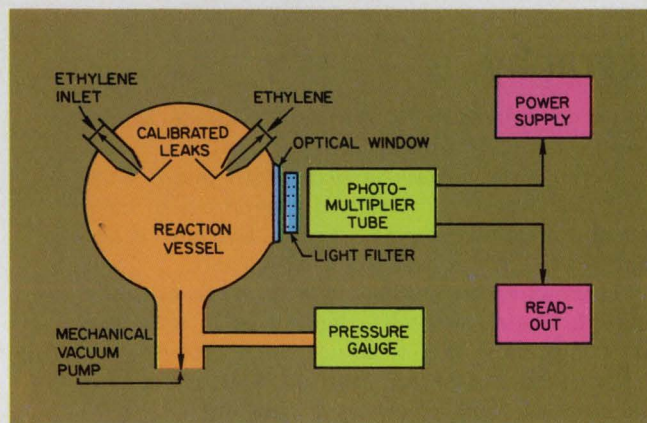

Fig. 2. Reaction of ozone with ethylene yields a chemiluminescent glow, the level of which is proportional to the concentration of ozone in the sample.

and emit radiation at a variety of wavelengths. This return can be detected, and the spectral signature of the constituent can be determined. These returns are of a higher intensity than those in Raman scattering and can be more precisely detected.

Milton Birnbaum, head of the Quantum Optics Dept. of Aerospace Corp., El Segundo, Calif., is working on a special case of absorption scattering. He is concerned with making the constituent of the gas fluoresce—that is, emit a characteristic color in the visible region. He is experimenting with detection of nitrogen dioxide by transmitting at about 4000 Å and looking for a return in the range from 5200 to 5500 Å.

To successfully perform absorption scattering experiments, it is necessary to have a laser that transmits at the absorption wavelength of concern. Ideally one needs a tunable high power laser.

To look at gases in the atmosphere at altitudes of several hundred feet, what is needed is a tun-

able laser that puts out peak powers of several megawatts. The ideal laser for the job would be tunable from 1 to 10 microns, but no such laser exists today.

A major advantage of this type of measurement is that it can be made without sampling and at a considerable distance. Laser scattering techniques would be used primarily for ambient monitoring.

Stich notes that monitoring of the particulate output of a stack could be accomplished with simple laser range-finder techniques (Fig. 5). A low-power laser beam could be transmitted into the effluent from the stack, and the reflected return could be monitored. The amount of return would be proportional to the quantity of particulate matter in the effluent.

To cure pollution at the source, industrial plants will be required not only to monitor their own effluents, but also link the measurements in real time to the process control. For example, Bates Murphy, manager of marketing communications at Westinghouse Electric Corp. in Pittsburgh, points to the use of oxygen analyzers in the stacks of some new furnaces. The measurement of oxygen in the effluent is a factor in determining the combustion efficiency. In turn, combustion efficiency is a measure of pollutant output. Therefore, as the amount of oxygen varies from some nominal value, the fuel-air mixture in the furnace is automatically varied to increase the combustion efficiency and decrease the pollutant output from the stack.

Kyle W. Charlton, environmental instrumentation manager at Time-Zero Corp., Hawthorne, Calif., says: "Most pollution sensors used in plants today are operated in open-loop fashion. Feedback to the process, closing the loop, is still off in the future for most companies."

One industry where the process itself helps to solve pollution problems is sewage treatment. Garber, the assistant chief engineer of the Los Angeles Dept. of Public Works, says electronics can be used to reclaim valuable by-products from polluted sewage. But he notes:

"If we are required to reclaim all of our water, we will need more sophisticated sensors for a variety of heavy metals, various hydrocarbons and other trace elements. We certainly need automatic zeroing and calibration of our instruments. Some of our measurements need only be of the go-no-go variety.

"However—particularly in the process-control field—it is necessary to make precise measurements of either relative change or absolute magnitude. For process control, we can sometimes get away with  $\pm 25\%$  precision. For ambient monitoring, we need precision of at least  $\pm 5\%$ , and preferably  $\pm 2\%$ . Many measurements are



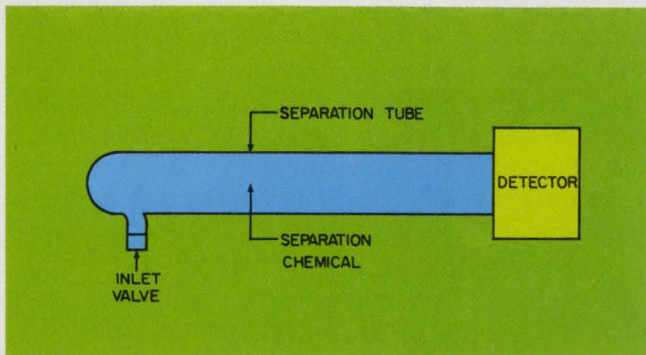

**Fig. 3. Different gases pass through certain chemicals at different rates. The time it takes a gas to travel down the separation tube in a gas chromatograph determines the constituents of the gas. The level of the detection pulse at the end of the tube is a measure of the concentration of the constituents.**

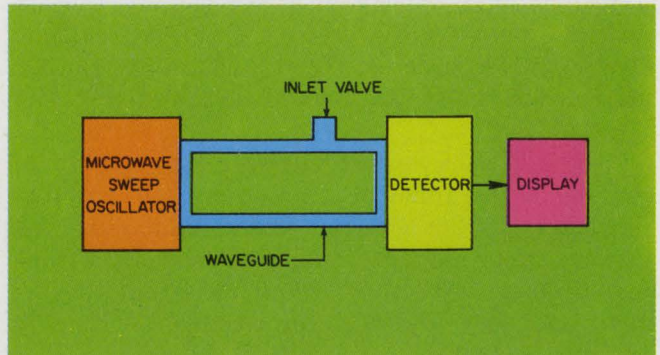

**Fig. 4. Absorptions at different wavelengths characterize the constituents of a gas in the form of a spectral signature. When microwave energy is passed through the gas, dips in the detected signal indicate the locations of the absorptions. The depth of the dips is proportional to the concentration of the various pollutants.**

## To detect oil spills: IR aerial photography

Water pollution due to oil spills and thermal effluents can now be analyzed by the use of infrared aerial photography.

In the case of oil leakage from wells or from tankers, the oil has a different temperature than the surrounding water. Therefore an infrared scan from the air shows how far the oil is spreading.

Stanley Schlosser, vice president of Spatial Data Systems, Goleta, Calif., notes that since normal infrared scans are difficult to get precise data from, some method of enhancement is necessary. Spatial makes an instrument called the Datacolor 703, which breaks up the gray scale on a black-and-white infrared photograph into as many as 3 distinct bands, and displays each on a CRT as a unique color. By viewing any given color, an isothermal contour is displayed. Since the oil has a distinct temperature

range associated with it, the spread of the oil can be uniquely displayed.

If the water around a plant with major thermal discharges is viewed and techniques of color enhancement are employed, the thermal gradients in the water will show up clearly.

Techniques are needed to help track oil spills back to their source. If the source is a tanker, it is important to determine which tanker.

Frank G. Compton, president of Environmental Control Corp., Denver, points out:

"Every drop of oil has a chemical signature that indicates where it came from. If the signature of the oil in each tanker is recorded on magnetic tape, any oil spill could be tracked down to the source by signature comparison," Compton says.

Such a device would be a challenge to design engineers in the pollution field.

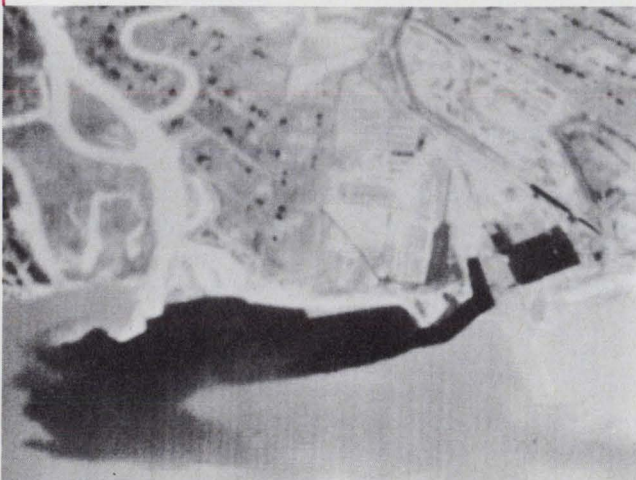

**Infrared scan (left) shows the hot water discharge from a power plant into a waterway. After conversion of the gray scale into discrete colors (purple is the hottest and**



**yellow and green are cool), the isothermal contours of the waterway become evident and the thermal pollution of the waterway can be analyzed.**



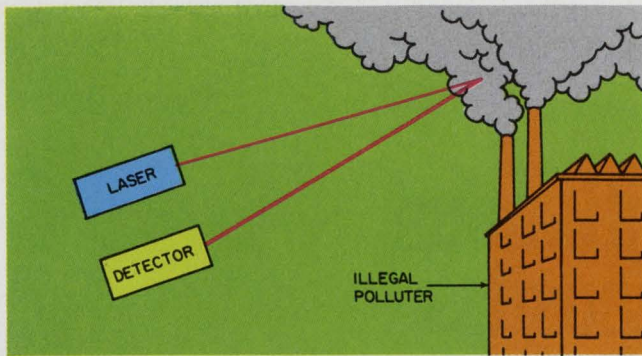

**Fig. 5.** Either absorption scattering or Raman scattering can be used for remote monitoring of air pollution. Stack emissions or layers of smog can be analyzed with laser techniques. A characteristic emission spectra is transmitted from the constituents of the gas when hit at certain wavelengths by a pulse of high-power laser energy.

now  $\pm 50\%$  or worse."

Most serious of the problems faced by the manufacturers of source sensors is fouling of the probes by pollutants other than those that are being measured in water; and high temperatures and corrosive action on the probes in stacks.

#### Antipollution network envisioned

"We see a network of remote pollution sensing stations around the world," says Frank G. Compton, president of Environmental Control Corp. in Denver. "These stations would be ground, water, air and satellite-borne. They would be tied together in a huge computerized network, the output of which would be a real-time pollution map of the world. This would be similar to the weather prediction network now in use."

Compton notes that the biggest technical drawback at present to this type of a network is the lack of reliable, service-free sensors for ambient monitoring. The network would require remote sensors, signal-conditioning equipment, interface electronics, telemetry equipment, data-processing equipment and display equipment.

The remote sensors would have to be non-wet chemical types. The signal-conditioning equipment would be such that each sensor had the same type of output. John M. Mylne, program manager at the Motorola Applied Systems Unit in Riverside, Calif., says:

"There is a strong need for standardization of sensor outputs. Some sensors have millivolt outputs, and some have volt outputs. A standard linear scale of 0 to 5 V would make design of automated systems a lot easier. Zero to 5 V is much better than 0 to 20 mV in a data-acquisition system, because of millivolt-level common-mode noise problems and any other low-level

noise in the system."

Thomas G. Hynes, general manager of the Thermal Systems Div. of Axial Corp., Los Angeles, describes a typical signal-conditioning system of the type used with temperature sensors:

"Platinum resistance temperature sensors become one leg of a Wheatstone bridge. The millivolt output of the bridge is fed into an op amp. You need feedback circuitry from the output of the op amp to the bridge to linearize the signal. The output of the op amp can be in the 0-5 V range."

Interface electronics normally consist of analog to digital conversion. Telemetry equipment depends upon the required bit rate of data transmission and the frequency of measurement.

Mylne of Motorola notes:

"Remotely operated gas chromatographs will typically take a sample once every five minutes. Some other sensors might make measurements once every two or three minutes. To monitor about 16 sensors once every two or three minutes, all you need is a data rate of about 250 bits per second."

That type of bit rate allows a great deal of flexibility in the choice of a telemetry system. If convenient, a telephone line would do. If not, a simple FM transmitter operated off a battery pack or a panel of solar cells would be sufficient, provided that the distances were not too great. Most pollution-control specialists feel that a measurement every 15 minutes is sufficient.

Minicomputers are capable of doing all of the data-processing in a system such as this. Mylne suggests that about 16-k bits of storage is all that would be necessary.

Display electronics is commonly teleprinter. However, more and more interest is being shown in CRT terminals. A terminal would give the operator a variety of ways of looking at his data. He might want to look at histograms of performance or plots of sensor down time, for example, as well as printed output data of pollutant levels.

Kenneth Sawa, R&D manager at Beckman Instruments in Fullerton, Calif., says that one of his display problems is the lack of inexpensive linearization circuitry. Most sensors have non-linear outputs, but the operator wants to see only straight-line relationships.

Pollution monitoring and control will be standard in plants and buildings before too long, most specialists in the field believe. John Hearn of Hewlett-Packard draws an analogy to plumbing. He says:

"When we build a building or plant today, we don't question the need for bathrooms or plumbing. I believe that the same will be true of pollution-control equipment in about 10 years." ■■



**We're doing  
the unheard of in continuous  
fusion bonded composites.**

**Ever hear of  
copper-clad glass-supported  
silicone rubber as a  
flexible circuitry material?**

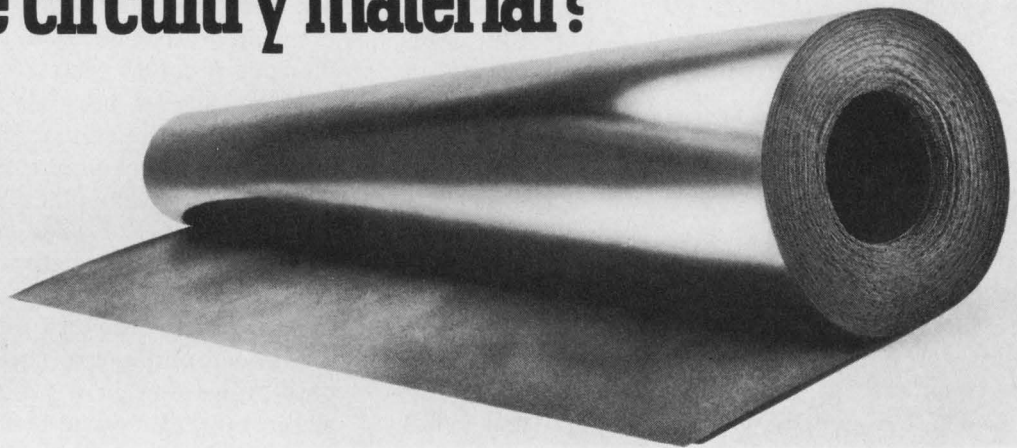

Right now, we're the only ones making it. And we're selling it for nearly half the price of copper-clad polyimide film.

The price, we admit, doesn't mean much if you've never heard of copper-clad glass-supported silicone rubber. But it means a lot if you can use it.

Consider its properties: outstanding flexibility, dimensional stability and electrical properties; peel strength of approximately 9 lbs./inch; readily etched and soldered; retention of properties over a broad temperature range ( $-65^{\circ}\text{F}$  to  $600^{\circ}\text{F}$ ); flame retardant if desired; bondable to a glass-supported silicone rubber cover sheet without the use of adhesives; cushioned circuitry to minimize fracture; and no circuit "swimming".

If this isn't enough, one customer uses our material to make flexible *multilayer* circuits.

A typical configuration is .003" silicone rubber/.004" glass fabric/.003" silicone rubber, clad either one or two sides with electrolytic or rolled copper. You choose.

We can make continuous composites by fusion or adhesive bonding in an almost unlimited number of material combinations . . . copper, steel, and other foils, bonded to silicone rubber, FEP film, polyimide film, ionomer film, or polyester film . . . FEP/Nomex combinations . . . you name it. And since they all come in continuous rolls (up to 40" wide), you can get the economy of continuous etching. (Our composites can also be supplied in sheets, slit to width coils, or cut to size panels if desired.)

If you have a problem that requires an unusual composite material, we can solve it. And probably save you some money, too.

Make us prove it.

Contact The Budd Company

Polychem Division

70 S. Chapel St., Newark, Delaware 19711

**THE *Budd* COMPANY**  
POLYCHEM DIVISION



# Take a GOOD LOOK at ERIE'S LOW COST SUBMINIATURE CERAMIC TRIMMER CAPACITOR...

## Series 511

- OFF THE SHELF DELIVERY
- LOW COST
- SPACE SAVER ... OCCUPIES ONLY .007<sup>3</sup> IN.
- DESIGNED TO ASSURE RIGID MOUNTING STABILITY

Plus, you get a wide capacitance range in either of two low-profile mounting arrangements ... for top or side adjustment. When you consider the low cost, excellent reliability, tiny size and fast delivery, Erie's 511 is the perfect trimmer for your current circuit applications. Erie 511 ... take a good look, then try it. Write for Bulletin 511 — ask for samples too.

### APPLICATIONS

Typical applications include crystal filters and oscillators, CATV amplifiers, attenuators ... and equipment such as avionics, telemetry and color TV cameras where high component density is vital.

### SPECIFICATIONS

Working Voltage . . . . . 100 WVdc @ 85°C.  
50 WVdc @ 125°C.

Dielectric Strength . . . . . 200 WVdc for 1-5 sec.  
Operating Temperature Range —55°C. to 125°C.  
Q Factor @ 1 MHz 500 min. (values 5pF and above)

### CAPACITANCE RANGES

1-3 pF      3-9 pF      6-22 pF  
2-5 pF      3-15 pF

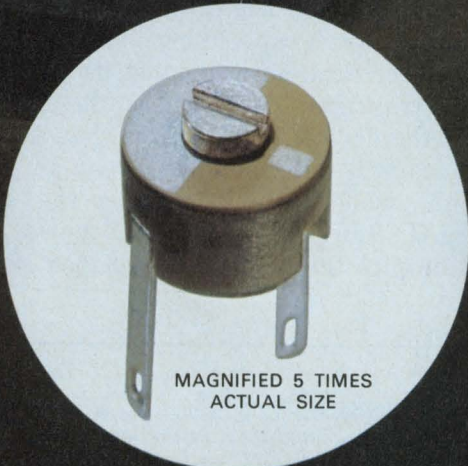
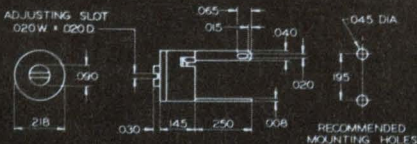



## **Watch those losses** in low-power amplifiers. Otherwise you may be rudely surprised to find that your transistors aren't lasting as long as they should.

All engineers know that efficiency is very important in high-power rf amplifier design. What is often not appreciated is that unexpected losses can have catastrophic consequences in low and medium-power circuits as well.

The catastrophe comes about because economic considerations usually dictate that an amplifier should contain the smallest possible number of transistors, all pushed very close to their operating limits. Then, if a small unexpected loss is encountered, transistor failure—either immediate or slightly delayed—is almost sure to follow because of the “quick fix” measures that are commonly employed to make up for the loss.

The most tempting way to compensate for the loss is to push a little more dc bias through the transistor to pick up the needed additional gain. And here is the often-unexpected rub: *Low-power, high-gain devices tend to be significantly less efficient than their high-power, low-gain counterparts* (Fig. 1). Hence, getting a little more power out of one of them may involve dissipating quite a bit more heat. And if the junction temperature is already operating near its safe limit, disaster is just a short step away.

### **Direct heating is a problem, too**

Lossy interstage components can create thermal problems in yet another way: They can simply heat up the transistors directly. For wide bandwidths, impedance-transforming networks of the type shown in Fig. 2 are often used.

Although each capacitor causes some loss,  $C_4$  is the most critical, since it must be placed directly at the transistor case, where the metallic lead enters the device. This ensures that the input inductance will not cause too great an impedance step-up, which would increase the amplifier's loaded-Q. Since  $P_{in}$ , the input power, remains fixed despite the drop in impedance level, circu-

lating current  $I_4$  may be on the order of several amperes.

Significant amounts of heat can be generated in  $C_4$  if the capacitor's dissipation factor is poor (in some types, it's enough to melt the solder). For example, if its equivalent rf series resistance were only  $0.1 \Omega$ , an input of only a few watts would cause about 0.25 W of dissipation in the capacitor.

Because of the intimate connection between this capacitor and the transistor, they mutually degrade each other's operation—the capacitor adding to the transistor's heat burden, and the transistor's heat degrading the capacitor's Q (usually exponentially with temperature). Since the transistor is usually operating at its maximum safe power level ( $T_j$ , typically hovering just at or above  $180^\circ\text{C}$ ), any heat input from sources outside the transistor will eat into this safety margin, making the junction more likely to develop hot spots that will lead to degradation and eventual failure.

### **0.5 dB may be bigger than you think**

To see just how serious these seemingly simple considerations really are, let us assume that we wish to design an inexpensive amplifier capable of producing 5 W at 400 MHz from a 28-V dc supply. According to Fig. 1, the average output transistor will have about 7 dB of gain. Therefore the driver stage will have to deliver about 1 W of rf power.

Now, if we are unaware of the existence of extremely low-loss capacitors for the interstage network, we may be rudely surprised to discover that there is, say, a 0.5-dB transmission loss between the driver and the output stage.

Two quick fixes come immediately to mind:

1. Pull out the driver and replace it with a higher gain—but more expensive—device.
2. Bias the driver closer toward saturation to pick up the needed gain.

Since higher-gain devices have lower collector efficiencies (Fig. 1) and cost more, and we already have a working device in the circuit, we choose to push more dc through the one we have.

---

Vincent F. Perna Jr., Vice President, Microwave Engineering, American Technical Ceramics, 1 Norden Lane, Huntington Station, N. Y. 11746.



## Keep cool: Heat can kill transistors in two ways

Operating a transistor at too high a temperature can lead to device failure in these ways:

- Secondary breakdown—a catastrophic failure mechanism in which the collector and emitter get shorted together.

- The mass transport phenomenon—a more subtle occurrence in which the transistor's lifetime is greatly shortened by the migration of its metallization under the influence of both high-temperature and high-current density.

The effect of junction temperature on transistor lifetime, through the mass-transport mechanism, is profound. Going from a junction temperature of 180° to 190°C, cuts the device life in half. And going to 200°C cuts it down to a quarter of the 180°C value. At this rate even the seemingly small temperature rise of 4°C (cited in the example in the text) will reduce the transistor's lifetime to 75% of what it would have been at 180°C (see illustration).

### Secondary breakdown is sudden death

Secondary breakdown is the result of localized current crowding that raises temperatures enough to melt the semiconductor material. As the material melts, its resistivity is drastically reduced, and the collector-to-emitter junction takes on the electrical characteristics of a metallic conductor. This typically occurs between 200 and 300°C, depending upon the material.

Although manufacturers usually specify 200°C as the maximum safe junction temperature,  $T_{j(max)}$ , it should be borne in mind that the temperature at a localized hot spot may be well above the average. If this occurs, the hot spot can trigger secondary breakdown at that point.

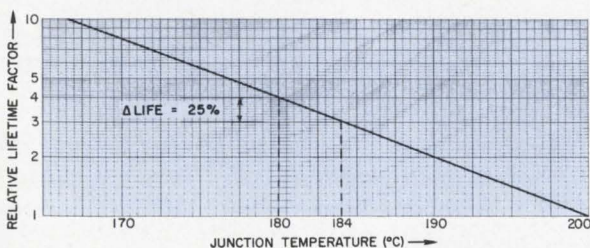

Consequently most manufacturers recommend keeping  $T_j$  well below 180°C for reliable long-term operation.

Secondary breakdown is energy dependent—that is, it is a function of time, voltage and current. To fight it, therefore, some devices are provided with curves showing safe operating conditions. When these are not available—as is often the case with microwave transistors—the engineer must be exceedingly careful.

### Mass-transport phenomenon works 2 ways

Silicon devices with aluminum metallization exhibit two distinct wear-out failure modes. The first is the formation of an open circuit in a conductor, caused by the stripping away of metal ions by the high-intensity “electron wind.”

The second is the etching of pits into the silicon, caused by its diffusion into the aluminum, and its subsequent transport away from the Si-Al interface. As the silicon is carried away, it is replaced by aluminum, and the process continues until a pit grows deep enough to short out an underlying junction.

The transported silicon and aluminum are deposited where the conductor path widens—where the current density falls—and build up hillocks, whiskers and crystals that can then short out to other circuit points.

Metal ions can be more easily stripped away by the electron wind when they have been thermally activated enough to be essentially free of the metal lattice. The square of the current density determines the magnitude of the force acting on activated silicon ions. Thus the mass transport mechanism is dependent upon both current density and temperature.

For typical small conductor geometries (ignoring the increased rate of failure caused by a positive gradient in either current density, temperature or ion-diffusion coefficient), failures caused by mass transport become especially important when the temperature exceeds 150°C. By the time 200°C is reached, the lifetime can be measured in hours—provided, of course, that secondary breakdown doesn't strike first.



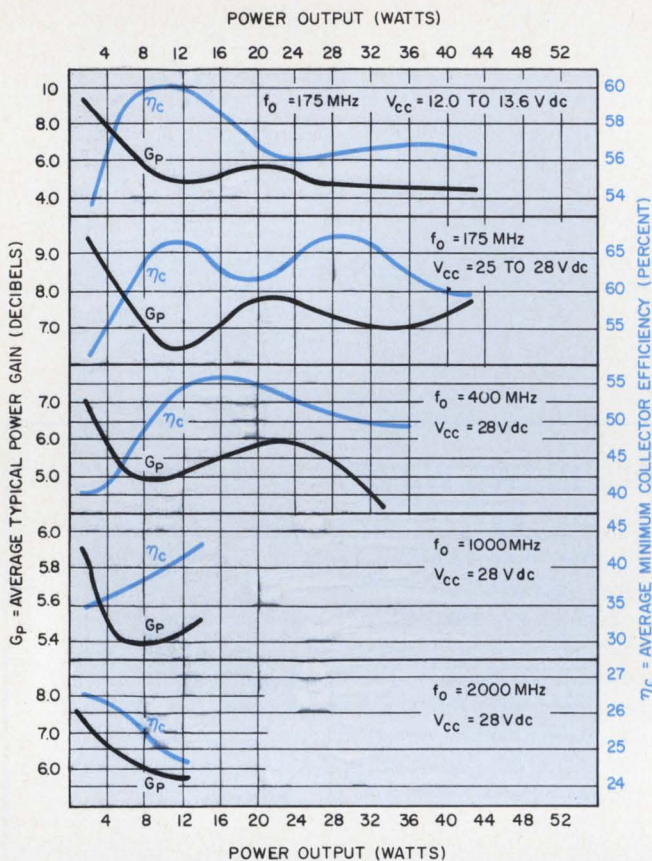

1. Gain and efficiency are inversely related below about 10 W, especially at low frequencies. These curves are based on the published data for over 100 devices made by 10 manufacturers. The curves are only a guide to typical behavior—they are not definitive for a specific transistor. Note that an efficiency reduction of about 25% can be expected when a high-gain, low-power device is compared with its high-powered counterpart.

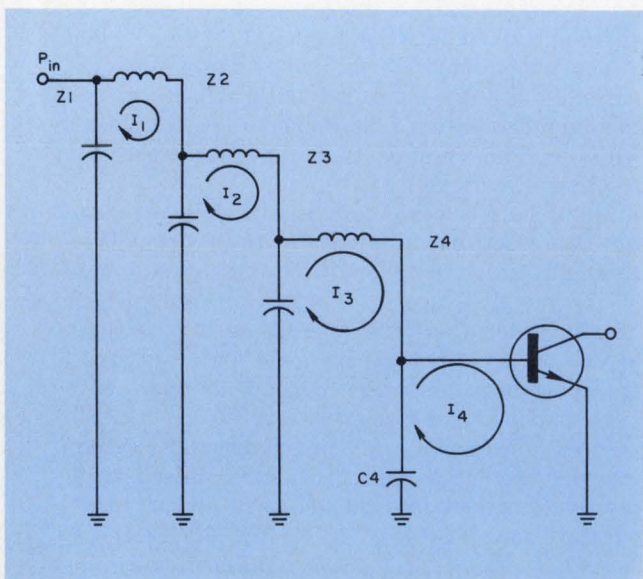

2. If  $C_4$  is lossy, it can get hot enough to melt solder because of the high circulating current ( $I_4$ ) that flows in a low-impedance circuit. Since  $C_4$  is intimately connected to the transistor, this temperature increase doesn't do the latter any good either.

For a driver collector efficiency of 40% and a need for 0.1 W of additional rf power, we'll have to put  $0.1 \text{ W}/0.40 = 0.25$  more watts of dc through the device, leaving  $0.25 - 0.10 = 0.15 \text{ W}$  more power to be dissipated as heat.

The average junction-to-stud (or case) thermal resistance of the types of transistor under consideration is approximately  $24.3^\circ\text{C}/\text{W}$ . Thus, even if we assume that the transistor is operating on an infinite heat sink with zero thermal resistance between itself and the outside world, the temperature rise at the junction due to the increased dc dissipation is  $0.15 \text{ W} \times 24.3^\circ\text{C}/\text{W} = 3.64^\circ\text{C}$ . This temperature rise in the driver could have been avoided by using lower-loss capacitors.

For a transistor with a maximum temperature rating of  $200^\circ\text{C}$ —and which we'll push to the accepted limit and operate at  $180^\circ\text{C}$ —we would discover that the hoped-for margin of  $20^\circ\text{C}$  had shrunk to  $16^\circ\text{C}$ . Add to this the fact that an infinite heat sink with zero thermal resistance is not ordinarily available, nor is a zero thermal resistance connection between the heat sink and the transistor, and we see even more of that safety margin disappear.

If getting out that last 0.5 dB forces the transistor into saturation, there will be a further decrease in stage efficiency, leading to an additional temperature rise. And all of this does not include the possibility that extra power will be demanded from the preceding stage because of the gain non-linearity of the saturated transistor.

It should be noted here that the transistor-gain data of Fig. 1 is based on average—not minimum—values. In practice, of course, the engineer must face the prospect that he will receive a moderate number of minimum-gain devices along with the average ones. This is one further reason for exercising care in selecting external components that can contribute to losses. ■

### Test your retention

Here are questions based on the main points of this article. Their purpose is to help you make sure you have not overlooked any important ideas. You'll find the answers in the article.

1. What are two ways in which a lossy interstage capacitor can lead to transistor failure?

2. How are the efficiency, power rating and gain of rf transistors related?

3. Why is it desirable to mount the matching capacitor ( $C_4$  in Fig. 2) so close to the transistor that mutual heating becomes a problem?



# CUTLER-HAMMER'S BIG NEW LINE OF COMMERCIAL MINIATURES.

Toggles. Pushbuttons. Rockers. Rotaries. Available in a vast array of operator styles, colors, and shapes. Including illuminated pushbuttons and rockers. Many featuring snap-in mounting. And all in stock for fast delivery!

Now the same great quality, service and availability you've come to expect from Cutler-Hammer is available in miniature size—at a competitive price!

Make your selection. Standard or watertight. Single or multiple pole. A wide range of decorator caps, buttons, bezels that extend application flexibility. And for their size, hefty electrical/mechanical ratings.

Before you place that next order, check with your new source for commercial miniature switches—your nearest Cutler-Hammer Sales Office or Authorized Stocking Distributor.



**CUTLER-HAMMER**  
SPECIALTY PRODUCTS DIVISION, Milwaukee, Wis. 53201



Switch  
to No. 1

More than just switches:  
prompt availability,  
field help, innovation,  
quality assurance, too.



# All Relays Are Not Created Equal!

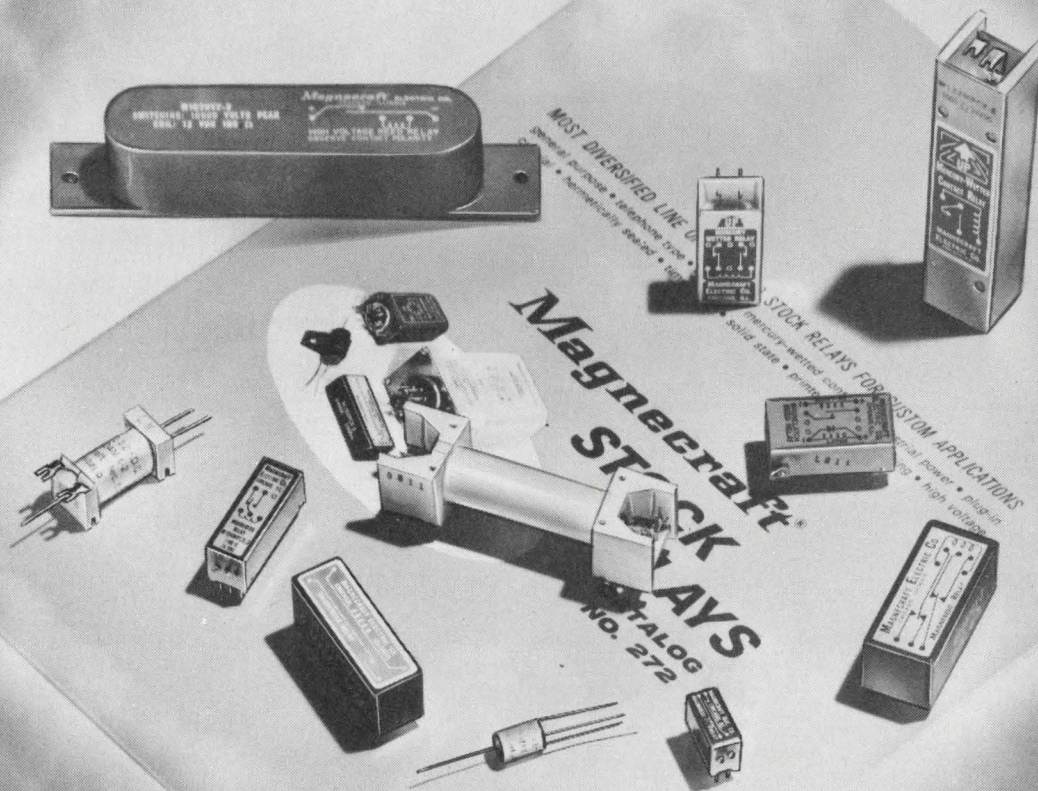

## Magnecraft Creates Better Reed Relays.

Magnecraft relays are not created equal because they are created to be better. Created better than its competitors, created better than the most demanding requirements, created better because reliability is important. We are then in the best position to help solve your switching and control needs, not just sell you a relay.

We have demonstrated our Engineering leadership in reed relays, over the past decade, in many ways. Our break-through in high voltage switching, utilizing a reed relay. The Class 102UHV is capable of switching 20,000 volts at 1 milliamp. Our I. C. compatible reed relays operate directly from TTL or DTL circuits without the use of Buffers, Op Amps, or anything else, as they require only 40 to 50 milliwatts of power at 2.5 VDC or 5.0 VDC. We have also brought you the latest advancements in mercury-wetted reed relays, offering bounce free switching and virtually a limitless lifetime of operations. Magnecraft reed relays are created better because of features such as, hermetically sealed contacts, molded nylon coil bobbins, and contact leads that are soldered stress free to terminal pins. The next time your circuit calls for a reed relay, turn to Magnecraft with confidence.

Your first step is simple. Send today for Stock Catalog #272, listing over 550 different relays stocked by Magnecraft and its nationwide network of distributors.

**Magnecraft**<sup>®</sup> ELECTRIC COMPANY

5575 NORTH LYNCH AVENUE • CHICAGO, ILLINOIS 60630 • 312 • 282-5500 • TWX-910-221-5221

INFORMATION RETRIEVAL NUMBER 36



# Over 50-million SCR's from General Electric... one for every application

In 1957, General Electric introduced the first silicon controlled rectifier. The SCR has gone on to prove itself a real workhorse in power-control applications. And GE has gone on to manufacture 50-million SCR's for use in power supplies, appliances, automobiles, business machines, industrial process controls . . . its uses are limitless.

GE took the lead in SCR technology and manufacture and extended it over the years. Fifty million SCR's later, GE still offers a broader and more complete line of high quality, high reliability devices than anyone else. No one offers a wider selection of electrical ratings—from 800 ma. to 1300 amps, 25 volts to 2600 volts. No one offers more package types—stud mounts, lead mounts, Press Paks, plastic-encapsulated devices, press fits. No one offers greater reliability than that which comes from making 50 million SCR's. And no one offers greater application assistance—application engineers, published spec sheets, application notes, and GE's 500-page SCR Manual.

The result—there is no greater coverage of SCR applications than that offered by General Electric. When you use a GE SCR in your circuit, you benefit from all the skill that we've acquired in 14 years of SCR leadership.

For more information about these and other General Electric semiconductor products, call or write your GE sales engineer or distributor or write General Electric Company, Section 221-35, 1 River Road, Schenectady, New York 12305. In Canada: Canadian General Electric, 189 Dufferin Street, Toronto, Ont. Export: General Electric Co. International Sales Division, 159 Madison Avenue, New York, N. Y. 10016.

**Over 50-million SCR's . . . practice makes perfect!**

GENERAL  ELECTRIC

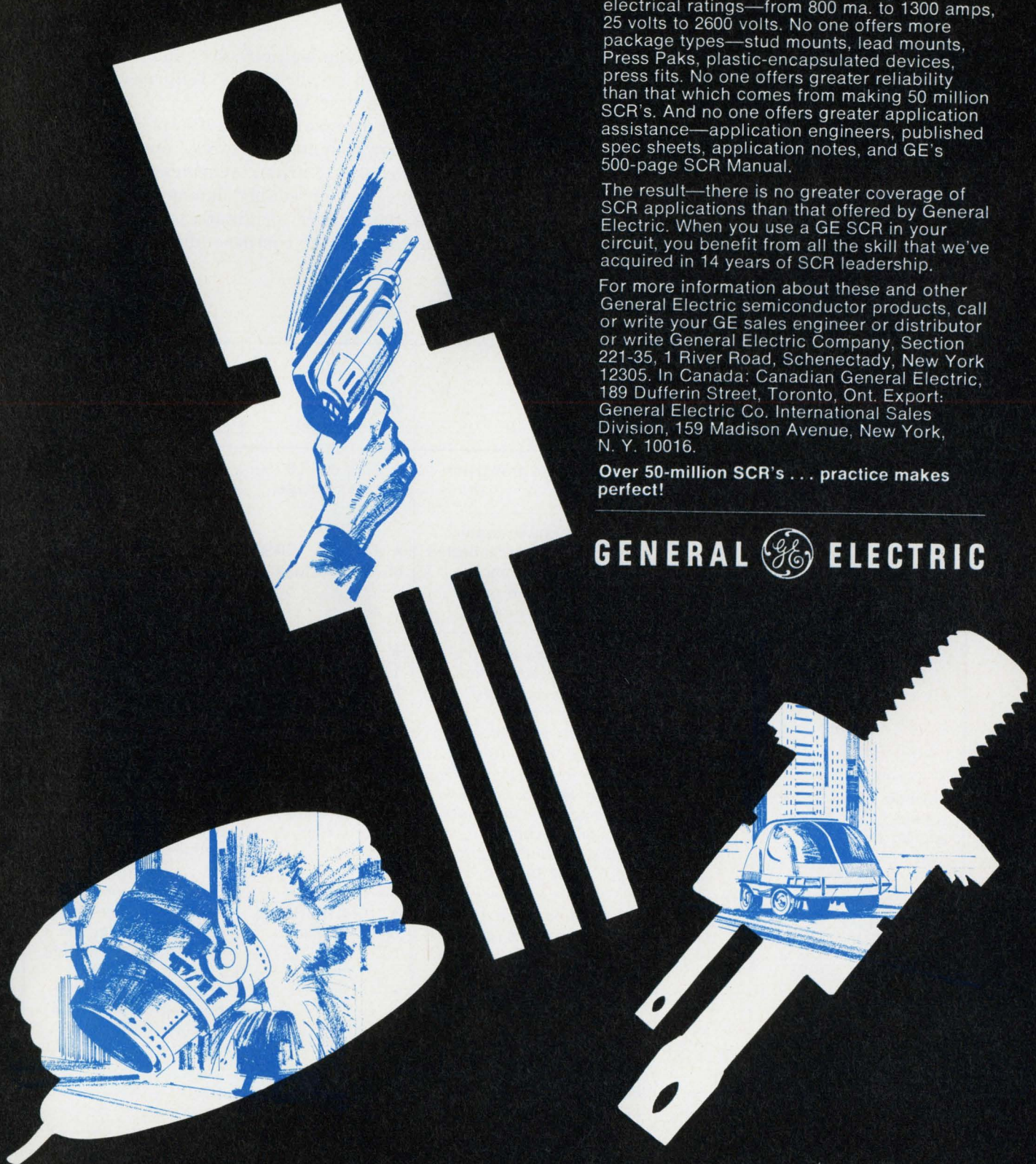



# Here are more protective circuits

for power supplies and their loads. They can keep a local failure from destroying an entire system.

*Second of two articles*

It is pretty well known that power supplies must be protected from short-circuits. In costly electronic systems—computers, say—it is equally

---

**Anthony Annunziato**, Research Section Supervisor, Mail Station A-37, Sperry Gyroscope Div., Sperry Rand Corp., Great Neck, N.Y. 11020.

---

evident that the load circuitry must be protected against such power-supply failures as overvoltage and reverse voltage.

Table 1 summarizes the faults caused by internal power-supply failures, operating errors and overloads. Various schemes for preventing extensive load or supply damage (regardless of where the failure originates) are outlined in Table 2 and in the corresponding figures. ■■

**Table 1. How damage is caused.**

Fault	Damage		Major causes	Magnitude (approximate)	Typical protective circuit
	Load	Power supply			
Overvoltage applied to load	X		<ul style="list-style-type: none"> <li>Series pass transistor fails short.</li> </ul>	<ul style="list-style-type: none"> <li>30% to 100% of rated voltage.</li> </ul>	<ul style="list-style-type: none"> <li>SCR crowbar and fuse decoupling (Fig. 2).</li> </ul>
	X	X	<ul style="list-style-type: none"> <li>Several power-supply outputs are interconnected (bridged) by common circuits, and one power supply fails to turn on.</li> </ul>	<ul style="list-style-type: none"> <li>30% to 100% of rated voltage.</li> </ul>	
	X	X	<ul style="list-style-type: none"> <li>External power cable (ac or dc power lines) touches power-supply output terminals (technician troubleshooting).</li> </ul>	<ul style="list-style-type: none"> <li>For ac lines 115 V-208 V; for dc lines 15 V to 300 V.</li> </ul>	
Reverse voltage applied to load	X	X	<ul style="list-style-type: none"> <li>Positive and negative power supplies are bridged together by common circuits, and one power supply fails to turn on.</li> </ul>	<ul style="list-style-type: none"> <li>30% to 100% of rated voltage.</li> </ul>	<ul style="list-style-type: none"> <li>Reverse diode is connected across the power-supply output terminals (Fig. 2).</li> </ul>
Power supply subjected to overcurrent		X	<ul style="list-style-type: none"> <li>Partial load circuit failures (short circuit).</li> <li>Pinched cables. Decoupling capacitors short-circuit (electrolytic failures).</li> <li>Troubleshooting results in shorted power-supply output terminals.</li> </ul>	<ul style="list-style-type: none"> <li>10% to 300% of rated load.</li> </ul>	<ul style="list-style-type: none"> <li>Crowbar and fuse decoupling (Fig. 2) or automatic resetting. Turn-off circuits (Figs. 8 &amp; 9) or line-toggling reset (Fig. 4) or current-limiting (Figs. 1 &amp; 5).</li> </ul>



**Table 2. Select the protection that suits your needs.**

Figure	Protection			Advantages	Disadvantages
	Over-voltage	Reverse voltage	Overload or short circuit		
12			X	<ul style="list-style-type: none"> <li>■ Simplicity.</li> <li>■ Dc current sampling offers fast response.</li> <li>■ Inexpensive.</li> <li>■ Automatic recovery.</li> </ul>	<ul style="list-style-type: none"> <li>■ Half-cycle response time.</li> <li>■ Resistor sampling reduces power-supply efficiency.</li> </ul>

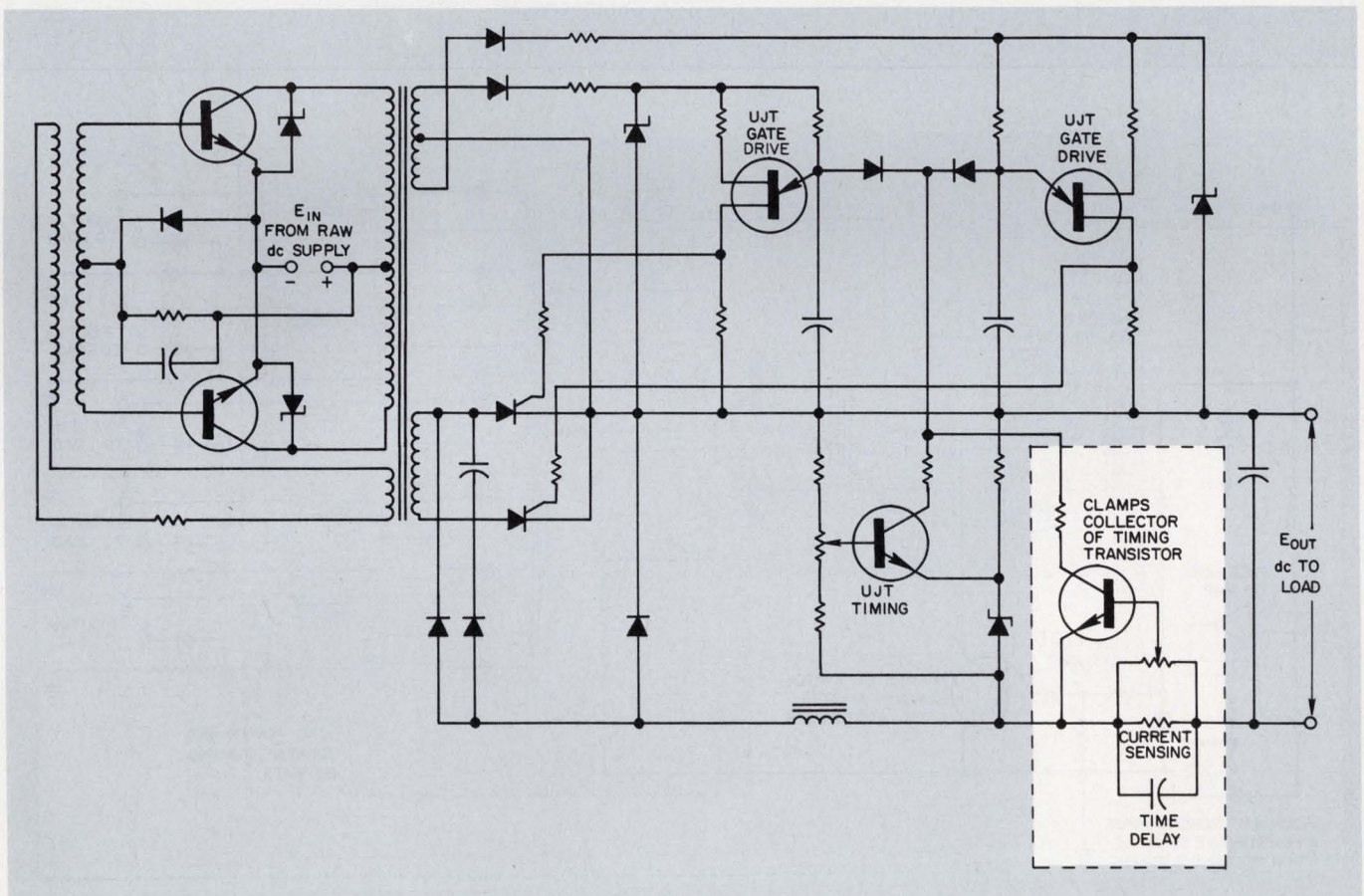

**12. SCR switching regulator using resistor sensing automatic recovery.**

*(continued on next page)*



**Table 2. Select the protection that suits your needs.**

Figure	Protection			Advantages	Disadvantages
	Over-voltage	Reverse voltage	Overload or short circuit		
13			X	<ul style="list-style-type: none"> <li>Low-cost method of providing protection for many outputs.</li> <li>Simple and reliable.</li> <li>Line-toggle recovery.</li> <li>Fast response.</li> </ul>	<ul style="list-style-type: none"> <li>Increases source impedance of each output (poorer regulation).</li> <li>Resistors sensing decreases over-all power-supply efficiency.</li> </ul>
14			X	<ul style="list-style-type: none"> <li>Same as Fig. 13 except capacitive sensing is lossless.</li> </ul>	<ul style="list-style-type: none"> <li>Capacitance is additive, requiring large changes in normal load current to shut down (basically a short-circuit protection scheme).</li> <li>More expensive than Fig. 13</li> </ul>
15	X	X		<ul style="list-style-type: none"> <li>Provides fast response, line decoupling and load overvoltage arresting simultaneously.</li> <li>May be added externally to purchased off-the-shelf power supplies.</li> </ul>	<ul style="list-style-type: none"> <li>Expensive.</li> </ul>

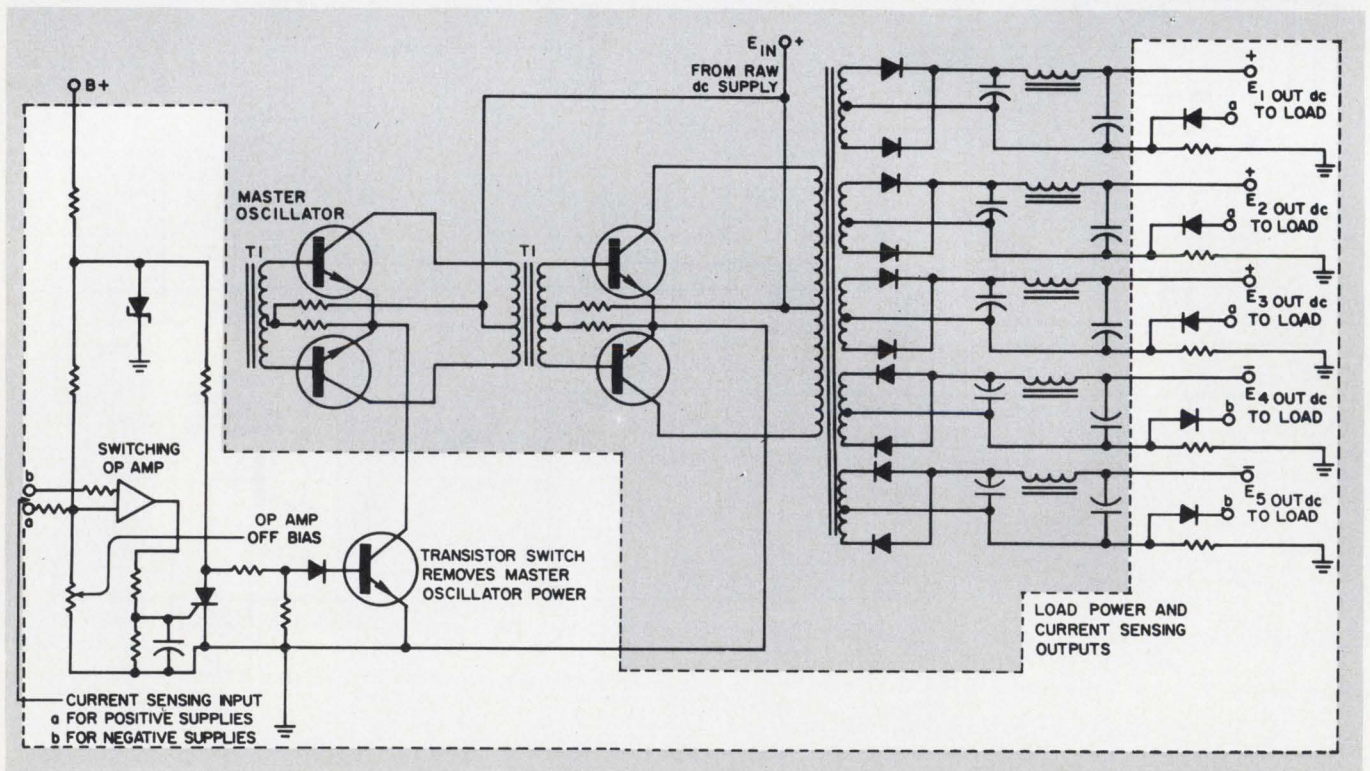

**13. Multiple output line toggle reset using OR'd resistor sensing.**



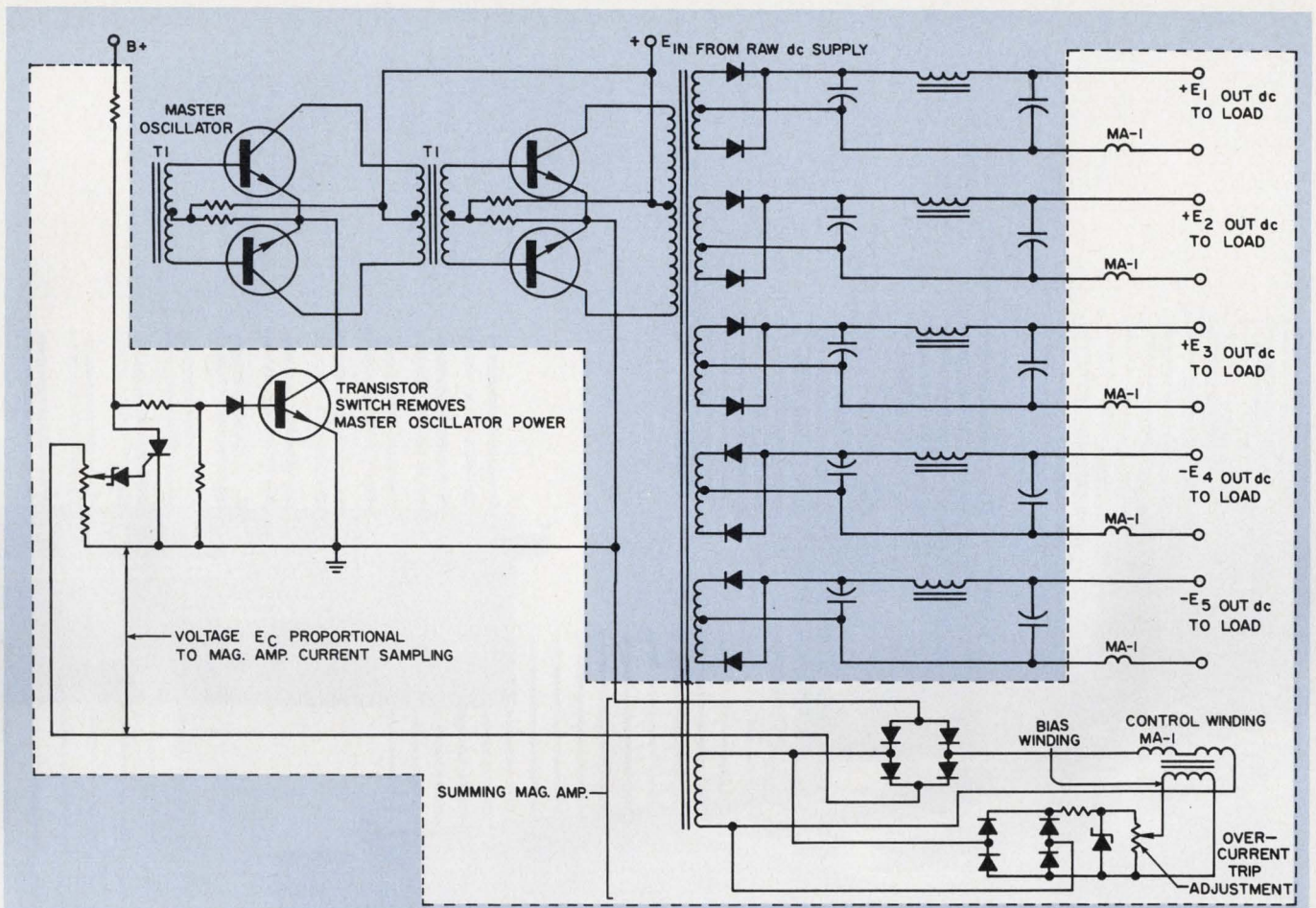

14. Multiple output line toggle reset using summing mag. amp.

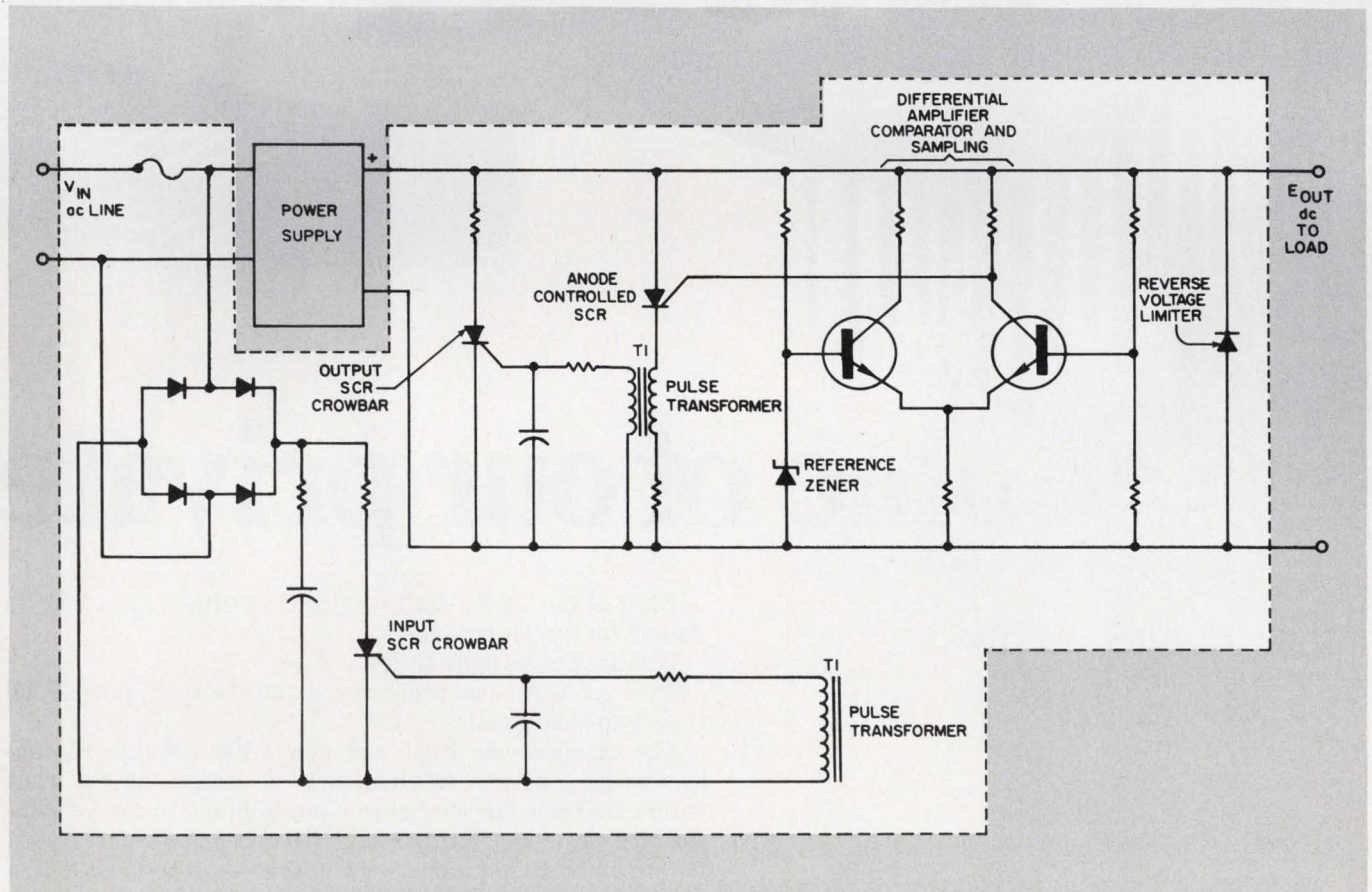

15. SCR crowbar.



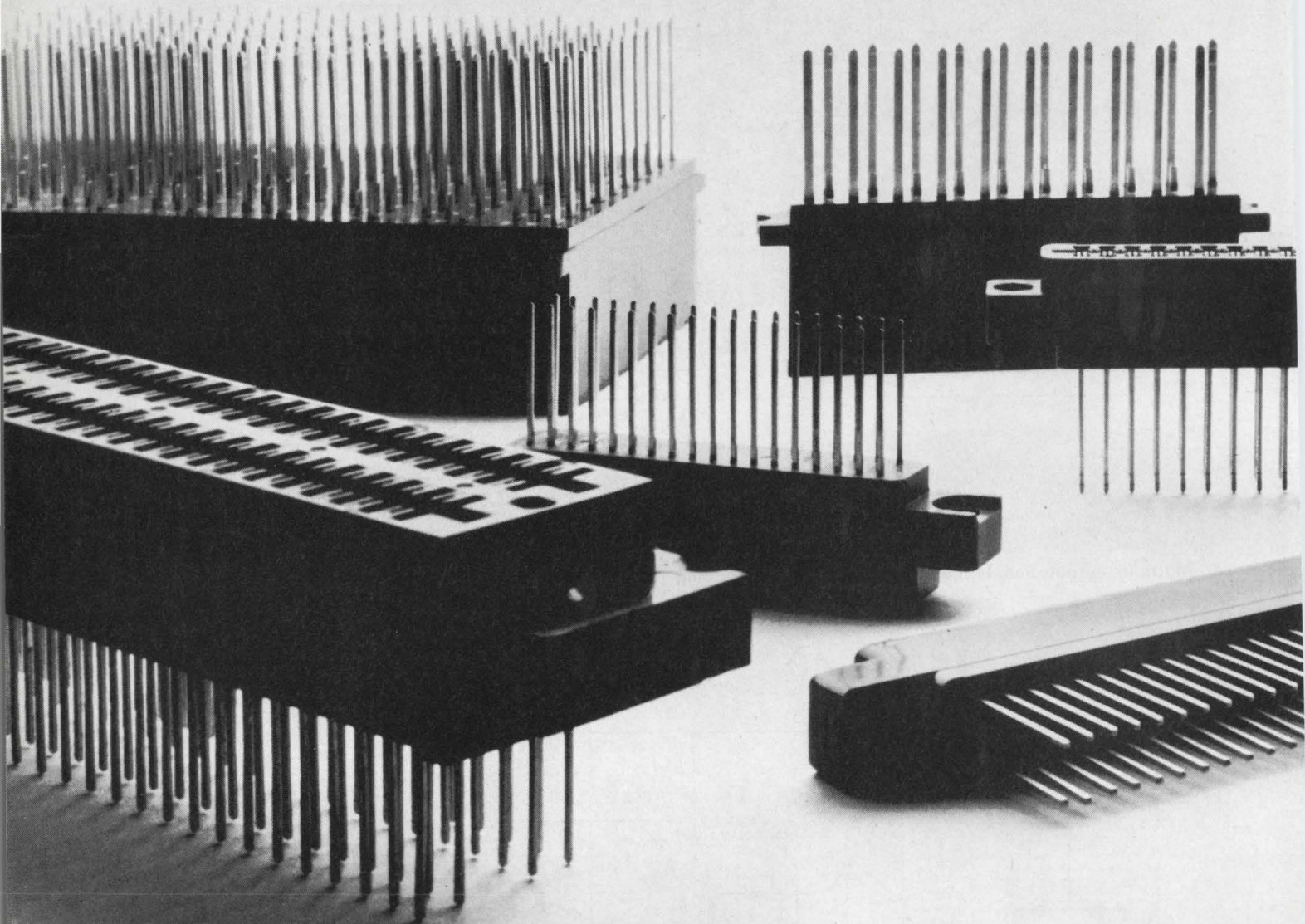

# Some of our private

Most of our off-the-shelf connectors started out as custom designs for specific customers.

Now they're available to you.

You get a custom connector at off-the-shelf prices—and there's no tooling cost.

For example, our P101 and new P201 circuit-card connectors have custom features such as contact-tail tip locus within .020 inch diameter of true position; our exclusive gold-dot contact system (the dots don't fall off) and a life of at least 500 trouble-free insertions and withdrawals. The P101 is also available with gold-plated bellows contacts.

In addition to these, we've got other connectors coming off the drawing board.

For example, our soon-to-be-ready P108 is a rack-and-



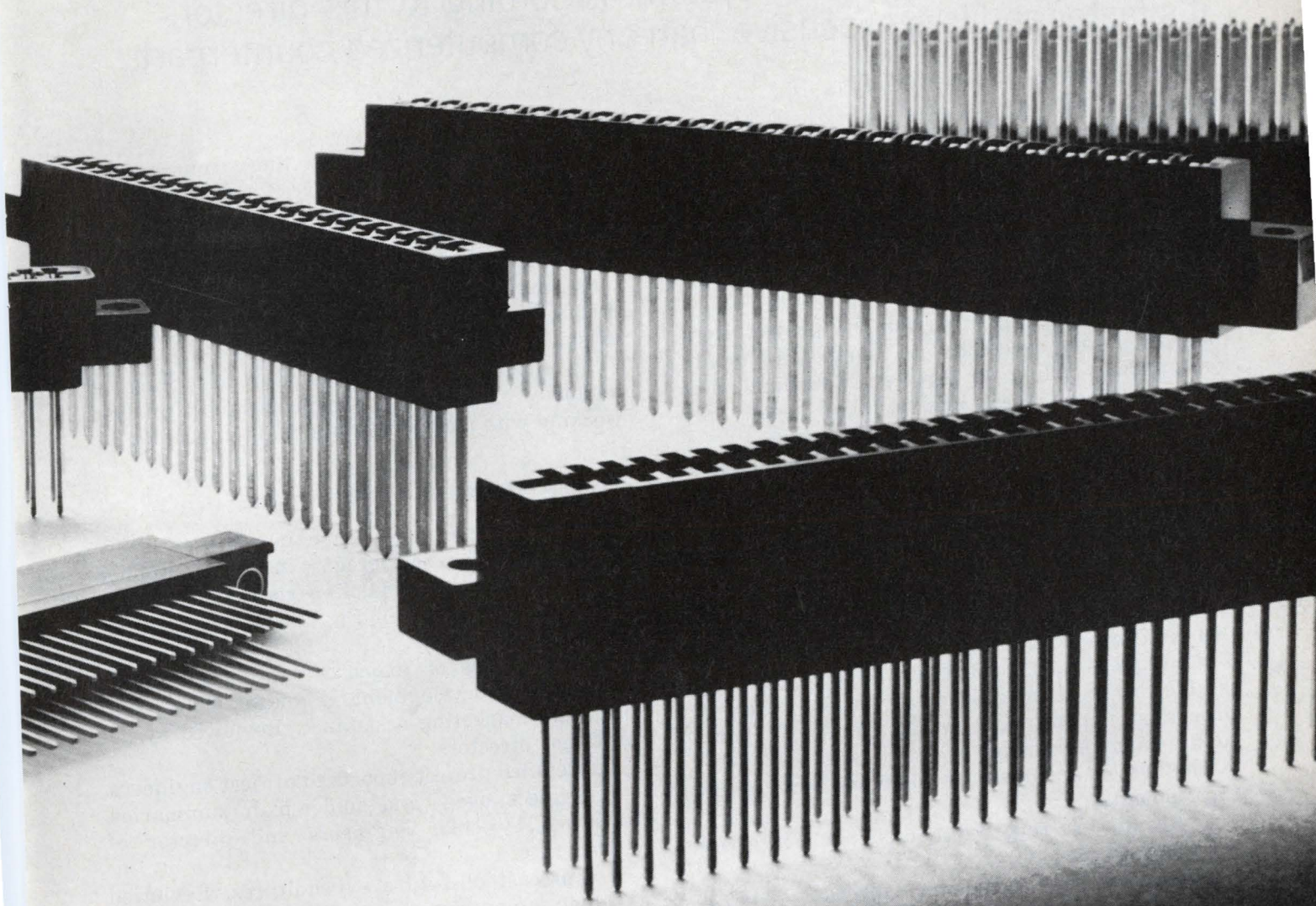

# lines have gone public.

panel connector designed for the same tight contact-tail tolerances. It features a solid pin, solid housing construction and a low price.

The P101 is available with 12 to 100 contacts, and the P201 comes in 36, 72 and 100 contact sizes. The P108 has 50 and 104 contacts. Additional sizes can be made available.

They can become public property at low cost.

And, of course, we still have our complete custom facility available.

For those things you just wouldn't want to do in public.

*GTE Sylvania, Precision Materials Group, Parts Division,  
Warren, Pa. 16365.*

**GTE SYLVANIA**

INFORMATION RETRIEVAL NUMBER 38



## Improve your project control with this 'hand-operated' reporting system. According to this director, it's faster and less expensive than any computerized counterpart.

Although the professional project engineer has all the skills needed to plan and perform his work, he frequently falters when he must predict the cost and completion time of a project. For those engineers who are looking for a better way to plan, cost and control a project, here's a reporting system that is:

- **Fast.** Reporting time for the project engineer should not exceed two to four hours a month on a project calling for three engineers and their support. The project analyst need spend only about one hour a month on each project.

- **Inexpensive.** This hand-operated system costs about \$400 a month to maintain; a comparable system that relies entirely on a computer costs around \$900, plus programming expenses that would run to \$20,000 or more.

- **Innovative.** There are six distinct checkpoints where a different expertise is applied to examine results against plans.

- **Simple.** One experienced project cost analyst is able to report monthly detail on more than 40 programs, and provide several summary reports to upper management.

The system includes the following four essential elements:

1. Results are reported against plans in given time periods.

2. Reports are made on projects; on all projects grouped by several product lines; on expenses in defined categories, and on expenses by departmental source.

3. Control is by hours and dollars.

4. All expenditures are compared with authorized limits.

Here's how the system works:

**Data collection.** Time cards for the system are kept on project personnel by name, skill and department. A similar system is used to collect factory labor time. Dollar expenditures resulting from purchase orders and the value of materials withdrawn from stock are collected by methods established by accounting.

The data collected from these four sources represents all the costs incurred and is input to a computer. The computer summarizes the data prior to printing out reports, some of which are weekly and all of which are monthly. The print-outs group the data by source of charge (departments, etc.) and by project, and show the type of skill resource on time charges.

All reports from this point on are prepared manually on forms by the project cost analyst, working with a calculator and adding machine.

### Monthly reports and who sees them

The reports produced in a monthly cycle are listed in Fig. 1. A different expertise is applied at review of each report. Reports that match the numerical references in Fig. 1 are issued in the following sequence:

1. Summaries of expenses vs allocations for new-product development, manufacturing support, and marketing assistance. Reviewed by department directors.

2. Detailed project reports to project engineers.

3. Project over- and under-plan summaries. Reviewed by chief engineers and director of engineering.

4. Forecast of future expenditures. Reviewed by chief engineers and director of engineering.

5. Department actual expenses by program and product lines. Reviewed by department supervisors.

6. Summary of burden expenses. Reviewed by section supervisors and director of engineering.

7. Collections of costs by product lines in each category of expense. Reviewed by department directors, chief engineers and product-line managers.

Each supervisor also receives a copy of his department budget with actual expenditures vs plan (Ref. 8, Fig. 1), which permits an additional review of all the elements of costs contributing to programs by those responsible for control at the sources of costs.

Inherent to all the report structures are plans, against which actual results will be reported.

---

**Art Binkley**, Administrative Engineer, Honeywell Test Instruments Div., Denver, Colo. 80217



**Figure 1. DESIGN ENGINEERING MONTHLY REPORTING PLAN**

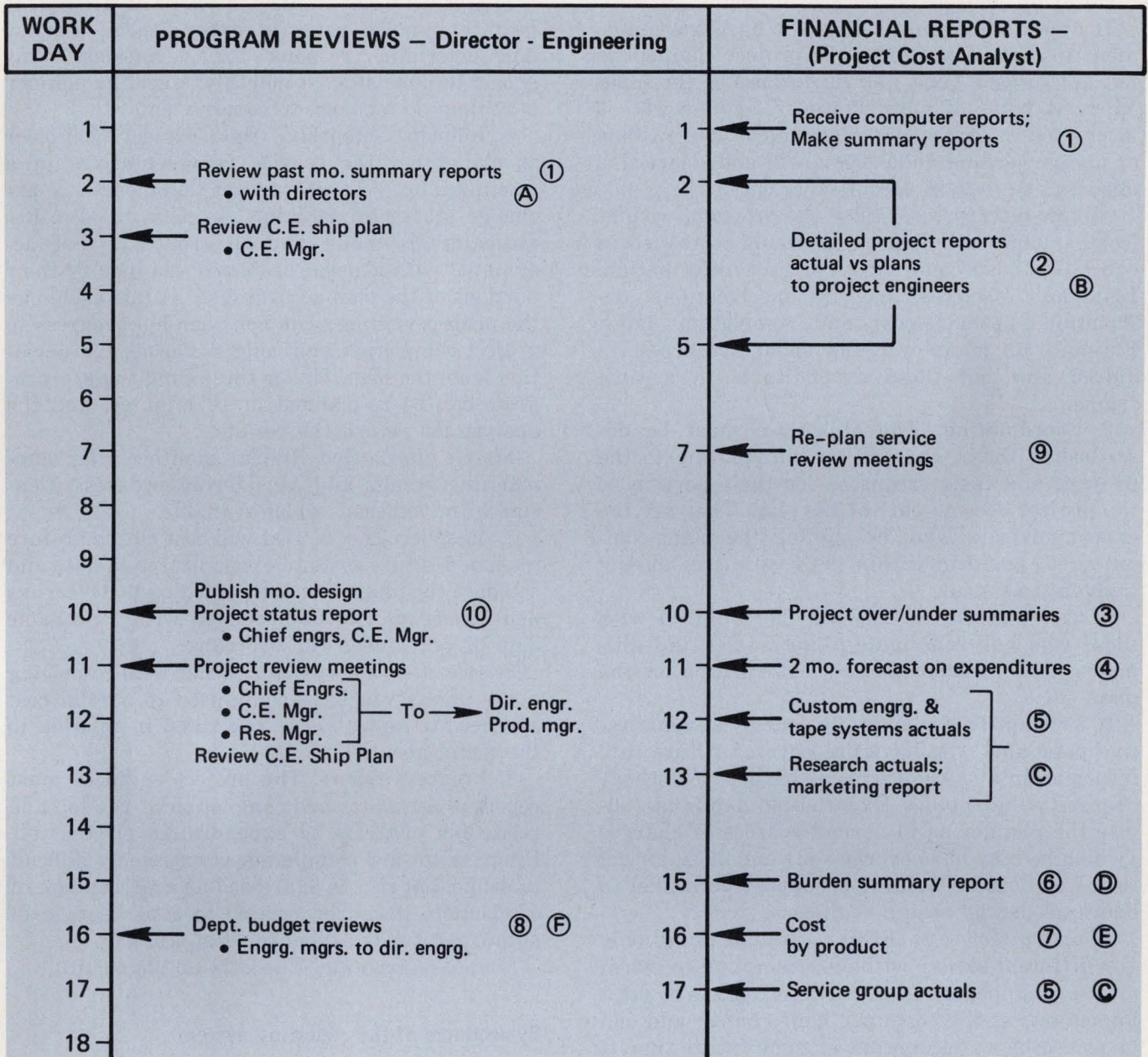

Thus, reference points are established and deviations will be subject to questioning, cross-checking or detailed search when the reason for deviation is known by the reviewer. Figure 2 illustrates one type of report that shows actuals vs plan.

The reporting cycle offers six distinct checkpoints (letter references on Fig. 1) where a different expertise is applied to examine the actuals vs plans.

In true servo-mechanism fashion, deviation from plan permits course corrections to be made. Deviations may also trigger searches of detail

that reveal errors. The errors are corrected, and the reports are refined to that extent. This by-product of the reporting cycle is discussed later.

**Operations and the simple alternatives**

Included with each activity required of the project engineer to operate the reporting system is a simple alternative action, suggested to show how each purpose may be achieved in those situations where administrative services are limited.

1. **Planning.** The objective is to get all the required resources in a time frame to define man-



power needs and expenditure rates, thus providing a baseline for comparison with results. By putting the plans (and those of service groups) in written form, the project engineer will also have created a useful device for coordinating the efforts of all who assist on the project.

If upper management does not have a commitment to serious planning, the project engineer is not apt to do a good job. Regardless of the management point of view, however, anyone who is interested in evaluating what he can do in terms of manpower and dollar costs will not ignore this opportunity to gain useful experience.

*Simple alternative.* Define the program with at least a name and identifying number to use in collecting costs and other project information. List the objectives, such as specifications, description, product cost and completion dates. Estimate all manpower and dollar resources required and put these expenditures in a time frame.

**2. Coordinating.** The objectives must be described to those who will be contributing to the project, and their estimates for their portion of the project become part of the plan. They are the expert advisers, and, by signing the plan, committed to perform within their estimates during a given time span.

*Simple alternative.* Discuss the program with those who will contribute to get advice and estimates, and incorporate this information in the plan.

**3. Pricing.** This is normally done by administrative personnel who have present and future rate information and knowledge of burden (or other) charges to be applied. Experienced hands can advise the planner as to normal sources of charges (which he may have overlooked) and of historical ratios of hours required by support personnel to hours needed by design engineers, etc.

*Simple alternative.* Keep records of hours only (by different skills) without attempting to price; or use assumed average rates. Hours are most important, as the costs per hour change and can be priced by an accountant at some future time if needed. Keep records of dollar expenses.

**4. Data collection.** The system described earlier is operated by administrative personnel. The only time the project engineer has to spend is that needed to learn the use of account numbers and to ensure that personnel under his direction use correct account numbers.

*Simple alternative.* Use the help of a clerk, if possible, to collect time charges weekly on a spread sheet. Your estimates of time spent, recorded daily or weekly, will be better than nothing. Collect copies of purchase orders in a folder to be summarized periodically.

**5. Reporting.** The project engineer's responsibility is to review reports prepared by others, to

look for charges from unexpected sources and for costs that are higher or lower than expected. An alert cost analyst will already have detail ready to explain deviations and will have flagged potential problems.

*Simple alternative.* Use the help of a clerk, if next to planned rates of expenditures. Review and determine reasons for deviations. This should be done at least monthly, since the planner is relying on memory to some extent.

**6. Re-plan.** Monthly the project engineer should gather the service representatives in a meeting and request project engineers to exchange status information on each project. Re-estimates are made, and all groups become acquainted with general problems and modify their portions of the plan accordingly. At this exchange the project engineer can consider his progress to project completion and collect reasons for deviation from the plan. Under these conditions, a program can be re-planned in 10 minutes, and the analyst can record the results.

*Simple alternative.* Re-plan monthly after summarizing results and considering progress. Consult with "experts" when available.

**7. Re-price.** The analyst will cost out the future plan, add future costs to expenditures-to-date and compare the total with authorized costs. Overruns and underruns will be predicted with a probable date of occurrence for overruns.

*Simple alternative.* Don't bother with re-pricing hours unless you have committed to a total cost and need to know where you stand in relation to the commitment.

**8. Progress report.** The project engineer must report progress toward completion of the job and relate his progress to expenditures on the job. Progress toward completion is extremely difficult to define, but if it is expressed as a percentage of completion, it can be related to a percentage of authorized funds expended (Ref. 10, Fig. 1).

*Simple alternative.* There is no shortcut.

### By-products of the reporting system

The reporting system produces certain by-products that may not be obvious but that are extremely important:

**1. Refined data.** The scrutiny of actual vs plans at various points by reviewers with expert knowledge results in refined data at the end of the reporting cycle. A common mistake of the user of a computer printout is to expect it to be an accurate picture of what happened in the period under review. Everybody knows that the computer is a highly accurate device. This assumption ignores the fact that the data entered could have been assigned to incorrect account or job numbers, could contain mistakes in addition to key-punch errors, could represent misdirection of ef-



**Figure 2. MARKETING EXPENDITURES, Cumulative**

(Actual vs. Plan — Product Line A)

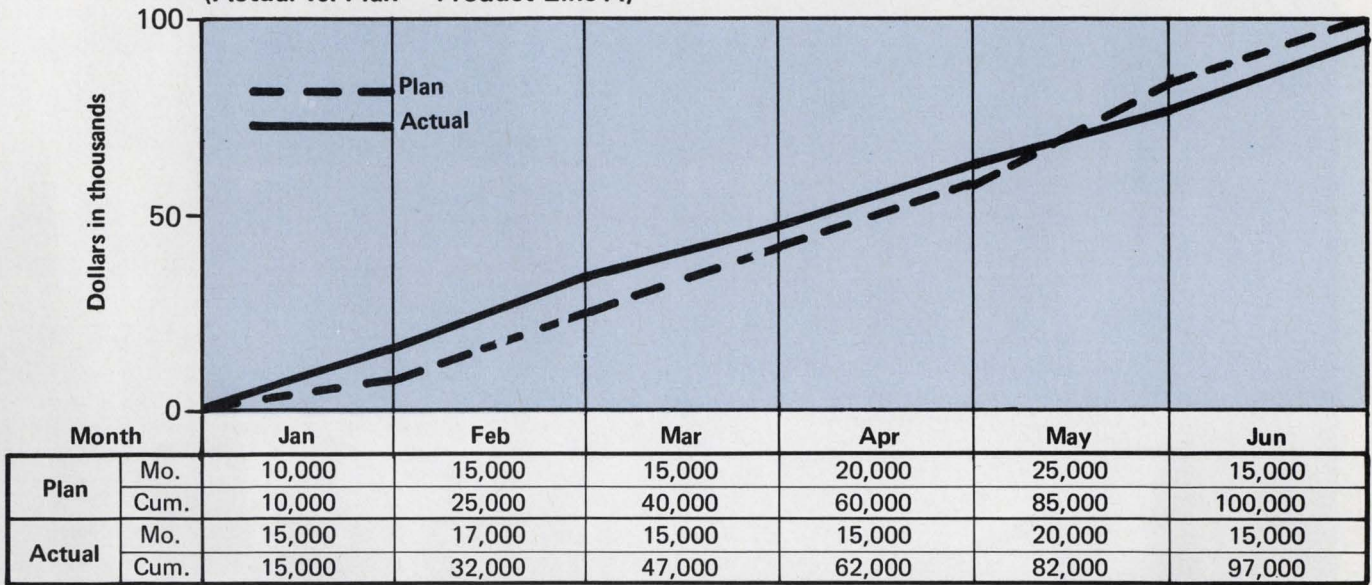

fort, unauthorized charging or a complete dropout of charges.

The plans in our reports provide test points to detect errors and make refinements. The recorded plans also relieve the several reviewers of the need to memorize the detail as to what the expenditures should have been.

**2. Forecasts.** The monthly re-plan meeting allows the project cost analyst to calculate a new cost-to-complete, add it to the costs-to-date and compare the total to the authorized cost. From these calculations, the analyst derives latest forecasts for manpower, expected total costs and predicted program overruns and underruns.

The important feature of this information is the early warning it provides. Trends are apparent, and the probable outcome is known far enough in advance to permit corrective action. It's also a chance to gain insight into your ability to plan and forecast results.

**3. Closed loops.** There are no unclosed loops or open pots for expenditures in the system. Cost planning and control is exercised by program; by all programs in a product line; by all programs in defined expense categories; by each department contributing to costs, and by all burden expenses, including burden time charges.

Significant mischarges (or accumulations of many small charges) cannot be made without detection. A correction resulting from scrutiny of any report will be entered in all reports.

**4. Control.** A matter of concern to all who rely on the efforts of personnel from other departments is controlling and directing the efforts of these personnel. Each program requires a commitment from all departments at the planning stage. Each department or section supervisor

estimates his portion of the job and signs to indicate what he will perform during the period and what it will cost. Periodic reporting against the plan provides the project engineer with a necessary control device for those personnel not under his supervision.

**5. Data base.** The data base used to develop the reports and the data accumulated in a consistent fashion in the reports provide a convenient source of information for a variety of other needs. Data is available for:

- Historical averages for planning and budgeting.
- "Team rates" and ratios of supporting personnel to design engineers.
- Staffing plans.
- Analysis of programs for improvement of operating practices.
- Estimating similar programs in the future.

With the history now available, the planner is able to apply his judgment as to how changed methods, new requirements, higher rates or new technology may alter the history, and he can do a better job of planning.

**6. Special resources.** A special resource developed by the reporting system is the expertise of the project cost analyst. The experience gained in planning and reporting on a wide range of programs develops the analyst's skill as a consultant and adviser to each program manager.

**7. Integrated planning.** The central reporting group facilitates planning to ensure a fit of departmental plans with programs, and programs with over-all allocations of resources. All the planning data is available to this group for summing, comparing and recommending adjustments when a misfit is revealed. ■■



# Feel Free To Flex

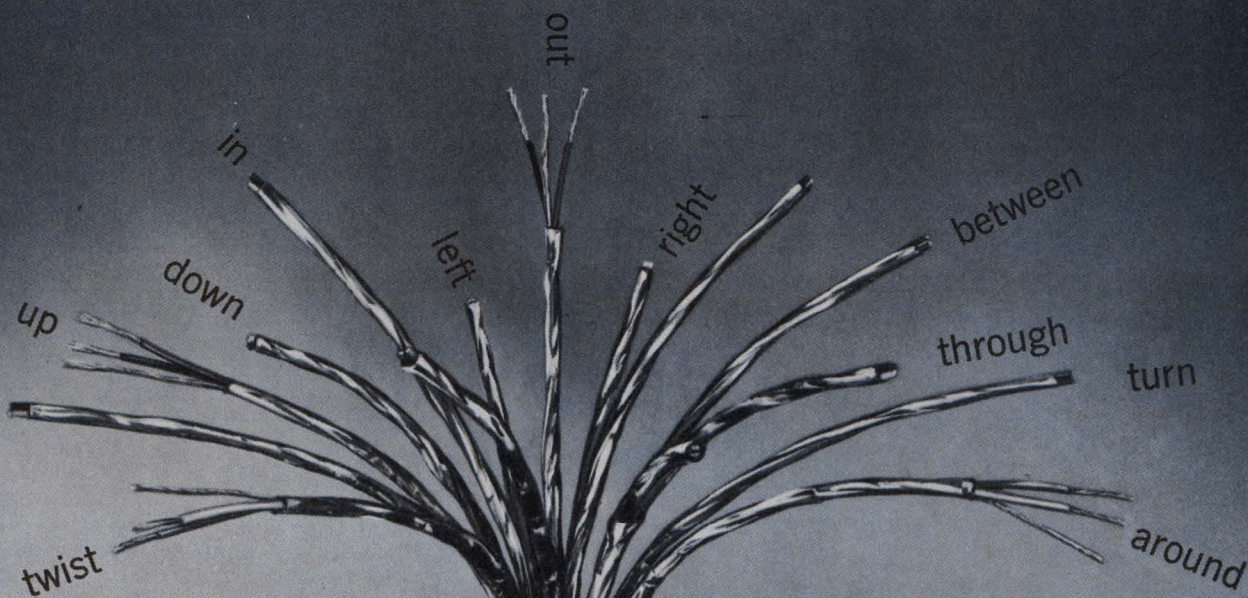

Yes, we know . . . we used to recommend Beldfoil Shielded Cable only for fixed applications. We were too modest. Extended testing proves Beldfoil, even after repeated flexing, provides more physical shield coverage than braided wire or spiral wrapped (served) shields. And greater shield effectiveness. □ Beldfoil is a layer of aluminum foil bonded to a tough polyester film (for insulation and added strength). A Belden invention. We apply it in different ways for different applications. We can even form a unique shield that's like a continuous aluminum tube. This we call ISO-Shield™. □ When new (or in fixed applications) Beldfoil ISO-Shield is extremely effective in limiting crosstalk or interference . . . whether from outside sources or between shielded elements in the same cable. □ Under frequent flexing minor separations may occur in the foil. But special Beldfoil construction features prevent performance from becoming seriously affected. We do, however, recommend that you tell us if cable flexing is to be extreme. We have special designs available to meet severe flexing requirements. □ Beldfoil makes possible a small, lightweight cable that terminates easily and is modest in

price. Your Belden distributor stocks or can quickly obtain just about any size or type you need . . . from single conductor audio and sound cable up to data cable having 27 individually shielded pairs (more pairs available on special order). Ask him for the latest "Belden Electronic Wire and Cable Catalog." Or for technical information, contact Belden Corporation, P. O. Box 5070-A, Chicago, Illinois 60680; phone (312) 378-1000.

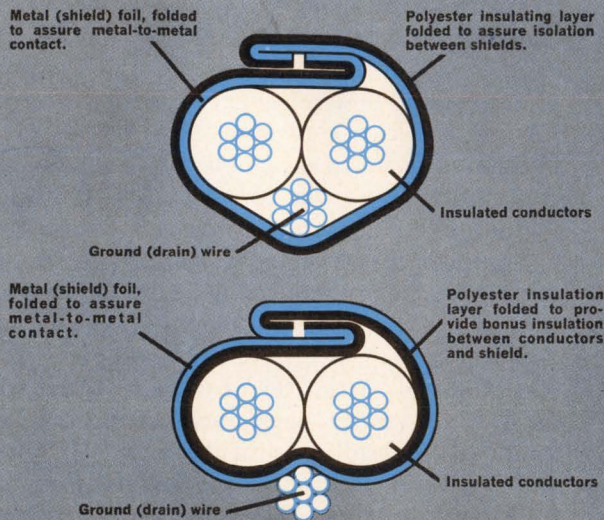



# Beldfoil<sup>®</sup> Shielded Cable

-shield effectiveness remains outstanding

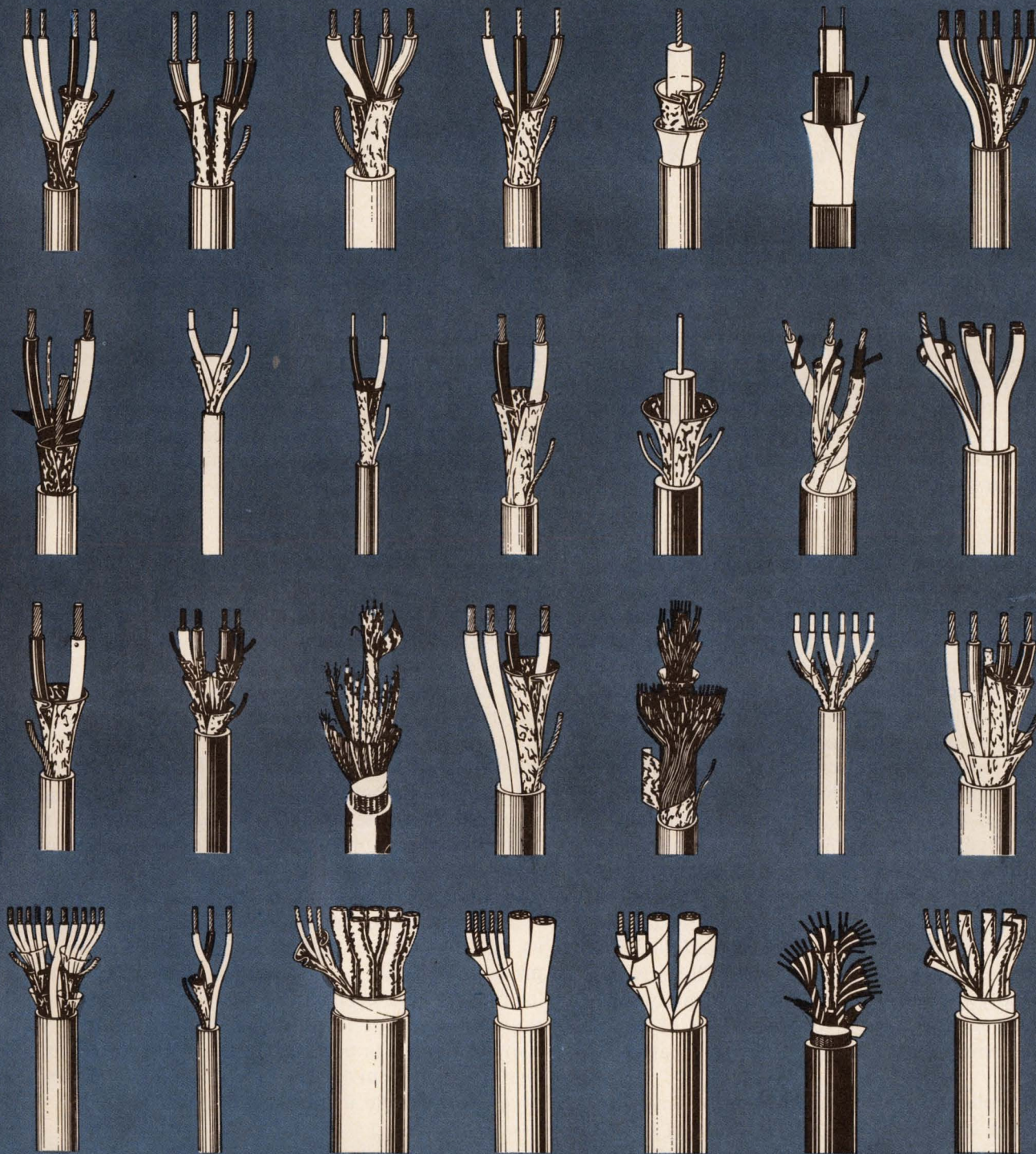

8-5-9A

*new ideas for moving electrical energy*

INFORMATION RETRIEVAL NUMBER 39



## The minicomputer and the engineer—Part 3

# Programming: the key to your mini's success

Most minicomputers are not too bright. They can understand only very simple instructions. Such as, "Add two numbers." But it's possible to program almost any logical or mathematical task by combining thousands of these elementary steps. The key to minicomputers is programming—the ease or the horror of it. Because the available resources on a minicomputer are limited, programs must be especially well planned and concise.

The key to the program is the algorithm, or procedure for finding the solution. It must be a fool-proof, step-by-step procedure that takes account of all possible situations and exceptions.

Certain programs are written by the user and are designed to solve some specific task. These are called applications programs. Other programs are usually supplied by the manufacturer and are designed to help the user develop, test and run his own programs. This collection of programs extends the capabilities of the computer hardware and makes it easier to use. To distinguish these functions from the more elementary ones of the hardware, these programs are called software.

Software programs take over some of the mundane, routine, clerical problems involved in translating algorithms into machine instructions and in controlling input/output devices. The advantages of software are easier development of application programs, automatic operation of computer systems and standardization between programs.

For simplicity, software programs can be divided into two classes:

1. Software that aids in the preparation of application programs.
2. Software that controls the operation of the

computer and its input/output devices.

Minicomputers vary widely in the quality, quantity and variety of software that is available for them. Software is usually provided by the manufacturer, and the user is responsible for his own applications programs. However, some manufacturers provide only the bare minimum of software to write computer instructions. Usually the cost of the software is included in the price of the computer, but some manufacturers now charge separately for it.

If the software provided by the manufacturer is not adequate, there are several options; attempt to modify the manufacturer's software, write your own custom software, or buy special software from a software house.

A user first interacts with the software when he tries to write a program for his computer. This occurs with the programming language in which he writes his program. His second interaction comes when he tries to run his program. This requires interaction with another software entity, called an operating system, which sets up and controls the program while it runs.

Although it's possible to write a program directly in machine "language"—binary codes, such as 0110111—it's a difficult and time-consuming process. For this reason, artificial programming languages have been developed to allow the programmer to write in a more natural format. The computer itself is used to translate the programmer's "source" program into a binary "object" program that the machine can execute.

### Two types of programming languages

The artificial programming languages fall into two categories: assembly and high-level.

Assembly languages follow the structure of the machine language very closely—that is, each "sentence" (statement, line or instruction) of the program consists of a machine operation and an

---

**Robert Green**, Software Publications Specialist, Hewlett-Packard, Cupertino Division, 11000 Wolfe Rd., Cupertino, Calif. 95014



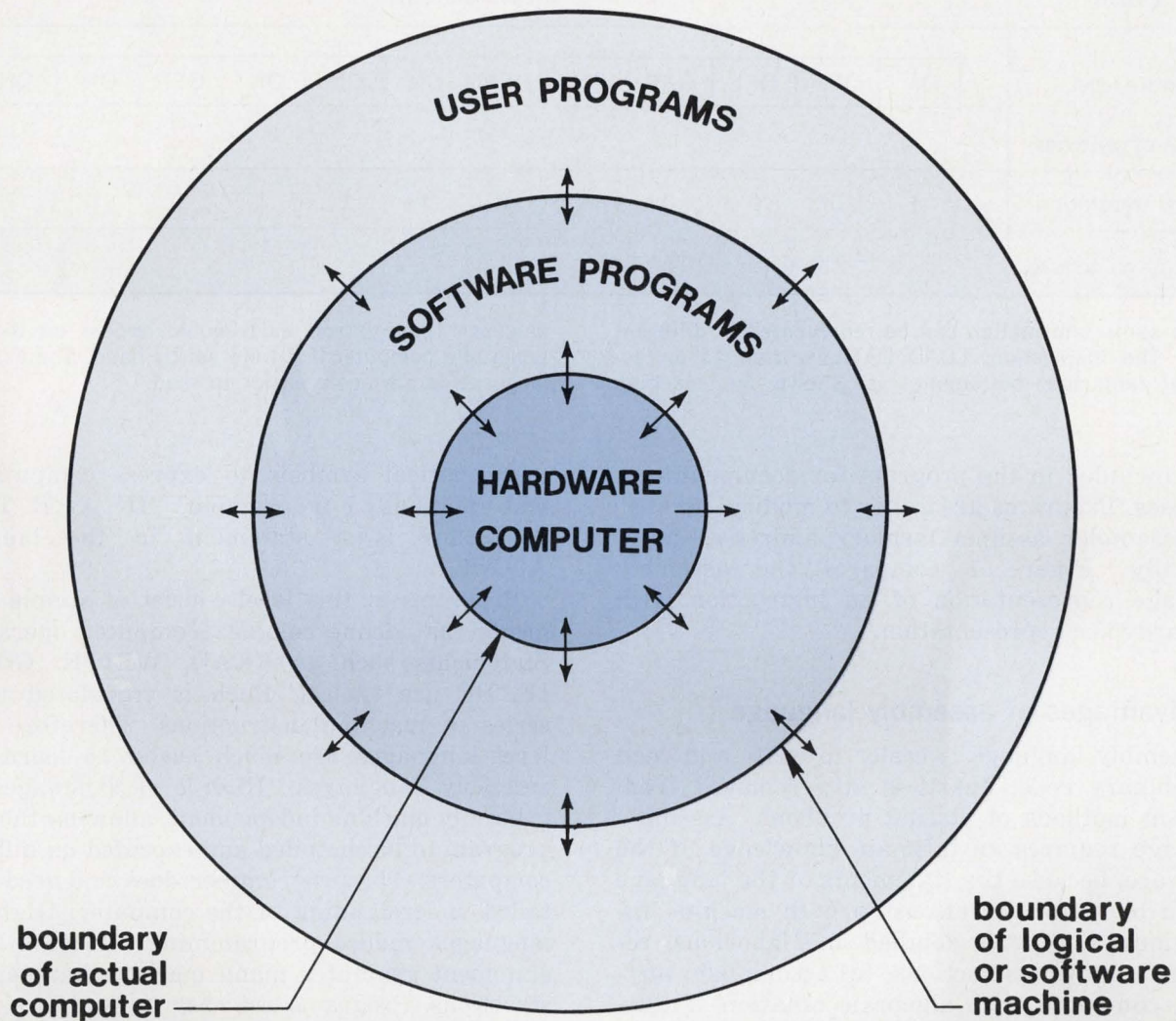

Software extends the capabilities of the computer hardware and isolates the user from routine problems. The software programs (middle circle) are usually supplied

by the minicomputer manufacturer and are designed to help the user develop, test and run his own application programs. Software is as important as hardware.

operand address. The machine operations, however, are specified by easy-to-remember mnemonics (for example, ADD instead of 0111) and the addresses are specified by symbolic names (for example, NAME instead of 00100). There is still a one-to-one correspondence between each assembly language instruction and the corresponding machine language instruction.

Assembly language programming requires translation before the program is accepted by the computer for execution. The program that does the translation is called an assembler. It also keeps a table of all symbols and assigns them to binary storage locations. In this way the assembler is able to translate assembly language into machine language.

For example, the following three commands are identical:

1. English: Load the contents of memory location 605 into the A-register.
2. Machine Code: 00110000110000101.

3. Assembly language: LDA X (where X is the name of location 605).

Assembly language is used to write most software provided with the computer (the assembler itself is written in assembly language). This is because assembly language produces the most efficient code. It uses the least number of locations in memory to solve a problem, an important asset in small computers. It also gives the most detailed control of the hardware operation. This is necessary for handling input/output and other operations. Almost all manufacturers provide an assembler with their computer.

Compared to machine language, assembly language reduces the time needed to write programs. It is easier to learn than machine language, eliminates the need for keeping track of memory locations in such detail, makes programs easier to read and debug, and allows tasks to be divided among several programmers. Also, assembly language allows remarks and comments



Form	Representation											
Hardware level (series of switches)	ON	OFF	OFF	OFF	ON	OFF	ON	ON	ON	OFF	ON	ON
Binary translation	1	0	0	0	1	0	1	1	1	0	1	1
Assembly Language	LOAD			DATA								

1. The same information can be represented in different forms. The instruction, LOAD DATA, written as an assembly language statement, is shown in machine

language (binary) and as it would appear on the front panel of a computer if it were set by hand. The assembly language is obviously easier to read.

to be included in the program for documentation purposes. Programs are easier to modify, because the assembler assigns memory addresses automatically. Figure 1 compares the assembly language representation of an instruction with the hardware representation.

### Disadvantages of assembly language

Assembly language is easier to write and read than binary code, but it is still removed from common methods of stating problems. Assembly language requires an intimate knowledge of the hardware, because the statements of the language have a one-to-one relationship with machine instructions. Coding is detailed and laborious, requiring many instructions to accomplish anything, compared with algebraic notation. Therefore it takes a long time to program a problem, because the solution must be broken down into simple operations by the programmer. These intricate operations cause programmers to make errors. Because simple structures are repeated over and over, much unnecessary effort is exerted.

In addition programs written in assembly language are machine-dependent; they are not transferable in any way to another computer. If a user switches computer vendors, he has to rewrite all of his assembly language programs.

These problems provide the motivation for high-level languages that develop a structure closer to normal speech and mathematical usage and that develop a standardized language structure, so that programs can be transferred from one computer to another merely by translating the program into the new machine code.

### Use English with high-level languages

High-level languages have a structure that is farther removed from the machine and closer to the structure of human discourse. High-level languages use English phrases and words to represent common program structures, and

mathematical symbols to express computations and relations. For example, "IF  $A < B$  THEN  $A \leftarrow B + 1$ ;" is a statement in the language ALGOL.

Programs at this level consist of simple statements that define complex computer operations. Statements such as READ, WRITE, GO TO, IF, DO are typical. Each is translated into a series of machine instructions. Therefore high-level languages are much easier to learn than assembly languages. High-level languages are generally machine independent, allowing the same program to be compiled and executed on different computers. The programmer does not need a detailed understanding of the computer. High-level languages reduce programming effort; a single statement generates many machine language instructions. Programs are easy to read, are somewhat self-documenting, and are easy to modify.

Since each programming structure in a high-level language handles many specific cases, each structure is somewhat inefficient in the code used to solve a specific situation—that is, any structure could, with sufficient time, usually be programmed in assembly language with the use of fewer memory locations than the equivalent structure in a high-level language. However, the extra time required to code in assembly language is usually not worth the small savings in core or execution time.

Certain problems cannot be written in a high-level language, because such a language isolates the programmer from the machine. An example is an I/O device control program. A program of this type must have access to detailed machine instructions available only in a machine-dependent assembly language.

Because the high-level language is not the cure-all for every situation, the ability to combine high-level programs with assembly language programs is an important feature to look for in software. It allows the programmer to find the best compromise of high-level convenience and assembler economy and control when solving



complex problems on a small computer.

Like assembly languages, high-level language programs must be processed before they can be run on the computer. There are two different approaches to this problem.

One follows the same line as assemblers and translates the program into machine codes that are then loaded into the computer and run. This process is called compilation, and the programs that compile are called compilers.

The other approach is called interpretation. Programs are converted into a series of instructions in an intermediate code that is between the original program and the machine code. This intermediate code is then executed by the interpreter program, not the computer directly. Although this process is inefficient in terms of execution speed and memory used, it has advantages in many applications.

### Compilers are similar to assemblers

A compiler is a program that compiles a particular high-level language. Since the development of compilers is a complicated and expensive process, the languages should be as well-organized and easy to learn as possible. Programmers should be able to write any type of program they need. In addition the language should have an internationally accepted standard definition of its format. For small computers, two languages meet these standards: FORTRAN (FORmula TRANslator) and ALGOL (ALGOrithmic Language).

Most minicomputer manufacturers provide compilers for at least one of these two languages. Therefore the user has a degree of portability if he writes in these languages; he can transfer to another computer system with minimal program change. Although these languages have standard definitions, every manufacturer's compiler has certain limitations and extensions that make them slightly incompatible. Small changes to programs are sometimes necessary.

### In engineering, FORTRAN leads

The most widely used standard language in science and engineering is FORTRAN. There are probably more compilers for FORTRAN than for any other language. Because FORTRAN has been used over 15 years, programs in it have already been written to solve many general problems in engineering, mathematics and science. Thus FORTRAN is a desirable language to implement on any computer. A user's FORTRAN program can be converted to another computer with minor changes. In this way the user's program development effort may be eased.

FORTRAN is much easier to program in than

assembly language, because its form is closer to the language of science and mathematics. The grammar, symbols, rules, and syntax used in FORTRAN are familiar to the general public. For example, the symbols, +, -, /, and \* indicate addition, subtraction, division and multiplication, respectively.

A typical statement in FORTRAN is:

$$X = (Y + B/C)/2.$$

This straightforward arithmetic formula would require many statements in assembly language. The FORTRAN compiler translates this statement into a number of machine instructions.

Languages vary in the degree of complexity and power built into them. FORTRAN allows the programmer to construct loops (repetitions), conditional jumps to another statement or sub-program, and arithmetic formulas. However, complex and intricate logical relationships—such as, "If  $x > 100$  and  $y < 100$  then do exercises, or else if  $G = 10$  then do recreations for  $K$  times"—must still be broken down into independent FORTRAN statements. The structure of FORTRAN does not show the relationships involved, it hides them. In addition, the language has limitations on the mixing of different types of numbers in formulas.

Note: There are two levels of FORTRAN: Basic FORTRAN and FORTRAN IV. The latter has additional features not found in Basic FORTRAN.

### ALGOL gives more flexibility

The need for a more general, flexible and powerful language than FORTRAN motivated the development of ALGOL. ALGOL defines certain basic language elements, such as variables, constants, expressions and procedures, from which the user can build more complex structures. Almost every level of structure can be nested inside another structure. The result is a general framework for expressing any logical or mathematical process, similar to the way you would describe it in English.

A goal of ALGOL was to make programs closer to the natural way of stating problems, so that a person could see the logic of a program without having written it. Variable names in the program describe the information. Statements can be formatted on the page in any manner the programmer finds useful. These features make ALGOL programs almost self-documenting.

Most algorithms that appear in the computer science journals today are given in ALGOL. Thus ALGOL is a widely used language for the statement of methods underlying programs. It is easier to convert the ALGOL description of a method into FORTRAN than it is to decipher the logic behind a FORTRAN program and convert



it to ALGOL (Fig. 2).

This excerpt from an imaginary ALGOL program shows what can be done:

```
COMMENT THIS PROGRAM EATS ALL THE FRUIT;
IF NUMBEROFAPPLES<NUMBEROFORANGES THEN
    BEGIN
        A←NUMBEROFAPPLES + NUMBEROFORANGES;
        FOR N←1 STEP 1 UNTIL A
            DO EAT(N);
        IF NUMBEROFPEACHES<A THEN
            FOR X←1 STEP 1 UNTIL NUMBEROFPEACHES
                DO EAT(X);
    END;
```

### For simplicity, use BASIC

BASIC (Beginner's All-Purpose Symbolic Instruction Code) is a simple language designed specifically for interpretation instead of compilation. The BASIC language is defined by a very simple set of rules. It is easy for even beginners to learn, yet powerful enough for advanced users.

An interpreter program is a self-contained system. It always remains in core memory. It handles complete editing, translating and executing of programs, so no other systems are necessary.

The interpreter interacts with the user conversationally to develop his program. The user types in the statements of his program in any order; if he finds he needs another step, he simply types it in. The interpreter arranges all statements in numerical order. To change a specific statement, the user simply types in the new statement, and the interpreter automatically makes the replacement. The interpreter program reacts instantly to each line of typing so the user knows immediately what error he has made.

Here is a simple program in BASIC that determines the average of five numbers typed in by the user:

```
100 INPUT A,B,C,D,E
200 LET X=(A+B+C+D+E)/5
300 PRINT X
400 END
```

BASIC does have certain drawbacks, however. For example, the conversational editing and running of programs is based on the interpretation process. Because BASIC is not executed directly by the computer, the execution is much slower. For small programs, however, the difference in time is not noticeable to the user. Because the interpreter is designed around an interactive user terminal, there are no input/output capabilities, other than those provided on the terminal (usually paper tape reader and punch).

If the user has many problems for which he needs solutions quickly, BASIC is the most convenient and easy language. The table compares the features of the common high-level languages and assembly language.

### Let operating systems do routine tasks

An operating system is an organized collection of programs that increases the productivity and convenience of a computer by providing common functions for all user programs. Having the computer control many of its own functions relieves the user of much routine and repetitive detail work.

Depending upon its complexity, an operating system can be responsible for any or all of the following functions:

- Controlling input/output.
- Storing and retrieving data and programs.
- Preparing, loading and executing programs.

### Controlling input/output functions

The input/output function connects the computer program with the outside world through a series of input and output devices. Usually this is done by connecting the CPU to a number of general-purpose I/O channels. Each I/O channel can be connected to either one input device or one output device. The hardware provides an unambiguous method of referencing each channel, and the CPU recognizes special I/O instructions in the program that exercise these channels.

A program in the computer memory is responsible for setting up each transfer on the device by using the special I/O instructions. In the simplest possible situation, this program then handles each item of data separately, until all are transferred (Fig. 3).

In the I/O structure only one I/O transfer can occur at one time, since the I/O program must wait in a loop until it is complete. One way to get around this and to allow concurrent I/O transfers on different devices is to provide interrupts. With interrupts, the I/O program actively executes only when a device needs attention.



Binary	Assembly Language	FORTRAN	ALGOL
1001001011010010	LOAD A	IF(A+5-B)100,200,300	IF A+5<B THEN C ←A ELSE C← B;
1100010001000011	ADD 5	100 C=A	
1111100010101010	CMP B	GOTO 300	
0010001110011000	JMP LABEL1	200 C=B	
0010000100010000	LOAD A	300 CONTINUE	
1100100100111010	STORE C		
0101010101100011	JMP LABEL2		
0100011100010010	LABEL1: LOAD B		
0111100001111101	STORE C		
1110010010000111	LABEL2: CONTINUE		

2. High-level languages are more concise and readable than assembly or machine languages. The simple ALGOL

statement becomes progressively more complex as it is translated for use by the computer.

When an interrupt system is used, the software drivers become more complex. Software drivers are the subprograms that perform the data transfer between a specific peripheral device and the minicomputer. A central routine is needed to route all I/O requests from the user program to the appropriate driver. The driver initiates the operation and returns to the program. The hardware takes care of interrupting the main program whenever the peripheral device needs attention from the driver. Several devices can be "active" at the same time in this organization, so several I/O operations can occur concurrently. Each driver, however, can only handle one specific device at a time.

Another function that I/O software provides is buffering. The software takes the output from the user program and stores it in a buffer until the appropriate device is available. The user program need not become involved in whether the output is complete or not and can continue processing.

There are obviously many possible ways to set up I/O software, and not necessarily in any of the exact patterns described. The user should be aware of the capabilities of his software, since he may have to write driver programs for any nonstandard devices he connects to the computer.

### Storing and retrieving data and programs

Besides input/output, there is the problem of storing and retrieving data and programs that are to be accessed more than once over a period of time. The degree of flexibility and convenience is largely determined by the I/O storage devices available and what the software does with them.

The simplest and most common input/output medium on minicomputers is the punched paper tape. If this is the only storage medium available, then all data and programs must be punched on paper tape. The disadvantages include: All information must be retrieved manually; a tape

cannot be updated without repunching the entire tape; and the entire process is very slow.

A certain degree of flexibility is added by substituting punched cards for punched tape. A card deck can be changed simply by replacing a card; the entire card deck need not be repunched.

With the addition of a magnetic tape unit, more powerful software can be written. Magnetic tape can be both written and read automatically by the computer. The only limitation (on most units) is that previously written data cannot be read after a new write, since the new write may overlap the old data. It is not physically possible to write a block of information on an exact spot. Programs can be stored permanently on the magnetic tape and loaded into memory by the software whenever the user requests them. Note, however, that magnetic tape is a sequential medium. To find a program in the middle of the tape, you must read through the entire tape.

Rotating magnetic disc and drum memories circumvent the limitations of magnetic tape. The computer can read or write independently in any random location on the disc or drum. Rotating magnetic memory has two advantages: high speed and the ability to update a single location without destroying all the locations around it.

There are two phases during the writing of a program in FORTRAN or ALGOL: editing and translating. Luckily, most computers have a software program called the editor that makes these program changes. The usual method is to give the editor a source program to edit and a list of commands, telling the editor where to change, delete or insert lines. The editor makes the changes and punches out a new program tape.

Translation of such source programs into machine instructions is considerably more complicated. Since the programs that perform translation (the assemblers and compilers) are often too large to fit into the computer, they are broken into parts. The original source program has to be put in again and again to each part of the



**Table. Language features chart**

	ASSEMBLY LANG.	FORTRAN	FORTRAN IV	ALGOL	BASIC
Most efficient in use of memory and execution time	X				
Most convenient for writing programs					X
Most widely used			X		
Most powerful structure				X	
Machine independent		X	X	X	X
Machine dependent	X				
Readable (self-documenting)		X	X	X	X
Conversational editing					X
Mnemonic instruction codes	X				
Symbolic names	X	X	X	X	X
Arithmetic expressions (Math formulas)		X	X	X	X
General nesting				X	
Integer arithmetic	X	X	X	X	
Floating point arithmetic	X	X	X	X	X
Double precision and complex arithmetic	X		X		
All machine instructions possible	X				

translator. In this situation magnetic tape can speed up a function significantly. Because all parts of the translator can be stored on magnetic tape, they need not be loaded manually from paper tape; the original program can be written on the magnetic tape and read back later. The user need only enter it manually once.

The generalization of this software trend away from manual loading is called batch processing—the automatic execution of user tasks without operator intervention. The user prepares a “job” (a collection of tasks) and submits it to the computer in the form of a card deck. The computer automatically finds and uses the necessary software to perform the requested tasks without requiring operator intervention. Such systems are usually disc or drum-based, because of the speed with which information can be accessed on a rotating memory.

### Two ways to load programs

After a program has been translated, it must be loaded into the computer before it can be executed. The two basic types of loading are absolute and relocatable. In absolute loading, the program is assigned specific memory locations as it is translated. The loader simply places the program in the proper location without changing it in any way. In relocatable loading, the translated program can be located as a unit anywhere in memory. The loader is responsible for making sure that all instructions in the program reference the correct memory locations.

Another function of the loader is to link the user program with any subprograms (subroutines) that it has requested. Programs usually require subroutines to perform arithmetic and mathematical functions, such as sine, cosine, etc. When a program is too large to fit into memory, it is useful to divide it into parts. This is done as a main program, and a number of segments that overlay each other in memory as needed. A segmentation scheme works best when a magnetic tape or disc unit is available. The software can load in the segments quickly when called for by the main program.

On many small computers, the process of setting up and running programs is manual to a large extent. The user must load the software needed from paper tape and execute it by pressing a run or start button on the computer. With more sophisticated software, however, it is possible to turn over responsibility for executing programs to the computer itself.

In batch processing, there is a command called “compile, load and go” that instructs the software to do everything necessary to prepare a source program and to execute it. This eliminates many unnecessary actions on the user’s part. ■■

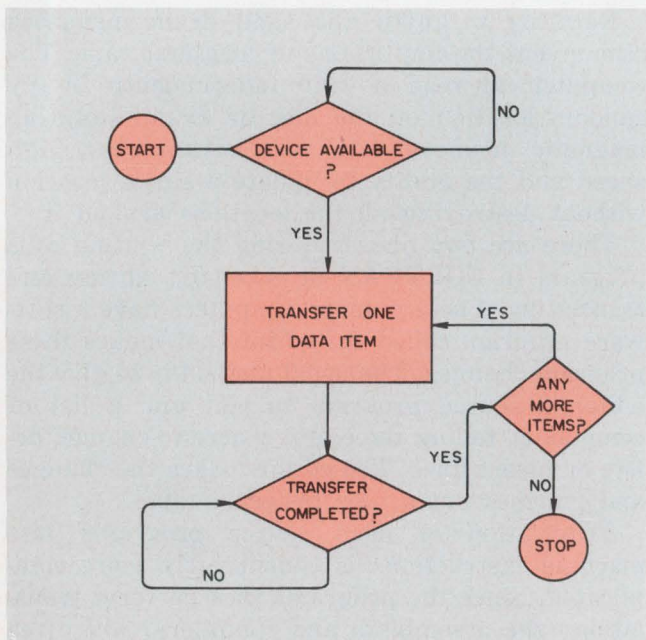

3. Software in the computer’s memory contains the instructions for carrying out a complete I/O transfer. Only one I/O transfer occurs at a time.



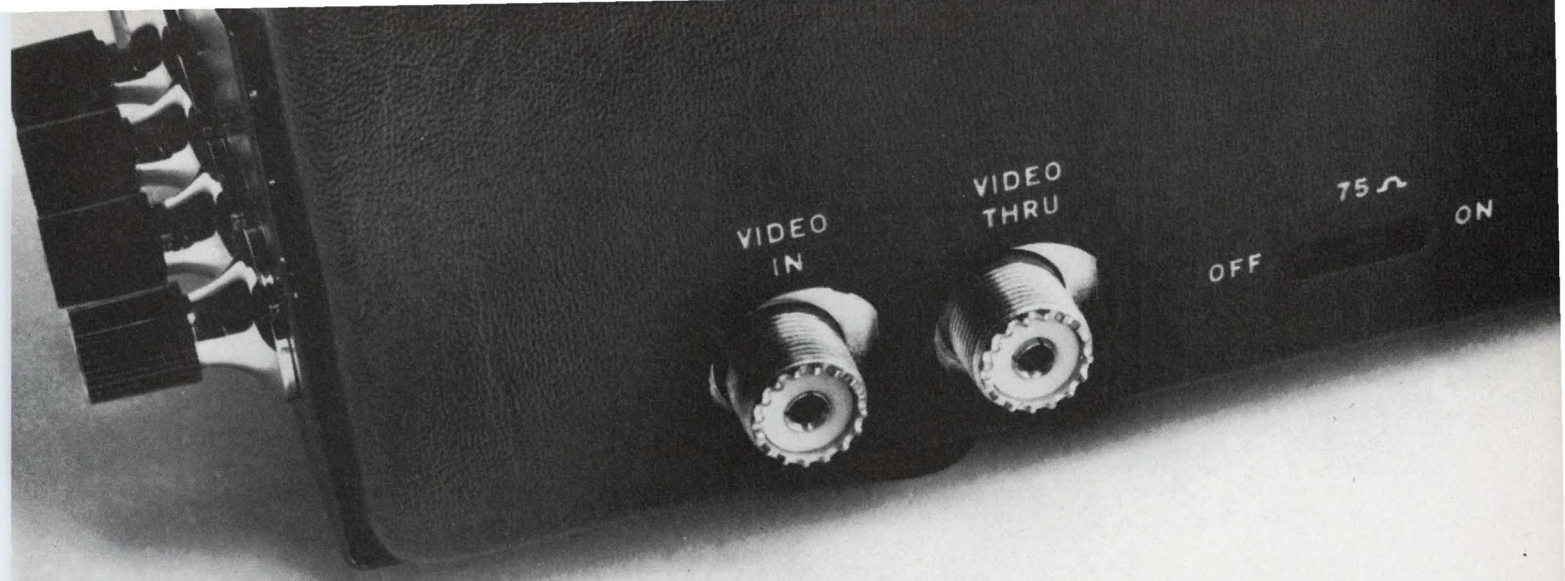

# This is where you come in.

Right at the back of our 12-inch CRT monitor module.

You supply a composite video signal between 0.5 and 1.5 V, and we supply the rest—a complete CRT display package designed for alphanumeric that is suitable for rack, console or cabinet mounting.

Of course, you also have to provide a power source, but we've even made that easy. Your module comes off-the-shelf for either 120 V AC or 22 V DC operation.

Despite the fact that our 12-inch display module is an off-the-shelf design, you'll be surprised at the number of options available to you. Depending on lighting conditions you can have 92%, 70%, or 55% light-transmittance filter plates, with or without antireflection coating. You have a wide choice of phosphor types. All of our tube types meet UL requirements for implosion protection.

If our 12-inch monitor doesn't meet your needs, send us your specs and we'll come up with a custom design.

You take care of the system. We'll take care of the display module.

Because that's where we come in.

Sylvania Electronic Components,  
Electronic Tube Division,  
Seneca Falls, N.Y.

**SYLVANIA**  
GENERAL TELEPHONE & ELECTRONICS

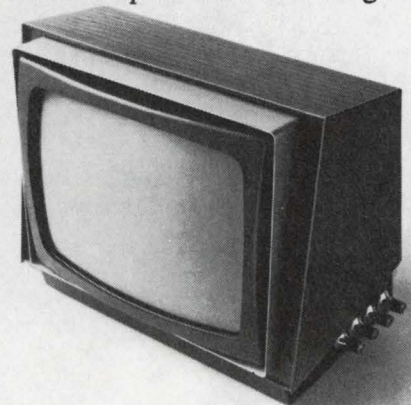



# The Year



Sooner or later, almost every computer company gets around to comparing itself to DIGITAL. And for good reason. DIGITAL has delivered over 10,000 small computers; more minis than all other computer companies combined.

Sure it's nice to be the manufacturer everyone tries to measure up to. But it's a responsibility too. Being the yardstick means always having the best. The best processors, the best peripherals, the best software. And we do.

But take a closer look at what it takes to be best.

Like service. DIGITAL has over 1400 sales and service engineers in 65 locations around the world.

Or software and peripherals. DIGITAL offers more than 70 small computer peripherals – all the usuals, plus specials available only from us. And the most extensive software library and the most active users' society.

Cost performance? Our PDP-8/e and 11 have the broadest cost/performance range in the industry and we'll prove it any way you like.

We could go on but you get the point. Sooner or later everyone has to measure up. To us.

Digital Equipment Corporation, Main Street, Maynard, Mass. 01754 (617) 897-5111.

**digital**

**More than 10,000 mini-computers delivered.**







# If you spec'd an I/O printer that would turn your 'mini' into a 'maxi' accounting system... it would look like this

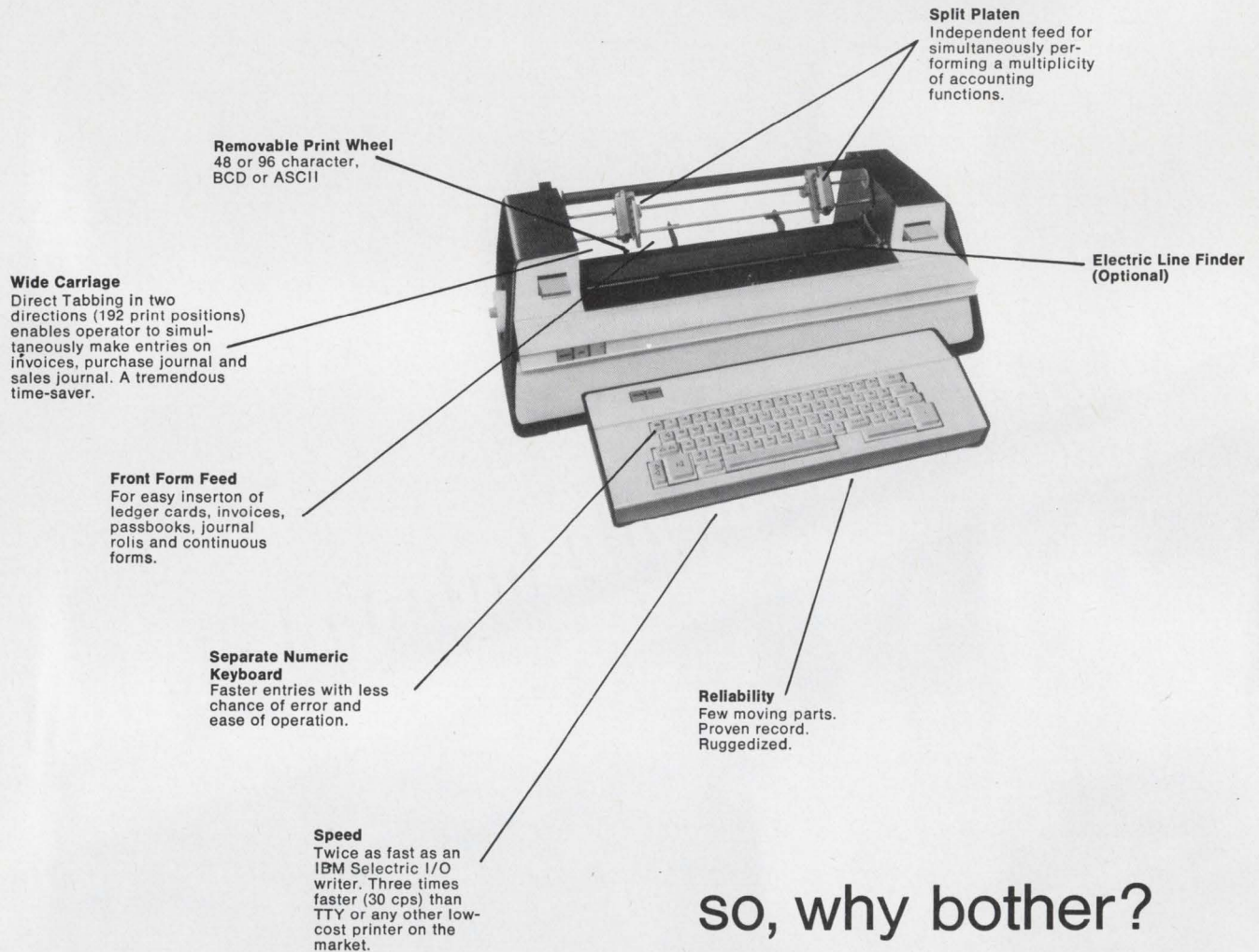

## so, why bother?

Our Model 30 is the *only* printer that can economically satisfy *all* accounting applications. It's ready for fast delivery. With or without control electronics or companion keyboard. And, it costs less than other printers with less capabilities.

Sales and Service on OEM Products are available in: United Kingdom, Germany, France, Italy, Yugoslavia, Spain, Switzerland, Belgium, Holland, Luxemburg, Sweden, Australia, New Zealand, Japan, Canada, Mexico, Puerto Rico and the U.S.A.

See it at **BOOTH 2315-17 — SJCC**

For more information  
call Frank Misiewicz  
OEM Products Division  
(201) 935-2200

**LITTON ABS**  
automated business systems

600 WASHINGTON AVENUE, CARLSTADT, NEW JERSEY 07072



INFORMATION RETRIEVAL NUMBER 42



# Look what's happened to PDP-11 since January

Four months ago, PDP-11 was simply the world's hottest 16-bit computer. It still is. But, now it's more than that.

Now it's a resource timesharing system. RSTS-11. Up to 16 users. With the capacity, easy-to-use language elements, file structure, data-base capacity, and speed you need to handle big computer problems. At far less cost than the HP or Honeywell systems.

Now it's a data communications system. With a data transparent front end for your applications programs. It's a modular, expandable multi-task executive called Comtex-11. Plus four interface units—a single-line multiplexer, a 16-line multiplexer

(both asynchronous), a synchronous-line interface and an automatic-calling interface.

Now it comes in a rugged version. The PDP-11R20. With vibration, shock, temperature, and power-line specs that make it the toughest machine in the industry. And at a price that lets it fit commercial applications without a strain on the pocketbook.

All this has happened since January. But it's just a beginning. More PDP-11's are coming. Watch for the next additions to the growing PDP-11 family. Digital Equipment Corporation, 146 Main Street, Maynard, Massachusetts 01754, (617) 897-5111.

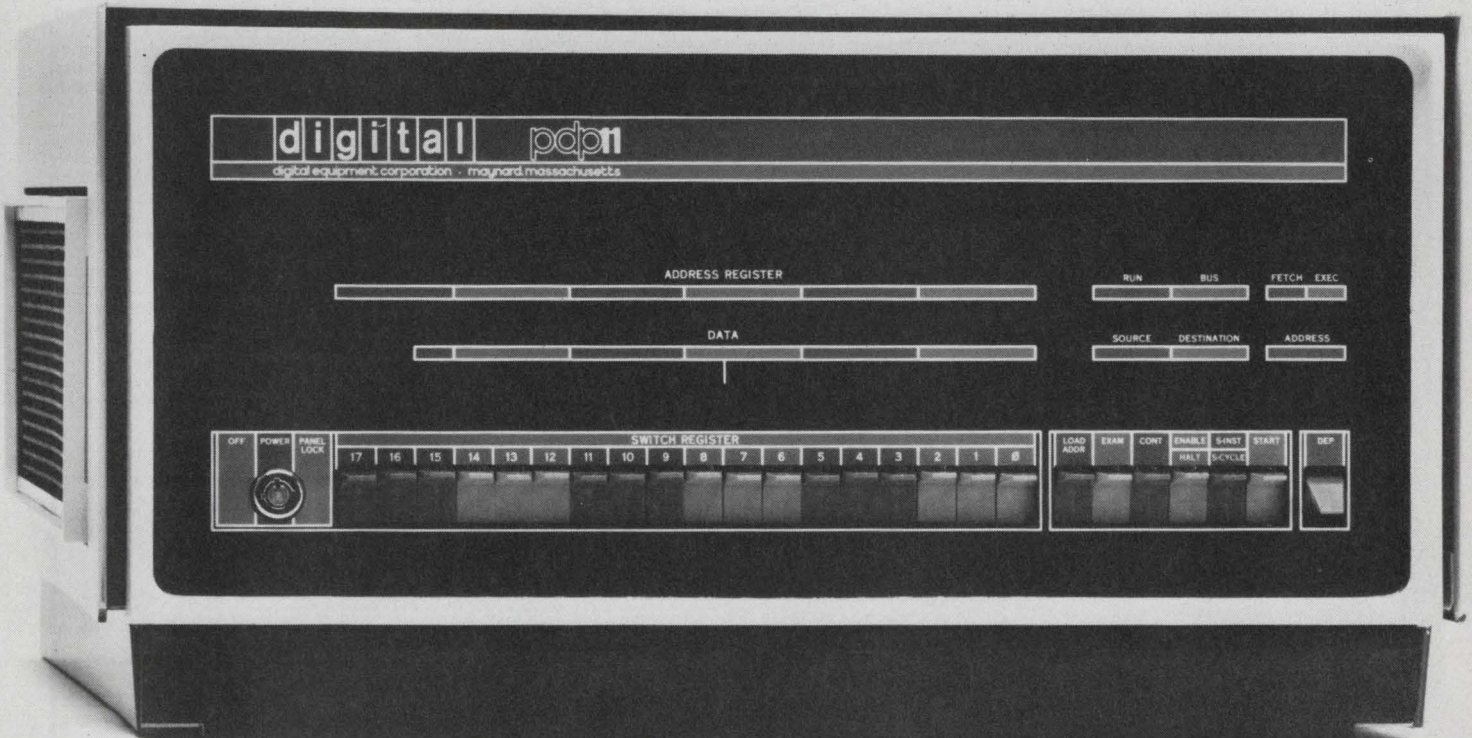

**digital**



# The Data Communications Breakthrough in a New Practical Guide from Hayden

## JUST PUBLISHED! Modern Data Communications: Concepts, Language and Media

WILLIAM P. DAVENPORT

This comprehensive and practical source provides an up-to-date working knowledge of how business and technical information is transmitted and received. It enables the data systems manager, engineer, student, or technician to evaluate current transmitting techniques and their potential applications. The book gets to the core of intricate theories and concepts, such as coding, channel capacity, and modulation and multiplexing, without losing the essence of their meaning. It

clearly explains how stored information is moved from point to point in machine language. Both an in-depth introduction and a practical working guide, the book eliminates complex mathematics and provides an extensive glossary of terms. Space has been provided in the many illustrative lists and tables so the reader may enter additional information of particular interest.

208 pp., 6 x 9, illus., cloth, #5810, \$7.95

## OTHER VALUABLE BOOKS IN CONTEMPORARY COMPUTER TECHNOLOGY

**Basic BASIC: An Introduction to Computer Programming in Basic Language** James S. Coan. Written in a precalculus mathematics setting, this new text is designed to work in conjunction with a math course or as a separate programming course. Progressing from short complete programs to more sophisticated problems, the text encourages the use of flowcharts as an aid in program-writing. Solutions to even-numbered problems appear in the text; the remainder, in a separate teacher's guide. 272 pp., 6 x 9, illus., paper, #5872, \$5.95; cloth, #5873, \$7.95

**Comprehensive Standard Fortran Programming** James N. Haag. This up-to-date course teaches how to program effectively using the full version of FORTRAN IV as standardized by the U.S.A. Standards Institute. From the outset, portions of the language are applied in writing programs drawn from a variety of disciplines. This well-organized, clearly written book is ideally suited for either self-study or classroom use. 312 pp., 7 1/2 x 9 3/4, illus., paper, #5811, \$6.95; cloth, #5812, \$8.95.

**Comprehensive Fortran Programming** James N. Haag. The highly successful course in FORTRAN II teaches the language as used by the IBM 1620 computer with an attached 1311 Disk Drive, with adaptations to suit other systems. 246 pp., 7 3/8 x 10 1/8, illus., paper, #5645, \$5.95.

**Basics of Digital Computers** Revised Second Edition, John S. Murphy. Offering a complete foundation in today's equipment and systems, the fully updated edition of this three-volume work is excellent for self-teaching or classroom use. Free of needlessly confusing jargon, it includes over 300 all-new illustrations to drive home its discussion of concepts relevant to all systems. The first volume explains how in-

formation is programmed into the machine to produce an answer or to be stored for later use. Volume two covers the construction and function of the various components. The linkup and control of an overall system, covered in volume three, completes the background needed to master specific systems. 391 pp., 6 x 9, illus., 3 vol. set, paper, #0737, \$11.25; 3 vol. combined cloth, #0741, \$9.95; indiv. paper vols., #0738, #0739, #0740, \$3.75.

**Understanding Digital Computers** Ronald Benrey. A comprehensive guide for those who need in-depth understanding of computers, but not a technical grasp of the equipment. Describing computers in terms of similar, and simple building blocks that make up a system, the book stresses the function of these elements, rather than their actual electronic construction. Programming, binary arithmetic, logical design, and other key topics are fully explained. 166 pp., 6 x 9, illus., paper, #0473, \$4.75

**Digital Magnetic Tape Recording** Bernard B. Bycer. This unique design tool fully describes functions and operations, also providing valuable data for specification, purchase and use of the equipment. 328 pp., 6 x 9, illus., cloth, #5031, \$12.50

**Computer Arithmetic** Henry Jacobowitz. A refresher course in the basic operations of all positional number systems with applications in computers, this compact volume explains binary, octal, hexadecimal, and ternary arithmetic, along with conversion methods. 128 pp., 5 1/2 x 8 1/2, illus., paper, #0297, \$3.75

**Computer Numbering Systems and Binary Arithmetic** Training Systems, Inc., and Stanley L. Levine. This programmed course proceeds gradually through all the required mathematical processes. No previous knowledge of

binary or octal numbering systems, or computers, is needed, 232 pp., 6 x 9 paper, #0380, \$5.45

**Discovering Basic: A Problem Solving Approach** Robert E. Smith. This new course starts the reader programming on page three, pinpointing the vocabulary of BASIC as it develops skill and confidence. Clear explanations speed the reader through the brief exercises and reviews which reflect this language's growing importance in timesharing systems. More than thirty-five pages of programs for the lessons and reviews are easily located at the back of the book. 224 pp., 5 3/8 x 8 1/4, illus., paper, #5783, \$5.95; cloth, #5784, \$7.95

**Basics of Digital Computer Programming** John S. Murphy. This invaluable introduction to business-data programming uses general programming examples to illustrate practical computer applications. Discussion is clarified through continual reference to the internal organization of a typical computer. 118 pp., 6 x 9, illus., paper, #0405, \$3.95

**Standard Dictionary of Computers and Information Processing** Martin H. Weik. Widely praised for its broad scope, detailed definitions, and illustrative examples, this essential reference encompasses more than 10,000 hardware and software terms in general use throughout the burgeoning field of computers and their applications. Thorough cross-referencing permits complete mastery of the vocabulary of hundreds of topics: programming and computer engineering to input-output devices and checking systems. The Computer Tree, reproduced on the endpapers, traces the lineage of more than 500 computer models built to date. 336 pp., 6 x 9, illus., cloth, #5677, \$10.95

15-DAY

FREE

EXAMINATION

Please send the book(s) listed on a 15-day free examination basis. At the end of that time, I will remit payment, plus postage, or return the book(s) without further obligation.

CAT. # \_\_\_\_\_ TITLE \_\_\_\_\_ PRICE \_\_\_\_\_

\_\_\_\_\_

\_\_\_\_\_

\_\_\_\_\_

Name \_\_\_\_\_

Firm/Institution \_\_\_\_\_

Address \_\_\_\_\_

City/State \_\_\_\_\_ Zip \_\_\_\_\_

\$10.00 minimum for free exam orders. Because of higher billing and collection costs, we must ask for payment in full with any order for less than \$10.00. Books will be shipped postpaid. Same 15-day return privilege for full refund if not satisfied. On all overseas orders, payment in U.S. dollars must be enclosed.

Save Money! On all pre-paid orders Hayden pays postage — same return guarantee!

71-59



HAYDEN BOOK COMPANY, INC., 116 W. 14 St., N.Y., N.Y. 10011



It's a disease that can hit solder reflow assembly operations hard. You put your chips perfectly in place, but lo and behold at the end of the line the circuits won't play.

So you go back and test everything by hand to find out what went wrong. Frequently it's something called silver leaching or scavenging. (And sometimes a thing called migration.) The silver end terminations of a chip don't complete the circuit. Or they short out.

Solder at reflow temperatures is the villain. It eats at the terminations (even palladium alloys), especially at the corners where contact is vital.

But the prevention of this disease is simple. So simple in fact, that we include it on every one of our KEMET® ceramic chip capacitors.

It's called "Solder Guard." We invented it.

After we put the silver end terminations on our ceramic chips, we cover them with copper to protect the silver. Then we cover the copper with solder. That's "Solder Guard." And where something like an end termination of palladium-silver can only take a 260°C solder bath for two minutes max, "Solder Guard" is good for twenty minutes.

"Solder Guard" KEMET ceramic chip capacitors. An ounce of prevention you measure in milligrams.

Union Carbide, Components Department, Greenville, South Carolina 29606. (803) 963-7421.



COMPONENTS DEPARTMENT

A black and white photograph of a hand holding a pair of tweezers, which are holding a small, rectangular electronic component. The background is a plain, light-colored surface.

**Certain hybrid circuits have a disease.  
And we have the cure.**







# KOH-I-NOOR Announces Another Revolutionary New Product:

# Rapiddraw Drafting Film

The first and only polyester film especially formulated for direct ink drafting.

For nearly 20 years, there were only two types of drafting film available — the less expensive film for pencil only, and the more expensive film for pencil and ink. Now Koh-I-Noor, after many years of research, introduces Rapiddraw Drafting Film to add an important new dimension as the first and only film formulated especially for ink. It is being made available in the standard range of sheet sizes and rolls, coated on one or both sides.

Virtually indestructible, Koh-I-Noor's new polyester film provides the perfect base for engineering drawings that must maintain utmost line precision and highest dimensional stability for even the most demanding microfilm requirements. The new Rapiddraw Drafting Film is matched perfectly for use with Rapidograph Technical Fountain Pens, Koh-I-Noor and Pelikan Inks.

These matched components are basic elements in the Rapiddraw Microfilm Drafting System (RMDS®) which makes possible permanent, top quality precision drawings ideally suited for repeated erasure of ink and subsequent redrawing . . . perfect reproductions due to high contrast of the drawing ink and the unequalled translucency of the film . . . no loss of detail in microfilming . . . indestructible originals with permanent line adhesion. The quality produced by RMDS® eliminates the need for future restoring and redrawing, thus saving the enormous costs involved in such operations.

The new Koh-I-Noor Rapiddraw Drafting Film is being rushed to your dealer as fast as it can be produced. See him, or write directly to us on your company letterhead for a free sample sheet. Address Koh-I-Noor Rapidograph, Inc., 133 North Street, Bloomsbury, N.J. 08804. In Canada: Koh-I-Noor/Canada/Ltd., 4180 Ave. de Courtrai, Montreal 249, Quebec.

YOU GET MORE FROM  
**KOH-I-NOOR**  
 The "Breakthrough" Company





## Precisely control op-amp gain and output voltage limits

Depending on the components used, you can define gain accuracy to better than 0.002% and limit the output voltage swing of an operational amplifier with the circuit shown. Amplifier gain is accurately defined by  $R_2/R_1$ , and output voltage can swing from  $+V_{D4}$  to  $-V_{D3}$  (neglecting forward voltage diode drops).

$D_1$  and  $D_2$  are low-leakage planar diodes connected in anti-parallel. This arrangement usually yields leakage currents of less than 0.1 nA for forward or reverse voltages of less than 100 mV.

During normal operation, the voltage at the inverting input of the amplifier is within a few millivolts of ground. Leakage currents through zener diodes  $D_3$  and  $D_4$  flow to ground through  $R_4$ , producing a voltage of only a few millivolts at point X. Since the voltage across  $D_1$  and  $D_2$  is very small, the leakage or feedback current is negligible, and amplifier gain can be precisely defined as  $R_2/R_1$ .

When the amplifier output causes the zener diodes to conduct, the voltage across  $R_4$  follows the amplifier output. Now, either  $D_1$  or  $D_2$  will conduct when its threshold is reached. The feedback impedance that shunts  $R_2$  then rapidly de-

creases from infinity to a few ohms (the slope resistance of  $D_3$ ,  $D_4$ , and  $D_1$  or  $D_2$ ).

In this way, amplifier output voltage is limited between  $+V_{D4}$  and  $-V_{D3}$ . The value of  $R_4$  depends on the maximum zener leakage current; it is typically 3 k $\Omega$  or less.

*J. I. Roberts, Section Leader, Instrumentation, Machine Tool Industry Research Association, Hulley Rd., Macclesfield, Cheshire, England SK10 2NE.*

VOTE FOR 312

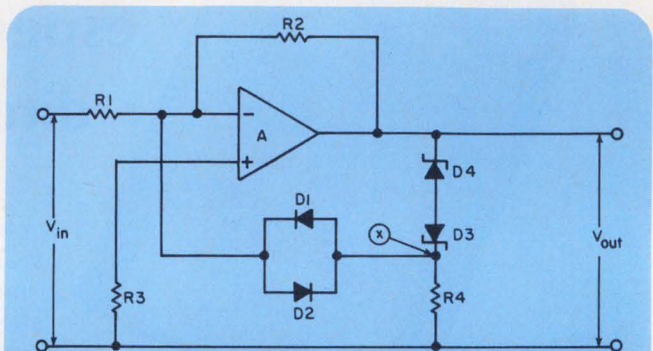

Because diode leakage current is minimized, the gain of this operational amplifier configuration is accurately defined by  $R_2/R_1$ . In addition, the zener diodes precisely limit output voltage swing.

## TTL-compatible crystal oscillator operates from 5-V power supply

By building your own high-frequency crystal oscillator you can gain three distinct advantages: It will use a minimum number of parts, run from only a 5-V supply and be directly compatible with TTL circuits. The design can be used in a number of applications for frequencies from 1 to 20 MHz with loosely specified crystals.

A wideband video amplifier, the circuit's first stage, is connected essentially as a Pierce oscillator. For the amplifier to operate from only a 5-V supply, the design prevents its output voltage swing from going all the way to ground.

Since TTL levels must approach 0 V, the output of the amplifier is shifted by the expandable AND-OR-invert gate. This second stage accepts the sinusoidal output of the first stage and delivers a completely TTL-compatible signal. All the fan-in and fan-out properties of TTL are preserved.

The two capacitors,  $C_1$  and  $C_2$ , are equal in value:

$$C_1 = C_2 \approx 2.1 \times 10^{-3}/f,$$

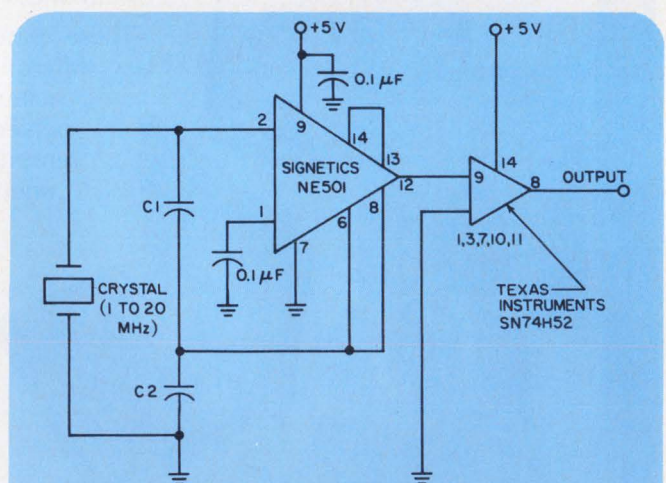

Solve your interfacing problems with this high-frequency crystal oscillator. Its second stage, an AND-OR-invert gate, shifts the level of the Pierce-oscillator first stage so the latter is compatible with TTL circuits, without sacrificing operating speeds. Only a 5-V supply is needed.

where  $f$  is the frequency of the Pierce oscillator.

*John A. DeFalco, Principal Engineer, Honeywell Information Systems, Framingham, Mass. 01701.*

VOTE FOR 313



HEWLETT  PACKARD  
POWER SUPPLIES

*take a  
close look  
when you  
specify a  
power  
supply...*

There's a lot to consider when you specify a power supply, and HP gives you a lot. Take selection for example. HP offers well over 100 models ranging from 10uV to 4000V, from 1uA to 2000A . . . plus a selection of options that satisfy most applications. Performance is another major consideration. At HP, we don't practice "specsman-ship". We present specifications conservatively and completely, so you get the performance you expect. And, every model is backed by a comprehensive operating and service manual detailing every aspect of the supply from operation to maintenance. But it doesn't end there . . . if you need assistance, we have an international network of 220 offices to serve you. And it's all based on a concept of quality and reliability — your assurance that you are getting the best value. Hewlett-Packard, New Jersey Division, 100 Locust Avenue, Berkeley Height, New Jersey 07922, Telephone (201) 464-1234.

**DC POWER SUPPLY SELECTION GUIDE**—this 36-page guide is factual and informative . . . clearly lists all the specs, features, options, prices, etc. on every HP power supply . . . makes it easy to find the right model for any application. Write for your copy.

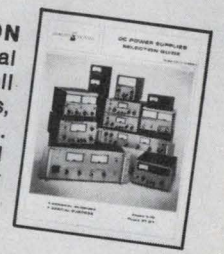

21103



**6259B DC POWER SUPPLY**  
HEWLETT - PACKARD 0-10V 0-50A

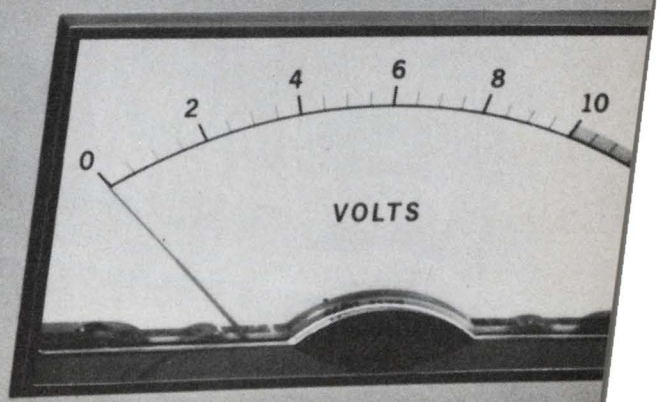



# Telemetry Subsystems

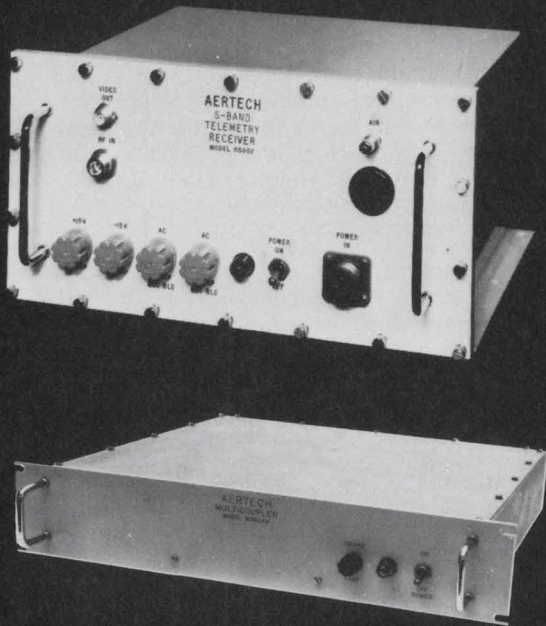

- Receivers
- Down Converters
- Multicouplers

Aertech has the capability and experience to design and build custom telemetry subsystems—our standard line of telemetry subsystems and microwave components proves it.

Our products range from subsystems to semiconductor chips and include solid state amplifiers and sources, mixers, detectors, power dividers, hybrid couplers, and diode modules.

For detailed specifications or applications assistance on any of our UHF/microwave products, call your Aertech representative, or contact us direct.

*Aertech*  
INDUSTRIES

825 Stewart Drive, Sunnyvale, California 94086  
(408) 732-0880. TWX: 910-339-9207

## Drive high-power loads from logic-level signals

High-power loads can be driven for a timed interval from logic-level signals by the accompanying circuit. It delivers a high-power output pulse—up to 10 A at 100 V—for an accurate timed interval of 100  $\mu$ s to 50 ms. The circuit is activated by the positive edge of a pulse from an RTL, DTL or TTL gate.

Functionally the circuit is a monostable multivibrator with good pulse-width accuracy and stability, high output power and low standby power dissipation. It is ideally suited for driving print hammers, solenoids, stepping motors and latching ferrite phase shifters.

The circuit consists of an input latching switch ( $Q_1$  and  $Q_2$ ), a programmable-unijunction-transistor (PUT) timer ( $Q_3$ ), a transistor amplifier and isolator ( $Q_4$ ), and a Darlington output ( $Q_5$ ). When  $Q_1$  is turned ON, it activates the PUT timer, turns ON the amplifier and the Darlington, and is kept ON by  $Q_2$ . At the end of the timing interval, the PUT fires to turn everything OFF.

Ac input coupling makes the output pulse width independent of the input pulse width. Output pulse width is determined by the RC timing network of the PUT. When this network is energized,  $C_2$  charges from 0 V toward the supply voltage. As soon as capacitor voltage exceeds the reference voltage of the PUT gate, the PUT will turn ON. This discharges the capacitor and turns OFF the input switch, the amplifier and the Darlington output. The resulting output pulse width is approximately  $R_3C_2$  seconds. When the PUT recovers, the circuit is back in its quiescent state.

The circuit draws virtually no power when OFF, and only a few milliamperes from the timing supply when ON. The Darlington output is deliberately left floating, so that the load may be

**VOTE!** Go through all Idea-for-Design entries, select the best, and circle the appropriate number on the Reader-Service-Card.

**SEND US YOUR IDEAS FOR DESIGN.** You may win a grand total of \$1050 (cash)! Here's how. Submit your IFD describing a new or important circuit or design technique, the clever use of a new component or test equipment, packaging tips, cost-saving ideas to our Ideas-for-Design editor. You will receive \$20 for each accepted idea, \$30 more if it is voted best-of-issue by our readers. The best-of-issue winners become eligible for the Idea Of the Year award of \$1000.



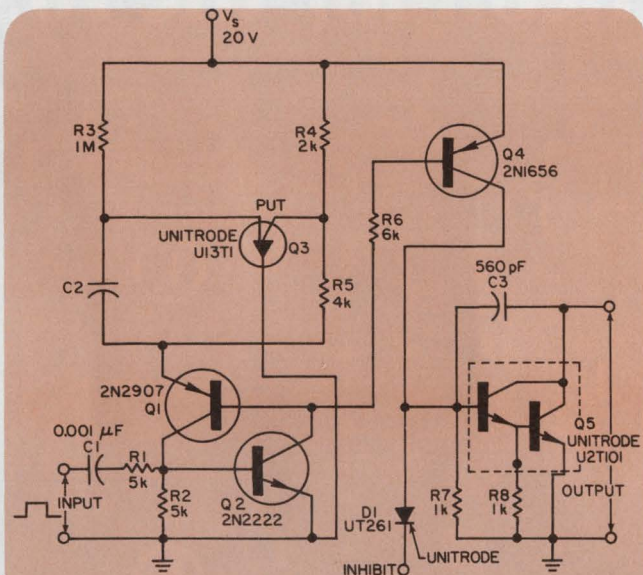

This low-power circuit drives high-power loads for a controlled time interval. Its Darlington output provides up to 10 A at 100 V for pulse widths ranging from 100  $\mu$ s to 50 ms.

placed either in the emitter or collector circuit, and either a positive collector supply or negative emitter supply, or both, may be used.

A Miller capacitance,  $C_3$ , can be used to control the risetimes and falltimes of the output. In addition the output may be inhibited simply by pulling the Darlington base down to the emitter supply voltage with a single transistor.

Either inductive, resistive or capacitive loads can be switched with ease. For inductive loads, a clamp is required to limit the induced voltage when the Darlington output interrupts the load current. In the case of capacitive loads, a series resistance should be used to limit the charging current to a maximum of 10 A.

*E. Crocker, Applications Engineer, Unitrode Corp., 580 Pleasant St., Watertown, Mass. 02172.*

VOTE FOR 314

#### IFD Winner for January 21, 1971

**R. C. Nybo**, Principal Engineer, Standards Engineering, Univac, Federal Systems Div., 322 N. 21 St. West, Salt Lake City, Utah 84116. His idea "Digital Hysteresis Amplifier Cleans Up Noisy Signals" has been voted the Most Valuable of Issue Award.

**Vote for the Best Idea in this Issue.**

## ROCKER SWITCH

New brilliance in a miniature rocker featuring front panel lamp replacement. Entire switch simply snaps into .655" x .728" hole. Choice of 3 doublepole switching actions; 4 lens colors & 4 voltages. Replaceable lamp. Rated 6A @ 125 VAC.

### ILLUMINATED



**ALCOSWITCH®**

MINIATURE SIZE

DIV. OF ALCO ELECTRONIC PRODUCTS, INC., LAWRENCE, MASS.

Telephone: HENRY O'CONNOR (617) 686-3887

## ROCKER & PADDLE MINIATURES

New series of economy "snap-in" switches have high 6 amps rating. Features ease of installation in .49 x .59" hole. Choice of SPDT & DPDT in 4 colors, adds distinction to front panel. Molded "silver" terminals & contacts.

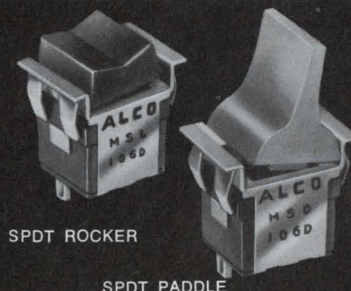

**ALCOSWITCH®**

DIV. OF ALCO ELECTRONIC PRODUCTS, INC., LAWRENCE, MASS.

INFORMATION RETRIEVAL NUMBER 49

## TOGGLE SWITCH MINIATURES

Accident-proof mini switches have toggles locking in position to guard against human errors. Interchangeable colored toggles. 1-2-3-4 poles in many configurations. 6A @ 125 VAC.

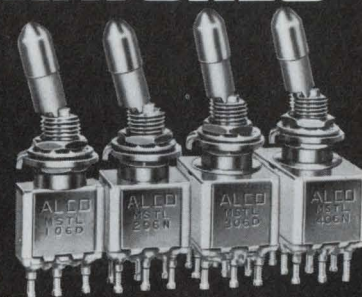

**ALCOSWITCH®**

ALSO AVAILABLE WITH WATERPROOF CASE

DIV. OF ALCO ELECTRONIC PRODUCTS, INC., LAWRENCE, MASS.

Telephone: BOB LAFFEY (617) 686-3887

## ROTARY SWITCH MINIATURES

Two series: MRA Series with adjustable stop & in 1-2-3-4 poles on a single deck with max. of 10 or 12 positions. MSRE waterproof series meet high reliability standards; non-adj. 1 to 4 poles. 500 mA @ 125 VAC.



**ALCOSWITCH®**

DIV. OF ALCO ELECTRONIC PRODUCTS, INC., LAWRENCE, MASS.

INFORMATION RETRIEVAL NUMBER 50



# High Energy Silicon for the 70's.

For Audio Amplification.

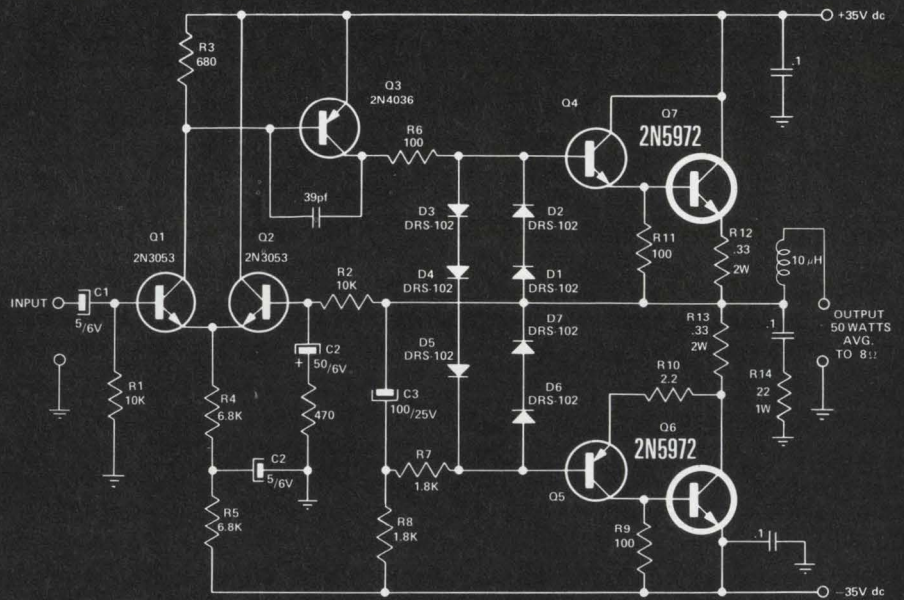

For Switching.

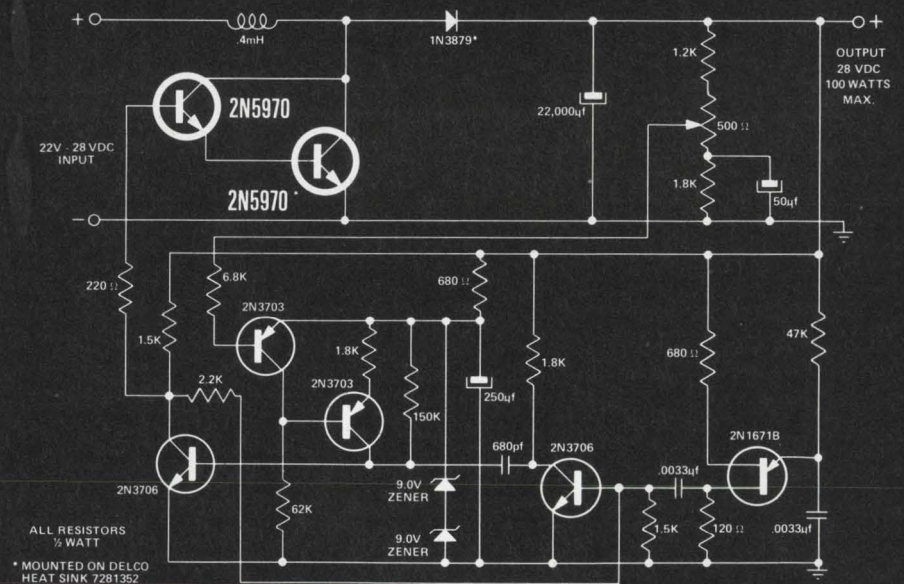

ALL RESISTORS  
1/2 WATT  
\* MOUNTED ON DELCO  
HEAT SINK 7281352

TYPE	I <sub>c</sub> Cont. Amps.	I <sub>c</sub> Pulsed Amps.	V <sub>CE0</sub> Volts	V <sub>CEX</sub> Volts	V <sub>CE0(SUS)</sub> Volts	h <sub>FE</sub> (min.) @ I <sub>c</sub> =5A	h <sub>FE</sub> (min.) @ I <sub>c</sub> =15A	V <sub>CE</sub> (Sat.) Volts @ I <sub>c</sub> =10A, I <sub>B</sub> =1A
2N5970	15	20	60	80	60	20	10	2.0
2N5971	15	20	60	80	60	50	20	1.5
2N5972	15	20	80	100	70	25	10	1.8
2N5973	15	20	100	120	80	25	10	1.8

Pulse Energy Test — @ V<sub>CE</sub>=40V, I<sub>c</sub>=4.5A  
t<sub>p</sub>=10 ms, duty cycle ≤ 4%      ALL TYPES=1.8 Joules

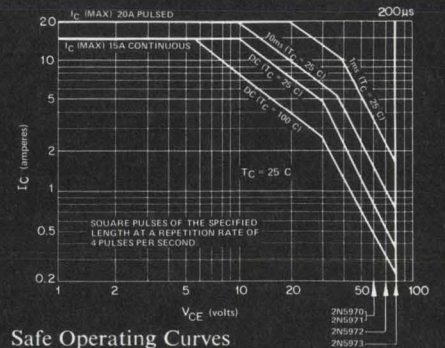

NPN Triple diffused silicon power transistors in TO-3 Solid Copper cases.



# Delco's New 2N5970 Series Transistors: 15 Ampere, Medium Voltage Fast, Versatile, Strong.

These high energy workhorses have built an excellent reputation for linear power amplification as well as for high efficiency switching.

The 2N5970 series offers switching capability up to 120V and 15 Amperes at rates of up to 50 kHz. They provide an optimum balance of energy handling capability and speed for maximum protection against failure from circuit fault conditions. When used for amplification the 2N5970s' linear transconductance over wide current ranges gives them superior performance.

As usual, Delco houses the high energy silicon elements in solid copper TO-3 cases for maximum thermal capacitance and low thermal resistance (1.17° C/W max.) to assure extra reliability in the toughest applications.

They're ideal for voltage regulators, power amplifiers and high efficiency switching circuits. The 28

volt shunt regulator shown is amply handled by the 2N5970 ( $V_{CEX}$  of 80 Volts). In the direct coupled audio amplifier, the 2N5972 displays its excellent frequency response, gain linearity and transconductance.

For fast shipment of small or large quantities of Delco's 2N5970 series, call your nearest Delco Electronics Distributor.

Application Notes 42 and 43 provide the data on the circuits.



## Delco Electronics

DIVISION OF GENERAL MOTORS CORPORATION, KOKOMO, INDIANA

### Available from these Delco distributors:

ALA., BIRMINGHAM • Forbes Distributing Co., Inc. (205)-251-4104  
ARIZ., PHOENIX • Cramer/Arizona (602)-263-1112 • Sterling Electronics (602)-258-4531  
CAL., LOS ANGELES • Kierulff Electronics, Inc. (213)-685-5511 • Radio Products Sales, Inc. (213)-748-1271  
CAL., PALO ALTO • Kierulff Electronics, Inc. (415)-968-6292  
CAL., SAN DIEGO • Milo of California, Inc. (714)-232-8951  
COLO., COLORADO SPRINGS • Walker Electronics (303)-636-1661  
COLO., DENVER • Cramer/Denver (303)-758-2100 • Denver Walker Electronics (305)-935-2406  
FLA., MIAMI • Mountain Electronics Subsidiary of Avnet, Inc. (305)-634-4556  
FLA., WEST PALM BEACH • Mountain Electronics, Subsidiary of Avnet, Inc. (305)-833-5701  
ILL., ROSEMONT (Chicago) • Kierulff/F-J-R (312)-678-8560  
ILL., SKOKIE (Chicago) • Merquip Electronics (312)-282-5400  
IND., INDIANAPOLIS • Graham Electronics Supply, Inc. (317)-634-8486  
MD., BALTIMORE • Radio Electric Service Co. (301)-823-0070  
MASS., NEWTON • The Greene-Shaw Co., Inc. (617)-969-8900  
MICH., ROMULUS • Harvey/Detroit (313)-729-5500

MINN., MINNEAPOLIS • Stark Electronics Supply Co. (612)-332-1325  
MO., KANSAS CITY • Walters Radio Supply, Inc. (816)-531-7015  
MO., NO. KANSAS CITY • ECI Semiconductors, Inc. (816)-221-2400  
MO., ST. LOUIS • Electronic Components for Industry Co. (314)-647-5505  
N.J., CLIFTON • Eastern Radio Corporation (201)-471-6600  
N.M., ALBUQUERQUE • Cramer/New Mexico (505)-265-5767 • Sterling Electronics (505)-247-2486  
N.Y., BINGHAMTON • Harvey/Federal (607)-748-8211  
N.Y., NEW YORK • Harvey/New York (212)-582-2590  
N.Y., WOODBURY • Harvey/New York (516)-921-8700  
OHIO, CINCINNATI • United Radio, Inc. (513)-761-4030  
OHIO, CLEVELAND • Pattison Supply (216)-441-3000  
OHIO, DAYTON • Kierulff/F-J-R (513)-278-9411  
OKLA., OKLAHOMA CITY • Radio, Inc. (405)-235-1551  
OKLA., TULSA • Radio, Inc. (918)-587-9123  
PENN., PHILADELPHIA • Almo Electronics (215)-676-6000  
PENN., PITTSBURGH • RPC Electronics (412)-782-3770  
S.C., COLUMBIA • Dixie Radio Supply Co., Inc. (803)-253-5333

TEXAS, DALLAS • Adleta Electronics Company (214)-742-8257  
TEXAS, FORT WORTH • Adleta Electronics Co. (817)-336-7446  
TEXAS, HOUSTON • Harrison Equipment Co., Inc. (713)-224-9131  
UTAH, SALT LAKE CITY • Cramer/Utah (801)-487-3681  
VA., RICHMOND • Meridian Electronics, Inc., a Sterling Electronics Company (703)-353-6648  
WASH., SEATTLE • Kierulff Electronics, Inc. (206)-763-1550  
WASH., TACOMA • C & G Electronics Co. (206)-272-3181  
CANADA, ONT., SCARBOROUGH • Lake Engineering Co., Ltd. (416)-751-5980  
ALL OVERSEAS INQUIRIES:  
General Motors Overseas Operations  
Power and Industrial Products Dept.,  
767 Fifth Avenue, New York, N.Y.  
10022. Phone: (212)-486-3723.

Regional Headquarters. Union, New Jersey\*  
07083, Box 1018 Chestnut Station, (201)-  
687-3770 ■ El Segundo, Calif. 90245, 354  
Coral Circle, (213)-772-5181  
■ Chicago, Illinois\* 60656,  
5151 N. Harlem Avenue,  
(312)-775-5411 ■ Kokomo,  
Ind. 46901, 700 E. Firmin,  
(317)-459-2175 Home Office  
■ \*Office includes field lab and  
resident engineer for applica-  
tion assistance.





If you need more accuracy and resolution than a 2½-digit V-O-M, but don't want to pay the price of 3½-digits ...

Buy Triplet's new 6028

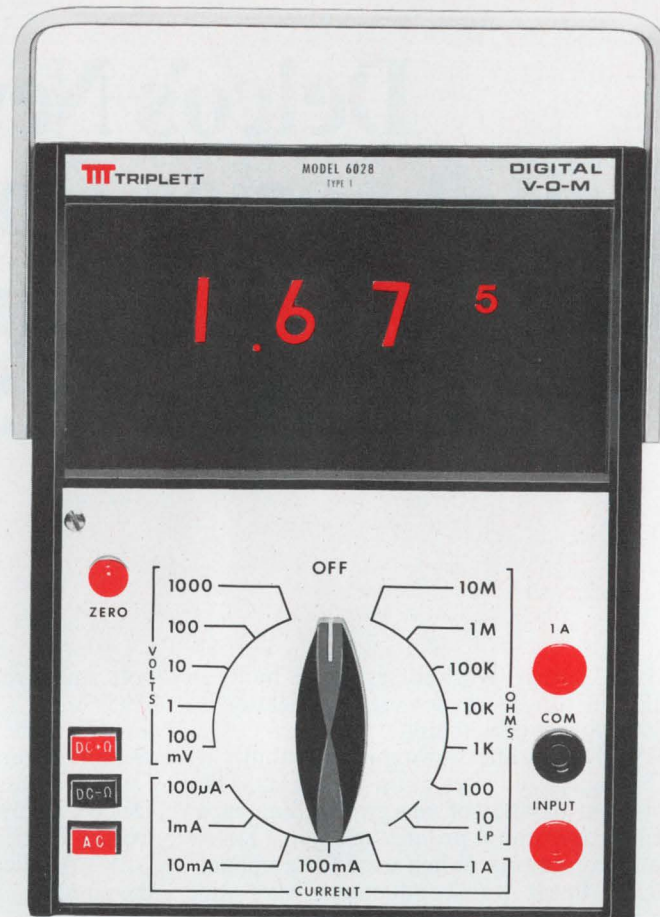

Model 6028 \$275

1. 2¾ DIGITS— Provides high accuracy with resolution to 500 Microvolts.
2. 10 OHMS TO 10 MEGOHMS — 7 Ohms ranges with zero adjust to null lead resistance.
3. LOW CIRCUIT LOADING — Greater measurement accuracy with 10 megohm input resistance for all AC and DC voltage ranges.

Its exclusive 2¾ digit readout lets you read to the nearest "0" or "5" one decimal place beyond the capability of 2½ digit instruments. And at accuracies of  $\pm 0.35\%$  of reading  $\pm \frac{1}{2}$  digit on DC voltage ( $\pm 0.50\%$  of reading  $\pm \frac{1}{2}$  digit, DC current), AC voltage  $\pm 0.50\%$  (current 1.0%) of reading  $\pm \frac{1}{2}$  digit, and resistance to  $\pm 0.5\%$  of reading  $\pm \frac{1}{2}$  digit. It also offers (among its 27 ranges) a 10

Ohm range and a front-panel zero adjust to zero out the test-lead resistance. Add to those advantages 100% overrange capability, positive out-of-range and reverse polarity indication, and the familiar single range-switch feature of Triplet's famous analog V-O-M'S . . . so that no retraining is necessary to switch to digital accuracy and readability . . . and you have just a few of the many reasons for

buying Triplet's new Model 6028 Digital V-O-M.

Designed for R&D, production, quality control, maintenance and classroom use, the Model 6028 is priced at \$275. See it at your local Triplet distributor or, for more information or for a free demonstration of all of its great features, call him or your Triplet representative. Triplet Corporation, Bluffton, Ohio 45817.

**TRIPLET**  
BLUFFTON, OHIO 45817

The World's most complete line of V-O-M's choose the one that's just right for you



# new products

## Unique bipolar semiconductor memory can tolerate a 5-ms total power loss

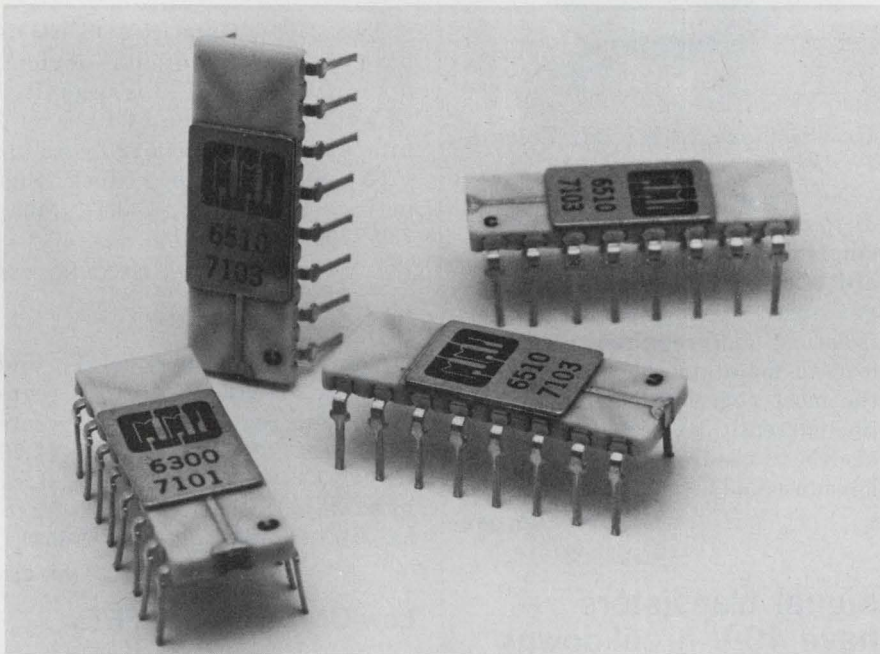

Monolithic Memories, Inc., 1165 E. Arques Ave., Sunnyvale, Calif. Phone: (408) 739-3535. P&A: see text.

Tolerance of total power shutdown for up to 5 ms without loss of memory distinguish a 256-bit bipolar random-access memory. It also features extremely low power dissipation in the standby mode—100  $\mu$ W per bit at collector supply voltages of 5 V.

Formerly semiconductor RAMs were not considered for certain applications where nonvolatility was a necessity and loss of data could not be tolerated.

Typical commercial users in that category include electric power companies, natural gas pipeline concerns and automated refineries. The military also cannot tolerate loss of data in fire-control systems, missile navigation systems and cryptographic data transmission.

Nonvolatility in this new memory is achieved by the use of a charge storage mechanism on the chip. Each memory cell includes

two charge storage devices connected in a cross-coupled manner. The state of the cell is determined by whichever device is conducting.

If power is shut off to the cell, the energy stored in the field of the conducting device discharges through the device in the form of about 1 pA of holding current.

Enough energy is stored to keep the device in a conducting state for about 5 ms. This is enough time to switch in a standby power supply.

The requirement for holding the cell in its state for an unlimited length of time is 2 V,  $V_{cc}$  at 0.6 mA.

A simple battery, attached to a circuit board, could hold several of these memories in state for many hours. The battery could be switched in with a FET device, a reed relay or any of several other common switching techniques.

Although the MM 6510 memory consumes 100  $\mu$ W/bit at 5 V  $V_{cc}$ , it only consumes 6  $\mu$ W/bit at 2 V  $V_{cc}$ . It is this low power con-

sumption that makes nonvolatility realizable.

At an operating level, the MM 6510 dissipates 1 mW/bit. Due to the low power consumption, much higher bit densities can also be achieved on the chip.

Since the power-handling capability of the package is a constant, the lower the dissipation per bit, the more bits in the package.

Density can be enhanced further by the new technology employed, since the area occupied by a memory cell in this circuit is about 30% less than that normally occupied by a bipolar memory cell.

Access time to the memory is 70 ns, and the cycle time is 110 ns maximum under any worst-case operation.

Schottky-barrier technology is used instead of gold-doped technology. The memory is fully DTL/TTL compatible, and full decoding and sense amplifiers are included on the chip.

Pnp addressing circuitry on the input lines allows a tenfold reduction of fan-in current. Fan-in current in the operational mode is 160  $\mu$ A, maximum; in the standby mode it is 10  $\mu$ A maximum. When the chip enable is deactivated, the memory automatically drops into a standby mode. The MM 6510 is the only bipolar memory that uses a dual-power state.

Full operating specifications are guaranteed over a temperature range of 0 to +75°C.

Organization of the memory is 256  $\times$  1 bits. The memory is encapsulated in a 16-pin ceramic dual-in-line package.

MTBF for the memory, per MIL-HDBK-175 is greater than 100 M hours.

Price of the MM 6510 is \$27 in 100 quantities and delivery is from stock.

CIRCLE NO. 250



# Our D servomotor is mad with power.

That's our SU-680D-29 permanent-magnet D-C servomotor. We call it our D motor for short. It's small, rugged and powerful. It delivers 12.7 watts of continuous power output at 8600 rpm and is a natural for any servomechanism that requires a prime mover. It has a high repeatability-to-time ratio which makes it immensely stable, a 0-10,000 rpm speed range and a high acceleration Torque/Inertia. Torque peaks at 15 oz-in., 2 oz-in. continuous at 8600 rpm. It measures only 1½ inches in diameter and weighs just 8¼ ounces.

SERVO-TEK PRODUCTS COMPANY  
1086 Goffle Road, Hawthorne, New Jersey 07506.

**SERVO-TEK**  
PRODUCTS COMPANY

For full details write for our interesting technical sheets and get mad with power yourself.



## ICs & SEMICONDUCTORS

### Monolithic JFETs use 2N 6-lead packages

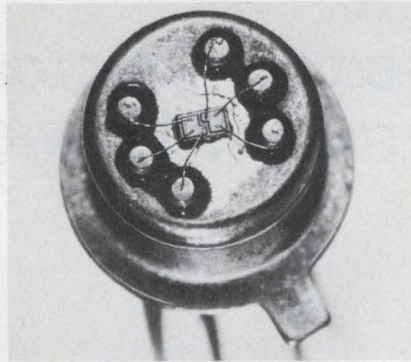

Unisem Corp., Street Rd., Treviso, Pa. Phone: (215) 355-5000.

New monolithic dual JFETs with dielectric-isolation separation on a single chip are available in standard 6-lead 2N packages. Older devices used a separate p channel for isolation, and required a seventh lead to maintain the p channel as the most negative one. The JFET line currently includes 19 standard models including fast-switching, low-noise and high-frequency types.

CIRCLE NO. 251

### Signal transistors have 40-V breakdowns

Texas Instruments, Inc., 13500 N. Central Expressway, Dallas, Tex. Phone: (214) 238-2011. P&A: 34¢ and 35¢; stock.

Two new npn and two new pnp small-signal plastic transistors, all second-source devices, feature collector-emitter breakdowns of 40 V. The npn devices are 2N3903 and 2N3904, and the pnp devices are 2N3905 and 2N3906.

CIRCLE NO. 252

### MOS 2-channel switch handles 20 V analog

Siliconix, Inc., 2201 Laurelwood Rd., Santa Clara, Calif. Phone: (408) 246-8000. P&A: \$6; stock.

A new 2-channel monolithic MOS switch with driver switches analog signals up to 20 V pk-pk. The DGM111BK is designed to operate over -20 to +85°C and incorporates p-channel normally off MOS-FETs. Large-signal channel resistance at 25°C is 100 to 450 Ω.

CIRCLE NO. 253

### 35-ns-access RAM

The Am301 TTL 64-bit RAM offers access time of 35 ns and write time of 20 ns. The off-the-shelf RAM is organized 16 words by 4 bits. Price: \$21.50. Advanced Micro Devices, Sunnyvale, Calif. (408) 732-2400.

CIRCLE NO. 254

### Tri-state MOS ROMs

Two 2560-bit static MOS ROMs have three-state outputs—logic 1, 0 and OFF. The 2513 is organized 64 by 7 by 5 bits or 64 by 8 by 5 bits, and the 2514 as 512 by 5 bits. P&A: \$15.60, \$22.50; stock. Signetics, Sunnyvale, Calif. (408) 739-7700.

CIRCLE NO. 255

### IC 5-V regulators

New SG109T/209T/309T and SG109K/209K/309K are 5-V regulators for regulation at currents in excess of 1 A. P&A: \$5.20 (SG309T), \$6.15 (SG309K); stock to 30 days. Silicon General, Westminster, Calif. (714) 892-5531.

CIRCLE NO. 256

### Low-ON-resistance FETs

The SDF1001, SDF1002, and SDF1003 FETs have low ON resistances of 7, 10 and 15 Ω, respectively. Minimum breakdowns are 30 V and input capacitances are 20 pF. Availability: stock. Solitron Devices, San Diego, Calif. (714) 278-8780.

CIRCLE NO. 257

### High-speed 4-bit adders

Two high-speed 4-bit adders are the RL3100 and RL3102 MSI ICs. They have four full adders in a look-ahead-carry mode. Availability: stock. Raytheon Semiconductor, Mountain View, Calif. (415) 968-9211.

CIRCLE NO. 258

### Asynchronous counters

Two new strobed parallel-entry asynchronous counters are available. Types USN828PA and USN-8281A are MSI decade and binary counters, respectively. Sprague Electric, N. Adams, Mass. (413) 664-4481.

CIRCLE NO. 259



# Centralab Ultra-Kaps semiconductor type capacitors are an economical approach to miniaturization. As low as 2½¢ each on quantity orders.

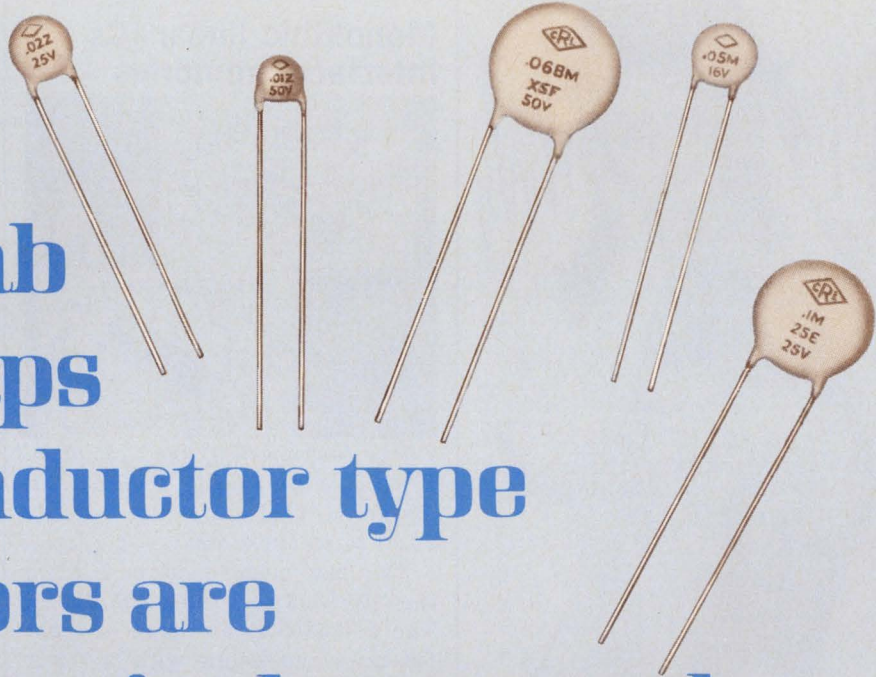

Ultra-Kaps® replace mylar and "Hi-K" ceramic capacitors and you still save space and money. Their reliability has been field tested and proven on millions of circuits. To obtain samples for independent evaluation, write, on your letterhead, to Capacitor Sales Manager, Centralab.

RANGE CHART

Maximum Diameter	16 volt		25 volt		50 volt	
	Max. Cap. MFD	Min. I.R. Megohms	Max. Cap. MFD	Min. I.R. Megohms	Max. Cap. MFD	Min. I.R. Megohms
.290	.02	5.0	.015	65.0	.01	1000
.390	.033	3.0	.022	45.0	.015	1000
.405	.05	2.0	.033	30.0	—	—
.485	—	—	.05	20.0	.022	1000
.515	.068	1.5	—	—	.033	1000
.590	0.1	1.0	.068	15.0	.047	1000
.690	0.15	0.65	0.1	10.0	.05	1000
.760	—	—	—	—	.068	1000
.820	0.2	0.5	0.15	6.5	—	—
.920	0.3	0.33	0.2	5.0	0.1	1000

Thickness: .156 inches maximum  
 Temperature Characteristics: 16 and 25 volt: X5R, Y5F, Z5E  
 50 volt: X5F, Y5F, Z5F



**CENTRALAB**

Electronics Division  
GLOBE-UNION INC.

5757 NORTH GREEN BAY AVENUE  
MILWAUKEE, WISCONSIN 53201

CENTRALAB PRODUCTS ARE MARKETING THROUGH  
CENTRALAB INDUSTRIAL DISTRIBUTORS AND INTERNATIONALLY  
THROUGH GLOBE-UNION INC., INTERNATIONAL DIVISION.





**unwanted**

noise or signals  
effectively reduced  
or eliminated  
with



**Rtron**

### Cylindrical Style Interference Filters

that reduce or eliminate unwanted noise or signals. Small size, light weight, maximum attenuation. Voltage current or insertion loss characteristics required, determine physical size. Maximum isolation of terminals and high frequency performance are assured by threaded neck design for bulkhead mounting. Feed-thru capacitor circuitry conservatively rated for both military and commercial applications.

Send us your specifications.  
Ask for catalog and complete details.  
Dept. E-10

**Rtron** corporation  
P.O. Box 743 Skokie, Illinois 60076  
Phone 312 • 327-4020

INFORMATION RETRIEVAL NUMBER 57

## ICs & SEMICONDUCTORS

### Monolithic linear ICs interface memories

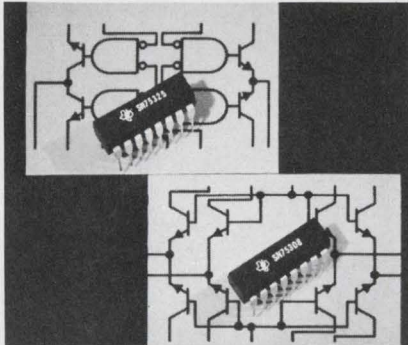

Texas Instruments, Inc., 13500 N. Central Expressway, Dallas, Tex. Phone: (214) 238-2011. P&A: \$4.20 to \$9.40; stock.

Two new memory-driver ICs are the SN75308 and the SN55/75325. The SN75308 is an array of eight 600-mA transistors with a 0.5-A drive. It is designed for use in two-dimension memory systems. Designed for use with magnetic memories, the SN55/75325 driver has two logic inputs. It contains two 600-mA source-switch transistor pairs and two 600-mA sink-switch transistor pairs.

CIRCLE NO. 260

### Monolithic op amps upgrade performances

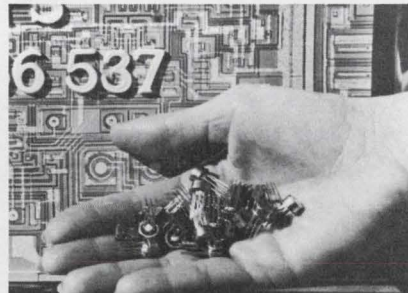

Signetics Corp., 811 E. Arques Ave., Sunnyvale, Calif. Phone: (408) 739-7700. P&A: \$30, \$12.60, \$45, \$15; stock.

A family of four new IC op amps are available. They are the 537 precision op amp with low input offset and bias currents and a max differential input of  $\pm 30$  V; the 536 general-purpose 12-pA-bias FET-input op amp; the 533 high-performance op amp which consumes only 100  $\mu$ W at  $\pm 3$  V and the 531 with a 35-V/ $\mu$ s slew rate.

CIRCLE NO. 261

DATA TECHNOLOGY, inc./a subsidiary of the Allen-Bradley Company.

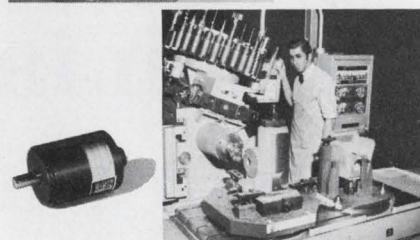
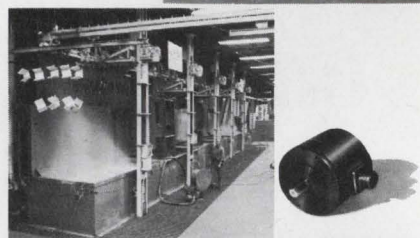
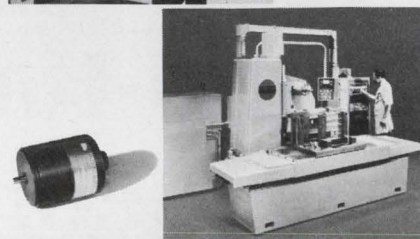
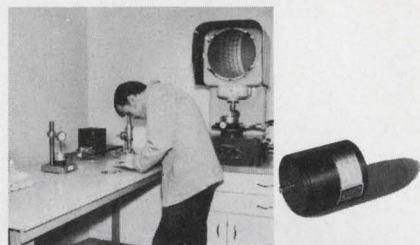

### WE'VE ALREADY SOLVED MANY OF YOUR ENCODER PROBLEMS.

For over ten years, Data Tech has been solving industry's problems in precision measurement, numerical control feedback, instrumentation, design and display. Our solutions are technically sound, economical and offer years of reliable repetitive system operation. Wherever encoder technology makes good sense our technical skills and years of experience are available to you.

- Typical **OPTECON**<sup>tm</sup> Encoder Applications -
1. Measurement Laboratory Digitizing
  2. N/C Machines and Readouts
  3. Severe Industrial Environment Operations
  4. Machining Center and Numerous Others



New **SUPERCON**<sup>tm</sup> Offers High Performance:  
Frequency: 125 KHz Max.  
Accuracy: 3 arc min.  
Resolution: to 2500 cycles/turn  
Speed: up to 3000 RPM  
Drive Capability: up to 400 feet  
WRITE FOR PUBLICATION 1-700 for complete information.

Write for **OPTECON**<sup>tm</sup> Publication 1-601 and Application Notes.



<sup>tm</sup> - Trade Names describing Data Technology, Inc., series of Optical Encoders

DATA TECHNOLOGY, inc.  
65 Grove Street, Watertown, Massachusetts 02172 / 617 : 924-1773

INFORMATION RETRIEVAL NUMBER 58  
ELECTRONIC DESIGN 10, May 13, 1971



## Power transistors

The SVT450-3 power transistors feature a continuous current of 3 A with  $V_{CE(sat)}$  of less than 1 V and a beta greater than 10. P&A: \$14.50; stock. TRW Semiconductor Div., Lawndale, Calif. (213) 679-4561.

CIRCLE NO. 262

## Dynamic shift register

The MK1007P is a 4 by 80-bit MOS dynamic shift register. It is TTL/DTL compatible and includes a single-phase clock input. Clock range of 10 kHz to 2.5 MHz. P&A: \$13.50, stock. Mostek, Carrollton, Tex. (214) 242-1494.

CIRCLE NO. 263

## Function generator IC

A \$6 voltage-controlled oscillator IC produces accurate buffered square waves and linear buffered triangular waves, simultaneously. Frequency for the 566 is 100-ppm/°C stable. Availability: stock. Signetics, Sunnyvale, Calif. (408) 739-7700.

CIRCLE NO. 264

## Precision IC op amp

Isothermal chip layout of the new  $\mu A777$  precision op amp reduces temperature drifts and output current effects which cause input offset voltage shifts. Fairchild Semiconductor, Mountain View, Calif. (415) 962-3562.

CIRCLE NO. 265

## MOS 2-MHz ROM

The S8327 is an MOS 2-phase dynamic 448 by 5-bit ROM for character generation with TTL compatibility on address inputs and 2-MHz synchronous operation. P&A: \$21, stock. American Micro-Systems, Santa Clara, Calif. (408) 246-0330.

CIRCLE NO. 266

## MOS static ROM

A new 4096-bit static MOS ROM, UA2596, operates from -55 to +125°C and prevents field-inversion at voltages over -20 V. Availability: 4 wks. Unisem, Trevese, Pa. (215) 355-5000.

CIRCLE NO. 267

# precision metals applications?

**Diaphragms - Pressure Transducers  
Delay Lines - Strain Gages**

# without question, ask Hamilton!

**Leader in strip, foil and wire.**

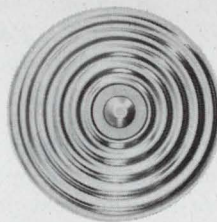

**strip** Ni Span C, Chace 720, 300 and 400 Series stainless steels, copper alloys, Havar®, precipitation hardening grades and other diaphragm materials are regularly produced at 0.010" and thinner with standard thickness tolerances of  $\pm 5\%$ . Diaphragm and pressure transducer manufacturers will find Hamilton personnel technically familiar with design considerations, material selection and fabrication techniques.

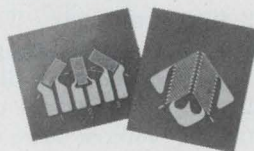

**foil** Hamilton's many years of experience in producing thin metal products for such applications as strain gages for stress analysis has made us a leader in foil product quality. Hamilton produces to electrical resistance specifications and dimensional restraints. Most alloys including Havar®, Titanium, BeCu, etc. are available in foil thickness down to 0.00009".

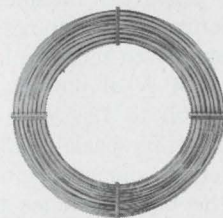

**wire** The production of constant modulus wire for use in magnetostrictive delay line systems represents a significant technical base in Hamilton's drawn product capabilities. The material, Elinvar Extra®, is available only from Hamilton. The experience and technology gained in the proprietary manufacture of delay line wire places Hamilton in the forefront of capabilities for specialty wire drawing.

These applications are representative of Hamilton's ability to provide sound solutions to precision metal product manufacturing problems. Under one roof, with absolute control, we can melt, cast, forge, hot and cold roll, draw, heat treat and slit specialty alloys to your most exacting requirements. Call or write for immediate assistance or complete literature.



**PRECISION METALS DIVISION  
HAMILTON**

WATCH COMPANY • LANCASTER, PA. 17604

PHONE 717/394-7161

INFORMATION RETRIEVAL NUMBER 59



## SOLID-LITE

# SOLID STATE NUMERIC INDICATORS AND LAMPS

New Solid-Lite display devices use gallium phosphide, the most efficient visible light emitting semiconductor. You get bright light at low current.



### SOLID-LITE Solid State Numeric Indicators

- Large (.33" x .21") bright numerals are pleasing to the eye
- Standard 14-pin dual-in-line package
- Low voltage operation at less than ¼ watt total power
- Compatible with TTL and DTL IC's
- Single-plane wide-angle viewing
- High reliability — long life
- Excellent shock and vibration resistance
- Low cost

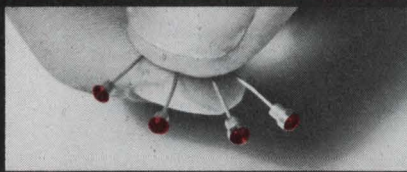

### SOLID-LITE Solid State Lamps

- 2 millicandelas luminous intensity at 15 mA and 2.1 V
- Area light source — not a pinpoint
- Easy wide-angle viewing
- IC compatible
- Excellent shock and vibration resistance
- High reliability — long life
- Low cost

For technical literature or applications assistance, write or call OPCOA, Inc., 330 Talmadge Road, Edison, New Jersey 08817; phone (201) 287-0355.

# OPCOA

INFORMATION RETRIEVAL NUMBER 60

## INSTRUMENTATION

# DVOM pair offers 50-m $\Omega$ resolution and 0.1% accuracy



Triplet Corp., Bluffton, Ohio.  
Phone: (419) 358-5015. P&A:  
\$275 (6029), \$385 (8035); stock.

Resistance resolution down to 50 m $\Omega$  and dc voltage accuracy of  $\pm 0.1\%$  are just two of the many features of two new low-cost portable digital VOMs.

Model 6028 (above right) is a 2-3/4-digit volt-ohmmeter with a unique 1/2-digit concept. The meter has a 10- $\Omega$  full-scale range with a resolution of 50 m $\Omega$ , displays a 10-M $\Omega$  input resistance on all its ac and dc voltage ranges, and 100% over-range, out-of-range, and reverse-polarity indications.

Additional features include a zero-adjust control for low-resistance measurements to zero out lead resistance, only 4 W of power dissipation from 105 to 125 V ac 60 Hz, optional battery-pack (\$130), and ac frequency compensation.

Basically, the 6028 includes five dc voltage ranges: 0.1, 1, 10, 100 and 1000 V full scale. Accuracies are 0.25% on 0.1 and 1-V ranges and 0.35% on the other ranges. Full-scale dc response is in 1 s.

Ac voltages are measured in five ranges: 0.1, 1, 10, 100 and 1000 V full scale. Accuracy is  $\pm 0.5\%$ . Full-scale response is in 3 s and is of the average sensing rms calibrated type of response.

The 6029 can measure resistances from 10  $\Omega$  to 10 M $\Omega$  full

scale in seven ranges at  $\pm 0.5\%$  accuracy. Full-scale response is in 2 s on all ranges except the 10-M $\Omega$  range, which takes 10 s.

Ac and dc currents are measured from 100  $\mu$ A to 1 A full scale in five ranges. Accuracy is  $\pm 1\%$  for ac and  $\pm 0.5\%$  for dc. Full-scale response is 3 s for ac and 1 s for dc.

The other half of this DVOM pair is the high-accuracy model 8035 3-1/2-digit meter (above left). It features a chopper-stabilized amplifier that provides a 10-M $\Omega$  input resistance on all ac and dc ranges, accuracies of  $\pm 0.1\%$  and  $\pm 0.2\%$  for dc and ac voltages, respectively, and frequency-compensated ac voltage ranges.

In addition, it includes automatic polarity display, 100% over-ranging (1999 counts), out-of-range display blanking and 3 W of power consumption.

Five dc voltage and five ac voltage ranges of 0.1, 1, 10, 100 and 1000 V full scale are included. Response times for full-scale voltage measurements are 1 and 3 s, respectively.

Six resistance ranges from 100  $\Omega$  to 10 M $\Omega$  full scale are also included. Basic resistance measurement accuracy is  $\pm 0.25\%$ .

Ac and dc currents are measured in five ranges each from 100  $\mu$ A to 1 A full scale at accuracies of  $\pm 0.2\%$  for dc and  $\pm 0.5\%$  for ac.

CIRCLE NO. 268



# Add 'DZM' to your vocabulary for 'Digital Impedance Meter'

## Then add a DZM to your lab for quick, easy component measurements!

Think about the last time you needed a quick component measurement on an impedance bridge! How long did it take you to go back and forth from one dial to the other to get a balance and then to interpolate the reading yourself?

The familiar old GR impedance bridges are still fine engineering tools, but now GR's 1684 DZM can save you time and bother. The DZM gives you the same measurement ranges and basic 1% accuracy as the old bridges but cuts test time from minutes to seconds because you don't have to make any manual balances to get an easy-to-read, automatic readout.

All the added convenience of the DZM is yours for as little as \$1050. Get all the details from the nearest GR office or from 300 Baker Avenue, Concord, Mass. 01742. In Europe write to Postfach 124, CH 8034, Zurich, Switzerland.

Price is net FOB, Concord, Mass.



## General Radio

BOSTON 617 646-0550 / CHICAGO 312 992-0800 / LOS ANGELES 714 540-9830  
NEW YORK (N.Y.) 212 964-2722 (N.J.) 201 791-8990 / WASHINGTON, D.C. 301 881-5333  
TORONTO 416 252-3395 / ZURICH (051) 47 70 20  
GRASON-STADLER 617 369-3787 / TIME/DATA 415 327-8322

### DZM Specifications

*C Range:* 0.1 pF to 200  $\mu$ F  
*R Range:* 1 m $\Omega$  to 200 M $\Omega$   
*L Range:* 0.1  $\mu$ H to 200 H  
*Oscillator:* 1 kHz, internal  
*C Bias:* 0 to 50 V, external



INFORMATION RETRIEVAL NUMBER 61



## Portable 500-MHz counter adds-on low-cost modules

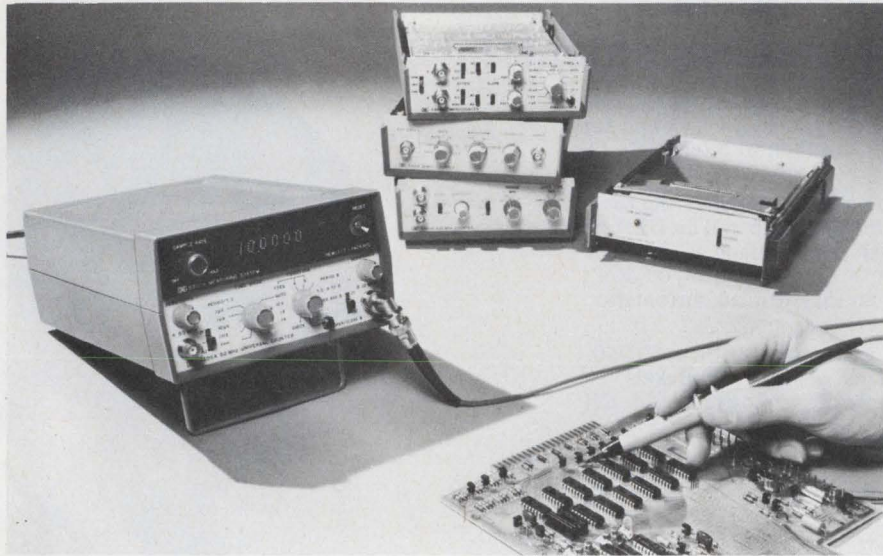

Hewlett-Packard Co., 1501 Page Mill Rd., Palo Alto, Calif. Phone: (415) 493-1501. P&A: see text; 8 to 12 wks.

A new portable six-digit frequency measurement system with MOS/LSI circuitry and a LED readout provides economy and flexibility.

It consists of a \$395 mainframe with the flexibility of adding any one of four different snap-on counter modules for measuring frequencies up to 500 MHz.

The system can operate from either 115/230 V ac 50 to 400 Hz or from a snap-on rechargeable Ni-Cd battery pack.

The 5300A mainframe snaps together with the following modules: the 50-MHz 5320A universal counter/timer with period, ratio and totalizing capabilities (\$250); the 500-MHz 5303A counter (\$750); and the 10-MHz 5304A timer/counter with 100-ns time-interval resolution and period-average function (\$300).

The mainframe module contains, as standard features, a LED display; serial BCD output; a 10-MHz crystal with a  $3 \times 10^{-7}$ /month aging rate and a  $5 \times 10^{-6}$  drift rate over 0 to +50°C; a time base; power supply, and control circuits that include all the logic necessary for autoranging.

Serial BCD output is 8-4-2-1, with floating decimal point, exponent, sign and overflow indication. A \$100 accessory cable (10533A) is available to convert the serial output code to parallel BCD output.

The 5310A battery pack, which costs \$175, operates from 4 to 8 hours. The battery may be recharged whenever the mainframe is plugged into an ac line, regardless of whether the instrument is on or off. The instrument switches to battery power automatically if the line power goes off.

Since 90% of the electronics in the 5300A are contained in five custom ICs and a solid-state display, all produced by Hewlett-Packard, power consumption is kept low (25 VA maximum) and servicing is simplified.

A special \$90 plug-in test card (10548A) is available for troubleshooting. It contains a diagnostic routine that quickly isolates troubles to a functional block.

CIRCLE NO. 269

## 500-MHz real-time scope can also handle 1 GHz

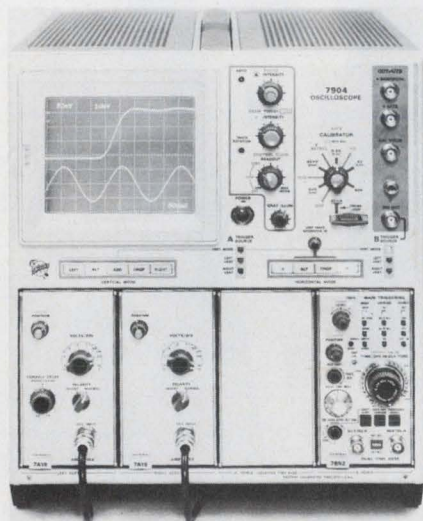

Tektronix, Inc., Box 500, Beaverton, Ore. Phone: (503) 644-0161. P&A: \$2900 (without plug-ins); 4th quarter, 1971.

Stretching bandwidth to a new high is the 7904 scope with a 500 MHz real-time bandwidth. A deflection factor of 10 mV/cm is obtained by using the 7A19 plug-in amplifier with an input impedance of 50  $\Omega$ . Direct access to its 8 by 10-cm CRT makes possible a 1-GHz bandwidth at a deflection factor of 5 V/cm.

The new scope includes the 7B92 dual time base with calibrated sweep rates from 500 ps/cm to 0.2 s/cm, and three display modes:

intensified delaying sweep, delayed sweep and alternate sweep. The alternate mode allows the simultaneous display of the intensified delaying and delayed sweep modes.

The time base's internal trigger requirements are 0.5 cm, increasing to 1 cm at 600 MHz. External requirement is 100 mV up to 600 MHz.

The 7904's CRT provides a writing speed of 10 cm/ns with the use of the C-51-R camera, P11 phosphor and 10,000 ASA film.

An optional 4 by 5-cm CRT and the writing-rate enhancement of Tektronix's new film-fogging technique extends writing speed to 30 cm/ns and beyond.

The 7904's CRT is labeled with deflection factors, sweep rates and uncalibrated and invert symbols.

CIRCLE NO. 270





# Dialight announces **DIODE-LITE™** the industry's broadest line of LED light sources, indicator lights and readouts.

Here is every component or package you might need to capitalize on the long life and reliability of LEDs: DIODE-LITE light sources . . . indicator lights utilizing DIODE-LITES in cartridges and complete assemblies . . . illuminated pushbutton switches . . . readout modules in .125", .205" and .600" character heights . . . these modules incorporated in readout packages complete with decoder/drivers . . . and finally, display assemblies of 2 to 10 read-

out packages mounted in a bezel frame with window. All are attractively priced. All are available off-the-shelf from Dialight or through selected distributors.

No one else offers you one-stop shopping in LED visual display. And no one has more experience in the visual display field. That's important too. Write today for our Data File on DIODE-LITES and compare it with anybody else's.

**DIALIGHT**



# tunable multi-frequency tone trans- formers from Bulova

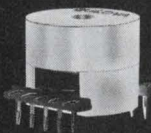
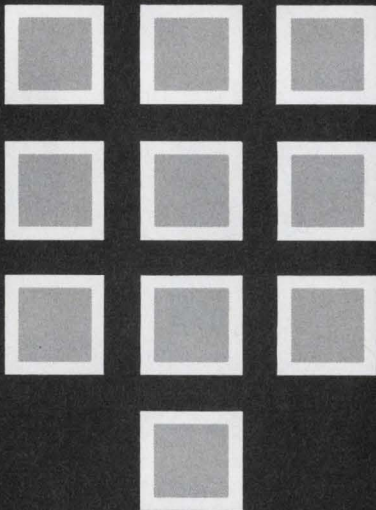

designed for signaling applications

- with four to ten terminals for pc mounting
- have a high Q factor
- excellent temperature stability
- standard and low profile

For telephones, modems and communication applications in general, these Bulova Tunable Tone Transformers provide the answer to multi-frequency signaling requirements. What's not available off-the-shelf, we will be glad to custom design. For fast follow-up, call (212) 335-6000 . . . or write



**BULOVA**  
FREQUENCY CONTROL PRODUCTS  
fcp  
Electronics Division  
Bulova Watch Co., Inc.

61-20 Woodside Avenue  
Woodside, N. Y. 11377 / (212) 335-6000

INFORMATION RETRIEVAL NUMBER 63

## INSTRUMENTATION

### 80-MHz synthesizer costs down to \$2600



RF Communications, Inc., 1680 University Ave., Rochester, N. Y. Phone: (716) 244-5830. Price: see text.

A new five-digit programmable frequency synthesizer, the RF-828, covers 1 kHz to 80 MHz in 1-kHz steps and has optional 1-Hz resolution, yet costs only \$2900 (\$2600 for standard 1-kHz resolution). The synthesizer's stability is 1 part in  $10^6$  per month and it provides an output of 1 mV to 1 V rms into 50  $\Omega$ . Optional stability of 1.25 parts in  $10^7$  per month is available.

CIRCLE NO. 271

### Transistor/diode tester works over a wide range

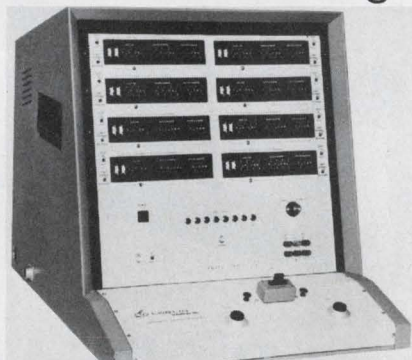

Lorlin Industries, Inc., Precision Rd., Danbury, Conn. Phone: (203) 744-0096. P&A: \$7400; 4 wks.

The new low-cost high-speed, automatic transistor and diode tester model T8BQ is programmable over a range of 0.1 nA to 10 A and 10 mV to 600 V. All types of transistors and diodes can be tested for breakdown voltage, leakage, gain and saturation voltage with 1% accuracy. The T8BQ can perform up to 8 tests in automatic sequential operation.

CIRCLE NO. 272

### Digital C/L meter

Model 700C 4-digit C/L meter measures capacitance with 0.001-pF resolution and  $\pm 0.03\%$  accuracy. Inductance is measured with 0.5-nH resolution and  $\pm 1\%$  accuracy. P&A: \$2600, 2 wks. Boonton, Parsippany, N. J. (201) 887-5110.

CIRCLE NO. 273

### 20-MHz pulse generator

The PGPS-4 20-MHz pulse generator has four individual outputs with variable offsets, amplitudes, widths and delays, and independently variable transition times. P&A: \$1975, stock to 40 days. Simetrics, Lincoln, Mass. (617) 897-7647.

CIRCLE NO. 274

### Low-cost impedance meter

The new 1684 4-digit impedance meter for \$1050 makes four measurements/s with 1% accuracy for R, L, C and dissipation factor. Measures 0.1 pF to 200  $\mu$ F, 0.1  $\mu$ H to 200 H and 1 m $\Omega$  to 2 M $\Omega$ . General Radio, Concord, Mass. (617) 369-4400.

CIRCLE NO. 275

### Low-cost DPMs

Two new low-cost DPMs are 3-digit model 420 at \$124 and 4-digit model 740 at \$295 (1 to 9). Datascan, Clifton, N. J. (201) 478-2800.

CIRCLE NO. 276

### Recorder modules

Series GR-700 recorder modules offer rectilinear analog recording with heated stylus on 50-mm channel spans. Linearity is 1% and response is  $\pm 1/2$  dB from dc to 80 Hz. Price: from \$209. General Scanning, Watertown, Mass. (617) 924-6620.

CIRCLE NO. 277

### Versatile recorder

The flexible REC51 Servograph recorder by Radiometer offers 10, 100 and 500-mV and pH interface plug-ins and chart speeds of 1 cm/s to 0.5 cm/h. Sensitivities from 4  $\mu$ V/cm to 500 mV/cm. The London Co., Cleveland, Ohio. (216) 871-8900.

CIRCLE NO. 278



# A new CRT for photographic reproduction of computer-generated copy

Introducing RCA-4506... a new, 7-inch diameter, high-resolution Cathode Ray Tube that is especially designed for photographic reproduction of computer-generated graphics. Bright, and sharp-focusing, this attractive CRT is already being used successfully in RCA's own Video Comp computer printing system.

RCA-4506 is a premium design, a natural development of RCA's long experience in display devices. Meeting all the criteria for blemishes, this

extraordinary CRT features a .0009-inch maximum spot size for 1  $\mu$ ampere of cathode current measured at 50% of beam amplitude.

Because RCA uses one of the brightest phosphors available; because this phosphor has a persistence of less than 5  $\mu$ s; and because once adjusted, the beam intensity remains essentially constant, the RCA-4506 also can be applied in flying-spot scanner systems, optical character recognition, geophysical surveys,

and side-looking radar for mapping.

Custom variants with specific phosphors and bulb size, of course, are available upon inquiry. Discuss your needs with your local RCA Representative or your RCA Distributor. For technical data, write: RCA, Commercial Engineering,\* Harrison, N. J. 07029. International: RCA, 2-4 rue du Lièvre, 1227 Geneva, Switzerland, or P.O. Box 112, Hong Kong.

## RCA

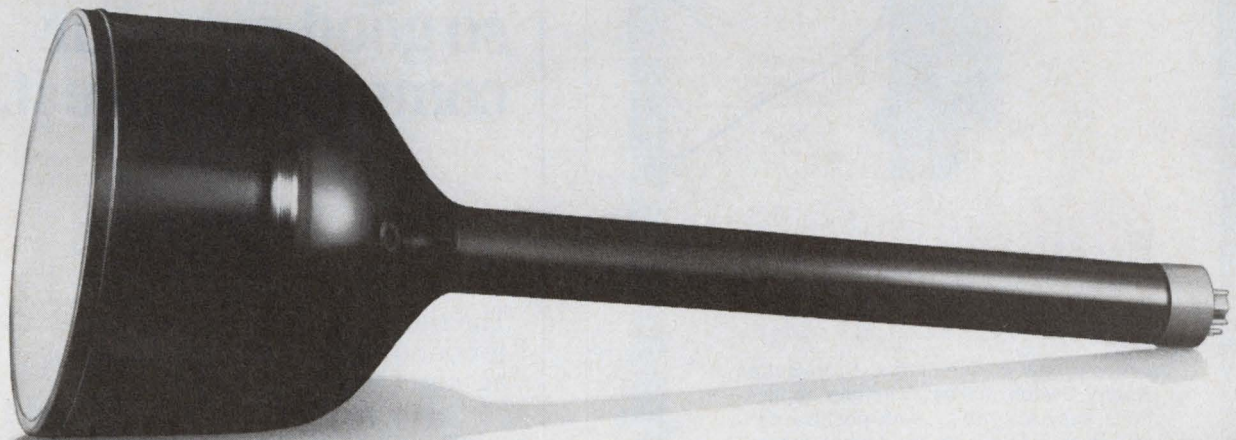

## RCA-4506

High brightness, short persistence, and uniformity make RCA's new CRT useful in many applications. It has a useful screen diameter of 6 $\frac{1}{4}$ ".

\*Section 57E-13/ZC9.



### Calculator with memory downs price to \$479



Commodore, 390 Reed St., Santa Clara, Calif. Phone: (408) 247-4114. Price: see text.

A new 12-digit electronic calculator features automatic overflow, register exchange, true credit balance and grand-total accumulation and retails at only \$479. The 432 is capable of instantly retaining and accumulating the results of individual problems in a series. Its register exchange key instantaneously exchanges figures in the working register with those on the display.

CIRCLE NO. 279

### 12-bit minicomputer mixes bipolar and core

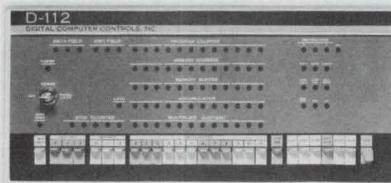

Digital Computer Controls, Inc., 23 Just Rd., Fairchild, N. J. Phone: (201) 227-4861. P&A: \$5400; summer, 1971.

The D-112H highspeed 12-bit MSI minicomputer features a solid-state bipolar read/write memory which can be mixed with a 1.2- $\mu$ s random-access core memory whose cycle time is 300 ns. This core memory is expandable to 32,768 words with 256-word solid-state memory increments substituted for core.

CIRCLE NO. 280

### CRT display keyboard interfaces Teletypes

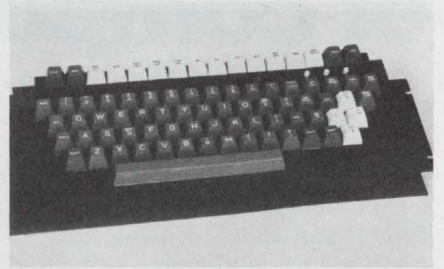

Data Electronics Corp., 12 Cambridge St., Burlington, Mass. Phone: (617) 272-7460.

A new keyboard for model 37 teletypewriters is the MK-37/2040 for high-speed data transmissions with extra keys for use in a CRT display. Standard features include 128 ASCII codes, three operating modes, two-key rollover, error and data lockout, and DTL/TTL interface with positive logic. Options include parity, automatic repeat and code selection.

CIRCLE NO. 281

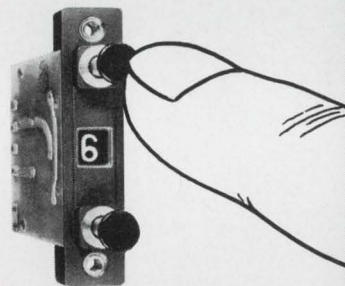

## Positive Control... At your finger tip!

Janco's new Bi-Directional Push-Button Rotary Switch makes switching applications easy for you... with positive control at your finger tip. And what control! Eight, ten, or twelve individual circuits. Or do you require more? If so, let's gang two, three, four or more switches together. **NOW THAT'S CONTROL!**

**JANCO**  
CORPORATION

3111 Winona Ave., Burbank, Calif. 91504  
Phone 213-845-7473 • TWX 910-498-2701

## The heart of our gaussmeter is so good, even our competitors use it.

The Hall generators that we make for our own gaussmeters are so accurate and dependable, our competitors even use them. But that's where the similarity ends. We have other special features like internal calibration, temperature stable probes, and many more items that are covered in our gaussmeter brochure. Write to: 4949 Freeway Drive East, Columbus, Ohio 43229.

**E.W. Bell Inc.** A member company of Allegheny Ludlum Industries.



# OUR ANGLE: Modular D/S and S/D Converters

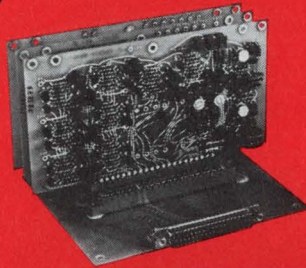

IN

A

## Do Low Cost Repairable Circuit Cards Make Sense from Your Angle?

North Atlantic's new 701 D/S and 711 S/D Converters offer unmatched advantages for the digital/analog interface at low-low cost . . . typically \$1000. Open-card construction is easily and economically maintained. Adaptable to systems needs, interchangeable converter cards are compatible with your automatic test, simulation or digital control systems.

Compared to 19" panel designs, these units provide a choice of accuracy, frequency, resolution, and systems customization without the extra bulk and expense of unnecessary power supplies and other panel controls. They are ideal for multi-channel applications where a converter is assigned to a specific function.

These new converters are available to meet a wide range of systems needs. The 701 D/S has selectable accuracies of 9 or 12 bits with resolution of 8 through 14 bits, transformer output isolation and short circuit protection, operation at 60 Hz or 400 Hz with 1VA or 10VA output. The 711 S/D has 0.05° accuracy, 13 bit resolution with input transformer isolation, and continuously tracks 400 Hz synchro data to 1000°/second.

Don't these converters make sense from any angle? Talk it over with your North Atlantic sales engineering representative today.

**NORTH ATLANTIC**  
*industries, inc.*

200 TERMINAL DRIVE, PLAINVIEW, NEW YORK 11803  
cable: noatlantic / twx: 510-221-1879 / phone: (516) 681-8600



### \$7500 moving-head disc

The XMD-2100 minicomputer mass memory system offers 10 megabits storage at 1025 bits/in. yet costs just \$7500. Xebec Systems, Mountain View, Calif. (415) 964-4263.

CIRCLE NO. 282

### 75-ns core ROM

The Q core ROM system uses a 75-ns access and total cycle of 200 ns. A 13 by 11-in. card holds 0.1 megabits. P&A: 1.5¢/bit, stock. Quadri, Phoenix, Ariz. (602) 263-9555.

CIRCLE NO. 283

### Custom-designed mini can be bought for \$800



Digital Equipment Corp., Maynard, Mass. Phone: (617) 897-5111. P&A: see text; June, 1971.

The PDP-16 minicomputer represents a new concept in small computers. It is custom-designed for the user's specific application, and has a price that depends on the complexity of that application.

In its simplest form the PDP-16 has no memory, being essentially a hard-wired controller, and sells for \$800. The price ranges up to \$3000, which includes a braided-wire ROM and 16 to 512 words of scratch-pad memory.

The PDP-16 is designed to appeal to OEM designers who desire to put together a computer-based system, without paying for unnecessary hardware or software.

Instead of the usual software, the PDP-16 uses a programming approach known as Chartware.

With Chartware, a user need only be able to construct a simple flow chart of the task for which he needs the computer, and Digital Equipment Corp. will design a PDP-16 for that task.

That design is done by using Digital Equipment's larger PDP-10 computer.

Word lengths of 8, 12 or 16 bits can be accommodated because of the PDP-16's internal architecture.

Its bidirectional buss structure permits the interfacing of peripherals.

The minicomputer's operation is asynchronous. Its typical add times are in the 400 to 500-ns range, depending on application.

CIRCLE NO. 284

# You may think the switch you need hasn't been made yet

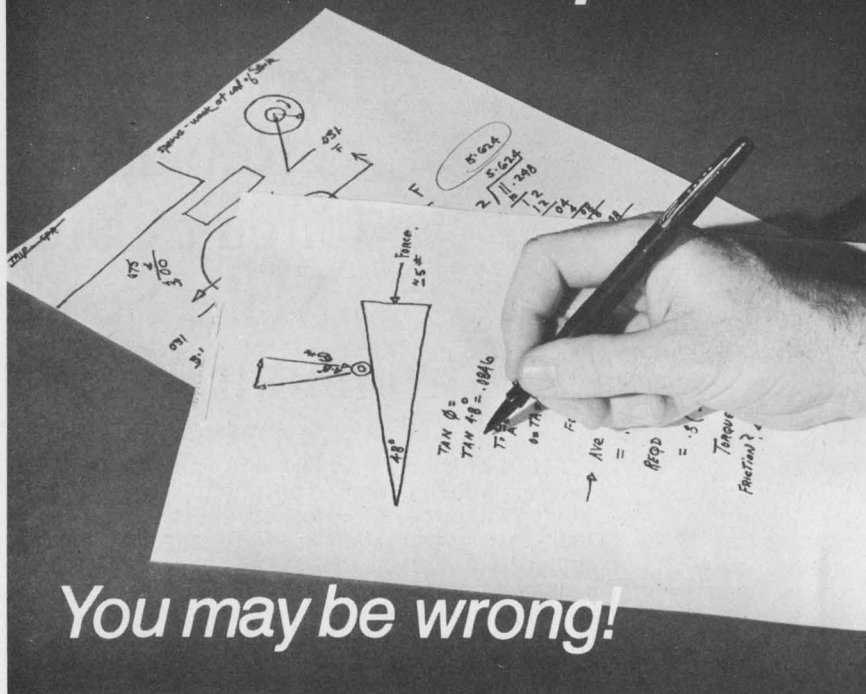

# You may be wrong!

Before you design that *custom* switch, browse through our catalogs. There are literally *hundreds* of types *in stock*. Or you can specify a special and have it assembled pronto from *millions* of components off-the-shelf! Choose from Rotary, Cam, Detent & Snap Action, Pushbutton and other types. Standard specs range from 1/2 up to 200 amps...from one to 75 poles per switch...plus combinations (tandem, gear train, etc.). We can't promise an exact match to your custom needs *every time*...but don't take bets on it!

Send for Bulletin C-1 describing our lines and catalogs or tell us your specific needs for detailed specifications.



**ELECTRO SWITCH**  
CORP.

Weymouth, Massachusetts 02188

Telephone: 617/335/5200 TWX: 710/388/0377



# VCXOs

## Get 'em straight from Damon!

Whether you're in a sweat on a VCXO prototype for a tough application – or need a production run in a hurry, you can get 'em straight from Damon. Speedy proficiency in design and production of VCXOs allows Damon to deliver all-silicon solid state devices with linearity to within 1% of best straight line and frequency deviation to  $\pm 0.25\%$ .

Just glance at the specification guide below for more good news on available characteristics. Computer-assisted designs are available, too. Ask Damon today for a quote on VCXOs tailored to your specifications – and deadlines. Call or write: Damon/Electronics Division, 115 Fourth Ave., Needham, Mass. 02194. Phone: (617) 449-0800.

### SPECIFICATION GUIDE\*

Parameter	Basic and Multiplier VCXOs	Mixer and Mixer-Multiplier VCXOs
Center Frequency	1 KHz to 300 MHz	100 Hz to 300 MHz
Frequency Deviation	$\pm 0.01\%$ to $\pm 0.25\%$ of C.F.	$\pm 10$ Hz to $\pm 1$ MHz
Frequency Stability 24 hr. @ 25°C	$\pm 1$ to $\pm 10$ ppm	$\pm 0.5\%$ of peak deviation
0 to 65°C (no oven)	$\pm 10$ to $\pm 50$ ppm	$\pm 2\%$ of peak deviation
Linearity	to within 1% of best straight line	to within 1% of best straight line
Minimum Deviation Rate	0 (dc)	0 (dc)
Maximum Deviation Rate	0.2% of C.F. (100 KHz max.)	10 KHz to 100 KHz
Mod. Voltage (Typical)	$\pm 5$ V peak	$\pm 5$ V peak
Mod. Input Impedance	$>50$ K ohms	$>50$ K ohms
Output Power Available	0.5 mw to 20 mw	0.5 mw to 20 mw
Load Impedance	50 ohms to 10 K ohms	50 ohms to 10 K ohms
Power Requirements (Typical)	$-25$ V $\pm 1$ V @ 30 ma	$-25$ V $\pm 1$ V @ 40-50 ma
C.F. Manual Adjustment Range	$\pm 0.01\%$	$\pm 5\%$ of peak deviation

\* Obviously, the limits are not absolute. The interrelationship of parameters for VCXOs are of such a nature as to permit optimization of any one or more characteristics to satisfy customer requirements.

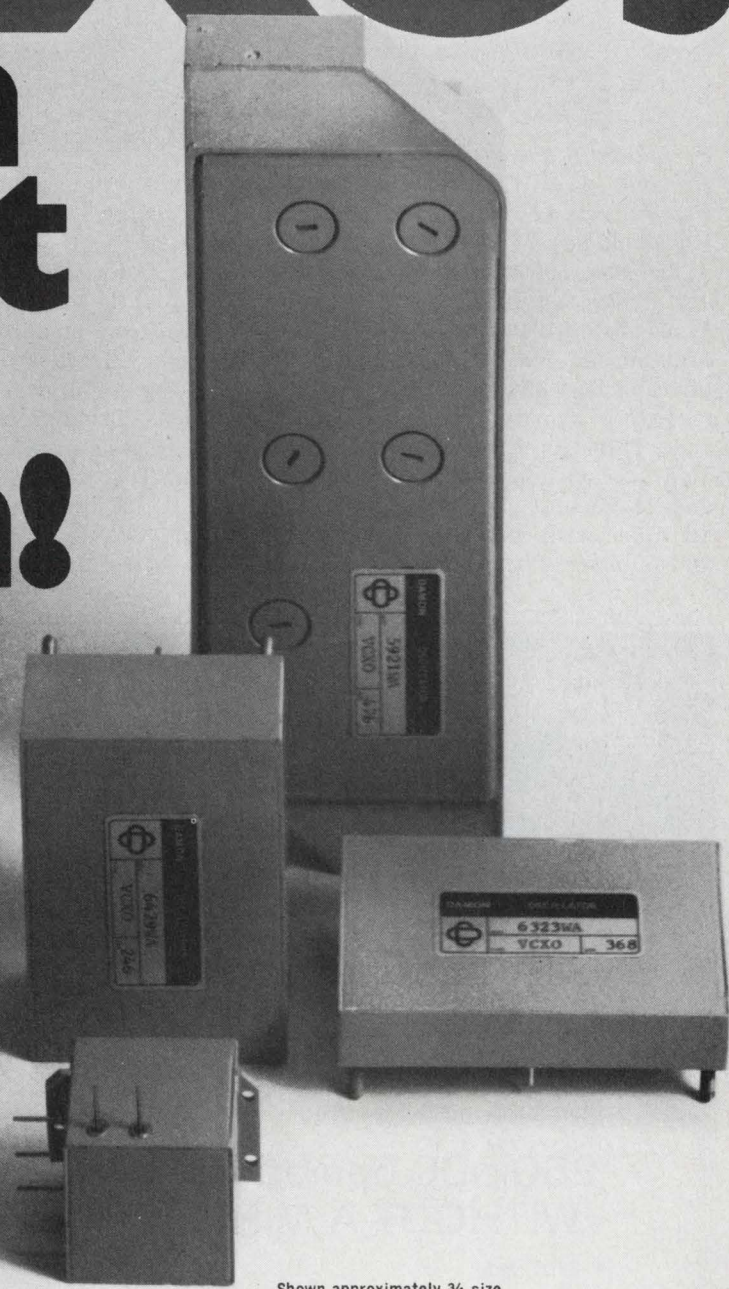

Shown approximately 3/4 size





### Low-cost disc drives access in 60 ms

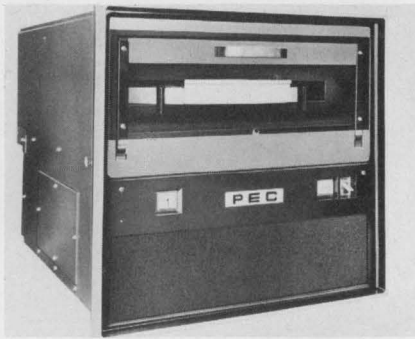

Peripheral Equipment Corp., 9600 Irondale Ave., Chatsworth, Calif. Phone: (213) 882-0030. P&A: \$2900; 60 days.

The new 5000 series of low-cost disc drives feature 60-ms access in 4 models: 5101 single disc with 1100-bit/in. density and 12-megabit capacity; 5201 single disc with recording density of 2200-bit/in., and 25-megabit capacity; 5121 dual disc with 1100-bit/in. density and 24-megabit capacity; and 5221 dual disc with 2200-bit/in. density and 50-megabit capacity.

CIRCLE NO. 285

### Data coder/decoders give offline security



Datotek, Inc., 8220 Westchester Dr., Dallas, Tex. Phone: (214) 363-4495.

The Datocoder 105 and 108 attach directly to teleprinter systems in an offline mode to provide comprehensive security for sensitive point-to-point digital message transmissions. The 105 works with five-level systems such as the Western Union Telex network, while the 108 is designed for eight-level AT&T TWX networks. In either case, their functions are the same.

CIRCLE NO. 286

### Portable page terminal weighs a mere 30 lbs



Mite Corp., 446 Blake St., New Haven, Conn. Phone: (203) 387-2572. P&A: \$2100; 30 days.

A new low-cost portable page multicopy computer-access terminal, capable of full alphanumeric input and output, weighs under 30 lbs. The 123T data communications terminal is acoustically coupled to the public telephone network and requires only a telephone and 115 V 47 to 420 Hz for full operation. It operates with ordinary paper and standard typewriter ribbons, and produces one to six copies.

CIRCLE NO. 287

## NEW ALTERNATE ACTION PUSH BUTTON SWITCHES

(Push-On, Push-Off)  
...the Reliable Ones by Grayhill

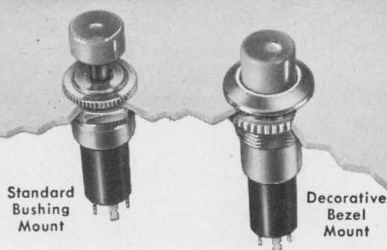

250,000 operations — WITHOUT A MISS.

- SPDT, SPST
- 1/4 Amp., 115 VAC resistive
- Totally enclosed
- Space saving - .937" behind panel
- Momentary action counterpart available

For your Grayhill Engineering Catalog offering complete technical data — contact

**Grayhill** 565 Hillgrove Avenue  
LaGrange, Illinois 60525  
Area Code 312, Phone 354-1040

... the Difference Between Excellent and Adequate

INFORMATION RETRIEVAL NUMBER 68

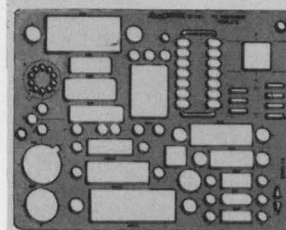
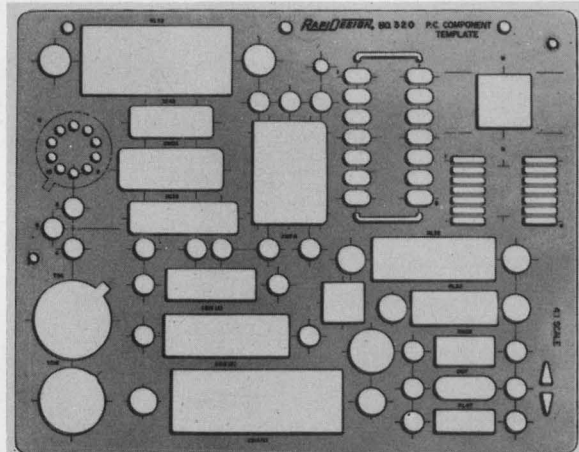

## Printed Circuit Templates

These new templates contain the most used symbols in Printed Circuit design to make your layouts easier and more accurate. Component outlines are for MIL-

STD maximum dimensions. A choice of two sizes is offered: 4:1 and 2:1 scales. Both are available in either .030 or .060 thickness. Some 200 of the finest templates available are described and pictured in the 1971 RapiDesign catalog. Send for your free copy today.

**RAPIDESIGN**

RAPIDESIGN, INC., P.O. BOX 6039, BURBANK, CALIF. 91505  
A SUBSIDIARY OF BEROL CORPORATION

**BEROL**

INFORMATION RETRIEVAL NUMBER 69

INFORMATION RETRIEVAL NUMBER 70 ►



# ANYONE IN THE FIELD CAN MAKE ALTERATIONS IN MINUTES WITH LOW COST DATAPAC ROMS

Datapac Read-Only Memory Systems are unique in their design to let you easily change individual bits, words or an entire memory in the field. Datapac ROMs are available in a wide choice of models, sizes and configurations. Capacities from 1K to 1 Megabit. Word lengths to 80 bits. Speeds as fast as 200 Nsec. Cycle and 75 Nsec. Access. Off the shelf delivery—50,000 MTBF. Mil Spec compatible. And 1.5c per bit. Write today for our FREE brochure containing the complete Datapac story.

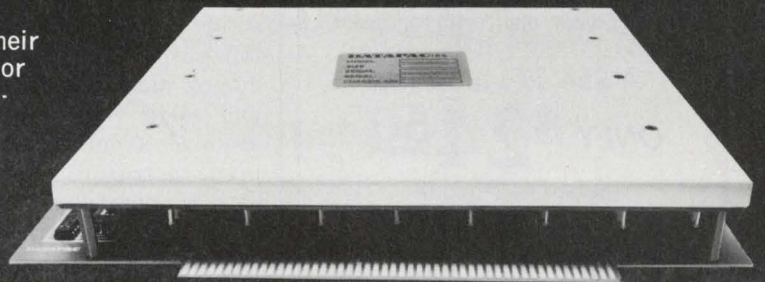

**DATAPAC INCORPORATED**

3839 S. Main St., Santa Ana, Calif. 92702, Tel. (714) 546-7781

**"#1 in the field"**

INFORMATION RETRIEVAL NUMBER



# 1%

AMERICAN

MADE

## Tolerance **SCHAUER** 1-Watt **ZENERS**

### Immediate Shipment Low Prices

ANY voltage from 2.0 to 18.0

Quantity	Price each
1-99	\$1.07
100-499	.97
500-999	.91
1000-4999	.86
5000 up	.82



All welded and brazed assembly

No fragile nail heads

Gold plated leads

Write for complete rating data and other tolerance prices.

## Buy the kit- Save a lot



Kit contains a 51-piece assortment of SCHAUER 1% tolerance 1-watt zeners covering the voltage range of 2.7 to 16.0. Three diodes of each voltage packaged in reusable poly bags. Stored in a handy file box. Contact your distributor or order direct.

A \$54.57 value for  
ONLY **\$24<sup>50</sup>**

Semiconductor Division

## **SCHAUER**

Manufacturing Corp.

4511 Alpine Ave. Cincinnati, Ohio 45242  
Telephone: 513/791-3030

INFORMATION RETRIEVAL NUMBER 71

### PACKAGING & MATERIALS

## 18-pin PC sockets come in two styles

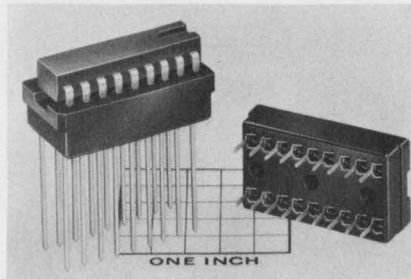

Cambridge Thermionic Corp., 445 Concord Ave., Cambridge, Mass. Phone: (617) 491-5400. Availability: stock.

Two new basic styles of 18-pin sockets for PC boards are available. They come in configurations for wirewrapping (series 704-3895) and for soldering (series 703-3787). Each series is available in two versions: one with gold-plated contacts and the other with tin-plated contacts. A sample socket can be obtained by requests on company letterhead.

CIRCLE NO. 288

## Reusable edge strips protect PC boards

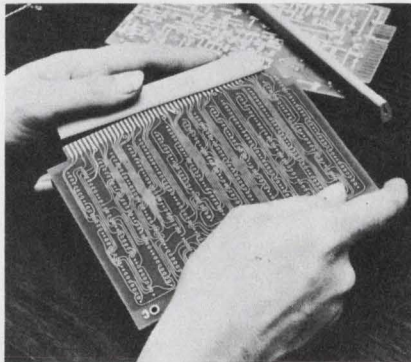

By-Buk, 4326 W. Pico Blvd., Los Angeles, Calif. Phone: (213) 937-3511. Price: \$1.50/strip.

New reusable edge-protector strips cover and protect connector fingers on card-edge PC boards during handling, spraying, dipping and solder-wave operations. They are made from a non-staining Neoprene extrusion that contains no carbon and will not slide off until physically removed. Available with slot widths of 0.05, 0.062 and 0.093 in. and slot depths of 0.18, 0.312 and 0.437 in.

CIRCLE NO. 289

## DIP and transistor receptacles cut costs

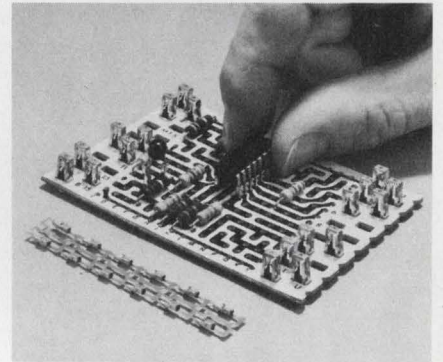

Amp, Inc., Harrisburg, Pa. Phone: (717) 564-0101.

The A-MP DIP and transistor receptacles provide an economic and reliable method for component insertion. The receptacles for DIPs are produced in a 2-up strip form with a contact area designed to accept 0.008 to 0.011-in.-thick by 0.025-in.-wide leads. Those for transistors are produced in a single-strip form with a contact area designed to accept transistor leads from 0.016 to 0.019 in. in dia.

CIRCLE NO. 290

## Ceramic LID carriers increase densities

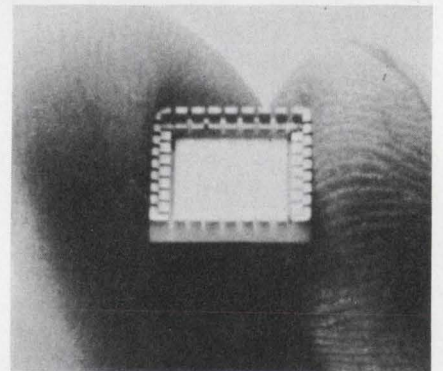

Frenchtown/CFI, Inc., 8th & Harrison Sts., Frenchtown, N. J. Phone: (201) 996-2121.

A new family of square ceramic LID carriers for 24-lead plastic MOS packages feature high packaging density. Any number of lands can be furnished on 15 to 20-mil centers, with die attach area increasing or decreasing proportionately. Carriers are supplied in white 96%-alumina, opaque black or brown high-alumina bodies.

CIRCLE NO. 291





# Take your pick.

You're sure to find exactly what you want.

Simply because MICRO SWITCH has a larger selection of toggles to pick from. With an almost limitless choice of size, circuitry and toggle action.

There are miniatures (Type TW); environment-proof (Type TL); magnetically held (Type ET); rocker button (Type TP); standard sized (Type TS); and assemblies with sub-miniature, high capacity or hermetically sealed basics (Type AT). Many of them designed to meet military specifications.

More special features, too, right off the shelf.

Like shape-coded and color-coded bat handles, each in a variety of lengths. A choice of locking configurations as well as a choice of mounting bushings and hardware. And several types of terminations, including an Integrated Wire Termination System (IWTS).

For more information, call your MICRO SWITCH Branch Office or Authorized Distributor (Yellow Pages under "Switches, Electric"). Or write for Cat. 51.

**MICRO SWITCH**

FREEPORT, ILLINOIS 61032

A DIVISION OF HONEYWELL

MICRO SWITCH products are available worldwide through Honeywell International.



### 3.25 by 4.5-in. card holds 16 multi-pin ICs

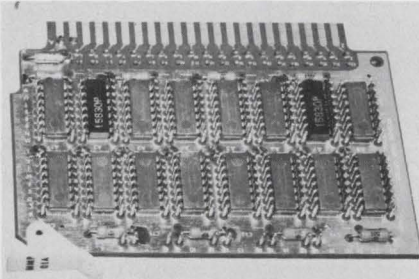

Wyle Computer Products, 128 Maryland St., El Segundo, Calif. Phone: (213) 322-1763.

Featuring design versatility for maximum density, the new Pac-3 PC board utilizes a method of interconnecting as many as 15 ICs of any mix, 14 or 16 pins, on a single 3.25 by 4.5-in card. Pac-3 PC cards can be mounted on 0.562-in. centers, allowing as many as 448 ICs to be packaged in a single card file. Features include 10 test points and decoupling capacitors.

CIRCLE NO. 292

### Tiny connection modules house up to 10 contacts

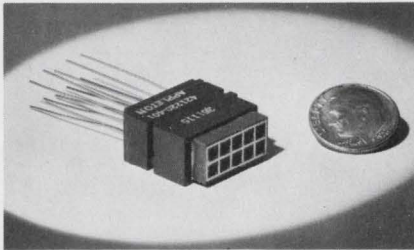

Appleton Electric Co., Electronics Div., 1701 Wellington Ave., Chicago, Ill. Phone: (312) 281-6400.

A variety of miniature interconnection modules for PC-board or black-box mounting provide I/O sources with up to 10 contacts. Their internal contacts also handle buss lines. The modules are designed to the specifications of MIL-T-81714 and are environmentally sealed. The 10-contact version accepts AWG #20 wires and requires a mounting volume of 0.39-in. wide by 0.85-in. long by 0.815-in. high.

CIRCLE NO. 293

### 50-W soldering tool is full of features

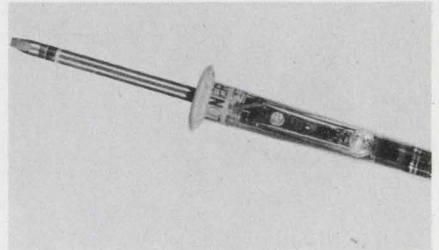

Edsyn, Inc., 15954 Arminta St., Van Nuys, Calif. Phone: (213) 989-2324. Price: \$37.50.

The new Loner soldering tool is loaded with features with nothing to hide—all its controls and electronics are in plain view in a clear handle case. It features a temperature sensor, a 50-W element, fast 25-s warmup and an indicator lamp that tells when the precise preset temperature has been reached by blinking on and off. A temperature control knob is provided.

CIRCLE NO. 294

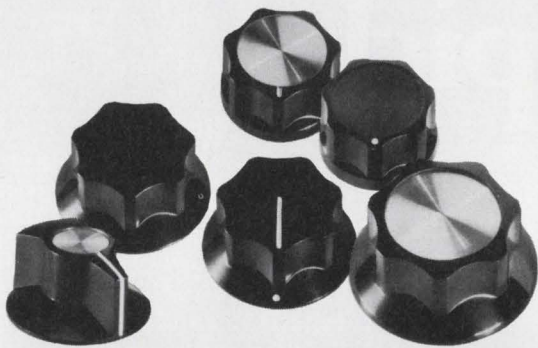

# 1,500,000

## KNOBS TO CHOOSE FROM...

and they're "Warranted for Life"

Kurz-Kasch has over 1½ million low cost, high quality knobs in inventory, ready to ship to you. (You save . . . no tooling cost on stock knobs, specials 4 to 6 weeks delivery.) Your local distributor's stock is available at factory prices. Select instrument and control knobs from 24 families with 367 basic sizes and shapes in general purpose phenolics, melamines and ureas. All Kurz-Kasch knobs are warranted for the life of the product on which they're used. Send now for free 20 page catalog. (Also found in THOMAS REGISTER "THOMCAT."®)



**Kurz-Kasch, Inc.**

1421 S. Broadway  
Dayton, Ohio 45401  
513/223-8161

## The big line of little switches.

**Lighted,  
unlighted  
QPL 8805/64**

The Clare-Pendar subminiature snap-action switchlight measures only .625" behind panel and .375" in diameter. It's the smallest switchlight available. Select from several momentary versions: Lighted or unlighted industrial, and unlighted MIL-approved (QPL 8805/64). Bezel or sub-panel mount. Choice of button colors. Real versatility for dense packaging situations in computer, communication and test equipment.

Call your Clare Group Sales Engineer or Clare-Pendar Co., Post Falls, Idaho 83854. Telephone 208-773-4541.

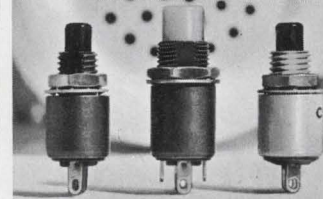

**CLARE-PENDAR™**



# “**Celco** superfast” **DYNA YOKE**



When CELCO talks about “superfast” recovery times, we mean 5  $\mu$ sec to 0.1%.

We mean 4  $\mu$ sec when you need it. And three . . . if your display designs call for it.

Or, you can plan your precision CRT display around 2  $\mu$ sec recovery time to 0.1%.

We’re even talking about 1 microsecond recovery time. To 0.1%. Now that’s *really* a “superfastDYNA YOKE”. But you’ll be hearing a lot more about that soon enough!

Tremendous amounts of data in very short times can now be produced on the CRT face of wide-band magnetic deflection high resolution CRTs. With CELCO “superfastDYNA YOKES”.

If you have designs like these on a 66° CRT with 1-7/16” neck, CELCO has a “superfastDYNA YOKE” to fit it for a *superfast* display.

## 2 $\mu$ s Recovery Time To 0.1%

MAHWAH, N. J. 07430 TEL. 714-982-0215  
UPLAND, CAL. 91786 TEL. 201-327-1123

CONSTANTINE ENGINEERING LABORATORIES COMPANY

INFORMATION RETRIEVAL NUMBER 75



# DELIVERY FROM STOCK

a series of  
**DUAL OUTPUT  
POWER  
SUPPLIES**

FROM  
**\$49.00**



## for OP AMPS and IC'S

An exceptional value, the new Deltron OS/PS Series are Independent Dual Output Power Supplies for use with operational amplifiers, integrated circuits and digital logic. Check these features—

- 0.02% regulation
- 500 microvolts ripple and noise
- 10 microsecond recovery time
- Master-slave series and parallel
- Built to top quality standards . . . MIL P-13949 & MIL A-8625
- Plug/wire in — compact design
- All Silicon . . . 71°C operation

### OS/PS SERIES—RATINGS AND PRICES

MODEL	Each Output		Price
	Volts	Amps	
OS6-0.2D	5-6	0.2	\$49.
PS6-0.2D	5-6	0.2	\$69.
OS6-0.6D	5-6	0.6	\$69.
PS6-0.6D	5-6	0.6	\$89.
OS15-0.1D	8-15	0.1	\$49.
PS15-0.1D	8-15	0.1	\$69.
OS15-0.3D	8-15	0.3	\$69.
PS15-0.3D	8-15	0.3	\$89.

WRITE FOR TECHNICAL BULLETIN

# Deltron

WISSAHICKON AVE., NORTH WALES, PA. 19454  
PHONE: (215) 699-9261 TWX: (510) 661-8061

D 117

INFORMATION RETRIEVAL NUMBER 76

## COMPONENTS

### Fiber-optic CRT has twin screens

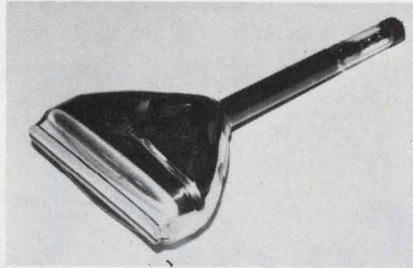

Toshiba America, Inc., 477 Madison Ave., New York, N. Y. Phone: (212) 758-6161. P&A: \$420 (100 quantities); 4 months.

The E2611PYP high-resolution fiber-optic CRT, designed for facsimile transceivers, features two separate 0.12 by 8.27-in. useful screen areas. One is the conventional glass screen and the other is the fiber-optic glass screen, both with PYP phosphor. PYP phosphor has short persistence and high light-output characteristics.

CIRCLE NO. 295

### Thick-film thermistors come as flakes

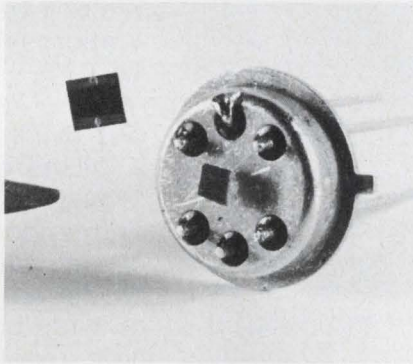

Thermometrics, Inc., 15 Jean Pl., Edison, N. J. Phone: (201) 548-2299. P&A: \$7.60 to \$19.10; stock to 3 wks.

By combining thermistor technology with thick-film techniques, a new line of low-cost, low-noise flake thermistors have been developed. Called Thermoflakes, they are thick-film thermistors which are not supported by any substrate backings. Standard thicknesses of 0.001 and 0.002 in. are available. Resistance values at 25°C span 1000 Ω to 2 MΩ.

CIRCLE NO. 296

### Proximity switch senses all metals

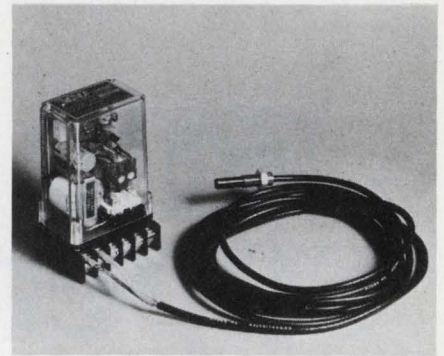

General Equipment & Mfg. Co., Inc., 3300 Fern Valley Rd., Louisville, Ky. Phone: (502) 969-2386.

The new GO-tronic proximity switch detects all metallic materials, including the thinnest aluminum foil, and senses objects as small as AWG#36 iron wire. Besides detecting, it can be used for measuring, counting and positioning. Sensing range is up to 1 in. It offers complete stability within an operating temperature range of -20 to +70°C.

CIRCLE NO. 299

### 25-A power contactor is only 1 in.<sup>3</sup> in size

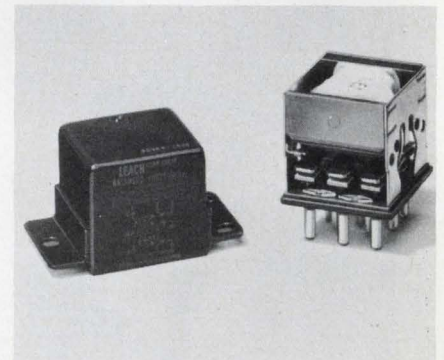

Leach Corp., 717 N. Coney Ave., Azusa, Calif. Phone: (213) 334-8211. P&A: \$50; 6 wks.

The series KC 3pdt power contactor is capable of switching a 25-A resistive load yet measures only 1 by 1.015 by 1.015 in. and weighs only 3 oz. A magnetic latch version (series KCL) is also available. Specifications at 28 V dc include coil resistance of 290 Ω, minimum operating cycles of 50,000 and operate/release time (includes bounce) of 15 ms.

CIRCLE NO. 300



## Low-cost pilot lights snap into panels

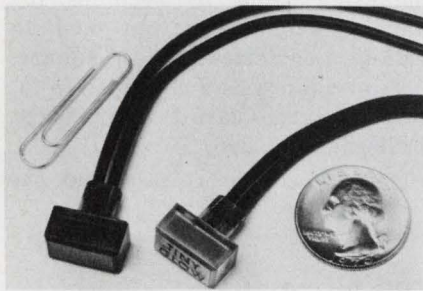

Industrial Devices, Inc., Edgewater, N. J. Phone: (201) 943-4884. P&A: 35¢ (1000 quantities); 6 to 8 wks.

Tiny-Glow 3700 series low-cost neon pilot lights require little back-of-panel space and rapidly mount in 5/16-in.-dia holes (round or with flats) by means of a push-on speednut. Front-panel dimensions are 3/8 by 5/8 in. with a 5/16-in. profile. Operation is from 115 or 250 V ac. Built-in resistors are included with the lights. A wide range of colors is available.

CIRCLE NO. 297

## 12-position switch plugs into PC boards

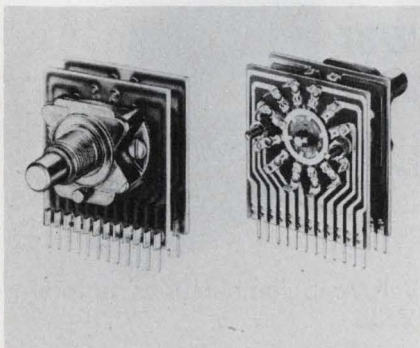

Oak Mfg. Co., Div. of Oak Eletero/Netics Corp., Crystal Lake, Ill. Phone: (815) 459-5000.

A 12-position miniature switch—slightly more than 1-in. square—is available for PC board plug-in applications. Each compact section of the 0.5-A 28-V-dc switch has 12 terminal pins on 0.1-in. centers. Users may specify that contacts on each stator be soldered to the PC paths leading to the terminal pins or obtain the switches with unsoldered contacts.

CIRCLE NO. 298

# the Giant Killer strikes again...



## New Heath SM-105A

# \$350.00\*

ASSEMBLED  
& TESTED

- 10 Hz to over 80 MHz range
- Advanced design — new Texas Instruments 74S Series superspeed Schottky TTL
- 5-digit LED readout
- Wide range input without adjustment
- 1 megohm input
- Crystal clock
- Send for free SM-105A spec sheet... and watch the giants fall!

**SM-105A SPECIFICATIONS** — Sensitivity: 100 mV RMS to 50 MHz; 250 mV RMS, 50 MHz to 80 MHz. Frequency Range: 10 Hz to 80 MHz. Input Impedance: 1 Megohm shunted by less than 15 pF. Overload: 50 V RMS from 10 Hz to 40 MHz; from 40 MHz to 80 MHz derate linearly to 2.0 V RMS. Maximum DC input is  $\pm 50$  V. Time Base: 1 MHz  $\pm 2$  Hz. 0° C to 40° C ambient,  $\pm 10$  ppm. Readout: Five 7-segment light-emitting-diode displays. One single light-emitting-diode for overrange. Overrange: Flashing, 40 ms on, 60 ms off. Power Requirements: 120/240 VAC, 12 watts. Dimensions: 9 $\frac{1}{4}$ " D x 6 $\frac{1}{4}$ " W x 2 $\frac{1}{4}$ " H. Net Weight: 3 $\frac{1}{2}$  lbs. Shipping Weight: 6 lbs.

### FREE HEATH SCIENTIFIC INSTRUMENTATION CATALOG

Investigate these and other new ideas in Spectroscopy, Digital Instrumentation, Lab Equipment and Test Equipment. Send for your FREE catalog now.

HEATH COMPANY, Dept. 520-26  
Benton Harbor, Michigan 49022



Please send free Heath Scientific Instrumentation Catalog

Name \_\_\_\_\_

Address \_\_\_\_\_

City \_\_\_\_\_ State \_\_\_\_\_ Zip \_\_\_\_\_

\*Mail order prices; FOB factory.

Prices & specifications subject to change without notice. EK-296R



**Compact dual trimmer**

New dual type FD trimmer is designed for bridged-T or L-pad attenuators and trimmers. Single shaft rotates both contact brushes simultaneously. Designed for PC board mounting. Price: \$4.04, Allen-Bradley, Milwaukee, Wis. (414) 671-2000.

CIRCLE NO. 340

**Solid-state switches**

Three new spdt solid-state switches in small plug-in packages switch in 1 ns. SW100 units operate over 10 to 200 MHz and isolate 50 dB between outputs. Price: \$85 to \$105. Anzac, Waltham, Mass. (617) 899-1900.

CIRCLE NO. 341

**Economy keyboard switch**

A new low-cost keyboard switch for PC boards, with specified 3 to 16-oz operating force, is priced at less than 40¢ each in production quantities. Oak Mfg., Crystal Lake, Ill. (815) 459-5000.

CIRCLE NO. 342

**Wirewound resistor DIP**

Up to 7 wirewound resistors are provided in a 14-pin DIP. Type WDP has 3.5-W rating, ranges from 1 to 800  $\Omega$  with tolerances from 0.1% to 5%. Dale Electronics, Columbus, Neb. (402) 564-3131.

CIRCLE NO. 343

**LED indicators**

Light source, housing and lens are available in the series 249 LED indicators. Voltages from 3.6 to 28 V dc to 20 mA. Dialight, Brooklyn, N. Y. (212) 497-7600.

CIRCLE NO. 344

**Pots with 3 elements**

A new 1/8-in. pot is available with 3 resistance elements—wire, conductive plastic or cermet. Designations are 152, 158, and 159, respectively. From 5  $\Omega$  to 2 M $\Omega$ . Spectrol Electronics, City of Industry, Calif. (213) 964-6565.

CIRCLE NO. 345

**Lighted pushbuttons**

Inexpensive off-the-shelf lighted pushbutton switches cut mounting time to seconds for panel thicknesses from 0.04 to 0.25-in. Lens sizes: 3/4-in. square, 5/8-in. square and 3/4 by 7/8-in. rectangular. Clare-Pendar, Post Falls, Idaho. (208) 773-4541.

CIRCLE NO. 346

**DIP has 4 xformers**

A new 16-pin DIP houses 4 transformers and measures 0.76 by 0.26 by 0.2 in. Grid spacing is 0.1 in. Pulse Engineering, San Diego, Calif. (714) 755-9723.

CIRCLE NO. 347

**20-W DIP reed relay**

A 14-pin DIP form A reed relay, the 20A series, handles 20 W with resistive loads of 1 A and 200 V. Micronix, Torrance, Calif. (213) 530-0444.

CIRCLE NO. 348

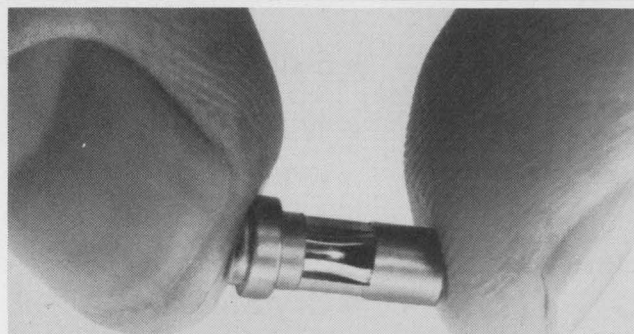

### it takes guts to be a good connector

The kind that can hold without appreciable change in contact resistance through 50,000 cycles and more. And that's the kind of guts you get with CAMBION cage jacks. Permanently swaged inside a precisely machined brass body, these beryllium copper cages come in jacks ranging from .016"-.080" in a wide variety of shapes and types for mounting components, patching, plugging. Complete range of mating pins also available. Our latest catalog has a complete selection - it's free for the asking.

The next time a salesman tries to sell you a connector, ask to see the insides - it isn't caged, it's not a CAMBION.

Cambridge Thermionic Corporation, 445 Concord Ave., Cambridge, Mass. 02138. Phone: (617) 491-5400. In Los Angeles, 8703 La Tijera Blvd. 90045. Phone: (213) 776-0472.

Standardize on

**CAMBION**<sup>®</sup>  
The Guaranteed Electronic Components

INFORMATION RETRIEVAL NUMBER 78

## bargain hunters

5 Vdc @ 3 Amp  
**Quality Power  
Supply**  
Only \$24.95



... plus 14 other Volt/Amp combinations to total 15 Watts up to 24 Volts.

## compare:

.1% Regulation/.1% Ripple & Noise

- Input: 120/240 VAC  $\pm$  10% 60 Hz
- Remote Sensing Capabilities
- Foldback Current Limiting
- Overvoltage Protection\*
- 50 Hz Input\*\*
- Mechanical Size 4" x 4 1/2" x 2 3/4"
- OEM Contracts Available
- Off-the-Shelf Units Available
- Electrostatically Shielded Transformer

*Overvoltage Crowbar Option \$6.00. **50 Hz Input Option \$2.00	
1 - 9	10 - 24      25 - 49      50 - 99
\$24.95	\$23.70      \$22.50      \$21.25

OEM quantity prices available by contacting factory direct call (714) 540-9510

# ELEXON INC.

1422 E. St. Gertrude • Santa Ana, California • 92705

INFORMATION RETRIEVAL NUMBER 79

ELECTRONIC DESIGN 10, May 13, 1971



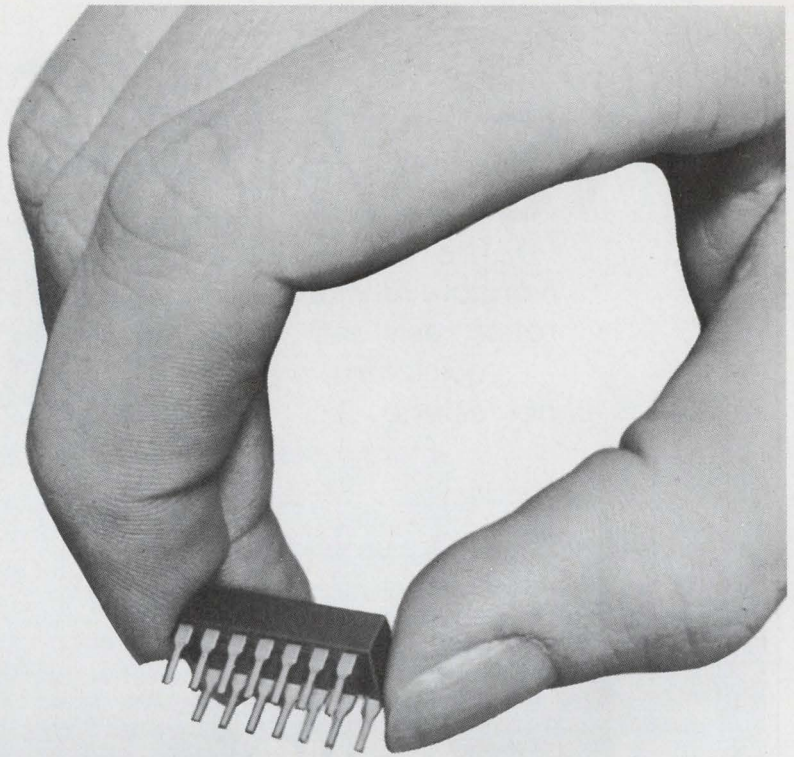

## **THIS LATCHING RELAY**

**...HAS A LIFETIME OF 100 MILLION BOUNCE-FREE OPERATIONS  
IN ANY MOUNTING POSITION**

It's a Logcell® Mercury Film Relay. It has an inherent contact memory. So no extra parts are needed to make it latch. It needs no holding current, either. The surface tension of a mercury film does it.

The same mercury film assures a bounce-free closure every time. Since it doesn't use a pool of mercury, a Logcell Relay can operate in any mounting position. Even under shock and vibration.

Logcell Latching Relays have been tested to billions

of operating cycles. That's why they can be rated at 100 million operations with a 90% confidence level.

The contacts of a Logcell Relay are self-healing. And produce virtually no contact noise. Contact resistance is constant within a four milliohm range.

For more information about latching and nonlatching Logcell Relays, and Logcell Switches, too, write Fifth Dimension Inc., Box 483, Princeton, New Jersey 08540. Or call (609) 924-5990.

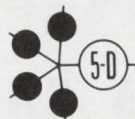

**FIFTH DIMENSION INC.**



# PVS 3½

The variable tension, vibration resistant, quick-turn, panel fastener from Dzus.

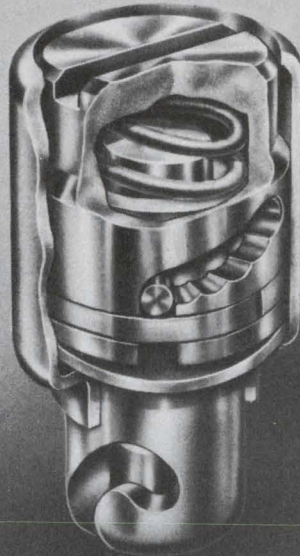

- Pre-Assembled
- Single Motion Lock-up
- Variable Tension
- Vibration Resistant
- Designed for Automated Assembly

The PVS 3½ panel fastener assembly features a variable step cam which provides a "hard mount" lock-up. This offers higher locking strengths and practically no sheet separation. It is ideal for use in demanding panel applications.

## DZUS

Dzus Fastener Co. Inc.

425 Union Boulevard, West Islip, New York 11795 516/669-0494 / TWX 96-1454 Dzus Fast Wslip  
West Coast: 910 S Brookhurst, Anaheim, California 92804 714/535-6915

INFORMATION RETRIEVAL NUMBER 81

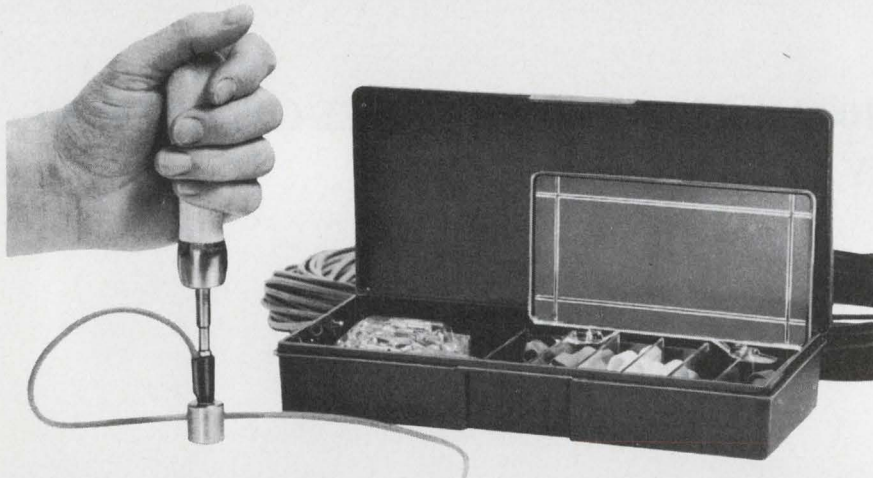

**Make and repair your own patchcord stacking plugs in seconds.**  
**Any color, any length for 40% less cost.**

These new kits contain everything you need to custom assemble and/or replace damaged molded stacking patchcord plugs: 60 metal banana or .080 standard tip metal plugs, 60 housings, 10 in each of the six standard colors. An assembly tool and fixture for fast, easy assembly. Use with standard 0.144" wire (not included in kit). To assemble, simply feed stripped end of wire through cross-hole metal contact. Insert contact and wire into housing. Place in fixture and snap contact into place.

Convenience and flexibility, plus savings of at least 40% over molded stacking patchcord plugs.

E. F. Johnson Company, Waseca, Minnesota 56093

ED/5

Please send me complete information on your new stacking patchcord kits.



Name \_\_\_\_\_ Firm \_\_\_\_\_  
Address \_\_\_\_\_  
City \_\_\_\_\_ State \_\_\_\_\_ Zip \_\_\_\_\_

## E. F. JOHNSON COMPANY

INFORMATION RETRIEVAL NUMBER 82

## MODULES & SUBASSEMBLIES

**\$29 8-bit d/a**  
**shrinks down in size**



Hybrid Systems Corp., 95 Terrace Hall Ave., Burlington, Mass. Phone: (617) 272-1522. P&A: see text; stock to 2 wks.

The DAC 329 is a low-cost (\$29) 8-bit d/a converter available in an ultra-small DIP-compatible package—1.1 by 1.7 by 0.38 in. The package contains switches, ladder, reference, and an output amp. It operates from +15 V with a supply rejection of 0.05%/%. Temperature range is 0 to +70°C, output is 0 to +10 V and settling is in 5 μs. Slew rate is 6 V/μs.

CIRCLE NO. 349

**10-position reed switch**  
**mounts on PC boards**

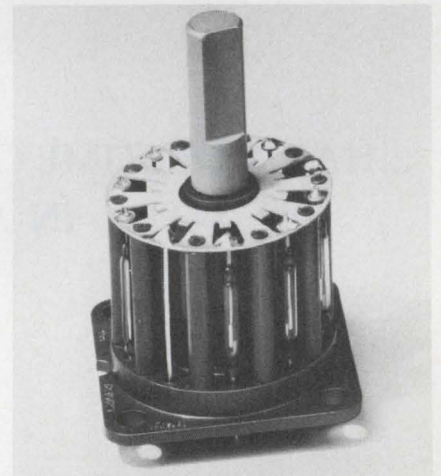

Ansley Div. of Thomas & Betts Corp., Doylestown, Pa. Phone: (215) 345-1800. Price: 90¢ per contact position.

A new compact 10-position reed switch is designed for mounting to PC boards. The ARS shaft-operated switch is available with one to 10 contact positions. Contact locations are spaced every 36 degrees to customer specifications. Contact arrangement is break-before-make, with a positive detent stop at each contact. The switch can be rotated in either direction.

CIRCLE NO. 350



**relays...** general purpose, sensitive,  
miniature, mechanical and magnetic latching

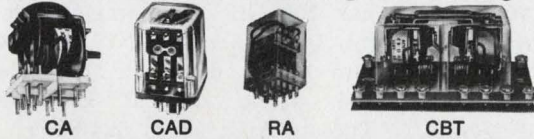

**stepping switches...**

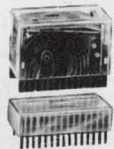

**NEW**  
RTM miniature  
— 2 pole,  
10 or 12  
position

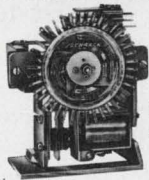

RT rotary  
— 1, 2, &  
4 pole

**accessories...**

plugs, sockets and dust covers



HIGH QUALITY • LOW COST • IMMEDIATE DELIVERY  
SEND FOR FREE CATALOGS

**SCHRACK** ELECTRICAL SALES CORP.

1140 Broadway, New York, New York 10001 Tel: (212) 683-0790

INFORMATION RETRIEVAL NUMBER 83

**BUCKEYE**

MATCHING  
INSTRUMENT  
SERIES

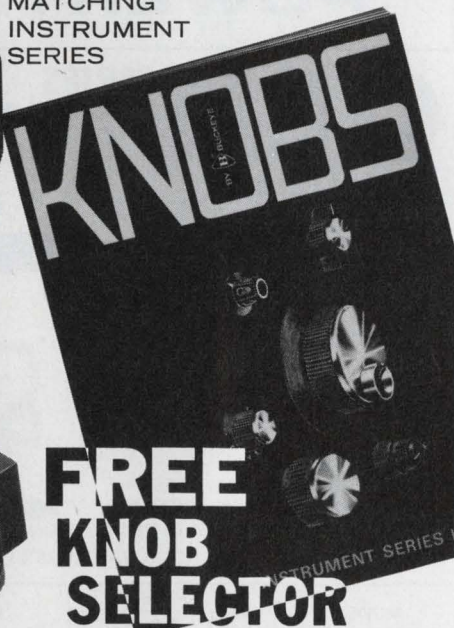

**FREE  
KNOB  
SELECTOR  
GUIDE**

Buckeye MATCHING INSTRUMENT KNOBS will enhance your instrumentation. They are available in six basic sizes, in six attractive styles and in four stock color variations — and in single-round, concentric, bar and half-bar, spinners, pointers and skirted types, plus many variations including hot-stamping and silk-screening. Write TODAY.



**THE BUCKEYE STAMPING COMPANY**  
555 Marion Rd., Columbus, Ohio 43207

INFORMATION RETRIEVAL NUMBER 84

ELECTRONIC DESIGN 10, May 13, 1971

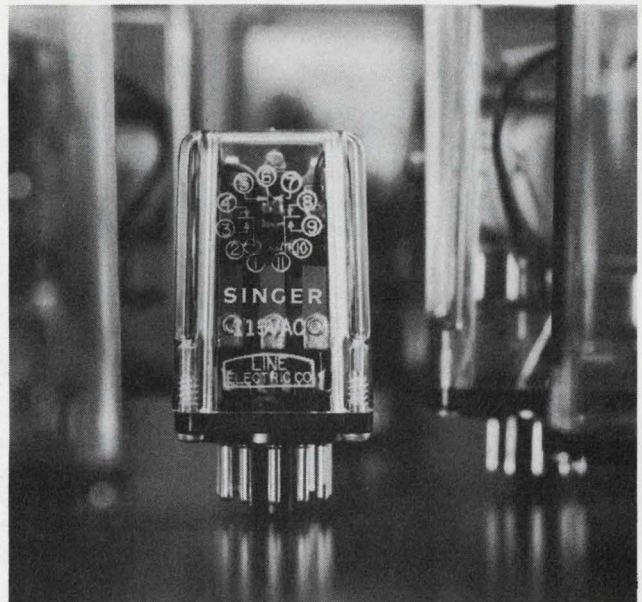

**Does the work of  
relays twice its size.**

Its applications are practically unlimited—this series MK medium power General Purpose Relay. A versatile little fellow who wears so many hats. For instance, he comes open, hermetically sealed, or enclosed in plastic dust covers made of Styrene, Butyrate, Polycarbonate-clear, translucent and opaque. Colors? A variety at no extra charge.

And in the matter of mounting you have four choices of terminals: solder lug, plug-in, printed circuit and .110 snap-ons. For chassis mounting—studs on side or base.

As you can see, it's a real space-saver. Yet electrically it stands "ten feet tall" with 5 and 10 amp. load contacts (AC & DC) and sensitivity down to 60 Milliwatts per pole DC—ideal for plate circuits.

Even the contacts are varied: Fine Silver or Silver Cadmium Oxide (gold flashed), Gold diffused in addition to 1, 2, and 3 PDT combinations. With a few extras like spot-lights to indicate coil state and a true 10 amp. socket which can be used for PC boards, also solder terminals for .110 snap-ons.

And to top it off, this little giant is U.L. Component Recognized.

About the price—as low as \$1.60 in quantity. For a prototype, please specify coil and contact requirements.

**SINGER**  
LINE ELECTRIC DIVISION

Line Electric Division, U.S. Highway 287, Parsippany, N.J. 07054 201/887-8200  
INFORMATION RETRIEVAL NUMBER 85



**30-MHz 7-bit a/d**

New a/d 7-bit converter operates at 30 MHz. The AD 3000-7 spews out data at 210 megabits/s. P&A: \$13,900, 6 wks. American Astrionics, Hollywood, Calif. (213) 466-9741.

CIRCLE NO. 351

**Seven-segment LED**

A new seven-segment numeric display, FND10, has 1/8-in.-high characters, in 0.22 by 0.27-in. plastic packages. Leads on 0.1-in. centers ease PC mounting. P&A: \$12, stock. Fairchild MOD. Palo Alto, Calif. (415) 961-9644.

CIRCLE NO. 352

**Twin dual power supply**

New twin dual power supply offers  $\pm 15$  V dc at 60 mA regulated (0.5% line and load) and  $\pm 28$  V dc at 100 mA unregulated, simultaneously. Model 220 costs \$38. California Electronic Mfg., Alamo, Calif. (415) 932-3911.

CIRCLE NO. 353

**\$9.75 FET op amp**

Model 163A FET op amp is priced at \$9.75 in unit quantity. Gain of  $10^5$ , 100-kHz full-power response, 6-V/ $\mu$ s slew, 50- $\mu$ V/ $^{\circ}$ C drift and 50-pA bias. Availability: stock. Dynamic Measurements, Winchester, Mass. (617) 729-7870.

CIRCLE NO. 354

**Alphanumeric displays**

Series CM5 alphanumeric display lights offer 7-segment readouts with up to 10 numerals and 11 alphabets. Only 0.446-in. high. Chicago Miniature Lamp Works, Chicago, Ill. (312) 784-1020.

CIRCLE NO. 355

**Liquid crystal display**

The 1003 liquid crystal display is a layer of normally transparent liquid crystal material between two electrodes. When an electric field is applied, the material reflects and scatters ambient light. Optel, Princeton, N. J. (609) 452-9250.

CIRCLE NO. 356

**FET voltage follower**

The 9746 FET voltage follower has 100 G $\Omega$  input impedance, 30 pA bias current,  $\pm 10$  V output into 100  $\Omega$ , dc to 30 MHz. P&A: \$36, stock. Optical Electronics, Tucson, Ariz. (602) 624-8358.

CIRCLE NO. 357

**Dc-to-dc converter**

A new line of dual-output dc-to-dc converters, CC1.0 series, convert 24 to 30 V dc to dual-output between  $\pm 3$  to  $\pm 30$  V dc at 1 A per output. P&A: from \$370; stock. Abbott Transistor Labs, Los Angeles, Calif. (213) 936-8185.

CIRCLE NO. 358

**Seven-segment LED**

Data-Lit 8 is a 1/4-in.-high 7-segment display. Its stagger-bent leads ease PC card mounting. Digits mount on 0.3-in. centers. P&A: \$15; stock. Litronix, Cupertino, Calif. (408) 257-7910.

CIRCLE NO. 359

# Cut Engineering Costs

Corning Graphics Software for antenna design reduces design time by 80 percent over conventional computer solution techniques. Similar savings are possible in electronic circuit design and control systems analysis.

If your design load is increasing faster than your payroll, we can probably help you.

Corning software is operated on the Corning 904™ Graphics Terminal.

For more information, call (919) 876-1100 or write: Corning Data Systems, 3900 Electronics Drive, Raleigh, N.C. 27602

**CORNING**  
DATA SYSTEMS

INFORMATION RETRIEVAL NUMBER 86

## POWERTEC

THE POWER HOUSE

**OEM** SERIES  
ADJUSTABLE POWER SUPPLIES

**\$24<sup>95</sup>**

**TO 12 AMPS**

4 TO 26 VDC 3 TO 12 AMPS  
RIPPLE: 1 MVRMS  
SHORT CIRCUIT PROTECTED  
FOLD BACK CURRENT LIMITING  
OPTIONAL OVER VOLTAGE PROTECTION  
REGULATION: LINE  $\pm 0.25\%$  LOAD  $\pm 0.25\%$

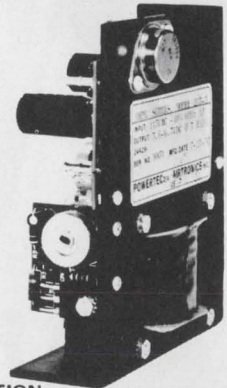

MODEL	PRICE		DIMENSIONS
	1-9	100	
2B5 - 3 AMPS	\$24.95	\$19.50	4.8 W X 4 L X 1.8 D
2C5 - 6 AMPS	\$44.00	\$36.00	4.8 W X 5.7 L X 2.8 D
2C5 - 12 AMPS	\$75.00	\$60.00	4.8 W X 9 L X 3 D

OEM CONTRACTS AVAILABLE

### POWERTEC AIRTRONICS INC.

A DIVISION OF  
9168 DESOTO AVENUE  
CHATSWORTH, CALIFORNIA 91311  
(213) 882-0004 TWX 910-494-2092

INFORMATION RETRIEVAL NUMBER 87



# Face it.

In panel design, looks are everything.

But, you don't have to sacrifice good looks for the sake of function. Every Rogan control knob and dial is designed to enhance your front panel *and* perform flawlessly.

Rogan offers hundreds of different shapes and sizes and 17 handsome ABS standard colors—with custom colors readily available. So no matter what your application, Rogan control knobs will contribute both functionally *and* aesthetically.

See for yourself. Write for our new "R-71" catalog. Or outline your requirements for quotation. Free samples of particular items will be sent on request.

## Rogan

8019 North Monticello Avenue, Skokie, Illinois 60076  
Phone: (312) 675-1234 • TWX: 910-223-4547





## FREE 1971 MINIATURE CERAMIC CAPACITOR CATALOG



New from USCC/CENTRALAB! 16 informative pages featuring the latest in miniature ceramic capacitors. Shown are both lead and chip types with higher capacitance values in your choice of NPO and W dielectrics. Included are listings

of MIL-C-11015 and MIL-C-39014 capacitors, the HI-REL tests available, typical characteristics graphs and other technical data.

For your free copy, write:  
USCC/CENTRALAB, 2151 N. Lincoln St., Burbank, California 91504,  
(213) 843-4222 — or circle the information retrieval number below.



U. S. CAPACITOR CORPORATION



CENTRALAB Electronics Division • GLOBE-UNION INC.

INFORMATION RETRIEVAL NUMBER 89

## No room for a digital panel meter?

Actual size.  
Cut out and  
use as a  
template.

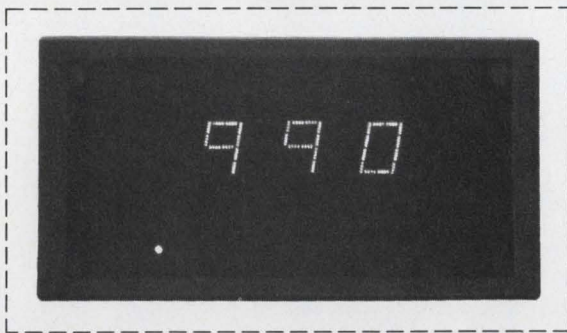

### Try the Digilin 3330 on for size

If you've got space for a commemorative stamp, you've got room for our new 3½-digit light-emitting diode meter, the world's smallest digital panel meter. It's all-solid-state — an industry first — and reliability and ruggedness are practically MIL-spec so it's perfect for aircraft instrument panels and mobile units. Brilliant red numbers make it easier to read — even

in direct sunlight. A dream for portable applications because of its small size, light weight and 5 volt power requirement. True floating differential input. Standard TTL-compatible BCD output. Digilin auto-zero and constant high input impedance features are included, of course. Get all the details today. Digilin, Inc., 1007 Air Way, Glendale, Calif. 91201 • (213) 240-1200.

**digilin**  
DIGITAL INSTRUMENTS

INFORMATION RETRIEVAL NUMBER 90

## MODULES & SUBASSEMBLIES

### 50-W hybrid audio amp boasts a \$23.40 price

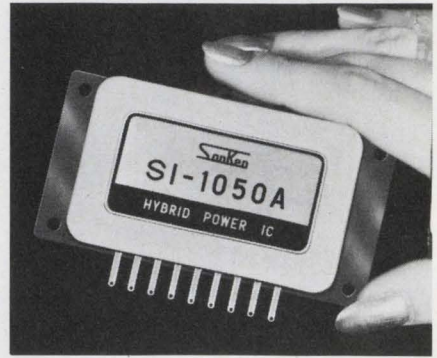

Airpax Electronics, Box 8488, Fort Lauderdale, Fla. Phone: (305) 587-1100. Price: see text.

A 50-W true rms hybrid audio amplifier, small in size and price (\$23.40) has been introduced to the U. S. market by Sanken Electric of Tokyo and Airpax Electronics. Model S1050A uses flip-chip design for full-power delivery at less than 1/2% distortion and at any frequency from 20 to 20,000 Hz. It has 30 dB gain, input impedance of 2 kΩ and output impedance of 8 Ω for direct speaker coupling.

CIRCLE NO. 360

### Edge-card GaAsP lights dissipate a mere 15 mW

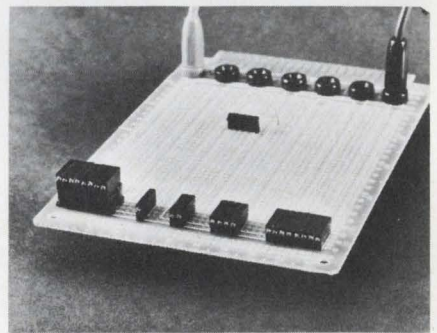

Monsanto Electronic Special Products, 10131 Budd Rd., Cupertino, Calif. Phone: (408) 257-2140. P&A: \$2 (1 lamp), \$8.20 (4 lamps).

A series of low-power GaAsP edge-card lights intended for diagnostic applications on PC boards feature input power dissipation of merely 15 mW (5 V at 3 mA). Designated the MV9100 series, the lights are input-power compatible with most commonly used micrologic circuits (15 mW represents only two logic-gate loads).

CIRCLE NO. 361



## Lead Frames for I. C. Packaging

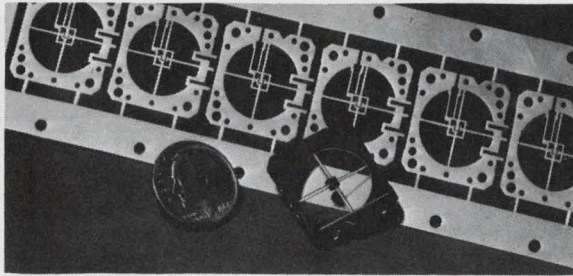

Precision etched or stamped lead frames for integrated circuits. Any configuration can be made adequately framed for support. Lead widths available equal to material thickness. We have produced parts in materials from .001 to .020 inches thick. Etched or stamped lead frames are available in Kovar, Nickel, Alloy 42, Copper, Aluminum and other metals and alloys suitable for microcircuit packaging.

Nickel, Copper, Gold, Silver, Tin or Solder plating is available in all thickness ranges with strict adherence to your plating specifications. Process and functional tests are performed and certified by our process engineering and quality control departments.

BMC reliability in etching, stamping & plating guarantees precision and repeatability at all volume levels. For more information call or write:

### BUCKBEE-MEARS COMPANY

245 E. 6th Street, St. Paul, Minn. 55101 / (612) 227-6371



INFORMATION RETRIEVAL NUMBER 91

## NOW! MORE APPLICATIONS!

Teflon-FEP  
**SHRINK-FIT**  
Tubing



## PENNTUBE<sup>†</sup> II-SST

(Super Shrinkable Teflon\*)

### 1<sup>2</sup>/<sub>3</sub>:1 SHRINKDOWN

Now, more applications including encapsulating many heat sensitive materials. Insulates, strain relieves, moisture proofs, protects. Fewer sizes need be stocked.

Chemically inert with excellent electrical and mechanical properties. Will not burn or support flame.

Excellent for: chafe guards—electrical terminal and splice insulation—covering over plastic, metal and wood—jacketing for cable harness assemblies, etc.



**FREE! SEND FOR FOLDER.**

**PENNTUBE PLASTICS CO., INC.** /  SUBSIDIARY OF DIXON INDUSTRIES

Madison Ave. & Holley St., Clifton Heights, Pa. 19018 • (215) 622-2300



Export Div. • 5710 Empire State Bldg., N.Y. 10001

\*Du Pont Reg. TM. †Penntube Plastics Co. Reg. TM.

INFORMATION RETRIEVAL NUMBER 92

ELECTRONIC DESIGN 10, May 13, 1971

## NEW!



### A True-Thru shielded coaxial cable lets you pre-program removable patchboards.

Now you can plug in hundreds of pre-programmed coaxial cables simultaneously and instantly. The combination of a newly designed cable receptacle plus precise machining of rack camming action make it possible to program removable panels with as many coaxial cables as you need — at present, up to 2,448.

“True-through shielded” means that each cable has its own separate shield, isolated from other shields, carried through the system. It also means that cross-talk is down 120 to 150 db from ordinary commoned systems.

High frequencies present no problem. At 100 megacycles, VSWR is 1.02. And you don't destroy this by crimping the outer shield: the connection is held by a screw-on collar. This collar also lets you rewire the cable as often as needed—and rewire with maximum speed. VSWR has remained constant after more than 10,000 cycles.

A 50-ohm matched impedance and .002-ohm contact resistance are two more reasons why you may want to telephone in your order rather than just writing for our complete brochure on this new development. But the main reason is change-over speed. By using a panel programmed with these new through-shielded coaxial cables, you can switch a computer from one program to another in less than 30 seconds.

Let us tell you more—including how little all these advantages are going to cost you. Write to VPC in Waynesboro, Virginia, or telephone (703) 942-8376. We're looking forward to working with you.

That's why we developed the new True-Thru shielded coaxial cable programming system in the first place.



VIRGINIA PANEL CORPORATION WAYNESBORO, VA.

INFORMATION RETRIEVAL NUMBER 93



### Tiny 6-GHz coax switch costs only \$30

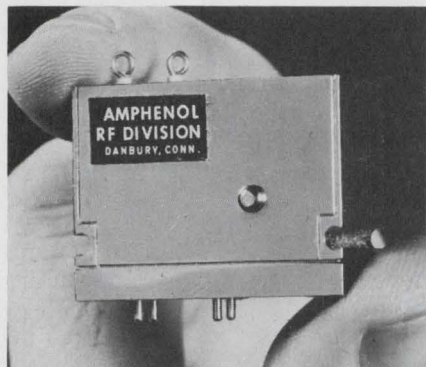

Amphenol RF Div., 33 E. Franklin St., Danbury, Conn. Phone: (203) 743-9372. P&A: see text; 6 wks.

Offering performance through 6 GHz, the series 303 Mini-Form microwave coaxial switch weighs only 1.2 oz and costs about \$30 (depending on quantity and configuration). Displacing less than 1/2-in. cube of volume, the tiny spdt switch rates at 150 W. It is offered with SMA or Amphenol series 27 connectors, or with PC contacts suitable for solder and solderless wrapboard termination.

CIRCLE NO. 362

### Photodetector arrays contain up to 20 cells

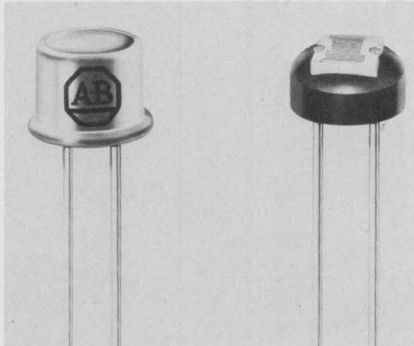

Allen-Bradley Co., 1201 S. Second St., Milwaukee, Wis. Phone: (414) 671-2000. P&A: from 42¢; 3 to 4 wks.

A new line of cadmium sulfide and cadmium sulfo-selenide photodetectors, designated Photochips, are available individually or in arrays up to 20 cells with several peak spectral responses. Three basic materials are offered, with peak spectral responses at 515, 575 and 625 nm. ON resistance with respect to material is 1000, 3000 and 10,000  $\Omega$  when measured at 10 foot-candles.

CIRCLE NO. 363

### Calibrated VFOs cover 2.5 to 6 MHz

TRW, Inc., Electronic Functions Div., Davis & Copewood Sts., Camden, N. J. Phone: (609) 365-5500.

A new series of precision calibrated variable-frequency oscillators include frequency ranges between 2.5 and 6 MHz. The solid-state units are available with either air-variable capacitors or with permeability tuning.

CIRCLE NO. 364

### X-band Gunn diodes provide 10 and 25 mW

Fairchild Microwave & Optoelectronics Div., 215 Charleston Rd., Mountain View, Calif. Phone: (415) 961-9644. P&A: \$33, \$49; 30 days.

A new series of Gunn-effect diodes feature minimum-output-power units of 10 and 25 mW over X-band. The 10-mW units are designated GD(X)-100, while the 25-mW units are called GD(X)-110.

CIRCLE NO. 365

### This literature tells you about

# QUIK BUS

by ROGERS

Custom-designed laminated bus bars at off-the-shelf prices delivered in three weeks!

Prototypes, short-runs or large production orders — MEKTRON QUIK/BUS can save time and money on all of them. Our new design manual is the key. It permits you to work with a range of standard options, "customizing" voltage-distributing assemblies to fit your needs. No tooling charge. Write for your QUIK/BUS manual today . . . or call (203) 774-9605.



Rogers Corporation / Rogers, Conn. 06263



# Miniature High Voltage Resistors



new Mini-MOX resistors offer 100 ppm TCR plus low noise characteristics

Mini-MOX resistors have all the ingredients you need for new designs for ultra-critical applications. For instance, Mini-MOX resistors are a fraction the size of conventional types; they meet or exceed MIL-R-10509-F for environmental parameters . . . 100 ppm or less; T.C.R. stability better than  $\pm 2\%$  for 2,000 hours at full load; low-voltage coefficient less than 5 ppm/volt, measured between 100 volts and full-rated voltage; in addition typical quantech noise at 20 megohms is less than 0.5 microvolt/volt. Available off-the-shelf, Mini-MOX resistors are ideally-suited for high-voltage applications where long-term stability and power-to-size ratios are critical.

Model	Resistance	Rating @70°C	*Max. Oper. Volts	Length Inches	Diameter Inches
MOX-400	1-2500 megs	.25W	1000V	.420	.130
MOX-750	1-5000 megs	.50W	2000V	.790	.130
MOX-1125	1-10,000 megs	1.00W	5000V	1.175	.130

Write for complete Technical Data Sheet on Mini-MOX Resistors: Victoreen Instrument Div. of VLN Corp., 10101 Woodland Ave., Cleveland, Ohio 44104. Telephone: 216/795-8200. DMA 558



Expertise in high voltage



Here's the solution...

# Philips' miniature Plumbicon\*

...now what's your problem?

We'll tell you the truth. It took a lot of imagination to build this TV camera tube.

With a diameter of just 5/8", it's just about half the size of Philips' famous Plumbicon tube preferred all over the world for its speed of response, resolution and sensitivity.

Yet the performance of the mini-Plumbicon is comparable to that of its big brother.

Now it's your turn.

What could a half-sized Plumbicon mean to you?

A whole new range of miniature broadcast cameras?

A solution to a tricky CCTV application . . . maybe industrial . . . or military . . . or even in space? A new medical monitoring concept, perhaps? Or something to simplify outside broadcasting reportage?

Maybe it's the key to a new idea for a data transmission link . . . or the heart of an intelligence or security system.

What about colour microscopy?

But as we said it's your turn.

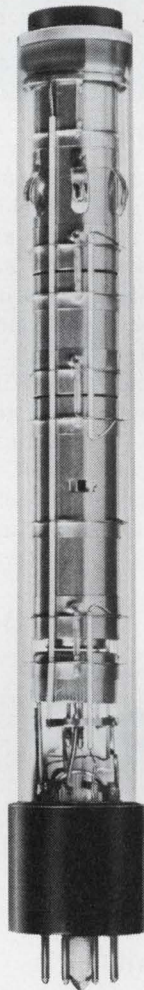

(actual size)

**\* Registered trademark of N.V. Philips' Gloeilampenfabrieken for TV camera tubes.**

N.V. Philips' Gloeilampenfabrieken – Eindhoven, the Netherlands

Manufactured, distributed and sold in the U.S. by  
Amperex Electronic Corporation, Electro-Optical Devices Division,  
Slatersville R.I.



electronic components  
and materials

# PHILIPS

INFORMATION RETRIEVAL NUMBER 96



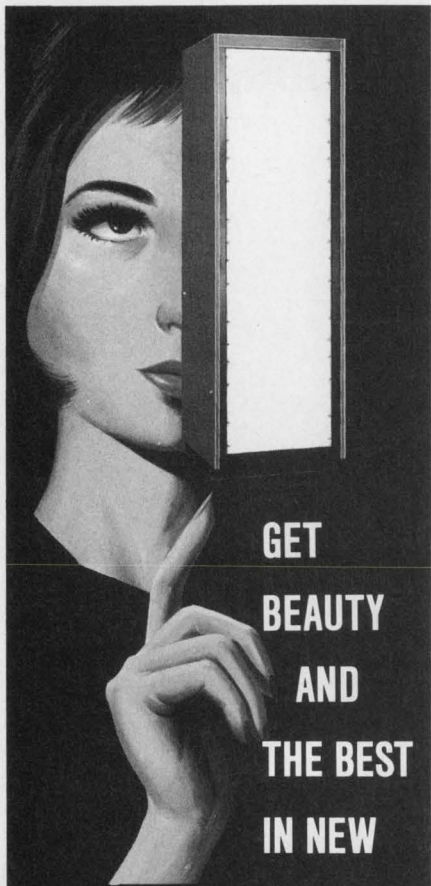

GET  
BEAUTY  
AND  
THE BEST  
IN NEW

## STYLELINE MODU-MOUNT CABINETRY

- NEW ALUMINUM TRIM
- NEW VINYL INSERTS
- NEW EXTENDED PANELS
- SIX NEW COLORS
- AND MANY MORE

FEATURES BY . . .

## Honeywell

"Styleline" Series 4000 Cabinets offer you 84 different frames with hundreds of modular panels and styling combinations to enable customizing your systems, yet retaining standard parts economy with rapid delivery!

### DESIGNERS FACTBOOK

... all the design data and specs you want at your elbow are yours... FREE... if you let us rush your copy of this new 52-page factbook.



**Honeywell**

Wabash, Indiana 46992

## evaluation samples

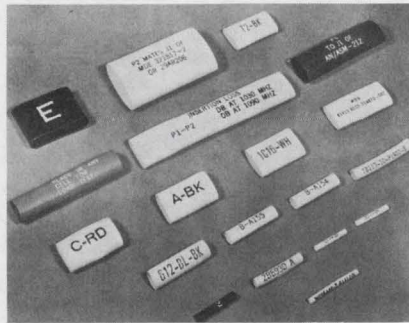

### Heat-shrinkable markers

Free samples of new heat-shrinkable wire markers are available. These permanent markers are made of polyolefin plastic and are imprinted by a cold stamping process using special vinyl compound inks. When heat is applied, a chemical reaction occurs which instantly penetrates and fuses the ink with the markers. The result is a permanent impression that is clear and won't smear or rub off. In addition, the impression is impervious to chemicals. Markwik Corp.

CIRCLE NO. 366

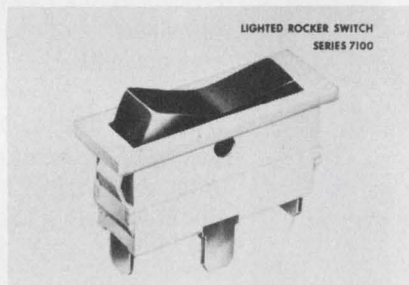

### Lighted rocker switch

The new Rock-A-Lite spst switch is designed to minimize arcing. This illuminated rocker-type switch is engineered to snap securely into 1.281 by 0.395-in. panel openings without any hardware. It is rated at 125 V ac for 10 A, and contains a high-brightness neon lamp with a 1/3-W series resistor for 125 and 250-V operation. It is also available with an incandescent lamp for 6, 14 or 28-V applications. White nylon housing is standard. The lens is of Lexan in several colors. Free samples are available. Leecraft Mfg., Inc.

CIRCLE NO. 367

## design aids

### Mixer IMD chart

A chart which shows the relative amplitude of mixer-generated intermodulation harmonics for three types of frequency mixers is available. The first mixer is a low-level double-balanced type with a compression level of +1 dBm. The other two mixers are high-level double-balanced models with compression levels of +8 and +20 dBm. The chart enables an engineer to properly select the best local oscillator frequency, optimum input level and correct type of mixer for each application. Relcom.

CIRCLE NO. 368

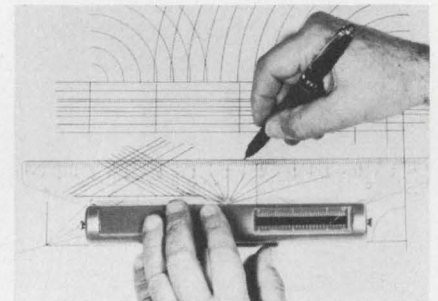

### All-purpose ruler

Anyone who draws lines or uses a ruler will save time and effort with the new Rol-Ruler that has a double scale and measures in tenths or sixteenths of an inch. It's an all-purpose instrument that does the work of three—a triangle, T-square and a parallel ruler. Horizontal and parallel lines are easily drawn without any pointing off. The Rol-Ruler makes layouts, rough sketches, forms, charts, graphs and prepares stencils, mimeographs and offset plates for reproduction. It can even be used for cross-hatching, makes circles and arcs up to 22 in., and many geometric constructions without lifting the pen, pencil or stylus from the paper. The Rol-Ruler is lightweight—only 6 oz. This West German imported product costs only \$5.95 plus 35¢ for handling charges. Professional Aids Co.

CIRCLE NO. 369



# Stalwart compounds rubber every witch way

True. Some of our compound specifications seem to be a regular witch's brew. They have to be complex to meet the exacting performance requirements of our customers in just about every conceivable type of industry — from appliances to missiles, from poultry pluckers to snowmobiles, from outdoor lighting to pasteurizing equipment. To meet these diverse operating conditions, Stalwart compounds stocks from all 14

types of elastomers—molds, extrudes, calenders, splices or cuts to precise tolerances. Laboratory research and development, plus an effective quality assurance program, insure that a Stalwart customer gets the exact rubber part he specified. The "Stalwart Rubber Selector" is a guide to evaluating and specifying special rubber compounds for engineered parts. Write for your copy today.

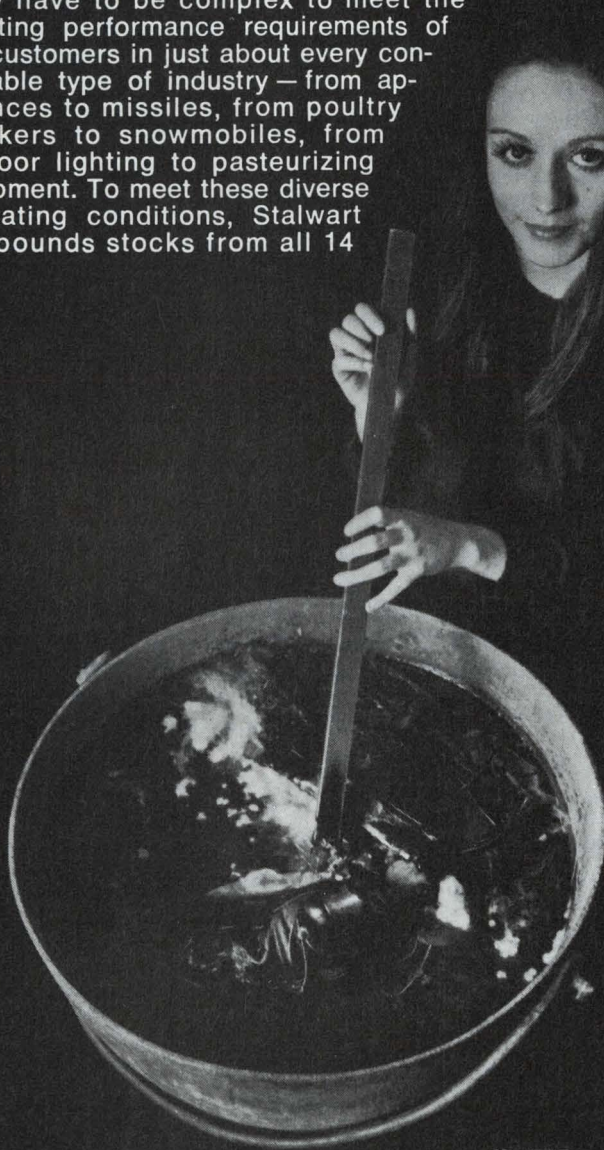

**SR**  
Subsidiary of  
**BLASIUS**  
INDUSTRIES, INC.

**Stalwart Rubber Company** • 160 Northfield Road • Bedford, Ohio. 44146



Trompeter

# TEF-LOCK®

Pat.  
Pend.

## Anchor Cone Connector



Having problems obtaining and attaching coax connectors to Teflon† or glass braided coax cable?

**TEF-LOCK® is your answer!** →

**NOW — Trompeter** introduces a new connector-to-cable attachment concept that cold-flows the TFE jacket material into numerous small holes in an anchor cone that is likewise held in place by other connector hardware for additional pull and twist strength as shown.

The connector-to-cable, pull-to-destroy now approaches the tear strength of the cable itself. The connectors also provide captive center contact pins that are pre-positioned for simple installation, using ordinary tools (no expensive crimp equipment), and are re-useable over and over again with no parts to be replaced. (Category A of Mil-C-39012)

Typical connectors supplied are BNC, TNC, TPS, Triax and Twinax, with other types also available. When ordering TEF-LOCK® versions from our T-8 Catalog simply add "T" after the part number i.e. PL-25T. Ask for a demonstration from our sales representatives in your area.

† Trademark, DuPont Corp.

® Trademark, Trompeter Elec., Inc.

Write or call for our T-8 Catalog



# TROMPETER

Electronics, Inc.  
8936 Comanche Avenue  
Chatsworth, Calif. 91311  
213/882-1020  
TWX 910-494-1210

INFORMATION RETRIEVAL NUMBER 106

## application notes



### Solder handbook

The third edition of "Solder . . . Its Fundamentals and Usage" is available to those engineers and technicians desiring the newest information on solder, fluxes and soldering techniques. Included in the book are sections on the basic chemistry and physics of soldering, electrical and physical properties of soldered joints and characteristics of various alloys (primarily tin and lead). Techniques of soldering are completely explained, starting with the golden rule for the soldering iron and ranging through such methods of soldering as dip pot, soldering of printed circuitry, automatic, oven, electrical resistance, induction heating and flame soldering techniques. Kester Solder Co.

CIRCLE NO. 370

### Unijunction transistors

A 10-page application report tells all about unijunction transistors. It explains what they are, their temperature dependence, discusses programmable types and gives examples of how unijunction transistors can be used for many applications. AEG-Telefunken.

CIRCLE NO. 371

### Control handbook

A new solid-state industrial control handbook contains 94 pages of information for use by those who want to adapt from relay control system design to solid state logic design. Dynage.

CIRCLE NO. 372

### Monolithic transistors

Two technical publications are available dealing with monolithic transistors. One contains a discussion of monolithic matched transistor pairs—what they are used for, how they are made and their advantages. The other publication includes a thorough treatment of the specification and use of transistor dice and micro-packaged forms—how to interpret and formulate transistor specification documentation. Teledyne Semiconductor.

CIRCLE NO. 373

### Op amp principles

A practical, concise and thorough review of the fundamentals and applications of op amps is afforded in a 22-page guide that is well illustrated with diagrams and response curves. It starts off with an easy-to-follow treatment of the basics of an ideal op amp. After going into many types of op amps, it gives a practical discussion on the performance of real op amps and their limiting factors. Discussions are fortified with pertinent equations. Microsystems International Ltd.

CIRCLE NO. 374

### The Analog Dialogue

The latest issue of "Analog Dialogue," a publication for engineers and scientists who use or think about circuits, is available. The 16-page issue covers such topics as the review of a new analog multiplier plus an historical perspective on analog multipliers in general and new approaches to data acquisition system design. A self-balancing bridge used for air-flow measurement and brief reviews of interesting technical papers furnished in the technical trade press are additional contents. Analog Devices.

CIRCLE NO. 375



# Introducing our new Mono-Kap<sup>TM</sup> ceramic capacitor

- \* Lowest prices ever
- \* Highest capacitance—to 10 Mfd
- \* Free evaluation samples



A brand-new product line from USCC/CENTRALAB. Lowest prices in radial-lead, epoxy-coated ceramic capacitors. Highest capacitance values: 4.7 pF to 10 Mfd, in 50, 100 and 200 VDC ratings. Six standard sizes available in your choice of four dielectrics: NPO, W, Z5U and General Purpose. Only Mono-Kap offers maximum economy with three-way quality assurance; 100 percent testing; exclusive Ceramolitic<sup>®</sup> construction; and our unrivaled reputation for highest reliability products. For free evaluation samples, write on company letterhead to USCC/CENTRALAB, Dept. A5, 2151 N. Lincoln Street, Burbank, Calif. 91504 • (213) 843-4222 • TWX 910-498-2222. Or circle Information Retrieval Number below for complete technical data.



U.S. CAPACITOR CORPORATION



CENTRALAB Electronics Division • GLOBE-UNION INC.



# new literature

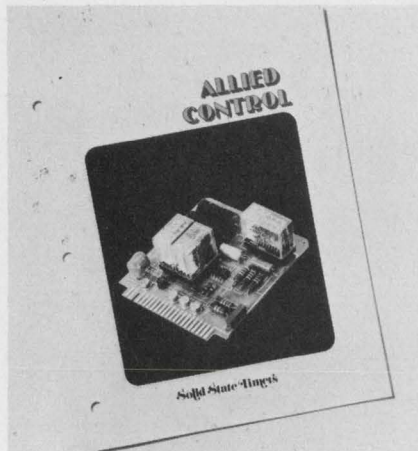

## Solid-state timers

A 10-page catalog describes a new line of solid-state timers that are available with time-delay-on-energization and internal-timing functions. The catalog features cradle relays combined with solid-state timing circuits that provide timing from 0.1 to 300 s with  $\pm 2\%$  repeat accuracy. It includes full specifications, wiring diagrams, application notes, mounting dimensions, ordering instructions and lists of representatives and distributors. Allied Control Co., Inc.

CIRCLE NO. 376

## COS/MOS ICs

An extensive data package on the new low-voltage low-cost line of COS/MOS (complementary symmetry metal-oxide-semiconductor) ICs is now available. The package includes a 72-page data bulletin, an eight-page product guide, eight application notes, technical articles and reliability reports. RCA.

CIRCLE NO. 377

## Photo-electric readers

Photo-electric code readers are described along with their various applications and uses in a 16-page multi-color foldout booklet. Photographs and illustrations of several different types of code reader systems are in the booklet. It concisely describes each of the several basic systems. General Electric.

CIRCLE NO. 378

## Teletype terminals

Teletype 37 data terminals and their components are described in a 28-page catalog. The terminals shown operate at 15 characters/s and have complete ASCII capabilities. The illustrated booklet describes how receive-only (RO), keyboard send-receive (KSR) and automatic send-receive (ASR) sets are used for switched network services. Teletype Corp.

CIRCLE NO. 379

## Annunciator systems

A new catalog on annunciators provides a complete selection for any conceivable annunciator purpose or combination. Hathaway Instruments Inc.

CIRCLE NO. 380

## Waveform generators

A short-form condensed catalog describes a line of waveform, programmable, multiple-output and mechanical-testing generators and waveform synthesizers. Exact Electronics, Inc.

CIRCLE NO. 381

## Memories

A new four-page brochure describes a line of memory systems. These include field-alterable programmable ROMs, bipolar read/write units, military ROMs and read/write stacks and systems, and digital function and ROM verifiers. Quadri Corp.

CIRCLE NO. 382

## Op amps

A supplementary catalog shows a line of wideband op amps packaged in 7 and 9-pin epoxy cases. Optical Electronics, Inc.

CIRCLE NO. 383

## Switch kits

A new four-page brochure is available on a series of rotary thumbwheel switch kits. Electronic Engineering Co. of California.

CIRCLE NO. 384



## GC Electronics catalog

A new general catalog published by GC Electronics (FR-71-72) lists over 14,000 products across 312 pages. Product lines include chemicals, servicing tools, PC materials, servicing aids, automotive connectors and hardware, accessories and replacement parts. Accessories for high-fidelity, stereo, tape and phonographs are also included. GC Electronics.

CIRCLE NO. 385

## 6-bit 30-MHz a/d

The fastest commercially available six-bit a/d converter is detailed in a four-page bulletin. Computer Labs.

CIRCLE NO. 386

## Linear/digital IC tester

A 12-page descriptive brochure on a bench-top tester for linear and digital ICs is available. Microdyne.

CIRCLE NO. 387

## Instrument enclosures

A new line of modular extruded aluminum instrument cases, identified as the Designer series, is thoroughly described in a 12-page bulletin. Cases in the series are assembled with concealed fastenings and are styled with satin finish etched and anodized aluminum panels. Buckeye Stamping Co.

CIRCLE NO. 388





### Metric cutting tools

"U. S. A. Metric Cutting Tools and Gages" is a catalog that features metric taps, dies, drills, reamers, milling cutters and gages. The remainder of the catalog contains tables, explanations of metric screw thread nomenclature, mm/-inch conversion charts and engineering reference data—all dedicated towards a better understanding of the metric system. Beloit Tool Corp.

CIRCLE NO. 389

### Edge connector guide

The 1971 edition of this 28-page edge connector guide has been revised and includes two completely new connector series expanding the total numbers of connectors to 32 sizes ranging from 4 to 126 contacts. Elco

CIRCLE NO. 390

### Optoelectronic products

An optoelectronic product guide is available. The guide lists seven-segment displays, visible and IR LEDs and isolators. Litronix, Inc.

CIRCLE NO. 391

### Transistor dice

Npn and pnp transistor dice are described in a 32-page brochure. Devices shown are for small and large-signal and low and high-frequency rf applications. Teledyne Semiconductor.

CIRCLE NO. 392

# Mil spec synchro/digital converters:

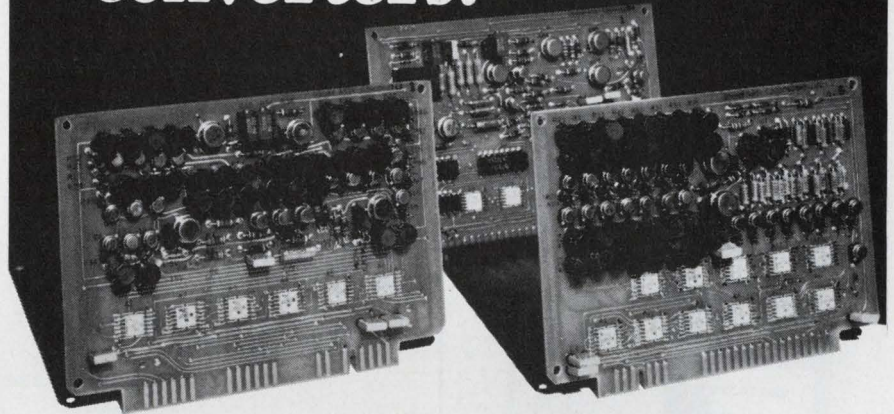

## We've got 'em in cards. Or cased. For off-the-shelf delivery.

Kearfott can solve your conversion problems with two production model solid state synchro/resolver digital converters. Both meet MIL-E-5400.

**TRIGAC I**—A low cost, successive approximation converter, accurate to 12 minutes.

**TRIGAC III**—Using demodulators, integrators, inverters and zero crossing detectors, this converter offers high accuracy at moderate cost.

	Typical Characteristics	
Model Number	TRIGAC I C70 4773 001	TRIGAC III C70 4773 013
Input Signal	3 wire synchro	11.8 V line-to-line 400 Hz
Output	13 bit BCD code or 13 bit natural parallel	14 bit natural parallel
Resolution	6 minutes arc	LSB—1'9"
Accuracy	12 minutes arc	± 2 LSB
Logic Levels	Logic "1" = ±5V ± 10%	Logic "0" = 0—0.5 V

We can supply either cards as shown, or in corrosion-resistant metal enclosures. Write today for new catalog. Singer-General Precision, Inc., Kearfott Division, 1150 McBride Avenue, Little Falls, New Jersey 07424.

**SINGER**  
KEARFOTT DIVISION

INFORMATION RETRIEVAL NUMBER 108



# AMPERITE

Top Quality  
STILL AT  
LOW  
PRICE



## Thermostatic DELAY RELAYS

Offer true hermetic sealing...  
Assure maximum stability and life.

### Delays: 2 to 180 seconds\*

Actuated by a heater, they operate on A.C., D.C., or Pulsating Current... Being hermetically sealed, they are not affected by altitude, moisture, or climate changes... **SPST only** — normally open or normally closed... Compensated for ambient temperature changes from -55° to +80°C... Heaters consume approximately 2 W. and may be operated continuously. The units are rugged, explosion-proof, long-lived, and inexpensive!

**TYPES:** Standard Radio Octal and 9-Pin Miniature.  
List Price, \$4.00

\*Miniatures Delays: 2 to 120 seconds.

All Amperite Delay Relays are recognized under component program of Underwriters' Laboratories, Inc. for all voltages up to and including 115V.

**PROBLEM?** Send for Bulletin No. TR-81.

## AMPERITE BALLAST REGULATORS

Hermetically sealed, they are not affected by changes in altitude, ambient temperature (-50° to +70°C.), or humidity... Rugged, light, compact, most inexpensive.

List Price, \$3.00

Write for 4-p. Bulletin No. AB-51.

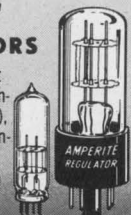

## AMPERITE

600 PALISADE AVE., UNION CITY, N.J. 07087

Telephone: 201 UNION 4-9503

In Canada: Atlas Radio Corp., Ltd.,  
50 Wingold Ave., Toronto 10

## NEW LITERATURE

### CCTV equipment

Low and medium-priced products offered for closed-circuit TV applications are described in a 20-page booklet. Both monochrome and color cameras are covered, including a convertible camera which may be purchased for monochrome use and modified for color at any time. Live and film cameras and related film, tape, terminal and switching equipment are also illustrated and described. RCA.

CIRCLE NO. 393

### Alumina materials

Properties and applications of Lucalox ceramics—polycrystalline alumina materials—are described in detail in a new 12-page booklet. General Electric Co.

CIRCLE NO. 394

### Used instruments

A 16-page catalog, which serves as a blue book of prices for the used-equipment market, lists used instruments for sale. Leasametric.

CIRCLE NO. 395

### MOS devices

A full line of MOS devices is covered in a new catalog. Included are single and dual field-effect transistors; read-only and random-access memories; dynamic and static shift registers and multiplexers. Solitron Devices.

CIRCLE NO. 396

### PC board buss bars

An illustrated design guide for low-cost PC board buss bar systems is available. Rogers Corp.

CIRCLE NO. 397

### MSI handbook

"MSI Specification Handbook DCL Vol. II, Series 8000 Designer's Choice Logic" is presently available. It supplements the recently released Vol. I handbook. Both books provide specifications, descriptions and typical applications of MSI ICs. Signetics Corp.

CIRCLE NO. 398

## Low Frequency MECHANICAL FILTERS



(actual size)

- Applications:
  - Paging systems
  - Remote control systems
  - Remote supervisory systems

Mechanical filters distributed by Seiko Instruments Inc. are derivatives of world renowned SEIKO precision, the outcome of exacting processes and production technology. With almost a decade of experience in the manufacturer of mechanical filters, DAINI SEIKOSHA is able to offer miniature types exhibiting truly high performance. Reliability? Not questionable if you're talking about one of our products.

Many types are available. On special order, we can satisfy a wide range of specifications.

SI Sole distributor in the United States:  
**SEIKO INSTRUMENTS INC.**  
14333, South Figueroa Street, Gardena, Calif.  
90247 Phone: 213-770-0152  
Telex No. 673686

INFORMATION RETRIEVAL NUMBER 110

## The cure for cancer



There is no doubt  
that sooner or later research  
will find the ultimate cure  
for cancer.

We can help make it sooner.

If you help us.

Give all you can to  
the American Cancer Society.

Fight cancer with a checkup and a check.

THIS SPACE CONTRIBUTED BY THE PUBLISHER

INFORMATION RETRIEVAL NUMBER 109



# bulletin board

of product news and development

A **high-energy lithium battery**, developed by Honeywell Inc., for special military applications, is now being made available for commercial use. Designated G2600-B, the battery is said to be the first primary-reserve lithium power source to be manufactured in volume. It has a nominal voltage of 3.2 V and operates on a flat-discharge curve for 500 hours, from  $-40$  to  $+75^{\circ}\text{F}$  at a 1-mA continuous drain, and up to 400 hours for  $165^{\circ}\text{F}$  temperatures. It will also operate over  $-40$  to  $+75^{\circ}\text{F}$  for 20 hours at a 20-mA drain and for 12 hours at a 50-mA drain. Storage life is said to be up to 10 years.

CIRCLE NO. 399

High-threshold logic (HTL) users can now benefit from three circuits added to Motorola Semiconductor's line of MHTL ICs. The circuits are a quad latch, a quad exclusive OR gate and a dual pulse stretcher.

CIRCLE NO. 400

Fairchild Semiconductor has added **three more devices** to its 54/74 line of ICs—two decoders and a shift register.

CIRCLE NO. 401

Electronic Arrays is introducing nine of its **MOS shift registers** in **silicone molded packages**.

CIRCLE NO. 402

Texas Instruments has announced its complete line of 40 standard **MOS ICs** are now available in **plastic dual-in-line packages**.

CIRCLE NO. 403

Weller Div. of Cooper Industries has announced that it is offering a **\$3 trade-in allowance** for any used **soldering tool**, regardless of its make or condition, toward the purchase of its new W-TCP-L and W-MCP soldering tools. The offer expires August 31, 1971.

CIRCLE NO. 404

nickel-cadmium battery  
APPLICATION ENGINEERING HANDBOOK

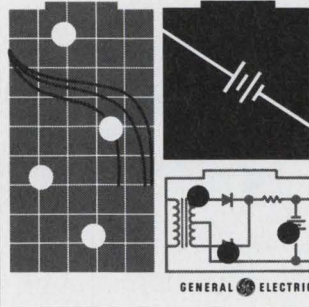

Here's a new, comprehensive manual of interest to all designers—200 pages of application information. To find out how you can order this unique engineering handbook, circle the number below on the reader service card. Or write—General Electric Company, P. O. Box 114, Gainesville, Florida 32601.

GENERAL  ELECTRIC

## all you need to know about nickel-cadmium rechargeable batteries

INFORMATION RETRIEVAL NUMBER 111

## High Power PULSE GENERATOR

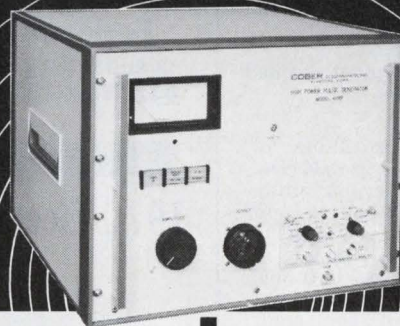

Ideal for driving —

- LSA DEVICES • GUNN DIODES
- MICROWAVE TUBES
- POCKEL CELLS • KERR CELLS

- Delivers 24Kw (2200V at 11A)
- Fast 20ns Rise Time
- Wide Pulse Range 50ns to 5ms
- Single Shot to 1MHz Repetition Rate and Both Polarities
- It all adds up to a highly versatile general purpose test instrument. Other voltages and currents available.

For Model 605P data, send Coupon:

**COBER**  
ELECTRONICS  
*The High-Power People*

Power supplies, pulse modulators, microwave test equipment, transmitters.

7 Gleason Avenue  
Stamford, Conn. 06902  
Phone: (203) 327-0003

Name \_\_\_\_\_ Title \_\_\_\_\_

Firm & Dept. \_\_\_\_\_

Address \_\_\_\_\_

City \_\_\_\_\_ State \_\_\_\_\_ Zip \_\_\_\_\_

INFORMATION RETRIEVAL NUMBER 112



ELECTRONIC DESIGN's function is:

- To aid progress in the electronics manufacturing industry by promoting good design.
- To give the electronic design engineer concepts and ideas that make his job easier and more productive.
- To provide a central source of timely electronics information.
- To promote two-way communication between manufacturer and engineer.

**Want a subscription?** ELECTRONIC DESIGN is sent free to qualified engineers and engineering managers doing design work, supervising design or setting standards in the United States and Western Europe. For a free subscription, use the postfree application form inside the back cover. If none is included, write to us direct for an application form.

If you do not qualify, you may take out a paid subscription for \$25 a year in the U.S.A., \$35 a year elsewhere. Single copies are \$1.50 each.

**If you change your address,** send us an old mailing label and your new address; there is generally a prepaid postcard for this inside the back cover. You will have to requalify to continue receiving ELECTRONIC DESIGN free.

**The accuracy policy of ELECTRONIC DESIGN is:**

- To make reasonable efforts to ensure the accuracy of editorial matter.
- To publish prompt corrections whenever inaccuracies are brought to our attention. Corrections appear at the end of the Letters column.
- To refuse any advertisement deemed to be misleading or fraudulent.

Microfilm copies are available of complete volumes of ELECTRONIC DESIGN at \$19.00 per volume, beginning with Volume 9, 1961. Work is now in process to complete the microfilm edition of Volumes 1-8. Reprints of individual articles may be obtained for \$2.00 each, prepaid (\$.50 for each additional copy of the same article) no matter how long the article. For further details and to place orders, contact the Customer Services Department, University Microfilms, 300 North Zeeb Road, Ann Arbor, Michigan 48106; telephone (313) 761-4700.

**Want to contact us?** If you have any comments or wish to submit a manuscript or article outline, address your correspondence to:

Editor  
ELECTRONIC DESIGN,  
850 Third Avenue,  
New York, N.Y. 10022.

## NEW RELAY SOCKET ASSEMBLIES CATALOG

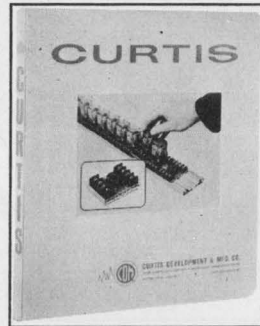

The new Curtis line of printed circuit snap-in track-mounted relay socket assemblies is completely illustrated in this new 2-color, 6 page catalog. Variations include RS8 octal relay sockets, as well as RS11 and RS15 with eleven and fifteen pin relay sockets. Complete dimensional drawings and list prices are included. All units snap in or pop out vertically from prepunched vinyl track and feature Curtis barrier terminal blocks. CSA approved. Send today for your free copy.

CIRCLE NO. 174

**Curtis Development & Mfg. Co.**  
3236 North 33rd Street  
Milwaukee, Wisconsin 53216

## Get Detailed Analysis Of Spectra To 0.02 Hz Bandwidth

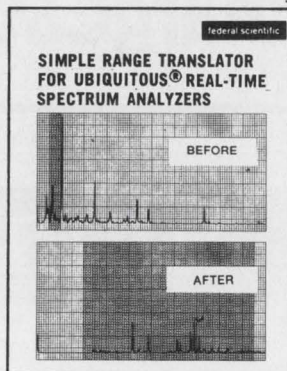

New 30A Range Translator selects narrow bands of frequency, translates them down so they can be analyzed by a Ubiquitous® Low Frequency Real-Time Spectrum Analyzer. (Special version feeds FFT computer inputs, etc.) Selects bands with widths of 20 kHz, 10 kHz, 2 kHz, 1 kHz. Up to 7 ranges supplied, the lowest 10 Hz. Ideal for expansion of small sections of spectrum for detailed analysis. With 500-line UA-6B Analyzer on 10 Hz scale, nominal bandwidth is 0.02 Hz. Customize: you can order even one range. Inexpensive low frequency oscillator can be used; or up to 10 precision oscillator steps can be integral to 30A.

CIRCLE NO. 175

**Federal Scientific Corporation**  
a subsidiary of Elgin National Industries, Inc.  
615 West 131st Street, New York, N. Y. 10027

## 1970 Electronic Components Drafting Aids Catalog

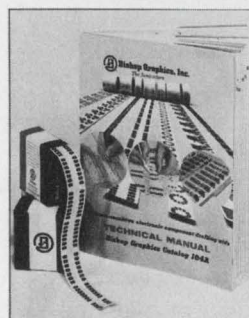

**Free Catalog! Free Samples!** Exciting innovations in pressure-sensitive electronic component drafting aids and methods are detailed in the new 1970 edition of the combined Bishop Technical Manual and Catalog 104A.

68 illustrated pages of over 15,000 multi-pad configurations, symbols, tapes, sequential reference designations plus hundreds of time-and-money-saving hints in making artwork for PC boards. Includes instructions for using the industry's only red and blue tape system for making two-sided boards in perfect registration. Send now for free Catalog 104A and free samples.

CIRCLE NO. 176

**Bishop Graphics, Inc.**  
7300 Radford Avenue  
North Hollywood, California 91605  
(213) 982-2000 Telex: 674672



# Manufacturers

Advertisements of booklets, brochures, catalogs and data sheets. To order use Reader-Service Card.  
(Advertisement)

## Experi/Board: From Schematics to Electronics in Minutes

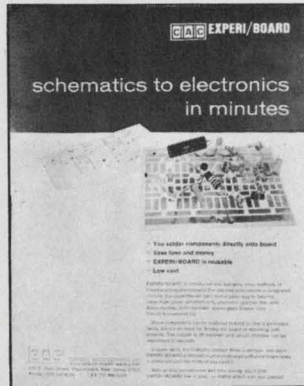

Circuit Accessories Co. has introduced a new method of breadboarding, "Experi/Board." CAC's "Experi/Board" is introduced and suddenly all other methods of breadboarding are obsolete. For integrated circuits or discrete components, the engineer can't find a faster way to bring his ideas from schematics to electronic realities than with "Experi/Boards." The new "Experi/Boards" are offered in 24 different sizes and models. The four page catalog covers complete specs, model numbers, mechanical dimensions and prices. "Experi/Boards" are shipped from stock. Write, call or TWX for your free catalog.

CIRCLE NO. 177

### Circuit Accessories Co.

514 S. River Street  
Hackensack, New Jersey 07601  
(201) 343-6294 TWX: (710) 990-5023

## World's Largest Line of Smallest Supplies

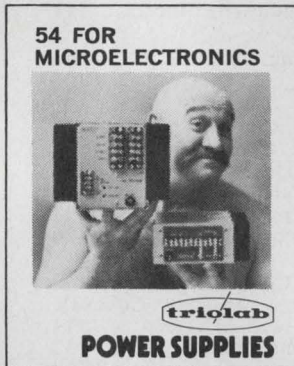

Now the world's smallest power supplies for microelectronics are available in the world's largest line of high power density, high efficiency supplies: 54 off-the-shelf models. From 100W to 500W; from 3VDC to 30VDC; single, dual, triple outputs; commercial, military, export models. Now in use by such leaders as Burroughs, Control Data, Honeywell, IBM, Litton, NCR, RCA, Univac, and many Government installations. Shown (left): Model SP631, 5VDC/100A, typical efficiency 70%, 8.50" x 6.81" x 8.85", 21.5 lbs., \$695. (Right): Model SP601, 5VDC/20A, typical efficiency 65%, 3.25" x 6.50" x 7.50", 6 lbs., \$400. Custom development and production also available.

CIRCLE NO. 178

### Trio Laboratories, Inc.

80 Dupont Street,  
Plainview, L. I., N. Y. 11803

## Free — New Alvin Template Catalog



A must for every electronic engineer and draftsman! The comprehensive 36 page Alvin catalog clearly illustrates and describes over 400 templates for practically every use. This template catalog is categorized in sections and shows the templates used for each field, ie, electrical and electronic symbol templates, mechanical engineering templates and many others. Alvin's precision made, time-saving templates cover completely the needs of draftsmen and engineers in all categories. Send for free catalog now.

CIRCLE NO. 179

### ALVIN & CO., INC.

611 Palisado Avenue  
Windsor, Connecticut 06095

# Electronic Design

## Advertising Sales Staff

Keith Aldrich  
Sales Manager

### New York 10022

Robert W. Gascoigne  
Samuel M. Deitch  
Daniel J. Rowland  
850 Third Avenue  
(212) Plaza 1-5530  
TWX: 710-581-2874

### Philadelphia 19025

Mort Sullivan  
P.O. Box 126  
Dresher, Pa.  
(215) 884-6880

### Boston 02154

Joseph F. Palmer  
1268 Main Street  
Waltham, Mass.  
(617) 894-2700

### Chicago 60611

Thomas P. Kavooras  
Berry Conner, Jr.  
200 East Ontario  
(312) 337-0588

### Cleveland

Thomas P. Kavooras  
(Chicago)  
(312) 337-0588  
(call collect)

### Los Angeles 90303

Stanley I. Ehrenclou  
2930 Imperial Highway  
Inglewood, Calif.  
(213) 757-0183

### San Francisco 94022

Jerry D. Latta  
95 Main Street  
Los Altos, Calif.  
(415) 941-3084

### London W. 1

For United Kingdom and Holland  
Brayton C. Nichols  
For Eastern Europe  
Peter Kehr  
44 Conduit Street  
Tel: REGent 4714

### Verviers, Belgium

For Continental Europe  
Andre Jamar  
1, Ru Mallar, 1  
(087) 253.83 Telex 41563

### Tokyo

Haruki Hirayama  
Electronic Media Service  
5th Floor, Lila Bldg.,  
4-9-8 Roppongi  
Minato-ku  
Phone: 402-4556  
Cable: Electronicmedia, Tokyo





# New Micro-Miniature Form C Reed Relays



- The First FORM C Micro-Min. Relay Available!
- Measures .435 x .290 OD, only 0.03 cu. in.!
- Min. Overall Length with Bent Leads .600
- High Speed 100 microsec. Operate Time (ex. Bounce)
- Stock Voltages 3, 6, 12 and 24
- Leads or Pins. Also Available with Form A.

Special voltages, resistances, electrostatic and/or magnetic shields available. Write for new Bulletin MR-9.2.



**COTO-COIL COMPANY, INC.**  
59 Pavilion Avenue, Providence, R. I. 02905  
Tel: (401) 941-3355

INFORMATION RETRIEVAL NUMBER 113

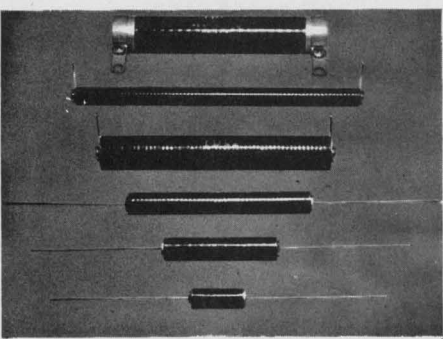

## high voltage high ohmic carbon film resistors

15 basic styles available from stock

- WATTS: .25 to 100w.
- RESISTANCE: 10 to 10<sup>14</sup>Ω
- TOLERANCE: to ±1%
- STAND. SIZES: .563" L x .1" dia. to 19.687" L x 2" dia.

**NEW:**  
Metal Oxide Film Resistors . . . ask for data



914 SOUTH 13TH STREET  
HARRISBURG, PENNSYLVANIA 17104  
PHONE 717-236-5081

INFORMATION RETRIEVAL NUMBER 114

# advertiser's index

Advertiser	Page	Advertiser	Page
Aertech Industries .....	94	Hewlett-Packard .....	Cover II, 4, 5, 40, 41, 45
Alco Electronic Products, Inc.....	95	Hewlett Packard, New Jersey.....	93
Alvin & Co., Inc. ....	141	Honeywell, Inc. ....	132
Allen-Bradley Co. ....	31	Howard Industries, A Division MSL Industries, Inc.....	46
Amperite .....	138	Janco Corporation .....	110
Amphenol Components Group.....	12	Johanson Manufacturing Corp.....	32
Automatic Business Systems, Division of Litton Industries.....	86	Johnson Company, E. F.....	124
Automatic Electric Company.....	34, 35	Keithley Instruments, Inc.....	6
Bal-seal Engineering Co.....	143	Koh-I-Noor Radiograph, Inc.....	91
Belden Corporation .....	74, 75	Kurz-Kasch, Inc. ....	118
Bell, Inc., F. W.....	110	Magnecraft Electric Company.....	62
Bishop Graphics, Inc.....	140	MicroSwitch, A Division of Honeywell .....	117
Bourns, Inc. ....	15	Molex, Incorporated .....	27
Buckbee Mears Company.....	129	Motorola Semiconductor Products, Inc. ....	48
Buckeye Stamping Co., The.....	125	North Atlantic Industries, Inc.....	111
Budd Company, The.....	56	Oak Manufacturing Co.....	43
Bulova Frequency Control Products.....	108	OPCOA, Inc. ....	104
Burrughs Corporation .....	18	Penntube Plastics Co., Inc.....	129
Cambridge Thermionic Corporation.....	122	Philips Electronic Components and Materials Division.....	36, 131
CELCO (Constantine Engineering Laboratories Co.) .....	119	Plessey, Incorporated .....	10
Centralab, the Electronics Division Globe-Union, Inc. ....	101	Power/Mate Corp. ....	13
Cinch Manufacturing Company.....	33	Power-Tec Division, Airtronics, Inc.....	126
Circuit Accessories Co.....	141	RCA Electronic Components and Devices .....	109, Cover IV
Clare & Co., C. P.....	1	Rapidesign, Inc. ....	114
Clare-Pendar .....	118	Resistance Products Company.....	142
Computer Automation, Inc.....	7	Rtron Corporation .....	102
Constantine Engineering Labs. Co. (CELCO) .....	119	Rogan Brothers, Inc.....	127
Corning Data Systems.....	126	Rogers Corporation .....	130
Coto Coil Company, Inc.....	142	Schauer Manufacturing Corp.....	116
Curtis Development & Mfg. Co.....	140	Schrack Electrical Sales Corp.....	125
Cutler-Hammer .....	61	Seiko Instruments, Inc. ....	138
Dale Electronics, Inc.....	Cover III	Semtech Corporation .....	14
Damon Electronics Division.....	113	Servo Tek Products Company.....	100
Data Technology, Inc.....	102	Siemens Corporation .....	36
Datapac, Inc. ....	115	Sigma Instruments, Inc.....	14
Delco Electronics, Division of General Motors Corporation.....	96, 97	Simpson Electric Company.....	11
Deltron, Inc. ....	120	Singer, Line Electric Division.....	125
Dialight Corporation .....	107	Singer-General Precision, Inc. Kearfott Division .....	137
Digilin, Inc. ....	128	Sprague Electric Company.....	21
Digital Equipment Corporation .....	84, 85, 87	Stalwart Rubber Co.....	133
Dzus Fastener Co., Inc.....	124	Sylvania Electronic Components, Electronic Tube Division.....	68, 69, 83
Edmund Scientific Company.....	143	TRW, Inc. ....	2
Elco Corporation .....	17	Tektronix, Inc. ....	39
Electro Switch Corp.....	112	Teledyne Electro-Mechanisms .....	44
Electronic Design .....	143	Trio Laboratories, Inc.....	141
Electronic Memories .....	42	Triplett Corporation .....	98
Elexon, Inc. ....	122	Trompeter Electronics, Inc.....	134
Erie Technological Products, Inc.....	57	Union Carbide Corporation.....	89
Fairchild Semiconductor, A Division Fairchild Camera and Instrument Corporation .....	8, 9	U. S. Capacitor Corporation.....	128, 135
Federal Scientific Corporation.....	140	Unitrode Corporation .....	29
Fifth Dimension Inc.....	123	Victoreen Instrument Division.....	130
General Electric Company.....	63, 139	Virginia Panel Corporation.....	129
General Radio Company.....	105		
Grayhill, Inc. ....	114		
Hamilton Watch Company, Precision Metals Division.....	103		
Hayden Book Company, Inc.....	88		
Heath Company .....	121		



## COMPLETE SEAL LINE

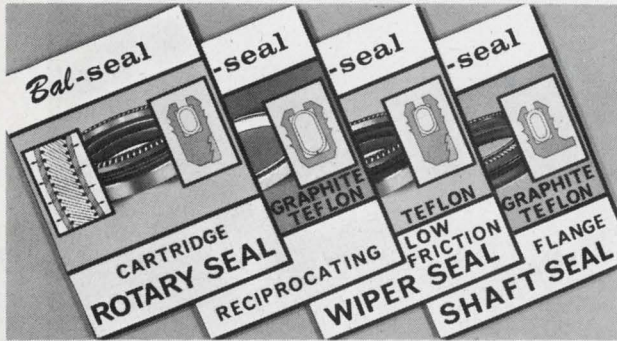

### NEW SEAL GUIDES

- SPRING LOADED TEFLON AND GRAPHITE FILLED TEFLON SEALS.
- LONGER SEAL LIFE.
- SELF COMPENSATING FOR RUNOUT, WEAR AND TEMPERATURE.
- SEND FOR FREE SAMPLE AND SEAL GUIDE ●

Rotary: From vacuum to 250 PSI.

Reciprocating: From vacuum to 10,000 PSI.

Wiper: For extremely low friction.

Flange seal: Low priced rotary seal.

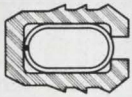

**Bal-seal ENGINEERING CO.**

17592 SHERBROOK DR., TUSTIN, CALIF. 92680 • 714/838-9640

INFORMATION RETRIEVAL NUMBER 115

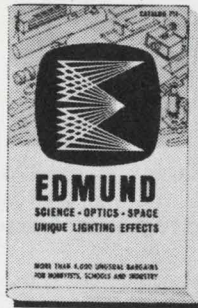

## FREE CATALOG!

148 PAGES • MORE THAN 4000 UNUSUAL BARGAINS  
SCIENCE • OPTICS • SPACE

1000's OF HARD-TO-FIND BUYS FOR INDUSTRY.

Speed your work! Improve quality! Cut development and production costs! Completely new edition loaded with on-the-job helps, quality control aids, unique items available nowhere else. 148 easy-to-read pages packed with new products, charts, diagrams, illustrations. A treasure house of optical and scientific equipment available direct from stock for industry, research labs, design engineers, experimenters, hobbyists.

**AMERICA'S GREATEST ONE-SOURCE MARKET PLACE**  
Hard-to-get surplus bargains. Ingenious scientific tools. Thousands of components: lenses, prisms, wedges, mirrors, mounts, accessories of all descriptions. Hundreds of instruments: lasers, comparators, magnifiers, microscopes, projectors, telescopes, binoculars, photo attachments, black light equipment and the largest selection of unique lighting items in the country.

**ORDER DIRECT WITH ABSOLUTE CONFIDENCE**  
Edmund ships more than 5,000 orders monthly to the country's largest industrials. Every item completely guaranteed. You must be satisfied with any purchase or return it in 30 days for your money back. Shop the catalog of America's largest Science-Optics-Space Mart. Send for your free copy today. Absolutely no obligation. No salesman will call. Request FREE catalog "DA"

**EDMUND SCIENTIFIC CO.**  
300 EDSCORP BLDG.  
BARRINGTON, NEW JERSEY 08007



### MAIL COUPON FOR GIANT FREE CATALOG!

EDMUND SCIENTIFIC CO.  
300 Edscorp Building, Barrington, N. J. 08007  
Please send Free Giant Catalog "DA"

NAME \_\_\_\_\_  
COMPANY \_\_\_\_\_  
ADDRESS \_\_\_\_\_  
CITY \_\_\_\_\_ STATE \_\_\_\_\_ ZIP \_\_\_\_\_

INFORMATION RETRIEVAL NUMBER 116

# a new space unit from Electronic Design

**A NEW 1/9 PAGE SIZE FOR ONLY \$300 INCLUDING PRODUCTION CHARGES!**

Quick Ads will be placed in their own special section, attractively laid out to insure maximum attention. Each will have its own Information Retrieval Number, assuring many inquiries, many sales leads. You simply provide an 8 x 10" glossy photograph, plus approximately 40 words of copy. We do the rest at no cost to you.

For full information, including even lower frequency rates, mail the form at right to Peter D. Coley, Publisher, Electronic Design, 850 Third Avenue, New York, N.Y. 10022

**Quick Ads**

PLEASE RUSH ME FULL DETAILS ON QUICK ADS IN ELECTRONIC DESIGN

NAME \_\_\_\_\_ FIRM \_\_\_\_\_  
STREET \_\_\_\_\_ CITY \_\_\_\_\_ STATE \_\_\_\_\_ ZIP \_\_\_\_\_  
TITLE \_\_\_\_\_



# product index

**Information Retrieval Service.** New Products, Evaluation Samples (ES), Design Aids (DA), Application Notes (AN), and New Literature (NL) in this issue are listed here with page and Information Retrieval numbers. Reader requests will be promptly processed by computer and mailed to the manufacturer within three days.

Category	Page	IRN	Category	Page	IRN	Category	Page	IRN
<b>Components</b>			transistors, power	103	<b>262</b>	sockets, 18-pin	116	<b>288</b>
annunciators (NL)	136	<b>380</b>	transistors, signal	100	<b>252</b>	solder fundamentals		
components (NL)	136	<b>385</b>	UJTs (AN)	134	<b>371</b>	(AN)	134	<b>370</b>
contactor, power	120	<b>300</b>	<b>Instrumentation</b>			soldering tool	118	<b>294</b>
CRT, fiber-optic	120	<b>295</b>	CCTV (NL)	138	<b>393</b>	tools, metric (NL)	137	<b>389</b>
DIP, transformer	122	<b>347</b>	counter, 500-MHz	106	<b>269</b>	wire markers (ES)	132	<b>366</b>
DIP, wirewound resistor	122	<b>343</b>	DPMs, 3 and 4-digit	108	<b>276</b>			
LED indicators	122	<b>344</b>	generator, pulse	108	<b>274</b>			
pilot lights, neon	121	<b>297</b>	generators (NL)	136	<b>381</b>			
potentiometers	122	<b>345</b>	impedance meter	108	<b>275</b>			
relay, reed	122	<b>348</b>	instrument cases (NL)	136	<b>388</b>			
ruler, all-purpose (DA)	132	<b>369</b>	instruments, used (NL)	138	<b>395</b>			
switch, keyboard	122	<b>342</b>	meter, C/L	108	<b>273</b>			
switch, proximity	120	<b>299</b>	recorder	108	<b>278</b>			
switch, rocker (ES)	132	<b>367</b>	recorder modules	108	<b>277</b>			
switch, 12-position	121	<b>298</b>	scope, 500-MHz	106	<b>270</b>			
switch kits (NL)	136	<b>384</b>	synthesizer, 80-MHz	108	<b>271</b>			
switches, pushbutton	122	<b>346</b>	synthesizers (NL)	136	<b>381</b>			
switches, rotary (NL)	136	<b>384</b>	tester, IC (NL)	136	<b>387</b>			
switches, spdt	122	<b>341</b>	tester, transistor	108	<b>272</b>			
thermistors, flake	120	<b>296</b>	VOMs, digital	104	<b>268</b>			
timers, solid-state (NL)	136	<b>376</b>						
tools, metric (NL)	137	<b>389</b>	<b>Microwaves &amp; Lasers</b>					
trimmer, dual	122	<b>340</b>	CCTV (NL)	138	<b>393</b>			
			diodes, X-band Gunn	130	<b>365</b>	<b>new literature</b>		
<b>Data Processing</b>			mixer chart (DA)	132	<b>368</b>	alumina materials	138	<b>394</b>
calculator, 12-digit	110	<b>279</b>	optoelectronics (NL)	137	<b>391</b>	annunciators	136	<b>380</b>
code readers (NL)	136	<b>378</b>	oscillators, variable	130	<b>364</b>	buss bars, PC	138	<b>397</b>
coder/decoders, data	114	<b>286</b>	photodetector arrays	130	<b>363</b>	CCTV equipment	138	<b>393</b>
data acquisition (AN)	134	<b>375</b>	photo readers (NL)	136	<b>378</b>	components	136	<b>385</b>
disc drives	114	<b>285</b>	switch, coaxial	130	<b>362</b>	connectors, edge	137	<b>390</b>
disc system	112	<b>282</b>				converter, a/d	136	<b>386</b>
keyboard, terminal	110	<b>281</b>	<b>Modules &amp; Subassemblies</b>			enclosures, instrument	136	<b>388</b>
memories (NL)	136	<b>382</b>	amplifier, 50-W audio	128	<b>360</b>	generators, waveform	136	<b>381</b>
minicomputer, custom	112	<b>284</b>	annunciator systems			ICs, COS/MOS	136	<b>377</b>
minicomputer, 12-bit	110	<b>280</b>	(NL)	136	<b>380</b>	instruments, used	138	<b>395</b>
ROMs (NL)	136	<b>382</b>	control, industrial (AN)	134	<b>372</b>	memories, read/write	136	<b>382</b>
ROMs, programmable			converter, a/d (NL)	136	<b>386</b>	MOS devices	138	<b>396</b>
(NL)	136	<b>382</b>	converter, dc-to-dc	126	<b>358</b>	MSI handbook	138	<b>398</b>
Teletype terminals (NL)	136	<b>379</b>	converter, 8-bit d/a	124	<b>349</b>	op amps	136	<b>383</b>
terminal, page	114	<b>287</b>	converter, 7-bit a/d	126	<b>351</b>	optoelectronic products	137	<b>391</b>
			display, liquid crystal	126	<b>356</b>	readers, photo-electric	136	<b>378</b>
<b>ICs &amp; Semiconductors</b>			displays, alphanumeric	126	<b>355</b>	ROMs	136	<b>382</b>
adders, 4-bit	100	<b>258</b>	LED, seven-segment	126	<b>352</b>	ROMs, programmable	136	<b>382</b>
counters, asynchronous	100	<b>259</b>	LED, seven-segment	126	<b>359</b>	switch kits	136	<b>384</b>
FETs	100	<b>257</b>	lights, GaAsP card	128	<b>361</b>	switches, rotary	136	<b>384</b>
FETs, MOS (NL)	138	<b>396</b>	multipliers, analog (AN)	134	<b>375</b>	switches, thumbwheel	136	<b>384</b>
IC, function generator	103	<b>264</b>	op amp, FET	126	<b>354</b>	synthesizers	136	<b>381</b>
ICs, COS/MOS (NL)	136	<b>377</b>	op amp principles (AN)	134	<b>374</b>	terminals, Teletype	136	<b>379</b>
JFETs, monolithic	100	<b>251</b>	op amps (NL)	136	<b>383</b>	tester, IC	136	<b>387</b>
memory drivers	102	<b>260</b>	power supply, twin dual	126	<b>353</b>	timers, solid-state	136	<b>376</b>
MOS devices (NL)	138	<b>396</b>	switch, reed	124	<b>350</b>	tools, metric cutting	137	<b>389</b>
MSI handbook (NL)	138	<b>398</b>	voltage follower, FET	126	<b>357</b>	transistors, dice	137	<b>392</b>
op amp, precision IC	103	<b>265</b>						
op amp principles (AN)	134	<b>374</b>	<b>Packaging &amp; Materials</b>					
op amps, IC	102	<b>261</b>	alumina (NL)	138	<b>394</b>			
RAM, nonvolatile	99	<b>250</b>	buss bars, PC (NL)	138	<b>397</b>	<b>application notes</b>		
RAM, 64-bit	100	<b>254</b>	carriers, LID	116	<b>291</b>	analog circuitry	134	<b>375</b>
register, shift	103	<b>263</b>	cases, instrument (NL)	136	<b>388</b>	control handbook	134	<b>372</b>
regulators, IC voltage	100	<b>256</b>	connectors, edge (NL)	137	<b>390</b>	op amp principles	134	<b>374</b>
ROM, MOS	103	<b>266</b>	control handbook (AN)	134	<b>372</b>	solder handbook	134	<b>370</b>
ROM, MOS	103	<b>267</b>	interconnection modules	118	<b>293</b>	transistors, monolithic	134	<b>373</b>
ROMs, MOS tri-state	100	<b>255</b>	PC board	118	<b>292</b>	transistors, unijunction	134	<b>371</b>
switch, MOS 2-channel	100	<b>253</b>	protector strips, PC	116	<b>289</b>			
transistors (AN)	134	<b>373</b>	receptacles, component	116	<b>290</b>			
transistors (NL)	137	<b>392</b>						



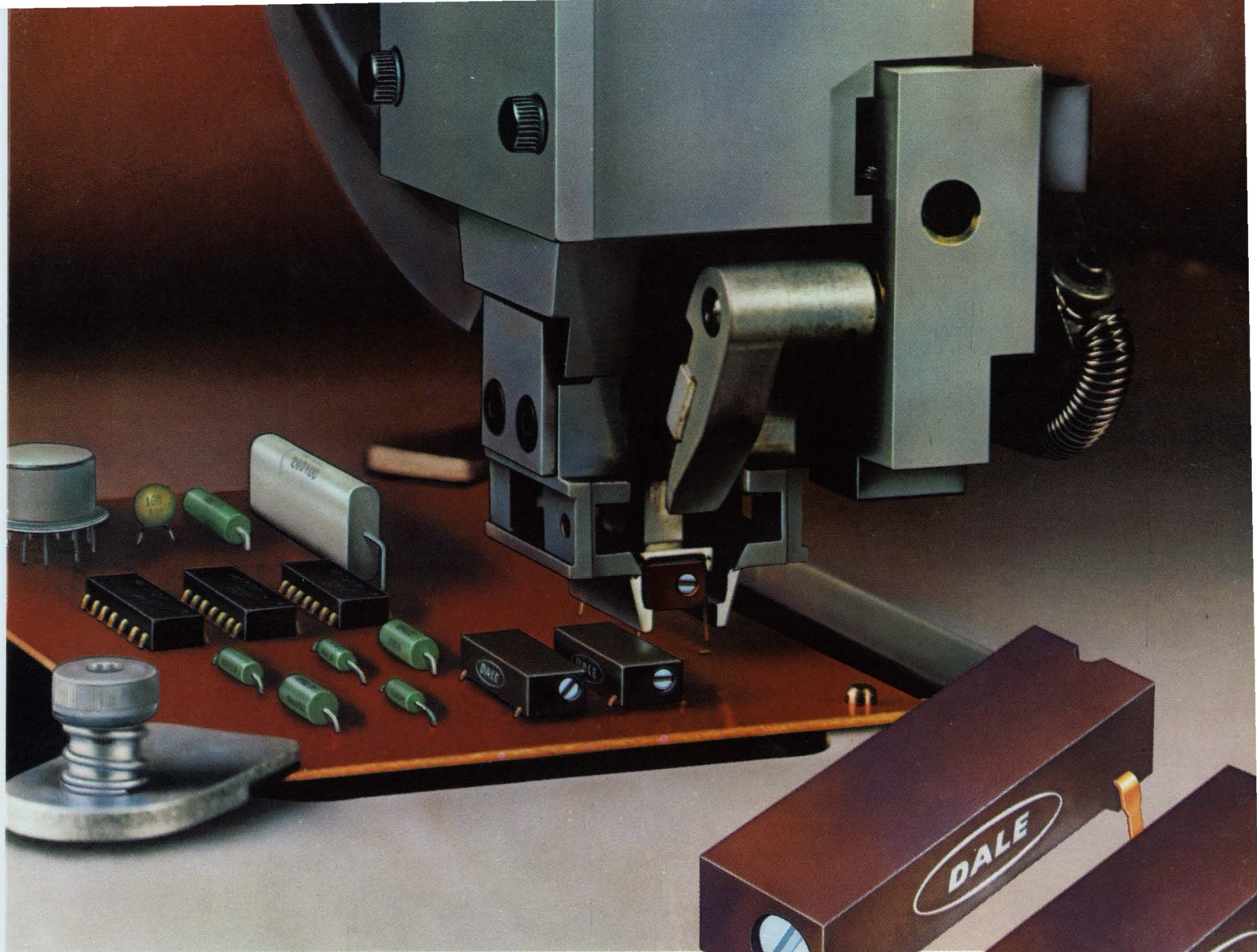

# New Dale Fastpacks!

3/4" DIP Trimmers — wirewound or film — ready for automatic testing and insertion

Count us in when you design or specify trimmers for automatic assembly. New Dale 3/4" DIP trimmers give you a choice of wirewound or film element performance—plus full compatibility with your high speed automatic testing and insertion equipment. Shipped in ready-to-use magazines, these new DIP trimmers are ready to go now. Prices and delivery schedules meet or beat the best you've seen. Check the specs, then see your Dale distributor or call the number below.

## SPECIFICATIONS

	2600 Wirewound	8600 Film
<b>Resistance Range</b>	10 ohms to 50K ohms	10 ohms to 2 Megohms
<b>Tolerance</b>	±10%	±10% 100 ohms thru 500K ±20% all others
<b>Power Rating</b>	1 watt at 40°C derated to 0 at 125°C	.75 watt at 25°C, derated to 0 at 125°C

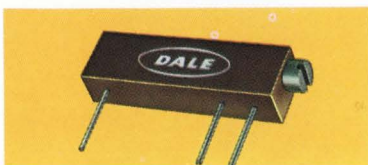

## NEW Space-saving 1/2" Film Trimmer

Dale's new film element 800 Series lets you squeeze 10-turn adjustment and infinite resolution into a .500" x .100" x .150" space. Dissipates .3 watt over a resistance range of 10 ohms to 2 megohms.

For details call  
402-564-3131 today



## DALE ELECTRONICS, INC.

1300 28th Ave., Columbus, Nebr. 68601  
In Canada: Dale Electronics Canada, Ltd.  
A subsidiary of The Lionel Corporation



# NEW 3V COS/MOS ICs

RCA gives you: a new solution to the problem of interfacing logic technologies... a 50% (av.) cut in plastic IC prices.

Now, gain maximum cost effectiveness and circuit reliability in your logic-circuit designs. Use RCA's COS/MOS Integrated Circuits exclusively in your new designs . . . or mix and match COS/MOS ICs with T<sup>2</sup>L and DTL devices in either new or existing circuit designs—they're compatible!

Look into it! You've always been able to save engineering and production expense by using COS/MOS ICs. Now, you have the new 3 to 15 V operating range in plastic-packaged devices at very substantial cost savings.

•New operating-voltage range makes COS/MOS ICs still easier to use over a much broader range of applications.

•One 5 V supply will provide power for both COS/MOS and T<sup>2</sup>L ICs (in some complex circuit functions, a T<sup>2</sup>L IC may drive a COS/MOS IC — or vice-versa).

•The 3 V operating level makes COS/MOS ICs suitable for portable (battery operated) digital systems.

Two added bonuses with COS/MOS ICs. They require less rigid voltage regulation than T<sup>2</sup>L ICs: COS/MOS,  $5 \pm 1\frac{1}{2}$  V; T<sup>2</sup>L,  $5 \pm 0.5$  V. RCA specifies ceramic-packaged COS/MOS ICs' characteristic limits at -55°C and +125°C — the full military operating temperature range. (Plastic COS/MOS ICs' limits are specified from -40°C to +85°C.) Typical COS/MOS logic speeds are:

•Gate propagation delay— 35 ns @ 5 V  
— 25 ns @ 10 V

•Flip-flop toggle rate } 4 MHz @ 5 V  
and MSI clock rate } 10 MHz @ 10 V  
For special applications, RCA will custom-tailor COS/MOS ICs to meet your needs. Ask your local RCA Representative about this service.

See your local RCA Representative or RCA Distributor for COS/MOS IC price and delivery information and a copy of RCA's new "Low-Voltage COS/MOS Product Guide" (COS-278) — which presents basic data on RCA's complete COS/MOS line. Copies of this product guide may also be obtained by writing to RCA, Commercial Engineering, Sec. 57E-13 /CDC56, Harrison, N.J. 07029. International: RCA, Sunbury-on-Thames, U.K., or 2-4 rue du Lièvre, 1227 Geneva, Switzerland, or P.O. Box 112, Hong Kong.

RCA, Commercial Engineering  
Section 57E-13/CDC56R  
Harrison, N.J. 07029

## RCA COS/MOS Integrated Circuits Manual

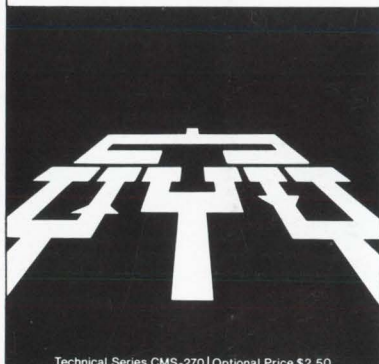

Technical Series CMS-270 | Optional Price \$2.50

COS/MOS Manual CMS-270 may also be purchased at your RCA Distributor's.

Send me RCA's new COS/MOS IC manual CMS-270 that provides device fundamentals including characteristics, processing essentials, and layout procedures. This complete guide to existing RCA COS/MOS products contains an informative "how to use and design" section plus extensive applications data.

Name \_\_\_\_\_

Title \_\_\_\_\_

Company \_\_\_\_\_

Street \_\_\_\_\_

City \_\_\_\_\_

State \_\_\_\_\_ Zip \_\_\_\_\_

Enclosed please find my check or money order for \$2.50\*

\* Optional price

# RCA

Solid State