



Section 10
**Physical Dimensions/
Appendices**



Section 10 Contents

TapePak	10-3
Physical Dimensions	10-4
Bookshelf	
Distributors	

TapePak®

The latest generation in VLSI packaging, TapePak is the package of the future—low-cost, reliable, high-leadcount package that's easy to handle, easy to test, and easy to mount. It's also compatible with existing surface-mount technology.

TapePak uses tape-automated bonding technology and a unique, patented outer ring to protect the leads and, at the same time, provide an effective test interface.

This outer ring is molded at the same time as the body of the package and creates test points outside the package leads. The test ring is discarded along with the tape as the package is excised by the automatic pick-and-place machine at the point of assembly.

During testing, the leads themselves never come in contact with the test socket, so lead damage and coplanarity problems are eliminated. The test ring also allows burn-in to be performed on each device.

Not only does this ring protect the leads during handling, testing and assembly, but it also allows leads to be placed on centers of 0.012 inch–0.020 inch (0.3 mm–0.5 mm), while the test points are placed on standard centers of 0.020 inch (0.5 mm), 0.025 inch (0.65 mm) or 0.050 inch (1.27 mm). That way, the test points are compatible with existing automatic test equipment.

TapePak packages are significantly smaller than conventional and alternative surface-mount packages. TapePak lead counts range from 40 to greater than 360, yet the largest package measures only 1.1 inches (28 mm) square.

Comparison of TapePak and Conventional Packages

	40L DIP		44L PLCC		40L TapePak	
Lead thickness (mils)	10.0		10.0		2.8	
Lead pitch (mils)	100		50		20	
Package length (mils)	2050		650		350	
Package width (mils)	600		650		350	
Package thickness (mils)*	175		180		71	
Volume ratio	24.4		9.1		1	
	40L DIP		44L PLCC		40L TapePak	
	Long	Short	Long	Short	Long	Short
Lead length (in)	1.0	0.3	0.35	0.25	0.1	0.1
Resistance (mOhm)	7	4	4	3	2.4	2.4
Inductance (nH)	22	6.0	6.5	5	1.2	1.2
Capacitance (pF) (lead to lead)	0.5	0.2	0.3	0.2	0.2	0.1

*Measured from seating plane to the top of the package.

A TapePak device can be less than $\frac{1}{10}$ the size of a traditional DIP and $\frac{1}{5}$ the size of other surface-mount packages such as a PLCC.

TapePak technology was designed to take full advantage of automatic assembly systems with their high speed and precision. It can be used with existing precision surface-mount assembly equipment with minimal modification. The only requirement is an accessory for removing the test ring and forming the leads at the point of assembly.

TapePak also provides a significant improvement in the electrical characteristics of each package. Lead capacitance and inductance, for example, can be reduced up to ten times that of other packages. Signal propagation time is also reduced, and thermal characteristics are improved. Because of the tremendous space savings, TapePak technology offers much greater power density per unit area as compared to DIP or alternative surface-mount packages.

Performance and reliability are improved because there are one-third fewer connections between the die and the PC board. Low-stress molding compounds also improve package reliability. TapePak devices pass stringent environmental tests, including autoclaving at 121°C at 15 psi and thermal shock from -65°C to +150°C for 1000 cycles.

No other package takes similar advantage of materials technology to provide the combination of low cost, high density, testability, damage resistance, and reliability.

TapePak has been accepted as an industry standard by the Joint Electronic Device and Engineering Council (JEDEC) and registration is in progress with the Electronic Industries Association of Japan (EIAJ). TapePak technology has also been licensed to other manufacturers for their own proprietary devices.

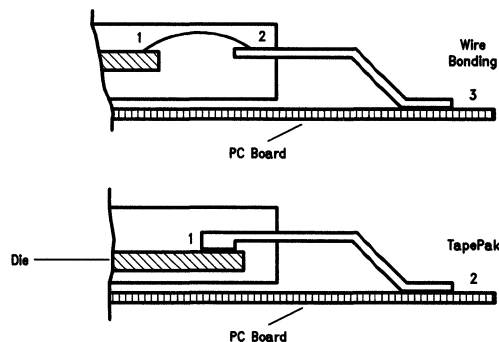

TL/XX/0077-1

With TapePak, there are one-third fewer connections between die and board than with traditional wire bonding.



All dimensions are in inches (millimeters)

10 Lead Ceramic Flatpack Package (F) NS Package Number F10B

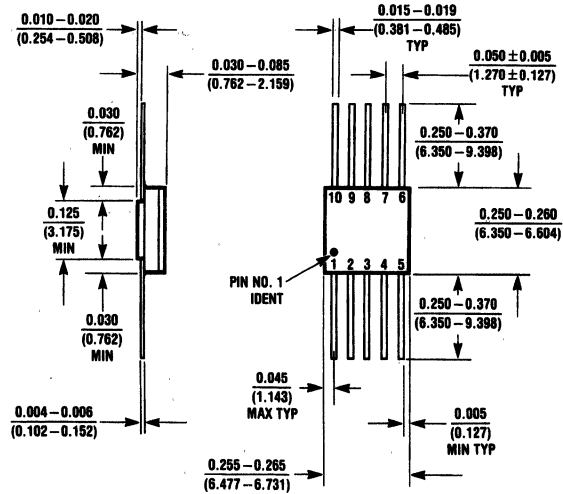

F10B (REV F)

8 Lead Ceramic Dual-In-Line Package (J) NS Package Number J08A

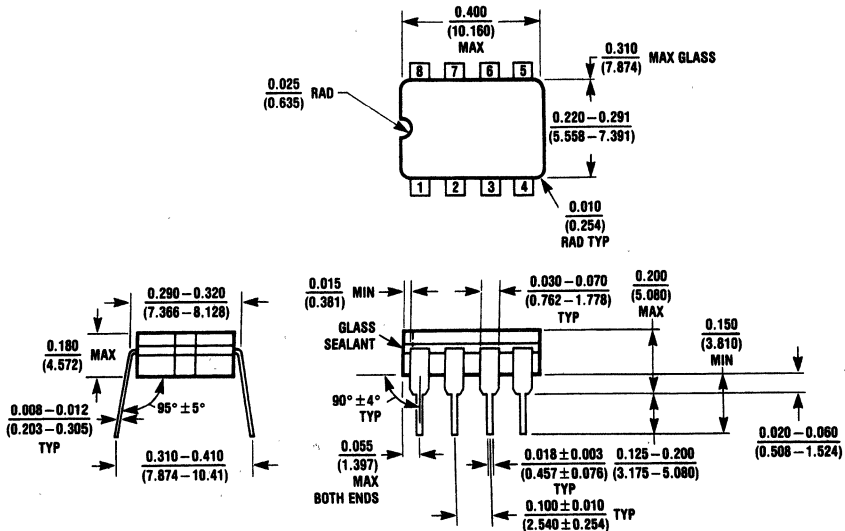

J08A (REV J)

24 Lead Ceramic Dual-In-Line Package (J) NS Package Number J24F

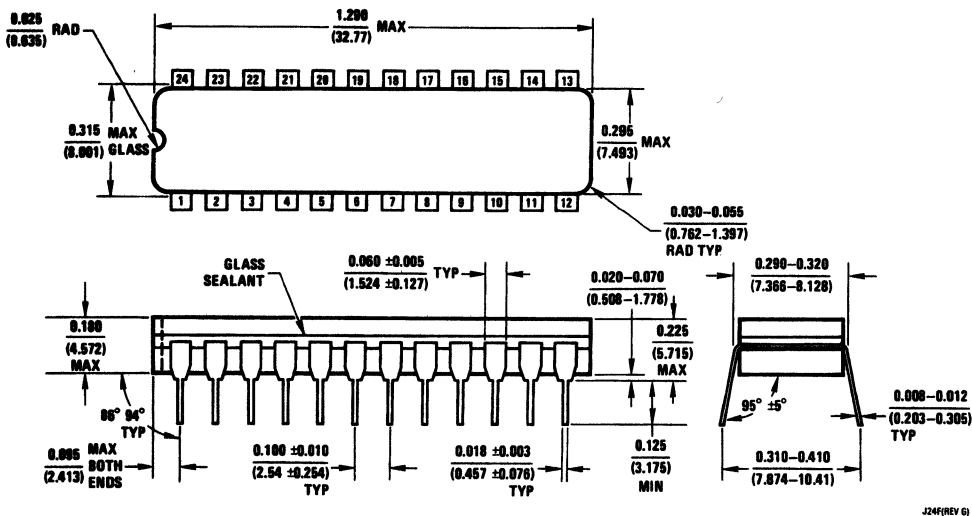

J24F (REV D)

28 Lead Ceramic Dual-In-Line Package (J) NS Package Number J28A

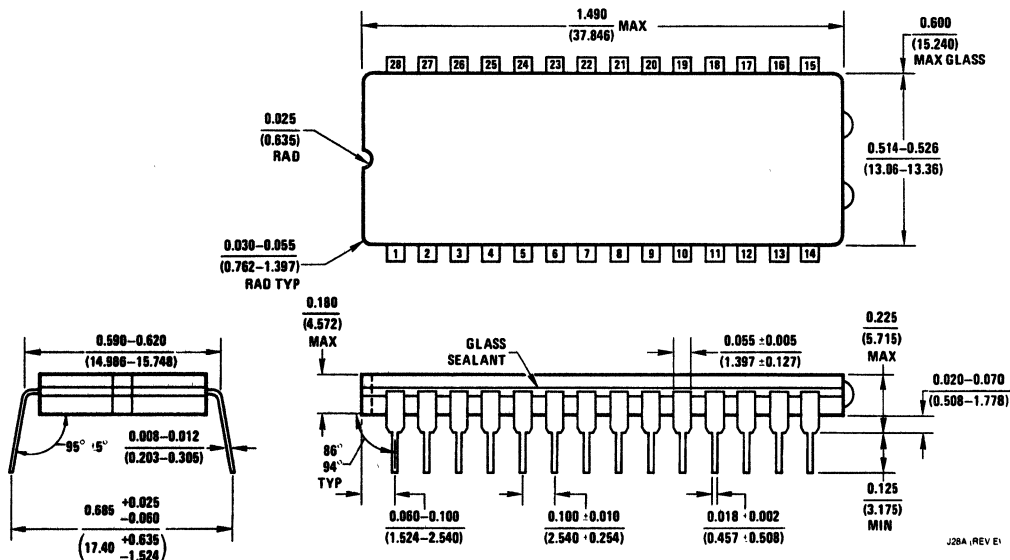

J28A (REV E)

8 Lead Molded Dual-In-Line Package (N) NS Package Number N08E

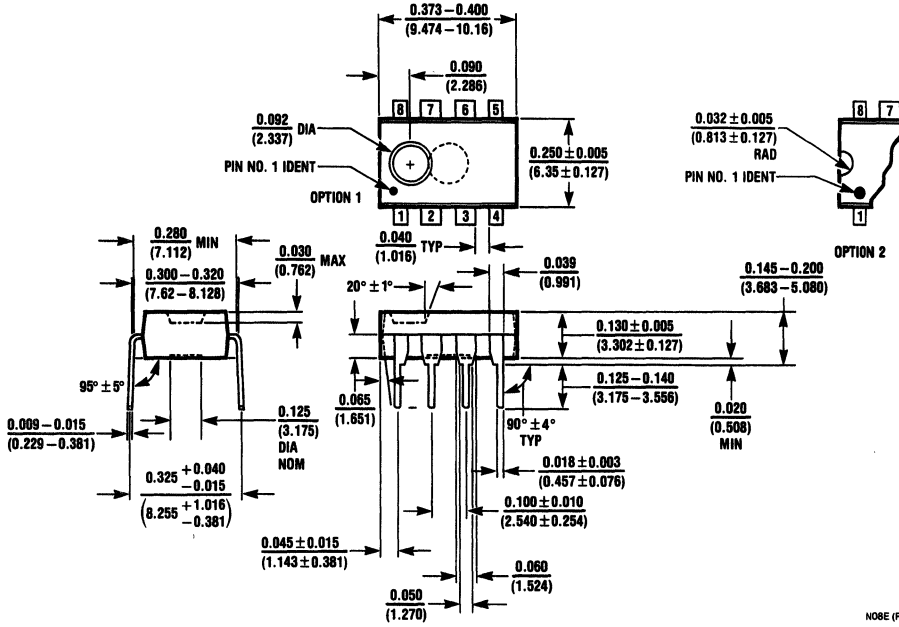

18 Lead Molded Dual-In-Line Package (N) NS Package Number N18A

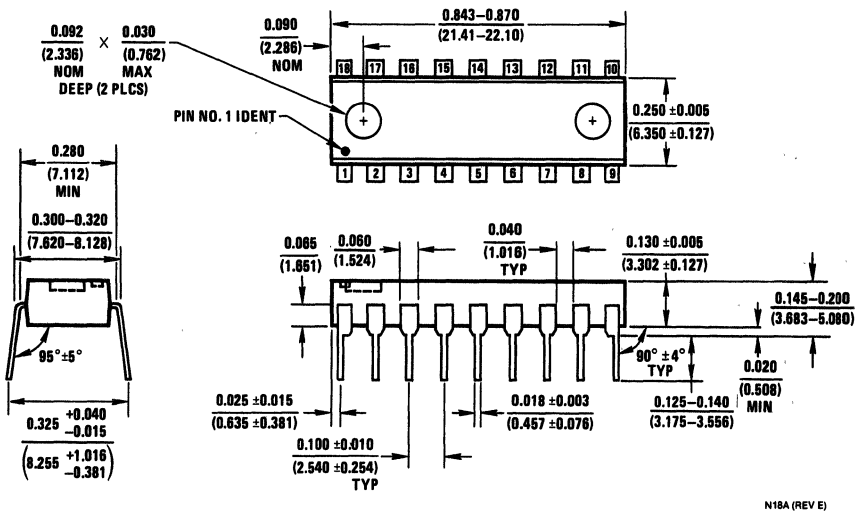

20 Lead Molded Dual-In-Line Package (N) NS Package Number N20A

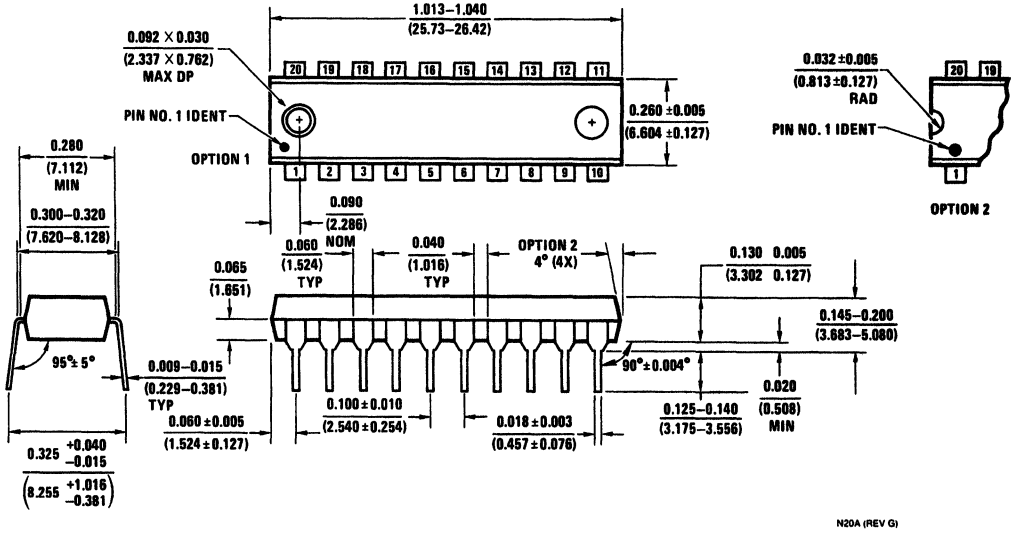

22 Lead Molded Dual-In-Line Package (N) NS Package Number N22A

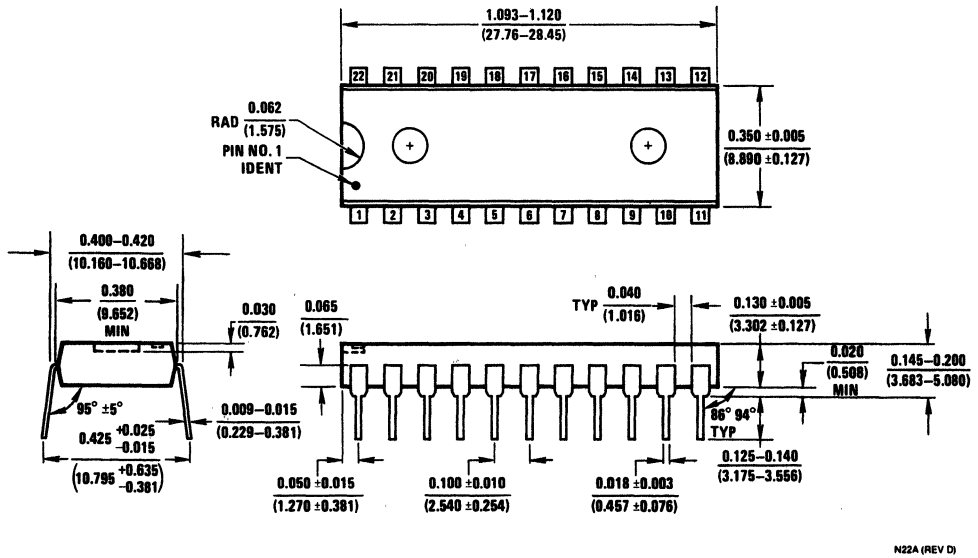

24 Lead Skinny Dual-In-Line Package (0.300" Centers Molded) (N) NS Package Number N24C

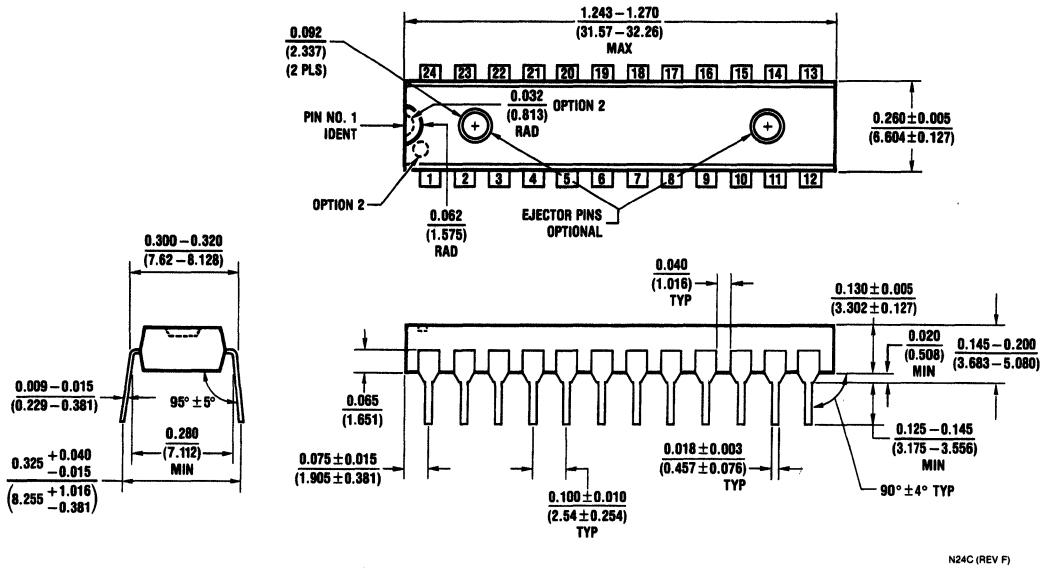

28 Lead Molded Dual-In-Line Package (N) NS Package Number N28B

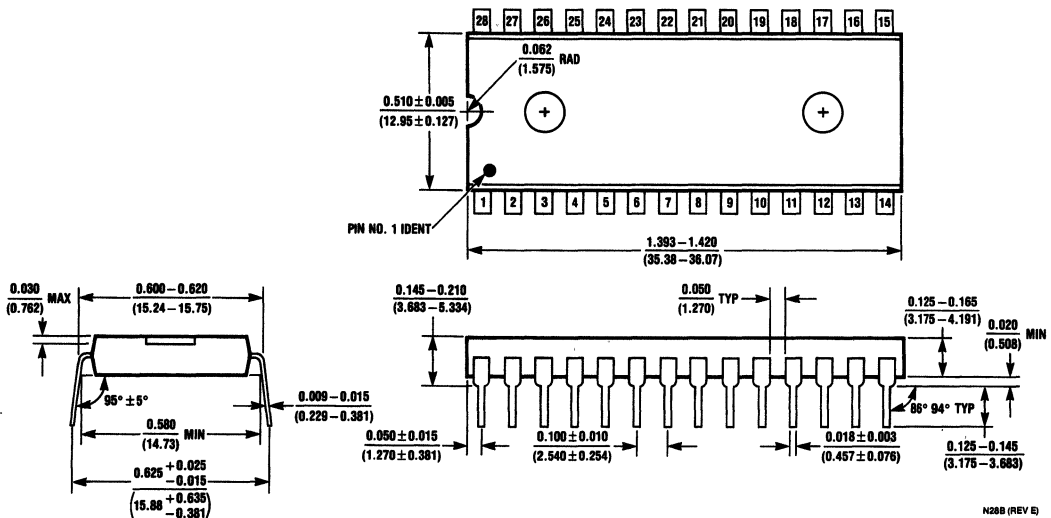

40 Lead Molded Dual-In-Line Package (N) NS Package Number N40A

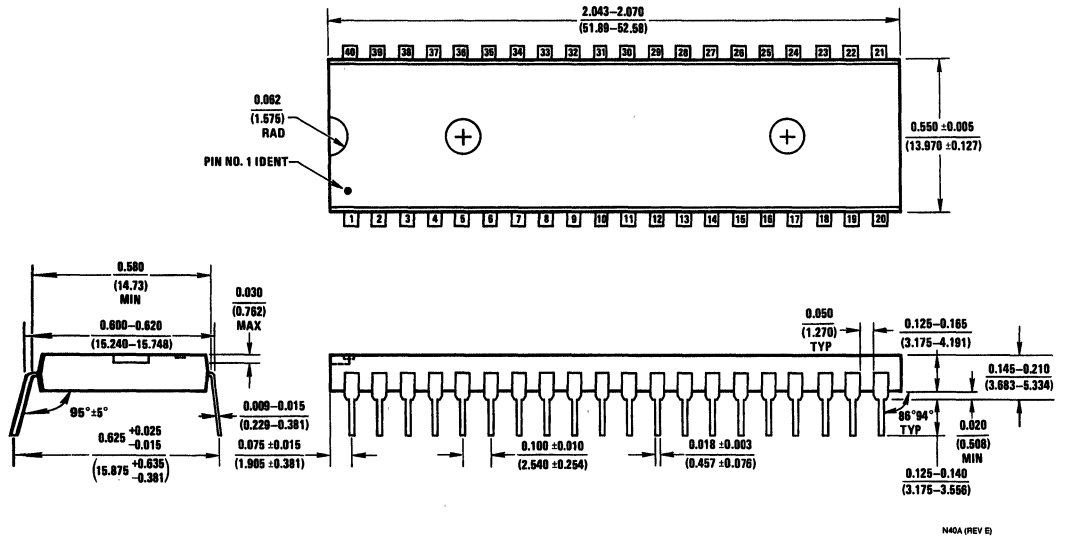

48 Lead Molded Dual-In-Line Package (N) NS Package Number N48A

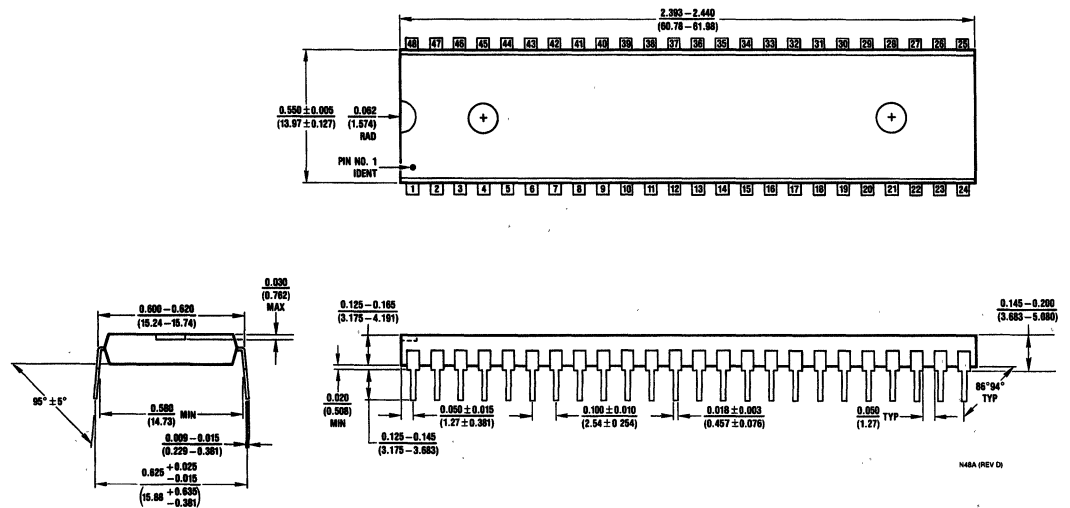

40 Lead TapePak® Package (TP) NS Package Number TP40A

PACKAGE CONFIGURATION AS SHIPPED

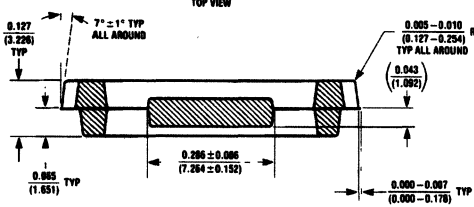
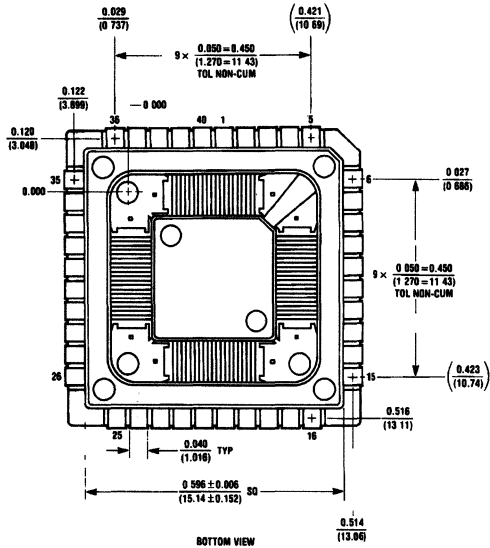
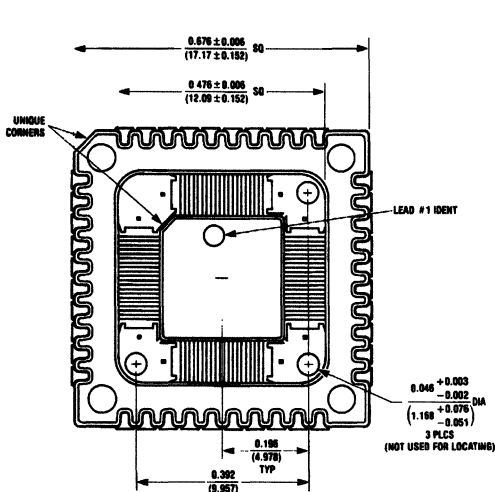

RECOMMENDED FORMED AND EXCISED PACKAGE OUTLINE

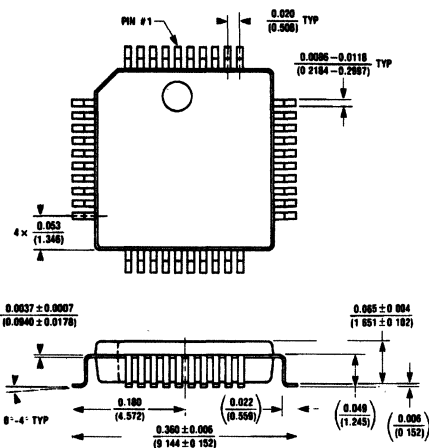

RECOMMENDED FOOTPRINT

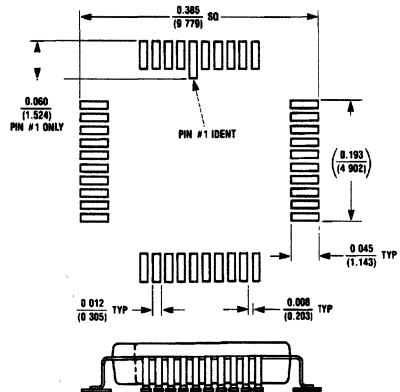

TP40A (REV A)

28 Lead Plastic Chip Carrier (V) NS Package Number V28A

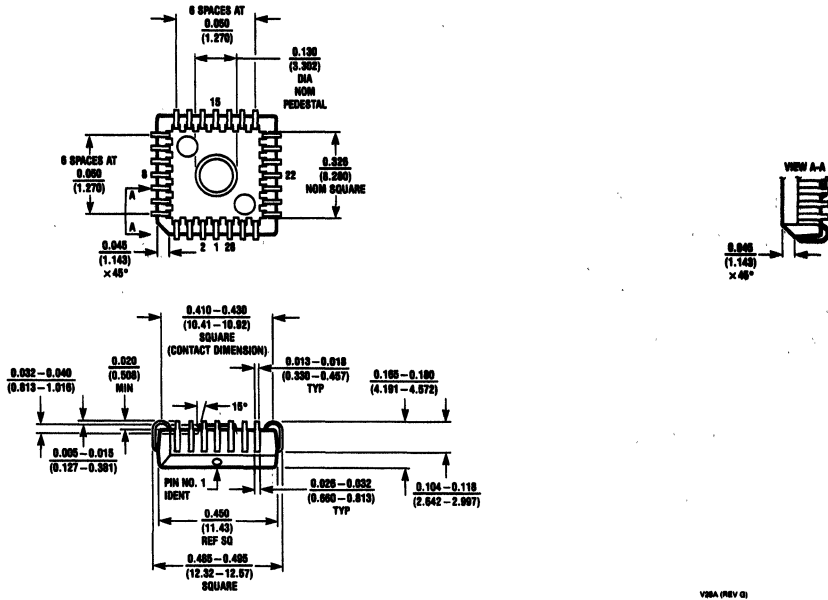

44 Lead Plastic Chip Carrier (V) NS Package Number V44A

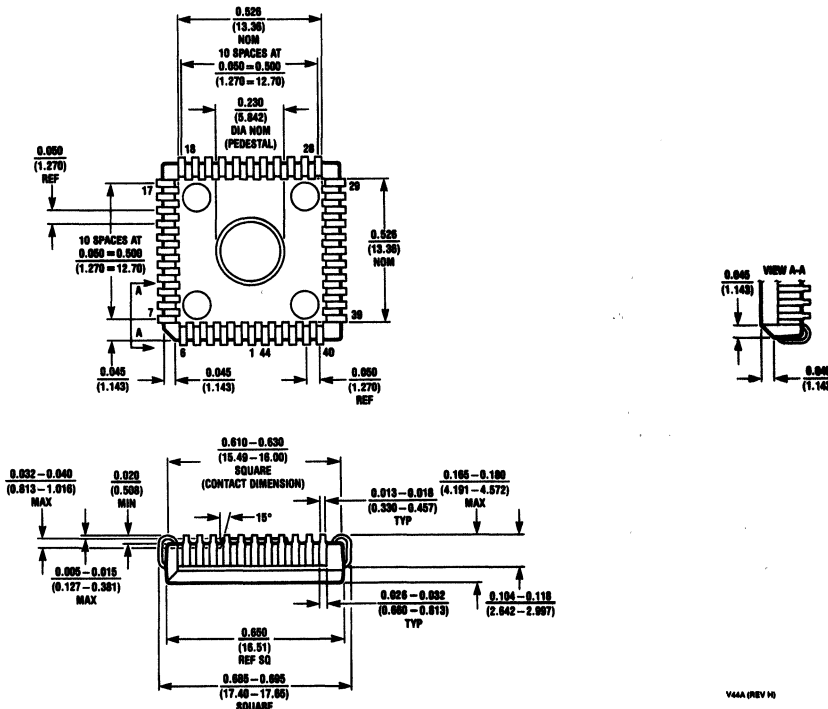

52 Lead Plastic Chip Carrier (V) NS Package Number V52A

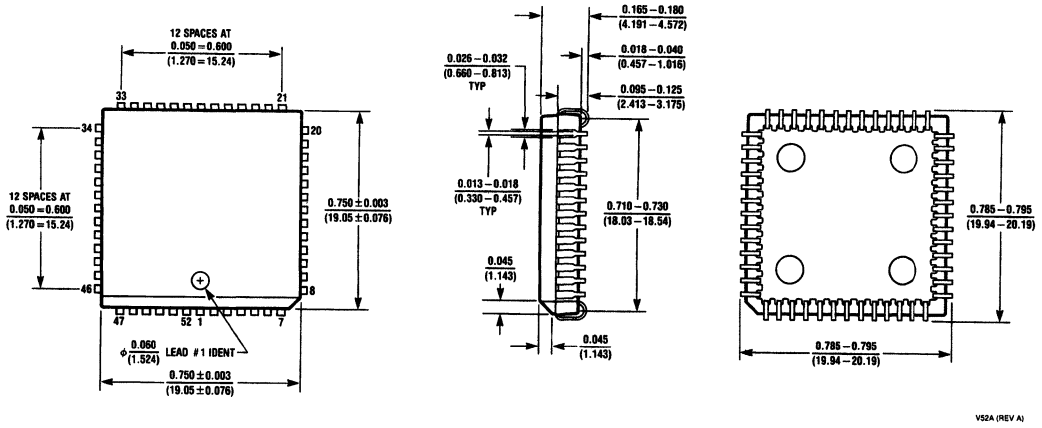

68 Lead Plastic Chip Carrier (V) NS Package Number V68A

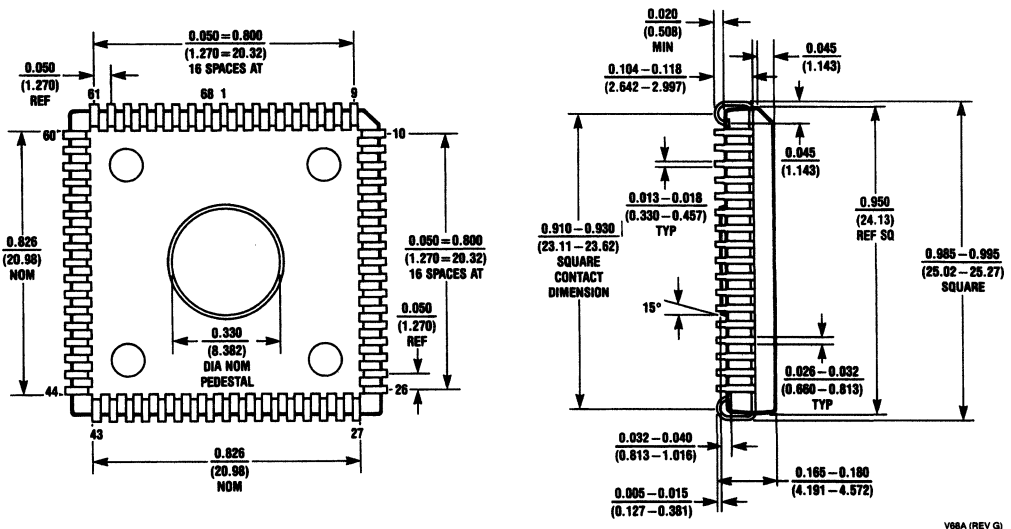

NOTES

NOTES

NOTES