

American National Standard

*for Telecommunications –
Integrated Services
Digital Network (ISDN) –
Basic Access Interface for
Use on Metallic Loops
for Application on the
Network Side of the NT
(Layer 1 Specification)*



American National Standards Institute

11 West 42nd Street
New York, New York
10036

American National Standard
for Telecommunications –

Integrated Services Digital Network (ISDN)
Basic Access Interface for Use on Metallic Loops
for Application on the Network Side of the NT
(Layer 1 Specification)

Secretariat
Exchange Carriers Standards Association

Approved February 21, 1992
American National Standards Institute, Inc.

Abstract

This interface standard was written to provide the minimal set of requirements to provide for satisfactory transmission between the network and the NT, while conforming, wherever possible, with the I-Series of International Telegraph and Telephone Consultative Committee (CCITT) Recommendations, and while not compromising the principles of evolution expressed therein. Equipment may be implemented with additional functions and procedures.

This standard presents the electrical characteristics of the integrated services digital network (ISDN) basic access signals appearing at the network side of the NT. It also describes the physical interface between the network and the NT. The transport medium of the signal is a single twisted-wire pair that supports full-duplex (i.e., simultaneous two-way) service.

American National Standard

Approval of an American National Standard requires verification by ANSI that the requirements for due process, consensus, and other criteria for approval have been met by the standards developer.

Consensus is established when, in the judgment of the ANSI Board of Standards Review, substantial agreement has been reached by directly and materially affected interests. Substantial agreement means much more than a simple majority, but not necessarily unanimity. Consensus requires that all views and objections be considered, and that a concerted effort be made toward their resolution.

The use of American National Standards is completely voluntary; their existence does not in any respect preclude anyone, whether he has approved the standards or not, from manufacturing, marketing, purchasing, or using products, processes, or procedures not conforming to the standards.

The American National Standards Institute does not develop standards and will in no circumstances give an interpretation of any American National Standard. Moreover, no person shall have the right or authority to issue an interpretation of an American National Standard in the name of the American National Standards Institute. Requests for interpretations should be addressed to the secretariat or sponsor whose name appears on the title page of this standard.

CAUTION NOTICE: This American National Standard may be revised or withdrawn at any time. The procedures of the American National Standards Institute require that action be taken periodically to reaffirm, revise, or withdraw this standard. Purchasers of American National Standards may receive current information on all standards by calling or writing the American National Standards Institute.

Published by

**American National Standards Institute
11 West 42nd Street, New York, New York 10036**

Copyright © 1992 by Exchange Carriers Standards Association
All rights reserved.

No part of this publication may be reproduced in any form, in an electronic retrieval system or otherwise, without prior written permission of the publisher.

Printed in the United States of America

APS3C792/100

Contents

	Page
Foreword	iii
1 Scope, purpose, and structure	1
2 Normative references	2
3 Definitions	2
4 Physical characteristics	3
5 Transmission method	4
6 Functional characteristics	8
7 Electrical characteristics	16
8 M-channel bit functions	18
9 Environmental conditions	22
Tables	
1 Pin assignments for 8-position jack and plug	23
2 26 AWG PIC cable at 70°F	23
3 24 AWG PIC cable at 70°F	24
4 22 AWG PIC cable at 70°F	25
5 Definitions of signals during start-up	26
6 Characteristics of dc metallic termination in the NT	26
7 Power status bit assignments and messages	27
8 Messages required for command/response eoc mode	27
Figures	
1 Echo canceler with hybrid principle	28
2 Interface on the network side of the NT	28
3 2B1Q encoding of 2B+D bit fields	28
4 DSL framer functional description	29
5 Example of 2B1Q quaternary symbols	29
6 Normalized pulse from NT appearing at interface	30
7 Upper bound of power spectral density of signal from NT at interface	31
8 Loops for testing received signal performance	32
9 Laboratory test set-up for measuring BER	35
10 PSD for simulated near end crosstalk (NEXT) for testing 2B1Q system	36
11 Crosstalk calibration impedance, Z_c	37
12 Waveform for longitudinal noise	37
13 ISDN basic access 2B1Q DSL 1.5-millisecond basic frame	37

14	2B1Q superframe technique and overhead bit assignments	38
15	DSL framing and overhead function temporal relationships	39
16	Scrambler and descrambler	40
17	State sequence for DSL transceiver start-up.....	41
18	NT loop testing states.....	41
19	Minimum return loss	42
20	Measurement method for longitudinal output voltage	42
21	Minimum longitudinal balance requirement.....	43
22	Measurement method for longitudinal balance.....	43
23	Range of permissible sinusoidal jitter, signal originating from network	44
24	Illustration of dc characteristics of the NT (bilateral switch and holding current)	45
25	CRC-12 generator	46
Annexes		
A	Test loops and performance measurements	47
B	Overvoltage, surge protection, and EMC	49
C	DSL start-up and activation.....	51
D	Linearity measurement	67
E	Discussion of eoc addressing	68
F	Supporting information relating to dc metallic termination	70
G	Primary constants of typical telephone cable	72
H	Optional powering across the interface.....	82
J	Quiet mode, insertion loss measurement test, and NT metallic termination considerations for other countries.....	84
K	Changes from ANSI T1.601-1988.....	85
L	Bibliography.....	88

Foreword (This foreword is not part of American National Standard T1.601-1992.)

This specification of the layer 1 characteristics of the ISDN basic access interface on the network side of the NT for use on metallic loops was initiated under the auspices of the Accredited Standards Committee on Telecommunications, T1.

The link between the ISDN switch or remote digital terminal and the ISDN user for basic access (up to two B-channels and a D-channel) is a critical component in the end-to-end digital path that is the basis of ISDN. Since a majority of users are presently served by a single twisted pair of telephone wires, full-duplex (i.e. simultaneous two-way) service at rates sufficient to accommodate ISDN basic access must be provided over this single pair. The digital subscriber line that provides this link, using a single pair, is specified in this standard in terms of the interface on the network side of the customer-end termination.

This standard has been written to help ensure the proper interfacing of digital subscriber line units; i.e. customer-end terminating unit (ISDN NT1 or a unit including this function located at a customer premises) with a combination of the loop and network-end terminating unit (LT). It is expected that the customer-end terminating unit will normally be manufactured and provided independently of the loop and network-end termination.

This specification is the second issue of the layer 1 characteristics of the ISDN basic access interface on the network side for the NT for use on metallic loops, and supersedes American National Standard for Telecommunications – Integrated services digital network (ISDN) – Basic access interface for use on metallic loops for application on the network side of the NT (Layer 1 specification), ANSI T1.601-1988, in its entirety. The basic transmission format has not changed, and equipment designed to either issue of this standard should be interoperable. The implementation of the following technical enhancements requires a period of time wherein equipment that conforms to ANSI T1.601-1988 may continue to be deployed. Many revisions were editorial in nature. These were made to improve clarity and consistency. A few revisions of technical substance were made. The more significant revisions include:

- provisions for the quiet mode and insertion loss test functions;
- provisions for activation at the U reference point without activation at the S/T reference points;
- provisions for an alarm indication bit from an intermediate transmission system to the NT;
- revisions and clarifications of the dc metallic termination characteristics;
- optional provisions for powering NT(s) via an additional pair of wires at the network side of the NT;
- clarifications in usage of the terms "start-up" and "activation" and substitution of "turn-off" for "deactivation."

Though the extent of the revisions is small, this standard has been reissued in its entirety to provide the reader with a single specification that is current and comprehensive.

There are 11 annexes in this standard. They are informative and are not considered part of this standard.

Suggestions for improvement of this standard are welcome. They should be sent to the Exchange Carriers Standards Association, 1200 G Street, NW, Washington, DC 20005.

This standard was processed and approved for submittal to ANSI by Accredited Standards Committee on Telecommunications, T1. Committee approval of the standard does not necessarily imply that all committee members voted for its approval. At the time it approved this standard, Accredited Standards Committee T1 had the following members:

Ivor N. Knight, Chairman
 Arthur K. Reilly, Vice-Chairman
 Alvin Lai, Secretary

<i>Organization Represented</i>	<i>Name of Representative</i>
EXCHANGE CARRIERS	
Ameritech Services, Inc.	Laurence A. Young Robert Koren (Alt.)
Bell Atlantic Corporation.....	John W. Seazholtz Roger Nucho (Alt.)
Belcore	Gary G. Schlanger Ralph E. Jensen (Alt.)
BellSouth Corporation	Leonard Strickland, Jr. William J. McNamara, III (Alt.)
Centel Corporation.....	Bruce Becker (Alt.)
Cincinnati Bell Telephone.....	William P. Keidel T. C. Grimes (Alt.)
Contel Corporation.....	Steve Linskey Stephen P. Welsh (Alt.)
Exchange Carriers Standards Association	Joseph Mendoza Gregory L. Theus (Alt.)
GTE Telephone Operations.....	Gregory L. Theus Richard L. Cochran (Alt.)
National Telephone Cooperative Association	Joseph M. Flanigan
NYNEX	Bencilla Jenkins Leo Katz (Alt.)
Pacific Bell.....	Fred Doell Stanley Chum (Alt.)
Southwestern Bell Corporation	C.C. Bailey Joseph Mendoza (Alt.)
United Telecommunications, Inc.	Robert P. McCabe Harold L. Fuller (Alt.)
US Telephone Association – USTA.....	Paul K. Hart Thomas Gajeski (Alt.)
US WEST	James L. Eitel James Dahl (Alt.)
INTEREXCHANGE CARRIERS	
AT&T Communications.....	Gerald H. Peterson Dennis Thovson (Alt.)
COMSAT Corporation	Carl A. Sederquist Mark T. Niebert (Alt.)
Contel ASC.....	Horst Bornkast Kap Kim (Alt.)
International Telecharge, Inc.	Dennis Garaghty Diane Harbaugh (Alt.)
MCI Telecommunications Corporation	Michael Varrassi Stephen J. Engelman (Alt.)
National Telecommunications Network	John Gurzick Phillip E. Belvere (Alt.)
Operator Assistance Network	Louis Wardlow Joseph E. Sharkey (Alt.)

American National Standard for Telecommunications –

Integrated Services Digital Network (ISDN) – Basic Access Interface for Use on Metallic Loops for Application on the Network Side of the NT (Layer 1 Specification)

1 Scope, purpose, and structure

1.1 Scope

The requirements of this standard apply to a single digital subscriber line (DSL) consisting of an LT, a two-wire metallic cable pair, and an NT (see clause 3). The transmission system is designed to operate on two-wire twisted metallic cable pairs with mixed gauges.

This standard is based on the use of cables without loading coils, but bridged taps are acceptable with the exception of unusual situations. See 5.4 for a definition of cable plant over which the system should operate.

Specifically, the scope of this standard is as follows:

- it describes the transmission technique used to support full-duplex service on a single twisted-wire pair;
- it specifies both the input signal with which the NT must operate and the output signal that the NT must produce;
- it defines the line code to be used, and the spectral composition of the transmitted signal;
- it describes the electrical and mechanical specifications of the network interface;
- it describes the organization of transmitted data into frames and superframes;
- it defines the functions of the operations channel;

- it describes the maintenance modes of the NT.

Although this standard does not include, except for some aspects of the frame structure, any direct requirements concerning the network side of the interface, such requirements are implied. It shall be understood that the network side conforms to the standard if it interfaces appropriately with any conforming NT or equivalent. Appropriate interfacing shall be understood to mean that the aspects of the network service related to physical characteristics associated with the interface can be provided.

1.2 Purpose

This interface standard was written to provide the minimal set of requirements to provide for satisfactory transmission between the network and the NT, while conforming, wherever possible, with the I-Series of International Telegraph and Telephone Consultative Committee (CCITT) Recommendations, and while not compromising the principles of evolution expressed therein. Equipment may be implemented with additional functions and procedures.

This standard presents the electrical characteristics of the integrated services digital network (ISDN) basic access signal appearing at the network side of the NT. It also describes the physical interface between the network and the NT. The transport medium of the signal is a single twisted-wire pair that supports full-duplex (i.e., simultaneous two-way) service.

While this standard is written explicitly to describe the physical interface of the network and the NT, its use in other circumstances, such as equivalent use of NT1 functionalities behind an NT2 (e.g., a PBX) is not prohibited.

1.3 Structure

Clause 1 describes the scope, purpose, and structure of this document. Clause 2 lists referenced documents. Clause 3 lists definitions helpful in interpreting the specifications. Clause 4 describes the physical characteristics of the interface over which the transmission method specified in the document in clause 5 is intended to operate. Clause 6 describes the functional characteristics of the transmission method. Clause 7 describes the electrical characteristics of the interface. Clause 8 describes the functions and operating procedures associated with the overhead bits included with the transmitted data. Clause 9 describes the environmental conditions. Information on testing is given in annex A, while information on surge protection and out-of-band energy is given in annex B. Annex C provides information on activation, annex D provides information on linearity measurements, annex E is a discussion on embedded operations channel addressing, and annex F gives supporting information relating to dc metallic termination. Annex G contains tables of primary constants for telephone cable. Annex H gives a description of a method of NT powering using pins of the interface connector. Annex J discusses options that may be appropriate if these requirements are adopted as national standards in countries that require NT powering over the loop. Annex K documents the changes in this revised standard from requirements given in ANSI T1.601. Annex L consists of a bibliography for informative purposes only of related standards and publications.

2 Normative reference

The following standard contains provisions which, through reference in this text, constitute

provisions of this American National Standard. At the time of publication, the edition indicated was valid. All standards are subject to revision, and parties to agreements based on this American National Standard are encouraged to investigate the possibility of applying the most recent edition of the standard indicated below.

ISO 8877:1987, *Information processing systems – Interface connector and contact assignments for ISDN basic access interface located at reference points S and T*¹⁾

3 Definitions

3.1 basic access: A term used to describe a standardized combination of access channels that constitute the access arrangements for the majority of ISDN users; specifically, any of the following combinations of access channels:

- one D-channel;
- one B-channel plus one D-channel;
- two B-channels plus one D-channel.

3.2 B-channel: A 64-kbit/s channel that carries customer information, such as voice calls, circuit-switched data, or packet-switched data.

3.3 D-channel: An access channel carrying control or signaling information and, optionally, packetized information and telemetry. When a part of basic access, the D-channel has a capacity of 16 kbit/s.

3.4 digital subscriber line (DSL): A technology that provides full-duplex service on a single twisted metallic pair at a rate sufficient to support ISDN basic access and additional framing, timing recovery, and operations functions. The physical termination of the DSL at the network end is the LT; the physical termination at the user end is the NT.

3.5 echo cancellation: A technique used for implementing a DSL in which a replica of the transmitted signal is used to remove echoes of this signal that may have mixed with and corrupted the received signal (see figure 1).

¹⁾ Available from the American National Standards Institute, 11 West 42nd Street, New York, NY 10036.

3.6 integrated services digital network (ISDN): An ISDN provides a wide range of voice and nonvoice services within the same network using a limited set of connection types and multipurpose user-network interface arrangements. A variety of implementation configurations is supported, including circuit-switched, packet-switched, and nonswitched connections and their concatenations. New services are arranged to be compatible with 64-kbit/s switched digital connections. Service features, maintenance capabilities, and network management functions are provided through intelligence built into the network and compatible intelligence in the user terminals.

ISDNs will evolve over one or more decades from the existing telephone network into comprehensive ISDNs by progressively incorporating additional functions to provide for both existing and new services. Until then, interworking arrangements will provide for the inclusion of other capabilities such as circuit-switching and packet-switching of data. During the transition, equipment such as digital transmission systems using techniques such as frequency-division multiplexing, time-division multiplexing, time-compression multiplexing, time-division multiplex switching, and space-division multiplex switching equipment will provide for the digital end-to-end connectivity of ISDNs. In the early stages of the evolution of ISDNs, some interim user-network arrangements may be needed to facilitate early penetration of digital service capabilities.

3.7 interface point: The location of the interface of the access line with the NT is commonly called the U-interface (see figure 2). The location of the interface is on the customer's premises at a location mutually agreed upon by the telephone company or administration and the customer.

3.8 International Telecommunication Union (ITU): The ITU is a specialized agency (since 1948) of the United Nations and is an international treaty organization. It traces its formal beginnings to 1865.

3.9 International Telegraph and Telephone Consultative Committee (CCITT): The CCITT is one of seven ITU organizations. The CCITT has responsibility for standards work done in the ITU. The general purpose of the

CCITT is to promote and ensure the operation of international telecommunications systems.

3.10 line termination (LT): The equipment that terminates the access line at the network end.

3.11 M-channel: The maintenance channel is a 4-kbit/s channel that exists between the LT and the NT. It carries information for maintenance and other purposes relating to operation of the access. See 6.2.3 and clause 8.

3.12 network termination (NT): In this standard the equipment that terminates the DSL on the customer side of the interface. The NT function may be in an NT1, an NT2, or a TE. An NT1 is a network termination of an access line that provides only physical layer functionality. An NT2 is a network termination with functionality that can include interfacing higher layer protocols. A TE is customer terminal equipment (e.g., a computer terminal) that may include network termination functions.

3.13 network or network side: In this standard these terms represent the network side of the interface or the network functions as seen from the interface.

4 Physical characteristics

4.1 Wiring polarity integrity

The NT shall not be dependent on a specific polarity for the two wires of the access line as the pair may be reversed.

4.2 Connector

For single mountings, the NT shall connect to the network through a miniature 8-position nonkeyed jack. The cord from the NT shall terminate in a miniature 8-position nonkeyed plug. For multiple mountings (and PBXs), other connection arrangements may be appropriate. Except for pin assignments, specifications for the 8-position plug and jack shall be as described in ISO 8877. The jack is equipped with the center two contacts (pins), which are used for the cable pair, commonly called *tip* (T) and *ring* (R). Whenever possible, the terms *tip* and *ring* will not be used in this standard because of the requirement given in 4.1. Table 1 gives the pin assignments for the 8-position jack and the 8-position plug.

5 Transmission method

5.1 General

The transmission system uses the echo canceler with hybrid (ECH) principle to provide full duplex operation over a two-wire subscriber loop. With the ECH method, as illustrated in figure 1, the echo canceler (EC) produces a replica of the echo of the near-end transmitted signal, which is then subtracted from the total received signal.

The system is intended for service on twisted-pair cables, including about 99% coverage of the North American nonloaded loop population. This equates to operation over cables up to the limits of 18-kilofoot (5.5-km) 1300-ohm resistance design, or about 42-dB loss at 40 kHz.

The foregoing is a general description that is not a specific performance requirement. For laboratory test requirements, see 5.4. Performance requirements for equipment and systems installed on actual loops are beyond the scope of this standard.

5.2 Line code

The line code shall be 2B1Q (2 binary, 1 quaternary). The 2-bit binary pairs are converted into quaternary symbols that are called "quats" in the following text. This is a 4-level pulse amplitude modulation (PAM) code without redundancy.

The user-data bit stream, comprised of two 64-kbit/s B-channels and a 16-kbit/s D-channel, entering the NT from the S/T-interface (i.e., entering the S/T-interface toward the NT) and the equivalent bit stream entering the LT from the network side shall be grouped into pairs of digits (bit fields) for conversion to quats. In each pair of bits so formed, the first bit is called the sign bit and the second is called the magnitude bit. Figure 3 shows the relationship of the bits in the B- and D-channels to quats. The B- and D-channel bits are also scrambled before coding. M_1 through M_6 bits are also paired, scrambled, and coded in the same way. See 6.2, 6.3, and figure 4, for a functional description of the coding, framing, and scrambling operations of the transceiver.

Each pair of scrambled bits in either binary data stream that is converted to a quaternary

symbol shall be output from the transmitter at the interface, as specified in the following table:

First bit (sign)	Second bit (magnitude)	Quaternary symbol (quat)
1	0	+3
1	1	+1
0	1	-1
0	0	-3

The four values listed under "Quaternary symbol" in the table should be understood as symbol names, not numerical values.

At the receiver, each quaternary symbol is converted to a pair of bits by reversing the table, descrambled, and finally formed into a bit stream or bit streams representing B- and D-channels, and M-channel bits for maintenance and other purposes as described in clauses 6 and 8. The bits in the B- and D-channels are properly placed by reversing the relationship in figure 3.

Figure 5 is an example of 2B1Q pulses over time. Square pulses are used only for convenience of display and do not in any way represent the specified shape of real 2B1Q pulses (see 5.3.1). Quat identifications and bit representations, after scrambling (see 6.3), are given beneath the waveform. Time flows from left to right.

5.3 Pulses originating at the NT

For measurement reference purposes, the termination impedance shall be 135 ohms resistive over a frequency band of 0 Hz to 160 kHz for all the requirements of this clause.

5.3.1 Pulse shape

The transmitted pulse shall have the shape specified in figure 6.

The pulse mask for the four quaternary symbols shall be obtained by multiplying the normalized pulse mask shown in figure 6 by 2.5 V, 5/6 V, -5/6 V, or -2.5 V. Compliance of transmitted pulses with boundaries of the pulse mask is not sufficient to ensure compliance with the power spectral density requirement and the absolute power requirement. Compliance with requirements in 5.3.2.1 and 5.3.2.2 is also required.

NOTE – It is recognized that for an interim period, until December 1992, certain implementations may not be able to meet the 2.5-volt nominal pulse amplitude requirement. During this period of time, nominal pulse amplitudes between 2.5 volts and 2.0 volts will be acceptable.

5.3.2 Signal power

5.3.2.1 Power spectral density

The upper bound of the power spectral density of the signal transmitted by the NT shall be as shown in figure 7. Measurements to verify compliance with this requirement are to use a noise power bandwidth of 1.0 kHz.

5.3.2.2 Total power

The average power over multiple frames of a signal consisting of a framed sequence of symbols with a synchronization word and equiprobable symbols at all other positions shall be between 13.0 dBm and 14.0 dBm (nominally 13.5 dBm) over the frequency band from 0 Hz to 80 kHz. The nominal peak of the largest pulse shall be 2.5 V (see 5.3.1).

NOTE – Consistent with 5.3.1. during an interim period, until December 1992, a corresponding reduction in transmitted power (i.e., with a nominal pulse peak of 2.0 V, the average power shall be between 11.1 and 12.1 dBm) will be acceptable.

5.3.3 Transmitter linearity

The pulses at the interface from the NT toward the network, corresponding to the symbol names +3, +1, -1, and -3 shall nominally all have the same shape and have the ratio 3:1:-1:-3. The pulses at the interface received from the network, though distorted by the transmission medium, shall have the same property, though this property is best checked at the source. Impairment resulting from deviations from this ratio is called nonlinearity. This nonlinearity is defined as the residual after subtracting a perfectly linear signal (a linearity standard) from the transmitter output line signal. The linear signal is constructed from the same random data as is input to the transmitter and processed through a linear filter. The parameters of the linear filter are first optimized to reduce the residual to a minimum. The test principles, hardware, and procedures are described further in annex D.

The transmitted and received signals shall have sufficient linearity so that the residual rms signal

is at least 36 dB below the rms signal at the interface. This requirement applies under all normal transceiver conditions and over the prescribed range of sealing current (see 7.5.1).

5.4 Received line signal characteristics

When the pulses described above are transmitted over the loop plant, as defined in 5.4.1, the NT shall receive any random sequences of these pulses with a bit error ratio (BER) of less than 10^{-7} , as described in the remainder of clause 5.

5.4.1 Definition of loop plant

For the purpose of 5.4, the loop plant is defined as a set of 16 loops, one being a null (zero length) loop, and crosstalk and other impairments as specified in this clause and in 5.4.4. The make-ups of the 15 non-null loops are presented in figure 8.

The characteristics of the loops in figure 8 are precisely defined over a broad frequency range by means of the primary constants listed in tables 2, 3, and 4. The tables give values of resistance per mile (R), inductance per mile (L), conductance per mile (G), and capacitance per mile (C) based on a commonly used model of polyethylene insulated cable (PIC) at approximately room temperature (70°F). Obviously, actual cable deviates from the precise model, depending on such factors as temperature, insulation type, manufacturer, and detailed manufacturing conditions. Further information on the test loops and on the characteristics of cable are given in annexes A and G.

5.4.2 Performance test requirement

Satisfactory performance ($BER < 10^{-7}$) with sufficient margin (see 5.4.3) is required when the NT is receiving a pseudorandom sequence of pulses attenuated and distorted as would result from transmission over each loop from a nominal source and with simulated crosstalk, and other impairments superimposed, and while transmitting a pseudorandom sequence. The added impairments are described specifically in 5.4.4 and 7.4.1. The following detailed description of the performance requirement in the presence of simulated crosstalk and other impairments is in terms of a laboratory test, though the test description is intended only to clarify the interface requirement.

5.4.3 Margin

Satisfactory performance shall be obtained, as described in 5.4.4, with a margin of at least 6 dB with the null loop and with test loops 4–15, listed in figure 8. It is desirable to obtain satisfactory performance with a margin of at least 0 dB with test loops 1–3.

NOTE – Consistent with 5.3.1, during an interim period until December 1992, a corresponding reduction in margin is allowed for performance tests of transceivers receiving signals from transmitters with reduced nominal pulse amplitudes. For instance, when the transmitter has a 2.0-V nominal pulse amplitude, the margin at the receiver on all 16 loops is reduced by 2 dB. The level of the simulated NEXT described in 5.4.4.1 applies to all transceivers.

5.4.4 Test procedure

To perform the test, two transceivers are required, one for each end of the test loop, as shown in figure 9. A pseudorandom binary source (PRBS) test signal (binary sequence) shall be applied at point A and received at point B. Another PRBS shall be applied at point C to create realistic echo conditions for the receiver at that end. No pattern receiver is required at point D because only one direction is under test at one time.

Point F shall be on a transceiver controlled by an independent external clock signal; point E shall be on a transceiver that derives timing from the received signal. When these tests are performed in a laboratory, the test loops are likely to be assembled from pairs on cable reels with both ends of the pair appearing in the same laboratory. The tests shall be performed with no connections other than the test loop between the two transceivers. The loops for testing received signal performance, numbered 1 through 15 in figure 8, are individually inserted between points F and E in figure 9. The test shall be repeated for each direction on each test loop; that is, point F (figure 9) at the end labeled LT (figure 8) and point E at the end labeled NT, and then again with point F at the end labeled NT and point E at the end labeled LT.

5.4.4.1 Simulated crosstalk

Simulated crosstalk is introduced at point E in figure 9 by applying a calibrated filtered Gaussian random white noise source to the receiver input terminals. The source is fre-

quency-shaped and its level set to simulate near end crosstalk (NEXT) from 49 disturbers in a binder group. The assumed power spectral density (PSD) of these disturbers is greater at high frequencies (above 50 kHz) than any 2B1Q signal that meets the standard. The details of the assumed PSD of the disturbers are discussed in annex A.

After application of a simplified NEXT model to the assumed PSD of the disturbers, one obtains the PSD of the NEXT, as given in figure 10, both as a plot and as an equation for P_{NEXT} .

The equation and the figure are single-sided PSDs, meaning that the integral of P_{NEXT} , with respect to f , from 0 to ∞ , gives the power in watts.

The simplified NEXT model has decreasing loss with a constant slope of 15 dB per decade of frequency, and 57-dB loss at 80 kHz.

Note that P_{NEXT} has a significant amount of power in its 160 to 320 kHz lobe, and continues to have significant power in successive lobes above that. However, as discussed in annex A, a bandlimiting filter may be used to sharply limit the PSD at frequencies above 320 kHz.

The simulated crosstalk shall be applied in such a way as to achieve the appropriate voltage level without disturbing the impedance of the cable or the transceiver.

NOTE – See note in 5.4.3.

5.4.4.1.1 Calibration of crosstalk simulation filter

To set the simulated NEXT at the reference level (also called the point of 0 margin), the simulated NEXT must have the power and power spectral density implied by the equation for P_{NEXT} . However, the accuracy obtained will depend on the design of the filter used to create the simulated crosstalk. The greatest accuracy is required at the highest points of the P_{NEXT} function. In the band 0 to 320 kHz, the highest point is at approximately 50 kHz, and a second peak occurs at approximately 220 kHz. The value of P_{NEXT} is approximately -95.9 dBm/Hz at 50 kHz. The accuracy of the PSD obtained must be ± 1 dB at all values of PSD between the peak, -95.9 dBm/Hz, and

-106 dBm/Hz. This is the case approximately over the two frequency ranges 8 to 145 kHz, and 175 to 300 kHz. Elsewhere, the accuracy shall be ± 3 dB. At the notches (0 kHz, 160 kHz, and 320 kHz), the upper bound never goes below -113 dBm/Hz, and the lower bound is absent in the same frequency ranges. Some of the tolerance limits are plotted in figure 10 in order to illustrate the tolerance requirements. To allow for the bandlimiting filter, there is no lower bound at frequencies higher than 270 kHz.

The integral of the P_{NEXT} function over the limits 0 to 320 kHz is -44.2 dBm. However, the total power in the simulated crosstalk should take into account the effects of the bandlimiting filter. The theoretical value of the total simulated NEXT power should be recomputed after P_{NEXT} is multiplied by the transfer function of the bandlimiting filter used.

The total power of the simulated NEXT shall be within ± 0.1 dB of the theoretical value computed as indicated.

5.4.4.1.2 Measurement of simulated NEXT power and PSD

The PSD of the simulated NEXT, and its average power, shall be measured at the output of a voltage source of between 4000 and 6000 ohms Thevenin impedance, terminated in a load consisting of a parallel combination of 135 ohms and Z_c the network shown in figure 11. The power dissipated in the 135 ohms resistor represents the power at the receiver input; thus, the NEXT power is the power dissipated in this resistor. Z_c is a complex load and the calibration mechanism must ensure that the required simulated crosstalk PSD, P_{NEXT} , is coupled into the 135-ohm resistor within limits specified in figure 10.

5.4.4.2 Longitudinal noise

Noise simulating longitudinal power line induction (60 Hz and associated harmonics) shall also be introduced at point E (figure 9). The method of introducing the longitudinal noise, and the amplitude and waveform of the induced signal shall be as follows:

a) For the loop under test (e.g., one of the test loops) use an induction-type neutralizing transformer to inductively couple longitudinal voltage/current to the loop. To metallic signals, the transformer looks like a few hun-

dred feet of cable. The loop make-up should be maintained by accounting for the length and gauge characteristic of that particular transformer. Insert the neutralizing transformer at 40% to 60% (nominal 50%) of the distance from the network side (the end labeled LT in figure 8).

b) Use a sawtooth longitudinal voltage waveform because it has a harmonic content similar to power line induction. See figure 12. The applied voltage should be 50 V rms. Average value (dc) and even harmonics are negligible.

c) If desired, the test may be run with a low-impedance longitudinal termination on the network side (the end labeled LT in figure 8). For that case, the longitudinal termination shall be adjusted so that the longitudinal current in the termination is between 3.6 and 4 mA rms.

5.4.4.3 Power-related metallic noise

Noise simulating power line induction (60 Hz and associated harmonics) shall also be introduced at point E (figure 9). The noise will consist of any two of the harmonics listed in this subclause at the power level indicated. The harmonics shall be coupled to the line via a high-impedance coupling circuit (J in figure 9) and the power measured by the same technique indicated in 5.4.4.1.2. The noise test shall be conducted with all combinations of two of the harmonics listed in the following table at the power level indicated.

Frequency (Hz)	Tone power (dBm into 135 ohms)
60	-47
180	-49
300	-59
420	-65
540	-70
660	-74

5.4.4.4 Procedure

BER measurements may be performed on one or more subchannels (e.g., B, 2B, or 2B+D). B- or D-channels not used for BER measurements shall also be driven by a PRBS. The averaging time for determination of error rate shall be at least 10 minutes when the bit stream under test is 144 kbit/s, at least 13 minutes when the bit stream is 128 kbit/s, and

at least 25 minutes when the bit stream under test is only 64 kbit/s.

For each test loop, and for each direction of transmission, the measurement procedure shall be as follows:

BER is tested with noise applied at point E. The noise applied at point E includes simulated NEXT (5.4.4.1), longitudinally induced voltage (5.4.4.2) and power-line-related noise (5.4.4.3). Jitter, as specified in 7.4.1, also must be present. The attenuator G in figure 9 shall be set so that the power spectral density of the resulting simulated NEXT on the line is greater, by a margin specified in 5.4.3, than the calculated power spectral density P_{NEXT} .

6 Functional characteristics

6.1 Baud rate, timing, and synchronization

The NT shall operate, as required, with the received signal baud rate in the range of 80 kbaud \pm 5 ppm.

The digital subscriber line shall operate in a master-slave mode with the NT slaved to the signal received from the network; that is, the signals transmitted from the NT towards the network shall be synchronized to a clock that is synchronized to the received signal.

NOTE – NT implementations intended for applications other than providing direct network access [such as behind an NT2 (e.g., a PBX) or other piece of network equipment operating in stand-alone mode] should be designed to operate with a received signal having a tolerance as large as \pm 32 ppm.

6.2 Frame structure

The information flow across the interface point shall utilize frames and superframes as shown in figures 13 and 14.

As shown in figure 13, a frame shall be 120 quaternary symbols. The nominal time for the frame is 1.5 ms.

A functional description of the framing process is shown in figure 4.

6.2.1 Synchronization word

The first nine symbols of the frame shall be a synchronization word (SW), with the quater-

nary symbols in the following sequence, except as noted in 6.2.5:

$$SW = +3 +3 -3 -3 -3 +3 -3 +3 +3$$

6.2.2 User data (2B+D)

Following the synchronization word, the next 108 quaternary symbols in the frame shall be as shown in figure 3 (9-symbol (18-bit) field repeated 12 times). Except during start-up, the channels shall be transparent to user data bits (see 6.4.6.6).

NOTE – No idle code is specified across the interface. However, when one or more B- or D-channels are not in use in either direction, the time slots allocated to the channel or channels contain the idle code specified in ANSI T1.605 and in CCITT Recommendation I.430 (see annex L). This idle code originates in the network or in the TE.

6.2.3 M-channel

The last three symbols (6 bits) form a 4-kbit/s M-channel for maintenance and other purposes (see figure 14).

6.2.4 Frame offset

Received and transmitted frames at the NT shall be offset by 60 quaternary symbols \pm 2 quaternary symbols (i.e., about 0.75 ms), as shown in figure 15.

6.2.5 Superframes

Frames shall be organized into superframes, as shown in figure 14. Eight frames (12 ms) shall constitute a superframe. The first frame in the superframe shall be identified by inverting the polarity of the synchronization word (SW) in this frame. The inverted synchronization word is abbreviated ISW:

$$ISW = -3 -3 +3 +3 +3 -3 +3 -3 -3$$

The first frame in the superframe of the signal transmitted from the NT shall be the next frame following the first frame in the superframe of the signal received from the network. See 6.2.4, and figure 15, for specific alignment of transmitted and received frames.

The 48 M-bits in the superframe shall be assigned as indicated in clause 8, in figure 14, and as summarized here:

eoc – 24 bits — Embedded operations channel (network to NT and NT to network)

crc	- 12 bits — Cyclic redundancy check (network to NT and NT to network)
febe	-1 bit — Far end block error (network to NT and NT to network)
dea ²⁾	- 1 bit — Turn-off (network to NT)
act ³⁾	- 1 bit — Start-up (network to NT and NT to network)
ps _{1,2}	- 2 bits — Power status (NT to network)
ntm	- 1 bit — NT in test mode (NT to network)
cs0	- 1 bit — Cold-start-only (NT to network)
uoa ⁴⁾	- 1 bit — U-interface only activation (network to NT)
sai ⁴⁾	- 1 bit — S/T-interface activity indicator (NT to network)
aib ⁴⁾	- 1 bit — Alarm indicator bit (network to NT)
1 * 4)	- 1 bit — Network indicator bit (NT to network, reserved for network use)
1	- 4 bits — NT to network (reserved for future standardization)
1	- 7 bits — Network to NT (reserved for future standardization)

6.3 Scrambling

The data stream in each direction shall be scrambled (see figure 4) according to a 23rd-order polynomial (see figure 16) prior to insertion of SW.

In the network-NT direction the polynomial shall be:

$$1 \oplus x^{-5} \oplus x^{-23}$$

where

\oplus is the modulo 2 summation.

In the NT-network direction the polynomial shall be:

$$1 \oplus x^{-18} \oplus x^{-23}$$

²⁾ Previously called deactivation bit.

³⁾ Previously called activation bit

⁴⁾ Previously, a bit reserved for future standardization.

where

\oplus is the modulo 2 summation.

The binary data stream shall be recovered in the receiver by applying the same polynomial to the scrambled data as was used in the transmitter.

NOTE — Binary ONEs and ZEROs entering the NT transceiver from the S/T interface or entering the network side transceiver from the network shall appear as binary ONEs and ZEROs, respectively, at the input of the scrambler. Also, during transmission/reception of the synchronization word or inverted synchronization word, the state of the scrambler shall remain unchanged.

CAUTION — It is common for the input bits to be all ONEs, e.g., during idle periods or during start-up. For the ONEs to become scrambled, the initial state of the scrambling shift register shall not be all ONEs.

6.4 Start-up and control

The master-slave mode described in 6.1 does not apply immediately after connecting the transmission line to the NT, turning on its power, or both. This happens at the time of installation, following power failures, or after temporarily disconnecting the NT or temporarily switching off its power. In these situations, the network may begin a start-up sequence in order to achieve the master-slave mode. The NT is responsible for initiating the start-up sequence upon power-up or upon a request for service from the customer terminal (TE).

Also, for NTs that have the optional warm-start capability, master-slave mode does not apply until start-up has been requested and synchronization achieved.

While the system is not in master-slave mode, that is, during the start-up sequence or while the system is in the RESET or RECEIVE RESET state, signals generated by the network and the NT transceivers do not carry user data (B_1 -, B_2 -, or D-channel bits). The signals that are present at the interface are generated by the network and the NT transceivers.

6.4.1 Definitions

The following definitions are for the purpose of clarifying requirements that are to follow.

6.4.1.1 total activation: The word *activation* is used in this standard to describe a process that includes the start-up process as described here for this interface (see 6.4.1.2) and activation of the S/T interface as described in ANSI T1.605 (see annex L).

6.4.1.2 start-up: A process characterized at the interface by a sequence of signals produced by the network and by the NT. Start-up results in establishment of the training of equalizers and echo cancelers to the point that two-way transmission requirements are met.

6.4.1.3 warm start: The start-up process that applies to transceivers meeting the start-up time requirements for the warm-start option after they have once been synchronized and have subsequently responded to a turn-off announcement. Warm start applies only if there have been no changes in line characteristics and equipment. Transceivers that meet warm-start requirements are called *warm-start transceivers*.

6.4.1.4 cold start: The start-up process that applies to transceivers that either do not meet start-up time requirements for the warm-start option, or have not been continuously in a RESET state that resulted from a turn-off request to the NT. Cold start also applies if there have been changes in line characteristics or equipment or both. A cold start shall always start from the RESET state.

6.4.1.5 cold-start-only: Transceivers that do not meet start-up time requirements (see 6.4.7) for the warm-start option are called *cold-start-only transceivers*.

6.4.1.6 full operational status: Full operational status of the transceiver means that it has:

- a) acquired bit timing (for NT), bit timing phase (for LT), and frame synchronization from the incoming signal from the other transceiver;
- b) recognized the incoming superframe marker; and
- c) fully converged both echo canceler and equalizer coefficients.

6.4.1.7 total deactivation: The word *deactivation* is used in this standard to describe a process that includes the turn-off process as described here for this interface (see 6.4.1.8) and deactivation of the S/T-interface as described in ANSI T1.605.

6.4.1.8 turn-off: The process by which a pair of fully operational transceivers transition to the RESET state.

6.4.1.9 transparency: The word *transparency* is used in this standard to mean that the B_1 -, B_2 -, or D-channel (2B+D) bits received by the transceiver from the interface are passed to the TE at the NT and to the network at the LT. Likewise, when a transceiver is transparent, 2B+D bits sent to the transceiver at the LT from within the network or at the NT from the TE are transmitted to the interface. Conversely, when a transceiver is not transparent, 2B+D bits received from the interface are not passed along to the TE at the NT or to the network at the LT. Likewise, when a transceiver is not transparent, 2B+D bits from within the network at the LT or from the TE at the NT are not transmitted to the interface. Transparency applies separately to each transceiver. Conditions for transparency are discussed in 6.4.6.6.

6.4.2 RESET

The RESET state consists of two sub-states: the RECEIVE RESET and the FULL RESET states. In other clauses of this standard, the term RESET is used to refer to the FULL RESET state.

RESET has no implications about the state of convergence of the equalizer or echo canceler coefficients of the transceiver. The RESET states are applicable to cold-start-only as well as warm-start transceivers.

For specific transceiver implementations, RESET states (or sub-states) may mean different and possibly multiple internal states.

6.4.2.1 FULL RESET

The FULL RESET state is one in which a transceiver has detected the loss of signal from the far-end and is not transmitting (sending signal to the loop).

The FULL RESET state shall also be entered following power-up.

Because the time for a cold start may be longer than desirable for normal operation (call origination), start-up shall be attempted upon NT power-up. After an unsuccessful start-up attempt, the NT DSL transmitter may re-enter FULL RESET.

While in FULL RESET, NTs shall initiate transmission if responding to a new power off/on cycle or to a new request for service from the customer terminal (TE). Under all other conditions, where the transceivers have been turned off (see 6.4.6.5), the NTs shall remain quiet; i.e., NTs shall not start transmitting any signal until they have received the TL signal (wake-up tone) from the network (see table 5).

6.4.2.2 RECEIVE RESET

The RECEIVE RESET state is a transient state in which an NT or a network side transceiver has detected the loss of signal from the far-end and is not transmitting (sending signal to the loop). In addition, the transceiver is not permitted to initiate the start-up sequence (send wake-up tone) but shall be capable of responding to the start-up sequence (detecting wake-up tone). Unless it responds to a wake-up tone, an NT or a network side transceiver must remain in this state for at least 40 ms after detecting the loss of received signal, as specified in 6.4.3 and 6.4.6.5, after which time, the transceiver shall enter the FULL RESET state.

6.4.3 Timers

Timers shall be used to determine entry into the RESET states. Upon the occurrence of any of the following conditions:

- a) failure to complete start-up within 15 seconds (warm or cold start);
- b) loss of received signal for more than 480 ms;
- c) loss of synchronization for more than 480 ms;

a transceiver shall cease transmission and, as specified in 6.4.2.2, enter the RECEIVE RESET state and remain for at least 40 ms, (unless it responds to a wake-up tone) after which it shall enter the FULL RESET state. The manner of entering the RECEIVE RESET state is different for the different conditions listed above.

For conditions (a) or (c), the transceiver shall cease transmission and then, upon the subsequent detection of the loss of received signal, it shall enter the RECEIVE RESET state. Its response time to a loss of signal (after conditions (a) or (c) have been satisfied) shall be such that it shall enter the RECEIVE RESET state (and be capable of responding to the initiation of wake-up tone by the far-end transceiver) within 40 ms after the far-end transceiver ceases transmission.

For condition (b), the transceiver shall immediately enter the RECEIVE RESET state.

For conditions (b) or (c), these requirements apply to transceivers after superframe synchronization is achieved (see T6 and T7 in table 5 and figure 17).

In addition, an NT shall enter the FULL RESET state if signal is not received within 480 ms after it ceases the transmission of TN (or SN1 if it is sent (see T2 to T3 in table 5 and figure 17)).

An approach to the use of timers in DSL transceivers is found in annex C.

6.4.4 Signals during start-up

Table 5 defines the signals produced by the transceivers during start-up. These signals apply during both types of start-up (cold start and warm start). During start-up, all signals at the interface shall consist of sequences of symbols of the shape defined in 5.3 and 5.4.

With the exception of the wake-up tones (TN and TL), the scrambler shall be used in the normal way in formulating the signals. For example, table 5 shows ONEs for B- and D-channel bits and the overhead bits in the signal SN1. These ONEs are scrambled before coding, producing random pulses in these positions at the interface.

Except where noted otherwise in table 5, all the pulse sequences are framed and superframed in accordance with the normal frame structure shown in figures 3, 13, and 14, and all pulses represent scrambled bits except those in the synchronization word. The signals TN and TL are 10-kHz tones generated by repeating the following unscrambled and unframed symbol pattern:

... +3 +3 +3 +3 -3 -3 -3 -3 ...

6.4.5 Line rate during start-up

During start-up, the network shall produce symbols at the nominal line rate within the tolerance specified in 6.1.

The symbol rate from the NT shall be 80 kbaud ± 100 ppm.

6.4.6 Start-up sequence

Figure 17 shows the sequence of signals at the interface that are generated by the transceivers. The transition points in the sequence are also defined in figure 17. Annex C gives an example in its discussion of how these startup signals at the interface may relate to other events away from the interface. For further information on the events at the S and T reference points, the reader is referred to ANSI T1.605 and to CCITT Recommendation I.430.

6.4.6.1 Wake-up

When transceivers are in the RESET state, either transceiver may initiate start-up by sending a tone as defined in table 5.

6.4.6.2 Start-up from customer equipment

While the NT and network are in the RESET state, a request for start-up from the customer terminal equipment shall result in the TN signal (tone) being sent from the NT toward the network. The network, on receiving TN shall remain silent until detection of cessation of signal from the NT. The rest of the sequence then follows as indicated in table 5 and figure 17. If the LT happens to try to start-up at the same time, it may send a TL tone during the TN tone without conflict.

While in RESET, NTs may initiate start-up only if responding to a new power off/on cycle or to a new request for service from the customer terminal equipment. Under all other conditions, where the transceivers have been turned off, the NTs shall remain quiet; i.e., NTs shall not start transmitting any signal until they have received the TL signal (wake-up tone) from the network.

6.4.6.3 Start-up from the network

While the NT and network are in the RESET state, a request for start-up from the network shall result in the TL signal being sent from the network toward the NT. The NT, on receiv-

ing TL, shall respond with TN within 4 ms from the beginning of TL. The rest of the sequence then follows as indicated in table 5 and figure 17.

NOTE – The dea bit from the network shall be set to 1 before start-up is initiated.

6.4.6.4 Progress indicators

In the NT-to-network direction, the act bit remains set equal to 0 until the customer equipment is ready to transmit. The corresponding action at the T reference point in the customer equipment is receipt of the signal INFO3. To communicate this progress indication, act from the NT is set equal to 1. Assuming INFO3 occurs before T6 and T7, this progress indication shall not affect overhead symbols at the interface until T6, when the NT overhead bits are allowed to be normal, and may not be detected by the network until T7.

After event T7 (figure 17) and after act = 1 is received from the NT, the network sets the act bit equal to 1 to communicate readiness for layer 2 communication (see 6.2 and 8.2.2).

6.4.6.5 Turn-off procedure

All transceivers shall cease transmission following loss of received signal. There are different turn-off procedures for transceivers that have achieved full operational status than for transceivers that have not (see 6.4.3).

The network may take advantage of the capabilities of warm-start NTs by announcing turn-off. In announcing turn-off, the network shall change dea from 1 to 0 and send dea = 0 in at least three consecutive superframes before ceasing transmission. It shall cease transmission before sending the dea bit in the superframe following the superframe in which dea = 0 is sent the last time. During the superframes with dea = 0, the NT has time to prepare for turn-off. Cold-start-only NTs may ignore the status of the dea bit.

After the warm-start NT has prepared itself for turn-off, it shall upon detection of loss of signal from the network, cease transmission, and enter the RECEIVE RESET state within 40 ms of the occurrence of the transition to no signal at its interface. As specified in 6.4.2, unless it responds to a TL signal from the network, it shall not initiate the transmission of wake-up

tone for a period of at least 40 ms after it ceases transmission, and then it shall enter the FULL RESET state.

The network (network-side transceiver), after announcing turn-off and ceasing transmission, shall enter the FULL RESET state upon detection of loss of received signal from the NT.

Although NTs are not permitted to initiate turn-off, the LT shall respond to loss of signal as stated above. However, in this scenario, there is no stated means of taking advantage of warm-start capabilities.

6.4.6.6 Transparency

Transparency of the transmission in both directions by the NT shall be provided after the NT achieves full operational status (T6), and both $act = 1$ from the network and $act = 1$. Full operational status of the NT means that the NT has:

- a) acquired bit timing and frame synchronization from the incoming signal from the network;
- b) recognized the superframe marker from the network; and
- c) fully converged both its echo canceler and equalizer coefficients.

Transparency of the transmission in both directions within the network shall be provided when the network achieves full operational status (T7), detects the presence of the superframe marker from the NT, and receives $act = 1$ from the NT. Full operational status of the network means that the network has:

- a) acquired bit timing phase of the incoming signal from the NT, and frame synchronization;
- b) recognized the superframe marker from the NT; and
- c) fully converged both its echo canceler and equalizer coefficients.

At the LT, transparency of the B- and D-channels shall occur at any time during either the first LT-transmitted superframe with $act = 1$ or during the last LT-transmitted superframe with $act = 0$. Transparency occurs at the transition from all ZEROs to "normal" in the B- and D-channels in SL3. For example, referring to figure 15, suppose superframe A is the last

transmit superframe with $act = 0$, superframe B is the first transmit superframe with $act = 1$, and superframes C and D continue with $act = 1$. The transition to transparency may occur not later than the fast bit of superframe C. This means that all B- and D-channel bits in superframes C and D shall be transmitted transparently, provided that conditions for transparency have been maintained.

At the LT, transparency of the B- and D-channels in the LT-to-network direction may occur at a different time than transparency in the LT-to-NT direction. However, in both directions the LT shall become transparent during the two transmit superframes A and B described in the example. The NT may not yet have achieved transparency during this interval.

After both the network and the NT achieve transparency in both directions, the act bits shall continue to reflect the state of readiness of the network and the terminal equipment for layer-2 communication. The act bit in the network-to-NT direction shall reflect the status of the network side of the interface, except during 2B+D loopback toward the network. The act bit in the NT-to-network direction shall reflect the status of the NT side of the interface. Whenever either end, for any reason, loses its readiness to communicate at layer 2 (e.g., the terminal is unplugged), that end shall set its transmitted act bit to zero. A change of status of this bit shall be repeated in at least three consecutive transmitted superframes.

Transparency required to perform loopbacks is independent of the state of the act bit (see 8.3.4).

6.4.7 Start-up time requirements

The network and the NT shall complete the start-up process, including synchronization and training of equalizers to the point of meeting performance criteria within the following lengths of time: cold-start-only transceivers shall synchronize within 15 seconds; warm-start transceivers shall synchronize within 300 ms on warm starts and within 15 seconds on cold starts. The 15-second cold-start time requirement is apportioned such that the NT is allowed 5 seconds and the network is allowed 10 seconds. For warm starts, the 300-ms start-up time requirement is apportioned

equally between the NT and the network, 150 ms each. See figure 17 for details.

NOTE – The 300-ms requirement applies to laboratory tests only. No 300-ms timer is involved in actual in-service loops. (See the definitions in 6.4.1.3 and 6.4.1.4 for warm and cold starts.)

As indicated in figure 17, the start-up time requirements cover the time span from wake-up tone to T7, and do not include time for activation of customer terminal equipment. All start-up times apply only to the DSL, and do not apply to the entire customer access link where carrier systems may be involved (see figure E.1).

The following description of a laboratory test of start-up time is intended only to clarify the start-up time requirements. The test shall be started by a wake-up tone (either TN or TL) and time recorded from the beginning of TN until event T7 (see figure 17). It is desirable to separately record the accumulation of time components A + C and B + D as defined in figure 17.

The test shall be conducted on each of 16 test loops (see 5.4.1 and figure 8). The test shall be conducted with an LT-NT pair on each test loop, first with the LT and NT as shown in figure 8, and then with the NT and LT interchanged. Artificial crosstalk, power-related metallic noise, and longitudinal noise as described in 5.4.4 shall be applied throughout the test. Furthermore:

- a) It is desirable to apply the interference to both ends of the test loop;
- b) It is desirable to conduct the test using clock sources with maximum frequency offsets;
- c) It is desirable to repeat the test a number of times in order to determine the degree of repeatability.

For warm starts, the test shall begin from a RESET state that has been entered without loss of power following the turn-off announcement as described in 6.4.6.5.

Start-up time on actual loops is beyond the scope of this standard.

6.5 NT maintenance modes

The NT quiet mode (QM) functionality with an NT (or customer equipment containing the NT functionality) will ensure that an NT will not

attempt a start-up or will not initiate transmission during metallic loop tests conducted by the network. The insertion loss measurement test (ILMT) will cause a known test signal to be generated by an NT. This test will be used in network measurements of DSL transmission characteristics and may provide the ability to determine, from a single-ended test of the metallic loop, if the loop can support DSL transmission.

Figure 18, NT loop testing states, illustrates the various NT states associated with both the NT quiet mode and the insertion loss measurement test.

6.5.1 NT quiet mode

The NT quiet mode implementation shall be as follows:

- a) The NT shall unconditionally enter the quiet mode upon receipt of 6 consecutive pulses in the trigger signal (see 6.5.3, 6.5.4, and 6.5.5). Once triggered, the function shall latch until either timeout or turnoff;
- b) While in quiet mode, the NT shall cease all transmission, and not attempt start-up;
- c) The NT quiet mode duration shall be 75 seconds. If no trigger signal is received to change the NT state during the 75-second QM duration, the NT shall exit the maintenance mode. Upon exiting the maintenance mode, the NT and the network shall be responsible for operation described in 6.4.6.2 and 6.4.6.3;
- d) A receipt of 6 consecutive pulses in the trigger signal during quiet mode shall cause the NT to return to the start of the quiet mode state (the quiet mode would then continue for another 75 seconds until either timeout or receipt of a new trigger signal that would alter the NT state);
- e) A receipt of 8 consecutive pulses in the trigger signal during quiet mode shall cause the NT to enter the insertion loss measurement test state;
- f) A receipt of 10 consecutive pulses in the trigger signal during quiet mode shall cause the NT to exit the maintenance mode (see (c) above);
- g) If the NT receives a sequence of any other number of consecutive pulses in the trigger signal, then the state-change com-

mand is not valid, and no action is taken by the NT.

6.5.2 Insertion loss measurement test

The insertion loss measurement test implementation shall be as follows:

- a) The receipt by the NT of 8 consecutive pulses in the trigger signal (see 6.5.3, 6.5.4, and 6.5.5) shall unconditionally initiate the insertion loss measurement test. Once triggered, the function shall latch until either timeout or turnoff. The NT shall not attempt start-up during the insertion loss measurement test;
- b) While in the insertion loss measurement test state, the NT shall generate a scrambled, framed, 2B1Q signal. SN1 and SN2 (see 5.3) are examples of scrambled, framed, 2B1Q signals suitable for the insertion loss measurement test signal;
- c) The insertion loss measurement test duration shall be 75 seconds. Upon exiting the maintenance mode, the NT and the network shall be responsible for operation as described in 6.4.6.2 and 6.4.6.3;
- d) Receipt of 8 consecutive pulses in the trigger signal during the insertion loss measurement test duration shall cause the NT to return to the start of the insertion loss measurement test (the ILMT would then continue for 75 seconds until timeout or receipt of a new trigger signal to alter the NT state);
- e) A receipt of 6 consecutive pulses in the trigger signal during insertion loss measurement test shall cause the NT to enter the quiet mode state;
- f) A receipt of 10 consecutive pulses in the trigger signal during insertion loss measurement test shall cause the NT to exit the maintenance mode (see (c) above);
- g) If the NT receives a sequence of any other number of consecutive pulses in the trigger signal, then the state-change command is not valid, and no action is taken by the NT.

6.5.3 NT quiet mode and insertion loss measurement test trigger signal

The NT shall be capable of detecting the following two types of signals: The NT shall respond to either (a) dc signaling that begins

with a steady current flow (start interval) followed by 6, 8, or 10 pulses sent as breaks in the current flow and ends with steady dc current flow (stop interval), or (b) ac signaling that begins with no current flow (start interval, less than 200 μ A dc) followed by 6, 8, or 10 half cycles of a 2- to 3-Hz sine wave, and ends with no current flow (stop interval). When receiving the ac signaling, the NT shall count each half cycle of the same wave as one pulse.

A valid test trigger signal shall consist of a valid start interval followed by either 6, 8, or 10 consecutive pulses, followed by a valid stop interval. Unless an entire trigger sequence consisting of start interval pulses, and stop interval is received, the NT shall take no action.

A stop interval may be followed by a start interval without any intervening breaks. Signals on the loop before the start interval or after the stop interval shall not affect the NT trigger detection function.

The start and stop intervals shall be ≥ 500 ms. The NT shall be capable of detecting and validating the trigger signal and entering into the desired state required by the number of pulses transmitted.

A request for the same or a new state shall occur no sooner than 1 second after the beginning of the preceding stop interval. On receipt of a valid signal, the NT shall transition from one state to the requested state within 500 ms.

The pulse detector in the NT shall be implemented so that there is no aliasing for pulse rates up to 64 pulses per second.

6.5.4 dc signaling format

The dc signal shall begin with a steady current flow with pulses sent as breaks in the current. These pulses shall:

- a) be applied to the NT by test equipment in the network at a pulse speed of 4 to 8 pps;
- b) have a 40 to 60 per cent break;
- c) have source voltage of 43.5 to 56 volts; and
- d) have source resistance of 200 to 4000 ohms (includes test system, test trunk, loop, and margin resistance).

6.5.5 Low frequency ac signaling format

The ac signal shall consist of 6, 8, or 10 half cycles of a 2- to 3-Hz sine wave. Each half cycle of the sine wave is equivalent to one pulse described in 6.5.4. This sine wave shall:

- a) be applied to the NT by test equipment in the network at a frequency between 2 and 3 Hz;
- b) have peak voltage between 60 and 62 volts; and
- c) have a source resistance between 900 and 4500 ohms (ac source, test system, test trunk, loop, and margin resistance).

7 Electrical characteristics

7.1 Impedance and return loss

The nominal driving point impedance at the interface looking toward the NT shall be 135 ohms. The return loss with respect to 135 ohms, over a frequency band from 1 kHz to 200 kHz, shall be as shown in figure 19.

7.2 Longitudinal output voltage

The NT shall present to the interface a longitudinal component whose rms voltage, in any 4-kHz bandwidth averaged in any 1-second period, is less than -50 dBV over the frequency range 100 Hz to 170 kHz, and less than -80 dBV over the range from 170 kHz to 270 kHz. Compliance with this limitation is required with a longitudinal termination having an impedance equal to or greater than a 100-ohm resistor in series with a 0.15- μ F capacitor.

Figure 20 defines a measurement method for longitudinal output voltage. For direct use of this test configuration, the NT should be able to generate a signal in the absence of a signal from the network.

The ground reference for these measurements shall be the building or green-wire ground of the NT.

7.3 Longitudinal balance

The longitudinal balance (impedance to ground) is given in the following equation:

$$LBal = 20 \log \left| \frac{e_l}{e_m} \right| \text{ dB}$$

where

e_l is the applied longitudinal voltage (referenced to the building or green wire ground of the NT);

e_m is the resultant metallic voltage appearing across a 135-ohm termination.

The balance shall be >20 dB at frequencies up to 5 Hz. The minimum requirement increases above 5 Hz at 20 dB per decade to 55 dB at 281.2 Hz. The balance shall be >55 dB between 281.2 Hz and 40 000 Hz. Above 40 000 Hz, the minimum requirement decreases at 20 dB per decade. See figure 21.

NOTE – Longitudinal balance requirements given here apply to the NT. Longitudinal balance requirements for the network side are beyond the scope of this standard.

Figure 22 defines a measurement method for longitudinal balance. For direct use of this test configuration, measurement should be performed with the NT powered up but inactive, driving 0 V.

7.4 Jitter

In this standard, jitter is specified in terms of unit intervals (UI) of the nominal 80-kbaud signal (12.5 μ s).

7.4.1 NT input signal jitter tolerance

The NT shall meet the performance objectives specified in 5.4.2, with wander/jitter at the maximum magnitude indicated in figure 23, for single jitter frequencies in the range of 0.1 Hz to 20 kHz, superimposed on the test signal source with the received signal baud rate in the range of 80 kbauds \pm 5 ppm. The NT shall also meet the performance objectives with wander per day of up to 1.44 UI peak-to-peak where the maximum rate of change of phase is 0.06 UI/hour.

7.4.2 NT output jitter limitations

With the wander/jitter as specified in 7.4.1, except as noted, superimposed on the NT input signal, the jitter on the transmitted signal of the NT towards the network shall conform to the following, with the received signal baud rate in the range of 80 kbaud \pm 5 ppm, as described in 6.1:

- a) The jitter shall be equal to or less than 0.04 UI peak-to-peak and less than 0.01 UI rms when measured with a high-pass filter having a 6-dB/octave roll-off below 80 Hz;

b) The jitter in the phase of the output signal (the signal transmitted towards the network) relative to the phase of the input signal (from the network) shall not exceed 0.05 UI peak-to-peak and 0.015 UI rms when measured with a band-pass filter having 6-dB/octave roll-offs above 40 Hz and below 1.0 Hz. (Note that the 1.0-Hz cut-off ensures that the average difference in the phase of the input and output signals is subtracted.) This requirement applies with superimposed jitter in the phase of the input signal as specified in 7.4.1 for single frequencies up to 19 Hz;

c) The maximum (peak) departure of the phase of the output signal from its nominal difference (long-term average) from the phase of the input signal (from the network) shall not exceed 0.1 UI. This requirement applies during normal operation including following a "warm start." (Note that this means that, if deactivated and subsequently activated in conformance with the "warm start" requirements, the long-term average difference in phase of the output signal from the phase of the input signal shall be essentially unchanged.)

7.5 dc characteristics

7.5.1 Sealing current

Sealing current may or may not be provided by the network. The NT shall meet the requirements of this specification for a current of 0 mA and, if sealing current is present, for currents in the range of 1.0 to 20 mA and where the maximum rate of change of the current is no more than 20 mA per second (see 7.5.2).

7.5.2 Metallic termination

Table 6 and figure 24 give characteristics that apply to the dc metallic termination of the NT.

The metallic termination provides a direct current path from tip to ring at the NT, providing a path for sealing current. By exercising the nonlinear functions of the metallic termination, a network-side test system may identify the presence of a conforming NT on the customer side of the interface. The characteristics of the metallic termination shall not be affected by whether the NT is powered in any state, or unpowered.

There are two operational states of the dc metallic termination:

- a) the ON or conductive state; and
- b) the OFF or nonconductive state.

7.5.2.1 ON state

The application of a voltage across the metallic termination greater than V_{AN} , the activate/nonactivate voltage, for a duration greater than the activate time shall cause the termination to transition to the ON state. The activate/nonactivate voltage shall be in the range of 30.0 to 39.0 V. The activate time shall be in the range of 3.0 to 50.0 ms. If a change of state is to occur, the transition shall be completed within 50 ms from the point where the applied voltage across the termination first exceeds V_{AN} . Application of a voltage greater than V_{AN} for a duration less than 3.0 ms shall not cause the termination to transition to the ON state. See table 6 and figure 24.

While in the ON state, when the voltage across the termination is 15 V, the current shall be greater than or equal to 20 mA. The metallic termination shall remain in the ON state as long as the current is greater than the threshold I_{HR} (see table 6 and figure 24) whose value shall be in the range of 0.1 to 1.0 mA. Application of 90.0 V through 200 to 4000 ohms (for a maximum duration of 2 seconds) shall result in a current greater than 9.0 mA.

7.5.2.2 OFF state

The metallic termination shall transition to the OFF state if the current falls below the threshold I_{HR} whose value shall be in the range of 0.1 to 1.0 mA for a duration greater than the "guaranteed release" time (100 ms) (see table 6 and figure 24). If a change of state is to occur, the transition shall be completed within 100 ms from the point where the current first falls below I_{HR} . If the current falls below I_{HR} for a duration less than 3.0 ms, the termination shall not transition to the OFF state.

While in the OFF state, the current shall be less than 5.0 μ A whenever the voltage is less than 20.0 V. The current shall not exceed 1.0 mA while the voltage across the termination remains less than the activate voltage.

Descriptive material can be found in table 6, figure 24, and annex F.

7.5.2.3 NT capacitance

While the metallic termination is OFF, the tip-to-ring capacitance of the NT when measured at a frequency of less than 100 Hz shall be $1.0 \mu\text{F} \pm 10\%$.

7.5.3 Behavior of the NT during metallic testing

During metallic testing, the NT shall behave as follows:

- a) When a test voltage of up to 90 V⁵⁾ is applied across the loop under test, the NT shall present its dc metallic termination as defined in 7.5.2, table 6, and figure 24, and not trigger any protective device that will mask this signature. The series resistance (test system + test trunk + loop + margin) can be from 200 to 4000 ohms (balanced between the two conductors);
- b) The NT may optionally limit current in excess of 25 mA (20 mA maximum sealing current + 5 mA implementation margin).

7.5.4 NT network-side resistance to ground

The dc resistance between the NT's tip conductor and earth ground and between the NT's ring conductor and earth ground shall be greater than 5 megohms for all dc voltages up to and including 100 V.

8 M-channel bit functions

The M-channel bit functions specified below are based on the bit allocation for the DSL superframe defined in figures 14(a) and 14(b).

8.1 Error monitoring function

8.1.1 Cyclic redundancy check (crc)

Twelve bits per superframe (1 kbit/s) shall be allocated to the cyclic redundancy check (crc) function. The crc bits are the M_5 and M_6 bits in frames 3 through 8 of the superframe (see figures 14(a) and 14(b)). The crc is an error detection code that shall be generated from the appropriate bits in the superframe and inserted into the bit stream by the transmitter. At the receiver, a crc calculated from the

same bits shall be compared with the crc value transmitted in the bit stream. If the two crcs differ, there has been at least one error in the covered bits in the superframe.

8.1.2 crc algorithms

The crc code shall be computed using the polynomial:

$$P(x) = x^{12} \oplus x^{11} \oplus x^3 \oplus x^2 \oplus x \oplus 1$$

where

\oplus is the modulo 2 summation.

One method of generating the crc code for a given superframe is illustrated in figure 25. At the beginning of a superframe all register cells are cleared. The superframe bits to be crc'd are then clocked into the generator from the left. During bits that are not covered by the crc (SW, ISW, M_1 , M_2 , M_3 , M_5 , M_6), the state of the crc generator is frozen and no change in state of any of the stages takes place. After the last superframe bit to be crc'd is clocked into REGISTER CELL 1, the 12 register cells contain the crc code of the next superframe. Between this point and the beginning of the next superframe, the register cell contents are stored for transmission in the crc field of the next superframe. Notice that superframe bit CRC1 resides in REGISTER CELL 12, CRC2 in REGISTER CELL 11, and so on.

Other viable methods for generating the crc bits exist. In the case that a method other than the one presented is used, the CRC1 shall correspond to the most significant bit of the crc remainder, the CRC2 to the next most significant bit, and so on. The block diagram presented is intended to clarify the definition of the crc superframe bits. Other implementations are possible.

NOTE – The binary ONES and ZEROS from the S/T-interface, and corresponding bits from the network, shall be treated as binary ONES and ZEROS, respectively, for the computation of the crc.

8.1.3 Bits covered by the crc

The crc bits shall be calculated from the bits in the D-channel, both B-channels, and the M_4 bits (see figure 4).

⁵⁾ One test system in common use today applies a 70 V dc plus 10 V rms ac (84.4 V peak) to one conductor of the loop while grounding the other conductor. The addition of a 5.8 V margin yields the 90-V requirement.

8.2 Overhead bit functions

A number of transceiver operations and maintenance functions are handled by M_4 , M_5 , and M_6 bits in the superframe. These bits are defined in the following subsections. To reflect a change in status, a new value for M_4 bits shall be repeated in at least three consecutively transmitted superframes.

8.2.1 Far end block error (febe) bit

The far end block error (febe) bits are the " M_6 " bits in the second basic frame of superframes transmitted by either transceiver (see figures 14(a) and 14(b)). As crc errors are detected at the receiver, a febe bit shall be generated. The febe bit shall be set to binary ONE if there are no errors in the superframe and binary ZERO if the superframe contains an error. The febe bit shall be placed in the next available outgoing superframe and transmitted back to the originator. The febe bits in each direction of transmission may be monitored to determine the performance of the far end receiver.

8.2.2 The act bit

The start-up (act) bit is the M_4 bit in the first basic frame of superframes transmitted by either transceiver (see 6.2 and figure 14). The act bit is set to binary ONE as a part of the start-up sequence to communicate readiness for layer-2 communication (see 6.4.6.4).

8.2.3 The dea bit

The turn-off (dea) bit is the M_4 bit in the second basic frame of superframes transmitted by the network (see figures 14(a) and 14(b) and 6.2). The dea bit is set to binary ZERO by the network to communicate to the NT its intention to turn off (see 6.4.6.5).

8.2.4 NT power status (ps) bits

The power status (ps_1 , ps_2) bits are the M_4 bits in the second and third basic frames of superframes transmitted by the NT (see figure 14(b)). The power status bits shall be used to indicate NT power status. Table 7 shows the ps bit assignments and the corresponding messages and definitions.

These bits are set and held constant until the power status of the NT changes. It is expected that primary power will be provided by the normal ac mains. Secondary power (if provid-

ed) would normally be provided via a backup battery at the customer location.

The NT shall have sufficient energy storage to transmit the dying gasp indication for a minimum of three superframes.

8.2.5 NT test mode (ntm) indicator bit

The NT test mode indicator (ntm) bit is the M_4 bit in the fourth basic frame of superframes transmitted by the NT (see figure 14(b)). The ntm bit shall be used to indicate that the NT is in a customer-initiated test mode. The NT is considered to be in a test mode when the D-channel or either one of the B-channels are involved in a customer locally initiated maintenance action. While in test mode, the NT may be unavailable for service or the NT may be unable to perform actions requested by eoc messages. The bit shall be a binary ONE to indicate normal operation and binary ZERO to indicate test mode. When indicating test mode (binary ZERO), this bit is held constant until the test mode status of the NT changes. The return to binary ONE (ntm = 1) indicates the return of normal mode.

8.2.6 Cold-start-only (cso) bit

The cso bit is the M_4 bit in the fifth basic frame of the superframe transmitted by an NT. It shall be used to indicate the start-up capabilities of the NT transceiver. If the NT has a cold-start-only transceiver, as defined in 6.4.1.5, this bit is set to binary ONE. Otherwise, this bit shall be set to binary ZERO in SN3.

8.2.7 U-interface-only-activation (uoa) bit

The uoa bit is the M_4 bit in the seventh basic frame of superframes transmitted by the network. It shall be used to request the NT to activate or deactivate the S/T-interface (if present). If the S/T-interface is to be activated, this bit shall be set to binary ONE. Otherwise, this bit shall be set to binary ZERO.

8.2.8 S/T-interface-activity-indicator (sai) bit

The sai bit is the M_4 bit in the seventh basic frame of superframes transmitted by an NT. It shall be used to indicate to the network when there is activity at the S/T reference point. If there is activity (INFO1 or INFO3) at the S/T reference point, this bit shall be set to binary ONE. Otherwise, this bit shall be set to binary ZERO.

8.2.9 Alarm indication bit (aib)

The aib bit is the M_4 bit in the eighth basic frame of superframes transmitted toward the NT. When the transmission path for the D-, B_{1-} , and B_{2-} channels has been established all the way to the local exchange (see figure 2), a binary ONE (aib = 1) shall be forwarded to the NT. Failure or interruption of an intermediate transmission system that transports the D-, B_{1-} , or B_{2-} channels shall result in forwarding binary ZERO (aib = 0) to the NT. Such failures may include loss of signal, loss of frame synchronization (carrier link or basic access DSL), and transmission terminal failure. Intermediate transmission interruptions may include loopbacks at intermediate points or the absence of provisioning of an intermediate transmission system.

8.2.10 Network indicator bit for network use

The M_4 bit in the eighth basic frame of superframes transmitted toward the network is reserved for network use. The NT shall always set this bit to binary ONE towards the network.

8.2.11 Reserved bits

All bits in M_4 , M_5 , and M_6 not otherwise assigned are reserved for future standardization. Reserved bits shall be set to binary ONE before scrambling.

8.3 Embedded operations channel (eoc) functions

Twenty-four bits per superframe (2 kbit/s) are allocated to an embedded operations channel (eoc) that supports operations communications needs between the network and the NT.

8.3.1 eoc frame

The eoc frame shall be composed of 12 bits synchronized to the superframe:

Bits	3	1	8
Function provided	Address field	Data/msg indicator	Info field

The three-bit address field may be used to address up to seven locations. Only the specification of addresses of messages for the NT are within the scope of this standard. However, addresses of intermediate network elements are discussed in annex E.

The data/message indicator bit shall be set to ONE to indicate that the information field contains an operations message; it shall be set to ZERO to indicate that the information field contains numerical data.⁶⁾ Up to 256 messages may be encoded in the information field.

Exactly two eoc frames shall be transmitted per superframe consisting of all M_1 , M_2 , and M_3 bits (see figures 14(a) and 14(b)).

8.3.2 Mode of operation

The eoc protocol operates in a repetitive command/response mode. Three identical properly addressed consecutive messages shall be received before an action is initiated. Only one message, under the control of the network, shall be outstanding (not yet acknowledged) on a complete basic access eoc at any one time.

The network shall continuously send an appropriately addressed message. In order to cause the desired action in the addressed element, the network shall continue to send the message until it receives three identical consecutive eoc frames from the addressed device that agree with the transmitted eoc frame. When the network is trying to activate an eoc function, autonomous messages from the NT will interfere with confirmation of receipt of a valid eoc message. The sending by the NT and receipt by the network of three identical consecutive properly addressed unable-to-comply messages constitutes notification to the network that the NT does not support the requested function, at which time the network may abandon its attempt.⁷⁾

The addressed element shall initiate action when, and only when, three identical, consecutive, and properly addressed eoc frames,

⁶⁾ At the present time there is no numerical data transfer required from or to the NT. Such data transfer is anticipated only for internal network applications.

⁷⁾ Failure by the network side to abandon the request for the unsupported function may interfere with further use of the eoc (e.g., by contending operating systems within the network). The network has the responsibility to keep the eoc free for such use by timely substitution of "hold state," "return to normal," or an alternate request after validation of the "unable-to-comply" response.

which contain a message recognized by the addressed element, have been received. The NT shall respond to all received messages. The response shall be an echo of the received eoc frame towards the network with two exceptions described below; any reply or echoed eoc frame shall be in the next available returning eoc frame, which allows a limited processing time, approximately 2.25 ms. (See figure 15.)

If the NT does not recognize the message (data/message bit = 1) in a properly addressed eoc frame, rather than echo, on the third and all subsequent receipts of that same correctly addressed eoc frame, it shall return the unable-to-comply message in the next available eoc frame.

If the NT receives eoc frames with addresses other than its own address (000), or the broadcast address (111), it shall, in the next available eoc frame, return an eoc frame toward the network containing the hold state message with its own address (the NT address, 000).

If an NT not implementing eoc data transfer functions receives a data byte (data/message bit = 0) in a properly addressed eoc frame, rather than echo, on the third and all subsequent receipts of that same correctly addressed eoc frame, it shall return the unable-to-comply⁸⁾ message in the next available eoc frame.

The protocol specification has made no provision for autonomous eoc messages from the NT.

All actions to be initiated at the NT shall be latching, permitting multiple eoc-initiated actions to be in effect simultaneously. A separate message shall be transmitted by the network to unlatch.

⁸⁾ The requirement for an unable-to-comply response to a data byte addressed to an NT that does not implement a data reception feature is new in the 1992 edition of this standard. Implementations of eoc capabilities existing on the date of publication of the 1992 edition or that are new within a period of one year thereafter are specifically exempt from this requirement. The requirement applies to all new implementations of eoc capabilities thereafter.

⁹⁾ Loopbacks may be performed after point T7 in the start-up sequence. The establishment of loopbacks is independent of the state of the act bit. Note, however, that the act bit from the NT must continue to reflect readiness to communicate at layer 2 (presence of INFO3) during B1- and B2-channel loopbacks.

¹⁰⁾ This requirement is consistent with requirements found in CCITT Recommendation I.603.

¹¹⁾ "Transparent" is the CCITT term used to indicate that the bits toward the loop are passed onward as well as looped back.

8.3.3 Addressing

An NT shall recognize either of two addresses, an NT and a broadcast address. These addresses are as follows:

Node	Address
NT	000
Broadcast (all nodes)	111

An NT shall use the address 000 in sending the unable-to-comply message.

8.3.4 Definition of required eoc functions

a) *Operate 2B+D loopback*⁹⁾: This function directs the NT to loopback the user-data (2B+D) bit stream toward the network.¹⁰⁾ This loopback may be transparent or non-transparent¹¹⁾ but in either case will continue to provide sufficient signal to allow the TE to maintain synchronization to the NT.

b) *Operate B₁-channel (or B₂-channel) loopback*⁹⁾: This function directs the NT to loopback an individual B-channel toward the network.¹⁰⁾ The individual B-channel loopback can provide per-channel maintenance capabilities without totally disrupting service to the customer. This loopback is transparent¹¹⁾;

c) *Return to normal*: The purpose of this message is to release all outstanding eoc-controlled operations and to reset the eoc processor to its initial state;

d) *Unable-to-comply acknowledgment*: This will be the confirmation that the NT has validated the receipt of an eoc message, but that the eoc message is not in the menu of the NT;

e) *Request corrupt crc*: This message requests the sending of corrupt crcs toward the network, until canceled with return to normal;

f) *Notify of corrupted crc*: This message notifies the NT that intentionally corrupted crcs will be sent from the network until cancellation is indicated by return to normal;

g) *Hold state*: This message is sent by the network to maintain the NT eoc processor and any active eoc-controlled operations in their present state. This message may also be sent by the NT toward the network to indicate that the NT has received an eoc frame with an address other than its own (000 or 111).

8.3.5 Codes for required eoc functions

Table 8 shows the codes for each of the eoc functions defined in 8.3.4.

Sixty-four eoc message codes have been reserved for nonstandard applications ¹²⁾ in the following four blocks of 16 codes each (*x* is 1 or 0): 0100 xxxx, 0011 xxxx, 0010 xxxx, 0001 xxxx. Another 64 eoc message codes have been reserved for internal network use ¹³⁾ in the following four blocks of 16 codes each (*x* is 1 or 0): 0110 xxxx, 0111 xxxx, 1000 xxxx, 1001 xxxx. All remaining codes not defined in table 8 and not reserved for nonstandard applications or for internal network use are reserved for future standardization. Thus, 120 codes associated with the NT (000) and broadcast (111) addresses, are available for future standardization (i.e., 256 codes minus 8 defined codes from the table minus 64 codes for nonstandard applications minus 64 codes for internal network use).

When no functions are latched, and the network has no other messages to send, the network may send either the hold-state message or the return-to-normal message without changing the state of the NT. When one or more functions are latched, and the network has no other messages to send, the network shall send the hold-state message to keep the

function(s) latched. However, the network may continue to send the message for one of the latched functions for some period during which the function is latched, with no change in NT state. The network shall send the return-to-normal message to unlatch any previously latched function(s). When the functions are unlatched, the network shall send the hold-state message, or continue to send the return-to-normal message until there is a need to send some other message.

The following lists categorize the M-channel eoc messages according to corresponding operations functions:

Request diagnostic data function

Notify of corrupted crc
Request corrupted crc
Return to normal
Unable to comply
Hold state

Operate/release loopback function

Operate 2B+D loopback
Operate B₁-channel loopback
Operate B₂-channel loopback
Return to normal
Unable to comply
Hold state

9 Environmental conditions

9.1 Protection

Material referring to protection may be found in annex B of this standard.

9.2 Electromagnetic compatibility

Material referring to electromagnetic compatibility may be found in annex B of this standard.

¹²⁾ The reservation of codes for nonstandard applications does not in any way endorse their use. Any use of such messages shall not interfere with the eoc protocol. A transceiver that supports messages for nonstandard applications shall operate properly for standard functions with other transceivers that meet requirements.

¹³⁾ The reservation of codes for internal network applications does not in any way endorse their use. Any use of such messages shall not interfere with the eoc protocol. An NT is not expected to recognize these codes and should respond as discussed in 8.3.2.

Table 1 – Pin assignments for 8-position jack and plug

Pin number	Function	Notes
1	Battery status	Optional battery status indication as described in annex H
2	Battery status	Optional battery status indication as described in annex H
3	No connection	Reserved for future standardization
4	Signal	Tip or ring of pair to and from the network interface
5	Signal	Tip or ring of pair to and from the network interface
6	No connection	Reserved for future standardization
7	Powering	Optional powering as described in annex H
8	Powering	Optional powering as described in annex H

Table 2 – 26 AWG PIC cable at 70°F

Freq Hz	Primary constants 1 Hz to 5 MHz			
	R ohms/mi	L mH/mi	G μ mho/mi	C μ F/mi
1.	440.75	0.9861	0.000	0.083 00
5.	440.75	0.9861	0.001	0.083 00
10.	440.75	0.9861	0.002	0.083 00
15.	440.76	0.9861	0.003	0.083 00
20.	440.76	0.9861	0.004	0.083 00
30.	440.76	0.9861	0.005	0.083 00
50.	440.76	0.9861	0.008	0.083 00
70.	440.76	0.9861	0.011	0.083 00
100.	440.76	0.9861	0.016	0.083 00
150.	440.76	0.9861	0.022	0.083 00
200.	440.76	0.9860	0.028	0.083 00
300.	440.76	0.9660	0.040	0.083 00
500.	440.77	0.9859	0.063	0.083 00
700.	440.78	0.9859	0.084	0.083 00
1 000.	440.79	0.9858	0.115	0.083 00
1 500.	440.81	0.9856	0.164	0.083 00
2 000.	440.83	0.9854	0.210	0.083 00
3 000.	440.88	0.9850	0.299	0.083 00
5 000.	441.01	0.9843	0.466	0.083 00
7 000.	441.15	0.9836	0.625	0.083 00
10 000.	441.39	0.9825	0.853	0.083 00
15 000.	441.87	0.9807	1.213	0.083 00
20 000.	442.88	0.9789	1.558	0.083 00
30 000.	443.88	0.9753	2.217	0.083 00
50 000.	447.81	0.9660	3.458	0.083 00
70 000.	453.09	0.9546	4.634	0.083 00
100 000.	463.39	0.9432	6.320	0.083 00
150 000.	485.80	0.9306	8.993	0.083 00
200 000.	513.04	0.9212	11.550	0.083 00
300 000.	575.17	0.9062	16.436	0.083 00
500 000.	699.61	0.8816	25.633	0.083 00
700 000.	812.95	0.8614	34.351	0.083 00
1 000 000.	956.65	0.8381	46.849	0.083 00
1 500 000.	1154.38	0.8146	66.665	0.083 00
2 000 000.	1321.07	0.8001	85.624	0.083 00
3 000 000.	1600.68	0.7823	121.841	0.083 00
5 000 000.	2044.07	0.7638	190.021	0.083 00

Table 3 – 24 AWG PIC cable at 70°F

Freq Hz	Primary constants 1 Hz to 5 MHz			
	R ohms/mi	L mH/mi	G μ mho/mi	C μ F/mi
1.	277.19	0.9861	0.000	0.083 00
5.	277.19	0.9861	0.001	0.083 00
10.	277.19	0.9861	0.002	0.083 00
15.	277.19	0.9861	0.003	0.083 00
20.	277.19	0.9861	0.004	0.083 00
30.	277.19	0.9861	0.005	0.083 00
50.	277.19	0.9861	0.008	0.083 00
70.	277.19	0.9861	0.011	0.083 00
100.	277.19	0.9861	0.016	0.083 00
150.	277.20	0.9860	0.022	0.083 00
200.	277.20	0.9860	0.028	0.083 00
300.	277.20	0.9860	0.040	0.083 00
500.	277.21	0.9859	0.063	0.083 00
700.	277.22	0.9858	0.084	0.083 00
1 000.	277.23	0.9857	0.115	0.083 00
1 500.	277.25	0.9854	0.164	0.083 00
2 000.	277.28	0.9852	0.210	0.083 00
3 000.	277.34	0.9848	0.299	0.083 00
5 000.	277.48	0.9839	0.466	0.083 00
7 000.	277.66	0.9829	0.625	0.083 00
10 000.	277.96	0.9816	0.853	0.083 00
15 000.	278.58	0.9793	1.213	0.083 00
20 000.	279.35	0.9770	1.558	0.083 00
30 000.	281.30	0.9723	2.217	0.083 00
50 000.	286.82	0.9577	3.458	0.083 00
70 000.	294.29	0.9464	4.634	0.083 00
100 000.	308.41	0.9347	6.320	0.083 00
150 000.	337.22	0.9204	8.993	0.083 00
200 000.	369.03	0.9087	11.550	0.083 00
300 000.	431.55	0.8885	16.436	0.083 00
500 000.	541.69	0.8570	25.633	0.083 00
700 000.	632.08	0.8350	34.351	0.083 00
1 000 000.	746.04	0.8146	46.849	0.083 00
1 500 000.	902.84	0.7947	66.665	0.083 00
2 000 000.	1035.03	0.7825	85.624	0.083 00
3 000 000.	1256.77	0.7676	121.841	0.083 00
5 000 000.	1608.38	0.7523	190.021	0.083 00

Table 4 – 22 AWG PIC cable at 70°F

Freq Hz	Primary constants 1 Hz to 5 MHz			
	R ohms/mi	L mH/mi	G μ mho/mi	C μ F/mi
1.	174.27	0.9861	0.000	0.083 00
5.	174.27	0.9861	0.001	0.083 00
10.	174.27	0.9861	0.001	0.083 00
15.	174.27	0.9861	0.001	0.083 00
20.	174.27	0.9861	0.002	0.083 00
30.	174.27	0.9861	0.003	0.083 00
50.	174.27	0.9861	0.005	0.083 00
70.	174.27	0.9861	0.006	0.083 00
100.	174.27	0.9861	0.009	0.083 00
150.	174.27	0.9860	0.013	0.083 00
200.	174.27	0.9860	0.017	0.083 00
300.	174.28	0.9860	0.024	0.083 00
500.	174.29	0.9858	0.040	0.083 00
700.	174.29	0.9857	0.054	0.083 00
1 000.	174.31	0.9856	0.076	0.083 00
1 500.	174.34	0.9853	0.110	0.083 00
2 000.	174.37	0.9850	0.145	0.083 00
3 000.	174.44	0.9844	0.211	0.083 00
5 000.	174.62	0.9833	0.341	0.083 00
7 000.	174.83	0.9821	0.467	0.083 00
10 000.	175.22	0.9804	0.652	0.083 00
15 000.	176.06	0.9778	0.954	0.083 00
20 000.	177.11	0.9744	1.248	0.083 00
30 000.	179.86	0.9672	1.824	0.083 00
50 000.	187.64	0.9491	2.943	0.083 00
70 000.	197.71	0.9372	4.032	0.083 00
100 000.	215.55	0.9237	5.630	0.083 00
150 000.	247.57	0.9055	8.229	0.083 00
200 000.	277.95	0.8898	10.772	0.083 00
300 000.	333.39	0.8642	15.744	0.083 00
500 000.	421.57	0.8309	25.396	0.083 00
700 000.	493.24	0.8123	34.796	0.083 00
1 000 000.	583.59	0.7950	48.587	0.083 00
1 500 000.	707.91	0.7783	71.014	0.083 00
2 000 000.	812.72	0.7681	92.958	0.083 00
3 000 000.	988.53	0.7557	135.865	0.083 00
5 000 000.	1267.31	0.7429	219.158	0.083 00

Table 5 – Definitions of signals during start-up

Signal	Synch Word (SW)	Superframe (ISW)	2B+D	M	Start	Stop	Time
TN	$\pm 3^1)$	$\pm 3^1)$	$\pm 3^1)$	$\pm 3^1)$	2)	2)	6 frames
SN1	Present	Absent	1	1	T1	T2	—
SN2	Present	Absent	1	1	T5	T6	—
SN3	Present	Present	Normal ⁺	Normal	T6	3)	—
TL	$\pm 3^1)$	$\pm 3^1)$	$\pm 3^1)$	$\pm 3^1)$	2)	2)	2 frames
SL1	Present	Absent	1	1	T3	T4	—
SL2	Present	Present	0	Normal	T4	T7	—
SL3	Present	Present	Normal ⁺	Normal	T7	3)	—

NOTES

- 1 TN, TL are tones produced by NT or LT, respectively (see 6.4.4).
 - 2 SNx, SLx are pulse patterns produced by NT or LT, respectively.
 - 3 Notation "Tx" refers to transition instants defined in figure 17.
 - 4 Notation "Absent" under superframe means that only SW is transmitted, not ISW.
 - 5 Notation "Normal" means that the M-bits are transmitted onto the 2-wire line as required during normal operation (e.g., valid crc bits, eoc bits, and indicator bits are transmitted).
 - 6 Notation "Normal+" means that except to perform a loopback, B- and D-channel bits shall remain in the previous state (i.e., the B- and D-channel bits shall remain set to 1 in SN3 and set to 0 in SL3) until transparency is achieved as described in 6.4.6.6.
- 1) Tones have alternating pattern of four +3s followed by four -3s, and no SW.
- 2) See figure 17 and 6.4.6 for start and/or stop time of this signal.
- 3) Signals SN3 and SL3 continue indefinitely (or until turn-off).

Table 6 – Characteristics of dc metallic termination in the NT

Type of operation.....	Normally OFF dc termination. Turned ON by application of metallic voltage. Held ON by loop current flow. Turned OFF by cessation of loop current flow.
Current in the ON state and at 15 V	≥ 20 mA
dc voltage drop (when ON) at 20-mA current.....	≤ 15 V
dc current with the application of 90 V through 4000 ohms for up to 2 seconds	min 9 mA. ¹⁾ See figure 24.
dc leakage current (when OFF) at 20 V.....	≤ 5.0 μ A
Activate/non-activate voltage.....	30.0 V dc $\leq V_{AN} \leq 39.0$ V dc
Activate (break over) current at V_{AN}	≤ 1.0 mA
Activate time for voltage $\geq V_{AN}$	3 ms to 50 ms
Hold/release current	0.1 mA $\leq I_{HR} \leq 1.0$ mA
Release/non-release time for current $\leq I_{HR}$	3 ms to 100 ms
Maximum voltages and currents.....	See annex B.
Supporting information.....	See annex F.

1) This requirement is intended to ensure a termination consistent with test system operation.

Table 7 – Power status bit assignments and messages

NT status	ps ₁ ps ₂ binary values	Definition
All power normal	11	Primary and secondary power supplies are both normal.
Secondary power out	10	Primary power is normal, but the secondary power is marginal, unavailable, or not provided.
Primary power out	01	Primary power is marginal or unavailable, secondary power is normal.
Dying gasp	00	Both primary and secondary power are marginal or unavailable. The NT may shortly cease normal operation.

Table 8 – Messages required for command/response eoc mode

Messages	Msg. code ¹⁾	Origin (o) & dest. (d)	
		Network	NT
Operate 2B+D loopback	0101 0000	o	d
Operate B ₁ -channel loopback	0101 0001	o	d
Operate B ₂ -channel loopback	0101 0010	o	d
Request corrupted crc	0101 0011	o	d
Notify of corrupted crc	0101 0100	o	d
Return to normal	1111 1111	o	d
Hold state	0000 0000	d/o	o/d
Unable-to-comply acknowledgment ²⁾	1010 1010	d	o

¹⁾ The leftmost bit of the Message Code is eoc₁₁ in figures 14a) and 14b). It is also the most significant bit, and it is transmitted and received before the other seven bits of the message code

²⁾ Affirmative acknowledgment implicit in eoc protocol.

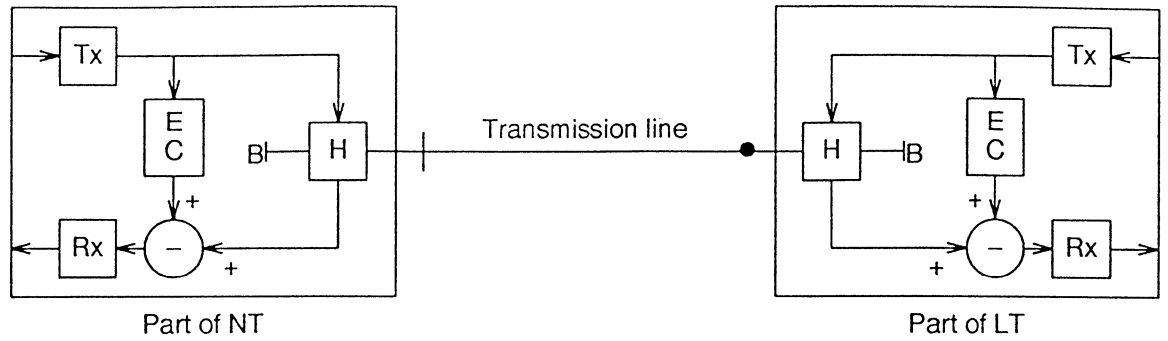

- B - Hybrid balance impedance
- Tx - Transmitter
- Rx - Receiver
- EC - Echo canceler
- H - Hybrid
- ⊖ - Subtractor

Figure 1 – Echo canceler with hybrid principle

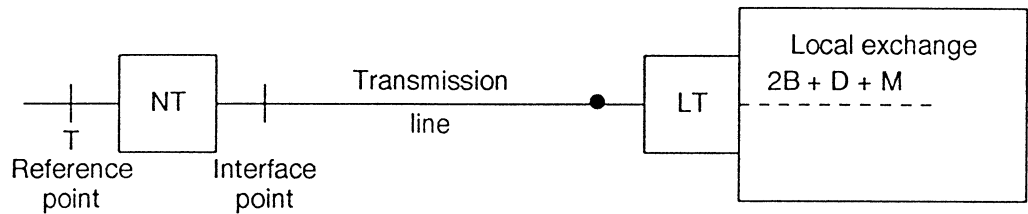

Figure 2 – Interface on the network side of the NT

Data	Time →								
	B ₁				B ₂				D
Bit pairs	b ₁₁ b ₁₂	b ₁₃ b ₁₄	b ₁₅ b ₁₆	b ₁₇ b ₁₈	b ₂₁ b ₂₂	b ₂₃ b ₂₄	b ₂₅ b ₂₆	b ₂₇ b ₂₈	d ₁ d ₂
Quat # (relative)	q ₁	q ₂	q ₃	q ₄	q ₅	q ₆	q ₇	q ₈	q ₉
# Bits	8				8				2
# Quats	4				4				1

NOTE — There are twelve 2B+D 18-bit fields per 1.5 ms basic frame.

where:

- b₁₁ = first bit of B₁ octet as received at the S/T-interface;
- b₁₈ = last bit of B₁ octet as received at the S/T-interface;
- b₂₁ = first bit of B₂ octet as received at the S/T-interface;
- b₂₈ = last bit of B₂ octet as received at the S/T-interface;
- d₁d₂ = consecutive D-channel bits (d₁ is first bit of pair as received at the S/T-interface);
- q_i = ith quat relative to start of given 18-bit 2B+D data field.

Figure 3 – 2B1Q encoding of 2B+D bit fields

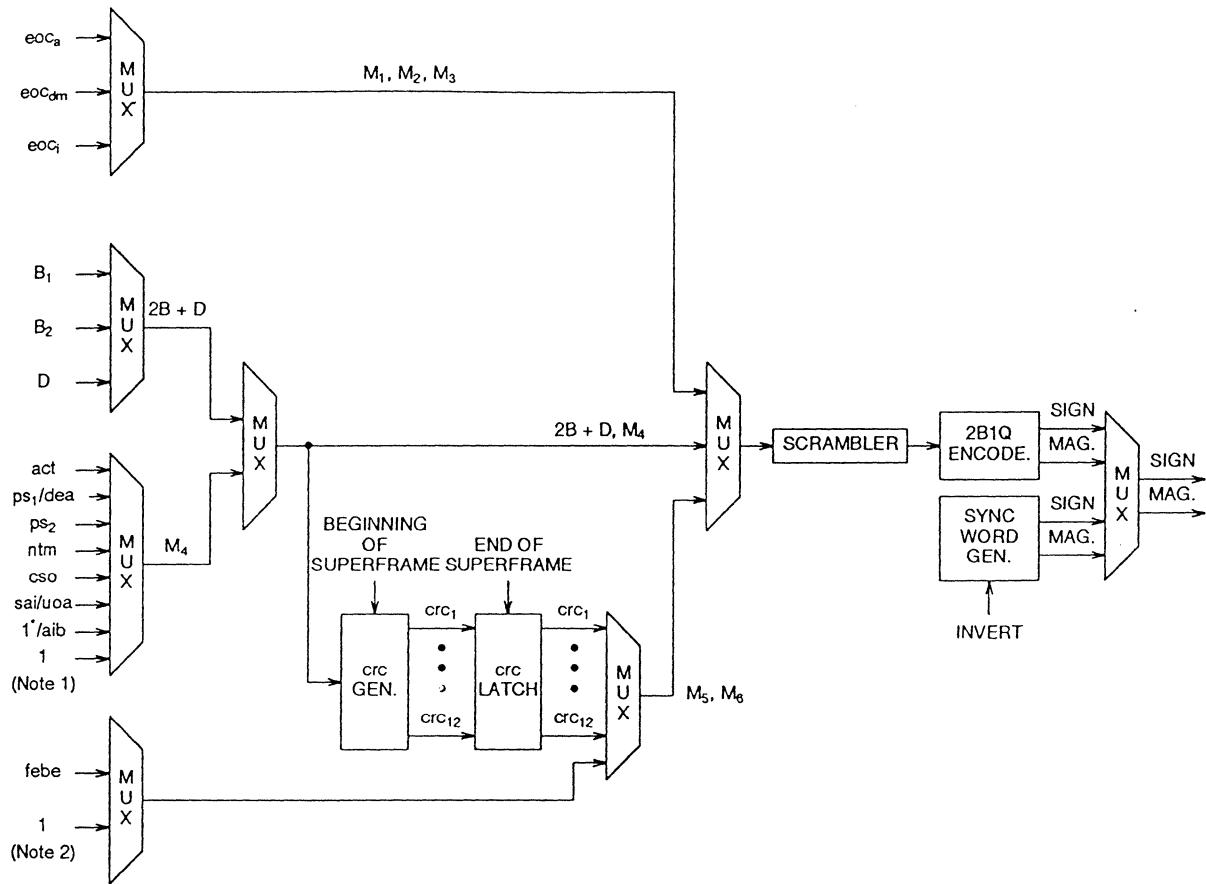

NOTES

- 1 M_4 bits reserved for future standardization (included in crc check).
- 2 M_5 and M_6 bits reserved for future standardization (excluded from crc check).

Figure 4 – DSL framer functional description

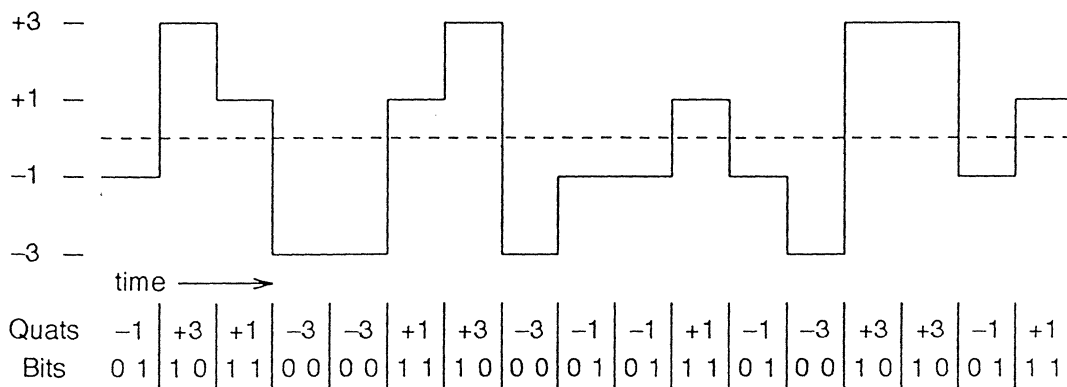
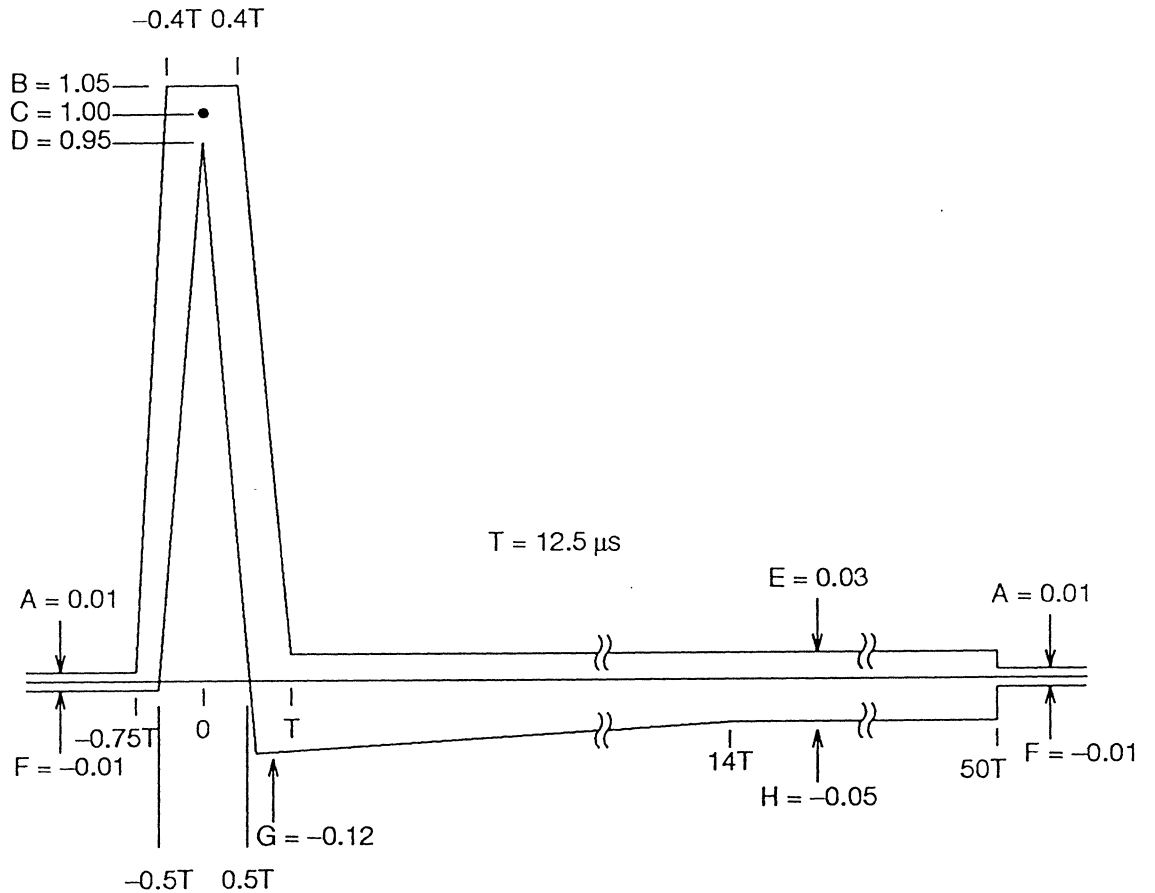

Figure 5 – Example of 2B1Q quaternary symbols



Normalized level:	Quaternary symbols:			
	+3	+1	-1	-3
A 0.01	0.025 V	0.00833 V	-0.00833 V	-0.025 V
B 1.05	2.625 V	0.8750 V	-0.8750 V	-2.625 V
C 1.00	2.5 V	5/6 V	-5/6 V	-2.5 V
D 0.95	2.375 V	0.79167 V	-0.79167 V	-2.375 V
E 0.03	0.075 V	0.025 V	-0.025 V	-0.075 V
F -0.01	-0.025 V	-0.00833 V	0.00833 V	0.025 V
G -0.12	-0.3 V	-0.1 V	0.1 V	0.3 V
H -0.05	-0.125 V	-0.04167 V	0.04167 V	0.125 V

NOTE – Compliance of transmitted pulses within boundaries of the pulse mask is not sufficient to ensure compliance with the power spectral density requirement and the absolute power requirement. Compliance with the requirements in 5.3.2.1 and 5.3.2.2 is also required.

Figure 6 – Normalized pulse from NT appearing at interface

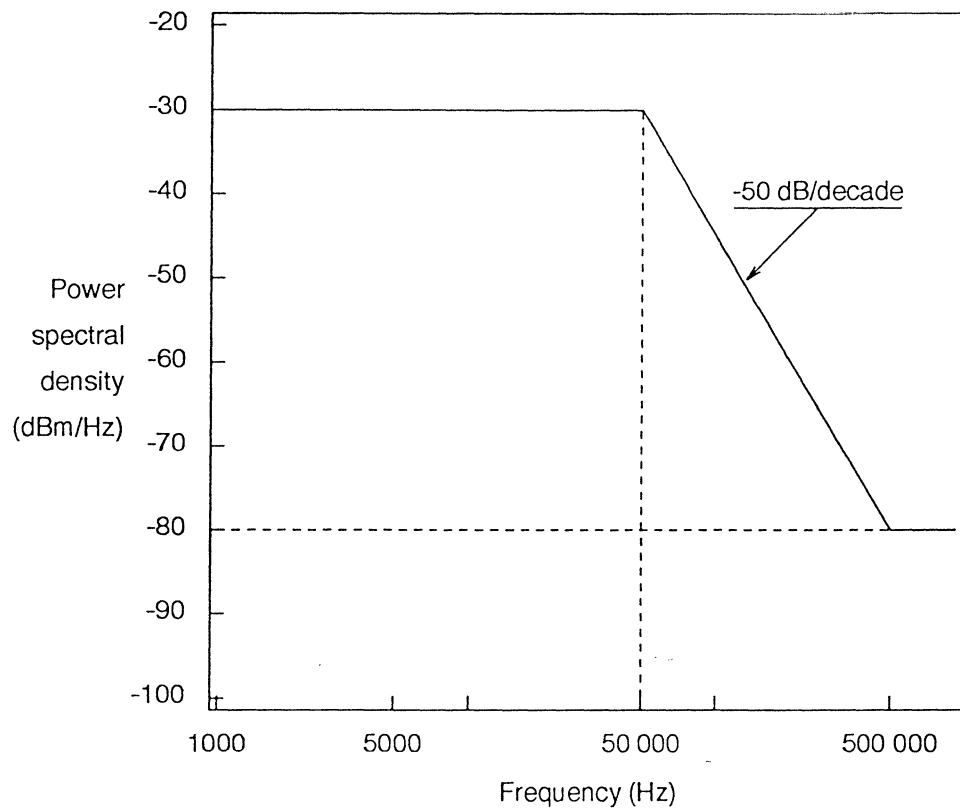
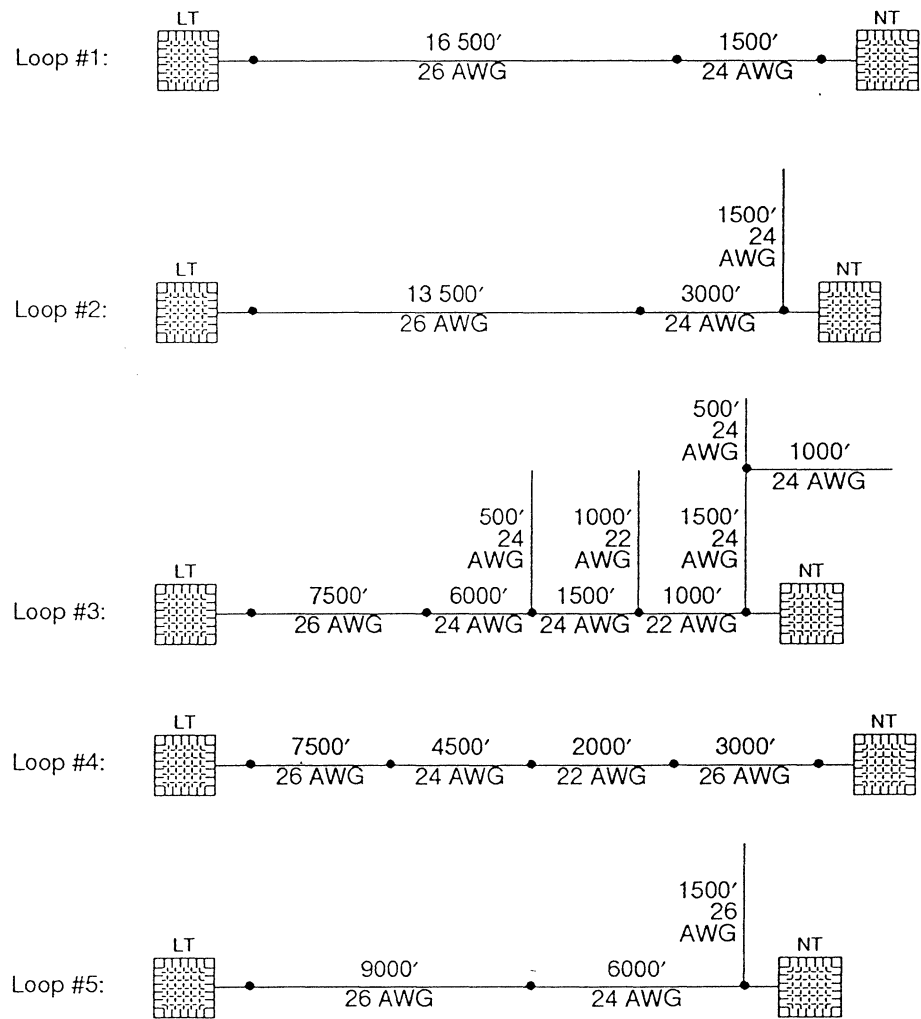

Figure 7 – Upper bound of power spectral density of signal from NT at interface



NOTES

- 1 AWG = American Wire Gauge.
- 2 Distances are in feet ('): 1000' = 0.3048 km.

a) Loops #1 – #5

Figure 8 – Loops for testing received signal performance

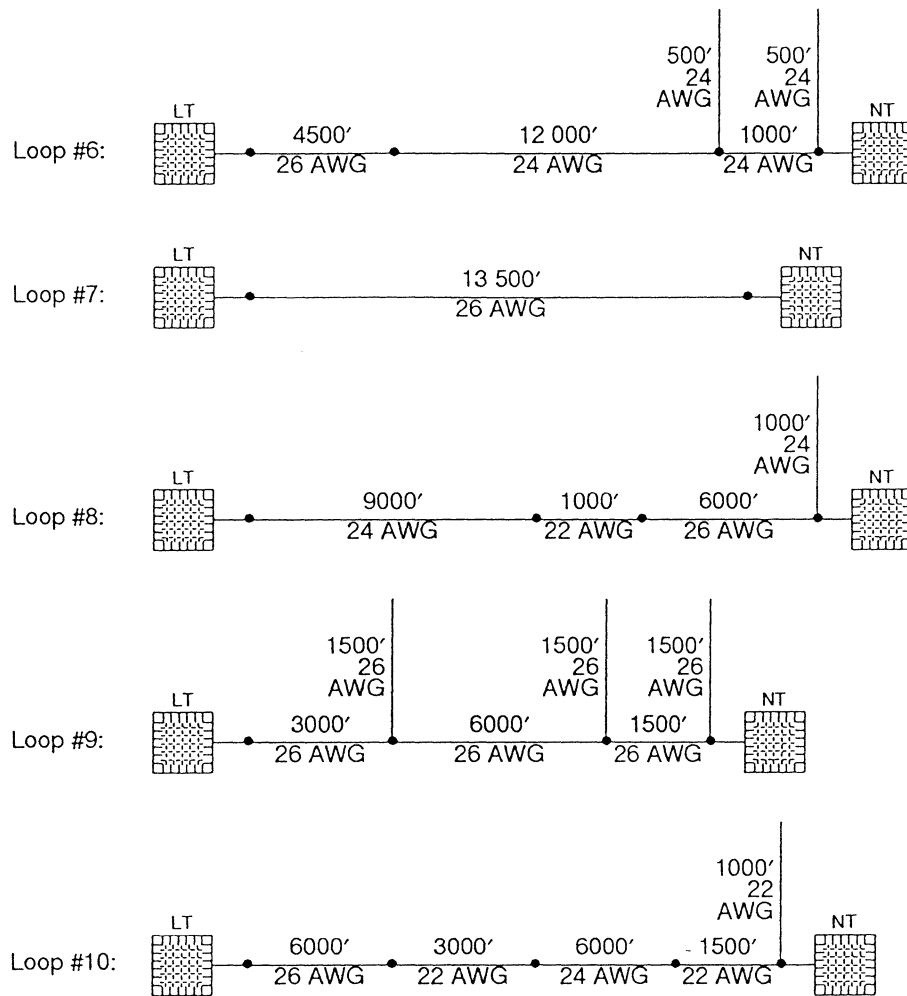

NOTES

- 1 AWG = American Wire Gauge.
- 2 Distances are in feet ('): 1000' = 0.3048 km.

b) Loops #6 – #10

Figure 8 (continued)

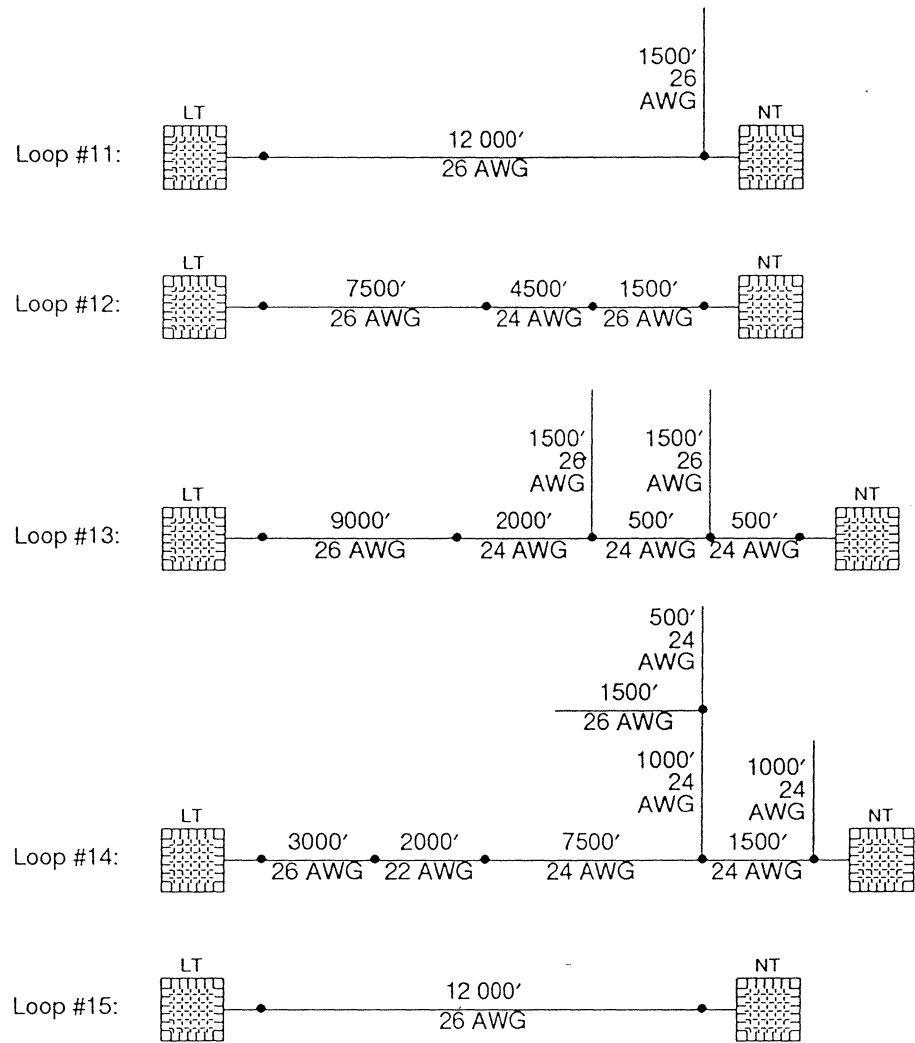

NOTES

- 1 AWG = American Wire Gauge.
- 2 Distances are in feet ('): 1000' = 0.3048 km.

c) Loops #11 – #15

Figure 8 (concluded)

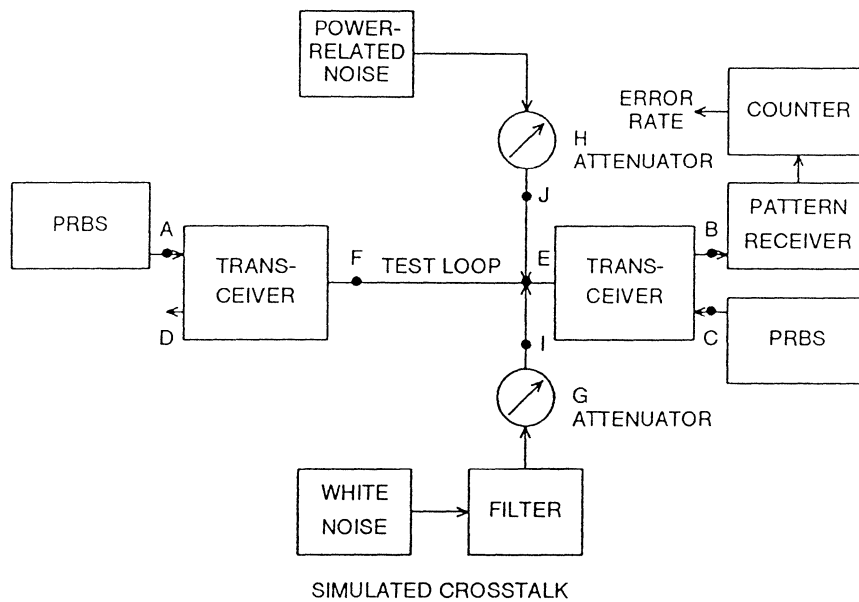

KEY

A	Far end transceiver binary input	F	Far end transceiver interface (not under test)
B	Near end transceiver binary output	G	Attenuator for calibration of simulated NEXT
C	Near end transceiver binary input	H	Attenuator for calibration of power-related noise
D	Far end transceiver binary output	I	High-impedance coupling circuit for simulated NEXT
E	Near end transceiver interface (noise sum point)	J	High-impedance coupling circuit for power-related noise

Figure 9 – Laboratory test set-up for measuring BER

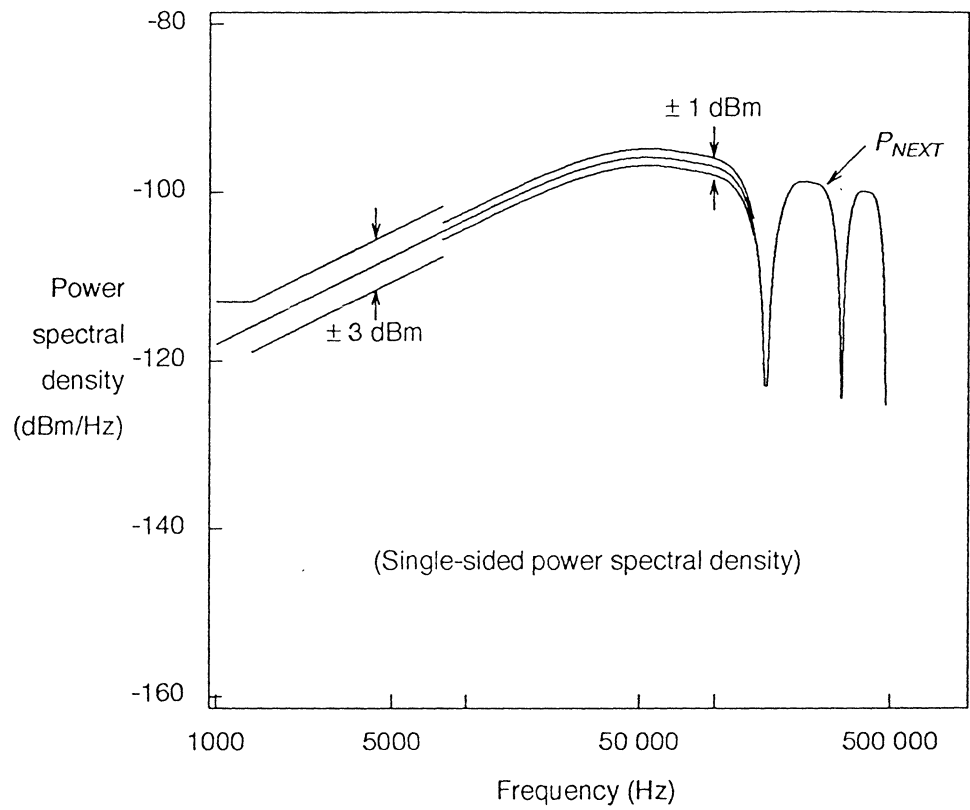

$$P_{NEXT} = \left[K \times \frac{1}{f_o} \times \frac{\left[\sin \left(\frac{\pi f}{f_o} \right) \right]^2}{\left[\frac{\pi f}{f_o} \right]^2} + K \times \frac{2}{2f_o} \times \frac{\left[\sin \left(\frac{\pi f}{2f_o} \right) \right]^2}{\left[\frac{\pi f}{2f_o} \right]^2} \right] \times \frac{\frac{3}{f^2}}{1.134 \times 10^{13}}$$

where

f = frequency in Hz;

f_o = 80 000 Hz;

$K = \frac{5}{9} \times \frac{V_p^2}{R}$;

$V_p = 2.33$ V;

$R = 135$ ohms.

Figure 10 – PSD for simulated near end crosstalk (NEXT) for testing 2B1Q system

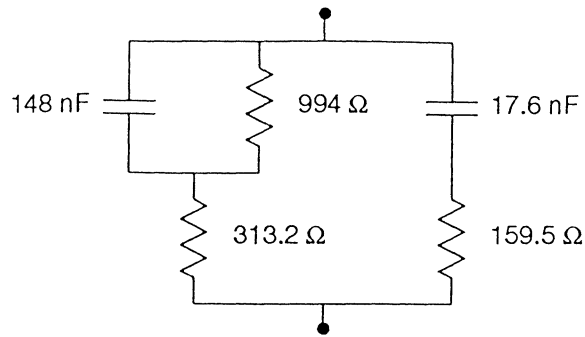

NOTE — Component tolerances $\pm 1\%$.

Figure 11 — Crosstalk calibration impedance, Z_c

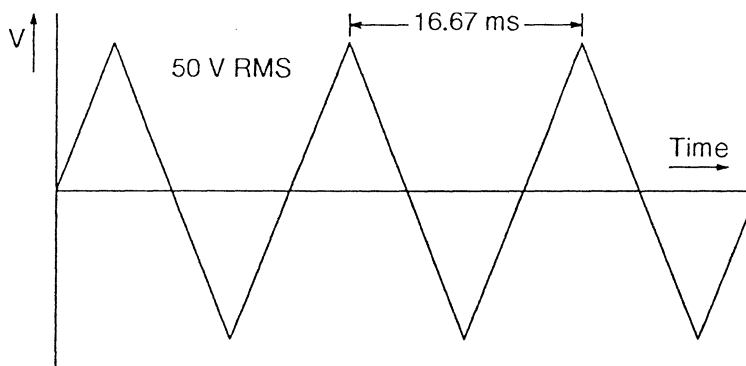

Figure 12 — Waveform for longitudinal noise

FRAME	← 1.5 milliseconds →		
	SW/ISW	12 x (2B+D)	M
Function	Sync word	2B+D	Overhead
# Quats	9	108	3
Quat positions	1-9	10-117	118-120
# Bits	18	216	6
Bit Positions	1-18	19-234	235-240

Frames in the NT-to-network direction are offset from frames in the network-to-NT direction by 60 ± 2 quats.

Symbols and abbreviations

quat	= quaternary symbol = 1 baud
- 3, - 1, + 1, + 3	= symbol names
2B+D	= Customer data channels B_1 , B_2 and D
SW	= Synchronization word (9-symbol code)
	= +3 +3 -3 -3 -3 +3 -3 +3 +3
ISW	= Inverted (or complementary) sync word
	= -3 -3 +3 +3 +3 -3 +3 -3 -3
M	= M-channel bits, M_1 - M_6

Figure 13 — ISDN basic access 2B1Q DSL 1.5-millisecond basic frame

Superframe #	Basic frame #	Sync word	2B+D	Overhead bits (M ₁ -M ₆)							
				FRAMING	2B+D						
				Quat positions	1-9	10-117	118s	118m	119s	119m	120s
Bit positions	1-18	19-234	235	236	237	238	239	240			
A	1	ISW	2B+D	eoc _{a1}	eoc _{a2}	eoc _{a3}	act	1	1		
	2	SW	2B+D	eoc _{dm}	eoc _{i1}	eoc _{i2}	dea	1	febe		
	3	SW	2B+D	eoc _{i3}	eoc _{i4}	eoc _{i5}	1	crc ₁	crc ₂		
	4	SW	2B+D	eoc _{i6}	eoc _{i7}	eoc _{i8}	1	crc ₃	crc ₄		
	5	SW	2B+D	eoc _{a1}	eoc _{a2}	eoc _{a3}	1	crc ₅	crc ₆		
	6	SW	2B+D	eoc _{dm}	eoc _{i1}	eoc _{i2}	1	crc ₇	crc ₈		
	7	SW	2B+D	eoc _{i3}	eoc _{i4}	eoc _{i5}	uoa	crc ₉	crc ₁₀		
	8	SW	2B+D	eoc _{i6}	eoc _{i7}	eoc _{i8}	aib	crc ₁₁	crc ₁₂		
B, C, ...											

a) Network → NT

Superframe #	Basic frame #	Sync word	2B+D	Overhead bits (M ₁ -M ₆)							
				FRAMING	2B+D						
				Quat positions	1-9	10-117	118s	118m	119s	119m	120s
Bit positions	1-18	19-234	235	236	237	238	239	240			
1	1	ISW	2B+D	eoc _{a1}	eoc _{a2}	eoc _{a3}	act	1	1		
	2	SW	2B+D	eoc _{dm}	eoc _{i1}	eoc _{i2}	ps ₁	1	febe		
	3	SW	2B+D	eoc _{i3}	eoc _{i4}	eoc _{i5}	ps ₂	crc ₁	crc ₂		
	4	SW	2B+D	eoc _{i6}	eoc _{i7}	eoc _{i8}	ntm	crc ₃	crc ₄		
	5	SW	2B+D	eoc _{a1}	eoc _{a2}	eoc _{a3}	cso	crc ₅	crc ₆		
	6	SW	2B+D	eoc _{dm}	eoc _{i1}	eoc _{i2}	1	crc ₇	crc ₈		
	7	SW	2B+D	eoc _{i3}	eoc _{i4}	eoc _{i5}	sai	crc ₉	crc ₁₀		
	8	SW	2B+D	eoc _{i6}	eoc _{i7}	eoc _{i8}	1	crc ₁₁	crc ₁₂		
2, 3, ...											

b) NT → Network

Symbols and abbreviations

act = start-up bit (set = 1 during start-up)
aib = alarm indication bit (set = 0 to indicate interruption)
crc = cyclic redundancy check: covers 2 B+D & M₄
1 = most significant bit
2 = next most significant bit
etc.
cso = cold-start-only bit (set = 1 to indicate cold-start-only)
dea = turn-off bit (set = 0 to announce turn-off)
eoc = embedded operations channel
a = address bit
dm = data/message indicator (0 = data, 1 = message)
i = information (data or message)
febe = far end block error bit (set = 0 for errored superframe)

ntm = NT in test mode bit (set = 0 to indicate test mode)
ps₁, ps₂ = power status bits (set = 0 to indicate power problems)
quat = pair of bits forming quaternary symbol
s = sign bit (first in quat)
m = magnitude bit (second in quat)
sai = S-activation-indic. bit (optional, set = 1 for S/T activation)
uoa = U-only-activation bit (optional, set = 1 to activate S/T)
"1" = reserved bit for future standard (set = 1)
"1" = network indicator bit (reserved for network use, set = 2B+D = user data, bits 19-234 in frame.
M = M-channel, bits 235-240 in frame
SW/ISW = synchronization word/inverted synchronization word, bits 1-19 in frame

NOTES

- 8 × 1.5 ms basic frames → 12 ms superframe.
- NT-to-network superframe delay offset from network-to-NT superframe by 60±2 quats (about 0.75 ms).
- All bits other than the sync word are scrambled.

Figure 14 – 2B1Q superframe technique and overhead bit assignments

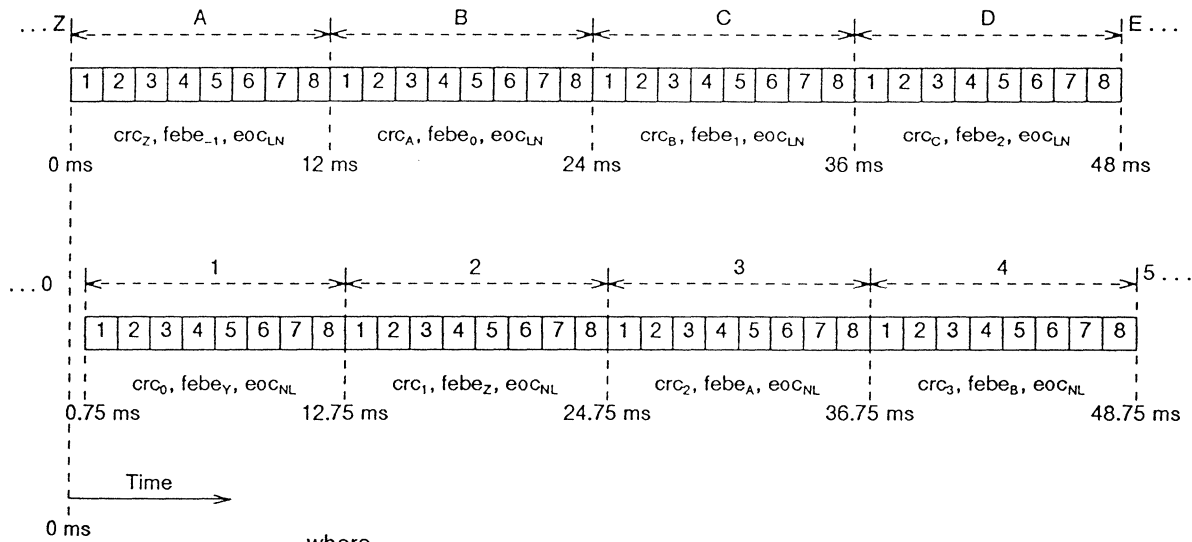

where

..., Y, Z, A, B, C, ... = Network-to-NT superframes;

..., -1, 0, 1, 2, 3, ... = NT-to-network superframes;

$[i]$ = i th 1.5 ms basic frame in given superframe;

crc_γ = Cyclic redundancy check code for superframe γ ;

$febe_\delta$ = Far end block error bit for superframe δ ;

eoc_{ij} = Embedded operations channel;

$ij = LN =$ Network-to-NT direction

$= NL =$ NT-to-network direction.

Figure 15 – DSL framing and overhead function temporal relationships

NT transmit scrambler (NT to LT) :

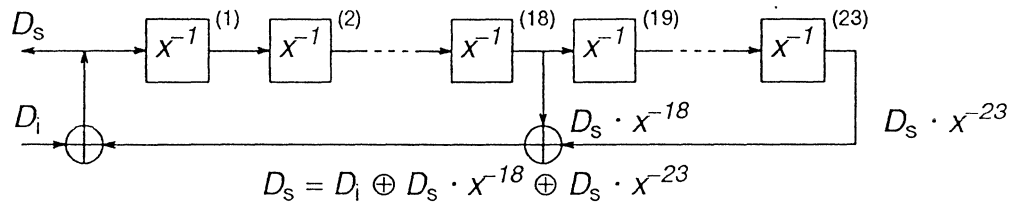

LT transmit scrambler (LT to NT) :

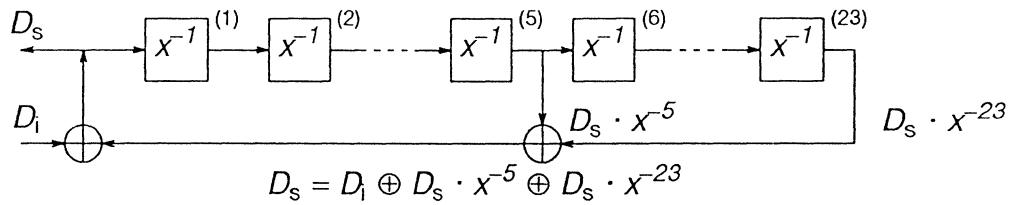

LT receive descrambler (NT to LT) :

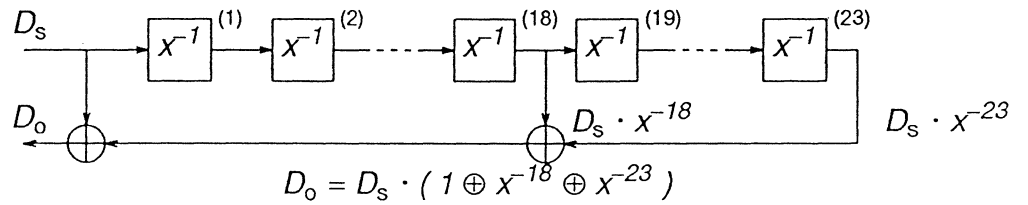

NT receive descrambler (LT to NT) :

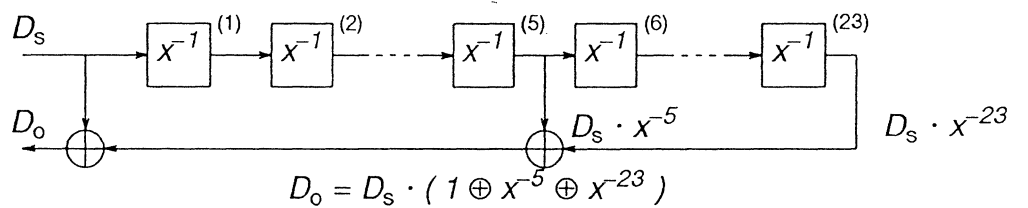
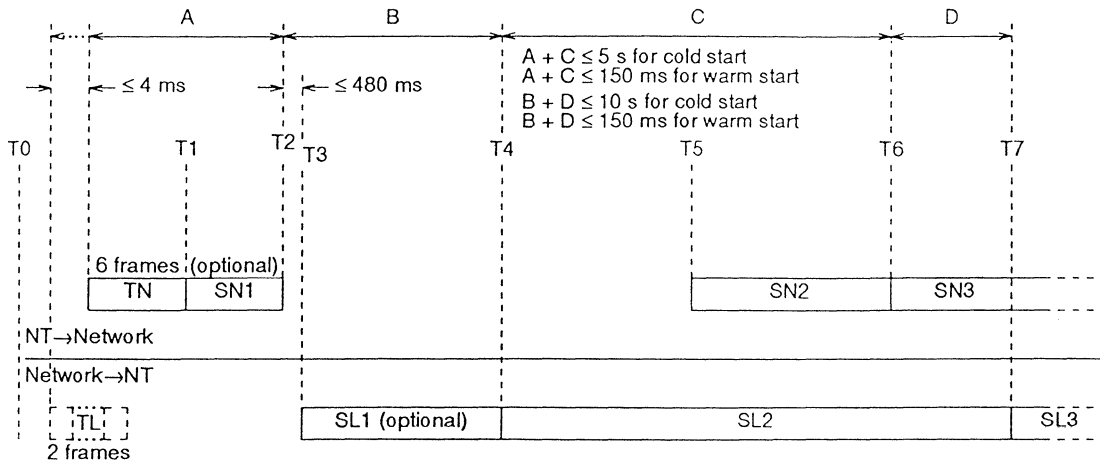
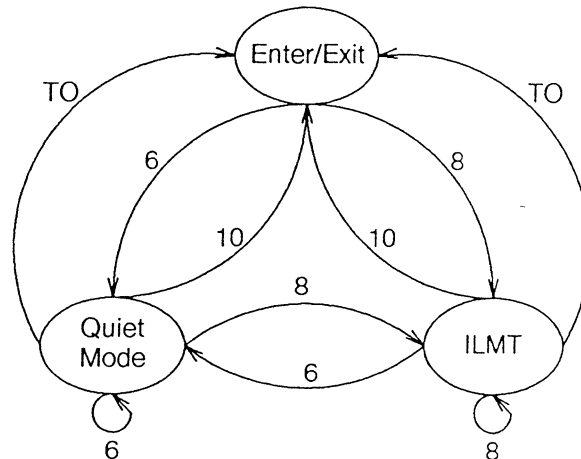

Figure 16 – Scrambler and descrambler



Time	Description of event or state
T0	RESET state.
T1	Network and NT are awake.
T2	NT discontinues transmission, indicating that the NT is ready to receive signal.
T3	Network responds to termination of signal and begins transmitting signal toward the NT.
T4	Network begins transmitting SL2 toward the NT, indicating that the network is ready to receive SN2.
T5	NT begins transmitting SN2 toward the network, indicating that NT has acquired SW frame and detected SL2.
T6	NT has acquired superframe marker, and is fully operational.
T7	Network has acquired superframe marker, and is fully operational.

Figure 17 – State sequence for DSL transceiver start-up



ILMT = Insertion loss measurement test
 Insertion loss signal = Scrambled, framed 2B1Q
 6, 8, 10 = Number of pulses within trigger signal
 Trigger signal = dc or low frequency ac pulses
 TO = Timeout = 75 seconds

NOTE — As a result of a power off/on cycle, the NT exits the maintenance mode and attempts start-up as described in 6.4.2.1. All knowledge of previous maintenance modes is lost.

Figure 18 – NT loop testing states

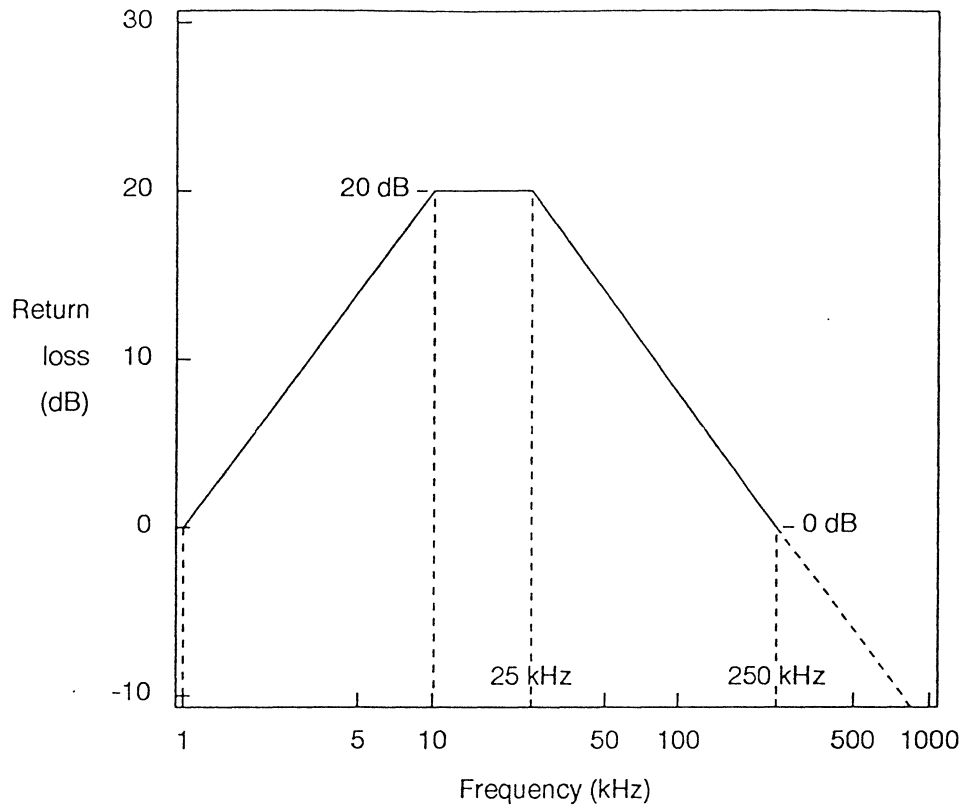
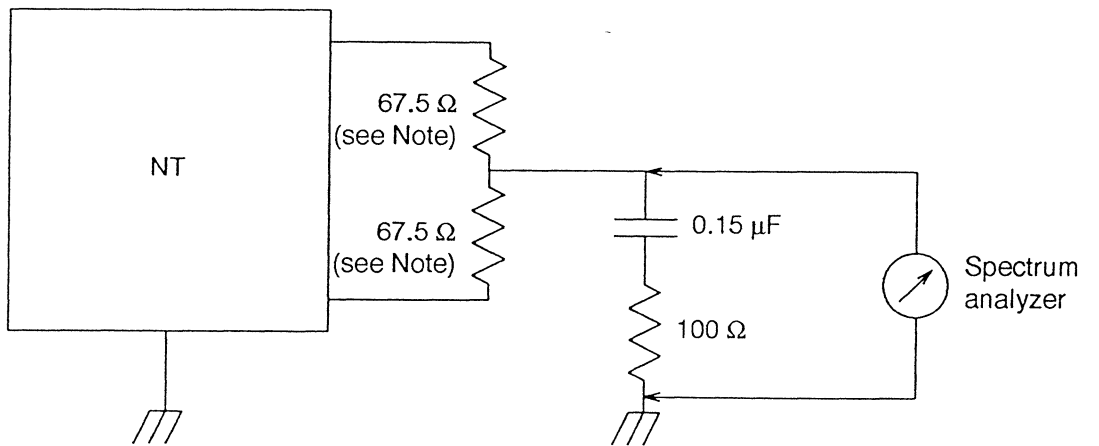

Figure 19 – Minimum return loss



NOTE – These resistors to be matched to better than 0.1% tolerance.

Figure 20 – Measurement method for longitudinal output voltage

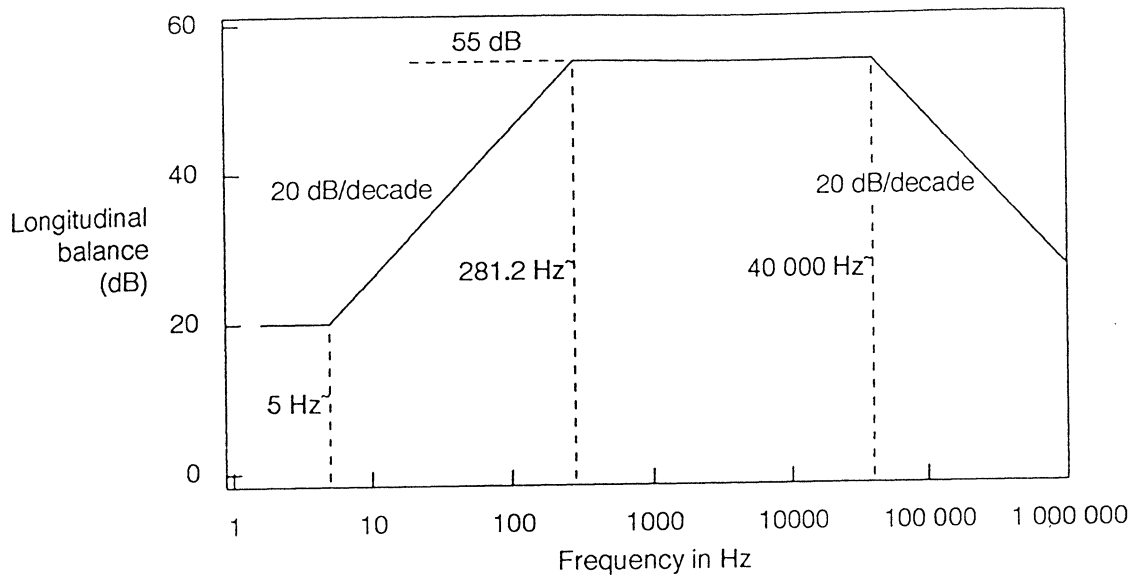
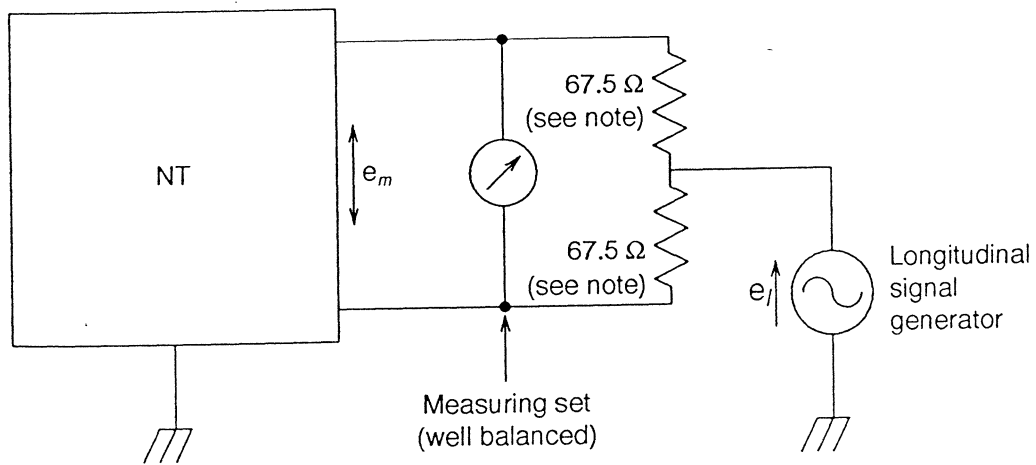
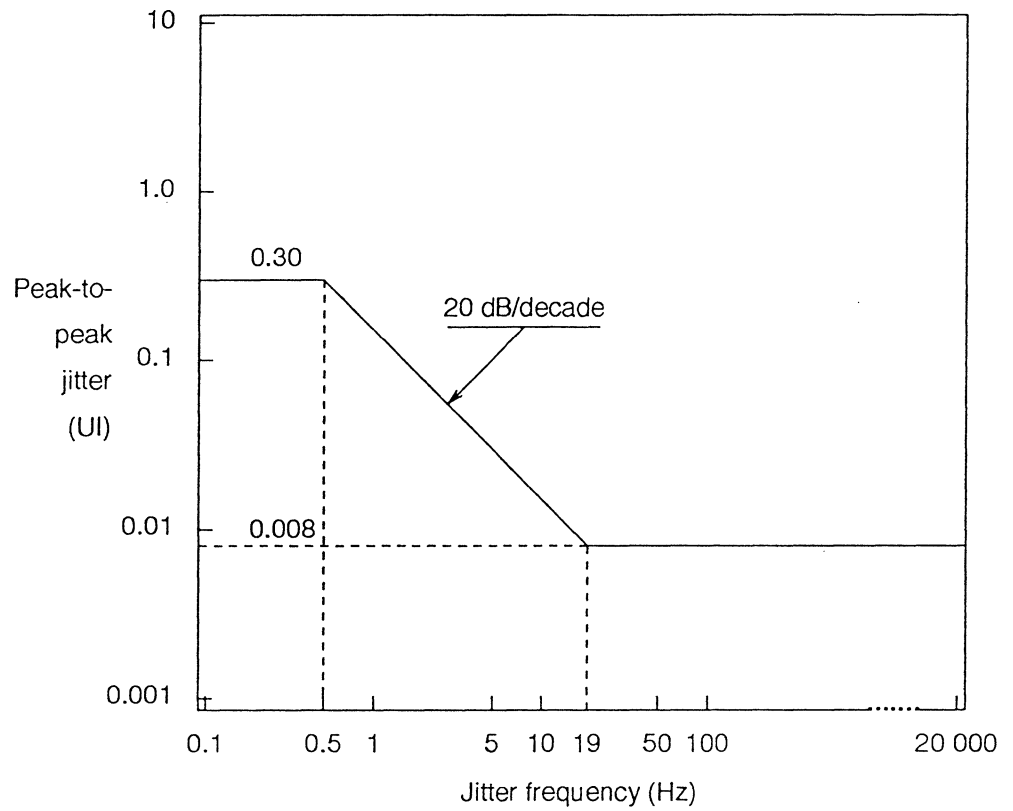

Figure 21 – Minimum longitudinal balance requirement



NOTE – These resistors to be matched to better than 0.03% tolerance.

Figure 22 – Measurement method for longitudinal balance



NOTE – Unit Interval (UI) = 12.5 μ s.

Figure 23 – Range of permissible sinusoidal jitter, signal originating from network

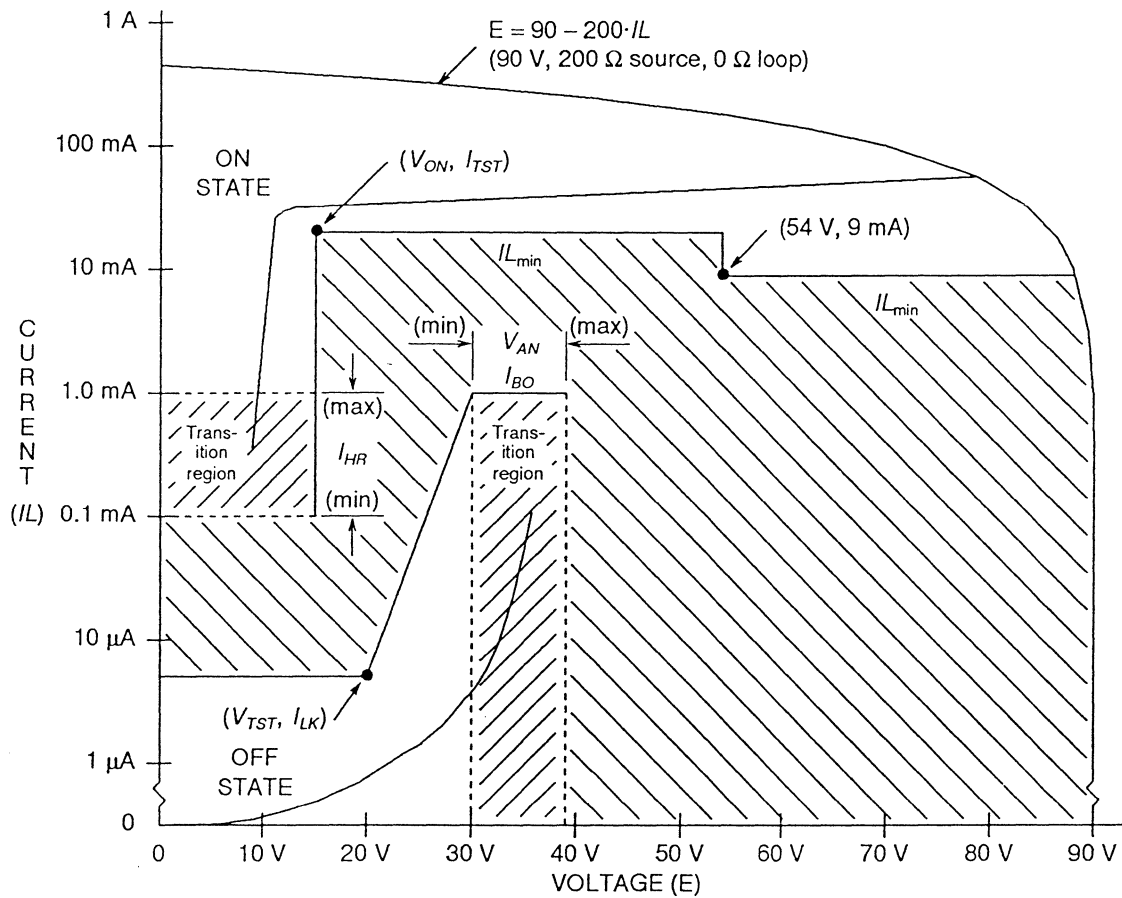

DC CHARACTERISTICS (EITHER POLARITY)

Parameter	Meaning	Limit	Condition	Meaning
I_{LK}	Leakage current	$I_{LK} \leq 5 \mu\text{A}$	$V_{TST} = 20 \text{ V}$	Test voltage
V_{AN}	Activate/Non-activate voltage	$30 \text{ V} \leq V_{AN} \leq 39 \text{ V}$		
I_{BO}	Break over current	$I_{BO} \leq 1.0 \text{ mA}$		
I_{HR}	Hold/Release current	$0.1 \text{ mA} \leq I_{HR} \leq 1.0 \text{ mA}$		
V_{ON}	ON voltage	$V_{ON} \leq 15 \text{ V}$	$I_{TST} = 20 \text{ mA}$	Test current
$I_{L_{min}}$	Minimum ON current	9 mA	54 V	

Figure 24 – Illustration of dc characteristics of the NT (bilateral switch and holding current)

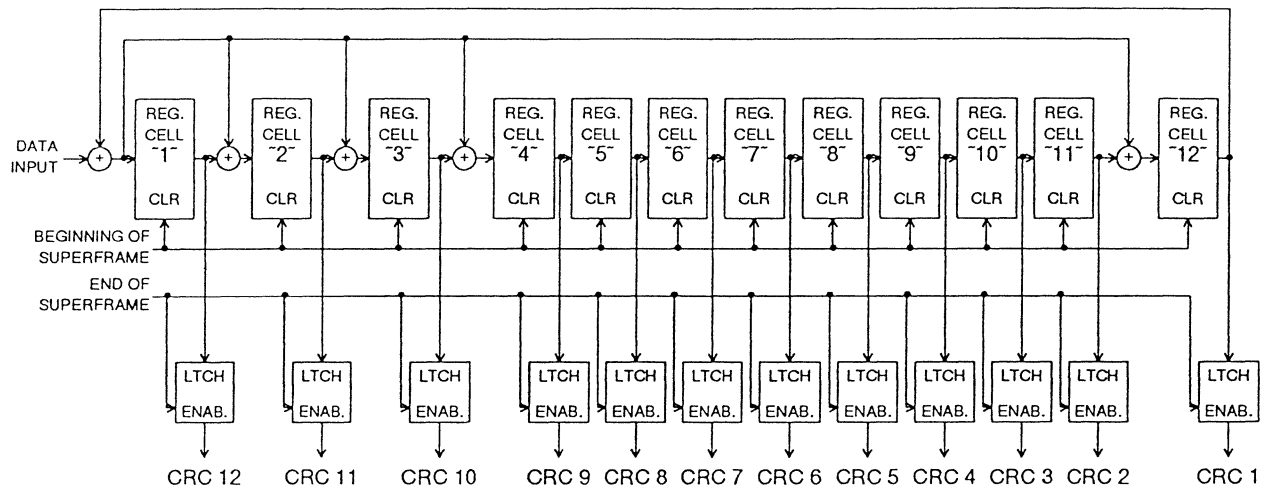

Figure 25 – CRC-12 generator

Annex A (informative)

Test loops and performance measurements

A.1 Notes on the class of test loops

The cable make-ups of 15 loops to be used in the measurement of BER were chosen with the help of configurations from a survey of customer loops taken in 1983. However, the actual loop make-ups, as found in the survey, have been somewhat simplified to make it easier to simulate these loops in a laboratory. Thus, the sections of different gauge are relatively long, and in multiples of a convenient length in kilofeet. The units, kilofeet and gauge, are used to conform to records for most existing North American telephone plants. Further information about the characteristics of the test loops is found in 5.4.1 and in annex G.

A.2 Notes on test procedure for measuring BER

The filter needed to simulate the crosstalk interference from 49 disturbers can be conceptually divided into three sections: one that is shaped like the power spectral density (PSD) of an assumed interferer; one representing a model for near-end crosstalk (NEXT) characteristics for 49 disturbers; and one that bandlimits the simulated crosstalk at four times the baud rate of the 2B1Q system (320 kHz). The design of the filter is not considered here. Requirements to ensure sufficient accuracy of the resulting simulated NEXT are given in the main text of the standard.

Figure A.1 shows the PSD of the assumed interferers, the basis of the first conceptual section, and is also expressed as P in an accompanying equation. The equation and the figure are single-sided PSDs, meaning that the integral of P , with respect to f , from 0 to infinity, gives the power in watts.

The first term in the equation for P is *half* of the PSD of an 80-kbaud 2B1Q signal with random equiprobable levels, full-baud square-topped pulses and no filtering (10.5 dBm). The second term is the PSD of a similar signal of twice the baud rate (13.5 dBm).

To complete our understanding of the assumed interferer, consider P_1 , also given in

figure A.1 and in another accompanying equation. P_1 is the *full* PSD of an 80-kbaud 2B1Q signal with random equiprobable levels, full-baud square-topped pulses, and no filtering (13.5 dBm). P_1 has the property that it is essentially identical to the PSD of most 2B1Q systems at frequencies below 50 kHz, but because there is no pulse shaping (filtering) it is greater than the PSD of most 2B1Q systems at frequencies above 50 kHz, and in fact it violates the upper bound for PSD (figure 7).

P is nearly identical to P_1 at frequencies below 50 kHz, but the second term causes the null in P_1 at 80 kHz to be filled in. Selection of P to represent the interferers is a deliberate attempt to force designers to sharply reduce the sensitivity of their receivers to interference components above 50 kHz. Because P has essentially the same value below 50 kHz as a transceiver meeting the standard, the margin should be the same as is achieved using the transceiver's own PSD as the basis for producing simulated crosstalk, as long as the receiver is properly filtered.

The second conceptual section, the simplified NEXT model, is a transfer function with loss decreasing at 15 dB per decade of frequency and having 57 dB loss at 80 kHz.

This transfer function results in the $f^{3/2}$ factor in P_{NEXT} (see 5.4.4.1). This transfer function cannot be realized as a separate filter because it exhibits a singularity at infinity. The transfer function is an approximation to the average NEXT loss for the worst 1% of pair combinations in a binder group in the population of all binder groups.

The problem of a singularity at infinity is moot because the complete filter includes a third conceptual section to bandlimit the simulated NEXT at four times the baud rate (320 kHz).

The electronic components that produce the artificial NEXT must permit the Gaussian signal to have unclipped peaks to at least six times its rms value.

The NEXT source defined in 5.4.4.1 is used by connecting it in parallel with the connection of the loop to the transceiver. See point I in figure 9.

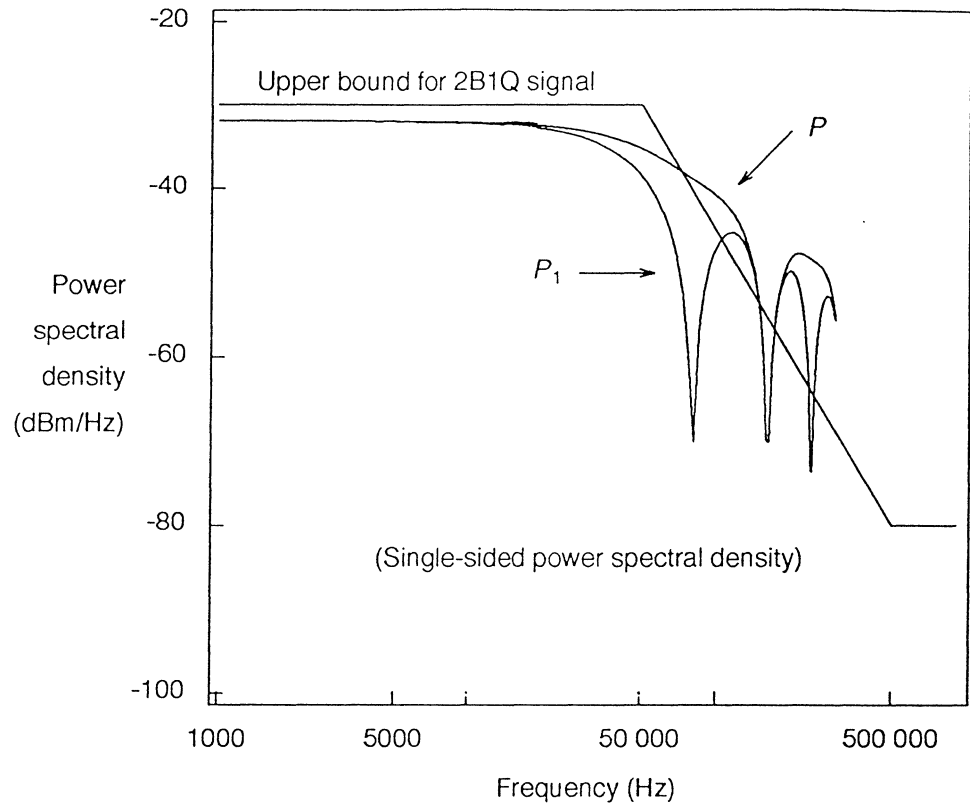

$$P = K \times \frac{1}{f_o} \times \frac{\left[\sin \left[\frac{\pi f}{f_o} \right] \right]^2}{\left[\frac{\pi f}{f_o} \right]^2} + K \times \frac{2}{2f_o} \times \frac{\left[\sin \left[\frac{\pi f}{2f_o} \right] \right]^2}{\left[\frac{\pi f}{2f_o} \right]^2}$$

$$P_1 = K \times \frac{2}{f_o} \times \frac{\left[\sin \left[\frac{\pi f}{f_o} \right] \right]^2}{\left[\frac{\pi f}{f_o} \right]^2}$$

where

f = frequency in Hz;

f_o = 80 000 Hz;

$K = \frac{5}{9} \times \frac{V_p^2}{R}$;

$V_p = 2.33$ V;

$R = 135$ ohms.

Figure A.1 – Power spectral density (PSD) of assumed interferers

Annex B (informative)

Overvoltage, surge protection, and EMC

The purpose of this interface standard is to present the electrical characteristics of the ISDN basic access signals appearing at the network side of the NT, and to describe the physical interface between the network and the NT. Such phenomena as lightning and overvoltages due to inductive interference or power crosses lie beyond the scope of this standard. However, these topics are discussed in other readily available documents, to which the interested reader is referred.

On lightning and 60-Hz overvoltages:

ANSI/IEEE C62.42-1986, *Guide for the application of gas tube arrester low-voltage surge protective devices*.

Lightning, radio frequency and 60-Hz disturbances at the Bell Operating Company Network Interface. Technical report TR-EOP-000001, issue 2, Piscataway, NJ.: Bellcore; 1987 June.

Both documents contain useful information on the application of surge arresters and the loop electrical environment.

The following standards documents are also applicable:

ANSI/EIA/TIA 571-1991, *Environmental considerations for telephone terminals*. This standard discusses the normal operating environment of telephone terminal equipment, fire hazards, and protection.

UL 1459, *Standard for telephone equipment*. This standard deals with safety considerations for telephone equipment.

The reader may also wish to consult:

Bodle, D. W.; Gresh, P. A. Lightning surges in paired telephone cable facilities. *Bell System Technical Journal* 40: 1961 March.

Gresh, P. A. Physical and transmission characteristics of customer loop plant. *Bell System Technical Journal* 48: 1969 December.

Heirman, Donald N. Time variations and harmonic content of inductive interference in

urban/suburban and residential/rural telephone plants. *IEEE, 1976 Annals No. 512C0010*.

Carroll, R. L.; Miller, P. S. Loop transients at the customer station. *Bell System Technical Journal* 59(9): 1980 November.

Carroll, R. L.; Loop transient measurements in Cleveland, South Carolina. *Bell System Technical Journal* 59(9): 1980 November.

Measurement of transients at the subscriber termination of a telephone loop, CCITT, COM V-No. 53 (November 1983).

Batorsky, D. V.; Burke M.E. 1980 Bell system noise survey of the loop plant, *AT&T Bell Laboratories Technical Journal* 63(5): 1984 May-June.

Koga, Hiroaki; Motomitsu, Tamio. Lightning-induced surges in paired telephone subscriber cable in Japan. *IEEE Transactions of Electromagnetic Compatibility* EMC-27: 1985 August.

Clarke, Gord; Coleman, Mike. Study sheds light on overvoltage protection. *Telephony*: 1986 November 24.

The power emitted by the DSL is limited by the masks presented in figures 6 and 7 of the standard. Notwithstanding any information contained or implied in these figures, it is assumed that the DSL will comply with applicable FCC requirements on emission of electromagnetic energy. These requirements may be found in the Title 47, *Code of Federal Regulations*, Parts 15 and 68, and other FCC documents.

In the design of the NT, consideration should be given to the handling of the following additional environmental conditions:

- a) *The maximum continuous (sealing current) voltage*: The maximum dc voltage that can be applied from a sealing current source is -72 V (limited by safety considerations).

b) *Maximum short-term dc test voltages:* Metallic testing systems can apply voltages as high as +135 V. This voltage in combination with the -52-V office battery could result in voltages as high as 190 V across the NT. Source impedances in this case could be as low as 200 ohms. Test voltages such as this are applied for less than 1 second with repeated applications occurring with no greater than 25% duty cycle.

c) *Maximum accidental ringing voltages:* Ringing voltages can be accidentally applied to the NT. The largest ringing voltage that is applied to a loop from present-day switching systems is 105 V rms, 20 Hz superimposed on -52 V dc (-200.5 V peak) with a minimum source impedance of 200 ohms. Ringing cadences typically have a 33% duty cycle over a 6-second period.

Annex C (informative)

DSL start-up and activation

The requirements for start-up of digital subscriber line transceivers at the interface on the network side of the NT are given in 6.4. The standard covers both the case in which the transmission system remains active essentially all the time as well as the optional case in which the transceivers are turned-on only when needed for transmission. Total activation is a term used to include both DSL start-up and activation of the S/T-interface. Operation involving the U-only activation feature (see 6.2.5, 8.2.7, and 8.2.8) is also described. The activation process is controlled from points away from the interface, and therefore the context of the requirements given in 6.4 is much more than the interface requirements given there.

The purpose of this annex is to discuss examples of how the start-up sequence described in 6.4 may relate to other activation events away from the interface. It is not the intention of this annex to specify requirements on how the NT relates events at its two interfaces. For a complete discussion of the activation requirements at the S and T reference points, see ANSI T1.605 or CCITT Recommendation I.430.

Figure C.1 shows the layer 1 customer access, including the ISDN system, the LT, the NT, and the TE. Signals that cross each boundary are listed below it, with arrows indicating direction. For instance, the signals TL, SLO, SL1, SL2, and SL3, as discussed in 6.4, are shown going from the LT to the NT. As indicated in figure C.1, CCITT Recommendation G.960 discusses signals crossing all the boundaries. The signals crossing the NT-TE boundary are discussed in greater detail in both CCITT Recommendation I.430 and in ANSI T1.605. The signals on the interface between the NT and LT are discussed in greater detail in both CCITT Recommendation G.961 and the main body of this standard.

Not all signals shown crossing the "boundary" between the ISDN system and the LT may actually cross that boundary. For instance, either the status of DSL synchronization, or the presence of DSL signal could be used entirely within the LT with only the primitives (AI, DI) indicating DSL status to the ISDN system. Furthermore, the indication primitives or the status indicators may simply be deliverable on request, as opposed to actively transmitted across the boundary. This depends on the architecture of the ISDN system and on where one draws the boundary between the LT and the rest of the ISDN system.

The purpose in detailing the activation process in this annex is to understand the context for the requirements found in 6.4. Therefore, only those functions found in figure C.1 that relate to start-up or turn-off will be discussed further.

Figure C.2 illustrates the total activation process; figure C.2(a) when initiated by the exchange, and figure C.2(b) when initiated by the terminal equipment. The boxes in figure C.2 represent the start-up process; time moves toward the right; events at the network end of the system are represented across the bottom; and events at the TE end of the system are represented across the top. Signals above the box are at the T reference point. Signals below the box are inside the exchange. Signals inside the box are at the network side of the NT.

Other forms of illustration are also given in figures C.3 – C.8. In figures C.3 – C.8, time moves down, and additional details about signals exchanged by the LT and NT is shown. Deactivation and DSL-only activation is also illustrated.

The most complex form of illustration is found in the finite-state matrices, tables C.1 – C.5. See clauses C.4 and C.7.

C.1 Total activation initiated by the exchange (see 6.4.1.1)

Figure C.2(a) illustrates the total activation process initiated by the exchange.

The PH activate request (AR) is a switching system primitive impinging on the DSL from the network. The effect of this request is to start the process leading to total activation as described in 6.4, and figure 17, in which the network sends a tone toward the NT. The PH activate request also causes the overhead bit *dea* to be set equal to 1 in the network. At first this action has no effect, because there is no communication between network and the NT; no framing or synchronization, no convergence of the equalizer and echo canceler coefficients. Once the NT has acquired the superframe marker (at T6 of figure 17), the NT is in a position to begin to interpret overhead bits. After the NT has acquired the superframe marker (T6), and verifies *uoa* = 1, it sends INFO2 toward the TE. In time, the TE replies to INFO2 with INFO3. This event is signaled to the network by setting the overhead bit *act* in the NT-to-network direction equal to 1.

Again, setting *act* = 1 has no effect initially, because until T7 the network receiver cannot detect overhead bits from the NT.

At the NT, full operational status means that the NT has:

- a) acquired bit timing and frame synchronization;
- b) recognized the superframe marker; and
- c) fully converged both its echo canceler and equalizer coefficients.

This point is labeled T6 in figure 17. At this point, the NT introduces the superframe marker into its signal toward the network as an indication that the NT is fully operational. The presence of *act* = 1 in the signal SN3 from the NT conveys the presence of INFO3 at the T reference point. As long as the conditions for T6 hold, and if the presence of *dea* = 1 indicates a continuing request for activation from the exchange, and if INFO3 remains present at the T reference point and if *act* = 1 is received from the network, then the NT opens transparent transmission in the B- and D-channels in both directions.

At the network, full operational status of the DSL (beginning at point T7 in figure 17) means that the network has:

- a) acquired bit timing phase of the signal from the NT, and frame synchronization;
- b) fully converged its echo canceler and equalizer coefficients; and
- c) recognized the superframe marker from the NT.

After detecting *act* = 1 from the NT, the network sets *act* = 1 in the signal toward the NT. This last event is a signal to the NT that the network is ready for layer 2 communication. As long as full operational status is maintained, and if the total activate request from the exchange continues, and if the network continues to receive *act* = 1 from the NT, then the network begins transparent transmission in B- and D-channels in both directions.

Only after transceivers in the NT and LT have attained transmission transparency can the customer initiate or receive calls on the B- or D-channels.

The time scale in figure C.2 is not meant to be representative of the relative amounts of time spent on different parts of the processes.

The reader is referred to ANSI T1.605 or CCITT Recommendation I.430 for more information on the activation process at the S/T reference point, the interface between the NT and the customer terminal equipment.

Figure C.3(a) is an alternative illustration of total activation initiated by the network. The diagonal arrows show the direction of signal flow while the horizontal arrows show the direction of information flow.

C.2 Total activation initiated by the terminal equipment (see 6.4.1.1)

Figure C.2(b) illustrates the total activation process initiated by the terminal equipment. It is essentially similar to figure C.2(a), except that INFO1 from the TE begins the process. In this case, the NT starts the process described in 6.4 and figure 17 by sending a tone toward the network. Once the NT has acquired the super-

frame marker (at T6 in figure 17) it sends the INFO2 signal. The rest of the process is identical to figure C.2(a).

Although a process setting $dea = 1$ is not shown in figure C.2(b), the bit must be set equal to 1 by the network transceiver at some time before instant T4 of the start-up procedure (see figure 17). This is to ensure that the NT does not receive an inadvertent turn-off announcement after having achieved superframe synchronization.

Figure C.3(b) is an alternate illustration of total activation initiated by the terminal equipment. The diagonal arrows show the direction of signal flow while the horizontal arrows show the direction of information flow.

C.3 Total deactivation (see 6.4.1.7)

The PH deactivate request (DR) is a switching system primitive which starts the turn-off process described in 6.4.6.5. After detecting $dea = 0$, the NT deactivates the S/T-interface by sending INFO0.

Figure C.4 illustrates a method of showing total deactivation (a process that starts from total activation and is always initiated by the exchange).

C.4 Activation finite state matrices

The total activation/deactivation procedures for NTs and LTs are shown in the form of finite state matrices, tables C.1 and C.2, respectively. The finite state matrices reflect the requirements necessary to ensure proper interfacing of LTs with NTs and vice versa. The primitives at the layer 1 boundary are also described.

C.5 S/T-only activation

If the NT does not acquire the superframe marker within the maximum permitted time (15 seconds), the NT may send the INFO2 signal synchronized to an internal free-running clock. Once the NT receives the INFO3 signal from a

TE in response to this INFO2 signal, it may send the INFO4 signal. This procedure is required to permit the S/T-interface to activate for maintenance reasons when the network interface cannot activate.

C.6 DSL-only turn-on

The DSL-only turn-on request (UTR) is an optional switching system primitive. The effect of this request is to start the process described in 6.4 and in figure 17 in which the network sends the tone toward the NT. The PH DSL-only turn-on request also causes the overhead bits, $dea = 1$ and $uoa = 0$ toward the NT.

After the NT has acquired the superframe marker (at T6 in figure 17) and detected uoa bit = 0, it does not activate the S/T-interface.

After the network has acquired the superframe marker (at T7 in figure 17), the DSL is fully operational. Figure C.5 illustrates DSL-only turn-on (a process that starts from reset and is only initiated by the exchange).

C.6.1 Total activation initiated by the exchange when DSL-only is turned on

This process is initiated when the PH activate request AR replaces the UTR request. The network sets $uoa = 1$ toward the NT.

After detecting $uoa = 1$, the NT allows S/T-interface activation as described in clause C.1. Figure C.6 illustrates this process.

C.6.2 Total activation initiated by the terminal equipment when DSL-only is turned on

This process is initiated after receiving INFO1 from the TE while the DSL-only feature is turned on. The NT sends the sai bit = 1 toward the network. After detecting the sai bit = 1, the exchange may send back the PH activate request (AR). The network may refuse to send AR, for instance, when the access link is undergoing maintenance. Then the process continues as described in C.6.1. Figure C.7 illustrates this process.

C.6.3 S/T-interface-only deactivation

This process is initiated by the PH DSL-only turn-on request (UTR) and starts from total activation.

The network sends $uoa = 0$ toward the NT. After detecting $uoa = 0$, the NT shall deactivate the S/T-interface by sending INFO0. Then the NT sets $sai = 0$ toward the network. Figure C.8 illustrates this process.

C.7 Activation finite state matrices when DSL-only turn-on option is implemented

The activation/deactivation procedures for NTs and LTs including the DSL-only turn-on processes are shown in the form of finite-state matrices in tables C.4 and C.5.