

MALLORY

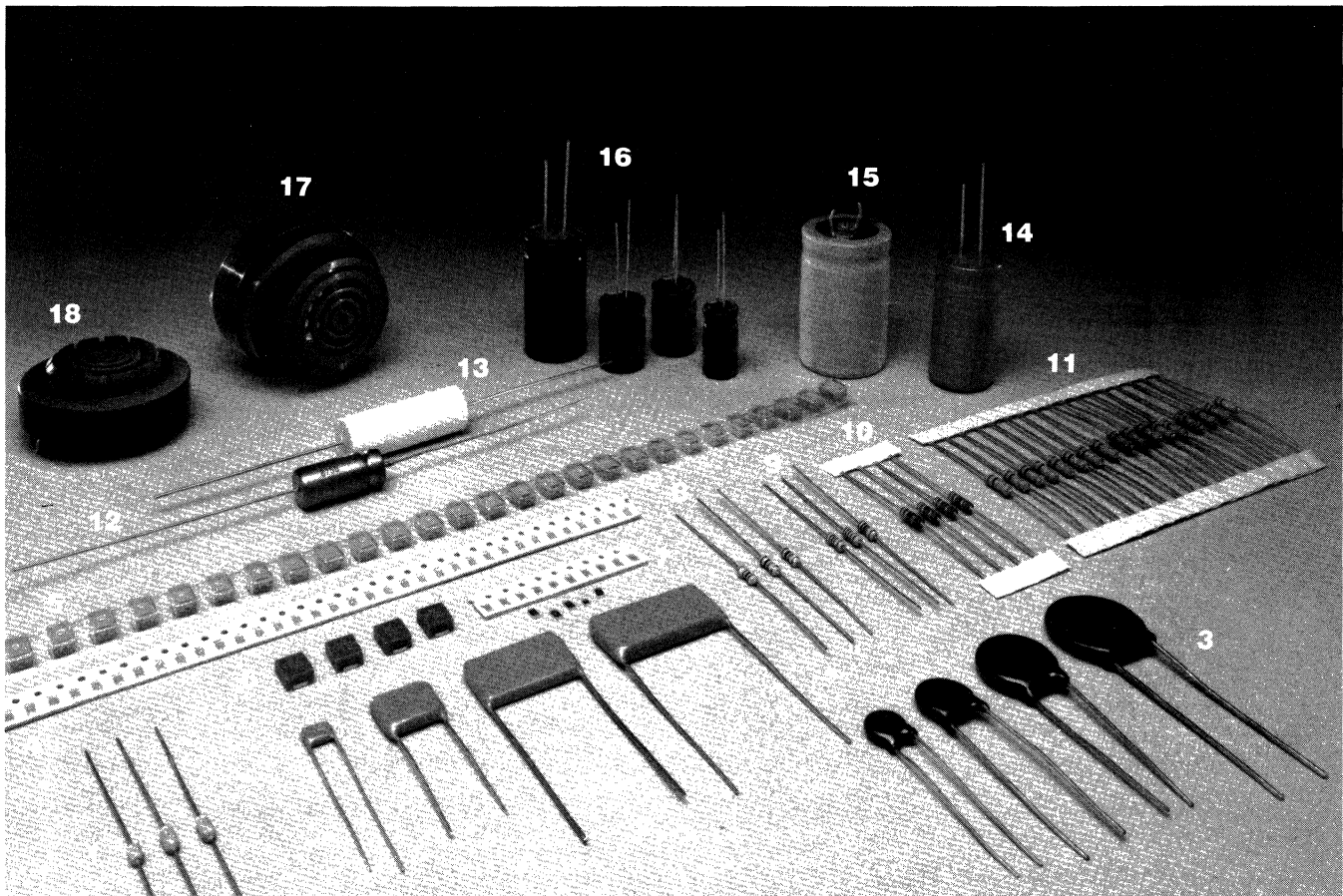

ELECTRONIC
COMPONENTS
GENERAL
CATALOG

NEW PRODUCTS



NAME	PAGE	NAME	PAGE
1 P Series Axial Leaded Multilayer Ceramic Capacitors	85-87	13 LP66N Metallized Polycarbonate, Axial Leaded Capacitors	14
2 M60 High Capacitance, High Voltage Multilayer Ceramic Capacitors	91-92	14 VTU 125°C Radial Leaded Aluminum Capacitors	60-61
3 VSA Voltage Surge Absorbers—Varistors	145-147	15 LP 105°C Low Profile, Snap-in Capacitors	52
4 0805/1206 Multilayer Ceramic Chip Capacitors	93	16 VTH 105°C Radial Leaded Aluminum Capacitors	57-59
5 TSC Solid Tantalum Chip Capacitors	39-40	17 SC307N Loud, Low Voltage Continuous Tone Sonalerts	94
6 198 Polyester Film Surface Mount Capacitors	11	SC416 Lower Voltage Continuous Tone Sonalerts	94
7 CR Chip Resistors	120-121	SC628N Loud, Continuous Tone Sonalerts	94
8 MFR Metal-Film Resistors	116-117	ST628 High Trigger, Continuous Tone Sonalerts	94
9 CFR Carbon-Film Resistors	119	18 SNP616P/J Slow and Fast Pulse Sonalerts for Snap-In Panel Assembly	95
10 CCR Carbon-Composition Resistors	115		
11 MOR Metal-Oxide Resistors	118		
12 CLR81 Tantalum Case, High Ripple, Extended Capacitance, Wet Slug Tantalum Capacitors	23-24		
THT Tantalum Case, High-Temperature Capacitors	22		

Introduction

The Mallory General Catalog presents in condensed form the vast array of electronic components distributed by The Mallory Capacitor Company. Mallory is a world leading supplier of DC film, tantalum, aluminum, AC electrostatic, monolithic and ceramic capacitors. Mallory also offers a complete line of audible signals and other electronic components, including metal oxide varistors, resistors, controls, switches, filters, fasteners, capacitor hardware and Mallobin component cabinets.

Throughout this catalog we have listed items representing standard popular ratings Mallory intends to stock in its central warehouse facility (with the exception of some Mil-spec part numbers). Over the life of this catalog, Mallory cannot guarantee availability of individual parts, and in limited cases, line item minimums may be required. In addition to the General Catalog, Mallory maintains detailed technical bulletins which can be used for your special order requirements.

Up to date price sheets and technical information bulletins are referenced for each product in this catalog and can be obtained from any one of the Mallory offices listed on the inside back cover.

Table of Contents

Product	Page	Product	Page
DC FILM CAPACITORS		MILITARY ESTABLISHED RELIABILITY MIL-C-39006 TYPES	
150 Series — Metallized Polyester, Axial	1	CLR65 — Silver Case, Hermetic Seal	18-19
152 Series — Film-Foil Polyester, Axial	2	CLR69 — Silver Case, High Capacitance, Hermetic Seal	20
160 Series — Metallized Polyester, Radial	3	CLR79 — Tantalum Case, High Ripple Hermetic Seal	21
167/184 Series — Metallized Polyester, Radial	4	• CLR81 — Tantalum Case, High Ripple Hermetic Seal, Extended Capacitance	23-24
168 Series — Metallized Polyester, Radial	5	SOLID TANTALUM ELECTROLYTIC CAPACITORS	
185 Series — Metallized Polyester, Radial	6	INDUSTRIAL (NON-MILITARY) TYPES	
170 Series — Metallized Polypropylene, Axial	7	TDC/TDL — Epoxy-Dipped, Radial Leads	27-28
171 Series — Metallized Polypropylene, Radial ...	8	TIM — Molded Rectangular Case, Radial Leads ...	29-30
158X Series — Metallized Polyester Suppressor, Radial	9	TAC — Molded Case, Axial Leads	31
172Y Series — Film-Foil Polypropylene Suppressor, Axial	10	TAS — Metal Case, Hermetic Seal, Axial Leads ...	32-33
173Y Series — Film-Foil Polypropylene Suppressor, Radial	10	TXA — Metal Case, Axial Leads, Extended Range	32-33
• 198 Series — Metallized Polyester, Surface Mount Chip	11	THF — Metal Case, High Frequency, Axial Leads ...	34
PVC — Polyester/Polypropylene, Epoxy Dipped, Radial	12	• TSC — Solid Tantalum Chip	39-40
SX — Polystyrene Film-Foil, Axial	13	MILITARY (NON-ER) MIL-C-26655 TYPE	
• LP66N — Metallized Polycarbonate, Axial	14	CS12/CS13 — Metal Case, Hermetic Seal	35
172/173/145/148/135 Series — DC Film Capacitors	14	MILITARY ESTABLISHED RELIABILITY MIL-C-39003 TYPES	
WET SLUG TANTALUM ELECTROLYTIC CAPACITORS		CSR13 — Metal Case, Hermetic Seal	36
INDUSTRIAL (NON-MILITARY) TYPES		CSR21 — Metal Case, High Frequency	37
MTP — Silver Case, Epoxy End Fill, Subminiature	15	CSR23 — Metal Case, Extended Range	38
CMT — Copper Case, Epoxy End Fill, Subminiature	15	CSR33 — Metal Case, Low DCL	38
TLS — Silver Case, Elastomer Seal	16	ALUMINUM ELECTROLYTIC CAPACITORS	
TLH — Silver Case, Extended Range	16	CYLINDRICAL TYPES	
• THT — Tantalum Case, High Temperature	22	CGS — Computer Grade, High Capacitance ..	41-42
TLW — Silver Case, High Temperature	22	CG — Computer Grade, High Reliability	43
XT — High Temperature, Hermetic Seal	25	MILITARY (NON-ER) MIL-C-3965 TYPES	
MILITARY (NON-ER) MIL-C-3965 TYPES		CL64/CL65 — Silver Case, Elastomer Seal	16
CL64/CL65 — Silver Case, Elastomer Seal	16	CL66/67 — Silver Case, Elastomer Seal	17
CL66/67 — Silver Case, Elastomer Seal	17	CL55 — Rectangular Case, High Capacitance, Hermetic Seal	26
CL55 — Rectangular Case, High Capacitance, Hermetic Seal	26		

Please note that, within each product class, other ratings are available by special order.

Product	Page
CGR — Computer Grade, High Ripple	44
CGO — Computer Grade, Power Supply Output	45
HES — Storage Capacitor, High Energy Discharge	46
SFC — Computer Grade, Stacked Foil, Bus	48
HC/NP — Phenolic Case, Polar/Non-Polar	49
FP, PFP, WP, PWP — Metal Can, Twist Prong	50-51
• LP — 105° C Low Profile, Snap-In	52
VPR — High Performance, Radial Leads	53-54
VTL — Miniature, Radial	55-56
• VTH — 105° C Miniature, Radial	57-59
• VTU — 125° C Miniature, Radial	60-61
TUBULAR TYPES	
TCG — Computer Grade, Long Life, Axial	62
TCX — Computer Grade, High Performance, Axial	63
TC — Industrial Grade, Axial Lead	64
TA — Miniature, Decade Ratings, Axial Lead	65
TT — Miniature, Axial Leads	66
AC CAPACITORS	
PSU — AC Motor Start, Round Bakelite Case ...	67
MPD/MPF — AC Motor Run, Metallized	
Polypropylene	68
OPN/RPN — AC Motor Run, Oil Filled, Oval/Round	
Can	69
MSF — AC Power Supply, Metallized Paper	70
CAPACITOR HARDWARE	71-74
DISC CERAMIC CAPACITORS	
General Purpose Discs, 50 to 1000WVDC, EIA	
Class II	75-77
Temperature Compensating Discs, 50 to	
3000WVDC, EIA Class I	78-79
Temperature/Frequency Stable Discs, 500 and	
1000WVDC	80
High Voltage Discs, 2000 and 3000WVDC, EIA	
Class II	80
Reduced Titanite Discs, EIA Class III	81
UL Recognized Across-The-Line Discs	81
Spark-Arrestor Discs, 1KV to 3KV	81
MONOLITHIC CERAMIC CAPACITORS	
INDUSTRIAL TYPES	
M — Epoxy Dipped, Z5U, X7R and NPO, Radial ...	82-84
• P — Epoxy Dipped, Z5U, X7R and NPO, Axial	85-87
MILITARY (NON-ER) MIL-C-11015 TYPE	
CK — Epoxy Molded Case, X7R, Radial and Axial	88-90
MILITARY ESTABLISHED RELIABILITY MIL-C-39014	
TYPES	
CKR — Epoxy Molded Case, X7R, Radial and Axial	88-90
• M60 — High CV, Y5U, X7V, Radial	91-92
• Multilayer Ceramic Chip, X7R, COG	93

Product	Page
SONALERT® AUDIO PRODUCTS	94-104
RFI FILTERS	105-112
RESISTOR/CONTROL PRODUCTS	
AE, AV, HJ, HHJ — Wirewound Resistors	113-114
• CCR — Carbon-Composition Resistors	115
• MFR — Metal-Film Resistors	116-117
• MOR — Metal-Oxide Resistors	118
• CFR — Carbon-Film Resistors	119
• CR — Chip Resistors	120-121
RVA/RVG — Subminiature Trimmers, Carbon and	
Cermet	122-123
MTC — Subminiature Carbon Trimmers	124
24U, 16M, 24S, 24Z — Carbon Control, Bushing	
Mount	125-126
MG, LW, MR, M, R, VW, VWS — Wirewound Control,	
Bushing Mount	127-129
MRC, MR-P — Wirewound Control, PC Mount	128-129
MR — Wirewound Control, Flange Mount	128
MR-T — Wirewound Control, Tab Mount	129
T, L, LL, RT, MGL, MGLL — Wirewound Audio	
Attenuators	130
M, K — Power Rheostats	131
Control and Switch Hardware	132
FASTENING DEVICES	133-142
SWITCHES	143
SEMICONDUCTORS	144
• VARISTORS — Transient/Surge Absorbers ...	145-147
DILB — DIP SOCKETS	148
CIRCUIT BREAKERS	149
MALLOBINS — Electronic Component Lab Kits ..	150
DATA & FORMULAS	151-153
TAPE & REEL SPECIFICATIONS	154-156

Please note that, within each product class, other ratings are available by special order.

Product Index

SERIES	DESCRIPTION	PAGE	SERIES	DESCRIPTION	PAGE	SERIES	DESCRIPTION	PAGE
ACR15KT	Bleeder	72	FBH	Tie Holder	134	MSF	Metallized Paper Capacitor	70
AE	Wirewound Resistor	113	FW	Bridge Rectifier	144	MTC	Carbon Trimmer	124
ASR	Spark Arrestor Disc Ceramic Capacitor	81	FWLC	Bridge Rectifier	144	MTC151	Mallobin	150
AT	Spark Arrestor Disc Ceramic Capacitor	81	GE	Disc Ceramic Capacitor	76	MTP	Wet Tantalum Capacitor	15
ATR	Spark Arrestor Disc Ceramic Capacitor	81	GH	Disc Ceramic Capacitor	76	M10 to M50	Monolithic Ceramic Capacitor	82-84
AV	Wirewound Resistor	114	GM	Disc Ceramic Capacitor	76	M60	• Multilayer Ceramic Capacitor	91-92
A1126012	Nut	132	GP	Disc Ceramic Capacitor	77	M2.5A	Rectifier Diode	144
A112602	Nut	132	GS5149A	Knob	132	M5104 to M5106	Knob	132
B	RFI Power Line Filter	105	G301	Mallobin	150	N	Cable Clamp	136
BP	Capacitor Mounting Plate	74	HB	Capacitor Mounting Bracket	74	NGS	Grommet	141
CBB	Adapter	149	HC	Aluminum Electrolytic Capacitor	49	NP	Aluminum Electrolytic Capacitor	49
CBE	Circuit Board Ejector	140	HES	Aluminum Electrolytic Capacitor	46	OB2 to OB4	Capacitor Mounting Bracket	73
CBS	Circuit Board Support	138	HHJ	Wirewound Resistor	114	OC1	Terminal Boot	73
CCP	Circuit Board Puller	137	HJ	Wirewound Resistor	114	OPN	AC Motor Run Capacitor	69
CCR	• Carbon Composition Resistor	115	HR	Harnessrap	135	PFP	Aluminum Electrolytic Capacitor	50-51
CE	Cardboard Sleeve	74	HS	Hex Spacer/Standoff	140	PGS	Grommet	141
CEC	Disc Ceramic Capacitor	78	HT	Disc Ceramic Capacitor	80	PL	Plastic End Cap	72
CES	Disc Ceramic Capacitor	79	J	RFI Power Line Filter	108	PLA	Plastic End Cap	72
CEU	Disc Ceramic Capacitor	79	K	RFI Power Line Filter	112	PSU	AC Motor Start Capacitor	67
CFCC	Cable Clamp	135	KK	Kwik Klip	137	PVC	Polyester Film Capacitor	12
CFR	• Carbon-Film Resistor	119	L	Audio Attenuator	130	PWP	Aluminum Electrolytic Capacitor	50-51
CG	Computer Grade Capacitor	43	LA	Disc Ceramic Capacitor	81	P10-P40	• Monolithic Ceramic Capacitors	85-87
CGO	Computer Grade Capacitor	45	LC	Disc Ceramic Capacitor	81	R	RFI Power Line Filter	109
CGR	Computer Grade Capacitor	44	LCBS	Circuit Board Support	138	R	Wirewound Control	129
CGS	Computer Grade Capacitor	41-42	LE	Disc Ceramic Capacitor	81	RB	Capacitor Mounting Bracket	71
CKR05/CKR06	Monolithic Ceramic Capacitor	88-89	LK171-1	Knob	132	RB	Mounting Bracket	132
CKR11 to CKR16	Monolithic Ceramic Capacitor	89	LL	Audio Attenuator	130	RI	Audio Attenuator	130
CK05/CK06	Monolithic Ceramic Capacitor	88-89	LP	• Low Profile Snap-In Capacitor	52	RPN	AC Motor Run Capacitor	69
CK12 to CK16	Monolithic Ceramic Capacitor	89	LP66N	• Metallized Polycarbonate Film Capacitor	14	RT	Audio Attenuator	130
CLR10 to CLR17	Wet Tantalum Capacitor	25	LW	Wirewound Control	128	RVA	Carbon Trimmer	122-123
CLR65	Wet Tantalum Capacitor	18-19	M	Rheostat	131	RVG	Cermet Trimmer	122-123
CLR69	Wet Tantalum Capacitor	20	M	Wirewound Control	129	RVS151	Mallobin	150
CLR79	Wet Tantalum Capacitor	21	MCP	Miniert	104	S	RFI Power Line Filter	110
CLR81	• Wet Tantalum Capacitor	23-24	MFR	• Metal Film Resistor	116-117	SBM	Sonalert	94
CL10 to CL18	Wet Tantalum Capacitor	25	MG	Wirewound Control	128	SC	Sonalert	94-104
CL55	Wet Tantalum Capacitor	26	MGL	Audio Attenuator	130	SCBS	Circuit Board Support	139
CL64/CL65	Wet Tantalum Capacitor	16	MGLL	Audio Attenuator	130	SD	Sonalert	101-102
CL66/CL67	Wet Tantalum Capacitor	17	MGT	Audio Attenuator	130	SFC	Stacked Foil Capacitor	48
CMC	Disc Ceramic Capacitor	78	MIL-C-11015/18	Monolithic Ceramic Capacitor	88	SM	Disc Ceramic Capacitor	80
CMT	Wet Tantalum Capacitor	15	MIL-C-11015/19	Monolithic Ceramic Capacitor	88-89	SNGS	Grommet	141
CMU	Disc Ceramic Capacitor	79	MIL-C-11015/20	Monolithic Ceramic Capacitor	88-89	SNP	Sonalert	94
CMW	Disc Ceramic Capacitor	79	MIL-C-11015/20	Monolithic Ceramic Capacitor	88-89	SP	Disc Ceramic Capacitor	80
CPC	Disc Ceramic Capacitor	78	MIL-C-26655	Solid Tantalum Capacitor	35	SS	Spacer	14
CPU	Disc Ceramic Capacitor	79	MIL-C-39003/01	Solid Tantalum Capacitor	36	ST	Sonalert	94
CPW	Disc Ceramic Capacitor	79	MIL-C-39003/03	Solid Tantalum Capacitor	38	SX	Polystyrene Film Capacitor	13
CR	• Chip Resistor	120-121	MIL-C-39003/06	Solid Tantalum Capacitor	38	SXK/SXL/SXM	Polystyrene Film Capacitor	13
CSR13	Solid Tantalum Capacitor	36	MIL-C-39003/09	Solid Tantalum Capacitor	37	SX301	Mallobin	150
CSR21	Solid Tantalum Capacitor	37	MIL-C-39006/09	Wet Tantalum Capacitor	18-19	T	Audio Attenuator	130
CSR23	Solid Tantalum Capacitor	38	MIL-C-39006/18	Wet Tantalum Capacitor	25	TA	Aluminum Electrolytic Capacitor	65
CSR33	Solid Tantalum Capacitor	38	MIL-C-39006/19	Wet Tantalum Capacitor	25	TAC	Solid Tantalum Capacitor	31
CS12/CS13	Solid Tantalum Capacitor	35	MIL-C-39006/20	Wet Tantalum Capacitor	25	TAS	Solid Tantalum Capacitor	32
CTZ	Disc Ceramic Capacitor	79	MIL-C-39006/21	Wet Tantalum Capacitor	20	TC	Aluminum Electrolytic Capacitor	64
DB	Circuit Breaker	149	MIL-C-39006/22	Wet Tantalum Capacitor	21	TCBS	Circuit Board Support	139
DILB	DIP Socket	148	MIL-C-39006/25	Wet Tantalum Capacitor	23	TCG	Aluminum Electrolytic Capacitor	62
DISC151	Mallobin	150	MIL-C-39014/01	Monolithic Ceramic Capacitor	88-89	TCG151	Mallobin	150
DISC151M	Mallobin	150	MIL-C-39014/02	Monolithic Ceramic Capacitor	88-89	TCX	Aluminum Electrolytic Capacitor	63
DLCBS	Circuit Board Spacer	139	MIL-C-39014/05	Monolithic Ceramic Capacitor	89	TCX151	Mallobin	150
E	Cable Clamp	136	MIL-C-3965/21	Wet Tantalum Capacitor	26	TC151	Mallobin	150
EB	Bushing	132	MIL-C-3965/24	Wet Tantalum Capacitor	17	TC151A	Mallobin	150
ED	RFI Power Line Filter	106	MONO151A	Mallobin	150	TDC	Epoxy-Dipped Tantalum Capacitor	27-28
EF	RFI Power Line Filter	106	MOR	• Metal Oxide Resistor	118	TDC151	Mallobin	150
EFB	• Sonalert	99-100	MP	Capacitor Mounting Plate	74	TDC151A	Mallobin	150
EH	RFI Power Line Filter	107	MPD/MPF	Metallized Polypropylene Run Capacitor	68	TDL	Epoxy-Dipped Tantalum Capacitor	27-28
EP	RFI Power Line Filter	111	MR	Wirewound Control	128-129	TH	Component Mounting Clip	71
EZ	Wire Tie	134	MRC	Wirewound Control	128	THF	Solid Tantalum Capacitor	34
FCC	Cable Clamp	135						
FF	Photoflash Capacitor	49						
FP	Aluminum Electrolytic Capacitor	50-51						

Please note that, within each product class, other ratings are available by special order.

Product Index

SERIES	DESCRIPTION	PAGE	SERIES	DESCRIPTION	PAGE	SERIES	DESCRIPTION	PAGE
THT	• Wet Tantalum Capacitor . . .	22	XTH/XTL/			20AV	Wirewound Resistor	114
TIM	Solid Tantalum Capacitor . . .	29-30	XTM/XTV	Wet Tantalum Capacitor . . .	25	20HJ	Wirewound Resistor	114
TL	Wire Tie	135	0805/1206	• Ceramic Chip Capacitor . . .	93	203 to 225	Washer	132
TLH	Wet Tantalum Capacitor . . .	16				21DE to 24DE	Metallized Polypropylene Run Capacitor	68
TLS	Wet Tantalum Capacitor . . .	16	1AV	Wirewound Resistor	114	21FB to 24FB	Metallized Polypropylene Run Capacitor	68
TLW	Wet Tantalum Capacitor . . .	22	1HJ	Wirewound Resistor	114	21FD to 24FD	Metallized Polypropylene Run Capacitor	68
TSC	• Tantalum Chip Capacitor . . .	39-40	1N4000 to 1N4007	Rectifier Diode	144	2115 to 2133	Adjustable Clips	114
TT	Aluminum Electrolytic Capacitor	66	10AE	Wirewound Resistor	114	232 to 255	Nut	132
TT151	Mallobin	150	10AV	Wirewound Resistor	114	24S	Carbon Control	125
TT151A	Mallobin	150	10HJ	Wirewound Resistor	114	24U	Carbon Control	125
TXA	Solid Tantalum Capacitor . . .	33	12	Mounting Foot	113	24Z	Carbon Control	126
UL	Circuit Breaker	149	150	Metallized Polyester Film Capacitor	1	2.5HJ	Wirewound Resistor	114
UN	Disc Ceramic Capacitor . . .	81	152	Film-Foil Polyester Film Capacitor	2	25K	Rheostat	131
V	Component Clip	136	158X	Metallized Polyester Film Suppressor	9	3AE	Wirewound Resistor	113
V	RFI Power Line Filter	110	16HJ	Wirewound Resistor	114	31112J to 3243J	Rotary Switch	143
VB	RFI Power Line Filter	105	16M	Carbon Control	125	32FD to 38FD	Metallized Polypropylene Run Capacitor	68
VJ	RFI Power Line Filter	108	160	Metallized Polyester Film Capacitor	3	32KD to 37KD	AC Metallized Paper Capacitor	70
VK	RFI Power Line Filter	112	167	Metallized Polyester Film Capacitor	4	32KE	AC Metallized Paper Capacitor	70
VPR	Aluminum Electrolytic Capacitor	53-54	168	Metallized Polyester Film Capacitor	5	364 to 368	Knob	132
VPR151	Mallobin	150	170	Metallized Polypropylene Film Capacitor	7	369 to 495	Dial Plate	132
VR	Capacitor Mounting Clamp . . .	73	171	Metallized Polypropylene Film Capacitor	8	37FB to 38FB	Metallized Polypropylene Run Capacitor	68
VR	RFI Power Line Filter	109	172Y	Film-Foil Polypropylene Film Capacitor	10	37KC to 38KC	AC Metallized Paper Capacitor	70
VSA	• Varistors	145-147	173Y	Film-Foil Polypropylene Film Capacitor	10	5	Mounting Foot	113
VSK	RFI Power Line Filter	108	18	Mounting Foot	113	5AE	Wirewound Resistor	113
VTH	• Aluminum Electrolytic Capacitor	57-59	184	Metallized Polyester Film Capacitor	4	5AV	Wirewound Resistor	114
VTL	Aluminum Electrolytic Capacitor	55-56	185	Metallized Polyester Film Capacitor	6	5HJ	Wirewound Resistor	114
VTL151	Mallobin	150	1910K	Metallized Polyester Film Capacitor	132	50K	Rheostat	131
VTU	• Aluminum Electrolytic Capacitor	60-61	198	• Chip Film Capacitor	11	7	Mounting Foot	113
VW	Wirewound Control	127	2AV	Wirewound Resistor	114	9	Mounting Foot	113
VWS	Wirewound Control	127	2HJ	Wirewound Resistor	114			
W	RFI Power Line Filter	110						
WIT	Cable Tie	133						
WP	Aluminum Electrolytic Capacitor	50-51						
WS	Wire Saddle	137						

Please note that, within each product class, other ratings are available by special order.

This General Catalog is not a contract. Its contents are limited by size. The information contained herein has been obtained from sources believed to be reliable, but no guarantee or warranty with respect to accuracy, completeness or results is implied and no liability is assumed. Nothing herein is to be construed as advising or authorizing practice of any invention covered by existing patents owned by Emhart or others without license from the owners thereof. In the interest of improved design and performance, Emhart reserves the right to make changes in any specification, data, or material contained herein without notice. It is the user's responsibility to see that the product is proper for use in user's application. Emhart's warranty for its products is subject to the limitations, exclusions, terms and conditions of its express warranty, a copy of which is available upon request.

Series 150 Metallized Polyester

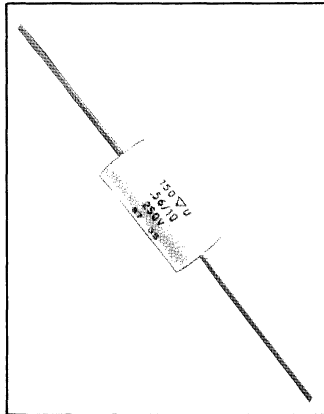

The 150 Series is a axial lead, metallized polyester capacitor, non-inductively wound, that is tape wrapped with epoxy end sealed. Temperature range is -55°C to 125°C with voltage derating above 85°C. Suggested applications are blocking, bypass, decoupling, smoothing, timing and tuning. For complete technical information, request bulletin 5-100. For pricing, reference price sheet E-450.

HIGHLIGHTS

Capacitance: .001μF to 3.3μF
(Other cap values available on special order)
Voltage: 100V, 250V, 400V and 630V
Temperature: -55°C to +125°C
(With voltage derating above +85°C)

Metallized Polyester

Cap μF	WVDC	Diameter	Length	P/N#
63 WVDC				
.47	63V -	.276	.650	150474*63DB
1.0	63V -	.315	.807	150105*63EC
100 WVDC				
.068	100V -	.197	.433	150683*100AA
.1	100V -	.197	.433	150104*100AA
.15	100V -	.236	.650	150154*100BB
.22	100V -	.256	.650	150224*100CB
.33	100V -	.315	.650	150334*100EB
.47	100V -	.276	.807	150474*100DC
.56	100V -	.315	.807	150564*100EC
.68	100V -	.335	.807	150684*100FC
1.0	100V -	.394	.807	150105*100IC
2.2	100V -	.453	1.102	150225*100LE
250 WVDC				
.015	250V -	.197	1.433	150153*250AA
.022	250V -	.197	.433	150223*250AA
.027	250V -	.197	.433	150273*250AA
.033	250V -	.197	.433	150333*250AA
.047	250V -	.197	.433	150473*250AA
.056	250V -	.197	.433	150563*250AA
.1	250V -	.256	.650	150104*250CB
.22	250V -	.335	.650	150224*250FB
.33	250V -	.335	.807	150334*250FC
.47	250V -	.374	.807	150474*250HC
.56	250V -	.394	.807	150564*250IC
.68	250V -	.354	1.102	150684*250GE
1.0	250V -	.413	1.102	150105*250JE

Cap μF	WVDC	Diameter	Length	P/N#
250 WVDC				
1.5	250V -	.492	1.102	150155*250ME
3.3	250V -	.610	1.299	150335*250TF
400 WVDC				
.01	400V -	.197	.433	150103*400AA
.018	400V -	.236	.650	150183*400BB
.022	400V -	.236	.650	150223*400BB
.047	400V -	.276	.650	150473*400DB
.1	400V -	.315	.807	150104*400EC
.15	400V -	.354	.807	150154*400GC
.22	400V -	.335	1.102	150224*400FE
.33	400V -	.394	1.102	150334*400IE
.47	400V -	.453	1.102	150474*400LE
.56	400V -	.453	1.102	150564*400LF
630 WVDC				
.001	630V -	.197	.433	150102*630AA
.0015	630V -	.197	.433	150152*630AA
.0022	630V -	.197	.433	150222*630AA
.0033	630V -	.197	.433	150332*630AA
.0039	630V -	.197	.433	150392*630AA
.0047	630V -	.197	.433	150472*630AA
.0068	630V -	.197	.433	150682*630AA
.01	630V -	.236	.650	150103*630BB
.047	630V -	.315	.807	150473*630EC
.1	630V -	.335	1.102	150104*630FE
.22	630V -	.453	1.102	150224*630LE
1.0	630V -	.807	1.299	150105*630YF

***Specify Tolerance**

- J = ±5%
- K = ±10%
- M = ±20%

Note: To order Tape and Reel Version see Specifications on Page 156.

MALLORY

Series 152 Film-Foil Polyester

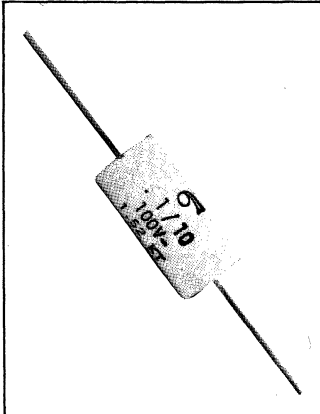

The 152 Series Capacitors are wound with a polyester film dielectric and thin gage foil under carefully controlled conditions, permitting reliable working voltages of 100, 200, 400, and 600 volts. The capacitor features extended foil sections, which are non-inductively wound, a flame retardent polyester outer wrap and flame retardent epoxy seals. Physical sizes of the 152 Series Capacitors have been chosen as closely as possible to those of various composition resistors for compatibility with automatic insertion equipment.

Request bulletin 5-101 for complete specifications. For pricing, reference price sheet 461.

HIGHLIGHTS

Capacitance: .00047 μ F to .33 μ F
(Other capacitance values available on special order)
Voltage: 100, 200, 400 and 600 VDC
Tolerance: \pm 10% (Other tolerances available on special orders)
Temperature: -55°C to $+125^{\circ}\text{C}$
(With voltage derating above $+85^{\circ}\text{C}$)

Film-Foil Polyester

Capacitance μ F	Diameter	Length	Catalog Number
100 WVDC			
.0022	.185	.421	152222K100AA
.0033	.185	.421	152332K100AA
.0047	.185	.421	152472K100AA
.0068	.185	.421	152682K100AA
.01	.185	.433	152103K100AB
.015	.185	.433	152153K100AB
.022	.236	.590	152223K100DC
.033	.295	.590	152333K100GC
.047	.335	.650	152473K100JD
.068	.295	.748	152683K100GE
.1	.335	.748	152104K100IE
.15	.354	1.024	152154K100JG
.22	.394	1.024	152224K100LG
.33	.492	1.279	152334K100NJ
200 WVDC			
.001	.185	.421	152102K200AA
.0015	.185	.421	152152K200AA
.0022	.185	.421	152222K200AA
.0047	.185	.421	152472K200AA
.0068	.185	.421	152682K200AA
.010	.185	.590	152103K200AC
.015	.236	.590	152153K200DC
.022	.236	.650	152223K200DD
.033	.256	.748	152333K200EE
.047	.295	.748	152473K200GE
.068	.354	.748	152683K200JE
.1	.394	.748	152104K200LE
.15	.374	1.024	152154K200KG
.22	.394	1.279	152224K200LI

Capacitance μ F	Diameter	Length	Catalog Number
400 WVDC			
.001	.185	.421	152102K400AA
.0015	.185	.421	152152K400AA
.0022	.185	.421	152222K400AA
.0033	.185	.421	152332K400AA
.0047	.236	.590	152472K400DC
.0068	.256	.650	152682K400ED
.01	.256	.650	152103K400ED
.015	.315	.590	152153K400HC
.022	.315	.748	152223K400HE
.033	.354	.748	152333K400JE
.047	.354	1.024	152473K400JG
.068	.354	1.299	152683K400JJ
.1	.453	1.102	152104K400MH
600 WVDC			
.00047	.185	.433	152471K600AB
.00068	.185	.433	152681K600AB
.001	.185	.433	152102K600AB
.0015	.197	.433	152152K600BB
.0022	.197	.433	152222K600BB
.0033	.236	.650	152332K600DD
.0047	.256	.650	152472K600ED
.0068	.275	.650	152682K600FD
.01	.315	.650	152103K600HD
.015	.315	.807	152153K600HF
.022	.335	.807	152223K600IF
.033	.354	1.102	152333K600JH

Series 160 Metallized Polyester

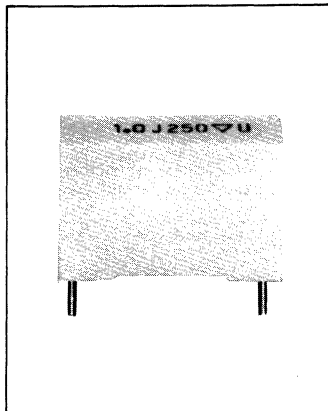

The Series 160 is a radial leaded, metallized polyester capacitor, non-inductively wound that is housed in flame retardant preformed case with epoxy fill. Operating temperature is -55°C to 125°C with voltage derating above 85°C. For complete technical information, request bulletin 5-104. For prices, reference price sheet E-425.

HIGHLIGHTS

Capacitance: .001μF to 4.7μF
(Other cap values available on special order)
Voltage: 160V, 250V, 400V, 630V, 1000V
Temperature: -55°C to +125°C
(With voltage derating above +85°C)

Metallized Polyester

Cap μF	WVDC	L	T	H	S	Od	P/N#
63 WVDC							
.27	63V-	.512	.157	.354	.394	.031	160274*63C
.33	63V-	.512	.157	.354	.394	.031	160334*63C
.47	63V-	.512	.197	.433	.394	.031	160474*63D
.68	63V-	.512	.236	.472	.394	.031	160684*63E
1.0	63V-	.512	.236	.472	.394	.031	160105*63E
1.0	63V-	.709	.197	.433	.591	.031	160105*63F
1.5	63V-	.709	.236	.472	.591	.031	160155*63G
2.2	63V-	.709	.295	.571	.591	.031	160225*63I
100 WVDC							
.1	100V-	.512	.157	.354	.394	.031	160104*100C
.12	100V-	.512	.157	.354	.394	.031	160124*100C
.15	100V-	.512	.157	.354	.394	.031	160154*100C
.18	100V-	.512	.157	.354	.394	.031	160184*100C
.22	100V-	.512	.197	.433	.394	.031	160224*100D
.27	100V-	.512	.197	.433	.394	.031	160274*100D
.33	100V-	.512	.236	.472	.394	.031	160334*100E
.33	100V-	.709	.197	.433	.591	.031	160334*100F
.39	100V-	.709	.197	.433	.591	.031	160394*100F
.47	100V-	.709	.197	.433	.591	.031	160474*100F
.56	100V-	.709	.236	.472	.591	.031	160564*100G
.68	100V-	.709	.236	.472	.591	.031	160684*100G
.82	100V-	.709	.295	.531	.591	.031	160824*100H
1.0	100V-	.709	.295	.531	.591	.031	160105*100H
1.5	100V-	1.04	.276	.650	.886	.031	160155*100M
3.3	100V-	1.04	.394	.748	.886	.031	160335*100O
4.7	100V-	1.26	.433	.787	1.08	.031	160475*100P
250 WVDC							
.033	250V-	.512	.157	.354	.394	.031	160333*250C
.039	250V-	.512	.157	.354	.394	.031	160393*250C
.047	250V-	.512	.157	.354	.394	.031	160473*250C
.056	250V-	.512	.157	.354	.394	.031	160563*250C
.068	250V-	.512	.157	.354	.394	.031	160683*250C
.082	250V-	.512	.157	.354	.394	.031	160823*250C
.12	250V-	.512	.197	.433	.394	.031	160124*250D
.12	250V-	.709	.197	.433	.591	.031	160124*250F
.15	250V-	.512	.236	.472	.394	.031	160154*250E
.15	250V-	.709	.197	.433	.591	.031	160154*250F
.18	250V-	.709	.197	.433	.591	.031	160184*250F
.22	250V-	.709	.197	.433	.591	.031	160224*250F
.27	250V-	.709	.236	.472	.591	.031	160274*250G
.337	250V-	.709	.236	.472	.591	.031	160334*250G
.47	250V-	.709	.295	.531	.591	.031	160474*250H
.47	250V-1.04	.237	.591	.886	.031	160474*250L	
.56	250V-	.709	.335	.571	.591	.031	160564*250I
.56	250V-1.04	.237	.591	.886	.031	160564*250L	
.68	250V-1.04	.276	.650	.886	.031	160684*250M	
1.0	250V-1.04	.335	.669	.886	.031	160105*250N	
1.5	250V-1.04	.394	.748	.886	.031	160155*250O	

Cap μF	WVDC	L	T	H	S	Od	P/N#
250 WVDC							
1.5	250V-	1.26	.354	.669	1.08	.031	160155*250P1
2.2	250V-	1.26	.433	.787	1.08	.031	160225*250P
3.3	250V-	1.26	.512	.866	1.08	.031	160335*250Q
400 WVDC							
.012	400V-	.512	.157	.354	.394	.031	160123*400C
.015	400V-	.512	.157	.354	.394	.031	160153*400C
.018	400V-	.512	.157	.354	.394	.031	160183*400C
.022	400V-	.512	.157	.354	.394	.031	160223*400C
.027	400V-	.512	.157	.354	.394	.031	160273*400C
.033	400V-	.512	.197	.433	.394	.031	160333*400D
.039	400V-	.512	.197	.433	.394	.031	160393*400D
.047	400V-	.709	.236	.472	.394	.031	160473*400E
.047	400V-	.709	.197	.433	.591	.031	160473*400F
.056	400V-	.709	.197	.433	.591	.031	160563*400F
.068	400V-	.709	.197	.433	.591	.031	160683*400F
.1	400V-	.709	.236	.472	.591	.031	160104*400G
.15	400V-	.709	.295	.531	.591	.031	160154*400H
.18	400V-	1.04	.237	.591	.886	.031	160184*400L
.22	400V-	1.04	.433	.591	.886	.031	160224*400L
1.0	400V-	1.26	.157	.787	1.08	.031	160105*400P
630 WVDC							
.0039	630V-	.512	.157	.354	.394	.031	160392*630C
.0047	630V-	.512	.157	.354	.394	.031	160472*630C
.0056	630V-	.512	.157	.354	.394	.031	160562*630C
.0068	630V-	.512	.157	.354	.394	.031	160682*630C
.0082	630V-	.512	.157	.354	.394	.031	160822*630C
.01	630V-	.512	.157	.354	.394	.031	160103*630C
.012	630V-	.512	.157	.354	.394	.031	160123*630C
.022	630V-	.512	.236	.472	.394	.031	160223*630E
.033	630V-	.709	.197	.433	.591	.031	160333*630F
.047	630V-	.709	.236	.472	.591	.031	160473*630G
.056	630V-	.709	.236	.472	.591	.031	160563*630G
.1	630V-	1.04	.236	.591	.886	.031	160104*630L
1000 WVDC							
.001	1000V-	.512	.157	.354	.394	.031	160102*1000C
.0012	1000V-	.512	.157	.354	.394	.031	160122*1000C
.0015	1000V-	.512	.157	.354	.394	.031	160152*1000C
.0018	1000V-	.512	.157	.354	.394	.031	160182*1000C
.0022	1000V-	.512	.157	.354	.394	.031	160222*1000C
.0027	1000V-	.512	.157	.354	.394	.031	160272*1000C
.0033	1000V-	.512	.157	.354	.394	.031	160332*1000C
.0047	1000V-	.512	.157	.354	.394	.031	160472*1000D
.0068	1000V-	.512	.236	.472	.394	.031	160682*1000E
.0082	1000V-	.512	.236	.472	.394	.031	160822*1000E
.01	1000V-	.709	.197	.433	.591	.031	160103*1000F
.022	1000V-	.709	.295	.531	.591	.031	160223*1000H
.1	1000V-	1.04	.394	.748	.886	.031	160104*1000D

***Specify Tolerance**

- J = ±5%
- K = ±10%
- M = ±20%



Series 167/184 Metallized Polyester

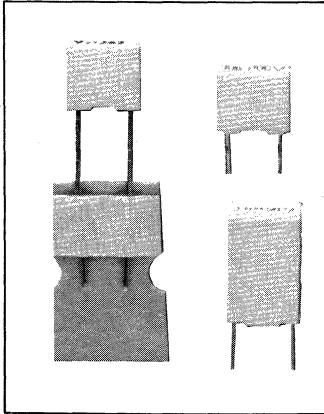

The Series 167/184 is a radial leaded metallized polyester film capacitor, non-inductively wound, that is housed in a pre-molded, flame retardant plastic case with epoxy fill. Temperature range is -55°C to 125°C with voltage derating above 85°C. **For complete technical information, request bulletin 5-103. For prices, reference price sheet E-454.**

HIGHLIGHTS

Capacitance: .001 μ F to .56 μ F
 (Other cap values available on special order)
 Voltage: 63V, 100V, 250V, 400V, 630V
 Temperature: -55°C to +125°C
 (With voltage derating above +85°C)

Metallized Polyester

Cap μ F	WVDC	L	T	H	S	Od	P/N#
63 WVDC							
.1	63V-	.418	.143	.261	.295	.024	167104*63A
.15	63V-	.418	.143	.261	.295	.024	167154*63A
.27	63V-	.418	.162	.359	.295	.024	167274*63B
.33	63V-	.418	.162	.359	.295	.024	167334*63B
.56	63V-	.418	.202	.438	.295	.024	167564*63C
100 WVDC							
.068	100V-	.418	.162	.359	.295	.024	167683*100B
.082	100V-	.418	.162	.359	.295	.024	167823*100B
.1	100V-	.418	.162	.359	.295	.024	167104*100B
.12	100V-	.418	.162	.359	.295	.024	167124*100B
.15	100V-	.418	.162	.359	.295	.024	167154*100B
.18	100V-	.418	.162	.359	.295	.024	167184*100B
.22	100V-	.418	.202	.438	.295	.024	167224*100C
.33	100V-	.418	.202	.438	.295	.024	167334*100C
250 WVDC							
.01	250V-	.418	.143	.261	.295	.024	167103*250A
.018	250V-	.418	.162	.359	.295	.024	167183*250B
.022	250V-	.418	.143	.261	.295	.024	167223*250A
.022	250V-	.418	.162	.359	.295	.024	167223*250B
.033	250V-	.418	.162	.359	.295	.024	167333*250B

Cap μ F	WVDC	L	T	H	S	Od	P/N#
250 WVDC							
.047	250V-	.418	.162	.359	.295	.024	167473*250B
400 WVDC							
.0047	400V-	.418	.143	.261	.295	.024	167472*400A
.0082	400V-	.418	.162	.359	.295	.024	167882*400B
.01	400V-	.418	.162	.359	.295	.024	167103*400B
.015	400V-	.418	.162	.359	.295	.024	167153*400B
630 WVDC							
.001	630V-	.418	.143	.261	.295	.024	167102*630A
.001	630V-	.418	.162	.359	.295	.024	167102*630B
.0015	630V-	.418	.162	.359	.295	.024	167152*630B
.0018	630V-	.418	.143	.261	.295	.024	167182*630A
.0018	630V-	.418	.162	.359	.295	.024	167182*630B
.0022	630V-	.418	.143	.261	.295	.024	167222*630A
.0022	630V-	.418	.162	.359	.295	.024	167222*630B
.0033	630V-	.418	.162	.359	.295	.024	167332*630B
.0039	630V-	.418	.143	.261	.295	.024	167392*630A
.0047	630V-	.418	.162	.359	.295	.024	167472*630B
.0056	630V-	.418	.162	.359	.295	.024	167562*630B
.0068	630V-	.418	.162	.359	.294	.024	167682*630B

*Specify Tolerance

J = \pm 5%
 K = \pm 10%
 M = \pm 20%

Note: To order Tape and Reel Version Specify as follows:

Part Number Sequence/184 (Ammo/T&R)
 Example .1 μ F 5% 100V-

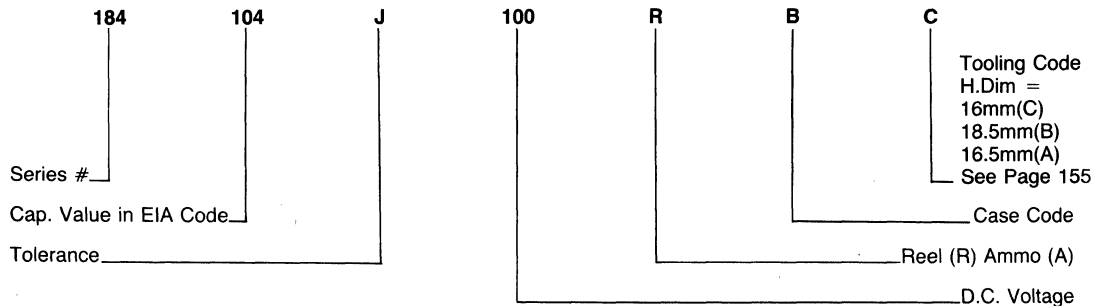

Series 168 Metallized Polyester

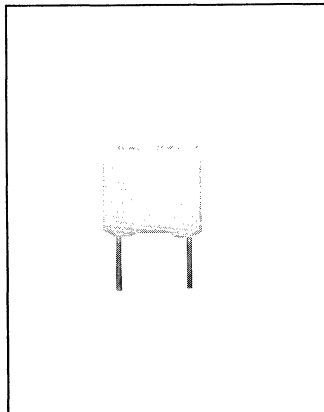

The series 168 is a radial leaded metallized polyester film capacitor. Non-inductively wound, housed in a molded flame-retardant case with epoxy fill. Temperature range is -55°C to 125°C with voltage derating above 85°C. Suggested applications are blocking, bypass, decoupling, smoothing, timing and tuning. **For complete technical information, request bulletin 5-102. For prices, reference price sheet E-455.**

HIGHLIGHTS

Capacitance: .001μF to 1.0μF
 (Other cap values available on special order)
 Voltage: 50V, 63V and 100V
 Temperature: -55°C to +125°C
 (With voltage derating above +85°C)

Metallized Polyester

Cap μF	WVAC	L	T	H	S	Od	P/N #
50 WVDC							
.1	50V -	.289	.103	.261	.197"	.024	168104*50A
.15	50V -	.289	.123	.261	.197"	.024	168154*50B
.33	50V -	.298	.143	.340	.197"	.024	168334*50D
.47	50V -	.289	.182	.379	.197"	.024	168474*50E
.56	50V -	.289	.202	.399	.197"	.024	168564*50F
.68	50V -	.289	.202	.399	.197"	.024	168684*50F
1.0	50V -	.289	.241	.438	.197"	.024	168105*50G
63 WVDC							
.068	63V -	.289	.103	.261	.197"	.024	168683*63A
.1	63V -	.289	.123	.261	.197"	.024	168104*63B
.15	63V -	.289	.143	.300	.197"	.024	168154*63C
.22	63V -	.289	.143	.340	.197"	.024	168224*63D
.27	63V -	.289	.182	.379	.197"	.024	168274*63E
.33	63V -	.289	.182	.379	.197"	.024	168334*63E
.47	63V -	.289	.202	.399	.197"	.024	168474*63F

Cap μF	WVAC	L	T	H	S	Od	P/N #
100 WVDC							
.001	100V -	.289	.103	.261	.197"	.024	168102*100A
.0015	100V -	.289	.103	.261	.197"	.024	168152*100A
.0022	100V -	.289	.103	.261	.197"	.024	168222*100A
.0033	100V -	.289	.103	.261	.197"	.024	168332*100A
.0039	100V -	.289	.103	.261	.197"	.024	168392*100A
.0047	100V -	.289	.103	.261	.197"	.024	168472*100A
.01	100V -	.289	.103	.261	.197"	.024	168103*100A
.015	100V -	.289	.103	.261	.197"	.024	168153*100A
.022	100V -	.289	.103	.261	.197"	.024	168223*100A
.033	100V -	.289	.103	.261	.197"	.024	168333*100A
.047	100V -	.289	.123	.261	.197"	.024	168473*100B
.068	100V -	.289	.143	.340	.197"	.024	168683*100D
.1	100V -	.289	.182	.379	.197"	.024	168104*100E

***Specify Tolerance**

- J = ±5%
- K = ±10%
- M = ±20%

Series 185 Metallized Polyester

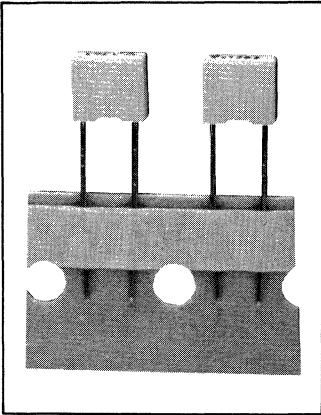

The series 185 is a radial leaded metallized polyester film capacitor. Non-inductively wound, housed in a molded flame-retardant case with epoxy fill. This Series is supplied tape and reeled per EIA 468. Temperature range is -55°C to 125°C with voltage derating above 85°C. Suggested applications are blocking, bypass, decoupling, smoothing, timing and tuning. For complete technical information, request bulletin 5-102. For prices, reference price sheet E-455.

HIGHLIGHTS
 Capacitance: 001µF to 1.0µF
 (Other cap values available on special order)
 Voltage: 50V, 63V and 100V
 Temperature: -55°C to +125°C
 (With voltage derating above +85°C)

Metallized Polyester

Cap µF	WVAC	L	T	H	S	Od	P/N #
50 WVDC							
.1	50V-	.289	.103	.261	.197"	.024	185104*50(1)A(2)
.22	50V-	.289	.143	.300	.197"	.024	185224*50(1)C(2)
.33	50V-	.298	.143	.300	.197"	.024	185334*50(1)C(2)
.47	50V-	.289	.182	.379	.197"	.024	185474*50(1)E(2)
.68	50V-	.289	.202	.399	.197"	.024	185684*50(1)F(2)
1.0	50V-	.289	.241	.438	.197"	.024	185105*50(1)G(2)
63 WVDC							
.056	63V-	.289	.103	.261	.197"	.024	185563*63(1)A(2)
.1	63V-	.289	.123	.261	.197"	.024	185104*63(1)B(2)
.12	63V-	.289	.123	.261	.197"	.024	185124*63(1)B(2)
.15	63V-	.289	.143	.300	.197"	.024	185154*63(1)C(2)
.22	63V-	.289	.143	.30	.197"	.024	185224*63(1)C(2)
.22	63V-	.289	.143	.340	.197"	.024	185224*63(1)D(2)
.33	63V-	.289	.182	.379	.197"	.024	185334*63(1)E(2)
.39	63V-	.289	.202	.399	.197"	.024	185394*63(1)F(2)
.47	63V-	.289	.202	.399	.197"	.024	185474*63(1)F(2)

Cap µF	WVAC	L	T	H	S	Od	P/N #
100 WVDC							
.001	100V-	.289	.103	.261	.197"	.024	185102*100(1)A(2)
.0022	100V-	.289	.103	.261	.197"	.024	185222*100(1)A(2)
.0033	100V-	.289	.103	.261	.197"	.024	185332*100(1)A(2)
.0047	100V-	.289	.103	.261	.197"	.024	185472*100(1)A(2)
.0056	100V-	.289	.103	.261	.197"	.024	185562*100(1)A(2)
.0068	100V-	.289	.103	.261	.197"	.024	185682*100(1)A(2)
.01	100V-	.289	.103	.261	.197"	.024	185103*100(1)A(2)
.012	100V-	.289	.103	.261	.197"	.024	185123*100(1)A(2)
.015	100V-	.289	.103	.261	.197"	.024	185153*100(1)A(2)
.022	100V-	.289	.103	.261	.197"	.024	185223*100(1)A(2)
.027	100V-	.289	.103	.261	.197"	.024	185273*100(1)A(2)
.033	100V-	.289	.103	.261	.197"	.024	185333*100(1)A(2)
.047	100V-	.289	.123	.261	.197"	.024	185473*100(1)B(2)
.1	100V-	.289	.182	.379	.197"	.024	185104*100(1)E(2)
.22	100V-	.289	.241	.438	.197"	.024	185224*100(1)G(2)

***Specify Tolerance**

- J = ±5%
- K = ±10%
- M = ±20%

- Specify (1) A Ammo Pack
- R Tape & Reel
- (2) Tooling Code

See Page 154

Note: To order Tape and Reel Version Specify as follows:

Part Number Sequence/185 (T&R)
 Example .1µF 10% 50V

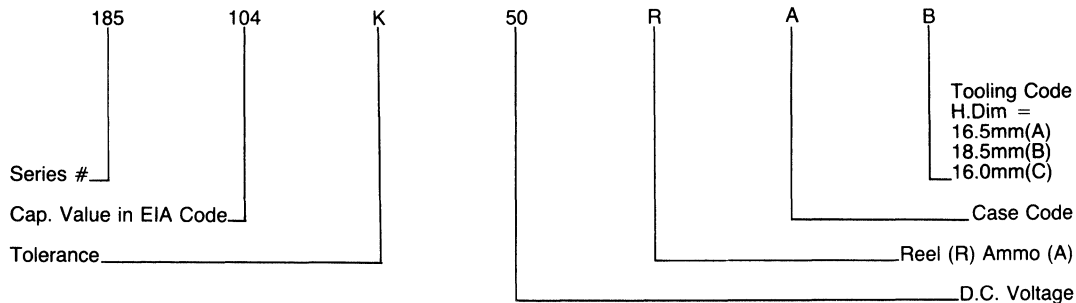

Series 170 Metallized Polypropylene

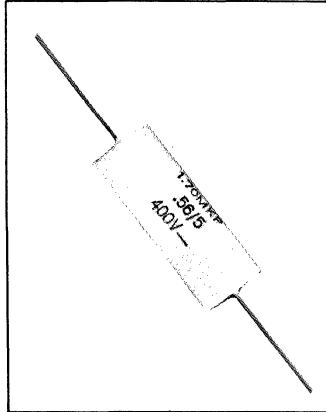

The Series 170 is an axial leaded, metallized polypropylene capacitor with a polyester outer wrap and epoxy endseal. Temperature range is -55°C to +105°C with voltage derating above 85°C. Suggested applications are blocking, bypass, coupling, decoupling, smoothing, timing and tuning. **For complete technical information, request bulletin 5-207. For prices, reference price sheet E-457.**

HIGHLIGHTS

Capacitance: .022 μ F to 4.7 μ F (Other cap values available on special order)
 Voltage: 160V, 250V, 400V, and 630V
 Tolerance: \pm 10% (Other tolerances available on special order)
 Temperature: -55°C to +105°C (With voltage derating above +85°C)

Metallized Polypropylene

Cap uF	WVDC	Diameter	Length	Od	P/N#	Cap uF	WVDC	Diameter	Length	Od	P/N#
160 WVDC						400 WVDC					
.22	160V-	.315	.650	.031	170224K160EB	.047	400V-	.315	.650	.031	170473K400EB
.33	160V-	.315	.807	.031	170334K160EC	.068	400V-	.315	.807	.031	170683K400EC
.47	160V-	.374	.807	.031	170474K160HC	.1	400V-	.354	.807	.031	170104K400GC
1.0	160V-	.413	1.102	.031	170105K160JE	.15	400V-	.335	1.102	.031	170154K400FE
2.2	160V-	.531	1.299	.031	170225K160PF	.22	400V-	.394	1.102	.031	170224K400IE
3.3	160V-	.630	1.299	.031	170335K160TF	.33	400V-	.453	1.102	.031	170334K400LE
4.7	160V-	.709	1.299	.031	170475K160XF	.47	400V-	.512	1.102	.031	170474K400NE
250 WVDC						630 WVDC					
.1	250V-	.335	.650	.031	170104K250FB	.022	630V-	.335	.650	.031	170223K630FB
.15	250V-	.335	.807	.031	170154K250FC	.033	630V-	.335	.807	.031	170333K630FC
.22	250V-	.374	.807	.031	170224K250HC	.047	630V-	.374	.807	.031	170473K630HC
.33	250V-	.354	1.102	.031	170334K250GE	.068	630V-	.354	1.102	.031	170683K630GE
.47	250V-	.413	1.10w	.031	170474K250JE	.1	630V-	.394	1.102	.031	170104K630IE
.68	250V-	.472	1.102	.031	170684K250ME	.15	630V-	.472	1.102	.031	170154K630ME
1.0	250V-	.512	1.299	.031	170105K250NF	.22	630V-	.512	1.299	.031	170224K630NF
2.2	250V-	.709	1.299	.031	170225K250XF	.33	630V-	.610	1.299	.031	170334K630TF
3.3	250V-	.846	1.299	.031	170335K250ZF	.47	630V-	.709	1.299	.031	170474K630XF
						.68	630V-	.827	1.299	.031	170684K630ZF

Series 171 Metallized Polypropylene "Minibox"

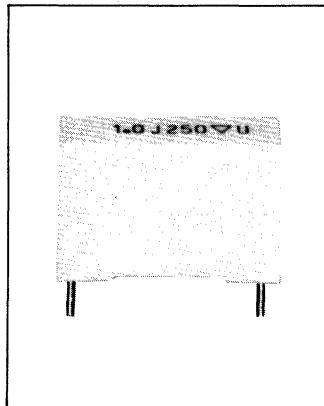

The Series 171 is a radial leaded, metallized polypropylene film capacitor, that is housed in a flame retardant preformed case with epoxy end fill. The winding construction is non-inductive. Operating temperature range of -55°C to +105°C with voltage derating above 85°C. **For complete technical information, request bulletin 5-204. For prices, reference price sheet 458.**

HIGHLIGHTS

Capacitance: .022uF to 10uF (Other cap values available on special order)
 Voltage: 160V, 250V, 400V, and 630V
 Tolerance: ± 10% (Other tolerances available on special order)
 Temperature: -55°C to +105°C (With voltage derating above +85°C)

Metallized Polypropylene "Minibox"

Cap uF	WVDC	L	T	H	S	Od	P/N#
160 WVDC							
.33	160V-	.714	.241	.477	.591	.031	171334K160G
.47	160V-	.714	.300	.536	.591	.031	171474K160H
1.0	160V-	1.048	.340	.674	.886	.031	171105K160N
2.2	160V-	1.265	.438	.792	1.08	.031	171225K160P
3.3	160V-	1.265	.517	.871	1.08	.031	171335K160Q
4.7	160V-	1.265	.596	1.186	1.08	.031	171475K160R
10.0	160V-	1.265	.871	1.462	1.08	.031	171106K106T
250 WVDC							
.1	250V-	.714	.202	.438	.591	.031	171104K250F
.15	250V-	.714	.241	.477	.591	.031	171154K250G
.22	250V-	.714	.300	.536	.591	.031	171224K250H
.33	250V-	1.048	.241	.596	.886	.031	171334K250L
.47	250V-	1.048	.281	.635	.886	.031	171474K250M
1.0	250V-	1.265	.438	.792	1.08	.031	171105K250P
2.2	250V-	1.265	.596	1.186	1.08	.031	171225K250R
3.3	250V-	1.265	.714	1.304	1.08	.031	171335K250S
4.7	250V-	1.265	.871	1.462	1.08	.031	171475K250T
400 WVDC							
.068	400V-	.714	.202	.438	.591	.031	171683K400F
.1	400V-	.714	.300	.536	.591	.031	171104K400H

Cap uF	WVDC	L	T	H	S	Od	P/N#
400 WVDC							
.15	400V-	.714	.340	.576	.591	.031	171154K400I
.22	400V-	1.048	.281	.635	.886	.031	171224K400M
.33	400V-	1.048	.340	.674	.886	.031	171334K400N
.47	400V-	1.048	.399	.733	.886	.031	171474K400O
.68	400V-	1.265	.438	.792	1.08	.031	171684K400P
1.0	400V-	1.265	.596	1.186	1.08	.031	171105K400R
2.2	400V-	1.265	.714	1.304	1.08	.031	171225K400S
630 WVDC							
.022	630V-	.714	.202	.438	.591	.031	171223K630F
.033	630V-	.714	.241	.477	.591	.031	171333K630G
.047	630V-	.714	.300	.536	.591	.031	171473K630H
.068	630V-	.714	.340	.576	.591	.031	171683K630I
.1	630V-	1.048	.281	.635	.886	.031	171104K630M
.15	630V-	1.048	.340	.674	.886	.031	171154K630N
.22	630V-	1.265	.359	.674	1.08	.031	171224K630P
.33	630V-	1.265	.517	.871	1.08	.031	171334K630Q
.47	630V-	1.265	.596	1.186	1.08	.031	171474K630R
.68	630V-	1.265	.596	1.186	1.08	.031	171684K630R
1.0	630V-	1.265	.714	1.304	1.08	.031	171105K630S

Series 158X Metallized Polyester Suppressor

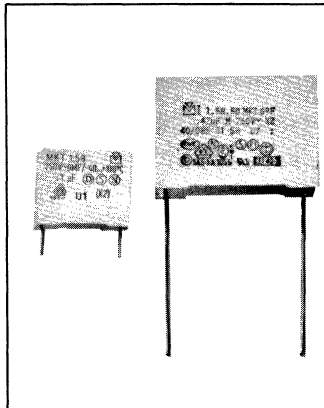

The series 158X is a radial leaded metallized polyester, A.C. line suppression capacitor, housed in a flame retardant pre-molded plastic case with epoxy resin fill. Temperature range is -55°C to 125°C with voltage derating above 85°C . Capacitors range from $.047\mu\text{F}$ to $1.0\mu\text{F}$. Two lead configurations are available, short .236" and long 1.18". Suggested applications are energy storage, filtering, pulse discharge, discrimination, and suppression. **For complete technical information, request bulletin 4-1001. For prices, reference price sheet E-451.**

HIGHLIGHTS

Capacitance: $.01\mu\text{F}$ to $1.0\mu\text{F}$
 (Other cap values available on special order)
 Voltage: 250 VAC
 Temperature: -55°C to $+125^{\circ}\text{C}$
 (With voltage derating above $+85^{\circ}\text{C}$)

Metallized Polyester Suppressor

Cap μF	WVAC	L	T	H	S	Od	P/N #
250 WVAC							
.01	250V -	.714	.202	.438	.590	.031	158103*250F
.022	250V -	.714	.202	.438	.590	.031	158223*250F
.047	250V -	.714	.241	.477	.590	.031	158473*250G
.068	250V -	.714	.300	.536	.590	.031	158683*250H
.1	250V -	.714	.340	.576	.590	.031	158104*250I
.1	250V -	.950	.300	.536	.800	.031	158104*250X

Cap μF	WVAC	L	T	H	S	Od	P/N #
250 WVAC							
.15	250V -	1.048	.281	.635	.886	.031	158154*250M
.22	250V -	1.048	.399	.733	.886	.031	158224*250O
.33	250V -	1.265	.438	.797	1.063	.031	158334*250P1
.47	250V -	1.265	.517	.871	1.063	.031	158474*250Q
⁽¹⁾ 1.0	250V -	1.265	.714	1.304	1.063	.031	158105*250S

*Specify Tolerance

K = $\pm 10\%$
 M = $\pm 20\%$

International Approvals Held:

VDE 0565-1 West Germany
 FEMKO-Finland
 SEMKO 432901 Sweden
 ASEV 1055 Switzerland
 IMQ CEI 40-7 Italy
 NEMKO Norway
 UL 1283 U.S.
 UL File Number E88238

Suffix For Lead Configuration

/S = .236" Lead

No suffix indicates standard long lead.

⁽¹⁾UL & VDE Approvals on these values only, other approvals pending.

Application Characteristics

Series 158X suppressors are single section two terminal capacitors suitable for X-type application as defined by the IEC (International Electrotechnical Commission). X-type devices are connected from line-to-line on 250 VAC systems, and are used only in a position where a failure of the capacitor would not expose anyone to an electrical shock.

Safety Characteristics

The safety aspects of Series 158X suppression capacitors are carefully specified and maintained. Those characteristics are governed by a number of international standards, notably: VDE, ASEV, SEMKO, DEMKO, BS, OVE. These standards call for rigorous tests to provide maximum operational safety and reliability. Series 158X suppressors hold the current approvals VDE 0560-7; SEMKO 432901; ASEV 1055 and UL1283.



Series 172Y Film-Foil Polypropylene Line to GND Suppressor

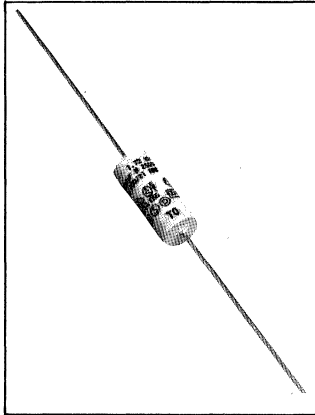

The Series 172Y is an axial leaded film-foil polypropylene capacitor, with a polyester tape outer wrap and epoxy end fill enclosure. The dielectric material is polypropylene with the electrode being aluminum or tin foil, non-inductively wound. The temperature range is -55°C to $+105^{\circ}\text{C}$ with voltage derating above 85°C . Suggested applications are energy storage, pulse discharge, and suppression. **For complete technical information, request bulletin 5-202. For prices, reference price sheet 459.**

HIGHLIGHTS

Capacitance: $.0015\mu\text{F}$ to $.047\mu\text{F}$
 (Other cap values available on special order)
 Voltage: 250VAC
 Tolerance: $\pm 20\%$ (Other tolerances available on special order)
 Temperature: -55°C to $+105^{\circ}\text{C}$
 (With voltage derating above $+85^{\circ}\text{C}$)

Film-Foil Polypropylene Line to GND

Cap μF	WVAC	Diameter	Length	Od	P/N#
250 WVDC					
.0015	250V-	.335	.807	.031	172152M250Y
.0022	250V-	.335	.807	.031	172222M250Y
.01	250V-	.374	1.102	.031	172103M250Y
.047	250V-	.630	1.299	.031	172473M250Y

International Approvals Held:

VDE 0565-1
 ASEV
 SEMKO 432901
 NEMKO
 FEMKO
 DEMKO
 CSA

Series 173Y Film-Foil Polypropylene Line to GND Suppressor

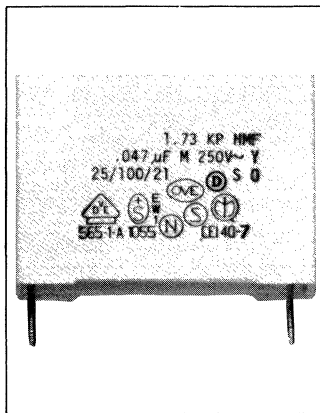

The Series 173Y is a radial leaded, film-foil polypropylene capacitor, housed in a pre-molded flame retardant case with epoxy end fill. The dielectric material is polypropylene with the electrode being aluminum or tin foil, and is non-inductively wound. The temperature range is from -55°C to 105°C with voltage derating above 85°C . Suggested applications are energy storage, pulse discharge and suppression. **For complete technical information, request bulletin 5-203. For prices, reference price sheet 460.**

HIGHLIGHTS

Capacitance: $.0015\mu\text{F}$ to $.047\mu\text{F}$
 (Other cap values available on special order)
 Voltage: 250VAC
 Tolerance: $\pm 20\%$ (Other tolerances available on special order)
 Temperature: -55°C to $+105^{\circ}\text{C}$
 (With voltage derating above $+85^{\circ}\text{C}$)

Film-Foil Polypropylene Line to GND Suppressor

Cap μF	WVAC	L	T	H	S	Od	P/N#
250 WVDC							
.0015	250V-	.714	.202	.438	.591	.031	173152M250Y
.0022	250V-	.714	.241	.477	.591	.031	173222M250Y
.0047	250V-	.714	.340	.576	.591	.031	173472M250Y
.01	250V-	1.048	.241	.596	.886	.031	173103M250Y
.047	250V-	1.265	.517	.871	.886	1.08	173473M250Y

International Approvals Held:

VDE 0565-1
 ASEV 1055
 SEMKO 432901
 NEMKO
 FEMKO
 DEMKO
 CSA

Series 198 ● Surface Mount Chip Capacitors



Metallized Polyester Dielectric Cast Epoxy Enclosure

The series 198 is a metallized polyester capacitor designed for surface mount technology. It is suitable for vapor phase, reflow, and packaging or tape and reel for automatic placement. Suggested applications are blocking, bypass, or decoupling. **Request bulletin 5-105 for complete specifications. For pricing, reference price sheet 462.**

HIGHLIGHTS

Capacitance range available .001 μ F thru 1.0 μ F
Voltage 50V
Tolerance $\pm 10\%$ (Other tolerances available on special orders)
Temperature -55°C to $+125^{\circ}\text{C}$
(With voltage derating above $+85^{\circ}\text{C}$)

METALLIZED POLYESTER

Capacitance μ F	Length	Height	Width	Part Number
		50 WVDC		
.01	.287	.118	.197	198103K50F
.022	.287	.118	.197	198223K50F
.033	.287	.118	.197	198333K50F
.047	.287	.118	.197	198473K50F
.068	.287	.118	.197	198683K50F
.1	.287	.118	.197	198104K50F
.15	.287	.118	.217	198154K50G
.22	.287	.118	.217	198224K50G
.33	.287	.138	.256	198334K50H
.47	.287	.157	.276	198474K50L
.68	.386	.177	.295	198684K50P
1.0	.386	.177	.295	198105K50P

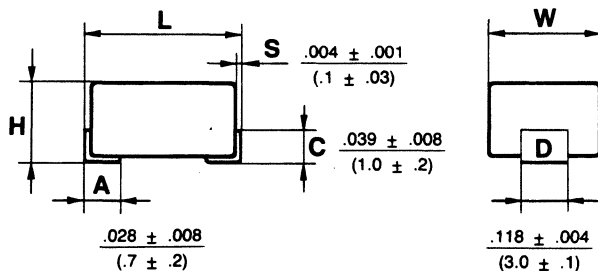



Type PVC Film Capacitors

Epoxy-Dipped, Radial Leaded

Mallory Type PVC capacitors are made from the finest materials available to assure excellent performance and long life. We utilize combinations of polyester film and polypropylene film dielectrics which are wound under carefully controlled atmospheric conditions, these capacitors are conformally coated with a flame retardant epoxy that protects the capacitor from heat of soldering irons or flow solder equipment. This type of capacitor is adaptable to all electronic circuit applications call-

ing for bypass and coupling. Request bulletin 9-769 for complete specifications. For pricing refer to price sheet No. 435. PVC Capacitor Mallobins are also available. See complete Mallobin listing, page 150.

HIGHLIGHTS

Capacitance Range: .001 to .47 (other capacitance values available on special order)
 Voltage: 100 to 1,600 V
 Tolerance: ±10%
 Temperature Range: -55°C to +125°C -55°C to +105°C (1,600).

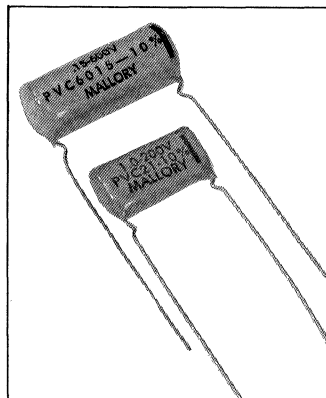

Capacitance μF	Length "L"	Diameter "D"	Thickness "T"	Lead Spacing "S"	Outline Figure	Catalog Number
100 WVDC						
.033	.70	.35	—	.500	1	PVC1133
.04	.70	.35	—	.500	1	PVC114
.047	.70	.35	—	.500	1	PVC1147
.056	.70	.38	—	.500	1	PVC1156
.10	.90	.40	—	.688	1	PVC101
.22	1.20	.45	—	.969	1	PVC1022
.47	1.60	.50	—	1.344	1	PVC1047
200 WVDC						
.01	.70	.33	—	.500	1	PVC211
.015	.70	.33	—	.500	1	PVC2115
.02	.70	.33	—	.500	1	PVC212
.022	.70	.33	—	.500	1	PVC2122
.033	.90	.38	—	.688	1	PVC2133
.05	1.20	.38	—	.969	1	PVC215
.10	1.20	.40	—	.969	1	PVC201
.47	1.60	.56	—	1.344	1	PVC2047
400 WVDC						
.01	.70	.35	—	.500	1	PVC411
.047	1.20	.40	—	.969	1	PVC4147
.05	1.20	.40	—	.969	1	PVC415
.10	1.20	.53	—	.969	1	PVC401
.22	1.20	.60	—	.969	1	PVC4022
.25	1.20	.60	—	.969	1	PVC4025

Capacitance μF	Length "L"	Diameter "D"	Thickness "T"	Lead Spacing "S"	Outline Figure	Catalog Number
600 WVDC						
.001	.70	.31	—	.500	1	PVC621
.0022	.70	.34	—	.500	1	PVC6222
.0033	.70	.35	—	.500	1	PVC6233
.005	.70	.39	—	.500	1	PVC625
.0068	.70	.40	—	.500	1	PVC6268
.01	.90	.40	—	.688	1	PVC611
.022	.90	.45	—	.688	1	PVC6122
.03	1.20	.45	—	.969	1	PVC613
.039	1.20	.56	—	.969	1	PVC6139
.047	1.20	.56	—	.969	1	PVC6147
.05	1.20	.56	—	.969	1	PVC615
.056	1.20	.60	—	.969	1	PVC6156
.068	1.20	.60	—	.969	1	PVC6168
.082	1.20	.65	—	.969	1	PVC6182
.10	1.20	.65	—	.969	1	PVC601
.15	1.60	.70	—	1.344	1	PVC6015
.22	1.60	.81	—	1.344	1	PVC6022
.25	1.81	.82	—	1.344	1	PVC6025
1000 WVDC						
.10	1.60	.85	—	1.344	1	PVC10010
1600 WVDC						
.001	1.31	.50	—	.969	1	PVC1621
.0022	1.31	.50	—	.969	1	PVC16222
.0033	1.31	.50	—	.969	1	PVC16233
.0047	1.31	.50	—	.969	1	PVC16247
.0068	1.31	.56	—	.969	1	PVC16268
.01	1.31	.60	—	.969	1	PVC1611
.015	1.31	.65	—	.969	1	PVC16115
.022	1.70	.65	—	1.344	1	PVC16122
.033	1.70	.75	—	1.344	1	PVC16133
.047	1.70	.85	—	1.344	1	PVC16147

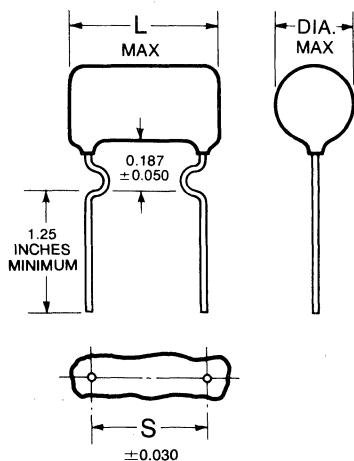

AC APPLICATION GUIDE @ +85°C:

Rated Voltage DC	Max. AC (RMS) Volts @ 60Hz
100	70
200	100
400	220
600	220
1000	220
1600	500

Type SX Film Capacitors

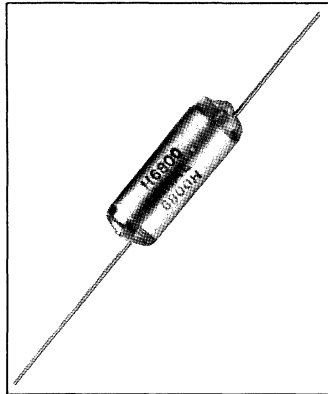

Polystyrene, Axial Leaded
SX types are manufactured from a unique form of stretched and fused polystyrene to provide the ultimate in temperature stability and humidity protection. Can be used to replace mica, film, paper and ceramic types in most applications. Leads are tinned copper wire; the lead closest to the color band indicating the working volt-

age is connected to outer foil. For complete information, request Bulletin 9-770. For prices, reference price sheet No. 425. SX Capacitor Mallobins are available. See complete Mallobin listing, page 150.

HIGHLIGHTS

Capacitance: 20pF to .1μF (other capacitance values available on special orders)
Voltage: 33, 63, 160, and 630V
Tolerance: ±5% (SX), ±2.5% (SXX, SXL, SXM)
Temperature: -40°C to +40°C (To +70° C with derating)
Note: Not Recommended for Wave Solder

**RATED VOLTAGE @ +40°C, 33 WVDC
RATED VOLTAGE @ +70°C, 25 WVDC
(Blue Color Band)**

Capacitance pF	Maximum Size, Inches Diameter x Length	Lead Diameter (Inches, ±.002")	Catalog Number
100	.12 x .315	.012"	SXK310
150	.12 x .315	.012"	SXK315
220	.13 x .315	.012"	SXK322
330	.14 x .315	.012"	SXK333
390	.14 x .315	.012"	SXK339
470	.15 x .315	.012"	SXK347
560	.150 x .315	.012"	SXK356
680	.16 x .315	.012"	SXK368
820	.17 x .315	.012"	SXK382
1,000	.18 x .315	.012"	SXK210
1,200	.19 x .473	.016"	SXK212
1,500	.19 x .473	.016"	SXK215
1,800	.20 x .473	.016"	SXK218
2,200	.21 x .473	.016"	SXK222
3,300	.24 x .473	.016"	SXK233
3,900	.25 x .473	.016"	SXK239
4,700	.26 x .473	.016"	SXK247
5,600	.28 x .670	.020"	SXK256
10,000	.33 x .670	.020"	SXK110
18,000	.41 x .670	.020"	SXK118
22,000	.43 x .670	.020"	SXK122
25,000	.46 x .670	.020"	SXK125
27,000	.46 x .670	.020"	SXK127
47,000	.55 x .870	.020"	SXK147
100,000	.71 x .870	.020"	SXK010

**RATED VOLTAGE @ +40°C, 63 WVDC
RATED VOLTAGE @ +70°C, 50 WVDC
(Yellow Color Band)**

Capacitance pF	Maximum Size, Inches Diameter x Length	Lead Diameter (Inches, ±.002")	Catalog Number
180	.13 x .315	.012"	SXL318
220	.13 x .315	.012"	SXL322
270	.14 x .315	.012"	SXL327
470	.16 x .315	.012"	SXL347
680	.18 x .315	.012"	SXL368
1,000	.19 x .473	.016"	SXL210
1,200	.20 x .473	.016"	SXL212
2,200	.25 x .473	.016"	SXL222
3,300	.29 x .473	.016"	SXL233
3,900	.31 x .473	.016"	SXL239
4,700	.33 x .473	.016"	SXL247
10,000	.34 x .670	.020"	SXL110
15,000	.35 x .870	.020"	SXL115

**RATED VOLTAGE @ +40°C, 160 WVDC
RATED VOLTAGE @ +70°C, 125 WVDC
(Red Color Band)**

Capacitance pF	Maximum Size, Inches Diameter x Length	Lead Diameter (Inches, ±.002")	Catalog Number
4,700	.36 x .670	.020"	SXM247
5,000	.36 x .670	.020"	SXM250
6,200	.33 x .870	.020"	SXM262
7,500	.36 x .870	.020"	SXM275
10,000	.41 x .870	.020"	SXM110
15,000	.47 x .870	.020"	SXM115

**RATED VOLTAGE @ +40°C, 630 WVDC
RATED VOLTAGE @ +70°C, 500 WVDC
(Black Color Band)**

Capacitance pF	Maximum Size, Inches Diameter x Length	Lead Diameter (Inches, ±.002")	Catalog Number
20	.17 x .473	.016"	SX420
22	.17 x .473	.016"	SX422
33	.18 x .473	.016"	SX433
47	.19 x .473	.016"	SX447
68	.19 x .473	.016"	SX468
75	.20 x .473	.016"	SX475
100	.21 x .473	.016"	SX310
150	.22 x .473	.016"	SX315
200	.23 x .473	.016"	SX320
220	.23 x .473	.016"	SX322
240	.23 x .473	.016"	SX324
270	.23 x .473	.016"	SX327
300	.24 x .473	.016"	SX330
330	.24 x .473	.016"	SX333
390	.25 x .473	.016"	SX339
470	.27 x .473	.016"	SX347
510	.23 x .670	.020"	SX351
680	.24 x .670	.020"	SX368
820	.26 x .670	.020"	SX382
1,000	.28 x .670	.020"	SX210
1,200	.30 x .670	.020"	SX212
1,500	.32 x .670	.020"	SX215
2,000	.34 x .670	.020"	SX220
2,200	.37 x .670	.020"	SX222
2,500	.37 x .670	.020"	SX225
3,000	.39 x .670	.020"	SX230
3,900	.44 x .870	.020"	SX239
4,700	.47 x .870	.020"	SX247
5,000	.47 x .870	.020"	SX250
6,800	.52 x .870	.020"	SX268
10,000	.58 x .870	.020"	SX110

**RATED VOLTAGE @ +40°C, 160 WVDC
RATED VOLTAGE @ +70°C, 125 WVDC
(Red Color Band)**

Capacitance pF	Maximum Size, Inches Diameter x Length	Lead Diameter (Inches, ±.002")	Catalog Number
20	.17 x .315	.012"	SXM420
47	.17 x .315	.012"	SXM447
68	.18 x .315	.012"	SXM468
100	.19 x .315	.012"	SXM310
120	.20 x .315	.012"	SXM312
150	.20 x .315	.012"	SXM315
180	.20 x .315	.012"	SXM318
220	.21 x .315	.012"	SXM322
270	.21 x .315	.012"	SXM327
300	.22 x .315	.012"	SXM330
330	.22 x .315	.012"	SXM333
390	.22 x .315	.012"	SXM339
430	.23 x .315	.012"	SXM343
470	.23 x .315	.012"	SXM347
500	.23 x .315	.012"	SXM350
620	.25 x .473	.016"	SXM362
680	.25 x .473	.016"	SXM368
820	.26 x .473	.016"	SXM382
910	.27 x .473	.016"	SXM391
1,000	.27 x .473	.016"	SXM210
1,200	.28 x .473	.016"	SXM212
1,300	.29 x .473	.016"	SXM213
1,500	.29 x .473	.016"	SXM215
1,800	.30 x .473	.016"	SXM218
2,000	.30 x .473	.016"	SXM220
2,200	.24 x .670	.020"	SXM222
2,400	.24 x .670	.020"	SXM224
2,700	.27 x .670	.020"	SXM227
3,000	.27 x .670	.020"	SXM230
3,300	.30 x .670	.020"	SXM233
3,900	.33 x .670	.020"	SXM239

SX Capacitor Markings

All SXX, SXL, SXM and SX Capacitors are marked with the following information:

Tolerance —
H = 2.5% (SXX, SXL, SXM)
J = 5% (SX)

Capacitance —
in picofarads

Voltage —
Blue Color Band = SXX or 33 WVDC
Yellow Color Band = SXL or 63 WVDC
Red Color Band = SXM or 160 WVDC
Black Color Band = SX or 630 WVDC

Color band also indicates outside foil.

Example: Part labeled TRW J1200 with blue color band represents part number SXK212.

MALLORY

Series LP66N● Metallized Polycarbonate

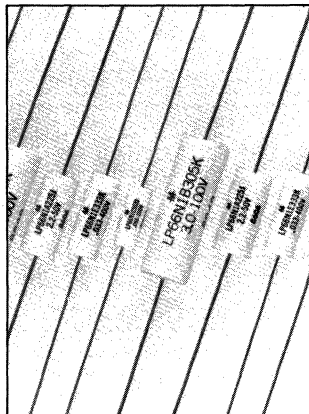

The Series LP66N is an axial leaded metallized polycarbonate capacitor with a flame retardant polyester outer wrap and epoxy endseals. Temperature Range is -55°C to $+125^{\circ}\text{C}$ without voltage derating. Series LP66N is commonly used for applications in military and aerospace equipment, in computer systems, industrial control apparatus, radio communication systems, etc. **For complete technical information, request bulletin 9-796. For prices, reference price sheet E-463.**

HIGHLIGHTS

Capacitance: $.01\mu\text{F}$ to $10\mu\text{F}$ (Other cap values available on special order)
 Voltage: 50V, 100V, 200V
 Tolerance: $\pm 5\%$, $\pm 10\%$
 (Other tolerances available on special order)
 Temperature: -55°C to $+125^{\circ}\text{C}$
 (Without voltage derating)

Metallized Polycarbonate

Cap μF	Diameter	Length	Tolerance	Catalog Number
50 WVDC				
.01	.170	.440	5%	LP66N1A103J
.1	.190	.560	5%	LP66N1A104J
.33	.250	.560	5%	LP66N1A334J
.47	.310	.560	10%	LP66N1A474K
.56	.310	.560	5%	LP66N1A564J
1.0	.310	.750	10%	LP66N1A105K
100	.600	1.310	10%	LP66N1A106K
100 WVDC				
.68	.400	.750	5%	LP66N1B684J

Cap μF	Diameter	Length	Tolerance	Catalog Number
100 WVDC				
1.0	.400	1.00	10%	LP66N1B105K
3.0	.500	1.250	10%	LP66N1B305K
200 WVDC				
.056	.270	.560	5%	LP66N1C563J
.1	.310	.560	5%	LP66N1C104J
.15	.310	.750	5%	LP66N1C154J
.33	.370	1.00	5%	LP66N1C334J
.39	.400	1.00	5%	LP66N1C394J

OTHER FILM CAPACITORS AVAILABLE ON SPECIAL ORDER:

172 Series Low-loss, high frequency polypropylene film capacitors. Capacitance range $.001\mu\text{F}$ to $.47\mu\text{F}$. Voltage range 250WVDC to 2000WVDC. The temperature coefficient is negative and typically 300 ppm/ $^{\circ}\text{C}$ over the temperature range of $+25^{\circ}\text{C}$ to $+105^{\circ}\text{C}$ (with voltage derating above $+85^{\circ}\text{C}$). Request bulletin 5-206 for complete specifications.

173 Series Radial leaded, low loss, high frequency polypropylene film capacitors. Capacitance range $.001\mu\text{F}$ to $.22\mu\text{F}$. Voltage range 250WVDC to 2000WVDC. Temperature range -55° to $+105^{\circ}\text{C}$ with voltage derating over 85°C . Request bulletin 5-205 for complete specifications.

145 Series Axial leaded, high stability polypropylenen film capacitors. Capacitance range $.00039\mu\text{F}$ to $.47\mu\text{F}$. Voltage range 100WVDC to 200WVDC. Temperature range -55° to $+105^{\circ}\text{C}$ with voltage derating over 85°C . Request bulletin 5-201 for complete specifications.

148 Series Axial leaded, close tolerance, metallized polypropylenen capacitors. Capacitance range $.001\mu\text{F}$ to $4.7\mu\text{F}$. Voltage range 160WVDC to 250WVDC. Temperature range -55° to $+105^{\circ}\text{C}$ with voltage derating over 85°C . Request bulletin 5-208 for complete specifications.

135 Series Axial leaded, high current metallized polypropylene film capacitors. Capacitance range $1\mu\text{F}$ to $30\mu\text{F}$. Voltage range 100WVDC to 400WVDC. Operating temperature range -55° to $+105^{\circ}\text{C}$. Request bulletin 5-200 for complete specifications.

• New Product

Type MTP/CMT Wet Slug Tantalum Capacitors

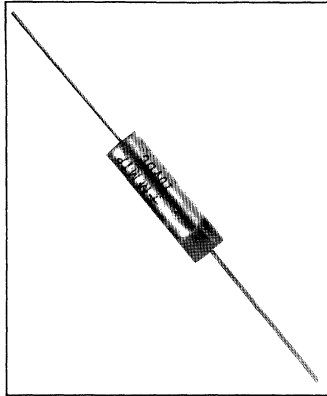

Subminiature, Epoxy End Fill

Mallory Type MTP capacitors have a higher capacity-voltage product per unit volume than any conventional wet slug, foil or solid tantalum. Sealed in silver case, this size factor makes these capacitors very desirable for applications with thin film and micro-electronic circuits. An additional advantage of the wet slug construction is the absence of the familiar catastrophic failure mode of solid tantalum devices. The low and stable DCL characteristic of MTP capacitors is ideally suited for application

in timing circuits. Request bulletin No. 4-606 for complete specifications. For pricing refer to price sheet No. 230.

The CMT is comparable to the MTP line except for the copper alloy case. Request bulletin No. 4-609 for complete specifications. For pricing refer to price sheet No. 234.

HIGHLIGHTS

Capacitance Range: 3.3 to 470 μ F
Voltage: 6 to 60VDC
Temperature Range: -55°C to +85°C
Capacity Tolerance: \pm 20%

Type MTP

Cap. (μ F)	Case Code	Catalog Number
6 WVDC		
47	A	MTP476M006P1A
150	B	MTP157M006P1B
180	B	MTP187M006P1B
450	C	MTP457M006P1C
470	C	MTP477M006P1C
10 WVDC		
10	D	MTP106M010P1D
33	A	MTP336M010P1A
100	B	MTP107M010P1B
120	B	MTP127M010P1B
300	C	MTP307M010P1C
330	C	MTP337M010P1C
15 WVDC		
22	A	MTP226M015P1A
68	B	MTP686M015P1B
80	B	MTP806M015P1B
200	C	MTP207M015P1C
220	C	MTP227M015P1C
20 WVDC		
6.8	D	MTP685M020P1D
15	A	MTP156M020P1A
47	B	MTP476M020P1B
60	B	MTP606M020P1B
150	C	MTP157M020P1C

Cap. (μ F)	Case Code	Catalog Number
30 WVDC		
6	D	MTP605M030P1D
10	A	MTP106M030P1A
45	B	MTP456M030P1B
120	C	MTP127M030P1C
35 WVDC		
4.7	D	MTP475M035P1D
10	A	MTP106M035P1A
100	C	MTP107M035P1C
50 WVDC		
4	D	MTP405M050P1D
6.8	A	MTP685M050P1A
30	B	MTP306M050P1B
33	B	MTP336M050P1B
68	C	MTP686M050P1C
78	C	MTP786M050P1C
60 WVDC		
3.3	D	MTP335M060P1D
4.7	A	MTP475M060P1A
10	B	MTP106M060P1B
15	B	MTP156M060P1B
22	B	MTP226M060P1B
33	C	MTP336M060P1C
47	C	MTP476M060P1C
68	C	MTP686M060P1C

OUTLINE DIMENSIONS

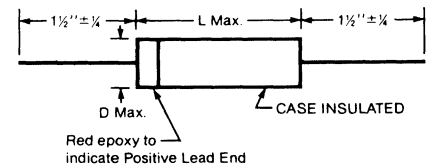

Lead Size: .020 \pm .001 inch Diameter
Lead Material: Positive, Tinned Nickel; Negative, Tinned Copper
Polarity Marking: Plus signs at the positive end

CMT/MTP CASE CODE CHART

Case Code	Dia. x Length	Lead Dia. (+ .001)
D	.115" x .300"	.02"
A	.115" x .403"	.02"
B	.145" x .600"	.02"
C	.225" x .778"	.02"

Type CMT

Cap. (μ F)	Case Code	Catalog Number
6 WVDC		
180	B	CMT187M006P1B
470	C	CMT477M006P1C
10 WVDC		
100	B	CMT107M010P1B
120	B	CMT127M010P1B
300	C	CMT307M010P1C
330	C	CMT337M010P1C
15 WVDC		
68	B	CMT686M015P1B
80	B	CMT806M015P1B
220	C	CMT227M015P1C

Cap. (μ F)	Case Code	Catalog Number
20 WVDC		
6.8	D	CMT685M020P1D
15	A	CMT156M020P1A
47	B	CMT476M020P1B
150	C	CMT157M020P1C
30 WVDC		
10	A	CMT106M030P1A
45	B	CMT456M030P1B
120	C	CMT127M030P1C
35 WVDC		
10	A	CMT106M035P1A
100	C	CMT107M035P1C

Cap. (μ F)	Case Code	Catalog Number
50 WVDC		
33	B	CMT336M050P1B
68	C	CMT686M050P1C
78	C	CMT786M050P1C
60 WVDC		
6.8	A	CMT685M060P1A
22	B	CMT226M060P1B
47	C	CMT476M060P1C
68	C	CMT686M060P1C

Type TLS (CL64/65) and TLH Wet Slug Tantalum Capacitors

WET SLUG
TANTALUM CAPACITORS

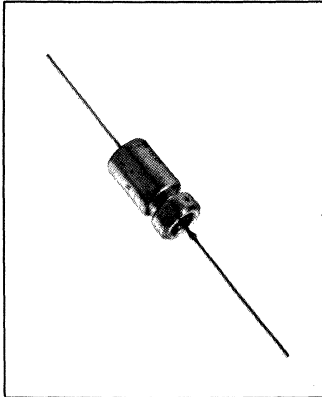

Silver Case

Type TLS is the commercial version of MIL-C-3965/4. Type CL64/65 is a cancelled military specification and is no longer recommended for new design. Mallory will continue to supply parts labeled with the Military CL64 or CL65 designation on request. The Mallory TLS meets all the requirements of the Military specification and can, therefore, be used as replacement for applications in the field where the CL64/65 was used in original equipment. Type TLH is an extended range version of the TLS capacitor. The TLH exhibits the same physical characteristics

as the TLS, however, provides higher capacitance per case size. Type TLS-TLH exhibit very high performance and very low DCL. Types listed are in insulating Mylar sleeves. For uninsulated part change 12th digit in TLS part number to a "0". **Request bulletin No. 4-604 for complete specifications. For prices, request price sheet No. 201.**

HIGHLIGHTS

Capacitance range: 10 to 2200 μ F
Voltage range: 6 to 75 WVDC
Temperature range: -55°C to +125°C
Tolerance: $\pm 20\%$, $\pm 10\%$, $\pm 5\%$

Type TLS

Cap. (μ F)	WVDC		Case Code‡	MIL-C-3965/4 Reference No.	Catalog No.
	+85°C	+125°C			
1,200	6	4	F		TLS128*006C1F
22	25	15	A	CL65BG220*PE	TLS226*025C1A
100	25	15	B	CL65BG101*PE	TLS107*025C1B
150	30	20	C	CL65BH151*PE	TLS157*030C1C

*Specify Tolerance: K = $\pm 10\%$; M = $\pm 20\%$; Special order J = $\pm 5\%$.

‡See page 17 for case code identification.

Cap. (μ F)	WVDC		Case Code‡	MIL-C-3965/4 Reference No.	Catalog No.
	+85°C	+125°C			
10	50	30	A	CL65BJ100*PE	TLS106*050C1A
25	50	30	B	CL65BJ250*PE	TLS256*050C1B
47	50	30	B	CL65BJ470*PE	TLS476*050C1B
82	50	30	C	CL65BJ820*PE	TLS826*050C1C
56	75	50	C	CL65BL560*PE	TLS566*075C1C

Extended Range

Type TLH

Cap. (μ F)	WVDC		Case Code‡	Catalog No.
	+85°C	+125°C		
820	6	4	B	TLH827*006C1B
1500	6	4	C	TLH158*006C1C
2200	6	4	F	TLH228*006C1F
150	10	7	A	TLH157*010C1A
100	15	10	A	TLH107*015C1A
390	15	10	B	TLH397*015C1B
820	15	10	C	TLH827*015C1C
68	25	15	A	TLH686*025C1A
270	25	15	B	TLH277*025C1B
560	25	15	C	TLH567*025C1C
680	25	15	F	TLH687*025C1F
220	30	20	B	TLH227*030C1B

*Specify Tolerance: K = $\pm 10\%$; M = $\pm 20\%$; Special order J = $\pm 5\%$.

‡See page 17 for case code identification.

Cap. (μ F)	WVDC		Case Code‡	Catalog No.
	+85°C	+125°C		
470	30	20	C	TLH477*030C1C
560	30	20	F	TLH567*030C1F
33	50	30	A	TLH336*050C1A
120	50	30	B	TLH127*050C1B
270	50	30	C	TLH277*050C1C
330	50	30	F	TLH337*050C1F
100	60	40	B	TLH107*060C1B
220	60	40	C	TLH227*060C1C
22	75	50	A	TLH226*075C1A
82	75	50	B	TLH826*075C1B
220	75	50	F	TLH227*075C1F

Type CL66/67 Liquid Electrolyte Tantalum Capacitors

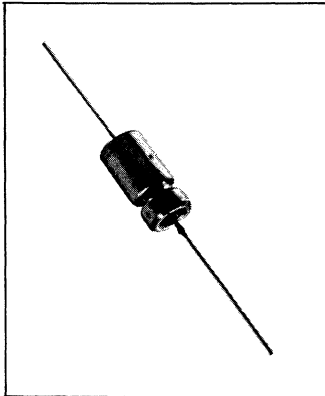

Silver Case

The Mallory hermetically sealed wet slug tantalum capacitor meets all the physical size and electrical/environmental performance requirements of MIL-C-3965/24 in Styles CL66 and CL67. Reliability and long life are assured by the double seal construction which includes an inner seal and an external hermetic seal. Insulated style CL67 part numbers are shown. For uninsulated parts,

specify CL66. Request bulletin 4-613 for complete specifications. For pricing, reference price sheet No. 212.

HIGHLIGHTS

Capacitance: 3.5 to 180 μ F
Voltage: 6 to 125 VDC @ 85°C
4 to 85 VDC @ 125°C
Tolerance: $\pm 20\%$, $\pm 10\%$, $\pm 5\%$
Temperature: -55°C to $+125^\circ\text{C}$
Case Sizes: 3 sizes, .188" \times .453" to .375" \times .766" per MIL-C-3965

WET SLUG
TANTALUM CAPACITORS

MIL-C-3965/24
STYLE CL66 & CL67

Cap. μ F	Rated Voltage		Case** Code	Catalog Number
	+85°C	+125°C		
120	15	10	T2	CL67BE121*PG
22	25	15	T1	CL67BG220*PG
180	25	15	T3	CL67BG181*PG

Cap. μ F	Rated Voltage		Case** Code	Catalog Number
	+85°C	+125°C		
8	30	20	T1	CL67BH080*PG
150	30	20	T3	CL67BH151*PG
10	50	30	T1	CL67BJ100*PG
25	50	30	T2	CL67BJ250*PG

Cap. μ F	Rated Voltage		Case** Code	Catalog Number
	+85°C	+125°C		
3.5	75	50	T1	CL67BL3R5*PG
6.8	75	50	T1	CL67BL6R8*PG
30	100	65	T3	CL67BN300*PG
9	125	85	T2	CL67BP090*PG
25	125	85	T3	CL67BP250*PG

* Specify Tolerance M = $\pm 20\%$ (Standard);
K = $\pm 10\%$;
J = $\pm 5\%$

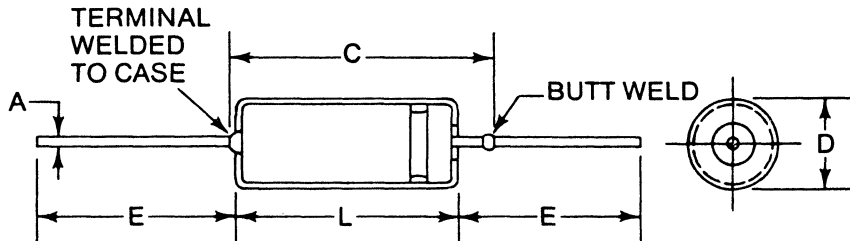

PART NUMBERING SYSTEM
MIL-C-3965 STYLE CL66, CL67

CL66/67 — CLR65-CLR69 — TLW, THT
TLS, TLH; CASE CODE CHART
DIMENSIONS (INCHES)

Case	Uninsulated		Insulated		Overall C	Lead Dia. A Inch	Lead Lgth. E	
	D	L	D	L				
	Mil $\pm .016$	$.453, +.031, -.016$	Max.	Max.				Max.
A T1	.188	.453	.219	.608	.734	.025	#22	1.50
B T2	.281	.641	.312	.796	.922	.025	#22	2.25
C T3	.375	.766	.406	.921	1.047	.025	#22	2.25
F T4	.375	1.062	.406	1.217	1.343	.025	#22	2.25

DIMENSIONS (MILLIMETERS)

Case	Uninsulated		Insulated		Overall C	Lead Dia. A	Lead Lgth. E	
	D	L	D	L				
	Mil $\pm .41$	$11.51, +.79, -.41$	Max.	Max.				Max.
A T1	4.78	11.51	5.56	15.45	18.64	.64	#22	38.10
B T2	7.41	16.28	7.92	20.22	23.41	.64	#22	57.15
C T3	9.53	19.46	10.31	23.40	26.59	.64	#22	57.15
F T4	9.53	26.97	10.31	30.91	34.11	.64	#22	57.15

Type CLR65 Liquid Electrolyte Tantalum Capacitors

WET SLUG
TANTALUM CAPACITORS

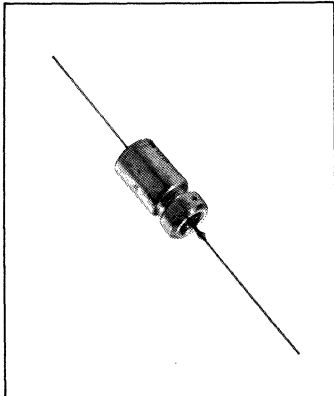

Silver Case, Hermetic Seal

Established Reliability type CLR65 meets all requirements of MIL-C-39006 specification. These sintered anode tantalum capacitors are hermetically sealed and have a plastic insulating sleeve. Stored and marked in compliance with MIL-STD-790. Failure rate level to "R". To order: Indicate type CLR65, then specify 4-digit dash number which corresponds with desired tolerance and failure rate level. (Example—CLR658206 = 30 μ F/6 VDC 20% "M" Level).

Request bulletin 4-612 for complete specifications. For pricing refer to price sheet No. 214 ("L") and No. 215 ("M", "P", "R").

HIGHLIGHTS

Capacitance Range: 1.7 to 1,200 μ F
Voltage: 6 to 125 WVDC
Temperature Range: -55°C to +85°C, to 125°C with derating
Tolerance: \pm 20%, \pm 10%, \pm 5%
Failure Rate: To Level R.

Cap. μ F	Tol.	MIL* Case Code	Part No. M39006/09D			
			Failure rate level (%/1000 hr)			
			L(2.0%)	M(1.0%)	P(0.1%)	R(.01%)
6 WVDC						
68	\pm 10	T1	8005	8210	8415	8620
270	\pm 10	T2	8011	8216	8421	8626
330	\pm 10	T3	8014	8219	8424	8629
1200	\pm 10	T4	8020	8225	8430	8635
8 WVDC						
25	\pm 10	T1	8022	8227	8432	8637
56	\pm 20	T1	8024	8229	8434	8639
430	\pm 10	T3	8031	8236	8441	8646
850	\pm 10	T4	8034	8239	8444	8649
10 WVDC						
47	\pm 10	T1	8039	8244	8449	8654
180	\pm 10	T2	8045	8250	8455	8660
180	\pm 5	T2	8046	8251	8456	8661
250	\pm 10	T3	8048	8253	8458	8663
250	\pm 5	T3	8049	8254	8459	8664
390	\pm 20	T3	8050	8255	8460	8665
750	\pm 10	T4	8054	8259	8464	8669
15 WVDC						
15	\pm 10	T1	8055	8260	8465	8670
15	\pm 10	T1	8056	8261	8466	8671
33	\pm 10	T1	8059	8264	8469	8674
70	\pm 10	T2	8062	8267	8472	8677

Cap. μ F	Tol.	MIL* Case Code	Part No. M39006/09D			
			Failure rate level (%/1000 hr)			
			L(2.0%)	M(1.0%)	P(0.1%)	R(.01%)
15 WVDC						
120	\pm 20	T2	8064	8269	8474	8679
120	\pm 10	T2	8065	8270	8475	8680
270	\pm 10	T3	8071	8276	8481	8686
540	\pm 20	T4	8073	8278	8483	8688
540	\pm 10	T4	8074	8279	8484	8689
25 WVDC						
10	\pm 10	T1	8076	8281	8486	8691
22	\pm 20	T1	8078	8283	8488	8693
22	\pm 10	T1	8079	8284	8489	8694
100	\pm 20	T2	8081	8286	8491	8696
100	\pm 10	T2	8082	8287	8492	8697
180	\pm 20	T3	8084	8289	8494	8699
180	\pm 10	T3	8085	8290	8495	8700
350	\pm 20	T4	8087	8292	8497	8702
350	\pm 10	T4	8088	8293	8498	8703
30 WVDC						
8	\pm 10	T1	8090	8295	8500	8705
15	\pm 20	T1	8092	8297	8502	8707
15	\pm 10	T1	8093	8298	8503	8708
40	\pm 10	T2	8096	8301	8506	8711
68	\pm 20	T2	8098	8303	8508	8713

Type CLR65 Liquid Electrolyte Tantalum Capacitors

Cap. μF	Tol.	MIL* Case Code	Part No. M39006/09D			
			Failure rate level (%/1000 hr)			
			L(2.0%)	M(1.0%)	P(0.1%)	R(.01%)
30 WVDC						
68	±10	T2	8099	8304	8509	8714
68	±5	T2	8100	8305	8510	8715
100	±20	T3	8101	8306	8511	8716
100	±10	T3	8102	8307	8512	8717
100	±5	T3	8103	8308	8513	8718
150	±20	T3	8104	8309	8514	8719
150	±10	T3	8105	8310	8515	8720
150	±5	T3	8106	8311	8516	8721
300	±20	T4	8107	8312	8517	8722
300	±10	T4	8108	8313	8518	8723
50 WVDC						
5	±10	T1	8110	8315	8520	8725
10	±20	T1	8112	8317	8522	8727
10	±10	T1	8113	8318	8523	8728
25	±10	T2	8116	8321	8526	8731
25	±5	T2	8117	8322	8527	8732
47	±20	T2	8118	8323	8528	8733
47	±10	T2	8119	8324	8529	8734
47	±5	T2	8120	8325	8530	8735
60	±10	T3	8122	8327	8532	8737
82	±20	T3	8124	8329	8534	8739
82	±10	T3	8125	8330	8535	8740
160	±20	T4	8127	8332	8537	8742
160	±10	T4	8128	8333	8538	8743
60 WVDC						
4	±10	T1	8130	8335	8540	8745
8.2	±10	T1	8133	8338	8543	8748
20	±10	T2	8136	8341	8546	8751
39	±10	T2	8139	8344	8549	8754
50	±20	T3	8141	8346	8551	8756
50	±10	T3	8142	8347	8552	8757
68	±10	T3	8145	8350	8555	8760
140	±10	T4	8148	8353	8558	8763

Cap. μF	Tol.	MIL* Case Code	Part No. M39006/09D			
			Failure rate level (%/1000 hr)			
			L(2.0%)	M(1.0%)	P(0.1%)	R(.01%)
75 WVDC						
3.5	±10	T1	8150	8355	8560	8765
6.8	±20	T1	8152	8357	8562	8767
6.8	±10	T1	8153	8358	8565	8768
15	±20	T2	8155	8360	8565	8770
33	±20	T2	8158	8363	8568	8773
33	±10	T2	8159	8364	8569	8774
40	±10	T3	8162	8367	8572	8777
40	±5	T3	8163	8368	8573	8773
56	±10	T3	8165	8370	8575	8780
110	±20	T4	8167	8372	8577	8782
110	±10	T4	8168	8373	8578	8783
100 WVDC						
2.5	±10	T1	8170	8375	8580	8785
2.5	±5	T1	8171	8376	8581	8786
4.7	±10	T1	8173	8378	8583	8788
11	±10	T2	8176	8381	8586	8791
22	±10	T2	8179	8384	8589	8794
30	±10	T3	8182	8387	8592	8797
43	±20	T3	8184	8389	8594	8799
43	±10	T3	8185	8390	8595	8800
86	±10	T4	8188	8393	8598	8803
125 WVDC						
1.7	±10	T1	8190	8395	8600	8805
3.6	±10	T1	8193	8398	8603	8808
9	±10	T2	8196	8401	8606	8811
14	±20	T2	8198	8403	8608	8813
14	±10	T2	8199	8404	8609	8814
14	±5	T2	8200	8405	8610	8815
25	±20	T3	8204	8409	8614	8819
25	±10	T3	8205	8410	8615	8820
56	±10	T4	9028	9031	9034	9037

WET SLUG
TANTALUM CAPACITORS

*See page 17 for case code identification.

Type CLR69 Wet Slug Tantalum Capacitors

Silver Case, Hermetic Seal

Established Reliability type CLR69 meets all requirements of MIL-C-39006 specification. These sintered anode tantalum capacitors are hermetically sealed and have a plastic insulating sleeve. Stored and marked in compliance with MIL-STD-790. Failure rate level to "R". To order: Indicate type CLR69, then specify 4-digit dash number which corresponds with desired tolerance and failure rate level. (Example—CLR690089 = 220 μ F/6 VDC \pm 20% "M" level).

Request bulletin 4-612A for complete specifications. For pricing refer to price sheet No. 224 ("L"), and No. 225 ("M", "P", and "R")

HIGHLIGHTS

Capacitance Range: 10 to 1500 μ F
Voltage: 6 to 100 WVDC
Temperature Range: -55°C to +85°C
Tolerance: \pm 20%, \pm 10%
Failure Rate: To Level R.

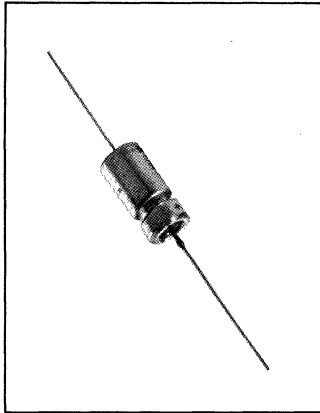

WET SLUG TANTALUM CAPACITORS

Cap. μ F	Cap. tolerance percent	†MIL Case Code	Part No. M39006/21			
			Failure rate level (%/1,000 hr)			
			L(2.0%)	M(1.0%)	P(0.1%)	R(0.01%)
8 WVDC						
680	\pm 10	T2	0012	0100	0188	0276
10 WVDC						
150	\pm 20	T1	0017	0105	0193	0281
560	\pm 10	T2	0020	0108	0196	0284
1500	\pm 20	T4	0023	0111	0199	0287
15 WVDC						
100	\pm 20	T1	0025	0113	0201	0289
390	\pm 10	T2	0028	0116	0204	0292
820	\pm 10	T3	0030	0118	0206	0294
1000	\pm 20	T4	0031	0119	0207	0295
1000	\pm 10	T4	0032	0120	0208	0296
25 WVDC						
68	\pm 20	T1	0033	0121	0209	0297
68	\pm 10	T1	0034	0122	0210	0298
270	\pm 20	T2	0035	0123	0211	0299
560	\pm 20	T3	0037	0125	0213	0301
560	\pm 10	T3	0038	0126	0214	0302
680	\pm 20	T4	0039	0127	0215	0303
680	\pm 10	T4	0040	0128	0216	0304
30 WVDC						
56	\pm 20	T1	0041	0129	0217	0305
56	\pm 10	T1	0042	0130	0218	0306
220	\pm 20	T2	0043	0131	0219	0307
220	\pm 10	T2	0044	0132	0220	0308
470	\pm 20	T3	0045	0133	0221	0309
470	\pm 10	T3	0046	0134	0222	0310
560	\pm 20	T4	0047	0135	0223	0311
560	\pm 10	T4	0048	0136	0224	0312

Cap. μ F	Cap. tolerance percent	†MIL Case Code	Part No. M39006/21			
			Failure rate level (%/1,000 hr)			
			L(2.0%)	M(1.0%)	P(0.1%)	R(0.01%)
50 WVDC						
33	\pm 20	T1	0049	0137	0225	0313
33	\pm 10	T1	0050	0138	0226	0314
120	\pm 20	T2	0051	0139	0227	0315
120	\pm 10	T2	0052	0140	0228	0316
270	\pm 20	T3	0053	0141	0229	0317
270	\pm 10	T3	0054	0142	0230	0318
330	\pm 20	T4	0055	0143	0231	0319
330	\pm 10	T4	0056	0144	0232	0320
60 WVDC						
27	\pm 10	T1	0058	0146	0234	0322
100	\pm 20	T2	0059	0147	0235	0323
100	\pm 10	T2	0060	0148	0236	0324
220	\pm 20	T3	0061	0149	0237	0325
220	\pm 10	T3	0062	0150	0238	0326
270	\pm 20	T4	0063	0151	0239	0327
270	\pm 10	T4	0064	0152	0240	0328
75 WVDC						
82	\pm 20	T2	0067	0155	0243	0331
82	\pm 10	T2	0068	0156	0244	0332
180	\pm 20	T3	0069	0157	0245	0333
180	\pm 10	T3	0070	0158	0246	0334
220	\pm 20	T4	0071	0159	0247	0335
220	\pm 10	T4	0072	0160	0248	0336
100 WVDC						
39	\pm 20	T2	0075	0163	0251	0339
120	\pm 20	T4	0079	0167	0255	0343

†See page 17 for case size chart.

Type CLR79 Wet Slug Tantalum Capacitors

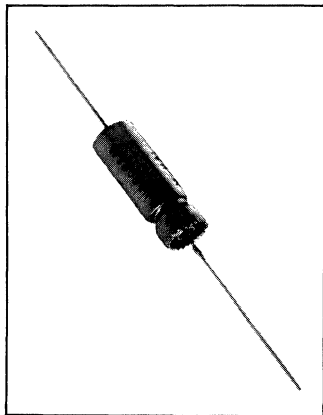

Tantalum Case High Ripple
MIL-C-39006/22 style CLR79 wet slug capacitor is intended for reverse voltage and high ripple current applications that are beyond the capability of silver case wet slug capacitors. Style CLR79 will handle up to 3 volts reverse voltage at 85°C or 2 volts reverse voltage at 125°C. Lower ESR, extremely low DCL, and very stable capacitance under extreme environmental conditions are characteristic of the capacitor. Rugged construction includes the anode firmly seated on shock

pads and one piece riser design that eliminates internal welds. The capacitor is sealed by a glass to tantalum hermetic seal welded to the tantalum case.

HIGHLIGHTS
Capacitance: 1.7 to 1200µF
Voltage: 6 to 125WVDC
Tolerance: ±5%, ±10%, ±20%
Temperature: -55°C to 85°C (to 125°C with proper derating)
Failure Rate: To Level R.

To order: Indicate CLR79 — followed by the appropriate 4 digit dash number. **Request bulletin 4-616 for complete specifications.** For pricing, reference price sheet No. 227 ("L") and 228 ("M", "P", and "R")

WET SLUG
TANTALUM CAPACITORS

Cap µF	Cap Tolerance percent	MIL Case Code	Part Number CLR79			
			Failure rate level (%/1000 hr)			
			L (2.0%)	M (1.0%)	P (0.1%)	R (0.01%)
6 WVDC						
1200	±10	T4	6020	0020	0240	0460
10 WVDC						
47	±10	T1	6039	0045	0265	0485
100	±10	T2	6042	0048	0268	0488
180	±10	T2	6045	0051	0271	0491
750	±10	T4	6054	0060	0280	0500
15 WVDC						
15	±10	T1	6056	0062	0282	0502
33	±10	T1	6059	0065	0285	0505
120	±10	T2	6065	0071	0291	0511
120	±5	T2	6066	0072	0292	0512
270	±10	T3	6071	0077	0297	0517
540	±10	T4	6074	0080	0300	0520
25 WVDC						
10	±10	T1	6076	0082	0302	0522
22	±10	T1	6079	0085	0305	0525
100	±10	T2	6082	0091	0311	0531
180	±20	T3	6084	0096	0316	0536
180	±10	T3	6085	0097	0317	0537
350	±10	T4	6088	0100	0320	0540
30 WVDC						
15	±20	T1	6092	0104	0324	0544
15	±10	T1	6093	0105	0325	0545
68	±10	T2	6099	0111	0331	0551
100	±20	T3	6101	0113	0333	0553
150	±10	T3	6105	0117	0337	0557
150	±5	T3	6106	0118	0338	0558
300	±10	T4	6108	0120	0340	0560
50 WVDC						
5	±10	T1	6110	0122	0342	0562
10	±10	T1	6113	0125	0345	0565
10	±5	T1	6114	0126	0346	0566

Cap µF	Cap Tolerance percent	MIL Case Code	Part Number CLR79			
			Failure rate level (%/1000 hr)			
			L (2.0%)	M (1.0%)	P (0.1%)	R (0.01%)
50 WVDC						
25	±20	T2	6115	0127	0347	0567
25	±10	T2	6116	0128	0348	0568
47	±10	T2	6119	0131	0351	0571
47	±5	T2	6120	0132	0352	0572
60	±10	T3	6122	0134	0354	0574
60	±5	T3	6123	0135	0355	0575
82	±20	T3	6124	0136	0356	0576
82	±10	T3	6125	0137	0357	0577
160	±10	T4	6128	0140	0360	0580
60 WVDC						
8.2	±10	T1	6133	0145	0365	0585
39	±20	T2	6138	0150	0370	0590
50	±20	T3	6141	0153	0373	0593
50	±10	T3	6142	0154	0374	0594
68	±20	T3	6144	0156	0376	0596
68	±10	T3	6145	0157	0377	0597
140	±10	T4	6148	0160	0380	0600
75 WVDC						
3.5	±10	T1	6150	0162	0382	0602
6.8	±10	T1	6153	0165	0385	0605
15	±20	T2	6155	0167	0387	0607
15	±10	T2	6156	0168	0388	0608
33	±10	T2	6159	0171	0391	0611
56	±10	T3	6165	0177	0397	0617
56	±5	T3	6166	0178	0398	0618
110	±10	T4	6168	0180	0400	0620
100 WVDC						
2.5	±10	T1	6170	0182	0402	0622
4.7	±10	T1	6173	0185	0405	0625
4.7	±5	T1	6174	0186	0406	0626
11	±20	T2	6175	0187	0407	0627
11	±10	T2	6176	0188	0408	0628
11	±5	T2	6177	0189	0409	0629
22	±10	T2	6179	0191	0411	0631
30	±10	T3	6182	0194	0414	0634
43	±10	T3	6185	0197	0417	0637
86	±20	T4	6187	0199	0419	0639
86	±10	T4	6188	0200	0420	0640

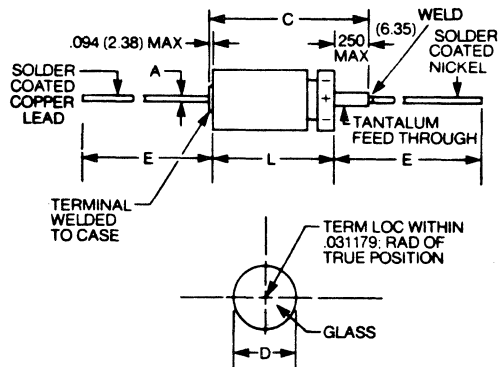

DIMENSIONS (INCHES)

CASE	UNINSULATED		INSULATED		OVERALL C MAX.	LEAD DIA. A INCH NOM.	LEAD LGTH. E ±.250
	D ±.016	L +.031, -.016	D MAX.	L MAX.			
T1	.188	.453	.219	.608	.734	025 #22	1.50
T2	.281	.641	.312	.796	.922	025 #22	2.50
T3	.375	.766	.406	.921	1.047	025 #22	2.50
T4	.375	1.062	.406	1.217	1.343	025 #22	2.50

Type THT • High Temperature Wet Slug Tantalum Capacitors

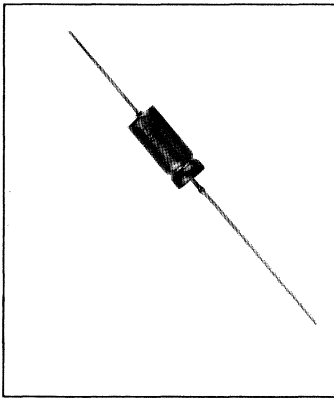

Tantalum Case High Ripple, Reverse Voltage

Mallory THT tantalum case wet slug capacitors are intended for high temperature operation to 200°C at reduced voltage. Tantalum case design allows reverse voltage and high ripple current capability. The THT will handle up to 3 volts reverse at 85°C, 2 volts reverse at 125°C, 1 volt reverse at 200°C. Low ESR, low DCL and stable capacitance under extreme

environmental conditions are characteristic of the THT. Rugged construction includes rigid mounting of the sintered anode between teflon shock pads. One piece riser design eliminates internal welds. The capacitor is sealed by a glass to tantalum seal laser welded to the tantalum case. Lead wires are solder coated nickel wire. Kapton insulating sleeving is available.

Request bulletin 4-618 for complete technical data.

HIGHLIGHTS:

Capacitance: to 1200 μ F
 Voltage: 6 to 125 VDC @ 85°C
 2.4 to 75 VDC @ 200°C
 Tolerance: $\pm 10\%$, $\pm 20\%$
 Temperature: -55°C to 200°C with voltage derating.

Cap	WVDC		Case Code	Catalog Number
	85°C	200°C		
50.	25	12	B	THT506M025P6B
150.	30	18	C	THT157M030P6C
82.	50	30	C	THT826M050P6C
160.	50	30	F	THT167M050P6F
8.2	60	36	A	THT825M060P6A
2.5	100	60	A	THT255M110P6A
11.	100	60	B	THT116M100P6B
1.7	125	75	A	THT175M125P6A

Type TLW High Temperature Wet Slug Tantalum Capacitors

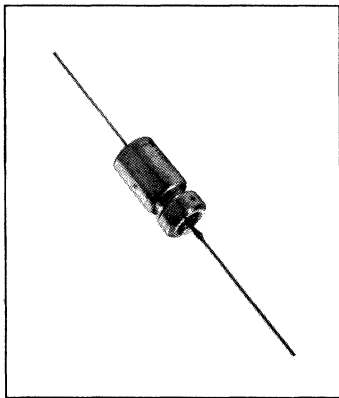

The TLW is the same design and construction as the Mallory TLX which meets the high reliability specifications of MIL-C-39006/9. The glass to metal hermetic seal allows high temperature operation to 175°C (with proper derating). Rugged internal construction will withstand severe shock and vibra-

tion. **Request bulletin No. 4-611 for complete specifications. For pricing contact factory.**

HIGHLIGHTS

Capacitance Range: 4.7 to 1,200 μ F
 Voltage: 6 to 100 VDC @ 85°C
 4 to 65 VDC @ 125°C
 3 to 50 VDC @ 175°C
 Temperature Range: -55°C to 175°C

Cap μ	WVDC		*Case Code	Catalog Number
	+85°C	+125°C		
1200	6	4	F	TLW128M006P6F
47	25	15	A	TLW476M025P6A
100	25	15	B	TLW107M025P6B
350	25	15	F	TLW357M025P6F
40	30	20	B	TLW406M030P6B
68	30	20	B	TLW686M030P6B
300	30	20	F	TLW307M030P6F
22	50	30	A	TLW226M050P6A
82	50	30	C	TLW826M050P6C
160	50	30	F	TLW167M050P6F
68	60	40	C	TLW686M060P6C
110	75	50	F	TLW117M075P6F
4.7	100	65	A	TLW475M100P6A

Type CLR81 • Wet Slug Tantalum Case Extended Range Capacitors

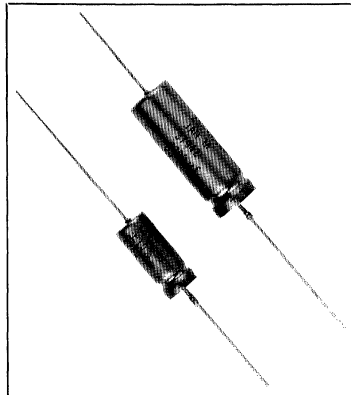

Tantalum Case High Ripple

MIL-C-39006/25 style CLR81 wet slug capacitor is the extended capacitance version of the CLR79. The CLR81 extended capacitance wet slug capacitor is intended for reverse voltage and high ripple current applications that are beyond the capability of silver case wet slug capacitors. Style CLR81 will handle up to 3 volts reverse voltage at 85°C or 2 volts reverse voltage at 125°C. Lower ESR, extremely low DCL, and

very stable capacitance under extreme environmental conditions are characteristic of the capacitor.

Rugged construction includes the anode firmly seated on shock pads and one piece riser design that eliminates internal welds. The capacitor is sealed by a glass to tantalum hermetic seal welded to the tantalum case.

To order: Indicate CLR81 — followed by the appropriate 4 digit dash number.

HIGHLIGHTS

Capacitance: 6.8 to 2200 μ F
Voltage: 6 to 125VVDC
Tolerance: $\pm 10\%$, $\pm 20\%$
Temperature: -55°C to 85°C (to 125°C with proper derating)
Failure Rate: To Level M.

Failure rates P and R subject to approval of continued Mil qualification testing.

WET SLUG
TANTALUM CAPACITORS

Cap μ F	Cap Tolerance percent	MIL Case Code	Part Number CLR81		
			Failure rate level (%/1000 hr)		
			M (1.0%)	P (0.1%)	R (0.01%)
6 WVDC					
220	± 20	T1	0001	0089	0177
220	± 10	T1	0002	0090	0178
820	± 20	T2	0003	0091	0179
820	± 10	T2	0004	0092	0180
1500	± 20	T3	0005	0093	0181
1500	± 10	T3	0006	0094	0182
2200	± 20	T4	0007	0095	0183
2200	± 10	T4	0008	0096	0184
8 WVDC					
180	± 20	T1	0009	0097	0185
180	± 10	T1	0010	0098	0186
680	± 20	T2	0011	0099	0187
† 680	± 10	T2	0012	0100	0188
1500	± 20	T3	0013	0101	0189
1500	± 10	T3	0014	0102	0190
1800	± 20	T4	0015	0103	0191
1800	± 10	T4	0016	0104	0192
10 WVDC					
† 150	± 20	T1	0017	0105	0193
150	± 10	T1	0018	0106	0194
560	± 20	T2	0019	0107	0195
† 560	± 10	T2	0020	0108	0196
1200	± 20	T3	0021	0109	0197
1200	± 10	T3	0022	0110	0198
† 1500	± 20	T4	0023	0111	0199
1500	± 10	T4	0024	0112	0200
15 WVDC					
† 100	± 20	T1	0025	0113	0201
100	± 10	T1	0026	0114	0202
390	± 20	T2	0027	0115	0203
† 390	± 10	T2	0028	0116	0204
820	± 20	T3	0029	0117	0205
† 820	± 10	T3	0030	0118	0206
† 1000	± 20	T4	0031	0119	0207
† 1000	± 10	T4	0032	0120	0208
25 WVDC					
† 68	± 20	T1	0033	0121	0209
† 68	± 10	T1	0034	0122	0210
† 270	± 20	T2	0035	0123	0211
270	± 10	T2	0036	0124	0212
† 560	± 20	T3	0037	0125	0213
† 560	± 10	T3	0038	0126	0214
† 680	± 20	T4	0039	0127	0215
† 680	± 10	T4	0040	0128	0216
30 WVDC					
† 56	± 20	T1	0041	0129	0217
† 56	± 10	T1	0042	0130	0218
† 220	± 20	T2	0043	0131	0219
† 220	± 10	T2	0044	0132	0220
† 470	± 20	T3	0045	0133	0221
† 470	± 10	T3	0046	0134	0222
† 560	± 20	T4	0047	0135	0223
† 560	± 10	T4	0048	0136	0224

Cap μ F	Cap Tolerance percent	MIL Case Code	Part Number CLR81		
			Failure rate level (%/1000 hr)		
			M (1.0%)	P (0.1%)	R (0.01%)
50 WVDC					
† 33	± 20	T1	0049	0137	0225
† 33	± 10	T1	0050	0138	0226
† 120	± 20	T2	0051	0139	0227
† 120	± 10	T2	0052	0140	0228
† 270	± 20	T3	0053	0141	0229
† 270	± 10	T3	0054	0142	0230
† 330	± 20	T4	0055	0143	0231
† 330	± 10	T4	0056	0144	0232
60 WVDC					
27	± 20	T1	0057	0145	0233
† 27	± 10	T1	0058	0146	0234
† 100	± 20	T2	0059	0147	0235
† 100	± 10	T2	0060	0148	0236
† 220	± 20	T3	0061	0149	0237
† 220	± 10	T3	0062	0150	0238
† 270	± 20	T4	0063	0151	0239
† 270	± 10	T4	0064	0152	0240
75 WVDC					
22	± 20	T1	0065	0153	0241
22	± 10	T1	0066	0154	0242
† 82	± 20	T2	0067	0155	0243
† 82	± 10	T2	0068	0156	0244
† 180	± 20	T3	0069	0157	0245
† 180	± 10	T3	0070	0158	0246
† 220	± 20	T4	0071	0159	0247
† 220	± 10	T4	0072	0160	0248
100 WVDC					
10	± 20	T1	0073	0161	0249
10	± 10	T1	0074	0162	0250
† 39	± 20	T2	0075	0163	0251
† 39	± 10	T2	0076	0164	0252
68	± 20	T3	0077	0165	0253
68	± 10	T3	0078	0166	0254
† 120	± 20	T4	0079	0167	0255
120	± 10	T4	0080	0168	0256
125 WVDC					
6.8	± 20	T1	0081	0169	0257
6.8	± 10	T1	0082	0170	0258
27	± 20	T2	0083	0171	0259
27	± 10	T2	0084	0172	0260
47	± 20	T3	0085	0173	0261
47	± 10	T3	0086	0174	0262
82	± 20	T4	0087	0175	0263
82	± 10	T4	0088	0176	0264

†Mallory Preferred Ratings

• New Product

Type CLR81 • Wet Slug Tantalum Case Extended Range Capacitors

WET SLUG
TANTALUM CAPACITORS

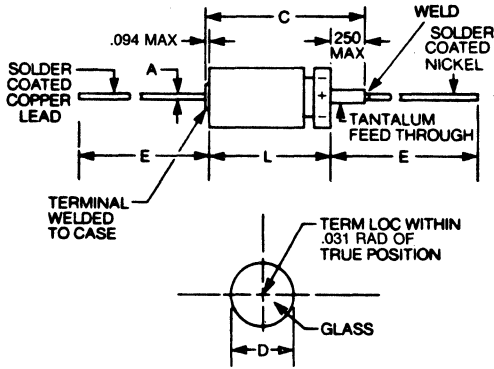

Dimensions (Inches)

Case	Uninsulated		Insulated		Overall C	Lead Dia. A Inch	Lead Lgth. E Awg
	D	L	D	L			
Mil	±.016	+ .031, - .016	Max.	Max.	Max.	Nom.	±.250
T1	.188	.453	.219	.608	.734	.025	#22 1.50
T2	.281	.641	.312	.796	.922	.025	#22 2.25
T3	.375	.766	.406	.921	1.047	.025	#22 2.25
T4	.375	1.062	.406	1.217	1.343	.025	#22 2.25

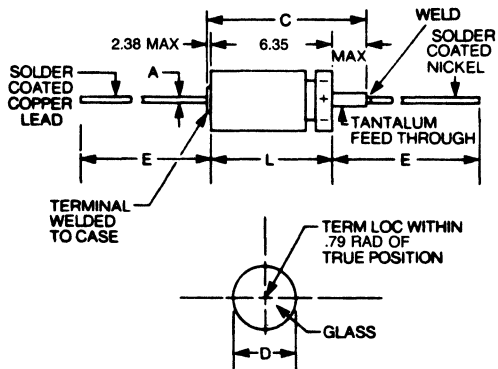

Dimensions (Millimeters)

Case	Uninsulated		Insulated		Overall C	Lead Dia. A MM	Lead Lgth. E Awg
	D	L	D	L			
Mil	±.41	+ .79, - .41	Max.	Max.	Max.	MM	±6.35
T1	4.78	11.51	5.56	15.45	18.64	.64	#22 38.10
T2	7.14	16.28	7.92	20.22	23.41	.64	#22 57.15
T3	9.53	19.46	10.31	23.40	26.59	.64	#22 57.15
T4	9.53	26.97	10.31	30.91	34.11	.64	#22 57.15

• New Product

Type XTM, XTH, XTL and XTV Tantalum Capacitors

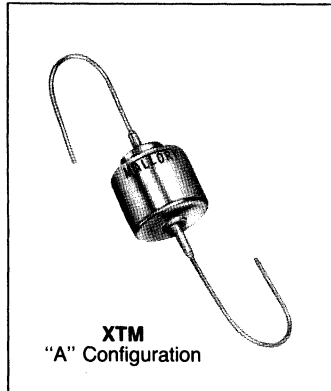

XTM
"A" Configuration

High Temperature +200°C

Mallory high temperature capacitors (200°C) are furnished in hermetically sealed metal cases and are wet-slug polarized types. XTM-A types have axial leads. All XTL, H and V types are available in a wide variety of terminal arrangements on special request. These same ratings are available to meet the requirements of MIL-C-39006. Military approved parts are available in failure rates L, M and P.

Request bulletin 4-501 for complete specifications. For pricing, refer to price sheet no. 240.

HIGHLIGHTS

Capacitance: 5. to 1300 μ F,
Voltage: 30 to 630 WVDC
Tolerance: XTM & XTV —
- 15%, + 50% XTH & XTL —
- 15%, + 75%

TYPE XTM -55°C to +85°C (200°C with proper voltage derating, see Bulletin 4-84A)

*Commercial equivalent to MIL-C-39006/18, Style CLR10. Also available to MIL-C-3965, Style CL10 and CL13.

Tolerance: - 15, + 50%

Cap., μ F	WVDC +85°C	Catalog Number*
8	180	XTM805T180POA
5	270	XTM505T270POA



XTL
"C" Configuration

TYPE XTL -55°C to +85°C (200°C with proper voltage derating, see Bulletin 4-84A)

*Commercial equivalent to MIL-C-39006/19, Style CLR14. Also available to MIL-C-3965, Style CL14 and CL16.

Tolerance: - 15, + 75%

Cap., μ F	WVDC +85°C	Catalog Number*
6	360	XTL605U360POC

TYPE XTH -55°C to +85°C (200°C with proper voltage derating, see Bulletin 4-84A)

*Commercial equivalent to MIL-C-39006/19, Style CLR14. Also available to MIL-C-3965, Style CL14 and CL16.

Tolerance: - 15, + 75%

Cap., μ F	WVDC +85°C	Catalog Number*
150	30	XTH157U030POC
50	90	XTH506U090POC
25	180	XTH256U180POC
16	270	XTH166U270POC
12	360	XTH126U360POC

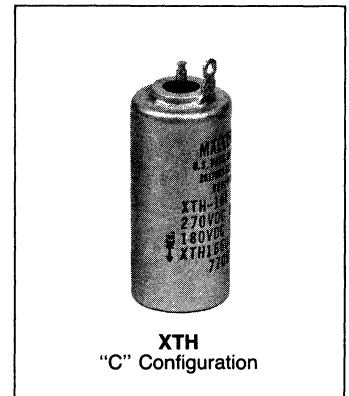

XTH
"C" Configuration

TYPE XTV -55°C to +85°C (200°C with proper voltage derating, see Bulletin 4-84A)

*Commercial equivalent to MIL-C-39006/20, Style CLR17. Also available to MIL-C-3965, Style CL17 and CL18.

Tolerance: - 15, + 50%

Cap., μ F	WVDC +85°C	Catalog Number*
1300	30	XTV138T030POC
120	90	XTV127T090POC

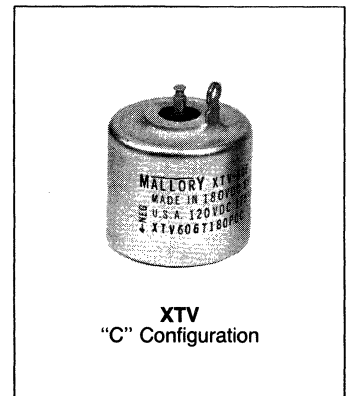

XTV
"C" Configuration

WET SLUG
TANTALUM CAPACITORS

Type CL55 Liquid Electrolyte Tantalum Capacitors

Rectangular Case

The Mallory Type CL55 is designed to meet all requirements of the MIL-C-3965/21 specification. This unit is an assembly of tubular wet tantalum capacitors potted in a metal case and hermetically sealed with each terminal insulated from the capacitor case. These units are supplied with solder-lug type terminals. Refer to MIL-C-3965/21 for complete specifications. **For pricing request price sheet number 209.**

HIGHLIGHTS

Capacitance Range: 270 to 2,400 μ F
Voltage: 15 to 100 VDC
Temperature Range: -55°C to +125°C
Power Factor: 15% (max.)



WET SLUG
TANTALUM CAPACITORS

Cap. (μ F)	Rated Voltage VDC		Case Code	Catalog Number
	85°C	125°C		
2400	15	10	A5	CL55BE242MPG
520	30	20	A1	CL55BH521MPG
1200	30	20	A4	CL55BH122MPG
800	50	30	A4	CL55BJ801MPG
1000	50	30	A5	CL55BJ102MPG
270	75	50	A1	CL55BL271MPG
400	75	50	A3	CL55BL401MPG
600	75	50	A4	CL55BL601MPG
220	100	65	A2	CL55BN221MPG
350	100	65	A4	CL55BN351MPG
440	100	65	A5	CL55BN441MPG

CASE CODE CHART

Case Code	Dimensions	
	L \pm .031 (.79)	
	in.	mm.
A1	1.062	26.97
A2	1.375	34.93
A3	1.625	41.28
A4	2.000	50.80
A5	2.500	63.50

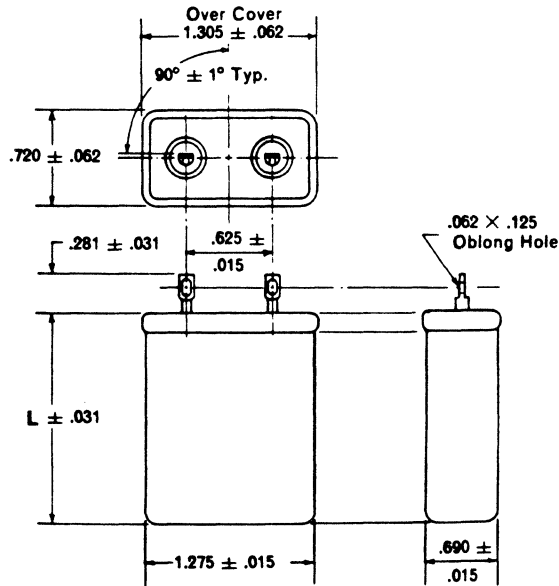

Type TDC/TDL Epoxy Dipped Solid Tantalum Capacitors

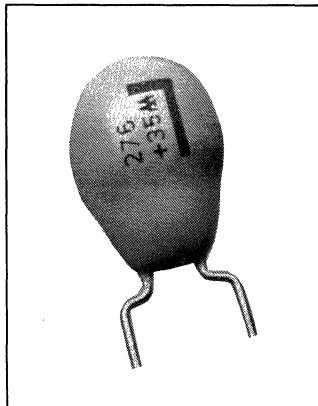

Radial Leads

Type TDC/TDL capacitors offer the long life electrical stability characteristics of solid tantalum at low cost. The tough epoxy coating provides uniform lead spacing and protection against mechanical damage and moisture. These capacitors are ideal for industrial and consumer applications where premium performance, minimum size, and low cost are essential.

For prices, refer to price sheet No. 290(TDC) and 292(TDL). For additional information request bulletin 4-810. TDC capacitor Mallobins are available. See complete Mallobin listing, page 150.

HIGHLIGHTS

Capacitance: To 330 μ F
Voltage: 6 to 50 WVDC
Tolerance: $\pm 20\%$ $\pm 10\%$
Temperature Range: -55°C to $+85^{\circ}\text{C}$ (to $+125^{\circ}\text{C}$ with voltage derating)

TDL EPOXY DIPPED SOLID TANTALUM CAPACITORS

Cap. μ F	Case Code	Mallory Standard Part Number
6 Volts WVDC, 8 VDC Surge @ 85°C		
10.0	E	TDC106*006NSE
47.0	F	TDC476*006NSF
68.0	F	TDC686*006NSF
100.0	F	TDC107*006NSF
150.0	G	TDC157*006WSG
220.0	G	TDC227*006WSG
330.0	H	TDC337*006WSH
10 Volts WVDC, 13 VDC Surge @ 85°C		
4.7	E	TDC475*010NSE
10.0	F	TDC106*010NSF
22.0	F	TDC226*010NSF
33.0	F	TDC336*010NSF
39.0	F	TDC396*010NSF
47.0	F	TDC476*010NSF
100.0	G	TDC107*010WSG
120.0	G	TDC127*010WSG
150.0	G	TDC157*010WSG
220.0	H	TDC227*010WSH
15 Volts WVDC, 20 VDC Surge @ 85°C		
3.3	E	TDC335*015NSE
3.9	E	TDC395*015NSE
4.7	E	TDC475*015NSE
6.8	E	TDC685*015NSE
10.0	F	TDC106*015NSF
12.0	F	TDC126*015NSF
15.0	F	TDC156*015NSF
22.0	F	TDC226*015NSF
27.0	F	TDC276*015NSF
33.0	F	TDC336*015NSF
39.0	G	TDC396*015WSG

Cap. μ F	Case Code	Mallory Standard Part Number
15 Volts WVDC, 20 VDC Surge @ 85°C		
68.0	G	TDC686*015WSG
100.0	H	TDC107*015WSH
150.0	H	TDC157*015WSH
20 Volts WVDC, 26 VDC Surge @ 85°C		
2.2	E	TDC225*020NSE
4.7	E	TDC475*020NSE
10.0	F	TDC106*020NSF
12.0	F	TDC126*020NSF
15.0	F	TDC156*020NSF
18.0	F	TDC186*020NSF
22.0	F	TDC226*020NSF
33.0	G	TDC336*020WSG
39.0	G	TDC396*020WSG
47.0	G	TDC476*020WSG
100.0	H	TDC107*020WSH
25 Volts WVDC, 32 VDC Surge @ 85°C		
2.2	E	TDC225*025NSE
4.7	F	TDC475*025NSF
5.6	F	TDC565*025NSF
6.8	F	TDC685*025NSF
8.2	F	TDC825*025NSF
10.0	F	TDC106*025NSF
15.0	F	TDC156*025NSF
22.0	F	TDC226*025NSF
27.0	G	TDC276*025WSG
33.0	G	TDC336*025WSG
47.0	G	TDC476*025WSG
56.0	H	TDC566*025WSH
68.0	H	TDC686*025WSH

Cap. μ F	Case Code	Mallory Standard Part Number
35 Volts WVDC, 46 VDC Surge @ 85°C		
0.10	E	TDC104*035NSE
0.22	E	TDC224*035NSE
0.33	E	TDC334*035NSE
0.47	E	TDC474*035NSE
0.56	E	TDC564*035NSE
0.68	E	TDC684*035NSE
1.0	E	TDC105*035NSE
1.5	E	TDC155*035NSE
2.2	E	TDC225*035NSE
2.7	F	TDC275*035NSF
3.3	F	TDC335*035NSF
4.7	F	TDC475*035NSF
5.6	F	TDC565*035NSF
6.8	F	TDC685*035NSF
10.0	F	TDC106*035NSF
15.0	G	TDC156*035WSG
22.0	G	TDC226*035WSG
27.0	H	TDC276*035WSH
33.0	H	TDC336*035WSH
47.0	H	TDC476*035WSH
50 Volts WVDC, 65 VDC Surge @ 85°C		
0.10	E	TDC104*050NSE
0.33	E	TDC334*050NSE
0.47	E	TDC474*050NSE
0.68	E	TDC684*050NSE
1.0	E	TDC105*050NSE
1.5	E	TDC155*050NSE
2.2	F	TDC225*050NSF
3.3	F	TDC335*050NSF
4.7	F	TDC475*050NSF
6.8	G	TDC685*050WSG
10.0	G	TDC106*050WSG
22.0	H	TDC226*050WSH

*Tolerance — M = $\pm 20\%$
K = $\pm 10\%$

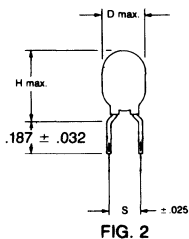
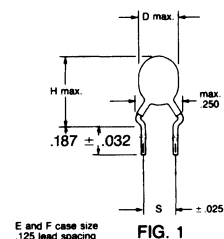

TYPE TDC OUTLINE DIMENSIONS

Case Code	Diameter (D)		Height (H)		Leads				
	In.	(mm)	In.	(mm)	Space (s)	Case Code	Diameter (mm)	Awg.	
E	.175	(4.45)	.350	(8.89)	.125	(3.17)	N	.020	(.51) #24
					.250	(6.35)	W	.020	(.51) #24
F	.250	(6.35)	.500	(12.7)	.125	(3.17)	N	.020	(.51) #24
					.250	(6.35)	W	.020	(.51) #24
G	.350	(8.89)	.650	(16.51)	.250	(6.35)	W	.020	(.51) #24
H	.400	(10.16)	.750	(19.05)	.250	(6.35)	W	.020	(.51) #24

Note 1: Normally stocked parts have straight leads and lead spacing as indicated in the standard part number shown.

Note 2: Mallory reserves the right to substitute a tighter tolerance and higher voltage part in the same case size.

* Long lead length of .500 inch minimum is available on special order only. Long lead length is designated with letter 'M' in Part Number.

Specifications subject to change without notice.

SOLID TANTALUM CAPACITORS

Type TDC/TDL Epoxy Dipped Solid Tantalum Capacitors

TDC EPOXY DIPPED SOLID TANTALUM CAPACITORS

Cap. μ F	Case Code	Mallory Standard Part Number	Cap. μ F	Case Code	Mallory Standard Part Number	Cap. μ F	Case Code	Mallory Standard Part Number
6.3 Volts WVDC, 8 VDC Surge @ 85°C			16 Volts WVDC, 20 VDC Surge @ 85°C			35 Volts WVDC, 46 VDC Surge @ 85°C		
10.0	B	TDL106*006S1B	22.0	D	TDL226*016S1D	0.68	A	TDL684*035S1A
47.0	D	TDL476*006S1D	33.0	D	TDL336*016S1D	1.0	B	TDL105*035S1B
68.0	D	TDL686*006S1D	47.0	E	TDL476*016M1E	1.5	B	TDL155*035S1B
100.0	D	TDL107*006S1D	68.0	E	TDL686*016M1E	2.2	C	TDL225*035S1C
150.0	E	TDL157*006M1E	100.0	F	TDL107*016M1F	3.3	C	TDL335*035S1C
220.0	E	TDL227*006M1E	150.0	F	TDL157*016M1F	4.7	D	TDL475*035S1D
330.0	F	TDL337*006M1F				6.8	D	TDL685*035S1D
10 Volts WVDC, 13 VDC Surge @ 85°C			25 Volts WVDC, 32 VDC Surge @ 85°C			50 Volts WVDC, 65 VDC Surge @ 85°C		
4.7	A	TDL475*010S1A	1.0	A	TDL105*025S1A	0.10	A	TDL104*050S1A
10.0	B	TDL106*010S1B	1.5	A	TDL155*025S1A	0.33	A	TDL334*050S1A
22.0	C	TDL226*010S1C	2.2	B	TDL225*025S1B	0.47	B	TDL474*050S1B
33.0	D	TDL336*010S1D	4.7	C	TDL475*025S1C	0.68	B	TDL684*050S1B
47.0	D	TDL476*010S1D	6.8	C	TDL685*025S1C	1.0	C	TDL105*050S1C
100.0	E	TDL107*010M1E	10.0	C	TDL106*025S1C	1.5	C	TDL155*050S1C
150.0	E	TDL157*010M1E	15.0	D	TDL156*025S1D	2.2	D	TDL225*050S1D
220.0	F	TDL227*010M1F	22.0	D	TDL226*025S1D	3.3	D	TDL335*050S1D
			33.0	E	TDL336*025M1E	4.7	D	TDL475*050S1D
			47.0	E	TDL476*025M1E	6.8	F	TDL685*050M1F
			68.0	F	TDL686*025M1F	10.0	F	TDL106*050M1F
16 Volts WVDC, 20 VDC Surge @ 85°C			35 Volts WVDC, 46 VDC Surge @ 85°C					
1.5	A	TDL155*016S1A	0.10	A	TDL104*035S1A			
2.2	A	TDL225*016S1A	0.22	A	TDL224*035S1A			
3.3	B	TDL335*016S1B	0.33	A	TDL334*035S1A			
4.7	B	TDL475*016S1B	0.47	A	TDL474*035S1A			
6.8	B	TDL685*016S1B						
10.0	C	TDL106*016S1C						
15.0	C	TDL156*016S1C						

SOLID TANTALUM CAPACITORS

TYPE TDL OUTLINE DIMENSIONS

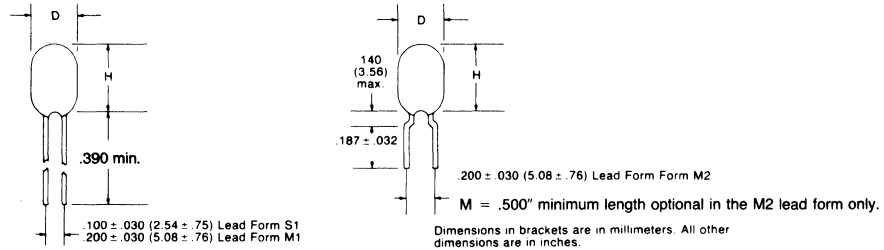

Case Code	Available Lead Forms	Diameter Max.		Height Max.	
		In.	(mm)	In.	(mm)
A	S1, M2	.18	4.57	.28	7.11
B	S1, M2	.20	5.08	.30	7.62
C	S1, M2	.26	6.60	.36	9.14
D	S1, M2	.34	8.64	.40	10.16
E	M1	.40	10.16	.56	14.22
F	M1	.44	11.18	.68	17.27

- NOTE: 1. Lead spacing is measured within .050" (1.27 mm) from lead egress or bottom of standoff crimp.
 2. Lead diameter is .020" (.51) for all lead forms.
 3. Mallory reserves the right to substitute a tighter tolerance and higher voltage part in the same case size.

Type TIM Molded Solid Tantalum Capacitors

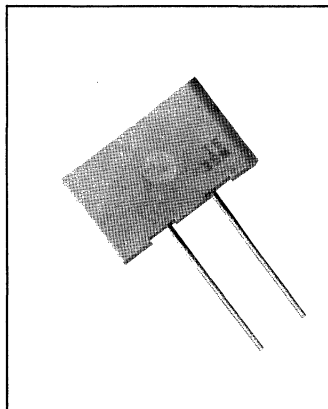

Radial Leads

Type TIM solid electrolyte tantalum capacitors are fully molded in a rectangular epoxy case. Radial leads are precisely positioned to provide easy mounting on printed circuit boards. Electrical and environmental performance fits the needs of computer and industrial users. Four case sizes are available. Operating Temperature: -55°C to + 85°C, (to + 125°C with proper voltage derating).

Request bulletin 4-806 for complete technical data. For prices, request price sheet No. 280.

HIGHLIGHTS

Capacitance: .10 to 220 μ F
 Voltage: 6 to 50 WVDC
 Tolerance: \pm 20%, \pm 10%
 Temperature: -55°C to +85°C (to +125°C with voltage derating.)
 Case Sizes: 4 sizes, .345 \times .230 \times .105 to .375 \times .600 \times .195

μ F	Case Code	Catalog Number
6 WVDC		
22	X	TIM226*006P0X
56	Y	TIM566*006P0Y
68	Y	TIM686*006P0Y
220	Z	TIM227*006P0Z
10 WVDC		
6.8	X	TIM685*010P0X
10	W	TIM106*010P0W
10	X	TIM106*010P0X
15	W	TIM156*010P0W
15	X	TIM156*010P0X
22	Y	TIM226*010P0Y
33	Y	TIM336*010P0Y
39	Y	TIM396*010P0Y
56	Z	TIM566*010P0Z
150	Z	TIM157*010P0Z
15 WVDC		
5.6	X	TIM565*015P0X
8.2	X	TIM825*015P0X
10	Y	TIM106*015P0Y
15	Y	TIM156*015P0Y
22	Y	TIM226*015P0Y
27	Y	TIM276*015P0Y
33	Y	TIM336*015P0Y

*Specify Tolerance M = \pm 20%
 K = \pm 10%

μ F	Case Code	Catalog Number
20 WVDC		
6.8	W	TIM685*020P0W
25 WVDC		
3.3	W	TIM335*025P0W
3.3	X	TIM335*025P0X
4.7	X	TIM475*025P0X
10	Y	TIM106*025P0Y
12	Y	TIM126*025P0Y
15	Y	TIM156*025P0Y
35 WVDC		
.10	X	TIM104*035P0X
.22	X	TIM224*035P0X
.47	X	TIM474*035P0X
1.0	X	TIM105*025P0X
2.2	W	TIM225*035P0W
2.2	X	TIM225*035P0X
2.7	W	TIM275*035P0W
3.3	X	TIM335*035P0X
3.9	Y	TIM395*035P0Y
4.7	Y	TIM475*035P0Y
6.8	Y	TIM685*035P0Y
8.2	Y	TIM825*035P0Y
10	Y	TIM106*035P0Y
22	Z	TIM226*035P0Z
27	Z	TIM276*035P0Z
33	Z	TIM336*035P0Z

μ F	Case Code	Catalog Number
50 WVDC		
.10	X	TIM104*050P0X
.22	X	TIM224*050P0X
.33	X	TIM334*050P0X
1.0	W	TIM105*050P0W
1.0	X	TIM105*050P0X
1.5	W	TIM155*050P0W
1.5	X	TIM155*050P0X
2.2	X	TIM225*050P0X
4.7	Y	TIM475*050P0Y
5.6	Y	TIM565*050P0Y
6.8	Z	TIM685*050P0Z
10	Z	TIM106*050P0Z
15	Z	TIM156*050P0Z

SOLID TANTALUM CAPACITORS

Mallory reserves the right to substitute a tighter tolerance and higher voltage capacitor in the same case size.

Type TIM Molded Solid Tantalum Capacitors

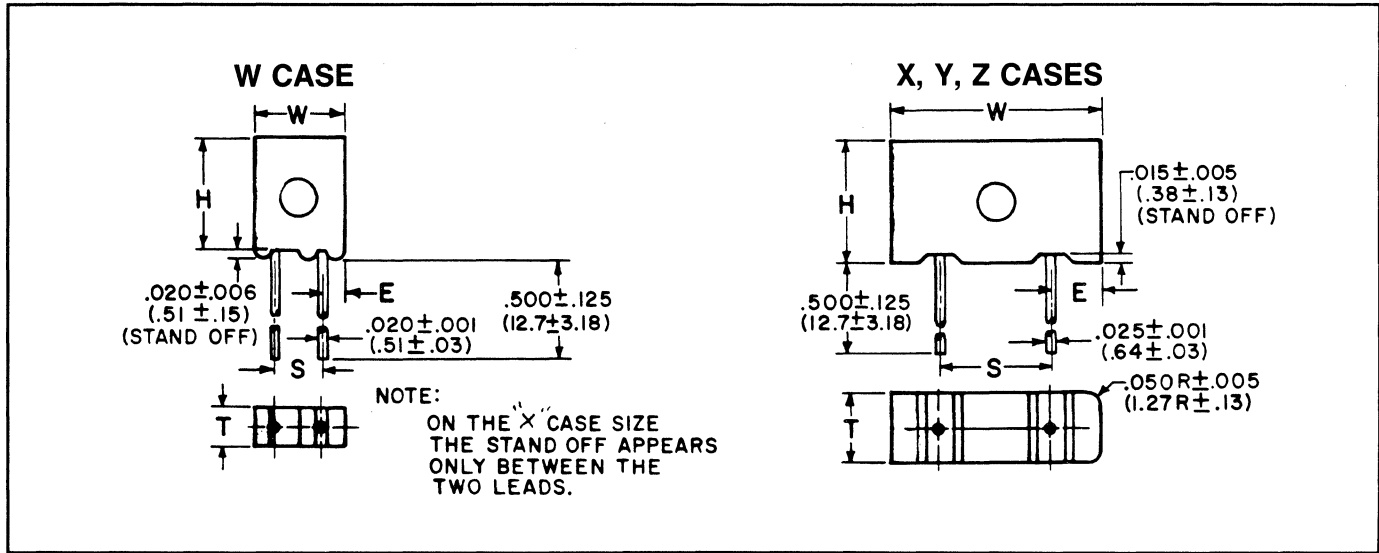

DIMENSIONS — INCHES & (MILLIMETERS)

CASE SIZE	H CASE HEIGHT	W CASE WIDTH	T CASE THICKNESS	E CASE TO WIRE	S LEAD SPACING
W	.345 ±.008 (8.76 ±.203)	.230 ±.005 (5.84 ±.127)	.105 ±.005 (2.67 ±.127)	.050 ± .010 (1.27 ± 0.25)	.125 ±.005 (3.18 ±.127)
X	.225 ±.015 (5.71 ±0.38)	.285 ±.015 (7.24 ±0.38)	.170 ±.015 (4.32 ±0.38)	.042 ± 0.10 (1.07 ± 0.25)	.200 ±.005 (5.08 ±.127)
Y	.325 ±.015 (8.26 ±0.38)	.325 ±.015 (8.26 ±0.38)	.170 ±.015 (4.32 ±0.38)	.062 ±.010 (1.57 ±0.25)	.200 ±.005 (5.08 ±.127)
Z	.375 ±.015 (9.53 ±0.38)	.600 ±.015 (15.24 ±0.38)	.195 ±.015 (4.95 ±0.38)	.200 ±.010 (5.08 ±0.25)	.200 ±.005 (5.08 ±.127)

SOLID TANTALUM CAPACITORS

Type TAC Molded Solid Tantalum Capacitor

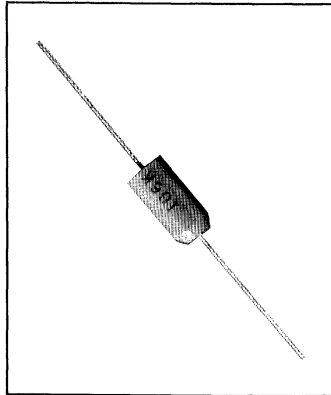

Axial Leads

The TAC construction includes the same dry electrolyte sintered tantalum anode as used in high reliability military type capacitors. The capacitor is fully precision molded in high impact resistant epoxy cases specifically designed to close tolerances for adaptation to high speed automatic insertion applications. Cases are tapered at the positive lead for quick polarity identification. Lead wires are high purity nickel with solder coating.

Request bulletin 4-807 for complete technical data. For pricing, refer to price sheet No. 282.

HIGHLIGHTS

Capacitance Range: .10 to 330 μ F
Voltage: 6 to 50 VDC
Temperature Range: -55°C to +125°C
Operating Frequency: 120Hz

Cap. μ F	Case Code	Mallory Standard Part Number
6 VOLTS WVDC 8 VOLTS SURGE 85°C		
4.7	1	TAC475*006P01
10	2	TAC106*006P02
15	2	TAC156*006P02
22	5	TAC226*006P05
27	5	TAC276*006P05
47	6	TAC476*006P06
56	6	TAC566*006P06
68	6	TAC686*006P06
100	7	TAC107*006P07
150	7	TAC157*006P07
220	7	TAC227*006P07
330	8	TAC330*006P08
10 VOLTS WVDC 13 VOLTS SURGE 85°C		
2.2	1	TAC226*010P01
4.7	2	TAC475*010P02
5.6	2	TAC565*010P02
6.8	2	TAC685*010P02
10	2	TAC106*010P02
15	5	TAC156*010P05
22	5	TAC226*010P05
27	6	TAC276*010P06
33	6	TAC336*010P06
39	6	TAC396*010P06
47	6	TAC476*010P06
68	7	TAC686*010P07
100	7	TAC107*010P07
150	7	TAC157*010P07
220	8	TAC227*010P08
15 VOLTS WVDC 20 VOLTS SURGE 85°C		
2.2	1	TAC225*015P01
3.3	2	TAC335*015P02
4.7	2	TAC475*015P02

Cap. μ F	Case Code	Mallory Standard Part Number
15 VOLTS WVDC 20 VOLTS SURGE 85°C		
6.8	2	TAC685*015P02
8.2	5	TAC825*015P05
10	5	TAC106*015P05
15	5	TAC156*015P05
22	6	TAC226*015P06
33	6	TAC336*015P06
47	7	TAC476*015P07
56	7	TAC566*015P07
68	7	TAC686*015P07
100	7	TAC107*015P07
150	8	TAC157*015P08
20 VOLTS WVDC 26 VOLTS SURGE 85°C		
1.0	1	TAC105*020P01
2.2	2	TAC225*020P02
3.3	2	TAC335*020P02
4.7	2	TAC475*020P02
6.8	5	TAC688*020P05
10	5	TAC106*020P05
12	6	TAC126*020P06
15	6	TAC156*020P06
22	6	TAC226*020P06
33	7	TAC336*020P07
47	7	TAC476*020P07
68	7	TAC686*020P07
100	8	TAC107*020P08
25 VOLTS WVDC 33 VOLTS SURGE 85°C		
1.2	2	TAC125*025P02
1.5	2	TAC155*025P02
2.2	2	TAC225*025P02
3.3	2	TAC335*025P05
4.7	5	TAC475*025P05
10	5	TAC106*025P05
12	6	TAC126*025P06
15	6	TAC156*025P06
22	7	TAC226*025P07
33	7	TAC336*025P07
47	7	TAC476*025P07
68	8	TAC686*025P08

Cap. μ F	Case Code	Mallory Standard Part Number
35 VOLTS WVDC 46 VOLTS SURGE 85°C		
.12	1	TAC124*035P01
.22	1	TAC224*035P01
.33	1	TAC334*035P01
.47	1	TAC474*035P01
.56	2	TAC564*035P02
1.0	2	TAC105*035P02
1.2	2	TAC125*035P02
1.5	2	TAC155*035P02
2.2	5	TAC225*035P05
3.3	5	TAC335*035P05
4.7	5	TAC475*035P05
5.6	6	TAC565*035P06
6.8	6	TAC685*035P06
8.2	6	TAC825*035P06
10	6	TAC106*035P06
15	7	TAC156*035P07
22	7	TAC226*035P07
33	7	TAC336*035P07
47	8	TAC476*035P08
50 VOLTS WVDC 65 VOLTS SURGE 85°C		
.10	1	TAC104*050P01
.22	1	TAC224*050P01
.33	2	TAC334*050P02
.39	2	TAC394*050P02
.47	2	TAC474*050P02
.68	2	TAC684*050P02
1.0	2	TAC105*050P02
2.2	5	TAC225*050P05
4.7	6	TAC475*050P06
6.8	7	TAC685*050P07
10	7	TAC106*050P07
15	8	TAC156*050P08
22	8	TAC226*050P08

* Tolerance M = \pm 20%
K = \pm 10%

OUTLINE DIMENSIONS

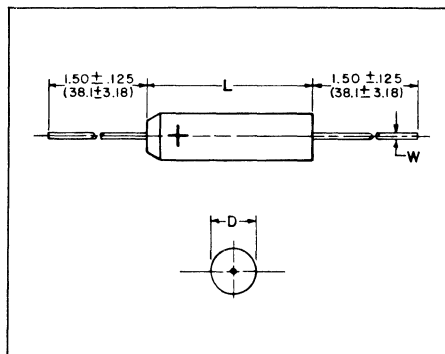

DIMENSIONS—INCHES & (MILLIMETERS)

CASE SIZE	D (MAX)	L (MAX)	W
1	.095 (2.41)	.260 (6.6)	.020 (.51)
2	.110 (2.79)	.290 (7.37)	.020 (.51)
5	.180 (4.57)	.345 (8.76)	.020 (.51)
6	.180 (4.57)	.420 (10.67)	.020 (.51)
7	.280 (7.11)	.550 (13.97)	.025 (.64)
8	.300 (7.62)	.710 (18.03)	.025 (.64)

LEAD WIRES

Positive and negative lead wires are high purity nickel with solder coating.

MARKING

TAC capacitors are stamped to indicate Mallory identification, capacitance and tolerance, voltage and polarity.

Type TAS-TXA Solid Tantalum Electrolytic Capacitors

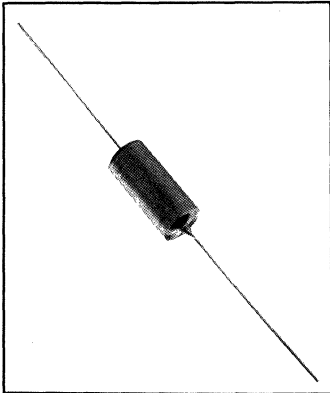

Hermetic Seal

TAS-TXA construction combines a sintered slug with solid electrolyte in a hermetically sealed case to provide long life with very stable electrical characteristics over a temperature range of -80°C to +85°C (To +125°C with proper voltage derating). Standard TAS capacitors offer ratings from 22μF at 50 VDC to 330μF at 6 VDC in 4 sizes. Extended capacitance range is available as type TXA with ratings to 1000μF at 6 VDC, in the same 4 sizes as the TAS. TAS types are listed with insulated sleeves; for uninsulated cases, change 12th digit of catalog number from 1 to 0. Case Sizes: TAS-TXA sizes are indicated by the last letter in the part number (A, C, F & G).

Request bulletin 4-801 for additional information. For prices see price sheet No. 250. TAS Capacitor Mallobins are available. See complete Mallobin listing, page 150.

HIGHLIGHTS

Capacitance: to 1000μF
Voltage: 6 to 100 VDC
Temperature: -80°C to +125°C
Tolerance: ±20%, ±10%
Case Sizes: 4 sizes available .125 × .250 to .341 × .750, same as Mil-C-39003

SOLID TANTALUM CAPACITORS

Cap. μF	Case Code	Standard Part Number
6 VOLTS WVDC 8 SURGE VDC 85°C		
5.6	A	TAS565K006P1A
6.8	A	TAS685*006P1A
47	C	TAS476*006P1C
56	C	TAS566K006P1C
180	F	TAS187K006P1F
330	G	TAS337*006P1G
10 VOLTS WVDC 13 SURGE VDC 85°C		
3.9	A	TAS395K010P1A
10	C	TAS106*010P1C
15	C	TAS156*010P1C
22	C	TAS226*010P1C
27	C	TAS276K010P1C
33	C	TAS336*010P1C
39	C	TAS396K010P1C
82	F	TAS826K010P1F
100	F	TAS107*010P1F
120	F	TAS127*010P1F
150	G	TAS157*010P1G
180	G	TAS187K010P1G
220	G	TAS227*010P1G
15 VOLTS WVDC 20 SURGE VDC 85°C		
2.2	A	TAS225*015P1A
2.7	A	TAS275K015P1A
3.3	A	TAS335*015P1A
4.7	C	TAS475*015P1C
10	C	TAS106*015P1C
15	C	TAS156*015P1C
18	C	TAS186K015P1C
22	C	TAS226*015P1C
39	F	TAS396K015P1F
56	F	TAS566K015P1F
68	F	TAS686*015P1F
120	G	TAS127K015P1G
150	G	TAS157*015P1G

Cap. μF	Case Code	Standard Part Number
20 VOLTS WVDC 26 SURGE VDC 85°C		
1.0	A	TAS105*020P1A
1.2	A	TAS125K020P1A
1.5	A	TAS155*020P1A
1.8	A	TAS185K020P1A
2.2	A	TAS225*020P1A
4.7	C	TAS475*020P1C
8.2	C	TAS825K020P1C
10	C	TAS106*020P1C
12	C	TAS126K020P1C
15	C	TAS156*020P1C
22	F	TAS226*020P1F
27	F	TAS276K020P1F
33	F	TAS336*020P1F
39	F	TAS396K020P1F
47	F	TAS476*020P1F
56	G	TAS566K020P1G
68	G	TAS686*020P1G
82	G	TAS826K020P1G
100	G	TAS107*020P1G
35 VOLTS WVDC 46 SURGE VDC 85°C		
.10	A	TAS104*035P1A
.22	A	TAS224*035P1A
.27	A	TAS274K035P1A
.33	A	TAS334*035P1A
.47	A	TAS474*035P1A
.68	A	TAS684*035P1A
1.0	A	TAS105*035P1A
1.5	C	TAS155*035P1C
2.2	C	TAS225*035P1C
2.7	C	TAS275K035P1C
3.3	C	TAS335*035P1C
3.9	C	TAS395K035P1C
4.7	C	TAS475*035P1C

Cap. μF	Case Code	Standard Part Number
35 VOLTS WVDC 46 SURGE VDC 85°C		
5.6	C	TAS565K035P1C
6.8	C	TAS685*035P1C
10	F	TAS106*035P1F
15	F	TAS156*035P1F
22	F	TAS226*035P1F
33	G	TAS336*035P1G
39	G	TAS396K035P1G
47	G	TAS476*035P1G
50 VOLTS WVDC 65 SURGE VDC 85°C		
.056	A	TAS563K050P1A
.068	A	TAS683*050P1A
.10	A	TAS104*050P1A
.22	A	TAS224*050P1A
.33	A	TAS334*050P1A
.47	A	TAS474*050P1A
.68	A	TAS684*050P1A
.82	A	TAS824K050P1A
1.0	A	TAS105*050P1A
1.2	C	TAS125K050P1C
1.5	C	TAS155*050P1C
2.2	C	TAS225*050P1C
2.7	C	TAS275K050P1C
3.3	C	TAS335*050P1C
3.9	C	TAS395K050P1C
4.7	C	TAS475*050P1C
6.8	F	TAS685*050P1F
8.2	F	TAS825K050P1F
10	F	TAS106*050P1F
12	F	TAS126K050P1F
15	F	TAS156*050P1F
18	F	TAS186K050P1F
22	G	TAS226*050P1G

*Specify K for ±10% tolerance or M for ±20% tolerance.

Type TXA Solid Tantalum Electrolytic Capacitors Extended Range

Extended Range

Cap. μ F	Case Code	Extended Range Part Number	Cap. μ F	Case Code	Extended Range Part Number	Cap. μ F	Case Code	Extended Range Part Number
6 VOLTS WVDC 8 SURGE VDC 85°C			15 VOLTS WVDC 20 SURGE VDC 85°C			30 VOLTS WVDC 39 SURGE VDC 85°C		
100.	C	TXA100M6C	39.	C	TXA39M15C	100.	G	TXA100M30G
390.	F	TXA390M6F	20 VOLTS WVDC 26 SURGE VDC 85°C			35 VOLTS WVDC 46 SURGE VDC 85°C		
1000.	G	TXA1000M6G	100.	F	TXA100M20F	2.2	A	TXA2R2M35A
10 VOLTS WVDC 13 SURGE VDC 85°C			150.	G	TXA150M20G	50 VOLTS WVDC 65 SURGE VDC 85°C		
82.	C	TXA82M10C	30 VOLTS WVDC 39 SURGE VDC 85°C			1.5	A	TXA1R5M50A
220.	F	TXA220M10F	15.	C	TXA15M30C			
560.	G	TXA560M10G	82.	F	TXA82M30F			

Cases are insulated—for uninsulated case add "0" suffix to part number.

Example: TXA8R2M6A0.

TAS-TXA — CS12/13 CASE SIZES

Case Code		Uninsulated Case Dimensions		Shrink-Fit Insulated Case Dimensions	
Mallory TAS-TXA	Mil CS12/13	D +.016 -.010	L $\pm .031$	D +.016 -.010	L $\pm .031$
A	A	.125	.250	.135	.286
C	B	.175	.438	.185	.474
F	C	.279	.650	.289	.686
G	D	.341	.750	.351	.786

TAS, TXA AND CS12/13 DIMENSION

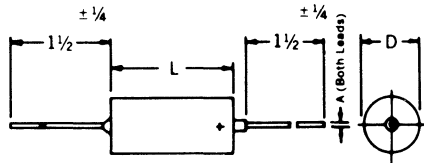

SOLID TANTALUM CAPACITORS

Type THF Solid Tantalum Electrolytic Capacitors

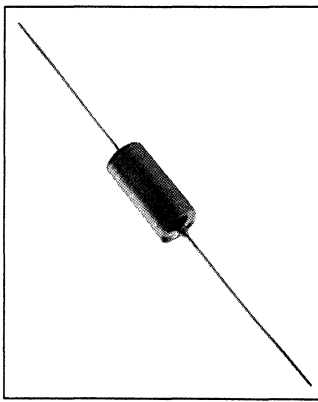

High Frequency
The THF solid tantalum capacitor is designed to offer low impedance to ripple current at frequencies above 1kHz through 100kHz. Special sintered anodes provide lower equivalent series resistance (ESR) at these frequencies in comparison to conventional type solid tantalum capacitors. Lower ESR means lower power losses. Ripple Current ratings by part number are shown in the Standard Rating Table. The solid electrolyte combined with the hermetic seal provides an inherently long life and very stable electrical characteristics over a temperature range of -80° through +125°C.

Request bulletin 4-805 for complete technical data. For prices, request price sheet No. 278.

HIGHLIGHTS
Capacitance: 5.6 to 220 μ F
Voltage: 6 to 50 VDC
Tolerance: \pm 10% standard; \pm 20% (optional)
Temperature: -80°C to +85°C (to +125°C with proper voltage derating).

SOLID TANTALUM CAPACITORS

Max. RMS Ripple Current @ +25°C				
Cap. (μ F)	WVDC +85°C	@ 10kHz (amperes)	Case Size	Catalog No.
6 WVDC				
180	6	2.88	F	THF187K006P1F
10 WVDC				
82	10	2.16	F	THF826K010P1F
100	10	2.64	F	THF107K010P1F
120	10	3.0	F	THF127K010P1F
150	10	3.72	G	THF157K010P1G
220	10	4.08	G	THF227K010P1G
15 WVDC				
56	15	2.16	F	THF566K015P1F
68	15	2.64	F	THF686K015P1F
120	15	3.36	G	THF127K015P1G

Max. RMS Ripple Current @ +25°C				
Cap. (μ F)	WVDC +85°C	@ 10kHz (amperes)	Case Size	Catalog No.
15 WVDC				
150	15	3.72	G	THF157K015P1G
20 WVDC				
27	20	1.44	F	THF276K020P1F
33	20	1.68	F	THF336K020P1F
47	20	2.16	F	THF476K020P1F
100	20	3.0	G	THF107K020P1G
35 WVDC				
10	35	.84	F	THF106K035P1F
15	35	1.32	F	THF156K035P1F
18	35	1.68	F	THF186K035P1F
22	35	1.8	F	THF226K035P1F

Max. RMS Ripple Current @ +25°C				
Cap. (μ F)	WVDC +85°C	@ 10kHz (amperes)	Case Size	Catalog No.
35 WVDC				
27	35	2.28	G	THF276K035P1G
47	35	2.64	G	THF476K035P1G
50 WVDC				
5.6	50	.72	F	THF565K050P1F
6.8	50	.84	F	THF685K050P1F
10	50	1.32	F	THF106K050P1F
18	50	1.68	F	THF186K050P1F
22	50	2.04	G	THF226K050P1G

THF CASE SIZES

Case Code	MIL	Uninsulated Case Dimensions		Shrink-Fit Insulated Case Dimensions		
		D	L	D	L	A
Mallory	CS12/	+.016		+.016		+.005
TAS-TXA	CS13	-.010	\pm .031	-.010	\pm .031	-.001
F	C	.279	.650	.289	.686	.025
G	D	.341	.750	.351	.786	.025

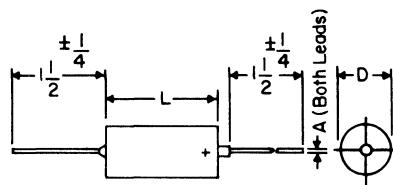

Type CS12/13 Solid Tantalum Electrolytic Capacitors

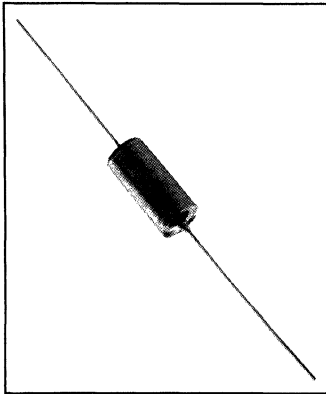

Hermetic Seal

Mallory offers Solid Tantalum Capacitors constructed to meet MIL-C-26655A and MIL-C-26655B, types CS12 and CS13. Although these specifications are obsolete for new government contracts there are still many prints in the field which call for this Military designation. Insulated type CS13 shown. For uninsulated part, specify CS12.

For prices, reference price sheet No. 250.

HIGHLIGHTS:

Capacitance: To 330 μ F
Voltage: 6 to 50 VDC
Tolerance: $\pm 20\%$, $\pm 10\%$
Temperature: -55°C to $+85^{\circ}\text{C}$ (to $+125^{\circ}\text{C}$ with proper voltage derating)
Case Sizes: 4 MIL case sizes A, B, C, D

Cap. μ F	WVDC	Tol. $\pm\%$	MIL-C-26655B Part Number	MIL-C-26655A Part Number	*MIL Case Size
6 WVDC					
5.6	6	10	CS13BB565K	CS13AB5R6K	A
6.8	6	10	CS13BB685K	CS13AB6R8K	A
47	6	10	CS13BB476K	CS13AB470K	B
56	6	10	CS13BB566K	CS13AB560K	B
180	6	10	CS13BB187K	CS13AB181K	C
330	6	10	CS13BB337K	CS13AB331K	D
10 WVDC					
3.9	10	10	CS13BC395K	CS13AC3R9K	A
4.7	10	10	CS13BC475K	CS13AC4R7K	A
27	10	10	CS13BC276K	CS13AC270K	B
33	10	10	CS13BC336K	CS13AC330K	B
39	10	10	CS13BC396K	CS13AC390K	B
82	10	10	CS13BC826K	CS13AC820K	C
100	10	10	CS13BC107K	CS13AC101K	C
120	10	10	CS13BC127K	CS13AC121K	C
180	10	10	CS13BC187K	CS13AC181K	D
220	10	10	CS13BC227K	CS13AC221K	D
15 WVDC					
2.7	15	10	CS13BD225K	CS13AD2R7K	A
3.3	15	10	CS13BD335K	CS13AD3R3K	A
18	15	10	CS13BD186K	CS13AD180K	B
22	15	10	CS13BD226K	CS13AD220K	B
56	15	10	CS13BD566K	CS13AD560K	C
68	15	10	CS13BD686K	CS13AD680K	C
120	15	10	CS13BD127K	CS13AD121K	D
150	15	10	CS13BD157K	CS13AD151K	D
20 WVDC					
1.2	20	10	CS13BE125K	CS13AE1R2K	A
1.5	20	10	CS13BE155K	CS13AE1R5K	A
1.8	20	10	CS13BE185K	CS13AE1R8K	A
2.2	20	10	CS13BE225K	CS13AE2R2K	A
8.2	20	10	CS13BE825K	CS13AE8R2K	B
10	20	10	CS13BE106K	CS13AE100K	B
12	20	10	CS13BE126K	CS13AE120K	B
15	20	10	CS13BE156K	CS13AE150K	B
15	20	20	CS13BE156M	CS13AE150M	B
27	20	10	CS13BE276K	CS13AE270K	C
33	20	10	CS13BE336K	CS13AE330K	C
33	20	20	CS13BE336M	CS13AE330M	C
39	20	10	CS13BE396K	CS13AE390K	C

Cap. μ F	WVDC	Tol. $\pm\%$	MIL-C-26655B Part Number	MIL-C-26655A Part Number	*MIL Case Size
20 WVDC					
47	20	10	CS13BE476K	CS13AE470K	C
56	20	10	CS13BE566K	CS13AE560K	D
68	20	10	CS13BE686K	CS13AE680K	D
82	20	10	CS13BE826K	CS13AE820K	D
100	20	10	CS13BE107K	CS13AE101K	D
35 WVDC					
.33	35	10	CS13BF334K	CS13AFR33K	A
.47	35	10	CS13BF474K	CS13AFR47K	A
.68	35	10	CS13BF684K	CS13AFR68K	A
1.0	35	10	CS13BF105K	CS13AF010K	A
1.5	35	10	CS13BF155K	CS13AF1R5K	B
2.2	35	10	CS13BF225K	CS13AF2R2K	B
2.7	35	10	CS13BF275K	CS13AF2R7K	B
3.3	35	10	CS13BF335K	CS13AF3R3K	B
3.9	35	10	CS13BF395K	CS13AF3R9K	B
4.7	35	10	CS13BF475K	CS13AF4R7K	B
5.6	35	10	CS13BF565K	CS13AF5R6K	B
6.8	35	10	CS13BF685K	CS13AF6R8K	B
10	35	10	CS13BF106K	CS13AF100K	C
15	35	10	CS13BF156K	CS13AF150K	C
22	35	10	CS13BF226K	CS13AF220K	C
33	35	10	CS13BF336K	CS13AF330K	D
39	35	10	CS13BF396K	CS13AF390K	D
47	35	10	CS13BF476K	CS13AF470K	D
50 WVDC					
1.0	50	10	CS13BG105K	CS13AG010K	A
1.2	50	10	CS13BG125K	CS13AG1R2K	B
1.5	50	10	CS13BG155K	CS13AG1R5K	B
2.2	50	10	CS13BG225K	CS13AG2R2K	B
2.7	50	10	CS13BG275K	CS13AG2R7K	B
3.3	50	10	CS13BF335K	CS13AF3R3K	B
3.9	50	10	CS13BG395K	CS13AG3R9K	B
4.7	50	10	CS13BG475K	CS13AG4R7K	B
6.8	50	10	CS13BG685K	CS13AG6R8K	C
8.2	50	10	CS13BG825K	CS13AG8R2K	C
10	50	10	CS13BG106K	CS13AG100K	C
12	50	10	CS13BG126K	CS13AG120K	C
15	50	10	CS13BG156K	CS13AG150K	C
18	50	10	CS13BG186K	CS13AG180K	C
22	50	10	CS13BG226K	CS13AG220K	D

SOLID TANTALUM CAPACITORS

*See size chart page 38.

Type CSR13 Solid Tantalum Electrolytic Capacitors

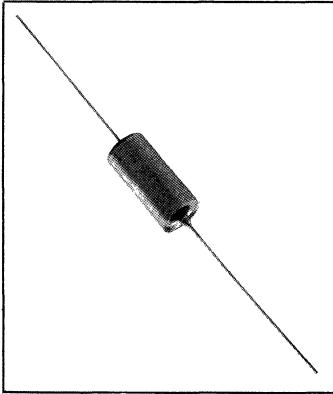

Hermetic Seal

Mallory style CSR13 established reliability solid electrolyte tantalum capacitors are built in accordance with MIL-C-39003/01 in all four MIL case sizes. Style CSR13 is available in capacitance values .056 μ F to 270 μ F in voltages 6 through 50 volts dc with life failure rate approval to level S. Construction features of the CSR13 are hermetic sealed metal case with insulating sleeve and solder coated nickel leads.

To order: Indicate CSR13 _____ followed by the appropriate 4 digit MIL dash number which indicates capacitance, voltage, tolerance, failure rate level.

Request bulletin 4-813 for technical data. For prices, refer to price sheet No. 254 ("L") and No. 255 ("M", "P", "R", and "S").

Highlights

Capacitance: .056 to 270 μ F
Voltage: 6 to 100 WVDC
Tolerance: $\pm 10\%$, $\pm 20\%$
Temperature: -55°C to $+85^{\circ}\text{C}$
Full rated VDC, to $+125^{\circ}\text{C}$ with proper derating
Case Sizes: 4 MIL Sizes, A, B, C, D
Failure Rate: To Level S.
Wiebull B, C and D failure rate levels available by special order.

M39003/01

Cap. μ F	Tol.	WVDC At $+85^{\circ}\text{C}$	L		M		P		R		S		MIL Ref. No.
			Level Mil	Level Mil	Level Mil	Level Mil	Level Mil	Level Mil	Case Size**				
6 WVDC													
5.6	$\pm 10\%$	6	-2001	-2241	-2481	-2721	-2961	A	CSR13B565K*				
6.8	$\pm 10\%$	6	-2002	-2242	-2482	-2722	-2962	A	CSR13B685K*				
47	$\pm 10\%$	6	-2004	-2244	-2484	-2724	-2964	B	CSR13B476K*				
56	$\pm 10\%$	6	-2006	-2246	-2486	-2726	-2966	B	CSR13B566K*				
180	$\pm 10\%$	6	-2009	-2249	-2489	-2729	-2969	C	CSR13B187K*				
270	$\pm 10\%$	6	-2010	-2250	-2490	-2730	-2970	D	CSR13B277K*				
10 WVDC													
3.9	$\pm 10\%$	10	-2013	-2253	-2493	-2733	-2973	A	CSR13C395K*				
4.7	$\pm 10\%$	10	-2014	-2254	-2494	-2734	-2974	A	CSR13C475K*				
4.7	$\pm 20\%$	10	-2015	-2255	-2495	-2735	-2975	A	CSR13C475M*				
27	$\pm 10\%$	10	-2016	-2256	-2496	-2736	-2976	B	CSR13C276K*				
33	$\pm 10\%$	10	-2017	-2257	-2497	-2737	-2977	B	CSR13C336K*				
33	$\pm 20\%$	10	-2018	-2258	-2498	-2738	-2978	B	CSR13C336M*				
120	$\pm 10\%$	10	-2023	-2263	-2503	-2743	-2983	C	CSR13C127K*				
180	$\pm 10\%$	10	-2024	-2264	-2504	-2744	-2984	D	CSR13C187K*				
220	$\pm 10\%$	10	-2025	-2265	-2505	-2745	-2985	D	CSR13C227K*				
15 WVDC													
3.3	$\pm 10\%$	15	-2028	-2268	-2508	-2748	-2988	A	CSR13D335K*				
18	$\pm 10\%$	15	-2030	-2270	-2510	-2750	-2990	B	CSR13D186K*				
22	$\pm 10\%$	15	-2031	-2271	-2511	-2751	-2991	B	CSR13D226K*				
22	$\pm 20\%$	15	-2032	-2272	-2512	-2752	-2992	B	CSR13D226M*				
56	$\pm 10\%$	15	-2033	-2273	-2513	-2753	-2993	C	CSR13D566K*				
68	$\pm 10\%$	15	-2034	-2274	-2514	-2754	-2994	C	CSR13D686K*				
120	$\pm 10\%$	15	-2036	-2276	-2516	-2756	-2996	D	CSR13D127K*				
150	$\pm 10\%$	15	-2037	-2277	-2517	-2757	-2997	D	CSR13D157K*				
20 WVDC													
1.2	$\pm 10\%$	20	-2039	-2279	-2519	-2759	-2996	A	CSR13E125K*				
1.5	$\pm 10\%$	20	-2040	-2280	-2520	-2760	-3000	A	CSR13E155K*				
1.8	$\pm 10\%$	20	-2042	-2282	-2522	-2762	-3002	A	CSR13E185K*				
2.2	$\pm 10\%$	20	-2043	-2283	-2523	-2763	-3003	A	CSR13E225K*				
2.2	$\pm 20\%$	20	-2044	-2284	-2524	-2764	-3004	A	CSR13E225M*				
8.2	$\pm 10\%$	20	-2045	-2285	-2525	-2765	-3005	B	CSR13E825K*				
10	$\pm 10\%$	20	-2046	-2286	-2526	-2766	-3006	B	CSR13E106K*				
12	$\pm 10\%$	20	-2048	-2288	-2528	-2768	-3008	B	CSR13E126K*				
15	$\pm 10\%$	20	-2049	-2289	-2529	-2769	-3009	B	CSR13E156K*				
15	$\pm 20\%$	20	-2050	-2290	-2530	-2770	-3010	B	CSR13E156M*				
27	$\pm 10\%$	20	-2051	-2291	-2531	-2771	-3011	C	CSR13E276K*				
33	$\pm 10\%$	20	-2052	-2292	-2532	-2772	-3012	C	CSR13E336K*				
39	$\pm 10\%$	20	-2054	-2294	-2534	-2774	-3014	C	CSR13E396K*				
47	$\pm 10\%$	20	-2055	-2295	-2535	-2775	-3015	C	CSR13E476K*				
47	$\pm 20\%$	20	-2056	-2296	-2536	-2776	-3016	C	CSR13E476M*				
56	$\pm 10\%$	20	-2057	-2297	-2537	-2777	-3017	D	CSR13E566K*				

*Specify "L", "M", "P", "R" or "S" Level on Order.

**See page 38 for case code identification.

†L Level numbers available from stock although they no longer are listed in MIL-C-39003.

M39003/01

Cap. μ F	Tol.	WVDC At $+85^{\circ}\text{C}$	L		M		P		R		S		MIL Ref. No.
			Level Mil	Level Mil	Level Mil	Level Mil	Level Mil	Level Mil	Case Size**				
20 WVDC													
68	$\pm 10\%$	20	-2058	-2298	-2538	-2778	-3018	D	CSR13E686K*				
82	$\pm 10\%$	20	-2060	-2300	-2540	-2780	-3020	D	CSR13E826K*				
100	$\pm 10\%$	20	-2061	-2301	-2541	-2781	-3021	D	CSR13E107K*				
100	$\pm 20\%$	20	-2062	-2302	-2542	-2782	-3022	D	CSR13E107M*				
35 WVDC													
5.6	$\pm 10\%$	35	-2063	-2303	-2543	-2783	-3023	B	CSR13F565K*				
6.8	$\pm 10\%$	35	-2064	-2304	-2544	-2784	-3024	B	CSR13F685K*				
6.8	$\pm 20\%$	35	-2065	-2305	-2545	-2785	-3025	B	CSR13F685M*				
22	$\pm 10\%$	35	-2066	-2306	-2546	-2786	-3026	C	CSR13F226K*				
22	$\pm 20\%$	35	-2067	-2307	-2547	-2787	-3027	C	CSR13F226M*				
27	$\pm 10\%$	35	-2068	-2308	-2548	-2788	-3028	D	CSR13F276K*				
33	$\pm 10\%$	35	-2069	-2309	-2549	-2789	-3029	D	CSR13F336K*				
39	$\pm 10\%$	35	-2071	-2311	-2551	-2791	-3031	D	CSR13F396K*				
47	$\pm 10\%$	35	-2072	-2312	-2552	-2792	-3032	D	CSR13F476K*				
47	$\pm 20\%$	35	-2073	-2313	-2553	-2793	-3033	D	CSR13F476M*				
50 WVDC													
.056	$\pm 10\%$	50	-2094	-2334	-2574	-2814	-3054	A	CSR13G563K*				
.1	$\pm 10\%$	50	-2098	-2338	-2578	-2818	-3058	A	CSR13G104K*				
.22	$\pm 10\%$	50	-2104	-2344	-2584	-2824	-3064	A	CSR13G224K*				
.33	$\pm 10\%$	50	-2107	-2347	-2587	-2827	-3067	A	CSR13G334K*				
.47	$\pm 10\%$	50	-2110	-2350	-2590	-2830	-3070	A	CSR13G474K*				
.82	$\pm 10\%$	50	-2115	-2355	-2595	-2835	-3075	A	CSR13G824K*				
1.0	$\pm 10\%$	50	-2116	-2356	-2596	-2836	-3076	A	CSR13G105K*				
1.0	$\pm 20\%$	50	-2117	-2357	-2597	-2837	-3077	A	CSR13G105M*				
1.2	$\pm 10\%$	50	-2118	-2358	-2598	-2838	-3078	B	CSR13G125K*				
1.5	$\pm 10\%$	50	-2119	-2359	-2599	-2839	-3079	B	CSR13G155K*				
1.8	$\pm 10\%$	50	-2121	-2361	-2601	-2841	-3081	B	CSR13G185K*				
2.2	$\pm 10\%$	50	-2122	-2362	-2602	-2842	-3082	B	CSR13G225K*				
2.2	$\pm 20\%$	50	-2123	-2363	-2603	-2843	-3083	B	CSR13G225M*				
3.3	$\pm 10\%$	50	-2125	-2365	-2605	-2845	-3085	B	CSR13G335K*				
3.9	$\pm 10\%$	50	-2127	-2367	-2607	-2847	-3087	B	CSR13G395K*				
4.7	$\pm 10\%$	50	-2128	-2368	-2608	-2848	-3088	B	CSR13G475K*				
4.7	$\pm 20\%$	50	-2129	-2369	-2609	-2849	-3089	B	CSR13G475M*				
6.8	$\pm 10\%$	50	-2131	-2371	-2611	-2851	-3091	C	CSR13G685K*				
6.8	$\pm 10\%$	50	-2132	-2372	-2612	-2852	-3092	C	CSR13G685M*				
8.2	$\pm 10\%$	50	-2133	-2373	-2613	-2853	-3093	C	CSR13G825K*				
10	$\pm 10\%$	50	-2134	-2374	-2614	-2854	-3094	C	CSR13G106K*				
15	$\pm 10\%$	50	-2137	-2377	-2617	-2857	-3097	C	CSR13G156K*				
18	$\pm 10\%$	50	-2139	-2379	-2619	-2859	-3099	C	CSR13G186K*				
22	$\pm 10\%$	50	-2140	-2380	-2620	-2860	-3100	D	CSR13G226K*				
22	$\pm 20\%$	50	-2141	-2381	-2621	-2861	-3101	D	CSR13G226M*				

*Specify "L", "M", "P", "R" or "S" Level on Order.

**See page 38 for case code identification.

†L Level numbers available from stock although they no longer are listed in MIL-C-39003.

Type CSR21 Solid Tantalum Electrolytic Capacitors

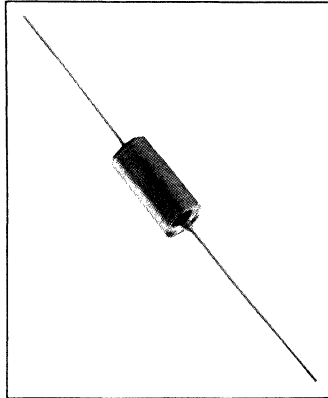

High Frequency
The Established Reliability MIL-C-39003/9 CSR21 offers superior electrical characteristics at high frequencies over a wide temperature range. Capacitance, ESR, impedance are more stable at temperature extremes in the CSR21 than any other electrolytic capacitor.

The unique design combined with established reliability make the CSR21 the ideal capacitor for high frequency and high ripple applications in avionics, radar, navigation and guidance control systems, communications, and wherever advanced performance and reliability are required. To order, specify M39003/09_____ plus 4 digit MIL dash number. **Request bulletin 4-819 for complete technical data. For prices, reference price sheet No. 261.**

HIGHLIGHTS
Capacitance: 10. to 220 μ F
Voltage: 6 to 50 VDC
Tolerance: $\pm 5\%$, $\pm 10\%$, $\pm 20\%$
Temperature: -55°C to $+125^{\circ}\text{C}$
with derating above 85°C
Case Size: .289" \times .686" and
.351" \times .786"
Failure Rate: To Level S.
Weibull B, C and D failure rate levels available by special order.

MIL-C-39003/9 TABLE OF RATINGS CSR21

μ F	TOL %	DC RATED VOLTAGE	MIL CASE SIZE	MIL DASH NO. M39003/09-FR%/1000 HRS.		
				M (1.0)	P (0.1)	R (0.01)
10 WVDC						
120	10	10	C	0017	0117	0217
220	5	10	D	0020	0120	0220
220	10	10	D	0021	0121	0221
220	20	10	D	0022	0122	0222
15 WVDC						
68	10	15	C	0026	0126	0226
150	10	15	D	0031	0131	0231
150	20	15	D	0032	0132	0232
20 WVDC						
47	10	20	C	0041	0141	0241

μ F	TOL %	DC RATED VOLTAGE	MIL CASE SIZE	MIL DASH NO. M39003/09-FR%/1000 HRS.		
				M (1.0)	P (0.1)	R (0.01)
20 WVDC						
100	10	20	D	0051	0151	0251
100	20	20	D	0052	0152	0252
35 WVDC						
22	10	35	C	0054	0154	0254
39	5	35	D	0061	0161	0261
47	10	35	D	0064	0164	0264
47	20	35	D	0065	0165	0265
50 WVDC						
10	10	50	C	0074	0174	0274
18	10	50	C	0082	0182	0282
22	10	50	D	0084	0184	0284

OUTLINE DIMENSIONS

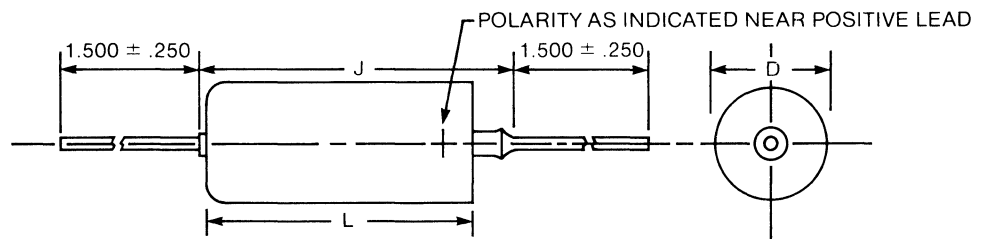

OUTLINE DIMENSIONS (INCHES)

Case Size	Uninsulated Case		Insulated Case		Overall Max. J	Lead Wire Dia. +.005 - .001
	D +.016 - .010	L \pm .031	D +.016 - .010	L \pm .031		
C	.279	.650	.289	.686	.822	.025
D	.341	.750	.351	.786	.922	.025

Type CSR23/CSR33 Solid Tantalum Electrolytic Capacitors

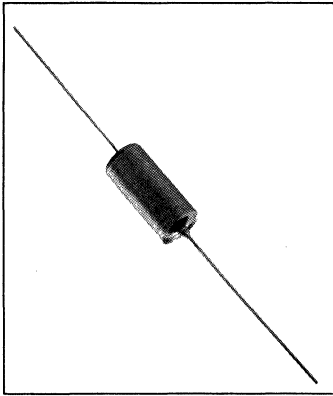

Extended Range ESTABLISHED RELIABILITY MIL-C-39003

Type CSR23 is an extended range version of the CSR13. It offers a high c/v product in MIL case sizes A, B, C & D. Available in MIL failure rate levels "L", "M", "P", and "R". (Failure rate level "L" is no longer included in the MIL-C-39003. However, "L" level is available from stock.) **For prices, request price sheet No. 264 ("L") and No. 265 ("M", "P", and "R")**

The CSR33 capacitors are available in the same ratings as the CSR23, however, the DCL is much lower. The DCL on the CSR23 ranges from .9 thru 11 microamperes as compared with the CSR33 which ranges from .5 — 2 microamperes @ +25°C. The CSR33 is available in failure rate level "M" and "P" in MIL case sizes A, B, C, & D. **For prices, request price sheet No. 275.**

HIGHLIGHTS

- Capacitance: 1.5 to 560μF
- Voltage: 6 to 50 WVDC
- Tolerance: ±10%, ±20%
- Temperature: -55°C to +125°C
- Case Sizes: 4 sizes to MIL A, B, C, D
- Failure Rate: To Level S.
- Wiebull B, C and D failure rate levels available by special order.

Type CSR23

Cap. (μF)	Tol.	WVDC At +85°C	Part No. M39003/03- Failure rate level for (%/1,000 hrs)				MIL Case Size
			L 2.0%	M 1.0%	P 0.1%	R 0.01%	
6 WVDC							
10.0	10%	6	0001	0101	0201	0301	A
10 WVDC							
8.2	10%	10	0018	0118	0218	0318	A
68.0	10%	10	0022	0122	0222	0322	B
270.0	10%	10	0027	0127	0227	0327	C
470.0	20%	10	0030	0130	0230	0330	D
560.0	10%	10	0031	0131	0231	0331	D
15 WVDC							
39.0	10%	15	0037	0137	0237	0337	B
330.0	10%	15	0044	0144	0244	0344	D
330.0	20%	15	0045	0145	0245	0345	D
20 WVDC							
3.3	20%	20	0048	0148	0248	0348	A
22.0	10%	20	0051	0151	0251	0351	B

Cap. (μF)	Tol.	WVDC At +85°C	Part No. M39003/03- Failure rate level for (%/1,000 hrs)				MIL Case Size
			L 2.0%	M 1.0%	P 0.1%	R 0.01%	
20 WVDC							
22.0	20%	20	0052	0152	0252	0352	B
27.0	10%	20	0053	0153	0253	0353	B
100.0	10%	20	0058	0158	0258	0358	C
180.0	10%	20	0063	0163	0263	0363	D
35 WVDC							
10.0	10%	35	0066	0166	0266	0366	B
47.0	10%	35	0071	0171	0271	0371	C
47.0	20%	35	0072	0172	0272	0372	C
68.0	10%	35	0074	0174	0274	0374	D
68.0	20%	35	0075	0175	0275	0375	D
50 WVDC							
6.8	10%	50	0080	0180	0280	0380	B
27.0	10%	50	0084	0184	0284	0384	C
39.0	10%	50	0087	0187	0287	0387	D

Type CSR33

Cap. (μF)	Tol.	WVDC At +85°C	Part No. M39003/06- Failure rate level for (%/1,000 hrs)		MIL Case Size
			M 1.0	P 0.1%	
47.0	10%	10	0019	0119	B
560.0	10%	10	0031	0131	D

Cap. (μF)	Tol.	WVDC At +85°C	Part No. M39003/06- Failure rate level for (%/1,000 hrs)		MIL Case Size
			M 1.0	P 0.1%	
100.0	10%	20	0058	0158	C
1.5	20%	50	0078	0178	A
39.0	10%	50	0087	0187	D

Ordering information: Indicate CSR___ followed by the appropriate 4 digit dash number which indicates the desired capacitance, voltage, tolerance and failure rate level, etc. **Example:** To order Style CSR23 — 10μF; 6 WVDC; ±10%; "M" failure rate; Order as follows: CSR230101. **Request bulletin 4-813 for complete technical data.**

CSR13, CSR23 and CSR33 Dimensions

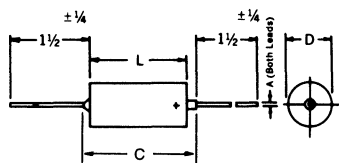

CSR13, CSR23 and CSR33 Size Chart

Case	Uninsulated		Insulated Sleeve		Overall C inch	Lead Dia. A inch	
	D inch	L inch	D inch	L inch		inch	AWG
Mil-C-39003	+.016 -.010	+.031 —	+.016 -.015	+.031 —	Max.	+.015 -.001	
A	.125	.250	.135	.286	.422	.020	#24
B	.175	.438	.185	.474	.610	.020	#24
C	.279	.650	.289	.686	.822	.025	#22
D	.341	.750	.351	.786	.922	.025	#22

Type TSC • Tantalum Solid Chip



The Mallory type TSC precision molded chip capacitor is specifically designed for surface mount applications. This capacitor is precision molded to offer dimensional consistency and uniform surfaces necessary for use with automatic, high speed pick and place equipment. These parts are supplied on 8mm and 12mm tape, packaged on 7" reels per EIA-481.

The TSC chip capacitor may be soldered directly to the substrate via wave solder, 1R reflow and phase reflow techniques. The

excellent resistance to solder heat of this device, will allow for immersion in +260 degrees C solder for ten seconds.

The TSC chip capacitor is capable of meeting or exceeding all the performance requirements of the EIA IS-28, and the IECQ tantalum chip standard QC300801/US0001. Capacitance values range for .1 μ F to 68 μ F. Operating voltages of 6 to 50 VDC at temperatures of -55 degrees C through +125 degrees C.

These capacitors may be used in applications such as, filtering, bypassing, coupling, blocking and RC timing circuits.

For further technical information request bulletin 4-820. For prices, request price sheet no. 296.

HIGHLIGHTS

Capacitance: 0.1 μ F to 68 μ F
Voltage: 6 to 50 VDC
Tolerance: ± 10 , $\pm 20\%$
Temperature Range: -55°C to +125°C

Cap. μ F	Case Code	Mallory Catalog Number
6 VOLTS DC		
1.5	A	TSC155*006A
2.2	A	TSC225*006A
3.3	B	TSC335*006B
4.7	B	TSC475*006B
+ 6.8	B	TSC685*006B
10.0	C	TSC106*006C
15.0	C	TSC156*006C
22.0	D	TSC226*006D
33.0	D	TSC336*006D
47.0	D	TSC476*006D
68.0	D	TSC686*006D
10 VOLTS DC		
1.0	A	TSC105*010A
1.5	A	TSC155*010A
2.2	B	TSC225*010B
3.3	B	TSC335*010B
+ 4.7	B	TSC475*010B
6.8	C	TSC685*010C
10.0	C	TSC106*010C
15.0	C	TSC156*010C
22.0	D	TSC226*010D
33.0	D	TSC336*010D
+47.0	D	TSC476*010D
16 VOLTS DC		
.68	A	TSC684*016A
+ 1.0	A	TSC105*016A
1.5	B	TSC155*016B
2.2	B	TSC225*016B
+ 3.3	B	TSC335*016B
4.7	C	TSC475*016C
+ 6.8	C	TSC685*016C
+10.0	C	TSC106*016C
15.0	D	TSC156*016D
22.0	D	TSC226*016D
+33.0	D	TSC336*016D

Cap. μ F	Case Code	Mallory Catalog Number
20 VOLTS DC		
.47	A	TSC474*020A
.68	A	TSC684*020A
1.0	B	TSC105*020B
1.5	B	TSC155*020B
+ 2.2	B	TSC225*020B
3.3	C	TSC335*020C
+ 4.7	C	TSC475*020C
6.8	D	TSC685*020D
10.0	D	TSC106*020D
15.0	D	TSC156*020D
+22.0	D	TSC226*020D
25 VOLTS DC		
.33	A	TSC334*025A
.47	A	TSC474*025A
.68	B	TSC684*025B
1.0	B	TSC105*025B
+ 1.5	B	TSC155*025B
2.2	C	TSC225*025C
3.3	C	TSC335*025C
4.7	D	TSC475*025D
6.8	D	TSC685*025D
+10.0	D	TSC106*025D
+15.0	D	TSC156*025D

Cap. μ F	Case Code	Mallory Catalog Number
35 VOLTS DC		
.10	A	TSC104*035A
.15	A	TSC154*035A
.22	A	TSC224*035A
+ .33	A	TSC334*035A
+ .47	B	TSC474*035B
.68	B	TSC684*035B
+ 1.0	B	TSC105*035B
1.5	C	TSC155*035C
+ 2.2	C	TSC225*035C
3.3	D	TSC335*035D
+ 4.7	D	TSC475*035D
+ 6.8	D	TSC685*035D
50 VOLTS DC		
.10	A	TSC104*050A
.15	B	TSC154*050B
.22	B	TSC224*050B
.33	B	TSC334*050B
.47	C	TSC474*050C
.68	C	TSC684*050C
1.0	C	TSC105*050C
1.5	D	TSC155*050D
2.2	D	TSC225*050D
3.3	D	TSC335*050D

+ = Preferred ratings
* to complete part number, insert M for $\pm 20\%$ tolerance, or K for $\pm 10\%$ tolerance
Higher voltage ratings and better capacitance tolerance product may be substituted within the same case size at Mallory's option.

SOLID TANTALUM CAPACITORS

Type TSC • Tantalum Solid Chip

OUTLINE DRAWING

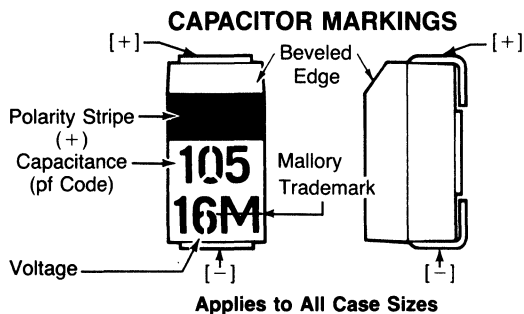
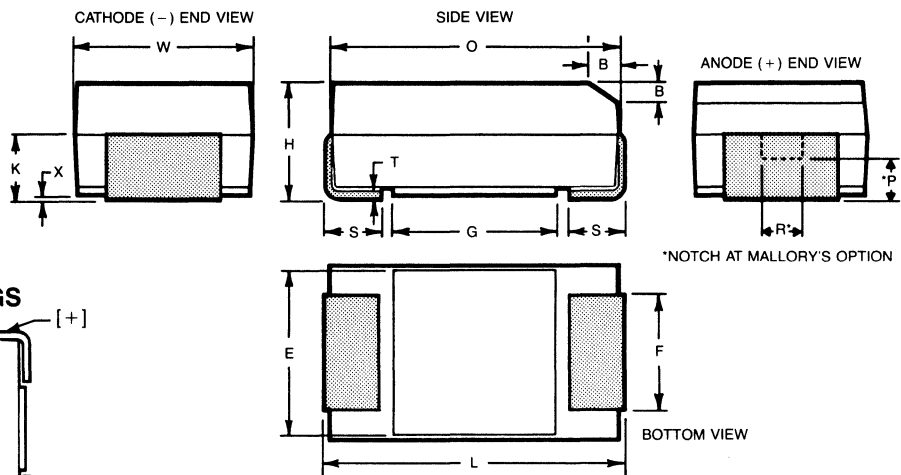

DIMENSIONS Millimeters (inches)

Case Size		Component													
MALLORY	EIA/IECQ	L	W	H	X	O ± 0.1 $-(.004)$	F ± 0.1 $-(.006)$	S ± 0.3 $-(.012)$	B $\pm .15$ $-(.006)$	K $\pm .20$ $-(.008)$	P (Ref)	R (Ref)	T (Ref)	G (Ref)	E (Ref)
A	3216	3.2 ± 0.2 (.126 ± .008)	1.6 ± 0.2 (.063 ± .008)	1.6 ± 0.2 (.063 ± .008)	0.05 ± 0.05 (.002 ± .002)	3.0 (.118)	1.2 (.047)	0.8 (.031)	0.4 (.014)	0.9 (.028)	0.4 (.016)	0.4 (.016)	0.13 (.005)	1.4 (.055)	1.3 (.050)
B	3528	3.5 ± 0.2 (.138 ± .008)	2.8 ± 0.2 (.110 ± .008)	1.9 ± 0.2 (.079 ± .008)	0.05 ± 0.05 (.002 ± .002)	3.3 (.130)	2.2 (.087)	0.8 (.031)	0.4 (.016)	1.1 (.043)	0.5 (.020)	1.0 (.039)	0.13 (.005)	1.8 (.071)	2.5 (.097)
C	6032	6.0 ± 0.3 (.236 ± .012)	3.2 ± 0.3 (.126 ± .012)	2.5 ± 0.3 (.098 ± .012)	0.10 ± 0.10 (.004 ± .004)	5.8 (.228)	2.2 (.087)	1.3 (.051)	0.5 (.020)	1.4 (.055)	0.9 (.035)	1.0 (.039)	0.13 (.005)	2.8 (.110)	2.9 (.113)
D	7343	7.3 ± 0.3 (.287 ± .012)	4.3 ± 0.3 (.169 ± .012)	2.8 ± 0.3 (.110 ± .012)	0.10 ± 0.10 (.004 ± .004)	7.1 (.280)	2.4 (.094)	1.3 (.051)	0.5 (.020)	1.5 (.059)	0.9 (.035)	1.0 (.039)	0.13 (.005)	4.0 (.157)	3.9 (.155)

Notes: 1. Metric dimensions govern.
2. Ref—dimensions provided for reference only.

Ordering Information

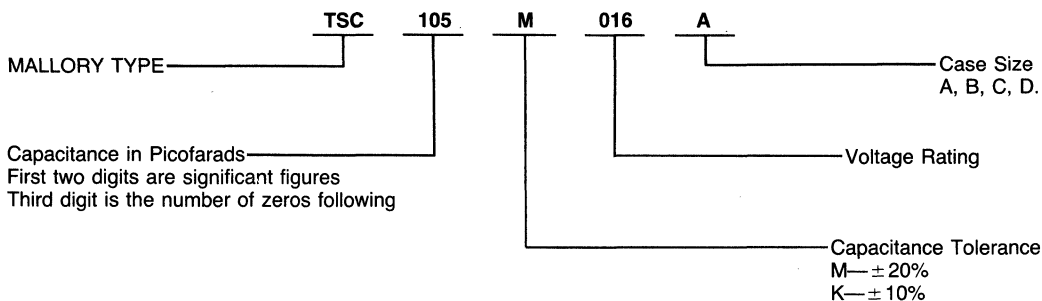

Type CGS Computer Grade Capacitors

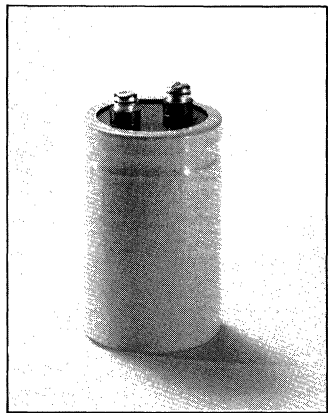

High CV Product
The CGS is a high performance computer grade aluminum electrolytic capacitor in a rugged aluminum can with high (standard) post terminal configurations for mounting. The CGS excels in initial electrical performance and high ripple capability. For applications requiring exceptionally long life, for work-horse power filtering and energy storage applications, the CGS is the top performer. With capacitances up to 490,000 μ F and ripple capability up to 29 amperes RMS at 85°C, the CGS handles extreme application requirements with

ease. Request bulletin 4-303 for complete technical data. For pricing, refer to price sheet No. 102. For capacitor hardware, see page 47.

HIGHLIGHTS
Capacitance Range: 75 to 490,000 μ F
Voltage Range: 3 to 450 WVDC
Capacitance Tolerance:
-10, +75% (10 to 150 WVDC)
-10, +50% (200 to 450 WVDC)
Operating Temperature:
-40°C to +85°C

Cap. μ F	Max ERS (ohms) @ 120Hz	Max Ripple RMS Amps @ 120Hz +85°C	*Case Code	Catalog Number High Post
10 WVDC; 12 VDC Surge				
7,200	.181	2.14	R2C	CGS722U010R2C
12,000	.108	2.78	R2C	CGS123U010R2C
14,000	.093	2.99	R2C	CGS143U010R2C
20,000	.065	3.92	R2L	CGS203U010R2L
26,000	.050	4.83	R3C	CGS263U010R3C
30,000	.062	5.35	V2C	CGS303U010V2C
33,000	.050	4.88	R3C	CGS333U010R3C
33,000	.039	6.21	R4C	CGS333U010R4C
44,000	.042	7.35	V2C	CGS443U010V2C
94,000	.020	10.65	V4C	CGS943U010V4C
110,000	.023	10.64	W3L	CGS114U010W3L
140,000	.013	15.20	V5L	CGS144U010V5L
180,000	.022	12.09	X3L	CGS184U010X3L
490,000	.008	29.35	X8L	CGS494U010X8L
16 WVDC; 20 VDC Surge				
5,500	.167	2.23	R2C	CGS552U016R2C
8,900	.103	2.84	R2C	CGS892U016R2C
10,000	.092	3.56	R3C	CGS103U016R3C
10,000	.092	3.01	R2C	CGS103U016R2C
12,000	.077	3.29	R2C	CGS123U016R2C
15,000	.061	4.97	R2L	CGS153U016R2L
17,000	.054	4.65	R3C	CGS173U016R3C
19,000	.048	4.93	R3C	CGS193U016R3C
23,000	.063	5.31	V3C	CGS233U016V3C
25,000	.037	6.38	R4C	CGS253U016R4C
25,000	.058	4.71	V2C	CGS253U016V2C
34,000	.043	7.26	V4C	CGS343U016V4C
34,000	.027	7.47	R4C	CGS343U016R4C
38,000	.038	6.84	V3C	CGS383U016V3C
50,000	.029	7.83	V3C	CGS503U016V3C
55,000	.026	8.82	V3L	CGS553U016V3L
66,000	.022	10.15	V4C	CGS663U016V4C
70,000	.021	10.39	V4C	CGS703U016V4C
77,000	.019	11.50	V4L	CGS773U016V4L
80,000	.034	10.27	X4C	CGS803U016X4C
83,000	.017	13.29	V5L	CGS833U016V5L
91,000	.019	10.00	V4C	CGS913U016V4C
100,000	.028	12.42	X5C	CGS104U016X5C
110,000	.018	12.71	W4C	CGS114U016W4C
120,000	.023	11.83	X3L	CGS124U016X3L
130,000	.015	14.64	W4L	CGS134U016W4L
180,000	.015	16.23	X4L	CGS184U016X4L
210,000	.013	19.38	X5R	CGS214U016X5R
220,000	.013	18.70	X4C	CGS224U016X4C
25 WVDC; 30 VDC Surge				
4,700	.172	2.20	R2C	CGS472U025R2C
5,600	.145	2.84	R3C	CGS562U025R3C
6,000	.135	2.48	R2C	CGS602U025R2C
8,200	.099	3.90	R4C	CGS822U025R4C
8,900	.091	3.58	R3C	CGS892U025R3C
10,000	.081	3.80	R3C	CGS103U025R3C

Cap. μ F	Max ERS (ohms) @ 120Hz	Max Ripple RMS Amps @ 120Hz +85°C	*Case Code	Catalog Number High Post
25 WVDC; 30 VDC Surge				
12,000	.068	4.50	R3C	CGS123U025R3C
12,000	.091	4.42	V3C	CGS123U025V3C
14,000	.078	4.06	V2C	CGS143U025V2C
16,000	.051	5.43	R4C	CGS163U025R4C
18,000	.045	6.45	R4C	CGS183U025R4C
20,000	.055	5.68	V3C	CGS203U025V3C
20,000	.041	6.70	R5C	CGS203U025R5C
28,000	.039	6.75	V3C	CGS283U025V3C
29,000	.038	7.72	V4C	CGS293U025V4C
30,000	.040	7.58	W3C	CGS303U025W3C
32,000	.034	8.16	V4C	CGS323U025V4C
41,000	.027	9.16	V4C	CGS413U025V4C
43,000	.043	9.13	X4C	CGS433U025X4C
47,000	.024	9.75	V4C	CGS473U025V4C
50,000	.024	10.42	W3L	CGS503U025W3L
57,000	.032	11.62	X5C	CGS573U025X5C
65,000	.019	12.38	W4C	CGS653U025W4C
67,000	.027	13.43	X5R	CGS673U025X5R
68,000	.018	13.50	W4C	CGS683U025W4C
70,000	.026	11.74	X4C	CGS703U025X4C
90,000	.013	17.16	W5L	CGS903U025W5L
92,000	.020	14.70	X5C	CGS923U025X5C
95,000	.019	13.73	X4C	CGS953U025X4C
110,000	.017	16.60	X5L	CGS114U025X5L
110,000	.017	15.94	X5C	CGS114U025X5C
120,000	.015	18.55	X4C	CGS124U025X4C
200,000	.009	27.67	X8L	CGS2043U25X8L
30 WVDC; 40 VDC Surge				
4,500	.171	2.21	R2C	CGS452U030R2C
5,000	.154	2.32	R2C	CGS502U030R2C
8,000	.096	3.49	R3C	CGS802U030R3C
9,200	.084	3.73	R3C	CGS922U030R3C
12,000	.064	4.85	R4C	CGS123U030R4C
13,000	.059	5.05	R4C	CGS133U030R4C
15,000	.051	5.73	R4L	CGS153U030R4L
20,000	.039	7.18	R5L	CGS203U030R5L
30,000	.033	8.29	V4C	CGS303U030V4C
33,000	.030	8.69	V4C	CGS333U030V4C
50,000	.020	12.25	V5L	CGS503U030V5L
55,000	.021	11.77	W4C	CGS553U030W4C
78,000	.020	13.39	X4C	CGS783U030X4C
100,000	.016	17.11	X5L	CGS104U030X5L
35 WVDC; 45 VDC Surge				
8,200	.089	3.62	R3C	CGS822U035R3C
10,000	.090	3.78	V2C	CGS103U035V2C
12,000	.061	4.97	R4C	CGS123U035R4C
21,000	.043	6.43	V3C	CGS213U035V3C
30,000	.036	7.99	W3C	CGS303U035W3C
31,000	.029	8.84	V4C	CGS313U035V4C
70,000	.020	13.39	X4C	CGS703U035X4C

Cap. μ F	Max ERS (ohms) @ 120Hz	Max Ripple RMS Amps @ 120Hz +85°C	*Case Code	Catalog Number High Post
40 WVDC; 50 VDC Surge				
2,220	.318	1.62	R2C	CGS222U040R2C
2,700	.259	1.79	R2C	CGS272U040R2C
3,500	.200	2.04	R2C	CGS352U040R2C
4,200	.167	2.75	R3C	CGS422U040R3C
4,700	.160	2.25	R2C	CGS472U040R2C
5,100	.137	2.92	R3C	CGS512U040R3C
6,000	.117	3.16	R3C	CGS602U040R3C
6,200	.113	3.65	R4C	CGS622U040R4C
7,500	.093	4.02	R4C	CGS752U040R4C
9,000	.078	4.39	R4C	CGS902U040R4C
9,300	.086	4.55	V3C	CGS932U040V3C
11,000	.073	4.93	V3C	CGS113U040V3C
13,000	.062	6.05	V4C	CGS133U040V4C
17,000	.047	6.94	V4C	CGS173U040V4C
17,000	.047	6.15	V3C	CGS173U040V3C
20,000	.040	8.66	V5L	CGS203U040V5L
23,000	.035	8.05	V4C	CGS233U040V4C
35,000	.023	11.42	V5L	CGS353U040V5L
40,000	.034	10.27	X4C	CGS403U040X4C
40,000	.026	10.58	W4C	CGS403U040W4C
43,000	.031	11.80	X5C	CGS433U040X5C
47,000	.023	11.00	W4C	CGS473U040W4C
53,000	.025	13.14	X5C	CGS533U040X5C
55,000	.019	14.20	W5L	CGS553U040W5L
55,000	.025	11.97	X4C	CGS553U040X4C
68,000	.021	13.50	X4C	CGS683U040X4C
78,000	.017	17.86	X6L	CGS783U040X6L
50 WVDC; 65 VDC Surge				
1,600	.406	1.43	R2C	CGS162U050R2C
2,200	.295	1.68	R2C	CGS222U050R2C
2,900	.224	2.28	R3C	CGS292U050R3C
3,000	.217	1.96	R2C	CGS302U050R2C
4,100	.159	2.71	R3C	CGS412U050R3C
4,300	.151	3.16	R4C	CGS432U050R4C
4,900	.133	3.17	R3L	CGS492U050R3L
5,000	.130	3.00	R3C	CGS502U050R3C
6,100	.107	3.75	R4C	CGS612U050R4C
6,500	.115	3.93	V3C	CGS652U050V3C
6,700	.097	3.71	R3L	CGS672U050R3L
6,800	.097	3.42	R3C	CGS682U050R3C
7,500	.087	4.16	R4C	CGS752U050R4C
8,000	.094	3.70	V2C	CGS802U050V2C
9,600	.078	5.40	V4C	CGS962U050V4C
10,000	.066	4.82	R4C	CGS103U050R4C
10,000	.075	4.06	V2C	CGS103U050V2C
12,000	.068	5.44	R5L	CGS123U050R5L
13,000	.058	6.25	V4C	CGS133U050V4C
13,000	.058	5.53	V3C	CGS133U050V3C
14,000	.054	7.46	V5L	CGS143U050V5L

*See page 47 for case size identification. Case code is last 3 characters of part no.

Type CGS Computer Grade Capacitors

Cap. μ F	Max ESR (ohms) @ 120Hz	Max Ripple RMS Amps @ +85°C	*Case Code	Catalog Number High Post
50 WVDC; 65 VDC Surge				
14,500	.052	5.85	V3C	CGS1452U050V3C
15,000	.050	6.73	V4C	CGS153U050V4C
20,000	.038	8.89	V5L	CGS203U050V5L
20,000	.038	7.72	V4C	CGS203U050V4C
24,000	.042	7.40	W3C	CGS243U050W3C
25,000	.040	8.53	W4C	CGS253U050W4C
28,000	.027	10.10	V5C	CGS283U050V5C
30,000	.025	10.96	V5L	CGS303U050V5L
31,000	.032	9.54	W4C	CGS313U050W4C
41,000	.032	11.11	X4L	CGS413U050X4L
43,000	.030	12.00	X5C	CGS433U050X5C
48,000	.027	11.52	X4C	CGS483U050X4C
50,000	.020	15.31	W5L	CGS503U050W5L
56,000	.024	12.22	X3L	CGS563U050X3L
60,000	.022	14.01	X5C	CGS603U050X5C
63,000	.021	16.07	X6L	CGS633U050X6L
100,000	.013	23.02	X8L	CGS104U050X8L

Cap. μ F	Max ESR (ohms) @ 120Hz	Max Ripple RMS Amps @ +85°C	*Case Code	Catalog Number High Post
75 WVDC; 95 VDC Surge				
1,500	.373	1.77	R3C	CGS152U075R3C
2,100	.267	2.09	R3C	CGS212U075R3C
2,200	.255	1.85	R2C	CGS222U075R2C
2,300	.243	2.48	R4C	CGS232U075R4C
2,900	.193	2.46	R3C	CGS292U075R3C
4,200	.133	3.36	R4C	CGS422U075R4C
4,800	.135	3.63	V3C	CGS482U075V3C
5,000	.130	4.18	V4C	CGS502U075V4C
5,600	.100	4.05	R4C	CGS562U075R4C
6,300	.089	4.75	R5L	CGS632U075R5L
7,100	.092	4.96	V4C	CGS712U075V4C
7,500	.087	5.87	V5L	CGS752U075V5L
10,000	.065	5.81	V3C	CGS103U075V3C
10,000	.065	5.91	V4C	CGS103U075V4C
12,000	.055	7.50	V4C	CGS123U075V4C
15,000	.043	8.36	V5L	CGS153U075V5L
17,000	.065	7.43	X4C	CGS173U075X4C
17,000	.051	7.55	W4C	CGS173U075W4C
25,000	.034	10.61	W5L	CGS253U075W5L
25,000	.044	9.02	X4C	CGS253U075X4C
27,000	.041	10.94	X3L	CGS273U075X3L
37,000	.030	12.50	X5L	CGS373U075X5L
55,000	.020	18.56	X8L	CGS553U075X8L

Cap. μ F	Max ESR (ohms) @ 120Hz	Max Ripple RMS Amps @ +85°C	*Case Code	Catalog Number High Post
100 WVDC; 125 VDC Surge				
850	.482	1.31	R2C	CGS851U100R2C
1,200	.342	1.85	R3C	CGS122U100R3C
1,700	.241	2.20	R3C	CGS172U100R3C
2,400	.171	2.97	R4C	CGS242U100R4C
4,000	.120	4.35	V4C	CGS402U100V4C
6,000	.080	5.32	V4C	CGS602U100V4C
9,000	.053	7.53	V5L	CGS902U100V5L
10,000	.065	6.69	W4C	CGS103U100W4C
15,000	.048	8.64	X4C	CGS153U100X4C
21,000	.034	11.74	X5L	CGS213U100X5L
33,000	.022	17.70	X8L	CGS333U100X8L

Cap. μ F	Max ESR (ohms) @ 120Hz	Max Ripple RMS Amps @ +85°C	*Case Code	Catalog Number High Post
150 WVDC; 175 VDC Surge				
400	.700	1.09	R2C	CGS401U150R2C
720	.389	1.73	R3C	CGS721U150R3C
950	.295	1.99	R3C	CGS951U150R3C
1,100	.225	2.43	R4C	CGS112U150R4C
3,300	.097	5.33	V5C	CGS332U150V5C
3,500	.091	5.74	V5L	CGS352U150V5L
4,800	.075	6.55	W4L	CGS482U150W4L
5,700	.070	7.16	X4C	CGS572U150X4C
6,200	.058	8.12	W5L	CGS622U150W5L
7,700	.052	9.11	X5C	CGS772U150X5C
8,700	.046	10.29	X5R	CGS872U150X5R
12,000	.033	11.92	X5L	CGS123U150X5L

Cap. μ F	Max ESR (ohms) @ 120Hz	Max Ripple RMS Amps @ +85°C	*Case Code	Catalog Number High Post
200 WVDC; 250 VDC Surge				
320	.750	1.05	R2C	CGS321T200R2C
590	.407	1.69	R3C	CGS591T200R3C
1,000	.240	2.66	R4C	CGS102T200R4C
1,000	.280	2.33	V2C	CGS102T200V2C
1,400	.200	2.98	V3C	CGS142T200V3C
1,600	.175	3.19	V3C	CGS162T200V3C
2,000	.140	4.02	V4C	CGS202T200V4C
2,200	.127	4.22	V4C	CGS222T200V4C
2,700	.104	5.12	V4C	CGS272T200V4C
4,600	.083	6.57	X4C	CGS462T200X4C
5,000	.060	7.66	W5C	CGS502T200W5C
7,400	.051	9.59	X5L	CGS742T200X5L

Cap. μ F	Max ESR (ohms) @ 120Hz	Max Ripple RMS Amps @ +85°C	*Case Code	Catalog Number High Post
250 WVDC; 300 VDC Surge				
200	1.150	.85	R2C	CGS201T250R2C
250	.920	.95	R2C	CGS251T250R2C
550	.418	1.90	R4C	CGS551T250R4C
720	.320	2.30	R4C	CGS721T250R4C
1,000	.230	2.96	R5L	CGS102T250R5L
1,200	.200	2.98	V3C	CGS122T250V3C
1,700	.141	4.01	V4C	CGS172T250V4C
2,500	.096	5.59	V5L	CGS252T250V5L
2,900	.090	5.98	W4L	CGS292T250W4L
2,900	.114	5.61	X4C	CGS292T250X4C
4,200	.062	7.86	W5L	CGS422T250W5L
6,000	.055	9.23	X5L	CGS602T250X5L

Cap. μ F	Max ESR (ohms) @ 120Hz	Max Ripple RMS Amps @ +85°C	*Case Code	Catalog Number High Post
350 WVDC; 400 VDC Surge				
130	1.615	.72	R2C	CGS131T350R2C
250	.840	1.18	R3C	CGS251T350R3C
380	.553	1.65	R4C	CGS381T350R4C
650	.338	2.29	V3C	CGS651T350V3C

Cap. μ F	Max ESR (ohms) @ 120Hz	Max Ripple RMS Amps @ +85°C	*Case Code	Catalog Number High Post
350 WVDC; 400 VDC Surge				
800	.275	2.87	V4C	CGS801T350V4C
1,000	.220	3.21	V4C	CGS102T350V4C
1,300	.169	4.21	V5L	CGS132T350V5L
2,100	.124	5.38	X4C	CGS212T350X4C
2,200	.100	6.19	W5L	CGS222T350W5L
3,000	.087	7.48	X5R	CGS302T350X5R
3,300	.079	7.70	X5L	CGS332T350X5L
3,400	.076	7.85	X5L	CGS342T350X5L

Cap. μ F	Max ESR (ohms) @ 120Hz	Max Ripple RMS Amps @ +85°C	*Case Code	Catalog Number High Post
450 WVDC; 525 VDC Surge				
75	2.533	.57	R2C	CGS750T450R2C
100	1.900	.66	R2C	CGS101T450R2C
140	1.357	.93	R3C	CGS141T450R3C
170	1.118	1.02	R3C	CGS171T450R3C
210	.905	1.29	R4C	CGS211T450R4C
250	.760	1.41	R4C	CGS251T450R4C
320	.656	1.65	V3C	CGS321T450V3C
350	.543	1.84	R5C	CGS351T450R5C
400	.475	2.06	R5L	CGS401T450R5L
450	.467	1.95	V3C	CGS451T450V3C
480	.438	2.27	V4C	CGS481T450V4C
650	.323	2.65	V4C	CGS651T450V4C
800	.263	3.09	V4L	CGS801T450V4L
1,000	.210	3.72	W4C	CGS102T450W4C
1,100	.218	4.05	X4C	CGS112T450X4C
1,400	.150	4.85	W5C	CGS142T450W5C
1,500	.160	5.20	X5C	CGS152T450X5C
1,500	.160	4.73	X4C	CGS152T450X4C
1,800	.133	6.05	X5R	CGS182T450X5R
2,000	.120	6.00	X5C	CGS202T450X5C
2,400	.100	6.85	X5L	CGS242T450X5L

*See page 47 for case size identification.
Case code is last 3 characters of part no.

ALUMINUM CAPACITORS

Type CG Computer Grade Capacitors

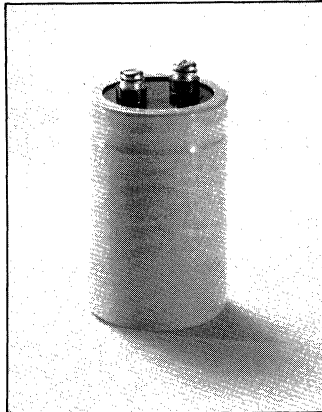

High Reliability

The original CG aluminum electrolytic computer grade capacitors, were specifically designed and produced by Mallory during the early 1950's. They were made to provide the optimum in high reliability energy storage and filtering circuits demanded by a most vital national defense electronic system. These many thousands of CG capacitors are continuing to perform their functions. Mallory's present CG capacitor product retains all of the basic, time proven design standards of reliability to meet + 85°C operating conditions.

Modern processing techniques also make CG capacitors available in high capacitance values and lower ESR per container size without sacrifice of quality or performance. **Request bulletin 4-304 for complete technical data. For pricing, refer to price sheet No. 101. For capacitor hardware, see page 73.**

HIGHLIGHTS

- Capacitance Range: 40 to 48000 μ F
- Voltage Range: 10 to 450 WVDC
- Operating Temperature: -40°C to +85°C
- Capacitance Tolerance:
 - 10, +75% (10 to 150 WVDC)
 - 10, +50% (200 to 450 WVDC)

Cap. μ F	Max. ESR (ohms) @ 120Hz	Max. Ripple RMS Amps @ +85°C	Case Code	Catalog Number
10 WVDC; 15 VDC Surge				
7,500	.180	2.15	R2C	CG752U010R2C
14,000	.096	3.49	R3C	CG143U010R3C
16 WVDC; 20 VDC Surge				
2,500	.460	1.34	R2C	CG252U016R2C
6,500	.177	2.17	R2C	CG652U016R2C
8,000	.150	3.19	U3C	CG802U016U3C
10,500	.129	3.71	V3C	CG1052U016V3C
12,000	.096	3.49	R3C	CG123U016R3C
18,000	.064	4.85	R4C	CG183U016R4C
21,000	.057	5.18	U3C	CG213U016U3C
27,000	.050	5.96	V3C	CG273U016V3C
40,000	.034	8.16	V4C	CG403U016V4C
25 WVDC; 40 VDC Surge				
1,500	.567	1.21	R2C	CG152U025R2C
2,800	.304	1.96	R3C	CG282U025R3C
3,300	.258	1.80	R2C	CG332U025R2C
4,500	.216	2.66	U3C	CG452U025U3C
6,000	.175	3.19	V3C	CG602U025V3C
6,300	.135	2.94	R3C	CG632U025R3C
8,500	.124	4.28	V4C	CG852U025V4C
9,200	.092	4.05	R4C	CG922U025R4C
10,000	.097	3.97	U3C	CG103U025U3C
13,000	.081	4.68	V3C	CG133U025V3C
20,000	.053	6.54	V4C	CG203U025V4C
20,000	.100	5.99	X4C	CG203U025X4C
32,000	.055	7.27	W4C	CG323U025W4C
48,000	.042	9.24	X4C	CG483U025X4C
35 WVDC; 50 VDC Surge				
1,100	.736	1.06	R2C	CG112U035R2C
2,100	.386	1.74	R3C	CG212U035R3C
2,300	.352	1.54	R2C	CG232U035R2C
4,300	.188	2.49	R3C	CG432U035R3C
9,500	.100	4.21	V3C	CG952U035V3C
11,000	.127	4.79	W4C	CG113U035W4C
11,000	.081	4.91	U4C	CG113U035U4C
14,000	.068	5.77	V4C	CG143U035V4C
22,000	.064	6.74	W4C	CG223U035W4C
33,000	.053	8.22	X4C	CG333U035X4C
50 WVDC; 75 VDC Surge				
800	.925	.95	R2C	CG801U050R2C
1,500	.493	1.54	R3C	CG152U050R3C

Cap. μ F	Max. ESR (ohms) @ 120Hz	Max. Ripple RMS Amps @ +85°C	Case Code	Catalog Number
1,500	.493	1.30	R2C	CG152U050R2C
2,000	.370	2.02	R4C	CG202U050R4C
2,500	.320	2.18	U3C	CG252U050U3C
2,900	.255	2.14	R3C	CG292U050R3C
3,300	.264	2.59	V3C	CG332U050V3C
4,300	.172	2.96	R4C	CG432U050R4C
4,500	.193	3.43	V4C	CG452U050V4C
5,000	.160	3.09	U3C	CG502U050U3C
6,500	.134	3.64	V3C	CG652U050V3C
7,300	.158	4.29	W4C	CG732U050W4C
7,400	.108	4.26	U4C	CG742U050U4C
9,500	.092	4.96	V4C	CG952U050V4C
10,000	.140	5.06	X4C	CG103U050X4C
15,000	.077	6.15	W4C	CG153U050W4C
16,500	.085	7.43	X5L	CG1652U050X5L
22,000	.064	7.48	X4C	CG223U050X4C
33,000	.042	10.56	X5L	CG333U050X5L
75 WVDC; 100 VDC Surge				
600	1.150	.85	R2C	CG601U075R2C
800	.863	.98	R2C	CG801U075R2C
1,000	.690	1.30	R3C	CG102U075R3C
1,500	.460	1.81	R4C	CG152U075R4C
1,500	.460	1.59	R3C	CG152U075R3C
2,000	.370	2.03	U3C	CG202U075U3C
2,200	.314	2.19	R4C	CG222U075R4C
2,500	.316	2.37	V3C	CG252U075V3C
2,600	.285	2.32	U3C	CG262U075U3C
3,300	.239	2.73	V3C	CG332U075V3C
3,450	.229	3.15	V4C	CG3451U075V4C
4,900	.161	3.75	V4C	CG492U075V4C
7,900	.124	4.84	W4C	CG792U075W4C
8,200	.144	4.99	X4C	CG822U075X4C
11,000	.107	5.97	X4C	CG113U075X4C
12,500	.094	7.06	X5L	CG1252U075X5L
17,000	.069	8.24	X5L	CG173U075X5L
100 WVDC; 135 VDC Surge				
400	1.275	.81	R2C	CG401U100R2C
770	.662	1.33	R3C	CG771U100R3C
1,000	.510	1.72	R4C	CG102U100R4C
1,300	.408	1.94	U3C	CG132U100U3C
1,700	.312	2.50	U4C	CG172U100U4C
2,500	.224	4.82	V4C	CG252U100V4C
3,600	.181	4.01	W4C	CG362U100W4C

Cap. μ F	Max. ESR (ohms) @ 120Hz	Max. Ripple RMS Amps @ +85°C	Case Code	Catalog Number
150 WVDC; 185 VDC Surge				
275	1.055	.89	R2C	CG2750U150R2C
500	.580	1.42	R3C	CG501U150R3C
1,550	.200	3.37	V4C	CG1551U150V4C
2,500	.144	4.50	W4C	CG252U150W4C
3,600	.111	5.68	X4C	CG362U150X4C
5,600	.071	8.12	X3L	CG562U150X3L
200 WVDC; 250 VDC Surge				
180	1.556	.73	R2C	CG181T200R2C
450	.622	1.56	R4C	CG451T200R4C
550	.527	1.70	U3C	CG551T200U3C
750	.400	2.11	V3C	CG751T200V3C
1,000	.300	2.75	V4C	CG102T200V4C
1,650	.194	3.87	W4C	CG1651T200W4C
2,450	.147	4.94	X4C	CG2451T200X4C
3,800	.095	7.02	X5L	CG382T200X5L
250 WVDC; 300 VDC Surge				
140	2.000	.64	R2C	CG141T250R2C
375	.747	1.42	R4C	CG3750T250R4C
600	.500	1.88	V3C	CG601T250V3C
800	.375	2.46	V4C	CG801T250V4C
3,000	.110	6.53	X5L	CG302T250X5L
300 WVDC; 350 VDC Surge				
525	.552	2.33	V3C	CG5250T300V3C
350 WVDC; 400 VDC Surge				
100	2.700	.56	R2C	CG101T350R2C
180	1.500	.88	R3C	CG181T350R3C
250	1.080	1.18	R4C	CG251T350R4C
400	.700	1.59	V3C	CG401T350V3C
550	.509	2.11	V4C	CG551T350V4C
2,000	.145	5.69	X5L	CG202T350X5L
400 WVDC; 475 VDC Surge				
150	1.733	.93	R4C	CG151T400R4C
325	.831	1.65	V4C	CG3250T400V4C
450 WVDC; 525 VDC Surge				
40	5.625	.38	R2C	CG400T450R2C
110	2.045	.86	R4C	CG111T450R4C
240	.958	1.54	V4C	CG241T450V4C

*See page 47 for case size identification. Case code is last 3 characters of part no.

Type CGR Computer Grade Capacitors



High Ripple Capability

The CGR is specifically designed as a low ESR, high ripple current power supply filtering capacitor. Constructed in a rugged aluminum can with a high No. 10-32 screw insert terminal assemblies. (High post terminals are standard.) Outstanding features of the CGR are low ESR, low DC leakage current plus high ripple current capability over broad temperature and frequency ranges.

With capacitances up to 100,000 μ F and ripple capability up to 29.6 amperes at 20kHz at +85°C the CGR handles extreme

application requirements with ease and reliability. The CGR has been successfully utilized as an output capacitor in some high frequency switching regulator power supplies. **Ask for Bulletin 4-313 for additional ratings and complete specifications. For pricing, refer to price sheet No. 104. For capacitor hardware, see page 73.**

HIGHLIGHTS

- Capacitance Range: 550 to 100,000 μ F
- Voltage Range: 6.3 to 100 WVDC
- Operating Temperature: -55°C to +85°C (Excursions to +105°C)
- Capacitance Tolerance:
 - 10, +75% (6.3 to 50 WVDC)
 - 10, +50% (75 to 100 WVDC)

Cap. μ F	Max. ESR (ohms) @ 20KHz	Max. Ripple RMS Amps @ +85°C	*Case Code	Catalog Number
7.5 WVDC; 12 VDC Surge				
34,000	.0128	10.9	U3C	CGR343U7R5U3C
47,000	.0098	13.5	V3C	CGR473U7R5V3C
66,000	.0068	17.9	V4C	CGR663U7R5V4C
12 WVDC; 15 VDC Surge				
12,000	.0154	8.0	R2L	CGR123U012R2L
100,000	.0043	27.9	W5C	CGR104U012W5C
16 WVDC; 20 VDC Surge				
7,700	.0231	6.1	R2C	CGR772U016R2C
11,000	.0161	8.0	R2L	CGR113U016R2L
14,000	.0119	9.8	R3C	CGR143U016R3C
16,000	.0173	8.7	U2L	CGR163U016U2L
20,000	.0084	13.2	R4C	CGR203U016R4C
30,000	.0098	13.2	V3C	CGR303U016V3C
35,000	.0083	15.3	V3L	CGR353U016V3L
42,000	.0075	17.7	V4C	CGR423U016V4C
46,000	.0060	20.2	U5L	CGR463U016U5L
51,000	.0085	16.6	W3C	CGR513U016W3C
100,000	.0043	30.6	W5L	CGR104U016W5L
20 WVDC; 30 VDC Surge				
4,600	.0224	6.1	R2C	CGR462U020R2C
10,000	.0105	11.4	R3L	CGR103U020R3L
21,000	.0090	15.3	V3L	CGR213U020V3L

Cap. μ F	Max. ESR (ohms) @ 20KHz	Max. Ripple RMS Amps @ +85°C	*Case Code	Catalog Number
30 WVDC; 45 VDC Surge				
2,200	.0350	4.6	R1N	CGR222U030R1N
4,900	.0248	6.6	U2C	CGR492U030U2C
7,400	.0105	11.3	R3L	CGR742U030R3L
10,000	.0077	14.9	R4L	CGR103U030R4L
12,000	.0098	13.1	V3C	CGR123U030V3C
15,000	.0090	15.1	V3L	CGR153U030V3L
27,000	.0053	24.4	V5L	CGR273U030V5L
30,000	.0060	21.7	W4C	CGR303U030W4C
40 WVDC; 60 VDC Surge				
1,400	.0364	4.4	R1N	CGR142U040R1N
2,100	.0245	5.9	R2C	CGR212U040R2C
3,900	.0133	9.5	R3C	CGR392U040R3C
5,600	.0091	12.7	R4C	CGR562U040R4C
9,600	.0090	14.7	V3L	CGR962U040V3L
13,000	.0068	19.3	V4L	CGR133U040V4L
17,000	.0053	23.8	V5L	CGR173U040V5L
22,000	.0060	24.1	W4L	CGR223U040W4L
31,000	.0051	28.1	X4L	CGR313U040X4L

Cap. μ F	Max. ESR (ohms) @ 20KHz	Max. Ripple RMS Amps @ +85°C	*Case Code	Catalog Number
50 WVDC; 75 VDC Surge				
1,000	.1001	2.6	R1N	CGR102U050R1N
1,500	.0672	3.5	R2C	CGR152U050R2C
2,900	.0357	5.8	R3C	CGR292U050R3C
6,200	.0168	10.9	R5L	CGR622U050R5L
7,600	.0165	10.5	V3C	CGR762U050V3C
10,000	.0113	13.9	V4C	CGR103U050V4C
16,000	.0085	19.6	V5L	CGR163U050V5L
21,000	.0077	20.2	W4L	CGR213U050W4L
27,000	.0060	24.9	W5L	CGR273U050W5L
37,000	.0051	29.6	X5L	CGR373U050X5L
75 WVDC; 100 VDC Surge				
550	.1078	2.5	R1N	CGR551T075R1N
1,200	.0497	4.4	R2L	CGR122T075R2L
1,800	.0329	6.5	R3L	CGR182T075R3L
2,600	.0231	8.5	R4L	CGR262T075R4L
3,100	.0225	8.2	V2L	CGR312T075V2L
4,700	.0150	11.6	V3L	CGR472T075V3L
9,600	.0094	17.4	W4C	CGR962T075W4C
11,000	.0102	18.0	X3L	CGR113T075X3L
19,000	.0056	28.8	X5L	CGR193T075X5L
100 WVDC; 135 VDC Surge				
2,700	.0120	14.3	V4L	CGR272T100V4L
4,500	.0094	18.6	W4L	CGR452T100W4L

*See page 47 for case code identification.

Type CGO Computer Grade Capacitors

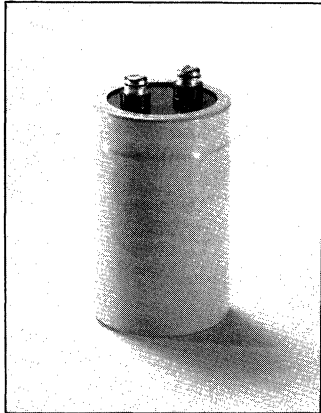

Power Supply Output

The Mallory CGO capacitor, with its unique internal construction combined with a low resistance, non-aqueous electrolyte, provides the performance required for output filtering in switching power supplies. All CGO capacitors are designed in a 1 3/8" diameter case and are available with either low (standard) No. 10-32 threaded insert terminals. Supplied with

PVC Sleeve. Request bulletin 4-314 for complete technical data. For pricing, request price sheet No. 106. For capacitor hardware, see page 73.

Highlights

Capacitance: 2800 to 45,000 μ F
Voltage: 5 to 55 WVDC
Capacitance tolerance: \pm 20%
Temperature: -55°C to +85°C

Cap. μ F	ESR (milliohms) @ 20KHz @ 25°C		Max. AC Ripple Current (Amps RMS) @ 20KHz @ 85°C	*Case Code	†Catalog Number (Low Post)
	Max.	Min.			
5 WVDC; 6 VDC Surge					
18000	7.5	4.1	9.8	R2C	CGO183M005L
7.5 WVDC; 9 VDC Surge					
15000	7.8	4.2	9.6	R2C	CGO153M7R5L
21000	6.8	3.6	11.2	R2L	CGO213M7R5L
27000	6.0	3.2	12.8	R3C	CGO273M7R5L
33000	5.5	2.9	14.2	R3L	CGO333M7R5L
39000	5.1	2.7	15.6	R4C	CGO393M7R5L
45000	4.7	2.5	17.1	R4L	CGO453M7R5L
10 WVDC; 12 VDC Surge					
14000	7.9	4.3	9.5	R2C	CGO143M010L
19000	6.9	3.7	11.1	R2L	CGO193M010L
16 WVDC; 18 VDC Surge					
10000	8.3	4.5	9.3	R2C	CGO103M016L
18000	6.4	3.4	12.4	R3C	CGO183M016L
22000	5.7	3.1	13.9	R3L	CGO223M016L
20 WVDC; 22 VDC Surge					
12000	7.4	4.0	10.7	R2L	CGO123M020L
16000	6.5	3.5	12.3	R3C	CGO163M020L
20000	5.9	3.1	13.8	R3L	CGO203M020L
22000	5.3	2.9	15.3	R4C	CGO223M020L
27000	4.9	2.7	16.6	R4L	CGO273M020L
34000	4.2	2.2	19.8	R5L	CGO343M020L

Cap. μ F	ESR (milliohms) @ 20KHz @ 25°C		Max. AC Ripple Current (Amps RMS) @ 20KHz @ 85°C	*Case Code	†Catalog Number (Low Post)
	Max.	Min.			
28 WVDC; 32 VDC Surge					
6300	9.2	5.0	8.8	R2C	CGO632M028L
14000	6.2	3.4	13.3	R3L	CGO143M028L
35 WVDC; 40 VDC Surge					
4500	9.8	5.2	8.6	R2C	CGO452M035L
6300	8.3	4.5	10.1	R2L	CGO632M035L
8100	7.2	3.8	11.7	R3C	CGO812M035L
14000	5.3	2.9	16.0	R4L	CGO143M035L
45 WVDC; 50 VDC Surge					
3800	10.0	5.4	8.3	R2C	CGO382M045L
4600	9.1	4.9	9.8	R2L	CGO462M045L
10000	5.6	3.0	15.6	R4L	CGO103M045L
55 WVDC; 64 VDC Surge					
2800	11.3	6.1	8.0	R2C	CGO282M055L
3900	9.5	5.1	9.5	R2L	CGO392M055L
10000	4.7	2.5	18.7	R5L	CGO103M055L

*See page 47 for case code identification.

Type HES Storage Capacitor

High Energy Discharge

The HES is an aluminum electrolytic capacitor in a round can with a molded top similar in appearance to our computer grade types. It is an energy storage capacitor having low DC leakage current, low internal resistance and inductance which contribute to a minimum of loss during high peak current discharge. Circuits demanding these discharge currents can destroy conventional type capacitors. The HES is

designed for charge-discharge applications such as: Capacitor discharge welders; Photoflash; Strobe lights; Magnetizers and Demagnetizers; Laser activation. Screw terminal standard. Solder Lug Terminal available special order. Consult factory for other ratings.

HIGHLIGHTS

Capacitance: 300 to 2100 μ F
 Voltage: 400 and 450 WVDC
 Tolerance: -0%, +50%
 Operating Temperature: -40°C to +85°C



Cap. (μ F)	Voltage	Max. ESR (ohms) @ 120Hz	Max. \ddagger DCL (MA) @ +25°C	*Size	Catalog No.
2100	400	0.102	2.750	3 \times 5 $\frac{5}{8}$	HES212G400X5L
300	450	0.492	1.257	2 \times 3 $\frac{1}{8}$	HES301G450V3C
400	450	0.419	1.350	2 \times 3 $\frac{3}{8}$	HES401G450V3L
550	450	0.350	1.492	2 \times 4 $\frac{1}{8}$	HES551G450V4C
1200	450	0.156	2.205	3 \times 4 $\frac{5}{8}$	HES122G450X4L
1500	450	0.145	2.465	3 \times 5 $\frac{5}{8}$	HES152G450X5L

\ddagger 5 minutes electrification time @ +25°C.

*Bare Can Size.

*See page 47 for case code identification.

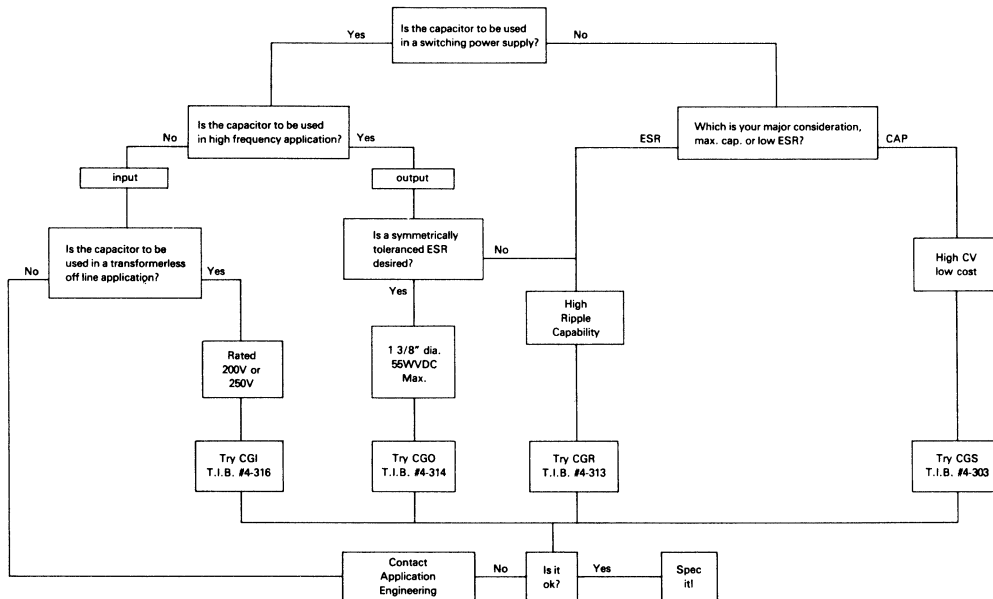

Many of these capacitors are available in PC Board Mount Configuration. Contact Application Engineering for more information.

Type CG, CGO, CGR, CGS, and HES Computer Grade Capacitors

COMPUTER GRADE CASE CODE CHART

Case Code	Size (Inches)*		Size (mm)		Dimension "C"		Use Mounting Clamp
	Dia. x Length		Dia. x Length		(Inches)	(mm)	
R1N	1 ³ / ₈ x 1 ³ / ₄		35 x 44.5		1/2	12.7	VR3
R2C	1 ³ / ₈ x 2 ¹ / ₈		35 x 54		1/2	12.7	VR3
R2L	1 ³ / ₈ x 2 ⁵ / ₈		35 x 67		1/2	12.7	VR3
R3C	1 ³ / ₈ x 3 ¹ / ₈		35 x 79.4		1/2	12.7	VR3
R3L	1 ³ / ₈ x 3 ⁵ / ₈		35 x 92		1/2	12.7	VR3
R4C	1 ³ / ₈ x 4 ¹ / ₈		35 x 105		1/2	12.7	VR3
R4L	1 ³ / ₈ x 4 ⁵ / ₈		35 x 117.5		1/2	12.7	VR3
R5C	1 ³ / ₈ x 5 ¹ / ₈		35 x 130		1/2	12.7	VR3
R5L	1 ³ / ₈ x 5 ⁵ / ₈		35 x 143		1/2	12.7	VR3
U2C	1 ³ / ₄ x 2 ¹ / ₈		44.5 x 54		3/4	19	VR6
U2L	1 ³ / ₄ x 2 ⁵ / ₈		44.5 x 67		3/4	19	VR6
U3C	1 ³ / ₄ x 3 ¹ / ₈		44.5 x 79.4		3/4	19	VR6
U4C	1 ³ / ₄ x 4 ¹ / ₈		44.5 x 105		3/4	19	VR6
U5L	1 ³ / ₄ x 5 ⁵ / ₈		44.5 x 143		3/4	19	VR6
V2C	2 x 2 ¹ / ₈		50.8 x 54		7/8	22.23	VR8
V3C	2 x 3 ¹ / ₈		50.8 x 79.4		7/8	22.23	VR8
V3L	2 x 3 ⁵ / ₈		50.8 x 92		7/8	22.23	VR8
V4C	2 x 4 ¹ / ₈		50.8 x 105		7/8	22.23	VR8
V4L	2 x 4 ⁵ / ₈		50.8 x 117.5		7/8	22.23	VR8
V5C	2 x 5 ¹ / ₈		50.8 x 130		7/8	22.23	VR8
V5L	2 x 5 ⁵ / ₈		50.8 x 143		7/8	22.23	VR8
W3C	2 ¹ / ₂ x 3 ¹ / ₈		63.5 x 79.4		1 ¹ / ₈	28.58	VR10
W3L	2 ¹ / ₂ x 3 ⁵ / ₈		63.5 x 92		1 ¹ / ₈	28.58	VR10
W4C	2 ¹ / ₂ x 4 ¹ / ₈		63.5 x 105		1 ¹ / ₈	28.58	VR10
W4L	2 ¹ / ₂ x 4 ⁵ / ₈		63.5 x 117.5		1 ¹ / ₈	28.58	VR10
W5C	2 ¹ / ₂ x 5 ¹ / ₈		63.5 x 130		1 ¹ / ₈	28.58	VR10
W5L	2 ¹ / ₂ x 5 ⁵ / ₈		63.5 x 143		1 ¹ / ₈	28.58	VR10
X3L	3 x 3 ⁵ / ₈		76.2 x 92		1 ¹ / ₄	31.75	VR12
X4C	3 x 4 ¹ / ₈		76.2 x 105		1 ¹ / ₄	31.75	VR12
X4L	3 x 4 ⁵ / ₈		76.2 x 117.5		1 ¹ / ₄	31.75	VR12
X5C	3 x 5 ¹ / ₈		76.2 x 130		1 ¹ / ₄	31.75	VR12
X5L	3 x 5 ⁵ / ₈		76.2 x 143		1 ¹ / ₄	31.75	VR12
X5R	3 x 5 ⁷ / ₈		76.2 x 149		1 ¹ / ₄	31.75	VR12
X6L	3 x 6 ⁵ / ₈		76.2 x 168		1 ¹ / ₄	31.75	VR12
X8L	3 x 8 ⁵ / ₈		76.2 x 219		1 ¹ / ₄	31.75	VR12

* Bare Can Size. Add. 015 inches to diameter and .045 inches to length for PVC insulating sleeve.

OUTLINE DIMENSIONS

Molded High Screw-Insert Terminal (H)

MOLDED INSULATING SHOULDER 7/16 DIA.

CAN DIA	E
1 3/8	25/64
1 3/4	29/64
2	1/2
2 1/2	5/8
3	3/4

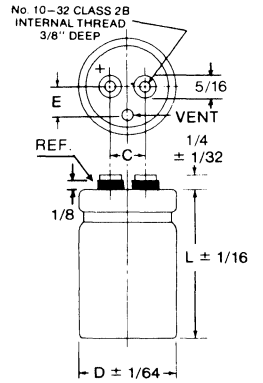

Type SFC Stacked Foil Capacitors

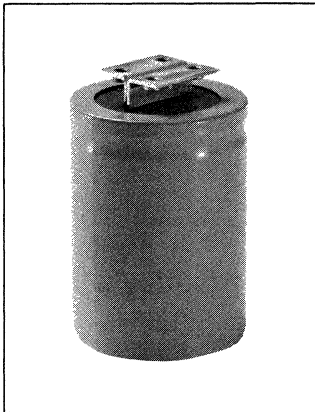

Bus Terminals

Design features of the SFC capacitor, including welded plate to terminal connections and massive bus type terminals have made it possible to significantly lower the equivalent series resistance and inductance of the SFC capacitor type as compared to the more conventional computer grade capacitor.

The lower AC loss characteristics of the SFC capacitor are manifested in lower equivalent series resistance, inductance, and impedance over a wide frequency range. This improved efficiency

makes the SFC an excellent selection for those applications where high ripple current is encountered or where maximum effectiveness in accepting and releasing charge is required. The improved efficiency of this capacitor type additionally allows economy in size and weight where a multiple capacitor bank is necessary. **Ask for technical bulletin No. 4-310 for more detail. For prices, reference price sheet No. 112.**

HIGHLIGHTS

Capacitance: 6800 to 100,000 μ F
Voltage: 6 to 50 WVDC
Tolerance: -0, +100%
Operating Temperature: -40°C to +85°C

CASE CODE CHART

Case Code	No Outer Sleeve		Outer Insulation		Typical Weight in Grams
	D ± 0.031	L ± 0.062	D Max.	L Max.	
X4C	3.000	4.125	3.078	4.250	555
X5L	3.000	5.625	3.078	5.750	666

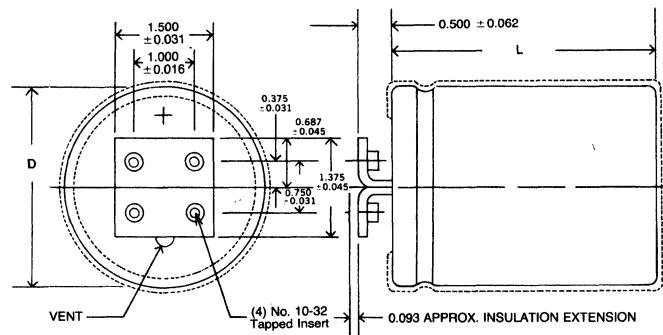

Cap (μ F)	Max. ESR (ohms) @ 120Hz	Max. Ripple RMS Amps @ 120 Hz +85°C	Case Code	Catalog No.
6 WVDC; 8 VDC Surge				
56,000	.0025	36.0	X4C	SFC563006X4C3
100,000	.0020	48.0	X5L	SFC104006X5L3
7.5 WVDC; 10 VDC Surge				
47,000	.003	35.0	X4C	SFC4737R5X4C3
68,000	.0025	40.0	X5L	SFC6837R5X5L3
10 WVDC; 15 VDC Surge				
33,000	.003	30.0	X4C	SFC333010X4C3
56,000	.0025	37.0	X5L	SFC563010X5L3
15 WVDC; 20 VDC Surge				
27,000	.005	24.0	X4C	SFC273015X4C3
39,000	.0035	30.0	X5L	SFC393015X5L3
20 WVDC; 30 VDC Surge				
18,000	.006	20.0	X4C	SFC183020X4C3
27,000	.004	26.0	X5L	SFC273020X5L3

Cap (μ F)	Max. ESR (ohms) @ 120Hz	Max. Ripple RMS Amps @ 120 Hz +85°C	Case Code	Catalog No.
25 WVDC; 40 VDC Surge				
15,000	.0075	18.0	X4C	SFC153025X4C3
22,000	.005	24.0	X5L	SFC223025X5L3
30 WVDC; 45 VDC Surge				
12,000	.009	16.0	X4C	SFC123030X4C3
18,000	.006	22.0	X5L	SFC183030X5L3
40 WVDC; 55 VDC Surge				
8,200	.012	15.0	X4C	SFC822040X4C3
12,000	.010	20.0	X5L	SFC123040X5L3
50 WVDC; 70 VDC Surge				
6,800	.015	12.0	X4C	SFC682050X4C3
10,000	.012	16.0	X5L	SFC103050X5L3

ALUMINUM CAPACITORS

Type HC and NP Electrolytic Capacitors

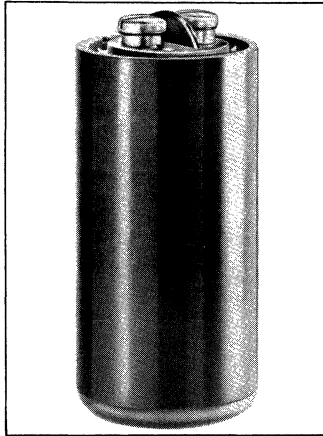

Dry Electrolytics

HC and NP capacitors are furnished in heavy-duty molded phenolic cases with integral safety vent. HC types are polarized; NP types are non-polarized. For prices, reference price sheet No. 114.

HIGHLIGHTS

Capacitance: 15 to 4,000 μ F
 Voltage: 20 to 450 WVDC
 Tolerance: HC — 0 to 50 WVDC, -10%, +150%
 80 to 250 WVDC, -10%, +100%
 450 WVDC, -10%, +50%
 NP — \pm 25%
 Operating Temperature: -20°C to +85°C

POLARIZED TYPE HC

Cap., (μ F)	WVDC	Size	Catalog No.
2x5,000	20	7	HC2050.50*
1,000	25	1	HC2510A
2,000	25	2	HC2520A
3,000	25	4	HC2530
4,000	25	4	HC2540A
500	50	1	HC5005A
1,000	50	2	HC5010A
2,000	50	4	HC5020A
4,000	50	7	HC5040
2,000	80	4	HC8020
1,500	100	7	HC10015
1,000	150	7	HC15010
1,000	150	5	HC15010A
500	200	4	HC20005A
100	450	4	HC45001
300	450	7	HC45003

NON-POLARIZED TYPE NP

Cap., (μ F)	WVDC	Size	Catalog No.
200	125	2	NP1225A
500	125	5	NP1255A
100	250	2	NP2514
150	250	2	NP2520
15	300	1	NP3003A
50	300	1	NP3008
100	300	4	NP3014A
150	300	7	NP3020
200	300	7	NP3025
50	450	4	NP4505
100	450	7	NP4510

‡PHOTOFLASH CAPACITORS

HC45003—300 mfd, 450 WVDC. Plastic case, 2 1/16" dia. \times 4 3/8". Max. DCL (at 5 min.) 2.2 mA.

FF45052—525 mfd, 450 WVDC. Plastic case, 2 1/16" dia. \times 4 3/8". Max. DCL (at 5 min.) 3.1 mA.

FP240—Specially engineered FP capacitor for photoflash use. Dual separate section, 50 mfd at 450 WVDC each section. May be used in parallel for 100 mfd. Supplied with cardboard insulating tube. Uses standard FP mounting plate. 1 3/8" \times 3" dia.

*-20°C to +65°C & with Combo Lid

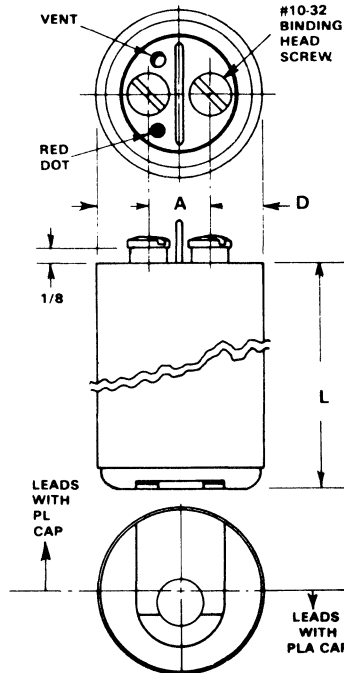

‡HES types are recommended for photoflash applications. See page 46.

HC-NP DATA & DIMENSIONS

Code	DIMEN. — INCHES		
	D	L	A
1	17/16	2 3/4	1/2
2	17/16	3 3/8	1/2
4	1 13/16	3 3/8	5/8
5	1 13/16	4 3/8	5/8
7	2 1/16	4 3/8	7/8

See page 72 for capacitor hardware.

Type FP-WP Metal Can Electrolytic Capacitors



Twist-Prong/PC Mount

FP-WP Capacitors are designed for +85°C operation, through 450 volts, higher voltages designed for +65°C, and have standard twist-prong mounting lugs with solder terminals. PFP-PWP types use standard EIA printed circuit terminals and can be used in place of normal solder terminal types. All types use etched cathode construction for hum-free operation, and have an exclusive vent and seal design. Standard tolerances: Up to 50 WVDC, -10% to +150%; 51 to 350 WVDC, -10% to +100%, 351 WVDC and up

-10% to +50%. For complete technical information request bulletin 4-101A. For prices, reference price sheet No. 160. For FP-WP capacitor hardware, see page 74.

HIGHLIGHTS

Capacitance: 2 to 10,000 μ F
Voltage: 10 to 475 WVDC
Configurations Available: Single, Double, Triple, and Quad

Singles

Cap. μ F	WVDC	Case Code	Catalog Number	Cap. μ F	WVDC	Case Code	Catalog Number
2500	10	M	PWP031	1400	175	N	FP123.2
10000	10	G	FP031.8	120	200	F	FP121
1000	15	L	WP039	125	200	B	PFP121.5
2000	15	F	WP041	400	200	F	PFP122.9
3000	15	F	WP042	500	200	H	WP123
5000	15	G	FP042.6	950	200	H	FP123.3
10000	15	H	FP042.8				
				150	250	C	WP125.9
500	25	L	WP057	160	250	D	FP125.95M*
1000	25	F	WP059	200	250	D	FP127
1500	25	C	PWP060	750	250	I	FP128.1
2000	25	R	FP060.2				
4000	25	G	FP060.4	100	300	C	FP129.1
5000	25	H	FP060.6	160	300	G	WP131.5M*
				200	300	G	WP132
4700	40	G	FP061.1				
5000	45	N	FP062	50	350	B	FP137
				80	350	F	FP138
100	50	L	WP064	125	350	G	FP140
500	50	F	WP065	150	350	G	FP140.6
500	50	B	WP066	200	350	F	FP140.7
1000	50	B	PFP066.4	250	350	G	FP140.91
1000	50	F	FP066.5	320	350	I	FP141
1250	50	G	PWP067				
1500	50	F	WP068	20	450	M	FP144
2000	50	H	FP070	20	450	M	PFP144
4000	50	G	FP071	30	450	B	FP145
				40	450	C	FP146
50	150	L	FP115	50	450	D	FP147
100	150	L	FP116	80	450	G	FP149
140	150	B	PFP116.8	100	450	G	FP150
150	150	B	FP117	125	450	H	FP155
300	150	F	FP119				
1200	160	I	FP123.1				

Duals

Cap. μ F	WVDC	Case Code	Catalog Number	Cap. μ F	WVDC	Case Code	Catalog Number
1000-1000	15-15	F	WP200	200-200	250-250	H	FP217.74
1000-1000	25-25	F	PWP201.15	40-40	300-300	F	FP217.87
1500-1500	25-25	G	PWP201.3	75-75	300-300	G	FP217.9
1000-1000	35-35	F	WP201.5	150-100	300-300	H	FP219.7
3000-800	35-35	D	PFP201.6	200-100	300-300	J	FP219.9
2000-2000	40-40	G	FP202	20-20	350-350	B	FP227
100-100	50-50	L	WP202.5	30-30	350-350	C	FP227.3
1000-1000	50-50	G	FP202.9	80-80	350-350	H	FP227.6
1500-1500	50-50	G	FP204	100-100	350-350	J	FP227.7
750-500	125-125	N	FP207.5	150-20	350-350	H	FP228.3
40-40	150-150	L	FP212	150-150	350-350	H	FP227.95
50-30	150-150	L	PFP213.1	200-200	350-350	J	FP227.96
50-50	150-150	L	FP214	250-100	350-350	J	PFP227.97
70-30	150-150	B	PFP214.3	250-250	350-350	N	FP228.2
80-50	150-150	B	WP216.24	270-150	350-350	N	FP227.98
100-50	150-150	B	PFP214.7	10-50	450-350	D	FP230.5
125-100	150-150	R	FP215	80-2	450-350	H	PFP230.7
200-200	150-150	G	FP216.4	10-10	450-450	M	FP231
500-500	175-175	I	FP216.51	20-20	450-450	B	FP234
250-100	200-200	G	FP216.7	40-40	450-450	G	FP238
300-250	200-200	G	FP216.71	50-50	450-450	H	FP240‡
400-200	200-200	G	FP216.81	80-80	450-450	J	FP245.5
300-300	200-200	I	FP216.9	100-40	450-450	J	FP247
20-20	250-250	L	FP217	100-60	450-450	I	FP248
40-40	250-250	M	FP221	80-160	475-250	N	FP253
750-100	250-250	S	FP217.81				
150-150	250-250	G	FP217.7				

* Suffix "M" designates plastic sleeve.

‡ Can ungrounded for photoflash.

ALUMINUM CAPACITORS

Type FP-WP Metal Can Electrolytic Capacitors

Triples

Cap. μ F	WVDC	Case Code	Catalog Number	Cap. μ F	WVDC	Case Code	Catalog Number
500-450-100	16-16-16	L	FP300.18	100-60-20	350-350-200	H	FP330.26
1900-1900-1900	40-40-40	H	FP303.2	20-20-20	350-350-350	C	FP330.6
750-700-500	50-40-40	R	FP303.3	30-20-10	350-350-350	C	FP330.7
750-1500-500	50-40-40	G	FP303.9	40-40-40	350-350-350	G	FP330.8
500-500-100	50-50-50	C	FP310.1	200-80-120	350-350-350	S	FP331.91
1500-1500-200	50-50-50	H	FP310.2	80-80-200	400-200-25	G	FP332.452
40-40-20	150-150-25	L	FP310	50-10-160	450-400-250	J	FP343.2
400-400-500	150-150-35	H	FP311.31	10-10-20	450-450-20	B	FP345.2
40-40-40	150-150-150	M	FP311.5	20-20-20	450-450-25	C	FP345.8
70-40-40	150-150-150	B	FP311.8	40-40-20	450-450-25	G	FP346
80-60-40	150-150-150	C	FP311.76	80-80-20	450-450-400	N	FP375.75
120-80-40	150-150-150	F	FP311.85	10-10-10	450-450-450	C	FP375.8
700-500-150	175-175-50	H	FP311.78	20-10-10	450-450-450	D	FP376.3
200-50-400	175-175-175	H	FP312.71	20-20-20	450-450-450	F	FP376.5
250-200-50	200-200-200	H	FP318.85	30-30-30	450-450-450	G	FP376.7
250-200-50	200-200-200	H	FP318.85	40-40-10	450-450-450	G	FP376.8
150-150-200	200-200-200	H	FP318.86	40-40-20	450-450-450	H	FP376.9
250-150-200	200-200-200	H	FP318.87	40-40-40	450-450-450	H	FP377.1
500-200-50	200-200-200	G	FP318.91	60-40-40	450-450-450	J	FP377.7
100-100-600	250-250-100	J	FP318.883	80-30-20	450-450-450	G	FP377.71
100-100-750	250-250-100	G	FP318.89	80-40-20	450-450-450	I	FP378
100-100-150	250-250-200	F	FP318.9	80-40-40	450-450-450	I	FP378.4
20-20-20	250-250-250	M	FP319.8	80-50-30	450-450-450	H	FP378.45
40-20-20	250-250-250	B	FP321	80-80-20	475-475-350	H	FP385.7
40-40-40	250-250-250	C	FP321.5	10-10-10	475-475-475	L	FP394
100-400-400	275-200-200	N	FP323.01	30-30-20	475-475-475	G	FP396
80-40-40	300-300-300	G	FP326.62	40-20-20	475-475-475	G	FP396.1
250-250-50	350-175-175	I	FP327.82	80-10-18	475-475-475	H	FP396.22

Quads

Cap. (μ F)	WVDC	Case Code	Catalog Number	Cap. (μ F)	WVDC	Case Code	Catalog Number
400-600-200-60	125-100-50-40	J	FP407.4	20-20-20-20	475-475-475-475	F	FP475
400-400-500-500	150-150-35-35	N	FP407.7	40-20-10-10	475-475-475-475	G	FP476
250-650-50-10	200-175-175-150	N	FP412.06	80-30-4-4	475-475-475-475	H	FP472.5
250-400-50-5	200-175-175-175	H	FP412.143				
350-350-150-500	200-200-100-100	S	FP412.145				
80-400-400-500	250-150-150-35	I	FP412.79				
40-100-200-300	350-175-175-175	H	FP414.10				
40-20-20-10	350-350-350-350	F	FP420.35				
40-40-30-20	350-350-350-350	G	FP420.36				
100-100-50-50	350-350-350-350	H	FP420.37				
10-4-4-20	400-350-150-25	F	FP420.438				
80-10-4-100	400-400-400-50	F	FP421.81				
10-140-100-20	450-350-300-300	I	WP423.5				
20-15-20-20	450-450-25-25	F	FP426				
80-50-20-150	450-450-250-25	H	FP427.66				
80-50-20-50	450-450-250-50	I	FP427.67				
80-30-40-40	450-450-350-150	I	FP427.75				
40-30-10-20	450-450-450-25	H	FP429				
80-30-20-40	450-450-450-150	I	FP433.3				
10-10-10-10	450-450-450-450	F	FP434				
20-10-10-10	450-450-450-450	F	FP434.5				
20-20-20-20	450-450-450-450	G	FP444				
40-40-20-20	450-450-450-450	J	FP447				
40-40-30-30	450-450-450-450	J	FP447.5				
40-40-40-40	450-450-450-450	H	WP447.7				
80-40-20-20	450-450-450-450	I	FP450.16				

FP - WP AND PFP - PWP Case Code Chart

Key	Dia.	Lgth.	Key	Dia.	Lgth.
B	1"	2"	J	1 3/8"	3 1/2"
C	1"	2 1/2"	L	1"	1 1/2"
D	1"	3"	M	1"	1 3/4"
F	1 3/8"	2"	N	1 3/8"	4 1/2"
G	1 3/8"	2 1/2"	R	1 3/8"	1 3/4"
H	1 3/8"	3"	S	1 3/8"	5"
I	1 3/8"	4"			

Type LP • New 105°C Design Aluminum Electrolytic Capacitors

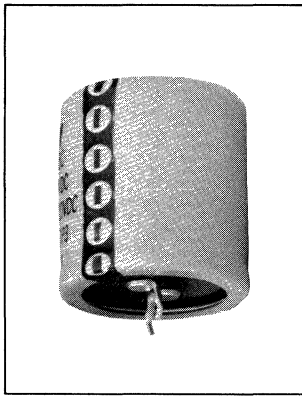

Low Profile, Snap-In Terminals New 105° Design

The LP capacitor is designed for quick easy snap-in insertion in PC board power supplies. Direct positive mounting eliminates the need for mounting hardware. Standard CV ratings are available in small diameter, low profile configurations that meet height and PC board space restrictions.

Designed specifically for switching power supply applications, the LP can be used in other applications that require high CV in minimum size. The LP offers low ESR, high ripple capability over a temperature range of -40°C to +105°C. **For complete specifications, refer to Bulletin 4-318. For pricing request price sheet No. 115.**

HIGHLIGHTS

Capacitance: to 47000µF
Voltage: 6.3 VDC to 250 VDC
Tolerance: ±20%
Temperature: -40°C to +105°C

Cap. µF	Mallory Part No.
6.3 WVDC	
6800	LP682M6R3A1P3
10000	LP103M6R3A3P3
10000	LP103M6R3C1P3
15000	LP153M6R3A7P3
15000	LP153M6R3E1P3
22000	LP223M6R3C7P3
22000	LP223M6R3E5P3
27000	LP273M6R3C9P3
27000	LP273M6R3H5P3
39000	LP393M6R3E9P3
10 WVDC	
5600	LP562M010A1P3
8200	LP822M010C1P3
12000	LP123M010A5P3
12000	LP123M010E1P3
15000	LP153M010C5P3
15000	LP153M010E3P3
22000	LP223M010C9P3
22000	LP223M010H3P3
33000	LP333M010E9P3
33000	LP333M010H7P3
47000	LP473M010H9P3

Cap. µF	Mallory Part No.
16 WVDC	
4700	LP472M016A1P3
5600	LP562M016C1P3
8200	LP822M016A5P3
8200	LP822M016E1P3
12000	LP123M016C5P3
12000	LP123M016E3P3
15000	LP153M016C7P3
15000	LP153M016H3P3
22000	LP223M016E7P3
22000	LP223M016H3P3
27000	LP273M016H7P3
33000	LP333M016H9P3
25 WVDC	
2700	LP272M025C1P3
3300	LP332M025C1P3
4700	LP472M025C1P3
5600	LP562M025A5P3
5600	LP562M025C3P3
5600	LP562M025E1P3
6800	LP682M025E1P3
6800	LP682M025C5P3
10000	LP103M025C7P3
10000	LP103M025H3P3
12000	LP123M025H3P3
15000	LP153M025E7P3
22000	LP223M025H9P3

Cap. µF	Mallory Part No.
35 WVDC	
1800	LP182M035A1P3
2700	LP272M035C1P3
3900	LP392M035A5P3
3900	LP392M035E1P3
5600	LP562M035C5P3
5600	LP562M035E3P3
6800	LP682M035C7P3
6800	LP682M035E5P3
8200	LP822M035H3P3
10000	LP103M035E7P3
15000	LP153M035H9P3
50 WVDC	
1200	LP122M050A1P3
1500	LP152M050A1P3
2200	LP222M050A5P3
2200	LP222M050E1P3
3300	LP332M050C5P3
3300	LP332M050E3P3
3900	LP392M050C7P3
4700	LP472M050H3P3
5600	LP562M050H5P3
6800	LP682M050E9P3
8200	LP822M050H9P3

Cap. µF	Mallory Part No.
63 WVDC	
820	LP821M063A1P3
1200	LP122M063C1P3
1800	LP182M063A7P3
1800	LP182M063E1P3
2200	LP222M063C7P3
2200	LP222M063E3P3
3300	LP332M063C9P3
3300	LP332M063H3P3
4700	LP472M063E9P3
6800	LP682M063H9P3
80 WVDC	
1800	LP182M080C7P3
4700	LP472M080H9P3
100 WVDC	
820	LP821M100E1P3
2200	LP222M100H7P3
2700	LP272M100H9P3
200 WVDC	
150	LP151M200C1P3
180	LP181M200C1P3
220	LP221M200A3P3
220	LP221M200C1P3
220	LP221M200E1P3

Cap. µF	Mallory Part No.
200 WVDC	
270	LP271M200C3P3
270	LP271M200E1P3
330	LP331M200E3P3
390	LP391M200C5P3
470	LP471M200H3P3
470	LP471M200E5P3
560	LP561M200E5P3
560	LP561M200H3P3
680	LP681M200H5P3
820	LP821M200H7P3
1000	LP102M200H9P3
250 WVDC	
100	LP101M250C1P3
150	LP151M250C1P3
150	LP151M250E1P3
180	LP181M250C3P3
220	LP221M250C3P3
220	LP221M250E1P3
270	LP271M250E3P3
270	LP271M250C5P3
330	LP331M250E3P3
330	LP331M250H1P3
390	LP391M250H3P3
470	LP471M250E7P3
470	LP471M250H5P3
680	LP681M250H9P3

ORDERING INFORMATION

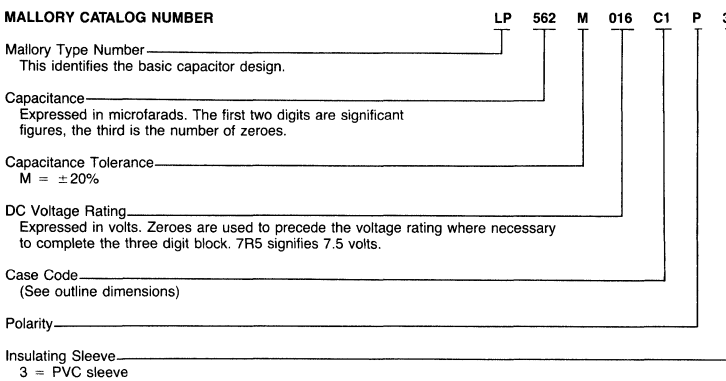

CASE CODES

Diameter mm (in.)	Length				
	25 (1.00)	30 (1.18)	35 (1.38)	40 (1.57)	50 (2.00)
22 (.87)	A1	A3	A5	A7	A9
25 (1.00)	C1	C3	C5	C7	C9
30 (1.18)	E1	E3	E5	E7	E9
35 (1.38)	H1	H3	H5	H7	H9

DIMENSIONS IN INCHES

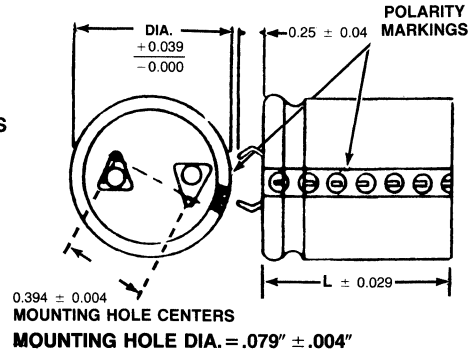

• New Product

Type VPR Single-Ended Tubular Capacitors

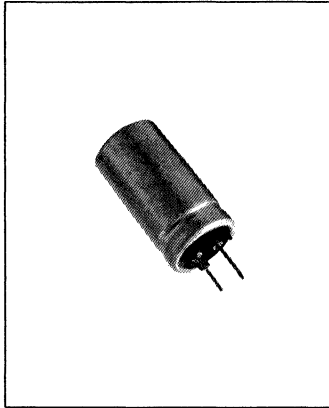

**High Performance
+ 105°C**

Designed for use in high frequency switching regulators where low impedance and low inductance characteristics are required. The A & C lead configuration are standard distributor items.

Low loss high frequency characteristics make this capacitor ideal in bypass and coupling applications in data processing equipment. Supplied with PVC insulating sleeve. **Ask for bulletin 4-106. For pricing, refer to Price Sheet No. 150.**

HIGHLIGHTS

- Capacitance: From 34 to 12,000µF
- Voltage: From 6.3 to 100 volts
- Tolerance: -10 +75% Standard, -10 +50% Available on special request
- Temperature: -55°C to +105°C
- Case Sizes: 22 sizes available from 1/2" x 1" to 1" x 3 5/8" for vertical mounting on PC boards

(µF)	Max. ESR @ 10 KHz	Max. RMS Amps @ 10 KHz +85°C	Case Code	Catalog No.
6.3 WVDC; 8 VDC SURGE				
880	.121	1.43	E1A	VPR881U6R3E1A
1,300	.084	1.87	E1E	VPR132U6R3E1E
2,900	.050	3.46	J1L	VPR292U6R3J1L
4,100	.038	4.32	L1L	VPR412U6R3L1L
5,600	.030	5.24	N1L	VPR562U6R3N1L
6,500	.027	5.78	L2C	VPR652U6R3L2C
8,800	.023	6.74	N2C	VPR882U6R3N2C
12,000	.019	8.16	N2L	VPR123U6R3N2L
7.5 WVDC; 10 VDC SURGE				
780	.117	1.45	E1A	VPR781U7R5E1A
1,100	.084	1.87	E1E	VPR112U7R5E1E
1,700	.057	2.59	E1L	VPR172U7R5E1L
2,600	.047	3.57	J1L	VPR262U7R5J1L
4,900	.029	5.33	N1L	VPR492U7R5N1L
5,800	.025	6.00	L2C	VPR582U7R5L2C
7,800	.021	7.05	N2C	VPR782U7R5N2C
10,000	.018	8.38	N2L	VPR103U7R5N2L
10 WVDC; 13 VDC SURGE				
660	.115	1.47	E1A	VPR661U010E1A
990	.076	1.97	E1E	VPR991U010E1E
1,400	.056	2.61	E1L	VPR142U010E1L
2,100	.047	3.57	J1L	VPR212U010J1L
3,100	.034	4.57	L1L	VPR312U010L1L
4,200	.027	5.53	N1L	VPR422U010N1L
12 WVDC; 18 VDC SURGE				
560	.116	1.46	E1A	VPR561U012E1A
1,200	.055	2.64	E1L	VPR122U012E1L
1,800	.046	3.60	J1L	VPR182U012J1L
2,600	.033	4.64	L1L	VPR262U012L1L
3,600	.026	5.63	N1L	VPR362U012N1L
4,200	.023	6.26	L2C	VPR422U012L2C
5,600	.018	7.67	N2C	VPR562U012N2C
8,500	.014	10.28	L3L	VPR852U012L3L

(µF)	Max. ESR @ 10 KHz	Max. RMS Amps @ 10 KHz +85°C	Case Code	Catalog No.
16 WVDC; 20 VDC SURGE				
500	.110	1.50	E1A	VPR501U016E1A
1,600	.043	3.73	J1L	VPR162U016J1L
2,300	.031	4.78	L1L	VPR232U016L1L
3,200	.024	6.22	J2L	VPR322U016J2L
3,200	.024	5.86	N1L	VPR322U016N1L
3,700	.021	6.55	L2C	VPR372U016L2C
5,000	.017	7.84	N2C	VPR502U016N2C
6,900	.014	9.50	N2L	VPR692U016N2L
10,000	.011	12.45	N3L	VPR103U016N3L
25 WVDC; 30 VDC SURGE				
640	.067	2.39	E1L	VPR641U025E1L
940	.054	3.33	J1L	VPR941U025J1L
1,300	.040	4.21	L1L	VPR132U025L1L
1,400	.038	4.48	J2C	VPR142U025J2C
1,800	.030	5.56	J2L	VPR182U025J2L
1,800	.030	5.24	N1L	VPR182U025N1L
2,800	.021	7.22	L2L	VPR282U025L2L
2,800	.021	7.05	N2C	VPR282U025N2C
3,900	.016	8.89	N2L	VPR392U025N2L
4,900	.013	10.68	N3C	VPR492U025N3C
5,900	.012	11.92	N3L	VPR592U025N3L
40 WVDC; 50 VDC SURGE				
160	.171	1.20	E1A	VPR161U040E1A
240	.114	1.61	E1E	VPR241U040E1E
360	.091	2.05	E1L	VPR361U040E1L
540	.061	3.13	J1L	VPR541U040J1L
760	.043	4.06	L1L	VPR761U040L1L
850	.038	4.48	J2C	VPR851U040J2C
1,000	.033	5.00	N1L	VPR102U040N1L
1,100	.030	5.56	J2L	VPR112U040J2L
1,200	.028	5.67	L2C	VPR122U040L2C
1,600	.021	7.05	N2C	VPR162U040N2C
2,200	.016	8.89	N2L	VPR222U040N2L
2,800	.013	10.68	N3C	VPR282U040N3C
3,300	.012	11.92	N3L	VPR332U040N3L

(µF)	Max. ESR @ 10 KHz	Max. RMS Amps @ 10 KHz +85°C	Case Code	Catalog No.
50 WVDC; 65 VDC SURGE				
110	.317	.88	E1A	VPR111U050E1A
160	.218	1.16	E1E	VPR161U050E1E
250	.139	1.66	E1L	VPR251U050E1L
420	.056	2.92	J1L	VPR421U050J1L
600	.039	3.81	L1L	VPR601U050L1L
810	.029	4.77	N1L	VPR811U050N1L
900	.026	5.26	L2C	VPR901U050L2C
1,200	.020	6.68	L2L	VPR122U050L2L
1,200	.020	6.53	N2C	VPR122U050N2C
1,600	.015	8.30	N2L	VPR162U050N2L
2,000	.012	10.05	N3C	VPR202U050N3C
2,400	.010	11.80	N3L	VPR242U050N3L
75 WVDC; 95 VDC SURGE				
62	.489	.71	E1A	VPR620U075E1A
93	.326	.90	E1E	VPR930U075E1E
140	.216	1.33	E1L	VPR141U075E1L
230	.102	2.16	J1L	VPR231U075J1L
330	.071	2.82	L1L	VPR331U075L1L
350	.067	3.01	J2C	VPR351U075J2C
450	.052	3.55	N1L	VPR451U075N1L
470	.050	3.85	J2L	VPR471U075J2L
500	.047	3.92	L2C	VPR501U075L2C
680	.035	4.92	N2C	VPR681U075N2C
900	.026	6.22	N2L	VPR901U075N2L
1,100	.021	7.45	N3C	VPR112U075N3C
1,300	.018	8.68	N3L	VPR132U075N3L
100 WVDC; 125 VDC SURGE				
34	.691	.53	E1A	VPR340U100E1A
52	.452	.73	E1E	VPR520U100E1E
78	.301	1.01	E1L	VPR780U100E1L
130	.181	1.63	J1L	VPR131U100J1L
250	.094	2.65	N1L	VPR251U100N1L

ALUMINUM CAPACITORS

Type VPR Single-Ended Tubular Capacitors

TABLE OF DIMENSIONS

CASE SIZE	CASE CODE	UNINSULATED				INSULATED				FIG. A S	FIG. "T" & "J" S	FIG. "B"		LEAD WIRE SIZE	
		D ± .015		H ± .031		D ± .015		H ± .015				S	X	DIA.	AWG.
		in.	mm	in.	mm	in.	mm	in.	mm						
1/2 × 1	E1A	.512	13	1.024	26	.527	13.4	1.039	26.4	—	.20	—	—	.032	#20
1/2 × 1 1/4	E1E	.512	13	1.30	33	.527	13.4	1.315	33.4	—	.20	—	—	.032	#20
1/2 × 1 5/8	E1L	.512	13	1.654	42	.527	13.4	1.669	42.4	—	.20	—	—	.032	#20
3/4 × 1 5/8	J1L	.750	19.1	1.625	41.3	.765	19.4	1.64	41.7	.25	.25	.20	.30	.040	#18
3/4 × 2 1/8	J2C	.750	19.1	2.125	53.9	.765	19.4	2.14	54.4	.25	.25	.20	.30	.040	#18
3/4 × 2 5/8	J2L	.750	19.1	2.625	66.7	.765	19.4	2.64	67.1	.25	.25	.20	.30	.040	#18
7/8 × 1 5/8	L1L	.875	22.2	1.625	41.3	.890	22.6	1.64	41.7	.30	.30	.30	.40	.040	#18
7/8 × 2 1/8	L2C	.875	22.2	2.125	53.9	.890	22.6	2.14	54.4	.30	.30	.30	.40	.040	#18
7/8 × 2 5/8	L2L	.875	22.2	2.625	66.7	.890	22.6	2.64	67.1	.30	.30	.30	.40	.040	#18
7/8 × 3 1/8	L3C	.875	22.2	3.125	79.4	.890	22.6	3.14	79.8	.30	.30	.30	.40	.040	#18
7/8 × 3 5/8	L3L	.875	22.2	3.625	92.1	.890	22.6	3.64	92.5	.30	.30	.30	.40	.040	#18
1 × 1 5/8	N1L	1.00	25.4	1.625	41.3	1.015	28.8	1.64	41.7	.40	.40	.30	.40	.040	#18
1 × 2 1/8	N2C	1.00	25.4	2.125	53.9	1.015	28.8	2.14	54.4	.40	.40	.30	.40	.040	#18
1 × 2 5/8	N2L	1.00	25.4	2.625	66.7	1.015	28.8	2.64	67.1	.40	.40	.30	.40	.040	#18
1 × 3 1/8	N3C	1.00	25.4	3.125	79.4	1.015	28.8	3.14	79.8	.40	.40	.30	.40	.040	#18
1 × 3 5/8	N3L	1.00	25.4	3.625	92.1	1.015	28.8	3.64	92.5	.40	.40	.30	.40	.040	#18

FIG. A
(3/4", 7/8", 1" DIA.)
STANDARD

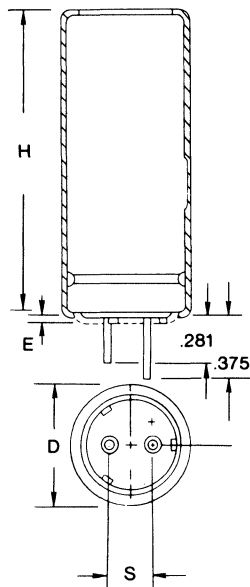
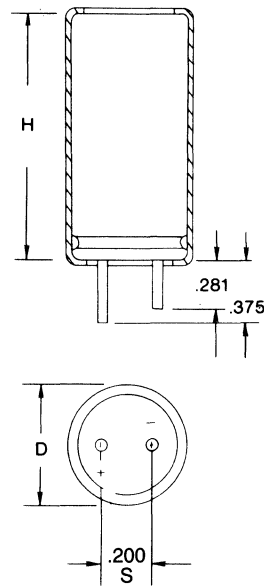

FIG. C
(1/2" DIA. ONLY)
STANDARD



NOTE:
1. Dimension "E" stand-off is nominally 0.100.

NOTE: Fig. T, J and B are available on special order only.

Type VTL Tubular Electrolytic Capacitors

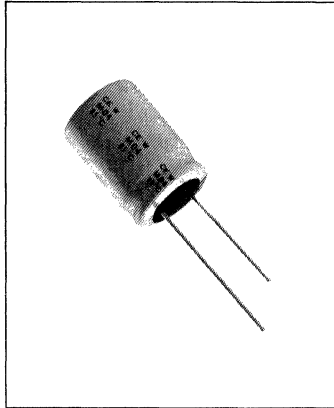

**RADIAL LEAD POLAR
GENERAL PURPOSE**

Miniature, Single-Ended
The VTL is a miniaturized Aluminum Electrolytic Single-ended Capacitor which uses a newly developed high quality aluminum foil. These capacitors offer a maximum capacitance in low profile case sizes at operating voltages to 100 WVDC. The VTL offers excellent electrical performance and stability over a temperature range of -40°C to +85°C. Diameters .394" or greater will have a vent.

To special order parts with epoxy end seal place "E" suffix on part number and add .078" to part length. **For more detailed information request Bulletin 9-765. For prices, reference price sheet No. 148. VTL Mallobins are available, see complete Mallobin listing on page 150.**

HIGHLIGHTS:
Capacitance Range: 0.47 to 10,000 μ F
Voltage Range: 6.3 to 100 WVDC
Temperature Range: -40°C to +85°C
Capacitance Tolerance: \pm 20%

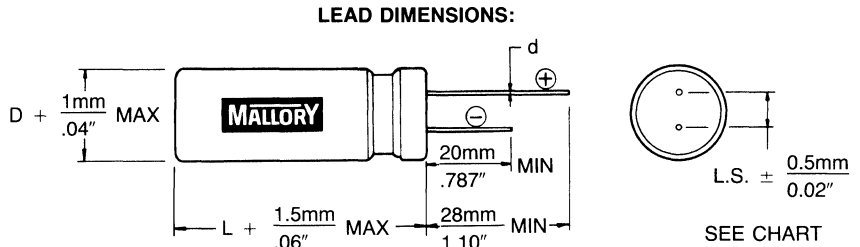

TYPE VTL OUTLINE DIMENSIONS

Cap. (μ F)	Maximum Size (inches) Dia. (D) x Length (L)	Lead Spacing (inches) (s)	Lead Diameter (inches) (d)	Max. Permissible Ripple Current (mA rms) @ 120Hz +85°C	DF (%) @ 120Hz	Max. ESR (ohms) 120Hz +25°C	Max. DCL (μ A) @ +25°C	Catalog No.
6.3 WVDC; 8 VDC Surge								
33	.197 x .433	.079	.020	70	22	8.84	3.0	VTL33S6
47	.197 x .433	.079	.020	90	22	6.21	3.0	VTL47S6
100	.236 x .433	.098	.020	140	22	2.92	6.3	VTL100S6
220	.315 x .453	.138	.020	240	22	1.33	13.0	VTL220S6
330	.394 x .492	.197	.024	310	22	0.88	20.0	VTL330S6
470	.394 x .492	.197	.024	380	22	0.62	29.0	VTL470S6
1000	.394 x .630	.197	.024	600	22	0.29	63.0	VTL1000S6
2200	.512 x .827	.197	.024	920	24	0.14	138.0	VTL2200S6
3300	.512 x .827	.295	.031	1100	26	0.10	207.0	VTL3300S6
4700	.512 x 1.023	.295	.031	1400	28	0.08	296.0	VTL4700S6
6800	.630 x 1.240	.295	.031	1600	32	0.06	428.0	VTL6800S6
10000	.709 x 1.457	.295	.031	2000	40	0.05	630.0	VTL10000S6
10 WVDC; 13 VDC Surge								
22	.197 x .433	.079	.020	55	19	11.45	3.0	VTL22S10
33	.197 x .433	.079	.020	70	19	7.64	3.3	VTL33S10
47	.197 x .433	.079	.020	90	19	5.36	4.7	VTL47S10
100	.236 x .433	.098	.020	150	19	2.52	10.0	VTL100S10
220	.315 x .453	.138	.020	260	19	1.15	22.0	VTL220S10
330	.394 x .492	.197	.024	340	19	0.76	33.0	VTL330S10
470	.394 x .630	.197	.024	430	19	0.54	47.0	VTL470S10
1000	.394 x .630	.197	.024	700	19	0.25	100.0	VTL1000S10
2200	.512 x .826	.197	.031	1050	21	0.13	220.0	VTL2200S10
3300	.630 x 1.220	.295	.031	1350	23	0.09	330.0	VTL3300S10
4700	.630 x 1.063	.295	.031	1600	25	0.07	470.0	VTL4700S10
6800	.630 x 1.418	.295	.031	2000	29	0.06	680.0	VTL6800S10
16 WVDC; 20 VDC Surge								
10	.197 x .433	.079	.020	40	16	21.22	3.0	VTL10S16
22	.197 x .433	.079	.020	70	16	9.65	3.5	VTL22S16
33	.197 x .433	.079	.020	85	16	6.43	5.2	VTL33S16
47	.236 x .433	.098	.020	110	16	4.52	7.5	VTL47S16
68	.315 x .453	.138	.020	160	16	3.12	10.8	VTL68S16
100	.315 x .453	.138	.020	190	16	2.12	16.0	VTL100S16A
220	.394 x .492	.197	.024	320	16	0.97	35.0	VTL220S16A
330	.394 x .630	.197	.024	410	16	0.64	52.0	VTL330S16A
470	.394 x .492	.197	.024	520	16	0.45	75.0	VTL470S16A
1000	.394 x .787	.197	.024	800	16	0.21	160.0	VTL1000S16
1000	.512 x .787	.295	.024	800	16	0.21	160.0	VTL1000S16A
2200	.512 x 1.024	.295	.031	1200	18	0.11	352.0	VTL2200S16
3300	.630 x 1.062	.295	.031	1500	20	0.08	528.0	VTL3300S16
4700	.630 x 1.497	.295	.031	1800	22	0.06	752.0	VTL4700S16

Type VTL Tubular Electrolytic Capacitors

Cap. (μF)	Maximum Size (inches) Dia. (D) × Length (L)	Lead Spacing (inches) (s)	Lead Diameter (inches) (d)	Max. Permissible Ripple Current (mA rms) @ 120Hz +85°C	DF (%) @ 120Hz	Max. ESR (ohms) 120Hz +25°C	Max. DCL (μA) @ +25°C	Catalog No.
25 WVDC; 32 VDC Surge								
4.7	.197 × .433	.079	.020	30	14	39.51	3.0	VTL4R7S25
22	.197 × .433	.079	.020	90	14	8.44	5.5	VTL22S25
33	.236 × .433	.098	.020	115	14	5.63	8.2	VTL33S25
47	.236 × .433	.098	.020	150	14	3.95	11.0	VTL47S25
68	.315 × .453	.138	.020	200	14	2.73	17.0	VTL68S25
100	.315 × .453	.138	.020	250	14	1.86	25.0	VTL100S25
220	.394 × .630	.197	.024	430	14	0.84	55.0	VTL220S25
330	.394 × .630	.197	.024	560	14	0.56	82.0	VTL330S25
470	.394 × .630	.197	.024	720	14	0.40	117.0	VTL470S25
1000	.512 × .827	.295	.031	1100	14	0.19	250.0	VTL1000S25
2200	.630 × 1.220	.295	.031	1500	16	0.10	550.0	VTL2200S25
3300	.709 × 1.338	.295	.031	1800	18	0.07	825.0	VTL3300S25
35 WVDC; 44 VDC Surge								
4.7	.197 × .433	.079	.020	30	12	33.88	3.0	VTL4R7S35
10	.197 × .433	.079	.020	50	12	15.92	3.5	VTL10S35
22	.236 × .433	.098	.020	100	12	7.24	7.7	VTL22S35
33	.236 × .433	.098	.020	130	12	4.83	11.0	VTL33S35
47	.236 × .433	.098	.020	170	12	3.39	16.0	VTL47S35
100	.394 × .492	.197	.024	300	12	1.59	35.0	VTL100S35
220	.394 × .630	.197	.024	480	12	0.72	77.0	VTL220S35
330	.394 × .787	.197	.024	610	12	0.48	115.0	VTL330S35
470	.512 × .827	.197	.024	750	12	0.34	164.0	VTL470S35
1000	.512 × 1.024	.295	.031	1200	12	0.16	350.0	VTL1000S35
2200	.709 × 1.339	.295	.031	1800	14	0.08	770.0	VTL2200S35
50 WVDC; 63 VDC Surge								
.47	.197 × .433	.079	.020	7	10	282.33	3.0	VTLR47S50
1	.197 × .433	.079	.020	12	10	132.70	3.0	VTL1S50
2.2	.197 × .433	.079	.020	21	10	60.32	3.0	VTL2R2S50
3.3	.197 × .433	.079	.020	28	10	40.21	3.0	VTL3R3S50
4.7	.197 × .433	.079	.020	35	10	28.23	3.0	VTL4R7S50
10	.197 × .433	.079	.020	60	10	13.27	5.0	VTL10S50
22	.236 × .433	.098	.020	110	10	6.03	11.0	VTL22S50
33	.315 × .452	.138	.020	150	10	4.02	16.0	VTL33S50
47	.315 × .452	.138	.020	190	10	2.82	23.0	VTL47S50
100	.394 × .630	.197	.024	330	10	1.33	50.0	VTL100S50
220	.394 × 1.024	.197	.024	540	10	0.60	110.0	VTL220S50
330	.512 × .787	.197	.024	650	10	0.40	165.0	VTL330S50
470	.512 × .984	.295	.031	800	10	0.28	235.0	VTL470S50
1000	.630 × 1.220	.295	.031	1250	10	0.13	500.0	VTL1000S50
63 WVDC; 80 VDC Surge								
4.7	.197 × .433	.079	.020	35	10	28.23	3.0	VTL4R7S63
10	.236 × .433	.098	.020	65	10	13.27	6.3	VTL10S63
22	.315 × .453	.138	.020	120	10	6.03	13.0	VTL22S63
33	.315 × .453	.138	.020	165	10	4.02	20.0	VTL33S63
47	.394 × .492	.197	.024	210	10	2.82	29.0	VTL47S63
100	.394 × .630	.197	.024	340	10	1.33	63.0	VTL100S63
220	.512 × .787	.197	.024	580	10	0.60	138.0	VTL220S63
330	.512 × 1.181	.197	.031	760	10	0.40	207.0	VTL330S63
470	.630 × 1.026	.295	.031	900	10	0.28	296.0	VTL470S63
1000	.630 × 1.496	.295	.031	1400	10	0.13	630.0	VTL1000S63
100 WVDC; 125 VDC Surge								
.47	.197 × .433	.079	.020	8	8	225.87	3.0	VTLR47S100
1	.197 × .433	.079	.020	15	8	106.16	3.0	VTL1S100
2.2	.197 × .433	.079	.020	25	8	48.25	3.0	VTL2R2S100
3.3	.197 × .433	.079	.020	35	8	32.17	3.3	VTL3R3S100
4.7	.236 × .433	.098	.020	45	8	22.59	4.7	VTL4R7S100
10	.315 × .452	.138	.020	80	8	10.62	10.0	VTL10S100
22	.394 × .492	.197	.024	140	8	4.83	22.0	VTL22S100
33	.394 × .630	.197	.024	195	8	3.22	33.0	VTL33S100
47	.394 × .787	.197	.024	250	8	2.26	47.0	VTL47S100
100	.512 × .787	.197	.024	420	8	1.06	100.0	VTL100S100
220	.512 × 1.220	.295	.031	700	8	0.48	220.0	VTL220S100
330	.630 × 1.220	.295	.031	900	8	0.32	330.0	VTL330S100
470	.630 × 1.496	.295	.031	1100	8	0.23	470.0	VTL470S100

ALUMINUM CAPACITORS

Type VTH • New 105°C Capacitors

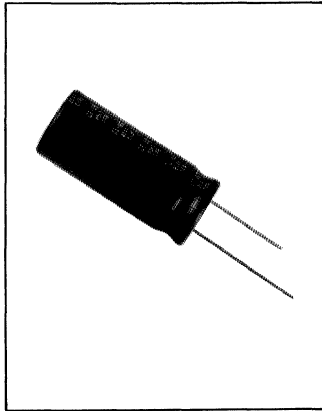

The all new VTH is a miniature aluminum electrolytic single-ended capacitor which is for use in application requiring 105°C. The VTH offers excellent electrical performance over the temperature range of -40°C to +85°C and may be derated to 85°C with 1.50 × listed 105°C ripple current. For more detail information, request Bulletin 9-798.

Highlights:

- Capacitance Range: 0.1 to 10,000 μ F
- Voltage range: 6.3 to 250 WVDC
- Temperature Range: -40°C to +105°C
- Capacitance Tolerance: \pm 20%

Dimensions

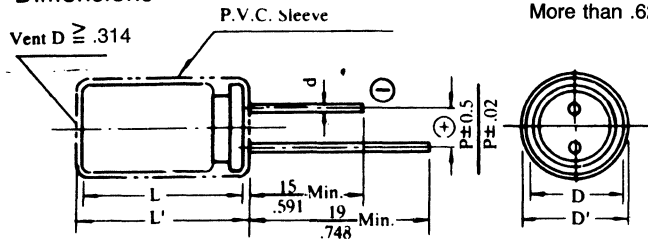

Tolerance on length is as follows:
 Less than .629 L' = (L + .039) max
 More than .629 L' = (L + .079) max
 D' = (D + .020) max

Dimensions

Unit = $\frac{\text{mm}}{\text{inch}}$

	5	6.3	8	10	13	16	18
D ϕ	.196	.248	.314	.393	.511	.629	.708
P	2.0	2.5	3.5	5.0	5.0	7.5	7.5
d ϕ	0.5	0.5	0.6	0.6	0.6	0.8	0.8
AWG	24	24	23	23	23	20	20

MFD	Volt DC	Dia	Length	Lead Space	Lead Dia	Max ESR 120HZ	Max Dcl UA +20C	Max Ripple (MA) 105 C 120 Hz	Part Number
220	6.3	.314	.452	.138	.024	1.81	17	240	VTH220M6
330	6.3	.393	.492	.197	.024	1.20	24	320	VTH330M6
470	6.3	.393	.492	.197	.024	.85	33	420	VTH470M6
1000	6.3	.393	.787	.197	.024	.40	66	550	VTH1000M6
2200	6.3	.511	.984	.197	.024	.21	142	800	VTH2200M6
3300	6.3	.629	.984	.295	.031	.15	210	1035	VTH3300M6
4700	6.3	.629	1.240	.295	.031	.11	299	1275	VTH4700M6
6800	6.3	.629	1.400	.295	.031	.09	431	1750	VTH6800M6
10000	6.3	.708	1.570	.295	.031	.07	633	2045	VTH10000M6
22	10	.196	.433	.078	.020	15.10	5	54	VTH22M10
33	10	.196	.433	.078	.020	10.00	6	63	VTH33M10
47	10	.196	.433	.078	.020	7.05	8	83	VTH47M10
100	10	.248	.433	.098	.020	3.31	13	146	VTH100M10
220	10	.314	.452	.138	.024	1.51	25	260	VTH220M10
330	10	.393	.492	.197	.024	1.00	36	340	VTH330M10
470	10	.393	.629	.197	.024	.70	50	440	VTH470M10
1000	10	.511	.787	.197	.024	.33	103	680	VTH1000M10
2200	10	.629	.984	.295	.031	.18	223	960	VTH2200M10
3300	10	.629	1.240	.295	.031	.13	333	1195	VTH3300M10
4700	10	.629	1.400	.295	.031	.10	473	1425	VTH4700M10
6800	10	.708	1.570	.295	.031	.08	683	1850	VTH6800M10
10	16	.196	.433	.078	.020	28.10	5	40	VTH10M16
22	16	.196	.433	.078	.020	12.80	6	75	VTH22M16
33	16	.196	.433	.078	.020	8.54	8	100	VTH33M16
47	16	.248	.433	.098	.020	5.99	11	125	VTH47M16
100	16	.314	.452	.138	.024	2.82	19	200	VTH100M16
220	16	.393	.492	.197	.024	1.28	38	335	VTH220M16
330	16	.393	.629	.197	.024	.85	56	430	VTH330M16
470	16	.393	.787	.197	.024	.60	78	575	VTH470M16
1000	16	.511	.984	.295	.031	.28	163	780	VTH1000M16
2200	16	.629	.984	.295	.031	.16	335	1055	VTH2200M16
3300	16	.629	1.400	.295	.031	.11	531	1590	VTH3300M16
4700	16	.708	1.400	.295	.031	.09	755	1890	VTH4700M16
10	25	.196	.433	.079	.020	24.90	6	45	VTH10M25
22	25	.196	.433	.079	.020	11.30	9	80	VTH22M25
33	25	.248	.433	.098	.020	7.53	11	115	VTH33M25
47	25	.248	.433	.098	.020	5.29	15	145	VTH47M25
100	25	.314	.452	.138	.024	2.49	28	250	VTH100M25
220	25	.393	.629	.197	.024	1.13	58	400	VTH220M25
330	25	.393	.787	.197	.024	.75	86	480	VTH330M25

• New Product

Specifications subject to change without notice.

Type VTH • New 105°C Capacitors

MFD	Volt DC	Dia	Length	Lead Space	Lead Dia	Max Esr 120HZ	Max Dcl UA +20C	Max Ripple (MA) 105 C 120 Hz	Part Number
470	25	.511	.787	.197	.024	.53	121	620	VTH470M25
1000	25	.629	.984	.295	.031	.25	253	805	VTH1000M25
2200	25	.629	1.400	.295	.031	.14	553	1235	VTH2200M25
3300	25	.708	1.570	.295	.031	.10	828	1630	VTH3300M25
3.3	35	.196	.433	.079	.020	60.20	4	22	VTH3R3M35
4.7	35	.196	.433	.079	.020	42.30	5	35	VTH4R7M35
10	35	.196	.433	.079	.020	19.90	7	61	VTH10M35
22	35	.248	.433	.098	.020	9.04	10	105	VTH22M35
33	35	.248	.433	.098	.020	6.02	15	140	VTH33M35
47	35	.314	.452	.138	.024	4.23	20	175	VTH47M35
100	35	.393	.492	.197	.024	1.00	38	290	VTH100M35
220	35	.393	.787	.197	.024	.90	80	480	VTH220M35
330	35	.511	.787	.197	.024	.60	119	580	VTH330M35
470	35	.511	.984	.197	.024	.42	168	670	VTH470M35
1000	35	.629	.984	.295	.031	.20	353	870	VTH1000M35
2200	35	.709	1.400	.295	.031	.12	773	1365	VTH2200M35
.1	50	.196	.433	.079	.020	1658.00	4	4	VTHR10M50
.22	50	.196	.433	.079	.020	754.00	4	6	VTHR22M50
.33	50	.196	.433	.079	.020	502.00	4	7	VTHR33M50
.47	50	.196	.433	.079	.020	352.00	4	9	VTHR47M50
1	50	.196	.433	.079	.020	165.00	4	15	VTH1M50
2.2	50	.196	.433	.079	.020	75.30	4	21	VTH2R2M50
3.3	50	.196	.433	.079	.020	50.20	5	30	VTH3R3M50
4.7	50	.196	.433	.079	.020	35.20	5	35	VTH4R7M50
10	50	.196	.433	.079	.020	16.50	8	61	VTH10M50
22	50	.248	.433	.098	.020	7.53	14	110	VTH22M50
33	50	.314	.452	.138	.024	5.02	20	150	VTH33M50
47	50	.314	.452	.138	.024	3.52	27	190	VTH47M50
100	50	.393	.629	.197	.024	1.65	53	330	VTH100M50
220	50	.511	.787	.197	.024	.75	113	545	VTH220M50
330	50	.511	.787	.197	.024	.50	168	630	VTH330M50
470	50	.629	.984	.295	.031	.35	238	710	VTH470M50
1000	50	.629	1.240	.295	.031	.16	503	1025	VTH1000M50
4.7	63	.196	.433	.079	.020	35.20	6	35	VTH4R7M63
10	63	.248	.433	.098	.020	16.50	9	61	VTH10M63
22	63	.314	.452	.138	.024	7.53	17	120	VTH22M63
33	63	.314	.452	.138	.024	5.02	24	155	VTH33M63
47	63	.393	.492	.197	.024	3.52	33	210	VTH47M63
100	63	.393	.787	.197	.024	1.65	66	340	VTH100M63
220	63	.511	.787	.197	.024	.75	142	550	VTH220M63
330	63	.511	.984	.197	.024	.50	211	650	VTH330M63
470	63	.629	.984	.295	.031	.35	299	725	VTH470M63
1000	63	.708	1.400	.295	.031	.15	633	1220	VTH1000M63
33	80	.393	.629	.197	.024	5.02	29	160	VTH33M80
47	80	.393	.629	.197	.024	3.53	41	220	VTH47M80
100	80	.511	.787	.197	.024	1.65	83	360	VTH100M80
220	80	.511	.984	.197	.024	.75	179	600	VTH220M80
330	80	.629	1.240	.295	.031	.50	267	690	VTH330M80
470	80	.629	1.400	.295	.031	.35	379	810	VTH470M80
.47	100	.196	.433	.079	.020	282.00	4	9	VTHR47M100
1	100	.196	.433	.079	.020	132.00	4	17	VTH1M100
2.2	100	.196	.433	.079	.020	60.20	5	27	VTH2R2M100
3.3	100	.196	.433	.079	.020	40.20	6	44	VTH3R3M100
4.7	100	.248	.433	.098	.020	28.20	8	50	VTH4R7M100
10	100	.314	.452	.138	.024	13.20	13	100	VTH10M100
22	100	.393	.492	.197	.024	6.02	25	170	VTH22M100
33	100	.393	.629	.197	.024	4.02	36	210	VTH33M100
47	100	.393	.787	.197	.024	2.82	50	320	VTH47M100
100	100	.511	.787	.197	.024	1.32	103	470	VTH100M100
220	100	.629	.984	.295	.031	.60	223	620	VTH220M100
330	100	.629	1.240	.295	.031	.40	333	705	VTH330M100
470	100	.708	1.400	.295	.031	.28	473	890	VTH470M100
3.3	160	.314	.551	.138	.024	60.20	8	35	VTH3R3M160
4.7	160	.314	.551	.138	.024	42.30	11	45	VTH4R7M160
10	160	.393	.787	.197	.024	19.90	19	70	VTH10M160
22	160	.511	.787	.197	.024	9.04	38	120	VTH22M160
33	160	.511	.984	.197	.024	6.02	56	160	VTH33M160
47	160	.629	.984	.295	.031	4.23	78	200	VTH47M160
100	160	.629	1.400	.295	.031	1.99	163	300	VTH100M160
1	200	.314	.551	.138	.024	198.00	5	17	VTH1M200
2.2	200	.314	.551	.138	.024	90.40	8	30	VTH2R2M200
3.3	200	.314	.551	.138	.024	60.20	10	40	VTH3R3M200

• New Product

ALUMINUM CAPACITORS

Type VTH● New 105°C Capacitors

MFD	Volt DC	Dia	Length	Lead Space	Lead Dia	Max Esr 120HZ	Max Dcl UA +20C	Max Ripple (MA) 105 C 120 Hz	Part Number
4.7	200	.314	.551	.138	.024	42.30	13	50	VTH4R7M200
10	200	.393	.787	.197	.024	19.90	23	80	VTH10M200
22	200	.511	.787	.197	.024	9.04	47	140	VTH22M200
33	200	.511	.984	.197	.024	6.02	69	175	VTH33M200
47	200	.629	.984	.295	.031	4.23	97	215	VTH47M200
100	200	.708	1.400	.295	.031	1.99	203	340	VTH100M200
2.2	250	.314	.551	.138	.024	90.40	9	30	VTH2R2M250
3.3	250	.314	.551	.138	.024	60.20	11	40	VTH3R3M250
4.7	250	.393	.629	.197	.024	42.30	15	50	VTH4R7M250
10	250	.511	.787	.197	.024	19.90	28	85	VTH10M250
22	250	.511	.984	.197	.024	9.04	58	145	VTH22M250
33	250	.629	.984	.295	.031	6.02	86	185	VTH33M250
47	250	.629	1.240	.295	.031	4.23	121	230	VTH47M250
100	250	.708	1.400	.295	.031	1.99	253	360	VTH100M250

General Specifications

Leakage current
(at 20°C)

After 5 minutes, the maximum leakage current shall not exceed the value from: $I = 0.01 CV + 3 (\mu A)$

where I: Leakage current (μA) C: Nominal capacitance (μF)

V: Rated voltage (VDC)

Maximum tangent
of loss angle
(120 Hz, 20°C, Initial)

CAP \ WV	6.3	10	16	25	35	50-80	100	160-250
1000 μF or less	0.24	0.20	0.17	0.15	0.12	0.10	0.08	0.12
More than 1000 μF	Add .02 to above value for every 1000 μF or less							

Low temperature
characteristics
(Initial)

The maximum ratio of impedance between +20°C and -25°C, and -40°C, of the capacitor shall satisfy following requirements at 120 Hz.

RATIO \ WV	6.3	10	16	25	35	50-80	100	160-250
-25°C/20°C	4	3	2	2	2	2	2	2
-40°C/20°C	8	6	4	4	3	3	3	3

Life test

*At 85°C \pm 2°C for a period of 2,000 hours with rated voltage.

Capacitance change	6.3V-16V, within \pm 25% of initial value 25V-250V, within \pm 20% of initial value
Leakage current	Same as specified value in this table or smaller
Dissipation factor	150% or less of the value given in this table

*At 105°C \pm 2°C for a period of 1,000 hours with rated voltage

Capacitance change	6.3V-16V, within \pm 30% of initial value 25V-250V, within \pm 25% of initial value
Leakage current	Same as specified value in this table or smaller
Dissipation factor	150% or less of the value given in this table

Type VTU • New 125°C Capacitors

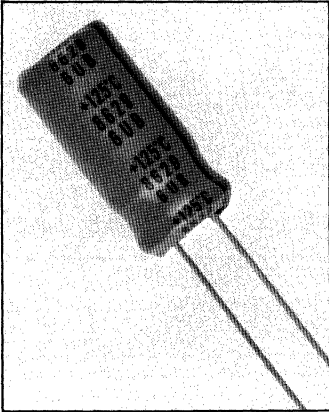

The VTU is a long life, high temperature radial aluminum capacitor. The VTU offers excellent electrical performance over a temperature range of -40°C to +125°C. Low leakage current and tangent of loss angle.

HIGHLIGHTS:

- Capacitance Range: 0.47 to 1000 μ f
- Voltage Range: 10 to 63 WVDC
- Temperature Range: -40°C to +125°C 5000 hrs guaranteed life test with rated voltage
- Capacitance Tolerance: \pm 20%
- Reverse Voltage: 5V DC max

Tolerance on length is as follows: Less than .629 L' = (L + .039) max
More than .629 L' = (L + .079) max
D' = (D + .020) max

Dimensions

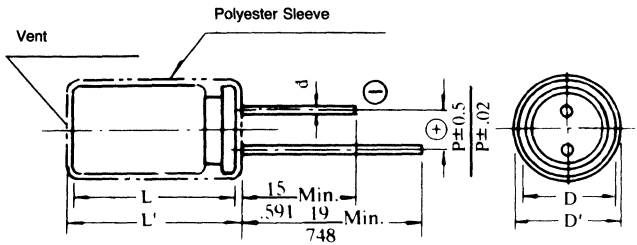

Dimension Unit = $\frac{\text{mm}}{\text{inch}}$

D ϕ	10	13	16	18
	.394	.512	.630	.709
P	5.0	5.0	7.5	7.5
	.197	.197	.295	.295
d ϕ	0.6	0.6	0.8	0.8
	.024	.024	.031	.031
AWG	23	23	20	20

ALUMINUM CAPACITORS

MFD	Volt DC	Dia	Length	Lead Space	Lead Dia	Max ESR 120HZ	Max Dcl UA +20C	Max Ripple (MA) 105 C 120 Hz	Part Number
100	10	.394	.787	.197	.024	2.49	2.0	176	VTU100M10
220	10	.512	.984	.197	.024	1.13	4.4	320	VTU220M10
330	10	.630	.984	.295	.031	.75	6.6	488	VTU330M10
470	10	.630	.984	.295	.031	.53	9.4	576	VTU470M10
1000	10	.709	1.57	.295	.031	.25	20.0	1034	VTU1000M10
47	16	.394	.630	.197	.024	4.23	2.0	136	VTU47M16
100	16	.512	.787	.197	.024	1.99	3.2	240	VTU100M16
220	16	.512	.984	.197	.024	.90	7.0	473	VTU220M16
330	16	.630	.984	.295	.031	.60	10.6	576	VTU330M16
470	16	.630	1.240	.295	.031	.42	15.0	790	VTU470M16
33	25	.394	.630	.197	.024	5.02	2.0	101	VTU33M25
47	25	.394	.630	.197	.024	3.53	2.4	153	VTU47M25
100	25	.512	.787	.197	.024	1.66	5.0	300	VTU100M25
220	25	.630	.984	.295	.031	.75	11.0	513	VTU220M25
330	25	.630	1.240	.295	.031	.50	16.5	720	VTU330M25
470	25	.709	1.400	.295	.031	.35	23.5	924	VTU470M25
22	35	.394	.630	.197	.024	7.54	2.0	99	VTU22M35
33	35	.394	.630	.197	.024	5.02	2.3	130	VTU33M35
47	35	.394	.787	.197	.024	3.53	3.3	187	VTU47M35
100	35	.512	.984	.197	.024	1.66	7.0	330	VTU100M35
220	35	.630	.984	.295	.031	.75	15.4	590	VTU220M35
330	35	.630	1.400	.295	.031	.50	23.1	776	VTU330M35
470	35	.709	1.570	.295	.031	.35	32.9	1040	VTU470M35

• New Product

Type VTU • New 125°C Capacitors

MFD	Volt DC	Dia	Length	Lead Space	Lead Dia	Max ESR 120HZ	Max Dcl UA +20C	Max Ripple (MA) 105 C 120 Hz	Part Number
.47	50	.394	.630	.197	.024	282.00	2.0	11	VTUR47M50
1	50	.394	.630	.197	.024	133.00	2.0	17	VTU1M50
2.2	50	.394	.630	.197	.024	60.30	2.0	25	VTU2R2M50
3.3	50	.394	.630	.197	.024	40.20	2.0	31	VTU3R3M50
4.7	50	.394	.630	.197	.024	28.20	2.0	37	VTU4R7M50
10	50	.394	.630	.197	.024	13.30	2.0	59	VTU10M50
22	50	.394	.630	.197	.024	6.03	2.2	102	VTU22M50
33	50	.394	.787	.197	.024	4.02	3.3	172	VTU33M50
47	50	.512	.787	.197	.024	2.82	4.7	240	VTU47M50
100	50	.512	.984	.197	.024	1.33	10.0	351	VTU100M50
220	50	.630	1.240	.295	.031	.60	22.0	633	VTU220M50
.47	63	.394	.630	.197	.024	282.00	2.0	11	VTUR47M63
1	63	.394	.630	.197	.024	133.00	2.0	17	VTU1M63
2.2	63	.394	.630	.197	.024	60.30	2.0	25	VTU2R2M63
3.3	63	.394	.630	.197	.024	40.20	2.0	31	VTU3R3M63
4.7	63	.394	.630	.197	.024	28.20	2.0	37	VTU4R7M63
10	63	.394	.630	.197	.024	13.30	2.0	59	VTU10M63
22	63	.394	.630	.197	.024	6.03	2.8	102	VTU22M63
33	63	.394	.787	.197	.024	4.02	4.2	172	VTU33M63
47	63	.512	.787	.197	.024	2.82	5.9	240	VTU47M63
100	63	.630	.984	.295	.031	1.33	12.6	351	VTU100M63
220	63	.630	1.400	.295	.031	.60	27.7	633	VTU220M63

General Specifications

Leakage current
(At 20°C, after 5 minutes)

$I \leq 0.002CV$ or $2\mu A$ (whichever is greater)

I: Leakage current (μA), C: Nominal capacitance (μF).

V: Rated voltage (VDC)

Tangent of loss angle
 $\tan \delta$ (At 20°C, 120 Hz)

Shall not exceed the following value.

RV (VDC)	10	16	25	35	50	63
Tan δ	0.15	0.12	0.10	0.10	0.08	0.08

Impedance ratio at low temperature
(At 120 Hz)

Shall not exceed the following value.

T/T20°C/RV (VDC)	10	16	25	35~63
-25°C/20°C	2	2	2	2
-40°C/20°C	8	6	5	4

Life test

At 125°C $\pm 2^\circ C$ for a period of 5,000 hours with rated voltage.

Capacitance change	$\leq \pm 20\%$ of initial value
Leakage current	Same as specified value in this table or less
Tan δ	200% or less of the value in this table

Type TCG Tubular Computer Grade Capacitors

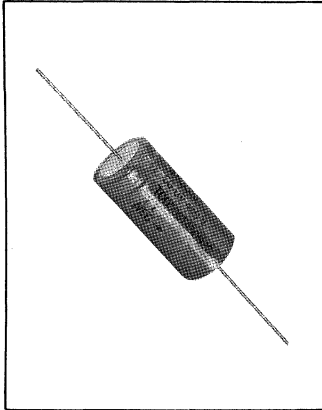

Long Life, Axial Leads

The TCG is a small tubular version of the Mallory Type CG capacitor. The TCG features long life and low ESR and utilizes a PVC insulating sleeve as well as a safety vent on diameters .5 inches and larger. 7th digit of part number indicates tolerance. Lead length is 1.25 inches minimum.

Request bulletin 4-307 for complete technical information. For prices, reference price sheet No. 140.

HIGHLIGHTS

- Capacitance Range: 5 to 10,000 μ F
- Voltage Range: 6 to 450 WVDC
- Capacitance Tolerance:
 - M = \pm 20%
 - T = -10%, +50%
 - U = -10%, +75%
- Operating Temperature: -40°C to +85°C

Cap μ F	Size (Inches) Diameter \times Length	Catalog No.
6 WVDC; 8 VDC SURGE		
6,000	1.000 \times 1.625	TCG602U006N1L
10 WVDC; 12 VDC SURGE		
1,000	.394 \times .945	TCG102M010D1A
2,500	.875 \times 1.125	TCG252U010L1C
2,500	1.000 \times 1.125	TCG252U010N1C
5,000	1.000 \times 1.375	TCG502U010N1G
5,500	1.000 \times 1.625	TCG552U010N1L
10,000	1.000 \times 2.125	TCG103U010N2C
10,000	.875 \times 3.125	TCG103U010L3C
15-16 WVDC; 20 VDC SURGE		
600	.394 \times .945	TCG601M015D1A
1,200	.394 \times 1.181	TCG122M015D1D
2,500	.625 \times 2.625	TCG252U015G2L
2,900	.625 \times 2.625	TCG292U015G2L
4,000	1.000 \times 1.625	TCG402U015N1L
4,100	1.000 \times 1.625	TCG412U015N1L
6,300	.875 \times 2.625	TCG632U015L2L
8,000	1.000 \times 2.625	TCG802U015N2L
8,200	1.000 \times 2.625	TCG822U015N2L
10,000	1.000 \times 2.625	TCG103U015N2L
25 WVDC; 30 VDC SURGE		
230	.315 \times .787	TCG231M025B0P
500	.394 \times .945	TCG501M025D1A
520	.394 \times .945	TCG521M025D1A
1,000	1.000 \times 1.125	TCG102U025N1C
1,100	.750 \times 1.625	TCG112U025J1L
2,200	.750 \times 2.625	TCG222U025J2L
2,300	.750 \times 2.625	TCG232U025J2L
4,000	.875 \times 3.125	TCG402U025L3C
4,100	.875 \times 3.125	TCG412U025L3C

Cap μ F	Size (Inches) Diameter \times Length	Catalog No.
30 WVDC; 40 VDC SURGE		
500	.625 \times 1.625	TCG501U030G1L
500	.750 \times 1.125	TCG501U030J1C
1,100	.625 \times 2.625	TCG112U030G2L
1,100	.875 \times 1.375	TCG112U030L1G
2,100	.875 \times 2.625	TCG212U030L2L
2,400	.875 \times 2.625	TCG242U030L2L
3,000	.875 \times 2.125	TCG302U030L2C
50 WVDC; 65 VDC SURGE		
100	.500 \times 1.375	TCG101U050E1G
100	.315 \times .787	TCG101M050B0P
250	.625 \times 1.375	TCG251U050G1G
290	.625 \times 1.375	TCG291U050G1G
500	.512 \times .945	TCG501M050E1A
500	.625 \times 2.625	TCG501U050G2L
500	1.000 \times 1.125	TCG501U050N1C
600	.875 \times 1.375	TCG601U050L1G
600	.625 \times 2.625	TCG601U050G2L
1,100	1.000 \times 2.125	TCG112U050N2C
1,200	.875 \times 2.125	TCG122U050L2C
2,300	1.000 \times 2.625	TCG232U050N2L
2,500	1.000 \times 2.625	TCG252U050N2L
150 WVDC; 175 VDC SURGE		
10	.315 \times .787	TCG100M150B0P
25	.394 \times .945	TCG250M150D1A
25	.500 \times 1.375	TCG250T150E1G
50	.512 \times 1.260	TCG500M150E1E
100	.750 \times 1.625	TCG101T150J1L
110	.750 \times 1.625	TCG111T150J1L
250	.875 \times 2.125	TCG251T150L2C
530	1.000 \times 3.125	TCG531T150N3C
560	1.000 \times 3.125	TCG561T150N3C

Cap μ F	Size (Inches) Diameter \times Length	Catalog No.
250 WVDC; 300 VDC SURGE		
20	.500 \times 2.125	TCG200T250E2C
50	.875 \times 1.375	TCG500T250L1G
100	.875 \times 2.125	TCG101T250L2C
200	1.000 \times 2.625	TCG201T250N2L
350 WVDC; 400 VDC SURGE		
20	.625 \times 1.625	TCG200T350G1L
20	.750 \times 1.125	TCG200T350J1C
30	.625 \times 2.125	TCG300T350G2C
30	.875 \times 1.125	TCG300T350L1C
40	1.000 \times 1.125	TCG400T350N1C
50	1.000 \times 1.375	TCG500T350N1G
80	1.000 \times 1.375	TCG600T350N1G
100	1.000 \times 2.125	TCG101T350N2C
160	1.000 \times 2.625	TCG161T350N2L
180	1.000 \times 3.125	TCG181T350N3C
450 WVDC; 525 VDC SURGE		
5	.500 \times 1.625	TCG5R0T450E1L
10	.625 \times 1.625	TCG100T450G1L
10	.750 \times 1.125	TCG100T450J1C
12	.625 \times 1.625	TCG120T450G1L
12	.750 \times 1.125	TCG120T450J1G
20	.625 \times 2.625	TCG200T450G2L
20	1.000 \times 1.125	TCG200T450N1C
50	1.000 \times 1.625	TCG500T450N2C
75	1.000 \times 2.125	TCG750T450N2L
85	1.000 \times 2.625	TCG850T450N2L

ALUMINUM CAPACITORS

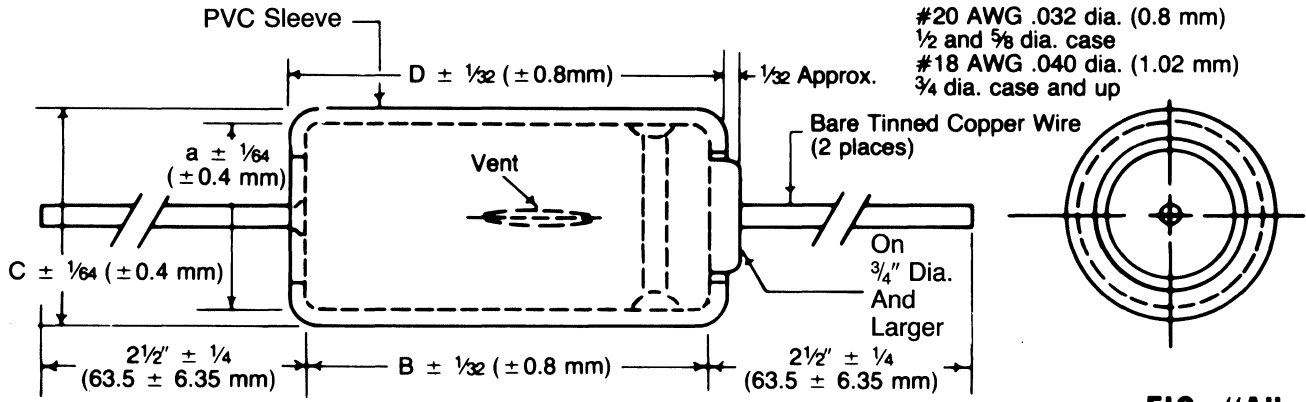
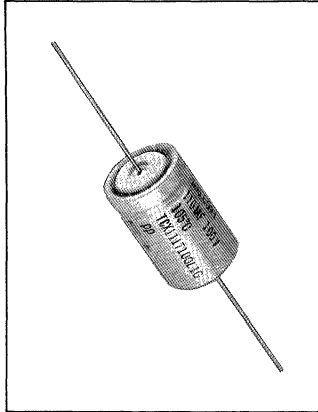

FIG. "A"

Type TCX Tubular Computer Grade Capacitors



High Performance + 105°C

The type TCX axial leaded aluminum capacitors demonstrate good, reliable performance over the operating temperature range of -55°C to +105°C. In addition to its wide temperature range, this capacitor type also presents the advantages of moderately high CV product, excellent DC leakage current and dissipation factor performance, good stability versus temperature and a high ripple current capability. Supplied with insu-

lated sleeve. **Request bulletin 4-311 for complete technical data. For prices, reference price sheet no. 142.**

HIGHLIGHTS

Capacitance: 27 to 12,000µF
Voltage: 6 to 150 WVDC
Tolerance: 6 to 75 WVDC: -10%, +75%
100 to 150 WVDC: -10%, +50%
Operating Temperature: -55°C to +105°C

Cap µF	Case Code	Catalog No.
6 WVDC; 8 VDC Surge		
4,800	L1L	TCX482U006L1L
10 WVDC; 12 VDC Surge		
10,000	L3C	TCX103U010L3C
15 WVDC; 20 VDC Surge		
710	G1C	TCX711U015G1C
1,000	J1C	TCX102U015J1C
1,600	J1G	TCX162U015J1G
2,100	J1L	TCX212U015J1L
2,300	G2L	TCX232U015G2L
3,100	L1L	TCX312U015L1L
4,100	N1L	TCX412U015N1L
4,600	L2C	TCX462U015L2C
6,200	L2L	TCX622U015L2L
8,200	N2L	TCX822U015N2L
12,000	N3L	TCX123U015N3L
25 WVDC; 30 VDC Surge		
560	E2C	TCX561U025E2C
950	J1G	TCX951U025J1G
1,200	N1C	TCX122U025N1C
1,800	L1L	TCX182U025L1L
2,400	N1L	TCX242U025N1L
3,700	L2L	TCX372U025L2L
7,200	N3L	TCX722U025N3L

Cap µF	Case Code	Catalog No.
30 WVDC; 40 VDC Surge		
310	G1C	TCX311U030G1C
470	J1C	TCX471U030J1C
880	N1C	TCX881U030N1C
1,400	J2C	TCX142U030J2C
2,700	L2L	TCX272U030L2L
3,000	L3C	TCX302U030L3C
4,400	N3C	TCX442U030N3C
40 WVDC; 50 VDC Surge		
360	J1C	TCX361U040J1C
1,000	L1L	TCX102U040L1L
2,100	L2L	TCX212U040L2L
4,200	N3L	TCX422U040N3L
50 WVDC; 65 VDC Surge		
110	E1G	TCX111U050E1G
250	G1G	TCX251U050G1G
370	L1C	TCX371U050L1C
500	G2C	TCX501U050G2C
710	N1G	TCX711U050N1G
950	N1L	TCX951U050N1L
1,400	L2L	TCX142U050L2L
1,900	N2L	TCX192U050N2L
2,800	N3L	TCX282U050N3L

Cap µF	Case Code	Catalog No.
75 WVDC; 95 VDC Surge		
65	G1C	TCX650U075G1C
100	J1C	TCX101U075J1C
140	J1G	TCX141U075J1G
370	J2L	TCX371U075J2L
560	L2L	TCX561U075L2L
740	N2L	TCX741U075N2L
1,100	N3L	TCX112U075N3L
100 WVDC; 125 VDC Surge		
35	G1C	TCX350T100G1C
75	J1G	TCX750T100J1G
110	L1G	TCX111T100L1G
150	L1L	TCX151T100L1L
520	N3C	TCX521T100N3C
620	N3L	TCX621T100N3L
150 WVDC; 175 VDC Surge		
27	G1C	TCX270T150G1C
85	J1L	TCX850T150J1L
150	J2L	TCX151T150J2L
240	N2C	TCX241T150N2C

SIZE CHART—TCG AND TCX CAPACITORS (SEE FIG. "A" ON PRECEDING PAGE)

Case Size	Case Code	Uninsulated				Insulated			
		A		B		C		D	
		(in.)	(mm)	(in.)	(mm)	(in.)	(mm)	(in.)	(mm)
1/2 x 1 3/8	E1G	.500	(12.70)	1.375	(34.92)	.515	(13.10)	1.390	(35.32)
1/2 x 2 1/8	E2C	.500	(12.70)	2.125	(53.97)	.515	(13.10)	2.140	(54.37)
5/8 x 1 1/8	G1C	.625	(15.87)	1.125	(28.57)	.640	(16.27)	1.140	(28.97)
5/8 x 1 3/8	G1G	.625	(15.87)	1.375	(34.92)	.640	(16.27)	1.390	(35.32)
5/8 x 1 5/8	G1L	.625	(15.87)	1.625	(41.27)	.640	(16.27)	1.640	(41.67)
5/8 x 2 1/8	G2C	.625	(15.87)	2.125	(53.97)	.640	(16.27)	2.140	(54.37)
5/8 x 2 3/8	G2L	.625	(15.87)	2.625	(66.67)	.640	(16.27)	2.640	(67.07)
3/4 x 1 1/8	J1C	.750	(19.05)	1.125	(28.57)	.765	(19.44)	1.140	(28.97)
3/4 x 1 3/8	J1G	.750	(19.05)	1.375	(34.92)	.765	(19.44)	1.390	(35.32)
3/4 x 1 5/8	J1L	.750	(19.05)	1.625	(41.27)	.765	(19.44)	1.640	(41.67)
3/4 x 2 1/8	J2C	.750	(19.05)	2.125	(53.98)	.765	(19.44)	2.140	(54.37)
3/4 x 2 3/8	J2L	.750	(19.05)	2.625	(66.67)	.765	(19.44)	2.640	(67.07)

Case Size	Case Code	Uninsulated				Insulated			
		A		B		C		D	
		(in.)	(mm)	(in.)	(mm)	(in.)	(mm)	(in.)	(mm)
7/8 x 1 1/8	L1C	.875	(22.22)	1.125	(28.57)	.890	(22.62)	1.140	(28.97)
7/8 x 1 3/8	L1G	.875	(22.22)	1.375	(34.92)	.890	(22.62)	1.390	(35.32)
7/8 x 1 5/8	L1L	.875	(22.22)	1.625	(41.27)	.890	(22.62)	1.640	(41.67)
7/8 x 2 1/8	L2C	.875	(22.22)	2.125	(53.97)	.890	(22.62)	2.140	(54.37)
7/8 x 2 3/8	L2L	.875	(22.22)	2.625	(66.67)	.890	(22.62)	2.640	(67.07)
7/8 x 3 1/8	L3C	.875	(22.22)	3.125	(79.37)	.890	(22.62)	3.140	(79.77)
1 x 1 1/8	N1C	1.000	(25.40)	1.125	(28.57)	1.015	(25.80)	1.140	(28.97)
1 x 1 3/8	N1G	1.000	(25.40)	1.375	(34.92)	1.015	(25.80)	1.390	(35.32)
1 x 1 5/8	N1L	1.000	(25.40)	1.625	(41.27)	1.015	(25.80)	1.640	(41.67)
1 x 2 1/8	N2C	1.000	(25.40)	2.125	(53.97)	1.015	(25.80)	2.140	(54.37)
1 x 2 3/8	N2L	1.000	(25.40)	2.625	(66.67)	1.015	(25.80)	2.640	(67.07)
1 x 3 1/8	N3C	1.000	(25.40)	3.125	(79.37)	1.015	(25.80)	3.140	(79.77)
1 x 3 3/8	N3L	1.000	(25.40)	3.625	(92.07)	1.015	(25.80)	3.640	(92.47)

ALUMINUM CAPACITORS

TYPE TC Tubular Electrolytic Capacitors

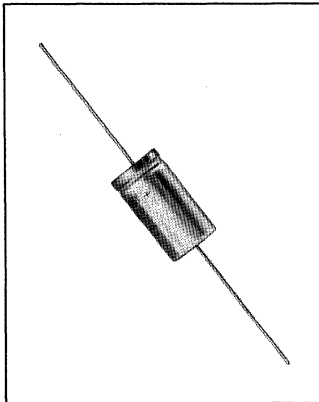

Industrial Grade, Axial Leads

Mallory type TC capacitors are polar, single section, metal tubulars with plastic insulating sleeves. Sizes are bare can sizes. Etched cathode construction is used to manufacture TC capacitors for maximum reliability. TC leads are 1.250 inches minimum. For prices refer to price sheet No. 136.

HIGHLIGHTS

Capacitance Range: 1 to 5000 μ F
Voltage Range: 6 to 450 WVDC
Otherwise, -10%, +100% (6 to 350 WVDC),
-10%, +50% (450 WVDC)
Operating Temperature: -20°C to +85°C

Cap μ F	Size (Inches) Diameter x Length	Catalog No.
6 WVDC; 8 VDC SURGE		
2,000	.512 x .945	TC615A
16 WVDC; 20 VDC SURGE		
500	.394 x .826	TC1505A
1,000	.394 x 1.181	TC1501A
2,000	.512 x 1.259	TC1520A
3,000	.875 x 1.625	TC1530
4,000	.875 x 1.875	TC1540
5,000	.875 x 2.625	TC1550
25 WVDC; 30 VDC SURGE		
10	.197 x .472	TC22A
25	.236 x .472	TC26A
50	.197 x .630	TC29A
100	.315 x .630	TC2501A
150	.315 x .630	TC25015A
250	.315 x .787	TC25025A
500	.394 x .945	TC2505A
1,000	.512 x .945	TC2510A
1,500	.750 x 2.125	TC2515
2,000	.875 x 1.875	TC2520
3,000	.875 x 2.625	TC2530
4,000	1.000 x 2.625	TC2540
5,000	1.000 x 2.625	TC2550
50 WVDC; 65 VDC SURGE		
1	.197 x .472	TC31A
2	.197 x .472	TC302A
5	.197 x .472	TC30A
10	.236 x .472	TC32A
25	.236 x .630	TC36A
50	.315 x .630	TC39A
100	.315 x .787	TC3501A
150	.394 x .945	TC50015A
250	.394 x .945	TC50025A
500	.512 x .945	TC50050A
1,000	.875 x 2.625	TC50100
1,500	1.000 x 2.625	TC50150
2,000	1.000 x 2.625	TC50200
3,000	1.000 x 3.625	TC50300
5,000	1.000 x 3.625	TC50500

Cap μ F	Size (Inches) Diameter x Length	Catalog No.
75 WVDC; 95 VDC SURGE		
100	.625 x 1.375	TC75101
250	.750 x 1.625	TC75251
500	.875 x 2.125	TC75501
1,000	1.000 x 1.625	TC75102
2,000	1.000 x 2.625	TC75202
100 WVDC; 125 VDC SURGE		
1	.197 x .472	TC10010A
10	.394 x .630	TC10100A
50	.394 x .826	TC10500A
100	.750 x 1.375	TC10101
150	.750 x 1.625	TC10151
250	.875 x 1.875	TC10251
500	1.000 x 2.625	TC10501
1,000	1.000 x 3.875	TC10102
1,500	1.000 x 3.625	TC10152
150 WVDC; 175 VDC SURGE		
5	.315 x .787	TC40A
10	.315 x .787	TC42A
12	.315 x .787	TC43A
20	.394 x .945	TC45A
50	.512 x 1.259	TC49A
80	.750 x 1.625	TC492
100	.750 x 1.625	TC493
150	.875 x 1.625	TC495
200	.875 x 2.125	TC496
300	1.000 x 2.125	TC499
500	1.000 x 2.625	TC4990
250 WVDC; 300 VDC SURGE		
5	.315 x .787	TC50X
8	.625 x 1.125	TC51
10	.625 x 1.125	TC52
12	.625 x 1.125	TC53
16	.625 x 1.375	TC54
20	.750 x 1.125	TC55
30	.750 x 1.375	TC57
40	.750 x 1.625	TC58
50	.750 x 1.625	TC59
100	.875 x 2.625	TC1265
160	1.000 x 2.625	TC1266
225	1.000 x 3.125	TC1267

Cap μ F	Size (Inches) Diameter x Length	Catalog No.
300 WVDC; 350 VDC SURGE		
150	1.000 x 3.125	TC593
200	1.000 x 3.125	TC594
350 WVDC; 400 VDC SURGE		
2	.500 x 1.125	TC595
5	.625 x 1.125	TC60
8	.625 x 1.375	TC61
10	.625 x 1.375	TC62
12	.750 x 1.125	TC63
16	.750 x 1.375	TC64
20	.750 x 1.375	TC65
40	.875 x 1.625	TC67
60	.875 x 2.125	TC68
100	.875 x 2.625	TC69
150	1.000 x 3.625	TC692
450 WVDC; 525 VDC SURGE		
1	.500 x 1.125	TC6942
2	.625 x 1.125	TC695
4	.625 x 1.125	TC697
5	.750 x 1.125	TC70
8	.750 x 1.125	TC71
10	.875 x 1.375	TC72
12	.875 x 1.375	TC73
16	.750 x 1.625	TC74
20	.875 x 1.625	TC75
30	1.000 x 1.625	TC77
40	1.000 x 2.125	TC78
50	1.000 x 2.125	TC79
60	1.000 x 2.625	TC795
80	1.000 x 3.125	TC80
100	1.000 x 3.125	TC807

ALUMINUM CAPACITORS

Type TA Miniature Aluminum Electrolytic Capacitor

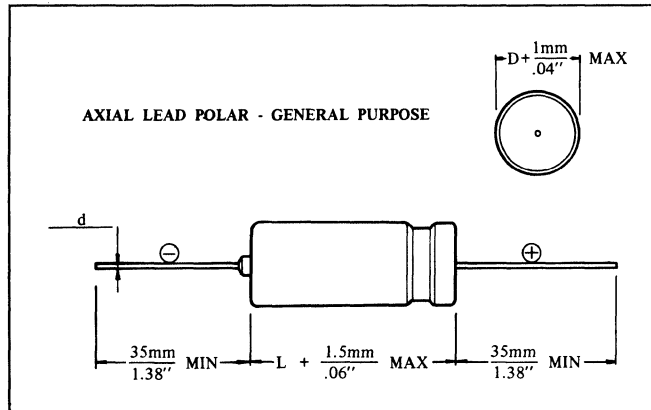

Decade Ratings, Axial Leads (For new designs)

Type TA capacitors provide high capacitance at WVDC from 6 VDC to 100 VDC for application in temperatures ranging from -40 C to +85 C. All welded construction is provided. The TA capacitor offers excellent capacitance stability along with low DCL and low ESR. These capacitors are available with insulating sleeving. Epoxy coated end-seal construction is available when specified.

HIGHLIGHTS

Capacitance Range: to 6,800 μ F
Voltage: 6 to 100V
Cap. Tol.: 20%
Temperature: -40 C to +85 C

MFD	Part Number	Dia.	Length	Max Ripple MA 120 HZ 85 C	Max ESR OHMS 120 HZ 25 C	% D.F. At 25 C 120 HZ	Max DCL UA
6.3 WVDC							
470	TA470M6	.315	.787	282	.7839	25	62.22
6,800	TA6800M6	.630	1.575	1,786	.0802	27	859.80
10 WVDC							
68	TA68M10	.236	.472	83	4.334	20	16.60
100	TA100M10	.236	.630	101	2.947	20	23.00
1,000	TA1000M10	.394	.945	604	.2947	20	203.00
16 WVDC							
22	TA22M16	.197	.472	45	10.05	17	10.04
47	TA47M16	.236	.472	75	5.33	17	18.04
100	TA100M16	.236	.630	133	2.505	17	35.00
220	TA220M16	.315	.630	234	1.139	17	73.40
470	TA470M16	.394	.827	408	.533	17	153.40
680	TA680M16	.394	.945	476	.3684	17	220.40
1,000	TA1000M16	.394	1.181	698	.2505	17	323.00
2,200	TA2200M16	.512	1.260	1,202	.1273	19	707.00
4,700	TA4700M16	.630	1.575	1,826	.0784	19	1507.00
6,800	TA6800M16	.866	1.575	2,640	.0628	19	2179.00
25 WVDC							
10	TA10M25	.197	.472	29	14.74	15	8.00
22	TA22M25	.236	.472	45	10.05	15	14.00
47	TA47M25	.236	.630	75	4.703	15	26.50
100	TA100M25	.315	.630	142	2.210	15	53.00
330	TA330M25	.394	.827	364	.6698	15	16.80
680	TA680M25	.394	1.181	613	.3251	15	343.00
1,000	TA1000M25	.512	.945	827	.2210	15	503.00
2,200	TA2200M25	.630	1.260	1,389	.1139	17	1103.00
4,700	TA4700M25	.709	2.087	2,132	.0721	17	2353.00

Decade Ratings, Axial Leads (For new designs)

Bare Can		Sleeve Size				Lead Size				
Dia +.04 (1 MM)		Dia +.06 (1.5 MM)		Dia +.04 (1 MM)		Dia +.06 (1.5 MM)		Inch	MM	Awg
Inch	MM	Inch	MM	Inch	MM	Inch	MM			
.197	(5)	.472	(12)	.207	(5.25)	.482	(12.25)	.024	(.6)	23
.236	(6)	.472	(12)	.246	(6.25)	.482	(12.25)	.024	(.6)	23
.236	(6)	.630	(16)	.246	(6.25)	.640	(16.25)	.024	(.6)	23
.315	(8)	.787	(20)	.325	(8.25)	.797	(20.25)	.024	(.6)	23
.394	(10)	.945	(24)	.404	(10.25)	.955	(24.25)	.024	(.6)	23
.394	(10)	1.181	(30)	.404	(10.25)	1.191	(30.25)	.024	(.6)	23
.512	(13)	.945	(24)	.522	(13.25)	.955	(24.25)	.031	(.8)	21
.512	(13)	1.260	(32)	.522	(13.25)	1.270	(32.25)	.031	(.8)	21
.512	(13)	1.417	(36)	.522	(13.25)	1.427	(36.25)	.031	(.8)	21
.630	(16)	1.260	(32)	.640	(16.25)	1.270	(32.25)	.031	(.8)	21
.630	(16)	1.575	(40)	.640	(16.25)	1.585	(40.25)	.031	(.8)	21
.630	(16)	1.890	(48)	.640	(16.25)	1.900	(48.25)	.031	(.8)	21
.630	(16)	2.008	(51)	.640	(16.25)	2.018	(51.25)	.031	(.8)	21
.709	(18)	2.087	(53)	.719	(18.25)	2.097	(53.25)	.031	(.8)	21
.866	(22)	1.575	(40)	.876	(22.25)	1.585	(40.25)	.031	(.8)	21
.866	(22)	2.008	(51)	.876	(22.25)	2.018	(51.25)	.031	(.8)	21

MFD	Part Number	Dia.	Length	Max Ripple MA 120 HZ 85 C	Max ESR OHMS 120 HZ 25 C	% D.F. At 25 C 120 HZ	Max DCL UA
40 WVDC							
4.7	TA4.7M40	.197	.472	26	31.35	12	6.76
10	TA10M40	.236	.472	29	14.74	12	11.00
22	TA22M40	.236	.630	61	8.038	12	20.60
220	TA220M40	.394	.827	332	.0838	12	179.00
470	TA470M40	.394	1.181	570	.3763	12	379.00
680	TA680M40	.512	1.260	802	.2601	12	547.00
1,000	TA1000M40	.512	1.417	1,115	.1768	12	803.00
2,200	TA2200M40	.630	1.890	1,651	.0938	14	1763.00
63 WVDC							
2.2	TA2.2M63	.197	.472	21	53.59	10	5.77
4.7	TA4.7M63	.236	.472	26	31.35	10	8.92
10	TA10M63	.236	.630	45	14.74	10	15.60
33	TA33M63	.315	.630	99	4.466	10	44.58
47	TA47M63	.315	.630	141	3.135	10	62.22
68	TA68M63	.394	.827	183	2.167	10	88.68
100	TA100M63	.394	.827	245	1.474	10	129.00
220	TA220M63	.394	1.181	527	.6698	10	280.20
470	TA470M63	.512	1.417	765	.3135	10	595.20
680	TA680M63	.630	1.575	1,007	.2167	10	859.80
1,000	TA1000M63	.630	1.890	1,318	.1474	10	1263.00
2,200	TA2200M63	.866	2.008	2,000	.0804	12	2775.00
100 WVDC							
.1	TA.10M100	.197	.472	1	1179.0	08	3.20
.22	TA.22M100	.197	.472	3	535.90	08	3.44
.33	TA.33M100	.197	.472	4	357.30	08	3.66
.47	TA.47M100	.197	.472	5	250.80	08	3.94
.68	TA.68M100	.197	.472	9	173.40	08	4.36
1	TA1M100	.197	.472	12	117.90	08	5.00
2.2	TA2.2M100	.236	.472	21	53.59	08	7.40
4.7	TA4.7M100	.236	.630	34	25.08	08	12.40
6.8	TA6.8M100	.236	.630	50	17.34	08	16.60
10	TA10M100	.315	.630	610	11.79	08	23.00
22	TA22M100	.315	.787	108	5.359	08	47.00
47	TA47M100	.394	.827	188	2.508	08	97.00
68	TA68M100	.394	.945	249	1.734	08	139.00
100	TA100M100	.394	1.181	322	1.179	08	203.00
220	TA220M100	.512	1.417	558	.5359	08	443.00
470	TA470M100	.630	1.575	1,021	.2508	08	943.00
680	TA680M100	.709	2.087	1,083	.1734	08	1363.00
1,000	TA1000M100	.866	2.008	1,420	.1179	08	2003.00

ALUMINUM CAPACITORS

Type TT Tubular Electrolytic Capacitors

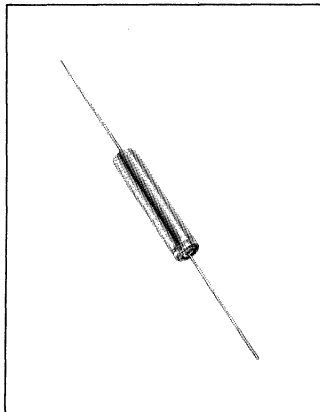

Miniature, Axial Leads

Mallory TT capacitors are made from very high purity aluminum foil, deep-etched to provide maximum capacitance per unit of volume. Etched cathode construction assures long hum-free operation. Utilizes all-welded construction; exhibits low DCL and ESR. Supplied in aluminum case with insulating sleeve; wire leads 1.38" min.

Request bulletin 4-104B for technical data. For prices refer to price sheet No. 310. TT capacitor Mallobins are available. See complete Mallobin listing, page 150.

HIGHLIGHTS

Capacitance Range: 1 to 2400 μ F
Voltage Range: 6 to 250 WVDC
Capacitance Tolerance: \pm 20%
Operating Temperature: -40°C to +85°C

CAP. μ F	BARE CASE SIZE Diameter x Length		CATALOG NO.
6 WVDC; 8 VDC SURGE			
100	.236 x .472		TT6M100A
150	.236 x .630		TT6M150A
200	.315 x .630		TT6M200A
250	.315 x .630		TT6M250A
300	.315 x .630		TT6M300A
560	.394 x .827		TT6M560A
1000	.394 x .945		TT6M1000A
10 WVDC; 12 VDC SURGE			
300	.315 x .630		TT10M300A
1500	.512 x .945		TT10M1500A
2400	.512 x .945		TT10M2400A
12 WVDC; 15 VDC SURGE			
25	.197 x .472		TT12M25A
50	.236 x .472		TT12M50A
100	.236 x .630		TT12M100A
250	.315 x .630		TT12M250A
500	.394 x .827		TT12M500A
1000	.394 x 1.181		TT12M1000A
16 WVDC; 20 VDC SURGE			
2	.197 x .472		TT16M2A
5	.197 x .472		TT16M5A
10	.197 x .472		TT16M10A
20	.197 x .472		TT16M20A
25	.197 x .472		TT16M25A
50	.236 x .472		TT16M50A
100	.236 x .630		TT16M100A
150	.315 x .630		TT16M150A
200	.315 x .630		TT16M200A
260	.315 x .630		TT16M260A
350	.315 x .787		TT16M350A
500	.394 x .827		TT16M500A
600	.394 x .945		TT16M600A
1000	.394 x 1.181		TT16M1000A
1500	.512 x 1.260		TT16M1500A

CAP. μ F	BARE CASE SIZE Diameter x Length		CATALOG NO.
25 WVDC; 35 VDC SURGE			
1	.197 x .472		TT25M1A
2	.197 x .472		TT25M2A
5	.197 x .472		TT25M5A
10	.197 x .472		TT25M10A
15	.197 x .472		TT25M15A
20	.236 x .472		TT25M20A
25	.236 x .472		TT25M25A
35	.236 x .630		TT25M35A
50	.236 x .630		TT25M50A
75	.236 x .630		TT25M75A
100	.315 x .630		TT25M100A
150	.315 x .630		TT25M150A
200	.315 x .787		TT25M200A
300	.394 x .827		TT25M300A
400	.394 x .945		TT25M400A
500	.394 x .945		TT25M500A
600	.394 x 1.181		TT25M600A
800	.512 x .945		TT25M800A
50 WVDC; 65 VDC SURGE			
1	.197 x .472		TT50M1A
2	.197 x .472		TT50M2A
4	.197 x .472		TT50M4A
5	.197 x .472		TT50M5A
10	.236 x .472		TT50M10A
15	.236 x .630		TT50M15A
20	.236 x .630		TT50M20A
25	.236 x .630		TT50M25A
35	.315 x .630		TT50M35A
50	.315 x .630		TT50M50A
75	.315 x .787		TT50M75A
100	.315 x .787		TT50M100A
150	.394 x .945		TT50M150A
200	.394 x .945		TT50M200A
250	.394 x .945		TT50M250A
300	.394 x 1.181		TT50M300A
350	.394 x 1.181		TT50M350A
400	.512 x .945		TT50M400A
450	.512 x .945		TT50M450A

CAP. μ F	BARE CASE SIZE Diameter x Length		CATALOG NO.
100 WVDC; 120 VDC SURGE			
10	.315 x .630		TT100M10A
20	.315 x .787		TT100M20A
50	.394 x .827		TT100M50A
150 WVDC; 175 VDC SURGE			
1	.236 x .551		TT150M1A
5	.315 x .787		TT150M5A
10	.315 x .787		TT150M10A
15	.394 x .827		TT150M15A
20	.394 x .945		TT150M20A
25	.394 x .945		TT150M25A
200 WVDC; 250 VDC SURGE			
1	.236 x .630		TT200M1A
2	.315 x .630		TT200M2A
250 WVDC; 300 VDC SURGE			
2	.315 x .630		TT250M2A
4	.394 x .945		TT250M4A
10	.394 x .945		TT250M10A
20	.512 x .945		TT250M20A

Type PSU AC Motor Start Capacitors

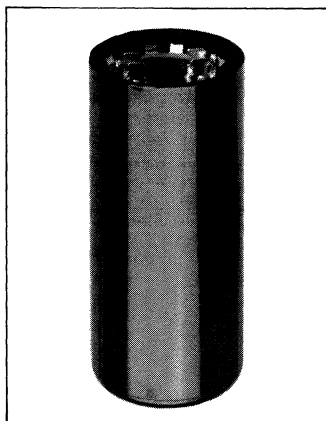

Round Bakelite Case

The PSU motor start capacitor is an electrolytic device that can be used to provide the torque necessary to start AC motors and in other intermittent AC applications. Cases are of moisture and oil resistant molded plastic. Equipped with two quick disconnect terminals. Mallory replacement motor start capacitors are designed in accordance with EIA RS-463, Type 2. May be mounted by means of PL plastic end cap and HB metal snap-in bracket or VR clamp bracket (order separately). Request bulletin 4-401 for complete technical data. For pricing,

refer to price sheet No. 180. See page 72 for capacitor hardware.

HIGHLIGHTS

Capacitance Range: 21 to 1536 μ F
Voltage: 110 to 330 VAC
Operating Frequency: 50 to 60 Hz
Power Factor: 10% Max.
Temperature Range: -40 °C to +65 °C

Cap. μ F	VAC	Case Code	Catalog Number
21-25	110/125	1	PSU2115
25-30	110/125	1	PSU2515
30-36	110/125	1	PSU3015
36-43	110/125	1	PSU3615
43-52	110/125	1	PSU4315
47-56	110/125	1	PSU4715
53-64	110/125	1	PSU5315
72-86	110/125	1	PSU7215
88-106	110/125	1	PSU8815
108-130	110/125	1	PSU10815
124-149	110/125	1	PSU12415
130-156	110/125	1	PSU13015
145-174	110/125	1	PSU14515
161-193	110/125	1	PSU16115
189-227	110/125	1	PSU18915A
200-240	110/125	2	PSU20015
216-259	110/125	2	PSU21615
233-280	110/125	2	PSU23315A
243-292	110/125	2	PSU24315A
270-324	110/125	2	PSU27015A
300-360	110/125	4	PSU30015
324-389	110/125	3	PSU32415A
340-408	110/125	4	PSU34015
378-454	110/125	4	PSU37815
400-480	110/125	4	PSU40015
430-516	110/125	4	PSU43015A
460-552	110/125	4	PSU46015A
540-648	110/125	4	PSU54015A
540-648	110/125	5	PSU54015B
590-708	110/125	5	PSU59015A
645-774	110/125	5	PSU64515
708-850	110/125	5	PSU70815
720-864	110/125	5	PSU72015
800-960	110/125	5	PSU80015
815-978	110/125	5	PSU81515
829-995	110/125	5	PSU82915A
850-1020	110/125	5	PSU85015
1000-1200	110/125	7	PSU100015A
1020-1224	110/125	7	PSU102015

Cap. μ F	VAC	Case Code	Catalog Number
1175-1410	110/125	7	PSU117515
1280-1536	110/125	7	PSU128015
21-25	165	1	PSU2165A
47-56	165	1	PSU4765A
53-64	165	1	PSU5365A
72-86	165	1	PSU7265A
88-106	165	2	PSU8865
108-130	165	2	PSU10865
145-174	165	2	PSU14565
161-193	165	2	PSU16165
189-227	165	2	PSU18965B
216-259	165	4	PSU21665A
233-280	165	3	PSU23365
270-324	165	3	PSU27065A
324-389	165	5	PSU32465
340-408	165	5	PSU34065
378-454	165	5	PSU37865
400-480	165	5	PSU40065
430-516	165	5	PSU43065
540-648	165	7	PSU54065
21-25	220/250	1	PSU2135
25-30	220/250	1	PSU2535
30-36	220/250	1	PSU3035
36-43	220/250	1	PSU3635
43-52	220/250	2	PSU4335B
47-56	220/250	2	PSU4735
53-64	220/250	2	PSU5335
64-77	220/250	2	PSU6435
72-86	220/250	4	PSU7235
88-106	220/250	4	PSU8835
108-130	220/250	4	PSU10835A
124-149	220/250	5	PSU12435
130-156	220/250	5	PSU13035
145-174	220/250	5	PSU14535
161-193	220/250	7	PSU16135A
189-227	220/250	7	PSU18935A
216-259	220/250	7	PSU21635A
233-280	220/250	7	PSU23335A
243-292	220/250	7	PSU24335

Cap. μ F	VAC	Case Code	Catalog Number
270-324	220/250	7	PSU27035A
21-25	330	1	PSU2130
25-30	330	2	PSU2530
30-36	330	2	PSU3030
36-43	330	2	PSU3630
43-52	330	2	PSU4330
47-56	330	4	PSU4730
53-64	330	4	PSU5330B
64-77	330	4	PSU6430
72-86	330	5	PSU7230B
88-106	330	5	PSU8830A
108-130	330	7	PSU10830B
124-149	330	8	PSU12430
124-149	330	7	PSU12430A
130-156	330	7	PSU13030
145-174	330	7	PSU14530A
161-193	330	8	PSU16130
189-227	330	8	PSU18930
216-259	330	8	PSU21630

PSU CASE SIZES

Case Number	Diameter	Height
1	1 ⁷ / ₁₆	2 ³ / ₄
†2	1 ⁷ / ₁₆	3 ³ / ₈
3	1 ⁷ / ₁₆	4 ³ / ₈
†4	1 ¹³ / ₁₆	3 ³ / ₈
†5	1 ¹³ / ₁₆	4 ³ / ₈
6	2 ¹ / ₁₆	3 ³ / ₈
†7	2 ¹ / ₁₆	4 ³ / ₈
8	2 ⁹ / ₁₆	4 ³ / ₈

† EIA Standard Sizes.

Type MPD,MPF AC Metallized Polypropylene Capacitors

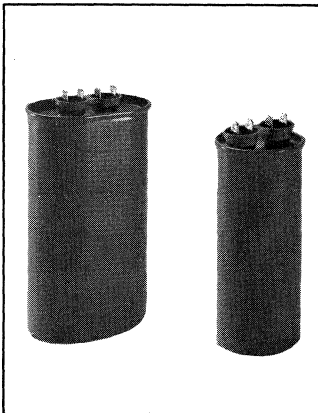

Round and Oval Can
Metallized polypropylene film dielectric capacitors offer a new alternative for alternating current applications. All devices have metal cases and 4-prong quick disconnect terminal. These capacitors pack the same capacitance and voltage capabilities of a conventional paper capacitor into a smaller case of considerably lighter weight. In addition these parts have extremely low dissipation factors. They offer high reliability and long life and meet EIA Standard RS-456 Characteristic 'E'. Allow 1/2 inch clearance above the terminals on fluid-filled capaci-

tors for interrupter operation. **Request bulletin 4-404B for complete technical data. For pricing, refer to price sheet No. 190. See page 71-73 for capacitor hardware.**

HIGHLIGHTS
Capacitance Range: 7.5 to 65 μ F
Capacitance Tolerance: $\pm 10\%$ (standard)
Voltage: 240 VAC dry; 370 to 440 VAC oil-filled.
Operating Frequency: 50 to 60 Hz
Dissipation Factor: 0.1% Max. @ 60Hz
Operating Temperature: -40°C to +70°C
UL Recognized: Yellow Card Number E65270

ROUND TYPE

Cap. μ F	VAC	Base Style	Height Inches	Cap. Tol.	Catalog Number
15	240	21	2 ³ / ₈ "	$\pm 10\%$	21DE2415
17.5	240	21	2 ⁷ / ₈ "	$\pm 10\%$	21DE24175
20	240	21	2 ⁵ / ₈ "	$\pm 10\%$	21DE2420
22.5	240	21	2 ⁷ / ₈ "	$\pm 10\%$	21DE24225
25	240	21	2 ⁷ / ₈ "	$\pm 10\%$	21DE2425
27.5	240	21	3 ³ / ₈ "	$\pm 10\%$	21DE24275
30	240	21	3 ³ / ₈ "	$\pm 10\%$	21DE2430
35	240	21	3 ³ / ₈ "	$\pm 10\%$	21DE2435
40	240	21	4 ³ / ₈ "	$\pm 10\%$	21DE2440
45	240	23	3 ³ / ₈ "	$\pm 10\%$	23DE2445
50	240	23	4 ³ / ₈ "	$\pm 10\%$	23DE2450
55	240	23	4 ³ / ₈ "	$\pm 10\%$	23DE2455
60	240	24	3 ³ / ₈ "	$\pm 10\%$	24DE2460
65	240	24	3 ³ / ₈ "	$\pm 10\%$	24DE2465
15	370	21	2 ⁵ / ₈ "	$\pm 10\%$	21FD3715
17.5	370	21	2 ⁷ / ₈ "	$\pm 10\%$	21FD37175
20	370	21	2 ⁷ / ₈ "	$\pm 10\%$	21FD3720
22.5	370	21	3 ³ / ₈ "	$\pm 10\%$	21FD37225
25	370	23	3 ³ / ₈ "	$\pm 10\%$	23FD3725
27.5	370	23	3 ³ / ₈ "	$\pm 10\%$	23FD37275
30	370	23	3 ³ / ₈ "	$\pm 10\%$	23FD3730
35	370	23	4 ³ / ₈ "	$\pm 10\%$	23FD3735
40	370	23	4 ³ / ₈ "	$\pm 10\%$	23FD3740
45	370	24	3 ³ / ₈ "	$\pm 10\%$	24FD3745
50	370	24	3 ³ / ₈ "	$\pm 10\%$	24FD3750
55	370	24	4 ³ / ₈ "	$\pm 10\%$	24FD3755
60	370	24	4 ³ / ₈ "	$\pm 10\%$	24FD3760
15	440	21	2 ⁷ / ₈ "	$\pm 10\%$	21FB4415
17.5	440	23	2 ⁷ / ₈ "	$\pm 10\%$	23FB44175
20	440	23	3 ³ / ₈ "	$\pm 10\%$	23FB4420
22.5	440	23	3 ³ / ₈ "	$\pm 10\%$	23FB44225
25	440	23	3 ³ / ₈ "	$\pm 10\%$	23FB4425
27.5	440	23	4 ³ / ₈ "	$\pm 10\%$	23FB44275
30	440	24	2 ⁷ / ₈ "	$\pm 10\%$	24FB4430
35	440	24	3 ³ / ₈ "	$\pm 10\%$	24FB4435
40	440	24	3 ³ / ₈ "	$\pm 10\%$	24FB4440
45	440	24	3 ³ / ₈ "	$\pm 10\%$	24FB4445
50	440	24	4 ³ / ₈ "	$\pm 10\%$	24FB4450
55	440	24	4 ³ / ₈ "	$\pm 10\%$	24FB4455

FLAT OVAL (SINGLE) TYPE

Cap. μ F	VAC	Base Style	Height Inches	Cap. Tol.	Catalog Number
7.5	370	32	2 ⁷ / ₈ "	$\pm 10\%$	32FD37075
10.0	370	32	3 ³ / ₈ "	$\pm 10\%$	32FD3710
12.5	370	37	2 ⁵ / ₈ "	$\pm 10\%$	37FD37125
15.0	370	37	2 ⁵ / ₈ "	$\pm 10\%$	37FD3715
17.5	370	37	2 ⁷ / ₈ "	$\pm 10\%$	37FD37175
20.0	370	37	2 ⁷ / ₈ "	$\pm 10\%$	37FD3720
22.5	370	37	3 ³ / ₈ "	$\pm 10\%$	37FD37225
25.0	370	37	3 ³ / ₈ "	$\pm 10\%$	37FD3725
27.5	370	38	3 ³ / ₈ "	$\pm 10\%$	38FD37275
30.0	370	38	3 ³ / ₈ "	$\pm 10\%$	38FD3730
35.0	370	38	4 ³ / ₈ "	$\pm 10\%$	38FD3735
40.0	370	38	4 ³ / ₈ "	$\pm 10\%$	38FD3740
45.0	370	38	4 ³ / ₈ "	$\pm 10\%$	38FD3745
50.0	370	38	4 ³ / ₈ "	$\pm 10\%$	38FD3750
7.5	440	37	2 ⁵ / ₈ "	$\pm 10\%$	37FB44075
10.0	440	37	2 ⁵ / ₈ "	$\pm 10\%$	37FB4410
12.5	440	37	2 ⁷ / ₈ "	$\pm 10\%$	37FB44125
15.0	440	37	2 ⁷ / ₈ "	$\pm 10\%$	37FB4415
17.5	440	37	3 ³ / ₈ "	$\pm 10\%$	37FB44175
20.0	440	38	3 ³ / ₈ "	$\pm 10\%$	38FB4420
22.5	440	38	3 ³ / ₈ "	$\pm 10\%$	38FB44225
25.0	440	38	3 ³ / ₈ "	$\pm 10\%$	38FB4425
27.5	440	38	4 ³ / ₈ "	$\pm 10\%$	38FB44275
30.0	440	38	4 ³ / ₈ "	$\pm 10\%$	38FB4430
35.0	440	38	4 ³ / ₈ "	$\pm 10\%$	38FB4435
40.0	440	38	4 ³ / ₈ "	$\pm 10\%$	38FB4440

FLAT OVAL (DUAL) TYPE

Cap. μ F	VAC	Base Style	Height Inches	Cap. Tol.	Catalog Number
15+4	370	37	2 ⁷ / ₈ "	$\pm 10\%$	37FD371504
15+5	370	37	2 ⁷ / ₈ "	$\pm 10\%$	37FD371505
15+10	370	37	2 ⁷ / ₈ "	$\pm 10\%$	37FD371510
17.5+4	370	37	2 ⁷ / ₈ "	$\pm 10\%$	37FD3717504
17.5+5	370	37	2 ⁷ / ₈ "	$\pm 10\%$	37FD3717505
20+5	370	37	2 ⁷ / ₈ "	$\pm 10\%$	37FD372005
20+15	370	38	2 ⁷ / ₈ "	$\pm 10\%$	38FD372015
25+4	370	38	3 ³ / ₈ "	$\pm 10\%$	38FD372504
25+5	370	38	3 ³ / ₈ "	$\pm 10\%$	38FD372505
30+5	370	38	3 ³ / ₈ "	$\pm 10\%$	38FD373005
35+3	370	38	4 ³ / ₈ "	$\pm 10\%$	38FD373503
35+4	370	38	4 ³ / ₈ "	$\pm 10\%$	38FD373504
35+5	370	38	4 ³ / ₈ "	$\pm 10\%$	38FD373505
40+5	370	38	4 ³ / ₈ "	$\pm 10\%$	38FD374005
40+7.5	370	38	4 ³ / ₈ "	$\pm 10\%$	38FD3740075
45+5	370	38	4 ³ / ₈ "	$\pm 10\%$	38FD374505
45+7.5	370	38	4 ³ / ₈ "	$\pm 10\%$	38FD3745075
45+10	370	38	4 ³ / ₈ "	$\pm 10\%$	38FD374510
25+4	440	37	3 ³ / ₈ "	$\pm 10\%$	37FD442504
25+5	440	37	3 ³ / ₈ "	$\pm 10\%$	37FD442505
25+7.5	440	38	3 ³ / ₈ "	$\pm 10\%$	38FD4425075
25+15	440	38	3 ³ / ₈ "	$\pm 10\%$	38FD442515
30+4	440	38	4 ³ / ₈ "	$\pm 10\%$	38FD443004
30+5	440	38	4 ³ / ₈ "	$\pm 10\%$	38FD443005

Type OPN,RPN AC Motor Run Capacitors

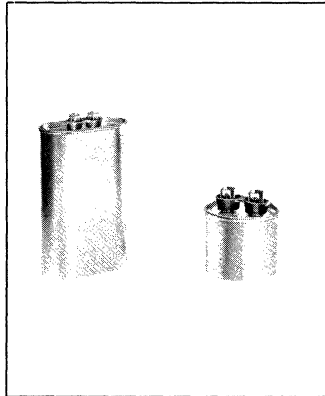

Oval, and Round Can
All types have metal cases and four blade quick-connect terminals with flash guards. Impregnating oil is biodegradable non-PCB. Always connect AC line to red or marked terminal and winding to other terminal. Letter suffix "R" indicates a resistor across terminals of capacitor. All other suffix letters indicate case size revisions. Allow 1/2 inch clearance above terminals for

interrupter operation. **Request bulletin 4-403 for complete technical data. For pricing, refer to price sheet No. 185. See page 71-73 for capacitor hardware.**

HIGHLIGHTS
Capacitance Range: 1 to 10 μ F
Voltage: 236 to 660 VAC
Temperature Range: -55°C to +70°C
Operating Frequency: 50 to 60 Hz
UL Recognized: Yellow Card
Number E65270

OVAL TYPE

Cap μ F	VAC	Base Style	Height Inches	Cap. Tol.	Catalog Number
3	236	32	2 ¹ / ₈	± 10%	OPN336
4	236	32	2 ¹ / ₈	± 10%	OPN436
5	236	32	2 ¹ / ₂	± 10%	OPN536
7.5	236	32	3 ³ / ₈	± 10%	OPN7X36
1	370	32	2 ¹ / ₈	± 10%	OPN170
2	370	32	2 ¹ / ₈	± 10%	OPN270
3	370	32	2 ¹ / ₈	± 10%	OPN370
4	370	32	2 ¹ / ₈	± 10%	OPN470
5	370	32	2 ¹ / ₂	± 10%	OPN570
6	370	32	2 ⁷ / ₈	± 10%	OPN670
7.5	370	32	3 ³ / ₈	± 10%	OPN7X570
10	370	32	4 ¹ / ₈	± 10%	OPN1070
1	440	32	2 ¹ / ₈	± 10%	OPN140
2	440	32	2 ¹ / ₈	± 10%	OPN240
3	440	32	2 ¹ / ₂	± 10%	OPN340
3.5	440	32	3	± 10%	OPN3X40
4	440	32	3	± 10%	OPN440
5	440	32	3 ¹ / ₂	± 10%	OPN540
6	440	32	4	± 10%	OPN640
10	440	37	3 ⁵ / ₈	± 10%	OPN1040

Cap μ F	VAC	Base Style	Height Inches	Cap. Tol.	Catalog Number
1	660	32	2 ⁵ / ₈	± 6%	OPN160
2	660	32	2 ⁵ / ₈	± 6%	OPN260
3	660	37	2 ⁵ / ₈	± 6%	OPN360
4	660	37	2 ⁵ / ₈	± 6%	OPN460
5	660	37	2 ⁵ / ₈	± 6%	OPN560
6	660	37	2 ⁵ / ₈	± 6%	OPN660
7.5	660	37	2 ⁵ / ₈	± 6%	OPN7X60
8	660	37	2 ⁵ / ₈	± 6%	OPN860
10	660	37	3 ¹ / ₈	± 6%	OPN1060

ROUND TYPE

Cap μ F	VAC	Base Style	Height Inches	Cap. Tol.	Catalog Number
3	330	23	2 ³ / ₈	± 10%	RPN3303
4	330	23	2 ³ / ₈	± 10%	RPN3304
5	330	23	2 ³ / ₈	± 10%	RPN3305
6	330	23	2 ³ / ₈	± 10%	RPN3306
7	330	23	2 ³ / ₈	± 10%	RPN3307
8	330	23	2 ³ / ₈	± 10%	RPN3308
10	330	23	2 ³ / ₈	± 10%	RPN3310

Type MSF AC Power Supply Capacitors

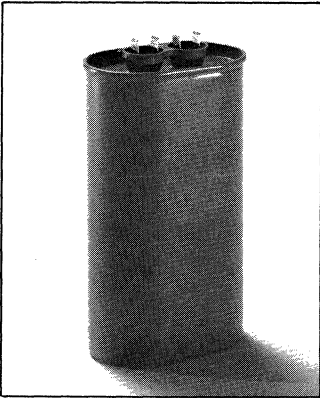

Metallized Paper
Metallized Paper capacitors are suitable for use in ferroresonant power supplies as well as other AC continuous duty applications. They are supplied in the same rigid metal cases as the OPN series, have biodegradable oil, and are UL recognized.

For complete specifications, request bulletin no. 4-409. For pricing, reference price sheet no. 195.

HIGHLIGHTS
Capacitance Range: 1 to 30 μ F
Voltage: 660 VAC
Temperature Range: -40°C to +70°C
Capacitance Tolerance: \pm 6%
UL Recognized: Yellow Card Number E65270

Cap. μ F	VAC	Base Style	Height Inches	Cap Tol.	Catalog Number
1	660	32	2 ⁵ / ₈	\pm 6%	32KB6601
2	660	32	2 ⁵ / ₈	\pm 6%	32KC6602
3	660	32	2 ⁵ / ₈	\pm 6%	32KE6603
4	660	32	2 ⁵ / ₈	\pm 6%	32KE6604
5	660	32	3 ¹ / ₈	\pm 6%	32KE6605
6	660	32	3 ¹ / ₈	\pm 6%	32KE6606
7	660	32	3 ⁵ / ₈	\pm 6%	32KD6607
8	660	32	3 ⁵ / ₈	\pm 6%	32KD6608

Cap. μ F	VAC	Base Style	Height Inches	Cap Tol.	Catalog Number
10	660	37	3 ¹ / ₈	\pm 6%	37KD6610
12	660	37	3 ¹ / ₈	\pm 6%	37KD6612
15	660	37	3 ³ / ₈	\pm 6%	37KD6615
18	660	37	4 ¹ / ₈	\pm 6%	37KD6618
20	660	38	3 ⁵ / ₈	\pm 6%	38KC6620
25	660	38	4 ¹ / ₈	\pm 6%	38KC6625
30	660	38	4 ⁵ / ₈	\pm 6%	38KD6630

OUTLINE DIMENSIONS [Inches]

Flat Oval Containers

Style	A	B	H	D	Industry Type
32	1 ⁵ / ₁₆	2 ⁵ / ₃₂	*	13 ¹ / ₁₆ "	1 ¹ / ₄ " F.O.
37	1 ²⁹ / ₃₂	2 ²⁹ / ₃₂	*	13 ¹ / ₁₆ "	1 ³ / ₄ " F.O.
38	1 ³¹ / ₃₂	3 ²¹ / ₃₂	*	13 ¹ / ₁₆ "	2" F.O.

Round Containers

Style	A	B	H	D	Industry Type
21	1 ³ / ₄	1 ⁷ / ₈	*	13 ¹ / ₁₆ "	1 ³ / ₄ " Round
23	2	2 ¹ / ₈	*	13 ¹ / ₁₆ "	2" Round
24	2 ¹ / ₂	2 ⁵ / ₈	*	13 ¹ / ₁₆ "	2 ¹ / ₂ " Round

*See Rating Tables for "H" dim.

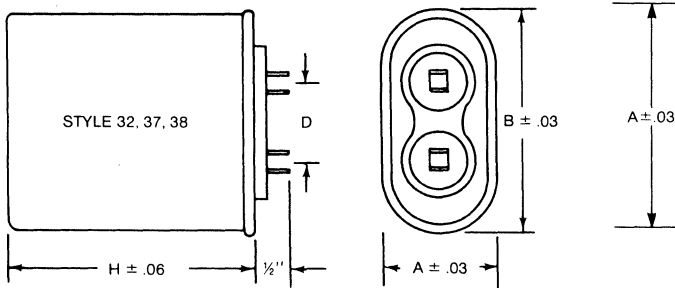

*See Rating Tables for "H" dim.

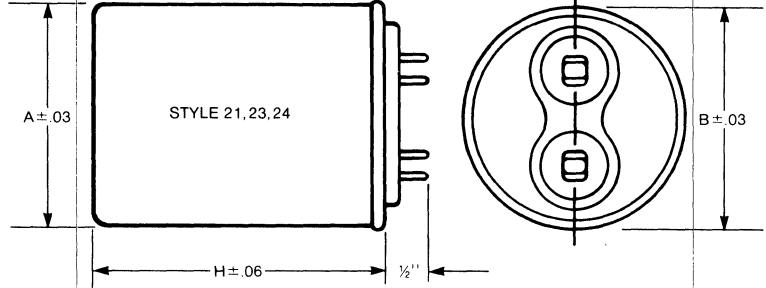

Capacitor Hardware

TUBULAR CAPACITOR MOUNTING CLIPS

These clips though designed for use with capacitors have varied applications to retain many cylindrical components. They are used extensively in the electrical and electronic industries to hold spindles, condensers, capacitors, tubes, rods and conduit. Clips have a phosphate and oil finish.

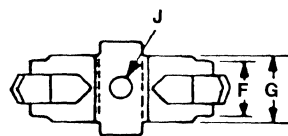
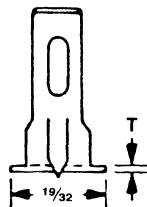
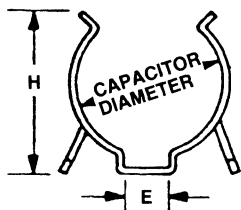

SPRING STEEL

Design Size	Component Diameter		E	F	G	H	J	T	Catalog Number
	Minimum	Maximum							
.38	.36	.44	.25	.34	.47	.135	.016	TH13	
.50	.47	.56	.25	.34	.62	.135	.016	TH15	
.63	.61	.69	.31	.34	.72	.135	.016	TH17	
.75	.72	.78	.31	.34	.89	.135	.020	TH19	
.88	.85	.94	.31	.34	1.00	.135	.020	TH21	
1.00	.96	1.03	.31	.34	1.06	.135	.020	TH23	
1.38	1.34	1.50	.31	.59	1.50	.135	.020	TH25	

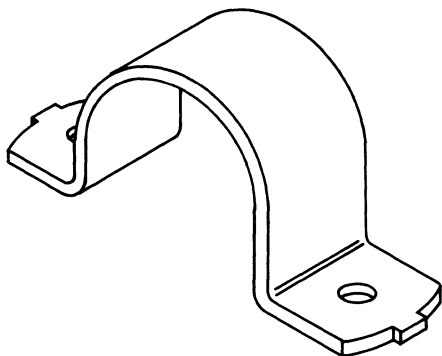
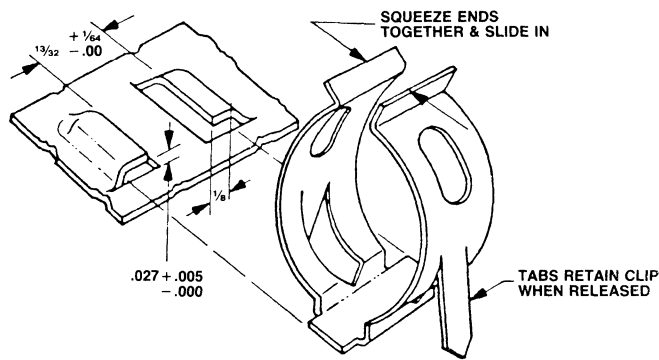

CYLINDRICAL CAPACITOR MOUNTING CLAMP, TYPE RB

This clamp has a galvanized finish and is designed for use with the round base style motor run capacitor, types MPD/MPF and RPN.

Fig.	Description	Dimensions					Catalog Number
		A	B	C	D	R	
4	Vert. Mtg. Clamp	1 3/4"	2 1/2"	2 7/8"	1.656"	7/8"	RB175
	Vert. Mtg. Clamp	2"	2 3/4"	3 1/8"	1.906"	1"	RB200
	Vert. Mtg. Clamp	2 1/2"	3 1/4"	3 5/8"	2.406"	1 1/4"	RB250
5	Vert. Mtg. Clamp	1 3/4"	2 1/2"	3 1/4"	1.656"	7/8"	RB175A
	Vert. Mtg. Clamp	2"	2 3/4"	3 1/2"	1.906"	1"	RB200A
	Vert. Mtg. Clamp	2 1/2"	3 1/4"	4"	2.406"	1 1/4"	RB250A

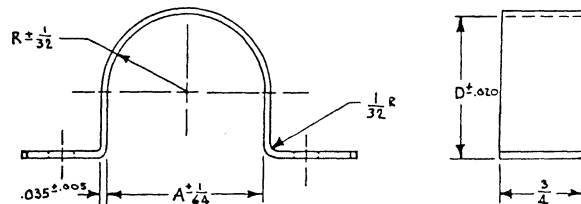
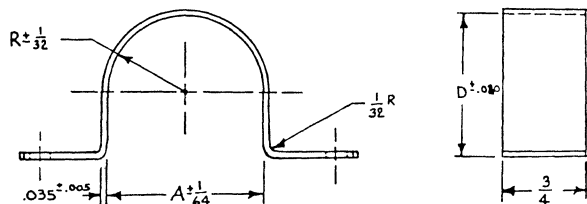
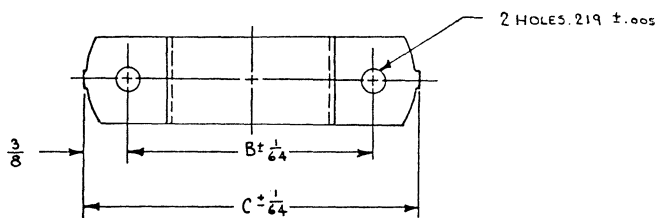
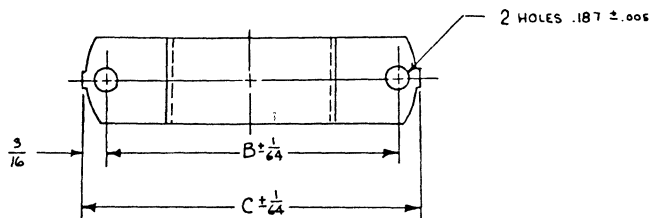
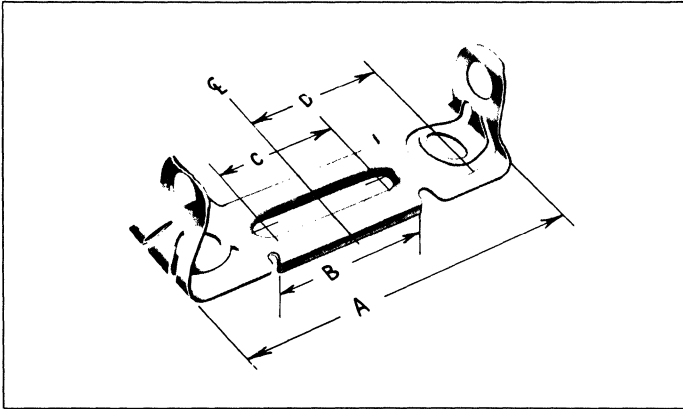

FIG. 4

FIG. 5

Capacitor Hardware



MOUNTING ACCESSORIES

A single end cap and a simple bracket are all that is required to mount these Mallory Capacitors.

The improved Type HB bracket, illustrated, is assembled to the motor or any suitable surface by

two screws in line at any convenient position within the center-to-center dimension (C) shown in the chart.

Type VR brackets illustrated are available for vertical mounting.

Type	Case No.	A	B	C*	D
HB2	1	3 ³ / ₈	1 ¹ / ₆₄	7 ⁷ / ₈	1.258
HB4	2-4-6	4 ¹ / ₆₄	1 ¹³ / ₁₆	1 ¹ / ₂	1 ³⁷ / ₆₄
HB8	3-5-7-8	5 ¹ / ₆₄	2 ²³ / ₃₂	1 ²⁵ / ₃₂	2 ⁵ / ₆₄

*C dimension = maximum mounting hole center. Use 10¹⁰/₃₂" flat head screws.
Material: .042 Spring Steel. Finish: Black Parkerize.

PL AND PLA END CAPS

When assembling directly to the motor frame, the wires are brought through the bracket hole and soldered to the capacitor terminals. Type PL end cap is then placed in position and the entire assembly snapped into place. Off-motor mounting is similarly accomplished except that Type PLA

caps should be used to provide for leads emerging from the opposite side of the cap without going through the bracket hole.

End caps and brackets are shipped loose and should be separately ordered when required. Add A to the PL part numbers if PLA cap is desired (Example: PLA-3).

Type	Dia.	A	B	C	D
PL-3	1 ⁷ / ₁₆	1.427-1.447	.077-.083	1.088-1.098	1.239-1.244
PL-6	1 ¹³ / ₁₆	1.804-1.820	.107-.113	1.463-1.473	1.604-1.614
PL-8	2 ¹ / ₁₆	2.052-2.072	.232-.238	1.713-1.723	1.863-1.869
PL-10	2 ⁹ / ₁₆	2.562-2.571	.482-.488	2.213-2.223	2.363-2.369

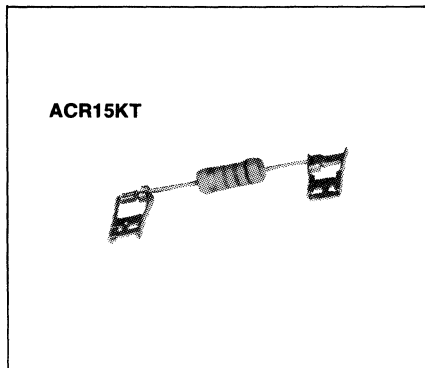
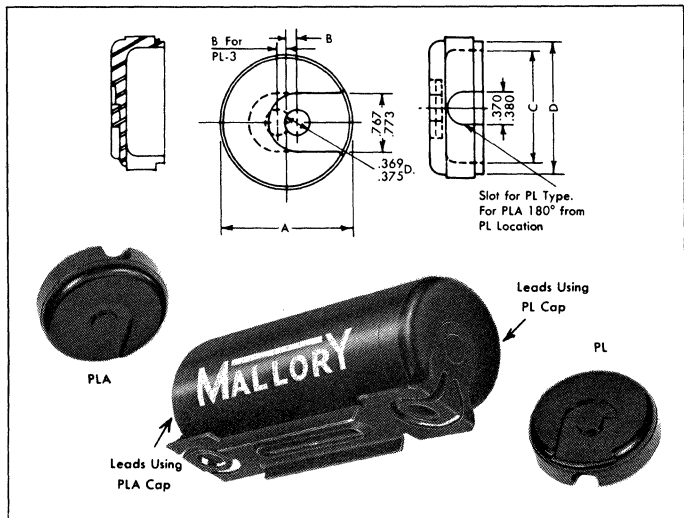

ACR15KT MOTOR START RESISTOR

15K 2 watt bleeder resistor for AC motor start applications. Saves relay switch contacts and capacitor, particularly in capacitor start-run applications. 1/4" quick connect terminals eliminate need for soldering.

Capacitor Hardware

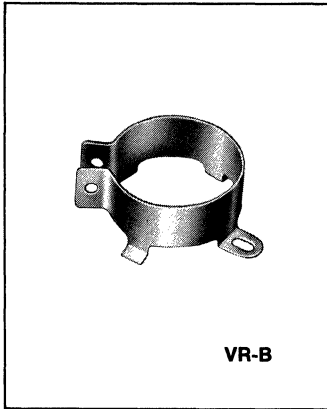

VR-B

Cylindrical Capacitor Mounting Clamp, Type VR

The Mallory VR mounting clamps can be used to mount any cylindrical

capacitor with a 1 1/8" to 3" diameter that is to be mounted in a vertical position. The standard finish is .0001" (nominal) zinc chromic

plating. Use for mounting CG/CGS types, PSU/HC/NP types, RPN/MPD/MPF types.

Fig.	Description	Dimensions			Diameter of Part to be Mounted	Catalog Number		
		A	B	C		Without Screw & Nut	Unassembled Screw & Nut Incl.	Assembled With Nut & Screw
1	Vert. Mtg. Clamp	1"	1 1/16"	1 7/8"	1" - 1 1/16"	VR1B	VR1	VR1A
1	Vert. Mtg. Clamp	1 3/8"	1 29/32"	2 7/32"	1 3/8" - 1 7/16"	VR3B	VR3	VR3A
1	Vert. Mtg. Clamp	1 1/2"	1 15/16"	2 1 1/32"	1 1/2" - 1 9/16"	VR4B	VR4	VR4A
2	Vert. Mtg. Clamp	1 3/4"	2 1/4"	2 9/16"	1 3/4" - 1 13/16"	VR6B	VR6	VR6A
2	Vert. Mtg. Clamp	2"	2 1/2"	2 1 3/16"	2" - 2 1/16"	VR8B	VR8	VR8A
2	Vert. Mtg. Clamp	2 1/2"	3"	3 9/16"	2 1/2" - 2 9/16"	VR10B	VR10	VR10A
3	Vert. Mtg. Clamp	3"	3 7/16"	3 1 3/16"	3" - 3 1/8"	VR12B	VR12	VR12A
—	Vert. Mtg. Clamp Screw	—	—	—	—	VRSCREW	—	—
—	Vert. Mtg. Clamp Nut	—	—	—	—	VRNUT	—	—

*Dimensions shown are nominal as manufactured. The assembled dimensions may vary slightly from these values depending upon the use of uninsulated can or the particular type of insulating sleeve selected.

FIGURE 1
VR 1, 3 & 4

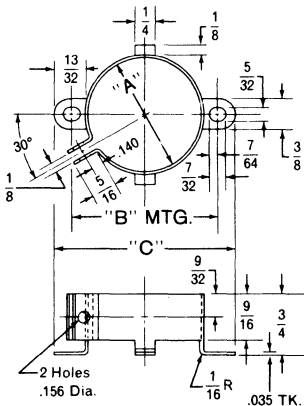

(INCHES)
FIGURE 2
VR 6, 8 & 10

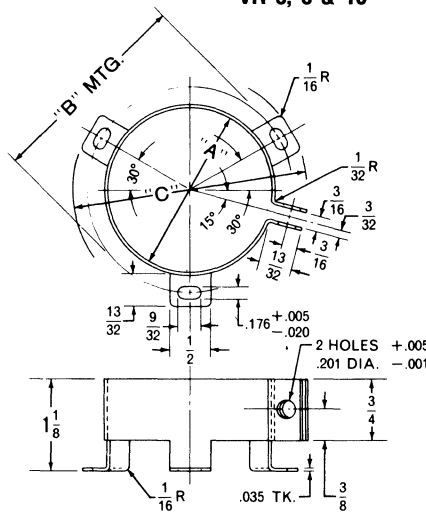
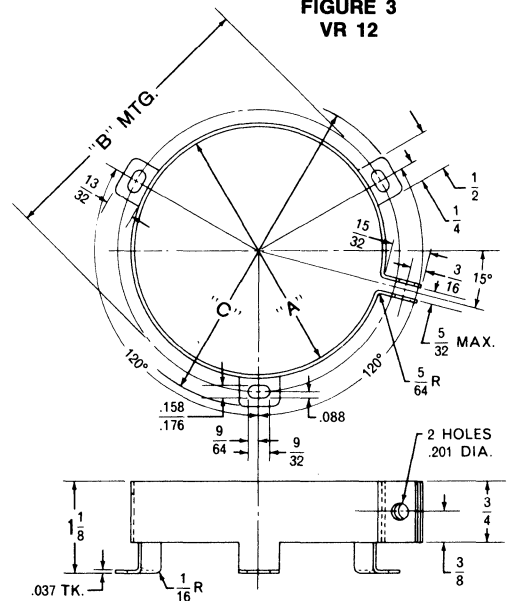

FIGURE 3
VR 12



Motor Run Capacitor Hardware

OB clamp has been designed for use with the Mallory line of Motor Run Capacitors types, OPN/OPRN.

Use with Base Style	Dim. B inch	mm.	Catalog Number
32 (1 5/16" x 2 5/32")	2 9/16	65.1	OB2
38 (1 3 1/32" x 3 2 1/32")	4 1/16	103.1	OB3
37 (1 3 1/32" x 2 2 9/32")	3 9/16	84.1	OB4

Neoprene terminal insulator OC for use with single section OPN/MPF capacitors. Material is classified 94V-1 when tested per UL94.

Use with Base Style	Catalog Number
32, 37, 38	OC1

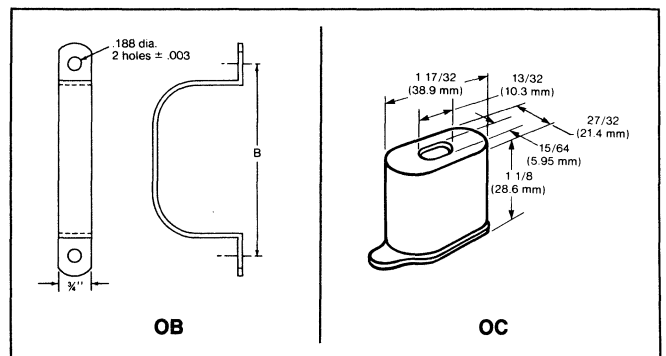

Capacitor Hardware

TYPE CE- CARDBOARD INSULATORS FOR USE WITH TYPE "FP" CAPACITORS.

Capacitor Dimensions D x L (inches)	Catalog Number
1 x 2	CE3
1 x 2 1/2	CE7
1 x 3	CE4
1 3/8 x 2	CE5
1 3/8 x 2 1/2	CE9
1 3/8 x 3	CE6
1 3/8 x 3 1/2	CE12
1 3/8 x 4	CE10

INSULATING SLEEVES — Closed end cardboard tubes used to insulate metal can where shock potential is present. Tubes add 3/32" to can base diameter and 3/16" to overall height.

HARDWARE FOR TYPE "FP" CAPACITORS

FP series capacitors are available in two diameters: 1", and 1 3/8". Lengths and mounting hardware are shown below. Chassis punch details are shown to the right. Use BP (phenolic) or MP (metal) plates where direct chassis layout is not desired.

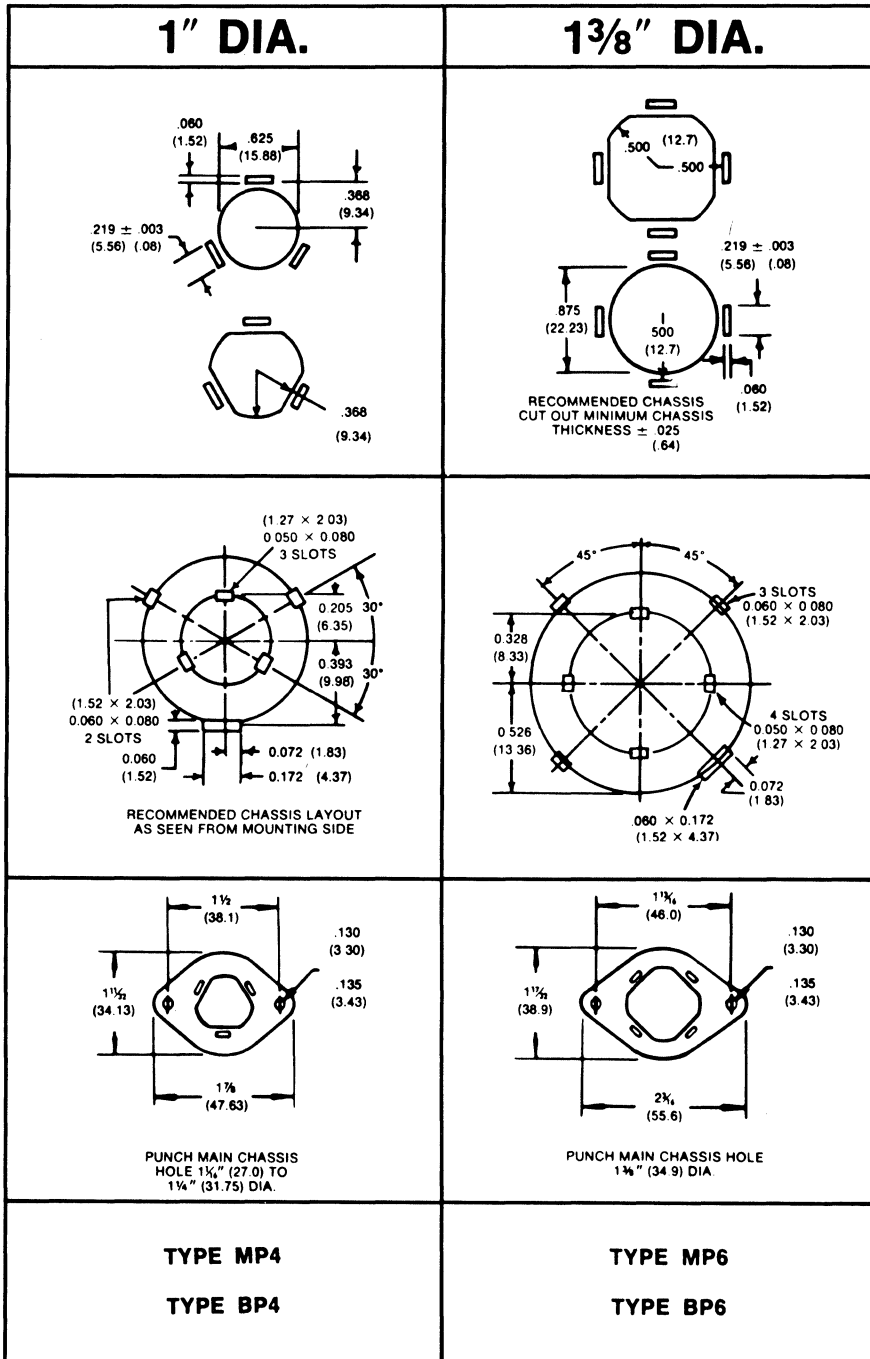

Ceramic Disc Capacitors

TYPICAL PERFORMANCE

CLASS 1

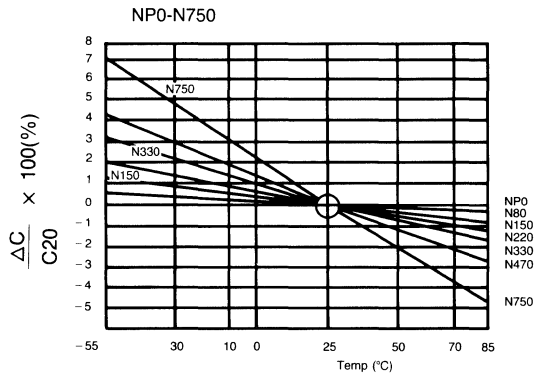

(CAPACITANCE VS. TEMPERATURE)

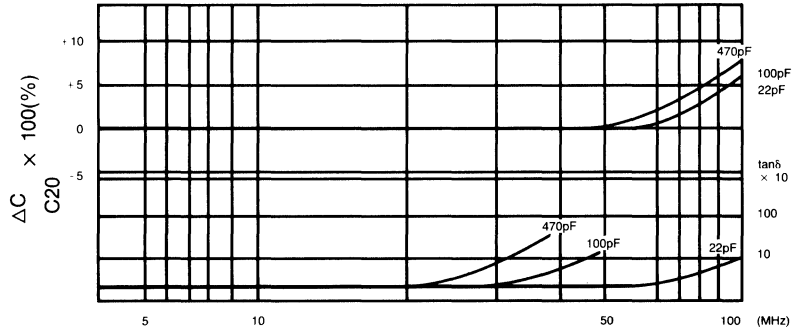

(CAPACITANCE AND DIS. FACTOR VS. FREQUENCY)

SL Temperature coefficient: P350 to N1000 PPM/°C

CLASS 2 AND 3

JIS STANDARD		E.I.A. STANDARD			
Temp. range -25 to +85°C	Cap Change (%)	Temp. range -30 to 85°C	Cap Change (%)	Temp. range -55 to 85°C	Cap Change (%)
YA	± 4.7	Y5D (special) (50V, only)	± 3.3	X5F	± 7.5
		Y5E	± 4.7		
		Y5F	± 7.5		
		Y5P	± 10		
YB	± 8	Y5R	± 15	X5R	± 15
		Y5S	± 22		
		Y5T	+22, -33		
YD	+5, -30	Y5U	+22, -56	X5T	+22, -33
YE	+5, -55	Y5V	+22, -82		
YF	+10, -80	Z5V	+22, -82		
ZF	+10, -80				

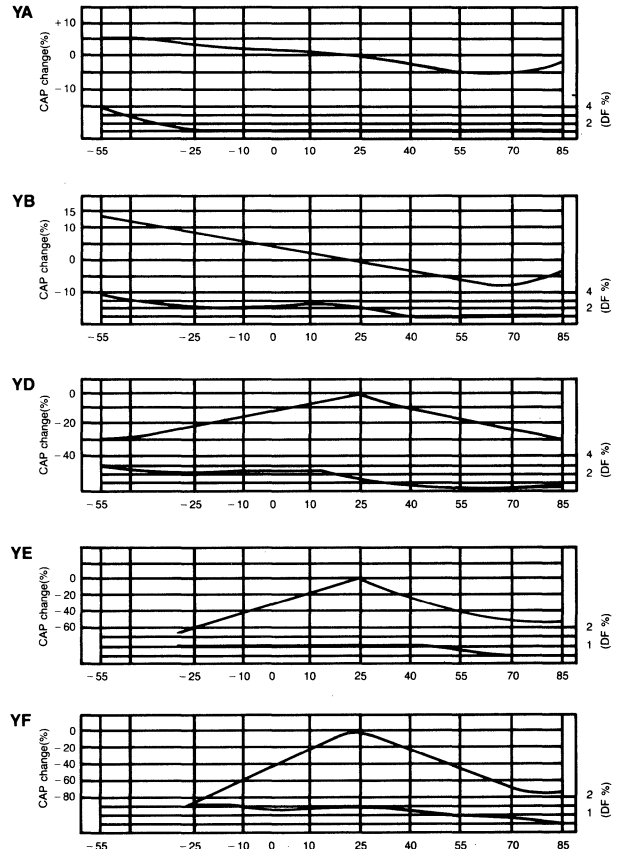

General Purpose Disc Ceramic Capacitors

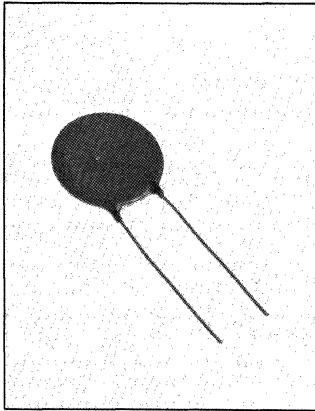

The Mallory general purpose disc ceramic capacitors provide a wide choice of 50, 100, 500 and 1,000 volt DC rated units. These are designed for transistor circuitry and applications requiring high capacitance and low power factor for general purpose application. All capacitors are coated with tough humidity resistant coating and primarily designed for non-critical coupling, bypass and filter applications, found in all types of entertainment, industrial and medical equipment.

Disc ceramic capacitor Mallobins are available. See complete Mallobin listing, page 150. For pricing, reference price sheet no. 410.

HIGHLIGHTS

- Capacitance Range: 1 to 100,000 pF
- Voltage: 50, 100, 500 and 1,000 WVDC
- Insulation Resistance: 10,000 megohms (min.)
- Power Factor: 2.5% max. (Y5V:5%)
- Test Frequency: 1,000 Hz
- Flash Voltage: 2.5x rated .5 sec max
- Lead Length = 1 in. min.

GENERAL PURPOSE DISC CERAMICS

Cap. pF	Tol. ±	Temp. Coef.	Max. Dia. In.	Thickness In.	Lead Spacing In.	Catalog Number	Cap. pF	Tol. ±	Temp. Coef.	Max. Dia. In.	Thickness In.	Lead Spacing In.	Catalog Number
50 WVDC							100 WVDC						
1	.25pF	SL	.196	.118	.10	GE010C	2,200	10%	Y5P	.236	.118	.250	GH222K
3	.25pF	SL	.196	.118	.10	GE030C	2,200	20%	Y5U	.236	.118	.250	GH222M
5	.25pF	SL	.196	.118	.10	GE050C	3,900	10%	Y5P	.315	.118	.250	GH392K
6	.5pF	SL	.196	.118	.10	GE060D	4,700	10%	Y5P	.375	.118	.250	GH472K
7	.5pF	SL	.196	.118	.10	GE070D	4,700	-20%, +80%	Y5U	.315	.118	.250	GH472Z
8	.5pF	SL	.196	.118	.10	GE080D	5,600	10%	Y5P	.375	.118	.250	GH562K
10	.5pF	SL	.196	.118	.10	GE100D	10,000	10%	Y5P	.472	.118	.250	GH103K
12	10%	SL	.196	.118	.10	GE120K	10,000	20%	Y5U	.375	.118	.250	GH103M
15	10%	SL	.196	.118	.10	GE150K	10,000	-20%, +80%	Y5U	.375	.118	.250	GH103Z
18	10%	SL	.196	.118	.10	GE180K	22,000	-20%, +80%	Y5V	.472	.118	.250	GH223Z
20	10%	SL	.196	.118	.10	GE200K	47,000	-20%, +80%	Y5V	.551	.118	.375	GH473Z
22	10%	SL	.196	.118	.10	GE220K	100,000	-20%, +80%	Z5U	.400	.150	.375	GH104XZ
24	10%	SL	.196	.118	.10	GE240K							
27	10%	SL	.196	.118	.10	GE270K							
33	10%	SL	.196	.118	.10	GE330K							
39	10%	SL	.196	.118	.10	GE390K							
47	10%	SL	.196	.118	.10	GE470K	5	.25pF	SL	.236	.156	.250	GM050C
51	10%	SL	.196	.118	.10	GE510K	7.5	.5pF	SL	.236	.156	.250	GM7R5D
56	10%	SL	.196	.118	.10	GE560K	10	.5pF	SL	.236	.156	.250	GM100D
68	10%	SL	.196	.118	.10	GE680K	15	10%	SL	.236	.156	.250	GM150K
75	10%	SL	.196	.118	.10	GE750K	18	10%	SL	.236	.156	.250	GM180K
82	10%	SL	.196	.118	.10	GE820K	20	10%	SL	.236	.156	.250	GM200K
91	10%	SL	.196	.118	.10	GE910K	22	10%	SL	.236	.156	.250	GM220K
100	10%	Y5P	.157	.118	.10	GE101K	24	10%	SL	.236	.156	.250	GM240K
120	10%	Y5P	.157	.118	.10	GE121K	27	10%	SL	.236	.156	.250	GM270K
150	10%	Y5P	.157	.118	.10	GE151K	39	10%	SL	.236	.156	.250	GM390K
180	10%	Y5P	.157	.118	.10	GE181K	47	10%	SL	.236	.156	.250	GM470K
220	10%	Y5P	.157	.118	.10	GE221K	100	10%	Y5P	.236	.156	.250	GM101K
270	10%	Y5P	.157	.118	.10	GE271K	150	10%	Y5P	.236	.156	.250	GM151K
330	10%	Y5P	.157	.118	.10	GE331K	220	10%	Y5P	.236	.156	.250	GM221K
390	10%	Y5P	.157	.118	.10	GE391K	270	10%	Y5P	.236	.156	.250	GM271K
470	10%	Y5P	.157	.118	.10	GE471K	330	10%	Y5P	.236	.156	.250	GM331K
560	10%	Y5P	.157	.118	.10	GE561K	390	10%	Y5P	.236	.156	.250	GM391K
680	10%	Y5P	.157	.118	.10	GE681K	470	10%	Y5P	.236	.156	.250	GM471K
820	10%	Y5P	.157	.118	.10	GE821K	680	10%	Y5P	.236	.156	.250	GM681K
1,000	10%	Y5P	.196	.118	.10	GE102K	1,000	10%	Y5P	.236	.156	.250	GM102K
1,000	20%	Y5T	.157	.118	.10	GE102M	1,000	20%	Y5U	.236	.156	.250	GM102M
1,000	-20%, +80%	Y5V	.157	.118	.10	GE102Z	1,000	-20%, +80%	Y5U	.236	.156	.250	GM102Z
1,500	10%	Y5P	.196	.118	.10	GE152K	2,200	10%	Y5P	.338	.156	.250	GM222K
1,500	20%	Y5T	.196	.118	.10	GE152M	2,200	20%	Y5U	.236	.156	.250	GM222M
2,200	10%	Y5P	.236	.118	.20	GE222K	2,200	-20%, +80%	Y5U	.236	.156	.250	GM222Z
2,200	20%	Y5U	.196	.118	.10	GE222M	3,300	10%	Y5P	.433	.156	.250	GM332K
3,300	10%	Y5P	.276	.118	.20	GE332K	3,300	20%	Y5U	.291	.156	.250	GM332M
3,900	10%	Y5P	.315	.118	.20	GE392K	4,700	10%	Y5P	.492	.156	.250	GM472K
4,700	10%	Y5P	.315	.118	.20	GE472K	4,700	20%	Y5U	.338	.156	.250	GM472M
4,700	20%	Y5U	.236	.118	.20	GE472M	6,800	-20%, +80%	Y5U	.433	.156	.250	GM682Z
4,700	-20%, +80%	Y5V	.196	.118	.10	GE472Z	10,000	10%	Y5P	.642	.156	.375	GM103K
6,800	10%	Y5P	.374	.118	.20	GE682K	10,000	20%	Y5U	.492	.156	.250	GM103M
8,200	10%	Y5P	.394	.118	.20	GE822K	10,000	-20%, +80%	Y5U	.492	.156	.250	GM103Z
10,000	10%	Y5P	.472	.118	.20	GE103K	22,000	20%	Y5U	.642	.156	.375	GM223M
10,000	20%	Y5U	.315	.118	.20	GE103M	22,000	-20%, +80%	Y5U	.642	.156	.375	GM223Z
10,000	-20%, +80%	Y5V	.276	.118	.20	GE103Z	30,000	20%	Z5U	.400	.150	.375	GM303MX
22,000	20%	Y5U	.354	.118	.20	GE223M	50,000	20%	Z5U	.400	.150	.375	GM503MX
47,000	-20%, +80%	Y5V	.492	.118	.20	GE473Z	100,000	20%	Z5U	.400	.150	.375	GM104MX

General Purpose Disc Ceramic Capacitors

Cap. pF	Tol. ±	Temp. Coef.	Max. Dia. In.	Thickness In.	Lead Spacing In.	Catalog Number
1,000 WVDC						
3.3	.25pF	SL	.236	.156	.250	GP533
5	.25pF	SL	.236	.156	.250	GP550
6.8	.5pF	SL	.236	.156	.250	GP568
10	.5pF	SL	.236	.156	.250	GP410
12	10%	SL	.236	.156	.250	GP412
15	10%	SL	.236	.156	.250	GP415
20	10%	SL	.236	.156	.250	GP420
22	10%	SL	.236	.156	.250	GP422
27	10%	SL	.236	.156	.250	GP427
30	10%	SL	.236	.156	.250	GP430
33	10%	SL	.236	.156	.250	GP433
39	10%	SL	.236	.156	.250	GP439
47	10%	SL	.236	.156	.250	GP447
56	10%	SL	.236	.156	.250	GP456
68	10%	SL	.236	.156	.250	GP468
91	10%	Y5P	.236	.156	.250	GP491
100	10%	Y5P	.236	.156	.250	GP310
120	10%	Y5P	.236	.156	.250	GP312
150	10%	Y5P	.236	.156	.250	GP315
180	10%	Y5P	.236	.156	.250	GP318

Cap. pF	Tol. ±	Temp. Coef.	Max. Dia. In.	Thickness In.	Lead Spacing In.	Catalog Number
1,000 WVDC						
220	10%	Y5P	.236	.156	.250	GP322
270	10%	Y5P	.236	.156	.250	GP327
330	10%	Y5P	.236	.156	.250	GP333
390	10%	Y5P	.236	.156	.250	GP339
470	10%	Y5P	.236	.156	.250	GP347
560	10%	Y5P	.236	.156	.250	GP356
680	10%	Y5P	.236	.156	.250	GP368
750	10%	Y5P	.236	.156	.250	GP375
820	10%	Y5P	.236	.156	.250	GP382
1,000	10%	Y5P	.291	.156	.250	GP210
1,500	10%	Y5P	.339	.156	.250	GP215
2,200	10%	Y5P	.374	.156	.250	GP222
2,700	10%	Y5P	.433	.156	.250	GP227
3,300	20%	Y5T	.433	.156	.250	GP233
3,900	10%	Y5P	.412	.156	.250	GP239
4,700	20%	Y5U	.433	.156	.250	GP247
5,600	10%	Y5P	.590	.156	.375	GP256
6,800	20%	Y5T	.590	.156	.375	GP268
10,000	20%	Y5U	.590	.156	.375	GP110
22,000	20%	Y5U	.748	.156	.375	GP122

CERAMIC CAPACITORS

CLASS 2 & 3

EIA DESIGNATION CODE

LETTER SYMBOL	LOW TEMP. REQUIREMENT	NUMBER SYMBOL	HIGH TEMP. REQUIREMENT	LETTER SYMBOL	MAX. CAPACITANCE CHANGE OVER TEMP RATING
Z	+10°C	2	+45°C	A	± 1.0%
		4	+65°C	B	± 1.5%
Y	-30°C	5	+85°C	C	± 2.2%
				D	± 3.3%
X	-55°C	6	+105°C	E	± 4.7%
				F	± 7.5%
				P	± 10.0%
		7	+125°C	R	± 15.0%
				S	± 22.0%
				T	+22%, -33%
				U	+22%, -56%
				V	+22%, -82%

CLASS 1

TEMPERATURE COEFFICIENT CODE

TEMP RANGE -55 +125°C	% CH PER 1°C
NPO—(COG)	± 30ppm
N330	-330ppm
N470	-470ppm
N750	-750ppm
N1000	-1000ppm
N1500	-1500ppm
N2200	-2200ppm
N3300	-3300ppm
N4700	-4700ppm
N5600	-5600ppm

EIA Class 1 Temperature Compensating Ceramic Discs

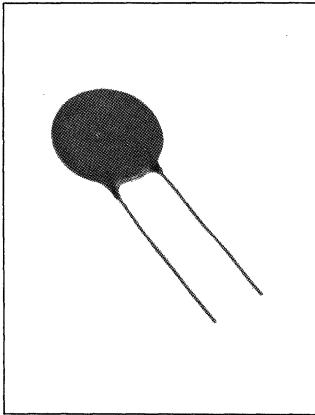

Mallory has now expanded its offering in the temperature compensating disc ceramic. These are now being offered in five temperature coefficients (NPO, N330, N750, N1500 and SL) in voltages ranging from 50 to 3000 volts. These discs are used in timing circuits, oscillator circuits and similar applications where changes in capacitance with temperature would be predictable and closely controlled.

Disc ceramic capacitor Mallobins are available. See complete Mallobin listing, page 150. For pricing, reference price sheet no. 410.

HIGHLIGHTS
 Capacitance Range: 1 to 910 pF
 Voltage: 50-500-1,000-3,000 WVDC
 Insulation Resistance: 10,000 megohms (min.)
 Test Frequency: 1 MHz
 Flash Voltage: 3x rated 5 sec max
 Lead Length = 1 in. min.

Cap. pF	Tol. ±	Temp. Coef.	Max. Dia. In.	Thickness In.	Lead Spacing In.	Catalog Number
TEMPERATURE COMPENSATING DISC—NPO						
50 WVDC						
1	.25pF	NPO	.157	.118	.098	CEC010C
1.5	.25pF	NPO	.157	.118	.098	CEC1R5C
2	.25pF	NPO	.157	.118	.098	CEC020C
3	.25pF	NPO	.157	.118	.098	CEC030C
4	.25pF	NPO	.157	.118	.098	CEC040C
5	.25pF	NPO	.157	.118	.098	CEC050C
6	.5pF	NPO	.157	.118	.098	CEC060D
7	.5pF	NPO	.157	.118	.098	CEC070D
8	.5pF	NPO	.157	.118	.098	CEC080D
9	.5pF	NPO	.157	.118	.098	CEC090D
10	5%	NPO	.157	.118	.098	CEC100J
12	5%	NPO	.157	.118	.098	CEC120J
13	5%	NPO	.157	.118	.098	CEC130J
15	5%	NPO	.157	.118	.098	CEC150J
18	5%	NPO	.157	.118	.098	CEC180J
20	5%	NPO	.157	.118	.098	CEC200J
22	5%	NPO	.157	.118	.098	CEC220J
24	5%	NPO	.157	.118	.098	CEC240J
27	5%	NPO	.196	.118	.098	CEC270J
30	5%	NPO	.196	.118	.098	CEC300J
33	5%	NPO	.196	.118	.098	CEC330J
39	5%	NPO	.196	.118	.196	CEC390J
43	5%	NPO	.236	.118	.196	CEC430J
47	5%	NPO	.236	.118	.196	CEC470J
51	5%	NPO	.236	.118	.196	CEC510J
56	5%	NPO	.236	.118	.196	CEC560J
62	5%	NPO	.276	.118	.196	CEC620J
68	5%	NPO	.276	.118	.196	CEC680J
75	5%	NPO	.276	.118	.196	CEC750J
82	5%	NPO	.276	.118	.196	CEC820J
91	5%	NPO	.315	.118	.196	CEC910J
100	5%	NPO	.315	.118	.196	CEC101J
110	5%	NPO	.315	.118	.196	CEC111J
120	5%	NPO	.315	.118	.196	CEC121J
130	5%	NPO	.354	.118	.196	CEC131J
150	5%	NPO	.354	.118	.196	CEC151J
180	5%	NPO	.374	.118	.196	CEC181J
220	5%	NPO	.413	.118	.196	CEC221J
240	5%	NPO	.472	.118	.196	CEC241J
270	5%	NPO	.472	.118	.196	CEC271J
300	5%	NPO	.472	.118	.196	CEC301J
500 WVDC						
1	.25pF	NPO	.236	.118	.250	CMC010C
1.5	.25pF	NPO	.236	.118	.250	CMC1R5C
2	.25pF	NPO	.236	.118	.250	CMC020C
3	.25pF	NPO	.236	.118	.250	CMC030C
4	.25pF	NPO	.236	.118	.250	CMC040C
5	.25pF	NPO	.236	.118	.250	CMC050C
6	.5pF	NPO	.236	.118	.250	CMC060D
9	.5pF	NPO	.236	.118	.250	CMC090D

Cap. pF	Tol. ±	Temp. Coef.	Max. Dia. In.	Thickness In.	Lead Spacing In.	Catalog Number
TEMPERATURE COMPENSATING DISC—NPO (Continued)						
500 WVDC (Continued)						
10	5%	NPO	.236	.118	.250	CMC100J
12	5%	NPO	.236	.118	.250	CMC120J
15	5%	NPO	.236	.118	.250	CMC150J
18	5%	NPO	.236	.118	.250	CMC180J
20	5%	NPO	.236	.118	.250	CMC200J
22	5%	NPO	.236	.118	.250	CMC220J
24	5%	NPO	.236	.118	.250	CMC240J
27	5%	NPO	.236	.118	.250	CMC270J
30	5%	NPO	.236	.118	.250	CMC300J
33	5%	NPO	.291	.118	.250	CMC330J
39	5%	NPO	.291	.118	.250	CMC390J
47	5%	NPO	.291	.118	.250	CMC470J
56	5%	NPO	.375	.118	.250	CMC560J
62	5%	NPO	.375	.118	.250	CMC620J
68	5%	NPO	.375	.118	.250	CMC680J
75	5%	NPO	.375	.118	.250	CMC750J
82	5%	NPO	.375	.118	.250	CMC820J
100	5%	NPO	.433	.118	.250	CMC101J
120	5%	NPO	.433	.118	.250	CMC121J
150	5%	NPO	.492	.118	.250	CMC151J
160	5%	NPO	.492	.118	.250	CMC161J
180	5%	NPO	.570	.118	.375	CMC181J
220	5%	NPO	.570	.118	.375	CMC221J
TEMPERATURE COMPENSATING DISC—NPO						
1000 WVDC						
1.5	.25pF	NPO	.236	.118	.250	CPC1R5C
2.2	.25pF	NPO	.236	.118	.250	CPC2R2C
3.3	.25pF	NPO	.236	.118	.250	CPC3R3C
4.7	.25pF	NPO	.236	.118	.250	CPC4R7C
6.8	.5pF	NPO	.236	.118	.250	CPC6R8D
8.2	.5pF	NPO	.236	.118	.250	CPC8R2D
9.6	.5pF	NPO	.236	.118	.250	CPC9R6D
10	.5pF	NPO	.236	.118	.250	CPC100D
11	5%	NPO	.236	.118	.250	CPC110J
12	5%	NPO	.236	.118	.250	CPC120J
13	5%	NPO	.236	.118	.250	CPC130J
15	5%	NPO	.236	.118	.250	CPC150J
18	5%	NPO	.236	.118	.250	CPC180J
20	5%	NPO	.236	.118	.250	CPC200J
22	5%	NPO	.236	.118	.250	CPC220J
24	5%	NPO	.291	.118	.250	CPC240J
27	5%	NPO	.291	.118	.250	CPC270J
30	5%	NPO	.291	.118	.250	CPC300J
33	5%	NPO	.291	.118	.250	CPC330J
36	5%	NPO	.375	.118	.250	CPC360J
39	5%	NPO	.375	.118	.250	CPC390J
47	5%	NPO	.375	.118	.250	CPC470J
51	5%	NPO	.375	.118	.250	CPC510J
56	5%	NPO	.375	.118	.250	CPC560J
68	5%	NPO	.433	.118	.250	CPC680J

EIA Class 1 Temperature Compensating Ceramic Discs

Cap. pF	Tol. ±	Temp. Coef.	Max. Dia. In.	Thickness In.	Lead Spacing In.	Catalog Number
TEMPERATURE COMPENSATING DISC—NPO (Continued)						
1000 WVDC (Continued)						
75	5%	NPO	.433	.118	.250	CPC750J
100	5%	NPO	.492	.118	.250	CPC101J
150	5%	NPO	.570	.118	.375	CPC151J
180	5%	NPO	.570	.118	.375	CPC181J
200	5%	NPO	.642	.118	.375	CPC201J
220	5%	NPO	.642	.118	.375	CPC221J
270	5%	NPO	.748	.118	.375	CPC271J
300	5%	NPO	.748	.118	.375	CPC301J
330	5%	NPO	.748	.118	.375	CPC331J

TEMPERATURE COMPENSATING DISC—N330						
50 WVDC						
10	5pF	N330	.157	.118	.098	CES100D
12	5%	N330	.157	.118	.098	CES120J
15	5%	N330	.157	.118	.098	CES150J
18	5%	N330	.157	.118	.098	CES180J
27	5%	N330	.157	.118	.098	CES270J
33	5%	N330	.196	.118	.098	CES330J
43	5%	N330	.196	.118	.196	CES430J

TEMPERATURE COMPENSATING DISC—N750						
50 WVDC						
10	.5pF	N750	.157	.118	.098	CEU100D
22	5%	N750	.157	.118	.098	CEU220J
51	5%	N750	.196	.118	.098	CEU510J
68	5%	N750	.196	.118	.196	CEU680J
100	5%	N750	.236	.118	.196	CEU101J
120	5%	N750	.236	.118	.196	CEU121J
220	5%	N750	.315	.118	.196	CEU221J
270	5%	N750	.354	.118	.196	CEU271J
300	5%	N750	.354	.118	.196	CEU301J
330	5%	N750	.354	.118	.196	CEU331J
390	5%	N750	.413	.118	.196	CEU391J
470	5%	N750	.413	.118	.196	CEU471J

TEMPERATURE COMPENSATING DISC—N750						
500 WVDC						
1.5	.25pF	N750	.236	.118	.250	CMU1R5C
3.3	.25pF	N750	.236	.118	.250	CMU3R3C
4.7	.25pF	N750	.236	.118	.250	CMU4R7C
5	.25pF	N750	.236	.118	.250	CMU050C
6.8	.5pF	N750	.236	.118	.250	CMU6R8D
8.2	.5pF	N750	.236	.118	.250	CMU8R2D
10	.5pF	N750	.236	.118	.250	CMU100D
12	5%	N750	.236	.118	.250	CMU120J
15	5%	N750	.236	.118	.250	CMU150J
18	5%	N750	.236	.118	.250	CMU180J
20	5%	N750	.236	.118	.250	CMU200J
22	5%	N750	.236	.118	.250	CMU220J
33	5%	N750	.236	.118	.250	CMU330J
39	5%	N750	.236	.118	.250	CMU390J

Cap. pF	Tol. ±	Temp. Coef.	Max. Dia. In.	Thickness In.	Lead Spacing In.	Catalog Number
TEMPERATURE COMPENSATING DISC—N750						
500 WVDC (Continued)						
51	5%	N750	.236	.118	.250	CMU510J
56	5%	N750	.236	.118	.250	CMU560J
68	5%	N750	.291	.118	.250	CMU680J
100	5%	N750	.291	.118	.250	CMU101J
110	5%	N750	.375	.118	.250	CMU111J
620	5%	N750	.642	.118	.375	CMU621J

TEMPERATURE COMPENSATING DISC—N750						
1000 WVDC						
10	5%	N750	.236	.118	.250	CPU100J
12	5%	N750	.236	.118	.250	CPU120J
15	5%	N750	.236	.118	.250	CPU150J
20	5%	N750	.236	.118	.250	CPU200J
22	5%	N750	.236	.118	.250	CPU220J
33	5%	N750	.236	.118	.250	CPU330J
39	5%	N750	.236	.118	.250	CPU390J
47	5%	N750	.236	.118	.250	CPU470J
100	5%	N750	.375	.118	.250	CPU101J
270	5%	N750	.492	.118	.250	CPU271J
330	5%	N750	.570	.118	.375	CPU331J

TEMPERATURE COMPENSATING DISC—N1500						
500 WVDC						
10	.5pF	N1500	.236	.118	.250	CMW100D
22	5%	N1500	.236	.118	.250	CMW220J
47	5%	N1500	.291	.118	.250	CMW470J
51	5%	N1500	.291	.118	.250	CMW510J
100	5%	N1500	.374	.118	.250	CMW101J
390	5%	N1500	.492	.118	.250	CMW391J

TEMPERATURE COMPENSATING DISC—N1500						
1000 WVDC						
100	5%	N1500	.291	.118	.250	CPW101J
120	5%	N1500	.291	.118	.250	CPW121J
330	5%	N1500	.590	.118	.375	CPW331J
390	5%	N1500	.642	.118	.375	CPW391J
470	5%	N1500	.748	.118	.375	CPW471J

TEMPERATURE COMPENSATING DISC—SL						
3,000 WVDC						
22	10%	SL	.394	.197	.375	CTZ220K
100	10%	SL	.472	.197	.375	CTZ101K

CERAMIC CAPACITORS

EIA Class 2 Temperature/Frequency Stable Disc Ceramic Capacitors

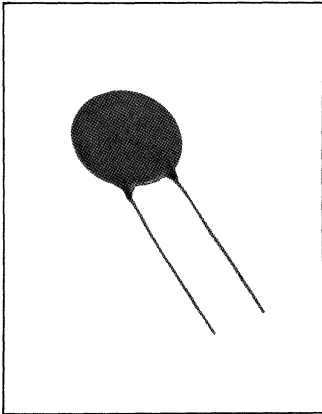

These discs provide exceptional stability in applications where temperature and frequency are critical. Exhibit minimum variation in capacitance and power factor with change in frequency from audio to high radio frequencies. Suitable for use in wide band audio R.F. coupling and bypass applications. Can be used in low "Q" resonant circuits as well as R-C response shaping networks and feedback loops in addition to conventional applications. Can be used as general replacement for mica and general purpose tubular types. Insulation Resistance: Greater than 10,000 megohms at 500

VDC. Disc ceramic capacitor Mallobins are available. See complete Mallobin listing, page 150. For pricing, refer to price sheet no. 410.

HIGHLIGHTS

- Capacitance Range: 100 to 10,000 pF
- Voltage: 500 and 1,000 VDC
- Power Factor: 1.5% (Max.)
- Insulation Resistance: 10,000 megohms (min.)
- Test Frequency: 1,000 Hz
- Flash Voltage: 2.5x rated 5 sec max
- Lead Length = 1 in. min.

CERAMIC CAPACITORS

TEMPERATURE/FREQUENCY STABLE DISC CERAMIC CAPACITORS

Cap. pF	Tol. ±	Temp. Coef.	Max. Dia. In.	Thickness In.	Lead Spacing In.	Catalog Number
500 WVDC						
150	10%	Y5E	.236	.157	.250	SM151K
220	10%	Y5E	.236	.157	.250	SM221K
390	10%	Y5E	.236	.157	.250	SM391K
470	10%	Y5E	.236	.157	.250	SM471K
560	10%	Y5E	.236	.157	.250	SM561K
680	10%	Y5E	.236	.157	.250	SM681K
1000	10%	Y5E	.339	.157	.250	SM102K
2200	10%	Y5E	.433	.157	.250	SM222K
4700	10%	Y5E	.590	.157	.375	SM472K
6800	10%	Y5E	.748	.157	.375	SM682K
10,000	10%	Y5E	.748	.157	.375	SM103K

Cap. pF	Tol. ±	Temp. Coef.	Max. Dia. In.	Thickness In.	Lead Spacing In.	Catalog Number
1000 WVDC						
100	10%	Y5E	.236	.157	.250	SP101K
150	10%	Y5E	.236	.157	.250	SP151K
180	10%	Y5E	.236	.157	.250	SP181K
220	10%	Y5E	.236	.157	.250	SP221K
270	10%	Y5E	.236	.157	.250	SP271K
330	10%	Y5E	.236	.157	.250	SP331K
390	10%	Y5E	.236	.157	.250	SP391K
470	10%	Y5E	.236	.157	.250	SP471K
560	10%	Y5E	.291	.157	.250	SP561K
680	10%	Y5E	.291	.157	.250	SP681K
1000	10%	Y5E	.374	.157	.250	SP102K
1500	10%	Y5E	.433	.157	.250	SP152K
1800	10%	Y5E	.433	.157	.250	SP182K
2200	10%	Y5E	.492	.157	.250	SP222K
3300	10%	Y5E	.590	.157	.375	SP332K
3900	10%	Y5E	.669	.157	.375	SP392K
4700	10%	Y5E	.669	.157	.375	SP472K

EIA Class 2 High Voltage Disc Ceramic Capacitors

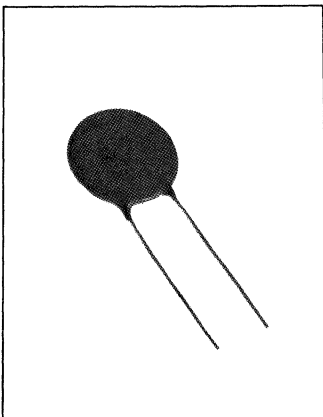

These discs are designed around EIA Test Specification RS-165A. These capacitors are designed for low frequency use. Highly efficient for bypass and coupling applications. For pricing, refer to price sheet no. 410.

HIGHLIGHTS

- Capacitance Range: 100 to 10,000 pF
- Voltage: 2,000 and 3,000 VDC
- Power Factor: 2.5% (Max.)
- Insulation Resistance: 10,000 megohms (min.)
- Test Frequency: 1,000 Hz
- Flash Voltage: 2.5x rated 5 sec max
- Lead Length = 1 in. min.

HIGH VOLTAGE CLASS 2 DISC CERAMICS

Cap. pF	Tol. ±	Temp. Coef.	Max. Dia. In.	Thickness In.	Lead Spacing In.	Catalog Number
2,000 WVDC						
1,000	20%	Y5U	.394	.157	.250	HS102M
10,000	20%	Y5U	.905	.157	.375	HS103M
3,000 WVDC						
270	20%	Y5P	.394	.197	.375	HT271M
330	20%	Y5P	.394	.197	.375	HT331M
470	20%	Y5P	.394	.197	.375	HT471M
560	20%	Y5P	.394	.197	.375	HT561M
680	20%	Y5P	.472	.197	.375	HT681M
1,000	20%	Y5U	.394	.197	.375	HT102M
1,500	20%	Y5U	.590	.197	.375	HT152M
1,800	20%	Y5U	.590	.197	.375	HT182M
2,200	20%	Y5U	.590	.197	.375	HT222M
4,700	20%	Y5U	.787	.197	.375	HT472M

EIA Class 3, Semiconductor Type, Reduced Titanite Discs

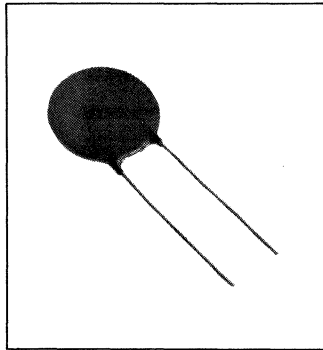

Mallory reduced titanite ceramic discs are ideal for use in transistorized circuitry for bypass and coupling applications. Ultra miniature in size they are economical replacements for electrolytic capacitors of similar capacitance values because of their low power factor and superior radio frequency impedance characteristics. Mallory Type L discs meet or exceed EIA RS-198B specifications for Class 3 ceramic capacitors.

Disc ceramic capacitor Mallobins are available. See complete Mallobin listing, page 150. For pricing reference price sheet no. 410.

HIGHLIGHTS

Capacitance Range: 0.01 to 0.22 μ F
 Voltage: 12, 25 and 50 WVDC
 Insulation Resistance: 1 megohm (min.)
 Operating Frequency: 1,000 Hz
 Power Factor: 7% (max.)
 Flash Voltage: 2.5 x Rated, 5 sec
 Lead Length; 1 inch min.

CLASS 3, SEMICONDUCTOR TYPE REDUCED TITANITE CERAMIC DISC CAPS.

Cap. μ F	Tol. %	Temp. Coef.	Dia. In.	Thickness In.	Lead Spacing	Catalog Number
12 WVDC						
.047	± 20	Y5U	.235	.156	.250	LA473M
.10	± 20	Y5U	.287	.156	.250	LA104M
.22	± 20	Y5U	.433	.156	.250	LA224M
25 WVDC						
.01	± 20	Y5R	.197	.156	.250	LC103M
.022	± 20	Y5R	.236	.156	.250	LC223M
.033	± 20	Y5R	.276	.156	.250	LC333M
.047	± 20	Y5R	.315	.156	.250	LC473M

Cap. μ F	Tol. %	Temp. Coef.	Dia. In.	Thickness In.	Lead Spacing	Catalog Number
25 WVDC						
.10	± 20	Y5R	.433	.156	.250	LC104M
.22	± 20	Y5U	.472	.156	.250	LC224M
50 WVDC						
.01	± 20	Y5U	.236	.156	.250	LE103M
.022	± 20	Y5U	.236	.156	.250	LE223M
.047	± 20	Y5U	.354	.156	.250	LE473M
.10	± 20	Y5U	.433	.156	.250	LE104M

U.L. & CSA Recognized, Across-The-Line Disc Ceramic Capacitors

Underwriters Laboratories and C.S.A. recognized for use in across the line and AC bypass applications rated 150V rms @ 60Hz. The UN types also meet or exceed all of the EIA RS-165, Class 2 ceramic disc capacitor specifications for Z5U. **For pricing, refer to price sheet no. 410.**

HIGHLIGHTS

Capacitance Range: 1,000 to 10,000 pF
 Voltage: 150V rms
 Power Factor: 2.5% @ 1KC
 Insulation Resistance = 10,000 megohms (min.)
 Operating Frequency: 50-60Hz
 UL Yellow Card No. E32491(N)
 Lead Length = 1 in. min.

**150 VAC (RMS) 1400 VDC
 U/L RECOGNIZED, ACROSS-THE-LINE,
 A-C BYPASS DISC CERAMIC CAPACITORS**

Cap. pF	Tol. %	Temp. Coef.	Max. Dia. In.	Thickness In.	Lead Spacing In.	Catalog Number
1,000	± 20	Z5U	.470	.225	.375	UN102M
1,500	± 20	Z5U	.590	.225	.375	UN152M
2,000	± 20	Z5U	.590	.225	.375	UN202M
3,000	± 20	Z5U	.720	.225	.375	UN302M
4,700	± 20	Z5U	.960	.225	.375	UN472M
5,000	± 20	Z5U	.960	.225	.375	UN502M
6,800	± 20	Z5U	1.10	.225	.375	UN682M
10,000	± 20	Z5U	1.10	.225	.500	UN103M
10,000	± 20	Z5U	1.10	.225	.375	UN103MS

Spark-Arrestor Disc Ceramics

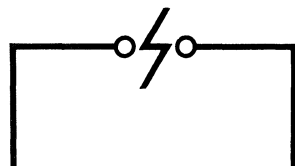

TYPE 1

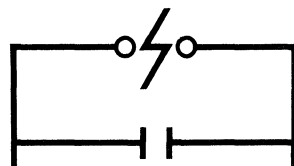

TYPE 2

The Type 1 Spark-arrestors consist of a wire loop encased in phenolic resin. After the loop has been encased, a precise slot is cut through the wire loop and its protective case to form a gap. Type 1 does not include a parallel disc ceramic. Type 2, Spark-arrestors, is a combination of a

ceramic disc in parallel with the gap. Useful in either industrial or commercial applications which require bypassing of transient over voltages. The precise gap allows the stray transients to be harmlessly bypassed. Temp. Characteristic = Z5U. **For pricing, refer to price sheet no. 410.**

SPARK-ARRESTOR DISC CERAMICS

Cap.	Voltage	Type	Dia. In.	HT In.	Lead Spacing In.	Catalog Number
1-3 KVDC						
*.75pF max.	1-2 KVDC	1	.350	.500	.250	ASR75A
*.75pF max.	2-3 KVDC	1	.350	.500	.250	ATR75A
†.01 μ F	2-3 KVDC	2	.770	1.00	.375	AT103A
+80, -20%						

*Inherent capacity of gap only. No parallel disc ceramic.

†Includes parallel disc ceramic.

Type M Multilayer Ceramic Capacitors

Reliable performance of these conformally coated parts is built-in through automated manufacture and precision process control techniques that assure uniform dielectric thickness, excellent electrode integrity, and electrode-to-termination continuity. Internal construction consists of the same superior monolithic body used in Mallory's molded capacitor. Encapsulation consists of a multilayer moisture and shock resistant coating that meets the flame test requirements of Underwriter's Laboratory Standard 94. Additional CV values, sizes and lead configurations are available on special

order. For pricing refer to price sheet No. 417. Request Bulletin 9-760A for complete information. Multilayer Ceramic Capacitor Mallobins are available. See complete Mallobin listing, page 150.

HIGHLIGHTS

Capacitance Range: 1.0pF to 3.3 μ F
Voltage Range: 50, 100, and 200WVDC
Temperature Coefficients; Z5U, X7R, and NPO

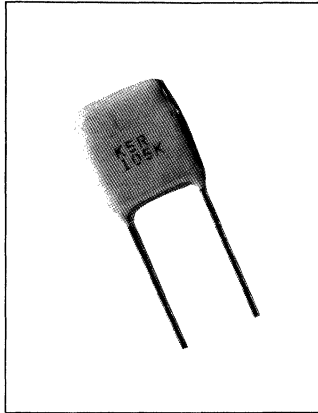

CERAMIC CAPACITORS

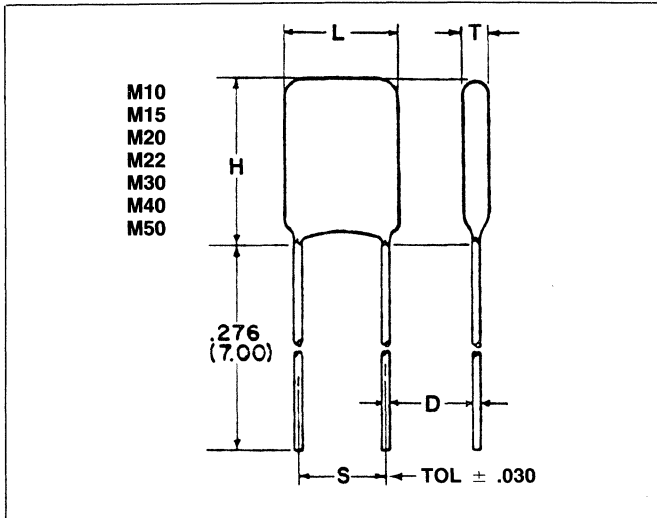

DIMENSIONS — INCHES (MILLIMETERS)					
Case Code	L	H	T	S	D & Awg #
M10	.120 (3.05)	.160 (4.06)	.100 (2.54)	.100 (2.54)	.016 (.41) 26
M15	.150 (3.81)	.210 (5.33)	.100 (2.54)	.100 (2.54)	.016 (.41) 26
M20	.200 (5.08)	.260 (6.60)	.125 (3.18)	.100 (2.54)	.020 (.51) 24
M22	.200 (5.08)	.260 (6.60)	.125 (3.18)	.200 (5.08)	.020 (.51) 24
M30	.300 (7.62)	.360 (9.14)	.150 (3.81)	.200 (5.08)	.020 (.51) 24
M40	.400 (10.16)	.460 (11.68)	.150 (3.81)	.200 (5.08)	.020 (.51) 24
M50	.500 (12.70)	.560 (14.22)	.200 (5.08)	.400 (10.16)	0.25 (.64) 22

RATINGS & CATALOG NUMBER REFERENCE

STABLE TEMPERATURE CHARACTERISTIC: EIA X7R

200 Volts		100 Volts		50 Volts	
Capacitance	Catalog Number	Capacitance	Catalog Number	Capacitance	Catalog Number
CASE CODE M10					
180 pF	M10R181*2	820 pF	M10R821*1	3,300 pF	M10R332*5
220 pF	M10R221*2	1,000 pF	M10R102*1	4,700 pF	M10R472*5
270 pF	M10R271*2	1,500 pF	M10R152*1	.01 μ F	M10R103*5
330 pF	M10R331*2				
470 pF	M10R471*2				
560 pF	M10R561*2				
680 pF	M10R681*2				
CASE CODE M15					
270 pF	M15R271*2	1,000 pF	M15R102*1	.01 μ F	M15R103*5
330 pF	M15R331*2	1,500 pF	M15R152*1		
390 pF	M15R391*2	2,700 pF	M15R272*1		
470 pF	M15R471*2				
820 pF	M15R821*2				
1,000 pF	M15R102*2				

* = Specify Tolerance. K = \pm 10%, M = \pm 20%.

Δ = Insert "0" for M20 Series or .100" lead spacing
Insert "2" for M22 Series or .200" lead spacing

Type M Multilayer Ceramic Capacitors

RATINGS & CATALOG NUMBER REFERENCE STABLE TEMPERATURE CHARACTERISTIC: EIA X7R

200 Volts		100 Volts		50 Volts	
Capacitance	Catalog Number	Capacitance	Catalog Number	Capacitance	Catalog Number
CASE CODE M20 or M22					
1,000 pF	M2△R102*2	4,700 pF	M2△R472*1	.015 μF	M2△R153*5
1,200 pF	M2△R122*2			.018 μF	M2△R183*5
1,500 pF	M2△R152*2			.022 μF	M2△R223*5
2,200 pF	M2△R222*2	.01 μF	M2△R103*1	.027 μF	M2△R273*5
2,700 pF	M2△R272*2			.033 μF	M2△R333*5
3,300 pF	M2△R332*2			.047 μF	M2△R473*5
4,700 pF	M2△R472*2	.022 μF	M2△R223*1	.068 μF	M2△R683*5
5,600 pF	M2△R562*2			.1 μF	M2△R104*5
6,800 pF	M2△R682*2	.033 μF	M2△R333*1		
.01 μF	M2△R103*2	.039 μF	M2△R393*1		
.012 μF	M2△R123*2	.047 μF	M2△R473*1		
		.068 μF	M2△R683*1		
CASE CODE M30					
		.082 μF	M30R823*1	.15 μF	M30R154*5
.022 μF	M30R223*2	.1 μF	M30R104*1	.22 μF	M30R224*5
		.15 μF	M30R154*1	.33 μF	M30R334*5
.047 μF	M30R473*2	.22 μF	M30R224*1	.47 μF	M30R474*5
		.27 μF	M30R274*1	.68 μF	M30R684*5
				1.0 μF	M30R105*5
CASE CODE M40					
.1 μF	M40R104*2	.47 μF	M40R474*1	1.5 μF	M40R155*5
.15 μF	M40R154*2	.68 μF	M40R684*1	2.2 μF	M40R225*5
CASE CODE M50					
		1.0 μF	M50R105*1	3.3 μF	M50R335*5

* = Specify Tolerance. K = ±10%, M = ±20%.

△ = Insert "0" for M20 Series or .100" lead spacing
Insert "2" for M22 Series or .200" lead spacing

ULTRA-STABLE TEMPERATURE CHARACTERISTIC: EIA COG, VERNACULAR NPO

200 Volts		100 Volts	
Capacitance	Catalog Number	Capacitance	Catalog Number
CASE CODE M10			
1.0 pF	M10G109D2	120 pF	M10G121†1
1.5 pF	M10G159D2	220 pF	M10G221†1
2.2 pF	M10G229D2		
2.7 pF	M10G279D2		
3.3 pF	M10G339D2		
4.7 pF	M10G479D2		
5.6 pF	M10G569D2		
6.8 pF	M10G689D2		
8.2 pF	M10G829D2		
10 pF	M10G100†2		
12 pF	M10G120†2		
15 pF	M10G150†2		
18 pF	M10G180†2		
22 pF	M10G220†2		
27 pF	M10G270†2		
33 pF	M10G330†2		
47 pF	M10G470†2		
56 pF	M10G560†2		
68 pF	M10G680†2		
100 pF	M10G101†2		

ULTRA-STABLE TEMPERATURE CHARACTERISTIC: EIA COG, VERNACULAR NPO

200 Volts		100 Volts	
Capacitance	Catalog Number	Capacitance	Catalog Number
CASE CODE M15			
4.7 pF	M15G479D2	270 pF	M15G271†1
10 pF	M15G100†2	330 pF	M15G331†1
12 pF	M15G120†2	390 pF	M15G391†1
15 pF	M15G150†2	470 pF	M15G471†1
22 pF	M15G220†2	560 pF	M15G561†1
27 pF	M15G270†2		
33 pF	M15G330†2		
39 pF	M15G390†2		
47 pF	M15G470†2		
82 pF	M15G820†2		
100 pF	M15G101†2		
120 pF	M15G121†2		
CASE CODE M20 or M22			
3.3 pF	M2△G339D2		
5.6 pF	M2△G569D2		
10 pF	M2△G100†2		
22 pF	M2△G220†2		
27 pF	M2△G270†2		

△ = Insert "0" for M20 Series or .100" lead spacing
Insert "2" for M22 Series or .200" lead spacing

† = Insert J for ±5%, K for ±10% (Ratings < 10pF available in ±.5pF D tolerance only)

Type M Multilayer Ceramic Capacitors

CERAMIC CAPACITORS

**ULTRA-STABLE TEMPERATURE CHARACTERISTIC: EIA COG,
VERNACULAR NPO**

200 Volts		100 Volts	
Capacitance	Catalog Number	Capacitance	Catalog Number
CASE CODE M20 or M22			
33 pF	M2△G330†2	1,000 pF	M2△G102†1
47 pF	M2△G470†2	1,200 pF	M2△G122†1
100 pF	M2△G101†2	1,800 pF	M2△G182†1
150 pF	M2△G151†2	2,200 pF	M2△G222†1
180 pF	M2△G181†2	2,700 pF	M2△G272†1
220 pF	M2△G221†2	3,300 pF	M2△G332†1
330 pF	M2△G331†2	3,900 pF	M2△G392†1
470 pF	M2△G471†2	4,700 pF	M2△G472†1
560 pF	M2△G561†2		
820 pF	M2△G821†2		
1,000 pF	M2△G102†2		
1,200 pF	M2△G122†2		
1,500 pF	M2△G152†2		
CASE CODE M30			
3,300 pF	M30G332†2	6,800 pF	M30G682†1
3,900 pF	M30G392†2	8,200 pF	
4,700 pF	M30G472†2	.01 μF	M30G103†1
		.015 μF	
		.018 μF	
		.022 μF	
8,200 pF	M30G822†2		
.01 μF	M30G103†2		
CASE CODE M40			
.033 μF	M40G333†2	.047 μF	M40G473†1

△ = Insert "0" for M20 Series or .100" lead spacing
 Insert "2" for M22 Series or .200" lead spacing

† = Insert J for ±5%, K for ±10% (Ratings < 10pF available in ±.5pF D tolerance only)

**GENERAL-PURPOSE TEMPERATURE CHARACTERISTIC: EIA Z5U
(STANDARD), ±20% TOLERANCE**

100 Volts		50 Volts	
Capacitance	Catalog Number	Capacitance	Catalog Number
CASE CODE M10			
1500 pF	M10U152M1	4700 pF	M10U472M5
		.01 μF	M10U103M5
CASE CODE M15			
1500 pF	M15U152M1	.01 μF	M15U103M5
2700 pF	M15U272M1		
CASE CODE M20 or M22			
		.027 μF	M2△U273M5
.01 μF	M2△U103M1	.033 μF	M2△U333M5
		.047 μF	M2△U473M5
		.068 μF	M2△U683M5
.022 μF	M2△U223M1	.1 μF	M2△U104M5
.033 μF	M2△U333M1	.15 μF	M2△U154M5
.039 μF	M2△U393M1	.22 μF	M2△U224M5
.047 μF	M2△U473M1		
.068 μF	M2△U683M1		
CASE CODE M30			
.082 μF	M30U823M1	.33 μF	M30U334M5
.1 μF	M30U104M1	.47 μF	M30U474M5
.15 μF	M30U154M1	.68 μF	M30U684M5
.22 μF	M30U224M1		
.27 μF	M30U274M1		
.33 μF	M30U334M1	1.0 μF	M30U105M5
CASE CODE M40			
.47 μF	M40U474M1	1.5 μF	M40U155M5
.68 μF	M40U684M1	2.2 μF	M40U225M5
CASE CODE M50			
		3.3 μF	M50U335M5

CAPACITOR MARKINGS

SIZE M10 & M15

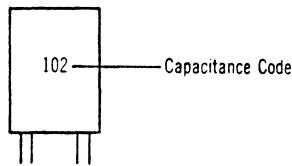

SIZE M20 & M22

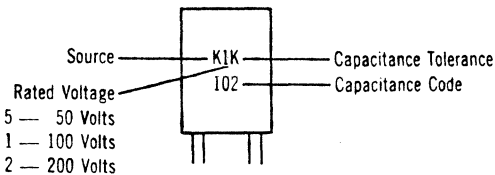

SIZE M30

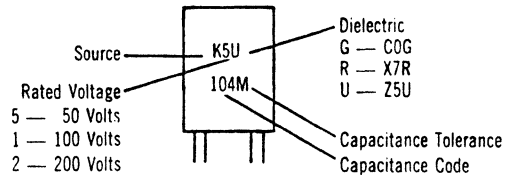

SIZE M40 & M50

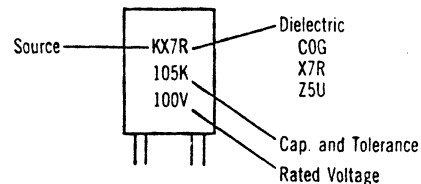

Type P ● Series - Axial Leaded

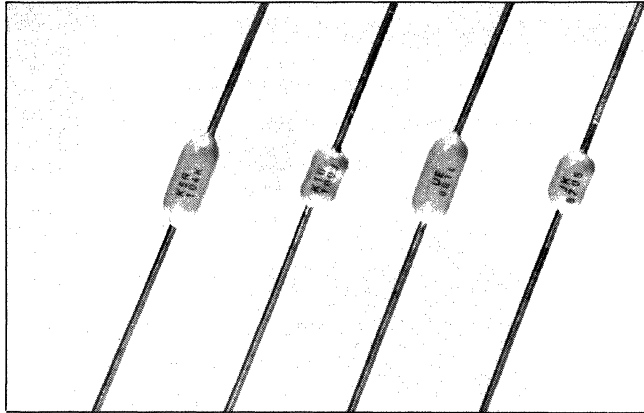

Multilayer Ceramic Capacitors

High capacitance in a small case size is achieved through the use of multiple precious metal electrodes in the construction of the capacitor. Alternate layers of ceramic dielectric and electrode are stacked and compressed and then sintered into a single structure, hence the term "monolithic" capacitor. The resulting capacitor chip is then conformally coated in a moisture and shock resistant epoxy encapsulant.

Highlights

Capacitance: To 6.8 μ F
Voltage: 50, 100 & 200 VDC
Tolerance: \pm 0.5pF (D), \pm 5% (J), \pm 10% (K), \pm 20% (M)
Temperature Coefficients: Z5U, X7R, and NPO (COG)

Key Features

Epoxy-Dipped Multilayer Styles
Axial Leads
Low Dissipation Factor
High Insulation Resistance
Laser Marking

Applications

Filtering
Bypass
Coupling

Ordering Information

Catalog Number

2 0 G 1 0 2 M 2

Capacitor Series / Case Code:

P = Axial
(See case code charts for dimensions)

Dielectric: G = NPO (COG) Ultra-Stable
R = X7R Stable
U = Z5U General Purpose

Capacitance Code:

(Expressed in picofarads)
First 2 Digits - Significant Figures
Third Digit - Number of Zeros following
(Use 9 for 1.0 through 9.9 pF - example: 2.2pF = 229)

Voltage: 2 = 200V
1 = 100V
5 = 50V

Capacitance Tolerance:
D = \pm 0.5pF (<10pF only)
J = \pm 5%
K = \pm 10%
M = \pm 20%

Outline Drawing and Dimensions

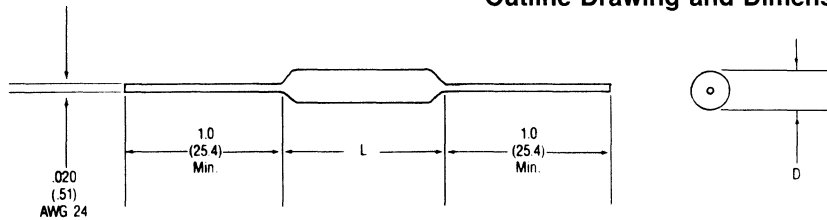

CAPACITOR MARKINGS

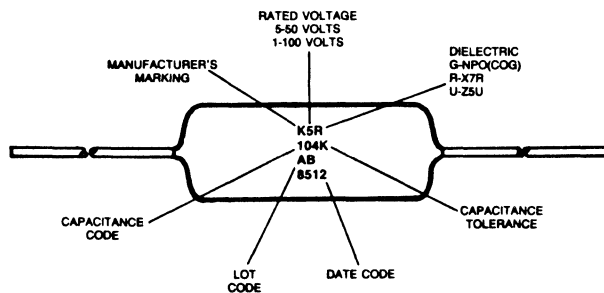

Maximum Dimensions - Inches & (Millimeters)		
Case Code	D	L
P10	.100 (2.54)	.170 (4.32)
P12	.120 (3.05)	.170 (4.32)
P20	.100 (2.54)	.260 (6.60)
P30	.150 (3.81)	.290 (7.37)
P40	.150 (3.81)	.400 (10.16)

Type P • Series - Axial Leaded

Standard Ratings
P Series - Axial Leaded Multilayer Ceramic
Capacitors

ULTRA-STABLE TEMPERATURE CHARACTERISTIC: NPO (COG)

100 Volts		50 Volts	
Capacitance	Catalog Number	Capacitance	Catalog Number
CASE CODE P10			
10 pF	P10G100†1	560 pF	P10G561†5
12 pF	P10G120†1	680 pF	P10G681†5
15 pF	P10G150†1	820 pF	P10G821†5
18 pF	P10G180†1	1,000 pF	P10G102†5
22 pF	P10G220†1		
27 pF	P10G270†1		
33 pF	P10G330†1		
39 pF	P10G390†1		
47 pF	P10G470†1		
56 pF	P10G560†1		
68 pF	P10G680†1		
82 pF	P10G820†1		
100 pF	P10G101†1		
120 pF	P10G121†1		
150 pF	P10G151†1		
180 pF	P10G181†1		
220 pF	P10G221†1		
270 pF	P10G271†1		
330 pF	P10G331†1		
390 pF	P10G391†1		
470 pF	P10G471†1		
CASE CODE P20			
560 pF	P20G561†1	1,200 pF	P20G122†5
680 pF	P20G681†1	1,500 pF	P20G152†5
820 pF	P20G821†1	1,800 pF	P20G182†5
1,000 pF	P20G102†1	2,200 pF	P20G222†5
1,200 pF	P20G122†1		
1,500 pF	P20G152†1		
CASE CODE P30			
1,800 pF	P30G182†1	2,700 pF	P30G272†5
2,200 pF	P30G222†1	3,300 pF	P30G332†5
2,700 pF	P30G272†1	3,900 pF	P30G392†5
3,300 pF	P30G332†1	4,700 pF	P30G472†5
3,900 pF	P30G392†1	5,600 pF	P30G562†5
4,700 pF	P30G472†1		
CASE CODE P40			
5,600 pF	P40G562†1	6,800 pF	P40G682†5
6,800 pF	P40G682†1	8,200 pF	P40G822†5
		.01 μF	P40G103†5

† = Tolerance. Insert J for ± 5%, K for ± 10%.

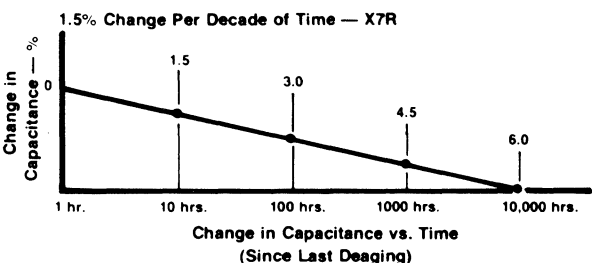

Typical Performance Curve

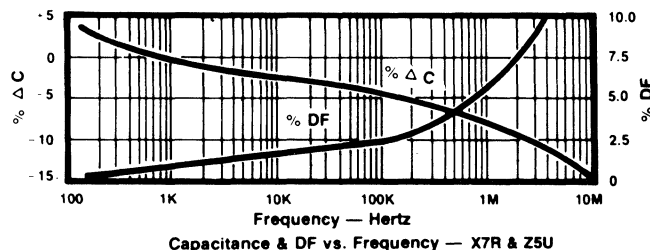
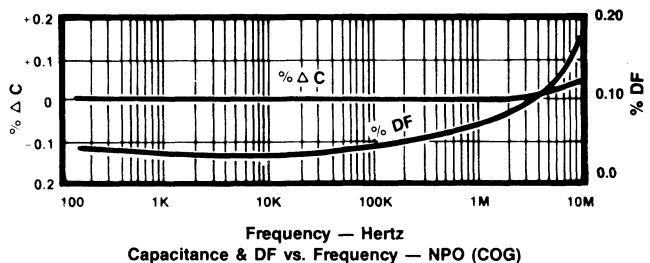
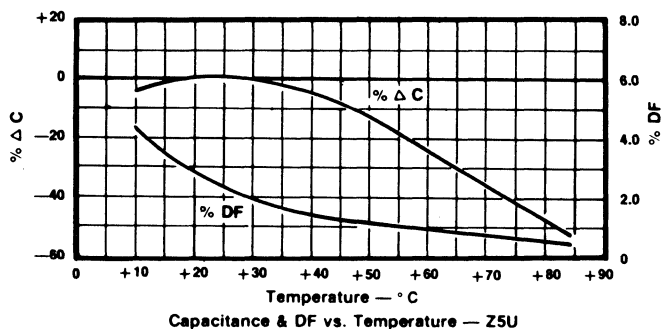
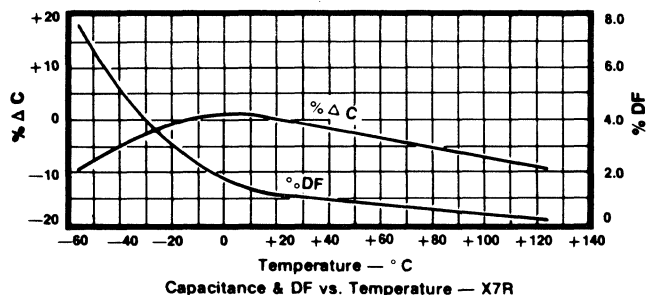
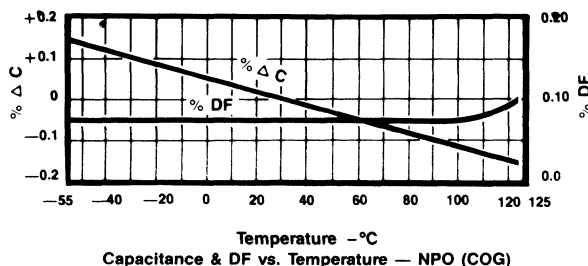

• New Product

Type P • Series - Axial Leaded

STABLE TEMPERATURE CHARACTERISTIC: X7R

100 Volts		50 Volts	
Capacitance	Catalog Number	Capacitance	Catalog Number
CASE CODE P10			
470 pF	P10R471*1	.01 μF	P10R103*5
560 pF	P10R561*1	.012 μF	P10R123*5
680 pF	P10R681*1	.015 μF	P10R153*5
820 pF	P10R821*1	.018 μF	P10R183*5
1,000 pF	P10R102*1	.022 μF	P10R223*5
1,200 pF	P10R122*1	.027 μF	P10R273*5
1,500 pF	P10R152*1	.033 μF	P10R333*5
1,800 pF	P10R182*1	.039 μF	P10R393*5
2,200 pF	P10R222*1	.047 μF	P10R473*5
2,700 pF	P10R272*1		
3,300 pF	P10R332*1		
3,900 pF	P10R392*1		
4,700 pF	P10R472*1		
5,600 pF	P10R562*1		
6,800 pF	P10R682*1		
8,200 pF	P10R822*1		
.01 μF	P10R103*1		
CASE CODE P20			
.012 μF	P20R123*1	.056 μF	P20R563*5
.015 μF	P20R153*1	.068 μF	P20R683*5
.018 μF	P20R183*1	.082 μF	P20R823*5
.022 μF	P20R223*1	.1 μF	P20R104*5
.027 μF	P20R273*1		
CASE CODE P30			
.033 μF	P30R333*1	.12 μF	P30R124*5
.039 μF	P30R393*1	.15 μF	P30R154*5
.047 μF	P30R473*1	.18 μF	P30R184*5
.056 μF	P30R563*1	.22 μF	P30R224*5
.068 μF	P30R683*1		
CASE CODE P40			
.082 μF	P40R823*1	.27 μF	P40R274*5
.1 μF	P40R104*1		
.12 μF	P40R124*1		

* = Tolerance. Insert K for ± 10%, M for ± 20%.

GENERAL-PURPOSE TEMPERATURE CHARACTERISTIC: Z5U

100 Volts		50 Volts	
Capacitance	Catalog Number	Capacitance	Catalog Number
CASE CODE P10			
.01 μF	P10U103M1	.027 μF	P10U273M5
.012 μF	P10U123M1	.033 μF	P10U333M5
.015 μF	P10U153M1	.039 μF	P10U393M5
.018 μF	P10U183M1	.047 μF	P10U473M5
.022 μF	P10U223M1	.056 μF	P10U563M5
		.068 μF	P10U683M5
		.082 μF	P10U823M5
		.1 μF	P10U104M5
CASE CODE P12			
		.12 μF	P12U124M5
		.15 μF	P12U154M5
		.18 μF	P12U184M5
		.22 μF	P12U224M5
		.27 μF	P12U274M5
		.33 μF	P12U334M5
CASE CODE P20			
.027 μF	P20U273M1	.12 μF	P20U124M5
.033 μF	P20U333M1	.15 μF	P20U154M5
.039 μF	P20U393M1	.18 μF	P20U184M5
.047 μF	P20U473M1		
CASE CODE P30			
.056 μF	P30U563M1	.22 μF	P30U224M5
.068 μF	P30U683M1	.27 μF	P30U274M5
.082 μF	P30U823M1	.33 μF	P30U334M5
.1 μF	P30U104M1	.39 μF	P30U394M5
.12 μF	P30U124M1	.47 μF	P30U474M5
.15 μF	P30U154M1		
CASE CODE P40			
.18 μF	P40U184M1	.56 μF	P40U564M5
.22 μF	P40U224M1	.68 μF	P40U684M5
		.82 μF	P40U824M5
		1.0 μF	P40U105M5

CERAMIC CAPACITORS

Performance Characteristics

GENERAL

Capacitance:

NPO (COG) - 10pF to .01μF (Axial)
 X7R - 470pF to .27μF (Axial)
 Z5U - .01μF to 1.0μF (Axial)

Working Voltage:

NPO (COG) - 50 & 100 Volts (Axial)
 X7R - 50 & 100 Volts (Axial)
 Z5U - 50 & 100 Volts (Axial)

Temperature Characteristic:

NPO (COG) - 0 ± 30 PPM/°C from - 55° to + 125°C
 X7R - ± 15% from - 55° to + 125°C
 Z5U - + 22%, - 56% from + 10°C to + 85°C

Capacitance Tolerance:

NPO (COG) - ± 0.5pF, ± 5%, ± 10%
 X7R - ± 10%, ± 20%
 Z5U - ± 20%

Construction:

Epoxy encapsulated - meets flame test requirements of UL Standard 94.
 High temperature solder (meets EIA RS-198C, method B4, condition B)

Lead Material:

Solder Coated Copper Clad Steel

Case Color:

Gold

ELECTRICAL

***Capacitance:**

Within specified tolerance at 25°C and following test conditions.
 NPO (COG) - Greater than 1000 pF with 1.0 vrms at 1 KHz.
 - 1000 pF and less with 1.0 vrms at 1 MHz.
 X7R - with 1.0 vrms at 1 KHz
 Z5U - with 0.5 vrms at 1 KHz

Dissipation Factor:

At 25°C - same test conditions as capacitance.
 NPO (COG) - 0.15% maximum
 X7R - 2.5% maximum
 Z5U - 3.0% maximum

Insulation Resistance:

EIA RS-198C, Method A4, Condition A (after 2 minutes electrification at 25°C and rated voltage)
 NPO (COG) - 100K megohms or 1000 megohm - μF, whichever is less.
 X7R - 100K megohms or 1000 megohm - μF, whichever is less.
 Z5U - 10K megohms or 1000 megohm - μF, whichever is less.

Dielectric Withstanding Voltage:

EIA RS-198C, Method A3 (250% of rated voltage with current limited to 50 mA at 25°C).

*NOTE: X7R & Z5U dielectrics exhibit aging characteristics; therefore, it is highly recommended that capacitors be deaged for 2 hours at 150°C and stabilized at room temperature for 48 hours before capacitance measurements are made.

Monolithic Ceramic Capacitors

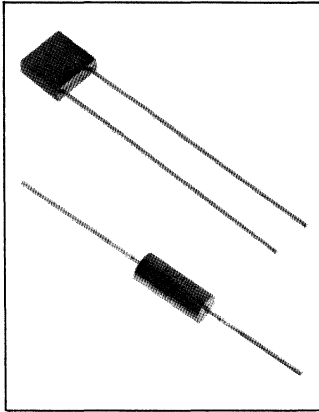

Mallory ceramic capacitors are offered in the most popular temperature characteristics. These are designated by the Electronics Industry Association (EIA), the stable X7R (military BX or BR). For pricing refer to price sheet No. 415 and No. 416. Request Bulletin 9-760 for complete information. Monolithic Capacitor Mallobins are available. See complete Mallobin listing, page 150.

HIGHLIGHTS

Capacitance Range: 10pF to 3.3μF
 Voltage Range: 50, 100, and 200 WVDC
 Military Styles: MIL-C-11015 and MIL-C-39014

CERAMIC CAPACITORS

Stable Temperature Characteristic: EIA X7R; Military BX & BR Ratings & Part Number Reference
CK05, CKR06 or MIL-C-39014/01

Cap (pF)	Tol (%)	MIL-C-11015/18 Part No.	MIL-C-39014/01 Style No.	MIL-C-39014/01 Dash No. for Failure Rate Levels			
				M	P	R	S
200 WVDC							
10	10	CK05BX100K	CKR05BX100K*	1201	1241	1281	1321
12	10	CK05BX120K	CKR05BX120K*	1203	1243	1283	1323
15	10	CK05BX150K	CKR05BX150K*	1204	1244	1284	1324
18	10	CK05BX180K	CKR05BX180K*	1206	1246	1286	1326
22	10	CK05BX220K	CKR05BX220K*	1207	1247	1287	1327
27	10	CK05BX270K	CKR05BX270K*	1209	1249	1289	1329
33	10	CK05BX330K	CKR05BX330K*	1210	1250	1290	1330
39	10	CK05BX390K	CKR05BX390K*	1212	1252	1292	1332
47	10	CK05BX470K	CKR05BX470K*	1213	1253	1293	1333
56	10	CK05BX560K	CKR05BX560K*	1215	1255	1295	1335
68	10	CK05BX680K	CKR05BX680K*	1216	1256	1296	1336
82	10	CK05BX820K	CKR05BX820K*	1218	1258	1298	1338
100	10	CK05BX101K	CKR05BX101K*	1219	1259	1299	1339
120	10	CK05BX121K	CKR05BX121K*	1221	1261	1301	1341
150	10	CK05BX151K	CKR05BX151K*	1222	1262	1302	1342
180	10	CK05BX181K	CKR05BX181K*	1224	1264	1304	1344
220	10	CK05BX221K	CKR05BX221K*	1225	1265	1305	1345
270	10	CK05BX271K	CKR05BX271K*	1227	1267	1307	1347
330	10	CK05BX331K	CKR05BX331K*	1228	1268	1308	1348
390	10	CK05BX391K	CKR05BX391K*	1230	1270	1310	1350
470	10	CK05BX471K	CKR05BX471K*	1231	1271	1311	1351
560	10	CK05BX561K	CKR05BX561K*	1233	1273	1313	1353
680	10	CK05BX681K	CKR05BX681K*	1234	1274	1314	1354
680	20	CK05BX681M	CKR05BX681M*	1235	1275	1315	1355
820	10	CK05BX821K	CKR05BX821K*	1236	1276	1316	1356
1,000	10	CK05BX102K	CKR05BX102K*	1237	1277	1317	1357
1,000	20	CK05BX102M	CKR05BX102M*	1238	1278	1318	1358
100 WVDC							
1,200	10	CK05BX122K	CKR05BX122K*	1239	1279	1319	1359
1,500	10	CK05BX152K	CKR05BX152K*	1240	1280	1320	1360
1,800	10	CK05BX182K	CKR05BX182K*	1442	1482	1522	1562
2,200	10	CK05BX222K	CKR05BX222K*	1443	1483	1523	1563
2,700	10	CK05BX272K	CKR05BX272K*	1445	1485	1525	1565
3,300	10	CK05BX332K	CKR05BX332K*	1446	1486	1526	1566
3,900	10	CK05BX392K	CKR05BX392K*	1448	1488	1528	1568
4,700	10	CK05BX472K	CKR05BX472K*	1449	1489	1529	1569
4,700	20	CK05BX472M	CKR05BX472M*	1450	1490	1530	1570
5,600	10	CK05BX562K	CKR05BX562K*	1451	1491	1531	1571
6,800	10	CK05BX682K	CKR05BX682K*	1452	1492	1532	1572
8,200	10	CK05BX822K	CKR05BX822K*	1454	1494	1534	1574
10,000	10	CK05BX103K	CKR05BX103K*	1455	1495	1535	1575
10,000	20	CK05BX103M	CKR05BX103M*	1456	1496	1536	1576

CK05, CKR06 or MIL-C-39014/01

Cap (pF)	Tol. (%)	MIL-C-11015/19 Part No.	MIL-C-390014/01 Style No.	MIL-C-39014/01 Dash No. for Failure Rate Levels			
				M	P	R	S
50 WVDC							
12,000	10	CK05BX123K	CKR05BX123K*	1457	1497	1537	1577
15,000	10	CK05BX153K	CKR05BX153K*	1458	1498	1538	1578
18,000	10	CK05BX183K	CKR05BX183K*	1460	1500	1540	1580
22,000	10	CK05BX223K	CKR05BX223K*	1461	1501	1541	1581
27,000	10	CK05BX273K	CKR05BX273K*	1463	1503	1543	1583
33,000	10	CK05BX333K	CKR05BX333K*	1464	1504	1544	1584
39,000	10	CK05BX393K	CKR05BX393K*	1466	1506	1546	1586
47,000	10	CK05BX473K	CKR05BX473K*	1467	1507	1547	1587
56,000	10	CK05BX563K	CKR05BX563K*	1469	1509	1549	1589
68,000	10	CK05BX683K	CKR05BX683K*	1470	1510	1550	1590
82,000	10	CK05BX823K	CKR05BX823K*	1472	1512	1552	1592
100,000	10	CK05BX104K	CKR05BX104K*	1473	1513	1553	1593
100,000	20	CK05BX104M	CKR05BX104M*	1474	1514	1554	1594

CK06, CKR06 or MIL-C-39014/02

Cap (pF)	Tol. (%)	MIL-C-11015/19 Part No.	MIL-C-390014/02 Style No.	MIL-C-39014/02 Dash No. for Failure Rate Levels			
				M	P	R	S
200 WVDC							
1,200	10	CK06BX122K	CKR06BX122K*	1201	1241	1281	1321
1,500	10	CK06BX152K	CKR06BX152K*	1202	1242	1282	1322
1,800	10	CK06BX182K	CKR06BX182K*	1204	1244	1284	1324
2,200	10	CK06BX222K	CKR06BX222K*	1206	1246	1286	1326
2,700	10	CK06BX272K	CKR06BX272K*	1208	1248	1288	1328
3,300	10	CK06BX332K	CKR06BX332K*	1209	1249	1289	1329
3,900	10	CK06BX392K	CKR06BX392K*	1211	1251	1291	1331
4,700	10	CK06BX472K	CKR06BX472K*	1212	1252	1292	1332
5,600	10	CK06BX562K	CKR06BX562K*	1214	1254	1294	1334
6,800	10	CK06BX682K	CKR06BX682K*	1215	1255	1295	1335
6,800	20	CK06BX682M	CKR06BX682M*	1216	1256	1296	1336
8,200	10	CK06BX822K	CKR06BX822K*	1217	1257	1297	1337
10,000	10	CK06BX103K	CKR06BX103K*	1218	1258	1298	1338
10,000	20	CK06BX103M	CKR06BX103M*	1219	1259	1299	1339
100 WVDC							
12,000	10	CK06BX123K	CKR06BX123K*	1231	1271	1311	1351
15,000	10	CK06BX153K	CKR06BX153K*	1220	1260	1300	1340
18,000	10	CK06BX183K	CKR06BX183K*	1221	1261	1301	1341
22,000	10	CK06BX223K	CKR06BX223K*	1222	1262	1302	1342
27,000	10	CK06BX273K	CKR06BX273K*	1232	1272	1312	1352
33,000	10	CK06BX333K	CKR06BX333K*	1223	1263	1303	1343
39,000	10	CK06BX393K	CKR06BX393K*	1224	1264	1304	1344
47,000	10	CK06BX473K	CKR06BX473K*	1225	1265	1305	1345
56,000	10	CK06BX563K	CKR06BX563K*	1226	1266	1306	1346
68,000	10	CK06BX683K	CKR06BX683K*	1227	1267	1307	1347
82,000	10	CK06BX823K	CKR06BX823K*	1229	1269	1309	1349
100,000	10	CK06BX104K	CKR06BX104K*	1230	1270	1310	1350

*The 12th character of a CKR-style part number indicates the applicable failure rate level, M, P, R, or S.

Monolithic Ceramic Capacitors

CK06, CKR06 or MIL-C-39014/02

Cap (pF)	Tol. (%)	MIL-C-11015/19 Part No.	MIL-C-390014/02 Style No.	MIL-C-39014/02 Dash No. for Failure Rate Levels			
				M	P	R	S
50 WVDC				1.0%	0.1%	0.01%	0.001%
120,000	10	CK06BX124K	CKR06BX124K*	1233	1273	1313	1353
150,000	10	CK06BX154K	CKR06BX154K*	1234	1274	1314	1354
180,000	10	CK06BX184K	CKR06BX184K*	1235	1275	1315	1355
220,000	10	CK06BX224K	CKR06BX224K*	1236	1276	1316	1356
270,000	10	CK06BX274K	CKR06BX274K*	1237	1277	1317	1357
330,000	10	CK06BX334K	CKR06BX334K*	1238	1278	1318	1358
390,000	10	CK06BX394K	CKR06BX394K*	1239	1279	1319	1359
470,000	10	CK06BX474K	CKR06BX474K*	1240	1280	1320	1360
470,000	20	CK06BX474M	—	—	—	—	—
560,000	10	CK06BX564K	CKR06BX564K*	1404	1408	1412	1416
680,000	10	CK06BX684K	CKR06BX684K*	1405	1409	1413	1417
680,000	20	CK06BX684M	—	—	—	—	—
820,000	10	CK06BX824K	CKR06BX824K*	1406	1410	1414	1418
1,000,000	10	CK06BX105K	CKR06BX105K*	1407	1411	1415	1419
1,000,000	20	CK06BX105M	—	—	—	—	—

CK12, CKR11 or MIL-C-39014/05

Cap. (pF)	Tol. (%)	MIL-C-11015/20 Part No.	MIL-C-39014/05 Style No.	MIL-C-39014/05 Dash No. for Failure Rate Levels			
				M	P	R	S
100 WVDC				1.0%	0.1%	0.01%	0.001%
10	10	CK12BX100K	CKR11BX100K*	2601	2801	2001	2201
12	10	CK12BX120K	CKR11BX120K*	2603	2803	2003	2203
15	10	CK12BX150K	CKR11BX150K*	2604	2804	2004	2204
18	10	CK12BX180K	CKR11BX180K*	2606	2806	2006	2206
22	10	CK12BX220K	CKR11BX220K*	2607	2807	2007	2207
27	10	CK12BX270K	CKR11BX270K*	2609	2809	2009	2209
33	10	CK12BX330K	CKR11BX330K*	2610	2810	2010	2210
47	10	CK12BX470K	CKR11BX470K*	2613	2813	2013	2213
56	10	CK12BX560K	CKR11BX560K*	2615	2815	2015	2215
68	10	CK12BX680K	CKR11BX680K*	2616	2816	2016	2216
68	20	CK12BX680M	CKR11BX680M*	2617	2817	2017	2217
82	10	CK12BX820K	CKR11BX820K*	2618	2818	2018	2218
100	10	CK12BX101K	CKR11BX101K*	2619	2819	2019	2219
120	10	CK12BX121K	CKR11BX121K*	2621	2821	2021	2221
150	10	CK12BX151K	CKR11BX151K*	2622	2822	2022	2222
180	10	CK12BX181K	CKR11BX181K*	2624	2824	2024	2224
220	10	CK12BX221K	CKR11BX221K*	2625	2825	2025	2225
270	10	CK12BX271K	CKR11BX271K*	2627	2827	2027	2227
330	10	CK12BX331K	CKR11BX331K*	2628	2828	2028	2228
390	10	CK12BX391K	CKR11BX391K*	2630	2830	2030	2230
470	10	CK12BX471K	CKR11BX471K*	2631	2831	2031	2231
470	20	CK12BX471M	CKR11BX471M*	2632	2832	2032	2232
560	10	CK12BX561K	CKR11BX561K*	2633	2833	2033	2233
680	10	CK12BX681K	CKR11BX681K*	2634	2834	2034	2234
820	10	CK12BX821K	CKR11BX821K*	2636	2836	2036	2236
1,000	10	CK12BX102K	CKR11BX102K*	2637	2837	2037	2237
1,200	10	CK12BX122K	CKR11BX122K*	2639	2839	2039	2239
1,500	10	CK12BX152K	CKR11BX152K*	2640	2840	2040	2240
1,800	10	CK12BX182K	CKR11BX182K*	2642	2842	2042	2242
2,200	10	CK12BX222K	CKR11BX222K*	2643	2843	2043	2243
2,700	10	CK12BX272K	CKR11BX272K*	2645	2845	2045	2245
3,300	10	CK12BX332K	CKR11BX332K*	2646	2846	2046	2246
3,900	10	CK12BX392K	CKR11BX392K*	2648	2848	2048	2248
4,700	10	CK12BX472K	CKR11BX472K*	2649	2849	2049	2249

*The 12th character of a CKR-style part number indicates the applicable failure rate level, M, P, R, or S.

MOLDED RADIAL AND AXIAL CERAMIC INFORMATION

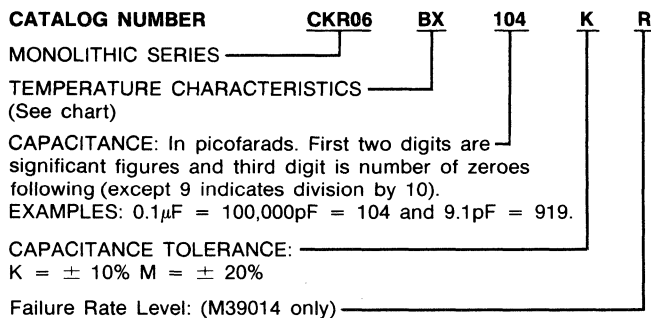

CK12, CKR11 or MIL-C-39014/05

Cap. (pF)	Tol. (%)	MIL-C-11015/20 Part No.	MIL-C-39014/05 Style No.	MIL-C-39014/05 Dash No. for Failure Rate Levels			
				M	P	R	S
50 WVDC				1.0%	0.1%	0.01%	0.001%
8,200	10	CK12BX822K	CKR11BX822K*	2654	2854	2054	2254
10,000	10	CK12BX103K	CKR11BX103K*	2655	2855	2055	2255
10,000	20	CK12BX103M	CKR11BX103M*	2656	2856	2056	2256

CK13, CKR12 or MIL-C-39014/05

Cap. (pF)	Tol. (%)	MIL-C-11015/20 Part No.	MIL-C-39014/05 Style No.	MIL-C-39014/05 Dash No. for Failure Rate Levels			
				M	P	R	S
50 WVDC				1.0%	0.1%	0.01%	0.001%
22,000	10	CK13BX223K	CKR12BX223K*	2667	2867	2067	2267
47,000	10	CK13BR473K	CKR12BR473K*	2673	2873	2073	2273

CK14, CKR14 or MIL-C-39014/05

Cap. (pF)	Tol. (%)	MIL-C-11015/20 Part No.	MIL-C-39014/05 Style No.	MIL-C-39014/05 Dash No. for Failure Rate Levels			
				M	P	R	S
100 WVDC				1.0%	0.1%	0.01%	0.001%
22,000	10	CK14BX223K	CKR14BX223K*	2679	2879	2079	2279
22,000	20	CK14BX223M	CKR14BX223M*	2680	2880	2080	2280
47,000	10	CK14BX473K	CKR14BX473K*	2685	2885	2085	2285

100 WVDC

100,000	10	CK14BR104K	CKR14BR104K*	2697	2897	2097	2297
---------	----	------------	--------------	------	------	------	------

50 WVDC

120,000	10	CK14BR124K	CKR14BR124K*	2699	2899	2099	2299
150,000	10	CK14BR154K	CKR14BR154K*	2700	2900	2100	2300
220,000	10	CK14BR224K	CKR14BR224K*	2703	2903	2103	2303

CK15, CKR15 or MIL-C-39014/05

Cap. (pF)	Tol. (%)	MIL-C-11015/20 Part No.	MIL-C-39014/05 Style No.	MIL-C-39014/05 Dash No. for Failure Rate Levels			
				M	P	R	S
100 WVDC				1.0%	0.1%	0.01%	0.001%
330,000	10	CK15BR334K	CKR15BR334K*	2719	2919	2119	2319
50 WVDC							
470,000	10	CK15BR474K	CKR15BR474K*	2721	2921	2121	2321
1,000,000	10	CK15BR105K	CKR15BR105K*	2725	2925	2125	2325

**M—1%/khr, P—0.1%/khr, R—0.01%/khr, S—0.001%/khr

*The 12th character of a CKR-style part number indicates the applicable failure rate level, M, P, R, or S.

TEMPERATURE CHARACTERISTIC

Mallory Designator	Military Equivalent	EIA Equivalent	Temp. Range, °C	Capacitance Change With Temp.	
				Measured Without DC Bias Voltage	Measured With Bias Voltage
X (Stable)	BX	X7R	-55 to +125	±15%	+15% -25%
R (Stable)	BR	X7R	-55 to +125	±15%	+15% -40%

SPECIFIED ELECTRICAL LIMITS

PARAMETER	TEMPERATURE CHARACTERISTIC	
	X7R OR BX/BR	
Dissipation Factor: Measured at 1 KHz and 1 vrms if capacitance >100pF. (1000 pF per MIL-C-20), measured at 1 MHz if capacitance ≤100pF.	2.5%	
Dielectric Strength: At 2.5 times rated DC voltage.	Pass Subsequent IR Test	
Insulation Resistance (IR): At rated DC voltage, whichever of the two is smaller.	1,000 MΩ-μF or 100 GΩ	
Temperature Characteristic: Range, °C	-55 to 125	
Capacitance Change: Without DC voltage	±15%	
At rated DC voltage	+15%, -25%	

Monolithic Ceramic Capacitors

STABLE TEMPERATURE CHARACTERISTIC EIA, X7R, MILITARY BX AND BR CAPACITOR OUTLINE DRAWINGS

RADIAL CAPACITOR MARKINGS

CK05 PER MIL-C-11015/18 &
CK06 PER MIL-C 11015/19

MOLDED CASES WITH RADIAL LEADS

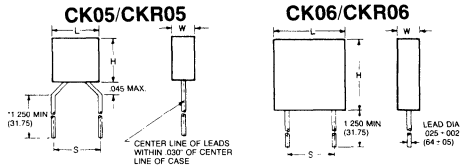

DIMENSIONS — INCHES & MILLIMETERS

MILITARY EQUIVALENT STYLES	H HEIGHT	L LENGTH	W WIDTH	S LEAD SPACING
CK05, CKR05	.190 ± .010 (4.83 ± .25)	.190 ± .010 (4.83 ± .25)	.090 ± .010 (2.29 ± .25)	.200 ± .015 (5.08 ± .38)
CK06, CKR06	.290 ± .010 (7.37 ± .25)	.290 ± .010 (7.37 ± .25)	.090 ± .010 (2.29 ± .25)	.200 ± .015 (5.08 ± .38)

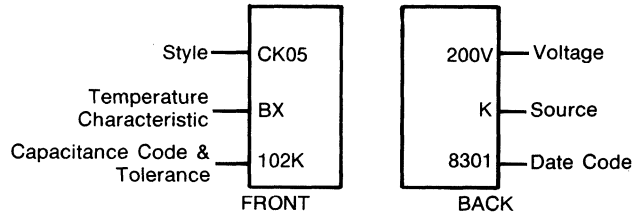

(CKR05) PER MIL-C-39014/01

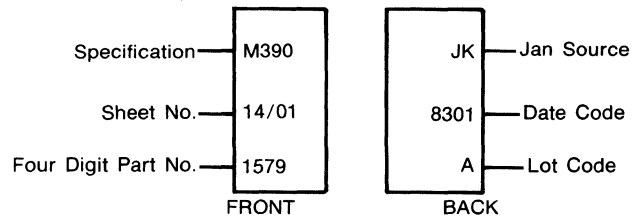

(CKR06) PER MIL-C-39014/02

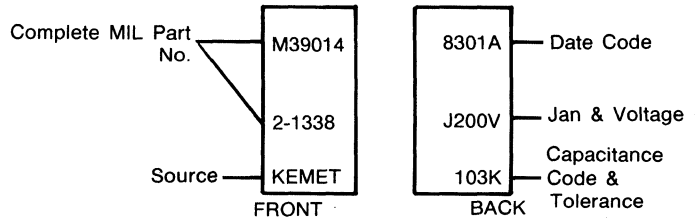

MOLDED CASES WITH AXIAL LEADS

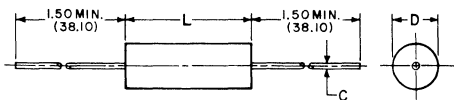

DIMENSIONS — INCHES & (MILLIMETERS)

L	D	C	Military Styles	
			MIL-C-11015	MIL-C-39014
.160 ± .010 (4.06 ± .25)	.090 ± .010 (2.29 ± .25)	.019 ± .002 (.48 ± .05)	CK12	CKR11
.250 ± .010 (6.35 ± .25)	.090 ± .010 (2.29 ± .25)	.019 ± .002 (.48 ± .05)	CK13	CKR12
.390 ± .010 (9.91 ± .25)	.140 ± .010 (3.56 ± .25)	.025 ± .002 (.64 ± .05)	CK14	CKR14
.500 ± .020 (12.70 ± .51)	.250 ± .015 (6.35 ± .38)	.025 ± .002 (.64 ± .05)	CK15	CKR15
.690 ± .030 (17.53 ± .76)	.350 ± .020 (8.89 ± .51)	.025 ± .002 (.64 ± .05)	CK16	CKR16

AXIAL CAPACITOR MARKINGS

MIL-C-11015

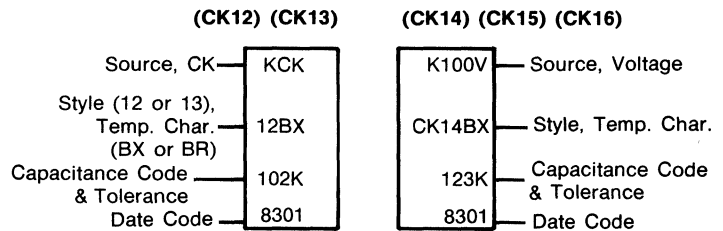

MIL-C-39014

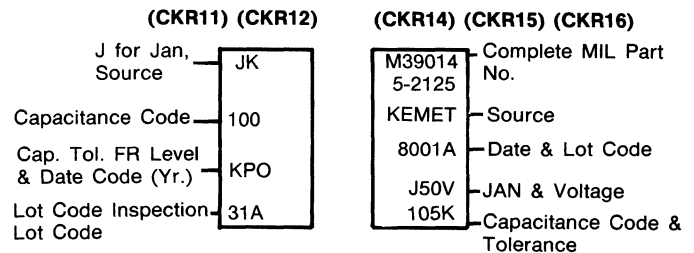

Type M60 • Multilayer Ceramic Capacitors

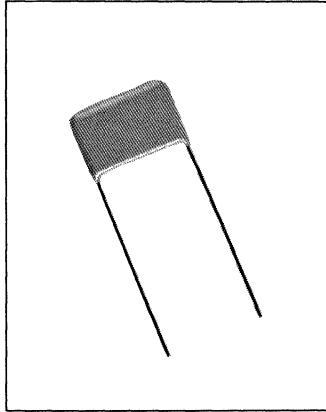

Mallory now offers a new type of Multilayer Ceramic Capacitor. The M60 Series, has a very high volumetric efficiency and excellent performance. Newly developed niobium oxide base Y5U (or X7V) dielectric material has twice as high dielectric constant compared to conventional dielectrics.

- Features**
- Highest CV value in compact size
 - Excellent capacitance stability
 - Small DC Bias voltage dependency
 - Ultra high insulation resistance at high temperature

- Application**
- Surge Suppressor for ICs
 - Filtering for switching power supplies
 - By-Pass decoupling
 - Small size electronic equipment

Ordering Information

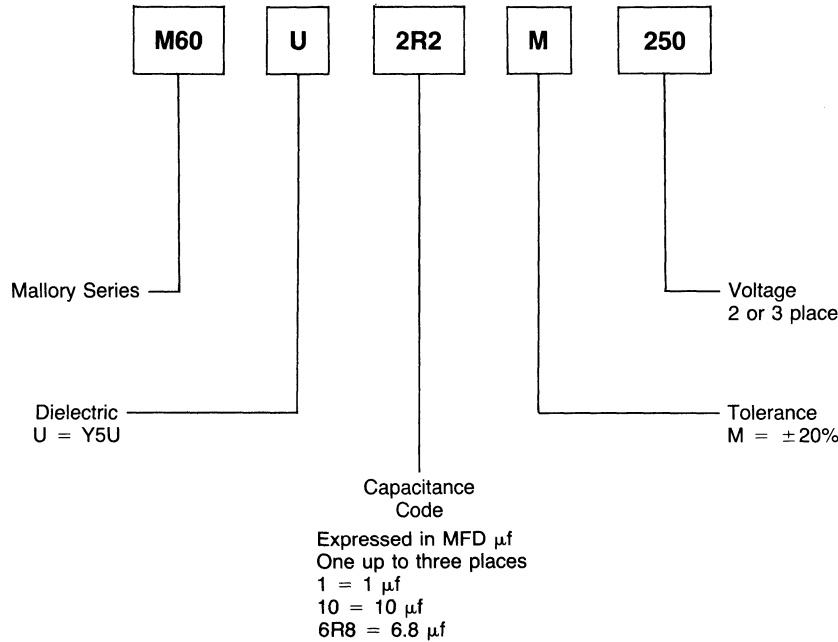

Dimensions

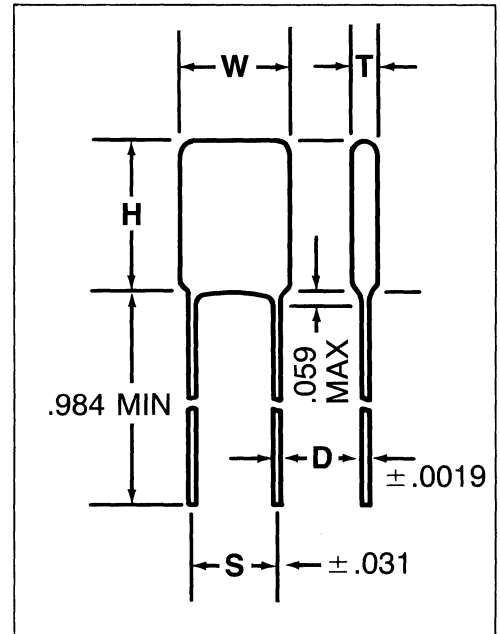

RATINGS & CATALOG NUMBER REFERENCE

Part Number	MFDS	Volt DC	Max Width	Max Height	Max Thick	Lead Space	Lead Dia
M60U1M25	1	25	.197	.177	.138	.197	.020
M60U1R5M25	1.5	25	.248	.197	.157	.197	.020
M60U2R2M25	2.2	25	.248	.197	.157	.197	.020
M60U3R3M25	3.3	25	.295	.295	.157	.197	.020
M60U4R7M25	4.7	25	.295	.295	.157	.197	.020
M60U6R8M25	6.8	25	.394	.394	.197	.197	.020
M60U10M25	10	25	.394	.394	.197	.197	.020
M60U15M25	15	25	.500	.472	.197	.394	.024
M60U22M25	22	25	.500	.472	.197	.394	.024
M60U33M25	33	25	.866	.591	.295	.787	.031
M60U47M25	47	25	.866	.591	.295	.787	.031
M60U68M25	68	25	1.102	.591	.295	.984	.031
M60U100M25	100	25	1.102	.591	.295	.984	.031

Type M60 ● Multilayer Ceramic Capacitors

RATINGS & CATALOG NUMBER REFERENCE

Part Number	MFDS	Volt DC	Max Width	Max Height	Max Thick	Lead Space	Lead Dia
M60U4R7M50	4.7	50	.394	.394	.197	.197	.020
M60U6R8M50	6.8	50	.394	.394	.197	.197	.020
M60U10M50	10	50	.500	.472	.197	.394	.024
M60U15M50	15	50	.500	.472	.197	.394	.024
M60U22M50	22	50	.866	.591	.295	.787	.031
M60U33M50	33	50	.866	.591	.295	.787	.031
M60U47M50	47	50	1.102	.591	.295	.984	.031
M60U68M50	68	50	1.102	.591	.295	.984	.031
M60U2R2M100	2.2	100	.394	.394	.197	.197	.020
M60U3R3M100	3.3	100	.394	.394	.197	.197	.020
M60U4R7M100	4.7	100	.500	.472	.197	.394	.024
M60U6R8M100	6.8	100	.500	.472	.197	.394	.024
M60U10M100	10	100	.866	.591	.295	.787	.031
M60U15M100	15	100	.866	.591	.295	.787	.031
M60U22M100	22	100	1.102	.591	.295	.984	.031
M60U33M100	33	100	1.102	.591	.295	.984	.031
M60UR10M250	.1	250	.197	.177	.138	.197	.020
M60UR15M250	.15	250	.248	.197	.157	.197	.020
M60UR22M250	.22	250	.295	.295	.157	.197	.020
M60UR33M250	.33	250	.295	.295	.157	.197	.020
M60UR47M250	.47	250	.394	.394	.197	.197	.020
M60UR68M250	.68	250	.394	.394	.197	.197	.020
M60U1M250	1	250	.500	.472	.197	.394	.024
M60U1R5M250	1.5	250	.500	.472	.197	.394	.024
M60U2R2M250	2.2	250	.866	.591	.295	.787	.031
M60U3R3M250	3.3	250	.866	.591	.295	.787	.031
M60U4R7M250	4.7	250	1.102	.591	.295	.984	.031
M60U6R8M250	6.8	250	1.102	.591	.295	.984	.031

CERAMIC CAPACITORS

● New Product

Multilayer Ceramic Chip Capacitors •

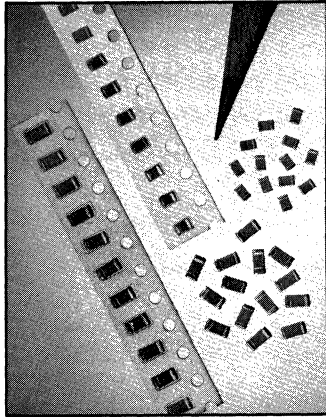

Ceramic Chip Capacitors are designed to offer a combination of cost effectiveness and field reliability. The standard sequence is: destructive and physical analysis; 100% voltage conditioning at 125°C; 100% dielectric withstanding voltage; sample insulation resistance (IR), 100% visual and 1.0 AQL sample mechanical (except for destructive and physical analysis). All of above are in accordance with Table V11, Group A test of MIL-C-55681. Ask for TIB 9-795.

HIGHLIGHTS

Temperature
Coefficients: X7R, COG (NPO)
Voltage: 50 VDC
Tolerance: 5% and 10%

KEY FEATURES

Surface mount
Tape and reel available

APPLICATIONS

Filtering
Bypass
Coupling

CERAMIC CAPACITORS

X7R DIELECTRIC

SIZE	0805	1206
LENGTH (L)	.080 ± .010 (2.03 ± .25)	.125 ± .010 (3.18 ± .25)
WIDTH (W)	.050 ± .010 (1.27 ± .25)	.065 ± .010 (1.65 ± .25)
THICKNESS (T) MAX.	.050 (1.27)	.065 (1.65)
METALIZED BAND (MB)	.025 ± .010 (.50 ± .25)	.020 ± .010 (.50 ± .25)
WVdc	50	50
CAPACITANCE		
μF/μF	CODE	CATALOG NUMBERS
1000	102	0805X102K2B 1206X102K2B
4700	472	0805X472K2B 1206X472K2B
10000	103	0805X103K2B 1206X103K2B
15000	153	0805X153K2B 1206X153K2B
22000	223	0805X223K2B 1206X223K2B
47000	473	1206X473K2B
100000	104	1206X104K2B
100000	104	1206X104M2B
220000	224	

COG (NPO) DIELECTRIC

SIZE	0805	1206
LENGTH (L)	.080 ± .010 (2.03 ± .25)	.125 ± .010 (3.18 ± .25)
WIDTH (W)	.050 ± .010 (1.27 ± .25)	.065 ± .010 (1.65 ± .25)
THICKNESS (T) MAX.	.050 (1.27)	.065 (1.65)
METALIZED BAND (MB)	.025 ± .010 (.50 ± .25)	.020 ± .010 (.50 ± .25)
WVdc	50	50
CAPACITANCE		
μF/μF	CODE	CATALOG NUMBERS
10	100	0805C100J2B
22	220	0805C220J2B
33	330	0805C330J2B
47	470	0805C470J2B
68	680	0805C680J2B
100	101	0805C101J2B 1206C101J2B
150	151	0805C151J2B 1206C151J2B
220	221	0805C221J2B 1206C221J2B
330	331	1206C331J2B
470	470	1206C471J2B
1000	1000	0805C102J2B 1206C102J2B

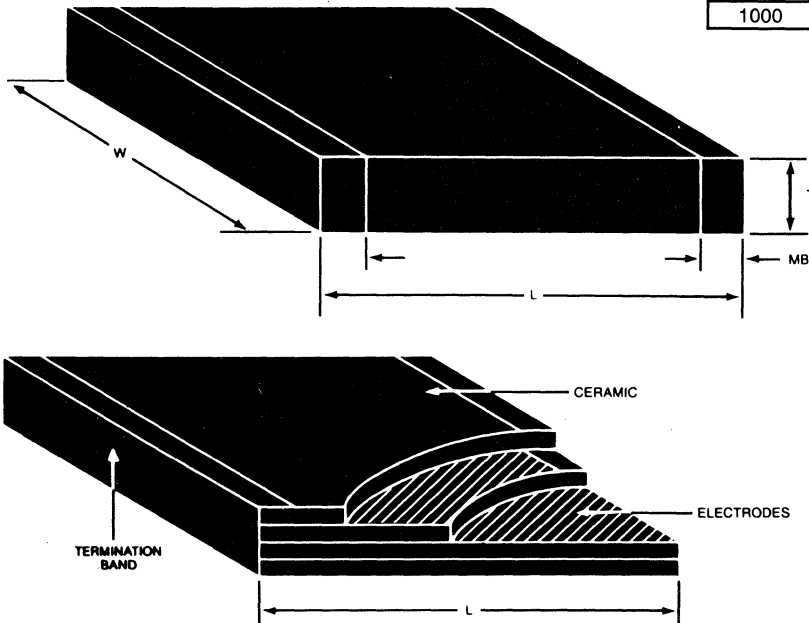

How To Order

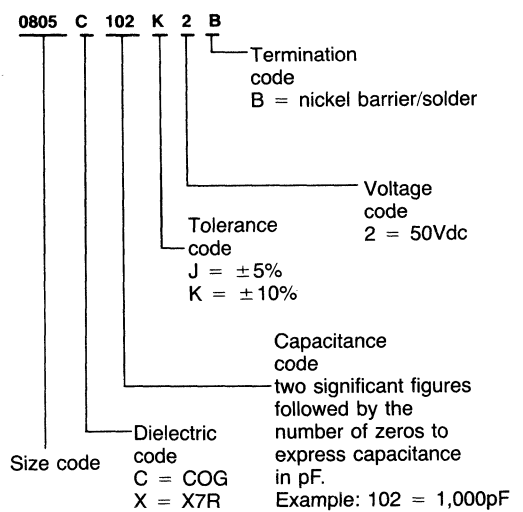

Sonalert Audible Signal Devices

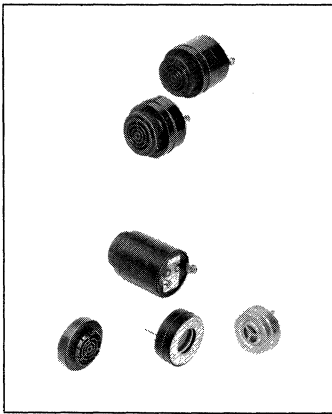

Mallory Sonalert® signals produce an audible tone by electronic means when voltage is applied. Voltages from 1V to 250V may be used depending upon the model.

Electrical power is converted to sound by means of a piezoelectric transducer operating substantially at resonance in a solid state oscillator resulting in efficient power conversion.

Sonalert signals may be powered by many electrical sources ranging from single cell batteries to industrial power lines. Little electrical power is required making them ideally suitable for portable battery operated equipment. This low power feature allows the Sonalert signal to be turned on or off with a low power transistor, SCR, or inte-

grated circuit. Completely solid state with no circuit interruptions which may cause arcing or electrical noise. And no mechanical wear. The Mallory Sonalert signals should give you many years of trouble-free service. **Request bulletin 4-10-03 for complete specifications. For pricing refer to price sheet number 300.**

Audio and Electrical Specifications

CONTINUOUS TONES

Catalog Number	Loudness Category	Mounting Method	Case Style	Frequency ± 500Hz	Minimum Sound Pressure dB (A) at Two Feet		Operating Voltage *AC/DC Non-polar All others DC Only		Typical Operating Current MA	
					At Min. V	At Max. V	**Min.	Max.	At Min. V	At Max. V
SC110N	LOUD	PANEL	D	2900	80	95	*30	120	8	28
SC307N	LOUD	PANEL	C	2900	80	90	3	7	3	8
SC616N	LOUD	PANEL	C	2900	80	95	6	16	4	16
SC616NL	LOUD	PANEL	C-3	2900	80	95	6	16	4	16
SC628N	LOUD	PANEL	C	2900	80	90	6	28	3	14
SC628AN	LOUD	PANEL	D	2900	80	95	* 6	28	8	28
SC648AN	LOUD	PANEL	D	2900	80	95	*10	48	8	28
SBM2	MEDIUM	PRINTED BOARD	F	2900	55	68	1	5	2	12
SBM428	MEDIUM	PRINTED BOARD	F	2900	64	78	4	28	2	14
SNP2	MEDIUM	SNAP IN PANEL	B	2900	55	68	1	5	2	12
SNP428●	MEDIUM	SNAP IN PANEL	B	2900	64	78	4	28	2	14
SC105	MEDIUM	PANEL	C	2900	60	75	1	5	3	16
SC110●	MEDIUM	PANEL	D	2900	68	80	*30	120	4	16
SC110D	MEDIUM	PANEL	D	1900	60	75	*30	120	4	16
SC110H	MEDIUM	PANEL	D	4500	68	80	*30	120	4	16
SC250	MEDIUM	PANEL	D	2900	68	80	*60	250	4	16
SC250D	MEDIUM	PANEL	D	1900	60	75	*60	250	4	16
SC250H	MEDIUM	PANEL	D	4500	68	80	*60	250	4	16
SC416	MEDIUM	PANEL	C	2900	68	80	4	16	3	11
SC628●	MEDIUM	PANEL	C	2900	68	80	6	28	3	14
SC628A	MEDIUM	PANEL	D	2900	68	80	* 6	28	4	16
SC628AD	MEDIUM	PANEL	D	1900	60	75	* 6	28	4	16
SC628AH	MEDIUM	PANEL	D	4500	68	80	* 6	28	4	16
SC628D	MEDIUM	PANEL	C	1900	60	75	6	28	3	14
SC628H	MEDIUM	PANEL	C	4500	68	80	6	28	3	14
SC628L	MEDIUM	PANEL	C-3	2900	68	80	6	28	3	14
ST628†	MEDIUM	PANEL	C	2900	60	80	6	28	1.5	12
SC648●	MEDIUM	PANEL	C	2900	68	80	10	48	3	14
SC648A	MEDIUM	PANEL	D	2900	68	80	*10	48	4	16
SC648AD	MEDIUM	PANEL	D	1900	60	75	*10	48	4	16
SC648AH	MEDIUM	PANEL	D	4500	68	80	*10	48	4	16
SC648D	MEDIUM	PANEL	C	1900	60	75	10	48	3	14
SC648H	MEDIUM	PANEL	C	4500	68	80	10	48	3	14
SC1.5	SOFT	TWIST TAB	A	3500	60 @ 1.5V		1	4	4 @ 1.5V	
SC6	SOFT	TWIST TAB	A	3500	70 @ 6V		4	8	12 @ 6V	
SC12	SOFT	TWIST TAB	A	3500	70 @ 12V		8	15	14 @ 12V	
SC18	SOFT	TWIST TAB	A	3500	70 @ 18V		14	22	16 @ 18V	
SC24	SOFT	TWIST TAB	A	3500	70 @ 24V		20	30	16 @ 24V	
SNP428F	SOFT	SNAP IN PANEL	B	2900	55	70	4	28	0.5	3
SC110E	SOFT	PANEL	D	1900	55	65	*30	120	3	14
SC110F	SOFT	PANEL	D	2900	55	70	*30	120	1	4
SC250E	SOFT	PANEL	D	1900	55	65	*60	250	3	14
SC250F	SOFT	PANEL	D	2900	55	70	*60	250	1	4
SC628AE	SOFT	PANEL	D	1900	55	65	* 6	28	3	14
SC628AF	SOFT	PANEL	D	2900	55	70	* 6	28	1	4
SC628E	SOFT	PANEL	C	1900	55	68	6	28	3	8
SC628F	SOFT	PANEL	C	2900	55	70	6	28	0.5	3

** Minimum voltage specified for sound test does not represent sound turn-on or turn-off points. Units will sound at lower voltages.

● Denotes U/L Models

† Denotes High Trigger Model (Start Up Voltage Approx. 3 V.)

SONALERT® AUDIO PRODUCTS

Sonalert Audible Signal Devices

INTERMITTENT TONES

Catalog Number	Loudness Category	Mounting Method	Case Style	Frequency ±500Hz	Minimum Sound Pressure dB (A) at Two Feet		Operating Voltage		Typical Operating Current MA		
					At Min. V	At Max. V	*AC/DC Non-polar All others DC Only	**Min. Max.	At Min. V	At Max. V	
▼ Fast Pulse Turns on and off at 2 to 10 pulses per second depending upon voltage at 50% duty cycle.											
▼ Slow Pulse Turns on and off at .5 to 1.2 pulses per second depending upon voltage at 50% duty cycle.											
SC110NP	SC110NJ	LOUD	PANEL	D	2900	80	95	*30	120	8	28
SC616NP	SC616NJ	LOUD	PANEL	C	2900	80	95	6	16	4	16
SC628ANP	SC628ANJ	LOUD	PANEL	D	2900	80	95	*6	28	8	28
SC648ANP	SC648ANJ	LOUD	PANEL	D	2900	80	95	*10	48	8	28
SBM616P	SBM616J	MEDIUM	PRINTED BOARD	F	2900	68	78	6	16	1	4
SC110DP	SC110DJ	MEDIUM	PANEL	E	1900	60	75	*30	120	4	16
SC110HP	SC110HJ	MEDIUM	PANEL	E	4500	68	80	*30	120	4	16
SC110P●	SC110J	MEDIUM	PANEL	E	2900	68	80	*30	120	4	16
SC250DP	SC250DJ	MEDIUM	PANEL	E	1900	60	75	*60	250	4	16
SC250HP	SC250HJ	MEDIUM	PANEL	E	4500	68	80	*60	250	4	16
SC250P	SC250J	MEDIUM	PANEL	E	2900	68	80	*60	250	4	16
SNP616P	SNP616J	MEDIUM	SNAP IN PANEL	B-1	2900	68	78	6	16	1	4
SC616P	SC616J	MEDIUM	PANEL	C-1	2900	68	78	6	16	1	4
SC616P-1	SC616J-1	MEDIUM	PANEL	C-2	2900	68	78	6	16	1	4
SC628ADP	SC628ADJ	MEDIUM	PANEL	E	1900	60	75	*6	28	4	16
SC628AHP	SC628AHJ	MEDIUM	PANEL	E	4500	68	80	*6	28	4	16
SC628AP	SC628AJ	MEDIUM	PANEL	E	2900	68	80	*6	28	4	16
SC628DP	SC628DJ	MEDIUM	PANEL	D	1900	60	75	6	28	3	14
SC628HP	SC628HJ	MEDIUM	PANEL	D	4500	68	80	6	28	3	14
SC628P●	SC628J	MEDIUM	PANEL	D	2900	68	80	6	28	3	14
SC648ADP	SC648ADJ	MEDIUM	PANEL	E	1900	60	75	*10	48	4	16
SC648AP	SC648AJ	MEDIUM	PANEL	E	2900	68	80	*10	48	4	16
SC110EP	SC110EJ	SOFT	PANEL	E	1900	55	68	*30	120	3	14
SC110FP	SC110FJ	SOFT	PANEL	E	2900	55	70	*30	120	4	16
SC250EP	SC250EJ	SOFT	PANEL	E	1900	55	68	*60	250	3	14
SC250FP	SC250FJ	SOFT	PANEL	E	2900	55	70	*60	250	4	16
SC628AEP	SC628AEJ	SOFT	PANEL	E	1900	55	68	*6	28	3	14
SC628AFP	SC628AFJ	SOFT	PANEL	E	2900	55	70	*6	28	4	16
SC628EP	SC628EJ	SOFT	PANEL	D	1900	55	68	6	28	3	8
SC628FP	SC628FJ	SOFT	PANEL	D	2900	55	70	6	28	3	14

SHORT PULSE

Turns on and off at .5 to 1.2 pulses per second depending upon voltage at 10% duty cycle.

SC110K	MEDIUM	PANEL	E	2900	68	80	*30	120	4	16
SC628K	MEDIUM	PANEL	D	2900	68	80	6	28	3	14
SC110FK	SOFT	PANEL	E	2900	55	70	*30	120	4	16
SC628FK	SOFT	PANEL	D	2900	55	70	6	28	3	14

DUAL MODE OPERATION

Continuous or Fast Pulse
Continuous or Slow Pulse

When power terminals are connected, third terminal may be switched to common (-) to select a continuous sound or switched to positive (+) to select a pulsing sound. Switching current is less than .15 milliamp.

SC616NPU	SC616NJU	LOUD	PANEL	D-1	2900	80	95	6	16	4	16
SBM616PU	SBM616JU	MEDIUM	PRINTED BOARD	F	2900	68	78	6	16	3	12
SC616PU	SC616JU	MEDIUM	PANEL	D-1	2900	68	78	6	16	3	12

FAST WARBLE SLOW WARBLE

Produces two tones alternately when used with additional continuous tone unit.

SC628W	SC628JW	MEDIUM	PANEL	D-1	2900	68	80	6	28	3	16
(Use with SC628D or SC628H)											
SC628FW	SC628FJW	SOFT	PANEL	D-1	2900	55	70	6	28	3	14
(Use with SC628E)											

CHIME TONE

A pleasant sound which chimes every one or two seconds as long as voltage is applied.

SC616CP	MEDIUM	PANEL	D	2900	68	80	6	16	3	8
---------	--------	-------	---	------	----	----	---	----	---	---

CHIRP

A unique sound which pulses at 20-60 pulses per second rate.

SC110Q (AC ONLY)	MEDIUM	PANEL	C	2900	68	80	30 AC	120 AC	3	12
SC616Q	MEDIUM	PANEL	C-1	2900	68	78	6	16	1	4

** Minimum voltage specified for sound test does not represent sound turn-on or turn-off points. Units will sound at lower voltages.

● Denotes U/L Models

Underwriters Laboratories

The following models are listed as recognized components—audible signal appliances: **SNP428 SC628 SC648 SC628P SC110 SC110P**
Guide Number UCST2, Yellow Card Number S1290.

The following models are new products: **SC307N SC416 SC628N ST628 SNP616P SNP616J**

Sonalert Audible Signal Devices

Case Styles

OUTLINE DIMENSIONS FRACTIONS $\pm \frac{1}{32}$ DECIMALS $\pm .01$

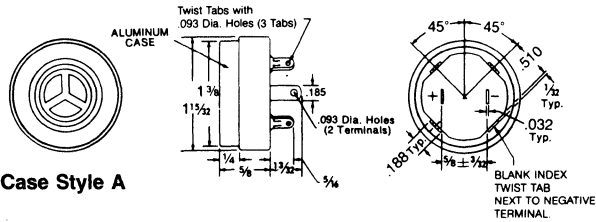

Case Style A

Terminals—.032 steel, tin plated with .093 dia. wire hole, will accept standard $\frac{3}{16}$ " quick disconnect.



BP6 BAKELITE MOUNTING WAFER

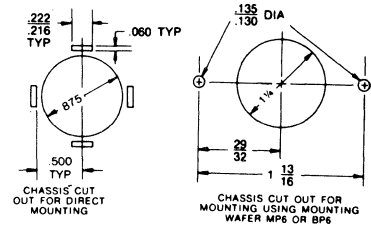

Mounting—For Twist Tabs per EIA std. RS395 are provided for mounting. Terminals are electrically isolated from case and Twist Tabs. Also may be mounted using mounting wafer number MP6 for uninsulated mounting or mounting wafer number BP6 to insulate case from chassis.

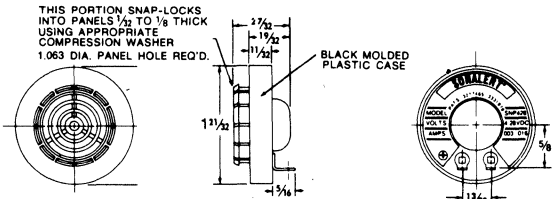

Case Style B

Terminals—.020 brass, hot tin finish with .065 wire hole. Terminal will accept standard $\frac{1}{8}$ " quick disconnect.

Case Style B-1

This case style is similar to Style B except the molded protrusion on the rear is a different shape and extends $\frac{21}{32}$ " instead of $\frac{19}{32}$ ". Terminals are also a different shape.

Mounting—Panel hole 1.063 \pm .005 diameter should be punched from the back side so that locking fingers enter on the slightly rounded edge of the hole. Assemble proper compression washer and press into panel hole until locking fingers snap over hole edge. Installation pressure should be applied only at the circumference of the device.

Part No.	Thickness	Panel Thickness
PW1	.063	11-12 GA (.125-.109)
PW2	.125	13-17 GA (.093-.056)
PW3	.187	18-22 GA (.050-.031)

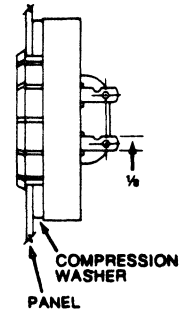

TYPICAL PANEL INSTALLATION

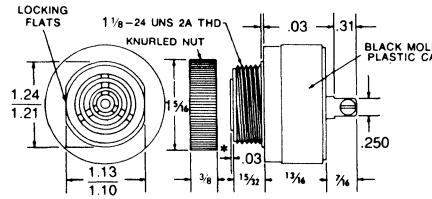

Case Style C

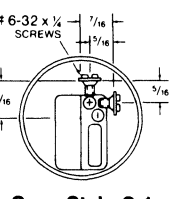
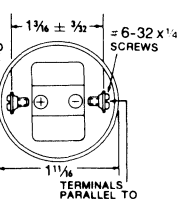

Case Style C-1

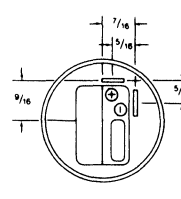

Case Style C-2

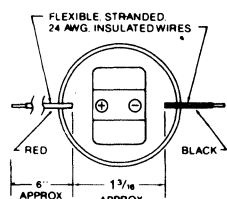

Case Style C-3

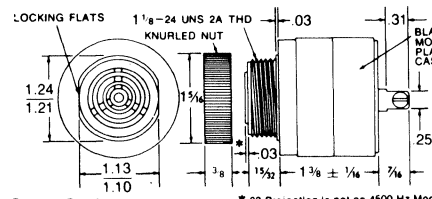

Case Style D

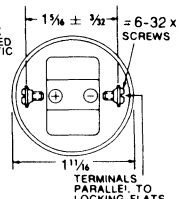

Case Style D-1

Terminals—.032 brass, tin plated, tapped for #6-32 screw. Two #6-32 zinc plated steel screws included. Will accept $\frac{1}{4}$ " quick disconnect.

Mounting—Remove black plastic nut and insert threaded front through 1.25" hole punched in panel. If orientation is needed, note locking flats on drawing. Screw nut back on. Do not overtighten.

Case Style E—Outline dimensions are the same as case style D except length is changed to $1\frac{15}{16} \pm \frac{3}{32}$.

Electrical Mounting Box—Part Number SCMB Used to mount Sonalert® signal case styles C and D on standard $\frac{3}{4}$ inch electrical conduit. $\frac{3}{2}$ inch diameter, 2 inch deep ABS plastic.

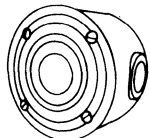

Optional Mounting Nuts—To substitute natural finished aluminum nut, add C to catalog number. To substitute black anodized aluminum nut, add B to catalog number. EXAMPLE: SC628B.

Sonalert Audible Signal Devices

Case Styles

Black Molded Plastic Housing

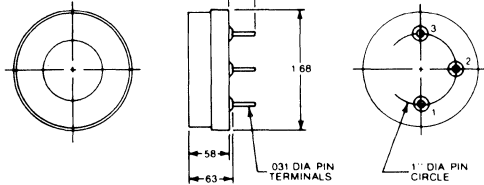

Case Style F

Terminals—.031 dia. soldercoated copperclad steel.

Electrical Connections—SBM2, SBM428, SBM616P, SBM616J—When pin 1 is connected to + voltage and pin 3 is connected to common

(-), unit will sound. Pin 2 is for mechanical support only and is not connected internally.

SBM616PU, SBM616JU—When pin 1 is connected to + voltage, and pin 3 is connected to common (-), and the voltage on pin 2 is within 1.25V of pin 1 or higher, the unit will sound a pulsing tone. When the voltage on pin 2 is within .9V of pin 3 or lower, the unit will sound a continuous tone. The maximum voltage which may be applied to pin 2 before damage may occur is ±16V referenced to pin 3. Pin 2 input impedance is 110K ohm.

Mounting—Insert into printed circuit board and hand or machine solder. For recommended fluxing, soldering, and cleaning procedures, send for Mallory Audio Signal Engineering Bulletin 778.

Environmental Specifications

Surge Voltage

15% over maximum rated voltage applied for less than one minute.

Reverse Voltage—DC Models

Maximum reverse polarity equal to rated voltage for one minute. Some models may sound softly when subjected to reversed polarity voltage.

Life Specification

Continuous—100 hours continuous operation at 65°C with maximum rated voltage applied.

Intermittent—A duty cycle of 1 minute on, 5 minutes off, a minimum of 5000 times at room temperature and maximum rated voltage applied.

Life Expectancy

5 years under normal operating conditions.

Storage Temperature

-40°C to +85°C.

Operating Temperature

-30°C to +65°C.

Humidity

The Sonalert® signal should operate after having been subjected to 95% Relative Humidity at +40°C continuously for 100 hours. After removal from test, the unit should be allowed to dry a minimum of 4 hours at room temperature before operation. Units should deliver original output characteristics.

Vibration

The Sonalert signal should be mounted in the standard manner on a mounting panel. The specimens should be subjected to a harmonic motion having an amplitude of 0.03 inch (0.06 inch maximum total excursion). The frequency should be varied uniformly between a limit of 10 and 55 Hertz. The entire frequency range from 10 to 55 Hertz and return to 10 Hertz should be traversed in approximately one minute. Motion should be applied for two hours in each of 3 mutually perpendicular planes (total 6 hours). This test should be conducted while the Sonalert signal is not operating. After completion of test, Sonalert signals should meet specifications.

Salt Spray

The Sonalert signal should meet specified operating conditions after completing 96 hours in an atomized salt spray while not operating. The spray should consist of a 5% salt solution atomized by a forced air supply. The solution should be sprayed through a nozzle into a chamber maintained at 35°C. After salt spray, the unit should be removed and washed in running water not warmer than 40°C. A soft hairbrush or plastic bristle brush should be used, lightly brushing to remove salt deposits from the unit. The cleaned Sonalert signals should be placed on absorbent material with the nose cone pointed downward and allowed to dry at room temperature for 24 hours prior to use.

Terminal Strength

5 pounds, applied axially for a period of 5 minutes. This is considered a destructive test.

Custom Designed Sonalerts

Even though there are many standard Sonalert models listed in this catalog, we encourage you to contact Mallory regarding other audio signalling devices for your OEM custom applications. These can involve the modification of existing models, a completely new design or an entire system to provide multi-signals for various functions.

Our engineering staff has over 15 years experience in the design of audible signalling products for commercial, military, industrial, and automotive applications. We have an excellent, well equipped laboratory for the measurement of electrical and acoustical characteristics and can assist you in establishing audible signal specifications.

Shown here are three examples of custom Sonalert models currently being used in automotive, agricultural, and space applications.

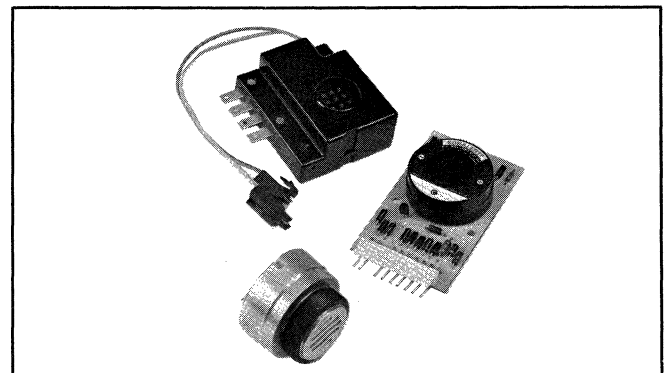

Sonalert Audible Signal Devices

Sonalert Signals for MILITARY Applications

For applications requiring operation over extended temperature ranges, or in extreme environmental conditions, military models are recommended. These special units use MIL approved components if available. Exposed surface of the sound transducer is treated with a corrosion protective coating. Mounting nut is anodized aluminum. Terminals are tin plated brass with nickel plated 6-32 screws. All units are marked with Mallory name, part number, polarity and date code per MIL-STD-1285. Marking is permanently preserved by a layer of clear epoxy. Customer part number may be included on label if desired. A certificate of compliance to Mallory specifications will be supplied if requested.

Black plastic case and black anodized aluminum mounting nut is standard. To specify olive drab case and mounting nut, add G to part number. Example: SC628MG. To specify black case and clear anodized mounting nut add C to part number.

Example: SC628MC.

Life Specifications—250 hours continuous operation at 85°C and maximum rated voltage applied. 5000 cycles one minute on, 5 minutes off at 25°C and maximum rated voltage applied.

Life Expectancy—5 years under normal operating conditions.

Operating Temperature— -40°C to +85°C

Storage Temperature— -65°C to +85°C.

Altitude Change— 10,000 feet per minute maximum.

Quality Specifications

Operating—100% measurement of sound output and frequency at 25°C. Data is supplied with parts. Operation of each part confirmed at -40°C and +85°C.

Environmental—MIL Std. 105D Level II single normal inspection. .65 AQL.

MALLORY CAPACITOR CO.
CODE IDENTIFICATION—37942

Environmental Specifications

Test	MIL-STD-202 method	Test Condition
Thermal shock	107	A
Humidity	103	B
Salt Spray	101	A
Shock	213	H
Vibration	201	None
Terminal strength	211	A (5 lbs.)

Operating Specifications

Continuous Tones

Catalog Number	Loudness Category	Mounting Method	Case Style	Frequency ±500Hz	Minimum Sound Pressure dB(A) at Two Feet		Operating Voltage		Typical Operating Current MA	
					At Min. V	At Max. V	*AC/DC Non-polar All Others DC Only **Min. Max.	At Min. V	At Max. V	
SC628MN	LOUD	PANEL	C	2900	80	90	6	28	4	16
SC628M	MEDIUM	PANEL	C	2900	68	80	6	28	3	14
SC628MD	MEDIUM	PANEL	C	1900	60	75	6	28	3	14
SC628MH	MEDIUM	PANEL	C	4500	68	80	6	28	3	14
SC648M	MEDIUM	PANEL	C	2900	68	80	10	48	3	14
SC648MD	MEDIUM	PANEL	C	1900	60	75	10	48	3	14
SC648MH	MEDIUM	PANEL	C	4500	68	80	10	48	3	14
SC628MA	MEDIUM	PANEL	D	2900	68	80	* 6	28	4	16
SC628MAH	MEDIUM	PANEL	D	4500	68	80	* 6	28	4	16
SC648MA	MEDIUM	PANEL	D	2900	68	80	*10	48	4	16
SC648MAH	MEDIUM	PANEL	D	4500	68	80	*10	48	4	16
SC110M	MEDIUM	PANEL	D	2900	68	80	*30	120	4	16
SC110MH	MEDIUM	PANEL	D	4500	68	80	*30	120	4	16
SC250M	MEDIUM	PANEL	D	2900	68	80	*60	250	4	16

Fast Pulse: Turns on and off at 2 to 9 pulses per second depending upon voltage at 50% duty cycle.

SC628MP	MEDIUM	PANEL	D	2900	68	80	6	28	3	14
SC628MHP	MEDIUM	PANEL	D	4500	68	80	6	28	3	14

Fast Warble: Produces two tones alternately when used with additional unit.

SC628MW	MEDIUM	PANEL	D-1	2900	68	80	6	28	3	16
---------	--------	-------	-----	------	----	----	---	----	---	----

Continuous or Fast Pulse: Dual Mode Operation.

SC616MPU	MEDIUM	PANEL	D-1	2900	68	78	6	16	3	12
----------	--------	-------	-----	------	----	----	---	----	---	----

**Minimum voltage specified for sound test does not represent sound turn-on or turn-off points. Units will sound at lower voltages.

SONALERT® AUDIO PRODUCTS

Piezoelectric Transducer Units Model EFB

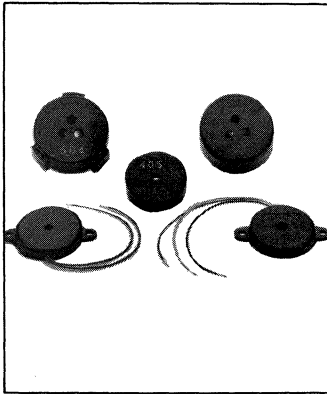

The Piezoelectric Transducer Unit consists of a piezoelectric ceramic element enclosed in a housing that provides acoustic enhancement and a convenient mounting vehicle. Models are provided for direct mounting on a chassis or soldering onto a P.C. board. When activated with a typical drive circuit, the unit will produce a clear, audible tone requiring a very low electronic power input for the acoustic output.

Characteristics EXTERNAL DRIVE

Part Number	Input Voltage Max.	Sound Output 2.5KHz and 10 cm	Capacitance pF ± 30%
EFB-RC24C41	30V.	Min 70dB @ 5V p-p	12,000
EFB-RD24C41	30V.	Min 70dB @ 5V p-p	12,000
EFB-RU25C01	30V.	Min 70dB @ 9V p-p	24,000

SELF DRIVE (FEEDBACK)

Part Number	Input Voltage Max.	Sound Output 12V.DC and 10 cm	Resonant Freq. KHz
EFB-RN65C11	20V.	85dB	6.5 ± 0.7
EFB-RL37C20	30V.	100dB	3.7 ± 0.5

Environmental Specifications

Storage Temperature -25 to + 70°C
 Operating Temperature -20 to + 60°C
 Terminal Strength 1 Kg 10 seconds

Other requirements may be available upon special request.

Shape and Dimensions

EXTERNAL DRIVE UNITS

EFB-RC24C41

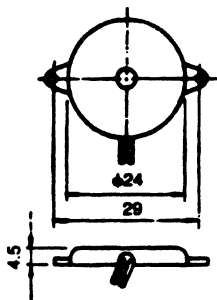

Tolerance: ± 0.3
 Dimensions in mm

EFB-RD24C41

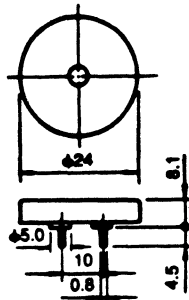

Tolerance: ± 0.3
 Dimensions in mm

EFB-RU25C01

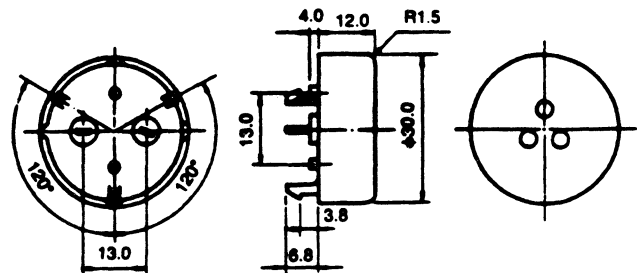

Tolerance: ± 0.3
 Dimensions in mm

Piezoelectric Transducer Units Model EFB

Frequency Characteristic

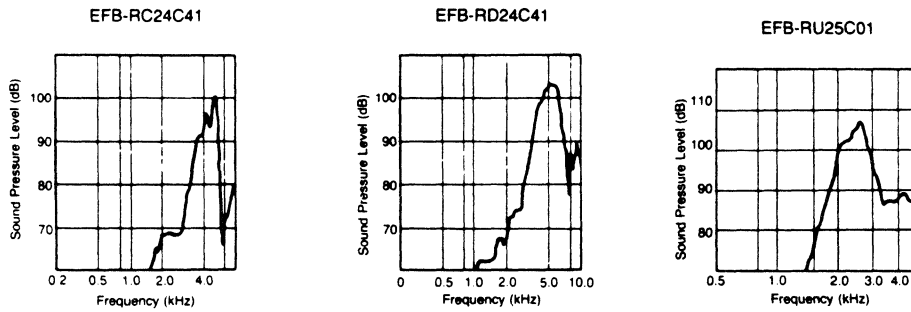

Self Drive (Feedback) Units

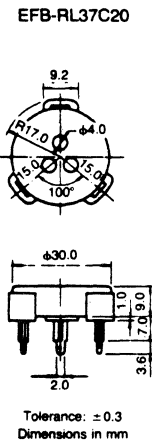
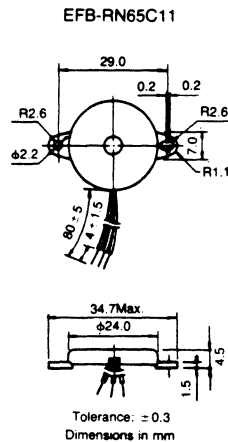

Typical Drive Circuits

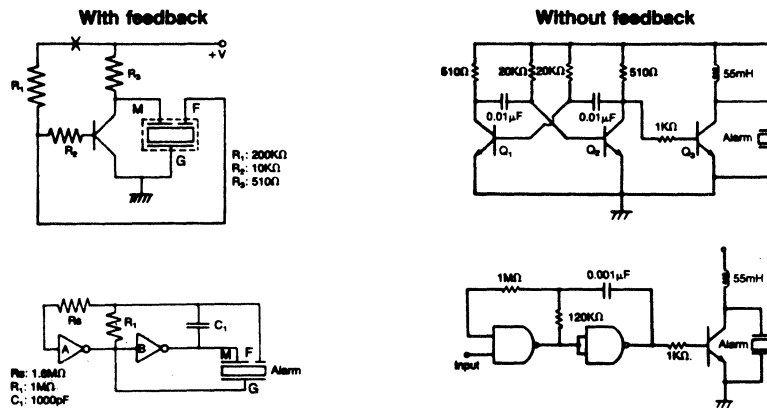

(M) Red + (G) Black - (F) Yellow Feedback

Sounducers (Magnetic Buzzers)

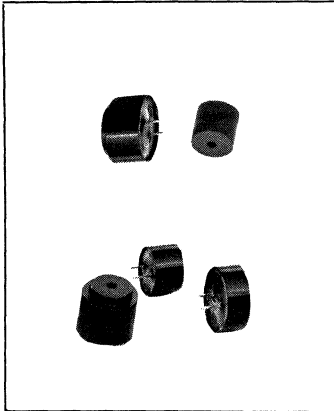

Mallory Sounducers are, in principle, similar to magnetic speakers, and are compact, inexpensive acoustic transducers. They can be used to produce single tones, melodies and speech synthesis.

Characteristics Table

Part No.	Dimensions (outside diameter x height [mm])	Typical signal voltage [Vo-p]	Operating signal voltage [Vo-p]	Frequency [Hz]	Sound pressure [dB(A)/10Cm]	Current (typ.) [mAo-p]	DC resistance [Ω]	Weight [g]	Terminal construction	Features	Applications					
											Clocks	Toys	Portable equipments	Office automation equipments	Home appliances	Automobiles
SD120802	• 12x8	1.5	1 to 3	4,096	85	30	46	1.8	Printed circuit board	Compact, high sound pressure type	✓	✓	✓			
SD120901	• 12x9	3	1 to 4	2,048	80	60	50	2	Pin terminals	Compact, pin type	✓	✓	✓	✓		✓
SD141001	• 14x10	3	1 to 5	2,048	80	60	50	2.5	Pin terminals	Mid-sized • 14 pin type	✓	✓	✓	✓		✓
SD160710	• 16x7	1.5	1 to 3	4,086	80	80	15	3.5	Pin terminals	Thin • 16 type		✓	✓	✓		
SD161210	• 16x12	1.5	1 to 3	2,048	80	80	15	4	Pin terminals	Ample sound pressure, inexpensive type		✓	✓	✓	✓	
SD162910	• 16x29	1.5	1 to 3	2,048	90	85	15	5	Pin terminals	High sound pressure, long tube type	✓	✓		✓	✓	✓

Shape And Dimensions

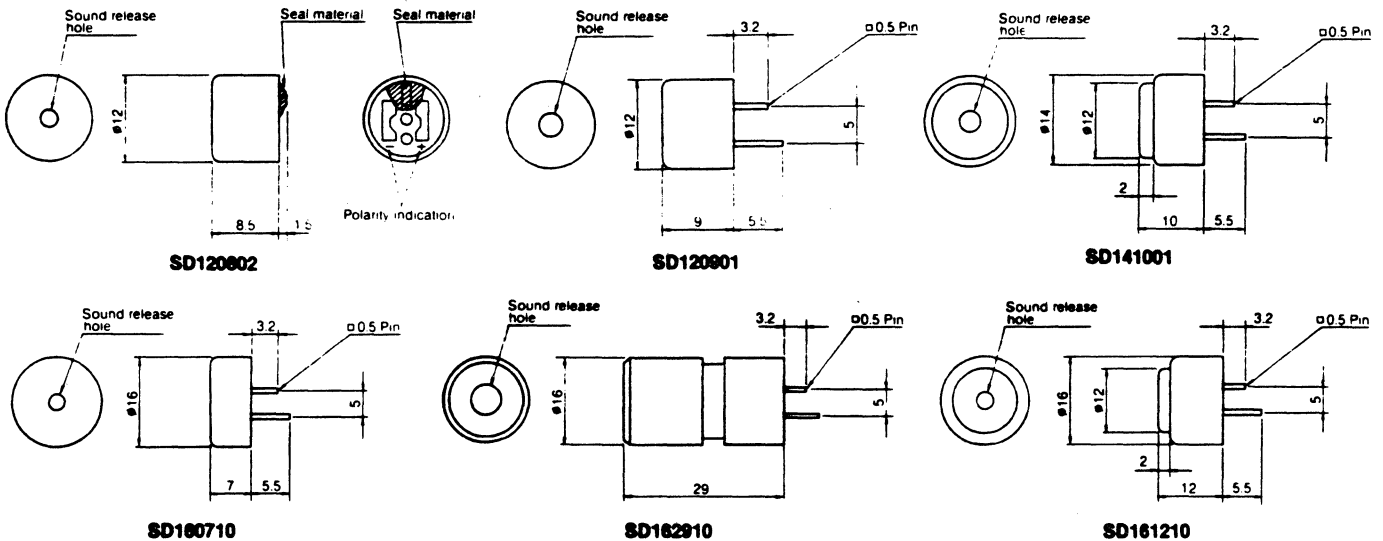

• Dimensions in mm
 • The longer pin is the ⊕ side

Specifications subject to change without notice.

Sounducers (Magnetic Buzzers)

Typical Drive Circuits

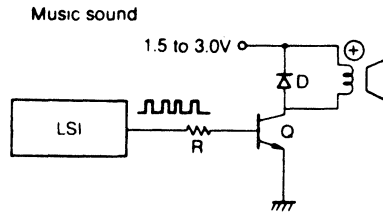
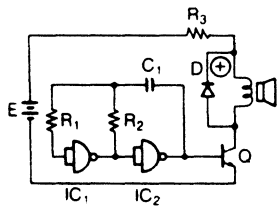
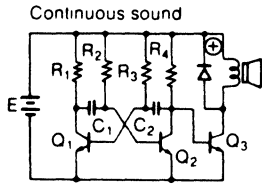

Component values are variable depending upon desired voltage, frequency and sound pressure.

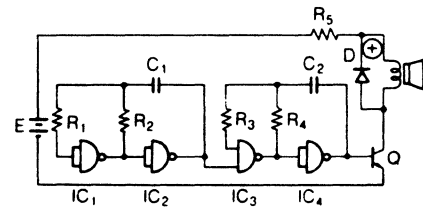
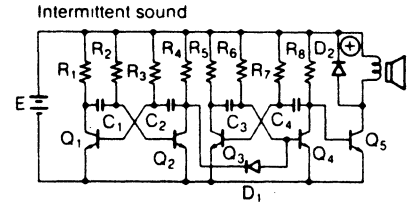

Environmental Specifications

Storage Temperature	-20°C to +80°C
Operating Temperature	10° to 70°C
Humidity	Items should operate after having been subjected to 95% relative humidity at 40°C continuously for 240 hours.
Vibration	Items should operate after having been subjected to a harmonic motion having an amplitude of 1.5mm and a varied frequency range from 10 to 55 Hz for 30 minutes.

Models SC616WY & SC616WXY Multi-Tone Sonalert

Mechanical

Outline drawing and dimensions—see figure 1.

Case material: Nylon

Mounting method: Panel (see Sonalert Bulletin for details)

Terminals: .032 brass, tin plated, tapped for #6-32 screw. Two #6-32 cadmium or zinc plated steel screws included. Will accept 1/4" quick disconnect.

Control lead wire size: 24AWG. stranded, 6' long.

Control Functions

The red and black leads control the several functions. A logic "Low" is a voltage less than 1/3 of supply voltage. A logic "High" is a voltage greater than 1/2 supply voltage. A red or black input lead left unconnected is considered an open state.

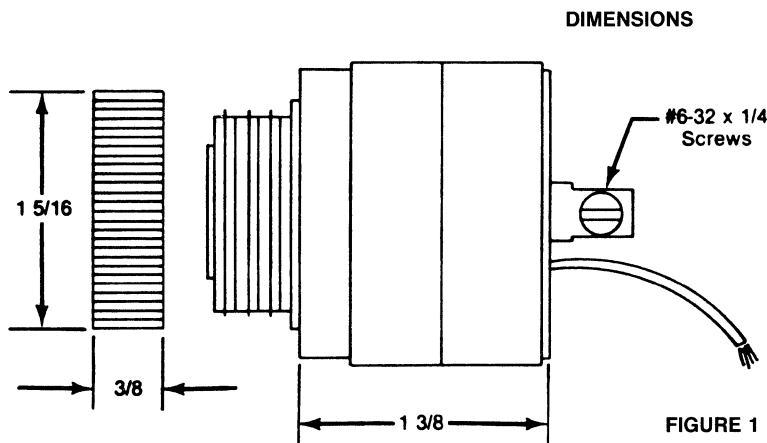
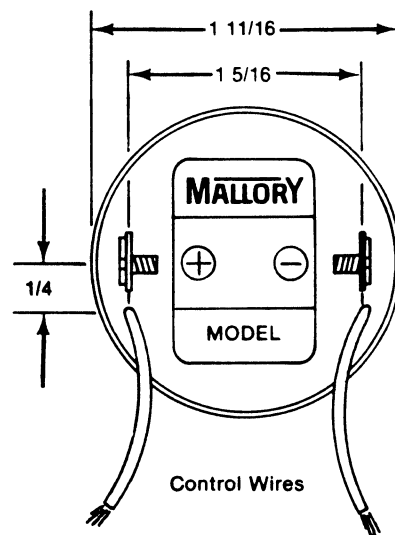

FIGURE 1



Electrical

Model No.	Voltage		Typical Current mA		High Tone Frequency ±300 Hz	Low Tone Frequency ±300 Hz	Pulse Rate Per Second *	Min. Sound Pressure dB at Two Feet	
	min.	max.	At min. V	At max. V				At min. V	At max. V
SC616WY	6	16	2	18	3000	1750	.5-1.2	60	75
SC616WXY	6	16	2	18	3000	1750	.5-1.2	60	75

* 50% Duty Cycle

Operating temperature for both models is -30°C to +65°C.

The environmental specifications are the same as present Sonalert specifications.

Truth Table For SC616WY

Control Lead		Function Mode
Red	Black	
Low	Low	Off
High	Low	High Pulse
Low	High	Low Pulse
High	High	Warble

Truth Table For SC616WXY

Control Lead		Function Mode
Red	Black	
High	Low	Off
Open	High	High Cont.
Open	Low	Low Cont.
High	Open	High Pulse
Low	Open	Low Pulse
Open	Open	Warble

Typical Performance

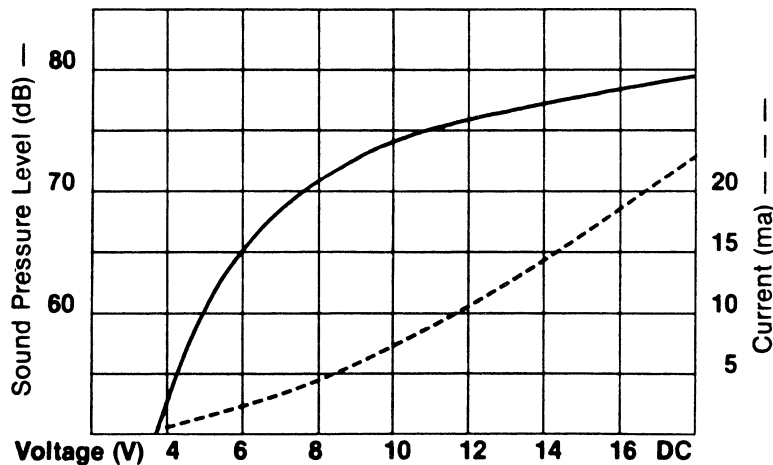

Minilert

Electronic Audible Signal Model MCP320B2

The Minilert Model MCP320B2 is a high-performance, low-cost piezoelectric audible signal comprising an audio transducer and all the driving electronics contained in a small attractive package. This unit is designed to be mounted on the printed circuit board. Applications include fire alarms, smoke detectors, intrusion systems, call buzzers, car alarm systems, clocks, and cash registers. **For complete specifications request bulletin No 9-789.**

HIGHLIGHTS

Extremely low power consumption in comparison to electromagnetic buzzers.
Contact-free design insures long life and no electrical noise.
Compact and produces high sound pressure with minimum voltage.

SPECIFICATIONS

Resonant Frequency (KHz) 2.5 ± 0.5 kHz
Sound Pressure (dB/40 in.) 70 dB Min. @12 VDC
Rated Voltage (VDC) @ 25°C 3 to 20 VDC
Current (mA) @ 12 VDC 10 mA Max.
Operating Temperature -20 to 60°C
Storage Temperature -25 to 70°C

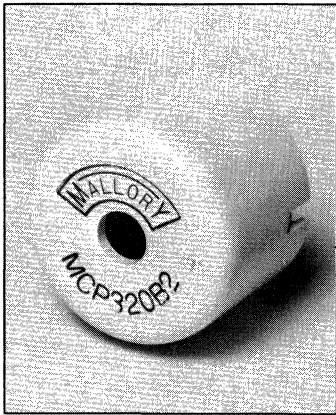

Outline Dimensions

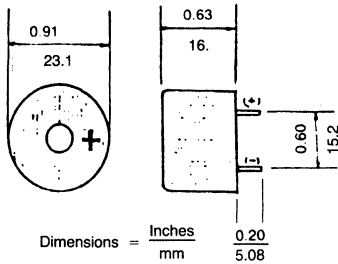

Typical Characteristics

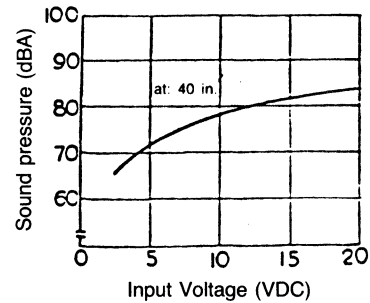
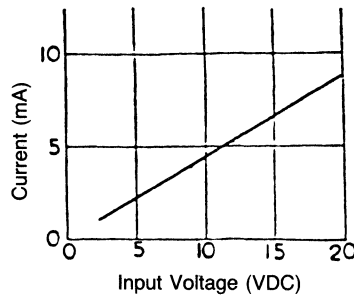

SONALERT® AUDIO PRODUCTS

Audible Alarm

Model SC194

The Model SC194 is a high-intensity, low-cost alarm comprising an audio transducer and horn assembly plus all the driving electronics contained in a small attractive package. The small light-weight unit is designed for O.E.M.'s or other users who have need for a self-contained, high-intensity alarm which can be operated from a 9V battery. The SC194 delivers a sound level of +118dB vs. .0002 μ bar at 1 foot over the frequency range of 2½ to 3½ kHz when connected to a 9-volt battery

with a current drain of less than 120 ma. The acoustic power output is 13 dB greater than present UL specification requirements for smoke alarms and intrusion alarms. UL Listed. **For complete specifications, request bulletin No. 9-784.**

SPECIFICATIONS

Voltage: +5 to +15 VDC (+9V Nominal)
Sound Pressure Level: +123 dB (+15VDC Supply)
Current: 120 ma max. @ +9 VDC
Operating Temp. Range: 0° to +70°C
Humidity: 0 to 90% Non-Condensing

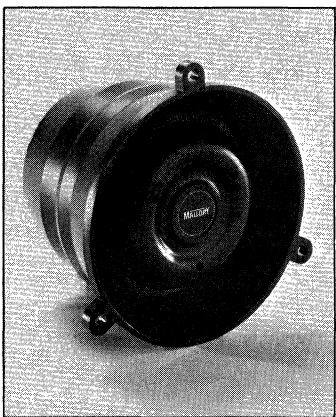

Performance Characteristics

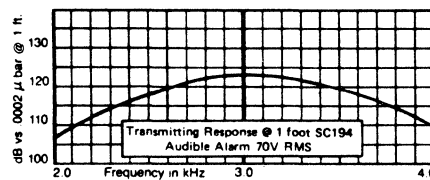
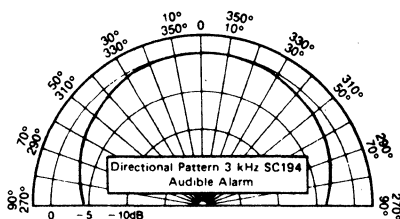

Outline Dimensions SC194

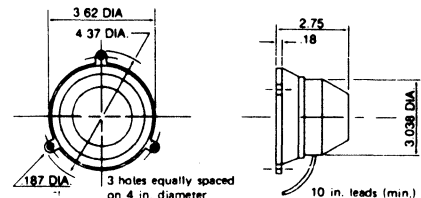

Mounting Bracket available from Stock. Black Anodized Aluminum. Mallory Number 200188-501.

RFI Power Line Filters

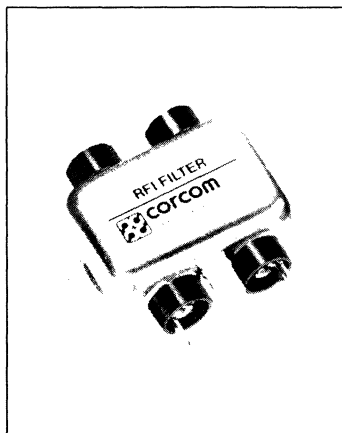

The Corcom RFI filter is designed to provide effective attenuation of high frequency conducted RFI while producing little or no attenuation of 50/60Hz signals. Because of the filter's bilateral design, attenuation of RFI in both directions is accomplished, thus protecting the power line as well as the equipment requiring an RFI-free AC power source.

The Corcom RFI filter is also intended for utilization by computing devices required to meet FCC regulations concerning conducted RFI. **Request bulletin 9-778 for complete specifications. For prices, reference price sheet No. 702.**

The B series power line filters are general purpose common-mode filters effectively providing RFI control of line-to-ground noise in a small size at lowest cost. These filters are designed to meet a wide variety of electronic and electrical applications and are available in a broad selection of current ratings and termination styles. The EB models meet the very low leakage current requirements on SEV, VDE portable equipment and (120 volt) UL 544 non patient medical equipment.

HIGHLIGHTS

- Rated Voltage: 115-250 VAC
- Operating Frequency: Ranges from 50-400Hz
- Current Ratings: Ranges available from 1-30 Amps
- Overload: 6 times rated current for 8 seconds
- Insulation Resistance: 6000 meg-ohms @ 100VDC
- Temperature/Humidity: 21 days @ 40°C, 95% RH

ORDERING INFORMATION

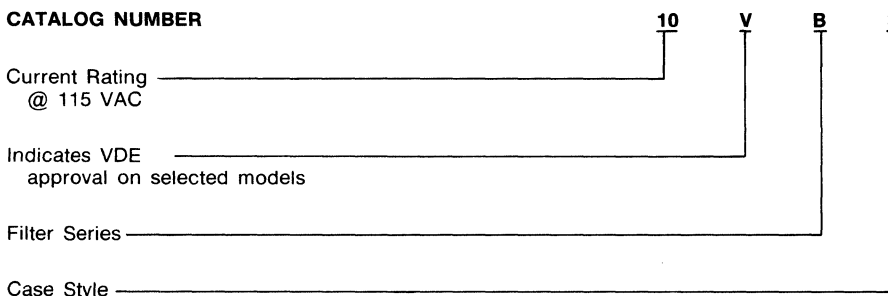

B Series — General Purpose Line-To-Ground Filters

Maximum leakage current each, line-to-ground

- @ 115 VAC 60 Hz: .5mA
- @ 250 VAC 50 Hz: 1.0mA

Case Dimensions
Metric shown in italics.

Part No.	A (max)	B (max)	C (max)	D $\pm .015$ $\pm .38$	E (max)
1B1*/1VB1/1EB1	<i>2.25</i>	<i>1.82</i>	<i>0.66</i>	<i>2.125</i>	<i>2.53</i>
2B1*/2VB1/2EB1	<i>57.1</i>	<i>46.1</i>	<i>16.7</i>	<i>53.98</i>	<i>64.2</i>
1VB3/1EB3	<i>0.96</i>	<i>1.82</i>	<i>0.66</i>	<i>2.125</i>	<i>2.53</i>
2VB3/2EB3	<i>24.3</i>	<i>46.1</i>	<i>16.7</i>	<i>53.98</i>	<i>64.2</i>
3B1*/3VB1/3EB1	<i>2.61</i>	<i>1.82</i>	<i>0.78</i>	<i>2.125</i>	<i>2.53</i>
5B1*/5VB1/5EB1	<i>66.1</i>	<i>46.1</i>	<i>19.9</i>	<i>53.98</i>	<i>64.2</i>
3VB3/3EB3	<i>1.32</i>	<i>1.82</i>	<i>0.78</i>	<i>2.125</i>	<i>2.53</i>
5VB3/5EB3	<i>33.2</i>	<i>46.1</i>	<i>19.9</i>	<i>53.98</i>	<i>64.2</i>
10B1*	<i>2.61</i>	<i>1.82</i>	<i>1.16</i>	<i>2.125</i>	<i>2.53</i>
10VB1/10EB1	<i>66.1</i>	<i>46.1</i>	<i>29.4</i>	<i>53.98</i>	<i>64.2</i>
10VB3/10EB3	<i>1.32</i>	<i>1.82</i>	<i>1.16</i>	<i>2.125</i>	<i>2.53</i>
	<i>33.4</i>	<i>46.1</i>	<i>29.4</i>	<i>53.98</i>	<i>64.2</i>
20B1*	<i>3.36</i>	<i>2.07</i>	<i>1.16</i>	<i>2.375</i>	<i>2.81</i>
20VB1/20EB1	<i>85.2</i>	<i>52.4</i>	<i>29.4</i>	<i>60.33</i>	<i>71.3</i>
20B6	<i>3.46</i>	<i>2.07</i>	<i>1.16</i>	<i>2.375</i>	<i>2.81</i>
	<i>87.9</i>	<i>52.4</i>	<i>29.4</i>	<i>60.33</i>	<i>71.3</i>
30B6	<i>5.34</i>	<i>3.38</i>	<i>1.53</i>	<i>3.750</i>	<i>4.20</i>
	<i>135.6</i>	<i>85.7</i>	<i>38.9</i>	<i>95.30</i>	<i>106.7</i>

*Deduct $\frac{0.15}{3.81}$ from "A" dimension.

Electrical Schematic

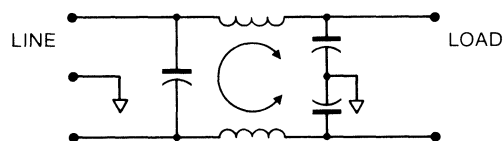

B and K Series Case Styles

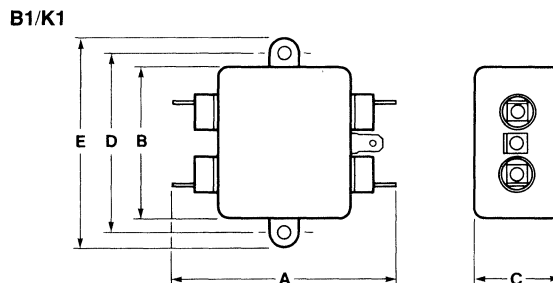

Typical dimensions
Fastons: $\frac{250}{6.35}$ (5) Holes: $\frac{07}{1.8}$ Dia. Mounting holes: $\frac{188}{4.78}$ Dia. (2)

RFI FILTERS

RFI Power Line Filters

EF Series — Internationally Approved Line-To-Ground Filters with IEC Connector

EF Series — RFI Power Line Filters

This rugged international series of RFI filters incorporates the special IEC (International Electrotechnical Commission) power line connector. They are UL recognized, CSA certified, and VDE approved and comply with BSI standards.

Electrically the EF series are general purpose filters effectively providing RFI control of line to ground

noise. The compact design meets the very low leakage current requirements of SEV and VDE portable non patient medical equipment. Models with F suffix have .250 faston terminals on load side; other models have solder lugs.

Maximum leakage current each, line-to-ground

@ 115 VAC 60 Hz: .25mA
 @ 250 VAC 50 Hz: .50mA

Case Dimensions

Metric shown in italics.

Part No.	A (max)	B (max)	C (max)	D $\pm .015$ $\pm .38$	E (max)
1EF1,3EF1, 6EF1	<i>1.99</i>	<i>1.19</i>	<i>0.81</i>	<i>1.575</i>	<i>1.98</i>
	<i>50.6</i>	<i>30.1</i>	<i>20.6</i>	<i>40.01</i>	<i>50.3</i>
1EF2,3EF2, 6EF2	<i>1.55</i>	<i>1.19</i>	<i>0.85</i>	<i>1.575</i>	<i>1.98</i>
	<i>39.4</i>	<i>30.1</i>	<i>21.6</i>	<i>40.01</i>	<i>50.3</i>
1EF1F,3EF1F, 6EF1F	<i>2.20</i>	<i>1.19</i>	<i>0.81</i>	<i>1.575</i>	<i>1.98</i>
	<i>55.9</i>	<i>30.1</i>	<i>20.6</i>	<i>40.01</i>	<i>50.3</i>
3EF2F, 6EF2F	<i>1.55</i>	<i>1.19</i>	<i>0.85</i>	<i>1.575</i>	<i>1.98</i>
	<i>39.4</i>	<i>30.1</i>	<i>21.6</i>	<i>40.01</i>	<i>50.3</i>

Electrical Schematic

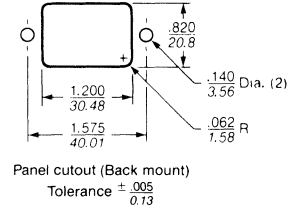
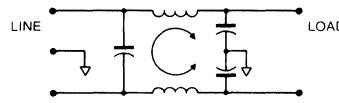

EF and ED Series Case Styles

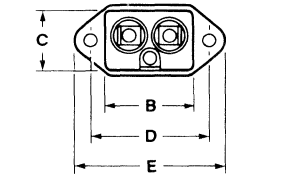
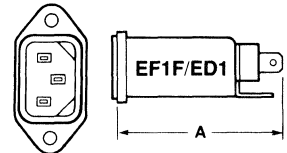
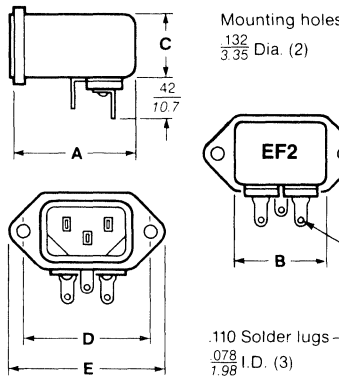

Typical dimensions
Fastons: $\frac{.250}{6.35}$ (3) Holes: $\frac{.07}{1.8}$ Dia.
Mounting holes: $\frac{132}{3.35}$ Dia. (2)

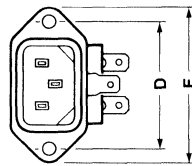
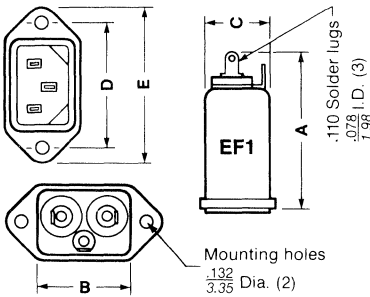

Typical dimensions
Fastons: $\frac{.250}{6.35}$ (3) Holes: $\frac{.07}{1.8}$ Dia.

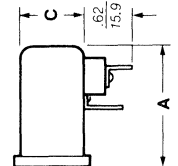
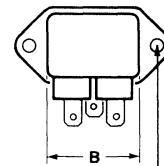
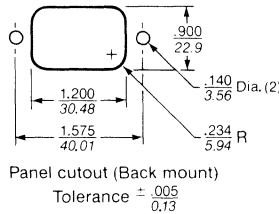

EF2F/ED2

Mounting holes: $\frac{132}{3.35}$ Dia. (2)

ED Series — High Performance EF Series Filters

ED Series

ED series filters are more effective than general-purpose filters in applications where line-to-line and low-frequency line-to-ground noise must be controlled, for example, to

bring equipment into compliance with FCC conducted emissions standards. The ED series offers significantly higher performance than comparably sized filters,

especially at high frequencies, yet is in the EF series package which incorporates the IEC power line connector. Model 6ED1C additionally incorporates a separate

ground-circuit inductor to isolate the equipment chassis from power line ground at RF frequencies.

Maximum leakage current each, line-to-ground

@ 115 VAC 60 Hz: .25mA
 @ 250 VAC 50 Hz: .50mA

Case Dimensions

Metric shown in italics.

Part No.	A (max)	B (max)	C (max)	D $\pm .015$ $\pm .38$	E (max)
3ED1, 6ED1	<i>2.20</i>	<i>1.19</i>	<i>0.81</i>	<i>1.575</i>	<i>1.98</i>
	<i>55.9</i>	<i>30.1</i>	<i>20.6</i>	<i>40.01</i>	<i>50.3</i>
3ED2, 6ED2	<i>1.55</i>	<i>1.19</i>	<i>0.85</i>	<i>1.575</i>	<i>1.98</i>
	<i>39.4</i>	<i>30.1</i>	<i>21.6</i>	<i>40.01</i>	<i>50.3</i>

Electrical Schematic

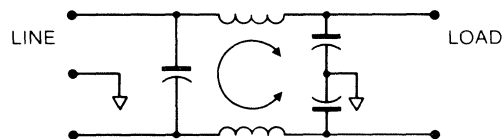

See EF Series for EF and ED Series Case Styles

RFI Power Line Filters

EH Series — Low Leakage Filters For Health Care Equipment

EH Series

Underwriters Laboratories' medical and dental equipment specification UL544 is broken down into two basic categories.

A. Patient Care Equipment:

"Equipment that is intended to be used on or with, or likely to be contacted by, a patient in a health care facility in the course of his treatment." This equipment can have a maximum leakage current of 100 micro amps at 120 VAC, 60 Hz.

B. Nonpatient Equipment: "Equipment primarily for use in a health care facility that is intended for use where contact with a patient is unlikely." This equipment can have a maximum leakage current of 500 micro amps at 120 VAC, 60 Hz.

Model 6EH1 for Patient Care Equipment

Our filters 6EH1 and 6EH1 (Category A above) have 2 micro amps maximum leakage current.

Models 6EH4 & 6EH9 for Nonpatient Equipment

Our filters 6EH4 and 6EH9, which fulfill Category B above, include the special IEC (International Electrotechnical Commission) power line connector. Use with our No. 80-1245 line cord. Maximum leakage currents: filters have 2 micro amps; line cord has 50 micro amps.

Maximum leakage current each, line-to-ground

@ 115 VAC 60 Hz:	2 μ A
@ 250 VAC 50 Hz:	5 μ A

Case Dimensions

Metric shown in italics.

Part No.	A (max)	B (max)	C (max)	D $\pm .015$ $\pm .38$	E (max)
6EH1	<i>2.25</i> 57.2	<i>1.82</i> 46.1	<i>0.66</i> 16.7	<i>2.125</i> 53.98	<i>2.53</i> 64.2
6EH4	<i>2.20</i> 55.9	<i>1.19</i> 30.1	<i>0.81</i> 20.6	<i>1.575</i> 40.01	<i>1.98</i> 50.3
6EH9	<i>1.55</i> 39.4	<i>1.19</i> 30.1	<i>0.85</i> 21.6	<i>1.575</i> 40.01	<i>1.98</i> 50.3

Electrical Schematic

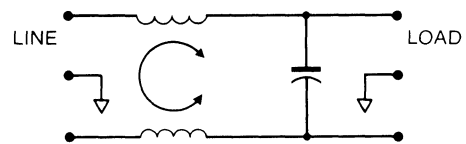

EH Series Case Styles

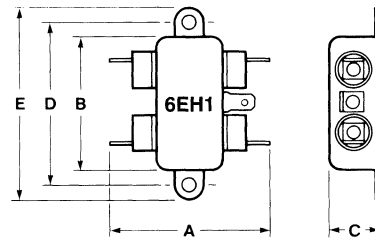

Typical dimensions

Fastons: $\frac{.250}{6.35}$ (5) Holes: $\frac{.07}{1.8}$ Dia. Mounting holes: $\frac{.188}{4.78}$ Dia. (2)

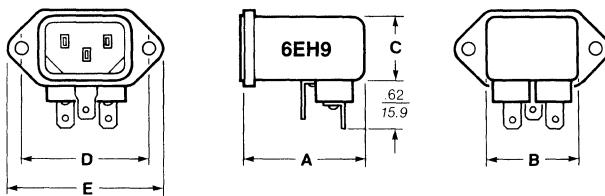

Typical dimensions

Fastons: $\frac{.250}{6.35}$ (3) Holes: $\frac{.07}{1.8}$ Dia.

Mounting holes: $\frac{.132}{3.35}$ Dia. (2)

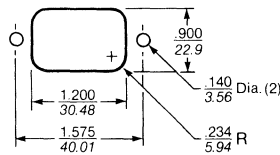

Panel cutout (Back mount)
Tolerance $\pm \frac{.005}{0.13}$

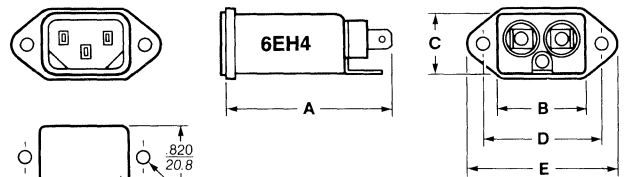

Typical dimensions

Fastons: $\frac{.250}{6.35}$ (3) Holes: $\frac{.07}{1.8}$ Dia.

Mounting holes: $\frac{.132}{3.35}$ Dia. (2)

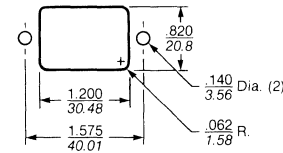

Panel cutout (Front mount)
Tolerance $\pm \frac{.005}{0.13}$

RFI Power Line Filters

SK Series — High Performance K Series Filters

SK Series

This new series of RFI filters was designed to reduce conducted noise to acceptable limits for equipment that must comply with the FCC specifications in the USA and requirements of VDE 0871 in West Germany.

The SK (Super K) series filters are significantly higher performance than the K series which makes this new series particularly suited for equipment with high line-to-ground as well as line-to-line conducted emissions.

Maximum leakage current each, line-to-ground

@ 115 VAC 60 Hz: .5mA
 @ 250 VAC 50 Hz: 1.0mA

Case Dimensions

Metric shown in italics.

Part No.	A (max)	B (max)	C (max)	D $\pm .015$ $\pm .38$	E (max)
3VSK1	<u>3.85</u> 97.7	<u>2.07</u> 52.4	<u>1.16</u> 29.4	<u>2.938</u> 74.63	<u>3.35</u> 85.1
				$\dagger \pm .02$ $\pm .5$	

Electrical Schematic

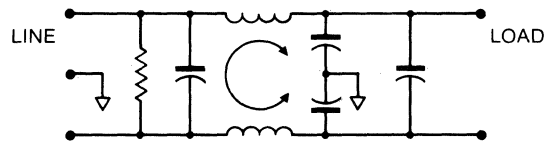

SK Series Case Styles

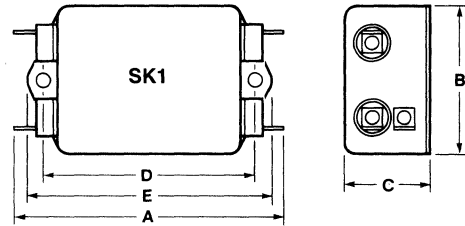

Typical dimensions

Fastons: $\frac{250}{6.35}$ (5) Slots: $\frac{.07}{1.8} \times \frac{.156}{3.96}$ Mounting holes: $\frac{.188}{4.78}$ Dia. (2)

J Series — Voltage Selecting And Fused Connector

Voltage Selecting and Fused Connector

Developed for the manufacturer who markets his products worldwide, the VS&F eliminates the need for internal wiring changes, special power supplies or the need for stocking different line cords.

The VS&F, in less than 3 1/2 square inches of panel space, provides an internationally approved con-

necter, a fuse holder and a means to change transformer primary connections with a unique voltage selector card. With the VS&F, equipment can be operated anywhere in the world without modification at time of installation.

The VS&F is also available with a built-in filter for RFI protection of the equipment.

Maximum leakage current each, line-to-ground

@ 250 VAC 50 Hz: 5μA 500μA

Case Dimensions

Metric shown in italics.

Part No.	A (max)	B (max)	C (max)	D (max)
6VJ1	<u>1.52</u> 38.6	<u>2.68</u> 68.1	<u>1.17</u> 29.7	<u>1.23</u> 31.2
6J4	<u>1.87</u> 47.5	<u>2.75</u> 69.9	<u>1.17</u> 29.7	<u>1.58</u> 40.1

J Series Case Styles

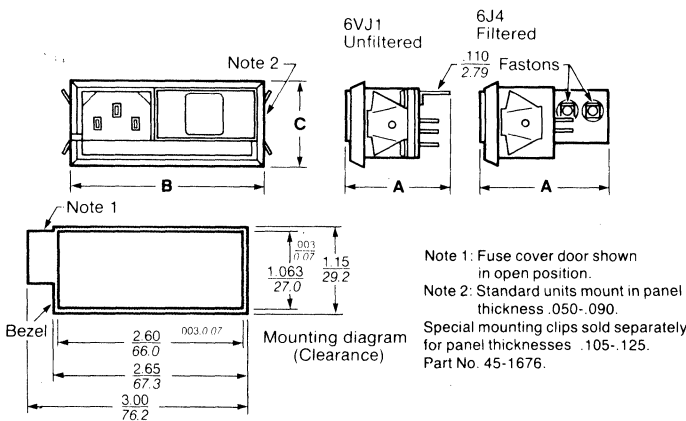

Electrical Schematics

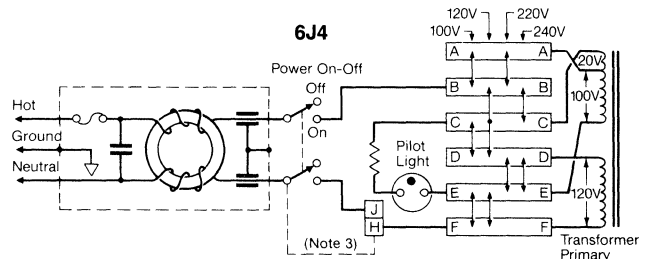
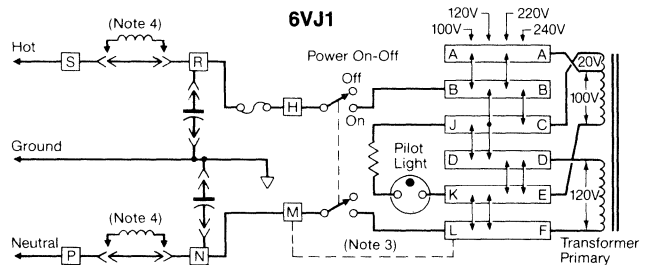

Note 3: Jumper required if only SPST Power Switch is used.
 Note 4: Jumpers required if no input filtering is used.

FILTER ACCESSORIES

Part Number
45-1676

Description
 Special mounting clip (2 required) for mounting J Series units to panel thicknesses up to .125" (standard mounting clips may be used only on panels .090" or less)
 4 voltage selector card for J Series units
 2 voltage selector card for J Series units
 Standard line cord (50 microamps leakage) to mate with IEC connector
 Hospital grade line cord (6 microamps leakage) for use with model 6EH1

70-1470
70-1495
80-1245

80-1430

RFI Power Line Filters

R Series — For Low Impedance Motor Loads

R Series — RFI Power Line Filter

The dual T section RFI power line filters provide premium performance at moderate cost. They are well suited for low impedance loads where noisy RFI environments are present. They control pulsed, continuous and/or intermittent interference, insuring protection of your equipment from power line noise in addition to protecting the line from equipment noise.

The R series dual T type provides low leakage current without deterioration of insertion loss characteristics and at a competitive cost. The ER models meet the very low leakage current requirements of SEV, VDE portable equipment, and (120 volt) UL 544 non patient medical equipment.

Maximum leakage current each, line-to-ground

- @ 115 VAC 60 Hz: .5mA
- @ 250 VAC 50 Hz: 1.0mA

Case Dimensions

Metric shown in italics.

Part No.	A (max)	B (max)	C (max)	D ±.015 ±.38	E (max)
1R1*/1VR1/1ER1	3.35	1.81	1.16	2.375	2.78
2R1*/2VR1/2ER1	85.1	45.9	29.4	60.33	70.6
1ER3	2.07	1.81	1.16	2.375	2.78
2VR3/2ER3	52.4	45.9	29.4	60.33	70.6
3R1*/3VR1/3ER1	3.85	2.07	1.16	2.938	3.35
5R1*/5VR1/5ER1	97.7	52.4	29.4	74.63	85.1
3VR3/3ER3	2.56	2.07	1.16	2.938	3.35
5VR3/5ER3	65.0	52.4	29.4	74.63	85.1
3VR7M	4.33	2.25	1.28	1.575	0.64
3ER7/3ER7M	110.0	57.1	32.4	40.01	16.3
5VR7M	4.33	2.25	1.28	1.575	0.64
5ER7/5ER7M	110.0	57.1	32.4	40.01	16.3
10R1*	3.85	2.07	1.53	2.938	3.35
10VR1/10ER1	97.7	52.4	38.8	74.63	85.1
10ER3	2.56	2.07	1.53	2.938	3.35
	65.0	52.4	38.8	74.63	85.1
10R6	3.96	2.07	1.53	2.938	3.35
	100.6	52.4	38.8	74.63	85.1
10VR7M	4.33	2.25	1.53	1.575	0.88
10ER7/10ER7M	110.0	57.1	38.8	40.01	22.3
20R1*	5.23	3.37	1.53	3.750	4.20
20ER1	132.7	85.6	38.8	95.30	106.7
20R6	5.34	3.37	1.53	3.750	4.20
	135.6	85.6	38.8	95.30	106.7

*Deduct $\frac{0.15}{3.87}$ from "A" dimension.

† ±.02
±.5

Note Same layout for 20VR* except $\frac{250}{6.35}$ (5) Fastons instead of Screw Terminals

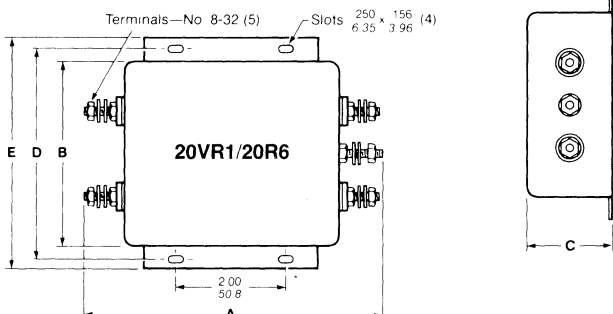

Electrical Schematic

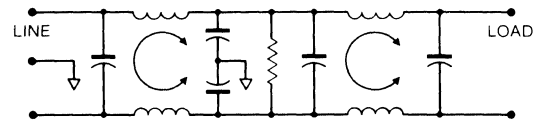

R Series Case Styles

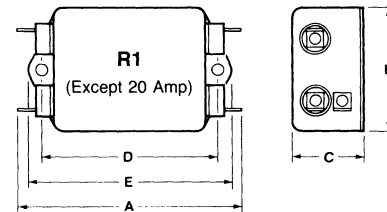

Typical dimensions

Fastons: $\frac{250}{6.35}$ (5) Holes: $\frac{07}{18}$ Dia. Mounting holes: $\frac{188}{478}$ Dia (2)

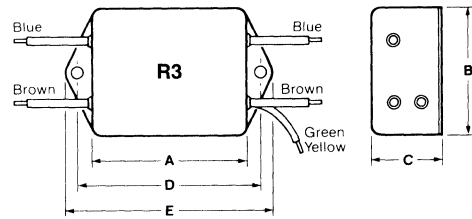

Typical dimensions Wire leads: $\frac{4.0}{101.6}$ Min Mounting holes: $\frac{188}{478}$ Dia. (2)

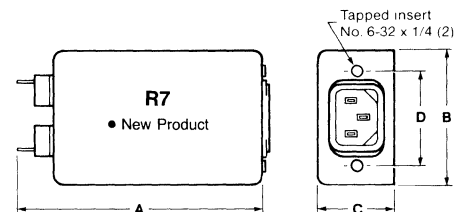

Typical dimensions

Fastons: $\frac{250}{6.35}$ (3) Holes: $\frac{07}{18}$ Dia.

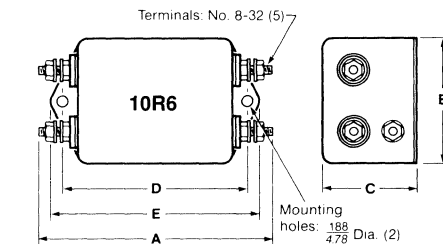
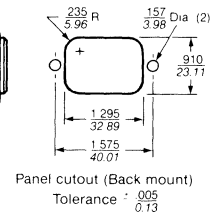

RFI Power Line Filters

S, V, W, VS, VV, VW Series — Line-To-Line, Line-To-Ground Filters For Switching Power Supplies, SCR, and TTL Applications

S, V, W and VS, VV, VW

These filter series combine Corcom's successful line-to-ground interference rejection filters with additional circuitry designed to reduce line-to-line noise and transients. These designs and a balanced N=3 ("PI") line-to-line filter with high rejection at low frequencies, to the N=2 ("L") and N=3 ("T") sections that have been so successful in eliminating line-to-ground noise.

These filters will protect equipment from malfunctions due to conducted interference coming into

the equipment from the line (susceptibility). They will also provide needed noise suppression to allow most equipment to meet FCC and VDE specifications for conducted emissions.

The S, V, W series and VS, VV, VW series filters are particularly effective when applied in equipment using switching type power supplies. SCR and T²L circuits, for compliance with FCC Part 15, Subpart J, and VDE 0871, Level A, down to 150 kHz.

Maximum leakage current each, line-to-ground

- @ 115 VAC 60 Hz: 0.5mA
- @ 250 VAC 50 Hz: 1.0mA

Case Dimensions

Metric shown in italics.

Part No.	A (max)	B (max)	C (max)	D $\pm .015$ $\pm .38$	E (max)
3S1A,	<i>3.21</i>	<i>1.82</i>	<i>1.28</i>	<i>2.375</i>	<i>2.78</i>
3W1A	<i>81.5</i>	<i>46.1</i>	<i>32.6</i>	<i>60.33</i>	<i>70.5</i>
6S1, 6V1,	<i>3.71</i>	<i>2.08</i>	<i>1.53</i>	<i>2.938</i>	<i>3.34</i>
6W1	<i>94.2</i>	<i>52.8</i>	<i>38.9</i>	<i>74.63</i>	<i>84.8</i>
10S1, 10V1,	<i>3.71</i>	<i>2.08</i>	<i>1.53</i>	<i>2.938</i>	<i>3.34</i>
10W1	<i>94.2</i>	<i>52.8</i>	<i>38.9</i>	<i>74.63</i>	<i>84.8</i>
20S1, 20V1,	<i>5.08</i>	<i>3.38</i>	<i>1.53</i>	<i>3.750</i>	<i>4.20</i>
20W1	<i>129.0</i>	<i>85.7</i>	<i>38.9</i>	<i>95.25</i>	<i>106.7</i>
3VS1	<i>3.36</i>	<i>1.82</i>	<i>1.16</i>	<i>2.375</i>	<i>2.78</i>
	<i>85.3</i>	<i>46.1</i>	<i>29.4</i>	<i>60.33</i>	<i>70.5</i>
3VV1, 3VW1,	<i>3.36</i>	<i>1.82</i>	<i>1.28</i>	<i>2.375</i>	<i>2.78</i>
	<i>85.3</i>	<i>46.1</i>	<i>32.6</i>	<i>60.33</i>	<i>70.5</i>
6VS1, 6VV1,	<i>3.86</i>	<i>2.08</i>	<i>1.53</i>	<i>2.938</i>	<i>3.34</i>
6VW1	<i>98.0</i>	<i>52.8</i>	<i>38.9</i>	<i>74.63</i>	<i>84.8</i>
10VS1, 10VV1,	<i>3.86</i>	<i>2.08</i>	<i>1.53</i>	<i>2.938</i>	<i>3.34</i>
10VW1	<i>98.0</i>	<i>52.8</i>	<i>38.9</i>	<i>74.63</i>	<i>84.8</i>
20VS1, 20VV1,	<i>5.23</i>	<i>3.38</i>	<i>1.53</i>	<i>3.750</i>	<i>4.20</i>
20VW1	<i>132.8</i>	<i>85.7</i>	<i>38.9</i>	<i>95.25</i>	<i>106.7</i>

Metric shown in italics.

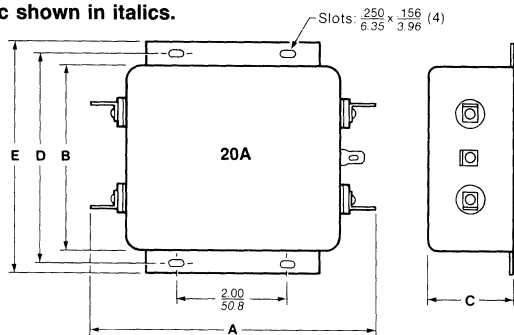

Typical dimensions Fastons: $\frac{250}{6.35}$ (5) †Holes: $\frac{.07}{1.8}$ Dia. *Slots: $\frac{.07}{1.8} \times \frac{156}{3.96}$
 * S, V, W models only. †VS, VV, VW models only.
 Note: Smaller terminal insulators on S, V, W models do not meet VDE spacing requirements.

Electrical Schematic

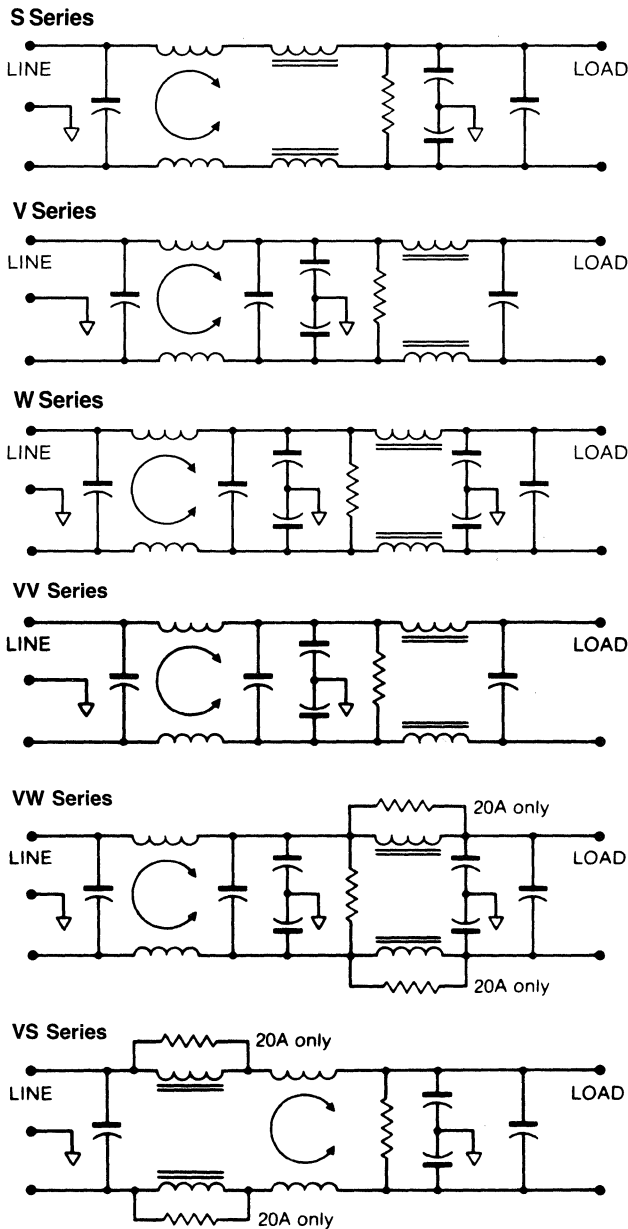

S, V, W Series Case Styles

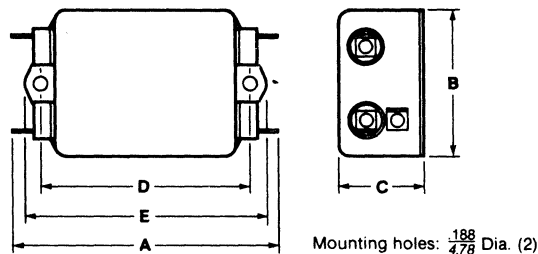

Typical dimensions Fastons: $\frac{250}{6.35}$ (5) †Holes: $\frac{.07}{1.8}$ Dia. *Slots: $\frac{.07}{1.8} \times \frac{156}{3.96}$

RFI Power Line Filters

EP Series — For Switching Power Supply Applications

EP Series — RFI Power Line Filters

For Switching Power Supply

The EP series of RFI filters has been developed to reduce conducted noise to acceptable limits for equipment that must comply with the requirements of the FCC specifications and the VDE-0871 specification in West Germany and in the USA. These filters provide high insertion loss for both line-to-line emissions throughout the fre-

Noise Suppression

quency range. They are particularly well suited for equipment that must meet both stringent emissions specifications (such as VDE-0871, B level and FCC Part 15J, Class B) and very low leakage current requirements such as SEV, VDE portable equipment and (120 volt) UL 544 non patient medical equipment.

EP Series

Maximum leakage current each, line-to-ground

- @ 115 VAC 60 Hz: .25mA
- @ 250 VAC 50 Hz: .40mA

Case Dimensions

Metric shown in italics.

Part No.	A (max)	B (max)	C (max)	D $\pm .015$ $\pm .38$	E (max)
3EP1	<i>3.85</i> 97.7	<i>2.07</i> 52.3	<i>1.78</i> 45.1	<i>2.938</i> 74.63	<i>3.35</i> 85.1
3EP3	<i>2.56</i> 65.0	<i>2.07</i> 52.3	<i>1.78</i> 45.1	<i>2.938</i> 74.63	<i>3.35</i> 85.1
3EP7	<i>3.21</i> 81.5	<i>2.25</i> 57.1	<i>1.78</i> 45.1	<i>1.575</i> 40.01	<i>0.66</i> 16.8
6EP3	<i>5.33</i> 135.3	<i>2.07</i> 52.4	<i>2.28</i> 57.9	<i>5.625</i> 142.88	<i>6.03</i> 153.2
10EP1	<i>6.62</i> 168.1	<i>2.07</i> 52.4	<i>2.78</i> 70.6	<i>5.625</i> 142.88	<i>6.03</i> 153.2

† $\pm .02$
 $\pm .5$

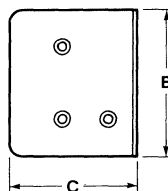
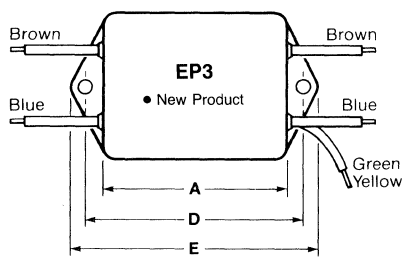

Typical dimensions

Wire leads: $\frac{4.0}{101.6}$ Min.

Mounting holes: $\frac{.188}{4.78}$ Dia. (2)

Electrical Schematic

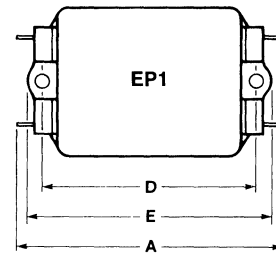
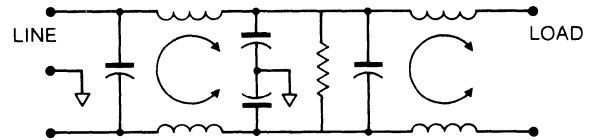

Typical dimensions

Fastons: $\frac{.250}{6.35}$ (5)

Holes: $\frac{.07}{1.8}$ Dia.

Mounting holes: $\frac{.188}{4.78}$ Dia. (2)

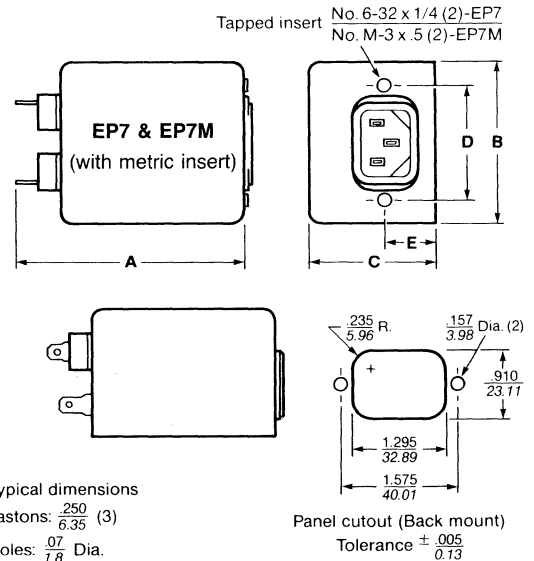
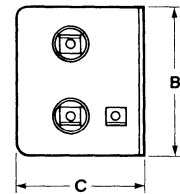

RFI Power Line Filters

K Series — Power Line Filters

The K series power line filters are general purpose common-mode filters. They are effective in the control of line to line as well as line to ground RFI interference. The K series filters are particularly suited in applications where pulsed continuous and/or intermittent RFI

interference is present. The K series is UL recognized, CSA certified and VDE approved. The EK models meet the very low leakage current requirements of SEV, VDE portable equipment, and (120 volt) UL 544 non patient medical equipment.

Case Dimensions

Metric shown in italics.

Part No.	A (max)	B (max)	C (max)	D ±.015 ±.38	E (max)
1K1*/1VK1/1EK1	3.10	2.07	0.91	2.375	2.81
2K1*/2VK1/2EK1	78.7	52.4	23.1	60.33	71.3
1VK3/1EK3	1.81	2.07	0.91	2.375	2.81
2VK3/2EK3	45.9	52.4	23.1	60.33	71.3
3K1*/3VK1/3EK1	3.10	2.07	1.16	2.375	2.81
5K1*/5VK1/5EK1	78.7	52.4	29.4	60.33	71.3
3VK3/3EK3	1.81	2.07	1.16	2.375	2.81
5VK3/5EK3	45.9	52.4	29.4	60.33	71.3
10K1*	3.35	2.07	1.16	2.375	2.81
10VK1/10EK1	85.1	52.4	29.4	60.33	71.3
10VK3/10EK3	2.07	2.07	1.16	2.375	2.81
	52.4	52.4	29.4	60.33	71.3
10VK6	3.46	2.07	1.16	2.375	2.81
	87.9	52.4	29.4	60.33	71.3
10VK7/10VK7M	3.71	2.25	1.28	1.575	0.63
10EK7/10EK7M	94.1	57.1	32.4	40.01	16.0
20K1*	3.35	2.56	1.53	2.938	3.35
20VK1/20EK1	85.1	65.0	38.8	74.63	85.1
20VK6	3.46	2.56	1.53	2.938	3.35
	87.9	65.0	38.8	74.63	85.1
30VK6	5.34	3.38	1.53	3.750	4.20
	135.6	85.7	38.9	95.30	106.7

*Deduct $\frac{0.15}{3.87}$ from "A" dimension.

† $\pm .02$
 $\pm .5$

Electrical Schematic

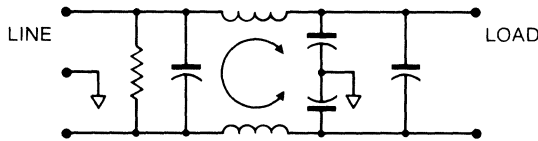

See B Series for
B and K Series Case Styles

RFI FILTERS

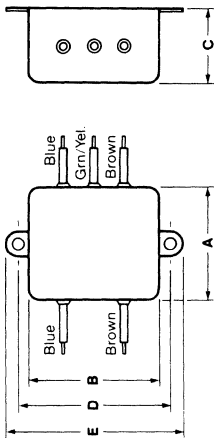

Typical dimensions
Wire leads: $\frac{4.0}{107.6}$ Min.
Mounting holes: $\frac{1.88}{47.8}$ Dia. (2)

B3/K3

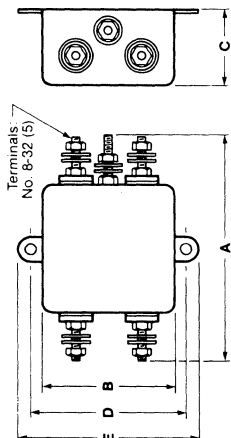

Typical dimensions
Mounting holes: $\frac{1.88}{47.8}$ Dia. (2)

10B6/10VK6 & 20B6/20VK6

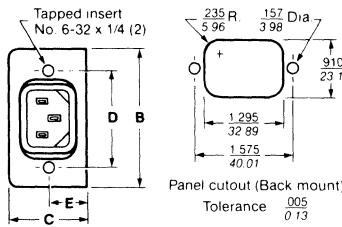

Typical dimensions
Fastens: $\frac{2.50}{6.35}$ (3) Holes: $\frac{0.7}{1.8}$ Dia.

K7

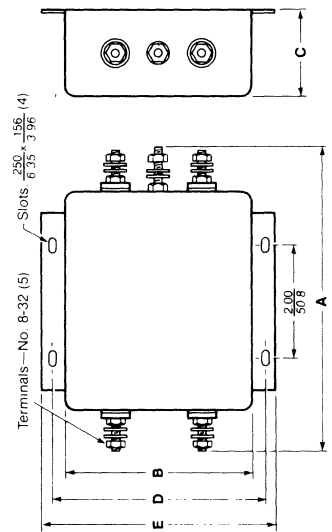

30B6/30K6

K Series — General Purpose Line-To-Line And Line-To-Ground Filters

Maximum leakage current each, line-to-ground

@ 115 VAC 60 Hz: .5mA
@ 250 VAC 50 Hz: 1.0mA

Power Resistors

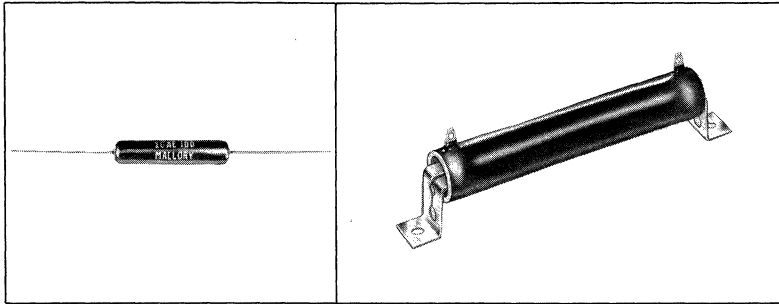

Fixed and Adjustable Wirewound

Highlights:
 Power Ratings: 3 watts to 225 watts
 Leadless types furnished with hardware
 Resistance: 1 Ω to 100 K Ω
 Coating: Vitreous enamel
 Adjustable vitreous wire wound available

TYPE AE WIRE-WOUND RESISTORS AXIAL LEAD VITREOUS ENAMEL COATED

Mallory type AE wire-wound resistors have axial leads and a tough vitreous enamel coating. Available in three power ratings: 3, 5 and 10 watts.
To order: use type number followed by resistance value (e.g., 3AE4000).

Specifications
 Tolerance ± 5%
 Temperature Coefficient 0 ± 30 ppm/°C 10 ohms and above.
 0 ± 50 ppm/°C 1 to 9.99 ohms.
 Dielectric Withstanding Voltage 1000 VAC.

Overload 10X rated wattage for 5 sec. for 5 watt size and larger. 5X rated wattage for 5 sec. under 5 watt size.

	Ohms								
3-WATT TYPE 3AE	1.0	5.0	27	75	150	270	500	1200	3300
	1.5	7.5	30	82	180	400	600	1500	4000
	2.0	10	33	100	200	450	680	2700	5000
	3.0	15	50	120	250	470	1000	3000	10,000
	4.0	25	56	125					

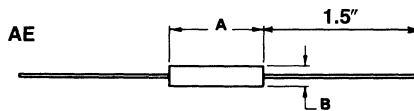

TYPE AE RESISTOR SIZES

Diameter	Length	Lead	Catalog No.
1/4"	9/16"	#20	3AE
1/4"	1"	#20	5AE
11/32"	15/64"	#20	10AE

	Ohms								
5-WATT TYPE 5AE	1.0	10	30	82	220	470	1500	3000	5000
	1.5	12	33	100	250	500	1800	3300	6000
	2.0	15	35	125	300	750	2000	3500	7500
	3.0	20	40	150	330	820	2200	3900	10,000
	4.0	22	47	180	400	1000	2500	4000	12,000
	5.0	25	50	200	450	1200	2700	4700	20,000
7.5	27	75							
10-WATT TYPE 10AE	1.0	7.5	30	75	220	750	2000	4700	15,000
	1.5	10	33	100	300	800	2500	5000	20,000
	2.0	15	35	125	350	1000	3000	5600	25,000
	3.0	20	47	150	390	1200	4000	6000	40,000
	4.0	22	50	200	500	1750	4500	10,000	50,000
	5.0	25	68						

Derating (AE, HHJ, HJ, AV)

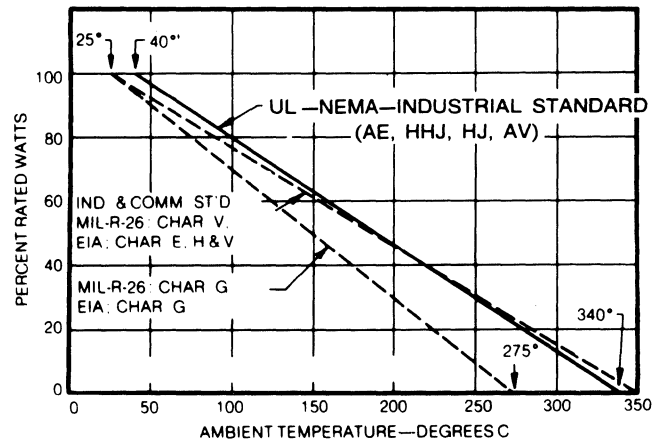

Types HHJ, HJ, AV

To Order: Use type number followed by resistance value (e.g., 1HJ10, 1AV10).

Specifications
 Tolerance ± 5% HJ, ± 10% AV
 Temperature Coefficient 0 ± 400 ppm/°C 1 ohm to 20 ohms
 0 ± 260 ppm/°C above 20 ohms.
 Dielectric Withstanding Voltage Measured from terminal to mounting bracket

12 to 100 watts size, 1000 volts AC.
 175 and 225 watts size, 3000 volts AC.
 Overload 10 times rated wattage for 5 sec.
 Core Tubular ceramic.
 Coating Vitreous Enamel.

MOUNTING FEET (For HHJ, HJ, AV types)

Fits Type	Catalog No.
8, 12 watt	5
20 watt	7
25, 50 watt	9
100 watt	12
175, 225 watt	18

Power Resistors

FIXED VITREOUS TYPE HHJ AND HJ RESISTORS (Tol. ± 5%)

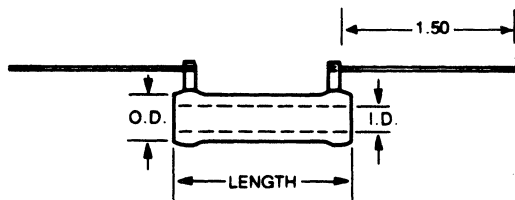

HHJ thru 2HJ

DIMENSIONS
(Inches)

Type	Length	O.D.	I.D.
HHJ	1.000	0.313	0.188
1HJ	1.750	0.313	0.188
2HJ	2.000	0.438	0.250

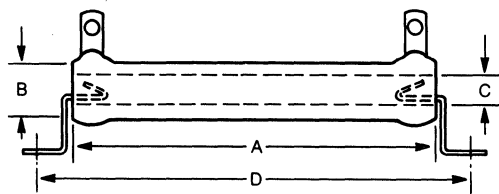

2.5HJ thru 20HJ

8-WATTS TYPE HHJ	Ohms								
	1.0	10	40	225	500	1000	2250	4500	10,000
	1.5	15	50	250	600	1100	2500	5000	12,500
	2.0	20	75	300	700	1200	3000	6000	15,000
	4.0	25	100	350	750	1250	3500	7000	20,000
	5.0	30	150	400	800	1500	4000	7500	25,000
	7.5	35	200	450	900	2000			

12-WATT TYPE 1HJ	Ohms								
	1.0	5.0	25	50	225	1000	2500	5000	13,500
	1.5	10	30	100	250	1500	3000	7500	15,000
	2.0	12	35	150	300	1750	4000	10,000	20,000
	3.0	15	40	200	600	2000	4500	12,500	50,000
	4.0	20							

20-WATT TYPE 2HJ	Ohms								
	1.0	10	150	700	1200	2000	5000	10,000	15,000
	3.0	25	400	750	1250	3000	6000	12,500	25,000
	5.0	100	500	1000	1500	4000			

25-WATT TYPE 2.5HJ	Ohms								
	1.0	4.0	25	75	150	250	1000	2500	10,000
	2.0	5.0	50	100	200	500	1500	5000	20,000
	3.0	15							

50-WATT TYPE 5HJ	Ohms								
	1.0	3.0	5.0	25	100	500	1500	7500	25,000
	2.0	4.0 <td>10</td> <td>50</td> <td>150</td> <td>1000</td> <td>5000</td> <td>10,000</td> <td>50,000</td>	10	50	150	1000	5000	10,000	50,000

100-WATT TYPE 10HJ	Ohms			
	1.0	4.0	10	50
	2.0	5.0 <td>25</td> <td>75</td>	25	75
				100

175-WATT TYPE 16HJ	Ohms			
	10	100	1000	100,000

225-WATT TYPE 20HJ	Ohms			
	1.0	5.0	25	100
	2.0	10	50	150
				500
				25,000
				1000

ADJUSTABLE VITREOUS TYPE AV RESISTORS (Tol. ± 10%)

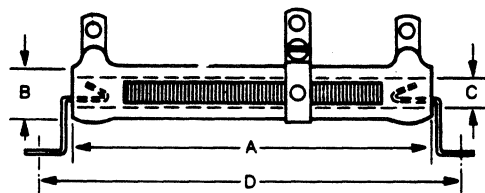

1AV thru 20AV

DIMENSIONS
(Inches)

Type	A	B	C	D
1AV	1.75	.313	.188	2.19
2.5HJ, 2AV	2.00	.562	.313	2.75
5HJ, 5AV	4.00	.562	.313	4.75
10HJ, 10AV	6.50	.750	.500	7.38
16HJ	8.50	1.125	.750	9.38
20HJ, 20AV	10.50	1.125	.750	11.38

12-WATT TYPE 1AV	Ohms		
	20	2000	10,000
	50	2250	
	150	2500	
	1000	5000	

25-WATT TYPE 2AV	Ohms								
	1.0	3.0	7.5	15	50	150	1000	3000	10,000
	2.0	5.0 <td>10</td> <td>25</td> <td>100</td> <td>300</td> <td>2500</td> <td>5000</td> <td>15,000</td>	10	25	100	300	2500	5000	15,000

50-WATT TYPE 5AV	Ohms								
	1.0	5.0	25	75	200	400	1000	2000	20,000
	2.0	10	50	100	300	500	1500	2500	50,000

100-WATT TYPE 10AV	Ohms		
	1.0	5.0	50
	2.0	10	100
	3.0	25	500

225-WATT TYPE 20AV	Ohms			
	10	25	50	250
				500
				1500

ADJUSTABLE CLIPS

Fits Type	Catalog No.	Fits Type	Catalog No.
1AV	2115	10AV	2125
2AV, 5AV	2121	20AV	2133

NOTE: HHJ, HJ, and AV resistors are supplied less mounting feet when packaged bulk. To order use catalog number listed on previous page.

Type CCR • Carbon-Composition Resistors

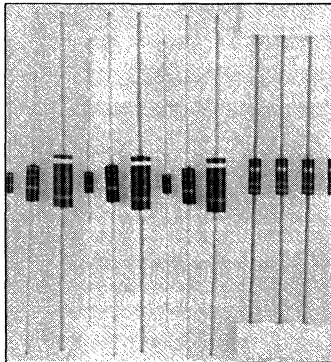

Carbon-composition resistors

Mallory 1/8 1/4 1/2 watt carbon-composition resistors are manufactured in an exclusive hot-molding process which affords the utmost in product uniformity. These resistors are available for commercial and industrial applications and meet the performance standards for EIA Fixed Composition Standard RS-172 as well as Military Specification MIL-R-11.

Resistance elements and outer insulating shells are molded of similar materials into solid homogeneous structures that defy catastrophic failure and erratic resistance changes in severe environments. These resistors exhibit a low current noise as well as improved pulse-load handling.

PACKAGING

Standard pack bulk.
Reel pack is available.

Part Numbering System

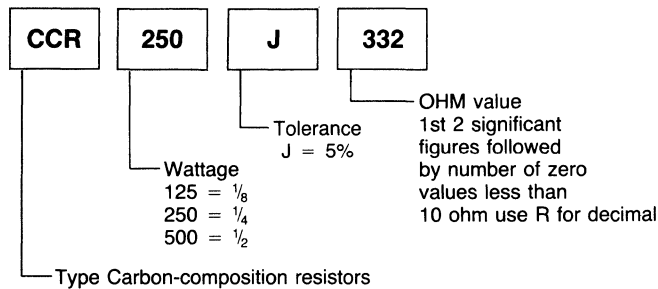

OHM Ratings 5%

2.2	10	100	1000	10000	100000	1000000	10000000
2.4	11	110	1100	11000	110000	1100000	11000000
2.7	12	120	1200	12000	120000	1200000	12000000
3.0	13	130	1300	13000	130000	1300000	13000000
3.3	15	150	1500	15000	150000	1500000	15000000
3.6	16	160	1600	16000	160000	1600000	16000000
3.9	18	180	1800	18000	180000	1800000	18000000
4.3	20	200	2000	20000	200000	2000000	20000000
4.7	22	220	2200	22000	220000	2200000	22000000
5.1	24	240	2400	24000	240000	2400000	24000000
5.6	27	270	2700	27000	270000	2700000	27000000
6.2	30	300	3000	30000	300000	3000000	30000000
6.8	33	330	3300	33000	330000	3300000	33000000
7.5	36	360	3600	36000	360000	3600000	36000000
8.2	39	390	3900	39000	390000	3900000	39000000
9.1	43	430	4300	43000	430000	4300000	43000000
	47	470	4700	47000	470000	4700000	47000000
	51	510	5100	51000	510000	5100000	51000000
	56	560	5600	56000	560000	5600000	56000000
	62	620	6200	62000	620000	6200000	62000000
	68	680	6800	68000	680000	6800000	68000000
	75	750	7500	75000	750000	7500000	75000000
	82	820	8200	82000	820000	8200000	82000000
	91	910	9100	91000	910000	9100000	91000000

Resistance Range:

CCR 125 (1/8 watt) 2.2 ohm to 1 meg
CCR 250 (1/4 watt) 2.2 ohm to 5.6 meg
CCR 500 (1/2 watt) 2.2 ohm to 20 meg

General Characteristics

Performance Characteristics (Tested Per MIL-STD-202)

Power Rating	1/8-WATT	1/4-WATT	1/2-WATT
Determined by load life tests 100% load at 70°C ambient	0.125 watt	0.25 watt	0.50 watt
Rated Continuous Working Voltage (RCWV)	\sqrt{PxR} Or 150 volts whichever is less	\sqrt{PxR} Or 250 volts whichever is less	\sqrt{PxR} Or 350 volts whichever is less
Maximum Ambient Temperature Resistors derated to zero load at this temperature	+ 130°C	+ 130°C	+ 130°C
Nominal Resistance Range	2.2 ohms to 1 megohm	2.2 ohms to 5.6 megohms	2.2 ohms to 22 megohms
Standard Resistance Tolerance	± 5%	± 5%	± 5%

Mechanical Dimensions

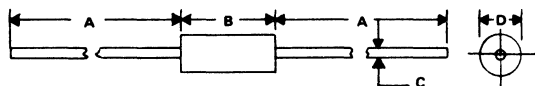

Type	Maximum Power Rating	Maximum Operating Voltage	Dimensions A	B	C	D
CCR 125	1/8 watt	150 V	.984 ± .032 (25.0 ± 0.8)	.145 ± .015 (3.68 ± .38)	.016 ± .002 (0.4 ± .05)	.062 ± .004 (1.57 ± 0.1)
CCR 250	1/4 watt	250V	1.102 ± .032 (28.0 ± 0.8)	.248 ± .028 (6.3 ± 0.7)	.024 ± .002 (0.6 ± .05)	.094 ± .004 (2.4 ± 0.1)
CCR 500	1/2 watt	350V	1.024 ± .032 (26.0 ± 0.8)	.374 + .032 / - .028 (9.5 + 0.8 / - 0.7)	.0275 ± .002 (0.7 ± .05)	.142 ± .008 (3.6 ± 0.2)

Type MFR • Metal-Film Resistors

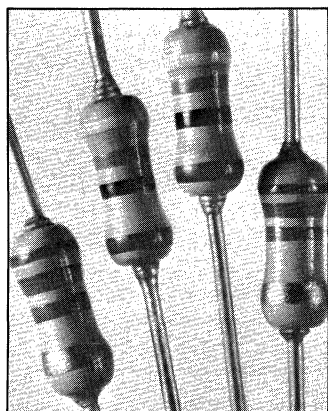

Mallory precision metal-film resistors provide the accuracy, stability and performance necessary to meet today's exacting electronic needs.

Mallory metal-film resistors are manufactured using ultrahigh-vacuum deposition of mixed metals on specially developed ceramic substrates. The end caps are expansion fitted to ensure a positive grip and a low noise level. The resistors are coated with a

thermosetting, solventless resin which protects the metal-film element. This affords outstanding protection from mechanical and environmental damage. Metal-film resistors are designed to meet the most exacting quality control, reliability, miniaturization and environmental specifications of military and other precision application.

Mallory metal-film resistors are available in lead-tape reels, ammo packs and bulk packs.

- Meets requirements of MIL-R-10509 and MIL-R-22684
- TC ± 25 ppm to ± 200 ppm
- Power range: $\frac{1}{8}$ watt to $\frac{1}{2}$ watt
- Resistance range: 10 ohm to 1 megohm
- Tolerance $\pm 1\%$
- Flame-retardant coatings are standard
- Flame proof product available

PACKAGING

Standard pack reel tape. Bulk pack is available.

Part Numbering System

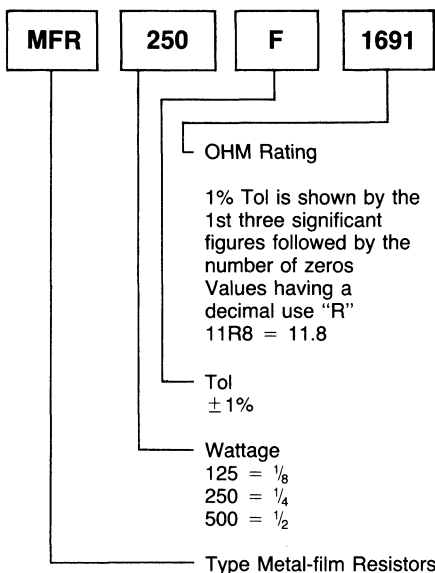

$\pm 1\%$ Tolerance OHM Ratings

10.0	34.0	100	340	1000	3400	10000	34000	100000	340000
10.2	34.8	102	348	1020	3480	10200	34800	102000	348000
10.5	35.7	105	357	1050	3570	10500	35700	105000	357000
10.7	36.5	107	365	1070	3650	10700	36500	107000	365000
11.0	37.4	110	374	1100	3740	11000	37400	110000	374000
11.3	38.3	113	383	1130	3830	11300	38300	113000	383000
11.5	39.2	115	392	1150	3920	11500	39200	115000	392000
11.8	40.2	118	402	1180	4020	11800	40200	118000	402000
12.1	41.2	121	412	1210	4120	12100	41200	121000	412000
12.4	42.2	124	422	1240	4220	12400	42200	124000	422000
12.7	43.2	127	432	1270	4320	12700	43200	127000	432000
13.0	44.2	130	442	1300	4420	13000	44200	130000	442000
13.3	45.3	133	453	1330	4530	13300	45300	133000	453000
13.7	46.4	137	464	1370	4640	13700	46400	137000	464000
14.0	47.5	140	475	1400	4750	14000	47500	140000	475000
14.3	48.7	143	487	1430	4870	14300	48700	143000	487000
14.7	49.9	147	499	1470	4990	14700	49900	147000	499000
15.0	51.1	150	511	1500	5110	15000	51100	150000	511000
15.4	52.3	154	523	1540	5230	15400	52300	154000	523000
15.8	53.6	158	536	1580	5360	15800	53600	158000	536000
16.2	54.9	162	549	1620	5490	16200	54900	162000	549000
16.5	56.2	165	562	1650	5620	16500	56200	165000	562000
16.9	57.2	169	572	1690	5720	16900	57200	169000	572000
17.4	59.0	174	590	1740	5900	17400	59000	174000	590000
17.8	60.4	178	604	1780	6040	17800	60400	178000	604000
18.2	61.9	182	619	1820	6190	18200	61900	182000	619000
18.7	63.4	187	634	1870	6340	18700	63400	187000	634000
19.1	64.9	191	649	1910	6490	19100	64900	191000	649000
19.6	66.5	196	665	1960	6650	19600	66500	196000	665000
20.0	68.1	200	681	2000	6810	20000	68100	200000	681000
20.5	69.8	205	698	2050	6980	20500	69800	205000	698000
21.0	71.5	210	715	2100	7150	21000	71500	210000	715000
21.5	73.2	215	732	2150	7320	21500	73200	215000	732000
22.1	75.0	221	750	2210	7500	22100	75000	221000	750000
22.6	76.8	226	768	2260	7680	22600	76800	226000	768000
23.2	78.7	232	787	2320	7870	23200	78700	232000	787000
23.7	80.6	237	806	2370	8060	23700	80600	237000	806000
24.3	82.5	243	825	2430	8250	24300	82500	243000	825000
24.9	84.5	249	845	2490	8450	24900	84500	249000	845000
25.5	86.6	255	866	2550	8660	25500	86600	255000	866000
26.1	88.7	261	887	2610	8870	26100	88700	261000	887000
26.7	90.9	267	909	2670	9090	26700	90900	267000	909000
27.4	93.1	274	931	2740	9310	27400	93100	274000	931000
28.0	95.3	280	953	2800	9530	28000	95300	280000	953000
28.7	97.6	287	976	2870	9760	28700	97600	287000	976000
29.4		294		2940	29400		294000		1 MEG
30.1		301		3010	30100		301000		
30.9		309		3090	30900		309000		
31.6		316		3160	31600		316000		
32.4		324		3240	32400		324000		
33.2		332		3320	33200		332000		

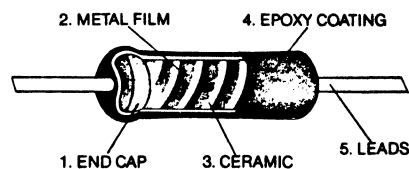

- End caps expansion fitted.
- Evaporated-metal film.
- Specially developed ceramic substrate.
- Conformal epoxy coating.
- Tinned copper leads.

• New Product

Type MFR • Metal-Film Resistors

General Specifications

Mallory	Power Rating		Maximum Working Voltage	Resistance Temp. Coefficient PPM/°C	Resistance Range (Ω)	± Tolerance (%)
	70°C	125°C				
MFR 125	1/8	1/10	200	100	10-1 meg	± 1
MFR 250	1/4	1/8	250	100	10-1 meg	± 1
MFR 500	1/2	1/4	350	100	10-1 meg	± 1

Dimensions

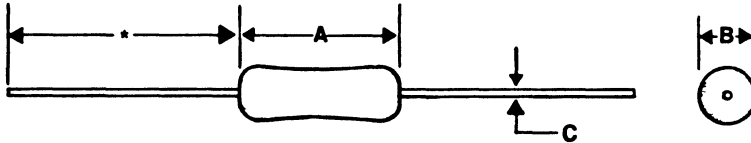

*General-purpose have 1.102 ± .079-inch (28 ± 2 mm) lead length.

Type	Dimensions	Type	Dimensions	Type	Dimensions
MFR 125	A .145 ± .015 (3.68 ± .38)	MFR 250	A .250 ± .031 (6.35 ± .79)	MFR 500	A .362 ± .031 (9.19 ± .79)
	B .075 ± .005 (1.90 ± .12)		B .093 ± .005 (2.36 ± .12)		B .114 ± .015 (2.89 ± .38)
	C .020 ± .002 (.50 ± .05)		C .025 ± .002 (.64 ± .05)		C .025 ± .002 (.64 ± .05)

Current Noise (Typical)

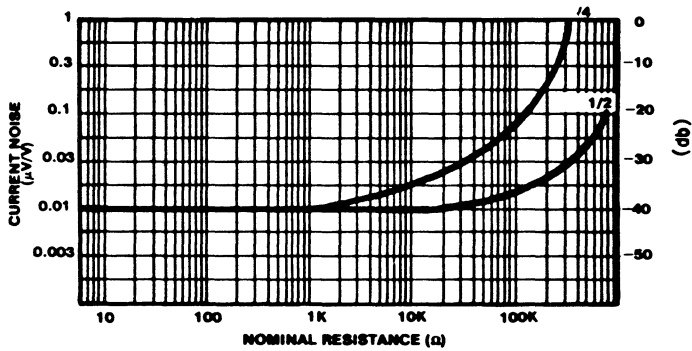

High-Frequency Characteristics (Typical)

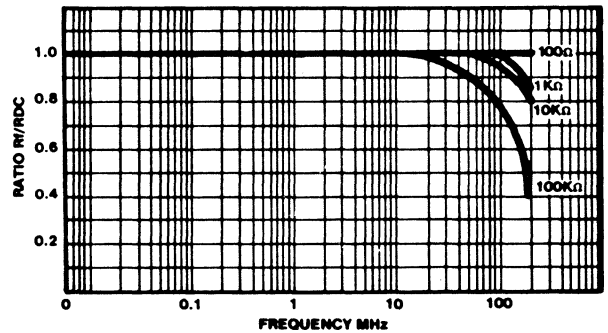

Derating Curve (Typical)

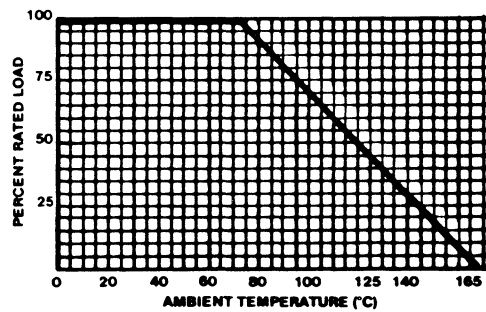

Type MOR • Metal-Oxide Resistors

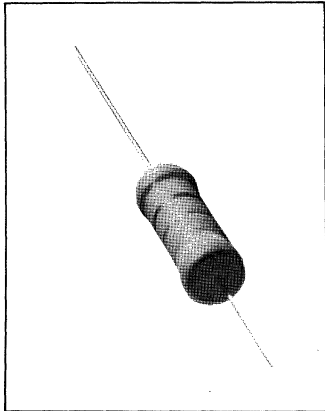

Metal-oxide resistors
Mallory metal-oxide resistors offer excellent performance in applications where stability and uniformity of characteristics are desired. They provide lower-cost alternatives to 1- and 2-watt carbon-composition resistors and general-purpose metal films. Metal oxides also can replace many low-power general-purpose wirewound applications, saving both money and time, with shorter delivery cycles.

Mallory metal oxides meet overload tests in accordance with UL Specification #1412 without producing a fire hazard (the standard for fusing resistors and temperature-limited resistors). Mallory metal oxides withstand solvents test in accordance with method 215 of Mil-Std-202 without producing mechanical or electrical damage.

PACKAGING
Standard pack bulk.
Reel tape pack is available.

Part Numbering System

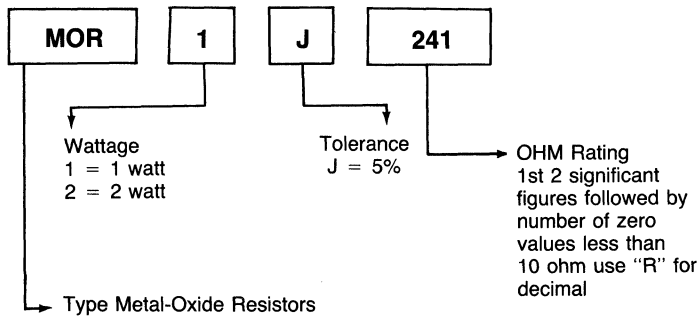

Resistance Range

MOR 1 - one watt .2 watt to 100k
MOR 2 - two watt .2 watt to 120k

Performance Characteristics (Tested Per MIL R-22684)

ELECTRICAL	MOR-1	MOR-2
Power rating @ 70°C	1 watt	2 watts
Derated to 0 load at	200°C	200°C
Maximum working voltage	500 V	500 V
Operating temperature range	-55°C to +200°C	-55°C to +200°C
Tolerance	Resistive Range	Tolerance Resistive Range
±5%	.22 ohm-100K ohm	±5% .22 ohm-120K ohm
ENVIRONMENTAL		
Moisture resistance	±5%	±5%
Thermal shock (-55°C +150°C)	±1%	±1%
Load life @ 70°C 1000 hours	±3%	±5%
Shock and vibration	±0.5%	±0.5%
Resistance to soldering heat	±(0.5% + 0.05 ohm)	±(0.5% + 0.05 ohm)
Terminal strength	±0.05%	±0.05%
Dielectric withstanding voltage	700 V RMS	700 V RMS
Maximum pulse voltage	750 V	1,000 V
Insulation resistance	10,000 megohms or greater	10,000 megohms or greater
Short-time overload	±(0.5% + 0.05 ohm)	±(0.5% + 0.05 ohm)

• New Product

OHM Ratings 5%

1.0	10	100	1000	10000	100000
1.1	11	110	1100	11000	110000
1.2	12	120	1200	12000	120000
1.3	13	130	1300	13000	
1.5	15	150	1500	15000	
1.6	16	160	1600	16000	
1.8	18	180	1800	18000	
.20	2.0	20	200	2000	20000
.22	2.2	22	220	2200	22000
.24	2.4	24	240	2400	24000
.27	2.7	27	270	2700	27000
.30	3.0	30	300	3000	30000
.33	3.3	33	330	3300	33000
.36	3.6	36	360	3600	36000
.39	3.9	39	390	3900	39000
.43	4.3	43	430	4300	43000
.47	4.8	47	470	4700	47000
.51	5.1	51	510	5100	51000
.56	5.6	56	560	5600	56000
.62	6.2	62	620	6200	62000
.68	6.8	68	680	6800	68000
.75	7.5	75	750	7500	75000
.82	8.2	82	820	8200	82000
.91	9.1	91	910	9100	91000

Dimensions

MOR-1	1-Watt	MOR-2	2-Watt
A.	1.496 ± .118 inches (38.0 ± 3.0 mm)	A.	1.496 ± .118 inches (38.0 ± 3.0 mm)
B.	.551 inch maximum (14.0 mm)	B.	.748 inch maximum (19.0 mm)
C.	.031 ± .001 inch (.80 ± .02 mm)	C.	.031 ± .001 inch (.80 ± .025 mm)
D.	.157 ± .020 inch (4.0 ± 0.5 mm)	D.	.236 ± .039 inch (6.0 ± 1.0 mm)

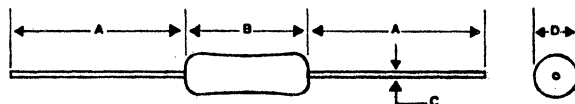

Type CFR • Carbon-Film Resistors

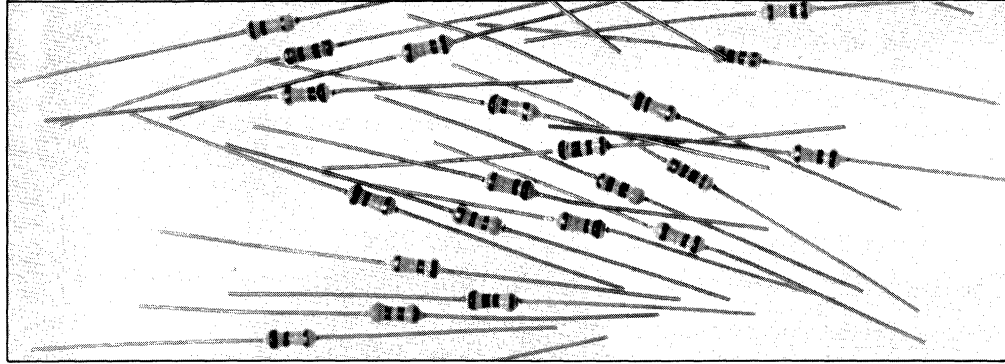

Carbon-film resistors
Mallory carbon-film resistors offer reliable performance in both commercial and industrial applications where high stability and uniformity of characteristics are required. They are interchangeable in size with composition resistors and are compatible with commercially available automatic sequencing and insertion equipment. Mallory carbon-film resistors are available in bulk package, cut and formed, and lead-tape reel.

PACKAGING
Standard pack reel tape.
Bulk pack available.

Part Numbering System

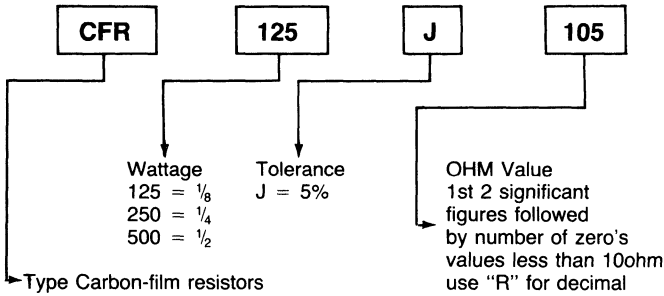

OHM Ratings 5%

1.0	10	100	1000	10000	100000	1000000	10000000
1.1	11	110	1100	11000	110000	1100000	11000000
1.2	12	120	1200	12000	120000	1200000	12000000
1.3	13	130	1300	13000	130000	1300000	13000000
1.5	15	150	1500	15000	150000	1500000	15000000
1.6	16	160	1600	16000	160000	1600000	16000000
1.8	18	180	1800	18000	180000	1800000	18000000
2.0	20	200	2000	20000	200000	2000000	20000000
2.2	22	220	2200	22000	220000	2200000	22000000
2.4	24	240	2400	24000	240000	2400000	24000000
2.7	27	270	2700	27000	270000	2700000	27000000
3.0	30	300	3000	30000	300000	3000000	30000000
3.3	33	330	3300	33000	330000	3300000	33000000
3.6	36	360	3600	36000	360000	3600000	36000000
3.9	39	390	3900	39000	390000	3900000	39000000
4.3	43	430	4300	43000	430000	4300000	43000000
4.7	47	470	4700	47000	470000	4700000	47000000
5.1	51	510	5100	51000	510000	5100000	51000000
5.6	56	560	5600	56000	560000	5600000	56000000
6.2	62	620	6200	62000	620000	6200000	62000000
6.8	68	680	6800	68000	680000	6800000	68000000
7.5	75	750	7500	75000	750000	7500000	75000000
8.2	82	820	8200	82000	820000	8200000	82000000
9.1	91	910	9100	91000	910000	9100000	91000000

Resistance Range

CFR 125 (1/8 watt) 1 ohm to 1 megohm
CFR 250 (1/4 watt) 1 ohm to 10 megohm
CFR 500 (1/2 watt) 1 ohm to 10 megohm

Performance Characteristics (Tested Per MIL-STD-202)

ELECTRICAL	CFR 125	CFR250	CFR500
Power rating @ 70°C	1/8 watt	1/4 watt	1/2 watt
Derated to 0 load at	155°C	155°C	155°C
Max. working voltage	200	250	350

ELECTRICAL	CFR 125	CFR250	CFR500
Operating temp. range	-55°C to +155°C	-55°C to +155°C	-55°C to +155°C
Resistance range (5%)	1.0 ohm to 1 megohm	1.0 ohm to 10 megohms	1.0 ohms to 10 megohm
Resistance range (2%)	10 ohms to .220 megohm	10 ohms to .820 megohm	4.7 ohms to 1.0 megohm

Construction:

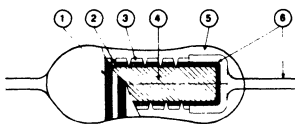

1. **COLOR BANDS.** The resistors are permanently color banded for resistance value and tolerance in accordance with EIA specifications.

2. **HELIXING.** The units are helixed to a pre-determined base to final value ratio to obtain the best TCR, noise and stability characteristics.

3. **FILM.** Carbon-film resistors have a homogeneous film of pure carbon deposited by a pyrolytic process at carefully controlled temperatures.

4. **SUBSTRATES.** The substrates are of a proprietary nonalkaline ceramic, prepared and processed under exacting conditions to guarantee the utmost in uniformity and sur-

face characteristics.

5. **INSULATION.** The resistors are coated with multiple layers of a baked-on fire-retardant synthetic resin which provides the units with a high degree of mechanical and electrical protection in the most adverse operating conditions.

6. **TERMINATIONS.** Positive contact is provided to the resistant element by precision-make end caps. The lead wires are attached by using proprietary welding techniques.

Dimensions:

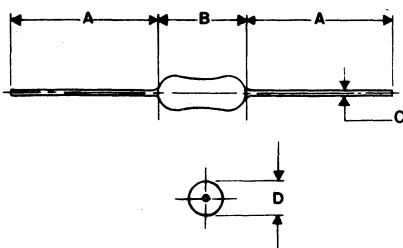

CFR125	
A.	1.102 ± .039 inch (28 ± 1.0 mm)
B.	.150 inch max. (3.8 mm)
C.	.019 ± .002 inch (0.5 ± 0.05 mm)
D.	.070 ± .008 inch (1.8 ± 0.2 mm)

CFR250	
A.	1.102 ± .039 inch (28 ± 1.0 mm)
B.	.281 inch max. (7.1 mm)
C.	.024 ± .002 inch (0.61 ± 0.05 mm)
D.	.093 ± .005 inch (2.36 ± 0.12 mm)

CFR500	
A.	1.102 ± .039 inch (28 ± 1.0 mm)
B.	.369 inch max. (9.4 mm)
C.	.028 ± .002 inch (0.71 ± 0.05 mm)
D.	.106 ± .015 inch (2.7 ± 0.38 mm)

inches (mm)

Type CR ● Chip Resistors for Surface Mount

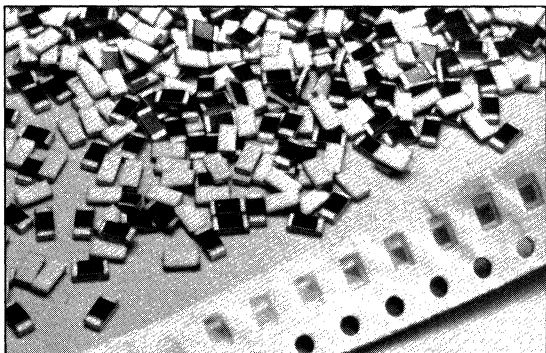

Mallory chip resistors employ a highly stable and reliable resistive material. This resistor film is protected by a glass coat which improves reliability and mechanical strength. The end terminations are plated to provide excellent solderability.

Chip resistors are available in 1/10-watt and 1/8-watt sizes making them suitable for miniature

devices, hybrid circuits or any other application requiring small-size or direct-mount resistors. They exhibit excellent high-frequency characteristics and reduced lead inductance. These are available packaged in polybags, taped and reel.

PACKAGING

Standard pack reel tape.
Bulk pack available.

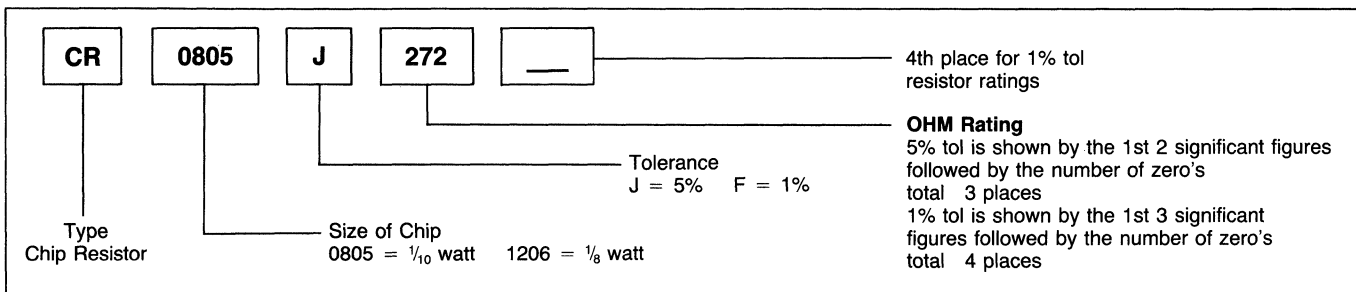

Part Numbering System

EG = CR0805J272 = 1/10 watt 5% tol
2700 OHM's
CR1206F3241 = 1/8 watt 1% tol
3240 OHM's

Performance Characteristics

Electrical	0805 1/10	1206 1/8
Power rating @ 70°C	0.10 watt	0.125 watt
Temperature coefficient	±200 ppm/°C	±200 ppm/°C
Derated to 0 load at	155°C	155°C
Maximum working voltage	150 V	200 V
Operating-temperature range	-55°C to +155°C	-55°C to +155°C
Resistance range*		
** (1% Tolerance)	47.5 ohms to 1 megohm	10 ohms to 1 megohm
(5% Tolerance)	10 ohms to 1 megohms	10 ohms to 1 megohm
Environmental		
Moisture resistance	±3%	±3%
Thermal shock -55°C to +125°C	±1%	±1%
Load life @ 70°C, 1000 hours	±3%	±3%
Vibration	±1%	±1%
Resistance to soldering heat	±1%	±1%
Terminal strength	±1%	±1%
Dielectric withstanding voltage	500 V RMS	500 V RMS
Short-term overload	±1%	±1%

*Zero-ohm chips—available in 1/8- and 1/10-watt sizes for use as jumpers.

** (± 100 ppm product available)

5% Tolerance OHMS Ratings

10	100	1000	10000	100000	1 MEG
11	110	1100	11000	110000	
12	120	1200	12000	120000	
13	130	1300	13000	130000	
15	150	1500	15000	150000	
16	160	1600	16000	160000	
18	180	1800	18000	180000	
20	200	2000	20000	200000	
22	220	2200	22000	220000	
24	240	2400	24000	240000	
27	270	2700	27000	270000	
30	300	3000	30000	300000	
33	330	3300	33000	330000	
36	360	3600	36000	360000	
39	390	3900	39000	390000	
43	430	4300	43000	430000	
47	470	4700	47000	470000	
51	510	5100	51000	510000	
56	560	5600	56000	560000	
62	620	6200	62000	620000	
68	680	6800	68000	680000	
75	750	7500	75000	750000	
82	820	8200	82000	820000	
91	910	9100	91000	910000	

Type CR • Chip Resistors for Surface Mount

NOTE: $\frac{1}{10}$ watt 0805 size $\pm 1\%$ Tol
The Res: Range starts at 47.5 OHMS to 1 meg

$\pm 1\%$ Tolerance OHM Ratings

PERFORMANCE:

Humidity Load Life (1,000 Hrs.)

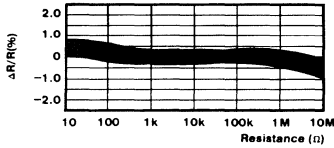

Resistance to Solder Heat

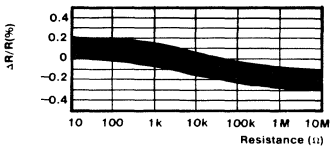

Load Life (1,000 Hrs.)

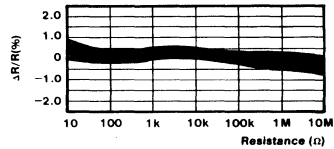

Current Noise

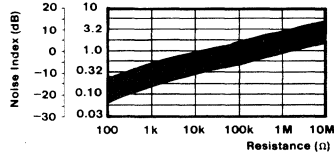

TERMINATION

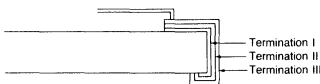

10.0	34.0	100	340	1000	3400	10000	34000	100000	340000
10.2	34.8	102	348	1020	3480	10200	34800	102000	348000
10.5	35.7	105	357	1050	3570	10500	35700	105000	357000
10.7	36.5	107	365	1070	3650	10700	36500	107000	365000
11.0	37.4	110	374	1100	3740	11000	37400	110000	374000
11.3	38.3	113	383	1130	3830	11300	38300	113000	383000
11.5	39.2	115	392	1150	3920	11500	39200	115000	392000
11.8	40.2	118	402	1180	4020	11800	40200	118000	402000
12.1	41.2	121	412	1210	4120	12100	41200	121000	412000
12.4	42.2	124	422	1240	4220	12400	42200	124000	422000
12.7	43.2	127	432	1270	4320	12700	43200	127000	432000
13.0	44.2	130	442	1300	4420	13000	44200	130000	442000
13.3	45.3	133	453	1330	4530	13300	45300	133000	453000
13.7	46.4	137	464	1370	4640	13700	46400	137000	464000
14.0	47.5	140	475	1400	4750	14000	47500	140000	475000
14.3	48.7	143	487	1430	4870	14300	48700	143000	487000
14.7	49.9	147	499	1470	4990	14700	49900	147000	499000
15.0	51.1	150	511	1500	5110	15000	51100	150000	511000
15.4	52.3	154	523	1540	5230	15400	52300	154000	523000
15.8	53.6	158	536	1580	5360	15800	53600	158000	536000
16.2	54.9	162	549	1620	5490	16200	54900	162000	549000
16.5	56.2	165	562	1650	5620	16500	56200	165000	562000
16.9	57.2	169	572	1690	5720	16900	57200	169000	572000
17.4	59.0	174	590	1740	5900	17400	59000	174000	590000
17.8	60.4	178	604	1780	6040	17800	60400	178000	604000
18.2	61.9	182	619	1820	6190	18200	61900	182000	619000
18.7	63.4	187	634	1870	6340	18700	63400	187000	634000
19.1	64.9	191	649	1910	6490	19100	64900	191000	649000
19.6	66.5	196	665	1960	6650	19600	66500	196000	665000
20.0	68.1	200	681	2000	6810	20000	68100	200000	681000
20.5	69.8	205	698	2050	6980	20500	69800	205000	698000
21.0	71.5	210	715	2100	7150	21000	71500	210000	715000
21.5	73.2	215	732	2150	7320	21500	73200	215000	732000
22.1	75.0	221	750	2210	7500	22100	75000	221000	750000
22.6	76.8	226	768	2260	7680	22600	76800	226000	768000
23.2	78.7	232	787	2320	7870	23200	78700	232000	787000
23.7	80.6	237	806	2370	8060	23700	80600	237000	806000
24.3	82.5	243	825	2430	8250	24300	82500	243000	825000
24.9	84.5	249	845	2490	8450	24900	84500	249000	845000
25.5	86.6	255	866	2550	8660	25500	86600	255000	866000
26.1	88.7	261	887	2610	8870	26100	88700	261000	887000
26.7	90.9	267	909	2670	9090	26700	90900	267000	909000
27.4	93.1	274	931	2740	9310	27400	93100	274000	931000
28.0	95.3	280	953	2800	9530	28000	95300	280000	953000
28.7	97.6	287	976	2870	9760	28700	97600	287000	976000
29.4		294		2940		29400		294000	1 MEG
30.1		301		3010		30100		301000	
30.9		309		3090		30900		309000	
31.6		316		3160		31600		316000	
32.4		324		3240		32400		324000	
33.2		332		3320		33200		332000	

MATERIALS:

Items	Material	Remarks Reference Only
Substrate	Alumina Porcelain	Purity 96% Over
Resistive Film	Ruthenium-Oxide Thick Film	20 Microns Thick
Coating	Boro-Silicated Acid Lead Glass	20 Microns Thick
Termination I	AG-PD (Silver-Palladium (Glaze, Printed)	8 Microns Thick
Termination II	Nickel (Electrical Plate)	3 Microns Thick
Termination III	Tin-Lead (Electrical Plate)	3 Microns Thick

Dimensions

Type	L	W	H	a	b
0805 1/10	.078 ± .008 (2.0 ± 0.2)	.049 ± .008 (1.25 ± 0.2)	.018 ± .004 (0.45 ± 0.1)	.013 ± .008 (0.35 ± 0.2)	.010 mm (0.254 mm)
1206 1/8	.122 ± .004 (3.1 ± 0.1)	.061 ± .004 (1.55 ± 0.1)	.021 ± .004 (0.55 ± 0.1) - .002 (-0.05)	.017 ± .008 (0.45 ± 0.2)	.010 min (0.254 mm)

inches (mm)

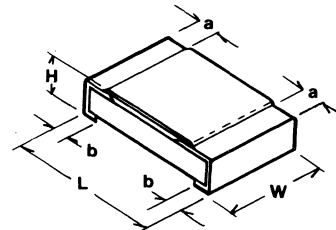
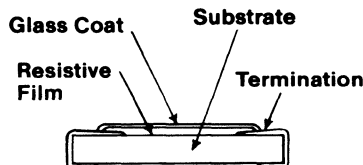

Trimmer Potentiometers

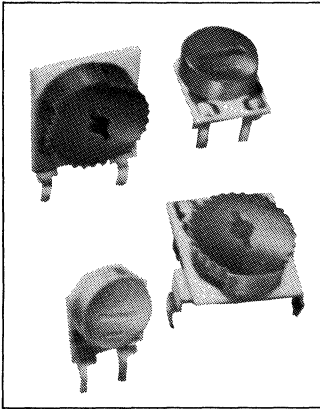

SUBMINIATURE TRIMMING POTENTIOMETERS

1/5 and 1/3 WATT CARBON and 1/2 and 3/4 WATT CERMET

Mallory subminiature trimming potentiometers are applicable to a variety of consumer and industrial applications. They provide excellent long-term reliability under adverse environmental conditions in an extremely small overall package. Cermet units, additionally, provide considerably increased power dissipating capability in the

same package. This line of quality trimming potentiometers is backed by Mallory and is your guarantee to performance and economy you can depend upon. **RVA/RVG Mallobins are available. See complete Mallobin listing on page 150.**

HIGHLIGHTS

- Resistance: 50 ohms to 1 Meg-ohm (cermet)
- 50 ohms to 5 Megohms (carbon)
- Temperature Coefficient: 350ppm/°C (carbon)
- 250ppm/°C (cermet)
- Taper: Linear

HOW TO ORDER:

RV	A	0911	V	501
Series	Resistive Element A = Carbon G = Cermet	Model (See Dimensional Diagrams)	Adjustment V = Vertical H = Horizontal	Resistance Code 501 = 500Ω 102 = 1000Ω (See Chart Below)

RESISTANCE CHART

Type	500Ω	1KΩ	2.5KΩ	5KΩ	10KΩ	25KΩ	50KΩ	100KΩ	250KΩ	500KΩ	1 megΩ	2 megΩ
RVA0911H	501	102	252	502	103	253	503	104	254	504		205
RVA0911V		102	252	502	103	253	503	104	254	504	105	205
RVA1214H	501	102	252	502	103	253	503	104	254	504	105	205
RVA1214V	501	102	252	502	103			104	254			205
RVG0911H	501	102	252	502	103	253	503	104	254	504	105	205
RVG0911V	501	102	252	502	103	253	503	104	254		105	205
RVG1214H	501	102	252	502	103	253	503	104	254	504	105	205
RVG1214V	501		252	502	103	253	503	104	254	504	105	205

1214H

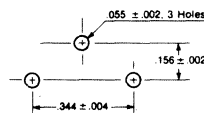
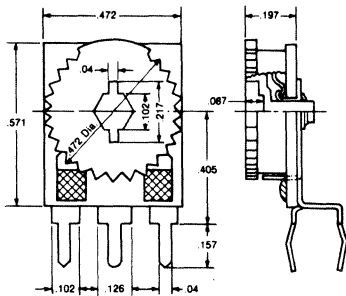

1214V

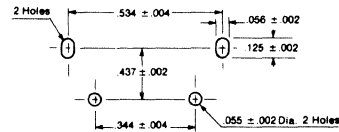
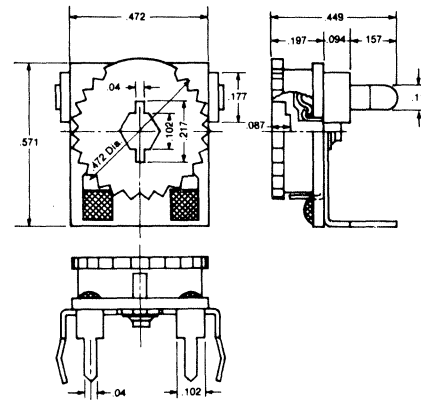

Trimmer Potentiometers

RV Series

ENVIRONMENTAL SPECIFICATIONS

	RVA (Carbon) 9011/1214	RVG (Cermet) 0911/1214
Humidity Characteristics	After 24 hours at 40°C, 90-95% RH without loading, the change in resistance is less than +5%, -1%.	After 500 hours at 40°C, 90-95% RH without loading, the change in resistance is less than ±3%.
Temperature Characteristics	After 5 hours at 70°C without loading, the change in resistance is less than +0%, -5%.	After 500 hours at 70°C without loading, the change in resistance is less than ±3%.
Humidity Load Life	When rated voltage is applied intermittently on a cycle of 1.5 hours ON and 0.5 hours OFF for 1,000 hours @ 40°C, 90-95% RH, the change in resistance is ±7%.	When rated voltage is applied intermittently on a cycle of 1.5 hours ON and 0.5 hours OFF for 1,000 hours @ 40°C, 90-95% RH, the change in resistance is less than ±3%.
Temperature Load Life	When rated voltage is applied intermittently on a cycle of 1.5 hours ON and 0.5 hours OFF for 1,000 hours @ 70°C, the change in resistance is less than ±7%.	When rated voltage is applied intermittently on a cycle of 1.5 hours ON and 0.5 hours OFF for 1,000 hours @ 70°C, the change in resistance is less than ±3%.
Rated Voltage Load Life	When voltage is applied for 3 hours, the change in resistance is less than ±5%.	When voltage is applied for 3 hours, the change in resistance is less than ±3%.
Temperature Cycling	After 5 temperature cycles are made without loading, the change in resistance is less than ±5%. One cycle is: -25°C (30 minutes) to room temp. @ +25°C (15 minutes) to +125°C (30 minutes) to room temp. @ +25°C (15 minutes).	After 5 temperature cycles are made without loading, the change in resistance is less than ±3%. One cycle is: -55°C (30 minutes) to room temp. @ +25°C (15 minutes) to +125°C (30 minutes) to room temp. @ +25°C (15 minutes).
Influence of Soldering	After the terminals are dipped in a solder bath at 350°C for 3 seconds, the change in resistance is less than ±2%.	
Rotation Life	After 100 continuous cycles at 10 cycles per minute, the change in resistance is less than +3%, -7%.	After 100 continuous cycles at 10 cycles per minute, the change in resistance is less than ±5%.
Temperature Coefficient of Resistance	±350ppm/°C	±250ppm/°C max.

SPECIFICATIONS

Characteristic	RV	
	0911	1214
Resistance	500— 1M	500— 1M
Range	ohms	ohms
Tolerance	±20%	±20%
Residual Resistance	less than 1% of nominal rated resistance	
Taper	Linear	Linear
Power Rating	RVA RVG	1/5W 1/2W 3/4W
Max. Working Voltage	RVA RVG	250VDC 350VDC 500VDC
Torque	0.56- 4.86 in. oz.	0.83-6.0 in. oz.
Terminal Strength	35.27 oz.	35.27 oz.
Effective	Elec. Mech.	240° 280°
Rotation	±10°	±10°
Stop Strength	13.9 in. oz.	

0911V

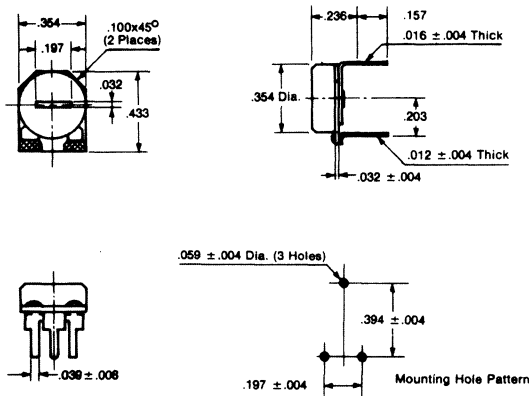

0911H

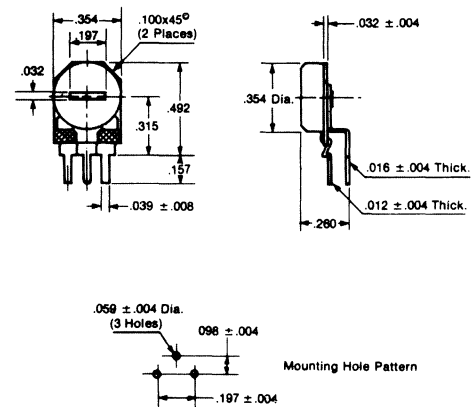

MTC Trimmers

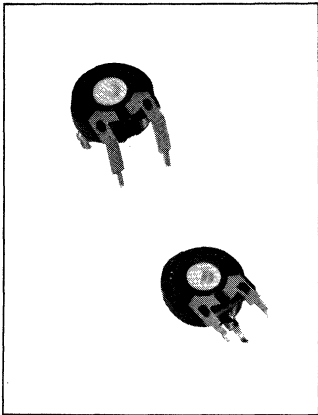

Designed for printed circuitry. Use wherever an occasionally adjusted, low wattage variable resistance source is needed. MTC-1 terminals for standup mounting, MTC-4 terminals for flat mounting. Open slot allows adjustments with a screwdriver. Tolerance: $\pm 20\%$. Linear Taper. **For prices, reference price sheet No. 575.** Element voltage 500 volts max. Rated 1/4 watt linear. **Warning:** do not exceed wattage rating

of control. **MTC Mallobins are available. See complete Mallobin listing on page 150.**

HIGHLIGHTS

- Static Noise: $\leq 5\mu V/V$
- Tolerance: $\pm 20\%$
- Enclosed construction
- Mechanical Rotation $240^\circ \pm 10^\circ$
- Electrical Rotation $220^\circ \pm 20^\circ$

MTC MINIATURE TRIMMER CONTROL

Vertical Mounting	Horizontal Mounting	Resistance, Ohms
MTC12L1A	MTC12L4A	100
MTC22L1A	MTC22L4A	200
MTC251L1A	MTC251L4A	250
MTC32L1A	MTC32L4A	300
MTC52L1A	MTC52L4A	500
MTC751L1A	MTC751L4A	750
MTC13L1A	MTC13L4A	1000
MTC152L1A	MTC152L4A	1500
MTC23L1A	MTC23L4A	2000
MTC252L1A	MTC252L4A	2500
MTC33L1A	MTC33L4A	3000
MTC53L1A	MTC53L4A	5000
MTC63L1A	MTC63L4A	6000
MTC682L1A	MTC682L4A	6800
MTC14L1A	MTC14L4A	10K
MTC153L1A	MTC153L4A	15K
MTC24L1A	MTC24L4A	20K
MTC253L1A	MTC253L4A	25K
MTC54L1A	MTC54L4A	50K
MTC15L1A	MTC15L4A	100K
MTC184L1A	MTC184L4A	180K
MTC254L1A	MTC254L4A	250K
MTC454L1A	MTC454L4A	450K
MTC55L1A	MTC55L4A	500K
MTC16L1A	MTC16L4A	1 meg
MTC26L1A	MTC26L4A	2 meg
MTC355L1A	MTC355L4A	3.5 meg
MTC56L1A	MTC56L4A	5 meg

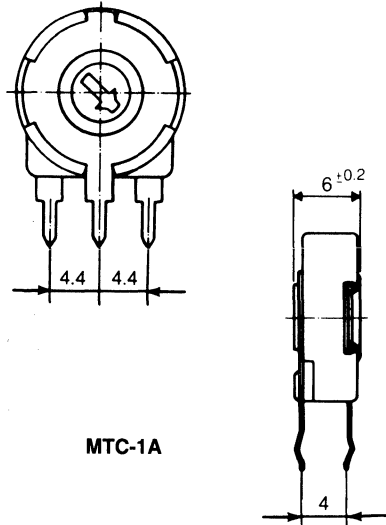

MTC-1A

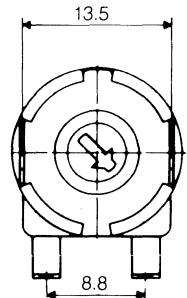
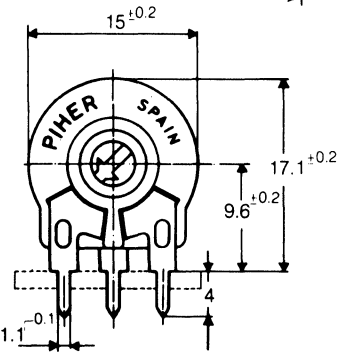

MTC-4A

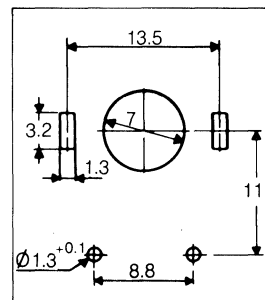
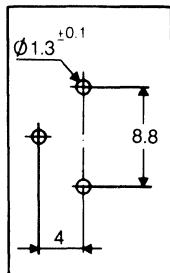
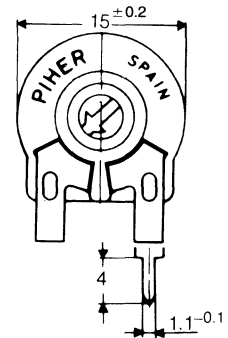
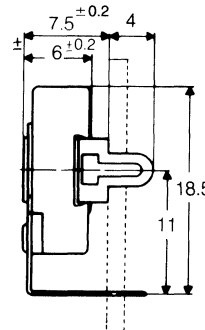

Carbon Controls

TYPE 24U BUSHING MOUNT—METAL SHAFT

Rated .25 watt (4 taper) .5 watt (4 taper below 200K), 1 & 2 taper .25w. Bushing is 8mm dia × 7mm long with thread pitch of .75mm. Shaft is 6mm dia × 30mm long FMS (Front Mounting Surface) and is slotted. Control body dia is 24mm. For pricing, reference price sheet No. 575.

Resistance Ohms	*Taper	Catalog No.	Resistance Ohms	*Taper	Catalog No.
500	4	24U501BX	100K	1	24U104AX
1K	2	24U102CX†	100K	4	24U104BX
1K	4	24U102BX	200K	4	24U204BX
5K	1	24U502AX	250K	4	24U254BX
5K	4	24U502BX	500K	1	24U504AX
10K	1	24U103AX	500K	4	24U504BX
10K	4	24U103BX	1 meg	1	24U105AX
20K	4	24U203BX	1 meg	4	24U105BX
25K	4	24U253BX			
50K	1	24U503AX			
50K	4	24U503BX			

*For description of taper, see page 126.

† These parts feature a Reverse Audio Taper (taper C). To access this Reverse Audio Taper one must use terminals 2 and 3.

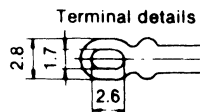
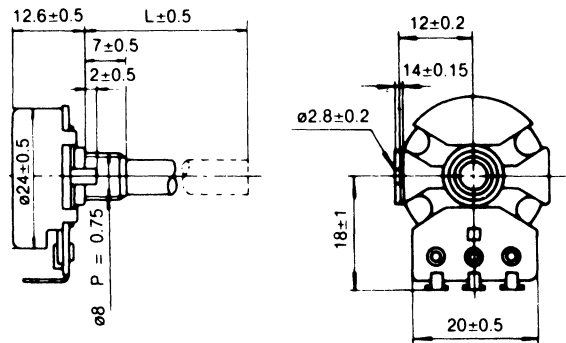

TYPE 16M MINIATURE CONTROLS

Control Body only 16.4mm dia. Bushing is 7mm dia × 5mm long with thread pitch of .75mm. Metal shaft is 6mm dia × 25mm long FMS. Controls with switch have a flatted plastic shaft 6mm dia × 25mm long FMS. Metal shaft has 18 serrations and is slotted. SPST switch rated 3 amps at 125 VAC, U/L recognized. Control rated .2 W linear and .1 W audio. For prices, reference price sheet 575.

Resistance Ohms	*Taper	Switch	Catalog No.	Resistance Ohms	Taper	Switch	Catalog No.
1000	4		16M102BX	100K	1	SPST	16M104AR
2200	4	SPST	16M222BR	100K	4		16M104BX
5000	1		16M502AX	250K	4		16M254BX
5000	1	SPST	16M502AR	1 meg	4	SPST	16M105BR
5000	4		16M502BX				
5000	4	SPST	16M502BR				
10K	1		16M103AX				
10K	1	SPST	16M103AR				
10K	4		16M103BX				
50K	4		16M503BX				
100K	1		16M104AX				

*For description of taper, see page 126.

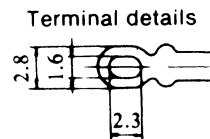
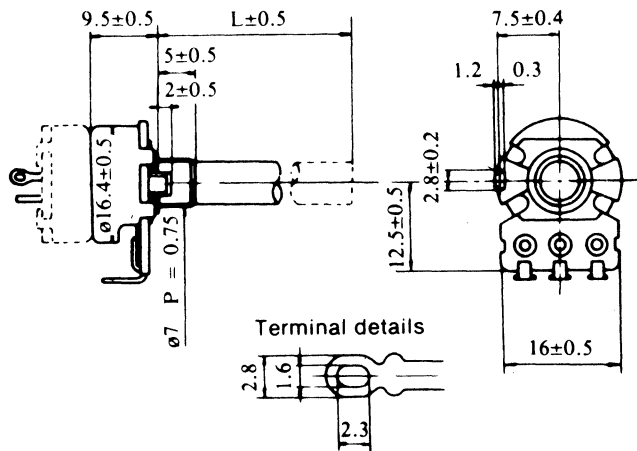

TYPE 24S CONTROL

Rated .5W linear below 200K, .25 W above 200K. Same as 24U Control except for plastic insulated shaft. Flatted shaft is 6mm dia × 25mm long FMS. Bushing is 8mm dia × 7mm long. For prices, reference price sheet No. 575.

Resistance Ohms	*Taper	Catalog No.
1500	4	24S152BX
5K	4	24S502BX
50K	4	24S503BX
2 megs	4	24S205BX

*For description of taper, see page 126.

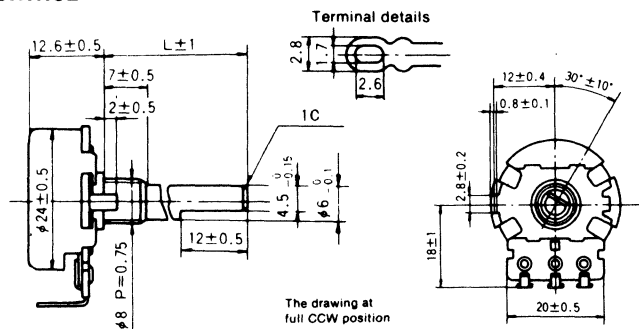

The drawing at full CCW position

Carbon Controls

TYPE 24Z CONTROLS

24Z Controls are .25 watt audio taper. All have either rotary or push-pull SPST, 6A @ 125 VAC switch. Bushing is 8mm dia × 7mm long with thread pitch of .75mm. Flatted plastic insulated shaft is 6mm dia × 25mm long FMS. Body is 24mm in dia. **For pricing, reference price sheet No. 575.**

Ohms Res	SW Type	Catalog No.
500K	Rotary	24Z504AR
500K	Push-pull	24Z504AP
1 meg	Rotary	24Z105AR
1 meg	Push-pull	24Z105AP

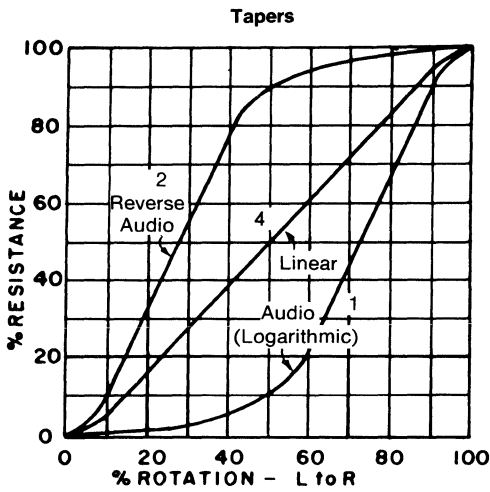
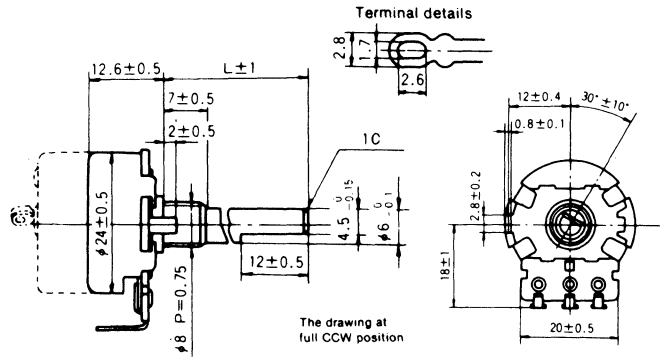

Power Derating Curve

The rated power should be derated in accordance with the power derating curve when ambient temperature exceeds 50°C.

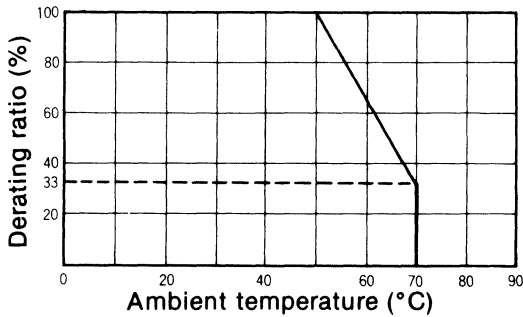

Available current between terminal, 2 & 3 at full CCW end position.

Total Nominal Resistance Value	Current
750Ω & less than 750Ω	40mA
more than 750Ω	$\sqrt{\frac{0.8}{R}}$ A R : Ω

Shaft Trims & Dimensions

Type 16M with switch, Type 24S and 24Z

Type F (Flatted), Insulated shaft

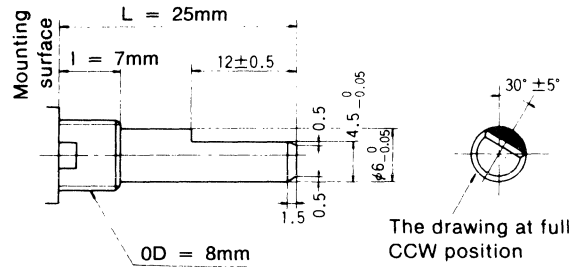

16M without switch

(18 serrations)

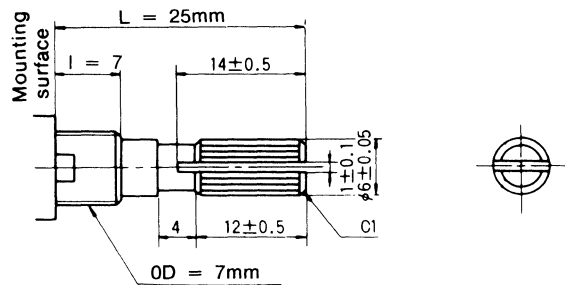

Type 24U

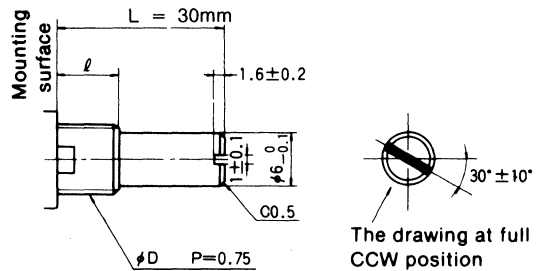

Wirewound Controls

SUBMINIATURE 5-WATT TYPE VW

Rated 5 watts at 35°C. $\frac{3}{4}$ " diameter. **Mech. Rotation:** 305°. **Elec. Rotation:** 275°. **Resis. Tolerance:** $\pm 10\%$. **Voltage Breakdown:** 900 VAC rms. **Bushing:** $\frac{3}{8}$ -32 \times $\frac{3}{8}$. **Shaft:** $\frac{1}{4}$ " dia. \times $2\frac{1}{2}$ " FMS. Furnished with nut and lug.

Ohms Res.	Max. Amps	Catalog Number
1	2.2	VW1
8	.8	VW8
10	.71	VW10
15	.58	VW15
20	.50	VW20
25	.45	VW25
50	.32	VW50
100	.22	VW100
200	.16	VW200
250	.14	VW250
300	.13	VW300
500	.10	VW500
1000	.071	VW1K
2000	.050	VW2K
2500	.045	VW2P5K
3000	.041	VW3K
4000	.035	VW4K
5000	.032	VW5K
10K	.022	VW10K
20K	.016	VW20K
25K	.014	VW25K

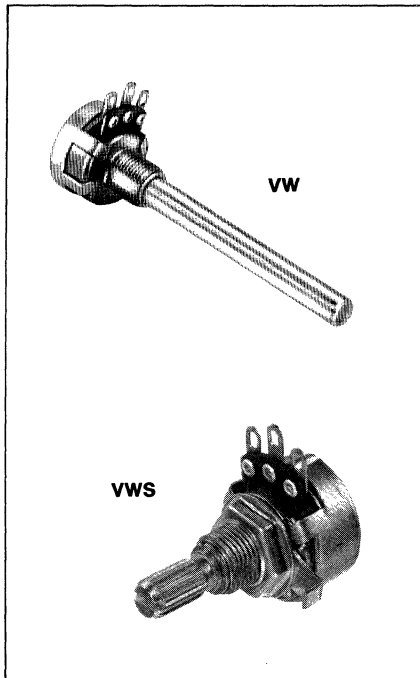

SUBMINIATURE 5 WATT TYPE VWS

The VWS Control is identical to the VW except that the shaft is knurled and slotted and the shaft length is $\frac{7}{8}$ " FMS. **Tolerance:** $\pm 10\%$.

Ohms Res.	Max. Amps	Catalog Number
1	2.2	VWS1
100	.22	VWS100
200	.16	VWS200
1000	.071	VWS1K
5000	.032	VWS5K

Wirewound Control Data

<p>R</p>	<p>MR-P</p>	<p>MR-T</p>	<p>MR-F</p>
<p>M, MG</p>	<p>MRC</p>	<p>MR-B</p>	<p>(L) VW = $2\frac{1}{2}$" VWS = $\frac{7}{8}$"</p>

Wirewound Controls

Mallory wirewound controls are available in eleven types covering four wattage ratings from 3 watts to 12½ watts. Available in solderlug, flange and PC mount. Also available are Mallory audio attenuators. Ideal for remote stereo volume control. For pricing, reference price sheet 570C. Wirewound control Mallobins are available. See complete Mallobin listing on page 150.

HIGHLIGHTS

- 3, 4, 5, and 12½ watts available
- MR type extension shafts available
- 1.5 to 100K ohms available
- MR Resistance tolerance is ± 20% others ± 10%
- Mono or stereo attenuators available

MR-F 3-WATT FLANGE MOUNT

Mounting ears with .130" dia. holes on 1" center. Shafts MRS1250 or MRS1563 shown below can be inserted in control from front or rear.

Ohms Res.	Max. Amps	Catalog Number
15	.45	MR15F
40	.27	MR40F
100	.17	MR100F
500	.077	MR500F
1000	.055	MR1000F
2500	.035	MR2500F
10K	.017	MR10000F

SHAFTS FOR MR CONTROLS

Catalog No. MRS1250—¼" dia. × 1¼" FMS knurled and slotted nylon. Plugs into either end of MR controls.

Catalog No. MRS1563—¼" dia. × 1½" FMS, knurled, slotted nylon.

MRC-P 3-WATT PC MOUNT

Convergence controls with printed circuit board mounting and permanent knob. Contact arm grounded.

Ohms Res.	Max. Amps	Catalog Number
100	.17	MRC100P

MR-F

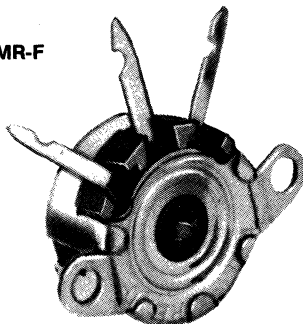

MG

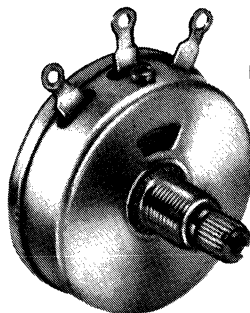

MRS

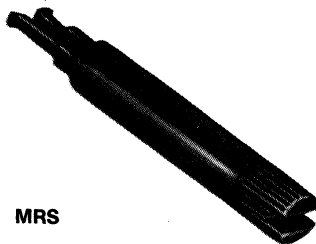

MRC

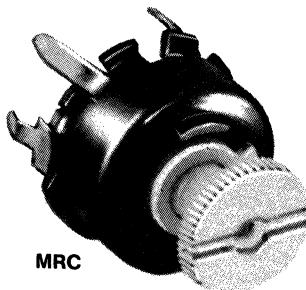

12½-WATT TYPE MG

Rated 12½ watts at 35°C. 1½" diameter. Mech. Rotation: 294°. Elec. Rotation: 275°. Resis. Tolerance: ± 10%. Voltage Breakdown: 900 VAC rms.: Bushing: 3/8"-32 × 3/8" FMS. Shaft: ¼" dia. × 3/4" FMS, knurled with screwdriver slot. Furnished with nut.

Ohms Res.	Max. Amps	Catalog Number
10	1.1	MG10
25	.71	MG25
50	.55	MG50
500	.16	MG500
1000	.11	MG1000
2500	.07	MG2500
25K	.022	MG25K

4 WATT TYPE LW

Rated 5 watts @ 25°C; 4 watts @ 55°C. 1½/16 cup dia. Mechanical Rotation: 300°; Electrical Rotation: 280° ± 5%; Tolerance ± 10% standard; Taper: linear; Screwdriver slotted shaft. Request Bulletin 9/673 for complete technical data.

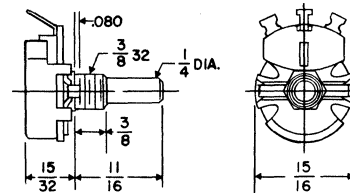

Ohms Res.	Max. Amps	Catalog Number
5	.89	LW5
8	.71	LW8
10	.63	LW10
20	.44	LW20
50	.28	LW50
100	.2	LW100
250	.13	LW250
500	.089	LW500
1K	.063	LW1K
1.5K	.051	LW1P5K
2.5K	.040	LW2P5K
5K	.028	LW5K
10K	.020	LW10K

Wirewound Controls

3-WATT TYPE MR WIRE-WOUND CONTROLS

Only 3/4" diameter, MR controls are used for applications in AGC, convergence, hum-balance, etc. Case is fully enclosed: MR, all metal; MRC, metal mounting plate and cup with molded nylon knob. Five mounting configurations available. Conversion from cross-slot adjustment to shaft may be made using plug-in shafts listed. **Wattage Rating at 40°C:** 3 watts. **Rotation:** 250° mechanical; 248° electrical. **Resistance Tolerance:** MR, ±20%; MRC, ±10%. **Voltage Breakdown:** MR, 900 VAC rms; MRC has grounded contact arm.

MR-B 3-WATT BUSHING MOUNT

Bushing 3/8"-32 x 1/4". One MRS1250 Shaft is packaged with each control. Supplied with pal nut.

Ohms Res.	Max. Amps	Catalog Number
10	.55	MR10B
100	.17	MR100B
5000	.024	MR5000B

POTENTIOMETERS 4-WATT TYPE M

Rated 4 watts at 40° C. 1 1/8" diameter. **Mech. Rotation:** 294°. **Elec. Rotation:** 275°. **Resis. Tolerance:** ±10%. **Voltage Breakdown:** 900 VAC rms. **Tolerance:** ±10%. **Bushing:** 3/8"-32 x 3/8" FMS. **Shaft:** 1/4" dia. x 3/4" FMS, knurled with screwdriver slot. Furnished with nut.

Ohms Resis.	Capacity In Amps	Catalog No.
6	.82	M6PK
25	.4	M25PK
50	.28	M50PK
100	.20	M100PK
200	.14	M200PK
300	.116	M300PK
500	.09	M500PK
1K	.063	M1MPK
2K	.045	M2MPK
5K	.028	M5MPK
10K	.02	M10MPK
20K	.014	M20MPK
25K	.013	M25MPK
50K	.009	M50MPK
100K	.0062	M100MPK

MR-T 3-WATT TAB MOUNT

Shafts MRS1250 or MRS1563 shown below can be inserted in control from front or rear.

Ohms Res.	Max. Amps	Catalog Number
50	.24	MR50T
250	.11	MR250T
500	.08	MR500T
1000	.055	MR1000T
2500	.035	MR2500T
10K	.017	MR10KT

MR-P 3-WATT PC MOUNT

Printed circuit board mounting. Shafts MRS-1250 or MRS1563 shown below can be inserted in control from front or rear.

Ohms Res.	Max. Amps	Catalog Number
15	.45	MR15P
100	.17	MR100P
600	.071	MR600P
1000	.055	MR1000P
1500	.045	MR1500P
3000	.032	MR3000P
5000	.024	MR5000P

3-WATT TYPE R

Standard TV wirewound control rated 3 watts at 40°C. 1 7/64" diameter. **Mech Rotation:** 297°. **Elec. Rotation:** 290°. **Voltage Breakdown:** 900 VAC rms. **Tolerance:** ±10%. **Bushing:** 3/8"-32 x 1/4". **Shaft:** 1/4" dia. x 1 9/32" FMS, knurled with screwdriver slot. Furnished with nut. See listing below for switch for R controls.

Ohms Res.	Max. Amps	Catalog Number
10	.55	R10L
500	.077	R500L
1000	.055	R1000L
2500	.035	R2500L

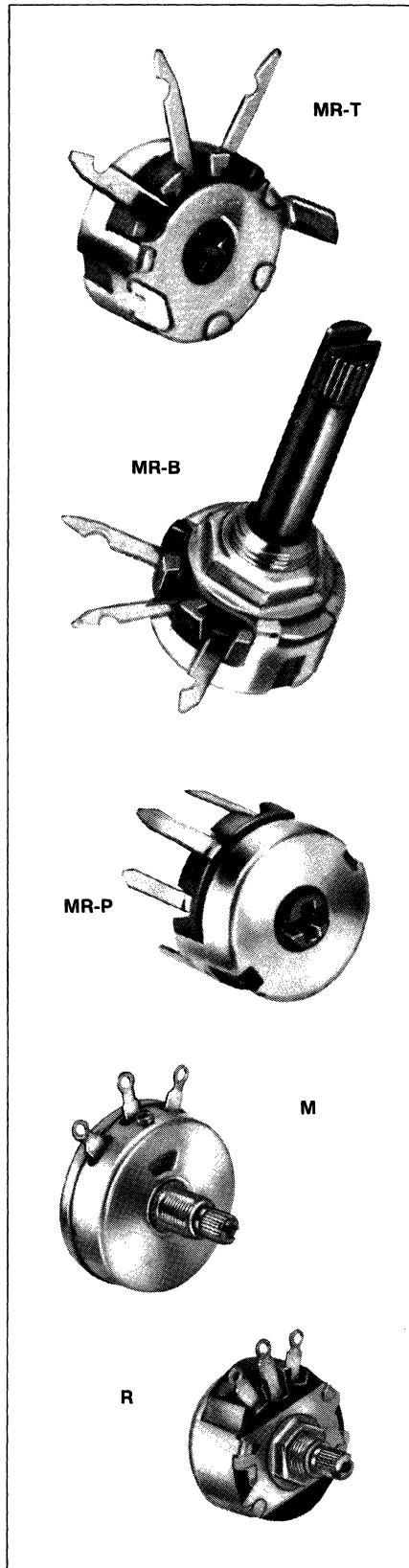

*See page 132 for control hardware.

Wirewound Audio Attenuators

AUDIO ATTENUATORS

Mallory audio attenuators are available in three wattage ratings; 10watt RT, RL, and RR; 15watts T, L, and LL; and 50watts MGL and MGLL. All are made to critical audio standards; come complete with mounting hardware. Shunt elements in pads open at minimum attenuation position (full counter clockwise rotation) placing load directly across output source for maximum volume.

T PAD ATTENUATORS

Present constant impedance to both source (amplifier) and output (speaker). Supplied with palnut and dial plate.

T PAD STOCK VALUES

Imped., Ohms	Catalog No for Audio and Rating of	
	10 W	15 W
8	RT8	T8
600	T600	

T PAD DIMENSIONS

With nuts, washers, and dial plate.

Bushing	Shaft D x L FMS	Catalog No.
$\frac{3}{8}$ "-32 x 1"	$\frac{1}{4}$ " x $1\frac{1}{2}$ "	RT
$\frac{3}{8}$ "-32 x $\frac{3}{8}$ "	$\frac{1}{4}$ " x $2\frac{3}{8}$ "	T
$\frac{3}{8}$ "-32 x 1"	$\frac{1}{4}$ " x $1\frac{1}{2}$ "	MGT

L PAD ATTENUATORS

Present constant impedance to source (amplifier) used in audio circuits where output (speaker) impedance is not critical. Supplied with palnut and dial plate.

L PAD STOCK VALUES

Imped., Ohms	Catalog No. for Audio Rating of	
	15 W	50 W
4	L4	
8	L8	
8	L8A	MGL8
15	L15	
16		MGL16
50	L50	
600	L600	
2000	L2000	
4000	L4000	

L PAD DIMENSIONS

With nut, washer, and dial plate.

Bushing	Shaft D x L FMS	Catalog No.
$\frac{3}{8}$ "-32 x 1"	$\frac{1}{4}$ " x $1\frac{1}{2}$ "	RL
$\frac{3}{8}$ "-32 x $\frac{3}{8}$ "	$\frac{1}{4}$ " x $2\frac{3}{8}$ "	L
$\frac{3}{8}$ "-32 x 1"	$\frac{1}{4}$ " x $1\frac{1}{2}$ "	L-A
$\frac{3}{8}$ "-32 x 1"	$\frac{1}{4}$ " x $1\frac{1}{2}$ "	MGL

LL PAD ATTENUATORS

Two L pads in tandem for stereo level control. Bushings $\frac{3}{8}$ "-32 x 1". Shaft $\frac{1}{4}$ " dia. x $1\frac{1}{2}$ " lg. With nuts, washers and deluxe "Level" dial plate supplied.

Imped., Ohms	Audio Watts	Catalog No.
8	15	LL8
8	50	MGLL8

STEREO LEVEL CONTROL

50 Ohm tandem dual, level control for low-priced 4- and 8-ohm stereo speakers. Rated 10 watts, audio. Supplied with nuts, washers, dial plate. Bushing $\frac{3}{8}$ "-32 x 1". Shaft $\frac{1}{4}$ " dia. x $1\frac{1}{4}$ " lg.
Catalog No. RR50.

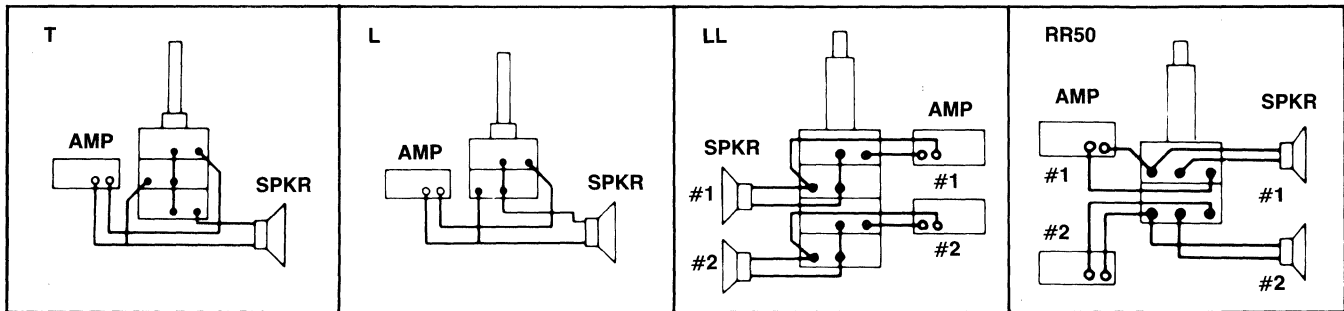

Power Rheostats

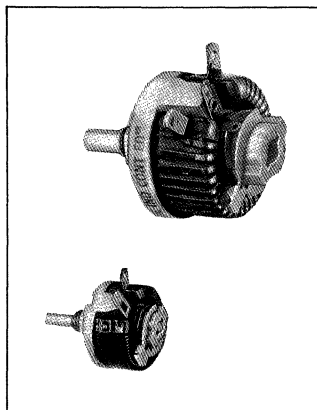

Vitreous Enamel

Mallory power rheostats utilize vitreous enamel construction for maximum environmental protection. All current-carrying parts are electrically insulated by dimensionally stable ceramic. Current ratings listed are for continuous operation in free air. If units are enclosed currents should be reduced by as much as 50% depending upon ventilation. The rheostat will dissipate rated wattage at rated current with the total resistance of the rheostat in the circuit. All tapers are

linear. All bushings are non-locking types. **For prices on all power rheostats, reference price sheet No. 585B.**

HIGHLIGHTS

- 3 Sizes available
- Solid Ceramic Core
- Metal Graphite Brushes
- Nothing to Shrink or Burn

TYPE M 12.5 WATTS

Dia. $\frac{7}{8}$ " O.D. Depth behind panel $\frac{11}{16}$ "—Rotation 300° —Mounts on panels up to $\frac{1}{8}$ " thick by means of $\frac{1}{4}$ "-32 Bushing and Hex Nut. Non-turn lug requires $\frac{1}{8}$ " hole $\frac{1}{4}$ " below center of shaft.

Ohms	Max. Amps	Catalog No.
1	3.53	M0101
6	1.44	M0104
10	1.12	M0106
25	.71	M0108
50	.50	M0110
75	.41	M0111
350	.19	M0116
500	.16	M0117
2500	.071	M0121
10000	.035	M4191

TYPE 25K 25-WATTS

Dia. $1\frac{9}{16}$ "—Depth behind panel $1\frac{3}{8}$ "—Shaft $\frac{1}{4}$ " dia. Rotation 300° —Mounts on panels up to $\frac{1}{4}$ " by means of $\frac{3}{8}$ "-32 Bushing and Hex. Nut—Non-turn lug requires $\frac{3}{16}$ " hole $\frac{1}{2}$ " below center of shaft. UL listed. Weight 0.19 lb.

Ohms	Max. Amps	Catalog No.
1	5.000	25K1P
2	3.540	25K2P
6	2.040	25K6P
8	1.770	25K8P
10	1.580	25K10P
25	1.000	25K25P
50	.707	25K50P
100	.500	25K100P
250	.316	25K250P
500	.222	25K500P
1000	.155	25K1000P
2500	.100	25K2500P
5000	.070	25K5000P
10000	.05	25K10000P

TYPE 50K 50-WATTS

Dia. $2\frac{5}{16}$ "—Depth behind panel $1\frac{3}{8}$ "—Shaft $\frac{1}{4}$ " dia. Rotation 300° —Mounts on panels up to $\frac{1}{4}$ " by means of $\frac{3}{8}$ "-32 Bushing and Hex. Nut—Non-turn lug requires $\frac{3}{16}$ " hole $\frac{1}{2}$ " below center of shaft. UL listed. Weight 0.32 lb.

Ohms	Max. Amps	Catalog No.
.5	10.000	50K.5P
2	5.000	50K2P
4	3.530	50K4P
6	2.880	50K6P
22	1.500	50K22P
35	1.190	50K35P
50	1.000	50K50P
80	.790	50K80P
125	.630	50K125P
225	.470	50K225P
300	.408	50K300P
500	.316	50K500P
1000	.224	50K1000P
1600	.176	50K1600P
2500	.141	50K2500P
5000	.100	50K5000P
10000	.070	50K10000P

Control and Switch Hardware

For Wirewound Controls and Rotary Switches

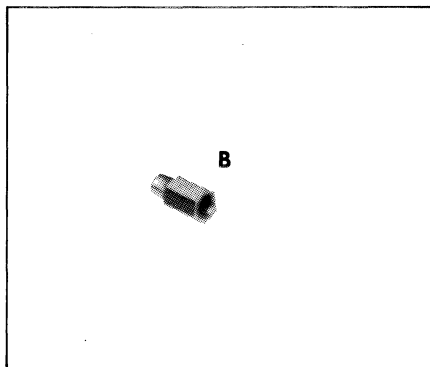

COUPLERS, BUSHINGS

Fig.	Description	Catalog No.
B	Univ. extension bushing extends mounting surface from panel by $\frac{5}{8}$ "	EB247

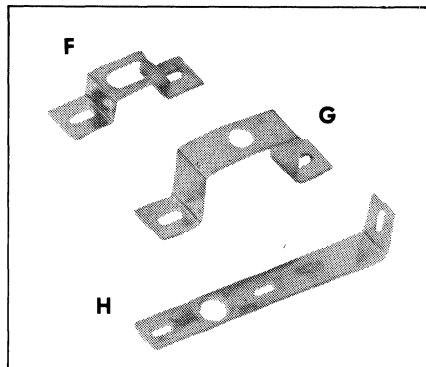

ADJUSTABLE MOUNTING BRACKETS

Fig.	Description	Catalog No.
F	1 1/2" mounting centers	RB248
G	2 1/2" mounting centers	RB249
H	Universal	RB254

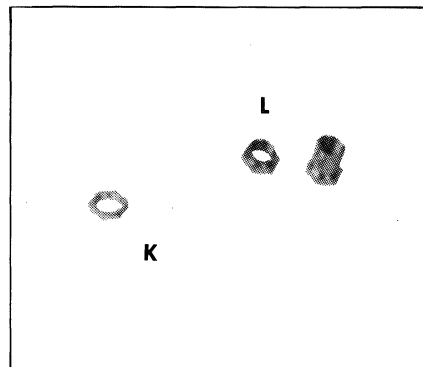

HEX NUTS

Fig.	Description	Catalog No.
	All $\frac{3}{8}$ "-32"	
K	1/2" HEX, 3/8"-32	232
L	.218" shoulder length	255
L	.328" shoulder length	A1126012
L	.578" shoulder length	A112602

CONTROL AND SWITCH WASHERS

Description	Catalog No.
Extruded fiber; 3/4" O.D., 3/8" I.D.	203
Flat phenolic; 3/4" O.D., 3/8" I.D.	212
Nickel finish metal; 3/8" I.D.*	225

*5/8" O.D. †11/16" O.D., 25/64" I.D.

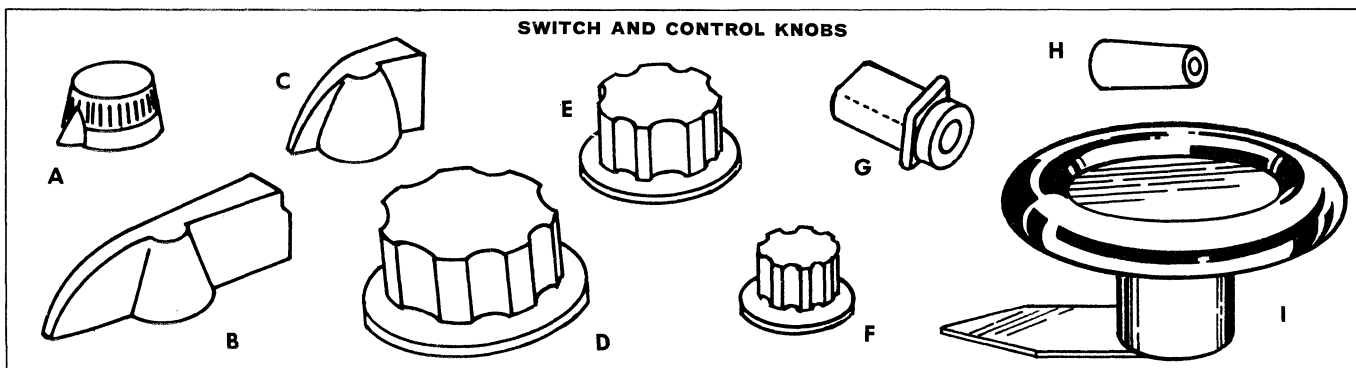

SWITCH AND CONTROL KNOBS

Fig.	Description	Catalog No.
A	1 1/16" dia. black; pointer, 1/4" shaft	364
B	2 1/4" blk bar; 1/4" shaft	365-1
C	1 1/4" blk bar; 1/4" shaft	366-1
D	1 1/2" black; 1/4" shaft	367-1
E	1" dia. blk; 1/4" shaft	368-1
F	3/4" black; 1/8" shaft	1910K
G	9/16" x 13/16" for lever switches; black	GS5149A
H	5/64" dia., x 3/4" thd. for lever switch; black	LK171-1
I	3 1/4" dia., blk, 3/8" shaft	M5104
I	3 1/4" dia., blk, 1/4" shaft	M5106

STANDARD DIAL PLATES

Aluminum dial plates with figures etched on solid black background. 1 13/16" dia., 7/16" hole, figures 7/64" high, .020" thick.

Marking	Catalog Number
1 to 2	372
1 to 3	373
1 to 4	374
1 to 6	376
1 to 7	377
1 to 8	378
1 to 9	379
1 to 10	380
1 to 11	381
1 to 12	382
Off 1 to 3	383
Off 1 to 9	389
Off 1 to 10	390

SPECIAL DIAL PLATES

Description	Catalog No.
1 13/16" dia., 1 to 24, 15° spacing	394
2 1/4" dia., 0-10 (330°)	369
2 1/4" dia., 0-10 (275°)	395
2 1/4" dia., 0-10 (265°)	397
2 1/4" dia., 0-10 (305°)	399
2" sq. Level	495
1 13/16" dia., 1-17 20° spacing	467

Mallory Fastening Devices

MALLORY fastening devices are durable yet economical and they are convenient to use. This line consists of clamps, clips, wire saddles, ties spacers, cable hangers and circuit board supports, guides and accessories. Whenever you are working with electrical or electronic components and accessories you will find a MALLORY fastening device makes the job

easier for you. For prices in quantities of less than 100, consult your local Mallory distributor. **For prices on all fastening devices reference price sheet No. 401.**

Mallory cable ties are precision molded of high strength, fungus resistant nylon. The tapered tail is inserted into the tie's self-locking head. It is then pulled through until

the bundle is secured. Our ties remain fully serviceable through 185°F. All Mallory ties are bagged 100 ties per package to attain maximum freshness.

Our heavy duty releaseable ties can be reused by pressing the conveniently located release lever. This allows complete removal for areas requiring frequent service or

adjustment. They are perfect for prototype construction and temporary maintenance applications.

Standard Mallory ties are available in heat stabilized or weather resistant materials on special order.

Wire Ties

WRAP-IT-TIES

PART #	BUNDLE DIA.	LENGTH (APPROX.)	WIDTH	THICKNESS	TENSILE
WIT-18S	5/8 (15.9)	3 (76.2)	.100 (2.5)	.041 (1.0)	18 Lbs.
WIT-18R	3/4 (19.1)	4-33/64 (114.7)	.100 (2.5)	.041 (1.0)	18 Lbs.
WIT-18L	1-3/8 (34.9)	5-3/4 (146.1)	.100 (2.5)	.041 (1.0)	18 Lbs.
WIT-30R	1-1/4 (31.8)	5-3/4 (146.1)	.138 (3.6)	.048 (1.2)	30 Lbs.
WIT-30L	1-7/8 (47.6)	7-5/16 (185.7)	.138 (3.6)	.048 (1.2)	30 Lbs.
WIT-50S	1-1/2 (38.1)	6 (152.4)	.190 (4.8)	.055 (1.4)	50 Lbs.
WIT-50R	2 (50.8)	8 (203.2)	.190 (4.8)	.055 (1.4)	50 Lbs.
WIT-50L	4-1/2 (114.3)	15-5/16 (388.9)	.190 (4.8)	.055 (1.4)	50 Lbs.
WIT-60R	2-3/4 (69.9)	10-3/4 (273.1)	.190 (4.8)	.055 (1.4)	60 Lbs.
WIT-120R	4-1/4 (108.0)	15-1/16 (382.6)	.310 (7.9)	.080 (2.0)	120 Lbs.
WIT-120L	5-7/8 (149.2)	21-1/4 (539.8)	.310 (7.9)	.080 (2.0)	120 Lbs.

- Material: Nylon 6/6, RMS-01

ALL FLAT TIES U.L. RECOGNIZED STANDARD

Bundle Diameter		Length Overall	Minimum Tensile Strength	Cat. No.
MIN.	MAX.			
1/16"	3/4"	4 3/16"	18 lb.	WIT18R
1/16"	5/8"	3"	18 lb.	WIT18S
1/16"	1 3/8"	5 3/4"	18 lb.	WIT18L
1/16"	1 1/4"	5 3/4"	30 lb.	WIT30R
1/16"	2"	7 1/2"	30 lb.	WIT30L
1/16"	1 1/2"	6"	50 lb.	WIT50S
1/16"	2"	8"	50 lb.	WIT50R
1/16"	4 1/2"	15 1/2"	50 lb.	WIT50L
1/16"	2 3/4"	10 3/4"	60 lb.	WIT60R
3/16"	4 1/4"	15"	120 lb.	WIT120R
1/4"	5 7/8"	21 1/4"	120 lb.	WIT120L

STANDARD COLOR: NATURAL

WRAP-IT-TIES

PART #	BUNDLE DIA.	LENGTH (APPROX.)	WIDTH	THICKNESS	TENSILE
WIT-50SR	1-1/2 (38.1)	6 (152.4)	.190 (4.8)	.055 (1.4)	50 Lbs.
WIT-50RR	2 (50.8)	8 (203.2)	.190 (4.8)	.055 (1.4)	50 Lbs.

RELEASABLE

Bundle Diameter		Length Overall	Minimum Tensile Strength	Cat. No.
MIN.	MAX.			
1/16"	1 1/2"	6"	50 lb.	WIT50SR
1/16"	2"	8"	50 lb.	WIT50RR

SCREW-MOUNT TIES

WRAP-IT-TIES

PART #	BUNDLE DIA.	LENGTH (APPROX.)	WIDTH	THICKNESS	TENSILE
WITS-50MS	1-1/2 (38.1)	6-3/4 (171.5)	.195 (5.0)	.055 (1.4)	50 Lbs.
WITS-50MRL	2 (50.8)	9 (228.6)	.195 (5.0)	.055 (1.4)	50 Lbs. 1000
WITS-50MR	3 (76.2)	11-1/4 (285.8)	.195 (5.0)	.055 (1.4)	50 Lbs. 1000
WITS-50ML	4 (101.6)	16 (406.4)	.190 (4.8)	.055 (1.4)	50 Lbs. 1000
WITS-120MR	4 (101.6)	15-5/8 (396.9)	.310 (7.9)	.080 (2.0)	120 Lbs. 500
WITS-120ML	6 (152.4)	21-7/8 (555.6)	.310 (7.9)	.080 (2.0)	120 Lbs. 500

SCREW MOUNT

Bundle Diameter		Length Overall	Minimum Tensile Strength	Cat. No.
MIN.	MAX.			
1/16"	1 1/2"	6 3/4"	50 lb.	WITS50MS
1/16"	3"	11 1/4"	50 lb.	WITS50MR
1/16"	2"	9"	50 lb.	WITS50MRL
1/16"	4"	16"	50 lb.	WITS50ML
3/16"	4"	15 5/8"	120 lb.	WITS120MR
1/4"	6"	21 7/8"	120 lb.	WITS120ML

Mallory Fastening Devices

Wire Ties & Accessories Tie Holders

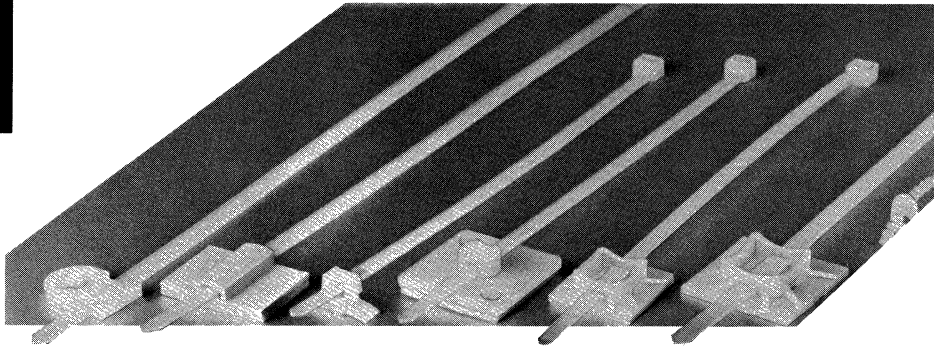

EZ Wire Ties

Just wrap them around the wire bundle, thread the end through the specially designed loop, pull it tight and lock in place. It stays put, holds your harness together until you release it. Should you want to add more conductors to the bundle, open the E-Z Wire Tie, add your wires and refasten it. It's as easy as that.

E-Z Wire Ties are strong and durable with a high dielectric that makes them the perfect tie for electrical harnesses.

FTH-1 FTH-2 FTH-3 FTH-4A FTH-5A FTH-7

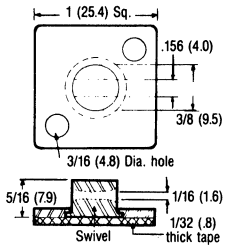

- FTH-4/FTH-4A**
- For WIT Series 18 and 30 ties
 - Swivel base makes rerouting easy
 - FTH-4 mounts with #8 screw; FTH-4A has adhesive, RMS-15
 - Material: Nylon 6/6, RMS-01
 - Standard Pack: 1000 per bag

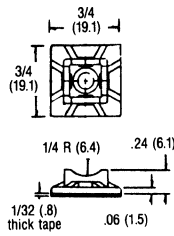

- FTH-5/FTH-5A**
- For WIT Series 18 and 30 ties
 - Multi-directional; WIT can enter from any side
 - FTH-5 mounts with #6 flat head screw; FTH-5A has adhesive back, RMS-15
 - Material: Nylon 6/6, RMS-01
 - Standard Pack: 1000 per bag

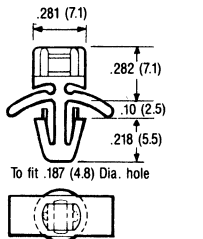

- FTH-3**
- For WIT Series 18 and 30 ties
 - Barbed Arrow mount locks into .187" (4.8 mm) dia. hole in .03" to .08" (.8-2.0 mm) thick panel
 - Material: Nylon 6/6, RMS-01
 - Standard Pack: 1000 per bag

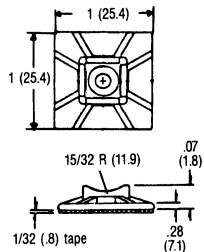

- FTH-7A**
- For WIT Series 50 and 60 ties
 - Multi-directional holder for heavier loads
 - FTH-7 mounts with #8 flat head screw; FTH-7A has adhesive back, RMS-15
 - Material: Nylon 6/6, RMS-01
 - Standard Pack: 1000 per bag

Cross Reference Part # / Color	inches (mm)		Fig.
	Over All Length	Material	
EZ-30 RD	2.0 (50.8) Min.	Polyallomer	1
EZ-31 YL			
EZ-32 BL			
EZ-10 RD	4.0 (101.6) Min.	Polyallomer	1
EZ-11 YL			
EZ-12 BL		Nylon	
EZ-13 BK			
EZ-18 NT	5.0 (127.0) Min.	Polyallomer	1
EZ-4 RD			
EZ-5 YL			
EZ-6 BL	6.0 (152.4) Min.	Polyallomer	1
EZ-2 NT			
EZ-7 RD	6.0 (152.4) Min.	Polyallomer	1
EZ-8 YL			
EZ-9 BL			
EZ-3 NT	8-3/4 (222.3) Min.	Nylon	2
EZ-19 NT			
EZ-20 RD			
EZ-21 YL	10-3/4 (273.1) Min.	Polyallomer	2
EZ-22 BL			
EZ-14 RD	10-3/4 (273.1) Min.	Polyallomer	2
EZ-15 YL			
EZ-16 BL			
EZ-17 NT	Min.	Nylon	

- Materials: Polyallomer, RMS-10; Nylon 6/6, RMS-01

- Easy to install and release
- Beaded design keeps wires from shifting or slipping

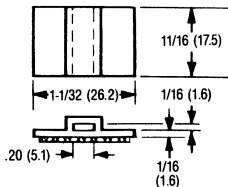

- FTH-2**
- For WIT Series 18, 30 and 50 wire ties
 - Easy-mounting adhesive, RMS-15
 - Material: Noryl, RMS-05
 - Standard Pack: 1000 per bag

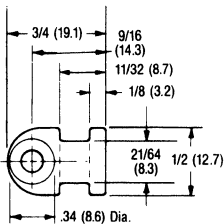

- FTH-1**
- For WIT Series 18, 30 and 50 wire ties
 - Mounts with #8-32 flat head screw
 - Works in small spaces
 - Material: Nylon 6/6, RMS-01
 - Standard Pack: 1000 per bag

FIG. 1

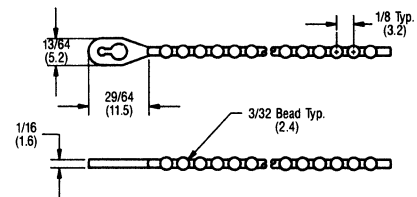
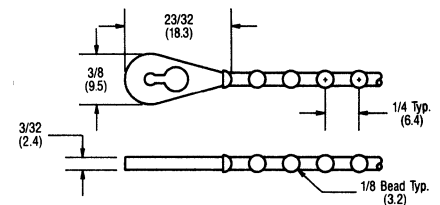

FIG. 2



MALLORY

Mallory Fastening Devices

Harness Rap

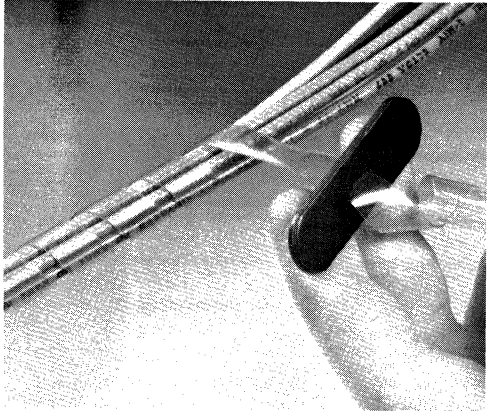

- Materials:
 - (P) Polyethylene, RMS-06;
 - (N) Nylon 11, RMS-22;
 - (R) Flame Retardant Polyethylene, RMS-07;
 - (U) Ultra-violet Stabilized Polyethylene, RMS-06;
 - (V) V-O Rated Clear Polycarbonate, RMS-23

TYPE HR HARNESSRAP

This new spiral wrapping provides a readily flexible and strong protection for groups of conductors. Leads can be brought out at any point to make a "tailor-made" harness, strong, secure, tight-fitting. HarnessRAP retains its elasticity and can be removed as easily as it is applied, and reused again and again.

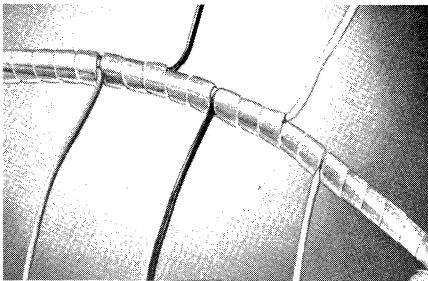

Material	O.D.	Catalog No.
Nylon	1/8"	HR125
Polyethylene	1/8"	HR125P
Flame Retardant	1/8"	HR125R
Ultraviolet Resistant	1/8"	HR125U
Polyethylene	3/16"	HR1875P
Flame Retardant	3/16"	HR1875R
Nylon	3/16"	HR1875
Ultraviolet Resistant	3/16"	HR1875U
Nylon	1/4"	HR250
Polyethylene	1/4"	HR250P
Flame Retardant	1/4"	HR250R
Ultraviolet Resistant	1/4"	HR250U
Nylon	3/8"	HR375
Polyethylene	3/8"	HR375P
Flame Retardant	3/8"	HR375R
Ultraviolet Resistant	3/8"	HR375U
Nylon	1/2"	HR500
Polyethylene	1/2"	HR500P
Flame Resistant	1/2"	HR500R
Ultraviolet Resistant	1/2"	HR500U

- Material: Nylon 6/6, RMS-01

TYPE TL TWIST-LOK® TIES

Slip bundle of wires into the tie, then twist the ends together with a flick of the fingers. The TWIST-LOK locks in place and holds your wire bundle securely and firmly. To open, another flick of the fingers releases the tie instantly—ready to be used again.

SPECIFICATIONS TWIST-LOK WIRE TIES

Approximate Overall Height	Wire Bundle Diameter	Catalog Number
.900"	.200-.300"	TL250
1.032"	.300-.400"	TL350
1.200"	.400-.500"	TL450
1.550"	.700-.800"	TL750

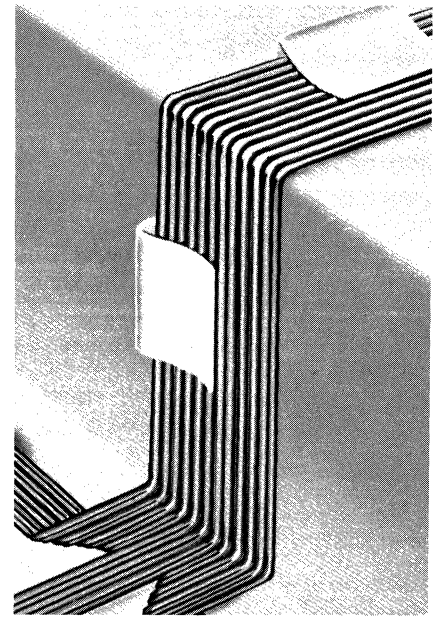

TYPE CFCC FLAT CABLE CLAMPS

Designed for routing from one to six layers of 26-30 AWG flat or woven cable. They feature a serrated gripper for secure positioning without slippage. Ideal for limited access applications. Self-adhesive backing eliminates need for mounting holes or tools.

- Material: Noryl, RMS-05

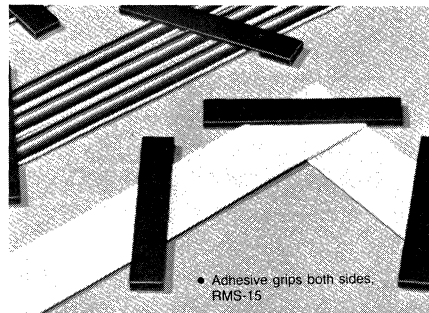

TYPE FCC FLAT CABLE CLAMPS

Designed expressly for holding flat flexible cable, ribbon cable, etc.—firmly in position. Made of high dielectric, self-extinguishing PVC. Peel off the Mylar backing from the clamp's two legs, and press over the cable.

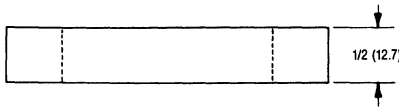

- Material: PVC, RMS-04

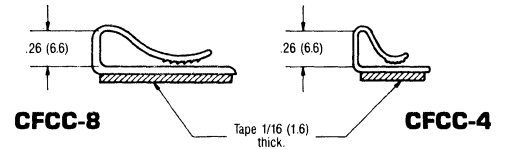
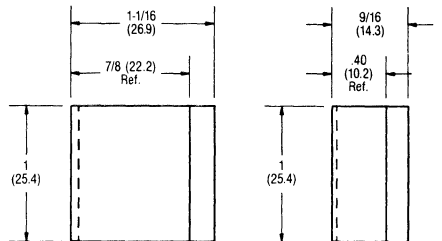
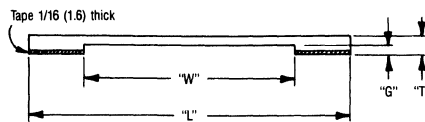

+ 1/8"	+ 1/16"	+ 015"	+ .01"	Catalog No.
L-0"	W-0"	T-010"	G-02"	
1 1/2"	1/2"	5/32"	3/32"	FCC43
2"	1"	5/32"	3/32"	FCC83
3"	2"	5/32"	3/32"	FCC163
4"	3"	5/32"	3/32"	FCC243



Mallory Fastening Devices

Clips & Clamps

Cable Clamps

SERIES E PROPIONATE

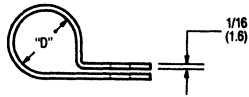
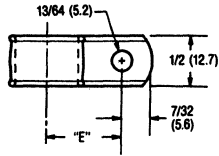

- Series "E" in inexpensive propionate, RMS-12

Ethocel combines light weight and chemical resistance with excellent shock resisting properties in a temperature range from 185 F. to -40 F.

With toughness and excellent electrical properties, ethocel clamps have satisfied unlimited fastening problems throughout the electrical industry.

Approved 7-21-44 Army-Navy Aeronautical AN742.

TYPE E 1/2" ETHYL CELLULOSE PLASTIC CABLE CLAMPS

D	E	T (±.005")	H	Cat. No.
1/8"	.328	.055"	.199-.204	E2
3/16"	.390			E3
1/4"	.421			E4
5/16"	.453			E5
3/8"	.483			E6
7/16"	.531			E7
1/2"	.562			E8
9/16"	.625			E9
19/32"	.618			E9 1/2
5/8"	.610			E10
11/16"	.666			E11
3/4"	.765			E12
7/8"	.812			E14
1"	.906			E16
1 1/8"	.968			E18
1 1/4"	1.025			E19
1 1/2"	1.156			E20
1 5/8"				E21
1 3/4"				E22
1 7/8"				E23
1 1/2"				E24

Cable Clamps

- Series N and NB in strong flexible Nylon 6/6, RMS-01
- Versatile N20B, N24B and N32B will accommodate 3 different bundle diameters

N NB

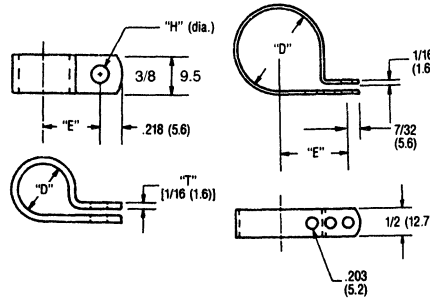

TYPE N 3/8" WIDE NYLON CABLE CLAMPS

D	E	T	H	Cat. No.
1/16"	9/32"	3/64"	1/8"	N1
1/8"	21/64"	1/16"	11/64"	N2
3/8"	25/64"			N3
3/16"	27/64"			N4
1/4"	29/64"			N5
5/16"	31/64"			N6
3/8"	17/64"			N7
7/16"	9/16"			N8

TYPE N-B 1/2" WIDE NYLON CABLE CLAMPS

D	E	T	H	Cat. No.
1/8"	21/64"	1/16"	13/64"	N2B
3/16"	25/64"			N3B
1/4"	27/64"			N4B
5/16"	29/64"			N5B
3/8"	31/64"			N6B
7/16"	17/32"			N7B
1/2"	9/16"			N8B
9/16"	19/32"			N9B
5/8"	5/8"			N10B
1 1/16"	21/32"			N11B
3/4"	49/64"			N12B
7/8"	13/16"			N14B
1"	29/32"			N16B
1 1/8"	31/32"			N18B
1 1/4"	1 1/16"			N20B
1 1/2"	1 1/32"			N24B
2"	1 1/2"			N32B

TYPE V-VINYL COMPONENT CLIPS

Mallory Plastic Component Clips are a convenient, economical means for fastening and, where required, insulating a wide variety of electrical and electronic components, accessories and parts. They permit fast and easy insertion, hold firmly, yet allow removal. Typical applications are capacitors, resistors, lamps, batteries and fuses.

They are made of strong, black vinyl and have high dielectric strength.

The floor of the clip is pierced for screws or other fastening devices.

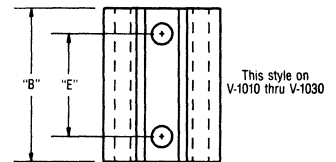

- V-series material: PVC, RMS-04

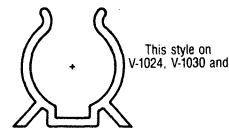
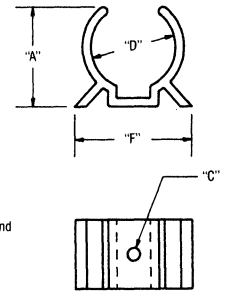

Part No.	Dia. of Part To Be Held "D"	Height "A" Ref.	Length "B"	Hole Dia. "C"	inches (mm)	
					"E"	"F"
V-1000	1/4 (6.4)	19/64 (7.5)				1/2 (12.7)
V-1001	5/16 (7.9)	25/64 (9.9)				
V-1002	3/8 (9.5)	13/32 (10.3)				35/64 (13.9)
V-1003	7/16 (11.1)	31/64 (12.3)		3/32 (2.4)		
V-1004	1/2 (12.7)	33/64 (13.1)	1/2 (12.7)			43/64 (17.1)
V-1005	9/16 (14.3)	41/64 (16.3)				55/64 (21.8)
V-1006	5/8 (15.9)	23/32 (18.3)				7/8 (22.2)
V-1007	11/16 (17.5)	13/16 (20.6)				29/32 (23.0)
V-1008	3/4 (19.1)	23/32 (18.3)				2 (50.8)
V-1009	7/8 (22.2)	27/32 (21.4)				2-23/32 (69.1)
V-1010	1 (25.4)	1-1/16 (27.0)	1-1/8 (28.6)	5/32 (4.0)		1-11/64 (29.8)
V-1011	1-3/8 (34.9)	1-27/64 (36.1)			3/4 (19.1)	1-25/64 (35.3)
V-1024	1-1/2 (38.1)	1-13/16 (46.0)	1-3/4 (44.5)			
V-1030	2-1/4 to 2-3/4 (57.2-69.9)	2-5/8 (66.7)	1-1/2 (38.1)			

Mallory Fastening Devices

TYPE KK—KWIK-KLIP

Just strip off the protective backing and press KWIK-KLIP in place—it will stay there permanently. For anchoring cable, tubing, pipe or rod up to 1/2" in diameter.

Made from strong but resilient CPVC plastic—elastic enough to receive cable, tubing, etc.—but strong and firm to hold it securely.

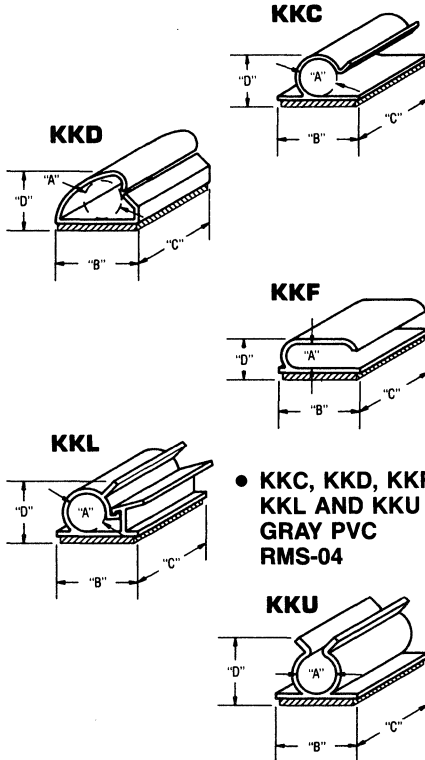

● KKC, KKD, KKF
KKL AND KKK IN
GRAY PVC
RMS-04

SPECIFICATIONS				
A (inches)	B (inches)	C (inches)	D (inches)	Cat. No.
1/8	3/4	3/4	—	KKU2
1/4	3/4	3/4	—	KKU4
3/8	3/4	3/4	—	KKU6
1/2	1	1	—	KKU8
3/4	1	1	—	KKU12
1/8	3/4	3/4	—	KKC2
3/16	3/4	3/4	—	KKC3
1/4	3/4	3/4	—	KKC4
5/16	3/4	3/4	—	KKC5
3/8	3/4	3/4	—	KKC6
1/2	1	1	—	KKC8
3/4	1	1	—	KKC12
1/4	3/4	3/4	—	KKL4
1/2	1	1	—	KKL8
3/4	1	1	—	KKL12
1/2	3/4	3/4	—	KKD8
5/8 x 1/4	3/4	3/4	5/8	KKF10 x 4*

*Made especially to hold 3 wire leads, e.g. air conditioner leads. Consult your local Mallory distributor for price information.

Wire Saddles

TYPE WS WIRE SADDLES

Used to channel a group or bundle of wires over a given course. This may be done to avoid components that operate at dangerously high temperatures or that would react unfavorably to the proximity of other electrical currents. Or they may be used solely for the sake of orderly arrangement. Wire Saddles are available with a regular tip which may be removed or a permanent locking barbed arrow tip. Both easily snap into position into punched or drilled holes .187 in diameter.

Also available with "Barbed Arrow" locking tip. Order by adding Suffix A.

Dim. "H"	Dim. "A"	Dim. "B"	Catalog No.	
			Nylon	Flame Retardant
3/8"	.510	.19	WS1N	WS1R
3/8"	.510	.19	WS1NA	WS1RA
37/64"	.71	.39	WS2N	WS2R
37/64"	.71	.39	WS2NA	WS2RA
15/16"	1.06	.75	WS3N	WS3R
15/16"	1.06	.75	WS3NA	WS3RA
1 1/4"	1.37	1.07	WS4N	WS4R
1 1/4"	1.37	1.07	WS4NA	WS4RA

- Material: Nylon 6/6, RMS-01 and Flame Retardant Nylon, RMS-19
- Color: Natural

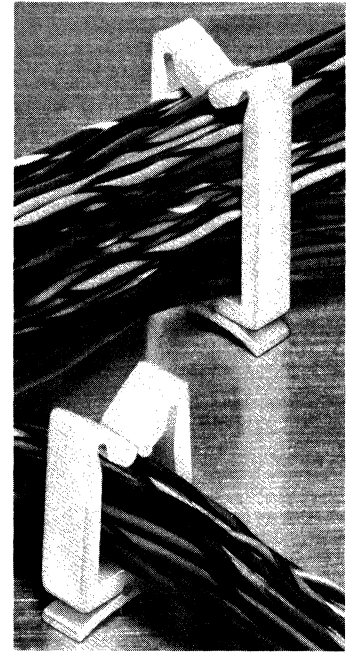

- Easily installed by hand
- Secure hold in any position
- Assures precision routing
- Cuts cost by speeding assembly
- Lifts wires off board to avoid hot components and minimize transient interference

WS

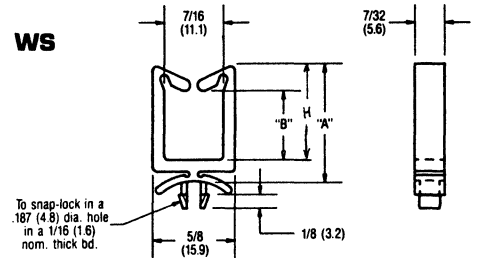

To snap-lock in a .187 (4.8) dia. hole in a 1/16 (1.6) nom. thick bd.

Catalog No. CCP1

Circuit Board Pullers

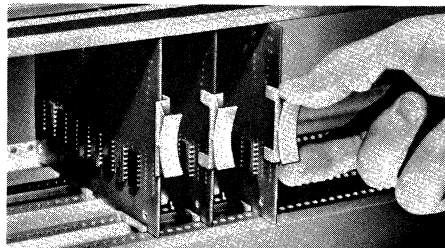

- Snap into two .125" (3.2 mm) dia. holes in 1/16" (1.6 mm) nominal board
- Curved tab provides fingertip grip for board insertion and removal
- Material: Nylon 6/6, RMS-01
- Color: Natural

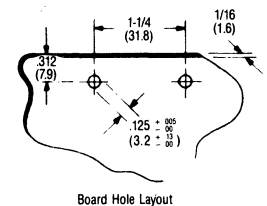
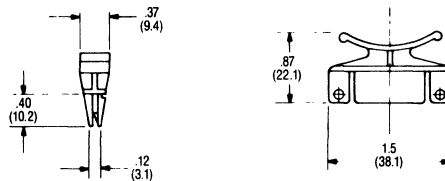
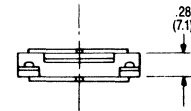

Board Hole Layout

MALLORY

Mallory Fastening Devices

Circuit Board Hardware Locking Circuit Board Supports

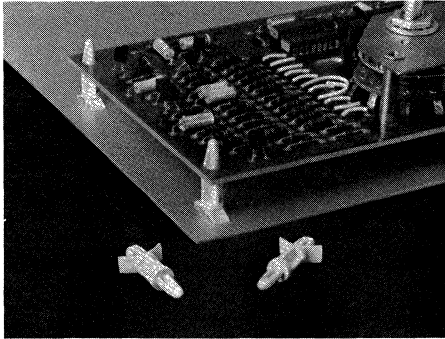

- Both ends lock by hand; no tools required
- Strong, dependable grip
- Material: Nylon 6/6, RMS-01; or Flame Retardant Nylon, RMS-19
- Color: Natural

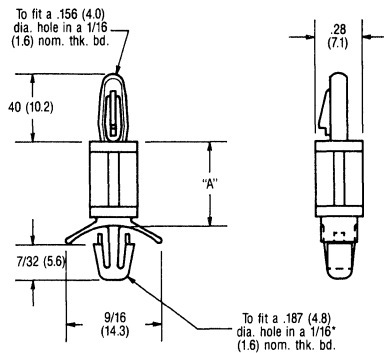

Nylon Circuit Board Supports feature a locking tension flange which laps over the board to hold securely in position. Supports up to 100 lbs. No need for tools. An arrow-type locking head snaps into a .187" dia. hole in the chassis where it expands to lock permanently in position. A squeeze of the fingers permits removal of the board from the support for repair or replacement.

Nom. Dim. A	Catalog No.	
	Nylon	Flame Ret.
3/16"	LCBS3N	LCBS3R
1/4"	LCBS4N	LCBS4R
3/8"	LCBS6N	LCBS6R
7/16"	LCBS7N	LCBS7R
1/2"	LCBS8N	LCBS8R
5/8"	LCBS10N	LCBS10R
3/4"	LCBS12N	LCBS12R
7/8"	LCBS14N	LCBS14R
1"	LCBS16N	LCBS16R
1 1/8"	LCBS18N	LCBS18R
1 1/4"	LCBS20N	LCBS20R
1 3/8"	LCBS22N	LCBS22R

Available for special 1/8" chassis thickness.

TYPE CBS CIRCUIT BOARD SUPPORTS

Designed to hold printed circuits in position with sufficient clearance above the chassis for their assembled components. They snap into .187" drilled or punched holes in the chassis where they lock into position securely. Supports lock on any chassis thickness from .030" to .090". They are, however, easily removed for replacement. Made from strong, tough nylon with high dielectric strength.

CIRCUIT BOARD SUPPORTS

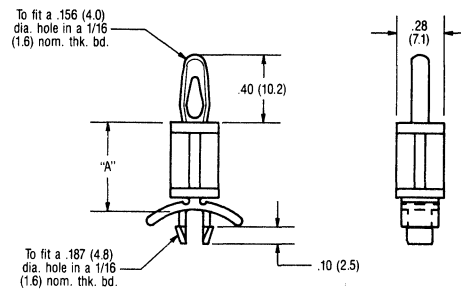
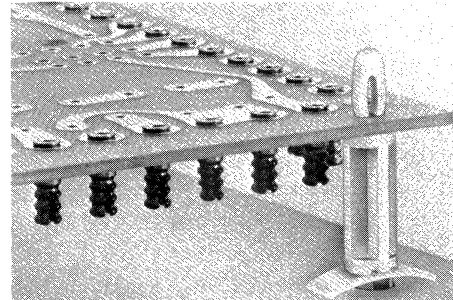

- Lock to chassis, snap to board
- Easily installed by hand
- Releasable for repairs
- Materials: Nylon 6/6, RMS-01; or Flame Retardant Nylon, RMS-19
- Color: Natural

Nom. Dia. A	Catalog No.	
	Nylon	Flame Ret.
1/8"	CBS2NA	—
3/16"	CBS3N	CBS3R
1/4"	CBS4N	CBS4R
3/8"	CBS6N	CBS6R
1/2"	CBS8N	CBS8R
5/8"	CBS10N	CBS10R
3/4"	CBS12N	CBS12R
7/8"	CBS14N	CBS14R

Mallory Fastening Devices

Screw Mount Circuit Board Support

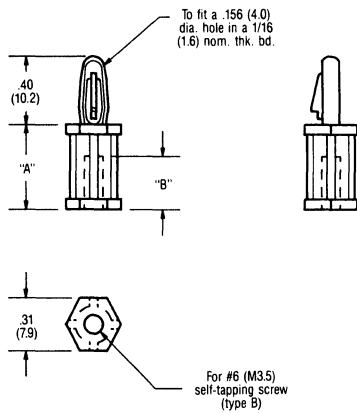
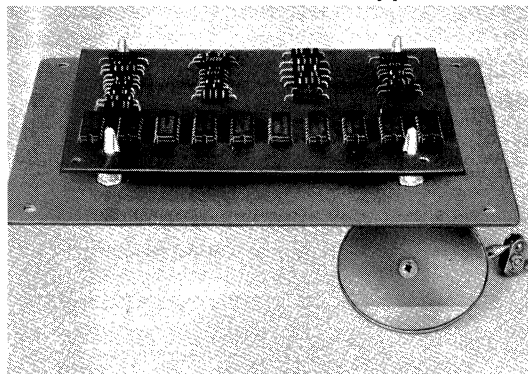

- Install quickly by hand
- Releasable for repairs
- Available to fit three different board and chassis hole size combinations
- .156"/.187" (4.0mm/4.8mm) hole size combination
- Material: Nylon 6/6, RMS-01; or Flame Retardant Nylon, RMS-19
- Color: Natural

TYPE TCBS CIRCUIT BOARD SUPPORT (SCREW FASTENED)

Drive a #6 self-tapping screw directly through the chassis and into the TCBS support. Then snap the circuit board over the top of the support. A tension flange compresses and then springs back to overlap and secure the board. Simply squeeze the end of the support to permit removal of the board for repair or replacement.

Nom. Dim. A	Nom. Dim. B	Catalog No.	
		Nylon	Flame Ret.
1/4"	13/64"	TCBS4N	TCBS4R
3/8"	21/64"	TCBS6N	TCBS6R
1/2"		TCBS8N	TCBS8R
5/8"		TCBS10N	TCBS10R
3/4"		TCBS12N	TCBS12R
7/8"		TCBS14N	TCBS14R
1 1/8"		TCBS18N	TCBS18R
1 13/32"		TCBS22.5N	TCBS822.5R

Dual Locking Circuit Board Support

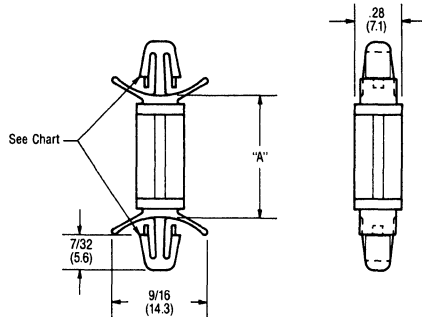
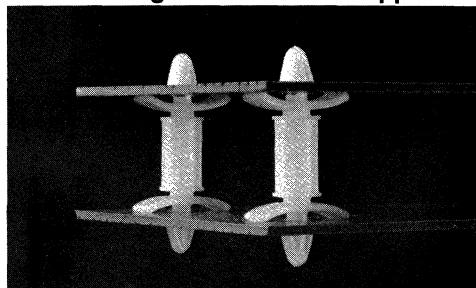

- Minimal chassis protrusion for limited space or slimline applications
- Board-mount head locks and releases by hand
- Materials: Nylon 6/6, RMS-01 or Flame Retardant Nylon, RMS-19
- Color: Natural

TYPE DLCBS DUAL LOCKING CIRCUIT BOARD SPACER

Seven sizes, rigid and rugged nylon spacers will space two boards from 3/16" to 7/8" apart—either vertically or horizontally. The spacer simply compression-snaps into .156" dia. hole on the two boards to be joined and spaced. Once inserted, the "Barbed Arrow" locking tips expand for permanent fastening on both boards to maintain the desired spacing.

Nom. Dia. A	Catalog No.	
	Nylon	Flame Ret.
3/16"	DLCBS3N	DLCBS3R
1/4"	DLCBS4N	DLCBS4R
3/8"	DLCBS6N	DLCBS6R
1/2"	DLCBS8N	DLCBS8R
5/8"	DLCBS10N	DLCBS10R
3/4"	DLCBS12N	DLCBS12R
7/8"	DLCBS14N	DLCBS14R

Studded Circuit Board Supports

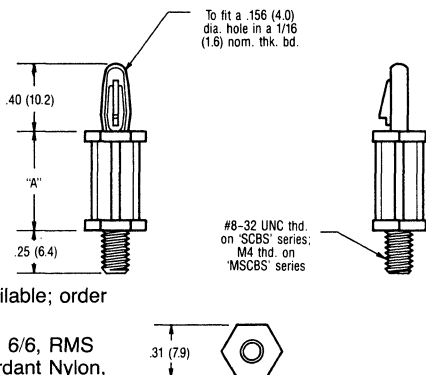
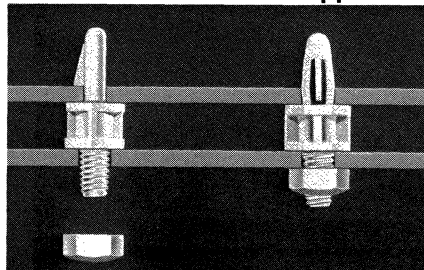

- No tools required for installation
- Board mount head is releasable
- Chassis mount end fastens with #8-32 nut, also available with M4 metric thread
- Plastic nuts available; order separately
- Materials: Nylon 6/6, RMS 01; Flame Retardant Nylon, RMS-19
- Color: Natural

TYPE SCBS THREADED CIRCUIT BOARD SUPPORT

One-piece unit has #8-32 thread for speedy fastening to nut or receiver. Locking tab secures board. Flame retardent nylon supports available in eight spacing heights 1/4" to 1 13/32".

Nom. Dim. A	Catalog No.	
	U.L. 94 V-2 Nylon	U.L. 94 V-0 Nylon
.25"	SCBS4N	SCBS4R
.37"	SCBS6N	SCBS6R
.50"	SCBS8N	SCBS8R
.62"	SCBS10N	SCBS10R
.75"	SCBS12N	SCBS12R
.87"	SCBS14N	SCBS14R
1.12"	SCBS18N	SCBS18R
1.43"	SCBS22.5N	SCBS22.5R

Mallory Fastening Devices

Round Plastic Spacers

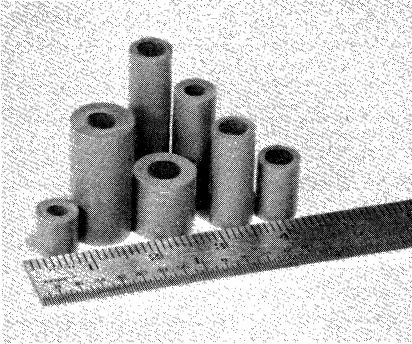

- High dielectric strength
- UL94 V-0 rated material
- Wide range of sizes for #4, #6, #8 and #10 screws, plus heavy duty sizes for 1/4" and 3/8" bolts
- Material: CPVC, RMS-11
- Color: Gray

PLASTIC SPACERS

Tough, rigid, strong and low cost. High temperature resistant (225°F), CPVC (Fig. A)

Screw Size	"A" Nom. Dim. and Cat. Nos. (Fig. A)						Nom. Dim.	
	1/4"	3/8"	1/2"	5/8"	3/4"	1"	B	C
No. 4	SS42	SS43	SS44	SS45	SS46	SS48	1/4"	.120"
No. 6	SS62	SS63	SS64	SS65	SS66	SS68	1/4"	.147"
No. 8	SS82	SS83	SS84	SS85	SS86	SS88	1/4"	.175"
No. 8	SS82L	SS83L	SS84L	SS85L	SS86L	SS88L	3/8"	.175"
No. 10	SS102	SS103	SS104	SS105	SS106	SS108	3/8"	.200"

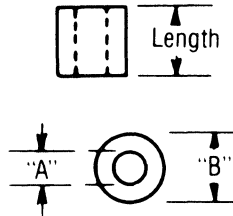
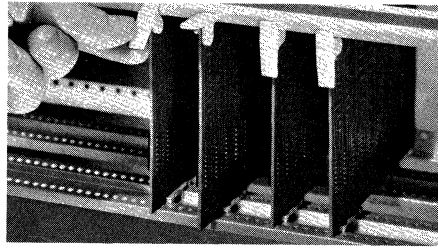

Circuit Board Ejectors

- Material: Nylon 6/6, RMS-01

TYPE CBE CIRCUIT BOARD EJECTOR

EJECTOR—Snap into single .109" dia. hole on circuit board. Flared easy-grip tab provides lever action against guide, rack or chassis to eject board. One size fits all boards up to 1/16" thick. Nylon.

CBE-8 thru CBE-18

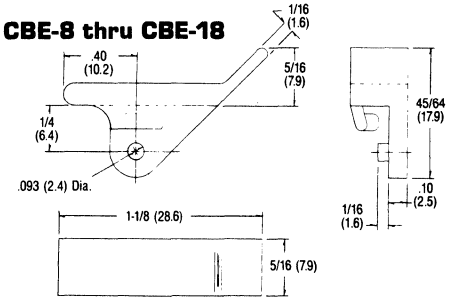

CBE-1

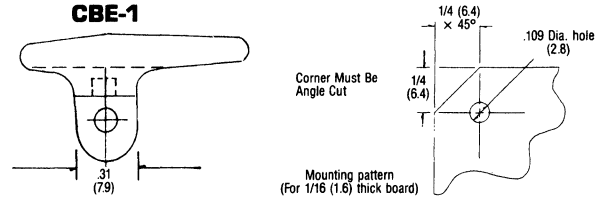

Color	Cat. No.	Color	Cat. No.
Natural	CBE1	Orange	CBE14
Natural	CBE8	Yellow	CBE15
Green	CBE9	Blue	CBE16
Black	CBE11	Violet	CBE17
Brown	CBE12	Gray	CBE18
Red	CBE13		

Hex Spacer Standoffs

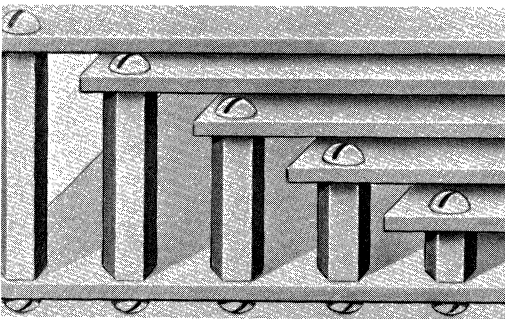

- Self-extinguishing
- Low moisture absorption
- Chemical resistant
- UL 94V-0 rated material
- Mount with self-tapping screws
- Material: CPVC, RMS-11
- Color: Gray

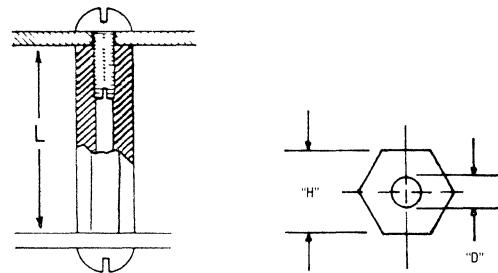

HEX SPACER-STANDOFFS

For use with self-tapping screws. Made from CPVC. Good mechanical strength, low moisture absorption. Resistant to chemicals. (Fig. B)

Self-Tapping Screw Size	"L" Lengths and Cat. Nos.							Nom. Dim.	
	3/8"	1/2"	5/8"	3/4"	7/8"	1"	H	D	
No. 4	HS43	HS44	HS45	HS46	HS47	HS48	.187"	.102"	
No. 6		HS64	HS65	HS66	HS67	HS68	.250"	.110"	
No. 8			HS85	HS86	HS87	HS88	.375"	.141"	

#25 Plastic thread cutting screw recommended

Mallory Fastening Devices

Continuous Grommet Strip

- Materials: NGS in nylon RMS-17; PGS in polyethylene, RMS-13

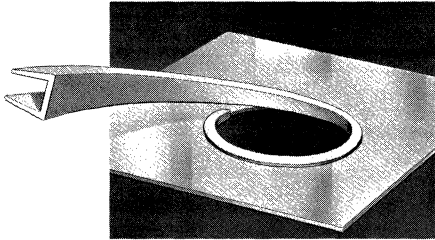

SOLID . . .

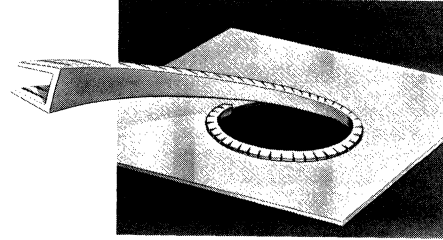
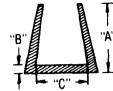

. . . OR SERRATED

Now available in your choice of solid or serrated lengths . . . in polyethylene for normal service or nylon for severe service . . . in conveniently packaged 50 and 100 ft. lengths as shown below.

	Description	Material	Reference Dimensions (in.)			Panel Thickness	Catalog No.
			A	B	C		
100'	solid length	Polyethylene	1/8"	1/32"	1/32"	To .036" (20 Ga.)	PGS1
50'	solid length	Nylon	1/8"	1/32"	1/32"	To .036" (20 Ga.)	NGS1
100'	serrated length	Polyethylene	1/8"	1/32"	1/32"	To .036" (20 Ga.)	SPGS1
50'	serrated length	Nylon	1/8"	1/32"	1/32"	To .036" (20 Ga.)	SNGS1
100'	solid length	Polyethylene	5/32"	1/32"	7/64"	.037-.105" (19-12 Ga.)	PGS2
50'	solid length	Nylon	5/32"	1/32"	7/64"	.037-.105" (19-12 Ga.)	NGS2
100'	serrated length	Polyethylene	5/32"	1/32"	7/64"	.037-.105" (19-12 Ga.)	SPGS2
50'	serrated length	Nylon	5/32"	1/32"	7/64"	.037-.105" (19-12 Ga.)	SNGS2
100'	solid length	Polyethylene	5/32"	3/64"	5/32"	.106-.164" (11-8 Ga.)	PGS3
50'	solid length	Nylon	5/32"	3/64"	5/32"	.106-.164" (11-8 Ga.)	NGS3
100'	serrated length	Polyethylene	5/32"	3/64"	5/32"	.106-.164" (11-8 Ga.)	SPGS3
50'	serrated length	Nylon	5/32"	3/64"	5/32"	.106-.164" (11-8 Ga.)	SNGS3
100'	solid length	Polyethylene	3/16"	3/64"	3/16"	.165-.187"	PGS4
50'	solid length	Nylon	3/16"	3/64"	3/16"	.165-.187"	NGS4
100'	serrated length	Polyethylene	3/16"	3/64"	3/16"	.165-.187"	SPGS4
50'	serrated length	Nylon	3/16"	3/64"	3/16"	.165-.187"	SNGS4
100'	solid length	Polyethylene	3/16"	3/64"	1/4"	.188-.250"	PGS5
50'	solid length	Nylon	3/16"	3/64"	1/4"	.188-.250"	NGS5
100'	serrated length	Polyethylene	3/16"	3/64"	1/4"	.188-.250"	SPGS5
50'	serrated length	Nylon	3/16"	3/64"	1/4"	.188-.250"	SNGS5

Natural color. Special colors available on request

*Conforms to MIL 1-613D

**Conforms to MIL 22096. Type 4.

Mallory Fastening Devices

Raw Material Specification [RMS]

RMS NO.	MATERIAL	TENSILE STRENGTH AT YIELD	ELONGATION AT FAIL	FLEXUARL MODULOUS	IZOD IMPACT	DEFLECTION TEMPERATURE
	TEST METHOD	D 638	D638	D790	D256	D648
	UNIT OF MEASURE	psi	%	psi	ft.-lb./in.	66 psi °F
RMS-01	Nylon 6/6	9,000	200	190,000	3.0	430
RMS-04	PVC	6,200	N.R.	350,000	17.0	N.R.
RMS-05	Noryl	9,600	60	360,000	5	279
RMS-06	Low Density Polyethylene	600-2,300	400	80,000	No break	100-121
RMS-07	Flame Retardant Polyethylene	2,150	N.R.	118,000	1.26	N.R.
RMS-10	Polyallomer	4,100	400	110,000	1.7	210
RMS-11	CPVC	8,000	N.R.	398,800	1.0	N.R.
RMS-12	Propionate	3,000	50	230,000	10.7	157
RMS-13	Polyethylene	1,200-3,500	50-600	100,000	.6-1.15	120-165
RMS-17	Nylon H.M.W.	11,200	>300	175,000	2.5	455
RMS-19	Flame Retardant Nylon	5,700	75	200,100	1.7	397
RMS-22	Nylon 11	3,500	100	40,000	N.R.	N.R.
RMS-23	Flame Retardant Polycarbonate	9,000	90	325,000	12	280

RMS NO.	Deflection Temperature	Dielectric Strength	Volume Resistivity	Water Absorption	UL Yellow Card File	Flamability/ Thickness	UL Continuous Use Temperature	Hardness
	D648	D149	D257	D570		UL94	w/impact w/o impact	
	264 psi °F	Volts / Mil	ohm / cm	24 hrs., %		in.	°C	
RMS-01	160	550	2.0×10^{13}	1.1	E70062	V-2 .028	75 85 @ .058	R105
RMS-04	163	690	5.1×10^8	.04	E41877	V-0 .028	50 50 @ .028	R111
RMS-05	265	500	1.0×10^{17}	.007	E42239	V-1 .058	105 110 @ .030	R119
RMS-06	90-105	450-1,000	$>10^{16}$	<.01	N.R.	N.R.	N.R.	D48
RMS-07	N.R.	N.R.	N.R.	N.R.	E51346	V-2 .062	N.R.	N.R.
RMS-10	124	850	1.0×10^{15}	<.01	N.R.	N.R.	N.R.	R85
RMS-11	205	N.R.	N.R.	N.R.	E41877	V-0 .058	N.R.	R117
RMS-12	127	N.R.	1.0×10^{14}	1.9	N.R.	N.R.	N.R.	N.R.
RMS-13	105-120	450-1,000	N.R.	<.01	N.R.	N.R.	N.R.	D50-D60
RMS-17	194	N.R.	1.0×10^{13}	1.2	E41938	V-2 .028	75 85 @ .058	R108
RMS-19	158	559	1.1×10^{13}	.91	E70062	V-0 .028	75 85 @ .058	R120
RMS-22	N.R.	N.R.	N.R.	.50	N.R.	N.R.	N.R.	D63
RMS-23	270	425	$>10^{16}$.15	E36063	V-0 .120	110 125 @ .120	M70

RMS-15 Double Coated Urethane Foam Tape	Physical Properties		Adhesive Properties		
	This tape is a high density, flexible polyurethane foam, coated on both sides with pressure-sensitive acrylic adhesive. U.L. Card File E93368	Density 30 lbs./ft ³ Water penetration rate (% volume): 2.00 max. Solvent resistance, after 24 hr. immersion	Toluene JP-4 Petrol Heptane Lacquer Thinner Perchloroethylene Motor Oil	Foam swelling, adhesive weakening Slight foam swelling, adhesive softened Some foam swelling, adhesive softened Slight foam swelling, adhesive softened Considerable foam swelling, adhesive softened and partially dissolved Some foam swelling, adhesive softened No effect	Polyethylene Polypropylene Acrylic ABS Polystyrene Other Plastics Anodized Aluminum Stainless Steel Other Metal Surfaces

Note: Foam splits upon removal.

N.R. - NOT RATED

Characteristics	Proper Application
1. The adhesive's aggressiveness permits tape to be applied to rough surfaces with only enough pressure for maximum contact. 2. The long aging adhesive is suitable for permanent holding. 3. Best surface adhesion is attained when application temp. range is between 70°-120°F (20°-50°C). Application at slightly lower temperature range is possible if initial holding power is not critical. Once applied, adhesive is not effected by lower temperature. Tape will hold for extended periods of time at temperatures of 200°F (95°C) or slightly higher.	1. Max. recommended static loading at the adhesive surface is 1/4 pound per sq. in. of tape. 2. Remove dirt, wax, dust, soap, or oil from contact surface. 3. Apply to relatively flat surface on glass, metal, wood, tile, plastic, etc. 4. Do not use on fabric, coarse concrete, loose paint, or rough wallpaper. 5. Do not touch adhesive. 6. Remove liner. Place article in desired position and press firmly to insure good adhesive contact. 7. Do not attempt to reposition article. 8. If possible, allow overnight dwell before loading.

Switches

GENERAL PURPOSE ROTARY SWITCHES 3000 SERIES

Single section with formed cup enclosing contacts.

SPECIFICATIONS:

TERMINALS: Silver plated high quality non-ferrous material. Ground rings silver plated brass. Rotor silver plated copper alloy.

CONTACT RESISTANCE:—Less than .010 OHMS. Will not increase more than 50% throughout life of switch.

DIELECTRIC STRENGTH:—Will withstand 500 WVDC or WVAC RMS. High grade phenolic used for wafer material.

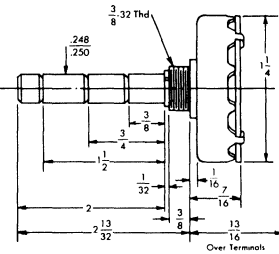

30° SMALL BASE SWITCH

ELECTRICAL RATINGS:

300 VDC	.2 AMP	300 VAC	.25 AMP
100 VDC	.4 AMP	100 VAC	.5 AMP
50 VDC	1 AMP	50 VAC	1 AMP
25 VDC	2 AMP	25 VAC	2 AMP
12 VDC	4 AMP	12 VAC	4 AMP
6 VDC	5 AMP	6 VAC	6 AMP

Index	No. of Poles	Max. Positions	Base Dia., In.	Catalog Number	
				Shorting	Non-Shorting
30°	1	5	1 1/4	3215J
30°	1	12	1 1/4	31112J	32112J
30°	2	2	1 1/4	3222J
30°	2	3	1 1/4	3123J	3223J
30°	2	6	1 1/4	3126J	3226J
30°	3	4	1 1/4	3134J	3234J
30°	4	2	1 1/4	3242J
30°	4	3	1 1/4	3143J	3243J

SWITCHES

Semiconductors

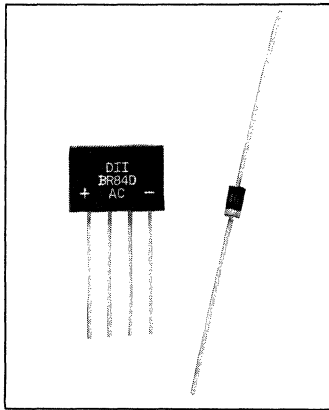

Bridge and Diode Rectifiers

Mallory offers these Rectifier Diodes and Full-wave Bridge Rectifiers for power supplies or any application where rectification is required. **For pricing, reference price sheet no. 600.**

Features

- Low cost
- Low leakage
- Low forward voltage drop
- High current capability

Mechanical Data

- Case: Molded plastic
- Epoxy: UL 94V-0 rate flame retardant
- Lead: MIL-STD-202E method 208C guaranteed
- Mounting position: Any
- Weight: 0.36 grams 2.5A = 0.70 grams

Features

- Ideal for printed circuit board
- Surge overload rating: 50 amperes peak
- Mounting position: Any
- Weight: 2.74 grams

MAXIMUM RATINGS AND ELECTRICAL CHARACTERISTICS

Ratings at 25°C ambient temperature unless otherwise specified. Single phase, half wave, 60 Hz, resistive or inductive load. For capacitive load, derate current by 20%

PART NUMBERS	1N4001	1N4002	1N4003	1N4004	1N4005	1N4006	1N4007	M2.5A	UNITS
Maximum Recurrent Peak Reverse Voltage	50	100	200	400	600	800	1000	1000	V
Maximum RMS Voltage	35	70	140	280	420	560	700	700	V
Maximum DC Blocking Voltage	50	100	200	400	600	800	1000	1000	V
Maximum Average Forward Rectified Current .375" (9.5 mm) lead length at T _A = 75°C	1.0							2.5	A
Peak Forward Surge Current 8.3 ms single half sine-wave superimposed on rated load (JEDEC method)	50							150	A
Maximum Instantaneous Forward Voltage at 1.0A DC	1.1							1.0	V
Maximum DC Reverse Current T _A = 25°C at Rated DC Blocking Voltage T _A = 100°C	5.0							5.0	μA
Maximum Full Load Reverse Current Full Cycle Average .375" (9.5 mm) lead length at T _L = 75°C	30							30	μA
Typical Junction Capacitance (Note 1)	30							60	pF
Typical Thermal Resistance R _{θJA}	50							35	°C/W
Operating and Storage Temperature Range T _J , T _{STG}	-65 to +175								°C

NOTES:

1. Measured at 1 MHz and applied reverse voltage of 4.0 volts.

BRIDGE RECTIFIERS

OPERATING TEMPERATURE RANGE: -55°C to +125°C
STORAGE TEMPERATURE RANGE: -55°C to +150°C

Part Number	Maximum Peak Reverse Voltage	Maximum Average Rectified Current @ Half-Wave Resistive Load 60Hz		Maximum Forward Peak Surge Current @ 8.3ms Superimposed	Maximum Reverse Current @ PRV @ 25°C T _A	Maximum Forward Voltage @ 25°C T _A	
	PRV	I _O @ T _A		I _{FM} (Surge)	I _R	I _{FM}	V _{FM}
	V _{PK}	A _{AV}	°C	A _{PK}	μA _{DC}	A _{PK}	V _{PK}
FW50	50	2.0	75	50	10	1.0	1.0
FW100	100	2.0	75	50	10	1.0	1.0
FW200	200	2.0	75	50	10	1.0	1.0
FW400	400	2.0	75	50	10	1.0	1.0
FW600	600	2.0	75	50	10	1.0	1.0
FW800	800	2.0	75	50	10	1.0	1.0
FW1000	1000	2.0	75	50	10	1.0	1.0
FWLC50	50	4.0	50	200	10	3.0	1.0
FWLC100	100	4.0	50	200	10	3.0	1.0
FWLC200	200	4.0	50	200	10	3.0	1.0
FWLC400	400	4.0	50	200	10	3.0	1.0
FWLC600	600	4.0	50	200	10	3.0	1.0
FWLC800	800	4.0	50	200	10	3.0	1.0
FWLC1000	1000	4.0	50	200	10	3.0	1.0

4.0 AMPERES / 2.0 AMPERES

CURRENT 1.0 Ampere

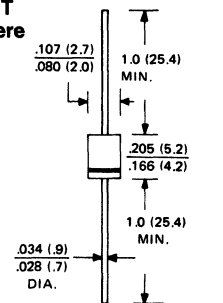

2.5 Amperes

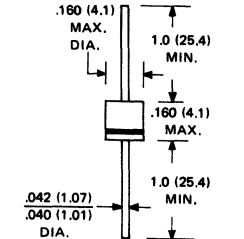

CASE OUTLINE FOR FULL WAVE BRIDGES

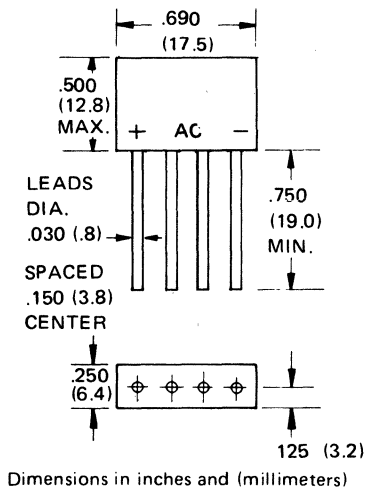

Type VSA● Varistors: Transient/Surge Absorbers

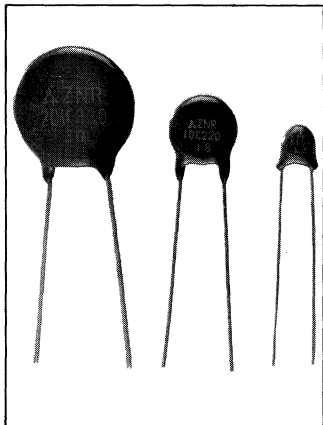

Mallory VSA are zinc oxide non-linear resistors whose resistance changes as a function of the applied voltage. The VSA has a bilateral and symmetrical V-I characteristic curve and can therefore be used in circuits in place of back-to-back zener diodes. This gives your circuit clamping protection in either direction. The VSA thus provides a highly reliable and economical way to protect against repeated high voltage transients and surges such as those produced by lightning, switching surges and noise spikes.

The VSA utilizes a ceramic element composed of zinc oxide and

several kinds of metal oxide additives that have been sintered at relatively high temperatures. Ohmic electrodes are connected to each end of the element by firing. The specific characteristics of each VSA are determined by the properties of the ceramics used.

Features

- Fast response to the rapidly rising surge voltage.
- High performance clamping voltage characteristics.
- Broad products range
Varistor voltage: 18v to 1.2 kv
Withstanding surge current: 50A to 6.500A
(8 × 20μsec., 1 time)

Applications

- Transistor, diode, IC, thyristor and triac semiconductor protection.
- Surge protection in consumer electronics.
- Surge protection in industrial electronics.
- Surge protection in communication, measuring and controller electronics.
- Surge protection in electronic home appliances and gas and petroleum appliances.
- Electrostatic discharge and noise spike suppression.
- Relay and electromagnetic valve surge absorption.

Part No.	Maximum Allowable Voltage		Varistor* Voltage (V)	Max. Clamping Voltage @ Test Current (8 × 20μsec.)		Energy (2ms.) (J)	Withstanding Surge Current (8 × 20μsec. 1 time) (A)	Typical Capacitance @ 1kHz(pF)
	ACrms(V)	DC(V)		Vc(V)	Ip(A)			
VSAC05DK180	11	14	18 (16 ~ 20)	40	1	0.3	100	1600
VSAC07DK180				36	2.5	0.8	250	3500
VSAC10DK180				36	5	1.5	500	7500
VSAC14DK180				36	10	3.5	1000	18000
VSAC20DK180				36	20	10	2000	37000
VSAC05DK220	14	18	22 (20 ~ 24)	48	1	0.4	100	1300
VSAC07DK220				43	2.5	0.9	250	2800
VSAC10DK220				43	5	2.0	500	6000
VSAC14DK220				43	10	4.0	1000	15000
VSAC20DK220				43	20	13	2000	30000
VSAC05DK270	17	22	27 (24 ~ 30)	60	1	0.5	100	1050
VSAC07DK270				53	2.5	1.0	250	2000
VSAC10DK270				53	5	2.5	500	4000
VSAC14DK270				53	10	5.0	1000	10000
VSAC20DK270				53	20	15	2000	22000
VSAC05DK330	20	26	33 (30 ~ 36)	73	1	0.6	100	900
VSAC07DK330				65	2.5	1.2	250	1500
VSAC10DK330				65	5	3.0	500	3000
VSAC14DK330				65	10	6.0	1000	7500
VSAC20DK330				65	20	20	2000	17000
VSAC05DK390	25	31	39 (35 ~ 43)	86	1	0.8	100	500
VSAC07DK390				77	2.5	1.5	250	1350
VSAC10DK390				77	5	3.5	500	2600
VSAC14DK390				77	10	7.0	1000	6500
VSAC20DK390				77	20	24	2000	15000
VSAC05DK470	30	38	47 (42 ~ 52)	104	1	1.0	100	450
VSAC07DK470				93	2.5	1.8	250	1150
VSAC10DK470				93	5	4.5	500	2200
VSAC14DK470				93	10	8.5	1000	5500
VSAC20DK470				93	20	30	2000	13000
VSAC05DK560	35	45	56 (50 ~ 62)	123	1	1.0	100	400
VSAC07DK560				110	2.5	2.2	250	950
VSAC10DK560				110	5	5.5	500	1800
VSAC14DK560				110	10	10.0	1000	4500
VSAC20DK560				110	20	35	2000	11000
VSAC05DK680	40	56	68 (61 ~ 75)	150	1	1.2	100	350
VSAC07DK680				135	2.5	2.5	250	700
VSAC10DK680				135	5	6.5	500	1300
VSAC14DK680				135	10	12.0	1000	3300
VSAC20DK680				135	20	40	2000	7000

Type VSA● Varistors: Transient/Surge Absorbers

Part No.	Maximum Allowable Voltage		Varistor* Voltage (V)	Max. Clamping Voltage @ Test Current (8 × 20μsec.)		Energy (2ms.) (J)	Withstanding Surge Current (8 × 20μsec. 1 time) (A)	Typical Capacitance @ 1kHz(pF)
	ACrms(V)	DC(V)		Vc(V)	Ip(A)			
VSAC05DK820	50	65	82 (74 ~ 90)	145	5	1.7	400	250
VSAC07DK820				135	10	3.5	1200	550
VSAC10DK820				135	25	8	2500	1800
VSAC14DK820				135	50	14	4500	2900
VSAC20DK820				135	100	27	6500	5500
VSAC05DK101	60	85	100 (90 ~ 110)	175	5	2.0	400	200
VSAC07DK101				165	10	4	1200	500
VSAC10DK101				165	25	10	2500	1400
VSAC14DK101				165	50	18	4500	2400
VSAC20DK101				165	100	30	6500	4800
VSAC05DK121	75	100	120 (108 ~ 132)	210	5	2.5	400	170
VSAC07DK121				200	10	5	1200	450
VSAC10DK121				200	25	12	2500	1100
VSAC14DK121				200	50	20	4500	1900
VSAC20DK121				200	100	40	6500	3800
VSAC05DK151	95	125	150 (135 ~ 165)	260	5	3.0	400	140
VSAC07DK151				250	10	6	1200	350
VSAC10DK151				250	25	16	2500	900
VSAC14DK151				250	50	25	4500	1500
VSAC20DK151				250	100	50	6500	3000
* VSAC05DK201	130	170	200 (185 ~ 225)	355	5	4.0	400	80
* VSAC07DK201				340	10	10	1200	250
* VSAC10DK201				340	25	20	2500	500
* VSAC14DK201				340	50	35	4500	1000
* VSAC20DK201				340	100	70	6500	2000
* VSAC05DK221	140	180	220 (196 ~ 242)	380	5	4.5	400	70
* VSAC07DK221				360	10	10	1200	250
* VSAC10DK221				360	25	23	2500	450
* VSAC14DK221				360	50	40	4500	1000
* VSAC20DK221				360	100	75	6500	2000
* VSAC05DK241	150	200	240 (216 ~ 264)	415	5	5.0	400	70
* VSAC07DK241				395	10	10	1200	200
* VSAC10DK241				395	25	25	2500	400
* VSAC14DK241				395	50	40	4500	900
* VSAC20DK241				395	100	80	6500	1800
* VSAC05DK271	175	225	270 (247 ~ 303)	475	5	6.0	400	65
* VSAC07DK271				455	10	12	1200	170
* VSAC10DK271				455	25	30	2500	350
* VSAC14DK271				455	50	50	4500	750
* VSAC20DK271				455	100	90	6500	1600
* VSAC05DK361	230	300	360 (324 ~ 396)	620	5	7.5	400	50
* VSAC07DK361				595	10	15	1200	130
* VSAC10DK361				595	25	35	2500	300
* VSAC14DK361				595	50	65	4500	550
* VSAC20DK361				595	100	120	6500	1200
* VSAC05DK391	250	320	390 (351 ~ 429)	675	5	8.0	400	50
* VSAC07DK391				650	10	17	1200	130
* VSAC10DK391				650	25	40	2500	270
* VSAC14DK391				650	50	70	4500	500
* VSAC20DK391				650	100	130	6500	1000
* VSAC05DK431	275	350	430 (387 ~ 473)	745	5	9.0	400	45
* VSAC07DK431				710	10	20	1200	110
* VSAC10DK431				710	25	45	2500	250
* VSAC14DK431				710	50	75	4500	450
* VSAC20DK431				710	100	140	6500	900
* VSAC05DK471	300	385	470 (423 ~ 517)	810	5	10.0	400	40
* VSAC07DK471				775	10	20	1200	100
* VSAC10DK471				775	25	45	2500	230
* VSAC14DK471				775	50	80	4500	400
* VSAC20DK471				775	100	150	6500	900
* VSAC10DK621	385	505	620 (558 ~ 682)	1025	25	45	2500	130
* VSAC14DK621				1025	50	85	4500	250
* VSAC20DK621				1025	100	150	6500	500
* VSAC10DK681	420	560	680 (612 ~ 748)	1120	25	45	2500	130
* VSAC14DK681				1120	50	90	4500	250
* VSAC20DK681				1120	100	160	6500	460
* VSAC10DK751	460	615	750 (675 ~ 825)	1240	25	50	2500	120
* VSAC14DK751				1240	50	100	4500	230
* VSAC20DK751				1240	100	175	6500	420

*See notes on next page.

• New Product

Type VSA • Varistors: Transient/Surge Absorbers

Part No.	Maximum Allowable Voltage		Varistor* Voltage (V)	Max. Clamping Voltage @ Test Current (8 × 20μsec.)		Energy (2ms.) (J)	Withstanding Surge Current (8 × 20μsec. 1 time) (A)	Typical Capacitance @ 1kHz(pF)
	ACrms(V)	DC(V)		Vc(V)	Ip(A)			
* VSAC10DK781 * VSAC14DK781 * VSAC20DK781	485	640	780 (702 ~ 858)	1290	25	50	2500	120
1290				50	105	4500	230	
1290				100	180	6500	420	
* VSAC10DK821 * VSAC14DK821 * VSAC20DK821	510	670	820 (738 ~ 902)	1355	25	55	2500	110
1355				50	110	4500	200	
1355				100	190	6500	400	
* VSAC10DK911 * VSAC14DK911 * VSAC20D9111	550	745	910 (819 ~ 1001)	1500	25	60	2500	100
1500				50	120	4500	180	
1500				100	215	6500	350	
* VSAC10DK102 * VSAC14DK102 * VSAC20DK102	625	825	1000 (900 ~ 1100)	1650	25	65	2500	90
1650				50	130	4500	150	
1650				100	230	6500	320	
* VSAC10DK112 * VSAC14DK112 * VSAC20DK112	680	895	1100 (990 ~ 1210)	1815	25	70	2500	80
1815				50	140	4500	150	
1815				100	250	6500	300	

Notes: 1. *Varistor Voltage: 5 Series – V01mA
7, 10, 14, 20 Series – V1mA

2. Rated Wattage:

Part No.	Rated Wattage (W)	Part No.	Rated Wattage (W)
VSAC05DK180 ~ 680	0.01	VSAC05DK820 ~ 471	0.1
VSAC07DK180 ~ 680	0.02	VSAC07DK820 ~ 471	0.25
VSAC10DK180 ~ 680	0.05	VSAC10DK820 ~ 112	0.4
VSAC14DK180 ~ 680	0.1	VSAC14DK820 ~ 182	0.6
VSAC20DK180 ~ 680	0.2	VSAC20DK820 ~ 182	1.0

- Operating temperature range: -40 to 85°C (-40 to 185°F)
- Storage temperature range: -40 to 125°C (-40 to 257°F)
- Maximum clamping voltage as a function of surge current is obtainable from the respective V-I characteristic curves.
- Maximum leakage current: refer to the V-I curves.
- *: UL approved model available with your indication of suffix "U".

File No. E62674 Across the line varistor.
File No. E86821 Transient Voltage surge suppressor.

Features

* Excellent clamping voltage characteristic and fast response time (<50nsec.) when subjected to impulse surges. Eliminates the discharge lag that is inductive of gap-type arrestors.

* Bilateral and symmetrical V-I characteristic curve. The VSA can, therefore, be used both in AC and DC circuits, for protection of either positive or negative transient.

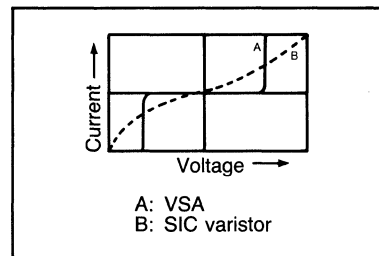
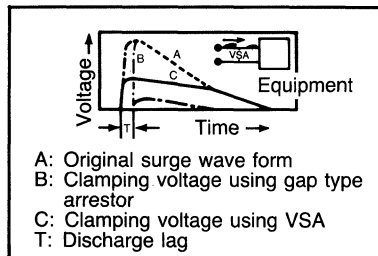

Part Number Code

V	S	A	C							
Common Code				Element Dia.		Type	Tolerance	Varistor Voltage		Suffix
05	07	10	14	20	05mm (.197") 07mm (.276") 10mm (.394") 14mm (.551") 20mm (.787")	D Type D	J ± 5% K ± 10% S Special	The first two digits are significant figures and the third one denotes the number of zeros following. Decimal point is expressed by R.		

VARISTORS

DIP Sockets

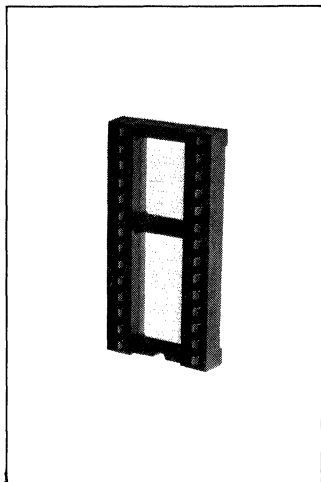

Solder in Type PRINTED CIRCUIT BOARD DIP SOCKETS:

Available in 8 thru 40 pin styles. The tin alloy plated contacts incorporate a patented high pressure contact (when mated with pin being inserted) which removes surface oxides and seals out potential oxidation that occurs in looser fitting contacts. This feature assures, essentially, the same contact resistance as gold without the use of gold. Consistent performance is assured over the continuous operating temperature, see Performance Characteristics below. Will accommodate I.C. packages having any type finish—even unplated if resistance requirements will permit. Low pro-

file design—compact body provides maximum utilization of the available P.C. board area with a profile height of only .175 inch maximum. The body is a thermoplastic polyester, glass reinforced black color. Flammability rating: UL94V-0.

For prices, reference price sheet No. 520.

HIGHLIGHTS

- Insulation Resistance (500VDC): 100,000 megohms minimum
- Dielectric Withstanding Voltage: 1000 volts AC rms minimum
- Durability: 50 cycles—no electrical degradation

- Thermal Shock: MIL-STD-1344, Method 1003, Condition B. No physical or electrical degradation
- Moisture Resistance: MIL-STD-202, Method 106, except omit steps 7a and 7b, 300 megohms minimum
- Vibration: MIL-STD-1344, Method 2005, Condition 111. No electrical interruption greater than 1 micro-second
- Mechanical Shock: MIL-STD-202, Method 213, Condition 1. No electrical interruption greater than 1 microsecond.
- Performance Characteristics conform to requirements of MIL-S-83734A.

*Tin Alloy Catalog Number	†Tin Alloy Catalog Number	Number of Contacts	Dimensions Inches			
			A	Max	C ±.010	D ±.010
DILB8P11	DILB8P108	8	.400	.400	.300	.130
DILB14P11	DILB14P108	14	.700	.400	.300	.130
DILB16P11	DILB16P108	16	.800	.400	.300	.130
DILB18P11	DILB18P108	18	.900	.400	.300	.130
DILB20P11	DILB20P108	20	1.000	.400	.300	.130
DILB22P11	DILB22P108	22	1.100	.500	.400	.130
DILB24P11	DILB24P108	24	1.200	.700	.600	.130
DILB28P11	DILB28P108	28	1.400	.700	.600	.130
DILB40P11	DILB40P108	40	2.000	.700	.600	.130

PRINTED CIRCUIT BOARD DIP SOCKETS:

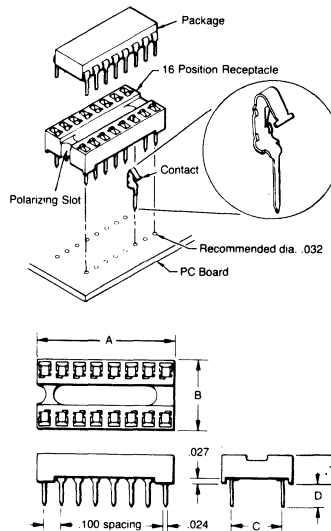

Terminal contact material and plating is as follows:

- * P-11 Copper alloy, tin alloy pre-plated
- † P-108 Beryllium copper, tin alloy post-plated

Performance Characteristics:

- Contact Resistance: 20 milliohms maximum, type P-108; 30 milliohms maximum, types P-11

Test current: 1 ampere

Operating temperature continuous:

- P-11 -40°C to +75°C
- P-108 -40°C to +105°C

Circuit Breakers

CIRCUIT BREAKERS

Exact replacement circuit breakers for television and industrial applications. These circuit breakers are manufactured to the same specifications as original equipment. "Anti-cheat" reset action is non-cycling. Button must be pressed to reset. Tripping mechanism is temperature compensating for constant protection. Normal tripping time is ten seconds or less. Supplied with twist tab mounting lugs. May be converted to bushing mount by ordering CBB $\frac{3}{8}$ "-32 \times $\frac{1}{4}$ " adapter bushing listed below. For prices, reference price sheet No. 610.

Catalog No. CBB Adapter Bushing — Adapts U/L types to bushing mounting. Bushing: $\frac{3}{8}$ "-32 \times $\frac{1}{4}$ " with nut.

U/L APPROVED CIRCUIT BREAKERS

Catalog Number	Hold Amps	Break Amps	Surge Amps	Littelfuse Equivalent
UL0875	.49	.86	6	815.650
UL105	.60	1.05	6	815.800
UL175	1.0	1.75	15	81501.5
UL219	1.2	2.1	35	8151.75
UL263	1.5	2.63	50	8152.25
UL306	1.65	2.89	50	81502.5
UL350	1.92	3.3	50	8152.75
UL394	2.2	3.85	50	8153.25
UL438*	2.5	4.37	50	815004
UL525*	3.0	5.25	50	81504.5
UL613	3.25	5.68	50	815005

*We have improved the surge ratings on our standard circuit breaker. The ratings are now comparable to the high surge circuit breakers previously offered by Mallory.

The correct ratings are on the package/bag. The numbers on body do not reflect all specifications. Contact Mallory for further details.

DUAL CIRCUIT BREAKERS

For use in color TV; supplies protection for B+ circuits and horizontal output circuit. Excessive current in either circuit will open the circuit breaker, thus removing all B+ voltage from set. Positive dependable, exact duplicate of RCA and many others.

Current, Amps				Catalog Number
B+ Section Horiz. Hold				
Break	Hold	Break	Hold	
1.2	.9	.48	.325	DB900T325
1.35	.95	.59	.4	DB950T400
1.75	1.25	.8	.6	DB125T600
2.5	1.75	.59	.4	DB175T400

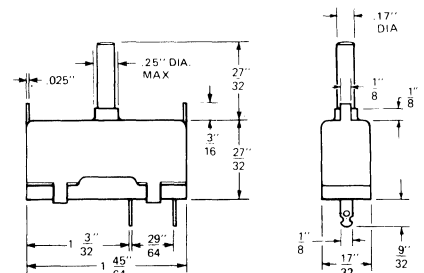
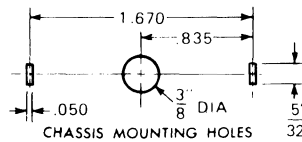
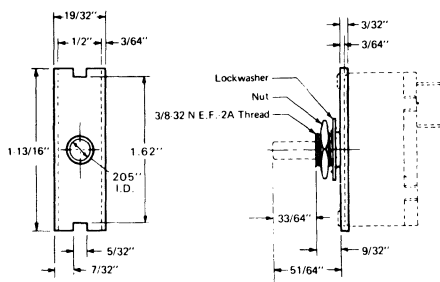

Mallobin® Merchandisers

For complete listing of part numbers and quantities in each Mallobin, request bulletin No. 9-780. For pricing, refer to price sheet No. 660.



Mallory components are available in popular Mallobin Merchandisers. The Mallobin is a handsome, easy to stack display case designed for quick access to a variety of electronic components.

The Mallobin is a sturdy, metal cabinet containing fifteen drawers. When you choose a Mallobin you can rest assured you will receive the component reliability you've come to expect from Mallory.

Contact your Mallory salesman for details on other possible Mallobin configurations.

MALLOBINS

MALLOBINS

TT151 An assortment of axial leaded miniature aluminum electrolytic capacitors with voltages to 50WVDC. Values from 1 μ F to 1,500 μ F.

TT151A A selection of axial leaded miniature electrolytic similar to TT151. Voltages to 50WVDC. Capacitances to 1000 μ F.

TC151 Assorted axial leaded aluminum electrolytic capacitors with voltages to 600WVDC. Values from 1 μ F to 5,000 μ F.

TC151A An assortment of axial leaded aluminum electrolytic capacitors similar to TC151. Voltages to 600 WVDC. Values from 1 μ F to 5000 μ F.

MONO151A A collection of monolithic ceramic capacitors with voltages to 200WVDC. Values from 10pF to 1 μ F.

TDC151A An assortment of epoxy dipped solid tantalum capacitors. Voltages to 35 WVDC. Values from 1 μ F to 150 μ F, capacitance tolerance \pm 10%.

MALLOBINS

RVS151 A package containing cermet and carbon subminiature trimmer potentiometers. Horizontal and vertical mounting styles. Values from 500 ohms to 2 megohms.

MTC151 An assortment of horizontal and vertical mount miniature trimmer potentiometers. Values from 100 ohms to 5 megohms.

G301 Kit containing two Mallobin cabinets with general purpose ceramic disc capacitors.

SX301 Kit containing two Mallobin cabinets with polystyrene film capacitors. Values from 5pF to .01 μ F.

VTL151 A selection of single ended aluminum electrolytic capacitors with voltages to 100WVDC. Values to 1 μ F to 3,300 μ F.

DISC151 An assortment of general purpose disc ceramic capacitors. Voltages of 50 and 100 volts.

MALLOBINS

DISC151M A smaller assortment of general purpose disc ceramic capacitors. Voltages of 50 and 100 volts.

TCG151 A selection of tubular computer grade capacitors. Voltages from 10 to 150 WVDC. Capacitances from 10 to 10,000 μ F.

TCX151 A selection of high performance tubular computer grade capacitors. Voltages from 15 to 75 WVDC. Capacitances from 65 to 6200 μ F.

VPR151 An assortment of vertical-mount single ended aluminum electrolytic capacitors. Voltages from 10 to 50 WVDC. Capacitances from 10 to 4900 μ F.

DATA & FORMULAS

CAPACITANCE	$C = \frac{.0885 \times 10^{-6}KA}{d}$
CAPACITIVE REACTANCE (OHMS)	$X_c = \frac{10^6}{2 \pi fC}$
CAPACITANCE IN PARALLEL	$C_T = C_1 + C_2 + C_3 \dots + C_N$
CAPACITANCE IN SERIES	$\frac{1}{C_T} = \frac{1}{C_1} + \frac{1}{C_2} + \frac{1}{C_3} \dots + \frac{1}{C_N}$
DISSIPATION FACTOR (%)	$DF = (2\pi fC)(ESR)(10^{-6})$
EQUIVALENT SERIES RESISTANCE (OHMS)	$ESR = (DF)(X_c) = \frac{DF \times 10^6}{2\pi fC}$
IMPEDANCE (OHMS)	$Z = \sqrt{X_c^2 + ESR^2}$
POWER FACTOR (%)	$PF = \frac{ESR}{Z}$
POWER LOSS (WATTS)	$PL = (2\pi fCV^2)(DF)(10^{-6})$
Q FACTOR	$Q = \frac{1}{DF}$
ENERGY STORED	... JOULES or WATT-SEC = $\frac{1}{2}CV^2 \times 10^{-6}$
TEMPERATURE COEFFICIENT (PPM C°)	$TC = \% \frac{\Delta C}{\Delta T} \times 10^4$

SYMBOLS:

- A = Area, CM²
- C = CAPACITANCE, MICROFARADS
- d = DISTANCE BETWEEN PLATES, CM
- f = FREQUENCY, Hz
- K = DIELECTRIC CONSTANT
- ΔC = CAPACITANCE CHANGE
- ΔT = TEMPERATURE CHANGE
- V = VOLTAGE

DATA & FORMULAS

METRIC CONVERSION CHART

Inch Fractions, Decimals, Millimeters

Inch	Decimal	MM	Inch	Decimal	MM	Inch	Decimal	MM	Inch	Decimal	MM
	.008	0.2032		.258	6.5532		.508	12.9032		.756	19.2024
1/64	.0156	0.3969	7/64	.2656	6.7469	33/64	.5156	13.0968	49/64	.7656	19.4469
	.023	0.5842		.273	6.9342		.523	13.2842		.773	19.6342
1/32	.0312	0.7937	9/32	.2812	7.1437	17/32	.5312	13.4937	25/32	.7812	19.8433
	.039	0.9906		.289	7.3406		.539	13.6906		.789	20.0406
3/64	.0469	1.1906	19/64	.2969	7.5406	35/64	.5469	13.8906	51/64	.7969	20.2402
	.054	1.3716		.305	7.7470		.555	14.0970		.805	20.4470
1/16	.0625	1.5875	5/16	.3125	7.9375	9/16	.5625	14.2875	13/16	.8125	20.6375
	.070	1.7780		.320	8.1280		.570	14.4780		.820	20.8280
5/64	.0781	1.9844	21/64	.3281	8.3344	37/64	.5781	14.6844	53/64	.8281	21.0344
	.086	2.1844		.336	8.5344		.586	14.8844		.836	21.2344
3/32	.0937	2.3812	11/32	.3437	8.7312	19/32	.5937	15.0812	27/32	.8437	21.4312
	.102	2.5908		.352	8.9408		.602	15.2908		.852	21.6408
7/64	.1094	2.7781	23/64	.3594	9.1281	39/64	.6094	15.4781	55/64	.8594	21.8281
	.117	2.9781		.367	9.3218		.617	15.6718		.867	22.0218
1/8	.125	3.1750	3/8	.375	9.5250	5/8	.625	15.8750	7/8	.875	22.2250
	.133	3.3782		.383	9.7282		.633	16.0782		.883	22.4282
9/64	.1406	3.5719	25/64	.3906	9.9219	41/64	.6406	16.2719	57/64	.8906	22.6219
	.148	3.7592		.398	10.1092		.648	16.4592		.898	22.8092
5/32	.1562	3.9687	13/32	.4062	10.3187	21/32	.6562	16.6687	29/32	.9062	23.0187
	.164	4.1656		.414	10.5156		.664	16.8656		.914	23.2156
11/64	.1719	4.3656	27/64	.4219	10.7156	43/64	.6719	17.0656	59/64	.9219	23.4156
	.180	4.5720		.430	10.9220		.680	17.2720		.930	23.6220
3/16	.1875	4.7625	7/16	.4375	11.1125	11/16	.6875	17.4625	15/16	.9375	23.8125
	.195	4.9530		.445	11.3030		.695	17.6530		.945	24.0030
13/64	.2031	5.1594	29/64	.4531	11.5094	45/64	.7031	17.8594	61/64	.9531	24.2094
	.211	5.3594		.461	11.7094		.711	18.0594		.961	24.4094
7/32	.2187	5.5562	15/32	.4687	11.9062	23/32	.7187	18.2562	31/32	.9687	24.6062
	.227	5.7658		.477	12.1158		.727	18.4658		.977	24.8158
15/64	.2344	5.9531	31/64	.4844	12.3031	47/64	.7344	18.6532	63/64	.9844	25.0031
	.242	6.1468		.492	12.4968		.742	18.8468		.992	25.1968
1/4	.250	6.3500	1/2	.500	12.7000	3/4	.750	19.0500	1	1.000	25.4000

DATA & FORMULAS

EIA CAPACITANCE CODE VS MICRO-PICO-NANO FARAD																			
(MF)			(PF)			(NF)			(MF)			(PF)			(NF)				
EIA CODE	MICRO-FARAD	PICO-FARAD	NANO-FARAD	EIA CODE	MICRO-FARAD	PICO-FARAD	NANO-FARAD	EIA CODE	MICRO-FARAD	PICO-FARAD	NANO-FARAD	EIA CODE	MICRO-FARAD	PICO-FARAD	NANO-FARAD	EIA CODE	MICRO-FARAD	PICO-FARAD	NANO-FARAD
1R5		1.5	.0015	391	.00039	390	.39	273	.027	27000	27.0	333	.033	33000	33.0	393	.039	39000	39.0
2R2		2.2	.0022	401	.00040	400	.4	393	.039	39000	39.0	473	.047	47000	47.0	563	.056	56000	56.0
3R3		3.3	.0033	471	.00047	470	.47	683	.068	68000	68.0	823	.082	82000	82.0	104	.1		100.0
4R7		4.7	.0047	501	.00050	390	.5	102	.001	1000	1.0	124	.12		120.0	154	.15		150.0
6R8		6.8	.0068	561	.00056	560	.56	122	.0012	1200	1.2	184	.18		180.0	202	.02	2000	2.0
100		10	.01	681	.00068	680	.68	222	.0022	2200	2.2	274	.27		270.0	252	.0025	2500	2.5
150		15	.015	751	.00075	750	.75	272	.0027	2700	2.7	334	.33		330.0	394	.39		390.0
220		22	.022	821	.00082	820	.82	302	.003	3000	3.0	474	.47		470.0	564	.56		560.0
250		25	.025	102	.001	1000	1.0	332	.0033	3300	3.3	564	.56		560.0	684	.68		680.0
330		33	.033	122	.0012	1200	1.2	392	.0039	3900	3.9	824	.82		820.0	105	1.0		1000.0
390		39	.039	152	.0015	1500	1.5	472	.0047	4700	4.7	125	1.2			155	1.5		
470		47	.047	202	.002	2000	2.0	562	.0056	5600	5.6	205	2.0			305	3.0		
500		50	.050	222	.0022	2200	2.2	682	.0068	6800	6.8	405	4.0			505	5.0		
560		56	.056	252	.0025	2500	2.5	822	.0082	8200	8.2	106	10.0						
680		68	.068	272	.0027	2700	2.7	103	.01	10000	10.0								
750		75	.075	302	.003	3000	3.0	123	.012	12000	12.0								
820		82	.082	332	.0033	3300	3.3	153	.0015	15000	15.0								
101	.00010	100	.1	392	.0039	3900	3.9	183	.018	18000	18.0								
121	.00012	120	.12	472	.0047	4700	4.7	223	.022	22000	22.0								
151	.00015	150	.15	562	.0056	5600	5.6												
181	.00018	180	1.8	682	.0068	6800	6.8												
201	.00020	200	.2	822	.0082	8200	8.2												
221	.00022	220	.22	103	.01	10000	10.0												
251	.00025	250	.25	123	.012	12000	12.0												
271	.00027	270	.27	153	.015	15000	15.0												
301	.00030	300	.3	183	.018	18000	18.0												
331	.00033	330	.33	223	.022	22000	22.0												

DATA & FORMULAS

TEMPERATURE		TEMPERATURE	
°C	°F	°C	°F
-80	-112	90	194
-55	-67	100	212
-45	-49	105	221
-40	-40	115	239
-35	-31	125	257
-30	-22	140	284
-20	-4	150	302
-10	14	175	347
0	32	190	374
20	68	200	392
25	77	220	428
45	113	250	482
65	149	275	527
70	158	300	572
80	176	400	752
85	185	500	932

WIRE SIZE	
AWG#	MILS.
26	.016
25	.018
24	.020
23	.023
22	.025
21	.029
20	.032
19	.036
18	.040
17	.045
16	.051
15	.057
14	.064
13	.072
12	.081

Per EIA 468 Radial Tape and Reel Specification

Tooling Code

- H = $\frac{16.0\text{mm (C)}}{.630}$
- H = $\frac{16.5\text{mm (A)}}{.650}$
- H = $\frac{18.5\text{mm (B)}}{.729}$

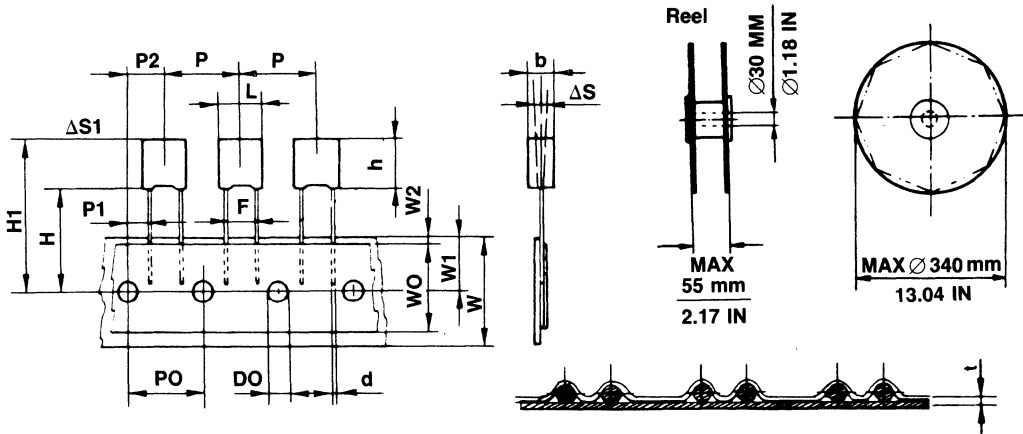

ITEM	SYMBOL	DIMENSIONS		TOLERANCE	
		MM	INCHES	MM	INCHES
Body width	L	7.5	.296	Max	Max
Body height	h	6-8.5	.236-.335	Max	Max
Body thickness	b	6.5	.256	Max	Max
Lead-wire diameter	d	0.6	.024	+0.06-0.05	.002
Pitch of component	P	12.7	.500	±1.0	.04
Feed hole pitch	P _o	12.7	.500	±0.2	.006
Feed hole centered to lead	p ₁	3.85	.153	±0.7	0.27
Hole center to comp. center	p ₂	6.35	.250	±1	.04
Lead-to-lead distance	F	5	.197	±0.6-0.1	.002-.004
Component alignment, F-R	ΔS	0	0	±2±.08	.08-.003
Tape width	W	18	.709	±1-0.5	.039-.02
Hold-down tape width	W _o	15	.591	±0.5	.02
Hole position	W ₁	9	.354	±0.5	.02
Hold down tape position	W ₂	3	.118	Max	Max
Component height	H ₁	32.25	1.27	Max	Max
Feed hole diameter	D _o	4	.157	±0.2	.008
Total tape thickness	t	0.7	.028	±0.2	.008

TAPE & REEL SPECIFICATIONS

For .295 (7.5 MM) Lead Spacing Radial Tape and Reel Specification

Dimensions

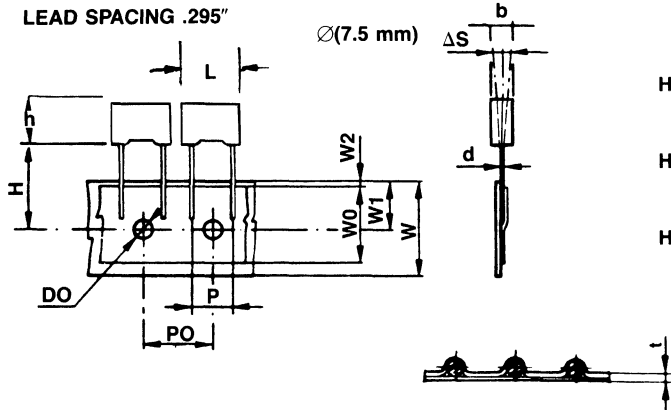
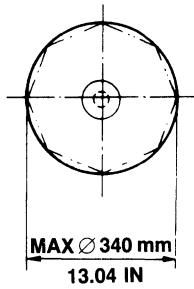
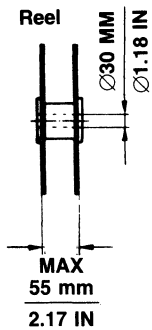

Tooling Code

- H = .630 (C)
(16.0)
- H = .650 (A)
(16.5)
- H = .729 (B)
18.5

ITEM	SYMBOL	DIMENSIONS		TOLERANCE	
		MM	INCHES	MM	INCHES
Body width	L	10.5	.414	Max	Max
Body height	h	6.5-12	.473	Max	Max
Body thickness	b	3.5-6	.236	Max	Max
Lead-wire diameter	d	0.6	.024	+ 0.06-0.05	.002
Feed hole pitch	P ₀	12.7	.5	± 0.2	.006
Lead-to-lead distance	P	7.5	.295	± 0.6-0.1	.002-.004
Component alignment F-R	ΔS	0	0	± 2	.08-.003
Height from sprocket hole center to the comp. body	H*	16.0(C)	.630	± .5	± .02
	H*	16.5(A)	.650	± .3	± .01
	H*	18.5(B)	.729	± .5	± .02
Tape width	W	18	.709	± 1-0.5	.039-.02
Hold-down tape width	W ₀	15	.591	± 0.5	.02
Hole position	W ₁	9	.355	± 0.5	.02
Hold down tape position	W ₂	3	.118	Max	Max
Feed hole diameter	D ₀	4	.158	± 0.2	.008
Total tape thickness	t	0.7	.0276	± 0.2	.008

*The H dimension depends on the insertion equipment used. Specify the required dimension and tolerance when ordering.

TAPE & REEL SPECIFICATIONS

Per EIA RS 296-D Axial Tape & Reel Specification

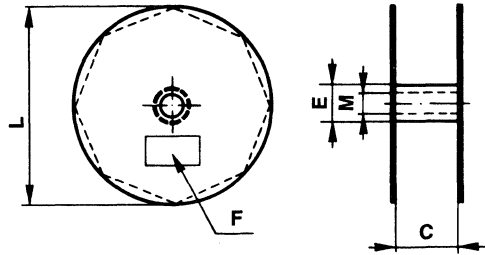
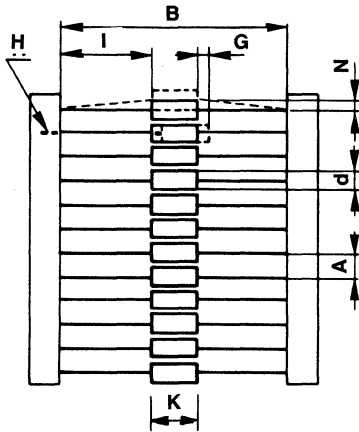

Tape detail

Description	Symbol	inches	Dimensions (mm)
Component diameter	d	.098 - .374	(2.5 - 9.5)
Body length	K	.189 - 1.102	(4.8 - 28)
Component pitch	A*	.197 or .394	(5 or 10) see table 1
Reel core diameter	E	3.35	(85)
Arbor hole diameter	M	.787	(20)
Reel diameter	L	13.39	(340)
Marking	F	For data shown see below	
Tape width	H	.25	(6.35)
Body location (lateral deviation)	G	≤ .031	(0.8)
Body location (longitudinal deviation)	N	≤ .05	(1.2)
Tape spacing	B	see table II	
Lead length from the component body to the adhesive tape	I	≥ .787	(20)
Distance between reel flanges	C	see table II	

Table I

d	A pitch
0 - .197 (0 - 5)	.197 ± .020 (5 ± 0.5)
.201 - .374 (5.1 - 9.5)	.394 ± .020 (10 ± 0.5)

Table II

K max Comp. length	Class	± .06	C
		B (± 1.5)	
≤ .422 (≤ 11.0)	I	2.126 (54)	2.95 (75)
.650 - .807 (16.5 - 20.5)		2.50 (63.6)	3.39 (86)
≥ 1.10 (28)	III	2.87 (73)	3.74 (95)

Marking

- Reel marking consist of:
- Components quantity
 - Manufacturer's name
 - Date
 - Component type and code
 - Electrical values

Remarks

*Cumulative pitch tolerance do not exceed $\frac{.06}{(1.5)}$ over six consecutive components.

SALES OFFICES & MANUFACTURING REPRESENTATIVES

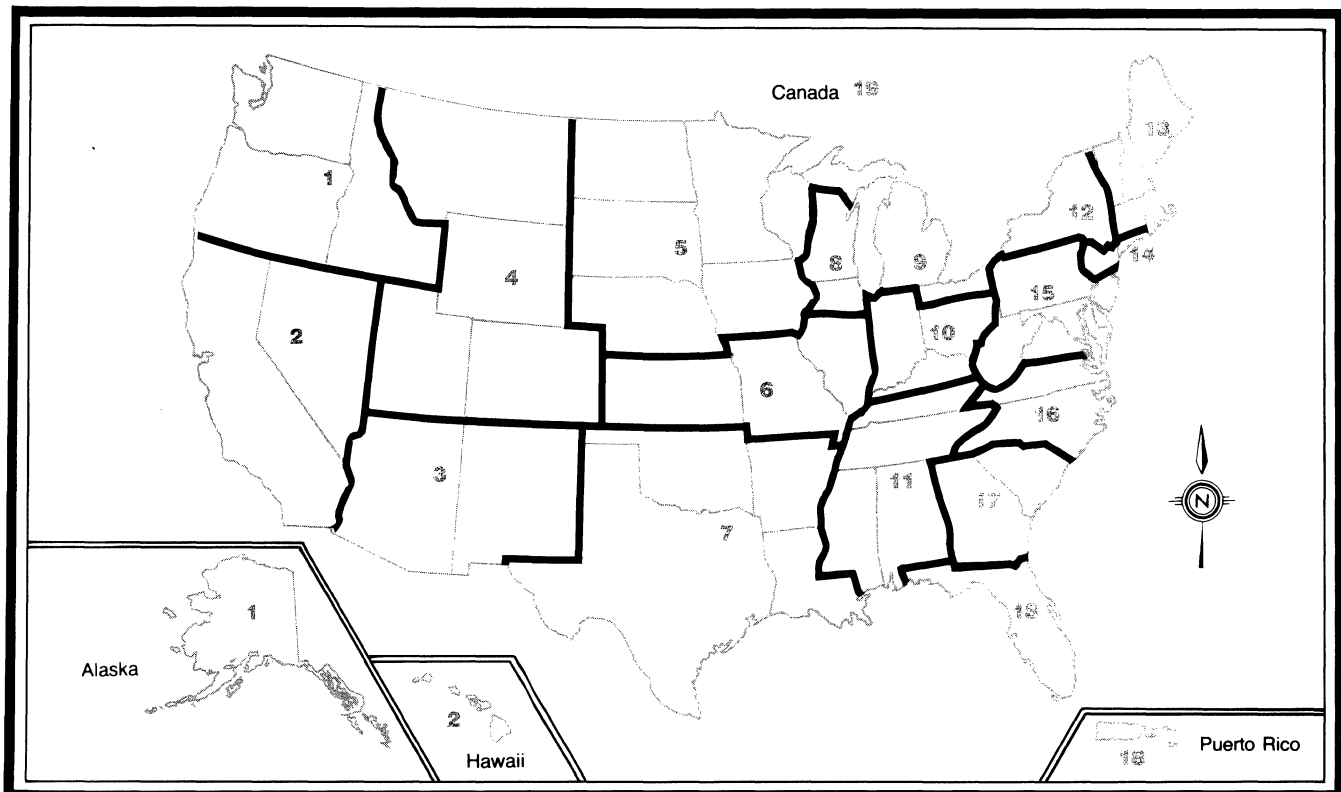

- | | | | |
|--|--|---|--|
| <p>1. Quadra Sales Corp.
2651 151st Place, N.E.
Redmond, WA 98052
Phone: (206) 883-3550
(503) 635-3545
FAX: (206) 882-3184</p> <p>2. Mallory Capacitor Company
7342 Orangethorpe, Suite C111
Buena Park, CA 90621
Phone: (714) 523-7992
(213) 921-7939
FAX: (714) 523-2510</p> <p>3. Summit Sales
7802 East Gray Road
Scottsdale, AZ 85260
Phone: (602) 998-4850
FAX: (602) 998-5274</p> <p>2659B Pan American, N.E.
Albuquerque, NM 87107
Phone: (505) 345-5003
FAX: (505) 345-5812</p> | <p>6. KKB & Company
1610 S. Big Bend Blvd.
St. Louis, MO 63117
Phone: (314) 647-2400
FAX: (314) 647-3773</p> <p>7. Pro-Comp Sales Company
231 Loop 820 N.E., Suite 124
Hurst, TX 76053
Phone: (817) 589-0336
FAX: (817) 595-1369</p> <p>1701 N. Greenville Ave.
Suite 824
Richardson, TX 75081
Phone: (214) 669-1500
FAX: (214) 669-1293</p> <p>8. Mallory Capacitor Company
2300 E. Higgins Road
Suite 306B
Elk Grove Village, IL 60007
Phone: (312) 364-5750
FAX: (312) 364-7073</p> <p>9. Electronic Salesmasters, Inc.
24100 Chagrin Blvd.
Beachwood, OH 44122
Phone: (216) 831-9555
TWX: 910-427-2900
FAX: (216) 831-8647</p> | <p>11. Jack Harvey & Associates, Inc.
Meadow Green Centre
9238 Highway 20 West
Suite 1500
Madison, AL 35758
Phone: (205) 461-8591
FAX: (205) 461-8653</p> <p>12. LamTec Sales Corporation
119 Stanwood Lane
Manlius, NY 13104
Phone: (315) 637-3738
FAX: (315) 637-4814</p> <p>11 Heatherwood Road
Fairport, NY 14450
Phone: (716) 377-1210
FAX: (716) 377-6235</p> <p>13. The Newscott Company, Inc.
687 Highland Ave.
Needham Heights, MA 02194
Phone: (617) 444-1923
FAX: (617) 449-4689</p> <p>14. Aurora Marketing, Inc.
26-06 Jerusalem Ave.
North Bellmore, NY 11710
Phone: (516) 221-0764</p> <p>15. S.K. Macdonald, Inc.
16105 Frederick Road
Lisbon, MD 21765
Phone: (301) 982-1088
(301) 442-1590
FAX: (301) 442-1597</p> <p>Maryland Road, Suite 417
Willow Grove, PA 19090
Phone: (215) 659-4414
FAX: (215) 659-4607</p> | <p>716 Cottonwood Drive
Monroeville, PA 15146
Phone: (412) 373-1723</p> <p>16. Mallory Capacitor Company
4110 Wake Forest Road
Suite 100
Raleigh, NC 27609
Phone: (919) 872-0711
FAX: (919) 876-4065</p> <p>17. Jack Harvey & Associates, Inc.
4046 Wetherburn Way, Suite 1
Norcross, GA 30092
Phone: (404) 449-4643
FAX: (404) 449-5169</p> <p>18. Semtronic Associates, Inc.
657 Maitland Ave.
Altamonte Springs, FL 32701
Phone: (305) 831-8233
FAX: (305) 831-2844</p> <p>3471 N.W. 55th Street
Ft. Lauderdale, FL 33309
Phone: (305) 731-2484
(305) 944-0149
(305) 276-0809
FAX: (305) 731-1019</p> <p>1467 S. Missouri Ave.
Clearwater, FL 34616
Phone: (813) 461-4675
FAX: (813) 442-2234</p> <p>19. A.C. Simmonds & Sons
975 Dillingham Road
Pickering, Ontario Canada
L1W 3B2
Phone: (416) 839-8041
FAX: (416) 839-2667</p> |
|--|--|---|--|

Mallory Capacitor Company
4760 Kentucky Avenue
Indianapolis, Indiana 46241
Phone: (317) 856-3731
FAX: (317) 856-2710
TLX: 687-6027 or 687-6015

MALLORY

ELECTRONIC
COMPONENTS
GENERAL
CATALOG

Capacitors

- D.C. Film
- Wet-Slug Tantalum Electrolytic
- Solid Tantalum Electrolytic
- Aluminum Electrolytic
- AC Electrostatic
- Monolithic Ceramic
- Disc Ceramic
- Surface Mount

Sonalert® Audible Signal Devices

RFI Power Line Filters

Resistor/Control Products

Fastening Devices

Hardware

Switches

Semiconductors

Varistors—Voltage Surge Absorbers

Dip Sockets

Circuit Breakers

Mallobins®

Mallory Capacitor Company
4760 Kentucky Avenue
Indianapolis, Indiana 46241
Phone: (317) 856-3731
FAX: (317) 856-2710
TLX: 687-6027 or 687-6015