

FAIRCHILD  
A Schlumberger Company

OPTOELECTRONICS DATA BOOK

# OPTOELECTRONICS DATA BOOK



**FAIRCHILD**

A Schlumberger Company

# OPTOELECTRONICS DATA BOOK

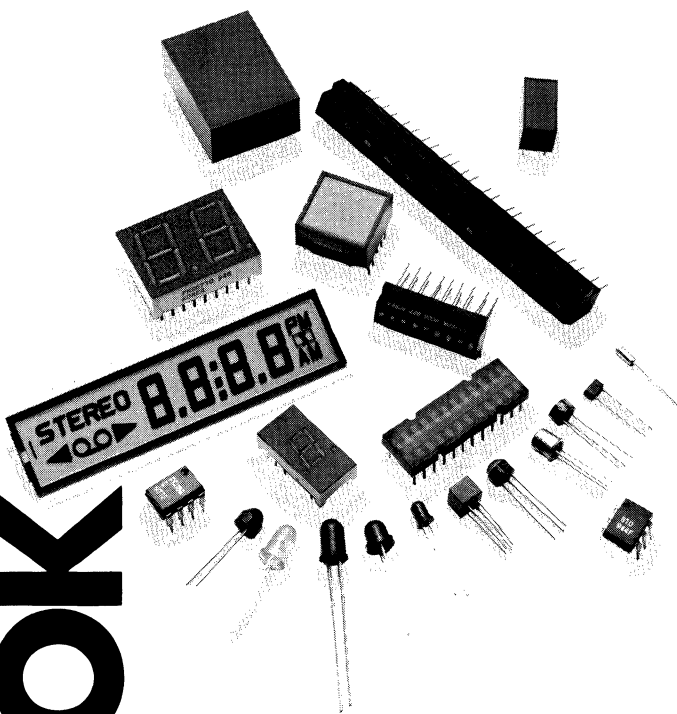

**FAIRCHILD**

A Schlumberger Company

©1980 Fairchild Camera and Instrument Corporation

464 Ellis Street, Mountain View, California 94042 (415) 964-5011/TWX 910-379-6435



# Introduction

Welcome to Fairchild Optoelectronics!

From our introduction of a phototransistor into the marketplace 15 years ago, Fairchild Optoelectronics has grown to be a major supplier of quality optoelectronic products, offering the broadest product range in the industry, including:

LED Lamps and Lamp Hardware  
 7-Segment LED Displays and Display Arrays  
 Photocouplers  
 Phototransistors  
 Photodiodes  
 Photo Arrays  
 Liquid Crystal Displays

Within this product breadth are incorporated our philosophies of quality, reliability and cost-competitiveness, backed by a sincere belief in customer service and satisfaction.

Our catalog has been designed with you, the customer, in mind. If you have further inquiries outside the realm of our data book, we hope you will contact the local Fairchild sales office, franchised distributor or sales representative in your area. A complete listing of these worldwide locations is contained in Section 10.

We welcome you to the world of Fairchild Optoelectronics. We look forward to serving your optoelectronic requirements.

## Our Philosophies

### Quality — *built-in*

The philosophy of the Optoelectronics R&QA department is that quality must be built into each and every optoelectronic device that leaves Fairchild for the marketplace. *Built-in* quality begins in the product design stages and continues, under strict monitoring, throughout the development, production and testing of that product. All semiconductor and liquid-crystal materials used in processing LEDs, phototransistors and LCDs are produced by Fairchild, with optimum yield, superior quality and reliability as prime design considerations. Product testing and comparative studies are ongoing processes at Fairchild in our continuous search for newer and more effective methods of manufacturing products with *built-in* quality.

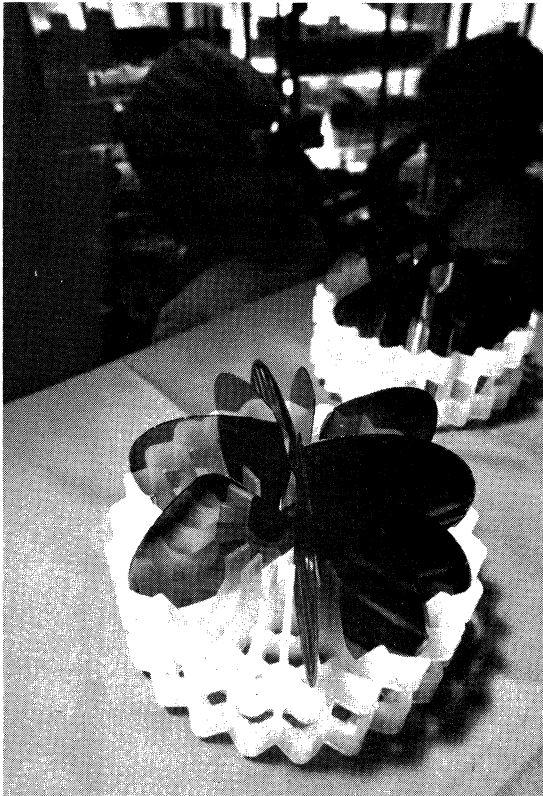

The philosophy that quality must be built into each product starts in the fabrication process. These LED wafers were produced from ultra-pure materials in the controlled environment of Fairchild's crystal-growing facility. Here, each wafer is being carefully inspected for correct mask alignment prior to diffusion.



## Introduction (Cont'd)

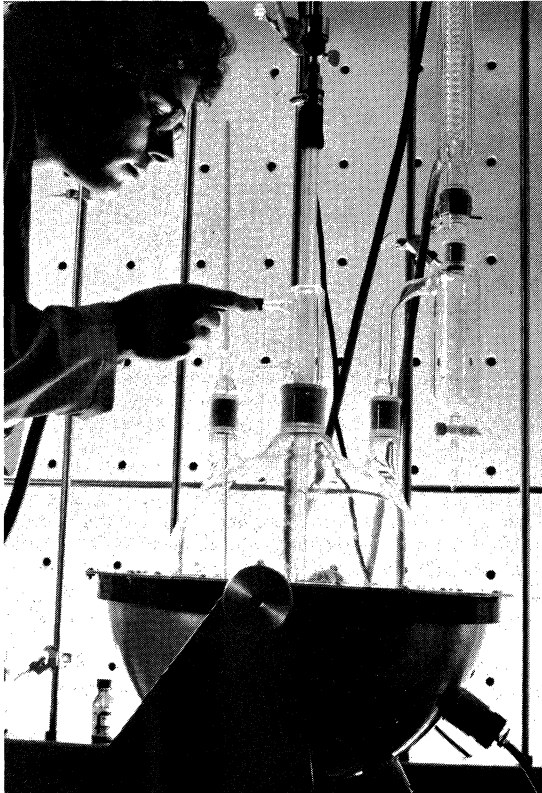

Fairchild maintains a high standard of process control by manufacturing many of the primary fabrication materials. This research chemist is experimenting with new compounds to improve LCD performance. Fairchild is one of the few companies that produces its own liquid crystal material.

### **Service—*timely***

The philosophy of our service groups is based on *timeliness*. With Fairchild sales offices, sales representatives and franchised distributors based worldwide, the ability for us to respond to a customer request is only a local phone call away. Our sales teams are eager to respond to all customer requests, from answering product and pricing questions, to arranging technical seminars and training sessions. Included within our vast network of field sales offices are our field application engineers, trained specialists who offer valuable technical assistance and recommendations regarding our optoelectronics line. In addition to field support, we have a factory equally dedicated to serving customer needs. Our Customer-Service team is a group of conscientious, customer-oriented people whose main objective is supplying accurate information in a *timely* manner. A customer's time is highly respected and considered when our services are required, and customer satisfaction is a primary goal.

### **Delivery—*credible***

The philosophy of our Production Control department is based on *credibility*. We currently enjoy the position of being able to quote short lead times on most of our optoelectronic products and offer products that are available *now*. Current lead times for all our optoelectronic devices are telexed to every Fairchild sales office around the world on a monthly basis. Our Production Control staff consistently reviews the influx of new orders against our current backlog in order to accurately gear production capacity to meet customer demand.

### **Our Product**

#### **LED Lamps**

Semiconductor lamps have come a long way from the large incandescent lamps of the past. The reduction in both size and power consumption has allowed these tiny LEDs to be used in an expanding range of applications, from general-purpose indicators to show on/off status, to being the light source for activating phototransistors. Fairchild Optoelectronics offers a variety of both diffused and non-diffused (point source) lamps in a wide range of packages, profiles, colors and luminous intensities. We offer our own proprietary (FLV) lamp series, in addition to second sourcing several GI (MV), TI (TIL) and HP (5082) series lamps. Lamp hardware is also available for both our proprietary lamp series and for our second-source GI lamps.

## Introduction (Cont'd)

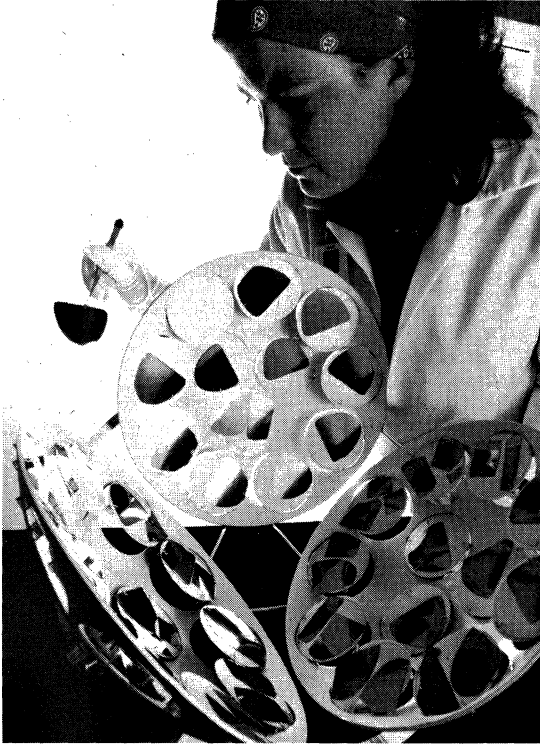

Fairchild Optoelectronics' modern Palo Alto facility fabricates wafers for LED display and photo devices. This technician is preparing wafers for aluminum coating.

### LED Displays

With the advent of LED watches, clocks and calculators in the consumer marketplace came an increased demand for electronic digital read-outs in many other marketplaces. Their popularity continues to grow, as applications expand into gas pumps, microwave ovens, TV channel indicators, industrial test equipment and electronic toys and games. Fairchild Optoelectronics' line of 7-segment LED displays continues to grow with this increasing demand, offering a variety of colors, including red, orange, yellow and green. Digit sizes include .3-inch, .362-inch, .5-inch, .56-inch and .8-inch. In addition, we offer both the air-gap light pipe and filled-digit technologies. Our digit line includes our own proprietary FND series, in addition to second sourcing several GI (MAN) and HP (5082) series digits. Hardware is also available for our .362-inch line.

### Photo

From the introduction of one phototransistor 15 years ago, Fairchild Optoelectronics' photo line now encompasses over 150 device types offering a wide range of both proprietary and second-source products in a variety of packages. This range includes photo-couplers, phototransistors, photodiodes, photo emitters and photo arrays. In the photocoupler line we offer both transistor and Darlington output in the standard 6-pin mini DIP and in the 8-pin DIP. Not only do we offer our FCD proprietary series and the standard JEDEC 4N coupler series, we also second source TI (TIL series), GI (MCT and MCA series), GE (H11 series) and Litronix (ILD series). In the other photo areas, we offer many highly sensitive, highly reliable photo emitters and photosensors in a variety of packages for use in both the visible and infrared light ranges. Package options include plastic, glob top, TO-18 and miniature coaxial.

---

## Introduction (Cont'd)

---

### LCD (Liquid Crystal Displays)

The addition of LCD technology to the Fairchild Optoelectronic group continues our commitment to serve the ever-expanding optoelectronic marketplace with the most suitable device and technology for the optimum end customer application. LCD has become the preferred technology over LED in many modern design applications due to its low power consumption, excellent readability in full sunlight and its alphanumeric capabilities. Our commitment to quality and reliability in our LCD product line starts with our unique, fully hermetic glass-frit seal technique. This technique is used on all displays to seal the LCD material from the external environment for long-term display reliability and performance. Our current standard LCD line offers both a variety of watch displays and large area displays (LAD), including 3½- and 4-digit digital panel meter-type displays, a 4-digit stereo display, a 12-digit telephone display and an 8-digit alphanumeric display. Custom displays, outside the realm of our standard LCD line, are reviewed on an individual basis, and we welcome the opportunity to discuss and review your application needs.

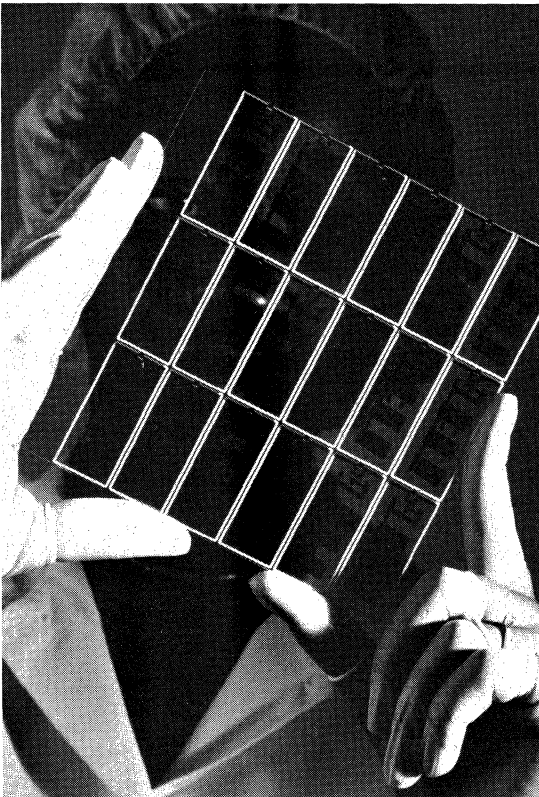

Fairchild employs several innovative technologies for manufacturing LCD devices. This glass frit seal, along with a final solder seal, is a unique Fairchild feature that ensures both a fully hermetic package and long-term reliability.

---

---

# Table of Contents

---

<b>Alphanumeric Listing</b> .....	ix
<b>Section 1</b> Selection Guides .....	1-3
<b>Section 2</b> Visible LED Lamps and Mounting Hardware .....	2-3
<b>Section 3</b> LED Digits .....	3-3
<b>Section 4</b> Phototransistors, Infrared Emitters and Sensors .....	4-3
<b>Section 5</b> Couplers .....	5-3
<b>Section 6</b> Liquid Crystal Displays .....	6-3
<b>Section 7</b> Fiber Optics .....	7-3
<b>Section 8</b> Cross Reference .....	8-3
<b>Section 9</b> Definitions of Symbols and Terms .....	9-3
<b>Section 10</b> Fairchild Field Sales Offices, Sales Representatives and Distributor Locations .....	10-3

---





# Alphanumeric Listing

Device	Page No.	Device	Page No.
FCD810/A/B/C/D	5-3	FLV104A	2-6
FCD820/A/B/C/D	5-6	FLV110	2-10
FCD825/A/B/C/D	5-9	FLV111	2-13
FCD830/A/B/C/D	5-11	FLV112	2-13
FCD831/A/B/C/D	5-13	FLV117	2-13
FCD836/C/D	5-15	FLV140	2-10
FCD850/C/D	5-17	FLV150	2-10
FCD855/C/D	5-17	FLV160	2-10
FCD860/C/D	5-19	FLV310	2-15
FCD865/C/D	5-19	FLV340	2-15
FCD880	5-21	FLV350	2-15
FCD885	5-21	FLV360	2-15
FCD890	5-23	FLV410	2-18
FLB1208X1	6-3	FLV440	2-18
FLB350401	6-27	FLV450	2-18
FLB350407	6-28	FLV460	2-18
FLB350501	6-29	FLV510	2-21
FLB350502	6-30	FLV540	2-21
FLB350508	6-31	FLV550	2-21
FLB350601	6-32	FLV560	2-21
FLB350701	6-33	FNA12	3-3
FLB3511X1	6-6	FND350	3-5
FLB3513X1	6-9	FND357	3-5
FLB3513X2	6-9	FND358	3-9
FLB3513X3	6-12	FND360	3-5
FLB3513X4	6-12	FND367	3-5
FLB4010X1	6-15	FND368	3-9
FLB4013X1	6-17	FND500	3-12
FLB4013X2	6-17	FND501	3-15
FLB4018X1	6-20	FND507	3-12
FLB4018X2	6-20	FND508	3-15
FLB450401	6-34	FND530	3-18
FLB450501	6-35	FND531	3-21
FLB550503	6-36	FND537	3-18
FLB600301	6-37	FND538	3-21
FLB600506	6-38	FND540	3-18
FLB600601	6-39	FND541	3-21
FLB600602	6-40	FND547	3-18
FLB650401	6-41	FND548	3-21
FLB8009X1	6-23	FND550	3-18
FLS010	2-3	FND551	3-21
FLV100	2-4	FND557	3-18
FLV101	2-4	FND558	3-21
FLV102	2-4	FND560	3-12
FLV104	2-6	FND561	3-15

Device	Page No.	Device	Page No.
FND567	3-12	FPT550A	4-62
FND568	3-15	FPT560	4-64
FND800	3-24	FPT570	4-64
FND807	3-24	FPT610	4-66
FNS700	3-27	FPT630	4-66
FPA100	4-3	FPT700	4-68
FPA101	4-3	FPT720	4-70
FPA102	4-3	H11A1	5-25
FPA103	4-8	H11A2	5-25
FPA104	4-8	H11A3	5-25
FPA105	4-8	H11A4	5-25
FPA106	4-8	H11B1	5-27
FPA107	4-8	H11B2	5-27
FPA108	4-8	H11D1	5-29
FPA700	4-11	H11D2	5-29
FPA700A	4-11	H11D3	5-29
FPA710	4-15	H11D4	5-29
FPA710A	4-15	ILD-74	5-31
FPA720	4-19	MAN71A	3-28
FPA720A	4-19	MAN72A	3-28
FPE104	4-23	MAN73A	3-28
FPE106	4-26	MAN74A	3-28
FPE500	4-28	MAN3610A	3-32
FPE510	4-28	MAN3620A	3-32
FPE520	4-31	MAN3630A	3-32
FPE530	4-31	MAN3640A	3-32
FPE700	4-34	MAN6610	3-36
FPT100/A/B	4-35	MAN6640	3-36
FPT101	4-39	MAN6710	3-39
FPT102	4-44	MAN6740	3-39
FPT110/A/B	4-35	MCA230	5-33
FPT120/A/B/C	4-47	MCA231	5-33
FPT130/A/B	4-47	MCA255	5-33
FPT131	4-51	MCT2	5-35
FPT132	4-55	MCT2E	5-35
FPT136	4-51	MCT6	5-38
FPT137	4-55	MCT26	5-35
FPT400	4-58	MCT66	5-38
FPT410	4-58	MP52	2-24
FPT500	4-60	MV5050	2-25
FPT500A	4-60	MV5051	2-25
FPT510	4-62	MV5052	2-25
FPT510A	4-62	MV5053	2-25
FPT520	4-60	MV5054-1	2-28
FPT520A	4-60	MV5054-2	2-28
FPT530	4-62	MV5054-3	2-28
FPT530A	4-62	MV5055	2-31
FPT540	4-60	MV5056	2-31
FPT540A	4-60	MV5152	2-34
FPT550	4-62	MV5153	2-34

---

<b>Device</b>	<b>Page No.</b>
MV5154 .....	2-34
MV5252 .....	2-37
MV5253 .....	2-37
MV5254 .....	2-37
MV5352 .....	2-40
MV5353 .....	2-40
MV5354 .....	2-40
MV5752 .....	2-43
MV5753 .....	2-43
MV5754 .....	2-43
TIL38 .....	4-72
TIL100 .....	4-73
TIL111 .....	5-40
TIL112 .....	5-43
TIL113 .....	5-45
TIL114 .....	5-40
TIL115 .....	5-43
TIL116 .....	5-40
TIL117 .....	5-40
TIL118 .....	5-43
TIL119 .....	5-45
TIL209A .....	2-46
TIL212 .....	2-46
TIL232 .....	2-46
5082-4480 .....	2-48
5082-4483 .....	2-48
5082-4486 .....	2-48
5082-7650 .....	3-42
5082-7651 .....	3-42
5082-7653 .....	3-42
5082-7750 .....	3-45
5082-7751 .....	3-45
5082-7760 .....	3-45
4N25 .....	5-47
4N26 .....	5-47
4N27 .....	5-47
4N28 .....	5-47
4N29 .....	5-49
4N30 .....	5-49
4N31 .....	5-49
4N32 .....	5-49
4N33 .....	5-49
4N35 .....	5-51
4N36 .....	5-51
4N37 .....	5-51
6N137 .....	5-53

---



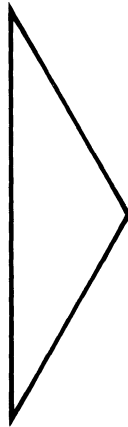
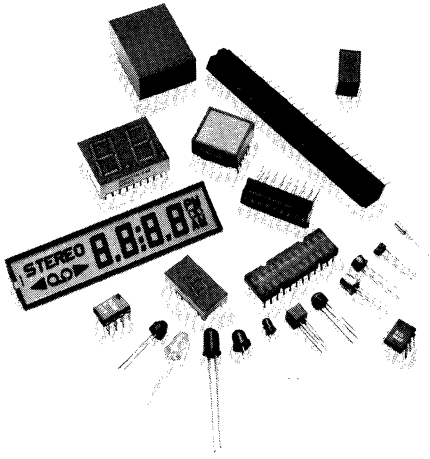

Selection Guides	1
Visible LED Lamps and Mounting Hardware	2
LED Digits	3
Phototransistors, Infrared Emitters and Sensors	4
Couplers	5
Liquid Crystal Displays	6
Fiber Optics	7
Cross Reference	8
Definitions of Symbols and Terms	9
Fairchild Field Sales Offices, Sales Representatives and Distributor Locations	10





# Section 1

## Selection Guides

# LED Visible Lamps

1

Device No.	Lens Characteristic	Max Forward Current mA	Typical Luminous Intensity mcd	Typical Forward Voltage @ $I_F = 20 \text{ mA}$ V	Data Sheet Page No.
FLV100	Red Point Source	50	0.5 @ 20 mA	1.8	2-4
FLV101	Red Diffused	50	0.45 @ 20 mA	1.8	2-4
FLV102	Red Diffused	50	1.0 @ 20 mA	1.8	2-4
FLV104	Clear	100	150 @ 100 mA	2.0*	2-6
FLV104A	Clear	100	150 @ 100 mA	2.0*	2-6
FLV110	Red Diffused	50	2.0 @ 20 mA	1.7	2-10
FLV111	Clear Point Source	50	2.0 @ 20 mA	1.7	2-13
FLV112	Clear Diffused	50	2.0 @ 20 mA	1.7	2-13
FLV117	Red Diffused	50	1.0 @ 20 mA	1.7	2-13
FLV140	Red Diffused	50	2.0 @ 20 mA	1.7	2-10
FLV150	Red Diffused	50	2.0 @ 20 mA	1.7	2-10
FLV160	Red Diffused	50	2.0 @ 20 mA	1.7	2-10
FLV310	Green Diffused	35	3.2 @ 20 mA	2.3	2-15
FLV340	Green Diffused	35	3.2 @ 20 mA	2.3	2-15
FLV350	Green Diffused	35	3.2 @ 20 mA	2.3	2-15
FLV360	Green Diffused	35	3.2 @ 20 mA	2.3	2-15
FLV410	Yellow Diffused	35	3.2 @ 20 mA	2.3	2-18
FLV440	Yellow Diffused	35	3.2 @ 20 mA	2.3	2-18
FLV450	Yellow Diffused	35	3.2 @ 20 mA	2.3	2-18
FLV460	Yellow Diffused	35	3.2 @ 20 mA	2.3	2-18
FLV510	Red Diffused	35	10 @ 20 mA	2.1	2-21
FLV540	Red Diffused	35	10 @ 20 mA	2.1	2-21
FLV550	Red Diffused	35	10 @ 20 mA	2.1	2-21
FLV560	Red Diffused	35	10 @ 20 mA	2.1	2-21

\* $I_F = 100 \text{ mA}$

## LED Visible Lamps (Cont'd)

Device No.	Lens Characteristic	Max Forward Current mA	Typical Luminous Intensity mcd	Typical Forward Voltage @ $I_F = 20 \text{ mA}$ V	Data Sheet Page No.
MV5050	Clear Point Source	100	2.0 @ 20 mA	1.7	2-25
MV5051	Clear Diffused	100	1.6 @ 20 mA	1.7	2-25
MV5052	Red Point Source	100	2.0 @ 20 mA	1.7	2-25
MV5053	Red Diffused	100	1.6 @ 20 mA	1.7	2-25
MV5054-1	Red Semi-Diffused	100	2.0 @ 10 mA	1.8	2-28
MV5054-2	Red Semi-Diffused	100	3.0 @ 10 mA	1.8	2-28
MV5054-3	Red Semi-Diffused	100	4.0 @ 10 mA	1.8	2-28
MV5055	Red Diffused	100	0.6 @ 20 mA	1.7	2-31
MV5056	Red Diffused	100	0.8 @ 20 mA	1.7	2-31
MV5152	Amber Point Source	35	20 @ 20 mA	2.0	2-34
MV5153	Amber Diffused	35	4.0 @ 20 mA	2.0	2-34
MV5154	Amber Semi-Diffused	35	8.0 @ 20 mA	2.0	2-34
MV5252	Green Point Source	35	30 @ 20 mA	2.2	2-37
MV5253	Green Diffused	35	3.0 @ 20 mA	2.2	2-37
MV5254	Green Semi-Diffused	35	6.0 @ 20 mA	2.2	2-37
MV5352	Yellow Point Source	35	20 @ 20 mA	2.1	2-40
MV5353	Yellow Diffused	35	6.0 @ 20 mA	2.1	2-40
MV5354	Yellow Semi-Diffused	35	10 @ 20 mA	2.1	2-40
MV5752	Red Point Source	35	30 @ 20 mA	2.0	2-43
MV5753	Red Diffused	35	4.0 @ 20 mA	2.0	2-43
MV5754	Red Semi-Diffused	35	8.0 @ 20 mA	2.0	2-43
TIL209A	Red Diffused T-1	40	1.0 @ 20 mA	1.6	2-46
TIL212	Yellow Diffused T-1	30	4.0 @ 25 mA	1.6	2-46
TIL232	Green Diffused T-1	30	4.0 @ 25 mA	1.6	2-46
5082-4480	Red Diffused	50	0.8 @ 20 mA	1.6	2-48
5082-4483	Clear Diffused	50	0.8 @ 20 mA	1.6	2-48
5082-4486	Clear Point Source	50	0.8 @ 20 mA	1.6	2-48

# LED Lamp Mounting Hardware

1

<b>Device No.</b>	<b>Panel Thickness</b>	<b>Panel Hole</b>	<b>Description</b>	<b>Data Sheet Page No.</b>
FLS010	.060 to .250	.265 ± .002	1-Piece Black Panel Mount Adapter for LED Lamps	2-3
MP52	.125	.250 ± .003	2-Piece Black Panel Mount Adapter for LED Lamps	2-24

# 7-Segment Numeric Displays

Device No.	Character Height Inches	Polarity	Color	Description	Decimal Point	$V_F$ $I_F = 20 \text{ mA/Seg}$ V	Luminous/Typ Intensity/Seg $I_F = 20 \text{ mA}$ $\mu\text{cd}$	Data Sheet Page No.
FND350	.362	CA	Red	7-Segment Display	RH	1.7	450	3-5
FND357	.362	CC	Red	7-Segment Display	RH	1.7	450	3-5
FND358	.362	CC	Red	Overflow $\pm 1$ Digit	RH	1.7	450	3-9
FND360	.362	CA	Red	7-Segment Display	RH	1.7	900	3-5
FND367	.362	CC	Red	7-Segment Display	RH	1.7	900	3-5
FND368	.362	CC	Red	Overflow $\pm 1$ Digit	RH	1.7	900	3-9
FND500	.500	CC	Red	7-Segment Display	RH	1.7	600	3-12
FND501	.500	CC	Red	Overflow $\pm 1$ Digit	RH	1.7	600	3-15
FND507	.500	CA	Red	7-Segment Display	RH	1.7	600	3-12
FND508	.500	CA	Red	Overflow $\pm 1$ Digit	RH	1.7	600	3-15
FND530	.500	CC	Grn	7-Segment Display	RH	2.2	2000	3-18
FND531	.500	CC	Grn	Overflow $\pm 1$ Digit	RH	2.2	2000	3-21
FND537	.500	CA	Grn	7-Segment Display	RH	2.2	2000	3-18
FND538	.500	CA	Grn	Overflow $\pm 1$ Digit	RH	2.2	2000	3-21
FND540	.500	CC	Yel	7-Segment Display	RH	2.2	1000	3-18
FND541	.500	CC	Yel	Overflow $\pm 1$ Digit	RH	2.2	2000	3-21
FND547	.500	CA	Yel	7-Segment Display	RH	2.2	1000	3-18
FND548	.500	CA	Yel	Overflow $\pm 1$ Digit	RH	2.2	2000	3-21
FND550	.500	CC	Amb	7-Segment Display	RH	2.2	2000	3-18
FND551	.500	CC	Amb	Overflow $\pm 1$ Digit	RH	2.2	2000	3-21
FND557	.500	CA	Amb	7-Segment Display	RH	2.2	2000	3-18
FND558	.500	CA	Amb	Overflow $\pm 1$ Digit	RH	2.2	2000	3-21
FND560	.500	CC	Red	7-Segment Display	RH	2.2	1200	3-12
FND561	.500	CC	Red	Overflow $\pm 1$ Digit	RH	1.7	1200	3-15
FND567	.500	CA	Red	7-Segment Display	RH	1.7	1200	3-12
FND568	.500	CA	Red	Overflow $\pm 1$ Digit	RH	1.7	1200	3-15
FND800	.800	CC	Red	7-Segment Display	RH	1.7	1100	3-24
FND807	.800	CA	Red	7-Segment Display	RH	1.7	1100	3-24
MAN71A	.300	CA	Red	7-Segment Display	RH	1.6	250	3-28
MAN72A	.300	CA	Red	7-Segment Display	LH	1.6	250	3-28
MAN73A	.300	CA	Red	Overflow $\pm 1$ Digit	None	1.7	450	3-28
MAN74A	.300	CC	Red	7-Segment Display	RH	1.6	250	3-28



# 7-Segment Numeric Displays (Cont'd)

1

Device No.	Character Height Inches	Polarity	Color	Description	Decimal Point	$V_F$ $I_F = 20 \text{ mA/Seg}$ V	Luminous/Typ Intensity/Seg $I_F = 20 \text{ mA}$ $\mu\text{cd}$	Data Sheet Page No.
MAN3610A	.300	CA	Orange	7-Segment Display	RH	2.5	510*	3-32
MAN3620A	.300	CA	Orange	7-Segment Display	LH	2.5	510*	3-32
MAN3630A	.300	CA	Orange	Overflow $\pm 1$ Digit	RH	2.5	510*	3-32
MAN3640A	.300	CC	Orange	7-Segment Display	RH	2.5	510*	3-32
MAN6610	.560	CA	Orange	7-Segment Display	RH	2.5	510*	3-36
MAN6640	.560	CC	Orange	7-Segment Display	RH	2.5	510*	3-36
MAN6710	.560	CA	Red	Dual-Digit Display	RH	1.7	250	3-39
MAN6740	.560	CC	Red	Dual-Digit Display	RH	1.7	250	3-39
5082-7650	.430	CA	Red	7-Segment Display	LH	2.0	1720	3-42
5082-7651	.430	CA	Red	7-Segment Display	RH	2.0	1720	3-42
5082-7653	.430	CC	Red	7-Segment Display	RH	2.0	1720	3-42
5082-7750	.430	CA	Red	7-Segment Display	LH	1.6	400	3-45
5082-7751	.430	CA	Red	7-Segment Display	RH	1.6	400	3-45
5082-7760	.430	CC	Red	7-Segment Display	RH	1.6	400	3-45

\* $I_F = 10 \text{ mA}$

# LED Bar Graph Display, Digit Hardware

## Bar Graph Display

Device No.	Character Height Inches	Polarity	Color	Description	Decimal Point	$V_F$ $I_F = 20 \text{ mA/Seg}$ V	Luminous/Typ Intensity/Seg $I_F = 20 \text{ mA}$ $\mu\text{cd}$	Data Sheet Page No.
FNA12	.050	Both	Red	12-Element Bar Display	None	1.7	200	3-3

## Digit Hardware

Device No.	Description	Data Sheet Page No.
FNS700	10-Position DIP Socket for Use with .362" FND300 Series 7-Segment Displays	3-27

# Photo Arrays

Device No.	Description	Source		Sensor		Matching Factor		Data Sheet Page No.
		$I_F$ mA/cell Max	$V_F$ $I_F = 50$ mA V Typ	$I_{CE(It)}$ H = 1.0 mW/cm <sup>2</sup> (GaAs) $V_{CE} = 5.0$ V $I_{CE} = 4.0$ mA mA Typ	$V_{CE(sat)}$ V Typ	$\frac{I_{OUT(Min)}}{I_{OUT(Max)}}$ $I_F = 50$ mA $V_{CE} = 5.0$ V Distance = 0.05" Min	Typ	
FPA100	9-Element Source/ Sensor Array .100" Centers Matched Pair	1.50	1.25	4.5	0.4	0.5	0.65	4-3
FPA101	12-Element Source/ Sensor Array .250" Centers Matched Pair	1.50	1.25	4.5	0.4	0.5	0.65	4-3
FPA102	10-Element Source/ Sensor Array .087" Centers Matched Pair	1.50	1.25	4.5	0.4	0.5	0.65	4-3

# Photo Sensors

Device No.	Description	Diode		Photo- Transistor	Combined I <sub>OUT</sub> I <sub>F</sub> = 50 mA V <sub>CE</sub> = 5.0 V Distance = 0.40"		Data Sheet Page No.
		I <sub>F</sub> mA Max	V <sub>F</sub> I <sub>F</sub> = 20 mA V Typ	V <sub>CEO</sub> I <sub>CE</sub> = 1.0 mA V Min	μA Min	μA Max	
FPA103	Light Reflective Transducer, Clear	75	1.25	12	20		4-8
FPA104	Light Reflective Transducer, Clear	75	1.25	12	60	180	4-8
FPA105	Light Reflective Transducer, Clear	75	1.25	12	80	160	4-8
FPA106	Light Reflective Transducer w/Ambient Light Filter	75	1.25	12	20		4-8
FPA107	Light Reflective Transducer w/Ambient Light Filter	75	1.25	12	60	180	4-8
FPA108	Light Reflective Transducer w/Ambient Light Filter	75	1.25	12	80	160	4-8

# Photo Sensors (Cont'd)

1

Device No.	Description	I <sub>CE</sub> mA Max	V <sub>CEO</sub> I <sub>C</sub> = 1.0 mA V Typ	I <sub>CE(it)</sub> H = 10 mW/cm <sup>2</sup> Tung. @ 2854°K mA Typ	V <sub>CE(sat)</sub> H = 20 mW/cm <sup>2</sup> I <sub>C</sub> = 500 mA V Typ	Matching Factor		Data Sheet Page No.
						I <sub>OUT(Min)</sub> I <sub>F</sub> = 50 mA V <sub>CE</sub> = 5.0 V Distance = 0.05" Min	I <sub>OUT(Max)</sub> Typ	
FPA700	9-Element Sensor Array .100" Centers	25	35	1.75	0.16	0.5	0.65	4-11
FPA700A	9-Element Sensor Array .100" Centers	25	35	1.75	0.16	0.75	0.85	4-11
FPA710	12-Element Sensor Array .250" Centers	25	35	1.75	0.16	0.5	0.65	4-15
FPA710A	12-Element Sensor Array .250" Centers	25	35	1.75	0.16	0.75	0.85	4-15
FPA720	10-Element Sensor Array .100" Centers	25	35	1.75	0.16	0.5	0.65	4-19
FPA720A	10-Element Sensor Array .100" Centers	25	35	1.75	0.16	0.75	0.85	4-19



# Infrared Photo Emitters

Device No.	Description	I <sub>F</sub> mA Max	V <sub>F</sub> I <sub>F</sub> = 100 mA V Typ	Wavelength @ Peak Emission nm Typ	Axial Intensity I <sub>F</sub> = 100 mA mW/sr Typ	Data Sheet Page No.
FPE104	Lead Frame Package Narrow Beam	100	1.35	890	10	4-23
FPE106	Miniature .085" X .150" X .095" Tall Flat Lens	100	1.35	890	0.4	4-26
FPE500	TO-18, Dome Lens	150	1.35	890	10.0	4-28
FPE510	TO-18, Flat Lens	150	1.35	890	1.0	4-28
FPE520	TO-18, Dome Lens	150	1.35	940	50	4-31
FPE530	TO-18, Flat Lens	150	1.35	940	5.0	4-31
FPE700	T-1 Clear Epoxy	40	1.35	890	2.0*	4-34
TIL38	T-1¾ Grey Tinted	150	1.40	940	12	4-72

\*I<sub>F</sub> = 40 mA

## Phototransistors

1

Device No.	Description	$V_{CE0}$ $I_C = 1.0 \text{ mA}$ V		$I_{CE}(It)$ $V_{CE} = 5.0 \text{ V}$ mA			$V_{CE}(\text{sat})$ $H = 20 \text{ mW/cm}^2$ V			$t_r/t_f$ $\mu\text{s}$ Typ	Data Sheet Page No.
		Min	Typ	Min	Typ	Max	Min	Typ	Max		
FPT100	Plastic, Dome Lens General Purpose	30	50	H = 5.0 mW/cm <sup>2</sup> 0.2	1.4		$I_C = 500 \mu\text{A}$ 0.16	0.3		2.8	4-35
FPT100A	Plastic, Dome Lens 1:3 Sensitivity	30	50	H = 5.0 mW/cm <sup>2</sup> 1.0	1.4	3.0	$I_C = 500 \mu\text{A}$ 0.16	0.3		2.8	4-35
FPT100B	Plastic, Dome Lens 1:2 Sensitivity	30	50	H = 5.0 mW/cm <sup>2</sup> 1.3	1.4	2.6	$I_C = 500 \mu\text{A}$ 0.16	0.3		2.8	4-35
FPT101	Miniature, 0.080" Dia Hermetic Package	$I_C = 0.1 \text{ mA},$ $H < 0.1 \mu\text{W/cm}^2$ 30 60		H = 20 mW/cm <sup>2</sup> 0.8	3.5		$I_C = 0.4 \text{ mA}$ 0.25	0.3		2.8	4-39
FPT110	Plastic Flat Lens General Purpose	30	50	H = 5.0 mW/cm <sup>2</sup> 0.2	0.88		$I_C = 500 \mu\text{A}$ 0.16	0.33		2.8	4-35
FPT110A	Plastic Flat Lens 1:3 Sensitivity	30	50	H = 5.0 mW/cm <sup>2</sup> 0.6	0.88	1.8	$I_C = 500 \mu\text{A}$ 0.16	0.33		2.8	4-35
FPT110B	Plastic Flat Lens 1:2 Sensitivity	30	50	H = 5.0 mW/cm <sup>2</sup> 0.8	0.88	1.6	$I_C = 500 \mu\text{A}$ 0.16	0.33		2.8	4-35
FPT120	Plastic, Dome Lens High Sensitivity	20	50	H = 1.0 mW/cm <sup>2</sup> 0.4	1.5		$I_C = 1.0 \text{ mA}$ 0.25	0.55		18	4-47
FPT120A	Plastic, Dome Lens 1:3 Sensitivity	15	30	H = 1.0 mW/cm <sup>2</sup> 1.5	4.5		$I_C = 1.0 \text{ mA}$ 0.25	0.55		18	4-47
FPT120B	Plastic, Dome Lens 1:1.5 Sensitivity	15	30	H = 1.0 mW/cm <sup>2</sup> 2.0	4.0		$I_C = 1.0 \text{ mA}$ 0.25	0.55		18	4-47
FPT120C	Plastic Cup, Dome Lens	11	20	H = 5.0 mW/cm <sup>2</sup> 16	25		$I_C = 1.0 \text{ mA}$ 0.35	0.55		18	4-47
FPT130	Plastic, Flat Lens High Sensitivity	20	50	H = 1.0 mW/cm <sup>2</sup> 0.4	0.9		$I_C = 1.0 \text{ mA}$ 0.25	0.55		18	4-47
FPT130A	Plastic, Flat Lens 1:3 Sensitivity	15	30	H = 1.0 mW/cm <sup>2</sup> 0.9	2.7		$I_C = 1.0 \text{ mA}$ 0.25	0.55		18	4-47
FPT130B	Plastic, Flat Lens 1:2 Sensitivity	15	30	H = 1.0 mW/cm <sup>2</sup> 1.2	2.4		$I_C = 1.0 \text{ mA}$ 0.25	0.55		18	4-47
FPT131	Plastic, Dome Lens	15	50	H = 5.0 mW/cm <sup>2</sup> 0.1	4.2		$I_C = 500 \mu\text{A}$ 0.16	0.7		2.8	4-51
FPT132	Plastic, Dome Lens	10	30	H = 1.0 mW/cm <sup>2</sup> 0.2	1.5		$I_C = 1.0 \text{ mA}$ 0.15	0.7		18	4-55
FPT136	Plastic, Flat Lens	15	50	H = 5.0 mW/cm <sup>2</sup> 0.2	2.7		$I_C = 500 \mu\text{A}$ 0.16	0.7		2.8	4-51

## Phototransistors (Cont'd)

Device No.	Description	$V_{CE0}$ $I_C = 1.0 \text{ mA}$ V		$I_{CE}(It)$ $V_{CE} = 5.0 \text{ V}$ mA			$V_{CE}(\text{sat})$ H = 20 mW/cm <sup>2</sup> V			$t_r/t_f$ $\mu\text{s}$ Typ	Data Sheet Page No.
		Min	Typ	Min	Typ	Max	Min	Typ	Max		
FPT137	Plastic, Flat Lens	10	30	H = 1.0 mW/cm <sup>2</sup> 0.2	0.9		$I_C = 1.0 \text{ mA}$ 0.15	0.7	18	4-55	
FPT400	Plastic, Dome Lens Photo Darlington	30	60	H = 1.0 mW/cm <sup>2</sup> 3.0	7.5		0.9	1.0	100	4-58	
FPT410	Plastic, Flat Lens Photo Darlington	30	60	H = 1.0 mW/cm <sup>2</sup> 2.0	5.0		0.9	1.0	100	4-58	
FPT500	TO-18, Dome Lens	45	60	H = 1.0 mW/cm <sup>2</sup> 1.0	3.0		0.16	0.33	3.0	4-60	
FPT500A	TO-18, Dome Lens 1:3 Sensitivity	45	60	H = 1.0 mW/cm <sup>2</sup> 2.0	6.0		0.16	0.33	3.0	4-60	
FPT510	TO-18, Flat Lens	45	60	H = 5.0 mW/cm <sup>2</sup> 0.5	1.5		0.16	0.33	3.0	4-62	
FPT510A	TO-18, Flat Lens 1:3 Sensitivity	45	60	H = 5.0 mW/cm <sup>2</sup> 1.0	3.0		0.16	0.33	3.0	4-62	
FPT520	TO-18, Dome Lens	30	60	H = 1.0 mW/cm <sup>2</sup> 5.0	8.0		0.16	0.33	8.0	4-60	
FPT520A	TO-18, Dome Lens 1:3 Sensitivity	30	60	H = 1.0 mW/cm <sup>2</sup> 6.0	18		0.16	0.33	8.0	4-60	
FPT530	TO-18, Flat Lens	30	60	H = 5.0 mW/cm <sup>2</sup> 3.0	5.0		0.16	0.33	10	4-62	
FPT530A	TO-18, Flat Lens 1:3 Sensitivity	30	60	H = 5.0 mW/cm <sup>2</sup> 4.0	12		0.16	0.33	10	4-62	
FPT540	TO-18, Dome Lens	12	30	H = 1.0 mW/cm <sup>2</sup> 8.0	1.5		0.25	0.55	18	4-60	
FPT540A	TO-18, Dome Lens 1:3 Sensitivity	12	30	H = 1.0 mW/cm <sup>2</sup> 10	30		0.25	0.55	18	4-60	
FPT550	TO-18, Flat Lens	12	30	H = 5.0 mW/cm <sup>2</sup> 8.0	10		0.25	0.55	18	4-62	
FPT550A	TO-18, Flat Lens 1:3 Sensitivity	12	30	H = 5.0 mW/cm <sup>2</sup> 8.0	24		0.25	0.55	18	4-62	
FPT560	TO-18, Dome Lens Photo Darlington	30	60	H = 1.0 mW/cm <sup>2</sup> 10	30		0.9	1.0	100	4-64	
FPT570	TO-18, Flat Lens Photo Darlington	30	60	H = 5.0 mW/cm <sup>2</sup> 1.0	6.0		0.9	1.0	100	4-64	
FPT610	Ceramic Miniature, .085" X .150"	30	60	H = 5.0 mW/cm <sup>2</sup> 0.2	1.0		$I_C = 500 \mu\text{A}$ 0.16	0.33	18	4-66	
FPT630	Flat Lens .85" X .185" X 0.95" Tall	20	60	H = 5.0 mW/cm <sup>2</sup> 2.0	5.0		$I_C = 1.0 \text{ mA}$ 0.16	0.33	18	4-66	
FPT700	T-1, Clear Plastic Phototransistor	15	50	H = 5.0 mW/cm <sup>2</sup> 0.10	0.88		0.16	0.7	2.8	4-68	

# Photodiodes

Device No.	Description	BV $I_R = 5.0 \mu\text{A}$ , $H \leq 0.1 \mu\text{W}/\text{cm}^2$		$V_R$ V	$I_R$ $V_R = -10 \text{ V}$ $H \leq 0.1 \mu\text{W}/\text{cm}^2$		$I_{LT}$ $V_R = -10 \text{ V}$ $H = 20 \text{ mW}/\text{cm}^2$		R(Tungsten) Responsivity $\mu\text{A}/\text{mW}/\text{cm}^2$ $T_C = 2854^\circ\text{K}$		R @ 0.9 $\mu$ Responsivity $\mu\text{A}/\text{mW}/\text{cm}^2$ No bias, GaAs	Data Sheet Page No.
		Min	Typ		Typ	Max	Min	Typ	Min	Typ	Typ	
FPT102	Photodiode Hermetic Package	50	20	50	0.1	25	12	20	0.6	1.0	3.0	4-44
FPT720	Photodiode T-1 Clear Epoxy	120	160	50	0.3	35	15	25	0.6	1.0	3.9	4-70

Device No.	Output	Max Ratings @ $T_A = 25^\circ\text{C}$					Coupled Characteristics			
		$P_D$ mW	Transistor $I_C$ mA	$V_{CEO}$ V	Diode $V_R$ V	$I_F$ mA	$V_{ISO}$ kV	Min Current Transfer Ratio $I_C/I_F$ %	@ $I_F$ mA	@ $V_{CE}$ V
FCD810 <sup>(1)</sup>	Trans	250	25	20	3.0	60	1.5 ac	10	10	10
FCD810A <sup>(1)</sup>	Trans	250	25	20	3.0	60	1.5	10	10	10
FCD810B <sup>(1)</sup>	Trans	250	25	20	3.0	60	2.5	10	10	10
FCD810C <sup>(1)</sup>	Trans	250	25	20	3.0	60	5.0	10	10	10
FCD810D <sup>(1)</sup>	Trans	250	25	20	3.0	60	6.0	10	10	10
FCD820 <sup>(1, 3)</sup>	Trans	250	25	30	3.0	60	1.5 ac	20	10	0.4
FCD820A <sup>(1)</sup>	Trans	250	25	30	3.0	60	1.5	20	10	10
FCD820B <sup>(1)</sup>	Trans	250	25	30	3.0	60	2.5	20	10	10
FCD820C <sup>(1)</sup>	Trans	250	25	30	3.0	60	5.0	20	10	10
FCD820D <sup>(1)</sup>	Trans	250	25	30	3.0	60	6.0	20	10	10
FCD825 <sup>(1, 5)</sup>	Trans	250	25	30	3.0	60	1.5 ac	50	10	10
FCD825A <sup>(1, 5)</sup>	Trans	250	25	30	3.0	60	1.5	50	10	10
FCD825B <sup>(1, 5)</sup>	Trans	250	25	30	3.0	60	2.5	50	10	10
FCD825C <sup>(1, 5)</sup>	Trans	250	25	30	3.0	60	5.0	50	10	10
FCD825D <sup>(1, 5)</sup>	Trans	250	25	30	3.0	60	6.0	50	10	10
FCD830 <sup>(2, 3)</sup>	Trans	250	25	30	3.0	60	1.5	20	10	0.4
FCD830A <sup>(2)</sup>	Trans	250	25	30	3.0	60	1.5 ac	20	10	10
FCD830B <sup>(2)</sup>	Trans	250	25	30	3.0	60	2.5	20	10	10
FCD830C <sup>(2)</sup>	Trans	250	25	30	3.0	60	5.0	20	10	10

**Notes**

- Standard Transistor output
- High-speed transistor output  
guaranteed 2.0  $\mu\text{s}$  max  $t_r$  and  $t_f$  with 100  $\Omega$   $R_L$   
8.0  $\mu\text{s}$  typ at 1 k $\Omega$   $R_L$
- CTR guaranteed with transistor in saturation
- JEDEC registered data and conditions
- CTR typ at 1.0 mA = 40%

Device No.	Output	Max Ratings @ T <sub>A</sub> = 25°C					Coupled Characteristics			
		P <sub>D</sub> mW	Transistor I <sub>C</sub> mA	V <sub>CEO</sub> V	Diode V <sub>R</sub> V	I <sub>F</sub> mA	V <sub>ISO</sub> kV	Min Current I <sub>C</sub> /I <sub>F</sub> %	Transfer Ratio @I <sub>F</sub> mA	@V <sub>CE</sub> V
FCD830D <sup>(2)</sup>	Trans	250	25	30	3.0	60	6.0	20	10	10
FCD831 <sup>(2)</sup>	Trans	250	25	30	3.0	60	1.5 ac	10	10	10
FCD831A <sup>(2)</sup>	Trans	250	25	30	3.0	60	1.5	10	10	10
FCD831B <sup>(2)</sup>	Trans	250	25	30	3.0	60	2.5	10	10	10
FCD831C <sup>(2)</sup>	Trans	250	25	30	3.0	60	5.0	10	10	10
FCD831D <sup>(2)</sup>	Trans	250	25	30	3.0	60	6.0	10	10	10
FCD836 <sup>(2)</sup>	Trans	250	25	20	3.0	60	1.5 ac	6.0	10	10
FCD836C <sup>(2)</sup>	Trans	250	25	20	3.0	60	5.0	6.0	10	10
FCD836D <sup>(2)</sup>	Trans	250	25	20	3.0	60	6.0	6.0	10	10
FCD850	Darlg	250	125	30	3.0	80	1.5 ac	100	10	5.0
FCD850C	Darlg	250	125	30	3.0	80	5.0	100	10	5.0
FCD850D	Darlg	250	125	30	3.0	80	6.0	100	10	5.0
FCD855	Darlg	250	125	55	3.0	80	1.5 ac	100	10	5.0
FCD855C	Darlg	250	125	55	3.0	80	5.0	100	10	5.0
FCD855D	Darlg	250	125	55	3.0	80	6.0	100	10	5.0
FCD860 <sup>(3)</sup>	Darlg	250	125	30	3.0	80	1.5 ac	200	1.0	1.0
FCD860C <sup>(3)</sup>	Darlg	250	125	30	3.0	80	5.0	200	1.0	1.0
FCD860D <sup>(3)</sup>	Darlg	250	125	30	3.0	80	6.0	200	1.0	1.0
FCD865 <sup>(3)</sup>	Darlg	250	125	30	3.0	80	1.5 ac	400	0.5	1.0
FCD865C <sup>(3)</sup>	Darlg	250	125	30	3.0	80	5.0	400	0.5	1.0
FCD865D <sup>(3)</sup>	Darlg	250	125	30	3.0	80	6.0	400	0.5	1.0

**Notes**

1. Standard Transistor output
2. High-speed transistor output  
guaranteed 2.0 μs max t<sub>r</sub> and t<sub>f</sub> with 100 Ω R<sub>L</sub>  
8.0 μs typ at 1 kΩ R<sub>L</sub>
3. CTR guaranteed with transistor in saturation
4. JEDEC registered data and conditions
5. CTR typ at 1.0 mA = 40%

# Couplers

Coupled Characteristics		Input Diode Characteristics		Output Transistor Characteristics			Output Darlington Characteristics		Data Sheet Page No.	Device No.
$T_r$ $\mu s$ Typ	$t_f$ $\mu s$ Typ	$V_F$ V Max	@ $I_F$ mA	$V_{CE(sat)}$ V Max	@ $I_C$ mA	@ $I_F$ mA	$I_{CEO}$ $\mu A$ Max	@ $V_{CE}$ V		
4.0	4.0	1.5	10	0.7	2.6	50		5-3	FCD810 <sup>(1)</sup>	
4.0	4.0	1.5	10	0.7	2.6	50		5-3	FCD810A <sup>(1)</sup>	
4.0	4.0	1.5	10	0.7	1.6	50		5-3	FCD810B <sup>(1)</sup>	
4.0	4.0	1.5	10	0.7	2.6	50		5-3	FCD810C <sup>(1)</sup>	
4.0	4.0	1.5	10	0.7	2.6	50		5-3	FCD810D <sup>(1)</sup>	
2.5	2.5	1.5	60	0.4	2.0	10		5-6	FCD820 <sup>(1, 3)</sup>	
2.5	2.5	1.5	60	0.4	2.2	15		5-6	FCD820A <sup>(1)</sup>	
2.5	2.5	1.5	60	0.4	2.2	15		5-6	FCD820B <sup>(1)</sup>	
2.5	2.5	1.5	60	0.4	2.2	15		5-6	FCD820C <sup>(1)</sup>	
2.5	2.5	1.5	60	0.4	2.2	15		5-6	FCD820D <sup>(1)</sup>	
3.0	3.0	1.5	60	0.4	2.0	10		5-9	FCD825 <sup>(1, 5)</sup>	
3.0	3.0	1.5	60	0.4	2.0	10		5-9	FCD825A <sup>(1, 5)</sup>	
3.0	3.0	1.5	60	0.4	2.0	10		5-9	FCD825B <sup>(1, 5)</sup>	
3.0	3.0	1.5	60	0.4	2.0	10		5-9	FCD825C <sup>(1, 5)</sup>	
3.0	3.0	1.5	60	0.4	2.0	10		5-9	FCD825D <sup>(1, 5)</sup>	
1.6	1.6	1.5	60	0.4	2.0	10		5-11	FCD830 <sup>(2, 3)</sup>	
1.6	1.6	1.5	60	0.4	2.2	15		5-11	FCD830A <sup>(2)</sup>	
1.6	1.6	1.5	60	0.4	2.2	15		5-11	FCD830B <sup>(2)</sup>	
1.6	1.6	1.5	60	0.4	2.2	15		5-11	FCD830C <sup>(2)</sup>	

# Couplers (Cont'd)

Coupled Characteristics		Input Diode Characteristics		Output Transistor Characteristics			Output Darlington Characteristics		Data Sheet Page No.	Device No.
$T_r$ $\mu s$ Typ	$t_f$ $\mu s$ Typ	$V_F$ V Max	@ $I_F$ mA	$V_{CE(sat)}$ V Max	@ $I_C$ mA	@ $I_F$ mA	$I_{CEO}$ $\mu A$ Max	@ $V_{CE}$ V		
1.6	1.6	1.5	60	0.4	2.2	15			5-11	FCD830D <sup>(2)</sup>
1.6	1.6	1.5	60	0.5	2.0	50			5-13	FCD831 <sup>(2)</sup>
1.6	1.6	1.5	60	0.5	2.0	50			5-13	FCD831A <sup>(2)</sup>
1.6	1.6	1.5	60	0.5	2.0	50			5-13	FCD831B <sup>(2)</sup>
1.6	1.6	1.5	60	0.5	2.0	50			5-13	FCD831C <sup>(2)</sup>
1.6	1.6	1.5	60	0.5	2.0	50			5-13	FCD831D <sup>(2)</sup>
1.6	1.6	1.5	20	0.7	2.0	50			5-15	FCD836 <sup>(2)</sup>
1.6	1.6	1.5	20	0.7	2.0	50			5-15	FCD836C <sup>(2)</sup>
1.6	1.6	1.5	20	0.7	2.0	50			5-15	FCD836D <sup>(2)</sup>
15	150	1.5	20	1.0	50	50	0.1	10	5-17	FCD850
15	150	1.5	20	1.0	50	50	0.1	10	5-17	FCD850C
15	150	1.5	20	1.0	50	50	0.1	10	5-17	FCD850D
15	150	1.5	20	1.0	50	50	0.1	10	5-17	FCD855
15	150	1.5	20	1.0	50	50	0.1	10	5-17	FCD855C
15	150	1.5	20	1.0	50	50	0.1	10	5-17	FCD855D
80	150	1.5	20	1.0	2.0	1.0	0.1	10	5-19	FCD860 <sup>(3)</sup>
80	150	1.5	20	1.0	2.0	1.0	0.1	10	5-19	FCD860C <sup>(3)</sup>
80	150	1.5	20	1.0	2.0	1.0	0.1	10	5-19	FCD860D <sup>(3)</sup>
80	150	1.5	20	1.0	2.0	1.0	0.1	10	5-19	FCD865 <sup>(3)</sup>
80	150	1.5	20	1.0	2.0	1.0	0.1	10	5-19	FCD865C <sup>(3)</sup>
80	150	1.5	20	1.0	2.0	1.0	0.1	10	5-19	FCD865D <sup>(3)</sup>



Device No.	Output	Max Ratings @ $T_A = 25^\circ\text{C}$					Coupled Characteristics			
		$P_D$ mW	Transistor $I_C$ mA	$V_{CE0}$ V	Diode $V_R$ V	$I_F$ mA	$V_{ISO}$ kV	Min Current Transfer Ratio $I_C/I_F$ %	@ $I_F$ mA	@ $V_{CE}$ V
H11A1	Trans	250	100	30	3.0	60	2.5	50	10	10
H11A2	Trans	250	100	30	3.0	60	1.5	20	10	10
H11A3	Trans	250	100	30	3.0	60	2.5	20	10	10
H11A4	Trans	250	100	30	3.0	60	1.5	10	10	10
H11B1	Darlg	250	100	25	3.0	60	2.5	50	10	5.0
H11B2	Darlg	250	100	25	3.0	60	1.5	20	10	5.0
H11D1	Trans	250	25	300	6.0	50	2.5	20	10	10
H11D2	Trans	250	25	300	6.0	50	1.5	20	10	10
H11D3	Trans	250	25	200	6.0	50	1.5	20	10	10
H11D4	Trans	250	25	200	6.0	50	1.5	10	10	10
MCA230	Darlg	300	0.1	30	3.0	60	1.5	40	10	5.0
MCA231 <sup>(3)</sup>	Darlg	300	0.1	30	3.0	60	1.5	4.0	1.0	1.0
MCA255	Darlg	300	0.1	55	3.0	60	1.5	40	10	5.0
MCT2	Trans	250	—	30	3.0	60	1.5	20	10	10
MCT2E	Trans	250	—	30	3.0	60	2.5	20	10	10
MCT26	Trans	250	—	30	3.0	60	1.5	6.0	10	10
TIL 111 <sup>(3)</sup>	Trans	250	—	30	3.0	100	1.5	7.0	16	0.4
TIL 112	trans	250	—	20	3.0	100	1.5	2.0	10	5.0
TIL 113 <sup>(3)</sup>	Trans	250	—	30	3.0	100	1.5	100	10	1.0
TIL 114 <sup>(3)</sup>	Trans	250	—	30	3.0	100	2.5	7.0	16	0.4
TIL 115	Trans	250	—	20	3.0	100	2.5	2.0	10	5.0
TIL 116	Trans	250	—	30	3.0	100	2.5	5.0	10	10
TIL 117	Trans	250	—	30	3.0	100	2.5	9.0	10	10
TIL 118	Trans	250	—	20	3.0	100	1.5	10	10	5.0
TIL 119	Darlg	250	—	30	3.0	100	1.5	160	10	2.0

**Notes**

- Standard Transistor output
- High-speed transistor output  
guaranteed 2.0  $\mu\text{s}$  max  $t_r$  and  $t_f$  with 100  $\Omega$   $R_L$   
8.0  $\mu\text{s}$  typ at 1 k $\Omega$   $R_L$
- CTR guaranteed with transistor in saturation
- JEDEC registered data and conditions
- CTR typ at 1.0 mA = 40%

# Couplers (Cont'd)

Coupled Characteristics		Input Diode Characteristics		Output Transistor Characteristics			Output Darlington Characteristics		Data Sheet Page No.	Device No.
$T_r$ $\mu s$ Typ	$t_f$ $\mu s$ Typ	$V_F$ V Max	@ $I_F$ mA	$V_{CE(sat)}$ V Max	@ $I_C$ mA	@ $I_F$ mA	$I_{CEO}$ $\mu A$ Max	@ $V_{CE}$ V		
2.0	2.0	1.5	10	0.4	0.5	10			5-25	H11A1
2.0	2.0	1.5	10	0.4	0.5	10			5-25	H11A2
2.0	2.0	1.5	10	0.4	0.5	10			5-25	H11A3
2.0	2.0	1.5	10	0.4	0.5	10			5-25	H11A4
125	100	1.5	10	1.0	1.0	1.0	0.1	10	5-27	H11B1
125	100	1.5	10	1.0	1.0	1.0	0.1	10	5-27	H11B2
5.0	5.0	1.5	10	0.4	0.5	10			5-29	H11D1
5.0	5.0	1.5	10	0.4	0.5	10			5-29	H11D2
5.0	5.0	1.5	10	0.4	0.5	10			5-29	H11D3
5.0	5.0	1.5	10	0.4	0.5	10			5-29	H11D4
40	50	1.5	20	1.0	50	50	0.1	10	5-33	MCA230
40	50	1.5	20	1.0	2.0	1.0	0.1	10	5-33	MCA231 <sup>(3)</sup>
40	50	1.5	20	1.0	50	50	0.1	10	5-33	MCA255
2.5	2.5	1.5	20	0.4	2.0	16			5-35	MCT2
2.5	2.5	1.5	20	0.4	2.0	16			5-35	MCT2E
2.5	2.5	1.5	20	0.5	1.6	60			5-35	MCT26
2.5	2.5	1.4	16	0.4	2.0	16			5-40	TIL111 <sup>(3)</sup>
15.0	15.0	1.4	16	0.5	2.0	50			5-43	TIL112
50	50	1.5	10	1.0	125	50	0.1	10	5-45	TIL113 <sup>(3)</sup>
2.0	2.0	1.4	16	0.4	2.0	16			5-40	TIL114 <sup>(3)</sup>
15.0	15.0	1.5	10	0.5	2.0	50			5-43	TIL115
2.0	2.0	1.5	60	0.4	2.2	15			5-40	TIL116
2.0	2.0	1.4	16	0.4	0.5	10			5-40	TIL117
15.0	15.0	1.5	10	0.5	2.0	50			5-43	TIL118
50	50	1.5	10	1.0	10	10	0.1	10	5-45	TIL119

Device No.	Output	Max Ratings @ $T_A = 25^\circ\text{C}$					Coupled Characteristics			
		$P_D$ mW	Transistor		Diode		Min Current Transfer Ratio			
			$I_C$ mA	$V_{CE0}$ V	$V_R$ V	$I_F$ mA	$V_{ISO}$ kV	$I_C/I_F$ %	$@I_F$ mA	$@V_{CE}$ V
4N25 <sup>(4)</sup>	Trans	250	—	30	3.0	80	2.5	20	10	10
4N26 <sup>(4)</sup>	Trans	250	—	30	3.0	80	1.5	20	10	10
4N27 <sup>(4)</sup>	Trans	250	—	30	3.0	80	1.5	10	10	10
4N28 <sup>(4)</sup>	Trans	250	—	30	3.0	80	0.5	10	10	10
4N29 <sup>(4)</sup>	Darlg	250	125	30	3.0	80	2.5	100	10	10
4N30 <sup>(4)</sup>	Darlg	250	125	30	3.0	80	1.5	100	10	10
4N31 <sup>(4)</sup>	Darlg	250	125	30	3.0	80	1.5	50	10	10
4N32 <sup>(4)</sup>	Darlg	250	125	30	3.0	80	2.5	500	10	10
4N33 <sup>(4)</sup>	Darlg	250	125	30	3.0	80	1.5	500	10	10
4N35 <sup>(4)</sup>	Trans	300	—	30	6.0	60	3.5	100	10	10
4N36 <sup>(4)</sup>	Trans	300	—	30	6.0	60	2.5	100	10	10
4N37 <sup>(4)</sup>	Trans	300	—	30	6.0	60	1.5	100	10	10

**Notes**

- Standard Transistor output
- High-speed transistor output  
guaranteed  $2.0 \mu\text{s}$  max  $t_r$  and  $t_f$  with  $100 \Omega R_L$   
 $8.0 \mu\text{s}$  typ at  $1 \text{ k}\Omega R_L$
- CTR guaranteed with transistor in saturation
- JEDEC registered data and conditions
- CTR typ at  $1.0 \text{ mA} = 40\%$

# Couplers (Cont'd)

Coupled Characteristics		Input Diode Characteristics		Output Transistor Characteristics			Output Darlington Characteristics		Data Sheet Page No.	Device No.
$T_r$ $\mu s$ Typ	$t_f$ $\mu s$ Typ	$V_F$ V Max	@ $I_F$ mA	$V_{CE(sat)}$ V Max	@ $I_C$ mA	@ $I_F$ mA	$I_{CEO}$ $\mu A$ Max	@ $V_{CE}$ V		
2.5	2.5	1.5	50	0.5	2.0	50			5-47	4N25 <sup>(4)</sup>
2.5	2.5	1.5	50	0.5	2.0	50			5-47	4N26 <sup>(4)</sup>
2.5	2.5	1.5	50	0.5	2.0	50			5-47	4N27 <sup>(4)</sup>
2.5	2.5	1.5	50	0.5	2.0	50			5-47	4N28 <sup>(4)</sup>
10	45	1.5	50	1.0	2.0	8.0	0.1	10	5-49	4N29 <sup>(4)</sup>
10	45	1.5	50	1.0	2.0	8.0	0.1	10	5-49	4N30 <sup>(4)</sup>
10	45	1.5	50	1.2	2.0	8.0	0.1	10	5-49	4N31 <sup>(4)</sup>
10	120	1.5	50	1.0	2.0	8.0	0.1	10	5-49	4N32 <sup>(4)</sup>
10	120	1.5	50	1.0	2.0	8.0	0.1	10	5-49	4N33 <sup>(4)</sup>
8.0	8.0	1.5	10	0.3	0.5	10			5-51	4N35 <sup>(4)</sup>
8.0	8.0	1.5	10	0.3	0.5	10			5-51	4N36 <sup>(4)</sup>
8.0	8.0	1.5	10	0.3	0.5	10			5-51	4N37 <sup>(4)</sup>

Device No.	Output	Max Ratings @ $T_A = 25^\circ\text{C}$					Coupled Characteristics			
		$P_D$ mW	Transistor		Diode		Min Current Transfer Ratio			
			$I_C$ mA	$V_{CE0}$ V	$V_R$ V	$I_F$ mA	$V_{ISO}$ kV	$I_C/I_F$ %	@ $I_F$ mA	@ $V_{CE}$ V
FCD880	Trans	400	30	30	3.0	60	2.5	30	10	10
FCD885	Trans	400	30	30	3.0	60	2.5	10	10	10
FCD890	Darlg	400	30	30	3.0	60	2.5	200	1.0	1.0
ILD74	Trans	150	30	20	3.0	100	1.5	12.5	16	5.0
MCT6	Trans	100	30	30	3.0	60	1.5	20	10	10
MCT66	Trans	100	30	30	3.0	60	1.5	6	10	10

**Notes**

1. Standard Transistor output
2. High-speed transistor output  
guaranteed  $2.0 \mu\text{s}$  max  $t_r$  and  $t_f$  with  $100 \Omega R_L$   
 $8.0 \mu\text{s}$  typ at  $1 \text{ k}\Omega R_L$
3. CTR guaranteed with transistor in saturation
4. JEDEC registered data and conditions
5. CTR typ at  $1.0 \text{ mA} = 40\%$

# Dual Couplers

1

Coupled Characteristics		Input Diode Characteristics		Output Transistor Characteristics			Output Darlington Characteristics		Data Sheet Page No.	Device No.
$T_r$ $\mu s$ Typ	$t_f$ $\mu s$ Typ	$V_F$ V Max	@ $I_F$ mA	$V_{CE(sat)}$ V Max	@ $I_C$ mA	@ $I_F$ mA	$I_{CEO}$ $\mu A$ Max	@ $V_{CE}$ V		
2.0	2.0	1.5	60	0.4	2.0	16			5-21	FCD880
2.0	2.0	1.5	60	0.3	2.5	20			5-21	FCD885
80	80	1.5	20	1.0	2.0	1.0	0.1	10	5-23	FCD890
6.0	6.0	1.3	60	0.5	2.0	16			5-31	ILD74
2.0	2.0	1.5	20	0.4	2.0	16			5-38	MCT6
2.0	2.0	1.5	20	0.4	2.0	40			5-38	MCT66

# LCD Large Area Displays

Device No. (Note 1)	No. Digits	Digit Height in. (mm)	Package Size in. (mm)	Connector Type	Description	Data Sheet Page No.
FLB1208X1	12	.30 (7.6)	3.00 (76.20) × .866 (22.00)	Elastomer	Decimal after each digit	6-3
FLB3511X1	3½	.45 (11.4)	2.00 (50.80) × 1.20 (30.48)	Elastomer <sup>2</sup>	Decimals, Colon, ±, "BT" Indicator	6-6
FLB3513X1	3½	.50 (12.5)	2.00 (50.80) × 1.20 (30.48)	Elastomer	Decimals, Colon, ±, Arrow Indicator	6-9
FLB3513X2	3½	.50 (12.5)	2.00 (50.80) × 1.20 (30.48)	Pins	Decimals, Colon, ±, Arrow Indicator	6-9
FLB3513X3	3½	.50 (12.5)	2.00 (50.80) × 1.20 (30.48)	Elastomer	Decimals, Colon, ±, "LO BAT" Indicator	6-12
FLB3513X4	3½	.50 (12.5)	2.00 (50.80) × 1.20 (30.48)	Pins	Decimals, Colon, ±, "LO BAT" Indicator	6-12
FLB4010X1	4	.40 (10.2)	2.70 (68.58) × .866 (22.00)	Elastomer	Stereo Radio, Cassette Readout; Decimal, Colon, Stereo, Dolby™, AM, FM, PM, Cassette and Tape Direction Indicators	6-15
FLB4013X1	4	.50 (12.5)	2.00 (50.80) × 1.20 (30.48)	Elastomer	Decimals, Colon	6-17
FLB4013X2	4	.50 (12.5)	2.00 (50.80) × 1.20 (30.48)	Pins	Decimals, Colon	6-17
FLB4018X1	4	.70 (17.8)	2.75 (69.85) × 1.50 (38.10)	Elastomer	Decimals, Colon	6-20
FLB4018X2	4	.70 (17.8)	2.75 (69.85) × 1.50 (38.10)	Pins	Decimals, Colon	6-20
FLB8009X1	8	.35 (9.0)	3.00 (76.20) × .866 (22.00)	Elastomer	14-Seg, Alphanumeric, Upper and Lower Decimal	6-23

#### Notes

1. X specifies polarizer configuration
  2. All connections made from side of display
- ™ Dolby and the double-D symbol are trademarks of Dolby Laboratories

# LCD Watch Displays

1

Device No. (Note 1)	No. Digits	Digit Height in. (mm)	Package Size in. (mm)	Special Features	Data Sheet Page No.
FLB350401	3½	.160 (4.40)	.590 (15.00) × .354 (9.00)	Colon	6-27
FLB350407	3½	.150 (3.81)	.590 (15.00) × .354 (9.00)	Colon, Alarm Bell, P Annunciator	6-28
FLB350501	3½	.180 (4.57)	.808 (20.52) × .520 (13.21)	Colon	6-29
FLB350502	3½	.200 (5.08)	.827 (21.00) × .460 (11.70)	Colon	6-30
FLB350508	3½	.200 (5.08)	.808 (20.52) × .520 (13.21)	Colon, Alarm Bell, P Annunciator	6-31
FLB350601	3½	.220 (5.59)	.808 (20.52) × .520 (13.21)	Colon	6-32
FLB350701	3½	.263 (6.68)	.910 (23.10) × .570 (14.48)	Colon	6-33
FLB450401*	4½	.150 (3.81)	.590 (15.00) × .354 (9.00)	Colon, Alarm & PM Indicators	6-34
FLB450501*	4½	.200 (5.08)	.808 (20.52) × .520 (13.21)	Colon, Alarm & PM Indicators	6-35
FLB550503	5½	.210 (5.35)	.910 (23.10) × .570 (14.48)	Colon, Date, Day of Week Flags	6-36
FLB600301	6	.118 (3.00)	.583 (14.80) × .354 (9.00)	European Colon, A/N, Flag (1)	6-37
FLB600506	6	.190 (4.82)	.827 (21.00) × .460 (11.70)	European Colon, A/N, Flag (1)	6-38
FLB600601	6	.220 (5.59)	.941 (23.90) × .453 (11.50)	European Colon, A/N, Flag (1)	6-39
FLB600602	6	.220 (5.59)	.941 (23.90) × .453 (11.50)	European Colon, A/N, Flag (1)	6-40
FLB650401	6	.157 (4.00)	.910 (23.10) × .570 (14.48)	Colon, Chrono, Date, Alarm, A/N	6-41

\*1980 proposed new product





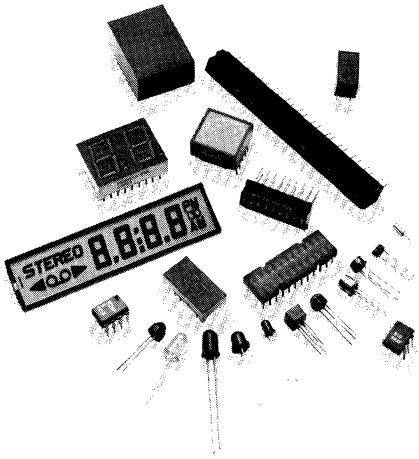

Selection Guides	1
Visible LED Lamps and Mounting Hardware	2
LED Digits	3
Phototransistors, Infrared Emitters and Sensors	4
Couplers	5
Liquid Crystal Displays	6
Fiber Optics	7
Cross Reference	8
Definitions of Symbols and Terms	9
Fairchild Field Sales Offices, Sales Representatives and Distributor Locations	10



# Front Panel Adapter For LED Lamp

Optoelectronic Products

## FLS010

### General Description

The FLS010 is a panel mount adapter specially designed for use with all Fairchild .200-inch LED lamps.

### Single Part Construction

### Simple Assembly Technique

**Black Finish Gives Maximum On/Off Contrast**

**Fits Panels .060-Inch to .250-Inch Thick**

**Fits Lamps .280-Inch Through .360-Inch Tall**

**Removable From Either Front Or Rear**

**Orients To Flat On LED For Easy Polarity Inspection**

**Nearly Flush With Front Panel Surface**

**Requires Standard H-Size Drill Hole In Panel**

### Mounting Instructions

1. The panel hole for the mounting clip should be 0.265-inch ( $\pm .002$ ), and the hole edges should be deburred (this permits a 17/64-inch or H-sized drill to be used).
2. Insert the LED, lens first, with the flat flush against the tab, into the tab end of the clip. Press firmly until the tab snaps over the flat and locks the unit into the clip.
3. Insert the mounting clip and LED assembly into the panel hole, pins first, from the front side of the panel. Use a hollowed cylinder with an internal diameter greater than .200-inch and less than .24-inch (i.e., either a piece of 3/8-inch poly-flo tubing or 3/16-inch nut driver) to "press fit" the clip into the panel until the flange is seated snugly on the panel.

### Dimensional Data

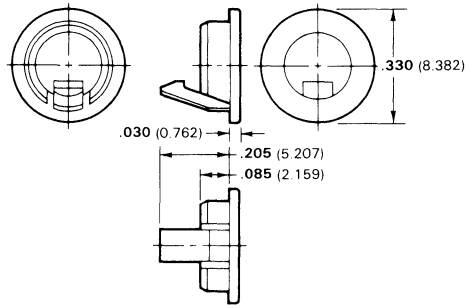

### Typical Mounting Technique

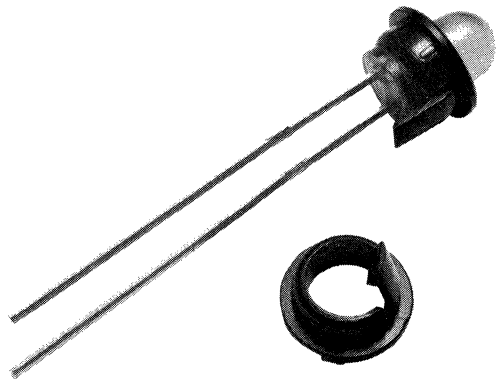
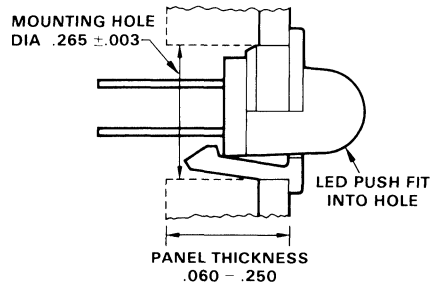

# Red GaAsP LED Lamps

Optoelectronic Products

# FLV100 FLV101 FLV102

## General Description

The FLV100, FLV101 and FLV102 are red light-emitting diodes encapsulated in plastic. Each light source is contained in a black case, giving excellent contrast when on, yet appearing black when off.

**High Brightness—1500 fL @ 200 mA**  
**Low Power Consumption—IC Compatible**  
**Vibration/Shock Resistant**  
**High On/Off Contrast**  
**FLV100 Is A Highly Intense Point Source**  
**FLV101 Is A Highly Diffused Light Source**  
**Viewable Over A Full 180° Angle**  
**Frosted Surface Eliminates**  
**Glare From Ambient Light**  
**FLV102 Is A Large-Area Light Source**

## Absolute Maximum Ratings

### Maximum Temperature and Humidity

Storage Temperature	-40°C to +100°C
Operating Temperature	-40°C to +100°C
Pin Temperature (Soldering 5 s .1-inch from seating plane)	250°C
Relative Humidity at 65°C	98%

### Maximum Power Dissipation

Total Dissipation at $T_A = 25^\circ\text{C}$	100 mW
Derate Linearly from 25°C	1.3 mW / °C

### Maximum Voltage and Currents

$V_R$ Reverse Voltage	3.0 V
$I_F$ Forward dc Current	50 mA

## Package Outlines

### FLV100/101

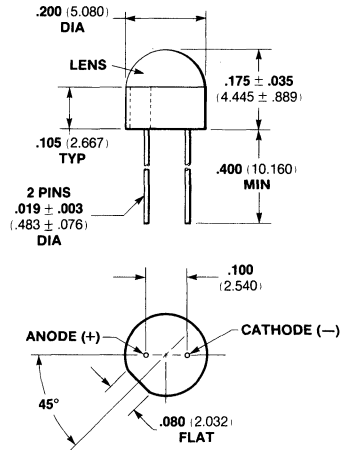

### FLV102

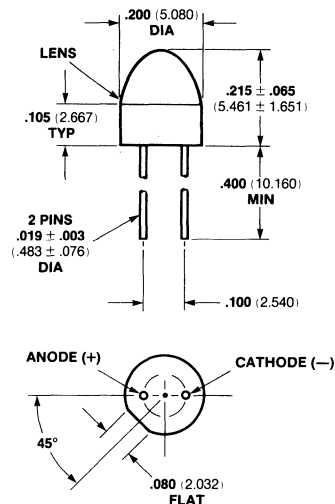

## Notes

\*Package height of the FLV102 is .190-.260 (4.826-6.604)  
 All dimensions in inches **bold** and millimeters (parentheses)  
 All pins electrically isolated from case  
 Tolerance unless specified =  $\pm .015$  ( $\pm .381$ )

# Typical Electrical Characteristic Curves

# FLV100 FLV101 FLV102

## Electrical and Radiant Characteristics $T_A = 25^\circ\text{C}$

Symbol	Characteristic	Min	Typ	Max	Units	Test Conditions
$V_F$	Forward Voltage		1.7	2.0	V	$I_F = 20\text{ mA}$
$BV_R$	Reverse Breakdown Voltage	3.0	8.0		V	$I_R = 10\ \mu\text{A}$
$I_O$	Axial Luminous Intensity					
	FLV100	.15	0.5		mcd	$I_F = 20\text{ mA}$
	FLV101	.10	0.45		mcd	
	FLV102	0.3	1.0		mcd	
$\lambda_{pk}$	Peak Wavelength		665			$I_F = 20\text{ mA}$
$\theta_{1/2}$	Angle of Half Intensity					
	FLV100		80		degrees	$I_F = 20\text{ mA}$
	FLV101		80		degrees	
	FLV102		30		degrees	

2

**Relative Intensity vs Viewing Angle**

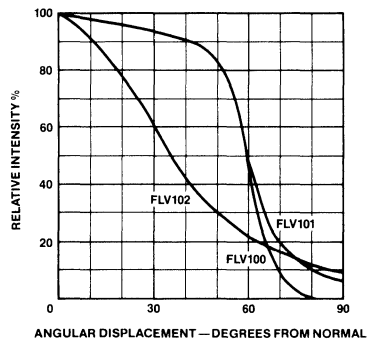

**Emission Spectrum**

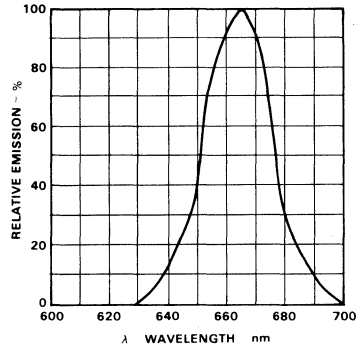

**Forward Current ( $I_F$ ) vs Forward Voltage ( $V_F$ )**

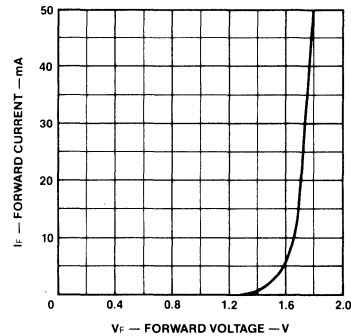

**Brightness vs Forward Current ( $I_F$ )**

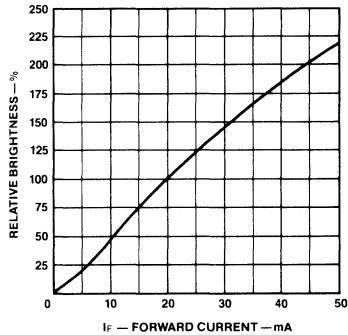

# Narrow Beam GaAsP Lamps

Optoelectronic Products

## FLV104 FLV104A

### General Description

The FLV104 and FLV104A, narrow beam visible lamps, are high-intensity sources specifically intended for excitation of photosensors, especially photodiodes and transistors, when the separation distances are measured from millimeters to several meters.

The FLV104 and FLV104A are visible beam companion devices to the FPE104 infrared LED. All three devices have identical optics and therefore identical radiation patterns.

### Very High Axial Intensity

#### Narrow Beamwidth

FLV104 8°

FLV104A 4°

Detectable at 30 ft

### Absolute Maximum Ratings

#### Maximum Temperatures and Humidity

Storage Temperature	-55°C to +100°C
Operating Temperature	-55°C to +125°C
Pin Temperature (Soldering, 5 s)	260°C
Relative Humidity at 65°C	98%

#### Maximum Power Dissipation

Total Dissipation at $T_A = 25^\circ\text{C}$	200 mW
Derate Linearly from 25°C	2.6 mW/°C

#### Maximum Voltages and Currents

$V_R$	Reverse Voltage	3.0 V
$I_F$	Forward dc Current	1.0 A
$I_{pk}$	Peak Forward Current (100 $\mu\text{s}$ pulsewidth, 1% duty cycle)	100 mA

### Electrical Characteristics $T_A = 25^\circ\text{C}$

Symbol	Characteristic	Min	Typ	Max	Units	Test Conditions
$V_F$	Forward Voltage		2.0	2.5	V	$I_F = 100 \text{ mA}$
$BV_R$	Reverse Breakdown Voltage	3.0	8.0		V	$I_R = 10 \mu\text{A}$

### Package Outline

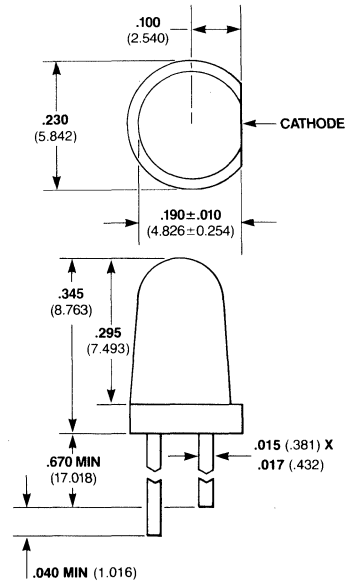

#### Notes

All dimensions in inches **bold** and millimeters (parentheses)  
Tolerance unless specified =  $\pm .015$  ( $\pm .381$ )

# Typical Electrical Characteristics

# FLV104 FLV104A

## Optoelectronic Characteristics $I_F = 100 \text{ mA}$ , $T_A = 25^\circ \text{C}$

Symbol	Characteristic	Min	Typ	Max	Units
$I_L$	Axial Luminous Intensity	50	150		mcd
$I$	Axial Radiometric Intensity		4.0		mw/sr
$L$	Average Effective Luminance		5.0		cd/cm <sup>2</sup>
$N$	Average Effective Radiance (Axial)		140		mw/sr/cm <sup>2</sup>
$A_s$	Effective Emitting Source Area (Axial)		0.028		cm <sup>2</sup>
$\Delta I / \Delta T$	Temperature Coefficient of Intensity (Note 1)		0.5		%/°C
$\Delta I \Delta I_F$	Excitation Coefficient of Intensity (Note 1)		1.0		%/°C
$\lambda_{pk}$	Peak Spectral Wavelength		670		nm
$\Delta \lambda$	Spectral Bandwidth		20		nm
$\Delta \lambda_{pk} / \Delta T$	Temperature Spectral Shift Coefficient (Note 2)		0.17		nm/°C
$\Delta \lambda_{pk} / \Delta T_F$	Excitation Spectral Shift Coefficient (Note 2)		0.1		nm/mA
$\theta_{50}$	Beam Angle at 50% Axial Intensity		4.3		degrees
$\Delta \theta_A$	Beam Axis to Mechanical Axis		1.5		degrees
$t_r$ and $t_f$	Light Output Rise and Fall Time (Note 3)		10		ns
$C_o$	Capacitance ( $V = 0$ , $f = 1.0 \text{ MHz}$ )		100		pF

2

### Beam Pattern of Intensity

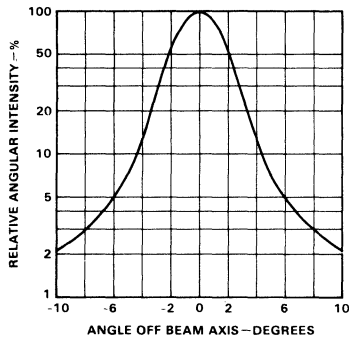

### Spot Diameter vs Separation Distance (Near Field)

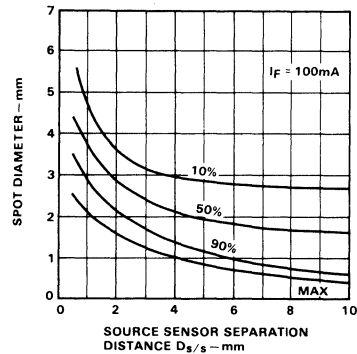



# Typical Electrical Characteristic Curves

# FLV104 FLV104A

## Spot Diameter vs Separation Distance (Near Field)

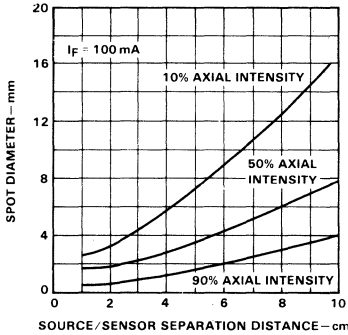

## Forward V-I Characteristics

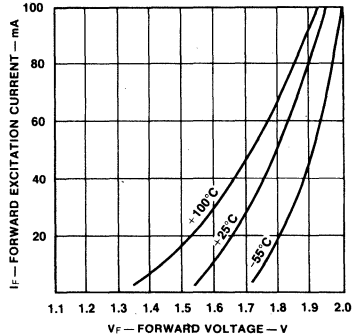

## Average Axial Irradiance, H (Note 6)

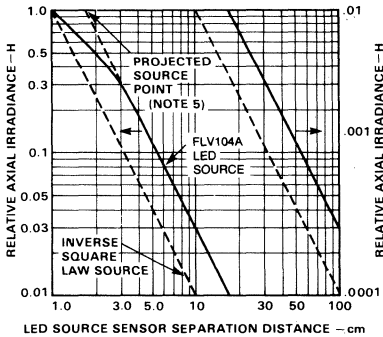

## Emission Spectrum

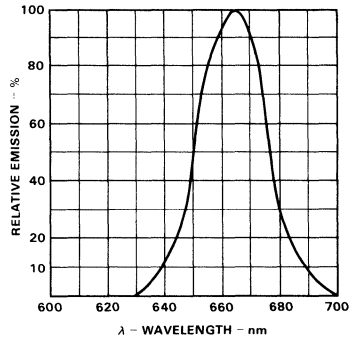

## Relative Radiometric Output (Note 4)

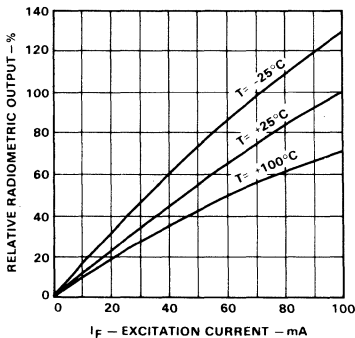

## Notes

- $\Delta I/\Delta T$  and  $\Delta I/\Delta I_F$  are the percentage derating factors for all radiometric output characteristics referenced to their typical value at 25°C ambient and  $I_F = 100$  mA.
  - $\Delta \lambda_{pk}/\Delta T$  and  $\Delta \lambda_{pk}/\Delta I_F$  are the derating factors for all wavelength characteristics referenced to their typical value at 25°C ambient and  $I_F = 100$  mA.
  - Time for a 10% to 90% change in light intensity with a step change in current.
  - Normalization: LED intensity  $\approx 10$  mW/sr sensor  $1 \text{ mm}^2$  area.
  - Projected source point is the distance,  $S_p$  from which LED inverse square LAW characteristics may be computed for  $S \geq 5$  cm.
- $$H = \frac{1.0 \text{ mW}}{\text{cm}^2} \times \frac{S_p^2}{(S - S_p)^2} \quad 1 < S_p < S_{cm}$$
- Irradiance (H) normalized to  $4 \text{ mW/cm}^2$  @  $S = 1$  cm.

# Narrow Beam Shape

## FLV104 FLV104A

### Narrow Beam Shape

FLV104

2

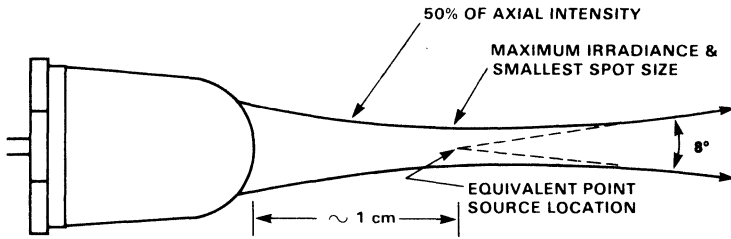

FLV104A

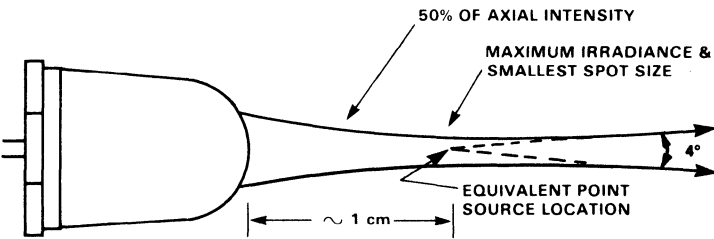

# Red GaAsP LED Lamps

Optoelectronic Products

# FLV110, FLV140 FLV150, FLV160

## General Description

The FLV110, FLV140, FLV150 and FLV160 are red light-emitting diodes encapsulated in diffused plastic. These LED devices provide an intense large-area light source with wide-angle viewing. Visual light emission is in the 600 nm to 700 nm range.

## Solid State Thus No Replacement Required

### No Socket Required

### High On/Off Contrast

### Flexible Pin On FLV110, FLV140 and FLV150

#### For Good Heat Sinking

#### For Right-Angle Bending

#### Fits Standard Sockets and Drilled Holes

### Heavy Copper Leads On FLV160

#### For Wire Wrapping

#### For Rigid Standoff From PC Board

### Single Molded Body Eliminates

#### Thermal Cycling Problems

### High-Temperature Epoxy Encapsulation Withstands

#### Severe Environmental Temperatures

### Low Power Consumption Means IC Compatibility

## Absolute Maximum Ratings

### Maximum Temperature and Humidity

Storage Temperature  $-55^{\circ}\text{C}$  to  $+100^{\circ}\text{C}$

Operating Temperature  $-55^{\circ}\text{C}$  to  $+100^{\circ}\text{C}$

Pin Temperature (Soldering, 5 s)  $260^{\circ}\text{C}$

Relative Humidity at  $85^{\circ}\text{C}$  85%

### Maximum Power Dissipation

Total Dissipation at  $T_A = 25^{\circ}\text{C}$  120 mW

Derate Linearly from  $25^{\circ}\text{C}$  1.6 mW/ $^{\circ}\text{C}$

### Maximum Voltage and Currents

$V_R$  Reverse Voltage 3.0 V

$I_F$  Forward dc Current 50 mA

$I_{pk}$  Peak Forward Current  
(1.0  $\mu\text{s}$  pulse width) 1.0 A

## Package Outline

### FLV110

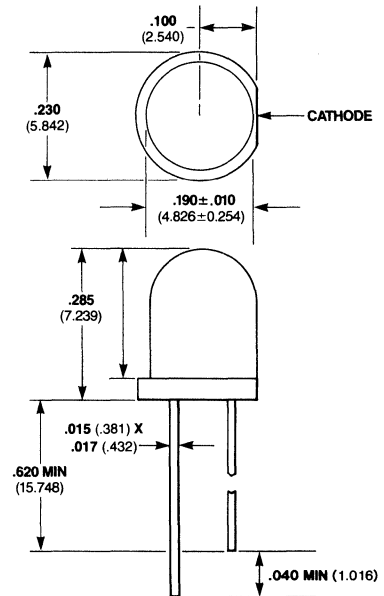

### Notes

All dimensions in inches **bold** and millimeters (parentheses)

Tolerance unless specified =  $\pm .015$  ( $\pm .381$ )

Other packages on following page

## Electrical and Radiant Characteristics $T_A = 25^{\circ}\text{C}$

Symbol	Characteristic	Min	Typ	Max	Units	Test Conditions
$V_F$	Forward Voltage		1.7	2.0	V	$I_F = 20$ mA
$BV_R$	Reverse Breakdown Voltage	3.0	8.0		V	$I_R = 10$ $\mu\text{A}$
$I_O$	Axial Luminous Intensity	0.8	2.0		mcd	$I_F = 20$ mA
$\theta_{1/2}$	Angle of Half Intensity		$\pm 35$		degrees	$I_F = 20$ mA
$\lambda_{pk}$	Peak Wavelength		665		nm	$I_F = 20$ mA

# Typical Electrical Characteristic Curves

# FLV 110, FLV 140 FLV 150, FLV 160

**Emission Spectrum**

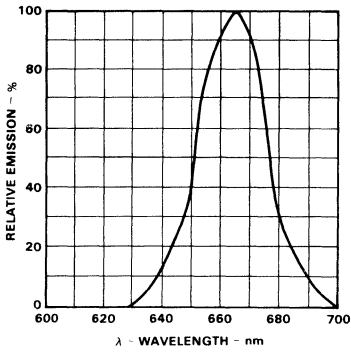

**Forward Current vs Forward Voltage**

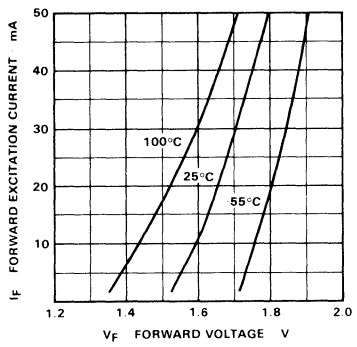

**Intensity vs Forward Current**

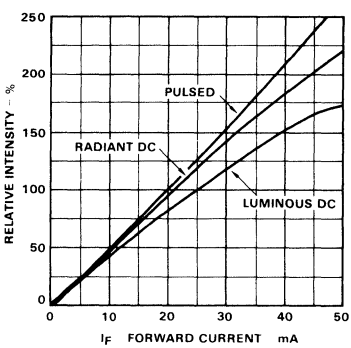

**Intensity vs Viewing Angle**

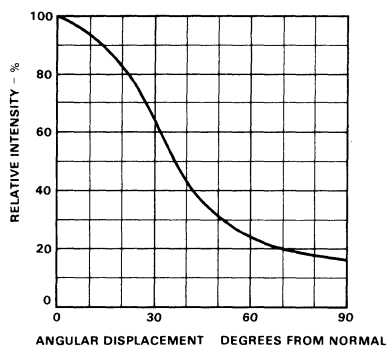

**Intensity vs Temperature**

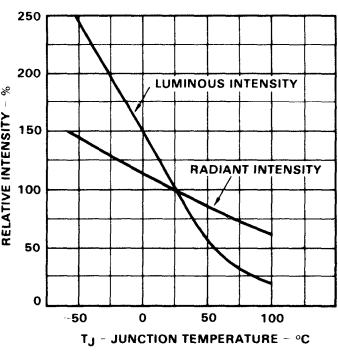

**Peak Wavelength vs Temperature**

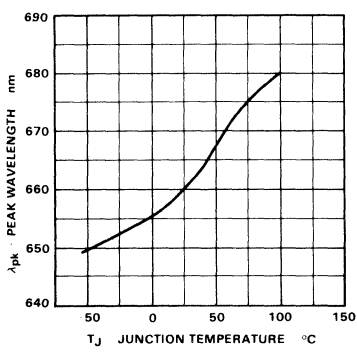



# Red GaAsP LED Lamps

Optoelectronic Products

# FLV111 FLV112 FLV117

2

## General Description

The FLV111 is a water clear version of the FLV110. The FLV112 is a diffused lens in clear (non-red) epoxy. FLV117 is a low-cost lamp encapsulated in diffused red epoxy. Visual light emission is in the 600-700 nm range.

**Solid State—No Replacement Required**  
**No Socket Required**  
**High On/Off Contrast**  
**Flexible Pins For Good Heat Sinking And Right-Angle Bending**  
**Fits Standard Sockets And Drilled Holes**  
**Single Molded Body Eliminates Thermal Cycling Problems**  
**High-Temperature Epoxy Encapsulation Withstands Severe Environmental Temperatures**  
**Low Power Consumption Means IC Compatibility**

## Absolute Maximum Ratings

### Maximum Temperature and Humidity

Storage Temperature	-55°C to +150°C
Junction Temperature	125°C
Pin Temperature (Soldering, 5 s)	260°C
Relative Humidity at 85°C	85%

### Maximum Power Dissipation

Total Dissipation at $T_A = 25^\circ\text{C}$	100 mW
Derate Linearly from 100°C	4.0 mW/°C

### Maximum Voltage and Currents

$V_R$ Reverse Voltage	3.0 V
$I_F$ Forward dc Current	50 mA
$I_{pk}$ Peak Forward Current (1.0 $\mu\text{s}$ pulse)	1.0 A

## Electrical and Radiant Characteristics $T_A = 25^\circ\text{C}$

Symbol	Characteristic	Min	Typ	Max	Units	Test Conditions
$V_F$	Forward Voltage		1.7	3.0	V	$I_F = 20\text{ mA}$
$BV_R$	Reverse Voltage		8.0		V	$I_R = 10\ \mu\text{A}$
$I_O$	Axial Luminous Intensity					
	FLV111, FLV112	0.8	2.0		mcd	$I_F = 20\text{ mA}$
	FLV117	0.2	1.0		mcd	$I_F = 20\text{ mA}$
$\theta_{1/2}$	Angle of Half Intensity				degrees	$I_F = 20\text{ mA}$
	FLV111, FLV112		$\pm 35$		degrees	$I_F = 20\text{ mA}$
	FLV117		$\pm 20$		degrees	$I_F = 20\text{ mA}$
$\lambda_{pk}$	Peak Wavelength		665		nm	$I_F = 20\text{ mA}$

## Package Outline

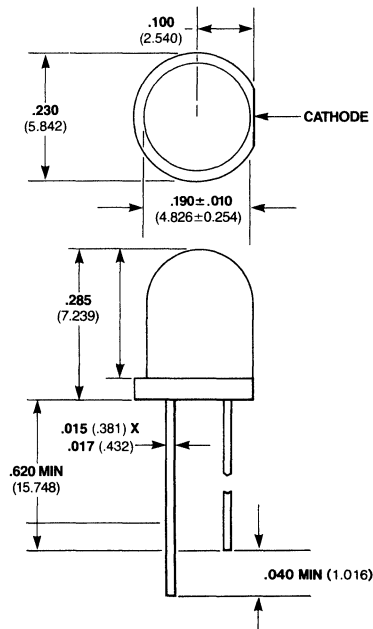

### Notes

All dimensions in inches **bold** and millimeters (parentheses)  
 Tolerance unless specified =  $\pm .015$  ( $\pm .381$ )

# Typical Electrical Characteristic Curves

# FLV111 FLV112 FLV117

**Emission Spectrum**

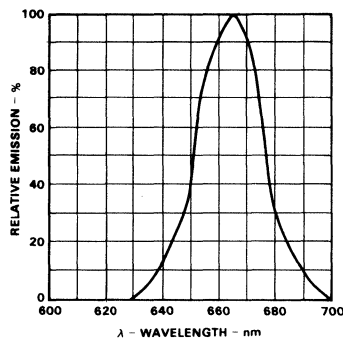

**Forward Current vs Forward Voltage**

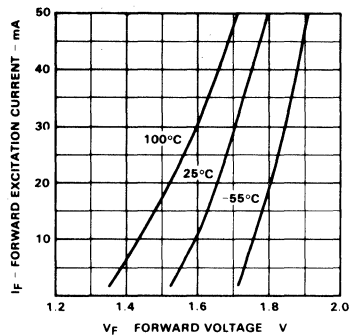

**Intensity vs Forward Current**

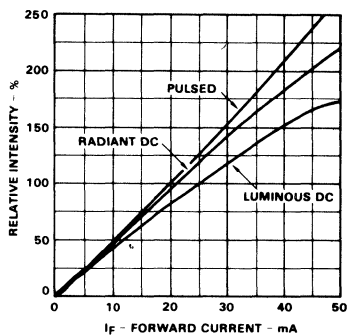

**Intensity vs Viewing Angle**

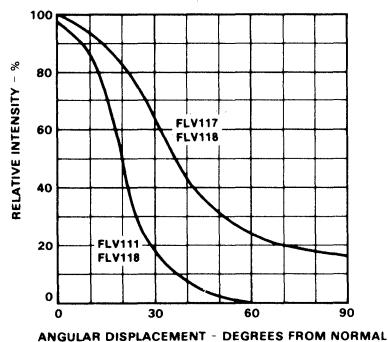

**Intensity vs Temperature**

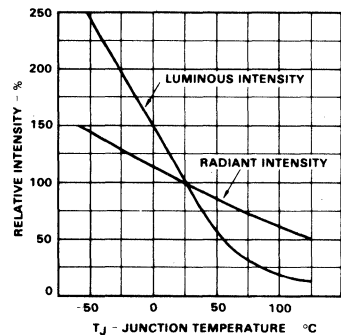

**Wavelength vs Temperature**

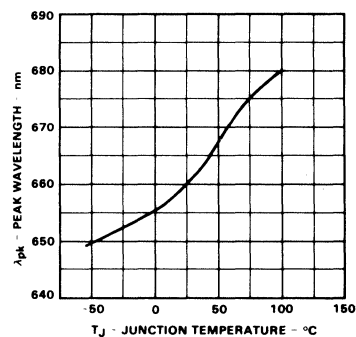

# Green GaP LED Lamps

Optoelectronic Products

# FLV310, FLV340 FLV350, FLV360

2

## General Description

The FLV310, FLV340, FLV350 and FLV360 are green light-emitting diodes encapsulated in green diffused plastic. These devices provide an intense large light source with wide-angle viewing. Visual light emission is in the 525 to 625 nm range.

## High Luminous Intensity For Room Ambient Light Levels

**Solid State Thus No Replacement Is Required**

**High On/Off Contrast**

**Flexible Pins On FLV310, FLV340 And FLV350**

**For Good Heat Sinking**

**For Right-Angle Bending**

**Fits Standard Sockets And Drilled Holes**

**Heavy Copper Pins On FLV360 For Wire Wrap**

**Applications And Rigid Standoff From PC Board**

**Single Molded Body Eliminates Thermal**

**Cycling Problems**

**High-Temperature Epoxy Encapsulation Withstands**

**Severe Environmental Temperatures**

**Low Power Means IC Compatibility**

## Package Outline

### FLV310

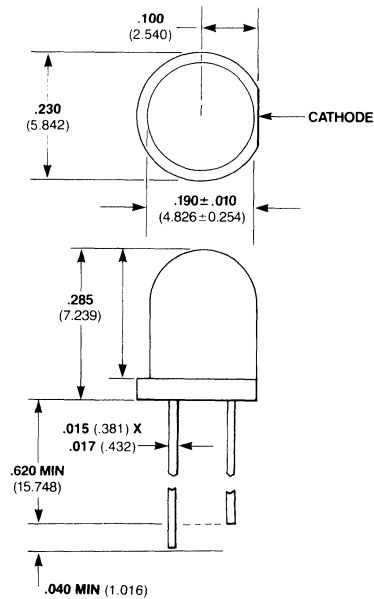

## Notes

All dimensions in inches **bold** and millimeters (parentheses)

Tolerance unless specified =  $\pm .015$  ( $\pm .381$ )

Other packages following

## Absolute Maximum Ratings

### Maximum Temperature and Humidity

Storage Temperature  $-55^{\circ}\text{C}$  to  $+100^{\circ}\text{C}$

Operating Temperature  $-55^{\circ}\text{C}$  to  $+100^{\circ}\text{C}$

Pin Temperature (Soldering, 5 s)  $260^{\circ}\text{C}$

Relative Humidity at  $85^{\circ}\text{C}$  85%

### Maximum Power Dissipation

Total Dissipation at  $T_A = 25^{\circ}\text{C}$  120 mW

Derate Linearly from  $50^{\circ}\text{C}$  1.6 mW/ $^{\circ}\text{C}$

### Maximum Voltage and Currents

$V_R$  Reverse Voltage 5.0 V

$I_F$  Forward dc Current 35 mA

$I_{pk}$  Peak Forward Current  
(1.0  $\mu\text{s}$  pulse width) 1.0 A

## Electrical and Radiant Characteristics $T_A = 25^{\circ}\text{C}$

Symbol	Characteristic	Min	Typ	Max	Units	Test Conditions
$V_F$	Forward Voltage		2.3	3.0	V	$I_F = 20$ mA
$BV_R$	Reverse Breakdown Voltage	5.0	18		V	$I_R = 100$ $\mu\text{A}$
$I_O$	Axial Luminous Intensity	1.6	3.2		mcd	$I_F = 20$ mA
$\theta_{1/2}$	Viewing Angle to Half Intensity		$\pm 25$		degrees	$I_F = 20$ mA
$\lambda_{pk}$	Peak Wavelength		565		nm	$I_F = 10$ mA



# Typical Electrical Characteristic Curves

# FLV310, FLV340 FLV350, FLV360

**Emission Spectrum**

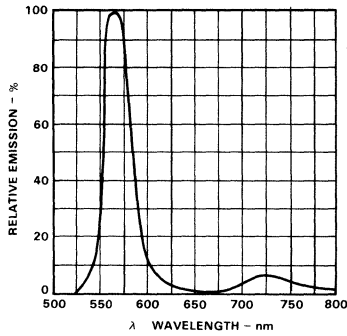

**Forward Current vs Forward Voltage**

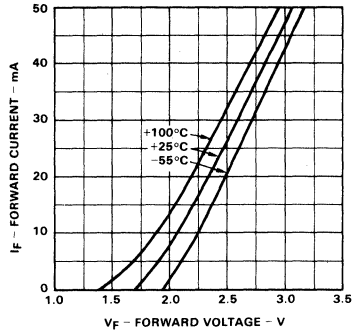

**Intensity vs Forward Current**

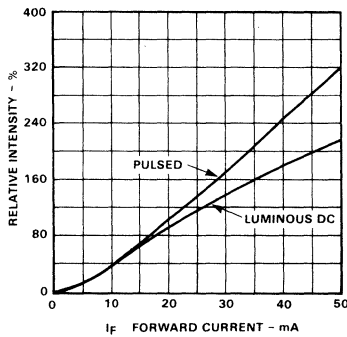

**Intensity vs Viewing Angle**

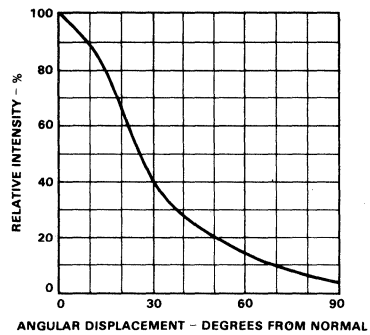

**Peak Wavelength vs Temperature**

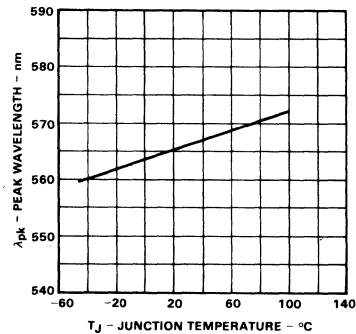

# Package Outlines

# FLV310, FLV340 FLV350, FLV360

**FLV340**

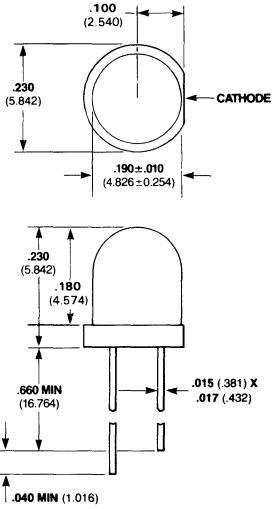

**FLV350**

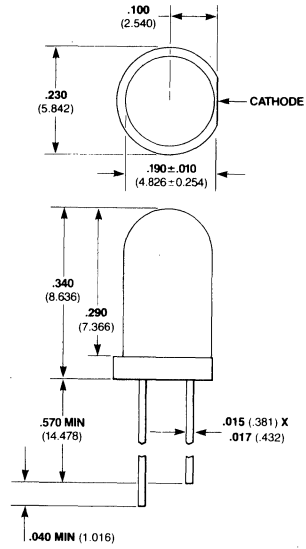

**FLV360**

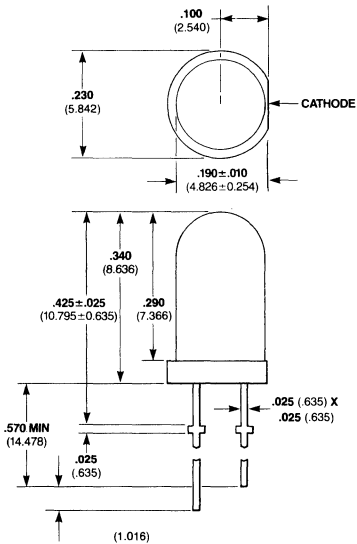

# Yellow GaP LED Lamps

Optoelectronic Products

# FLV410, FLV440 FLV450, FLV460

## General Description

The FLV410, FLV440, FLV450 and FLV460 are yellow light-emitting diodes encapsulated in yellow diffused plastic. These devices provide an intense large-area light source with wide-angle viewing. Visual light emission is in the 625 nm range.

## High Luminous Intensity For Room Ambient Light Levels

**Solid State Thus No Replacement Is Required**

**High On/Off Contrast**

**Flexible Pins On FLV410, FLV440 and FLV450**

**For Good Heat Sinking**

**For Right-Angle Bending**

**Fits Standard Sockets and Drilled Holes**

**Heavy Copper Pins On FLV460 For Wire Wrap**

**Applications and Rigid Standoff From PC Board**

**Single Molded Body Eliminates**

**Thermal Cycling Problems**

**High-Temperature Epoxy Encapsulation Withstands**

**Severe Environmental Temperatures**

**Low Power Means IC Compatibility**

## Absolute Maximum Ratings

### Maximum Temperature and Humidity

Storage Temperature -55°C to +100°C

Operating Temperature -55°C to +100°C

Pin Temperature (Soldering, 5 s) 260°C

Relative Humidity at 85°C 85%

### Maximum Power Dissipation

Total Dissipation at  $T_A = 25^\circ\text{C}$  120 mW

Derate Linearly from 25°C 1.6 mW/°C

### Maximum Voltage and Currents

$V_R$  Reverse Voltage 5.0 V

$I_F$  Forward dc Current 10 mA

$I_{pk}$  Peak Forward Current  
(1.0  $\mu\text{s}$  pulse width) 1.0 A

## Package Outline

### FLV410

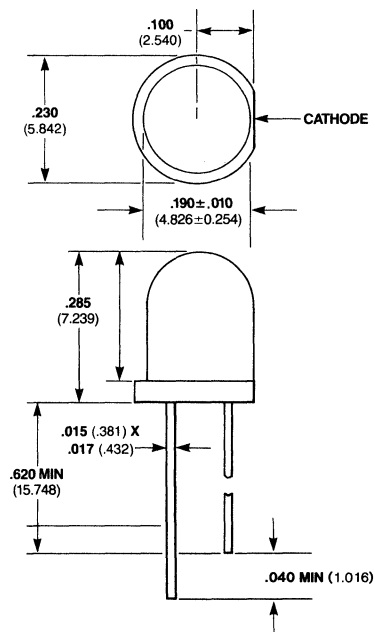

### Notes

All dimensions in inches **bold** and millimeters (parentheses)

Tolerance unless specified =  $\pm .015$  (0.381)

Other packages following

## Electrical and Radiant Characteristics $T_A = 25^\circ\text{C}$

Symbol	Characteristic	Min	Typ	Max	Units	Test Conditions
$V_F$	Forward Voltage		2.3	3.0	V	$I_F = 20$ mA
$BV_R$	Reverse Breakdown Voltage	5.0	18		V	$I_R = 100$ $\mu\text{A}$
$I_O$	Axial Luminous Intensity	1.6	3.2		mcd	$I_F = 20$ mA
$\theta_{1/2}$	Viewing Angle to Half Intensity		$\pm 25$		degrees	$I_F = 20$ mA
$\lambda_{pk}$	Peak Wavelength		585		nm	$I_F = 20$ mA

# Typical Electrical Characteristic Curves

# FLV410, FLV440 FLV450, FLV460

**Emission Spectrum**

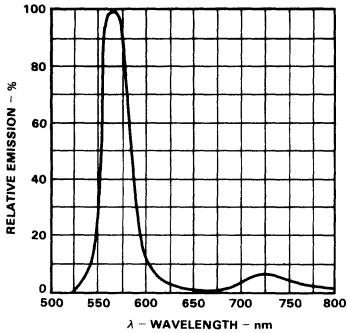

**Forward Current vs Forward Voltage**

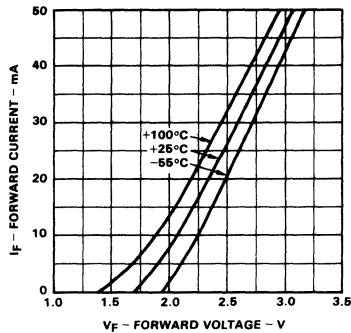

**Intensity vs Forward Current**

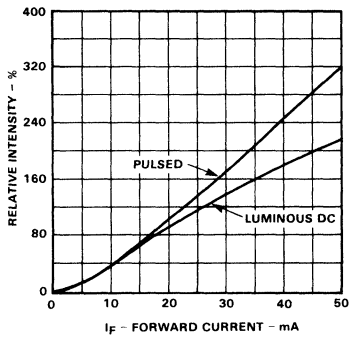

**Intensity vs Viewing Angle**

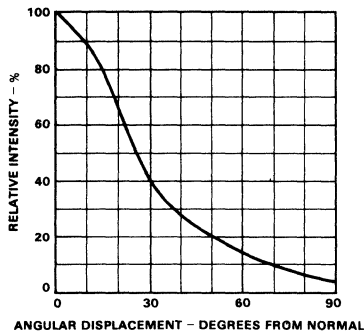

**Peak Wavelength vs Temperature**

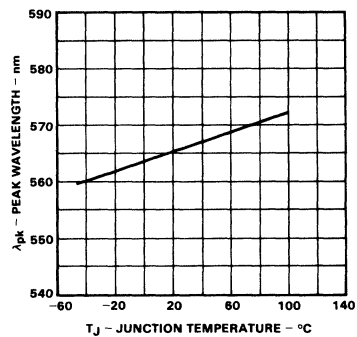

## Package Outlines

FLV410, FLV440  
FLV450, FLV460

FLV440

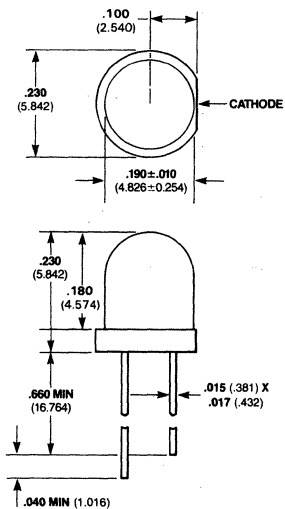

FLV450

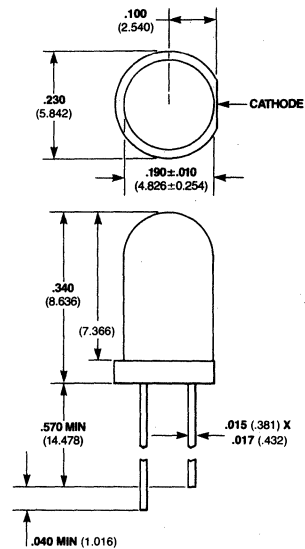

FLV460

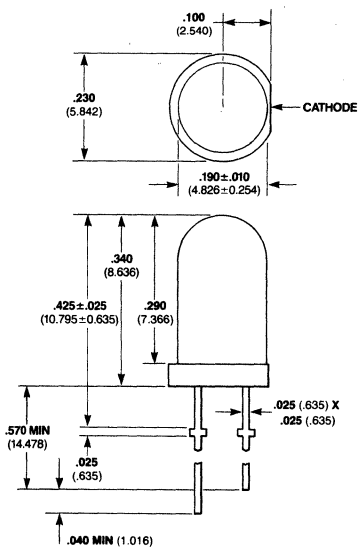

# Red Super GaAsP LED Lamps

Optoelectronic Products

# FLV510, FLV540 FLV550, FLV560

## General Description

The FLV510, FLV540, FLV550 and FLV560 are high-efficiency red light-emitting diodes encapsulated in red diffused plastic. These devices provide an intense large-area light source with wide-angle viewing. Visual light emission is in the 600 to 700 nm range.

## High Luminous Intensity For Room Ambient Light Levels

Solid State Thus No Replacement Is Required

High On/Off Contrast

Flexible Pins On FLV510, FLV540 And FLV550

For Good Heat Sinking

For Right-Angle Bending

Fits Standard Sockets And Drilled Holes

Heavy Copper Pins On FLV560 For Wire Wrap

Applications and Rigid Standoff From PC Board

Single Molded Body Eliminates Thermal

Cycling Problems

High-Temperature Epoxy Encapsulation Withstands Severe Environmental Temperatures

Low Power Means IC Compatibility

## Package Outline

### FLV510

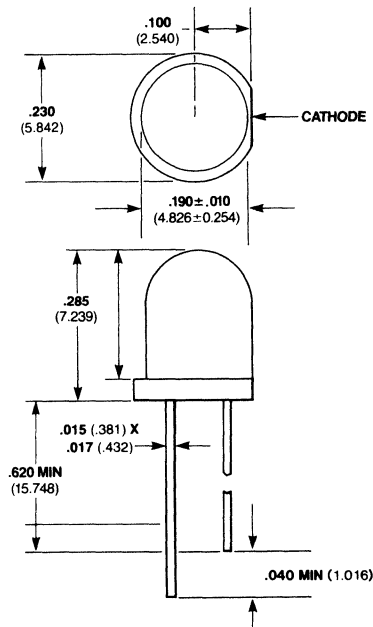

### Notes

All dimensions in inches **bold** and millimeters (parentheses)  
Tolerance unless specified =  $\pm .015$  ( $\pm .381$ )

## Absolute Maximum Ratings

### Maximum Temperature and Humidity

Storage Temperature	-55°C to +100°C
Operating Temperature	-55°C to +100°C
Pin Temperature (Soldering, 5 s)	260°C
Relative Humidity at 85°C	85%

### Maximum Power Dissipation

Total Dissipation at $T_A = 25^\circ\text{C}$	200 mW
Derate Linearly from 25°C	2.6 mW/°C

### Maximum Voltage and Currents

$V_R$	Reverse Voltage	5.0 V
$I_F$	Forward dc Current	35 mA
$I_{pk}$	Peak Forward Current (1.0 $\mu\text{s}$ pulse width)	1.0 A

## Electrical and Radiant Characteristics $T_A = 25^\circ\text{C}$

Symbol	Characteristic	Min	Typ	Max	Units	Test Conditions
$V_F$	Forward Voltage		2.1	2.8 3.0	V	$I_F = 10$ mA
$BV_R$	Reverse Breakdown Voltage	5.0	8.0		V	$I_F = 20$ mA
$I_O$	Axial Luminous Intensity	3.0	10		mcd	$I_R = 100$ $\mu\text{A}$
$\theta_{1/2}$	Viewing Angle to Half Intensity		$\pm 35$		degrees	$I_F = 20$ mA
$\lambda_{pk}$	Peak Wavelength		640		nm	$I_F = 10$ mA

# Typical Electrical Characteristic Curves

# FLV510, FLV540 FLV550, FLV560

### Emission Spectrum

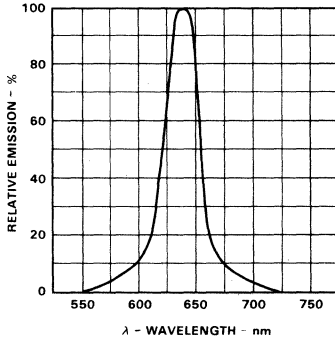

### Forward Current vs Forward Voltage

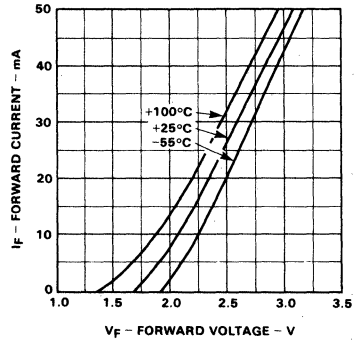

### Intensity vs Forward Current

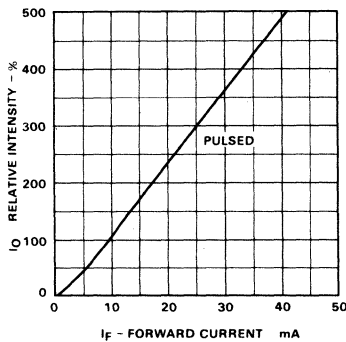

### Intensity vs Viewing Angle

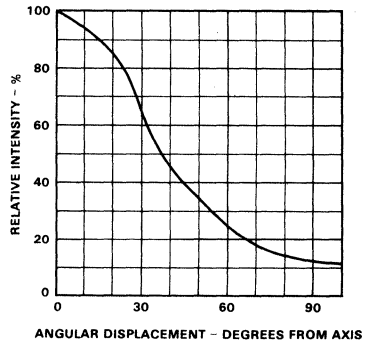

### Intensity vs Temperature

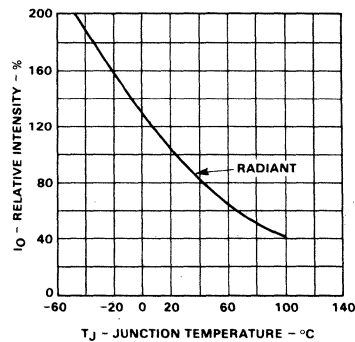

## Package Outlines

FLV510, FLV540  
FLV550, FLV560

2

## FLV540

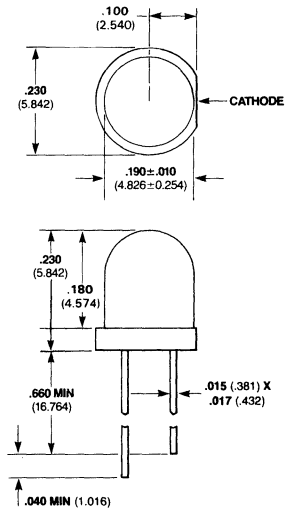

## FLV550

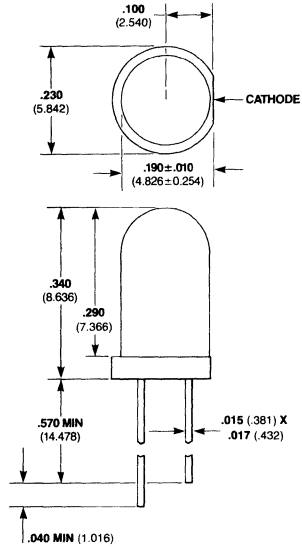

## FLV560

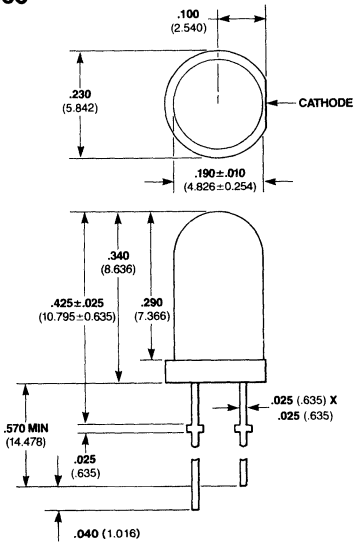

## Notes

All dimensions in inches bold and millimeters (parentheses)  
Tolerance unless specified =  $\pm .015$  ( $\pm .381$ )



# Front Panel Adapter for LED Lamp

Optoelectronic Products

## MP52

### General Description

The MP52 is a two-piece black plastic adapter for panel mounting many standard MV series LED indicator lamps. This adapter will easily mount the applicable lamps on any panel thickness up to .125-inch (3.18 mm).

### Dimensional Data

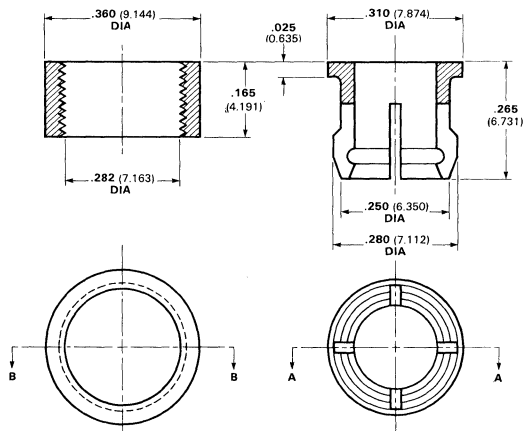

### Typical Mounting Technique

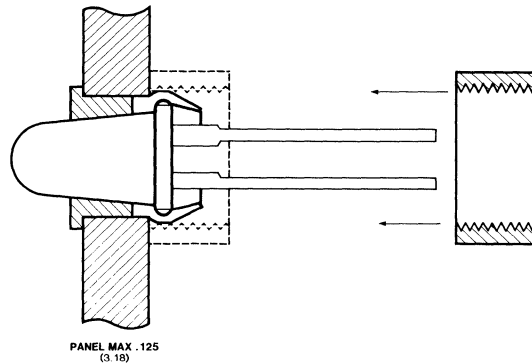

### Note

All dimensions in inches **bold** and millimeters (parentheses)  
Tolerance unless specified =  $\pm .015$  ( $\pm .381$ )

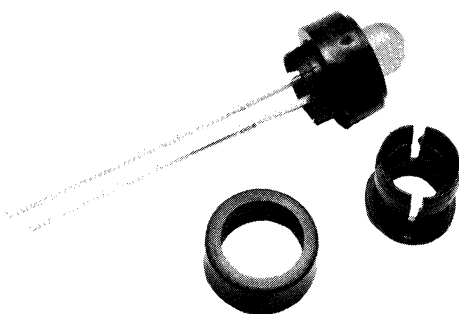

# Red GaAsP LED Lamps

Optoelectronic Products

# MV5050, MV5051 MV5052, MV5053

## General Description

The MV5050, MV5051, MV5052 and MV5053 are red light-emitting diodes encapsulated in diffused plastic. These devices provide an intense large-area light source with wide-angle viewing. Visual light emission is in the 600 nm to 700 nm range.

## Solid State Thus No Replacement Required

### No Socket Required

### High On/Off Contrast

### Flexible Pins On All Lamps

### For Good Heat Sinking

### For Right-Angle Bending

### Fits Standard Sockets or Drilled Holes

### Single Molded Body Eliminates Thermal Cycling Problems

### High-Temperature Epoxy Encapsulation Withstands

### Severe Environmental Temperatures

### Low Power Consumption Means IC Compatibility

### MV5050 In Clear Non-Diffused Epoxy

### MV5051 In Clear Diffused Epoxy

### MV5052 In Red Non-Diffused Epoxy

### MV5053 In Red Diffused Epoxy

## Absolute Maximum Ratings

### Maximum Temperature and Humidity

Storage Temperature	-55°C to +100°C
Operating Temperature	-55°C to +100°C
Pin Temperature (Soldering, 5 s)	260°C
Relative Humidity at 85°C	85%

### Maximum Power Dissipation

Total Dissipation at $T_A = 25^\circ\text{C}$	180 mW
Derate Linearly from 25°C	2.0 mW/°C

### Maximum Voltage and Currents

$V_R$	Reverse Voltage	5.0 V
$I_F$	Forward dc Current at $T_A = 25^\circ\text{C}$	100 mA
	Forward dc Current at $T_A = 100^\circ\text{C}$	15 mA
$I_{pk}$	Peak Forward Current, 1.0 $\mu\text{s}$ pulse width, 0.1% duty cycle	1.0 A

## Package Outline

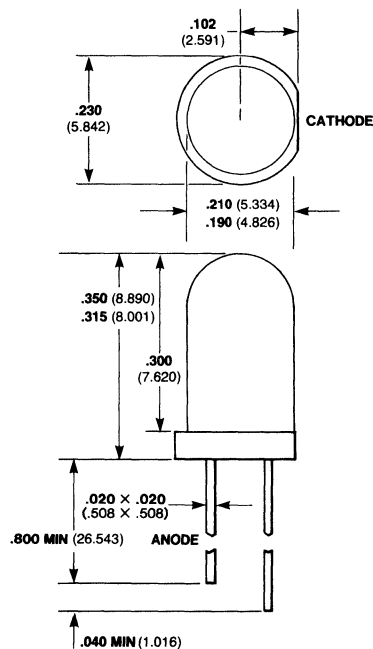

### Notes

All dimensions in inches **bold** and millimeters (parentheses)  
Tolerance unless specified =  $\pm .015$  (0.381)

# Typical Electrical Characteristics

# MV5050, MV5051 MV5052, MV5053

**Electrical and Radiant Characteristics**  $T_A = 25^\circ\text{C}$

Symbol	Characteristic	Min	Typ	Max	Units	Test Conditions
$V_F$	Forward Voltage		1.7	2.2	V	$I_F = 20\text{ mA}$
$BV_R$	Reverse Breakdown Voltage	5.0	25		V	$I_R = 100\ \mu\text{A}$
$I_O$	Axial Luminous Intensity				mcd	$I_F = 20\text{ mA}$
	MV5050 / MV5052	0.5 / 0.7	2.0			
	MV5051 / MV5053	0.4 / 0.5	1.6			
$\theta$	Viewing Angle Total				degrees	$I_F = 20\text{ mA}$
	MV5050		50			
	MV5051 / MV5052		70			
	MV5053		80			
$\lambda_{pk}$	Peak Wavelength			670	nm	$I_F = 20\text{ mA}$

**Emission Spectrum**

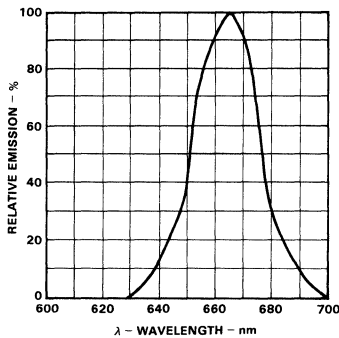

**Forward Current vs Forward Voltage**

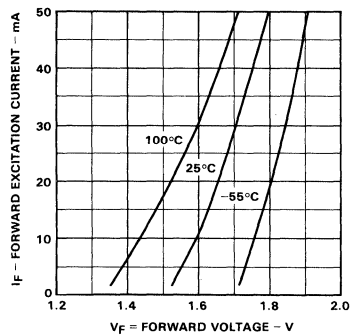

**Intensity vs Forward Current**

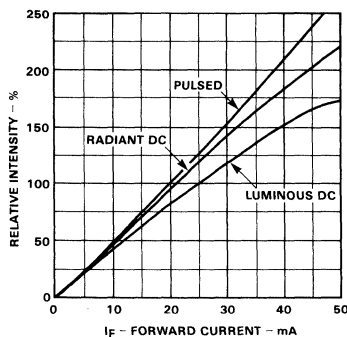

**Intensity vs Viewing Angle**

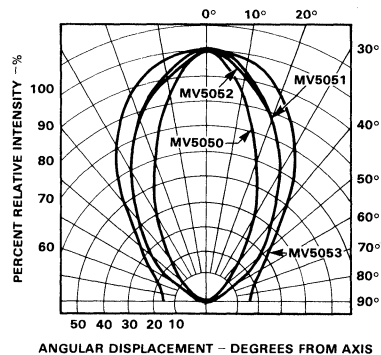

# Typical Electrical Characteristic Curves

## MV5050, MV5051 MV5052, MV5053

### Intensity vs Temperature

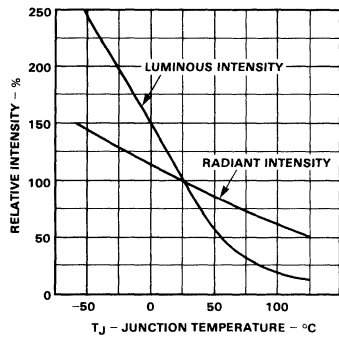

### Peak Wavelength vs Temperature

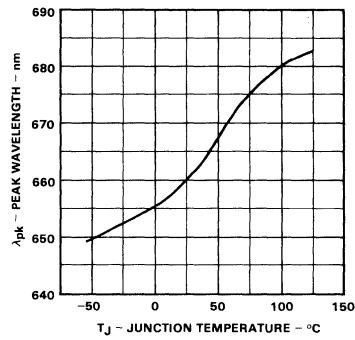

# Red GaAsP LED Lamps

Optoelectronic Products

# MV5054-1 MV5054-2 MV5054-3

## General Description

The MV5054 series lamps are red light-emitting diodes encapsulated in red diffused plastic. These devices provide an intense large-area light source with wide-angle viewing. Visual light emission is in the 600 nm to 700 nm range. Three brightness levels are available.

## Solid State Thus No Replacement Required

### No Socket Required

### High On/Off Contrast

### Flexible Pins On All Lamps

For Good Heat Sinking

For Right-Angle Bending

Fits Standard Sockets or Drilled Holes

### Single Molded Body Eliminates Thermal Cycling Problems

### High-Temperature Epoxy Encapsulation Withstands Severe Environmental Temperatures

### Low Power Consumption Means IC Compatibility

MV5054-1 Has 2.0 mcd TYP Luminous Intensity

MV5054-2 Has 3.0 mcd TYP Luminous Intensity

MV5054-3 Has 4.0 mcd TYP Luminous Intensity

## Absolute Maximum Ratings

### Maximum Temperature and Humidity

Storage Temperature	-55°C to +100°C
Operating Temperature	-55°C to +100°C
Pin Temperature (Soldering, 5 s)	260°C
Relative Humidity at 85°C	85%

### Maximum Power Dissipation

Total Dissipation at $T_A = 25^\circ\text{C}$	180 mW
Derate Linearly from 25°C	2.0 mW/°C

### Maximum Voltage and Currents

$V_R$	Reverse Voltage	5.0 V
$I_F$	Forward dc Current	
	at $T_A = 25^\circ\text{C}$	100 mA
	Forward dc Current	
	at $T_A = 100^\circ\text{C}$	15 mA
$I_{pk}$	Peak Forward Current,	
	1.0 $\mu\text{s}$ pulse width,	
	0.1% duty cycle	1.0 A

## Package Outline

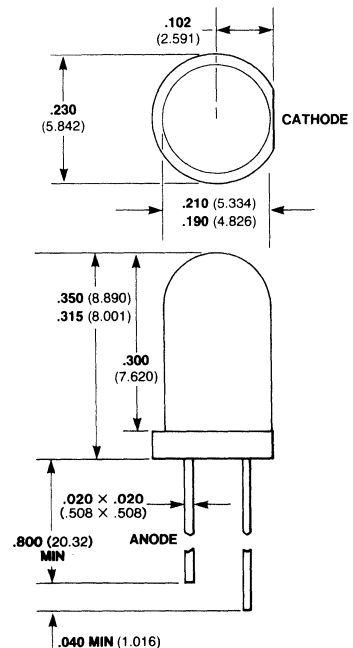

## Notes

All dimensions in inches **bold** and millimeters (parentheses)  
Tolerance unless specified =  $\pm .015$  (0.381)  
Not direct replacement for Monsanto package. Monsanto has  
offset on lead.

# Typical Electrical Characteristics

# MV5054-1 MV5054-2 MV5054-3

## Electrical and Radiant Characteristics $T_A = 25^\circ\text{C}$

Symbol	Characteristic	Min	Typ	Max	Units	Test Conditions
$V_F$	Forward Voltage		1.8	2.2	V	$I_F = 10\text{ mA}$ $I_R = 100\ \mu\text{A}$ $I_F = 10\text{ mA}$
$BV_R$	Reverse Breakdown Voltage	5.0	8.0		V	
$I_O$	Axial Luminous Intensity MV5054-1 MV5054-2 MV5054-3	1.0 2.0 3.0	2.0 3.0 4.0		mcd	
$\theta$	Viewing Angle Total		40		degrees	$I_F = 20\text{ mA}$
$\lambda_{pk}$	Peak Wavelength		660		nm	$I_F = 20\text{ mA}$

2

### Emission Spectrum

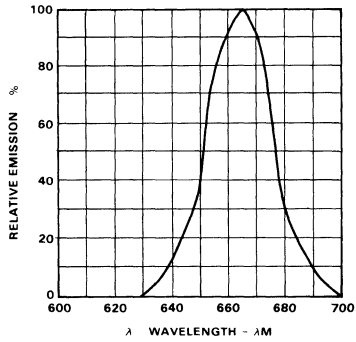

### Forward Current vs Forward Voltage

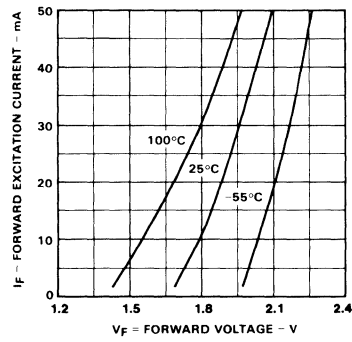

### Intensity vs Forward Current

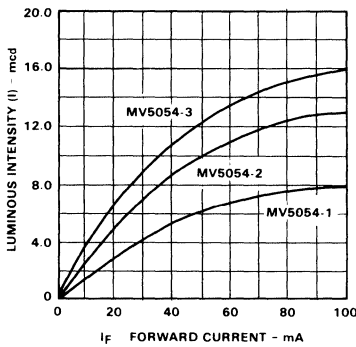

### Intensity vs Viewing Angle

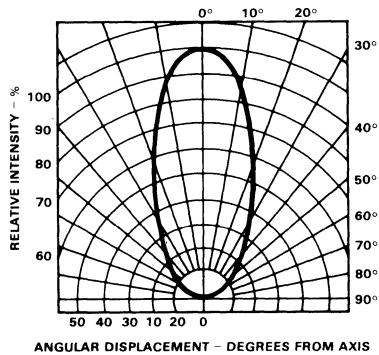

# Typical Electrical Characteristic Curves

MV5054-1  
MV5054-2  
MV5054-3

### Intensity vs Temperature

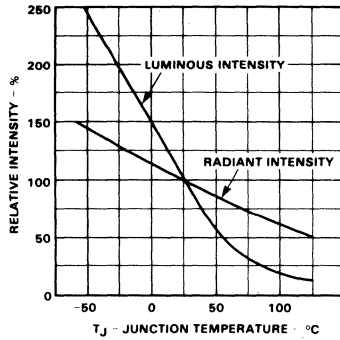

### Peak Wavelength vs Temperature

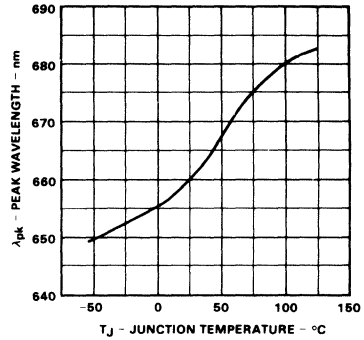

# Wide-Angle Red GaAsP LED Lamps

Optoelectronic Products

## MV5055 MV5056

### General Description

The MV5055 and MV5056 are red light-emitting diodes encapsulated in diffused plastic. These LED devices provide an intense large-area light source. Visual light emission is in the 600 nm to 700 nm range. The design has maximized viewing angle.

### Solid State Thus No Replacement Required

No Socket Required

High On/Off Contrast

Flexible Pins On All Lamps

For Good Heat Sinking

For Right-Angle Bending

Fits Standard Sockets For Drilled Holes

Single Molded Body Eliminates

Thermal Cycling Problems

High-Temperature Epoxy Encapsulation Withstand

Severe Environmental Temperatures

Low Power Consumption Means IC Compatibility

MV5055 In Red Diffused Epoxy

MV5056 In Red Diffused Epoxy

### Absolute Maximum Ratings

#### Maximum Temperature and Humidity

Operating Temperature	-55°C to +110°C
Storage Temperature	-55°C to +100°C
Pin Temperature (Soldering, 5 s)	260°C
Relative Humidity at 85°C	85%

#### Maximum Power Dissipation

Total Dissipation at $T_A = 25^\circ\text{C}$	180 mW
Derate Linearly from 25°C	2 mW/°C

#### Maximum Voltage and Currents

$V_R$ Reverse Voltage	5.0 V
$I_F$ Forward dc Current at	
$T_A = 25^\circ\text{C}$	100 mA
Forward dc Current at	
$T_A = 100^\circ\text{C}$	15 mA
$I_{pk}$ Peak Forward Current,	
1.0 $\mu\text{s}$ pulse	1.0 A

### Package Outline

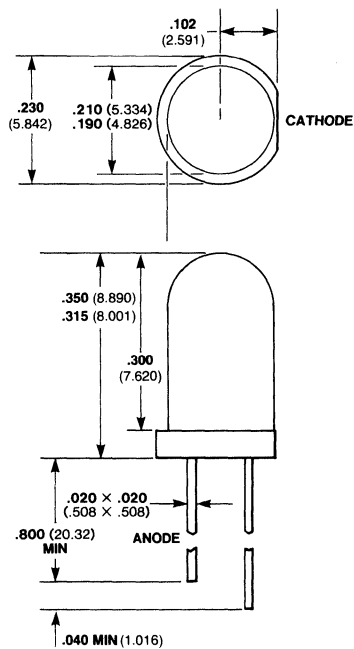

#### Notes

All dimensions in inches bold and millimeters (parentheses)  
Tolerance unless specified =  $\pm .015$  (0.381)



# Typical Electrical Characteristics

# MV5055 MV5056

**Electrical and Radiant Characteristics**  $T_A = 25^\circ\text{C}$

Symbol	Characteristic	Min	Typ	Max	Units	Test Conditions
$V_F$	Forward Voltage		1.7	2.2	V	$I_F = 20\text{ mA}$
$V_R$	Reverse Voltage	5.0	25		V	$I_R = 100\ \mu\text{A}$
$I_O$	Axial Luminous Intensity				mcd	$I_F = 20\text{ mA}$
	MV5055	0.1	0.6			
	MV5056	0.2	0.8			
$\theta$	Viewing Angle Total				degrees	$I_F = 20\text{ mA}$
	MV5055		150			
	MV5056		110			
$\lambda_{pk}$	Peak Wavelength		660		nm	$I_F = 20\text{ mA}$

**Emission Spectrum**

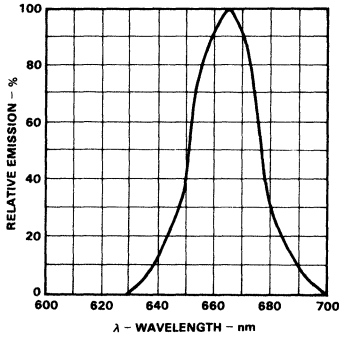

**Forward Current vs Forward Voltage**

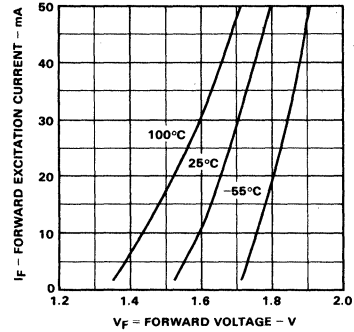

**Intensity vs Forward Current**

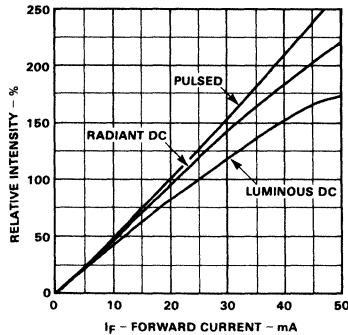

**Intensity vs Angle**

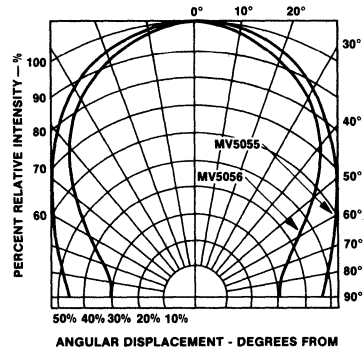

# Typical Electrical Characteristic Curves

## MV5055 MV5056

### Intensity vs Temperature

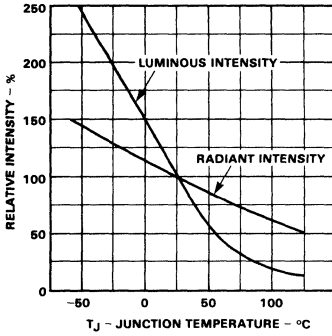

### Wavelength vs Temperature

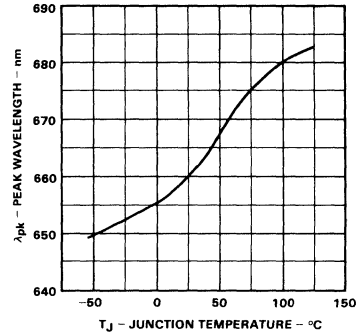

# Amber Super GaAsP LED Lamps

Optoelectronic Products

# MV5152 MV5153 MV5154

## General Description

The MV5152, MV5153 and MV5154 are red light-emitting diodes encapsulated in amber epoxy. Viewing angle can be selected from point source to wide angle. Visual light emission is in the 590 nm to 660 nm range.

## High Luminous Intensity For Ambient Light Levels

**Solid State—No Replacement Required**

**High On/Off Contrast**

**Flexible Pins On All Lamps**

**For Good Heat Sinking**

**For Right-Angle Bending**

**Fits Standard Sockets Or Drilled Holes**

**Single Molded Body Eliminates Thermal**

**Cycling Problems**

**Low Power For IC Compatibility**

**MV5152 For Point Source Lamps**

**MV5153 For Wide Angle Lamps**

**MV5154 For Intermediate Dispersion Lamps**

## Absolute Maximum Ratings

### Maximum Temperature and Humidity

Storage Temperature	-55°C to +100°C
Operating Temperature	-55°C to +100°C
Pin Temperature (Soldering, 5 s)	260°C
Relative Humidity at 85°C	85%

### Maximum Power Dissipation

Total Dissipation at $T_A = 25^\circ\text{C}$	105 mW
Derate Linearly from 25°C	1.14 mW/°C

### Maximum Voltage and Currents

$V_R$	Reverse Voltage	5.0 V
$I_F$	Forward dc Current at $T_A = 25^\circ\text{C}$	35 mA
$I_{pk}$	Peak Forward Current (1.0 $\mu\text{s}$ pulse width, 0.1% duty cycle)	1.0 A

## Package Outline

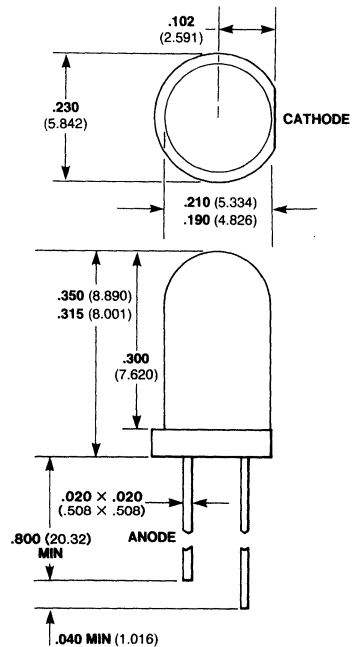

## Notes

All dimensions in inches **bold** and millimeters (parentheses)  
Tolerance unless specified =  $\pm .015$  (0.381)

# Typical Electrical Characteristics

# MV5152 MV5153 MV5154

## Electrical and Radiant Characteristics $T_A = 25^\circ\text{C}$

Symbol	Characteristic	Min	Typ	Max	Units	Test Conditions
$V_F$	Forward Voltage		2.0	3.0	V	$I_F = 20\text{ mA}$
$BV_R$	Reverse Breakdown Voltage	5.0	25		V	$I_R = 100\ \mu\text{A}$
$I_O$	Axial Luminous Intensity				mcd	$I_F = 20\text{ mA}$
	MV5152	17	40			
	MV5153	3.0	6.0			
	MV5154	3.0	8.0			
$\theta$	Viewing Angle Total				degrees	$I_F = 20\text{ mA}$
	MV5152		28			
	MV5153		65			
	MV5154		24			
$\lambda_{pk}$	Peak Wavelength		635		nm	$I_F = 20\text{ mA}$

### Emission Spectrum

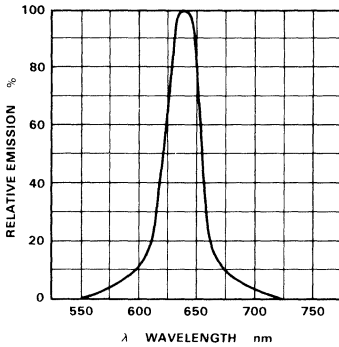

### Forward Current vs Forward Voltage

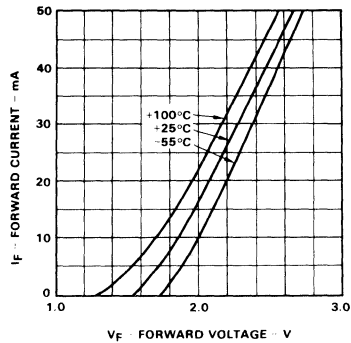

### Intensity vs Temperature

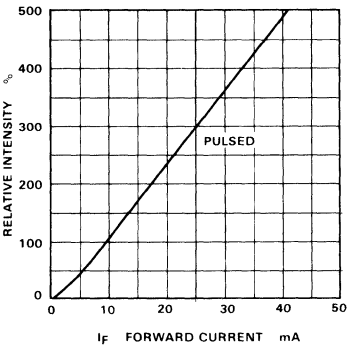

### Intensity vs Viewing Angle

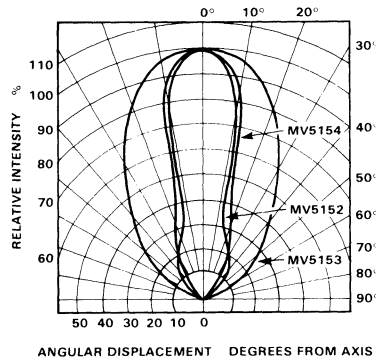

# Typical Electrical Characteristic Curves

MV5152  
MV5153  
MV5154

## Intensity vs Forward Current

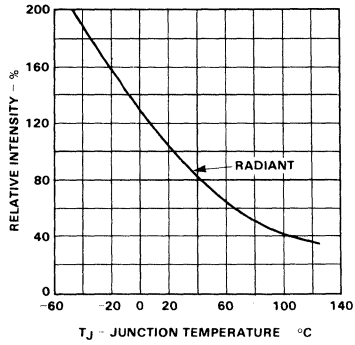

# Green GaP LED Lamps

Optoelectronic Products

# MV5252 MV5253 MV5254

## General Description

The MV5252, MV5253 and MV5254 are green light emitting diodes encapsulated in green epoxy. Viewing angle can be selected from point source to wide angle. Visual light emission is in the 530 nm to 590 nm range.

## High Luminous Intensity For Ambient Light Levels

**Solid State—No Replacement Required**

**High On/Off Contrast**

**Flexible Pins On All Lamps**

**For Good Heat Sinking**

**For Right-Angle Bending**

**Fits Standard Sockets or Drilled Holes**

**Single Molded Body Eliminates Thermal**

**Cycling Problems**

**Low Power for IC Compatibility**

**MV5252 For Point Source Lamps**

**MV5253 For Wide Angle Lamps**

**MV5254 For Intermediate Dispersion Lamps**

## Absolute Maximum Ratings

### Maximum Temperature and Humidity

Storage Temperature  $-55^{\circ}\text{C}$  to  $+100^{\circ}\text{C}$

Operating Temperature  $-55^{\circ}\text{C}$  to  $+100^{\circ}\text{C}$

Pin Temperature (Soldering, 5 s)  $260^{\circ}\text{C}$

Relative Humidity at  $85^{\circ}\text{C}$  85%

### Maximum Power Dissipation

Total Dissipation at  $T_A = 25^{\circ}\text{C}$  105 mW

Derate Linearly from  $25^{\circ}\text{C}$  1.14 mW/ $^{\circ}\text{C}$

### Maximum Voltage and Currents

$V_R$  Reverse Voltage 5.0 V

$I_F$  Forward dc Current at  
 $T_A = 25^{\circ}\text{C}$  35 mA

$I_{pk}$  Peak Forward Current  
(1.0  $\mu\text{s}$  pulse width,  
0.1% duty cycle) 1.0 A

## Package Outline

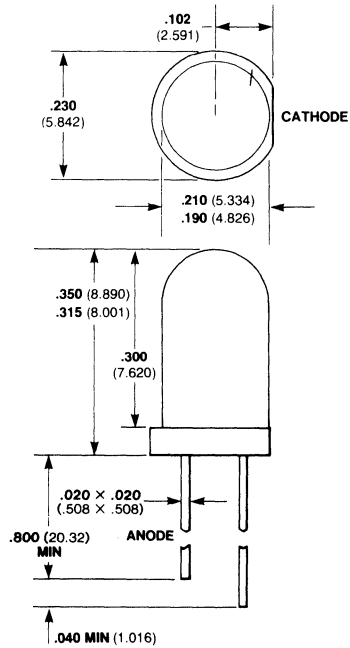

## Notes

All dimensions in inches **bold** and millimeters (parentheses)  
Tolerance unless specified =  $\pm .015$  ( $\pm .381$ )

# Typical Electrical Characteristics

# MV5252 MV5253 MV5254

## Electrical and Radiant Characteristics $T_A = 25^\circ\text{C}$

Symbol	Characteristic	Min	Typ	Max	Units	Test Conditions
$V_F$	Forward Voltage		2.1	3.0	V	$I_F = 20\text{ mA}$
$BV_R$	Reverse Breakdown Voltage	5.0	25		V	$I_R = 100\ \mu\text{A}$
$I_O$	Axial Luminous Intensity				mcd	$I_F = 20\text{ mA}$
	MV5252	2.0	15			
	MV5253	0.8	1.5			
$\theta$	Viewing Angle Total	0.9	3.0		degrees	$I_F = 20\text{ mA}$
	MV5252		28			
	MV5253		65			
$\lambda_{pk}$	Peak Wavelength		24		nm	$I_F = 20\text{ mA}$
	MV5254		565			

### Emission Spectrum

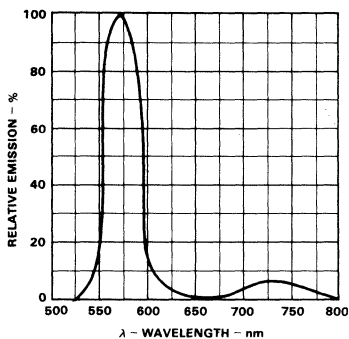

### Forward Current vs Forward Voltage

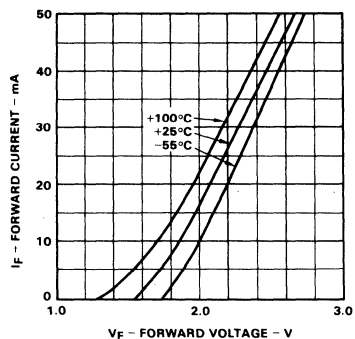

### Intensity vs Forward Current

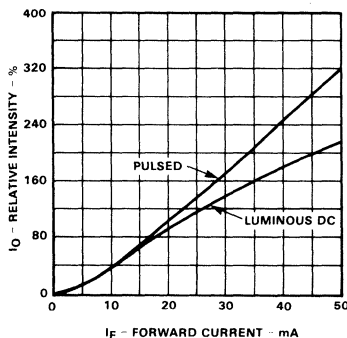

### Intensity vs Viewing Angle

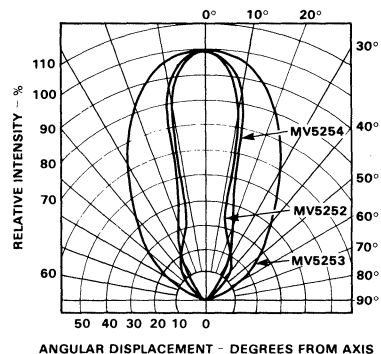

# Typical Electrical Characteristic Curves

MV5252  
MV5253  
MV5254

## Peak Wavelength vs Temperature

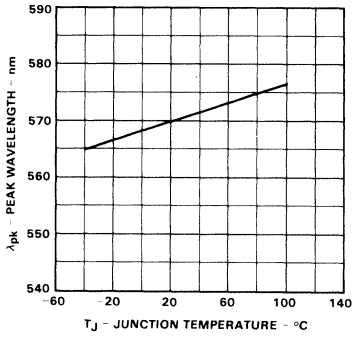



# Yellow GaP LED Lamps

Optoelectronic Products

# MV5352 MV5353 MV5354

## General Description

The MV5352, MV5353 and MV5354 are yellow light-emitting diodes encapsulated in yellow epoxy. Viewing angle can be selected from point source to wide angle. Visual light emission is in the 525 nm to 625 nm range.

## High Luminous Intensity For Ambient Light Levels

**Solid State — No Replacement Required**

**High On/Off Contrast**

**Flexible Pins On All Lamps**

**For Good Heat Sinking**

**For Right-Angle Bending**

**Fits Standard Sockets or Drilled Holes**

**Single Molded Body Eliminates Thermal**

**Cycling Problems**

**Low Power For IC Compatibility**

**MV5352 For Point Source Lamps**

**MV5353 For Wide Angle Lamps**

**MV5354 For Intermediate Dispersion Lamps**

## Absolute Maximum Ratings

### Maximum Temperature and Humidity

Storage Temperature -55°C to +100°C

Operating Temperature -55°C to +100°C

Pin Temperature (Soldering, 5 s) 260°C

Relative Humidity at 85°C 85%

### Maximum Power Dissipation

Total Dissipation at  $T_A = 25^\circ\text{C}$  105 mW

Derate Linearly from 25°C 1.14 mW/°C

### Maximum Voltage and Currents

$V_R$  Reverse Voltage 5.0 V

$I_F$  Forward dc Current at  
 $T_A = 25^\circ\text{C}$  35 mA

$I_{pk}$  Peak Forward Current  
(1.0  $\mu\text{s}$  pulse width,  
0.1% duty cycle) 1.0 A

## Package Outline

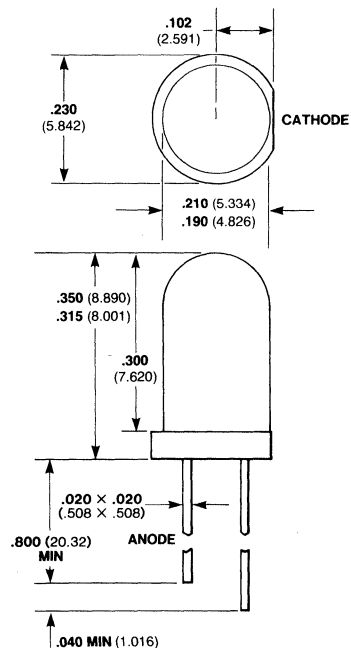

## Notes

All dimensions in inches **bold** and millimeters (parentheses)  
Tolerance unless specified =  $\pm .015$  (0.381)

# Typical Electrical Characteristics

# MV5352 MV5353 MV5354

## Electrical and Radiant Characteristics $T_A = 25^\circ\text{C}$

Symbol	Characteristic	Min	Typ	Max	Units	Test Conditions
$V_F$	Forward Voltage		2.1	3.0	V	$I_F = 20\text{ mA}$
$BV_R$	Reverse Breakdown Voltage	5.0	25		V	$I_R = 100\ \mu\text{A}$
$I_O$	Axial Luminous Intensity				mcd	$I_F = 20\text{ mA}$
	MV5352	10	45			
	MV5353	2.5	6.0			
	MV5354	3.0	10			
$\theta$	Viewing Angle Total				degrees	$I_F = 20\text{ mA}$
	MV5352		28			
	MV5353		65			
	MV5354		24			
$\lambda_{pk}$	Peak Wavelength		585		nm	$I_F = 20\text{ mA}$

2

### Emission Spectrum

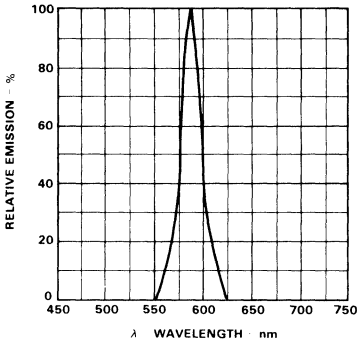

### Forward Current vs Forward Voltage

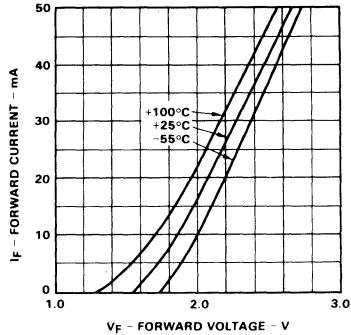

### Intensity vs Forward Current

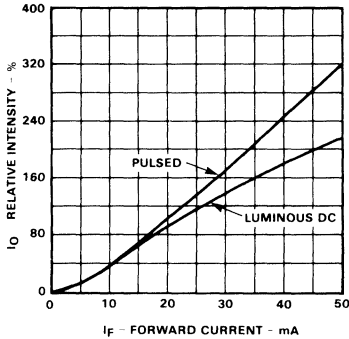

### Intensity vs Viewing Angle

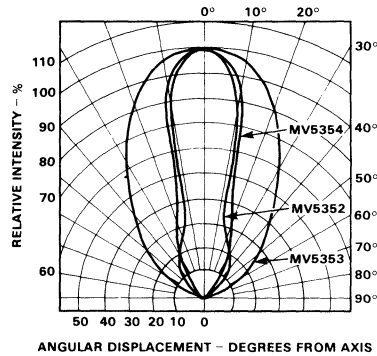

# Typical Electrical Characteristic Curves

MV5352  
MV5353  
MV5354

**Peak Wavelength vs Temperature**

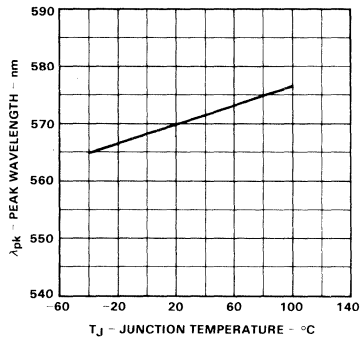

# Red Super GaAsP LED Lamps

Optoelectronic Products

## MV5752 MV5753 MV5754

### General Description

The MV5752, MV5753 and MV5754 are high-efficiency red light-emitting diodes encapsulated in red epoxy. Viewing angle can be selected from point source to wide angle. Visual light emission is in the 590 nm to 660 nm range.

**High Luminous Intensity For Ambient Light Levels**

**Solid State—No Replacement Required**

**High On/Off Contrast**

**Flexible Pins On All Lamps**

**For Good Heat Sinking**

**For Right-Angle Bending**

**Fits Standard Sockets or Drilled Holes**

**Single Molded Body Eliminates**

**Thermal Cycling Problems**

**Low Power for IC Compatibility**

**MV5752 For Point Source Lamps**

**MV5753 For Wide Angle Lamps**

**MV5754 For Intermediate Dispersion Lamps**

### Absolute Maximum Ratings

#### Maximum Temperature and Humidity

Storage Temperature	-55°C to +100°C
Operating Temperature	-55°C to +100°C
Pin Temperature (Soldering, 5 s)	260°C
Relative Humidity at 85°C	85%

#### Maximum Power Dissipation

Total Dissipation at $T_A = 25^\circ\text{C}$	105 mW
Derate Linearly from 25°C	1.14 mW/°C

#### Maximum Voltage and Currents

$V_R$ Reverse Voltage	5.0 V
$I_F$ Forward dc Current at $T_A = 25^\circ\text{C}$	35 mA
$I_{pk}$ Peak Forward Current (1.0 $\mu\text{s}$ pulse width, 0.1% duty cycle)	1.0 A

### Package Outline

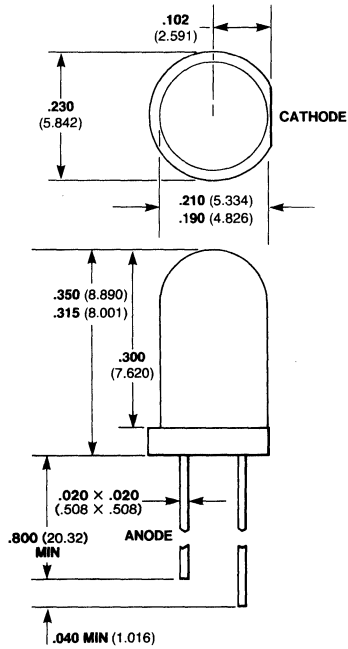

#### Notes

All dimensions in inches **bold** and millimeters (parentheses)  
Tolerance unless specified =  $\pm .015$  (0.381)

# Typical Electrical Characteristics

# MV5752 MV5753 MV5754

## Electrical and Radiant Characteristics $T_A = 25^\circ\text{C}$

Symbol	Characteristic	Min	Typ	Max	Units	Test Conditions
$V_F$	Forward Voltage		2.0	3.0	V	$I_F = 20\text{ mA}$
$BV_R$	Reverse Breakdown Voltage	5.0	25		V	$I_R = 100\ \mu\text{A}$
$I_O$	Axial Luminous Intensity				mcd	$I_F = 20\text{ mA}$
	MV5752	17	40			
	MV5753	3.0	6.0			
	MV5754	3.0	8.0			
$\theta$	Viewing Angle Total				degrees	$I_F = 20\text{ mA}$
	MV5752		28			
	MV5753		65			
	MV5754		24			
$\lambda_{pk}$	Peak Wavelength		635		nm	$I_F = 20\text{ mA}$

### Emission Spectrum

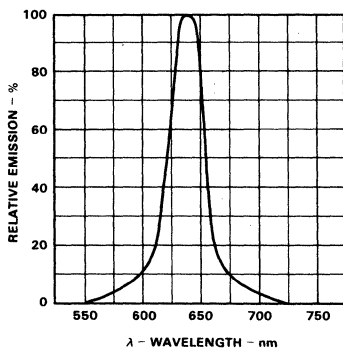

### Forward Current vs Forward Voltage

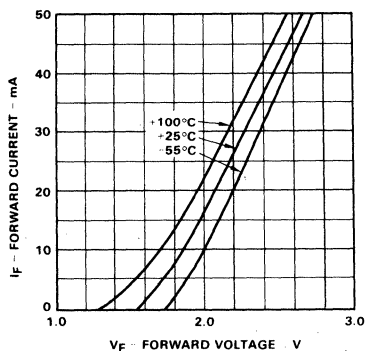

### Intensity vs Forward Current

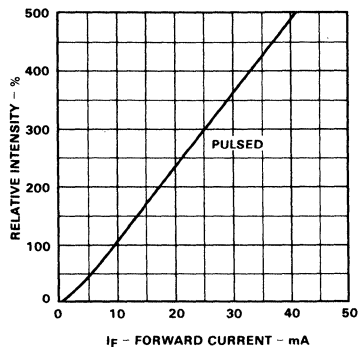

### Intensity vs Viewing Angle

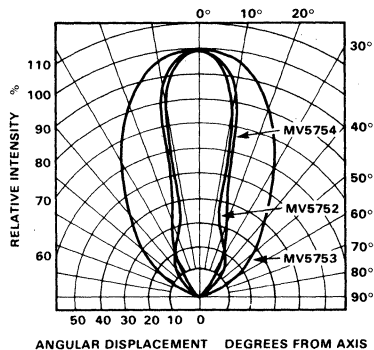

# Typical Electrical Characteristic Curves

MV5752  
MV5753  
MV5754

## Intensity vs Temperature

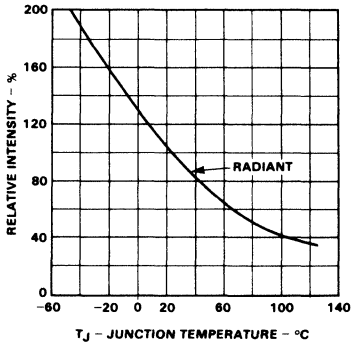

# Red, Green and Yellow T-1 LED Lamps

Optoelectronic Products

# TIL209A TIL212 TIL232

## General Description

The TIL209A is a red GaAsP T-1 lamp. The TIL212 is a yellow GaAsP/GaP T-1 lamp, and the TIL232 is a green GaP T-1 lamp. These devices provide a low-cost lamp for applications where space is at a premium.

## Small Size

## Three Colors Available

## Low Power Consumption Means IC Compatibility

## No Socket Required

## Absolute Maximum Ratings

### Maximum Temperature and Humidity

Operating Temperature	-40°C to +80°C
Storage Temperature	-40°C to +80°C
Pin Temperature (Soldering, 5 s)	230°C
Relative Humidity at 85°C	85%

### Maximum Power Dissipation

Total Dissipation at $T_A = 25^\circ\text{C}$	100 mW
Derate Linearly from 25°C	1.33 mW/°C

### Maximum Voltage and Currents

$V_R$	Reverse Voltage	3.0 V
$I_F$	Forward dc Current	TIL209A 40 mA TIL212, TIL232 30 mA
$I_{pk}$	Peak Forward Current (1.0 $\mu\text{s}$ pulse width)	1.0 A

## Electrical and Radiant Characteristics $T_A = 25^\circ\text{C}$

Symbol	Characteristic	Min	Typ	Max	Units	Test Conditions
$V_F$	Forward Voltage					
	TIL209A		1.6	2.0	V	$I_F = 20\text{ mA}$
$V_R$	Reverse Voltage					
	TIL212, TIL232		2.3	3.2	V	$I_F = 25\text{ mA}$
$I_O$	Axial Luminous Intensity					
	TIL209A	3.0			V	$I_R = 100\ \mu\text{A}$
$\lambda_{pk}$	Peak Wavelength					
	TIL209A		665		nm	$I_F = 20\text{ mA}$
	TIL212		585		nm	$I_F = 20\text{ mA}$
	TIL232		565		nm	$I_F = 20\text{ mA}$

## Package Outline

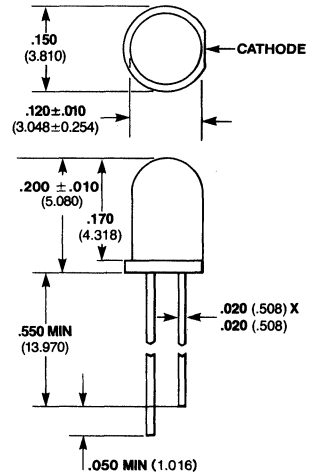

## Notes

All dimensions in inches **bold** and millimeters (parentheses)  
Tolerance unless specified =  $\pm 0.015$  ( $\pm 0.381$ )

# Typical Electrical Characteristic Curves

# TIL209A TIL212 TIL232

**Emission Spectrum  
TIL209A**

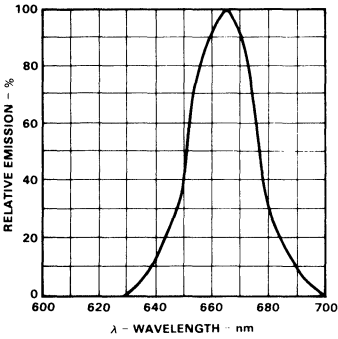

**Emission Spectrum  
TIL212, TIL232**

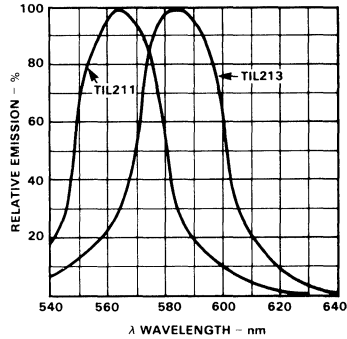

**Forward Current vs Forward Voltage  
TIL209A**

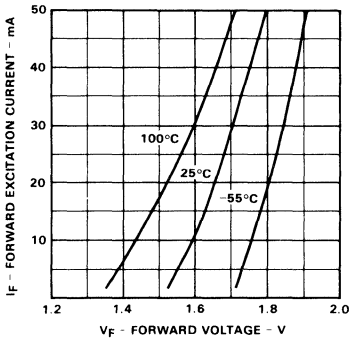

**Forward Current vs Forward Voltage  
TIL212, TIL232**

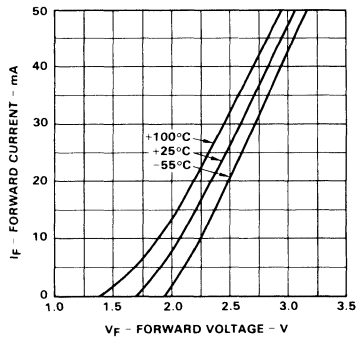

**Relative Luminous Intensity vs Forward Current  
TIL209A**

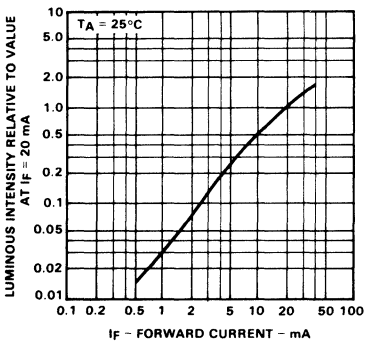

**Relative Luminous Intensity vs Forward Current  
TIL212, TIL232**

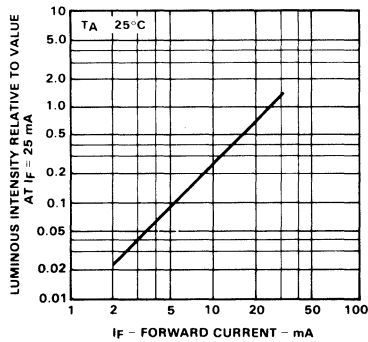



# Red GaAsP T-1 LED Lamps

Optoelectronic Products

**5082-4480**  
**5082-4483**  
**5082-4486**

## General Description

The 5082-4480, 5082-4483 and 5082-4486 are red light-emitting diodes encapsulated in plastic. The 5082-4480 has a red diffused lens, the 5082-4483 has a clear diffused lens, and the 5082-4486 has a clear non-diffused lens. These LED devices are designed for applications where space is at a premium. Visual light emission is in the 600 nm to 700 nm range.

**High Intensity—0.8 mcd Typical**

**Wide Viewing Angle**

**Small Size T-1 Diameter 0.125 inches (3.18 mm)**

**IC Compatible**

**Reliable and Rugged**

**5082-4480—Red Diffused Lens**

Excellent On/Off Contrast Ratio

High Axial Luminous Intensity

Wide Viewing Angle

**5082-4483—Clear Diffused**

Masks Red in Off Condition

**5082-4486—Clear Non-diffused**

For Illuminating External Lens, Annunciators or Photodetectors

## Absolute Maximum Ratings

### Maximum Temperature

Storage Temperature	-55°C to +100°C
Operating Temperature	-55°C to +100°C
Pin Temperature (Soldering, 7 s)	230°C

### Maximum Power Dissipation

Total Dissipation at $T_A = 25^\circ\text{C}$	100 mW
Derate Linearly from 50°C	

### Maximum Voltage and Currents

$I_F$	Forward dc Current at $T_A = 25^\circ\text{C}$	50 mA
$I_{pk}$	Peak Forward Current at 1.0 $\mu\text{s}$ pulse width, 300 pps	1.0 A

## Electrical and Radiant Characteristics $T_A = 25^\circ\text{C}$

Symbol	Characteristic	Min	Typ	Max	Units	Test Conditions
$I_V$	Luminous Intensity	0.3	0.8		mcd	$I_F = 20\text{ mA}$
$\lambda_{pk}$	Wavelength		655		nm	Measurement at Peak
$V_F$	Forward Voltage		1.6	2.0	V	$I_F = 20\text{ mA}$
$BV_R$	Reverse Breakdown Voltage	3.0	10		V	$I_R = 10\text{ }\mu\text{A}$

## Package Outline

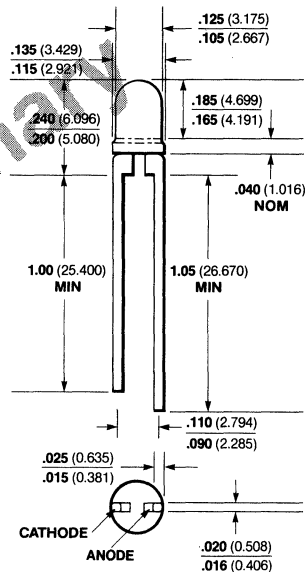

## Notes

All dimensions in inches **bold** and millimeters (parentheses).

Silver plated pins.

An epoxy meniscus may extend about .040 inches (1 mm) down the leads.

# Typical Electrical Characteristic Curves

5082-4480  
5082-4483  
5082-4486

## Relative Luminous Intensity vs Angular Displacement

5082-4480 • 5082-4483

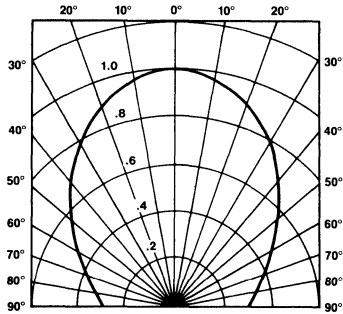

## Relative Luminous Intensity vs Angular Displacement

5082-4486

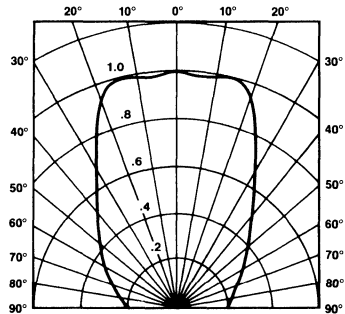

2

## Forward Current vs Forward Voltage

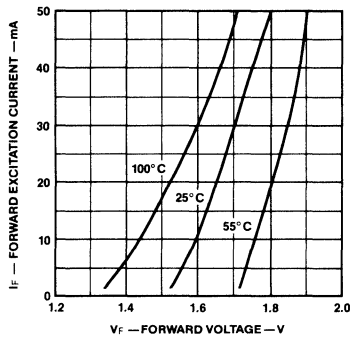

## Intensity vs Forward Current

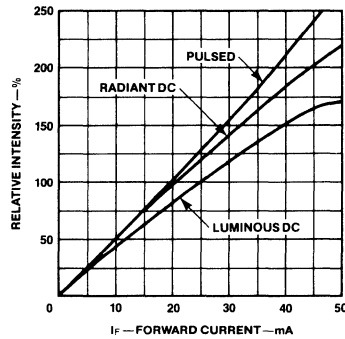



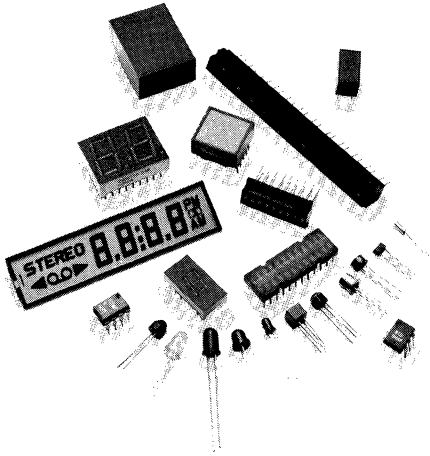

Selection Guides	1
Visible LED Lamps and Mounting Hardware	2
LED Digits	3
Phototransistors, Infrared Emitters and Sensors	4
Couplers	5
Liquid Crystal Displays	6
Fiber Optics	7
Cross Reference	8
Definitions of Symbols and Terms	9
Fairchild Field Sales Offices, Sales Representatives and Distributor Locations	10



# 12-Element Bar Display

# FNA12

Optoelectronic Products

## General Description

The FNA12 is a red 12-element analog display in a convenient, stackable dual in-line package. Applications include analog meter readouts, radio frequency indicator, or computer register displays.

## 12-Element Dual In-Line Package

End-Stackable For Scale Expansion

Separate Anode And Cathode Connections For Wiring Convenience

Up To 100 mA Peak Drive Current (20% Duty Cycle For High Ambient Conditions)

## Absolute Maximum Ratings

### Maximum Temperature and Humidity

Operating Temperature  $-40^{\circ}\text{C}$  to  $+80^{\circ}\text{C}$

Storage Temperature  $-40^{\circ}\text{C}$  to  $+80^{\circ}\text{C}$

Pin Temperature (Soldering, 5 s)  $230^{\circ}\text{C}$

Relative Humidity at  $85^{\circ}\text{C}$  85%

### Maximum Power Dissipation

Total Dissipation at  $T_A = 25^{\circ}\text{C}$  100 mW

Derate Linearly from  $25^{\circ}\text{C}$  1.33 mW/ $^{\circ}\text{C}$

### Maximum Voltage and Currents

$V_R$  Reverse Voltage 3.0 V

$I_F$  Average Forward dc Current per Element 20 mA

$I_{pk}$  Peak Forward Current (1.0  $\mu\text{s}$  Pulse Width) 1.0 A

## Package Outline

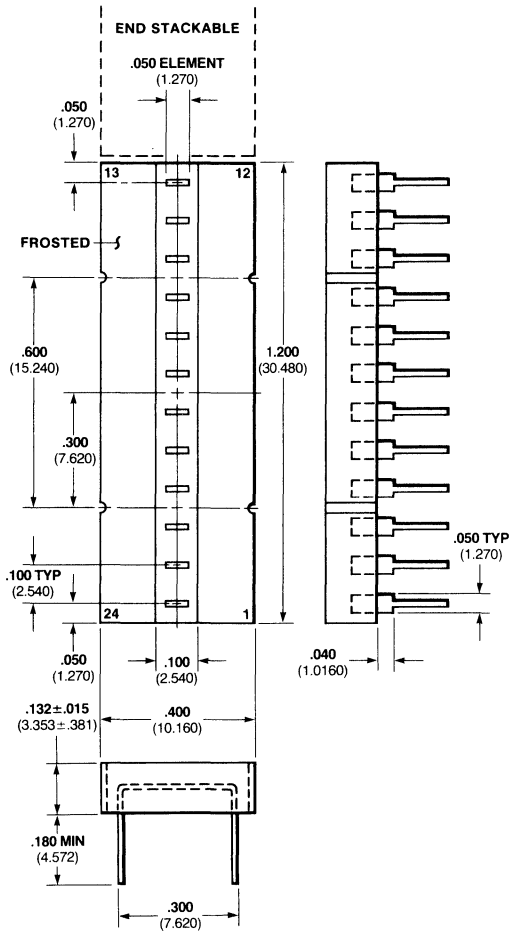

## Notes

All dimensions in inches **bold** and millimeters (parentheses)  
Tolerance unless specified =  $\pm .015$  (0.381)

## Electrical and Radiant Characteristics $T_A = 25^{\circ}\text{C}$

Symbol	Characteristic	Min	Typ	Max	Units	Test Conditions
$V_F$	Forward Voltage		1.7	2.0	V	$I_F = 20$ mA / seg
$V_R$	Reverse Voltage	3.0			V	$I_R = 100$ $\mu\text{A}$
$I_O$	Axial Luminous Intensity	60	100		$\mu\text{cd}$	$I_F = 6$ mA / seg
		100	200		$\mu\text{cd}$	$I_F = 10$ mA
$\lambda_{pk}$	Peak Wavelength		665		nm	$I_F = 20$ mA / seg
$\Delta I$	Intensity Matching Maximum Variation		$\pm 33$		%	

# Connection Diagram Typical Electrical Characteristic Curves

# FNA12

**Connection Diagram  
Bottom View**

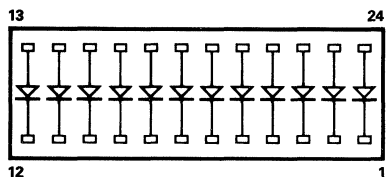

Pin		Pin	
1	Cathode 1	13	Anode 12
2	Cathode 2	14	Anode 11
3	Cathode 3	15	Anode 10
4	Cathode 4	16	Anode 9
5	Cathode 5	17	Anode 8
6	Cathode 6	18	Anode 7
7	Cathode 7	19	Anode 6
8	Cathode 8	20	Anode 5
9	Cathode 9	21	Anode 4
10	Cathode 10	22	Anode 3
11	Cathode 11	23	Anode 2
12	Cathode 12	24	Anode 1

**Forward Current vs Forward Voltage**

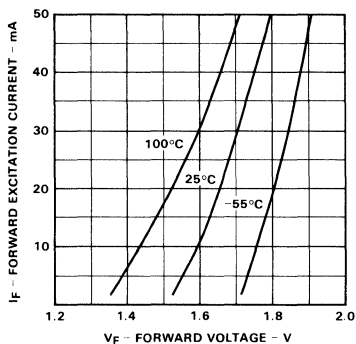

**Emission Spectrum**

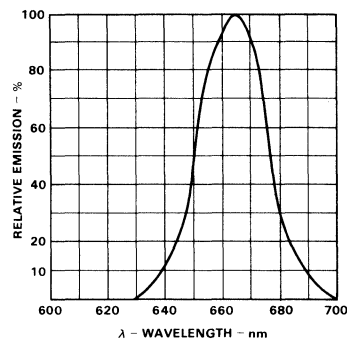

**Relative Luminous Intensity vs Forward Current**

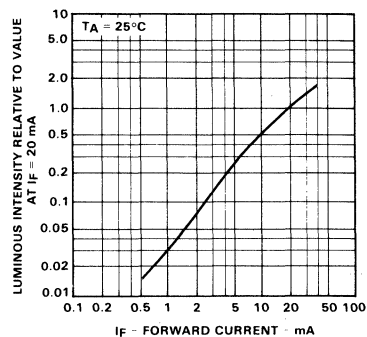

# Red GaAsP 0.362-Inch 7-Segment Numeric LED Displays

Optoelectronic Products

## FND350, FND360 FND357, FND367

### General Description

The FND350, FND360, FND357 and FND367 are red GaAsP 7-segment LED displays with a 0.362-inch character height. These displays are designed for applications in which the viewer is within fifteen feet of the display.

**Compact—10 Digits in 3-Inch Panel Width**  
**Low Current Requirements 2-20 mA/Segment**  
**Low Forward Voltage— $V_F = 1.7$  V**  
**Intensity Code Marking For Uniform Displays**  
**Maximized Contrast Ratio With Integral Lens Cap**  
**FND360, FND367 Suitable For Use in High Ambient Light**

**FND350—Common Anode, Right Hand Decimal Point**

**FND360—Common Anode, Right Hand Decimal Point, High Brightness**

**FND357—Common Cathode, Right Hand Decimal Point**

**FND367—Common Cathode, Right Hand Decimal Point, High Brightness**

### Absolute Maximum Ratings

#### Maximum Temperature and Humidity

Operating Temperature	-25°C to +85°C
Storage Temperature	-25°C to +85°C
Pin Temperature (Soldering, 5 s)	260°C
Relative Humidity at 65°C	98%

#### Maximum Voltage and Currents

$V_R$	Reverse Voltage	3.0 V
$I_F$	Average Forward dc Current / Segment or Decimal Point	25 mA
	Derate from 25°C Ambient Temperature	0.3 mA/°C
$I_{pk}$	Peak Current / Segment or Decimal Point (100 $\mu$ s pulse)	
	1000 pps, $T_A = 25^\circ\text{C}$	200 mA

### Package Outline

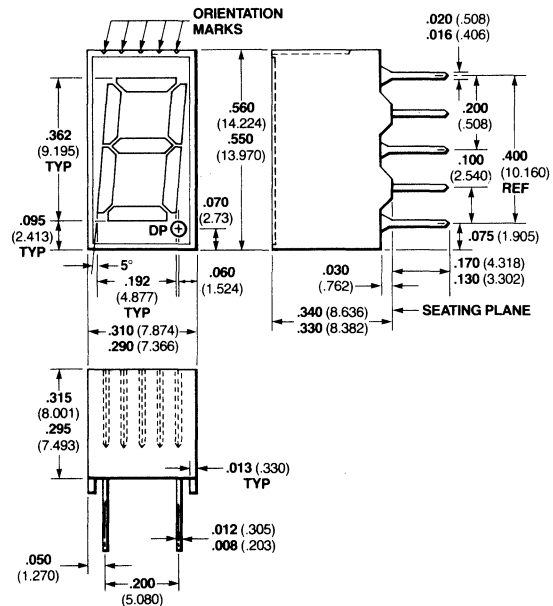

#### Notes

All dimensions in inches bold and millimeters (parentheses)  
 Tolerance unless specified =  $\pm .015$  ( $\pm .381$ )



# Connection Diagram Typical Electrical Characteristics

# FND350, FND357 FND360, FND367

**Pin Connections**  
(Front View)

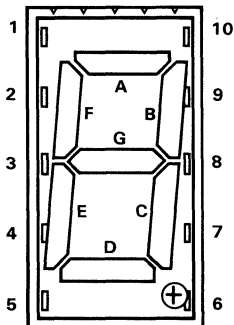

**Pin FND357/367**

- 1 Common Cathode
- 2 Segment F
- 3 Segment G
- 4 Segment E
- 5 Segment D
- 6 Common Cathode
- 7 Decimal Point
- 8 Segment C
- 9 Segment B
- 10 Segment A

**FND350/360**

- Common Anode
- Segment F
- Segment G
- Segment E
- Segment D
- Common Anode
- Decimal Point
- Segment C
- Segment B
- Segment A

**Electrical Characteristics**  $T_A = 25^\circ\text{C}$

Symbol	Characteristics	Min	Typ	Max	Units	Test Conditions
$V_F$	Forward Voltage		1.7	2.0	V	$I_F = 20\text{ mA}$
$BV_R$	Reverse Breakdown Voltage	3.0	12		V	$I_R = 1.0\text{ mA}$
$I_O$	Axial Luminous Intensity Each Segment (Note 1)					
	FND350, 357	240	450		$\mu\text{cd}$	$I_F = 20\text{ mA}$
	FND360, 367	590	900			
$\Delta I_O$	Intensity Matching, Segment-to-Segment (Note 3)		$\pm 33$		%	$I_F = 20\text{ mA}$
	Intensity Matching Within One Intensity Class		$\pm 20$		%	$I_F = 20\text{ mA}$ , all segments at once
$L_O$	Average Segment Luminance (Note 2)					
	FND350, 357		26		ftL	$I_F = 20\text{ mA}$
	FND360, 367		52			
$\theta_{1/2}$	Viewing Angle to Half Intensity		$\pm 27$		degrees	
$\lambda_{pk}$	Peak Wavelength		665		nm	$I_F = 20\text{ mA}$

**Notes**

1. Typical operating current under single digit (dc) drive is approximately 2 to 20 mA average per segment for most ambient light conditions. The 125 mA specification is a representative peak current.
2. Measured on mechanical axis of package. See Average Luminous Intensity curve for other forward currents.
3. Segment-to-segment from average segment intensity.

# Typical Electrical Characteristic Curves

# FND350, FND357 FND360, FND367

3

**Forward Current vs Forward Voltage**

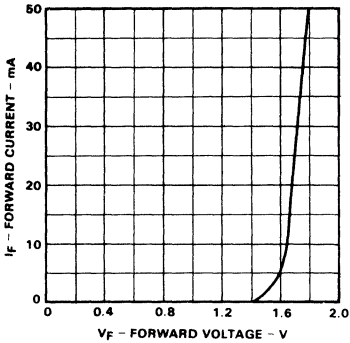

**Maximum Average Current Rating vs Ambient Temperature**

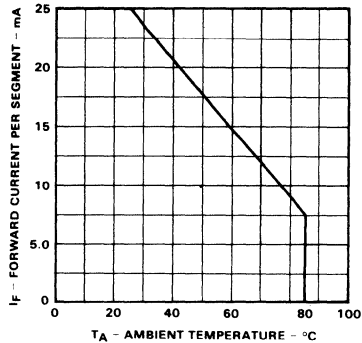

**Angular Distribution of Luminous Intensity**

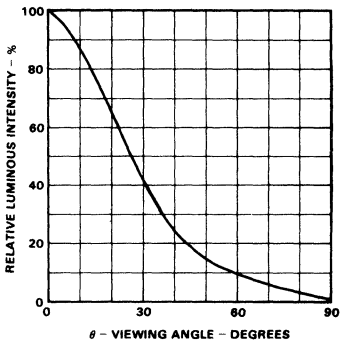

**Average Luminous Intensity vs Average Forward Current**

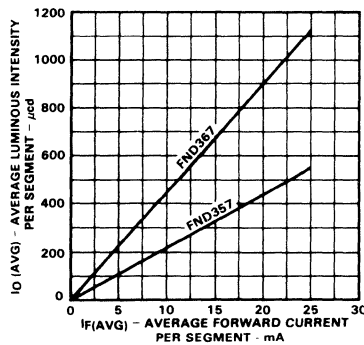

**Relative Luminous Efficiency (mcd per mA) vs Peak Current per Segment**

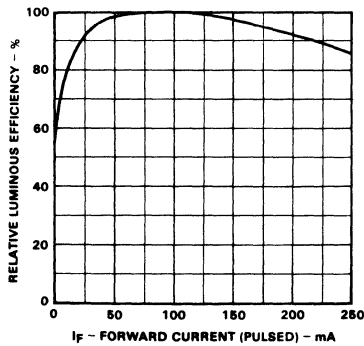

**Relative Luminous Intensity vs Junction Temperature**

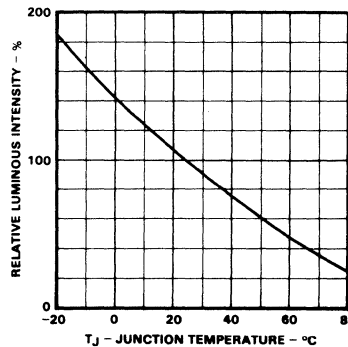

# Typical Electrical Characteristic Curves (Cont'd)

## FND350, FND357 FND360, FND367

### Emission Spectrum

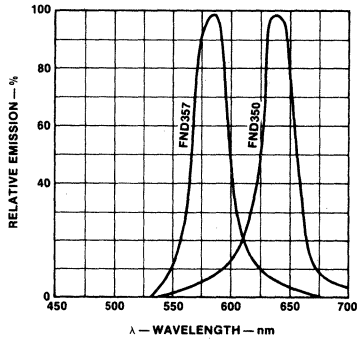

# Red GaAsP 0.362-Inch $\pm 1$ LED Displays

Optoelectronic Products

## FND358 FND368

### General Description

The FND358 and FND368 are red GaAsP  $\pm 1$  LED displays with nominal 0.362-inch character height in common-cathode configuration. These displays are for applications in which the viewer is within fifteen feet of the display.

### Ideal Companion to FND357/FND367

**Low Current Requirements 2–20 mA/Segment**  
**Low Forward Voltage—Typically  $V_F = 1.7$  V**  
**Intensity Code Marking For Uniform Displays**  
**FND368 Suitable For Use In High Ambient Light**  
**Maximized Contrast Ratio With Integral Lens Cap**  
**FND358—Common Cathode, Right-Hand**  
**Decimal Point**  
**FND368—Common Cathode, Right-Hand Decimal**  
**Point, High Brightness**

### Absolute Maximum Ratings

#### Maximum Temperature and Humidity

Storage Temperature	-25°C to +85°C
Operating Temperature	-25°C to +85°C
Pin Temperature (Soldering, 5 s)	260°C
Relative Humidity at 65°C	98%

#### Maximum Voltage and Currents

$V_R$	Reverse Voltage	3.0 V
$I_F$	Average Forward dc Current/Segment or Decimal Point	25 mA
	Derate from 25°C	
	Ambient Temperature	0.3 mA/°C
$I_{pk}$	Peak Forward Current/Segment or Decimal Point (100 $\mu$ s pulse width)	
	1000 pps, $T_A = 25^\circ\text{C}$	200 mA

### Package Outline

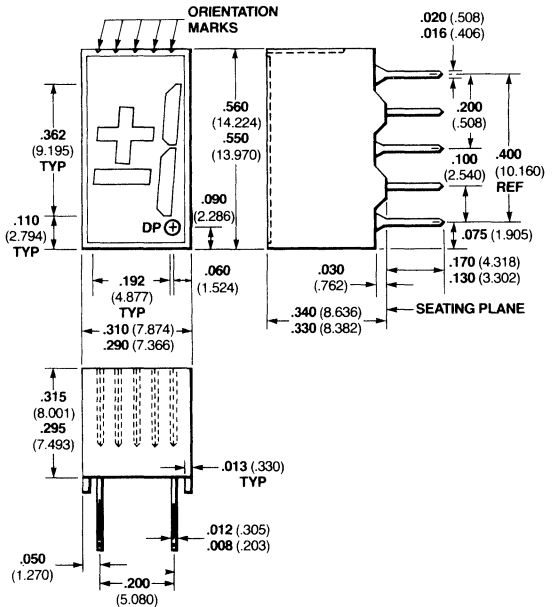

### Notes

All dimensions in inches **bold** and millimeters (parentheses)  
 For polarity indication the top surface is ribbed  
 The unit LED segments cannot necessarily be seen through the lens cap  
 Lens cap color is red for red LED  
 Pins 1 and 6 are common  
 All dimensions are  $\pm .015$  (.381)

# Connection Diagram

## Typical Electrical Characteristics

# FND358

# FND368

### Pin Connections (Top View)

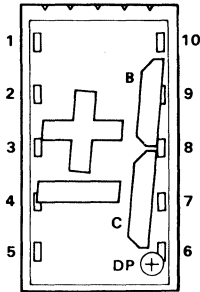

### Pin

- 1 Common Cathode
- 2 Plus Sign
- 3 Minus Sign
- 4 NC
- 5 Omitted
- 6 Common Cathode
- 7 Decimal Point
- 8 Segment C
- 9 Segment B
- 10 NC

### Electrical and Radiant Characteristics $T_A = 25^\circ\text{C}$

Symbol	Characteristic	Min	Typ	Max	Units	Test Conditions
$V_F$	Forward Voltage	1.5	1.7	2.0	V	$I_F = 20\text{ mA}$
$BV_R$	Reverse Breakdown Voltage	3.0	12		V	$I_R = 1.0\text{ mA}$
$I_O$	Axial Luminous Intensity, Average Each Segment (Note 1)					
	FND358	240	450		$\mu\text{cd}$	$I_F = 20\text{ mA}$
	FND368	590	900		$\mu\text{cd}$	$I_F = 20\text{ mA}$
$\Delta I_O$	Intensity Matching, Segment-to-Segment (Note 3)		$\pm 33$		%	$I_F = 20\text{ mA}$
	Intensity Matching Within One Intensity Class		$\pm 20$		%	$I_F = 20\text{ mA}$ , all segments at once
$L_O$	Average Segment Luminance (Note 2)					
	FND358		26		ftL	$I_F = 20\text{ mA}$
	FND368		52		ftL	$I_F = 20\text{ mA}$
$\theta_{1/2}$	Viewing Angle to Half Intensity		$\pm 27$		degrees	
$\lambda_{pk}$	Peak Wavelength		665		nm	$I_F = 20\text{ mA}$

#### Notes

1. Typical operating current under single digit (dc) drive is approximately 2 to 20 mA average per segment for most ambient light conditions.
2. Measured on mechanical axis of package. See Average Luminous Intensity curve for other forward currents.
3. Segment-to-segment from average segment intensity.

# Typical Electrical Characteristic Curves

# FND358 FND368

3

**Forward Current vs Forward Voltage**

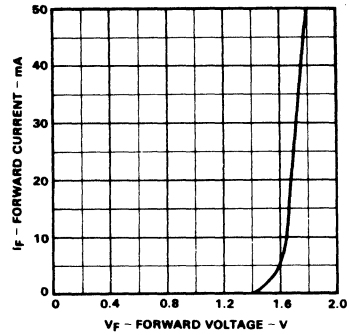

**Maximum Average Current Rating  
vs Ambient Temperature**

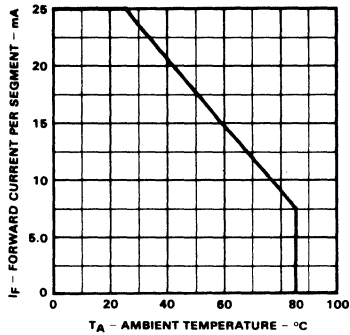

**Angular Distribution of Luminous Intensity**

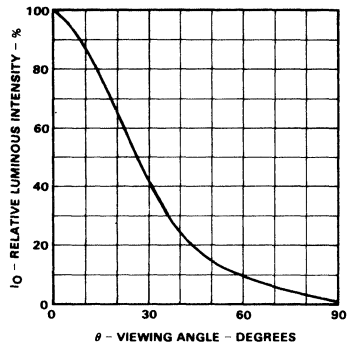

**Average Luminous Intensity  
vs Average Forward Current**

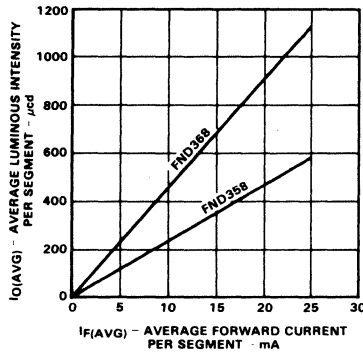

**Relative Luminous Efficiency (mcd per mA)  
vs Peak Current per Segment**

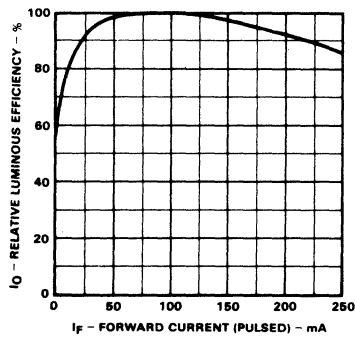

**Relative Luminous Intensity  
vs Junction Temperature**

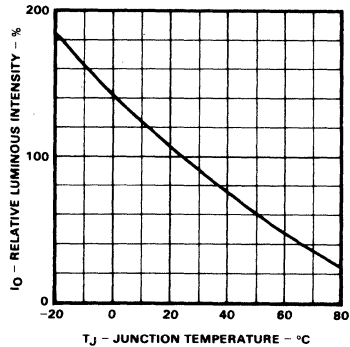

# Red GaAsP 0.5-Inch 7-Segment Numeric LED Displays

Optoelectronic Products

## FND500, FND507 FND560, FND567

### General Description

The FND500, FND507, FND560 and FND567 are red GaAsP single-digit 7-Segment LED displays with a 0.5-inch character height. These displays are designed for applications in which the viewer is within twenty feet of the display.

**Low Forward Voltage—Typically  $V_F = 1.7$  V**  
**Fits Standard DIP Sockets with 0.6-Inch Pin Row**  
**Maximized Contrast Ratio With Integral Lens Cap**  
**Horizontal Stacking 0.6-Inch Minimum,**  
**1-Inch Typical**

**FND560/567 Suitable For Use In High Ambient Light**

**FND500 Common Cathode, Right-Hand Decimal Point**

**FND507 Common Anode, Right-Hand Decimal Point**

**FND560 Common Cathode, Right-Hand Decimal Point, High Brightness**

**FND567 Common Anode, Right-Hand Decimal Point, High Brightness**

### Absolute Maximum Ratings

#### Maximum Temperature and Humidity

Storage Temperature	-25°C to +85°C
Operating Temperature	-25°C to +85°C
Pin Temperature (Soldering, 5 s)	260°C
Relative Humidity at 65°C	98%

#### Maximum Voltage and Currents

$V_R$	Reverse Voltage	3.0 V
$I_F$	Average Forward dc Current / Segment or Decimal Point	25 mA
	Derate from 25°C	
	Ambient Temperature	0.3 mA/°C
$I_{pk}$	Peak Forward Current Segment or Decimal Point (100 $\mu$ s pulse width)	
	1000 pps, $T_A = 25^\circ\text{C}$	200 mA

### Package Outline

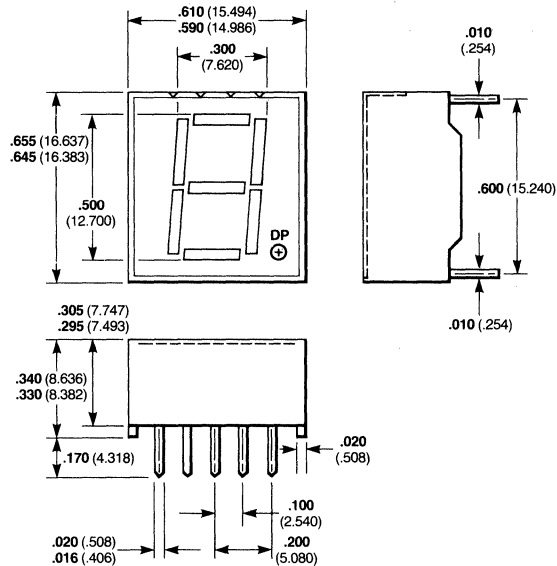

#### Notes

All dimensions in inches **bold** and millimeters (parentheses)  
 Tolerance unless specified =  $\pm .015$  ( $\pm .381$ )

# Connection Diagram

## Typical Electrical Characteristics

# FND500, FND507

## FND560, FND567

### Pin Connections (Front View)

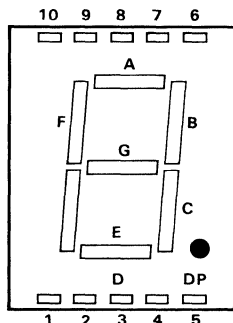

Pin	FND507/567	FND500/560
1	Segment E	Segment E
2	Segment D	Segment D
3	Common Anode	Common Cathode
4	Segment C	Segment C
5	Decimal Point	Decimal Point
6	Segment B	Segment B
7	Segment A	Segment A
8	Common Anode	Common Cathode
9	Segment F	Segment F
10	Segment G	Segment G

3

### Electrical and Radiant Characteristics $T_A = 25^\circ\text{C}$

Symbol	Characteristic	Min	Typ	Max	Units	Test Conditions
$V_F$	Forward Voltage	1.5	1.7	2.0	V	$I_F = 20\text{ mA}$
$BV_R$	Reverse Breakdown Voltage	3.0	12		V	$I_R = 1.0\text{ mA}$
$I_O$	Axial Luminous Intensity, Average Each Segment					
	FND500, FND507	300	600		$\mu\text{cd}$	$I_F = 20\text{ mA}$
	FND560, FND567	740	1200		$\mu\text{cd}$	$I_F = 20\text{ mA}$
$\Delta I_O$	Intensity Matching, Segment-to-Segment		$\pm 33$		%	$I_F = 20\text{ mA}$
	Intensity Matching Within One Intensity Class		$\pm 20$		%	$I_F = 20\text{ mA}$ , all segments at once
$L_O$	Average Segment Luminance					
	FND500, FND507		35		ftL	$I_F = 20\text{ mA}$
	FND560, FND567		70		ftL	$I_F = 20\text{ mA}$
$\theta_{1/2}$	Viewing Angle to Half Intensity		$\pm 27$		degrees	
$\lambda_{pk}$	Peak Wavelength		665		nm	$I_F = 20\text{ mA}$



# Typical Electrical Characteristic Curves

# FND500, FND507 FND560, FND567

**Forward Current vs Forward Voltage**

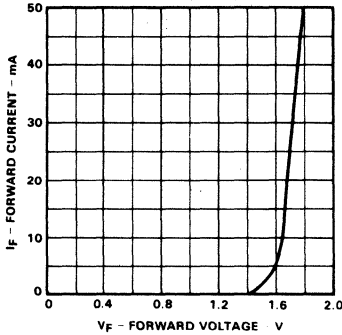

**Maximum Average Current Rating  
vs Ambient Temperature**

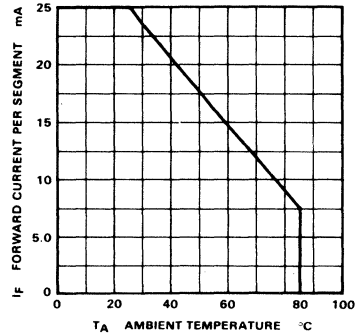

**Angular Distribution of Luminous Intensity**

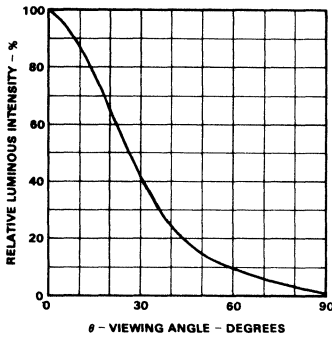

**Average Luminous Intensity  
vs Average Forward Current**

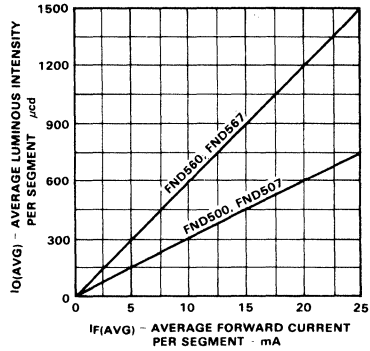

**Relative Luminous Efficiency (mcd per mA)  
vs Peak Current per Segment**

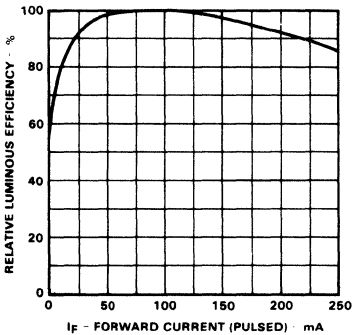

**Relative Luminous Intensity  
vs Junction Temperature**

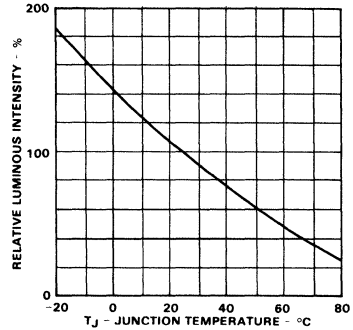

# Red GaAsP 0.5-Inch ± 1 LED Displays

Optoelectronic Products

# FND501, FND508 FND561, FND568

## General Description

The FND501, FND561, FND508 and FND568 are red GaAsP overflow LED displays with a nominal 0.5-inch character height. These displays are for applications where the viewer is within twenty feet of the display.

**Low Forward Voltage**—Typically  $V_F = 1.7$  V  
**Fits Standard DIP Sockets With 0.6-Inch Pin Row**  
**Maximized Contrast Ratio With Integral Lens Cap**  
**Horizontal Stacking 0.6-Inch Minimum,**  
**1-Inch Typical**

**The FND561 And FND568 Are Suitable For Applications in High Ambient Light**

**FND501—Common Cathode, Right-Hand Decimal Point**

**FND508—Common Anode, Right-Hand Decimal Point**

**FND561—Common Cathode, Right-Hand Decimal Point, High Brightness**

**FND568—Common Anode, Right-Hand Decimal Point, High Brightness**

## Absolute Maximum Ratings

### Maximum Temperature and Humidity

Storage Temperature	-25°C to +85°C
Operating Temperature	-25°C to +85°C
Pin Temperature (Soldering, 5 s)	260°C
Relative Humidity at 65°C	98%

### Maximum Voltage and Currents

$V_R$	Reverse Voltage	3.0 V
$I_F$	Average Forward dc Current / Segment or Decimal Point	25 mA
	Derate from 25°C Ambient Temperature	0.3 mA / °C
$I_{pk}$	Peak Forward Current / Segment or Decimal Point (100 $\mu$ s pulse width)	
	1000 pps, $T_A = 25^\circ\text{C}$	200 mA

## Package Outline

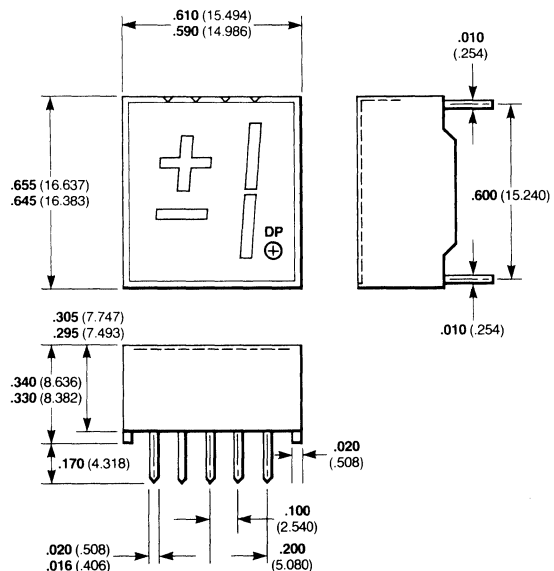

## Notes

All dimensions in inches **bold** and millimeters (parentheses)  
 Tolerance unless specified =  $\pm .015$  (0.381)  
 For polarity indication the surface is ribbed  
 The unit LED segments cannot necessarily be seen through the lens cap  
 Lens cap color is red for red LED  
 Pins 3 and 8 are common

# Connection Diagram Typical Electrical Characteristics

# FND501, FND508 FND561, FND568

## Pin Connections (Top View)

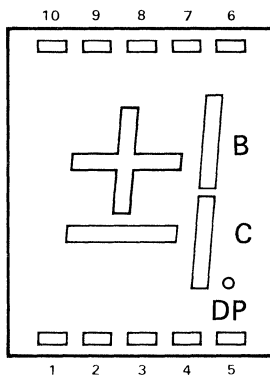

## Pin FND501/561

- 1 Minus
- 2 Cathode  $\pm$
- 3 Segment C
- 4 Cathode 1/DP
- 5 DP
- 6 Segment B
- 7 Cathode 1/DP
- 8 Cathode  $\pm$
- 9 Plus
- 10 NC

## FND508/568

- Minus
- Anode  $\pm$
- Segment C
- Anode 1/DP
- DP
- Segment B
- Anode 1/DP
- Anode  $\pm$
- Plus
- NC

## Electrical and Radiant Characteristics $T_A = 25^\circ\text{C}$

Symbol	Characteristic	Min	Typ	Max	Units	Test Conditions
$V_F$	Forward Voltage		1.7	2.0	V	$I_F = 20 \text{ mA}$
$BV_R$	Reverse Breakdown Voltage	3.0	12		V	$I_R = 1.0 \text{ mA}$
$I_O$	Axial Luminous Intensity, Each Segment FND501, FND508	300	600		$\mu\text{cd}$	$I_F = 20 \text{ mA}$
	FND561, FND568	740	1200		$\mu\text{cd}$	$I_F = 20 \text{ mA}$
$\Delta I_O$	Intensity Matching, Segment-to-Segment		$\pm 33$		%	$I_F = 20 \text{ mA}$
	Intensity Matching Within One Intensity Class		$\pm 20$		%	$I_F = 20 \text{ mA}$ , all segments at once
$L_O$	Average Segment Luminance FND501, FND508		35		ftL	$I_F = 20 \text{ mA}$
	FND561, FND568		70		ftL	$I_F = 20 \text{ mA}$
$\theta_{1/2}$	Viewing Angle to Half Intensity		$\pm 27$		degrees	
$\lambda_{pk}$	Peak Wavelength		665		nm	$I_F = 20 \text{ mA}$

# Typical Electrical Characteristic Curves

# FND501, FND508 FND561, FND568

3

**Forward Current vs Forward Voltage**

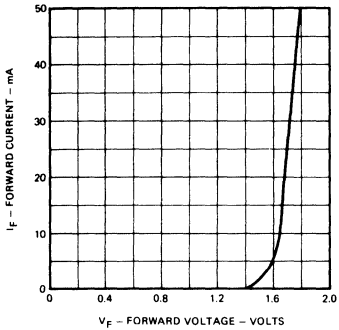

**Maximum Average Current Rating vs Ambient Temperature**

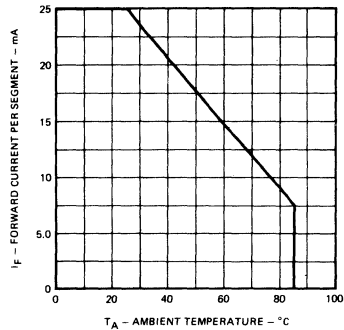

**Angular Distribution of Luminous Intensity**

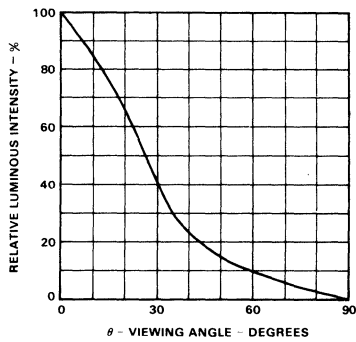

**Average Luminous Intensity vs Average Forward Current**

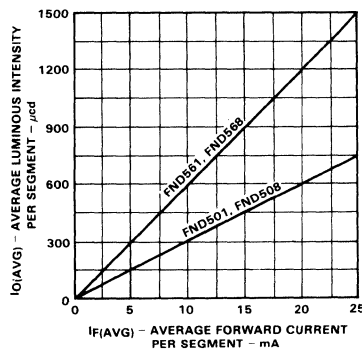

**Relative Luminous Efficiency (mcd per mA) vs Peak Current per Segment**

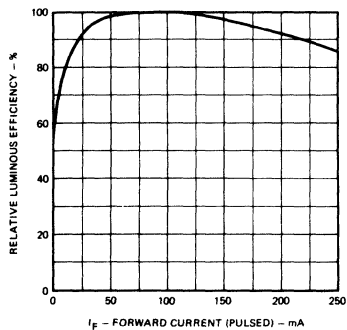

**Relative Luminous Intensity vs Junction Temperature**

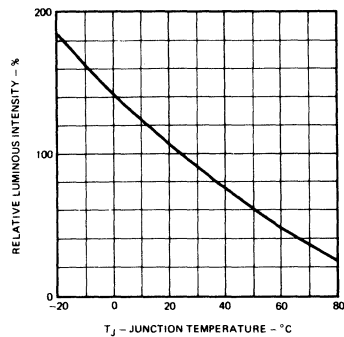

# Green GaP Yellow Super GaAsP Amber Super GaAsP 0.5-Inch 7-Segment LED Displays

Optoelectronic Products

## FND530, FND537 FND540, FND547 FND550, FND557

### General Description

The FND530 and FND537 are green GaP 7-segment LED displays; the FND540 and FND547 are yellow Super GaAsP 7-segment LED displays; and the FND550 and FND557 are amber Super GaAsP 7-segment LED displays. All have a 0.50-inch nominal character height. These displays are for applications where the viewer is within 20 feet of the display.

**Fits Standard Sockets With 0.6-Inch Pin Row  
Intensity Code Marking For Uniform Displays  
Maximized Contrast Ratio With Integral Lens Cap  
Maximized Use Of Digit Face**

**FND550/FND557—Suitable For Use In High  
Ambient Light**

**FND530—Common Cathode, Right-Hand Decimal  
Point, Green**

**FND537—Common Anode, Right-Hand Decimal  
Point, Green**

**FND540—Common Cathode, Right-Hand Decimal  
Point, Yellow**

**FND547—Common Anode, Right-Hand Decimal  
Point, Yellow**

**FND550—Common Cathode, Right-Hand Decimal  
Point, Amber**

**FND557—Common Anode, Right-Hand Decimal  
Point, Amber**

### Absolute Maximum Ratings

#### Maximum Temperature and Humidity

Storage Temperature	-25°C to +85°C
Operating Temperature	-25°C to +85°C
Pin Temperature (Soldering, 5 s)	260°C
Relative Humidity at 60°C	90%

#### Maximum Voltage and Currents

$V_R$	Reverse Voltage	3.0 V
$I_F$	Average Forward dc Current/Segment or Decimal Point	20 mA
$I_{pk}$	Peak Forward Current/ Segment or Decimal Point (100 $\mu$ s pulse width) 1000 pps, $T_A = 25^\circ\text{C}$	80 mA

### Package Outline

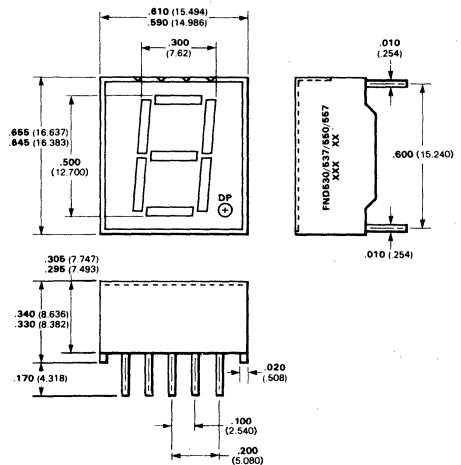

### Notes

All dimensions in inches **bold** and millimeters (parentheses)  
For polarity indication the surface is ribbed  
The unlit LED segments cannot necessarily be seen  
through the lens cap  
Lens cap color is red for red LED  
Pins 3 and 8 are common  
All dimensions are  $\pm .015$  ( $\pm .381$ )

# Connection Diagram Typical Electrical Characteristics

# FND530, FND537 FND540, FND547 FND550, FND557

## Pin Connections (Front View)

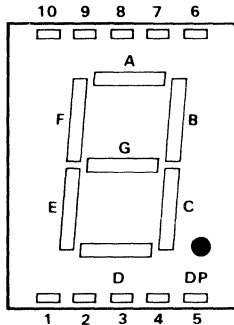

	FND530/540/550	FND537/547/557
Pin		
1	Segment E	Segment E
2	Segment D	Segment D
3	Common Cathode	Common Anode
4	Segment C	Segment C
5	Decimal Point	Decimal Point
6	Segment B	Segment B
7	Segment A	Segment A
8	Common Cathode	Common Anode
9	Segment F	Segment F
10	Segment G	Segment G

3

## Electrical and Radiant Characteristics $T_A = 25^\circ\text{C}$

Symbol	Characteristic	Min	Typ	Max	Units	Test Conditions
$V_F$	Forward Voltage		2.2	3.2	V	$I_F = 20 \text{ mA}$
$BV_R$	Reverse Breakdown Voltage	3.0			V	$I_R = 1.0 \text{ mA}$
$I_O$	Axial Luminous Intensity					
	Average Each Segment					
	FND530, FND537		600	2000	$\mu\text{cd}$	$I_F = 20 \text{ mA}$
	FND540, FND547		600	1000	$\mu\text{cd}$	$I_F = 20 \text{ mA}$
	FND550, FND557		700	2000	$\mu\text{cd}$	$I_F = 20 \text{ mA}$
$\theta_{1/2}$	Viewing Angle to Half Intensity		$\pm 30$		degrees	$I_F = 20 \text{ mA}$
$\lambda_{pk}$	Peak Wavelength					
	FND530, FND537		565		nm	$I_F = 20 \text{ mA}$
	FND540, FND547		585		nm	$I_F = 20 \text{ mA}$
	FND550, FND557		635		nm	$I_F = 20 \text{ mA}$
$L_O$	Average Segment Luminance					
	FND530, FND537		104		ftL	$I_F = 20 \text{ mA}$
	FND540, FND547		52		ftL	$I_F = 20 \text{ mA}$
	FND550, FND557		104		ftL	$I_F = 20 \text{ mA}$
$\Delta I_O$	Intensity Matching Segment-to-Segment		$\pm 33$		%	$I_F = 20 \text{ mA}$
	Intensity Matching Within One Intensity Class		$\pm 20$		%	$I_F = 20 \text{ mA}$

# Typical Electrical Characteristic Curves

## FND530, FND537 FND540, FND547 FND550, FND557

### Forward Current vs Forward Voltage

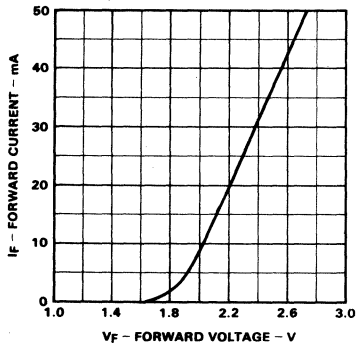

### Maximum Average Current Rating vs Ambient Temperature

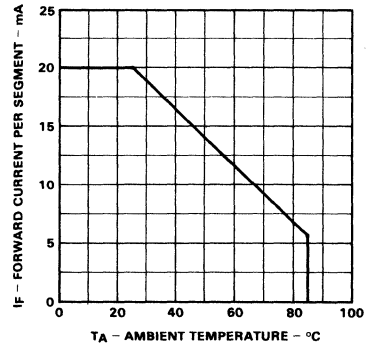

### Angular Distribution Of Luminous Intensity

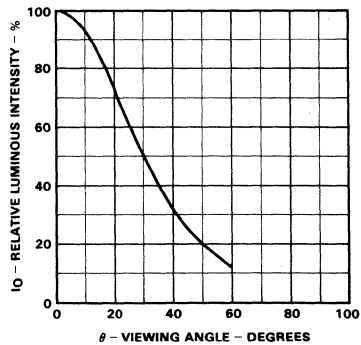

### Average Luminous Intensity vs Average Forward Current

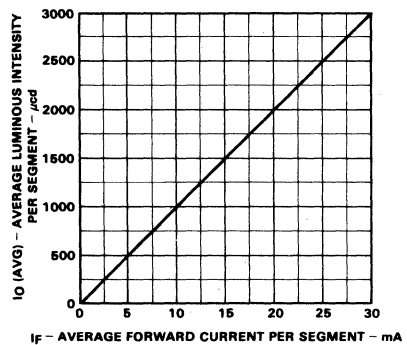

### Emission Spectrum

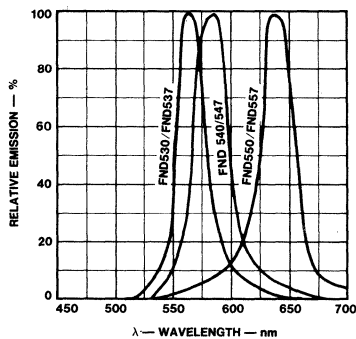

# Green GaP Yellow Super GaAsP Amber Super GaAsP 0.50 Inch $\pm 1$ LED Displays

Optoelectronic Products

## FND531, FND538 FND541, FND548 FND551, FND558

3

### General Description

The FND531 and FND538 are Green GaP  $\pm 1$  LED displays with a nominal 0.50-inch character height. The FND541 and FND548 are yellow Super GaAsP  $\pm 1$  LED displays with a nominal 0.50-inch character height. The FND551 and FND558 are amber Super GaAsP  $\pm 1$  LED displays with a nominal 0.50-inch character height. These displays are for applications where the viewer is within 20 feet of the display.

**Fits Standard Sockets With 0.6-Inch Pin Row Intensity Code Marking for Uniform Displays  
Maximized Contrast Ratio With Integral Lens Cap  
Maximized Use of Digit Face**

**Ideal Companions to FND Series 7-Segment LED Displays**

**FND531/FND538 With FND530/FND537**

**FND541/FND548 With FND540/FND547**

**FND551/FND558 With FND550/FND557**

**FND531—Common Cathode, Right-Hand  
Decimal Point, Green**

**FND538—Common Anode, Right-Hand  
Decimal Point, Green**

**FND541—Common Cathode, Right-Hand  
Decimal Point, Yellow**

**FND548—Common Anode, Right-Hand  
Decimal Point, Yellow**

**FND551—Common Cathode, Right-Hand  
Decimal Point, Amber**

**FND558—Common Anode, Right-Hand  
Decimal Point, Amber**

### Absolute Maximum Ratings

#### Maximum Temperature and Humidity

Storage Temperature	-25°C to +85°C
Operating Temperature	-25°C to +85°C
Pin Temperature (Soldering, 5 s)	260°C
Relative Humidity at 60°C	90%

#### Maximum Voltage and Currents

$V_R$	Reverse Voltage	3.0 V
$I_F$	Average Forward dc Current / Segment or Decimal Point	20 mA
$I_{pk}$	Peak Forward Current / Segment or Decimal Point (100 $\mu$ s pulse width) 1000 pps, $T_A = 25^\circ\text{C}$	80 mA

### Package Outline

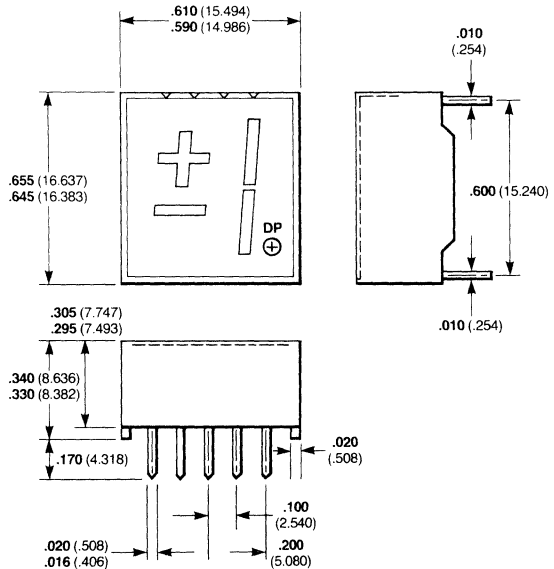

### Notes

All dimensions in inches **bold** and millimeters (parentheses).

For polarity indication the surface is ribbed.

The unlit LED segments cannot necessarily be seen through the lens cap.

Lens cap color is red for red LED.

Pins 3 and 8 are common.

All dimensions are  $\pm 0.015$  ( $\pm 0.381$ ).



# Connection Diagram Typical Electrical Characteristics

# FND531, FND538 FND541, FND548 FND551, FND558

Connection Diagram  
(Top View)

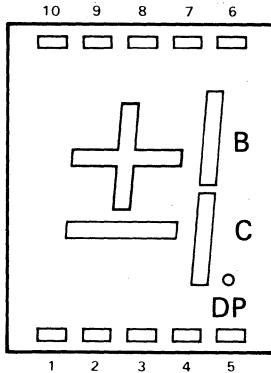

Pin	FND531 FND541 FND551	FND538 FND548 FND558
1	Minus	Minus
2	Cathode $\pm$	Anode $\pm$
3	Segment C	Segment C
4	Cathode 1/DP	Anode 1/DP
5	Decimal Point	Decimal Point
6	Segment B	Segment B
7	Cathode 1/DP	Anode 1/DP
8	Cathode $\pm$	Anode $\pm$
9	Plus	Plus
10	NC	NC

Electrical and Radiant Characteristics  $T_A = 25^\circ\text{C}$

Symbol	Characteristic	Min	Typ	Max	Units	Test Conditions
$V_F$	Forward Voltage		2.2	3.2	V	$I_F = 20\text{ mA}$
$BV_R$	Reverse Voltage Breakdown	3.0			V	$I_R = 1.0\text{ mA}$
$I_O$	Axial Luminous Intensity Average each Segment					
	FND531, FND538	600	2000		$\mu\text{cd}$	$I_F = 20\text{ mA}$
	FND541, FND548	700	2000		$\mu\text{cd}$	$I_F = 20\text{ mA}$
	FND551, FND558	700	2000		$\mu\text{cd}$	$I_F = 20\text{ mA}$
$\theta_{1/2}$	Viewing Angle to Half Intensity		$\pm 30$		degrees	
$\lambda_{pk}$	Peak Wavelength					
	FND531, FND538		565		nm	$I_F = 20\text{ mA}$
	FND541, FND548		570		nm	$I_F = 20\text{ mA}$
	FND551, FND558		635		nm	$I_F = 20\text{ mA}$
$L_O$	Average Segment Luminance		104		ftL	$I_F = 20\text{ mA}$
$\Delta I_O$	Intensity Matching Segment-to-Segment		$\pm 33$		%	$I_F = 20\text{ mA}$
	Intensity Matching Within One Intensity Glass		$\pm 20$		%	$I_F = 20\text{ mA}$

# Typical Electrical Characteristic Curves

# FND531, FND538 FND541, FND548 FND551, FND558

3

**Forward Current vs Forward Voltage**

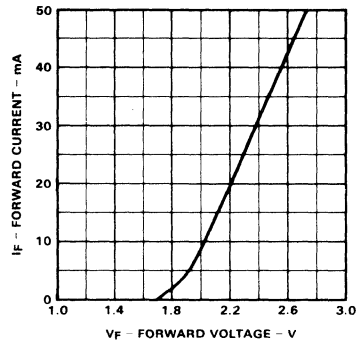

**Maximum Average Current Rating vs Ambient Temperature**

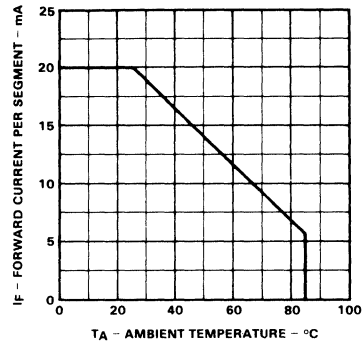

**Angular Distribution of Luminous Intensity**

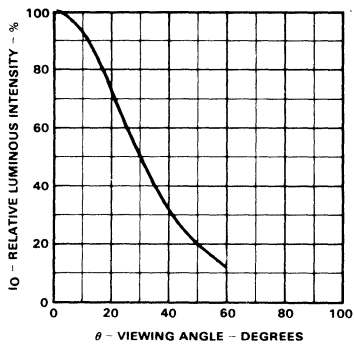

**Average Luminous Intensity vs Average Forward Current**

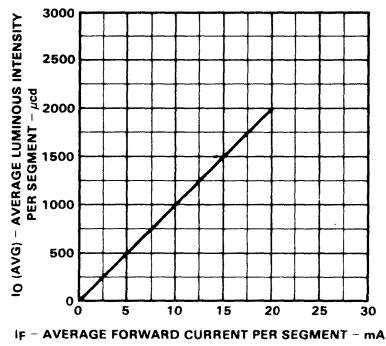

**Emission Spectrum**

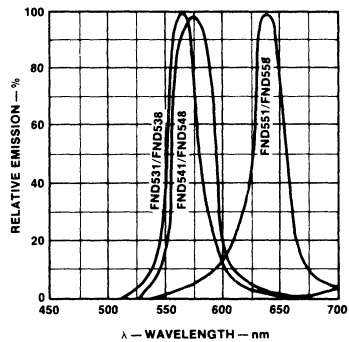

# Red GaAsP 0.8-Inch 7-Segment Numeric LED Display

Optoelectronic Products

## FND800 FND807

### General Description

The FND800 and FND807 are red GaAsP 7-Segment LED Displays with a nominal 0.8-inch character height. These displays are for applications where the viewer is within thirty feet of the display.

### Low Current Requirements of Typically 10 mA/ Segment

Low Forward Voltage Typically  $V_F = 1.7$  V  
Fits Standard DIP Sockets With 0.6-Inch Pin Row  
Decimal Point On Lower Right-Hand Side  
Overflow Point On Upper Left-Hand Side With  
Digit Reversed

Maximized Contrast Ratio With Integral Lens Cap  
Horizontal Stacking 1-Inch Typical  
FND800—Common Cathode, Right-Hand  
Decimal Point

FND807—Common Anode, Right-Hand  
Decimal Point

### Absolute Maximum Ratings

#### Maximum Temperature and Humidity

Storage Temperature	-25°C to +85°C
Operating Temperature	-25°C to +85°C
Pin Temperature (Soldering, 5 s)	260°C
Relative Humidity at 65°C	98%

#### Maximum Voltage and Currents

$V_R$	Reverse Voltage	3.0 V
$I_F$	Average Forward dc Current / Segment or Decimal Point	25 mA
	Derate from 25°C Ambient Temperature	0.3 mA / °C
$I_{pk}$	Peak Current / Segment or Decimal Point (100 $\mu$ s pulse width) 1000 pps, $T_A = 25^\circ\text{C}$	200 mA

### Package Outline

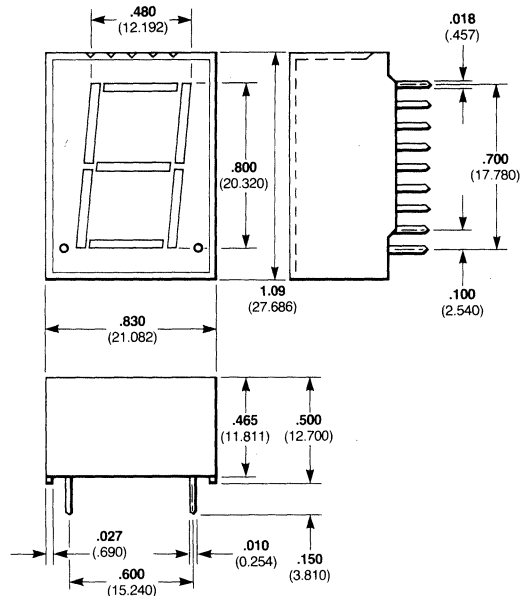

### Notes

All dimensions in inches **bold** and millimeters (parentheses)  
Tolerance unless specified =  $\pm .015$  ( $\pm .381$ )  
For polarity indication the surface is ribbed.  
The unit LED segments cannot necessarily be seen through the lens cap.  
Lens cap color is red for red LED.  
Pins 4, 6, 12 and 17 are common.

# Connection Diagram Typical Electrical Characteristics

# FND800 FND807

## Pin Connections (Top View)

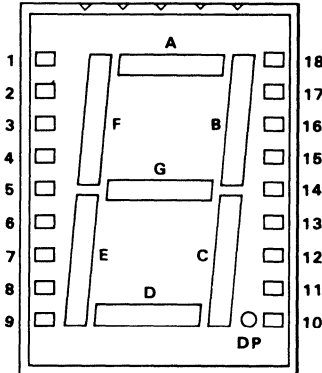

Pin	FND800	FND807
1	Omitted	Omitted
2	Segment A	Segment A
3	Segment F	Segment F
4	Common Cathode	Common Anode
5	Segment E	Segment E
6	Common Cathode	Common Anode
7	NC	NC
8	Omitted	Omitted
9	Omitted	Omitted
10	Decimal Point	Decimal Point
11	Segment D	Segment D
12	Common Cathode	Common Anode
13	Segment C	Segment C
14	Segment G	Segment G
15	Segment B	Segment B
16	Omitted	Omitted
17	Common Cathode	Common Anode
18	Omitted	Omitted

3

## Electrical and Radiant Characteristics $T_A = 25^\circ\text{C}$

Symbol	Characteristic	Min	Typ	Max	Units	Test Conditions
$V_F$	Forward Voltage	1.5	1.7	2.0	V	$I_F = 20\text{ mA}$
$BV_R$	Reverse Breakdown Voltage	3.0	12		V	$I_R = 1.0\text{ mA}$
$I_O$	Axial Luminous Intensity, Average Each Segment	380	1100		$\mu\text{cd}$	$I_F = 20\text{ mA}$
$\Delta I_O$	Intensity Matching, Segment-to-Segment Intensity Matching Within One Intensity Class		$\pm 33$ $\pm 20$		% %	$I_F = 20\text{ mA}$ $I_F = 20\text{ mA}$ , all segments at once
$L_O$	Average Segment Luminance		64		ftL	$I_F = 20\text{ mA}$
$\theta_{1/2}$	Viewing Angle to Half Intensity		$\pm 25$		degrees	
$\lambda_{pk}$	Peak Wavelength		665		nm	$I_F = 20\text{ mA}$

# Typical Electrical Characteristic Curves

# FND800 FND807

**Forward Current vs Forward Voltage**

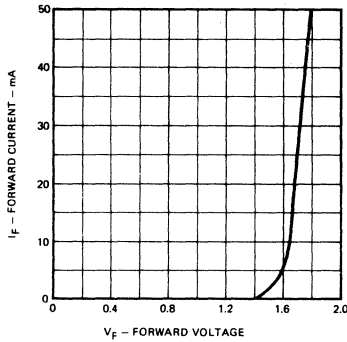

**Maximum Average Current Rating vs Ambient Temperature**

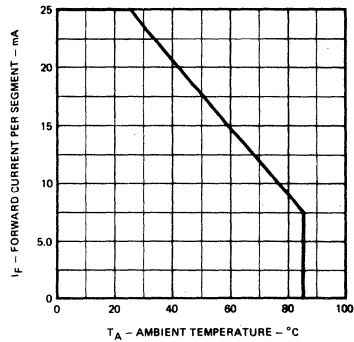

**Angular Distribution of Luminous Intensity**

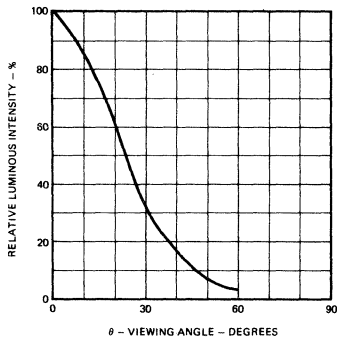

**Average Luminous Intensity vs Average Forward Current**

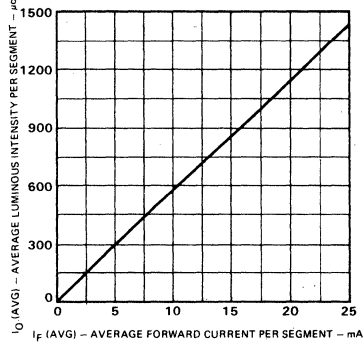

**Relative Luminous Efficiency (mcd Per mA) vs Peak Current Per Segment**

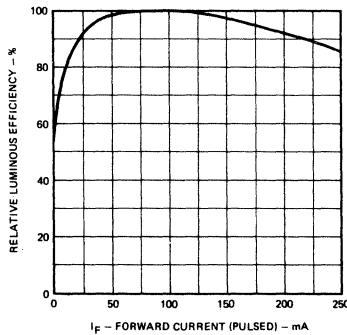

**Relative Luminous Intensity vs Junction Temperature**

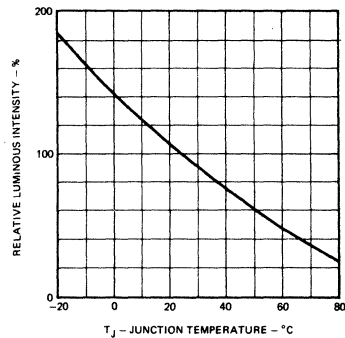

# 10-Position DIP Socket

Optoelectronic Products

## FNS700

### General Description

The FNS700 is a 10-position DIP socket with two rows of five positions each. It is designed for use with all Fairchild 0.362-inch 7-segment LED displays (FND300 Series).

### Package Outline

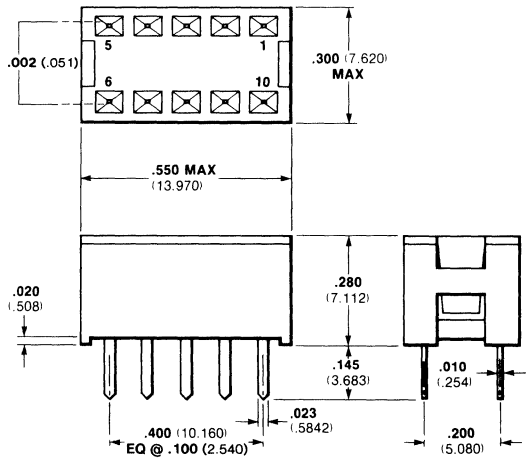

### Notes

All dimensions in inches **bold** and millimeters (parentheses)

Tolerance unless specified =  $\pm .015$  ( $\pm .381$ )

Black nylon, glass-filled Wellamid, or equivalent, insulator.

Phosphorous bronze and tin plate contact.

# Red GaAsP 0.3-Inch 7-Segment Digit

Optoelectronic Products

# MAN71A, MAN72A MAN73A, MAN74A

### General Description

The MAN71A, MAN72A, MAN73A and MAN74A are red GaAsP 7-segment LED displays with 0.3-inch character height. They can be mounted in arrays with 0.400-inch center-to-center spacing.

### Low Power Consumption

### Solid State Reliability—Long Operation Life

### Impact Resistant Plastic Case

### Standard 14-Pin DIP Configuration

### Wide Viewing Angle

### Intensity Coding for Uniform Display

### MAN71A—Common Anode Digit, Right-Hand

Decimal Point

### MAN72A—Common Anode Digit, Left-Hand

Decimal Point

### MAN73A—Common Anode Overflow ± Digit,

Left-Hand Decimal Point

### MAN74A—Common Cathode Digit, Right-Hand

Decimal Point

### Absolute Maximum Ratings

#### Maximum Temperature and Humidity

Storage Temperature	-40°C to +85°C
Operating Temperature	-40°C to +85°C
Pin Temperature (Soldering, 5 s)	260°C
Relative Humidity at 65°C	98%

#### Maximum Voltage and Currents

$V_R$	Reverse Voltage	5.0 V
$I_F$	Average Forward dc Current / Segment or Decimal Point	30 mA
	Derate from 25°C Ambient Temperature	0.5 mA / °C
$I_{pk}$	Peak Forward Current / Segment or Decimal Point (100 $\mu$ s pulse)	
	1000 pps, $T_A = 25^\circ\text{C}$	200 mA

### Electrical and Radiant Characteristics $T_A = 25^\circ\text{C}$

Symbol	Characteristic	Min	Typ	Max	Units	Test Conditions
$V_F$	Forward Voltage, Each Segment		1.7	2.0	V	$I_F = 20\text{ mA}$
$I_R$	Reverse Current, Each Segment			100	$\mu\text{A}$	$V_R = 5.0\text{ V}$
$I_O$	Axial Luminous Intensity, Each Segment	125	250		$\mu\text{cd}$	$I_F = 10\text{ mA}$
$\Delta I_O$	Intensity Matching, Segment-to-Segment		$\pm 33$		%	$I_F = 20\text{ mA}$
	Intensity Matching Within One Intensity Class		$\pm 20$		%	$I_F = 20\text{ mA}$ , all segments at once
$\lambda_{pk}$	Peak Wavelength		660		nm	$I_F = 20\text{ mA}$

### Package Outline

#### MAN71A

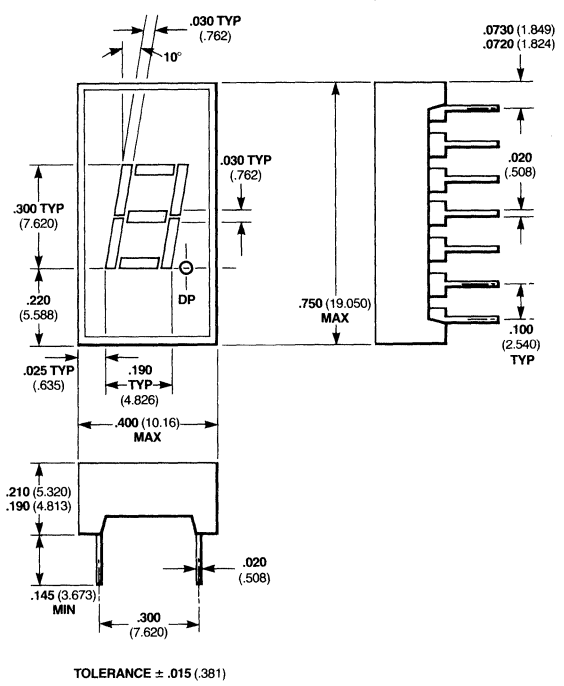

#### Notes

All dimensions in inches **bold** and millimeters (parentheses)  
Tolerance unless specified =  $\pm .015$  ( $\pm .381$ )  
Other packages following

# Connection Diagrams

## MAN71A, MAN72A MAN73A, MAN74A

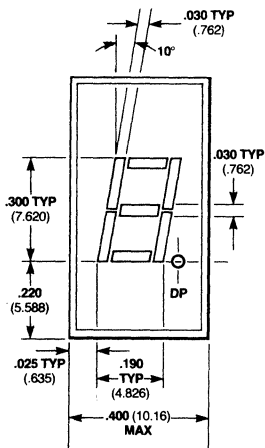

- Pin MAN71A**
- 1 Cathode A
  - 2 Cathode F
  - 3 Common Anode
  - 4 No Pin
  - 5 No Pin
  - 6 NC
  - 7 Cathode E
  - 8 Cathode D
  - 9 Cathode DP
  - 10 Cathode C
  - 11 Cathode G
  - 12 No Pin
  - 13 Cathode B
  - 14 Common Anode

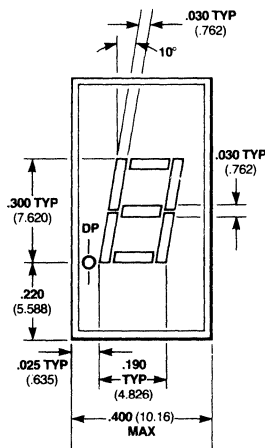

- Pin MAN72A**
- 1 Cathode A
  - 2 Cathode F
  - 3 Common Anode
  - 4 No Pin
  - 5 No Pin
  - 6 Cathode DP
  - 7 Cathode E
  - 8 Cathode D
  - 9 NC
  - 10 Cathode C
  - 11 Cathode G
  - 12 No Pin
  - 13 Cathode B
  - 14 Common Anode

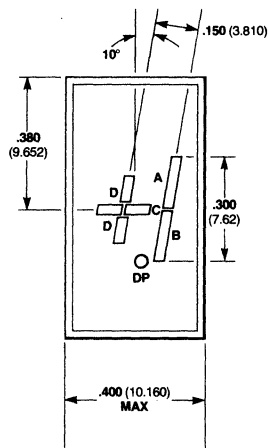

- Pin MAN73A**
- 1 Anode C, D
  - 2 No Pin
  - 3 Anode C, D
  - 4 No Pin
  - 5 No Pin
  - 6 No Pin
  - 7 Cathode D
  - 8 Cathode C
  - 9 NC
  - 10 Cathode B
  - 11 Cathode A
  - 12 No Pin
  - 13 No Pin
  - 14 Anode A, B

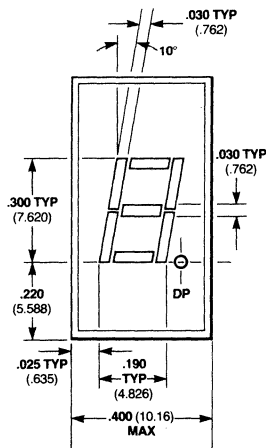

- Pin MAN74A**
- 1 Anode F
  - 2 Anode G
  - 3 No Pin
  - 4 Common Cathode
  - 5 No Pin
  - 6 Anode E
  - 7 Anode D
  - 8 Anode C
  - 9 Anode DP
  - 10 No Pin
  - 11 No Pin
  - 12 Common Cathode
  - 13 Anode B
  - 14 Anode A



# Typical Electrical Characteristic Curves

## MAN71A, MAN72A MAN73A, MAN74A

### Luminous Intensity vs Forward Current

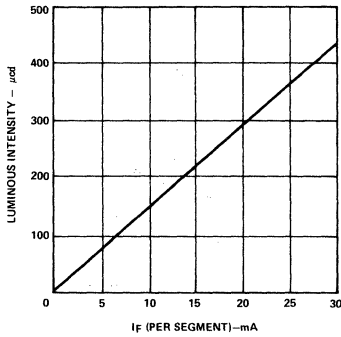

### Luminous Intensity vs Temperature

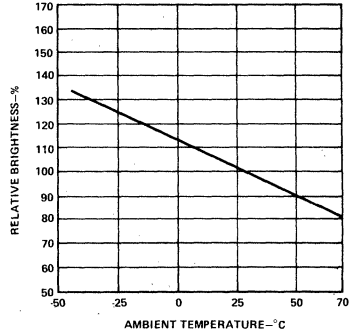

### Forward Current vs Forward Voltage

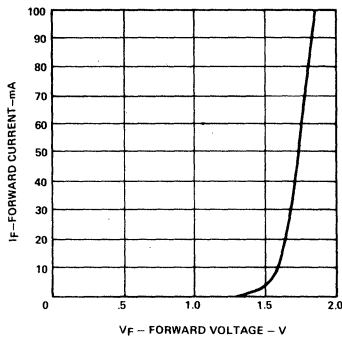

## Package Outlines

MAN71A, MAN72A  
MAN73A, MAN74A

MAN72A

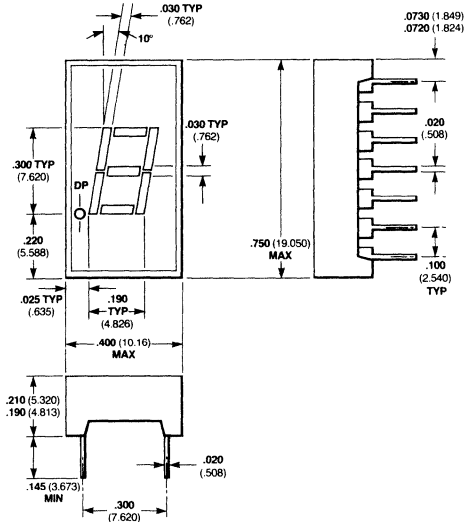

MAN73A

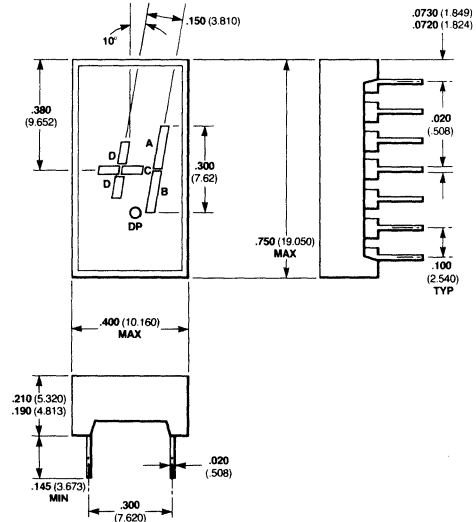

MAN74A

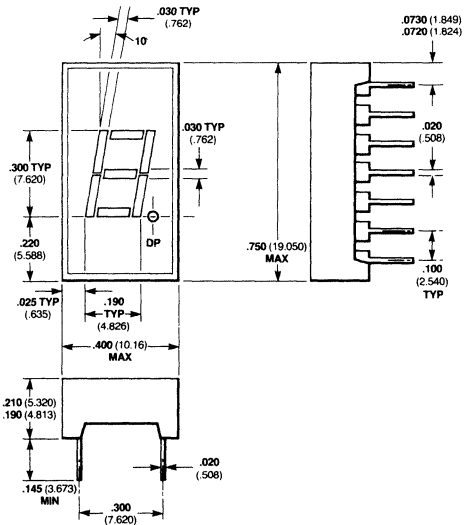

## Notes

All dimensions in inches **bold** and millimeters (parentheses)  
Tolerance unless specified =  $\pm .015$  ( $\pm .381$ )



# Connection Diagrams and Pin Assignments

# MAN3610A, MAN3620A MAN3630A, MAN3640A

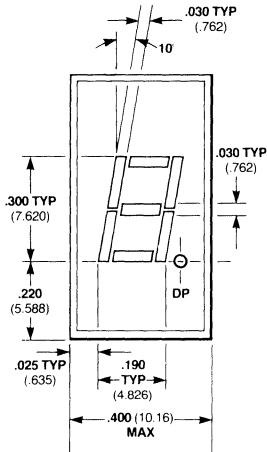

Pin	MAN3610A
1	Cathode A
2	Cathode F
3	Common Anode
4	No Pin
5	No Pin
6	NC
7	Cathode E
8	Cathode D
9	Cathode DP
10	Cathode C
11	Cathode G
12	No Pin
13	Cathode B
14	Common Anode

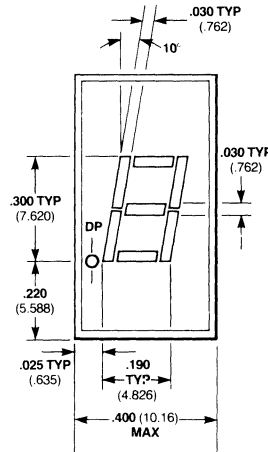

Pin	MAN3620A
1	Cathode A
2	Cathode F
3	Common Anode
4	No Pin
5	No Pin
6	Cathode DP
7	Cathode E
8	Cathode D
9	NC
10	Cathode C
11	Cathode G
12	No Pin
13	Cathode B
14	Common Anode

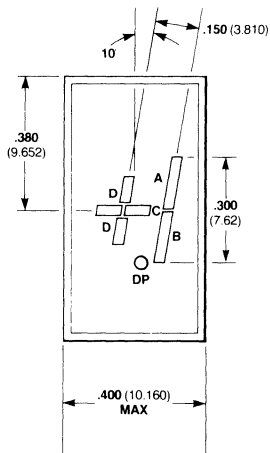

Pin	MAN3630A
1	Anode C, D
2	No Pin
3	Anode C, D
4	No Pin
5	No Pin
6	No Pin
7	Cathode D
8	Cathode C
9	NC
10	Cathode B
11	Cathode A
12	No Pin
13	No Pin
14	Anode A, B

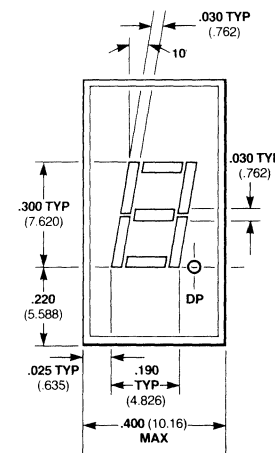

Pin	MAN3640A
1	Anode F
2	Anode G
3	No Pin
4	Common Cathode
5	No Pin
6	Anode E
7	Anode D
8	Anode C
9	Anode DP
10	No Pin
11	No Pin
12	Common Cathode
13	Anode B
14	Anode A

## Electrical and Radiant Characteristics $T_A = 25^\circ\text{C}$

Symbol	Characteristics	Min	Typ	Max	Units	Test Conditions
$V_F$	Forward Voltage / Segment or Decimal Point			2.5	V	$I_F = 20\text{ mA}$
$I_R$	Reverse Current / Segment or Decimal Point			100	$\mu\text{A}$	$V_R = 5.0\text{ A}$
$I_O$	Axial Luminous Intensity, Each Segment	510			$\mu\text{cd}$	$I_F = 10\text{ mA}$
$I_{O\text{DP}}$	D.P. and Segment C, D of MAN3630A	265			$\mu\text{cd}$	$I_F = 10\text{ mA}$
$\Delta I_O$	Intensity Matching, Segment-to-Segment		$\pm 33$		%	$I_F = 20\text{ mA}$
	Intensity Matching Within One Intensity Class		$\pm 20$		%	$I_F = 20\text{ mA}$
$\lambda_{pk}$	Peak Wavelength		630		nm	

# Typical Electrical Characteristic Curves

# MAN3610A, MAN3620A MAN3630A, MAN3640A

### Forward Current vs Forward Voltage

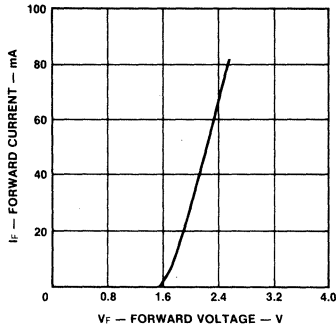

### Luminous Intensity vs Forward Current

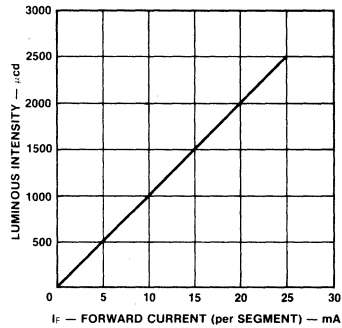

### Luminous Intensity vs Temperature

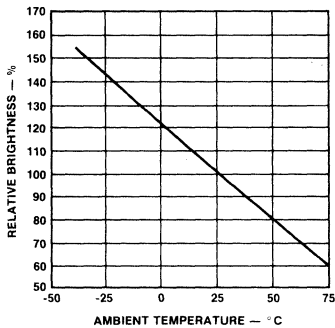

### Max Peak Current vs Duty Cycle

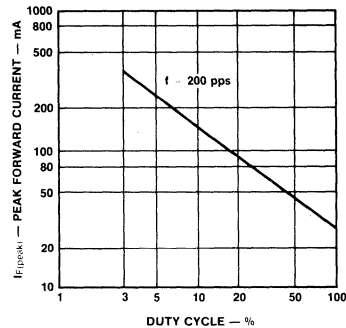

### Luminous Intensity vs Duty Cycle

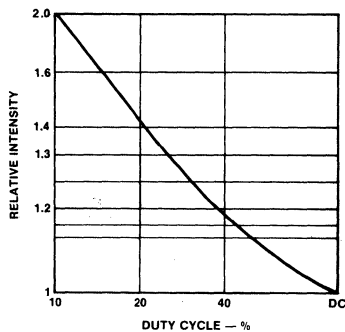

# Package Outlines

# MAN3610A, MAN3620A MAN3630A, MAN3640A

**MAN3620A**

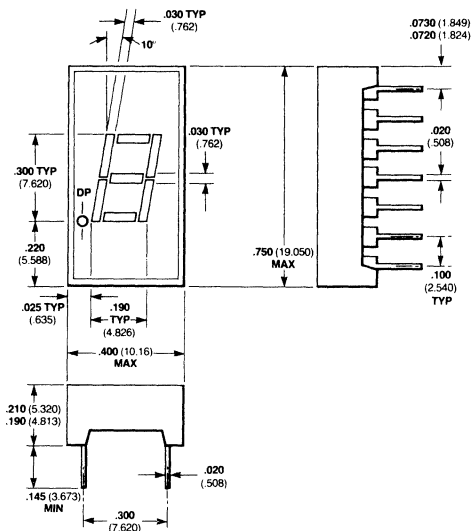

**MAN3630A**

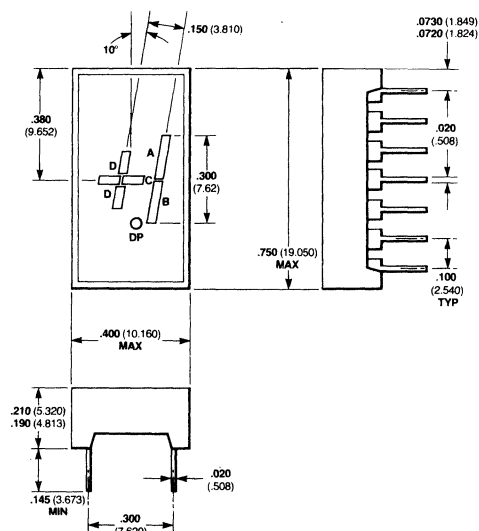

3

**MAN3640A**

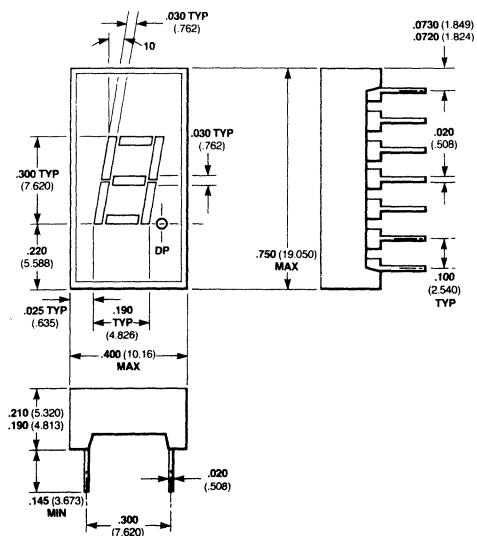

**Notes**  
All dimensions in inches bold and millimeters (parentheses).  
Total intensity divided by number of segments.

# Orange Super GaAsP 0.56-Inch Dual-Digit 7-Segment LED Display

Optoelectronic Products

## MAN6610 MAN6640

### General Description

The MAN6610 and MAN6640 are high-performance orange Super GaAsP 7-Segment dual-digit LED displays with right-hand decimal points.

### High Brightness and High Contrast

Low Power Consumption

Solid State Reliability

IC Compatible

Wide Angle Viewing

Standard Double-DIP Pin Configuration

Low Forward Voltage

MAN6610—Common Anode, Right-Hand

Decimal Points

MAN6640—Common Cathode, Right-Hand

Decimal Points

### Absolute Maximum Ratings

#### Maximum Temperature

Operating Temperature  $-40^{\circ}\text{C}$  to  $+85^{\circ}\text{C}$

Storage Temperature  $-40^{\circ}\text{C}$  to  $+85^{\circ}\text{C}$

Pin Temperature (Soldering, 5 s)  $260^{\circ}\text{C}$

#### Maximum Power Dissipation

Total Dissipation at  $T_A = 25^{\circ}\text{C}$  1200 mW

Derate Linearly from  $50^{\circ}\text{C}$   $-17.1\text{ mW}/^{\circ}\text{C}$

#### Maximum Voltage and Currents

$V_R$  Reverse Voltage/Segment  
or Decimal Point

6.0 V

$I_F$  Average Forward

dc Current Total

480 mA

Per Segment

or Decimal Point

30 mA

### Electrical and Radiant Characteristics $T_A = 25^{\circ}\text{C}$ Per Digit

Symbol	Characteristic	Min	Typ	Max	Units	Test Conditions
$V_F$	Forward Voltage/Segment or Decimal Point		2.0	2.5	V	$I_F = 20\text{ mA}$
$I_R$	Reverse Current/Segment or Decimal Point			100	$\mu\text{A}$	$V_R = 3.0\text{ V}$
$\Delta I_0$	Axial Luminous Intensity/Segment	510			$\mu\text{cd}$	$I_F = 10\text{ mA}$
$I_0$	Intensity Matching, Segment-to-Segment		$\pm 33$		%	$I_F = 10\text{ mA}$
$\lambda_{pk}$	Peak Wavelength		630		nm	$I_F = 20\text{ mA}$

### Package Outline

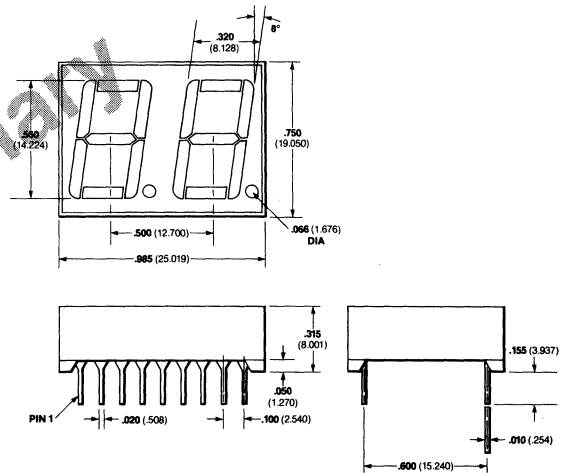

### Notes

All dimensions in inches **bold** and millimeters (parentheses)  
Tolerance unless specified =  $\pm .015$  ( $\pm .381$ )

## Pin Connections

MAN6610  
MAN6640

## Pin Connections

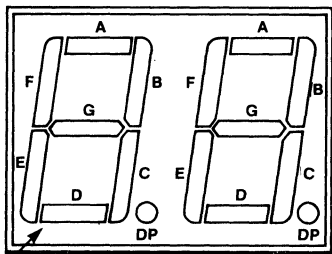

Pin	MAN6610
1	Cathode E, Digit 1
2	Cathode D, Digit 1
3	Cathode C, Digit 1
4	Cathode DP, Digit 1
5	Cathode E, Digit 2
6	Cathode D, Digit 2
7	Cathode G, Digit 2
8	Cathode C, Digit 2
9	Cathode DP, Digit 2
10	Cathode B, Digit 2
11	Cathode A, Digit 2
12	Cathode F, Digit 2
13	Anode, Digit 2
14	Anode, Digit 1
15	Cathode B, Digit 1
16	Cathode A, Digit 1
17	Cathode G, Digit 1
18	Cathode F, Digit 1

Pin	MAN6640
1	Anode E, Digit 1
2	Anode D, Digit 1
3	Anode C, Digit 1
4	Anode DP, Digit 1
5	Anode E, Digit 2
6	Anode D, Digit 2
7	Anode G, Digit 2
8	Anode C, Digit 2
9	Anode DP, Digit 2
10	Anode B, Digit 2
11	Anode A, Digit 2
12	Anode F, Digit 2
13	Cathode, Digit 2
14	Cathode, Digit 1
15	Anode B, Digit 1
16	Anode A, Digit 1
17	Anode G, Digit 1
18	Anode F, Digit 1



# Typical Electrical Characteristic Curves

# MAN6610 MAN6640

### Forward Current vs Forward Voltage

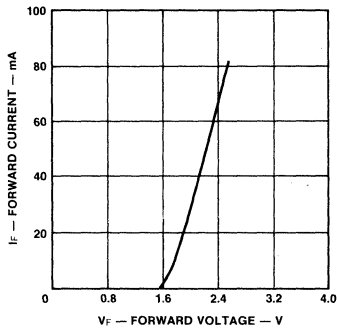

### Luminous Intensity vs Forward Current

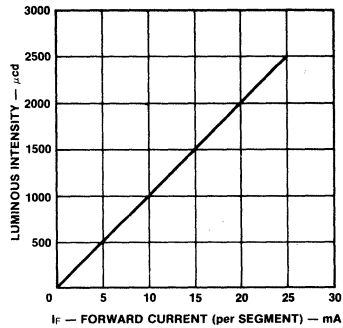

### Luminous Intensity vs Temperature

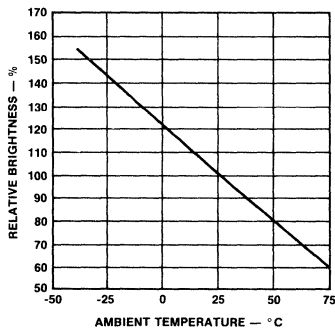

### Max Peak Current vs Duty Cycle

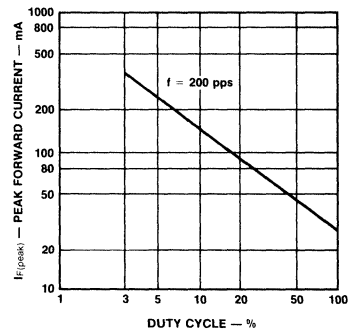

### Luminous Intensity vs. Duty Cycle

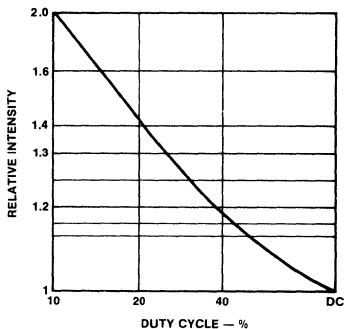

# Red GaAsP 0.56-Inch Dual-Digit 7-Segment LED Display

Optoelectronic Products

## MAN6710 MAN6740

### General Description

MAN6710 and MAN6740 are high-performance red GaAsP 7-segment dual-digit LED displays with right-hand decimal points.

**Low Current Requirements—Typically  
8 mA/Segment**

**Low Forward Voltage— $V_F = 1.7$  V**

**Standard Double-DIP Pin Configuration**

**Stackable on 0.5-Inch Centers**

**Maximized Contrast Ratio**

**Wide Viewing Angle**

**MAN6710—Common Anode, Right-Hand  
Decimal Points**

**MAN6740—Common Cathode, Right-Hand  
Decimal Points**

### Absolute Maximum Ratings

#### Maximum Temperature and Humidity

Operating Temperature	-40°C to +85°C
Storage Temperature	-40°C to +85°C
Pin Temperature (Soldering, 5 s)	260°C
Relative Humidity at 65°C	98%

#### Maximum Voltage and Current

$V_R$ Reverse Voltage	6.0 V
$I_F$ Average Forward Current/ Segment or Decimal Point Derate from 25°C Ambient Temperature/Segment	30 mA 1.0 mW/°C
$I_{pk}$ Peak Current/Segment or Decimal Point (100 $\mu$ s pulse) 1000 pps, $T_A = 25^\circ\text{C}$	200 mA

### Electrical and Radiant Characteristics $T_A = 25^\circ\text{C}$

Symbol	Characteristic	Min	Typ	Max	Units	Test Conditions
$V_F$	Forward Voltage	1.5	1.7	2.0	V	$I_F = 20$ mA
$I_R$	Reverse Current			100	$\mu$ A	$V_R = 5.0$ V
$\Delta I_O$	Axial Luminous Intensity, Each Segment	125	250		$\mu$ cd	$I_F = 10$ mA
$I_O$	Intensity Matching, Segment-to-Segment		$\pm 33$		%	$I_F = 10$ mA
$\lambda_{pk}$	Peak Wavelength		665		nm	$I_F = 20$ mA

### Package Outline

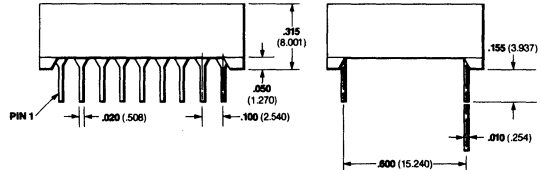
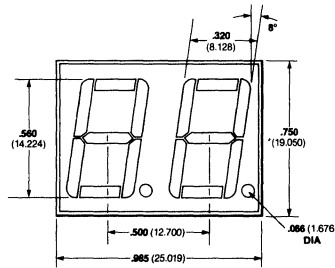

#### Note

All dimensions in inches **bold** and millimeters (parentheses)

# Pin Connections Typical Electrical Characteristic Curves

## MAN6710 MAN6740

### Pin Assignment

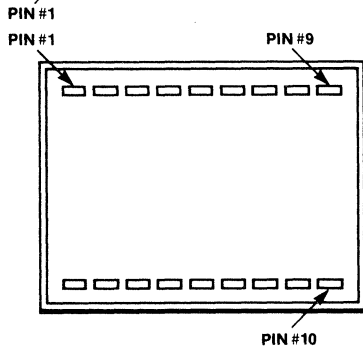
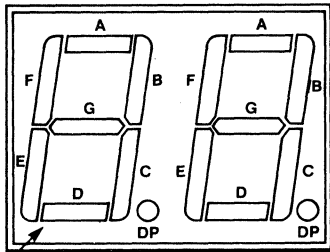

### MAN6710

Pin	Assignment	Pin	Assignment
1	E Cathode Digit 1	10	B Cathode Digit 2
2	D Cathode Digit 1	11	A Cathode Digit 2
3	C Cathode Digit 1	12	F Cathode Digit 2
4	DP Cathode Digit 1	13	Digit 2 Anode
5	E Cathode Digit 2	14	Digit 1 Anode
6	D Cathode Digit 2	15	B Cathode Digit 1
7	G Cathode Digit 1	16	A Cathode Digit 1
8	C Cathode Digit 2	17	G Cathode Digit 1
9	DP Cathode Digit 2	18	F Cathode Digit 1

### MAN6740

Pin	Assignment	Pin	Assignment
1	E Anode Digit 1	10	B Anode Digit 2
2	D Anode Digit 1	11	A Anode Digit 2
3	C Anode Digit 1	12	F Anode Digit 2
4	DP Anode Digit 1	13	Digit 2 Cathode
5	E Anode Digit 2	14	Digit 1 Cathode
6	D Anode Digit 2	15	B Anode Digit 1
7	G Anode Digit 2	16	A Anode Digit 1
8	C Anode Digit 2	17	G Anode Digit 1
9	DP Anode Digit 2	18	F Anode Digit 1

### Forward Current vs Forward Voltage

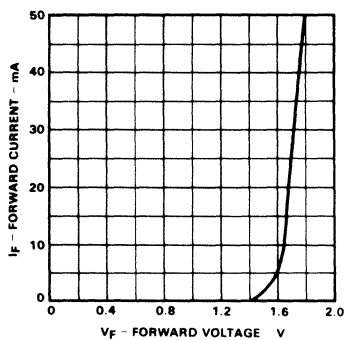

### Maximum Average Current Rating vs Ambient Temperature

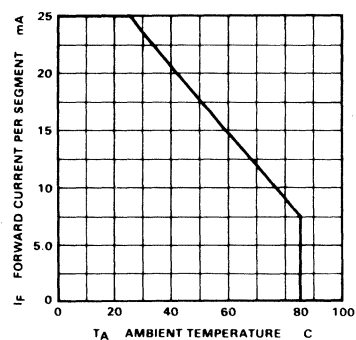

# Typical Electrical Characteristic Curves (Cont'd)

## MAN6710 MAN6740

### Angular Distribution of Luminous Intensity

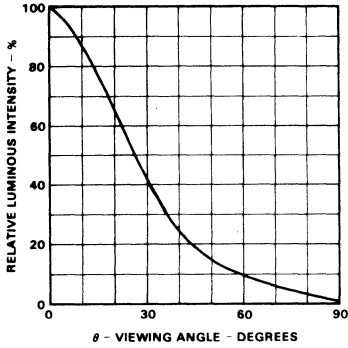

### Average Luminous Intensity vs Average Forward Current

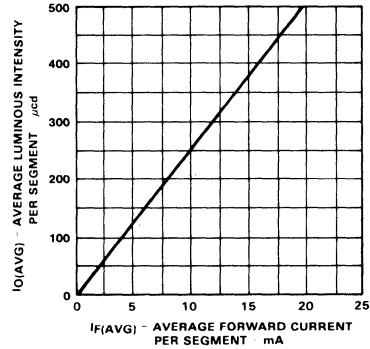

### Relative Luminous Efficiency (mcd per mA) vs Peak Current per Segment

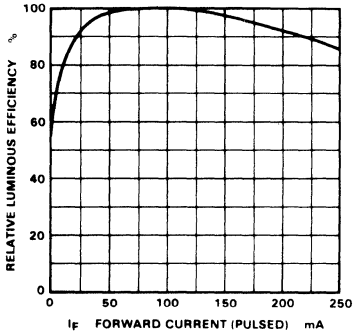

### Relative Luminous Intensity vs Junction Temperature

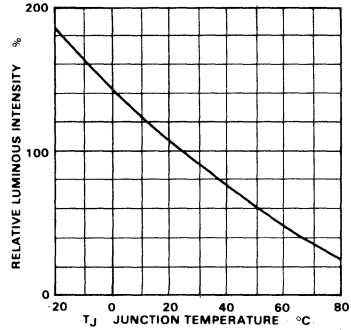

# High Efficiency Red Super GaAsP .43-Inch 7-Segment Numeric LED Displays

Optoelectronic Products

**5082-7650**  
**5082-7651**  
**5082-7653**

## General Description

The 5082-7650, 5082-7651 and 5082-7653 are high efficiency red Super GaAsP 7-segment displays with 0.43-inch character height.

## Low Current Operation

## Wide Viewing Angle

## Easy Mounting on PC Board or Sockets

.3-inch (7.62 mm) DIP pins on .1-inch (2.54 mm)

## Centers

## Intensity Code Marking for Uniform Displays

## IC Compatible

**5082-7650**— Common Anode, Left-Hand

## Decimal Point

**5082-7651**— Common Anode, Right-Hand

## Decimal Point

**5082-7653**— Common Cathode, Right-Hand

## Decimal Point

## Absolute Maximum Ratings

### Maximum Temperature and Humidity

Operating Temperature  $-40^{\circ}\text{C}$  to  $+85^{\circ}\text{C}$

Storage Temperature  $-40^{\circ}\text{C}$  to  $+85^{\circ}\text{C}$

Pin Temperature, Soldering, 3 s

(See Note)  $260^{\circ}\text{C}$

### Maximum Power Dissipation

Total Dissipation at  $T_A = 25^{\circ}\text{C}$ /  
Segment or Decimal Point 50 mW

Derate Linearly from  
 $25^{\circ}\text{C}$ /Segment 0.83 mW/ $^{\circ}\text{C}$

### Maximum Voltage and Currents

$V_R$  Reverse Voltage/  
Segment or Decimal Point 6.0 V

$I_F$  Average Forward dc  
Current/Segment or  
Decimal Point  $T_A = 25^{\circ}\text{C}$  20 mA

$I_{pk}$  Peak Forward Current/  
Segment or Decimal Point  
 $T_A = 25^{\circ}\text{C}$  60 mA

### Note

1/16-inch (1.59 mm) below seating plane. Clean only in water, isopropanol, ethanol, Freon TF or TE (or equivalent) and Genesolv DI-15 or DE-15 (or equivalent).

## Package Outline

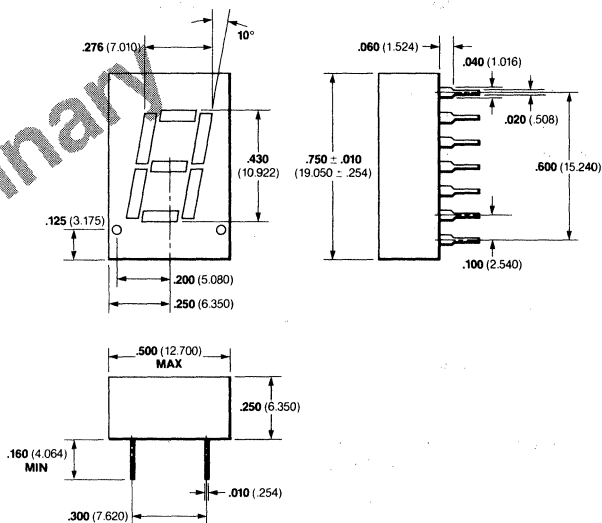

### Notes

All dimensions in inches bold and millimeters (parentheses)  
Tolerance unless specified =  $\pm .015$  ( $\pm .381$ )

# Pin Connections Typical Electrical Characteristic

# 5082-7650 5082-7651 5082-7653

## Pin Connections

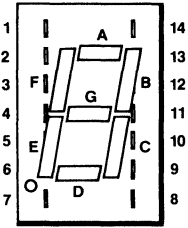

5082-7650

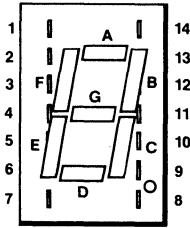
5082-7651  
5082-7653

## Pin Assignments

Pin	5082-7650	5082-7651	5082-7653
1	Cathode A	Cathode A	Anode A
2	Cathode F	Cathode F	Anode F
3	Anode	Anode	Cathode
4	No Pin	No Pin	No Pin
5	No Pin	No Pin	No Pin
6	Cathode DP	NC	NC
7	Cathode E	Cathode E	Anode E
8	Cathode D	Cathode D	Anode D
9	NC	Cathode DP	Anode DP
10	Cathode C	Cathode C	Anode C
11	Cathode G	Cathode G	Anode G
12	No Pin	No Pin	No Pin
13	Cathode B	Cathode B	Anode B
14	Anode	Anode	Cathode

3

## Electrical and Radiant Characteristics $T_A = 25^\circ\text{C}$

Symbol	Characteristic	Min	Typ	Max	Units	Test Conditions
$I_V$	Luminous Intensity/Segment	135	300		$\mu\text{cd}$	$I_F = 5 \text{ mA}$
$\lambda_{pk}$	Peak Wavelength		1720		$\mu\text{cd}$	$I_F = 20 \text{ mA}$
$V_F$	Forward Voltage/Segment or Decimal Point		635		nm	
			1.7	2.5	V	$I_F = 5 \text{ mA}$
			2.0		V	$I_F = 20 \text{ mA}$
$I_R$	Reverse Current/Segment or Decimal Point		10		$\mu\text{A}$	$V_R = 6 \text{ V}$

# Typical Electrical Characteristic Curves

5082-7650  
5082-7651  
5082-7653

**Emission Spectrum**

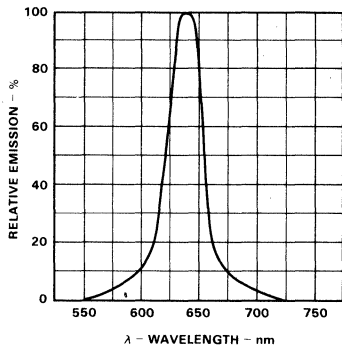

**Forward Current vs Forward Voltage**

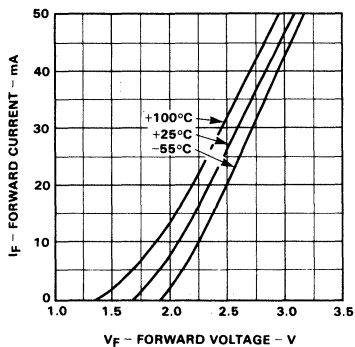

**Intensity vs Forward Current**

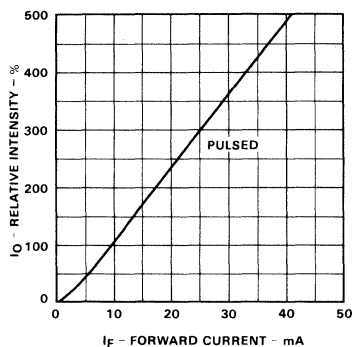

**Intensity vs Viewing Angle**

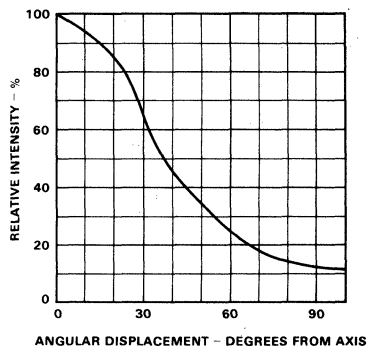

**Intensity vs Temperature**

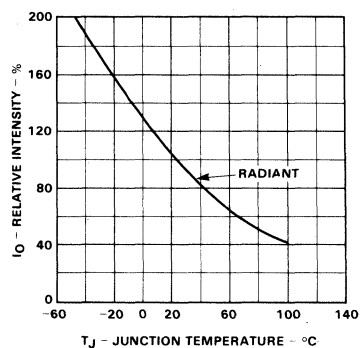

# Red GaAsP 0.43-Inch 7-Segment Numeric LED Displays

## 5082-7750 5082-7751 5082-7760

Optoelectronic Products

### General Description

The 5082-7750, 5082-7751 and 5082-7760 are red GaAsP 7-segment LED displays with a 0.43-inch character height. These displays are designed for viewing distances up to 20 feet and provide a high contrast and a wide viewing angle.

### Wide Viewing Angle

### High Contrast

### IC Compatible

### Easy Mounting on PC Board or Sockets

.3-inch (7.62 mm) DIP pins on .1-inch (2.54 mm) Centers

### Intensity Code Marking for Uniform Displays

5082-7750—Common Anode, Left-Hand

Decimal Point

5082-7751—Common Anode, Right-Hand

Decimal Point

5082-7760—Common Cathode, Right-Hand

Decimal Point

### Absolute Maximum Ratings

#### Maximum Temperature and Humidity

Operating Temperature -40°C to +85°C

Storage Temperature -40°C to +85°C

Pin Temperature (Soldering, 3 s) 260°C

(Note)

#### Maximum Power Dissipation

Total Dissipation at  $T_A = 25^\circ\text{C}$ /

Segment or Decimal Point 50 mW

Derate Linearly from 25°C/ 0.42 mA/°C

Segment

#### Maximum Voltage and Currents

$V_R$  Reverse Voltage/Segment or Decimal Point 6.0 V

$I_F$  Average Forward dc Current/Segment or Decimal Point at  $T_A = 25^\circ\text{C}$  25 mA

$I_{pk}$  Peak Forward Current/Segment or Decimal Point at  $T_A = 25^\circ\text{C}$  150 mA

#### Note

1/16-inch (1.59 mm) below seating plane. Clean only in water, isopropanol, ethanol, Freon TF or TE (or equivalent) and Genesolv DI-15 or DE-15 (or equivalent).

### Package Outline

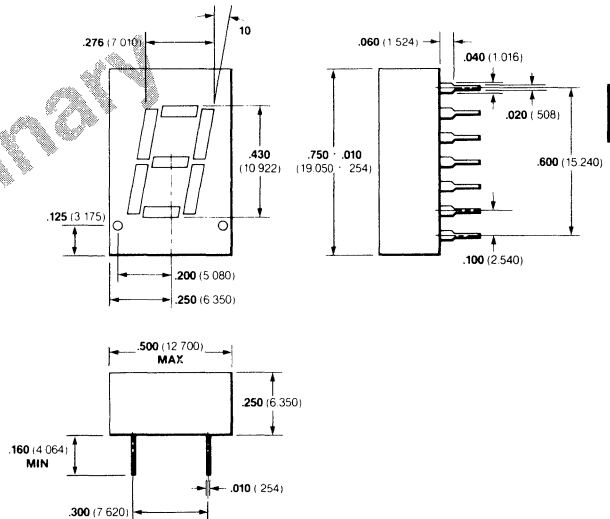

#### Notes

All dimensions in inches **bold** and millimeters (parentheses) Tolerance unless specified =  $\pm .015$  ( $\pm .381$ )



# Connection Diagram

5082-7750  
5082-7751  
5082-7760

## Pin Connections

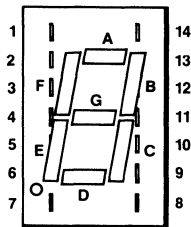

5082-7750

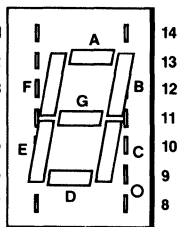
5082-7751  
5082-7760

## Pin Assignments

Pin	5082-7750	5082-7751	5082-7760
1	Cathode A	Cathode A	Anode A
2	Cathode F	Cathode F	Anode F
3	Anode	Anode	Cathode
4	No Pin	No Pin	No Pin
5	No Pin	No Pin	No Pin
6	Cathode DP	NC	NC
7	Cathode E	Cathode E	Anode E
8	Cathode D	Cathode D	Anode D
9	NC	Cathode DP	Anode DP
10	Cathode C	Cathode C	Anode C
11	Cathode G	Cathode G	Anode G
12	No Pin	No Pin	No Pin
13	Cathode B	Cathode B	Anode B
14	Anode	Anode	Cathode

## Electrical and Radiant Characteristics $T_A = 25^\circ\text{C}$

Symbol	Characteristic	Min	Typ	Max	Units	Test Conditions
$I_V$	Luminous Intensity / Segment (Digit Average)	150	400		$\mu\text{cd}$	$I_F = 20\text{ mA}$
$\lambda_{pk}$	Peak Wavelength		655		nm	$I_F = 20\text{ mA}$
$V_F$	Forward Voltage / Segment or Decimal Point		1.6	2.0	V	$I_F = 20\text{ mA}$
$I_R$	Reverse Current / Segment or Decimal Point		10		$\mu\text{A}$	$V_R = 6\text{ V}$

# Typical Electrical Characteristic Curves

5082-7750  
5082-7751  
5082-7760

**Forward Current vs Forward Voltage**

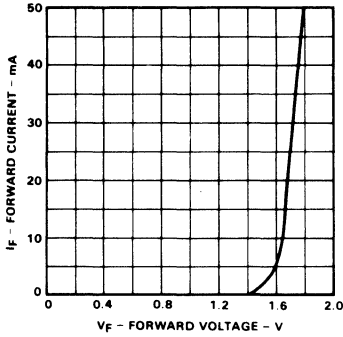

**Maximum Average Current Rating  
vs Ambient Temperature**

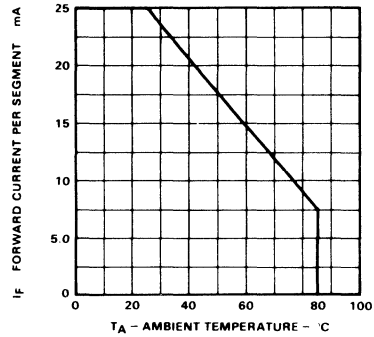

**Angular Distribution of Luminous Intensity**

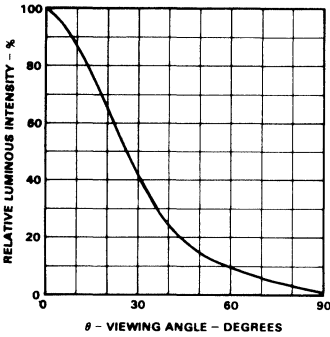

**Average Luminous Intensity  
vs Average Forward Current**

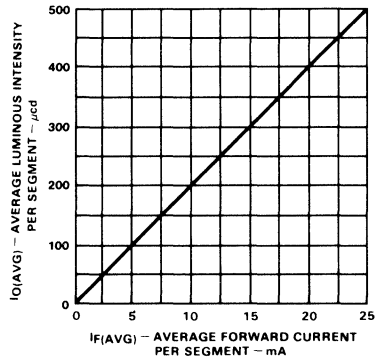

**Relative Luminous Efficiency (mcd Per mA)  
vs Peak Current Per Segment**

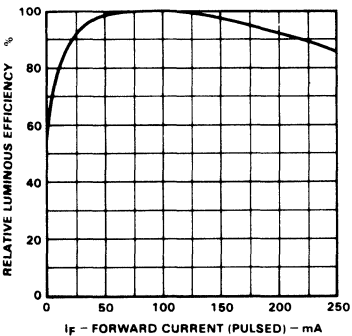

**Relative Luminous Intensity  
vs Junction Temperature**

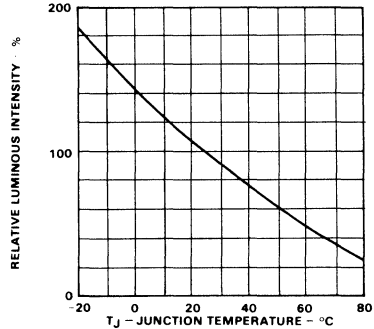



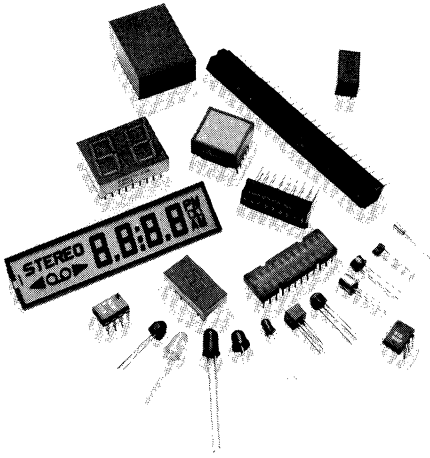

Selection Guides	1
Visible LED Lamps and Mounting Hardware	2
LED Digits	3
Phototransistors, Infrared Emitters and Sensors	4
Couplers	5
Liquid Crystal Displays	6
Fiber Optics	7
Cross Reference	8
Definitions of Symbols and Terms	9
Fairchild Field Sales Offices, Sales Representatives and Distributor Locations	10



# Emitter And Sensor Matched Pair Arrays

Optoelectronic Products

## FPA 100 FPA 101 FPA 102

### General Description

The FPA100, FPA101 and FPA102 are source/sensor arrays each of which consists of a set of two modules: one, an array of infrared emitters, and two, an array of infrared sensors.

The source module consists of an array of GaAs infrared-emitting diodes. When forward biased, these diodes emit an intense narrow band of infrared (non-visible) radiation at a wavelength of 900 nm. The sensor modules consist of an array of npn phototransistors which are sensitive to visible as well as infrared radiation (400 to 1100 nm). They are most sensitive to infrared radiation; therefore, the source module's emission wavelength is very nearly perfect for maximum coupling efficiency. The source and sensor modules of each set are identical in construction; when the modules are placed facing one another, each infrared emitting diode has a photo-transistor directly opposite it.

The FPA100 has nine source/sensor pairs in a single line on 0.100-inch centers, matching the format of standard-punched paper tape. The FPA101 has 12 source/sensor pairs in a single line on 0.250-inch centers, matching the row spacing of standard tab cards. The FPA102 has 10 source/sensor pairs in a single line on 0.087-inch centers, matching the column spacing of standard tab cards.

### Reduces Mechanical Design And Packaging Problems

#### Low Temperature Coefficient

#### Designed For Reading Punched Cards And Punched Tapes With The Sensor

#### Outputs Operable Directly Into Standard Digital ICs

#### Applications: Transmissible Reading Shaft

#### Encoding and Multi-Channel Optical Coupling

### Absolute Maximum Ratings

#### Maximum Temperatures and Humidity

Storage Temperature	-40°C to +100°C
Operating Temperature	-40°C to +100°C
Pin Temperature (Soldering, 10 s)	260°C
Relative Humidity at 65°C	85%

### Maximum Power Dissipation (Note 1)

Total Dissipation at $T_A = 25^\circ\text{C}$	
Source Array	110 mW/cell
Derate Linearly from 25°C	1.47 mW/°C
Total Dissipation at $T_A = 25^\circ\text{C}$	
Sensor Array	167 mW/cell
Derate Linearly from 25°C	2.22 mW/°C

### Maximum Voltage and Currents

<b>Source Array</b>	
$I_F$	Forward dc Current/Cell 75 mA
$V_R$	Reverse Voltage 3.0 V
<b>Sensor Array</b>	
$V_{CE(Sus)}$	Collector-to-Emitter Sustaining Voltage (Note 2)
	12 V
$I_C$	Collector Current 25 mA

### Package Outline

#### FPA 100

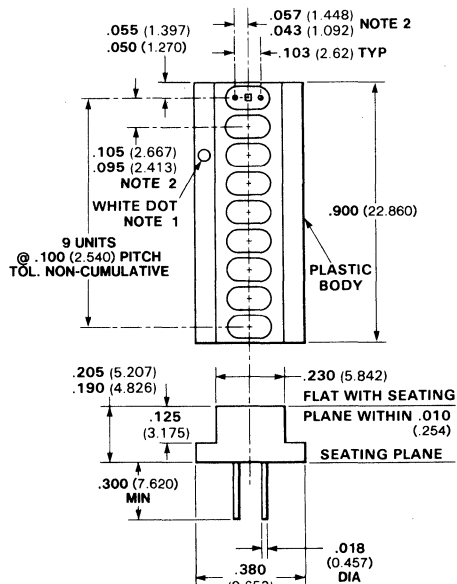

### Notes

1. Emitter terminal side of phototransistor (sensor array) or anode terminal side of diode (source array) defined by white dot.
2. The center of each element is aligned to  $\pm .010$  along the length and  $\pm .005$  across the width.
3. All dimensions in inches **bold** and millimeters (parentheses).
4. Tolerance unless specified =  $\pm 0.15$  (0.381).
5. Other packages following.

# Typical Electrical Characteristics

FPA 100  
FPA 101  
FPA 102

## Electrical Characteristics—Source Array $T_A = 25^\circ\text{C}$

Symbol	Characteristic	Min	Typ	Max	Units	Test Conditions
$V_F$	Forward Voltage		1.25	1.50	V	$I_F = 50\text{ mA}$
$BV_R$	Reverse Breakdown Voltage	3.0	6.0		V	$I_R = 100\ \mu\text{A}$

## Sensor Array

Symbol	Characteristic	Min	Typ	Max	Units	Test Conditions
$V_{CE(sus)}$	Sustaining Voltage (Notes 2 and 3)	12	20		V	$I_C = 1.0\text{ mA}$ , pulsed
$BV_{ECO}$	Emitter-to-Collector Breakdown Voltage (Note 2)		5.0		V	$I_{EC} = 100\ \mu\text{A}$
$V_{CE(sat)}$	Saturation Voltage (Note 4)		0.4		V	$I_C = 4\text{ mA}$ , $H = 10\text{ mW/cm}^2$ (GaAs)
$I_{CEO}$	Collector Dark Current (Note 2)		10	100	nA	$V_{CE} = 5.0\text{ V}$ , $H \leq 0.1\ \mu\text{W/cm}^2$
$I_{CE(I)}$	Photo Current (Note 4)		4.5		mA	$V_{CE} = 5.0\text{ V}$ , $H = 1.0\text{ mW/cm}^2$ (GaAs)

## Combination Source/Sensor Array

Symbol	Characteristic	Min	Typ	Max	Units	Test Conditions
$I_{OUT}$	Output Current	4.5	9.0	13.5	mA	$I_{IN} = 50\text{ mA}$ , $d = .050\text{-inch}$ , $V_{CE} = 5.0\text{ V}$
$\frac{I_{OUT(min)}}{I_{OUT(max)}}$	Matching Factor	0.5	0.65			$I_{IN} = 50\text{ mA}$ , $d = .050\text{-inch}$ , $V_{CE} = 5.0\text{ V}$
$V_{CE(sat)}$	Saturation Voltage		0.4	0.7	V	$I_{IN} = 50\text{ mA}$ , $d = .050\text{-inch}$ , $I_{OUT} = 3.7\text{ mA}$
$t_f$	Light Current Fall Time (Note 5)		40		$\mu\text{s}$	$I_{IN} = 50\text{ mA}$ , $d = .050\text{-inch}$
$t_r$	Light current Rise Time (Note 5)		40		$\mu\text{s}$	$I_{IN} = 50\text{ mA}$ , $d = .050\text{-inch}$

### Notes

- These are steady-state limits. The factory should be consulted on applications involving pulsed or low duty cycle operation.
- Measured with radiation flux intensity of less than  $0.1\ \mu\text{W/cm}^2$  over the spectrum from 0.1 micron to 1.5 microns.
- Rating refers to a high current point where collector-to-emitter voltage is lowest.
- Measured at an irradiance of  $5.0\text{ mW/cm}^2$  as emitted from a gallium arsenide diode.
- Rise time is defined as the time required for  $I_{CE}$  to rise from 10% to 90% of the peak value. Fall time is defined as the time required for  $I_{CE}$  to decrease from 90% to 10% of the peak value.

# Typical Electrical Characteristic Curves

## FPA 100 FPA 101 FPA 102

**Forward Current vs Forward Voltage (dc)**

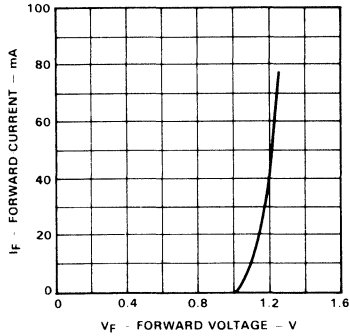

**Maximum  $P_D$  vs Ambient Temperature**

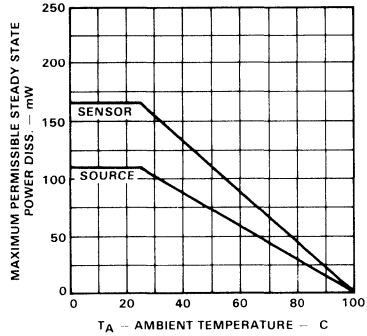

4

**Collector Dark Current vs Temperature**

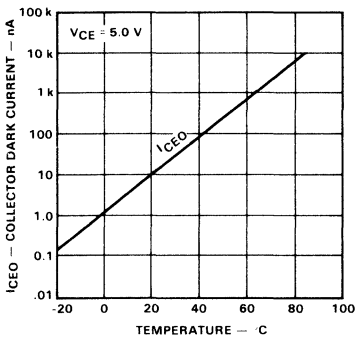

**Relative Spectral Response**

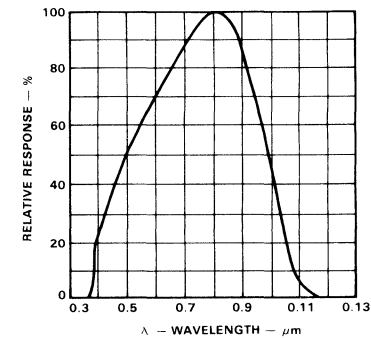

**Rise and Fall Time vs Collector Current**

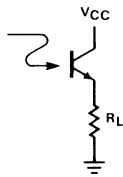
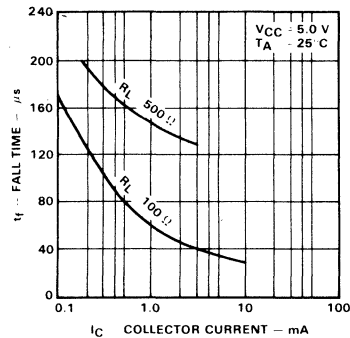

**Output Current vs Distance**

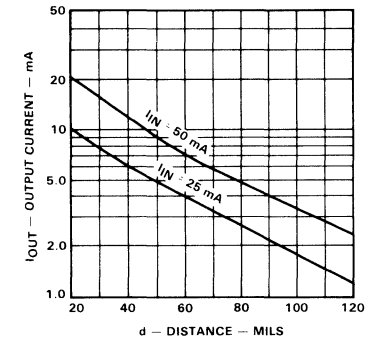



# Typical Electrical Characteristic Curves Typical Circuits

# FPA 100 FPA 101 FPA 102

### Relative Output vs Ambient Temperature

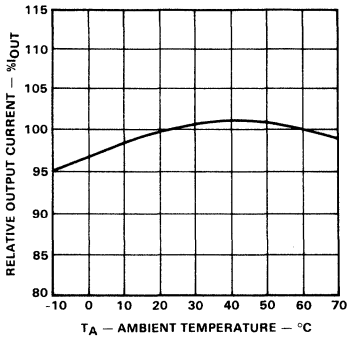

### Output Current vs Collector Voltage

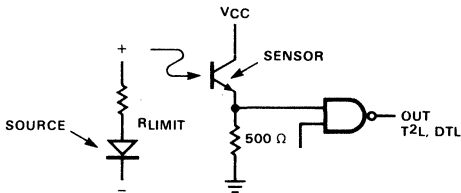
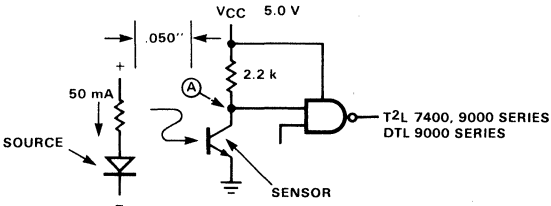
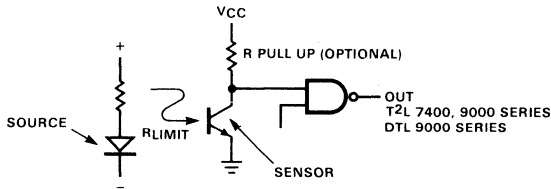
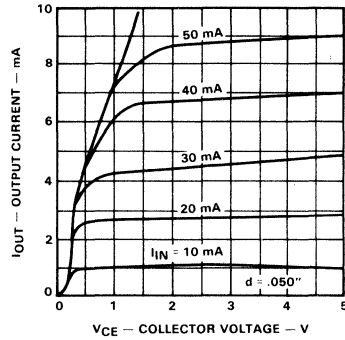

For a "hole" condition, point A for all sensors will be less than 0.8 V. For a "no hole" condition (where signal due to tape transmission is  $\leq 15\%$  of "hole"), point A will be greater than 2.0 V. These are the worst case conditions required to switch this type of logic.

### Source Circuits

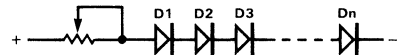

**Note**

Use where  $V_{supply} > 1.5$  n and transmission  $< 20\%$ .

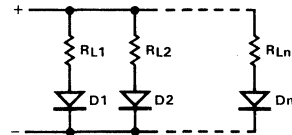

**Note**

Use where  $V_{supply} < 1.5$  n and transmission  $< 20\%$ . Rows must contain equal number of diodes.

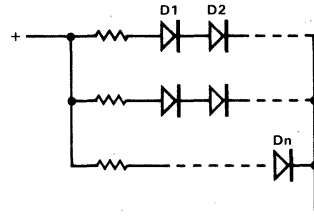

**Note**

Use where  $V_{supply} < 1.5$  n and transmission  $> 20\%$ .  $R_L$  may be adjusted so outputs of sensors are perfectly matched.

# Typical Circuits (Cont'd)

## Package Outlines

# FPA 100

# FPA 101

# FPA 102

### Package Outlines

#### FPA101

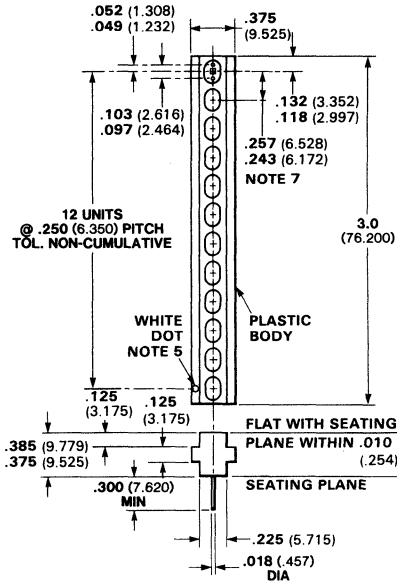

#### Notes

1. Emitter terminal side of phototransistor (sensor array) or anode terminal side of diode (source array) defined by white dot.
2. Leads alternate from emitter to collector (sensor) or anode to cathode (source), beginning from this end of the package.
3. All dimensions in inches **bold** and millimeters (parentheses).
4. Tolerance unless specified =  $\pm 0.15$  (0.381).

#### FPA102

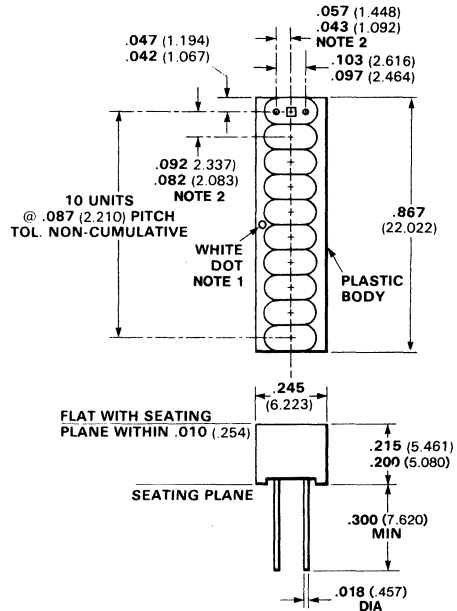

#### Notes

1. Emitter terminal side of phototransistor (sensor array) or anode terminal side of diode (source array) defined by white dot.
2. The center of each element is aligned to  $\pm .010$  along the length and  $\pm .005$  across the width.
3. All dimensions in inches **bold** and millimeters (parentheses).
4. Tolerance unless specified =  $\pm 0.15$  (0.381).

# Light Reflection Emitter / Sensor Array

Optoelectronic Products

# FPA103, FPA104 FPA105, FPA106 FPA107, FPA108

## General Description

The FPA103/104/105/106/107/108 consists of a GaAs infrared-emitting diode and a silicon npn phototransistor. The axial radiant intensity of the diode and the axial response of the phototransistor are perpendicular to the face of the device; therefore, the phototransistor responds to radiation emitted from the diode only when a reflective object or surface is in the field of view of the phototransistor.

The diode used in the FPA103/104/105/106/107/108 is similar to Fairchild's FPE104 GaAs infrared-emitting diode. It emits an intense, narrow band of radiation, peaking at approximately 900 nm (non-visible) when forward biased. The phototransistor used in this device is sensitive to radiation over the wavelength range of 400 to 1100 nm.

The FPA106/107/108 is electrically equivalent to the FPA103/104/105 respectively, with the addition of an infrared filter to prevent visible light from entering the phototransistor.

## Reduces Mechanical Design and Packaging Problems

**High Sensitivity**  
**Excellent Stability**  
**Low Temperature Coefficient**

## Absolute Maximum Ratings

### Maximum Temperature and Humidity

Storage Temperature	-40°C to +100°C
Operating Temperature	-40°C to +100°C
Pin Temperature (Soldering, 10 s)	260°C
Relative Humidity at 65°C	85%

### Input Diode

$I_F$ Forward dc Current	75 mA
$V_R$ Reverse Voltage	3.0 V
Power Dissipation at $T_A = 25^\circ\text{C}$	110 mW
Derate Linearly from 25°C	1.47 mW/°C

### Output Transistor

$I_C$ Collector dc Current	25 mA
$V_{CE}$ Collector-to-Emitter Voltage	12 V
Power Dissipation at $T_A = 25^\circ\text{C}$	167 mW
Derate Linearly from 25°C	2.22 mW/°C

## Package Outline

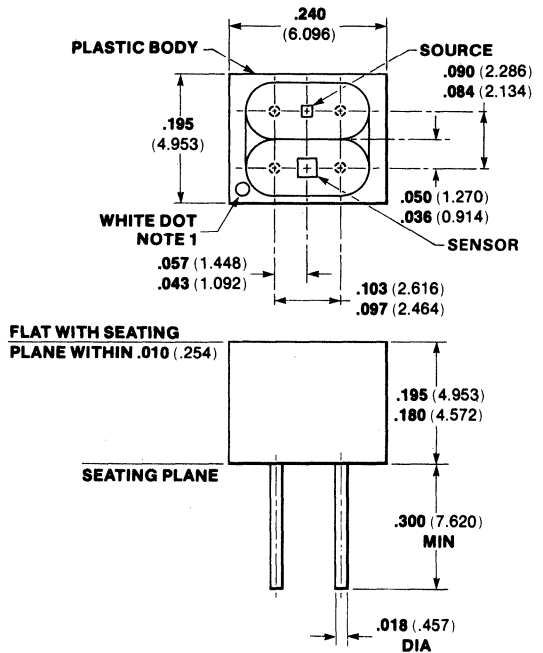

## Notes

- White dot defines collector of phototransistor. Read pinout clockwise, top view: collector, source cathode, source anode, emitter.
- All dimensions in inches **bold** and millimeters (parentheses)
- Tolerance unless specified =  $\pm .015$  (0.381)

## Connection Diagram (Top View)

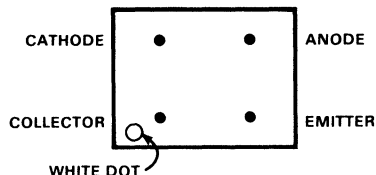

# Typical Electrical Characteristics

FPA 103, FPA 104  
FPA 105, FPA 106  
FPA 107, FPA 108

## Electrical Characteristics—Input Diode $T_A = 25^\circ\text{C}$

Symbol	Characteristic	Min	Typ	Max	Units	Test Conditions
$V_F$	Forward Voltage		1.25	1.5	V	$I_F = 50\text{ mA}$
$BV_R$	Reverse Breakdown Voltage	3.0	6.0		V	$I_R = 100\mu\text{A}$

## Electrical Characteristics—Output Transistor $T_A = 25^\circ\text{C}$

Symbol	Characteristic	Min	Typ	Max	Units	Test Conditions
$V_{CE(sus)}$	Sustaining Voltage (Note 2)	12	20		V	$I_C = 1.0\text{ mA}$ , pulsed
$BV_{ECO}$	Emitter-to-Collector Breakdown Voltage (Note 2)		5.0		V	$I_{EC} = 100\mu\text{A}$

## Electrical Characteristics—Combination $T_A = 25^\circ\text{C}$

Symbol	Characteristic	Min	Typ	Max	Units	Test Conditions
$I_C$	Photo Current (GaAs Source, Note 1) 103-106 104-107 105-108	20 60 80	80	180	$\mu\text{A}$ $\mu\text{A}$ $\mu\text{A}$	$I_F = 50\text{ mA}$ , $V_{CE} = 5.0\text{ V}$ $d = 0.40\text{-inch}$
$I_{CEO}$	Collector Dark Current (Note 2)		10	100	nA	$I_F = 50\text{ mA}$ , $V_{CE} = 5.0\text{ V}$ , Non-reflecting external surface
$V_{CE(sat)}$	Saturation Voltage (Note 1)		0.3	0.7	V	$I_F = 50\text{ mA}$ , $I_C = 5.0\mu\text{A}$ , $d = 0.40\text{-inch}$
$t_r$ & $t_f$	Rise & Fall Time (Note 3)		100		$\mu\text{s}$	$I_C = 80\mu\text{A}$ , $V_{CC} = 5.0\text{ V}$ , $R_L = 1\text{ k}\Omega$

### Notes

- Photocurrent is that obtained from a 4.0-inch X 4.0-inch 90% white surface placed at a distance of 0.40-inch from the face of the device. For test purposes, an Eastman Kodak neutral white test card with 90% diffuse reflectance was employed.
- Measured with radiation flux intensity of less than  $0.1\mu\text{W}/\text{cm}^2$  over the spectrum from 0.1 micron to 1.5 microns.
- Rise time is defined as the time required for  $I_{CE}$  to rise from 10% to 90% of the peak value. Fall time is defined as the time required for  $I_{CE}$  to decrease from 90% to 10% of the peak value.
- White dot defines collector of phototransistor. Read pinout clockwise, top view: collector, source cathode, source anode, emitter.

# Typical Electrical Characteristic Curves

FPA 103, FPA 104  
 FPA 105, FPA 106  
 FPA 107, FPA 108

**Output Current vs Input Current**

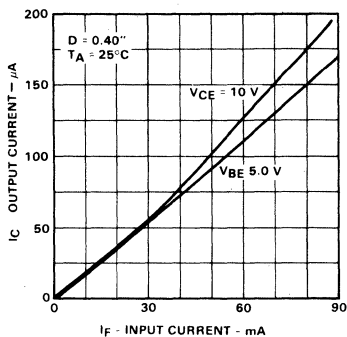

**Output Current vs Device To Card Spacing**

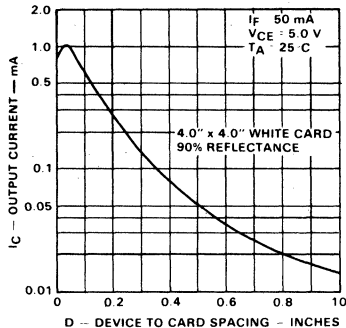

**Spectral Characteristics**

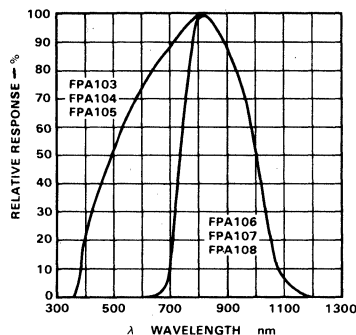

**Interfacing Circuit**

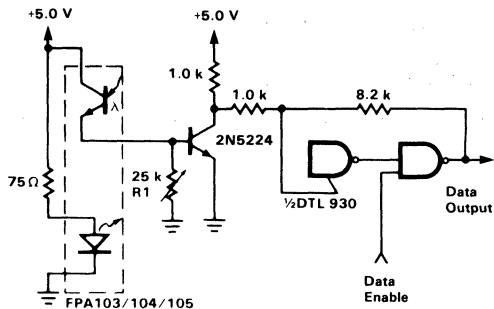

# 9-Element Phototransistor Tape Reader Array

Optoelectronic Products

## FPA700 FPA700A

### General Description

The FPA700 and FPA700A are 9-element npn Planar phototransistor arrays with exceptionally stable characteristics and high illumination sensitivity. Each transistor is electrically isolated and mounted on 100 mil centers. The case is a plastic compound with transparent resin encapsulation which exhibits stable characteristics under high humidity conditions.

### High Illumination Sensitivity

Exhibits Stable Characteristics Under High Humidity

Especially Designed for Punched or Marked Card Reading and Optical Encoder Applications

### Absolute Maximum Ratings

#### Maximum Temperature and Humidity

Storage Temperature	-40°C to +100°C
Operating Temperature	-40°C to +85°C
Pin Temperature (Soldering, 10 s)	260°C
Relative Humidity at 65°C	85%

#### Maximum Power Dissipation

Total Dissipation at $T_C = 25^\circ\text{C}$	200 mW
Derate Linearly from 25°C	3.33 mW/°C
Total Dissipation at $T_A = 25^\circ\text{C}$	133 mW
Derate Linearly from 25°C	2.22 mW/°C

#### Maximum Voltages and Currents (Note 1)

$V_{CE(sus)}$ Collector-to-Emitter Sustaining Voltage	20 V
$I_C$ Collector Current	25 mA

### Package Outline

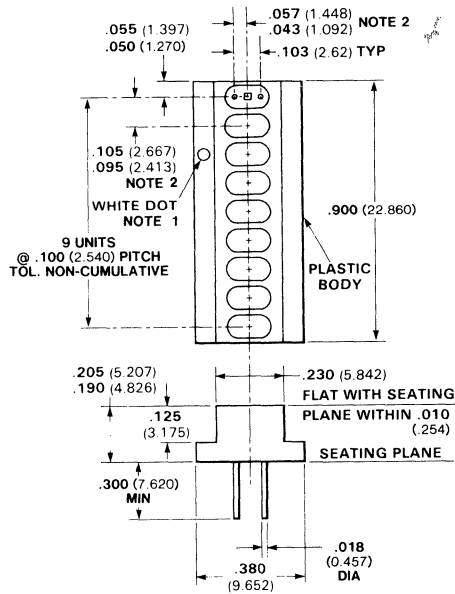

#### Notes

1. Emitter terminal side of phototransistor (sensor array) or anode terminal side of diode (source array) defined by white dot.
2. The center of each element is aligned to  $\pm 0.10$  along the length and  $\pm 0.005$  across the width.
3. All dimensions in inches **bold** and millimeters (parentheses).
4. Tolerance unless specified =  $\pm 0.15$  (0.381).

# Typical Electrical Characteristics

# FPA700 FPA700A

## Electrical Characteristics $T_A = 25^\circ\text{C}$

Symbol	Characteristic	Min	Typ	Max	Units	Test Conditions
$V_{CE(sus)}$	Collector-to-Emitter Sustaining Voltage (Note 2)	20	35		V	$I_C = 1.0 \text{ mA}$
$BV_{ECO}$	Emitter-to-Collector Breakdown Voltage (Note 2)		7.0		V	$I_{EC} = 100 \mu\text{A}$
$V_{CE(sat)}$	Collector-to Emitter Saturation Voltage		0.16	0.33	V	$I_C = 500 \mu\text{A}$ , $H = 20 \text{ mW/cm}^2$
$I_{CEO}$	Collector Dark Current/Cell (Note 2)		4.0	100	nA	$V_{CE} = 5.0 \text{ V}$
$I_{CE(lt)}$	Photo Current, Tungsten Source (Note 3)	200	750		$\mu\text{A}$	$V_{CE} = 5.0 \text{ V}$ , $H = 5 \text{ mW/cm}^2$
$I_{CE(lt)}$	Photo Current, Tungsten Source (Note 3)		1.75		mA	$V_{CE} = 5.0 \text{ V}$ , $H = 10 \text{ mW/cm}^2$
$I_{CE(lt)}$	Photo Current, GaAs Source (Note 4)		2.25		mA	$V_{CE} = 5.0 \text{ V}$ , $H = 5 \text{ mW/cm}^2$
$t_r$	Light Current Rise Time (Note 6)		4.0		$\mu\text{s}$	GaAs, $I_C = 2.0 \text{ mA}$
$t_f$	Light Current Fall Time (Note 6)		4.0		$\mu\text{s}$	$R_L = 100 \Omega$ , $V_{CC} = 5.0 \text{ V}$
$S_{min}/S_{max}$	Matching Factor (Notes 3 and 5) FPA700	0.5	0.65	1.0		$V_{CE} = 5.0 \text{ V}$ , $H = \text{mW/cm}^2$
	FPA700A	0.75	0.85	1.0		$V_{CE} = 5.0 \text{ V}$ , $H = \text{mW/cm}^2$

### Notes

- These are steady-state limits. The factory should be consulted on applications involving pulsed or low duty cycle operation.
- Measured with radiation flux intensity of less than  $0.1 \mu\text{W/cm}^2$  over the spectrum from 0.1 micron to 1.5 microns.
- Measured at noted irradiance as emitted from a tungsten lamp at a color temperature of  $2854^\circ\text{K}$ . The effective photosensitive areas is  $(0.8 \text{ mm}^2)$ .  
Illuminance (in lumens/ft<sup>2</sup>) = irradiance H (in  $\text{mW/cm}^2$ )  $\times$  20 at a color temperature of  $2854^\circ\text{K}$ .
- Measured at an irradiance of  $5.0 \text{ mW/cm}^2$  as emitted from a gallium arsenide diode.
- Matching factor is the ratio of minimum sensitivity to maximum sensitivity of any two cells.
- Rise time is defined as the time required for  $I_{CE}$  to rise from 10% to 90% of the peak value. Fall time is defined as the time required for  $I_{CE}$  to decrease from 90% to 10% of the peak value.
- The center of each element is aligned to  $\pm .010$ -inch along the length and  $\pm .005$ -inch across the width.
- Emitter-terminal side of phototransistor (sensor array) or anode-terminal side of diode (source array) defined by white dot.

# Typical Electrical Characteristic Curves

# FPA700 FPA700A

**Photo Current Characteristics**

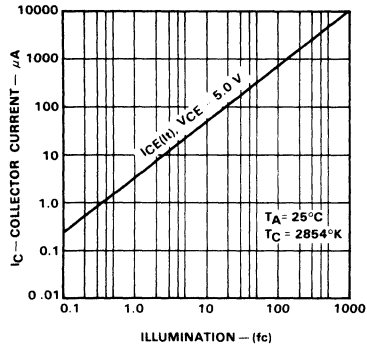

**Photo Current vs Collector**

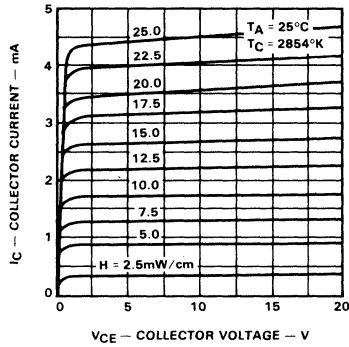

**Collector Dark Current vs Temperature**

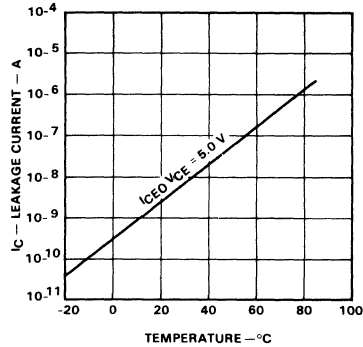

**Relative Spectral Response**

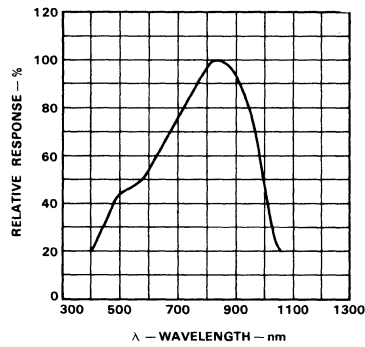

**Rise and Fall Time vs Collector Current**

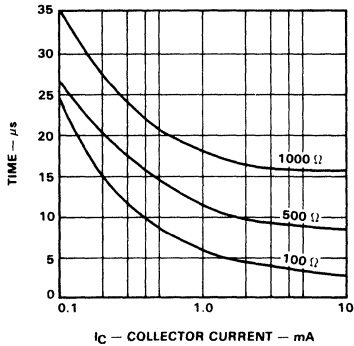

**Angular Response**

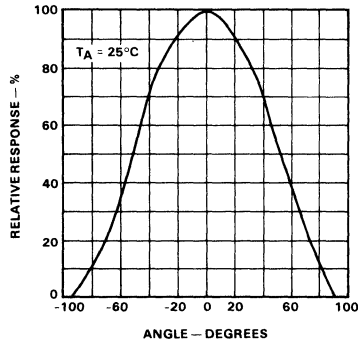



# Typical Electrical Characteristic Curves (Cont'd) Switching Test Circuits

FPA700  
FPA700A

## Turn-Off Delay Times

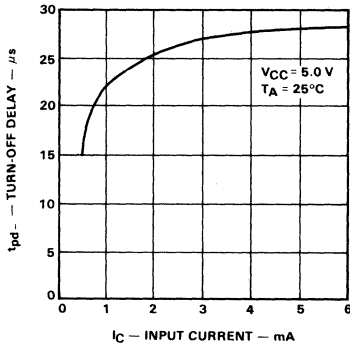

## Turn-On Delay Times

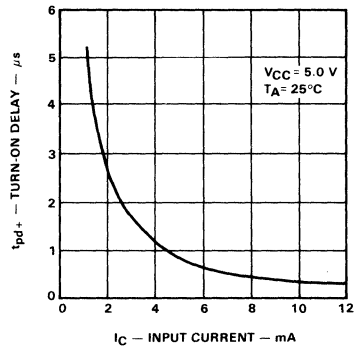

## Rise And Fall Times

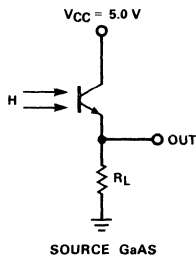

## Turn-On And Turn-Off Delay

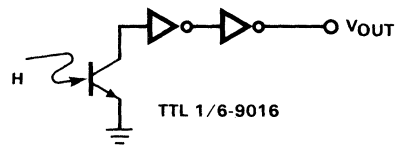

# 12-Element Phototransistor Card Reader Array

## FPA710 FPA710A

Optoelectronic Products

### General Description

The FPA710 and FPA710A are 12-element npn Planar phototransistor arrays with exceptionally stable characteristics and high illumination sensitivity. Each transistor is electrically isolated and mounted on 250 mil centers. The case is a plastic compound with transparent resin encapsulation that exhibits stable characteristics under high humidity conditions.

### High Illumination Sensitivity

Especially Designed For Punched Or Marked Card Reading And Optical Encoder Applications

### Absolute Maximum Ratings

#### Maximum Temperatures and Humidity

Storage Temperature	-40°C to +100°C
Operating Temperature	-40°C to +85°C
Pin Temperature (Soldering, 10 s)	260°C
Relative Humidity at 65°C	85%

#### Maximum Power Dissipation per Cell

Total Dissipation at $T_C = 25^\circ\text{C}$	200 mW
Derate Linearly from 25°C	3.33 mW/°C
Total Dissipation at $T_A = 25^\circ\text{C}$	133 mW
Derate Linearly from 25°C	2.22 mW/°C

#### Maximum Voltages and Currents (Note 1)

$V_{CE(sus)}$	Collector-to-Emitter Sustaining Voltage	20 V
$I_C$	Collector Current	25 mA

### Package Outline

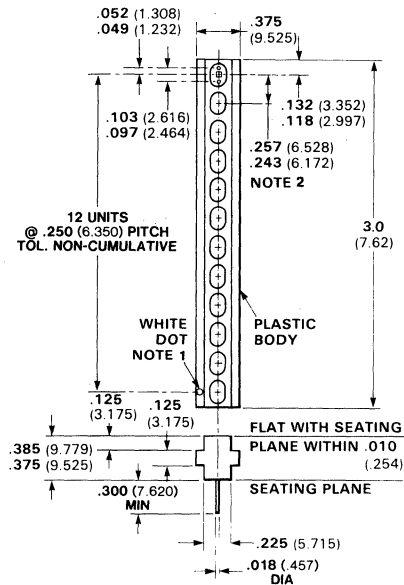

#### Notes

1. Emitter terminal side of phototransistor (sensor array) or anode terminal side of diode (source array) defined by white dot.
2. The center of each element is aligned to  $\pm .010^\circ$  along the length and  $\pm .005^\circ$  across the width.
3. All dimensions in inches bold and millimeters (parentheses).
4. Tolerance unless specified =  $\pm 0.15$  (0.381).
5. Other packages following.

# Typical Electrical Characteristics

# FPA710 FPA710A

## Electrical Characteristics $T_A = 25^\circ\text{C}$

Symbol	Characteristic	Min	Typ	Max	Units	Test Conditions
$V_{CE(sus)}$	Collector-to-Emitter Sustaining Voltage (Note 2)	20	35		V	$I_C = 1.0\text{ mA}$ , pulsed
$BV_{ECO}$	Emitter-to-Collector Breakdown Voltage (Note 2)		7.0		V	$I_{EC} = 100\text{ }\mu\text{A}$
$V_{CE(sat)}$	Collector-to-Emitter Saturation Voltage		0.16	0.33	V	$I_C = 500\text{ }\mu\text{A}$ , $H = 20\text{ mW/cm}^2$
$I_{CEO}$	Collector Dark Current (Note 2)		4.0	100	nA	$V_{CE} = 5.0\text{ V}$
$I_{CE(I_t)}$	Photo Current, Tungsten Source (Note 3)	200	750		$\mu\text{A}$	$V_{CE} = 5.0\text{ V}$ , $H = 5\text{ mW/cm}^2$
$I_{CE(I_t)}$	Photo Current, Tungsten Source (Note 3)		1.75		mA	$V_{CE} = 5.0\text{ V}$ , $H = 10\text{ mW/cm}^2$
$I_{CE(I_t)}$	Photo Current, GaAs Source (Note 4)		2.25		mA	$V_{CE} = 5.0\text{ V}$ , $H = 5\text{ mW/cm}^2$
$t_r$	Light Current Rise Time (Note 6)		4.0		$\mu\text{s}$	$I_C = 2.0\text{ mA}$ , $R_L = 100\text{ }\Omega$ , $V_{CC} = 5.0\text{ V}$
$t_f$	Light Current Fall Time (Note 6)		4.0		$\mu\text{s}$	
$S_{min}/S_{max}$	Matching Factor (Notes 3 and 5) FPA710 FPA710A	0.5 0.75	0.65 0.85	1.0 1.0		$V_{CE} = 5.0\text{ V}$ , $H = 5\text{ mW/cm}^2$

### Notes

- These are steady-state limits. The factory should be consulted on applications involving pulsed or low duty cycle operation.
- Measured with radiation flux intensity of less than  $0.1\text{ }\mu\text{W/cm}^2$  over the spectrum from 0.1 micron to 1.5 microns.
- Measured at noted irradiance as emitted from a tungsten lamp at a color temperature of  $2854^\circ\text{K}$ . The effective photosensitive area is  $(0.8\text{ mm}^2)$ .  
Illuminance (in lumens/ft<sup>2</sup>) = irradiance H (in  $\text{mW/cm}^2$ )  $\times$  20 at a color temperature of  $2854^\circ\text{K}$ .
- Measured at an irradiance of  $5.0\text{ mW/cm}^2$  as emitted from a gallium arsenide diode.
- Matching factor is the ratio of minimum sensitivity to maximum sensitivity of any two cells.
- Rise time is defined as the time required for  $I_{CE}$  to rise from 10% to 90% of the peak value. Fall time is defined as the time required for  $I_{CE}$  to decrease from 90% to 10% of peak value.

### Photo Current Characteristics

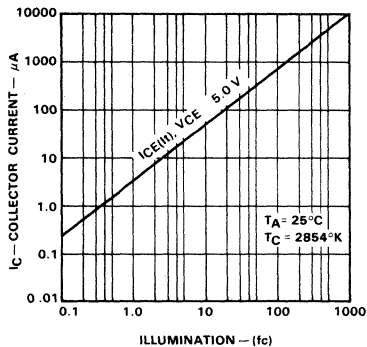

### Photo Current vs Collector Voltage

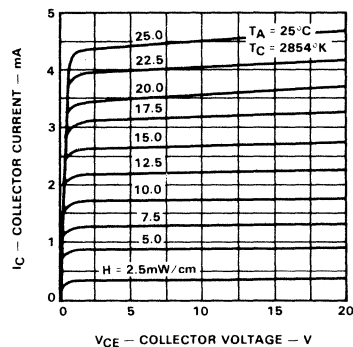

# Typical Electrical Characteristic Curves

# FPA710 FPA710A

4

**Collector Dark Current vs Temperature**

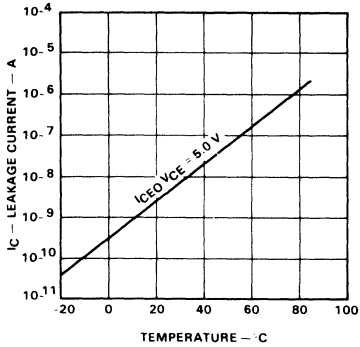

**Relative Spectral Response**

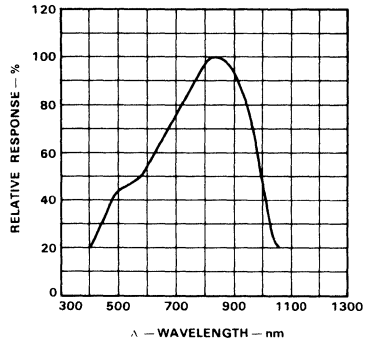

**Rise And Fall Time vs Collector Current**

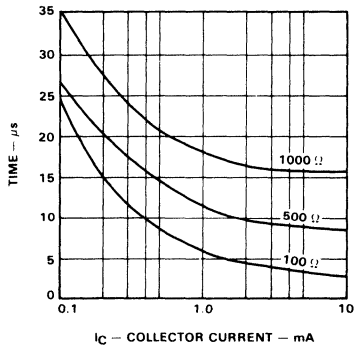

**Angular Response**

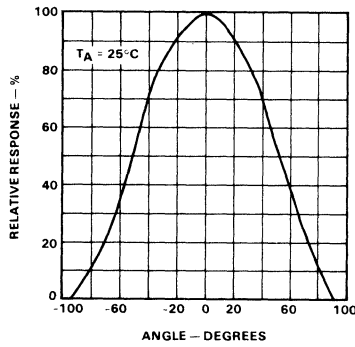

**Turn-Off Delay Times**

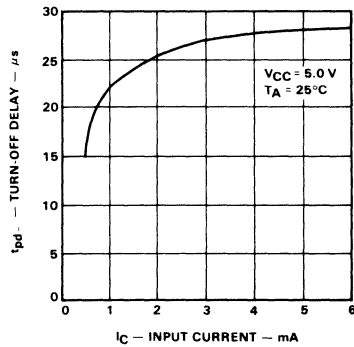

**Turn-On Delay Times**

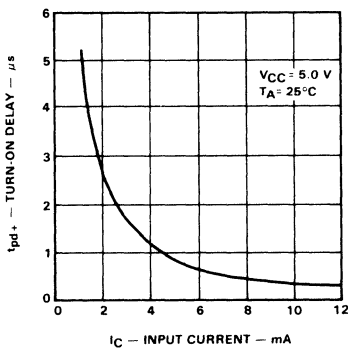

# Switching Test Circuits

## FPA710 FPA710A

### Rise And Fall Times

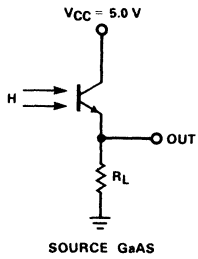

### Turn-On And Turn-Off Delay

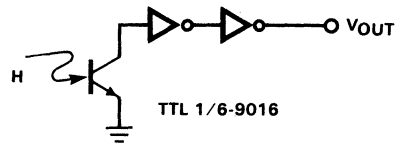

# 10-Element Phototransistor Card Reader Array

Optoelectronic Products

## FPA720 FPA720A

### General Description

The FPA720 and FPA720A are 9-element npn Planar phototransistor arrays with exceptionally stable characteristics and high illumination sensitivity. Each transistor is electrically isolated and mounted on 100 mil centers. The case is a plastic compound with transparent resin encapsulation that exhibits stable characteristics under high humidity conditions.

### High Illumination Sensitivity

Especially Designed For Punched Or Marked Card Reading And Optical Encoder Applications

### Absolute Maximum Ratings

#### Maximum Temperatures and Humidity

Storage Temperature	-40°C to +100°C
Operating Temperature	-40°C to +85°C
Pin Temperature (Soldering, 10 s)	260°C
Relative Humidity at 65°C	85%

#### Maximum Power Dissipation per Cell

Total Dissipation at $T_C = 25^\circ\text{C}$	200 mW
Derate Linearly from 25°C	3.33 mW/°C
Total Dissipation at $T_A = 25^\circ\text{C}$	133 mW
Derate Linearly from 25°C	2.22 mW/°C

#### Maximum Voltages and Currents (Note 1)

$V_{CE(sus)}$ Collector-to-Emitter Sustaining Voltage	20 V
$I_C$ Collector Current	25 mA

### Package Outline

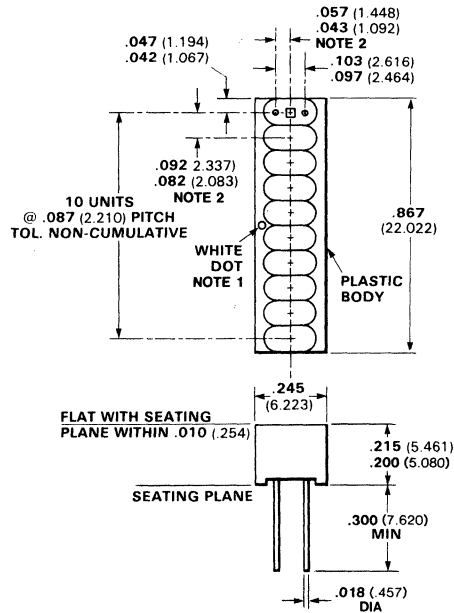

#### Notes

1. Emitter terminal side of phototransistor (sensor array) or anode terminal side of diode (source array) defined by white dot.
2. The center of each element is aligned to  $\pm .010$  along the length and  $\pm .005$  across the width.
3. All dimensions in inches bold and millimeters (parentheses).
4. Tolerance unless specified =  $\pm 0.15$  (0.381).

# Typical Electrical Characteristics

# FPA720 FPA720A

## Electrical Characteristics $T_A = 25^\circ\text{C}$

Symbol	Characteristic	Min	Typ	Max	Units	Test Conditions
$V_{CEO(sus)}$	Collector-to-Emitter Sustaining Voltage (Note 7)	20	35		V	$I_C = 1.0\text{ mA}$ pulsed
$BV_{ECO}$	Emitter-to-Collector Breakdown Voltage (Note 7)		7.0		V	$I_{EC} = 100\ \mu\text{A}$
$V_{CE(sat)}$	Collector-to-Emitter Saturation Voltage		0.16	0.33	V	$I_C = 500\ \mu\text{A}$ , $H = 20\text{ mW/cm}^2$
$I_{CEO}$	Collector Dark Current / Cell (Note 2)		4.0	100	nA	$V_{CE} = 5.0\text{ V}$
$I_{CE(t)}$	Photo Current, Tungsten Source (Note 3)	200	750		$\mu\text{A}$	$V_{CE} = 5.0\text{ V}$ , $H = 5\text{ mW/cm}^2$
$I_{CE(t)}$	Photo Current, Tungsten Source (Note 3)		1.75		mA	$V_{CE} = 5.0\text{ V}$ , $H = 10\text{ mW/cm}^2$
$I_{CE(t)}$	Photo Current, GaAs Source (Note 4)		2.25		mA	$V_{CE} = 5.0\text{ V}$ , $H = 5\text{ mW/cm}^2$
$t_r$	Light Current Rise Time (Note 6)		4.0		$\mu\text{s}$	GaAs, $I_C = 2.0\text{ mA}$ , $R_L = 100\ \Omega$ , $V_{CC} = 5.0\text{ V}$
$t_f$	Light Current Fall Time (Note 6)		4.0		$\mu\text{s}$	
$S_{min}/S_{max}$	Matching Factor (Notes 3 and 5) FPA720 FPA720A	0.5 0.75	0.65 0.85	1.0 1.0		$V_{CE} = 5.0\text{ V}$ , $H = 5\text{ mW/cm}^2$

### Notes

- These are steady-state limits. The factory should be consulted on applications involving pulsed or low duty cycle operation.
- Measured with radiation flux intensity of less than  $0.1\ \mu\text{W/cm}^2$  over the spectrum from 0.1 micron to 1.5 microns.
- Measured at noted irradiance as emitted from a tungsten lamp at a color temperature of  $2854^\circ\text{K}$ . The effective photosensitive area is  $(0.8\text{ mm}^2)$ .  
Illuminance (in lumens/ft<sup>2</sup>) = irradiance H (in  $\text{mW/cm}^2$ )  $\times 20$  at a color temperature of  $2854^\circ\text{K}$ .
- Measured at an irradiance of  $5.0\text{ mW/cm}^2$  as emitted from a gallium arsenide diode.
- Matching factor is the ratio of minimum sensitivity to maximum sensitivity of any two cells.
- Rise time is defined as the time required for  $I_{CE}$  to rise from 10% to 90% of the peak value. Fall time is defined as the time required for  $I_{CE}$  to decrease from 90% to 10% of peak value.
- Rating refers to a high current point where collector-to-emitter voltage is lowest.

### Photo Current Characteristics

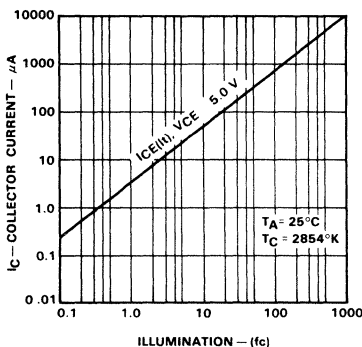

### Photo Current vs Collector Voltage

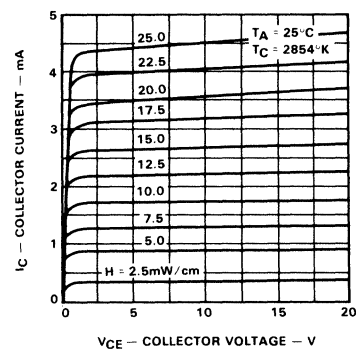

# Typical Electrical Characteristic Curves

# FPA720 FPA720A

4

**Collector Dark Current vs Temperature**

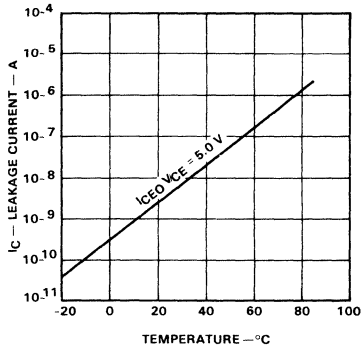

**Relative Spectral Response**

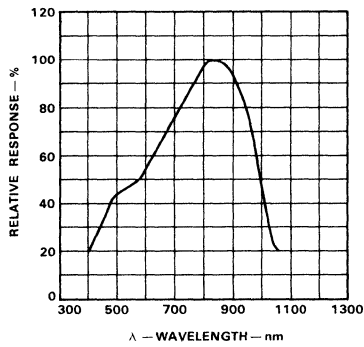

**Rise And Fall Time vs Collector Current**

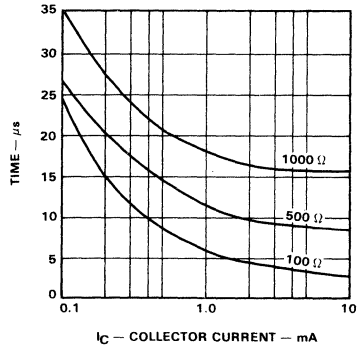

**Angular Response**

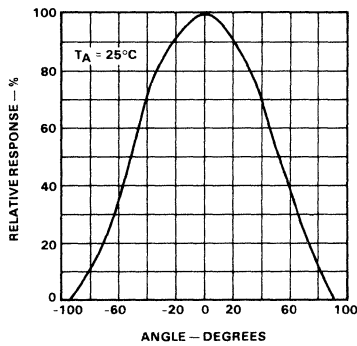

**Turn-Off Delay Times**

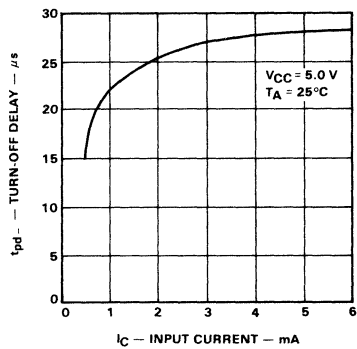

**Turn-On Delay Times**

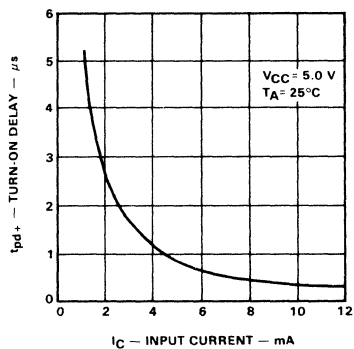



# Test Circuits

# FPA720 FPA720A

### Switching Circuit For Rise And Fall Times

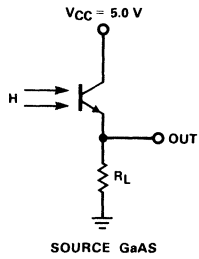

### Circuit For Turn-On And Turn-Off Delay

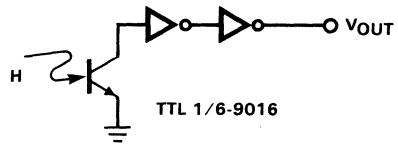

# GaAs Narrow Beam Infrared Emitter

## FPE104

Optoelectronic Products

### General Description

The FPE104 narrow beam infrared emitter is a high-intensity source specifically intended for excitation of photosensors, especially photodiodes and transistors, when the separation distances are measured from mm to several meters.

The FPE104 is the invisible infrared beam companion device to the FLV104, visible beam LED. Both devices have identical optics and, therefore, identical radiation patterns.

### Very High Axial Intensity Narrow (4°) Beamwidth Detectable At 30 Feet

### Absolute Maximum Ratings

#### Maximum Temperature and Humidity

Storage Temperature	-55°C to +100°C
Junction Temperature	-55°C to +100°C
Pin Temperature (Soldering, 10 s)	260°C
Relative Humidity at 65°C	98%

#### Maximum Power Dissipation

Total Dissipation at $T_A = 25^\circ\text{C}$	200 mW
Derate Linearly from 25°C	2.6 mW/°C

#### Maximum Voltages and Currents

$V_R$	Reverse Voltage	3.0 V
$I_F$	Forward dc Current	1.0 A
$I_{pk}$	Peak Forward Current, 100 $\mu\text{s}$ pulse, 1% duty cycle	100 mA

### Electrical Characteristics $T_A = 25^\circ\text{C}$

Symbol	Characteristic	Min	Typ	Max	Units
$V_F$	Forward Voltage at $I_F = 100\text{ mA}$		1.3	1.9	V
$BV_R$	Reverse Breakdown Voltage ( $I_R = 100\ \mu\text{A}$ )	3.0	6.0		V

### Package Outline

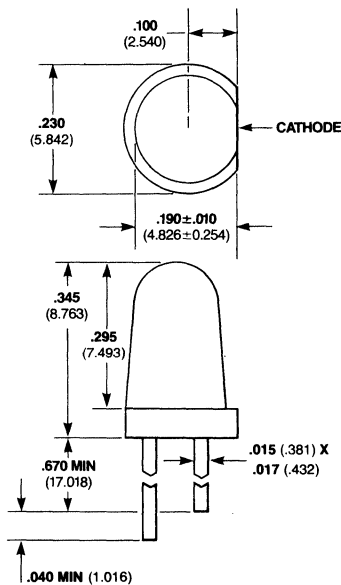

#### Notes

All dimensions in inches **bold** and millimeters (parentheses)  
Tolerance unless specified =  $\pm .015$  ( $\pm .381$ )

# Typical Electrical Characteristics

# FPE104

Optoelectronic Characteristics @  $I_F = 100 \text{ mA}$   $T_A = 25^\circ\text{C}$

Symbol	Characteristic	Min	Typ	Max	Units
$I_O$	Axial Intensity	3.0	10		mW/sr
$A_s$	Effective Source Area (Axial)		0.028		cm <sup>2</sup>
$N$	Average Effective Source Radiance (Axial)		360		mW/sr/cm <sup>2</sup>
$\Delta I / \Delta T$	Temperature Coefficient of Intensity (Note 1)		0.5		%/°C
$\Delta I / \Delta I_F$	Excitation Coefficient of Intensity (Note 1)		1.0		%/mA
$\lambda_{pk}$	Peak Spectral Wavelength		890		nm
$\Delta\lambda$	Spectral Bandwidth		40		nm
$\Delta\lambda_{pk} / \Delta T$	Temperature Spectral Shift Coefficient (Note 2)		0.3		nm/°C
$\Delta\lambda_{pk} / \Delta I$	Excitation Spectral Shift Coefficient (Note 2)		0.1		nm/mA
$\theta_{1/2}$	Beam Angle at 50% Axial Intensity		4.3		degrees
$\Delta\theta_A$	Beam Axis to Mechanical Axis		1.5		degrees
$t_r, t_f$	Light Output Rise and Fall Time (Note 3)		10		ns
$C_O$	Capacitance ( $V = 0, f = 1.0 \text{ MHz}$ )		100		pF

**Beam Pattern of Intensity**

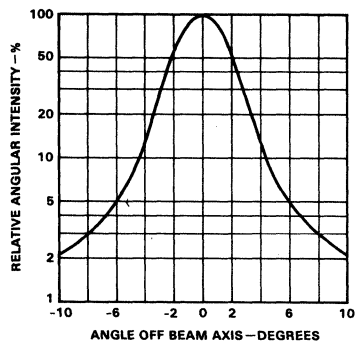

**Spot Diameter vs Separation Distance (Near Field)**

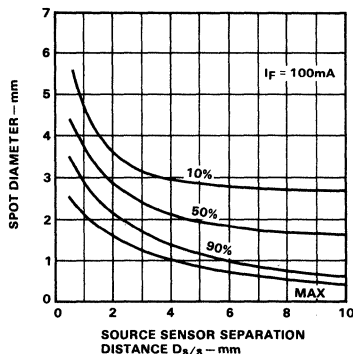

**Spot Diameter vs Separation Distance (Near Field)**

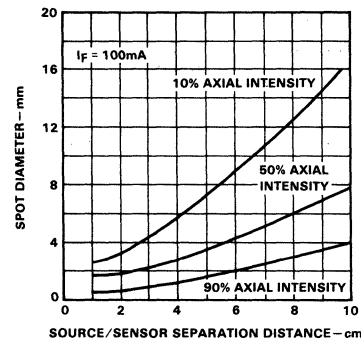

**Forward V-I Characteristics**

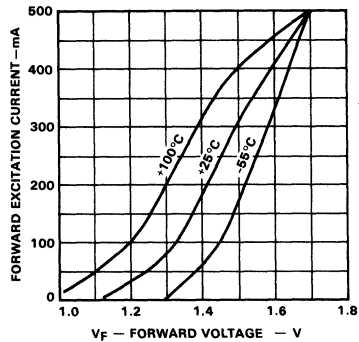

# Typical Electrical Characteristic Curves Narrow Beam Shape

## FPE104

Average Axial Irradiance, H (Note 6)

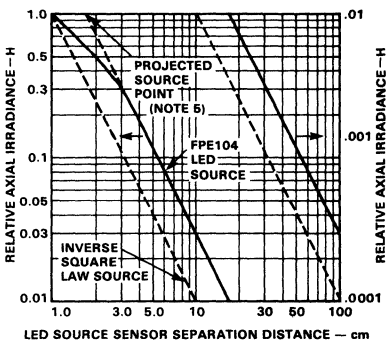

Emission Spectrum Infrared (GaAs) LED

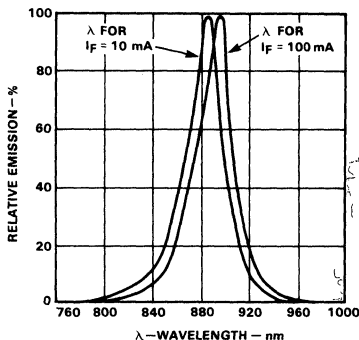

Relative Radiometric Output—% (Note 4)

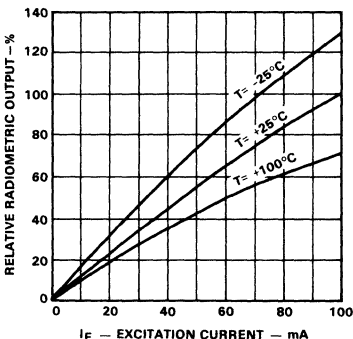

**Notes**

1.  $\Delta I/\Delta T$  and  $\Delta I/\Delta I_F$  are the percentage derating factors for all radiometric output characteristics referenced to their typical value at 25°C ambient and  $I_F = 100$  mA.
2.  $\Delta \lambda_{pk}/\Delta T$  and  $\Delta \lambda_{pk}/\Delta I_F$  are the derating factors for all wavelength characteristics referenced to their typical value at 25°C ambient and  $I_F = 100$  mA.
3. Time for a 10%-90% change in light intensity with a step change in current.
4. Normalization: LED intensity  $\approx 10$  mW/sr sensor 1 mm<sup>2</sup> area.
5. Projected source point is the distance,  $S_p$  from which LED inverse square LAW characteristics may be computed for  $S \geq 5$  cm.  

$$H = \frac{1.0 \text{ mW}}{\text{cm}^2} \times \frac{SP^2}{(S - Sp)^2}, \quad 1 < Sp < 2 \text{ cm}$$
6. Irradiance (H) normalized to 4 mW/cm<sup>2</sup> @  $S = 1$  cm.

**Narrow Beam Shape**

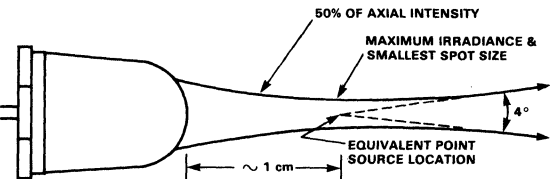

# GaAs Infrared Emitter

Optoelectronic Products

## FPE106

### General Description

The FPE106 is a GaAs infrared light-emitting diode in a miniature ceramic case with exceptionally stable characteristics. This device is used in applications where space is limited such as custom tape and card readers.

### Exceptionally Stable Characteristics

Miniature—85 × 185 × 95 MILS  
Suitable For PC Card Mounting

### Absolute Maximum Ratings

#### Maximum Temperature and Humidity

Storage Temperature	-40°C to +100°C
Operating Temperature	-40°C to +85°C
Pin Temperature (Soldering, 10 s)	260°C
Relative Humidity at 65°C	85%

#### Maximum Power Dissipation

Total Dissipation at $T_A = 25^\circ\text{C}$	150 mW
Derate Linearly from 25°C	2.5 mW/°C

#### Maximum Voltages and Currents

$V_R$ Reverse Voltage	3.0 V
$I_F$ Forward dc Current	100 mA

### Electrical Radiant Characteristics $T_A = 25^\circ\text{C}$

Symbol	Characteristic	Min	Typ	Max	Units	Test Conditions
$V_F$	Forward Voltage		1.3	1.5	V	$I_F = 50\text{ mA}$
$V_R$	Reverse Voltage	3.0	6.0		V	$I_R = 100\ \mu\text{A}$
$I_O$	Axial Intensity	35	200		$\mu\text{W}/\text{sr}$	$I_F = 50\text{ mA}$
$\theta_{1/2}$	Beam Angle at Half Power	3.5	80		degrees	
$\lambda_{pk}$	Peak Spectral Wavelength		890		nm	

### Package Outline

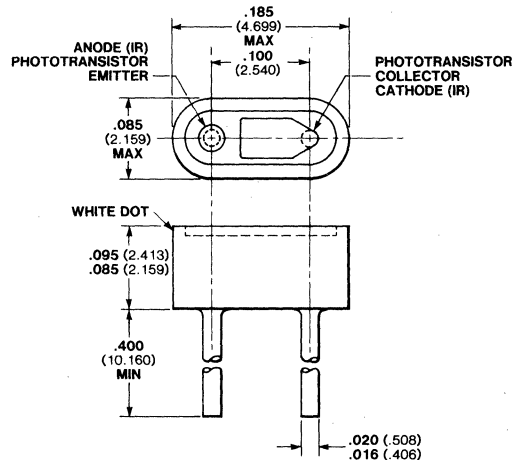

### Notes

All dimensions in inches **bold** and millimeters (parentheses)  
Tolerance unless specified =  $\pm .015$  (0.381)

# Typical Electrical Characteristic Curves

## FPE 106

4

**Radiant Output vs Temperature**

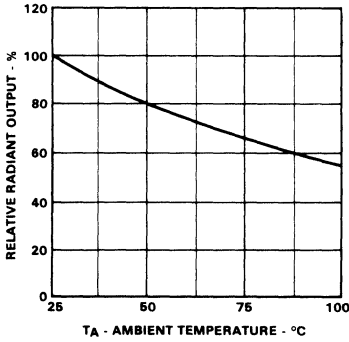

**Radiant Output vs DC Forward Current**

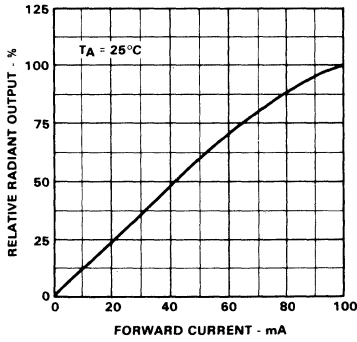

**Emission Spectrum**

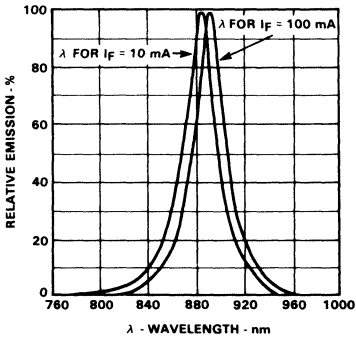

**Radiant Emission Transient Response**

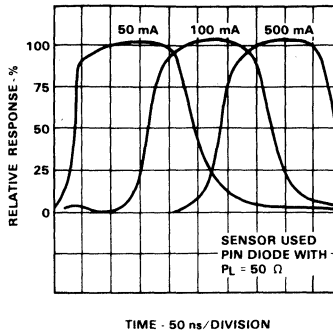

**Radiation Pattern**

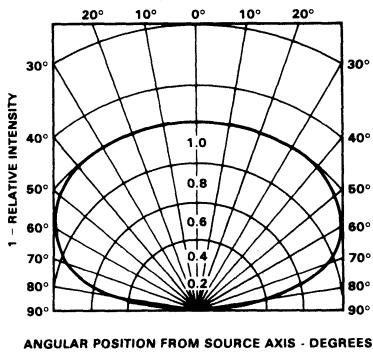

**Forward Current vs Forward Voltage (DC)**

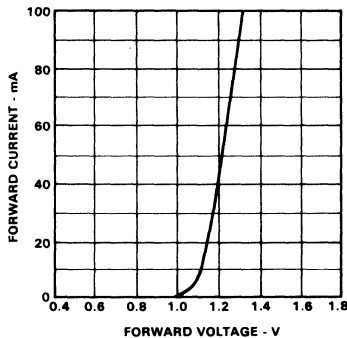

# GaAs Infrared Emitters

Optoelectronic Products

# FPE500 FPE510

## General Description

The FPE500/FPE510 are GaAs infrared-emitting diodes. When forward-biased, they emit an intense, narrow band of radiation peaking at approximately 900 nm (non-visible). The devices are packaged in TO-18 style hermetically-sealed packages with a glass lens.

These solid-state lamps are ideally suited for use in conjunction with silicon photosensors, since their spectral peaks are closely matched. The FPE500/FPE510 use a Planar process and are especially designed for high reliability and long life.

## High Reliability

## Long Life

## Ideally Suited For Use In Conjunction With Silicon Photosensors

Applications Include: Punched Card And Paper Tape Reading, Optical Shaft Encoders, Choppers, High-Speed High-Voltage Isolation Switches and High-Speed Optoelectronic Signal Links

## Hermetic Metal Package For Stability And Reliability

## Absolute Maximum Ratings

### Maximum Temperatures and Humidity

Storage Temperature	-65°C to +200°C
Operating Temperature	-65°C to +125°C
Pin Temperature (Soldering, 5 s)	260°C
Relative Humidity at 65°C	85%

### Maximum Power Distribution

Power Dissipation	250 mW
Derate Linearly from 25°C	2.5 mW/°C

### Maximum Voltages and Currents

$V_R$ Reverse Voltage	3.0 V
$I_F$ Forward dc Current	150 mA

## Package Outlines FPE500

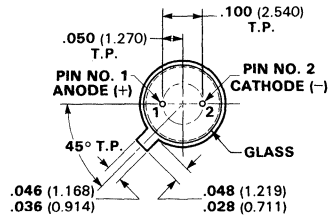
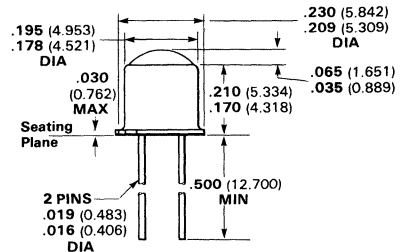

## FPE510

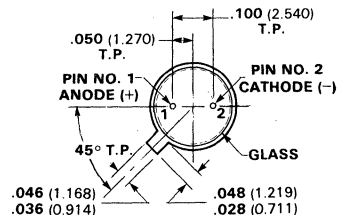
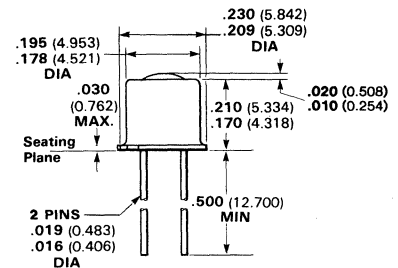

## Notes

All dimensions in inches **bold** and millimeters (parentheses)  
Tolerance unless specified =  $\pm 0.15$  (0.381)

# Typical Electrical Characteristics

# FPE500 FPE510

**Electrical Characteristics**  $T_A = 25^\circ\text{C}$ ,  $I_F = 100\text{ mA}$

Symbol	Characteristic	Min	Typ	Max	Units	Test Conditions
$V_F$	Forward Voltage		1.35	1.7	V	$I_R = 100\ \mu\text{A}$
$BV_R$	Reverse Breakdown Voltage	3.0	6.0		V	
$I_O$	Axial Intensity					
	FPE500	1.0	3.0		mW / Sr	
	FPE510	0.3	1.0		mW / Sr	
			0.5		mW	
$P_O$	Infrared Total Power Output					
$\Delta P_O / \Delta T$	Temperature Dependence of Power, Output				$\% / ^\circ\text{C}$	
BW	Spectral Bandwidth				nm	
$\theta_{1/2}$	Viewing Angle to Half Intensity		9.0		degrees	
	FPE500		30		degrees	
	FPE510		10		ns	$I_F = 50\text{ mA}$ , 10 to 90%
$t_r, t_f$	Emission Rise and Fall Time					

4

## Power Dissipation vs Ambient Temperature

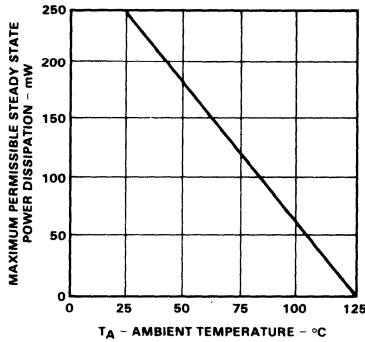

## Radiation Pattern

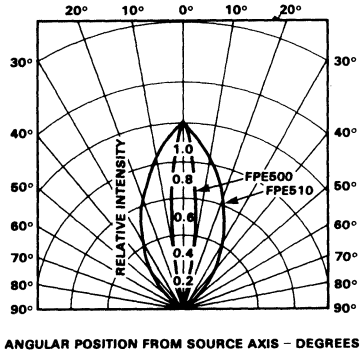

## Forward Current vs Forward Voltage (DC)

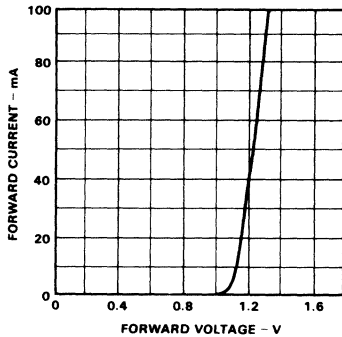

## Radiant Output vs Duty Cycle

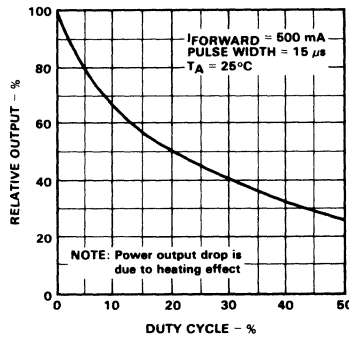



# Typical Electrical Characteristic Curves

# FPE500 FPE510

**Radiant Output vs Temperature**

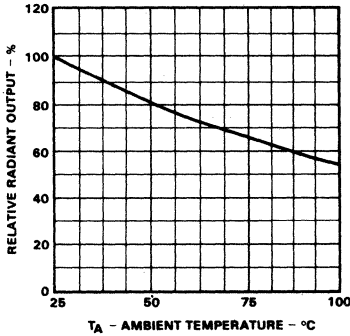

**Radiant Output vs Forward Current (Pulsed)**

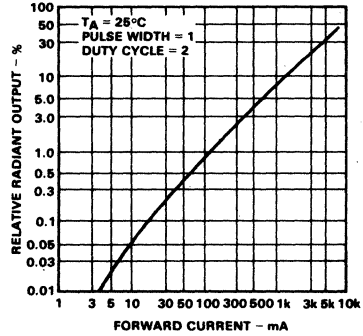

**Radiant Output vs DC Forward Current**

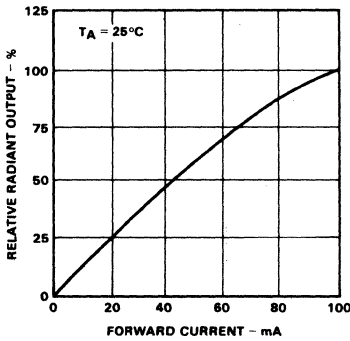

**Typical Emission Spectrum**

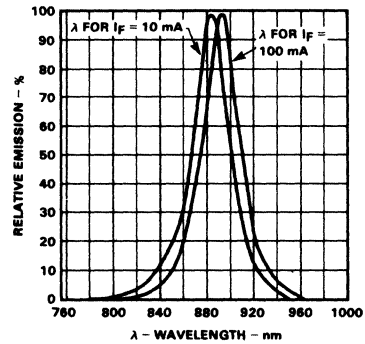

**Radiant Emission Transient Response**

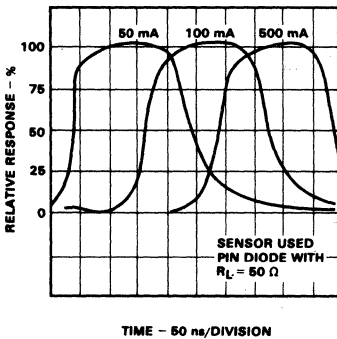

# GaAs Infrared Emitters

Optoelectronic Products

# FPE520 FPE530

## General Description

The FPE520 and FPE530 are GaAs infrared-emitting diodes. When forward-biased, they emit an intense, narrow band of radiation peaking at approximately 940 nm (non-visible). The devices are packaged in TO-18 style hermetically-sealed packages with a glass lens.

These solid state lamps are ideally suited for use in conjunction with silicon photosensors, since their spectral peaks are closely matched.

## High Reliability

### Long Life

Ideally Suited For Use In Conjunction With Silicon Photosensors

Applications: Punched Card And Paper Tape Readers, Optical Shaft Encoders, Choppers, High-Speed, High-Voltage, Isolation Switches and High-Speed Optoelectronic Signal Links

Hermetic Metal Package For Stability And Reliability

## Package Outlines

### FPE520

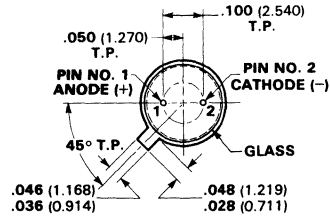
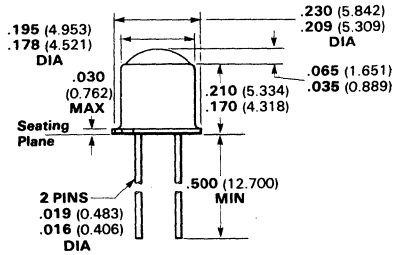

### FPE530

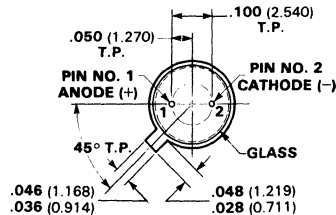
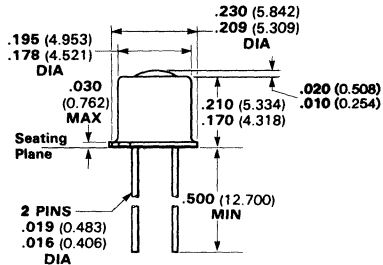

## Absolute Maximum Ratings

### Maximum Temperatures

Storage Temperature	-65°C to +200°C
Operating Temperature	-65°C to +150°C
Pin Temperature (Soldering, 5 s)	260°C
Relative Humidity at 85°C	85%

### Maximum Power Dissipation

Total Dissipation at T <sub>A</sub> = 25°C	250 mW
Derate Linearly from 25°C	2.0 mW/°C

### Maximum Voltage and Currents

V <sub>R</sub> Reverse Voltage	3.0 V
I <sub>F</sub> Forward dc Current	150 mA

## Notes

All dimensions in inches bold and millimeters (parentheses)  
Tolerance unless specified = ±.015 (0.381)

# Typical Electrical Characteristics

# FPE520 FPE530

**Electrical Characteristics**  $T_A = 25^\circ\text{C}$ ,  $I_F = 100\text{ mA}$ , unless otherwise specified

Symbol	Characteristic	Min	Typ	Max	Units	Test Conditions
$V_F$	Forward Voltage		1.35	1.7	V	$I_R = 100\ \mu\text{A}$
$V_R$	Reverse Voltage	3.0	6.0		V	
$I_O$	Axial Intensity					
	FPE520	3.0	6.0		mW / sr	
	FPE530	1.0	2.0		mW / sr	
$P_O$	Infrared Total Power Output		1.5		mW	
$\Delta P_O / \Delta T$	Temperature Dependence of Power Output		-0.8		% / $^\circ\text{C}$	
$\lambda_{pk}$	Peak Spectral Wavelength		940		nm	
BW	Spectral Bandwidth		50		nm	
$\theta_{1/2}$	Viewing Angle to Half Intensity		9.0		degrees	$I_F = 50\text{ mA}$ , 10 to 90%
	FPE520		30		degrees	
	FPE530		500		ns	
$t_r, t_f$	Emission Rise and Fall Time				ns	

**Power Dissipation vs Ambient Temperature**

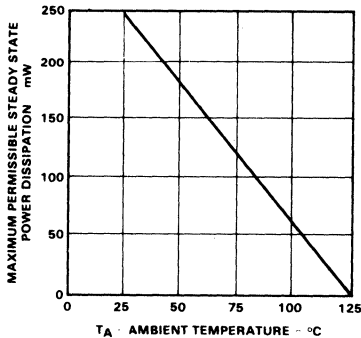

**Radiation Pattern**

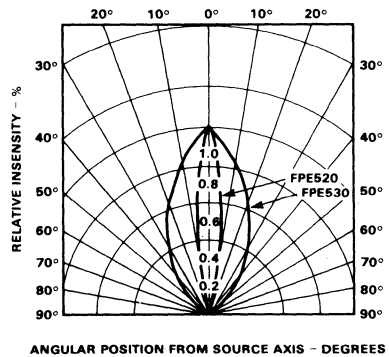

**Forward Current vs Forward Voltage (DC)**

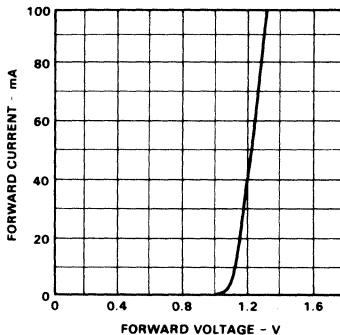

**Radiant Output vs Duty Cycle**

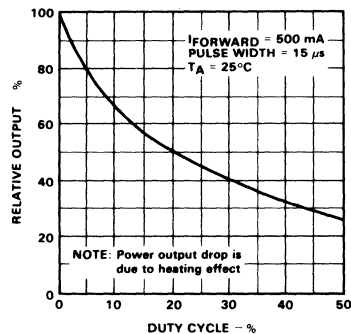

# Typical Electrical Characteristic Curves

# FPE520 FPE530

**Radiant Output vs Temperature**

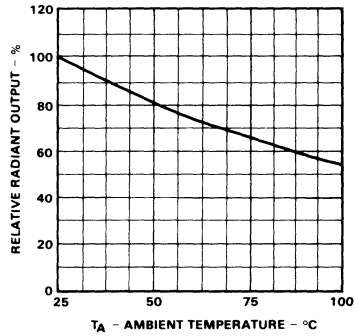

**Radiant Output vs Forward Current (Pulsed)**

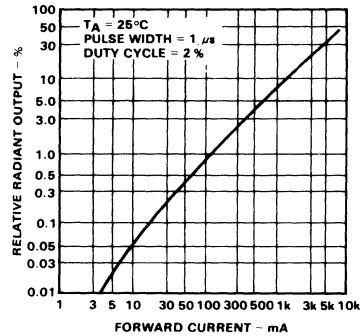

**Radiant Output vs DC Forward Current**

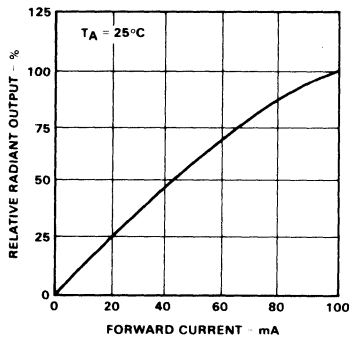

**Emission Spectrum**

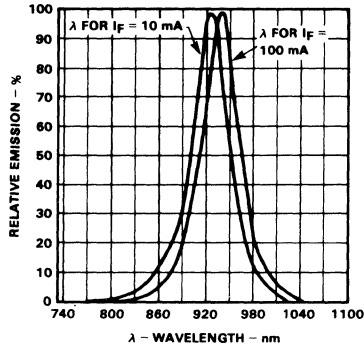

**Radiant Emission Transient Response**

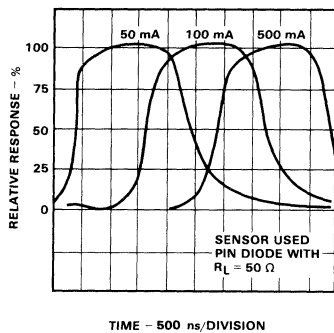

4

# Low-Cost General-Purpose GaAs Infrared Emitter

Optoelectronic Products

## FPE700

### General Description

The FPE700 is a low-cost, general-purpose, GaAs infrared-emitting diode encapsulated in a clear plastic T1 package.

### Absolute Maximum Ratings

#### Maximum Temperature and Humidity

Operating Temperature	-40°C to +85°C
Storage Temperature	-55°C to +100°C
Pin Temperature (Soldering, 5 s)	230°C
Relative Humidity at 85°C	85%

#### Maximum Power Dissipation

Total Dissipation at $T_A = 25^\circ\text{C}$	70 mW
Derate Linearly from 25°C	1.33 mW/°C

#### Maximum Voltage and Current

$V_R$ Reverse Voltage	3.0 V
$I_F$ Forward dc Current	40 mA

### Package Outline

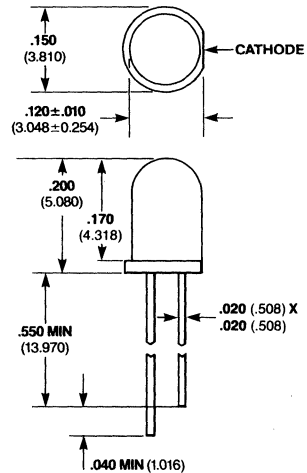

### Notes

All dimensions in inches **bold** and millimeters (parentheses).  
Tolerance unless specified =  $\pm .015$  ( $\pm .381$ ).

### Electrical and Radiant Characteristics $T_A = 25^\circ\text{C}$

Symbol	Characteristic	Min	Typ	Max	Units	Test Conditions
$V_F$	Forward Voltage		1.35	1.7	V	$I_F = 40$ mA
$BV_R$	Reverse Breakdown Voltage	3.0	6.0		V	$I_R = 100$ $\mu$ A
$I_O$	Axial Intensity	0.12	0.2		mW/Sr	$I_F = 40$ mA
$P_O$	Infrared Total Power Output		0.1		mW	$I_F = 40$ mA
$\theta_{1/2}$	Viewing Angle to Half Intensity		25		degrees	
$t_r, t_f$	Emission Rise and Fall Time		200		ns	$I_F = 20$ mA, 10% to 90%
$\lambda_{pk}$	Peak Spectral Wavelength		900		nm	

# General-Purpose Silicon Planar Phototransistor

Optoelectronic Products

# FPT100/A/B FPT110/A/B

## General Description

The FPT100 and FPT110 are 3-terminal npn Planar phototransistors with exceptionally stable characteristics and high illumination sensitivity. The availability of the base pin gives wide latitude for flexible circuit design. The case is a special plastic compound with transparent resin encapsulation that exhibits stable characteristics under high humidity conditions. The controlled sensitivities offered in the A and B versions give the circuit designer increased flexibility.

## Exceptionally Stable Characteristics Controlled Sensitivities

## Absolute Maximum Ratings

### Maximum Temperature and Humidity

Storage Temperature	-55°C to +100°C
Operating Temperature	-55°C to +85°C
Pin Temperature (Soldering, 5 s)	260°C
Relative Humidity at 65°C	85%

### Maximum Power Dissipation (Notes 1 and 2)

Total Dissipation at $T_C = 25^\circ\text{C}$	200 mW
Total Dissipation at $T_A = 25^\circ\text{C}$	100 mW

### Maximum Voltages and Current (Note 5)

$V_{CB}$ Collector-to-Base Voltage	50 V
$V_{CE}$ Collector-to-Emitter Sustaining Voltage (Note 3)	30 V
$I_C$ Collector Current	25 mA

## Package Outlines

### FPT100/A/B

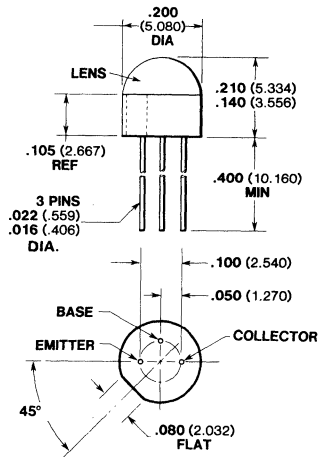

### FPT110/A/B

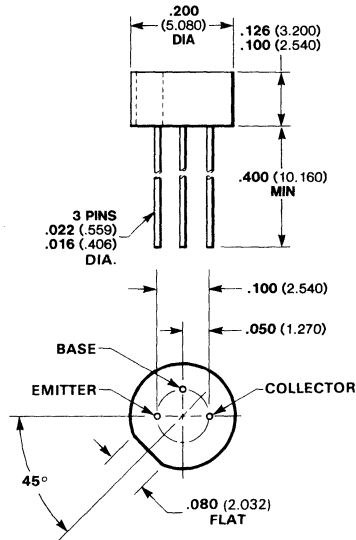

## Notes

All dimensions in inches **bold** and millimeters (parentheses)  
Tolerance unless specified =  $\pm .015$  ( $\pm .381$ )

# Typical Electrical Characteristics

# FPT100/A/B FPT110/A/B

**Electrical Characteristics**  $T_A = 25^\circ\text{C}$  unless otherwise noted

Symbol	Characteristic	Min	Typ	Max	Units	Test Conditions
$I_{CBO}$	Collector Dark Current		0.25	25	nA	$V_{CB} = 10\text{ V}$ (Note 5)
$I_{CBO}$	Collector Dark Current		0.025	0.5	$\mu\text{A}$	$V_{CB} = 10\text{ V}$ , $T_A = 65^\circ\text{C}$ (Note 5)
$I_{CEO}$	Collector Dark Current		2.0	100	nA	$V_{CE} = 5.0\text{ V}$ (Note 5)
$R_{CB}$	Responsivity (Tungsten)					
	FPT100/A/B	0.6	1.6		$\mu\text{A}/$	$V_{CB} = 10\text{ V}$
	FPT110/A/B	0.6	1.0		$\text{mW}/\text{cm}^2$	(Notes 3 and 8)
$R_{CB}$	Responsivity (GaAs)					
	FPT100/A/B	1.8	4.8		$\mu\text{A}/$	$V_{CB} = 10\text{ V}$
	FPT110/A/B	1.8	3.0		$\text{mW}/\text{cm}^2$	(Notes 4 and 8)
$I_{CE(I)}$	Photo Current (Tungsten)					
	FPT100/A/B	0.2	1.4		mA	$V_{CE} = 5.0\text{ V}$
	FPT110/A/B	0.2	0.88			$H = 5.0\text{ mW}/\text{cm}^2$ (Notes 3 and 7)
$I_{CE(I)}$	Photo Current (GaAs)					
	FPT100/A/B	0.6	4.2		mA	$V_{CE} = 5.0\text{ V}$
	FPT110/A/B	0.6	2.7			$H = 5.0\text{ mW}/\text{cm}^2$ (Notes 4 and 7)
$t_r$	Light Current Rise Time		2.8		$\mu\text{s}$	(Note 6)
$t_f$	Light Current Fall Time		2.8		$\mu\text{s}$	(Note 6)
$V_{CEO(sat)}$	Collector-to-Emitter Saturation Voltage					
	FPT100/A/B		0.16	0.3	V	$I_C = 500\text{ }\mu\text{A}$
	FPT110/A/B		0.16	0.33		$H = 20\text{ mW}/\text{cm}^2$
$BV_{CBO}$	Collector-to-Base Breakdown Voltage	50	120		V	$I_C = 100\text{ }\mu\text{A}$ (Note 5)
$V_{CEO(sus)}$	Collector-to-Emitter Sustaining Voltage	30	50		V	$I_C = 1.0\text{ mA}$ (pulsed) (Note 5)
$BV_{ECO}$	Emitter-to-Collector Breakdown		7.0		V	$I_E = 100\text{ }\mu\text{A}$ (Note 5)

The following values affect the A and B versions only:

Symbol	Characteristic	Min	Typ	Max	Units	Test Conditions
$I_{CE(I)}$	Photo Current (Tungsten Source)					
	FPT100A	1.0		3.0	mA	$V_{CE} = 5.0\text{ V}$ (Note 3)
	FPT110A	0.6		1.8		$H = 5.0\text{ mW}/\text{cm}^2$
$I_{CE(I)}$	Photo Current (Tungsten Source)					
	FPT100B	1.3		2.6	mA	$V_{CE} = 5.0\text{ V}$ (Note 3)
	FPT110B	0.8		1.6		$H = 5.0\text{ mW}/\text{cm}^2$

**Notes**

- These are steady-state limits. The factory should be consulted on applications involving pulsed or low duty cycle operations.
- These ratings give a maximum junction temperature of  $85^\circ\text{C}$  and junction-to-case thermal resistance of  $300^\circ\text{C}/\text{W}$  (derating factor of  $3.33\text{ mW}/^\circ\text{C}$ ), and a junction-to-ambient thermal resistance of  $600^\circ\text{C}/\text{W}$  (derating factor of  $1.67\text{ mW}/^\circ\text{C}$ ).
- Measured at noted irradiance as emitted from a tungsten filament lamp at a color temperature of  $2854^\circ\text{K}$ . The effective photosensitive area is typically  $1.25\text{ mm}^2$  (FPT100A/B) and  $0.78\text{ mm}^2$  (FPT110A/B).
- These are values obtained at noted irradiance as emitted from a GaAs source at  $900\text{ nm}$ .
- Measured with radiation flux intensity of less than  $0.1\text{ }\mu\text{W}/\text{cm}^2$  over the spectrum from  $100$  to  $1500\text{ nm}$ .
- Rise time is defined as the time required for  $I_{CE}$  to rise from 10% to 90% of peak value. Fall time is defined as the time required for  $I_{CE}$  to decrease from 90% to 10% of peak value. Test conditions are:  $I_{CE} = 4.0\text{ mA}$ ,  $V_{CE} = 5.0\text{ V}$ ,  $R_L = 100\text{ }\Omega$ , GaAs source.
- No electrical connection to base lead.
- No electrical connection to emitter lead.

# Typical Electrical Characteristic Curves

# FPT100/A/B FPT110/A/B

**FPT100/A/B Photo Current Characteristics**

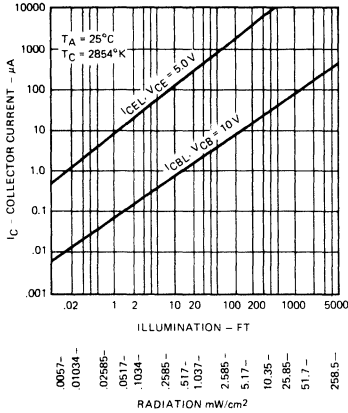

**FPT110/A/B Photo Current Characteristics**

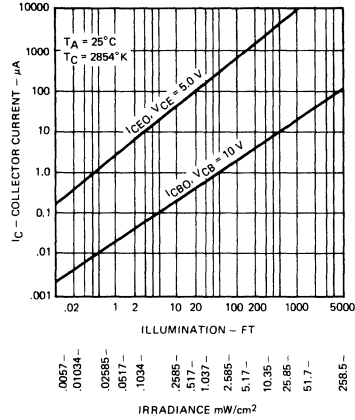

**Collector Current vs Collector Voltage**

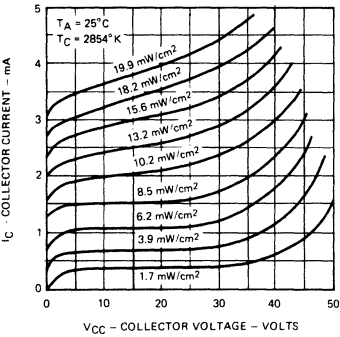

**Collector Base Characteristics**

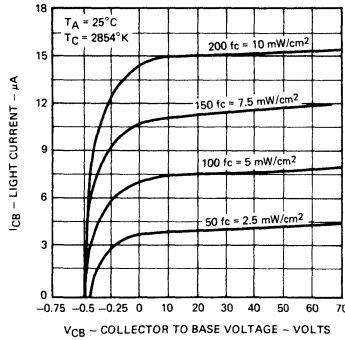

**Angular Response**

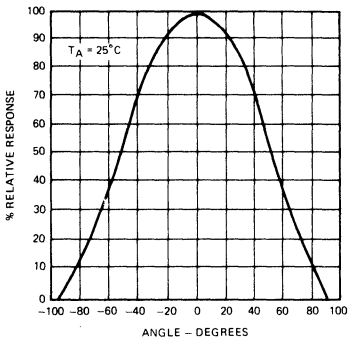

**Collector Dark Current vs Temperature**

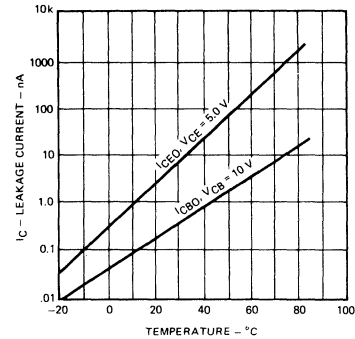



# Typical Electrical Characteristic Curves Circuits

# FPT100/A/B FPT110/A/B

## Spectral Characteristics

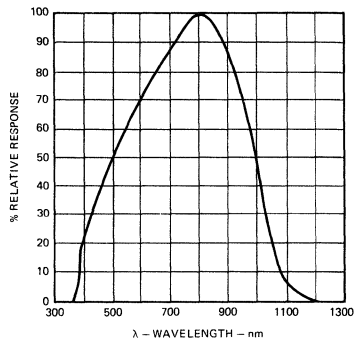

## Rise And Fall Time vs Collector Current

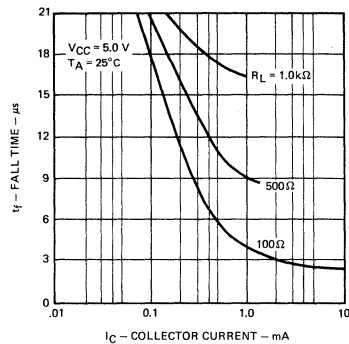

## Turn-Off Delay Times For Circuit

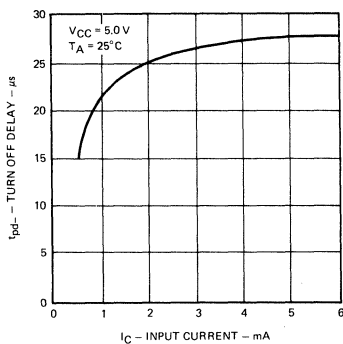

## Turn-On Delay Times For Circuit

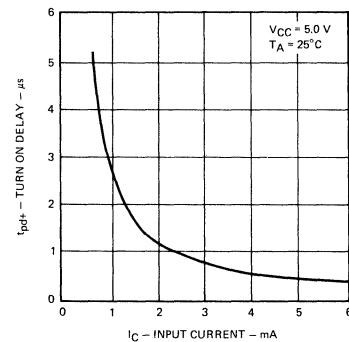

## Switching Circuit For Rise And Fall Times

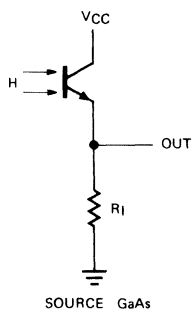

## Circuit For Turn-On And Turn-Off Data

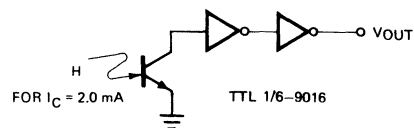

# Hermetic Coaxial Silicon Phototransistor

Optoelectronic Products

## FPT101

### General Description

The FPT101 is a miniature phototransistor in a hermetic, welded case. A large photosensitive base combined with a flat window affords exceptional sensitivity without the need for critical alignment. In tape and card reader applications, the flat window permits flush mounting in the wear-plate thereby minimizing cross-talk. The spectral response, extending from 400 to 1100 nm, is compatible with daylight, tungsten and gallium arsenide sources.

### Precision Optical Alignment

Miniature—80 Mils In Diameter

Suitable For PC Board Mounting

Applications Include Tape And Card Readers

### Absolute Maximum Ratings

#### Maximum Temperatures and Humidity

Storage Temperature	-65°C to +150°C
Operating Temperature	-65°C to +150°C
Pin Temperature (Soldering, 10 s)	260°C
Relative Humidity at 65°C	85%

#### Maximum Power Dissipation

Total Dissipation at $T_C = 25^\circ\text{C}$	75 mW
Derate Linearly from 25°C	0.6 mW/°C

#### Maximum Voltages and Currents (Note 1)

$V_{CE(sus)}$ Collector-to-Emitter Sustaining Voltage	30 V
$V_{EC(sus)}$ Emitter-to-Collector Sustaining Voltage	5 V
$I_C$ Collector Current	25 mA

### Package Outline

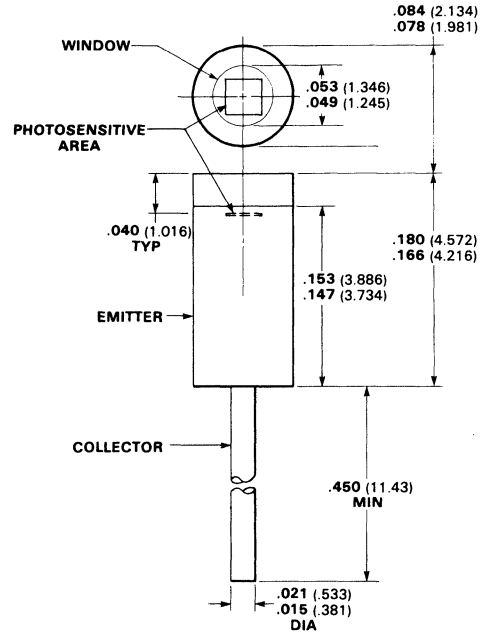

### Notes

All dimensions in inches **bold** and millimeters (parentheses)  
Tolerance unless specified =  $\pm .015 (\pm .381)$

# Typical Electrical Characteristics

# FPT101

## Electrical Characteristics $T_A = 25^\circ\text{C}$

Symbol	Characteristic	Min	Typ	Max	Units	Test Conditions
$V_{CEO(sus)}$	Collector-to-Emitter Sustaining Voltage	30	60		V	$I_C = 0.1 \text{ mA}$ , $H < 0.1 \mu\text{W}/\text{cm}^2$
$BV_{ECO}$	Emitter-to-Collector Breakdown Voltage		7.0		V	$I_C = 0.1 \text{ mA}$ , $H < 0.1 \mu\text{W}/\text{cm}^2$
$V_{CE(sat)}$	Collector Saturation Voltage (Note 2)		0.25	0.3	V	$I_C = 0.4 \text{ mA}$ , $H = 20 \text{ mW}/\text{cm}^2$
$I_{CEO}$	Collector Dark Current		2.0	100	nA	$V_{CE} = 5.0 \text{ V}$ , $H < 0.1 \mu\text{W}/\text{cm}^2$
$I_{CE(it)}$	Collector Photo Current (Notes 2 & 4)	0.8	3.5		mA	$V_{CE} = 5.0 \text{ V}$ , $H = 20 \text{ mW}/\text{cm}^2$
$I_{CE(it)}$	Collector Photo Current (Notes 2 & 4)		0.8		mA	$V_{CE} = 5.0 \text{ V}$ , $H = 5.0 \text{ mW}/\text{cm}^2$

### Notes

- These are steady-state limits. The factory should be consulted on applications involving pulsed or low duty cycle operation.
- Irradiation source is an unfiltered tungsten lamp operated at  $2854^\circ\text{K}$  color temperature. Unless otherwise stated, all H values refer to this color temperature.
- Switching time is defined here as the 10% to 90% rise time of  $I_{CE}$  for an irradiance step input. The rise and fall times are essentially equal.
- Silicon radiometric photocurrent efficiency with typical GaAs irradiance is approximately three times greater than with tungsten at  $2854^\circ\text{K}$  color temperature. Therefore, all graphs with H as a parameter of variable will apply for GaAs irradiation if the H values are divided by three.
- Emitter is connected to the case.

### Relative Spectral Response

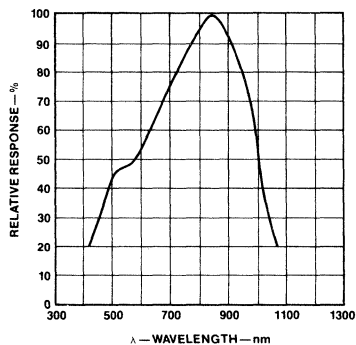

### Photo Current vs Angle of Incidence

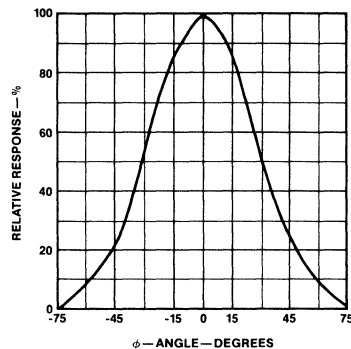

# Typical Electrical Characteristic Curves

## FPT101

### Maximum Power Limits

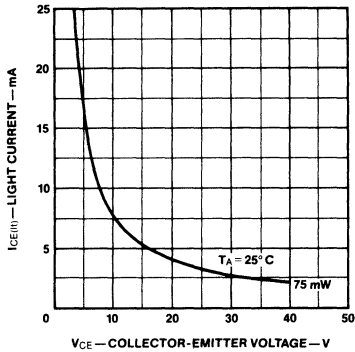

### Collector Characteristics

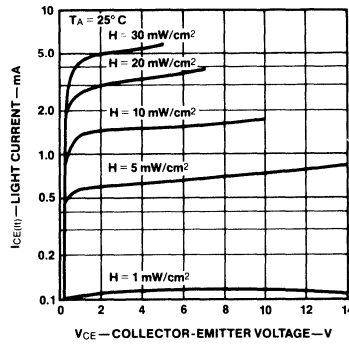

### Collector Characteristics

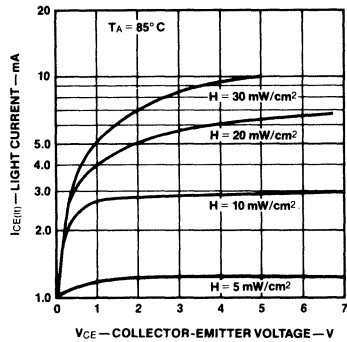

### Collector Characteristics

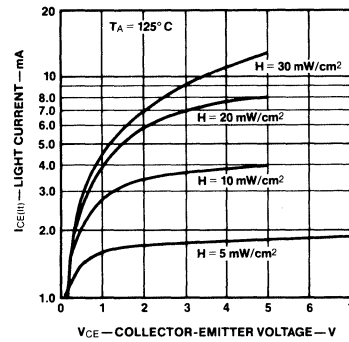

### Saturation Voltage Characteristics

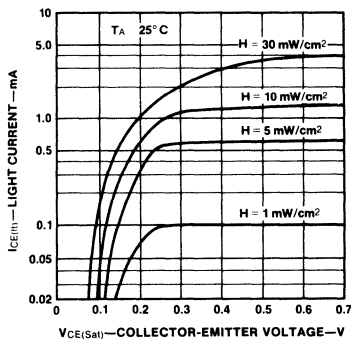

### Saturation Voltage Characteristics

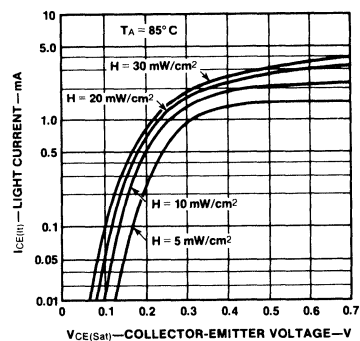

# Typical Electrical Characteristic Curves (Cont'd)

## FPT101

**Saturation Voltage Characteristics**

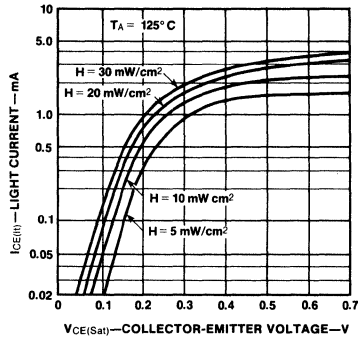

**Light Current vs Irradiance**

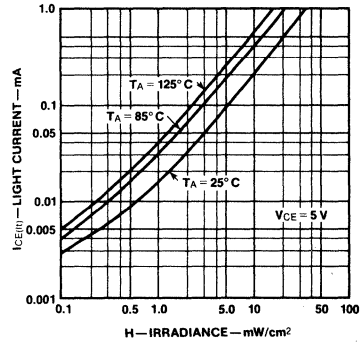

**Light Current vs Irradiance**

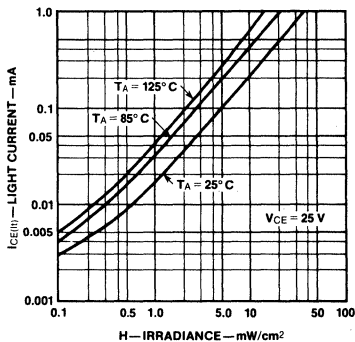

**Dark Current Characteristics**

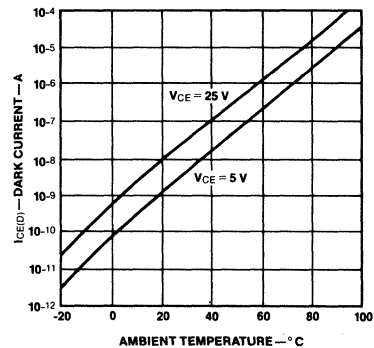

**Light Current vs Time**

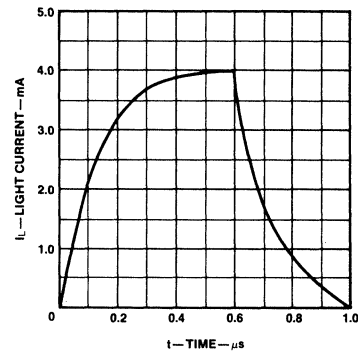

**Switching Time vs Light Current**

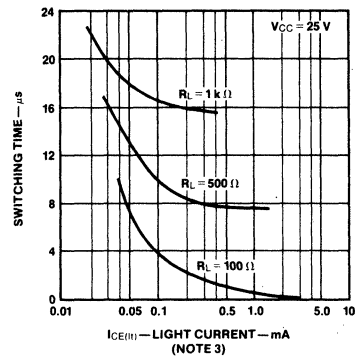

# Typical Electrical Characteristic Curves (Cont'd)

FPT101

## Switching Time vs Light Current

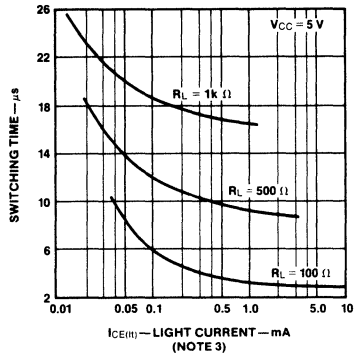

# Hermetic Coaxial Silicon Photodiode

Optoelectronic Products

## FPT102

### General Description

The FPT102 is a miniature light-sensing diode in a hermetic, welded case. In the reverse-bias mode of operation, excellent photocurrent linearity is obtained. In the photovoltaic mode, the open-circuit voltage varies in a logarithmic manner and is most sensitive to low-level light variations.

**Sensitive At Low Light Level Applications**  
**Excellent Photocurrent Linearity**  
**Fast Response To Light Pulses**  
**Precision Optical Alignment**  
**Miniature—80 Mils In Diameter**

### Absolute Maximum Ratings

#### Maximum Temperatures and Humidity

Storage Temperature	-55°C to +150°C
Junction Temperature	-55°C to +100°C
Pin Temperature (Soldering, 10 s)	260°C
Relative Humidity at 65°C	85%

#### Maximum Power Dissipation

Total Dissipation at $T_C = 25^\circ\text{C}$	75 mW
Derate Linearly from 25°C	0.6 mW/°C

#### Maximum Voltages

$V_R$ Reverse Voltage	50 V
-----------------------	------

### Package Outline

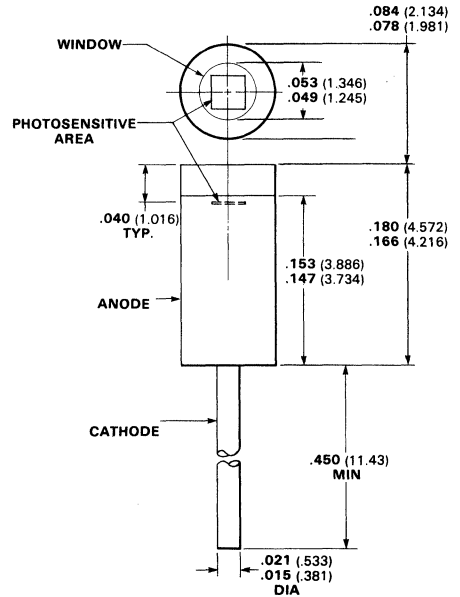

#### Notes

All dimension in inches **bold** and millimeters (parentheses)  
 Tolerance unless specified =  $\pm 0.15$  (0.381)

# Typical Electrical Characteristics

# FPT102

## Electrical Characteristics $T_A = 25^\circ\text{C}$

Symbol	Characteristic	Min	Typ	Max	Units	Test Conditions
BV	Breakdown Voltage	50	120		V	$I_R = 5.0 \mu\text{A}$ , $H \leq 0.1 \mu\text{W}/\text{cm}^2$
$V_{OC}$	Open Circuit Voltage (Note 1)	380	400		mV	No bias, $H = 20 \text{ mW}/\text{cm}^2$
$I_R$	Dark Current		0.1	25	nA	$V_R = -10.0 \text{ V}$ , $H \leq 0.1 \mu\text{W}/\text{cm}^2$
$I_L$	Photo Current (Note 1)	12	16		$\mu\text{A}$	$V_R = -10.0 \text{ V}$ , $H = 20 \text{ mW}/\text{cm}^2$
$I_{L(sc)}$	Short Circuit Current (Note 1)	12	16		$\mu\text{A}$	No bias, $H = 20 \text{ mW}/\text{cm}^2$
R (Tungsten)	Responsivity (Notes 1 & 2)	0.6	1.0		$\mu\text{A}/\text{mW}/\text{cm}^2$	No bias, $T_C = 2854^\circ \text{K}$
R @ 0.9 $\mu$	Responsivity 0.9 $\mu$ (Note 2)		3.0		$\mu\text{A}/\text{mW}/\text{cm}^2$	No bias, GaAs
$C_O$	Open Circuit Capacitance		70		pF	$V_R = 0$ , $H \leq 0.1 \text{ mW}/\text{cm}^2$
$C_R$	Reversed Bias Capacitance		20		pF	$V_R = -10 \text{ V}$ , $H \leq 0.1 \mu\text{W}/\text{cm}^2$
$R_{max}$	Responsivity (absolute) at Spectral Peak (Note 2)		0.6		A/W	$V_R = 0$ , $\lambda = 0.80 \mu$
NEP	Noise Equivalent Power (Note 2)		$1.0 \times 10^{-14}$		W	$V_R = -10 \text{ V}$ , $\lambda = 0.80 \mu$ , $\Delta f = 1.0 \text{ Hz}$
D	Detectivity (Note 2)		$8.8 \times 10^{12}$		$\frac{\text{cm}\sqrt{\text{Hz}}}{\text{W}}$	$V_R = 10 \text{ V}$ , $\lambda = 0.80 \mu$ , $f = 1.0 \text{ kHz}$ , $\Delta f = 1.0 \text{ Hz}$

### Notes

- Irradiation source is an unfiltered tungsten lamp operated at 2854°K color temperature.
- Sensitive Area =  $7.75 \times 10^{-3} \text{ cm}^2$ . (Response at metalization is negligible.)

### Typical Voltage vs Current Characteristics

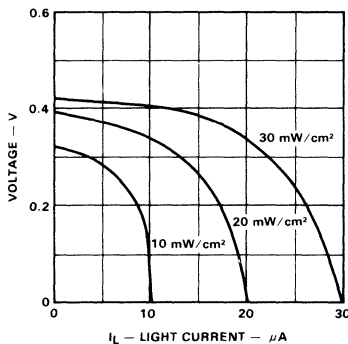

### Typical Short Circuit Current vs Irradiation

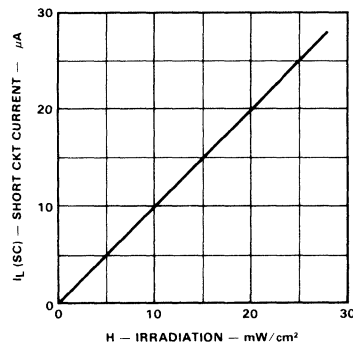



# Typical Electrical Characteristic Curves

## FPT102

### Typical Open Circuit Voltage vs Irradiation

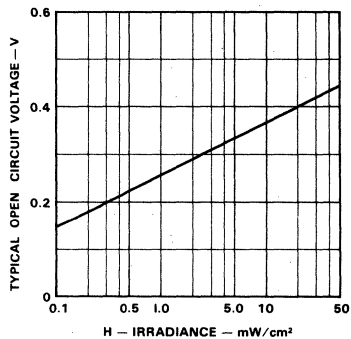

### Relative Spectral Response

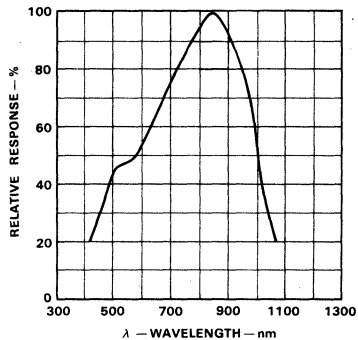

### Typical Photo Current vs Angle of Incidence

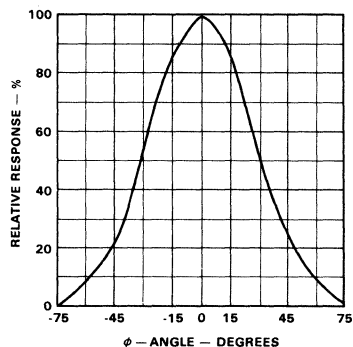

### Typical Light Current vs Time

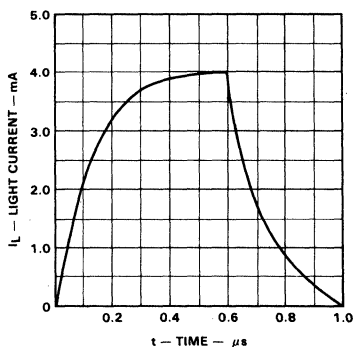

# High-Sensitivity Silicon Phototransistors

Optoelectronic Products

# FPT120/A/B/C FPT130/A/B

## General Description

The FPT120/A/B/C and FPT130/A/B are silicon nitride protected npn Planar phototransistors with exceptionally stable characteristics and high illumination-sensitivity. The case is made of a special plastic compound with transparent resin encapsulation. The controlled sensitivities offered in the A, B and C versions give the circuit designer increased flexibility.

## High Illumination Sensitivity

Availability Of Base Pins For Flexible Circuit Design

## Absolute Maximum Ratings

### Maximum Temperature and Humidity

Storage Temperature	-55°C to +100°C
Operating Temperature	-55°C to +85°C
Pin Temperature (Soldering, 5 s)	260°C
Relative Humidity at 65°C	85%

### Maximum Power Dissipation (Note 1)

Total Dissipation at $T_C = 25^\circ\text{C}$	200 mW
Derate Linearly from 25°C	3.33 mW/°C
Total Dissipation at $T_A = 25^\circ\text{C}$	100 mW
Derate Linearly from 25°C	1.67 mW/°C

### Maximum Voltage and Currents

$V_{CE(sus)}$ Collector-to-Emitter Sustaining Voltage (Note 4)	20 V
$I_C$ Collector Current	25 mA

## Package Outlines

### FPT120/A/B/C

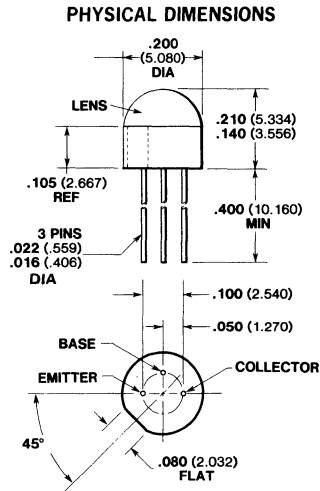

### FPT130/A/B

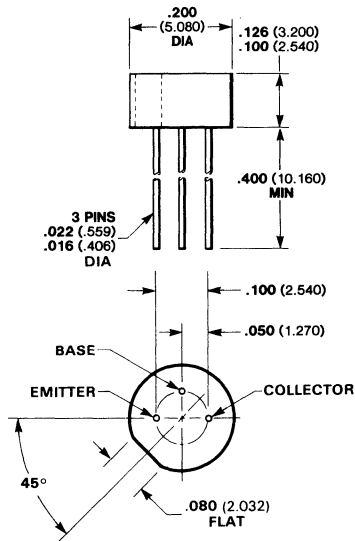

## Notes

All dimensions in inches **bold** and millimeters (parentheses)  
Tolerance unless specified =  $\pm .015$  ( $\pm .381$ )

# Typical Electrical Characteristics

# FPT120/A/B/C FPT130/A/B

## Electrical Characteristics $T_A = 25^\circ\text{C}$

Symbol	Characteristic	Min	Typ	Max	Units	Test Conditions
$V_{CEO(sus)}$	Collector-to-Emitter Sustaining Voltage (Note 4)	20	50		V	$I_C = 1\text{ mA}$ (Pulsed)
$BV_{ECO}$	Emitter-to-Collector Breakdown Voltage (Note 4)		5.0		V	$I_{EC} = 100\ \mu\text{A}$
$V_{CE(sat)}$	Collector-to-Emitter Saturation Voltage, Tungsten Source (Note 2)		0.25	0.55	V	$I_C = 1\text{ mA}$ , $H = 20\text{ mW/cm}^2$
$I_{CEO}$	Collector Dark Current (Note 4)		10	100	nA	$V_{CE} = 5.0\text{ V}$
$I_{CE(I)}$	Photo Current, Tungsten Source (Note 2)				mA	$V_{CE} = 5.0\text{ V}$ , $H = 5\text{ mW/cm}^2$
	FPT120	2.0	7.5			
	FPT120A (Note 6)	7.5		22.5		
	FPT120B (Note 6)	10		20		
	FPT120C (Note 6)	16		25		
	FPT130	2.0	4.5			
	FPT130A (Note 7)	4.5		13.5		
	FPT130B (Note 7)	6.0		12		
$I_{CE(I)}$	Photo Current, GaAs Source (Note 3)				mA	$V_{CE} = 5.0\text{ V}$ , $H = 1\text{ mW/cm}^2$
	FPT120	0.7	4.5			
	FPT130	0.7	2.7			
$t_r$	Light Current Rise Time (Note 5)		18		$\mu\text{s}$	
$t_f$	Light Current Fall Time (Note 5)		18		$\mu\text{s}$	

### Notes

- These are steady-state limits. The factory should be consulted on applications involving pulsed or low duty cycle operations.
- Measured at noted irradiance as emitted from a tungsten filament lamp at a color temperature of 2854°K. The effective photosensitive area is typically 1.25 mm<sup>2</sup> (FPT120A/B) and 0.78 mm<sup>2</sup> (FPT130A/B).
- These are values obtained at noted irradiance as emitted from a GaAs source at 900 nm.
- Measured with radiation flux intensity of less than 0.1  $\mu\text{W/cm}^2$  over the spectrum from 100-1500 nm.
- Rise time is defined as the time required for  $I_{CE}$  to rise from 10% to 90% of peak value. Fall time is defined as the time required for  $I_{CE}$  to decrease from 90% to 10% of peak value. Test conditions are:  $V_{CE} = 5.0\text{ V}$ ,  $I_{CC} = 4.0\text{ mA}$ ,  $R_L = 100\ \Omega$ , GaAs source.
- Same electrical characteristics as FPT120 except for  $I_{CE(I)}$ .
- Same electrical characteristics as FPT130 except for  $I_{CE(I)}$ .

# Typical Electrical Characteristic Curves

# FPT120/A/B/C FPT130/A/B

**FPT120/A/B/C Collector Current vs Collector Voltage**

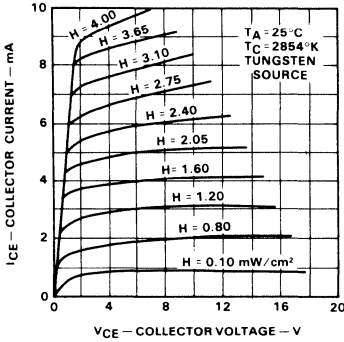

**FPT130/A/B/C Collector Current vs Collector Voltage**

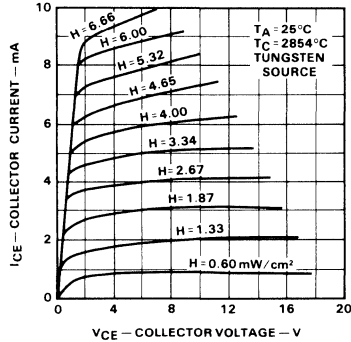

4

**Collector-Emitter Saturation Voltage vs Collector Current**

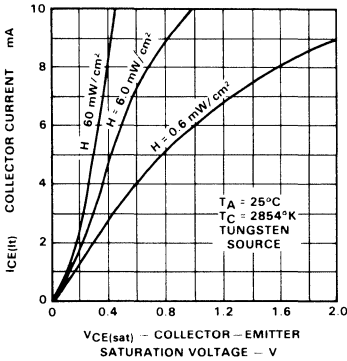

**Collector-Emitter Saturation Voltage vs Collector Current**

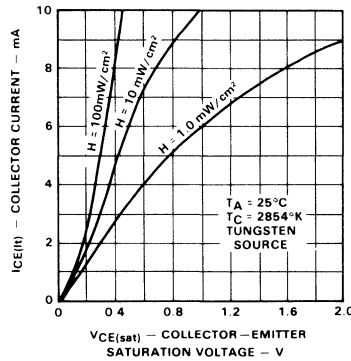

**Angular Response**

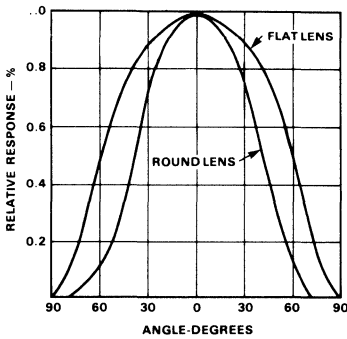

**Collector Dark Current vs Temperature**

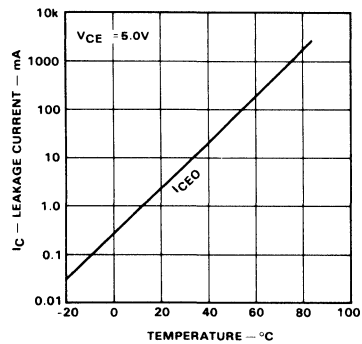

# Typical Electrical Characteristic Curves (Cont'd)

# FPT120/A/B/C FPT130/A/B

## Relative Spectral Response

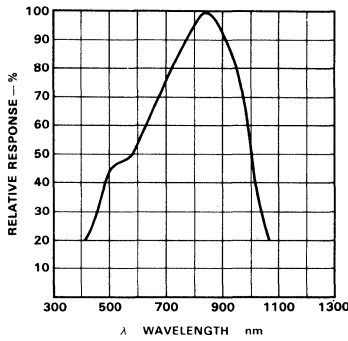

## Rise And Fall Time vs Collector Current

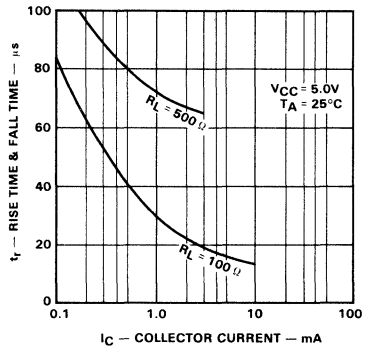

## Photo Current Characteristics

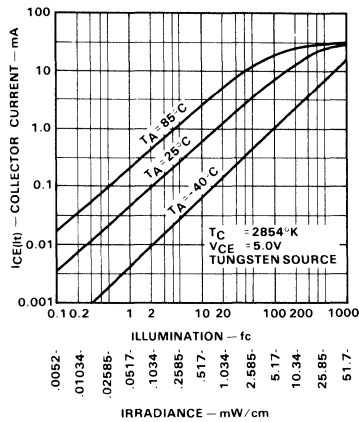

## Switching Time Measurement Circuit

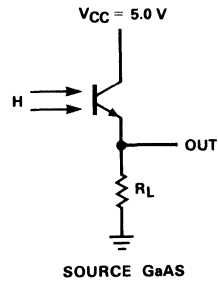

# General-Purpose Silicon Phototransistors

Optoelectronic Products

## FPT131 FPT136

### General Description

The FPT131 and FPT136 are 3-terminal npn Planar phototransistors with exceptionally stable characteristics and high illumination sensitivity. The availability of the base pins gives wide latitude for flexible circuit design. The case is a special plastic compound with transparent resin encapsulation that exhibits stable characteristics under high humidity conditions.

### High Illumination Sensitivity

Availability Of Base Pins For Flexible Circuit Design

### Low Cost

### Absolute Maximum Ratings

#### Maximum Temperature and Humidity

Storage Temperature	-55°C to +100°C
Operating Temperature	-55°C to +85°C
Pin Temperature (Soldering, 10 s)	260°C
Relative Humidity at 65°C	85%

#### Maximum Power Dissipation (Note 1)

Total Dissipation at $T_C = 25^\circ\text{C}$	200 mW
Derate Linearly from 25°C	3.33 mW/°C
Total Dissipation at $T_A = 25^\circ\text{C}$	100 mW
Derate Linearly from 25°C	1.67 mW/°C

#### Maximum Voltages and Current (Note 4)

$V_{CB}$	Collector-to-Base Voltage	20 V
$V_{CE(sus)}$	Collector-to-Emitter Sustaining Voltage (Note 4)	15 V
$I_C$	Collector Current	25 mA

### Package Outlines

#### FPT131

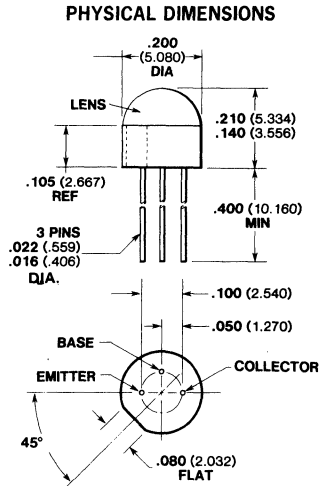

#### FPT136

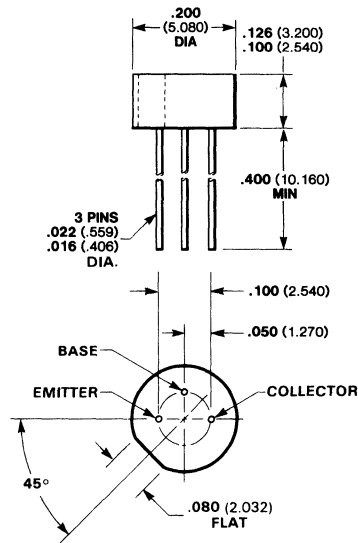

#### Notes

All dimensions in inches **bold** and millimeters (parentheses)  
Tolerance unless specified =  $\pm .015$  ( $\pm .381$ )

# Typical Electrical Characteristics

# FPT131 FPT136

## Electrical Characteristics $T_A = 25^\circ\text{C}$

Symbol	Characteristic	Min	Typ	Max	Units	Test Conditions
$V_{CE(sus)}$	Collector-to-Emitter Sustaining Voltage (Note 4)	15	50		V	$I_C = 1.0\text{ mA}$ (Pulsed)
$BV_{CBO}$	Collector-to-Base Breakdown Voltage (Note 4)	20	120		V	$I_C = 100\text{ }\mu\text{A}$
$BV_{ECO}$	Emitter-to-Collector Breakdown Voltage (Note 4)		7.0		V	$I_{EC} = 100\text{ }\mu\text{A}$
$V_{CE(sat)}$	Collector-to-Emitter Saturation Voltage		0.16	0.7	V	$I_C = 500\text{ }\mu\text{A}$ $H = 20\text{ mW/cm}^2$
$I_{CEO}$	Collector Dark Current (Note 4)		10	500	nA	$V_{CE} = 5.0\text{ V}$
$I_{CBO}$	Collector Dark Current (Note 4)		0.25		nA	$V_{CB} = 10\text{ V}$
$I_{CE(t)}$	Photo Current, Tungsten (Notes 2 and 6)					
	FPT131	0.1	1.4		mA	$V_{CE} = 5.0\text{ V}$
	FPT136	0.1	0.88			$H = 5.0\text{ mW/cm}^2$
$I_{CE(t)}$	Photo Current, GaAs (Notes 3 and 6)					
	FPT131	0.2	4.2		mA	$V_{CE} = 5.0\text{ V}$
	FPT136	0.2	2.7			$H = 5.0\text{ mW/cm}^2$
$t_r$	Light Current Rise Time (Note 5)		2.8		$\mu\text{s}$	
$t_f$	Light Current Fall Time (Note 5)		2.8		$\mu\text{s}$	
$R_{CB}$	Responsivity, Tungsten (Notes 2 and 7)					
	FPT131		1.6		$\mu\text{A}/\text{mW/cm}^2$	$V_{CB} = 10\text{ V}$
	FPT136		1.0			
$R_{CB}$	Responsivity, GaAs (Notes 3 and 7)					
	FPT131		4.8		$\mu\text{A}/\text{mW/cm}^2$	$V_{CB} = 20\text{ V}$
	FPT136		3.0			

### Notes

- These are steady-state limits. The factory should be consulted on applications involving pulsed or low duty cycle operations.
- Measured at noted irradiance as emitted from a tungsten filament lamp at a color temperature of  $2854^\circ\text{K}$ . The effective photosensitive area is typically  $1.25\text{ mm}^2$  (FPT131) and  $0.78\text{ mm}^2$  (FPT136).
- These are values obtained at noted irradiance as emitted from a GaAs source at  $900\text{ nm}$ .
- Measured with radiation flux intensity of less than  $0.1\text{ }\mu\text{W/cm}^2$  over the spectrum from  $100\text{--}1500\text{ nm}$ .
- Rise time is defined as the time required for  $I_{CE}$  to rise from 10% to 90% of peak value. Fall time is defined as the time required for  $I_{CE}$  to decrease from 90% to 10% of peak value. Test conditions are:  $I_{CE} = 4.0\text{ mA}$ ,  $V_{CE} = 5.0\text{ V}$ ,  $R_L = 100\text{ }\Omega$ , GaAs source.
- No electrical connection to base pin.
- No electrical connection to emitter pin.

# Typical Electrical Characteristic Curves

# FPT131 FPT136

**FPT131 Collector Current vs Collector Voltage**

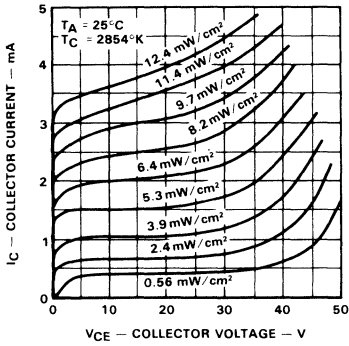

**FPT136 Collector Current vs Collector Voltage**

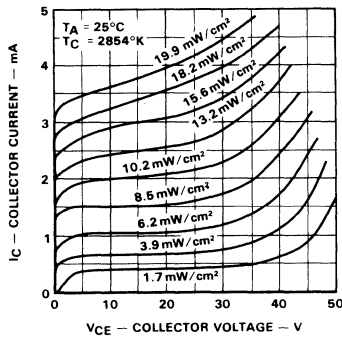

**Photo Current Characteristics**

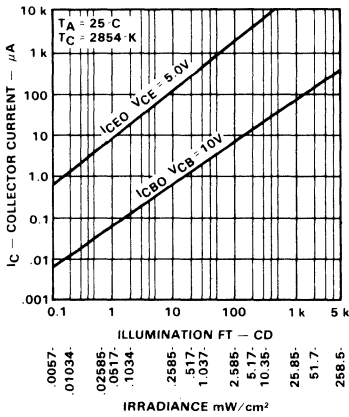

**Collector Base Characteristics**

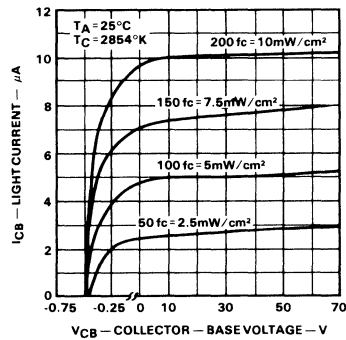

**Collector Dark Current vs Temperature**

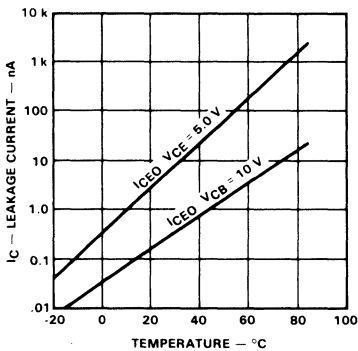

**Angular Response**

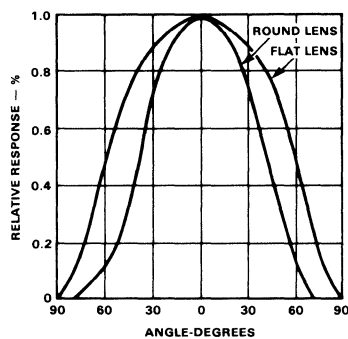



# Typical Electrical Characteristic Curves (Cont'd)

# FPT131 FPT136

**Rise And Fall Time vs Collector Current**

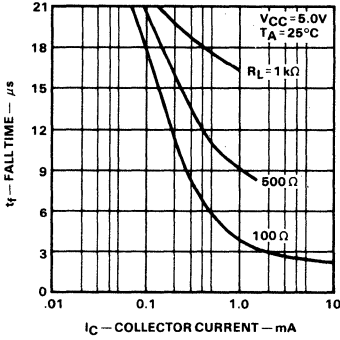

**Relative Spectral Response**

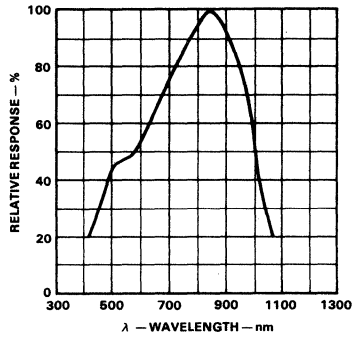

**Turn-Off Times For Circuit Shown**

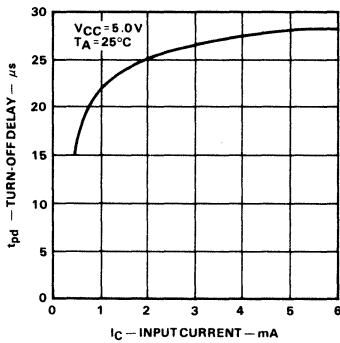

**Turn-On Delay Times For Circuit Shown**

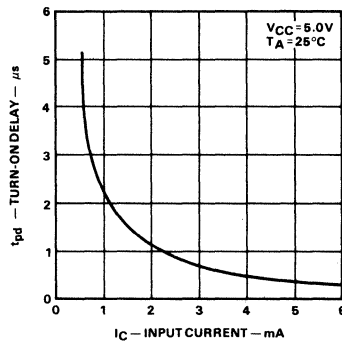

**Switching Circuit For Rise And Fall Times**

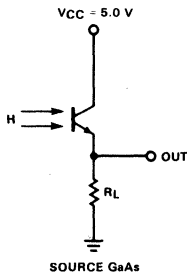

**Circuit For Turn-On And Turn-Off Data**

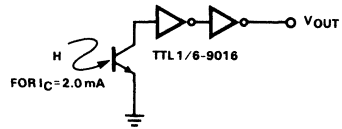

# General-Purpose, High-Sensitivity Silicon Phototransistors

Optoelectronic Products

## FPT132 FPT137

### General Description

The FPT 132 and FPT137 are silicon nitride protected npn Planar phototransistors with exceptionally stable characteristics and high illumination sensitivity. The case is made of a special plastic compound with transparent resin encapsulation that exhibits stable characteristics under high humidity conditions.

### High Illumination Sensitivity

Low Cost

### Absolute Maximum Ratings

#### Maximum Temperatures and Humidity

Storage Temperature	-55°C to +100°C
Operating Temperature	-55°C to +85°C
Pin Temperature (Soldering, 5 s)	260°C
Relative Humidity at 65°C	85%

#### Maximum Power Dissipation (Note 3)

Total Dissipation at $T_C = 25^\circ\text{C}$	200 mW
Derate Linearly from 25°C	3.33 mW/°C
Total Dissipation at $T_A = 25^\circ\text{C}$	100 mW
Derate Linearly from 25°C	1.67 mW/°C

#### Maximum Voltages and Current (Note 4)

$V_{CE(sus)}$ Collector-to-Emitter Sustaining Voltage (Note 4)	10 V
$I_C$ Collector Current	25 mA

### Package Outlines

#### FPT132

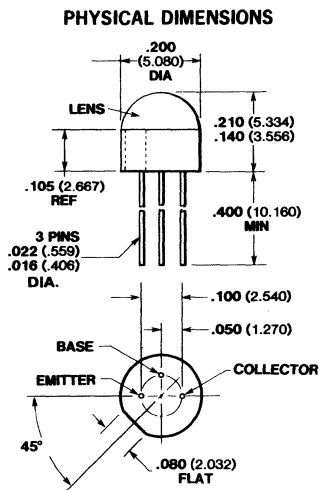

#### FPT137

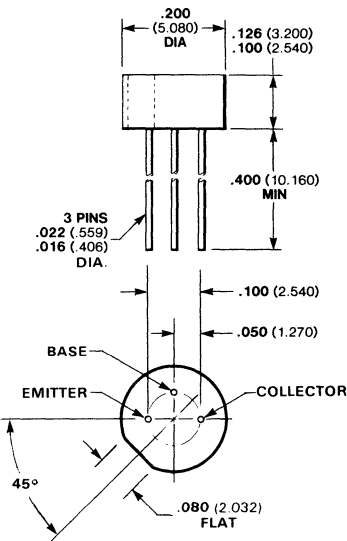

#### Notes

All dimensions in inches **bold** and millimeters (parentheses)  
Tolerance unless specified =  $\pm .015$  ( $\pm .381$ )

# Typical Electrical Characteristics

# FPT132 FPT137

## Electrical Characteristics $T_A = 25^\circ\text{C}$

Symbol	Characteristic	Min	Typ	Max	Units	Test Conditions
$V_{CE(sus)}$	Collector-to-Emitter Sustaining Voltage (Note 4)	10	30		V	$I_C = 1\text{ mA}$ (Pulsed)
$BV_{ECO}$	Emitter-to-Collector Breakdown Voltage (Note 4)		3.0		V	$I_{EC} = 100\text{ }\mu\text{A}$
$V_{CE(sat)}$	Collector-to-Emitter Saturation Voltage, Tungsten Source (Note 2)		0.15	0.7	V	$I_C = 1\text{ mA}$ , $H = 20\text{ mW/cm}^2$
$I_{CEO}$	Collector Dark Current (Note 4)		10	500	nA	$V_{CE} = 5.0\text{ V}$
$I_{CE(it)}$	Photo Current, Tungsten Source (Note 2) FPT132	0.2	1.5		mA	$V_{CE} = 5.0\text{ V}$ , $H = 1\text{ mW/cm}^2$
	FPT137	0.2	0.9			
$I_{CE(it)}$	Photo Current, Tungsten Source (Note 2) FPT132		7.5		mA	$V_{CE} = 5.0\text{ V}$ , $H = 5\text{ mW/cm}^2$
	FPT137		4.5			
$I_{CE(it)}$	Photo Current, GaAs Source (Note 3) FPT132	0.4	4.5		mA	$V_{CE} = 5.0\text{ V}$ , $H = 1\text{ mW/cm}^2$
	FPT137	0.4	2.7			
$t_r$	Light Current Rise Time (Note 5)		18		$\mu\text{s}$	
$t_f$	Light Current Fall Time (Note 5)		18		$\mu\text{s}$	

### Notes

- These are steady-state limits. The factory should be consulted on applications involving pulsed or low duty cycle operations.
- Measured at noted irradiance as emitted from a tungsten filament lamp at a color temperature of  $2854^\circ\text{K}$ . The effective photosensitive area is typically  $1.25\text{ mm}^2$  (FPT132), and  $0.78\text{ mm}^2$  (FPT137).
- These are values obtained at noted irradiance as emitted from a GaAs source at  $900\text{ nm}$ .
- Measured with radiation flux intensity of less than  $0.1\text{ }\mu\text{W/cm}^2$  over the spectrum from  $100\text{--}1500\text{ nm}$ .
- Rise time is defined as the time required for  $I_{CE}$  to rise from 10% to 90% of peak value. Fall time is defined as the time required for  $I_{CE}$  to decrease from 90% to 10% of peak value. Test conditions are:  $V_{CE} = 5.0\text{ V}$ ,  $I_{CE} = 4.0\text{ mA}$ ,  $R_L = 100\text{ }\Omega$ , GaAs source.

### FPT132 Collector Current vs Collector Voltage

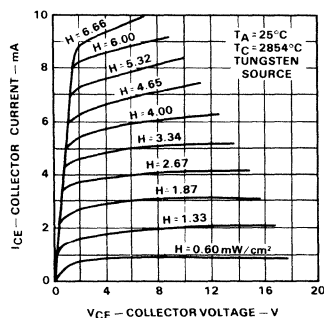

### FPT137 Collector Current vs Collector Voltage

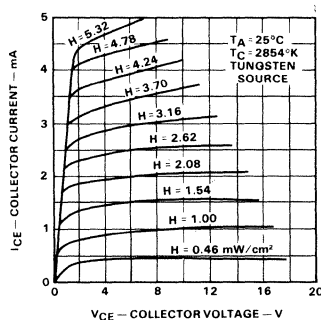

# Typical Electrical Characteristic Curves

# FPT 132 FPT 137

4

**Photo Current Characteristics**

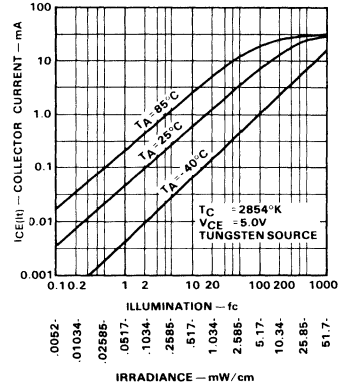

**Collector-Emitter Saturation Voltage and Collector Current**

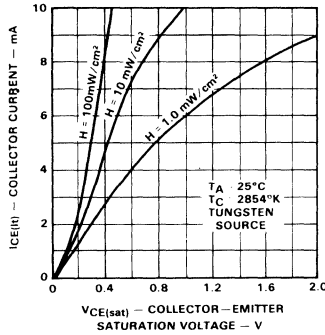

**Collector Dark Current vs Temperature**

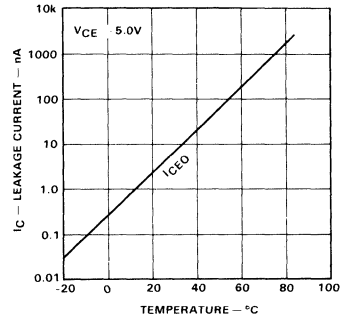

**Relative Spectral Response**

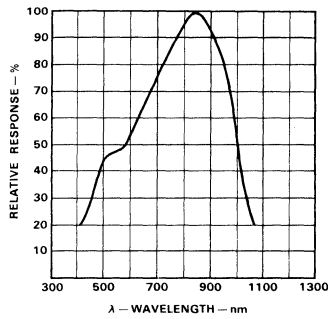

**Angular Response**

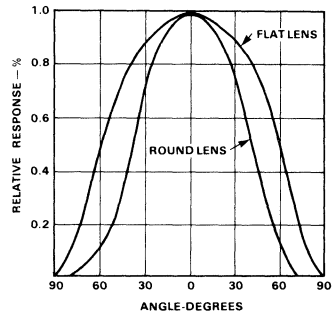

**Rise Time And Fall Time vs Collector Current**

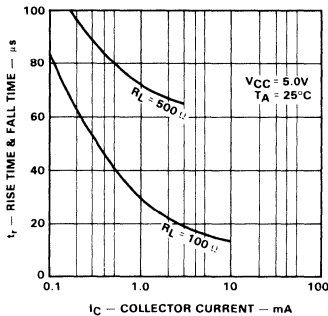

# Very High-Sensitivity Photo Darlington

Optoelectronic Product

# FPT400 FPT410

## General Description

The FPT400 and FPT410 are 3-terminal npn Planar photo-Darlington with exceptionally stable characteristics and high illumination sensitivity. The availability of the base pins gives wide latitude for flexible circuit design. The case is a special plastic compound with transparent resin encapsulation that exhibits stable characteristics under high humidity conditions.

**Super High Illumination Sensitivity**  
**Exceptionally Stable Characteristics**  
**Excellent For Low Light Level Applications**  
**High Output Current**

## Absolute Maximum Ratings

### Maximum Temperature and Humidity

Storage Temperature	-55°C to +100°C
Operating Temperature	-55°C to +85°C
Relative Humidity at 65°C	85%

### Maximum Power Dissipation (Note 7 and 8)

Total Dissipation at $T_C = 25^\circ\text{C}$	200 mW
Derate Linearly from 25°C	3.3 mW/°C
Total Dissipation at $T_A = 25^\circ\text{C}$	100 mW
Derate Linearly from 25°C	1.67 mW/°C

### Maximum Voltages and Currents

$V_{CB}$ Collector-to-Base Voltage	30 V
$V_{CE}$ Collector-to-Emitter Voltage	30 V
$I_C$ Collector Current	50 mA

## Package Outlines FPT400

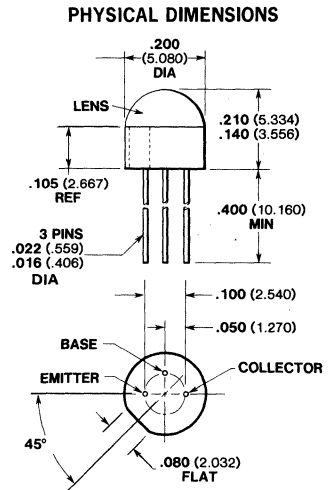

## FPT410

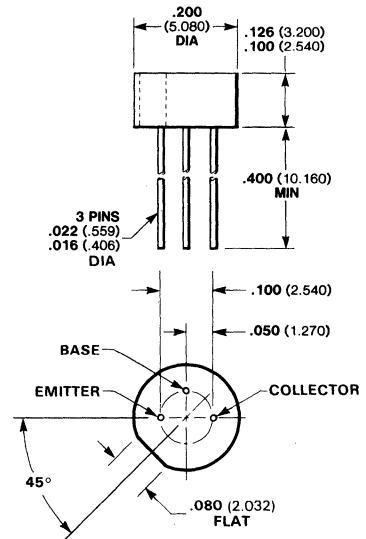

## Notes

All dimensions in inches **bold** and millimeters (parentheses)  
Tolerance unless specified =  $\pm .015$  (0.381)

# Typical Electrical Characteristics

# FPT400 FPT410

## Electrical Characteristics $T_A = 25^\circ\text{C}$

Symbol	Characteristic	Min	Typ	Max	Units	Test Conditions	
$V_{CE(sus)}$	Collector-to-Emitter Sustaining Voltage	30	60		V	$I_C = 1.0\text{ mA}$ (Note 3)	
$V_{CBO}$	Collector-to-Base Voltage	30	60		V	$I_C = 100\ \mu\text{A}$ (Note 3)	
$V_{ECO}$	Emitter-to-Collector Voltage		10		V	$I_E = 100\ \mu\text{A}$ (Note 3)	
$V_{CE(sat)}$	Collector-to-Emitter Saturation Voltage		0.9	1.0	V	$I_C = 5.0\text{ mA}$ , $H = 5.0\text{ mW/cm}^2$ (Note 1)	
$I_{CEO}$	Collector Dark Current		10	100	nA	$V_{CE} = 5.0\text{ V}$ (Note 3)	
$I_{CE(It)}$	Photo Current (Tungsten)	FPT400	3.0	7.5		mA	$V_{CE} = 5.0\text{ V}$ $H = 1.0\text{ mW/cm}^2$ (Notes 1, 5)
		FPT410	2.0	5.0		mA	
$I_{CE(It)}$	Photo Current (GaAs)	FPT400	6.0	15		mA	$V_{CE} = 5.0\text{ V}$ , $H = 1.0\text{ mW/cm}^2$ (Notes 2, 5)
		FPT410	4.0	10		mA	
$t_r$	Light Current Rise Time		100		$\mu\text{s}$	(Note 4)	
$t_f$	Light Current Fall Time		100		$\mu\text{s}$	(Note 4)	

4

### Notes

1. Measured at noted irradiance as emitted from a Tungsten filament lamp at a color temperature of 2854°K. The effective photosensitive area is typically 7 mm<sup>2</sup>.
2. These are values obtained at noted irradiance as emitted from a GaAs source at 900 nm.
3. Measured with radiation flux intensity of less than 0.1  $\mu\text{W/cm}^2$  over the spectrum from 100-1500 nm.
4. Rise time is defined as the time required for  $I_{CE}$  to rise from 10% to 90% of peak value. Fall time is defined as the time required for  $I_{CE}$  to decrease from 90% to 10% of peak value. Test conditions are  $V_{CE} = 10\text{ V}$ ,  $I_{CC} = 10\text{ mA}$ ,  $R_L = 100\ \Omega$  GaAs source.
5. No electrical connection to base pin.
6. No electrical connection to emitter pin.
7. These are steady-state limits. The factory should be consulted on applications involving pulsed or low duty cycle operations.
8. These ratings give a maximum junction temperature of 85°C and junction-to-case thermal resistance of 300°C/Watt (derating factor of 3.33 mW/°C, and a junction-to-ambient thermal resistance of 600°C/Watt (derating factor of 1.67 mW/°C).

# Hermetic TO-18 Silicon Phototransistors

Optoelectronic Products

# FPT500, FPT500A FPT520, FPT520A FPT540, FPT540A

## General Description

FPT500/FPT520/FPT540 are nitride-passivated npn Planar silicon phototransistors. These devices are packaged in a TO-18 style, hermetically sealed package with lens cap. For most applications two pins are used (collector and emitter pins). The availability of the base pin gives wide latitude for flexible circuit design. Phototransistors can be used as photodiodes (collector-base) which have excellent photo current linearity (for analog applications).

**High Illumination Sensitivity**  
**Exceptionally Stable Characteristics**  
**Large Range of Controlled Sensitivities**  
**Hermetic Metal Package**  
**High Operating Temperature**

## Absolute Maximum Ratings

### Maximum Temperature and Humidity

Storage Temperature	-65°C to +200°C
Operating Temperature	-55°C to +150°C
Pin Temperature (Soldering, 5 s)	260°C
Relative Humidity at 65°C	85%

### Maximum Power Dissipation

Total Dissipation at $T_C = 25^\circ\text{C}$	600 mW
Derate Linearly from 25°C	4.8 mW/°C
Total Dissipation at $T_A = 25^\circ\text{C}$	300 mW
Derate Linearly from 25°C	2.4 mW/°C

### Maximum Voltages and Currents

$V_{CB}$	Collector-to-Base Voltage	
	FPT500/FPT500A	60 V
	FPT520/FPT520A	50 V
$V_{CE(sus)}$	Collector-to-Emitter Sustaining Voltage	
	FPT500/FPT500A	45 V
	FPT520/FPT520A	30 V
$I_C$	Collector Current	50 mA

## Package Outline

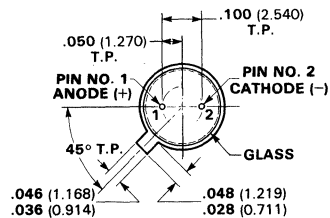
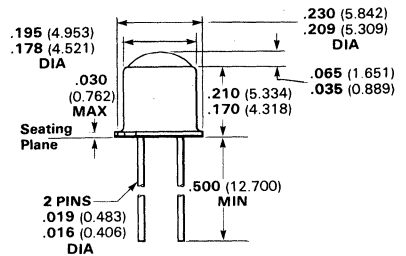

## Notes

All dimensions in inches **bold** and millimeters (parentheses)  
Tolerance unless specified =  $\pm .015$  ( $\pm .381$ )

# Typical Electrical Characteristics

## FPT500, FPT500A FPT520, FPT520A FPT540, FPT540A

### Electrical Characteristics $T_A = 25^\circ\text{C}$

Symbol	Characteristic	Min	Typ	Max	Units	Test Conditions
$V_{CE(sus)}$	Collector-to-Emitter Sustaining Voltage FPT500/FPT500A FPT520/FPT520A FPT540/FPT540A	45 30 12	60 60 30		V	$I_C = 1.0 \text{ mA}$ (Note 3)
$V_{CBO}$	Collector-to-Base Voltage FPT500/FPT500A FPT520/FPT520A FPT540/FPT540A	60 50 30	100 80 50		V	$I_C = 100 \mu\text{A}$ (Note 3)
$V_{EBO}$	Emitter-to-Collector Voltage FPT500/FPT500A FPT520/FPT520A FPT540/FPT540A		10 10 7.0		V	$I_E = 100 \mu\text{A}$ (Note 3)
$V_{CE(sat)}$	Collector-to-Emitter Saturation Voltage FPT500/FPT500A FPT520/FPT520A FPT540/FPT540A		0.16 0.16 0.25	0.33 0.33 0.55	V	$I_C = 500 \mu\text{A}$ (Note 1) $H = 2.0 \text{ mW/cm}^2$ $I_C = 1.0 \text{ mA}$ (Note 1) $H = 2.0 \text{ mW/cm}^2$
$I_{CEO}$	Collector Dark Current		10	100	nA	$V_{CE} = 5.0 \text{ V}$ (Note 3)
$I_{CBO}$	Collector Dark Current		0.25	25	nA	$V_{CB} = 10 \text{ V}$ (Note 3)
$I_{CB(It)}$	Photo Current		10		$\mu\text{A}$	$V_{CB} = 5.0 \text{ V}$ (Note 6) $H = 1.0 \text{ mW/cm}^2$
$\theta_{50}$	50% Angular Response		15		degrees	
$t_r$	Light Current Rise Time FPT500/FPT500A FPT520/FPT520A FPT540/FPT540A		3.0 8.0 18		$\mu\text{s}$	(Note 4)
$t_f$	Light Current Fall Time FPT500/FPT500A FPT520/FPT520A FPT540/FPT540A		3.0 8.0 18		$\mu\text{s}$	(Note 4)
$I_{CE(It)}$	Photo Current (Tungsten) FPT500 FPT500A FPT520 FPT520A FPT540 FPT540A	1.0 2.0 5.0 6.0 8.0 10	3.0 8.0 15	6.0 18 30	mA	$V_{CE} = 5.0 \text{ V}$ $H = 1.0 \text{ mW/cm}^2$ (Notes 1, 5)
$I_{CE(It)}$	Photo Current (GaAs) FPT500 FPT520 FPT540	3.0 10 16	6.0 24 30		mA	$V_{CE} = 5.0 \text{ V}$ $H = 1.0 \text{ mW/cm}^2$ (Notes 2, 5)

#### Notes

1. Measured at noted irradiance as emitted from a Tungsten filament lamp at a color temperature of 2854°K. The effective photosensitive area is typically 7 mm<sup>2</sup>.
2. These are values obtained at noted irradiance as emitted from a GaAs source at 900 nm.
3. Measured with radiation flux intensity of less than 0.1  $\mu\text{W/cm}^2$  over the spectrum from 100-1500 nm.
4. Rise time is defined as the time required for  $I_{CE}$  to rise from 10% to 90% of peak value. Fall time is defined as the time required for  $I_{CE}$  to decrease from 90% to 10% of peak value. Test conditions are:  $V_{CE} = 10 \text{ V}$ ,  $I_{CC} = 10 \text{ mA}$ ,  $R_L = 100 \Omega$ , GaAs source.
5. No electrical connection to base pin.
6. No electrical connection to emitter pin.



# Hermetic TO-18

## Silicon Phototransistors

Optoelectronic Products

# FPT510, FPT510A

# FPT530, FPT530A

# FPT550, FPT550A

### General Description

FPT510/FPT530/FPT550 are nitride-passivated npn Planar silicon phototransistors. These devices are packaged in a TO-18 style, hermetically sealed package with lens cap. For most applications two pins are used (collector and emitter pins). The availability of the base pin gives wide latitude for flexible circuit design. Phototransistors can be used as photodiodes (collector-base) which have excellent photo current linearity (for analog applications).

**High Illumination Sensitivity**  
**Exceptionally Stable Characteristics**  
**Large Range of Sensitivities**  
**Hermetic Metal Package**  
**High Operating Temperature**

### Absolute Maximum Ratings

#### Maximum Temperature and Humidity

Storage Temperature	-65°C to +200°C
Operating Temperature	-55°C to +150°C
Pin Temperature (Soldering, 5 s)	260°C
Relative Humidity at 65°C	85%

#### Maximum Power Dissipation

Total Dissipation at $T_C = 25^\circ\text{C}$	600 mW
Derate Linearly from 25°C	4.8 mW/°C
Total Dissipation at $T_A = 25^\circ\text{C}$	300 mW
Derate Linearly from 25°C	2.4 mW/°C

#### Maximum Voltages and Currents

$V_{CB}$	Collector-to-Base Voltage	
	FPT510/FPT510A	60 V
	FPT530/FPT530A	50 V
$V_{CE(sus)}$	Collector-to-Emitter Sustaining Voltage	
	FPT510/FPT510A	45 V
	FPT530/FPT530A	30 V
$I_C$	Collector Current	50 mA

### Package Outline

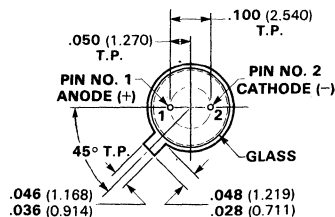
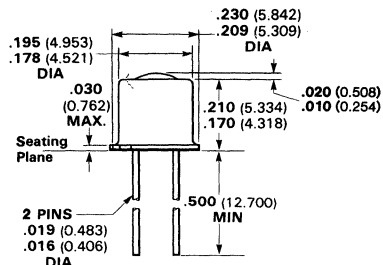

### Notes

All dimensions in inches **bold** and millimeters (parentheses)  
 Tolerance unless specified =  $\pm .015$  ( $\pm .381$ )

# Typical Electrical Characteristics

# FPT510, FPT510A FPT530, FPT530A FPT550, FPT550A

## Electrical Characteristics $T_A = 25^\circ\text{C}$

Symbol	Characteristic	Min	Typ	Max	Units	Test Conditions
$V_{CE(sus)}$	Collector-to-Emitter Sustaining Voltage FPT510/FPT510A FPT530/FPT530A FPT550/FPT550A	45 30 12	60 60 30		V	$I_C = 1.0\text{ mA}$ (Note 3)
$V_{CBO}$	Collector-to-Base Voltage FPT510/FPT510A FPT530/FPT530A FPT550/FPT550A	60 50 30	100 80 50		V	$I_C = 100\ \mu\text{A}$ (Note 3)
$V_{EBO}$	Emitter-to-Collector Voltage FPT510/FPT510A FPT530/FPT530A FPT550/FPT550A		10 10 7.0		V	$I_E = 100\ \mu\text{A}$ (Note 3)
$V_{CE(sat)}$	Collector-to-Emitter Saturation Voltage FPT510/FPT510A FPT530/FPT530A FPT550/FPT550A		0.16 0.16 0.25	0.33 0.33 0.55	V	$I_C = 500\ \mu\text{A}$ (Note 1) $H = 2.0\text{ mW/cm}^2$ $I_C = 1.0\text{ mA}$ (Note 1) $H = 2.0\text{ mW/cm}^2$
$I_{CEO}$	Collector Dark Current		10	100	nA	$V_{CE} = 5.0\text{ V}$ (Note 3)
$I_{CBO}$	Collector Dark Current		0.25	25	nA	$V_{CB} = 10\text{ V}$ (Note 3)
$I_{CB(it)}$	Photo Current		5.0		$\mu\text{A}$	$V_{CB} = 5.0\text{ V}$ (Note 6) $H = 5.0\text{ mW/cm}^2$
$\theta_{50}$	50% Angular Response		15		degrees	
$t_r$	Light Current Rise Time FPT510/FPT510A FPT530/FPT530A FPT550/FPT550A		3.0 8.0 18		$\mu\text{s}$	(Note 4)
$t_f$	Light Current Fall Time FPT510/FPT510A FPT530/FPT530A FPT550/FPT550A		3.0 8.0 18		$\mu\text{s}$	(Note 4)
$I_{CE(it)}$	Photo Current (Tungsten) FPT510 FPT510A FPT530 FPT530A FPT550 FPT550A	0.5 1.0 3.0 4.0 8.0 8.0	1.5 5.0 10	3.0 12 24	mA	$V_{CE} = 5.0\text{ V}$ $H = 5.0\text{ mW/cm}^2$ (Notes 1, 5)
$I_{CE(it)}$	Photo Current (GaAs) FPT510 FPT530 FPT550	1.5 6.0 16	4.5 15 30		mA	$V_{CE} = 5.0\text{ V}$ $H = 5.0\text{ mW/cm}^2$ (Notes 2, 5)

### Notes

1. Measured at noted irradiance as emitted from a Tungsten filament lamp at a color temperature of 2854°K. The effective photosensitive area is typically 7 mm<sup>2</sup>.
2. These are values obtained at noted irradiance as emitted from a GaAs source at 900 nm.
3. Measured with radiation flux intensity of less than 0.1  $\mu\text{W/cm}^2$  over the spectrum from 100-1500 nm.
4. Rise time is defined as the time required for  $I_{CE}$  to rise from 10% to 90% of peak value. Fall time is defined as the time required for  $I_{CE}$  to decrease from 90% to 10% of peak value. Test conditions are:  $V_{CE} = 10\text{ V}$ ,  $I_{CC} = 10\text{ mA}$ ,  $R_L = 100\ \Omega$ , GaAs source.
5. No electrical connection to base pin.
6. No electrical connection to emitter pin.

# Very High-Sensitivity Photo-Darlington

Optoelectronic Products

# FPT560 FPT570

## General Description

FPT560/FPT570 are nitride passivated silicon photo Darlington. Each device is packaged in a TO-18 style, hermetically sealed package with lens cap. For most applications two pins are used (collector and emitter pins). The availability of the base pin gives wide latitude for flexible circuit design.

**Super High Illumination Sensitivity**  
**Exceptionally Stable Characteristics**  
**Excellent For Low Light Level Applications**  
**High Output Current**

## Absolute Maximum Ratings

### Maximum Temperature and Humidity

Storage Temperature	-65°C to +200°C
Operating Temperature	-55°C to +150°C
Pin Temperature (Soldering, 5 s)	260°C
Relative Humidity at 65°C	85%

### Maximum Power Dissipation

Total Dissipation at $T_C = 25^\circ\text{C}$	600 mW
Derate Linearly from 25°C	4.8 mW/°C
Total Dissipation at $T_A = 25^\circ\text{C}$	300 mW
Derate Linearly from 25°C	2.4 mW/°C

### Maximum Voltages and Currents

$V_{CB}$ Collector-to-Base Voltage	30 V
$V_{CE}$ Collector-to-Emitter Voltage	30 V
$I_C$ Collector Current	125 mA

## Package Outlines

### FPT560

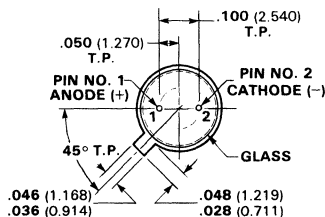
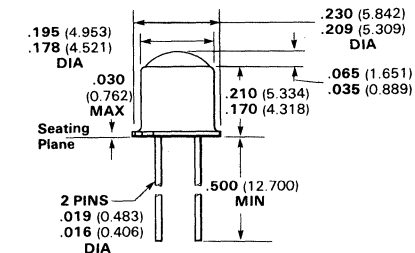

### FPT570

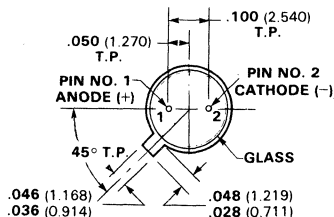
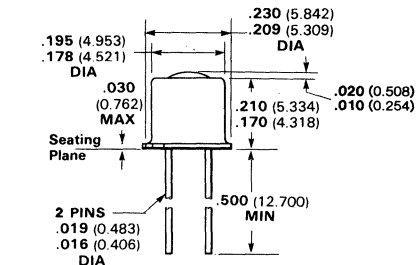

## Notes

All dimensions in inches **bold** and millimeters (parentheses)  
Tolerance unless specified =  $\pm .015$  ( $\pm .381$ )

# Typical Electrical Characteristics

# FPT560 FPT570

## Electrical and Radiant Characteristics $T_A = 25^\circ\text{C}$

Symbol	Characteristic	Min	Typ	Max	Units	Test Conditions
$V_{CE(sus)}$	Collector-to-Emitter Sustaining Voltage	30	60		V	$I_C = 1.0\text{ mA}$ (Note 3)
$V_{CBO}$	Collector-to-Base Voltage	30	60		V	$I_C = 100\ \mu\text{A}$ (Note 3)
$V_{ECO}$	Emitter-to-Collector Voltage		10		V	$I_E = 100\ \mu\text{A}$ (Note 3)
$V_{CE(sat)}$	Collector-to-Emitter Saturation Voltage		0.9	1.0	V	$I_C = 25\text{ mA}$ , $H = 2.0\text{ mW/cm}^2$ (Note 1)
$I_{CEO}$	Collector Dark Current		10	100	nA	$V_{CE} = 5.0\text{ V}$ (Note 3)
$I_{CE(tt)}$	Photo Current (Tungsten) FPT560 FPT570	10	30		mA	$V_{CE} = 5.0\text{ V}$ , $H = 1.0\text{ mW/cm}^2$ (Notes 1, 5)
		1.0	6.0		mA	
$I_{CE(tt)}$	Photo Current (GaAs) FPT560 FPT570	30	90		mA	$V_{CE} = 5.0\text{ V}$ , $H = 1.0\text{ mW/cm}^2$ (Notes 2, 5)
		3.0	18		mA	
$\theta_{50}$	50% Response Angle		15		degrees	
$t_r$	Light Current Rise Time		100		$\mu\text{s}$	(Note 4)
$t_f$	Light Current Fall Time		100		$\mu\text{s}$	(Note 4)

### Notes

1. Measured at noted irradiance as emitted from a Tungsten filament lamp at a color temperature of 2854°K. The effective photosensitive area is typically 7 mm<sup>2</sup>.
2. These are values obtained at noted irradiance as emitted from a GaAs source at 900 nm.
3. Measured with radiation flux intensity of less than 0.1  $\mu\text{W/cm}^2$  over the spectrum from 100-1500 nm.
4. Rise time is defined as the time required for  $I_{CE}$  to rise from 10% to 90% of peak value. Fall time is defined as the time required for  $I_{CE}$  to decrease from 90% to 10% of peak value. Test conditions are:  $V_{CE} = 10\text{ V}$ ,  $I_{CC} = 10\text{ mA}$ ,  $R_L = 100\ \Omega$ , GaAs source.
5. No electrical connection to base pin.
6. No electrical connection to emitter pin.

# Miniature Ceramic Silicon Phototransistors

Optoelectronic Products

## FPT610 FPT630

### General Description

The FPT610 and FPT630 are miniature phototransistors with exceptionally stable characteristics. They utilize a ceramic case with transparent resin encapsulation. The spectral response, extending from 400 to 1100 nm, is compatible with daylight, tungsten and gallium arsenide sources.

### High Illumination Sensitivity

**Exceptionally Stable Characteristics  
Can Be Staked On .087-Inch Centers  
Miniature—85 × 185 × 95 Mils High**

### Absolute Maximum Ratings

#### Maximum Temperature and Humidity

Storage Temperature	-40°C to +100°C
Operating Temperature	-40°C to +100°C
Pin Temperature (Soldering, 5 s)	260°C
Relative Humidity at 65°C	85%

#### Maximum Power Dissipation

Total Dissipation at $T_A = 25^\circ\text{C}$	100 mW
Derate Linearly from 25°C	1.33 mW/°C

#### Maximum Voltages and Currents

$V_{CE(sus)}$ Collector-to-Emitter Sustaining Voltage	
FPT610	30 V
FPT630	20 V
$I_C$ Collector Current	50 mA

### Package Outline

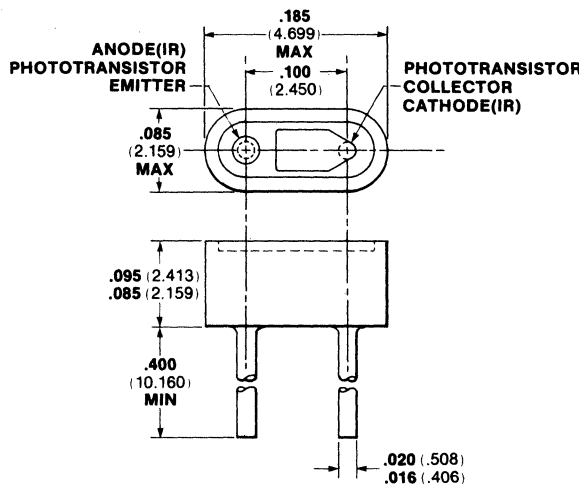

#### Notes

All dimensions in inches **bold** and millimeters (parentheses)  
Tolerance unless specified =  $\pm .015$  ( $\pm .381$ )

# Typical Electrical Characteristics

# FPT610 FPT630

## Electrical Characteristics $T_A = 25^\circ\text{C}$

Symbol	Characteristic	Min	Typ	Max	Units	Test Conditions
$V_{CEO(sus)}$	Collector-to-Emitter Sustaining Voltage (Note 1) FPT610 FPT630	30 20	60 40		V V	$I_C = 1.0\text{ mA}$
$V_{ECO}$	Emitter-to-Collector Voltage (Note 1)		10		V	$I_E = 100\ \mu\text{A}$
$V_{CE(sat)}$	Collector-to-Emitter Saturation Voltage (Note 2)		0.16	0.33	V	$I_C = 500\ \mu\text{A}$ $H = 20\text{ mW/cm}^2$
$I_{CEO}$	Collector Dark Current (Note 1)		10	100	nA	$V_{CE} = 5.0\text{ V}$
$I_{CE(it)}$	Photo Current (Tungsten) (Note 2) FPT610 FPT630	0.2 2.0	1.0 5.0		mA	$V_{CE} = 5.0\text{ V}$ $H = 5.0\text{ mW/cm}^2$
$I_{CE(it)}$	Photo Current (GaAs) (Note 3) FPT610 FPT630	0.4 4.0	3.0 15		mA	$V_{CE} = 5.0\text{ V}$ $H = 5.0\text{ mW/cm}^2$
$t_r$	Rise Time (Note 4) FPT610 FPT630		3.0 18		$\mu\text{s}$	$I_C = 2.0\text{ mA}$ , $R_L = 100\ \Omega$
$t_f$	Fall Time (Note 4) FPT610 FPT630		3.0 18		$\mu\text{s}$	$I_C = 2.0\text{ mA}$ , $R_L = 100\ \Omega$

### Notes

1. Measured with radiation flux intensity of less than  $0.1\ \mu\text{W/cm}^2$  over the spectrum from 100-1500 nm.
2. Measured at noted irradiance as emitted from a Tungsten filament lamp at a color temperature of  $2854^\circ\text{K}$ .
3. These are values obtained at noted irradiance as emitted from a GaAs source at 900 nm.
4. Rise time is defined as the time required for  $I_{CE}$  to rise from 10% to 90% of peak value. Fall time is defined as the time required for  $I_{CE}$  to decrease from 90% or 10% of peak value. Test conditions are:  $I_{CE} = 4.0\text{ mA}$ ,  $V_{CE} = 5.0\text{ V}$ ,  $R_L = 100\ \Omega$ , GaAs source.

# Low-Cost, General-Purpose NPN Silicon Phototransistor

Optoelectronic Products

## FPT700

### General Description

The FPT700 is a low-cost, general-purpose, NPN silicon phototransistor encapsulated in a clear plastic T1 package.

### Absolute Maximum Ratings

#### Maximum Temperature and Humidity

Operating Temperature	-40°C to +85°C
Storage Temperature	-55°C to +100°C
Pin Temperature (Soldering, 5 s)	230°C
Relative Humidity at 85°C	85%

#### Maximum Power Dissipation

Total Dissipation at $T_A = 25^\circ\text{C}$	100 mW
Derate Linearly from 25°C	1.33 mW/°C

#### Maximum Voltage and Current

$V_{CE(sus)}$	Collector-to-Emitter Sustaining Voltage	15 V
$I_C$	Collector Current	25 mA

### Package Outline

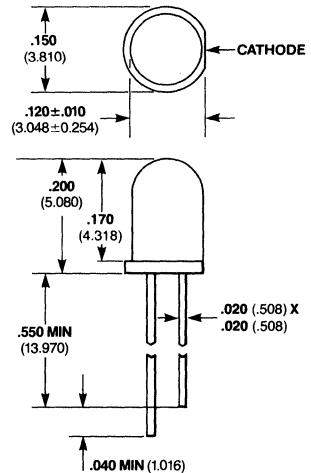

### Notes

All dimensions in inches **bold** and millimeters (parentheses)  
Tolerance unless specified =  $\pm .015$  ( $\pm .381$ )

### Electrical Characteristics $T_A = 25^\circ\text{C}$

Symbol	Characteristic	Min	Typ	Max	Units	Test Conditions
$V_{CE(sus)}$	Collector-to-Emitter Sustaining Voltage	15	50		V	$I_C = 1.0$ mA (Pulsed)
$BV_{ECO}$	Emitter-to-Collector Breakdown Voltage		7.0		V	$I_C = 100$ $\mu$ A
$V_{CE(sat)}$	Collector-to-Emitter Saturation Voltage		0.16	0.7	V	$I_C = 500$ $\mu$ A $H = 20$ mW/cm <sup>2</sup>
$I_{CEO}$	Collector Dark Current		10	500	nA	$V_{CE} = 5.0$ V
$I_{CE(1t)}$	Photo Current, Tungsten Source at Color Temperature of 2854°K	0.10	1.0		mA	$V_{CE} = 5.0$ V, $H = 5.0$ mW/cm <sup>2</sup>
$t_r$	Light Rise Time (10% to 90%)		2.8		$\mu$ s	$I_{CE} = 4.0$ mA, $V_{CE} = 5.0$ V
$t_f$	Light Fall Time (90% to 10%)		2.8		$\mu$ s	$R_L = 100$ $\Omega$

# Typical Electrical Characteristic Curves

## FPT700

### Normalized Light Current vs Angular Displacement

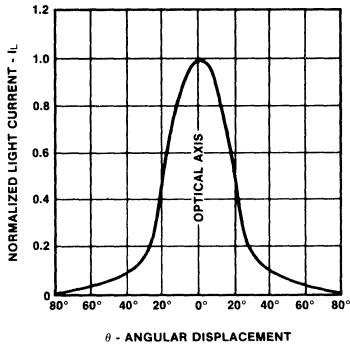

### Relative Spectral Response

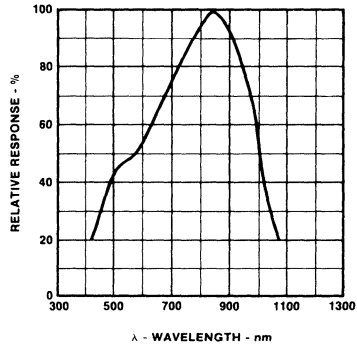



# Low-Cost, General-Purpose Silicon Photodiode

Optoelectronics Group

## FPT720

### General Description

The FPT720 is a low-cost, general-purpose, silicon photodiode encapsulated in a clear plastic T1 package.

### Absolute Maximum Ratings

#### Maximum Temperature and Humidity

Operating Temperature	-40°C to +85°C
Storage Temperature	-55°C to +100°C
Pin Temperature (Soldering, 5 s)	230°C
Relative Humidity at 85°C	85%

#### Maximum Power Dissipation

Total Dissipation at $T_A = 25^\circ\text{C}$	100 mW
Derate Linearly from 25°C	1.33 mW/°C

#### Maximum Voltage and Current

$V_R$ Reverse Voltage	50 V
-----------------------	------

### Package Outline

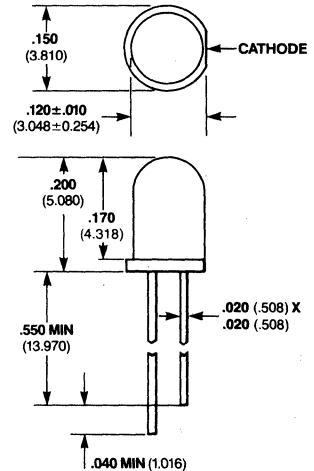

### Notes

All dimensions in inches **bold** and millimeters (parentheses)  
Tolerance unless specified =  $\pm .015$  ( $\pm .381$ )  
Blue Dot on package side differentiates PHOTODIODE from PHOTO  
EMITTER

# Typical Electrical Characteristic

## FPT720

### Electrical Characteristics $T_A = 25^\circ\text{C}$

Symbol	Characteristic	Min	Typ	Max	Units	Test Conditions
BV	Breakdown Voltage	50	120		V	$I_R = 10 \mu\text{A}$ , $H \leq 0.1 \mu\text{W}/\text{cm}^2$
$V_{OC}$	Open-Circuit Voltage (Note)	380	400		mV	No Bias, $H = 20 \text{ mW}/\text{cm}^2$
$I_R$	Dark Current		0.3	35	nA	$V_R = -10 \text{ V}$ , $H \leq 0.1 \mu\text{W}/\text{cm}^2$
$I_L$	Photo Current (Note)	15	25		$\mu\text{A}$	$V_R = -10 \text{ V}$ , $H = 20 \text{ mW}/\text{cm}^2$
$I_{L(sc)}$	Short-Circuit Current (Note)	15	25		$\mu\text{A}$	No Bias, $H = 20 \text{ mW}/\text{cm}^2$
R (Tungsten)	Responsivity (Note)	0.6	1.0		$\mu\text{A}/\text{mW}/\text{cm}^2$	No Bias, $T_C = 2854^\circ\text{K}$
R @ 900 nm	Responsivity 900 nm		3.9		$\mu\text{A}/\text{mW}/\text{cm}^2$	No Bias, GaAs
$C_O$	Open-Circuit Capacitance		60		pF	$V_R = 0 \text{ V}$ , $H \leq 0.1 \text{ mW}/\text{cm}^2$
$C_R$	Reversed Bias Capacitance		20		pF	$V_R = -10 \text{ V}$ , $H \leq 0.1 \mu\text{W}/\text{cm}^2$
$R_{max}$	Responsivity (Absolute) at Spectral Peak		0.6		A/W	$V_R = 0 \text{ V}$ , $\lambda = 800 \text{ nm}$
NEP	Noise Equivalent Power		$1.0 \times 10^{-14}$		W	$V_R = -10 \text{ V}$ , $\lambda = 800 \text{ nm}$ , $\Delta f = 1.0 \text{ Hz}$
D	Detectivity		$8.8 \times 10^{12}$		$\frac{\text{cm}\sqrt{\text{Hz}}}{\text{W}}$	$V_R = -10 \text{ V}$ , $\lambda = 800 \text{ nm}$ , $f = 1.0 \text{ kHz}$ , $\Delta f = 1.0 \text{ Hz}$

#### Note

Irradiation source is an unfiltered Tungsten Lamp operated at  $2854^\circ\text{K}$  color temperature

### Normalized Light Current vs Angular Displacement

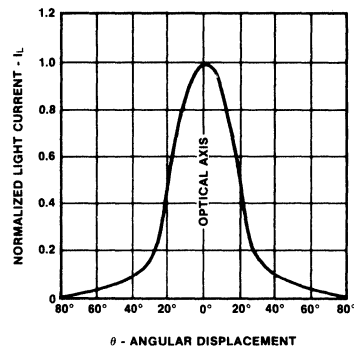

### Relative Spectral Response

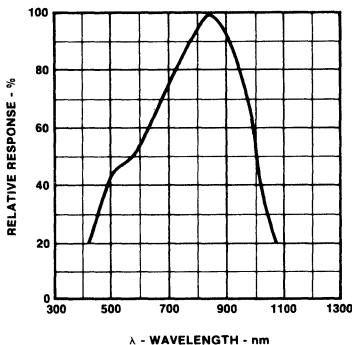

# P-N GaAs Infrared-Emitting Diode

Optoelectronic Products

## TIL38

### General Description

The TIL38 is a p-n GaAs infrared-emitting diode in a low-cost plastic T1- $\frac{3}{4}$  package.

**Output Spectrally Compatible With Silicon Sensors**  
**High Power Output**  
**High Radiant Intensity**

### Absolute Maximum Ratings

#### Maximum Temperature

Operating Temperature  $-55^{\circ}\text{C}$  to  $+100^{\circ}\text{C}$   
 Storage Temperature  $-55^{\circ}\text{C}$  to  $+100^{\circ}\text{C}$   
 Pin Temperature (Soldering, 3 s)  $260^{\circ}\text{C}$

#### Maximum Power Dissipation

Total Dissipation at  $T_A = 25^{\circ}\text{C}$  125 mW  
 Derate Linearly at  $25^{\circ}\text{C}$  1.3 mW/ $^{\circ}\text{C}$

#### Maximum Voltage and Current

$V_R$  Reverse Voltage 5 V  
 $I_F$  Forward dc Current ( $25^{\circ}\text{C}$ ) 150 mA

### Package Outline

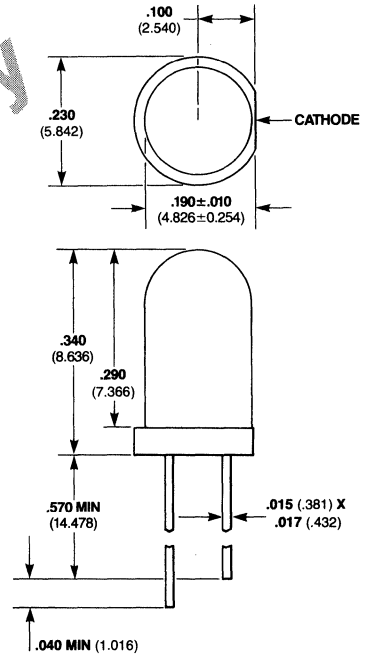

### Notes

This device has a gray-tinted plastic body  
 All dimensions in inches **bold** and millimeters (parentheses)  
 Tolerance unless specified =  $\pm .015$  ( $\pm .381$ )

### Electrical Characteristics $T_A = 25^{\circ}\text{C}$

Symbol	Characteristic	Min	Typ	Max	Units	Test Conditions
$P_O$	Radiant Power Output	6	12		mW	$I_F = 100$ mA
$\lambda_{pk}$	Wavelength @ Peak Emission	915	940	975	nm	$I_F = 100$ mA
$\Delta\lambda$	Spectral Bandwidth Between Half-Power Points		50	75	nm	$I_F = 100$ mA
$\theta_{HI}$	Emission Beam Angle Between Half Intensity		60		degree	$I_F = 100$ mA
C	Capacitance		25		pF	$V_F = 0$ , $f = 1$ MHz
$t_r$	Radiant Rise Time		600		ns	$I_{FM} = 20$ mA, $t_w = 2$ $\mu$ s
$t_f$	Radiant Fall Time		350		ns	$f = 45$ kHz
$V_F$	Forward Voltage		2.55		V	$I_F = 1$ A

# Silicon Photodiode

Optoelectronic Products

# TIL100

## General Description

The TIL100 is a high-speed PIN photodiode operating in a reverse-bias mode. It is spectrally matched with the TIL38 emitter. This photodiode was designed for infrared remote-control system.

## Low Capacitance

High Photosensitivity With Fast Response

## Absolute Maximum Ratings

### Maximum Temperature

Operating Temperature  $-25^{\circ}\text{C}$  to  $+100^{\circ}\text{C}$

Storage Temperature  $-25^{\circ}\text{C}$  to  $+100^{\circ}\text{C}$

Pin Temperature (Soldering, 3 s)  $260^{\circ}\text{C}$

### Maximum Power Dissipation

Total Dissipation at  $T_A = 25^{\circ}\text{C}$  150 mW

Derate Linearly at  $25^{\circ}\text{C}$  2 mW/ $^{\circ}\text{C}$

### Maximum Voltage

BV Breakdown Voltage 30 V

## Package Outline

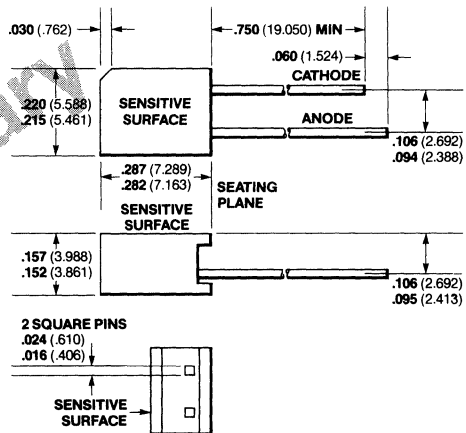

### Notes

All dimensions in inches bold and millimeters (parentheses)  
Tolerance unless specified =  $\pm .015$  ( $\pm .381$ )

## Electrical Characteristics $T_A = 25^{\circ}\text{C}$

Symbol	Characteristic	Min	Typ	Max	Units	Test Conditions
$C_T$	Total Capacitance		35	50	pF	$V_R = 3\text{ V}$ , $H = 0$ , $f = 1\text{ MHz}$
$t_r$	Rise Time			100	ns	$V_R = 10\text{ V}$ , $R_L = 1\text{ k}\Omega$
$t_f$	Fall Time			100	ns	$V_R = 10\text{ V}$ , $R_L = 1\text{ k}\Omega$
$I_L$	Light Current		10		$\mu\text{A}$	$V_R = 10\text{ V}$ , $H = 250\text{ W/cm}^2$ at $940\text{ nm}$
$I_D$	Dark Current			50	nA	$V_R = 10\text{ V}$ , $H = 0$



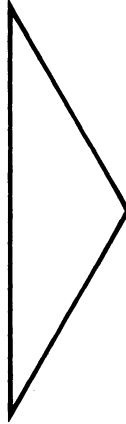
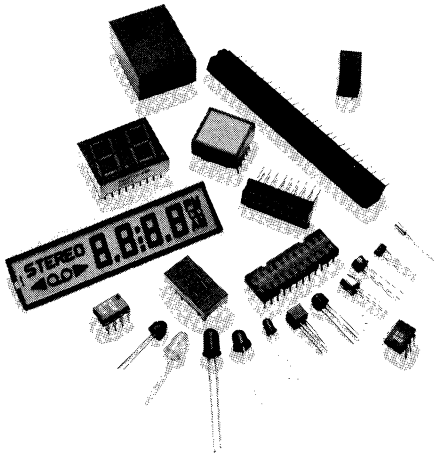

Selection Guides	1
Visible LED Lamps and Mounting Hardware	2
LED Digits	3
Phototransistors, Infrared Emitters and Sensors	4
Couplers	5
Liquid Crystal Displays	6
Fiber Optics	7
Cross Reference	8
Definitions of Symbols and Terms	9
Fairchild Field Sales Offices, Sales Representatives and Distributor Locations	10



# Optically-Coupled Isolator

Optoelectronic Products

# FCD810/A/B/C/D

## General Description

The FCD810 series of optoisolators combines a GaAs infrared-emitting diode and a silicon npn phototransistor in close proximity. Optical intercoupling provides a high degree of ac and dc isolation. A capability for continuous operation of the input diode results in a frequency response extending to dc. Connection to the transistor base is also provided for design flexibility.

## Glassolated™

1500 V To 6000 V Minimum Isolation

Input-to-Output

10<sup>11</sup> Ω Isolation Resistance

Low Coupling Capacitance—Typically 1.0 pF

## Absolute Maximum Ratings

Storage Temperature	-55°C to +150°C
Operating Temperature	-55°C to +100°C
Pin Temperature (Soldering, 5 s)	260°C
Total Package Power	
Dissipation at T <sub>A</sub> = 25°C	250 mW
(LED plus Detector)	
Derate Linearly from 25°C	3.3 mW/°C

## Input Diode

V <sub>R</sub>	Reverse Voltage	3.0 V
I <sub>F</sub>	Forward dc Current	60 mA
I <sub>pk</sub>	Peak Forward Current at 1 μs pulse width, 300 pps	3.0 A
P <sub>D</sub>	Power Dissipation at T <sub>A</sub> = 25°C	100 mW
	Derate Linearly from 25°C	1.33 mW/°C

## Output Transistor

V <sub>CE</sub>	Collector-to-Emitter Voltage	20 V
V <sub>CB</sub>	Collector-to-Base Voltage	50 V
I <sub>C</sub>	Collector Current	25 mA
P <sub>D</sub>	Power Dissipation at T <sub>A</sub> = 25°C	150 mW
	Derate Linearly from 25°C	2.0 mW/°C

## Package Outline

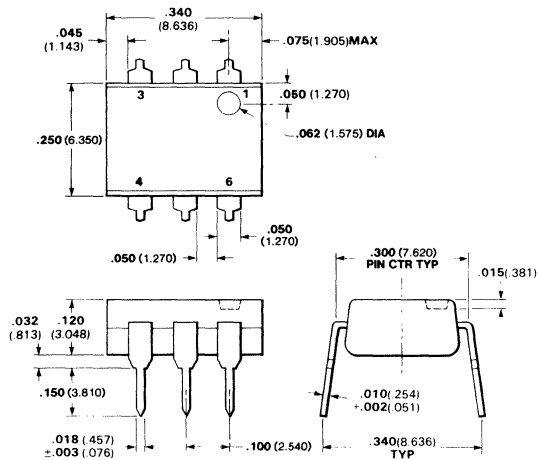

## Notes

All dimensions in inches **bold** and millimeters (parentheses)  
Tolerance unless specified = ±.015 (±.381)

## Connection Diagram DIP (Top View)

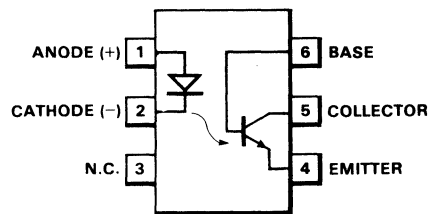

## Pin

1	Anode (+)	} Input Diode
2	Cathode (-)	
3	NC	
4	Emitter	} Output npn Phototransistor
5	Collector	
6	Base	



# Typical Electrical Characteristics

# FCD810/A/B/C/D

## Electrical Characteristics—Input Diode $T_A = 25^\circ\text{C}$

Symbol	Characteristic	Min	Typ	Max	Units	Test Conditions
$V_F$	Forward Voltage		1.2	1.5	V	$I_F = 10\text{ mA}$
$BV_R$	Reverse Breakdown Voltage	3.0	8.0		V	$I_R = 1.0\text{ mA}$

## Electrical Characteristics—Output Transistor $T_A = 25^\circ\text{C}$

Symbol	Characteristic	Min	Typ	Max	Units	Test Conditions
$V_{CE0}$	Collector-to-Emitter Voltage	20	50		V	$I_C = 1.0\text{ mA}$ , $I_F = 0$
$V_{CBO}$	Collector-to-Base Voltage	50			V	$I_C = 100\text{ }\mu\text{A}$ , $I_F = 0$
$I_{CE0}$	Collector-to-Emitter Leakage Current			100	nA	$V_{CE} = 10\text{ V}$ , $I_F = 0$
$I_{CBO}$	Collector-to-Base Leakage Current			100	nA	$V_{CB} = 10\text{ V}$ , $I_F = 0$
$h_{FE}$	Forward Current Gain	50	250			$V_{CE} = 5.0\text{ V}$ , $I_C = 100\text{ }\mu\text{A}$
$C_{cb}$	Collector-to-Base Capacitance		20		pF	$V_{CB} = 10\text{ V}$
$C_{eb}$	Emitter-to-Base Capacitance		10		pF	$V_{EB} = 0$

## Electrical Characteristics—Coupled $T_A = 25^\circ\text{C}$

Symbol	Characteristic	Min	Typ	Max	Units	Test Conditions
$V_{IO}$	Input-to-Output Voltage					
	FCD810	1500			$V_{rms}$	
	FCD810A	1500			$V_{pk}$	
	FCD810B	2500			$V_{pk}$	
	FCD810C	5000			$V_{pk}$	
	FCD810D	6000			$V_{pk}$	
$V_{CE(sat)}$	Collector-to-Emitter Saturation Voltage		0.3	0.7	V	$I_C = 2.6\text{ mA}$ , $I_F = 50\text{ mA}$
$I_C/I_F(CTR)$	Collector Current Transfer Ratio (Note 1)	10	25		%	$V_{CE} = 10\text{ V}$ , $I_F = 10\text{ mA}$
$R_{IO}$	Input-to-Output Resistance	$10^{11}$			$\Omega$	$V_{IO} = 500\text{ V}$
$C_{IO}$	Input-to-Output Capacitance		1.0		pF	$f = 1.0\text{ MHz}$
$t_r, t_f$	Collector Rise and Fall Times (Note 2)		4.0		$\mu\text{s}$	$I_C = 2.0\text{ mA}$ , $V_{CE} = 10\text{ V}$ , $R_L = 100\text{ }\Omega$

### Notes

- Collector current transfer ratio is defined as the ratio of the collector current to the forward bias input current.
- Rise time is defined as the time for the collector current to rise from 10% to 90% of peak value. Fall time is defined as the time required for the current to decrease from 90% to 10% of peak value.

# Typical Electrical Characteristic Curves

## FCD810/A/B/C/D

### Low Level Transfer Characteristics

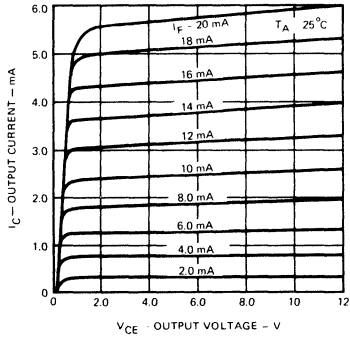

### Maximum Power Dissipation Rating vs Ambient Temperature

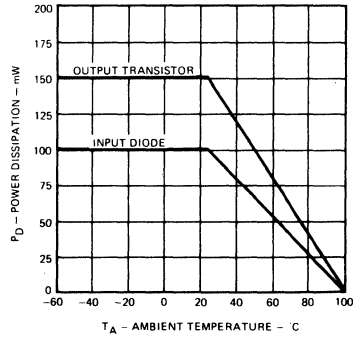

# Optically-Coupled Isolator

Optoelectronic Products

## FCD820/A/B/C/D

### General Description

The FCD820 series of optoisolators combines a GaAs infrared-emitting diode and a silicon npn phototransistor in close proximity. Optical intercoupling provides a high degree of ac and dc isolation. A capability for continuous operation of the input diode results in a frequency response extending to dc. Connection to the transistor base is also provided for design flexibility. The FCD820 is covered under UL component recognition program, reference file E55299.

### Glassolated™

**High Current Transfer Ratio—Typically 50%**

**1500 V To 6000 V Minimum Isolation**

**Input-To-Output**

**$10^{11} \Omega$  Isolation Resistance**

**Low Coupling Capacitance—Typically 1.0 pF**

### Absolute Maximum Ratings

#### Maximum Temperature and Humidity

Storage Temperature	-55°C to +150°C
Operating Temperature	-55°C to +100°C
Pin Temperature (Soldering, 5s)	260°C
Total Package Power Dissipation at $T_A = 25^\circ\text{C}$	
(LED plus Detector)	250 mW
Derate Linearly from 25°C	3.3 mW/°C

#### Input Diode

$V_R$ Reverse Voltage	3.0 V
$I_F$ Forward dc Current	60 mA
$I_{pk}$ Peak Forward Current (1 $\mu\text{s}$ pulse width, 300 pps)	3.0 A
$P_D$ Power Dissipation at $T_A = 25^\circ\text{C}$	100 mW
Derate Linearly from 25°C	1.33 mW/°C

#### Output Transistor

$V_{CE}$ Collector to Emitter Voltage	30 V
$V_{CB}$ Collector to Base Voltage	70 V
$I_C$ Collector Current	25 mA
$P_D$ Power Dissipation at $T_A = 25^\circ\text{C}$	150 mW
Derate Linearly from 25°C	2.0 mW/°C

### Package Outline

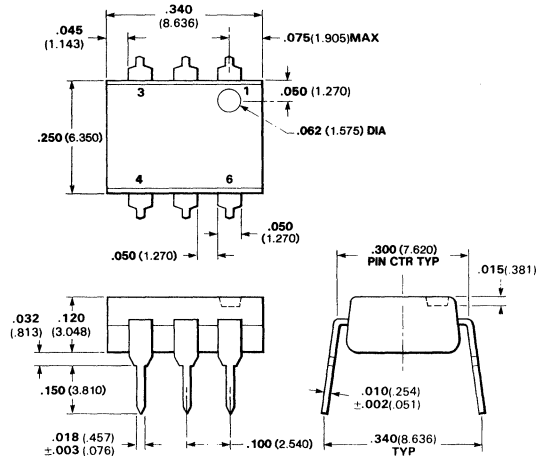

### Notes

All dimensions in inches **bold** and millimeters (parentheses). Tolerance unless specified =  $\pm .015$  (0.381)

### Connection Diagram DIP (Top View)

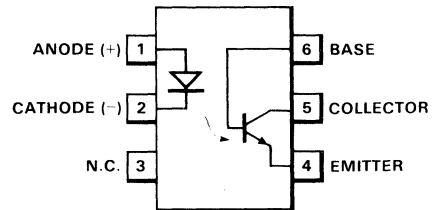

### Pin

1	Anode (+)	} Input Diode
2	Cathode (-)	
3	NC	
4	Emitter	} Output npn Phototransistor
5	Collector	
6	Base	

# Typical Electrical Characteristics

# FCD820/A/B/C/D

## Electrical Characteristics—Input Diode $T_A = 25^\circ\text{C}$

Symbol	Characteristic	Min	Typ	Max	Units	Test Conditions
$V_F$	Forward Voltage		1.2	1.5	V	$I_F = 60\text{ mA}$
$BV_R$	Reverse Breakdown Voltage	3.0	8.0		V	$I_R = 10\ \mu\text{A}$

## Electrical Characteristics—Output Transistor $T_A = 25^\circ\text{C}$

Symbol	Characteristic	Min	Typ	Max	Units	Test Conditions
$V_{CEO}$	Collector-to-Emitter Voltage	30	65		V	$I_C = 1.0\text{ mA}$ , $I_F = 0$
$V_{CBO}$	Collector-to-Base Voltage	70	165		V	$I_C = 100\ \mu\text{A}$ , $I_F = 0$
$I_{CEO}$	Collector-to-Emitter Leakage Current			50	nA	$V_{CE} = 10\text{ V}$ , $I_F = 0$
$I_{CBO}$	Collector-to-Base Leakage Current			20	nA	$V_{CB} = 10\text{ V}$ , $I_F = 0$
$h_{FE}$	Forward Current Gain	100	250			$V_{CE} = 5.0\text{ V}$ , $I_C = 100\ \mu\text{A}$
$C_{cb}$	Collector-to-Base Capacitance		20		pF	$V_{CB} = 10\text{ V}$
$C_{eb}$	Emitter-to-Base Capacitance		10		pF	$V_{EB} = 0$

## Electrical Characteristics—Coupled $T_A = 25^\circ\text{C}$

Symbol	Characteristic	Min	Typ	Max	Units	Test Conditions
$V_{IO}$	Input-to-Output Voltage FCD820 FCD820A FCD820B FCD820C FCD820D	1500 1500 2500 5000 6000			$V_{rms}$ $V_{pk}$ $V_{pk}$ $V_{pk}$ $V_{pk}$	
$V_{CE(sat)}$	Collector-to-Emitter Saturation Voltage		0.24	0.40	V	$I_C = 2.2\text{ mA}$ , $I_F = 15\text{ mA}$ (FCD820, $I_C = 2.0\text{ mA}$ , $I_F = 10\text{ mA}$ ) $V_{CE} = 10\text{ V}$ , $I_F = 10\text{ mA}$ (FCD820, $V_{CE} = 0.4\text{ V}$ ) $V_{IO} = 500\text{ V}$ $f = 1.0\text{ MHz}$
$I_C/I_F(\text{CTR})$	Collector Current Transfer Ratio (Note 1)	20	50		%	$I_C = 2.0\text{ mA}$ , $V_{CE} = 10\text{ V}$ , $I_F = 10\text{ mA}$ (FCD820, $V_{CE} = 0.4\text{ V}$ ) $V_{IO} = 500\text{ V}$ $f = 1.0\text{ MHz}$
$R_{IO}$	Input-to-Output Resistance	$10^{11}$			$\Omega$	
$C_{IO}$	Input-to-Output Capacitance		1.0		pF	
$t_r, t_f$	Collector Rise and Fall Times (Note 2)		2.5		$\mu\text{s}$	$I_C = 2.0\text{ mA}$ , $V_{CE} = 10\text{ V}$ , $R_L = 100\ \Omega$

### Notes

- Collector current transfer ratio is defined as the ratio of the collector current to the forward bias input current.
- Rise time is defined as the time for the collector current to rise from 10% to 90% of peak value. Fall time is defined as the time required for the current to decrease from 90% to 10% of peak value.

# Typical Electrical Characteristic Curves

# FCD820/A/B/C/D

## Low Level Transfer Characteristics

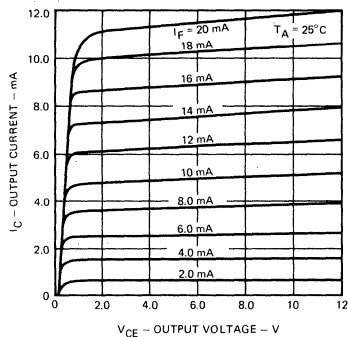

## Maximum Power Dissipation Rating vs Ambient Temperature

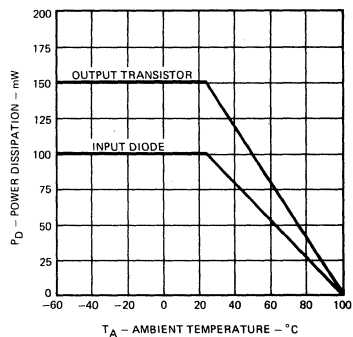

# Optically-Coupled Isolator

Optoelectronic Products

## FCD 825/A/B/C/D

### General Description

The FCD825 series of optoisolators have a npn silicon Planar phototransistor and a GaAs diode in close proximity. Optical intercoupling provides a high degree of ac and dc isolation. A capability for continuous operation of the input diode results in a frequency response extending to dc. Connection to the transistor base is also provided for design flexibility.

### Glassolated™

**High Current Transfer Ratio—Typically 80%**  
**1500 V To 6000 V Minimum Isolation**

**Input-To-Output**  
 **$10^{11} \Omega$  Isolation Resistance**  
**Low Coupling Capacitance—Typically 1.0 pF**

### Absolute Maximum Ratings

#### Maximum Temperature and Humidity

Storage Temperature	-55°C to +150°C
Operating Temperature	-55°C to +100°C
Pin Temperature (Soldering, 5 s)	260°C
Total Package Power	
Dissipation at $T_A = 25^\circ\text{C}$	250 mW
(LED plus Detector)	
Derate Linearly from 25°C	3.3 mW/°C

#### Input Diode

$V_R$ Reverse Voltage	3.0 V
$I_F$ Forward dc Current	60 mA
$I_{pk}$ Peak Forward Current (1 $\mu\text{s}$ pulse width, 300 pps)	3.0 A
$P_D$ Power Dissipation at $T_A = 25^\circ\text{C}$	100 mW
Derate Linearly from 25°C	1.33 mW/°C

#### Output Transistor

$V_{CE}$ Collector-to-Emitter Voltage	30 V
$V_{CB}$ Collector-to-Base Voltage	70 V
$I_C$ Collector Current	25 mA
$P_D$ Power Dissipation at $T_A = 25^\circ\text{C}$	150 mW
Derate Linearly from 25°C	2.0 mW/°C

### Package Outline

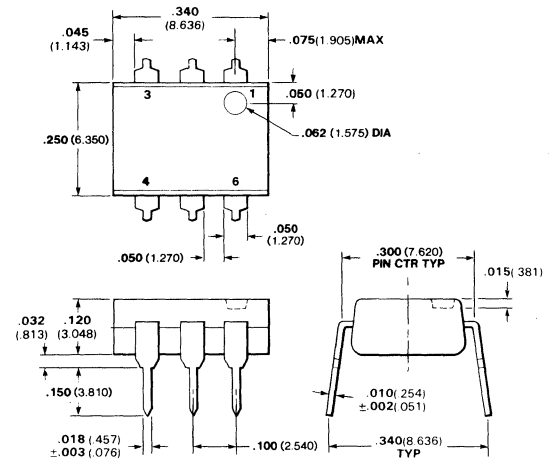

### Notes

All dimensions in inches **bold** and millimeters (parentheses).  
 Tolerance unless specified =  $\pm .015$  (0.381)

### Connection Diagram DIP (Top View)

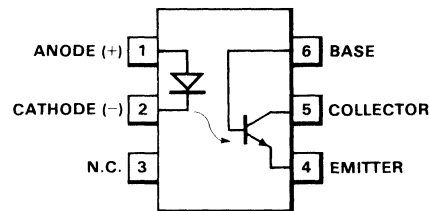

### Pin

1	Anode (+)	} Input Diode
2	Cathode (-)	
3	NC	
4	Emitter	} Output npn Phototransistor
5	Collector	
6	Base	

# Typical Electrical Characteristics

# FCD825 / A / B / C / D

## Electrical Characteristics—Input Diode $T_A = 25^\circ\text{C}$

Symbol	Characteristic	Min	Typ	Max	Units	Test Conditions
$V_F$	Forward Voltage		1.3	1.5	V	$I_F = 60\text{ mA}$
$BV_R$	Reverse Breakdown Voltage	3.0	8.0		V	$I_R = 10\ \mu\text{A}$

## Electrical Characteristics—Output Transistor $T_A = 25^\circ\text{C}$

Symbol	Characteristic	Min	Typ	Max	Units	Test Conditions
$V_{CEO}$	Collector-to-Emitter Voltage	30	50		V	$I_C = 1.0\text{ mA}$ , $I_F = 0$
$V_{CBO}$	Collector-to-Base Voltage	70	150		V	$I_C = 10\ \mu\text{A}$ , $I_F = 0$
$I_{CEO}$	Collector-to-Emitter Leakage Current		2.0	50	nA	$V_{CE} = 10\text{ V}$ , $I_F = 0$
$I_{CBO}$	Collector-to-Base Leakage Current			20	nA	$V_{CB} = 10\text{ V}$ , $I_F = 0$
$h_{FE}$	Forward Current Gain	100	350			$V_{CE} = 5.0\text{ V}$ , $I_C = 100\ \mu\text{A}$
$C_{cb}$	Collector-to-Base Capacitance		20		pF	$V_{CB} = 10\text{ V}$
$C_{eb}$	Emitter-to-Base Capacitance		10		pF	$V_{EB} = 0$

## Electrical Characteristics—Coupled $T_A = 25^\circ\text{C}$

Symbol	Characteristic	Min	Typ	Max	Units	Test Conditions
$V_{IO}$	Input-to-Output Voltage FCD825 FCD825A FCD825B FCD825C FCD825D	1500 1500 2500 5000 6000			$V_{rms}$ $V_{pk}$ $V_{pk}$ $V_{pk}$ $V_{pk}$	
$V_{CE(sat)}$	Collector-to-Emitter Saturation Voltage		0.24	0.4	V	$I_C = 2.0\text{ mA}$ , $I_F = 10\text{ mA}$
$I_C / I_F(\text{CTR})$	Collector Current Transfer Ratio (Note 1)	50	80		%	$V_{CE} = 10\text{ V}$ , $I_F = 10\text{ mA}$
$R_{IO}$	Input-to-Output Resistance	$10^{11}$			$\Omega$	$V_{IO} = 500\text{ V}$
$C_{IO}$	Input-to-Output Capacitance		1.0		pF	$f = 1.0\text{ MHz}$
$t_r, t_f$	Collector Rise and Fall Times (Note 2)		3.5		$\mu\text{s}$	$I_C = 2.0\text{ mA}$ , $V_{CE} = 10\text{ V}$ , $R_L = 100\ \Omega$

### Notes

- Collector current transfer ratio is defined as the ratio of the collector current to the forward bias input current.
- Rise time is defined as the time for the collector current to rise from 10% to 90% of peak value. Fall time is defined as the time required for the current to decrease from 90% to 10% of peak value.

# Optically-Coupled Isolator

Optoelectronic Products

## FCD830/A/B/C/D

### General Description

The FCD830 series of optoisolators have a npn silicon Planar phototransistor in close proximity with a GaAs diode. Optical coupling provides a high degree of ac and dc isolation. A capability for continuous operation of the input diode results in a frequency response extending to dc. Connection to the transistor base is also provided for design flexibility.

### Glassolated™

**High Current Transfer Ratio—Typically 50%**  
**1500 V To 6000 V Minimum Isolation**

#### Input-to-Output

**10<sup>11</sup> Isolation Resistance**  
**Low Coupling Capacitance—Typically 1.0 pF**  
**High Speed**

### Absolute Maximum Ratings

Storage Temperature	-55°C to +150°C
Operating Temperature	-55°C to +100°C
Pin Temperature (Soldering, 5 s)	260°C
Total Package Power	
Dissipation at T <sub>A</sub> = 25°C (LED plus Detector)	250 mW
Derate Linearly from 25°C	3.3 mW/°C

### Input Diode

V <sub>R</sub> Reverse Voltage	3.0 V
I <sub>F</sub> Forward dc Current	60 mA
I <sub>pk</sub> Peak Forward Current (1 μs pulse width, 300 pps)	3.0 A
P <sub>D</sub> Power Dissipation at T <sub>A</sub> = 25°C Derate Linearly from 25°C	100 mW 1.33 mW/°C

### Output Transistor

V <sub>CE</sub> Collector-to-Emitter Voltage	30 V
V <sub>CB</sub> Collector-to-Base Voltage	70 V
I <sub>C</sub> Collector Current	20 mA
P <sub>D</sub> Power Dissipation at T <sub>A</sub> = 25°C Derate Linearly from 25°C	150 mW 2.6 mW/°C

### Package Outline

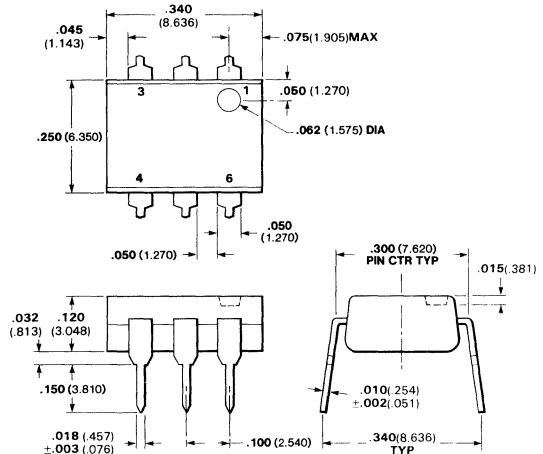

### Notes

All dimensions in inches **bold** and millimeters (parentheses).  
 Tolerance unless specified = ±.015 (0.381)

### Connection Diagram DIP (Top View)

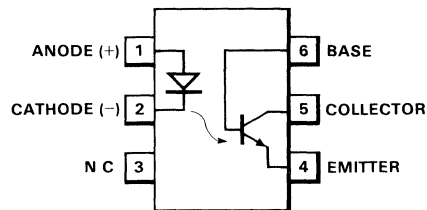

### Pin

1	Anode (+)	} Input Diode
2	Cathode (-)	
3	NC	
4	Emitter	} Output npn Phototransistor
5	Collector	
6	Base	



# Typical Electrical Characteristics

# FCD830/A/B/C/D

## Electrical Characteristics—Input Diode $T_A = 25^\circ\text{C}$

Symbol	Characteristic	Min	Typ	Max	Units	Test Conditions
$V_F$	Forward Voltage		1.3	1.5	V	$I_F = 60\text{ mA}$
$BV_R$	Reverse Breakdown Voltage	3.0	8.0		V	$I_R = 10\text{ }\mu\text{A}$

## Electrical Characteristics—Output Transistor $T_A = 25^\circ\text{C}$

Symbol	Characteristic	Min	Typ	Max	Units	Test Conditions
$V_{CEO}$	Collector-to-Emitter Voltage	30	65		V	$I_C = 1.0\text{ mA}$ , $I_F = 0$
$V_{CBO}$	Collector-to-Base Voltage	70	165		V	$I_C = 10\text{ }\mu\text{A}$ , $I_F = 0$
$I_{CEO}$	Collector-to-Emitter Leakage Current		2.0	50	nA	$V_{CE} = 10\text{ V}$ , $I_F = 0$
$I_{CBO}$	Collector-to-Base Leakage Current		0.1	20	nA	$V_{CB} = 10\text{ V}$ , $I_F = 0$
$h_{FE}$	Forward Current Gain	100				$V_{CE} = 5.0\text{ V}$ , $I_C = 100\text{ }\mu\text{A}$
$C_{cb}$	Collector-to-Base Capacitance		7.5		pF	$V_{CB} = 10\text{ V}$
$C_{eb}$	Emitter-to-Base Capacitance		10		pF	$V_{EB} = 0$

## Electrical Characteristics—Coupled $T_A = 25^\circ\text{C}$

Symbol	Characteristic	Min	Typ	Max	Units	Test Conditions
$V_{IO}$	Input-to-Output Voltage FCD830 FCD830A FCD830B FCD830C FCD830D	1500 1500 2500 5000 6000			$V_{rms}$ $V_{pk}$ $V_{pk}$ $V_{pk}$ $V_{pk}$	
$V_{CE(sat)}$	Collector-to-Emitter Saturation Voltage		0.24	0.40	$V_{pk}$	$I_C = 2.2\text{ mA}$ , $I_F = 15\text{ mA}$ (FCD830, $I_C = 2.0\text{ mA}$ , $I_F = 10\text{ mA}$ )
$I_C/I_F$ (CTR)	Collector Current Transfer Ratio (Note 1)	20	50		%	$V_{CE} = 10\text{ V}$ , $I_F = 10\text{ mA}$ (FCD830, $V_{CE} = 0.4\text{ V}$ )
$R_{IO}$	Input-to-Output Resistance	$10^{11}$			$\Omega$	$V_{IO} = 500\text{ V}$
$C_{IO}$	Input-to-Output Capacitance		1.0		pF	$f = 1.0\text{ MHz}$
$t_r, t_f$	Collector Rise and Fall Times (Note 2)		1.6	2.0	$\mu\text{s}$	$I_C = 2.0\text{ mA}$ , $V_{CC} = 10\text{ V}$ , $R_L = 100\text{ }\Omega$

### Notes

- Collector current transfer ratio is defined as the ratio of the collector current to the forward bias input current.
- Rise time is defined as the time for the collector current to rise from 10% to 90% of peak value. Fall time is defined as the time required for the current to decrease from 90% to 10% of peak value.

# Optically-Coupled Isolator

Optoelectronic Products

## FCD831/A/B/C/D

### General Description

The FCD831 series of optoisolators combines a GaAs infrared emitting diode and a silicon npn phototransistor in close proximity. Optical intercoupling provides a high degree of ac and dc isolation. A capability for continuous operation of the input diode results in a frequency response extending to dc. Connection to the transistor base is also provided for design flexibility.

### Glassolated™

1500 V to 6000 V Minimum Isolation  
Input-to-Output

10<sup>11</sup> Ω Isolation Resistance  
Low Coupling Capacitance—Typically 1.0 pF  
High Speed

### Absolute Maximum Ratings

#### Maximum Temperature and Humidity

Storage Temperature	-55°C to +150°C
Operating Temperature	-55°C to +100°C
Pin Temperature (Soldering, 5 s)	260°C
Total Package Power Dissipation at T <sub>A</sub> = 25°C,	
LED plus Detector	250 mW
Derate Linearly from 25°C	3.3 mW/°C

#### Input Diode

V <sub>R</sub>	Reverse Voltage	3.0 V
I <sub>F</sub>	Forward dc Current	60 mA
I <sub>pk</sub>	Peak Forward Current at 1 μs pulse width, 300 pps	3.0 A
P <sub>D</sub>	Power Dissipation at T <sub>A</sub> = 25°C	100 mW
	Derate Linearly from 25°C	1.33 mW/°C

#### Output Transistor

V <sub>CE</sub>	Collector-to-Emitter Voltage	30 V
V <sub>CB</sub>	Collector-to-Base Voltage	70 V
I <sub>C</sub>	Collector Current	20 mA
P <sub>D</sub>	Power Dissipation at T <sub>A</sub> = 25°C	150 mW
	Derate Linearly from 25°C	2.0 mW/°C

### Package Outline

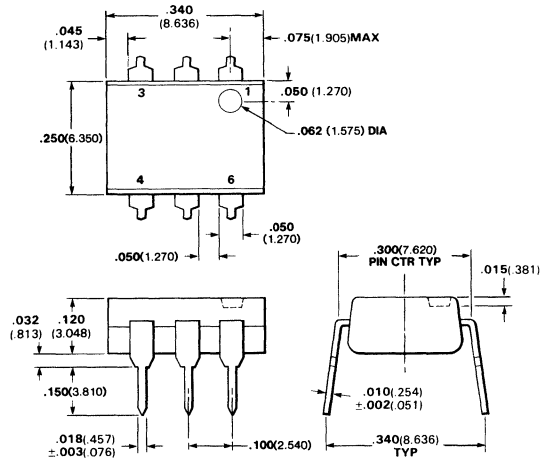

### Notes

All dimensions in inches bold and millimeters (parentheses)  
Tolerance unless specified = ±.015 (±.381)

### Connection Diagram DIP (Top View)

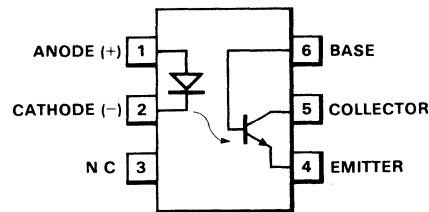

### Pin

1	Anode (+)	} Input Diode
2	Cathode (-)	
3	NC	
4	Emitter	} Output npn Phototransistor
5	Collector	
6	Base	

# Typical Electrical Characteristics

# FCD831/A/B/C/D

## Electrical Characteristics—Input Diode $T_A = 25^\circ\text{C}$

Symbol	Characteristic	Min	Typ	Max	Units	Test Conditions
$V_F$	Forward Voltage		1.3	1.5	V	$I_F = 60\text{ mA}$
$BV_R$	Reverse Breakdown Voltage	3.0	8.0		V	$I_R = 10\ \mu\text{A}$

## Electrical Characteristics—Output Transistor $T_A = 25^\circ\text{C}$

Symbol	Characteristic	Min	Typ	Max	Units	Test Conditions
$V_{CEO}$	Collector-to-Emitter Voltage	30	65		V	$I_C = 1.0\text{ mA}$ , $I_F = 0$
$V_{CBO}$	Collector-to-Base Voltage	70	165		V	$I_C = 10\ \mu\text{A}$ , $I_F = 0$
$I_{CEO}$	Collector-to-Emitter Leakage Current		2.0	50	nA	$V_{CE} = 10\text{ V}$ , $I_F = 0$
$I_{CBO}$	Collector-to-Base Leakage Current		0.1	20	nA	$V_{CB} = 10\text{ V}$ , $I_F = 0$
$h_{FE}$	Forward Current Gain	100	250			$V_{CE} = 5.0\text{ V}$ , $I_C = 100\ \mu\text{A}$
$C_{cb}$	Collector-to-Base Capacitance		7.5		pF	$V_{CB} = 10\text{ V}$
$C_{eb}$	Emitter-to-Base Capacitance		10		pF	$V_{EB} = 0$

## Electrical Characteristics—Coupled $T_A = 25^\circ\text{C}$

Symbol	Characteristic	Min	Typ	Max	Units	Test Conditions
$V_{IO}$	Input-to-Output Voltage					
	FCD831	1500			$V_{rms}$	
	FCD831A	1500			$V_{pk}$	
	FCD831B	2500			$V_{pk}$	
	FCD831C	5000			$V_{pk}$	
	FCD831D	6000			$V_{pk}$	
$V_{CE(sat)}$	Collector-to-Emitter Saturation Voltage		0.30	0.5	V	$I_C = 2.0\text{ mA}$ , $I_F = 50\text{ mA}$
$I_C/I_F$ (CTR)	Collector Current Transfer Ratio (Note 1)	10	15		%	$V_{CE} = 10\text{ V}$ , $I_F = 10\text{ mA}$
$R_{IO}$	Input-to-Output Resistance	$10^{11}$			$\Omega$	$V_{IO} = 500\text{ V}$
$C_{IO}$	Input-to-Output Capacitance		1.0		pF	$f = 1.0\text{ MHz}$
$t_r, t_f$	Collector Rise and Fall Times (Note 2)		1.6	2.0	$\mu\text{s}$	$I_C = 2.0\text{ mA}$ , $V_{CE} = 10\text{ V}$ , $R_L = 100\ \Omega$

### Notes

- Collector current transfer ratio is defined as the ratio of the collector current to the forward bias input current.
- Rise time is defined as the time for the collector current to rise from 10% to 90% of peak value. Fall time is defined as the time required for the current to decrease from 90% to 10% of peak value.

# Optically-Coupled Isolator

Optoelectronic Products

## FCD836/C/D

### General Description

The FCD836 series of optoisolators combines a GaAs infrared-emitting diode and a silicon npn phototransistor in close proximity. Optical intercoupling provides a high degree of ac and dc isolation. A capability for continuous operation of the input diode results in a frequency response extending to dc. Connection to the transistor base is also provided for design flexibility.

### Glassolated™

1500 V to 6000 V Minimum Isolation

Input-to-Output

10<sup>11</sup> Ω Isolation Resistance

Low Coupling Capacitance—Typically 1.0 pF

High Speed

### Absolute Maximum Ratings

#### Maximum Temperature and Humidity

Storage Temperature	-55°C to +150°C
Operating Temperature	-55°C to +100°C
Pin Temperature (Soldering, 5 s)	260°C
Total Package Power Dissipation at T <sub>A</sub> = 25°C	
(LED plus Detector)	250 mW
Derate Linearly from 25°C	3.3 mW/°C

#### Input Diode

V <sub>R</sub>	Reverse Voltage	3.0 V
I <sub>F</sub>	Forward dc Current	60 mA
I <sub>pk</sub>	Peak Forward Current (1 μs pulse width, 300 pps)	3.0 A
P <sub>D</sub>	Power Dissipation at T <sub>A</sub> = 25°C	100 mW
	Derate Linearly from 25°C	1.33 mW/°C

#### Output Transistor

V <sub>CE</sub>	Collector-to-Emitter Voltage	20 V
V <sub>CB</sub>	Collector-to-Base Voltage	30 V
I <sub>C</sub>	Collector Current	20 mA
P <sub>D</sub>	Power Dissipation at T <sub>A</sub> = 25°C	150 mW
	Derate Linearly from 25°C	2.0 mW/°C

### Package Outline

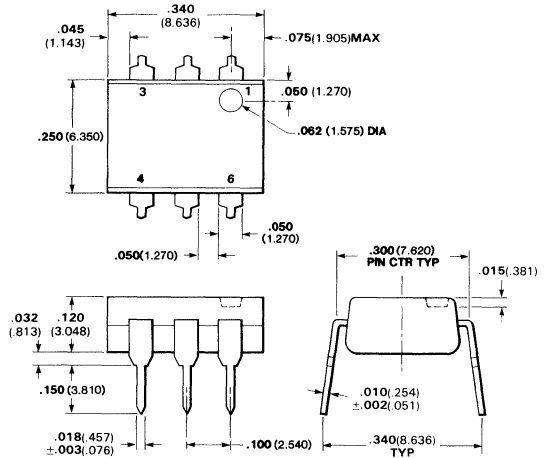

### Notes

All dimensions in inches bold and millimeters (parentheses)  
Tolerance unless specified = ±.015 (±.381)

### Connection Diagram DIP (Top View)

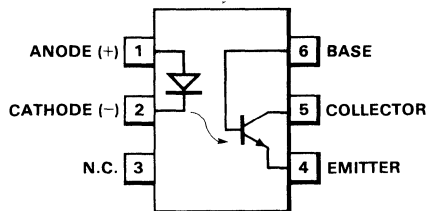

### Pin

1	Anode (+)	} Input Diode
2	Cathode (-)	
3	NC	
4	Emitter	} Output npn Phototransistor
5	Collector	
6	Base	

# Typical Electrical Characteristics

## FCD836/C/D

### Electrical Characteristics—Input Diode $T_A = 25^\circ\text{C}$

Symbol	Characteristic	Min	Typ	Max	Units	Test Conditions
$V_F$	Forward Voltage		1.3	1.5	V	$I_F = 10\text{ mA}$
$BV_R$	Reverse Breakdown Voltage	3.0	8.0		V	$I_R = 10\ \mu\text{A}$

### Electrical Characteristics—Output Transistor $T_A = 25^\circ\text{C}$

Symbol	Characteristic	Min	Typ	Max	Units	Test Conditions
$V_{CEO}$	Collector-to-Emitter Voltage	20	50		V	$I_C = 1.0\text{ mA}$ , $I_F = 0$
$V_{CBO}$	Collector-to-Base Voltage	30	60		V	$I_C = 10\ \mu\text{A}$ , $I_F = 0$
$I_{CEO}$	Collector-to-Emitter Leakage Current		2.0	100	nA	$V_{CE} = 10\text{ V}$ , $I_F = 0$
$I_{CBO}$	Collector-to-Base Leakage Current		0.1	20	nA	$V_{CB} = 10\text{ V}$ , $I_F = 0$
$h_{FE}$	Forward Current Gain	50	250			$V_{CE} = 5.0\text{ V}$ , $I_C = 100\ \mu\text{A}$
$C_{cb}$	Collector-to-Base Capacitance		7.5		pF	$V_{CB} = 10\text{ V}$
$C_{eb}$	Emitter-to-Base Capacitance		10		pF	$V_{EB} = 0$

### Electrical Characteristics—Coupled $T_A = 25^\circ\text{C}$

Symbol	Characteristic	Min	Typ	Max	Units	Test Conditions
$V_{IO}$	Input-to-Output Voltage FCD836 FCD836C FCD836D	1500 5000 6000			$V_{rms}$ $V_{pk}$ $V_{pk}$ V	
$V_{CE(sat)}$	Collector-to-Emitter Saturation Voltage		0.35	0.7		$I_C = 2.0\text{ mA}$ , $I_F = 50\text{ mA}$ , $V_{CE} = 10\text{ V}$ , $I_F = 10\text{ mA}$
$I_C/I_F(\text{CTR})$	Collector Current Transfer Ratio (Note 1)	6.0	10		%	$V_{IO} = 500\text{ V}$ $f = 1.0\text{ MHz}$
$R_{IO}$	Input-to-Output Resistance	$10^{11}$			$\Omega$	
$C_{IO}$	Input-to-Output Capacitance		1.0		pF	
$t_r, t_f$	Collector Rise and Fall Times (Note 2)		1.6	2.0	$\mu\text{s}$	$I_C = 2.0\text{ mA}$ , $V_{CE} = 10\text{ V}$ , $R_L = 100\ \Omega$

#### Notes

- Collector current transfer ratio is defined as the ratio of the collector current to the forward bias input current.
- Rise time is defined as the time for the collector current to rise from 10% to 90% of peak value. Fall time is defined as the time required for the current to decrease from 90% to 10% of peak value.

# Optically-Coupled Darlington Isolator

Optoelectronic Products

# FCD850/C/D FCD855/C/D

## General Description

The FCD850, FCD855 series of optoisolators have a silicon npn Planar Darlington phototransistor coupled to a GaAs diode. Each is mounted in a 6-pin plastic dual in-line package. The FCD850/FCD850C has a minimum collector-emitter breakdown voltage of 30 V; the FCD855/FCD855C has a minimum collector-emitter breakdown voltage of 55 V.

## Giassolated™

### High Current Transfer Ratio

1500 V to 6000 V Minimum Isolation

### Input-to-Output

$10^{11} \Omega$  Isolation Resistance

Low Coupling Capacitance—Typically 1.0 pF

## Absolute Maximum Ratings

Storage Temperature	-55°C to +150°C
Operating Temperature	-55°C to +100°C
Pin Temperature (Soldering, 10 s)	260°C
Total Package Power Dissipation at $T_A = 25^\circ\text{C}$ ,	
LED plus Detector	250 mW
Derate Linearly from 25°C	3.3 mW/°C

## Input Diode

$V_R$ Reverse Voltage	3.0 V
$I_F$ Forward Current	60 mA
$I_{pk}$ Peak Forward Current at 1 $\mu\text{s}$ pulse width, 300 pps	3.0 A
$P_D$ Power Dissipation at $T_A = 25^\circ\text{C}$	150 mW
Derate Linearly from 25°C	1.33 mW/°C

## Output Transistor (Darlington)

$V_{CE}$ Collector-to-Emitter Voltage	
FCD850	30 V
FCD855	55 V
$V_{CB}$ Collector-to-Base Voltage	
FCD850	30 V
FCD855	55 V
$V_{EC}$ Emitter-to-Collector Voltage	
FCD850	7.0 V
$I_C$ Collector Current	125 mA
$P_D$ Power Dissipation at $T_A = 25^\circ\text{C}$	150 mW
Derate Linearly from 25°C	2.0 mW/°C

## Package Outline

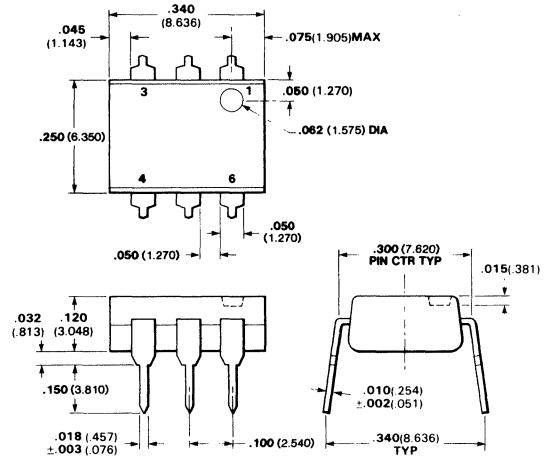

## Notes

All dimensions in inches bold and millimeters (parentheses) Tolerance unless specified =  $\pm .015$  ( $\pm .381$ )

## Connection Diagram DIP (Top View)

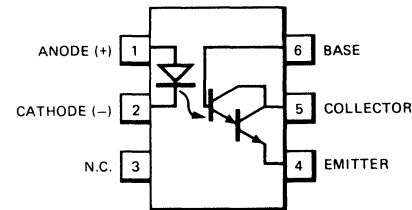

## Pin

1	Anode (+)	} Input Diode
2	Cathode (-)	
3	NC	
4	Emitter	} Output npn Phototransistor
5	Collector	
6	Base	

# Typical Electrical Characteristics

# FCD850/C/D FCD855/C/D

## Electrical Characteristics—Input Diode $T_A = 25^\circ\text{C}$

Symbol	Characteristic	Min	Typ	Max	Units	Test Conditions
$V_F$	Forward Voltage		1.25	1.5	V	$I_F = 20\text{ mA}$
$BV_R$	Reverse Breakdown Voltage	3.0	5.0		V	$I_R = 10\ \mu\text{A}$
C	Capacitance		150		pF	$V_R = 0\text{ V}$ , $f = 1\text{ MHz}$

## Electrical Characteristics—Output Transistor $T_A = 25^\circ\text{C}$

Symbol	Characteristic	Min	Typ	Max	Units	Test Conditions
$V_{CEO}$	Collector-to-Emitter Voltage FCD850, FCD850C	30			V	$I_C = 100\ \mu\text{A}$ , $I_F = 0$
	FCD855, FCD855C	55			V	$I_C = 100\ \mu\text{A}$ , $I_F = 0$
$V_{ECO}$	Emitter-to-Collector Voltage	7.0			V	$I_E = 100\ \mu\text{A}$ , $I_F = 0$
$V_{EBO}$	Emitter-to-Base Voltage	8.0			V	$I_E = 100\ \mu\text{A}$ , $I_F = 0$
$I_{CEO}$	Collector-to-Emitter Leakage Current			100	nA	$V_{CE} = 10\text{ V}$ , $I_F = 0$
$h_{FE}$	Forward Current Gain		7000			$V_{CE} = 5.0\text{ V}$ , $I_C = 25\text{ mA}$
$C_{cb}$	Collector-to-Base Capacitance		25		pF	$V_{CB} = 10\text{ V}$

## Electrical Characteristics—Coupled $T_A = 25^\circ\text{C}$

Symbol	Characteristic	Min	Typ	Max	Units	Test Conditions
$V_{IO}$	Input-to-Output Voltage (Note 1) FCD850, FCD855 FCD850C, FCD855C FCD850D, FCD855D	1500 5000 6000			$V_{rms}$ $V_{pk}$ $V_{pk}$ V	
$V_{CE(sat)}$	Collector-to-Emitter Saturation Voltage			1.0	V	$I_C = 50\text{ mA}$ , $I_F = 50\text{ mA}$
$I_C$	Collector Output Current	10	150		mA	$V_{CE} = 5.0\text{ V}$ , $I_F = 10\text{ mA}$
$R_{IO}$	Input-to-Output Resistance		$10^{11}$		$\Omega$	$V_{IO} = 500\text{ V}$
$C_{IO}$	Input-to-Output Capacitance		1.5		pF	$V_{IO} = 0$ , $f = 1.0\text{ MHz}$
$t_r$	Rise Time (Note 2)		15		$\mu\text{s}$	$I_C = 125\text{ mA}$ , $V_{CC} = 13.5\text{ V}$ , $R_L = 100\ \Omega$
$t_f$	Fall Time (Note 2)		150		$\mu\text{s}$	$I_C = 125\text{ mA}$ , $V_{CC} = 13.5\text{ V}$ , $R_L = 100\ \Omega$

### Notes

1. Isolation voltage defined as minimum of 5 s continuous application
2. Rise time is defined as the time for the collector current to rise from 10% to 90% of peak value. Fall time is defined as the time required for the current to decrease from 90% to 10% of peak value.

# Optically-Coupled Darlington Isolator

Optoelectronic Products

# FCD860/C/D FCD865/C/D

## General Description

The FCD860, FCD865 series of optoisolators have a silicon npn Planar Darlington phototransistor coupled to a GaAs diode. Each is mounted in a 6-pin plastic dual in-line package. The series was designed specifically as a high-sensitivity type for operation in the 1.0/mA input region.

## Glassolated™

**High Current Transfer Ratio at Low Input Current**  
**1500 V to 6000 V Minimum Isolation**

**Input-to-Output**  
**10<sup>11</sup> Ω Isolation Resistance**  
**Low Coupling Capacitance—Typically 1.5 pF**

## Absolute Maximum Ratings

### Maximum Temperature and Humidity

Storage Temperature	-55°C to +150°C
Operating Temperature	-55°C to +100°C
Pin Temperature (Soldering, 10 s)	260°C
Total Package Power Dissipation at T <sub>A</sub> = 25°C	
(LED plus Detector)	250 mW
Derate Linearly from 25°C	3.3 mW/°C

### Input Diode

V <sub>R</sub>	Reverse Voltage	3.0 V
I <sub>F</sub>	Forward dc Current	80 mA
I <sub>pk</sub>	Peak Forward Current (1 μs pulse width, 300 pps)	3.0 A
P <sub>D</sub>	Power Dissipation at T <sub>A</sub> = 25°C	150 mW
	Derate Linearly from 25°C	2.0 mW/°C

### Output Transistor (Darlington)

V <sub>CE</sub>	Collector-to-Emitter Voltage	30 V
V <sub>CB</sub>	Collector-to-Base Voltage	30 V
V <sub>EC</sub>	Emitter-to-Collector Voltage	7.0 V
P <sub>D</sub>	Power Dissipation at T <sub>A</sub> = 25°C (I <sub>C(max)</sub> 100 mA at V <sub>CE</sub> = 1.5 V)	150 mW
	Derate Linearly from 25°C	2.0 mW/°C

## Package Outline

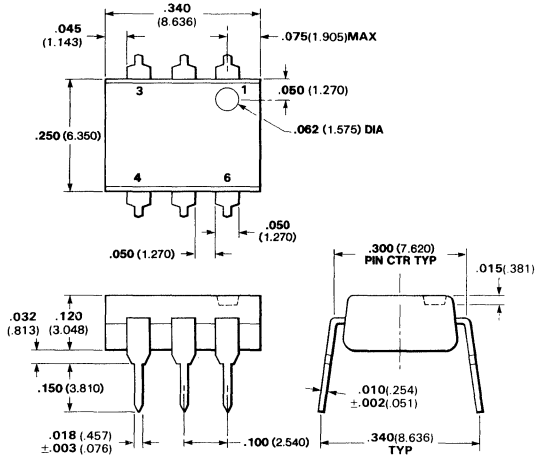

## Notes

All dimensions in inches **bold** and millimeters (parentheses)  
Tolerance unless specified = ±.015 (±.381)

## Connection Diagram DIP (Top View)

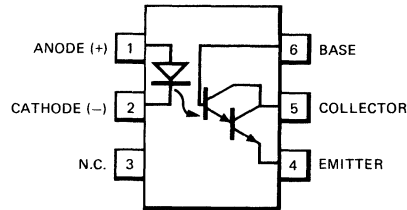

## Pin

1	Anode (+)	} Input Diode
2	Cathode (-)	
3	NC	
4	Emitter	} Output npn Phototransistor
5	Collector	
6	Base	



# Typical Electrical Characteristics

# FCD860/C/D FCD865/C/D

## Electrical Characteristics—Input Diode $T_A = 25^\circ\text{C}$

Symbol	Characteristic	Min	Typ	Max	Units	Test Conditions
$V_F$	Forward Voltage		1.25	1.5	V	$I_F = 20\text{ mA}$
$BV_R$	Reverse Breakdown Voltage	3.0	5.0		V	$I_R = 10\ \mu\text{A}$
C	Capacitance		150		pF	$V_R = 0\text{ V}$ , $f = 1\text{ MHz}$

## Electrical Characteristics—Output Transistor $T_A = 25^\circ\text{C}$ (Darlington)

Symbol	Characteristic	Min	Typ	Max	Units	Test Conditions
$V_{CEO}$	Collector-to-Emitter Voltage	30			V	$I_C = 1.0\text{ mA}$ , $I_F = 0$
$V_{CBO}$	Collector-to-Base Voltage	30			V	$I_C = 10\ \mu\text{A}$ , $I_F = 0$
$V_{ECO}$	Emitter-to-Collector Voltage	7.0			V	$I_E = 100\ \mu\text{A}$ , $I_F = 0$
$V_{EBO}$	Emitter-to-Base Voltage	6.0	8.0		V	$I_E = 100\ \mu\text{A}$ , $I_F = 0$
$I_{CEO}$	Collector-to-Emitter Leakage Current			100	nA	$V_{CE} = 10\text{ V}$ , $I_F = 0$
$h_{FE}$	Forward Current Gain		20 k			$V_{CE} = 5.0\text{ V}$ , $I_C = 25\text{ mA}$

## Electrical Characteristics—Coupled $T_A = 25^\circ\text{C}$

Symbol	Characteristic	Min	Typ	Max	Units	Test Conditions
$V_{IO}$	Input-to-Output Voltage (Note 1) FCD860, FCD865 FCD860C, FCD865C FCD860D, FCD865D	1500 5000 6000			$V_{rms}$ $V_{pk}$ $V_{pk}$ V	
$V_{CE(sat)}$	Collector-to-Emitter Saturation Voltage			1.0		$I_C = 2.0\text{ mA}$ , $I_F = 1.0\text{ mA}$
$I_C$	Collector Output Current FCD860, FCD860C	2.0			mA	$V_{CE} = 1.0\text{ V}$ , $I_F = 1.0\text{ mA}$
	FCD865, FCD865C	2.0			mA	$V_{CE} = 1.0\text{ V}$ , $I_F = 0.5\text{ mA}$
$R_{IO}$	Input-to-Output Resistance		$10^{11}$		$\Omega$	$V_{IO} = 500\text{ V}$
$C_{IO}$	Input-to-Output Capacitance		1.5		pF	$V_{IO} = 0$ , $f = 1.0\text{ MHz}$
$t_r, t_f$	Rise and Fall Times (Note 2)		80		$\mu\text{s}$	$I_C = 10\text{ mA}$ , $V_{CC} = 10\text{ V}$ , $R_L = 100\ \Omega$

### Notes

1. Isolation voltage defined as minimum of 5 s continuous application.
2. Rise time is defined as the time for the collector current to rise from 10% to 90% of peak value. Fall time is defined as the time required for the current to decrease from 90% to 10% of peak value.

# Dual Optically-Coupled Isolator

Optoelectronic Products

# FCD880, FCD885

## General Description

The FCD880 and FCD885 comprise two distinct optoisolators with transistor output, in a single 8-pin dual in-line package. Each channel consists of a GaAs emitter optically coupled to a phototransistor.

## High Current Transfer Ratio

2500 V Minimum Isolation Input-to-Output

$10^{11} \Omega$  Isolation Resistance

Low Coupling Capacitance—Typically 1.0 pF

I/O Compatible With Integrated Circuits

Two Packages Fit Into a Standard

16-Pin DIP Socket

## Absolute Maximum Ratings

Storage Temperature	-55°C to +150°C
Operating Temperature	-55°C to +100°C
Pin Temperature (Soldering, 5 s)	260°C
Total Package Power Dissipation at $T_A = 25^\circ\text{C}$	400 mW
Derate Linearly from 25°C	5.3 mW/°C

## Input Diode (Each Channel)

$V_R$ Reverse Voltage	3.0 V
$I_F$ Forward dc Current	60 mA
$I_{pk}$ Peak Forward Current (1 $\mu\text{s}$ pulse, 330 pps)	3.0 A

$P_D$ Power Dissipation at $T_A = 25^\circ\text{C}$	100 mW
Derate Linearly from 50°C	2 mW/°C

## Output Transistor (Each Channel)

$V_{CE}$ Collector-to-Emitter Voltage	30 V
$V_{EC}$ Emitter-to-Collector Voltage	6.0 V
$P_D$ Power Dissipation at $T_A = 25^\circ\text{C}$	150 mW
Derate Linearly from 25°C	2 mW/°C
$I_C$ Collector Current	30 mA

## Package Outline

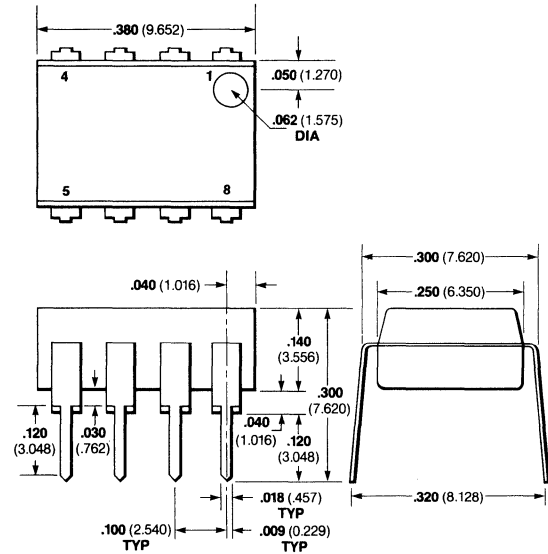

## Notes

All dimensions in inches **bold** and millimeters (parentheses)  
Tolerance unless specified =  $\pm .015$  ( $\pm .381$ )  
Package weight is 0.4 gram

## Connection Diagram DIP (Top View)

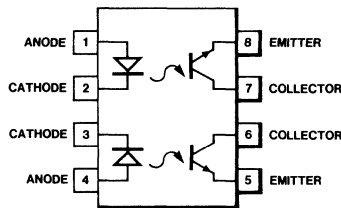

## Pin

1	Anode	Channel # 1
2	Cathode	
3	Cathode	Channel # 2
4	Anode	
5	Emitter	Channel # 2
6	Collector	
7	Collector	Channel # 1
8	Emitter	

# Typical Electrical Characteristics

# FCD880 FCD885

## Electrical Characteristics—Input Diode $T_A = 25^\circ\text{C}$

Symbol	Characteristic	Min	Typ	Max	Units	Test Conditions
$V_F$	Forward Voltage		1.25	1.5	V	$I_F = 60\text{ mA}$
$V_R$	Reverse Voltage	3.0	5.5		V	$I_R = 10\text{ }\mu\text{A}$
$C_J$	Junction Capacitance		100		pF	$V_F = 0\text{ V}$

## Electrical Characteristics—Output Transistor $T_A = 25^\circ\text{C}$

Symbol	Characteristic	Min	Typ	Max	Units	Test Conditions
$V_{CEO}$	Collector-to-Emitter Voltage FCD880, FCD885	30	65		V	$I_C = 1.0\text{ mA}$ , $I_F = 0$
$V_{ECO}$	Emitter-to-Collector Voltage FCD880, FCD885	6.0	10		V	$I_C = 100\text{ }\mu\text{A}$
$I_{CEO}$	Collector-to-Emitter Leakage Current FCD880, FCD885		5.0	100	nA	$V_{CE} = 10\text{ V}$ , $I_F = 0$
$C_{CE}$	Collector-to-Emitter Capacitance		8.0		pF	$V_{CE} = 0$

## Electrical Characteristics—Coupled $T_A = 25^\circ\text{C}$

Symbol	Characteristic	Min	Typ	Max	Units	Test Conditions
$V_{IO}$	Input-to-Output Voltage	2500	4000		V	
$V_{CE(sat)}$	Collector-to-Emitter Saturation Voltage FCD880		0.24	0.4	V	$I_C = 2.0\text{ mA}$ , $I_F = 16\text{ mA}$
	FCD885		0.2	0.3	V	$I_C = 250\text{ }\mu\text{A}$ , $I_F = 20\text{ mA}$
$I_C/I_F(\text{CTR})$	Collector Current Transfer Ratio (Note 1) FCD880	30	50		%	$V_{CE} = 10\text{ V}$ , $I_F = 10\text{ mA}$
	FCD885	10	20		%	$V_{CE} = 10\text{ V}$ , $I_F = 10\text{ mA}$
$R_{IO}$	Input-to-Output Resistance		$10^{11}$		$\Omega$	$V_{IO} = 500\text{ V}$
$C_{IO}$	Input-to-Output Capacitance		1.0		pF	$f = 1.0\text{ MHz}$
	Collector Rise and Fall Times (Note 2)		2.0		$\mu\text{s}$	$I_C = 2.0\text{ mA}$ , $V_{CE} = 10\text{ V}$ , $R_L = 100\text{ }\Omega$

### Notes

- Collector current transfer ratio is defined as the ratio of the collector current to the forward bias input current.
- Rise time is defined as the time for the collector current to rise from 10% to 90% of peak value. Fall time is defined as the time required for the current to decrease from 90% to 10% of peak value.

# Dual Optically-Coupled Darlington Isolator

Optoelectronic Products

## FCD890

### General Description

The FCD890 comprises two distinct optoisolators with transistor output, in a single 8-pin dual in-line package. Each channel consists of a GaAs emitter optically coupled to a photo-Darlington. The coupler was designed specifically as a high-sensitivity type for operation in the 1.0 mA input region.

### High Current Transfer Ratio at Low Input Current

2500 V Minimum Isolation Input-to-Output

$10^{11} \Omega$  Isolation Resistance

Low Coupling Capacitance—Typically 1.0 pF

I/O Compatible With Integrated Circuits

Two Packages Fit Into a Standard

16-Pin DIP Socket

### Absolute Maximum Ratings

#### Maximum Temperature and Humidity

Storage Temperature  $-55^{\circ}\text{C}$  to  $+150^{\circ}\text{C}$

Operating Temperature  $-55^{\circ}\text{C}$  to  $+100^{\circ}\text{C}$

Pin Temperature (Soldering, 5s)  $260^{\circ}\text{C}$

Total Package Power Dissipation

at  $T_A = 25^{\circ}\text{C}$  400 mW

Derate Linearly from  $25^{\circ}\text{C}$  5.3 mW/ $^{\circ}\text{C}$

#### Input Diode (Each Channel)

$V_R$  Reverse Voltage 3.0 V

$I_F$  Forward dc Current 60 mA

$I_{pk}$  Peak Forward Current at  
1  $\mu\text{s}$  pulse, 300 pps 3.0 A

$P_D$  Power Dissipation  
at  $T_A = 25^{\circ}\text{C}$  150 mW

Derate Linearly from  $50^{\circ}\text{C}$  2 mW/ $^{\circ}\text{C}$

#### Output Transistor (Each Channel)

$V_{CE}$  Collector-to-Emitter  
Voltage 30 V

$V_{EC}$  Emitter-to-Collector  
Voltage 7.0 V

$P_D$  Power Dissipation  
at  $T_A = 25^{\circ}\text{C}$  150 mW

Derate Linearly from  $25^{\circ}\text{C}$  2 mW/ $^{\circ}\text{C}$

$I_C$  Collector Current 30 mA

### Package Outline

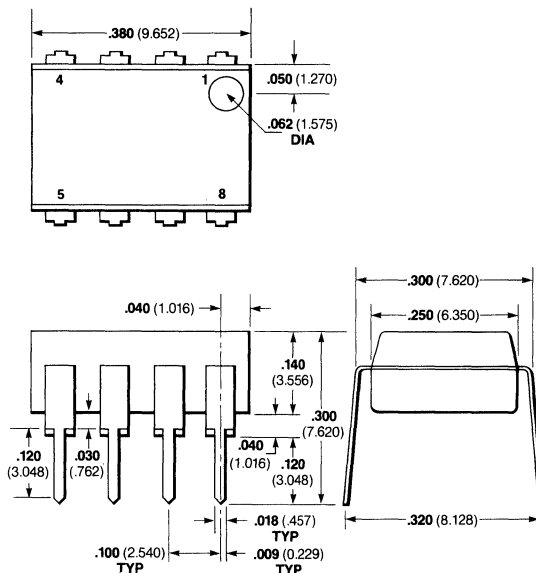

#### Notes

All dimensions in inches bold and millimeters (parentheses)

Tolerance unless specified =  $\pm .015$  ( $\pm .381$ )

Package weight is 0.4 gram

### Connection Diagram

#### DIP (Top View)

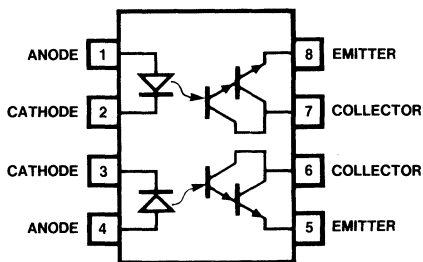

#### Pin

1	Anode	
2	Cathode	Channel # 1
3	Cathode	
4	Anode	Channel # 2
5	Emitter	
6	Collector	Channel # 2
7	Collector	
8	Emitter	Channel # 1

# Typical Electrical Characteristics

# FCD890

## Electrical Characteristics—Input Diode $T_A = 25^\circ\text{C}$

Symbol	Characteristic	Min	Typ	Max	Units	Test Conditions
$V_F$	Forward Voltage		1.25	1.5	V	$I_F = 20\text{ mA}$
$V_R$	Reverse Voltage	3.0	5.5		V	$I_R = 10\ \mu\text{A}$
$C_J$	Junction Capacitance		150		pF	$V_R = 0\text{ V}$ , $f = 1\text{ MHz}$

## Electrical Characteristics—Output Transistor $T_A = 25^\circ\text{C}$ (Darlington)

Symbol	Characteristic	Min	Typ	Max	Units	Test Conditions
$V_{CEO}$	Collector-to-Emitter Voltage	30	65		V	$I_C = 1.0\text{ mA}$ , $I_F = 0$
$V_{ECO}$	Emitter-to-Collector Voltage	7.0	10		V	$I_C = 100\ \mu\text{A}$
$I_{CEO}$	Collector-to-Emitter Leakage Current		5.0	100	nA	$V_{CE} = 10\text{ V}$ , $I_F = 0$
$h_{FE}$	Forward Current Gain		20 k			$V_{CE} = 5.0\text{ V}$ , $I_C = 25\text{ mA}$

## Electrical Characteristics—Coupled $T_A = 25^\circ\text{C}$

Symbol	Characteristic	Min	Typ	Max	Units	Test Conditions
$V_{IO}$	Input-to-Output Voltage	2500	4000		V	
$V_{CE(sat)}$	Collector-to-Emitter Saturation Voltage			1.0	V	$I_C = 2.0\text{ mA}$ , $I_F = 1.0\text{ mA}$
$I_C/I_F(\text{CTR})$	Collector Current Transfer Ratio (Note 1)	200			%	$V_{CE} = 1.0\text{ V}$ , $I_F = 1.0\text{ mA}$
$R_{IO}$	Input-to-Output Resistance		$10^{11}$		$\Omega$	$V_{IO} = 500\text{ V}$
$C_{IO}$	Input-to-Output Capacitance		1.0		pF	$f = 1.0\text{ MHz}$ , $V_{IO} = 0$
$t_r, t_f$	Collector Rise and Fall Times (Note 2)		80		$\mu\text{s}$	$I_C = 10\text{ mA}$ , $V_{CE} = 10\text{ V}$ , $R_L = 100\ \Omega$

### Notes

- Collector current transfer ratio is defined as the ratio of the collector current to the forward bias input current.
- Rise time is defined as the time for the collector current to rise from 10% to 90% of peak value. Fall time is defined as the time required for the current to decrease from 90% to 10% of peak value.

# Optically-Coupled Isolator

Optoelectronic Products

# H11A1, H11A2 H11A3, H11A4

## General Description

The H11A1, H11A2, H11A3 and H11A4 optical isolators are electrical and mechanical replacements for the General Electric series. Optical intercoupling provides a high degree of ac and dc isolation. A capability for continuous operation of the input diode results in a frequency response extending to dc. Connection to the base is also provided for design flexibility.

## Glassolated™

Electrically Equivalent to GE Devices  
Pin-for-Pin Equivalent to GE Devices  
Availability of Base Pin for Flexible Design

## Absolute Maximum Ratings

### Maximum Temperature and Humidity

Storage Temperature	-55°C to +150°C
Operating Temperature	-55°C to +100°C
Pin Temperature (Soldering, 5 s)	260°C
Total Package Power Dissipation at $T_A = 25^\circ\text{C}$ ,	
LED plus Detector	250 mW
Derate Linearly from 25°C	3.3 mW/°C

### Input Diode

$V_R$	Reverse Voltage	3.0 V
$I_F$	Forward dc Current	60 mA
$I_{pk}$	Peak Forward Current at 1 $\mu\text{s}$ pulse width, 300 pps	3.0 A
$P_D$	Power Dissipation at $T_A = 25^\circ\text{C}$	100 mW/°C
	Derate Linearly from 25°C	1.33 mW/°C

### Output Transistor

$V_{CE}$	Collector-to-Emitter Voltage	30 V
$V_{CB}$	Collector-to-Base Voltage	70 V
$I_C$	Collector Current	100 mA
$P_D$	Power Dissipation at $T_A = 25^\circ\text{C}$	150 mW
	Derate Linearly from 25°C	2.0 mW/°C

## Package Outline

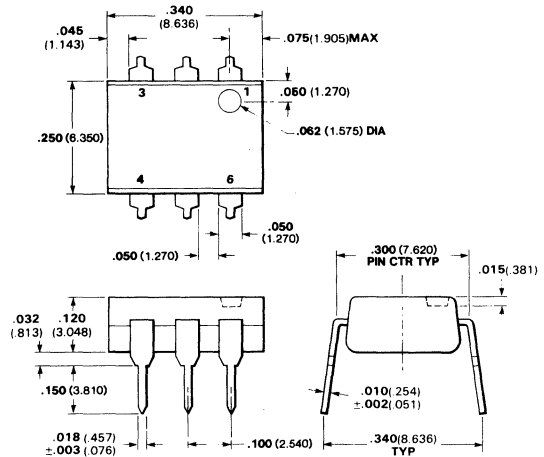

## Notes

All dimensions in inches bold and millimeters (parentheses)  
Tolerance unless specified =  $\pm .015$  ( $\pm .381$ )

## Connection Diagram DIP (Top View)

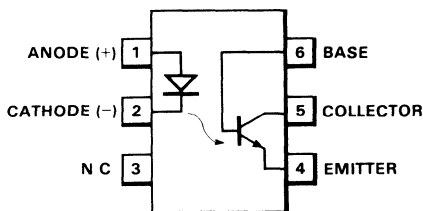

## Pin

1	Anode (+)	} Input Diode
2	Cathode (-)	
3	NC	
4	Emitter	} Output npn Phototransistor
5	Collector	
6	Base	

# Typical Electrical Characteristics

# H11A1, H11A2 H11A3, H11A4

## Electrical Characteristics—Input Diode $T_A = 25^\circ\text{C}$

Symbol	Characteristic	Min	Typ	Max	Units	Test Conditions
$V_F$	Forward Voltage		1.1	1.5	V	$I_F = 10\text{ mA}$
$I_R$	Reverse Current			10	$\mu\text{A}$	$V_R = 3.0\text{ V}$

## Electrical Characteristics—Output Transistor $T_A = 25^\circ\text{C}$

Symbol	Characteristic	Min	Typ	Max	Units	Test Conditions
$V_{CEO}$	Collector-to-Emitter Voltage	30			V	$I_C = 10\text{ mA}$ , $I_F = 0$
$V_{CBO}$	Collector-to-Base Voltage	70			V	$I_C = 100\ \mu\text{A}$ , $I_F = 0$
$V_{ECO}$	Emitter-to-Collector Voltage	7.0			V	$I_E = 100\ \mu\text{A}$ , $I_F = 0$
$I_{CEO}$	Collector-to-Emitter Leakage Current		5.0	50	nA	$V_{CE} = 10\text{ V}$ , $I_F = 0$

## Electrical Characteristics—Coupled $T_A = 25^\circ\text{C}$

Symbol	Characteristic	Min	Typ	Max	Units	Test Conditions
$V_{ISO}$	Isolation Voltage (Note 3) H11A1, H11A3 H11A2, H11A4	2500 1500			V V V	Peak Peak
$V_{CE(sat)}$	Collector-to-Emitter Saturation Voltage		0.1	0.4	V	$I_C = 0.5\text{ mA}$ , $I_F = 50\text{ mA}$ , $V_{CE} = 10\text{ V}$ , $I_F = 10\text{ mA}$
$I_C/I_F(\text{CTR})$	Collector Current Transfer Ratio (Note 1)  H11A1 H11A2, H11A3 H11A4	50 20 10 $10^{11}$			% % %	
$R_{IO}$	Input-to-Output Resistance				$\Omega$	$V_{IO} = 500\text{ V}$
$C_{IO}$	Input-to-Output Capacitance		2.0		pF	$f = 1.0\text{ MHz}$
$t_r, t_f$	Collector Rise and Fall Times (Note 2)		2.0		$\mu\text{s}$	$I_C = 2.0\text{ mA}$ , $V_{CE} = 10\text{ V}$ , $R_L = 100\ \Omega$

### Notes

- Collector current transfer ratio is defined as the ratio of the collector current to the forward bias input current.
- Rise time is defined as the time for the collector current to rise from 10% to 90% of peak value. Fall time is defined as the time required for the current to decrease from 90% to 10% of peak value.
- Isolation voltage defined as minimum of 5 s continuous application.

# Optically-Coupled Darlington Isolator

Optoelectronic Products

# H11B1 H11B2

## General Description

The H11B1 and H11B2 optical isolators are electrical and mechanical replacements for the General Electric series. Optical intercoupling provides a high degree of ac and dc isolation. A capability for continuous operation of the input diode results in a frequency response extending to dc. Connection to the base is also provided for design flexibility.

## Glassolated™

Electrically Equivalent to GE Devices

Pin-For-Pin Equivalent to GE Devices

Availability of Base Pin for Flexible Design

## Absolute Maximum Ratings

### Maximum Temperature and Humidity

Storage Temperature	-55°C to +150°C
Operating Temperature	-55°C to +100°C
Pin Temperature (Soldering, 10 s)	260°C
Total Package Power Dissipation at $T_A=25^\circ\text{C}$	
LED plus Detector	250 mW
Derate Linearly from 25°C	3.3 mW/°C

### Input Diode

$I_F$	Forward dc Current	
	Continuous	60 mA
$V_R$	Reverse Voltage	3.0 V
$I_{pk}$	Peak Forward Current (1 $\mu\text{s}$ pulse width, 300 pps)	3.0 A
$P_D$	Power Dissipation at $T_A = 25^\circ\text{C}$	100 mW
	Derate Linearly from 25°C	1.33 mW/°C

### Output Transistor (Darlington)

$V_{CE}$	Collector to Emitter Voltage	25 V
$V_{CB}$	Collector-to-Base Voltage	30 V
$V_{EC}$	Emitter-to-Collector Voltage	7.0 V
$P_D$	Power Dissipation at $T_A = 25^\circ\text{C}$ , $I_C$ (max) = 100 mA at $V_{CE} = 1.5$ V	150 mW
	Derate Linearly from 25°C	2.0 mW/°C

## Package Outline

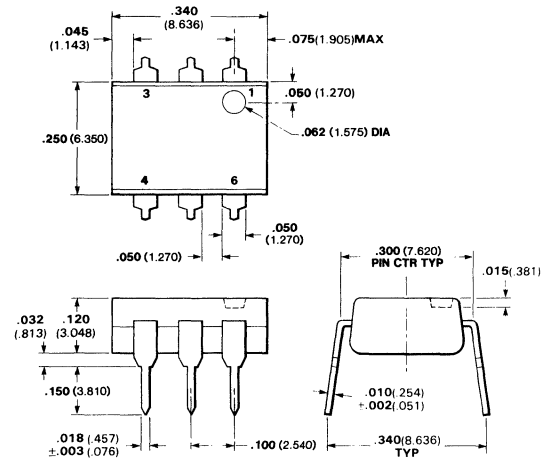

## Notes

All dimensions in inches bold and millimeters (parentheses)  
Tolerance unless specified =  $\pm .015$  ( $\pm .381$ )

## Connection Diagram DIP (Top View)

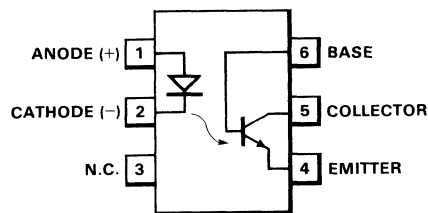

## Pin

1	Anode (+)	} Input Diode
2	Cathode (-)	
3	NC	
4	Emitter	} Output npn Phototransistor
5	Collector	
6	Base	



# Typical Electrical Characteristics

# H11B1 H11B2

## Electrical Characteristics—Input Diode $T_A = 25^\circ\text{C}$

Symbol	Characteristic	Min	Typ	Max	Units	Test Conditions
$V_F$	Forward Voltage		1.2	1.5	V	$I_F = 10\text{ mA}$ $V_R = 3.0\text{ V}$ $V_R = 0\text{ V}$ , $f = 1\text{ MHz}$
$I_R$	Reverse Current			10	$\mu\text{A}$	
C	Capacitance		150		pF	

## Electrical Characteristics—Output Transistor (Darlington) $T_A = 25^\circ\text{C}$

Symbol	Characteristic	Min	Typ	Max	Units	Test Conditions
$BV_{CEO}$	Collector-to-Emitter Breakdown Voltage	25			V	$I_C = 10\text{ mA}$ , $I_F = 0$
$BV_{ECO}$	Emitter-to-Collector Breakdown Voltage	7.0			V	$I_E = 100\text{ }\mu\text{A}$ , $I_F = 0$
$BV_{CBO}$	Collector-to-Base Breakdown Voltage	30			V	$I_C = 100\text{ }\mu\text{A}$
$I_{CEO}$	Collector-to-Emitter Leakage Current			100	nA	$V_{CE} = 10\text{ V}$ , $I_F = 0$
$C_{CE}$	Capacitance Collector-to-Emitter Junction		6.0		pF	$V_{CE} = 10\text{ V}$ , $f = 1.0\text{ MHz}$

## Electrical Characteristics—Coupled $T_A = 25^\circ\text{C}$

Symbol	Characteristic	Min	Typ	Max	Units	Test Conditions
$I_C$	Collector Output Current (Pulsed) H11B1	50			mA	$I_F = 10\text{ mA}$ , $V_{CE} = 5\text{ V}$
	H11B2	20			mA	
$V_{ISO}$	Isolation Voltage (Note 2) H11B1	2500			V	Peak Peak
	H11B2	1500			V	
$R_{ISO}$	Isolation Resistance		$10^{11}$		$\Omega$	$V = 500\text{ V}$
$V_{CE(sat)}$	Collector-to-Emitter Saturation Voltage			1.0	V	$I_C = 1.0\text{ mA}$ , $I_F = 1.0\text{ mA}$
$C_{ISO}$	Isolation Capacitance		2.0		pF	$V = 0$ , $f = 1.0\text{ MHz}$
$t_{on}$	Turn-on Time (Note 1)		125		$\mu\text{s}$	$I_C = 10\text{ mA}$ , $V_{CC} = 10\text{ V}$ , $R_L = 100\text{ }\Omega$
$t_{off}$	Turn-off Time		100		$\mu\text{s}$	$I_C = 10\text{ mA}$ , $V_{CC} = 10\text{ V}$ , $R_L = 100\text{ }\Omega$

### Notes

1. Turn-on time is defined as the time for the (base collector) current to rise from 10% to 90% of peak value. Turn-off time is defined as the time required for the current to decrease from 90% to 10% of peak value.
2. Isolation voltage defined as minimum of 5 s continuous application.

# Optically-Coupled Isolator

Optoelectronic Products

## H11D1, H11D2 H11D3, H11D4

### General Description

The H11D1, H11D2, H11D3, and H11D4 are optoisolators which have an npn silicon high-voltage phototransistor coupled to a GaAs infrared-emitting diode. Each is mounted in a 6-pin plastic DIP package.

**200 V or 300 V Phototransistor Breakdown**

**1500 V or 2500 V Peak Minimum Isolation**

**Input-to-Output**

**$10^{11} \Omega$  Isolation Resistance**

**Low Coupling Capacitance—Typically 1.0 pF**

### Absolute Maximum Ratings

#### Maximum Temperature and Humidity

Storage Temperature  $-55^{\circ}\text{C}$  to  $+150^{\circ}\text{C}$

Operating Temperature  $-55^{\circ}\text{C}$  to  $+100^{\circ}\text{C}$

Pin Temperature (Soldering, 5 s)  $260^{\circ}\text{C}$

Total Package Power Dissipation

at  $T_A = 25^{\circ}\text{C}$ ,

LED plus Detector 250 mW

Derate Linearly from  $25^{\circ}\text{C}$  3.3 mW/ $^{\circ}\text{C}$

#### Input Diode

$V_R$  Reverse Voltage 6.0 V

$I_F$  Forward dc Current 60 mA

$I_{pk}$  Peak Forward Current at  
1  $\mu\text{s}$  pulse width, 300 pps 3.0 A

$P_D$  Power Dissipation at  
 $T_A = 25^{\circ}\text{C}$  100 mW

Derate Linearly from  $25^{\circ}\text{C}$  1.33 mW/ $^{\circ}\text{C}$

#### Output Transistor

$V_{CE}$  Collector-to-Emitter  
Voltage

H11D1, H11D2 300 V

H11D3, H11D4 200 V

$V_{CB}$  Collector-to-Base Voltage

H11D1, H11D2 300 V

H11D3, H11D4 200 V

$V_{EC}$  Emitter-to-Collector

Voltage 7.0 V

$P_D$  Power Dissipation at

$T_A = 25^{\circ}\text{C}$  150 mW

Derate Linearly from  $25^{\circ}\text{C}$  2.0 mW/ $^{\circ}\text{C}$

### Package Outline

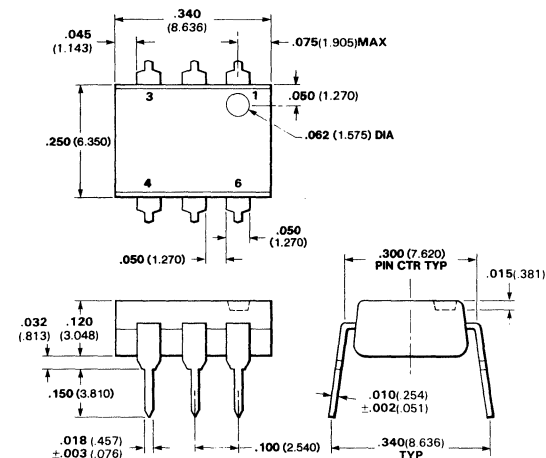

### Notes

All dimensions in inches **bold** and millimeters (parentheses)

Tolerance unless specified =  $\pm .015$  ( $\pm .381$ )

### Connection Diagram

#### DIP (Top View)

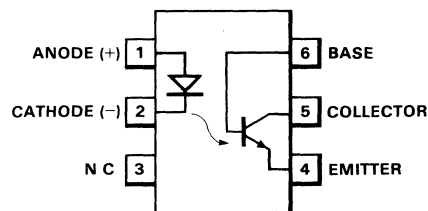

### Pin

1	Anode (+)	} Input Diode
2	Cathode (-)	
3	NC	
4	Emitter	} Output npn Phototransistor
5	Collector	
6	Base	

# Typical Electrical Characteristics

# H11D1, H11D2 H11D3, H11D4

## Electrical Characteristics—Input Diode $T_A = 25^\circ\text{C}$

Symbol	Characteristic	Min	Typ	Max	Units	Test Conditions
$V_F$	Forward Voltage		1.20	1.50	V	$I_F = 10\text{ mA}$
C	Capacitance		50		pF	$V_R = 0\text{ V}$ , $f = 1\text{ MHz}$
$I_R$	Reverse Leakage Current		0.05	10	$\mu\text{A}$	$V_R = 6.0\text{ V}$

## Electrical Characteristics—Output Transistor $T_A = 25^\circ\text{C}$

Symbol	Characteristic	Min	Typ	Max	Units	Test Conditions
$BV_{CEO}$	Collector-to-Emitter Breakdown Voltage H11D1, H11D2 H11D3, H11D4	300 200	350 250		V V	$I_C = 1.0\text{ mA}$ , Pulsed $I_F = 0$
$BV_{CBO}$	Collector-to-Base Breakdown Voltage H11D1, H11D2 H11D3, H11D4	300 200	350 250		V V	$I_C = 100\ \mu\text{A}$ $I_F = 0$
$I_{CEO}$	Collector Dark Current H11D1, H11D2 ( $25^\circ\text{C}$ ) ( $100^\circ\text{C}$ ) H11D3, H11D4 ( $25^\circ\text{C}$ ) ( $100^\circ\text{C}$ )			100 250 100 250	nA $\mu\text{A}$ nA $\mu\text{A}$	$V_{CE} = 200\text{ V}$ , $I_F = 0$ $V_{CE} = 100\text{ V}$ , $I_F = 0$
$BV_{EBO}$	Emitter-to-Base Breakdown Voltage	7.0			V	$I_E = 100\ \mu\text{A}$ , $I_F = 0$

## Electrical Characteristics—Coupled $T_A = 25^\circ\text{C}$

Symbol	Characteristic	Min	Typ	Max	Units	Test Conditions
$I_C$	Collector Output Current H11D1, H11D2, H11D3 H11D4	2.0 1.0	5.0 3.0		mA	$V_{CE} = 10\text{ V}$ , $I_F = 10\text{ mA}$ , $I_B = 0$
$V_{ISO}$	Isolation Voltage H11D1 H11D2, H11D3, H11D4	2500 1500			$V_{rms}$ $V_{rms}$	
$R_{IO}$	Isolation Resistance	$10^{11}$			$\Omega$	$V = 500\text{ V}$
$V_{CE(sat)}$	Collector-to-Emitter Saturation Voltage		0.2	0.4	V	$I_C = 0.5\text{ mA}$ , $I_F = 10\text{ mA}$
$C_{IO}$	Isolation Capacitance		1.0		pF	$V = 0$ , $f = 1.0\text{ MHz}$
$t_r, t_f$	Rise and Fall Times (Note)		5.0		$\mu\text{s}$	$I_C = 2.0\text{ mA}$ , $V_{CE} = 10\text{ V}$ , $R_L = 100\ \Omega$

### Notes

Rise time is defined as the time for the collector current to rise from 10% to 90% of peak value. Fall time is defined as the time required for the current to decrease from 90% to 10% of peak value.

# Dual Optically-Coupled Isolator

Optoelectronic Products

## ILD-74

### General Description

The ILD-74 comprises two distinct optoisolators with transistor output, in a single 8-pin dual in-line package. Each channel consists of a GaAs emitter optically coupled to a phototransistor.

### High Current Transfer Ratio

1500 V Minimum Isolation Input-to-Output

$10^{11} \Omega$  Isolation Resistance

Low Coupling Capacitance—Typically 0.5 pF

I/O Compatible With Integrated Circuits

Two Packages Fit Into a Standard

16-Pin DIP Socket

### Absolute Maximum Ratings

#### Maximum Temperature

Storage Temperature  $-55^{\circ}\text{C}$  to  $+150^{\circ}\text{C}$

Operating Temperature  $-55^{\circ}\text{C}$  to  $+100^{\circ}\text{C}$

Pin Temperature (Soldering, 7 s)  $260^{\circ}\text{C}$

Total Package Power Dissipation at  $T_A = 25^{\circ}\text{C}$  400 mW

Derate Linearly from  $25^{\circ}\text{C}$  5.33 mW/ $^{\circ}\text{C}$

#### Input Diode (Each Channel)

$V_R$  Reverse Voltage 3.0 V

$I_F$  Forward dc Current 100 mA

$I_{pk}$  Peak Forward Current at 1  $\mu\text{s}$  pulse, 300 pps 3.0 A

$P_D$  Power Dissipation at  $T_A = 25^{\circ}\text{C}$  150 mW

Derate Linearly from  $50^{\circ}\text{C}$  1.33 mW/ $^{\circ}\text{C}$

#### Output Transistor (Each Channel)

$V_{CE}$  Collector-to-Emitter Voltage 20 V

$V_{EC}$  Emitter-to-Collector Voltage 6.0 V

$P_D$  Power Dissipation at  $T_A = 25^{\circ}\text{C}$  150 mW

Derate Linearly from  $25^{\circ}\text{C}$  2.0 mW/ $^{\circ}\text{C}$

$I_C$  Collector Current 30 mA

### Package Outline

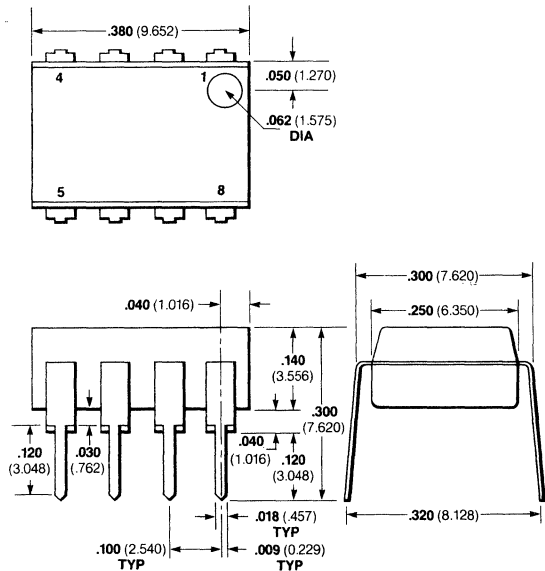

### Notes

All dimensions in inches bold and millimeters (parentheses)

Tolerance unless specified =  $\pm .015$  ( $\pm .381$ )

Package weight is 0.4 gram

### Connection Diagram

#### DIP (Top View)

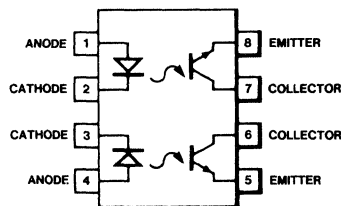

### Pin

1	Anode	Channel #1
2	Cathode	Channel #1
3	Cathode	Channel #2
4	Anode	Channel #2
5	Emitter	Channel #2
6	Collector	Channel #2
7	Collector	Channel #1
8	Emitter	Channel #1

# Typical Electrical Characteristics

# ILD-74

## Electrical Characteristics—Input Diode $T_A = 25^\circ\text{C}$

Symbol	Characteristic	Min	Typ	Max	Units	Test Conditions
$V_F$	Forward Voltage		1.3		V	$I_F = 60\text{ mA}$
$V_R$	Reverse Voltage		3.0		V	$I_R = 100\ \mu\text{A}$
$C_J$	Junction Capacitance		100		pF	$V_F = 0\text{ V}$

## Electrical Characteristics—Output Transistor $T_A = 25^\circ\text{C}$

Symbol	Characteristic	Min	Typ	Max	Units	Test Conditions
$V_{CE0}$	Collector-to-Emitter Voltage	20			V	$I_C = 1.0\text{ mA}$ , $I_F = 0$
$I_{CE0}$	Collector-to-Emitter Leakage Current		5.0	500	nA	$V_{CE} = 5.0\text{ V}$ , $I_F = 0$
$C_{CE}$	Collector-to-Emitter Capacitance		2.0		pF	$V_{CE} = 0$

## Electrical Characteristics—Coupled $T_A = 25^\circ\text{C}$

Symbol	Characteristic	Min	Typ	Max	Units	Test Conditions
$V_{IO}$	Input-to-Output Voltage	1500			V	
$V_{CE(sat)}$	Collector-to-Emitter Saturation Voltage			0.5	V	$I_C = 2.0\text{ mA}$ , $I_F = 16\text{ mA}$
$I_C/I_F(\text{CTR})$	Collector Current Transfer Ratio (Note 1)	12.5	35		%	$V_{CE} = 5.0\text{ V}$ , $I_F = 16\text{ mA}$
$R_{IO}$	Input-to-Output Resistance		$10^{14}$		$\Omega$	$V_{IO} = 500\text{ V}$
$C_{IO}$	Input-to-Output Capacitance		0.5		pF	$f = 1.0\text{ MHz}$
$t_{D(on)}$	Propagation Delay Times		6.0		$\mu\text{s}$	$V_{CE} = 5.0\text{ V}$ , $I_F = 16\text{ mA}$
$t_{D(off)}$			25		$\mu\text{s}$	$R_L = 2.4\text{ k}\Omega$

### Notes

- Collector current transfer ratio is defined as the ratio of the collector current to the forward bias input current.
- Rise time is defined as the time for the collector current to rise from 10% to 90% of peak value. Fall time is defined as the time required for the current to decrease from 90% to 10% of peak value.

# Optically-Coupled Darlington Isolator

Optoelectronic Products

## MCA230 MCA231 MCA255

### General Description

The MCA230, MCA231 and MCA255 series of optically-coupled isolators are electrical and mechanical replacements for the Monsanto series. Optical intercoupling provides a high degree of ac and dc isolation. Connection to the base is also provided for design flexibility.

### Glassolated™

**High Current Transfer Ratio At Low Input Current**

**$10^{11} \Omega$  Isolation Resistance**

**Low Coupling Capacitance—Typically 1.5 pF**

### Absolute Maximum Ratings

Storage Temperature	-55°C to +150°C
Operating Temperature	-55°C to +100°C
Pin Temperature (Soldering, 10 s)	260°C
Total Package Power Dissipation at $T_A = 25^\circ\text{C}$	300 mW
(LED plus Detector)	4.0 mW/°C
Derate Linearly from 25°C	

### Input Diode

$V_R$ Reverse Voltage	3.0 V
$I_F$ Forward dc Current	60 mA
$I_{pk}$ Peak Forward Current (1 $\mu\text{s}$ pulse width, 300 pps)	3.0 A
$P_D$ Power Dissipation at $T_A = 25^\circ\text{C}$	90 mW
Derate Linearly from 55°C	2.0 mW/°C

### Output Transistor (Darlington)

$V_{CE}$ Collector-to-Emitter Voltage	MCA230/231 30 V	MCA255 55 V
$V_{CB}$ Collector-to-Base Voltage	MCA230/231 30 V	MCA255 55 V
$P_D$ Power Dissipation at $T_A = 25^\circ\text{C}$	210 mW	
Derate Linearly from 25°C	2.8 mW/°C	

### Package Outline

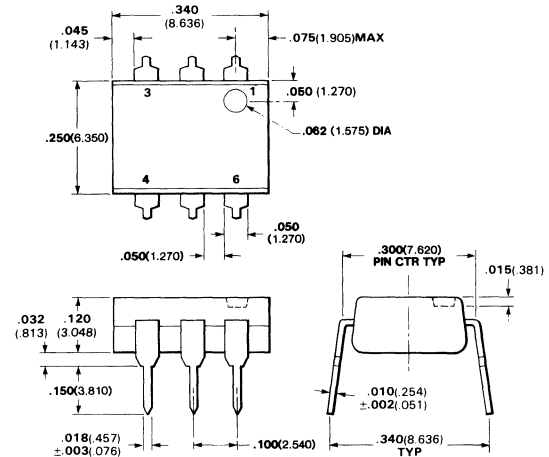

### Notes

All dimensions in inches **bold** and millimeters (parentheses)  
 Tolerance unless specified =  $\pm .015$  ( $\pm .381$ )

### Connection Diagram

#### DIP (Top View)

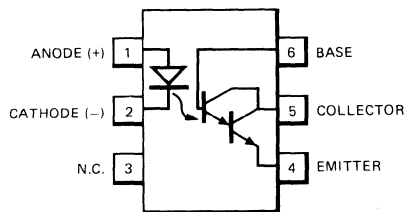

### Pin

1 Anode (+)	}	Input Diode
2 Cathode (-)		
3 NC		
4 Emitter	}	Output npn Phototransistor
5 Collector		
6 Base		

### Electrical Characteristics—Input Diode $T_A = 25^\circ\text{C}$

Symbol	Characteristic	Min	Typ	Max	Units	Test Conditions
$V_F$	Forward Voltage		1.2	1.5	V	$I_F = 20 \text{ mA}$
$BV_R$	Reverse Breakdown Voltage	3.0	5.0		V	$I_R = 10 \mu\text{A}$

# Typical Electrical Characteristics

# MCA230 MCA231 MCA255

## Electrical Characteristics—Output Transistor $T_A = 25^\circ\text{C}$

Symbol	Characteristic	Min	Typ	Max	Units	Test Conditions
$V_{CEO}$	Collector-to-Emitter Voltage MCA230/231	30			V	$I_C = 1.0\text{ mA}$ , $I_F = 0$
	MCA255	55			V	$I_C = 1.0\text{ mA}$ , $I_F = 0$
$V_{CBO}$	Collector-to-Base Voltage MCA230/231	30			V	$I_C = 10\text{ }\mu\text{A}$ , $I_F = 0$
	MCA255	55			V	
$I_{CEO}$	Collector-to-Emitter Leakage Current		1.0	100	nA	$V_{CE} = 10\text{ V}$ , $I_F = 0$
$h_{FE}$	Forward Current Gain		25 k			$V_{CE} = 5.0\text{ V}$ , $I_C = 500\text{ }\mu\text{A}$ , $I_E = 10\text{ }\mu\text{A}$
$V_{EBO}$	Emitter-to-Base Voltage MCA230/255	8			V	
	MCA231	6			V	

## Electrical Characteristics—Coupled $T_A = 25^\circ\text{C}$

Symbol	Characteristic	Min	Typ	Max	Units	Test Conditions
$I_C$	Collector Output Current MCA230	10	40		mA	$V_{CE} = 5.0\text{ V}$ , $I_F = 10\text{ mA}$
	MCA231	2.0	4.0		mA	$V_{CE} = 1.0\text{ V}$ , $I_F = 1.0\text{ mA}$
	MCA255	10	40		mA	$V_{CE} = 5.0\text{ V}$ , $I_F = 10\text{ mA}$
$V_{ISO}$	Isolation Voltage	1.5 k	2.0 k		V	
$R_{ISO}$	Isolation Resistance		$10^{11}$		$\Omega$	$V = 500\text{ V}$
$V_{CE(sat)}$	Collector-to-Emitter Saturation Voltage MCA230, MCA255		0.8	1.0	V	$I_C = 50\text{ mA}$ , $I_F = 50\text{ mA}$
	MCA231		0.8	1.0	V	$I_C = 2.0\text{ mA}$ , $I_F = 1.0\text{ mA}$
	MCA231		0.8	1.0	V	$I_C = 10\text{ mA}$ , $I_F = 5\text{ mA}$
	MCA231		0.9	1.2	V	$I_C = 40\text{ mA}$ , $I_F = 10\text{ mA}$
$t_{on}$	Turn-on Time		40		$\mu\text{s}$	$I_C = 1.0\text{ mA}$ , $V_{CC} = 10\text{ V}$ , $R_L = 100\text{ }\Omega$
$t_{off}$	Turn-off Time (See Note 1)		50		$\mu\text{s}$	

### Notes

- Collector current transfer ratio is defined as the ratio of the collector current to the forward bias input current.
- Rise time is defined as the time for the collector current to rise from 10% to 90% of peak value. Fall time is defined as the time required for the current to decrease from 90% to 10% of peak value.

# Optically-Coupled Isolator

Optoelectronic Products

# MCT2, MCT2E MCT26

## General Description

The MCT2, MCT2E and MCT26 optical isolators are electrical and mechanical replacements for the Monsanto series. Optical intercoupling provides a high degree of ac and dc isolation. A capability for continuous operation of the input diode results in a frequency response extending to dc. Connection to the base is also provided for design flexibility.

## Glassolated™

Electrically Equivalent to Monsanto Devices  
Pin-for-Pin Equivalent to Monsanto Devices  
Availability of Base Pin for Flexible Design

## Absolute Maximum Ratings

### Maximum Temperature and Humidity

Storage Temperature	-55°C to +150°C
Operating Temperature	-55°C to +100°C
Pin Temperature (Soldering, 5 s)	260°C
Total Package Power Dissipation at $T_A = 25^\circ\text{C}$ ,	
LED plus Detector	250 mW
Derate Linearly from 25°C	3.3 mW/°C

### Input Diode

$V_R$ Reverse Voltage	3.0 V
$I_F$ Forward Current	60 mA
$I_{pk}$ Peak Forward Current, 1 $\mu\text{s}$ pulse width, 330 pps	3.0 A
$P_D$ Power Dissipation at $T_A = 25^\circ\text{C}$	200 mW
Derate Linearly from 25°C	2.6 mW/°C

### Output Transistor

$V_{CE}$ Collector-to-Emitter Voltage	30 V
$V_{CB}$ Collector-to-Base Voltage	30 V
$V_{EC}$ Emitter-to-Collector Voltage	7.0 V
$P_D$ Power Dissipation at $T_A = 25^\circ\text{C}$	200 mW
Derate Linearly from 25°C	2.6 mW/°C

## Package Outline

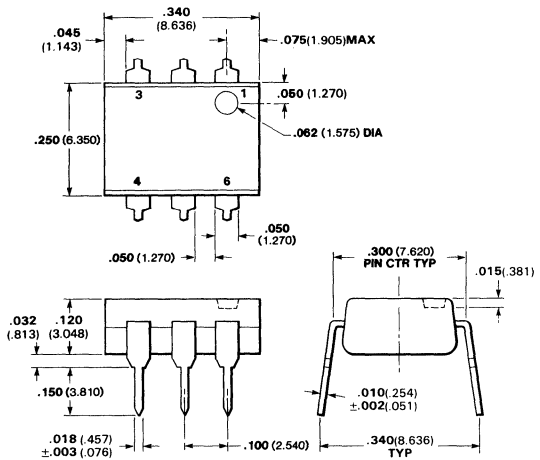

## Notes

All dimensions in inches bold and millimeters (parentheses)  
Tolerance unless specified =  $\pm .015$  ( $\pm .381$ )

## Connection Diagram DIP (Top View)

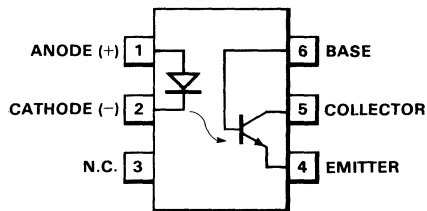

Pin		
1	Anode (+)	} Input Diode
2	Cathode (-)	
3	NC	
4	Emitter	} Output npn Phototransistor
5	Collector	
6	Base	



# Typical Electrical Characteristics

# MCT2, MCT2E MCT26

## Electrical Characteristics—Input Diode $T_A = 25^\circ\text{C}$

Symbol	Characteristic	Min	Typ	Max	Units	Test Conditions
$V_F$	Forward Voltage		1.25	1.5	V	$I_F = 20\text{ mA}$
$BV_R$	Reverse Breakdown Voltage	3.0	5.5		V	$I_R = 10\ \mu\text{A}$

## Electrical Characteristics—Output Transistor $T_A = 25^\circ\text{C}$

Symbol	Characteristic	Min	Typ	Max	Units	Test Conditions
$V_{CEO}$	Collector-to-Emitter Voltage MCT2/MCT2E	30	65		V	$I_C = 1.0\text{ mA}$ , $I_F = 0$
	MCT26	30	75		V	$I_C = 1.0\text{ mA}$ , $I_F = 0$
$V_{CBO}$	Collector-to-Base Voltage MCT2/MCT2E	70	165		V	$I_C = 100\ \mu\text{A}$
	MCT26	30	100		V	$I_C = 100\ \mu\text{A}$
$V_{ECO}$	Emitter-to-Collector Voltage MCT2/MCT2E	7.0	14		V	$I_C = 100\ \mu\text{A}$
	MCT26	7.0	12		V	$I_C = 100\ \mu\text{A}$
$I_{CEO}$	Collector-to-Emitter Leakage Current MCT2/MCT2E		5.0	50	nA	$V_{CE} = 10\text{ V}$ , $I_F = 0$
	MCT26		5.0	100	nA	$V_{CE} = 5.0\text{ V}$ , $I_F = 0$
$I_{CBO}$	Collector-to-Base Leakage Current MCT2/MCT2E		0.1	20	nA	$V_{CB} = 10\text{ V}$ , $I_F = 0$
	MCT26		1.0	100	nA	$V_{CB} = 5.0\text{ V}$ , $I_F = 0$
$h_{FE}$	Forward Current Gain MCT2/MCT2E	100	250			$V_{CE} = 5.0\text{ V}$ , $I_C = 100\ \mu\text{A}$
	MCT26	100	150			$V_{CE} = 5.0\text{ V}$ , $I_C = 100\ \mu\text{A}$
$C_{ce}$	Collector-to-Emitter Capacitance MCT2/MCT2E, MCT26		8.0		pF	$V_{CE} = 0$
$C_{cb}$	Collector-to-Base Capacitance MCT2/MCT2E		20		pF	$V_{CB} = 10\text{ V}$
$C_{eb}$	Emitter-to-Base Capacitance MCT2/MCT2E		10		pF	$V_{BE} = 0$

# Typical Electrical Characteristics (Cont'd)

# MCT2, MCT2E MCT26

## Electrical Characteristics—Coupled $T_A = 25^\circ\text{C}$

Symbol	Characteristic	Min	Typ	Max	Units	Test Conditions
$V_{IO}$	Input-to-Output Voltage					
	MCT2	1500	2300		$V_{dc}$	$f = 60\text{ Hz}$
	MCT2E	2500			$V_{dc}$	
$V_{CE(sat)}$	Collector-to-Emitter Saturation Voltage					
	MCT2, MCT2E	1500	2500		$V_{dc}$	
	MCT26	800			$V_{rms}$	
$I_C/I_F(CTR)$	Collector Current Transfer Ratio (Note 1)					
	MCT2, MCT2E		0.24	0.4	V	$I_C = 2.0\text{ mA}$ , $I_F = 16\text{ mA}$
	MCT26		0.2	0.3	V	$I_C = 250\text{ }\mu\text{A}$ , $I_F = 20\text{ mA}$
$R_{IO}$	Input-to-Output Resistance					
	MCT26	20	50		%	$V_{CE} = 10\text{ V}$ , $I_F = 10\text{ mA}$
$C_{IO}$	Input-to-Output Capacitance					
	MCT2, MCT2E	6	14		%	
$t_r, t_f$	Collector Rise and Fall Times (Note 2)					
	MCT26		$10^{11}$		$\Omega$	$V_{IO} = 500\text{ V}$
			$10^{11}$	$10^{12}$	$\Omega$	
			1.0		pF	$f = 1.0\text{ MHz}$
			1.0	2.0	pF	
			2.0		$\mu\text{s}$	$I_C = 2.0\text{ mA}$ , $V_{CE} = 10\text{ V}$

### Notes

- Collector current transfer ratio is defined as the ratio of the collector current to the forward bias input current.
- Rise time is defined as the time for the collector current to rise from 10% to 90% of peak value. Fall time is defined as the time required for the current to decrease from 90% to 10% of peak value.

# Dual Optically-Coupled Isolator

Optoelectronic Products

# MCT6, MCT66

## General Description

The MCT6 and MCT66 comprise two distinct optoisolators with transistor output, in a single 8-pin dual in-line package. Each channel consists of a GaAs emitter optically coupled to a phototransistor.

## High Current Transfer Ratio

1500 V Minimum Isolation Input-to-Output

$10^{11} \Omega$  Isolation Resistance

Low Coupling Capacitance—Typically 1.0 pF

I/O Compatible with Integrated Circuits

Two Packages Fit into a Standard 16-Pin DIP Socket

## Absolute Maximum Ratings

### Maximum Temperature

Storage Temperature  $-55^{\circ}\text{C}$  to  $+150^{\circ}\text{C}$

Operating Temperature  $-55^{\circ}\text{C}$  to  $+100^{\circ}\text{C}$

Pin Temperature (Soldering, 5 s)  $250^{\circ}\text{C}$

Total Package Power Dissipation at  $T_A = 25^{\circ}\text{C}$  400 mW

Derate Linearly from  $25^{\circ}\text{C}$  5.33 mW/ $^{\circ}\text{C}$

### Input Diode (Each Channel)

$V_R$  Reverse Voltage 3.0 V

$I_F$  Forward Current 60 mA

$I_{pk}$  Peak Forward Current at 1  $\mu\text{s}$  pulse, 300 pps 3.0 A

$P_D$  Power Dissipation at  $T_A = 25^{\circ}\text{C}$  100 mW  
Derate Linearly from  $50^{\circ}\text{C}$  2.0 mW/ $^{\circ}\text{C}$

### Output Transistor (Each Channel)

$V_{CE}$  Collector-to-Emitter Voltage 30 V

$V_{EC}$  Emitter-to-Collector Voltage 6.0 V

$P_D$  Power Dissipation at  $T_A = 25^{\circ}\text{C}$  150 mW  
Derate Linearly from  $25^{\circ}\text{C}$  2.0 mW/ $^{\circ}\text{C}$

$I_C$  Collector Current 30 mA

## Package Outline

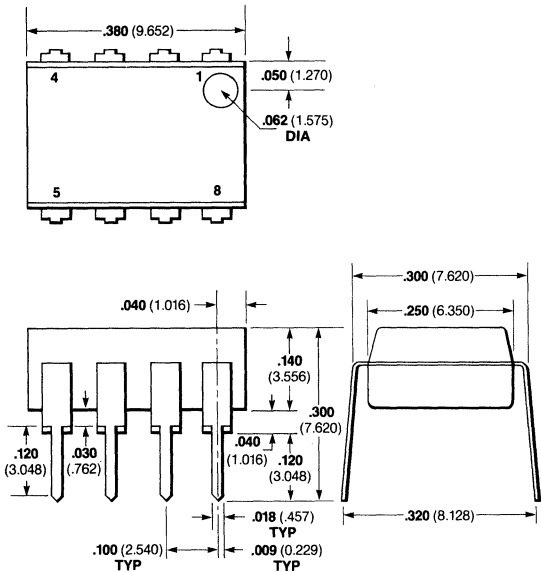

## Notes

All dimensions in inches **bold** and millimeters (parentheses)

Tolerance unless specified =  $\pm 0.015$  ( $\pm .381$ )

Package weight is 0.4 gram

## Connection Diagram DIP (Top View)

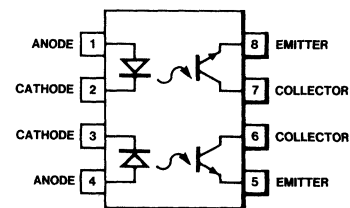

## Pin

1	Anode	
2	Cathode	Channel # 1
3	Cathode	
4	Anode	Channel # 2
5	Emitter	
6	Collector	Channel # 2
7	Collector	
8	Emitter	Channel # 1

# Typical Electrical Characteristics

## MCT6, MCT66

### Electrical Characteristics—Input Diode $T_A = 25^\circ\text{C}$

Symbol	Characteristic	Min	Typ	Max	Units	Test Conditions
$V_F$	Forward Voltage		1.25	1.5	V	$I_F = 20\text{ mA}$
$V_R$	Reverse Voltage	3.0	5.5		V	$I_R = 10\text{ }\mu\text{A}$
$C_J$	Junction Capacitance		50		pF	$V_F = 0\text{ V}$
$I_R$	Reverse Current		0.01	10	$\mu\text{A}$	$V_R = 3.0\text{ V}$

### Electrical Characteristics—Output Transistor $T_A = 25^\circ\text{C}$

Symbol	Characteristic	Min	Typ	Max	Units	Test Conditions
$V_{CE0}$	Collector-to-Emitter Voltage	30	85		V	$I_C = 1.0\text{ mA}$ , $I_F = 0$
$V_{ECO}$	Emitter-to-Collector Voltage	6.0	13		V	$I_C = 100\text{ }\mu\text{A}$
$I_{CE0}$	Collector-to-Emitter Leakage Current		5.0	100	nA	$V_{CE} = 10\text{ V}$ , $I_F = 0$
$C_{CE}$	Collector-to-Emitter Capacitance		8.0		pF	$V_{CE} = 0$

5

### Electrical Characteristics—Coupled $T_A = 25^\circ\text{C}$

Symbol	Characteristic	Min	Typ	Max	Units	Test Conditions
$V_{IO}$	Input-to-Output Voltage	1500	2500		V	
$V_{CE(sat)}$	Collector-to-Emitter Saturation Voltage MCT6		0.20	0.4	V	$I_C = 2.0\text{ mA}$ , $I_F = 16\text{ mA}$
	MCT66		0.20	0.4	V	$I_C = 2.0\text{ mA}$ , $I_F = 40\text{ mA}$
$I_C/I_F(\text{CTR})$	Collector Current Transfer Ratio (Note 1) MCT6	20	50		%	$V_{CE} = 10\text{ V}$ , $I_F = 10\text{ mA}$
	MCT66	6	15		%	$V_{CE} = 10\text{ V}$ , $I_F = 10\text{ mA}$
$R_{IO}$	Input-to-Output Resistance	$10^{11}$	$10^{12}$		$\Omega$	$V_{IO} = 500\text{ V}$
$C_{IO}$	Input-to-Output Capacitance		0.5		pF	$f = 1.0\text{ MHz}$
$t_r, t_f$	Collector Rise and Fall Times (Note 2)		2.0		$\mu\text{s}$	$I_C = 2.0\text{ mA}$ , $V_{CE} = 10\text{ V}$ , $R_L = 100\text{ }\Omega$
$B_W$	Bandwidth		150		kHz	$I_C = 2.0\text{ mA}$ , $V_{CC} = 10\text{ V}$ , $R_L = 100\text{ }\Omega$
$BV_{C-C}$	Breakdown Voltage Channel-to-Channel		1500		V	
$C_{C-C}$	Capacitance Channel-to-Channel		0.4		pF	$f = 1.0\text{ MHz}$

#### Notes

- Collector current transfer ratio is defined as the ratio of the collector current to the forward bias input current.
- Rise time is defined as the time for the collector current to rise from 10% to 90% of peak value. Fall time is defined as the time required for the current to decrease from 90% to 10% of peak value.

# Optically-Coupled Isolator

Optoelectronic Products

# TIL 111, TIL 114 TIL 116, TIL 117

## General Description

The TIL 111, TIL 114, TIL 116 and TIL 117 series of optically-coupled isolators are electrical and mechanical replacements for the Texas Instruments series. Optical intercoupling provides a high degree of ac and dc isolation. Connection to the base is also provided for design flexibility.

## Glassolated™

**High Current Transfer Ratio**

**High-Speed Switching—Typically 2  $\mu$ s**

**10<sup>11</sup>  $\Omega$  Isolation Resistance**

**Low Coupling Capacitance—Typically 1.0 pF**

## Absolute Maximum Ratings

### Maximum Temperature

Storage Temperature  $-55^{\circ}\text{C}$  to  $+150^{\circ}\text{C}$

Operating Temperature  $-55^{\circ}\text{C}$  to  $+100^{\circ}\text{C}$

Pin Temperature (Soldering, 5 s)  $260^{\circ}\text{C}$

Total Package Power Dissipation  
at  $T_A = 25^{\circ}\text{C}$ ,

LED plus Detector 250 mW

Derate Linearly from  $25^{\circ}\text{C}$  3.3 mW/ $^{\circ}\text{C}$

### Input Diode

$V_R$  Reverse Voltage 3.0 V

$I_F$  Forward dc Current 100 mA

$I_{pk}$  Peak Forward Current at  
1  $\mu$ s pulse width,  
300 pps 3.0 A

$P_D$  Power Dissipation  
at  $T_A = 25^{\circ}\text{C}$  150 mW  
Derate Linearly from  $25^{\circ}\text{C}$  2.6 mW/ $^{\circ}\text{C}$

### Output Transistor

$V_{CE}$  Collector-to-Emitter  
Voltage 30 V

$V_{CB}$  Collector-to-Base Voltage 70 V

$P_D$  Power Dissipation  
at  $T_A = 25^{\circ}\text{C}$  150 mW  
Derate Linearly from  $25^{\circ}\text{C}$  2.6 mW/ $^{\circ}\text{C}$

## Package Outline

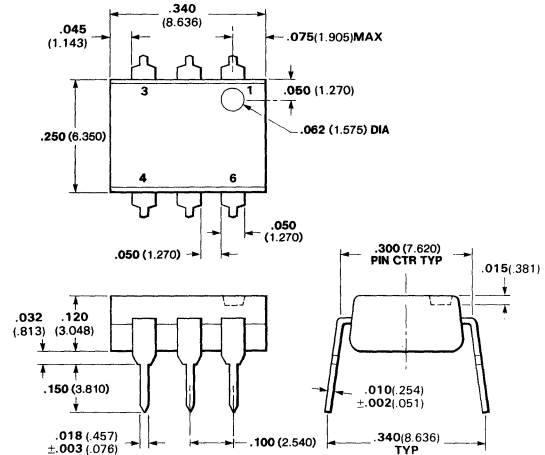

## Notes

All dimensions in inches bold and millimeters (parentheses)  
Tolerance unless specified =  $\pm .015$  ( $\pm .381$ )

## Connection Diagram

### DIP (Top View)

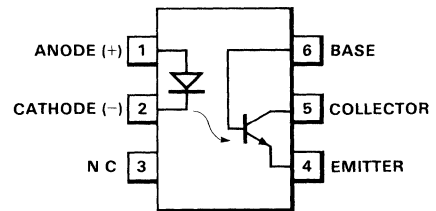

## Pin

1	Anode (+)	} Input Diode
2	Cathode (-)	
3	NC	
4	Emitter	} Output npn Phototransistor
5	Collector	
6	Base	

# Typical Electrical Characteristics

# TIL 111, TIL 114 TIL 116, TIL 117

## Electrical Characteristics—Input Diode $T_A = 25^\circ\text{C}$

Symbol	Characteristic	Min	Typ	Max	Units	Test Conditions
$V_F$	Forward Voltage TIL 111, TIL 114, TIL 117 TIL 116		1.2 1.2	1.4 1.5	V	$I_F = 16 \text{ mA}$ $I_F = 60 \text{ mA}$
$BV_R$	Reverse Breakdown Voltage	3.0	5.0		V	$I_R = 10 \mu\text{A}$

## Electrical Characteristics—Output Transistor $T_A = 25^\circ\text{C}$

Symbol	Characteristic	Min	Typ	Max	Units	Test Conditions
$V_{CEO}$	Collector-to-Emitter Voltage	30			V	$I_C = 1.0 \text{ mA}$ , $I_F = 0$
$V_{CBO}$	Collector-to-Base Voltage	70			V	$I_C = 10 \mu\text{A}$ , $I_F = 0$
$V_{EBO}$	Emitter-to-Base Voltage	7.0			V	$I_E = 10 \mu\text{A}$
$I_{CEO}$	Collector-to-Emitter Leakage Current		1.0	50	nA	$V_{CE} = 10 \text{ V}$ , $I_F = 0$
$I_{CBO}$	Collector-to-Base Leakage Current		0.1	20	nA	$V_{CB} = 10 \text{ V}$ , $I_F = 0$
$h_{FE}$	Forward Current Gain TIL 111, TIL 114	100	300			$V_{CE} = 5 \text{ V}$ , $I_C = 10 \text{ mA}$
	TIL 116	100	300			$V_{CE} = 5 \text{ V}$ , $I_C = 100 \mu\text{A}$
	TIL 117	200	550			$V_{CE} = 5 \text{ V}$ , $I_C = 10 \text{ mA}$

# Typical Electrical Characteristics (Cont'd)

# TIL 111, TIL 114 TIL 116, TIL 117

## Electrical Characteristics—Coupled $T_A = 25^\circ\text{C}$

Symbol	Characteristic	Min	Typ	Max	Units	Test Conditions
$I_C$	Collector Output Current TIL 111, TIL 114	2.0	7.0		mA	$V_{CE} = 0.4 \text{ V}$ , $I_F = 16 \text{ mA}$
	TIL 116	2.0	5.0		mA	
	TIL 117	5.0	9.0		mA	
$I_B$	Collector-to-Base Current	10	20		$\mu\text{A}$	$V_{CB} = 0.4 \text{ V}$ , $I_F = 16 \text{ mA}$
$V_{ISO}$	Isolation Voltage TIL 111	1500			V	$V = 500 \text{ V}$
	TIL 114, TIL 116, TIL 117	2500			V	
$R_{ISO}$	Isolation Resistance	$10^{11}$			$\Omega$	
$V_{CE(sat)}$	Collector-to-Emitter Saturation Voltage TIL 111, TIL 114		0.25	0.4	V	$I_C = 2.0 \text{ mA}$ , $I_F = 16 \text{ mA}$
	TIL 116		0.25	0.4	V	
	TIL 117		0.25	0.4	V	
$C_{ISO}$	Isolation Capacitance		1.0	1.3	pF	$V = 0$ , $f = 1.0 \text{ MHz}$
$t_r, t_f$	Rise Time, Fall time (See Note)					$I_C = 2.0 \text{ mA}$ , $V_{CC} = 10 \text{ V}$ , $R_L = 100 \Omega$ (See Note)
	TIL 111, TIL 114		5.0	10	$\mu\text{s}$	
	TIL 116		5.0	10	$\mu\text{s}$	
	TIL 117		5.0	10	$\mu\text{s}$	

**Note**

Rise time is defined as the time for the collector current to rise from 10% to 90% of peak value. Fall time is defined as the time required for the current to decrease from 90% to 10% of peak value.

# Optically-Coupled Isolator

Optoelectronic Products

## TIL112 TIL115 TIL118

### General Description

The TIL112, TIL115 and TIL118 series of optical isolators are electrical and mechanical replacements for the Texas Instrument series. Optical intercoupling provides a high degree of ac and dc isolation. Connection to the base is also provided for design flexibility.

### Glassolated™

#### High Current Transfer Ratio

High-Speed Switching—Typically 2  $\mu$ s

$10^{11}$   $\Omega$  Isolation Resistance

Low Coupling Capacitance—Typically 1.0 pF

### Absolute Maximum Ratings

#### Maximum Temperature

Storage Temperature	-55°C to +150°C
Operating Temperature	-55°C to +100°C
Pin Temperature (Soldering, 5 s)	260°C
Total Package Power Dissipation at $T_A = 25^\circ\text{C}$ ,	
LED plus Detector	250 mW
Derate Linearly from 25°C	3.3 mW/°C

#### Input Diode

$V_R$ Reverse Voltage	3.0 V
$I_F$ Forward dc Current	100 mA
$I_{pk}$ Peak Forward Current at 1 $\mu$ s pulse width, 300 pps	3.0 A
$P_D$ Power Dissipation at $T_A = 25^\circ\text{C}$	150 mW
Derate Linearly from 25°C	2.0 mW/°C

#### Output Transistor

$V_{CE}$ Collector-to-Emitter Voltage	20 V
$V_{CB}$ Collector-to-Base Voltage	30 V
$P_D$ Power Dissipation at $T_A = 25^\circ\text{C}$	150 mW
Derate Linearly from 25°C	2.0 mW/°C

### Package Outline

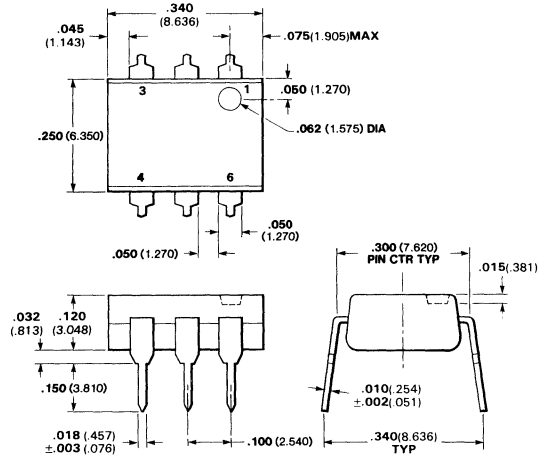

### Notes

All dimensions in inches bold and millimeters (parentheses) Tolerance unless specified =  $\pm .015$  ( $\pm .381$ )

### Connection Diagram DIP (Top View)

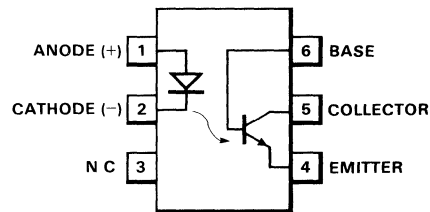

### Pin

1	Anode (+)	} Input Diode
2	Cathode (-)	
3	NC	
4	Emitter	} Output npn Phototransistor
5	Collector	
6	Base	



# Typical Electrical Characteristics

TIL 112  
TIL 115  
TIL 118

## Electrical Characteristics—Input Diode $T_A = 25^\circ\text{C}$

Symbol	Characteristic	Min	Typ	Max	Units	Test Conditions
$V_F$	Forward Voltage		1.2	1.5	V	$I_F = 10\text{ mA}$
$BV_R$	Reverse Breakdown Voltage	3.0	5.0		V	$I_R = 10\text{ }\mu\text{A}$

## Electrical Characteristics—Output Transistor $T_A = 25^\circ\text{C}$

Symbol	Characteristic	Min	Typ	Max	Units	Test Conditions
$V_{CEO}$	Collector-to-Emitter Voltage	20			V	$I_C = 1.0\text{ mA}$ , $I_F = 0$
$V_{CBO}$	Collector-to-Base Voltage	30			V	$I_C = 10\text{ }\mu\text{A}$ , $I_F = 0$
$V_{EBO}$	Emitter-to-Collector Voltage ( $V_{ECO}$ on TIL 118)	4.0			V	$I_E = 10\text{ }\mu\text{A}$ , $I_F = 0$
$I_{CEO}$	Collector-to-Emitter Leakage Current		1.0	100	nA	$V_{CE} = 5.0\text{ V}$ , $I_F = 0$
$I_{CBO}$	Collector-to-Base Leakage Current		0.1	50	nA	$V_{CB} = 5.0\text{ V}$ , $I_F = 0$
$h_{FE}$	Forward Current Gain	50	200			$V_{CE} = 5.0\text{ V}$ , $I_C = 10\text{ }\mu\text{A}$

## Electrical Characteristics—Coupled $T_A = 25^\circ\text{C}$

Symbol	Characteristic	Min	Typ	Max	Units	Test Conditions
$I_C$	Collector Output Current TIL 112, TIL 115	0.2	2.0		mA	$V_{CE} = 5.0\text{ V}$ , $I_F = 10\text{ mA}$
	TIL 118	1.0	2.0		mA	
$I_B$	Collector-to-Base Current TIL 112, TIL 115	2.0	10		$\mu\text{A}$	$V_{CB} = 5.0\text{ V}$ , $I_F = 10\text{ mA}$
$V_{ISO}$	Isolation Voltage TIL 112, TIL 118 TIL 115	1500			V	
		2500			V	
$R_{ISO}$	Isolation Resistance		$10^{11}$		$\Omega$	$V = 500\text{ V}$
$C_{ISO}$	Isolation Capacitance			2.0	pF	$f = 1\text{ MHz}$
$V_{CE(sat)}$	Collector-to-Emitter Saturation Voltage			0.5	V	$I_C = 2.0\text{ mA}$ , $I_F = 50\text{ mA}$
$t_r$	Rise Time		2.0	15	$\mu\text{s}$	$I_C = 2.0\text{ mA}$ , $V_{CC} = 10\text{ V}$ , $R_L = 100\text{ }\Omega$
$t_f$	Fall Time (See Note)		2.0	15	$\mu\text{s}$	$I_C = 2.0\text{ mA}$ , $V_{CC} = 10\text{ V}$ , $R_L = 100\text{ }\Omega$

### Note

Rise time is defined as the time for the collector current to rise from 10% to 90% of peak value. Fall time is defined as the time required for the current to decrease from 90% to 10% of peak value.

# Optically-Coupled Darlington Isolator

Optoelectronic Products

# TIL 113 TIL 119

## General Description

The TIL 113 and TIL 119 optical isolators are electrical and mechanical replacements for the Texas Instrument series. Optical coupling provides a high degree of ac and dc isolation. A capability for continuous operation of the input diode results in a frequency response extending to dc. Connection to the base is also provided for design flexibility.

## Glassolated™

Electrically Equivalent to TI Devices

Pin-for-Pin Equivalent

Availability of Base Pin for Flexible Design

## Absolute Maximum Ratings

Storage Temperature	-55°C to +150°C
Operating Temperature	-55°C to +100°C
Pin Temperature (Soldering, 10 s)	260°C
Total Package Power Dissipation at $T_A = 25^\circ\text{C}$ (LED plus Detector)	250 mW
Derate Linearly from 25°C	3.3 mW/°C

## Input Diode

$I_F$	Forward dc Current	
	Continuous	100 mA
$V_R$	Reverse Voltage	3.0 V
$I_{pk}$	Peak Forward Current, 1 $\mu\text{s}$ pulse width, 300 pps	3.0 A
$P_D$	Power Dissipation at $T_A = 25^\circ\text{C}$	150 mW
	Derate Linearly from 25°C	2.0 mW/°C

## Output Transistor (Darlington)

$V_{CE}$	Collector-to-Emitter Voltage	30 V
$V_{CB}$	Collector-to-Base Voltage	30 V
$V_{EC}$	Emitter-to-Collector Voltage	7.0 V
$P_D$	Power Dissipation at $T_A = 25^\circ\text{C}$ , $I_{C(max)}$ 100 mA, $V_{CE} = 1.5\text{ V}$	150 mW
	Derate Linearly from 25°C	2.0 mW/°C

## Package Outline

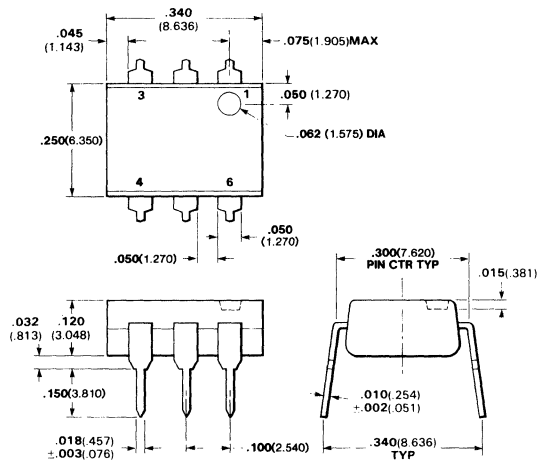

## Notes

All dimensions in inches bold and millimeters (parentheses)  
Tolerance unless specified =  $\pm 0.015$  (0.381)

## Connection Diagram DIP (Top View)

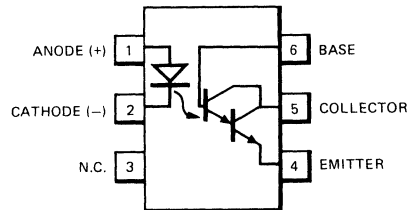

## Pin

1	Anode (+)	} Input Diode
2	Cathode (-)	
3	NC	
4	Emitter	} Output npn Phototransistor
5	Collector	
6	Base	

## Electrical Characteristics—Input Diode $T_A = 25^\circ\text{C}$

Symbol	Characteristic	Min	Typ	Max	Units	Test Conditions
$V_F$	Forward Voltage			1.5	V	$I_F = 10\text{ mA}$
$I_R$	Reverse Current			100	$\mu\text{A}$	$V_R = 3.0\text{ V}$

# Typical Electrical Characteristics

# TIL 113 TIL 119

## Electrical Characteristics—Output Transistor (Darlington) $T_A = 25^\circ\text{C}$

Symbol	Characteristic	Min	Typ	Max	Units	Test Conditions
$BV_{CEO}$	Collector-to-Emitter Breakdown Voltage	30			V	$I_C = 1.0\text{ mA}$ , $I_F = 0$
$BV_{CBO}$	Collector-to-Base Breakdown Voltage TIL 113	30				$I_C = 10\ \mu\text{A}$ , $I_F = 0$
$BV_{ECO}$	Emitter-to-Collector Breakdown Voltage TIL 119	7.0			V	$I_E = 10\ \mu\text{A}$ , $I_F = 0$
$BV_{EBO}$	Emitter-to-Base Breakdown Voltage TIL 113	7.0			V	$I_E = 10\ \mu\text{A}$ , $I_F = 0$
$I_{CEO}$	Collector-to-Emitter Leakage Current			100	nA	$V_{CE} = 10\text{ V}$ , $I_F = 0$
$h_{FE}$	Forward Current Gain TIL 113		15 k			$V_{CE} = 1.0\text{ V}$ , $I_C = 10\text{ mA}$ , $I_F = \phi$

## Electrical Characteristics—Coupled $T_A = 25^\circ\text{C}$

Symbol	Characteristic	Min	Typ	Max	Units	Test Conditions
$I_C$	Collector Output Current (Pulsed) TIL 113	30	100		mA	$I_F = 10\text{ mA}$ , $V_{CE} = 1.0\text{ V}$
	TIL 119	30	160		mA	$I_F = 10\text{ mA}$ , $V_{CE} = 2.0\text{ V}$ Peak
$V_{ISO}$	Isolation Voltage (Note 2)	1.5 k			V	$V = 500\text{ V}$
$R_{ISO}$	Isolation Resistance	$10^{11}$			$\Omega$	
$V_{CE(sat)}$	Collector-to-Emitter Saturation Voltage TIL 113			1.0	V	$I_C = 125\text{ mA}$ , $I_B = 0$ , $I_F = 50\text{ mA}$
	TIL 119			1.0	V	$I_C = 10\text{ mA}$ , $I_F = 10\text{ mA}$
$C_{ISO}$	Isolation Capacitance		1.0	1.3	pF	$V = 0$ , $f = 1.0\text{ MHz}$
$t_r, t_f$	Rise and Fall Time (Note 1) TIL 113		300		$\mu\text{s}$	$I_C = 125\text{ mA}$ , $V_{CC} = 15\text{ V}$ , $R_L = 100\ \Omega$
$t_r, t_f$	Rise and Fall Time (Note 1) TIL 119		300		$\mu\text{s}$	$I_C = 2.5\text{ mA}$ , $V_{CC} = 10\text{ V}$ , $R_L = 100\ \Omega$

### Notes

- Rise time is defined as the time for the (base collector) current to rise from 10% to 90% of peak value. Fall time is defined as the time required for the current to decrease from 90% to 10% of peak value.
- Isolation voltage defined as minimum of 5 s continuous application.

# Optically-Coupled Isolator

Optoelectronic Products

## 4N25, 4N26 4N27, 4N28

### General Description

The 4N25, 4N26, 4N27, and 4N28 series of optoisolators has a silicon npn Planar phototransistor coupled to a GaAs diode. Each is mounted in a 6-pin plastic dual in-line package.

### Glassolated™

**High Current Transfer Ratio—Typically 50%**  
**500 V to 2500 V Minimum Isolation**

**Input-To-Output**  
 **$10^{11} \Omega$  Isolation Resistance**  
**Low Coupling Capacitance—Typically 1.0 pF**

### Absolute Maximum Ratings

#### Maximum Temperature and Humidity

Storage Temperature*	-55°C to 150°C
Operating Temperature	-55°C to 100°C
Pin Temperature	
Soldering, 10 s*	260°C
Total Package Power Dissipation at $T_A = 25^\circ\text{C}$ ,	
LED plus Detector*	250 mW
Derate Linearly from 25°C*	3.3 mW/°C

#### Input Diode\*

$V_R^*$ Reverse Voltage	3.0 V
$I_F^*$ Forward dc Current	80 mA
$I_{pk}^*$ Peak Forward Current, 1 $\mu\text{s}$ pulse width, 300 pps	3.0 A
$P_D^*$ Power Dissipation at $T_A = 25^\circ\text{C}$	150 mW
Derate Linearly from 25°C	2.0 mW/°C

#### Output Transistor

$V_{CE}^*$ Collector-to-Emitter Voltage	30 V
$V_{CB}^*$ Collector-to-Base Voltage	70 V
$V_{EC}^*$ Emitter-to-Collector Voltage	7.0 V
$P_D^*$ Power Dissipation at $T_A = 25^\circ\text{C}$	150 mW
Derate Linearly from 25°C	2.0 mW/°C

\*Indicates JEDEC registered values.

### Package Outline

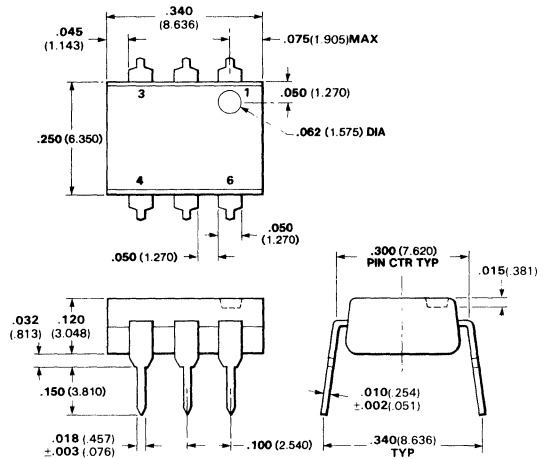

### Notes

All dimensions in inches **bold** and millimeters (parentheses)  
Tolerance unless specified =  $\pm .015$  ( $\pm .381$ )

### Connection Diagram DIP (Top View)

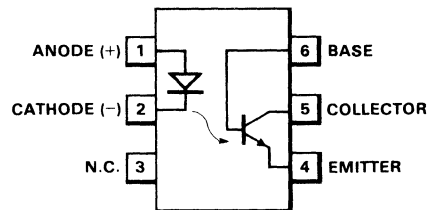

### Pin

1	Anode (+)	} Input Diode
2	Cathode (-)	
3	NC	
4	Emitter	} Output npn Phototransistor
5	Collector	
6	Base	

# Typical Electrical Characteristics

# 4N25, 4N26 4N27, 4N28

## Electrical Characteristics—Input Diode $T_A = 25^\circ\text{C}$

Symbol	Characteristic	Min	Typ	Max	Units	Test Conditions
$V_F^*$	Forward Voltage		1.2	1.5	V	$I_F = 50\text{ mA}$ $V_R = 3.0\text{ V}$ , $R_L = 1\text{ M}\Omega$ $V_R = 0\text{ V}$ , $f = 1\text{ MHz}$
$I_R^*$	Reverse Leakage Current		0.05	100	$\mu\text{A}$	
C	Capacitance		150		pF	

## Electrical Characteristics—Output Transistor $T_A = 25^\circ\text{C}$

Symbol	Characteristic	Min	Typ	Max	Units	Test Conditions
$V_{CE0}^*$	Collector-to-Emitter Voltage	30	65		V	$I_C = 1.0\text{ mA}$ , $I_B = 0$
$V_{CBO}^*$	Collector-to-Base Voltage	70	165		V	$I_C = 100\text{ }\mu\text{A}$ , $I_E = 0$
$V_{ECO}^*$	Emitter-to-Collector Voltage	7.0	14		V	$I_E = 100\text{ }\mu\text{A}$ , $I_B = 0$
$I_{CE0}^*$	Collector-to-Emitter Leakage Current 4N25, 4N26, 4N27		3.5	50	nA	$V_{CE} = 10\text{ V}$ , Base Open
	4N28			100	nA	$V_{CE} = 10\text{ V}$ , Base Open
$I_{CBO}^*$	Collector-to-Base Leakage Current		0.1	20	nA	$V_{CB} = 10\text{ V}$ , Emitter Open
$h_{FE}$	Forward Current Gain		250			$V_{CE} = 5.0\text{ V}$ , $I_C = 500\text{ }\mu\text{A}$
$C_{cb}$	Collector-to-Base Capacitance		65		pF	$V_{CB} = 0$ , $f = 1\text{ MHz}$

## Electrical Characteristics—Coupled $T_A = 25^\circ\text{C}$

Symbol	Characteristic	Min	Typ	Max	Units	Test Conditions
$V_{IO}^*$	Input-to-Output Voltage 4N25 4N26, 4N27 4N28	2500 1500 500			$V_{pk}$ $V_{pk}$ $V_{pk}$ V	$I_C = 2.0\text{ mA}$ , $I_F = 50\text{ mA}$
$V_{CE(sat)}^*$	Collector-to-Emitter Saturation Voltage		0.2	0.5	V	
$I_C^*$	Collector Output Current 4N25, 4N26 4N27, 4N28	2.0 1.0	5.0 3.0		mA mA	$V_{CE} = 10\text{ V}$ , $I_F = 10\text{ mA}$ , $I_B = 0$
$R_{IO}$	Input-to-Output Resistance		$10^{11}$		$\Omega$	$V_{IO} = 500\text{ V}$
BW	Collector Bandwidth		300		kHz	$I_C = 2.0\text{ mA}$ , $V_{CC} = 10\text{ V}$ , $R_L = 100\text{ }\Omega$
$C_{IO}$	Input-to-Output Capacitance		1.3		pF	$V_{IO} = 0$ , $f = 1.0\text{ MHz}$

\*Indicates JEDEC registered values.

# Optically-Coupled Darlington Isolator

Optoelectronics Products

# 4N29, 4N30 4N31, 4N32 4N33

### General Description

The 4N29, 4N30, 4N31, 4N32 and 4N33 series of optoisolators has a silicon npn Planar photo-Darlington transistor coupled to a GaAs diode. Each is mounted in a 6-pin plastic DIP package.

### High Current Transfer Ratio

1500 V or 2500 V Minimum Isolation

Input-To-Output

10<sup>11</sup> Ω Isolation Resistance

Low Coupling Capacitance

### Absolute Maximum Ratings

#### Maximum Temperature and Humidity

Storage Temperature\* -55°C to 150°C

Operating Temperature -55°C to 100°C

Pin Temperature

Soldering, 10 s\* 260°C

Total Package Power Dissipation

at T<sub>A</sub> = 25°C

(LED plus Detector)\* 250 mW

Derate Linearly from 25°C\* 3.3 mW/°C

#### Input Diode\*

I<sub>F</sub> Forward dc Current

Continuous\* 80 mA

V<sub>R</sub> Reverse Voltage 3.0 V

I<sub>pk</sub> Peak Forward Current

(1 μs pulse width, 300 pps) 3.0 A

P<sub>D</sub> Power Dissipation at

T<sub>A</sub> = 25°C 150 mW

Derate Linearly from 25°C 2.0 mW/°C

#### Output Transistor (Darlington)\*

V<sub>CE</sub> Collector-to-Emitter

Voltage 30 V

V<sub>CB</sub> Collector-to-Base Voltage 50 V

V<sub>EB</sub> Emitter-to-Base Voltage 8.0 V

V<sub>EC</sub> Emitter-to-Collector

Voltage 5.0 V

P<sub>D</sub> Power Dissipation at

T<sub>A</sub> = 25°C 150 mW

Derate Linearly from 25°C 2.0 mW/°C

\*Indicates JEDEC Registered Data

### Package Outline

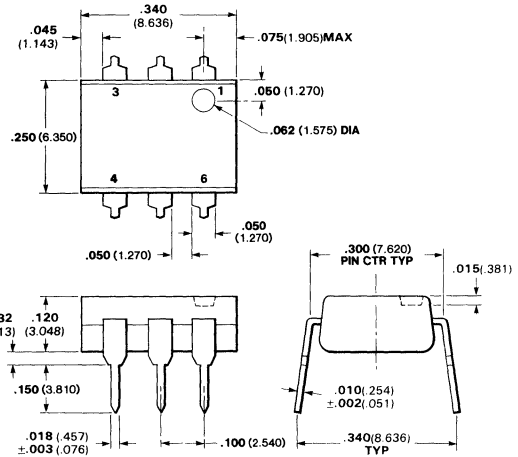

### Notes

All dimensions in inches bold and millimeters (parentheses)

Tolerance unless specified = ±.015 (±.381)

### Connection Diagram DIP (Top View)

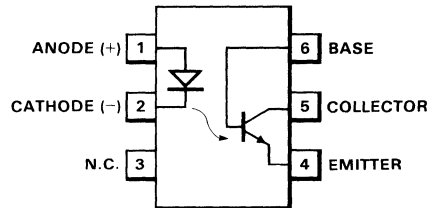

### Pin

1	Anode (+)	} Input Diode
2	Cathode (-)	
3	NC	
4	Emitter	} Output npn Phototransistor
5	Collector	
6	Base	

### Electrical Characteristics—Input Diode T<sub>A</sub> = 25°C

Symbol	Characteristic	Min	Typ	Max	Units	Test Conditions
V <sub>F</sub> *	Forward Voltage		1.2	1.5	V	I = 50 mA
I <sub>R</sub> *	Reverse Leakage Current		0.05	100	μA	V <sub>R</sub> = 3.0 V
C	Capacitance		150		pF	V <sub>R</sub> = 0 V, f = 1 MHz

# Typical Electrical Characteristics

# 4N29, 4N30 4N31, 4N32 4N33

## Electrical Characteristics—Output Transistor (Darlington) $T_A = 25^\circ\text{C}$

Symbol	Characteristic	Min	Typ	Max	Units	Test Conditions
$BV_{CEO}^*$	Collector-to-Emitter Breakdown Voltage	30	70		V	$I_C = 100\ \mu\text{A}$ , $I_B = 0$
$BV_{CBO}^*$	Collector-to-Base Breakdown Voltage	30			V	$I_C = 100\ \mu\text{A}$ , $I_E = 0$
$BV_{ECO}^*$	Emitter-to-Collector Breakdown Voltage	5.0			V	$I_E = 100\ \mu\text{A}$ , $I_B = 0$
$I_{CEO}^*$	Collector-to-Emitter Dark Current			100	nA	$V_{CE} = 10\ \text{V}$ , Base Open
$h_{FE}$	Forward Current Gain		2000			$V_{CE} = 5.0\ \text{V}$ , $I_C = 500\ \mu\text{A}$

## Electrical Characteristics—Coupled $T_A = 25^\circ\text{C}$

Symbol	Characteristic	Min	Typ	Max	Units	Test Conditions
$I_C^*$	Collector Output Current 4N32, 4N33	50			mA	$V_{CE} = 10\ \text{V}$ , $I_F = 10\ \text{mA}$
	4N29, 4N30	10			mA	$V_{CE} = 10\ \text{V}$ , $I_F = 10\ \text{mA}$
	4N31	5.0			mA	$V_{CE} = 10\ \text{V}$ , $I_F = 10\ \text{mA}$
$V_{ISO}^*$	Isolation Voltage 4N29, 4N32	2500			V	
	4N30, 4N31, 4N33	1500			V	
$R_{ISO}^*$	Isolation Resistance		$10^{11}$		$\Omega$	$V = 500\ \text{V}$
$V_{CE(sat)}^*$	Collector-to-Emitter Saturation Voltage 4N31			1.2	V	$I_C = 2.0\ \text{mA}$ , $I_F = 8.0\ \text{mA}$
	4N29, 4N30, 4N32, 4N33			1.0	V	$I_C = 2.0\ \text{mA}$ , $I_F = 8.0\ \text{mA}$
$C_{ISO}$	Isolation Capacitance		1.5		pF	$V = 0$ , $f = 1.0\ \text{MHz}$
$t_{on}$	Turn-on Time		10		$\mu\text{s}$	$I_C = 50\ \text{mA}$ , $V_{CC} = 10\ \text{V}$ , $R_L = 180\ \Omega$ , $I_F = 200\ \text{mA}$
$t_{off}$	Turn-off Time (See Note) 4N29, 4N30, 4N31		20	45	$\mu\text{s}$	$I_C = 50\ \text{mA}$ , $V_{CC} = 10\ \text{V}$ , $R_L = 180\ \Omega$ , $I_F = 200\ \text{mA}$
	4N32, 4N33		60	120	$\mu\text{s}$	

### Note

Turn-on time is defined as the time for the (base collector) current to rise from 10% to 90% of peak value. Turn-off time is defined as the time required for the current to decrease from 90% to 10% of peak value.

\*Indicates JEDEC Registered Data.

# Optically-Coupled Isolator

Optoelectronic Products

## 4N35 4N36 4N37

### General Description

The 4N35, 4N36 and 4N37 series of optoisolators has a silicon npn Planar phototransistor in close proximity to a GaAs diode. Optical coupling provides a high degree of ac and dc isolation. A capability for continuous operation of the input diode results in a frequency response extending to dc. Connection to the transistor base is also provided for design flexibility. This isolator series is covered under UL component recognition program, reference file E55299.

### Glassolated™

**High Current Transfer Ratio—Minimum 100%  
1500 V to 3500 V Minimum Isolation**  
**Input-to-Output**  
**10<sup>11</sup> Ω Isolation Resistance**  
**Low Coupling Capacitance—Typically 1.0 pF**

### Absolute Maximum Ratings

#### Maximum Temperature and Humidity

Storage Temperature*	-55°C to +150°C
Operating Temperature	-55°C to +100°C
Pin Temperature (Soldering, 10s)*	260°C
Relative Humidity at 85°C*	85%

#### Input Diode

V <sub>R</sub> * Reverse Voltage	6.0 V
I <sub>F</sub> * Forward Current	60 mA
I <sub>pk</sub> * Peak Forward Current at 1 μs pulse width, 300 pps	3.0 A
P <sub>D</sub> * Power Dissipation at T <sub>A</sub> = 25°C	100 mW
Derate Linearly from 25°C	1.33 mW/°C

#### Output Transistor

V <sub>CE</sub> * Collector-to-Emitter Voltage	30 V
V <sub>CB</sub> * Collector-to-Base Voltage	70 V
V <sub>EC</sub> * Emitter-to-Collector Voltage	7.0 V
I <sub>C</sub> * Collector Current	100 mA
P <sub>D</sub> * Power Dissipation at T <sub>A</sub> = 25°C	300 mW
Derate Linearly from 25°C	4.0 mW/°C

\*Indicates JEDEC registered values.

### Package Outline

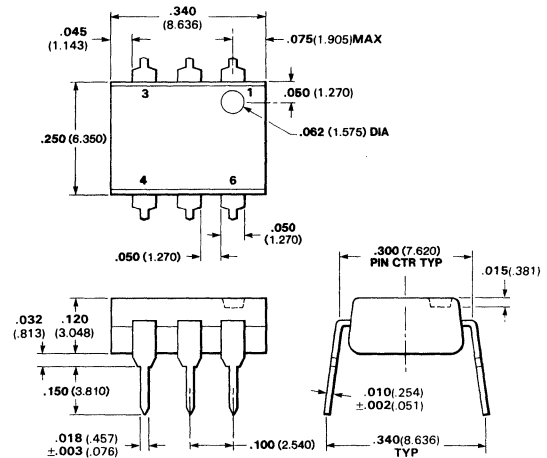

### Notes

All dimension in inches bold and millimeters (parentheses)  
Tolerance unless specified = ±0.15 (0.381)

### Connection Diagram DIP (Top View)

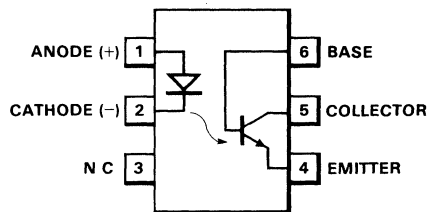

### Pin

1	Anode (+)	} Input Diode
2	Cathode (-)	
3	NC	} Output npn Phototransistor
4	Emitter	
5	Collector	
6	Base	



# Typical Electrical Characteristics

## 4N35 4N36 4N37

### Electrical Characteristics—Input Diode $T_A = 25^\circ\text{C}$

Symbol	Characteristic	Min	Typ	Max	Units	Test Conditions
$V_F^*$	Forward Voltage	0.8		1.5	V	$I_F = 10\text{ mA}$
$I_R^*$	Reverse Leakage Current		0.01	10	$\mu\text{A}$	$V_R = 6.0\text{ V}$
C	Capacitance			100	pF	$V_R = 0\text{ V}$ $f = 1\text{ MHz}$

### Electrical Characteristics—Output Transistor $T_A = 25^\circ\text{C}$

Symbol	Characteristic	Min	Typ	Max	Units	Test Conditions
$V_{CE0}^*$	Collector-to-Emitter Voltage	30	65		V	$I_C = 10\text{ mA}$
$V_{CB0}^*$	Collector-to-Base Voltage	70	165		V	$I_C = 100\text{ }\mu\text{A}$
$V_{EC0}^*$	Emitter-to-Collector Voltage	7.0	14		V	$I_E = 100\text{ }\mu\text{A}$ , $I_F = 0$
$I_{CE0}^*$	Collector-to-Emitter Leakage Current		5.0	50	nA	$V_{CE} = 10\text{ V}$ , $I_F = 0$
$I_{CE0}^*$	Collector-to-Emitter Leakage Current			500	$\mu\text{A}$	$V_{CE} = 30\text{ V}$ , $I_F = 0$ , $T_A = 100^\circ\text{C}$
$h_{FE}$	Forward Current Gain	100	250			$V_{CE} = 5.0\text{ V}$ , $I_C = 100\text{ }\mu\text{A}$
$C_{cb}$	Collector-to-Base Capacitance		25		pF	$V_{CB} = 10\text{ V}$

### Electrical Characteristics—Coupled $T_A = 25^\circ\text{C}$

Symbol	Characteristic	Min	Typ	Max	Units	Test Conditions
$I_{IO}^*$	Input-to-Output Current			100	$\mu\text{A}$	$PW = 8\text{ ms}$ $V_{IO} = 3550\text{ V}$
	4N35			100	$\mu\text{A}$	$V_{IO} = 2500\text{ V}$
	4N36			100	$\mu\text{A}$	$V_{IO} = 1500\text{ V}$
	4N37			100	$\mu\text{A}$	$V_{IO} = 1500\text{ V}$
$V_{CE(sat)}^*$	Collector-to-Emitter Saturation Voltage			0.3	V	$I_C = 0.5\text{ mA}$ , $I_F = 10\text{ mA}$
$I_C/I_F(\text{CTR})^*$	Collector Current Transfer Ratio (Note)	100			%	$V_{CE} = 10\text{ V}$ , $I_F = 10\text{ mA}$
$I_C/I_F(\text{CTR})^*$	Collector Current Transfer Ratio (Note)	40			%	$V_{CE} = 10\text{ V}$ , $I_F = 10\text{ mA}$ , $T_A = -55^\circ\text{C}$ to $100^\circ\text{C}$
$R_{IO}$	Input-to-Output Resistance	$10^{11}$			$\Omega$	$V_{IO} = 500\text{ V}$
$C_{IO}$	Input-to-Output Capacitance		1.0	2.5	pF	$V_{IO} = 0$ , $f = 1.0\text{ MHz}$
$t_{on}$	Turn-on Time		5.0	10	$\mu\text{s}$	$I_C = 2.0\text{ mA}$ , $V_{CC} = 10\text{ V}$ , $R_L = 100\text{ }\Omega$
$t_{off}$	Turn-off Time		5.0	10	$\mu\text{s}$	$I_C = 2.0\text{ mA}$ , $V_{CC} = 10\text{ V}$ , $R_L = 100\text{ }\Omega$

#### Notes

Collector current transfer ratio is defined as the ratio of the collector current to the forward bias input current.

\*Indicates JEDEC registered values.

# LSTTL/TTL Compatible Optocoupler

Optoelectronic Products

## 6N137

### General Description

The 6N137 optocoupler consists of a GaAsP light-emitting diode and an integrated circuit detector. Light is collected in the detector by the photodiode; then, it is amplified by a high-gain linear amplifier that drives a Schottky-clamped, open-collector output transistor. Temperature, current and voltage are compensated in the circuit.

This isolator design achieves LSTTL/TTL circuit compatibility while attaining a maximum dc and ac circuit isolation between input and output. The circuit operates from a 5 V supply, and the output is guaranteed to sink at least 13 mA (eight TTL loads) over the 0°C to 70°C temperature range, when the input LED current is 5 mA. When the device is in the coupling and isolating mode, the typical propagation delay is 45 ns. An LSTTL/TTL-compatible, active-HIGH enable input gates the output with a typical propagation delay of 25 ns.

The 6N137 is applicable for interfacing between subsystems that operate at different ground potentials, signal levels, or in the presence of very high common-mode noise levels. These situations include programmable floating power supplies, motors and other machine control systems.

### LSTTL/TTL Compatible: 5 V Supply

#### Ultra High Speed

#### Low Input Current Required

#### High Common-Mode Rejection

#### Guaranteed Performance Over Temperature

#### 3000 V dc Insulation Voltage

**Absolute Maximum Ratings\*** (No Derating Required Up to 70°C)

### Maximum Temperature

Operating Temperature 0°C to +70°C

Storage Temperature -55°C to +125°C

Pin Temperature (Soldering, 10 s)  
(1.6 mm below seating plane) 260°C

### Maximum Power Dissipation

Output Collector Power

Dissipation 85 mW

### Maximum Voltage and Currents

$V_R$  Reverse Input Voltage 5.0 V

$I_F$  Average Forward Input Current 10 mA

$I_{pk}$  Peak Forward Input Current, 1 ≤ 1 ms duration 40 mA

$V_E$  Enable Input Voltage (Not to exceed  $V_{CC}$  by more than 500 mV) 5.5 V

$V_{CC}$  Supply Voltage (1 minute maximum) 7.0 V

$I_{OUT}$  Output Current 50 mA

$V_{OUT}$  Output Voltage 7.0 V

### Package Outline

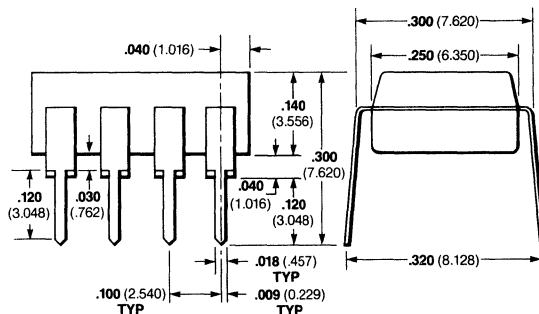
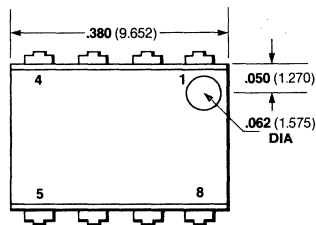

### Notes

All dimensions in inches **bold** and millimeters (parentheses)  
Tolerance unless specified =  $\pm .015$  ( $\pm .381$ )

# Typical Electrical Characteristics

# 6N137

## Recommended Operating Conditions

Symbol	Characteristic	Min	Typ	Max	Units
$I_{IL}$	Input Current, Low Level, Each Channel	0		250	$\mu$ A
$I_{HL}$	Input Current, High Level, Each Channel	6.3		15	mA
$V_{EH}$	High-Level Enable Voltage	2.0		$V_{CC}$	V
$V_{EL}$	Low-Level Enable Voltage (Output HIGH)	0		0.8	V
$V_{CC}$	Supply Voltage, Output	4.5		5.5	V
N	Fan Out (TTL Load)			8.0	
$T_A$	Operating Temperature	0		70	degrees

### Note

6.3 mA condition permits at least 20% CTR degradation guardband. Initial switching threshold is 5 mA or less.

## Electrical Characteristics Over Recommended Temperature $T_A = 0^\circ\text{C}$ to $70^\circ\text{C}$ Unless Otherwise Noted

Symbol	Characteristic	Min	Typ**	Max	Units	Test Conditions
$I_{OH}^*$	High-Level Output Current		50	250	$\mu$ A	$V_{CC} = 5.5$ V, $V_O = 5.5$ V, $I_F = 250$ $\mu$ A, $V_F = 2.0$ V
$V_{OL}^*$	Low-Level Output Voltage		0.5	0.6	V	$V_{CC} = 5.5$ V, $I_F = 5$ mA, $V_{EH} = 2.0$ V, $I_{OL}$ (Sinking) = 13 mA
$I_{EH}$	High-Level Enable Current		-1.0		mA	$V_{CC} = 5.5$ V, $V_E = 2.0$ V
$I_{EL}^*$	Low-Level Enable Current		-1.6	-2.0	mA	$V_{CC} = 5.5$ V, $V_E = 0.5$ V
$I_{CCH}^*$	High-Level Supply Current		7.0	15	mA	$V_{CC} = 5.5$ V, $I_F = 0$ , $V_E = 0.5$ V
$I_{CCL}^*$	Low-Level Supply		13	18	mA	$V_{CC} = 5.5$ V, $I_F = 10$ mA, $V_E = 0.5$ V
$I_{IO}^*$	Input-Output Insulation Leakage Current			1.0	$\mu$ A	Relative Humidity = 45%, $T_A = 25^\circ\text{C}$ , $t = 5$ s
$R_{IO}$	Resistance (Input-Output)		$10^{12}$		$\Omega$	$V_{IO} = 3000$ V, $V_{IO} = 500$ V, $T_A = 25^\circ\text{C}$
$C_{IO}$	Capacitance (Input-Output)		0.6		pF	$f = 1$ MHz, $T_A = 25^\circ\text{C}$
$V_F$	Input Forward Voltage		1.5	1.75	V	$I_F = 10$ mA, $T_A = 25^\circ\text{C}$
$BV_R^*$	Input Reverse Breakdown Voltage	5.0			V	$I_R = 10$ $\mu$ A, $T_A = 25^\circ\text{C}$
$C_{IN}$	Input Capacitance		60		pF	$V_F = 0$ , $f = 1$ MHz
CTR	Current Transfer Ratio		700		%	$I_F = 5.0$ mA, $R_L = 100$ $\Omega$

\*JEDEC Registered Data

\*\*All typical values are at  $V_{CC} = 5$  V,  $T_A = 25^\circ\text{C}$ .

# Typical Electrical Characteristics (Cont'd) Connection Diagram

6N137

Switching Characteristics  $T_A = 25^\circ\text{C}$ ,  $V_{CC} = 5\text{ V}$ 

Symbol	Characteristic	Min	Typ	Max	Units	Test Conditions
$t_{PLH}^*$	Propagation Delay Time to High Output Level		45	75	ns	$R_L = 350\ \Omega$ , $C_L = 15\ \text{pF}$ , $I_F = 7.5\ \text{mA}$
$t_{PHL}^*$	Propagation Delay Time to Low Output Level		45	75	ns	$R_L = 350\ \Omega$ , $C_L = 15\ \text{pF}$ , $I_F = 7.5\ \text{mA}$
$t_r, t_f$	Output Rise-Fall Time (10-90%)		25		ns	$R_L = 350\ \Omega$ , $C_L = 15\ \text{pF}$ , $I_F = 7.5\ \text{mA}$
$t_{ELH}$	Propagation Delay Time of Enable from $V_{EH}$ to $V_{EL}$		25		ns	$R_L = 350\ \Omega$ , $C_L = 15\ \text{pF}$ , $I_F = 7.5\ \text{mA}$ , $V_{EH} = 3.0\ \text{V}$ , $V_{EL} = 0.5\ \text{V}$
$t_{EHL}$	Propagation Delay Time of Enable from $V_{EL}$ to $V_{EH}$		15		ns	$R_L = 350\ \Omega$ , $C_L = 15\ \text{pF}$ , $I_F = 7.5\ \text{mA}$ , $V_{EH} = 3.0\ \text{V}$ , $V_{EL} = 0.5\ \text{V}$
$CM_H$	Common-Mode Transient Immunity at Logic HIGH Output Level		50		$\text{V}/\mu\text{s}$	$V_{CM} = 10\ \text{V}$ , $R_L = 350\ \Omega$ , $V_{O(\text{min})} = 2\ \text{V}$ , $I_F = 0\ \text{mA}$
$CM_L$	Common-Mode Transient Immunity at Logic LOW Output Level		-150		$\text{V}/\mu\text{s}$	$V_{CM} = 10\ \text{V}$ , $R_L = 350\ \Omega$ , $V_{O(\text{max})} = 0.8\ \text{V}$ , $I_F = 5\ \text{mA}$

5

\*JEDEC Registered Data

## Connection Diagram

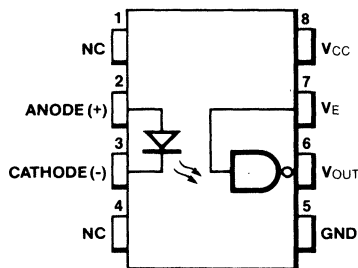

## Pin

1	NC
2	Anode (+)
3	Cathode (-)
4	NC
5	Ground
6	$V_{OUT}$
7	$V_E$
8	$V_{CC}$

# AC Test Circuits and Waveforms

# 6N137

## Test Circuit for $t_{PHL}$ and $t_{PLH}$

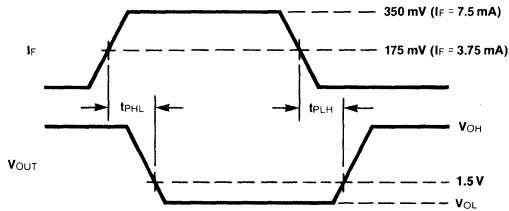
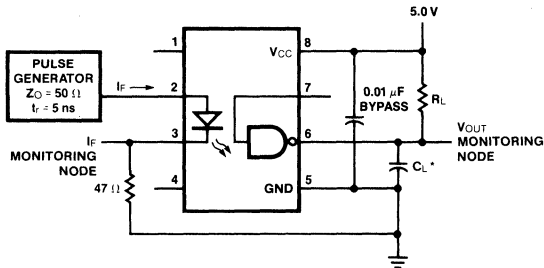

## Test Circuit for $t_{ELH}$ and $t_{EHL}$

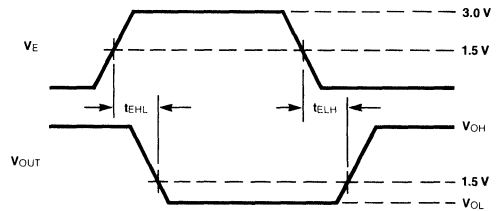
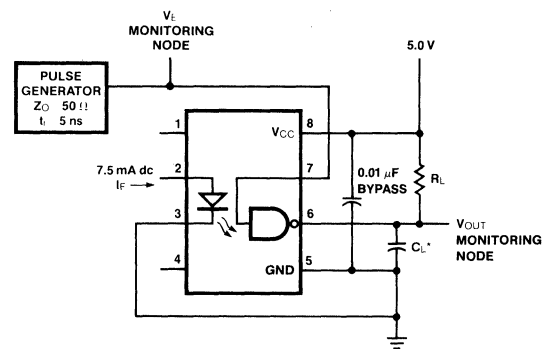

**Note**  
\* $C_L$  is approximately 15 pF, which includes probe and stray wiring capacitance.

## Response Delay Between TTL Gates

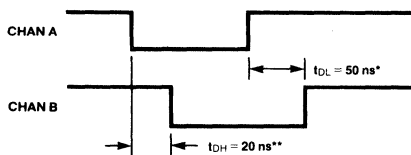
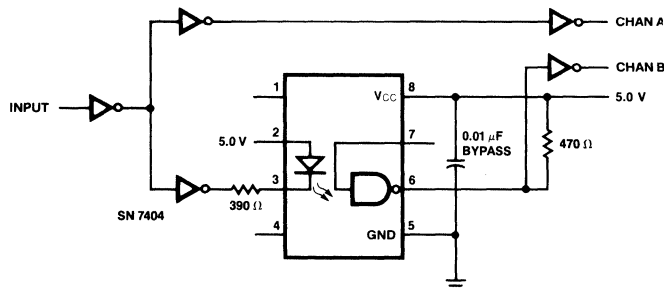

**Notes**  
\*Delay in response to logic HIGH level input  
\*\*Delay in response to logic LOW level input

# AC Test Circuits and Waveforms

## 6N137

### Test Circuit for Transient Immunity and Typical Waveforms

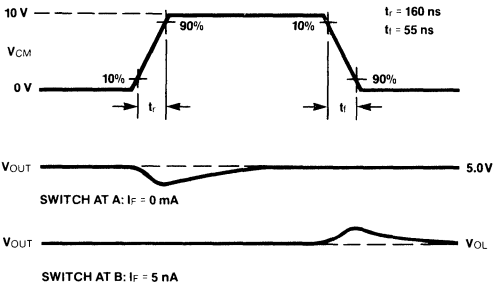
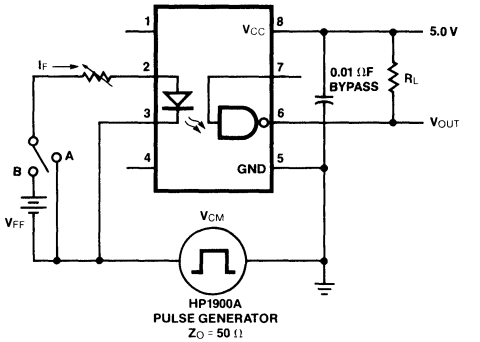

### Equivalent Circuit

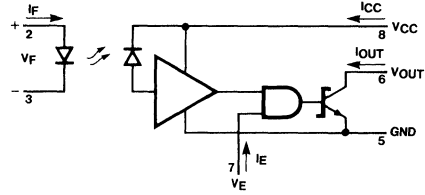

#### Notes

- Delay in response to logic HIGH level input
- Delay in response to logic LOW level input



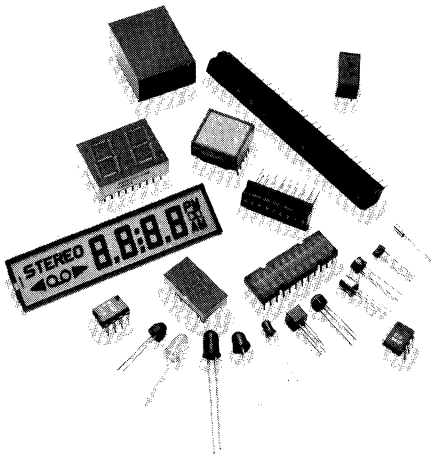

Selection Guides	1
Visible LED Lamps and Mounting Hardware	2
LED Digits	3
Phototransistors, Infrared Emitters and Sensors	4
Couplers	5
Liquid Crystal Displays	6
Fiber Optics	7
Cross Reference	8
Definitions of Symbols and Terms	9
Fairchild Field Sales Offices, Sales Representatives and Distributor Locations	10





# 12-Digit Telephone-Calculator Display

Optoelectronic Products

## FLB1208X1

### General Description

The FLB1208X1 is a non-multiplexed liquid crystal display that is hermetically sealed with glass frit. It interfaces with elastomeric connectors, is available in four polarizer options and operates at the standard temperature range of  $-20^{\circ}\text{C}$  to  $+60^{\circ}\text{C}$ . Applications include telephone, calculator and general instrumentation requiring multiple digits.

**0.3-Inch Digits (7.6 mm)**

**12 Decimal Points**

**Four Polarizer Options**

**Glass-Frit Seal for High Reliability**

**Electrical Characteristics** Measured at  $25^{\circ}\text{C}$  with drive voltage of 5.0 V, square wave at 32 Hz.

Characteristic	Min	Typ	Max	Units
Operating Voltage	2.8	5.0	12.0	$V_{\text{RMS}}$
Saturation Voltage	2.0	2.2	2.4	$V_{\text{RMS}}$
Operating Frequency Range	30	32	1000	Hz
Drive Current at 3.0 V, All Segments On			10	$\mu\text{A}$
Contrast Ratio		20:1		
Response Times: $t_{\text{on}}$ (Includes Delay Time)		70	150	ms
$t_{\text{off}}$ (Includes Delay Time)		100	150	ms
Operating Temperature Range (Note)	$-20$		60	$^{\circ}\text{C}$
Storage Temperature Range	$-20$		80	$^{\circ}\text{C}$
Humidity	50/60			$^{\circ}\text{C}/\text{RH}$
Life Time		50k		hrs
DC Drive Component Allowable			50	mV

6

**Note**  
Display may be operated beyond these limits for short periods of time. Extended periods of operation at high temperatures and humidities cause polarizer degradation resulting in reduced contrast. Higher operating temperature is available. Contact factory.

### Voltage Characteristics

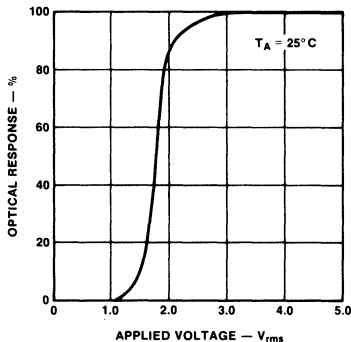

### Response Time

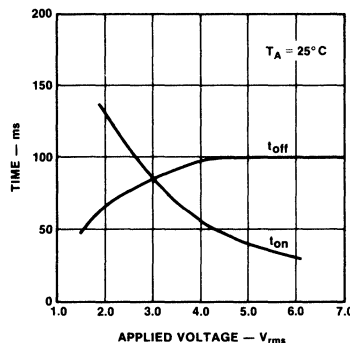

# Package Outline Pin Assignments

## FLB1208X1

### Package Outline

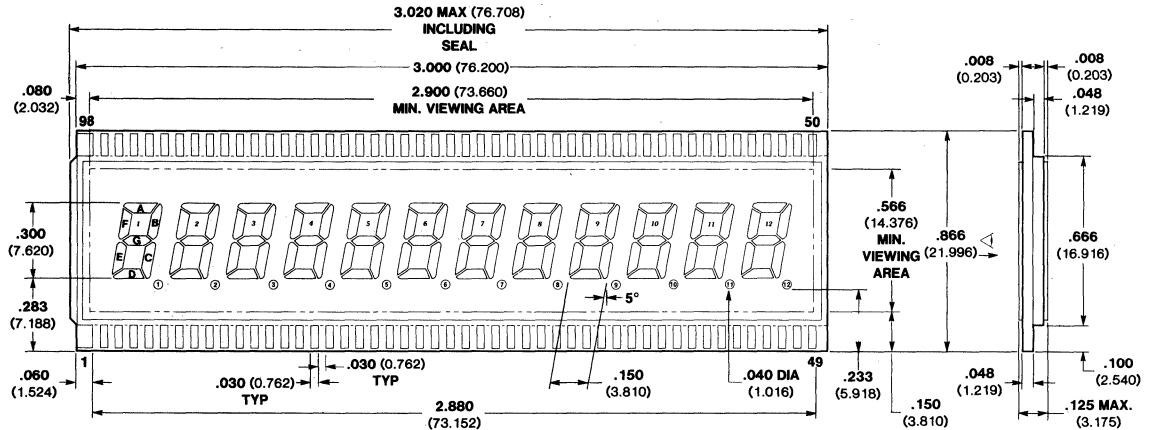

### Notes

- Front and rear polarizers are same size.
- All dimensions in inches **bold** and millimeters (parentheses).
- Solder seal shall not exceed backglass width.

### Pin Assignments

1 Backplane	21 Decimal Point 5	41 Decimal Point 10	61 Segment G <sub>10</sub>	81 Segment G <sub>5</sub>
2 Segment E <sub>1</sub>	22 Segment E <sub>6</sub>	42 Segment E <sub>11</sub>	62 Segment B <sub>9</sub>	82 Segment B <sub>4</sub>
3 Segment D <sub>1</sub>	23 Segment D <sub>6</sub>	43 Segment D <sub>11</sub>	63 Segment A <sub>9</sub>	83 Segment A <sub>4</sub>
4 Segment C <sub>1</sub>	24 Segment C <sub>6</sub>	44 Segment C <sub>11</sub>	64 Segment F <sub>9</sub>	84 Segment F <sub>4</sub>
5 Decimal Point 1	25 Decimal Point 6	45 Decimal Point 11	65 Segment G <sub>9</sub>	85 Segment G <sub>4</sub>
6 Segment E <sub>2</sub>	26 Segment E <sub>7</sub>	46 Segment E <sub>12</sub>	66 Segment B <sub>8</sub>	86 Segment B <sub>3</sub>
7 Segment D <sub>2</sub>	27 Segment D <sub>7</sub>	47 Segment D <sub>12</sub>	67 Segment A <sub>8</sub>	87 Segment A <sub>3</sub>
8 Segment C <sub>2</sub>	28 Segment C <sub>7</sub>	48 Segment C <sub>12</sub>	68 Segment F <sub>8</sub>	88 Segment F <sub>3</sub>
9 Decimal Point 2	29 Decimal Point 7	49 Decimal Point 12	69 Segment G <sub>8</sub>	89 Segment G <sub>3</sub>
10 Segment E <sub>3</sub>	30 Segment E <sub>8</sub>	50 Segment B <sub>12</sub>	70 Segment B <sub>7</sub>	90 Segment B <sub>2</sub>
11 Segment D <sub>3</sub>	31 Segment D <sub>8</sub>	51 Segment A <sub>12</sub>	71 Segment A <sub>7</sub>	91 Segment A <sub>2</sub>
12 Segment C <sub>3</sub>	32 Segment C <sub>8</sub>	52 Segment F <sub>12</sub>	72 Segment F <sub>7</sub>	92 Segment F <sub>2</sub>
13 Decimal Point 3	33 Decimal Point 8	53 Segment G <sub>12</sub>	73 Segment G <sub>7</sub>	93 Segment G <sub>2</sub>
14 Segment E <sub>4</sub>	34 Segment E <sub>9</sub>	54 Segment B <sub>11</sub>	74 Segment B <sub>6</sub>	94 Segment B <sub>1</sub>
15 Segment D <sub>4</sub>	35 Segment D <sub>9</sub>	55 Segment A <sub>11</sub>	75 Segment A <sub>6</sub>	95 Segment A <sub>1</sub>
16 Segment C <sub>4</sub>	36 Segment C <sub>9</sub>	56 Segment F <sub>11</sub>	76 Segment F <sub>6</sub>	96 Segment F <sub>1</sub>
17 Decimal Point 4	37 Decimal Point 9	57 Segment G <sub>11</sub>	77 Segment G <sub>6</sub>	97 Segment G <sub>1</sub>
18 Segment E <sub>5</sub>	38 Segment E <sub>10</sub>	58 Segment B <sub>10</sub>	78 Segment B <sub>5</sub>	98 Backplane
19 Segment D <sub>5</sub>	39 Segment D <sub>10</sub>	59 Segment A <sub>10</sub>	79 Segment A <sub>5</sub>	
20 Segment C <sub>5</sub>	40 Segment C <sub>10</sub>	60 Segment F <sub>10</sub>	80 Segment F <sub>5</sub>	

---

**Ordering Information****FLB1208X1**

---

**Ordering Information**

<b>Device Type</b>	<b>Polarizer Option</b>
FLB1208A1	Non-Polarized
FLB1208B1	Transflective
FLB1208C1	Reflective (smooth)
FLB1208D1	Transmissive

**Connectors**

Display interfaces with elastomeric connectors.  
See page 6-42 for elastomeric connector suppliers.

**Drivers**

See page 6-43 for available drivers.

# 3½-Digit Clock and Instrument Display

Optoelectronic Products

# FLB3511X1

## General Description

The FLB3511X1 is a liquid crystal display that is hermetically sealed with glass frit. It interfaces with elastomeric connectors, is available in four polarizer options and operates at the standard temperature range of  $-20^{\circ}\text{C}$  to  $+60^{\circ}\text{C}$ . Applications include clock, digital panel meter and general instrumentation.

## 0.45-Inch Digits (11.4 mm)

### Colon for Timekeeping

### Polarity and Decimal Points for DPMs

### Four Polarizer Options

### Glass-Frit Seal for High Reliability

**Electrical Characteristics** Measured at  $25^{\circ}\text{C}$  with drive voltage of 5.0 V, square wave at 32 Hz.

Characteristic	Min	Typ	Max	Units
Operating Voltage	2.8	5.0	12.0	$V_{\text{RMS}}$
Saturation Voltage	2.0	2.2	2.4	$V_{\text{RMS}}$
Operating Frequency Range	30	32	1000	Hz
Drive Current at 3.0 V, All Segments On			5	$\mu\text{A}$
Segment Capacitance			100	pF
Contrast Ratio		20:1		
Response Times: $t_{\text{on}}$ (Includes Delay Time)		70	150	ms
$t_{\text{off}}$ (Includes Delay Time)		100	150	ms
Operating Temperature Range (Note)	$-20$		60	$^{\circ}\text{C}$
Storage Temperature Range	$-20$		80	$^{\circ}\text{C}$
Humidity	50/60			$^{\circ}\text{C}/\text{RH}$
Life Time		50k		hrs
DC Drive Component Allowable			50	mV

## Note

Display may be operated beyond these limits for short periods of time. Extended periods of operation at high temperatures and humidities cause polarizer degradation resulting in reduced contrast. Higher operating temperature is available. Consult factory.

## Voltage Characteristics

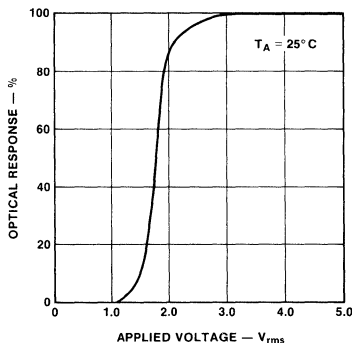

## Response Time

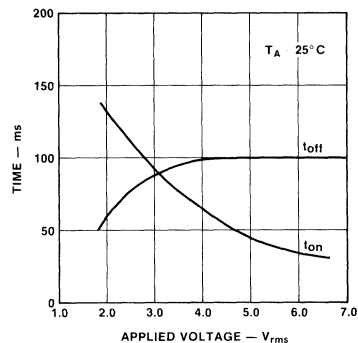



---

# Ordering Information

# FLB3511X1

---

## Ordering Information

**Device Type**

FLB3511A1

FLB3511B1

FLB3511C1

FLB3511D1

**Polarizer Option**

Non-Polarized

Transflective

Reflective (smooth)

Transmissive

**Connectors**

Display interfaces with elastomeric connectors.

See page 6-42 for elastomeric connector suppliers.

**Drivers**

See page 6-43 for available drivers.

# 3½-Digit Clock and Instrument Display

Optoelectronic Products

# FLB3513X1 FLB3513X2

## General Description

The FLB3513X1 and FLB3513X2 are liquid crystal displays that are hermetically sealed with glass frit. They are available in pinned or elastomeric connector configurations, offer four polarizer options and operate at the standard temperature range of  $-20^{\circ}\text{C}$  to  $+60^{\circ}\text{C}$ . Applications include clock, digital panel meter and general instrumentation.

## 0.5-Inch Digits (13 mm)

## Decimal Points for DPMS

## Colon for Timekeeping

## Four Polarizer Options

## Glass-Frit Seal for High Reliability

**Electrical Characteristics** Measured at  $25^{\circ}\text{C}$  with drive voltage of 5.0 V, square wave at 32 Hz.

Characteristic	Min	Typ	Max	Units
Operating Voltage	2.8	5.0	12	V
Saturation Voltage	2.0	2.2	2.4	V
Operating Frequency Range	30	32	1000	Hz
Drive Current at 3.0 V, All Segments On			5.0	$\mu\text{A}$
Viewing Angle		45		degrees
Contrast Ratio		20:1		
Response Times: $t_{\text{on}}$ (Includes Delay Time)		70	150	ms
$t_{\text{off}}$ (Includes Delay Time)		100	150	ms
Operating Temperature Range (Note)	$-20$		60	$^{\circ}\text{C}$
Storage Temperature Range	$-20$		80	$^{\circ}\text{C}$
Humidity	50/60			$^{\circ}\text{C}/\text{RH}$
Life Time		50K		hrs

## Note

Higher operating temperature is available. Consult the factory for details.

## Voltage Characteristics

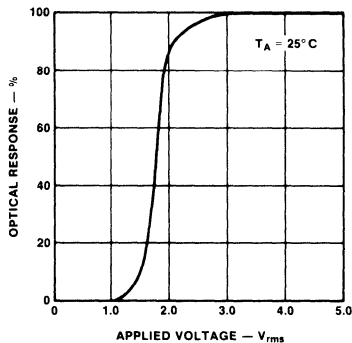

## Response Time

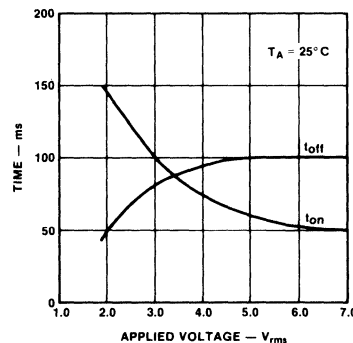





# Pin Assignments Ordering Information

# FLB35 13X1 FLB35 13X2

## FLB35 13X2 (Pin connection)

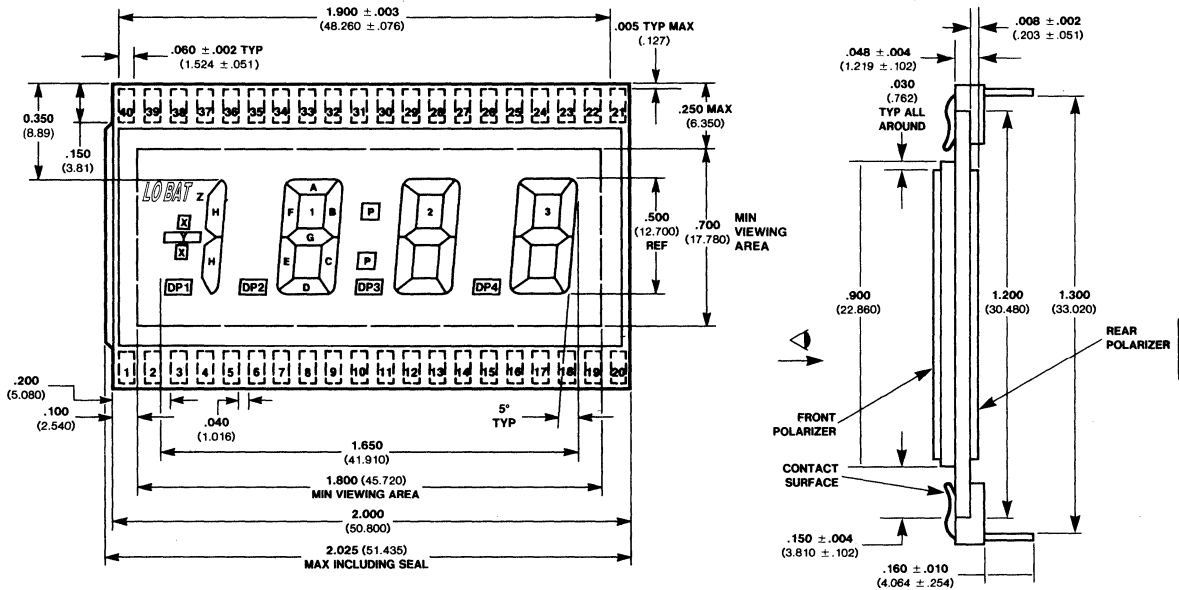

### Notes

All dimensions in inches bold and millimeters (parentheses)

## Ordering Information

### Elastomeric

Connector Configuration	Connector Pins	Polarizer Option
FLB35 13A1	FLB35 13A2	Non-polarized
FLB35 13B1	FLB35 13B2	Transflective
FLB35 13C1	FLB35 13C2	Reflective (smooth)
FLB35 13D1	FLB35 13D2	Transmissive

### Connectors

Display is available in pinned or elastomeric configuration.

See page 6-42 for elastomeric connector suppliers.

### Drivers

See page 6-43 for available drivers.

# 3½-Digit Clock and Instrument Display

Optoelectronic Products

# FLB3513X3 FLB3513X4

## General Description

The FLB3513X3 and FLB3513X4 are liquid crystal displays that are hermetically sealed with glass frit. They are available in pinned or elastomeric connector configurations, offer four polarizer options and operate at the standard temperature range of  $-20^{\circ}\text{C}$  to  $+60^{\circ}\text{C}$ . Applications include clock, digital panel meter and general instrumentation.

**0.5-Inch Digits (13 mm)**  
**Decimal Points for DPMs**  
**Colon for Timekeeping**  
**Four Polarizer Options**  
**Glass-Frit Seal for High Reliability**

**Electrical Characteristics** Measured at  $25^{\circ}\text{C}$  with drive voltage of 5.0 V, square wave at 32 Hz.

Characteristic	Min	Typ	Max	Units
Operating Voltage	2.8	5.0	12	V
Saturation Voltage	2.0	2.2	2.4	V
Operating Frequency Range	30	32	1000	Hz
Drive Current at 3.0 V, All Segments On			5.0	$\mu\text{A}$
Viewing Angle		45		degrees
Contrast Ratio		20:1		
Response Times: $t_{\text{on}}$ (Includes Delay Time)		70	150	ms
$t_{\text{off}}$ (Includes Delay Time)		100	150	ms
Operating Temperature Range (Note)	$-20$		60	$^{\circ}\text{C}$
Storage Temperature Range	$-20$		80	$^{\circ}\text{C}$
Humidity	50/60			$^{\circ}\text{C}/\text{RH}$
Life Time		50k		hrs

## Note

Higher operating temperature is available. Consult the factory for details.

## Voltage Characteristics

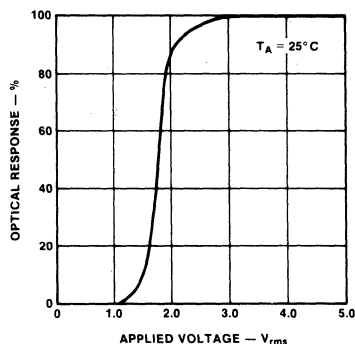

## Response Time

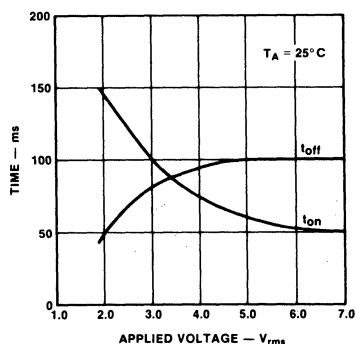

# Package Outline

# FLB35 13X3 FLB35 13X4

## FLB3513X3 Elastomer Connection

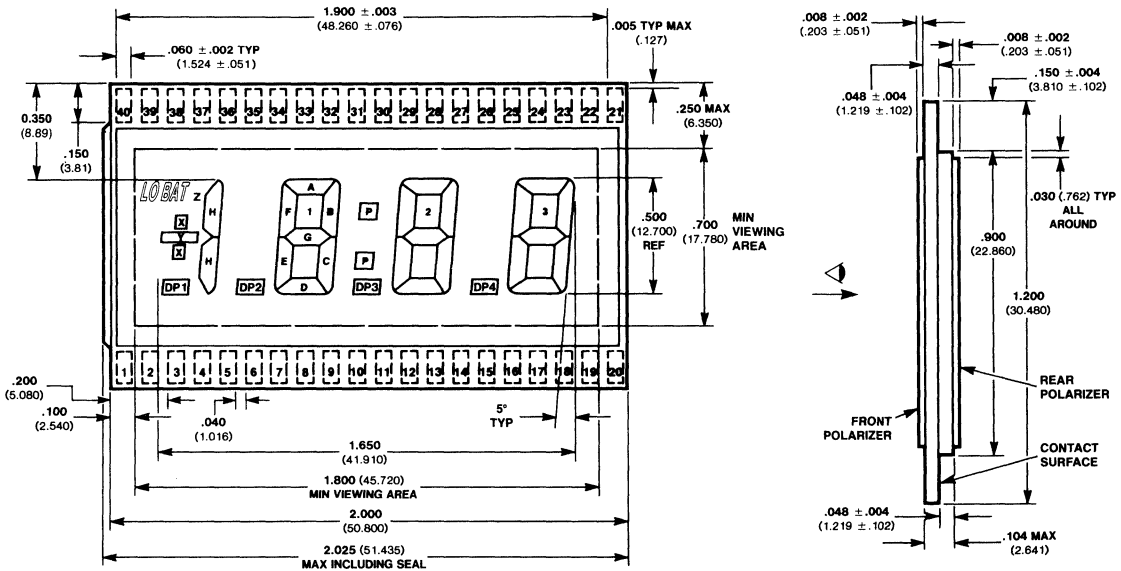

**Note**  
All dimensions in inches bold and millimeters (parentheses)

### Pin Assignments

1 Backplane	9 Segment E <sub>1</sub>	17 Segment E <sub>3</sub>	25 Segment A <sub>2</sub>	33 NC
2 Y	10 Segment D <sub>1</sub>	18 Segment D <sub>3</sub>	26 Segment F <sub>2</sub>	34 NC
3 H	11 Segment C <sub>1</sub>	19 Segment C <sub>3</sub>	27 Segment G <sub>2</sub>	35 NC
4 Decimal Point 1	12 Decimal Point 3	20 Segment B <sub>3</sub>	28 Segment P	36 NC
5 NC	13 Segment E <sub>2</sub>	21 Segment A <sub>3</sub>	29 Segment B <sub>1</sub>	37 NC
6 NC	14 Segment D <sub>2</sub>	22 Segment F <sub>3</sub>	30 Segment A <sub>1</sub>	38 Z
7 NC	15 Segment C <sub>2</sub>	23 Segment G <sub>3</sub>	31 Segment F <sub>1</sub>	39 X
8 Decimal Point 2	16 Decimal Point 4	24 Segment B <sub>2</sub>	32 Segment G <sub>1</sub>	40 NC

### Ordering Information

#### Elastomeric Connector Configuration

FLB35 13A3  
FLB35 13B3  
FLB35 13C3

FLB35 13D3

#### Connector Pins

FLB35 13A4  
FLB35 13B4  
FLB35 13C4

FLB35 13D4

#### Polarizer Option

Non-Polarized  
Transflective  
Reflective (smooth)  
Transmissive

### Connectors

Display is available in pinned or elastomeric configuration.

See page 6-42 for elastomeric connector suppliers.

### Drivers

See page 6-43 for available drivers.

# Pin Assignments Ordering Information

# FLB3513X3 FLB3513X4

## FLB3513X4 (Pin Connection)

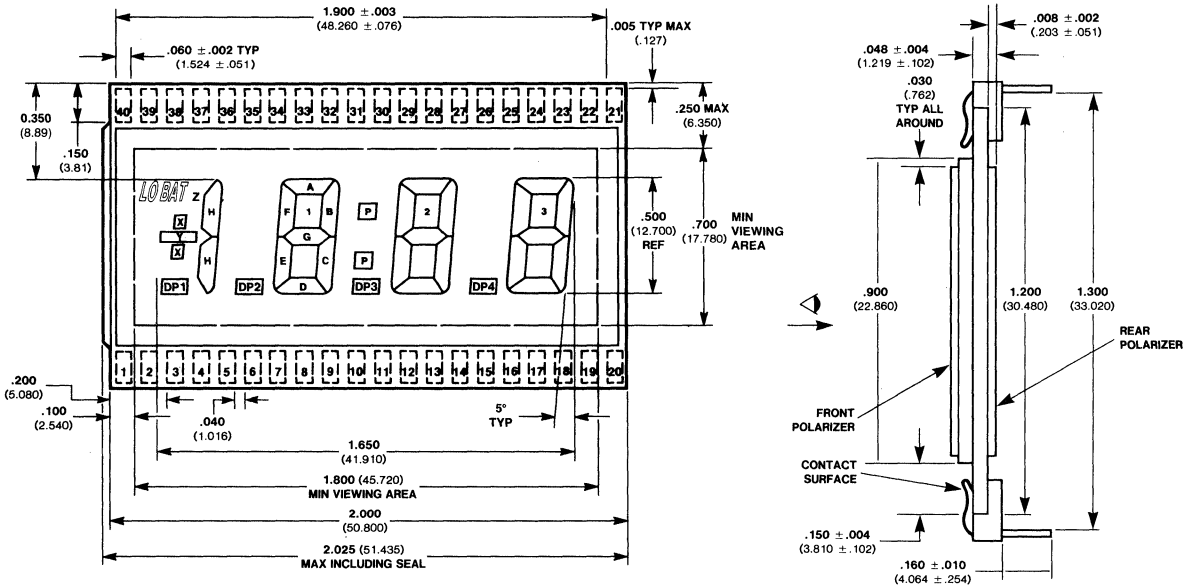

# 4-Digit Tape-Stereo- Radio-Clock Display

Optoelectronic Products

## FLB4010X1

### General Description

The FLB4010X1 is a liquid crystal display that is hermetically sealed with glass frit. It interfaces with elastomeric connectors, is available in four polarizer options and operates at the standard temperature range of  $-20^{\circ}\text{C}$  to  $+60^{\circ}\text{C}$ . The FLB4010X1 is intended for auto radio/stereo cassette player applications.

### 0.4-Inch Digits (10 mm)

### Decimal Points

### Colons for Time Display

### Digital Readout for Frequency and Time Display

### AM-PM Time Indicators

### Dolby™ Symbol (Note 1)

### AM-FM Radio Mode Indicators

### Stereo Mode Indicator

### Tape Mode Indicator

### Forward-Reverse Tape Direction Indicator

### Glass-Frit Seal for High Reliability

**Electrical Characteristics** Measured at  $25^{\circ}\text{C}$  with drive voltage of 5.0 V, square wave at 32 Hz.

Characteristic	Min	Typ	Max	Units
Operating Voltage	2.8	5.0	12.0	$V_{\text{rms}}$
Saturation Voltage	2.0	2.2	2.4	$V_{\text{rms}}$
Operating Frequency Range	30	32	1000	Hz
Drive Current at 3.0 V, All Segments On			100	$\mu\text{A}$
Segment Capacitance			3.0	pF
Contrast Ratio		20:1		
Response Times: $t_{\text{on}}$ (Includes Delay Time)		70	150	ms
$t_{\text{off}}$ (Includes Delay Time)		100	150	ms
Operating Temperature Range (Note)	$-20$		60	$^{\circ}\text{C}$
Storage Temperature Range	$-20$		80	$^{\circ}\text{C}$
Humidity	50/60			$^{\circ}\text{C}/\text{RH}$
Life Time		50k		hrs
DC Drive Component Allowable			50	mV

### Note

Display may be operated beyond these limits for short periods of time. Extended periods of operation at high temperatures and humidities cause polarizer degradation resulting in reduced contrast. Higher operating temperature is available. Contact factory.

### Voltage Characteristics

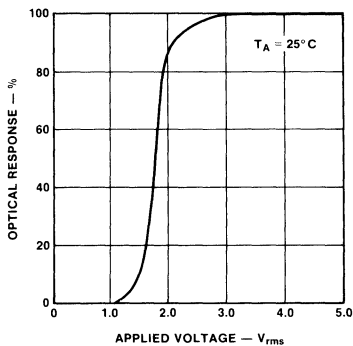

### Response Time

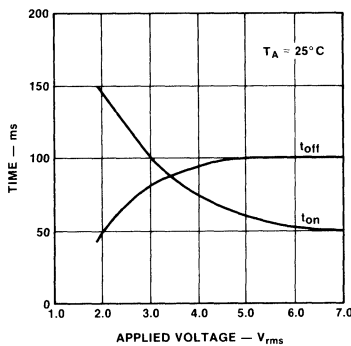

# Package Outline Pin Assignments

## FLB4010X1

### Package Outline

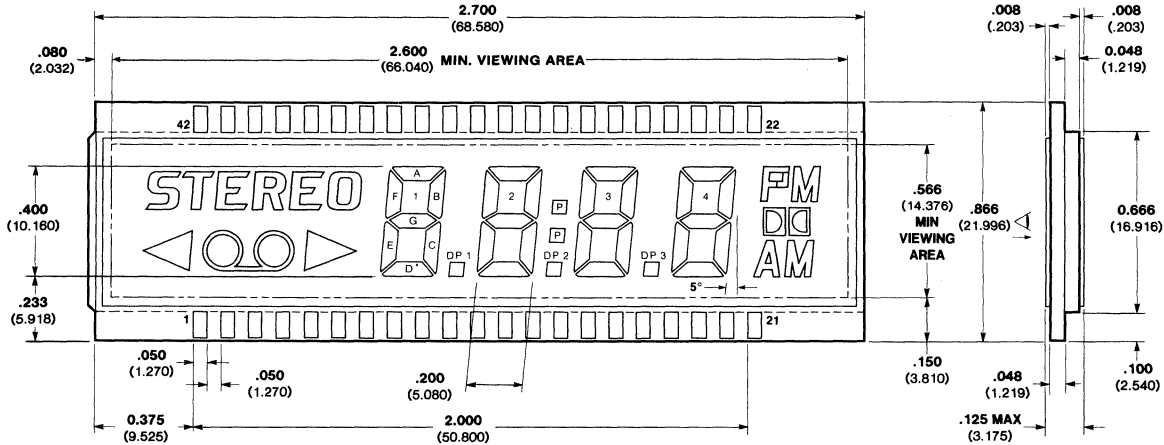

#### Notes

Dolby and the double-D symbol are trademarks of Dolby Laboratories. Permission for their use must be obtained from Dolby Laboratories.

All polarizers are the same size.

All dimensions in inches **bold** and millimeters (parentheses).

Decimal Points and colons (P) are the same width as segment widths.

Seal shall not exceed width of back glass.

### Pin Assignments

1 Backplane	10 Segment D <sub>2</sub>	19 Segment C <sub>4</sub>	28 Segment G <sub>4</sub>	37 Segment G <sub>2</sub>
2 ◁	11 Segment C <sub>2</sub>	20 AM	29 Segment B <sub>3</sub>	38 Segment B <sub>1</sub>
3 ○○	12 Decimal Point 2	21 NC	30 Segment A <sub>3</sub>	39 Segment A <sub>1</sub>
4 ▷	13 Segment E <sub>2</sub>	22 PM	31 Segment F <sub>3</sub>	40 Segment F <sub>1</sub>
5 Segment E <sub>1</sub>	14 Segment D <sub>3</sub>	23 FM	32 Segment G <sub>3</sub>	41 Segment G <sub>1</sub>
6 Segment D <sub>1</sub>	15 Segment C <sub>3</sub>	24 Dolby	33 Colon P	42 Stereo
7 Segment C <sub>1</sub>	16 Decimal Point 3	25 Segment B <sub>4</sub>	34 Segment B <sub>2</sub>	
8 Decimal Point 1	17 Segment E <sub>4</sub>	26 Segment A <sub>4</sub>	35 Segment A <sub>2</sub>	
9 Segment E <sub>2</sub>	18 Segment D <sub>4</sub>	27 Segment F <sub>4</sub>	36 Segment F <sub>2</sub>	

### Ordering Information

#### Device Type

FLB4010A1  
FLB4010B1  
FLB4010C1  
FLB4010D1

#### Polarizer Option

Non-Polarized  
Transflective  
Reflective (smooth)  
Transmissive

### Connectors

Display interfaces with elastomeric connectors.  
See page 6-42 for elastomeric connector suppliers.

### Drivers

See page 6-43 for available drivers.

# 4-Digit Large-Area Clock / DPM Display

Optoelectronic Products

# FLB4013X1 FLB4013X2

## General Description

The FLB4013X1 and FLB4013X2 are liquid crystal displays that are hermetically sealed with glass frit. They are available in pinned or elastomeric connector configurations, offer four polarizer options and operate at the standard temperature range of  $-20^{\circ}\text{C}$  to  $+60^{\circ}\text{C}$ . Applications include clock, digital panel meter and general instrumentation.

## 0.5-Inch Digits (13 mm)

## Decimal Points for DPMs

## Color for Timekeeping

## Four Polarizer Options

## Glass-Frit Seal for High Reliability

**Electrical Characteristics** Measured at  $25^{\circ}\text{C}$  with drive voltage of 5.0 V, square wave at 32 Hz.

Characteristic	Min	Typ	Max	Units
Operating Voltage	2.8	5.0	12	V
Saturation Voltage	2.0	2.2	2.4	V
Operating Frequency Range	30	32	1000	Hz
Drive Current at 3.0 V, All Segments On			5.0	$\mu\text{A}$
Viewing Angle		45		degrees
Contrast Ratio		20:1		
Response Times: $t_{\text{on}}$ (Includes Delay Time)		70	150	ms
$t_{\text{off}}$ (Includes Delay Time)		100	150	ms
Operating Temperature Range (Note)	$-20$		60	$^{\circ}\text{C}$
Storage Temperature Range	$-20$		80	$^{\circ}\text{C}$
Humidity	50/60			$^{\circ}\text{C}/\text{RH}$
Life Time		50k		hrs

## Note

Higher operating temperature is available. Consult the factory for details.

## Voltage Characteristics

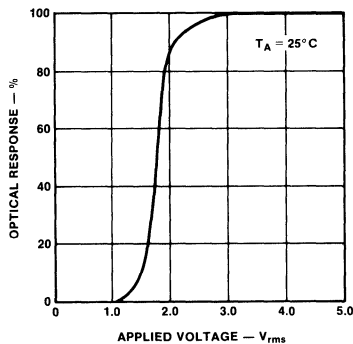

## Response Time

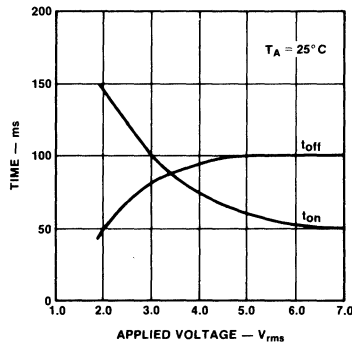



# Package Outline Pin Assignments

# FLB4013X1 FLB4013X2

## FLB4013X1 (Elastomer Connection)

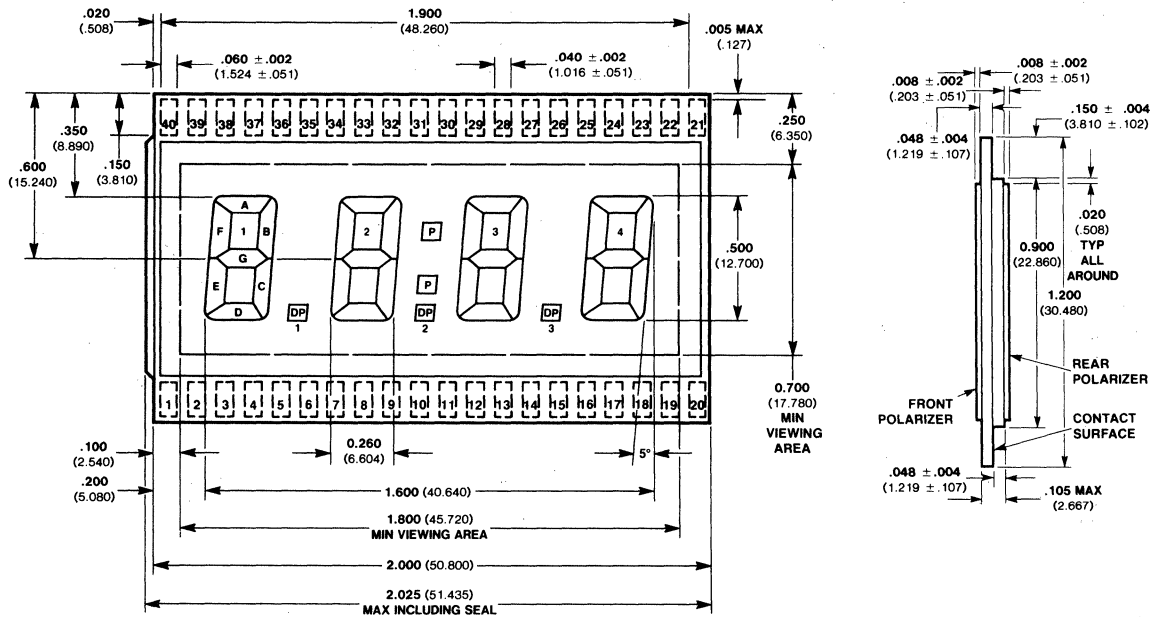

### Note

All dimensions in inches **bold** and millimeters (parentheses).

### Pin Assignments

1 Backplane BP	9 Segment E <sub>2</sub>	17 Segment E <sub>4</sub>	25 Segment A <sub>3</sub>	33 NC
2 NC	10 Segment D <sub>2</sub>	18 Segment D <sub>4</sub>	26 Segment F <sub>3</sub>	34 Segment B <sub>1</sub>
3 NC	11 Segment C <sub>2</sub>	19 Segment C <sub>4</sub>	27 Segment G <sub>3</sub>	35 Segment A <sub>1</sub>
4 NC	12 Decimal Point 2	20 Segment B <sub>4</sub>	28 Colon P	36 Segment F <sub>1</sub>
5 Segment E <sub>1</sub>	13 Segment E <sub>3</sub>	21 Segment A <sub>4</sub>	29 Segment B <sub>2</sub>	37 Segment G <sub>1</sub>
6 Segment D <sub>1</sub>	14 Segment D <sub>3</sub>	22 Segment F <sub>4</sub>	30 Segment A <sub>2</sub>	38 NC
7 Segment C <sub>1</sub>	15 Segment C <sub>3</sub>	23 Segment G <sub>4</sub>	31 Segment F <sub>2</sub>	39 NC
8 Decimal Point 1	16 Decimal Point 3	24 Segment B <sub>3</sub>	32 Segment G <sub>2</sub>	40 NC

# Pin Assignments (Cont'd) Ordering Information

## FLB4013X1 FLB4013X2

### FLB4013X2 (Pin Connection)

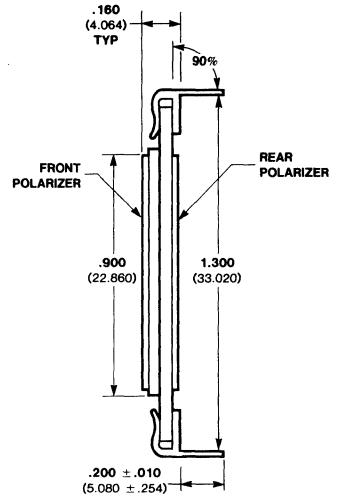
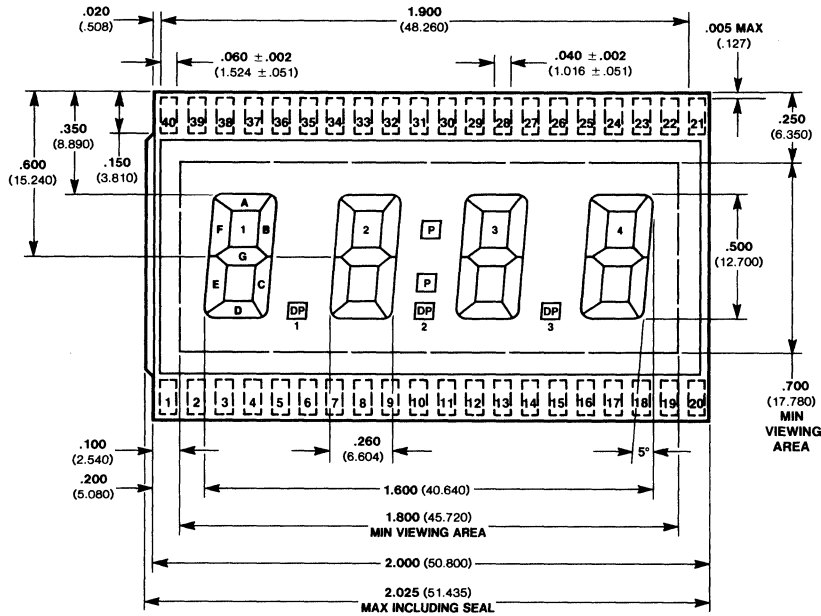

#### Note

All dimensions in inches **bold** and millimeters (parentheses).

### Ordering Information

Elastomeric Connector Configuration	Connector Pins	Polarizer Option
FLB4013A1	FLB4013A2	Non-polarized
FLB4013B1	FLB4013B2	Transflective
FLB4013C1	FLB4013C2	Reflective (smooth)
FLB4013D1	FLB4013D2	Transmissive

#### Connectors

Display is available in pinned or elastomeric configuration.

See page 6-42 for elastomeric connector suppliers.

#### Drivers

See page 6-43 for available drivers.

# 4-Digit Large-Area Clock / DPM Display

Optoelectronic Products

# FLB4018X1 FLB4018X2

## General Description

The FLB4018X1 and FLB4018X2 are liquid crystal displays that are hermetically sealed with glass frit. They are available in pinned or elastomeric connector configurations, offer four polarizer options and operate at the standard temperature range of  $-20^{\circ}\text{C}$  to  $+60^{\circ}\text{C}$ . Applications include clock, digital panel meter and general instrumentation.

## 0.7-Inch Digits (18 mm)

Decimal Points for DPMs

Colon for Timekeeping

Four Polarizer Options

Glass-Frit Seal for High Reliability

**Electrical Characteristics** Measured at  $25^{\circ}\text{C}$  with drive voltage of 5.0 V, square wave at 32 Hz.

Characteristic	Min	Typ	Max	Units
Operating Voltage	2.8	5.0	12	V
Saturation Voltage	2.0	2.2	2.4	V
DC Drive Component Allowable			50	mV
Operating Frequency Range	30	32	1000	Hz
Drive Current at 3.0 V, All Segments On			10	$\mu\text{A}$
Viewing Angle		45		degrees
Contrast Ratio		20:1		
Response Times: $t_{\text{on}}$ (Includes Delay Time)		70	150	ms
$t_{\text{off}}$ (Includes Delay Time)		100	150	ms
Operating Temperature Range (Note)	$-20$		60	$^{\circ}\text{C}$
Storage Temperature Range	$-20$		80	$^{\circ}\text{C}$
Humidity	50/60			$^{\circ}\text{C}/\text{RH}$
Life Time		50k		hrs

## Note

Higher operating temperature is available. Consult the factory for details.

## Voltage Characteristics

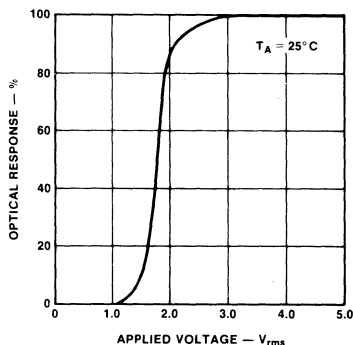

## Response Time

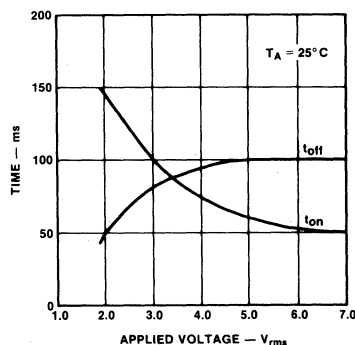

# Package Outline Pin Assignments

# FLB4018X1 FLB4018X2

## FLB4018X1 (Elastomer Connection)

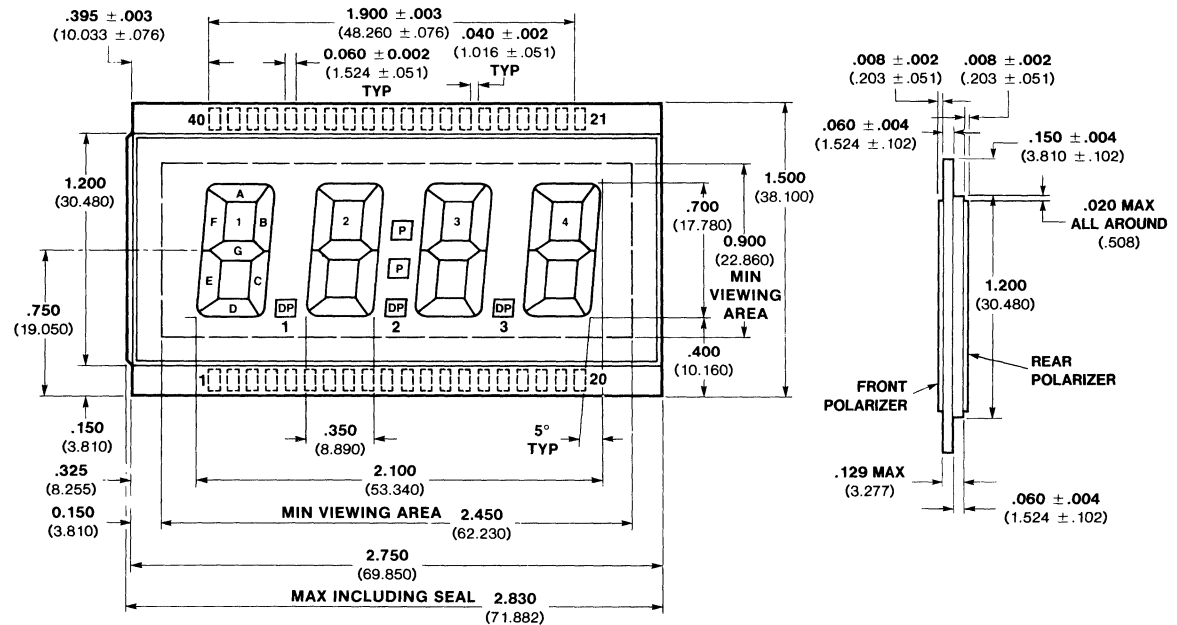

### Note

All dimensions in inches **bold** and millimeters (parentheses).

### Pin Assignments

1 Backplane BP	9 Segment E <sub>2</sub>	17 Segment E <sub>4</sub>	25 Segment A <sub>3</sub>	33 NC
2 NC	10 Segment D <sub>2</sub>	18 Segment D <sub>4</sub>	26 Segment F <sub>3</sub>	34 Segment B <sub>1</sub>
3 NC	11 Segment C <sub>2</sub>	19 Segment C <sub>4</sub>	27 Segment G <sub>3</sub>	35 Segment A <sub>1</sub>
4 NC	12 Decimal Point 2	20 Segment B <sub>4</sub>	28 Colon P	36 Segment F <sub>1</sub>
5 Segment E <sub>1</sub>	13 Segment E <sub>3</sub>	21 Segment A <sub>4</sub>	29 Segment B <sub>2</sub>	37 Segment G <sub>1</sub>
6 Segment D <sub>1</sub>	14 Segment D <sub>3</sub>	22 Segment F <sub>4</sub>	30 Segment A <sub>2</sub>	38 NC
7 Segment C <sub>1</sub>	15 Segment C <sub>3</sub>	23 Segment G <sub>4</sub>	31 Segment F <sub>2</sub>	39 NC
8 Decimal Point 1	16 Decimal Point 3	24 Segment B <sub>3</sub>	32 Segment G <sub>2</sub>	40 NC

### Ordering Information

#### Elastomeric

Connector Configuration	Connector Pins	Polarizer Option
FLB4018A1	FLB4018A2	Non-polarized
FLB4018B1	FLB4018B2	Transflective
FLB4018C1	FLB4018C2	Reflective (smooth)
FLB4018D1	FLB4018D2	Transmissive

#### Connectors

Display is available in pinned or elastomeric configuration. See page 6-42 for elastomeric connector suppliers.

#### Drivers

See page 6-43 for available drivers.



# 8-Character, 14-Segment Alphanumeric Display

Optoelectronic Products

## FLB8009X1

### General Description

The FLB8009X1 is a liquid crystal display that is hermetically sealed with glass frit. It interfaces with elastomeric connectors, is available in four polarizer options and operates at the standard temperature range of  $-20^{\circ}\text{C}$  to  $+60^{\circ}\text{C}$ . The 14-segment alphanumeric format is capable of displaying the alpha set, digits 0 through 9 and many of the special ASCII symbols. This display is suitable for general applications requiring alphanumeric capability.

### 0.35-Inch Characters (9 mm)

### Decimal Points

### 14-Segment Alphanumeric Format

### Glass-Frit Seal for High Reliability

**Electrical Characteristics** Measured at  $25^{\circ}\text{C}$  with drive voltage of 5.0 V, square wave at 32 Hz.

Characteristic	Min	Typ	Max	Units
Operating Voltage	2.8	5.0	12	V
Saturation Voltage	2.0	2.2	2.4	V
Operating Frequency Range	30	32	1000	Hz
Drive Current at 3.0 V, All Segments On			10	$\mu\text{A}$
Viewing Angle		45		degrees
Contrast Ratio		20:1		
Response Times: $t_{\text{on}}$ (Includes Delay Time)		70	150	ms
$t_{\text{off}}$ (Includes Delay Time)		100	150	ms
Operating Temperature Range (Note)	$-20$		60	$^{\circ}\text{C}$
Storage Temperature Range	$-20$		80	$^{\circ}\text{C}$
Humidity	50/60			$^{\circ}\text{C}/\text{RH}$
Life Time		50k		hrs

### Note

Higher operating temperature is available. Consult the factory for details.

### Voltage Characteristics

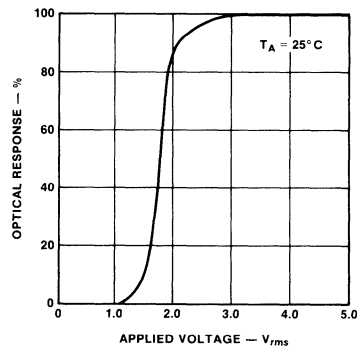

### Response Time

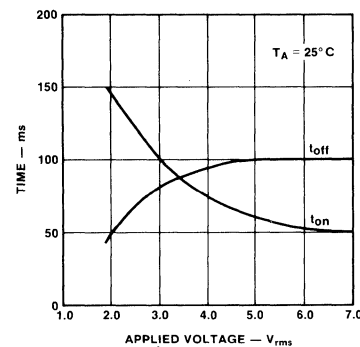



---

**Ordering Information****FLB8009X1**

---

**Ordering Information**

<b>Device Type</b>	<b>Polarizer Option</b>
FLB8009A1	Non-Polarized
FLB8009B1	Transflective
FLB8009C1	Reflective (smooth)
FLB8009D1	Transmissive

**Connectors**

Display interfaces with elastomeric connectors.  
See page 6-42 for elastomeric connector suppliers.

**Drivers**

See page 6-43 for available drivers.



# Fairchild Watch Displays

Optoelectronic Products

## General Description

Fairchild watch displays are liquid crystal displays that are hermetically sealed with glass frit. They interface with elastomeric connectors and operate at the standard temperature range of  $-20^{\circ}\text{C}$  to  $+60^{\circ}\text{C}$ . Packages and pin assignments appear on the following pages.

**Electrical Characteristics** Measured at  $25^{\circ}\text{C}$  with drive voltage of 3.0 V, square wave at 32 Hz.

Characteristic	Min	Typ	Max	Units
Operating Voltage	2.8	3.0	6.0	V
Saturation Voltage	2.0	2.2	2.4	V
Operating Frequency Range	30		1000	Hz
Drive Current at 3.0 V, All Segments On			1.0	$\mu\text{A}$
Viewing Angle		45		degrees
Contrast Ratio		20:1		
Response Times: $t_{\text{on}}$		100	150	ms
$t_{\text{off}}$		80	150	ms
Operating Temperature Range	$-20$		55	$^{\circ}\text{C}$
Storage Temperature Range	$-20$		65	$^{\circ}\text{C}$
Humidity	50/60			$^{\circ}\text{C}/\text{RH}$
Life Time		50k		hrs

## Voltage Characteristics

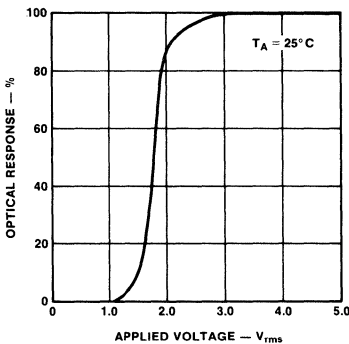

## Response Time

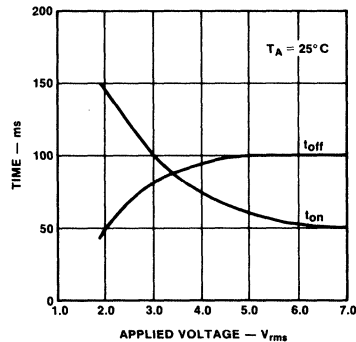

## Connectors

All Fairchild watch displays interface with elastomeric connectors.

See page 6-42 for elastomeric connector suppliers.

# Fairchild Watch Displays

Optoelectronic Products

## FLB350401

### Package Outline

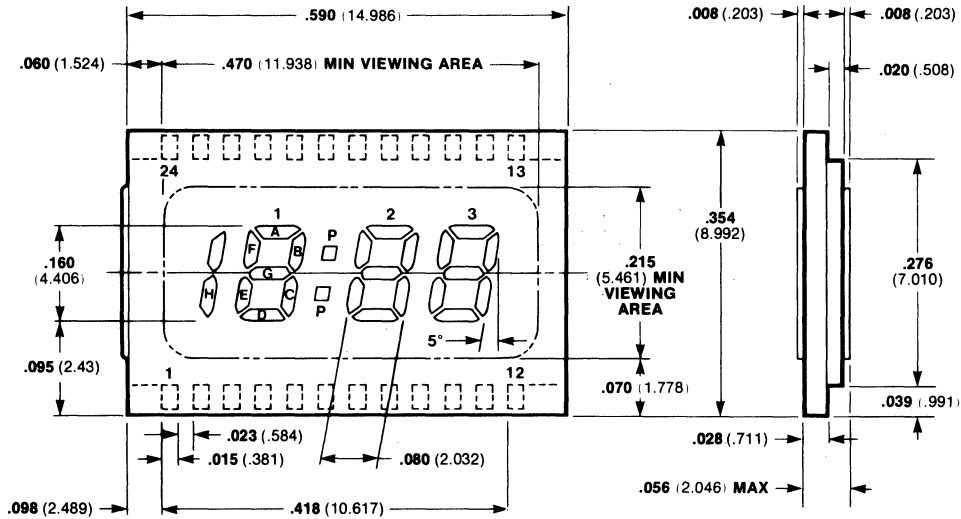

### Notes

All dimensions in inches **bold** and millimeters (parentheses)  
Tolerance unless specified =  $\pm .015$  ( $\pm .381$ )

### Pin Assignments

1 Backplane	6 Colons	11 Segment D <sub>3</sub>	16 Segment G <sub>3</sub>	21 Segment B <sub>1</sub>
2 Half Digit	7 Segment E <sub>2</sub>	12 Segment C <sub>3</sub>	17 Segment B <sub>2</sub>	22 Segment A <sub>1</sub>
3 Segment E <sub>1</sub>	8 Segment D <sub>2</sub>	13 Segment B <sub>3</sub>	18 Segment A <sub>2</sub>	23 Segment F <sub>1</sub>
4 Segment D <sub>1</sub>	9 Segment C <sub>2</sub>	14 Segment A <sub>3</sub>	19 Segment F <sub>2</sub>	24 Segment G <sub>1</sub>
5 Segment C <sub>1</sub>	10 Segment E <sub>3</sub>	15 Segment F <sub>3</sub>	20 Segment G <sub>2</sub>	



# Fairchild Watch Displays

Optoelectronic Products

## FLB350501

### Package Outline

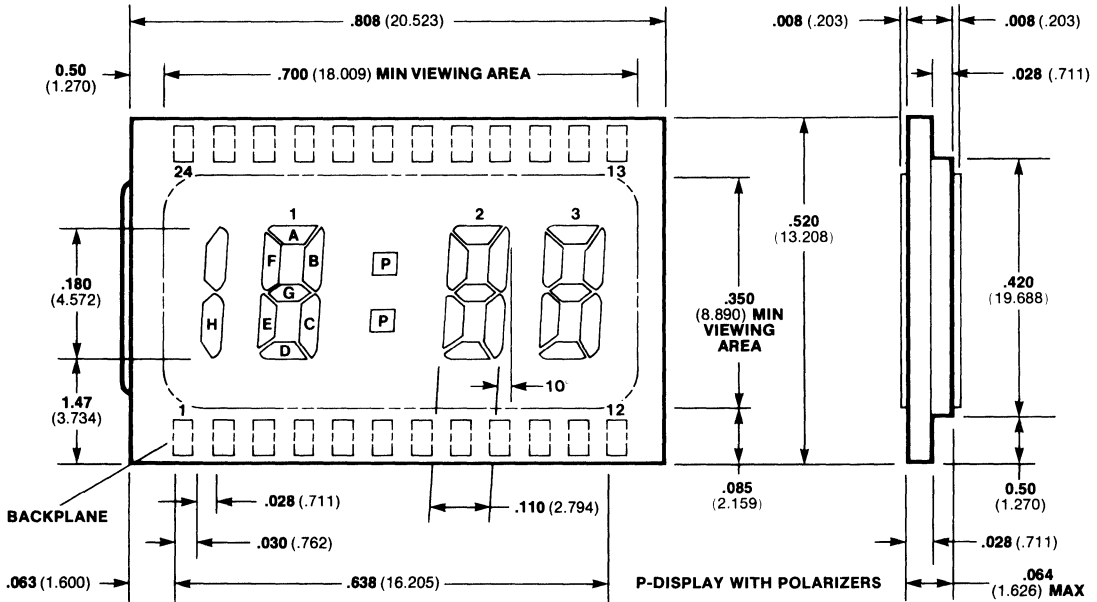

6

### Notes

All dimensions in inches bold and millimeters (parentheses)  
Tolerance unless specified =  $\pm .015$  ( $\pm .381$ )

### Pin Assignments

1 Backplane	6 Colons	11 Segment D <sub>3</sub>	16 Segment G <sub>3</sub>	21 Segment B <sub>1</sub>
2 Half Digit	7 Segment E <sub>2</sub>	12 Segment C <sub>3</sub>	17 Segment B <sub>2</sub>	22 Segment A <sub>1</sub>
3 Segment E <sub>1</sub>	8 Segment D <sub>2</sub>	13 Segment B <sub>3</sub>	18 Segment A <sub>2</sub>	23 Segment F <sub>1</sub>
4 Segment D <sub>1</sub>	9 Segment C <sub>2</sub>	14 Segment A <sub>3</sub>	19 Segment F <sub>2</sub>	24 Segment G <sub>1</sub>
5 Segment C <sub>1</sub>	10 Segment E <sub>3</sub>	15 Segment F <sub>3</sub>	20 Segment G <sub>2</sub>	

# Fairchild Watch Displays

Optoelectronic Products

# FLB350502

## Package Outline

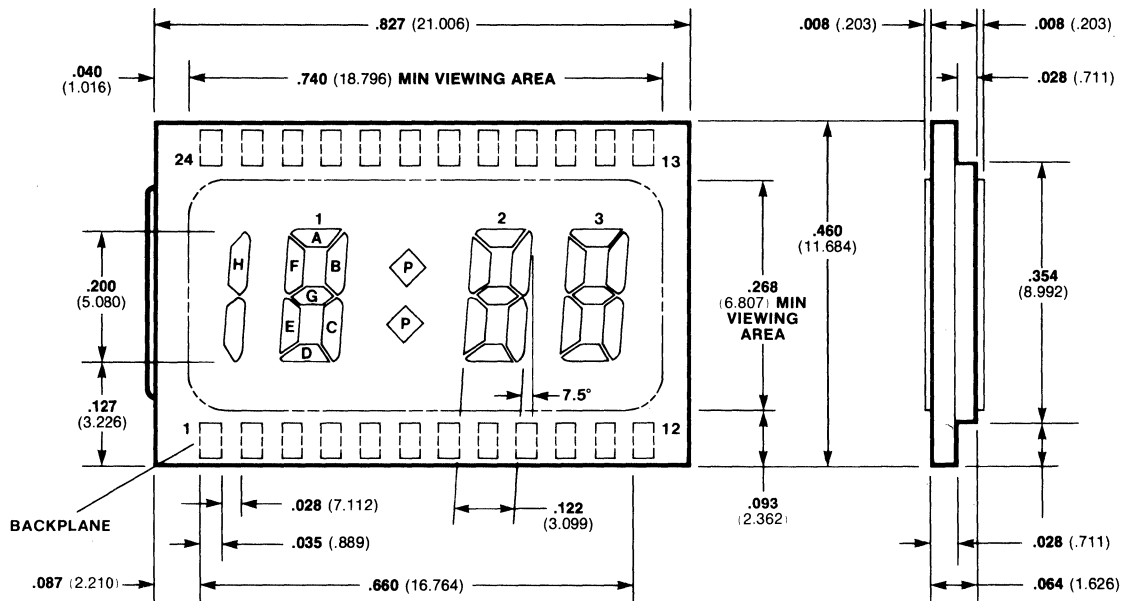

### Notes

All dimensions in inches **bold** and millimeters (parentheses)  
Tolerance unless specified =  $\pm .015$  ( $\pm .381$ )

### Pin Assignments

1 Backplane	6 Colons	11 Segment D <sub>3</sub>	16 Segment G <sub>3</sub>	21 Segment B <sub>1</sub>
2 Half Digit	7 Segment E <sub>2</sub>	12 Segment C <sub>3</sub>	17 Segment B <sub>2</sub>	22 Segment A <sub>1</sub>
3 Segment E <sub>1</sub>	8 Segment D <sub>2</sub>	13 Segment B <sub>3</sub>	18 Segment A <sub>2</sub>	23 Segment F <sub>1</sub>
4 Segment D <sub>1</sub>	9 Segment C <sub>2</sub>	14 Segment A <sub>3</sub>	19 Segment F <sub>2</sub>	24 Segment G <sub>1</sub>
5 Segment C <sub>1</sub>	10 Segment E <sub>3</sub>	15 Segment F <sub>3</sub>	20 Segment G <sub>2</sub>	



# Fairchild Watch Displays

Optoelectronic Products

# FLB350601

## Package Outline

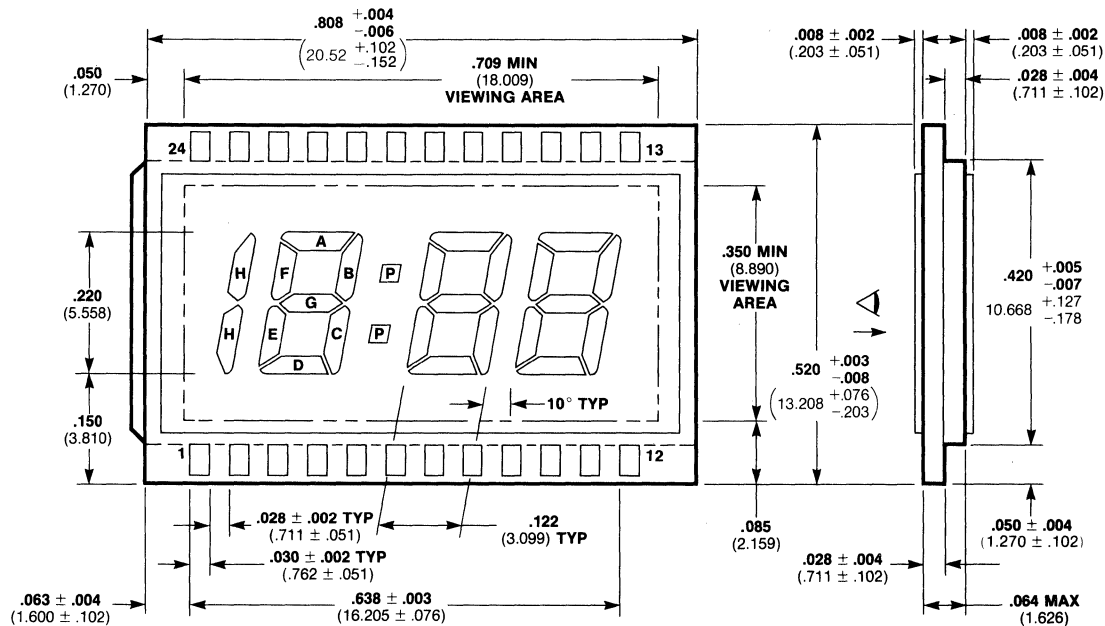

### Notes

All dimensions in inches **bold** and millimeters (parentheses)  
Tolerance unless specified =  $\pm .015$  ( $\pm .381$ )

### Pin Assignments

1 Backplane	6 Period	11 Segment D <sub>3</sub>	16 Segment G <sub>3</sub>	21 Segment B <sub>1</sub>
2 Segment H	7 Segment E <sub>2</sub>	12 Segment C <sub>3</sub>	17 Segment B <sub>2</sub>	22 Segment A <sub>1</sub>
3 Segment E <sub>1</sub>	8 Segment D <sub>2</sub>	13 Segment B <sub>3</sub>	18 Segment A <sub>2</sub>	23 Segment F <sub>1</sub>
4 Segment D <sub>1</sub>	9 Segment C <sub>2</sub>	14 Segment A <sub>3</sub>	19 Segment F <sub>2</sub>	24 Segment G <sub>1</sub>
5 Segment C <sub>1</sub>	10 Segment E <sub>3</sub>	15 Segment F <sub>3</sub>	20 Segment G <sub>2</sub>	

# Fairchild Watch Displays

Optoelectronic Products

## FLB350701

### Package Outline

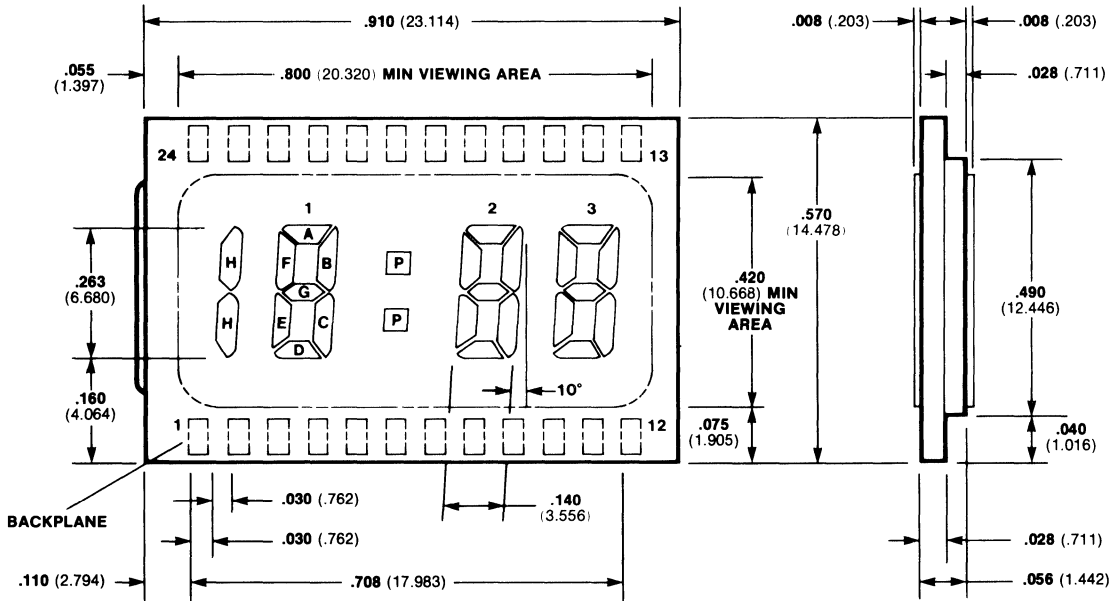

### Notes

All dimensions in inches **bold** and millimeters (parentheses)  
Tolerance unless specified =  $\pm .015$  ( $\pm .381$ )

### Pin Assignments

1 Backplane	6 Colons	11 Segment D <sub>3</sub>	16 Segment G <sub>3</sub>	21 Segment B <sub>1</sub>
2 Half Digit	7 Segment E <sub>2</sub>	12 Segment C <sub>3</sub>	17 Segment B <sub>2</sub>	22 Segment A <sub>1</sub>
3 Segment E <sub>1</sub>	8 Segment D <sub>2</sub>	13 Segment B <sub>3</sub>	18 Segment A <sub>2</sub>	23 Segment F <sub>1</sub>
4 Segment D <sub>1</sub>	9 Segment C <sub>2</sub>	14 Segment A <sub>3</sub>	19 Segment F <sub>2</sub>	24 Segment G <sub>1</sub>
5 Segment C <sub>1</sub>	10 Segment E <sub>3</sub>	15 Segment F <sub>3</sub>	20 Segment G <sub>2</sub>	



# Fairchild Watch Displays

Optoelectronic Products

# FLB450401

## Package Outline

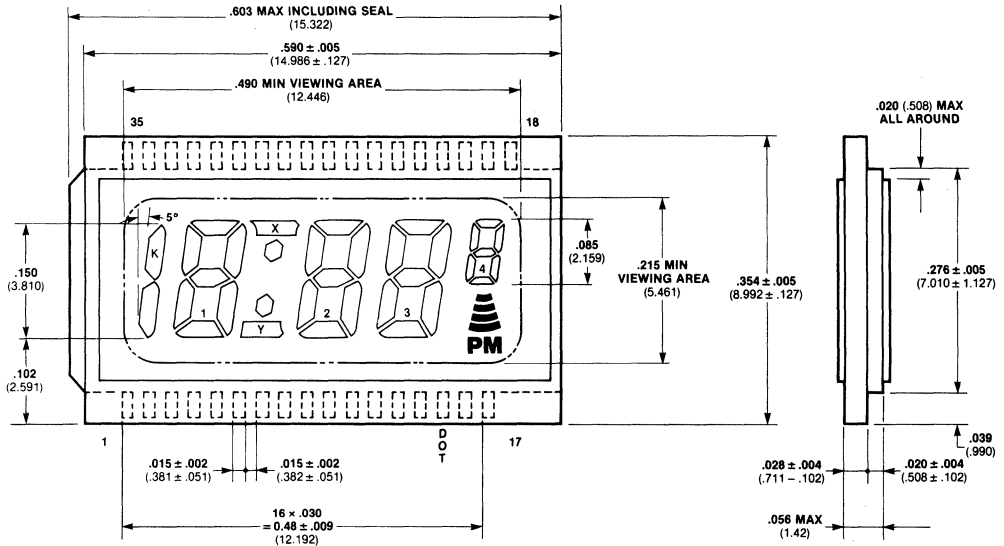

### Notes

All dimensions in inches **bold** and millimeters (parentheses)  
Tolerance unless specified =  $\pm .015$  ( $\pm .381$ )

### Pin Assignments

1 Common	8 Segment D2	15 PM	22 Segment E4	29 Segment F2
Backplane	9 Segment C2	16 Segment D4	23 Segment B3	30 X
2 Segment E1	10 Segment E3	17 Segment C4	24 Segment A3	31 Segment B1
3 Segment D1	11 Segment D3	18 Segment G4	25 Segment F3	32 Segment A1
4 Segment C1	12 Segment C3	19 Segment B4	26 Segment G2	33 Segment F1
5 Colon	13 Segment G3	20 Segment A4	27 Segment B2	34 Segment G1
6 Y	14 Alarm	21 Segment F4	28 Segment A2	35 K
7 Segment E2				

# Fairchild Watch Displays

Optoelectronic Products

## FLB450501

### Package Outline

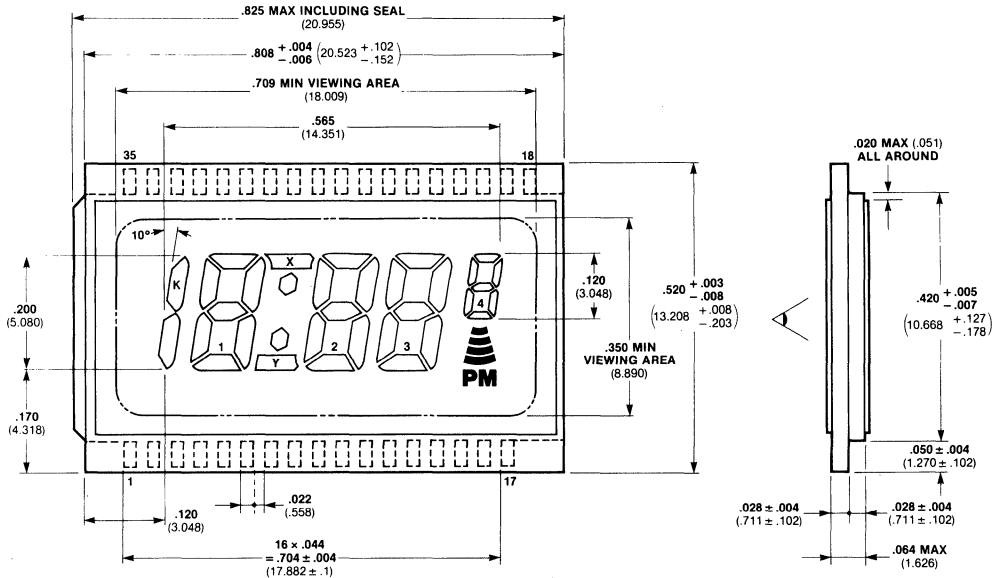

### Notes

All dimensions in inches **bold** and millimeters (parentheses)  
Tolerance unless specified =  $\pm .015$  ( $\pm .381$ )

### Pin Assignments

1 Common	8 Segment D2	15 PM	22 Segment E4	29 Segment F2
Backplane	9 Segment C2	16 Segment D4	23 Segment B3	30 X
2 Segment E1	10 Segment E3	17 Segment C4	24 Segment A3	31 Segment B1
3 Segment D1	11 Segment D3	18 Segment G4	25 Segment F3	32 Segment A1
4 Segment C1	12 Segment C3	19 Segment B4	26 Segment G2	33 Segment F1
5 Colon	13 Segment G3	20 Segment A4	27 Segment B2	34 Segment G1
6 Y	14 Alarm	21 Segment F4	28 Segment A2	35 K
7 Segment E2				

# Fairchild Watch Displays

Optoelectronic Products

# FLB550503

## Package Outline

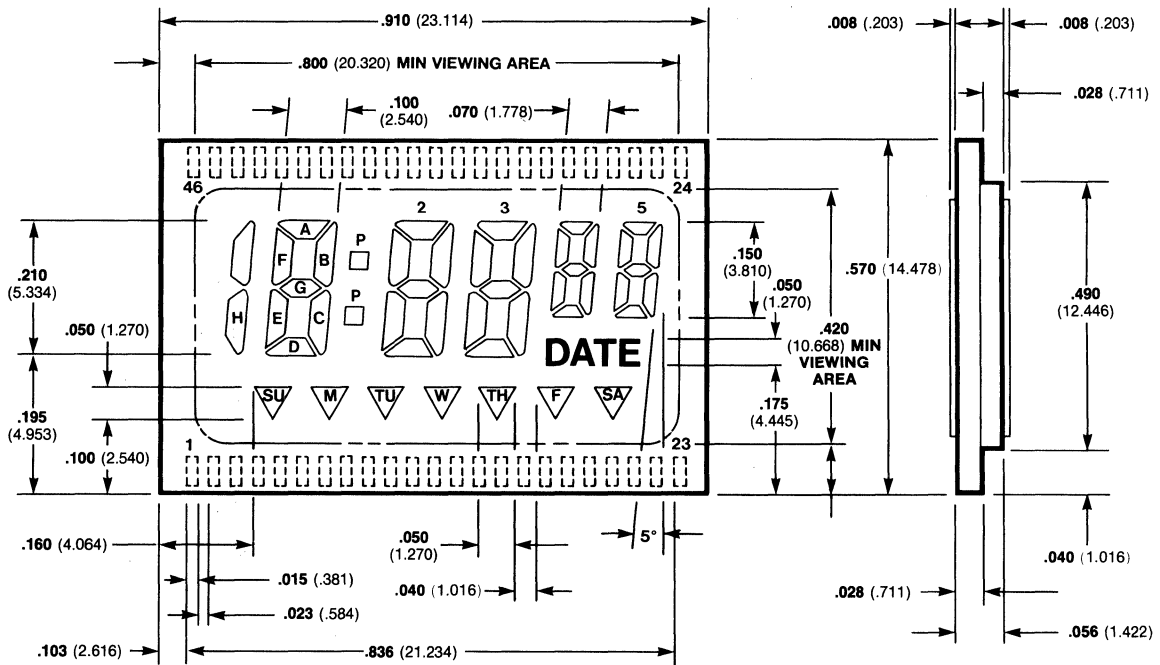

### Notes

All dimensions in inches **bold** and millimeters (parentheses)  
Tolerance unless specified =  $\pm .015$  ( $\pm .381$ )

### Pin Assignments

1 Backplane	11 Segment E <sub>3</sub>	21 Segment SA	31 Segment F <sub>4</sub>	40 Segment G <sub>2</sub>
2 Segment E <sub>1</sub>	12 Segment W	22 Segment E <sub>5</sub>	32 Segment G <sub>4</sub>	41 Colons
3 Segment SU	13 Segment D <sub>3</sub>	23 Segment D <sub>5</sub>	33 Segment B <sub>3</sub>	42 Segment B <sub>1</sub>
4 Segment D <sub>1</sub>	14 Segment C <sub>3</sub>	24 Segment C <sub>5</sub>	34 Segment A <sub>3</sub>	43 Segment A <sub>1</sub>
5 Segment C <sub>1</sub>	15 Segment TH	25 Segment B <sub>5</sub>	35 Segment F <sub>3</sub>	44 Segment F <sub>1</sub>
6 Segment M	16 Segment E <sub>4</sub>	26 Segment A <sub>5</sub>	36 Segment G <sub>3</sub>	45 Segment G <sub>1</sub>
7 Segment E <sub>2</sub>	17 Segment D <sub>4</sub>	27 Segment F <sub>5</sub>	37 Segment B <sub>2</sub>	46 Half Digit
8 Segment D <sub>2</sub>	18 Segment F	28 Segment G <sub>5</sub>	38 Segment A <sub>2</sub>	
9 Segment TU	19 Segment C <sub>4</sub>	29 Segment B <sub>4</sub>	39 Segment F <sub>2</sub>	
10 Segment C <sub>2</sub>	20 Date	30 Segment A <sub>4</sub>		

# Fairchild Watch Displays

Optoelectronic Products

## FLB600301

### Package Outline

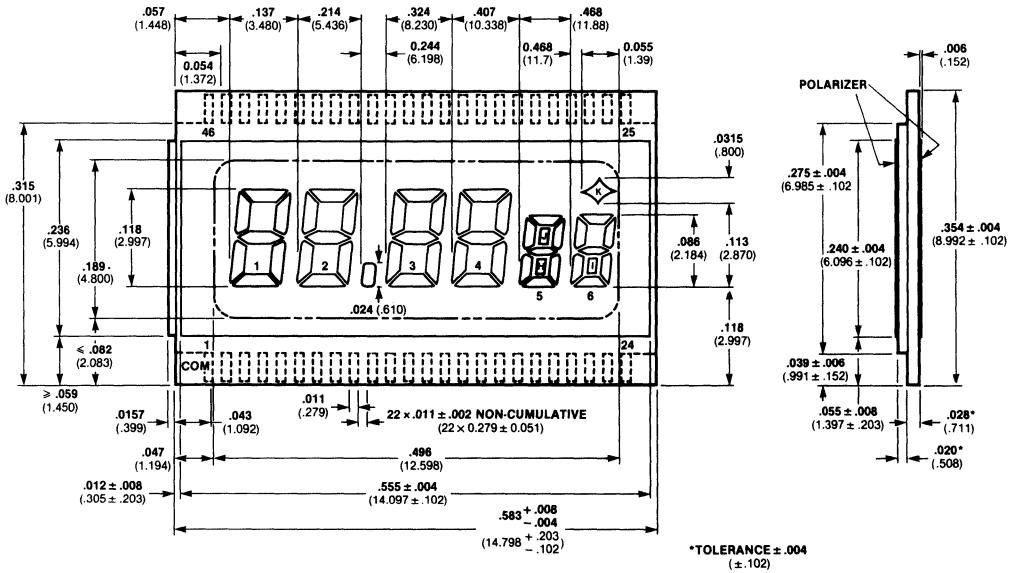

### Notes

All dimensions in inches **bold** and millimeters (parentheses)  
Tolerance unless specified = ± .015 (± .381)

### Pin Assignments

1 Common Backplane	10 Segment A/D3	20 Segment I6	30 Segment J5	40 Segment B2
2 Segment E1	11 Segment C3	21 Segment D6	31 Segment F5	41 Segment A2
3 Segment A/D1	12 Segment E4	22 Segment C6	32 Segment G5	42 Segment F2
4 Segment C1	13 Segment D4	23 Segment G6	33 Segment B4	43 Segment G2
5 Segment E2	14 Segment C4	24 Segment K	34 Segment A4	44 Segment B1
6 Segment D2	15 Segment E5	25 Segment B6	35 Segment F4	45 Segment F1
7 Segment C2	16 Segment H5	26 Segment A6	36 Segment G4	46 Segment G1
8 Decimal Point	17 Segment D5	27 Segment F6	37 Segment B3	
9 Segment E3	18 Segment C5	28 Segment B5	38 Segment F3	
	19 Segment E6	29 Segment A5	39 Segment G3	

# Fairchild Watch Displays

Optoelectronic Products

# FLB600506

## Package Outline

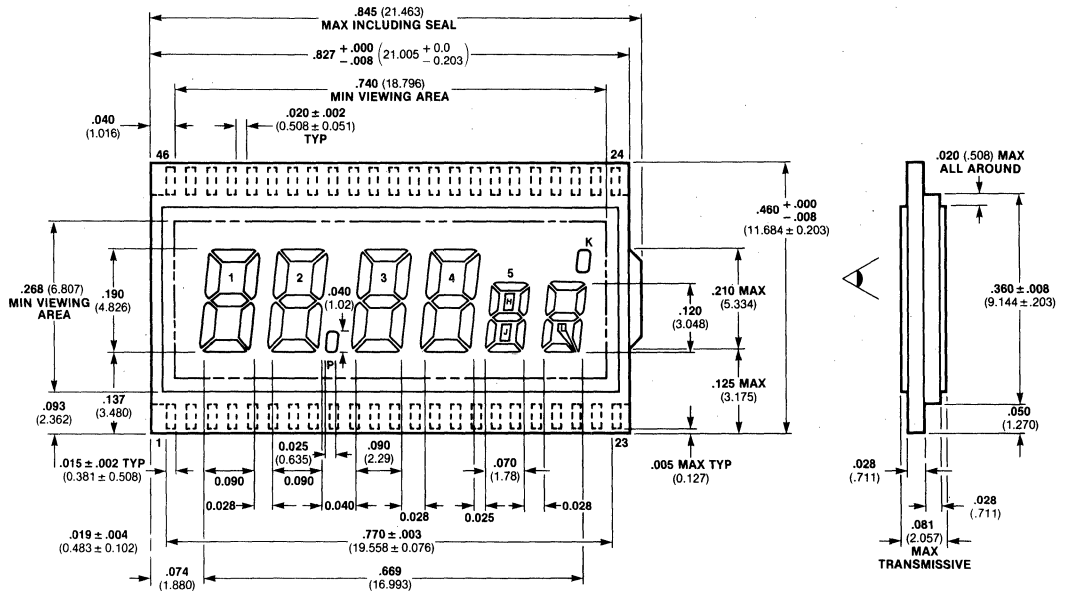

### Notes

All dimensions in inches **bold** and millimeters (parentheses)  
Tolerance unless specified =  $\pm .015$  ( $\pm .381$ )

## Pin Assignments

1 Segment E1	11 Segment E4	21 Segment C6	30 Segment H5	40 Segment B2
2 Segment A/D1	12 Segment D4	22 Segment G6	31 Segment F5	41 Segment A2
3 Segment C1	13 Segment C4	23 Common	32 Segment G5	42 Segment F2
4 Segment E2	14 Segment E5	Backplane	33 Segment B4	43 Segment G2
5 Segment D2	15 Segment J5	24 K	34 Segment A4	44 Segment B1
6 Segment C2	16 Segment D5	25 Segment B6	35 Segment F4	45 Segment F1
7 Decimal	17 Segment C5	26 Segment A6	36 Segment G4	46 Segment G1
8 Segment E3	18 Segment E6	27 Segment F6	37 Segment B3	
9 Segment A3	19 Segment D6	28 Segment B5	38 Segment F3	
10 Segment C3	20 Segment L6	29 Segment A5	39 Segment G3	

# Fairchild Watch Displays

Optoelectronic Products

## FLB600601

### Package Outline

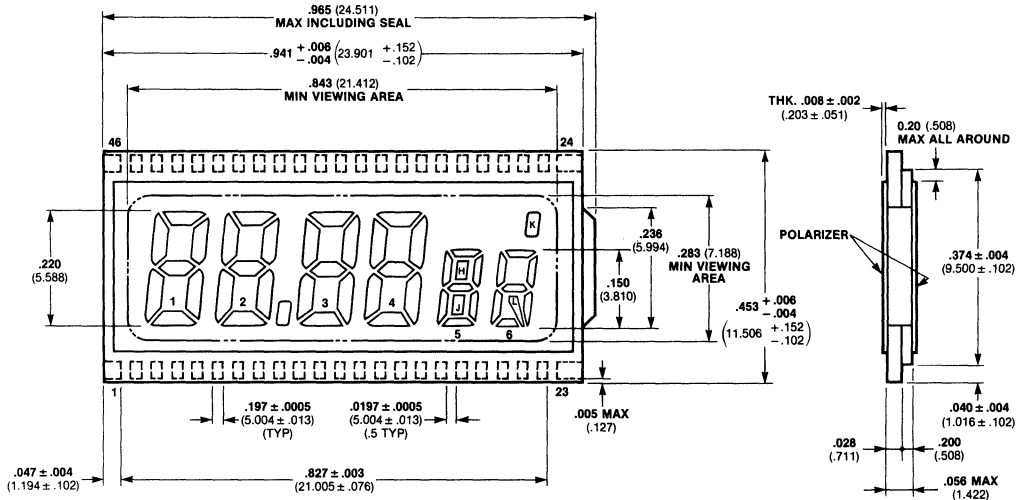

6

### Notes

All dimensions in inches **bold** and millimeters (parentheses)  
Tolerance unless specified =  $\pm .015$  ( $\pm .381$ )

### Pin Assignments

1 Segment E1	11 Segment E4	21 Segment C6	30 Segment H5	40 Segment B2
2 Segment A/D1	12 Segment D4	22 Segment G6	31 Segment F5	41 Segment A2
3 Segment C1	13 Segment C4	23 Common	32 Segment G5	42 Segment F2
4 Segment E2	14 Segment E5	Backplane	33 Segment B4	43 Segment G2
5 Segment D2	15 Segment J5	24 K	34 Segment A4	44 Segment B1
6 Segment C2	16 Segment D5	25 Segment B6	35 Segment F4	45 Segment F1
7 Decimal Point	17 Segment C5	26 Segment A6	36 Segment G4	46 Segment G1
8 Segment E3	18 Segment E6	27 Segment F6	37 Segment B3	
9 Segment A/D3	19 Segment D6	28 Segment B5	38 Segment F3	
10 Segment C3	20 Segment L6	29 Segment A5	39 Segment G3	

# Fairchild Watch Displays

Optoelectronic Products

# FLB600602

## Package Outline

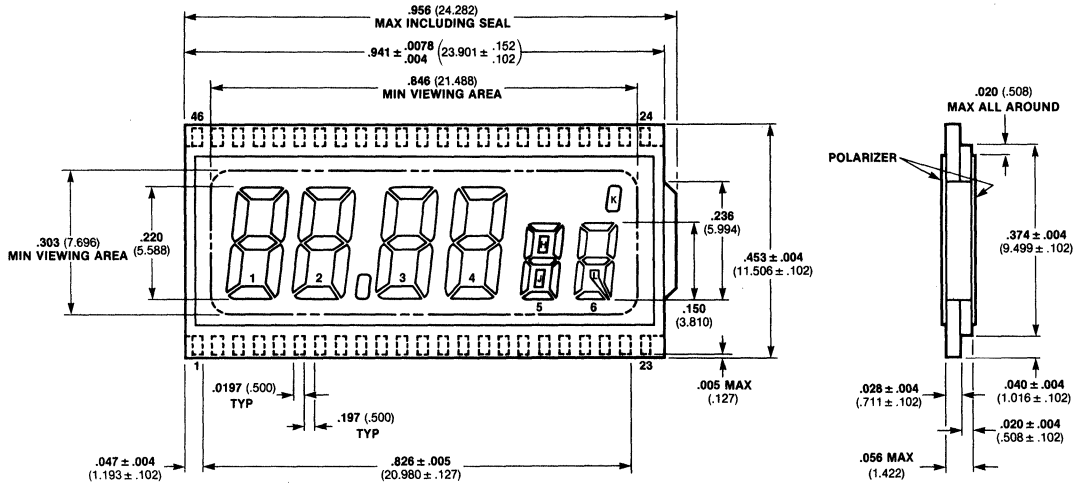

### Notes

All dimensions in inches **bold** and millimeters (parentheses)  
Tolerance unless specified =  $\pm .015$  ( $\pm .381$ )

### Pin Assignments

1 Segment E1	11 Segment E4	21 Segment C6	30 Segment H5	40 Segment B2
2 Segment A/D1	12 Segment D4	22 Segment G6	31 Segment F5	41 Segment A2
3 Segment C1	13 Segment C4	23 Common	32 Segment G5	42 Segment F2
4 Segment E2	14 Segment E5	Backplane	33 Segment B4	43 Segment G2
5 Segment D2	15 Segment J5	24 K	34 Segment A4	44 Segment B1
6 Segment C2	16 Segment D5	25 Segment B6	35 Segment F4	45 Segment F1
7 Decimal Point	17 Segment C5	26 Segment A6	36 Segment G4	46 Segment G1
8 Segment E3	18 Segment E6	27 Segment F6	37 Segment B3	
9 Segment A/D3	19 Segment D6	28 Segment B5	38 Segment F3	
10 Segment C3	20 Segment L6	29 Segment A5	39 Segment G3	

# Fairchild Watch Displays

Optoelectronic Products

## FLB650401

### Package Outline

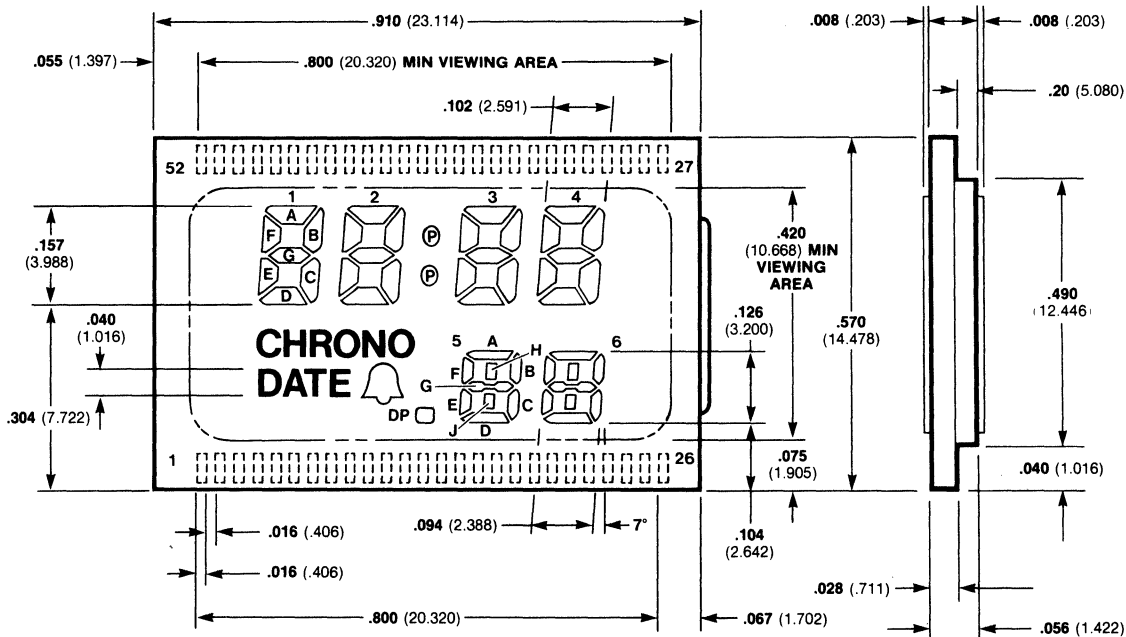

6

### Notes

All dimensions in inches **bold** and millimeters (parentheses)  
Tolerance unless specified =  $\pm .015$  ( $\pm .381$ )

### Pin Assignments

1 Alarm	12 Segment E <sub>5</sub>	23 Segment H <sub>6</sub>	34 Segment B <sub>3</sub>	45 Segment F <sub>2</sub>
2 Segment D <sub>1</sub>	13 Decimal	24 Segment A <sub>6</sub>	35 Segment A <sub>3</sub>	46 Segment B <sub>1</sub>
3 Segment C <sub>1</sub>	14 Segment J <sub>5</sub>	25 Segment F <sub>6</sub>	36 Segment F <sub>3</sub>	47 Segment A <sub>1</sub>
4 Segment E <sub>2</sub>	15 Segment D <sub>5</sub>	26 Backplane	37 Segment G <sub>3</sub>	48 Segment F <sub>1</sub>
5 Segment D <sub>2</sub>	16 Segment C <sub>5</sub>	27 Segment D <sub>4</sub>	38 Segment E <sub>3</sub>	49 Segment G <sub>1</sub>
6 Segment C <sub>2</sub>	17 Segment G <sub>6</sub>	28 Segment C <sub>4</sub>	39 Segment D <sub>3</sub>	50 Segment E <sub>1</sub>
7 Segment B <sub>5</sub>	18 Segment E <sub>6</sub>	29 Segment G <sub>4</sub>	40 Segment C <sub>3</sub>	51 Chrono
8 Segment A <sub>5</sub>	19 Segment D <sub>6</sub>	30 Segment B <sub>4</sub>	41 Colons	52 Date
9 Segment H <sub>5</sub>	20 Segment J <sub>6</sub>	31 Segment A <sub>4</sub>	42 Segment G <sub>2</sub>	
10 Segment F <sub>5</sub>	21 Segment C <sub>6</sub>	32 Segment F <sub>4</sub>	43 Segment B <sub>2</sub>	
11 Segment G <sub>5</sub>	22 Segment B <sub>6</sub>	33 Segment E <sub>4</sub>	44 Segment A <sub>2</sub>	



# LCD Connector Systems

There are two basic connector systems that can be used with liquid crystal displays:

1. Pins
2. Elastomeric Connectors

## 1. Typical Pin Connector

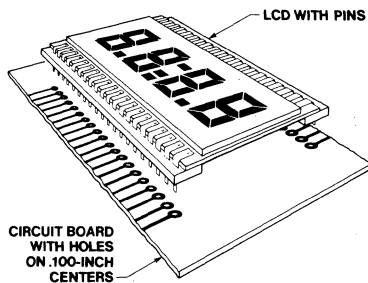

## 2. Typical Elastomeric Connection System

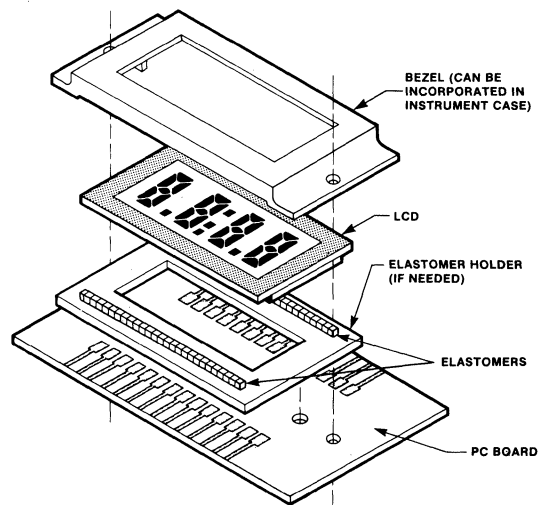

Certain Fairchild LCDs work with pins while other Fairchild LCDs interface with elastomer connectors. Displays are shipped with pins when that configuration is ordered; connectors for the elastomeric version are available from the following sources:

### Suppliers of Elastomeric Connectors

Tecknit  
129 Dermody St.  
Cranford, N.J. 07016  
(201) 272-5500

AMP Incorporated  
Harrisburg, Pa. 17105  
(717) 564-0100

Conductive Rubber Technology  
Olive Mill Plaza  
1230 Coast Village Circle  
Santa Barbara, Ca. 93108  
(805) 969-5807

Hulltronics, Inc.  
Davisville Road  
Hatboro, Pa. 19040  
(215) 672-0787

# Liquid Crystal Display Drivers

The following is a list of the most popular drivers for LCD's.

Description	Manufacturer	Part Number
<b>Digit Drivers</b>		
BCD to 7-Segment Single Digit	RCA RCA, MITEL RCA, MITEL Motorola	4054 4055 4056 MC14543B
Multiplexed BCD to 7-Segment Four Digit	Siliconix Hughes Intersil	DF411/412 HLCD-0437 ICM7211
<b>Open Format Drivers</b>		
Serial In—30 to 32 Segment Drivers	MITEL Hughes	4330, 4331, 4332 HLCD-0438
<b>Special Purpose Chips</b>		
3½-Digit Voltmeter/LCD Driver	Intersil	ICL7106
RF Counter/Clock/LCD Driver	OKI Electric	MSM5526
4½-Digit Counter/LCD Driver	Intersil	ICL7224
LCD Clock with Alarm	NEC	μPD833G
<b>Microprocessors with Multiplexed LCD Output</b>		
Four-Bit CMOS Processor	Sharp	SM4, SM5

Digital Voltmeter

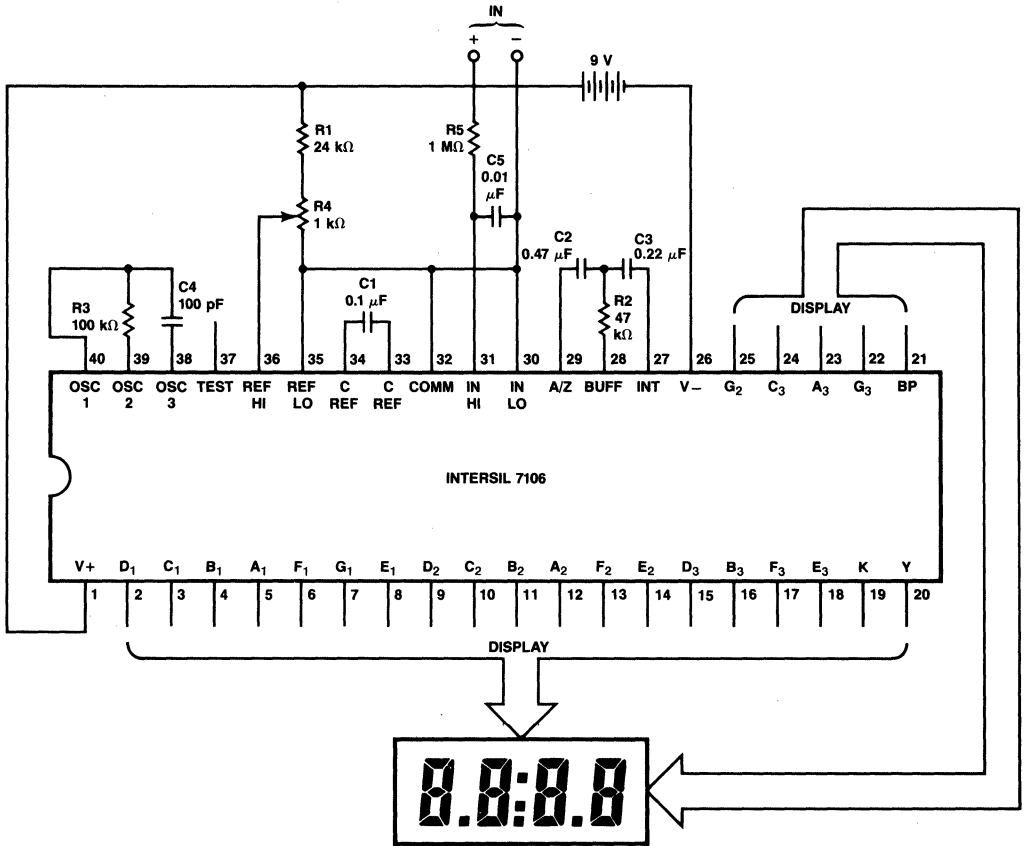

Exclusive 'OR' Gate For Decimal Point Drive

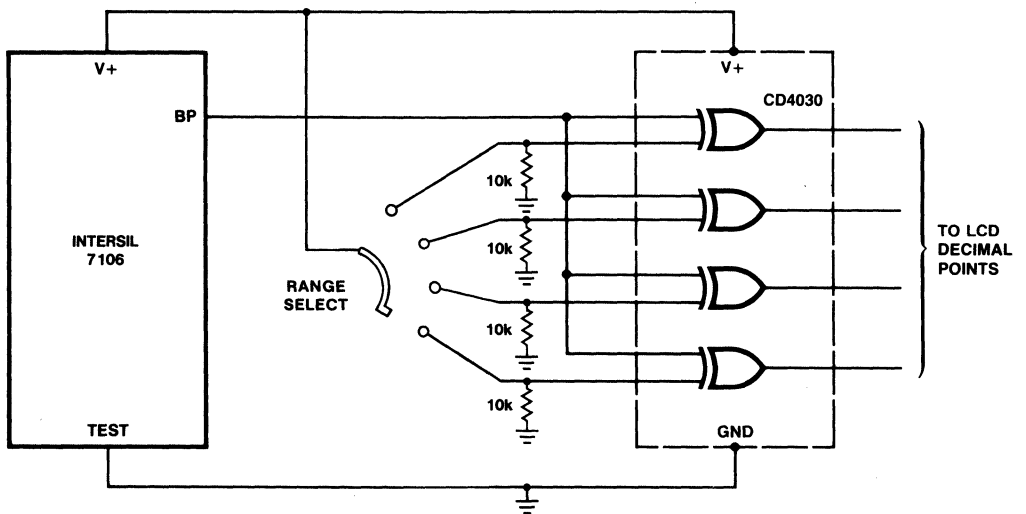

## 12-Digit Telephone Display Serial Drive

Fairchild FLB1208X1

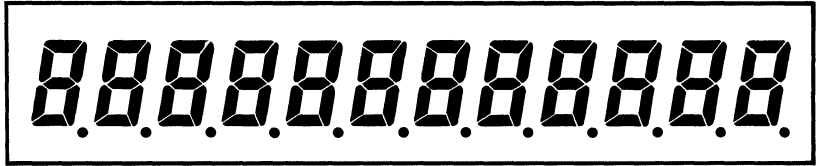

## Serial Driven LCD Drivers

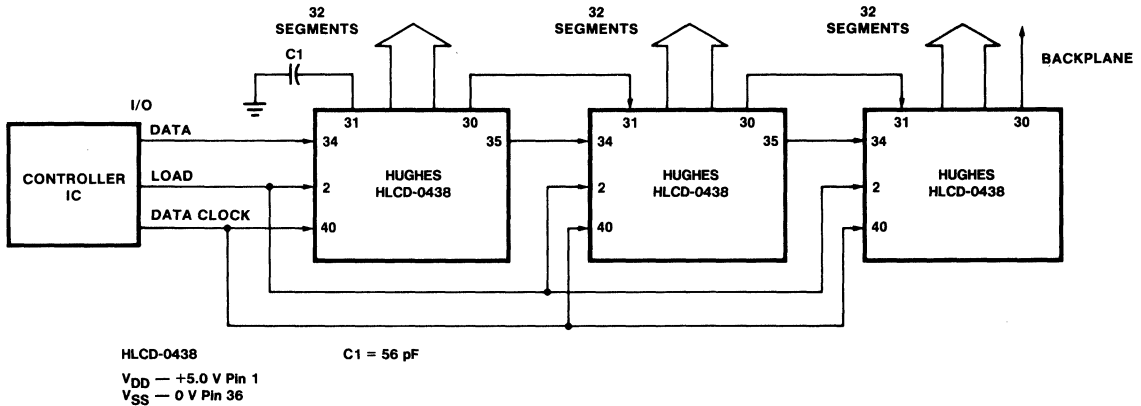

The drivers appear as a 96-bit shift register in this configuration. Fewer I/O outputs are required in the controller IC, when serial drive is selected over parallel drive.

**Comments:**

- The capacitor, C1, determines the frequency of the output waveforms.  $56 \text{ pF} \approx 30 \text{ Hz}$ .
- All segment lines must be in proper phase with the backplane. Therefore, the backplane output, Pin 30, is connected to Pin 31 of the following chip.
- The display backplane driver should not be connected to another HLCD-0438.

## 12-Digit Telephone Display Parallel Drive

Fairchild FLB1208X1

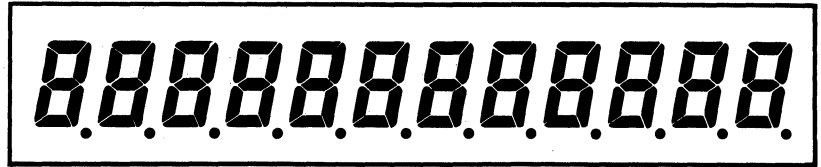

## Parallel Driven LCD Drivers

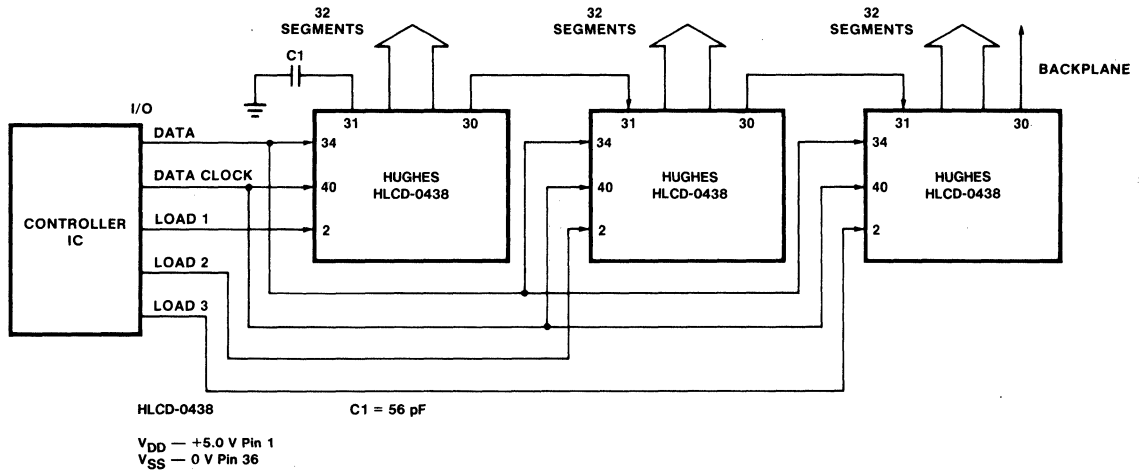

The drivers appear as a 32-bit shift register in this configuration. The maximum data shift required is 32 bits, when parallel drive is selected over serial drive.

**Comments:**

- A. The capacitor, C1, determines the frequency of the output waveforms.  $56 \text{ pF} \approx 30 \text{ Hz}$ .
- B. All segment lines must be in proper phase with the backplane. Therefore, the backplane output, Pin 30, is connected to Pin 31 of the following chip.
- C. The display backplane driver should not be connected to another HLCD-0438.

**4-Digit Display, 24-Hour Clock**

Provides for a combination tape cassette, stereo, 24-hour clock, and 3½-digit AM-FM radio display.



**FAIRCHILD FLB4010X1**

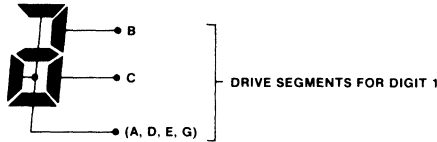
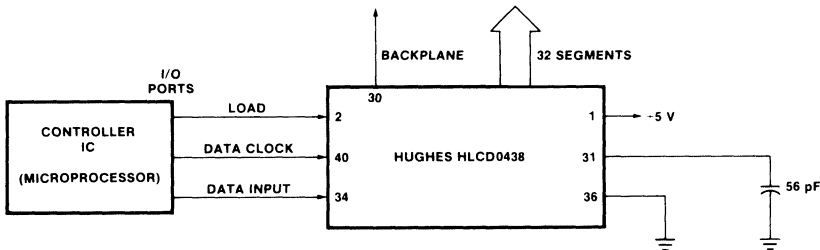

For a 24-hour clock form a "2" by connecting segments A, D, E and G, and drive as a single segment.

If more than 32 segments are to be used, additional LCD drive is required. Two additional segment drives are needed if the Dolby™ symbol and PM are desired.

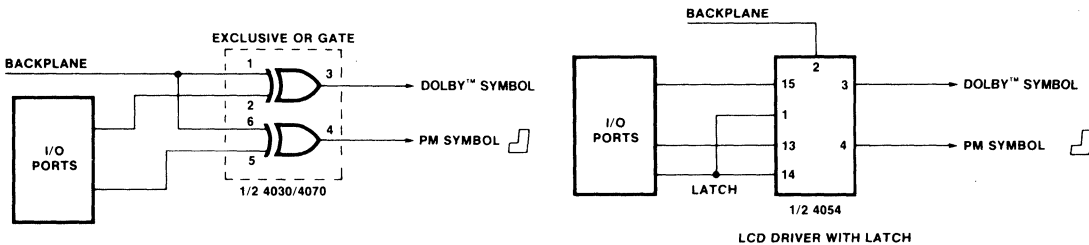

Use either of the two above schemes to add more than the 32 segments provided by the HLCD-4038.

Dolby™ and the double-D symbol are trademarks of Dolby Laboratories. Permission for their use must be obtained from Dolby Laboratories.

### 3½-Digit Display, 12-Hour Clock

Provides for a combination tape cassette, stereo, 12-hour clock, and 3½-digit AM-FM radio display.



FAIRCHILD FLB4010X1

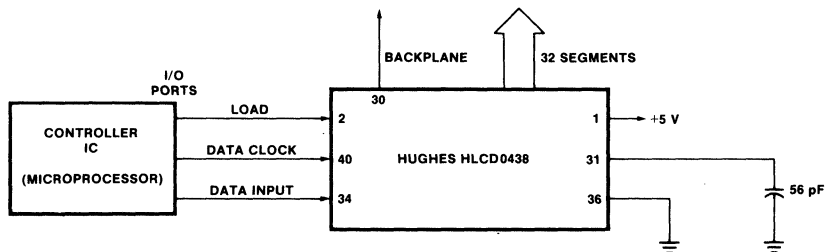

This display configuration requires one backplane connection and 32 segment connections.

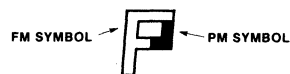
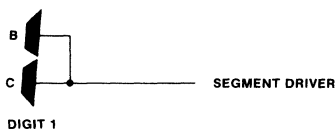

#### Comments:

A. Connect segment B and segment C of digit 1 together to form one segment.

B. To form the symbol PM, both the FM and PM symbols must be on.

C. The 56 pF capacitor provides a display frequency of  $\approx 30$  Hz.

D. The Hughes HLCD-4038 is a 32-bit shift register which receives data in a serial mode from the data input. The data is clocked into the shift register using the data clock. With load HIGH a data clock will latch the information in the LCD drivers.

Dolby™ and the double-D symbol are trademarks of Dolby Laboratories. Permission for their use must be obtained from Dolby Laboratories.

# Liquid Crystal Interface Display Applications

The following circuits are typical applications of Fairchild liquid crystal displays.

## Multiplexed BCD Input

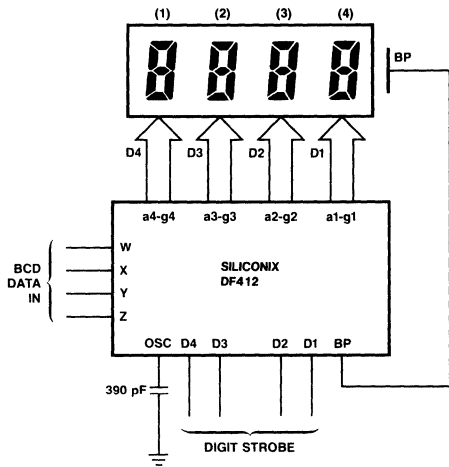

## Serial Input

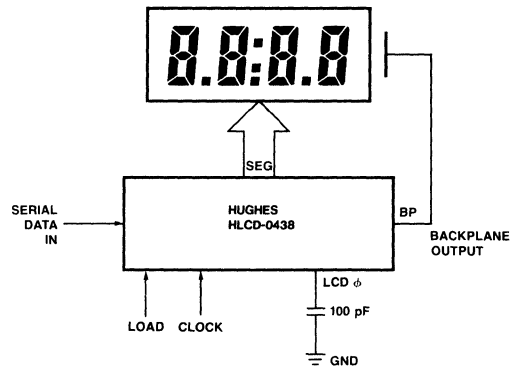

**Note**  
Digit designations on DF412 do not match designations on display.





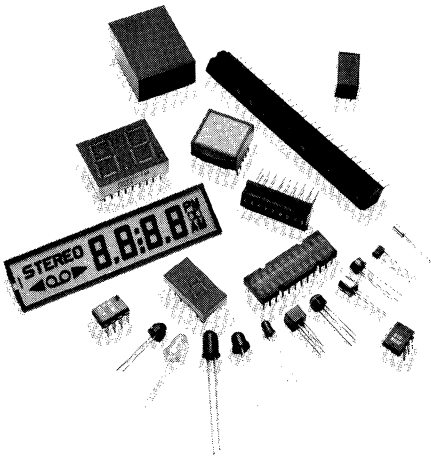

Selection Guides	1
Visible LED Lamps and Mounting Hardware	2
LED Digits	3
Phototransistors, Infrared Emitters and Sensors	4
Couplers	5
Liquid Crystal Displays	6
Fiber Optics	7
Cross Reference	8
Definitions of Symbols and Terms	9
Fairchild Field Sales Offices, Sales Representatives and Distributor Locations	10



---

## Section 7

# Fiber Optics

---

In 1972 Fairchild introduced the FPE104, a high-intensity, narrow-beam infrared emitter intended for excitation of photo detectors. This device can be used in fiber-optic systems in conjunction with Fairchild photo emitters and sensors.

In current designs, as with the FPE104, an objective of Fairchild Opto product development is to optimize device parameters for specific fiber-optic applications. At all times our customers' rapidly changing technological needs are considered. Each customer has individual fiber-optic package requirements, and Fairchild is currently evaluating packaging alternatives for this market.

Fairchild Optoelectronics products that are suitable for fiber-optic applications are:

FPE104  
FLV104/104A  
FPE500/510  
FPT520/530  
FPT500/550  
FPT560/570  
FPT700

For additional information contact your local Fairchild representative.



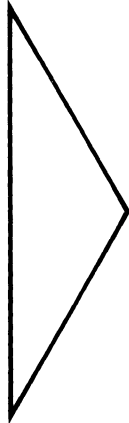
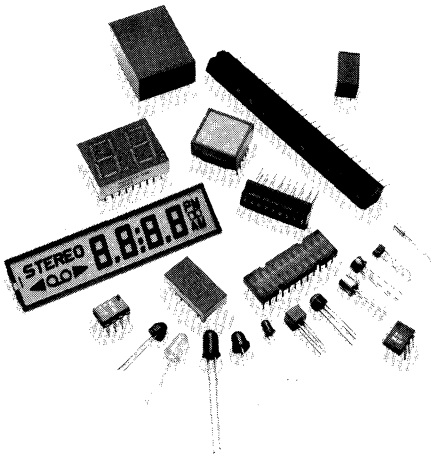

Selection Guides	1
Visible LED Lamps and Mounting Hardware	2
LED Digits	3
Phototransistors, Infrared Emitters and Sensors	4
Couplers	5
Liquid Crystal Displays	6
Fiber Optics	7
Cross Reference	8
Definitions of Symbols and Terms	9
Fairchild Field Sales Offices, Sales Representatives and Distributor Locations	10



## Section 8

## Cross Reference

The following is a cross-reference of known equivalent optoelectronic devices at the time of printing. This list is meant to serve as a substitution guide for existing competitive devices to Fairchild's optoelectronic product line. Fairchild's nearest equivalent devices are selected on the basis of general similarity of electrical characteristics. Interchangeability in particular applications is not guaranteed. Before using a substitute, please compare the detailed specifications of the substitute device to the data sheet of the original device.

In the event the device we recommend does not exactly meet your needs, we encourage you to contact your nearest distributor or Fairchild sales office or representative for further information.

**Code**

- A = Direct Replacement
- B = Minor Electrical Difference
- C = Minor Mechanical Difference
- D = Significant Electrical Difference
- E = Significant Mechanical Difference

Device	Company Name	Fairchild Device	Code
DL 701	LIT	MAN73A	A
DL 702	LIT	MAN74A	A
DL 704	LIT	MAN74A	A
DL 707	LIT	MAN72A	A
DL 707R	LIT	MAN71A	A
DL 721	LIT	MAN6730	E
DL 727	LIT	MAN6710	C
DL 728	LIT	MAN6740	C
FE0202A-E	AND	FLB4013X2	C
FE0202F-J	AND	FLB4013X1	C
FE0203A-E	AND	FLB3513X4	C
FE0203F-J	AND	FLB3513X3	C
FE0204A-E	AND	FLB3513X2	C
FE0204F-J	AND	FLB3513X1	C
GL 4484	LIT	TIL211	C
GL 4850	LIT	MV5253	C
H11A1	GE	H11A1	A
H11A2	GE	H11A2	A
H11A3	GE	H11A3	A
H11A4	GE	H11A4	A
H11A5	GE	FCD820A	A
H11A10	GE	4N26	B
H11A520	GE	FCD820D	A
H11A550	GE	FCD825D	A
H11A5100	GE	4N35	D
H11B1	GE	H11B1	A
H11B2	GE	H11B2	A
H11B3	GE	FCD850	A
H11B255	GE	FCD855	B
H11BX522	GE	FCD860C	B
H11D1	GE	H11D1	A
H11D2	GE	H11D2	A
H11D3	GE	H11D3	A
H11D4	GE	H11D4	A
H15A1	GE	FPA108	D
H15A2	GE	FPA108	D
H17A1	GE	FPT610	E
H17B1	GE	FPE106	E

Device	Company Name	Fairchild Device	Code
H5535	Crystalloid	FLB3513X2	C
H5540	Crystalloid	FLB4013X2	C
IL1	LIT	4N25	A
IL5	LIT	FCD825B	A
IL12	LIT	4N27	A
IL15	LIT	4N27	B
IL16	LIT	4N27	B
ILA30	LIT	MCA230	A
ILA55	LIT	MCA255	A
ILCA2-30	LIT	MCA230	A
ILCA2-55	LIT	MCA255	A
ILD74	LIT	ILD74	A
L14F1	GE	FPT400	B
L14G1	GE	FPT500	B
LAD201	LADCOR	FLB3513X2	C
LAD202	LADCOR	FLB3511X1	C
LAD203	LADCOR	FLB3513X1	C
LAD204	LADCOR	FLB4013X1	C
M5740	Crystalloid	FLB4018X2	C
MAN71A	MON	MAN71A	A
MAN72A	MON	MAN72A	A
MAN73A	MON	MAN73A	A
MAN74A	MON	MAN74A	A
MAN3610A	MON	MAN3610A	A
MAN3620A	MON	MAN3620A	A
MAN3630A	MON	MAN3630A	A
MAN3640A	MON	MAN3640A	A
MAN4630A	MON	FND557	E
MAN4640A	MON	FND550	E
MAN6610	MON	MAN6610	A
MAN6640	MON	MAN6640	A
MAN6710	MON	MAN6710	A
MAN6740	MON	MAN6740	A
MCA230	MON	MCA230	A
MCA231	MON	MCA231	A
MCA255	MON	MCA255	A
MCT2	MON	MCT2	A
MCT2E	MON	MCT2E	A



# Section 8 (Cont'd)

# Cross Reference

Device	Company Name	Fairchild Device	Code	Device	Company Name	Fairchild Device	Code
MCT6	MON	MCT6	A	MV5274B	MON	TIL211	C
MCT26	MON	MCT26	A	MV5274C	MON	TIL211	C
MCT66	MON	MCT66	A	MV5277B	MON	TIL211	E
MCT210	MON	*		MV5277C	MON	TIL211	E
MLC210	MOT	FLB3513X2	C	MV5374B	MON	TIL213	C
MLC410	MOT	FLB3513X1	C	MV5374C	MON	TIL213	C
MLED930	MOT	FPE410	B	MV5377B	MON	TIL213	E
MOC119	MOT	TIL119	A	MV5377C	MON	TIL213	E
MOC1005	MOT	FCD820C	A	MV5774B	MON	TIL209A	B/C
MOC1006	MOT	FCD810C	A	MV5774C	MON	TIL209A	B/C
MOC1200	MOT	4N30	A	MV5777B	MON	TIL209A	D/E
MRD160	MOT	FPT100	E	MV5777C	MON	TIL209A	D/E
MRD300	MOT	FPT500	A	RL2	LIT	FLV110	A
MRD360	MOT	FPT400	A	RL2-03	LIT	FLV112	A
MRD810	MOT	FPT510	A	RL2-04	LIT	FLV111	A
MRD3054	MOT	FPT510	A	RL20	LIT	MV5054-1	A
MRD3055	MOT	FPT510A	A	RL21	LIT	MV5053	C
MT2	MON	FPT500	B/C	RL209	LIT	TIL209A	C
MV5021	MON	FLV160	E	RL209-02	LIT	TIL209A	E
MV5023	MON	FLV160	C	RL209-03	LIT	TIL209A	E
MV5024	MON	FLV160	C	RL209-04	LIT	TIL209A	E
MV5025	MON	FLV160	C	RL2000	LIT	MV5054-2	C
MV5026	MON	FLV160	C	RL4403	LIT	MV5053	C
MV5050	MON	MV5050	A	RL4415	LIT	MV5053	E
MV5051	MON	MV5051	A	RL4484	LIT	TIL209A	C
MV5052	MON	MV5052	A	RL4850	LIT	MV5053	C
MV5053	MON	MV5053	A	RL5054-1	LIT	MV5054-1	C
MV5054-1	MON	MV5054-1	A	RL5054-2	LIT	MV5054-2	C
MV5054-2	MON	MV5054-2	A	RLT-1	LIT	TIL209A	E
MV5054-3	MON	MV5054-3	A	RLT1-02	LIT	TIL209A	E
MV5055	MON	MV5055	A	RLT1-03	LIT	TIL209A	E
MV5056	MON	MV5056	A	RLT1-04	LIT	TIL209A	E
MV5074B	MON	TIL209A	C	TIL78	TI	FPT700	B
MV5074C	MON	TIL209A	C	TIL111	TI	TIL111	A
MV5075B	MON	TIL209A	C	TIL112	TI	TIL112	A
MV5075C	MON	TIL209A	C	TIL113	TI	TIL113	A
MV5077B	MON	TIL209A	E	TIL114	TI	TIL114	A
MV5077C	MON	TIL209A	E	TIL115	TI	TIL115	A
MV5152	MON	MV5152	A	TIL116	TI	TIL116	A
MV5153	MON	MV5153	A	TIL117	TI	TIL117	A
MV5154	MON	MV5154	A	TIL118	TI	TIL118	A
MV5252	MON	MV5252	A	TIL119	TI	TIL119	A
MV5253	MON	MV5253	A	TIL125	TI	FCD820C	B
MV5254	MON	MV5254	A	TIL126	TI	FCD825C	B
MV5352	MON	MV5352	A	TIL127	TI	FCD855C	B
MV5353	MON	MV5353	A	TIL209A	TI	TIL209A	A
MV5354	MON	MV5354	A	TIL211	TI	TIL211	A
MV5752	MON	MV5752	A	TIL212	TI	TIL212	A
MV5753	MON	MV5753	A	TIL220	TI	MV5053	C
MV5754	MON	MV5754	A	TIL221	TI	MV5050	C

\* To be introduced in 1980

# Section 8

## (Cont'd)

# Cross Reference

Device	Company Name	Fairchild Device	Code	Device	Company Name	Fairchild Device	Code
TIL222	TI	MV5253	C	5082-4494	HP	TIL209A	C
TIL232	TI	TIL232	A	5082-4550	HP	MV5353	C
TIL312	TI	MAN72A	B	5082-4555	HP	MV5353	C
TIL313	TI	MAN74A	C	5082-4557	HP	MV5354	C
TIL321	TI	FND507	A	5082-4558	HP	MV5352	B/C
TIL322	TI	FND500	A	5082-4584	HP	TIL232	C
TIL323	TI	FND537	A	5082-4590	HP	FLV440	C
TIL324	TI	FND530	A	5082-4592	HP	FLV440	B/C
TIL325	TI	FND557	A	5082-4650	HP	MV5054-1	B
TIL326	TI	FND550	A	5082-4655	HP	MV5753	C
TIL327	TI	MAN73A	C	5082-4657	HP	MV5754	C
TIL330	TI	FND508	A	5082-4658	HP	MV5752	C
TIL331	TI	FND538	A	5082-4684	HP	TIL209A	B/C
TIL332	TI	FND558	A	5082-4690	HP	FLV540	C
YL4484	LIT	TIL232	C	5082-4693	HP	FLV540	B/C
YL4850	LIT	MV5353	C	5082-4694	HP	FLV540	E
4N25	MON/GE/MOT	4N25	A	5082-4695	HP	FLV540	E
4N26	MON/GE/MOT	4N26	A	5082-4790	HP	FLV140	C
4N27	MON/GE/MOT	4N27	A	5082-4791	HP	FLV140	B/C
4N28	MON/GE/MOT	4N28	A	5082-4850	HP	MV5053	C
4N29	MON/GE/MOT	4N29	A	5082-4855	HP	MV5053	C
4N30	MON/GE/MOT	4N30	A	5082-4880	HP	MV5054-1	C
4N31	MON/GE/MOT	4N31	A	5082-4881	HP	MV5054-1	C
4N32	MON/GE/MOT	4N32	A	5082-4882	HP	MV5054-2	C
4N33	MON/GE/MOT	4N33	A	5082-4883	HP	MV5054-1	E
4N35	MON/GE/MOT	4N35	A	5082-4884	HP	MV5054-1	E
4N36	MON/GE/MOT	4N36	A	5082-4885	HP	MV5054-2	E
4N37	MON/GE/MOT	4N37	A	5082-4886	HP	MV5054-1	E
1654	IEE	FLB3513X2	C	5082-4887	HP	MV5054-1	E
1657	IEE	FLB4013X2	C	5082-4888	HP	MV5054-2	E
1658	IEE	FLB4018X2	C	5082-4950	HP	MV5253	C
3901	Hamlin	FLB3513X4	C	5082-4955	HP	MV5253	B/C
3902	Hamlin	FLB3513X2	C	5082-4957	HP	MV5254	B/C
3906	Hamlin	FLB4013X2	C	5082-4958	HP	MV5252	B/C
3907	Hamlin	FLB4018X2	C	5082-4984	HP	TIL211	C
3933	Hamlin	FLB3513X3	C	5082-4990	HP	FLV340	C
3946	Hamlin	FLB8009X1	C	5082-4992	HP	FLV340	B/C
3962	Hamlin	FLB3513X1	C	5082-7610	HP	MAN72A	B
3966	Hamlin	FLB4013X1	C	5082-7611	HP	MAN71A	B
3967	Hamlin	FLB4018X1	C	5082-7650	HP	5082-7650	A
5082-4403	HP	FLV160	C	5082-7651	HP	5082-7651	A
5082-4415	HP	FLV160	E	5082-7653	HP	5082-7653	A
5082-4440	HP	FLV160	C	5082-7670	HP	FND537	E
5082-4444	HP	FLV160	E	5082-7671	HP	FND537	E
5082-4480	HP	5082-4480	A	5082-7673	HP	FND530	E
5082-4483	HP	5082-4483	A	5082-7676	HP	FND531	E
5082-4484	HP	TIL209A	C	5082-7730	HP	MAN72A	A
5082-4486	HP	5082-4486	A	5082-7731	HP	MAN71A	A
5082-4487	HP	TIL209A	E	5082-7736	HP	MAN73A	C
5082-4488	HP	TIL209A	E	5082-7740	HP	MAN74A	C

---

**Section 8**  
**(Cont'd)****Cross Reference**

---

<b>Device</b>	<b>Company Name</b>	<b>Fairchild Device</b>	<b>Code</b>
5082-7750	HP	5082-7750	A
5082-7751	HP	5082-7751	A
5082-7760	HP	5082-7760	A
65050	OPTEL	FLB3513X1	C
739-2	Beckman	FLB3513X3	C
739-3	Beckman	FLB3513X1	C
739-4	Beckman	FLB4013X1	C
739-22	Beckman	FLB3513X4	C
739-23	Beckman	FLB3513X2	C
739-24	Beckman	FLB4013X2	C
7543	LXD	FLB3513X2	C
7544	LXD	FLB4013X2	C
7554	LXD	FLB4018X2	C

---

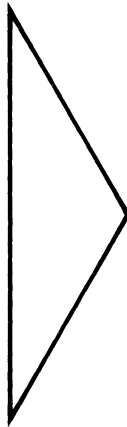
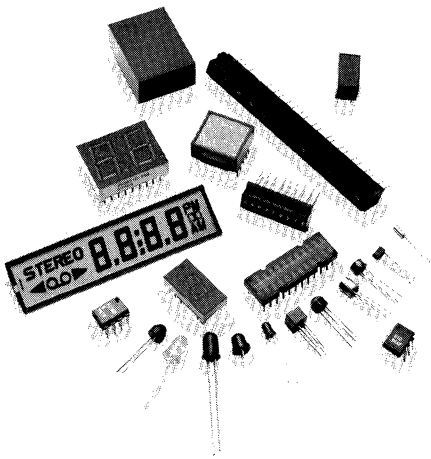

Selection Guides	1
Visible LED Lamps and Mounting Hardware	2
LED Digits	3
Phototransistors, Infrared Emitters and Sensors	4
Couplers	5
Liquid Crystal Displays	6
Fiber Optics	7
Cross Reference	8
Definitions of Symbols and Terms	9
Fairchild Field Sales Offices, Sales Representatives and Distributor Locations	10



## Section 9

# Definition of Symbols and Terms

### Angstrom (Å)

A unit of length particularly for measuring electromagnetic wavelengths; one angstrom =  $10^{-10}$  meters =  $10^{-4}$  microns =  $3.937 \times 10^{-9}$  inches.

### Angular Alignment

A measure of the deviation of the optical axis from the mechanical axis.

### Area Source

A source with a diameter greater than 10% of the distance between it and the detector.

### Axial Intensity ( $I_0$ )

The ratio of the flux emitted by a source and contained within an incremental on axis solid angle subtended by a sensor [units: lumens/steradian (photometric) or watts/steradian (radiometric)].

### $B_L$ (also "B")

A photometric unit of luminance in (lumens/steradian)/ft<sup>2</sup> or foot-Lamberts.

### Blackbody

A 100% efficient radiator and absorber of radiant energy used as a standard for all irradiance measurements.

### Blackbody Luminous Efficiency

As a function of temperature, the efficiency of an incandescent blackbody in terms of visible light.

### Candela

A photometric unit of luminous intensity (in lumens per steradian) defined as 1/60 the intensity of a one cm<sup>2</sup> blackbody radiator at platinum's solidification temperature (2,046°K).

### Candela/cm<sup>2</sup>

Luminance unit called "stilb".

### ( $1/\pi$ ) candela/cm<sup>2</sup>

Luminance unit called "Lambert".

### Channel Impedance

The parallel resistance and capacitance appearing between the active and guard ring junctions.

### Color Temperature

The temperature of a blackbody whose radiation has the same visible color as that of a given non-blackbody radiator. TYPICAL UNIT: K (formerly °K).

### Conversion Efficiency (of a Photoemissive Device)

The ratio of maximum available luminous or radiant flux output to total input power.

### Critical Angle

The maximum angle of incidence for which light will be transmitted from one medium to another. Light approaching the interface at angles greater than the critical angle will be reflected back into the first medium.

### Dark Current ( $I_D$ )

The current which flows in a photodetector when there is no incident radiation on the detector.

### Darlington Amplifier

A composite configuration of transistors which provides a high input impedance and a high degree of amplification.

### Darlington Connector Phototransistor

A phototransistor the collector and emitter of which are connected to the collector and base, respectively, of a second transistor. The emitter current of the input transistor is amplified by the second transistor and the device has very high sensitivity to light.

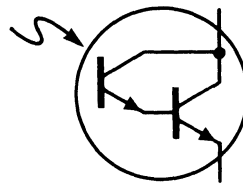

### DC Transfer Ratio (of an Optically Coupled Isolator)

The ratio of the dc output current to the dc input current.

### Delay Time ( $t_d$ )

The time interval from the point at which the leading edge of the input pulse has reached 10% of its maximum amplitude to the point at which the leading edge of the output pulse has reached 10% of its maximum amplitude.

**Diode**

A semiconductor device which passes current in only one direction.

**Duty Cycle**

A measure of the effect of a pulsed input to a lamp. Expressed as a percentage of on time as compared to total time.

**E**

Photometric unit of illuminance in lumens/ft<sup>2</sup> (foot-candle).

**Emission Beam Angle Between Half-Power Points ( $\theta_{HP}$ )**

The angle centered on the optical axis of a light-emitting diode within which the relative radiant power output or photon intensity is not less than half of the maximum output or intensity.

**Fall Time ( $t_f$ )**

The time duration during which the trailing edge of a pulse is decreasing from 90% to 10% of its maximum amplitude.

**Flux**

Power passing through a surface (energy per unit time); number of photons passing through a surface per unit time. Expressed in lumens or watts.

**Flux Density**

A measure of the strength of a wave; flux per unit area normal to the direction of the flux; number of photons passing through a surface per unit time per unit area. Expressed in watts/cm<sup>2</sup> or lumens/ft<sup>2</sup>.

**Foot-candle**

Unit of illumination. Defined as the illuminance on a surface of one square foot on which there is a uniformly distributed flux of one lumen, or lumens/ft<sup>2</sup>.

**Foot-Lambert**

Unit of luminance or brightness. Defined as the uniform luminance of a surface emitting or reflecting light at the rate of one lumen per square foot.

**Forward Voltage ( $V_F$ )**

The voltage across a semiconductor diode associated with the flow of forward current. The p-region is at a positive potential with respect to the n-region.

**GaAs, GaAsP, GaP**

The most commonly used emitter materials are gallium arsenide (GaAs), gallium arsenide phosphide (GaAsP) and gallium phosphide (GaP).

**H**

Irradiance or radiation flux density in watts/cm<sup>2</sup> (radiometric unit).

**Half Intensity Beam Angle ( $\theta_{HI}$ )**

The angle within which the radiant intensity is not less than half the maximum.

**Homogeneous Orientation**

The parallel orientation of the molecular axes of the nematic molecules in a nematic crystal, relative to the electrode plates.

**Illumination ( $E_V$ )**

The luminous flux density incident on a surface; the ratio of flux to area of illuminated surface.

TYPICAL UNITS: lm/ft<sup>2</sup>, lx = lm/m<sup>2</sup>. 1 lm/ft<sup>2</sup> = 10.764 lx.

**Infrared Light-Emitting Diode (Infrared Emitter)**

An optoelectronic device containing a semiconductor p-n junction which emits radiant energy in the 0.78  $\mu$ m to 100  $\mu$ m wavelength region when forward-biased.

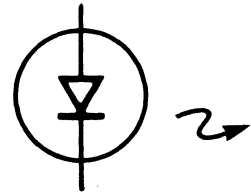
**Irradiance (H or  $E_e$ )**

The radiant flux density incident on a surface; the ratio of flux to area of irradiated surface.

TYPICAL UNITS: W/ft<sup>2</sup>, W/m<sup>2</sup>. 1 W/ft<sup>2</sup> = 10.764 W/m<sup>2</sup>.

**Junction Capacity**

The capacitance appearing across the junction of a photodiode. It is analogous to a parallel plate capacitor having a voltage controlled dielectric.

**Light**

For the purpose of these definitions, radiant energy transmitted by wave motion with wavelengths from about 0.3  $\mu$ m to 30  $\mu$ m; this includes visible wavelengths (0.38  $\mu$ m to 0.78  $\mu$ m) and those wavelengths, such as ultraviolet and infrared, which can be handled by optical techniques used for the visible region. In more restricted usage, radiant energy within the limits of the visual spectrum.

**Light Current ( $I_L$ )**

The current that flows through a photosensitive device, such as a phototransistor or a photodiode, when it is exposed to illumination or irradiance.

**Light-Emitting Diode (LED)**

Light-emitting diode that emits visible light.

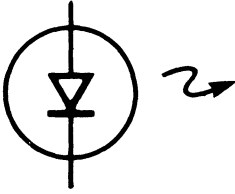
**Liquid Crystals**

Liquids that are doubly-refracting and that display interference patterns in polarized light. The turbid liquid produced on melting cholesteryl benzoate is an example of a liquid crystal.

**Lumen**

Unit of flux; flux through one steradian from a uniform point source of one candle.

**Luminance (L) (Photometric Brightness)**

The luminous intensity of a surface in a given direction per unit of projected area of the surface as viewed from that direction. TYPICAL UNITS: fL, cd/ft<sup>2</sup>, cd/m<sup>2</sup>.  
 $1 \text{ fL} = (1/\pi) \text{ cd/ft}^2 = 3.4263 \text{ cd/m}^2$ .

**Luminescence**

Emission of light due to any other cause than high temperature (incandescence).

**Luminous Flux ( $\Phi_v$ )**

The time rate of flow of light. TYPICAL UNIT: lm

**Note**

Luminous flux is related to radiant flux by the eye-response curve of the International Commission on Illumination (CIE). At the peak response ( $\lambda = 555 \text{ nm}$ ),  $1 \text{ W} = 680 \text{ lm}$ .

**Luminous Intensity ( $I_v$ )**

Luminous flux per unit solid angle in a given direction. TYPICAL UNIT: cd.  $1 \text{ cd} = 1 \text{ lm/sr}$ .

**Noise Current**

The RMS noise current generated by a photodiode with no incident light energy. Under reverse bias conditions, the noise current is a combination of shot noise produced by the dark current and thermal noise produced by the channel resistance. When operated photovoltaically, the noise generated is a thermal noise that is related to the value of shunt resistance.

**Off-State Collector Current (of an Optically Coupled Isolator) ( $I_{C(off)}$ )**

The output current when the input current is zero.

**On-State Collector Current (of an Optically Coupled Isolator) ( $I_{C(on)}$ )**

The output current when the input current is above a threshold level. An increase in the input current will usually result in a corresponding increase in the on-state collector current.

**Optical Axis**

A line about which the radiant-energy pattern is centered; usually perpendicular to the active area.

**Optically Coupled Isolator**

An optoelectronic device consisting of a photoemissive device and a photodetector integrated into a single entity and intended for the transfer of a signal from the input to the output.

**Optoelectronics**

Circuitry involving solid-state light emitters and detectors.

**Optoelectronic Transistor**

A transistor that uses an electroluminescent source, a transparent base and a photoelectric collector.

**Oriented Crystal**

A crystal having the axes of its grains aligned so that they have directional magnetic characteristics.

**Photocurrent**

The difference between light current ( $I_L$ ) and dark current ( $I_D$ ) in a photodetector.

**Photodetector**

A device which senses incident radiation.

**Photodiode**

A solid state device, much like an ordinary diode except that incident light on the pn junction causes the device to conduct. It acts as an open circuit (ideally) in the dark. The photodiode is characterized by a linear relationship between input radiation and output current. It has faster switching speeds than a phototransistor.

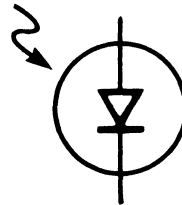
**Photometric Axis**

The direction from the source of radiant energy in which the measurement of photometric parameters is performed.

**Photometric Brightness**

See Luminance.

**Photon**

A quantum (the smallest possible unit) of radiant energy; a photon carries a quantity of energy equal to Planck's constant times the frequency.



**Phototransistor**

Solid state device similar to an ordinary transistor except that light incident on the pn junctions controls the response of this device; offers built-in gain and greater sensitivity than photodiodes.

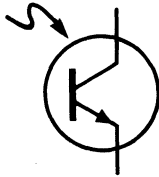
**Point Source**

Radiation source whose maximum dimension is less than  $1/10$  the distance between source and receiver.

**Quantum Efficiency (of a Photosensitive Device)**

The ratio of the number of carriers generated to the number of photons incident upon the active region.

**Radiant Flux ( $\Phi_e$ )**

The time rate of flow of radiant energy.  
TYPICAL UNIT: W.

**Radiant Pulse Fall Time ( $t_f$ )**

The time required for a photometric quantity to change from 90% to 10% of its peak value for a step change in electrical input.

**Radiant Pulse Time ( $t_r$ )**

The time required for a photometric quantity to change from 10% to 90% of its peak value for a step change in electrical input.

**Radiation and Illumination Sources**

The effect of a radiation source on a photodevice is dependent on the device spectral response and the spectral distribution of energy from the source. To discuss such energy, two related sets of terminology are available. The first, radiometric, is a physical system, and the second, photometric, is a physiological system, which defines energy relative to its visual effect.

The defining factor for the photometric system is the spectral response curve of a standard observer, whereas the defining spectral response of the radiometric system can be imagined as unit response for all wavelengths.

**Rise Time ( $t_r$ )**

The time duration during which the leading edge of a pulse is increasing from 10% to 90% of its maximum amplitude.

**Series Resistance**

The resistance of the undepleted bulk silicon.

**Shunt Resistance**

The dynamic resistance ( $dV/dI$ ) of the junction at zero volts.

**Spectral Output (of a Light-Emitting Diode)**

A description of the radiant-energy or light-emission characteristic versus wavelength. This information is usually given by stating the wavelength at peak emission and the bandwidth between half-power points or by means of a curve.

**Spectral Distribution of Energy ( $E_\lambda$ )**

A plot showing the variation of spectral emission with wavelength.

**Spectral Response (of a Photosensitive Device)**

A curve of the electrical-output characteristic versus wavelength of radiant energy incident upon the device.

**Steradian**

Solid angle subtending an area on the surface of a sphere equal to the square of the radius; there are  $4\pi$  steradians in a sphere.

**Storage Time ( $t_s$ )**

The time interval from a point at which the trailing edge of the input pulse has dropped to 90% of its maximum amplitude to a point at which the trailing edge of the output pulse has dropped to 90% of its maximum amplitude.

**Threshold Voltage**

Voltage at which a pn junction begins to pass a current; in a solid state lamp, the voltage at which light is first emitted.

**Visible Emission, Visible Light**

Radiation which is characterized by wavelengths of about  $0.38 \mu\text{m}$  to  $0.78 \mu\text{m}$ .

**Visible-Light-Emitting Diode (VLED)**

An optoelectronic device containing a semiconductor junction which emits visible light when forward-biased.

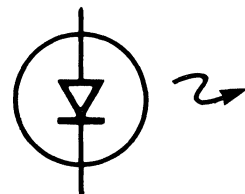
**Wavelength at Peak Emission ( $\lambda_p$ )**

The wavelength at which the power output from a light-emitting diode is maximum. TYPICAL UNITS:  $\text{\AA}$ ,  $\mu\text{m}$ , nm.  
 $1 \text{\AA} = 10^{-4} \mu\text{m} = 0.1 \text{ nm}$ .

## Conversion Table

Symbol	Unit	Note
A	Ampere	
Å	Angstrom	$1 \text{ Å} = 10^{-10} \text{ m} = 10^{-4} \text{ μm} = 0.1 \text{ nm}$
cd	Candela	$1 \text{ cd} = 1 \text{ lm/sr}$
°C	Degree Celsius	
°K		See K
ft	Foot	
fc	Foot-candle	The equivalent unit $\text{lm/ft}^2$ is preferred
fL	Foot-Lambert	$1 \text{ fL} = (1/\pi) \text{ cd/ft}^2 = 3.4263 \text{ cd/m}^2$
Hz	Hertz	
in	Inch	
K	Kelvin	Formerly °K, degree Kelvin
L	Lambert	
lm	lumen	
lx	Lux	$1 \text{ lx} = 1 \text{ lm/m}^2$
m	Meter	
μ	Micron	The equivalent unit $\text{μm}$ is preferred
nt	Nit	$1 \text{ nt} = 1 \text{ cd/m}^2$
Ω	Ohm	
s	Second	
sr	Steradian	
sb	Stilb	$1 \text{ sb} = 1 \text{ cd/cm}^2$
V	Volt	
W	Watt	

## Units of Measurement

To Convert From	To	Multiply By
Angstroms	Nanometers Millimicrons	0.1
Angstroms	Microns Micrometers	0.0001
Nanometers Millimicrons	Angstroms	10
Microns Micrometers	Angstroms	10,000
Nanometers Millimicrons	Microns Micrometers	.001
Microns Micrometers	Nanometers Millimicrons	1000

Description	Radiometric all wavelengths	Photometric visible light
Total Flux	Radiant Flux, P, in Watts	Luminous Flux, F, in Lumens.
Emitted Flux Density at a Source Surface	Radiant Emittance, W, in Watts/cm <sup>2</sup>	Luminous Emittance, L, in Lumens/ft <sup>2</sup> (foot-Lamberts), or lumens/cm <sup>2</sup> (Lamberts)
Source Intensity (Point Source)	Radiant Intensity, I <sub>r</sub> , in Watts/Steradian	Luminous Intensity, I <sub>L</sub> , in Lumens/Steradian (Candela)
Source Intensity (Area Source)	Radiance, B <sub>r</sub> , in (Watts/Steradian) /cm <sup>2</sup>	Luminance, B <sub>L</sub> , in (Lumens/Steradian)/ft <sup>2</sup> (foot-Lambert)
Flux Density Incident on a Receiver Surface	Irradiance, H, in Watts/cm <sup>2</sup>	Illuminance, E, in Lumens/ft <sup>2</sup> (foot-candle)

## Point Source Relationships

Description	Radiometric	Photometric
Point Source Intensity	I <sub>r</sub> , Watts/Steradian	I <sub>L</sub> , Lumens/Steradian
Incident Flux Density	H (Irradiance) = I <sub>r</sub> /r <sup>2</sup> watts/distance <sup>2</sup>	E (Illuminance) = I <sub>L</sub> /r <sup>2</sup> lumens/distance <sup>2</sup>
Total Flux Output of Point Source	P = 4πI <sub>r</sub> Watts	F = 4πI <sub>L</sub> Lumens

## Design Relationships For An Area Source

Description	Radiometric	Photometric
Source Intensity	B <sub>r</sub> , Watts/cm <sup>2</sup> /steradian	B <sub>L</sub> , Lumens/cm <sup>2</sup> /steradian
Emitted Flux Density	W = πB <sub>r</sub> , Watts/cm <sup>2</sup>	L = πB <sub>L</sub> , Lumens/cm <sup>2</sup>
Incident Flux Density	$\frac{B_r A_s}{H = r^2 + d/2^2}$ watts/cm <sup>2</sup>	$\frac{B_L A_S}{E = r^2 + d/2^2}$ Lumens/cm <sup>2</sup>



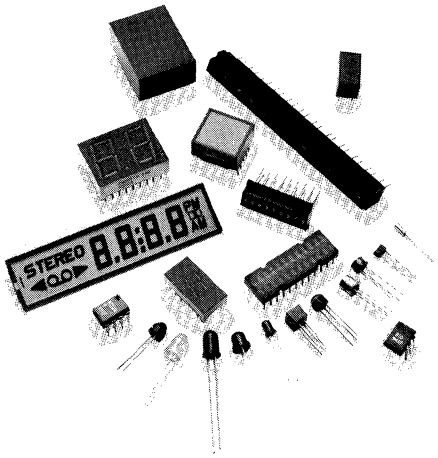

Selection Guides	1
Visible LED Lamps and Mounting Hardware	2
LED Digits	3
Phototransistors, Infrared Emitters and Sensors	4
Couplers	5
Liquid Crystal Displays	6
Fiber Optics	7
Cross Reference	8
Definitions of Symbols and Terms	9
Fairchild Field Sales Offices, Sales Representatives and Distributor Locations	10



# Fairchild Semiconductor Franchised Distributors

# United States and Canada

## Alabama

Hallmark Electronics  
4739 Commercial Drive  
Huntsville, Alabama 35805  
Tel: 205-837-8700 TWX: 810-726-2187

Hamilton/Avnet Electronics  
4692 Commercial Drive  
Huntsville, Alabama 35805  
Tel: 205-837-7210  
Telex: None — use HAMAVLECB DAL 73-0511  
(Regional Hq. in Dallas, Texas)

## Arizona

Hamilton/Avnet Electronics  
505 S. Madison Drive  
Tempe, Arizona 85281  
Tel: 602-275-7851 TWX: 910-951-1535

Kierulff Electronics  
4134 East Wood Street  
Phoenix, Arizona 85040  
Tel: 602-243-4101

Wyle Distribution Group  
8155 North 24th Ave.  
Phoenix, Arizona 85021  
Tel: 602-249-2232 TWX: 910-951-4282

## California

Avnet Electronics  
350 McCormick Avenue  
Costa Mesa, California 92626  
Tel: 714-754-8111 (Orange County)  
213-558-2345 (Los Angeles)  
TWX: 910-595-1928

Bell Industries  
Electronic Distributor Division  
1181 N. Fair Oaks Avenue  
Sunnyvale, California 94086  
Tel: 408-734-8570 TWX: 910-339-9378

Wyle Distribution Group  
3000 Bowers Avenue  
Santa Clara, California 95051  
Tel: 408-727-2500 TWX: 910-338-0541

Hamilton Electro Sales  
3170 Pullman Avenue  
Costa Mesa, California 92636  
Tel: 714-979-8864

Hamilton Electro Sales  
10912 W. Washington Blvd.  
Culver City, California 90230  
Tel: 213-558-2121 TWX: 910-340-6364

Hamilton/Avnet Electronics  
1175 Jordeaux Drive  
Sunnyvale, California 94086  
Tel: 408-743-3355 TWX: 910-379-6486

Hamilton/Avnet Electronics  
4545 Viewridge Avenue  
San Diego, California 92123  
Tel: 714-571-7527  
Telex: HAMAVELECD SDG 69-5415

Anthem Electronics  
1020 Stewart Drive  
P.O. Box 9085  
Sunnyvale, California 94086  
Tel: 408-738-1111

Anthem Electronics, Inc.  
4040 Sorrento Valley Blvd.  
San Diego, California 92121  
Tel: 714-279-5200

Anthem Electronics, Inc.  
2661 Dow Avenue  
Tustin, California 92680  
Tel: 714-730-8000

Wyle Electronics  
124 Maryland Street  
El Segundo, California 90245  
Tel: 213-322-8100 TWX: 910-348-7111

Wyle Distributor Group  
17872 Cowan Avenue  
Irvine, California 92714  
Tel: 714-641-1600  
Telex: 910-595-1572

\*\*Sertech Laboratories  
2120 Main Street, Suite 190  
Huntington Beach, California 92647  
Tel: 714-960-1403

Wyle Distribution Group  
9525 Chesapeake  
San Diego, California 92123  
Tel: 714-565-9171 TWX: 910-335-1590

## Colorado

Bell Industries  
8155 West 48th Avenue  
Wheatridge, Colorado 80033  
Tel: 303-424-1985 TWX: 910-938-0393

Arrow Electronics  
2121 South Hudson  
Denver, Colorado 80222  
Tel: 303-758-2100

Wyle Distribution Group  
6777 E. 50th Avenue  
Commerce City, Colorado 80022  
Tel: 303-287-9611 TWX: 910-936-0770

Hamilton/Avnet Electronics  
8765 E. Orchard Rd., Suite 708  
Englewood, Colorado 80111  
Tel: 303-740-1000 TWX: 910-931-0510

## Connecticut

Arrow Electronics, Inc.  
12 Beaumont Road  
Wallingford, Connecticut 06492  
Tel: 203-265-7741 TWX: 710-465-0780

Hamilton/Avnet Electronics  
643 Danbury Road  
Georgetown, Connecticut 06829  
Tel: 203-762-0361  
TWX: None — use 710-897-1405  
(Regional Hq. in Mt. Laurel, N.J.)

Harvey Electronics  
112 Main Street  
Norwalk, Connecticut 06851  
Tel: 203-853-1515

Schweber Electronics  
Finance Drive  
Commerce Industrial Park  
Danbury, Connecticut 06810  
Tel: 203-792-3500

## Florida

Arrow Electronics  
1001 Northwest 62nd Street  
Suite 402  
Ft. Lauderdale, Florida 33309  
Tel: 305-776-7790

Arrow Electronics  
115 Palm Bay Road N.W.  
Suite 10 Bldg. #200  
Palm Bay, Florida 32905  
Tel: 305-725-1408

Hallmark Electronics  
1671 W. McNab Road  
Ft. Lauderdale, Florida 33309  
Tel: 305-971-9280 TWX: 510-956-3092

Hallmark Electronics  
7233 Lake Ellenor Drive  
Orlando, Florida 32809  
Tel: 305-855-4020 TWX: 810-850-0183

Hamilton/Avnet Electronics  
6800 N.W. 20th Avenue  
Ft. Lauderdale, Florida 33309  
Tel: 305-971-2900 TWX: 510-954-9808

Hamilton/Avnet Electronics  
3197 Tech Drive, North  
St. Petersburg, Florida 33702

Schweber Electronics  
2830 North 28th Terrace  
Hollywood, Florida 33020  
Tel: 305-927-0511 TWX: 510-954-0304

## Georgia

Arrow Electronics  
2979 Pacific Drive  
Norcross, Georgia 30071  
Tel: 404-449-8252  
Telex: 810-766-0439

Hamilton/Avnet Electronics  
6700 Interstate 85 Access Road, Suite 1E  
Norcross, Georgia 30071  
Tel: 404-448-0800  
Telex: None — use HAMAVLECB DAL 73-0511  
(Regional Hq. in Dallas, Texas)

## Illinois

Hallmark Electronics, Inc.  
1177 Industrial Drive  
Bensenville, Illinois 60106  
Tel: 312-860-3800

Hamilton/Avnet Electronics  
3901 N. 25th Avenue  
Schiller Park, Illinois 60176  
Tel: 312-678-6310 TWX: 910-227-0060

Kierulff Electronics  
1536 Landmeier Road  
Elk Grove Village, Illinois 60007  
Tel: 312-640-0200 TWX: 910-227-3166

Schweber Electronics, Inc.  
1275 Brummel Avenue  
Elk Grove Village, Illinois 60007  
Tel: 312-593-2740 TWX: 910-222-3453

Semiconductor Specialists, Inc.  
(mailing address)  
O'Hare International Airport  
P.O. Box 66125  
Chicago, Illinois 60666

(shipping address)  
195 Spangler Avenue  
Elmhurst Industrial Park  
Elmhurst, Illinois 60126  
Tel: 312-279-1000 TWX: 910-254-0169

## Indiana

Graham Electronics Supply, Inc.  
133 S. Pennsylvania St.  
Indianapolis, Indiana 46204  
Tel: 317-634-8486 TWX: 810-341-3481

Pioneer Indiana Electronics, Inc.  
6408 Castle Place Drive  
Indianapolis, Indiana 46250  
Tel: 317-849-7300 TWX: 910-260-1794

## Kansas

Hallmark Electronics, Inc.  
11870 W. 91st Street  
Shawnee Mission, Kansas 66214  
Tel: 913-888-4746

Hamilton/Avnet Electronics  
9219 Guivira Road  
Overland Park, Kansas 66215  
Tel: 913-888-8900  
Telex: None — use HAMAVLECB DAL 73-0511  
(Regional Hq. in Dallas, Texas)

## Louisiana

Sterling Electronics Corp.  
4513 Fairfield  
Metairie, Louisiana 70002  
Tel: 504-887-7610  
Telex: STERLE LEC MRIE 58-328

## Maryland

Hallmark Electronics, Inc.  
6655 Amberton Drive  
Baltimore, Maryland 21227  
Tel: 301-796-9300

Hamilton/Avnet Electronics  
(mailing address)  
Friendship International Airport  
P.O. Box 8647  
Baltimore, Maryland 21240

(shipping address)  
7235 Standard Drive  
Hanover, Maryland 21076  
Tel: 301-796-5000 TWX: 710-862-1861  
Telex: HAMAVLECA HNVE 87-968

Pioneer Washington Electronics, Inc.  
9100 Gaither Road  
Gaithersburg, Maryland 20760  
Tel: 301-948-0710 TWX: 710-828-9784

Schweber Electronics  
9218 Gaither Road  
Gaithersburg, Maryland 20760  
Tel: 301-840-5900 TWX: 710-828-0536

**Massachusetts**

Arrow Electronics, Inc.  
96 D Commerce Way  
Woburn, Massachusetts 01801  
Tel: 617-933-8130 TWX: 710-393-6770

Arrow Electronics  
85 Wells Avenue  
Newton Centre, Massachusetts 02159  
Tel: 617-964-4000

Gerber Electronics  
128 Carnegie Row  
Norwood, Massachusetts 02026  
Tel: 617-329-2400

Hamilton/Avnet Electronics  
50 Tower Office Park  
Woburn, Massachusetts 01801  
Tel: 617-273-7500 TWX: 710-393-0382

Harvey Electronics  
44 Hartwell Avenue  
Lexington, Massachusetts 02173  
Tel: 617-661-9200 TWX: 710-326-6617

Schweber Electronics  
25 Wiggins Avenue  
Bedford, Massachusetts 01730  
Tel: 617-275-5100

\*\*Sertech Laboratories  
1 Peabody Street  
Salem, Massachusetts 01970  
Tel: 617-745-2450

**Michigan**

Hamilton/Avnet Electronics  
32487 Schoolcraft  
Livonia, Michigan 48150  
Tel: 313-522-4700 TWX: 810-242-8775

Pioneer/Detroit  
13485 Stamford  
Livonia, Michigan 48150  
Tel: 313-525-1600

R-M Electronics  
4310 Roger B. Chaffee  
Wyoming, Michigan 49508  
Tel: 616-531-9300

Schweber Electronics  
33540 Schoolcraft  
Livonia, Michigan 48150  
Tel: 313-525-8100

Arrow Electronics  
3921 Varsity Drive  
Ann Arbor, Michigan 48104  
Tel: 313-971-8220

**Minnesota**

Arrow Electronics  
5230 West 73rd Street  
Edina, Minnesota 55435  
Tel: 612-830-1800

Hamilton/Avnet Electronics  
7449 Cahill Road  
Edina, Minnesota 55435  
Tel: 612-941-3801  
TWX: None — use 910-227-0060  
(Regional Hq. in Chicago, Ill.)

Schweber Electronics  
7402 Washington Avenue S.  
Eden Prairie, Minnesota 55344  
Tel: 612-941-5280

**Missouri**

Hallmark Electronics, Inc.  
13789 Rider Trail  
Earth City, Missouri 63045  
Tel: 314-291-5350

Hamilton/Avnet Electronics  
13743 Shoreline Ct., East  
Earth City, Missouri 63042  
Tel: 314-344-1200 TWX: 910-762-0684

**New Jersey**

Hamilton/Avnet Electronics  
10 Industrial Road  
Fairfield, New Jersey 07006  
Tel: 201-575-3390 TWX: 710-994-5787

Hamilton/Avnet Electronics  
#1 Keystone Avenue  
Cherry Hill, New Jersey 08003  
Tel: 609-424-0100 TWX: 710-940-0262

Schweber Electronics  
18 Madison Road  
Fairfield, New Jersey 07006  
Tel: 201-227-7880 TWX: 710-480-4733

Sterling Electronics  
774 Pfeiffer Blvd  
Perth Amboy, N.J. 08861  
Tel: 201-442-8000 Telex: 138-679

Wilshire Electronics  
102 Gaither Drive  
Mt. Laurel, N.J. 08057  
Tel: 215-627-1920

Wilshire Electronics  
1111 Paulison Avenue  
Clifton, N.J. 07015  
Tel: 201-365-2600 TWX: 710-989-7052

**New Mexico**

Bell Industries  
11728 Linn Avenue N.E.  
Albuquerque, New Mexico 87123  
Tel: 505-292-2700 TWX: 910-989-0625

Hamilton/Avnet Electronics  
2450 Byalar Drive S.E.  
Albuquerque, New Mexico 87119  
Tel: 505-765-1500  
TWX: None — use 910-379-6486  
(Regional Hq. in Mt. View, Ca.)

**New York**

Arrow Electronics  
20 Oser Avenue  
Hauppauge, New York 11787  
Tel: 516-231-1000

\*Cadence Electronics  
40-17 Oser Avenue  
Hauppauge, New York 11787  
Tel: 516-231-6722

Arrow Electronics  
P.O. Box 370  
7705 Maltage Drive  
Liverpool, New York 13088  
Tel: 315-652-1000  
TWX: 710-545-0230

Components Plus, Inc.  
40 Oser Avenue  
Hauppauge, L.I., New York 11787  
Tel: 516-231-9200 TWX: 510-227-9869

Hamilton/Avnet Electronics  
167 Clay Road  
Rochester, New York 14623  
Tel: 716-442-7820  
TWX: None — use 710-332-1201  
(Regional Hq. in Burlington, Ma.)

Hamilton/Avnet Electronics  
16 Corporate Circle  
E. Syracuse, New York 13057  
Tel: 315-437-2642 TWX: 710-541-0959

Hamilton/Avnet Electronics  
5 Hub Drive  
Melville, New York 11746  
Tel: 516-454-6000 TWX: 510-224-6166

Harvey Electronics  
(mailing address)  
P.O. Box 1208  
Binghamton, New York 13902  
(shipping address)  
1911 Vestal Parkway East  
Vestal, New York 13850  
Tel: 607-748-8211

Rochester Radio Supply Co., Inc.  
140 W. Main Street  
P.O. Box 1971 Rochester, New York 14603  
Tel: 716-454-7800

Schweber Electronics  
Jericho Turnpike  
Westbury, L.I., New York 11590  
Tel: 516-334-7474 TWX: 510-222-3660

Jaco Electronics, Inc.  
145 Oser Avenue  
Hauppauge, L.I., New York 11787  
Tel: 516-273-1234 TWX: 510-227-6232

Summit Distributors, Inc.  
916 Main Street  
Buffalo, New York 14202  
Tel: 716-884-3450 TWX: 710-522-1692

**North Carolina**

Arrow Electronics  
938 Burke Street  
Winston Salem, North Carolina 27102  
Tel: 919-725-8711 TWX: 510-922-4765

Hamilton/Avnet  
2803 Industrial Drive  
Raleigh, North Carolina 27609  
Tel: 919-829-8030

Hallmark Electronics  
1208 Front Street, Bldg. K  
Raleigh, North Carolina 27609  
Tel: 919-823-4465 TWX: 510-928-1831

**Resco**

Highway 70 West  
Rural Route 8, P.O. Box 116-B  
Raleigh, North Carolina 27612  
Tel: 919-781-5700

Pioneer/Carolina Electronics  
103 Industrial Drive  
Greensboro, North Carolina 27406  
Tel: 919-273-4441

**Ohio**

Arrow Electronics  
3100 Plainfield Road  
Dayton, Ohio 45432  
Tel: 513-253-9176

Hamilton/Avnet Electronics  
4588 Emery Industrial Parkway  
Cleveland, Ohio 44128  
Tel: 216-831-3500  
TWX: None — use 910-227-0060  
(Regional Hq. in Chicago, Ill.)

Hamilton/Avnet Electronics  
954 Senate Drive  
Dayton, Ohio 45459  
Tel: 513-433-0610 TWX: 810-450-2531

Pioneer/Cleveland  
4800 E. 131st Street  
Cleveland, Ohio 44105  
Tel: 216-587-3600

Pioneer/Dayton  
1900 Troy Street  
Dayton, Ohio 45404  
Tel: 513-236-9900 TWX: 810-459-1622

Schweber Electronics  
23880 Commerce Park Road  
Beachwood, Ohio 44122  
Tel: 216-464-2970 TWX: 810-427-9441

Arrow Electronics  
6238 Cochran Road  
Solon, Ohio 44139  
Tel: 216-248-3990 TWX: 810-427-9409

Arrow Electronics  
mailing address  
P.O. Box 37826  
Cincinnati, Ohio 45222  
shipping address  
10 Knollcrest Drive  
Reading, Ohio 45237  
Tel: 513-761-5432 TWX: 810-461-2670

\*Minority Distributor

\*\*This distributor carries Fairchild die products only.

**Oklahoma**

**Hallmark Electronics**  
5460 S. 103rd East Avenue  
Tulsa, Oklahoma 74145  
Tel: 918-835-8458 TWX: 910-845-2290

**Radio Inc. Industrial Electronics**

1000 S. Main  
Tulsa, Oklahoma 74119  
Tel: 918-587-9123

**Pennsylvania**

**Hallmark Electronics, Inc.**  
458 Pike Road  
Huntingdon Valley, Pennsylvania 19006  
Tel: 215-355-7300 TWX: 510-667-1727

**Pioneer/Delaware Valley Electronics**

281 Gibraltar Road  
Horsham, Pennsylvania 19044  
Tel: 215-674-4000 TWX: 510-665-6778

**Pioneer Electronics, Inc.**

560 Alpha Drive  
Pittsburgh, Pennsylvania 15238  
Tel: 412-782-2300 TWX: 710-795-3122

**Schweber Electronics**

101 Rock Road  
Horsham, Pennsylvania 19044  
Tel: 215-441-0600

**Arrow Electronics**

4297 Greensburgh Pike  
Suite 3114  
Pittsburgh, Pennsylvania 15221  
Tel: 412-351-4000

**South Carolina**

**Dieix Electronics, Inc.**  
P.O. Box 408 ZIP Code 29202  
1900 Barnwell Street  
Columbia, South Carolina 29201  
Tel: 803-779-5332

**Texas**

**Allied Electronics**  
401 E. 8th Street  
Fort Worth, Texas 76102  
Tel: 817-336-5401

**Arrow Electronics**

13715 Gamma Road  
Dallas, Texas 75234  
Tel: 214-386-7500 TWX: 910-860-5377

**Hallmark Electronics Corp.**

10109 McKalla Place Suite F  
Austin, Texas 78758  
Tel: 512-837-2814

**Hallmark Electronics**

11333 Pagemill Drive  
Dallas, Texas 75243  
Tel: 214-234-7300 TWX: 910-867-4721

**Hallmark Electronics, Inc.**

8000 Westglen  
Houston, Texas 77063  
Tel: 713-781-6100

**Hamilton/Avnet Electronics**

10508A Boyer Boulevard  
Austin, Texas 78758  
Tel: 512-837-8911

**Hamilton/Avnet Electronics**

4445 Sigma Road  
Dallas, Texas 75240  
Tel: 214-861-8661  
Telex: HAMA VLECB DAL 73-0511

**Hamilton/Avnet Electronics**

3939 Ann Arbor  
Houston, Texas 77042  
Tel: 713-780-1771  
Telex: HAMA VLECB HOU 76-2589

**Schweber Electronics, Inc.**

14177 Proton Road  
Dallas, Texas 75240  
Tel: 214-861-5010 TWX: 910-860-5493

**Schweber Electronics, Inc.**

7423 Harwin Drive  
Houston, Texas 77036  
Tel: 713-784-3600 TWX: 910-881-1109

**Sterling Electronics**

4201 Southwest Freeway  
Houston, Texas 77027  
Tel: 713-627-9800 TWX: 901-881-504  
Telex: STELECO HOUA 77-5299

**Utah**

**Bell Industries**  
3639 W. 2150 South  
Salt Lake City, Utah 84120  
Tel: 801-972-6969 TWX: 910-925-5686

**Hamilton/Avnet Electronics**

1585 W. 2100 South  
Salt Lake City, Utah 84119  
Tel: 801-972-2800  
TWX: None — use 910-379-6486  
(Regional Hq. in Mt. View, Ca.)

**Washington**

**Hamilton/Avnet Electronics**  
14212 N.E. 21st Street  
Bellevue, Washington 98005  
Tel: 206-746-8750 TWX: 910-443-2449

**Wyle Distribution Group**

1750 132nd Avenue N.E.  
Bellevue, Washington 98005  
Tel: 206-453-8300 TWX: 910-444-1379

**Radar Electronic Co., Inc.**

168 Western Avenue W.  
Seattle, Washington 98119  
Tel: 206-282-2511 TWX: 910-444-2052

**Wisconsin**

**Hamilton/Avnet Electronics**  
2975 Moorland Road  
New Berlin, Wisconsin 53151  
Tel: 414-784-4510 TWX: 910-262-1182

**Marsh Electronics, Inc.**

1563 South 100th Street  
Milwaukee, Wisconsin 53214  
Tel: 414-475-6000 TWX: 910-262-3321

**Canada**

**Cam Gard Supply Ltd.**  
640 42nd Avenue S.E.  
Calgary, Alberta, T2G 1Y6, Canada  
Tel: 403-287-0520 Telex: 03-822811

**Cam Gard Supply Ltd.**

16236 116th Avenue  
Edmonton, Alberta T5M 3V4, Canada  
Tel: 403-453-6691 Telex: 03-72960

**Cam Gard Supply Ltd.**

4910 52nd Street  
Red Deer, Alberta, T4N 2C8, Canada  
Tel: 403-346-2088

**Cam Gard Supply Ltd.**

825 Notre Dame Drive  
Kamloops, British Columbia, V2C 5N8, Canada  
Tel: 604-372-3338

**Cam Gard Supply Ltd.**

1777 Ellice Avenue  
Winnipeg, Manitoba, R3H 0W5, Canada  
Tel: 204-786-8401 Telex: 07-57622

**Cam Gard Supply Ltd.**

Rookwood Avenue  
Fredericton, New Brunswick, E3B 4Y9, Canada  
Tel: 506-455-8891

**Cam Gard Supply Ltd.**

15 Mount Royal Blvd.  
Moncton, New Brunswick, E1C 8N6, Canada  
Tel: 506-855-2200

**Cam Gard Supply Ltd.**

3065 Robie Street  
Halifax, Nova Scotia, B3K 4P6, Canada  
Tel: 902-454-8581 Telex: 01-921528

**Cam Gard Supply Ltd.**

1303 Scarth Street  
Regina, Saskatchewan, S4R 2E7, Canada  
Tel: 306-525-1317 Telex: 07-12667

**Cam Gard Supply Ltd.**

1501 Ontario Avenue  
Saskatoon, Saskatchewan, S7K 1S7, Canada  
Tel: 306-652-6424 Telex: 07-42825

**Electro Sonic Industrial Sales**

Toronto Ltd.  
1100 Gordon Baker Rd  
Willowdale, Ontario, M2H 3B3, Canada  
Tel: 416-494-1666  
Telex: ESSCO TOR-06-22030

**Future Electronics Inc.**

Baxter Center  
1050 Baxter Road  
Ottawa, Ontario, K2C 3P2, Canada  
Tel: 613-820-9471

**Future Electronics Inc.**

4800 Dufferin Street  
Downsview, Ontario, M3H 5S8, Canada  
Tel: 416-693-5563

**Future Electronics Corporation**

5647 Ferner Street  
Montreal, Quebec, H4P 2K5, Canada  
Tel: 514-731-7441

**Hamilton/Avnet International**

(Canada) Ltd.  
3688 Nashua Drive, Units 6 & H  
Mississauga, Ontario, L4V 1M5, Canada  
Tel: 416-677-7432 TWX: 610-492-8867

**Hamilton/Avnet International**

(Canada) Ltd.  
1735 Courtwood Crescent  
Ottawa, Ontario, K1C 5L9, Canada  
Tel: 613-226-1700

**Hamilton/Avnet International**

2670 Sabourin Street  
St. Laurent, Quebec  
H4S 1M2, Canada  
Tel: 514-331-6443 TWX: 610-421-3731

**R A E Industrial Electronics, Ltd**

3455 Gardner Court  
Burnaby, British Columbia Z5G 4J7  
Tel: 604-291-8866 TWX: 610-929-3065  
Telex: RAE-VCR 04-54550

**Semad Electronics Ltd.**

620 Meloche Avenue  
Dorval, Quebec, H9P 2P4, Canada  
Tel: 604-2998-866 TWX: 610-422-3048

**Semad Electronics Ltd.**

105 Brisbane Avenue  
Downsview, Ontario, M3J 2K6, Canada  
Tel: 416-663-5670 TWX: 610-492-2510

**Semad Electronics Ltd.**

1485 Lapierre Avenue  
Ottawa, Ontario, K1Z 7S8, Canada  
Tel: 613-722-6571 TWX: 610-562-8966



# Fairchild Semiconductor Sales Representatives

# United States and Canada

## Alabama

Cartwright & Bean, Inc.  
2400 Bob Wallace Ave., Suite 201  
Huntsville, Alabama 35805  
Tel: 205-533-3509

## California

Celtec Company  
18009 Sky Park Circle Suite B  
Irvine, California 92714  
Tel: 714-557-5021 TWX: 910-595-2512

Celtec Company  
7867 Convoy Court, Suite 312  
San Diego, California 92111  
Tel: 714-279-7961 TWX: 910-335-1512

Magna Sales, Inc.  
3333 Bowers Avenue  
Suite 295  
Santa Clara, California 95051  
Tel: 408-985-1750 TWX: 910-338-0241

## Colorado

Simpson Associates, Inc.  
2552 Ridge Road  
Littleton, Colorado 80120  
Tel: 303-794-8381 TWX: 910-935-0719

## Connecticut

Phoenix Sales Company  
389 Main Street  
Ridgefield, Connecticut 06877  
Tel: 203-438-9644 TWX: 710-467-0662

## Florida

Lectromech, Inc.  
399 Whooping Loop  
Altamonte Springs, Florida 32701  
Tel: 305-831-1577 TWX: 810-853-0262

Lectromech, Inc.  
2280 U.S. Highway 19 North  
Suite 119 Bldg. L  
Clearwater, Florida 33515  
Tel: 813-726-0541  
TWX: 810-866-0884

Lectromech, Inc.  
17 E. Hibiscus Blvd.  
Suite A

Melbourne, Florida 32901  
Tel: 305-725-1950  
TWX: 810-853-0262

Lectromech, Inc.  
1350 S. Powerline Road, Suite 104  
Pompano Beach, Florida 33060  
Tel: 305-974-6780 TWX: 510-954-9793

## Georgia

Cartwright & Bean, Inc.  
P.O. Box 52846 (Zip Code 30355)  
90 W. Wieuca Square, Suite 155  
Atlanta, Georgia 30342  
Tel: 404-255-5262 TWX: 810-751-3220

## Illinois

Micro Sales, Inc.  
2256-B Landmeir Road  
Elk Grove Village, Illinois 60007  
Tel: 312-956-1000 TWX: 910-222-1833

## Maryland

Delta III Associates  
1000 Century Plaza Suite 224  
Columbia, Maryland 21044  
Tel: 301-730-4700 TWX: 710-826-9654

## Massachusetts

Spectrum Associates, Inc.  
109 Highland Avenue  
Needham, Massachusetts 02192  
Tel: 617-444-8600 TWX: 710-325-6665

## Minnesota

PSI Company  
5315 W. 74th Street  
Edina, Minnesota 55435  
Tel: 612-835-1777 TWX: 910-576-3483

## Mississippi

Cartwright & Bean, Inc.  
P.O. Box 16728  
5150 Keele Street  
Jackson, Mississippi 39206  
Tel: 801-981-1368  
TWX: 810-751-3220

## Nevada

Magna Sales  
4560 Wagon Wheel Road  
Carson City, Nevada 89701  
Tel: 702-883-1471

## New Jersey

BGR Associates  
3001 Greentree Executive Campus  
Marlton, New Jersey 08053  
Tel: 609-426-2440

Lorac Sales, Inc.  
1200 Route 23 North  
Bulter, New Jersey 07405  
Tel: 201-696-8875 TWX: 710-988-5846

## New York

Lorac Sales, Inc.  
550 Old Country Road, Room 410  
Hicksville, New York 11801  
Tel: 516-681-8746 TWX: 510-224-6480

Tri-Tech Electronics, Inc.  
3215 E. Main Street  
Englewood, New York 13760  
Tel: 607-754-1094 TWX: 510-252-0891

Tri-Tech Electronics, Inc.  
590 Perinton Hills Office Park  
Fairport, New York 14450  
Tel: 716-223-5720  
TWX: 510-253-6356

Tri-Tech Electronics, Inc.  
6836 E. Genesee Street  
Fayetteville, New York 13066  
Tel: 315-446-2881 TWX: 710-541-0604

Tri-Tech Electronics, Inc.  
19 Davis Avenue  
Poughkeepsie, New York 12603  
Tel: 914-473-3880  
TWX: 510-253-6356

## North Carolina

Cartwright & Bean, Inc.  
1165 Commercial Ave.  
Charlotte, North Carolina 28205  
Tel: 704-377-5673

Cartwright & Bean, Inc.  
P.O. Box 18465  
3948 Browning Place  
Raleigh, North Carolina 27619  
Tel: 919-781-6560

## Ohio

The Lyons Corporation  
4812 Frederick Road, Suite 101  
Dayton, Ohio 45414  
Tel: 513-278-0714  
TWX: 810-459-1803

The Lyons Corporation  
6151 Wilson Mills Road, Suite 101  
Highland Heights, Ohio 44143  
Tel: 216-461-8288  
TWX: 810-459-1803

## Oklahoma

Technical Marketing  
9717 E. 42nd Street, Suite 221  
Tulsa, Oklahoma 74145  
Tel: 918-622-5984

## Oregon

Magna Sales, Inc.  
8285 S.W. Nimbus Ave., Suite 138  
Beaverton, Oregon 97005  
Tel: 503-641-7045  
TWX: 910-467-8742

## Pennsylvania

The Lyons Corporation  
Affler Building  
2787 Babcock Boulevard  
Pittsburgh, Pennsylvania 15237  
Tel: 412-931-7751

## Tennessee

Cartwright & Bean, Inc.  
P.O. Box 4760  
560 S. Cooper Street  
Memphis, Tennessee 38104  
Tel: 901-276-4442  
TWX: 810-751-3220

Cartwright & Bean, Inc.  
8705 Unicorn Drive  
Suite B120  
Knoxville, Tennessee 37923  
Tel: 615-693-7450  
TWX: 810-751-3220

## Texas

Technical Marketing  
3320 Wiley Post Road  
Carrollton, Texas 75006  
Tel: 214-387-3601 TWX: 910-860-5158

Technical Marketing, Inc.  
9027 North Gate Blvd.  
Suite 140  
Austin, Texas 78758

Technical Marketing  
6430 Hillcroft, Suite 104  
Houston, Texas 77036  
Tel: 713-777-9228

## Utah

Simpson Associates, Inc.  
7324 South 1300 East  
Midvale, Utah 94047  
Tel: 801-566-3691  
TWX: 910-925-4031

## Washington

Magna Sales, Inc.  
Benaroya Business Park  
Building 3, Suite 115  
300-120th Avenue, N.E.  
Bellevue, Washington 98004  
Tel: 206-455-3190

## Wisconsin

Larsen Associates  
10855 West Potter Road  
Wauwatosa, Wisconsin 53226  
Tel: 414-258-0529 TWX: 910-262-3160

## Canada

R.N. Longman Sales, Inc. (L.S.I.)  
1715 Meyers Drive  
Suite 1  
Mississauga, Ontario, L5T 1C5 Canada  
Tel: 416-677-8100 TWX: 610-492-8976

R.N. Longman Sales, Inc. (L.S.I.)  
16891 Hymus Blvd.  
Kirkland, Quebec  
H9H 3L4 Canada  
Tel: 514-694-3911  
TWX: 610-422-3028

# Fairchild Sales Offices

# United States and Canada

## Alabama

Huntsville Office  
Executive Plaza, Suite 107  
4717 University Drive, N.W.  
Huntsville 35805  
Tel: 205-837-8960

## Arizona

Phoenix Office  
4414 N. 19th Avenue, Suite G  
Phoenix 85015  
Tel: 602-264-4948 TWX: 910-951-1544

## California

Los Angeles Office\*  
Crocker Bank Bldg.  
15750 Ventura Blvd., Suite 1027  
Encino 91436  
Tel: 213-990-9800 TWX: 910-495-1776

## Santa Ana Office\*

1570 Brookhollow Dr., Suite 206  
Santa Ana 92705  
Tel: 714-557-7350 TWX: 910-595-1109

## Santa Clara Office\*

3333 Bowers Avenue, Suite 299  
Santa Clara 95051  
Tel: 408-987-9530 TWX: 910-338-0241

## Florida

Ft. Lauderdale Office  
Executive Plaza, Suite 300-B  
1001 Northwest 62nd Street  
Ft. Lauderdale 33309  
Tel: 305-771-0320 TWX: 510-955-4098

## Orlando Office\*

Crane's Roost Office Park  
399 Whooping Loop  
Altamonte Springs 32701  
Tel: 305-834-7000 TWX: 810-850-0152

## Illinois

Chicago Office  
60 Gould Center  
The East Tower, Suite 710  
Rolling Meadows 60008  
Tel: 312-640-1000

## Indiana

Ft. Wayne Office  
2118 Inwood Drive, Suite 111  
Ft. Wayne 46815  
Tel: 219-483-6453 TWX: 810-332-1507

## Indianapolis Office

7202 N. Shadeland Castle Point  
Room 205  
Indianapolis 46250  
Tel: 317-849-5412 TWX: 810-260-1793

## Kansas

Kansas City Office  
8600 West 110th Street, Suite 209  
Overland Park 66210  
Tel: 913-649-3974

## Maryland

Columbia Office\*  
1000 Century Plaza, Suite 225  
Columbia 21044  
Tel: 301-730-1510 TWX: 710-826-9654

## Massachusetts

Boston Office\*  
888 Worcester Street  
Wellesley Hills 02181  
Tel: 617-237-3400 TWX: 710-348-0424

## Michigan

Detroit Office\*  
21999 Farmington Road  
Farmington Hills 48024  
Tel: 313-478-7400 TWX: 810-242-2973

## Minnesota

Minneapolis Office\*  
4570 West 77th Street, Room 360  
Minneapolis 55435  
Tel: 612-835-3322 TWX: 910-576-2944

## New Jersey

Wayne Office\*  
580 Valley Road, Suite 1  
Wayne 07490  
Tel: 201-696-7070 TWX: 710-988-5846

## New Mexico

Albuquerque Office  
2403 San Mateo N.E., Plaza 13  
Albuquerque 87110  
Tel: 505-884-5601 TWX: 910-379-6435

## New York

Melville Office  
275 Broadhollow Road, Suite 219  
Melville 11747  
Tel: 516-293-2900 TWX: 510-224-6480

## Poughkeepsie Office

19 Davis Avenue  
Poughkeepsie 12603  
Tel: 914-473-5730 TWX: 510-248-0030

## Fairport Office

260 Perinton Hills Office Park  
Fairport 14450  
Tel: 716-223-7700

## Ohio

Dayton Office  
4812 Frederick Road, Suite 105  
Dayton 45414  
Tel: 513-278-8278 TWX: 810-459-1803

## Oregon

Fairchild Semiconductor  
8285 S.W. Nimbus Avenue, Suite 138  
Beaverton, Oregon 97005  
Tel: 503-641-7871 TWX: 910-467-7842

## Pennsylvania

Philadelphia Office\*  
2500 Office Center  
2500 Maryland Road  
Willow Grove 19090  
Tel: 215-657-2711

## Texas

Dallas Office  
13771 N. Central Expressway, Suite 809  
Dallas 75243  
Tel: 214-234-3391 TWX: 910-867-4757

## Houston Office

6430 Hillcroft, Suite 102  
Houston 77081  
Tel: 713-771-3547 TWX: 910-881-8278

## Canada

Toronto Regional Office  
Fairchild Semiconductor  
1590 Matheson Blvd., Unit 26  
Mississauga, Ontario L4W 1J1, Canada  
Tel: 416-625-7070 TWX: 610-492-4311

# Fairchild Sales Offices

# International

## Australia

Fairchild Australia Pty Ltd.  
Branch Office Third Floor  
F.A.I. Insurance Building  
619 Pacific Highway  
St. Leonards 2065  
New South Wales, Australia  
Tel: (02)-439-5911  
Telex: AA20053

## Austria and Eastern Europe

Fairchild Electronics  
A-1010 Wien  
Schwedensplatz 2  
Tel: 0222 635821 Telex: 75096

## Brazil

Fairchild Semicondutores Ltda  
Caixa Postal 30407  
Rua Alagoas, 663  
01242 Sao Paulo, Brazil  
Tel: 66-9092 Telex: 011-23831  
Cable: FAIRLECO

## France

Fairchild Camera & Instrument S.A.  
121, Avenue d'Italie  
75013 Paris, France  
Tel: 331-584-55 66  
Telex: 0042 220614 or 260937

## Germany

Fairchild Camera and Instrument (Deutschland)  
Daimlerstr 15  
8046 Garching Hochbruck  
Munich, Germany  
Tel: (089) 320031 Telex: 52 4831 fair d

Fairchild Camera and Instrument  
(Deutschland) GmbH  
Oelzenstrasse 15  
3000 Hannover  
W. Germany  
Tel: 0511 17844 Telex: 09 22922

Fairchild Camera and Instrument (Deutschland)  
Poststrasse 37  
7251 Leonberg  
W. Germany  
Tel: 07152 41026 Telex: 07 245711

## Hong Kong

Fairchild Semiconductor (HK) Ltd.  
135 Hoi Bun Road  
Kwun Tong  
Kowloon, Hong Kong  
Tel: K-890271 Telex: HKG-531

## Italy

Fairchild Semiconduttori, S.P.A.  
Via Flaminia Vecchia 853  
00191 Roma, Italy  
Tel: 06 327 4006 Telex: 63046 (FAIR ROM)

Fairchild Semiconduttori S.P.A.  
Via Rosellini, 12  
20124 Milano, Italy  
Tel: 02 6 88 74 51 Telex: 36522

## Japan

Fairchild Japan Corporation  
Pola Bldg.  
1-15-21, Shibuya  
Shibuya-Ku, Tokyo 150  
Japan  
Tel: 03 400 8351 Telex: 242173

Fairchild Japan Corporation  
Yotsubashi Chuo Bldg.  
1-4-26, Shinmachi,  
Nishi-Ku, Osaka 550, Japan  
Tel: 06-541-6138/9

## Korea

Fairchild Semikor Ltd.  
K2 219-6 Gari Bong Dong  
Young Dug Po-Ku  
Seoul 150-06, Korea  
Tel: 85-0067 Telex: FAIRKOR 22705

(mailing address)  
Central P.O. Box 2806

## Mexico

Fairchild Mexicana S.A.  
Blvd. Adolfo Lopez Mateos No. 163  
Mexico 19, D.F.  
Tel: 905-563-5411 Telex: 017-71-038

## Scandinavia

Fairchild Semiconductor AB  
Svartengsgatan 5  
S-11620 Stockholm  
Sweden  
Tel: 8-449255 Telex: 17759

## Singapore

Fairchild Semiconductor Pty Ltd.  
No. 11, Lorong 3  
Toa Payoh  
Singapore 12  
Tel: 531-066 Telex: FAIRSIN-RS 21376

## Taiwan

Fairchild Semiconductor (Taiwan) Ltd.  
Hsietsu Bldg., Room 502  
47 Chung Shan North Road  
Sec. 3 Taipei, Taiwan  
Tel: 573205 thru 573207

## Benelux

Fairchild Semiconductor  
Paradijslaan 39  
Eindhoven, Holland  
Tel: 00-31-40-446909 Telex: 00-1451024

## United Kingdom

Fairchild Camera and Instrument (UK) Ltd.  
Semiconductor Division  
230 High Street  
Potters Bar  
Hertfordshire EN6 5BU  
England  
Tel: 0707 51111 Telex: 262835

Fairchild Semiconductor Ltd.  
17 Victoria Street  
Craigshill  
Livingston  
West Lothian, Scotland - EH54 5BG  
Tel: Livingston 0506 32691 Telex: 72629

**FAIRCHILD**

A Schlumberger Company

Fairchild cannot assume responsibility for use of any circuitry described other than circuitry embodied in a Fairchild product. Manufactured under one of the following U.S. Patents: 2981877, 3015048, 3064167, 3108359, 3117260; other patents pending.

No other circuit patent licenses are implied.

Fairchild reserves the right to make changes in the circuitry or specifications at any time without notice.

Printed in U.S.A. 2021-411-A-22-129 50M May 1980